

Seating

PRODUCT INFORMATION



ASSMANN

Contents



[A] Office swivel chairs
STREAMO Page 4



[A] Chairs
CONSENTO Page 20



[A] Stackable chairs
CONSENTO Page 38



[A] Side tables
PESARO Page 94



[A] Meeting chairs
STREAMO Page 14

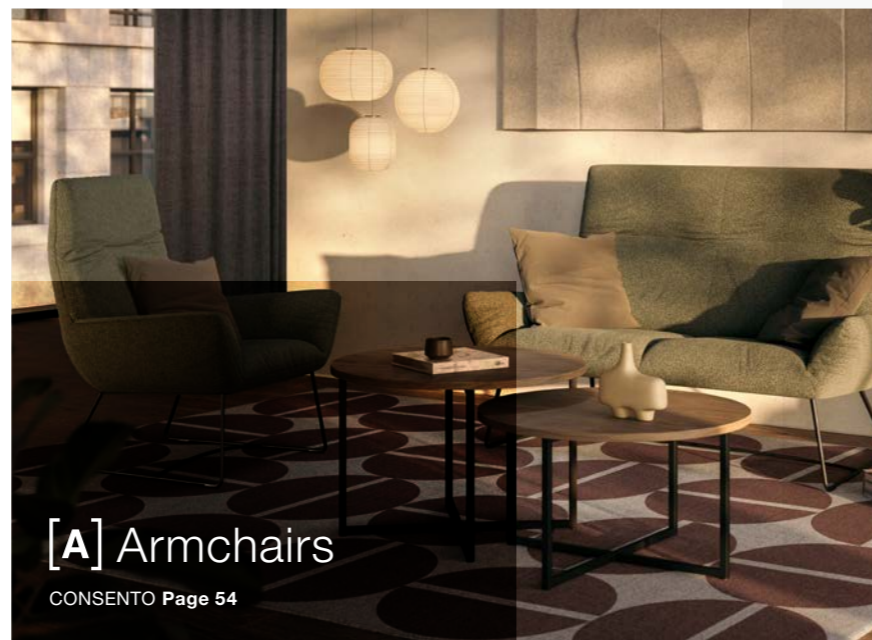

[A] Armchairs
CONSENTO Page 54



[A] Modular seating
CONSENTO Page 80

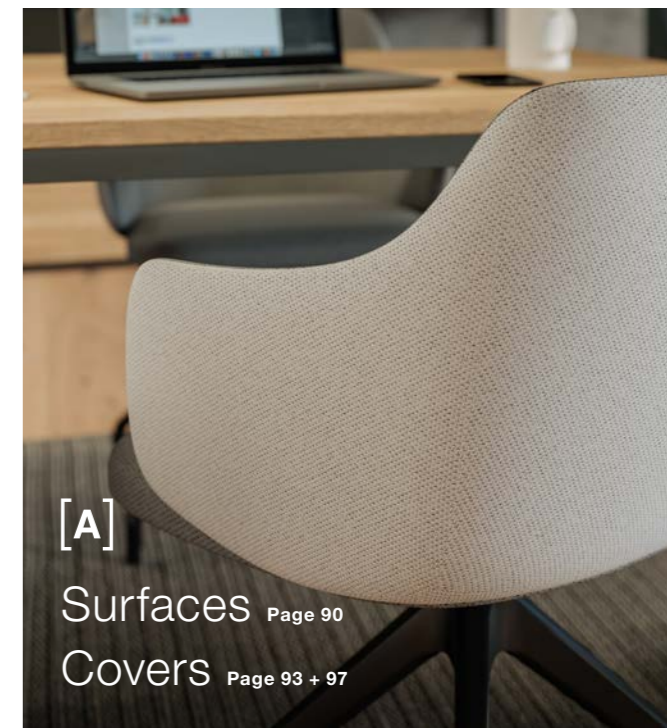

[A] Surfaces Page 90
Covers Page 93 + 97



[A] Sofas
CONSENTO Page 62

[A] STREAMMO | Office swivel chairs

The office swivel chair catches the eye with its ergonomic qualities, straightforward design, convenient variety and excellent seat quality. Streammo makes ergonomic work easier than ever before.



Learn more
ass.al/rc2u9x0

Thanks to the combination of its innovative autolift technology and synchronous mechanism, the Streamo swivel office chair automatically adjusts to any body weight.



Height adjustable lumbar support

The optionally available, variable lumbar support provides targeted support for the lumbar region of the back.



Synchronous mechanism with autolift system

The backrest resistance provided by the synchronous mechanism automatically adjusts to body weight.



Seat depth adjustment

The seat depth adjustment system ensures optimised adjustment to the thigh contact area.



Clothes hanger and headrest

The optional headrest provides support and ensures relaxation. It can be additionally equipped with a clothes hanger.



Swivel chair
Backrest and seat upholstered



Swivel chair
Upholstered seat, headrest with optional armrests

Pedestal	Standard	Optional
■ 5-pointed star base, black plastic	✓	
■ 5-pointed star base, polished aluminium		✓
■ Double castors, hard	✓	
■ Double castors, soft		✓

Configuration options

■ Backrest lockable in forward and backward positions	✓	
■ Autolift system (combined with synchronous mechanism) with automatic weight adjustment (45–120 kg)	✓	
■ Seat height freely adjustable from 420 to 510 mm	✓	
■ Seat depth adjustment, sliding seat surface, max. adjustment range 60 mm	✓	
■ Seat angle adjustable up to + 5.1° forwards		✓
■ Height adjustable lumbar support		✓

Accessories

■ Headrest with upholstered polyurethane inlay matching the seat cover		✓
■ Clothes hanger, black		✓
■ 2D-adjustable armrest (height and width) with soft polyurethane inlay		✓
■ 4D-adjustable armrest (height, width and depth) with swivel mechanism and soft polyurethane inlay		✓

Base material/upholstery

■ Seat upholstery made of high-quality polyurethane foam (approx. 70 kg/m ³)
■ Back cushion made of high-quality polyurethane foam (approx. 70 kg/m ³)

Covers

■ Fabrics from the Step, Step Melange, Blazer, Era, RePlay, Rivet and Penta collections
■ Artificial leathers from the Skai® Parotega NF collections

Load capacity

Up to 120 kg



Swivel chair
Netting backrest and upholstered seat



Swivel chair
Netting backrest and upholstered seat, headrest and armrests optional

Pedestal	Standard	Optional
■ 5-pointed star base, black plastic	✓	
■ 5-pointed star base, polished aluminium		✓
■ Double castors, hard	✓	
■ Double castors, soft		✓

Configuration options

■ Backrest lockable in forward and backward positions	✓	
■ Autolift system (combined with synchronous mechanism) with automatic weight adjustment (45–120 kg)	✓	
■ Seat height freely adjustable from 420 to 510 mm	✓	
■ Seat depth adjustment, sliding seat surface, max. adjustment range 60 mm	✓	
■ Seat angle adjustable up to + 5.1° forwards		✓
■ Height adjustable lumbar support		✓

Accessories

■ Headrest with upholstered polyurethane inlay matching the seat cover		✓
■ Clothes hanger, black		✓
■ 2D-adjustable armrest (height and width) with soft polyurethane inlay		✓
■ 4D-adjustable armrest (height, width and depth) with swivel mechanism and soft polyurethane inlay		✓

Base material/upholstery

■ Seat upholstery made of high-quality polyurethane foam (approx. 70 kg/m ³)
■ Net-covered backrest

Covers

■ Fabrics from the Step, Step Melange, Blazer, Era, RePlay, Rivet and Penta collections
■ Artificial leathers from the Skai® Parotega NF collections

Load capacity

Up to 120 kg

The Streamo office swivel chair with synchronous mechanism promotes healthy seating posture. Individual adjustment options and a modern design make the Streamo an ideal choice for working from home.



Highest seating comfort

The synchronous mechanism flexibly connects the backrest and seating surface. This means that the office swivel chair follows the movements of the body and eases the strain on the spine.

Height adjustable lumbar support

With its optionally available variable lumbar support, the backrest adapts specifically to the spine and offers optimum comfort even after hours of sitting.



Innovative synchronous mechanism

The synchronised mechanism offers weight adjustment that can be set manually in six stages to deliver ideal support to the lumbar spine.



Flexible accessories

The optional 4D-adjustable armrest (height, width and depth) with swivel mechanism and soft polyurethane inlay for individual adjustment.



Swivel chair
Backrest and seat upholstered



Swivel chair
Upholstered seat, headrest with optional armrests

Pedestal	Standard	Optional
■ 5-pointed star base, black plastic	✓	
■ 5-pointed star base, polished aluminium		✓
■ Double castors, hard	✓	
■ Double castors, soft		✓

Configuration options	Standard	Optional
■ Backrest lockable in four positions	✓	
■ Synchronous mechanism with multi-stage weight adjustment (45–120 kg)	✓	
■ Seat height freely adjustable from 420 to 510 mm	✓	
■ Seat depth adjustment, sliding seat surface, max. adjustment range 60 mm	✓	
■ Seat angle adjustable up to + 5.1° forwards		✓
■ Height adjustable lumbar support		✓

Accessories	Standard	Optional
■ Headrest with upholstered polyurethane inlay matching the seat cover		✓
■ Clothes hanger, black		✓
■ 2D-adjustable armrest (height and width) with soft polyurethane inlay		✓
■ 4D-adjustable armrest (height, width and depth) with swivel mechanism and soft polyurethane inlay		✓

Base material/upholstery
■ Seat upholstery made of high-quality polyurethane foam (approx. 70 kg/m³)
■ Back cushion made of high-quality polyurethane foam (approx. 70 kg/m³)

Covers
■ Fabrics from the Step, Step Melange, Blazer, Era, RePlay, Rivet and Penta collections
■ Artificial leathers from the Skai® Parotega NF collections

Load capacity
Up to 120 kg



Swivel chair
Netting backrest and upholstered seat



Swivel chair
Netting backrest and upholstered seat, headrest and armrests optional

Pedestal	Standard	Optional
■ 5-pointed star base, black plastic	✓	
■ 5-pointed star base, polished aluminium		✓
■ Double castors, hard	✓	
■ Double castors, soft		✓

Configuration options	Standard	Optional
■ Backrest lockable in four positions	✓	
■ Synchronous mechanism with multi-stage weight adjustment (45–120 kg)	✓	
■ Seat height freely adjustable from 420 to 510 mm	✓	
■ Seat depth adjustment, sliding seat surface, max. adjustment range 60 mm	✓	
■ Seat angle adjustable up to + 5.1° forwards		✓
■ Height adjustable lumbar support		✓

Accessories	Standard	Optional
■ Headrest with upholstered polyurethane inlay matching the seat cover		✓
■ Clothes hanger, black		✓
■ 2D-adjustable armrest (height and width) with soft polyurethane inlay		✓
■ 4D-adjustable armrest (height, width and depth) with swivel mechanism and soft polyurethane inlay		✓

Base material/upholstery
■ Seat upholstery made of high-quality polyurethane foam (approx. 70 kg/m³)
■ Net-covered backrest

Covers
■ Fabrics from the Step, Step Melange, Blazer, Era, RePlay, Rivet and Penta collections
■ Artificial leathers from the Skai® Parotega NF collections

Load capacity
Up to 120 kg

[A] STREAMO | Meeting chairs

Stackable conference chairs in four-leg or cantilever versions round off the Streamo product collection. The comfortable upholstery, available in a wide range of colours and coverings, guarantees optimum seating comfort.



Learn more
ass.al/rr8xioq



4-leg chair
Upholstered seat and back



4-leg chair
Back and seat upholstered,
armrests optional

Pedestal	Standard	Optional
▪ 4-leg tubular steel frame, powder-coated, black (stackable)	✓	
▪ 4-leg tubular steel frame, chromium-plated (stackable)		✓
▪ Plastic gliders for soft floors	✓	
▪ Felt gliders for hard floors		✓
Accessories		
▪ Plastic armrest, black		✓
Base material/upholstery		
▪ Seat and back cushion made from high-quality polyurethane foam (approx. 65 kg/m ³)		
▪ Plastic stacking well, black		
Covers		
▪ Fabrics from the Step, Step Melange, Blazer, Era, RePlay, Rivet and Penta collections		
▪ Artificial leathers from the Skai® Parotega NF collections		
Load capacity		
Up to 120 kg		
Stacking height		
6 pieces		



Cantilever frame
Back and seat upholstered



Cantilever frame
Back and seat upholstered,
armrests optional

Pedestal	Standard	Optional
▪ Tubular steel cantilever frame, powder-coated, black (stackable)	✓	
▪ Tubular steel cantilever frame, chromium-plated (stackable)		✓
▪ Plastic gliders for soft floors	✓	
▪ Felt gliders for hard floors		✓
Accessories		
▪ Plastic armrest, black		✓
Base material/upholstery		
▪ Seat and back cushion made from high-quality polyurethane foam (approx. 65 kg/m ³)		
▪ Plastic stacking well, black		
Covers		
▪ Fabrics from the Step, Step Melange, Blazer, Era, RePlay, Rivet and Penta collections		
▪ Artificial leathers from the Skai® Parotega NF collections		
Load capacity		
Up to 120 kg		
Stacking height		
5 pieces		

System

Streamo swivel chair

upholstered backrest
Width: 480 mm | Height: 1160 mm | Depth: 635 mm | Seat height: 400–515 mm | Seat depth: 390–450 mm | Seat width: 480 mm
Width with armrests: 650 mm | Height with headrest: 1320 mm



without armrests



headrest and armrests optional

Streamo swivel chair

Netting backrest
Width: 480 mm | Height: 1160 mm | Depth: 610 mm | Seat height: 400–515 mm | Seat depth: 390–450 mm | Seat width: 480 mm
Width with armrests: 650 mm | Height with headrest: 1320 mm



without armrests



headrest and armrests optional

Streamo 4-leg chair

Back and seat upholstered
Width: 495 mm | Height: 890 mm | Depth: 580 mm | Seat height: 440 mm | Seat depth: 470 mm | Seat width: 450 mm
Width with armrests: 580 mm



without armrests



armrests optional

Streamo cantilever frame

Back and seat upholstered
Width: 500 mm | Height: 905 mm | Depth: 580 mm | Seat height: 440 mm | Seat depth: 470 mm | Seat width: 450 mm
Width with armrests: 585 mm



without armrests



armrests optional

[A] CONSENTO | Chairs

Cosy gathering point for creative minds, quiet spots to chill or stylish eye-catchers for visitors – Consento chairs leave a lasting impression with their nonchalance, elegance and modern design.



Learn more
ass.al/r83fnpj

Triest



STH060200 Chair with 4-star base, plastic
STH060800 Chair with 4-star base, plastic
STH060100 Chair with wooden 4-leg base
STH060300 Swivel chair with 5-star metal base
STH060500 Chair with 4-star base, plastic
STH060600 Chair with 4-star base, plastic

Triest has a multitude of uses and a classic design that will inspire you. Its flowing forms give this range of chairs a fascinating allure. Equipped with various bases and available in a wide range of colours and cover qualities, the various models provide countless configuration possibilities to suit any situation.

Leg frame

Upholstered seat:

- 4-leg frame, upright pyramid form, plastic, black or white, 360° rotation
- 4-leg frame, solid wood, beech or black
- 5-star swivel chair frame on castors, gas pressure spring for height adjustment, matte black or chrome-plated metal, 360° rotation

Polypropylene (PP) seat:

- 4-leg frame, upright pyramid form, plastic, black or white, 360° rotation
- 4-leg swivel chair frame on hard rollers, plastic, black or white
- Upright pyramid form swivel chair with 4-star base, plastic frame in white, 360° rotation
- Swivel chair frame with 4-star base on castors, plastic frame in black or white

Base material/upholstery

Upholstered seat:

- Seat and back sections made of robust plywood in the basic variant
- Seat made of high-quality upholstery foam (RG 35), covered with padded fleece
- Back made of ergonomically moulded foam (RG 35), covered with padded fleece

Polypropylene (PP) seat:

- Seat made of 6 mm-thick polypropylene (PP), polar white
- Optionally available with seat upholstery of high-quality, 20 mm thick upholstery foam (RG 35), firmly screwed

Covers and plastic colours

- Fabrics from the Step, Step Melange, Blazer, Era, RePlay, Rivet and Penta collections
- Artificial leathers from the Skai® Parotega NF collections
- Plastic colours in polar white, grey, yellow, green, red and brown

Load capacity

- Up to 110 kg

Variants

- 2-tone upholstery (within one material group) possible, separation of inner/outer upholstery

Triest Highback



STH061000 Swivel chair with 4-star base, plastic
STH061300 Swivel chair with 4-star base, plastic
STH060900 Chair with wooden 4-leg base
STH061100 Swivel chair with 5-star metal base

The high-quality Triest Highback lounge chair impresses with its modern design and a high backrest that provides optimal seating comfort – ideal for use in meeting rooms or for working from home. The models in the Triest Highback series are available in a number of different versions and can be combined with a wide range of frame and colour variants.

Leg frame

- 4-leg frame, upright pyramid form, plastic, black or white, 360° rotation
- Upright pyramid form 4-leg frame on castors, plastic, black or white
- 4-leg frame, solid wood, beech or black
- 5-star swivel chair frame on castors, gas pressure spring for height adjustment, matte black or chrome-plated metal, 360° rotation
- 5-star swivel chair frame on castors, gas pressure spring for height adjustment, black matte or chrome-plated metal, 360° rotation, with rocker function

Base material/upholstery

- Seat and back sections made of robust plywood in the basic variant
- Seat made of high-quality upholstery foam (RG 35), covered with padded fleece
- Back made of ergonomically moulded foam (RG 35), covered with padded fleece

Covers

- Fabrics from the Step, Step Melange, Blazer, Era, RePlay, Rivet and Penta collections
- Artificial leathers from the Skai® Parotega NF collections

Variants

- 2-tone upholstery (within one material group) possible, separation of inner/outer upholstery

Triest

Waiting bench system



STH061900
2-seater, plastic seat with table element

STH061700
3-seater, upholstered seat

Netbox Juke

Triest catches the eye with its versatility, also as a waiting bench system. The waiting bench system can be equipped with fabric-covered seats or modern bucket seats. With its optional 2-tone inner and outer upholstery, Triest is a genuine highlight.

Leg frame

- Cast aluminium runner, polished chrome

Versions

- 2-seater | 3-seater, without table element
- 1-seater | 2-seater, with left- or right-sided table element or in the centre

Base material/upholstery

Upholstered seat:

- Seat and back sections made of robust plywood in the basic variant
- Seat made of high-quality upholstery foam (RG 35), covered with padded fleece
- Back made of ergonomically moulded foam (RG 35), covered with padded fleece

Polypropylene (PP) seat:

- Seat made of 6 mm-thick polypropylene (PP), polar white
- Optionally available with seat upholstery of high-quality, 20-mm thick upholstery foam (RG 35), firmly screwed

Covers and plastic colours

- Fabrics from the Step, Step Melange, Blazer, Era, RePlay, Rivet and Penta collections
- Artificial leathers from the Skai® Parotega NF collections
- Plastic colours in polar white, grey, yellow, green, red and brown

Variants

- 2-tone upholstery (within one material group) possible, separation of inner/outer upholstery
- Variations in colours and fabrics between the seats in each waiting bench system is not possible

Table element versions

- 430 x 480 x 19 mm, available in all Basic and Premium décors

Accessories

- Netbox Juke (beneath the table top)

Terni



STH020200
Chair with steel frame base, metal

STH020100
4-leg chair, metal

STH020300
4-leg barstool, metal

Terni is a soft-look chair programme with a straightforward design vocabulary. The stylish shape of the curved seat shells and the rounded backrest create perfect comfort and a relaxed place to linger.

Leg frame

- Steel frame base, chrome-plated or black metal
- Swivel chair with 4-star base on runners, chrome-plated or black metal, 360° rotation
- Barstool with 4-leg metal frame, chrome-plated or black

Base material/upholstery

- Seat and back sections made of robust, moulded plywood in the basic variant
- Seat upholstery made of high-quality cold foam (RG 35), covered with padded fleece
- Back made of ergonomically moulded cold foam (RG 25), covered with padded fleece

Covers

- Fabrics from the Step, Step Melange, Blazer, Era, RePlay, Rivet and Penta collections
- Artificial leathers from the Skai® Parotega NF collections

Load capacity

- Up to 110 kg

Trento



STH030200
4-leg chair, metal



STH030100
4-leg chair, metal



STH030400
Chair with wooden 4-leg base



STH030300
Swivel chair with 5-star metal base

The Trento chair series catches the eye with its classic design in a retro look. A stylishly crafted seat shell with flowing forms lends the chairs a fascinating charm.

Leg frame

- 4-leg frame, upright pyramid form, chrome-plated metal
- 4-leg frame, flat pyramid form, chrome-plated metal
- 4-leg frame, solid wood, beech or walnut look
- Chair with 5-star base on castors, gas pressure spring for height adjustment, chrome-plated metal, 360° rotation

Base material/upholstery

- Seat and back sections made of robust plywood in the basic variant
- Seat made of high-quality upholstery foam (RG 35), covered with padded fleece
- Back made of ergonomically moulded foam (RG 35), covered with padded fleece

Covers

- Fabrics from the Step, Step Melange, Blazer, Era, RePlay, Rivet and Penta collections
- Artificial leathers from the Skai® Parotega NF collections

Load capacity

- Up to 110 kg

Variants

- 2-tone upholstery (within one material group) possible, separation of inner/outer upholstery



STH030500
Swivel chair with 4-star base, plastic



STH030600
Swivel chair with 4-star base, plastic

Leg frame

- Upright pyramid form swivel chair with 4-star base, plastic frame in black or white, 360° rotation
- Swivel chair frame with 4-star base on castors, plastic frame in black or white

Base material/upholstery

- Seat and back sections made of robust plywood in the basic variant
- Seat made of high-quality upholstery foam (RG 35), covered with padded fleece
- Back made of ergonomically moulded foam (RG 35), covered with padded fleece

Covers

- Fabrics from the Step, Step Melange, Blazer, Era, RePlay, Rivet and Penta collections
- Artificial leathers from the Skai® Parotega NF collections

Load capacity

- Up to 110 kg

Variants

- 2-tone upholstery (within one material group) possible, separation of inner/outer upholstery

Tivoli

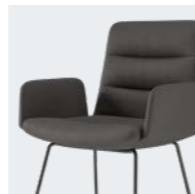

Optionally with armrests



Leather strap handle



STH110100
Chair with steel frame base, metal



STH110300
Chair with 4-star base, metal



STH300111
Swivel chair with castors



STH110300
Chair with wooden 4-leg base



STH111000
Bar stool with steel frame and low back



STH111100
Bar stool with steel frame and high back

The Tivoli series guarantees comfortable seating thanks to its upholstered backrest – whether as a chair or a bar stool. With a wide range of fabric colors, optional two-tone upholstery, and various metal or wooden base options, Tivoli can be customized to suit individual preferences. An optional leather loop handle makes handling easier and at the same time gives the upholstered chair an elegant appearance.

Leg frame

- Steel frame base, black metal
- Upright pyramid form swivel chair with 4-star base, black metal, 360° rotation
- 5-star swivel chair frame on castors, metal, black, 360° swivel
- 4-leg frame, solid wood, oiled oak
- Bar stool with steel base frame, black

Base material/upholstery

- Seat and back sections made of robust plywood in the basic variant
- Seat made of high-quality upholstery foam (RG 35), covered with padded fleece
- Back made of ergonomically moulded foam (at least RG 25), covered with padded fleece

Covers

- Fabrics from the Step, Step Melange, Blazer, Era, RePlay, Rivet, Penta, Cord and Loro collections
- Artificial leathers from the Skai® Parotega NF collections
- Thick leather from the Torero collection

Load capacity

- Up to 110 kg

Variants

- Two-tone upholstery possible (only within one fabric group, except leather and imitation leather)
Separation inner/outer upholstery
- The chair can be ordered either with or without armrests (apart from the Low back Tivoli bar stool)
- Optional leather strap handle (excluding Tivoli bar stools)



STH0110400
2-seater, steel frame/leg base



STH110600
3-seater, steel frame/leg base

The modern design of the Tivoli seating series also looks great as an upholstered bench. The wide range of design options and the optional two-tone look make the upholstered bench an eye-catching feature, ideal for communication, lounge and waiting areas.

Leg frame

- 4-leg bench frame, 2-seater | 2.5-seater | 3-seater | metal, black

Base material/upholstery

- Seat and back sections made of robust plywood in the basic variant
- Seat made of high-quality upholstery foam (RG 35), covered with padded fleece
- Back made of ergonomically moulded foam (at least RG 25), covered with padded fleece

Covers

- Fabrics from the Step, Step Melange, Blazer, Era, RePlay, Rivet, Penta, Cord and Loro collections
- Artificial leathers from the Skai® Parotega NF collections
- Thick leather from the Torero collection

Load capacity

- 2-seater: up to 200 kg
- 2.5-seater | 3-seater: up to 240 kg

Variants

- Two-tone upholstery possible (only within one fabric group, except leather and imitation leather)
Separation inner/outer upholstery

Torino

**STH010200**

Chair with steel frame base, 4-leg chair, metal

STH010100

Chair with steel frame base, 4-leg chair, metal

STH010300

Chair with wooden 4-leg base

STH010400

Chair with 5-star base, metal

STH010500

4-leg barstool, metal

STH010600

4-leg barstool with high back, metal

The Torino chair series catches the eye with its pared down and straightforward design. Curved back- and armrests promise excellent comfort, while the quilted upholstery gives the chair a unique silhouette.

Leg frame

- Steel frame base, chrome-plated or black metal (stackable 4-high)
- 4-leg, closed metal frame, chrome-plated or black metal (stackable 5-high)
- 4-leg frame, solid wood, oak, beech or walnut look
- Chair with 5-star base on castors, gas pressure spring for height adjustment, chrome-plated metal, 360° rotation
- Barstool with 4-leg metal frame, chrome-plated or black
- Barstool with 4-leg metal frame and high back, chrome-plated or black

Base material/upholstery

- Seat and back sections made of robust plywood in the basic variant
- Seat made of high-quality upholstery foam (RG 35), covered with padded fleece
- Back made of ergonomically moulded foam (RG 25), covered with padded fleece

Covers

- Fabrics from the Step, Step Melange, Blazer, Era, RePlay, Rivet and Penta collections
- Artificial leathers from the Skai® Parotega NF collections

Load capacity

- Up to 110 kg

Bari

**HCK010100**

Stool

HCK010100

Stool

HCK010100

Stool

Thanks to its ergonomic functions, the Bari stool actively supports back health and is the ideal feature in the workplace. The rocker function and tilt on the seat surface create ideal conditions for productive and healthy work.

Leg frame

- Stool with non-slip rubber leg

Ergonomic work

- Height adjustment possible from 530–760 mm
- Ergonomic rocker function
- Seat inclination of 20°
- 360° rotation of the seat surface

Colour variants

- Black
- White
- Red

Seat surface covers:

- Fabrics from the Step, Step Melange, Blazer, Era, RePlay, Rivet and Penta collections
- Artificial leathers from the Skai® Parotega NF collections

Load capacity

- Up to 110 kg

Bergamo



HCK020100
Stool



Stackable

Fashioned from high-quality beech plywood, the Bergamo stacking stools come with a compact and comfortable seat that is both functional and good looking. With its stackable design, the stools can be stowed away to save space, making them a practical solution for a wide range of uses. The stools are optionally available with felt wool seat cushions in stylish anthracite, which round off the design perfectly.

Properties

- Stool made of beech plywood with 0.8 mm CPL top layers on both sides
- Interior and exterior surface in melamine (same decor), sanded and oiled offset edge
- Stackable 4-high
- With two grip holes

Colour variants

- Black
- White

Accessories

- Felt seat upholstery made from 100% natural sheep's wool (Ø 320 mm), 20 mm upholstery wool made from sheep's wool (100% compostable)
- Colour: Anthracite

Load capacity

- Up to 110 kg

Bocca



HCK010100
Stool



Leather strap

The Consento Bocca is a space-saving stool that proves ideal wherever spontaneous seating, flexible space design and collaborative working are required. Thanks to the leather strap, the stool can be carried effortlessly. A particular advantage: its reduced design and compact construction allow the stool to be stored neatly and space-efficiently in the matching Cubas Flex shelving units when not in use.

Properties

- With leather strap

Covers

- Fabrics from the Step, Step Melange, Blazer, Era, RePlay, Rivet and Penta collections
- Artificial leathers from the Skai® Parotega NF collections

System

Triest

Width: 560 mm | Height: 790 mm | Depth: 580 mm | Seat height: 480 mm | Seat depth: 480 mm



Chair with 4-star base, plastic



Chair with wooden 4-leg base



Swivel chair with 5-star metal base



Chair with 4-star base, plastic



Chair with 4-star base, plastic

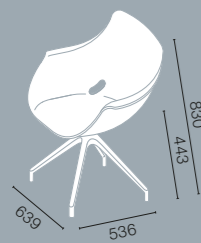

Chair with 4-star base, plastic



Chair with 4-star base, plastic

Triest Highback

Width: 560 mm | Height: 940 mm | Depth: 630 mm | Seat height: 470 mm | Seat depth: 480 mm



Swivel chair with 4-star base, plastic



Swivel chair with 4-star base, plastic



Chair with wooden 4-leg base



Swivel chair with 5-star metal base, height adjustment



Swivel chair with 5-star metal base, height adjustment, rocker function

Triest waiting bench system

Height: 800 mm | Depth: 536 mm | Seat height: 435 mm

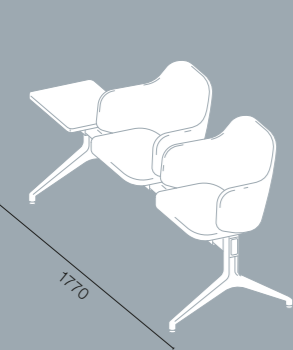

2-seater, plastic seat shell with table tray or upholstered seat shell

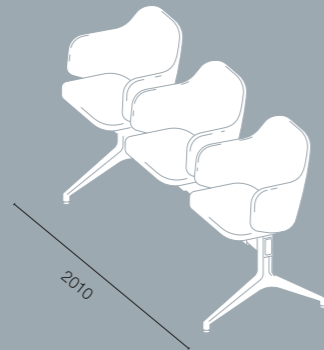

3-seater, upholstered seat shell or plastic shells

Terni

Width: 570 mm | Height: 810 mm | Depth: 480 mm | Seat height: 480 mm | Seat depth: 440 mm



Chair with steel frame base, metal



4-leg chair, metal

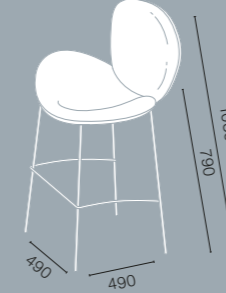

4-leg barstool, metal

Trento

Width: 570 mm | Height: 790 mm | Depth: 620 mm | Seat height: 450 mm | Seat depth: 470 mm



4-leg chair, metal



4-leg chair, metal



Chair with wooden 4-leg



Swivel chair with 5-star metal base



Chair with 4-star base, plastic



Chair with 4-star base, plastic

Tivoli

Chairs without armrests: Width: 520 mm | Height: 850 mm | Depth: 650 mm | Seat height: 460 mm | Seat depth: 450 mm
 Chairs with armrests: Width: 580 mm | Height: 850 mm | Depth: 690 mm | Seat height: 460 mm | Seat depth: 450 mm

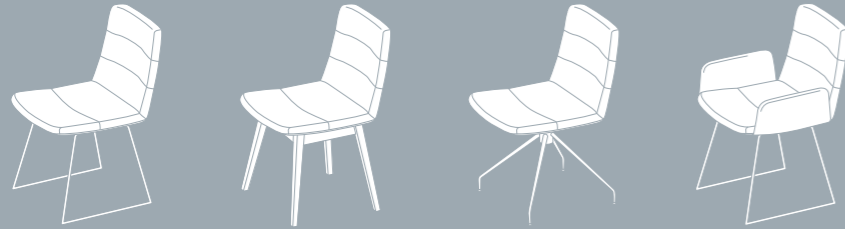

Chair with steel frame base, metal | Chair with wooden 4-leg base | Chair with 4-star base, metal | Chair with steel frame base, metal, with armrests



Swivel chair with castors | Chair with wooden 4-leg base with armrest | Chair with 4-star base, metal with armrest

Tivoli

Low back: Width: 520 mm | Depth: 630 mm | Height: 1070 mm
 High back: Width: 520 mm | Depth: 650 mm | Height: 1200 mm
 High back with armrest: Width: 580 mm | Depth: 650 mm | Height: 1200 mm

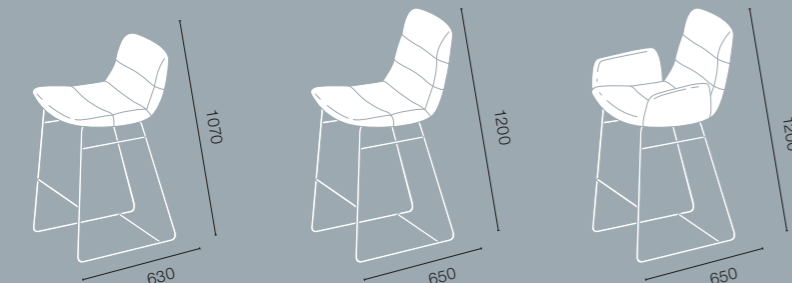

Bar stool with steel frame and low back | Bar stool with steel frame and high back | Bar stool with steel frame, high back with armrests

Tivoli

Height: 860 mm | Depth: 650 mm | Seat height: 460 mm | Seat depth: 470 mm

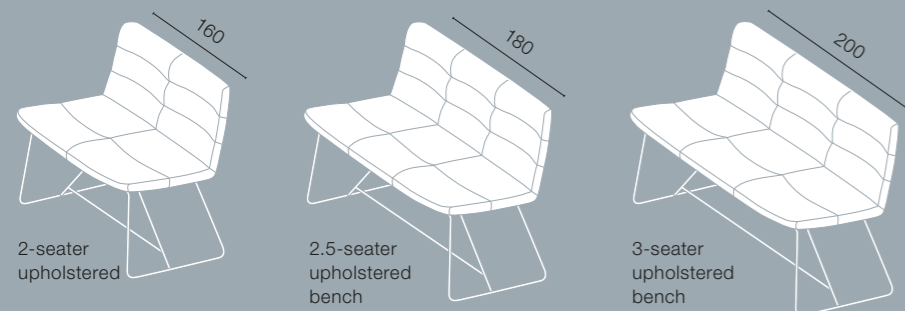

2-seater upholstered | 2.5-seater upholstered bench | 3-seater upholstered bench

Torino

Width: 460 mm | Height: 900 mm | Depth: 510 mm | Seat height: 450 mm | Seat depth: 400



Chair with steel frame base, metal | 4-leg chair, metal | Chair with wooden 4-leg base | Chair with 5-star base, metal

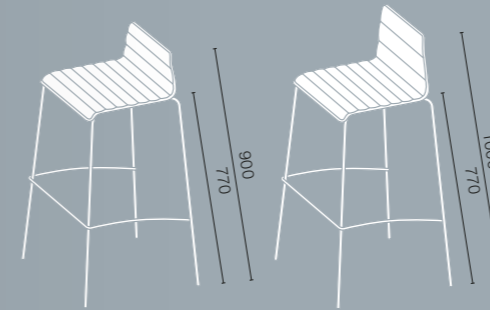

4-leg barstool, metal | 4-leg barstool, metal

Bari

Width: 435 mm | Height: 530-760 mm | Depth: 240 mm | Seat height: 530-760 mm | Seat depth 235 mm



Stool

Bergamo

Width: 572 mm | Height: 453 mm | Depth: 360 mm



Stool

Bocca

Width: 365 mm | Height: 395 mm | Depth: 305 mm



Stool

[A] CONSENTO Stacking chairs

The Consento stacking chairs catch the eye with their excellent seat comfort, various seat and upholstery options as well as their functional accessories. The upholstery can be varied thanks to the numerous colour options.



Learn more
ass.al/ksy962

Roma



215GU-10
Basic wooden seat shell,
without upholstery,
stackable 18-high



215GU-11
Basic wooden seat shell,
with seat upholstery,
stackable 18-high



215GU-12
Basic wooden seat shell,
with seat and back upholstery,
stackable 12-high



215GU-13
Basic wooden seat shell,
padding with centre seam,
stackable 12-high



Padding



Optionally with
armrests

Leg frame

- Precision reinforced steel tube, 20 x 1.5 mm, chrome-plated
- Extra thick chrome-plating, approx. 25 µ
- Up to 18 chairs can be stacked vertically on a flat surface
- Slider selection for various floor coverings*

Seat

- Beech laminate made using high-pressure beech veneering, thickness of at least 10 mm and at least 9 layers

Finish

- Several coats of a waterproof, environmentally friendly and low-solvent paint are applied to all wooden parts

Upholstery

- Seat and back upholstery screwed down and replaceable
- Upholstery approx. 20 mm foam (RG 35)

Armrests

- Armrests with Soft Grip, black

Covers

- Fabrics from the Step, Step Melange, Blazer, Era, RePlay, Rivet and Penta collections
- Artificial leathers from the Skai® Parotega NF collections

Load capacity

- Up to 120 kg



265GU-10
Comfort wooden seat shell,
without upholstery,
stackable 20-high



265GU-11
Wooden comfort seat shell,
with seat upholstery,
stackable 20-high



265GU-12
Comfort wooden seat shell,
with seat and back upholstery,
stackable 15-high



265GU-13
Comfort wooden seat shell,
padding with centre seam,
stackable 12-high



Padding



Optionally with
armrests

Leg frame

- Precision reinforced steel tube, 20 x 1.5 mm, chrome-plated
- Extra thick chrome-plating, approx. 25 µ
- Up to 20 chairs can be stacked vertically on a flat surface
- Slider selection for various floor coverings*

Seat

- Beech laminate made using high-pressure beech veneering, thickness of at least 10 mm and at least 9 layers
- Seat with integrated lumbar support to help keep a posture that is easy on the spine

Finish

- Several coats of a waterproof, environmentally friendly and low-solvent paint are applied to all wooden parts

Upholstery

- Seat and back upholstery screwed down and replaceable
- Upholstery approx. 20 mm foam (RG 35)

Armrests

- Armrests with Soft Grip, black

Covers

- Fabrics from the Step, Step Melange, Blazer, Era, RePlay, Rivet and Penta collections
- Artificial leathers from the Skai® Parotega NF collections

Load capacity

- Up to 120 kg

* The customer is exclusively responsible for selecting and approving the order for floor gliders that are suitable for the respective floor covering ASSMANN does not accept any liability for damage or defects.

Roma



265GL-10
Comfort wooden seat shell, narrow, without upholstery, stackable 20-high



265GL-11
Comfort wooden seat shell, narrow, with seat upholstery, stackable 20-high



265GL-12
Comfort wooden seat shell, narrow, with seat and back upholstery, stackable 15-high



Optionally with armrests

Leg frame

- Precision reinforced steel tube, 20 x 1.5 mm, chrome-plated
- Extra thick chrome-plating, approx. 25 µ
- Up to 20 chairs can be stacked vertically on a flat surface
- Slider selection for various floor coverings*

Seat

- Beech laminate made using high-pressure beech veneering, thickness of at least 10 mm and at least 9 layers
- Seat with integrated lumbar support to help keep a posture that is easy on the spine

Finish

- Several coats of a waterproof, environmentally friendly and low-solvent paint are applied to all wooden parts

Upholstery

- Seat and back upholstery screwed down and replaceable
- Upholstery approx. 20 mm foam (RG 35)

Armrests

- Armrests with Soft Grip, black

Covers

- Fabrics from the Step, Step Melange, Blazer, Era, RePlay, Rivet and Penta collections
- Artificial leathers from the Skai® Parotega NF collections

Load capacity

- Up to 120 kg



8519-10
Comfort wooden seat, bar stool, without upholstery, stackable 4 high

Leg frame

- 16 mm, chrome-plated steel tube
- Attached on three sides as a footrest, 11 mm steel
- Up to 4 chairs can be stacked vertically on a flat surface
- With plastic or felt gliders*

Seat

- Beech laminate made using high-pressure beech veneering, thickness of at least 10 mm and at least 9 layers
- Half-height backrest

Finish

- Several coats of a waterproof, environmentally friendly and low-solvent paint are applied to all wooden parts

Load capacity

- Up to 120 kg



565GK-10
Comfort plastic seat shell, without upholstery, stackable 10-high



565GK-11
Plastic comfort seat shell, with seat upholstery, stackable 10-high



Optionally with armrests

Leg frame

- Precision reinforced steel tube, 20 x 1.5 mm, chrome-plated
- Extra thick chrome-plating, approx. 25 µ
- Up to 10 chairs can be stacked vertically
- Slider selection for various floor coverings*

Seat

- Polypropylene (PP), approx. 5 mm
- Front of seat with rough surface, shiny at back
- Stability provided by a glass fibre inlay without upturned edges
- Seat available in the colours Alpine White, Lava Grey and Bright Red

Upholstery

- Seat upholstery screwed and replaceable
- Upholstery approx. 15 mm foam (RG 35)

Covers

- Fabrics from the Step, Step Melange, Blazer, Era, RePlay, Rivet and Penta collections
- Artificial leathers from the Skai® Parotega NF collections

Load capacity

- Up to 120 kg

Riva



- 255GU-10**
Comfort wooden seat shell, without upholstery, stackable 10-high
- 255GU-11**
Comfort wooden seat shell, with seat upholstery, stackable 10-high
- 255GU-12**
Comfort wooden seat shell, with seat and back upholstery, stackable 10-high
- 255GU-13**
Comfort wooden seat shell, padding with centre seam, stackable 10-high
- 255GU-18**
Comfort wooden seat shell, full upholstery with centre seam, stackable 10 high

Leg frame

- Precision steel tube, round, chrome-plated
- Leg frame front 18 x 2 mm and leg frame rear 22 x 2 mm
- 90° mitred angle
- Extra thick chrome-plating
- Up to 10 chairs can be stacked vertically on a flat surface
- With plastic or felt gliders*

Seat

- Beech laminate made using high-pressure beech veneering of at least 10 mm thickness and at least 9 layers
- Seat with integrated lumbar support to help keep a posture that is easy on the spine
- The seat is invisibly screwed to the frame

Armrests

- Armrests open to the front with black Soft Grip

Finish

- All wooden parts are painted with several coats of waterproof and environmentally friendly, low-solvent paint

Upholstery

- Seat and back upholstery screwed down
- Upholstery approx. 20 mm, foam (RG 35)

Covers

- Fabrics from the Step, Step Melange, Blazer, Era, RePlay, Rivet and Penta collections
- Artificial leathers from the Skai® Parotega NF collections

Load capacity

- Up to 120 kg



Padding Full upholstery Optionally with armrests



- 254GU-10**
Comfort wooden seat shell, without upholstery, stackable 10-high
- 254GU-11**
Comfort wooden seat shell, with seat upholstery, stackable 10-high
- 254GU-12**
Comfort wooden seat shell, with seat and back upholstery, stackable 10-high
- 254GU-13**
Comfort wooden seat shell, padding with centre seam, stackable 10-high
- 254GU-18**
Comfort wooden seat shell, full upholstery with centre seam, stackable 10 high

Leg frame

- Leg frame front in precision square steel tube 18 x 18 x 2 mm, chrome-plated
- 90° mitred angle
- Up to 10 chairs can be stacked vertically on a flat surface
- Extra thick chrome-plating
- With plastic or felt gliders*

Seat

- Beech laminate made using high-pressure beech veneering of at least 10 mm thickness and at least 9 layers
- Seat with integrated lumbar support to help keep a posture that is easy on the spine
- The seat is invisibly screwed to the frame

Armrests

- Armrests open to the front in seat colour

Finish

- All wooden parts are painted with several coats of waterproof and environmentally friendly, low-solvent paint

Upholstery

- Seat and back upholstery screwed down
- Upholstery approx. 20 mm foam (RG 35)

Covers

- Fabrics from the Step, Step Melange, Blazer, Era, RePlay, Rivet and Penta collections
- Artificial leathers from the Skai® Parotega NF collections

Load capacity

- Up to 120 kg



Padding Full upholstery Armrests with black plastic cover

Ravenna



546GU-10

Plastic comfort seat shell, seat and back separated, without upholstery, stackable 10-high

546GU-11

Comfort plastic seat shell, seat and back separated, with seat upholstery, stackable 10-high

546GU-12

Comfort plastic seat shell, seat and back separated, with seat and back upholstery, stackable 10-high



Seat and back upholstery



Optionally with armrests

Leg frame

- Solid steel 11 mm, chrome-plated
- The bracket under the seat is arched backwards for optimal legroom
- The seat is invisibly screwed to the frame
- Up to 10 chairs can be stacked vertically on a flat surface
- With plastic and felt gliders*
- Row connection integrated into the glider

Seat

- Seat is made of polypropylene (PP)
- The back is glass fibre-reinforced
- The front edge of the seat has extra stiffening
- Seat in the colours platinum white, steel grey and bright red

Upholstery

- Upholstery 10 mm
- Foam approx. RG 35

Armrests

- Armrests open to the front in seat colour

Covers

- Fabrics from the Step, Step Melange, Blazer, Era, RePlay, Rivet and Penta collections
- Artificial leathers from the Skai® Parotega NF collections

Load capacity

- Up to 120 kg



546BU-10

Comfort plastic seat shell, barstool, seat and back separated, without upholstery, stackable 4-high

546BU-11

Comfort plastic seat shell, barstool, seat and back separated, with seat upholstery, stackable 4-high

546BU-12

Comfort plastic seat shell, barstool, seat and back separated, with seat and back upholstery, stackable 4-high



Seat and back upholstered

Leg frame

- Solid steel 11 mm, chrome-plated
- The bracket under the seat is arched backwards for optimal legroom
- Non-marking, abrasion-resistant plastic floor gliders, firmly screwed to the frame so that they cannot be lost
- The seat is invisibly screwed to the frame
- Up to 4 chairs can be stacked vertically on a flat surface
- With plastic and felt gliders*
- Row connection integrated into the glider

Seat

- Seat is made of polypropylene (PP)
- The back is glass fibre-reinforced
- The front edge of the seat has extra stiffening
- Seat in the colours platinum white, steel grey and bright red

Upholstery

- Upholstery 10 mm
- Foam approx. RG 35

Covers

- Fabrics from the Step, Step Melange, Blazer, Era, RePlay, Rivet and Penta collections
- Artificial leathers from the Skai® Parotega NF collections

Load capacity

- Up to 120 kg

* The customer is exclusively responsible for selecting and approving the order for floor gliders that are suitable for the respective floor covering ASSMANN does not accept any liability for damage or defects.

Ravenna



544GU-10
Comfort wooden seat shell,
without upholstery,
stackable 10-high



544GU-11
Comfort wooden seat shell,
with seat upholstery,
stackable 10-high



544GU-12
Comfort wooden seat shell,
with seat and back upholstery,
stackable 10-high



544GU-13
Wooden comfort seat shell,
padding with centre seam,
stackable 10-high

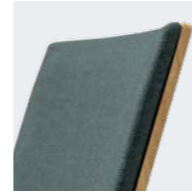

Padding

Leg frame

- Solid steel 11 mm, chrome-plated
- The seat is invisibly screwed to the frame
- Up to 10 chairs can be stacked vertically on a flat surface
- With plastic or felt gliders*
- Row connection integrated into the glider

Seat

- Beech laminate made using high-pressure beech veneering of at least 10 mm thickness and at least 9 layers

Finish

- All wooden parts are painted with several coats using waterproof and environmentally friendly, low-solvent paint

Upholstery

- Upholstery 10 mm
- Foam approx. RG 35

Covers

- Fabrics from the Step, Step Melange, Blazer, Era, RePlay, Rivet and Penta collections
- Artificial leathers from the Skai® Parotega NF collections

Load capacity

- Up to 120 kg

Accessories

The chairs come with a wide range of optional accessories, depending on the model.

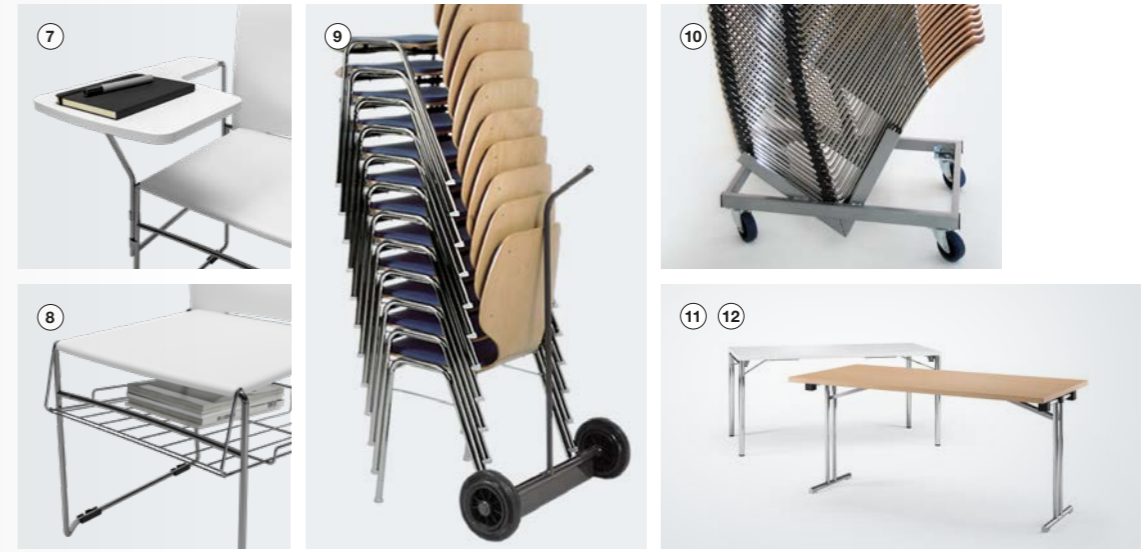

Without armrests

	215GU-10	215GU-11	215GU-12	215GU-13	265GU-10	265GU-11	265GU-12	265GU-13	265GL-10	265GL-11	265GL-12	8519-10	565GK-10	565GK-11
Concealed screws (* series-fitted))	✓	✓	✓	✓	✓	✓	✓	✓	✓	✓	✓	✓*	✓*	✓*
① Pull out row connector (** with stacking protection)	✓	✓	✓	✓	✓	✓	✓	✓	✓	✓	✓		✓	✓
② Panic bolt, in combination with row connectors only	✓	✓	✓	✓	✓	✓	✓	✓	✓	✓	✓			
Row connection using gliders														
③ Foldable book table	✓	✓	✓	✓	✓	✓	✓	✓	✓	✓	✓			
④ Half moon handle hole, top of backrest	✓	✓	✓		✓	✓	✓							
Half moon handle hole, bottom of backrest	✓	✓			✓	✓								
⑤ Rectangular handle hole, top of backrest														
⑥ Seat numbering	✓	✓			✓	✓			✓	✓				
⑦ Writing table, right- and left-handed, max. load 5 kg														
⑧ Wire basket beneath the seat														

With armrest

	215ZU-10	215ZU-11	215ZU-12	215ZU-13	265ZU-10	265ZU-11	265ZU-12	265ZU-13	265ZL-10	265ZL-11	265ZL-12	565ZK-10	565ZK-11
Concealed screws (*series-fitted)	✓	✓	✓	✓	✓	✓	✓	✓	✓	✓	✓	✓*	✓*
① Pull out row connector (** with stacking protection)	✓	✓	✓	✓	✓	✓	✓	✓	✓	✓	✓		
② Panic bolt, in combination with row connectors only													
③ Foldable book table	✓	✓	✓	✓	✓	✓	✓	✓	✓	✓	✓		
④ Handle hole, top of backrest	✓	✓	✓		✓	✓	✓						
Handle hole, bottom of backrest	✓	✓			✓	✓							
⑤ Rectangular handle hole, top of backrest													
⑥ Seat numbering	✓	✓			✓	✓			✓	✓			
⑦ Writing table, right- and left-handed, max. load 5 kg	✓	✓	✓	✓	✓	✓	✓	✓	✓	✓	✓		
⑧ Wire basket beneath the seat													

Chair transport trolley

⑨ STRW720, max. vertical transport	18	18	12	12	20	20	15	12	20	20	15		10	10
⑩ STRW726, max. horizontal transport and storage														

Folding tables

⑪ Padova folding table, 4-leg frame	✓	✓	✓	✓	✓	✓	✓	✓	✓	✓	✓	✓	✓	✓
⑫ Parma folding table, T-leg frame	✓	✓	✓	✓	✓	✓	✓	✓	✓	✓	✓	✓	✓	✓

Riva

	255GU-10	255GU-11	255GU-12	255GU-13	255GU-18	254GU-10	254GU-11	254GU-12	254GU-13	254GU-18
Concealed screws (* series-fitted))	✓*	✓*	✓*	✓*	✓*	✓*	✓*	✓*	✓*	✓*
① Pull out row connector (** with stacking protection)	✓**	✓**	✓**	✓**	✓**	✓**	✓**	✓**	✓**	✓**
② Panic bolt, in combination with row connectors only										
③ Foldable book table										
④ Handle hole, top of backrest	✓	✓				✓	✓			
Handle hole, bottom of backrest	✓	✓				✓	✓			
⑤ Rectangular handle hole, top of backrest										
⑥ Seat numbering	✓	✓				✓	✓			
⑦ Writing table, right- and left-handed, max. load 5 kg	✓	✓	✓	✓	✓	✓	✓	✓	✓	✓
⑧ Wire basket beneath the seat										
⑨ STRW720, max. vertical transport	10	10	10	10	10	10	10	10	10	10
⑩ STRW726, max. horizontal transport and storage										
⑪ Padova folding table, 4-leg frame	✓	✓	✓	✓	✓	✓	✓	✓	✓	✓
⑫ Parma folding table, T-leg frame	✓	✓	✓	✓	✓	✓	✓	✓	✓	✓

Ravenna

	546GU-10	546GU-11	546GU-12	546BU-10	546-BU11	546BU-12	544GU-10	544GU-11	544GU-12
Concealed screws (* series-fitted))	✓*	✓*	✓*	✓*	✓*	✓*	✓*	✓*	✓*
① Pull out row connector (** with stacking protection)									
② Panic bolt, in combination with row connectors only									
③ Foldable book table	✓	✓	✓	✓	✓	✓	✓	✓	✓
④ Handle hole, top of backrest									
Handle hole, bottom of backrest									
⑤ Rectangular handle hole, top of backrest									
⑥ Seat numbering	✓	✓					✓	✓	
⑦ Writing table, right- and left-handed, max. load 5 kg	✓	✓	✓						
⑧ Wire basket beneath the seat	✓	✓	✓						
⑨ STRW720, max. vertical transport									
⑩ STRW726, max. horizontal transport and storage	40	30	35				40	30	35
⑪ Padova folding table, 4-leg frame	✓	✓	✓	✓	✓	✓	✓	✓	✓
⑫ Parma folding table, T-leg frame	✓	✓	✓	✓	✓	✓	✓	✓	✓

System

Roma

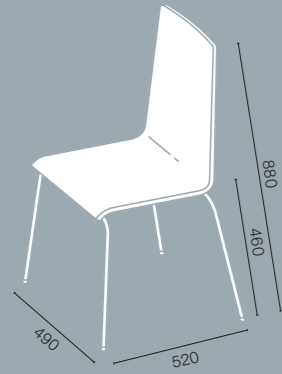

215GU-10
Basic wooden seat shell

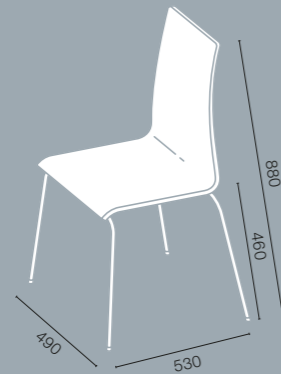

265GU-10
Comfort wooden seat shell

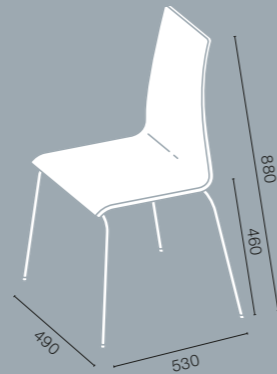

265GL-10
Comfort wooden seat shell

Riva

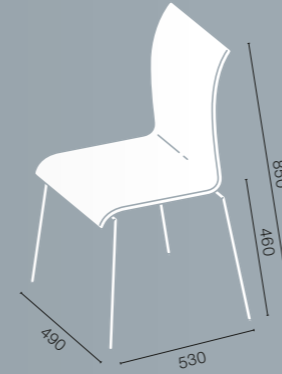

255GU-10
Comfort wooden seat shell

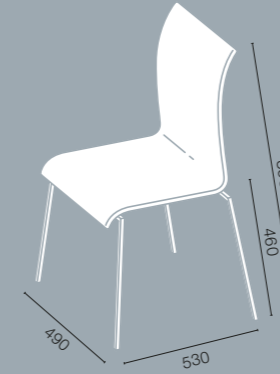

254GU-10
Comfort wooden seat shell

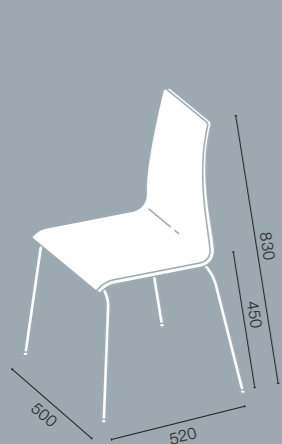

565GK-10
Comfort plastic seat shell

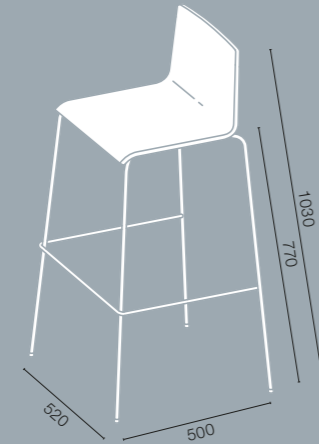

8519-10
Comfort wooden seat shell,
barstool

Ravenna

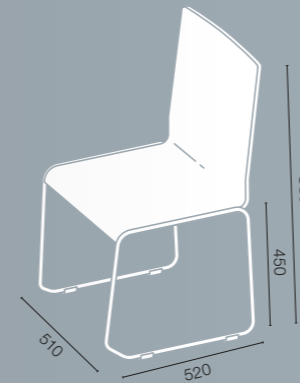

544GU-10
Comfort wooden seat shell

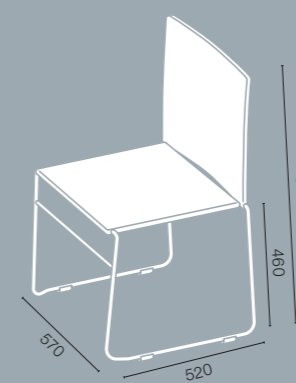

546GU-10
Comfort plastic seat shell

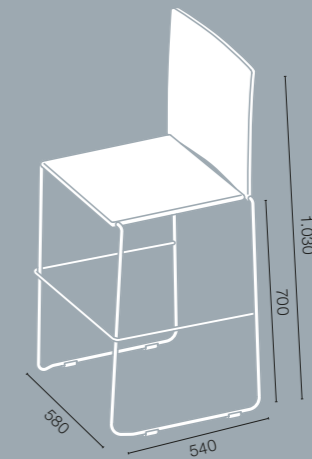

546BU-10
Comfort plastic seat shell

[A] CONSENTO | Armchairs

Consento armchairs create an inviting and relaxed ambience in reception and communication areas. Their broad range of colours and materials create individual looks.



Learn more
ass.al/f8yq6tz

Livorno



SES010100
Armchair with slender metal frame



SES010200
Stool with slender metal frame

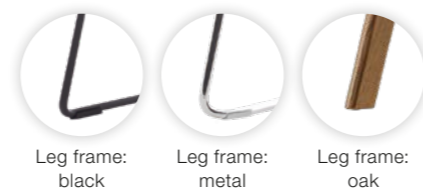

Leg frame: black Leg frame: metal Leg frame: oak

Livorno is a cosy-looking, versatile armchair. With its wavy lines, the soft, loose upholstery structure is a distinctive feature of the design vocabulary, promising pleasant seat comfort. The delicate wire frame lends the armchair a sense of nonchalance and elegance.

Leg frame

- Wire leg metal frame, powder-coated, chrome-plated or black matte
- 4-leg frame, solid oak

Base material/upholstery

- Supporting parts made of solid hardwood and wood composites, surfaces lined with padded cardboard
- Supported by permanently elastic steel wave springs (no-sag base) and a cover on top
- Seat made of high-quality upholstery foam (at least RG 35), covered with padded fleece

Covers

- Fabrics from the Step, Step Melange, Blazer, Era, RePlay, Rivet, Penta, Cord and Loro collections
- Artificial leathers from the Skai® Parotega NF collections
- Thick leather from the Torero collection



Variants

- 1-seater armchair
- Foot rest

Lamezia



SES020100
4-leg armchair, metal



SES020200
4-leg stool

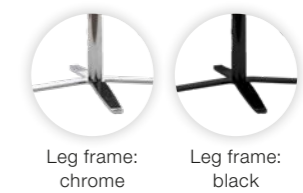

Leg frame: chrome Leg frame: black

Lamezia is an armchair with 360° rotation, a high backrest and extra-broad headrest in winged-chair look. Available with an optional rocker function, the armchair is a wonderful spot to relax and a delightful safe haven when combined with the footrest. With its wavy lines, the soft, loose upholstery structure guarantees pleasant seat comfort. The heavy 4-legged cantilever frame with a chrome-plated surface gives the armchair extra stability and excellent durability.

Leg frame

- 4-leg metal frame, chrome-plated or black, 360° rotation

Base material/upholstery

- Supporting parts made of solid hardwood and wood composites, surfaces lined with padded cardboard
- Supported by permanently elastic steel wave springs (no-sag base) and a cover on top
- Seat made of high-quality cold foam (at least RG 35), layered structure in various matching thickness and hardness levels, covered with padded fleece
- Fixed back made of ergonomically moulded foam (at least RG 25), covered with padded fleece

Covers

- Fabrics from the Step, Step Melange, Blazer, Era, RePlay, Rivet, Penta, Cord and Loro collections
- Artificial leathers from the Skai® Parotega NF collections
- Thick leather from the Torero collection



Variants

- 1-seater armchair
- Foot rest
- Rocking function, infinitely adjustable

Lucca

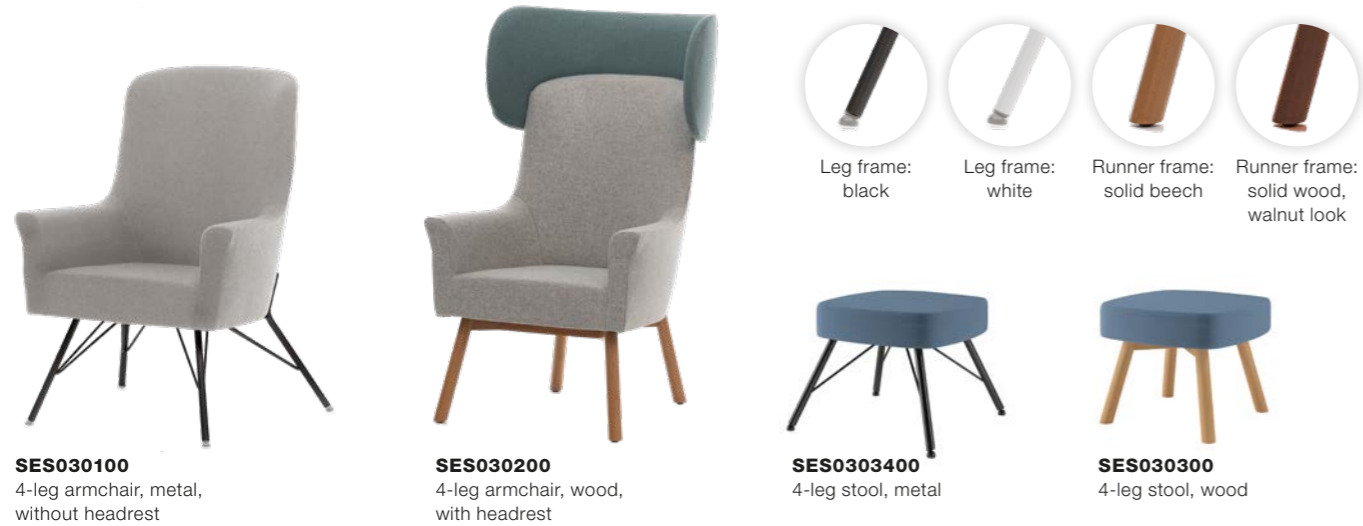

With its high backrest, comfortably wide seat and optional headrest, the Lucca armchair programme promises a sense of security and peace. The design radically reinterprets the classic winged-chair look to create a cosy safe haven.

Leg frame

- 4-leg metal frame, powder-coated, black matte or white
- 4-leg frame, solid wood, beech or walnut look

Base material/upholstery

- Supporting parts made of solid hardwood and wood composites, surfaces lined with padded cardboard
- Supported by permanently elastic, flexible belts and a cover on top
- Seat made of high-quality upholstery foam (RG 45), layered structure in various matching thickness and hardness levels, covered with padded fleece
- Fixed back made of ergonomically moulded foam (RG 45), covered with padded fleece

Covers

- Fabrics from the Step, Step Melange, Blazer, Era, RePlay, Rivet and Penta collections
- Artificial leathers from the Skai® Parotega NF collections

Variants

- 1-seater armchair with headrest
- 1-seater armchair without headrest
- Foot rest

Levanto

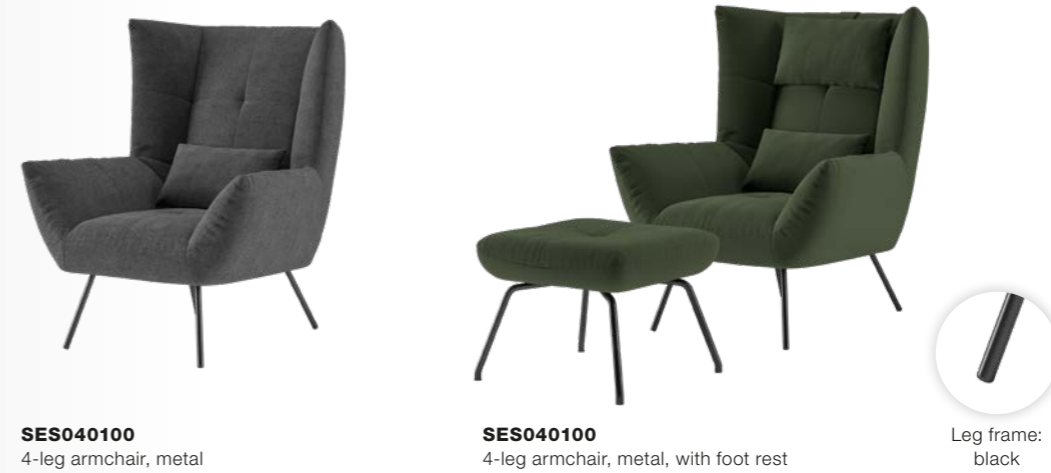

Not only does the Levanto armchair come in a visually enticing, curved look, it also ensures a particularly comfortable sitting experience. With the generous width of the seating surface and optional neck cushion, Levanto creates a pleasant sanctuary to take a deep breath and relax.

Leg frame

- 4-leg frame, metal, black or chrome

Base material/upholstery

- Supporting parts of the frame made of solid wood and wood composites
- Firm seat made of high-quality upholstery foam (RG 35), covered with cotton wool fleece
- Back made of ergonomically moulded foam (at least RG 25), covered with cotton wool fleece

Covers

- Fabrics from the Step, Step Melange, Blazer, Era, RePlay, Rivet, Penta, Cord and Loro collections
- Artificial leathers from the Skai® Parotega NF collections
- Thick leather from the Torero collection

Variants

- 1-seater armchair with back cushion (back cushion is always made from the same fabric as the armchair)
- 1-seater armchair with back cushion and optional neck cushion
- Foot rest



System

Livorno

Width: 820 mm | Height: 1020 mm | Depth: 810 mm | Seat height: 450 mm | Seat depth: 520 mm

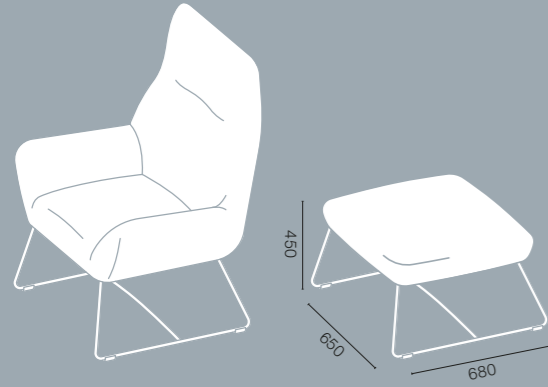

Armchair with slender frame

Foot rest

Lamezia

Width: 790 mm | Height: 1170 mm | Depth: 820-960 mm | Seat height: 440 mm | Seat depth: 480 mm

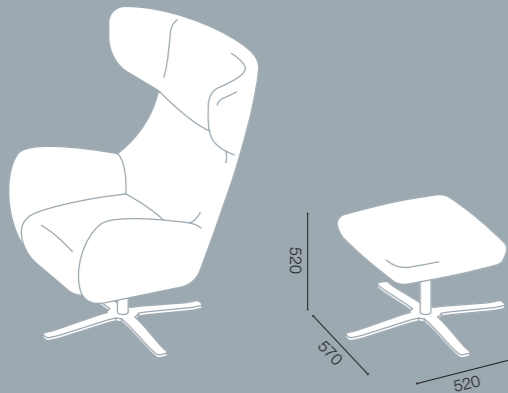

4-leg armchair, metal

Foot rest

Lucca

Width: 740 mm | Height: 1010 mm | Depth: 735 mm | Seat height: 455 mm | Seat depth: 490 mm
Height with headrest: 1220 mm | Depth with headrest: 790 mm

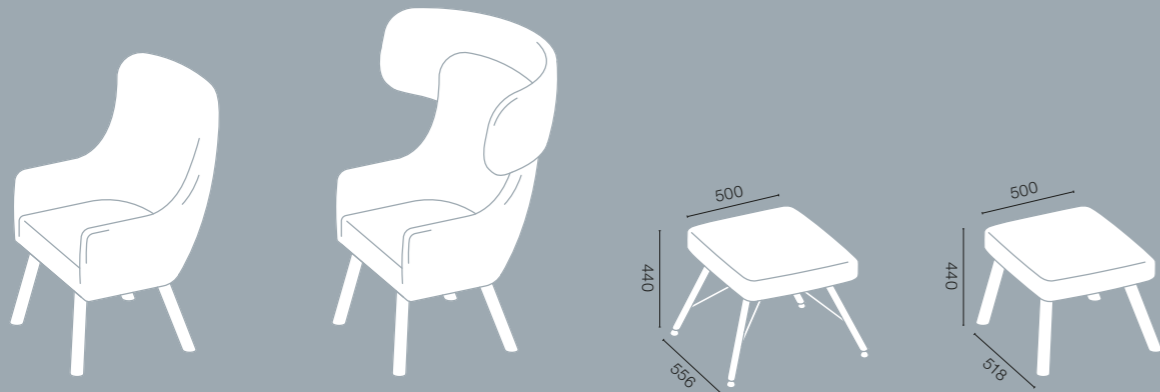

Armchair, 4 legs

4-leg armchair with headrest

4-leg stool, metal

4-leg stool, wood

Levanto

Width: 900 mm | Height: 1100 mm | Depth: 940 mm | Seat height: 450 mm | Seat depth: 610 mm
Stool: Width: 570 mm | Height: 450 mm | Depth: 520 mm

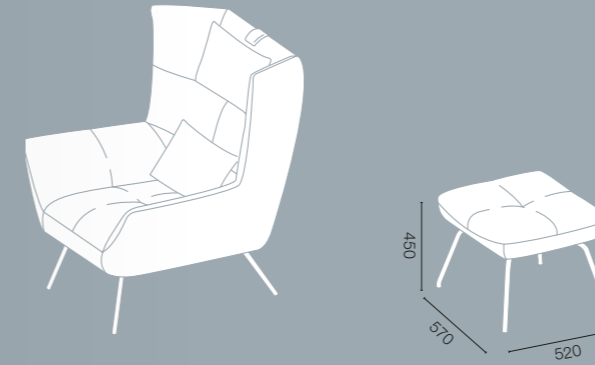

4-leg armchair, metal

Foot rest

[A] CONSENTO | Sofas

The Consento sofa series creates visual highlights which invite people to linger in modern working environments. They shape cosy safe spaces – with 1-, 2- or 3-seater sofas.



Learn more
ass.al/v77fhx1

Savona



SOF020300
2.5-seater, armrest cushions as optional extras



The timeless and elegant Savona sofa slips seamlessly into any interior design style. Various chrome and metal leg frames, coupled with a wide selection of fabrics and leathers, ensure innumerable design options. The appealing design, excellent comfort and high-quality haptics create classic elegance and a relaxed sense of well-being.

Leg frame

- 1-seater | 2-seater | 2.5-seater | 3-seater, runner frame, black matte or chrome-plated metal
- 1-seater | 2-seater | 2.5-seater | 3-seater, leg frame, black matte or chrome-plated metal

Base material/upholstery

- Supporting parts of the frame made of solid wood and wood composites, surfaces lined with padded cardboard
- Supported by permanently elastic steel wave springs (no-sag base) and a cover on top
- Seat made of upholstery foam (at least RG 35), layered structure in various matching thickness and hardness levels. Seat covered with cotton wool fleece. Fixed-position back cushions with a cotton wool fleece cover.
- The “relaxed upholstery” creates a soft/delicate surface. Even new, the covers have a distinctly wavy look.

Covers

- Fabrics from the Step, Step Melange, Blazer, Era, RePlay, Rivet, Penta, Cord and Loro collections
- Artificial leathers from the Skai® Parotega NF collections
- Thick leather from the Torero collection



Variants

- Armrest 19 cm
- Rectangular armrest cushions (approx. 50 x 40 cm) available as optional extras

Salo



SOF100300
2.5-seater, armrest cushions as optional extras



The Salo sofa series blends straightforward design and the soft, padded seat surface with an attractive look and outstanding comfort. The puristic metal base frames match beautifully with the modern style.

Leg frame

- 1.5-seater | 2-seater | 2.5-seater | 3-seater | Leg frame, black or chrome
- 1.5-seater | 2-seater | 2.5-seater | 3-seater | Runner frame, black

Base material/upholstery

- Supporting parts made of solid hardwood and wood composites, surfaces lined with padded cardboard
- Supported by permanently elastic steel wave springs and a cover on top
- Spring core seat made from drawn spring steel wire. Seat covered with textile fleece, HR/cold foam (at least RG 35) and cotton wool fleece
- Back made of ergonomically moulded polyurethane foam (at least RG 25), covered with cotton wool fleece

Covers

- Fabrics from the Step, Step Melange, Blazer, Era, RePlay, Rivet, Penta, Cord and Loro collections
- Artificial leathers from the Skai® Parotega NF collections
- Thick leather from the Torero collection



Covers

- Armrest 16 cm
- Armrest 18 cm
- Throw cushions (approx. 75 x 75 cm) available as optional extras

Sanremo



SOF030300
2.5-seater



Runner frame: White Runner frame: Black
Leg frame: solid wood, beech Leg frame: solid wood, walnut look

Pared down to the essentials, the Sanremo sofa catches the eye with its clear design vocabulary, offering soft yet firm upholstery for a pleasurable comfortable experience. Special design features include the modern runner frames in black or white lacquered metal and the solid wood leg frame in beech or walnut look.

Leg frame

- 1-seater | 2-seater | 2.5-seater, metal runner frame, black matte or white
- 1-seater | 2-seater | leg frame, solid wood, beech or walnut look

Base material/upholstery

- Supporting parts made of solid hardwood and wood composites, surfaces lined with MDF
- Supported by permanently elastic, flexible belts and a cover on top
- Seat made of high-quality upholstery foam (RG 35), layered structure in various matching thickness and hardness levels, covered with padded fleece
- Fixed back made of high-quality upholstery foam (RG 32), covered with padded fleece

Covers

- Fabrics from the Step, Step Melange, Blazer, Era, RePlay, Rivet and Penta collections
- Artificial leathers from the Skai® Parotega NF collections

Variants

- 2-tone upholstery (within one material group) possible, separation of inner/outer upholstery

Siena



SOF040300
2.5-seater



Leg frame: white Leg frame: black

The attractive colour variants accentuate the rounded look of the Siena sofa programme, while the optional two-tone design lends the pieces a special charisma. The contrast between the clearly contoured base in the area of the leg frames and the distinctly rounded upholstery of the seat and backrest surfaces creates a pleasant tension. The upholstery is kept tight to ensure perfect seating comfort.

Leg frame

- 1-seater | 2-seater | 2.5-seater | 3-seater, metal leg frame, black matte or white

Base material/upholstery

- Supporting parts made of steel, solid hardwood and wood composites
- The base construction is securely attached to the foam body
- Seat made of high-quality polyurethane foam (RG 45), covered with padded fleece
- Fixed back made of high-quality polyurethane foam (RG 45), covered with padded fleece

Covers

- Fabrics from the Step, Step Melange, Blazer, Era, RePlay, Rivet and Penta collections
- Artificial leathers from the Skai® Parotega NF collections

Variants

- 2-tone upholstery (within one material group) possible, separation of inner/outer upholstery

Como



SOF050200
2-seater



SOF050500
Recliner

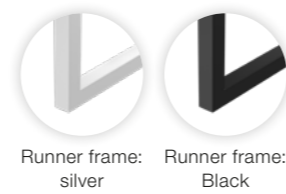

Runner frame: silver Runner frame: Black

With its clear design vocabulary, the Como sofa series is a particular favourite for lovers of stylishly timeless design. The slanted back section loosens up the straight lines and creates a comfortable sitting experience. The tightly upholstered seat retains its shape, even under heavy use. The optional cushions add a lighter touch to the straight lines and inject a beautifully contrasting colourfulness.

Leg frame

- 1-seater | 2-seater | 2.5-seater | 3-seater | Recliner, metal leg frame, black matte or silver

Base material/upholstery

- Supporting parts made of solid hardwood and wood composites, surfaces lined with padded cardboard
- Seat made of high-quality upholstery foam (RG 35), layered structure in various matching thickness and hardness levels, covered with padded fleece
- Fixed back made of high-quality upholstery foam (RG 35), covered with padded fleece

Covers

- Fabrics from the Step, Step Melange, Blazer, Era, RePlay, Rivet and Penta collections
- Artificial leathers from the Skai® Parotega NF collections

Variants

- Square cushions (approx. 40 x 40 cm) available as optional extras
- Rectangular cushions (approx. 80 x 30 cm) available as optional extras

Carpi



SOF080300
3-seater

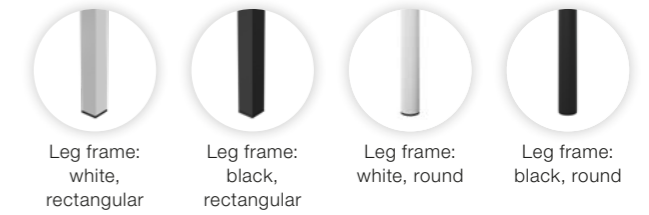

Leg frame: white, rectangular Leg frame: black, rectangular Leg frame: white, round Leg frame: black, round

Carpi is a sofa in retro-look, which combines perfect functionality with an attractive design vocabulary. The elegantly slanted armrests and modern foot frame add refinement to the otherwise straightforward design. Boasting high-quality upholstery, the chair is a delightfully comfortable spot to linger.

Leg frame

- 1-seater | 2-seater | 3-seater, angular leg frame, metal, black matte or white
- 1-seater | 2-seater | 3-seater, round leg frame, metal, black matte or white

Base material/upholstery

- Supporting parts made of solid hardwood and wood composites, surfaces lined with MDF
- Supported by permanently elastic, flexible belts and a cover on top
- Seat made of high-quality upholstery foam (RG 35), layered structure in various matching thickness and hardness levels, covered with padded fleece
- Fixed back made of high-quality upholstery foam (RG 32), covered with padded fleece

Covers

- Fabrics from the Step, Step Melange, Blazer, Era, RePlay, Rivet and Penta collections
- Artificial leathers from the Skai® Parotega NF collections

Cuneo



SOF060300
2.5-seater



Leg frame:
black

Designed in the retro style of the 1950s, the Cuneo sofa programme catches the eye with its amazing comfort and extravagant look that combines clear lines with soft, rounded edges. The black metal frame supports the structure and also highlights the unmistakable look.

Leg frame

- 1-seater | 2-seater | 2.5-seater | 3-seater, metal leg frame, black matte

Base material/upholstery

- Supporting parts of the frame made of solid wood and wood composites, surfaces lined with padded cardboard
- Supported by permanently elastic steel wave springs (no-sag base) and a cover on top
- Seat made of cold foam (at least RG 35), covered with cotton wool fleece. Ergonomically moulded and fixed-position back cushions (at least RG 25) with a cotton wool fleece cover. The enclosure is created with horizontal, ornamental seams and is quilted.
- The “relaxed upholstery” creates a soft/delicate surface. Even new, the covers have a distinctly wavy look.

Covers

- Fabrics from the Step, Step Melange, Blazer, Era, RePlay, Rivet, Penta, Cord and Loro collections
- Artificial leathers from the Skai® Parotega NF collections
- Thick leather from the Torero collection



Variants

- Armrest cover (two) available
- Square, pointed cushions (approx. 40 x 40 cm) available as optional extras

Cucco



SOF090300
2.5-seater



Leg frame:
black



Leg frame:
Chrome

The new Cucco sofa in classic Bauhaus style is – in addition to the well-known Consento covers – also available with a high-quality corduroy fabric cover in nine different colours. The black metal or chrome leg frame completes the modern, minimalist design.

Leg frame

- 1-seater | 2-seater | 2.5-seater | 3-seater, metal leg frame, matte black or chrome

Base material/upholstery

- Supporting parts made of solid hardwood and wood composites, surfaces lined with padded cardboard
- Supported by permanently elastic steel wave springs and a cover on top
- Seat made of high-quality upholstery foam (RG 35), covered with padded fleece
- Fixed back made of ergonomically moulded upholstery foam (RG 25), covered with an inlet (filled with high-quality padding that includes feathers). Cover made of cotton wool fleece.

Covers

- Fabrics from the Step, Step Melange, Blazer, Era, RePlay, Rivet, Penta, Cord and Loro collections
- Artificial leathers from the Skai® Parotega NF collections
- Thick leather from the Torero collection



Variants

- Square cushions (approx. 50 x 50 cm) available as optional extras

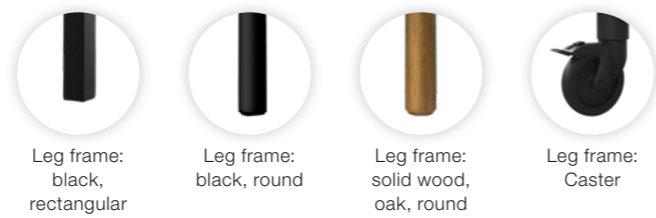

Leg frame:
black,
rectangular

Leg frame:
black, round

Leg frame:
solid wood,
oak, round

Leg frame:
Caster

Cremona



SOF070300
2.5-seater



SOF070700
2.5-seater

The modern design and the excellent comfort of the Cremona sofa series are true eye-catchers and invite you to linger. The relaxed upholstery with the large back cushions ensures unbeatable comfort. Available in two backrest heights, the sofa slips easily into a variety of interior design concepts. In the high version with linear stitching in the back and armrest sections, the Cremona provides additional space for one-on-one conversations.

Leg frame

- 1-seater | 2-seater | 2.5-seater | 3-seater, metal leg frame, round or rectangular, black matte
- 1-seater | 2-seater | 2.5-seater | 3-seater, solid oak leg frame (oiled), round
- 1-seater | 2-seater | 2.5-seater | 3-seater, casters with parking brake, black

Base material/upholstery

- Supporting parts of the frame made of solid wood and wood composites, surfaces lined with padded cardboard
- Supported by permanently elastic steel wave springs (no-sag base) and a cover on top
- Seat made of cold foam (at least RG 35), covered with cotton wool fleece. Ergonomically moulded and fixed-position back cushions (at least RG 25) with a cotton wool fleece cover. The enclosure is created with horizontal, ornamental seams and is quilted.
- The “relaxed upholstery” creates a soft/delicate surface. Even new, the covers have a distinctly wavy look.

Covers

- Fabrics from the Step, Step Melange, Blazer, Era, RePlay, Rivet, Penta, Cord and Loro collections
- Artificial leathers from the Skai® Parotega NF collections
- Thick leather from the Torero collection



Variants

- High or flat back section available
- Square, pointed cushions (approx. 40 x 40 cm) available as optional extras



SOF071300
1-seater



Table shelf with
optional Schuko
socket

As an ideal addition for notes, beverages and mobile devices, the Consento Cremona with high backrest is also available with a practical table shelf. It integrates harmoniously into the design and provides added comfort in all work and waiting areas — for a true sense of well-being.

Leg frame

- 1-seater, metal leg frame, round or rectangular, black matte
- 1-seater, solid oak leg frame (oiled), round
- 1-seater, casters with parking brake, black

Table shelf

- 19 mm, black, left and/or right configuration possible

Variants

- The table shelf is only available in combination with a high backrest and in the 1-seater or 1-seater cabin version
- Square, pointed cushions (approx. 40 x 40 cm) available as optional extras
- For powering the sofa cabin, Schuko sockets are optionally available

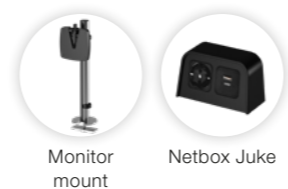

SOF071000
2-seater booth with back wall

Even more space to retreat to: The comfortable Cremona sofa is also available as a booth with back wall as a 2 to 6-seater. The sofa booth is equally impressive thanks to its high level of comfort and high-quality workmanship. This modern seating element can be ordered with optional table and power connections.

Leg frame

- 2-seater | 4-seater | 5-seater | 6-seater, metal, round or rectangular, matte black
- 2-seater | 4-seater | 5-seater | 6-seater, oak (oiled), round

Base material/upholstery

- Supporting parts of the frame made of solid wood and wood composites, surfaces lined with padded cardboard
- Supported by permanently elastic steel wave springs (no-sag base) and a cover on top
- Seat made of cold foam (at least RG 35), covered with cotton wool fleece. Ergonomically moulded and fixed-position back cushions (at least RG 25) with a cotton wool fleece cover. The enclosure is created with horizontal, ornamental seams and is quilted.
- The “relaxed upholstery” creates a soft/delicate surface. Even new, the covers have a distinctly wavy look.

Covers

- Fabrics from the Step, Step Melange, Blazer, Era, RePlay, Rivet, Penta, Cord and Loro collections
- Artificial leathers from the Skai® Parotega NF collections
- Thick leather from the Torero collection



Variants

- Also available with optional table
- The sofa booth is also available with optional screen mount and Schuko socket power connections
- Square, pointed cushions (approx. 40 x 40 cm) available as optional extras

Livorno



SOF110200
2-seater

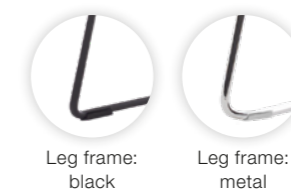

The Livorno is synonymous with comfort, also as a sofa. The soft, loose upholstery structure with its deliberate undulations is the true hallmark of the sofa and promising enticing comfort. The delicate wire frame imbues the sofa with a particularly elegant charisma.

Leg frame

- 2-seater, steel frame/leg base, black or chrome

Base material/upholstery

- Supporting parts made of solid hardwood and wood composites, surfaces lined with padded cardboard
- Supported by permanently elastic steel wave springs (no-sag base) and a cover on top
- Seat made of high-quality upholstery foam (at least RG 35), covered with padded fleece

Covers

- Fabrics from the Step, Step Melange, Blazer, Era, RePlay, Rivet, Penta, Cord and Loro collections
- Artificial leathers from the Skai® Parotega NF collections
- Thick leather from the Torero collection



System

Savona

Height: 860 mm | Depth: 970 mm | Seat height: 450 mm | Seat depth: 550 mm | Armrest width: 190 mm

Seat widths*:

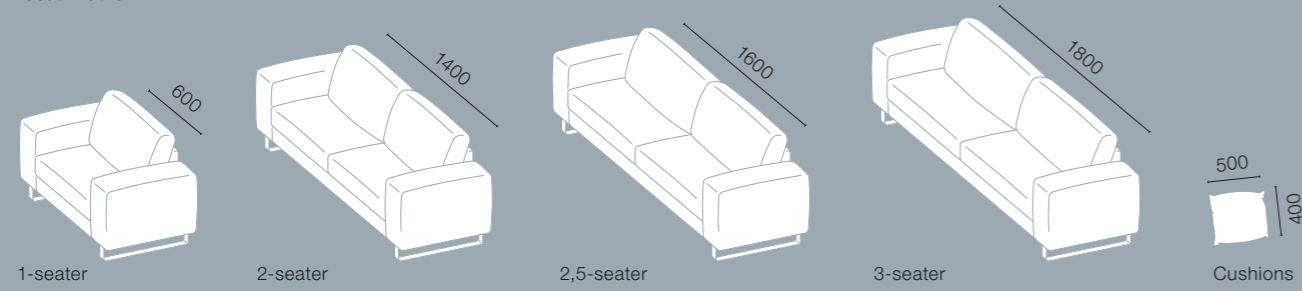

Salo

Height: 810 mm | Depth: 910 mm | Seat height: 470 mm | Seat depth: 600 mm | Armrest width: 160 or 180 mm

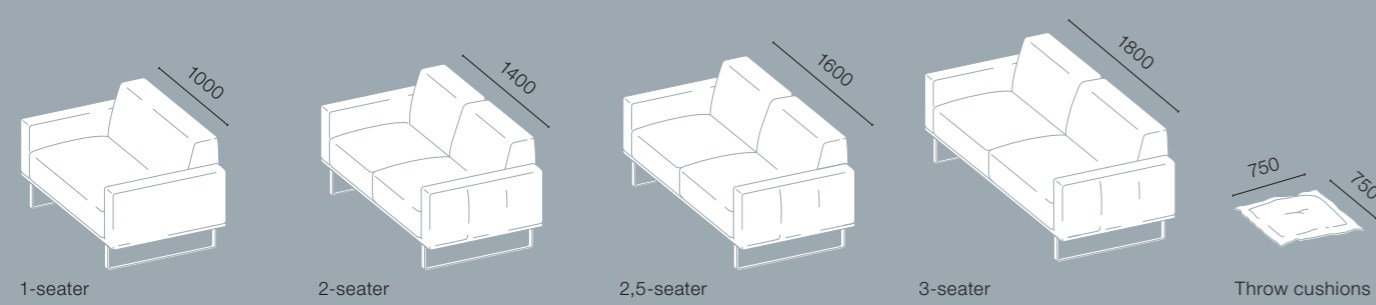

Sanremo

Height: 730 mm | Depth: 660 mm | Seat height: 440 mm | Seat depth: 480 mm | Armrest width: 60 mm

Seat widths*:

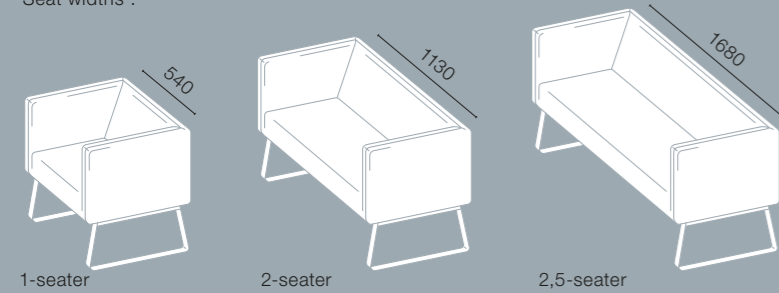

Siena

Height: 719 mm | Depth: 835 mm | Seat height: 409 mm | Seat depth: 546 mm | Armrest width: 180 mm

Seat widths*:

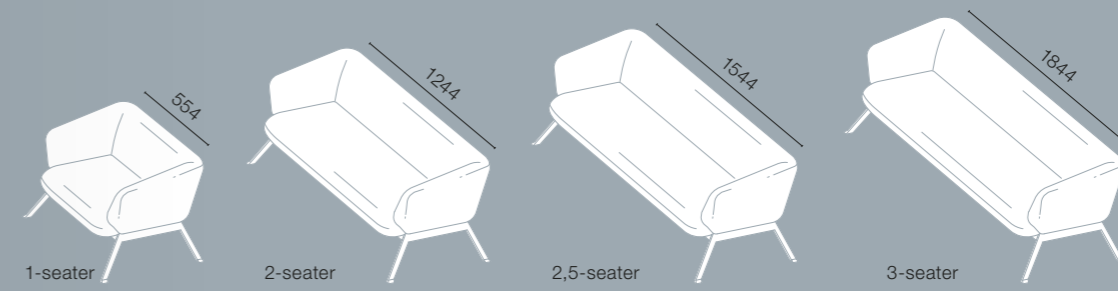

Como

Height: 730 mm | Depth: 750 mm | Seat height: 445 mm | Seat depth: 490 mm | Armrest width: 175 mm

Seat widths*:

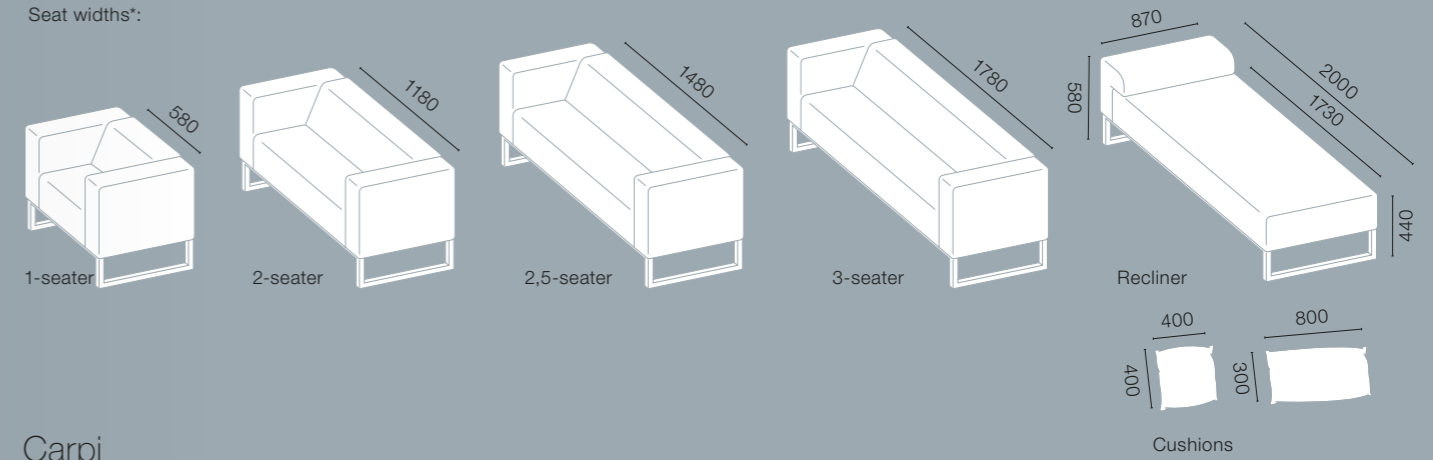

Carpi

Height: 750 mm | Depth: 750 mm | Seat height: 440 mm | Seat depth: 550 mm | Armrest width: 50 mm

Seat widths*:

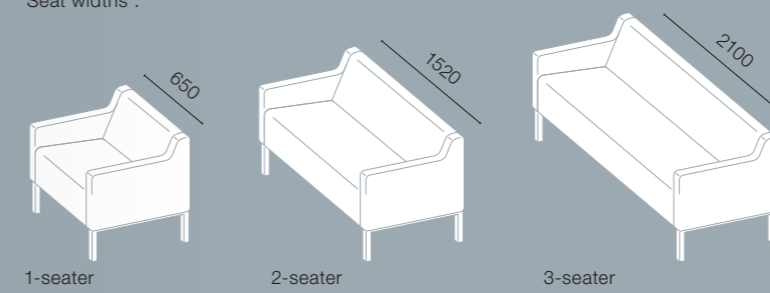

System

Cuneo

Height: 770 mm | Depth: 780 mm | Seat height: 410 mm | Seat depth: 510 mm | Armrest width: 35 mm

Seat widths:

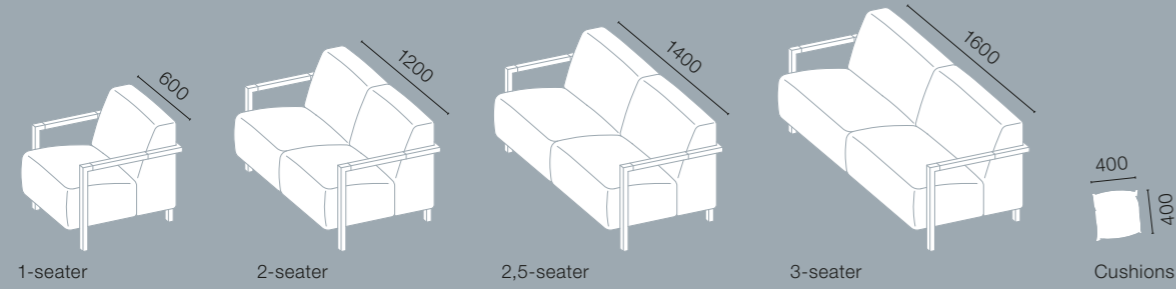

1-seater 2-seater 2,5-seater 3-seater Cushions

Cremona

High back height: 1400 mm | Low back height: 750 mm | Depth: 810 mm | Seat height: 430 mm | Seat depth: 520 mm | Armrest width: 120 mm

Seat widths*:

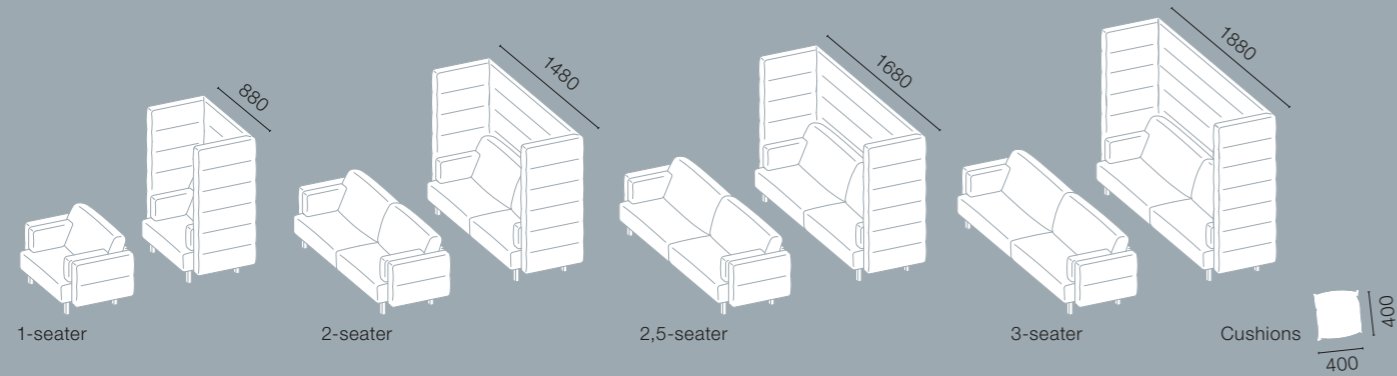

1-seater 2-seater 2,5-seater 3-seater Cushions

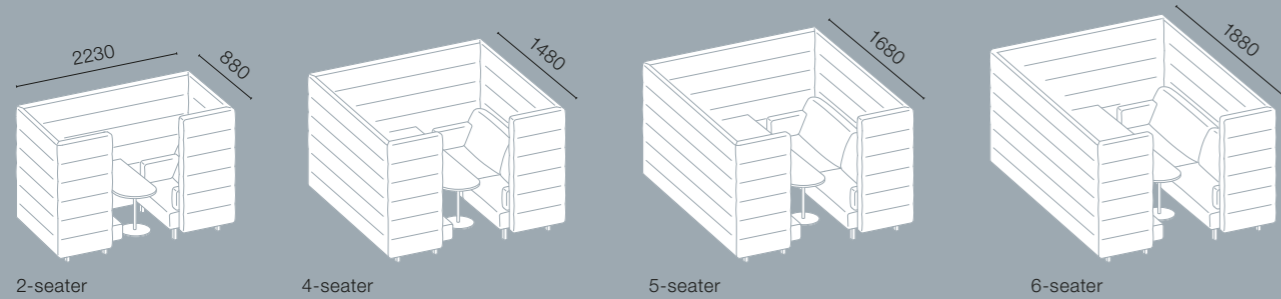

2-seater 4-seater 5-seater 6-seater

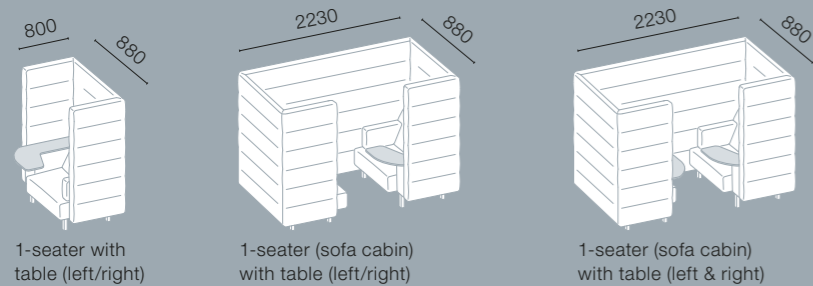

1-seater with table (left/right) 1-seater (sofa cabin) with table (left/right) 1-seater (sofa cabin) with table (left & right)

Cucco

Height: 670 mm | Depth: 960 mm | Seat height: 410 mm | Seat depth: 590 mm | Armrest width: 200 mm

Seat widths:

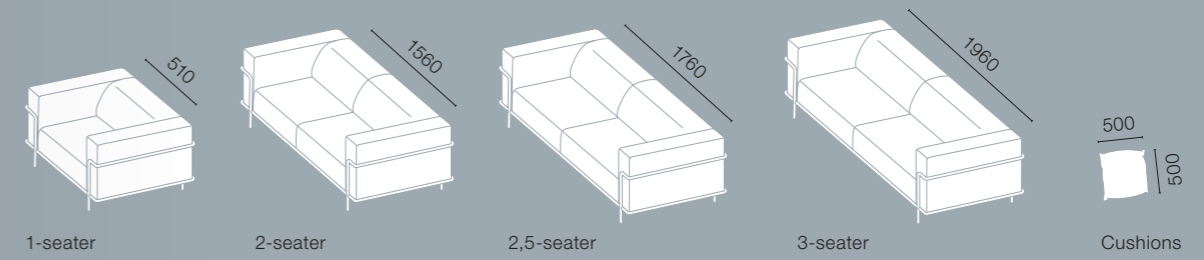

1-seater 2-seater 2,5-seater 3-seater Cushions

Livorno

Width: 1550 mm | Height: 1020 mm | Depth: 810 mm | Seat height: 450 mm | Seat depth: 520 mm



2-seater

[A] CONSENTO | Modular seating

The Consento module systems create flexibility for unlimited design options – in open-plan offices, reception areas or communication zones. Thanks to their versatile designs, the modules guarantee creative seating for spontaneous meetings or short breaks.



Learn more
ass.al/qdu173m

Marano



MOD010100L
Modular bench, small



MOD010300L
Modular bench, large



Leg frame:
black



Leg frame:
solid wood,
oak

The elaborately upholstered seating modules in the Marano series immediately seem homely thanks to their straightforward design. Combining round and straight elements, the characteristic design is a real eye-catcher. The seat modules can adapt easily to current interior designs thanks to the elegant and varied colour combinations.

Leg frame

- Modular bench, small | Modular bench, large, metal leg frame, black matte
- Modular bench, small | Modular bench, large, solid wood leg frame, oak

Base material/upholstery

- Supporting parts made of solid hardwood and wood composites, surfaces lined with padded cardboard
- Seat made of high-quality upholstery foam (RG 35), layered structure in various matching thickness and hardness levels, covered with padded fleece

Covers

- Fabrics from the Step, Step Melange, Blazer, Era, RePlay, Rivet and Penta collections
- Artificial leathers from the Skai® Parotega NF collections

Monza



MOD040200
Modular bench, large



MOD040100
Modular bench, small



Seating row



Block of 4

The high-quality seating elements in the Monza series are suitable for flexible uses. The ability to combine the different shapes creates a wide range of design options – whether as a row of seats or grouped as a block of 4. High-quality materials and numerous colours ensure that the modular system slips easily into any interior design.

Leg frame

- Modular bench, small | Modular bench, large, runners made of black plastic

Base material/upholstery

- Supporting parts made of solid hardwood and wood composites, surfaces lined with MDF
- Seat made of high-quality upholstery foam (RG 35), layered structure in various matching thickness and hardness levels, covered with padded fleece

Covers

- Fabrics from the Step, Step Melange, Blazer, Era, RePlay, Rivet and Penta collections
- Artificial leathers from the Skai® Parotega NF collections

Messina



MOD060100
Stool

MOD060200
Stool

MOD060500
Stool arrangement

MOD060700
Stool arrangement

The unique design of the Messina stool series offers maximum seating comfort and ensures that the furniture retains its shape and texture for a long time. Whether as standalone elements or stool groups – the compact, versatile seating furniture catches the eye with its design and colours.

Leg frame

- Stools, stool groups, black plastic runners

Base material/upholstery

- Supporting parts made of solid hardwood and wood composites, surfaces lined with MDF
- Seat made of high-quality upholstery foam (RG 35), layered structure in various matching thickness and hardness levels, covered with padded fleece

Covers

- Fabrics from the Step, Step Melange, Blazer, Era, RePlay, Rivet and Penta collections
- Artificial leathers from the Skai® Parotega NF collections

Massa



MOD050200
Pouf

The pouf in the Massa series catches the eye with its organic design vocabulary and comfy feel. It can be used flexibly as a seat, footrest or even as a small side table. The design, the different sizes and various materials adapt perfectly to every furnishing style.

Leg frame

- Pouf, black plastic runners

Base material/upholstery

- Supporting parts made of solid hardwood and wood composites, surfaces lined with MDF
- Seat made of high-quality upholstery foam (RG 35), layered structure in various matching thickness and hardness levels, covered with padded fleece

Covers

- Fabrics from the Step, Step Melange, Blazer, Era, RePlay, Rivet and Penta collections
- Artificial leathers from the Skai® Parotega NF collections

Modica



MOD02
Sofa module, high and low back, with angular elements, cushions available as optional extras



MOD02
Sofa module, high and low back, concave, rounded elements



MOD02
Sofa module, high and low back, concave and convex, rounded elements

Unique arrangements can be created using the seating elements in the Modica sofa series. Whether in small rooms or in larger spaces – the combination of seating elements with high and low backrests always creates a relaxed atmosphere. With its pleasant upholstery and generous seating area, Modica invites you to relax and feel good, while enabling a broad variety of design options.

Leg frame

- Sofa modules, black plastic runners

Base material/upholstery

- Supporting frames made of steel tube, with upper parts made of hardwood and wood composites, surfaces lined with MDF. Elements with high backrests are connected to each other by lateral suspension fittings; elements with low backrests by universal connectors below the seats.
- Supported by permanently elastic, flexible belts and a cover on top.
- Seat made of high-quality upholstery foam (RG 35), layered structure in various matching thickness and hardness levels, covered with padded fleece.
- Fixed back made of high-quality upholstery foam (RG 32), covered with padded fleece.

Covers

- Fabrics from the Step, Step Melange, Blazer, Era, RePlay, Rivet and Penta collections
- Artificial leathers from the Skai® Parotega NF collections

Variants

- Square cushions (approx. 35 x 35 cm) available as optional extras
- Rectangular cushions (approx. 74 x 35 cm) available as optional extras

Leg frame

- Sofa modules, black plastic runners

Base material/upholstery

- Supporting frames made of steel tube, with upper parts made of hardwood and wood composites, surfaces lined with MDF. Elements with high backrests are connected to each other by lateral suspension fittings; elements with low backrests by universal connectors below the seats.
- Supported by permanently elastic, flexible belts and a cover on top.
- Seat made of high-quality upholstery foam (RG 35), layered structure in various matching thickness and hardness levels, covered with padded fleece.
- Fixed back made of high-quality upholstery foam (RG 32), covered with padded fleece.

Covers

- Fabrics from the Step, Step Melange, Blazer, Era, RePlay, Rivet and Penta collections
- Artificial leathers from the Skai® Parotega NF collections

Variants

- Square cushions (approx. 35 x 35 cm) available as optional extras
- Rectangular cushions (approx. 74 x 35 cm) available as optional extras

System

Marano

Height: 450 mm

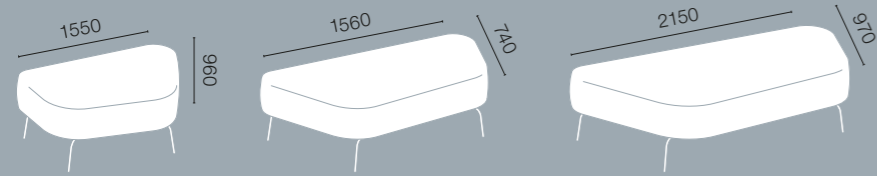

Seat modules

Monza

Height: 460 mm

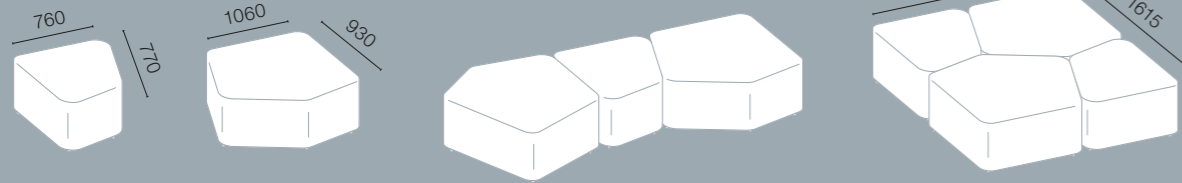

Modular bench, small/large

Messina

Height: 450 mm

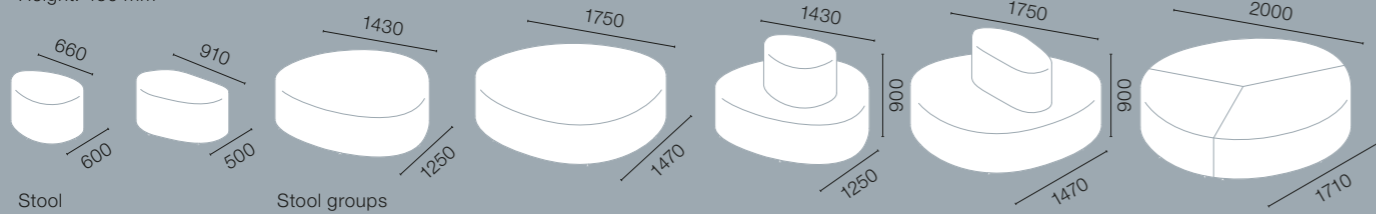

Stool

Stool groups

Massa

Diameter: 750/950/1150 mm | Height: 450 mm

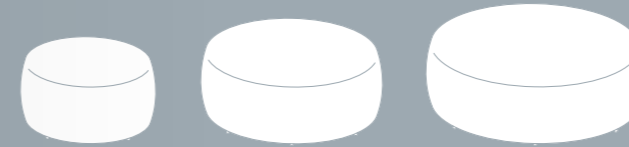

Poufs

Modica angular

High back height: 1450 mm | Low back height: 730 mm | Seat height: 430 mm | Seat depth: 560 mm

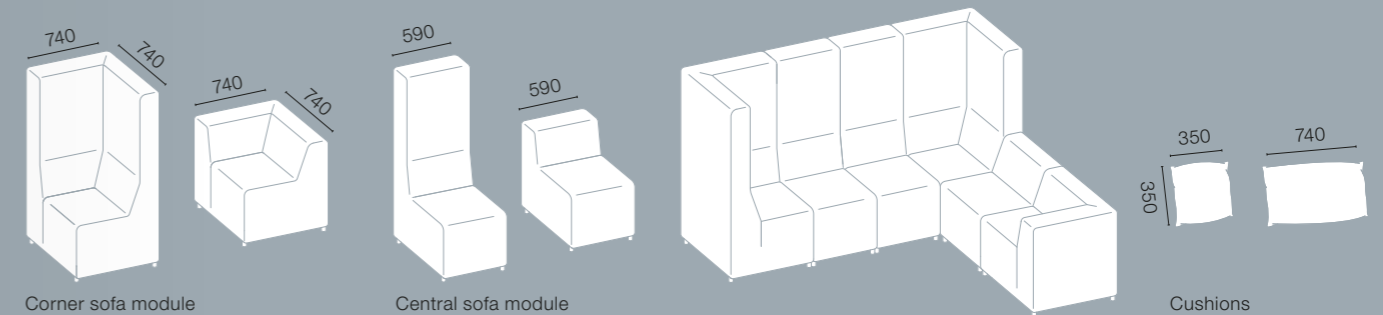

Corner sofa module

Central sofa module

Cushions

Modica round

High back height: 1450 mm | Low back height: 730 mm | Seat height: 430 mm | Seat depth: 551 mm

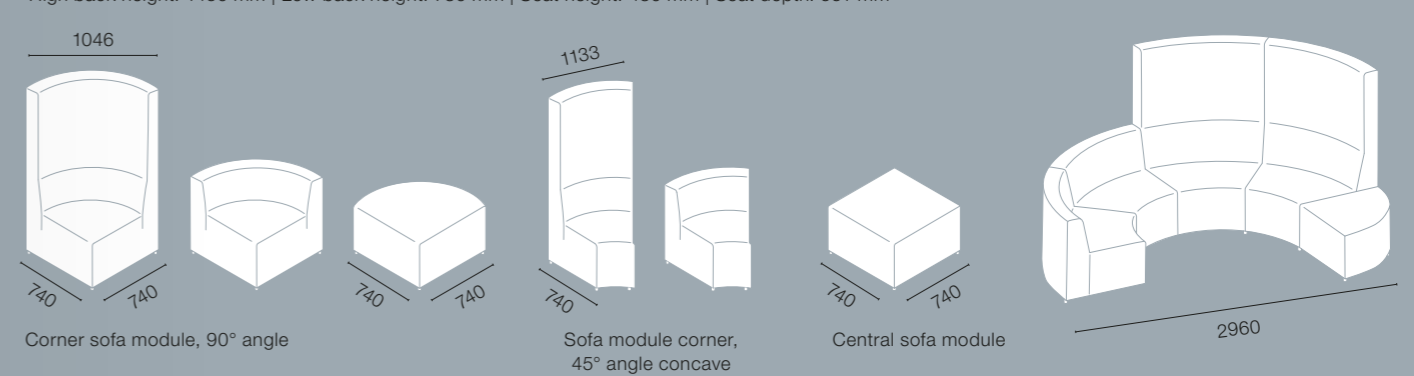

Corner sofa module, 90° angle

Sofa module corner, 45° angle concave

Central sofa module

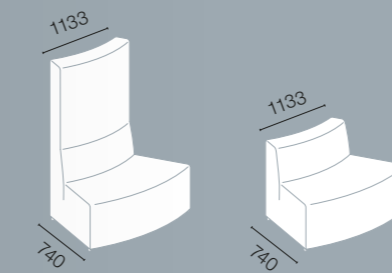

Convex sofa module, 45° angle

Covers Fabrics

STEP



STEP MELANGE

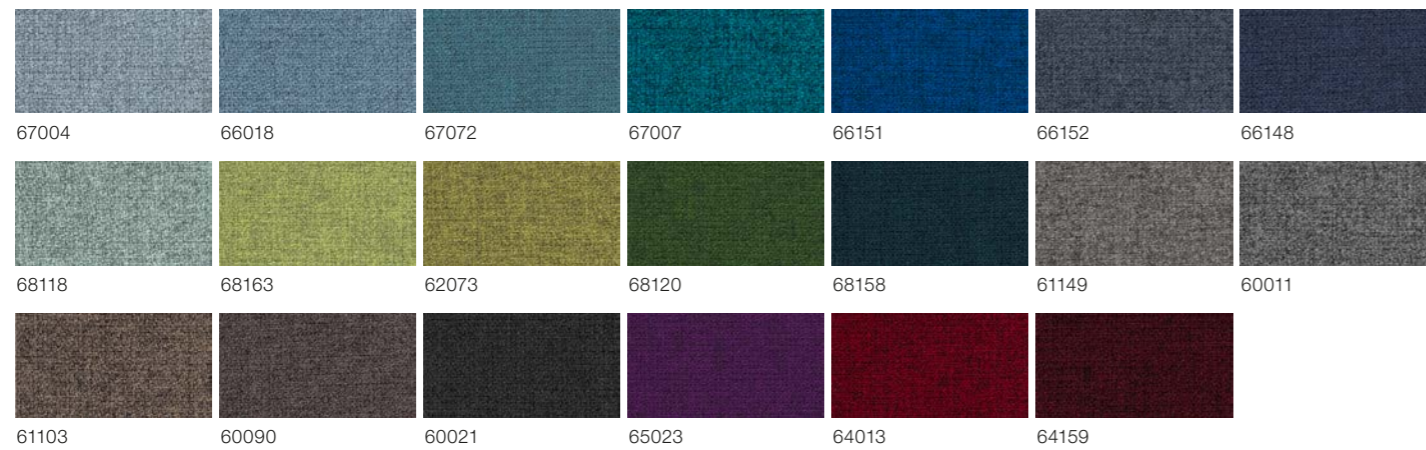

REPLAY



Step/Step Melange:
Gabriel

BLAZER

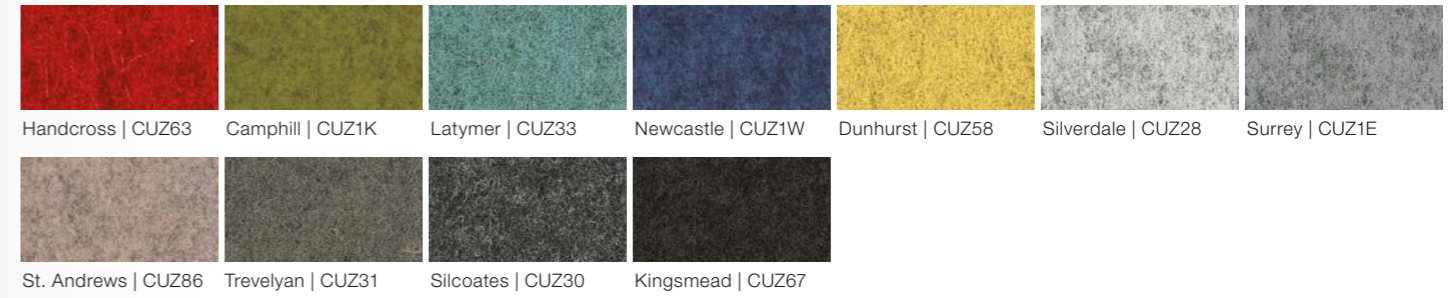

ERA



RIVET



PENTA



Blazer + Era +
Rivet + Penta:
camira

Covers

Fabrics

CORD* *Only for the following products: Livorno, Lamezia, Levanto, Tivoli, Cuneo, Cucco, Cremona, Salo and Savona

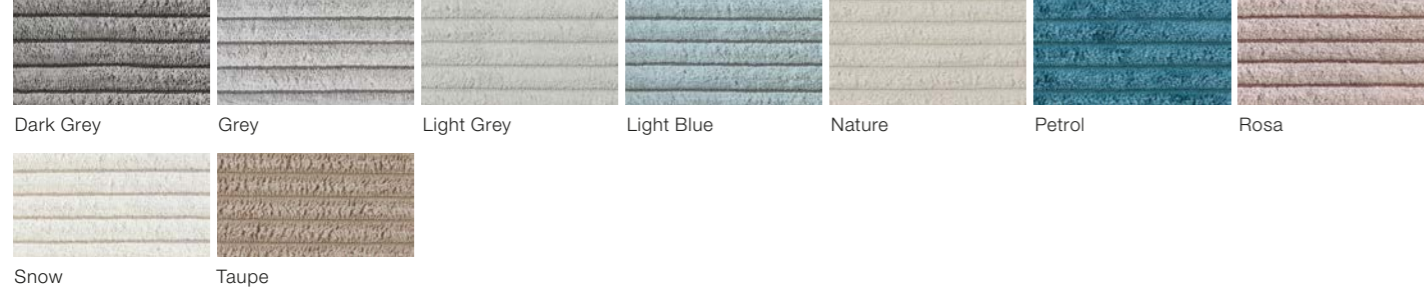

LORO* *Only for the following products: Livorno, Lamezia, Levanto, Tivoli, Cuneo, Cucco, Cremona, Salo and Savona

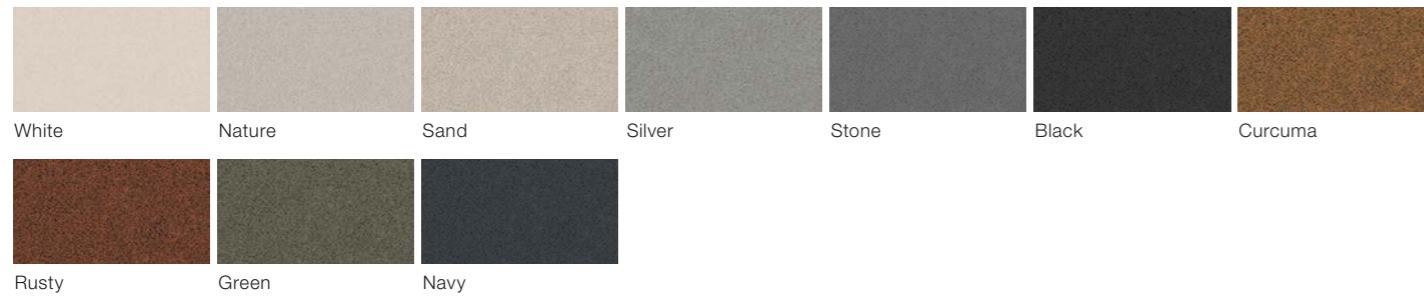

Genuine leather

TORERO/THICK LEATHER* *Only for the following products: Tivoli, Cremona, Cucco, Cuneo, Savona, Lamezia and Livorno

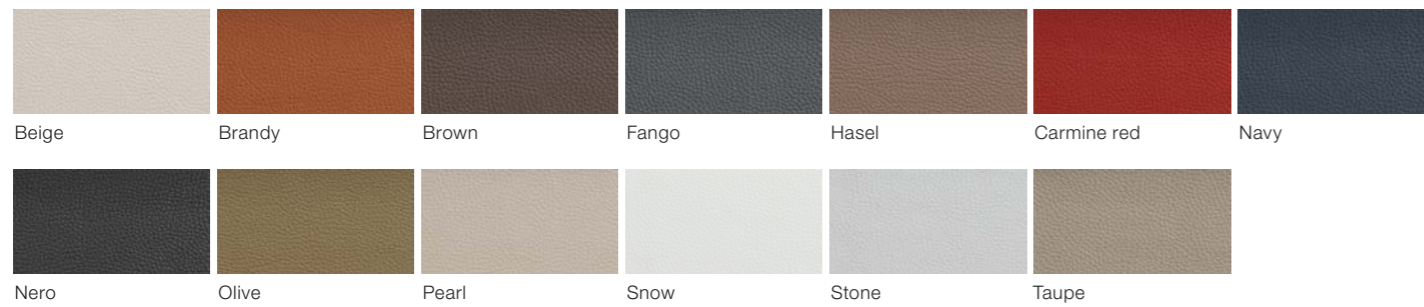

Artificial leather

SKAI® PAROTEGA NF



Skai® Parotega NF:
Continental

Note on Wrinkling
The formation of waves or creases on upholstered surfaces may vary depending on the model, upholstery construction, and cover fabric of our furniture. This is a natural characteristic of high-quality, soft upholstery and highlights the exceptional seating comfort and relaxed appearance of our furniture.

Surfaces

Stain tones

ROMA | RIVA | RAVENNA



Plastic shell

ROMA

RAVENNA



TRIEST



Frame colours

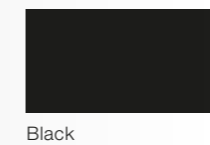
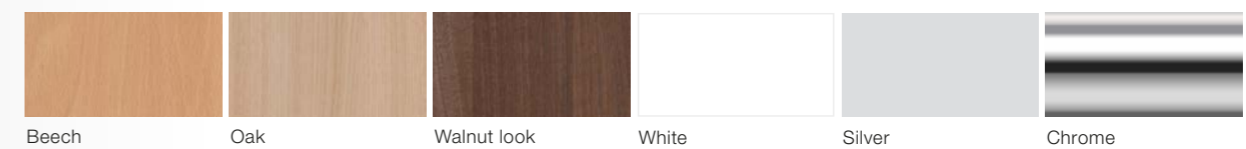

ROMA | RIVA | RAVENNA

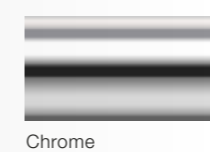

[A] PESARO | Side tables

Whether for waiting or lounge areas – the Pesaro side tables are the perfect and harmonious additions to the Consento seating line.



Learn more
ass.al/8aw9azj

Pesaro



TSH010100
Circular coffee table,
round plate base



TSH010500
Circular coffee table



TSH010800
Oval coffee table



TSH011100
Square coffee table



TSH011400
Circular coffee table I,
star base



TSH011600
Circular coffee table II,
star base



TSH011800
Square coffee table,
star base

With its combination of sleek design and metal leg frame, the Pesaro coffee table fits in perfectly with any room décor. This design classic can be used as both a coffee table and a side table.

Variants

Circular coffee table, round plate base
(The tabletop and table frame are always finished in a single colour in textured metal, deep black or traffic white.)

- Ø 450 mm, height: 420 mm
- Ø 450 mm, height: 490 mm
- Ø 450 mm, height: 560 mm

Circular coffee table

- Ø 750 mm, height: 420 mm
- Ø 750 mm, height: 495 mm
- Ø 750 mm, height: 570 mm

Oval coffee table

- Width: 950 mm, depth: 550 mm, height: 420 mm
- Width: 950 mm, depth: 550 mm, height: 495 mm
- Width: 950 mm, depth: 550 mm, height: 570 mm

Square coffee table

- Width: 700 mm, depth: 700 mm, height: 420 mm
- Width: 745 mm, depth: 745 mm, height: 495 mm
- Width: 790 mm, depth: 790 mm, height: 570 mm

Circular coffee table I, star base

- Ø 600 mm, height: 560 mm
- Ø 600 mm, height: 740 mm

Circular coffee table II, star base

- Ø 700 mm, height: 460 mm
- Ø 700 mm, height: 740 mm

Square coffee table, star base

- Width: 700 mm, depth: 700 mm, height: 460 mm
- Width: 700 mm, depth: 700 mm, height: 740 mm
-

Leg frame

- Matt black, metal
- Matt white, metal*
- Chrome**

Surfaces

Décors

BASIC UNI for round, oval and square coffee tables

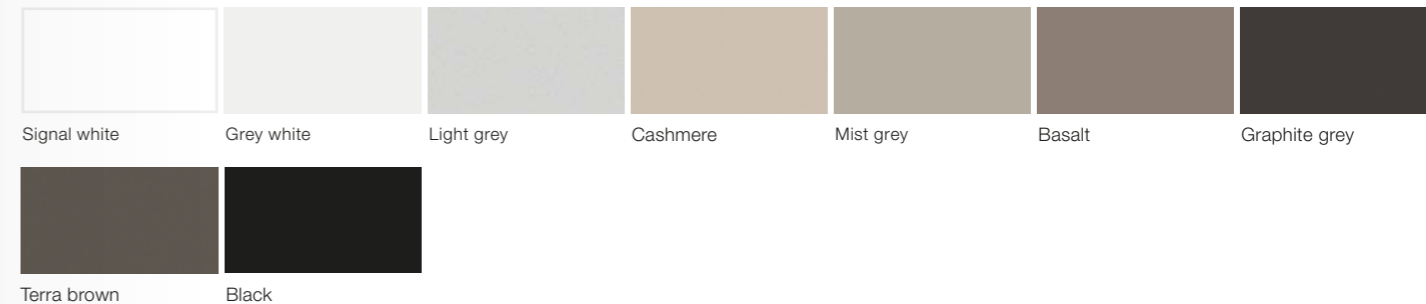

BASIC WOOD for round, oval and square coffee tables



TREND for round, oval and square coffee tables



PREMIUM for round, oval and square coffee tables

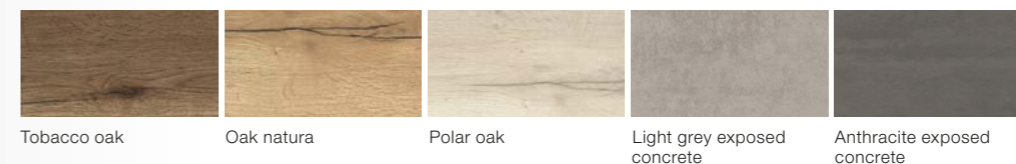

SOFT MATT for round, oval and square coffee tables

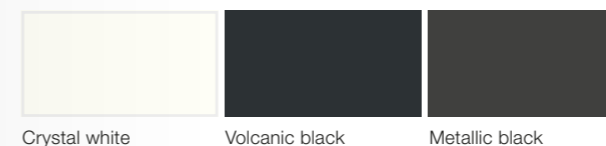

DÉCORS for coffee tables with round plate base

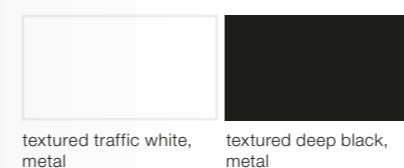

Frame colours



*Only for round disc base coffee table | **Frame colour in chrome is only available for round coffee tables, cross base I, cross base II, and square shape with cross base.

ALL YOUR WORKPLACE NEEDS

More information
[assmann.de/en/com-
 pany/awards/](https://assmann.de/en/company/awards/)



Whether flexible desk and storage systems or reception, seminar, and lounge furniture – we offer you not only a wide range of furnishing solutions, but also support you with holistic, all-in-one concepts: from space planning with **ASSMANN 4ROOMS**, through intelligent work solutions with **ASSMANN SMART**, to individual home office design with **ASSMANN HOME**.

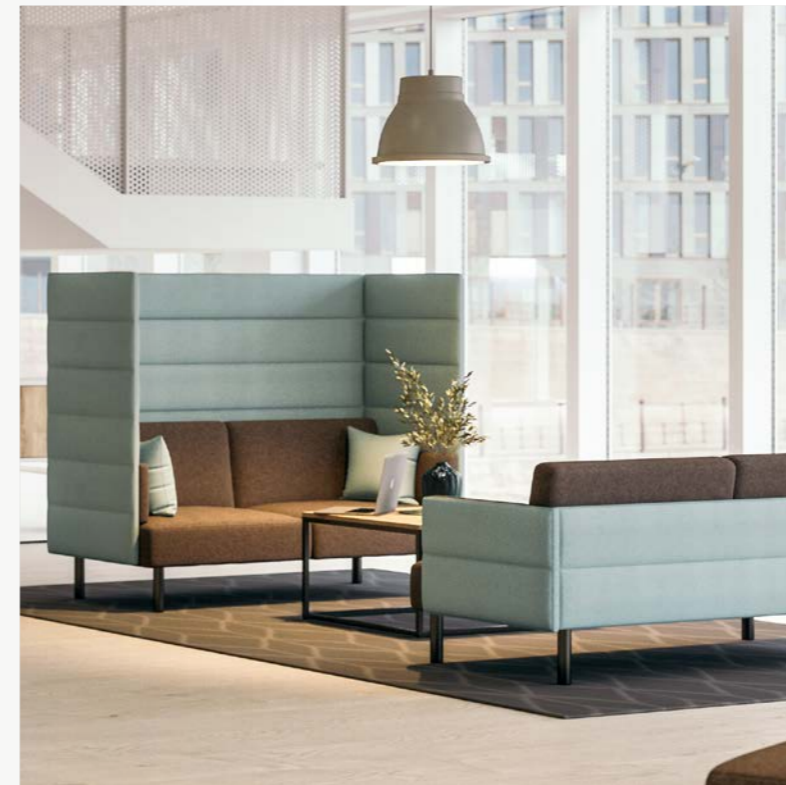

Awards for our products



Awards for our company





ASSMANN BÜROMÖBEL GMBH & CO. KG

Heinrich-Assmann-Straße 11
D-49324 Melle, Germany

Postfach 1222
D-49304 Melle, Germany

Phone +49 (0) 5422 706-0

info@assmann.de
www.assmann.de

