



Physical
Security
Systems

High Security

Physical Security Systems

On-ground (Temporary) &
In-ground (Permanent) use

Together,
We make safe

About Us

Time proven and trusted solutions from the pioneers of perimeter security solutions.

Established almost 50 years ago, CLD Physical Security Systems is the UK's largest manufacturer and supplier of rigid mesh fencing and security gates, shipping over 4km of fencing from its Cheshire locations every day. Its innovative systems have been specified on some of the most demanding environments around the world.

Working with CLD gives access to a flexible range of physical security solutions which include permanent, in-ground and temporary, on-ground options. The CLD high security range is tried, tested, and certified against the leading UK and EU standards: deterring, detecting and delaying intruders.

CLD continues to provide the very best in quality products, backed up with outstanding customer service. Its unique blend of UK ingenuity, engineering prowess and creativity has led to sustained growth. CLD now has offices in London, Sydney, Washington DC, Dubai and Buenos Aires, as well as distributors in more than 10 countries.

All CLD products are manufactured within ISO 9001:2015 as well as ISO 14001:2015 standards. Security rated products are externally tested by the Loss Prevention Certification Board (LPCB). We are members of the Perimeter Security Suppliers Association (PSSA), Secured by Design and the Temporary Works Forum (Twf). CLD products are approved for government use by the Centre for the Protection of National Infrastructure (CPNI). Please contact the CPNI for further information.



Contents

Introducing CLD Systems and our Approach			04-05
In Ground (Permanent) Security Rated Systems			06
Security Testing			07
Securus S1	08	Screenogril S1	14
Securus AC SR2	09	Screenogril S2	15
Securus S2	10	FibreSafe S1	16
Securus S3	11	FibreSafe S2	17
Securus S4	12	Rampart 30	18
Ultimate Extra S1	13	Rampart 50	19
Permanent Security Access Systems			20
LockMaster S1	21	LockMaster S4	27
LockMaster S2	22	SlideMaster SR1	28
LockMaster S2 Auto	23	SlideMaster SR2	29
LockMaster S3	24	SlideMaster SR3	30
LockMaster S3 Auto	25	SpeedMaster	31
LockMaster S3 Panic out	26		
On Ground (Temporary) Physical Security Systems			32-33
HoardSafe	34	Modsec Securus S2	39
HoardSafe S1	35	Modsec Securus S3	40
FenceSafe Eclipse	36	FenceSafe LockMaster	41
Fencesafe Securus SR1	37	Fencesafe SlideMaster	42
Modsec Securus S1	38	Fencesafe PedMaster	43
CLD Agile Guarding System			44
Securus Guard S1	45	LockMaster Guard	46
Sustainability			48-49
Installer Partners			50
Global Operations			51

Our Approach

About us

As the UK's largest manufacturer and supplier of rigid mesh fencing and security gates, CLD Systems operates in some of the most demanding environments around the world.

Our systems are widely regarded in the security community as the 'best in class', protecting environments including data centres, schools, transport, manufacturing, high security, sports grounds, protected open spaces and Critical National Infrastructure (CNI).

Our customers value our discreet, confidential and considered advice. As trusted advisors, they know we recognise a project has to be right first time and that our business has the scope and scale to meet their requirements.

Our Heritage

Established almost 50 years ago as CLD Fencing Systems, our values remain to provide the very best in quality products backed-up with outstanding customer service. The Wells family continues to run the business, with our headquarters in Cheshire in the north of England. We are proud of our British heritage and its world-renowned, globally recognised position in the world of security.

From our very first security project in Crewe, high levels of service delivery, knowledge on the ground and exceptional products remain at the heart of our business philosophy. From the start of the business to the present day, we have blended UK ingenuity, engineering prowess and a creative approach to deliver exactly the type of solutions our customers want.

It's an approach that has led to sustained growth across our business. Over the years, CLD has expanded to include offices in London, Sydney, Washington DC, Dubai and Buenos Aires, as well as distributors in more than 10 countries.

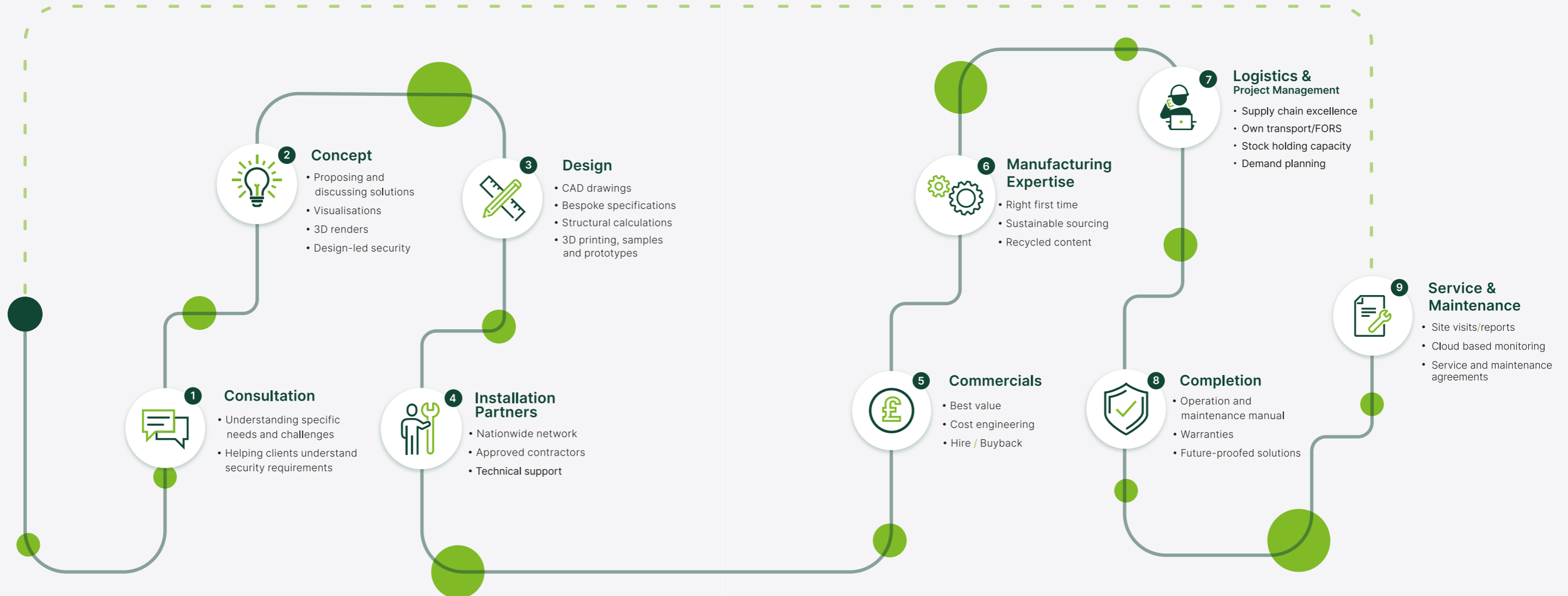

Our Systems



Permanent Security Rated Systems

Highly sensitive sites are subject to some of the most extreme levels of threat. CLD Systems will work with you to create a specification tailored to the individual site, ensuring the appropriate level of security is installed in each situation.

The security rated fencing range from CLD Systems has been tested and is certified by the Loss Prevention Certification Board. The LPCB is a globally recognised independent body which sets the standards that ensure that security products perform effectively. With increased durability and protection, our range includes fencing that is anti-climb and hard to cut.

Matching security rated access control options are also available to create a seamless fence line. See page 18 for more information.

Many sites are also vulnerable during construction. Please see pages 32 to 43 for our on ground (temporary) perimeter security options.

All of CLD's range is available in a wide range of RAL colours, making it easy to match to corporate colours or suit the local environment. We can also provide marine grade coatings for particularly harsh environments. All our steel mesh panel fences are manufactured in the UK using 90% recycled British and European steel.

CLD also offers products which are approved for Government use by the Centre for Protection of National Infrastructure (CPNI). Please contact CPNI for further information.

Scan to find out more and to download:
Technical Data Sheets
NBS Specifications
BIM Objects



Our Systems

Testing & Certification

Physical security concern four main areas: Deterring intruders, detecting and delaying attackers and responding to an attack.

LPS 1175 is the Loss Prevention Certification Board standard for physical security, including intruder resistant building components, strongpoints, security enclosures and free-standing barriers.

Issue 8 of the LPS 1175 standard was issued in November 2020. The new classifications are shown in the table below.



Understanding the Classifications

The standard uses different tool kits and durations to categorise security ratings. Tools in category A include pliers, screwdrivers and spanners, adds bolt cutters and drills, C includes crowbars, hacksaws and torches, and D introduces sledgehammers, grinders and jigsaws.

The delay, indicated by the number, corresponds with the minimum delay in minutes provided by the product.



		Security Ratings (Tool set + delay)						
Threat ↑	Extreme methods of access to very high value assets using portable tools	H	H1	H3	H5	H10	H15	H20 SR8
	Enhanced professional attempts of access to high value assets	G	G1	G3	G10	G10 SR7	G15	G20
	Professional attempts at forced entry into higher value storage areas	F	F1	F3	F5	F10 SR6	F15	F20
	Experienced attempts at forced entry using tools of a greater battery power	E	E1	E3	E5	E10 SR5	E15	E20
	Experienced attempts at forced entry	D	D1	D3	D5	D10 SR4	D15	D20
	Deliberate forced entry using a wide selection of commonly available, relatively easily concealed tools	C	C1	C3	C5 SR3	H10	C15	C20
	More determined attack using easily concealed tools of a greater mechanical advantage	B	B1	B3 SR2	B5	B10	B15	B20
Low technology level of attack using small, very easily concealed tools	A	A1 SR1	A3	A5	A10	A15	A20	
		1	3	5	10	15	20	
		Delay (mins) →						

CLD Securus S1

358 rigid mesh fencing system to LPS 1175 A1 (SR1) Issue 8

Approved for Government Use – contact CPNI for more information



Minimum of 60 seconds delay against attack



Find out more
Scan for more information

Description

Securus is CLD's range of specialist security fencing. Traditionally referred to as prison mesh or 358 mesh, the Securus range has been updated complete flexibility – the panels can be swapped out to change the security rating as the needs of the site change. Securus S1 has been certified by the Loss Prevention Certification Board to provide a minimum of 60 seconds delay against attack.

CLD Securus AC SR2

358 rigid mesh fencing system to LPS SR2 Issue 7

Approved for Government Use – contact CPNI for more information



Minimum of 3 Minutes delay against attack



Find out more
Scan for more information

Description

Securus is CLD's range of specialist security fencing. Traditionally referred to as prison mesh or 358 mesh, the Securus range has been updated complete flexibility – the panels can be swapped out to change the security rating as the needs of the site change. Securus AC SR2 has been certified by the Loss Prevention Certification Board to provide a minimum of 3 Minutes delay against attack.

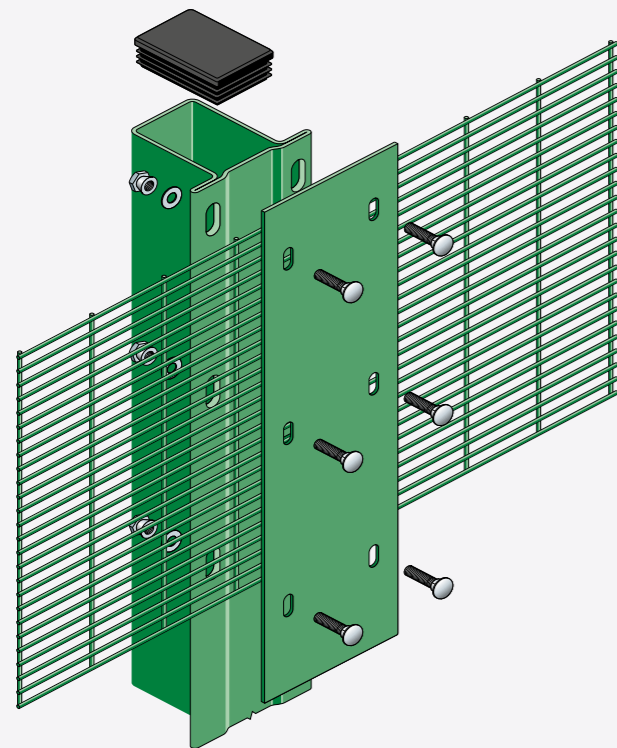

Features

Solid clamp bar for extra full-length security

Continuous flanged post made from high strength steel for added durability

Optional active anti-intruder toppings

Anti-climb mesh

Exploded view of post and fixing details for the CLD Securus S1
This product has additional features not demonstrated for security reasons

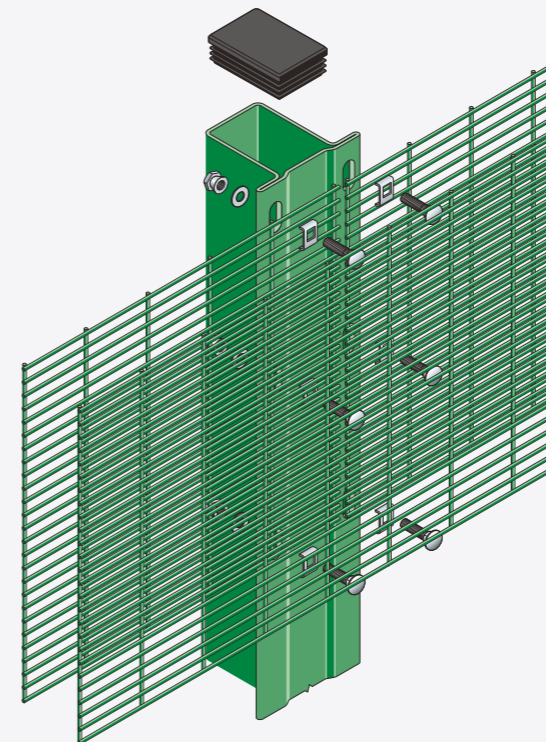

Features

Continuous flanged post made from high strength steel for added durability

Double layer Anti-Climb 358 mesh panels

Exploded view of post and fixing details for the CLD Securus AC SR2
This product has additional features not demonstrated for security reasons



CLD Securus S2

358 rigid mesh fencing system to LPS 1175 B3 (SR2) Issue 8



Minimum of 3 Minutes delay against attack

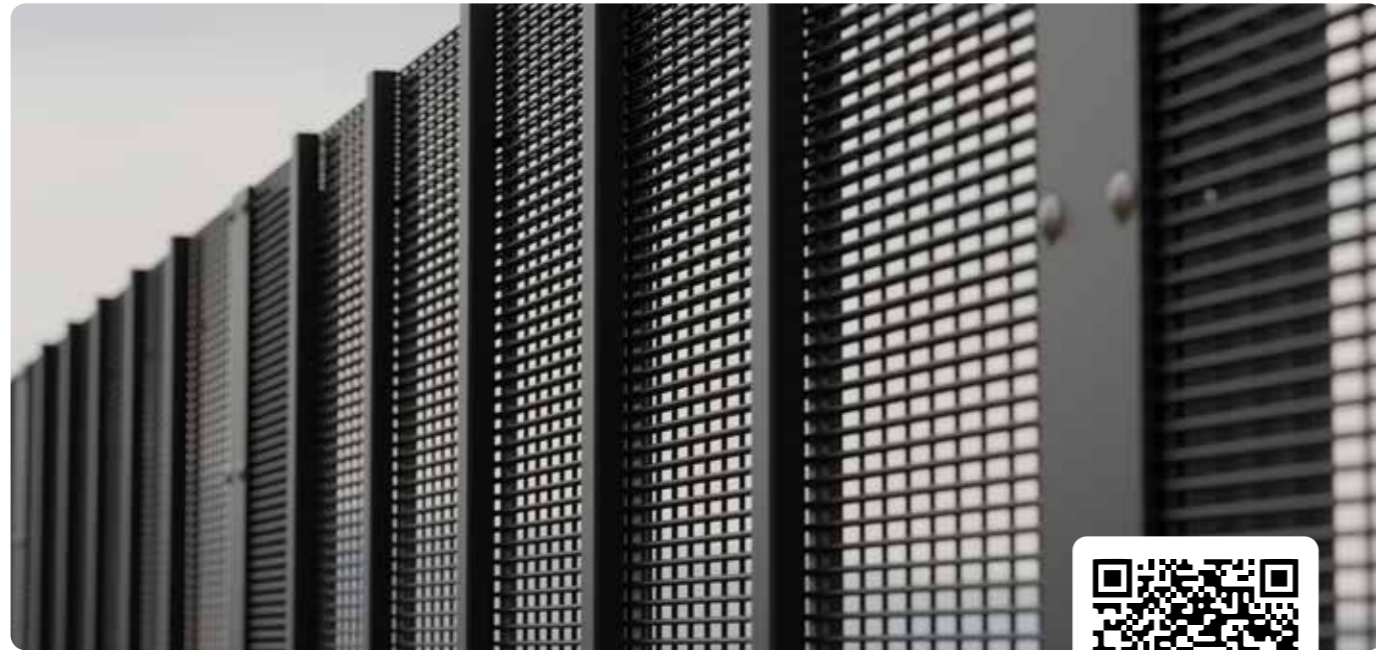

Find out more
Scan for more information

Description

Securus is CLD's range of specialist security fencing. Traditionally referred to as prison mesh or 358 mesh, the Securus range has been updated complete flexibility – the panels can be swapped out to change the security rating as the needs of the site change. Securus S2 has been certified by the Loss Prevention Certification Board to provide a minimum of 3 Minutes delay against attack.

CLD Securus S3

358 rigid mesh fencing system to LPS 1175 B3 (SR3) Issue 8



Minimum of 5 Minutes delay against attack



Find out more
Scan for more information

Description

Securus is CLD's range of specialist security fencing. Traditionally referred to as prison mesh or 358 mesh, the Securus range has been updated complete flexibility – the panels can be swapped out to change the security rating as the needs of the site change. Securus S3 has been certified by the Loss Prevention Certification Board to provide a minimum of 5 Minutes delay against attack.

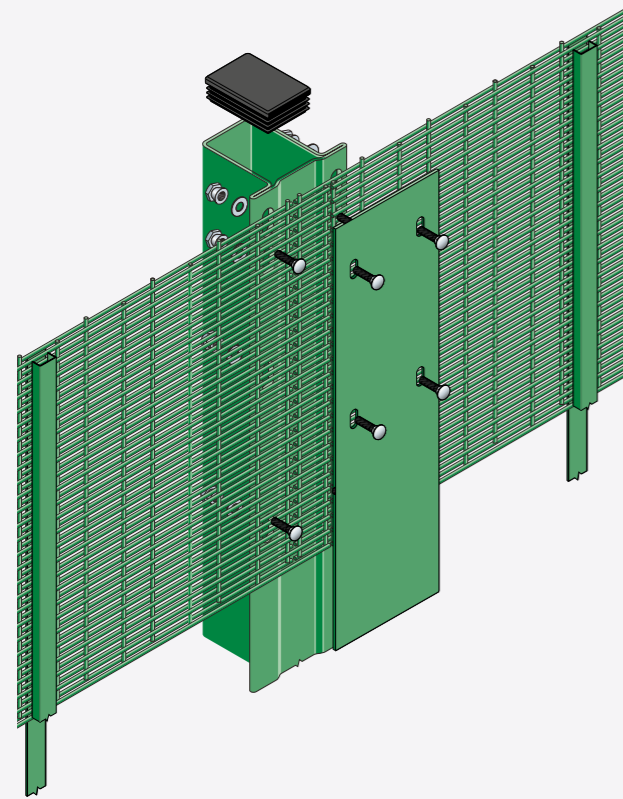

Exploded view of post and fixing details for the CLD Securus S2
This product has additional features not demonstrated for security reasons

Features

Solid clamp bar for extra full-length security

Continuous flanged post made from high strength steel for added durability

Offsite assembled fence panel cassettes

Double layer Anti-Climb 358 mesh panels

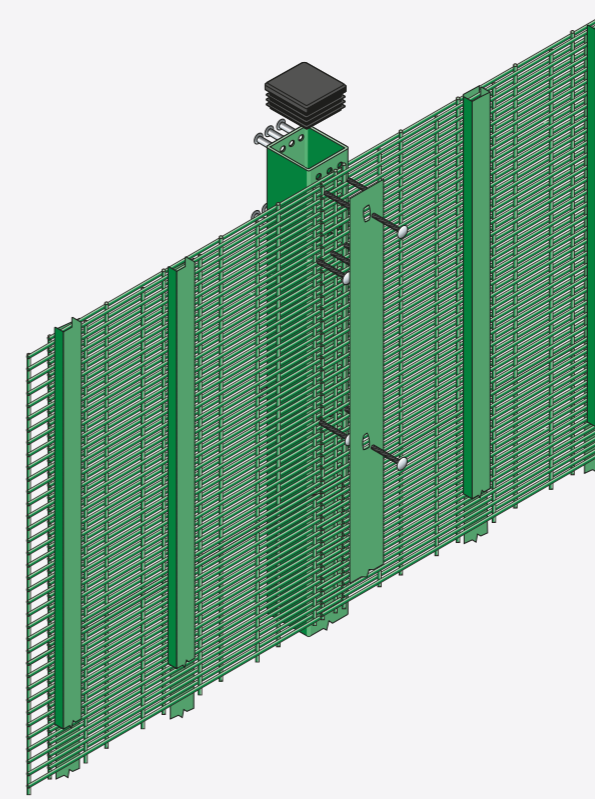

Exploded view of post and fixing details for the CLD Securus S3
This product has additional features not demonstrated for security reasons

Features

Solid clamp bar for extra security

Can be Adapted for Use with Third-Party PID Systems Allowing Connection to Command Centre

Double layer Anti-Climb 358 mesh panels

Off-site assembled fence panel cassettes for speed of installation



CLD Securus S4

358 rigid mesh fencing system to LPS 1175 D10 / E3 / G1 (SR4) Issue 8



Minimum of 10 Minutes delay against attack



Find out more
Scan for more information

Description

Securus is CLD's range of specialist security fencing. Traditionally referred to as prison mesh or 358 mesh, the Securus range has been updated complete flexibility – the panels can be swapped out to change the security rating as the needs of the site change. Securus S4 has been certified by the Loss Prevention Certification Board to provide a minimum of 10 minutes delay against attack.

CLD Ultimate Extra S1

Profiled panel mesh fencing system to LPS 1175 A1 (SR1) Issue 8



Minimum of 60 Seconds delay against attack



Find out more
Scan for more information

Description

Ultimate Extra S1 is CLD's profiled mesh panel system which has been certified by the Loss Prevention Certification Board to provide a minimum of 60 seconds delay against attack. It also has SecuredBy Design police preferred specification status confirming its effectiveness in crime prevention.

Features

Double cassette (front and rear)

Can be Adapted for Use with Third-Party PID Systems Allowing Connection to Command Centre

Double layer Anti-Climb 358 mesh panels

Off-site assembled fence panel cassettes for speed of installation

Exploded view of post and fixing details for the CLD Securus S4
This product has additional features not demonstrated for security reasons

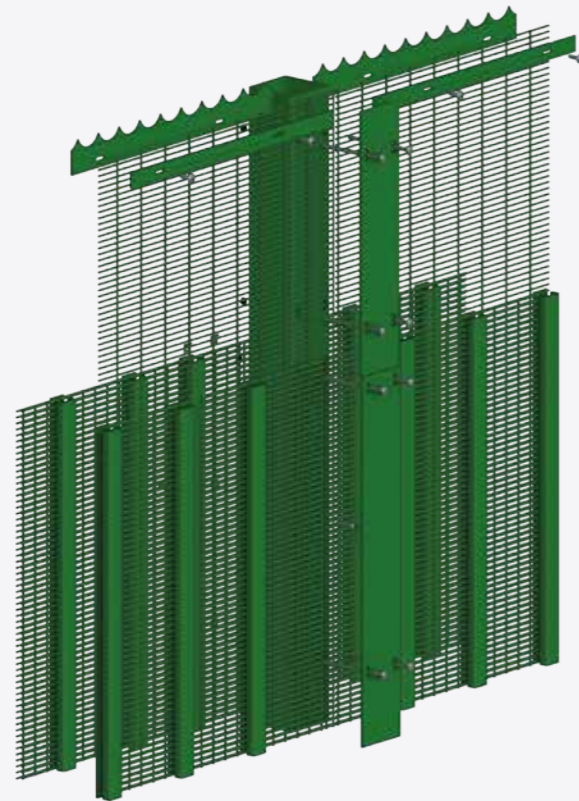

Features

Difficult to climb and cut

Secured by Design accredited system

Approved by planning authorities

Full range of RAL colours available

Exploded view of post and fixing details for the CLD Ultimate Extra S1
This product has additional features not demonstrated for security reasons

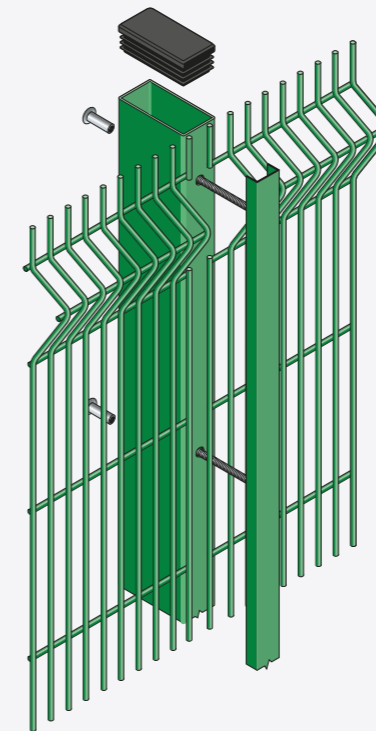

CLD Screenogril S1

Louvred Fence Panel system to LPS 1175 A1 (SR1) Issue 8



Minimum of 60 Seconds delay against attack



Find out more
Scan for more information

Description

CLD Screenogril is specially designed to limit the visibility of premises whilst preventing intrusion. Choose between 80% and 100% screening.

This high security version has been tested by the Loss Prevention Certification Board (LPCB), Screenogril S1 offers a minimum delay against attack of 60 seconds.

CLD Screenogril S2

Louvred Fence Panel system to LPS 1175 B3 (SR2) Issue 8



Minimum of 3 Minutes delay against attack



Find out more
Scan for more information

Description

CLD Screenogril S2 is specially designed to block straight-on visibility of premises whilst preventing intrusion. 69mm wide fin louvres blocks straight on visibility completely.

This high security version has been tested by the Loss Prevention Certification Board (LPCB), Securus S2 offers a minimum delay against attack of 3 minutes.

Features

2 screening level options

Contemporary louvred effect

Modular system

Restricts climbing

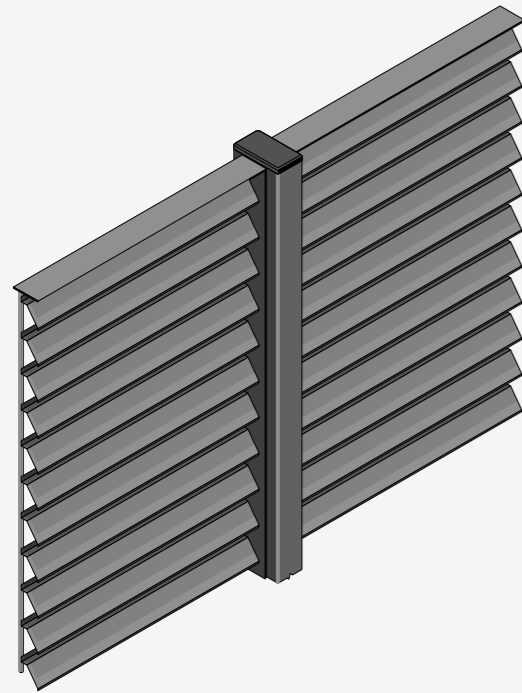

Exploded view of post and fixing details for the CLD Screenogril S1
This product has additional features not demonstrated for security reasons

Features

Contemporary louvred effect

Modular system

Restricts climbing

100/0 screening

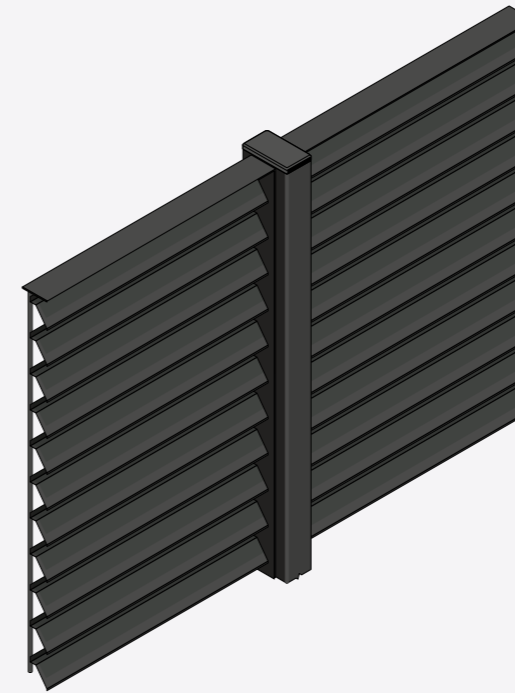

Exploded view of post and fixing details for the CLD Screenogril S2
This product has additional features not demonstrated for security reasons



CLD Fibresafe S1

GRP high security fencing system to LPS 1175 A1 (SR1) Issue 8



Minimum of 60 Seconds delay against attack

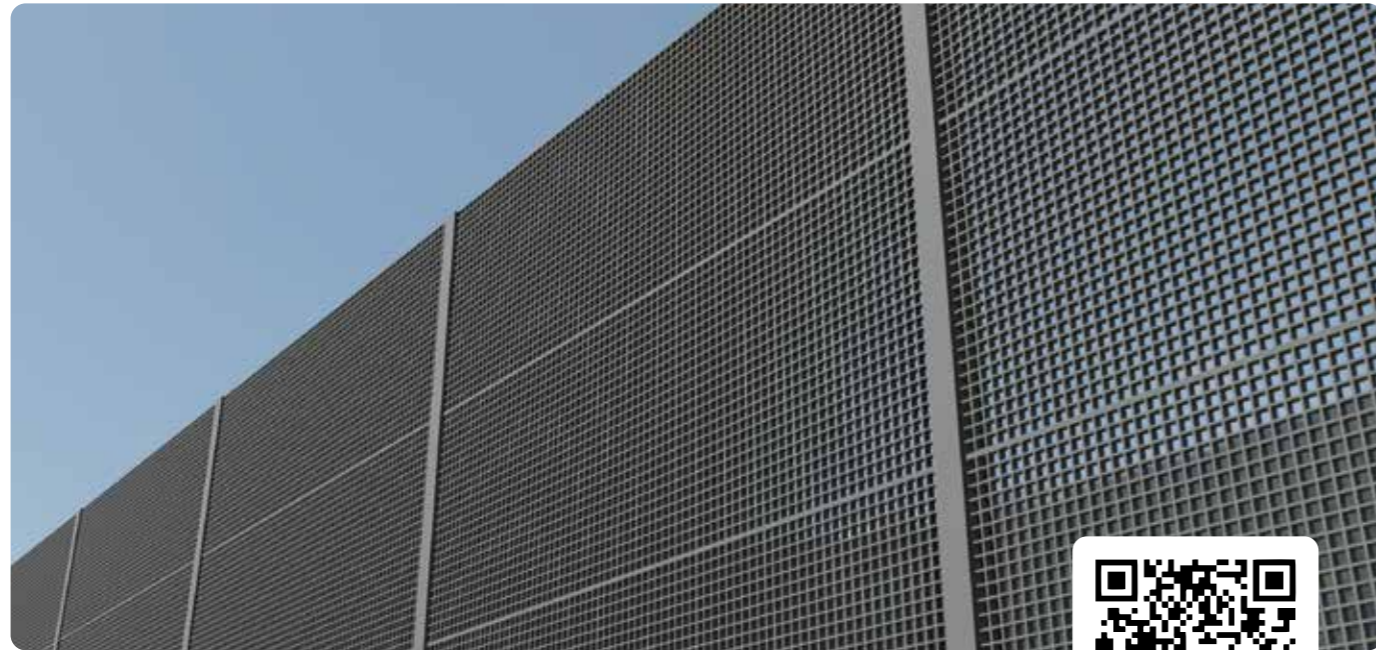

Find out more
Scan for more information

Description

FibreSafe is CLD's range of GRP (fibre glass) security rated grating fencing. FibreSafe S1 is certified by the Loss Prevention Certification Board to provide a minimum of 60 seconds against attack. The latest in GRP technology, FibreSafe offers a non-conductive, non-magnetic, non-corrosive, radio transparent fencing system, which is easy to handle during transportation and installation.

CLD Fibresafe S2

GRP high security fencing system to LPS 1175 B3 (SR2) Issue 8



Minimum of 3 Minutes delay against attack

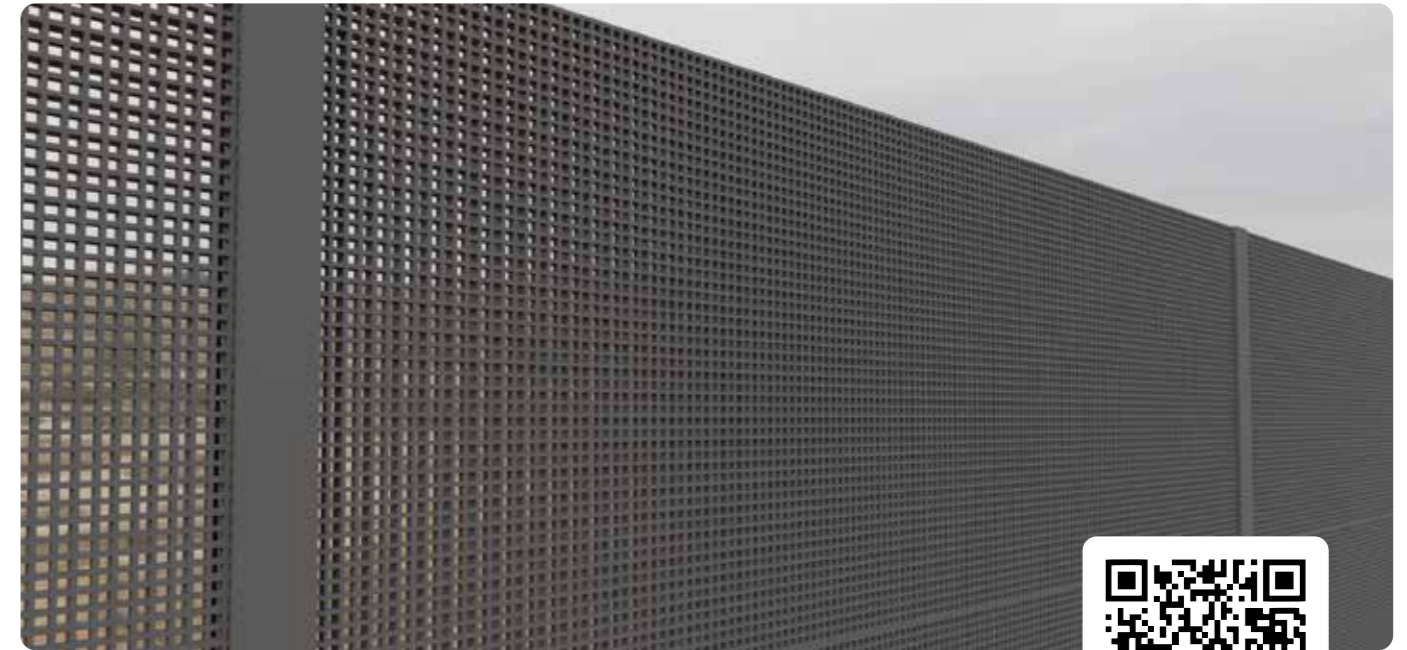

Find out more
Scan for more information

Description

FibreSafe is CLD's range of GRP (fibre glass) security rated grating fencing. FibreSafe S2 is certified by the Loss Prevention Certification Board to provide a minimum of 3 Minutes against attack. The latest in GRP technology, FibreSafe offers a non-conductive, non-magnetic, non-corrosive, radio transparent fencing system, which is easy to handle during transportation and installation.



Features

- Resistant to damage from corrosion and UV
- Lightweight and easy to handle
- Non-conductive
- Radio transparent

Exploded view of post and fixing details for the CLD Fibresafe S1
This product has additional features not demonstrated for security reasons



Features

- Resistant to damage from corrosion and UV
- Lightweight and easy to handle
- Non-conductive
- Radio transparent

Exploded view of post and fixing details for the CLD Fibresafe S2
This product has additional features not demonstrated for security reasons



CLD Rampart 30

Multi-threat Security Fence to LPS 1175 A1, B3, C5 or D10 (SR1, SR2, SR3 or SR4) and HVM to PAS 68:2010



Minimum of 1, 3, 5 or 10 minute delay against attack

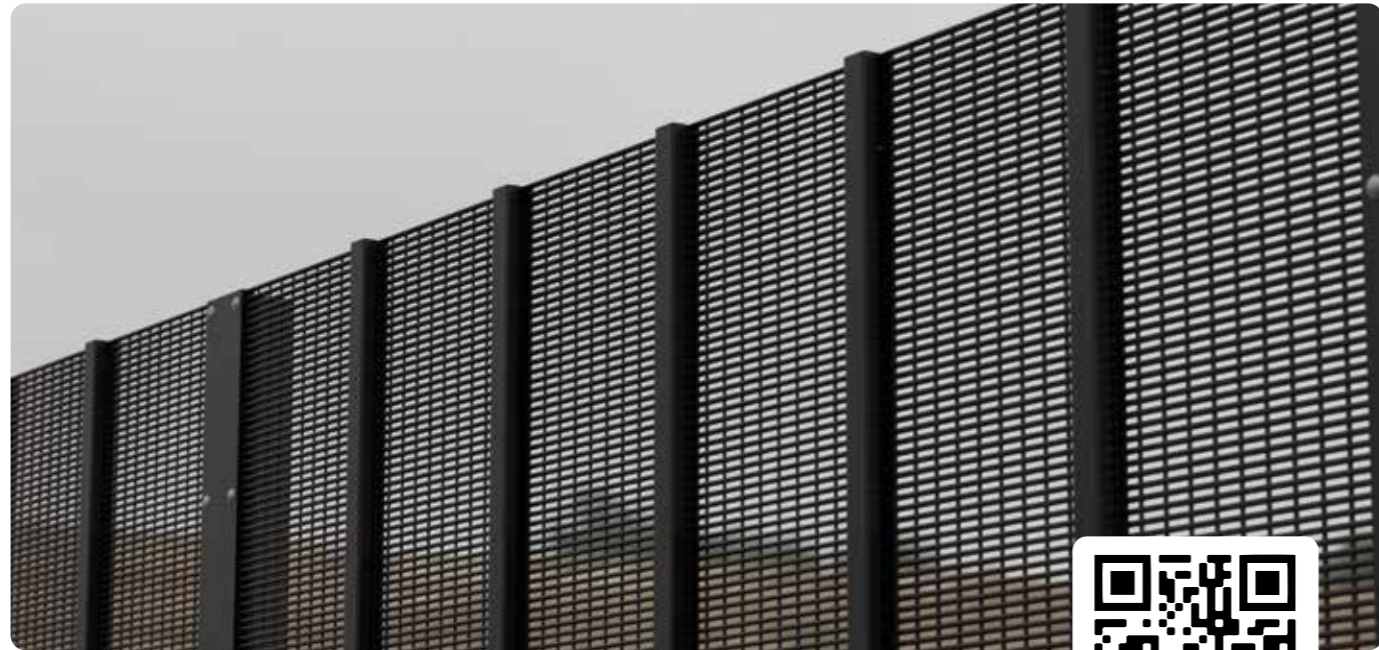

Find out more
Scan for more information

Description

Securus Rampart takes multi-threat protection to a new level for data centres and high risk sites, offering a high security fence system combined with a shallow foundation hostile vehicle mitigation. Securus Rampart 30 is tested to PAS 68:2010 – can stop a 7.5 tonne vehicle moving at 30 miles per hour (48 kilometres per hour) Can be used with any of CLD's LPS 1175 security rated Securus S1, S2, S3 or S4 fence panels.

CLD Rampart 50

Multi-threat Security Fence to LPS 1175 A1, B3, C5 or D10 (SR1, SR2, SR3 or SR4) and HVM to IWA 14-1:2013



Minimum of 1, 3, 5 or 10 minute delay against attack



Find out more
Scan for more information

Description

Securus Rampart 50 takes multi-threat protection to a new level for data centres and high risk sites, offering a high security fence system combined with a shallow foundation hostile vehicle mitigation. Securus Rampart 50 has been tested to IWA 14-1:2013 – can stop a 7.5 tonne vehicle moving at 50 miles per hour (80 kilometres per hour). Can be used with any of CLD's LPS 1175 security rated Securus S1, S2, S3 or S4 fence panels.



Features

- Full multi-threat fencing and integrated HVM system
- Ideal for data centres and high risk sites anywhere in the world
- Shallow single location foundation design. Smaller footprint.
- Only 400mm Foundation

PAS68 Securus Rampart 30 (BSI PAS68:2010) V/7500(N2)/48/90:3.4/6.4/400

Vehicle Test Weight	Vehicle Class	Vehicle Speed kph	Vehicle Angle	Vehicle Penetration	Footing Depth mm
V/7500KG	N2	48kph	90	3.4m	400mm

Exploded view of post and fixing details for the CLD Rampart 30
This product has additional features not demonstrated for security reasons



Features

- Full multi-threat fencing and integrated HVM system
- Ideal for data centres and high risk sites anywhere in the world
- Shallow single location foundation design. Smaller footprint.
- Equivalent to ASTM M50 (Former Department of State K12)

IWA 14 Securus Rampart 50 (IWA 14-1:2013) V/7200(N3C)/80/90:8.5

Vehicle Test Weight	Vehicle Class	Vehicle Speed kph	Vehicle Angle	Vehicle Penetration	Footing Depth mm
V/7200KG	N3C	80kph	90	8.5m	400mm

Exploded view of post and fixing details for the CLD Rampart 50
This product has additional features not demonstrated for security reasons



Our Systems

Permanent Security Access Systems

Our access control systems are designed to complement our security fencing solutions, offering the same level of protection for access control areas. Available for both temporary or on ground, and permanent fencing, and suitable for a wide range of sectors and settings, our solutions play a critical role in security at access points.



LockMaster Swing Gates

CLD's single or double leaf LockMaster swing gates fit seamlessly with our Securus security rated fence line. The Securus rigid welded steel mesh panels are fixed to a steel square hollow section using a solid clamp bar and secure fixings. They are supplied with steel drop bolt sockets to be set in concrete, and every gate features adjustable anti lift off hinges for protection against vandalism. Other enhanced security options depend on security ratings and individual site needs. Automatic and emergency exit versions of LockMaster are also available.

See pages 19 - 25



SlideMaster Cantilever Sliding Gate

Offering a unique blend of practicality and protection, CLD SlideMaster gates can be either manual or automated. Ideal for busy areas, SlideMaster's track system is fully enclosed ensuring protection from vandalism. Conforms to British Safety Standard (BS EN 12453) for power-operated industrial gates.

See pages 26 - 28



SpeedMaster Bi-Folding Trackless Gate

The fastest opening and closing gate in our range of physical access control, Speedmaster helps to prevent against tailgating making it the idea solution for a host of projects. With a choice of mesh infills for a flawless fenceline.

See page 29

CLD LockMaster S1

Swing Gate System to LPS 1175 A1 (SR1) Issue 8



Minimum of 60 Seconds delay against attack



Find out more
Scan for more information

Description

CLD's LockMaster swing gates have been specially developed to blend in seamlessly with a CLD fence line. Available in different mesh options Dulok and Dulok 25, Securus and Ultimate Extra, they offer security rated access control, whilst maintaining aesthetics. Rigorously tested by the Loss Prevention Certification Board (LPCB) to guarantee a minimum delay of 60 seconds against attack, LockMaster S1 is also Secured by Design accredited, making it a police preferred specification for security.

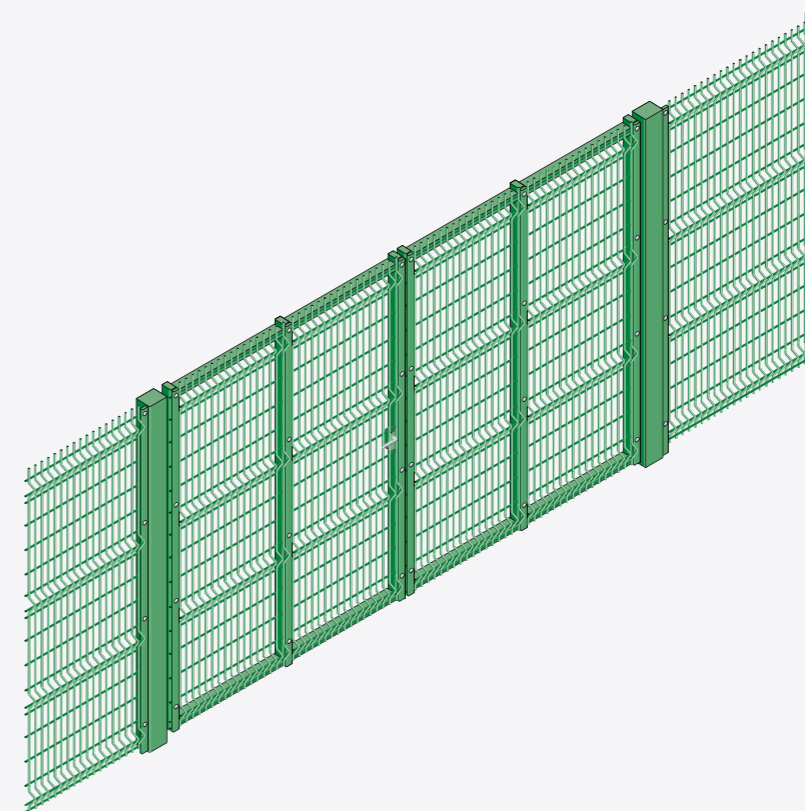

Exploded view of post and fixing details for the CLD Lockmaster S1
This product has additional features not demonstrated for security reasons

Features

Available in different mesh options to match fence line

Security rated gates

Double or single leaf opening

Rear or centre hung



CLD LockMaster S2

Swing Gate System to LPS 1175 B3 (SR2) Issue 8



Minimum of 3 Minutes delay against attack



Find out more
Scan for more information

Description

CLD's LockMaster S2 swing gates have been specially developed to blend in seamlessly with a CLD Securus fence line. Available using a Securus S2 infill panel, LockMaster S2 offers security rated access control, whilst maintaining aesthetics. Rigorously tested by the Loss Prevention Certification Board (LPCB) to guarantee a minimum delay of 3 minutes against attack, LockMaster S2 is also Secured by Design accredited, making it a police preferred specification for security.

CLD LockMaster S2 Auto

Swing Gate System to LPS 1175 B3 (SR2) Issue 8



Minimum of 3 Minutes delay against attack



Find out more
Scan for more information

Description

CLD's LockMaster S2 Auto swing gates have been specially developed to blend in seamlessly with a CLD Securus fence line. Available using a Securus S2 infill panel, LockMaster S2 offers security rated access control, whilst maintaining aesthetics. Rigorously tested by the Loss Prevention Certification Board (LPCB) to guarantee a minimum delay of 3 minutes against attack, LockMaster S2 is also Secured by Design accredited, making it a police preferred specification for security.



Features

Matches CLD Securus Fenceline

Security rated gates

Double or single leaf opening

Opening in or out

Exploded view of post and fixing details for the CLD Lockmaster S2
This product has additional features not demonstrated for security reasons



Features

Matches CLD Securus Fenceline

Security rated gates

Double or single leaf opening

Exploded view of post and fixing details for the CLD Lockmaster S2
This product has additional features not demonstrated for security reasons



CLD LockMaster S3

High Security Swing Gate System to LPS 1175 C5 (SR3) Issue 8



Minimum of 5 Minutes delay against attack



Find out more
Scan for more information

Description

CLD's LockMaster S3 swing gates have been specially developed to blend in seamlessly with a CLD Securus fence line. Available using a Securus S3 infill panel, LockMaster S3 offers security rated access control, whilst maintaining aesthetics. Rigorously tested by the Loss Prevention Certification Board (LPCB) to guarantee a minimum delay of 5 minutes against attack, LockMaster S3 is also Secured by Design accredited, making it a police preferred specification for security.

CLD LockMaster S3 Auto

High Security Swing Gate System to LPS 1175 C5 (SR3) Issue 8



Minimum of 5 Minutes delay against attack



Find out more
Scan for more information

Description

CLD's LockMaster S3 Auto swing gates have been specially developed to blend in seamlessly with a CLD Securus fence line. Available using a Securus S3 infill panel, LockMaster S3 Auto offers security rated access control, whilst maintaining aesthetics. Rigorously tested by the Loss Prevention Certification Board (LPCB) to guarantee a minimum delay of 5 minutes against attack, LockMaster S3 Auto is also Secured by Design accredited, making it a police preferred specification for security.

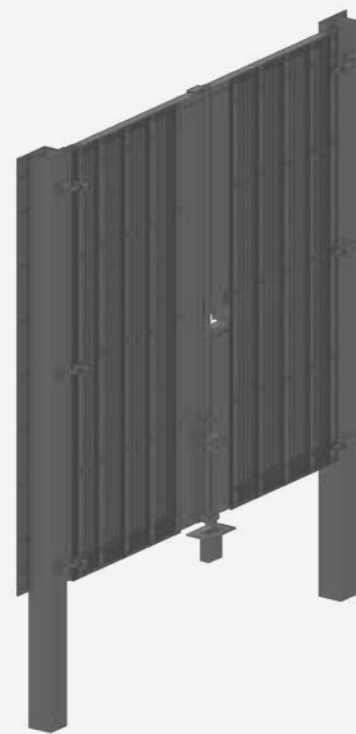

Features

Matches CLD Securus Fenceline

Security rated gates

Double or single leaf opening

Opening in or out

Exploded view of post and fixing details for the CLD Lockmaster S3
This product has additional features not demonstrated for security reasons

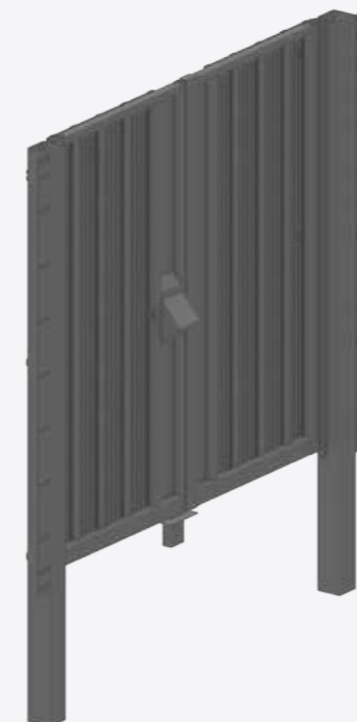

Features

Matches CLD Securus Fenceline

Security rated gates

Double or single leaf opening

Exploded view of post and fixing details for the CLD Lockmaster S3 Auto
This product has additional features not demonstrated for security reasons



CLD LockMaster SR3 Panic Out

Emergency exit gate to LPS 1175 SR3 Issue 7



Minimum of 5 Minutes delay against attack



Find out more
Scan for more information

Description

CLD LockMaster SR3 Panic out emergency exit gate has been specifically developed to blend in seamlessly with a CLD Securus fence line. Available using a Securus S3 infill panel, LockMaster SR3 Panic Out offers security rated access control, whilst maintaining aesthetics. Rigorously tested by the Loss Prevention Certification Board (LPCB) to guarantee a minimum delay of 5 minutes against attack, LockMaster SR3 Panic Out is also Secured by Design accredited, making it a police preferred specification for security.

CLD LockMaster S4

High Security Fencing to LPS 1175 D10 (SR4) / E3 / G1



Minimum of 10 Minutes delay against attack



Find out more
Scan for more information

Description

CLD's LockMaster S4 swing gates have been specially developed to blend in seamlessly with a CLD Securus fence line. Available using a Securus S4 infill panel, LockMaster S4 offers security rated access control, whilst maintaining aesthetics. Rigorously tested by the Loss Prevention Certification Board (LPCB) to guarantee a minimum delay of 10 minutes against attack, LockMaster S4 is also Secured by Design accredited, making it a police preferred specification for security.

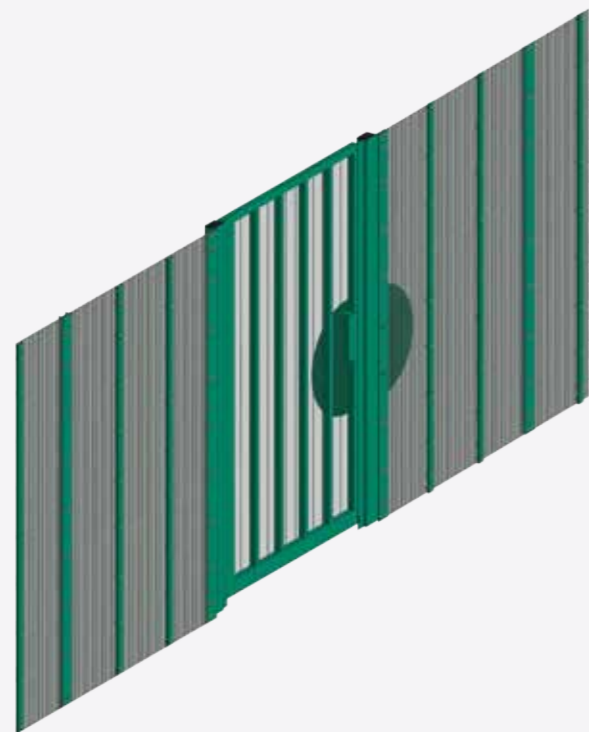

Exploded view of post and fixing details for the CLD Lockmaster SR3 Panic Out
This product has additional features not demonstrated for security reasons

Features

Compatible with access control on request

Security rated emergency exit gate

Single leaf opening

Outwards opening

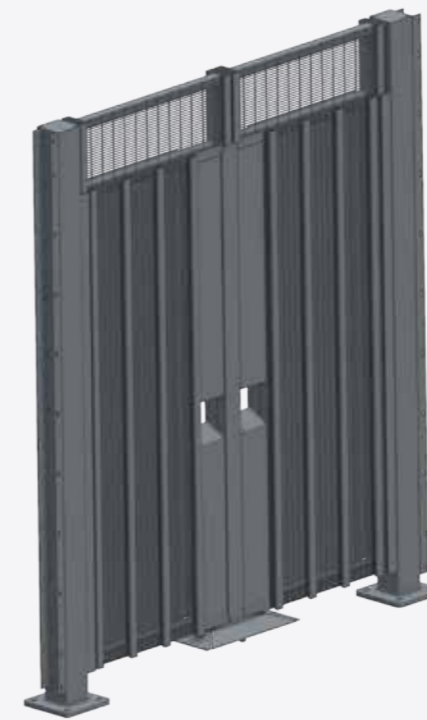

Exploded view of post and fixing details for the CLD Lockmaster S4
This product has additional features not demonstrated for security reasons

Features

Matches CLD Securus Fenceline

Security rated gates

Double or single leaf opening

Opening in or out



CLD SlideMaster SR1

Cantilever Auto Sliding Gate to LPS 1175 SR1 Issue 7



Minimum of 60 Seconds delay against attack



Find out more
Scan for more information

Description

CLD SlideMaster SR1 gates have been specially developed to blend in seamlessly with a CLD Securus fenceline. Offering excellent visibility, they are difficult to cut through and scale. Rigorously tested by the Loss Prevention Certification Board (LPCB) to guarantee a minimum delay of 60 seconds against attack, LockMaster S1 is also Secured by Design accredited, making it a police preferred specification for security.

CLD SlideMaster SR2

Cantilever Auto Sliding Gate to LPS 1175 SR2 Issue 7



Minimum of 3 Minutes delay against attack



Find out more
Scan for more information

Description

CLD SlideMaster SR2 gates have been specially developed to blend in seamlessly with a CLD Securus fenceline. Offering excellent visibility, they are difficult to cut through and scale. Rigorously tested by the Loss Prevention Certification Board (LPCB) to guarantee a minimum delay of 3 Minutes against attack, CLD SlideMaster SR2 is also Secured by Design accredited, making it a police preferred specification for security.

Features

- Clear drive through widths up to 8m
- Security rated gates
- Automatic operation

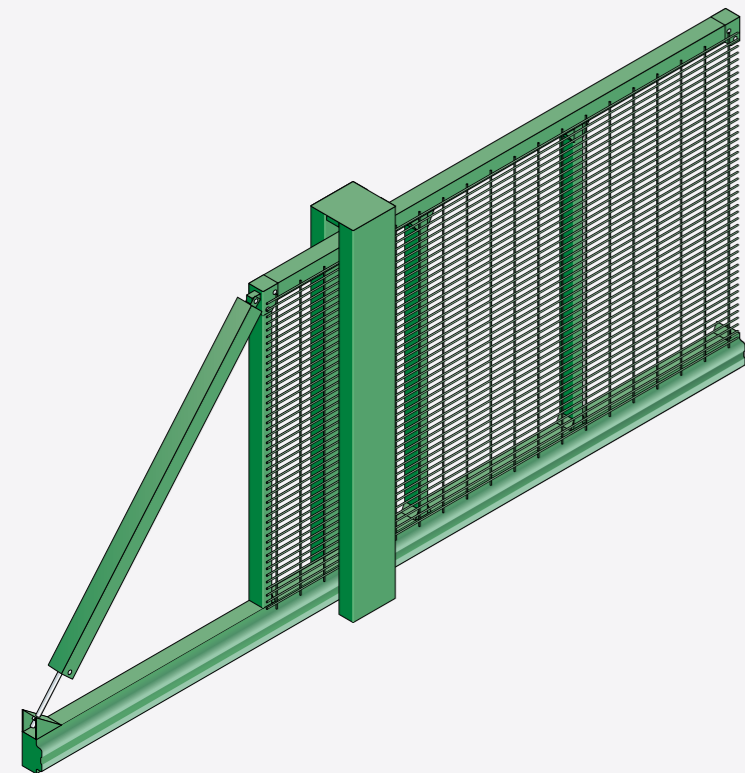

Exploded view of post and fixing details for the CLD SlideMaster SR1
This product has additional features not demonstrated for security reasons

Features

- Clear drive through widths up to 8m
- Security rated gates
- Automatic operation

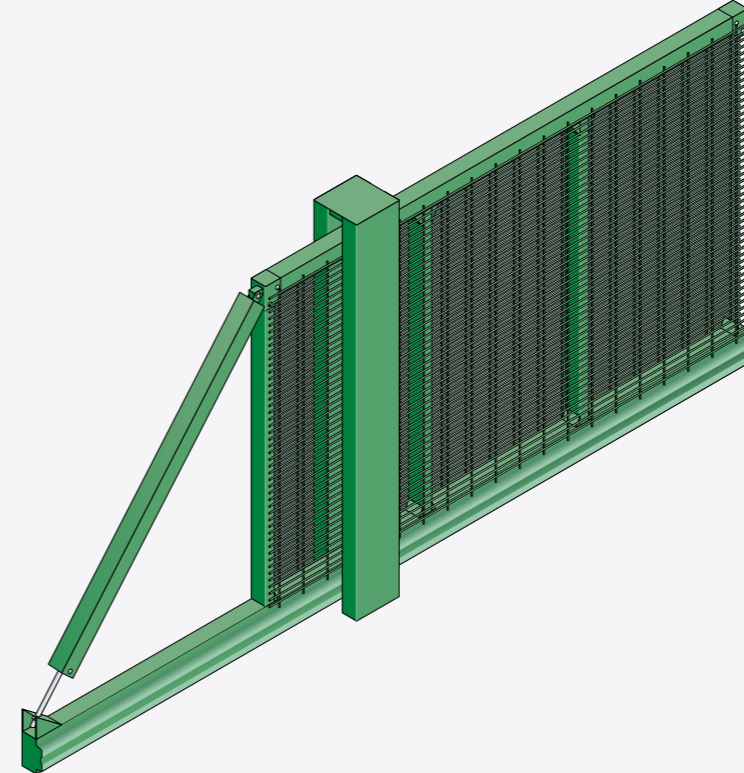

Exploded view of post and fixing details for the CLD SlideMaster SR2
This product has additional features not demonstrated for security reasons



CLD SlideMaster SR3

Cantilever Auto Sliding Gate to LPS 1175 SR3 Issue 7



Minimum of 5 Minutes
delay against attack

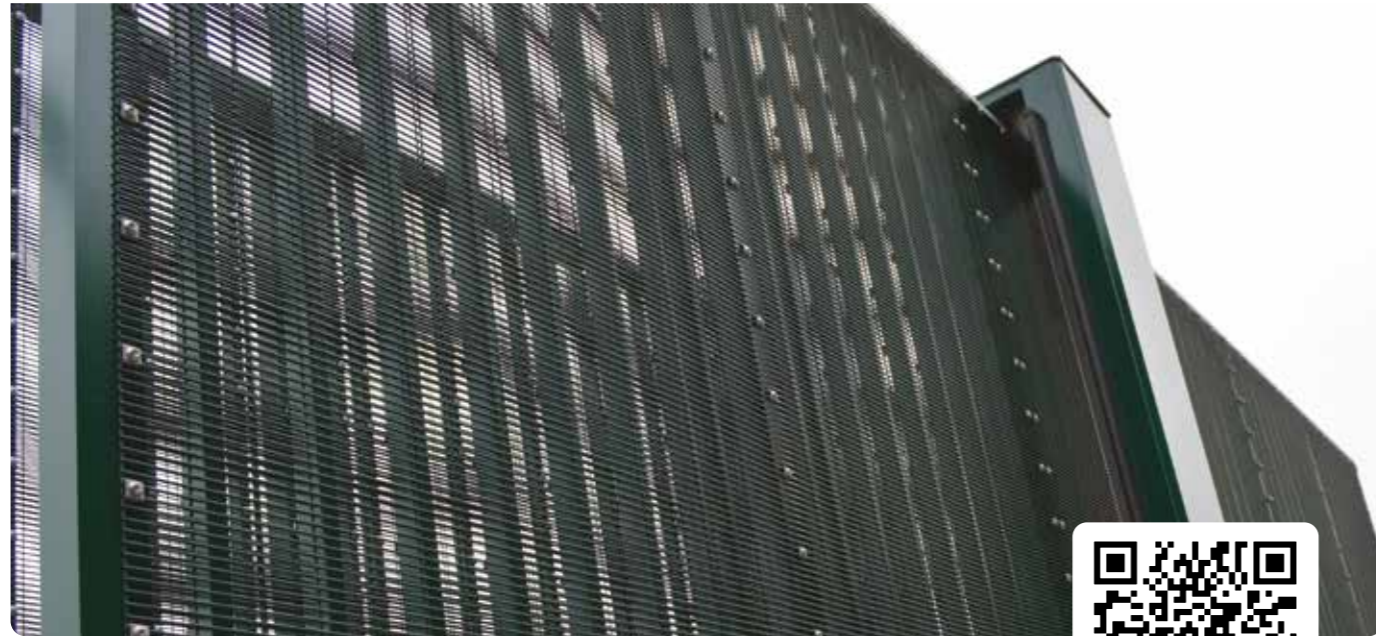

Find out more
Scan for more information

Description

CLD SlideMaster SR3 gates have been specially developed to blend in seamlessly with a CLD Securus fenceline. Offering excellent visibility, they are difficult to cut through and scale. Rigorously tested by the Loss Prevention Certification Board (LPCB) to guarantee a minimum delay of 5 Minutes against attack, CLD SlideMaster SR3 is also Secured by Design accredited, making it a police preferred specification for security.

CLD SpeedMaster

Bi-Folding Trackless Speed Gates

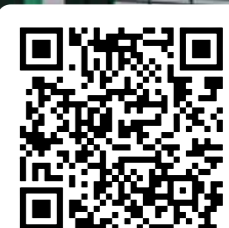

Find out more
Scan for more information

Description

CLD's SpeedMaster gates offer the perfect solution for high level security premises which needs gates that open and close quickly. Operating at twice the speed of traditional swinging gates, SpeedMaster allows the traffic to flow, reducing the opportunity for tailgating. Available in different mesh options to match the fenceline, including CLD's high security Securus range, SpeedMaster is compatible with most access control options, including keypad, proximity card and remote control.

Features

- Clear drive through widths up to 8m
- Security rated gates
- Automatic operation

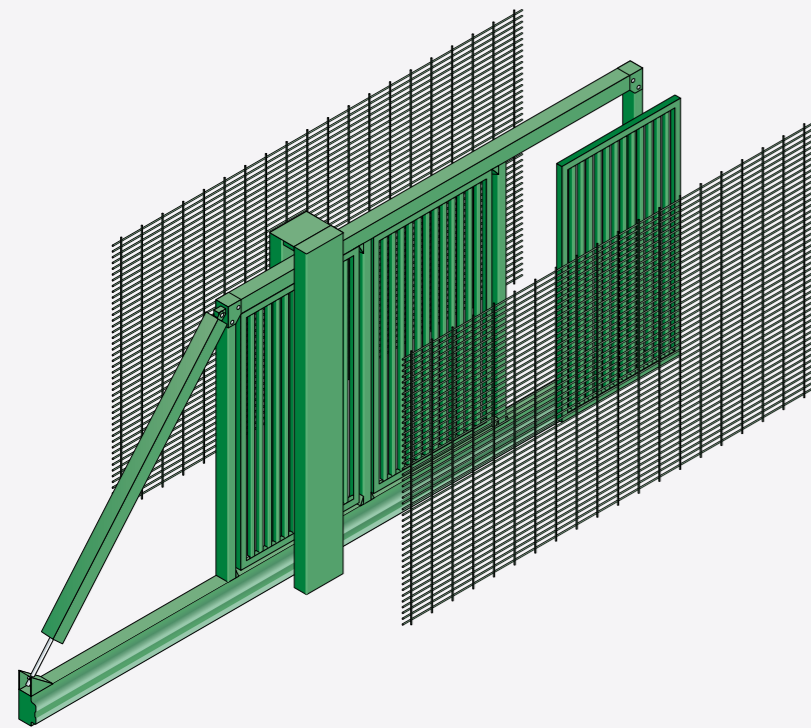

Exploded view of post and fixing details for the CLD SlideMaster SR3
This product has additional features not demonstrated for security reasons

Features

- Cost effective solution
- Fully compatible with other security products
- Available in different mesh options to match fence line
- Twice the speed of conventional gates

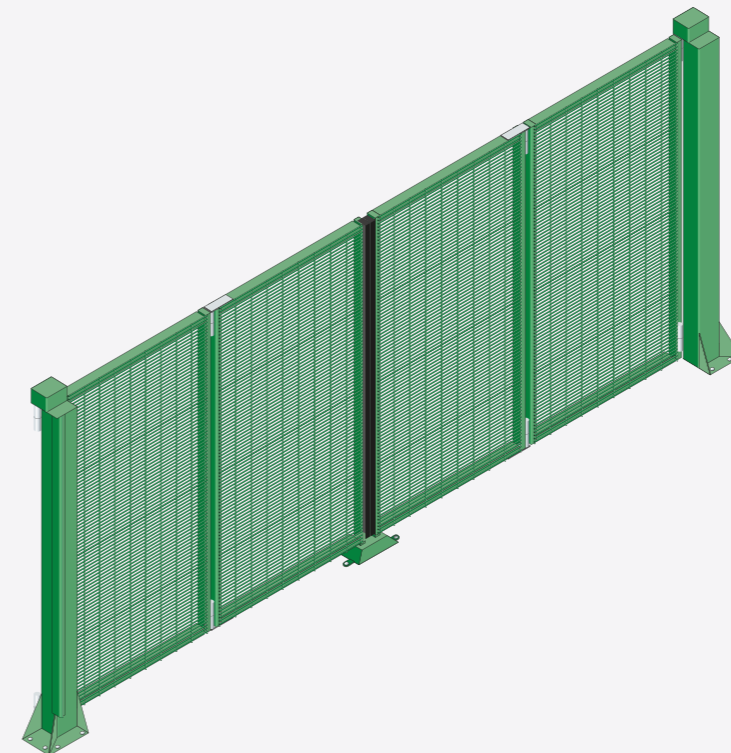

Exploded view of post and fixing details for the CLD SpeedMaster
This product has additional features not demonstrated for security reasons



Our Systems

Temporary & On-Ground Physical Security Systems

Construction sites and major events have traditionally been forced to compromise between the level of security they require and the impact on time and cost of installing a permanent system. CLD's innovative range now offers the choice of a permanent quality perimeter in a temporary format.

CLD's temporary solutions are available for hire or purchase.

Centred around individual project needs, our temporary fencing and hoarding systems can be installed with a range of on-ground options. Whether a project is likely to last for six months or 10 years, we have solutions which can be easily removed and leave no trace.

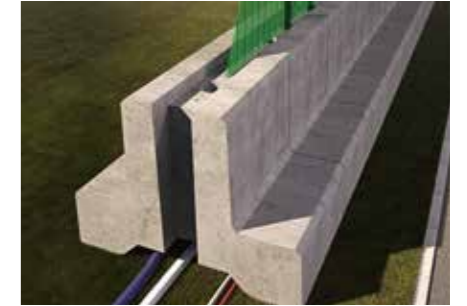

FenceSafe (On Ground System) Permanent Level Security which Leaves No Trace

When projects require a permanent level of security, but it is not possible to strike ground, CLD's innovative FenceSafe Base is the solution.

Made from a 100% recycled plastic, it is a cantilever base which can be ballasted up to 200kg to provide strong and reliable foundation for our most popular rigid mesh fencing systems, using the same panels and parts used in permanent fencing. Easy to move and reinstall as the site progresses, the FenceSafe Base installation system even allows the temporary fence to be converted into a permanent solution at the end of the project.

The ultimate innovation for a temporary to permanent perimeter solution, reducing complexity and cost.

HoardSafe Safety, Security and Sustainability

Site hoarding with a difference.

Designed using a robust composite uPVC recycled plastic profile, HoardSafe is the next generation of hoarding.

With the options of on-ground or in-ground installation, it conforms to BS EN 1991 for wind-loading and TWf2012:01 (revised 2014).

If the hoarding is installed in-ground, the existing posts can be used to create a permanent fence-line using panels from CLD's perimeter fencing range.

For extra-sensitive sites, HoardSafe is also available in a security rated option, tested by the Loss Prevention Certification Board to deliver up to 1 minute of delay against attack.

As with all CLD systems, complementary access control is also available to use with the HoardSafe system.

ModSec A Revolution In Security

ModSec is the first modular, physical security system that provides a true deterrent against attack, and can be installed either on-ground or in-ground as a trench system. The modular design allows for installation on either flat ground or gradients.

Any of CLD's rigid mesh fencing systems can be installed on the ModSec base and it also features an inbuilt channel for wires to be installed so that CCTV, PIDs or other electronic detection systems can be installed at the same time.

ModSec can also be used with our HoardSafe system and as a standalone vehicle deterrent.

A truly adaptable system, it can be relocated or have panels upgraded as and when security threat levels change.

CLD Hire

High levels of service delivery, knowledge on the ground and exceptional products are at the heart of our business philosophy. It was with those values in mind that CLD created its Hire Division, enabling our customers to be able to access the highest levels of perimeter security on a rental basis.

Our aim is to ensure you have exactly the fencing you need, for as long as you need it. We recognise that every project is unique, so whether you think you need temporary fencing for a few weeks or a few years, our team can help.

- Not only do we offer flexibility with regards to hire periods, we can offer total flexibility with regards to design of a temporary perimeter solution, with regards height, length and even electrification
- Access can be included within your temporary fenceline design, including swing gates, turnstiles, barriers and sliding gates.
- Technical support is readily available from our expert team
- Deliveries are made using our own FORS Silver accredited CLD delivery team.



CLD HoardSafe

Site hoarding system



Description

HoardSafe is CLD's range of sustainable and secure hoarding. Manufactured from composite recycled plastic panels which click easily into place and are installed on steel rails. The system can be fixed to blocks or ground buried. CLD's range of permanent fencing can easily be installed after the hoarding is removed, using the existing posts. HoardSafe can be vinyl wrapped with custom designs and re-used multiple times.



Find out more
Scan for more information

CLD HoardSafe S1

Site hoarding to LPS 1175 A1 (SR1) Issue 8

Minimum of 60 Seconds
delay against attack



Description

HoardSafe S1 offers a security perimeter, with the benefits of a hoarding system. Manufactured from composite recycled plastic panels which click easily into place and are installed on steel rails. HoardSafe S1 is a security rated version which incorporates a Securus steel mesh panel to the rear which has been certified by the Loss Prevention Certification Board to provide a minimum of 60 seconds against attack. The system can be fixed to blocks or ground buried. HoardSafe can be vinyl wrapped with an advertising message and can be re-wrapped for use time and again.



Find out more
Scan for more information



Features

- Sustainable alternative to standard site hoarding
- Easily updates to a permanent fence line
- BS EN 1991 wind loading tested to in excess of 100mph
- Dug in or surface mounted foundation options
- Hire or Purchase options

Exploded view of post and fixing details for the CLD HoardSafe
This product has additional features not demonstrated for security reasons

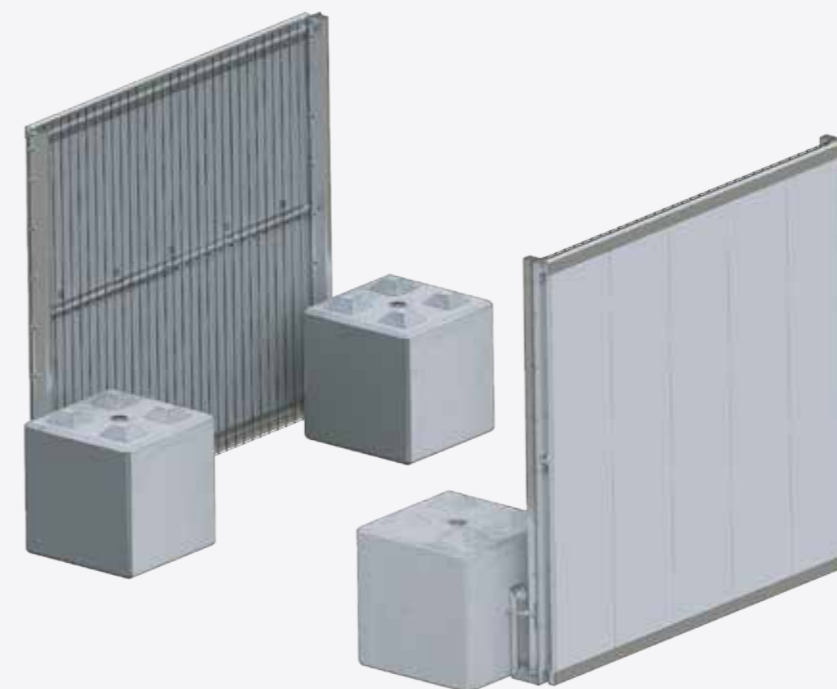

Features

- Sustainable alternative to standard site hoarding
- Easily updates to a permanent fence line
- BS EN 1991 wind loading tested to in excess of 100mph
- Security rated site hoarding
- Hire or Purchase options

Exploded view of post and fixing details for the CLD HoardSafe S1
This product has additional features not demonstrated for security reasons



CLD FenceSafe Eclipse

Profiled Rigid Mesh Panel System in On-Ground/Temporary Format



Find out more
Scan for more information

Description

CLD Eclipse is a general purpose perimeter fencing system offering a cost effective and attractive fenceline. With projecting spikes, Eclipse is difficult to climb over offering a good deterrent against vandals and intruders. FenceSafe Eclipse is on on-ground/temporary version, which is installed using CLD's FenceSafe Base unit. Both base unit and mesh panels can be reused again and again offering a highly cost effective and sustainable perimeter solution.

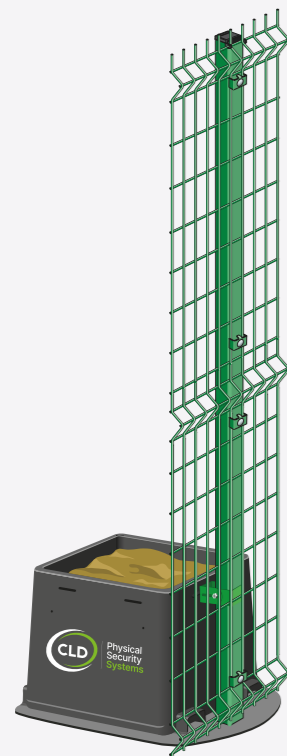

Features

Cost effective solution

Reusable base and panels

Hire or purchase

Sustainable

Exploded view of post and fixing details for the CLD FenceSafe Eclipse
This product has additional features not demonstrated for security reasons

CLD FenceSafe Securus SR1

Temporary & On-ground Fencing System Rated to LPS 1175 SR1 Issue 7



Minimum of 60 Seconds
delay against attack



Find out more
Scan for more information

Description

Offering safety, security and sustainability, CLD's FenceSafe Securus SR1 system is the world's first LPS 1175 security rated temporary fencing system. Using our innovative foundation free cantilevered FenceSafe base coupled with our Securus 358 mesh fencing, the system is guaranteed to offer at least 60 seconds delay against attack. Both the base and the Securus panels can be reused. The panels can even be used in a permanent fenceline.

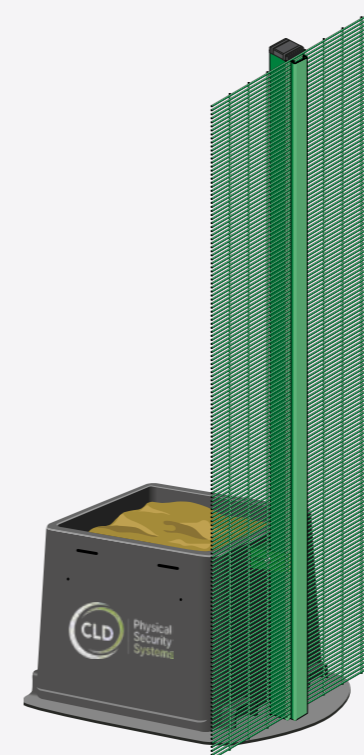

Features

Overlapping panels for added security

Full length clamp bar with no external fixings

Through bolt with rear fastening

Anti-Climb 358 mesh panels

Hire or Purchase options

Exploded view of post and fixing details for the CLD FenceSafe Securus SR1
This product has additional features not demonstrated for security reasons



CLD ModSec Securus S1

Modular physical security system with security fencing to LPS 1175 A1 (SR1) Issue 8



Minimum of 60 Seconds delay against attack



Find out more
Scan for more information

Description

ModSec is an innovative installation system which can be installed either at ground level or as a trench system. It features an in-built channel for wires or services enabling easy installation of CCTV, PIDS or other electronic devices. ModSec S1 incorporates CLD Securus S1 fence panels. Tested by the Loss Prevention Certification Board (LPCB), Securus S1 offers a minimum delay against attack of 60 seconds.

CLD ModSec Securus S2

Modular physical security system with security fencing to LPS 1175 B3 (SR2) Issue 8



Minimum of 3 Minutes delay against attack

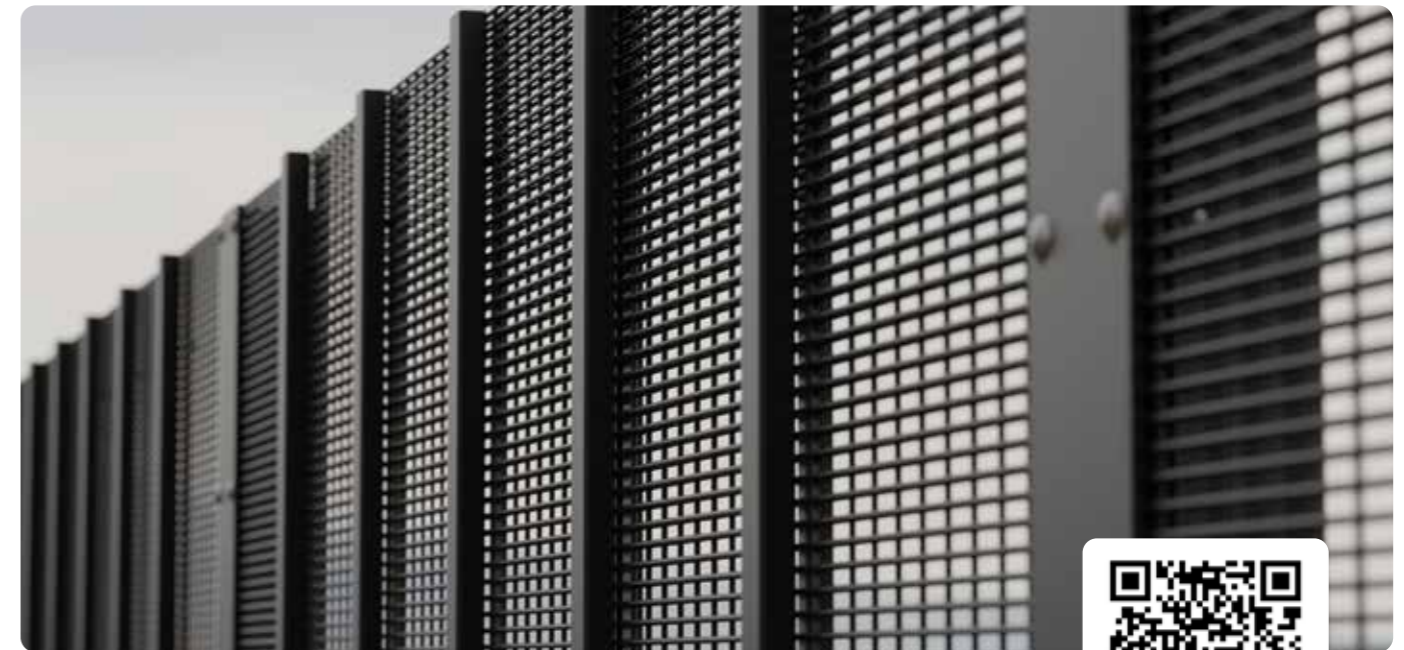

Find out more
Scan for more information

Description

ModSec is an innovative installation system which can be installed either at ground level or as a trench system. It features an in-built channel for wires or services enabling easy installation of CCTV, PIDS or other electronic devices. ModSec S2 incorporates CLD Securus S2 fence panels. Tested by the Loss Prevention Certification Board (LPCB), Securus S2 offers a minimum delay against attack of 3 Minutes.

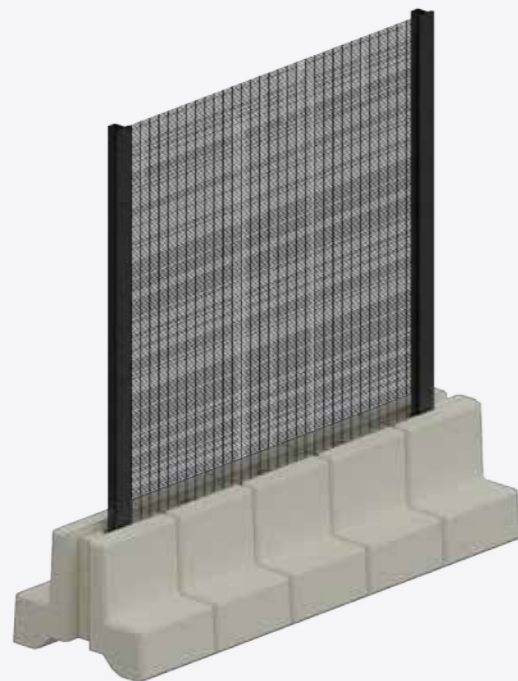

Exploded view of post and fixing details for the CLD ModSec Securus S1
This product has additional features not demonstrated for security reasons

Features

- Can be used on flat ground or gradients
- Built in channel for wires and services
- Modular base meaning security can be updated when threat levels change
- Toppings available
- Hire or purchase

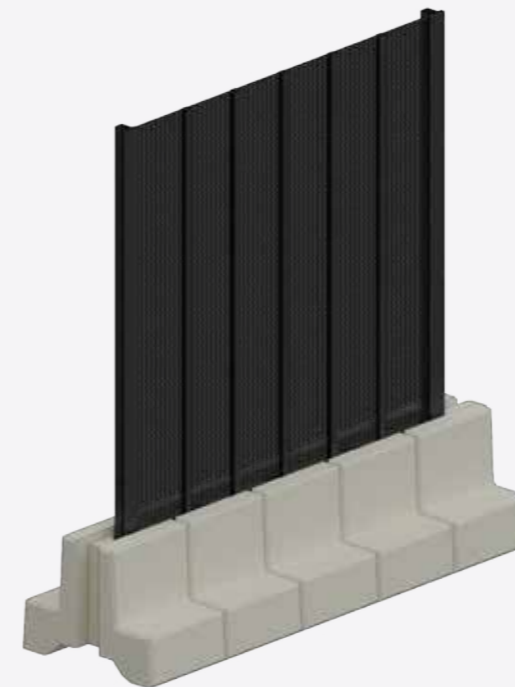

Exploded view of post and fixing details for the CLD ModSec Securus S2
This product has additional features not demonstrated for security reasons

Features

- Can be used on flat ground or gradients
- Built in channel for wires and services
- Modular base meaning security can be updated when threat levels change
- Toppings available
- Hire or purchase



CLD ModSec Securus S3

Modular physical security system with security fencing to LPS 1175 C5 (SR3) Issue 8



Minimum of 5 Minutes delay against attack



Find out more
Scan for more information

Description

ModSec is an innovative installation system which can be installed either at ground level or as a trench system. It features an in-built channel for wires or services enabling easy installation of CCTV, PIDS or other electronic devices. ModSec S3 incorporates CLD Securus S3 fence panels. Tested by the Loss Prevention Certification Board (LPCB), Securus S3 offers a minimum delay against attack of 5 Minutes.

CLD FenceSafe LockMaster

Permanent grade swing gates in a temporary format



Find out more
Scan for more information

Description

CLD FenceSafe LockMaster gates offer a permanent grade of security in a temporary or on-ground format. The gate is supplied complete with infills to match the fenceline and is installed using CLD's innovative FenceSafe 100% recycled bases. All CLD's temporary gates can be converted to permanent access control solutions. Fence-Safe LockMaster gates are available to suit site specific needs, including various locking methods and additional security toppings.



Exploded view of post and fixing details for the CLD ModSec Securus S3
This product has additional features not demonstrated for security reasons

Features

- Can be used on flat ground or gradients
- Built in channel for wires and services
- Modular base meaning security can be updated when threat levels change
- Toppings available
- Hire or purchase

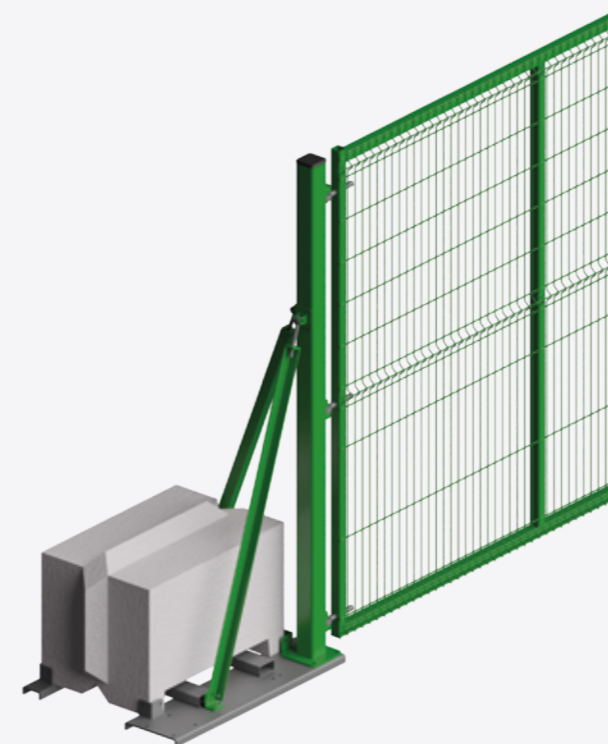

Exploded view of post and fixing details for the CLD FenceSafe LockMaster
This product has additional features not demonstrated for security reasons

Features

- Wind-rated to BS EN 1991
- Zero ground strike
- Options to suit every site
- Can be repurposed for permanent fenceline on site completion
- Hire or purchase



CLD FenceSafe SlideMaster

Permanent grade cantilever sliding gates in temporary or on-ground format



Find out more
Scan for more information

Description

CLD FenceSafe SlideMaster sliding gates offer a permanent grade quality in a temporary or on-ground format. The gates are supplied complete with infills to match the fenceline and are installed using CLD's innovative FenceSafe 100% recycled bases. All CLD's temporary gates can be redeployed as the site perimeter changes and even converted to permanent access control solutions upon completion. FenceSafe SlideMaster gates are available to suit site specific needs, including various heights and widths, locking methods and additional security toppings.

CLD FenceSafe PedMaster

Permanent grade turnstiles in a temporary format



Find out more
Scan for more information

Description

CLD PedMaster turnstiles offer a permanent grade of turnstile in a temporary or on-ground format. Featuring a self-contained weighted base with lifting point, they are easy to install and do not require any ground fixing. PedMaster turnstiles are available to suit site specific needs, including features such as 90° or 120° rotor assemblies, canopies, downlights and fire alarm activation.

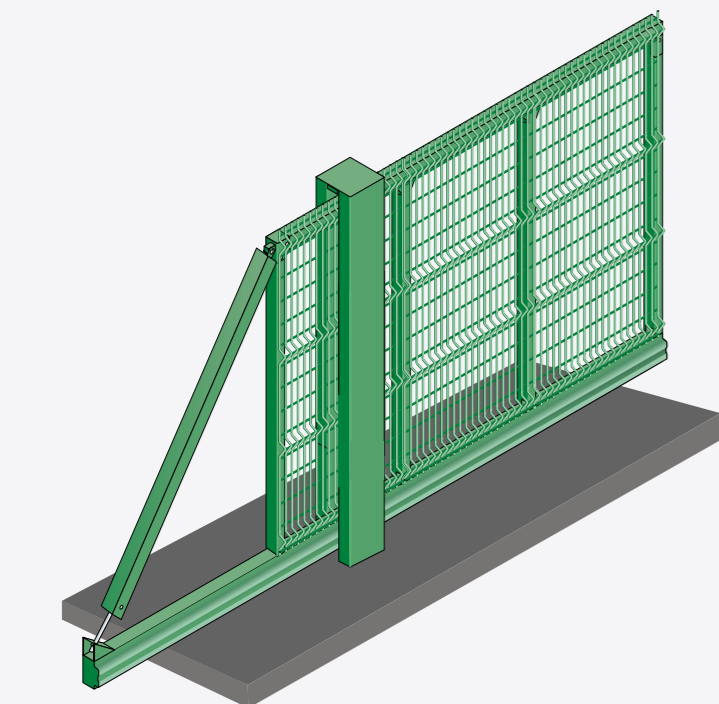

Exploded view of post and fixing details for the CLD FenceSafe Slidemaster
This product has additional features not demonstrated for security reasons

Features

Wind-rated to BS EN 1991

Zero ground strike

Options to suit every site

Anti trip hazard outside



Exploded view of post and fixing details for the CLD FenceSafe PedMaster
This product has additional features not demonstrated for security reasons

Features

Hire or purchase

Bi or single direction

Can support additional access control methods

Our Systems

Agile Guarding System

CLD's new perimeter guarding system has been developed in response to client requirements. Offering a permanent level of protection which, at the same time, is quickly deployable and removeable as the threat situation changes. Suitable for internal use for machine guarding, high security storage locations or hazard barriers. Also offers an agile perimeter security barrier for exterior use.

CLD Securus Guard S1

Permanent grade internal guarding screen to LPS 1175 A1 (SR1) Issue 8



Minimum of 60 Seconds delay against attack



Find out more
Scan the QR code

Description

CLD Securus S1 Guard offers a guarding system for internal security. Using CLD's Securus 358 rigid mesh panels, Securus Guard is perfect for internal applications requiring a security rated guarding system.

Features

Baseplated or bolted down

Added level of internal security

Access control systems to match

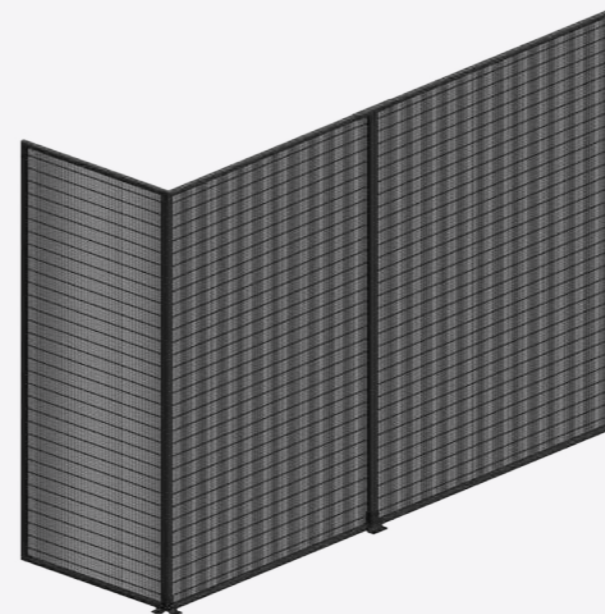

Exploded view of post and fixing details for the CLD Securus Guard S1
This product has additional features not demonstrated for security reasons



CLD LockMaster Guard

Permanent grade internal guarding access control system



Find out more
Scan the QR code

Description

CLD Lockmaster Guard S1 gates offers permanent grade access for internal security. Designed to complement CLD Securus Guard, LockMaster Guard is available to suit specific needs and offers a turnkey access system for internal use.

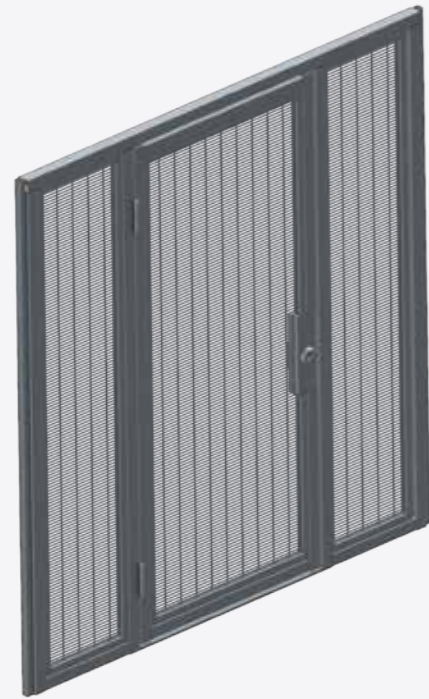

Features

Baseplated or bolted down

Added level of internal security

Pairs with the CLD Securus Guard S1

Exploded view of post and fixing details for the CLD LockMaster Guard
This product has additional features not demonstrated for security reasons



Sustainability

CLD Physical Security Systems is committed to operating in a more sustainable and less wasteful way, and to support customers and colleagues in making responsible choices.

80%

Recycled plastic used in our hoarding

100%

Recycled plastic used in our FenceSafe bases

90%

The amount of recycled steel used in all of CLD's steel fencing and posts

We are in the process of completely revising our approach, and appointing specialists to ensure our work is meaningful and makes a measured difference in this area.

In the meantime, our sustainability journey has already reached some significant milestones including:

ISO 14001 Environmental Management System

Our approach has accelerated with the implementation of the ISO: 14001 Environmental Management System.

This international standard offers us a framework that helps us manage the impact that our businesses have on the environment.

It guarantees to our stakeholders that we comply with all legislation, regulations, and other environmental requirements. It also gives us the tools to make continual improvements to our performance.

EcoVadis

In 2021 we received a Silver Medal in recognition of sustainability achievement from EcoVadis. The Ecovadis Sustainability Scorecard assesses our performance against 21 indicators across 4 themes:

- Environment
- Labour and Human Rights
- Ethics
- Sustainable procurement

The EcoVadis assessment gives us more signposts for improvement so that we can secure a Gold Medal in the future.

Planet Mark

It is well known that in business you can't manage what you can't measure. It is vital that we can measure the continuous improvements we are making. CLD is working closely in partnership with Planet Mark, to measure our carbon emissions, energy and water consumption, travel and waste. Planet Mark also supports us with an understanding of how our social activities impact on the community.

Sustainable procurement

All of CLD's steel fencing and posts are manufactured from at least 90% recycled British and European steel, and our FenceSafe bases are manufactured from 100% recycled plastic and our hoarding from at least 80% recycled plastic.

All our steel products are widely recyclable. Furthermore, the panels used in our innovative FenceSafe temporary fencing solutions can be repurposed for use in the permanent fence line, making them the perfect sustainable solution.

Transport is another crucial area that we are looking to improve. We operate our own dedicated logistics department, which holds FORS Silver across its fleets.



Assessed to ISO 9001:2015
Assessed to ISO 14001:2015
Cert/LPCB ref. 999

Installer Partners

Exceptional products are just part of our story. The best products require the best installation and that's why we spend time to seek the right teams to install our systems.

To ensure the best quality work, we can connect you with a member of our CLD Installation Partners network that covers the whole United Kingdom. All our contractors are carefully chosen by us after checking every aspect of their business and installation service to ensure professionalism and attention to detail.

Our installation partners undergo training on the installation of CLD projects and we make sure we continuously update and inform them about new development so that they remain the experts in fencing throughout your projects.



Global Operations

Global reach, local intelligence.

Early in our history, we gained recognition internationally for our pioneering approach, with our first works abroad in South Africa, where we were tasked with protecting precious stone mines and other sites where security was paramount. In subsequent years, CLD Systems has built up a reputation of being able to deliver the highest quality British made physical security systems to anywhere in the world. As a result, we have developed certified partners who operate on our behalf across the globe, including offices in London, Sydney, Washington, Dubai and most recently Buenos Aires, with distributors in more than 10 countries.

Our global approach ensures that our customers can replicate the same gold standard of tried and trusted physical security across all their sites worldwide.

Head Office

Modsec House
Moston Road
Sandbach
Cheshire
UK
CW11 3HL

Tel +44 (0)1270 764751

Offices in

Washington DC | Sandbach | London | Dubai | Jakarta | Sydney | Buenos Aires

cld-systems.com



Physical
Security
Systems