



Solera

...

Tarifa- Catálogo 2023

1 Accede a la versión más actualizada de la tarifa



2 Accede al portal para Profesionales de Solera



Configurador de cuadros para instalaciones fotovoltaicas

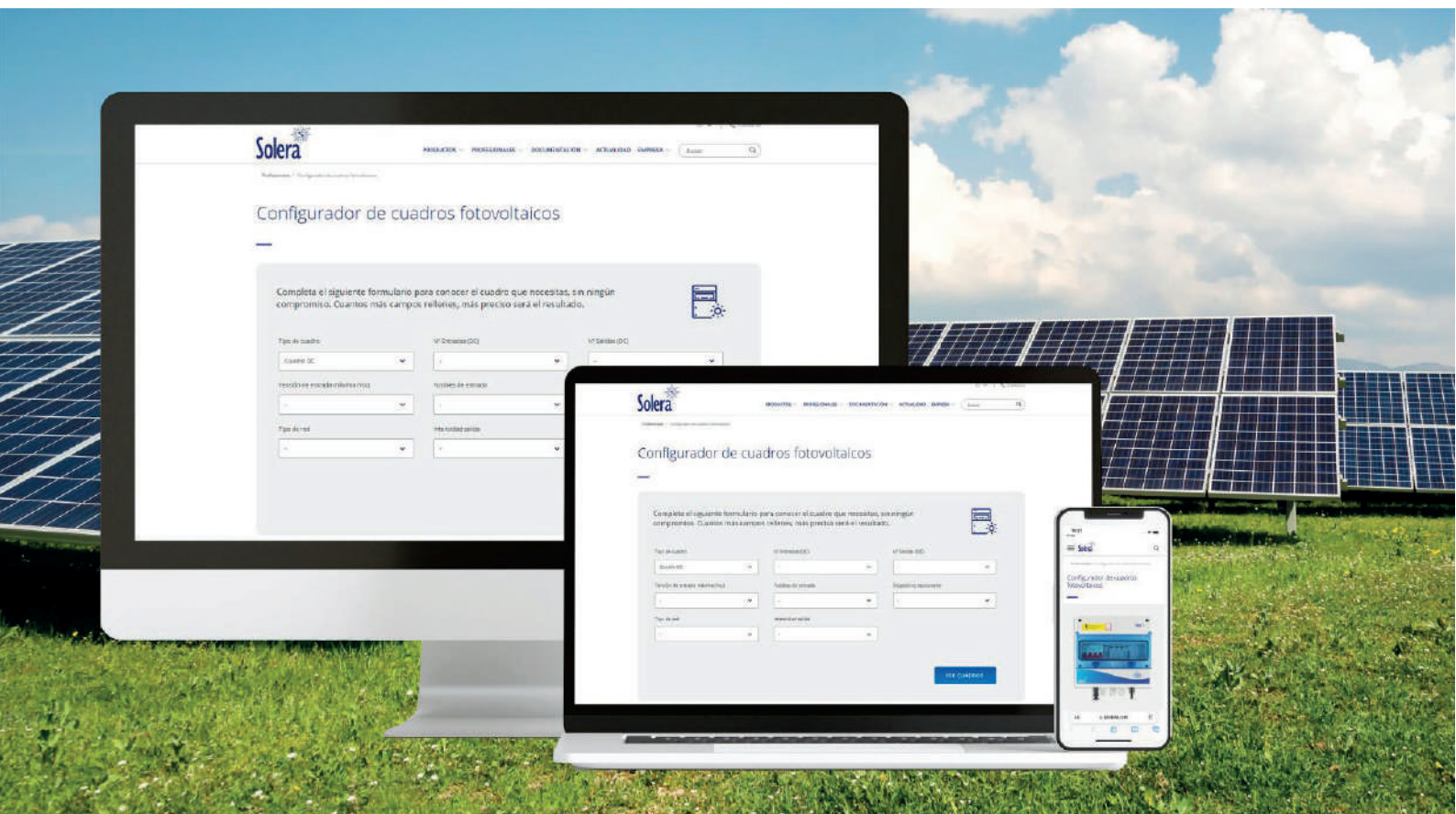

En Solera disponemos de una **amplia gama de soluciones** y materiales de instalación para **proyectos fotovoltaicos**. Cuadros de control de strings, envolventes termoplásticas y de poliéster, bridas y accesorios. Todos ellos fabricados con materiales de alta resistencia, diseñados para instalación en exteriores.

Y en este crecimiento y mejora hemos reforzado el servicio de solicitud de cuadros, lanzando un **nuevo configurador de cuadros de control de strings**, pensado para mejorar el servicio y atención a nuestro instalador, con el objetivo de facilitarle su trabajo.

- ✓ Configura tu cuadro a medida en pocos pasos.
- ✓ Rápido e intuitivo.
- ✓ Cajas totalmente electrificadas.
- ✓ Con declaración de conformidad incluida.

Configura tu cuadro
en **15 segundos**



Soluciones para carga de vehículo eléctrico

Configuramos los cuadros a medida para adaptarnos a tus necesidades



Protección + Carga

Protección puesto de recarga



Modo 1

Conexión directa del vehículo a la red

- Toma de corriente no exclusiva.
- Cable simple.
- Velocidad de recarga: lenta.



Modo 2

Conexión directa del vehículo a la red

- Toma de corriente no exclusiva.
- Cable con dispositivo de comunicación y supervisión de recarga.
- Velocidad de recarga: lenta.



Modo 3

Conexión directa del vehículo a la red

- Toma de corriente exclusiva con monitorización de carga.
- Velocidad de recarga: semirápida - rápida.

Descubre toda la gama





Solera
www.psolera.com

Índice General

 <p>Cajas de distribución METALBOX</p> <p>06</p>	 <p>Cajas de distribución ARELOS</p> <p>09</p>	 <p>Cajas de distribución CLÁSICA</p> <p>14</p>	 <p>Cajas para ICT</p> <p>21</p>
 <p>Cajas industriales de distribución (IP65) INDUBOX</p> <p>24</p>	 <p>Tomas industriales</p> <p>33</p>	 <p>Cajas de distribución (IP54)</p> <p>36</p>	 <p>Armarios metálicos STEELBOX</p> <p>37</p>
 <p>Armarios ESTANCOS MULTIBOX (IP65)</p> <p>40</p>	 <p>Armarios de poliéster POLIBOX (IP66)</p> <p>42</p>	 <p>Cajas estancas YBOX</p> <p>45</p>	 <p>Cajas estancas</p> <p>48</p>
 <p>Cajas estancas y conectores (IP68) BLACK</p> <p>56</p>	 <p>Cajas de conexión DERIBOX</p> <p>57</p>	 <p>Cajas de mecanismos MECABOX</p> <p>62</p>	 <p>Cajas para aire acondicionado CLIMABOX</p> <p>63</p>
 <p>Cajas para tabique hueco BLUE</p> <p>64</p>	 <p>Mecanismos de empotrar EUROPA</p> <p>70</p>	 <p>Mecanismos de superficie MURAL</p> <p>78</p>	 <p>Mecanismos estancos SOL54 (IP54)</p> <p>81</p>
 <p>Canales y minicanales</p> <p>83</p>	 <p>Bases múltiples ION</p> <p>87</p>	 <p>Bases múltiples 8000</p> <p>89</p>	 <p>Bases múltiples 900</p> <p>93</p>
 <p>Material diverso</p> <p>94</p>	 <p>Enrollables</p> <p>99</p>	 <p>Iluminación</p> <p>101</p>	 <p>Protecciones</p> <p>106</p>
 <p>Dispositivos de conexión, terminales y aislantes</p> <p>113</p>	 <p>Bridas y fijaciones</p> <p>116</p>	<p>Tablas informativas</p> <p>133</p>	

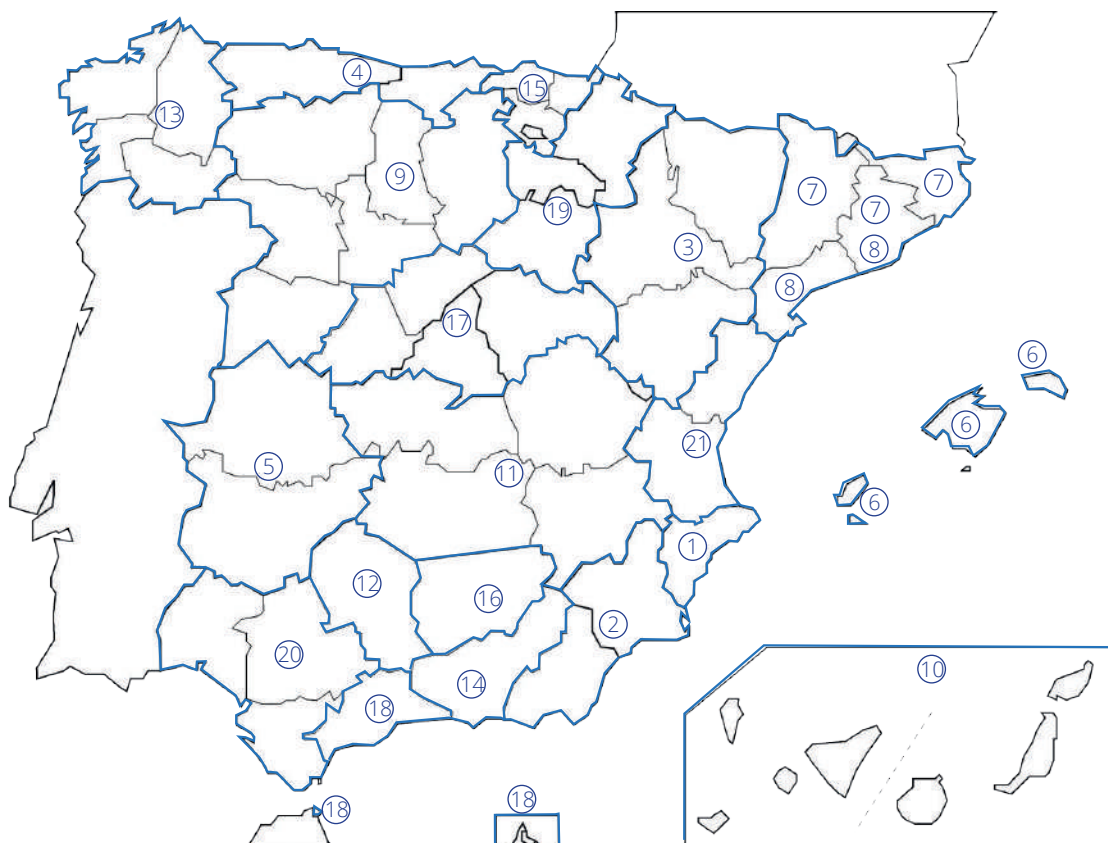
Delegaciones



1- ALICANTE

ERNESTO CONTERO PEIGNEUX

C/ Francisco Montero Pérez, 16 bis-Local
03009 Alicante
Tel. 96 517 55 82/ Fax. 96 518 59 25
Móvil 609 69 34 11 / 609 682 802
comercial@econtero.com

2- ALMERÍA Y MURCIA

EDUARDO BALLESTA GÓMEZ

Paseo Duques de Lugo, 14, Piso 2, Pta. 4
30009 Murcia
Móvil 630 91 42 46
eballesta@telefonica.net

3- ARAGÓN

ALBERTO PÉREZ GUTIÉRREZ

C/ Badajoz, local 8. 50014 Zaragoza
Móvil. 667 580 641
aragonalbtoperez@gmail.com

4- ASTURIAS Y CANTÁBRICA

ORLANDO DE DIEGO POLO

Carretera de Avilés, 19.
33213 - Gijón (Asturias)
Móvil 658 32 69 11
matelec@matelec.es

5- EXTREMADURA

RAFAEL LAVADO MONGE

C/ Salvador, 32.
06230 Los Santos de Maimona, Badajóz
Tel. 924 54 45 79
Móvil 639 11 38 07
rafalavadomonge@gmail.com

6- BALEARES

MIGUEL ESCUDERO

C/ Agnes de Pacs, 4. 07010 Palma de Mallorca
Tel. 971 20 65 15 / Fax. 971 20 58 24
Móvil 666 11 01 11
miguel@escuderoagents.es

7 Y 8- BARCELONA, TARRAGONA, LÉRIDA Y GERONA

ORIOI BADÍA CERVERA (8)

Móvil 630 47 87 46
oriol.badia@psolera.com

MANUEL PARDO Y JAVIER PARDO (7)

Apdo. Correos 22
08110 Montcada i Reixac, Barcelona
Móvil 607 87 70 13 / 699 76 28 61
representaciones@mjpardo.com

**9- BURGOS, LEÓN, ZAMORA,
SALAMANCA, VALLADOLID Y PALENCIA****ORLANDO DE DIEGO PEREDA**

Paseo Arco de Ladrillo, 92 - plta 1º Ofi. 11.
47008 Valladolid
Móvil 665 69 25 55
ventas@orlandogestion.com

11- CIUDAD REAL, CUENCA, ALBACETE Y TOLEDO**FRANCISCO MUÑOZ**

C/ Albacete, 6 B bajo A
13002 Ciudad Real
Tel. / Fax 926 25 43 79
Móvil 610 47 49 50
comercial@representacionesfj.com

13- GALICIA**ÁLVARO CASARIEGO Y MARCOS FERNÁNDEZ**

Camino de Mide 171. San Miguel de Oia
36390 Vigo, Pontevedra.
Móvil 600 68 77 92 / 600 00 91 79
acasariegob@yahoo.es

15- GUIPÚZCOA, ÁLAVA Y VIZCAYA**ITSASO BENAVENTE LACRUZ**

C/ Trinidad, 1-2º izquierda.
20800 Zarautz-Donostia, Guipuzcoa.
Móvil. 633 160 215
itsaso.benavente@gmail.com

17- MADRID, ÁVILA, SEGOVIA Y GUADALAJARA**REPRESENTACIONES RAMÓN LÓPEZ, S.L.**

C/ Melilla, 35-B Local N-1, 28005 Madrid
Tel. 91 354 50 38 / Fax 91 474 17 05
Móvil 656 37 67 83
ramonlopez@ramonlopez.es

19- RIOJA, NAVARRA Y SORIA**JAVIER SÁENZ**

C/ Fundición, 4 Entreplanta
26002 Logroño, La Rioja
Tel. / Fax 941 22 61 05
Móvil 696 32 80 31
resaenz@telefonica.net

21- VALENCIA Y CASTELLÓN**TRINI CALÁS**

C/ Humanista Furió, 26 bajo. 46022 Valencia
Tel. 96 369 41 00
Móvil 670 91 32 67
tcalas@jcalas.es

10- CANARIAS**ESMERALDA GONZÁLEZ**

Ctra. General, N 32, Edif. Fuente del
Lomo. Local - 1 AE. 38370 La Matanza de
Acentejo. Sta. Cruz de Tenerife
Móvil 637140435
esmeralda@iluminacioncanaria.es

12- CÓRDOBA**ÁNGEL ÁVALOS ACEITERO**

C/ Barroso, 12 Ático. 14003 Córdoba
Tel. 957 28 20 66
Móvil. 676 83 63 31
avalos_2@infonegocio.com

14- GRANADA**JOSÉ MIGUEL MONTORO**

Cr. Armilla 32. 18151 Ogijares, Granada
Móvil 658 76 46 32
amonrios@gmail.com

16- JAÉN**Mª ISABEL CORZO LUQUE**

C/ Pedro del Alcalde, 26, 23002 Jaén
Tel. 953 23 12 02
Móvil 610 55 67 50/ 661 413 794
eescribano@telefonica.net

18- MÁLAGA**JOSÉ ANTONIO DE LA CRUZ**

Parque empresarial Velázquez
C/ Suiza 10, 29004 Málaga
Tel. 952 24 25 10 / Fax 952 24 24 94
Móvil 616 04 82 60
jose@antoniodelacruz.com

20- SEVILLA, HUELVA Y CÁDIZ**JAIME PÉREZ MÁRQUEZ**

C/ Cueva del gato, 6, Bloque 3-3ªA
41020 Sevilla
Tel. / Fax 95 425 90 93
Móvil 629 25 33 52
j.perez29@cgac.es

Novedades

Serie Blue: Nuevas referencias



Pág. 64

Bases y clavijas: Nuevas referencias



Pág. 94

Sistemas y soluciones para una instalación eléctrica profesional.

Desde 1904, KAISER desarrolla y fabrica sistemas y productos como base para una buena instalación. Planificadores e instaladores utilizan las soluciones prácticas a nivel internacional para sus tareas diarias en todos los ámbitos de la instalación.



Construcción en hormigón

KAISER ha coordinado soluciones de sistemas de productos que son seguras, duraderas y prácticas para su uso en la rehabilitación, el acondicionamiento y la modernización.



Construcción industrializada

Sistema completo para la producción off site. Perfectamente optimizado para los trabajos de instalación eléctrica.



Eficiencia energética

Los innovadores productos de KAISER le ayudan a cumplir los requisitos de las directivas de la UE conforme normativa 2010/31/UE.



Protección contra incendios

Los sistemas de protección contra incendios de KAISER ofrecen soluciones fiables para las instalaciones eléctricas en paredes y techos cortafuegos.



Insonorización

Las innovadoras cajas de aislamiento acústico de KAISER garantizan el cumplimiento de los requisitos estructurales de las paredes de aislamiento acústico, incluso en las instalaciones ya montadas.



Protección contra las radiaciones

Con las nuevas cajas contra la radiación conserva la protección de la pared sin medidas de apantallamiento adicionales.



Cajas de distribución de empotrar con marco y puerta metálicos



Descárgate la documentación técnica y vídeos de montaje



Ventajas de la serie



Enlazables: vertical y horizontalmente



Amplio espacio para el cableado

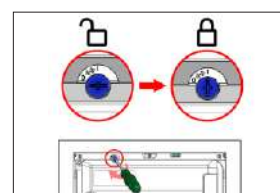

Cierre mediante tornillos de ¼ de vuelta



Combinables con cajas de ICT



IP 40



IK 07



650°C



HF

Productos complementarios



Pág. 106



Pág. 113



Pág. 113





Pág. 8



Pág. 21



Referencia	Descripción	Código GTIN-13	PVP		
14 elementos. 1 fila. Dimensiones para empotrar 333x300x88. Dimensiones exteriores 362x327.					
MP14	Tapa interior color blanco material termoplástico. Marco y puerta metálicos color blanco. Disipación térmica de 30 W. Incluye dispositivo de conexión de tierra.	8423220067912	78,89	1	1



28 elementos. 2 filas. Dimensiones para empotrar 333x435x88. Dimensiones exteriores 362x462.					
MP28	Tapa interior color blanco material termoplástico. Marco y puerta metálicos color blanco. Disipación térmica de 33 W. Incluye dispositivo de conexión de tierra.	8423220066878	101,54	1	1





42 elementos. 3 filas. Dimensiones para empotrar 333x620x88. Dimensiones exteriores 362x643.					
MP42	Tapa interior color blanco material termoplástico. Marco y puerta metálicos color blanco. Disipación térmica de 35 W. Incluye dispositivo de conexión de tierra.	8423220067929	141,22	1	1



56 elementos. 4 filas. Dimensiones para empotrar 333x752x88. Dimensiones exteriores 362x778.					
MP56	Tapa interior color blanco material termoplástico. Marco y puerta metálicos color blanco. Disipación térmica de 40 W. Incluye dispositivo de conexión de tierra.	8423220067936	166,60	1	1

METALBOX STILE. Cajas de distribución de empotrar con marco y puerta metálicos



Referencia	Descripción	Código GTIN-13	PVP		
14 elementos. 1 fila. Dimensiones para empotrar 333x300x88. Dimensiones exteriores 362x327.					
MP14NG	Tapa interior color blanco material termoplástico. Marco y puerta metálicos color grafito. Disipación térmica de 30 W. Incluye dispositivo de conexión de tierra.	8423220240902	87,29	1	1



28 elementos. 2 filas. Dimensiones para empotrar 333x435x88. Dimensiones exteriores 362x462.					
MP28NG	Tapa interior color blanco material termoplástico. Marco y puerta metálicos color grafito. Disipación térmica de 33 W. Incluye dispositivo de conexión de tierra.	8423220240919	111,89	1	1



42 elementos. 3 filas. Dimensiones para empotrar 333x620x88. Dimensiones exteriores 362x643.					
MP42NG	Tapa interior color blanco material termoplástico. Marco y puerta metálicos color grafito. Disipación térmica de 35 W. Incluye dispositivo de conexión de tierra.	8423220240926	155,37	1	1



56 elementos. 4 filas. Dimensiones para empotrar 333x752x88. Dimensiones exteriores 362x778.					
MP56NG	Tapa interior color blanco material termoplástico. Marco y puerta metálicos color grafito. Disipación térmica de 40 W. Incluye dispositivo de conexión de tierra.	8423220240933	185,10	1	1

METALBOX. Accesorios

CONVERSIÓN DE LA CAJA DE EMPOTRAR EN SUPERFICIE (CONJUNTO CLASE II)



1- Fijar zócalo metálico a la pared



2- Fijar la caja al zócalo, mediante tornillos



3- Colocar tapa con cierre mediante tornillos de ¼ de vuelta.



4- Colocar marco y puerta.

Dimensiones en mm - anchura x altura x profundidad.



Accede a la tarifa PVP actualizada



Referencia	Descripción	Código GTIN-13	PVP		
Zócalos metálicos para convertir las cajas de empotrar de la serie Metalbox en superficie.					
ZO-MP14	Zócalo para montar la referencia MP14.	8423220091122	102,69	1	6
ZO-MP28	Zócalo para montar la referencia MP28.	8423220091139	119,53	1	6
ZO-MP42	Zócalo para montar la referencia MP42.	8423220091146	144,94	1	3
ZO-MP56	Zócalo para montar la referencia MP56.	8423220091153	164,19	1	3



Cerradura para Metalbox.					
CER-MP28	Conjunto de bombín y 2 llaves.	8423220067943	23,42	1	1



Placa interior de montaje.					
PL-MP28	Para fijación de elementos a la caja. Multiperforada.	8423220073999	4,11	1	125



Tapa cubre huecos para Metalbox. 6 módulos.					
TA1300B03	Tapa ciega para cubrir huecos libres (6 módulos). Color blanco. Pretoquelada.	8423220067974	1,14	50	200



Peines de conexión tipo pin.					
P1P100010	Peine unipolar 56x1 módulo, sección 10 mm ² , 63A, longitud 1 m.	8423220092969	18,20	1	100
P2P21610	Peine bipolar 6x2 módulos, sección 10 mm ² , 63A, longitud 216 mm.	8423220070448	9,01	40	160
P2P100010	Peine bipolar 28x2 módulos, sección 10 mm ² , 63A, longitud 1 m.	8423220034082	42,11	1	50
P2P100016	Peine bipolar 28x2 módulos, sección 16 mm ² , 80A, longitud 1 m.	8423220053175	45,89	1	50
P3P100010	Peine tripolar 18x3 módulos, sección 10 mm ² , 63A, longitud 1 m.	8423220092976	48,35	1	50
P4P100010	Peine tetrapolar 14x4 módulos, sección 10 mm ² , 63A, longitud 1 m.	8423220087521	66,59	1	25
P4P100016	Peine tetrapolar 14x4 módulos, sección 16 mm ² , 80A, longitud 1 m.	8423220053243	84,03	1	25



Dispositivos de conexión por tornillo.					
180PE	Terminal Tierra PE 18x6 mm ² + 6x16 mm ² . Color verde.	8423220068001	7,77	1	20
180N	Terminal Neutro N 18x6 mm ² + 6x16 mm ² . Color azul.	8423220068018	7,77	1	20



105PE	Terminal Tierra PE 5x6 mm ² . Color verde.	8423220071124	2,73	1	500
105N	Terminal Neutro N 5x6 mm ² . Color azul.	8423220068049	2,73	1	500



113PE	Terminal Tierra PE 13x6 mm ² + 4x16 mm ² . Color verde.	8423220071117	6,91	1	20
113N	Terminal Neutro N 13x6 mm ² + 4x16 mm ² . Color azul.	8423220071131	6,91	1	20



113PE/N	Terminal Tierra PE 13x6 mm ² + 4x16 mm ² . Terminal Neutro N 13x6 mm ² + 4x16 mm ² . Color verde y azul.	8423220067998	11,27	1	20
---------	---	---------------	-------	---	----



128PE	Terminal Tierra PE 28x6 mm ² + 6x16 mm ² . Color verde.	8423220068025	8,89	1	20
128N	Terminal Neutro N 28x6 mm ² + 6x16 mm ² . Color azul.	8423220068032	8,89	1	20

*Consulta la tabla informativa de la serie Metalbox. Pág. 134



Dimensiones en mm - anchura x altura x profundidad.

Cajas de distribución de empotrar y de superficie

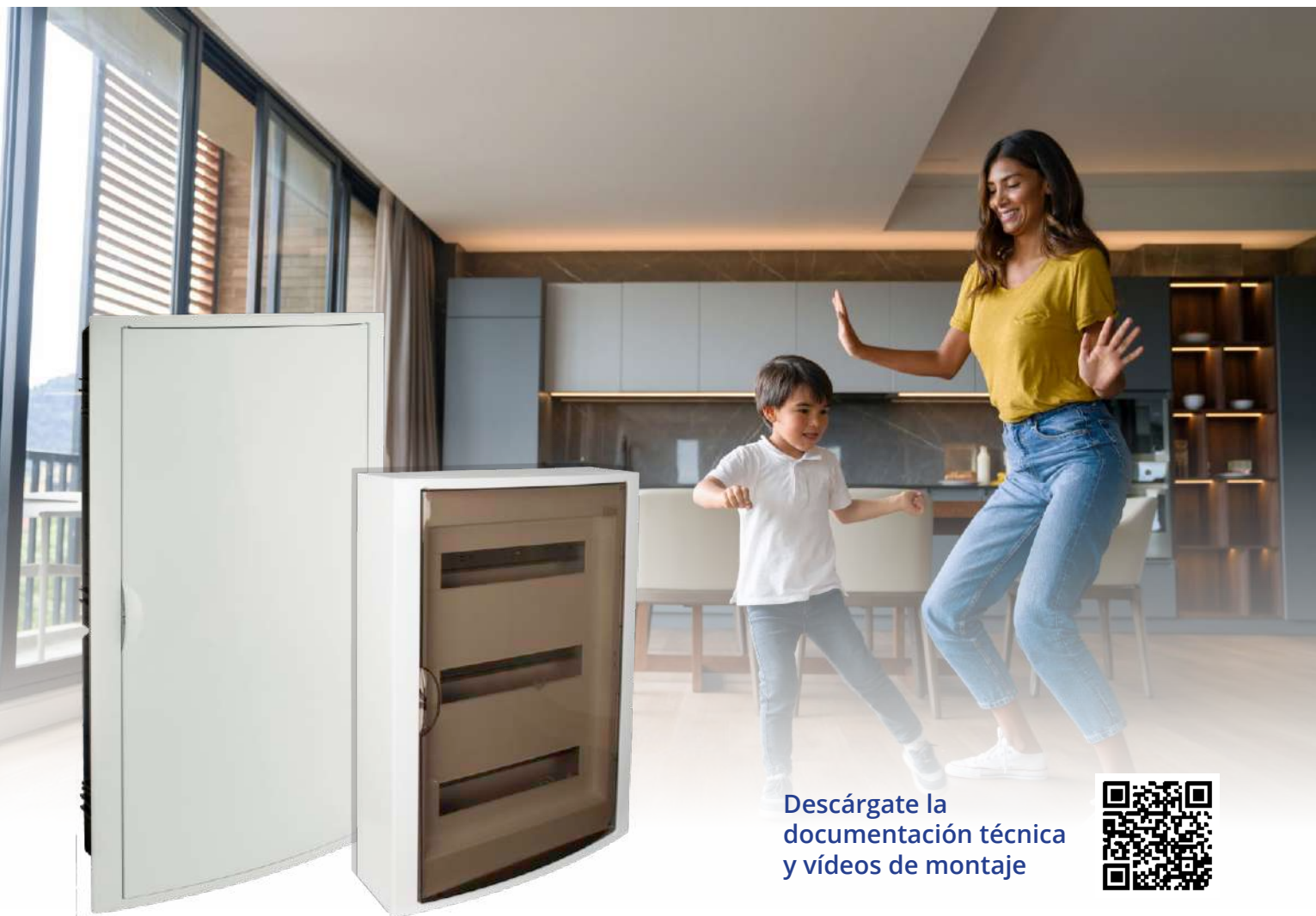

Descárgate la documentación técnica y vídeos de montaje



Ventajas de la serie



Combinables con cajas de ICT



Enlazables



Bastidor extraíble (Ver Referencia)

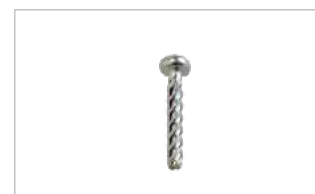

Tornillos de roscado rápido



Productos complementarios



Pág. 21



Pág. 106

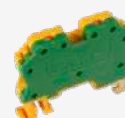

Pág. 113

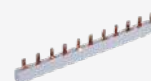

Pág. 14



Referencia	Descripción	Código GTIN-13	PVP		
2 elementos. Dimensiones para empotrar 60x130x62. Dimensiones exteriores 62x140x85.					
8692	Marco y puerta blancos.	8423220004566	3,41	1	120
8692PF	Marco blanco y puerta fumé.	8423220004566	3,82	1	120



4 elementos. Dimensiones para empotrar 125x195x72. Dimensiones exteriores 150x247.					
8694	Marco y puerta blancos.	8423220017504	15,26	1	30
8694PF	Marco blanco y puerta fumé.	8423220017511	16,01	1	30



4 elementos. Dimensiones para empotrar 140x270x72. Dimensiones exteriores 165x300.					
8208	Marco y puerta blancos.	8423220011212	18,69	1	22
8208PF	Marco blanco y puerta fumé.	8423220011229	22,02	1	22



8 elementos. Dimensiones para empotrar 205x233x72. Dimensiones exteriores 247x249.					
5108	Marco y puerta blancos.	8423220039537	21,88	1	12
5108PF	Marco blanco y puerta fumé.	8423220039551	22,92	1	12



12 elementos. Dimensiones para empotrar 277x220x72. Dimensiones exteriores 302x247.					
8688	Marco y puerta blancos.	8423220012110	23,17	1	10
8688PF	Marco blanco y puerta fumé.	8423220012127	26,78	1	10



14 elementos. Dimensiones para empotrar 320x233x75. Dimensiones exteriores 362x250.					
5012	Marco y puerta blancos.	8423220030183	30,94	1	11
5012PF	Marco blanco y puerta fumé.	8423220030190	33,25	1	11



18 elementos. Dimensiones para empotrar 386x225x72. Dimensiones exteriores 409x247.					
8685	Marco y puerta blancos.	8423220009783	30,73	1	12
8685PF	Marco blanco y puerta fumé.	8423220010014	34,13	1	12



22 elementos. Dimensiones para empotrar 450x222x72. Dimensiones exteriores 477x247.					
8690	Marco y puerta blancos.	8423220012158	31,75	1	10
8690PF	Marco blanco y puerta fumé.	8423220012165	37,47	1	10



28 elementos. Dimensiones para empotrar 320x420x75. Dimensiones exteriores 362x438. Bastidor extraíble.					
5250	Marco y puerta blancos.	8423220010994	53,10	1	5
5250PF	Marco blanco y puerta fumé.	8423220011007	57,57	1	5



36+4 elementos. Dimensiones para empotrar 400x320x72. Dimensiones exteriores 423x353. Bastidor extraíble.					
8206	Marco y puerta blancos.	8423220009929	52,22	1	5
8206PF	Marco blanco y puerta fumé.	8423220009981	60,13	1	5



42 elementos. Dimensiones para empotrar 360x528x86. Dimensiones exteriores 362x544. Bastidor extraíble.					
5260	Marco y puerta blancos.	8423220008489	67,72	1	4
5260PF	Marco blanco y puerta fumé.	8423220009387	74,52	1	4



Dimensiones en mm - anchura x altura x profundidad.



Referencia	Descripción	Código GTIN-13	PVP		
56 elementos. Dimensiones para empotrar 320x670x75. Dimensiones exteriores 362x686. Bastidor extraíble.					
5270	Marco y puerta blancos.	8423220011113	97,36	1	5
5270PF	Marco blanco y puerta fumé.	8423220011120	108,12	1	5

ARELOS. Cajas de distribución de superficie



Referencia	Descripción	Código GTIN-13	PVP		
2 elementos. Dimensiones exteriores 62x140x85.					
8692S	Color blanco.	8423220003347	3,96	1	120
8692SPF	Caja y marco blanco y puerta fumé.	8423220003538	4,45	1	126



4 elementos. Dimensiones exteriores 150x225x95.					
8684	Color blanco.	8423220017528	19,88	1	30
8684PF	Caja y marco blanco y puerta fumé.	8423220017535	20,83	1	30



8 elementos. Dimensiones exteriores 247x249x104.					
5109	Color blanco.	8423220039575	30,56	1	12
5109PF	Caja y marco blanco y puerta fumé.	8423220039582	32,52	1	12



12 elementos. Dimensiones exteriores 302x247x104.					
8703	Color blanco.	8423220012134	28,88	1	10
8703PF	Caja y marco blanco y puerta fumé.	8423220012141	31,99	1	10



14 elementos. Dimensiones exteriores 362x250x104.					
5021	Color blanco.	8423220030237	38,36	1	11
5021PF	Caja y marco blanco y puerta fumé.	8423220030244	43,93	1	11



18 elementos. Dimensiones exteriores 409x247x104.					
8704	Color blanco.	8423220009967	41,41	1	10
8704PF	Caja y marco blanco y puerta fumé.	8423220010055	44,97	1	10



28 elementos. Dimensiones exteriores 362x438x104.					
5281	Color blanco.	8423220017603	58,42	1	5
5281PF	Caja y marco blanco y puerta fumé.	8423220017610	71,96	1	5



28 elementos. Dimensiones exteriores 362x438x125. Caja con mayor profundidad para poder cablear.					
5281A	Color blanco.	8423220253957	68,53	1	5
5281APF	Caja y marco blanco y puerta fumé.	8423220253964	C*	1	5



36+4 elementos. Dimensiones exteriores 423x353x104.					
8216	Color blanco.	8423220009936	60,73	1	5
8216PF	Caja y marco blanco y puerta fumé.	8423220009998	66,78	1	5



42 elementos. Dimensiones exteriores 362x542x115.					
5261	Color blanco.	8423220009066	72,77	1	4
5261PF	Caja y marco blanco y puerta fumé.	8423220009394	86,52	1	4

Dimensiones en mm - anchura x altura x profundidad.



ARELOS. Cajas de distribución de superficie



Referencia	Descripción	Código GTIN-13	PVP		
56 elementos. Dimensiones exteriores 362x686x104.					
5271	Color blanco.	8423220017627	102,68	1	5
5271PF	Caja y marco blanco y puerta fumé.	8423220017634	106,37	1	5

ARELOS. Cajas de distribución de empotrar con compartimento precintable



Referencia	Descripción	Código GTIN-13	PVP		
4 elementos. Dimensiones para empotrar 125x195x72. Dimensiones exteriores 150x247.					
8695C	Marco y puerta blancos.	8423220010369	14,81	1	30
8695CPF	Marco blanco y puerta fumé.	8423220010376	16,38	1	30



12 elementos + 4 precintables. Dimensiones para empotrar 382x226x72. Dimensiones exteriores 409x247.					
8680	Marco y puerta blancos.	8423220009776	32,45	1	12
8680PF	Marco blanco y puerta fumé.	8423220010017	38,16	1	12



16 elementos + 4 precintables. Dimensiones para empotrar 450x222x72. Dimensiones exteriores 477x247.					
8881	Marco y puerta blancos.	8423220012097	34,26	1	10
8881PF	Marco blanco y puerta fumé.	8423220012103	39,82	1	10



18 elementos + 4 precintables. Dimensiones para empotrar 533x226x72. Dimensiones exteriores 560x247.					
8880	Marco y puerta blancos.	8423220011311	47,81	1	9
8880PF	Marco blanco y puerta fumé.	8423220011328	53,53	1	9



20 elementos + 4 precintables. Dimensiones para empotrar 320x420x75. Dimensiones exteriores 362x438.					
5420	Marco y puerta blancos.	8423220011144	47,95	1	5
5420PF	Marco blanco y puerta fumé.	8423220011151	54,18	1	5



24 elementos + 4 precintables. Dimensiones para empotrar 400x330x72. Dimensiones exteriores 423x353.					
8203	Marco y puerta blancos.	8423220009912	49,38	1	5
8203PF	Marco blanco y puerta fumé.	8423220009974	51,47	1	5



30 elementos + 4 precintables. Dimensiones para empotrar 320x528x86. Dimensiones exteriores 362x544.					
5430	Marco y puerta blancos.	8423220017542	67,98	1	4
5430PF	Marco blanco y puerta fumé.	8423220017559	77,95	1	4



40 elementos + 4 precintables. Dimensiones para empotrar 320x670x75. Dimensiones exteriores 362x686.					
5440	Marco y puerta blancos.	8423220011198	93,35	1	5
5440PF	Marco blanco y puerta fumé.	8423220011175	99,76	1	5

ARELOS. Cajas de distribución de superficie con compartimento precintable



Referencia	Descripción	Código GTIN-13	PVP		
4 elementos. Dimensiones exteriores 150x225x95. Superficie.					
8699	Color blanco.	8423220011274	20,16	1	30
8699PF	Caja y marco blanco y puerta fumé.	8423220011281	21,49	1	30



Dimensiones en mm - anchura x altura x profundidad.



Referencia	Descripción	Código GTIN-13	PVP		
4 elementos. Dimensiones exteriores 165x300x95. Superficie.					
8209	Color blanco.	8423220011236	25,38	1	22
8209PF	Caja y marco blanco y puerta fumé.	8423220011243	28,28	1	22



12 elementos + 4 precintables. Dimensiones exteriores 407x247x104.					
8698	Color blanco.	8423220009950	45,26	1	10
8698PF	Caja y marco blanco y puerta fumé.	8423220010048	53,24	1	10



20 elementos + 4 precintables. Dimensiones exteriores 362x438x104.					
5421	Color blanco.	8423220017566	63,21	1	5
5421PF	Caja y marco blanco y puerta fumé.	8423220017573	71,16	1	5



24 elementos + 4 precintables. Dimensiones exteriores 423x353x104.					
8220	Color blanco.	8423220009943	60,97	1	5
8220PF	Caja y marco blanco y puerta fumé.	8423220010000	68,99	1	5



30 elementos + 4 precintables. Dimensiones exteriores 362x542x115.					
5431	Color blanco.	8423220030268	77,56	1	4
5431PF	Caja y marco blanco y puerta fumé.	8423220030275	92,93	1	4



40 elementos + 4 precintables. Dimensiones exteriores 362x686x104.					
5441	Color blanco.	8423220017580	99,99	1	5
5441PF	Caja y marco blanco y puerta fumé.	8423220017597	108,47	1	5

ARELOS. Conjunto para vivienda



Referencia	Descripción	Código GTIN-13	PVP		
Conjunto para vivienda de la serie Arelos: caja de distribución + caja ICT.					
5250ICT	28 elementos. Referencia 5250 o 5250PF + 5504/2.	8423220240940	125,06	1	1
5260ICT	42 elementos. Referencia 5260 o 5260PF + 5504/2.	8423220240957	141,23	1	1
5270ICT	56 elementos. Referencia 5270 o 5270PF + 5504/2.	8423220240964	162,94	1	1

ARELOS. Accesorios



Referencia	Descripción	Código GTIN-13	PVP		
Tapa ciega aislante en tiras. Pretroquelada. Cubre hasta 6 módulos libres en cajas para distribución.					
TA1300	Tapa cubre huecos. 6 módulos. Color marfil.	8423220051195	0,91	50	200
TA1300B	Tapa cubre huecos. 6 módulos. Color blanco.	8423220051201	0,91	50	200
TA1300G	Tapa cubre huecos. 6 módulos. Color gris.	8423220051218	0,91	50	200





Tapa ciega aislante para separación de mecanismos o para cubrir ventanas libres.					
100	Tapa cubre huecos. 1 módulo. Color marfil.	8423220051008	0,29	100	7.000
100B	Tapa cubre huecos. 1 módulo. Color blanco.	8423220010116	0,29	100	7.000
100G	Tapa cubre huecos. 1 módulos Color gris.	8423220004559	0,29	100	7.000

Dimensiones en mm - anchura x altura x profundidad.



Accede a la tarifa PVP actualizada

Referencia	Descripción	Código GTIN-13	PVP		
Peines de conexión tipo pin.					
P1P100010	Peine unipolar 56x1 módulo, sección 10 mm ² , 63A, longitud 1 m.	8423220092969	18,20	1	100
P2P21610	Peine bipolar 6x2 módulos, sección 10 mm ² , 63A, longitud 216 mm.	8423220070448	9,01	4	160
P2P100010	Peine bipolar 28x2 módulos, sección 10 mm ² , 63A, longitud 1 m.	8423220034082	42,11	1	50
P2P100016	Peine bipolar 28x2 módulos, sección 16 mm ² , 80A, longitud 1 m.	8423220053175	45,89	1	50
P3P100010	Peine tripolar 18x3 módulos, sección 10 mm ² , 63A, longitud 1 m.	8423220092976	48,35	1	50
P4P100010	Peine tetrapolar 14x4 módulos, sección 10 mm ² , 63A, longitud 1 m.	8423220087521	66,59	1	25
P4P100016	Peine tetrapolar 14x4 módulos, sección 16 mm ² , 80A, longitud 1 m.	8423220053243	84,03	1	25
Dispositivos de conexión de tierra y neutro.					
108P	8 bornes para cable hasta 6 mm ² y 2 hasta 16 mm ² .	8423220011304	6,25	40	640
112P	12 bornes para cable hasta 6 mm ² y 2 hasta 16 mm ² .	8423220045187	7,43	50	400
Dispositivos de conexión aislados. Material no propagador de la llama. 12 bornes para cable hasta 6mm² y 2 hasta 16mm².					
212N	Para conexión de neutro. Color Azul.	8423220042544	9,08	1	200
212TT	Para conexión de tierra. Color verde.	8423220033887	9,08	1	125
Placa interior de montaje.					
PL-MP28	Para fijación de elementos a la caja. Multiperforada.	8423220073999	4,11	1	125

*Consulta la tabla informativa de la serie Arelos. Pág. 131

Cajas de distribución de empotrar y de superficie





Descárgate toda la documentación técnica de la serie escaneando este código



CLÁSICA. Cajas de distribución de empotrar precintables



Referencia	Descripción	Código GTIN-13	PVP		
4 elementos. Dimensiones para empotrar 115x188x55.					
692	Tapa gris.	8423220006928	8,56	5	75
695	Tapa marfil.	8423220006959	7,79	5	75
695B	Tapa blanca.	8423220011489	7,79	5	75
4 elementos. Dimensiones para empotrar 115x188x55 + 40mm de altura de marco.					
695CB	Marco y puerta blanca.	8423220047419	14,39	1	54
695CBT	Marco blanco y puerta transparente.	8423220047426	14,86	1	54
695CG	Marco y puerta gris.	8423220047396	15,93	1	54
695CGT	Marco gris y puerta transparente.	8423220047402	16,42	1	54
695CM	Marco y puerta marfil.	8423220047433	15,08	1	54
695CMT	Marco marfil y puerta transparente.	8423220047440	15,59	1	54

Dimensiones en mm - anchura x altura x profundidad.





Referencia	Descripción	Código GTIN-13	PVP		
4 elementos. Dimensiones para empotrar 125x270x68.					
5218	Tapa gris.	8423220004283	12,18	1	34
5208	Tapa marfil.	8423220004269	11,68	1	34
5208B	Tapa blanca.	8423220011502	11,68	1	34



Referencia	Descripción	Código GTIN-13	PVP		
4 elementos. Dimensiones exteriores 115x188x55.					
199	Gris.	8423220001992	9,71	5	75
699	Marfil.	8423220006997	10,22	5	75
699B	Blanco.	8423220011496	10,22	5	75



Referencia	Descripción	Código GTIN-13	PVP		
4 elementos. Dimensiones exteriores 115x188x55 + 40mm de altura de marco.					
699CB	Marco y puerta blanca.	8423220047471	14,07	1	54
699CBT	Marco blanco y puerta transparente.	8423220047488	15,85	1	54
699CG	Marco y puerta gris.	8423220047457	15,09	1	54
699CGT	Marco gris y puerta transparente.	8423220047464	15,75	1	54
699CM	Marco y puerta marfil.	8423220047495	15,82	1	54
699CMT	Marco marfil y puerta transparente.	8423220047501	18,87	1	54



Referencia	Descripción	Código GTIN-13	PVP		
4 elementos. Dimensiones exteriores 125x270x68.					
5219	Gris.	8423220004306	13,92	1	34
5209	Marfil.	8423220004276	15,65	1	34
5209B	Blanco.	8423220011519	15,65	1	34

CLÁSICA. Cajas de distribución de empotrar con compartimento precintable



Referencia	Descripción	Código GTIN-13	PVP		
8 elementos + 4 precintables. Dimensiones para empotrar 277x188x55.					
779	Tapa gris.	8423220007796	16,15	1	30
679	Tapa marfil.	8423220006799	13,16	1	30
679B	Tapa blanca.	8423220011526	13,16	1	30



Referencia	Descripción	Código GTIN-13	PVP		
8 elementos + 4 precintables. Dimensiones para empotrar 277x188x55 + 40mm de altura de marco.					
679CB	Marco y puerta blanca.	8423220047532	23,56	1	24
679CBT	Marco blanco y puerta transparente.	8423220047549	25,13	1	24
679CG	Marco y puerta gris.	8423220047518	21,88	1	24
679CGT	Marco gris y puerta transparente.	8423220047525	23,73	1	24
679CM	Marco y puerta marfil.	8423220047556	22,93	1	24
679CMT	Marco marfil y puerta transparente.	8423220047563	24,99	1	24



Referencia	Descripción	Código GTIN-13	PVP		
12 elementos + 4 precintables. Dimensiones para empotrar 348x188x55.					
780	Tapa gris.	8423220007802	16,73	1	24
680	Tapa marfil.	8423220006805	16,91	1	24
680B	Tapa blanca.	8423220011533	16,91	1	24



Referencia	Descripción	Código GTIN-13	PVP		
12 elementos + 4 precintables. Dimensiones para empotrar 348x188x55 + 40mm de altura de marco.					
680CB	Marco y puerta blanca.	8423220047594	26,64	1	18
680CBT	Marco blanco y puerta transparente.	8423220047600	27,58	1	18
680CG	Marco y puerta gris.	8423220047570	25,31	1	18
680CGT	Marco gris y puerta transparente.	8423220047587	27,27	1	18
680CM	Marco y puerta marfil.	8423220047617	28,84	1	18
680CMT	Marco marfil y puerta transparente.	8423220047624	30,10	1	18

Dimensiones en mm - anchura x altura x profundidad.

[Accede a la tarifa PVP actualizada](#)

CLÁSICA. Cajas de distribución de empotrar con compartimento precintable



Referencia	Descripción	Código GTIN-13	PVP		
16 elementos + 4 precintables. Dimensiones para empotrar 420x188x55.					
881	Tapa gris.	8423220008816	20,76	1	19
880	Tapa marfil.	8423220008809	18,27	1	18
880B	Tapa blanca.	8423220011540	18,27	1	18



16 elementos + 4 precintables. Dimensiones para empotrar 420x188x55 + 40mm de altura de marco.					
880CB	Marco y puerta blanca.	8423220047655	29,09	1	16
880CBT	Marco blanco y puerta transparente.	8423220047662	32,87	1	16
880CG	Marco y puerta gris.	8423220047631	28,99	1	16
880CGT	Marco gris y puerta transparente.	8423220047648	30,98	1	16
880CM	Marco y puerta marfil.	8423220047679	34,34	1	16
880CMT	Marco marfil y puerta transparente.	8423220047686	35,55	1	16



24 elementos + 4 precintables. Dimensiones para empotrar 410x270x68.					
5200	Tapa gris.	8423220052000	42,37	1	11
5203	Tapa marfil.	8423220052031	33,13	1	11
5203B	Tapa blanca.	8423220011694	33,13	1	11



24 elementos + 4 precintables. Dimensiones para empotrar 420x188x55 + 40mm de altura de marco.					
5203CB	Marco y puerta blanca.	8423220049284	45,59	1	10
5203CBT	Marco blanco y puerta transparente.	8423220049291	46,85	1	10
5203CG	Marco y puerta gris.	8423220049260	54,11	1	10
5203CGT	Marco gris y puerta transparente.	8423220049277	56,95	1	10
5203CM	Marco y puerta marfil.	8423220049307	45,59	1	10
5203CMT	Marco marfil y puerta transparente.	8423220049314	46,85	1	10

CLÁSICA. Cajas de distribución de empotrar



Referencia	Descripción	Código GTIN-13	PVP		
10 elementos. Dimensiones para empotrar 230x188x55. Con tornillo para precintado.					
761	Tapa gris.	8423220007611	11,72	1	38
661	Tapa marfil.	8423220006614	10,43	1	38
661B	Tapa blanca.	8423220011557	10,43	1	38



10 elementos. Dimensiones para empotrar 230x188x55 + 40mm de altura de marco. Con tornillo para precintado.					
661CB	Marco y puerta blanca.	8423220059351	16,42	1	28
661CBT	Marco blanco y puerta transparente.	8423220060302	18,10	1	28
661CG	Marco y puerta gris.	8423220060302	16,99	1	28
661CGT	Marco gris y puerta transparente.	8423220060326	18,69	1	28
661CM	Marco y puerta marfil.	8423220060333	18,34	1	28
661CMT	Marco marfil y puerta transparente.	8423220060340	19,64	1	28



14 elementos. Dimensiones para empotrar 277x188x55.					
788	Tapa gris.	8423220007888	14,01	1	36
688	Tapa marfil.	8423220006881	12,09	1	36
688B	Tapa blanca.	8423220011564	12,09	1	36



14 elementos. Dimensiones para empotrar 277x188x55. + 40mm de altura de marco.					
688CB	Marco y puerta blanca.	8423220047716	18,97	1	24
688CBT	Marco blanco y puerta transparente.	8423220047723	21,04	1	24
688CG	Marco y puerta gris.	8423220047693	21,23	1	24
688CGT	Marco gris y puerta transparente.	8423220047709	22,33	1	24
688CM	Marco y puerta marfil.	8423220047730	21,29	1	24
688CMT	Marco marfil y puerta transparente.	8423220047747	23,42	1	24



Dimensiones en mm - anchura x altura x profundidad.



Referencia	Descripción	Código GTIN-13	PVP		
18 elementos. Dimensiones para empotrar 348x188x55.					
785	Tapa gris.	8423220007857	16,19	1	24
685	Tapa marfil.	8423220006850	15,57	1	24
685B	Tapa blanca.	8423220011571	15,57	1	24



18 elementos. Dimensiones para empotrar 348x188x55. + 40mm de altura de marco.					
685CB	Marco y puerta blanca.	8423220047778	25,52	1	18
685CBT	Marco blanco y puerta transparente.	8423220047785	26,64	1	18
685CG	Marco y puerta gris.	8423220047754	23,42	1	18
685CGT	Marco gris y puerta transparente.	8423220047761	25,39	1	18
685CM	Marco y puerta marfil.	8423220047792	26,51	1	18
685CMT	Marco marfil y puerta transparente.	8423220047808	27,58	1	18



38 elementos. Dimensiones para empotrar 410x270x68.					
5207	Tapa gris.	8423220000667	35,93	1	10
5206	Tapa marfil.	8423220000650	31,68	1	11
5206B	Tapa blanca.	8423220011731	31,68	1	11



38 elementos. Dimensiones para empotrar 410x270x68. + 40mm de altura de marco.					
5206CB	Marco y puerta blanca.	8423220049406	43,63	1	10
5206CBT	Marco blanco y puerta transparente.	8423220049413	44,89	1	10
5206CG	Marco y puerta gris.	8423220049383	46,99	1	10
5206CGT	Marco gris y puerta transparente.	8423220049390	49,84	1	10
5206CM	Marco y puerta marfil.	8423220049420	45,36	1	10
5206CMT	Marco marfil y puerta transparente.	8423220049437	46,90	1	10

CLÁSICA. Cajas de distribución de superficie con compartimento precintable



Referencia	Descripción	Código GTIN-13	PVP		
6 elementos + 4 precintables. Dimensiones exteriores 235x188x55.					
191	Gris.	8423220001916	17,40	1	39
691	Marfil.	8423220006911	17,89	1	39
691B	Blanco.	8423220011588	17,89	1	39



6 elementos + 4 precintables. Dimensiones exteriores 235x188x55 + 40mm de altura de marco.					
691CB	Marco y puerta blanca.	8423220047839	22,46	1	24
691CBT	Marco blanco y puerta transparente.	8423220047846	25,51	1	24
691CG	Marco y puerta gris.	8423220047815	23,80	1	24
691CGT	Marco gris y puerta transparente.	8423220047822	25,41	1	24
691CM	Marco y puerta marfil.	8423220047853	27,48	1	24
691CMT	Marco marfil y puerta transparente.	8423220047860	28,56	1	24



8 elementos + 4 precintables. Dimensiones exteriores 277x188x55.					
197	Gris.	8423220001978	18,97	1	36
697	Marfil.	8423220006973	20,44	1	36
697B	Blanco.	8423220011595	20,44	1	36



8 elementos + 4 precintables. Dimensiones exteriores 277x188x55 + 40mm de altura de marco.					
697CB	Marco y puerta blanca.	8423220047891	26,22	1	24
697CBT	Marco blanco y puerta transparente.	8423220047907	28,18	1	24
697CG	Marco y puerta gris.	8423220047877	27,65	1	24
697CGT	Marco gris y puerta transparente.	8423220047884	28,91	1	24
697CM	Marco y puerta marfil.	8423220047914	30,36	1	24
697CMT	Marco marfil y puerta transparente.	8423220047921	30,14	1	24

Dimensiones en mm - anchura x altura x profundidad.

[Accede a la tarifa PVP actualizada](#)

CLÁSICA. Cajas de distribución de superficie con compartimento precintable



Referencia	Descripción	Código GTIN-13	PVP		
12 elementos + 4 precintables. Dimensiones exteriores 348x188x55.					
198	Gris.	8423220001985	23,56	1	24
698	Marfil.	8423220006980	22,68	1	24
698B	Blanco.	8423220011601	22,68	1	24



12 elementos + 4 precintables. Dimensiones exteriores 348x188x55 + 40mm de altura de marco.					
698CB	Marco y puerta blanca.	8423220047952	31,19	1	18
698CBT	Marco blanco y puerta transparente.	8423220049048	32,57	1	18
698CG	Marco y puerta gris.	8423220047938	30,29	1	18
698CGT	Marco gris y puerta transparente.	8423220047945	32,59	1	18
698CM	Marco y puerta marfil.	8423220049055	36,47	1	18
698CMT	Marco marfil y puerta transparente.	8423220049130	37,35	1	18



24 elementos + 4 precintables. Dimensiones exteriores 410x270x68.					
5210	Gris.	8423220002814	42,37	1	11
5220	Marfil.	8423220002845	39,66	1	11
5220B	Blanco.	8423220011717	39,66	1	11



24 elementos + 4 precintables. Dimensiones exteriores 410x270x68 + 40mm de altura de marco.					
5220CB	Marco y puerta blanca.	8423220049345	52,12	1	10
5220CBT	Marco blanco y puerta transparente.	8423220049352	54,53	1	10
5220CG	Marco y puerta gris.	8423220049321	54,11	1	10
5220CGT	Marco gris y puerta transparente.	8423220049338	56,95	1	10
5220CM	Marco y puerta marfil.	8423220049369	56,88	1	10
5220CMT	Marco marfil y puerta transparente.	8423220049376	58,94	1	10

CLÁSICA. Cajas de distribución de superficie



Referencia	Descripción	Código GTIN-13	PVP		
12 elementos. Dimensiones exteriores 240x192x68.					
694G	Gris.	8423220059764	14,89	1	36
694	Marfil.	8423220006942	16,84	1	36
694B	Blanco.	8423220011663	16,84	1	36



12 elementos. Dimensiones exteriores 240x192x68 + 40mm de altura de marco.					
694CB	Marco y puerta blanca.	8423220049147	22,12	1	24
694CBT	Marco blanco y puerta transparente.	8423220049154	23,73	1	24
694CG	Marco y puerta gris.	8423220059610	22,35	1	24
694CGT	Marco gris y puerta transparente.	8423220060357	24,08	1	24
694CM	Marco y puerta marfil.	8423220049161	26,18	1	24
694CMT	Marco marfil y puerta transparente.	8423220049178	27,58	1	24



14 elementos. Dimensiones exteriores 280x192x68.					
703G	Gris.	8423220060364	16,15	1	30
703	Marfil.	8423220007031	18,31	1	36
703B	Blanco.	8423220011670	18,31	1	36



Dimensiones en mm - anchura x altura x profundidad.



Referencia	Descripción	Código GTIN-13	PVP		
14 elementos. Dimensiones exteriores 280x192x68 + 40mm de altura de marco.					
703CB	Marco y puerta blanca.	8423220049185	24,29	1	24
703CBT	Marco blanco y puerta transparente.	8423220049192	26,91	1	24
703CG	Marco y puerta gris.	8423220060371	24,47	1	24
703CGT	Marco gris y puerta transparente.	8423220060388	26,43	1	24
703CM	Marco y puerta marfil.	8423220049208	27,97	1	24
703CMT	Marco marfil y puerta transparente.	8423220049215	29,19	1	24



18 elementos. Dimensiones exteriores 348x192x68.					
704G	Gris.	8423220060395	18,20	1	24
704	Marfil.	8423220007048	19,99	1	24
704B	Blanco.	8423220011687	19,99	1	24



18 elementos. Dimensiones exteriores 348x192x68 + 40mm de altura de marco.					
704CB	Marco y puerta blanca.	8423220049222	29,65	1	18
704CBT	Marco blanco y puerta transparente.	8423220049239	32,57	1	18
704CG	Marco y puerta gris.	8423220060401	27,79	1	18
704CGT	Marco gris y puerta transparente.	8423220060418	29,05	1	18
704CM	Marco y puerta marfil.	8423220049246	35,56	1	18
704CMT	Marco marfil y puerta transparente.	8423220049253	36,12	1	18



38 elementos. Dimensiones exteriores 410x270x68.					
5217	Gris.	8423220002838	35,49	1	11
5216	Marfil.	8423220002852	37,70	1	11
5216B	Blanco.	8423220011748	37,70	1	11



38 elementos. Dimensiones exteriores 410x270x68 + 40mm de altura de marco.					
5216CB	Marco y puerta blanca.	8423220049468	49,90	1	10
5216CBT	Marco blanco y puerta transparente.	8423220049475	52,82	1	10
5216CG	Marco y puerta gris.	8423220049444	48,06	1	10
5216CGT	Marco gris y puerta transparente.	8423220049451	49,88	1	10
5216CM	Marco y puerta marfil.	8423220049482	43,63	1	10
5216CMT	Marco marfil y puerta transparente.	8423220049499	45,44	1	10



2 elementos. Precintables. Dimensiones exteriores 40x140x58.					
689	Marfil.	8423220006898	3,66	10	230
689B	Blanco.	8423220011618	3,66	10	230



4 elementos. Precintable. Dimensiones exteriores 82x172x61.					
670	Marfil.	8423220058057	5,12	1	140
670B	Blanco.	8423220007260	5,12	1	140



6 elementos. Precintable. Dimensiones exteriores 120x140x58.					
621	Marfil.	8423220006218	6,91	5	100
621B	Blanco.	8423220011649	6,91	5	100



8 elementos. Precintable. Dimensiones exteriores 178x140x58.					
696	Marfil.	8423220006966	9,06	5	80
696B	Blanco.	8423220011656	9,06	5	80

Dimensiones en mm - anchura x altura x profundidad.

[Accede a la tarifa PVP actualizada](#)



Referencia	Descripción	Código GTIN-13	PVP		
Para Referencia 5200, 5203, 5203B, 5206, 5206B, 5207, 5210, 5216, 5216B, 5217, 5220 y 5220B. Altura del marco 40 mm.					
5201	Marco y puerta gris.	8423220052017	15,79	1	22
5202	Marco gris y puerta transparente.	8423220052024	18,87	1	22
5204	Marco y puerta marfil.	8423220052048	17,47	1	22
5205	Marco marfil y puerta transparente.	8423220052055	20,72	1	22
5204B	Marco y puerta blanca.	8423220011755	17,47	1	22
5205B	Marco blanco y puerta transparente.	8423220011816	20,72	1	22



Para Referencia 197, 679, 679B, 688, 688B, 697, 697B, 703, 703B, 703G, 779 y 788. Altura del marco 40 mm.					
5211	Marco y puerta gris.	8423220052116	9,09	1	44
5212	Marco gris y puerta transparente.	8423220052123	10,81	1	30
5213	Marco y puerta marfil.	8423220052130	10,12	1	44
5214	Marco marfil y puerta transparente.	8423220052147	11,03	1	44
5213B	Marco y puerta blanca.	8423220011786	10,12	1	44
5214B	Marco blanco y puerta transparente.	8423220011847	11,03	1	30



Para Referencia 198, 680, 680B, 685, 685B, 698, 698B, 704, 704B, 704G, 780 y 785. Altura del marco 40 mm.					
5221	Marco y puerta gris.	8423220052215	9,85	1	34
5222	Marco gris y puerta transparente.	8423220052222	11,79	1	34
5223	Marco y puerta marfil.	8423220052239	12,08	1	34
5224	Marco marfil y puerta transparente.	8423220052246	12,95	1	34
5223B	Marco y puerta blanca.	8423220011779	12,08	1	34
5224B	Marco blanco y puerta transparente.	8423220011830	12,95	1	34



Para Referencia 880, 880B y 881. Altura del marco 40 mm.					
5231	Marco y puerta gris.	8423220052314	13,11	1	28
5232	Marco gris y puerta transparente.	8423220052321	14,39	1	28
5233	Marco y puerta marfil.	8423220052338	14,39	1	28
5234	Marco marfil y puerta transparente.	8423220052345	16,45	1	28
5233B	Marco y puerta blanca.	8423220011762	14,39	1	28
5234B	Marco blanco y puerta transparente.	8423220011823	16,45	1	28



Para Referencia 191, 661, 661B, 691, 691B, 694, 694B, 694G y 761. Altura del marco 40 mm.					
5241	Marco y puerta gris.	8423220000315	8,41	1	45
5242	Marco gris y puerta transparente.	8423220000322	9,82	1	45
5243	Marco y puerta marfil.	8423220000339	8,61	1	45
5244	Marco marfil y puerta transparente.	8423220000346	10,08	1	45
5243B	Marco y puerta blanca.	8423220011793	8,61	1	45
5244B	Marco blanco y puerta transparente.	8423220011854	10,08	1	45



Para Referencia 199, 692, 695, 695B, 699 y 699B. Altura del marco 40 mm.					
5251	Marco y puerta gris.	8423220001640	5,84	1	105
5252	Marco gris y puerta transparente.	8423220001657	6,30	1	105
5253	Marco y puerta marfil.	8423220001664	6,13	1	105
5254	Marco marfil y puerta transparente.	8423220001671	6,97	1	105
5253B	Marco y puerta blanca.	8423220011809	6,13	1	105
5254B	Marco blanco y puerta transparente.	8423220011861	6,97	1	105



Dimensiones en mm - anchura x altura x profundidad.



Soluciones para vivienda de la serie Metalbox: caja de distribución + caja ICT

Soluciones para vivienda de la serie Arelos: caja de distribución + caja ICT



Descárgate la documentación técnica de la serie



Productos complementarios



Pág. 06



Pág. 09



Pág. 113



Pág. 116

ICT. Registros de Terminación de red



Referencia	Descripción	Código GTIN-13	PVP		
Para instalación empotrada. Dimensiones exteriores 730x544x113. Dimensiones para empotrar 688x526x86. Fabricados en material termoplástico. Puertas con rejillas para disipación de calor. Enlazables horizontal y verticalmente (Se suministran enlaces). Con tubos de Ø 50 mm para conexión entre cajas. Con separadores interiores incluidos.					
5504/2	Registro vacío.	8423220056084	88,14	1	1
5504/2B	Con 2 tomas de corriente 2P+T 16A 250V~.	8423220061361	97,20	1	1
5504/2L	Registro vacío. Con 2 cerraduras y llaves metálicas.	8423220060999	125,06	1	1
5504/2BL	Con 2 tomas de corriente 2P+T 16A 250V~. Con 2 cerraduras y llaves metálicas.	8423220064331	139,97	1	1



Referencia	Descripción	Código GTIN-13	PVP		
Para instalación empotrada. Dimensiones exteriores 725x544x113. Dimensiones para empotrar 723x526x86. Puertas con rejillas para disipación de calor. Enlazables horizontal y verticalmente. (Se suministran enlaces). Sin separadores interiores.					
5560/2	Registro vacío. Con 1 placa montaje.	8423220098145	96,10	1	1
5560/2B	Con 2 tomas de corriente 2P+T 16A 250V~. Con 1 placa montaje.	8423220098152	102,41	1	1
5560/2L	Registro vacío. Con 1 placa montaje. Con 2 cerraduras y llaves metálicas.	8423220227194	156,52	1	1
5560/2BL	Con 5 placas de montaje. Con 2 tomas de corriente 2P+T 16A 250V~. Con perfil DIN de 35 mm. Con 2 cerraduras y llaves metálicas.	8423220069022	163,84	1	1



Referencia	Descripción	Código GTIN-13	PVP		
Para instalación en superficie. Dimensiones exteriores 725x543x115. Fabricados en material termoplástico. Puertas con rejillas para disipación de calor. Enlazables horizontal y verticalmente (se suministran enlaces). Con 5 placas de montaje para elementos activos y pasivos de telecomunicaciones. Con perfil DIN de 35 mm. Con tubos de Ø 50 mm para conexión entre cajas. Con separadores interiores incluidos.					
5508/2B	Con 2 tomas de corriente 2P+T 16A 250V~.	8423220218949	163,72	1	2
5508/2BL	Con 2 tomas de corriente 2P+T 16A 250V~. Con 2 cerraduras y llaves metálicas.	8423220069015	257,46	1	2

ICT. Registros de Terminación de red con marco y puerta metálicos



Referencia	Descripción	Código GTIN-13	PVP		
Para instalación empotrada. Dimensiones exteriores 727x643x97. Dimensiones para empotrar 695x613x88. Caja fabricada en material termoplástico color gris. Marcos y puertas METÁLICOS. Puertas con rejillas para disipación de calor. Enlazables horizontal y verticalmente (se suministran enlaces). Con tubos de Ø 50 mm para conexión entre cajas. Sin separadores interiores.					
MP42/2	Registro con placa de montaje. Marco y puerta color blanco.	8423220068926	260,08	1	2
MP42/2NG	Registro con placa de montaje. Marco y puerta color grafito.	8423220246584	C*	1	2
MP42/2B	Con 5 placas de montaje y 2 tomas de corriente 2P+T 16A 250V~. Marco y puerta color blanco.	8423220068933	279,76	1	2
CER-MP28	Conjunto de bombín y 2 llaves.	8423220067943	23,42	1	1



Referencia	Descripción	Código GTIN-13	PVP		
Para instalación empotrada. Dimensiones para empotrar 720 x 528 x 86. Marcos y puertas METÁLICOS color blanco. Puertas con rejillas para disipación de calor.					
5260RTR	Registro de terminación de red. De empotrar. Vacío	8423220251755	267,58	1	1
5260RTR/B	Registro de terminación de red. De empotrar. Con 2 bases 2P+T, 16A 250V~	8423220251762	274,19	1	2



Referencia	Descripción	Código GTIN-13	PVP		
Para instalación empotrada. Con un marco y dos puertas. Dimensiones para empotrar 720 x 528 x 86. Marcos y puertas METÁLICOS color blanco. Puertas con rejillas para disipación de calor.					
5260RTR/2	Registro de terminación de red. De empotrar. Vacío.	8423220251779	299,88	1	1
5260RTR/2B	Registro de terminación de red. De empotrar. Con 2 bases 2P+T, 16A 250V~.	8423220251786	306,29	1	1

ICT. Registros Secundarios



Referencia	Descripción	Código GTIN-13	PVP		
450x450x150. Registros metálicos. Se puede instalar como registro de enlace. Con cerradura y llave metálica.					
454515E-ICT	Instalación empotrada. IP34.	8423220009868	178,89	1	1
454515S-ICT	Instalación en superficie. IP55.	8423220009875	178,89	1	1



Referencia	Descripción	Código GTIN-13	PVP		
Registros metálicos. Se puede instalar como registro de enlace. Con cerradura y llave metálica.					
507015S-ICT	Instalación vertical en superficie. IP55. 500x700x150.	8423220040878	261,61	1	1
705015E-ICT	Instalación horizontal empotrada. IP34. 700x500x150.	8423220039636	261,61	1	1



Dimensiones en mm - anchura x altura x profundidad.



Referencia	Descripción	Código GTIN-13	PVP		
1000x550x150. Registros metálicos. Con cerradura y llave metálica.					
1005515E-ICT	Instalación horizontal empotrada. IP34.	8423220009882	344,21	1	1
1005515S-ICT	Instalación horizontal en superficie. IP55.	8423220009899	344,21	1	1



550x1000x150. Registros metálicos. Con cerradura y llave metálica.					
5510015S-ICT	Instalación vertical en superficie. IP55.	8423220009905	344,21	1	1



Marcos y puerta metálico color blanco. Con cerradura y llave metálica.					
MP4545-ICT	Para tapar hueco de obra. Dimensiones exteriores 450x450.	8423220048225	115,52	1	1
MP7050-ICT	Para tapar hueco de obra. Dimensiones exteriores 700x500.	8423220053342	155,91	1	1
MP5045ICT60	Para tapar hueco de obra. El60. Dimensiones exteriores 500x450.	8423220250000	449,72	1	1
MP7050ICT60	Para tapar hueco de obra. El60. Dimensiones exteriores 700x500.	8423220250017	611,42	1	1
MP10055ICT60	Para tapar hueco de obra. El60. Dimensiones exteriores 1000x550.	8423220249509	912,88	1	1

ICT. Registros de paso



Referencia	Descripción	Código GTIN-13	PVP		
Dimensiones para empotrar 100x100x45.					
362	Registro de paso Tipo B. 12 entradas para tubo Ø 25. Tapa con tornillos.	8423220003620	2,41	4	168



Dimensiones para empotrar 160x100x50.					
363	Registro de paso Tipo C. 16 entradas para tubo Ø 25. Tapa con tornillos.	8423220003637	3,29	5	110



Para tabique hueco.					
5363	Registro de paso Tipo C. 14 entradas para tubo Ø 32 y 10 entradas para tubo Ø 40. Tapa para tornillos. Dimensiones para empotrar 164x106x47	8423220011137	6,65	5	110
5362	Registro de paso Tipo C. 12 entradas para tubo Ø 25. Tapa con tornillos. Dimensiones para empotrar 100x100x45.	8423220044494	4,57	4	168

ICT. Accesorios



Referencia	Descripción	Código GTIN-13	PVP		
Marco y puerta de material termoplástico color blanco.					
5505REJ	Marco y puerta embellecedora con rejilla de ventilación. Para reposición en las Refs. 5504/2, 5560/2 y 5508/2.	8423220096349	25,62	1	12



Placa interior de montaje.					
PL-MP28	Para fijación de elementos a la caja. Multiperforada.	8423220073999	4,11	1	125



Cerradura.					
CER-1300L2	Cerradura metálica para armarios 5560 y versiones.	8423220095489	21,53	1	20



Cerradura para Metalbox.					
CER-MP28	Conjunto de bombín y 2 llaves.	8423220067943	23,42	1	1

Dimensiones en mm - anchura x altura x profundidad.



Cajas industriales de distribución IP65, IK08



Descárgate la
documentación técnica
y vídeos de montaje



Ventajas de la serie



Tornillos INOX de cierre rápido



Amplio espacio para cableado:
45mm

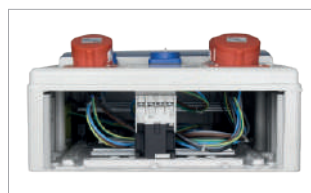

140mm de profundidad



Enlazables



Applus[®]

Productos complementarios



Pág. 106



Pág. 33



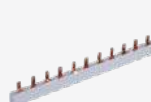

Pág. 113



Pág. 106



Pág. 106

Referencia	Descripción	Código GTIN-13	PVP		
3 elementos. Dimensiones exteriores 85x155x100.					
1303	Lateral liso.	8423220057043	22,65	1	50
4 elementos. Dimensiones exteriores 120x200x115.					
1304	Laterales pretroquelados.	8423220013049	26,51	1	33
6 elementos. Dimensiones exteriores 170x200x115.					
1306B	Laterales pretroquelados.	8423220057067	29,97	1	24
8 elementos. Dimensiones exteriores 215x200x115.					
1308B	Laterales lisos-punteados.	8423220057081	34,12	1	18
8 elementos. Dimensiones exteriores 215x200x160.					
1308A	Laterales lisos-punteados.	8423220057074	36,29	1	12
11 elementos. Dimensiones exteriores 270x250x160.					
1311A	Laterales lisos-punteados.	8423220063280	51,91	1	10
12 elementos. Dimensiones exteriores 270x250x160.					
1312	Laterales lisos-punteados.	8423220057098	49,47	1	10
22 elementos. Dimensiones exteriores 270x500x160.					
1322	Laterales lisos-punteados.	8423220087033	89,43	1	5
36 elementos. Dimensiones exteriores 362x362x160.					
1336	Laterales lisos-punteados.	8423220231689	119,01	1	6
48 elementos. Dimensiones exteriores 362x500x160.					
1348	Laterales lisos-punteados.	8423220050617	143,77	1	4

Dimensiones en mm - anchura x altura x profundidad.

[Accede a la tarifa PVP actualizada](#)



Referencia	Descripción	Código GTIN-13	PVP		
8 elementos. Dimensiones exteriores 215x500x160. Enlazable con todas las refs. 1308, 1311, 1316, 1322, 1332, 1348, 820 y 821. Tapa lisa.					
1308	Laterales lisos-punteados.	8423220045705	64,81	1	6



8 elementos. Dimensiones exteriores 215x500x160. Enlazable con todas las refs. 1308, 1311, 1316, 1322, 1332, 1348, 820 y 821. Tapa con 1 ventana para base industrial trascuadro.					
1308V1	Laterales lisos-punteados.	8423220049581	64,81	1	6

(Ver página 34 para conocer el marco y toma que le corresponde)



8 elementos. Dimensiones exteriores 215x500x160. Enlazable con todas las refs. 1308, 1311, 1316, 1322, 1332, 1348, 820 y 821. Tapa con 3 ventanas para bases industriales trascuadro.					
1308V3	Laterales lisos-punteados.	8423220049680	64,81	1	6

(Ver página 34 para conocer el marco y toma que le corresponde)



11 elementos. Dimensiones exteriores 270x500x160. Enlazable con todas las refs. 1308, 1311, 1316, 1322, 1332, 1348, 820 y 821. Tapa lisa.					
1311	Laterales lisos-punteados.	8423220045767	74,87	1	5



11 elementos. Dimensiones exteriores 270x500x160. Enlazable con todas las refs. 1308, 1311, 1316, 1322, 1332, 1348, 820 y 821. Tapa con 2 ventanas para tomas interbloqueantes trascuadro.					
1311V2	Laterales lisos-punteados.	8423220049864	74,87	1	5

(Ver página 34 para conocer el marco y toma que le corresponde)



11 elementos. Dimensiones exteriores 270x500x160. Enlazable con todas las refs. 1308, 1311, 1316, 1322, 1332, 1348, 820 y 821. Tapa con 4 ventanas para bases industriales trascuadro.					
1311V4	Laterales lisos-punteados.	8423220049963	74,87	1	5

(Ver página 34 para conocer el marco y toma que le corresponde)



16 elementos. Dimensiones exteriores 362x500x160. Enlazable con todas las refs. 1308, 1311, 1316, 1322, 1332, 1348, 820 y 821. Tapa lisa.					
1316	Laterales lisos-punteados.	8423220044876	117,81	1	4



16 elementos. Dimensiones exteriores 362x500x160. Enlazable con todas las refs. 1308, 1311, 1316, 1322, 1332, 1348, 820 y 821. Tapa con 3 ventanas para tomas interbloqueantes trascuadro.					
1316V3	Laterales lisos-punteados.	8423220050143	117,81	1	4

(Ver página 34 para conocer el marco y toma que le corresponde)



16 elementos. Dimensiones exteriores 362x500x160. Enlazable con todas las refs. 1308, 1311, 1316, 1322, 1332, 1348, 820 y 821. Tapa con 6 ventanas para bases industriales trascuadro.					
1316V6	Laterales lisos-punteados.	8423220048171	117,81	1	4

(Ver página 34 para conocer el marco y toma que le corresponde)



32 elementos. Dimensiones exteriores 362x500x160. Enlazable con todas las refs. 1308, 1311, 1316, 1322, 1332, 1348, 820 y 821. Tapa lisa.					
1332	Laterales lisos-punteados.	8423220048003	147,71	1	4



32 elementos. Dimensiones exteriores 362x500x160. Enlazable con todas las refs. 1308, 1311, 1316, 1322, 1332, 1348, 820 y 821. Tapa con 3 ventanas para tomas interbloqueantes trascuadro.					
1332V3	Laterales lisos-punteados.	8423220050419	147,71	1	4

(Ver página 34 para conocer el marco y toma que le corresponde)



Dimensiones en mm - anchura x altura x profundidad.



Referencia	Descripción	Código GTIN-13	PVP		
32 elementos. Dimensiones exteriores 362x500x160. Enlazable con todas las refs. 1308, 1311, 1316, 1322, 1332, 1348, 820 y 821. Tapa con 6 ventanas para bases industriales trescuadro.					
1332V6	Laterales lisos-punteados.	8423220053809	147,71	1	4

(Ver página 34 para conocer el marco y toma que le corresponde)

INDUBOX. Cajas de conexión IP65, IK08



Referencia	Descripción	Código GTIN-13	PVP		
IP65. IK08. Dimensiones exteriores 215x200x140. Dimensiones interiores 207x192x131. Lateral liso.					
818A	Tornillos INOX de cierre rápido. Tapa lisa.	8423220084452	27,11	1	18



IP65, IK08. Dimensiones exteriores 215x200x95. Dimensiones interiores 207x192x86. Lateral liso.					
818B	Tornillos INOX de cierre rápido. Tapa lisa.	8423220084469	24,82	1	22



Referencia	Descripción	Código GTIN-13	PVP		
IP65. IK08. Dimensiones exteriores 270x250x160. Dimensiones interiores 207x192x131. Lateral liso.					
819	Tornillos INOX de cierre ultra rápido. Tapa lisa.		C*	1	18



IP65. IK08. Dimensiones exteriores 270x500x140. Dimensiones interiores 263x493x129. Tapa lisa. Enlazable con todas las refs. 1311, 1316, 1332, 1348, 820 y 821. Tornillos INOX de cierre rápido.					
820	Laterales lisos-punteados.	8423220048089	69,45	1	6



Dimensiones exteriores 270x500x140. Dimensiones interiores 263x493x129. Tapa con 6 ventanas para bases industriales trescuadro. Enlazable con todas las refs. 1311, 1316, 1332, 1348, 820 y 821. Tornillos INOX de cierre rápido.					
820V6	Laterales lisos-punteados.	8423220048119	69,45	1	6



IP65. IK08. Dimensiones exteriores 362x500x140. Dimensiones interiores 355x493x129. Tapa lisa. Enlazable con todas las refs. 1311, 1316, 1332, 1348, 820 y 821. Tornillos INOX de cierre rápido.					
821	Laterales lisos-punteados.	8423220044951	79,41	1	5



Dimensiones exteriores 362x500x140. Dimensiones interiores 355x493x129. Tapa con 9 ventanas para bases industriales trescuadro. Enlazable con todas las refs. 1311, 1316, 1332, 1348, 820 y 821. Tornillos INOX de cierre rápido.					
821V9	Laterales lisos-punteados.	8423220048133	79,41	1	5



IP65. IK08. Dimensiones exteriores 362x362x140. Dimensiones interiores 354x354x131. Tapa lisa. Tornillos INOX de cierre rápido.					
822	Laterales lisos-punteados.	8423220227453	56,12	1	6

*Consulta la Tabla informativa de la serie indubox. Pág. 134



Cuadros a medida

Entra en nuestra **nueva Web** y solicita tu presupuesto a medida.

Cuadros de control de strings



Referencia	Descripción	Código GTIN-13	PVP		
Cuadros DC de conexión y protección para instalaciones fotovoltaicas con interruptor de corte, varias entradas/una salida.					
FV211016-63	Cuadro fotovoltaica 1000VDC. Máx. 63A DC 2 entradas	8423220229594	385,74	1	1
FV311016-63	Cuadro fotovoltaica 1000VDC. Máx. 63A DC 3 entradas	8423220229600	452,21	1	1
FV411016-63	Cuadro fotovoltaica 1000VDC. Máx. 63A DC 4 entradas	8423220229617	526,02	1	1
FV511016-63	Cuadro fotovoltaica 1000VDC. Máx. 63A DC 5 entradas	8423220229624	569,07	1	1
FV511016-125	Cuadro fotovoltaica 1000VDC. Máx. 125A DC 5 entradas	8423220232242	592,24	1	1
FV611016-125	Cuadro fotovoltaica 1000VDC. Máx. 125A DC 6 entradas	8423220229631	753,34	1	1



Referencia	Descripción	Código GTIN-13	PVP		
Cuadros DC de conexión y protección para instalaciones fotovoltaicas, varias entradas/varias salidas.					
FV111016	Cuadro fotovoltaica 1.000 Vdc. 1 entradas MC4 / 1 salidas	8423220229648	248,68	1	1
FV221016	Cuadro fotovoltaica 1.000 Vdc. 2 entradas MC4 / 2 salidas	8423220229655	473,47	1	1
FV331016	Cuadro fotovoltaica 1.000 Vdc. 3 entradas MC4 / 3 salidas	8423220229662	717,40	1	1
FV441016	Cuadro fotovoltaica 1.000 Vdc. 4 entradas MC4 / 4 salidas	8423220229679	890,02	1	1
FV551016	Cuadro fotovoltaica 1.000 Vdc. 5 entradas MC4 / 5 salidas	8423220229686	1091,02	1	1
FV661016	Cuadro fotovoltaica 1.000 Vdc. 6 entradas MC4 / 6 salidas	8423220229693	1300,43	1	1

Cuadros provisionales de obra e industriales



Referencia	Descripción	Código GTIN-13	PVP		
Cuadro de obra formado por dos cajas de 11 elementos. Dimensiones exteriores 540x500x160.					
1311P-CPI16	<ul style="list-style-type: none"> • 1 Kit Unión M-40. • 4 Bases Schuko 1P+N+T, 16A 250V~. IP67. • 2 Bases interblocantes 3P+T, 16A 400V~. IP67. • 2 Magnetotérmicos 1P+N, 16A. • 1 Magnetotérmico 3P, 16A. • 1 Magnetotérmico 4P, 40A. • 1 Diferencial 4P, 40A, 30mA. • 1 Bobina de mínima. • 1 Limitador de Sobretensiones transitorias 4P. • 1 Seta de emergencia. 	8423220063389	C*	1	1



Dimensiones en mm - anchura x altura x profundidad.



Referencia	Descripción	Código GTIN-13	PVP		
Cuadro de obra de 16 elementos. Dimensiones exteriores 362x500x160. Enlazable con todas las refs. 1311, 1316 y 1332.					
1316P-CPI97	<ul style="list-style-type: none"> • 3 Bases interbloqueantes 1P+N+T, 16A 250V~. IP67. • 2 Magnetotérmicos 2P, 16A. • 1 Magnetotérmico 2P, 25A. • 1 Diferencial 2P, 25A, 30mA. • 1 Bobina de mínima. • 1 Limitador de sobretensiones transitoria 2P. • 1 Seta de emergencia. 	8423220072732	C*	1	1



Cuadro industrial montado de 11 elementos. Dimensiones exteriores 270x500x160. Enlazable con todas las refs. 1311, 1316 y 1332.					
1311P-I14	<ul style="list-style-type: none"> • 4 Bases Schuko 1P+N+T, 16A 250V~. IP67. • 2 Magnetotérmicos 1P+N, 16A. • 1 Magnetotérmico 1P+N, 25A. • 1 Diferencial 2P, 25A, 30mA. • 1 Bobina de mínima. • 1 Limitador de Sobretensiones transitorias 2P. • 1 Seta de emergencia. 	8423220059825	C*	1	1

Cuadros de protección de puestos de recarga

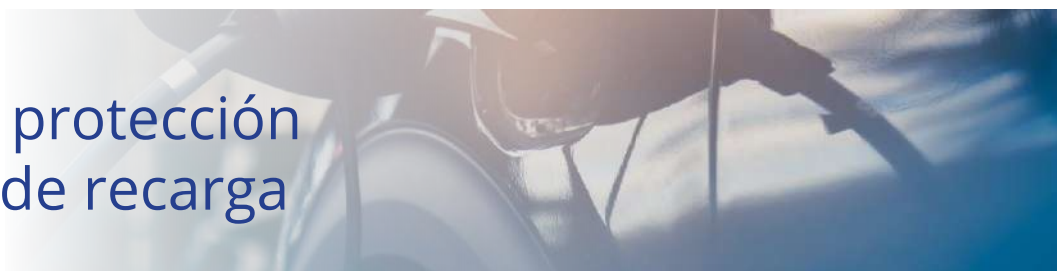

Referencia	Descripción	Código GTIN-13	PVP		
Cuadros de protección para puntos de recarga (Modo 3) + punto de recarga (Modo 1 y 2). 22 elementos. Dimensiones exteriores 270x500x160.					
1322P-VH2	<p>Protección general</p> <ul style="list-style-type: none"> • Protección IGA 2P, 50A. Clase C. 6kA. • Limitador sobretensiones permanente. • Limitador sobretensiones transitoria. <p>Protección para punto de recarga (Modo 3)</p> <ul style="list-style-type: none"> • Protección magnetotérmica 2P, 40A. Curva C. 6kA. • Protector diferencial superinmunizado. 2P, 40A, 30mA. • Potencia máxima: 9,2kW. <p>Punto de recarga (Modo 2)</p> <ul style="list-style-type: none"> • Protección magnetotérmica 2P, 10A. Curva C. 6kA. • Toma de carril DIN Schuko 2P+T, 16A, 250V. • Protector diferencial superinmunizado. 2P, 40A, 30mA. • Potencia máxima: 2,3kW. 	8423220232587	C*	1	1



Cuadros de protección para puntos de recarga (Modo 3) + punto de recarga (Modo 1 y 2). 22 elementos. Dimensiones exteriores 270x500x160.					
1322P-VH3	<p>Protección general</p> <ul style="list-style-type: none"> • Protección IGA 2P, 50A. Clase C. 6kA. • Limitador sobretensiones permanente. • Limitador sobretensiones transitoria. <p>Protección para punto de recarga (Modo 3)</p> <ul style="list-style-type: none"> • Protección magnetotérmica 2P, 40A. Curva C. 6kA. • Protector diferencial superinmunizado. 2P, 40A, 30mA. • Potencia máxima: 9,2kW. <p>Punto de recarga (Modo 2)</p> <ul style="list-style-type: none"> • Protección magnetotérmica 2P, 10A. Curva C. 6kA. • Toma traspunto Schuko 2P+T, 16A, 250V. IP67. • Protector diferencial superinmunizado. 2P, 40A, 30mA. • Potencia máxima: 2,3kW. 	8423220232594	C*	1	1



Cuadros de protección para puntos de recarga (Modo 3). 12 elementos. Dimensiones exteriores 270x250x160.					
1312P-I15	<ul style="list-style-type: none"> • Cuadro monofásico de protección. • Protección magnetotérmica 2P, 40A. Curva C. 10kA. • Protector diferencial superinmunizado. 2P, 40A, 30mA. • Limitador sobretensiones permanente. >265VAC. • Limitador sobretensiones transitoria. I. Máx: 15kA. Clase II. • Con regleta de tierra. • Potencia máxima: 9,2kW. 	8423220217645	C*	1	1

Dimensiones en mm - anchura x altura x profundidad.



Accede a la tarifa PVP actualizada



Referencia	Descripción	Código GTIN-13	PVP		
Cuadros de protección para puntos de recarga (Modo 3). 22 elementos. Dimensiones exteriores 270x500x160.					
1322P-I47	<ul style="list-style-type: none"> • Cuadro trifásico de protección. • Protección magnetotérmica 4P, 40A. Curva C. 10kA. • Protector diferencial superinmunizado. 4P, 40A, 30mA. • Limitador sobretensiones permanente. >265VAC. • Limitador sobretensiones transitoria. I. máx: 20kA. Clase II. • Con regleta de tierra. • Potencia máxima: 27,6kW. 	8423220226180	C*	1	1

Cuadros de protección para piscinas



Referencia	Descripción	Código GTIN-13	PVP		
11 elementos. Dimensiones exteriores 270x250x160.					
CSP-06	<ul style="list-style-type: none"> • 1 Magnetotérmico 1P+N, 16A. • 1 Magnetotérmico 1P+N, 10A. • 1 Diferencial 2P, 40A, 30mA. • 1 Interruptor horario digital. • 1 Guardamotor. • 1 Contactor modular. • 1 Interruptor selector de 3 posiciones. • 2 Indicadores luminosos verdes. • 1 Transformador para iluminación 100VA. 	8423220231269	C*	1	1

INDUBOX. Accesorios



Referencia	Descripción	Código GTIN-13	PVP		
Perfil DIN.					
TS35/SZ	De acero laminado en caliente. Sin perforar. Longitud 2m. PVP por metro.	8423220066731	5,13	2	20
	Perfil de plástico				



Asa para Indubox.					
KIT1300ASA	Asa con tornillos de sujeción, tuercas, arandelas y juntas para garantizar la protección IP.	8423220045118	28,06	1	90



Tapa ciega aislante en tiras. Pretroquelada. Cubre hasta 6 módulos libres en cajas para distribución.					
TA1300G	Gris.	8423220051218	0,91	50	200



Soporte metálico para Indubox.					
SOM1316	Para las Referencia 1316, 1332 y 1348.	8423220067158	89,74	1	1



Ruedas para soportes metálicos.					
KIT-SOMR	Kit de 2 ruedas para los soportes SOM1311 y SOM 1316.	8423220065628	17,04	1	25



Soporte de pared para Indubox.					
KIT1300SOP	Juego de 4 soportes para fijación exterior de la caja. Incluye tornillos de fijación a la caja.	8423220045101	2,53	1	250



Dimensiones en mm - anchura x altura x profundidad.



Referencia	Descripción	Código GTIN-13	PVP		
Unión - pasacable.					
KIT1300UN32	2 racores con junta de estanqueidad IP65 para unir 2 cajas, posibilitando el paso de conductores. Métrica 32.	8423220045828	11,73	1	100
KIT1300UN40	2 racores con junta de estanqueidad IP65 para unir 2 cajas, posibilitando el paso de conductores. Métrica 40.	8423220045835	12,94	1	100



Referencia	Descripción	Código GTIN-13	PVP		
Soporte Indubox para tubo. Kit de 2 soportes metálicos para poder fijar una caja Indubox a un tubo. Incluye 2 bridas metálicas y 4 tornillos de fijación.					
KIT-ST1308	Para refs. 818A, 818B, 1308A, 1308B, 1308P, 1308PV1 y 1308PV3.	8423220245440	46,11	1	25
KIT-ST1311	Para refs. 820P, 820PV6, 1311A, 1311P, 1311PV2, 1311PV4, 1312 y 1322P.	8423220245457	50,33	1	25
KIT-ST1316	Para refs. 822, 822P, 821P, 821PV9, 1316P, 1316PV3, 1316PV6, 1332P, 1332PV3, 1332PV6, 1336P, 1348P.	8423220245464	56,98	1	25



Referencia	Descripción	Código GTIN-13	PVP		
Dispositivos de conexión de tierra y neutro.					
108P	8 bornes para cable hasta 6 mm ² y 2 hasta 16 mm ² .	8423220011304	6,25	40	640
112P	12 bornes para cable hasta 6 mm ² y 2 hasta 16 mm ² .	8423220045187	7,43	50	400



Referencia	Descripción	Código GTIN-13	PVP		
Dispositivos de conexión aislados. Material no propagador de la llama. 12 bornes para cable hasta 6mm² y 2 hasta 16mm².					
212N	Para conexión de neutro. Color Azul.	8423220042544	9,08	1	200
212TT	Para conexión de tierra. Color verde.	8423220033887	9,08	1	125



Referencia	Descripción	Código GTIN-13	PVP		
Sistemas de cierre.					
1300TRI	Cierre triangular. No incluye llave.	8423220045132	8,33	1	1.000



1300MN	Maneta de cierre de plástico.	8423220045019	3,72	2	200
--------	-------------------------------	---------------	------	---	-----



1300L	Cierre con llave metálica. Incluye llave.	8423220045125	19,88	1	300
-------	---	---------------	-------	---	-----



1300LTRI	Llave para cierre triangular.	8423220048164	7,62	1	100
----------	-------------------------------	---------------	------	---	-----



Referencia	Descripción	Código GTIN-13	PVP		
Paro de emergencia con marco.					
PE1300	Marco con paro de Emergencia. Incluye portacontactos.	8423220050884	64,59	1	40



Referencia	Descripción	GTIN-13 unitario	PVP		GTIN-13 envase	
Paros de emergencia.						
PE12	Pulsador SETA y cámara portacontactos (contactos cerrados) para pulsador. Girar para desenclavar. Sin etiqueta.	8423220078581	21,56	1	8423220066267	180
PE12CA	Pulsador SETA y cámara portacontactos (contactos abiertos) para pulsador. Girar para desenclavar. Sin etiqueta.	8423220078598	21,56	6	8423220071179	180
ET12	Etiqueta para paro de emergencia.	8423220078604	4,89	20	8423220066274	1.200

Dimensiones en mm - anchura x altura x profundidad.

[Accede a la tarifa PVP actualizada](#)



Referencia	Descripción	GTIN-13 unitario	PVP		GTIN-13 envase	
Indicadores luminosos LED. Ø22mm. 250V.						
PLD22	Indicador luminoso led rojo.	8423220078543	7,51	12	8423220066250	288
PLD22V	Indicador luminoso led verde.	8423220078536	7,51	12	8423220066243	288



Pulsadores con retorno. Rasante. Ø 22 mm.						
PULSA5R	Pulsador rojo. Contacto NC.	8423220078567	9,43	12	8423220066229	288
PULSA5V	Pulsador verdes. Contacto NO.	8423220078574	9,43	12	8423220066236	288



Interruptor selector. Ø22mm. Tipo de contactos 2NO.						
INT5/3A2	Interruptor selector de 3 posiciones V/.	8423220078550	15,30	12	8423220066212	288

(Ver catálogo completo: pág. 112)



Referencia	Descripción	Código GTIN-13	PVP		
Marcos y tapas ciegas para Indubox.					
TA1300C	Tapa para cubrir ventanas. Para montaje de diversos elementos.	8423220050846	7,41	1	100
TA1300C/1	Para el montaje de tomas industriales fijas.	8423220081260	C*	1	75
TA1316C	Tapa para cubrir ventanas de tomas interbloqueantes. Para el montaje de diversos elementos, excepto en la caja Referencia 1332.	8423220050853	10,12	1	70
TA1332C	Tapa para cubrir ventanas de tomas interbloqueantes. Para el montaje de diversos elementos en la caja Referencia 1332.	8423220050860	10,43	1	80



Marcos y tapas ciegas para Indubox. (Ver referencias compatibles en pág. 34)					
MR1360	Para el montaje de bases trescuadro Schucko y clavijas trescuadro.	8423220050822	8,71	1	100
MR1316	Para el montaje de tomas industriales trescuadro.	8423220050808	8,31	1	100
MR1332	Para el montaje de tomas industriales trescuadro.	8423220050815	8,36	1	100
MR1363	Para el montaje de bases trescuadro.	8423220050839	12,44	1	85
MR1300X	Para el montaje de tomas industriales interbloqueantes trescuadro, excepto en la caja 1332V3.	8423220050716	9,34	1	50

(Ver Referencia compatibles con este marco: pág. 34)

Instalación de los marcos en las cajas indubox

1

Fijar los marcos a la caja por el interior, con los tornillos correspondientes.

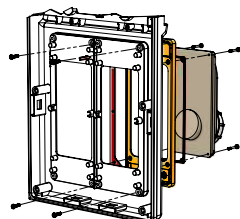

2

La base se fija al marco por la parte frontal.

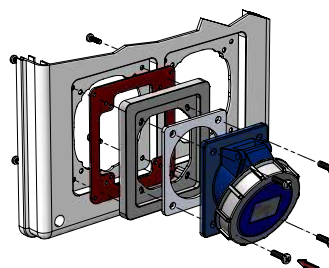
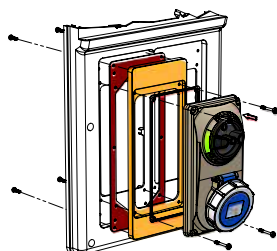
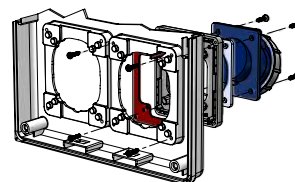

Dimensiones en mm - anchura x altura x profundidad.

Descárgate toda la documentación técnica de la serie escaneando este código



TOMAS INDUSTRIALES. Bases y clavijas móviles



Referencia	Descripción	Código GTIN-13	PVP		
Clavijas industriales móviles IP44.					
902131A	2P+T, 16A, 230V~.	8423220042599	5,53	1	10
902142A	3P+T, 16A, 400V~.	8423220042605	6,69	1	10
902152A	3P+N+T, 16A, 400V~.	8423220042612	8,58	1	10
902133A	2P+T, 32A, 230V~.	8423220042629	10,78	1	10
902144A	3P+T, 32A, 400V~.	8423220042636	11,83	1	10
902154A	3P+N+T, 32A, 400V~.	8423220042643	13,69	1	10
902156A	3P+N+T, 63A, 400V~.	8423220068841	57,89	1	2



Clavijas industriales móviles IP67.					
902431A	2P+T, 16A, 230V~.	8423220042711	11,83	1	10
902442A	3P+T, 16A, 400V~.	8423220042728	14,77	1	10
902452A	3P+N+T, 16A, 400V~.	8423220042735	16,59	1	10
902433A	2P+T, 32A, 230V~.	8423220042742	19,22	1	10
902444A	3P+T, 32A, 400V~.	8423220042759	20,72	1	10
902454A	3P+N+T, 32A, 400V~.	8423220042766	22,09	1	10
902435A	2P+T, 63A, 230V~.	8423220042650	51,80	1	2
902446A	3P+T, 63A, 400V~.	8423220042667	59,08	1	2
902456A	3P+N+T, 63A, 400V~.	8423220042674	66,47	1	2
902437A	2P+T, 125A, 230V~.	8423220042681	132,90	1	2
902448A	3P+T, 125A, 400V~.	8423220042698	140,25	1	2
902458A	3P+N+T, 125A, 400V~.	8423220042704	147,67	1	2



Clavijas inversoras de fase móviles. IP44.					
936142A	3P+T, 16A, 400V~.	8423220046511	40,64	1	10
936152A	3P+N+T, 16A, 400V~.	8423220046528	48,09	1	10
936144A	3P+T, 32A, 400V~.	8423220046535	59,08	1	10
936154A	3P+N+T, 32A, 400V~.	8423220046542	68,46	1	10



Bases industriales móviles IP44.					
903131A	2P+T, 16A, 230V~.	8423220042780	8,58	1	10
903142A	3P+T, 16A, 400V~.	8423220042797	10,47	1	10
903152A	3P+N+T, 16A, 400V~.	8423220042803	11,45	1	10
903133A	2P+T, 32A, 230V~.	8423220042810	14,77	1	10
903144A	3P+T, 32A, 400V~.	8423220042827	15,51	1	10
903154A	3P+N+T, 32A, 400V~.	8423220042834	16,35	1	10
903156A	3P+N+T, 63A, 400V~.	8423220068858	76,55	1	2



Bases industriales móviles IP67.					
903431A	2P+T, 16A, 230V~.	8423220042841	19,22	1	10
903442A	3P+T, 16A, 400V~.	8423220042858	21,39	1	10
903452A	3P+N+T, 16A, 400V~.	8423220042865	23,63	1	10
903433A	2P+T, 32A, 230V~.	8423220042872	24,50	1	10
903444A	3P+T, 32A, 400V~.	8423220042889	26,78	1	10
903454A	3P+N+T, 32A, 400V~.	8423220042896	27,34	1	10
903435A	2P+T, 63A, 230V~.	8423220047075	70,14	1	2
903446A	3P+T, 63A, 400V~.	8423220047082	73,82	1	2
903456A	3P+N+T, 63A, 400V~.	8423220047099	81,24	1	2
903437A	2P+T, 125A, 230V~.	8423220047105	155,09	1	2
903448A	3P+T, 125A, 400V~.	8423220047112	162,40	1	2
903458A	3P+N+T, 125A, 400V~.	8423220046344	177,21	1	2





Referencia	Descripción	Marco	Código GTIN-13	PVP		
Clavijas trascuadro IP44.						
934131	2P+T, 16A, 230V~.	MR1360	8423220046351	8,96	1	10
934142	3P+T, 16A, 400V~.	MR1360	8423220046368	10,78	1	10
934152	3P+N+T, 16A, 400V~.	MR1300C	8423220046375	12,57	1	10
934133	2P+T, 32A, 230V~.	MR1300C	8423220046382	13,02	1	10
934144	3P+T, 32A, 400V~.	MR1300C	8423220046399	14,42	1	10
934154	3P+N+T, 32A, 400V~.	MR1300C	8423220046405	16,35	1	10



Clavijas trascuadro IP67.						
934456	3P+N+T, 63A, 400V~.	---	8423220059832	63,56	2	33
934448	3P+T, 125A, 400V~.	---	8423220064393	127,09	2	33
934458	3P+N+T, 125A, 400V~.	---	8423220058583	140,80	2	33



Bases trascuadro inclinadas IP44.						
931121A	2P+T, 16A, 230V~.	MR1316	8423220042902	7,53	1	10
931142A	3P+T, 16A, 400V~.	MR1316	8423220042919	8,65	1	10
931152A	3P+N+T, 16A, 400V~.	MR1332	8423220042926	9,45	1	10
931123A	2P+T, 32A, 230V~.	MR1332	8423220042933	11,10	1	10
931144A	3P+T, 32A, 400V~.	MR1332	8423220042940	13,02	1	10
931154A	3P+N+T, 32A, 400V~.	MR1332	8423220042957	13,48	1	10
931156A	3P+N+T, 63A, 400V~.	MR1332	8423220089648	69,97	1	2



Bases trascuadro inclinadas IP67.						
931421A	2P+T, 16A, 230V~.	MR1316	8423220043008	13,79	1	10
931442A	3P+T, 16A, 400V~.	MR1316	8423220043015	15,30	1	10
931452A	3P+N+T, 16A, 400V~.	MR1332	8423220043053	17,43	1	10
931423A	2P+T, 32A, 230V~.	MR1332	8423220043022	18,17	1	10
931444A	3P+T, 32A, 400V~.	MR1332	8423220043039	22,26	1	10
931454A	3P+N+T, 32A, 400V~.	MR1332	8423220043046	24,40	1	10
931435A	2P+T, 63A, 230V~.	MR1363	8423220042964	66,47	1	2
931446A	3P+T, 63A, 400V~.	MR1363	8423220042971	70,18	1	1
931456A	3P+N+T, 63A, 400V~.	MR1363	8423220042988	73,82	1	1
931437A	2P+T, 125A, 230V~.	---	8423220047129	139,79	1	2
931448A	3P+T, 125A, 400V~.	---	8423220047136	147,63	1	2
931458A	3P+N+T, 125A, 400V~.	---	8423220042995	163,03	1	2



Bases trascuadro doméstica 16A.						
931131	2P+T, 16A, 250V~. IP54. Schuko.	MR1360	8423220019836	6,30	1	100
931431	2P+T, 16A, 250V~. IP67. Schuko.	MR1360	8423220048072	30,03	1	10



Referencia	Descripción	Marco	Código GTIN-13	PVP		
Bases interbloccantes trascuadro IP44.						
933131	2P+T, 16A, 230V~.	MR1300X	8423220043312	81,24	1	1
933142	3P+T, 16A, 400V~.	MR1300X	8423220043329	76,72	1	1
933152	3P+N+T, 16A, 400V~.	MR1300X	8423220043336	96,04	1	1
933133	2P+T, 32A, 230V~.	MR1300X	8423220043343	103,32	1	1
933144	3P+T, 32A, 400V~.	MR1300X	8423220043350	95,87	1	1
933154	3P+N+T, 32A, 400V~.	MR1300X	8423220043367	118,13	1	1



Bases interbloccantes trascuadro IP67.						
933431	2P+T, 16A, 230V~.	MR1300X	8423220043374	92,26	1	1
933442	3P+T, 16A, 400V~.	MR1300X	8423220043381	99,72	1	1
933452	3P+N+T, 16A, 400V~.	MR1300X	8423220043398	118,78	1	1
933433	2P+T, 32A, 230V~.	MR1300X	8423220043404	114,38	1	1
933444	3P+T, 32A, 400V~.	MR1300X	8423220043411	125,55	1	1
933454	3P+N+T, 32A, 400V~.	MR1300X	8423220043428	136,57	1	1





Referencia	Descripción	Código GTIN-13	PVP		
Bases industriales murales IP44.					
932131	2P+T, 16A, 230V~.	8423220043060	11,45	1	10
932142	3P+T, 16A, 400V~.	8423220043077	12,11	1	10
932152	3P+N+T, 16A, 400V~.	8423220043084	13,69	1	10
932133	2P+T, 32A, 230V~.	8423220043091	14,77	1	10
932144	3P+T, 32A, 400V~.	8423220043107	16,35	1	10
932154	3P+N+T, 32A, 400V~.	8423220043114	17,71	1	10



Bases industriales murales IP67.					
932444	3P+T, 32A, 400V~.	8423220140127	39,52	1	5
932454	3P+N+T, 32A, 400V~.	8423220058590	41,41	1	5
932435	2P+T, 63A, 230V~.	8423220043121	82,43	1	2
932446	3P+T, 63A, 400V~.	8423220043138	91,25	1	1
932456	3P+N+T, 63A, 400V~.	8423220043145	103,32	1	1
932437	2P+T, 125A, 230V~.	8423220043152	146,97	1	1
932448	3P+T, 125A, 400V~.	8423220043169	153,41	1	2
932458	3P+N+T, 125A, 400V~.	8423220043176	191,84	1	1



Base interbloqueante mural. IP67.					
933456	3P+T, 63A, 400V~.	8423220043435	531,34	1	1

TOMAS INDUSTRIALES. Clavijas murales



Referencia	Descripción	Código GTIN-13	PVP		
Clavijas industriales murales IP44.					
935131	2P+T, 16A, 230V~.	8423220046412	14,77	1	10
935142	3P+T, 16A, 400V~.	8423220046429	16,59	1	10
935152	3P+N+T, 16A, 400V~.	8423220046436	18,17	1	10
935133	2P+T, 32A, 230V~.	8423220046443	19,22	1	10
935144	3P+T, 32A, 400V~.	8423220046450	19,95	1	10
935154	3P+N+T, 32A, 400V~.	8423220046467	21,04	1	10



Clavijas industriales murales IP67.					
935446	3P+T, 63A, 400V~.	8423220046474	103,32	1	1
935456	3P+N+T, 63A, 400V~.	8423220046481	118,13	1	1
935448	3P+T, 125A, 400V~.	8423220046498	178,92	1	1
935458	3P+N+T, 125A, 400V~.	8423220046504	221,55	1	1

TOMAS INDUSTRIALES. Adaptadores industriales



Referencia	Descripción	Código GTIN-13	PVP		
Adaptadores industriales 2P+T, 16A, 230V~. IP44.					
904011	Clavija doméstica Schuko. Base industrial (6h).	8423220043473	23,00	1	10



904012	Clavija industrial (6h). Base doméstica schuko.	8423220044470	25,87	1	10
--------	---	---------------	-------	---	----



904013	1 Clavija industrial (6h). 2 bases industriales.	8423220062368	48,01	1	10
--------	--	---------------	-------	---	----



904014	1 Clavija industrial (6h). 2 bases industriales (6h). 1 base doméstica Schuko.	8423220043497	71,89	1	5
--------	--	---------------	-------	---	---



Adaptador industrial 2P+T, 16A, 230V~. IP67.					
904015	1 Clavija industrial (6h). 3 bases industriales (6h).	8423220043480	99,68	1	5



Cajas estancas de distribución DISTRIBUCIÓN IP54





- ✓ ABS+Policarbonato
- ✓ Perfil DIN metálico
- ✓ IP54, IK07
- ✓ Precintables

Descárgate la documentación técnica



CAJAS ESTANCAS DE DISTRIBUCIÓN IP54.

Referencia	Descripción	Código GTIN-13	PVP		
Hasta 3 elementos. Dimensiones exteriores 82x155x82. Dimensiones interiores 75x145x75. Cierre con tornillos roscados metálicos.					
898	Caja color blanco y tapa fumé.	8423220006331	17,79	1	72
898B	Caja color blanco y tapa blanca opaca.	8423220229891	17,79	1	72
Hasta 6 elementos. Dimensiones exteriores 145x165x84. Dimensiones interiores 135x160x70. Cierre con tornillos ¼ de vuelta.					
899	Caja color blanco y tapa fumé.	8423220006348	21,31	1	60
899B	Caja color blanco y tapa blanca opaca.	8423220229907	21,31	1	60
Hasta 7 elementos. Dimensiones exteriores 165x145x84. Dimensiones interiores 160x135x70. Cierre con tornillos ¼ de vuelta.					
895	Caja color blanco y tapa fumé.	8423220008953	21,35	1	56
895B	Caja color blanco y tapa blanca opaca.	8423220229914	21,35	1	56
Hasta 7 elementos. Dimensiones exteriores 180x230x86. Dimensiones interiores 170x220x80. Cierre con tornillos ¼ de vuelta.					
897	Caja color blanco y tapa fumé.	8423220008977	33,35	1	28
897B	Caja color blanco y tapa blanca opaca.	8423220229921	33,35	1	28
Hasta 11 elementos. Dimensiones exteriores 230x180x86. Dimensiones interiores 220x170x80. Cierre con tornillos ¼ de vuelta.					
896	Caja color blanco y tapa fumé.	8423220008960	40,03	1	28
896B	Caja color blanco y tapa blanca opaca.	8423220229938	40,03	1	28
Hasta 15 elementos. Dimensiones exteriores 320x250x135. Dimensiones interiores 310x240x125. Cierre con tornillos ¼ de vuelta.					
6888	Caja color blanco y tapa fumé.	8423220006720	98,53	1	10
6888B	Caja color blanco y tapa blanca opaca.	8423220229945	97,55	1	10
Hasta 11 elementos. Dimensiones exteriores 250x320x135. Dimensiones interiores 240x310x125. Cierre con tornillos roscados de plástico.					
6887	Caja color blanco y tapa fumé.	8423220006706	96,51	1	10
6887B	Caja color blanco y tapa blanca opaca.	8423220229952	95,54	1	10



Dimensiones en mm - anchura x altura x profundidad.

Armarios metálicos de distribución de empotrar y superficie



Descárgate la documentación técnica



Ventajas de la serie



Cable de conexión a toma de tierra



Carátulas independientes



Bastidor extraíble



Terminales de tierra y neutro incluidos



IP 30



IK09



CLASE I



RoHS



HF

Productos complementarios



Pág. 106

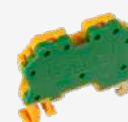



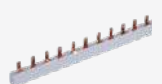







Pág. 113









Pág. 106







STEELBOX. Armarios metálicos de distribución de empotrar. IP30, IK09

	Referencia	Descripción	Código GTIN-13	PVP		
De empotrar. Profundidad del fondo ajustable. Con perfil DIN de 35mm.						
	M3E72-1	72 módulos. 3 filas x 24 módulos. Dimensiones para empotrar 545x585 x (140 a 165).	8423220073074	481,56	1	1
	M4E96-1	96 módulos. 4 filas x 24 módulos. Dimensiones para empotrar 545x735 x (140 a 165).	8423220073081	527,51	1	1
	M5E120-1	120 módulos. 5 filas x 24 módulos. Dimensiones para empotrar 545x885 x (140 a 165).	8423220073098	664,01	1	1
	M6E144-1	144 módulos. 6 filas x 24 módulos. Dimensiones para empotrar 545x1035 x (140 a 165).	8423220073104	735,75	1	1
	M4E132-1	132 módulos. 4 filas x 33 módulos. Dimensiones para empotrar 707x735 x (140 a 165).	8423220081291	637,75	1	1
De empotrar. Profundidad del fondo ajustable. Con perfil DIN de 35mm.						
	M5E165-1	165 módulos. 5 filas x 33 módulos. Dimensiones para empotrar 707x885 x (140 a 165).	8423220073128	780,17	1	1
	M6E198-1	198 módulos. 6 filas x 33 módulos. Dimensiones para empotrar 707x1035 x (140 a 165).	8423220073135	892,95	1	1



STEELBOX. Armarios metálicos de distribución de superficie. IP30, IK09

	Referencia	Descripción	Código GTIN-13	PVP		
De superficie. Con perfil DIN de 35mm.						
	M3S72-1	72 módulos. 3 filas x 24 módulos. Dimensiones exteriores 532x602x155.	8423220073142	530,30	1	1
	M4S96-1	96 módulos. 4 filas x 24 módulos. Dimensiones exteriores 532x752x155.	8423220073159	618,52	1	1
	M5S120-1	120 módulos. 5 filas x 24 módulos. Dimensiones exteriores 532x902x155.	8423220073166	777,29	1	1



Referencia	Descripción	Código GTIN-13	PVP		
De superficie. Con perfil DIN de 35mm.					
 M6S144-1	144 módulos. 6 filas x 24 módulos. Dimensiones exteriores 532x1052x155.	8423220073173	863,14	1	1
 M4S132-1	132 módulos. 4 filas x 33 módulos. Dimensiones exteriores 694x752x155.	8423220073180	756,11	1	1
 M5S165-1	165 módulos. 5 filas x 33 módulos. Dimensiones exteriores 694x902x155.	8423220073197	938,81	1	1
 M6S198-1	198 módulos. 6 filas x 33 módulos. Dimensiones exteriores 694x1052x155.	8423220073203	974,09	1	1

STEELBOX. Accesorios

Referencia	Descripción	Código GTIN-13	PVP		
Cerradura.					
 CER-1300L2	Cerradura metálica para armarios Steelbox.	8423220095489	21,53	1	20

Dimensiones en mm - anchura x altura x profundidad.



Accede a la tarifa PVP actualizada

Armarios estancos termoplásticos IP65.



Descárgate la documentación técnica



Ventajas de la serie



Protección UV



Protección IP65



Placa metálica opcional



Puerta opaca o transparente



Productos complementarios



Pág. 106



Pág. 113



Pág. 33



Referencia	Descripción	Código GTIN-13	PVP		
Armario estanco termoplástico. Puerta lisa (opaca).					
MBK203013	Dimensiones exteriores 200x300x130.	8423220251120	28,84	1	1
MBK253515	Dimensiones exteriores 250x350x150.	8423220251137	42,91	1	1
MBK304017	Dimensiones exteriores 300x400x170.	8423220251144	58,10	1	1
MBK304022	Dimensiones exteriores 300x400x220.	8423220251151	66,78	1	1
MBK355019	Dimensiones exteriores 350x550x190.	8423220251168	81,69	1	1
MBK405018	Dimensiones exteriores 400x500x180.	8423220251175	86,45	1	1
MBK405024	Dimensiones exteriores 400x500x240.	8423220251182	101,85	1	1
MBK406020	Dimensiones exteriores 400x600x200.	8423220251199	108,29	1	1
MBK506023	Dimensiones exteriores 500x600x230.	8423220253230	C*	1	1
MBK507025	Dimensiones exteriores 500x700x250.	8423220251205	192,57	1	1
MBK608026	Dimensiones exteriores 600x800x260.	8423220251212	409,85	1	1



Referencia	Descripción	Código GTIN-13	PVP		
Armario estanco termoplástico. Puerta transparente.					
MBK203013T	Dimensiones exteriores 200x300x130.	8423220251229	33,95	1	1
MBK253515T	Dimensiones exteriores 250x350x150.	8423220251236	50,61	1	1
MBK304017T	Dimensiones exteriores 300x400x170.	8423220251243	68,60	1	1
MBK304022T	Dimensiones exteriores 300x400x220.	8423220251250	85,05	1	1
MBK355019T	Dimensiones exteriores 350x550x190.	8423220251267	93,59	1	1
MBK405018T	Dimensiones exteriores 400x500x180.	8423220251274	113,05	1	1
MBK405024T	Dimensiones exteriores 400x500x240.	8423220251281	120,05	1	1
MBK406020T	Dimensiones exteriores 400x600x200.	8423220251298	124,04	1	1
MBK506023T	Dimensiones exteriores 500x600x230.	8423220253223	C*	1	1
MBK507025T	Dimensiones exteriores 500x700x250.	8423220251304	216,37	1	1
MBK608026T	Dimensiones exteriores 600x800x260.	8423220251311	437,85	1	1

MULTIBOX. Accesorios



Referencia	Descripción	Código GTIN-13	PVP		
Chasis para colocación de automáticos. Incluye carátula.					
MB-CH253515	MBK253515 y MBK253515T. 2 filas x 9 módulos = 18 módulos.	8423220230040	33,71	1	1
MB-CH304017	MBK304017 y MBK304017T. 2 filas x 12 módulos = 24 módulos.	8423220230057	42,14	1	1
MB-CH355019	MBK355019 y MBK355019T. 3 filas x 14 módulos = 42 módulos.	8423220230064	50,51	1	1
MB-CH406020	MBK406020 y MBK406020T. 4 filas x 17 módulos = 68 módulos.	8423220230071	58,94	1	1



Referencia	Descripción	Código GTIN-13	PVP		
Dispositivo de ventilación.					
DVX1	Dispositivo de ventilación diámetro 18mm	8423220221420	1,53	1	500
DVX2	Conjunto de dos dispositivos de ventilación diámetro 29mm	8423220221437	8,77	1	150



Referencia	Descripción	Código GTIN-13	PVP		
Placa metálica.					
PMK2030	Para ref. MBK203013 y MBK203013T	8423220250536	3,64	1	1
PMK2535	Para ref. MBK253515 y MBK253515T	8423220250543	5,39	1	1
PMK3040	Para ref. MBK304017, MBK304017T, MBK304022 y MBK304022T	8423220251069	7,00	1	1
PMK3550	Para ref. MBK355019 y MBK355019T	8423220251076	11,41	1	1
PMK4050	Para ref. MBK405018, MBK405018T, MBK405024 y MBK405024T	8423220251083	12,95	1	1
PMK4060	Para ref. MBK406020 y MBK406020T	8423220251090	15,96	1	1
PMK5060	Para ref. MBK506022 y MBK506022T	8423220253247	C*	1	1
PMK5070	Para ref. MBK507025 y MBK507025T	8423220251106	23,73	1	1
PMK6080	Para ref. MBK608026 y MBK608026T	8423220251113	52,15	1	1

Dimensiones en mm - anchura x altura x profundidad.

[Accede a la tarifa PVP actualizada](#)

Armarios estancos de Poliéster IP66, IK10



Descárgate la documentación técnica



Ventajas de la serie



Junta de EPDM



Protección UV



Protección IP66



Protección IK10



IP 66



IK 10



960 °C



Productos complementarios



Pág. 106



Pág. 106



Pág. 33



Pág. 83



Referencia	Descripción	Código GTIN-13	PVP		
Armario vacío con puerta lisa (opaca). Color gris RAL 7035.					
PX253016	Dimensiones exteriores 250x300x160.*	8423220216211	121,31	1	1
PX304020	Dimensiones exteriores 300x400x200.	8423220216228	156,77	1	1
PX405020	Dimensiones exteriores 400x500x200.	8423220216235	225,15	1	1
PX506025	Dimensiones exteriores 500x600x250.	8423220216242	266,16	1	1
PX608030	Dimensiones exteriores 600x800x300.	8423220216259	378,88	1	1
PX8510035	Dimensiones exteriores 850x1000x350.*	8423220241299	1133,97	1	1

(En las Ref. PX253016 y PX8510035 no hay opción de placa desplazable.)



Referencia	Descripción	Código GTIN-13	PVP		
Armario vacío con puerta transparente. Color gris RAL 7035.					
PX253016TP	Dimensiones exteriores 250x300x160.	8423220216266	222,92	1	1
PX304020TP	Dimensiones exteriores 300x400x200.	8423220216273	262,01	1	1
PX405020TP	Dimensiones exteriores 400x500x200.	8423220216280	369,36	1	1
PX506025TP	Dimensiones exteriores 500x600x250.	8423220216297	502,99	1	1
PX608030TP	Dimensiones exteriores 600x800x300.	8423220216303	732,27	1	1

POLIBOX. Accesorios

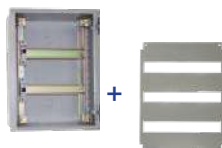

Referencia	Descripción	Código GTIN-13	PVP		
Chasis para colocación de automáticos. Incluye carátula de material autoextinguible.					
CHX1	Chasis para armarios PX253016 y PX253016TP. 2 filas x 8 módulos = 16 módulos.	8423220216419	71,51	1	1
CHX2	Chasis para armarios PX304020 y PX304020TP. 2 filas x 12 módulos = 24 módulos.	8423220216426	109,48	1	1
CHX3	Chasis para armarios PX405020 y PX405020TP. 3 filas x 18 módulos = 54 módulos.	8423220216433	113,89	1	1
CHX4	Chasis para armarios PX506025 y PX506025TP. 3 filas x 23 módulos = 69 módulos.	8423220221376	139,44	1	1
CHX5	Chasis para armarios PX608030 y PX608030TP. 4 filas x 29 módulos = 116 módulos.	8423220221413	234,89	1	1



Referencia	Descripción	Código GTIN-13	PVP		
Conjunto placa desplazable modular.					
CDM-200	Conjunto placa desplazable modular para armarios fondo 200. PX304020, PX405020, PX304020TP y PX405020TP.	8423220221550	48,93	1	1
CDM-250	Conjunto placa desplazable modular para armarios fondo 250. PX506025 y PX506025TP.	8423220221567	51,24	1	1
CDM-300	Conjunto placa desplazable modular para armarios fondo 300. PX608030 y PX608030TP.	8423220221956	54,29	1	1

(En las Ref. PX253016 y PX8510035 no hay opción de placa desplazable.)



Referencia	Descripción	Código GTIN-13	PVP		
Tapa ciega aislante en tiras. Pretoquelada. Cubre hasta 6 módulos libres en cajas para distribución.					
TA1300G	Gris.	8423220051218	0,91	50	200



Referencia	Descripción	Código GTIN-13	PVP		
Dispositivo de ventilación.					
DVX1	Dispositivo de ventilación diámetro 18mm.	8423220221420	1,53	1	500
DVX2	Conjunto de dos dispositivos de ventilación diámetro 29mm.	8423220221437	8,77	1	150



Referencia	Descripción	Código GTIN-13	PVP		
Soportes de fijación a la pared. (Bolsa con 4 unidades).					
FIXP	Soporte de fijación de plástico.	8423220216396	10,01	1	100
FIXM	Soporte de fijación metálica.	8423220216402	15,08	1	100

Dimensiones en mm - anchura x altura x profundidad.



Accede a la tarifa PVP actualizada



Referencia	Descripción	Código GTIN-13	PVP		
Kit prensaestopas. Compuesto de prensaestopas + junta selladora de estanqueidad + contratuerca. IP68.					
KIT-PL12G	Kit M12. Para cables Ø3 - 6,5 mm. Longitud espárrago roscado 13 mm.	8423220051959	1,44	60	960
KIT-PL16G	Kit M16. Para cables Ø5 - 10 mm. Longitud espárrago roscado 15 mm.	8423220051986	1,88	60	960
KIT-PL20G	Kit M20. Para cables Ø6 - 12 mm. Longitud espárrago roscado 15 mm.	8423220051973	2,10	60	960
KIT-PL25G	Kit M25. Para cables Ø13 - 18 mm. Longitud espárrago roscado 15 mm.	8423220051980	2,67	60	480
KIT-PL32G	Kit M32. Para cables Ø18 - 25 mm. Longitud espárrago roscado 16 mm.	8423220051997	4,55	40	320
KIT-PL40G	Kit M40. Para cables Ø24 - 32 mm. Longitud espárrago roscado 18 mm.	8423220052062	13,12	24	96



Placas de poliéster para Polibox.					
PPX253016	Para ref. PX253016, PX253016TP.	8423220216495	10,30	1	1
PPX304020	Para refs. PX304020, PX304020TP. Espesor de 2 mm.	8423220216501	18,11	1	1
PPX405020	Para refs. PX405020, PX405020TP. Espesor de 2 mm.	8423220216518	26,21	1	1
PPX506025	Para refs. PX506025, PX506025TP. Espesor de 2 mm.	8423220216525	44,05	1	1
PPX608030	Para refs. PX608030, PX608030TP. Espesor de 2 mm.	8423220216532	76,33	1	1



Placas metálicas para Polibox.					
PMX253016	Para ref. PX253016, PX253016TP.	8423220216440	12,69	1	1
PMX304020	Para refs. PX304020, PX304020TP. Espesor de 2 mm.	8423220216457	20,93	1	1
PMX405020	Para refs. PX405020, PX405020TP. Espesor de 2 mm.	8423220216464	39,04	1	1
PMX506025	Para refs. PX506025, PX506025TP. Espesor de 2 mm.	8423220216471	57,58	1	1
PMX608030	Para refs. PX608030, PX608030TP. Espesor de 2 mm.	8423220216488	92,30	1	1



Cerraduras para armario Polibox.					
LOCK0	Cierre estándar. Incorpora llave doble barra de plástico.	8423220221963	14,12	1	200
LOCK1	Cierre con llave metálica.	8423220216365	28,89	1	200
LOCK2	Cierre de triángulo (11 mm). Llave incluida.	8423220216372	14,12	1	200
LOCK3	Dispositivo de bloqueo candado.	8423220216389	10,68	1	200



Dimensiones en mm - anchura x altura x profundidad.

Cajas estancas de conexión IP55/65, IK08

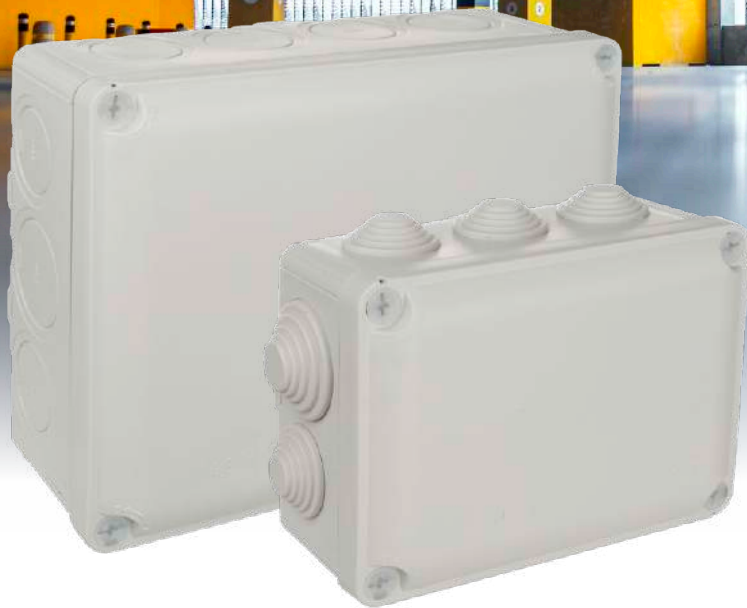

Descárgate la documentación técnica



Ventajas de la serie



Certificación AENOR



Ojales para fijar las cajas con bridas



Dos alojamientos para fijar a la pared sin perder estanqueidad

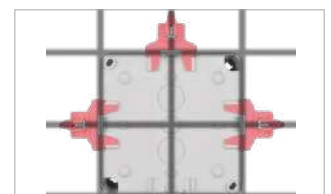

Sistema para fijación a bandeja de rejilla portables



IP55-65



IK08



650°C



UV



HF

Productos complementarios



Pág. 113



Pág. 33



Pág. 45



Pág. 116

YBOX. Cajas estancas de conexión color gris

Referencia	Descripción	Código GTIN-13	PVP		
IP55, IK08. Tornillos ¼ de vuelta. Precintable. Color gris. Dimensiones interiores 100x100x55.					
Y715	7 conos para tubo Ø 25 (M25).	8423220094758	4,23	6	108
IP55, IK08. Tornillos ¼ de vuelta. Precintable. Color gris. Dimensiones interiores 153x110x65.					
Y716	8 conos para tubo Ø 25 (M25) y 2 conos para tubo Ø 32 (M32).	8423220094772	5,99	4	64
IP55, IK08. Tornillos ¼ de vuelta. Precintable Color gris. Dimensiones exteriores 230x180x88. Dimensiones interiores 220x170x80.					
Y686	12 conos para tubo Ø 32 (M32) y 2 conos para tubo Ø 40 (M40).	8423220095359	12,34	1	30
IP65, IK08. Tornillos ¼ de vuelta. Precintable. Color gris. Dimensiones exteriores 110x100x60. Dimensiones interiores 100x100x55.					
Y815P	7 pretroquelados laterales Ø 25 (M25).	8423220095373	3,43	6	120
IP65, IK08. Tornillos ¼ de vuelta. Precintable. Color gris. Dimensiones exteriores 160x120x71. Dimensiones interiores 153x110x65.					
Y816P	10 pretroquelados laterales (8 de Ø 25 y 2 de Ø 32).	8423220095380	4,80	4	64
IP65, IK08. Tornillos ¼ de vuelta. Precintable. Color gris. Dimensiones exteriores 230x180x88. Dimensiones interiores 220x170x80.					
Y886P	14 pretroquelados laterales (12 de Ø 32 y 2 de Ø 40).	8423220095397	8,74	1	32

YBOX. Cajas estancas de conexión color negro

Referencia	Descripción	Código GTIN-13	PVP		
IP55, IK08. Tornillos ¼ de vuelta. Precintable. Color negro. Dimensiones exteriores 110x110x60. Dimensiones interiores 100x100x55.					
Y715N	7 conos para tubo Ø 25 (M25).	8423220220553	5,28	6	108
IP55, IK08. Tornillos ¼ de vuelta. Precintable. Color negro. Dimensiones exteriores 160x120x71. Dimensiones interiores 153x110x65.					
Y716N	8 conos para tubo Ø 25 (M25) y 2 conos para tubo Ø 32 (M32).	8423220220560	6,99	4	64
IP55, IK08. Tornillos ¼ de vuelta. Precintable Color negro. Dimensiones exteriores 230x180x88. Dimensiones interiores 220x170x80.					
Y686N	12 conos para tubo Ø 32 (M32) y 2 conos para tubo Ø 40 (M40).	8423220220577	12,99	1	30
IP65, IK08. Tornillos ¼ de vuelta. Precintable. Color negro. Dimensiones exteriores 110x100x60. Dimensiones interiores 100x100x55.					
Y815NP	7 pretroquelados laterales Ø máximo 25 (M25).	8423220220584	4,28	6	120



Dimensiones en mm - anchura x altura x profundidad.



Referencia	Descripción	Código GTIN-13	PVP		
IP65, IK08. Tornillos ¼ de vuelta. Precintable. Dimensiones exteriores 160x120x71. Dimensiones interiores 153x110x65.					
Y816NP	10 pretroquelados laterales (8 de Ø 25 y 2 de Ø 32).	8423220220591	6,09	4	64



Referencia	Descripción	Código GTIN-13	PVP		
IP65, IK08. Tornillos ¼ de vuelta. Precintable. Color negro. Dimensiones exteriores 230x180x88. Dimensiones interiores 220x170x80.					
Y886NP	14 pretroquelados laterales (12 de Ø 32 y 2 de Ø 40).	8423220221048	10,89	1	32

YBOX. Accesorios

SISTEMAS DE FIJACIÓN



Sistema para fijación a bandeja de rejilla portacables.
Ref. SOP-716Y

Ojales para fijar con bridas.

Dos alojamientos para fijar a la pared.

Sistema exterior para soporte a pared. Ref. SOP-715Y



Referencia	Descripción	Código GTIN-13	PVP/ 2 ud.		
Soportes de fijación.					
SOP-715Y	Soporte externo de fijación en cajas Ybox.	8423220095403	1,23	1	1
SOP-716Y	Soporte para fijar cajas de la serie Ybox a las bandejas de rejilla metálica. Altura mínima de la bandeja 60mm.	8423220095410	1,30	1	1



Referencia	Descripción	Código GTIN-13	PVP		
Conos grises.					
CO-M25/A	Cono para cajas Ybox. Ø25.	8423220061552	0,36	1	1.700
CO-M32/A	Cono para cajas Ybox. Ø32.	8423220061569	0,39	1	1.100
CO-M40/A	Cono para cajas Ybox. Ø40.	8423220061576	0,65	1	750



Referencia	Descripción	Código GTIN-13	PVP		
Tapones para orificios de fijación de cajas estancas. Para mantener el IP después de fijar la caja.					
TPO-715	Bolsa de 24 uds. Válidos para todas las cajas de la Serie YBOX. Válido para las cajas estancas 615, 686, 715, 716, 717 y 100888.	8423220095458	1,09	1	2.500

Dimensiones en mm - anchura x altura x profundidad.



Accede a la tarifa PVP actualizada

Cajas estancas de conexión IP55/65, IK07/08/09

Descárgate toda la documentación técnica y vídeos de la serie escaneando este código



ESTANCAS. Cajas estancas de conexión con conos



Referencia	Descripción	Código GTIN-13	PVP		
IP55, IK07. Cierre con tapa a presión. Sistema de apertura fácil. Color gris. Dimensiones exteriores Ø 77x40. Dimensiones interiores Ø 70x35.					
665	4 conos para tubo Ø máximo 20 (M20).	8423220036062	2,59	8	320
100665	4 conos para tubo Ø máximo 20 (M20). 4 orificios para prensaestopas M20.	8423220059184	3,27	8	320



IP55, IK07. Cierre con tapa a presión. Sistema de apertura fácil. Color gris. Dimensiones exteriores 90x90x40. Dimensiones interiores 80x80x35.					
604	7 conos para tubo Ø máximo 20 (M20).	8423220036055	3,05	6	288



IP55, IK07. Cierre con tapa a presión. Sistema de apertura fácil. Color gris. Dimensiones exteriores 110x110x50. Dimensiones interiores 100x100x45.					
615	7 conos para tubo Ø máximo 25 (M25).	8423220006157	5,03	5	175



IP55, IK08. Tornillos ¼ de vuelta. Precintable. Color gris. Dimensiones exteriores 110x110x60. Dimensiones interiores 100x100x55.					
715	7 conos para tubo Ø máximo 25 (M25).	8423220010451	5,99	6	108



IP55, IK08. Tornillos metálicos autoroscantes. Color gris. Dimensiones exteriores 165x120x60. Dimensiones interiores 153x110x55.					
616	8 conos para tubo Ø máximo 25 (M25) y 2 conos para tubo Ø máximo 32 (M32).	8423220006164	10,72	1	60



IP55, IK08. Tornillos ¼ de vuelta. Precintable. Color gris. Dimensiones exteriores 160x120x71. Dimensiones interiores 153x110x65.					
716	8 conos para tubo Ø máximo 25 (M25) y 2 conos para tubo Ø máximo 32 (M32).	8423220009264	9,80	4	64



IP55, IK08. Tornillos ¼ de vuelta. Precintable. Color gris. Dimensiones exteriores 165x145x84. Dimensiones interiores 160x135x70.					
717	8 conos para tubo Ø máximo 32 (M32) y 2 conos para tubo Ø máximo 40 (M40).	8423220007178	11,73	1	50



IP55, IK09. Tornillos ¼ de vuelta. Precintable. Color gris. Dimensiones exteriores 230x180x88. Dimensiones interiores 220x170x80. Certificado APPLUS.					
686	12 conos para tubo Ø máximo 32 (M32) y 2 conos para tubo Ø máximo 40 (M40).	8423220006867	16,96	1	30



IP55, IK08. Tornillos ¼ de vuelta. Precintable. Color gris. Dimensiones exteriores 230x180x150. Dimensiones interiores 220x170x140.					
686A	12 conos para tubo Ø máximo 32 (M32) y 2 conos para tubo Ø máximo 40 (M40).	8423220058675	22,56	1	20



Dimensiones en mm - anchura x altura x profundidad.



Referencia	Descripción	Código GTIN-13	PVP		
IP55, IK09. Tornillos roscados de plástico. Precintable. Color gris. Dimensiones exteriores 320x251x134. Dimensiones interiores 310x240x125.					
100888	4 conos para tubo Ø máximo 32 (M32), 2 conos para tubo Ø máximo 40 (M40) y 6 conos para tubo Ø máximo 50 (M50). Certificado APPLUS.	8423220140202	70,62	1	10

ESTANCAS. Cajas estancas de conexión sin conos



Referencia	Descripción	Código GTIN-13	PVP		
IP55, IK07. Cierre con tapa a presión. Sistema de apertura fácil. Color gris. Dimensiones exteriores 90x90x40. Dimensiones interiores 80x80x35.					
604C	Lateral liso.	8423220036123	2,47	6	270



IP55, IK07. Cierre con tapa a presión. Sistema de apertura fácil. Color gris. Dimensiones exteriores 110x110x50. Dimensiones interiores 100x100x45.					
615C	Lateral liso.	8423220011380	3,99	5	145



IP65, IK08. Tornillos ¼ de vuelta. Precintable. Color gris. Dimensiones exteriores 110x100x60. Dimensiones interiores 100x100x55.					
815	Lateral liso.	8423220010468	5,13	6	120



IP65, IK08. Tornillos ¼ de vuelta. Precintable. Color gris. Dimensiones exteriores 160x120x71. Dimensiones interiores 153x110x65.					
816	Lateral liso.	8423220009271	8,71	4	64



IP65, IK08. Tornillos ¼ de vuelta. Precintable. Color gris. Dimensiones exteriores 165x145x84. Dimensiones interiores 160x135x70.					
817	Lateral liso.	8423220008175	9,99	1	58



IP65, IK08. Tornillos ¼ de vuelta. Precintable. Color gris. Dimensiones exteriores 230x180x88. Dimensiones interiores 220x170x80.					
886	Lateral liso. Certificado APPLUS.	8423220008861	15,96	1	32



IP65, IK08. Tornillos ¼ de vuelta. Precintable. Color gris. Dimensiones exteriores 230x180x150. Dimensiones interiores 220x170x140.					
886A	Lateral liso.	8423220058699	20,48	1	20



IP65, IK09. Tornillos roscados de plástico. Precintable. Color gris. Dimensiones exteriores 320x250x135. Dimensiones interiores 310x240x125.					
100887	Lateral liso. Certificado APPLUS.	8423220058040	68,23	1	12



IP65, IK08. Dimensiones exteriores 215x200x140. Dimensiones interiores 207x192x131. Lateral liso.					
818A	Tornillos INOX de cierre rápido. Tapa lisa.	8423220084452	27,11	1	18

Dimensiones en mm - anchura x altura x profundidad.

[Accede a la tarifa PVP actualizada](#)

ESTANCAS. Cajas estancas de conexión sin conos



Referencia	Descripción	Código GTIN-13	PVP		
IP65, IK08. Dimensiones exteriores 215x200x95. Dimensiones interiores 207x192x86. Tornillos INOX de cierre rápido. Tapa lisa.					
818B	Laterales lisos.	8423220084469	24,82	1	22



IP65, IK08. Dimensiones exteriores 270x500x140. Dimensiones interiores 263x493x129. Tapa lisa. Tornillos INOX de cierre rápido.					
820	Laterales lisos-punteados.	8423220048089	69,45	1	6



IP65, IK08. Dimensiones exteriores 362x500x140. Dimensiones interiores 355x493x129. Tapa lisa. Tornillos INOX de cierre rápido.					
821	Laterales lisos-punteados.	8423220044951	79,41	1	5



IP65, IK08. Dimensiones exteriores 362x362x140. Dimensiones interiores 355x355x129. Tapa lisa. Tornillos INOX de cierre rápido.					
822	Laterales lisos-punteados.	8423220227453	56,12	1	6

ESTANCAS. Cajas estancas de conexión color negro



Referencia	Descripción	Código GTIN-13	PVP		
IP55, IK08. Tornillos ¼ de vuelta. Precintable. Dimensiones exteriores 110x110x60. Dimensiones interiores 100x100x55.					
715N	7 conos para tubo Ø máximo 25 (M25).	8423220010482	6,96	6	108



IP55, IK08. Tornillos ¼ de vuelta. Precintable. Dimensiones exteriores 160x120x71. Dimensiones interiores 153x110x65.					
716N	8 conos para tubo Ø máximo 25 (M25) y 2 conos para tubo Ø máximo 32 (M32).	8423220009165	9,65	4	64



IP55, IK08. Tornillos ¼ de vuelta. Precintable. Dimensiones exteriores 165x145x71. Dimensiones interiores 153x135x70.					
717N	8 conos para tubo Ø máximo 32 (M32) y 2 conos para tubo Ø máximo 40 (M40).	842322000457	12,07	1	50



IP55, IK08. Tornillos ¼ de vuelta. Precintable. Dimensiones exteriores 230x180x88. Dimensiones interiores 220x170x80.					
686N	12 conos para tubo Ø máximo 32 (M32) y 2 conos para tubo Ø máximo 40 (M40). Certificado APPLUS.	8423220004764	16,16	1	30



IP65, IK08. Tornillos ¼ de vuelta. Precintable. Dimensiones exteriores 110x100x60. Dimensiones interiores 100x100x55.					
815N	Lateral liso.	8423220010475	5,46	6	120



IP65, IK08. Tornillos ¼ de vuelta. Precintable. Dimensiones exteriores 160x120x71. Dimensiones interiores 153x110x65.					
816N	Lateral liso.	8423220009172	8,21	4	64



IP65, IK08. Tornillos ¼ de vuelta. Precintable. Dimensiones exteriores 165x145x84. Dimensiones interiores 160x135x70.					
817N	Lateral liso.	8423220004870	10,79	1	58



Dimensiones en mm - anchura x altura x profundidad.



Referencia	Descripción	Código GTIN-13	PVP		
IP65, IK08. Tornillos ¼ de vuelta. Precintable. Dimensiones exteriores 230x180x88. Dimensiones interiores 220x170x80.					
886N	Lateral liso. Certificado APPLUS.	8423220004887	14,62	1	32



IP65, IK08. Tornillos roscados de plástico. Precintable. Dimensiones exteriores 320x250x135. Dimensiones interiores 310x240x125.					
100887N	Lateral liso. Certificado APPLUS.	8423220066021	68,23	1	12

ESTANCAS. Cajas estancas de conexión con tapa transparente



Referencia	Descripción	Código GTIN-13	PVP		
IP55, IK08. Tornillos ¼ de vuelta. Precintable. Caja color gris. Dimensiones exteriores 110x110x60. Dimensiones interiores 100x100x55.					
715TP	7 conos para tubo Ø máximo 25 (M25).	8423220046672	7,34	6	108



IP55, IK08. Tornillos ¼ de vuelta. Precintable. Caja color gris. Dimensiones exteriores 160x120x71. Dimensiones interiores 153x110x65.					
716TP	8 conos para tubo Ø máximo 25 (M25) y 2 conos para tubo Ø máximo 32 (M32).	8423220031128	10,78	4	64



IP55, IK08. Tornillos ¼ de vuelta. Precintable. Caja color gris. Dimensiones exteriores 165x145x84. Dimensiones interiores 160x135x70.					
717TP	8 conos para tubo Ø máximo 32 (M32) y 2 conos para tubo Ø máximo 40 (M40).	8423220031142	13,45	1	50



IP55, IK08. Tornillos ¼ de vuelta. Precintable. Caja color gris. Dimensiones exteriores 230x180x88. Dimensiones interiores 220x170x80.					
686TP	12 conos para tubo Ø máximo 32 (M32) y 2 conos para tubo Ø máximo 40 (M40). Certificado APPLUS.	8423220042353	19,97	1	30



IP55, IK08. Tornillos ¼ de vuelta. Precintable. Caja color gris. Dimensiones exteriores 230x180x150. Dimensiones interiores 220x170x140.					
686ATP	12 conos para tubo Ø máximo 32 (M32) y 2 conos para tubo Ø máximo 40 (M40). Certificado APPLUS.	8423220058682	26,69	1	20



IP55, IK08. Tornillos roscados de plástico. Precintable. Caja color gris. Dimensiones exteriores 320x251x134. Dimensiones interiores 310x240x125.					
100888TP	4 conos para tubo Ø máximo 32 (M32), 2 conos para tubo Ø máximo 40 (M40) y 6 conos para tubo Ø máximo 50 (M50). Certificado APPLUS.	8423220073067	124,18	1	10



IP65, IK08. Tornillos ¼ de vuelta. Precintable. Caja color gris. Dimensiones exteriores 110x100x60. Dimensiones interiores 100x100x55.					
6815	Lateral liso.	8423220004771	8,07	6	120



IP65, IK08. Tornillos ¼ de vuelta. Precintable. Caja color gris. Dimensiones exteriores 160x120x71. Dimensiones interiores 153x110x65.					
6816	Lateral liso.	8423220004801	14,16	4	64



IP65, IK08. Tornillos ¼ de vuelta. Precintable. Caja color gris. Dimensiones exteriores 165x145x84. Dimensiones interiores 160x135x70.					
6817	Lateral liso.	8423220004818	18,21	1	58

Dimensiones en mm - anchura x altura x profundidad.



ESTANCAS. Cajas estancas de conexión con tapa transparente

Referencia	Descripción	Código GTIN-13	PVP		
IP65, IK08. Tornillos ¼ de vuelta. Precintable. Color gris. Dimensiones exteriores 230x180x88. Dimensiones interiores 220x170x80.					
6886	Lateral liso. Certificado APPLUS.	8423220004832	25,57	1	32
IP65, IK08. Tornillos ¼ de vuelta. Precintable. Caja color gris. Dimensiones exteriores 230x180x150. Dimensiones interiores 220x170x140.					
886ATP	Lateral liso. Certificado APPLUS.	8423220058705	25,25	1	20
IP65, IK08. Tornillos roscados de plástico. Precintable. Color gris. Dimensiones exteriores 320x250x135. Dimensiones interiores 310x240x125.					
100887TP	Lateral liso. Certificado APPLUS.	8423220059337	118,04	1	12

ESTANCAS. Cajas estancas de conexión con perfil DIN de 35 mm









Referencia	Descripción	Código GTIN-13	PVP		
IP55, IK08. Tornillos ¼ de vuelta. Precintable. Color gris. Dimensiones exteriores 165x145x84. Dimensiones interiores 160x135x70.					
717G	8 conos para tubo Ø máximo 32 (M32) y 2 conos para tubo Ø máximo 40 (M40).	8423220087729	14,51	1	50
IP55, IK08. Tornillos ¼ de vuelta. Precintable. Color gris. Dimensiones exteriores 230x180x88. Dimensiones interiores 220x170x80.					
686G	12 conos para tubo Ø máximo 32 (M32) y 2 conos para tubo Ø máximo 40 (M40). Certificado APPLUS.	8423220066106	19,72	1	30
IP55, IK08. Tornillos ¼ de vuelta. Precintable. Color gris. Dimensiones exteriores 230x180x150. Dimensiones interiores 220x170x140.					
686AG	12 conos para tubo Ø máximo 32 (M32) y 2 conos para tubo Ø máximo 40 (M40). Certificado APPLUS.	8423220058675	26,27	1	20
IP65, IK08. Tornillos ¼ de vuelta. Precintable. Color gris. Dimensiones exteriores 165x145x84. Dimensiones interiores 160x135x70.					
817G	Lateral liso.	8423220006270	12,01	1	58
IP65, IK08. Tornillos ¼ de vuelta. Precintable. Color gris. Dimensiones exteriores 230x180x88. Dimensiones interiores 220x170x80.					
886G	Lateral liso. Certificado APPLUS.	8423220006195	19,53	1	32
IP65, IK08. Tornillos ¼ de vuelta. Precintable. Color gris. Dimensiones exteriores 230x180x150. Dimensiones interiores 220x170x140.					
886AG	Lateral liso. Certificado APPLUS.	8423220064942	23,76	1	20
IP65, IK08. Tornillos roscados de plástico. Precintable. Color gris. Dimensiones exteriores 320x250x135. Dimensiones interiores 310x240x125.					
100887G	Lateral liso. Certificado APPLUS.	8423220039889	71,51	1	12



Dimensiones en mm - anchura x altura x profundidad.

Referencia	Descripción	Código GTIN-13	PVP		
 <p>IP65, IK08. Tornillos 1/4 de vuelta. Precintable. Caja color gris. Dimensiones exteriores 165x145x84. Dimensiones interiores 160x135x80.</p>					
6817G	Lateral liso.	8423220005372	20,56	1	50
 <p>IP65, IK08. Tornillos 1/4 de vuelta. Precintable. Caja color gris. Dimensiones exteriores 230x180x150. Dimensiones interiores 220x170x140.</p>					
886ATPG	Lateral liso. Certificado APPLUS.	8423220058712	28,99	1	20
 <p>IP65, IK08. Tornillos 1/4 de vuelta. Precintable. Caja color gris. Dimensiones exteriores 230x180x88. Dimensiones interiores 220x170x80.</p>					
6886G	Lateral liso. Certificado APPLUS.	8423220005389	29,63	1	30
 <p>IP65, IK08. Tornillos roscados de plástico. Precintable. Caja color gris. Dimensiones exteriores 320x250x135. Dimensiones interiores 310x240x125.</p>					
100887TPG	Lateral liso. Certificado APPLUS.	8423220001039	120,24	1	12

ESTANCAS. Ejemplos de montajes especiales

Referencia	Descripción	Código GTIN-13	PVP		
 <p>Paro de emergencia.</p>					
815-1	Caja IP65, IK08. Dimensiones interiores 100x100x55. Tornillos 1/4 de vuelta. Precintable.	8423220004665	28,53	1	50
 <p>Toma schuko.</p>					
815-2	Caja IP65, IK07. Dimensiones interiores 100x100x55. Tornillos 1/4 de vuelta. Precintable. 1 base Schuko 2P+T, 16A, 230V~, IP54.	8423220065857	27,44	1	40
 <p>Interruptores.</p>					
815I2P16	IP55, IK08. Dimensiones interiores 100x100x55. Tornillos 1/4 de vuelta. Precintable. Interruptor 0-1, 2P, 16A. Bloqueo por candado.	8423220067240	39,59	1	35
 <p>2 bases.</p>					
816-5	IP54, IK08. Dimensiones interiores 153x110x65. Tornillos 1/4 de vuelta. Precintable. 2 bases Schuko 2P+T, 16A, 250V~, IP54.	8423220079939	34,33	1	25
 <p>Seccionador de neutro Int: 160A en caja estanca sin conos. IP65, IK08. Precintable. Dimensiones interiores 153x110x65. Tornillos 1/4 de vuelta.</p>					
816PR1P160	Tapa color gris.	8423220020184	27,88	1	27
816PR1P160TP	Tapa transparente.	8423220064904	29,41	1	27
 <p>3 bases.</p>					
817-9	IP44, IK08. Dimensiones interiores 165x135x70. Tornillos 1/4 de vuelta. Precintable. 2 bases Schuko 2P+T, 16A, 230V~, IP54. 1 base CE 3P+T, 16A, 400V~, IP44.	8423220078406	55,06	1	58

Dimensiones en mm - anchura x altura x profundidad.



Accede a la tarifa PVP actualizada

ESTANCAS. Ejemplos de montajes especiales



Referencia	Descripción	Código GTIN-13	PVP		
4 bases.					
817-42P	IP54, IK08. Dimensiones interiores 165x135x70. Tornillos ¼ de vuelta. Precintable. 4 bases Schuko 2P+T, 16A, 250V~, IP54.	8423220078413	57,19	1	58



Referencia	Descripción	Código GTIN-13	PVP		
2 bases.					
886-6	IP44, IK08. Dimensiones interiores 220x170x80. Tornillos ¼ de vuelta. Precintable. 1 base Schuko 2P+T, 16A, 230V~, IP54. 1 base CE 3P+T, 16A, 400V~, IP44.	8423220083592	53,45	1	6



Referencia	Descripción	Código GTIN-13	PVP		
6 bases.					
886-15	IP54, IK08. Dimensiones interiores 220x170x80. Tornillos ¼ de vuelta. Precintable. 6 bases Schuko 2P+T, 16A, 250V~, IP54.	8423220079946	109,87	1	32

ESTANCAS. Accesorios



Referencia	Descripción	Código GTIN-13	PVP/metro		
Perfil DIN.					
TS35/SZ	Perfil DIN de acero laminado en caliente. Sin perforar. Longitud 2m.	8423220066731	5,13	2	20
	Perfil DIN de plástico.				



Referencia	Descripción	Código GTIN-13	PVP		
Kit prensaestopos. Compuesto de prensaestopos + junta selladora de estanqueidad + contratuerca. IP68.					
KIT-PL12G	Kit M12. Para cables Ø3 - 6,5 mm. Longitud espárrago roscado 13 mm.	8423220051959	1,44	60	960
KIT-PL16G	Kit M16. Para cables Ø5 - 10 mm. Longitud espárrago roscado 15 mm.	8423220051986	1,88	60	960
KIT-PL20G	Kit M20. Para cables Ø6 - 12 mm. Longitud espárrago roscado 15 mm.	8423220051973	2,10	60	960
KIT-PL25G	Kit M25. Para cables Ø13 - 18 mm. Longitud espárrago roscado 15 mm.	8423220051980	2,67	60	480
KIT-PL32G	Kit M32. Para cables Ø18 - 25 mm. Longitud espárrago roscado 16 mm.	8423220051997	4,55	40	320
KIT-PL40G	Kit M40. Para cables Ø24 - 32 mm. Longitud espárrago roscado 18 mm.	8423220052062	13,12	24	96



Referencia	Descripción	Código GTIN-13	PVP		
Conos color gris.					
CO-M20	Cono para cajas estancas. Ø20.	8423220061545	0,32	1	2.850
CO-M25/A	Cono para cajas estancas. Ø25.	8423220061552	0,36	1	1.700
CO-M32/A	Cono para cajas estancas. Ø32.	8423220061569	0,39	1	1.100
CO-M40/A	Cono para cajas estancas. Ø40.	8423220061576	0,65	1	750
CO-M50/A	Cono para cajas estancas. Ø50.	8423220061583	0,99	1	500



Referencia	Descripción	Código GTIN-13	PVP		
Regletas de 12 bornes. 450V~. Material Polipropileno.					
RE2,5/10B	Hasta 2,5mm². 18A. Par 0,4Nm. Color blanco.	8423220085107	1,61	10	1.000
RE2,5/10N	Hasta 2,5mm². 18A. Par 0,4Nm. Color negro.	8423220085176	1,61	10	1.000
RE4/10B	Hasta 4mm². 24A. Par 0,4Nm. Color blanco.	8423220085114	1,68	10	1.000
RE4/10N	Hasta 4mm². 24A. Par 0,4Nm. Color negro.	8423220085183	1,68	10	1.000
RE6/10B	Hasta 6mm². 41A. Par 0,5Nm. Color blanco.	8423220085121	2,49	10	1.000
RE6/10N	Hasta 6mm². 41A. Par 0,5Nm. Color negro.	8423220085190	2,49	10	1.000
RE10/10B	Hasta 10mm². 57A. Par 0,8Nm. Color blanco.	8423220085138	3,16	10	500
RE10/10N	Hasta 10mm². 57A. Par 0,8Nm. Color negro.	8423220085206	3,16	10	500
RE16/10B	Hasta 16mm². 76A. Par 1,2Nm. Color blanco.	8423220085145	5,27	10	300
RE16/10N	Hasta 16mm². 76A. Par 1,2Nm. Color negro.	8423220085213	5,27	10	300
RE25/10B	Hasta 25mm². 100A. Par 2Nm. Color blanco.	8423220085152	11,13	10	100
RE25/10N	Hasta 25mm². 100A. Par 2Nm. Color negro.	8423220085220	11,13	10	100
RE35/10B	Hasta 35mm². 125A. Par 2Nm. Color blanco.	8423220085169	11,55	10	100
RE35/10N	Hasta 35mm². 125A. Par 2Nm. Color negro.	8423220085572	11,55	10	100



Dimensiones en mm - anchura x altura x profundidad.



Referencia	Descripción	Código GTIN-13	PVP		
Placas metálicas (para otras medidas de espesor, consultar al Departamento Técnico).					
PM817	Placa metálica para refs. 717, 817 y 6817. Dimensiones 150x130x1,5 mm. Con 4 tornillos de fijación.	8423220003606	5,81	1	50
PM820	Placa metálica para ref. 820. Dimensiones 440x200x2 mm. Con 8 tornillos de fijación.	8423220003668	20,31	1	10
PM821	Placa metálica para ref. 821. Dimensiones 440x290x2 mm. Con 8 tornillos de fijación.	8423220003675	24,51	1	10
PM886	Placa metálica para refs. 686, 686A, 886, 886A y 6886. Dimensiones 214x164x1,5 mm. Con 4 tornillos de fijación.	8423220003644	9,65	1	20
PM887	Placa metálica para refs. 100888 y 100887. Dimensiones 295x224x2 mm. Con 4 tornillos de fijación.	8423220003651	16,59	1	10



Seccionador.					
SEC1P160A	Seccionador neutro IN 160A.	8423220074378	11,62	1	120



Referencia	Descripción	GTIN-13 unitario	PVP		GTIN-13 envase	
Dispositivos de conexión para cables rígidos y flexibles. Color gris y naranja.						
CLE24	Regleta de 2 bornes para cables rígidos 4 mm ² o flexibles 2,5 mm ² . 32A 400V. (5 uds.).	8423220080072	5,27	20	8423220065222	640
CLE34	Regleta de 3 bornes para cables rígidos 4 mm ² o flexibles 2,5 mm ² . 32A 400V. (5 uds.).	8423220080089	6,41	20	8423220065239	640
CLE54	Regleta de 5 bornes para cables rígidos 4 mm ² o flexibles 2,5 mm ² . 32A 400V. (4 uds.).	8423220080096	8,03	20	8423220065246	450
CLE4-5	Conjunto de bloques. Contenido de la bolsa: 2 de ref. CLE24, 2 de ref. CLE34 y 1 de ref. CLE54.	8423220088337	7,01	20	8423220065086	320



Referencia	Descripción	Código GTIN-13	PVP		
Tapones para orificios de fijación de cajas estancas. Para mantener el IP después de fijar la caja.					
TPO-715	Bolsa de 24 uds. Válidos para todas las cajas de la Serie YBOX. Válido para las cajas estancas 615, 686, 715, 716, 717 y 100888.	8423220095458	1,09	1	2.500

*Consulta la Tabla informativa de la serie Estancas. Pág. 135

Dimensiones en mm - anchura x altura x profundidad.



Accede a la tarifa PVP actualizada



- ✓ GWT 650-850°C
- ✓ Incluye regleta 3P
- ✓ Prensaestopas

Descárgate la documentación técnica



BLACK. Conector para luminarias IP68

Referencia	Descripción	GTIN-13 unitario	PVP		GTIN-13 envase	
Conector aéreo estanco. IP68. Profundidad máxima 4 m. Para Instalación permanente. Ø 25x105. GWT 850°C.						
CE-3PV	Con válvula anti-condensación. Regleta de tornillo de 3 P. Sección 1,5 mm². 16 A-250V~. Con dos prensaestopas para cable de 6,5-12 mm. Pelado: Cable (7-8 mm)- Cubierta (14-15 mm).	8423220201422	11,32	1	8423220201378	200
Conector derivador en T aéreo estanco. IP68: Profundidad máxima 4 m. Para Instalación permanente. Ø33x115x100. GWT 850°C.						
CE-3P4T	1 entrada (3G4) y 2 salidas (3G2,5). Regleta de tornillo de 3P. Sección 4 mm². 24A-250V~. Con 3 prensaestopas para cable de Ø4-8 mm, 3 juntas de goma intercambiables para cable de Ø9-12 mm y 3 para cable de Ø10-14 mm. Pelado: Cable (7-8 mm) - Cubierta (18-20 mm).	--	13,62	1	8423220229464	125

BLACK. Cajas estancas de conexión IP68

Referencia	Descripción	GTIN-13 unitario	PVP		GTIN-13 envase	
Caja estanca de conexión. IP68: Profundidad máxima 4 metros. Dimensiones interiores 73x44x30. Fijación exterior. GWT 850°C.						
BK-3P	Con terminal de conexión incluido. 4 Polos. Hasta 2,5 mm² . 24A-250V~. 3 prensaestopas de M20 con junta de goma para cable de Ø 4 a 8 mm + 3 juntas para cable de Ø 9 a 12 mm y un tapón.	8423220201439	13,81	1	8423220201385	100
Caja estanca de conexión. IP68: Profundidad máxima 4 metros. Dimensiones interiores 70x57x30. Fijación exterior. GWT 850°C.						
BK-3PT	Con terminal de conexión incluido. 4 Polos. Hasta 2,5 mm² . 24A-250V~. 3 prensaestopas de M25 con junta de goma para cable de Ø 4 a 8 mm, 3 juntas para cable de Ø 9 a 12 mm, 3 para cable de Ø 10 a 14 mm y un tapón.	8423220201446	17,79	1	8423220201392	110
Caja estanca de conexión. IP68: Profundidad máxima 4 metros. Dimensiones interiores 112x92x48. Fijación exterior. GWT 850°C.						
BK-6P	Con terminal de conexión incluido. 4 Polos. Hasta 2,5 mm². 24A-250V~. 6 prensaestopas de M25 con junta de goma para cable de Ø 4 a 8 mm, 3 juntas para cable de Ø 9 a 12 mm, 3 para cable de Ø 10 a 14 mm y tres tapones.	8423220201460	44,18	1	8423220201408	30



Dimensiones en mm - anchura x altura x profundidad.

Cajas de conexión



Descárgate la documentación técnica



Ventajas de la serie



Refuerzo en los laterales que evita la rotura y deformación de la caja



Ojales en el fondo de la caja para fijar los cables con bridas



Diferentes sistemas de cierre:

- Con tornillo
- Con garra de plástico
- Con garra metálica



Productos complementarios



Pág. 113





Pág. 64



Pág. 116





Referencia	Descripción	Código GTIN-13	PVP		
Dimensiones para empotrar 31x59x40. 7 entradas para tubo Ø 16.					
525	Caja con tapa, con garra de plástico.	8423220057227	1,57	35	140
Dimensiones para empotrar 31x59x40. 7 entradas para tubo Ø 16.					
527	Caja para punto de luz.	8423220005273	1,37	20	1.260
Dimensiones para empotrar 67x67x42. 5 entradas para tubo Ø 25.					
635	Caja con tapa, con tornillos.	8423220057258	1,62	1	48
Dimensiones para empotrar 65x65x40. 9 entradas para tubo Ø 25.					
6635	Caja con tapa con tornillos.	8423220057241	1,54	1	84
Dimensiones para empotrar 100x50x45. 6 entradas para tubo Ø 32.					
361	Caja con tapa, con tornillos.	8423220003613	1,99	10	280
561	Caja con tapa, con garra metálica.	8423220005617	1,74	10	280
Dimensiones para empotrar 100x100x45. 12 entradas para tubo Ø 25.					
262	Caja con tapa, con garra de plástico.	8423220030121	2,43	1	168
362	Caja con tapa, con tornillos.	8423220003620	2,41	4	168
562	Caja con tapa, con garra metálica.	8423220005624	2,56	4	168
Dimensiones para empotrar 160x100x50. 16 entradas para tubo Ø 25.					
263	Caja con tapa, con garra de plástico.	8423220030138	3,31	1	110
363	Caja con tapa, con tornillos.	8423220003637	3,29	5	110
563	Caja con tapa, con garra metálica.	8423220005631	3,41	5	110
Dimensiones para empotrar 150x150x50. 12 entradas para tubo Ø 32.					
223	Caja con tapa, con garra de plástico.	8423220030084	3,74	1	78
323	Caja con tapa, con tornillos.	8423220003231	4,01	1	78
623	Caja con tapa, con garra metálica.	8423220006232	4,41	1	78
Dimensiones para empotrar 200x130x60. 20 entradas para tubo Ø 32.					
214	Caja con tapa, con garra de plástico.	8423220020009	4,54	1	62
314	Caja con tapa, con tornillos.	8423220003149	4,37	1	62
614	Caja con tapa, con garra metálica.	8423220103887	5,03	1	62
Dimensiones para empotrar 200x200x65. 16 entradas para tubo Ø 40.					
220	Caja con tapa, con garra de plástico.	8423220004061	5,85	1	30
320	Caja con tapa, con tornillos.	8423220003200	6,59	1	30
620	Caja con tapa, con garra metálica.	8423220006201	6,76	1	30
Dimensiones para empotrar 250x250x60. 20 entradas para tubo Ø 40.					
224	Caja con tapa, con garra de plástico.	8423220030091	8,36	1	28
324	Caja con tapa, con tornillos.	8423220003248	9,99	1	28
624	Caja con tapa, con garra metálica.	8423220006249	4,41	1	28

Dimensiones en mm - anchura x altura x profundidad.



Referencia	Descripción	Código GTIN-13	PVP		
Dimensiones para empotrar 430x147,5x65. 30 entradas para tubo Ø 32.					
277	Caja con tapa, con garra de plástico y posibilidad de poner tornillos adicionalmente.	8423220019881	9,80	1	25
Dimensiones para empotrar 170x100x40. 16 entradas para tubo Ø 32.					
5501	Caja con tapa, con tornillos.	8423220007147	3,37	5	125
Dimensiones para empotrar 300x200x60. 20 entradas para tubo Ø 40.					
5502	Caja con tapa, con tornillos. 1 tabique de separación.	8423220007185	12,71	1	23
50 entradas para tubo Ø 40. Caja con tapa con tornillos.					
5503	Dimensiones 300x500x85. 2 tabiques de separación.	8423220008472	23,42	1	5
5504	Dimensiones 300x500x85. Con marco y puerta color blanco. 2 tabiques de separación.	8423220009080	43,51	1	4
5506	Dimensiones 300x500x60. 2 tabiques de separación.	8423220009141	22,82	1	10
5507	Dimensiones 300x500x60. Con marco y puerta color blanco. 2 tabiques de separación.	8423220009158	35,56	1	5
Dimensiones para empotrar 200x160x70. 18 entradas para tubo Ø 40.					
5520	Caja con tapa, con tornillos. 1 tabique de separación.	8423220011977	7,60	1	40
Dimensiones para empotrar 300x160x70. 14 entradas para tubo Ø 32 y 10 entradas para tubo Ø 40.					
5530	Caja con tapa, con tornillos. 2 tabiques de separación.	8423220011984	8,89	1	31
Dimensiones para empotrar 400x160x70. 30 entradas para tubo Ø 40.					
5540	Caja con tapa, con tornillos. 3 tabiques de separación.	8423220011991	10,82	1	22
Dimensiones para empotrar 500x160x70. 12 entradas para tubo Ø 40 y 18 entradas para tubo Ø 50.					
5550	Caja con tapa, con tornillos. 2 tabiques de separación.	8423220012004	12,85	1	19

DERIBOX. Cajas de conexión de empotrar redondas



Referencia	Descripción	Código GTIN-13	PVP		
Dimensiones para empotrar Ø 65x40. 5 entradas para tubo Ø 25.					
575	Caja con tapa, con tornillos.	8423220057234	1,54	1	104
Dimensiones para empotrar Ø 60x40. 7 entradas para tubo Ø 16.					
513	Caja con tapa, con garras de plástico.	8423220005136	1,32	20	560

Dimensiones en mm - anchura x altura x profundidad.





Accede a la tarifa PVP actualizada



DERIBOX. Cajas de conexión de empotrar redondas

Referencia	Descripción	Código GTIN-13	PVP		
Dimensiones para empotrar Ø 80x40.					
414	Caja con tapa roscada. 8 entradas para tubo Ø 25.	8423220004146	2,28	20	320
514	Caja con tapa, con garra metálica. 6 entradas para tubo Ø 25.	8423220005143	1,78	8	288
Dimensiones para empotrar Ø 100x50. 6 entradas para tubo Ø 32.					
515	Caja con tapa, con garra metálica.	8423220005150	2,49	6	180
Dimensiones para empotrar Ø 100x46. 10 entradas para tubo Ø 25.					
6514	Caja con tapa cuadrada nivelable. Ajuste perimetral. Con tornillo central.	8423220064935	2,32	4	120
Dimensiones para empotrar Ø 150x46. 14 entradas para tubo Ø 25 y 4 entradas para tubo Ø 32.					
6515	Caja con tapa redonda con garra de plástico. Con tornillo central.	8423220340220	3,96	1	72
6516	Caja con tapa cuadrada nivelable. Ajuste perimetral. Con tornillo central.	8423220140233	4,37	1	72

DERIBOX. Accesorios

Referencia	Descripción	Código GTIN-13	PVP		
Marco y puerta de material termoplástico color blanco. Sin rejilla.					
5505	Marco y puerta embellecedora. Para reposición en las Refs. 5503, 5504, 5508 y 5506.	8423220009097	25,62	1	12
Tapa para arqueta de registro.					
AR25256	Dimensiones: 250x250x61.	8423220140226	22,58	1	26

DERIBOX. Cajas de superficie

Referencia	Descripción	Código GTIN-13	PVP		
4 entradas para tubo Ø 20 y 4 entradas en el fondo para tubo Ø 18. Tapa redonda y roscada en el centro de la caja.					
414S	Dimensiones exteriores Ø 93,5x35,5. Dimensiones interiores Ø 80,5x32.	8423220140219	2,63	1	400
515S	Dimensiones exteriores Ø 113x41. Dimensiones interiores Ø 106x37.	8423220340213	2,99	1	230
Registros de empalme y derivación. Entradas para canaleta hasta 10x22.					
1662	Dimensiones exteriores 65x65x35.	8423220003194	2,59	24	192
1664	Dimensiones exteriores 132x65x35.	8423220004108	5,55	11	88
Registro de empalme y derivación. Entrada para canaletas de 10x12, 10x16, 10x22 y 10x35.					
1762	Dimensiones exteriores 82x82x40.	8423220002005	3,38	12	96
Con marco y puerta color blanco.					
5508	Dimensiones exteriores 362x542x115.	8423220009745	62,97	1	4



Dimensiones en mm - anchura x altura x profundidad.



Referencia	Descripción	Código GTIN-13	PVP		
Tapas.					
13	Tapa con garra de plástico para ref. 513.	8423220000131	0,74	50	1.200
14	Tapa con garra metálica para ref. 514.	8423220000148	1,33	1	250
15	Tapa con garra metálica para ref. 515.	8423220000155	1,53	1	200
20G	Tapa con garra metálica para ref. 620.	8423220010949	4,85	10	100
20T	Tapa con tornillos para ref. 320.	8423220010956	3,61	10	40
23G	Tapa con garra metálica para ref. 623.	8423220042278	3,80	10	180
23T	Tapa con tornillos para ref. 323.	8423220042261	2,49	10	120
24G	Tapa con garra metálica para ref. 624.	8423220010963	7,16	4	80
24T	Tapa con tornillos para ref. 324.	8423220010970	5,41	10	60
25G	Tapa con garra de plástico para ref. 635,625, 6625, 6635 y 625C.	8423220041325	1,49	50	400
25T	Tapa con tornillos para ref. 575, 625, 635, 625C y 6625.	8423220041318	1,43	50	400
61G	Tapa con garra metálica para ref. 561.	8423220039612	1,66	1	192
61T	Tapa con tornillos para ref. 361.	8423220037267	1,31	25	450
62G	Tapa con garra metálica para ref. 562.	8423220000629	2,08	1	50
62T	Tapa con tornillos para ref. 362.	8423220001442	1,61	25	200
63G	Tapa con garra metálica para ref. 563.	8423220000636	2,10	1	70
63T	Tapa con tornillos para ref. 363.	8423220001459	1,82	15	210
64G	Tapa con garra metálica para ref. 614.	8423220000643	3,10	1	162
64T	Tapa con tornillos para ref. 314.	8423220001466	2,51	25	150
214TA	Tapa con garra de plástico para ref. 214.	8423220058781	2,16	1	72
215TA	Tapa con garra de plástico para ref. 6515.	8423220030053	2,21	1	50
216TA	Tapa con garra de plástico para ref. 6516.	8423220030060	2,55	25	250
220TA	Tapa con garra de plástico para ref. 220.	8423220058767	2,80	1	34
223TA	Tapa con garra de plástico para ref. 223.	8423220058729	1,88	1	96
224TA	Tapa con garra de plástico para ref. 224.	8423220058071	3,89	1	30
262TA	Tapa con garra de plástico para ref. 262.	8423220056978	0,91	1	160
263TA	Tapa con garra de plástico para ref. 263.	8423220058743	1,44	1	130
277TA	Tapa con tornillos y garra de plástico para refs. 77, 177 y 277.	8423220030145	6,65	1	30
414TA	Tapa roscada para ref. 414.	8423220054813	0,92	25	100
527TA	Tapa con tornillos para ref. 527.	8423220041301	0,79	50	1.200
5501TA	Tapa con tornillos para ref. 5501.	8423220008496	2,55	1	150
5502TA	Tapa con tornillos para ref. 5502.	8423220008526	6,79	1	50
5503TA	Tapa con tornillos para refs. 5503 y 5506.	8423220008595	14,25	1	30
5520TA	Tapa con tornillos para ref. 5520.	8423220054882	5,01	1	120
5530TA	Tapa con tornillos para ref. 5530.	8423220054899	5,52	1	80
5540TA	Tapa con tornillos para ref. 5540.	8423220054905	6,53	1	60

DERIBOX. Marcos y puertas metálicas para tapar hueco de obra



Referencia	Descripción	Color	Código GTIN-13	PVP		
Marcos y puertas metálicas para tapar hueco de obra. IK07. Acabado mate y tratamiento EPOXI. Con cierre. Con llave opcional referencia CER-MP28 (ver página 7).						
KIT-MRP14	Dimensiones interiores 304x279x27. Dimensiones exteriores 362x327.		8423220073500	43,19	1	3
KIT-MRP14NG	Dimensiones interiores 304x279x27. Dimensiones exteriores 362x327.		8423220246508	45,47	1	3
KIT-MRP28	Dimensiones interiores 304x414x27. Dimensiones exteriores 362x462.		8423220073517	52,68	1	3
KIT-MRP28NG	Dimensiones interiores 304x414x27. Dimensiones exteriores 362x462.		8423220246515	55,13	1	3
KIT-MRP42	Dimensiones interiores 304x595x27. Dimensiones exteriores 362x643.		8423220073524	65,09	1	3
KIT-MRP42NG	Dimensiones interiores 304x595x27. Dimensiones exteriores 362x643.		8423220246522	73,71	1	3
KIT-MRP56	Dimensiones interiores 304x730x27. Dimensiones exteriores 362x778.		8423220073531	79,52	1	3
KIT-MRP56NG	Dimensiones interiores 304x730x27. Dimensiones exteriores 362x778.		8423220246539	88,06	1	3

Dimensiones en mm - anchura x altura x profundidad.



Accede a la tarifa PVP actualizada

Cajas para mecanismos



Descárgate toda la documentación técnica de la serie escaneando este código



MECABOX. Cajas para empotrar mecanismos

Referencia	Descripción	Código GTIN-13	PVP		
Dimensiones para empotrar 65x65x40. 9 entradas para tubo Ø 25. Certificado AENOR.					
6625	Caja universal enlazable por dos caras para 1 elemento. Con 2 tornillos de roscado rápido. Alojamiento para tornillos en las cuatro caras.	8423220005365	0,61	20	500
Dimensiones para empotrar 67x77x42. 5 entradas para tubo Ø 25. Certificado AENOR.					
625	Caja universal enlazable para 1 elemento.	8423220006256	0,81	20	500
Dimensiones para empotrar 145x67x42. 6 entradas para tubo Ø 25.					
725	Caja universal para 2 elementos. Con tabique de separación.	8423220007253	1,99	10	260
Dimensiones para empotrar 217x67x42. 8 entradas para tubo Ø 25.					
825	Caja universal para 3 elementos. Con tabiques de separación.	8423220008250	2,81	10	180
Dimensiones para empotrar 97x80x42. 8 entradas para tubo Ø 25.					
733	Caja para 1 elemento.	8423220006508	1,58	10	360
Dimensiones para empotrar 110x73x51. 6 entradas para tubo Ø 20 a 25, 4 para tubo Ø 22 a 26. y 2 para tubo Ø 20 a 35.					
24CH/6	Caja tipo americana de 3 módulos.	8423220083417	1,24	6	216

MECABOX. Tapas y protectores para cajas para empotrar mecanismos

Referencia	Descripción	Código GTIN-13	PVP		
70x70. Protector para evitar la entrada de yeso.					
625TA	Válida para cualquier caja universal del mercado.	8423220008373	0,41	1	350
Protector para evitar yeso en la cabeza de los tornillos. Material termoplástico.					
PROT-6625	Para caja 6625.	8423220091115	2,74	1	10000
Tapas.					
6635TCP	Cuadrada con garra de plástico para cajas universales. Para refs. 625 y 6625. 104x104.	8423220087002	1,20	1	200
6635TCT	Cuadrada con tornillos para cajas universales. Para refs. 625 y 6625. 104x104.	8423220087019	1,13	1	150
25G	Redonda con garras de plástico para refs. 625 y 6625. Ø104.	8423220041325	1,49	50	450
25T	Redonda con tornillos para refs. 625 y 6625. Ø104.	8423220041318	1,43	50	400
527TA	Redonda con garra de plástico para ref. 525. Ø82.	8423220041301	0,79	50	1.200



Dimensiones en mm - anchura x altura x profundidad.



Referencia	Descripción	Código GTIN-13	PVP		
Caja de superficie para mecanismos. Desmontable y ampliable. Color blanco.					
9	Para 1 elemento. 96x94x43. Entradas para canales: 10x16, 10x20, 16x25 y 25x40. Para ampliar con accesorios CP-9	8423220092624	3,61	1	100



Accesorio para hacer ampliaciones de la caja ref. 9.					
CP-9	Dimensiones para 2 elementos 167x94x43, y de 3 elementos 238x94x43.	8423220092631	2,14	1	102



Cajas de superficie para mecanismos variados. Incluye taco + tornillo. Color blanco.					
91	94x96x43. Para 1 elemento.	8423220908895	3,22	1	102
92	165x96x43. Para 2 elementos.	8423220908901	4,34	1	52
93	235x96x43. Para 3 elementos.	8423220908918	5,81	1	38

Cajas para la pre-instalación de aire acondicionado



Descárgate toda la documentación técnica y el vídeo de la serie escaneando este código



Referencia	Descripción	Código GTIN-13	PVP		
Salida de agua VERTICAL. Dimensiones para empotrar 430x147,5x65. 30 entradas para tubo Ø 32. Con tabique central antideformación. Con evacuador independiente y reversible. Tapa con garra de plástico con opción para poner tornillos simultáneamente.					
77	Con caja estanca interna para realizar conexiones eléctricas (Ref. 665).	8423220019874	14,67	1	25
177	Sin caja estanca interior.	8423220019898	12,37	1	25



Salida de agua HORIZONTAL. Dimensiones para empotrar 430x147,5x65. 30 entradas para tubo Ø 32. Con tabique central antideformación. Con evacuador independiente y reversible. Tapa con garra de plástico y opción de poner tornillos simultáneamente.					
78	Con caja estanca interna para realizar conexiones eléctricas (Ref. 665).	8423220033306	14,67	1	25
178	Sin caja estanca interior.	8423220033313	12,37	1	25

Dimensiones en mm - anchura x altura x profundidad.



Accede a la tarifa PVP actualizada

¡Instalación hasta un **40%** más rápida!



Descárgate la documentación técnica y vídeos de montaje



Ventajas de la serie



Certificación AENOR



Faldón perimetral más amplio y delgado



Ojales para fijar los tubos con una brida



Entradas para tubos en el fondo







Productos complementarios





Pág. 113







Pág. 70

Referencia	Descripción	Código GTIN-13	PVP		
Dimensiones para empotrar Ø 68x46. 4 entradas para tubo Ø 20 y 2 para tubo Ø 25. Fijación mediante bridas.					
5625GW	Para 1 elemento. Utilizar corona de Ø 68 mm.	8423220090545	1,72	20	320
	Caja con Certificación AENOR				
Dimensiones para empotrar 139x68x46. 6 entradas para tubo Ø 25-20 y 2 entradas para tubo Ø16. Fijación mediante bridas.					
5725GW	Para 2 elementos.	8423220201712	2,94	10	220
	Caja con Certificación AENOR				
Dimensiones para empotrar 219x68x46. 4 entradas para tubo Ø 20-25 y 4 entradas para tubo Ø 20-16. Fijación mediante bridas.					
5825GW	Para 3 elementos.	8423220201729	4,17	6	144
	Caja con Certificación AENOR				
Dimensiones para empotrar 281x68x46. 8 entradas para tubo Ø 25-20, 4 entradas para tubo Ø 20 y 4 para tubo de Ø 16. Fijación mediante bridas.					
5925GW	Para 4 elementos.	8423220217270	6,79	4	12
	Caja con Certificación AENOR				

SERIE BLUE. Caja de mecanismos con membrana

Referencia	Descripción	Código GTIN-13	PVP		
Caja de mecanismo con membranas que preservan la energía en el edificio. Evita pérdidas de calor o frío hasta un 92%. Dimensiones para empotrar Ø 68x46. 2 entradas para tubo Ø 20-25 y 2 entradas para tubo Ø16.					
5625E	Para 1 elemento. Utilizar corona de Ø 68 mm. Fijación mediante bridas.	8423220215870	2,77	20	320
Caja de mecanismo con membranas que preservan la energía en el edificio. Evita pérdidas de calor o frío hasta un 92%. Dimensiones para empotrar 139x68x46. 4 entradas para tubo Ø 25-20 y 2 entradas para tubo Ø20-16.					
5725E	Para 2 elementos. Fijación mediante bridas.	8423220231184	4,09	10	220
5725EG	Para 2 elementos. Fijación mediante garra metálica.	8423220231573	4,45	10	220
Caja de mecanismo con membranas que preservan la energía en el edificio. Evita pérdidas de calor o frío hasta un 92%. Dimensiones para empotrar 219x68x46. 4 entradas para tubo Ø 20-25 y 4 entradas para tubo Ø 20-16.					
5825E	Para 3 elementos. Fijación mediante bridas.	8423220231191	5,85	6	144
5825EG	Para 3 elementos. Fijación mediante garra metálica.	8423220231580	6,27	6	144

SERIE BLUE. Caja de mecanismos con fijación mediante garras





Referencia	Descripción	Código GTIN-13	PVP		
Dimensiones para empotrar Ø 68x46. 4 entradas para tubo Ø 20 y 2 entradas para tubo Ø 25. Fijación mediante garras.					
5625	Para 1 elemento. Utilizar corona de Ø 68 mm.	8423220007215	1,84	20	520
	Caja con Certificación AENOR				
Dimensiones para empotrar 140x68x46. 4 entradas para tubo Ø 20 y 4 para tubo Ø 25. Fijación mediante garras.					
5725	Para 2 elementos.	8423220011960	3,34	10	260
	Caja con Certificación AENOR				

Dimensiones en mm - anchura x altura x profundidad.





Accede a la tarifa PVP actualizada



SERIE BLUE. Caja de mecanismos con fijación mediante garras

Referencia	Descripción	Código GTIN-13	PVP		
Dimensiones para empotrar 218x68x46. 6 entradas para tubo Ø 20 y 4 para tubo Ø 25. Fijación mediante garras.					
5825	Para 3 elementos.	8423220039599	5,21	6	180
	Caja con Certificación AENOR				
Dimensiones para empotrar 281x68x46. 12 entradas para tubo Ø 20, 8 para tubo Ø 25 y 4 para tubo de Ø 16. Fijación mediante garras.					
5925	Para 4 elementos.	8423220217256	7,85	4	12
	Caja con Certificación AENOR				

SERIE BLUE. Cajas de conexión con fijación mediante bridas

Referencia	Descripción	Código GTIN-13	PVP		
Dimensiones para empotrar 107x107x45. 12 entradas para tubo Ø 25. Fijación mediante bridas.					
5362GW	Tapa con tornillos.	8423220201118	4,61	4	168
5562GW	Tapa con garra metálica.	8423220201743	4,32	4	168
Dimensiones para empotrar 170x112x47. 16 entradas para tubo Ø 25. Fijación mediante bridas.					
5363GW	Tapa con tornillos. Se puede utilizar como registro de Tipo C para ICT.	8423220204669	5,88	5	110
5563GW	Tapa con garra metálica.	8423220201750	5,66	5	110
Dimensiones para empotrar 188x148x50. 8 entradas para tubo Ø 25, 2 entradas para tubo Ø 32 y 6 para tubo Ø 40. Fijación mediante bridas.					
5314GW	Tapa con tornillos.	8423220204676	10,85	1	66
Dimensiones para empotrar 252x252x50. 12 entradas para tubo Ø 25 y 12 para tubo de Ø 30. Tapa con tornillos.					
324GW	Laterales desfondables. Sujeción de tubos mediante bridas.	8423220090583	11,34	2	28

SERIE BLUE. Cajas de conexión con fijación mediante garras

Referencia	Descripción	Código GTIN-13	PVP		
Dimensiones para empotrar 100x100x45. 12 entradas para tubo Ø 25. Fijación mediante garras.					
5362	Tapa con tornillos.	8423220044494	4,57	4	168
5562	Tapa con garra metálica.	8423220044784	5,81	4	168
Dimensiones para empotrar 164x106x47. 16 entradas para tubo Ø 25. Fijación mediante garras.					
5363	Tapa con tornillos. Se puede utilizar como registro de Tipo C para ICT.	8423220011137	6,65	5	110
5563	Tapa con garra metálica.	8423220011183	7,63	5	110
Dimensiones para empotrar 188x148x50. 8 entradas para tubo Ø 25, 2 para tubo Ø 32 y 6 para tubo Ø 40. Fijación mediante garras.					
5314	Tapa con tornillos.	8423220011953	9,17	1	66
Dimensiones para empotrar 252x252x50. 12 entradas para tubo Ø 25 y 12 para tubo de Ø 30. Tapa con tornillos.					
5324	Laterales desfondables. Sujeción de tubos mediante bridas.	8423220246027	12,92	1	28



Dimensiones en mm - anchura x altura x profundidad.

Referencia	Descripción	Código GTIN-13	PVP		
Dimensiones para empotrar 300x150x75. Apta para instalaciones domóticas. Tapa con tornillos. Fijación mediante garras.					
5530GW	Caja vacía.	8423220225305	19,71	1	31
5530GWD	Con perfil DIN.	8423220225312	21,85	1	31
Dimensiones para empotrar 390x150x60. Tapa con tornillos. Fijación mediante garras.					
5540GW	Caja vacía.	8423220225329	19,85	1	22
Dimensiones para empotrar Ø 100x46. 10 entradas para tubo Ø 25. Fijación mediante garras.					
5514GW	Tapa cuadrada nivelable con tornillo central. Ajuste perimetral. Utilizar corona de Ø 104.	8423220204683	4,97	4	120
Dimensiones para empotrar Ø 150x46. 14 entradas para tubo Ø 25 y 4 para tubo Ø 32. Fijación mediante garras.					
5515GW	Tapa redonda con garra de plástico. Con tornillo central.	8423220204690	7,95	4	72
5516GW	Tapa cuadrada nivelable. Ajuste perimetral. Con tornillo central.	8423220204706	8,19	4	72
Dimensiones para empotrar 300x500x60. 50 entradas para tubo Ø 40. Fijación mediante garras.					
5506HGW	Tapa con tornillos. Sistema fijación BOLCOR5506/4*	8423220095496	45,68	1	10
5507HGW	Con marco y puerta embellecedora color blanco. Sistema fijación BOLCOR5506/4*	8423220095328	62,65	1	5

SERIE BLUE. Cajas de distribución METALBOX

Referencia	Descripción	Código GTIN-13	PVP		
14 elementos. 1 fila. Dimensiones 333x300x88. Caja y tapa interior material termoplástico. Marco y puerta metálicos. Disipación térmica de 30W. Incluye garras de fijación.					
MP14HGW	Color blanco. Consulte otros acabados.	8423220094406	88,59	1	1
MP14NGHGW	Color grafito.	8423220245990	101,47	1	1
28 elementos. 2 filas. Dimensiones 333x435x88. Caja y tapa interior material termoplástico. Marco y puerta metálicos. Disipación térmica de 33W. Incluye garras de fijación.					
MP28HGW	Color blanco. Consulte otros acabados.	8423220094468	115,89	1	1
MP28NGHGW	Color grafito.	8423220246003	128,70	1	1
42 elementos. 3 filas. Dimensiones 333x620x88. Caja y tapa interior material termoplástico. Marco y puerta metálicos. Disipación térmica de 35W. Incluye garras de fijación.					
MP42HGW	Color blanco. Consulte otros acabados.	8423220094413	150,61	1	1
MP42NGHGW	Color grafito.	8423220246010	164,33	1	1
56 elementos. 4 filas. Dimensiones 333x752x88. Caja y tapa interior material termoplástico. Marco y puerta metálicos. Disipación térmica de 40W. Incluye garras de fijación.					
MP56HGW	Color blanco. Consulte otros acabados.	8423220094475	178,05	1	1
MP56NGHGW	Color grafito.	8423220246027	194,43	1	1

Dimensiones en mm - anchura x altura x profundidad.



Accede a la tarifa PVP actualizada



Referencia	Descripción	Código GTIN-13	PVP		
8 elementos. Dimensiones para empotrar 205x233x72. Dimensiones exteriores 247x249. Precintable. Nuevos sistemas de fijación.					
5108HGW	Marco y puerta blancos. Sistema fijación BOLCOR5504/4*.	8423220092761	32,14	1	12
5108PFHGW	Marco blanco y puerta fumé.	8423220092778	33,79	1	12



14 elementos. Dimensiones para empotrar 320x233x75. Dimensiones exteriores 362x250. Precintable. Nuevos sistemas de fijación.					
5012HGW	Marco y puerta blancos. Sistema fijación BOLCOR5504/4*.	8423220092747	40,63	1	11
5012PFHGW	Marco blanco y puerta fumé.	8423220092785	43,93	1	11



22 elementos. Dimensiones para empotrar 450x222x72. Dimensiones exteriores 477x247.					
8690HGW	Marco y puerta blancos. Sistema fijación G-MP28/4.	8423220092792	40,68	1	10
8690PFHGW	Marco blanco y puerta fumé.	8423220092808	45,92	1	10



28 elementos. Dimensiones para empotrar 320x420x75. Dimensiones exteriores 362x438x102. Nuevos sistemas de fijación.					
5250HGW	Marco y puerta blancos. Sistema fijación BOLCOR5504/4*.	8423220092754	65,98	1	5
5250PFHGW	Marco blanco y puerta fumé.	8423220092815	78,72	1	5



42 elementos. Dimensiones para empotrar 360x528x86. Dimensiones exteriores 362x544x113.					
5260HGW	Marco y puerta blancos. Sistema fijación BOLCOR5260/4*.	8423220092822	87,47	1	4
5260PFHGW	Marco blanco y puerta fumé.	8423220092839	96,56	1	4



56 elementos. Dimensiones para empotrar 320x670x75. Dimensiones exteriores 362x686x102. Nuevos sistemas de fijación.					
5270HGW	Marco y puerta blancos. Sistema fijación BOLCOR5504/4*.	8423220092846	125,62	1	5
5270PFHGW	Marco blanco y puerta fumé.	8423220092853	130,86	1	5



16 elementos + 4 precintables. Dimensiones para empotrar 450x222x72. Dimensiones exteriores 477x247.					
8881HGW	Marco y puerta blancos. Sistema fijación G-MP28/4.	8423220092860	47,71	1	10
8881PFHGW	Marco blanco y puerta fumé.	8423220092877	50,37	1	10



20 elementos + 4 precintables. Dimensiones para empotrar 320x420x75. Dimensiones exteriores 362x438. Nuevos sistemas de fijación.					
5420HGW	Marco y puerta blancos. Sistema fijación BOLCOR5504/4*.	8423220092884	64,59	1	5
5420PFHGW	Marco blanco y puerta fumé.	8423220092891	73,04	1	5



24 elementos + 4 precintables. Dimensiones para empotrar 400x330x72. Dimensiones exteriores 423x353.					
8203HGW	Marco y puerta blancos. Sistema fijación BOLCOR5260/4*.	8423220092907	64,99	1	5
8203PFHGW	Marco blanco y puerta fumé.	8423220092914	66,92	1	5



30 elementos + 4 precintables. Dimensiones para empotrar 360x528x86. Dimensiones exteriores 362x544.					
5430HGW	Marco y puerta blancos. Sistema fijación BOLCOR5260/4*.	8423220092921	92,52	1	4
5430PFHGW	Marco blanco y puerta fumé.	8423220092952	99,99	1	4



40 elementos + 4 precintables. Dimensiones para empotrar 320x670x75. Dimensiones exteriores 362x686.					
5440HGW	Marco y puerta blancos. Sistema fijación BOLCOR5504/4*.	8423220092938	117,93	1	5
5440PFHGW	Marco blanco y puerta fumé.	8423220092945	130,15	1	5

*Consulta el sistema de fijación para tabique hueco. Pág. 133

Dimensiones en mm - anchura x altura x profundidad.





Referencia	Descripción	Código GTIN-13	PVP		
Registro de terminación de red. Dimensiones para empotrar 698x613x88. Incluye garras de fijación.					
MP42/2HGW	Vacío.	8423220208834	272,17	1	2
MP42/2BHGW	Con una base de dos tomas 2P+T, 16A 250V~	8423220208841	294,68	1	2



Referencia	Descripción	Código GTIN-13	PVP		
Registro de terminación de red. Dimensiones para empotrar 685x530x85. Incluye garras de fijación.					
5504/2HGW	Vacío. Sistema fijación BOLCOR5504/4.*	8423220241275	137,73	1	1

SERIE BLUE. Accesorios



Referencia	Descripción	Código GTIN-13	PVP/ud		
Brida de Nylon para fijación. (Reposición).					
BR5625GW	Bolsa de 20 uds. Para serie Blue.	8423220090934	0,47	20	2.000

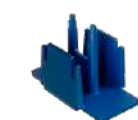

Referencia	Descripción	Código GTIN-13	PVP/ud		
Unión para 2 o más cajas de mecanismo 5625GW.					
UN5625GW	Bolsa de 10 uds.	8423220090606	0,29	10	1.400



Referencia	Descripción	Código GTIN-13	PVP/ud		
Plantilla para marcar los agujeros de las cajas de mecanismos Blue en el tabique.					
7157	Bolsa de 4 unidades. La marca que se debe emplear para medir los centros de los mecanismos en España y Portugal es de 71 mm. La marca de 57 mm es para Francia.	8423220213036	3,01	4	96



Referencia	Descripción	Código GTIN-13	PVP/ud		
Corona Ø68 con avellanado para tabique hueco.					
COR68TH	Corona Ø68 con avellanado para tabique hueco. Para refs. 5625GW, 5625E y 5625.	8423220235878	99,99	1	1
COR-68S	Cuerpo de corona de 68 mm de diámetro.	8423220254565	C*	1	1
AC-68	Placa avellanadora de acero. Con tratamiento anti-oxidación.	8423220254572	C*	1	1
M-68	Muelle expulsor.	8423220254589	C*	1	1



Referencia	Descripción	Código GTIN-13	PVP/ud		
Unión.					
5625UNIÓN	Unión para la caja 5625.	8423220008229	0,27	5	3.800



Referencia	Descripción	Código GTIN-13	PVP/ud		
Tapa con garra de plástico.					
5625TA	Para caja Ref. 5625. Color blanco. Dimensiones Ø 82 mm.	8423220041035	0,81	1	500



Referencia	Descripción	Código GTIN-13	PVP/ud		
Tabique para mecanismos de tabique hueco.					
BOL-TB725	Bolsa con 5 uds. del tabique TB725.	8423220255067	C*	1	500

Dimensiones en mm - anchura x altura x profundidad.



Accede a la tarifa PVP actualizada



Descárgate la documentación técnica y vídeos de montaje



Ventajas de la serie



Garras de fijación



Producto certificado



Chasis enlazables



Todos los materiales conductores están fabricados en **CuSn94**



Productos complementarios



Pág. 62



Pág. 62



Pág. 64



Referencia	Descripción	GTIN-13 unitario	PVP		GTIN-13 envase	
Conmutador / interruptor 10AX 250V~. Dimensiones 83x81. Embornamiento por tornillo.						
ERP02U	Color blanco.	8423220076556	6,79	10	8423220076914	120



Doble conmutador / interruptor 10AX 250V~. Dimensiones 83x81. Embornamiento por tornillo.						
ERP12U	Color blanco.	8423220076563	9,11	10	8423220076921	120



Conmutador de cruce 10AX 250V~. Dimensiones 83x81. Embornamiento por tornillo.						
ERP09U	Color blanco.	8423220076570	9,59	10	8423220076938	120



Pulsador 10A 250V~. Dimensiones 83x81. Embornamiento por tornillo.						
ERP03U	Color blanco.	8423220076549	6,68	10	8423220076907	120



Pulsador persiana 10A 250V~. Dimensiones 83x81. Embornamiento por tornillo.						
ERP20U	Color blanco.	8423220076587	9,24	10	8423220076945	120



Conmutador persiana 10A 250V~. 3 posiciones. Dimensiones 83x81. Embornamiento por tornillo.						
ERP21U	Color blanco.	8423220220898	8,44	10	8423220220867	120



Conmutador / Interruptor luminoso 10AX 250V~. Dimensiones 83x81. Embornamiento por tornillo.						
ERP02ILU	Color blanco.	8423220076600	8,47	10	8423220076969	120



Pulsador luminoso 10A 250V~. Dimensiones 83x81. Embornamiento por tornillo.						
ERP04ILU	Color blanco.	8423220076594	7,50	10	8423220076952	120



Interruptor bipolar 10AX 250V~. Dimensiones 83x81. Embornamiento por tornillo.						
ERP22U	Color blanco.	8423220085237	8,09	10	8423220085404	120



Regulador LED. Dimensiones 83x81. Embornamiento por tornillo.						
ERP31LEDU	Color blanco.	8423220098848	36,19	10	8423220098855	120



Kit conmutador + base fija 2P+T, 16A 250V~ con USB POWER: 5.0V=2.1A Total 10.5W. Dimensiones 154x81.						
KIT-ERP-ROOM	Color blanco.	8423220096301	46,23	1	8423220094079	50





Referencia	Descripción	GTIN-13 unitario	PVP		GTIN-13 envase	
Piloto de escalera. Color blanco. Intensidad de flujo 120 lúmenes. 2W. Dimensiones 83x81. Embornamiento por tornillo.						
ERP90U	Cada producto incluye 3 piezas de color intercambiables adicionales: azul, verde y rojo.	8423220096158	14,19	10	8423220095786	120



Piloto con reserva de 3 horas. Color blanco. 2W. Tiempo de carga inicial: 24 h. Con interruptor de desconexión. Tensión: 230V~ (50/60 Hz). Dimensiones 83x81. Montaje en caja universal. Embornamiento por tornillo.						
ERP90CR3	Cada producto incluye 3 piezas de color intercambiables adicionales: azul, verde y rojo.	8423220229969	28,63	10	8423220229877	120



Interruptor de tarjeta. Dimensiones 83x81. Embornamiento por tornillo.						
ERP01TU	Color blanco.	8423220096134	28,42	10	8423220095762	120



Salida de cables 4x2,5 mm². Dimensiones 83x81. Embornamiento por tornillo.						
ERP40U	Color blanco.	8423220085275	6,86	10	8423220085442	120



Zumbador. Dimensiones 83x81. Embornamiento por tornillo.						
ERP1ZU	Color blanco.	8423220208988	21,58	10	8423220208964	120



Base fija 2P+T, 16A 250V~. Dimensiones 83x81. Embornamiento por tornillo.						
ERP60U	Color blanco.	8423220076624	8,12	10	8423220076983	120



Base fija 2P+T, 16A 250V~ + toma USB POWER: 5.0V_{DC}; 2.1A; Total 10,5W. Dimensiones 83x81. Embornamiento rápido.						
ERP60USB-U	Color blanco.	8423220084797	31,47	10	8423220084766	120



Base fija 2P+T, 16A 250V~ + 1 USB-A + 1 USB-C, 2,1A 5V. Dimensiones 83x81. Embornamiento rápido.						
ERP60USBC-U	Color blanco.	8423220243873	51,66	10	8423220243866	120



2 tomas USB POWER: 5.0V_{DC}; 4.2A; Total 21W. Dimensiones 83x81. Embornamiento por tornillo.						
ERP2USBU	Color blanco.	8423220208995	34,51	10	8423220208971	120



Referencia	Descripción	Color	GTIN-13 unitario	PVP		GTIN-13 envase	
Base fija doble 2P+T, 16A 250V~. Dimensiones 117x81. Embornamiento por tornillo.							
ERP60/2U	Color blanco.		8423220076631	9,28	10	8423220076990	120
ERP60/2NU	Color negro.		8423220076815	12,25	10	8423220077171	120
ERP60/2AU	Color plata.		8423220221284	12,39	10	8423220220997	120
ERP60/2NGU	Color grafito.		8423220221277	12,32	10	8423220220980	120





Referencia	Descripción	GTIN-13 unitario	PVP		GTIN-13 envase	
Tapa ciega. Dimensiones 83x81.						
ERP75U	Color blanco.	8423220085381	4,23	10	8423220085558	120



Toma intermedia de señal para TV y Radio. Dimensiones 83x81.						
ERP46U	Color blanco.	8423220216860	22,68	10	8423220216853	120



Toma final de señal para TV y Radio. Dimensiones 83x81.						
ERP47U	Color blanco.	8423220076648	22,68	20	8423220077003	120



Toma final de señal de satélite, TV y Radio. Dispone de entrada única (necesario instalar con mezclador). Dimensiones 83x81.						
ERP48U	Color blanco.	8423220076655	33,12	10	8423220077010	120



Toma de teléfono RJ11. Dimensiones 83x81.						
ERP84U	Color blanco.	8423220076662	6,30	10	8423220077027	120



Toma de datos RJ45. Cat 6. Dimensiones 83x81.						
ERP88U	Color blanco.	8423220076679	18,17	10	8423220077034	120



Toma doble de datos RJ45. Cat 6. Dimensiones 83x81.						
ERP88/2U	Color blanco.	8423220096172	24,07	10	8423220095809	120

Nuevos acabados

Ver Referencia



Blanco



Plata



Grafito



Referencia	Descripción	Color	GTIN-13 unitario	PVP		GTIN-13 envase	
Conmutador / interruptor 10AX 250V~. Embornamiento rápido.							
ERP02QC	Color blanco.		8423220094307	5,95	10	8423220080966	120
ERP02AQC	Color plata.		8423220221246	8,08	10	8423220220959	120
ERP02NGQC	Color grafito.		8423220221215	8,08	10	8423220220928	120



Doble conmutador / interruptor 10AX 250V~. Embornamiento rápido.							
ERP12QC	Color blanco.		8423220094314	8,15	10	8423220080973	120
ERP12AQC	Color plata.		8423220235014	11,55	10	8423220234543	120
ERP12NGQC	Color grafito.		8423220235175	11,55	10	8423220234703	120





Referencia	Descripción	Color	GTIN-13 unitario	PVP		GTIN-13 envase	
Conmutador de cruce 10AX 250V~. Embornamiento rápido.							
ERP09QC	Color blanco.		8423220094321	8,18	10	8423220080980	120
ERP09AQC	Color plata.		8423220235021	11,55	10	8423220234550	120
ERP09NGQC	Color grafito.		8423220235182	11,55	10	8423220234710	120



Pulsador 10A 250V~. Embornamiento rápido.							
ERP03QC	Color blanco.		8423220094291	5,71	10	8423220080959	120
ERP03AQC	Color plata.		8423220235007	7,14	10	8423220334536	120
ERP03NGQC	Color grafito.		8423220235168	7,14	10	8423220234697	120



Pulsador persiana 10A 250V~. Embornamiento rápido.							
ERP20QC	Color blanco.		8423220094338	8,29	10	8423220080997	120
ERP20AQC	Color plata.		8423220235045	9,87	10	8423220234574	120
ERP20NGQC	Color grafito.		8423220235205	9,87	10	8423220234734	120



Conmutador / interruptor luminoso 10AX 250V~. Embornamiento rápido.							
ERP021LQC	Color blanco.		8423220094352	7,49	10	8423220081017	120
ERP021LAQC	Color plata.		8423220235069	8,93	10	8423220234598	120
ERP021LNGQC	Color grafito.		8423220235229	8,93	10	8423220234758	120



Pulsador luminoso 10A 250V~. Embornamiento rápido.							
ERP041LQC	Color blanco.		8423220094345	6,51	10	8423220081000	120
ERP041LAQC	Color plata.		8423220235052	8,92	10	8423220234581	120
ERP041LNGQC	Color grafito.		8423220235212	8,92	10	8423220234741	120



Conmutador persiana 10AX 250V~. 3 posiciones. Embornamiento por tornillo.							
ERP21	Color blanco.		8423220220904	6,58	10	8423220220850	120



Interruptor bipolar 10AX 250V~. Embornamiento rápido.							
ERP22QC	Color blanco.		8423220090330	6,86	10	8423220085046	120
ERP22AQC	Color plata.		8423220235144	8,27	10	8423220234673	120
ERP22NGQC	Color grafito.		8423220235304	8,27	10	8423220234833	120



Regulador LED. Embornamiento por tornillo.							
ERP31LED	Color blanco.		8423220098824	34,65	10	8423220098831	120
ERP31LEDA	Color plata.		8423220235496	35,62	10	8423220235489	120
ERP31LEDNG	Color grafito.		8423220235519	35,62	10	8423220235502	120



Piloto de escalera. Intensidad de flujo 120 lúmenes. 2W. Embornamiento por tornillo. Cada producto incluye 3 piezas de color intercambiables adicionales: azul, verde y rojo.							
ERP90	Tecla color blanco.		8423220098213	12,81	10	8423220095847	120



Piloto con reserva de 3 horas. Color blanco. 2W. Tiempo de carga inicial: 24 h. Con interruptor de desconexión. Tensión: 230V~ (50/60 Hz). Dimensiones 83x81. Montaje en caja universal. Embornamiento por tornillo. Cada producto incluye 3 piezas de color intercambiables adicionales: azul, verde y rojo.							
ERP90CR3	Tecla color blanco.		8423220229969	27,16	10	8423220229877	120





Referencia	Descripción	Color	GTIN-13 unitario	PVP		GTIN-13 envase	
Interruptor de tarjeta. Embornamiento por tornillo.							
ERP01T	Color blanco.		8423220096202	26,85	10	8423220095830	120



Tapa ciega.							
ERP75	Color blanco.		8423220086067	2,38	10	8423220085091	120
ERP75A	Color plata.		8423220235151	4,03	10	8423220234680	120
ERP75NG	Color grafito.		8423220235311	4,03	10	8423220234840	120



Salida de cables 4x2,5 mm². Embornamiento por tornillo.							
ERP40	Color blanco.		8423220085060	5,38	10	8423220095328	120
ERP40A	Color plata.		8423220235137	10,57	10	8423220234666	120
ERP40NG	Color grafito.		8423220235298	10,57	10	8423220234826	120



Zumbador. Embornamiento por tornillo.							
ERP1Z	Color blanco.		8423220208896	19,62	10	8423220208872	120



Base fija 2P+T, 16A 250V~. Embornamiento por tornillo.							
ERP60	Color blanco.		8423220094369	6,30	10	8423220081024	120
ERP60A	Color plata.		8423220221253	7,81	10	8423220220966	120
ERP60NG	Color grafito.		8423220221222	7,81	10	8423220220935	120



Base fija 2P+T, 16A 250V~ + toma USB POWER: 5.0V~; 2.1A; Total 10,5W. Embornamiento rápido.							
ERP60USB	Color blanco.		8423220085367	30,14	10	8423220085084	120
ERP60USBA	Color plata.		8423220235120	31,78	10	8423220234659	120
ERP60USBNG	Color grafito.		8423220235281	31,78	10	8423220234819	120



Base fija 2P+T, 16A 250V~ + 1 USB-A + 1 USB-C, 2,1A 5V. Embornamiento rápido.							
ERP60USBC	Color blanco.		8423220247505	50,47	10	8423220247499	120



2 tomas USB POWER: 5.0V~; 4.2A; Total 21W. Embornamiento por tornillo.							
ERP2USB	Color blanco.		8423220208902	32,68	10	8423220208889	120



Toma intermedia de TV y Radio. Embornamiento por tornillo.							
ERP46	Color blanco.		8423220218888	20,26	10	8423220218871	120



Toma final de TV y Radio. Embornamiento por tornillo.							
ERP47	Color blanco.		8423220094376	20,37	10	8423220081031	120
ERP47A	Color plata.		8423220235076	20,93	10	8423220234604	120
ERP47NG	Color grafito.		8423220235236	20,93	10	8423220234765	120



Toma final de Satélite, TV y Radio. Dispone de entrada única (necesario instalar con mezclador). Embornamiento por tornillo.							
ERP48	Color blanco.		8423220094383	31,78	10	8423220081048	120



SERIE EUROPA. Mecanismos sin marco



Referencia	Descripción	Color	GTIN-13 unitario	PVP		GTIN-13 envase	
Toma de teléfono RJ11.							
ERP84	Color blanco.		8423220094390	5,29	10	8423220081055	120
ERP84A	Color plata.		8423220235090	6,51	10	8423220234628	120
ERP84NG	Color grafito.		8423220235250	6,51	10	8423220234789	120



Referencia	Descripción	Color	GTIN-13 unitario	PVP		GTIN-13 envase	
Toma de datos RJ45. Cat 6.							
ERP88	Color blanco.		8423220094208	16,34	10	8423220081062	120
ERP88A	Color plata.		8423220235106	17,50	10	8423220234635	120
ERP88NG	Color grafito.		8423220235267	17,50	10	8423220234796	120



Referencia	Descripción	Color	GTIN-13 unitario	PVP		GTIN-13 envase	
Toma doble de datos RJ45. Cat 6.							
ERP88/2	Color blanco.		8423220096226	22,26	10	8423220095854	120
ERP88/2A	Color plata.		8423220235113	23,65	10	8423220234642	120
ERP88/2NG	Color grafito.		8423220235274	23,65	10	8423220234802	120

SERIE EUROPA. Cajas de superficie



Referencia	Descripción	GTIN-13 unitario	PVP		GTIN-13 envase	
Caja para montaje de la serie Europa en superficie. Dimensiones 85x83x43.						
ERP-100U	Entradas para canaletas de 10x16, 10x20, 16x25 y 25x40. Color blanco.	8423220096233	2,45	--	8423220095861	96



Referencia	Descripción	GTIN-13 unitario	PVP		GTIN-13 envase	
Accesorio para hacer ampliaciones de la caja ERP-100U.						
ERP-CP100U	Dimensiones para 2 elementos 156x83x43. Dimensiones para 3 elementos 227x83x43. Color blanco.	8423220096240	1,70	28	8423220095878	112

SERIE EUROPA. Tapas



Referencia	Descripción	Color	GTIN-13 unitario	PVP		GTIN-13 envase	
Tapa universal							
ERP47TLV	Para radio y TV. Sin marco.		8423220087781	1,44	10	8423220086807	240
ERP47TLVU	Para radio y TV. Con marco.		8423220085299	2,77	20	8423220085466	240
ERP47TLVA	Para radio y TV. Sin marco.		8423220241114	2,80	10	8423220241107	240
ERP47TLVNG	Para radio y TV. Sin marco.		8423220241138	2,80	10	8423220241121	240
ERP48TLV	Para radio, TV y satélite. Sin marco.		8423220087798	1,44	10	8423220086814	240
ERP48TLVU	Para radio, TV y satélite. Con marco.		8423220085305	2,77	20	8423220085473	240



Referencia	Descripción	Color	GTIN-13 unitario	PVP		GTIN-13 envase	
Tapa + chasis para toma de datos RJ45. Sin conector.							
ERP88/1	Sin marco. Color blanco.		8423220220874	3,59	10	8423220220775	120
ERP88/1U	Con marco. Color blanco.		8423220220881	4,82	10	8423220220805	120

SERIE EUROPA. Marcos

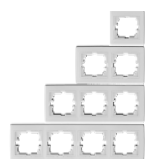

Referencia	Descripción	GTIN-13 unitario	PVP		GTIN-13 envase	
Marco horizontal color blanco.						
ERP71U	Para 1 elemento. Dimensiones 83x81.	8423220076686	1,58	20	8423220077041	240
ERP72U	Para 2 elementos. Dimensiones 154x81x10.	8423220076693	3,99	10	8423220077058	120
ERP73U	Para 3 elementos. Dimensiones 225x81x10.	8423220076709	5,71	10	8423220077065	120
ERP74U	Para 4 elementos. Dimensiones 296x81x10.	8423220076716	7,77	10	8423220077072	120





Referencia	Descripción	GTIN-13 unitario	PVP		GTIN-13 envase	
Marco horizontal color negro con aro perla.						
ERP71NU	Para 1 elemento. Dimensiones 83x81.	8423220076860	3,38	20	8423220077225	240
ERP72NU	Para 2 elementos. Dimensiones 154x81x10.	8423220076877	7,67	10	8423220077232	120
ERP73NU	Para 3 elementos. Dimensiones 225x81x10.	8423220076884	10,29	10	8423220077249	120
ERP74NU	Para 4 elementos. Dimensiones 296x81x10.	8423220076891	11,41	10	8423220077256	120

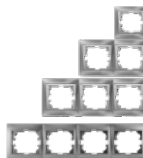

Referencia	Descripción	GTIN-13 unitario	PVP		GTIN-13 envase	
Marco horizontal color plata.						
ERP71AU	Para 1 elemento. Dimensiones 83x81.	8423220215337	2,52	20	8423220215276	240
ERP72AU	Para 2 elementos. Dimensiones 154x81x10.	8423220215351	7,91	10	8423220215290	120
ERP73AU	Para 3 elementos. Dimensiones 225x81x10.	8423220215375	9,98	10	8423220215313	120
ERP74AU	Para 4 elementos. Dimensiones 296x81x10.	8423220221444	13,78	10	8423220221185	120

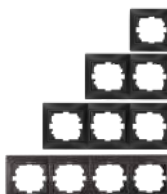

Referencia	Descripción	GTIN-13 unitario	PVP		GTIN-13 envase	
Marco horizontal color grafito.						
ERP71NGU	Para 1 elemento. Dimensiones 83x81.	8423220215344	2,52	20	8423220215283	240
ERP72NGU	Para 2 elementos. Dimensiones 154x81x10.	8423220215368	7,91	10	8423220215306	120
ERP73NGU	Para 3 elementos. Dimensiones 225x81x10.	8423220215382	9,98	10	8423220215320	120
ERP74NGU	Para 4 elementos. Dimensiones 296x81x10.	8423220221383	13,78	10	8423220221123	120

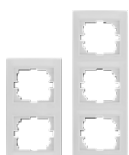

Referencia	Descripción	GTIN-13 unitario	PVP		GTIN-13 envase	
Marco vertical color blanco.						
ERP62U	Para 2 elementos. Dimensiones 81x154x10.	8423220085312	4,08	10	8423220085480	120
ERP63U	Para 3 elementos. Dimensiones 81x225x10.	8423220085336	5,48	10	8423220085503	120



Referencia	Descripción	GTIN-13 unitario	PVP		GTIN-13 envase	
Marco vertical color negro con aro perla.						
ERP62NU	Para 2 elementos. Dimensiones 81x154x10.	8423220085329	6,93	10	8423220085497	120
ERP63NU	Para 3 elementos. Dimensiones 81x225x10.	8423220085343	9,11	10	8423220085510	120



Referencia	Descripción	GTIN-13 unitario	PVP		GTIN-13 envase	
Marco vertical color plata.						
ERP62AU	Para 2 elementos. Dimensiones 81x154x10.	8423220221451	7,63	10	8423220221192	120
ERP63AU	Para 3 elementos. Dimensiones 81x225x10.	8423220221468	10,47	10	8423220221208	120

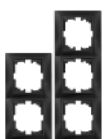

Referencia	Descripción	GTIN-13 unitario	PVP		GTIN-13 envase	
Marco vertical color grafito.						
ERP62NGU	Para 2 elementos. Dimensiones 81x154x10.	8423220221390	7,63	10	8423220221130	120
ERP63NGU	Para 3 elementos. Dimensiones 81x225x10.	8423220221406	10,47	10	8423220221147	120

SERIE EUROPA. Marcos para reposición



Referencia	Descripción	Código GTIN-13	PVP		
Placas embellecedoras grandes.					
420	Para 1 elemento. 80 x 115 x 8.	8423220004207	1,75	10	300
421	Para 2 elementos. 120 x 115 x 8.	8423220004214	2,17	10	200
422	Para 3 elementos. 139 x 115 x 8.	8423220004221	2,34	10	200



Referencia	Descripción	Código GTIN-13	PVP		
Placas embellecedoras pequeñas.					
520	Para 1 elemento. 46 x 75 x 8.	8423220005204	1,42	10	510
521	Para 2 elementos. 80 x 75 x 8.	8423220005211	1,96	10	400
522	Para 3 elementos. 102 x 75 x 8.	8423220005228	2,39	10	300





Descárgate la documentación técnica y vídeos de montaje



Ventajas de la serie



Pretroquelados para entrada vertical y horizontal



Polycarbonato



Fácil de instalar



Producto certificado



Productos complementarios



Pág. 83



Pág. 94



Referencia	Descripción	GTIN-13 unitario	PVP		GTIN-13 envase	
Conmutador / interruptor 10AX 250V~. Dimensiones 74x72x28.						
MUR02U	Color blanco.	8423220082656	5,95	10	8423220082564	120



Interruptor bipolar 10AX 250V~. Dimensiones 74x72x28.						
MUR22U	Color blanco.	8423220087811	7,32	10	8423220087804	120



Doble conmutador / interruptor 10AX 250V~. Dimensiones 74x72x28.						
MUR12U	Color blanco.	8423220082694	8,12	10	8423220082601	120



Conmutador / interruptor con indicador luminoso 10AX 250V~. Dimensiones 74x72x28.						
MUR02ILU	Color blanco.	8423220082663	7,59	10	8423220082571	120



Conmutador de cruce 10AX 250V~. Dimensiones 74x72x28.						
MUR09U	Color blanco.	8423220084926	8,02	10	8423220084919	120



Pulsador campana 10A 250V~. Dimensiones 74x72x28.						
MUR03U	Color blanco.	8423220082670	5,18	10	8423220082588	120



Pulsador luz 10A 250V~. Dimensiones 74x72x28.						
MUR04U	Color blanco.	8423220082687	5,18	10	8423220082595	120



Base fija 2P+T, 16A 250V. Dimensiones 74x72x42.						
MUR60U	Color blanco.	8423220082700	6,16	10	8423220082618	120





Base fija 2P, 16A 250V. Dimensiones 74x72x28.						
MUR07U	Color blanco.	8423220096264	5,29	10	8423220095892	120



Base fija doble 2P+T, 16A 250V~. Dimensiones 148x72x42.						
MUR66U	Color blanco.	8423220095199	11,48	10	8423220095182	120



Referencia	Descripción	GTIN-13 unitario	PVP		GTIN-13 envase	
Base fija 2P+T, 16A 250V~ + doble conmutador / interruptor 10AX 250V~. Dimensiones 148x72x42.						
MUR36U	Color blanco.	8423220095212	13,23	10	8423220095205	120
Base fija 2P+T, 16A 250V~ + conmutador / interruptor 10AX 250V~. Dimensiones 148x72x42.						
MUR63U	Color blanco.	8423220095236	10,96	10	8423220095229	120
Base fija 2P+T, 16A 250V~ + conmutador de cruce 10AX 250V~. Dimensiones 148x72x42.						
MUR96U	Color blanco.	8423220208926	12,99	10	8423220208919	120
Conmutador / interruptor estrecho 10AX 250V~. Dimensiones 33x70x25.						
MUR02/2U	Color blanco.	8423220217324	4,51	1	8423220217300	100
Pulsador luz estrecho 10A 250V~. Dimensiones 33x70x25.						
MUR03/2U	Color blanco.	8423220217331	4,29	1	8423220217317	100
Toma de señal única para TV. Dimensiones 74x72x28.						
MUR94U	Color blanco.	8423220082731	6,34	10	8423220082649	120
Toma de teléfono RJ11 (4 vías). Dimensiones 74x72x28.						
MUR84U	Color blanco.	8423220082717	5,36	10	8423220082625	120
Toma de datos. RJ45. Dimensiones 74x72x28.						
MUR88U	Cat 5e. Color blanco.	8423220082724	15,82	10	8423220082632	120
MUR87U	Cat 6e. Color blanco.	8423220227521	16,63	10	8423220227514	120
Registro de empalme. Dimensiones 74x72x28.						
MUR62U	Color blanco.	8423220087279	3,15	10	8423220087286	120
Registro doble de empalme. Dimensiones 148x72x28.						
MUR64U	Color blanco.	8423220095250	5,81	10	8423220095243	120



Mecanismos estancos de superficie



Descárgate la documentación técnica y vídeos de montaje



Ventajas de la serie



Tornillos imperdibles



Fácil de instalar



Certificaciones

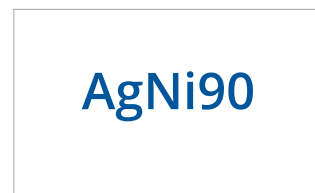

Contactos de plata



IP54-44



650/850°C



RoHS



HF

Productos complementarios



Pág. 48



Pág. 56



Pág. 45



Referencia	Descripción	GTIN-13 unitario	PVP		GTIN-13 envase	
Conmutador / interruptor 10AX 250V~. Dimensiones 65x80x55.						
3303	IP54. Certificado VDE.	8423220078437	5,85	20	8423220069244	100



Conmutador / interruptor 10AX 250V~. Dimensiones 65x80x55.						
3303IL	IP54. Con indicador luminoso. Certificado VDE.	8423220091498	7,04	20	8423220091481	100



Pulsador 10A 250V~. Dimensiones 65x80x55.						
3320	IP54. Certificado VDE.	8423220078444	5,77	20	8423220069268	100



Pulsador 10A 250V~. Dimensiones 65x80x55.						
3320IL	IP54. Con indicador luminoso. Certificado VDE.	8423220078468	7,28	20	8423220069275	100



Doble conmutador / interruptor 10AX 250V~. Dimensiones 65x80x55.						
3313	IP54. Certificado VDE.	8423220078451	8,15	20	8423220069251	100



Base fija 2P+T, 16A 250V. Dimensiones 65x80x55.						
3360	IP44. Certificado VDE.	8423220078475	5,36	20	8423220069312	100



Base fija 2P+T, 16A 250V+ conmutador / interruptor 10AX250V. Dimensiones 127x80x55.						
3363	IP44. Certificado VDE.	8423220078499	12,25	10	8423220069336	60



Base doble fija 2P+T, 16A 250V~. Dimensiones 127x80x55.						
3366	IP44. Certificado VDE.	8423220078512	10,89	10	8423220069350	60



Base doble fija 2P+T, 16A 250V. Vertical. Dimensiones 80x127x55.						
3366V	IP44. Certificado VDE.	8423220229518	11,13	10	8423220229501	60



Descárgate toda la documentación técnica de la serie escaneando este código



CANALES. Canales



Referencia	Descripción	Código GTIN-13	PVP/metro		
Canales. Fijación por tornillo. Formato presentación 2 metros.					
9154040	Canal de 40x40. Superficie útil 1.354 mm ² . Con cierre superior.	8423220031111	9,45	---	24
9154070B	Base para canal 40x70 ref. 9154070.	8423220019454	8,85	---	48
9154070T	Tapa para canal 40x70 ref. 9154070.	8423220019461	8,60	---	48
9156060B	Base para canal 60x60 ref. 9156060.	8423220019478	9,28	---	36
9156060T	Tapa para canal 60x60 ref. 9156060.	8423220019485	9,94	---	36
91560100B	Base para canal 60x100 ref. 91560100.	8423220019492	12,85	---	24
91560100T	Tapa para canal 60x100 ref. 91560100.	8423220019508	12,74	---	24

CANALES. Minicanales



Referencia	Descripción	Código GTIN-13	PVP/metro		
Minicanales. Fijación por tornillo. Formato presentación 2 metros.					
9150712	Minicanal de 7x12. Superficie útil 52 mm ² . Cierre inferior.	8423220016422	1,56	---	120
9151016	Minicanal de 10x16. Superficie útil 104 mm ² . Cierre inferior.	8423220016439	2,24	---	70
9151020	Minicanal de 10x20. Superficie útil 136 mm ² . Cierre inferior.	8423220016446	2,58	---	56
9151212	Minicanal de 12x12. Superficie útil 94 mm ² . Cierre inferior.	8423220016453	1,96	---	72
9151616	Minicanal de 16x16. Superficie útil 182 mm ² . Con cierre inferior.	8423220039308	2,94	---	40
9151625	Minicanal de 16x25. Superficie útil 308 mm ² . Con cierre inferior.	8423220016460	4,17	---	24
9152525	Minicanal de 25x25. Superficie útil 480 mm ² . Con cierre superior.	8423220033016	5,74	---	60
9152540	Minicanal de 25x40. Superficie útil 793 mm ² . Con cierre superior.	8423220018631	7,21	---	40
Minicanales. Fijación por base auto-adhesiva. Formato presentación 2 metros.					
9160712	Minicanal de 7x12. Superficie útil 52 mm ² . Cierre inferior.	8423220016477	2,54	---	120
9161016	Minicanal de 10x16. Superficie útil 104 mm ² . Cierre inferior.	8423220016484	2,97	---	70
9161020	Minicanal de 10x20. Superficie útil 136 mm ² . Cierre inferior.	8423220016491	3,29	---	56
9161212	Minicanal de 12x12. Superficie útil 94 mm ² . Cierre inferior.	8423220016507	2,98	---	72
9161616	Minicanal de 16x16. Superficie útil 182 mm ² . Con cierre inferior.	8423220039315	3,26	---	40
9161625	Minicanal de 16x25. Superficie útil 308 mm ² . Con cierre inferior.	8423220064539	5,36	---	24
9162525	Minicanal de 25x25. Superficie útil 480 mm ² . Con cierre superior.	8423220004658	6,51	---	60
9162540	Minicanal de 25x40. Superficie útil 793 mm ² . Con cierre superior.	8423220064546	8,79	---	40

Dimensiones en mm - altura x anchura.



Accede a la tarifa PVP actualizada



Referencia	Descripción	Código GTIN-13	PVP/ Ud.		
Ángulo plano.					
AP712	Ángulo plano para minicanal de 7x12.	8423220016514	0,56	30	2.400
AP1016	Ángulo plano para minicanal de 10x16.	8423220016521	0,60	30	1.200
AP1020	Ángulo plano para minicanal de 10x20.	8423220016538	0,72	40	1.200
AP1212	Ángulo plano para minicanal de 12x12.	8423220016545	0,69	40	1.200
AP1616	Ángulo plano para minicanal de 16x16.	8423220039988	0,73	20	800
AP1625	Ángulo plano para minicanal de 16x25.	8423220016552	0,96	20	600
AP2525	Ángulo plano para minicanal de 25x25.	8423220095908	1,52	20	160
AP2540	Ángulo plano para minicanal de 25x40.	8423220018679	2,71	20	160
AP4040	Ángulo plano para canal de 40x40.	8423220018730	3,34	15	120
AP4070	Ángulo plano para canal de 40x70.	8423220019164	3,99	10	64
AP6060	Ángulo plano para canal de 60x60.	8423220019287	4,65	10	48
AP60100	Ángulo plano para canal de 60x100.	8423220019225	5,70	6	24



Ángulo exterior.					
AE712	Ángulo exterior para minicanal de 7x12.	8423220016569	0,56	30	2.400
AE1016	Ángulo exterior para minicanal de 10x16.	8423220016576	0,60	30	1.200
AE1020	Ángulo exterior para minicanal de 10x20.	8423220016583	0,72	25	1.000
AE1212	Ángulo exterior para minicanal de 12x12.	8423220016590	0,69	40	1.200
AE1616	Ángulo exterior para minicanal de 16x16.	8423220039995	0,73	25	1.000
AE1625	Ángulo exterior para minicanal de 16x25.	8423220016606	0,96	20	600
AE2525	Ángulo exterior para minicanal de 25x25.	8423220095915	1,52	10	40
AE2540	Ángulo exterior para minicanal de 25x40.	8423220018655	2,71	20	160
AE4040	Ángulo exterior para canal de 40x40.	8423220018716	3,34	15	120
AE4070	Ángulo exterior para canal de 40x70.	8423220030664	3,99	10	40
AE6060	Ángulo exterior para canal de 60x60.	8423220019263	4,65	10	60
AE60100	Ángulo exterior para canal de 60x100.	8423220019201	5,70	8	32



Ángulo interior.					
AI712	Ángulo interior para minicanal de 7x12.	8423220016613	0,56	30	2.400
AI1016	Ángulo interior para minicanal de 10x16.	8423220016620	0,60	30	1.200
AI1020	Ángulo interior para minicanal de 10x20.	8423220016637	0,72	30	1.200
AI1212	Ángulo interior para minicanal de 12x12.	8423220016644	0,69	30	1.200
AI1616	Ángulo interior para minicanal de 16x16.	8423220040007	0,73	30	1.200
AI1625	Ángulo interior para minicanal de 16x25.	8423220016651	0,96	25	750
AI2525	Ángulo interior para minicanal de 25x25.	8423220095922	1,52	8	64
AI2540	Ángulo interior para minicanal de 25x40.	8423220018662	2,71	20	160
AI4040	Ángulo interior para canal de 40x40.	8423220018723	3,34	15	120
AI4070	Ángulo interior para canal de 40x70.	8423220019157	3,99	8	64
AI6060	Ángulo interior para canal de 60x60.	8423220019270	4,65	10	40
AI60100	Ángulo interior para canal de 60x100.	8423220019218	5,70	8	32



Derivación en T.					
DT712	Derivación en T para minicanal de 7x12.	8423220016668	0,56	20	1.600
DT1016	Derivación en T para minicanal de 10x16.	8423220016675	0,60	24	960
DT1020	Derivación en T para minicanal de 10x20.	8423220016682	0,72	25	750
DT1212	Derivación en T para minicanal de 12x12.	8423220016699	0,69	30	900
DT1616	Derivación en T para minicanal de 16x16.	8423220040052	0,73	15	600
DT1625	Derivación en T para minicanal de 16x25.	8423220016705	0,96	12	360
DT2525	Derivación en T para minicanal de 25x25.	8423220095939	1,52	--	---
DT2540	Derivación en T para minicanal de 25x40.	8423220018686	2,71	20	160
DT4040	Derivación en T para canal de 40x40.	8423220018747	3,34	15	90
DT4070	Derivación en T para canal de 40x70.	8423220019171	3,99	8	64
DT6060	Derivación en T para canal de 60x60.	8423220019294	4,65	10	40
DT60100	Derivación en T para canal de 60x100.	8423220019232	5,70	6	24



Dimensiones en mm - altura x anchura.



Referencia	Descripción	Código GTIN-13	PVP/ Ud.		
Unión.					
UN712	Unión para minicanal de 7x12.	8423220016712	0,43	50	4.000
UN1016	Unión para minicanal de 10x16.	8423220016729	0,46	50	2.000
UN1020	Unión para minicanal de 10x20.	8423220016736	0,58	50	2.000
UN1212	Unión para minicanal de 12x12.	8423220016743	0,56	50	2.000
UN1616	Unión para minicanal de 16x16.	8423220040090	0,60	40	1.600
UN1625	Unión para minicanal de 16x25.	8423220016750	0,83	40	1.200
UN2525	Unión para minicanal de 25x25.	8423220095946	1,52	10	80
UN2540	Unión para minicanal de 25x40.	8423220018709	2,47	20	400
UN4040	Unión para canal de 40x40.	8423220018761	3,14	15	300
UN4070	Unión para canal de 40x70.	8423220019195	3,99	10	80
UN6060	Unión para canal de 60x60.	8423220019317	4,65	10	80
UN60100	Unión para canal de 60x100.	8423220019256	5,74	10	60



Referencia	Descripción	Código GTIN-13	PVP/ Ud.		
Tapa final.					
TF712	Tapa final para minicanal de 7x12.	8423220016767	0,43	75	6.000
TF1016	Tapa final para minicanal de 10x16.	8423220016774	0,46	100	4.000
TF1020	Tapa final para minicanal de 10x20.	8423220016781	0,58	50	2.000
TF1212	Tapa final para minicanal de 12x12.	8423220016798	0,56	50	4.000
TF1616	Tapa final para minicanal de 16x16.	8423220040144	0,60	50	2.000
TF1625	Tapa final para minicanal de 16x25.	8423220016804	0,83	50	1.500
TF2525	Tapa final para minicanal de 25x25.	8423220095953	1,52	40	640
TF2540	Tapa final para minicanal de 25x40.	8423220018693	2,47	40	640
TF4040	Tapa final para canal de 40x40.	8423220018754	3,14	30	600
TF4070	Tapa final para canal de 40x70.	8423220019188	3,99	10	320
TF6060	Tapa final para canal de 60x60.	8423220019300	4,65	10	180
TF60100	Tapa final para canal de 60x100.	8423220019249	5,74	10	160



Referencia	Descripción	Código GTIN-13	PVP/ Ud.		
Kit de accesorios. Bolsa con auto-cierre que contiene: 2 x ángulo plano (AP), 1 x ángulo exterior (AE), 1 x ángulo interior (AI), 1 x derivación en T (DT), 2 x unión (UN) y 1 x tapa final (TF).					
KIT712	Kit de accesorios para minicanal de 7x12.	8423220018587	4,14	1	300
KIT1016	Kit de accesorios para minicanal de 10x16.	8423220018594	4,48	1	200
KIT1020	Kit de accesorios para minicanal de 10x20.	8423220018600	5,04	1	150
KIT1212	Kit de accesorios para minicanal de 12x12.	8423220018617	4,82	1	200
KIT1616	Kit de accesorios para minicanal de 16x16.	8423220040151	5,39	1	125
KIT1625	Kit de accesorios para minicanal de 16x25.	8423220018624	6,96	1	100
KIT2540	Kit de accesorios para minicanal de 25x40.	8423220060052	13,82	1	30
KIT4040	Kit de accesorios para minicanal de 40x40.	8423220066069	17,12	1	---

CANALES. Canal clima



Referencia	Descripción	Código GTIN-13	PVP/ metro		
Canal clima. Para el montaje con el soporte Ref. SOP915. Formato presentación 2 metros.					
9154070T	40x70.	8423220019461	8,60	---	48
9156060T	60x60.	8423220019485	9,94	---	36
91560100T	60x100.	8423220019508	12,74	---	24



Referencia	Descripción	Código GTIN-13	PVP/ Ud.		
Soporte de pared para canal clima. Bolsa de 10 unidades.					
SOP915	Soporte para canal clima adaptable a las 3 medidas de canal. Incorpora brida para sujetar el tubo. Incluye bolsa con tornillos y tacos.	8423220068995	21,07	1	20

Dimensiones en mm - altura x anchura.



Accede a la tarifa PVP actualizada

CANALES. Accesorios para canales y minicanales



Referencia	Descripción	Código GTIN-13	PVP/ Ud.		
Taco con tornillo incorporado. Bolsa de 100 unidades.					
9000425	Ø 4x25.	8423220016811		100	1.800
9000535	Ø 5x35.	8423220083424		100	1.800
9000640	Ø 6x40.	8423220018785		100	1.800

CANALES. Canal ranurado



Referencia	Descripción	GTIN-13 unitario	PVP/ metro		GTIN-13 envase	
Canal ranurado. Formato presentación 2 metros.						
CR4025	Canal de 40x25.	8423220076174	4,03	---	8423220070004	42
CR4040	Canal de 40x40.	8423220076181	4,69	---	8423220073210	40
CR6040	Canal de 60x40.	8423220076198	7,11	---	8423220070011	18

CANALES. Canal para suelos. IK08



Referencia	Descripción	GTIN-13 unitario	PVP/ metro		GTIN-13 envase	
Canal para suelos con fijación auto-adhesiva. IK08. Formato presentación 2 metros.						
CSG5	Canal de 8x50.	8423220076204	6,97	---	8423220070028	60
CSG6	Canal de 9x60.	8423220076211	8,79	---	8423220070035	50
CSG9	Canal de 15x90.	8423220076228	13,30	---	8423220070042	26



Dimensiones en mm - altura x anchura.



Descárgate la documentación técnica y vídeos de montaje



Ventajas de la serie

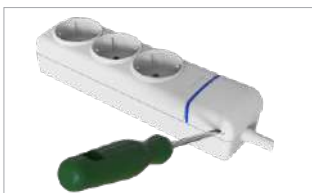

Tapa cubrebornes de extracción rápida y sencilla. No precisa tornillo.



Las bases se pueden fijar con bridas.

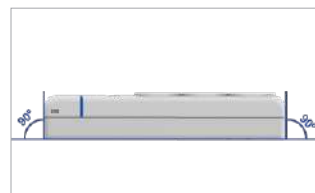

Diseño moderno y actual con los laterales rectos.

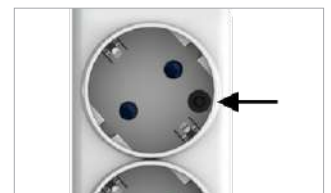

Fijación a la pared con tornillo pasante.



850°C



Polycarbonato

Productos complementarios





Pág. 83



Pág. 94

SERIE ION. Bases múltiples sin cable



Referencia	Descripción	GTIN-13 unitario	PVP		GTIN-13 envase	
Base múltiple de 3 tomas 2P+T, 16A 250V~. Máx. 3.680W.						
8003P	Color blanco.	8423220216839	10,22	16	8423220216792	64



SERIE ION. Bases múltiples sin cable, con interruptor luminoso



Referencia	Descripción	GTIN-13 unitario	PVP		GTIN-13 envase	
Base múltiple de 3 tomas 2P+T, 16A 250V~. Máx. 3.680W. Con interruptor luminoso.						
8003PIL	Color blanco.	8423220216846	12,71	15	8423220216808	60



SERIE ION. Prolongadores con bases múltiples



Referencia	Descripción	Código GTIN-13	PVP		
Prolongador de 3 tomas 2P+T, 16A 250V~. Máx. 3.680W. Cable H05VV-F, 3G1,5mm².					
8013P	Longitud 1,5 m.	8423220216815	17,50	1	20

SERIE ION. Prolongadores con bases múltiples con interruptor luminoso



Referencia	Descripción	Código GTIN-13	PVP		
Prolongador de 3 tomas 2P+T, 16A 250V~. Máx. 3.680W. Cable H05VV-F, 3G1,5mm². Con interruptor luminoso.					
8013PIL	Longitud 1,5 m.	8423220216822	19,92	1	20





Descárgate la documentación técnica



Ventajas de la serie



Agujeros para fijación en la pared



Policarbonato



Certificación Intertek / GS



Sistema de embornamiento fácil



850°C



HF



RoHS

Productos complementarios



Pág. 83





Pág. 94

SERIE 8000. Bases múltiples sin cable

Referencia	Descripción	GTIN-13 unitario	PVP		GTIN-13 envase	
Base múltiple de 2 tomas 2P+T, 16A 250V~. Máx. 3.680W.						
8002	Certificado Intertek.	8423220079601	7,20	12	8423220063624	96
Base múltiple de 3 tomas 2P+T, 16A 250V~. Máx. 3.680W.						
8003	Certificado Intertek.	8423220079618	8,55	18	8423220063686	72
Base múltiple de 4 tomas 2P+T, 16A 250V~. Máx. 3.680W.						
8004	Certificado Intertek.	8423220079625	9,78	16	8423220063747	64
Base múltiple de 5 tomas 2P+T, 16A 250V~. Máx. 3.680W.						
8005	Certificado Intertek.	8423220079632	11,25	15	8423220063808	60
Base múltiple de 6 tomas 2P+T, 16A 250V~. Máx. 3.680W.						
8006	Certificado Intertek.	8423220079649	12,56	10	8423220063860	40

SERIE 8000. Bases múltiples sin cable, con interruptor luminoso

Referencia	Descripción	GTIN-13 unitario	PVP		GTIN-13 envase	
Base múltiple de 2 tomas 2P+T, 16A 250V~. Máx. 3.680W. Con interruptor luminoso.						
8002IL	Certificado Intertek.	8423220079656	8,94	12	8423220063631	96
Base múltiple de 3 tomas 2P+T, 16A 250V~. Máx. 3.680W. Con interruptor luminoso.						
8003IL	Certificado Intertek.	8423220079663	10,43	16	8423220063693	64
Base múltiple de 4 tomas 2P+T, 16A 250V~. Máx. 3.680W. Con interruptor luminoso.						
8004IL	Certificado Intertek.	8423220079670	11,86	15	8423220063754	60
Base múltiple de 5 tomas 2P+T, 16A 250V~. Máx. 3.680W. Con interruptor luminoso.						
8005IL	Certificado Intertek.	8423220079687	13,02	10	8423220063815	40
Base múltiple de 6 tomas 2P+T, 16A 250V~. Máx. 3.680W. Con interruptor luminoso.						
8006IL	Certificado Intertek.	8423220079694	14,44	10	8423220063877	40





Referencia	Descripción	Código GTIN-13	PVP		
Prolongador de 2 tomas 2P+T, 16A 250V~. Máx. 3.680W. Cable H05VV-F, 3G1,5mm².					
8012	Longitud 1,5 m. Certificado Intertek GS.	8423220063648	12,64	1	48
8022	Longitud 2 m. Certificado Intertek GS.	8423220063655	21,81	1	35
8032	Longitud 3 m. Certificado Intertek GS.	8423220087859	26,18	1	40
8052	Longitud 5 m. Certificado Intertek GS.	8423220221482	34,22	1	20



Prolongador de 3 tomas 2P+T, 16A 250V~. Máx. 3.680W. Cable H05VV-F, 3G1,5mm².					
8013	Longitud 1,5 m. Certificado Intertek GS.	8423220063709	13,76	1	40
8023	Longitud 2 m. Certificado Intertek GS.	8423220063716	23,17	1	20
8033	Longitud 3 m. Certificado Intertek GS.	8423220070783	27,55	1	16
8053	Longitud 5 m. Certificado Intertek GS.	8423220070820	35,92	1	30



Prolongador de 4 tomas 2P+T, 16A 250V~. Máx. 3.680W. Cable H05VV-F, 3G1,5mm².					
8014	Longitud 1,5 m. Certificado Intertek GS.	8423220063761	15,05	1	34
8024	Longitud 2 m. Certificado Intertek GS.	8423220063778	24,57	1	36
8034	Longitud 3 m. Certificado Intertek GS.	8423220055155	28,98	1	14
8054	Longitud 5 m. Certificado Intertek GS.	8423220010741	37,14	1	25



Prolongador de 5 tomas 2P+T, 16A 250V~. Máx. 3.680W. Cable H05VV-F, 3G1,5mm².					
8015	Longitud 1,5 m. Certificado Intertek GS.	8423220063822	16,35	1	32
8025	Longitud 2 m. Certificado Intertek GS.	8423220063839	25,97	1	30
8035	Longitud 3 m. Certificado Intertek GS.	8423220010734	30,38	1	27
8055	Longitud 5 m. Certificado Intertek GS.	8423220010758	38,47	1	24



Prolongador de 6 tomas 2P+T, 16A 250V~. Máx. 3.680W. Cable H05VV-F, 3G1,5mm².					
8016	Longitud 1,5 m. Certificado Intertek GS.	8423220063884	17,68	1	16
8026	Longitud 2 m. Certificado Intertek GS.	8423220063891	27,41	1	30
8036	Longitud 3 m. Certificado Intertek GS.	8423220055162	31,78	1	12
8056	Longitud 5 m. Certificado Intertek GS.	8423220071650	39,88	1	20

SERIE 8000. Prolongadores con bases múltiples con interruptor luminoso



Referencia	Descripción	Código GTIN-13	PVP		
Prolongador de 2 tomas 2P+T, 16A 250V~. Máx. 3.680W. Cable H05VV-F, 3G1,5mm². Con interruptor luminoso.					
8012IL	Longitud 1,5 m. Certificado Intertek GS.	8423220063662	14,39	1	40
8022IL	Longitud 2 m. Certificado Intertek GS.	8423220063679	23,77	1	35
8032IL	Longitud 3 m. Certificado Intertek GS.	8423220066328	28,18	1	32
8052IL	Longitud 5 m. Certificado Intertek GS.	8423220066335	36,65	1	20



Prolongador de 3 tomas 2P+T, 16A 250V~. Máx. 3.680W. Cable H05VV-F, 3G1,5mm². Con interruptor luminoso.					
8013IL	Longitud 1,5 m. Certificado Intertek GS.	8423220063723	15,65	1	35
8023IL	Longitud 2 m. Certificado Intertek GS.	8423220063730	25,20	1	18
8033IL	Longitud 3 m. Certificado Intertek GS.	8423220020474	29,61	1	14
8053IL	Longitud 5 m. Certificado Intertek GS.	8423220020719	37,88	1	12



Prolongador de 4 tomas 2P+T, 16A 250V~. Máx. 3.680W. Cable H05VV-F, 3G1,5mm². Con interruptor luminoso.					
18014IL	Longitud 1,5 m. Certificado Intertek GS.	8423220034068	16,84	1	34
8024IL	Longitud 2 m. Certificado Intertek GS.	8423220063792	26,60	1	18
8034IL	Longitud 3 m. Certificado Intertek GS.	8423220020726	30,98	1	14
8054IL	Longitud 5 m. Certificado Intertek GS.	8423220020733	39,13	1	12



SERIE 8000. Prolongadores con bases múltiples, con interruptor luminoso



Referencia	Descripción	Código GTIN-13	PVP		
Prolongador de 5 tomas 2P+T, 16A 250V~. Máx. 3.680W. Cable H05VV-F, 3G1,5mm². Con interruptor luminoso.					
8015IL	Longitud 1,5 m. Certificado Intertek GS.	8423220063846	18,20	1	28
8025IL	Longitud 2 m. Certificado Intertek GS.	8423220063853	27,93	1	16
8035IL	Longitud 3 m. Certificado Intertek GS.	8423220020764	32,31	1	12
8055IL	Longitud 5 m. Certificado Intertek GS.	8423220020771	40,42	1	10



Prolongador de 6 tomas 2P+T, 16A 250V~. Máx. 3.680W. Cable H05VV-F, 3G1,5mm². Con interruptor luminoso.					
8016IL	Longitud 1,5 m. Certificado Intertek GS.	8423220063907	19,53	1	16
8026IL	Longitud 2 m. Certificado Intertek GS.	8423220063914	29,33	1	15
8036IL	Longitud 3 m. Certificado Intertek GS.	8423220020801	33,67	1	10
8056IL	Longitud 5 m. Certificado Intertek GS.	8423220020818	41,86	1	10



Prolongador de 3 tomas 2P+T, 16A 250V~ + USB POWER: 5.0V~; 2.1A; Total 10,5W. Máx. 3.680W. Cable H05VV-F, 3G1,5mm².					
8013USB	Longitud 1,5 m. Certificado GS.	8423220068940	27,97	1	18

SERIE 8000. Bases múltiples cuadradas



Referencia	Descripción	GTIN-13 unitario	PVP		GTIN-13 envase	
Base múltiple de 4 tomas 2P+T, 16A 250V~. Máx. 3.680W. Entrada para cable o minicanal.						
8104	Entrada para minicanal de 7x12, 10x16, 10x20 y 12x12.	8423220079700	10,33	14	8423220055728	56



Base múltiple de 6 tomas 2P+T, 16A 250V~. Máx. 3.680W. Entrada para cable o minicanal.						
8106	Entrada para minicanal de 7x12, 10x16, 10x20 y 12x12.	8423220076488	15,13	12	8423220902855	48



Base múltiple de 5 tomas 2P+T, 16A 250V~. Máx. 3.680W. Entrada para cable o minicanal. Con interruptor luminoso.						
8105IL	Entrada para minicanal de 7x12, 10x16, 10x20 y 12x12.	8423220079717	16,08	24	8423220075801	48

SERIE 8000. Prolongador con base múltiple cuadrada



Referencia	Descripción	Código GTIN-13	PVP		
Prolongador de 4 tomas 2P+T, 16A 250V~. Máx. 3.680W. Cable H05VV-F, 3G1,5mm².					
8114	Longitud 1,5 m. Entrada para minicanal de 7x12, 10x16, 10x20 y 12x12.	8423220068612	24,89	1	20
8124	Longitud 2 m. Entrada para minicanal de 7x12, 10x16, 10x20 y 12x12.	8423220072961	26,15	1	20



Prolongador de 6 tomas 2P+T, 16A 250V~. Máx. 3.680W. Cable H05VV-F, 3G1,5mm².					
8116	Longitud 1,5 m. Entrada para minicanal de 7x12, 10x16, 10x20 y 12x12.	8423220901629	29,72	1	30

SERIE 8000. Accesorios



Referencia	Descripción	Código GTIN-13	PVP		
Soportes metálicos para bases Serie 8000 para fijar en perfil DIN.					
KIT-DIN35	Juego de 2 soportes metálicos y 2 tornillos para fijar las bases de la Serie 8000 a un perfil DIN de 35 mm (Excepto refs. 8104, 8106, 8105IL, 8114 y 8116).	8423220054929	3,78	1	400



Prolongadores con bases múltiples



Descárgate la documentación técnica



SERIE 900. Prolongadores con bases múltiples



Referencia	Descripción	Código GTIN-13	PVP		
Prolongador de 3 tomas 2P+T, 16A 250V~. Máx. 3.680W. Cable H05VV-F, 3G1,5mm². Con interruptor luminoso.					
V913IL	Longitud 1,5 m.	8423220056121	12,05	1	38
V933IL	Longitud 3 m.	8423220064300	17,05	1	30
V953IL	Longitud 5 m.	8423220089938	22,02	1	25



Prolongador de 4 tomas 2P+T, 16A 250V~. Máx. 3.680W. Cable H05VV-F, 3G1,5mm². Con interruptor luminoso.					
V914IL	Longitud 1,5 m.	8423220064010	12,99	1	20
V934IL	Longitud 3 m.	8423220055520	18,02	1	26
V954IL	Longitud 5 m.	8423220089945	24,88	1	24



Prolongador de 5 tomas 2P+T, 16A 250V~. Máx. 3.680W. Cable H05VV-F, 3G1,5mm². Con interruptor luminoso.					
V915IL	Longitud 1,5 m.	8423220064003	13,91	1	30
V935IL	Longitud 3 m.	8423220066366	19,06	1	26
V955IL	Longitud 5 m.	8423220089952	25,88	1	20



Prolongador de 6 tomas 2P+T, 16A 250V~. Máx. 3.680W. Cable H05VV-F, 3G1,5mm². Con interruptor luminoso.					
V916IL	Longitud 1,5 m.	8423220057166	14,87	1	16
V936IL	Longitud 3 m.	8423220066373	19,87	1	24
V956IL	Longitud 5 m.	8423220089969	26,76	1	20

SERIE 900. Prolongadores con bases múltiples especiales



Referencia	Descripción	Código GTIN-13	PVP		
Prolongador de 3 tomas 2P+T, 16A 250V~. Máx. 3.680W. Cable H05RR-F, 3G1,5mm². Con interruptor luminoso.					
V1049	Longitud 1,5 m. Con tapa IP44. Certificado GS.	8423220065833	23,61	1	20



Prolongador de 6 tomas 2P+T, 16A 250V~. Máx. 3.680W. Cable H05VV-F, 3G1,5mm². Con interruptor luminoso.					
V1051	Con toma RJ11, toma RJ45, 2 tomas USB POWER: 5.0V~; 2.4A; Total 12W, protección para sobretensiones y manual de instrucciones. Longitud 2 m. Certificado GS.	8423220066809	63,96	1	10



Prolongador de 6 tomas 2P+T, 16A 250V~. Máx. 3.680W. Cable H05VV-F, 3G1,5mm².					
V1053	Con 2 tomas USB POWER: 5.0V~; 2.1A; Total 10,5W. Longitud 2 m. Certificado GS.	8423220066823	38,43	1	10



Accede a la tarifa PVP actualizada

Material diverso para uso doméstico

Descárgate toda la documentación técnica de la serie escaneando este código



MATERIAL DIVERSO. Clavijas de caucho

Referencia	Descripción	GTIN-13 unitario	PVP		GTIN-13 envase	
Clavija 2P+T, 16A 250V~. Con doble sistema de tierra. Con Prensaestopa. IP54 con base de similar IP. Posibilidad de utilizar cable 3x2,5mm2.						
706TK	Fabricado en España. Material caucho termoplástico.	8423220254695	C*	-	8423220254060	-
706T	Material caucho termoplástico.	8423220205024	5,81	13	8423220205000	208
Clavija 2P+T, 16A 250V~. Con doble sistema de tierra. Sujetacables abatible para facilitar el embornamiento. IP44 con base de similar IP.						
5706CK	Fabricado en España. Material caucho termoplástico.	8423220254657	C*	-	8423220254527	-
5706C	Material caucho termoplástico.	8423220079809	5,63	14	8423220081086	224
Clavija 2P+T, 16A 250V~. Con doble sistema de tierra. Sujetacables abatible para facilitar el embornamiento.						
706CK	Fabricado en España. Material caucho termoplástico.	8423220254671	C*	-	8423220254541	-
706C	Material caucho termoplástico.	8423220083011	5,41	20	8423220080942	320
Clavija 2P+T, 16A 250V~. Con doble sistema de tierra.						
16F	Material caucho termoplástico.	--	6,69	1	8423220220676	30

MATERIAL DIVERSO. Bases de caucho

Referencia	Descripción	GTIN-13 unitario	PVP		GTIN-13 envase	
Base móvil 2P+T, 16A 250V~. Con prensaestopa. IP54 con clavija de similar IP. Posibilidad de utilizar cable 3x2,5 mm2.						
707TK	Fabricado en España. Material caucho termoplástico.	8423220254701	C*	-	8423220254077	-
707T	Material caucho termoplástico.	8423220205017	7,07	8	8423220204997	128
Base móvil 2P+T, 16A 250V~. Sujetacables abatible para fácil embornamiento. IP44 con base de similar IP.						
5707CK	Fabricado en España. Material caucho termoplástico.	8423220254664	C*	-	8423220254534	-
5707C	Material caucho termoplástico.	8423220079816	6,23	17	8423220081093	136
Base móvil 2P+T, 16A 250V~. Sujetacables abatible para fácil embornamiento.						
707CK	Fabricado en España. Material caucho negro termoplástico.	8423220254688	C*	-	8423220254558	-
707C	Material caucho termoplástico.	8423220083028	5,69	14	8423220082960	224
Base móvil 2P+T, 16A 250V~.						
17	Material caucho termoplástico.	8423220220713	12,01	1	8423220220713	20
Base móvil 2P+T, 16A 250V~. IP54.						
57	Material caucho.	8423220220744	13,02	1	8423220220744	20





Referencia	Descripción	GTIN-13 unitario	PVP		GTIN-13 envase	
Base múltiple de 3 tomas 2P+T, 16A 250V~. Máx. 3.680W. Con asa de fijación. Embornamiento de fácil acceso.						
5586OB	IP44. Material caucho termoplástico.	---	68,78	1	8423220043275	5

MATERIAL DIVERSO. Clavijas móviles



Referencia	Descripción	GTIN-13 unitario	PVP		GTIN-13 envase	
Clavija 2P+T, 16A 250V~. Con doble sistema de tierra. Con prensaestopas. IP54 con base similar IP.						
706TKB	Fabricada en España. Material elastómero blanco. Posibilidad de utilizar cable de 3x2,5mm.	8423220254756	C*	-	8423220254633	-



Clavija 2P+T, 16A 250V~. Con doble sistema de tierra. Sujetacables abatible para facilitar el embornamiento.						
5706CKB	Fabricada en España. IP 44 con base de similar IP. Material elastómero blanco.	8423220254718	C*	-	8423220254084	-



Clavija 2P+T, 16A 250V~. Con doble sistema de tierra. Sujetacables abatible para facilitar el embornamiento.						
706CKB	Fabricada en España. Material elastómero blanco.	8423220254732	C*	-	8423220254107	-
706CB	Material elastómero blanco.	8423220095700	5,41	20	8423220095694	320



Clavija 2P +T 16A 250V~. Con doble sistema de tierra. Sujetacables abatible para facilitar el embornamiento. Con asa. Espiga de Ø4,8.						
6566A	Material termoplástico color blanco.	8423220080829	3,68	18	8423220079762	288
6566AN	Material termoplástico color negro.	8423220094024	3,68	18	8423220080720	288



Clavija 2P +T 16A 250V~. Espiga de Ø4,8. Con doble sistema de tierra. Dos opciones de entrada de cable.						
1428	Material termoplástico color blanco.	8423220216969	3,36	23	8423220216877	368



Clavija 2P +T 16A 250V~.						
6428	Material termoplástico color blanco.	8423220079359	2,42	25	8423220002807	400
6428N	Material termoplástico color negro.	8423220079366	2,42	25	8423220061460	400



Clavija 2P +T 16A 250V~. Con doble sistema a tierra.						
6566	Material termoplástico color blanco.	8423220079571	2,85	25	8423220004122	400
6566N	Material termoplástico color negro.	8423220200975	2,85	25	8423220080706	400



Clavija 2P, 10A 250V~.						
6118	Material termoplástico color blanco.	8423220079496	1,75	60	8423220002333	960
6118N	Material termoplástico color negro.	8423220079502	1,75	60	8423220002654	960



Clavija trasmueble 2P +T 16A 250V~. Con doble sistema de tierra. Embornamiento de fácil acceso. Asa abatible.						
CTM1	Material termoplástico color blanco.	8423220074224	4,45	16	8423220078352	256
CTM1N	Material termoplástico color negro.	8423220074330	4,45	16	8423220078369	256

MATERIAL DIVERSO. Bases de enchufe móviles



Referencia	Descripción	GTIN-13 unitario	PVP		GTIN-13 envase	
Base móvil 2P +T 16A 250V~. Con prensaestopa.						
707TKB	Fabricada en España. IP54 con clavija de similar IP. Material elastómero blanco. Posibilidad de utilizar cable 3x2,5 mm²	8423220254763	C*	-	8423220254640	-



Base móvil 2P+T, 16A 250V. Sujetacable abatible para fácil embornamiento.						
5707CKB	Fabricada en España. IP44 con clavija de similar IP. Material elastómero blanco	8423220254725	C*	-	8423220254091	-



Base móvil 2P+T, 16A 250V~. Sujetacables abatible para fácil embornamiento.						
707CKB	Fabricado en España. Material elastómero blanco.	8423220254749	C*	-	8423220254114	-
707CB	Material elastómero blanco.	8423220095724	5,69	14	8423220095717	224



Base móvil 2P+T, 16A 250V~. Sujetacables abatible para facilitar el embornamiento. Con asa.						
5019A	Material termoplástico color blanco.	8423220081079	3,68	14	8423220079793	224
5019AN	Material termoplástico color negro.	8423220094031	3,68	14	8423220080768	224



MATERIAL DIVERSO. Bases de enchufe móviles



Referencia	Descripción	GTIN-13 unitario	PVP		GTIN-13 envase	
Base móvil 2P+T, 16A 250V~.						
5019	Material termoplástico color blanco.	8423220079373	3,96	15	8423220045279	240
5019N	Material termoplástico color negro.	8423220079380	3,96	15	8423220045699	240



Referencia	Descripción	GTIN-13 unitario	PVP		GTIN-13 envase	
Base móvil 2P, 10A 250V~.						
7627	Material termoplástico color blanco.	8423220079397	2,24	65	8423220009288	520
7627N	Material termoplástico color negro.	8423220079403	2,24	65	8423220034662	520

MATERIAL DIVERSO. Bases de enchufe fijas



Referencia	Descripción	GTIN-13 unitario	PVP		GTIN-13 envase	
Base fija 2P+T, 16A 250V~. De superficie.						
517	Base redonda.	8423220079335	3,79	12	8423220005174	192



Referencia	Descripción	GTIN-13 unitario	PVP		GTIN-13 envase	
Base fija 2P+T, 16A 250V~. De superficie.						
5001	Material termoplástico.	8423220079311	4,46	24	8423220050013	192



Referencia	Descripción	GTIN-13 unitario	PVP		GTIN-13 envase	
Base para fijar en perfil DIN 2P+T, 16A 250V~. Ancho 2,5 módulos (45mm).						
99B	Color blanco.	---	11,21	8	8423220017498	128
99	Color gris.	---	11,21	8	8423220031050	120
99R	Color rojo.	---	11,09	8	8423220037953	128

MATERIAL DIVERSO. Varios



Referencia	Descripción	Código GTIN-13	PVP		
Protector para conexiones exteriores.					
PROT-1	IP44. Color naranja.	8423220069954	5,08	1	50



Referencia	Descripción	Código GTIN-13	PVP		
Obturador plano rotativo.					
OB5003	5 unidades. Con adhesivo.	8423220056381	2,06	1	1.000

MATERIAL DIVERSO. Cocina



Referencia	Descripción	GTIN-13 unitario	PVP		GTIN-13 envase	
Clavija 2P+T, 25A 250V~. Para cocina.						
6828K	Fabricado en España. Para base ref. 6827K.	8423220235595	12,08	10	8423220235571	160



Referencia	Descripción	GTIN-13 unitario	PVP		GTIN-13 envase	
Base fija 2P+T, 25A 250V~. Para cocina. De empotrar.						
6827K	Fabricado en España. Instalación empotrada en cajas universales. Instalación en superficie con zócalo ref. 6833.	8423220235588	10,43	11	8423220235564	88



Referencia	Descripción	GTIN-13 unitario	PVP		GTIN-13 envase	
Caja de superficie para montar la base 6827.						
6833	Entrada para minicanal hasta 16x40 mm.	---	2,02	10	8423220004160	300





Referencia	Descripción	Código GTIN-13	PVP		
Prolongador 2P+T, 16A 250V~. Máx. 3.680W. Cable H05VV-F, 3G1,5mm².					
6710	Longitud 10 m.	8423220010277	40,87	1	10
6710/25	Longitud 25 m.	8423220003996	90,07	1	6



Referencia	Descripción	Código GTIN-13	PVP		
Prolongador 2P+T, 16A 250V~ sin base. Para aparatos de Clase I. Clavija inyectada con salida de cable a 90 °C. Doble sistema a tierra. Cable H05VV-F, 3G1,5mm².					
7000/1	Longitud 1 m.	8423220096578	7,71	1	150
7000/1,5	Longitud 1,5 m.	8423220008823	9,84	1	80
7000/2	Longitud 2 m.	8423220033917	11,90	1	60
7000/3	Longitud 3 m.	8423220033924	15,64	1	35
7000/5	Longitud 5 m.	8423220057548	22,34	1	25



Referencia	Descripción	Código GTIN-13	PVP		
Prolongador 2P+T, 16A 250V~. Máx. 3.680W. Cable H05VV-F, 3G1,5mm².					
6762/1	Longitud 2 m.	8423220063921	12,22	1	40
6763/1	Longitud 3 m.	8423220063938	15,47	1	30
6764/1	Longitud 4 m.	8423220063945	19,01	1	25
6765/1	Longitud 5 m.	8423220063952	23,21	1	25



Referencia	Descripción	Código GTIN-13	PVP		
Prolongador 2P, 10A 250V~. Máx. 2.300W. Cable H05VV-F, 2x1mm².					
8672/1	Longitud 2 m.	8423220007727	6,86	1	50
8673/1	Longitud 3 m.	8423220007666	8,80	1	40
8675/1	Longitud 5 m.	8423220007451	11,97	1	30

MATERIAL DIVERSO. Adaptadores



Referencia	Descripción	GTIN-13 unitario	PVP		GTIN-13 envase	
Adaptador doble 2P+T, 16A 250V~. Máx. 3.680W.						
986	Material termoplástico.	8423220079274	5,58	14	8423220058491	112



Referencia	Descripción	GTIN-13 unitario	PVP		GTIN-13 envase	
Adaptador triple 2P+T, 16A 250V~. Máx. 3.680W.						
186F	Clavija con doble sistema de tierra. Material termoplástico.	8423220079267	6,33	12	8423220044807	96



Referencia	Descripción	GTIN-13 unitario	PVP		GTIN-13 envase	
Adaptador triple 2P+T, 16A 250V~. Máx. 3.680W. Con interruptor luminoso.						
V1302	Material termoplástico.	---	8,58	7	8423220068667	56



Referencia	Descripción	GTIN-13 unitario	PVP		GTIN-13 envase	
Adaptador 2P+T, 16A 250V~. Máx. 3.680W. Con interruptor luminoso.						
860IL	Material termoplástico.	8423220079281	5,94	18	8423220065789	144



Referencia	Descripción	GTIN-13 unitario	PVP		GTIN-13 envase	
Adaptador doble 2P+T, 16A 250V~. Máx. 3.680W.						
V1300	Material termoplástico.	8423220098725	4,10	14	8423220068650	112



Referencia	Descripción	GTIN-13 unitario	PVP		GTIN-13 envase	
Adaptador doble 2P, 10A 250V~. Máx. 2.300W.						
6010	Material termoplástico.	---	4,66	30	8423220009318	240





Referencia	Descripción	GTIN-13 unitario	PVP		GTIN-13 envase	
Adaptador triple 2P, 10A 250V~. Máx. 2.300W.						
6009	Material termoplástico. Color blanco.	---	5,34	25	8423220009356	200



Adaptador triple 2P, 10A 250V~. Máx. 2.300W.						
15098	Material termoplástico.	---	4,29	19	8423220087613	152



Adaptador triple 2P, 16A 250V~. Máx. 2.300W.						
15097	Material termoplástico.	---	4,46	19	8423220087606	152



Adaptador triple 2P, 16A 250V~. Máx. 2.300W.						
5113	Material termoplástico.	---	4,83	10	8423220051133	160



Adaptador de uso temporal 2P+T, 13A 250V~ (clavija schuko-base inglesa). Máx. 2.990W. Para viaje.						
AV1	Material termoplástico.	8423220090552	4,23	1	8423220034075	200



Adaptador de uso temporal 2P, 10A 250V~. Máx. 2.300W. Para viaje.						
88U	Material termoplástico.	---	3,57	35	8423220105256	140















Enrollacables

Descárgate toda la documentación técnica de la serie escaneando este código



ENROLLACABLES. Con tomas domésticas

Referencia	Descripción	Código GTIN-13	PVP		
Enrollacable con 3 bases 2P+T, 16A 230V~ + 2 tomas USB: 5V 2,5A; Total 12W. Clavija con asa. Cable H05VV-F.					
 7321USB	5 m de cable 3G1,5. Potencia máxima extendido / enrollado: 3.200 W / 1.100 W.	8423220221826	44,09	1	4
Enrollacable con 4 bases 2P+T, 16A 230V~. Cable H05VV-F.					
 7422/3	10 m de cable 3G1,5. Potencia máxima extendido / enrollado: 3.500 W / 1.200 W.	8423220073814	46,66	1	6
 7412/1	10 m de cable 3G1. Potencia máxima extendido / enrollado: 3.000 W / 1.000 W.	8423220055988	38,47	1	6
Enrollacable con 4 bases 2P+T, 16A 230V~. Cable H05VV-F.					
 7429	3 m de cable 3G1,5. Potencia máxima extendido / enrollado: 3.200 W / 1.100 W.	8423220069916	25,24	1	10
Enrollacable con 4 bases 2P+T, 16A 230V~. Cable H05VV-F.					
 7413/2	15 m de cable 3G1,5. Potencia máxima extendido / enrollado: 3.500 W / 1.200 W.	8423220080904	56,49	1	6
Enrollacable con 2 bases 2P+T, 16A 230V~. Cable H05VV-F.					
 7211/1	5 m de cable 3G1,5. Potencia máxima extendido / enrollado: 3.500 W / 1.500 W.	8423220074668	25,69	1	12
Enrollacable con 4 bases 2P+T, 16A 230V~. Cable H05VV-F.					
 7423/2	15 m de cable 3G1,5. Potencia máxima extendido / enrollado: 3.500 W / 1.200 W.	8423220073821	66,69	1	1
Enrollacable con 4 bases 2P+T, 16A 230V~. Cable H05VV-F.					
 7425/2	25 m de cable 3G1,5. Potencia máxima extendido / enrollado: 3.500 W / 1.000 W.	8423220073838	98,56	1	2
 7427/2	50 m de cable 3G1,5. Potencia máxima extendido / enrollado: 3.500 W / 1.000 W.	8423220073845	177,46	1	1
Enrollacable con 4 bases 2P+T, 16A 230V~. Con tapa.					
 7425/1T	25 m de cable 3G1,5. Potencia máxima extendido / enrollado: 3.500 W / 1.200 W. H05W-F.	8423220003552	119,42	1	2
Enrollacable con 4 bases 2P+T, 16A 230V~. Con tapa.					
 7427/1T	50 m de cable 3G1,5. Potencia máxima extendido / enrollado: 3.500 W / 1.200 W. H05W-F.	8423220046566	195,72	1	2





Accede a la tarifa PVP actualizada



ENROLLACABLES. Con tomas domésticas

Referencia	Descripción	Código GTIN-13	PVP		
Enrollacable sin cable con 4 bases 2P+T, 16A 250V~. Desmontable.					
 TB7427/3	Cables recomendados: H05VV-F, H05RR-F y H05RN-F. Secciones: 3G1,5 (60m máx.) y 3G2,5 (30m máx.).	8423220207820	40,04	1	2
Enrollacable vacío. No incluye contactos.					
 70	Carrete vacío para hacer prolongadores con distintos tipos de cables. Agujero para fijar la clavija.	8423220008243	49,81	1	5
Enrollacable manual.					
 ROL-1	Enrollador manual de cable.	8423220069961	3,99	1	60
Soporte mural para enrollacables.					
 SOP-7000	Soporte mural.	8423220218703	6,89	1	96

ENROLLACABLES. Automáticos

Referencia	Descripción	Código GTIN-13	PVP		
Enrollacable automático con 1 base 2P+T, 16A 250V~. Cable H05VV-F. Con soporte para fijar a la pared.					
 71251A	16 m (14+2) de cable 3G1,5. Potencia máx. extendido / enrollado: 2.000 W / 1.400 W.	8423220065819	135,07	1	2

ENROLLACABLES. Con tomas industriales

Referencia	Descripción	Código GTIN-13	PVP		
Enrollacable con 1 base + 1 clavija 2P+T (6h), 16A 250V~. IP44.					
 75562	30 m de cable H07RN-F 3G2,5. Potencia máxima extendido 3.680W.	8423220057678	450,87	1	2
Enrollacable con 3 bases 2P+T, 16A 250V~. IP44. Cable H05VV-F.					
 73362	30 m de cable 3G2,5. Potencia máxima extendido 3.680W.	8423220057647	326,41	1	2
Enrollacable con 1 base + 1 clavija 3P+T (6h), 12A 400V~.					
 75553	25 m de cable H07RN-F 4G2,5. Potencia máxima extendido 4.800W. Tomas IP67.	8423220057692	420,81	1	2



Iluminación

Descárgate toda la documentación técnica de la serie escaneando este código



ILUMINACIÓN. Portalámparas termoplásticos de conexión por tornillo



Referencia	Descripción	Código GTIN-13	PVP		
Portalámparas E-14. 2A 250V~. Entrada roscada M10-100.					
6584CLB	Cuerpo liso. Color blanco.	8423220003422	2,49	45	360
6584CLN	Cuerpo liso. Color negro.	8423220000421	2,49	45	360



Portalámparas E-14. 2A 250V~. Entrada roscada M10-100.					
6584CRB	Cuerpo roscado. Color blanco.	8423220003439	2,57	45	360
6584CRN	Cuerpo roscado. Color negro.	8423220000438	2,57	45	360



Portalámparas E-14. 2A 250V~. Entrada roscada M10-100.					
6584CTB	Cuerpo roscado con tope. Color blanco.	8423220002449	2,68	45	360
6584CTN	Cuerpo roscado con tope. Color negro.	8423220000445	2,68	45	360



Arandela contra anillo. Para Referencia 6584CR y 6584CT.					
731	Color blanco.	8423220037311	0,57	100	1.600
731N	Color negro.	8423220007314	0,57	100	1.600



Portalámparas E-27. 4A 250V~. Entrada roscada M10-100.					
6829CLB	Cuerpo liso. Color blanco.	8423220003583	2,78	40	320
6829CLN	Cuerpo liso. Color negro.	8423220000582	2,78	40	320



Portalámparas E-27. 4A 250V~. Entrada roscada M10-100.					
6829CRB	Cuerpo roscado. Color blanco.	8423220003590	2,83	40	320
6829CRN	Cuerpo roscado. Color negro.	8423220000599	2,83	40	320



Portalámparas E-27. 4A 250V~. Entrada roscada M10-100.					
6829CTB	Cuerpo roscado con tope. Color blanco.	8423220002609	2,88	40	320
6829CTN	Cuerpo roscado con tope. Color negro.	8423220000605	2,88	40	320



Arandela contra anillo. Para Referencia 6829CR y 6829CT.					
831	Color blanco.	8423220038318	0,64	55	880
831N	Color negro.	8423220028319	0,64	55	880



Velas para portalámparas de la serie 6829.					
855	Vela corta para portalámparas Refs. 6829CL. Color blanco.	8423220008557	1,06	1	150
855C	Vela corta para portalámparas Refs. 6829CL. Color crema.	8423220001336	1,06	1	200



ILUMINACIÓN. Portalámparas para feria



Referencia	Descripción	Código GTIN-13	PVP		
Portalámparas E-27 para ferias. 4A 250V~. Máx. 100W.					
6109	Anclaje por varilla comercial de 5x5. Máx. 100W.	8423220006669	2,66	50	400
6109A	Anclaje para cable rectangular de 5x13. Máx. 100W.	8423220006676	2,66	50	400
6109B	Anclaje por varilla comercial de 1,5x5. Máx. 100W.	8423220006690	2,66	50	400



Referencia	Descripción	Código GTIN-13	PVP		
Portalámparas E-27 para ferias con IP44 y junta de estanqueidad. 4A 250V~. Máx. 25W.					
27F	Para cable rectangular H05RNH2-F de 5 x 13 mm. Agujeros para fijar en la pared u otras superficies.	8423220206526	2,91	5	250

ILUMINACIÓN. Portalámparas para obra



Referencia	Descripción	Código GTIN-13	PVP		
Portalámparas E-27 para obra. 4A 250V~. Máx. 40W. Conexión con tornillos.					
6618	Color blanco. Resina termoestable.	8423220000469	2,01	70	560
6618N	Color negro. Resina termoestable.	8423220001350	2,01	70	560



Referencia	Descripción	Código GTIN-13	PVP		
Portalámparas E-27 para obra. 4A 250V~. Máx. 40W. Conexión rápida.					
161QC	Color blanco. Material termoplástico.	8423220235472	2,19	70	560

ILUMINACIÓN. Portalámparas de porcelana. Serie 479 (E-14)



Referencia	Descripción	Código GTIN-13	PVP		
Portalámparas E-14. 2A 250V~.					
479A	Soporte metálico M10-100. Protección anti-rotación.	8423220004795	2,46	45	360



Referencia	Descripción	Código GTIN-13	PVP		
Portalámparas E-14. 2A 250V~.					
479B	Soporte metálico M10-100. Protección anti-rotación.	8423220000797	2,46	45	360



Referencia	Descripción	Código GTIN-13	PVP		
Portalámparas E-14. 2A 250V~.					
479J	Soporte metálico para vela corta.	8423220008502	2,86	40	320



Referencia	Descripción	Código GTIN-13	PVP		
Portalámparas E-14. 2A 250V~.					
479K	Soporte metálico para vela larga.	8423220008519	2,86	40	320



Referencia	Descripción	Código GTIN-13	PVP		
Velas para portalámparas de la serie 479.					
853	Vela corta para portalámparas Ref. 479 J. Color blanco.	8423220008533	0,59	25	400
853C	Vela corta para portalámparas Ref. 479 J. Color crema.	8423220001312	0,59	25	400
854	Vela larga para portalámparas Ref. 479 K. Color blanco.	8423220008540	0,63	25	400
854C	Vela larga para portalámparas Ref. 479 K. Color crema.	8423220001329	0,63	25	400





Referencia	Descripción	Código GTIN-13	PVP		
Portalámparas E-27. 4A 250V~. Protección contra choques eléctricos.					
678A	Soporte metálico M10-100. Protección anti-rotación.	8423220007789	2,28	50	200



Portalámparas E-27. 4A 250V~. Protección contra choques eléctricos.					
678B	Soporte metálico M10-100. Protección anti-rotación.	8423220002418	2,28	50	200



Portalámparas E-27. 4A 250V~. Protección contra choques eléctricos.					
678D	Soporte metálico.	8423220002432	2,46	50	200



Portalámparas E-27. 4A 250V~. Protección contra choques eléctricos.					
678E	Con 2 remaches de M4.	8423220002456	2,28	50	200



Portalámparas E-27. 4A 250V~. Protección contra choques eléctricos.					
678F	Soporte metálico.	8423220002463	2,28	50	200



Portalámparas E-27. 4A 250V~. Protección contra choques eléctricos.					
678G	Soporte metálico.	8423220002470	2,28	50	200



Portalámparas E-27. 4A 250V~. Protección contra choques eléctricos.					
678R	Soporte metálico 3/8G. Protección anti-rotación.	8423220012226	2,66	50	200

ILUMINACIÓN. Portalámparas de porcelana. Serie 777 (E-40)



Referencia	Descripción	Código GTIN-13	PVP		
Portalámparas E-40. 16A 250V~. Protección contra choques eléctricos.					
777B	Soporte metálico roscado 3/8G.	8423220008779	14,35	6	72



Portalámparas E-40. 16A 250V~. Protección contra choques eléctricos.					
777SS	Sin soporte.	8423220007772	13,11	6	72



ILUMINACIÓN. Portalámparas de superficie



Referencia	Descripción	Código GTIN-13	PVP		
Portalámparas E-27 de superficie. 4A 250V~. Máx. 75W. Zócalo curvo.					
6510	Color blanco.	8423220000391	3,57	10	160
6510N	Color negro.	8423220001435	3,57	10	160



Referencia	Descripción	Código GTIN-13	PVP		
Portalámparas E-27 de superficie. 4A 250V~. Máx. 75W. Zócalo recto.					
6511	Color blanco.	8423220000407	3,57	10	160
6511N	Color negro.	8423220001343	3,57	10	160

ILUMINACIÓN. Portalámparas varios



Referencia	Descripción	Código GTIN-13	PVP		
Portalámparas GU10 cerámico. 2A 250V~.					
PGU10	Para lámparas GU10. Con 150 mm de cable de silicóna.	8423220073326	1,02	100	1.000



Referencia	Descripción	Código GTIN-13	PVP		
Portalámparas GU5,3 cerámico. 12V.					
PGU56	Para lámparas GU-5,3/6,35. Con 150 mm de cable de silicóna.	8423220010796	0,65	200	2.000



Referencia	Descripción	Código GTIN-13	PVP		
Portalámparas GZ10 cerámico. 2A 250V~.					
PGZ10	Para lámparas GU10 o GZ10. Con 150 mm de cable de silicóna.	8423220010604	1,02	100	1.000

ILUMINACIÓN. Portalámparas para tubos



Referencia	Descripción	Código GTIN-13	PVP		
Portalámparas G13 para tubo T8. 2A 250V~.					
801	Embarnamiento rápido. Material termoplástico.	8423220008014	1,61	70	560



Referencia	Descripción	Código GTIN-13	PVP		
Portalámparas G13 para tubo T8. 2A 250V~. Con portacebador incorporado.					
802	Embarnamiento rápido. Material termoplástico.	8423220008021	2,62	60	480



Referencia	Descripción	Código GTIN-13	PVP		
Portacebador.					
804	2A 250V~.	8423220008045	1,03	50	800

ILUMINACIÓN. Portalámparas adaptadores



Referencia	Descripción	GTIN-13 unitario	PVP		GTIN-13 envase	
Portalámparas adaptador de E40 a E27.						
AD40-27	Permite adaptar bombillas de un casquillo distinto al del portalámparas	8423220076136	2,84	25	8423220068742	500



Referencia	Descripción	GTIN-13 unitario	PVP		GTIN-13 envase	
Portalámparas adaptador de E27 a E14.						
AD27-14	Permite adaptar bombillas de un casquillo distinto al del portalámparas	8423220076150	3,01	12	8423220068759	600





Referencia	Descripción	GTIN-13 unitario	PVP		GTIN-13 envase	
Portalámparas adaptador de E14 a GU10.						
AD14-10	Permite adaptar bombillas de un casquillo distinto al del portalámparas	8423220076143	4,25	12	8423220068773	360



Portalámparas adaptador de E27 a GU10.						
AD27-10	Permite adaptar bombillas de un casquillo distinto al del portalámparas	8423220076167	4,36	12	8423220068766	360

ILUMINACIÓN. Interruptores de paso



Referencia	Descripción	Código GTIN-13	PVP		
Interruptor de paso 6A 250V~.					
6541	Sin indicador luminoso.	8423220004498	4,06	65	520



Conmutador 6A 250V~.					
6541C	Sin indicador luminoso.	8423220004535	3,96	65	520



Pulsador 6A 250V~.					
6541P	Sin indicador luminoso.	8423220004511	3,92	65	520



Pulsador 6A 250V~. Normalmente cerrado.					
6541PE	Sin indicador luminoso.	8423220010420	3,78	65	520



Referencia	Descripción	GTIN-13 unitario	PVP		GTIN-13 envase	
Interruptor de paso 4A 250V~. Con tecla basculante.						
40B	Color blanco.	8423220079298	2,63	75	8423220045255	1.200
40N	Color negro	8423220079304	2,63	75	8423220045262	1.200

ILUMINACIÓN. Luz guía



Referencia	Descripción	GTIN-13 unitario	PVP		GTIN-13 envase	
Luz guía 250V.						
V1705	Luz LED blanca. 1,5W. Con interruptor encendido / apagado.	8423220095687	5,13	32	8423220095670	512

ILUMINACIÓN. Caja para luminaria



Referencia	Descripción	GTIN-13 unitario	PVP		GTIN-13 envase	
Caja de conexión para luminaria. 73x27x32. IP20. Fabricado en Polipropileno.						
BK-L3P	Con terminal de conexión rápida incluido. 3 Polos. Hasta 2,5 mm². 16A-250V~. GWT 850°C. 4 entradas para cable. Diámetro máximo del cable: 5 mm.	8423220201415	2,48	50	8423220201347	350
BK-L	Vacía. 4 entradas para cable. GWT 650°C. 450V. Diámetro máximo del cable: 5 mm.	8423220201330	1,50	50	8423220201323	350



Protecciones, mando y señalización



Descárgate la documentación técnica



Ventajas de la serie



Certificación AENOR para los magnetotérmicos y los diferenciales



Sistema que evita falsas conexiones



Mejorado sistema de ventilación



Sistema de sujeción, sin muelle de retroceso



Productos complementarios



Pág. 06



Pág. 09



Pág. 37



Pág. 24



Referencia	Descripción	GTIN-13 unitario	PVP		GTIN-13 envase	
Interruptores magnetotérmicos. Sectores residencial y terciario. Poder de corte 6kA. 240/415V AC. (50-60Hz). Curva C.						
CBM110	1P. 1 módulo, 10A.	8423220093003	5,23	12	8423220091528	240
CBM116	1P. 1 módulo, 16A.	8423220093010	5,23	12	8423220091535	240
CBM120	1P. 1 módulo, 20A.	8423220093027	5,23	12	8423220091542	240
CBM125	1P. 1 módulo, 25A.	8423220093034	5,54	12	8423220091559	240
CBM132	1P. 1 módulo, 32A.	8423220093041	5,54	12	8423220091566	240
CBM140	1P. 1 módulo, 40A.	8423220093058	5,54	12	8423220091573	240
CBM150	1P. 1 módulo, 50A.	8423220093065	5,63	12	8423220091580	240
CBM163	1P. 1 módulo, 63A.	8423220093072	6,58	12	8423220091597	240



Referencia	Descripción	GTIN-13 unitario	PVP		GTIN-13 envase	
Interruptores magnetotérmicos. Sectores residencial y terciario. Poder de corte 6kA. 240 AC. (50-60Hz). Curva C.						
CBMM1N10	1P+N. 1 módulo, 10A.	8423220093089	19,05	12	8423220091603	180
CBMM1N16	1P+N. 1 módulo, 16A.	8423220093096	19,05	12	8423220091610	180
CBMM1N20	1P+N. 1 módulo, 20A.	8423220093102	19,05	12	8423220091627	180
CBMM1N25	1P+N. 1 módulo, 25A.	8423220093119	19,05	12	8423220091634	180
CBMM1N32	1P+N. 1 módulo, 32A.	8423220093126	19,05	12	8423220091641	180
CBMM1N40	1P+N. 1 módulo, 40A.	8423220093133	19,05	12	8423220091658	180



Referencia	Descripción	GTIN-13 unitario	PVP		GTIN-13 envase	
Interruptores magnetotérmicos. Sectores residencial y terciario. Poder de corte 6kA. 240 AC. (50-60Hz). Curva C.						
CBM1N10	1P+N. 2 módulos, 10A.	8423220093164	9,92	6	8423220091689	120
CBM1N16	1P+N. 2 módulos, 16A.	8423220093171	9,92	6	8423220091696	120
CBM1N20	1P+N. 2 módulos, 20A.	8423220093188	9,92	6	8423220091702	120
CBM1N25	1P+N. 2 módulos, 25A.	8423220093195	9,92	6	8423220091719	120
CBM1N32	1P+N. 2 módulos, 32A.	8423220093201	10,15	6	8423220091726	120
CBM1N40	1P+N. 2 módulos, 40A.	8423220093218	11,67	6	8423220091733	120
CBM1N50	1P+N. 2 módulos, 50A.	8423220093225	11,67	6	8423220091740	120
CBM1N63	1P+N. 2 módulos, 63A.	8423220093232	11,67	6	8423220091757	120



Referencia	Descripción	GTIN-13 unitario	PVP		GTIN-13 envase	
Interruptores magnetotérmicos. Sectores residencial y terciario. Poder de corte 6kA. 240/415V AC. (50-60Hz). Curva C.						
CBM210	2P. 2 módulos, 10A.	8423220093249	10,96	6	8423220091764	120
CBM216	2P. 2 módulos, 16A.	8423220093256	10,96	6	8423220091771	120
CBM220	2P. 2 módulos, 20A.	8423220093263	10,96	6	8423220091788	120
CBM225	2P. 2 módulos, 25A.	8423220093270	10,96	6	8423220091795	120
CBM232	2P. 2 módulos, 32A.	8423220093287	11,42	6	8423220091801	120
CBM240	2P. 2 módulos, 40A.	8423220093294	12,65	6	8423220091818	120
CBM250	2P. 2 módulos, 50A.	8423220093300	12,74	6	8423220091825	120
CBM263	2P. 2 módulos, 63A.	8423220093317	14,16	6	8423220091832	120



Referencia	Descripción	GTIN-13 unitario	PVP		GTIN-13 envase	
Interruptores magnetotérmicos. Sectores residencial y terciario. Poder de corte 6kA. 240/415V AC. (50-60Hz). Curva C.						
CBM310	3P. 3 módulos, 10A.	8423220093324	17,52	4	8423220091849	80
CBM316	3P. 3 módulos, 16A.	8423220093331	17,52	4	8423220091856	80
CBM320	3P. 3 módulos, 20A.	8423220093348	17,52	4	8423220091863	80
CBM325	3P. 3 módulos, 25A.	8423220093355	17,52	4	8423220091870	80
CBM332	3P. 3 módulos, 32A.	8423220093362	19,08	4	8423220091887	80
CBM340	3P. 3 módulos, 40A.	8423220093379	19,08	4	8423220091894	80
CBM350	3P. 3 módulos, 50A.	8423220093386	19,51	4	8423220091900	80
CBM363	3P. 3 módulos, 63A.	8423220093393	19,85	4	8423220091917	80



Referencia	Descripción	GTIN-13 unitario	PVP		GTIN-13 envase	
Interruptores magnetotérmicos. Sectores residencial y terciario. Poder de corte 6kA. 240/415V AC. (50-60Hz). Curva C.						
CBM410	4P. 4 módulos, 10A.	8423220093409	24,17	3	8423220091924	60
CBM416	4P. 4 módulos, 16A.	8423220093416	24,17	3	8423220091931	60
CBM420	4P. 4 módulos, 20A.	8423220093423	25,05	3	8423220091948	60
CBM425	4P. 4 módulos, 25A.	8423220093430	25,05	3	8423220091955	60
CBM432	4P. 4 módulos, 32A.	8423220093447	25,74	3	8423220091962	60
CBM440	4P. 4 módulos, 40A.	8423220093454	27,97	3	8423220091979	60
CBM450	4P. 4 módulos, 50A.	8423220093461	29,31	3	8423220091986	60
CBM463	4P. 4 módulos, 63A.	8423220093478	31,14	3	8423220091993	60

*El diseño del producto puede variar.



PROTECCIONES. Diferenciales



Referencia	Descripción	GTIN-13 unitario	PVP		GTIN-13 envase	
Diferenciales. Sectores residencial y terciario. Poder de corte 6kA. 240/415V AC. (50-60Hz). Clase A.						
RCBA2P2530	2P. 25A. Sensibilidad 30 mA. 2 módulos.	---	59,63	1	8423220093621	60
RCBA2P4030	2P. 40A. Sensibilidad 30 mA. 2 módulos.	---	59,63	1	8423220093638	60
RCBA4P2530	4P. 25A. Sensibilidad 30 mA. 4 módulos.	---	83,22	1	8423220093652	30
RCBA4P4030	4P. 40A. Sensibilidad 30 mA. 4 módulos.	---	84,77	1	8423220093669	100



Referencia	Descripción	GTIN-13 unitario	PVP		GTIN-13 envase	
Diferenciales. Sectores residencial y terciario. Poder de corte 6kA. 240/415V AC. (50-60Hz). Clase AC.						
RCB2P2530	2P. 25A. Sensibilidad 30 mA. 2 módulos.	---	42,95	1	8423220093508	60
RCB2P4030	2P. 40A. Sensibilidad 30 mA. 2 módulos.	---	42,95	1	8423220093515	60
RCB2P6330	2P. 63A. Sensibilidad 30 mA. 2 módulos.	---	45,29	1	8423220093522	60
RCB4P2530	4P. 25A. Sensibilidad 30 mA. 4 módulos.	---	50,11	1	8423220093539	30
RCB4P4030	4P. 40A. Sensibilidad 30 mA. 4 módulos.	---	50,46	1	8423220093546	30
RCB4P6330	4P. 63A. Sensibilidad 30 mA. 4 módulos.	---	50,46	1	8423220093553	30
RCB2P25300	2P. 25A. Sensibilidad 300 mA. 2 módulos.	---	48,98	1	8423220093560	50
RCB2P40300	2P. 40A. Sensibilidad 300 mA. 2 módulos.	---	48,98	1	8423220093577	50
RCB2P63300	2P. 63A. Sensibilidad 300 mA. 2 módulos.	---	50,58	1	8423220093584	50
RCB4P25300	4P. 25A. Sensibilidad 300 mA. 4 módulos.	---	54,87	1	8423220093591	30
RCB4P40300	4P. 40A. Sensibilidad 300 mA. 4 módulos.	---	54,75	1	8423220093607	30
RCB4P63300	4P. 63A. Sensibilidad 300 mA. 4 módulos.	---	55,92	1	8423220093614	30



Referencia	Descripción	GTIN-13 unitario	PVP		GTIN-13 envase	
Diferencial con reconexión automática. Sectores terciario e industrial. Poder de corte 10kA. 240/415V AC. (50-60Hz). Clase A.						
CBRA2P4030A	2P. 5 módulos. 40A. Sensibilidad 30 mA.	8423220093768	199,99	1	8423220092280	24



Referencia	Descripción	GTIN-13 unitario	PVP		GTIN-13 envase	
Diferencial superinmunitizado.						
RCBSI2P2530	2P. 25A. Sensibilidad 30 mA.	---	99,99	1	8423220216075	60
RCBSI2P4030	2P. 40A. Sensibilidad 30 mA.	---	99,99	1	8423220216082	60

PROTECCIONES. Protectores de sobretensiones



Referencia	Descripción	GTIN-13 unitario	PVP		GTIN-13 envase	
Protector de sobretensión transitoria. 230/400V AC. (50-60Hz). Con indicador de estado. Monofásica y trifásica.						
LST2	1P+N. 230V. 30 kA. 275 Uc. Clase C. Monofásica. 1 módulo.	8423220079106	130,68	1	8423220066182	100
LST4	3P+N. 400V. 20 kA. 275 Uc. Clase D. Trifásica. 3 módulos.	8423220079113	389,84	1	8423220066199	30



Referencia	Descripción	GTIN-13 unitario	PVP		GTIN-13 envase	
Protector de sobretensión permanentes. Con indicador de estado. Monofásica y trifásica.						
LSTP1/9	1P+N. 230V. 280U máx. Tiempo ≤ 0,1s. Monofásica. 1 módulo.	8423220093812	69,36	9	8423220093829	200
LSTP3/9	3P+N. 400V. 280U máx. Tiempo ≤ 0,1s. Trifásica. 3 módulos.	8423220093836	132,17	3	8423220093843	60



Referencia	Descripción	GTIN-13 unitario	PVP		GTIN-13 envase	
Protector de sobretensión transitoria L+/L-. Clase II.						
FV1250/3S	1250VDC II. 40kA.	--	172,90	1	8423220227705	200
FV600/2S	500VDC II. 40kA.	--	168,02	1	8423220227699	200



*El diseño del producto puede variar.



Referencia	Descripción	GTIN-13 unitario	PVP		GTIN-13 envase	
Protector de sobretensión transitoria permanente. Monofásicos. 2 polos. Protegen contra sobretensiones transitorias causadas por descargas atmosféricas, maniobras de conmutación en circuitos eléctricos y descargas electrostáticas. Clase II.						
COMBI2P25T15	2x25A.	--	196,82	1	8423220216976	20
COMBI2P40T15	2x40A.	--	204,75	1	8423220216983	20

PROTECCIONES. Guardamotores



Referencia	Descripción	GTIN-13 unitario	PVP		GTIN-13 envase	
Protección térmica, magnética y fallo de fase. Curva AC3.						
GM4	2,5 a 4A. 0,75kW para 230V y 1,5kW para 400V.	8423220094048	80,48	1	8423220094055	50
GM6.3	4 a 6.3 A. 1,1kW para 230V y 2,2kW para 400V.	8423220079168	80,48	1	8423220066205	50

PROTECCIONES. Interruptores horarios



Referencia	Descripción	GTIN-13 unitario	PVP		GTIN-13 envase	
Minutero de escalera automático. 230V AC.						
AE16/230	On-timer. Tiempo retardo: 30 s - 20 min. 1 contacto NO (16A).	8423220081208	47,10	12	8423220066298	120



Referencia	Descripción	GTIN-13 unitario	PVP		GTIN-13 envase	
Interruptor horario 24h. Analógico. 230V AC.						
R24	1 módulo. CON RESERVA (72 h). Contacto: 1NO (16A). Unidad mínima de tiempo 15 min.	8423220081215	82,89	12	8423220054028	120



Referencia	Descripción	GTIN-13 unitario	PVP		GTIN-13 envase	
Interruptor horario 24h. Analógico. 230V AC.						
R24R/3	3 módulos. CON RESERVA (150 h). Contacto: 1NOC (16A). Unidad mínima de tiempo: 15 min.	8423220081222	180,05	4	8423220066281	40



Referencia	Descripción	GTIN-13 unitario	PVP		GTIN-13 envase	
Interruptor horario semanal digital. 230V AC.						
R168D	2 módulos. CON RESERVA (> 3 años). Contacto: 1NOC (16A). Unidad mínima de tiempo: 1 min.	----	76,66	6	8423220077348	60

PROTECCIONES. Contador de energía



Referencia	Descripción	GTIN-13 unitario	PVP		GTIN-13 envase	
Contador monofásico de energía activa. Incluye salida de pulsos. Con RESET. Clase I.						
CONT30R	1,5 módulos. 230V AC. Entrada 65A. 5 + 1 dígitos. Intensidad mínima de trabajo 0,02A. Precintable. 0,02A.	---	163,99	1	8423220077355	45

PROTECCIONES. Contactores modulares



Referencia	Descripción	GTIN-13 unitario	PVP		GTIN-13 envase	
Tensión bobina 230V~, 240/415V AC. (50-60Hz).						
CM2A25	2P. 1 módulo. Contactos: 2NO. 25A.	8423220079120	47,04	1	8423220066120	200
CM2A40	2P. 2 módulos. Contactos: 2NO. 40A.	8423220093799	50,22	1	8423220092310	240
CM2A63	2P. 2 módulos. Contactos: 2NO. 63A.	8423220079137	83,25	1	8423220066137	100
CM4A25	4P. 3 módulos. Contactos: 4NO. 25A.	8423220079144	116,25	1	8423220066144	60
CM4A40	4P. 3 módulos. Contactos: 4NO. 40A.	8423220093805	143,01	1	8423220092327	60
CM4A63	4P. 3 módulos. Contactos: 4NO. 63A.	8423220079151	159,98	1	8423220066151	60

*El diseño del producto puede variar.



PROTECCIONES. Fusibles y portafusibles



Referencia	Descripción	Código GTIN-13	PVP		
Fusibles cilíndricos Ø5x20. Cristal.					
612 2	Fusible cilíndrico de cristal 2A.	8423220006126	0,40	100	10.000
612 4	Fusible cilíndrico de cristal 4A.	8423220001688	0,40	100	10.000
612 6	Fusible cilíndrico de cristal 6A.	8423220001695	0,40	100	10.000
612 10	Fusible cilíndrico de cristal 10A.	8423220001701	0,40	100	10.000
612 15	Fusible cilíndrico de cristal 15A.	8423220001718	0,40	100	10.000



Referencia	Descripción	GTIN-13 unitario	PVP		GTIN-13 envase	
Fusibles cilíndricos. Cerámicos.						
FC010	10A. 500V. Talla 0 (10x38). 3 unidades.	8423220088689	5,81	1	8423220065307	800
FC140	40A. 500V. Talla 1 (14x51). 3 unidades.	8423220088696	9,04	1	8423220065314	800
FC263	63A. 690V. Talla 2 (22x58). 3 unidades.	8423220088702	14,88	1	8423220065321	200
FC280	80A. 690V. Talla 2 (22x58). 3 unidades.	8423220088719	15,86	1	8423220065338	200



Referencia	Descripción	GTIN-13 unitario	PVP		GTIN-13 envase	
Fusibles DO-2. Cerámicos.						
FCDO235	3 unidades de fusible cerámico 35A. 400V. 50 kA.	8423220088726	8,22	1	8423220065345	640
FCDO250	3 unidades de fusible cerámico 50A. 400V. 50 kA.	8423220088733	9,44	1	8423220065352	640
FCDO263	3 unidades de fusible cerámico 63A. 400V. 50 kA.	8423220097803	9,84	1	8423220097193	640



Referencia	Descripción	GTIN-13 unitario	PVP		GTIN-13 envase	
Portafusibles para fusibles cilíndricos. 1P. Poder de corte 20 kA.						
PF1038	Para corriente alterna. Talla 0 (10x38). 50A 690V.	8423220073869	4,81	12	8423220077324	300
PF1451	Para corriente alterna. Talla 1 (14x51). 50A 690V.	8423220073876	9,12	6	8423220077331	192
PF2258	Para corriente alterna. Talla 2 (22x58). 125A 690V.	8423220216952	14,43	6	8423220216945	96

PROTECCIONES. Pulsadores e indicadores



Referencia	Descripción	GTIN-13 unitario	PVP		GTIN-13 envase	
Pulsadores de emergencia y etiqueta.						
PE12	Contactos cerrados. Girar para desenclavar. Sin etiqueta.	8423220078581	21,56	1	8423220066267	180
PE12CA	Contactos abiertos. Girar para desenclavar. Sin etiqueta.	8423220078598	21,56	6	8423220071179	180
ET12	Etiqueta para paro de emergencia: "Emergency stop".	8423220078604	4,89	20	8423220066274	1200



Referencia	Descripción	GTIN-13 unitario	PVP		GTIN-13 envase	
Pulsadores con retorno. Botón rasante. Ø22.						
PULSA5R	Pulsador rojo. Contactos tipo NC.	8423220078567	9,43	12	8423220066229	288
PULSA5V	Pulsador verde. Contactos tipo NO.	8423220078574	9,43	12	8423220066236	288



Referencia	Descripción	GTIN-13 unitario	PVP		GTIN-13 envase	
Indicadores luminosos LED. Ø22. 250V.						
PLD22	Indicador luminoso led rojo.	8423220078543	7,51	12	8423220066250	288
PLD22V	Indicador luminoso led verde.	8423220078536	7,51	12	8423220066243	288



Referencia	Descripción	GTIN-13 unitario	PVP		GTIN-13 envase	
Conmutador selector de 3 posiciones. Ø22. 250V.						
INT5/3A2	Interruptor selector de 3 posiciones V/. Tipo de contactos 2NO.	8423220078550	15,30	12	8423220066212	288



*El diseño del producto puede variar.



Referencia	Descripción	Código GTIN-13	PVP		
Interruptores rotativos 0-1. 90°. IP20. Color rojo. Sistema de bloqueo.					
IR2A016E9	2P, 16A. 220/440V.	8423220211490	16,99	1	100
IR2A020E9	2P, 20A. 220/440V.	8423220211506	16,99	1	100
IR2A025E9	2P, 25A. 220/440V.	8423220211513	22,51	1	100
IR2A032E9	2P, 32A. 220/440V.	8423220211520	32,99	1	72
IR2A040E9	2P, 40A. 220/440V.	8423220211537	39,29	1	72
IR3A016E9	3P, 16A. 220/440V.	8423220211544	23,49	1	100
IR3A020E9	3P, 20A. 220/440V.	8423220212831	23,49	1	100
IR3A025E9	3P, 25A. 220/440V.	8423220211551	31,59	1	100
IR3A032E9	3P, 32A. 220/440V.	8423220211568	44,99	1	72
IR3A040E9	3P, 40A. 220/440V.	8423220211575	57,99	1	72
IR3A050E9	3P, 50A. 220/440V.	8423220211582	83,21	1	30
IR3A063E9	3P, 63A. 220/440V.	8423220211599	83,21	1	30
IR3A080E9	3P, 80A. 220/440V.	8423220211605	127,99	1	30
IR3A120E9	3P, 120A. 220/440V.	8423220211612	127,99	1	30
IR4A016E9	4P, 16A. 220/440V.	8423220211629	23,41	1	100
IR4A020E9	4P, 20A. 220/440V.	8423220211636	23,41	1	100
IR4A025E9	4P, 25A. 220/440V.	8423220211643	31,49	1	100
IR4A032E9	4P, 32A. 220/440V.	8423220211650	44,99	1	72
IR4A040E9	4P, 40A. 220/440V.	8423220211667	57,99	1	72
IR4A050E9	4P, 50A. 220/440V.	8423220211674	83,39	1	30
IR4A063E9	4P, 63A. 220/440V.	8423220211681	83,39	1	30
IR4A080E9	4P, 80A. 220/440V.	8423220211698	127,99	1	30
IR4A120E9	4P, 120A. 220/440V.	8423220211704	127,99	1	30



Interruptores rotativos 0-1. 60°. IP20. Color negro.					
IR2A016S6	2P, 16A. 220/440V.	8423220208520	16,99	1	100
IR2A020S6	2P, 20A. 220/440V.	8423220208537	16,99	1	100
IR2A025S6	2P, 25A. 220/440V.	8423220208544	22,51	1	100
IR2A032S6	2P, 32A. 220/440V.	8423220208551	32,99	1	72
IR2A040S6	2P, 40A. 220/440V.	8423220208568	39,29	1	72
IR3A016S6	3P, 16A. 220/440V.	8423220208575	23,49	1	100
IR3A020S6	3P, 20A. 220/440V.	8423220208582	23,49	1	100
IR3A025S6	3P, 25A. 220/440V.	8423220208599	31,59	1	100
IR3A032S6	3P, 32A. 220/440V.	8423220208605	44,99	1	72
IR3A040S6	3P, 40A. 220/440V.	8423220211421	57,99	1	1
IR3A050S6	3P, 50A. 220/440V.	8423220211438	83,21	1	---
IR3A063S6	3P, 63A. 220/440V.	8423220208612	83,21	1	1
IR3A080S6	3P, 80A. 220/440V.	8423220211445	127,99	1	---
IR3A120S6	3P, 120A. 220/440V.	8423220211452	127,99	1	1
IR4A016S6	4P, 16A. 220/440V.	8423220208629	23,41	1	---
IR4A020S6	4P, 20A. 220/440V.	8423220211469	23,41	1	---
IR4A025S6	4P, 25A. 220/440V.	8423220208636	31,49	1	---
IR4A032S6	4P, 32A. 220/440V.	8423220208643	44,99	1	72
IR4A040S6	4P, 40A. 220/440V.	8423220208650	57,99	1	72
IR4A050S6	4P, 50A. 220/440V.	8423220208667	83,39	1	30
IR4A063S6	4P, 63A. 220/440V.	8423220208674	83,39	1	30
IR4A080S6	4P, 80A. 220/440V.	8423220211476	127,99	1	---
IR4A120S6	4P, 120A. 220/440V.	8423220211483	127,99	1	---

*El diseño del producto puede variar.



Accede a la tarifa PVP actualizada



Referencia	Descripción	Código GTIN-13	PVP		
Conmutadores rotativos 1-0-2. 60°. IP20. Color negro.					
IR2B016S6	2P, 16A. 220/440V.	8423220211711	23,25	1	---
IR2B020S6	2P, 20A. 220/440V.	8423220211728	23,25	1	100
IR2B025S6	2P, 25A. 220/440V.	8423220211735	31,59	1	100
IR2B032S6	2P, 32A. 220/440V.	8423220211742	44,99	1	---
IR2B040S6	2P, 40A. 220/440V.	8423220211759	57,99	1	---
IR3B016S6	3P, 16A. 220/440V.	8423220211766	29,89	1	---
IR3B020S6	3P, 20A. 220/440V.	8423220211773	29,89	1	---
IR3B025S6	3P, 25A. 220/440V.	8423220211780	40,05	1	---
IR3B032S6	3P, 32A. 220/440V.	8423220212336	56,99	1	---
IR3B040S6	3P, 40A. 220/440V.	8423220212343	75,99	1	---
IR3B050S6	3P, 50A. 220/440V.	8423220212350	113,59	1	---
IR3B063S6	3P, 63A. 220/440V.	8423220212367	113,59	1	---
IR3B080S6	3P, 80A. 220/440V.	8423220212374	175,99	1	---
IR3B120S6	3P, 120A. 220/440V.	8423220212381	175,99	1	---
IR4B016S6	4P, 16A. 220/440V.	8423220212398	36,21	1	---
IR4B020S6	4P, 20A. 220/440V.	8423220212404	36,21	1	---
IR4B025S6	4P, 25A. 220/440V.	8423220212411	49,21	1	---
IR4B032S6	4P, 32A. 220/440V.	8423220212428	69,11	1	---
IR4B040S6	4P, 40A. 220/440V.	8423220212435	94,49	1	---
IR4B050S6	4P, 50A. 220/440V.	8423220212442	144,59	1	---
IR4B063S6	4P, 63A. 220/440V.	8423220212459	144,59	1	---
IR4B080S6	4P, 80A. 220/440V.	8423220212466	223,89	1	---
IR4B120S6	4P, 120A. 220/440V.	8423220212473	223,89	1	---

PROTECCIONES. Accesorios



Referencia	Descripción	Código GTIN-13	PVP		
Peines de conexión tipo pin.					
P1P100010	Peine unipolar 56x1 módulo, sección 10 mm ² , 63A, longitud 1 m.	8423220092969	18,20	1	100
P2P21610	Peine bipolar 6x2 módulos, sección 10 mm ² , 63A, longitud 216 mm.	8423220070448	9,01	4	160
P2P100010	Peine bipolar 28x2 módulos, sección 10 mm ² , 63A, longitud 1 m.	8423220034082	42,11	1	50
P2P100016	Peine bipolar 28x2 módulos, sección 16 mm ² , 80A, longitud 1 m.	8423220053175	45,89	1	50
P3P100010	Peine tripolar 18x3 módulos, sección 10 mm ² , 63A, longitud 1 m.	8423220092976	48,35	1	50
P4P100010	Peine tetrapolar 14x4 módulos, sección 10 mm ² , 63A, longitud 1 m.	8423220087521	66,59	1	25
P4P100016	Peine tetrapolar 14x4 módulos, sección 16 mm ² , 80A, longitud 1 m.	8423220053243	84,03	1	25



Tapas para peines					
TAPA-1P	Tapa final para peine de 1 polo.	8423220226111	1,33	1	---
TAPA-2P	Tapa final para peine de 2 polos.	8423220226128	1,75	1	---
TAPA-3P	Tapa final para peine de 3 polos.	8423220226135	2,17	1	---
TAPA-4P	Tapa final para peine de 4 polos.	8423220226142	2,59	1	---



Junta de estanqueidad para conseguir un IP65 en los interruptores y conmutadores rotativos.					
JU48X48	Junta de estanqueidad para 48x48.	8423220220607	C*	--	---
JU64X64	Junta de estanqueidad para 64x64.	8423220220614	C*	--	---
JU88X88	Junta de estanqueidad para 88x88.	8423220220621	C*	--	---



Referencia	Descripción	Código GTIN-13	PVP/metro		
Perfil DIN.					
TS35/SZ	Perfil DIN de acero laminado en caliente. 35x7,5. Longitud de 2 m. Sin perforar.	8423220066731	5,13	2	20



*El diseño del producto puede variar.

Dispositivos de conexión, terminales y aislamientos

Descárgate toda la documentación técnica de la serie escaneando este código



DISPOSITIVOS DE CONEXIÓN, TERMINALES Y AISLAMIENTOS. Regletas y dispositivos de conexión



Referencia	Descripción	Código GTIN-13	PVP		
Regletas de 12 bornes. 450V~. Material Polipropileno.					
RE2,5/10B	Hasta 2,5mm ² . 18A. Par 0,4Nm. Color blanco.	8423220085107	1,61	10	1.000
RE2,5/10N	Hasta 2,5mm ² . 18A. Par 0,4Nm. Color negro.	8423220085176	1,61	10	1.000
RE4/10B	Hasta 4mm ² . 24A. Par 0,4Nm. Color blanco.	8423220085114	1,68	10	1.000
RE4/10N	Hasta 4mm ² . 24A. Par 0,4Nm. Color negro.	8423220085183	1,68	10	1.000
RE6/10B	Hasta 6mm ² . 41A. Par 0,5Nm. Color blanco.	8423220085121	2,49	10	1.000
RE6/10N	Hasta 6mm ² . 41A. Par 0,5Nm. Color negro.	8423220085190	2,49	10	1.000
RE10/10B	Hasta 10mm ² . 57A. Par 0,8Nm. Color blanco.	8423220085138	3,16	10	500
RE10/10N	Hasta 10mm ² . 57A. Par 0,8Nm. Color negro.	8423220085206	3,16	10	500
RE16/10B	Hasta 16mm ² . 76A. Par 1,2Nm. Color blanco.	8423220085145	5,27	10	300
RE16/10N	Hasta 16mm ² . 76A. Par 1,2Nm. Color negro.	8423220085213	5,27	10	300
RE25/10B	Hasta 25mm ² . 100A. Par 2Nm. Color blanco.	8423220085152	11,13	10	100
RE25/10N	Hasta 25mm ² . 100A. Par 2Nm. Color negro.	8423220085220	11,13	10	100
RE35/10B	Hasta 35mm ² . 125A. Par 2Nm. Color blanco.	8423220085169	11,55	10	100
RE35/10N	Hasta 35mm ² . 125A. Par 2Nm. Color negro.	8423220085572	11,55	10	100



Dispositivos de conexión de tierra y neutro. 76A.					
108P	8 bornes para cable hasta 6 mm ² y 2 hasta 16 mm ² .	8423220011304	6,25	40	646
112P	12 bornes para cable hasta 6 mm ² y 2 hasta 16 mm ² .	8423220045187	7,43	50	400



Dispositivos de conexión aislados. Material no propagador de la llama. 12 bornes para cable hasta 6mm² y 2 hasta 16mm². 76A.					
212N	Para conexión de neutro. Color zul.	8423220033894	9,08	1	200
212TT	Para conexión de tierra. Color verde.	8423220033887	9,08	1	125



Referencia	Descripción	GTIN-13 unitario	PVP		GTIN-13 envase	
Dispositivo de conexión rápida. Conexión tipo clema. Color gris y naranja. Precio por bolsa.						
CLE24	2 bornes para conductores rígidos 4 mm ² o flexibles 2,5 mm ² . 32A 400V. (5 uds.).	8423220080072	5,27	20	8423220065222	640
CLE34	3 bornes para conductores rígidos 4 mm ² o flexibles 2,5 mm ² . 32A 400V. (5 uds.).	8423220080089	6,41	20	8423220065239	640
CLE54	5 bornes para conductores rígidos 4 mm ² o flexibles 2,5 mm ² . 32A 400V. (4 uds.).	8423220080096	8,03	25	8423220065246	450
CLE4-5	Conjunto. Contenido de la bolsa: 2xCLE24, 2xCLE34 y 1 xCLE54.	---	7,01	20	8423220065086	320



DISPOSITIVOS DE CONEXIÓN, TERMINALES Y AISLAMIENTOS. Regletas y dispositivos de conexión



Referencia	Descripción	GTIN-13 unitario	PVP		GTIN-13 envase	
Conector estanco con gel. IP67.						
CLG15AZ	Para cable de 3 x 1,5 mm². Bolsa de 5 uds. Color azul.	---	12,41	15	8423220065260	240
Conector capucha para cable rígido y flexible.						
CLC5	Sec. máx. 0,5-2,5 mm². Bolsa de 10 uds. Color blanco-amarillo.	---	14,70	15	8423220065277	480
CLC16	Sec. máx. 0,5-6 mm². Bolsa de 6 uds. Color rojo-amarillo.	---	11,41	10	8423220065284	320
CLC32	Sec. máx. 0,5-10 mm². Bolsa de 3 uds. Color gris-azul.	---	12,36	10	8423220065291	320

DISPOSITIVOS DE CONEXIÓN, TERMINALES Y AISLAMIENTOS. Dispositivos de conexión para perfil DIN



Referencia	Descripción	Ancho Total	Alto Total	Ancho desde rail	Profundidad	Código GTIN-13	PVP/ Ud.		
Dispositivos de conexión para perfil DIN. De tornillo.									
TCD01N	Sección 1,5 mm². Negro.	40	34	23	5	8423220077386	1,33	100	800
TCD01A	Sección 1,5 mm². Azul.	40	40	23	5	8423220077393	1,33	100	800
TCD02N	Sección 2,5 mm². Negro.	40	40	28	6	8423220077409	1,36	100	800
TCD02A	Sección 2,5 mm². Azul.	40	40	28	6	8423220077416	1,36	100	800
TCD04N	Sección 4 mm². Negro.	40	40	28	6,5	8423220077423	1,45	100	800
TCD04A	Sección 4 mm². Azul.	40	40	28	6,5	8423220077430	1,45	100	800
TCD06N	Sección 6 mm². Negro.	40	40	28	8	8423220077447	2,19	100	800
TCD06A	Sección 6 mm². Azul.	40	40	28	8	8423220077454	2,19	100	800
TCD10N	Sección 10 mm². Negro.	40	40	28	9,5	8423220077461	2,38	100	800
TCD10A	Sección 10 mm². Azul.	40	40	28	9,5	8423220077478	2,38	100	800
TCD16N	Sección 16 mm². Negro.	51	54	43	12	8423220078055	3,79	100	400
TCD16A	Sección 16 mm². Azul.	51	54	43	12	8423220078079	3,79	100	400
TCD35N	Sección 35 mm². Negro.	51	54	43	15	8423220078093	4,38	100	200
TCD35A	Sección 35 mm². Azul.	51	54	43	15	8423220078116	4,38	100	200
Dispositivos de conexión para perfil DIN. De tornillo. Color verde / amarillo.									
TCD04T	Sección 4 mm².	43	36	24	7	8423220077485	4,15	100	800
TCD10T	Sección 10 mm².	40	40	28	9,5	8423220077492	4,99	100	800
TCD16T	Sección 16 mm².	58,2	61,3	57	12	8423220077508	11,06	100	400
TCD35T	Sección 35 mm².	58,2	61,3	57	15	8423220078123	12,75	100	200

DISPOSITIVOS DE CONEXIÓN, TERMINALES Y AISLAMIENTOS. Tubos termoretráctiles e identificador numérico



Referencia	Descripción	GTIN-13 unitario	PVP		GTIN-13 envase	
Tubos termoretráctiles. Longitud 1m.						
TBR-1,5	Ø 1,5 mm. Color negro.	8423220238626	0,43	200	8423220074071	6.000
TBR-1,5T	Ø 1,5 mm. Color transparente.	8423220238633	0,45	200	8423220074132	6.000
TBR-2,5	Ø 2,5 mm. Color negro.	8423220069848	0,49	200	8423220076020	4.000
TBR-2,5T	Ø 2,5 mm. Color transparente.	8423220238671	0,51	200	8423220074156	6.000
TBR-3,5	Ø 3,5 mm. Color negro.	8423220069855	0,58	100	8423220076037	2.000
TBR-3,5T	Ø 3,5 mm. Color transparente.	8423220238695	0,60	100	8423220074231	3.000
TBR-6	Ø 6 mm. Color negro.	8423220069862	0,84	50	8423220076044	1.000
TBR-6T	Ø 6 mm. Color transparente.	8423220238718	0,86	50	8423220074545	1.500
TBR-8	Ø 8 mm. Color negro.	8423220238725	0,74	50	8423220074835	1.500
TBR-8T	Ø 8 mm. Color transparente.	8423220238732	0,78	50	8423220074842	1.500
TBR-10	Ø 10 mm. Color negro.	---	0,87	40	8423220074118	1.200
TBR-10T	Ø 10 mm. Color transparente.	---	0,90	40	8423220074552	1.200





Referencia	Descripción	GTIN-13 unitario	PVP		GTIN-13 envase	
Tubos termoretráctiles. Bolsa de 10 tubos de 8cm de longitud.						
BOLTBR-1	-Color blanco: 2 uds. de Ø3,5 y 2 uds. de Ø5. -Color negro: 2 uds. de Ø3,5, 2 uds. de Ø5 y 2 uds. de Ø13.	8423220080027	1,02	1	8423220069879	500



Tubos termoretráctiles. Bolsa de 18 tubos de 8cm de longitud.						
BOLTBR-2	-Color rojo: 2 uds. de Ø3,5, 2 uds. de Ø5 y 2 uds. de Ø7. -Color azul: 2 uds. de Ø3,5, 2 uds. de Ø5 y 2 uds. de Ø7. -Color negro: 2 uds. de Ø3,5, 2 uds. de Ø5 y 2 uds. de Ø7.	8423220080034	1,23	1	8423220069886	500



Referencia	Descripción	Código GTIN-13	PVP		
Identificador de cables.					
NUM2	10 tiras del 0 al 9. 1,5 a 2,5 mm² de sección.	8423220077362	14,21	1	200
NUM3	10 tiras del 0 al 9. 4 a 6 mm² de sección.	8423220077379	14,52	1	175

DISPOSITIVOS DE CONEXIÓN, TERMINALES Y AISLAMIENTOS. Terminales



Referencia	Descripción	Código GTIN-13	PVP/Bolsa		
Terminales lengüeta. 0,8x6,35 mm. Bolsa de 50 unidades.					
TL15R/50	De 0,5 a 1,5 mm². Color rojo.	8423220096820	3,67	30	600
TL25A/50	De 1,5 a 2,5 mm². Color azul.	8423220096837	3,89	20	400
TL60AM/50	De 4 a 6 mm². Color amarillo.	8423220096844	4,59	16	320



Terminales faston. 0,8x6,35 mm. Bolsa de 50 unidades.					
TF15R/50	De 0,5 a 1,5 mm². Color rojo.	8423220096790	3,67	20	400
TF25A/50	De 1,5 a 2,5 mm². Color azul.	8423220096806	3,85	20	400
TF60AM/50	De 4 a 6 mm². Color amarillo.	8423220096813	4,59	16	320



Terminales puntera hueca sencilla. Bolsa de 50 unidades.					
TE-1508N/50	1,5 mm². 8 mm. Color negro.	8423220096646	1,43	70	1.400
TE-2508A/50	2,5 mm². 8 mm. Color azul.	8423220096653	1,73	50	1.000
TE-4009G/50	4 mm². 9 mm. Color gris.	8423220096660	2,24	30	600
TE-6012AM/50	6 mm². 12 mm. Color amarillo.	8423220096677	3,16	20	400
TE-1012R/50	10 mm². 12 mm. Color rojo.	8423220096684	4,28	16	320
TE-1612B/50	16 mm². 12 mm. Color blanco.	8423220096691	4,51	10	200
TE-2516N/50	25 mm². 16 mm. Color negro.	8423220096707	8,29	5	100
TE-3516R/50	35 mm². 16 mm. Color rojo.	8423220096714	8,78	4	80
TE-5020A/50	50 mm². 20 mm. Color azul.	8423220096721	20,02	2	40



Terminales puntera hueca doble. Bolsa de 50 unidades.					
TE2-1508N/50	2x1,5 mm². 8 mm. Color negro.	8423220075047	2,16	30	600
TE2-2510A/50	2x2,5 mm². 10 mm. Color azul.	8423220096745	3,44	20	400
TE2-4012G/50	2x4 mm². 12 mm. Color gris.	8423220096752	3,98	16	320
TE2-6014AM/50	2x6 mm². 14 mm. Color amarillo.	8423220096769	5,44	12	240
TE2-10014R/50	2x10 mm². 14 mm. Color rojo.	8423220096776	7,44	8	160
TE2-16014A/50	2x16 mm². 14 mm. Color azul.	8423220096783	9,83	4	80



Terminales empalme. Bolsa de 50 unidades.					
CTR15/50	De 0,5 a 1,5 mm². 26 mm. Color rojo.	8423220097445	5,43	16	320
CTR25/50	De 1,5 a 2,5 mm². 26 mm. Color azul.	8423220097452	6,06	16	320
CTR60/50	De 4 a 6 mm². 32 mm. Color amarillo.	8423220097469	9,73	10	200
CTR100/50	De 6 a 10 mm². 43 mm. Color rojo.	8423220097476	31,22	5	100
CTR160/50	De 10 a 16 mm². 42 mm. Color azul.	8423220097483	50,54	3	60





Referencia	Descripción	Código GTIN-13	PVP/Bolsa		
Terminales horquilla. Bolsa de 50 unidades.					
TH15R/50	De 0,5 a 1,5 mm ² . ø4,3 mm. Color rojo.	8423220096943	3,55	30	600
TH15-1R/50	De 0,5 a 1,5 mm ² . ø6,5 mm. Color rojo.	8423220096950	3,98	20	600
TH25A/50	De 1,5 a 2,5 mm ² . ø4,5 mm. Color azul.	8423220096967	3,90	20	400
TH25-1A/50	De 1,5 a 2,5 mm ² . ø6 mm. Color azul.	8423220096974	4,12	20	400
TH60AM/50	De 4 a 6 mm ² . ø5,5 mm. Color amarillo.	8423220096981	8,90	12	240
TH60AM-2/50	De 4 a 6 mm ² . ø6,5 mm. Color amarillo.	8423220097513	9,86	12	240



Terminales redondos. Bolsa de 50 unidades.					
TR15R/50	De 0,5 a 1,5 mm ² . Ø4,3 mm. Color rojo.	8423220096882	3,55	30	600
TR15-1R/50	De 0,5 a 1,5 mm ² . Ø5,3 mm. Color rojo.	8423220096899	3,90	30	600
TR25A/50	De 1,5 a 2,5 mm ² . Ø4,3 mm. Color azul.	8423220096905	3,90	20	400
TR25-1A/50	De 1,5 a 2,5 mm ² . Ø5,3 mm. Color azul.	8423220096912	4,24	20	400
TR60AM/50	De 4 a 6 mm ² . Ø5,3 mm. Color amarillo.	8423220096929	8,78	12	240
TR60-1AM/50	De 4 a 6 mm ² . Ø6,5 mm. Color amarillo.	8423220096936	9,78	12	240



Terminales punta. Bolsa de 50 unidades.					
TPP15R/50	De 0,5 a 1,5 mm ² . 10 mm. Color rojo.	8423220096851	3,90	30	600
TPP25A/50	De 1,5 a 2,5 mm ² . 10 mm. Color azul.	8423220096868	4,24	30	600
TPP60AM/50	De 4 a 6 mm ² . 12,5 mm. Color amarillo.	8423220096875	9,01	16	320



Terminales termoretráctiles. Bolsa de 50 unidades.					
TTR1/50	ø1,25 mm. Sección 1,5mm ² . Color rosa.	8423220097490	19,25	10	200
TTR2/50	ø2 mm. Sección 2,5mm ² . Color azul.	8423220097599	23,87	10	200
TTR5/50	ø5,5 mm. Sección 4-6mm ² . Color amarillo.	8423220097506	33,84	6	120



Terminales de pala. Para cables de cobre.					
TPCU-6D5/50	6 mm ² . Borne de 5mm. Bolsa de 50 unidades.	8423220096998	17,25	50	300
TPCU-10D8/50	10 mm ² . Borne de 8mm. Bolsa de 50 unidades.	8423220097001	21,72	40	240
TPCU-16D10/50	16 mm ² . Borne de 10mm. Bolsa de 50 unidades.	8423220097018	27,03	25	150
TPCU-25D10/10	25 mm ² . Borne de 10mm. Bolsa de 10 unidades.	8423220097025	8,36	60	360
TPCU-35D12/10	35 mm ² . Borne de 12mm. Bolsa de 10 unidades.	8423220097032	12,82	40	240
TPCU-50D12/10	50 mm ² . Borne de 12mm. Bolsa de 10 unidades.	8423220097049	20,98	30	180

Bridas y fijaciones

Descárgate toda la documentación técnica de la serie escaneando este código



BRIDAS Y FIJACIONES. Bridas de Nylon



Referencia	Descripción	Código GTIN-13	PVP/Bolsa		
Bridas de Nylon color gris. Bolsa de 100 unidades.					
BR48200G	4,8x200. Para tubo de Ø 49. Resistencia a la tracción 22 kgs.	8423220073685	5,39	1	100
BR48300G	4,8x300. Para tubo de Ø 81. Resistencia a la tracción 22 kgs.	8423220073692	8,36	1	100



LISTED
E470267
TYPE 21

PA6.6

Referencia	Descripción	Código GTIN-13	PVP/Bolsa		
Bridas de Nylon de color natural. Bolsa de 100 unidades.					
BR25100	2,5x100. Para tubo de Ø 20. Resistencia a la tracción 8 kgs.	8423220240025	1,24	1	250
BR25200	2,5x200. Para tubo de Ø 52. Resistencia a la tracción 8 kgs.	8423220240124	2,61	1	250
BR25260	2,5x260. Para tubo de Ø 68. Resistencia a la tracción 8 kgs.	8423220066922	3,64	1	200
BR36140	3,6x140. Para tubo de Ø 33. Resistencia a la tracción 18 kgs.	8423220240209	2,84	1	250
BR36200	3,6x200. Para tubo de Ø 52. Resistencia a la tracción 18 kgs.	8423220240216	4,05	1	150
BR36300	3,6x300. Para tubo de Ø 84. Resistencia a la tracción 18 kgs.	8423220240223	6,38	1	100
BR36370	3,6x370. Para tubo de Ø 106. Resistencia a la tracción 18 kgs.	8423220066960	7,67	1	100
BR48200	4,8x200. Para tubo de Ø 49. Resistencia a la tracción 22 kgs.	8423220240230	5,39	1	100
BR48250	4,8x250. Para tubo de Ø 65. Resistencia a la tracción 22 kgs.	8423220240247	7,05	1	100
BR48300	4,8x300. Para tubo de Ø 81. Resistencia a la tracción 22 kgs.	8423220240407	8,36	1	100
BR48360	4,8x360. Para tubo de Ø 100. Resistencia a la tracción 22 kgs.	8423220240612	9,57	1	50
BR76365	7,6x365. Para tubo de Ø 108. Resistencia a la tracción 55 kgs.	8423220520202	18,25	1	25
BR76450	7,6x450. Para tubo de Ø 130. Resistencia a la tracción 55 kgs.	8423220069510	23,66	1	25
BR76500	7,6x500. Para tubo de Ø 140. Resistencia a la tracción 55 kgs.	8423220069534	24,79	1	20

LISTED
E470267
TYPE 21

PA6.6



Bridas de Nylon de color negro. Bolsa de 100 unidades.					
BR25100N	2,5x100. Para tubo de Ø 20. Resistencia a la tracción 8 kgs.	8423220440036	1,24	1	250
BR25200N	2,5x200. Para tubo de Ø 52. Resistencia a la tracción 8 kgs.	8423220240131	2,61	1	250
BR25260N	2,5x260. Para tubo de Ø 68. Resistencia a la tracción 8 kgs.	8423220066939	3,64	1	200
BR36140N	3,6x140. Para tubo de Ø 33. Resistencia a la tracción 18 kgs.	8423220440203	2,84	1	250
BR36200N	3,6x200. Para tubo de Ø 52. Resistencia a la tracción 18 kgs.	8423220440210	4,05	1	150
BR36300N	3,6x300. Para tubo de Ø 84. Resistencia a la tracción 18 kgs.	8423220440227	6,38	1	100
BR36370N	3,6x370. Para tubo de Ø 106. Resistencia a la tracción 18 kgs.	8423220066977	7,67	1	100
BR48200N	4,8x200. Para tubo de Ø 49. Resistencia a la tracción 22 kgs.	8423220440234	5,39	1	100
BR48250N	4,8x250. Para tubo de Ø 65. Resistencia a la tracción 22 kgs.	84232204402047	7,05	1	100
BR48300N	4,8x300. Para tubo de Ø 81. Resistencia a la tracción 22 kgs.	8423220240506	8,36	1	100
BR48360N	4,8x360. Para tubo de Ø 100. Resistencia a la tracción 22 kgs.	8423220240643	9,57	1	50
BR76365N	7,6x365. Para tubo de Ø 108. Resistencia a la tracción 55 kgs.	8423220520219	18,25	1	25
BR76450N	7,6x450. Para tubo de Ø 130. Resistencia a la tracción 55 kgs.	8423220069527	23,66	1	25
BR76500N	7,6x500. Para tubo de Ø 140. Resistencia a la tracción 55 kgs.	8423220069541	24,79	1	20
BR9450N	8,8x450. Para tubo de Ø 130. Resistencia a la tracción 80 kgs.	8423220070226	29,49	1	20



PA6.6



Bridas de Nylon color verde. Bolsa de 100 unidades.					
BR48250V	4,8x250. Para tubo de Ø 65. Resistencia a la tracción 22 kgs.	8423220240254	7,36	1	100



PA6.6



Bridas de Nylon color marrón. Bolsa de 100 unidades.					
BR48250M	4,8x250. Para tubo de Ø 65. Resistencia a la tracción 22 kgs.	8423220440258	7,36	1	100





Referencia	Descripción	Código GTIN-13	PVP/Bolsa		
Bridas para identificar. Bolsa de 50 unidades.					
IDBR25100	2,5 x 100 para identificar productos.	8423220008441	2,19	1	600

BRIDAS Y FIJACIONES. Fijaciones



Referencia	Descripción	Código GTIN-13	PVP/Bolsa		
Soporte brida. Para fijación con tornillos. 100 unidades por bolsa.					
SOT2516	25,4x16,2. Para bridas de hasta 9 de ancho.	8423220039483	9,31	1	50



Taco brida. 100 unidades por bolsa.					
9280638	Taco de Ø 8x37,5. Agujero de cabeza de 10x3. Para broca de Ø 6. Color negro.	8423220055179	10,73	1	50
9280638G	Taco de Ø 8x37,5. Agujero de cabeza de 10x3. Para broca de Ø 6. Color gris.	8423220068964	10,73	1	50
9280834	Taco de Ø 10x43,5. Agujero de cabeza de 10x3. Para broca de Ø 8. Color negro.	8423220030480	11,30	1	50
9280834G	Taco de Ø 10x43,5. Agujero de cabeza de 10x3. Para broca de Ø 8. Color gris.	8423220068971	11,30	1	50



Tacos expansión de Nylon. 100 unidades por bolsa.					
9280525	Ø 5x25.	8423220030367	3,95	20	500
9280630	Ø 6x30.	8423220030473	4,21	1	300
9280840	Ø 8x40.	8423220030497	4,73	1	100
9281260	Ø 12x60.	8423220030510	7,99	1	18









Taco con tornillo incorporado.					
9000425	Ø 4x25.	8423220016811	0,27	100	1.800
9000535	Ø 5x35.	8423220083424	0,33	100	1.800
9000640	Ø 6x40.	8423220018785	0,34	100	1.800



Referencia	Descripción	GTIN-13 unitario	PVP		GTIN-13 envase	
Grapillones. 100 unidades por bolsa.						
GRAPA-1	Grapillones para Ø 3 mm plano.	8423220080805	1,23	20	8423220069688	320
GRAPA-4	Grapillones para Ø 4 mm.	8423220080140	1,30	20	8423220069695	320
GRAPA-6	Grapillones para Ø 6 mm.	8423220249158	C*	1	8423220249158	200
GRAPA-7	Grapillones para Ø 7 mm.	8423220080157	1,68	20	8423220069701	320
GRAPA-8	Grapillones para Ø 8 mm.	8423220080164	1,86	20	8423220069718	300
GRAPA-9	Grapillones para Ø 9 mm.	8423220080171	2,17	20	8423220069725	200
GRAPA-10	Grapillones para Ø 10 mm.	8423220080126	2,38	20	8423220069732	200
GRAPA-12	Grapillones para Ø 12 mm.	8423220080133	3,12	20	8423220069749	100
GRAPA-16	Grapillones para Ø 16 mm.	8423220249165	C*	1	8423220249165	200
GRAPA-20	Grapillones para Ø 20 mm.	8423220249172	C*	1	8423220249172	200
GRAPA-25	Grapillones para Ø 25 mm.	8423220249189	C*	1	8423220249189	200



ÍNDICE POR REFERENCIA







Ref.	PVP			Pág.	Ref.	PVP			Pág.	Ref.	PVP			Pág.
9	3,61	1	100	63	180N	7,77	1	20	8	527	1,37	20	1.260	58
13	0,74	50	1.200	61	180PE	7,77	1	20	8	527TA	0,79	50	1.200	61
14	1,33	1	250	61	186	6,33	12	96	97	561	1,74	10	280	58
15	1,53	1	200	61	191	17,40	1	39	17	562	2,56	4	168	58
16F	6,69	1	30	94	197	18,97	1	36	17	563	3,41	5	110	58
17	12,01	1	20	94	198	23,56	1	24	18	575	1,54	1	104	59
20G	4,85	10	100	61	199	9,71	5	75	15	604	3,05	6	288	48
20T	3,61	10	40	61	212N	9,08	1	200	113	604C	2,47	6	270	49
23G	3,80	10	180	61	212TT	9,08	1	125	113	612 2	0,40	100	10.000	110
23T	2,49	10	120	61	214	4,54	1	62	58	612 4	0,40	100	10.000	110
24CH/6	1,24	6	216	62	214TA	2,16	1	72	61	612 6	0,40	100	10.000	110
24G	7,16	4	80	61	215TA	2,21	1	50	61	612 10	0,40	100	10.000	110
24T	5,41	10	60	61	216TA	2,55	25	250	61	612 15	0,40	100	10.000	110
25G	1,49	50	400	61	220	5,85	1	30	58	614	5,03	1	62	58
25T	1,43	50	400	61	220TA	2,80	1	34	61	615	5,03	5	175	48
27F	2,91	5	250	102	223	3,74	1	78	58	615C	3,99	5	145	49
40B	2,63	75	1.200	105	223TA	1,88	1	96	61	616	10,72	1	60	48
40N	2,63	75	1.200	105	224	8,36	1	28	58	620	6,76	1	30	58
57	13,02	1	20	94	224TA	3,89	1	30	61	621	6,91	5	100	19
61G	1,66	1	192	61	262	2,43	1	168	58	621B	6,91	5	100	19
61T	1,31	25	450	61	262TA	0,91	1	160	61	623	4,41	1	78	58
62G	2,08	1	50	61	263	3,31	1	110	58	624	10,25	1	28	58
62T	1,61	25	200	61	263TA	1,44	1	130	61	625	0,81	20	500	62
63G	2,10	1	70	61	277	9,80	1	25	59	625TA	0,41	1	350	62
63T	1,82	15	210	61	277TA	6,65	1	30	61	635	1,62	1	48	58
64G	3,10	1	162	61	314	4,37	1	62	58	661	10,43	1	38	16
64T	2,51	25	150	61	320	6,59	1	30	58	661B	10,43	1	38	16
70	49,81	1	5	100	323	4,01	1	78	58	661CB	16,42	1	28	16
77	14,67	1	25	63	324	9,99	1	28	58	661CBT	18,10	1	28	16
78	14,67	1	25	63	324GW	11,34	2	28	66	661CG	16,99	1	28	16
88U	3,57	35	140	98	361	1,99	10	280	58	661CGT	18,69	1	28	16
91	3,22	1	102	63	362	2,41	4	168	58	661CM	18,34	1	28	16
92	4,34	1	52	63	363	3,29	5	110	58	661CMT	19,64	1	28	16
93	5,81	1	38	63	414	2,28	20	320	60	665	2,59	8	320	48
99	11,21	8	128	96	414S	2,63	1	400	60	670	5,12	1	140	19
99B	11,21	8	128	96	414TA	0,92	25	100	61	670B	5,12	1	35	19
99R	11,09	8	128	96	420	1,75	10	300	77	678A	2,28	50	200	103
100	0,29	100	7.000	13	421	2,17	10	200	77	678B	2,28	50	200	103
100B	0,29	100	7.000	13	422	2,34	10	200	77	678D	2,46	50	200	103
100G	0,29	100	7.000	13	479A	2,46	45	360	102	678E	2,28	50	200	103
105N	2,73	1	500	8	479B	2,46	45	360	102	678F	2,28	50	200	103
105PE	2,73	1	500	8	479J	2,86	40	320	102	678G	2,28	50	200	103
108P	6,25	40	640	113	479K	2,86	40	320	102	678R	2,66	50	200	103
112P	7,43	50	400	113	513	1,32	20	560	59	679	13,16	1	30	15
113N	6,91	1	20	8	514	1,78	8	288	60	679B	13,16	1	30	15
113PE	6,91	1	20	8	515	2,49	6	180	60	679CB	23,56	1	24	15
113PE/N	11,27	1	20	8	515S	2,99	1	230	60	679CBT	25,13	1	24	15
128N	8,89	1	20	8	517	3,79	12	192	96	679CG	21,88	1	24	15
128PE	8,89	1	20	8	520	1,42	10	510	77	679CGT	23,73	1	24	15
161QC	2,19	70	560	102	521	1,96	10	400	77	679CM	22,93	1	24	15
177	12,37	1	25	63	522	2,39	10	300	77	679CMT	24,99	1	24	15
178	12,37	1	25	63	525	1,57	35	140	58	680	16,91	1	24	15

C*: Consulte precio.



Accede a la tarifa PVP actualizada







ÍNDICE POR REFERENCIA

Ref.	PVP			Pág.	Ref.	PVP			Pág.	Ref.	PVP			Pág.
680B	16,91	1	24	15	695CB	14,39	1	54	14	706CK	C*	-	-	94
680CB	26,64	1	18	15	695CBT	14,86	1	54	14	706CKB	C*	-	-	94
680CBT	27,58	1	18	15	695CG	15,93	1	54	14	706T	5,81	13	208	94
680CG	25,31	1	18	15	695CGT	16,42	1	54	14	706TK	C*	-	-	94
680CGT	27,27	1	18	15	695CM	15,08	1	54	14	706TKB	C*	-	-	94
680CM	28,84	1	18	15	695CMT	15,59	1	54	14	707C	5,69	14	224	94
680CMT	30,10	1	18	15	696	9,06	5	80	19	707CB	5,69	14	224	95
685	15,57	1	24	17	696B	9,06	5	80	19	707CK	C*	-	-	94
685B	15,57	1	24	17	697	20,44	1	36	17	707CKB	C*	-	-	94
685CB	25,52	1	18	17	697B	20,44	1	36	17	707T	7,07	8	128	94
685CBT	26,64	1	18	17	697CB	26,22	1	24	17	707TK	C*	-	-	94
685CG	23,42	1	18	17	697CBT	28,18	1	24	17	707TKB	C*	-	-	94
685CGT	25,39	1	18	17	697CG	27,65	1	24	17	715	5,99	6	108	48
685CM	26,51	1	18	17	697CGT	28,91	1	24	17	715N	6,96	6	108	50
685CMT	27,58	1	18	17	697CM	30,36	1	24	17	715TP	7,34	6	108	51
686	16,96	1	30	48	697CMT	30,14	1	24	17	716	9,80	4	64	48
686A	22,56	1	20	48	698	22,68	1	24	18	716N	9,65	4	64	50
686AG	26,27	1	20	52	698B	22,68	1	24	18	716TP	10,78	4	64	51
686ATP	26,69	1	20	51	698CB	31,19	1	18	18	717	11,73	1	50	48
686G	19,72	1	30	52	698CBT	32,57	1	18	18	717G	14,51	1	50	52
686N	16,16	1	30	50	698CG	30,29	1	18	18	717N	12,07	1	50	50
686TP	19,97	1	30	51	698CGT	32,59	1	18	18	717TP	13,45	1	50	51
688	12,09	1	36	16	698CM	36,47	1	18	18	725	1,99	10	260	62
688B	12,09	1	36	16	698CMT	37,35	1	18	18	731	0,57	100	1.600	101
688CB	18,97	1	24	16	699	10,22	5	75	15	731N	0,57	100	1.600	101
688CBT	21,04	1	24	16	699B	10,22	5	75	15	733	1,58	10	360	62
688CG	21,23	1	24	16	699CB	14,07	1	54	15	761	11,72	1	38	16
688CGT	22,33	1	24	16	699CBT	15,85	1	54	15	777B	14,35	6	72	103
688CM	21,29	1	24	16	699CG	15,09	1	54	15	777SS	13,11	6	72	103
688CMT	23,42	1	24	16	699CGT	15,75	1	54	15	779	16,15	1	30	15
689	3,66	10	230	19	699CM	15,82	1	54	15	780	16,73	1	24	15
689B	3,66	10	230	19	699CMT	18,87	1	54	15	785	16,19	1	24	17
691	17,89	1	39	17	703	18,31	1	36	18	788	14,01	1	36	16
691B	17,89	1	39	17	703B	18,31	1	36	18	801	1,61	70	560	104
691CB	22,46	1	24	17	703CB	24,29	1	24	19	802	2,62	60	480	104
691CBT	25,51	1	24	17	703CBT	26,91	1	24	19	804	1,03	50	800	104
691CG	23,80	1	24	17	703CG	24,47	1	24	19	815	5,13	6	120	49
691CGT	25,41	1	24	17	703CGT	26,43	1	24	19	815-1	28,53	1	50	53
691CM	27,48	1	24	17	703CM	27,97	1	24	19	815-2	27,44	1	40	53
691CMT	28,56	1	24	17	703CMT	29,19	1	24	19	815I2P16	39,59	1	35	53
692	8,56	5	75	14	703G	16,15	1	30	18	815N	5,46	6	120	50
694	16,84	1	36	18	704	19,99	1	24	19	816	8,71	4	64	49
694B	16,84	1	36	18	704B	19,99	1	24	19	816-5	34,33	1	25	53
694CB	22,12	1	24	18	704CB	29,65	1	18	19	816N	8,21	4	64	50
694CBT	23,73	1	24	18	704CBT	32,57	1	18	19	816PR1P160	27,88	1	27	53
694CG	22,35	1	24	18	704CG	27,79	1	18	19	816PR1P160TP	29,41	1	27	53
694CGT	24,08	1	24	18	704CGT	29,05	1	18	19	817	9,99	1	58	49
694CM	26,18	1	24	18	704CM	35,56	1	18	19	817-42P	57,19	1	58	54
694CMT	27,58	1	24	18	704CMT	36,12	1	18	19	817-9	55,06	1	58	53
694G	14,89	1	36	18	704G	18,20	1	24	19	817G	12,01	1	58	52
695	7,79	5	75	14	706C	5,41	20	320	94	817N	10,79	1	58	50
695B	7,79	5	75	14	706CB	5,41	20	320	95	818A	27,11	1	18	27

C*: Consulte precio.



ÍNDICE POR REFERENCIA







Ref.	PVP			Pág.	Ref.	PVP			Pág.	Ref.	PVP			Pág.
818B	24,82	1	22	27	1304	26,51	1	33	25	5108	21,88	1	12	10
819	C*	1	10	27	1306B	29,97	1	24	25	5108HGW	32,14	1	12	68
820	69,45	1	6	27	1308A	36,29	1	12	25	5108PF	22,92	1	12	10
820V6	69,45	1	6	27	1308B	34,12	1	18	25	5108PFHGW	33,79	1	12	68
820PV6	69,45	1	6	27	1308	64,81	1	6	26	5109	30,56	1	12	11
821	79,41	1	5	27	1308V1	64,81	1	6	26	5109PF	32,52	1	12	11
821V9	79,41	1	5	27	1308V3	64,81	1	6	26	5113	4,83	10	160	98
822	56,12	1	6	27	1311A	51,91	1	10	25	5200	42,37	1	11	16
825	2,81	10	180	62	1311P-I14	C*	1	1	29	5201	15,79	1	22	20
831	0,64	55	880	101	1311P-CPI16	C*	1	1	28	5202	18,87	1	22	20
831N	0,64	55	880	101	1311	74,87	1	5	26	5203	33,13	1	11	16
853	0,59	25	400	102	1311V2	74,87	1	5	26	5203B	33,13	1	11	16
853C	0,59	25	400	102	1311V4	74,87	1	5	26	5203CB	45,59	1	10	16
854	0,63	25	400	102	1312	49,47	1	10	25	5203CBT	46,85	1	10	16
854C	0,63	25	400	102	1312P-I15	C*	1	1	29	5203CG	54,11	1	10	16
855	1,06	1	150	101	1316	117,81	1	4	26	5203CGT	56,95	1	10	16
855C	1,06	1	200	101	1316V3	117,81	1	4	26	5203CM	45,59	1	10	16
860IL	5,94	18	144	97	1316V6	117,81	1	4	26	5203CMT	46,85	1	10	16
880	18,27	1	18	16	1316P-CPI97	C*	1	1	29	5204	17,47	1	22	20
880B	18,27	1	18	16	1322	89,43	1	5	25	5204B	17,47	1	22	20
880CB	29,09	1	16	16	1322P-I47	C*	1	1	30	5205	20,72	1	22	20
880CBT	32,87	1	16	16	1322P-VH2	C*	1	1	29	5205B	20,72	1	22	20
880CG	28,99	1	16	16	1322P-VH3	C*	1	1	29	5206	31,68	1	11	17
880CGT	30,98	1	16	16	1332	147,71	1	4	26	5206B	31,68	1	11	17
880CM	34,34	1	16	16	1332V6	147,71	1	4	27	5206CB	43,63	1	10	17
880CMT	35,55	1	16	16	1332V3	147,71	1	4	26	5206CBT	44,89	1	10	17
881	20,76	1	19	16	1336	119,01	1	6	25	5206CG	46,99	1	10	17
886	15,96	1	32	49	1348	143,77	1	4	25	5206CGT	49,84	1	10	17
886-6	53,45	1	6	54	1428	3,36	23	368	95	5206CM	45,36	1	10	17
886-15	109,87	1	32	54	1662	2,59	24	192	60	5206CMT	46,90	1	10	17
886G	19,53	1	32	52	1664	5,55	11	88	60	5207	35,93	1	10	17
886N	14,62	1	32	51	1762	3,38	12	96	60	5208	11,68	1	34	15
886A	20,48	1	20	49	3303	5,85	20	100	82	5208B	11,68	1	34	15
886AG	23,76	1	20	52	3303IL	7,04	20	100	82	5209	15,65	1	34	15
886ATP	25,25	1	20	52	3313	8,15	20	100	82	5209B	15,65	1	34	15
886ATPG	28,99	1	20	53	3320	5,77	20	100	82	5210	42,37	1	11	18
895	21,35	1	56	36	3320IL	7,28	20	100	82	5211	9,09	1	44	20
895B	21,35	1	56	36	3360	5,36	20	100	82	5212	10,81	1	30	20
896	40,03	1	28	36	3363	12,25	10	60	82	5213	10,12	1	44	20
896B	40,03	1	28	36	3366	10,89	10	60	82	5213B	10,12	1	44	20
897	33,35	1	28	36	3366V	11,13	10	60	82	5214	11,03	1	44	20
897B	33,35	1	28	36	5001	4,46	24	192	96	5214B	11,03	1	30	20
898	17,79	1	72	36	5012	30,94	1	11	10	5216	37,70	1	11	19
898B	17,79	1	72	36	5012HGW	40,63	1	11	68	5216B	37,70	1	11	19
899	21,31	1	60	36	5012PF	33,25	1	11	10	5216CB	49,90	1	10	19
899B	21,31	1	60	36	5012PFHGW	43,93	1	11	68	5216CBT	52,82	1	10	19
986	5,58	14	112	97	5019	3,96	15	240	96	5216CG	48,06	1	10	19
1300L	19,88	1	300	31	5019A	3,68	14	224	95	5216CGT	49,88	1	10	19
1300LTRI	7,62	1	100	31	5019AN	3,68	14	224	95	5216CM	43,63	1	10	19
1300MN	3,72	2	200	31	5019N	3,96	15	240	96	5216CMT	45,44	1	10	19
1300TRI	8,33	1	1.000	31	5021	38,36	1	11	11	5217	35,49	1	11	19
1303	22,65	1	50	25	5021PF	43,93	1	11	11	5218	12,18	1	34	15

C*: Consulte precio.



Accede a la tarifa PVP actualizada







ÍNDICE POR REFERENCIA

Ref.	PVP			Pág.	Ref.	PVP			Pág.	Ref.	PVP			Pág.
5219	13,92	1	34	15	5270PF	108,12	1	5	11	5508/2B	163,72	1	2	22
5220	39,66	1	11	18	5270PFHGW	130,86	1	5	68	5508/2BL	257,46	1	2	22
5220B	39,66	1	11	18	5271	102,68	1	5	12	5514GW	4,97	4	120	67
5220CB	52,12	1	10	18	5271PF	106,37	1	5	12	5515GW	7,95	4	72	67
5220CBT	54,53	1	10	18	5281	58,42	1	5	11	5516GW	8,19	4	72	67
5220CG	54,11	1	10	18	5281PF	71,96	1	5	11	5520	7,60	1	40	59
5220CGT	56,95	1	10	18	5281A	68,53	1	5	11	5520TA	5,01	1	120	61
5220CM	56,88	1	10	18	5281APF	C*	1	5	11	5530	8,89	1	31	59
5220CMT	58,94	1	10	18	5314	9,17	1	66	66	5530GW	19,71	1	31	67
5221	9,85	1	34	20	5314GW	10,85	1	66	66	5530GWD	21,85	1	31	67
5222	11,79	1	34	20	5324	12,92	1	28	66	5530TA	5,52	1	80	61
5223	12,08	1	34	20	5362	4,57	4	168	66	5540	10,82	1	22	59
5223B	12,08	1	34	20	5362GW	4,61	4	168	66	5540GW	19,85	1	22	67
5224	12,95	1	34	20	5363	6,65	5	110	66	5540TA	6,53	1	60	61
5224B	12,95	1	34	20	5363GW	5,88	5	110	66	5550	12,85	1	19	59
5231	13,11	1	28	20	5420	47,95	1	5	12	5560/2	96,10	1	1	22
5232	14,39	1	28	20	5420HGW	64,59	1	5	68	5560/2L	156,52	1	1	22
5233	14,39	1	28	20	5420PF	54,18	1	5	12	5560/2B	102,41	1	1	22
5233B	14,39	1	28	20	5420PFHGW	73,04	1	5	68	5560/2BL	163,84	1	1	22
5234	16,45	1	28	20	5421	63,21	1	5	13	5562	5,81	4	168	66
5234B	16,45	1	28	20	5421PF	71,16	1	5	13	5562GW	4,32	4	168	66
5241	8,41	1	45	20	5430	67,98	1	4	12	5563	7,63	5	110	66
5242	9,82	1	45	20	5430HGW	92,52	1	4	68	5563GW	5,66	5	110	66
5243	8,61	1	45	20	5430PF	77,95	1	4	12	5586OB	68,78	1	5	95
5243B	8,61	1	45	20	5430PFHGW	99,99	1	4	68	5625	1,84	20	520	65
5244	10,08	1	45	20	5431	77,56	1	4	13	5625GW	1,72	20	320	65
5244B	10,08	1	45	20	5431PF	92,93	1	4	13	5625E	2,77	20	320	65
5250	53,10	1	5	10	5440	93,35	1	5	12	5625TA	0,81	1	500	69
5250HGW	65,98	1	5	68	5440HGW	117,93	1	5	68	5625UNIÓN	0,27	5	3.800	69
5250ICT	125,06	1	---	13	5440PF	99,76	1	5	12	5706C	5,63	14	224	94
5250PF	57,57	1	5	10	5440PFHGW	130,15	1	5	68	5706CK	C*	-	-	94
5250PFHGW	78,72	1	5	68	5441	99,99	1	5	13	5706CKB	C*	-	-	94
5251	5,84	1	105	20	5441PF	108,47	1	5	13	5707C	6,23	17	136	94
5252	6,30	1	105	20	5501	3,37	5	125	59	5707CK	C*	-	-	94
5253	6,13	1	105	20	5501TA	2,55	1	150	61	5707CKB	C*	-	-	94
5253B	6,13	1	105	20	5502	12,71	1	23	59	5725	3,34	10	260	65
5254	6,97	1	105	20	5502TA	6,79	1	50	61	5725GW	2,94	10	220	65
5254B	6,97	1	105	20	5503	23,42	1	5	59	5725E	4,09	10	220	65
5260	67,72	1	4	10	5503TA	14,25	1	30	61	5725EG	4,45	10	220	65
5260HGW	87,47	1	4	68	5504	43,51	1	4	59	5825	5,21	6	180	66
5260ICT	141,23	1	---	13	5504/2	88,14	1	1	22	5825GW	4,17	6	144	65
5260PF	74,52	1	4	10	5504/2B	97,20	1	1	22	5825E	5,85	6	144	65
5260PFHGW	96,56	1	4	68	5504/2BL	139,97	1	1	22	5825EG	6,27	6	144	65
5260RTR	267,58	1	1	22	5504/2L	125,06	1	1	22	5925	7,85	4	12	66
5260RTR/B	274,19	1	1	22	5504/2HGW	137,73	1	1	69	5925GW	6,79	4	12	65
5260RTR/2	299,88	1	1	22	5505	25,62	1	12	60	6009	5,34	25	200	98
5260RTR/2B	306,29	1	1	22	5505REJ	25,62	1	12	23	6010	4,66	30	240	97
5261	72,77	1	4	11	5506	22,82	1	10	59	6109	2,66	50	400	102
5261PF	86,52	1	4	11	5506HGW	45,68	1	10	67	6109A	2,66	50	400	102
5270	97,36	1	5	11	5507	35,56	1	5	59	6109B	2,66	50	400	102
5270HGW	125,62	1	5	68	5507HGW	62,65	1	5	67	6118	1,75	60	960	95
5270ICT	162,94	1	---	13	5508	62,97	1	4	60	6118N	1,75	60	960	95

C*: Consulte precio.



ÍNDICE POR REFERENCIA







Ref.	PVP			Pág.	Ref.	PVP			Pág.	Ref.	PVP			Pág.
6428	2,42	25	400	95	6888	98,53	1	10	36	8024IL	26,60	1	18	91
6428N	2,42	25	400	95	6888B	97,55	1	10	36	8025	25,97	1	30	91
6510	3,57	10	160	104	7000/1	7,71	1	150	97	8025IL	27,93	1	16	92
6510N	3,57	10	160	104	7000/1,5	9,84	1	80	97	8026	27,41	1	30	91
6511	3,57	10	160	104	7000/2	11,90	1	60	97	8026IL	29,33	1	15	92
6511N	3,57	10	160	104	7000/3	15,64	1	35	97	8032	26,18	1	40	91
6514	2,32	4	120	60	7000/5	22,34	1	25	97	8032IL	28,18	1	32	91
6515	3,96	1	72	60	7211/1	25,69	1	12	99	8033	27,55	1	16	91
6516	4,37	1	72	60	7157	3,01	4	96	69	8033IL	29,61	1	14	91
6541	4,06	65	520	105	TB7427/3	40,04	1	2	100	8034	28,98	1	14	91
6541C	3,96	65	520	105	7321USB	44,09	1	4	99	8034IL	30,98	1	14	91
6541P	3,92	65	520	105	7412/1	38,47	1	6	99	8035	30,38	1	27	91
6541PE	3,78	65	520	105	7413/2	56,49	1	6	99	8035IL	32,31	1	12	92
6566	2,85	25	400	95	7422/3	46,66	1	6	99	8036	31,78	1	12	91
6566N	2,85	25	400	95	7423/2	66,69	1	1	99	8036IL	33,67	1	10	92
6566A	3,68	18	288	95	7425/2	98,56	1	1	99	8052	34,22	1	20	91
6566AN	3,68	18	288	95	7425/1T	119,42	1	2	99	8052IL	36,65	1	20	91
6584CLB	2,49	45	360	101	7427/1T	195,72	1	2	99	8053	35,92	1	30	91
6584CLN	2,49	45	360	101	7427/2	177,46	1	1	99	8053IL	37,88	1	12	91
6584CRB	2,57	45	360	101	7429	25,24	1	10	99	8054	37,14	1	25	91
6584CRN	2,57	45	360	101	7627	2,24	65	520	96	8054IL	39,13	1	12	91
6584CTB	2,68	45	360	101	7627N	2,24	65	520	96	8055	38,47	1	24	91
6584CTN	2,68	45	360	101	8002	7,20	12	96	90	8055IL	40,42	1	10	92
6618	2,01	70	560	102	8002IL	8,94	12	96	90	8056	39,88	1	20	91
6618N	2,01	70	560	102	8003	8,55	18	72	90	8056IL	41,86	1	10	92
6625	0,61	20	500	62	8003IL	10,43	16	64	90	8104	10,33	14	56	92
6635	1,54	1	84	58	8003P	10,22	18	72	88	8105IL	16,08	24	48	92
6635TCP	1,20	1	200	62	8003PIL	12,71	18	72	88	8106	15,13	12	48	92
6635TCT	1,13	1	150	62	8004	9,78	16	64	90	8114	24,89	1	20	92
6710	40,87	1	10	97	8004IL	11,86	15	60	90	8116	29,72	1	30	92
6710/25	90,07	1	6	97	8005	11,25	15	60	90	8124	26,15	1	20	92
6762/1	12,22	1	40	97	8005IL	13,02	10	40	90	8203	49,38	1	5	12
6763/1	15,47	1	30	97	8006	12,56	10	40	90	8203HGW	64,99	1	5	68
6764/1	19,01	1	25	97	8006IL	14,44	10	40	90	8203PF	51,47	1	5	12
6765/1	23,21	1	25	97	8012	12,64	1	48	91	8203PFHGW	66,92	1	5	68
6815	8,07	6	120	51	8012IL	14,39	1	40	91	8206	52,22	1	5	10
6816	14,16	4	64	51	8013	13,76	1	40	91	8206PF	60,13	1	5	10
6817	18,21	1	58	51	8013IL	15,65	1	35	91	8208	18,69	1	22	10
6817G	20,56	1	50	53	8013P	17,50	1	40	88	8208PF	22,02	1	22	10
6827K	10,43	11	88	96	8013PIL	19,92	1	40	88	8209	25,38	1	22	13
6828K	12,08	9	144	96	8013USB	27,97	1	18	92	8209PF	28,28	1	22	13
6829CLB	2,78	40	320	101	8014	15,05	1	34	91	8216	60,73	1	5	11
6829CLN	2,78	40	320	101	18014IL	16,84	1	34	91	8216PF	66,78	1	5	11
6829CRB	2,83	40	320	101	8015	16,35	1	32	91	8220	60,97	1	5	13
6829CRN	2,83	40	320	101	8015IL	18,20	1	28	92	8220PF	68,99	1	5	13
6829CTB	2,88	40	320	101	8016	17,68	1	16	91	8672/1	6,86	1	50	97
6829CTN	2,88	40	320	101	8016IL	19,53	1	16	92	8673/1	8,80	1	40	97
6833	2,02	10	300	96	8022	21,81	1	35	91	8675/1	11,97	1	30	97
6886	25,57	1	32	52	8022IL	23,77	1	35	91	8680	32,45	1	12	12
6886G	29,63	1	30	53	8023	23,17	1	20	91	8680PF	38,16	1	12	12
6887	96,51	1	10	36	8023IL	25,20	1	18	91	8684	19,88	1	30	11
6887B	95,54	1	10	36	8024	24,57	1	36	91	8684PF	20,83	1	30	11

C*: Consulte precio.



Accede a la tarifa PVP actualizada







ÍNDICE POR REFERENCIA

Ref.	PVP			Pág.	Ref.	PVP			Pág.	Ref.	PVP			Pág.
8685	30,73	1	12	10	902431A	11,83	1	10	33	931446A	70,18	1	2	34
8685PF	34,13	1	12	10	902433A	19,22	1	10	33	931448A	147,63	1	2	34
8688	23,17	1	10	10	902435A	51,80	1	2	33	931452A	17,43	1	10	34
8688PF	26,78	1	10	10	902437A	132,90	1	2	33	931454A	24,40	1	10	34
8690	31,75	1	10	10	902442A	14,77	1	10	33	931456A	73,82	1	2	34
8690PF	37,47	1	10	10	902444A	20,72	1	10	33	931458A	163,03	1	2	34
8690HGW	40,68	1	10	68	902446A	59,08	1	2	33	932131	11,45	1	10	35
8690PFHGW	45,92	1	10	68	902448A	140,25	1	2	33	932133	14,77	1	10	35
8692	3,41	1	120	10	902452A	16,59	1	10	33	932142	12,11	1	10	35
8692PF	3,82	1	120	10	902454A	22,09	1	10	33	932144	16,35	1	10	35
8692S	3,96	1	120	11	902456A	66,47	1	2	33	932152	13,69	1	10	35
8692SPF	4,45	1	126	11	902458A	147,67	1	2	33	932154	17,71	1	10	35
8694	15,26	1	30	10	903131A	8,58	1	10	33	932435	82,43	1	2	35
8694PF	16,01	1	30	10	903133A	14,77	1	10	33	932437	146,97	1	1	35
8695C	14,81	1	30	12	903142A	10,47	1	10	33	932444	39,52	1	5	35
8695CPF	16,38	1	30	12	903144A	15,51	1	10	33	932446	91,25	1	1	35
8698	45,26	1	10	13	903152A	11,45	1	10	33	932448	153,41	1	1	35
8698PF	53,24	1	10	13	903154A	16,35	1	10	33	932454	41,41	1	5	35
8699	20,16	1	30	12	903156A	76,55	1	2	33	932456	103,32	1	1	35
8699PF	21,49	1	30	12	903431A	19,22	1	10	33	932458	191,84	1	1	35
8703	28,88	1	10	11	903433A	24,50	1	10	33	933131	81,24	1	1	34
8703PF	31,99	1	10	11	903435A	70,14	1	2	33	933133	103,32	1	1	34
8704	41,41	1	10	11	903437A	155,09	1	2	33	933142	76,72	1	1	34
8704PF	44,97	1	10	11	903442A	21,39	1	10	33	933144	95,87	1	1	34
8880	47,81	1	9	12	903444A	26,78	1	10	33	933152	96,04	1	1	34
8880PF	53,53	1	9	12	903446A	73,82	1	2	33	933154	118,13	1	1	34
8881	34,26	1	10	12	903448A	162,40	1	2	33	933431	92,26	1	1	34
8881PF	39,82	1	10	12	903452A	23,63	1	10	33	933433	114,38	1	1	34
8881HGW	47,71	1	10	68	903454A	27,34	1	10	33	933442	99,72	1	1	34
8881PFHGW	50,37	1	10	68	903456A	81,24	1	2	33	933444	125,55	1	1	34
15097	4,46	19	152	98	903458A	177,21	1	2	33	933452	118,78	1	1	34
15098	4,29	19	152	98	904011	23,00	1	10	35	933454	136,57	1	1	34
71251A	135,07	1	2	100	904012	25,87	1	10	35	933456	531,34	1	1	35
73362	326,41	1	2	100	904013	48,01	1	10	35	934131	8,96	1	10	34
75553	420,81	1	1	100	904014	71,89	1	5	35	934133	13,02	1	10	34
75562	450,87	1	2	100	904015	99,68	1	5	35	934142	10,78	1	10	34
100665	3,27	8	320	48	931121A	7,53	1	10	34	934144	14,42	1	10	34
100887	68,23	1	12	49	931123A	11,10	1	10	34	934152	12,57	1	10	34
100887G	71,51	1	12	52	931131	6,30	1	100	34	934154	16,35	1	10	34
100887N	68,23	1	12	51	931131F	8,58	1	100	34	934448	127,09	1	2	34
100887TP	118,04	1	12	52	931142A	8,65	1	10	34	934456	63,56	1	2	34
100887TPG	120,24	1	12	53	931144A	13,02	1	10	34	934458	140,80	1	2	34
100888	70,62	1	10	49	931152A	9,45	1	10	34	935131	14,77	1	10	35
100888TP	124,18	1	10	51	931154A	13,48	1	10	34	935133	19,22	1	10	35
100888G	73,52	1	12	52	931156A	69,97	1	2	34	935142	16,59	1	10	35
902131A	5,53	1	10	33	931421A	13,79	1	10	34	935144	19,95	1	10	35
902133A	10,78	1	10	33	931423A	18,17	1	10	34	935152	18,17	1	10	35
902142A	6,69	1	10	33	931431	30,03	1	10	34	935154	21,04	1	10	35
902144A	11,83	1	10	33	931435A	66,47	1	2	34	935446	103,32	1	1	35
902152A	8,58	1	10	33	931437A	139,79	1	2	34	935448	178,92	1	1	35
902154A	13,69	1	10	33	931442A	15,30	1	10	34	935456	118,13	1	1	35
902156A	57,89	1	2	33	931444A	22,26	1	10	34	935458	221,55	1	1	35



C*: Consulte precio.

ÍNDICE POR REFERENCIA







Ref.	PVP			Pág.	Ref.	PVP			Pág.	Ref.	PVP			Pág.
936142A	40,64	1	10	33	AE1020	0,72	25	1.000	84	BR36140	2,84	1	250	117
936144A	59,08	1	10	33	AE1212	0,69	40	1.200	84	BR36140N	2,84	1	250	117
936152A	48,09	1	10	33	AE1616	0,73	25	1.000	84	BR36200	4,05	1	150	117
936154A	68,46	1	10	33	AE1625	0,96	20	600	84	BR36200N	4,05	1	150	117
9000425	0,27	100	1.800	118	AE2525	1,52	10	40	84	BR36300	6,38	1	100	117
9000535	0,33	100	1.800	118	AE2540	2,71	20	160	84	BR36300N	6,38	1	100	117
9000640	0,34	100	1.800	118	AE4040	3,34	15	120	84	BR36370	7,67	1	100	117
9150712	1,56	---	120	83	AE4070	3,99	10	40	84	BR36370N	7,67	1	100	117
9151016	2,24	---	70	83	AE6060	4,65	10	60	84	BR48200	5,39	1	100	117
9151020	2,58	---	56	83	AE60100	5,70	8	32	84	BR48200G	5,39	1	100	116
9151212	1,96	---	72	83	AE16/230	47,10	12	120	109	BR48200N	5,39	1	100	117
9151616	2,94	---	40	83	AI712	0,56	30	2.400	84	BR48250	7,05	1	100	117
9151625	4,17	---	24	83	AI1016	0,60	30	1.200	84	BR48250M	7,36	1	100	117
9152525	5,74	---	60	83	AI1020	0,72	30	1.200	84	BR48250N	7,05	1	100	117
9152540	7,21	---	40	83	AI1212	0,69	30	1.200	84	BR48250V	7,36	1	100	117
9154040	9,45	---	24	83	AI1616	0,73	30	1.200	84	BR48300	8,36	1	100	117
9154070B	8,85	---	48	83	AI1625	0,96	25	750	84	BR48300G	8,36	1	100	116
9154070T	8,60	---	48	83	AI2525	1,52	8	64	84	BR48300N	8,36	1	100	117
9156060B	9,28	---	36	83	AI2540	2,71	20	160	84	BR48360	9,57	1	50	117
9156060T	9,94	---	36	83	AI4040	3,34	15	120	84	BR48360N	9,57	1	50	117
91560100B	12,85	---	24	83	AI4070	3,99	8	64	84	BR76365	18,25	1	25	117
91560100T	12,74	---	24	83	AI6060	4,65	10	40	84	BR76365N	18,25	1	25	117
9160712	2,54	---	120	83	AI60100	5,70	8	32	84	BR76450	23,66	1	25	117
9161016	2,97	---	70	83	AP712	0,56	30	2.400	84	BR76450N	23,66	1	25	117
9161020	3,29	---	56	83	AP1016	0,60	30	1.200	84	BR76500	24,79	1	20	117
9161212	2,98	---	72	83	AP1020	0,72	40	1.200	84	BR76500N	24,79	1	20	117
9161616	3,26	---	40	83	AP1212	0,69	40	1.200	84	BR9450N	29,49	1	20	117
9161625	5,36	---	24	83	AP1616	0,73	20	800	84	CBM110	5,23	12	240	107
9162525	6,51	---	60	83	AP1625	0,96	20	600	84	CBM116	5,23	12	240	107
9162540	8,79	---	40	83	AP2525	1,52	20	160	84	CBM120	5,23	12	240	107
9280525	3,95	20	500	118	AP2540	2,71	20	160	84	CBM125	5,54	12	240	107
9280630	4,21	1	300	118	AP4040	3,34	15	120	84	CBM132	5,54	12	240	107
9280638	10,73	1	50	118	AP4070	3,99	10	64	84	CBM140	5,54	12	240	107
9280638G	10,73	1	50	118	AP6060	4,65	10	48	84	CBM150	5,63	12	240	107
9280834	11,30	1	50	118	AP60100	5,70	6	24	84	CBM163	6,58	12	240	107
9280834G	11,30	1	50	118	AR25256	22,58	1	26	60	CBM1N10	9,92	6	120	107
9280840	4,73	1	100	118	AV1	4,23	1	200	98	CBM1N16	9,92	6	120	107
9281260	7,99	1	18	118	BOLTBR-1	1,02	1	500	115	CBM1N20	9,92	6	120	107
1005515E-ICT	344,21	1	1	23	BOLTBR-2	1,23	1	500	115	CBM1N25	9,92	6	120	107
1005515S-ICT	344,21	1	1	23	BOL-TB725				69	CBM1N32	10,15	6	120	107
454515E-ICT	178,89	1	1	22	BK-L	1,50	50	350	105	CBM1N40	11,67	6	120	107
454515S-ICT	178,89	1	1	22	BK-L3P	2,48	50	350	105	CBM1N50	11,67	6	120	107
5510015S-ICT	344,21	1	1	23	BK-3P	13,81	1	100	56	CBM1N63	11,67	6	120	107
507015S-ICT	261,61	1	1	22	BK-3PT	17,79	1	110	56	CBM210	10,96	6	120	107
705015E-ICT	261,61	1	1	22	BK-6P	44,18	1	30	56	CBM216	10,96	6	120	107
AC-68S	C*	1	1	69	BR5625GW	0,47	20	2000	69	CBM220	10,96	6	120	107
AD14-10	4,25	12	360	105	BR25100	1,24	1	250	117	CBM225	10,96	6	120	107
AD27-10	4,36	12	360	105	BR25100N	1,24	1	250	117	CBM232	11,42	6	120	107
AD27-14	3,01	12	600	104	BR25200	2,61	1	250	117	CBM240	12,65	6	120	107
AD40-27	2,84	25	500	104	BR25200N	2,61	1	250	117	CBM250	12,74	6	120	107
AE712	0,56	30	2.400	84	BR25260	3,64	1	200	117	CBM263	14,16	6	120	107
AE1016	0,60	30	1.200	84	BR25260N	3,64	1	200	117	CBM310	17,52	4	80	107

C*: Consulte precio.



Accede a la tarifa PVP actualizada







ÍNDICE POR REFERENCIA

Ref.	PVP			Pág.	Ref.	PVP			Pág.	Ref.	PVP			Pág.
CBM316	17,52	4	80	107	CO-M50/A	0,99	1	500	54	ERP03AQC	7,14	10	120	74
CBM320	17,52	4	80	107	CONT30R	163,99	1	45	109	ERP03NGQC	7,14	10	120	74
CBM325	17,52	4	80	107	COMBI2P25T15	196,82	1	20	109	ERP03U	6,68	10	120	71
CBM332	19,08	4	80	107	COMBI2P40T15	204,75	1	20	109	ERP04ILQC	6,51	10	120	74
CBM340	19,08	4	80	107	COR68TH	99,99	1	1	69	ERP04ILAQC	8,92	10	120	74
CBM350	19,51	4	80	107	COR-68S	C*	1	1	69	ERP04ILNGQC	8,92	10	120	74
CBM363	19,85	4	80	107	CP-9	2,14	1	102	63	ERP04ILU	7,50	10	120	71
CBM410	24,17	3	60	107	CR4025	4,03	---	42	86	ERP09QC	8,18	10	120	74
CBM416	24,17	3	60	107	CR4040	4,69	---	40	86	ERP09AQC	11,55	10	120	74
CBM420	25,05	3	60	107	CR6040	7,11	---	18	86	ERP09NGQC	11,55	10	120	74
CBM425	25,05	3	60	107	CSG5	6,97	---	60	86	ERP09U	9,59	10	120	71
CBM432	25,74	3	60	107	CSG6	8,79	---	50	86	ERP12QC	8,15	10	120	73
CBM440	27,97	3	60	107	CSG9	13,30	---	26	86	ERP12AQC	11,55	10	120	73
CBM450	29,31	3	60	107	CSP-06	C*	1	1	30	ERP12NGQC	11,55	10	120	73
CBM463	31,14	3	60	107	CTM1	4,45	16	256	95	ERP12U	9,11	10	120	71
CBMM1N10	19,05	12	180	107	CTM1N	4,45	16	256	95	ERP20QC	8,29	10	120	74
CBMM1N16	19,05	12	180	107	CTR15/50	5,43	16	320	115	ERP20AQC	9,87	10	120	74
CBMM1N20	19,05	12	180	107	CTR25/50	6,06	16	320	115	ERP20NGQC	9,87	10	120	74
CBMM1N25	19,05	12	180	107	CTR60/50	9,73	10	200	115	ERP20U	9,24	10	120	71
CBMM1N32	19,05	12	180	107	CTR100/50	31,22	5	100	115	ERP22QC	6,86	10	120	74
CBMM1N40	19,05	12	180	107	CTR160/50	50,54	3	60	115	ERP22AQC	8,27	10	120	74
CBRA2P4030A	199,99	1	24	108	DT712	0,56	20	1.600	84	ERP22NGQC	8,27	10	120	74
CDM-200	48,93	1	1	43	DT1016	0,60	24	960	84	ERP22U	8,09	10	120	71
CDM-250	51,24	1	1	43	DT1020	0,72	25	750	84	ERP21	6,58	10	120	74
CDM-300	54,29	1	1	43	DT1212	0,69	30	900	84	ERP21U	8,44	10	120	71
CE-3PV	11,32	1	200	56	DT1616	0,73	15	600	84	ERP31LED	34,65	10	120	74
CE-3P4T	13,62	1	125	56	DT1625	0,96	12	360	84	ERP31LEDA	35,62	10	120	74
CER-1300L2	21,53	1	20	39	DT2525	1,52	---	---	84	ERP31LEDNG	35,62	10	120	74
CER-MP28	23,42	1	1	8	DT2540	2,71	20	160	84	ERP31LEDU	36,19	10	120	71
CHX1	71,51	1	1	43	DT4040	3,34	15	90	84	ERP40	5,38	10	120	75
CHX2	109,48	1	1	43	DT4070	3,99	8	64	84	ERP40A	10,57	10	120	75
CHX3	113,89	1	1	43	DT6060	4,65	10	40	84	ERP40NG	10,57	10	120	75
CHX4	139,44	1	1	43	DT60100	5,70	6	24	84	ERP40U	6,86	10	120	72
CHX5	234,89	1	1	43	DVX1	1,53	1	500	43	ERP46	20,26	10	120	75
CLC5	14,70	15	480	114	DVX2	8,77	1	150	43	ERP46U	22,68	10	120	73
CLC16	11,41	10	320	114	ERP-CP100U	1,70	28	112	76	ERP47	20,37	10	120	75
CLC32	12,36	10	320	114	ERP-100U	2,45	---	96	76	ERP47A	20,93	10	120	75
CLE4-5	7,01	20	320	113	ERP01T	26,85	10	120	75	ERP47NG	20,93	10	120	75
CLE24	5,27	20	640	113	ERP01TU	28,42	10	120	72	ERP47U	22,68	20	120	73
CLE34	6,41	20	640	113	ERP1Z	19,62	10	120	75	ERP47TLV	1,44	10	240	76
CLE54	8,03	20	450	113	ERP1ZU	21,58	10	120	72	ERP47TLVA	2,80	10	240	76
CLG15AZ	12,41	15	240	114	ERP02ILQC	7,49	10	120	74	ERP47TLVNG	2,80	10	240	76
CM2A25	47,04	1	200	109	ERP02ILAQC	8,93	10	120	74	ERP47TLVU	2,77	20	240	76
CM2A40	50,22	1	240	109	ERP02ILNGQC	8,93	10	120	74	ERP48	31,78	10	120	75
CM2A63	83,25	1	100	109	ERP02ILU	8,47	10	120	71	ERP48TLV	1,44	10	240	76
CM4A25	116,25	1	60	109	ERP02QC	5,95	10	120	73	ERP48TLVU	2,77	20	240	76
CM4A40	143,01	1	60	109	ERP02AQC	8,08	10	120	73	ERP48U	33,12	10	120	73
CM4A63	159,98	1	60	109	ERP02NGQC	8,08	10	120	73	ERP60	6,30	10	120	75
CO-M20	0,32	1	2.850	54	ERP02U	6,79	10	120	71	ERP60A	7,81	10	120	75
CO-M25/A	0,36	1	1.700	54	ERP2USB	32,68	10	120	75	ERP60NG	7,81	10	120	75
CO-M32/A	0,39	1	1.100	54	ERP2USBU	34,51	10	120	72	ERP60/2NU	12,25	10	120	72
CO-M40/A	0,65	1	750	54	ERP03QC	5,71	10	120	74	ERP60/2U	9,28	10	120	72

C*: Consulte precio.



ÍNDICE POR REFERENCIA







Ref.	PVP			Pág.	Ref.	PVP			Pág.	Ref.	PVP			Pág.
ERP60/2AU	12,39	10	120	72	ERP90CR3	27,16	10	120	74	IR3A050E9	83,21	1	30	111
ERP60/2NGU	12,32	10	120	72	ERP90U	14,19	10	120	72	IR3A063E9	83,21	1	30	111
ERP60USBC-U	51,66	10	120	72	ERP90CR3U	28,63	10	120	72	IR3A080E9	127,99	1	30	111
ERP60USBC	50,47	10	120	75	ET12	4,89	20	1200	110	IR3A120E9	127,99	1	30	111
ERP60U	8,12	10	120	72	FC010	5,81	1	800	110	IR4A016E9	23,41	1	100	111
ERP60USB	30,14	10	120	75	FC140	9,04	1	800	110	IR4A020E9	23,41	1	100	111
ERP60USBA	31,78	10	120	75	FC263	14,88	1	200	110	IR4A025E9	31,49	1	100	111
ERP60USBNG	31,78	10	120	75	FC280	15,86	1	200	110	IR4A032E9	44,99	1	72	111
ERP60USB-U	31,47	10	120	72	FCDO235	8,22	1	640	110	IR4A040E9	57,99	1	72	111
ERP62NU	6,93	10	120	77	FCDO250	9,44	1	640	110	IR4A050E9	83,39	1	30	111
ERP62U	4,08	10	120	77	FCDO263	9,84	1	320	110	IR4A063E9	83,39	1	30	111
ERP62AU	7,63	10	120	77	FIXM	15,08	1	100	43	IR4A080E9	127,99	1	30	111
ERP62NGU	7,63	10	120	77	FIXP	10,01	1	100	43	IR4A120E9	127,99	1	30	111
ERP63NU	9,11	10	120	77	FV1250/3S	172,90	1	200	108	IR2A016S6	16,99	1	100	111
ERP63U	5,48	10	120	77	FV600/2S	168,02	1	200	108	IR2A020S6	16,99	1	100	111
ERP63AU	10,47	10	120	77	FV111016	248,68	1	1	28	IR2A025S6	22,51	1	100	111
ERP63NGU	10,47	10	120	77	FV211016-63	385,74	1	1	28	IR2A032S6	32,99	1	72	111
ERP71AU	2,52	20	240	77	FV221016	473,47	1	1	28	IR2A040S6	39,29	1	72	111
ERP71NGU	2,52	20	240	77	FV311016-63	452,21	1	1	28	IR3A016S6	23,49	1	100	111
ERP71NU	3,38	20	240	77	FV331016	717,40	1	1	28	IR3A020S6	23,49	1	100	111
ERP71U	1,58	20	240	76	FV411016-63	526,02	1	1	28	IR3A025S6	31,59	1	100	111
ERP72AU	7,91	10	120	77	FV441016	890,02	1	1	28	IR3A032S6	44,99	1	72	111
ERP72NGU	7,91	10	120	77	FV511016-125	592,24	1	1	28	IR3A040S6	57,99	1	1	111
ERP72NU	7,67	10	120	77	FV511016-63	569,07	1	1	28	IR3A050S6	83,21	1	---	111
ERP72U	3,99	10	120	76	FV551016	1091,02	1	1	28	IR3A063S6	83,21	1	1	111
ERP73AU	9,98	10	120	77	FV611016-125	753,34	1	1	28	IR3A080S6	127,99	1	---	111
ERP73NGU	9,98	10	120	77	FV661016	1300,43	1	1	28	IR3A120S6	127,99	1	1	111
ERP73NU	10,29	10	120	77	GM4	80,48	1	50	109	IR4A016S6	23,41	1	---	111
ERP73U	5,71	10	120	76	GM6.3	80,48	1	50	109	IR4A020S6	23,41	1	---	111
ERP74AU	13,78	10	120	77	GRAPA-1	1,23	20	320	118	IR4A025S6	31,49	1	---	111
ERP74NGU	13,78	10	120	77	GRAPA-4	1,30	20	320	118	IR4A032S6	44,99	1	72	111
ERP74NU	11,41	10	120	77	GRAPA-6	C*	1	200	118	IR4A040S6	57,99	1	72	111
ERP74U	7,77	10	120	76	GRAPA-7	1,68	20	320	118	IR4A050S6	83,39	1	30	111
ERP75	2,38	10	120	75	GRAPA-8	1,86	20	300	118	IR4A063S6	83,39	1	30	111
ERP75A	4,03	10	120	75	GRAPA-9	2,17	20	200	118	IR4A080S6	127,99	1	---	111
ERP75NG	4,03	10	120	75	GRAPA-10	2,38	20	200	118	IR4A120S6	127,99	1	---	111
ERP75U	4,23	10	120	73	GRAPA-12	3,12	20	100	118	IR2B016S6	23,25	1	---	112
ERP84	5,29	10	120	76	GRAPA-16	C*	1	200	118	IR2B020S6	23,25	1	100	112
ERP84A	6,51	10	120	76	GRAPA-20	C*	1	200	118	IR2B025S6	31,59	1	100	112
ERP84NG	6,51	10	120	76	GRAPA-25	C*	1	200	118	IR2B032S6	44,99	1	---	112
ERP84U	6,30	10	120	73	IDBR25100	2,19	1	600	118	IR2B040S6	57,99	1	---	112
ERP88	16,34	10	120	76	INT5/3A2	15,30	12	288	110	IR3B016S6	29,89	1	---	112
ERP88A	17,50	10	120	76	IR2A016E9	16,99	1	100	111	IR3B020S6	29,89	1	---	112
ERP88NG	17,50	10	120	76	IR2A020E9	16,99	1	100	111	IR3B025S6	40,05	1	---	112
ERP88/1	3,59	10	120	76	IR2A025E9	22,51	1	100	111	IR3B032S6	56,99	1	---	112
ERP88/1U	4,82	10	120	76	IR2A032E9	32,99	1	72	111	IR3B040S6	75,99	1	---	112
ERP88/2	22,26	10	120	76	IR2A040E9	39,29	1	72	111	IR3B050S6	113,59	1	---	112
ERP88/2A	23,65	10	120	76	IR3A016E9	23,49	1	100	111	IR3B063S6	113,59	1	---	112
ERP88/2NG	23,65	10	120	76	IR3A020E9	23,49	1	100	111	IR3B080S6	175,99	1	---	112
ERP88/2U	24,07	10	120	73	IR3A025E9	31,59	1	100	111	IR3B120S6	175,99	1	---	112
ERP88U	18,17	10	120	73	IR3A032E9	44,99	1	72	111	IR4B016S6	36,21	1	---	112
ERP90	12,81	10	120	74	IR3A040E9	57,99	1	72	111	IR4B020S6	36,21	1	---	112

C*: Consulte precio.



Accede a la tarifa PVP actualizada



ÍNDICE POR REFERENCIA



Ref.	PVP			Pág.	Ref.	PVP			Pág.	Ref.	PVP			Pág.
IR4B025S6	49,21	1	---	112	M4E96-1	527,51	1	1	38	MP56NG	185,10	1	1	7
IR4B032S6	69,11	1	---	112	M4E132-1	637,75	1	1	38	MP56HGW	178,05	1	3	67
IR4B040S6	94,49	1	---	112	M4S96-1	618,52	1	1	38	MP56NGHW	194,43	1	3	67
IR4B050S6	144,59	1	---	112	M4S132-1	756,11	1	1	39	MP42/2	260,08	1	2	22
IR4B063S6	144,59	1	---	112	M5E120-1	664,01	1	1	38	MP42/2B	279,76	1	2	22
IR4B080S6	223,89	1	---	112	M5S120-1	777,29	1	1	38	MP42/2BHW	294,68	1	2	69
IR4B120S6	223,89	1	---	112	M5E165-1	780,17	1	1	38	MP42/2HW	272,17	1	2	69
JU48X48	C*	---	---	112	M5S165-1	938,81	1	1	39	MP4545-ICT	115,52	1	1	23
JU64X64	C*	---	---	112	M6E144-1	735,75	1	1	38	MP7050-ICT	155,91	1	1	23
JU88X88	C*	---	---	112	M6S144-1	863,14	1	1	39	MP5045ICT60	449,72	1	1	23
KIT712	4,14	1	300	85	M6E198-1	892,95	1	1	38	MP7050ICT60	611,42	1	1	23
KIT1016	4,48	1	200	85	M6S198-1	974,09	1	1	39	MP10055ICT60	912,88	1	1	23
KIT1020	5,04	1	150	85	M-68	C*	1	1	69	MR1300X	9,34	1	50	32
KIT1212	4,82	1	200	85	MB-CH253515	33,71	1	1	41	MR1316	8,31	1	100	32
KIT1616	5,39	1	125	85	MB-CH304017	42,14	1	1	41	MR1332	8,36	1	100	32
KIT1625	6,96	1	100	85	MB-CH355019	50,51	1	1	41	MR1360	8,71	1	100	32
KIT2540	13,82	1	30	85	MB-CH406020	58,94	1	1	41	MR1363	12,44	1	85	32
KIT4040	17,12	1	---	85	MBK203013	28,84	1	1	41	MUR02U	5,95	10	120	79
KIT1300ASA	28,06	1	90	30	MBK253515	42,91	1	1	41	MUR02/2U	4,51	1	100	80
KIT1300UN32	11,73	1	100	31	MBK304017	58,10	1	1	41	MUR03/2U	4,29	1	100	80
KIT1300SOP	2,53	1	250	30	MBK304022	66,78	1	1	41	MUR02ILU	7,59	10	120	79
KIT1300UN40	12,94	1	100	31	MBK355019	81,69	1	1	41	MUR03U	5,18	10	120	79
KIT-DIN35	3,78	1	400	92	MBK405018	86,45	1	1	41	MUR04U	5,18	10	120	79
KIT-ERP-ROOM	46,23	1	50	71	MBK405024	101,85	1	1	41	MUR07U	5,29	10	120	79
KIT-MRP14	43,19	1	3	61	MBK406020	108,29	1	1	41	MUR09U	8,02	10	120	79
KIT-MRP28	52,68	1	3	61	MBK506023	C*	1	1	41	MUR12U	8,12	10	120	79
KIT-MRP42	65,09	1	3	61	MBK507025	192,57	1	1	41	MUR22U	7,32	10	120	79
KIT-MRP56	79,52	1	3	61	MBK608026	409,85	1	1	41	MUR36U	13,23	10	120	80
KIT-MRP14NG	45,47	1	3	61	MBK203013T	33,95	1	1	41	MUR60U	6,16	10	120	79
KIT-MRP28NG	55,13	1	3	61	MBK253515T	50,61	1	1	41	MUR62U	3,15	10	120	80
KIT-MRP42NG	73,71	1	3	61	MBK304017T	68,60	1	1	41	MUR63U	10,96	10	120	80
KIT-MRP56NG	88,06	1	3	61	MBK304022T	85,05	1	1	41	MUR64U	5,81	10	120	80
KIT-PL12G	1,44	60	960	54	MBK355019T	93,59	1	1	41	MUR66U	11,48	10	120	79
KIT-PL16G	1,88	60	960	54	MBK405018T	113,05	1	1	41	MUR84U	5,36	10	120	80
KIT-PL20G	2,10	60	960	54	MBK405024T	120,05	1	1	41	MUR87U	16,63	10	120	80
KIT-PL25G	2,67	60	480	54	MBK406020T	124,04	1	1	41	MUR88U	15,82	10	120	80
KIT-PL32G	4,55	40	320	54	MBK506023T	C*	1	1	41	MUR94U	6,34	10	120	80
KIT-PL40G	13,12	24	96	54	MBK507025T	216,37	1	1	41	MUR96U	12,99	10	120	80
KIT-SOMR	17,04	1	25	30	MBK608026T	437,85	1	1	41	NUM2	14,21	1	200	115
KIT-ST1308	46,11	1	25	31	MP14	78,89	1	1	7	NUM3	14,52	1	175	115
KIT-ST1311	50,33	1	25	31	MP14NG	87,29	1	1	7	OB5003	2,06	1	1000	96
KIT-ST1316	56,98	1	25	31	MP14HGW	88,59	1	1	67	P1P100010	18,20	1	100	112
LOCK0	14,12	1	200	44	MP14NGHW	101,47	1	1	67	P2P100010	42,11	1	50	112
LOCK1	28,89	1	200	44	MP28	101,54	1	1	7	P2P100016	45,89	1	50	112
LOCK2	14,12	1	200	44	MP28NG	111,89	1	1	7	P2P21610	9,01	40	160	112
LOCK3	10,68	1	200	44	MP28HGW	115,89	1	1	67	P3P100010	48,35	1	50	112
LSTP1/9	69,36	9	200	108	MP28NGHW	128,70	1	1	67	P4P100010	66,59	1	25	112
LSTP3/9	132,17	3	60	108	MP42	141,22	1	1	7	P4P100016	84,03	1	25	112
LST2	130,68	1	100	108	MP42NG	155,37	1	1	7	PE12	21,56	1	180	110
LST4	389,84	1	30	108	MP42HGW	150,61	1	1	67	PE12CA	21,56	6	180	110
M3E72-1	481,56	1	1	38	MP42NGHW	164,33	1	1	67	PE1300	64,59	1	40	31
M3S72-1	530,30	1	1	38	MP56	166,60	1	1	7	PF1038	4,81	12	300	110

C*: Consulte precio.



ÍNDICE POR REFERENCIA

Ref.	PVP			Pág.
PF1451	9,12	6	192	110
PF2258	14,43	6	96	110
PGU10	1,02	100	1000	104
PGU56	0,65	200	2000	104
PGZ10	1,02	100	1000	104
PL-MP28	4,11	1	125	8
PLD22	7,51	12	288	110
PLD22V	7,51	12	288	110
PM817	5,81	1	50	55
PM820	20,31	1	10	55
PM821	24,51	1	10	55
PM886	9,65	1	20	55
PM887	16,59	1	10	55
PMX253016	12,69	1	1	44
PMX304020	20,93	1	1	44
PMX405020	39,04	1	1	44
PMX506025	57,58	1	1	44
PMX608030	92,30	1	1	44
PMK2030	3,64	1	1	41
PMK2535	5,39	1	1	41
PMK3040	7,00	1	1	41
PMK3550	11,41	1	1	41
PMK4050	12,95	1	1	41
PMK4060	15,96	1	1	41
PMK5060	C*	1	1	41
PMK5070	23,73	1	1	41
PMK6080	52,15	1	1	41
PPX253016	10,30	1	1	44
PPX304020	18,11	1	1	44
PPX405020	26,21	1	1	44
PPX506025	44,05	1	1	44
PPX608030	76,33	1	1	44
PROT-1	5,08	1	50	96
PROT-6625	2,74	1	10000	62
PULSA5R	9,43	12	288	110
PULSA5V	9,43	12	288	110
PX253016	121,31	1	1	43
PX253016TP	222,92	1	1	43
PX304020	156,77	1	1	43
PX304020TP	262,01	1	1	43
PX405020	225,15	1	1	43
PX405020TP	369,36	1	1	43
PX506025	266,16	1	1	43
PX506025TP	502,99	1	1	43
PX608030	378,88	1	1	43
PX608030TP	732,27	1	1	43
PX8510035	1133,97	1	1	43
R24	82,89	12	120	109
R24R/3	180,05	4	40	109
R168D	76,66	6	60	109
RE2,5/10B	1,61	10	1000	113
RE2,5/10N	1,61	10	1000	113

Ref.	PVP			Pág.
RE4/10B	1,68	10	1000	113
RE4/10N	1,68	10	1000	113
RE6/10B	2,49	10	1000	113
RE6/10N	2,49	10	1000	113
RE10/10B	3,16	10	500	113
RE10/10N	3,16	10	500	113
RE16/10B	5,27	10	300	113
RE16/10N	5,27	10	300	113
RE25/10B	11,13	10	100	113
RE25/10N	11,13	10	100	113
RE35/10B	11,55	10	100	113
RE35/10N	11,55	10	100	113
RCB2P2530	42,95	1	60	108
RCB2P4030	42,95	1	60	108
RCB2P6330	45,29	1	60	108
RCB4P2530	50,11	1	30	108
RCB4P4030	50,46	1	30	108
RCB4P6330	50,46	1	30	108
RCB2P25300	48,98	1	50	108
RCB2P40300	48,98	1	50	108
RCB2P63300	50,58	1	50	108
RCB4P25300	54,87	1	30	108
RCB4P40300	54,75	1	30	108
RCB4P63300	55,92	1	30	108
RCBA2P2530	59,63	1	60	108
RCBA2P4030	59,63	1	60	108
RCBA4P2530	83,22	1	30	108
RCBA4P4030	84,77	1	100	108
RCBSI2P2530	99,99	1	60	108
RCBSI2P4030	99,99	1	60	108
ROL-1	3,99	1	60	100
SEC1P160A	11,62	1	120	55
SOM1316	89,74	1	1	30
SOP-7000	6,89	1	96	100
SOP915	21,07	1	20	85
SOP-715Y	1,23	---	1	47
SOP-716Y	1,30	---	1	47
SOT2516	9,31	1	50	118
TA1300	0,91	50	200	13
TA1300B	0,91	50	200	13
TA1300B03	1,14	50	200	8
TA1300C	7,41	1	100	32
TA1300G	0,91	50	200	30
TA1316C	10,12	1	70	32
TA1332C	10,43	1	80	32
TAPA-1P	1,33	1	---	112
TAPA-2P	1,75	1	---	112
TAPA-3P	2,17	1	---	112
TAPA-4P	2,59	1	---	112
TBR-1,5	0,43	200	6000	114
TBR-2,5	0,49	200	4000	114
TBR-3,5	0,58	100	2000	114





Ref.	PVP			Pág.
TBR-6	0,84	50	1000	114
TBR-8	0,74	50	1500	114
TBR-10	0,87	40	1200	114
TBR-1,5T	0,45	200	6000	114
TBR-2,5T	0,51	200	6000	114
TBR-3,5T	0,60	100	3000	114
TBR-6T	0,86	50	1500	114
TBR-8T	0,78	50	1500	114
TBR-10T	0,90	40	1200	114
TCD01A	1,33	100	800	114
TCD01N	1,33	100	800	114
TCD02A	1,36	100	800	114
TCD02N	1,36	100	800	114
TCD04A	1,45	100	800	114
TCD04N	1,45	100	800	114
TCD04T	4,15	100	800	114
TCD06A	2,19	100	800	114
TCD06N	2,19	100	800	114
TCD10A	2,38	100	800	114
TCD10N	2,38	100	800	114
TCD10T	4,99	100	800	114
TCD16A	3,79	100	400	114
TCD16N	3,79	100	400	114
TCD16T	11,06	100	400	114
TCD35A	4,38	100	200	114
TCD35N	4,38	100	200	114
TCD35T	12,75	100	200	114
TE-1508N/50	1,43	70	1400	115
TE-2508A/50	1,73	50	1000	115
TE-4009G/50	2,24	30	600	115
TE-6012AM/50	3,16	20	400	115
TE-1012R/50	4,28	16	320	115
TE-1612B/50	4,51	10	200	115
TE-2516N/50	8,29	5	100	115
TE-3516R/50	8,78	4	80	115
TE-5020A/50	20,02	2	40	115
TE2-1508N/50	2,16	30	600	115
TE2-2510A/50	3,44	20	400	115
TE2-4012G/50	3,98	16	320	115
TE2-6014AM/50	5,44	12	240	115
TE2-10014R/50	7,44	8	160	115
TE2-16014A/50	9,83	4	80	115
TF15R/50	3,67	20	400	115
TF25A/50	3,85	20	400	115
TF60AM/50	4,59	16	320	115
TF712	0,43	75	6000	85
TF1016	0,46	100	4000	85
TF1020	0,58	50	2000	85
TF1212	0,56	50	4000	85
TF1616	0,60	50	2000	85
TF1625	0,83	50	1500	85
TF2525	1,52	40	640	85

C*: Consulte precio.



Accede a la tarifa PVP actualizada

ÍNDICE POR REFERENCIA

Ref.	PVP			Pág.	Ref.	PVP			Pág.
TF2540	2,47	40	640	85	V934IL	18,02	1	26	93
TF4040	3,14	30	600	85	V935IL	19,06	1	26	93
TF4070	3,99	10	320	85	V936IL	19,87	1	24	93
TF6060	4,65	10	180	85	V953IL	22,02	1	25	93
TF60100	5,74	10	160	85	V954IL	24,88	1	24	93
TH15R/50	3,55	30	600	116	V955IL	25,88	1	20	93
TH15-1R/50	3,98	20	400	116	V956IL	26,76	1	20	93
TH25A/50	3,90	20	400	116	V1049	23,61	1	20	93
TH25-1A/50	4,12	20	400	116	V1051	63,96	1	10	93
TH60AM/50	8,90	12	240	116	V1053	38,43	1	10	93
TH60AM-2/50	9,86	12	240	116	V1300	4,10	14	112	97
TL15R/50	3,67	30	600	115	V1302	8,58	7	56	97
TL25A/50	3,89	20	400	115	V1705	5,13	32	512	105
TL60AM/50	4,59	16	320	115	Y686	12,34	1	30	46
TPCU-6D5/50	17,25	50	300	116	Y715	4,23	6	108	46
TPCU-10D8/50	21,72	40	240	116	Y716	5,99	4	64	46
TPCU-16D10/50	27,03	25	150	116	Y815P	3,43	6	120	46
TPCU-25D10/10	8,36	60	360	116	Y816P	4,80	4	64	46
TPCU-35D12/10	12,82	40	240	116	Y886P	8,74	1	32	46
TPCU-50D12/10	20,98	30	180	116	Y686N	12,99	1	30	46
TPO-715	1,09	1	2500	47	Y715N	5,28	6	108	46
TPP15R/50	3,90	30	600	116	Y716N	6,99	4	64	46
TPP25A/50	4,24	30	600	116	Y815NP	4,28	6	120	46
TPP60AM/50	9,01	16	320	116	Y816NP	6,09	4	64	47
TR15R/50	3,55	30	600	116	Y886NP	10,89	1	32	47
TR15-1R/50	3,90	30	600	116	ZO-MP14	102,69	1	6	8
TR25A/50	3,90	20	400	116	ZO-MP28	119,53	1	6	8
TR25-1A/50	4,24	20	400	116	ZO-MP42	144,94	1	3	8
TR60AM/50	8,78	12	240	116	ZO-MP56	164,19	1	3	8
TR60-1AM/50	9,78	12	240	116					
TS35/SZ	5,13	2	20	30					
TTR1/50	19,25	10	200	116					
TTR2/50	23,87	10	200	116					
TTR5/50	33,84	6	120	116					
UN712	0,43	50	4.000	85					
UN1016	0,46	50	2.000	85					
UN1020	0,58	50	2.000	85					
UN1212	0,56	50	2.000	85					
UN1616	0,60	40	1.600	85					
UN1625	0,83	40	1.200	85					
UN2525	1,52	10	80	85					
UN2540	2,47	20	400	85					
UN4040	3,14	15	300	85					
UN4070	3,99	10	80	85					
UN6060	4,65	10	80	85					
UN60100	5,74	10	60	85					
UN5625GW	0,29	10	1.400	69					
V913IL	12,05	1	38	93					
V914IL	12,99	1	20	93					
V915IL	13,91	1	30	93					
V916IL	14,87	1	16	93					
V933IL	17,05	1	30	93					



C*: Consulte precio.

Tablas informativas serie Arelos

Dimensiones interiores y exteriores

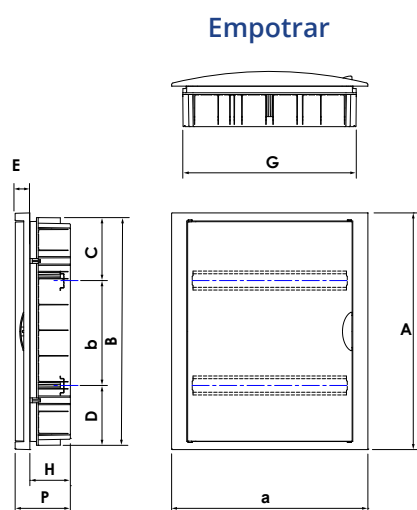

Ref.	Módulos	A	a	B	b	C	D	E	G	H	P
8692	2	140	62	130		65	65		60	62	85
8694	4	247	150	195		97	97		125	72	
8695C	4	247	150	195					125	72	
8208	4	300	165	270					140	72	
5108	8	249	247	233		116	166		205	72	
8688	12	247	302	220		110	110		277	72	
8680	12	247	409	226					382	72	
5012	14	250	362	233		116	116		320	75	
8881	16	247	477	222					450	72	
8685	18	247	409	225		112	112		386	72	
8880	18	247	560	226					533	72	
5420	20	438	362	420					320	75	
8690	22	247	477	222		111	111		450	72	
8203	24	253	423	320					400	72	
5250	28	438	362	420	193	110	116		320	75	102
5430	30	544	362	528					320	86	
5440	40	686	362	670					320	75	
8206	40	353	423	321	125	98	978		400	72	94
5260	42	544	362	526	150	113	113		360	86	113
5270	56	686	362	670	150	110	110		320	75	102

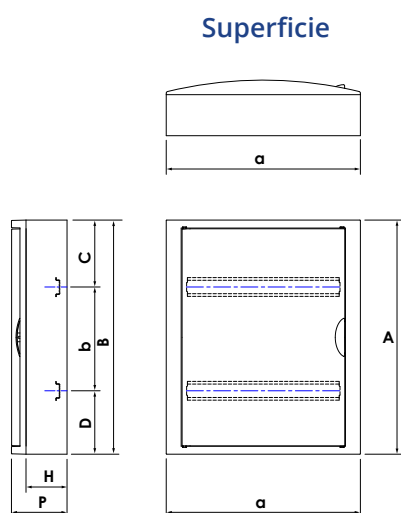

Ref.	Módulos	A	a	B	b	C	D	G	H	P
8692S	2	140	62							85
8684	4	225	150							95
8699	4	225	150							95
8209	4	300	165							95
5109	8	249	247							104
8703	12	246	302							104
8698	12	247	407							104
5021	14	250	362							104
8704	18	246	407							104
5421	20	438	362							104
8220	24	353	423							104
5281	28	436	362							104
5431	30	544	362							104
5441	40	686	362							104
8216	40	351	423							104
5261	42	543	362							104
5271	56	686	362							104



Tablas informativas serie Arelos

Marcos y puertas de reposición

Instalación	Caja	Marco + puerta	Caja	Marco + puerta
Empotrar	8680	8680RET	8680PF	8680PFRET
Empotrar	8881	8881RET	8881PF	8881PFRET
Empotrar	8880	8880RET	8880PF	8880PFRET
Empotrar	5420	5420RET	5420PF	5420PFRET
Empotrar	8203	8203RET	8203PF	8203PFRET
Empotrar	5430	5430RET	5430PF	5430PFRET
Empotrar	5440	5440RET	5440PF	5440PFRET
Empotrar	8692	8692RET	8692PF	8692PFRET
Empotrar	8695C	8695CRET	8695CPF	8695CPFRET
Empotrar	8694	8694RET	8694PF	8694PFRET
Empotrar	8208	8208RET	8208PF	8208PFRET
Empotrar	5108	5108RET	5108PF	5108PFRET
Empotrar	8688	8688RET	8688PF	8688PFRET
Empotrar	5012	5012RET	5012PF	5012PFRET
Empotrar	8685	8685RET	8685PF	8685PFRET
Empotrar	8690	8690RET	8690PF	8690PFRET
Empotrar	5250	5250RET	5250PF	5250PFRET
Empotrar	8206	8206RET	8206PF	8206PFRET
Empotrar	5260	5260RET	5260PF	5260PFRET
Empotrar	5270	5270RET	5270PF	5270PFRET

Instalación	Caja	Marco + puerta	Caja	Marco + puerta
Superficie	8699	8695CRET	8699PF	8695CPFRET
Superficie	8698	8880RET	8698PF	8880PFRET
Superficie	5421	5420RET	5421PF	5420PFRET
Superficie	8209	8208RET	8209PF	8208PFRET
Superficie	8220	8203RET	8220PF	8203PFRET
Superficie	5431	5430RET	5431PF	5430PFRET
Superficie	5441	5440RET	5441PF	5440PFRET
Superficie	8692S	8692RET	8692SPF	8692PFRET
Superficie	8684	8694RET	8684PF	8694PFRET
Superficie	5109	5108RET	5109PF	5108PFRET
Superficie	8703	8688RET	8703PF	8688PFRET
Superficie	5021	5012RET	5021PF	5012PFRET
Superficie	8704	8685RET	8704PF	8685PFRET
Superficie	5281	5250RET	5281PF	5250PFRET
Superficie	8216	8206RET	8216PF	8206PFRET
Superficie	5261	5260RET	5261PF	5260PFRET
Superficie	5271	5270RET	5271PF	5270PFRET

Enlaces entre cajas de la Serie ARELOS

		DISTRIBUCIÓN								ICT		
		5012 /PF	5108 /PF	5250 / PF	5260 /PF	5270 /PF	8206 /PF	8685 /PF	8688 /PF	8690 /PF	5504/2	5560/2
DISTRIBUCIÓN	5012 /PF	V (UN20) H (UN40)	H (UN40)	V (UN20)	V (UN20)	V (UN20)						
	5108 /PF	H (UN40)	V (UN20) H (UN40)									
	5250 /PF	V (UN20)		V (UN20) H (UN40)	V (UN20)	V (UN20)						
	5260/PF	V (UN20)		V (UN20)	V (UN20) H (UN10)	V (UN20)					V (UN20)	V (UN20)
	5270 /PF	V (UN20)		V (UN20)	V (UN20)	V (UN20) H (UN40)					V (UN20) H (UN30)	V (UN20) H (UN30)
	8206 /PF						VH (UN20)				V (UN20)	V (UN20)
	8685 /PF							VH (UN30)				
	8688 /PF								VH (UN30)			
	8690 /PF									VH (UN30)		

V	Enlace vertical
H	Enlace horizontal
VH	Enlace vertical y horizontal

NOTAS:

- Los posibles enlaces de las cajas para instalación en tabiques huecos serán los mismos que tienen esas cajas en su versión para instalación en tabiques de obra macizos.
- Las cajas de superficie no se enlazan.





BOLCOR5504/4

Ref.	Descripción
5108HGW	Caja de distribución
5012HGW	
5250HGW	
5270HGW	
5420HGW	
5440HGW	Caja ICT
5504/2HGW	



BOLCOR5260/4

Ref.	Descripción
5260HGW	Caja de distribución
5430HGW	
8203HGW	



BOLCOR5506/4*

Ref.	Descripción
5506HGW	Caja de conexión
5507HGW	

*Disponibilidad a finales de septiembre



G-MP28/4

Ref.	Descripción
8690HGW	Caja de distribución
8881HGW	



Tablas informativas series Indubox y Metalbox

Dimensiones cajas INDUBOX

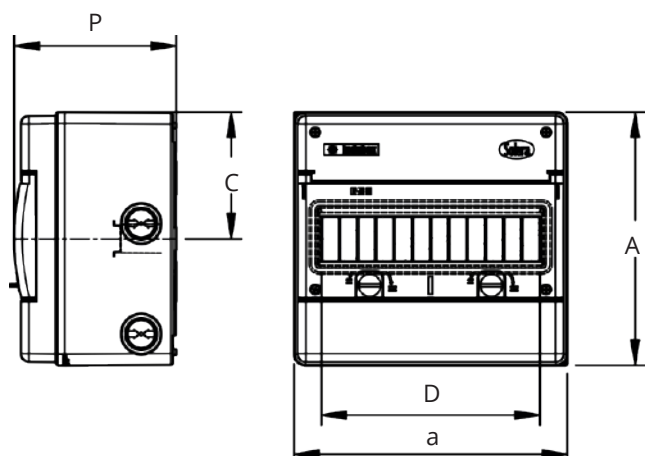

Ref.	A	a	C	D	P
1303	155	85	77,5	54	100
1304	200	120	100	72	115
1306B	200	170	100	108	115
1308A	200	215	100	144	160
1308B	200	215	100	144	115
1311A	250	270	75	198	160
1312	250	270	125	216	160
1322	500	270	125	198	160
1336	362	362	125	324	160
1348	500	362	125	288	160

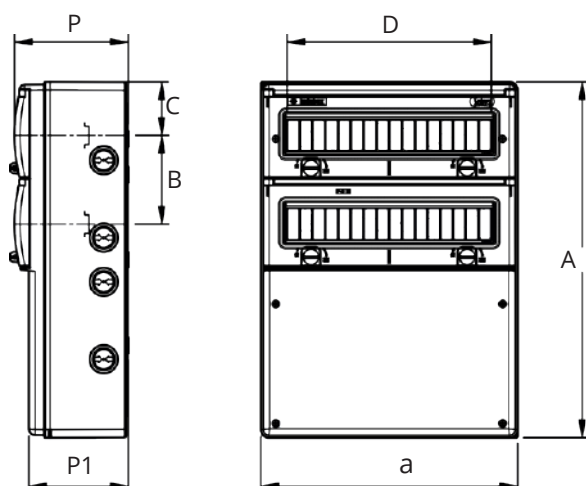

Ref.	A	a	B	C	D	P	P1
818A	200	215					140
818B	200	215					95
820	500	270	---	---	---	---	140
821	500	362	---	---	---	---	140
1308	500	215	---	87,5	144	160	140
1311	500	270	---	125	198	160	140
1316	500	362	---	125	288	160	140
1332	500	362	125	75	288	160	140

Dimensiones cajas METALBOX

Croquis	REF.	Dimensiones (mm)									
		A	a	B	C	D	E	F	G	P	
	Dimensiones caja de empotrar										
	MP14	327		297	161	136					
	MP28	462		432	161	136					
	MP42	643		613	184	159					
	MP56	778		748	184	159					
	Dimensiones caja con zócalo										
	MP14 + ZO-MP14	327	360								105
	MP28 + ZO-MP28	462	360								105
	MP42 + ZO-MP42	643	360								105
	MP56 + ZO-MP56	778	360								105



Tablas informativas serie Estancas



SIN CONOS

Ref.	Dimensiones exteriores (mm)	Grados de protección		Precintable	Color
		IP	IK		
604C	90x90x40	55	07	No	Gris
615C	110x110x50	55	07	No	Gris
815	110x110x60	65	08	Si	Gris
815N	110x110x60	65	08	Si	Negro
816	160x120x71	65	08	Si	Gris
816N	160x120x71	65	08	Si	Negro
817	165x145x84	65	08	Si	Gris
817G	165x145x84	65	08	Si	Gris
817N	165x145x84	65	08	Si	Negro
818A	215x200x140	65	08	No	Gris
818B	215x200x95	65	08	No	Gris
820	270x500x140	65	08	Si	Gris
821	362x500x140	65	08	Si	Gris
886	230x180x88	65	08	Si	Gris
886A	230x180x150	65	08	Si	Gris
886ATP	230x180x150	65	08	Si	Gris y tapa transparente
886ATPG	230x180x150	65	08	Si	Gris y tapa transparente
886G	230x180x88	65	08	Si	Gris
886N	230x180x88	65	08	Si	Negro
886AG	230x180x150	65	08	Si	Gris
6815	110x110x60	65	08	Si	Gris y tapa transparente
6816	160x120x71	65	08	Si	Gris y tapa transparente
6817	165x145x84	65	08	Si	Gris y tapa transparente
6817G	165x145x84	65	08	Si	Gris y tapa transparente
6886	230x180x88	65	08	Si	Gris y tapa transparente
6886G	230x180x88	65	08	Si	Gris y tapa transparente
100887	320x250x135	65	09	Si	Gris
100887TP	320x250x135	65	08	Si	Gris y tapa transparente
100887G	320x250x135	65	08	Si	Gris
100887TPG	320x250x135	65	08	Si	Gris y tapa transparente
100887N	320x250x135	65	08	Si	Negro



CON CONOS

Ref.	Dimensiones exteriores (mm)	Nº entradas y Métrica (Ø)					Grados de protección		Precintable	Color
		M20	M25	M32	M40	M50	IP	IK		
604	90x90x40	7	-	-	-	-	55	07	No	Gris
615	110x110x50	-	7	-	-	-	55	07	No	Gris
616	165x120x60	-	8	2	-	-	55	08	No	Gris
665	Ø 77x40	4	-	-	-	-	55	08	No	Gris
686	230x180x88	-	-	12	2	-	55	09	Si	Gris
686A	230x180x150	-	-	12	2	-	55	08	Si	Gris
686ATP	230x180x150	-	-	12	2	-	55	08	Si	Gris y tapa transparente
686N	230x180x88	-	-	12	2	-	55	08	Si	Negro
686TP	230x180x88	-	-	12	2	-	55	08	Si	Gris y tapa transparente
686G	230x180x88	-	-	12	2	-	55	08	Si	Gris
686AG	230x180x88	-	-	12	2	-	55	08	Si	Gris
715	110x110x60	-	7	-	-	-	55	08	Si	Gris
715TP	110x110x60	-	7	-	-	-	55	08	Si	Gris y tapa transparente
715N	110x110x60	-	7	-	-	-	55	08	Si	Negro
716	160x120x71	-	8	2	-	-	55	08	Si	Gris
716N	160x120x71	-	8	2	-	-	55	08	Si	Negro
716TP	160x120x71	-	8	2	-	-	55	08	Si	Gris y tapa transparente
717	165x145x84	-	-	8	2	-	55	08	Si	Gris
717G	165x145x84	-	-	8	2	-	55	08	Si	Gris
717N	165x145x84	-	-	8	2	-	55	08	Si	Negro
717TP	165x145x84	-	-	8	2	-	55	08	Si	Gris y tapa transparente
100888	320x251x134	-	-	4	2	6	55	09	Si	Gris
100888N	320x251x134	-	-	4	2	6	55	08	Si	Negro
100888TP	320x251x134	-	-	4	2	6	55	08	Si	Gris y tapa transparente



- Las fotografías contenidas en esta Tarifa - Catálogo no representan todos los productos de Solera, sino que son un ejemplo.
- La unidad de venta mínima de algunas referencias está indicado en su propia descripción.
- Existen algunas referencias que tienen dos códigos GTIN-13, es decir, el código unitario, y el código del envase.

DESCRIPCIÓN DE LAS COLUMNAS DE LA TARIFA-CATÁLOGO

PROTECCIONES. Pulsadores e indicadores

Referencias	Descripción	GTIN-13 unitario	PVP	Unidades de envase	GTIN-13 envase	Unidades de envase
	Interruptor selector de 3 posiciones. Sin retorno. Ø22mm. 250V.					
INT5/3A2	Interruptor selector de 3 posiciones. Tipo de contactos 2NO.	8423220078550	13,76	1	8423220066212	250

1. Descripción de la familia de los productos.
2. Descripción de las sub-familias de los productos.
3. Fotografía de ejemplo del producto.
4. Descripciones complementarias del producto (en algunos productos, también se indica la unidad de venta mínima en esta descripción).
5. Códigos GTIN-13: algunos productos tiene código unitario y código de envase (El código EAN13 (EAN = European Article Number) ha sido sustituido por el código GTIN13 (GTIN = Global Trade Item Number), para ampliar su rango de uso en todo el mundo, no solo en Europa).
6. Unidades de envase (en algunos productos la unidad de envase mínima y las unidades de envase no son las mismas).
7. Columna Referencias: referencia de los producto.
8. Columna PVP: precios de los productos.
9. Columna Unid. Emb.: Unidades del embalaje. En algunos productos se indica esta unidad en metros.





PORTALÁMPARAS Y ACC. SOLERA S.A.

FÁBRICA Y OFICINAS VALENCIA

Polígono Fuente del Jarro,
Calle Villa de Madrid, 53 - 46988 Paterna (Valencia)
Tel. 96 132 23 01 / Fax 96 132 39 54
solera@psolera.com / www.psolera.com
Coordenadas: N 39° 31' 06"
W 0° 28' 00"

FÁBRICA CUENCA

16300 Cañete (Cuenca) España



2023

Síguenos en:

