

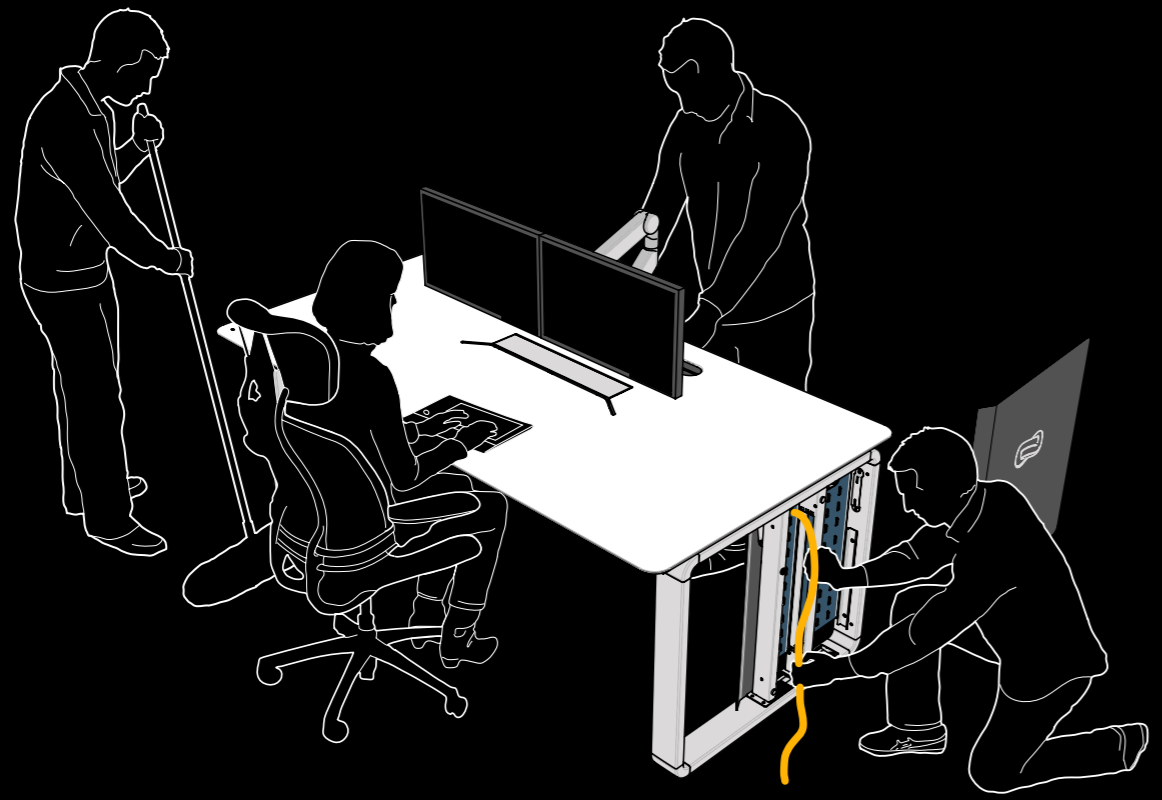

 **Gesab**[®]
guarantee for the future



advantis



Character

Pure lines. Vectors of beauty that come together to define a single architecture. Molecules floating in formal harmony. A new generation of organic minimalism.





Innovation

The perfect machine: power and control. Softness and firmness. Technology at the service of the imagination. Creativity for an efficient and safe environment.



Personality

Designed by people for people.
Sensory, emotional, intense.
An experience with identity.



Design

A line suggests an idea. A stroke conceives a way of seeing the world. The ADVANTIS concept is a philosophy of life, an attitude towards the challenges.





take control

Take control

Take the course, be in control. The future as destination and origin of the same trip. Technology and design that challenge the test of time.





advantis
NEW GENERATION

The system

*"Everything a person can imagine,
others can make it happen"*



Jules Verne

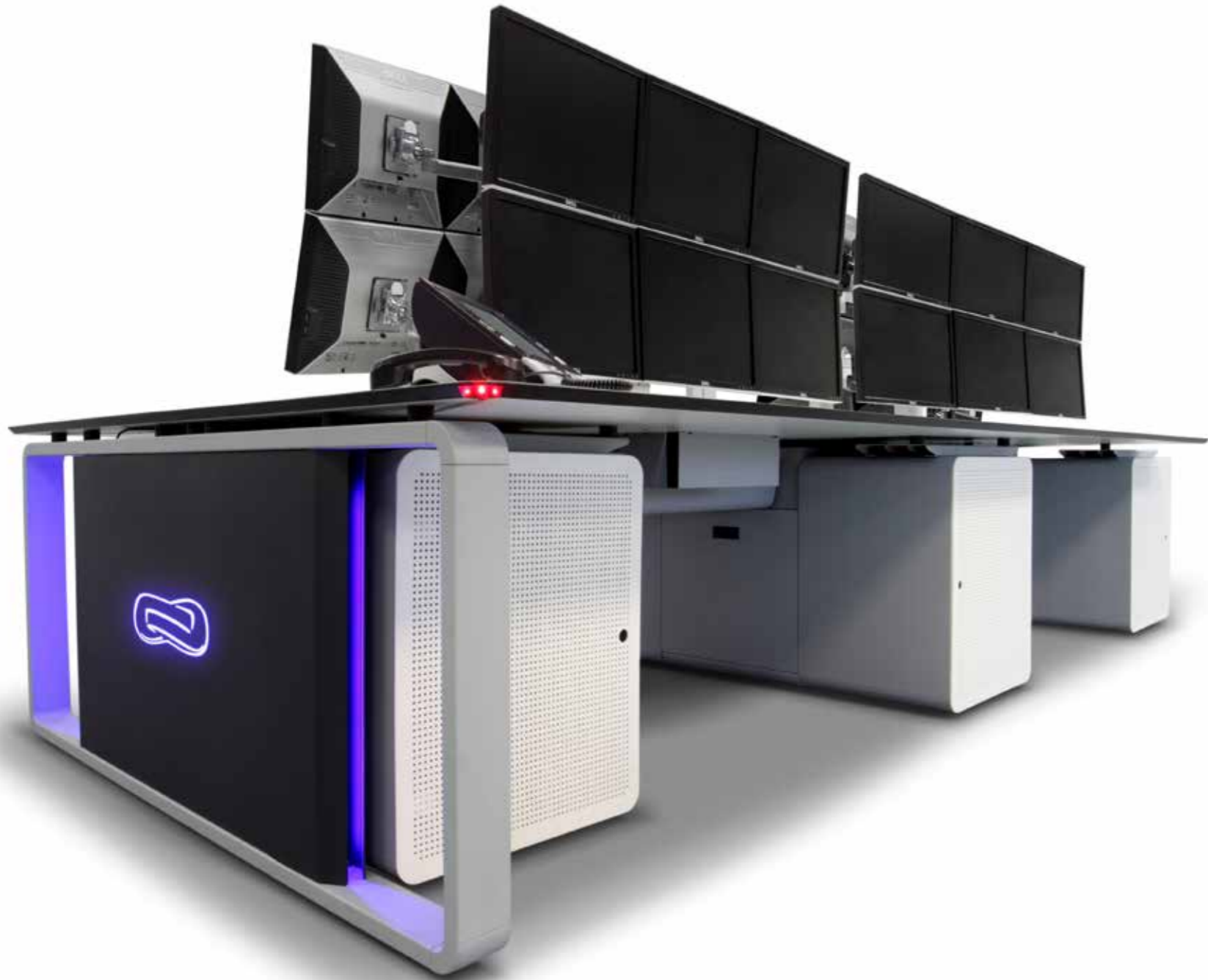





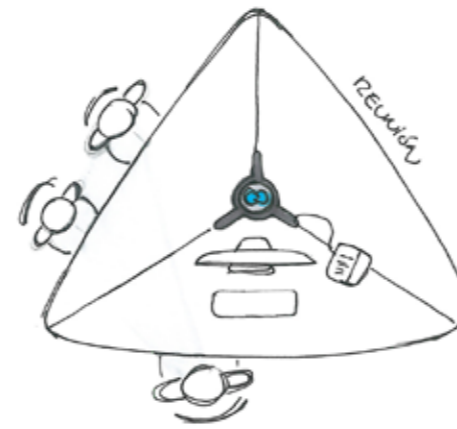

A global concept

"Practice should always be built on good theory"



Leonardo da Vinci

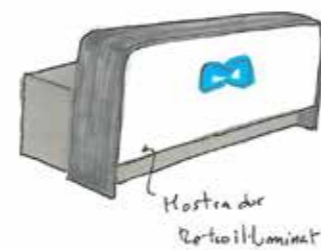
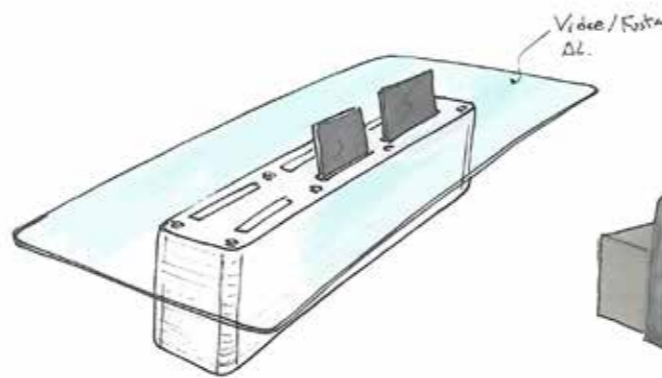
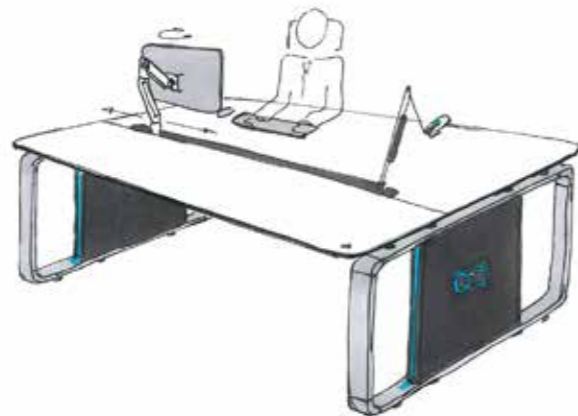
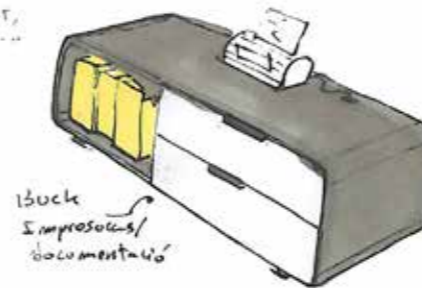
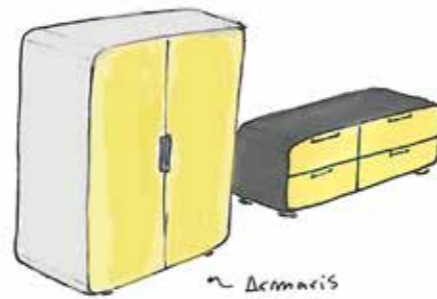

Beyond Technology

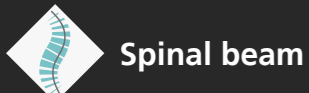

Spinal beam



Nexus Gate

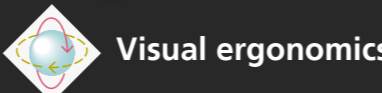

Visual ergonomics



i-Box



Safety

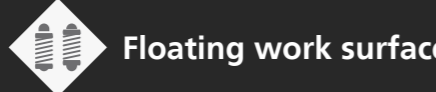

Floating work surface

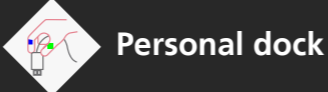

Personal dock



technical cabinet



Spinal beam

It is the backbone of the system. It fixes the structure and leads and distributes power and data cabling. Its amplitude can house inside KVM, thin client computers or any other kind of electronic equipment.

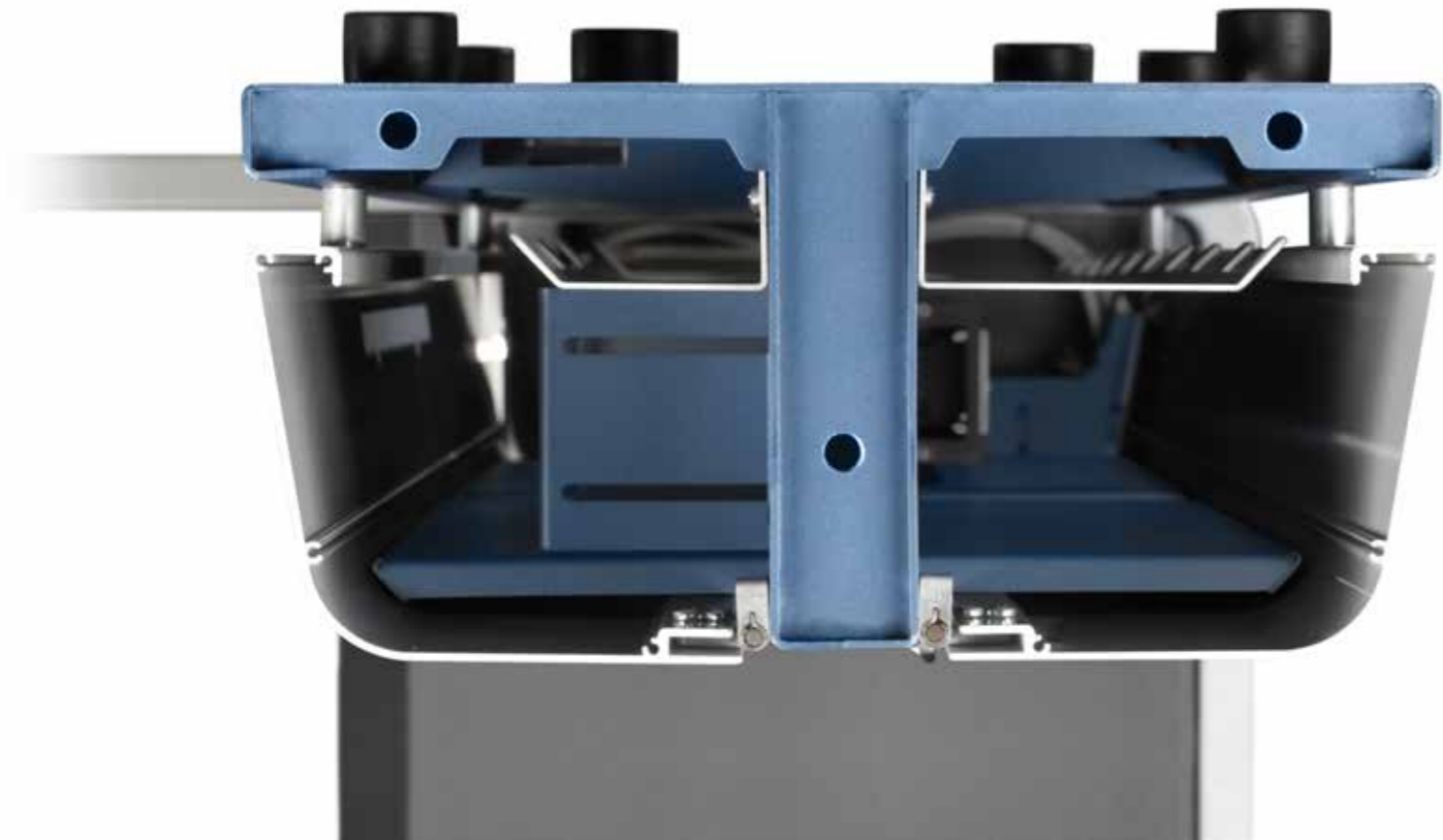



Nexus Gate

The ADVANTIS system favors maximum connectivity with an optimal wiring organization.

Its modular design adapts to all requirements and configurations of 24x7x365 operating environments.

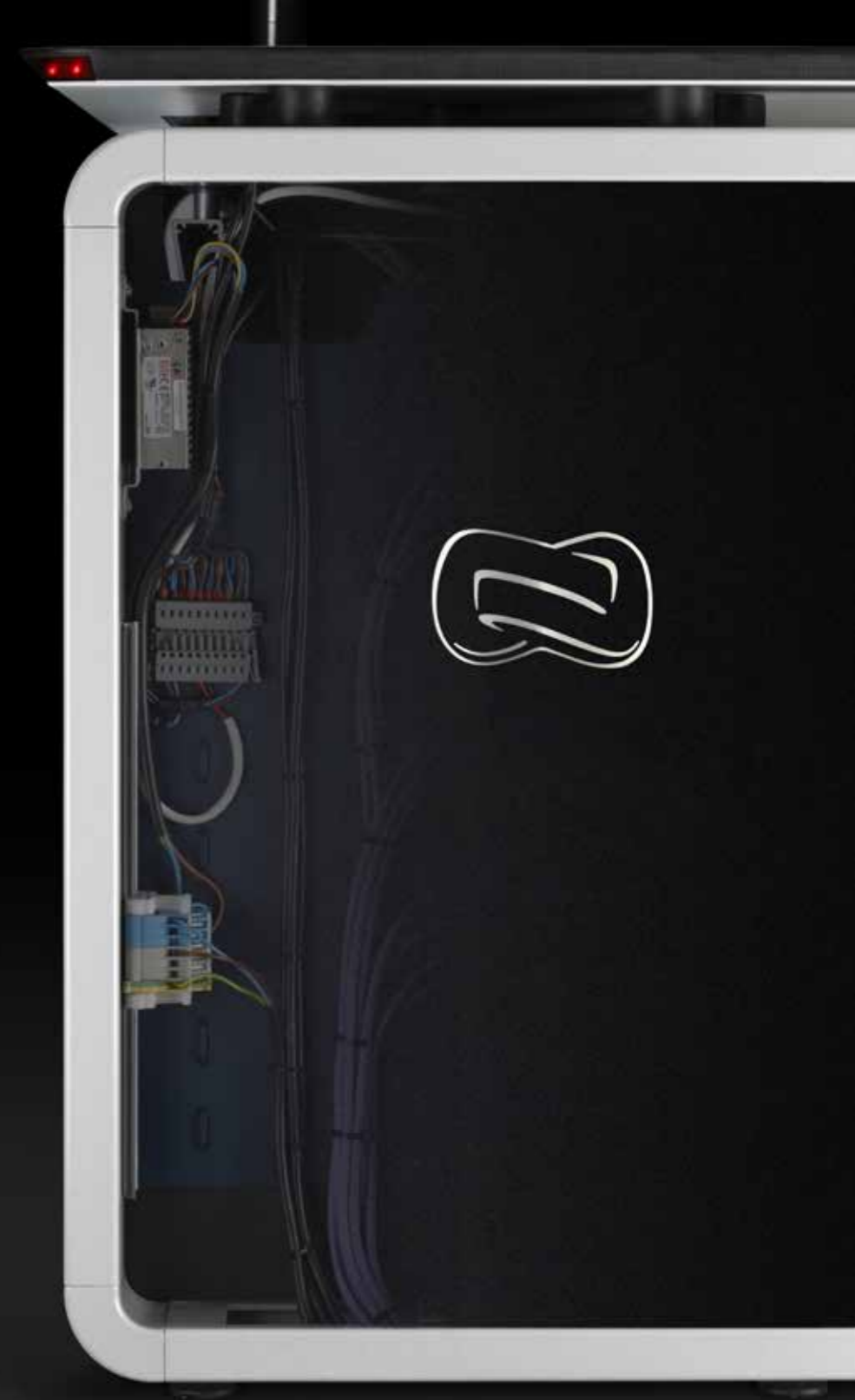



Floating work surface

In a place of high demand, the ADVANTIS console isolates the operator in a safe and healthy environment, free from vibration, thanks to the floating work plane.



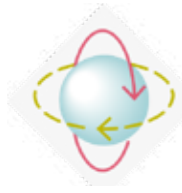

Visual ergonomics

The new and exclusive arms systems put cables away from the operator, hide them from view, leaving the operational area free. They fit all viewing needs and enhance the work with 4 dimensions ergonomics.





Safety

A unique integrated illumination system with LED beacons designed to meet safety and functionality requirements.

In any situation, everything remains under control.





Personal dock

A space for personal effects and operator connectivity.

Comfortable, flexible. Everything at hand, without leaving the control task.





i-Box

All the details are important. I-Box is a space designed for the comfort of people. This is a single container with the perfect size for documents and personal belongings.

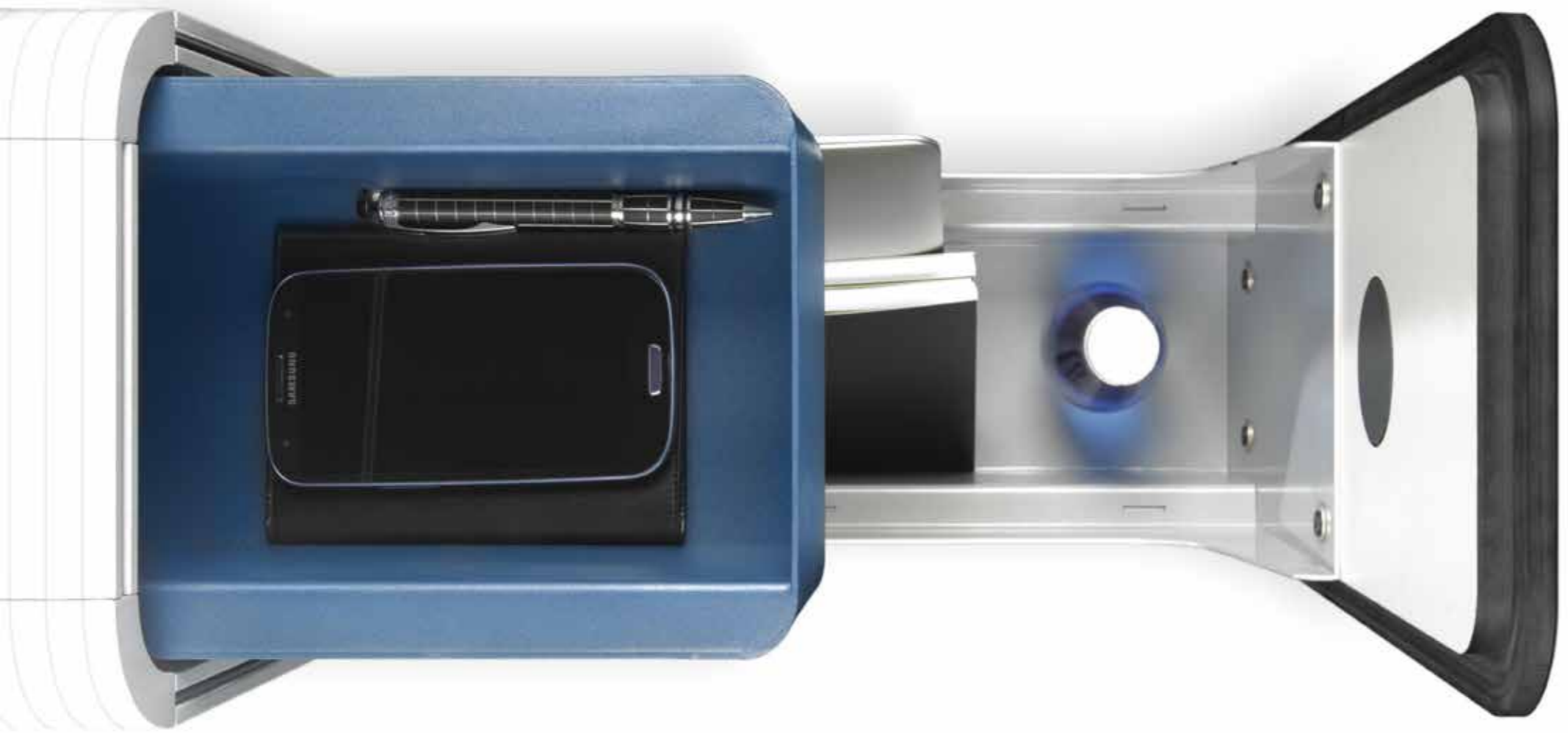

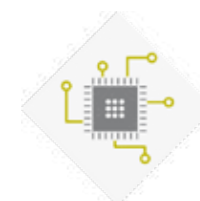

Technical cabinet

For the most demanding environments in terms of technical equipment, ADVANTIS has a wide range of technical cabinets that are integrated as never before in the very structure of the console to ensure direct communication with the rest of the console sectors and facilitate their integration.



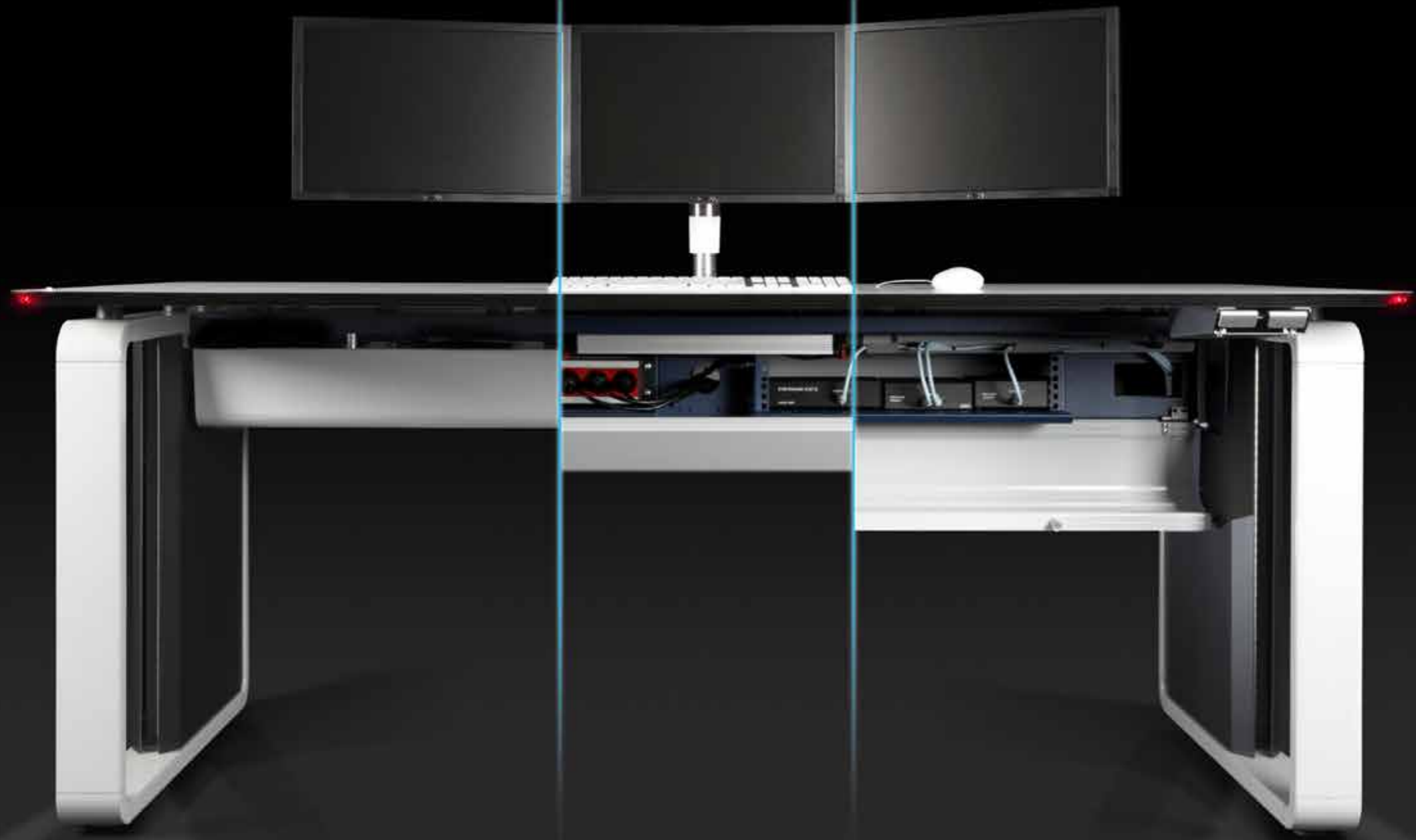



Conectivity

An infinite universe that comes together; it connects. Bidirectional pulses travel through the system to keep the information moving 24 hours a day. 365 days a year.





Smart KVM

Intelligent professional connectivity. No matter the distance or the difficulty of the task. ADVANTIS is ready for total control.





Human factor

Health, comfort and productivity. These are the three factors that, in that order, guide our designers.

GESAB'S ADVANTIS has been created fulfilling the UNE-EN 527-2011, ISO 11064-3 and NTP602.

"The action creates the form" is our philosophy in design: we provide solutions that are tailored to the working postures of the operator.

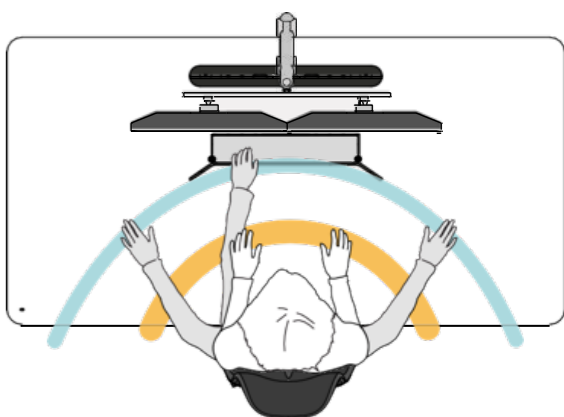
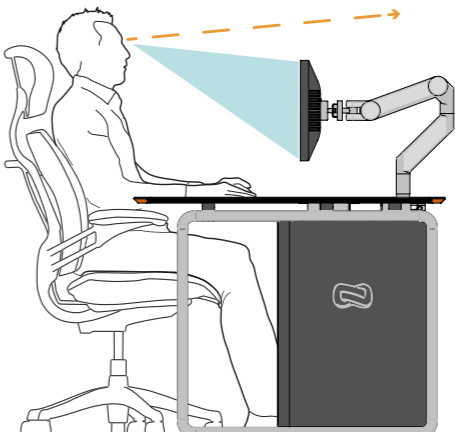
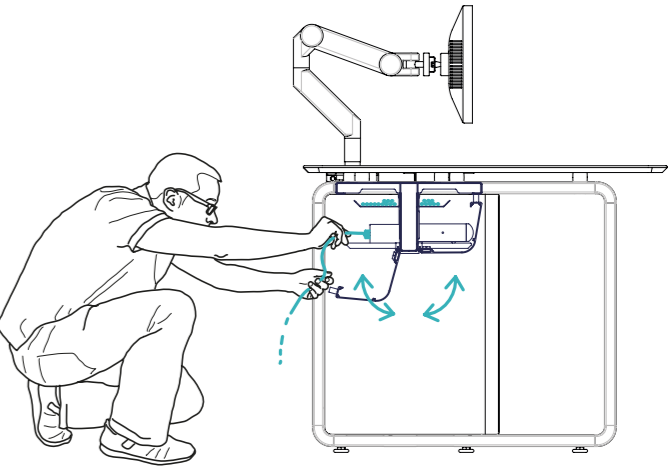

Ecology

GESAB designs its products and solutions with global, sustainable and future mindset. We design, manufacture and assemble with the awareness that the planet's resources are limited. So an ADVANTIS is highly made of recyclable materials that guarantee long life to the product. Such selective recycling process begins at the moment of its removal, after its useful life.



Finishes

The finishes are an intrinsic part of the product. For this reason GESAB has defined optimal colors and finishes for ADVANTIS that we recommend to apply, both for aesthetical and functionality reasons. DeepBlue NG is the color that guides the cable management, the nuclear part of the system.

advantis NEW GENERATION STANDARD METALLIC COLORS



DeepBlue NG



Anthracite



Metallic gray

FUNDERMAX

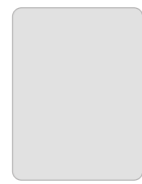

Efficiency and effectiveness

Instinct environmental protection for maximum performance. The greatest result with the least impact. The highest power with the lowest cost. ADVANTIS optimizes resources with an excellent result.

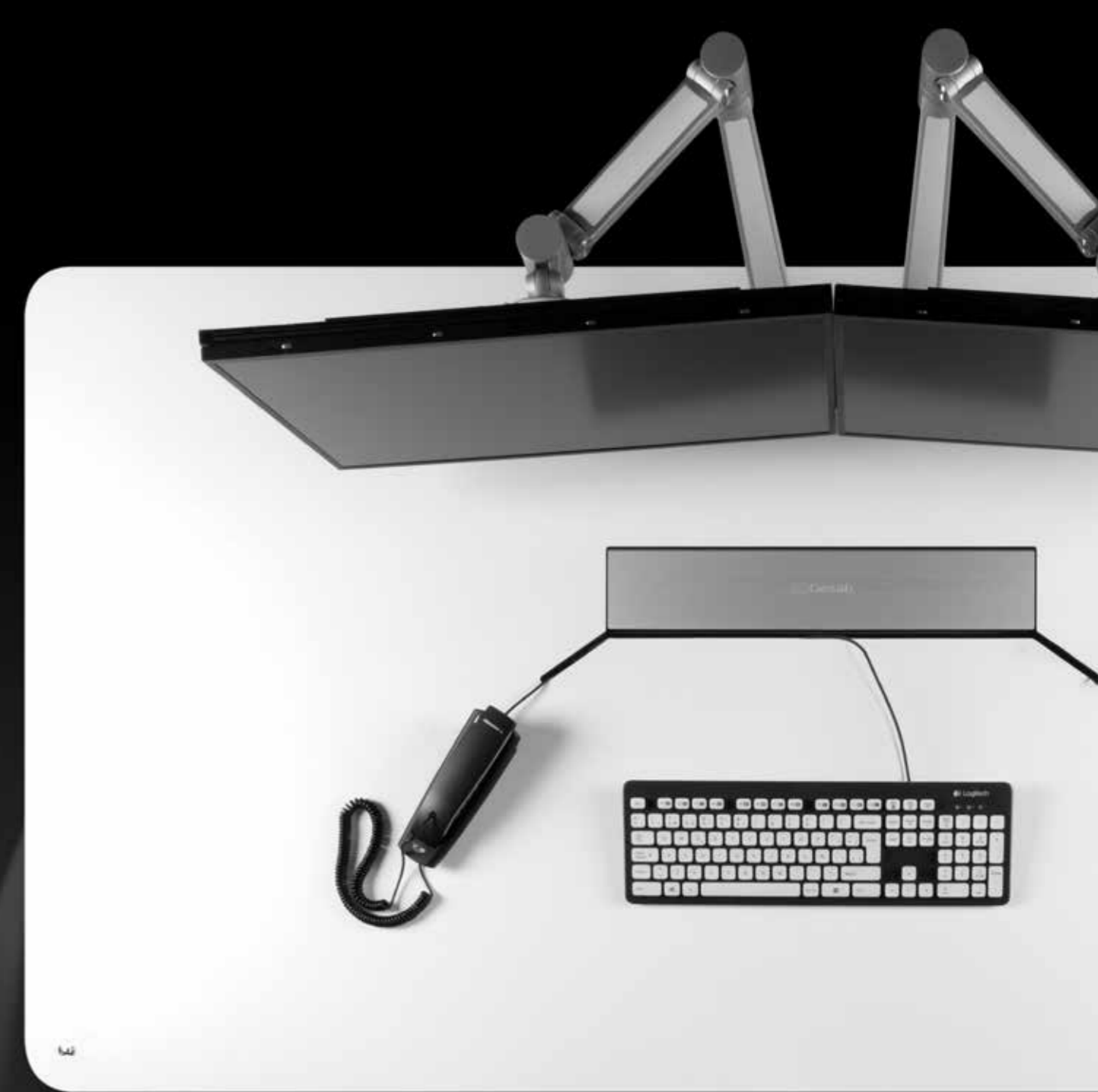
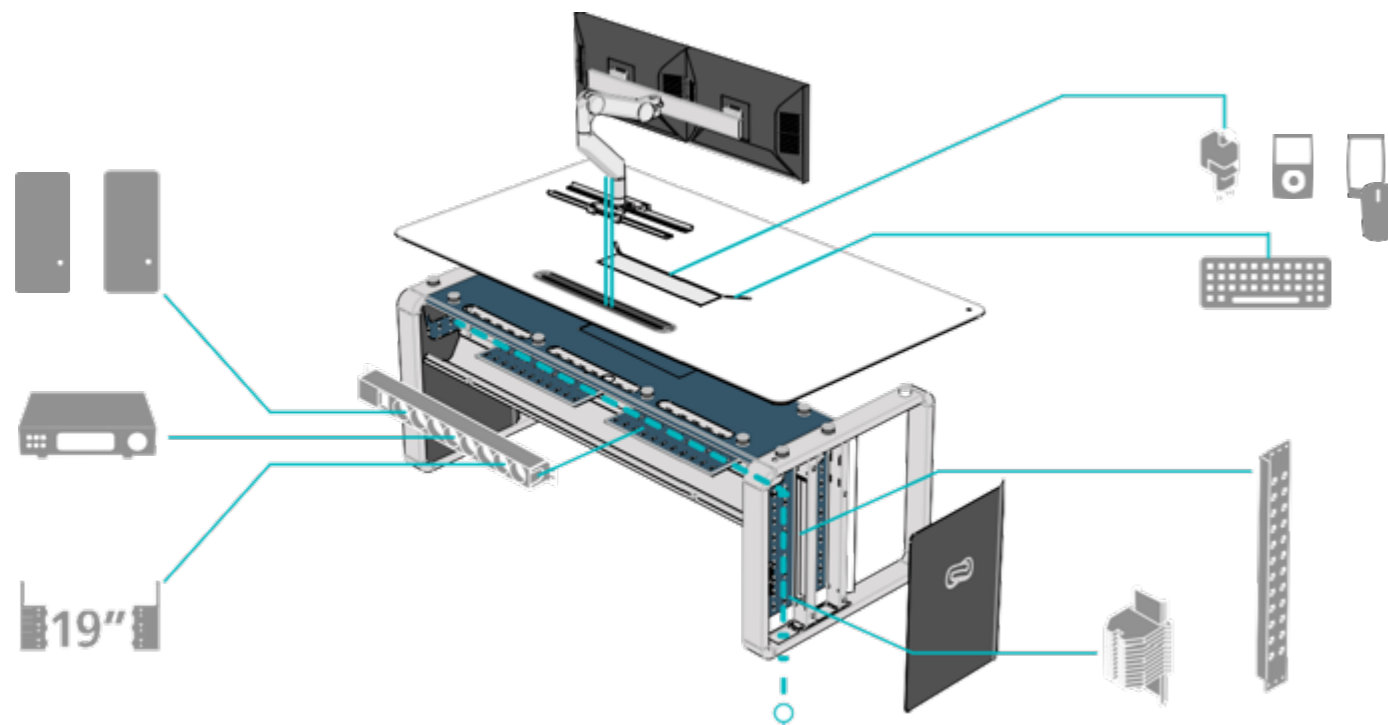



Integration

A melting pot of equipments, technologies, ideas and solutions that combine to provide balance, function and safety. No matter what setting or what performance is required, ADVANTIS integrates, perfectly, any device required.

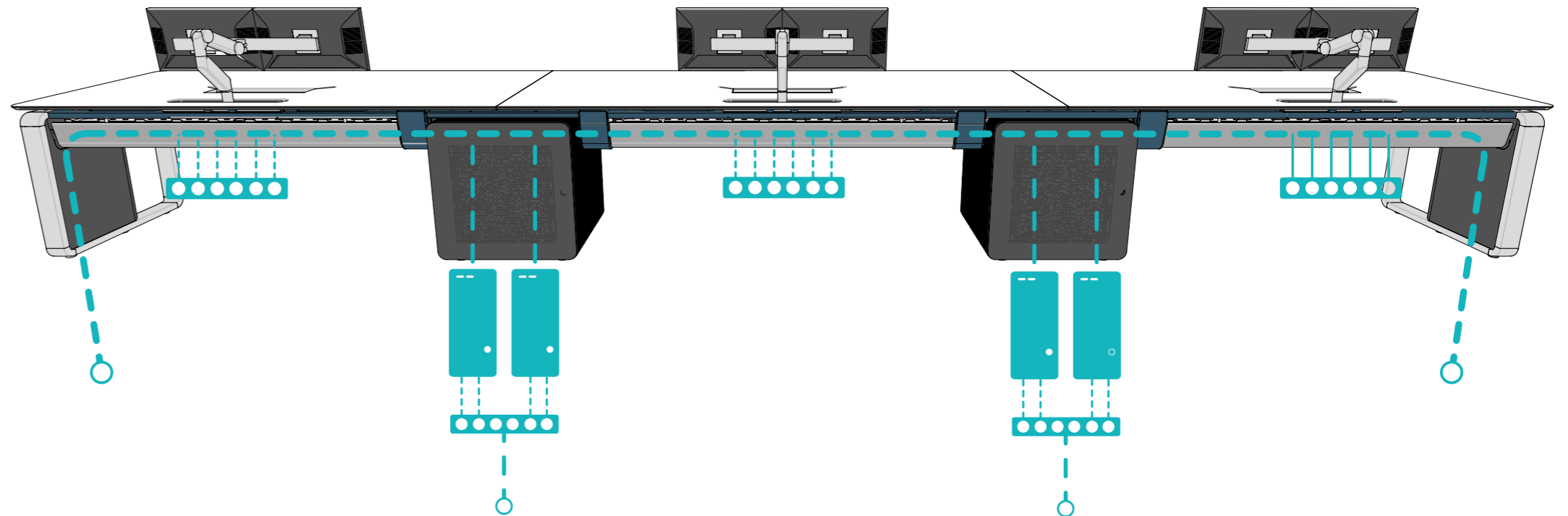

Modularity

ADVANTIS has been created as a part and as a whole. It may be a single or collective solution, in various forms and quantities: concave, convex, semicircular...

The degrees generator system allows conceiving solutions for any environment and requirement.

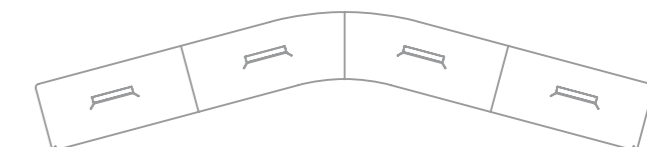
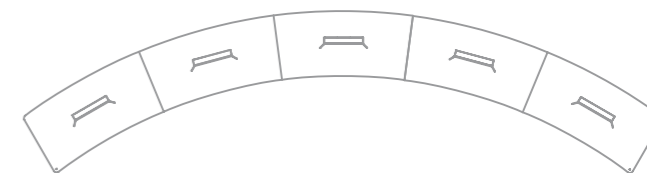
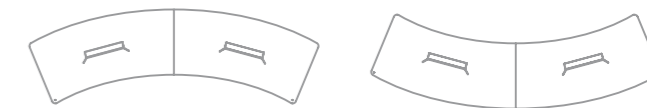
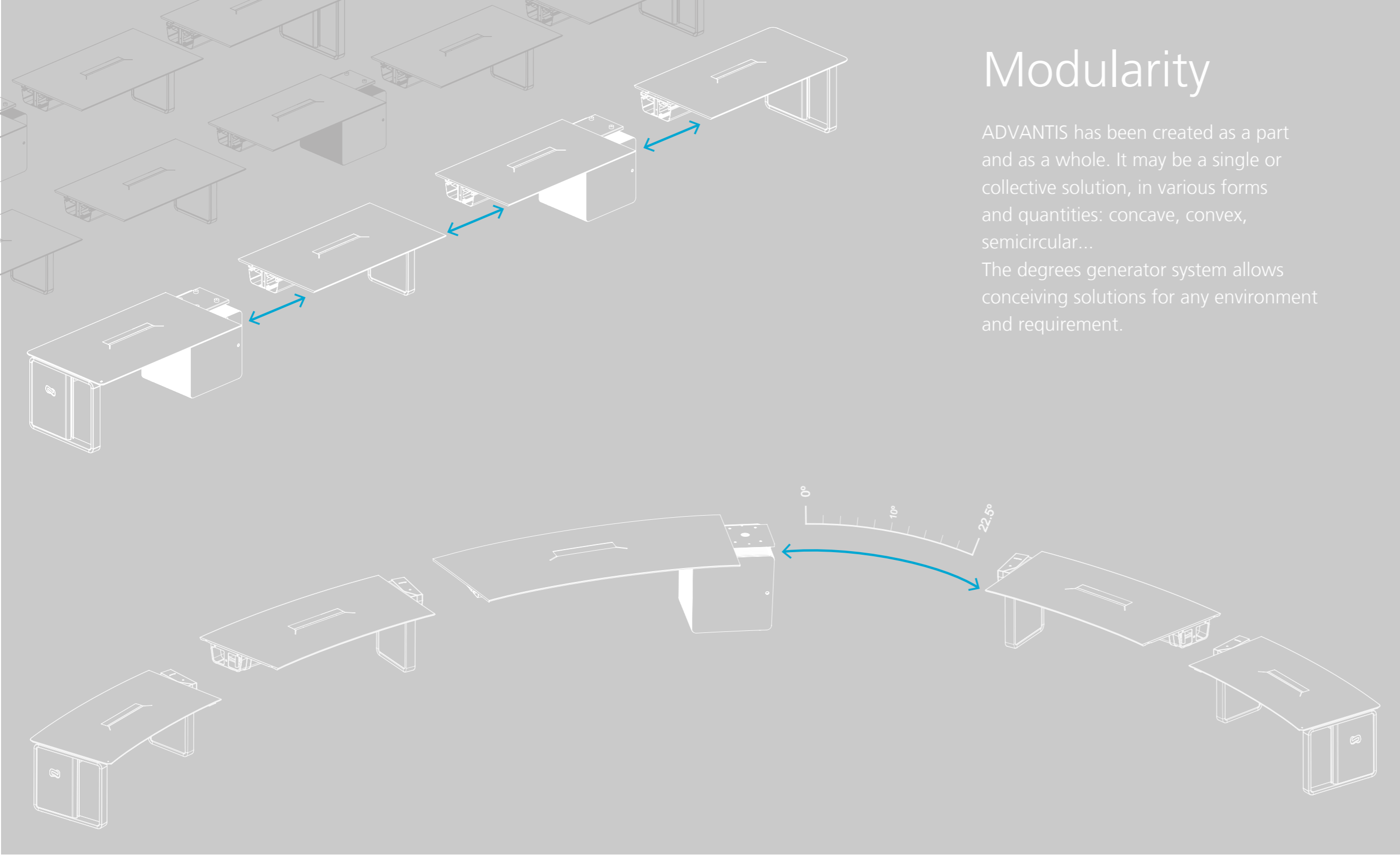

WI-4D SYSTEM

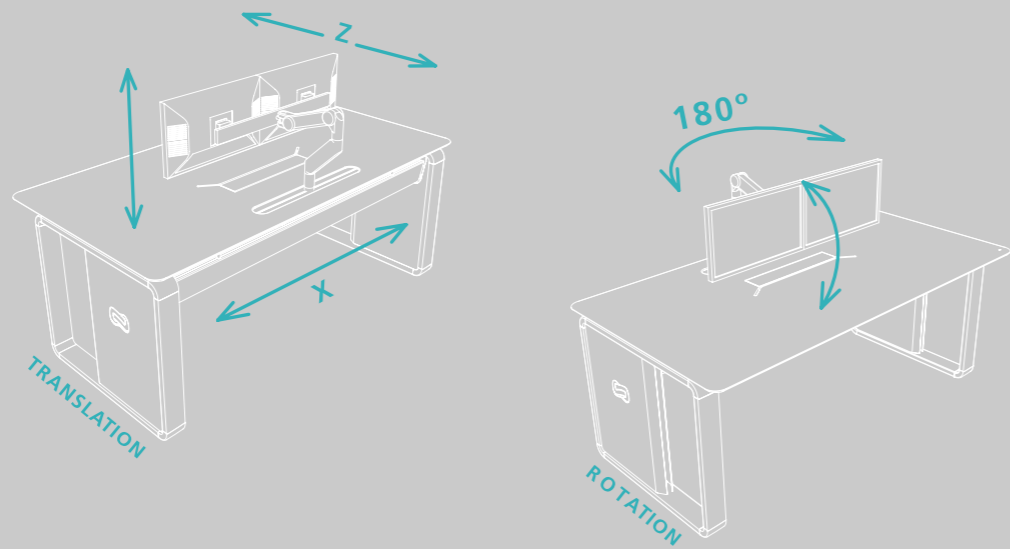

Regulation system hidden beneath the working surface. No tools need.

WI-RAIL SYSTEM

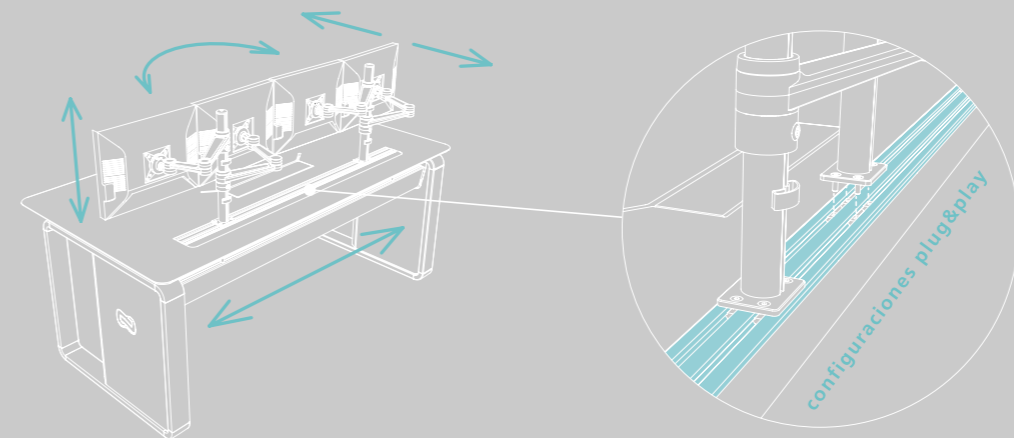

Control system using aluminum lane on the work

WI-STANDARD SYSTEM

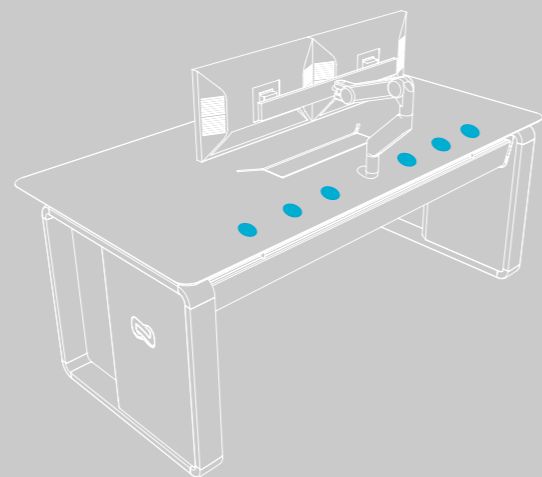





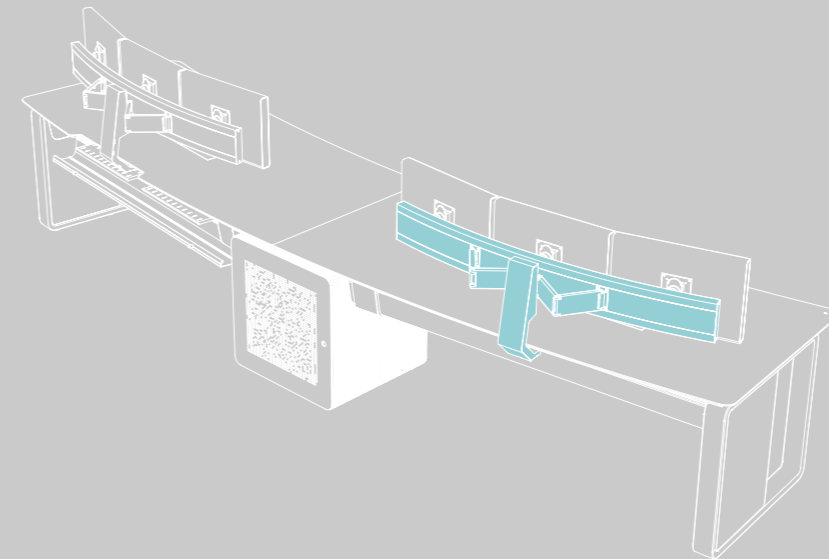

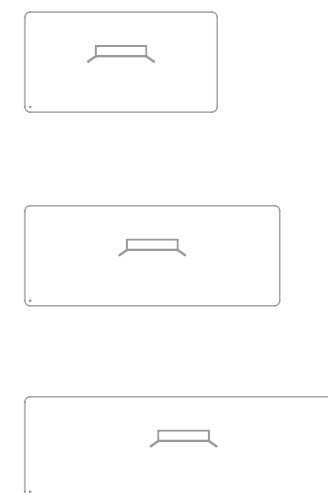
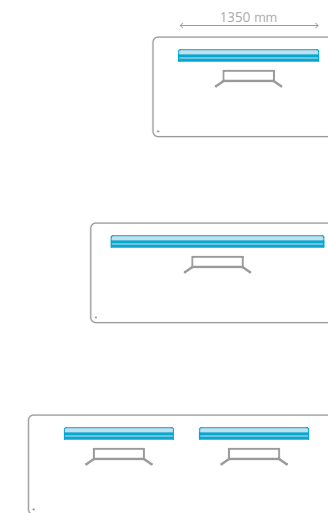
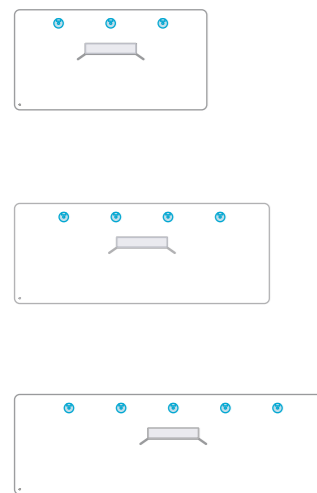
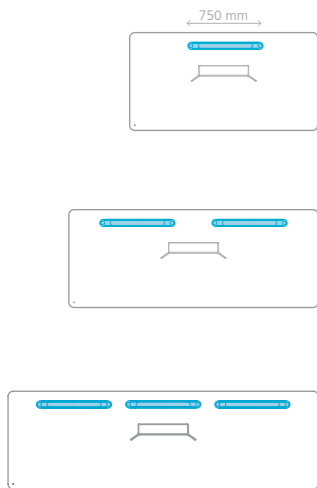

Standard articulated arm system without extended regulation.



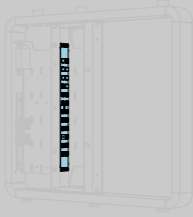

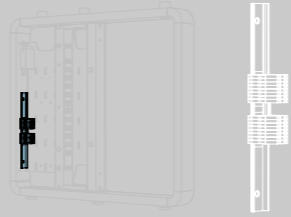
WI-ESPECIAL SYSTEM





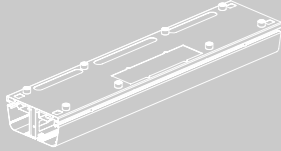
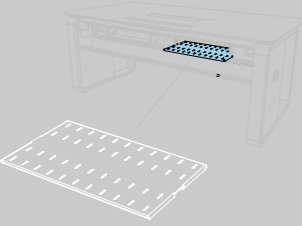
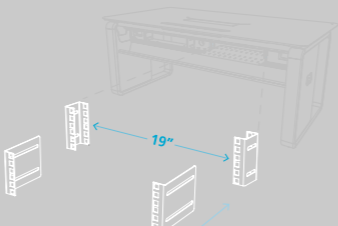



Development of special systems as required depending on the capacity and ergonomics of the project

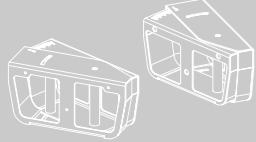
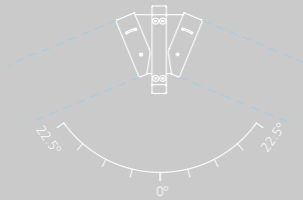
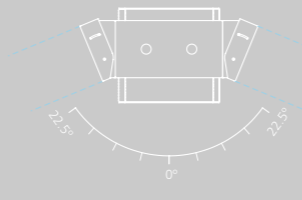



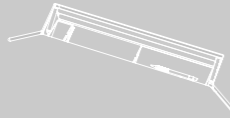
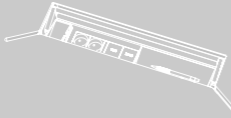
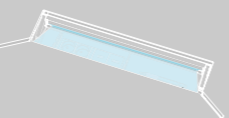





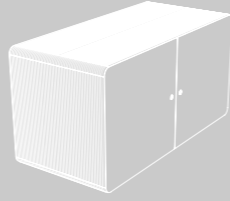
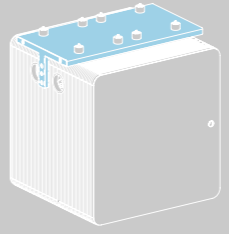
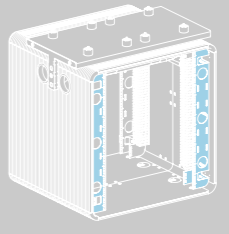



NEXUS GATE	Model	Accesories	Material / Finishes
	Extreme Intermediate Tradding Meetings Sit&Stand Peninsula	   	Steel caps  Aluminum profile frame  Steel frame  Steel channeling 



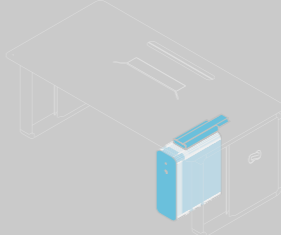

SPINAL BEAM	Model	Accesories	Material / Finishes
	1000mm 1300mm 1600mm 1900mm 2200mm 2500mm 2800mm	 	-Aluminium caps  -Steel structure  -Steel trays  -19" adapters 

ANGLE CREATION SYSTEM	Model	Options	Material / Finishes
	0°-22.5 22.5°-45°	 	-Steel creator structure 

PERSONAL DOCK	Model	Accesories	Material / Finishes
	Standard Meetings Two-sided version	  	-Nylon components  -Pivoting cover aluminum profile  -Steel tray 

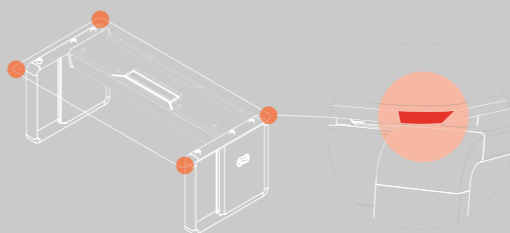
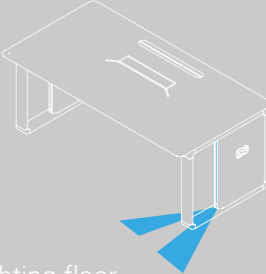
EQUIPMENT BUCK	Model	Accesories	Material / Finishes
	Individual (x1) Double (x2) Triple (x3) Aux. module	 	-Steel microperforated doors  -Structural aluminum profile  -Steel support  -Steel adapters 

i-BOX	Model	Options	Material / Finishes
	200MM 300MM	 	-Phenolic front  -Structural aluminum profile  -Steel integrator  -Internal steel drawer 

SAFETY	Model	Options	Material / Finishes
		 	-Red light  -White light  -Blue light 

GLOBAL CONCEPT
   
Advantis NG Sit&Stand Advantis NG Trading Advantis NG Supervisor Advantis NG Meeting

Contents

15 CONFIGURATION

- 16 The system
- 24 A global concept



47 TECHNOLOGY

- 48 Connectivity
- 50 Smart KVM
- 52 Human factor

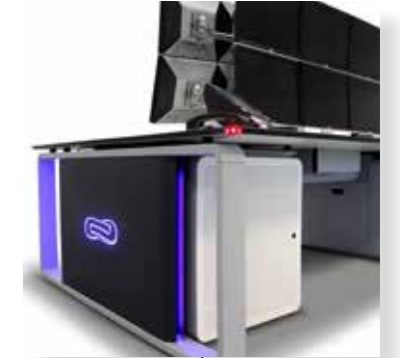

3 PRESENTATION

- 4 Character
- 6 Innovation
- 8 Personality
- 10 Design
- 12 Take Control



DIFFERENTIAL ELEMENTS 27

- Spinal Beam 28
- Nexus Gate 30
- Floating Operational Area 32
- Visual Ergonomics 34
 - Safety 36
- Personal Dock 38
 - i-Box 40
- Technical Cabinet 44

- Ecology 54
- Finishes 56
- Efficiency and effectiveness 58
- Integration 60

TECHNICAL DATA SHEET 63

- Modularity 62
- Systems 64
- Specs 66



Generation GESAB

Barcelona

938 427 050
Avda del Mogent 68
08450 Llinars del Valles

Madrid

915 345 064
C/ Marzo 61-67
28022 Madrid

Mexico City

+52 55 1997 0746
Homero #1205 Piso 3
Ciudad de México 11550

Atlanta

+1 404 990 3748
3020 Business Park Drive
Norcross, GA 30071 USA

Bogota

+57 1 2185459
Carrera 13 # 96 - 67
Bogotá, Colombia

Dubai

971 555 528 390
Al Quoz 1
Dubai, UAE

International

+34 915 345 064
C/ Marzo 61-67
28022 Madrid

gesab.com

info@gesab.com