

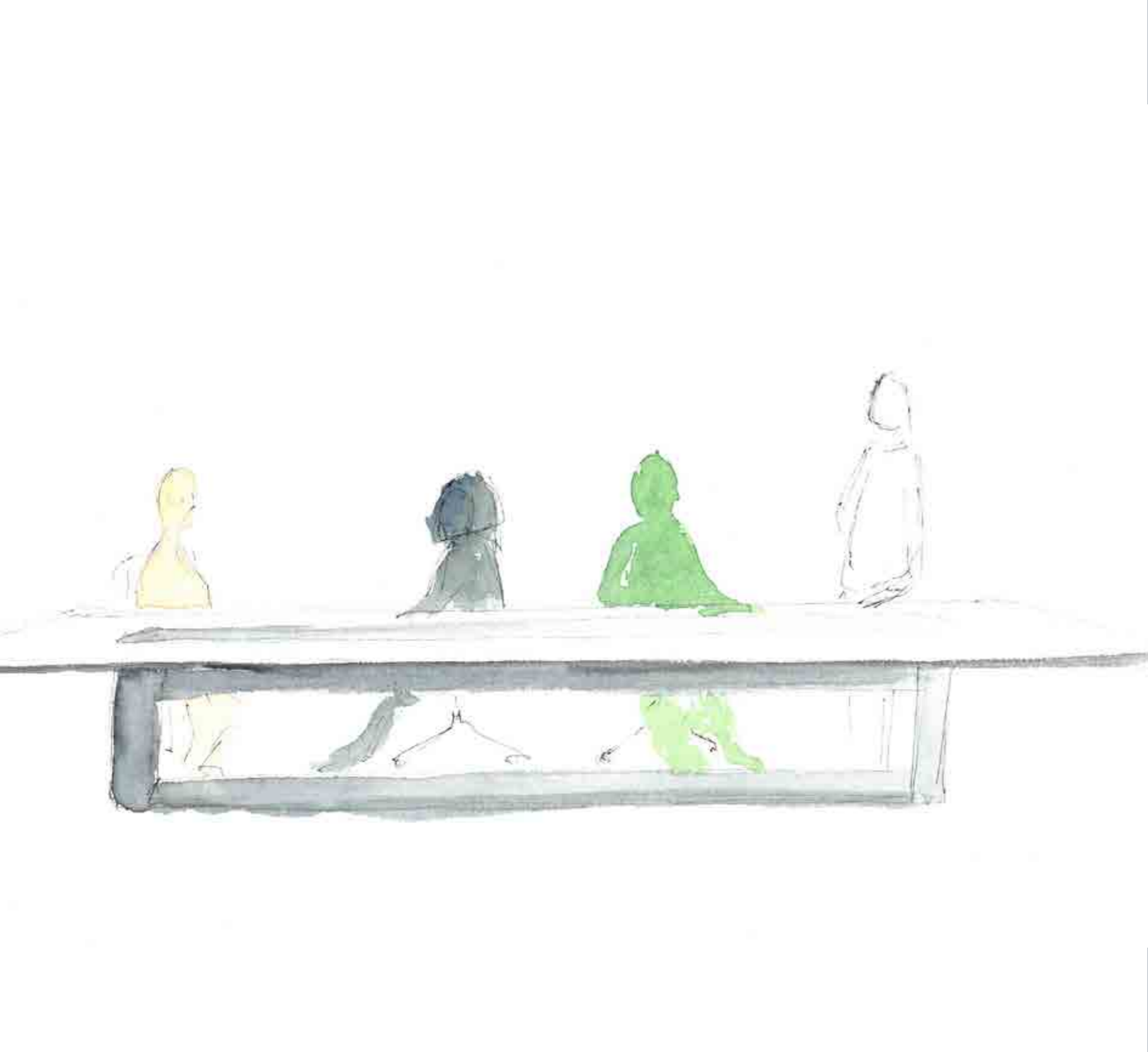

Meet

The GESAB vision  
for meeting rooms





Proper furniture and interior design enhances productivity and communication in collaborative rooms.



# Unified Design

All elements of the MEET family have the same geometric language. This homogenizes the design, creates harmony in the environment, and optimizes production by sharing parts for different pieces of furniture.

There is a MEET solution  
for every environment  
and requirement.



# Meeting Table

The MEET table offers maximum performance in terms of capacity, connection and cable management, with the least possible visual weight, resulting in an elegant, clean and functional design.

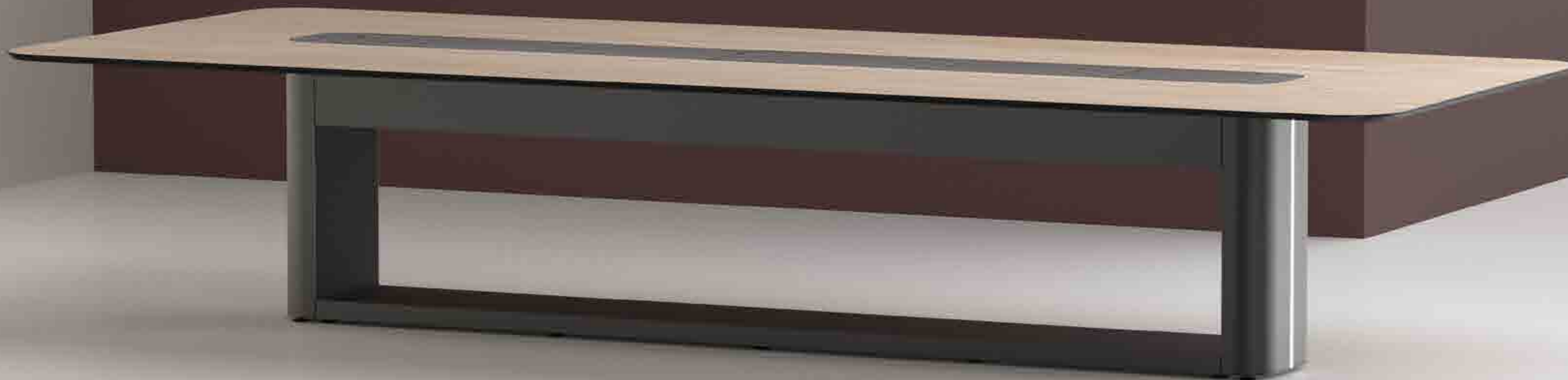

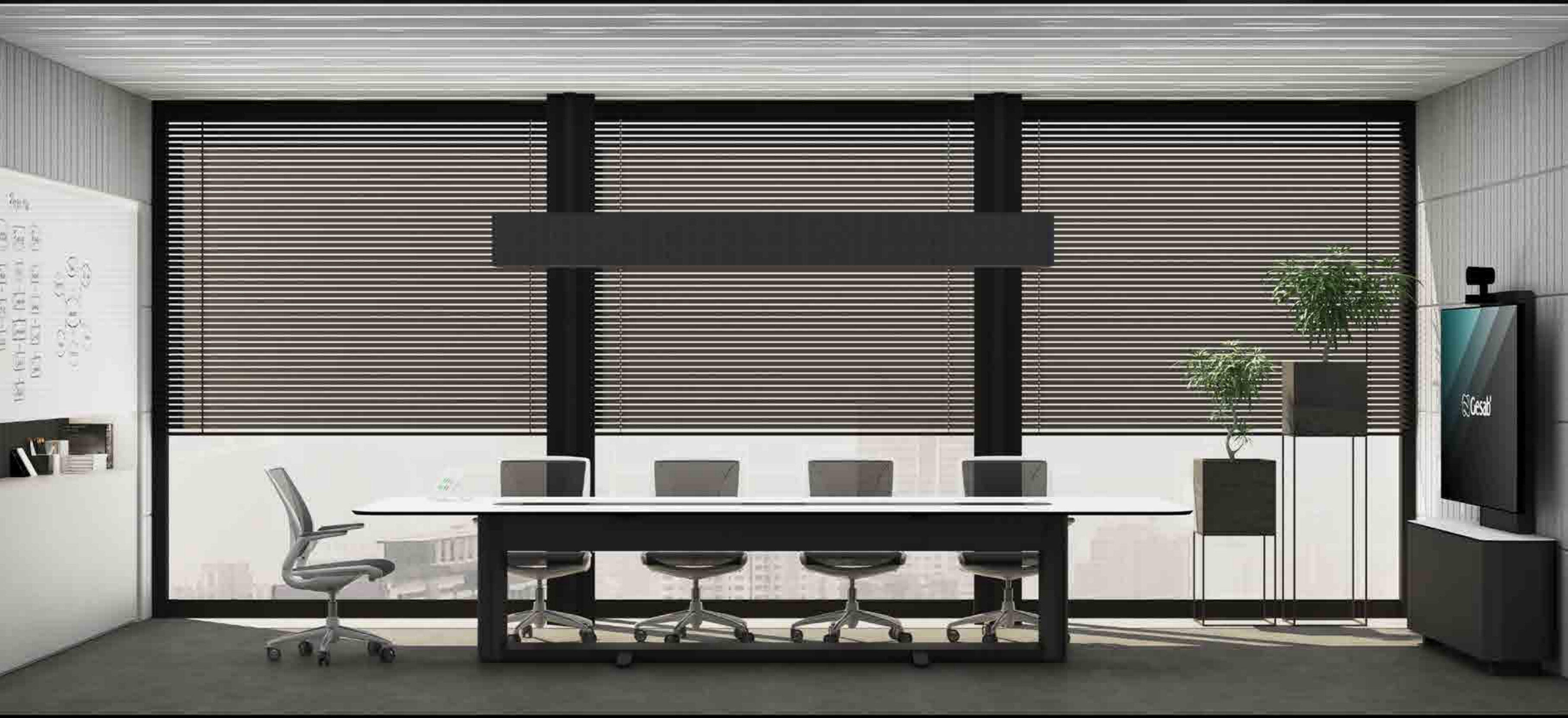

Handwritten notes on a whiteboard, including a list of items and a diagram.

Gesab logo displayed on a television screen.

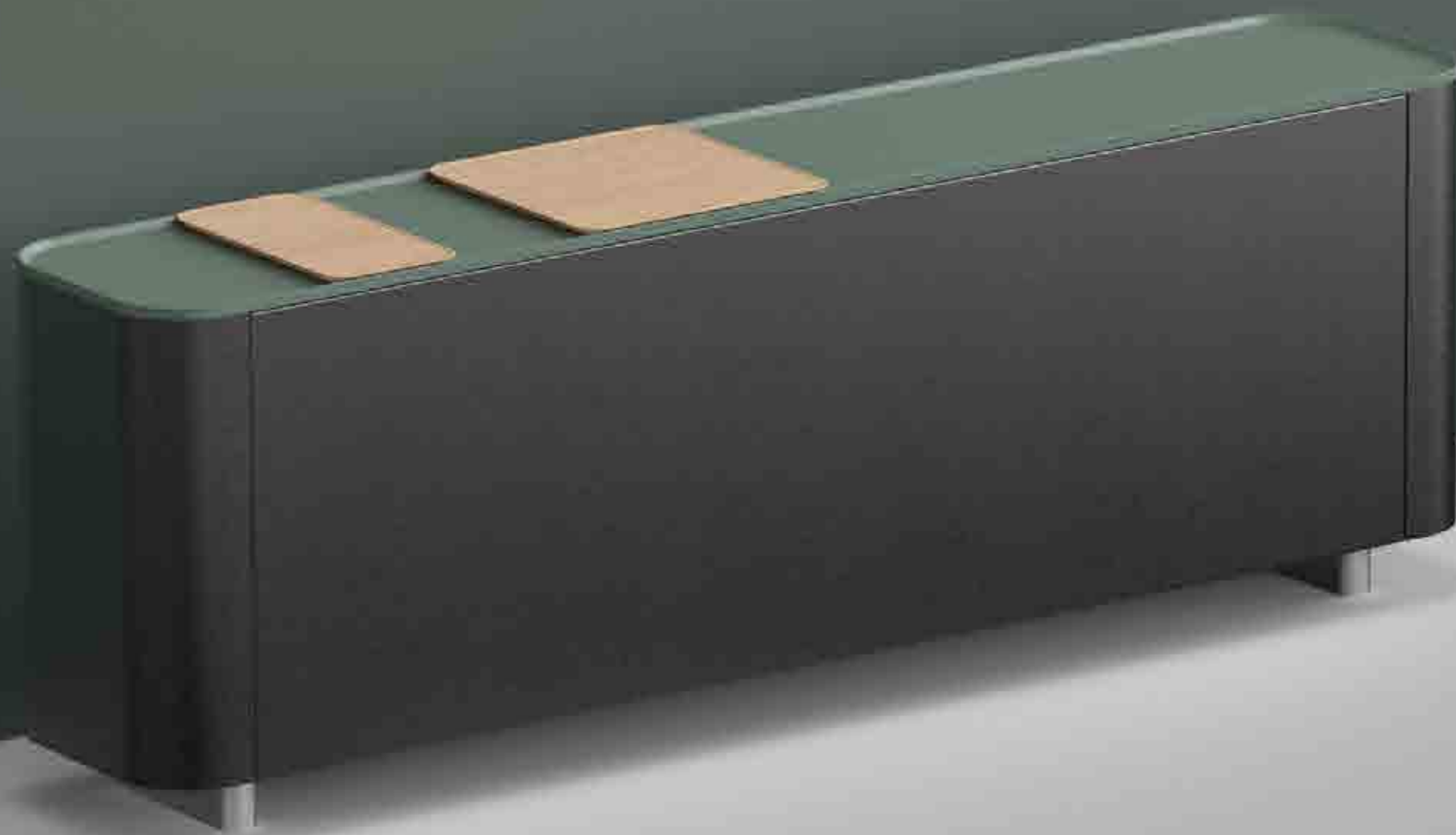

## AV Cabinet

An eye-catching technical compartment with an attractive design that will fit into any environment.



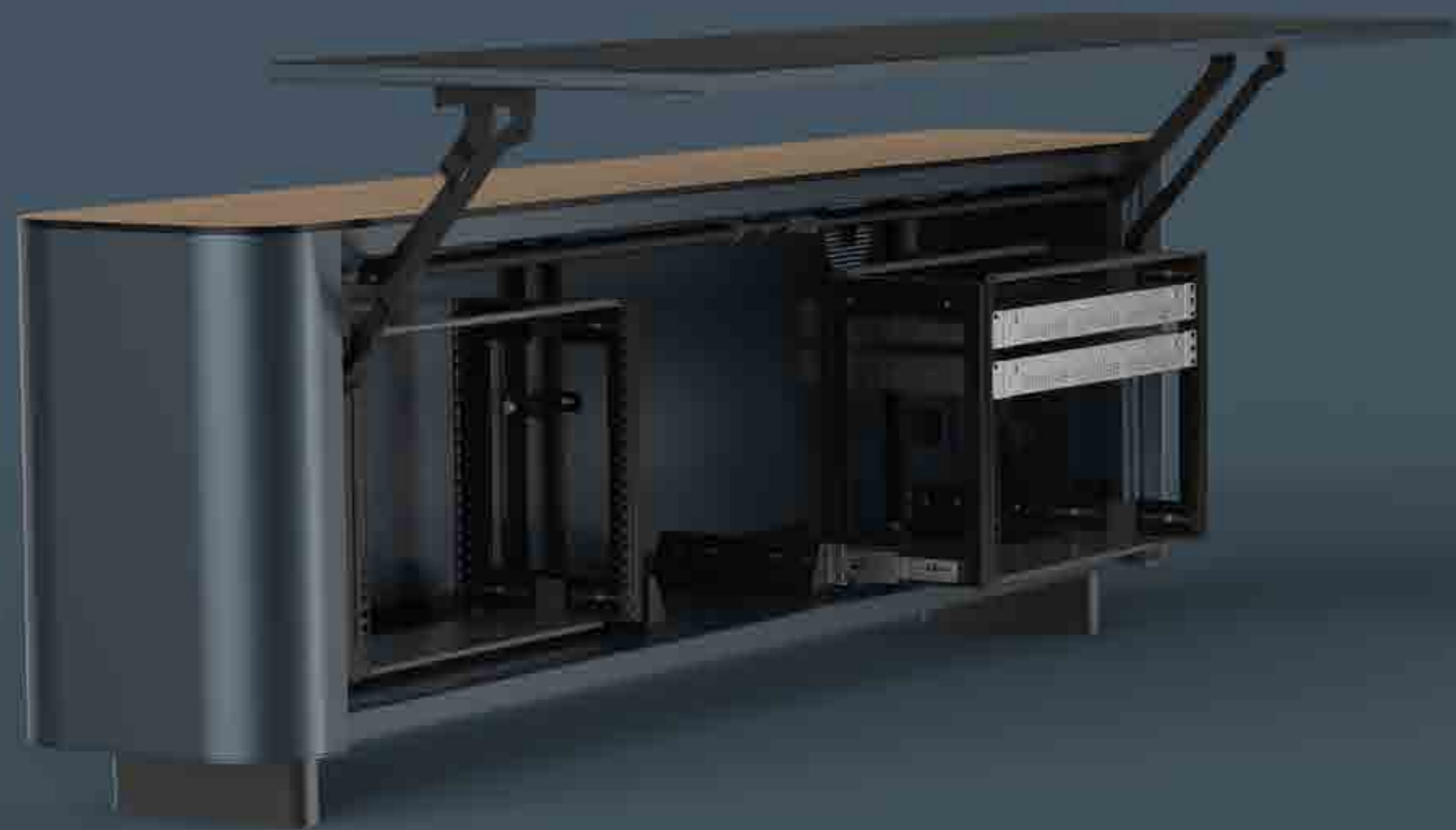



# Mural AV

A solution that integrates design and engineering. The AV mural allows a wide range of finishes and designs without reducing technical capacity.



 Gesab®

# Materials and finishes

The ability to offer a wide variety of materials and finishes is the main advantage when it comes to integrating design into a variety of unique environments.







Gesab

Gesab

THE LIGHT OF SEATTLE  
THE LIGHT OF TOKYO  
THE LIGHT OF SEATTLE



# Modular Design

MEET allows us to generate a large amount of different furniture solutions, dimensions and finishes, due to the large number of pieces made from aluminum profiles, the use of simple shapes and the easy placement of panels.

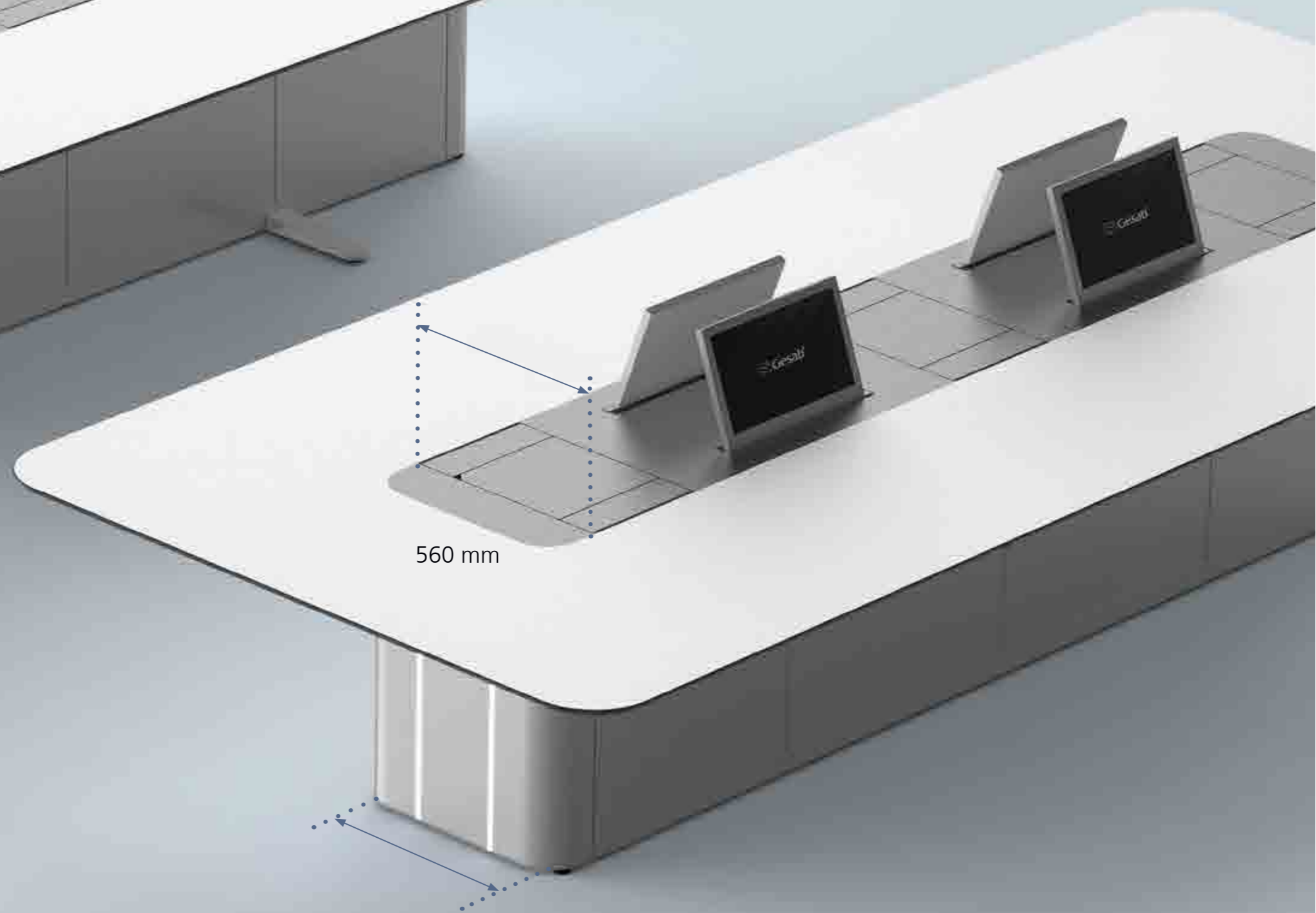
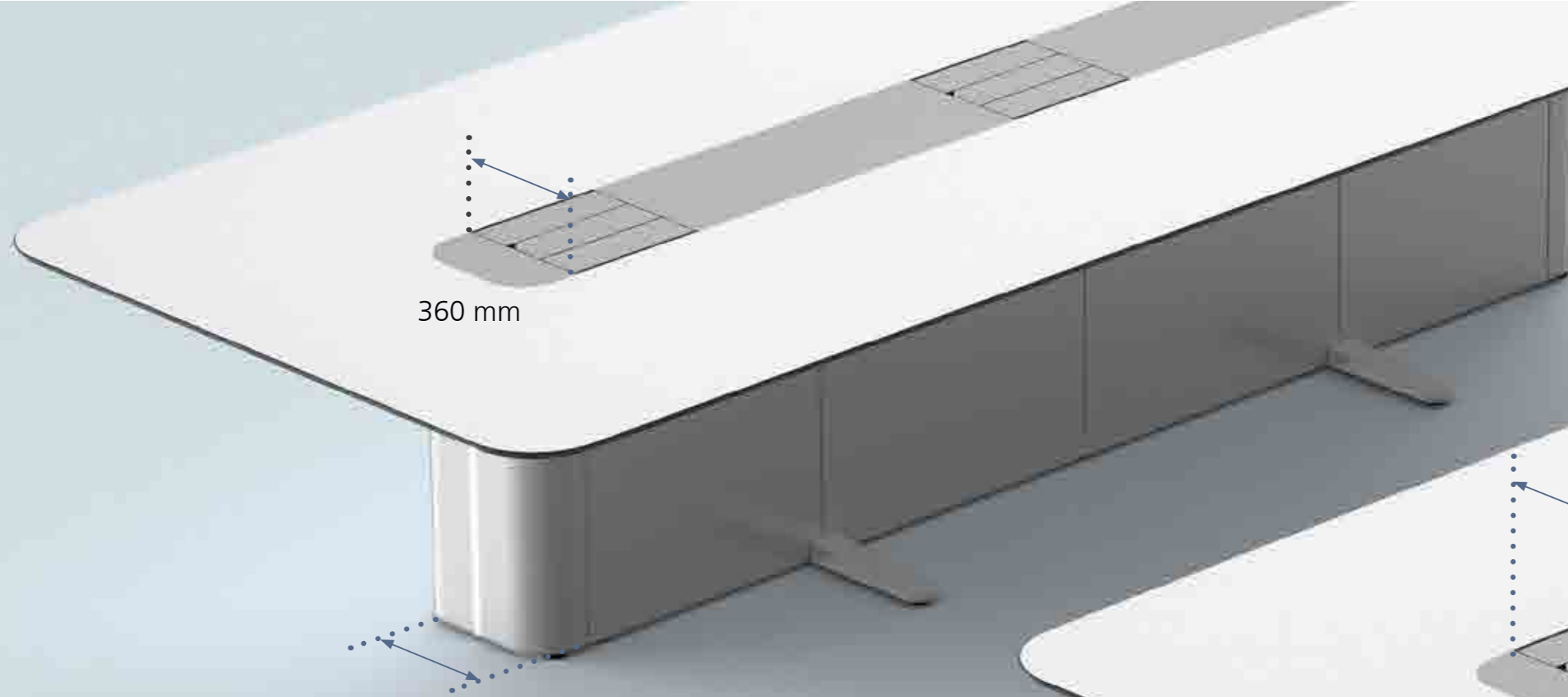





## Improved user experience.

Ease of use, attention to detail and the warmth of smart materials and solutions are key to delivering an exceptional experience to our customers.



## Everything runs smoothly and everything has its place with MEET

Connections reduced to the minimum  
expression to favor the organization of  
the elements and thus the development  
of the meetings.





## Visual lightness and structural robustness

MEET creates a perfect balance between visual lightness and structural robustness, offering ample possibilities in terms of storage capacity and equipment density.

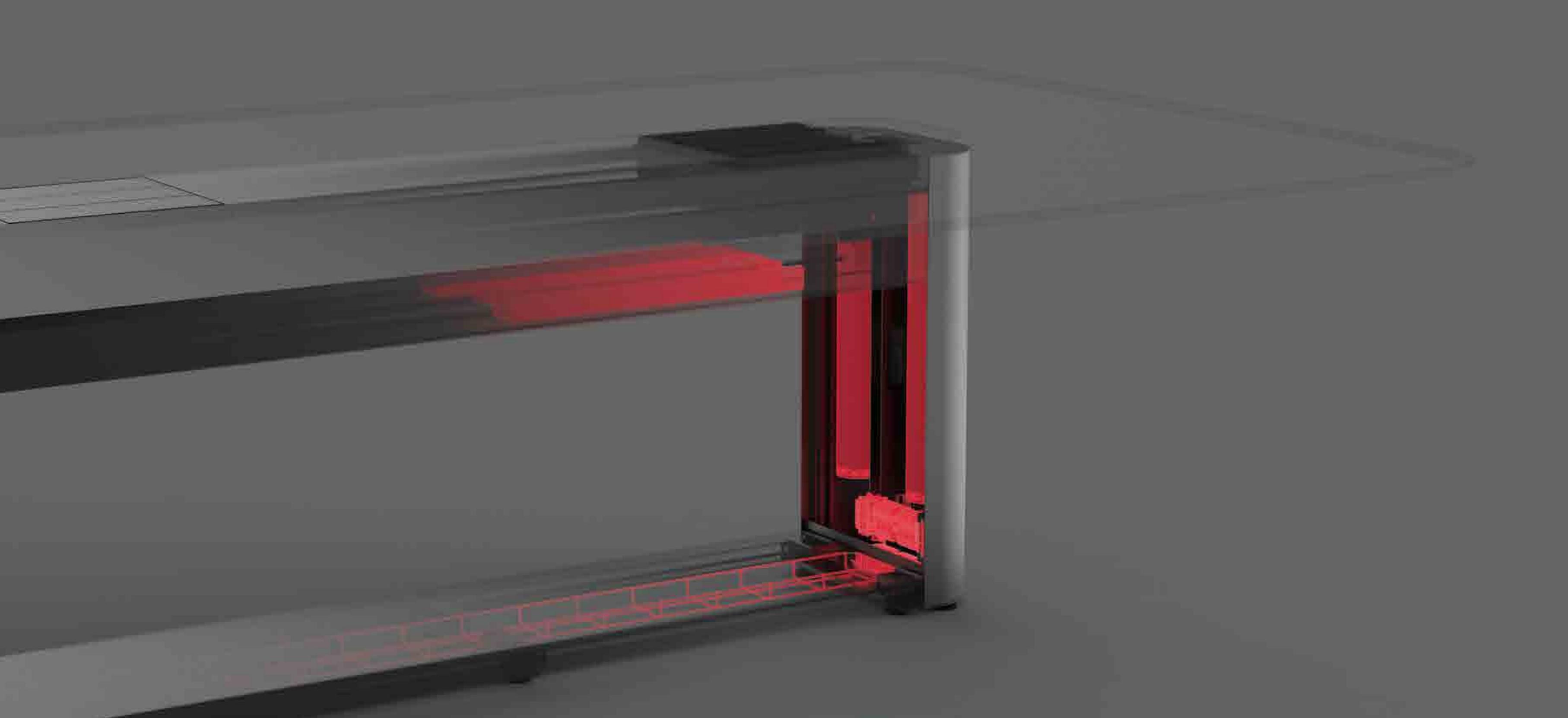

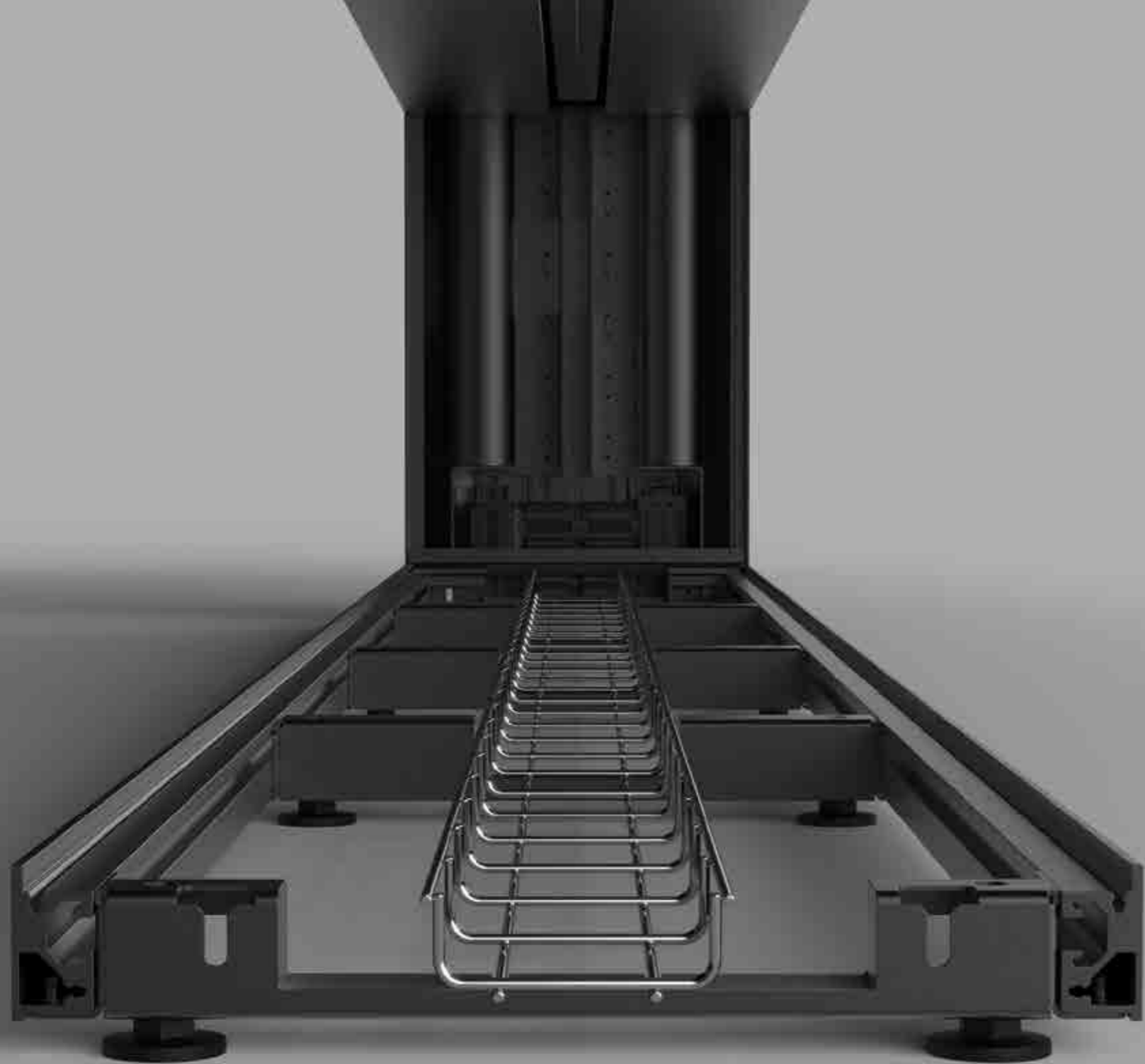

Meet offers high capacity to house equipment and manage cabling in a totally concealed way.

Open structure that allows the lateral introduction of the cabling, facilitating installation and maintenance tasks.

# The perfect complements to MEET tables.

Minimalist and elegant design solutions for meeting and collaboration environments. With an exceptional capacity to accommodate all types of computer equipment.

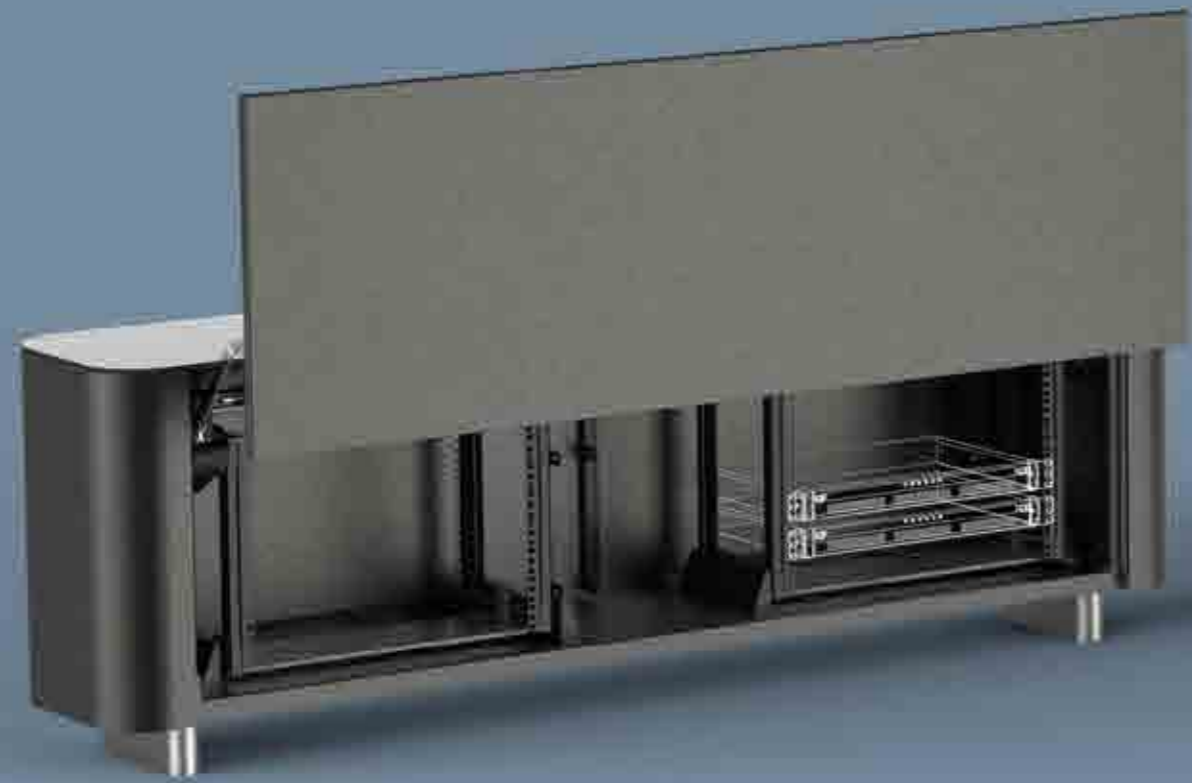





Control GESAB

**Barcelona**

938 427 050  
Avda del Mogent 68  
08450 Llinars del Valles

**Madrid**

915 345 064  
C/ Marzo 61-67  
28022 Madrid

**Mexico City**

+52 55 1997 0746  
Homero #1205 Piso 3  
Ciudad de México 11550

**Atlanta**

+1 404 990 3748  
3020 Business Park Drive  
Norcross, GA 30071 USA

**Bogotá**

+57 1 2185459  
Carrera 13 # 96 - 67  
Bogotá, Colombia

**Dubai**

971 555 528 390  
Al Quoz 1  
Dubai, UAE

**International**

+34 915 345 064  
C/ Marzo 61-67  
28022 Madrid

[gesab.com](http://gesab.com)

[info@gesab.com](mailto:info@gesab.com)