



VIVA RAILINGS®

LEADERS IN ARCHITECTURAL RAILING SYSTEMS

DESIGN + ENGINEER + FABRICATE + INSTALL



vivarailings.com

WCU

STUDENT SUCCESS

VIVA Railings has featured on the Inc. 500/5000 list 9 times since 2012

Inc. 500 | 5000

LIST OF FASTEST-GROWING PRIVATE COMPANIES IN AMERICA



INTERNATIONAL
CODE
COUNCIL®

SHIPPING & RECEIVING

STOCKED WAREHOUSE

WATER JET CUTTING MACHINE

BRAKE PRESS

FIBER LASER CUTTING MACHINE

C1

C2

C4

C5

C6

C7



VIVA RAILINGS
LEADERS IN ARCHITECTURAL RAILING SYSTEMS

DESIGN + ENGINEER + FABRICATE + INSTALL

CUTTING

WELDING

MACHINING

FINISHING

PACKAGING



DESIGN + ENGINEER + FABRICATE + INSTALL

VIVA Railings provides complete railing solutions for expertly designed spaces.

Our railing systems are durable, detailed and distinct, with a contemporary range of railing solutions for commercial buildings and public spaces.

Select from our core line design range of:

STRUCTURAL GLASS RAILING SYSTEMS, POST RAILING SYSTEMS,

PANEL RAILING SYSTEMS and LASER CUT DECORATIVE FORMED METAL PANELS

each with its own distinct look.

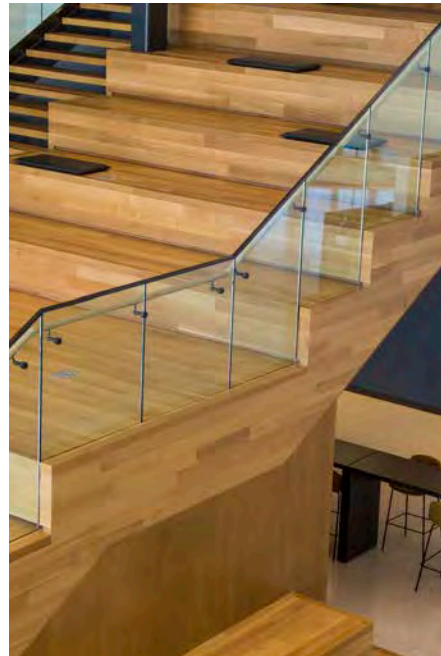

ICC-ES 4405 Certified SHOE™ Structural Glass Railing System

SHOE Structural Glass System is certified for

- International Building Code (IBC 2012-2021)
- California Building Code (CBC 2019-2022)
- Florida Building Code- Building (FBC 2020)

Includes Wind Borne Debris Regions & High-Velocity Hurricane Zone (HVHZ)



VIVA Railings Values

Our values are the guiding principle that govern our actions and decisions. They help to shape the culture of our organization, and serve as a reference point for making decisions that align with our goals and purpose.

Safety: Ensuring the safety of employees, customers, and the end users is a top priority.

Quality: Producing high-quality products and services that meet or exceed customer expectations.

Innovation: Continuously seeking out new and better ways of doing things, and embracing change and new technologies.

Sustainability: Ensuring that the company's operations and products are environmentally responsible and contribute to the long-term health of the planet.

Customer Satisfaction: Providing excellent service and support to customers, and striving to exceed their expectations.

Teamwork: Encouraging collaboration, communication, and mutual respect among employees, and fostering a positive and inclusive work culture.

Integrity: Operating with honesty, transparency, and fairness in all interactions and decision-making processes.

Responsibility: Taking ownership of actions and decisions, and being accountable for the company's performance and impact on stakeholders.

VIVA Railings is a leading provider of pre-engineered railing solutions and systems for commercial projects. Specializing in the design, engineering, fabrication, and installation of stainless steel and glass railings, we have built a reputation for delivering high-quality, durable products that meet the specific needs of each project.

Passion and Resilience

VIVA Railings owes its inception to a young student's passion and resilience in realizing a dream. The Tinwala Brothers aspired to be a leading name in the railings industry, their ambition and drive led them to set up a company that dealt with turnkey railing solutions, both utilitarian and ornamental. In the years since its inception, VIVA Railings has progressed to being an industry stalwart and trendsetter. We work consistently to stay abreast of global trends and codes and pride ourselves in setting benchmarks in the railing industry.

Dedication to Excellence

VIVA Railings' dedication to excellence has seen us make the Inc Magazine's 500|5000 Honoree list nine times, including being ranked at #211 among the fastest-growing companies in Texas. We continuously develop new designs to allow architects, designers, owners, and contractors more choices and innovative new expressions for their impressive commercial projects.

VIVA Railings has maintained a tradition of excellence in a continuously shifting market. Creating unique and innovative railing products is our forte, and we are dedicated to upholding our reputation for excellence. Our recent **ICC-ES certification for our SHOE™ Structural Glass Railing System** is a testament to our dedication and skill.

Harmonious Work Culture:

We take pride in having an inclusive work culture that welcomes each team member and supports their growth. We have built a diverse staff that brings the best possible service to our business clients, with high-quality goods and exceptional customer service.

Our team functions as a cohesive unit to bring a unified vision to reality. From our HR department, which hires and trains the right personnel, to our highly qualified staff, who ensure stability, continuity and integrity of operations. VIVA Railings fosters an inclusive work culture that cultivates our people's best aspects.

Commitment to "MADE IN USA"

VIVA Railings is proud to associate itself with "The Buy America Act", ensuring top-notch quality in many of our product lines and facilitating American businesses. We believe in being an integral part of the community and maintaining safety standards in our railings. Our leadership in products and processes is geared towards upholding cultural, social and ethical values.

Innovation in Design

Our unique and pre-engineered railing systems are built to enhance any space, be it public or corporate. We pride ourselves on turning building necessities into architectural masterpieces through our contemporary and innovative design. Our glass and metal railing systems are lauded for their modern look, sleek lines and aesthetics.







Setting Industry Standards

VIVA Railings believes in letting our work speak for itself. We have set industry standards through our dedication to quality craftsmanship and superior design. Due to our commitment to excellence, VIVA Railings has seen faster lead times, up to 50% faster, for most of our product lines. We are a one-stop railing solution provider for our clients, partners, employees, and community; our adherence to quality standards is our defining attribute.

Access to Latest Technology

Innovation in design is a demanding endeavor, which is why we aim to stay abreast of technological advancements within the industry. VIVA Railings has access to the latest technological tools that help us perform better and cut down fabrication time. We have the capacity to deliver before or on time for most projects. VIVA Railings stays up-to-date with manufacturing processes and has acquired the latest machinery in the business, helping us to remain the leaders in our field.



 SWINERTON	 BL HARBERT INTERNATIONAL	 POGUE CONSTRUCTION	 SKANSKA	 PCL CONSTRUCTION LEADERS	 Bank OZK	
 Frost	 TEXAS Live!	 CADENCE MCSHANE CONSTRUCTION	 CALLISON	 UFHealth UNIVERSITY OF FLORIDA HEALTH		
 UNIVERSAL	 THE Statler HOTEL & RESIDENCES	 Mercedes-Benz	 Hilton	 URS	 SUBARU	
 DPR Construction Inc.	 NORTHSTAR BUILDERS GROUP	 Balfour Beatty	 DFW	 PGA	 UNT UNIVERSITY OF NORTH TEXAS Discover the power of ideas.	
 UNK UNIVERSITY OF NEBRASKA KEARNEY	 Pizza Hut	 Rogers-O'Brien Construction	 BECK	 KDC	 VLK ARCHITECTS	
 COWBOYS	 HKS	 MA	 BRINKLEY SARGENT WIGINTON ARCHITECTS			
 UF UNIVERSITY OF FLORIDA	 BARTLETT COCKE GENERAL CONTRACTORS		 Manhattan	 PERKINS + WILL	 JOHN DEERE	
 KW COMMERCIAL	 ANDREWS ARCHITECTS	 UNIVERSITY AT ALBANY State University of New York	 University at Buffalo The State University of New York		 WAYNE STATE	 BOKA Powell
 JE DUNN CONSTRUCTION	 Virgin HOTELS DALLAS	 BRASFIELD & GORRIE GENERAL CONTRACTORS	 LISD REAL INNOVATION LIMITLESS OPPORTUNITY LEWISVILLE INDEPENDENT SCHOOL DISTRICT	 TSTC Texas State Technical College	 HTK ARCHITECTS PA	



Inc. Magazine ranks the fastest growing private companies every year. VIVA has been on that list nine times since 2012.

Inc. Magazine awards businesses that have been on the list for at least five years in a row with a Hall of Fame Award. VIVA Railings continues to be one of the fastest growing companies and maintains the same trust and quality for total railing solutions since we opened over a decade ago.



Inc. 5000 Series #211 in Texas List of Fastest-Growing Private Companies

“VIVA Railings is thrilled to earn a position on this prestigious list of companies!”

It’s a great tribute to the hard work of all our employees and the confidence our customers have entrusted in us.”

- Mark Tinwala & Huzefa Tinwala



Our ICC-ES 4405 Certified SHOE™ Structural Glass Railing System is an aluminum glass railing system with a patented compression set aluminum base shoe system. (US Patent No. 9127474)

Towards The Future

Our goal is to be the company of choice for our valued clients (owners, architects, designers, and contractors) by providing stunning, safe, and sustainable railings at an affordable price. Thus far, we have prided ourselves on leaving our clients not just satisfied but delighted with our products and services. We aim to continue on that same path to ensure an impeccable experience from start to finish with our clients. We are focused on providing solutions for outstanding railing systems across the United States.

SOME OF OUR CUSTOMERS

ARCHITECTS
Aecom
ASM Architects
BOKA Powell Architecture
Callison
Cannon Design
CH2M Hill
Corgan
Curry Architects
David Johnston Architects
EYP Architecture & Engineering
Furr & Wegman Architects
Gensler
Gresham, Smith and Partners
HDR
HGOR
HKS
Hodges and Associates
HOK
Ittner, Inc.
Jacobs
KSQ
Land 3 Architects
Leo A Daly
LS3P Associates Ltd.
Merriman Anderson Associates
NBBJ
NK Architects
PageSoutherlandPage
Perkins & Will
Perkins Eastman
RTKL
Seeberger Architecture
Stantec Dallas
United States Army Corps of Engineers
URS Corp
VLK Architects

GENERAL CONTRACTORS
Adolfson & Peterson Construction
Austin Industries
BECK
Balfour Beatty US
Bartlett Cocke General Contractors
Camp1 Construction
Candance McShane Construction Company
Choate Construction Co.
Consigli Construction Co. Inc.
CORE Construction Group
Crossland Construction Co.
DPR Construction
EMJ Corp.
EP Guidu, Inc.
Fiintco LLC
Gallagher Construction
Gilbane Federal
Hardin Construction Co. LLC
Hill & Wilkinson General Contractors
Hoar Construction LLC
Huckabee Construction
Hunt Construction Group
JE Dunn Construction Group
LeChase Construction
LeChase Construction Services LLC
Lee Lewis Construction Inc.
Manhattan Construction
Northstar Builders
PJ Dick
Pogue Construction
Rogers-O'Brien Construction
Satterfield & Pontikes Construction Inc
Skanska USA
Southern Glass & Mirror
SpawGlass
Whiting Turner

PRODUCT	STRUCTURAL GLASS	GLASS	WIRE MESH PANELS	PERF. METAL PANELS	CABLE	VERTICAL PICKET PANELS	HORIZONTAL MULTILINE	CABLENET	LASER CUT PANELS
SHOE™	●								
VIEW™	●								
VISIO™	●								
BLADE®		●	●	●		●	●		●
CIRCA®		●	●	●	●	●	●	●	●
CUBE™		●	●	●	●	●	●	●	●
FIN™		●	●	●					
SOLO™		●							
BEACON™		●	●	●	●			●	●
VORTEX™		●							
TEE™					●				
WINDWALL™		●							
ALUM. WINDWALL™		●							
ECO VISTA™		●							
ECO ELLIPSE™		●							
SLAT™						●			
FRAME™				●					
LASER CUT PANEL SYSTEMS									
STRUC™	Available in a wide range of laser cut patterns or custom patterns.								
FOLD™									

METALSPACES - DECORATIVE FORMED METAL			
WALL SYSTEMS Interior & Exterior Applications	CEILING SYSTEMS Ceiling Panels & Ceiling Clouds	SUN CONTROL SYSTEMS Sun Shades, Shade Structures, Metal and Glass Canopies	ARCHITECTURAL PANELS A wide range of standard laser cut panels and custom patterns are available

INTRODUCING

SLAT™

Picket System (pg 145)

The SLAT Picket Railing System (Patent Pending) is an array-type aluminum railing that features vertical slats installed at varying* rotational angles, creating a visual play of light and shadow. This design consists of a series of aluminum slats arranged in a linear fashion, offering a sleek and modern look.

SLAT is available in 0° and ±(15°, 30°, 45°) or varying symmetric angle orientations

30° degree orientation
shown here



SHOE[®] GLASS SYSTEM

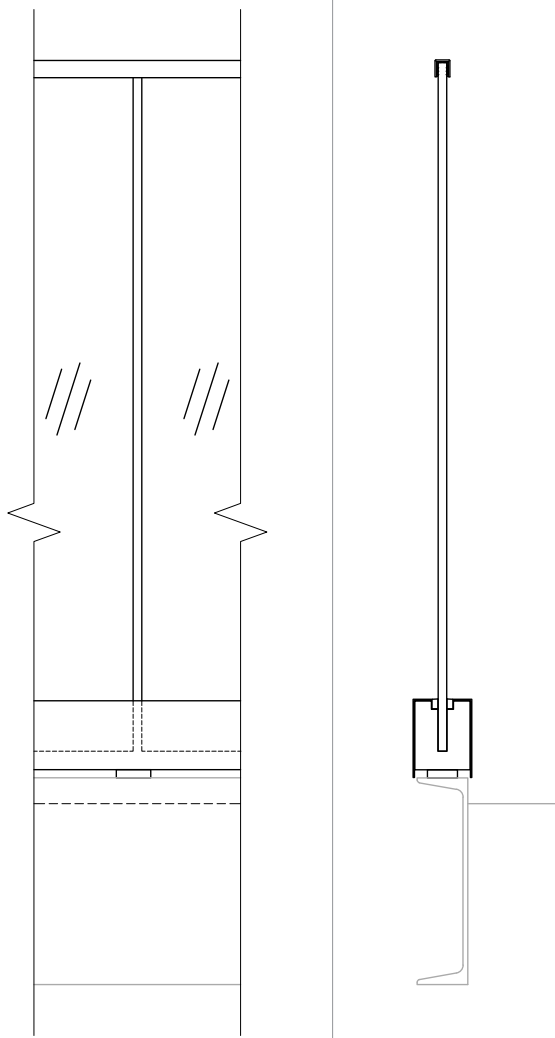

SHOE - AVAILABLE INFILL

Glass

SHOE has received the
ICC-ES 4405 Evaluation



Continuous Compression DrySet

U.S. PATENT NO. 9127474

Our **ICC-ES 4405 Certified SHOE** Structural Glass Railing System is an aluminum glass railing system with a patented compression set aluminum base shoe system. SHOE Glass Railing is perfect for commercial interior or exterior, balcony railing or stair railing applications. In addition, this architectural railing solution provides a fall protection system without the use of an unsightly barrier. SHOE Aluminum Glass Railing can be either top or fascia mounted. It is available with a glass bracket mounted handrail, round top cap, or a U-channel top cap.



Other mounting options available.



Scan the QR code to check out the SHOE system on our website and the interactive 3D viewport

SHOE GLASS SYSTEM - TECHNICAL DATA



	MATERIAL	FINISH	SIZE/SPACING
BASE	Aluminum SHOE	Mill / Anodized	3.25"x4" SHOE base, 5'-0" max. O.C. glass infill. Fascia or Top mount.
CLADDING	Aluminum - \$	CeraShield ⁵	4.5"x1" Cladding for SHOE only
	Stainless Steel - \$\$	#6 Satin / CeraShield	
INFILL OPTIONS	Glass	Clear, Tinted or Frit	1/2" to 1" Laminated Tempered Glass ¹ PVB or SGP interlayer.
TOP RAIL	Stainless Steel U-Cap	#6 Satin / CeraShield	1" Height U-Cap
	Stainless Steel U-Cap with LED ²		1" Height U-Cap with LED LINEAR
	Stainless Steel Tube with LED		Ø1-1/2" tube with LED LINEAR
HAND RAIL	Stainless Steel Tube	#6 Satin / CeraShield	Ø1-1/2" or Ø2" tube
	Stainless Steel Tube with LED	#6 Satin / CeraShield	Ø1-1/2" with LED LINEAR, Ø1-1/2" or Ø2" with LED POD
	Wood (Red Oak, Cherry or Maple) ³	Unstained	Ø2"
	Wood (Red Oak, Cherry or Maple) with LED		Ø2" with LED LINEAR

CERTIFIED FOR

- International Building Code (IBC 2012-2021)
- California Building Code (CBC 2019-2022) OSHPD, DSA
- Florida Building Code – Building (FBC 2020) includes Wind Borne Debris Regions & High-Velocity Hurricane Zone (HVHZ)



Intertek

1. Thickness and interlayer type typically to be determined based on engineering requirements.
2. All LED LINEAR products are ETL certified; ETL mark is proof of product compliance to North American safety standard.
3. Other species available upon request.
4. Viva Railings recommends using SGP for external applications.
5. CERASHIELD: Ceramic Coating, Enhanced durability and superior protection. Available in a wide range of colors. (Replaces traditional powder coat finish options.)
6. \$ to \$\$\$: Indicates finish type comparative cost.

SHOE GLASS SYSTEM - INFILL OPTIONS

GLASS



VIVA's tempered glass infills provide optimal line of sight as well as an understated elegance.
Clear Laminated (PVB or SGP) | Bent | Tinted | Ceramic Frit Patterned | Colored Interlayer

SHOE GLASS SYSTEM - MOUNTING CONDITIONS

TOP MOUNT	
STEEL	CONCRETE
WELD	ANCHOR CORE

FASCIA MOUNT	
STEEL	CONCRETE
WELD	ANCHOR

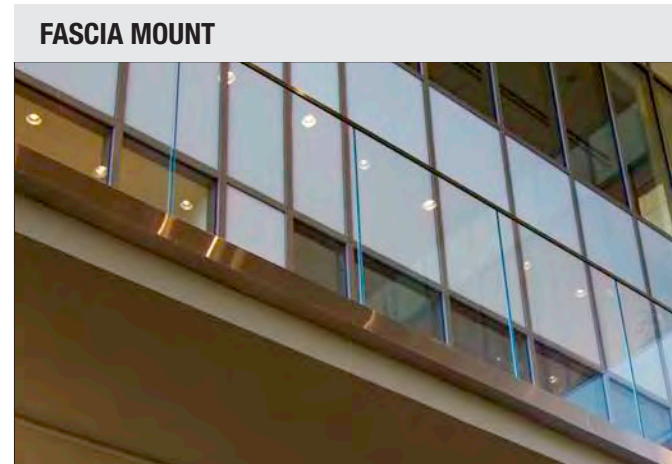
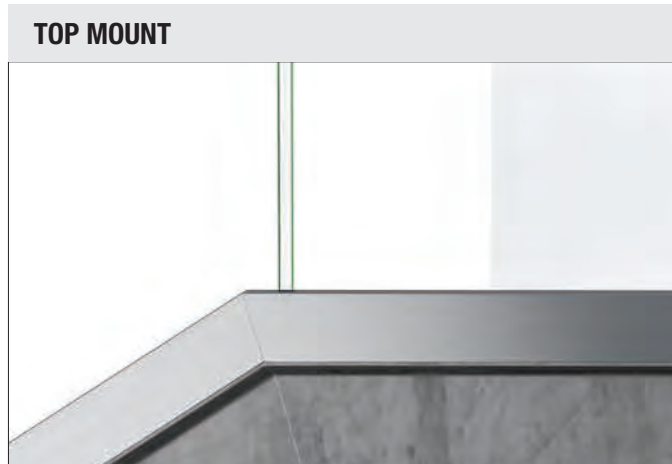

SHOE GLASS SYSTEM - FINISH OPTIONS



#8 Mirror Finish comes at an additional cost to our #6 Finish.

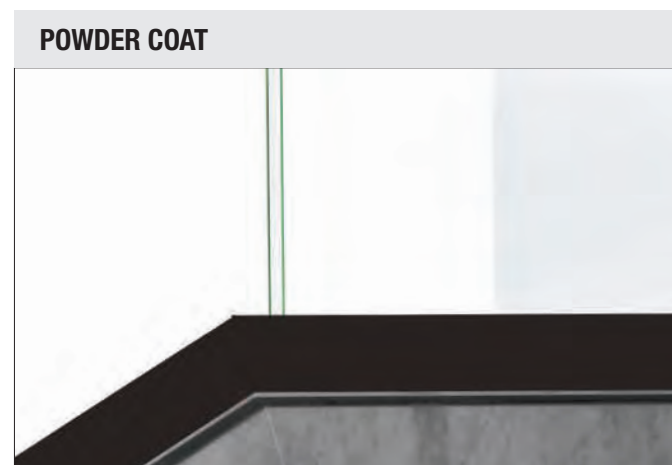

Available Standard and Premium colors on Pg 208

SHOE RAILING SYSTEM | INFILL: TEMPERED GLASS

PGA HEADQUARTERS, FRISCO, TX

General Contractor: Adolfson & Peterson Construction

Architect: Page Southerland Page



Our ICC-ES 4405 Certified SHOE Structural Glass Railing System is an aluminum glass railing system with a patented compression set (US Patent No. 9127474) aluminum base shoe system.

ESR-4405 - ICC Evaluation Service, LLC (ICC-ES)

- International Building Code (IBC 2012-2021)
- International Residential Code (IRC 2012-2021)
- California Building Code (CBC 2019-2022)
- California Residential Code (CBC 2019-2022)
- Florida Building Code – Building (FBC 2020) includes Wind Borne Debris Regions & High Velocity Hurricane Zone (HVHZ)
- Florida Building Code - Residential (FBC 2020) includes Wind Borne Debris Regions & High Velocity Hurricane Zone (HVHZ)

This confirmation, as evident in ICC-ES evaluation report ESR-4405, provides guidance to code officials faced with approving the use of SHOE GLASS PANEL RAILING SYSTEM under these codes. The evaluation report is available online at www.icc-es.org.





SHOE RAILING SYSTEM | INFILL: TEMPERED GLASS

SMU HUGHES-TRIGG STUDENT CENTER - DALLAS, TX

General Contractor: Hill & Wilkinson

Architect: Parkhill, Smith & Cooper, Inc

Remember to be socially distant when possible!

Change Starts Here

Visit the project gallery.



SHOE RAILING SYSTEM | INFILL: TEMPERED GLASS

VARISPAC HEADQUARTERS - LAS COLINAS, TX

General Contractor: Adolfsen & Peterson Construction

Architect: BOKA Powell

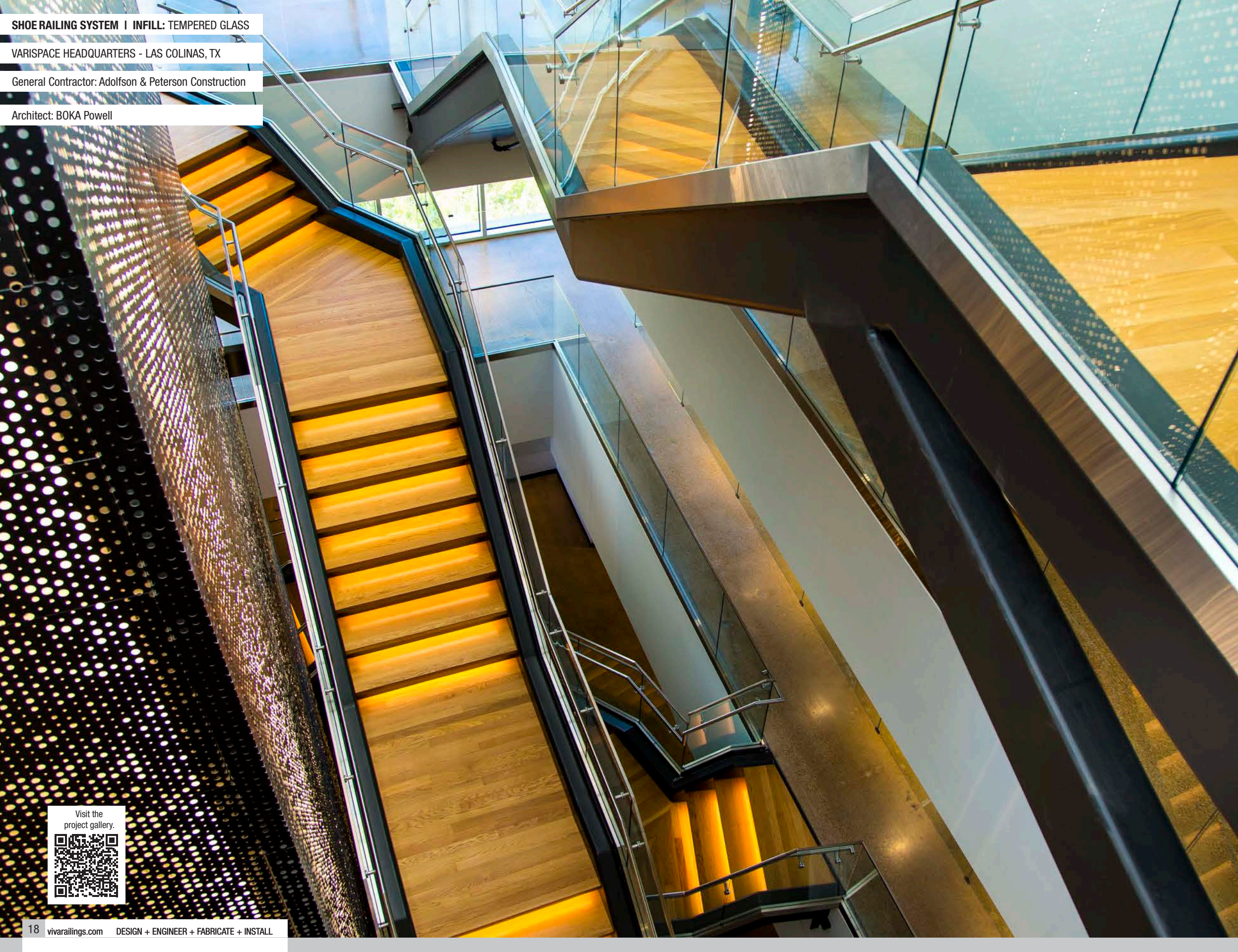

Visit the
project gallery.





Visit the
project gallery.



SHOE RAILING SYSTEM | INFILL: TEMPERED GLASS

TOYOTA U.S. HEADQUARTERS - PLANO, TX

General Contractor: Austin Commercial

Architect: Corgan Associates

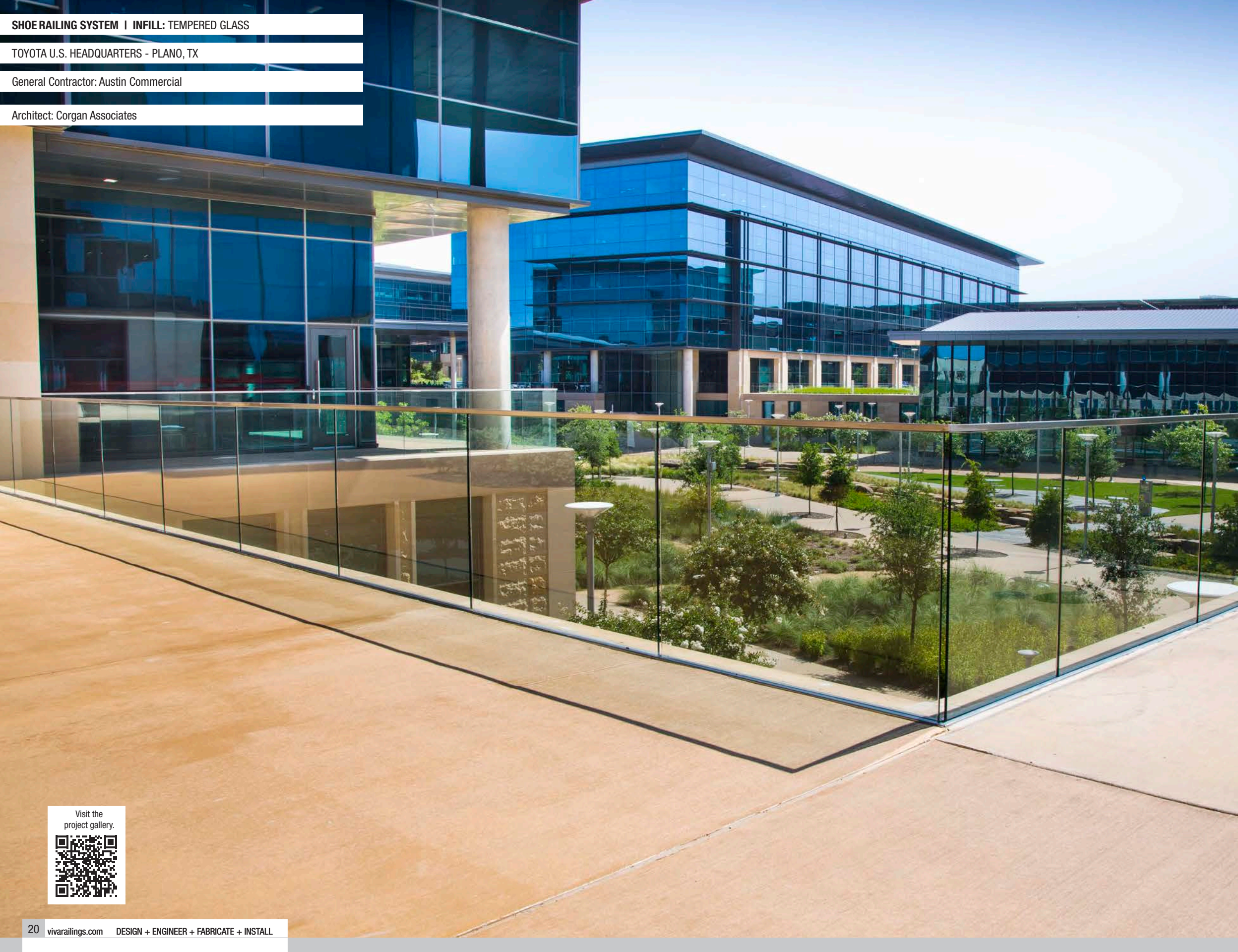

Visit the
project gallery.



SHOE RAILING SYSTEM | INFILL: TEMPERED GLASS

AMERICAN AIRLINES HEADQUARTERS - FT. WORTH, TX

General Contractor: Austin Commercial

Architect: Kendall/Heaton Associates

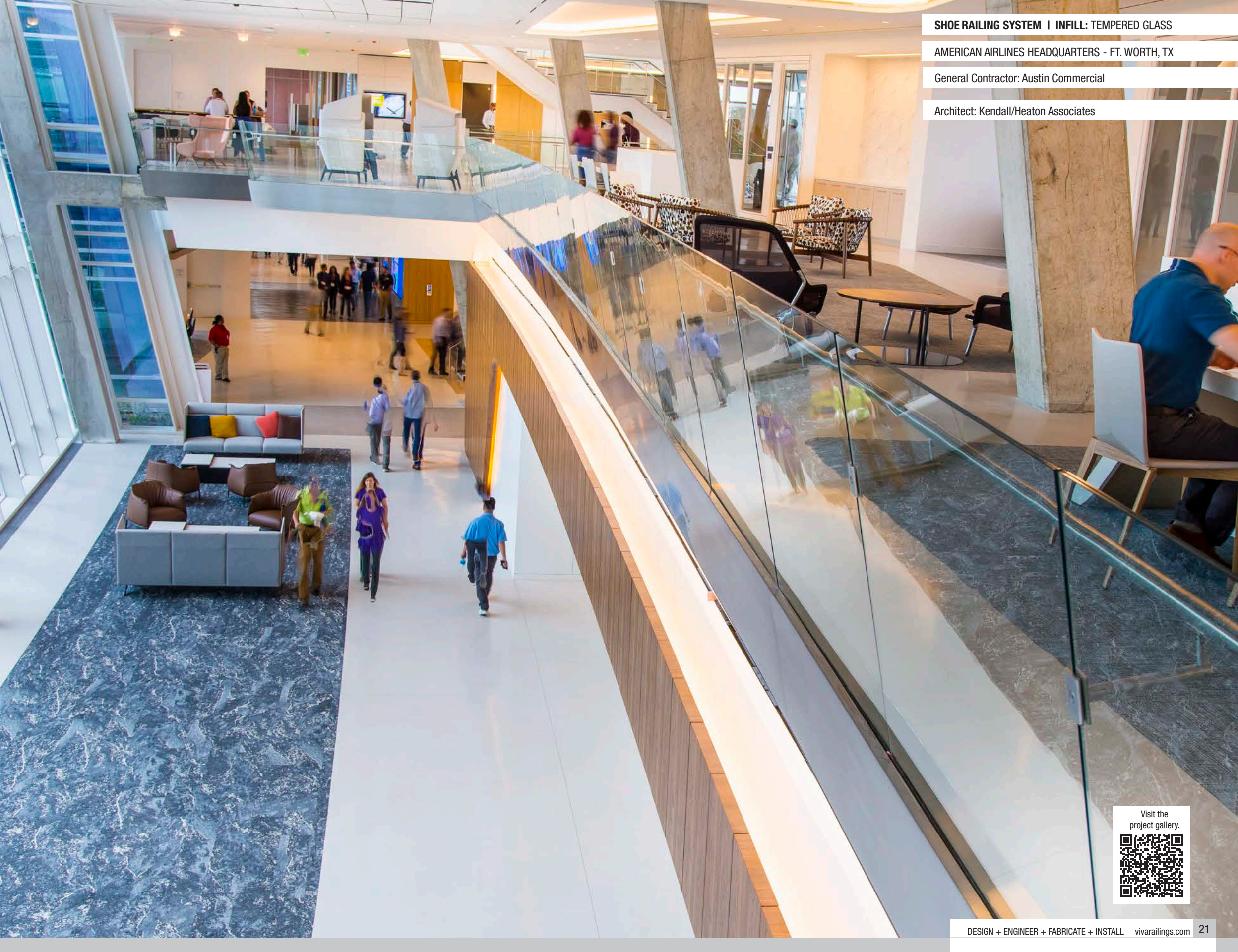

Visit the
project gallery.



VIEW™ GLASS SYSTEM

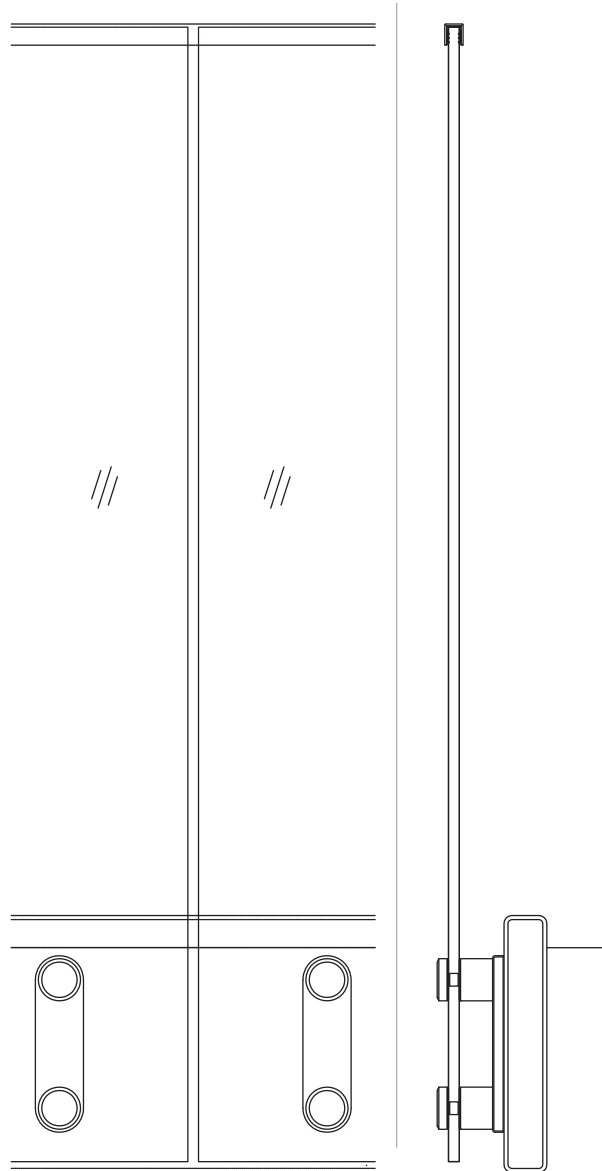

Other mounting options available.

VIEW - AVAILABLE INFILL

Glass

Our VIEW is a Button Structural Glass Balustrade Railing System that provides the clearest view imaginable. This system consists of 1/2" (minimum) SGP laminated glass or 5/8" PVB laminated glass and fascia mounted with fixed point holders in stainless steel.



Scan the QR code to check out the VIEW system on our website and the interactive 3D viewport

VIEW GLASS SYSTEM - TECHNICAL DATA

	MATERIAL	FINISH	SIZE/SPACING
STANDOFF	Stainless Steel (304 or 316)	#6 Satin, #8 Mirror	Ø2" Fascia mount, 4'-6" max.* Glass infill * Max. spacing changes upon glass thickness
		ECM	
	Stainless Steel (201)	Powder Coat	
INFILL OPTIONS	Glass	Clear, Tinted or Frit	Min. 1/2" SGP laminated glass ¹ or Min. 5/8" PVB laminated glass
TOP RAIL	Stainless Steel U-Cap	#6 Satin, Powder Coat	1" Height U-Cap
	Stainless Steel U-Cap with LED ³		1" Height U-Cap with LED LINEAR
	Stainless Steel Tube with LED	#6 Satin	Ø1-1/2" tube with LED LINEAR
HAND RAIL ECM finish is not available for U-cap, top rail or hand rail.	Stainless Steel Tube	#6 Satin, Powder Coat	Ø1-1/2" or Ø2" tube
	Stainless Steel Tube with LED	#6 Satin	Ø1-1/2" with LED LINEAR, Ø1-1/2" or Ø2" with LED POD
	Wood (Red Oak, Cherry or Maple) ²	Unstained	Ø2"
	Wood (Red Oak, Cherry or Maple) with LED		Ø2" with LED LINEAR



1. IBC 2015 & newer requires railing glass to be laminated. VIVA recommends SGP for exterior applications.

2. All LED LINEAR products are ETL certified; ETL mark is proof of product compliance to North American safety standard.

3. Other species available upon request.

VIEW GLASS SYSTEM - INFILL OPTIONS

GLASS

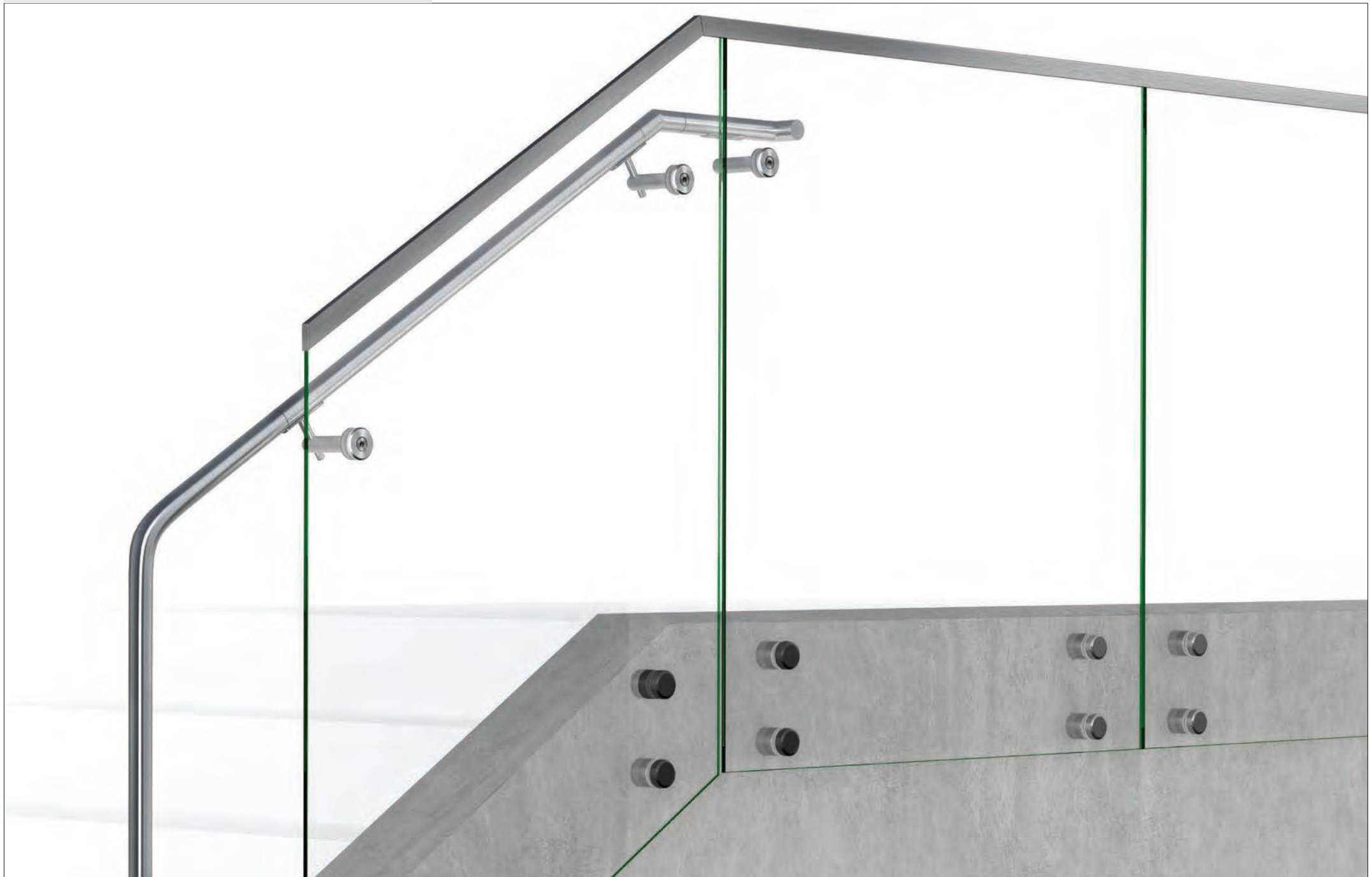

VIVA's tempered glass infills provide optimal line of sight as well as an understated elegance.
Clear Laminated (PVB or SGP) | Bent | Tinted | Ceramic Frit Patterned | Colored Interlayer

VIEW GLASS SYSTEM - MOUNTING CONDITIONS

FASCIA MOUNT	
STEEL	CONCRETE
WELD	ANCHOR

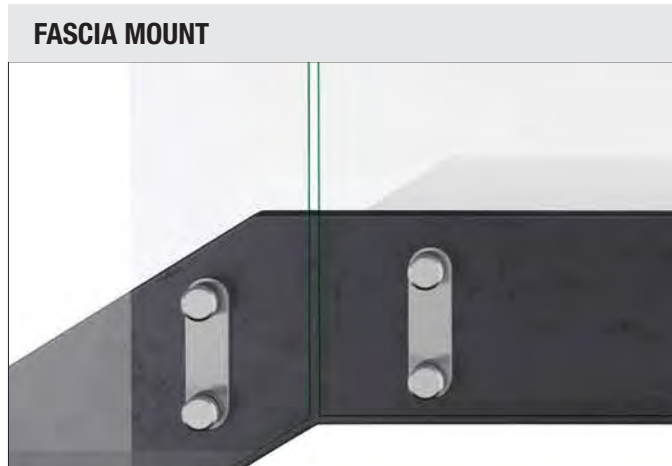

VIEW GLASS SYSTEM - FINISH OPTIONS

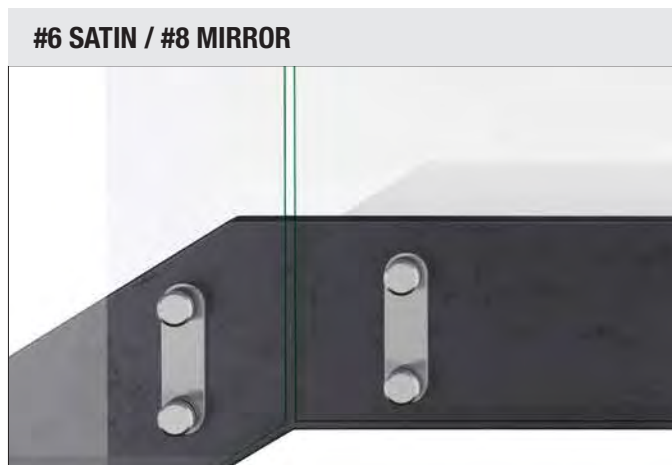

#8 Mirror Finish comes at an additional cost to our #6 Finish.

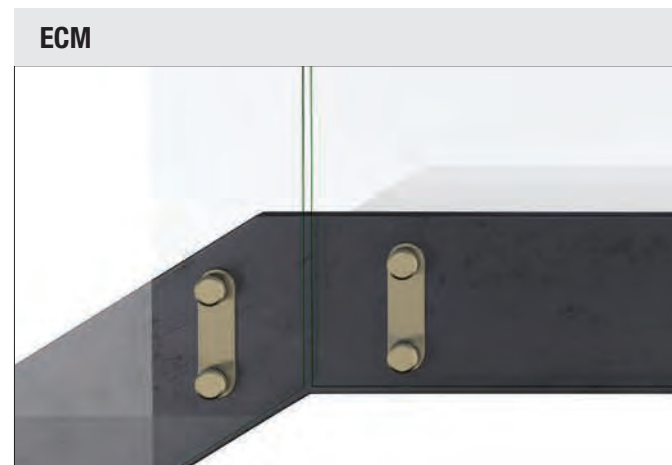

Available ECM colors on Pg 211

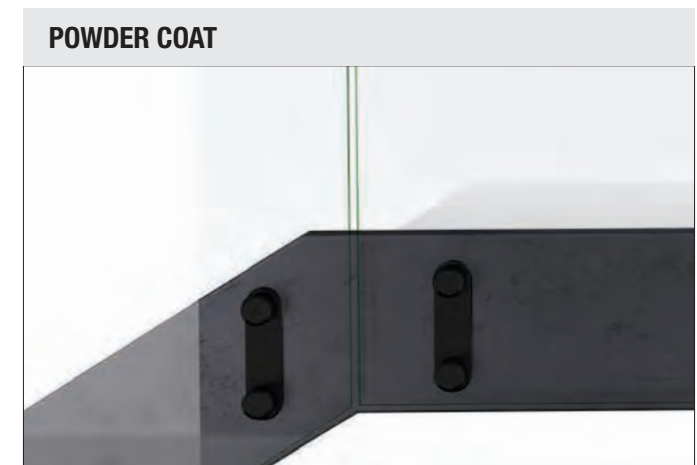

Available Standard and Premium colors on Pg 208

ECM finish is not available for U-cap, top rail or hand rail.



VIEW RAILING SYSTEM | INFILL: GLASS

ST. EDWARDS STATE UNIVERSITY - AUSTIN, TX

General Contractor: DPR Austin Inc

Architect: Moore Ruble Yudell

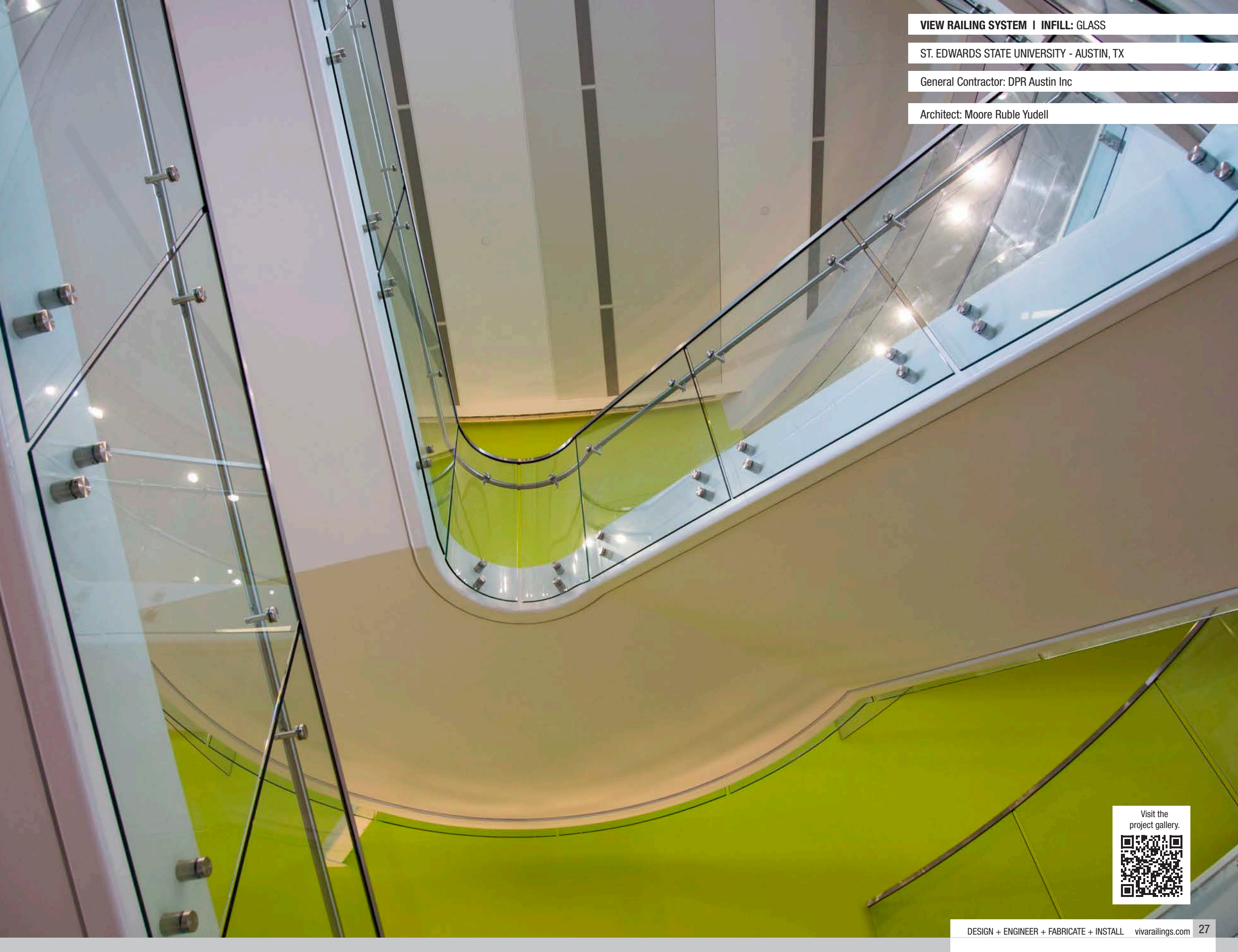

Visit the
project gallery.



VIEW RAILING SYSTEM | INFILL: GLASS

WEST COAST UNIVERSITY - RICHARDSON, TX

General Contractor: HRNCIR Construction

Architect: Gensler



Visit the project gallery.



VIEW RAILING SYSTEM | INFILL: GLASS

BANK OF THE OZARKS HEADQUARTERS - LITTLE ROCK, AR

General Contractor: Admiral Glass & Mirror-Houston TX

Architect: Polk Stanley Wilcox Architects

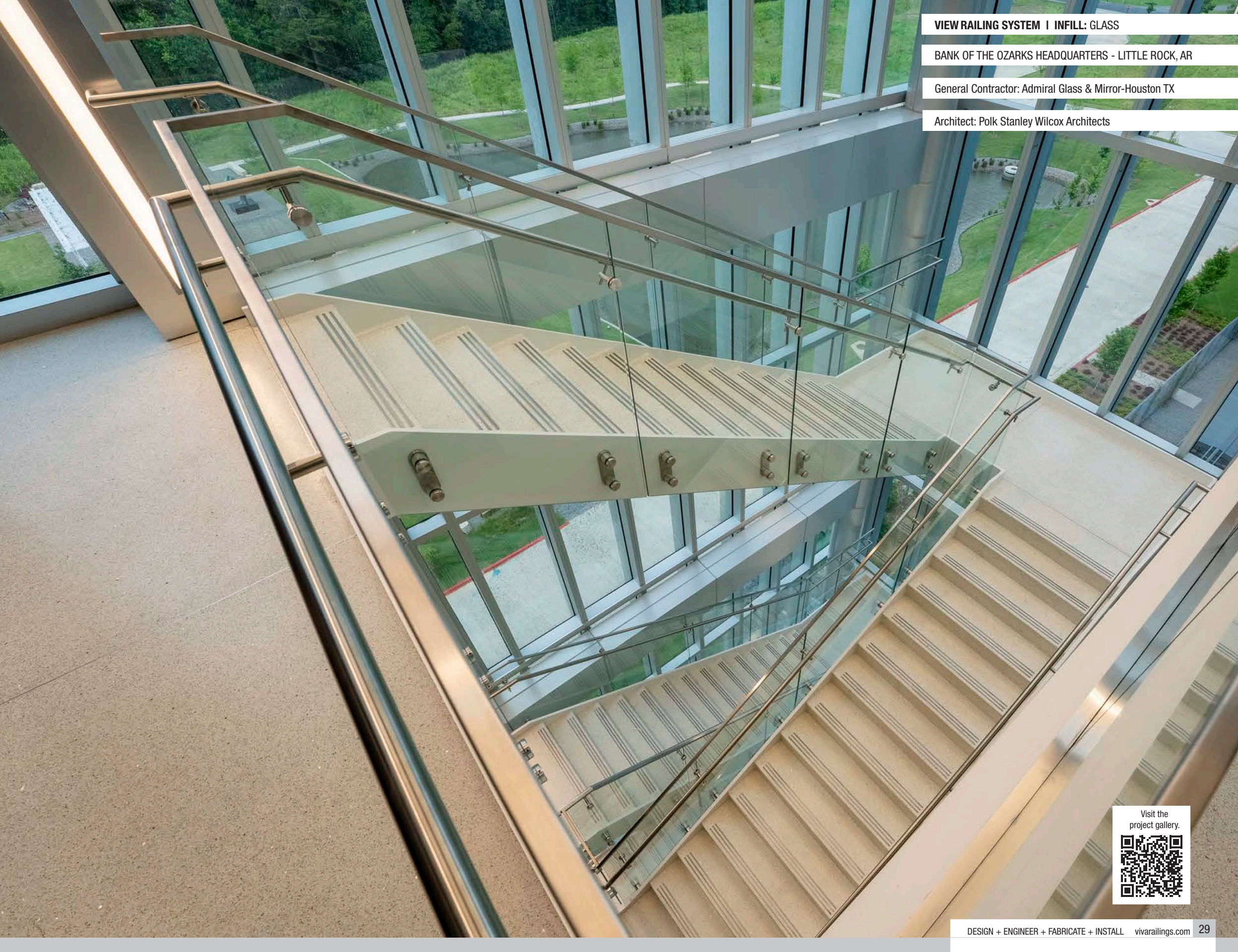

Visit the
project gallery.



VIEW RAILING SYSTEM | INFILL: TEMPERED GLASS

UNIVERSITY OF NEBRASKA-KEARNEY - KEARNEY, NE

General Contractor: Kearney Glass

Architect: RDG Planning & Design

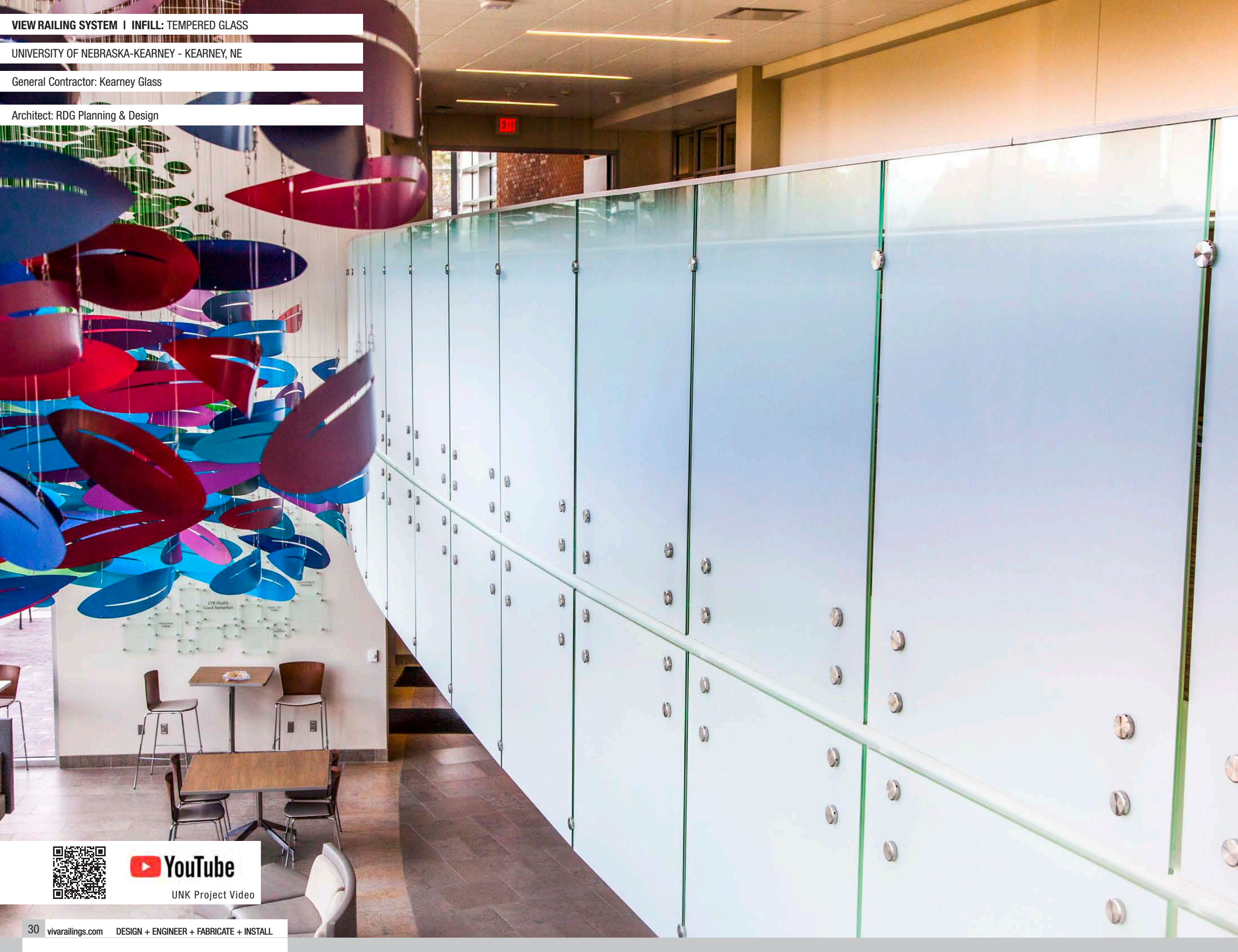

UNK Project Video

VIEW RAILING SYSTEM | INFILL: GLASS

ESPLANADE OTONOMY LAB - SAN DIEGO, CA

General Contractor: BNBuilders

Architect: Gensler

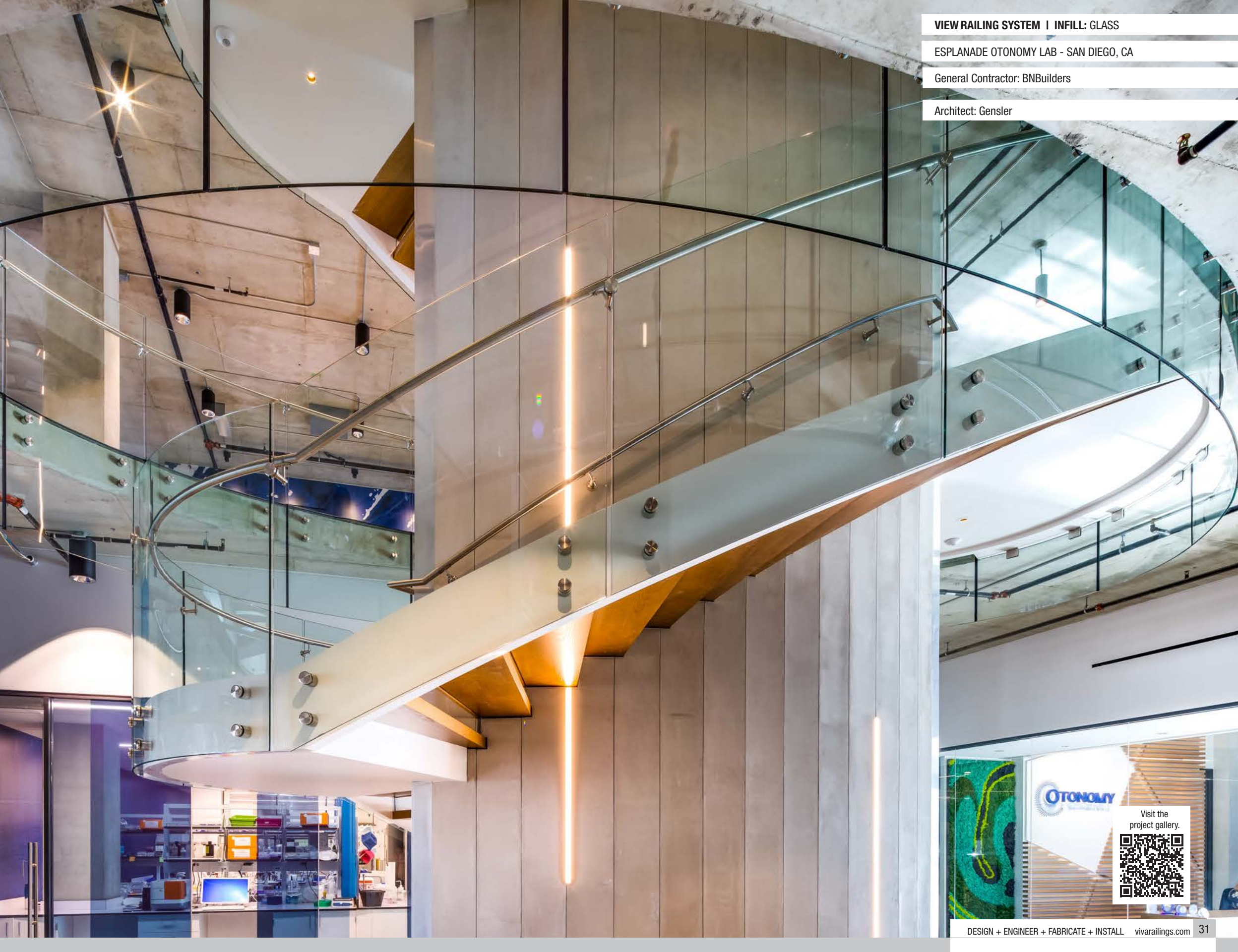

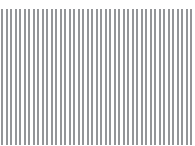

VISIO™ GLASS SYSTEM

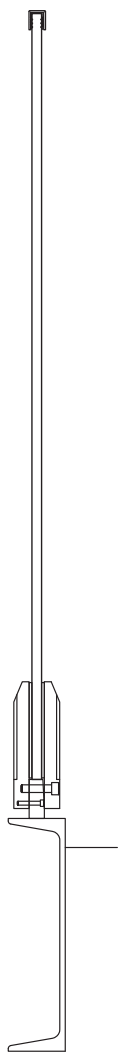
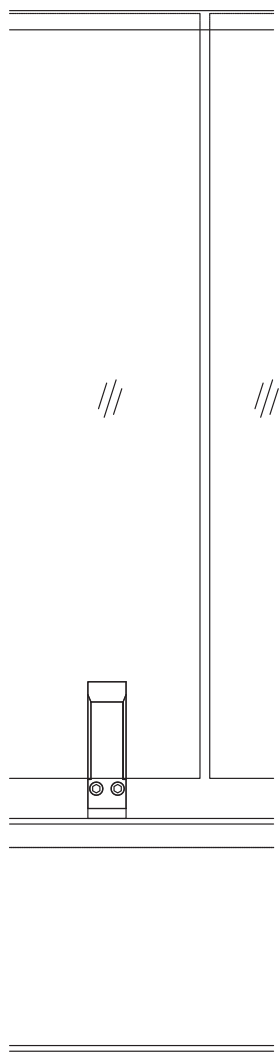

VISIO - AVAILABLE INFILL

Glass

Our VISIO Structural Glass Point Supported Stainless Steel Railing System offers high quality reliability with artistic flair. This completely stainless steel system is available in high-grade SS-304 and SS-316L alloy. In addition, VISIO is available for Top and Fascia mount.

Other mounting options available.

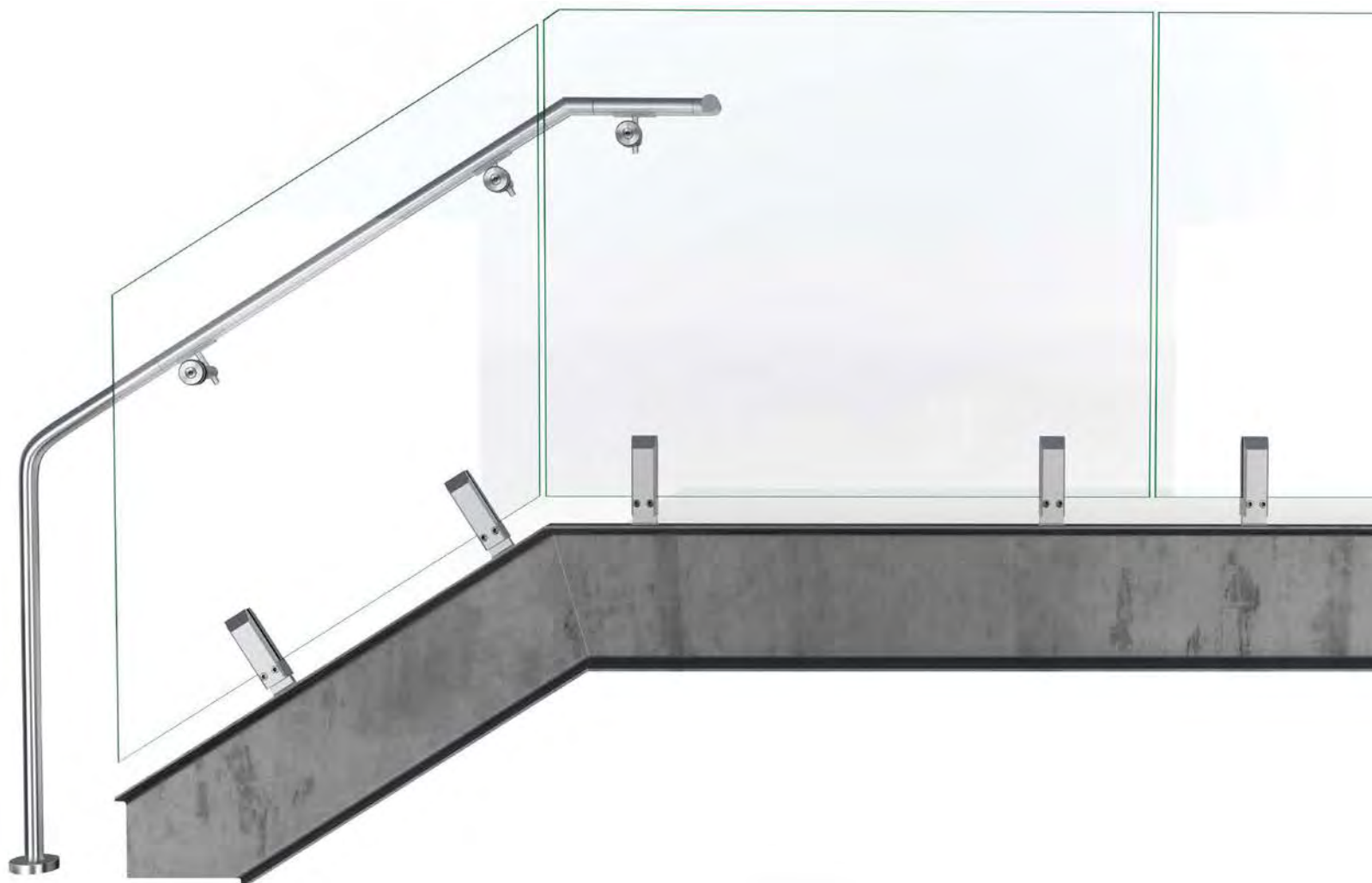

Scan the QR code to check out the VISIO system on our website and the interactive 3D viewport

VISIO GLASS SYSTEM - TECHNICAL DATA

	MATERIAL	FINISH	SIZE/SPACING
CLAMP	Stainless Steel (304 or 316)	#6 Satin, #8 Mirror	Clamp @ 4'-0" max. O.C. Spacing for Glass Panels. Fascia or Top Mount
		ECM	
	Stainless Steel (201)	Powder Coat	
INFILL OPTIONS	Glass with Cone Clamp	Clear, Tinted or Frit	Min. 1/2" SGP laminated glass ¹ or Min. 5/8" PVB laminated glass
TOP RAIL/HAND RAIL	Stainless Steel U-Cap	#6 Satin, Powder Coat	1" Height U-Cap for Glass Top Rail
	Stainless Steel U-Cap with LED ²	#6 Satin	Ø1-1/2" with LED LINEAR, Ø1-1/2" or Ø2" with LED POD
	Stainless Steel Tube	#6 Satin, Powder Coat	Ø1-1/2" or Ø2" for Hand Rail
			Ø2" or 2"x1" Rectangular tube for Top Rail
	Stainless Steel Tube with LED	#6 Satin	Ø1-1/2" with LED LINEAR, Ø1-1/2" or Ø2" with LED POD
	Wood (Red Oak, Cherry or Maple) ³	Unstained	Ø2"
	Wood (Red Oak, Cherry or Maple) with LED	Unstained	Ø2" with LED LINEAR

ECM finish is not available for U-cap, top rail or hand rail.



Intertek

1. IBC 2015 & newer requires railing glass to be laminated. VIVA recommends SGP for exterior applications.

2. All LED LINEAR products are ETL certified; ETL mark is proof of product compliance to North American safety standard.

3. Other species available upon request.

VISIO GLASS SYSTEM - INFILL OPTIONS

GLASS



VIVA's tempered glass infills provide optimal line of sight as well as an understated elegance.
Clear Laminated (PVB or SGP) | Bent | Tinted | Ceramic Frit Patterned | Colored Interlayer

VISIO GLASS SYSTEM - MOUNTING CONDITIONS

TOP MOUNT	
STEEL	CONCRETE
WELD	ANCHOR CORE

FASCIA MOUNT	
STEEL	CONCRETE
WELD	ANCHOR

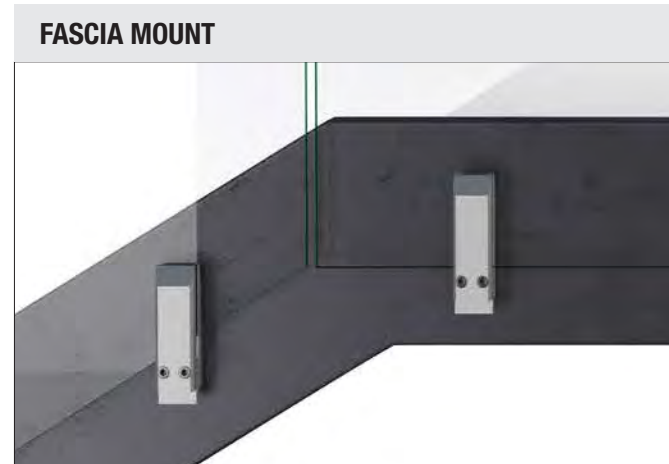
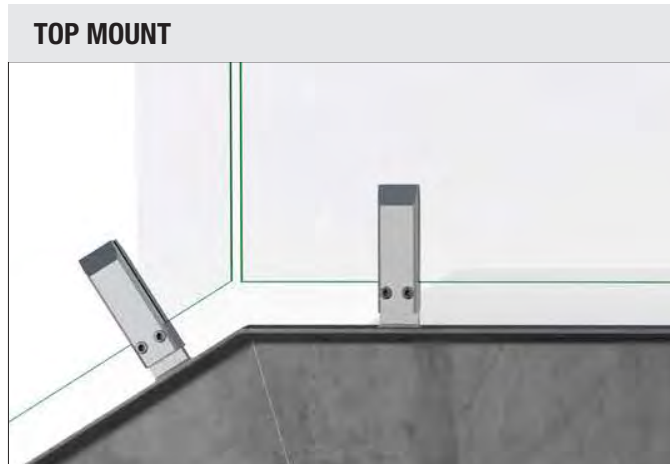

VISIO GLASS SYSTEM - FINISH OPTIONS

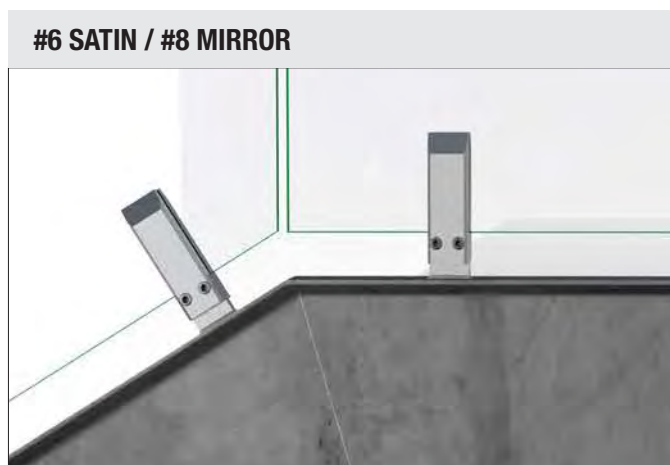

#8 Mirror Finish comes at an additional cost to our #6 Finish.



Available ECM colors on Pg 211

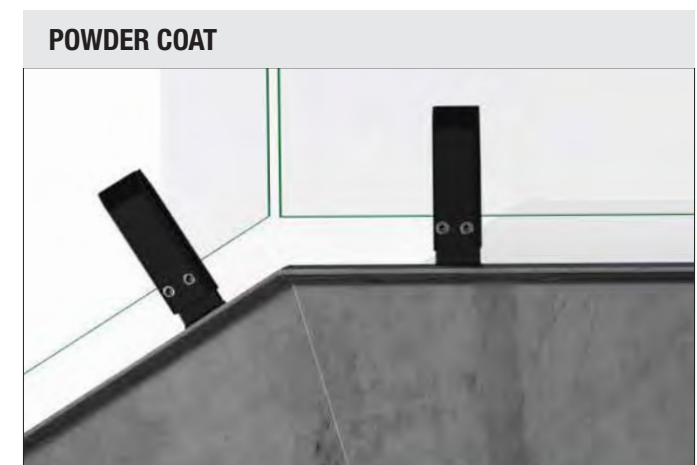

Available Standard and Premium colors on Pg 208

ECM finish is not available for U-cap, top rail or hand rail.

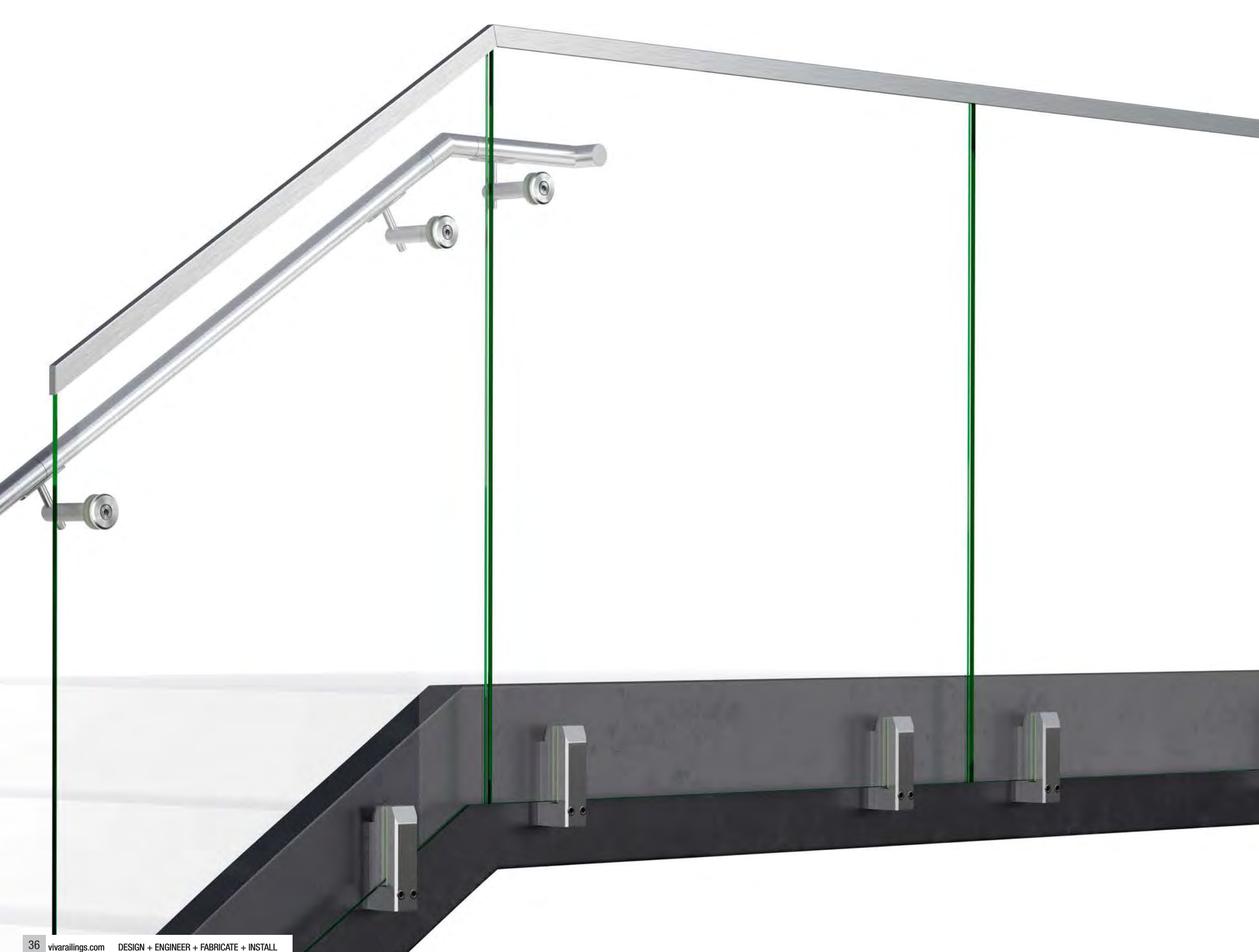

VISIO RAILING SYSTEM | INFILL: TEMPERED GLASS

MANOR ISD NEW TECH MIDDLE SCHOOL - MANOR, TX

General Contractor: Joeris General Contractors

Architect: Stantec Corporation



Visit the
project gallery.





Visit the
project gallery.



VISIO RAILING SYSTEM | INFILL: TEMPERED GLASS

RICHARD J. LEE ELEMENTARY SCHOOL - DALLAS, TX

General Contractor: Balfour Beatty Contractors

Architect: Stantec

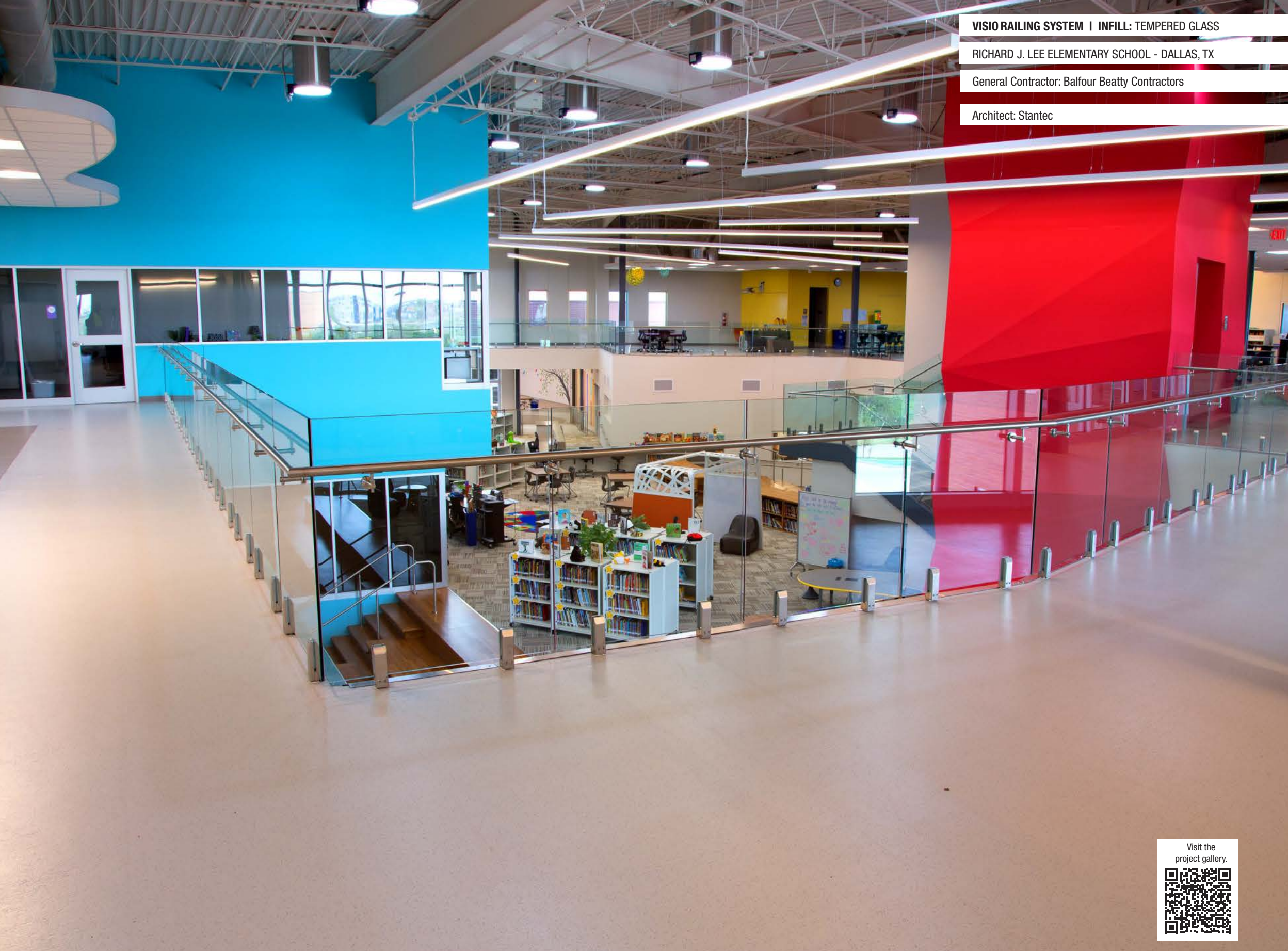

Visit the
project gallery.



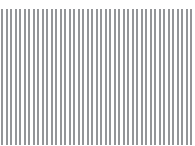

VORTEX™ GLASS SYSTEM

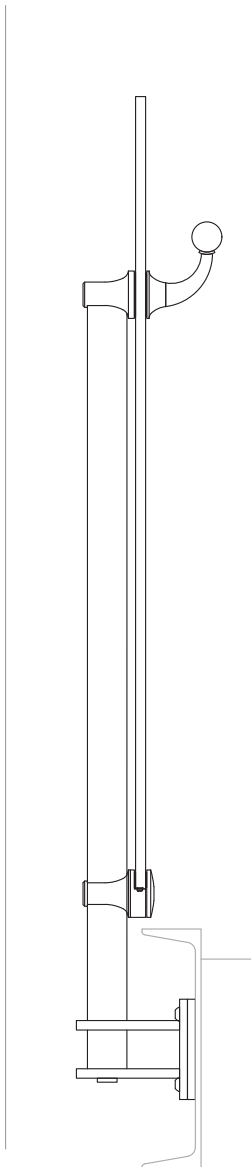
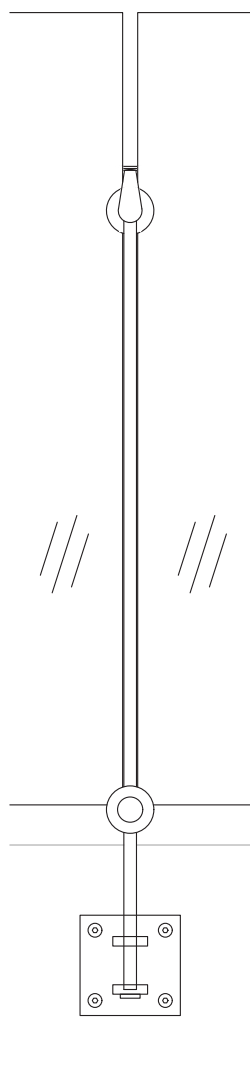

VORTEX - AVAILABLE INFILL

Glass

VORTEX glass panel railing system offers a sleek and contemporary design that is perfect for modern architectural projects. The system features a minimalist design with a single bar post and a unique funnel or vortex-shaped conical bracket that sits between the glass panels.

This bracket serves a dual purpose, supporting the glass panels and providing a sturdy handrail. 2-tone ECM finishing option is available for VORTEX.

Other mounting options available.

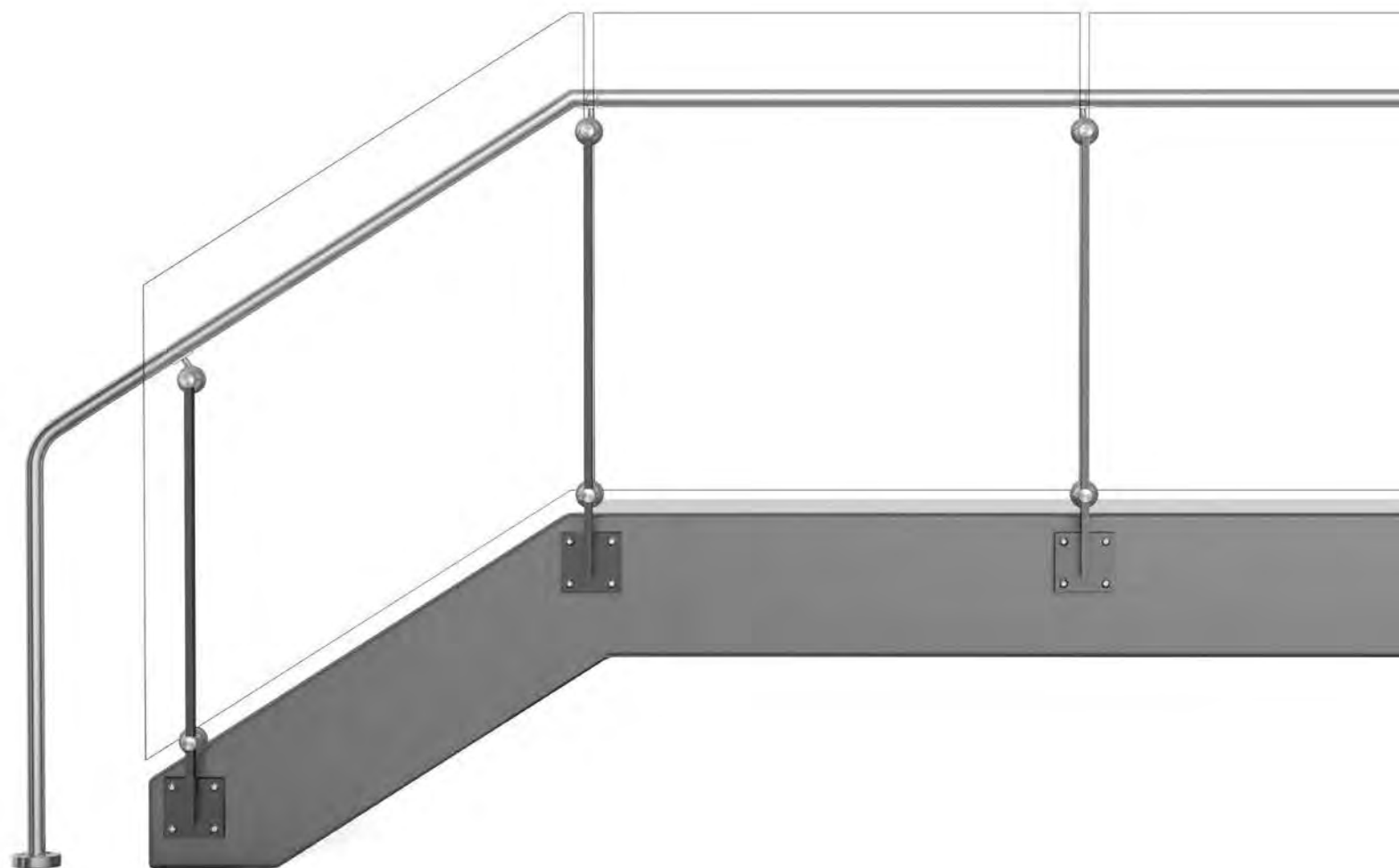

Scan the QR code to check out the VORTEX system on our website and the interactive 3D viewport

VORTEX GLASS SYSTEM - TECHNICAL DATA

	MATERIAL	FINISH	SIZE/SPACING
POST	Stainless Steel (304 or 316)	#6 Satin, #8 Mirror ECM	2" Flat bar @ 5'-0" max. O.C. for glass infill
	Stainless Steel (201)	Powder Coat	
INFILL OPTIONS	Glass with Cone Clamp	Clear, Tinted or Frit	Min. 3/8" laminated glass with PVB or SGP interlayer ¹ Glass standard thickness: 3/8", 1/2" Interlayer standard thickness, SGP: 0.035", 0.06" PVB: 0.035"
TOP RAIL/HAND RAIL	Stainless Steel U-Cap	#6 Satin, Powder Coat	1" Height U-Cap for Glass Top Rail
	Stainless Steel U-Cap with LED ³	#6 Satin	Ø1-1/2" with LED LINEAR, Ø1-1/2" or Ø2" with LED POD
	Stainless Steel Tube	#6 Satin, Powder Coat	Ø1-1/2" or Ø2" for Hand Rail
			Ø2" or 2"x1" Rectangular tube for Top Rail
	Stainless Steel Tube with LED	#6 Satin	Ø1-1/2" with LED LINEAR, Ø1-1/2" or Ø2" with LED POD
	Wood (Red Oak, Cherry or Maple) ²	Unstained	Ø2"
Wood (Red Oak, Cherry or Maple) with LED	Unstained	Ø2" with LED LINEAR	

ECM finish is not available for U-cap, top rail or hand rail.



Intertek

1. IBC 2015 & newer requires railing glass to be laminated. VIVA recommends SGP for exterior applications.

2. Other species available upon request.

3. All LED LINEAR products are ETL certified; ETL mark is proof of product compliance to North American safety standard.

VORTEX^{GLASS} SYSTEM - INFILL OPTIONS

GLASS

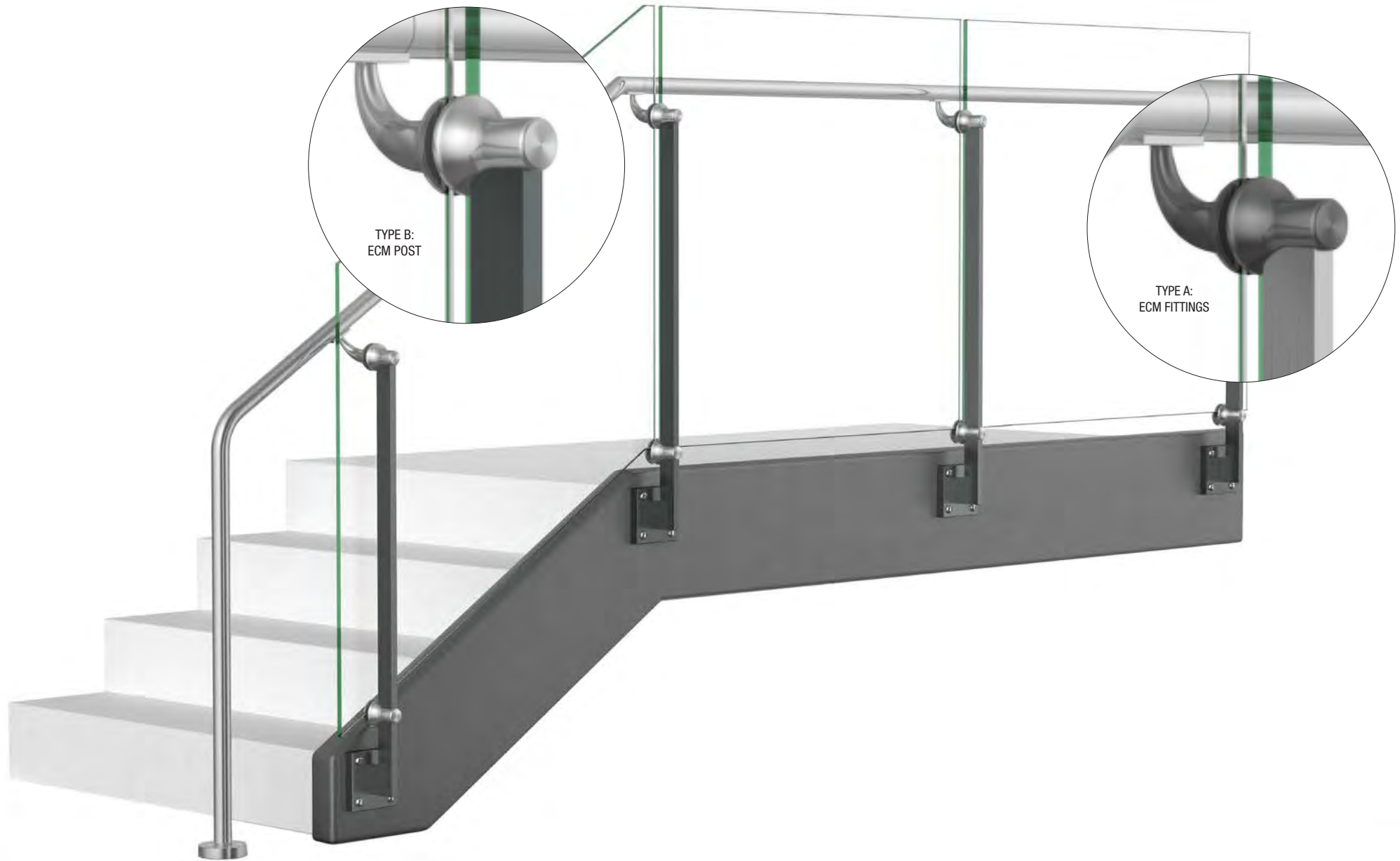

VIVA's tempered glass infills provide optimal line of sight as well as an understated elegance.
Clear Laminated (PVB or SGP) | Bent | Tinted | Ceramic Frit Patterned | Colored Interlayer

VORTEX_{GLASS SYSTEM} - MOUNTING CONDITIONS

TOP MOUNT	
STEEL	CONCRETE
WELD	ANCHOR
	CORE

FASCIA MOUNT	
STEEL	CONCRETE
WELD	ANCHOR

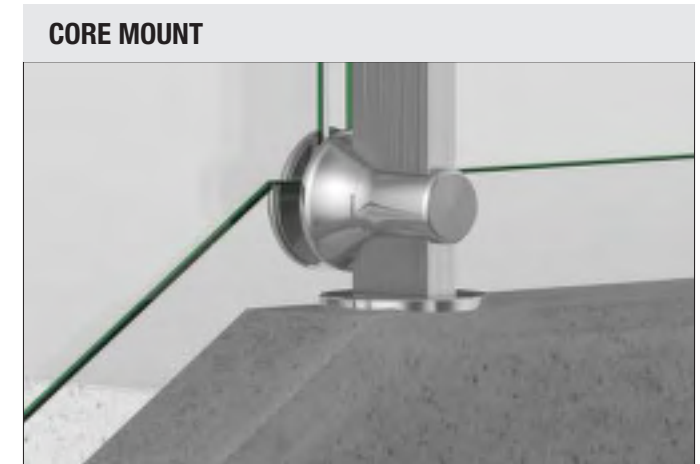
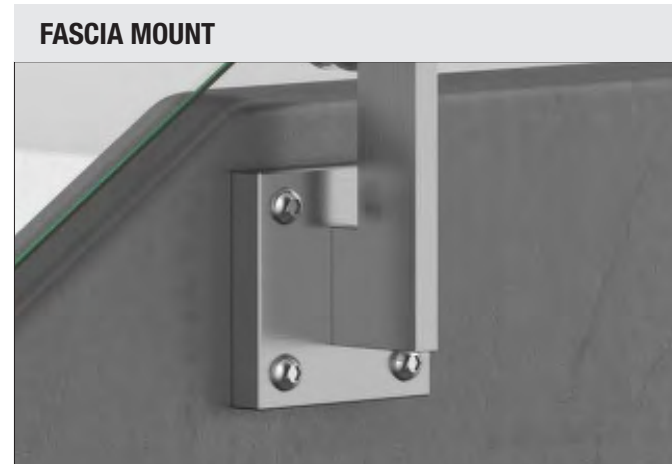
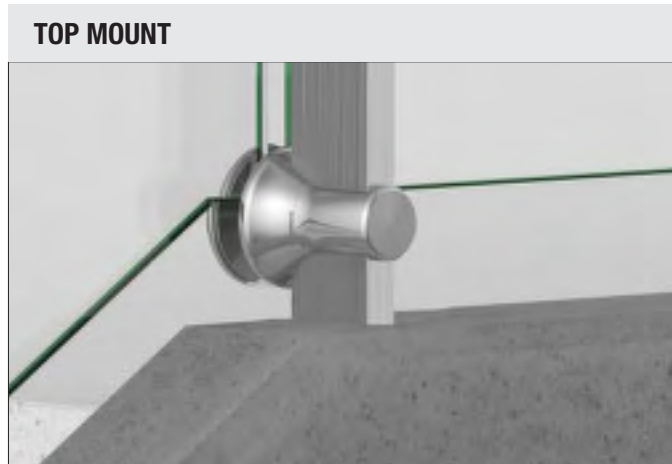

VORTEX_{GLASS SYSTEM} - FINISH OPTIONS

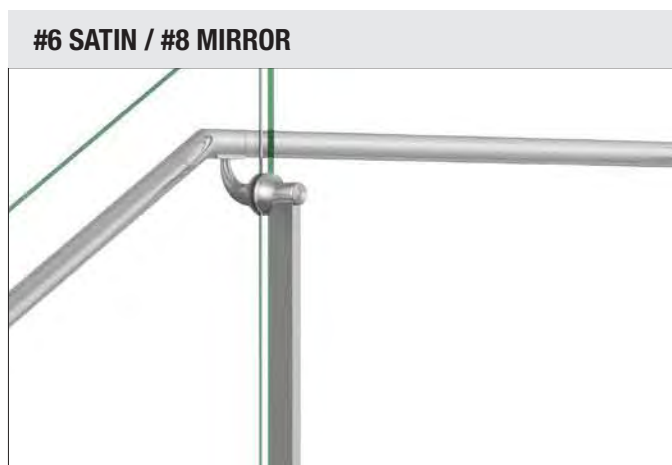

#8 Mirror Finish comes at an additional cost to our #6 Finish.

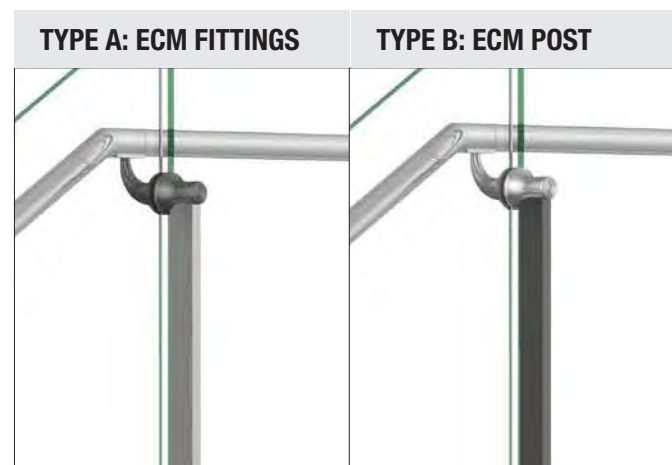

Available ECM colors on Pg 211

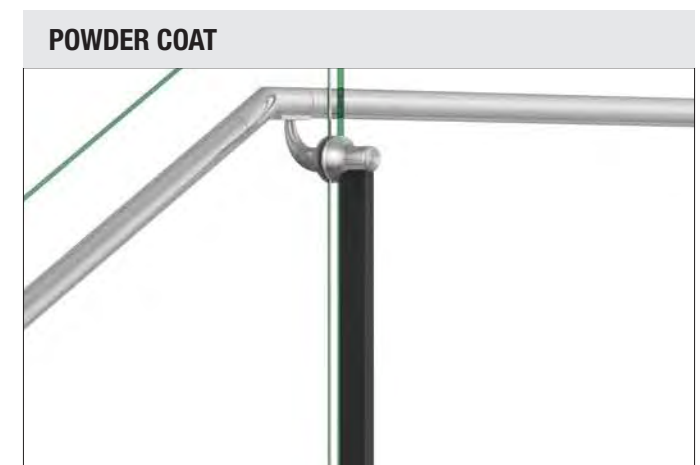

Available Standard and Premium colors on Pg 208

ECM finish is not available for U-cap, top rail or hand rail.

BEACON™ GLASS & METAL SYSTEM

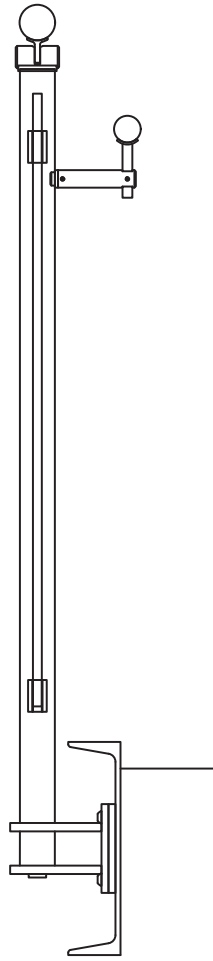
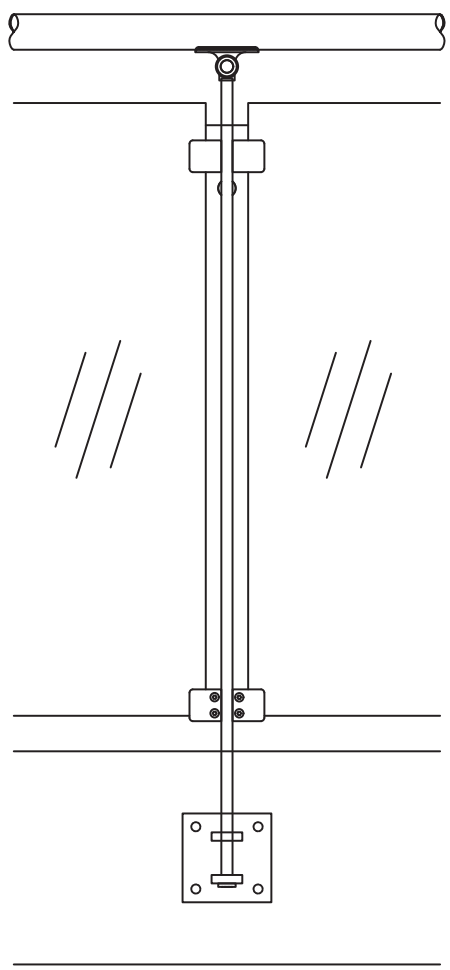

BEACON - AVAILABLE INFILLS

- Glass
- Perforated Metal
- Wire Mesh
- Cable
- CableNet
- Laser Cut Panels

Other mounting options available.

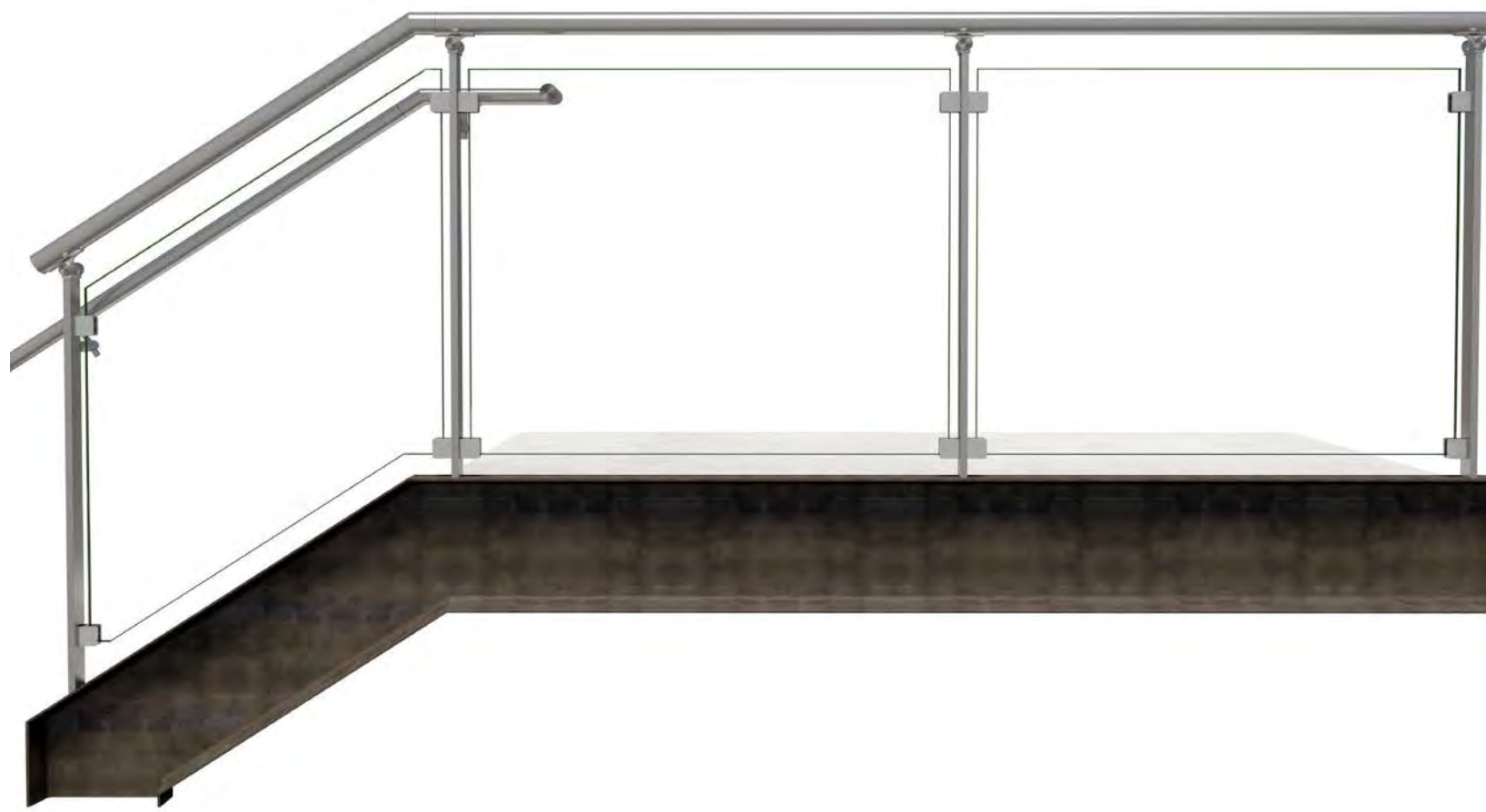

Scan the QR code to check out the BEACON system on our website and the interactive 3D viewport

BEACON GLASS & METAL SYSTEM - TECHNICAL DATA



	MATERIAL	FINISH	SIZE/SPACING
POST	Stainless Steel (304 or 316)	#6 Satin, #8 Mirror	2" Flat bar @ 5'-0" max. O.C. for glass infill, 4'-6" max. for perforated and wire mesh infill. 2"x2" End post, 2" flat bar intermediate post @ 4'-0" max. for cable infill. Fascia, Top or Core mount.
	Stainless Steel (201)	ECM Powder Coat	
INFILL OPTIONS	Glass with D-Clamps	Clear, Tinted or Frit	Min. 3/8" laminated glass with PVB or SGP interlayer ¹ Glass standard thickness: 3/8", 1/2" Interlayer standard thickness, SGP: 0.035", 0.06" PVB: 0.035"
	Perforated Metal	#6 Satin	1" wide frame
	Wire Mesh		Ø3/16" cable
	Cable		Ø1" frame, Ø1/16" (1.5mm) cable mesh
	CableNet		
Laser Cut	Powder Coat - Super Polyester (AAMA 2604) - \$ ⁴ Powder Coat - PVDF (AAMA 2605) - \$\$ ⁴	1/4" thick aluminum panel.	
TOP RAIL/HAND RAIL	Stainless Steel U-Cap	#6 Satin, Powder Coat	1" Height U-Cap for Glass Top Rail
	Stainless Steel U-Cap with LED ³	#6 Satin	1" Height U-Cap with LED LINEAR for Glass Top Rail
	Stainless Steel Tube	#6 Satin, Powder Coat	Ø1-1/2" or Ø2" for Hand Rail
			Ø2" or 2"x1" Rectangular tube for Top Rail
	Stainless Steel Tube with LED	#6 Satin	Ø1-1/2" with LED LINEAR, Ø1-1/2" or Ø2" with LED POD
	Wood (Red Oak, Cherry or Maple) ²	Unstained	Ø2"
Wood (Red Oak, Cherry or Maple) with LED	Ø2" with LED LINEAR		

ECM finish is not available for U-cap, top rail or hand rail.



- IBC 2015 & newer requires railing glass to be laminated. VIVA recommends SGP for exterior applications.
- All LED LINEAR products are ETL certified; ETL mark is proof of product compliance to North American safety standard.
- Other species available upon request.
- \$ to \$\$\$: Indicates finish type comparative cost.

BEACON GLASS & METAL SYSTEM - INFILL OPTIONS

GLASS



VIVA's tempered glass infills provide optimal line of sight as well as an understated elegance.
Clear Laminated (PVB or SGP) | Bent | Tinted | Ceramic Frit
Patterned | Colored Interlayer

PERFORATED METAL PANELS



VIVA's perforated metal infill panels feature a solid metal outer frame with rounded, slotted or square motifs.

Perforated Metal Panel Patterns on Pg. 213

WIRE MESH PANELS



VIVA's wire mesh infill features an organic, interwoven fabric as an infill. Mesh infills are timeless and easy to maintain. The signature box frame completes the system for a clean, sharp look.

Wire Mesh Panel Patterns on Pg. 212

CABLE



VIVA's stainless steel cable infill is a low maintenance, high visibility infill that is popularly used on exterior applications. Our cable comes in 1x19 type weave, 3/16" diameter in SS316 alloy.

CABLENET



VIVA's CableNet is an extremely versatile and strong infill, exceeding code requirements on load performance and opening size limitations. CableNet is available in an individual post to post frames or a continuous run.

LASER CUT PANELS

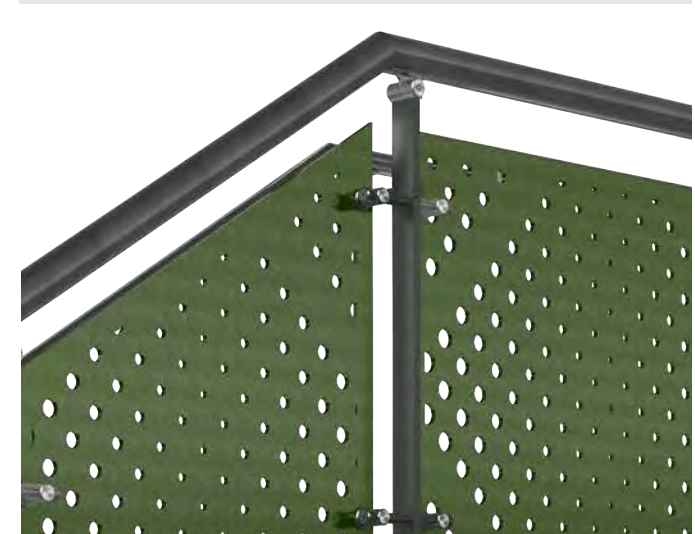

Customize your architectural spaces with VIVA Railings' laser-cut metal infill panels. These panels are designed for our post railing systems. We have a wide range of standard patterns available in primary, geometric and organic designs. Custom patterns are also possible.

BEACON GLASS & METAL SYSTEM - MOUNTING CONDITIONS

TOP MOUNT	
STEEL	CONCRETE
WELD	ANCHOR
	CORE

FASCIA MOUNT	
STEEL	CONCRETE
WELD	ANCHOR

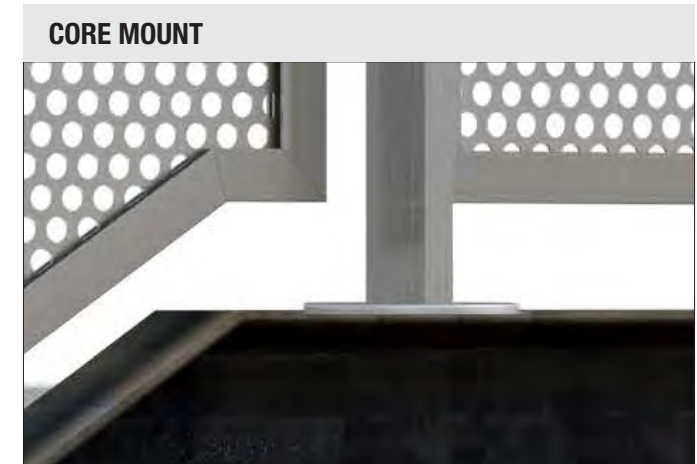
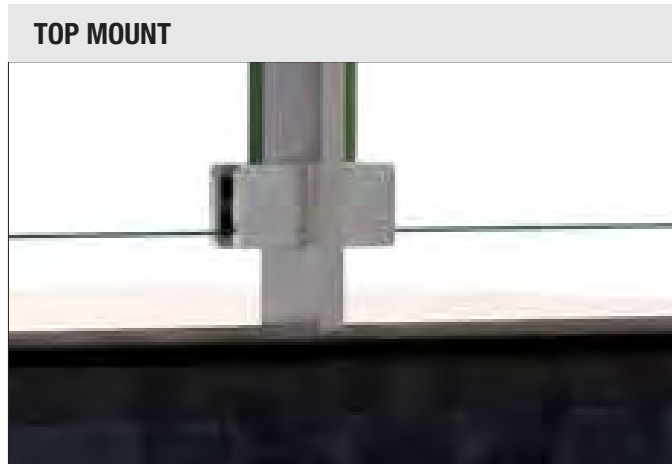

BEACON GLASS & METAL SYSTEM - FINISH OPTIONS



#8 Mirror Finish comes at an additional cost to our #6 Finish.



Available ECM colors on Pg 211



Available Standard and Premium colors on Pg 208

POST	FITTING TYPE	DESCRIPTION	SKU
SS	D-Clamp SS	BD-1 Beacon D-Clamp (Finish SS+SS)	BD-1
ECM	D-Clamp ECM	BD-2 Beacon D-Clamp (Finish ECM+ECM)	BD-2
PC	D-Clamp SS	BD-3 Beacon D-Clamp (Finish PC+SS)	BD-3

ECM finish is not available for U-cap, top rail or hand rail.



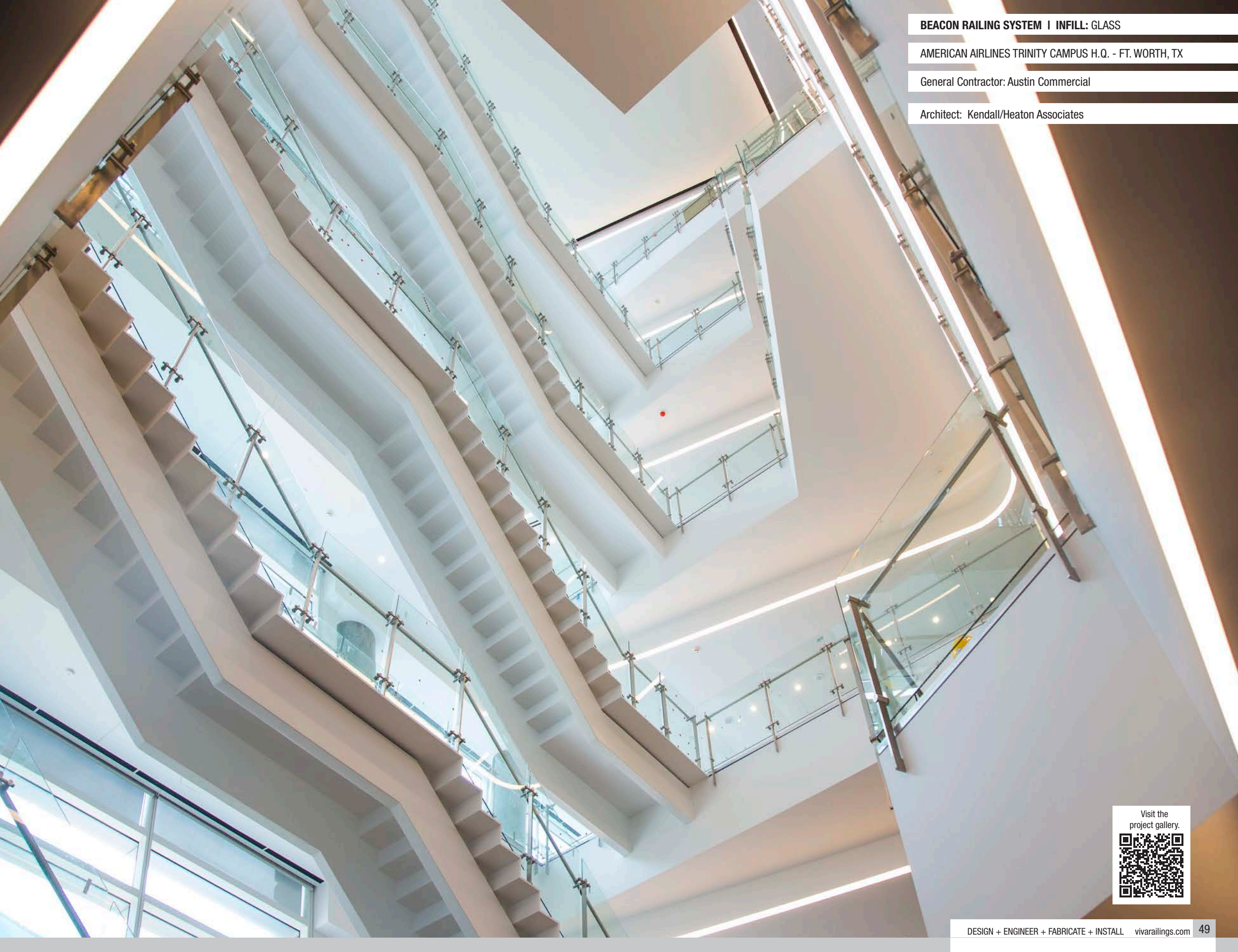

BEACON RAILING SYSTEM | INFILL: GLASS

AMERICAN AIRLINES TRINITY CAMPUS H.Q. - FT. WORTH, TX

General Contractor: Austin Commercial

Architect: Kendall/Heaton Associates

Visit the
project gallery.



BEACON RAILING SYSTEM | INFILL: GLASS

AMERICAN AIRLINES TRINITY CAMPUS H.Q. - FT. WORTH, TX

General Contractor: Austin Commercial

Architect: Kendall/Heaton Associates

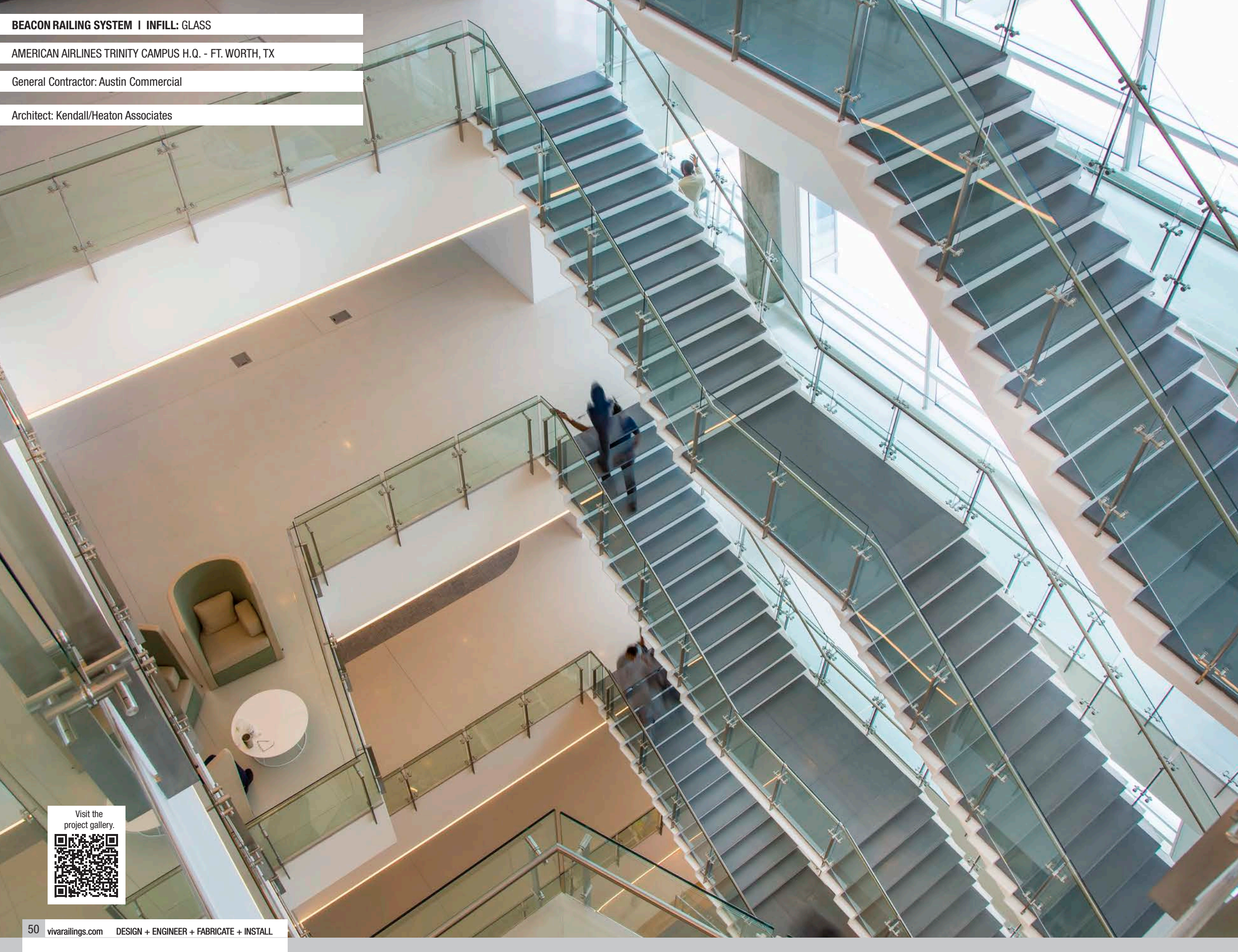

Visit the project gallery.



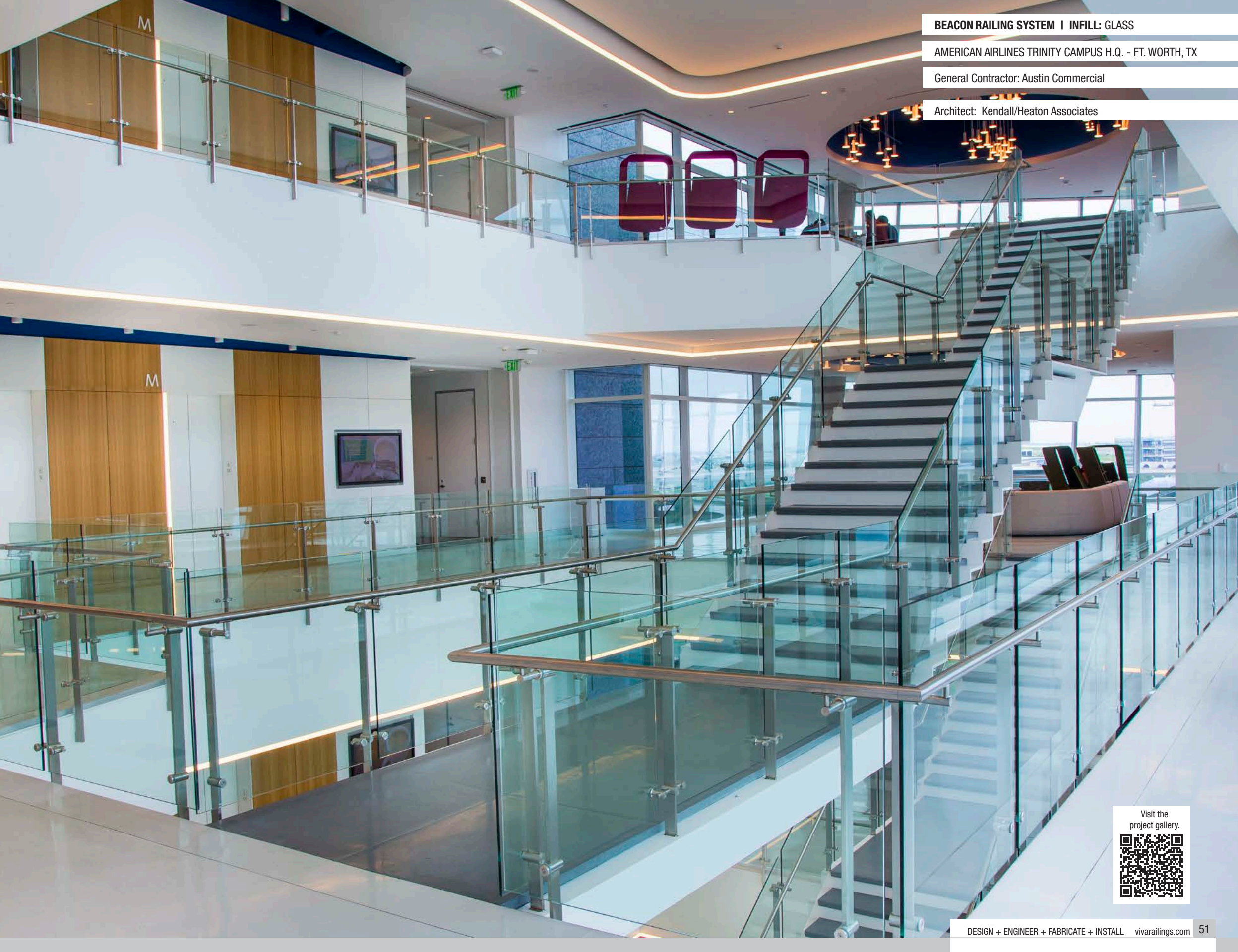

BEACON RAILING SYSTEM | INFILL: GLASS

AMERICAN AIRLINES TRINITY CAMPUS H.Q. - FT. WORTH, TX

General Contractor: Austin Commercial

Architect: Kendall/Heaton Associates

Visit the project gallery.



SOLO™ GLASS SYSTEM

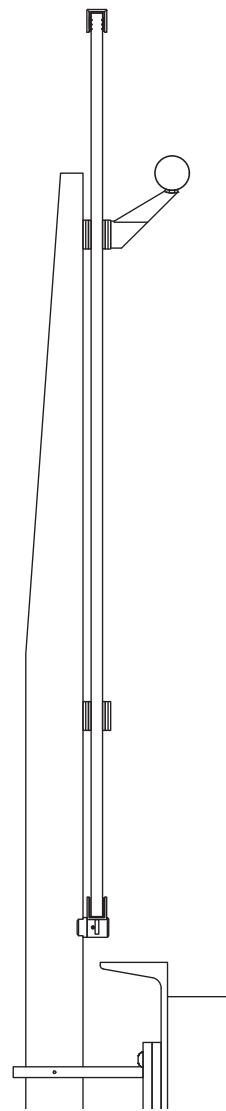
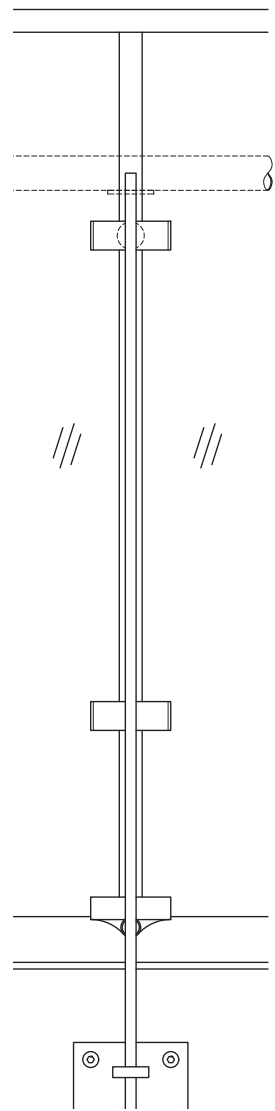

SOLO - AVAILABLE INFILLS

Glass

Our SOLO Ornamental Stainless Steel Glass Railing System exquisitely balances an unobstructed view with contemporary elegance. This railing system is ideal for balcony balustrades (as illustrated in the Toyota U.S. Headquarters stainless steel railings), commercial building atriums, and monumental stair railings. The variety of mounting options available (top, fascia, or core mount) means that whatever the demands of your design, VIVA will be able to provide the right solution.

Other mounting options available.

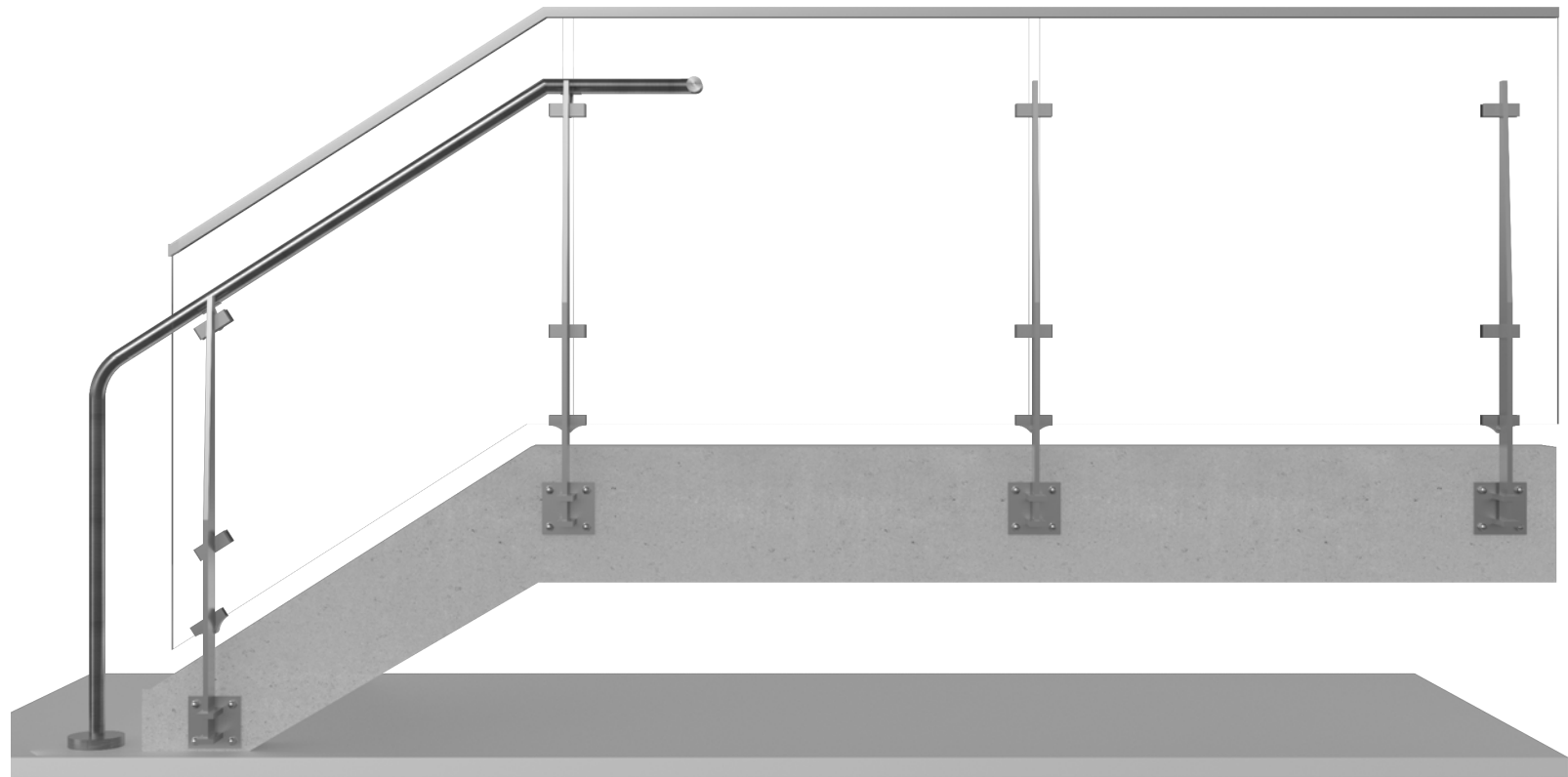

Scan the QR code to check out the SOLO system on our website and the interactive 3D viewport

SOLO GLASS SYSTEM - TECHNICAL DATA

	MATERIAL	FINISH	SIZE/SPACING
POST	Stainless Steel (304 or 316)	#6 Satin, #8 Mirror	2 1/2" Flat bar post @ 4'-6" max. at level and 4'-0" max. at stair. Fascia, Top or Core mount.
	Stainless Steel (201)	ECM Powder Coat	
INFILL OPTIONS	Glass	Clear, Tinted or Frit	Min. 3/8" laminated glass with PVB or SGP interlayer ¹ Glass standard thickness: 3/8", 1/2", 5/8", 3/4" Interlayer standard thickness, SGP: 0.035", 0.06" PVB: 0.035
TOP RAIL	Stainless Steel (304 or 316)	#6 Satin, Powder Coat	1" Height U channel or without Top Rail
HAND RAIL ECM finish is not available for U-cap, top rail or hand rail.	Stainless Steel Tube	#6 Satin, Powder Coat	Ø1-1/2" or 2"
	Stainless Steel Tube with LED ²	#6 Satin	Ø1-1/2" with LED LINEAR, Ø1-1/2" or Ø2" with LED POD
	Wood (Red Oak, Cherry or Maple) ³	Unstained	Ø2"
	Wood (Red Oak, Cherry or Maple) with LED		Ø2" with LED LINEAR



Intertek

1. IBC 2015 & newer requires railing glass to be laminated. VIVA recommends SGP for exterior applications.

2. All LED LINEAR products are ETL certified; ETL mark is proof of product compliance to North American safety standard.

3. Other species available upon request.

SOLO GLASS SYSTEM - INFILL OPTIONS

GLASS



VIVA's tempered glass infills provide optimal line of sight as well as an understated elegance.
Clear Laminated (PVB or SGP) | Bent | Tinted | Ceramic Frit Patterned | Colored Interlayer

SOLO GLASS SYSTEM - MOUNTING CONDITIONS

TOP MOUNT	
STEEL	CONCRETE
WELD	ANCHOR CORE

FASCIA MOUNT	
STEEL	CONCRETE
WELD	ANCHOR

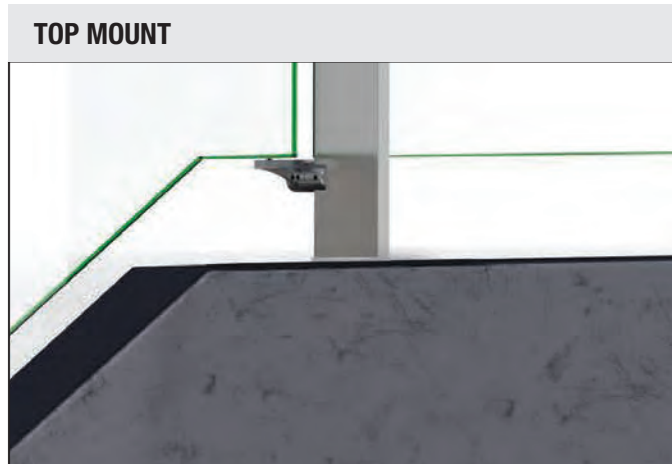

SOLO GLASS SYSTEM - FINISH OPTIONS



#8 Mirror Finish comes at an additional cost to our #6 Finish.



Available ECM colors on Pg 211



Available Standard and Premium colors on Pg 208

ECM finish is not available for U-cap, top rail or hand rail.

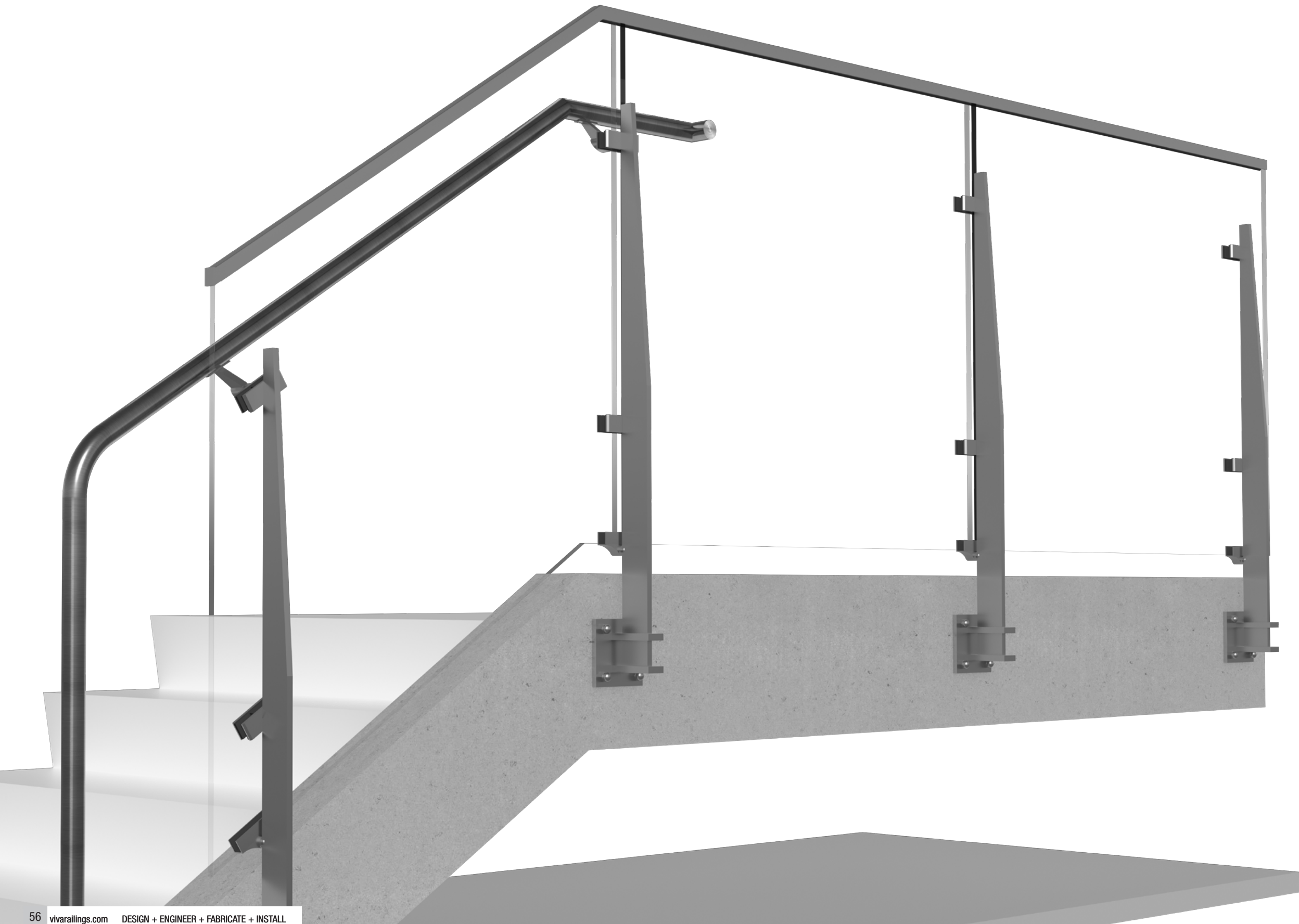



SOLO RAILING SYSTEM | INFILL: GLASS

RUNWAY AT PLAYA VISTA - LOS ANGELES, CA

General Contractor: Austin Commercial

Architect: Johnson Fain

Visit the project gallery.



SOLO RAILING SYSTEM | INFILL: TEMPERED GLASS

TOYOTA U.S. HEADQUARTERS - THE COLONY, TX

General Contractor: Austin Commercial

Architect: Corgan Associates

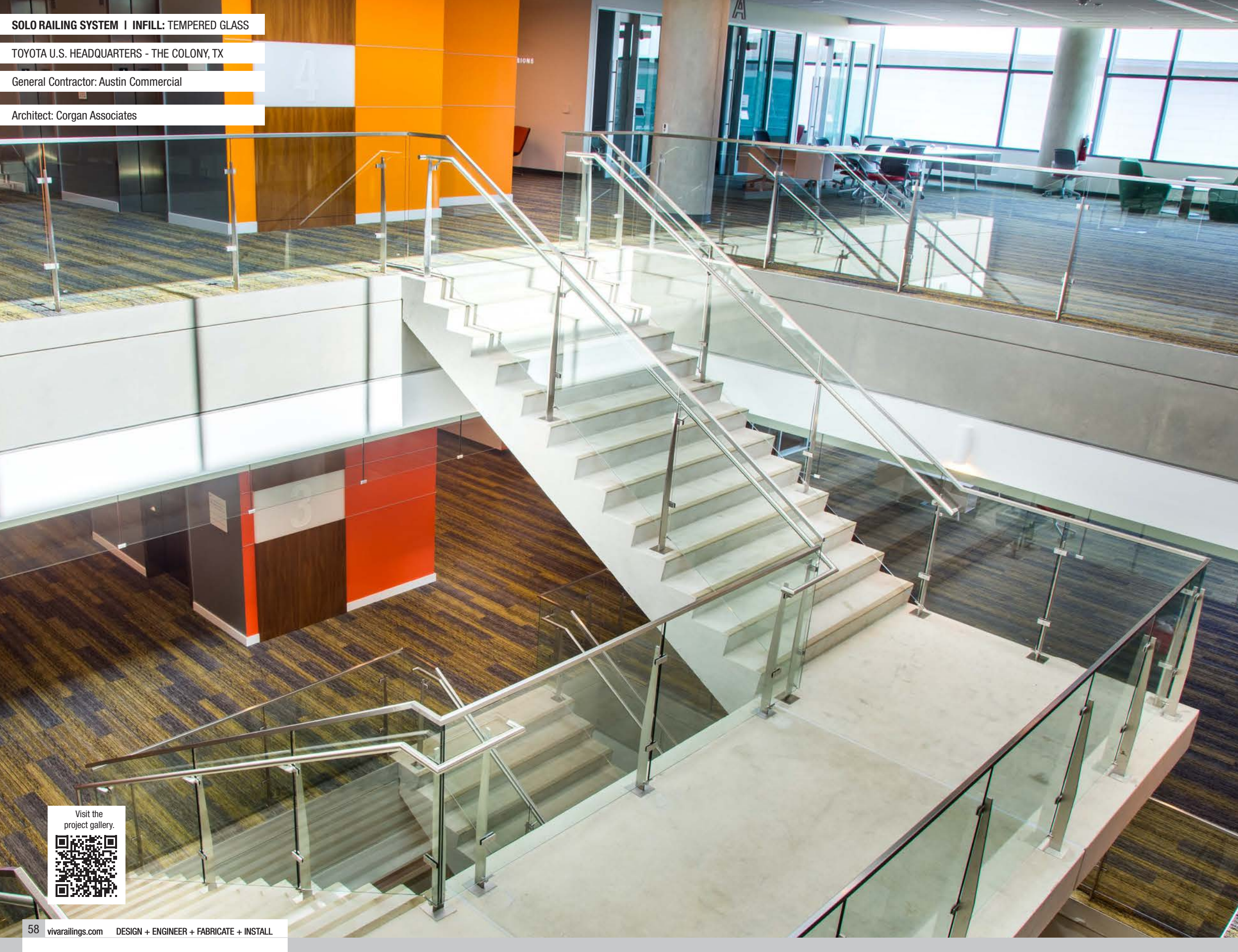

Visit the project gallery.



SOLO RAILING SYSTEM | INFILL: GLASS

GEORGETOWN ISD NEW TECH MIDDLE SCHOOL - GEORGETOWN, TX

General Contractor: Lee Lewis Construction

Architect: Huckabee Architects

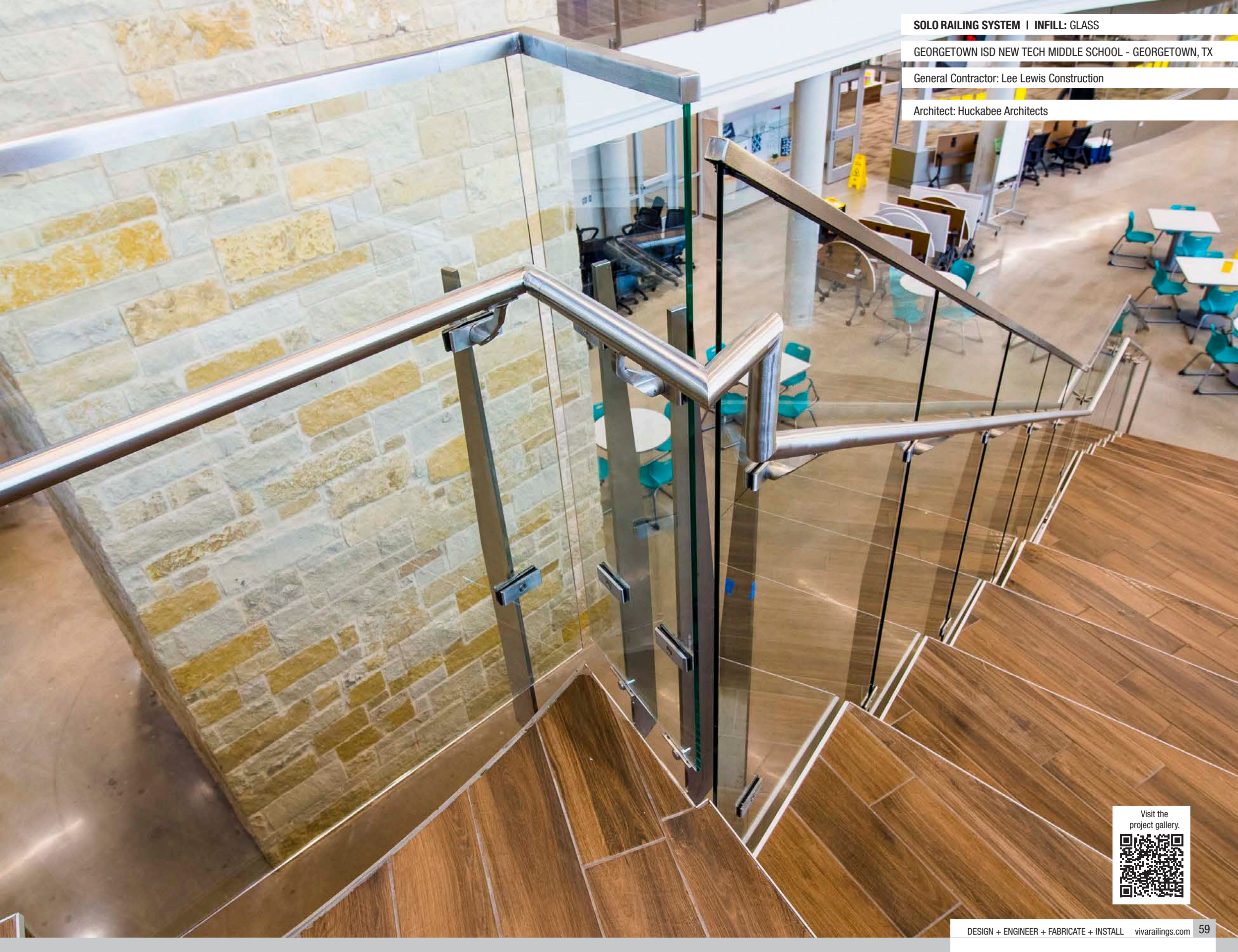

Visit the
project gallery.



BLADE[®] GLASS & METAL SYSTEM

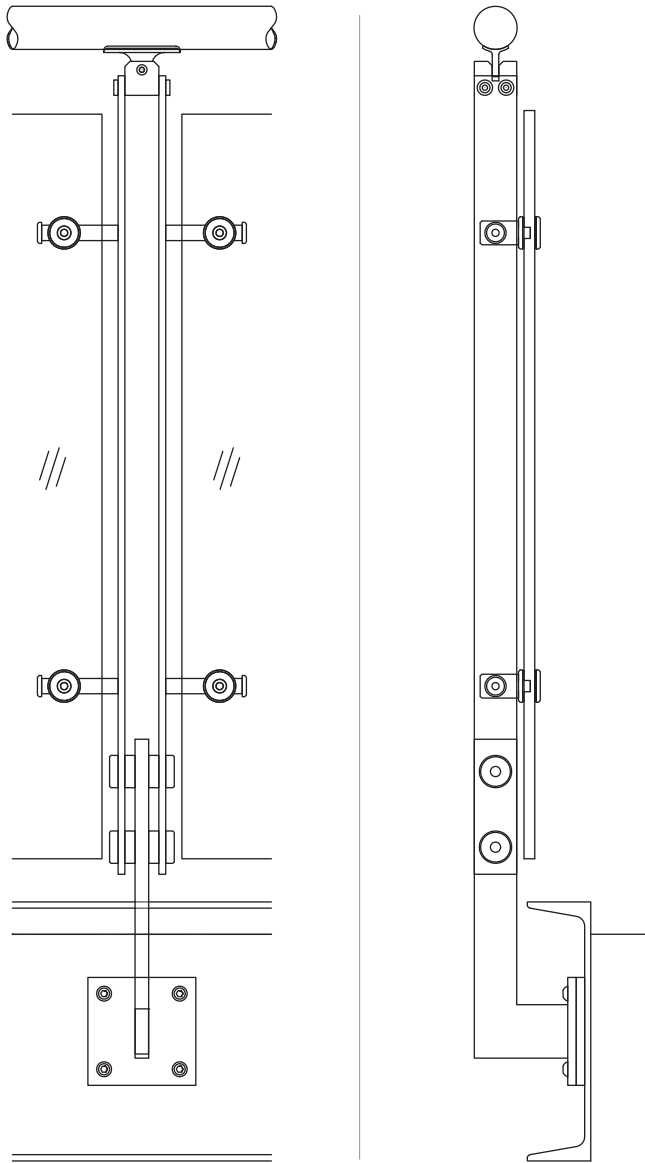

Other mounting options available.

BLADE - AVAILABLE INFILLS

- Glass
- Perforated Metal
- Wire Mesh
- Picket Panel
- CableNet
- Multiline
- Laser Cut Panels

Our BLADE Stainless Steel Railing System has an ultra-contemporary design with minimum obstruction to the line of sight. The system consists of two 2" wide vertical bars, with a cube cap at the top and barrel bolts at the bottom. This expertly-crafted system makes it appear as though the in-fill panels are suspended in air!

BLADE is available in ECM or powder-coated colors and with an option for LED illuminated rail.



Scan the QR code to check out the BLADE system on our website and the interactive 3D viewport

BLADE GLASS & METAL SYSTEM - TECHNICAL DATA

	MATERIAL	FINISH	SIZE/SPACING
POST	Stainless Steel (304 or 316)	#6 Satin, #8 Mirror	2" Double flat bar post: @ 5'-0" max. O.C. 4'-6" max. for Perforated and Wire Mesh infill. 4'-0" max. for MultiLine infill.
	Stainless Steel (201)	ECM	
INFILL OPTIONS	Glass	Clear, Tinted or Frit	Min. 3/8" laminated glass with PVB or SGP interlayer ¹ Glass standard thickness: 3/8", 1/2", 5/8", 3/4" Interlayer standard thickness: SGP: 0.035" , 0.06" PVB: 0.035"
	Perforated Metal	#6 Satin	1" wide frame
	Wire Mesh		Ø1/2" picket
	Picket Panel		Ø1/2" multiline
	Multiline		Ø1" Wide frame, Ø1/16" (1.5mm) cable mesh
	CableNet	Powder Coat - Super Polyester (AAMA 2604) - \$ ⁴	1/4" thick aluminum panel.
	Laser Cut		
TOP RAIL/HAND RAIL ECM finish is not available for U-cap, top rail or hand rail.	Stainless Steel Tube	#6 Satin, Powder Coat	Ø1-1/2" or Ø2" for Hand Rail Ø1-1/2", Ø2" or 2"x1" Rectangular Tube for Top Rail
	Stainless Steel Tube with LED ²	#6 Satin	Ø1-1/2" with LED LINEAR, Ø1-1/2" or Ø2" with LED POD
	Wood (Red Oak, Cherry or Maple) ³	Unstained	Ø2"
	Wood (Red Oak, Cherry or Maple) with LED		Ø2" with LED LINEAR



1. IBC 2015 & newer requires railing glass to be laminated. VIVA recommends SGP for exterior applications.

2. All LED LINEAR products are ETL certified; ETL mark is proof of product compliance to North American safety standard.

3. Other species available upon request.

4. \$ to \$\$\$: Indicates finish type comparative cost.

BLADE GLASS & METAL SYSTEM - INFILL OPTIONS



VIVA's tempered glass infills provide optimal line of sight as well as an understated elegance.
 Clear Laminated (PVB or SGP) | Bent | Tinted | Ceramic Frit
 Patterned | Colored Interlayer

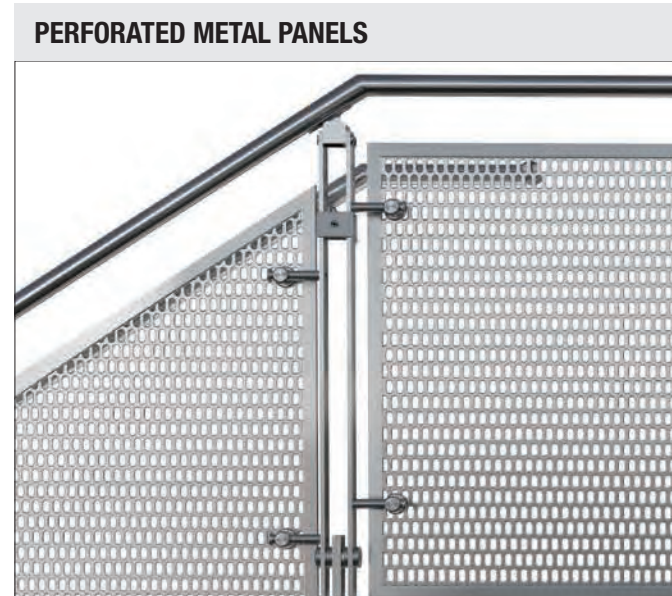

VIVA's perforated metal infill panels feature a solid metal outer frame with rounded, slotted or square motifs.

Perforated Metal Panel Patterns on Pg. 213

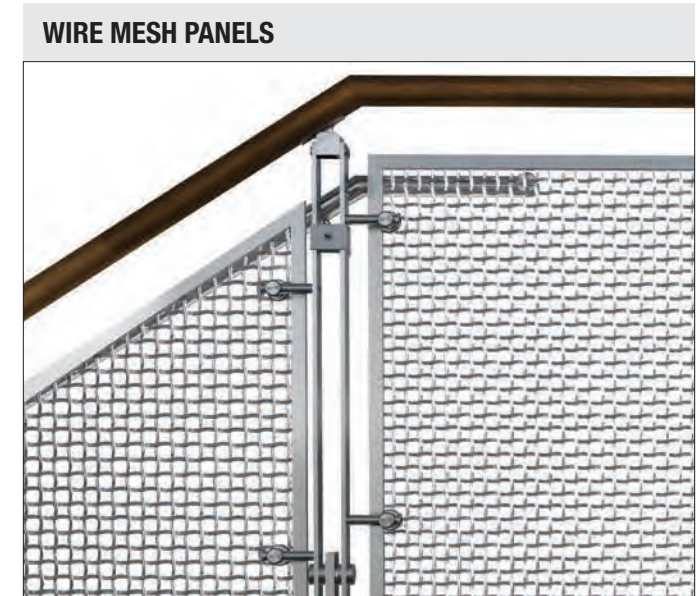

VIVA's wire mesh infill features an organic, interwoven fabric as an infill. Mesh infills are timeless and easy to maintain. The signature box frame completes the system for a clean, sharp look.

Wire Mesh Panel Patterns on Pg. 212



VIVA's uniquely designed picket infill is an economical vertical infill option that provides clear, clean lines.



VIVA's multiline infill is a perfect choice for clean modern designs of today. The fluid design works well with curved areas as well.

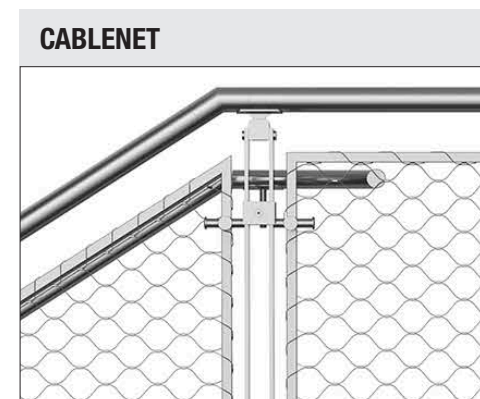

VIVA's CableNet is an extremely versatile and strong infill, exceeding code requirements on load performance and opening size limitations. CableNet is available in an individual post to post frames or a continuous run.

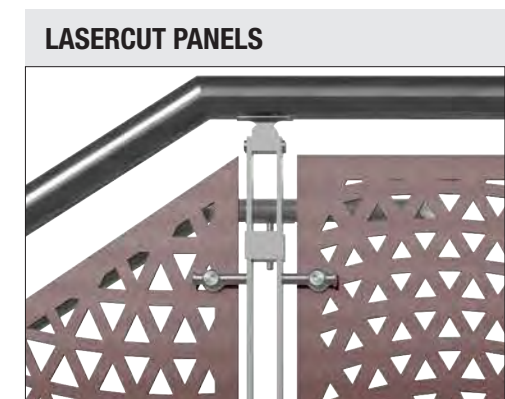

Customize your architectural spaces with VIVA Railings' laser-cut metal infill panels. These panels are designed for our post railing systems. We have a wide range of standard patterns available in primary, geometric and organic designs. Custom patterns are also possible.

BLADE GLASS & METAL SYSTEM - MOUNTING CONDITIONS

TOP MOUNT	
STEEL	CONCRETE
WELD	ANCHOR
	CORE

FASCIA MOUNT	
STEEL	CONCRETE
WELD	ANCHOR

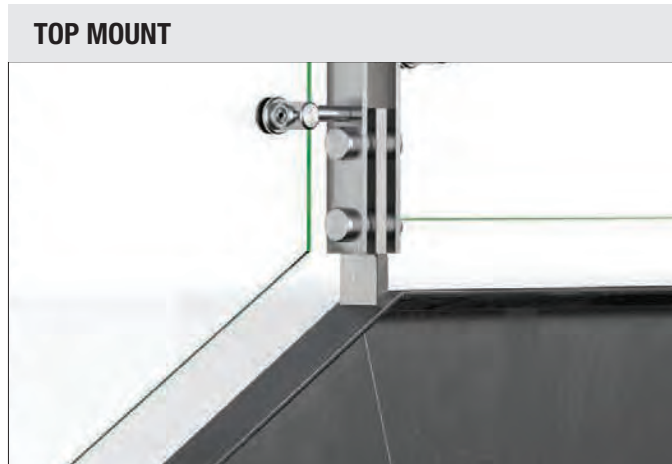

BLADE GLASS & METAL SYSTEM - FINISH OPTIONS



#8 Mirror Finish comes at an additional cost to our #6 Finish.

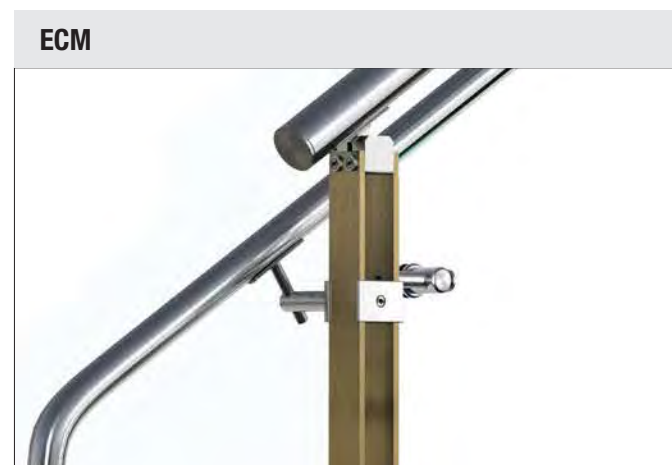

Available ECM colors on Pg 211

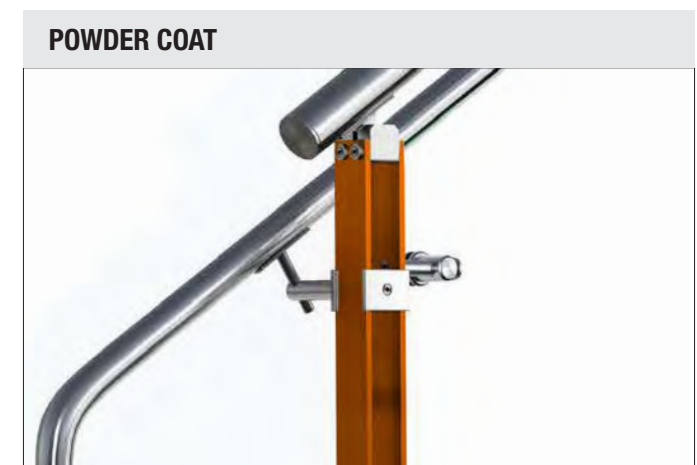

Available Standard and Premium colors on Pg 208

ECM finish is not available for U-cap, top rail or hand rail.

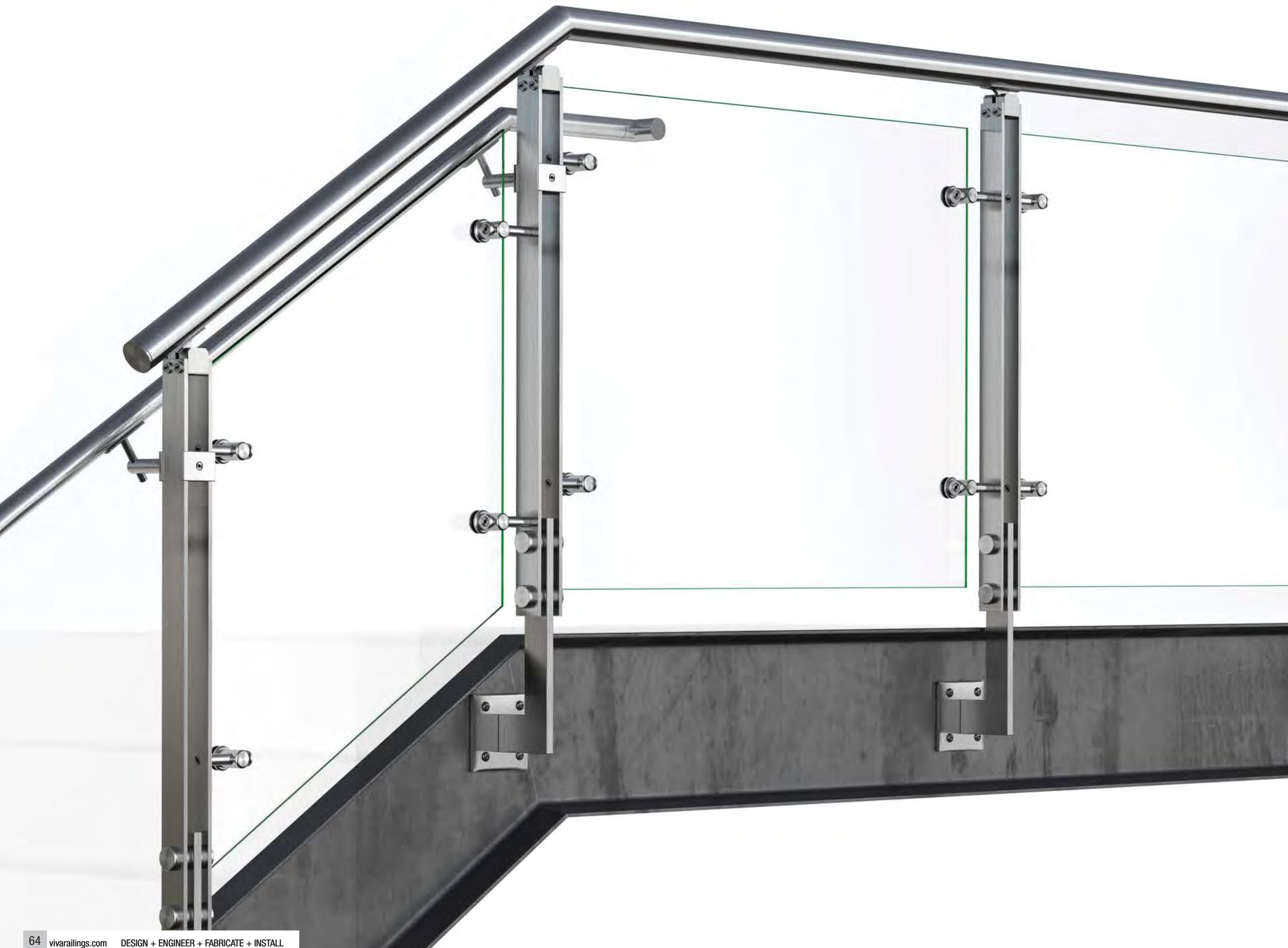

BLADE RAILING SYSTEM | INFILL: PERFORATED METAL PANEL

JM FAMILY ENTERPRISES HEADQUARTERS – DEERFIELD BEACH, FL

General Contractor: Kaufman Lynn Construction

Architect: PGAL Architects

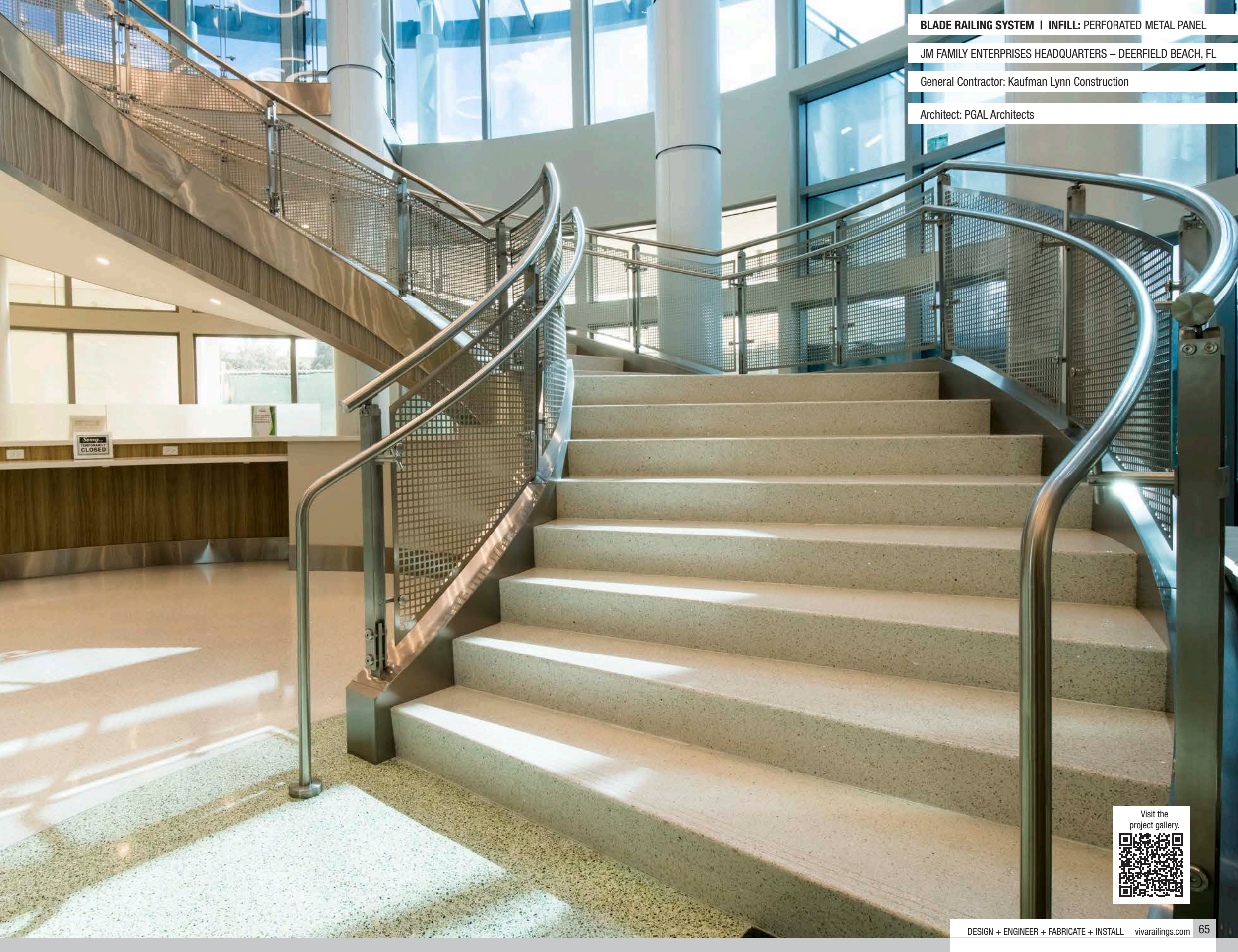

Sevvy
TEMPORARILY
CLOSED

Visit the
project gallery.



BLADE RAILING SYSTEM | INFILL: MULTILINE

DICK'S SPORTING GOODS - MINNETONKA, MN

General Contractor: WDS Construction

Architect: FOX Design Group Solon, OH

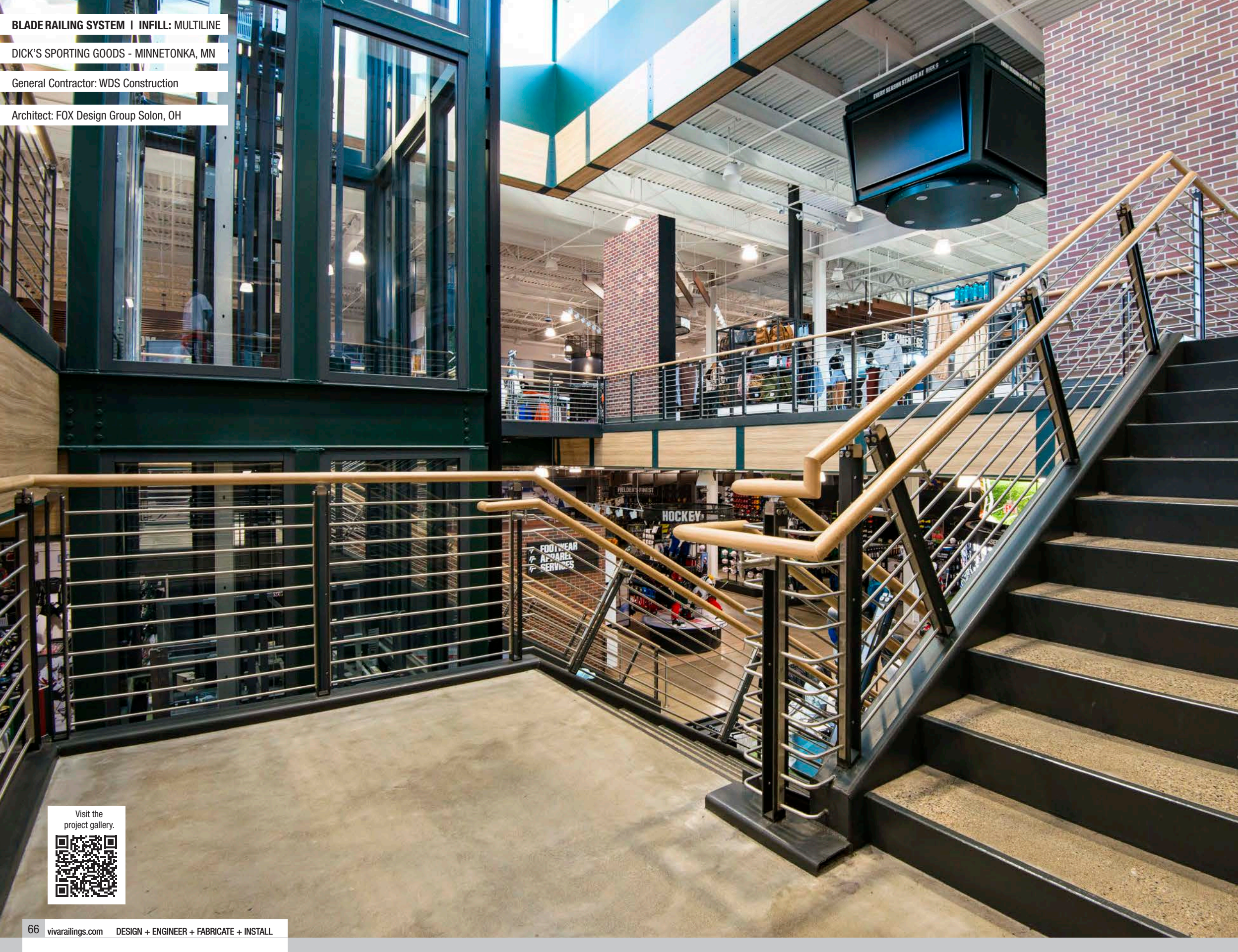

Visit the project gallery.



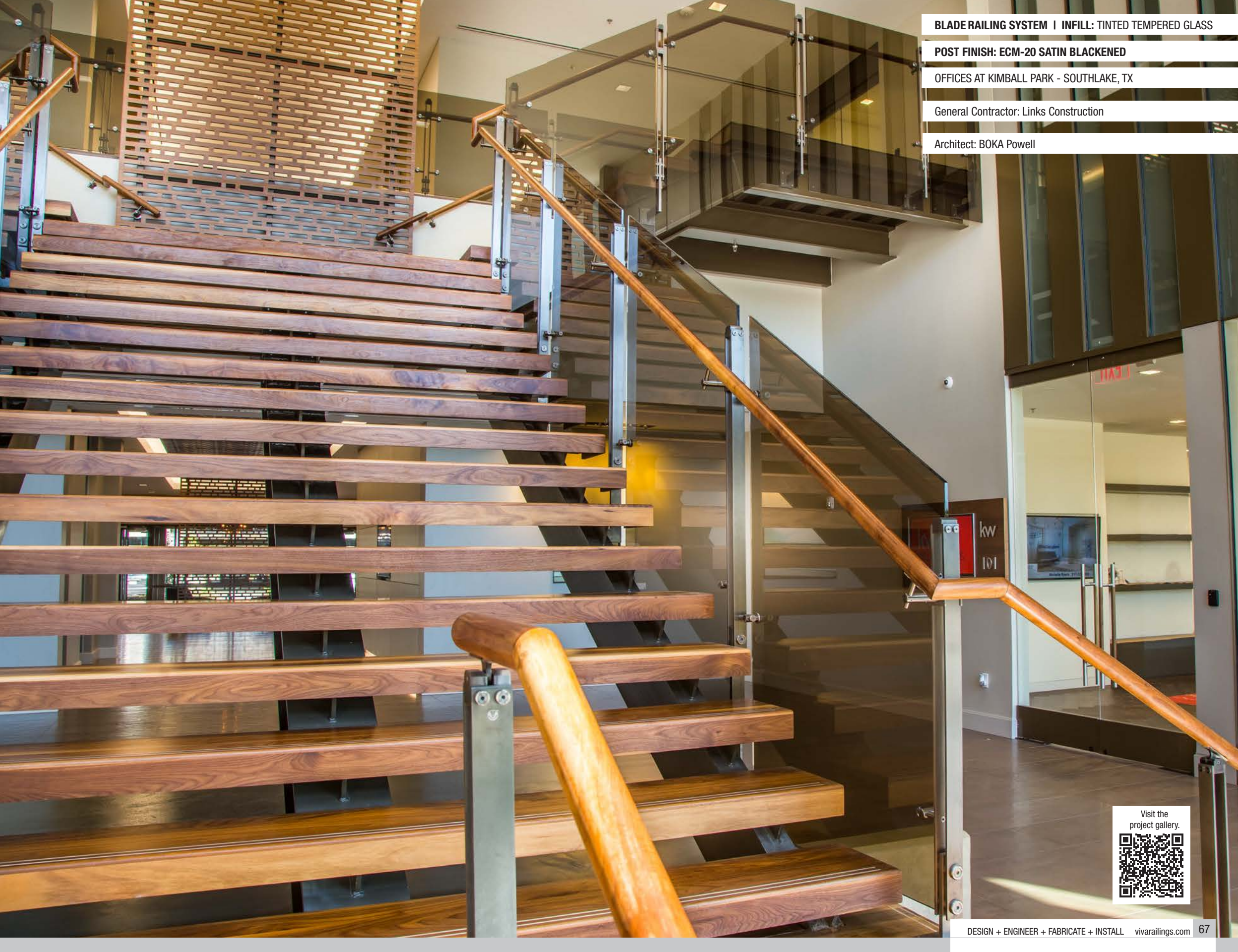

BLADE RAILING SYSTEM | INFILL: TINTED TEMPERED GLASS

POST FINISH: ECM-20 SATIN BLACKENED

OFFICES AT KIMBALL PARK - SOUTHLAKE, TX

General Contractor: Links Construction

Architect: BOKA Powell

kw
101

Visit the project gallery.



BLADE RAILING SYSTEM | INFILL: TEMPERED GLASS
SAN DIEGO INTERNATIONAL AIRPORT RENTAL CAR FACILITY - SAN DIEGO, CA
General Contractor: Built Pacific
Architect: FOX Design Group Solon, OH

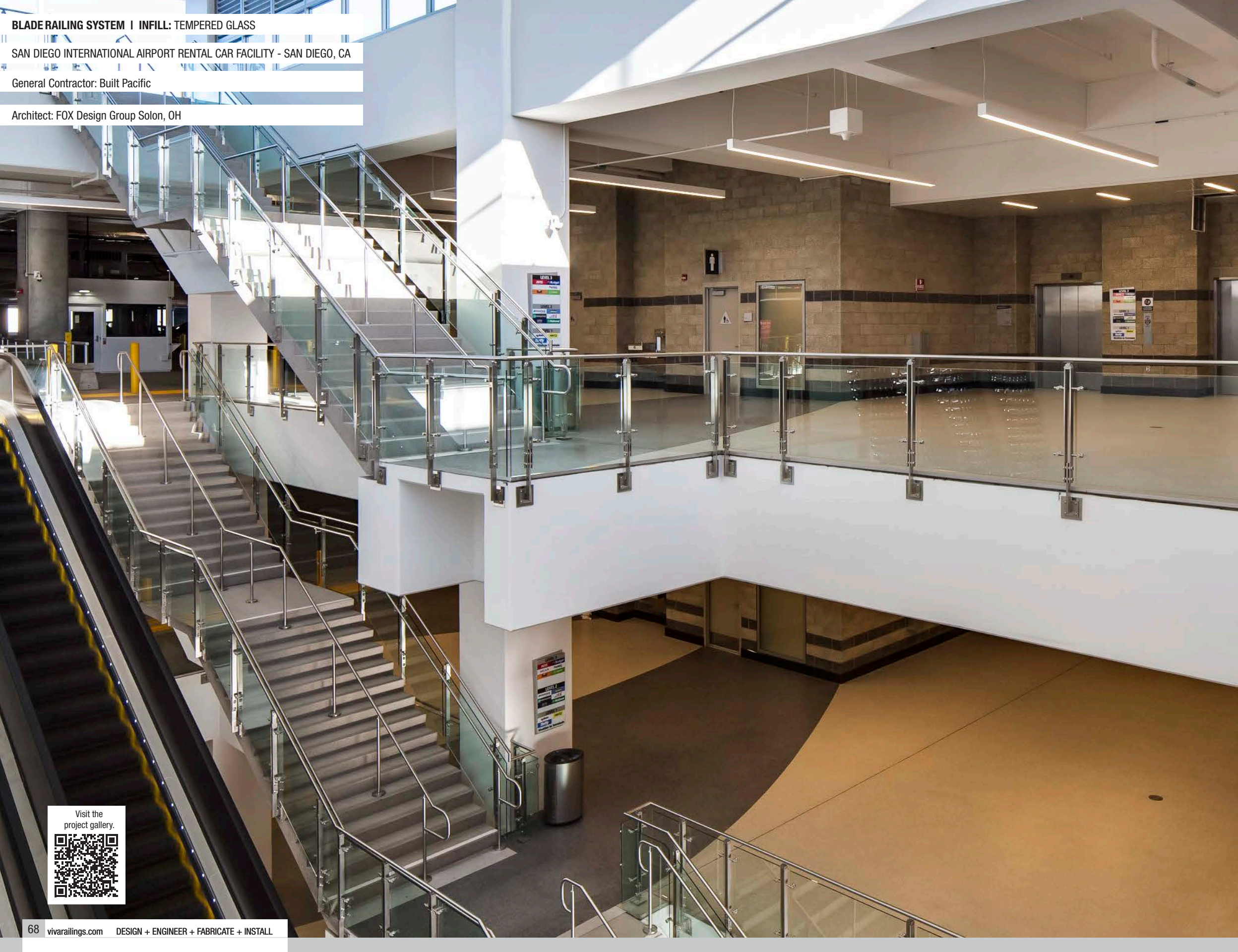

Visit the project gallery.



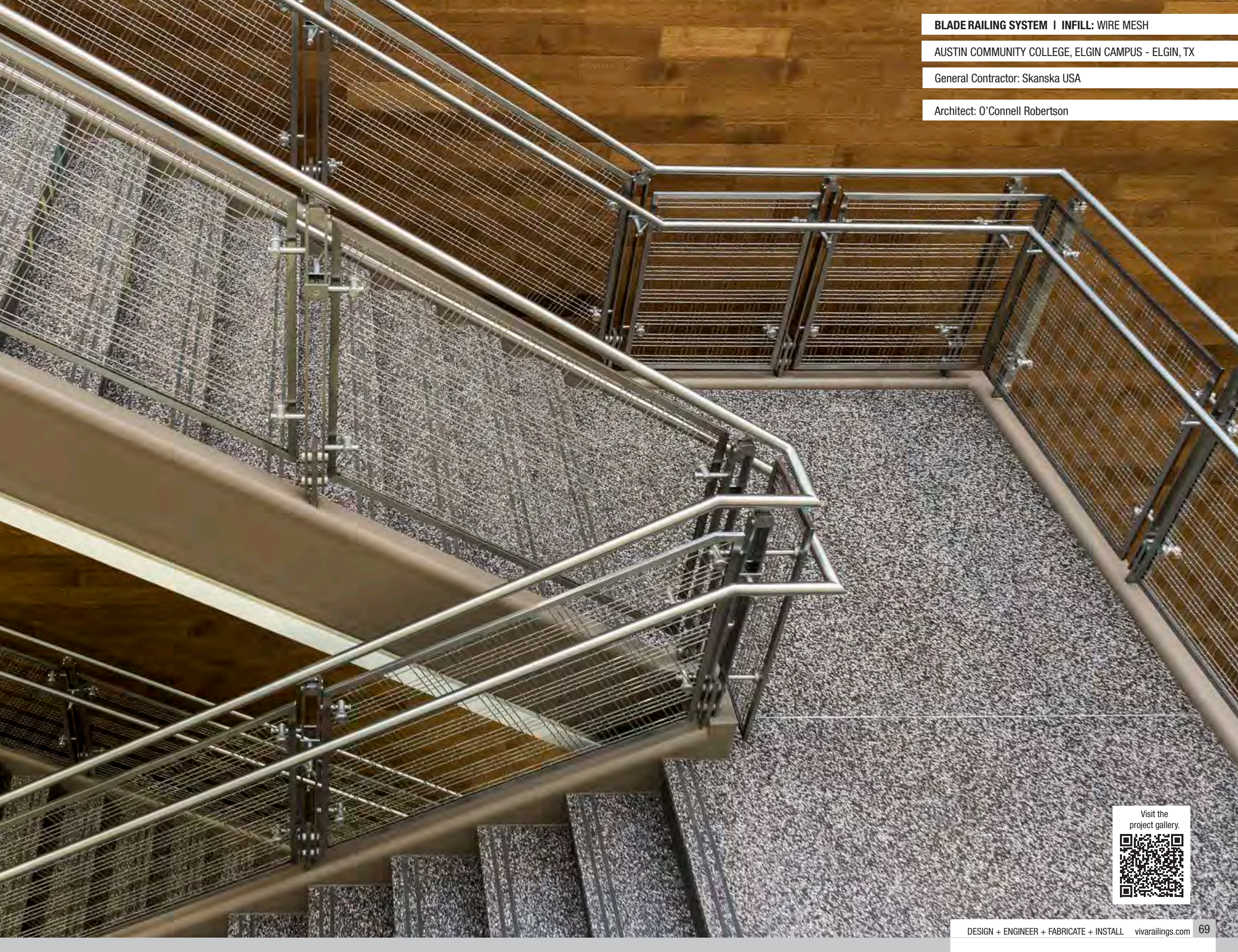

BLADE RAILING SYSTEM | INFILL: WIRE MESH

AUSTIN COMMUNITY COLLEGE, ELGIN CAMPUS - ELGIN, TX

General Contractor: Skanska USA

Architect: O'Connell Robertson

Visit the
project gallery.



CIRCA[®] GLASS & METAL SYSTEM

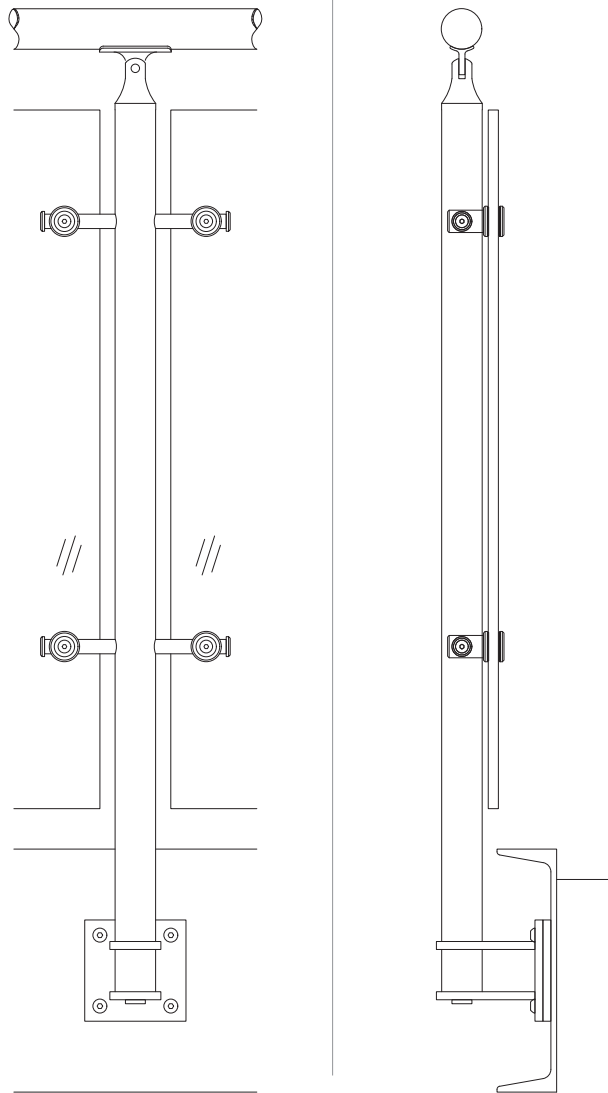

Other mounting options available.

CIRCA - AVAILABLE INFILLS

Glass

Perforated Metal

Wire Mesh

Picket Panel

MultiLine

Cable

CableNet

Laser Cut Panels

Our CIRCA Stainless Steel Railing System provides a simple yet timeless look. The system consists of round tubular posts and the railing in-fill between the posts is mounted via fixed point holders. CIRCA is available in ECM or powder-coated colors and with an option for LED illuminated rail.



Scan the QR code to check out the CIRCA system on our website and the interactive 3D viewport

CIRCA GLASS & METAL SYSTEM - TECHNICAL DATA

	MATERIAL	FINISH	SIZE/SPACING
POST	Stainless Steel (304 or 316)	#6 Satin, #8 Mirror	Ø2" @ 5'-0" max. O.C. 4'-6" max. for perforated and wire mesh infill. 4'-0" max. for Multiline and cable infill. Fascia, Top or Core mount.
	Stainless Steel (201)	ECM Powder Coat	
INFILL OPTIONS	Glass	Clear, Tinted or Frit	Min. 3/8" laminated glass with PVB or SGP interlayer ¹ Glass standard thickness: 3/8", 1/2", 5/8", 3/4" Interlayer standard thickness: SGP: 0.035", 0.06" PVB: 0.035"
	Perforated Metal	#6 Satin	1" wide frame
	Wire Mesh		Ø1/2" picket
	Picket Panel		Ø1/2" multiline
	Multiline		Ø3/16" cable
	Cable		Ø1" Wide frame, Ø1/16" (1.5mm) cable mesh
	CableNet		
Laser Cut	Powder Coat - Super Polyester (AAMA 2604) - \$ ⁴ Powder Coat - PVDF (AAMA 2605) - \$\$ ⁴	1/4" thick aluminum panel.	
TOP RAIL/HAND RAIL	Stainless Steel Tube	#6 Satin, Powder Coat	Ø1-1/2" or Ø2" for Hand Rail Ø1-1/2", Ø2" or 2"x1" Rectangular tube for Top Rail
	Stainless Steel Tube with LED ²	#6 Satin	Ø1-1/2" with LED LINEAR, Ø1-1/2" or Ø2" with LED POD
	Wood (Red Oak, Cherry or Maple) ³	Unstained	Ø2"
	Wood (Red Oak, Cherry or Maple) with LED		Ø2" with LED LINEAR

POST

INFILL OPTIONS

TOP RAIL/HAND RAIL

ECM finish is not available for U-cap, top rail or hand rail.



- IBC 2015 & newer requires railing glass to be laminated. VIVA recommends SGP for exterior applications.
- All LED LINEAR products are ETL certified; ETL mark is proof of product compliance to North American safety standard.
- Other species available upon request.
- \$ to \$\$\$: Indicates finish type comparative cost.

CIRCA GLASS & METAL SYSTEM - INFILL OPTIONS

GLASS



VIVA's tempered glass infills provide optimal line of sight as well as an understated elegance. Clear Laminated (PVB or SGP) | Bent | Tinted | Ceramic Frit | Patterned | Colored Interlayer

PERFORATED METAL PANELS



VIVA's perforated metal infill panels feature a solid metal outer frame with rounded, slotted or square motifs.

Perforated Metal Panel Patterns on Pg. 213

WIRE MESH PANELS



VIVA's wire mesh infill features an organic, interwoven fabric as an infill. Mesh infills are timeless and easy to maintain. The signature box frame completes the system for a clean, sharp look.

Wire Mesh Panel Patterns on Pg. 212

LASERCUT PANELS



Customize your architectural spaces with VIVA Railings' laser-cut metal infill panels. These panels are designed for our post railing systems. We have a wide range of standard patterns available in primary, geometric and organic designs. Custom patterns are also possible.

VERTICAL PICKET PANELS



VIVA's uniquely designed picket infill is an economical vertical infill option that provides clear, clean lines.

HORIZONTAL MULTILINE



VIVA's multiline infill is a perfect choice for clean modern designs of today. The fluid design works well with curved areas as well.

CABLE



VIVA's stainless steel cable infill is a low maintenance, high visibility infill that is popularly used on exterior applications. Our cable comes in 1x19 type weave, 3/16" diameter in SS316 alloy.

CABLENET

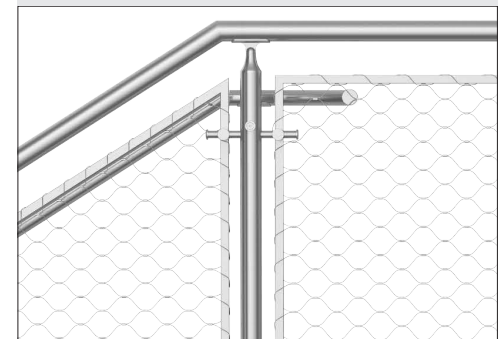

VIVA's CableNet is an extremely versatile and strong infill, exceeding code requirements on load performance and opening size limitations. CableNet is available in an individual post to post frames or a continuous run.

CIRCA GLASS & METAL SYSTEM - MOUNTING CONDITIONS

TOP MOUNT	
STEEL	CONCRETE
WELD	ANCHOR CORE

FASCIA MOUNT	
STEEL	CONCRETE
WELD	ANCHOR

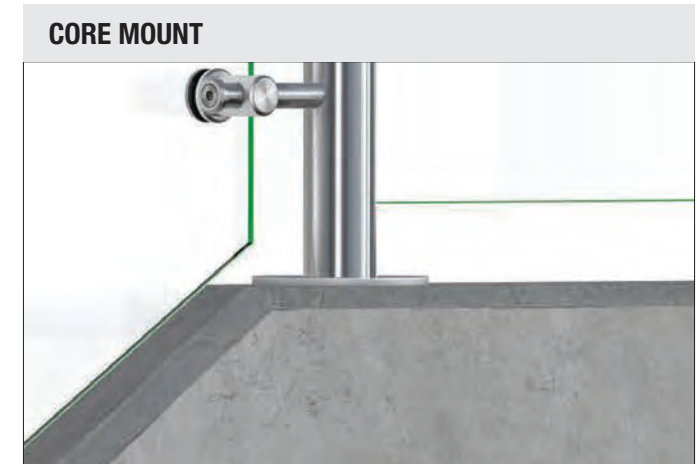
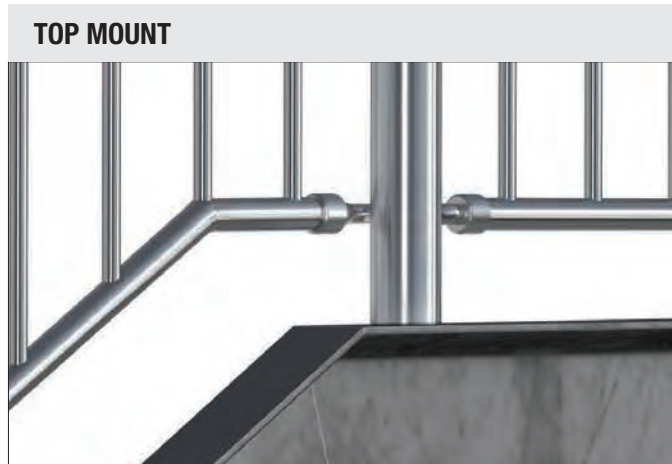

CIRCA GLASS & METAL SYSTEM - FINISH OPTIONS



#8 Mirror Finish comes at an additional cost to our #6 Finish.



Available ECM colors on Pg 211

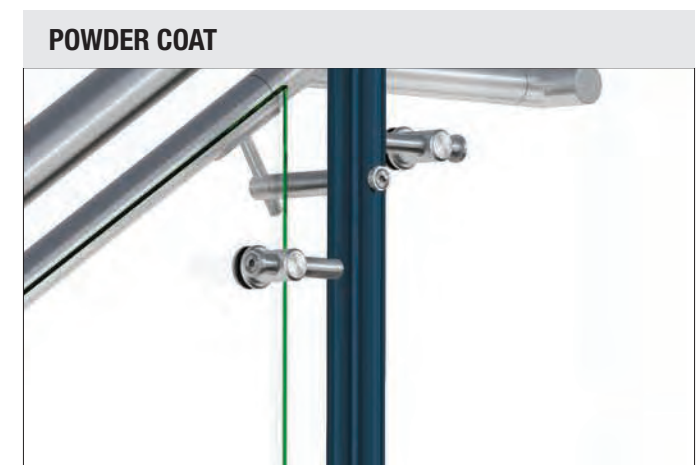

Available Standard and Premium colors on Pg 208



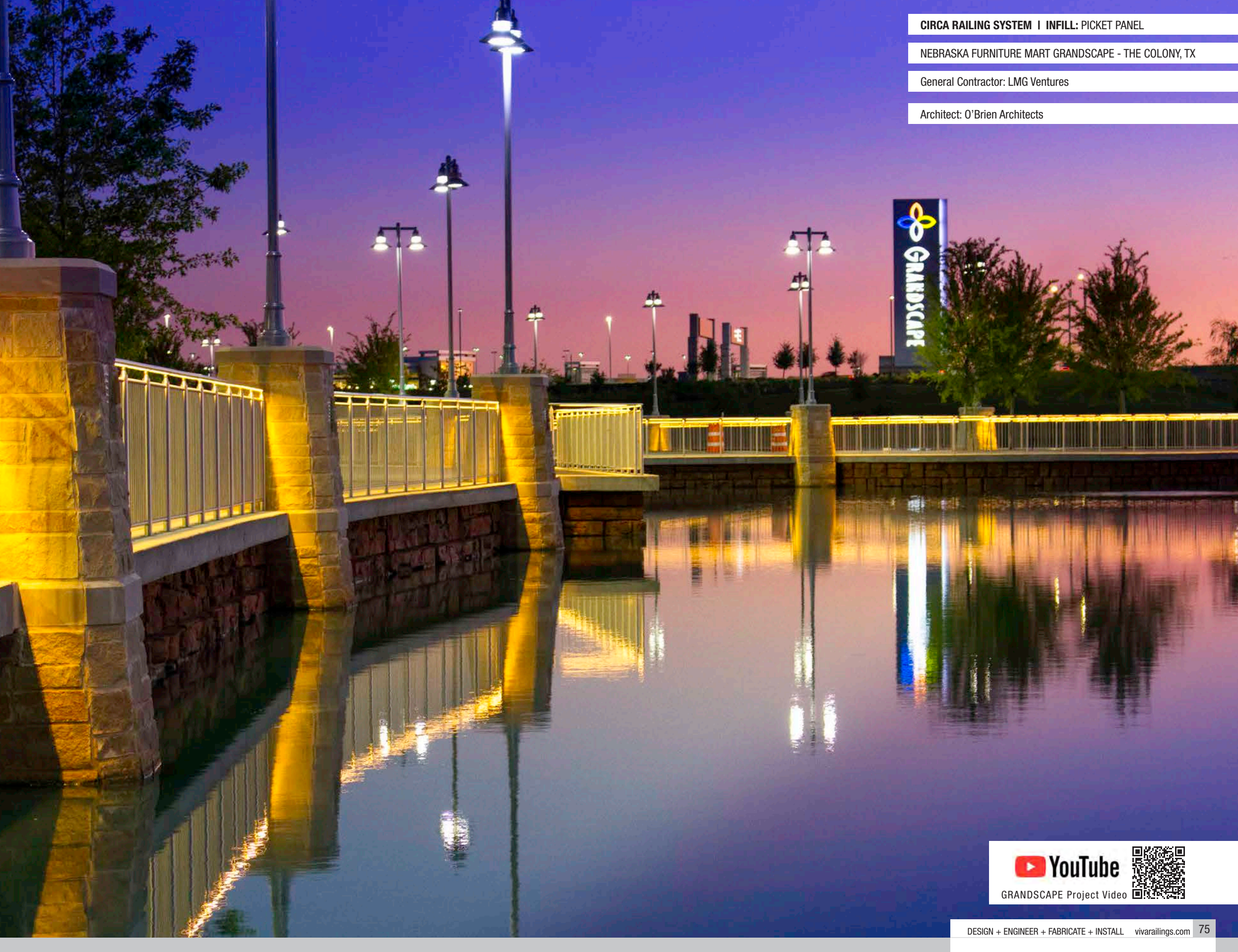

CIRCA RAILING SYSTEM | INFILL: PICKET PANEL

NEBRASKA FURNITURE MART GRANDSCAPE - THE COLONY, TX

General Contractor: LMG Ventures

Architect: O'Brien Architects

 **YouTube**
GRANDSCAPE Project Video 

CIRCA RAILING SYSTEM | INFILL: CABLE

JACKSONVILLE TRANSIT AUTHORITY ADMIN BUILDING - FL

General Contractor: Balfour Beatty Construction

Architect: Pond Company



Visit the project gallery.



CIRCA RAILING SYSTEM | INFILL: PERFORATED METAL PANEL

DENTON ISD STRICKLAND MIDDLE SCHOOL - DENTON, TX

General Contractor: Balfour Beatty Construction

Architect: VLK Architects



Visit the project gallery.



CIRCA RAILING SYSTEM | INFILL: PICKET PANEL

MCGRATH AMPHITHEATRE VENUE - CEDAR RAPIDS, IA

General Contractor: Justice Electric

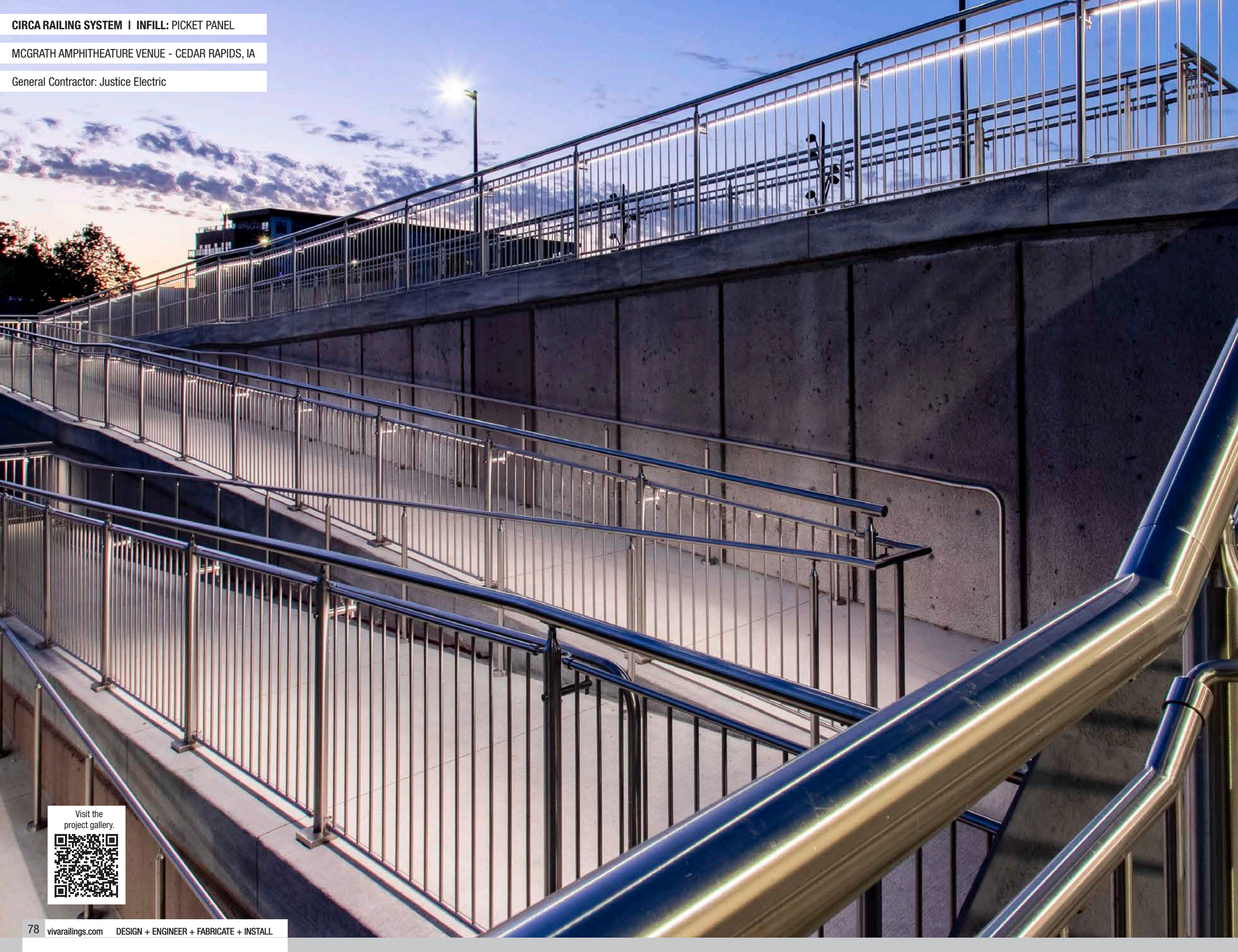

Visit the project gallery.



CIRCA RAILING SYSTEM | INFILL: TEMPERED GLASS

ZACHRY ENGINEERING ED. COMPLEX - COLLEGE STATION, TX

General Contractor: Vaughn Construction

Architect: Treanor Architects

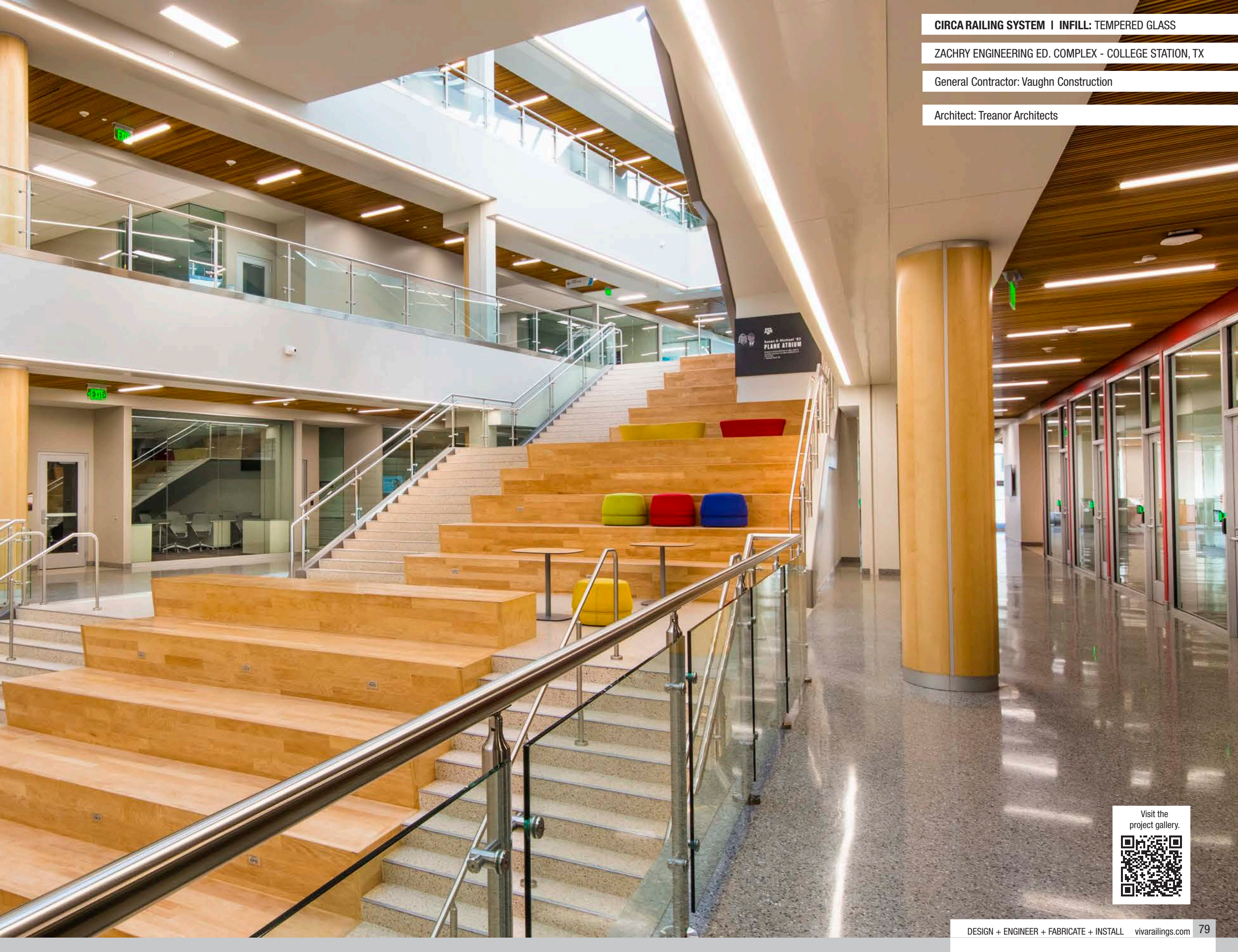

Visit the project gallery.



CUBE[®] GLASS & METAL SYSTEM

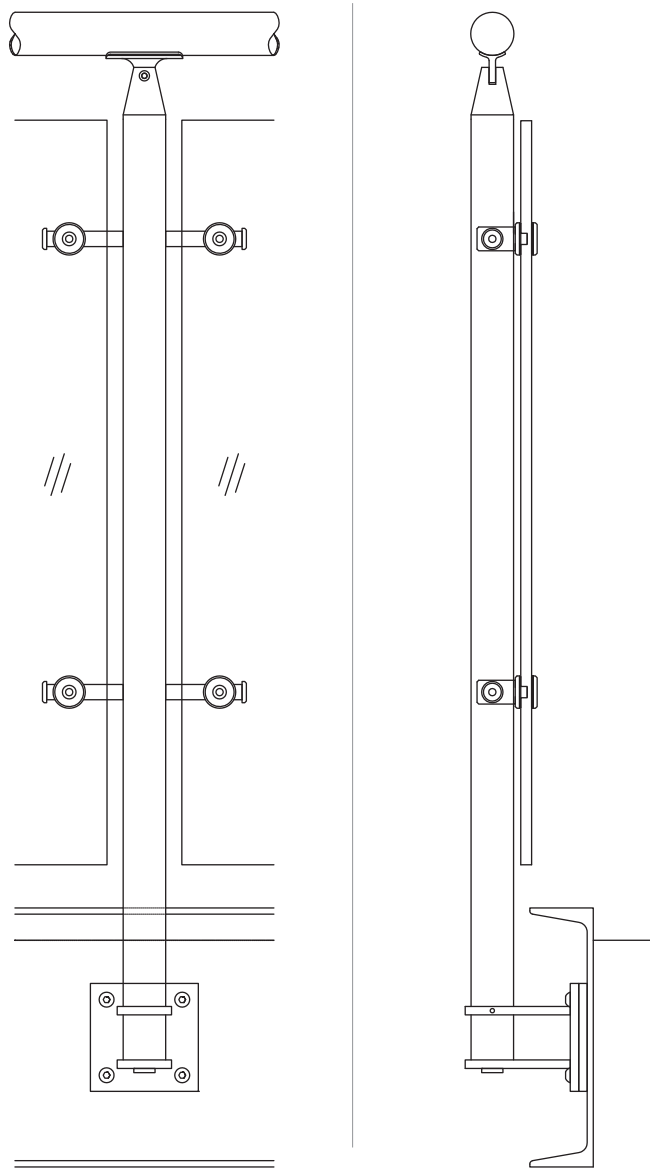

Other mounting options available.

CUBE - AVAILABLE INFILLS

- Glass
- Perforated Metal
- Wire Mesh
- Picket Panel
- MultiLine
- Cable
- CableNet
- Laser Cut Panels

Our CUBE Stainless Steel Railing System has a robust contemporary look. The system is made of 2"x 2" square posts, with monolithic pyramid top caps creating continuous clean lines throughout the components. The railing in-fill between the posts is mounted via fixed point holders and can accommodate any in-fill of your choice.

CUBE is available in ECM or powder-coated colors and with an option for LED illuminated rail.



Scan the QR code to check out the CUBE system on our website and the interactive 3D viewport

CUBE GLASS & METAL SYSTEM - TECHNICAL DATA

	MATERIAL	FINISH	SIZE/SPACING
POST	Stainless Steel (304 or 316)	#6 Satin, #8 Mirror	2"x2" @ 5'-0" max. O.C. 4'-6" max. for perforated and wire mesh infill. 4'-0" max. for Multiline and cable infill.
	Stainless Steel (201)	ECM	
INFILL OPTIONS	Glass	Clear, Tinted or Frit	Min. 3/8" laminated glass with PVB or SGP interlayer ¹ Glass standard thickness: 3/8", 1/2", 5/8", 3/4" Interlayer standard thickness: SGP: 0.035", 0.06" PVB: 0.035"
	Perforated Metal	#6 Satin	1" wide frame
	Wire Mesh		Ø1/2" picket
	Picket Panel		Ø1/2" multiline
	Multiline		Ø3/16" cable
	Cable		Ø1" Wide frame, Ø1/16" (1.5mm) cable mesh
	CableNet		
	Laser Cut	Powder Coat - Super Polyester (AAMA 2604) - \$ ⁴ Powder Coat - PVDF (AAMA 2605) - \$\$ ⁴	1/4" thick aluminum panel.
TOP RAIL/HAND RAIL ECM finish is not available for U-cap, top rail or hand rail.	Stainless Steel Tube	#6 Satin, Powder Coat	Ø1-1/2" or Ø2" for Hand Rail Ø1-1/2", Ø2" or 2"x1" Rectangular tube for Top Rail
	Stainless Steel Tube with LED ²	#6 Satin	Ø1-1/2" with LED LINEAR, Ø1-1/2" or Ø2" with LED POD
	Wood (Red Oak, Cherry or Maple) ³	Unstained	Ø2"
	Wood (Red Oak, Cherry or Maple) with LED		Ø2" with LED LINEAR



Intertek

- IBC 2015 & newer requires railing glass to be laminated. VIVA recommends SGP for exterior applications.
- All LED LINEAR products are ETL certified; ETL mark is proof of product compliance to North American safety standard.
- Other species available upon request.
- \$ to \$\$\$: Indicates finish type comparative cost.

CUBE GLASS & METAL SYSTEM - INFILL OPTIONS

GLASS



VIVA's tempered glass infills provide optimal line of sight as well as an understated elegance. Clear Laminated (PVB or SGP) | Bent | Tinted | Ceramic Frit
Patterned | Colored Interlayer

PERFORATED METAL PANELS



VIVA's perforated metal infill panels feature a solid metal outer frame with rounded, slotted or square motifs.

Perforated Metal Panel Patterns on Pg. 213

WIRE MESH PANELS



VIVA's wire mesh infill features an organic, interwoven fabric as an infill. Mesh infills are timeless and easy to maintain. The signature box frame completes the system for a clean, sharp look.

Wire Mesh Panel Patterns on Pg. 212

LASERCUT PANELS



Customize your architectural spaces with VIVA Railings' laser-cut metal infill panels. These panels are designed for our post railing systems. We have a wide range of standard patterns available in primary, geometric and organic designs. Custom patterns are also possible.

VERTICAL PICKET PANELS



VIVA's uniquely designed picket infill is an economical vertical infill option that provides clear, clean lines.

HORIZONTAL MULTILINE



VIVA's multiline infill is a perfect choice for clean modern designs of today. The fluid design works well with curved areas as well.

CABLE



VIVA's stainless steel cable infill is a low maintenance, high visibility infill that is popularly used on exterior applications. Our cable comes in 1x19 type weave, 3/16" diameter in SS316 alloy.

CABLENET

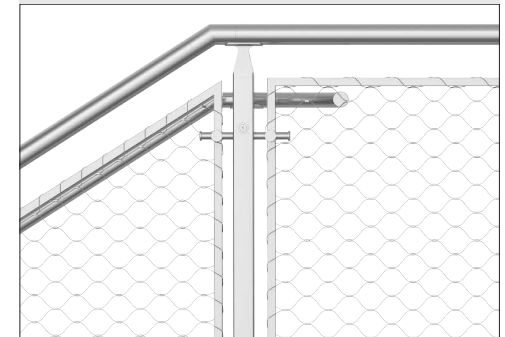

VIVA's CableNet is an extremely versatile and strong infill, exceeding code requirements on load performance and opening size limitations. CableNet is available in an individual post to post frames or a continuous run.

CUBE GLASS & METAL SYSTEM - MOUNTING CONDITIONS

TOP MOUNT	
STEEL	CONCRETE
WELD	ANCHOR
	CORE

FASCIA MOUNT	
STEEL	CONCRETE
WELD	ANCHOR

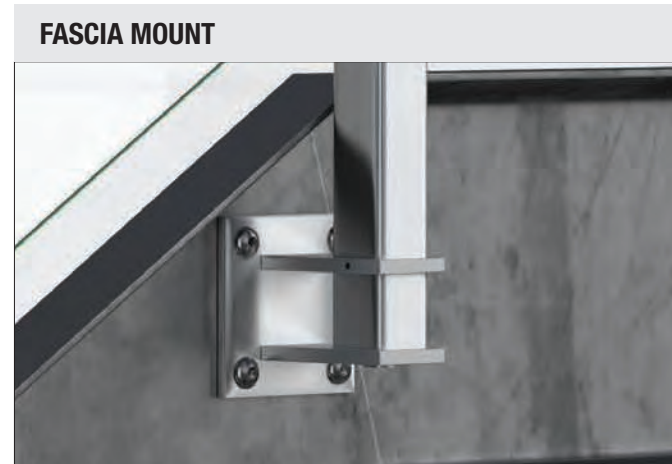
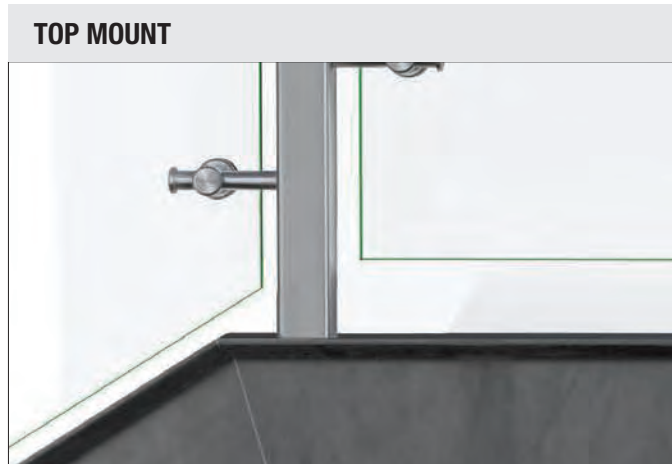

CUBE GLASS & METAL SYSTEM - FINISH OPTIONS



#8 Mirror Finish comes at an additional cost to our #6 Finish.



Available ECM colors on Pg 211



Available Standard and Premium colors on Pg 208

ECM finish is not available for U-cap, top rail or hand rail.



CUBE RAILING SYSTEM | INFILL: GLASS

CHOCTAW CASINO & RESORTS - DURANT, OK

General Contractor: TEPCO Glass



Architect: JCJ Architecture



CHOCTAW Project Video





  **YouTube**
ALBANY SKYWAY Project Video

CUBE RAILING SYSTEM | INFILL: CABLE

POST FINISH: PC-20 MATTE BLACK POSTS

PGA HEADQUARTERS - FRISCO, TX

General Contractor: Adolfson & Peterson Construction

Architect: Page Southerland Page

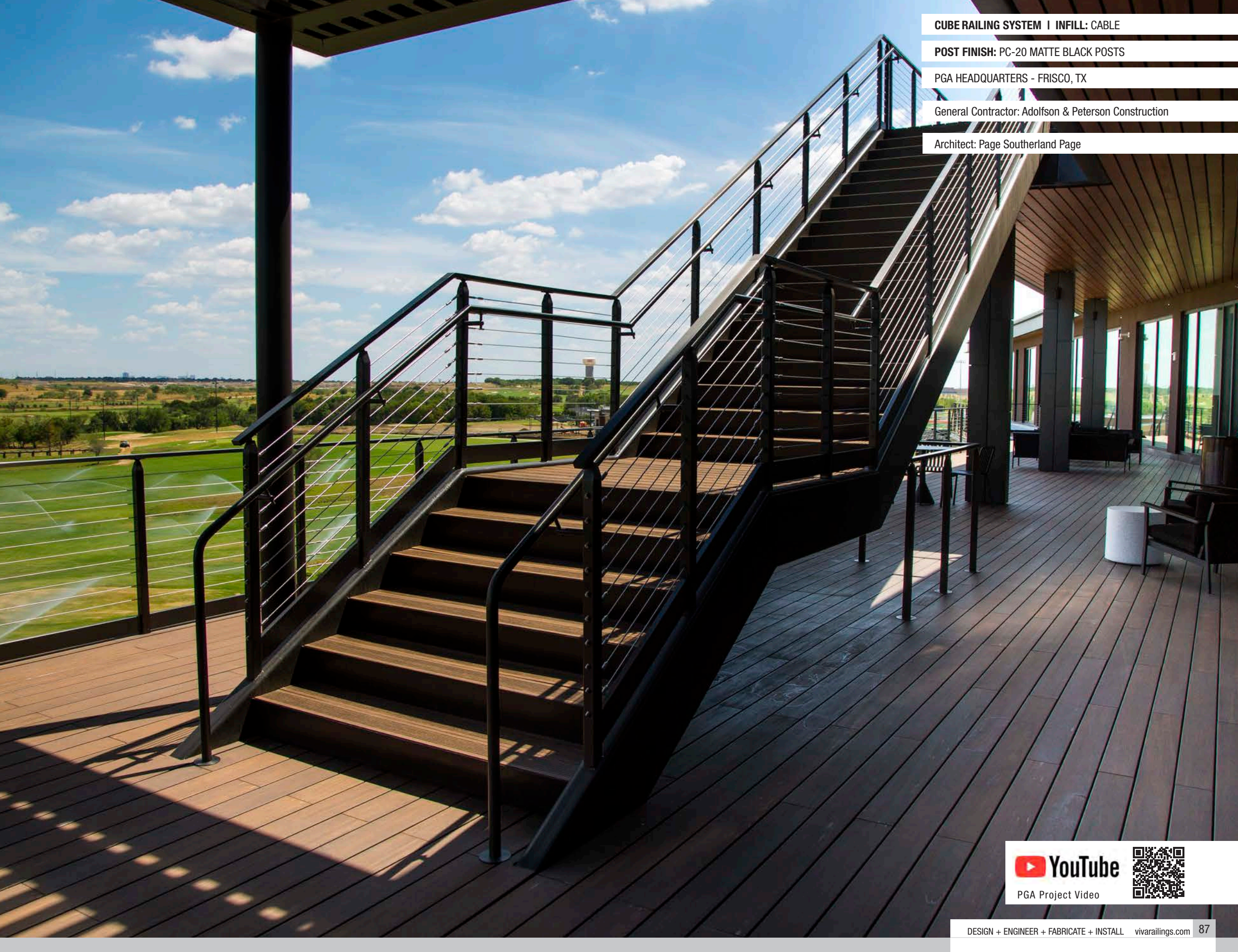

PGA Project Video



CUBE RAILING SYSTEM | INFILL: CABLE

BB & T LEADERSHIP CONFERENCE CENTER - GREENSBORO, NC

General Contractor: Frank L Blum Construction

Architect: CJMW Architecture



Visit the
project gallery.





Visit the
project gallery.



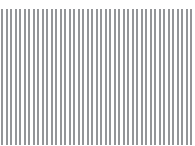

TEETM METAL SYSTEM

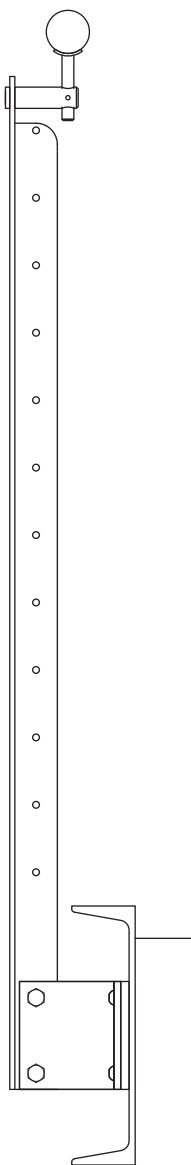
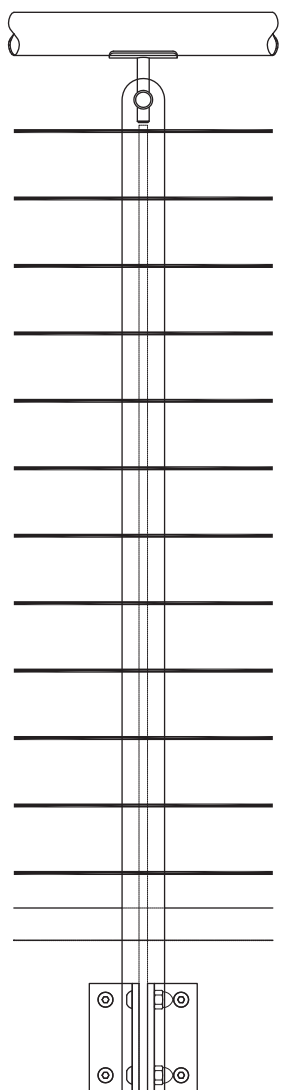

TEE - AVAILABLE INFILLS

Cable

Our TEE Stainless Steel Cable Railing System features a minimalist design for a cable railing application. The structural “T” section offers the post stability against the tension from cable strands while concealing cable mounting hardware. Stainless steel cable in-fill is available in 3/16” diameter cables. TEE stainless steel cable railing system is available in top and fascia mount. This railing system is widely used in deck railing and balcony railing applications, where a clear line of sight and safety are priorities.

Other mounting options available.

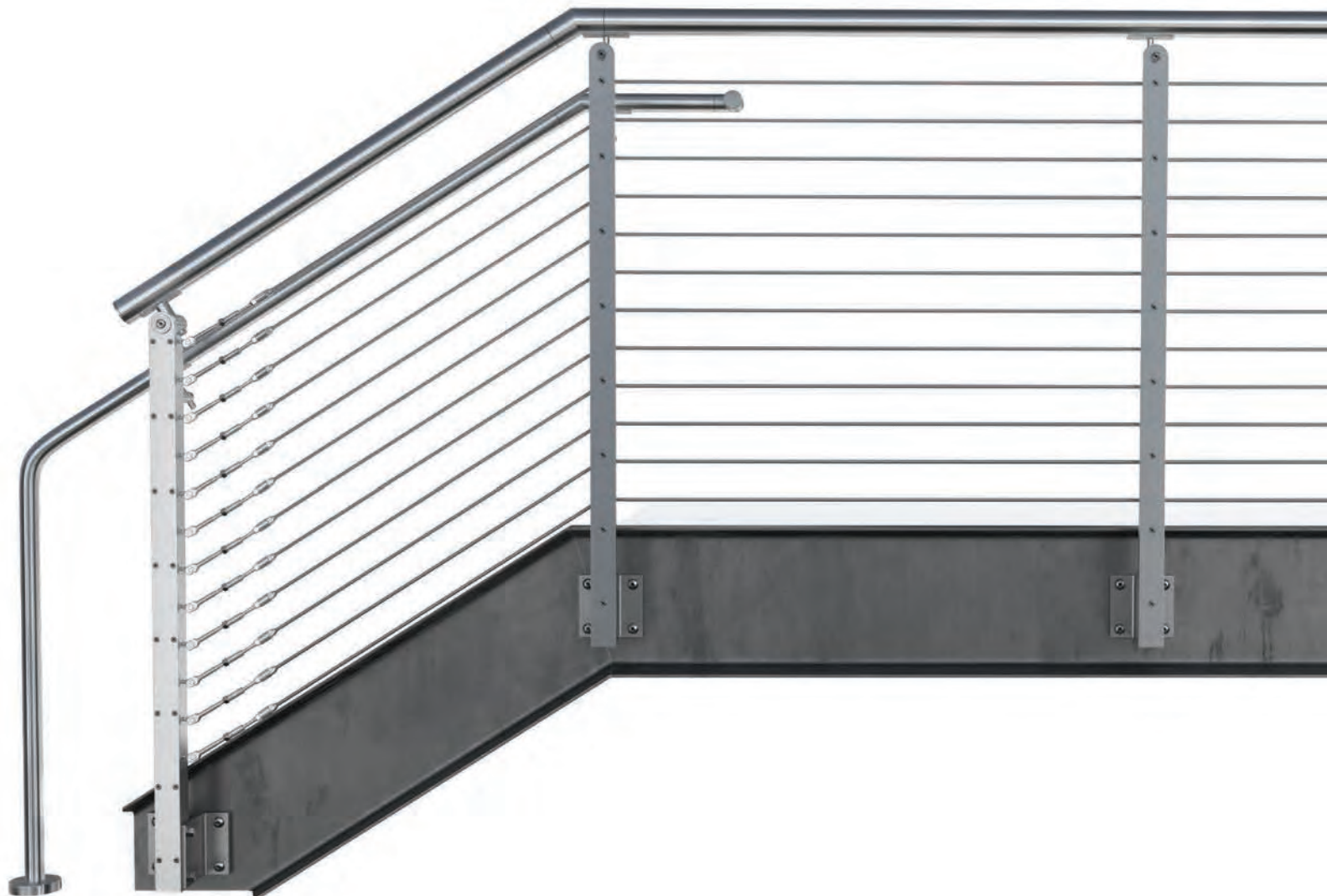

Scan the QR code to check out the TEE system on our website and the interactive 3D viewport

TEE METAL SYSTEM - TECHNICAL DATA

	MATERIAL	FINISH	SIZE/SPACING
POST	Stainless Steel (304 or 316)	#6 Satin, #8 Mirror	2x2.2" T Section intermediate post, 2x2.4" Section end post @ 4'-0" max. O.C. Fascia, Top or Core mount.
	Stainless Steel (201)	ECM	
INFILL OPTIONS	Cable	#6 Satin	Ø3/16" cable
TOP RAIL/HAND RAIL ECM finish is not available for U-cap, top rail or hand rail.	Stainless Steel Tube	#6 Satin, Powder Coat	Ø1-1/2" or Ø2" for Hand Rail Ø1-1/2", Ø2" or 2"x1" Rectangular tube for Top Rail
	Stainless Steel Tube with LED ¹	#6 Satin	Ø1-1/2" with LED LINEAR, Ø1-1/2" or Ø2" with LED POD
	Wood (Red Oak, Cherry or Maple) ²	Unstained	Ø2"
	Wood (Red Oak, Cherry or Maple) with LED		Ø2" with LED LINEAR



1. All LED LINEAR products are ETL certified; ETL mark is proof of product compliance to North American safety standard.
2. Other species available upon request.



¹ IBC 2015 & newer requires railing glass to be laminated. VIVA recommends SGP for exterior applications.
² All LED LINEAR products are ETL certified; ETL mark is proof of product compliance to North American safety standard.
³ Other species available upon request.

TEE METAL SYSTEM - INFILL OPTIONS

CABLE



VIVA's stainless steel cable infill is a low maintenance, high visibility infill that is popularly used on exterior applications. Our cable comes in 1x19 type weave, 3/16" diameter in SS316 alloy.

TEE METAL SYSTEM - MOUNTING CONDITIONS

TOP MOUNT	
STEEL	CONCRETE
WELD	ANCHOR CORE

FASCIA MOUNT	
STEEL	CONCRETE
WELD	ANCHOR

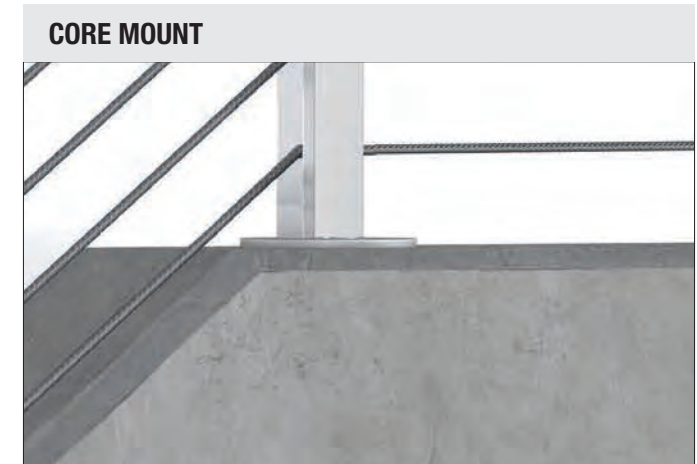
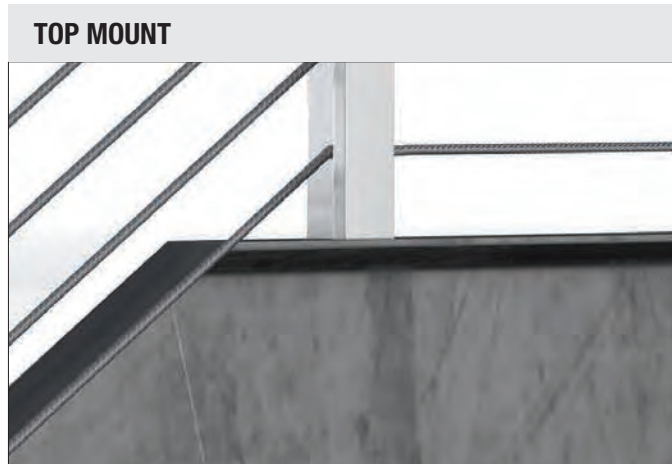

TEE METAL SYSTEM - FINISH OPTIONS



#8 Mirror Finish comes at an additional cost to our #6 Finish.

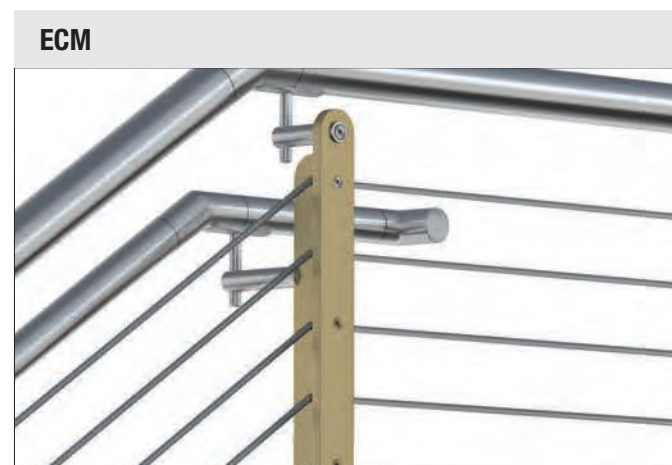

Available ECM colors on Pg 211



Available Standard and Premium colors on Pg 208

ECM finish is not available for U-cap, top rail or hand rail.



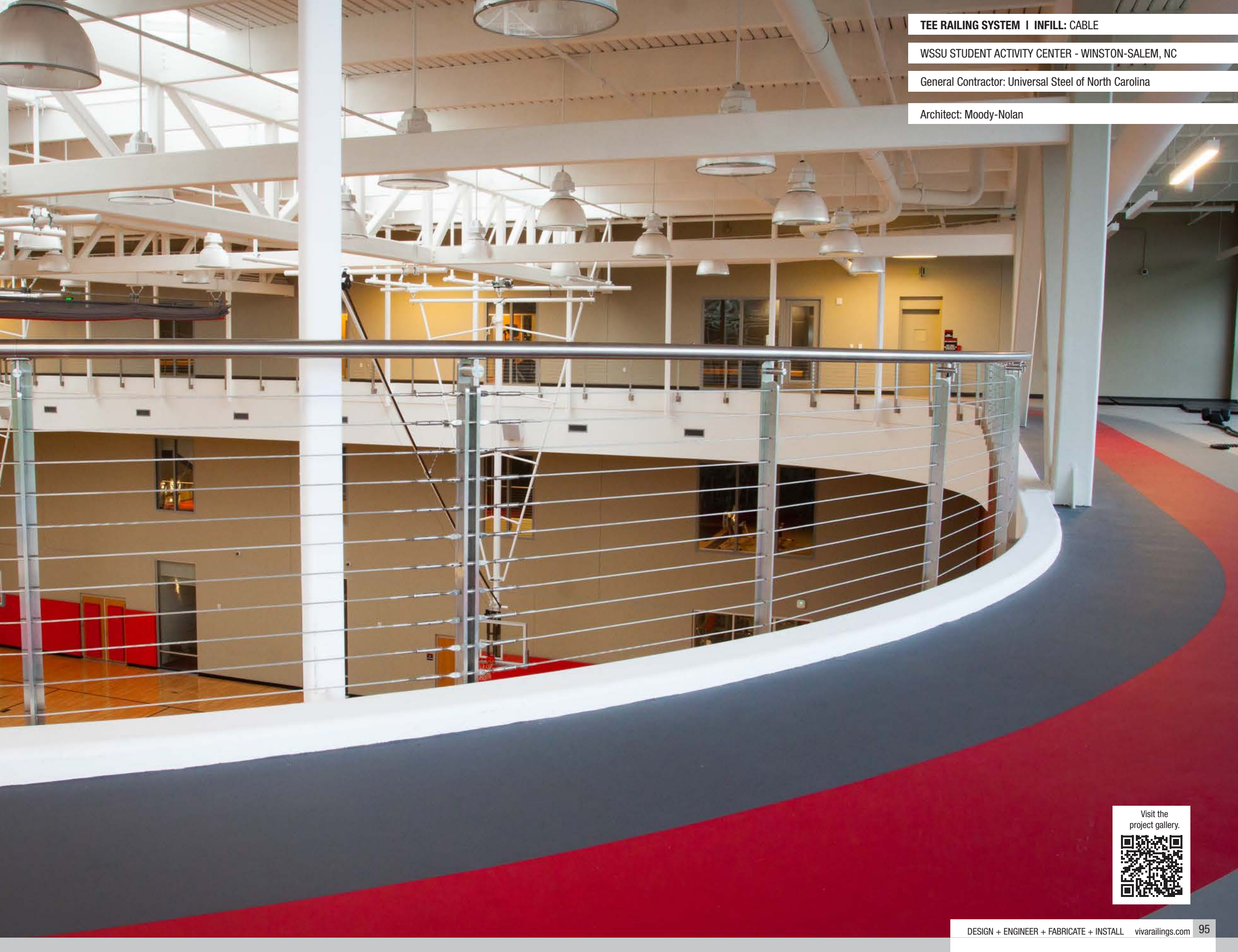

TEE RAILING SYSTEM | INFILL: CABLE

WSSU STUDENT ACTIVITY CENTER - WINSTON-SALEM, NC

General Contractor: Universal Steel of North Carolina

Architect: Moody-Nolan

Visit the project gallery.



TEE RAILING SYSTEM | INFILL: CABLE

HDR ARCHITECTS - DALLAS, TX

General Contractor: Balfour Beatty

Architect: FOX Design Group Solon, OH



Visit the
project gallery.



TEE RAILING SYSTEM | INFILL: CABLE

CHEROKEE NATION VINITA CLINIC - VINITA, OK

General Contractor: Flintco, LLC

Architect: James R. Childers Architect

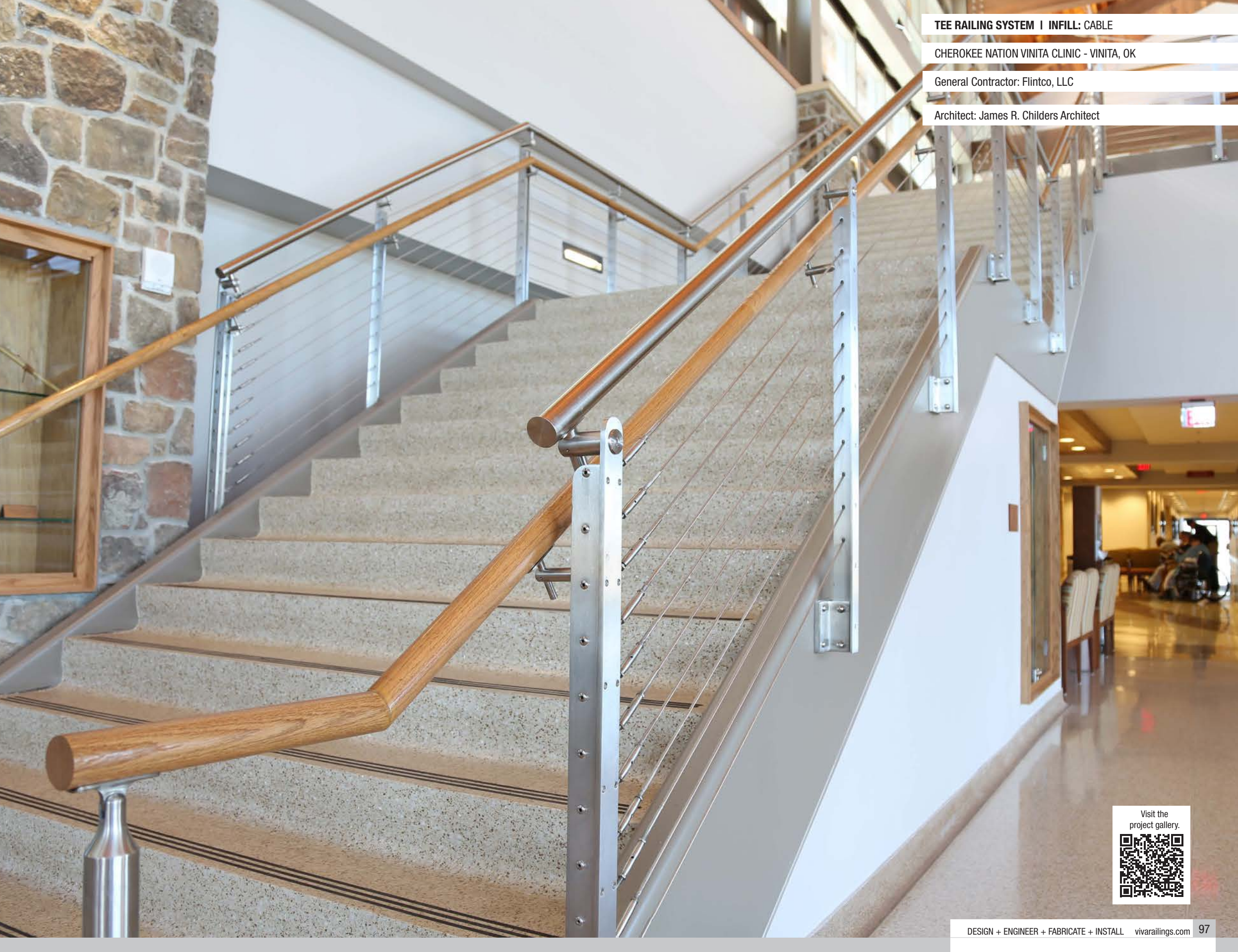

Visit the project gallery.



FIN™ GLASS & METAL SYSTEM

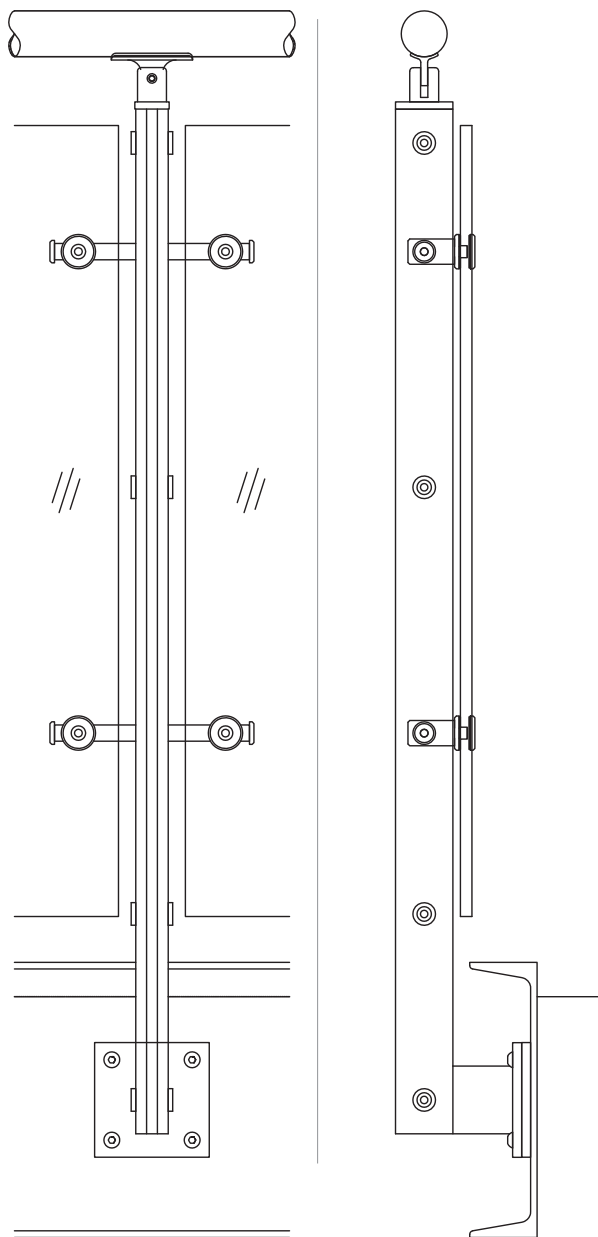

Other mounting options available.

FIN - AVAILABLE INFILLS

Glass

Perforated Metal

Wire Mesh

Our FIN Railing System beautifully combines the industrial look of stainless steel with the warmth of wood to create elegant interior railing applications. FIN wood stains are available in Red Oak, Cherry or Maple and the slender post profile provides minimal obstruction to the line of sight.

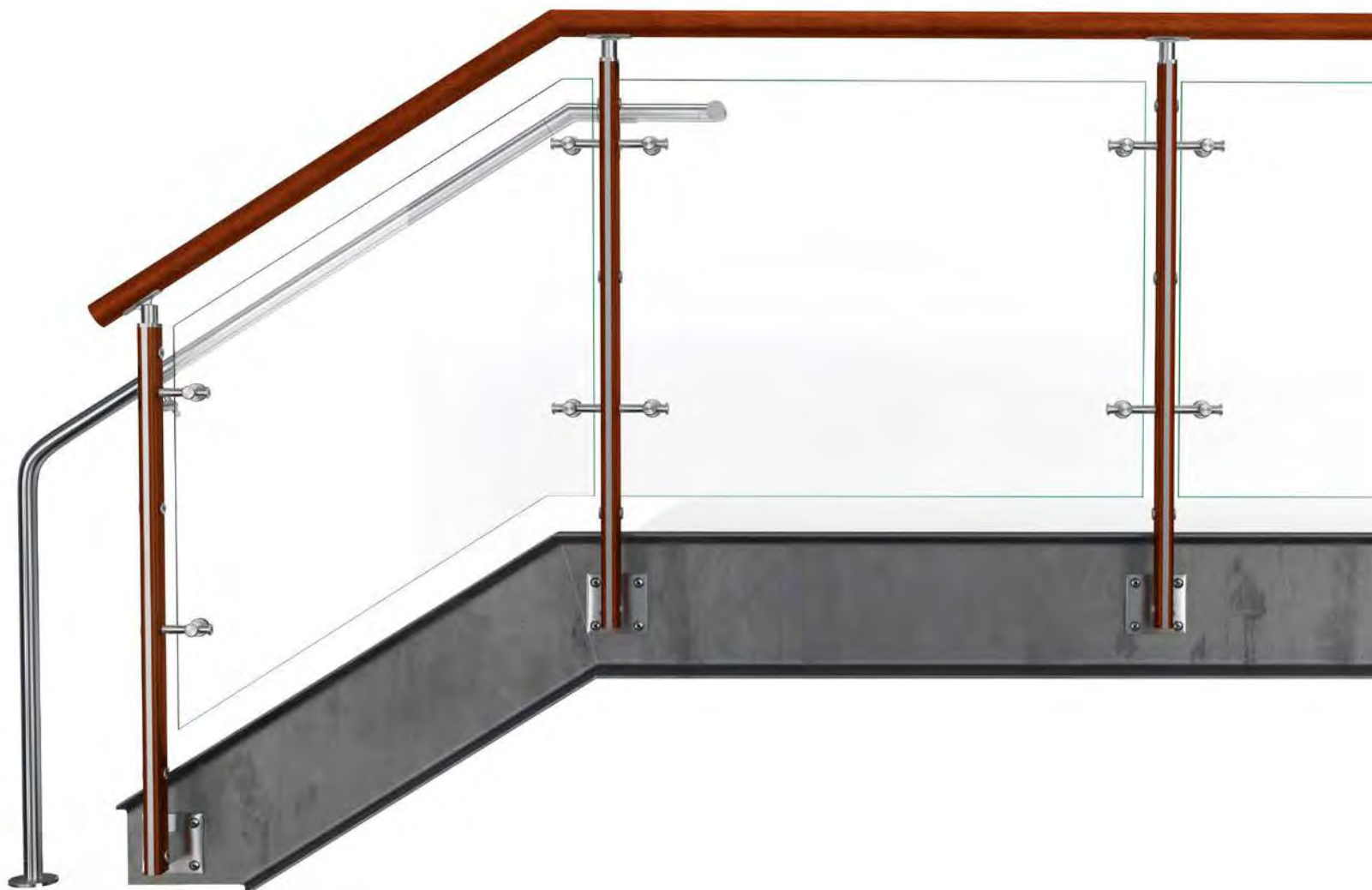

Scan the QR code to check out the FIN system on our website and the interactive 3D viewport

FIN GLASS & METAL SYSTEM - TECHNICAL DATA

	MATERIAL	FINISH	SIZE/SPACING
POST	Composite Stainless Steel (304 or 316) and Wood (Red Oak, Cherry or Maple)	#6 Satin + Unstained Wood	2.5"x1.4" @ 5'-0" max. O.C. 4'-6" max. for perforated and wire mesh infill. Fascia, Top or Core mount.
INFILL OPTIONS	Glass	Clear, Tinted or Frit	Min. 3/8" laminated glass with PVB or SGP interlayer ¹ Glass standard thickness: 3/8", 1/2", 5/8", 3/4" Interlayer standard thickness: SGP: 0.035", 0.06" PVB: 0.035"
	Perforated Metal	#6 Satin	1" wide frame
	Wire Mesh		
TOP RAIL/HAND RAIL	Stainless Steel Tube	#6 Satin, Powder Coat	Ø1-1/2" or Ø2" for Hand Rail Ø1-1/2", Ø2" or 2"x1" Rectangular tube for Top Rail
	Stainless Steel Tube with LED ²	#6 Satin	Ø1-1/2" with LED LINEAR, Ø1-1/2" or Ø2" with LED POD
	Wood (Red Oak, Cherry or Maple) ³	Unstained	Ø2"
	Wood (Red Oak, Cherry or Maple) with LED		Ø2" with LED LINEAR



1. IBC 2015 & newer requires railing glass to be laminated. VIVA recommends SGP for exterior applications.
2. All LED LINEAR products are ETL certified; ETL mark is proof of product compliance to North American safety standard.
3. Other species available upon request.

FIN GLASS & METAL SYSTEM - INFILL OPTIONS



VIVA's tempered glass infills provide optimal line of sight as well as an understated elegance.
Clear Laminated (PVB or SGP) | Bent | Tinted | Ceramic Frit
Patterned | Colored Interlayer

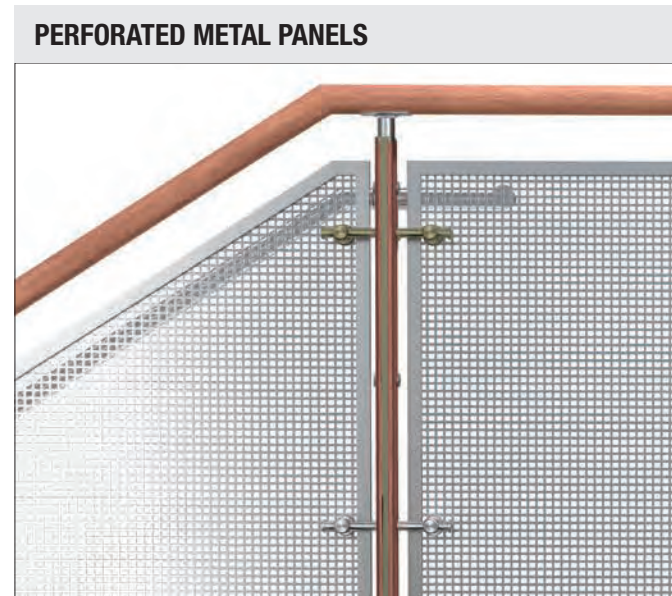

VIVA's perforated metal infill panels feature a solid metal outer frame with rounded, slotted or square motifs.

Perforated Metal Panel Patterns on Pg. 213

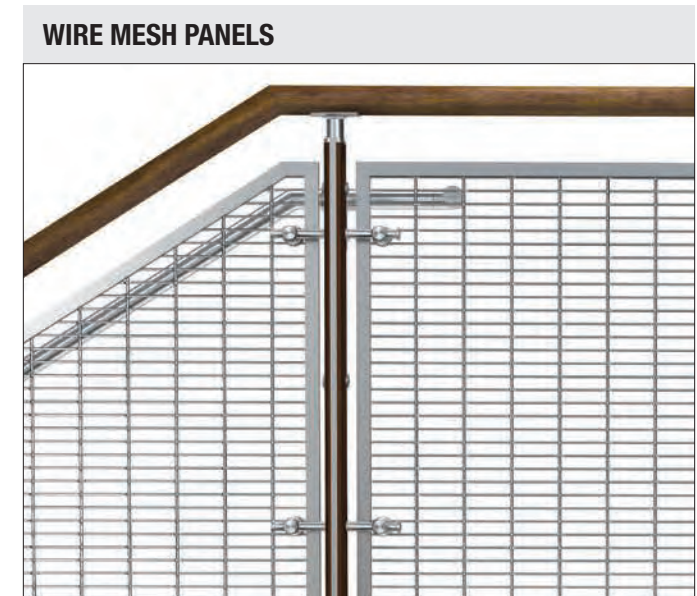

VIVA's wire mesh infill features an organic, interwoven fabric as an infill. Mesh infills are timeless and easy to maintain. The signature box frame completes the system for a clean, sharp look.

Wire Mesh Panel Patterns on Pg. 212

FIN GLASS & METAL SYSTEM - MOUNTING CONDITIONS

TOP MOUNT	
STEEL	CONCRETE
WELD	ANCHOR
	CORE

FASCIA MOUNT	
STEEL	CONCRETE
WELD	ANCHOR

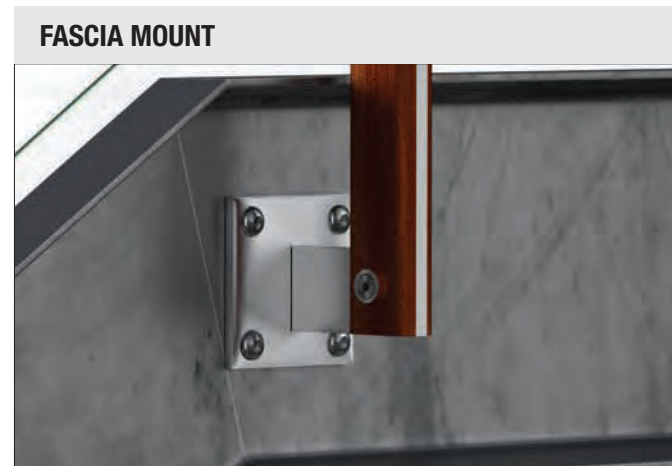
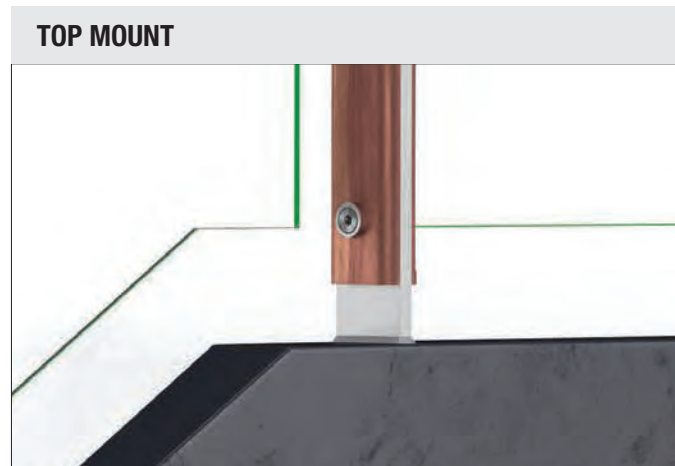

FIN GLASS & METAL SYSTEM - FINISH OPTIONS





FIN RAILING SYSTEM | INFILL: TEMPERED GLASS

ROBB & STUCKY SHOWROOM - BOCA RATON, FL

General Contractor: Fisher Contracting

Architect: MHK Architecture & Planning



Visit the
project gallery.



FIN RAILING SYSTEM | INFILL: TEMPERED GLASS

SHAWNEE MISSION BIRTH CENTER - MERRIAM, KS

General Contractor: United Excel Corp

Architect: HWA Hoefer Wysocki Architects

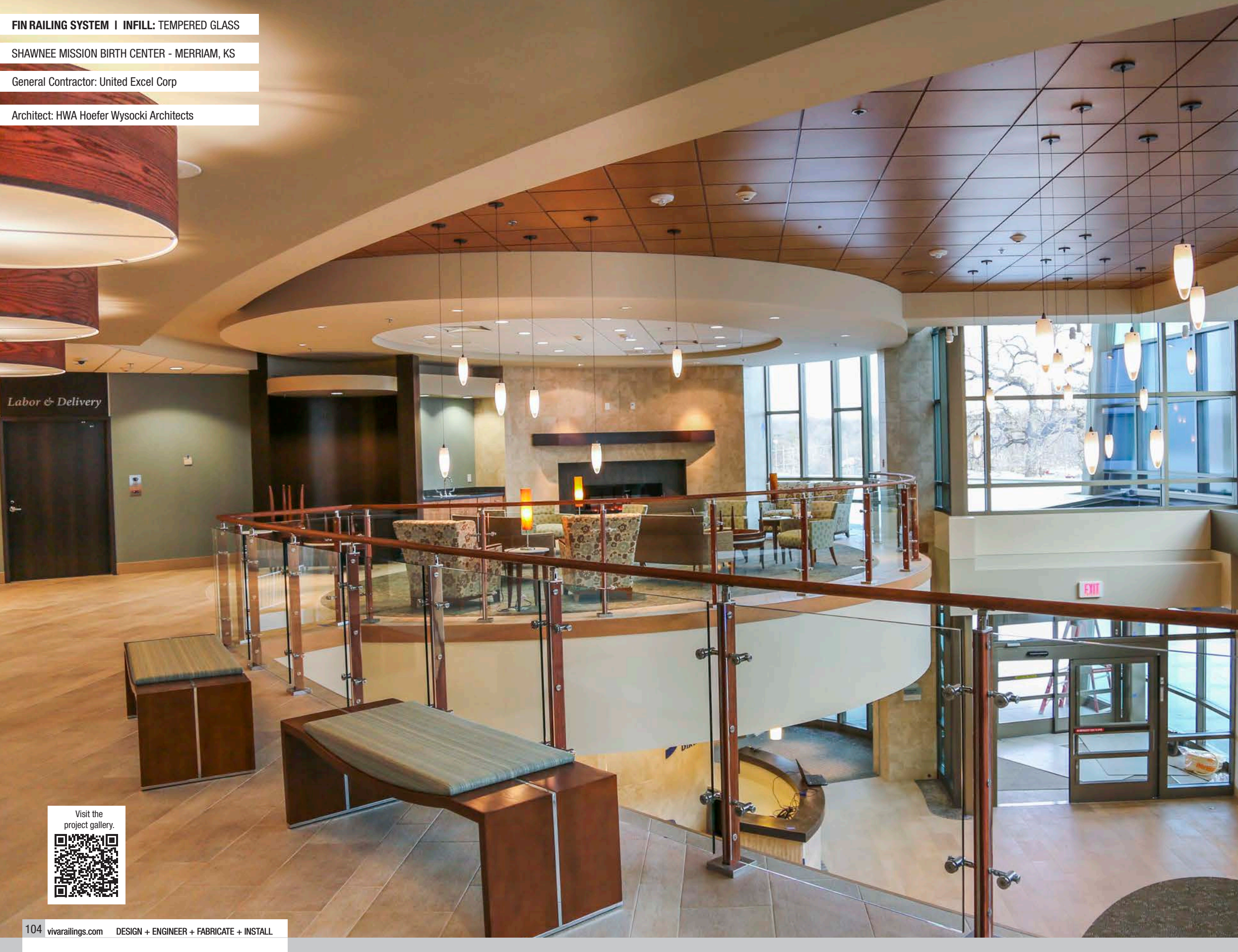

Labor & Delivery

EXIT

Visit the project gallery.





Visit the
project gallery.



ECO ELLIPSE™ GLASS SYSTEM

ECO ELLIPSE -
AVAILABLE INFILL

Glass

Our ECO Railing System is a fresh departure from the standard, bulky curtain wall aluminum railing systems currently on the market. The ECO line provides economically-conscious railing systems, while maintaining VIVA's commitment to making high quality products and innovating uber modern designs. The ECO ELLIPSE Aluminum Railing System is ideally suited for high-end multi-family residential applications.

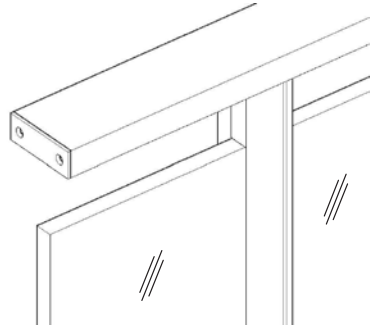

TR - 1

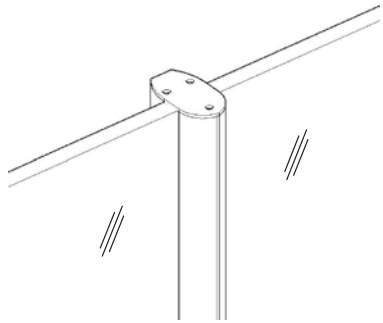

TR - 2 (NO TOP RAIL)

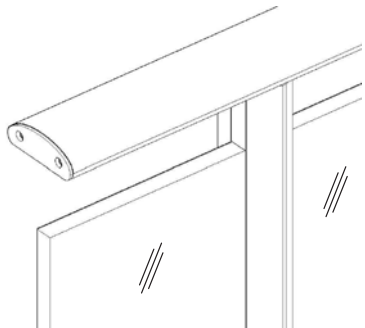

TR - 3

Other mounting options available.



Scan the QR code to check out the
ECO ELLIPSE system on our website
and the interactive 3D viewport



ECO ELLIPSE GLASS SYSTEM - TECHNICAL DATA

	MATERIAL	FINISH	SIZE/SPACING
BASE	Aluminum	Powder Coat - Super Polyester (AAMA 2604) - \$ ¹ Powder Coat - PVDF (AAMA 2605) - \$\$	3.2"x1.8" Oval section post @ 4'-0" max. O.C. Fascia, Top or Core mount.
INFILL OPTIONS	Glass	Clear, Tinted or Frit	Min. 3/8" laminated glass with PVB or SGP interlayer ² Glass standard thickness: 3/8", 1/2" Interlayer standard thickness, SGP: 0.035" , 0.06" PVB: 0.035"
TOP RAIL	Aluminum	Powder Coat - Super Polyester (AAMA 2604) - \$ Powder Coat - PVDF (AAMA 2605) - \$\$	Top rail options: -Rectangular 3.2"x1.1" (TR1) -Without top rail (TR2) -Oval 3.5"x1.9" (TR3)



Intertek

1. \$ to \$\$\$: Indicates finish type comparative cost.

2. IBC 2015 & newer requires railing glass to be laminated. VIVA recommends SGP for exterior applications.

ECO ELLIPSE_{GLASS SYSTEM} - INFILL OPTIONS

GLASS



VIVA's tempered glass infills provide optimal line of sight as well as an understated elegance.
Clear Laminated (PVB or SGP) | Bent | Tinted | Ceramic Frit Patterned | Colored Interlayer

ECO ELLIPSE GLASS SYSTEM - MOUNTING CONDITIONS

TOP MOUNT	
STEEL	CONCRETE
WELD	ANCHOR CORE

FASCIA MOUNT	
STEEL	CONCRETE
WELD	ANCHOR

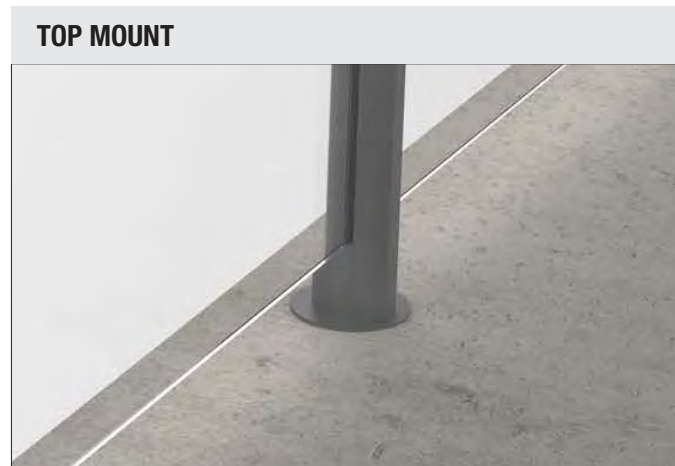

ECO ELLIPSE GLASS SYSTEM - FINISH OPTIONS



Available Standard and Premium colors on Pg 208

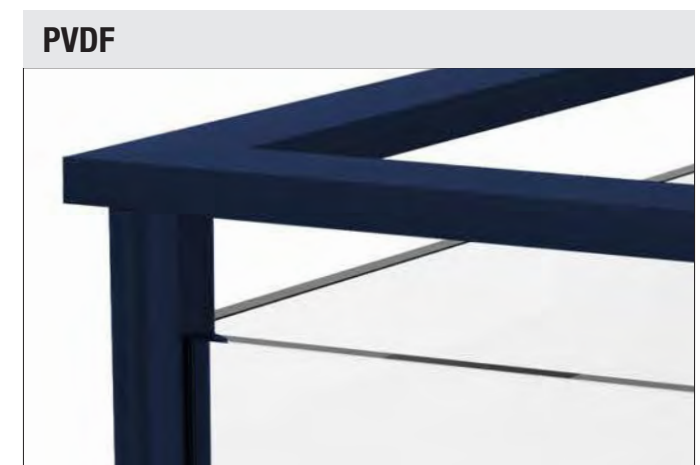

Available Standard and Premium colors on Pg 208





ECO ELLIPSE RAILING SYSTEM | INFILL: TEMPERED GLASS

HOME2 SUITES BY HILTON - SAN ANTONIO, TX

General Contractor: EBCO Construction

Architect: Bounds & Gillespie Architects

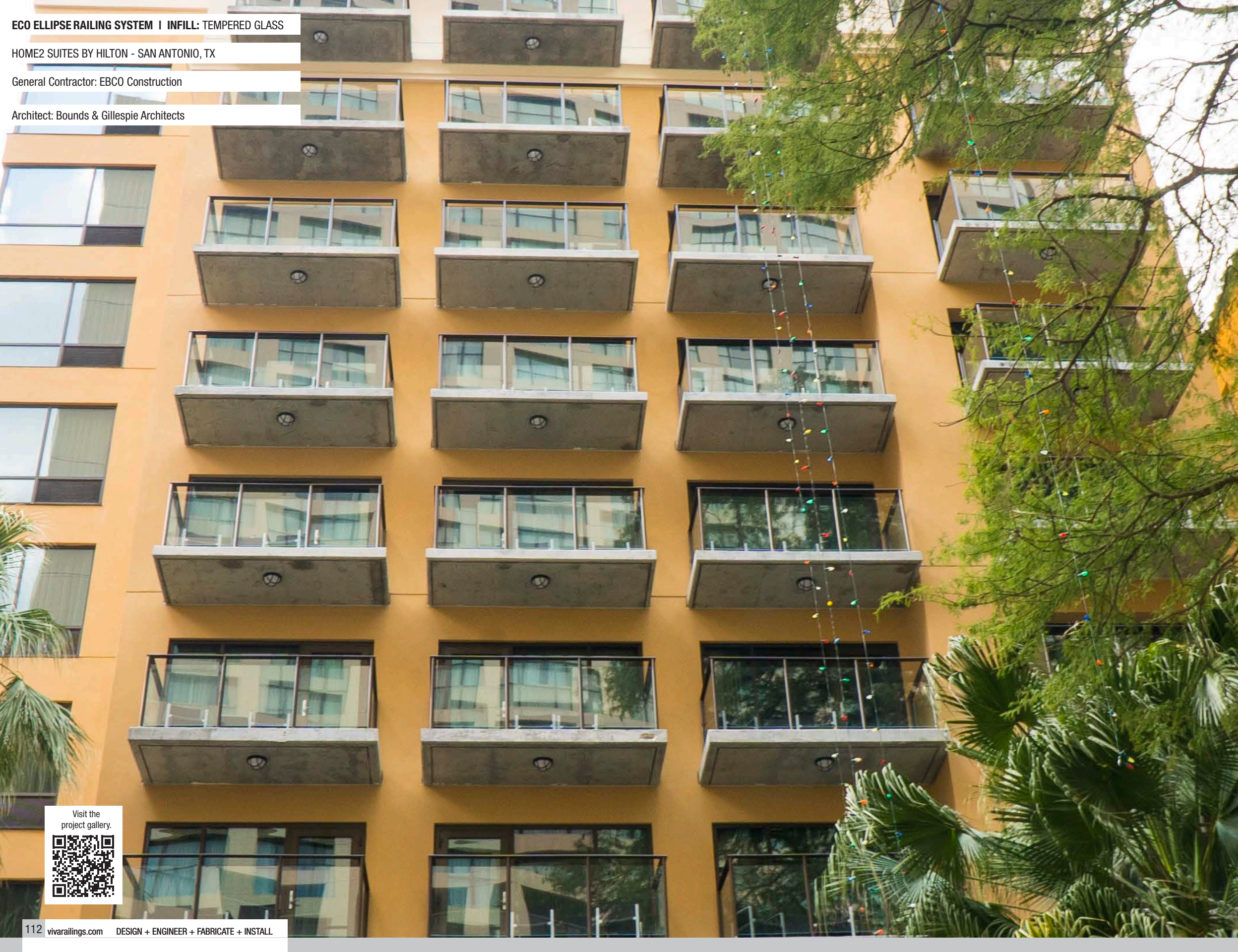

Visit the project gallery.





Visit the project gallery.



ECO VISTA™ GLASS SYSTEM

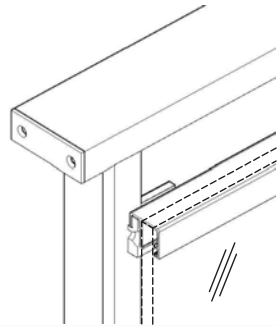

TR - 1

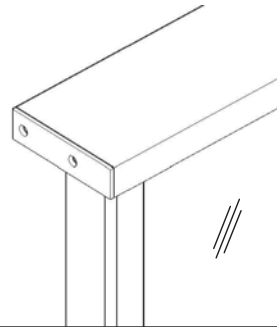

TR - 2

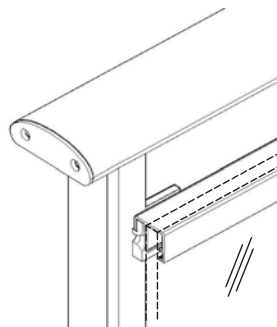

TR - 3

Other mounting options available.



Scan the QR code to check out the ECO VISTA system on our website and the interactive 3D viewport

ECO VISTA -
AVAILABLE INFILL

Glass

Our ECO Railing System is a fresh departure from the standard, bulky curtain wall aluminum railing systems currently on the market. The ECO line provides economically-conscious railing systems, while maintaining VIVA's commitment to making high quality products. The ECO VISTA Aluminum Railing System is ideally suited for high-end multi-family residential applications.



ECO VISTA_{GLASS SYSTEM} - TECHNICAL DATA

	MATERIAL	FINISH	SIZE/SPACING
BASE	Aluminum	Powder Coat - Super Polyester (AAMA 2604) - \$ ¹ Powder Coat - PVDF (AAMA 2605) - \$\$	2.5"x1.1" rectangular section for fascia mounted post, and T section for top or core mounted post, @ 4'-0" MAX. O.C.
INFILL OPTIONS	Glass	Clear, Tinted or Frit	3/8" laminated glass with PVB or SGP interlayer ² Interlayer standard thickness, SGP: 0.035" , 0.06" PVB: 0.035
TOP RAIL	Aluminum	Powder Coat - Super Polyester (AAMA 2604) - \$ Powder Coat - PVDF (AAMA 2605) - \$\$	Top rail options: -Rectangular 3.2"x1.1" (TR1) -Rectangular 4.3"x1.2" (TR2) -Oval 3.5"x1.9" (TR3)



1. IBC 2015 & newer requires railing glass to be laminated. VIVA recommends SGP for exterior applications.

2. All LED LINEAR products are ETL certified; ETL mark is proof of product compliance to North American safety standard.

3. Other species available upon request.



¹ IBC 2015 & newer requires railing glass to be laminated. VIVA recommends SGP for exterior applications.

² \$ to \$\$\$: Indicates finish type comparative cost.

ECO VISTA GLASS SYSTEM - INFILL OPTIONS

GLASS



VIVA's tempered glass infills provide optimal line of sight as well as an understated elegance.
Clear Laminated (PVB or SGP) | Bent | Tinted | Ceramic Frit Patterned | Colored Interlayer

ECO VISTA^{GLASS SYSTEM} - MOUNTING CONDITIONS

TOP MOUNT	
STEEL	CONCRETE
WELD	ANCHOR CORE

FASCIA MOUNT	
STEEL	CONCRETE
WELD	ANCHOR

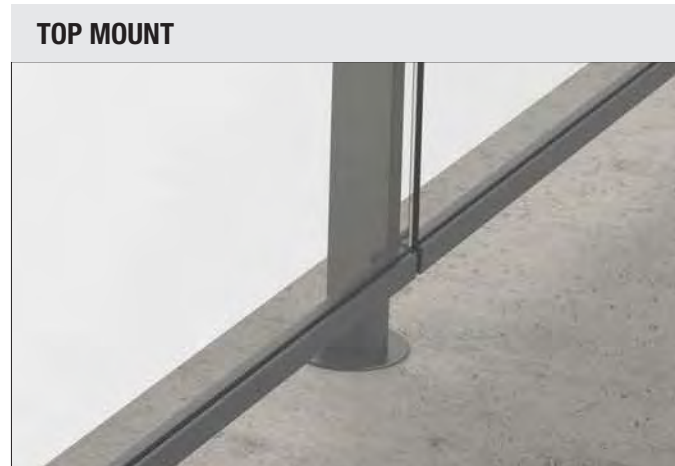

ECO VISTA^{GLASS SYSTEM} - FINISH OPTIONS



Available Standard and Premium colors on Pg 208



Available Standard and Premium colors on Pg 208





WINDWALL™ GLASS SYSTEM

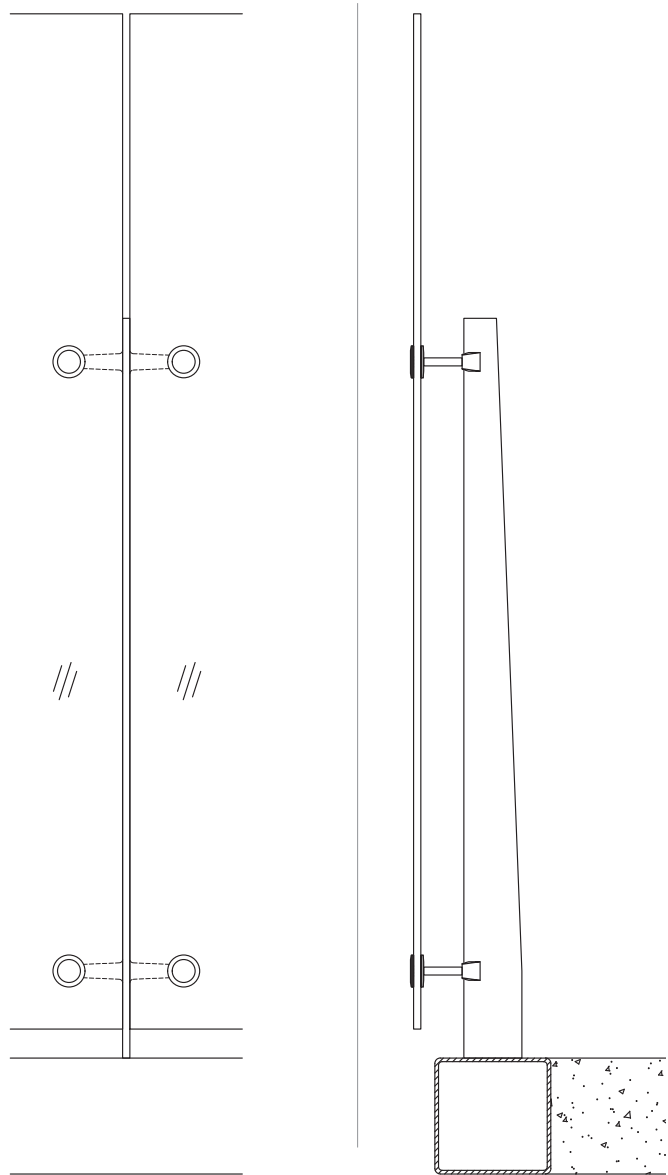

WINDWALL - AVAILABLE
INFILL

Glass

Our WINDWALL Solutions are typically used at amenity deck levels in high rise residential projects or by poolside. These applications require custom engineering solutions and hence every windwall design is project specific and depends on floor elevation, wind loads, layout and location of the building.

Other mounting options available.

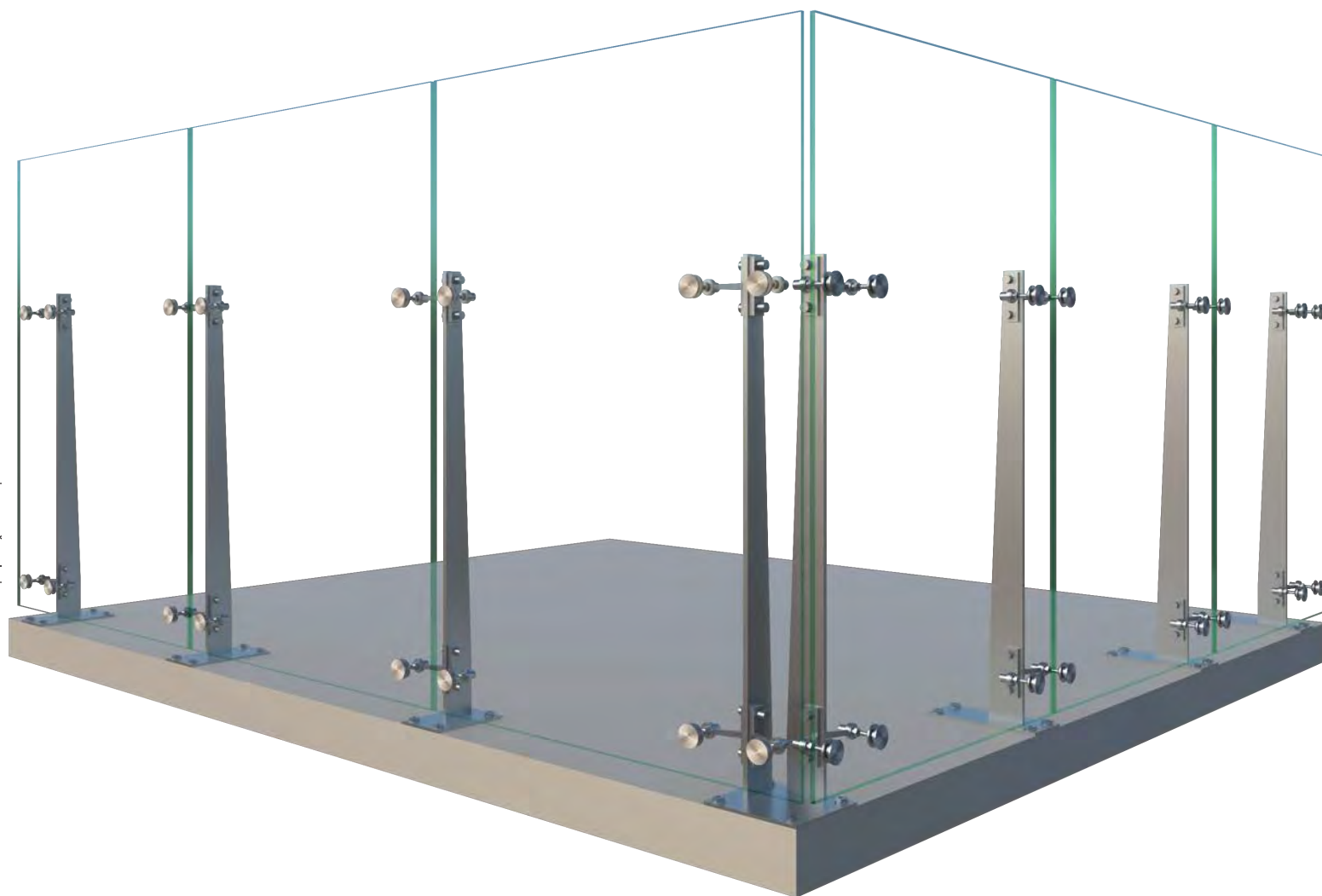

Scan the QR code to check out the
WINDWALL system on our website and
the interactive 3D viewport

WINDWALL GLASS SYSTEM - TECHNICAL DATA

	MATERIAL	FINISH	SIZE/SPACING
 POST	Stainless Steel (304 or 316)	#6 Satin	2 1/2" ~ 5" Wide flat bar post @ 4'-0" max. O.C. 4'-0" ~ 8'-0" Height Wind wall. Top or Core mount.
		Powder Coat	
		ECM	
INFILL ECM finish is not available for U-cap, top rail or hand rail.	Glass	Clear, Tinted or Frit	Min. 1/2" laminated glass with SGP interlayer ¹ Glass standard thickness: 1/2", 5/8", 3/4" Interlayer standard thickness, SGP: 0.035" , 0.06"

 Intertek
 1. IBC 2015 & newer requires railing glass to be laminated. VIVA recommends SGP for exterior applications.

WINDWALL GLASS SYSTEM - INFILL OPTIONS

GLASS



VIVA's tempered glass infills provide optimal line of sight as well as an understated elegance.
Clear Laminated (PVB or SGP) | Bent | Tinted | Ceramic Frit Patterned | Colored Interlayer

WINDWALL GLASS SYSTEM - MOUNTING CONDITIONS

TOP MOUNT	
STEEL	CONCRETE
WELD	ANCHOR
	CORE

FASCIA MOUNT	
STEEL	CONCRETE
WELD	ANCHOR

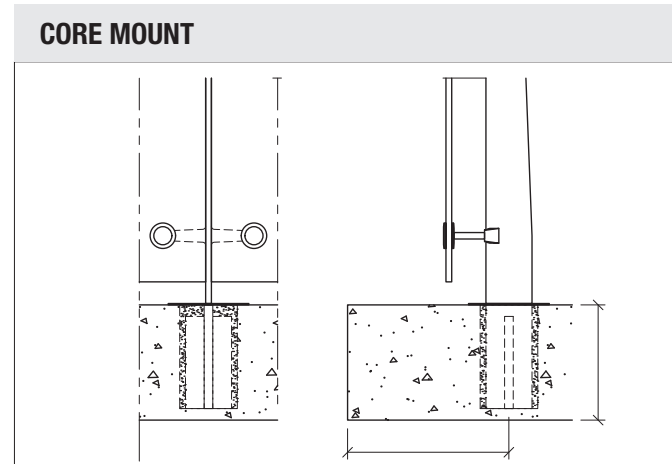
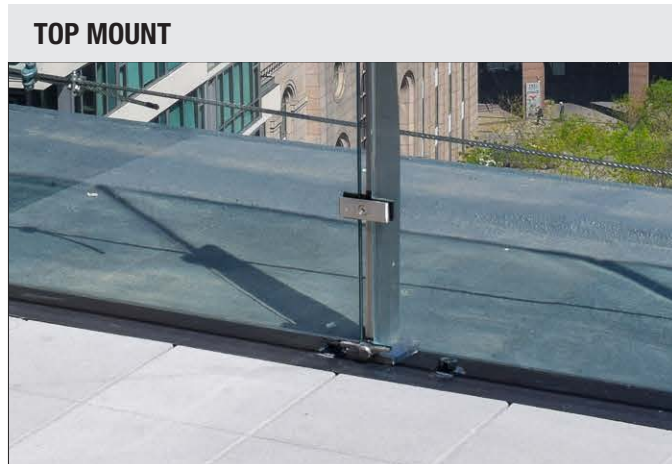

WINDWALL GLASS SYSTEM - FINISH OPTIONS

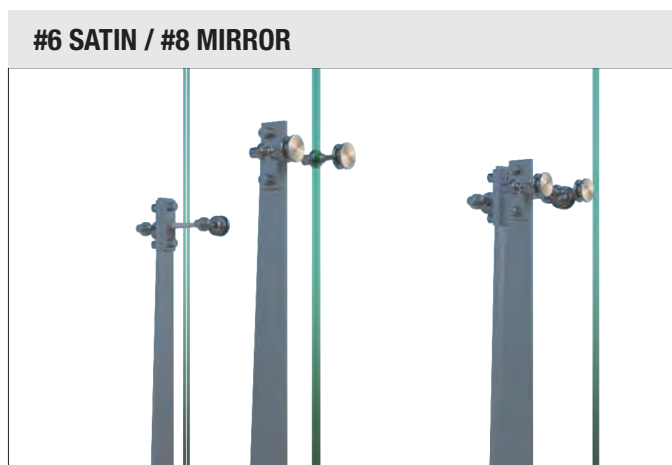

#8 Mirror Finish comes at an additional cost to our #6 Finish.

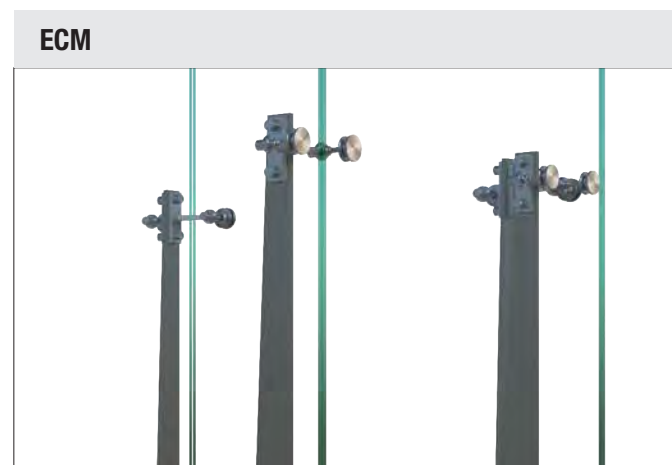

Available ECM colors on Pg 211



Available Standard and Premium colors on Pg 208

ECM finish is not available for U-cap, top rail or hand rail.

WINDWALL RAILING SYSTEM | INFILL: TEMPERED GLASS

STATLER HOTEL & RESIDENCE - DALLAS, TX

General Contractor: Hill & Wilkinson

Architect: Merriman - MAA Architects

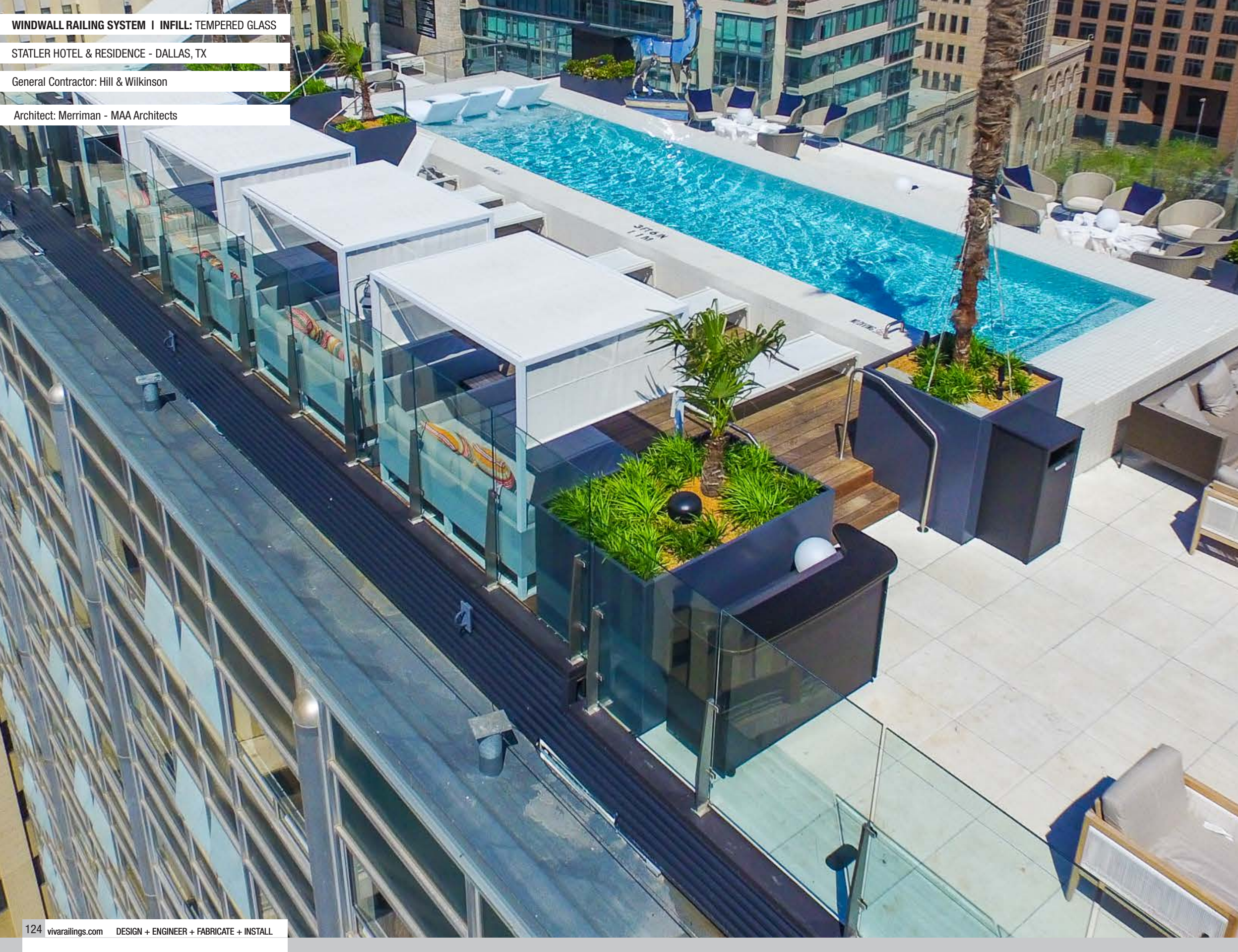



ALUM. WINDWALL™ GLASS SCREEN SYSTEM

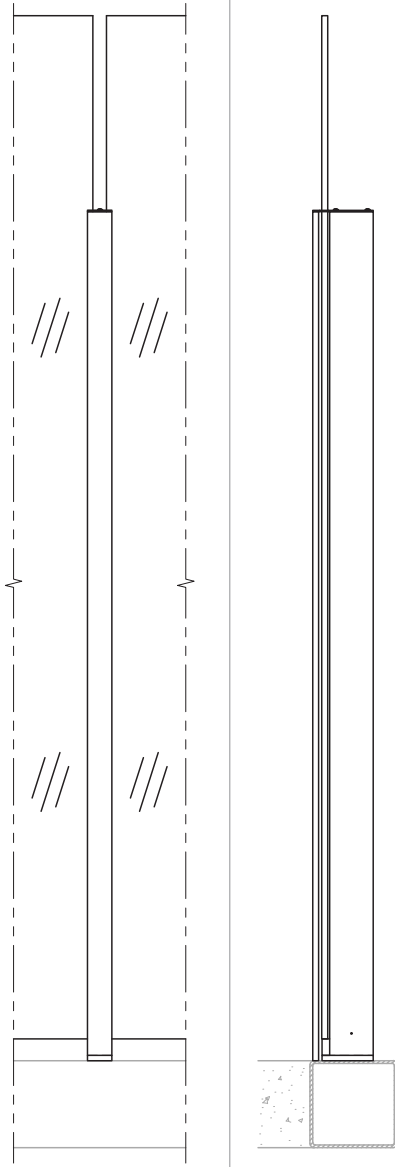

ALUM. WINDWALL -
AVAILABLE INFILL

Glass

The ALUM. WINDWALL system is an alternative addition to our windwall system and is typically used at amenity deck levels in high rise residential projects or by poolside. Windwall system applications require custom engineering solutions and hence every windwall design is project specific and depends on floor elevation, wind loads, layout and location of the building.

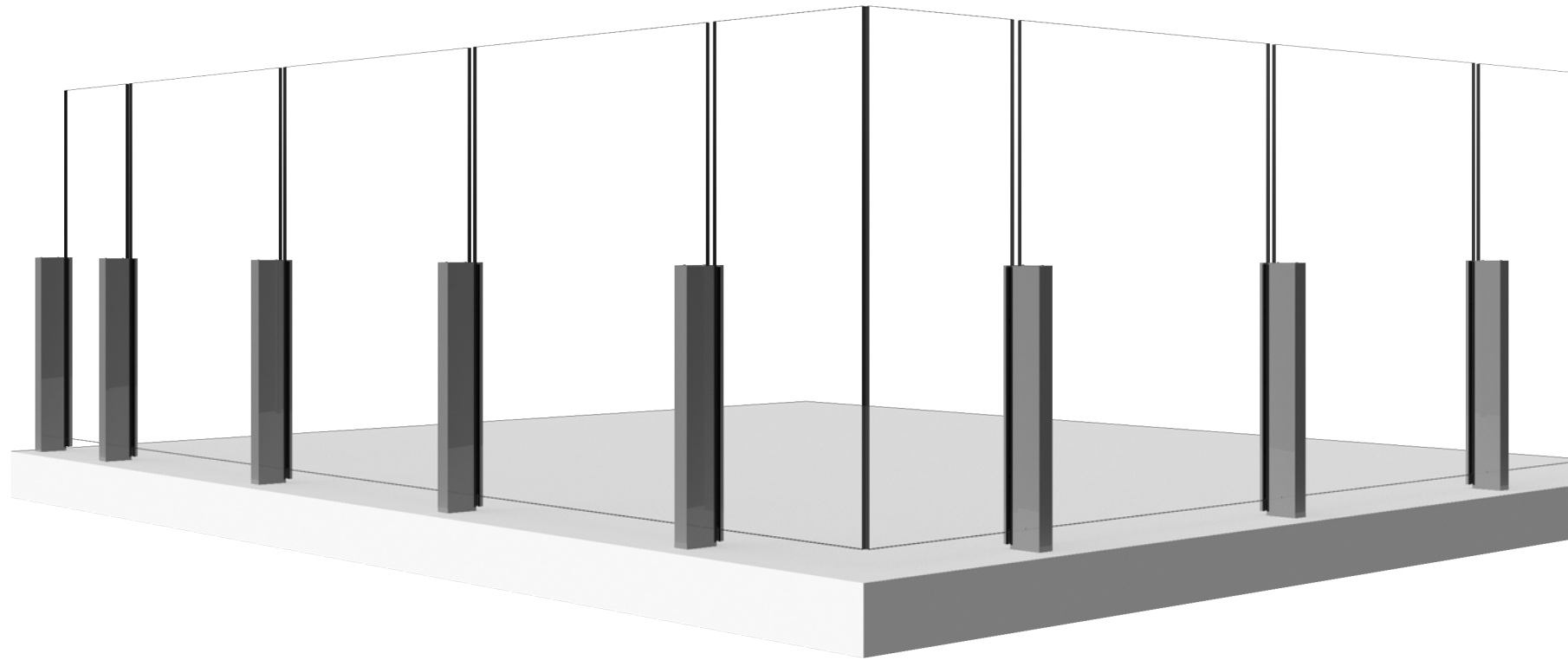

Other mounting options available.



Scan the QR code to check out the ALUM. WINDWALL system on our website and the interactive 3D viewport

ALUM. WINDWALL GLASS SCREEN SYSTEM - TECHNICAL DATA



Download ALUM. WINDWALL
Product Data

	MATERIAL	FINISH	SIZE/SPACING
POST	Aluminum	Powder Coat Super Polyester (AAMA 2604) ² Powder Coat PVDF (AAMA 2605) ²	2 1/4"x5 7/16" Square post @ 4'-0" max. O.C. 4'-0", 6'-0" & 8'-0" Height Alum. Windwall. Anchored, Cored or Welded mount.
INFILL	Glass	Clear, Tinted or Frit	Min. 1/2" laminated glass with SGP interlayer ¹ Glass standard thickness: 1/2", 5/8", 3/4" Interlayer standard thickness, SGP: 0.035" , 0.06"

1. IBC 2015 & newer requires railing glass to be laminated. VIVA rALUM.mmends SGP for exterior applications.

2. \$ to \$\$\$: indicates finish type comparative cost.

ALUM. WINDWALL GLASS SCREEN SYSTEM - INFILL OPTIONS

GLASS

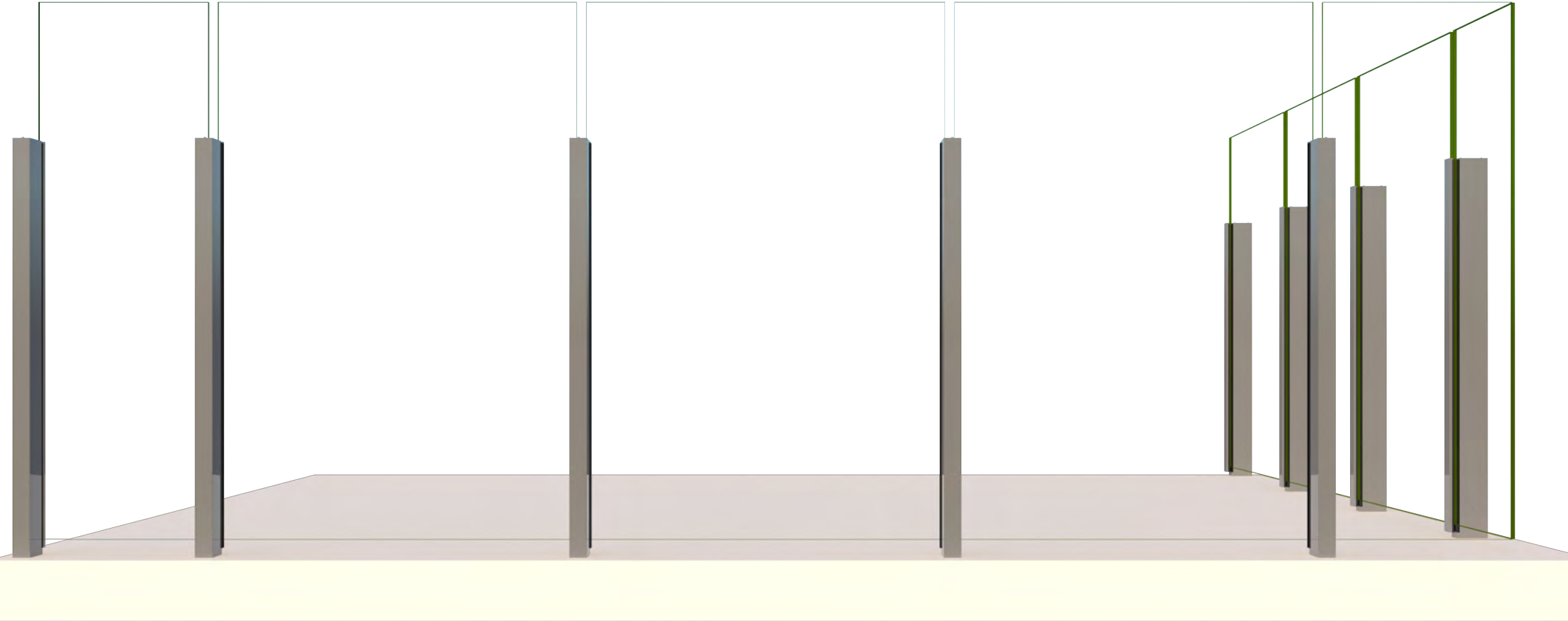

VIVA's tempered glass infills provide optimal line of sight as well as an understated elegance.
Clear Laminated (PVB or SGP) | Bent | Tinted | Ceramic Frit Patterned | Colored Interlayer

ALUM. WINDWALL GLASS - MOUNTING CONDITIONS

TOP MOUNT	
STEEL	CONCRETE
WELD	ANCHOR
	CORE

FASCIA MOUNT	
STEEL	CONCRETE
WELD	ANCHOR

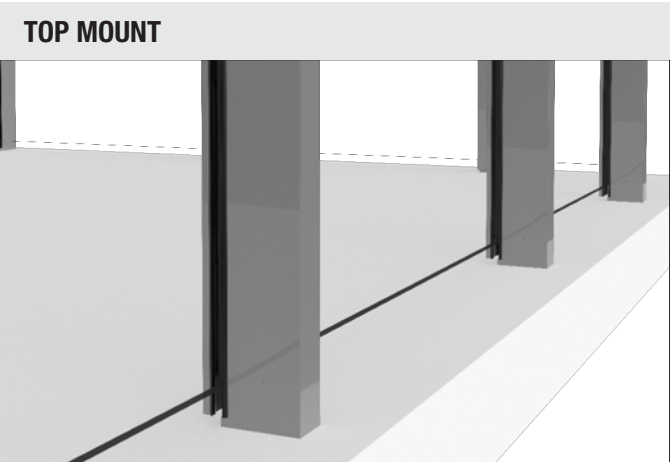

ALUM. WINDWALL GLASS - FINISH OPTIONS



Available Standard and Premium colors on Pg 208

FRAME™ METAL SYSTEM

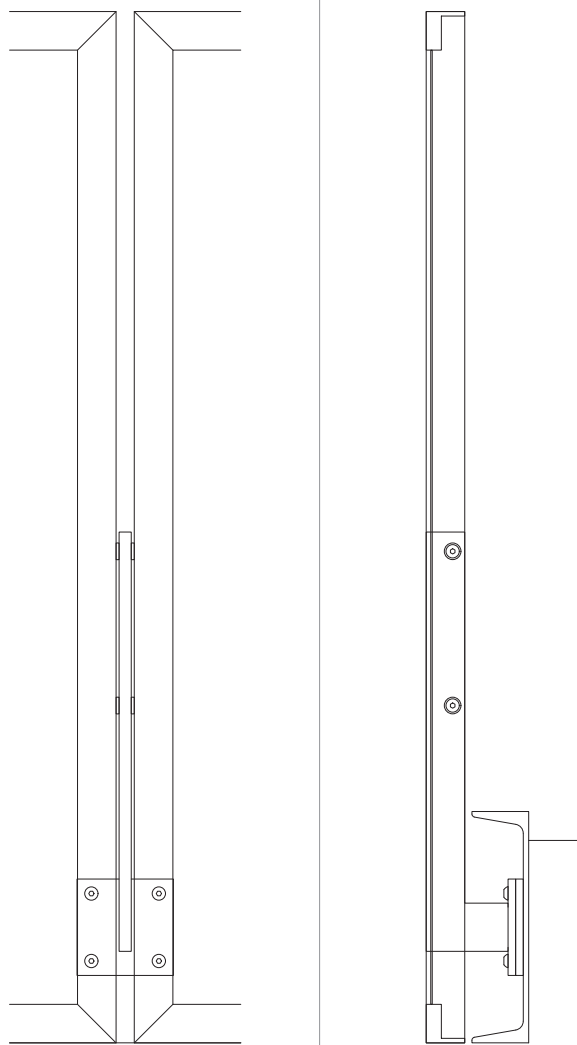

FRAME - AVAILABLE INFILLS

Perforated Metal

FRAME is a structural metal panel system that is picture framed with your favorite perforated metal panel. Wide edges of FRAME create a bold statement with an art deco look. The supporting base is minimalistic, almost out of sight, giving you a floating metal panel. Wide frame also creates an integral top guard edge, eliminating the need for the added top cap.

Other mounting options available.

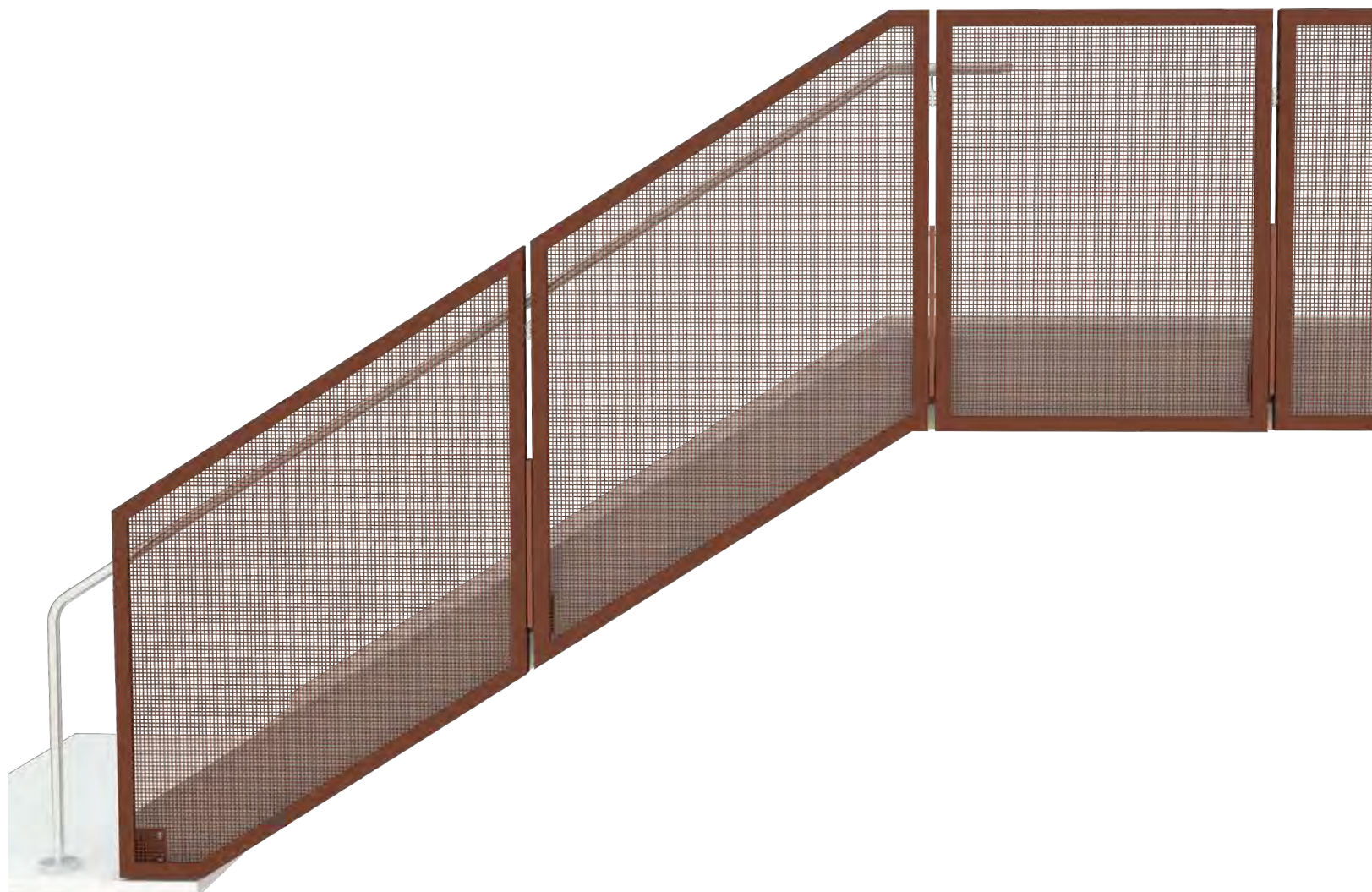

Scan the QR code to check out the FRAME system on our website and the interactive 3D viewport

FRAME METAL SYSTEM - TECHNICAL DATA

	MATERIAL	FINISH	SIZE/SPACING
POST	Stainless Steel (304 or 316)	#6 Satin, #8 Mirror ECM	Solid bar post @ 4'-3" max. O.C. Fascia, Top or Core mount.
	Stainless Steel (201)	Powder Coat	
INFILL OPTIONS	Aluminum Perforated	Powder Coat	2" wide with aluminum angle framed panel
HAND RAIL	Stainless Steel Tube	#6 Satin, Powder Coat	Ø1-1/2" or Ø2" tube
	Stainless Steel Tube with LED ¹	#6 Satin	Ø1-1/2" with LED LINEAR, Ø1-1/2" or Ø2" with LED POD
	Wood (Red Oak, Cherry or Maple) ²	Unstained	Ø2"
	Wood (Red Oak, Cherry or Maple) with LED		Ø2" with LED LINEAR



Intertek

1. All LED LINEAR products are ETL certified; ETL mark is proof of product compliance to North American safety standard.

2. Other species available upon request.

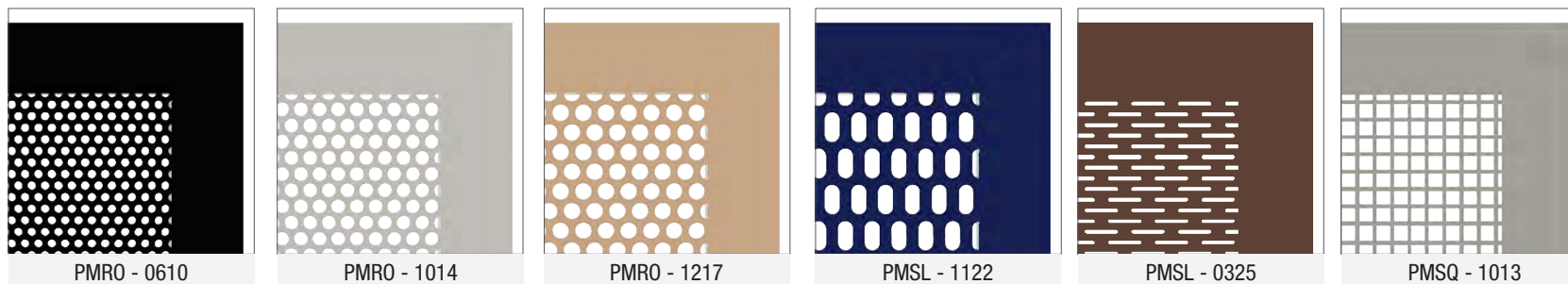

FRAME METAL SYSTEM - INFILL OPTIONS

PERFORATED METAL PANELS



VIVA's perforated metal infill panels feature a solid metal outer frame with rounded, slotted or square motifs.

Perforated Metal Panel Patterns on Pg. 213

FRAME METAL SYSTEM - MOUNTING CONDITIONS

TOP MOUNT	
STEEL	CONCRETE
WELD	ANCHOR CORE

FASCIA MOUNT	
STEEL	CONCRETE
WELD	ANCHOR

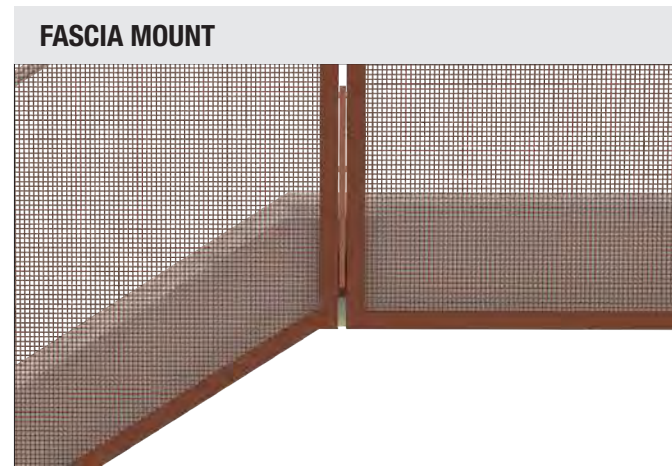
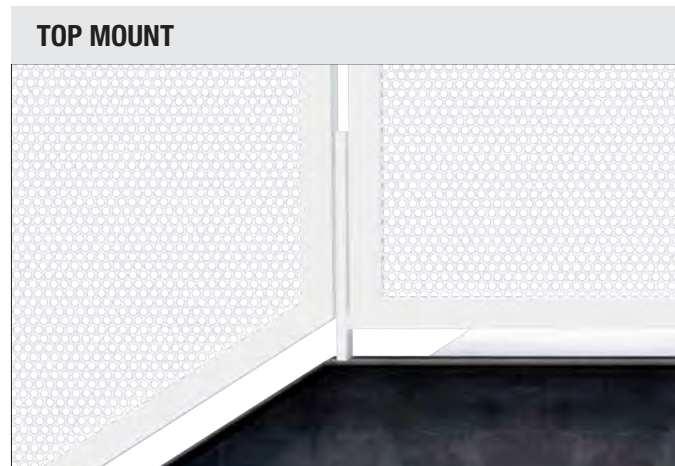

FRAME METAL SYSTEM - FINISH OPTIONS

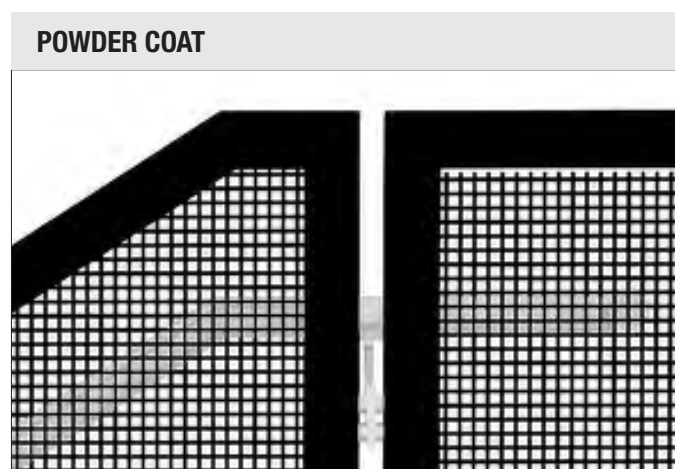

Available Standard and Premium colors on Pg 208

FRAME RAILING SYSTEM | INFILL: METAL PANEL

AUSTIN COMMUNITY COLLEGE HIGHLAND CAMPUS - AUSTIN, TX

General Contractor: Flintco, LLC

Architect: Perkins & Will

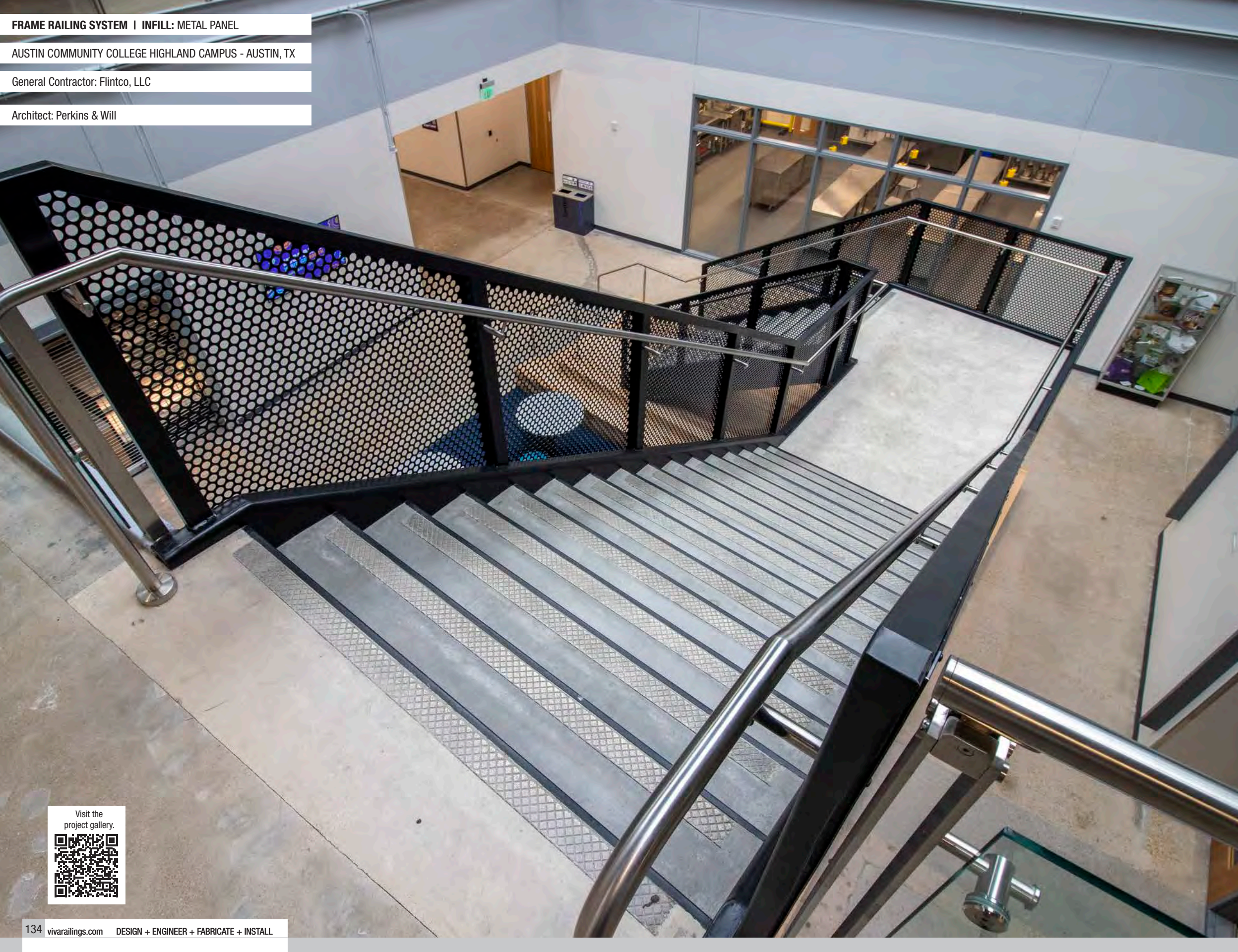

Visit the
project gallery.



FRAME RAILING SYSTEM | INFILL: METAL PANEL
WINGSTOP GLOBAL SUPPORT CENTER - ADDISON, TX
General Contractor: Structure Tone Southwest
Architect: Smithgroup Inc

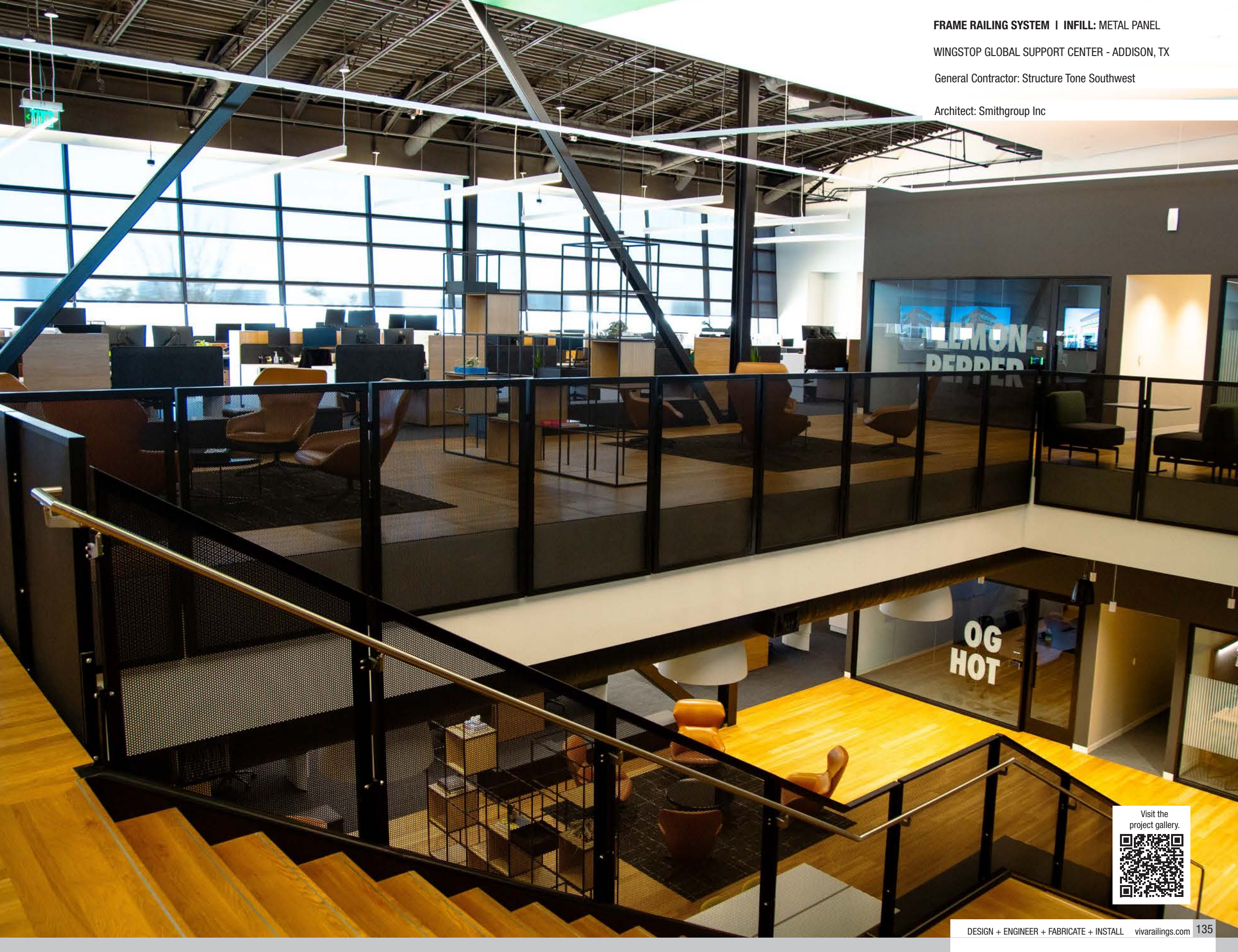

Visit the project gallery.



FOLD™ METAL SYSTEM

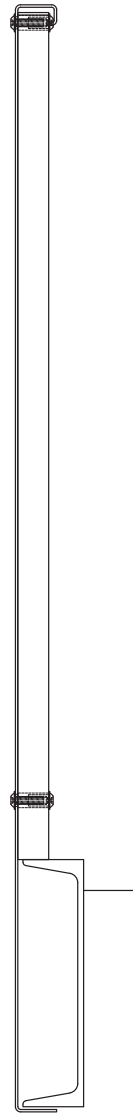
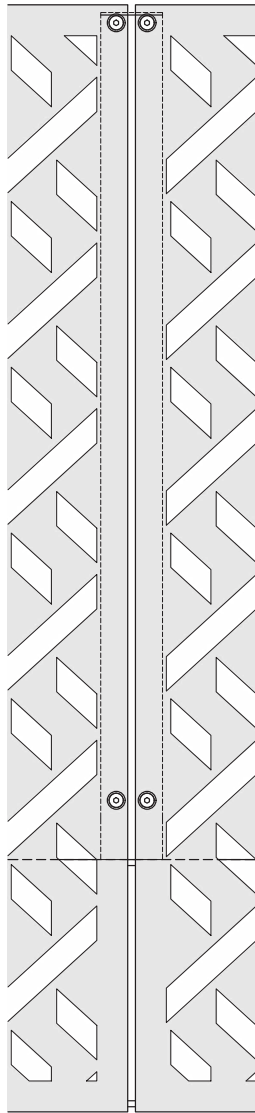

FOLD - LASER CUT PANELS

Aluminum

Powder Coated or Anodized

Powder Coated Steel

Our FOLD Panel Railing System is an ingeniously engineered structural sheet metal fabrication design. This system features CNC laser cut patterns that provide a range of pre-configured or custom designs of your choice. With material choices of aluminum in finishes of powder coating & anodized and stainless steel in #6 satin and ECM colors – what you can do with the fold panel system on your project is best left to your imagination.

Laser Cut Patterns on Pg. 150

IMPORTANT NOTE: Our perforated metal patterns PMRO, PMSQ & PMSL are punch-hole patterns and CANNOT BE USED with FOLD/STRUC Panel Railing systems.

Other mounting options available.



Scan the QR code to check out the FOLD system on our website and the interactive 3D viewport

FOLD METAL SYSTEM - TECHNICAL DATA

	MATERIAL	FINISH	SIZE/SPACING
POST	Stainless Steel (201) / Aluminum (With Stainless Steel infill panel)	Powder Coat	Formed panels @ 4'-6" max. O.C. Fascia, Top or Core mount.
	Stainless Steel (304 or 316) (With Stainless Steel infill panel)	#6 Satin, #8 Mirror ECM	
INFILL OPTIONS	Stainless Steel (304 or 316)	#6 Satin	2" wide with 14GA thickness. 4'-0" max. O.C.
		ECM	
	Aluminum	Powder Coat - Super Polyester (AAMA 2604) - \$ ¹	
		Powder Coat - PVDF (AAMA 2605) - \$\$	
Steel	Powder Coat		
HAND RAIL	Stainless Steel Tube	#6 Satin, Powder Coat	Ø1-1/2" or Ø2" tube
	Stainless Steel Tube with LED ²	#6 Satin	Ø1-1/2" with LED LINEAR, Ø1-1/2" or Ø2" with LED POD
	Wood (Red Oak, Cherry or Maple) ³	Unstained	Ø2"
	Wood (Red Oak, Cherry or Maple) with LED		Ø2" with LED LINEAR



1. \$ to \$\$\$: Indicates finish type comparative cost.

2. All LED LINEAR products are ETL certified; ETL mark is proof of product compliance to North American safety standard.

3. Other species available upon request.

FOLD METAL SYSTEM - INFILL OPTIONS

LASER CUT METAL PATTERNS



Laser Cut Patterns on Pg. 150

FOLD METAL SYSTEM - MOUNTING CONDITIONS

TOP MOUNT	
STEEL	CONCRETE
WELD	ANCHOR CORE

FASCIA MOUNT	
STEEL	CONCRETE
WELD	ANCHOR

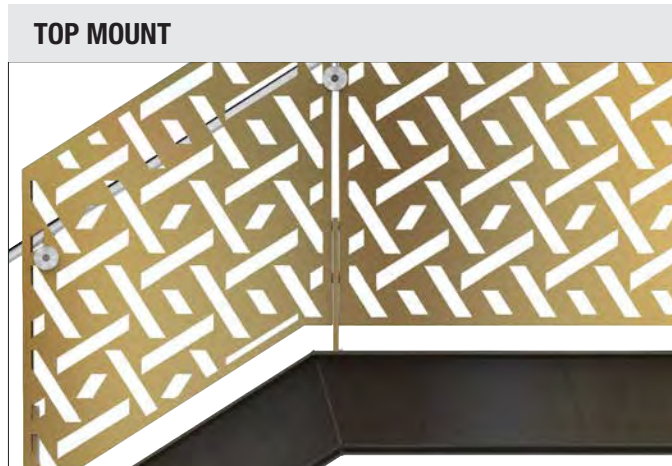

FOLD METAL SYSTEM - FINISH OPTIONS

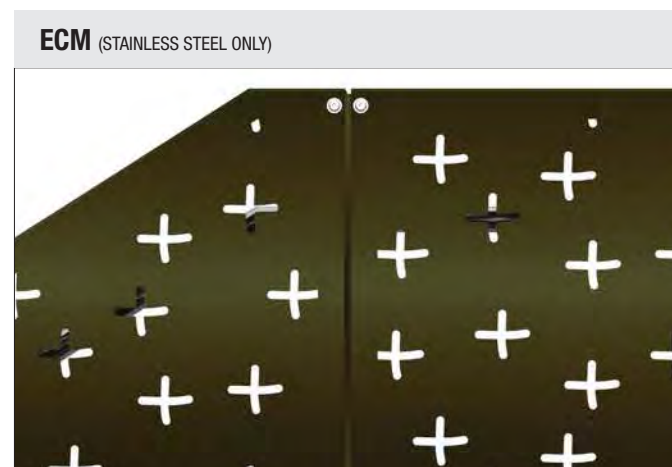
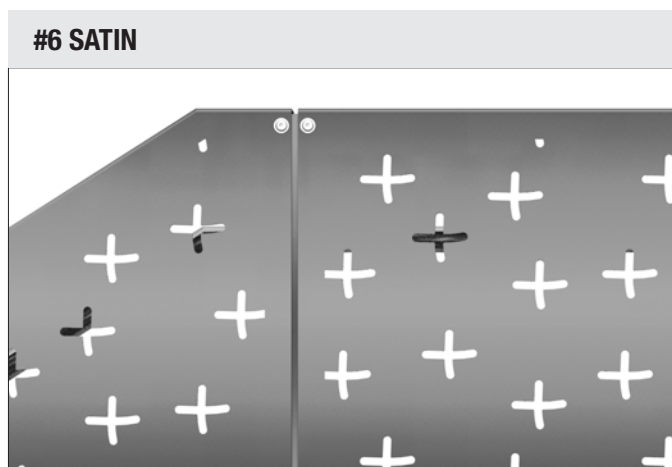

Available ECM colors on Pg 211

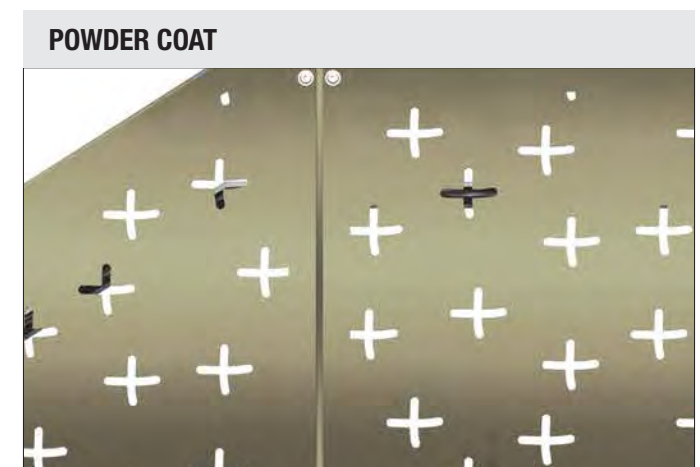

Available Standard and Premium colors on Pg 208

FOLD RAILING SYSTEM | INFILL: METAL PANEL

LEWISVILLE ISD CAREER CENTER - LEWISVILLE, TX

General Contractor: Northstar Builders

Architect: Stantec



Visit the project gallery.



FOLD RAILING SYSTEM | INFILL: METAL PANEL

TARRANT COUNTY COLLEGE NW CAMPUS - FT. WORTH, TX

General Contractor: Skanska USA Building - Dallas TX

Architect: Huckabee Architects - Fort Worth TX

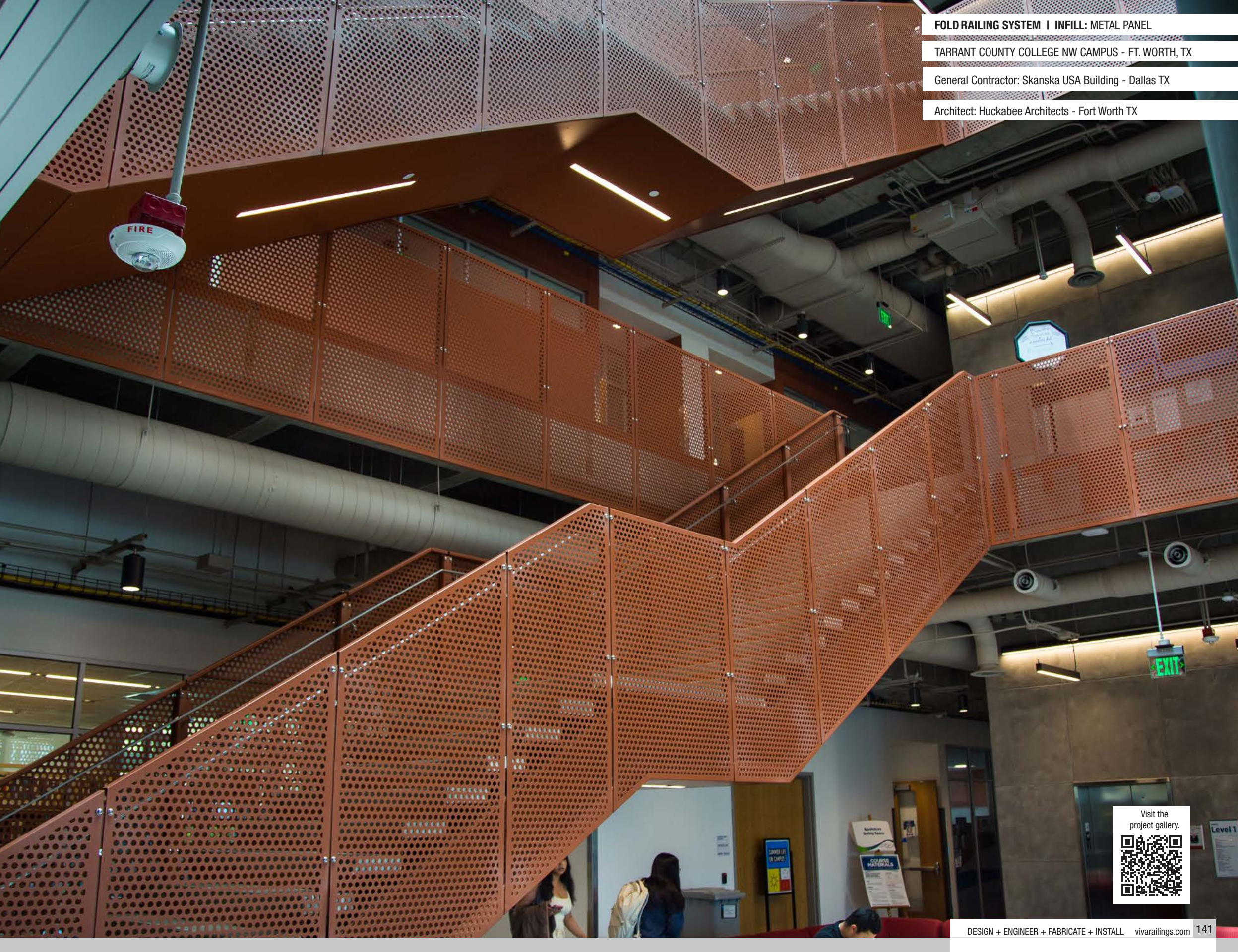

Visit the
project gallery.



STRUC™ METAL SYSTEM

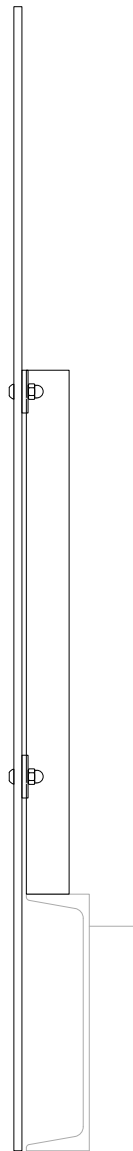
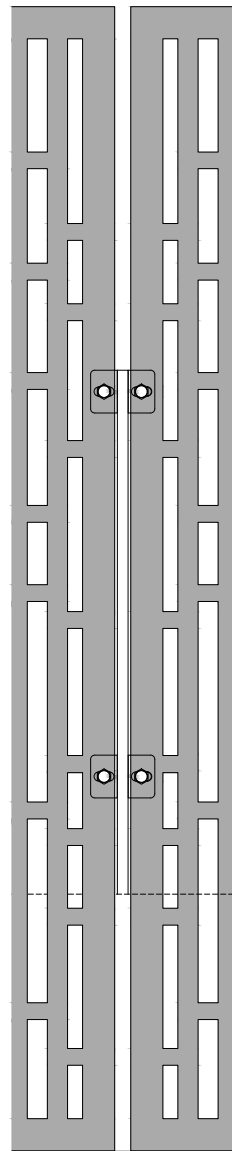

Other mounting options available.

STRUC - LASER CUT PANELS

Aluminum

Powder Coated or Anodized

Powder Coated Steel

Our STRUC Panel Railing System is an ingeniously engineered structural sheet metal fabrication design. This system features CNC laser cut patterns that provide a range of pre-configured or custom designs of your choice. With material choices of aluminum in finishes of powder coating & anodized and stainless steel in #6 satin. – what you can do with the struc panel system on your project is best left to your imagination. This system is available in a range of pre-configured patterns or custom designs of your choice and allows you to customize company logos and images.

Laser Cut Patterns on Pg. 150

IMPORTANT NOTE: Our perforated metal patterns PMRO, PMSQ & PMSL are punch-hole patterns and CANNOT BE USED with FOLD/STRUC Panel Railing systems.

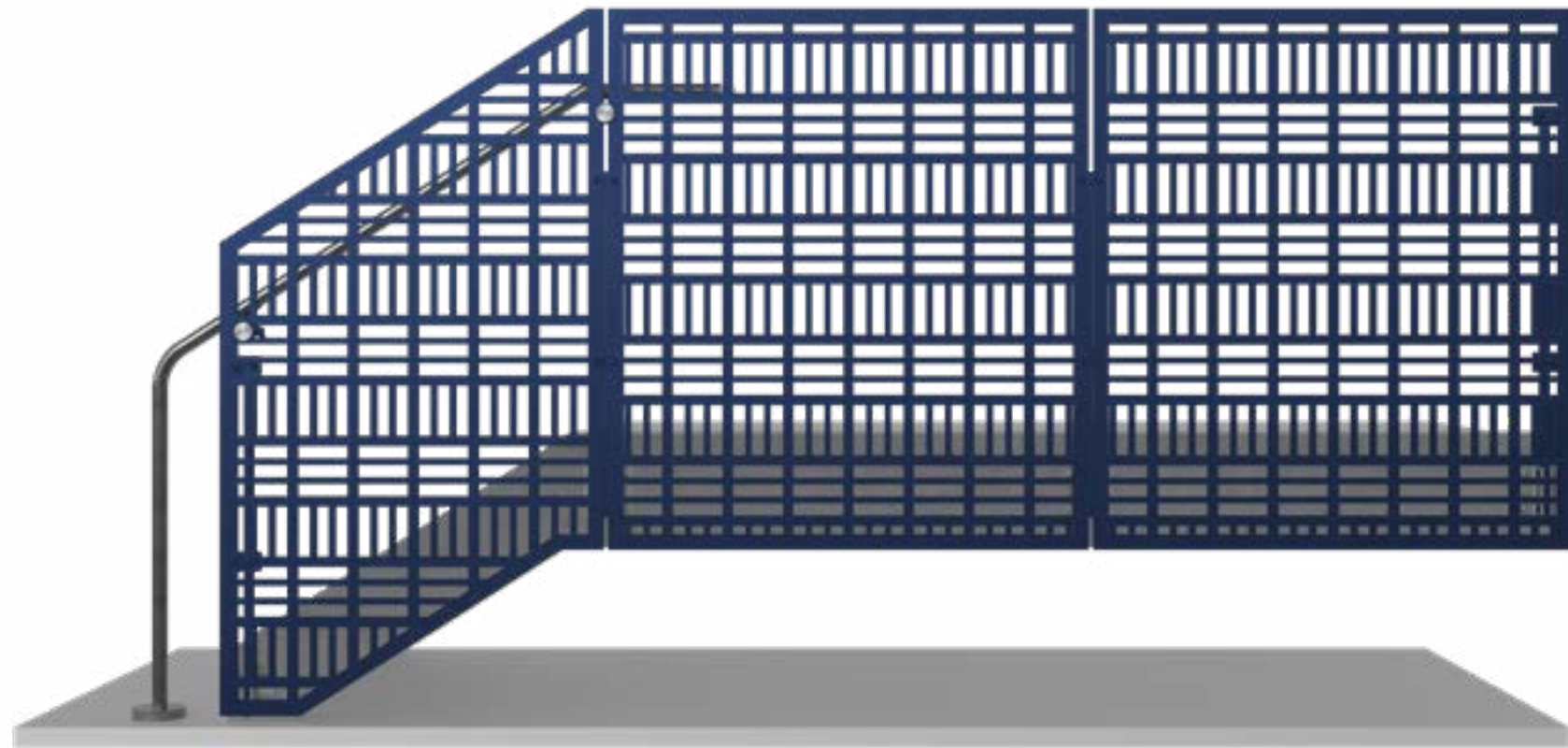

Scan the QR code to check out the STRUC system on our website and the interactive 3D viewport

STRUC METAL SYSTEM - TECHNICAL DATA



	MATERIAL	FINISH	SIZE/SPACING
POST	Stainless Steel (304 or 316)	#6 Satin, #8 Mirror	4'-0" max. O.C. post spacing, with 18" max. cantilever panel Fascia, Top or Core mount.
		ECM	
		Powder Coat	
INFILL OPTIONS	Aluminum	Powder Coat - Super Polyester (AAMA 2604) - \$ ¹	Flat aluminum panel
		Powder Coat - PVDF (AAMA 2605) - \$\$	
HAND RAIL	Stainless Steel Tube	#6 Satin	Ø1-1/2" or Ø2" tube
	Stainless Steel Tube with LED ²		Ø1-1/2" with LED LINEAR, Ø1-1/2" or Ø2" with LED POD
	Wood (Red Oak, Cherry or Maple) ³	Unstained	Ø2"
	Wood (Red Oak, Cherry or Maple) with LED		Ø2" with LED LINEAR



1. \$ to \$\$\$: Indicates finish type comparative cost.

2. All LED LINEAR products are ETL certified; ETL mark is proof of product compliance to North American safety standard.

3. Other species available upon request.

STRUC METAL SYSTEM - INFILL OPTIONS

LASER CUT METAL PANELS

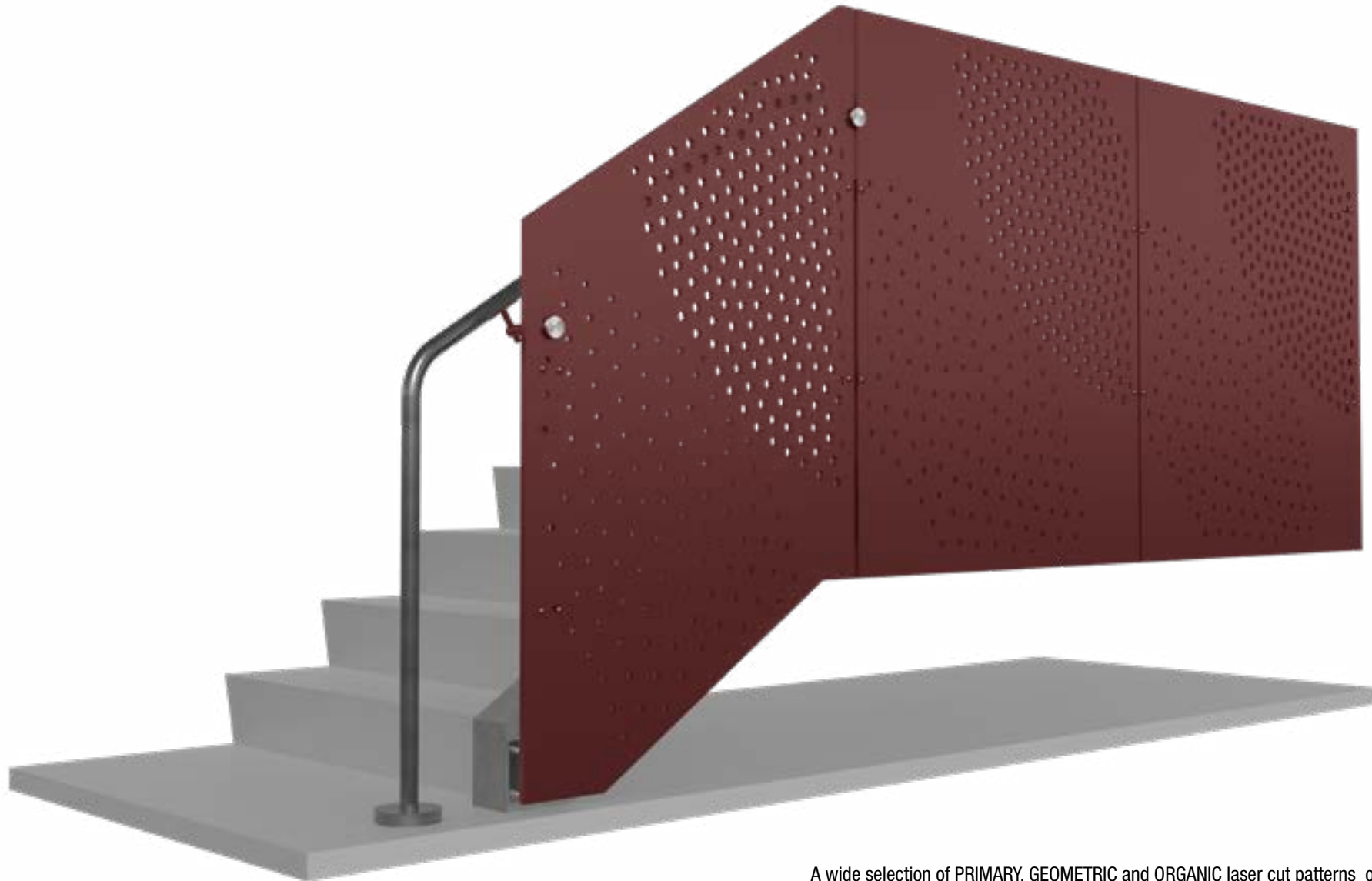

A wide selection of PRIMARY, GEOMETRIC and ORGANIC laser cut patterns on Pg. 150

STRUC METAL SYSTEM - MOUNTING CONDITIONS

TOP MOUNT	
STEEL	CONCRETE
WELD	ANCHOR CORE

FASCIA MOUNT	
STEEL	CONCRETE
WELD	ANCHOR

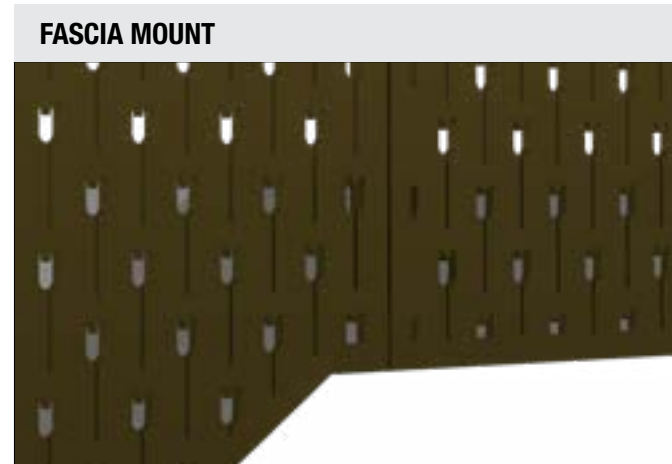

STRUC METAL SYSTEM - FINISH OPTIONS



Available Standard and Premium colors on Pg 208

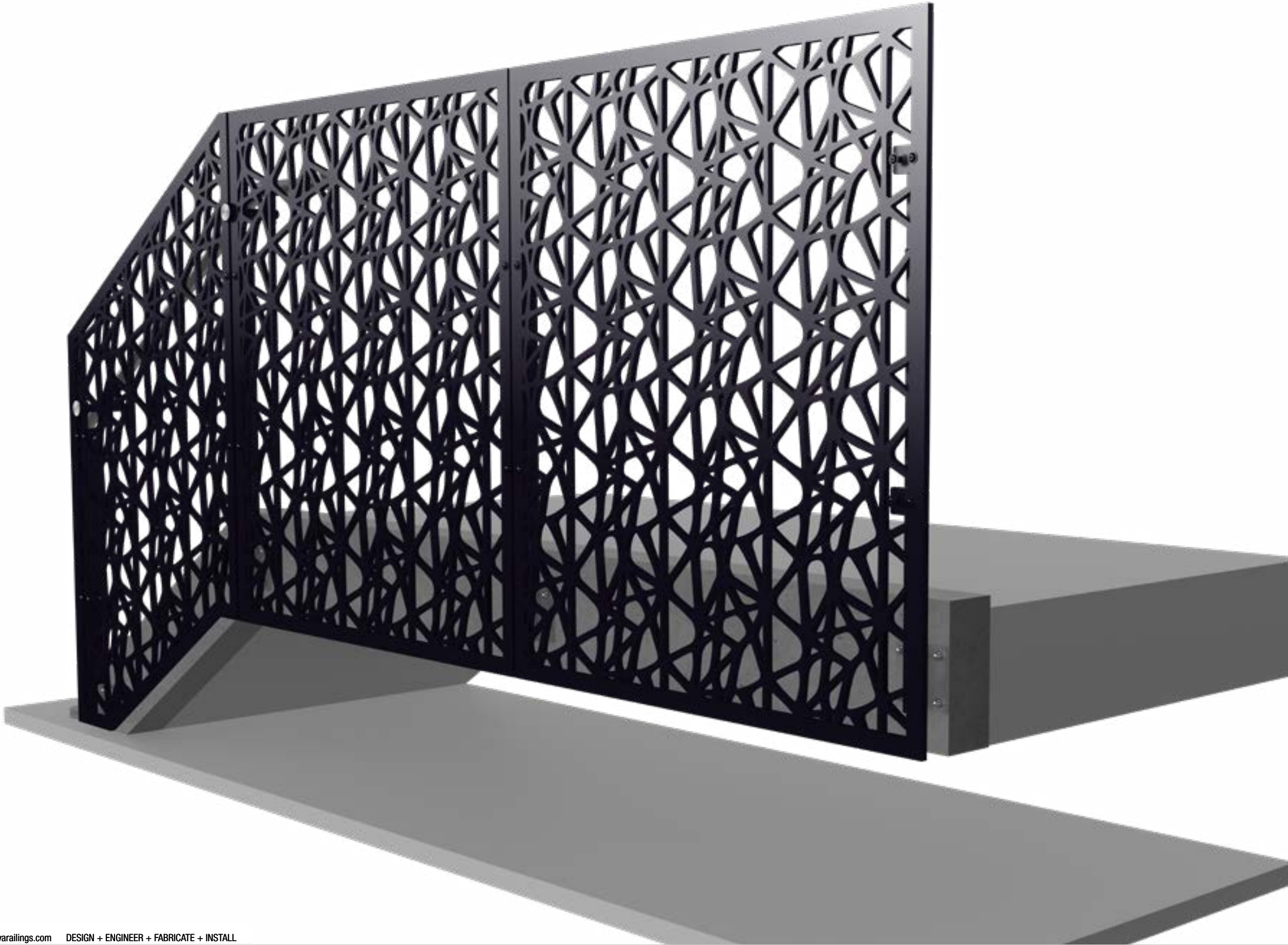

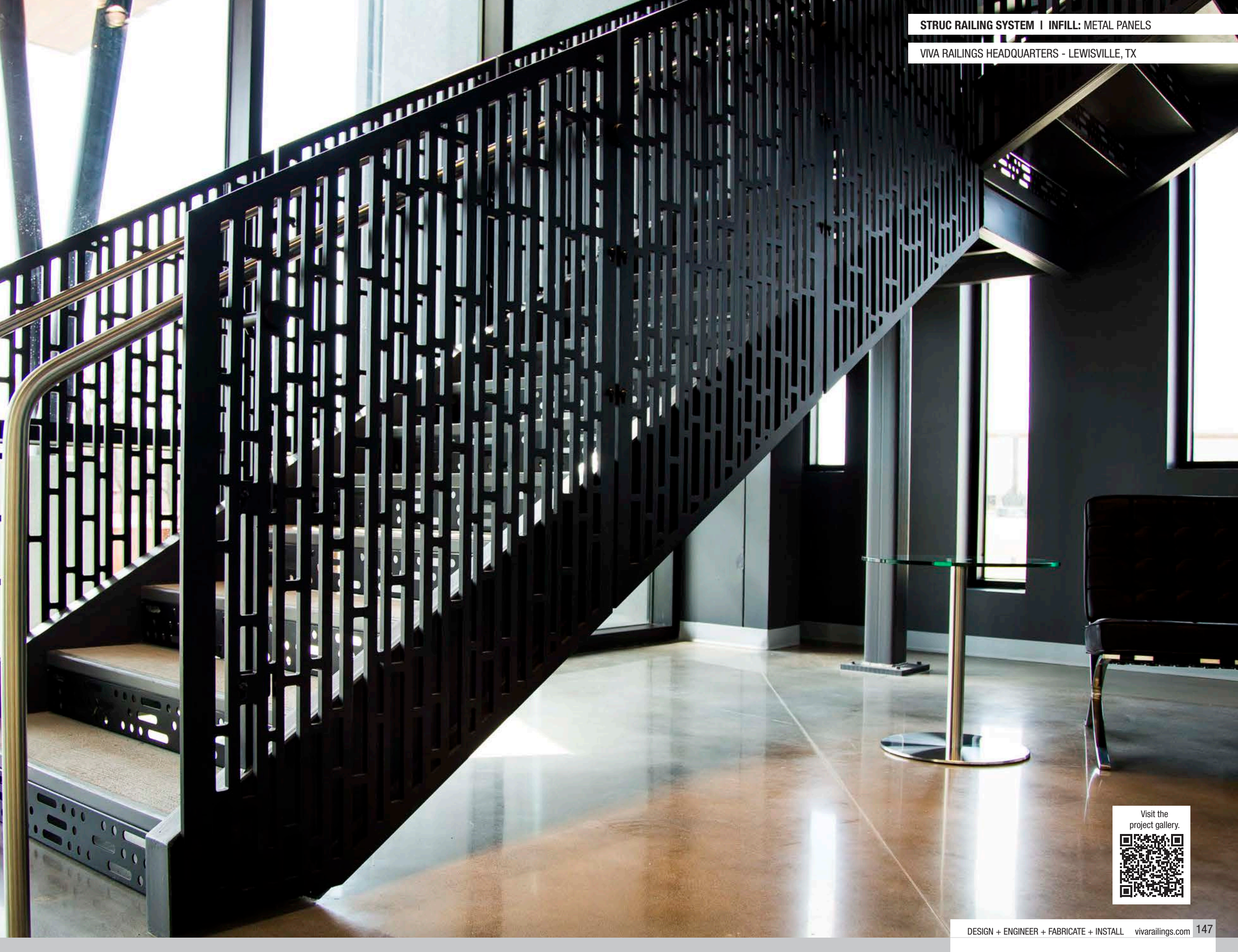

Visit the project gallery.



STRUC RAILING SYSTEM | INFILL: PERF METAL PANELS

BROOKLYN HEIGHTS LIBRARY - NEW YORK, NY

General Contractor: Lafayette Metal & Glass

Architect: Marvel Architects

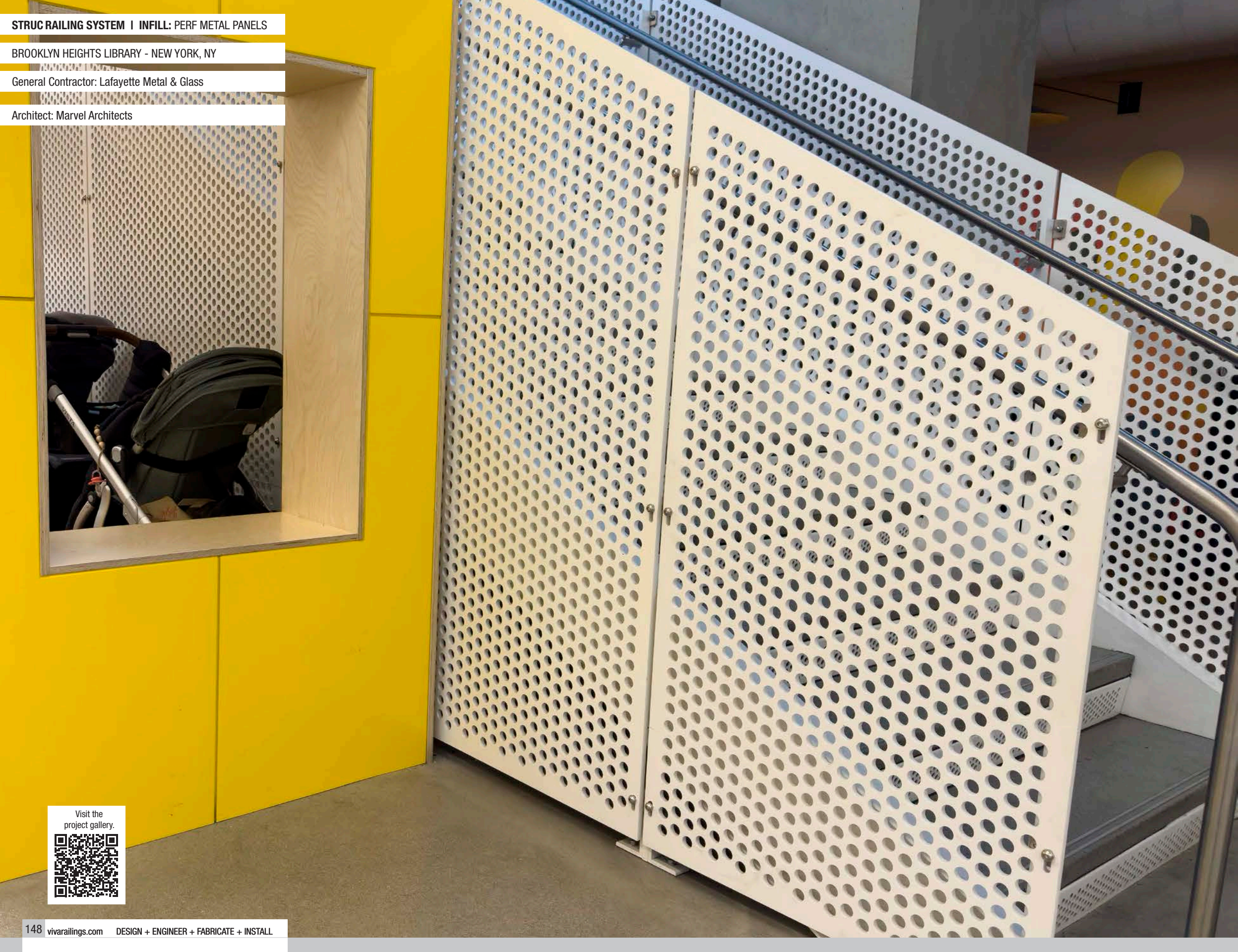

Visit the
project gallery.



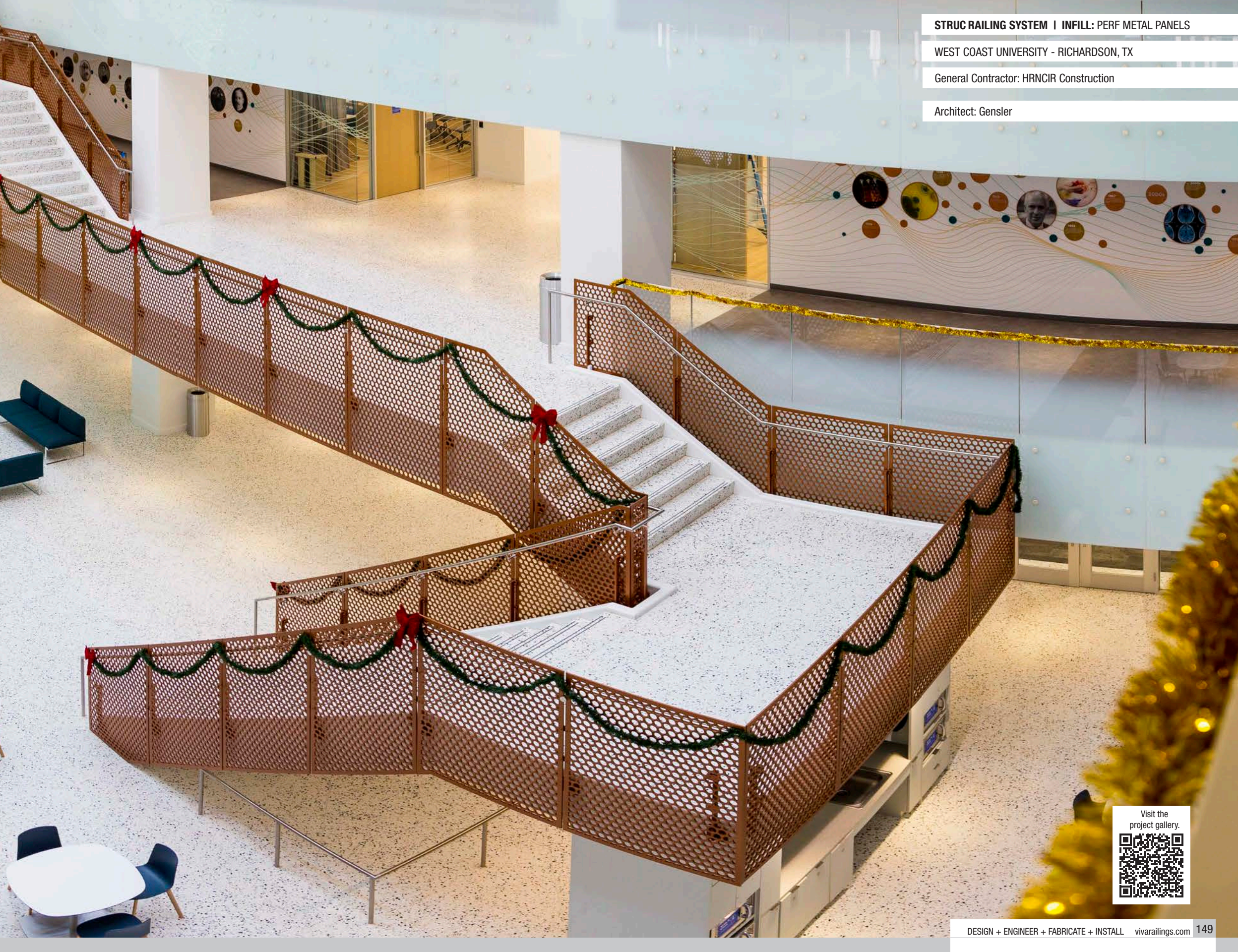

Visit the project gallery.



PRIMARY PATTERNS - LASER CUT PATTERNS FOR STRUC & FOLD

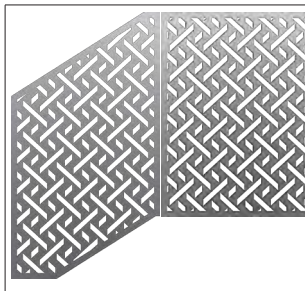

PP - 01 PALLADIAN

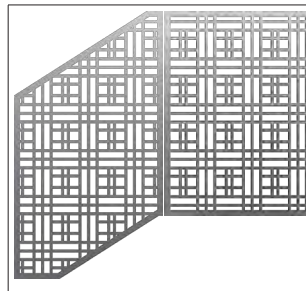

PP - 02 RAMIE

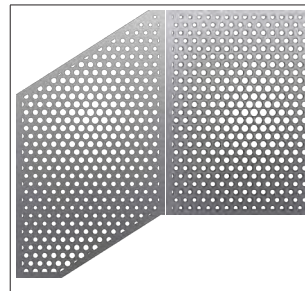

PP - 03 SCHOTTISCHE

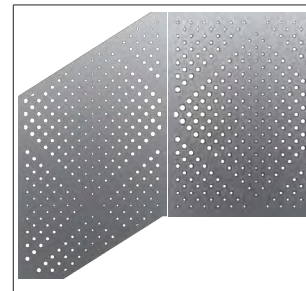

PP - 04 KALYPTRA

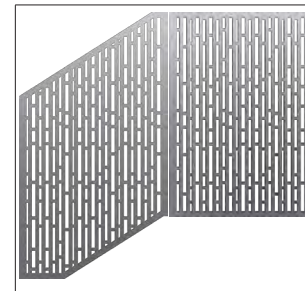

PP - 05 OCTAN

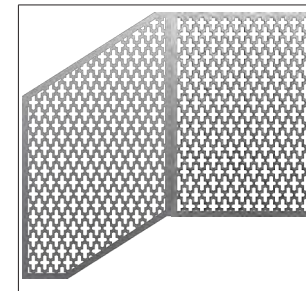

PP - 06 RIQQ

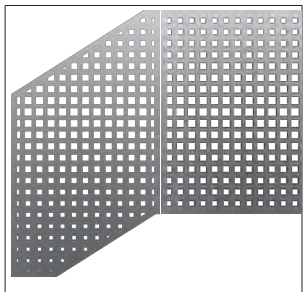

PP - 07 LATTEN

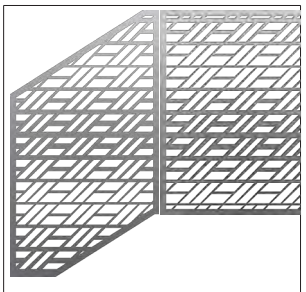

PP - 08 MASCLE

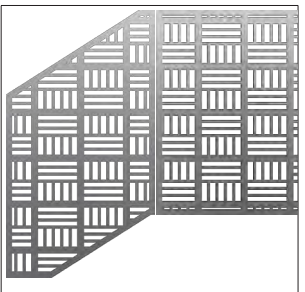

PP - 09 LENO

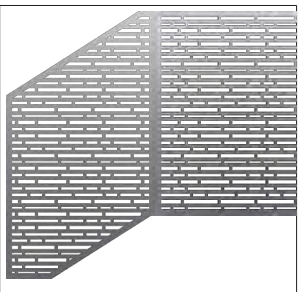

PP - 10 LACIS

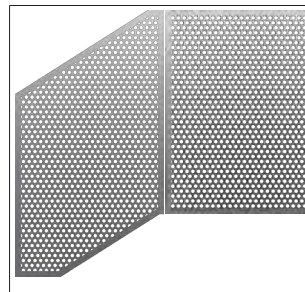

PP - 11 NEXAL

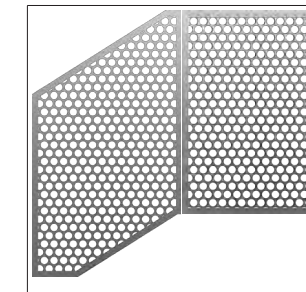

PP - 12 NOEMA

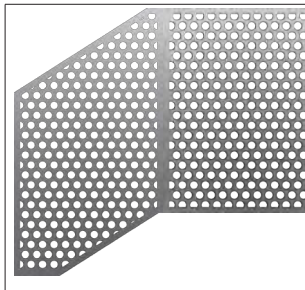

PP - 13 NOVALIA

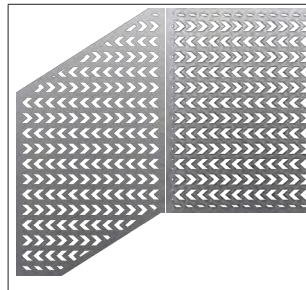

PP - 14 DAGERAAD

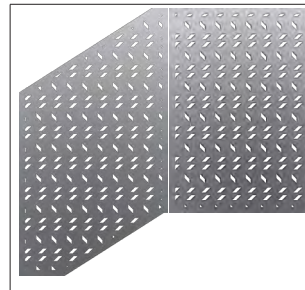

PP - 15 DARBY

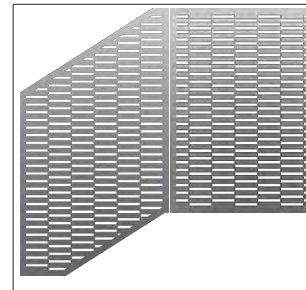

PP - 16 RADIX

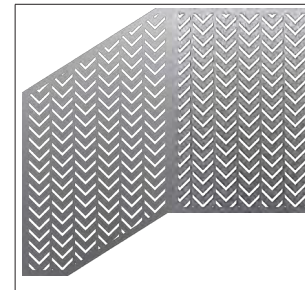

PP - 17 HASTATE

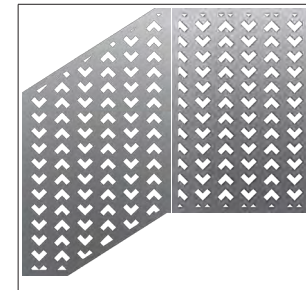

PP - 18 QUADRAL

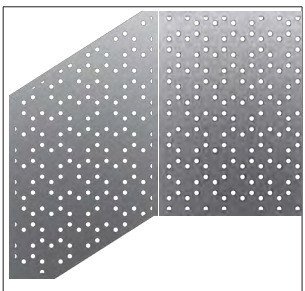

PP - 19 FAVIFORM

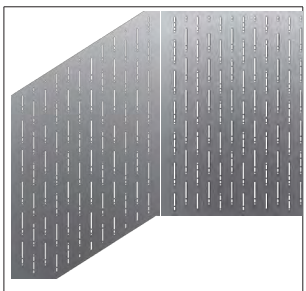

PP - 20 HALITOUS

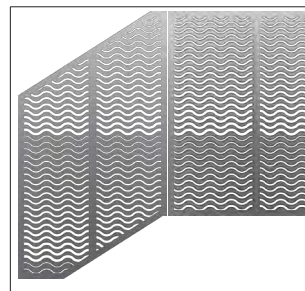

PP - 21 ONDOYANT

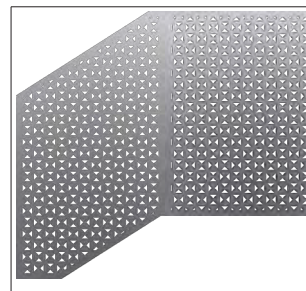

PP - 22 CABAS

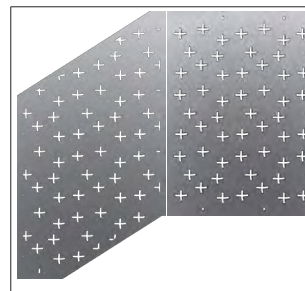

PP - 23 GRAMARIE

GEOMETRIC PATTERNS - LASER CUT PATTERNS FOR STRUC & FOLD

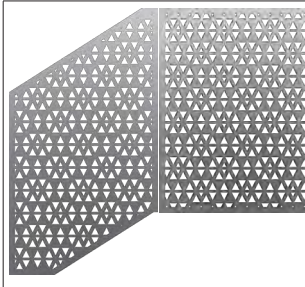

PG - 01 CESTA

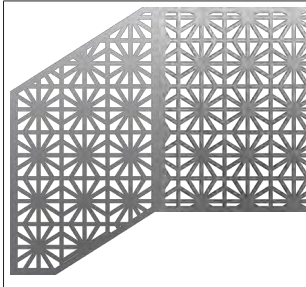

PG - 02 XIRIIR

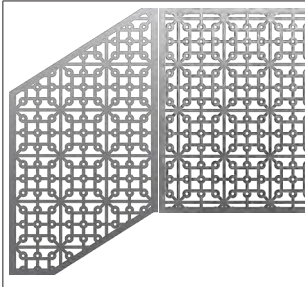

PG - 03 VESPER

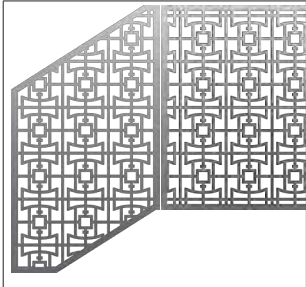

PG - 04 NAVETTE

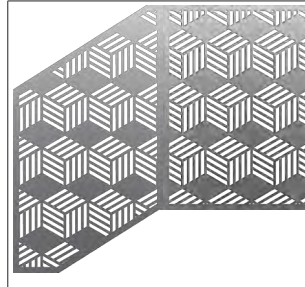

PG - 05 MAKAF

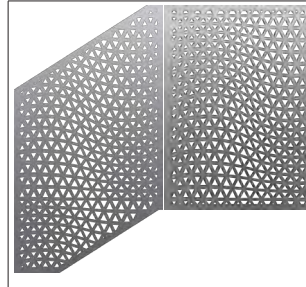

PG - 06 TROKUT

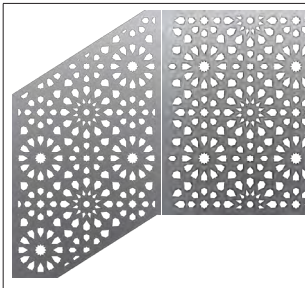

PG - 07 STRALEND

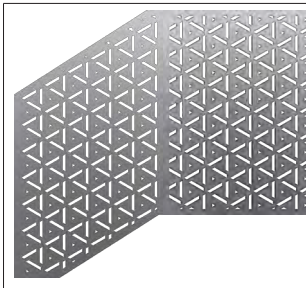

PG - 08 CHRILI

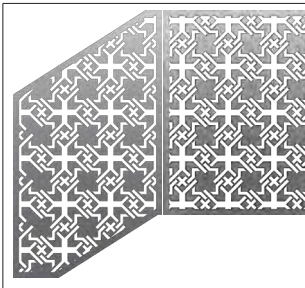

PG - 09 HANZAT

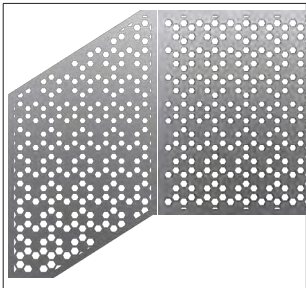

PG - 10 ESAGANO

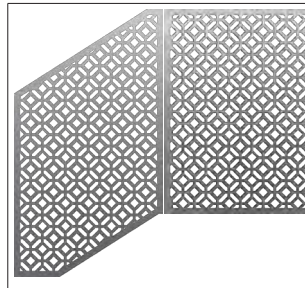

PG - 11 BINYA

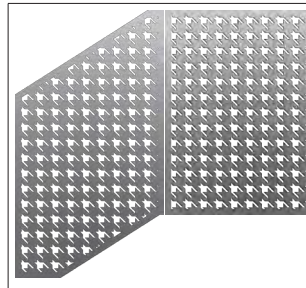

PG - 12 MACKSA

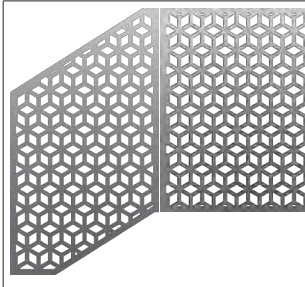

PG - 13 IBBANG

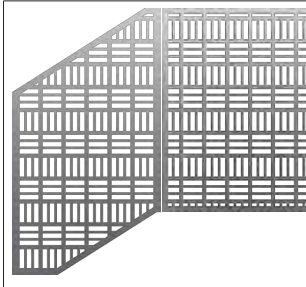

PG - 14 GARIS

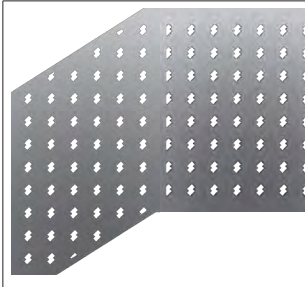

PG - 15 MUNJA

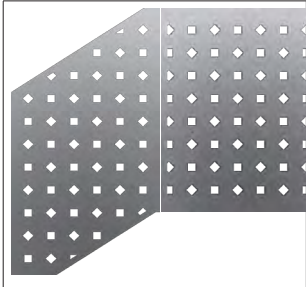

PG - 16 SKAYARA

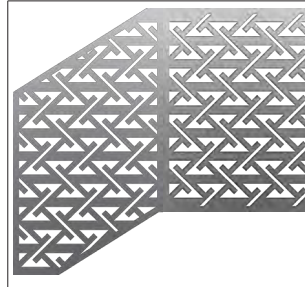

PG - 17 XAROMAR

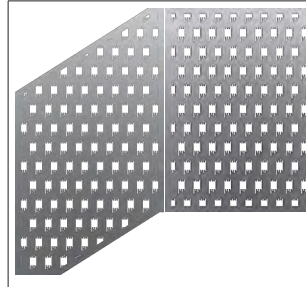

PG - 18 BIXAR

ORGANIC PATTERNS - LASER CUT PATTERNS FOR STRUC & FOLD

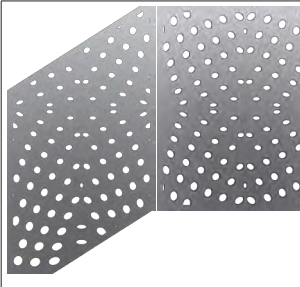

PO - 01 BICCHIERE

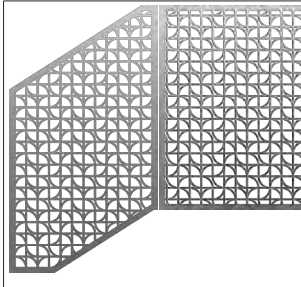

PO - 02 HANKEI

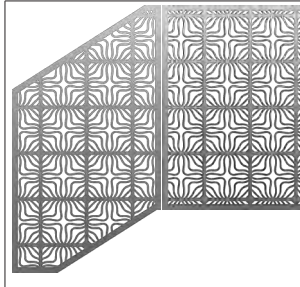

PO - 03 BLOEMEN

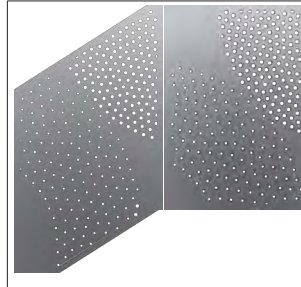

PO - 04 NOKTALI

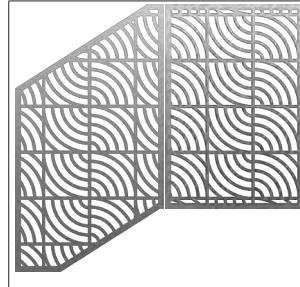

PO - 05 TOPOGRAF

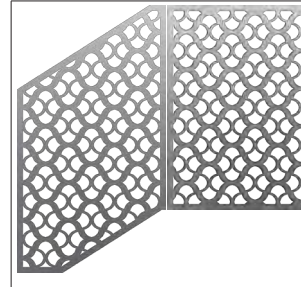

PO - 06 SHIRUDO

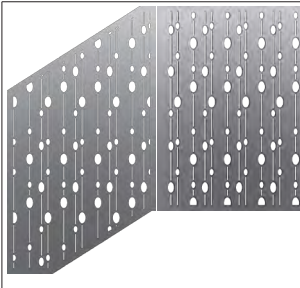

PO - 07 RENA

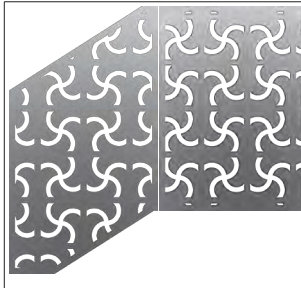

PO - 08 VINDMOLLE

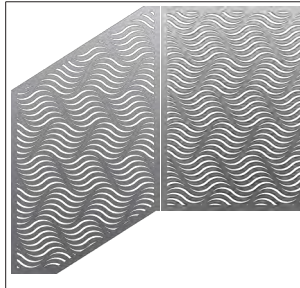

PO - 09 VEVA

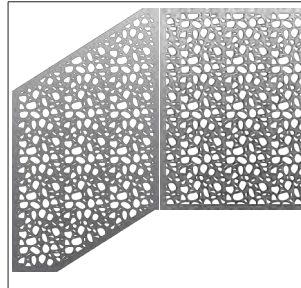

PO - 10 OBLAZ

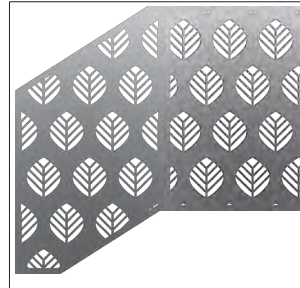

PO - 11 FYLLO

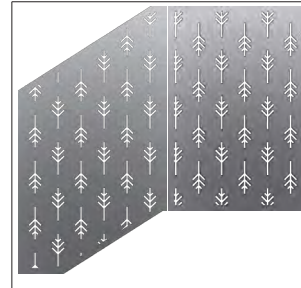

PO - 12 VERGANO

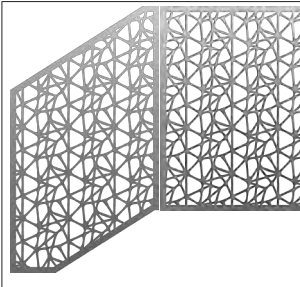

PO - 13 KIRIK

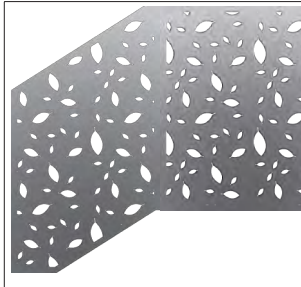

PO - 14 WERAQ

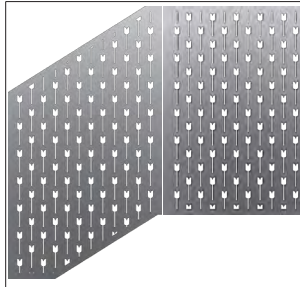

PO - 15 TULBI

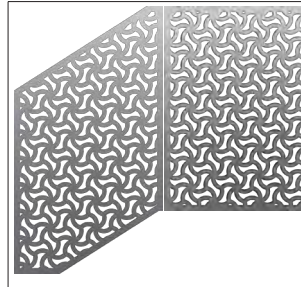

PO - 16 AIKASA

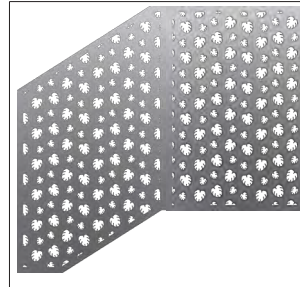

PO - 17 HAUST

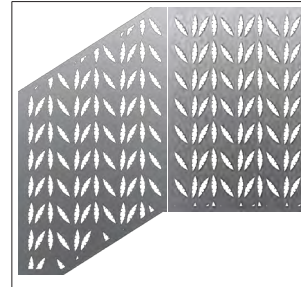

PO - 18 FRONS

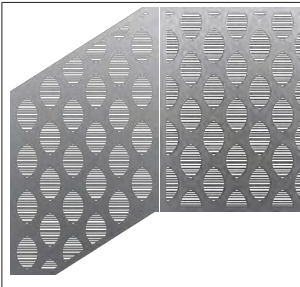

PO - 19 PETALO

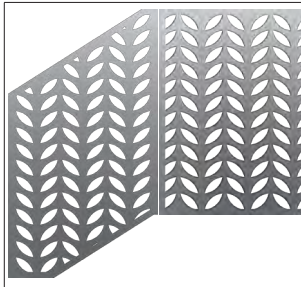

PO - 20 FOLGIA

STRUC METAL PANEL RAILING SYSTEM



FOLD METAL PANEL RAILING SYSTEM



SLAT™ METAL SYSTEM

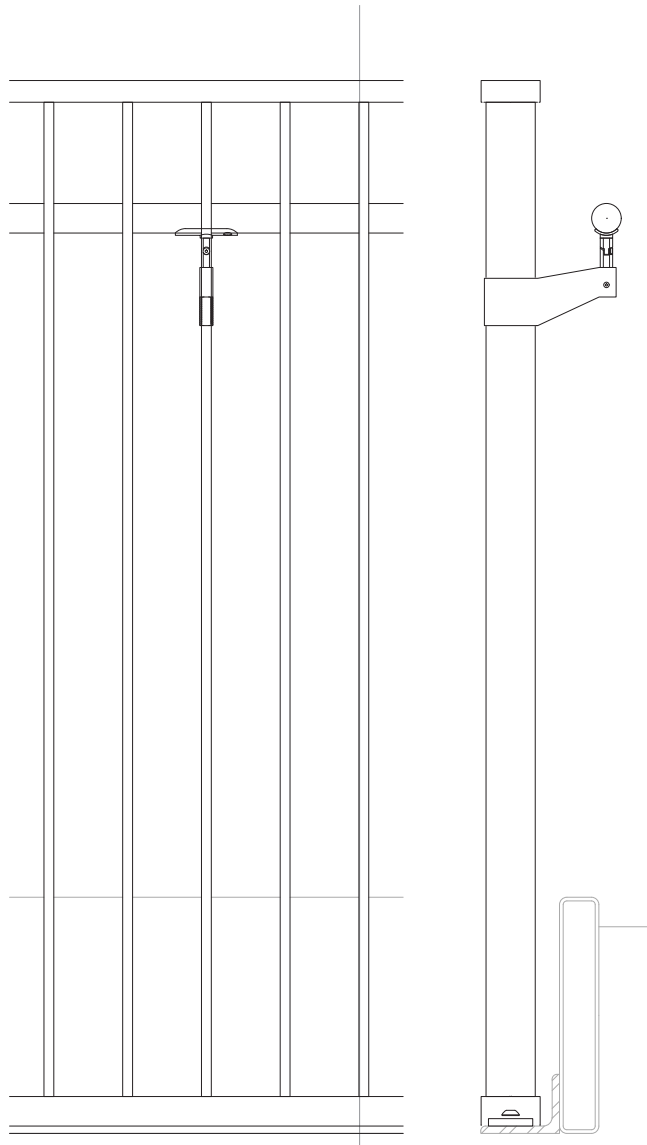

The SLAT Railing System (Patent Pending) is an array type aluminum railing that features vertical slats installed at varying rotational angles, creating a visual play of light and shadow. This design consist of a series of aluminum slats arranged in a linear fashion, offering a sleek and modern look.

By fabricating the slats at different angles, it is possible to create a wide range of visual effects, from subtle and understated to bold and eye-catching. Depending on the array you choose the based on your project application, you can create an element of privacy for onlookers while still having visibility from inside out, and durability and resistance to the elements.

The SLAT systems unique design adds a modern and visually striking element to any building or outdoor space.

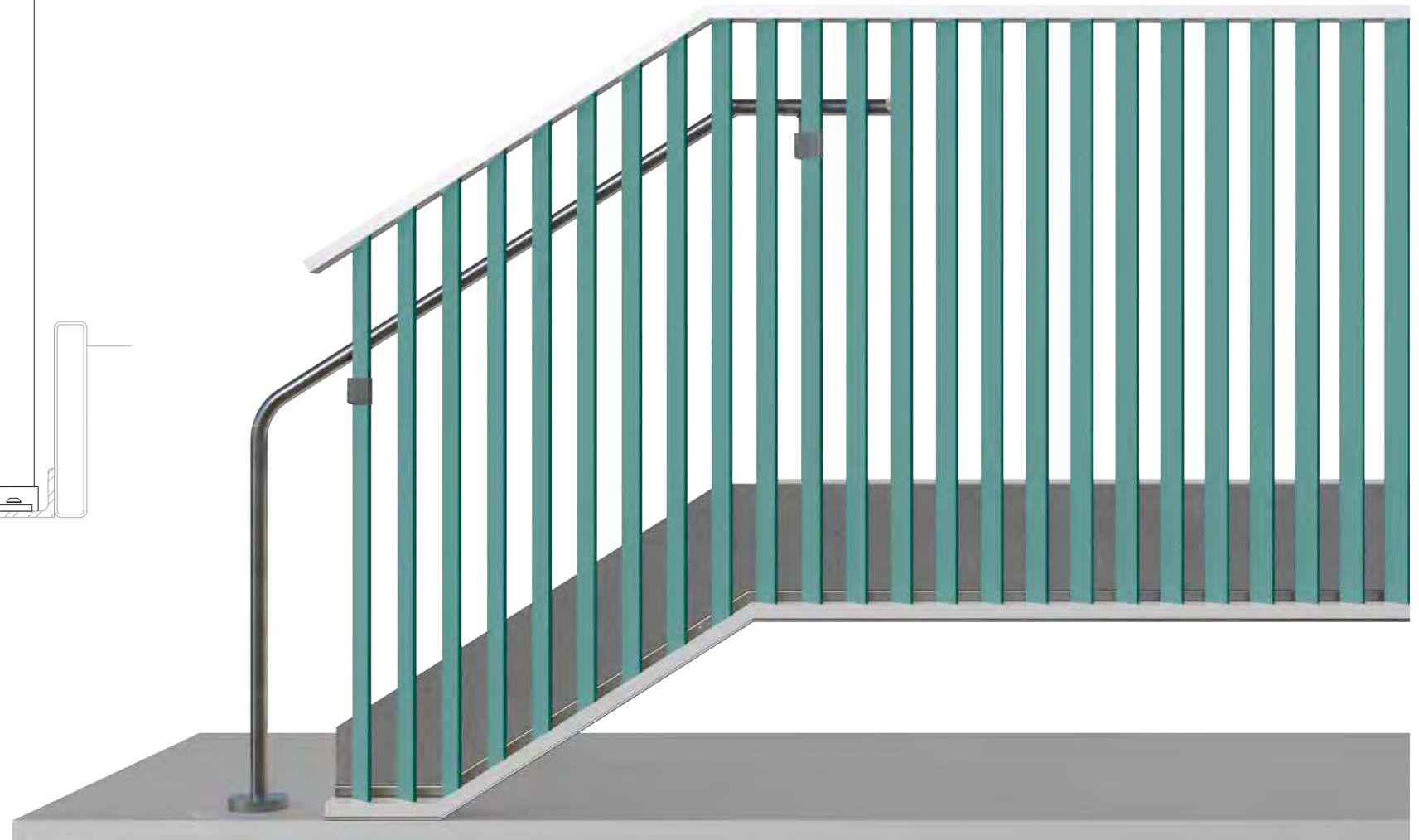

Scan the QR code to check out the SLAT system on our website and the interactive 3D viewport

SLAT METAL SYSTEM - TECHNICAL DATA

	MATERIAL	FINISH	SIZE/SPACING
TOP RAIL	Aluminum	Anodized - Clear - \$ ¹ Powder Coat - Super Polyester (AAMA 2604) - \$ ¹ Powder Coat - PVDF (AAMA 2605) - \$\$	TR1: Flat: 3" Wide TR2: Curved: 3-1/4" Wide
INFILL	Aluminum Picket		2.5" Wide rectangular picket with possible ±45° orientation
HAND RAIL	Stainless Steel Tube	#6 Satin, Powder Coat	Ø1-1/2" or Ø2" for Hand Rail Ø1-1/2", Ø2" or 2"x1" Rectangular tube for Top Rail
	Stainless Steel Tube with LED ³	#6 Satin	Ø1-1/2" with LED LINEAR, Ø1-1/2" or Ø2" with LED POD
	Wood (Red Oak, Cherry or Maple) ²	Unstained	Ø2"
	Wood (Red Oak, Cherry or Maple) with LED		Ø2" with LED LINEAR



- \$ to \$\$\$: Indicates finish type comparative cost.
- Other species available upon request.
- All LED LINEAR products are ETL certified; ETL mark is proof of product compliance to North American safety standard.

SLAT METAL SYSTEM - ORIENTATION OPTIONS

PICKET ORIENTATION

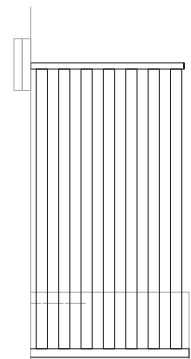
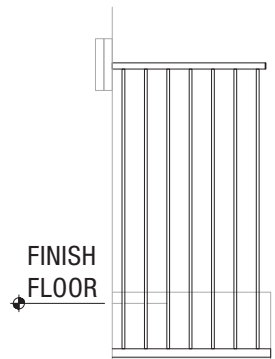
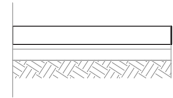
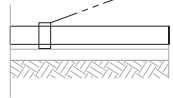
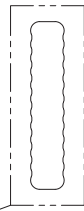

OR-1 0° ORIENTATION

OR-2 45° ORIENTATION

SLAT METAL SYSTEM - FINISH OPTIONS

POWDER COAT



Available Standard and Premium colors on Pg 208

6 MAX ARRAY

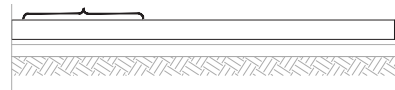

6 MAX ARRAY

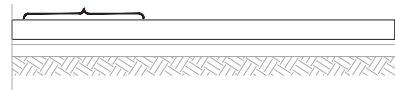

4 MAX ARRAY

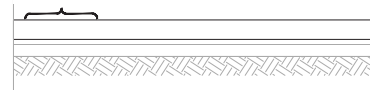

FINISH FLOOR

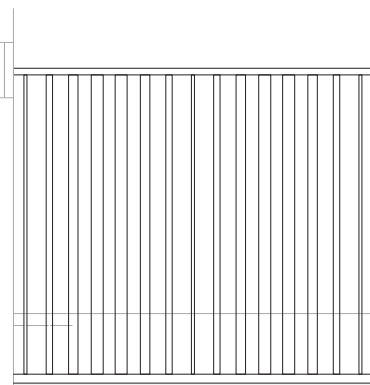
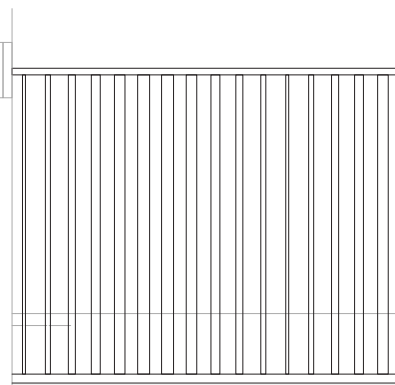
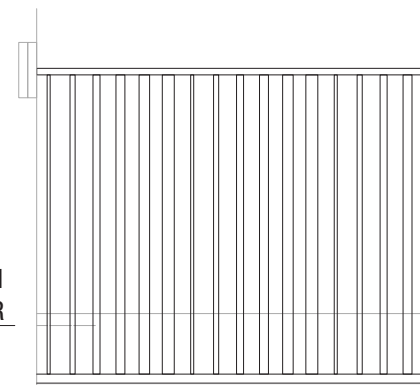

OR-3 VARYING ORIENTATION (-45° TO +45°)

OR-4 VARYING ORIENTATION (-45° TO +45°)

OR-5 VARYING ORIENTATION (-45° TO +45°)

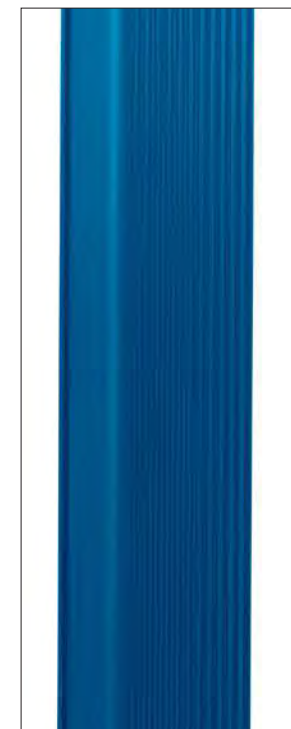

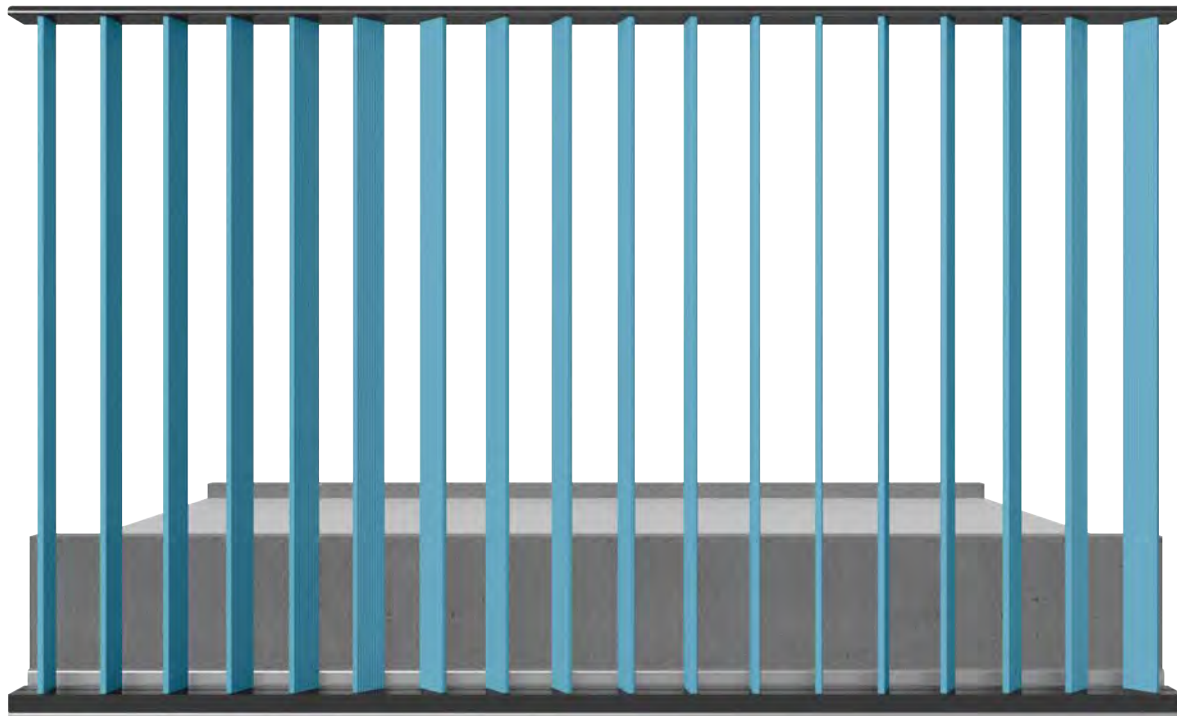

OR-4 VARYING ORIENTATION
(-45° TO +45°)

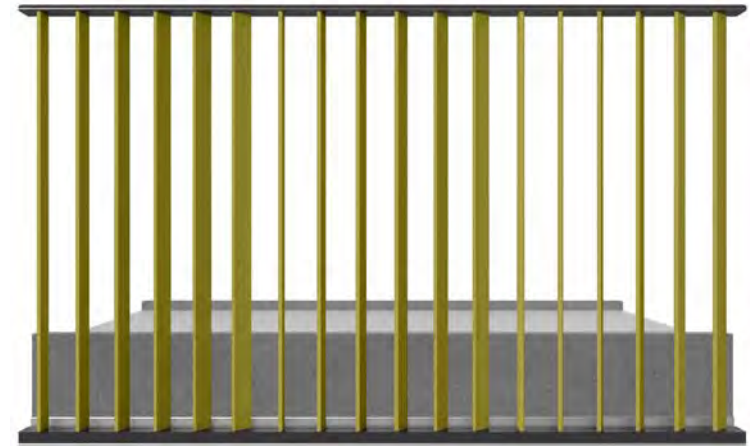

OR-3 VARYING ORIENTATION
(-45° TO +45°)



OR-5 VARYING ORIENTATION
(-45° TO +45°)

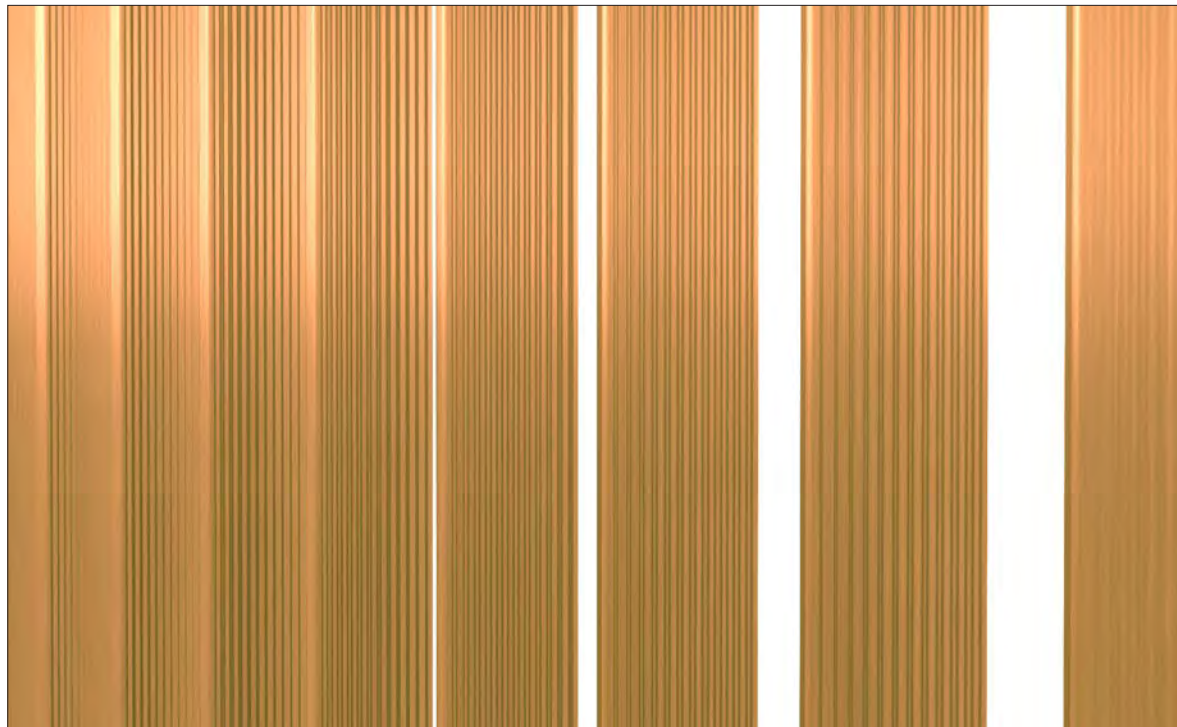



30° degree orientation
shown here



FSR METAL SYSTEM

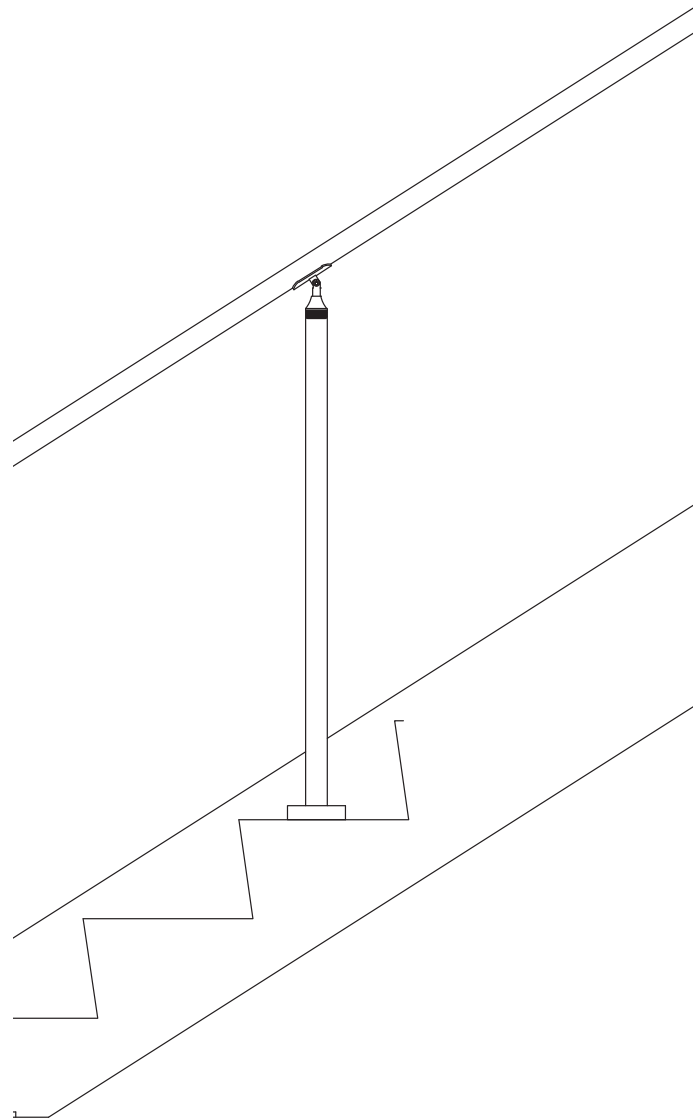

Other mounting options available.

Our Free Standing Rails (FSR) and posts are both available in 1.5" diameter stainless steel in SS304 and SS316 alloys. FSR posts can be core mounted, top flange mounted, welded to steel or welded to concrete embed. FSRs are excellent for stadium seating rails, building entrance rails, ramps, landscaping rails, stair centerline rails as well as numerous other applications. FSRs are also available with our iRail System (LED lighted rail).



Scan the QR code to check out the FSR system on our website and the interactive 3D viewport

FSR METAL SYSTEM - TECHNICAL DATA

	MATERIAL	FINISH	SIZE/SPACING	
BASE	Stainless Steel (304 or 316)	#6 Satin, #8 Mirror ECM	With Ø1-1/2" Post	With Ø2" Post
	Stainless Steel (201)	Powder Coat	4'-0" max. O.C. Top or Core mount.	5'-0" max. O.C., Top or Core mount.
HAND RAIL	Stainless Steel Tube	#6 Satin, Powder Coat	Ø1-1/2", Ø2" or 2"x1" Rectangular tube	
	Stainless Steel Tube with LED ²	#6 Satin	Ø1-1/2" LED Linear Ø1-1/2" LED Pods	Ø1-1/2" LED Linear Ø1-1/2" LED Pods Ø2" LED Pods
	Wood (Red Oak, Cherry or Maple) ³	Unstained	-	Ø2"
	Wood (Red Oak, Cherry or Maple) with LED		-	Ø2" with LED LINEAR



2. All LED LINEAR products are ETL certified; ETL mark is proof of product compliance to North American safety standard.

3. Other species available upon request.

FSR METAL SYSTEM



FSR METAL SYSTEM - MOUNTING CONDITIONS

TOP MOUNT	
STEEL	CONCRETE
WELD	ANCHOR
	CORE

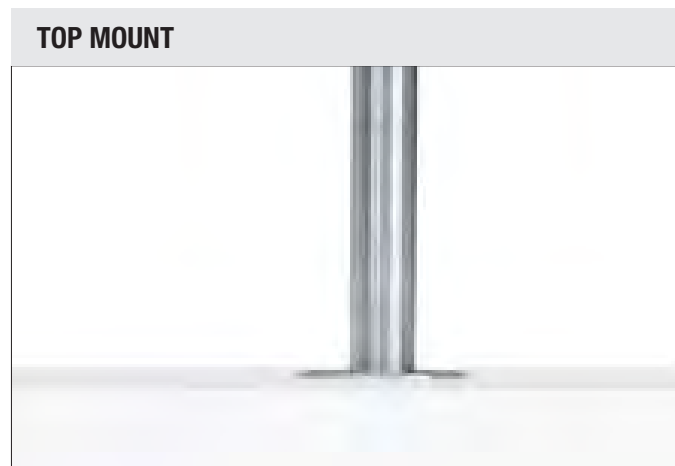

FSR METAL SYSTEM - FINISH OPTIONS



#8 Mirror Finish comes at an additional cost to our #6 Finish.



Available ECM colors on Pg 211

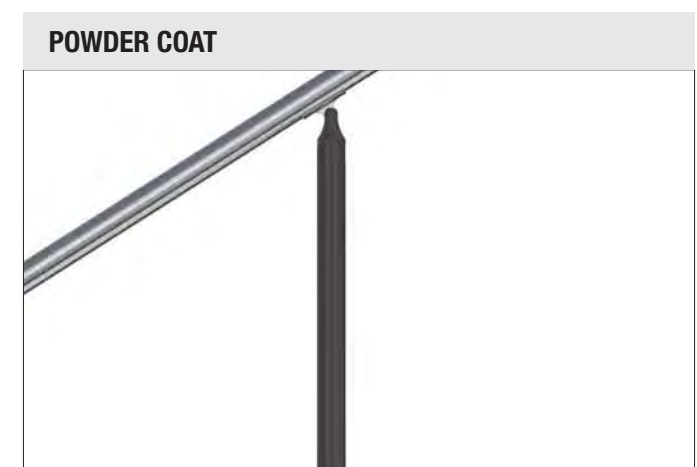

Available Standard and Premium colors on Pg 208

FSR RAILING SYSTEM

MANOR ISD NEW TECH MIDDLE SCHOOL - MANOR, TX

General Contractor: Joeris General Contractors

Architect: Shivani Langer, AIA, LEED, AP, WELL AP

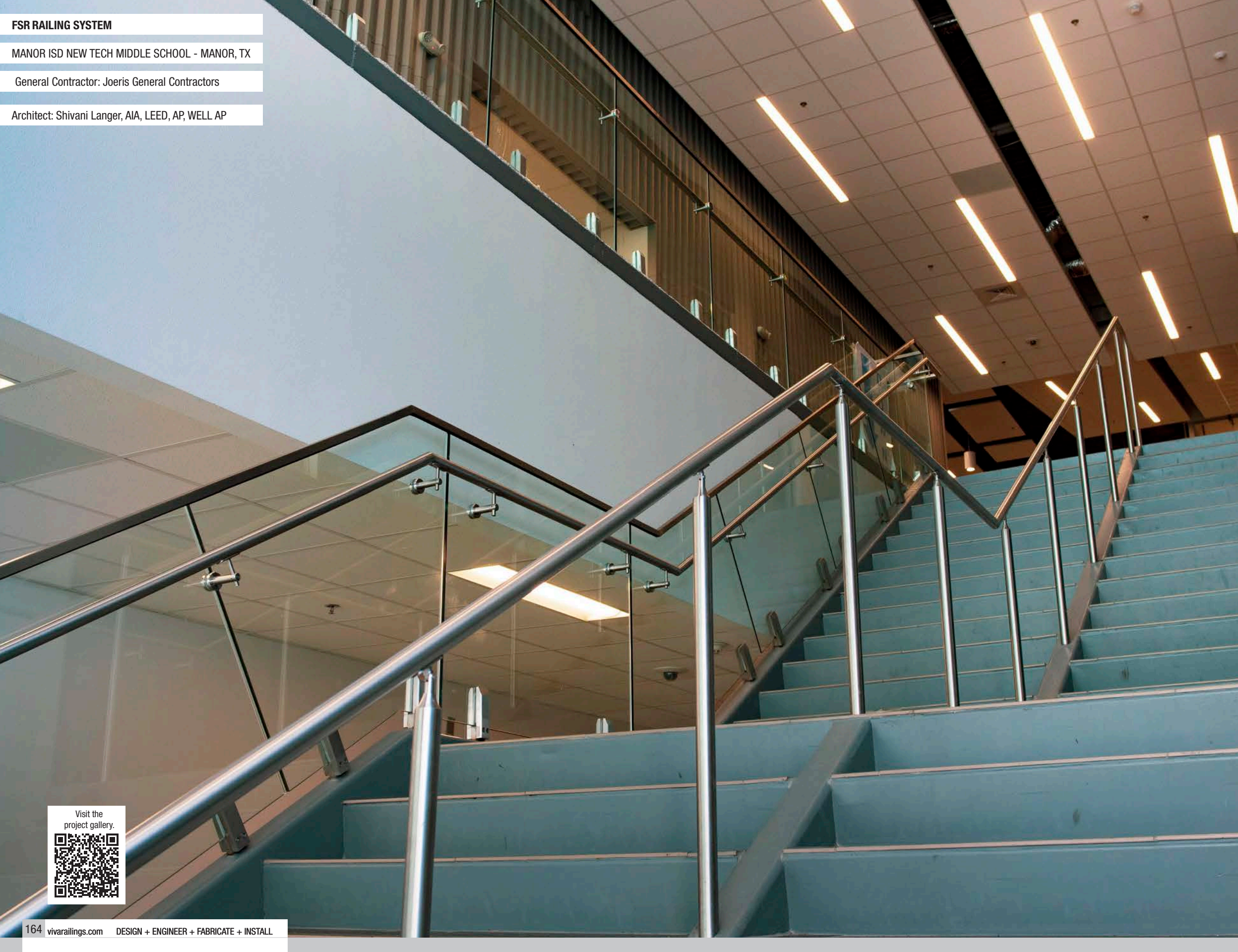

Visit the project gallery.



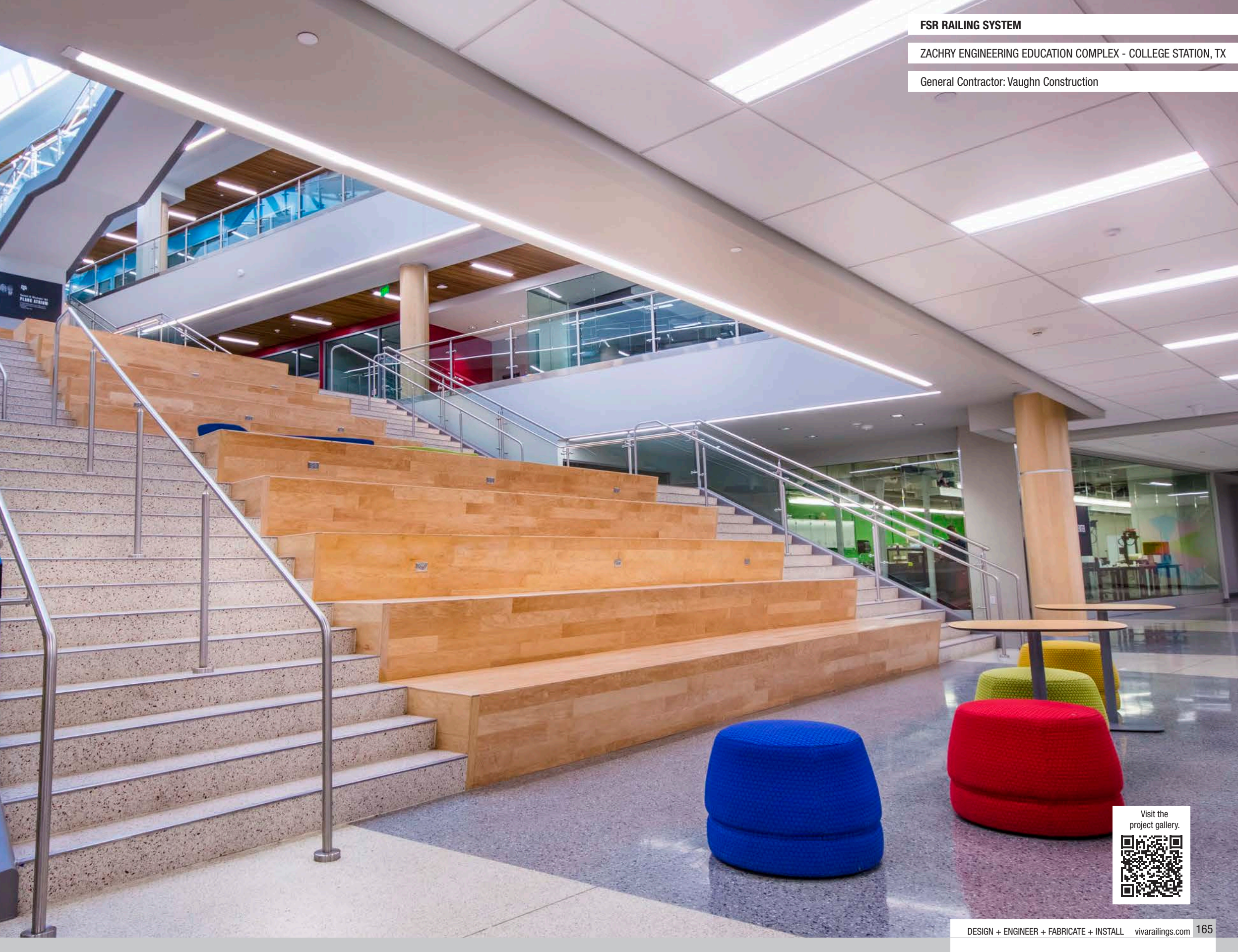

Visit the
project gallery.



IRAIL™ LIGHTED RAILING SYSTEM



Our iRAIL System is a LED illuminated version of our 1.5" diameter rails. iRAIL uses an ADA compliant roll-formed (monolithic) slotted rail, that houses a high-performance LED assembly.

VIVA iRAIL uses a specially designed LED that can provide full-length coverage of illumination for whatever your rail run may be, compared to the traditional LED railing assemblies that were only available in preset section lengths.

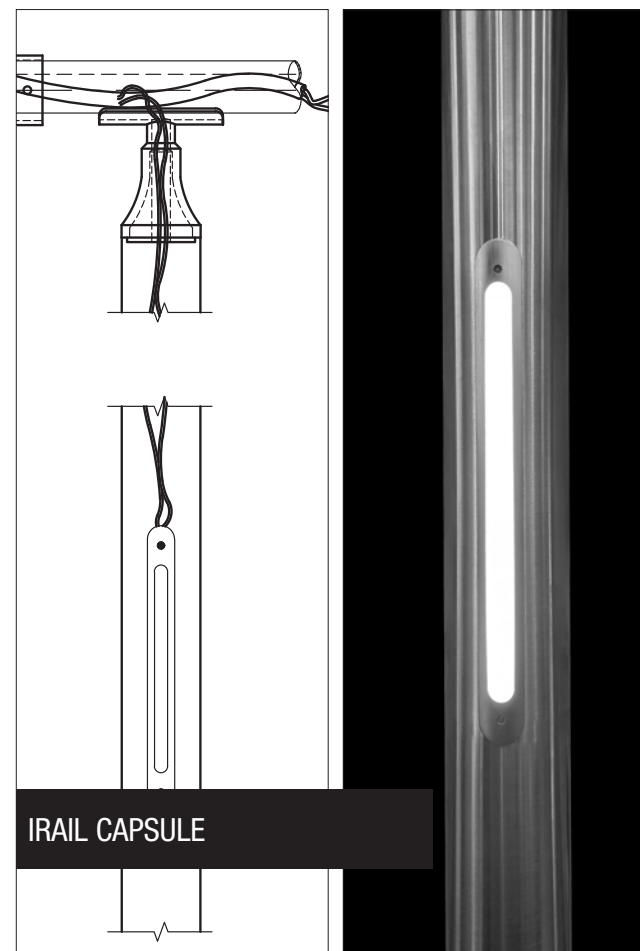

Scan the QR code to check out the IRAIL system on our website and the interactive 3D viewport

IRAIL LIGHTED RAILING SYSTEM - TECHNICAL DATA



	TOP RAIL / HAND RAIL	FINISH	SPEC
iRAIL LINEAR (CONTINUOUS iRAIL)	Ø1-1/2" Stainless Steel (304 or 316)	#6 Satin	Color: 3000K Warm White or 4000K Cool White ² Output: Medium: 3 Watt/ft – 185 lumens/ft. High: 5 Watt/ft – 250 lumens/ft. Beam Angle: 120° Orientation: Symmetrical or Asymmetrical at 30° Power: Input 120 - 277 V AC, Output 12 V DC Lens: Clear or Frosted CRI: >90 Rating: IP67
	Ø1-1/2" Stainless Steel 201	Powder Coat	
	Ø2" Wood (Red Oak, White Oak, Cherry or Maple) ²	Unstained	
iRAIL PODS	Ø1-1/2" Stainless Steel (304 or 316)	#6 Satin	Color: 3000K Warm White or 4000K Cool White ² Output: 1.5 Watt - 130 lumens for sym., 106 lumens for Asym. per pod Beam Angle: 60° Orientation: Symmetrical or Asymmetrical at 22° Power: Input 100 - 305 V AC, Output 12 V DC CRI: >80 Rating: IP67
	Ø1-1/2" Stainless steel (201)	Powder Coat	
	Ø2" Stainless Steel (304 or 316)	#6 Satin	
	Ø2" Stainless Steel (201)	Powder Coat	
iRAIL CAPSULE	POST	FINISH	SPEC
	Ø2" Post Stainless steel (304 or 316) 2"x2" Post Stainless steel(304 or 316)	#6 Satin	Color: 3000K Warm White or 4000K Cool White Output: 1.5W-117 Lumens Sym, 2.5W-190 Lumens Sym, 3.5W-248 Lm Sym. Beam Angle: 120° Orientation: Symmetrical 0° Power: Input 120-277 VAC, Output 24 V DC CRI: >80 Rating: IP67
Ø2" Post Stainless steel (201) 2"x2" Post Stainless steel (201)	Powder Coat		

iRAIL LED ILLUMINATED RAILING: LED LINEAR

CHOCTAW CASINO & RESORTS - DURANT, OK

General Contractor: TEPCO Glass

Architect: JCJ Architecture



 **YouTube**
CHOCTAW Project Video 

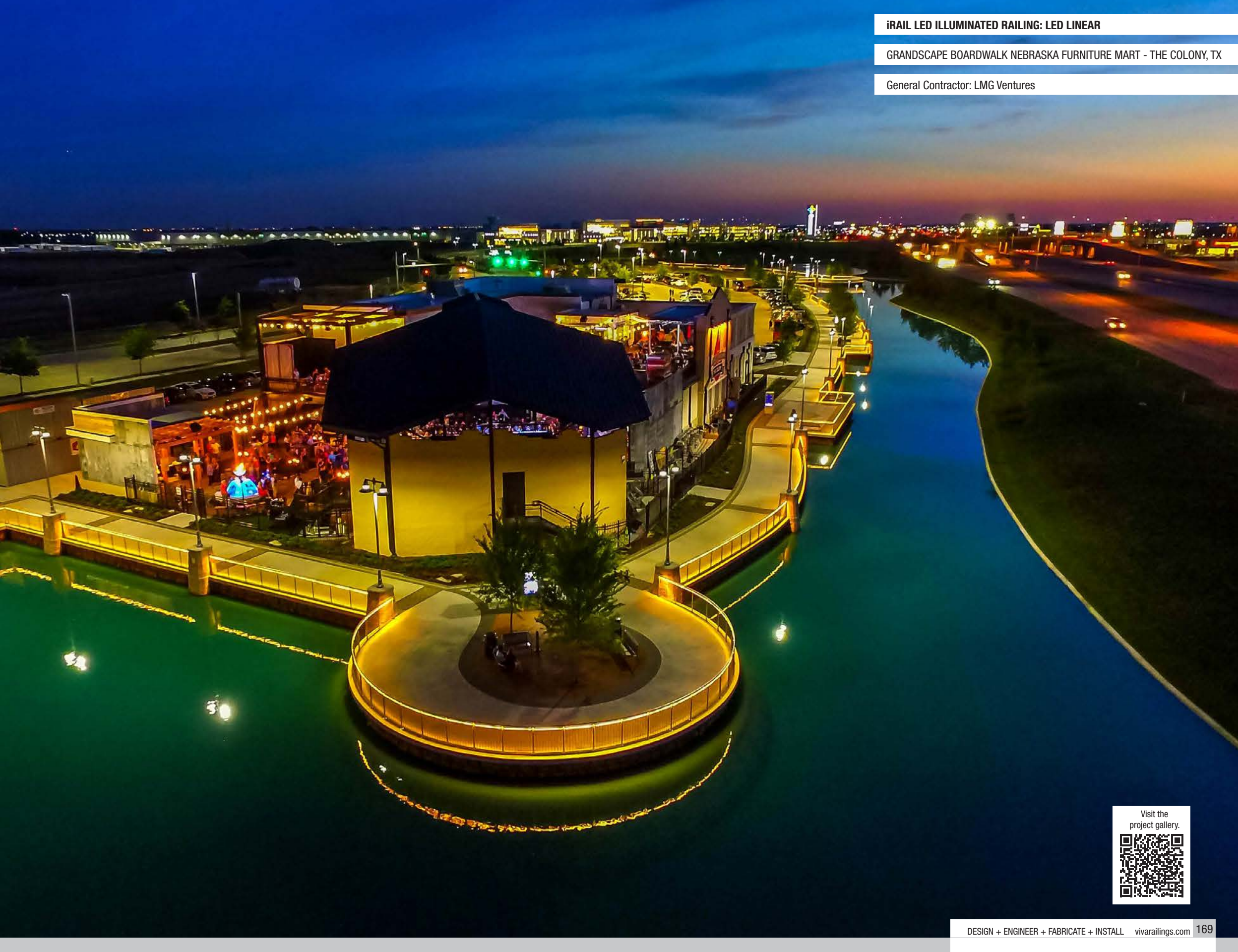

Visit the
project gallery.



iRAIL LED ILLUMINATED RAILING: LED LINEAR

WEST COAST UNIVERSITY - RICHARDSON, TX

General Contractor: HRNCIR Construction

Architect: FOX Design Group Solon, OH

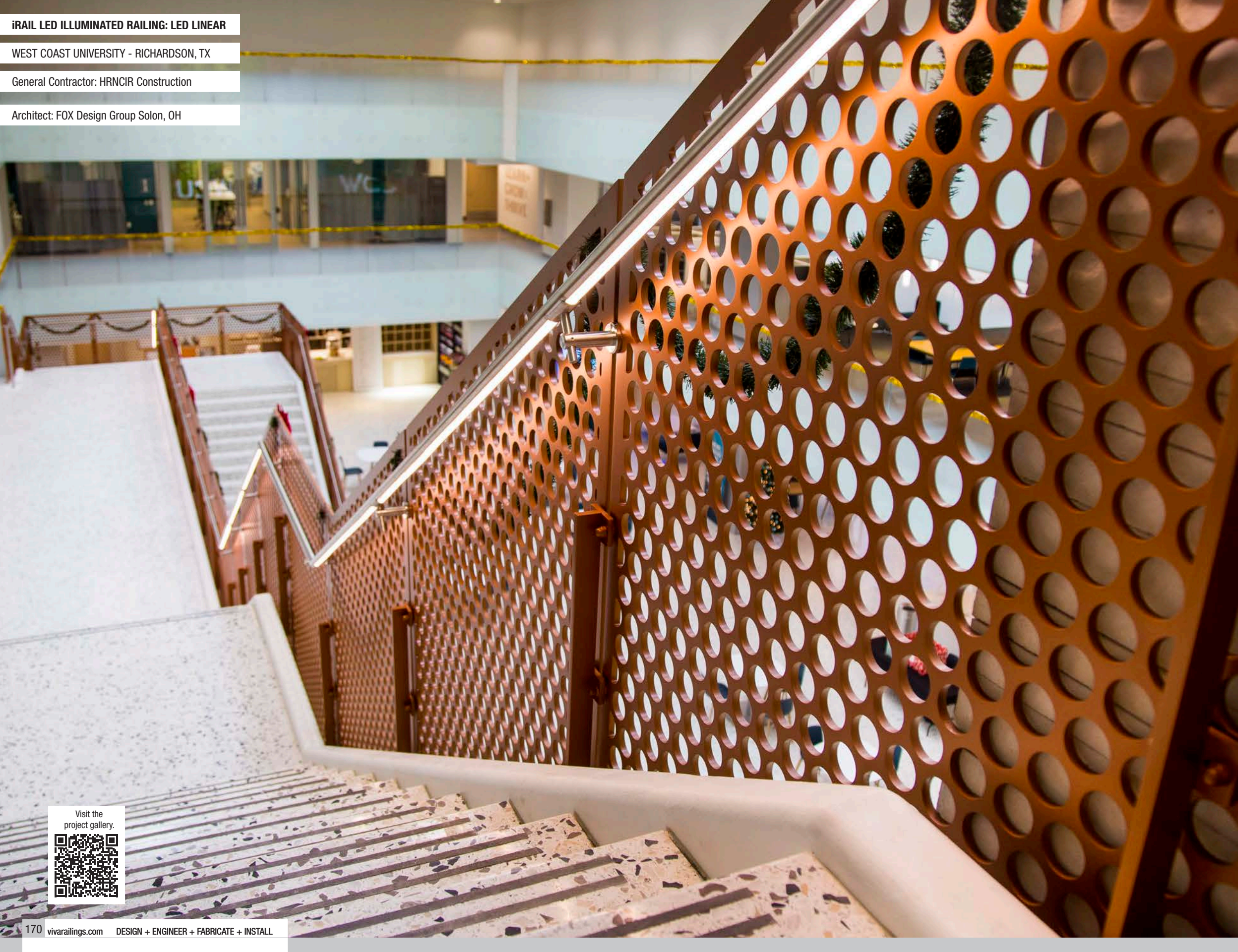

Visit the
project gallery.



iRAIL LED ILLUMINATED RAILING: LED LINEAR

ANDRETTI AT THE GRANDSCAPE - THE COLONY, TX

General Contractor: VCC Construction Corp.

Architect: Merriman - MAA Architects

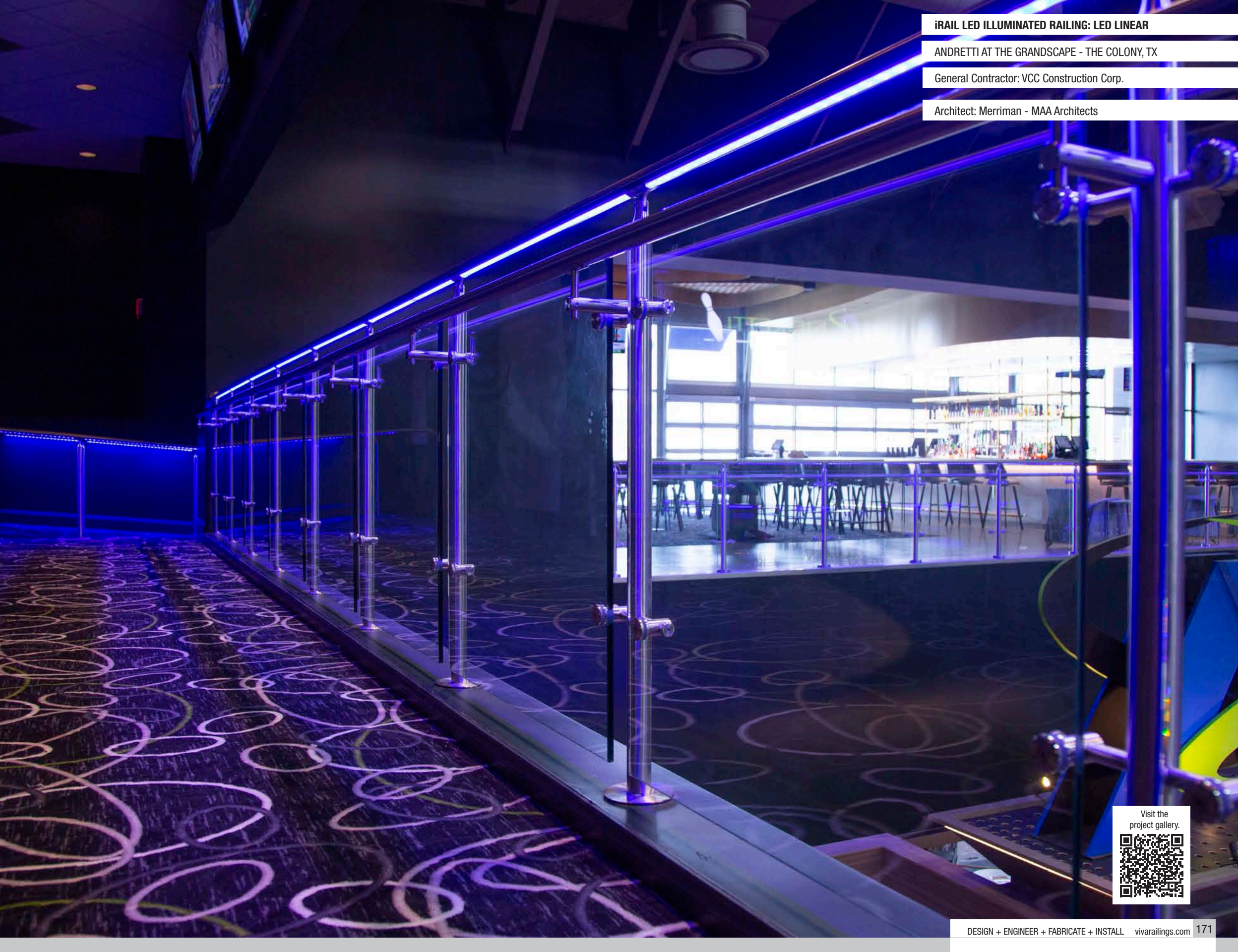

Visit the
project gallery.



SMOKE BAFFLE GLASS SYSTEM

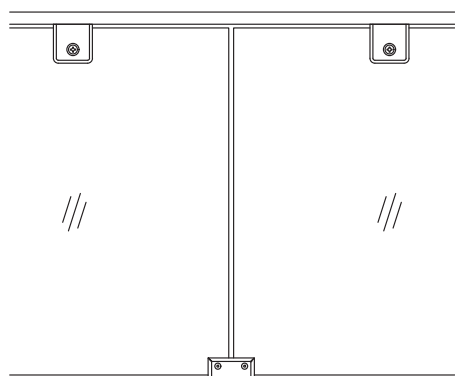

SBS-1

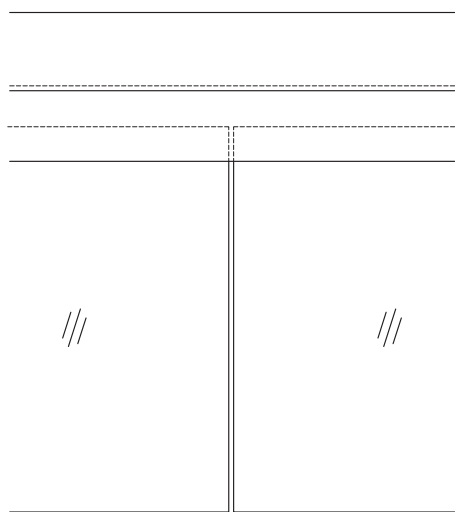
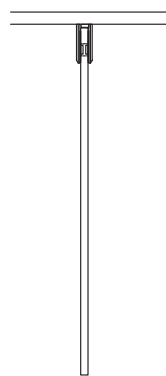

SBS-2

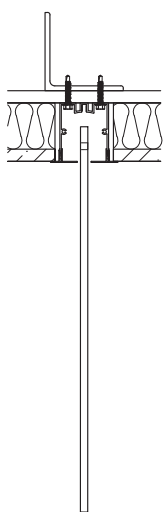

Our Smoke Baffle System seamlessly balances safety and aesthetics. Today's fire codes often require building smoke curtains in the event of a fire emergency. The Smoke Baffle system provides inconspicuous smoke barriers between slab openings, level changes or divisions of areas.

The Smoke Baffle is available in the following finishes: Stainless Steel, Powder Coat Standard, Custom Colors or Anodized Aluminum. **Available Standard and Premium powder coat colors on Pg 208**

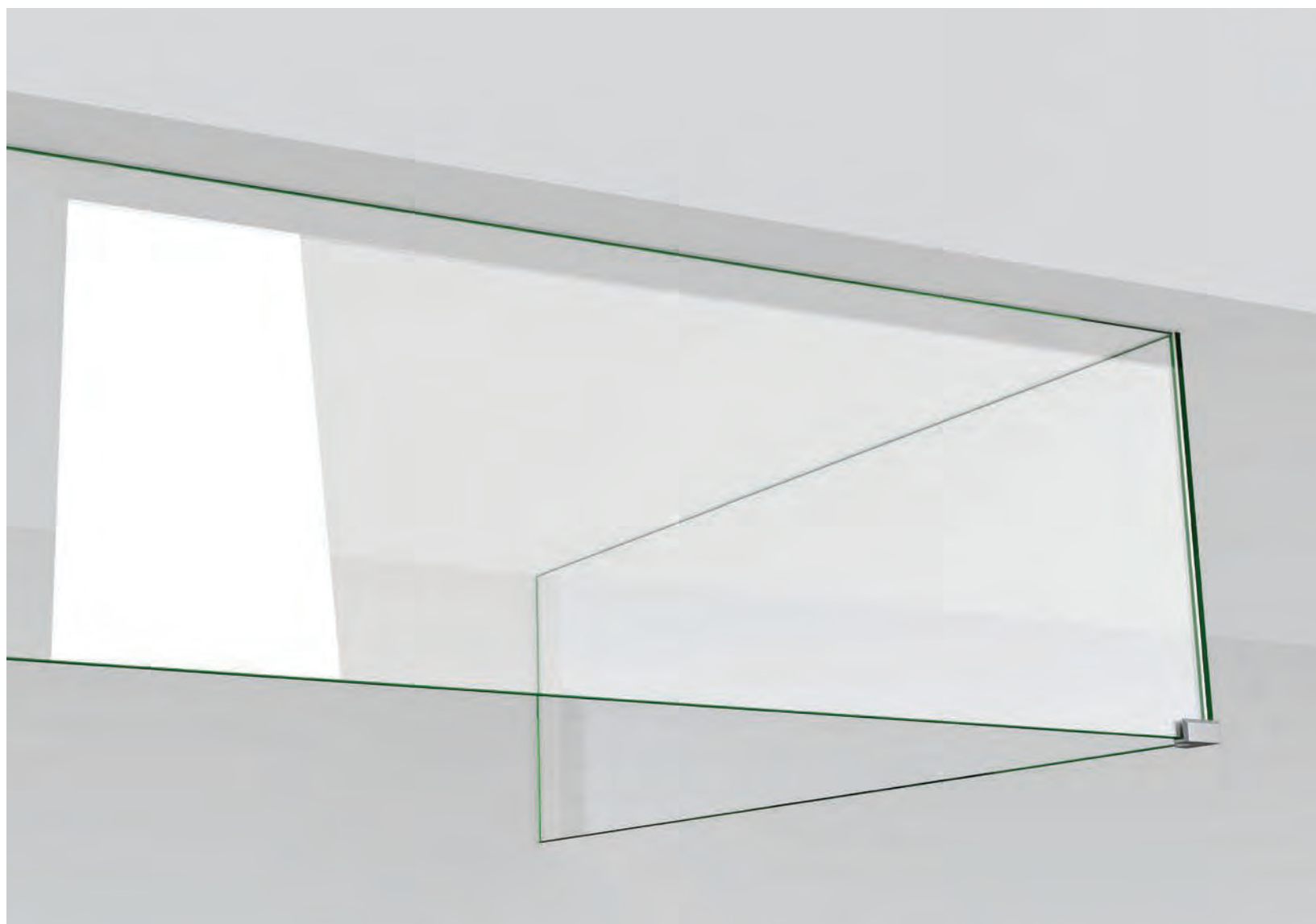

Scan the QR code to check out the SMOKE BAFFLE system on our website and the interactive 3D viewport

SMOKE BAFFLE GLASS SYSTEM - TECHNICAL DATA

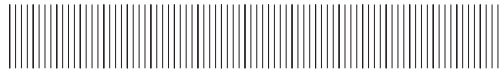

MATERIAL

FINISH

SIZE/SPACING

BASE TYPE

SBS-1 - Clamps - Stainless Steel

#6 Satin

ECM

SBS-2 - Two Part Smoke Baffle System*, Aluminum

Powder Coat

Clear Anodized

Surface or Concealed mount

GLASS

Monolithic Tempered

Clear, Tinted or Frit

Thickness: 3/8" or 1/2"
Height: 18" standard or custom

SMOKE BAFFLE SYSTEM | INFILL: TEMPERED GLASS

VARISPACE HEADQUARTERS - IRVING, TX

General Contractor: Adolfsen & Peterson Construction

Architect: BOKA Powell

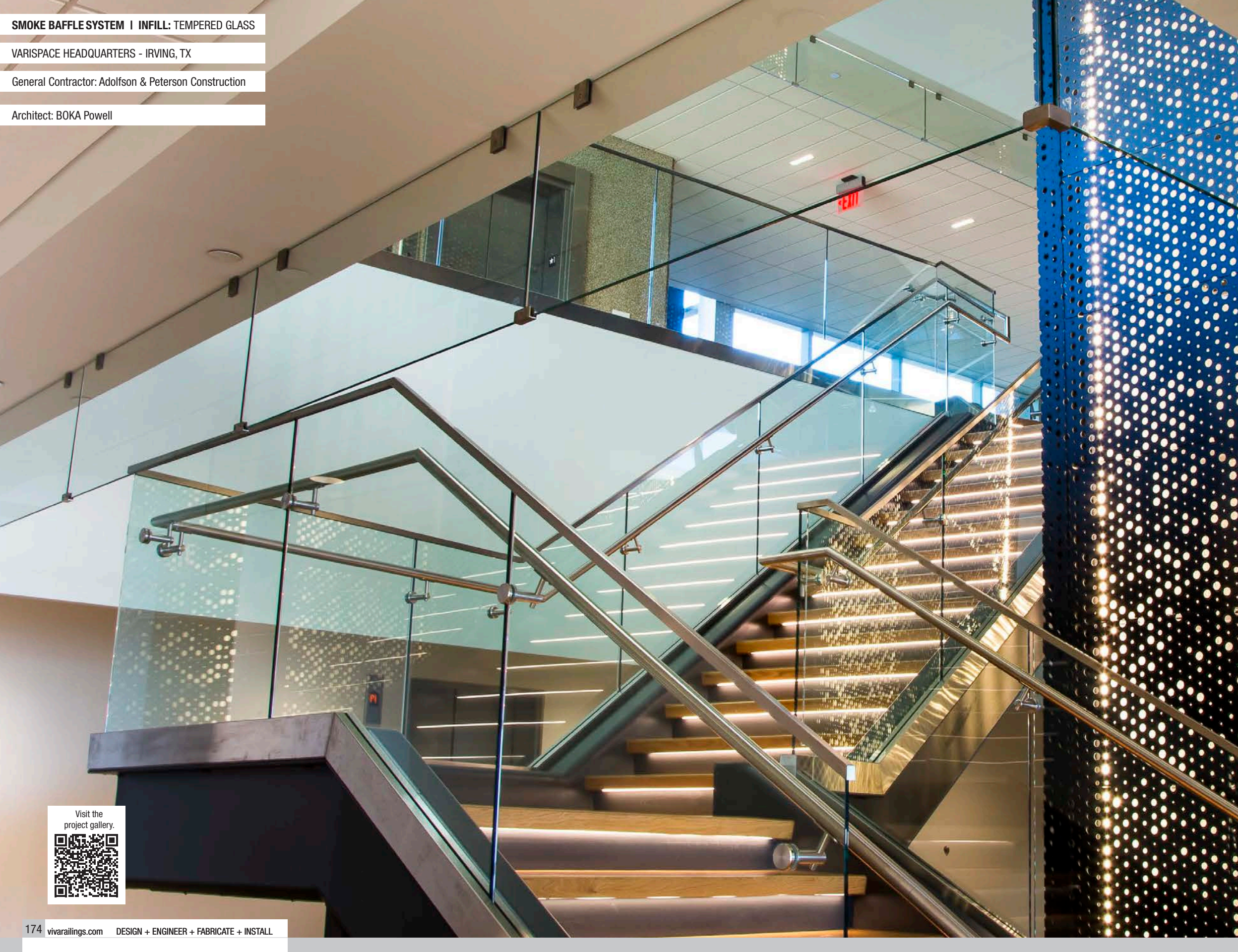

Visit the
project gallery.





Visit the project gallery.



WALL SYSTEM LASER CUT PANELS

TYPES

FOLD
FLAT
3D FOLD
FOTOFACADE

APPLICATIONS

LANDSCAPE SCREENS	WALL CLADDING
DIVIDER WALLS	GARAGE SCREENS
FACADE SCREENS	FOTOFACADE

Low maintenance, ease of installation, and customizable design choices, laser cut wall system panels have extensive flexibility for many commercial applications. We excel at bringing your decorative wall panel vision to life, expertly laser-cut to perfection.





WALL SYSTEM - FOLD TYPE - TECHNICAL DATA

	MATERIALS	FINISH	2" RETURN		3" RETURN		4" RETURN	
			WIDTH"	HEIGHT"	WIDTH"	HEIGHT"	WIDTH"	HEIGHT"
			FOLD PANEL - SINGLE RETURN FD-202 FD-203 FD-204 FD-205	Aluminum: 1/8", 3/16" & 1/4"	Powder Coat, PVDF			
Stainless Steel: 14GA	Brushed Satin	44 32 26		116 92 56 44	42 30 24	114 90 54 42	40 28 22	112 88 52 40
Steel: 14GA & 11GA	Powder Coat, Weathered, Mill							

Optional 3" or 4" returns may be required by engineering.

FOLD PANEL - DOUBLE RETURN FD-200 FD-201	Aluminum: 1/8", 3/16" & 1/4"	Powder Coat, PVDF						
	Stainless Steel: 14GA	Brushed Satin	40 28 22	112 88 52 40	38 26 20	110 86 50 38	36 24 18	108 84 48 36
	Steel: 14GA & 11GA	Powder Coat, Weathered, Mill						

Above options are available in any of our Standard Patterns, FotoFacade or Custom Pattern.

Standard cost-effective sizes shown, custom sizes available at a premium cost add.

SINGLE (SGL) RETURN



DOUBLE (DBL) RETURN



Intertek

All LED LINEAR products are ETL certified; ETL mark is proof of product compliance to North American safety standard.

WALL SYSTEM - FOLD TYPE - PLAN VIEW

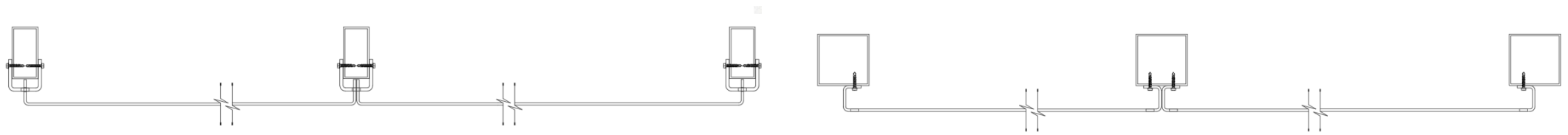

WALL SYSTEM - FOLD TYPE - MOUNTING OPTIONS

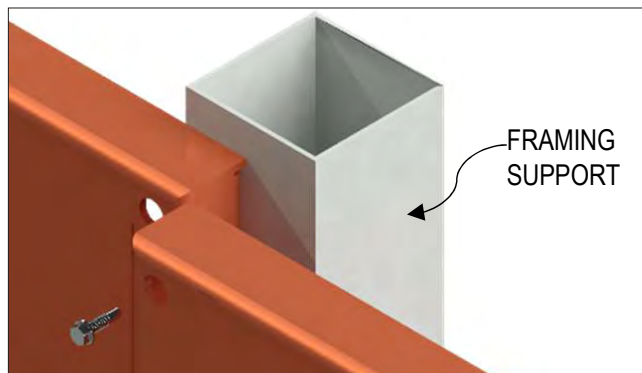

TYPE FD-200 – FLUSH MOUNT TO SUPPORT

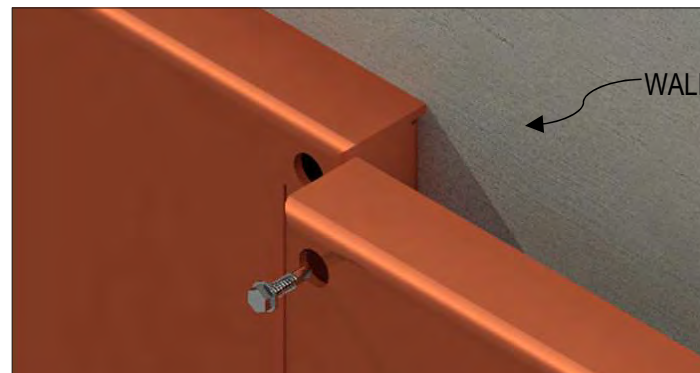

TYPE FD-201 – FLUSH MOUNT TO WALL

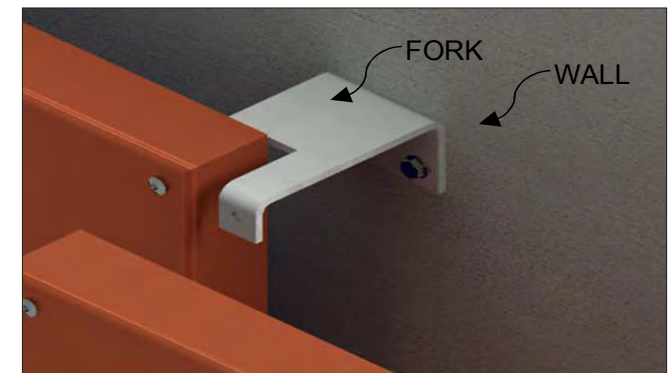

TYPE FD-202 – FORK MOUNT TO WALL

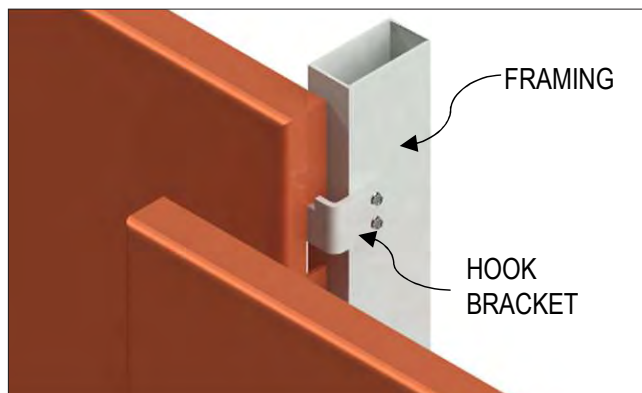

TYPE FD-203 – HOOK MOUNT TO SUPPORTS

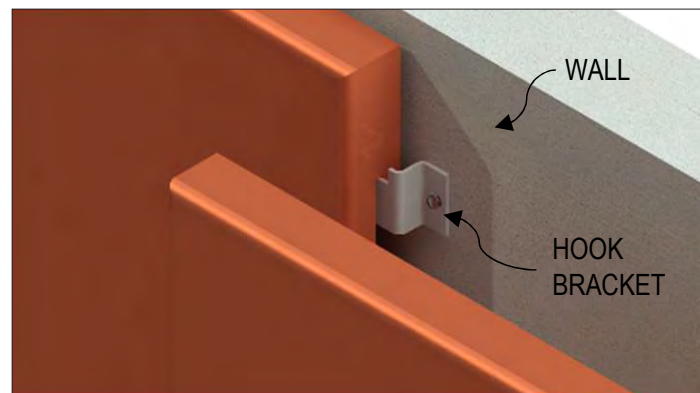

TYPE FD-204 – HOOK MOUNT TO WALL

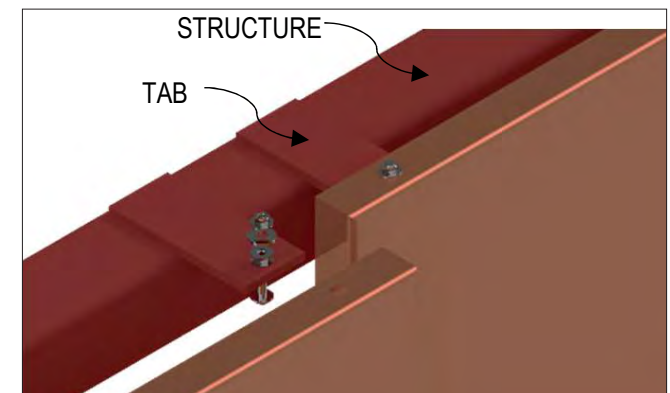

TYPE FD-205 – TAB MOUNT TO STRUCTURE

WALL SYSTEM - 3D FOLD TYPE

APPLICATIONS

FACADE SCREENS

GARAGE SCREENS

STAIR ENCLOSURE

From simple geometric patterns to more elaborate and detailed designs, these panels can be customized to suit the style and aesthetic of any space. Decorative laser cut wall panels offer more than just a beautiful aesthetic. They can be utilized as a sound barrier, to offer privacy to a space, or to separate areas visually.

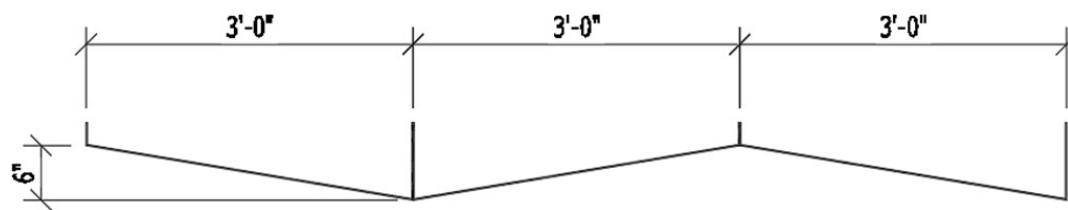

MS-3D 363600A

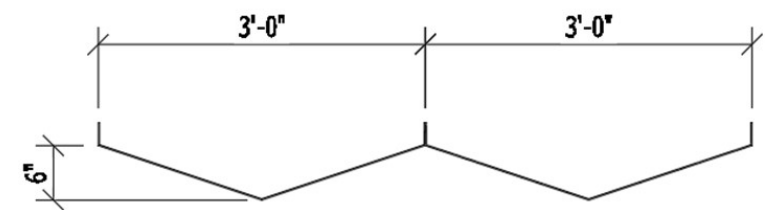

MS-3D 361818A

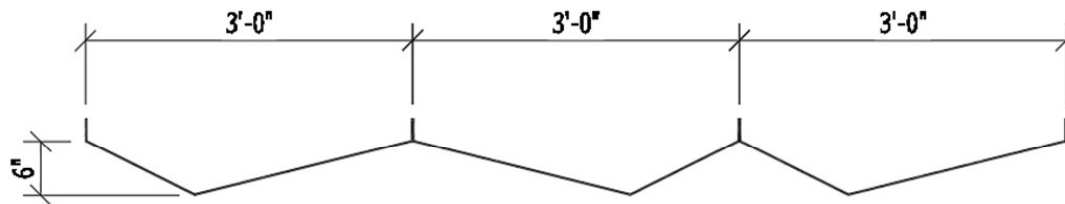

MS-3D 361224A

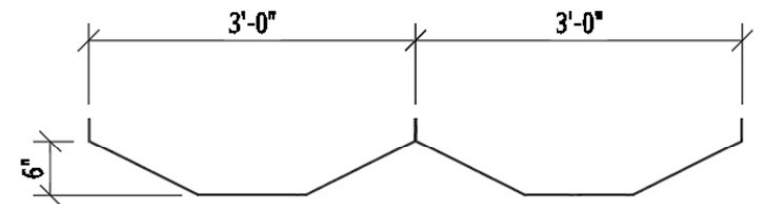

MS-3D 361212A

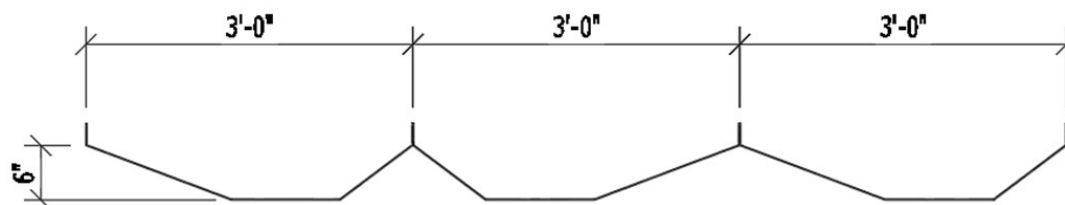

MS-3D 360816A

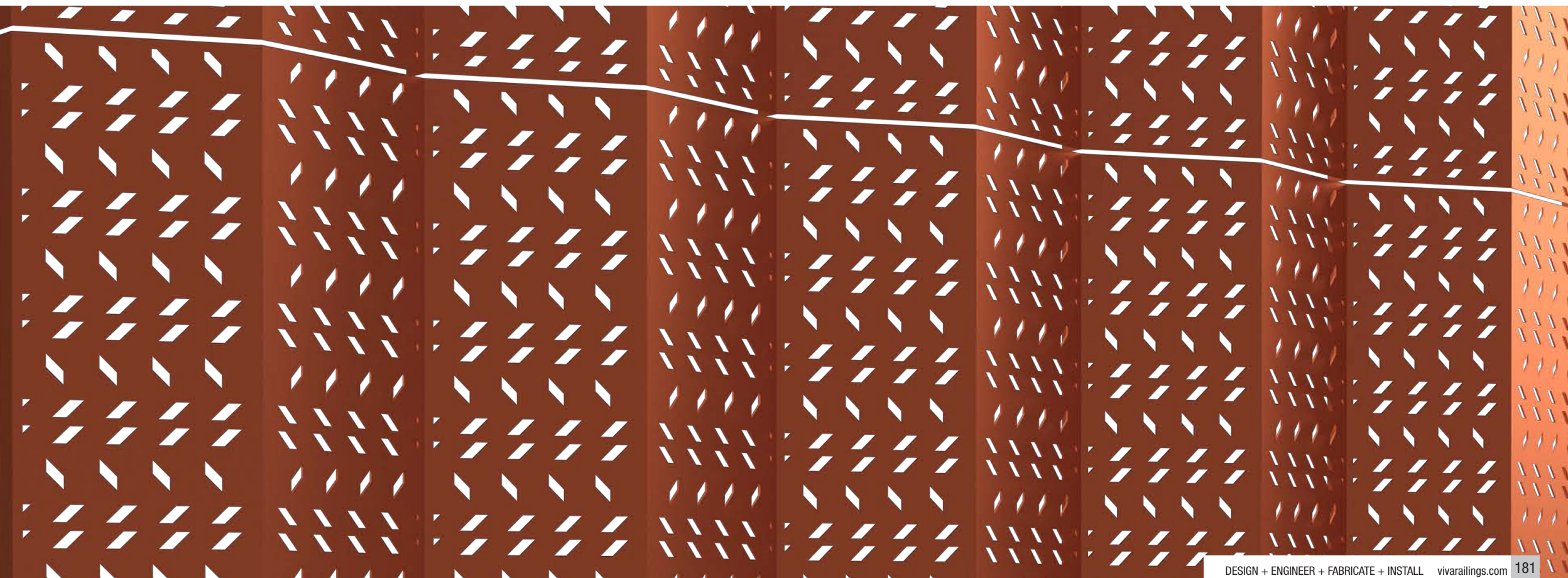
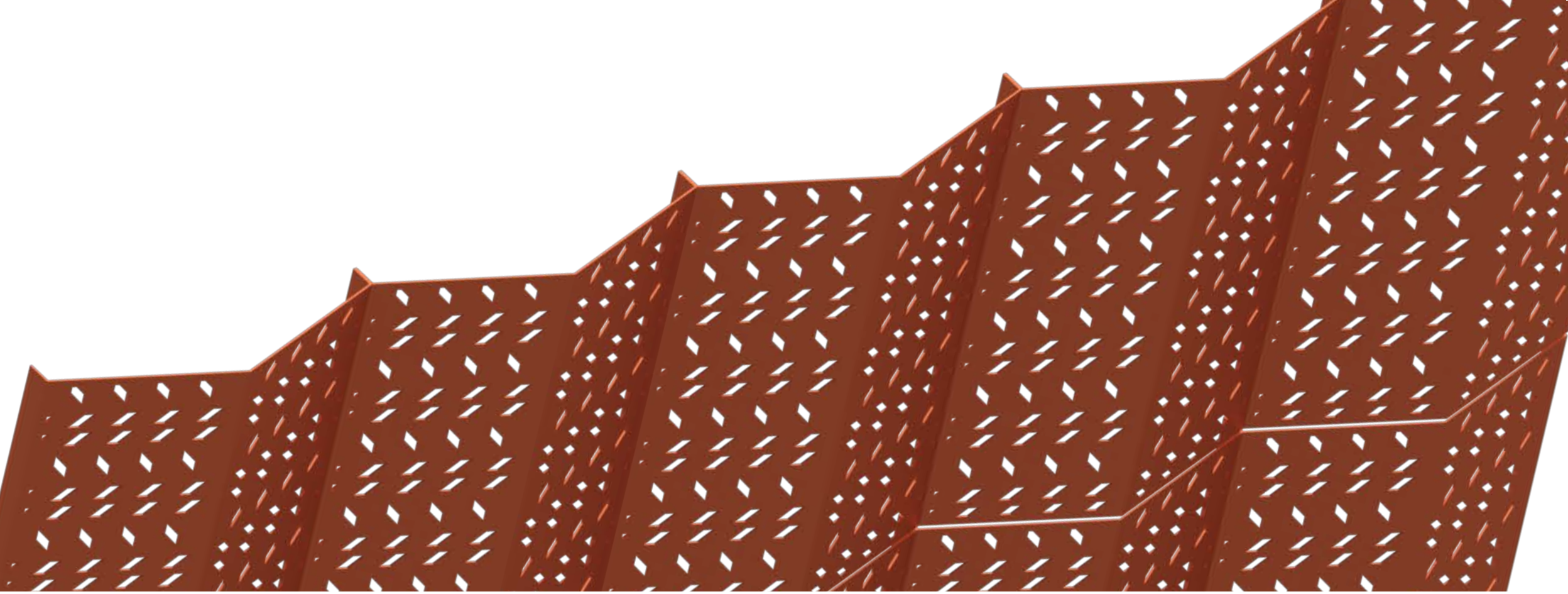

WALL SYSTEM - FLAT TYPE - TECHNICAL DATA



	MATERIALS	FINISH	WIDTH"	HEIGHT"
FLAT PANEL MOUNT TYPES FT-100 FT-101 FT-102 FT-103 FT-104	Aluminum: 1/8", 3/16" & 1/4"	Powder Coat, PVDF	48 36 24	120 96 60 48 24
	Stainless Steel: 14GA	Brushed Satin		
	Steel: 14GA & 11GA	Powder Coat, Weathered, Mill		

Above options are available in any of our Standard Patterns (pg 150), FotoFacade (pg 180) or Custom Pattern.

Standard cost-effective sizes shown, custom sizes available at a premium cost add.

Available Standard and Premium powder coat colors on Pg 208

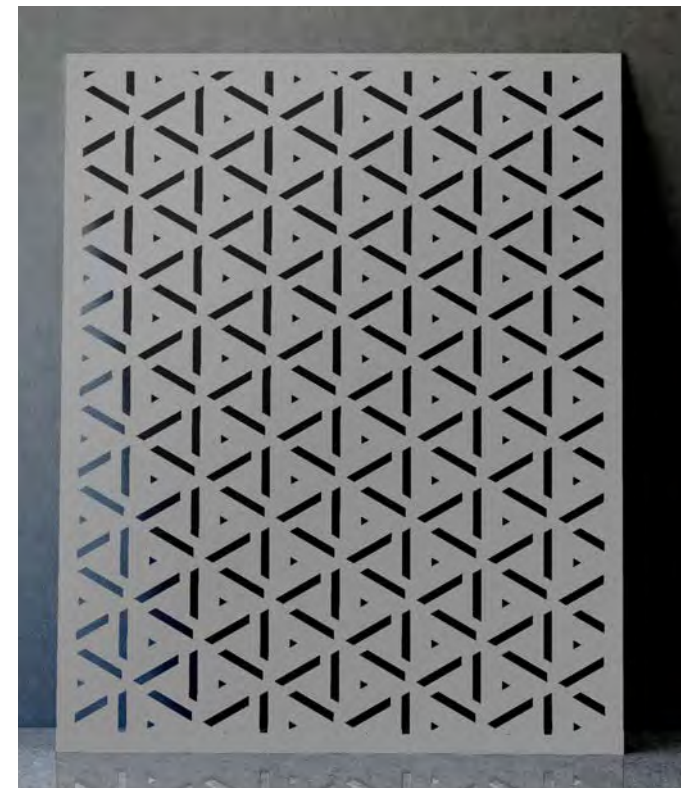
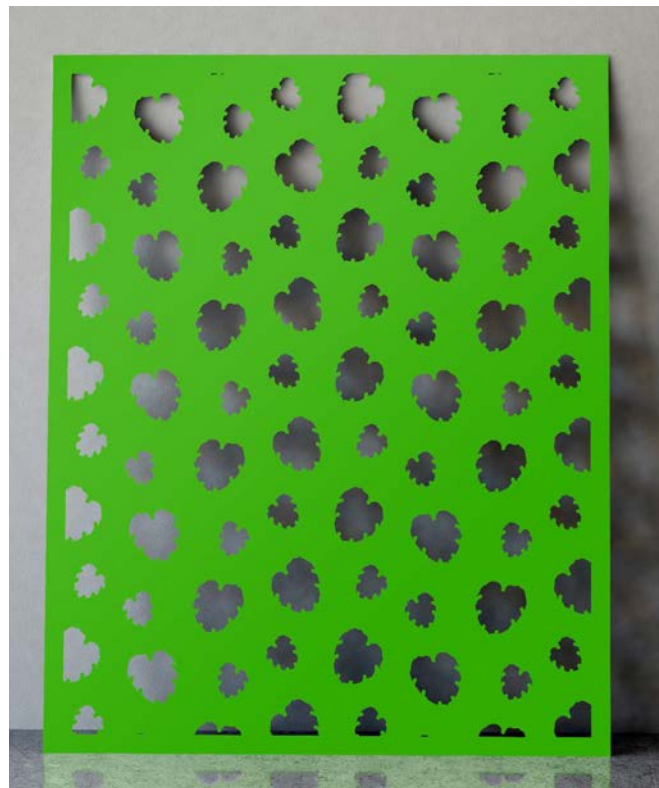

WALL SYSTEM - FLAT TYPE - PLAN VIEW

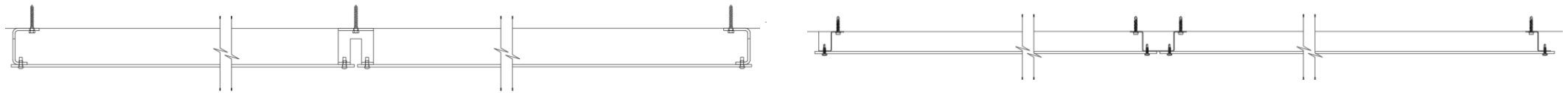

WALL SYSTEM - FLAT TYPE - MOUNTING OPTIONS

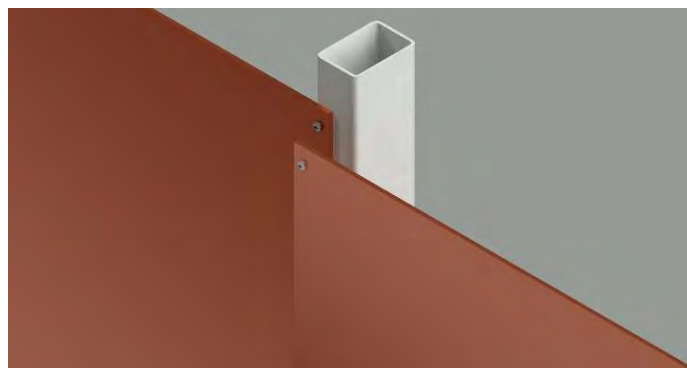

TYPE FT-100 MOUNT TO SUPPORT STRUCTURE



TYPE FT-101 MOUNT TO HAT CHANNEL

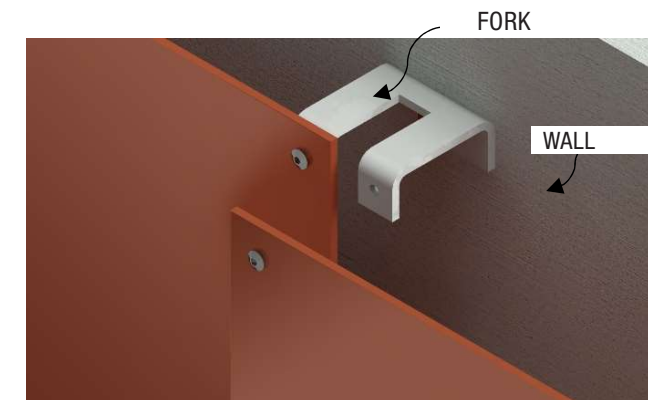

TYPE FT-102 MOUNT TO FORK

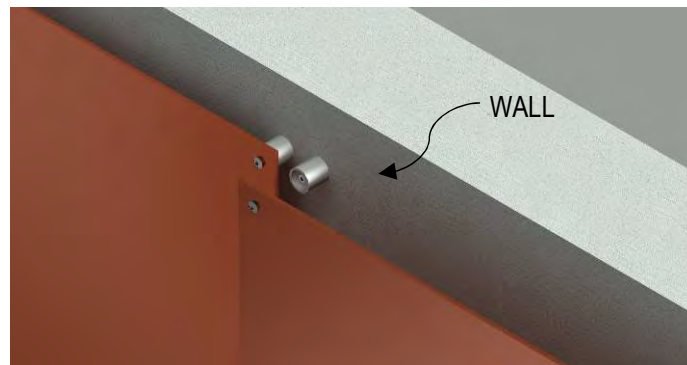

TYPE FT-103 MOUNT TO STAND-OFF

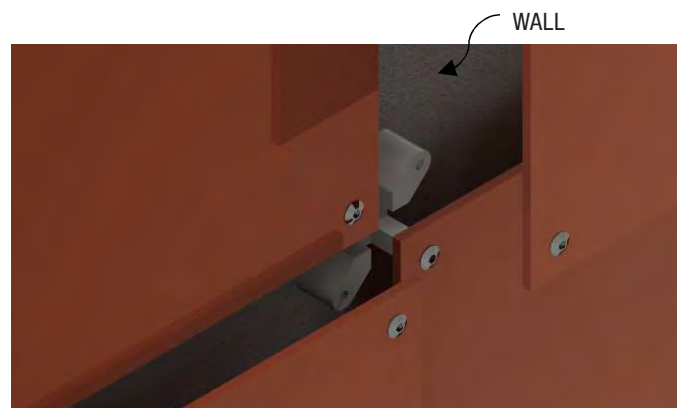

TYPE FT-104 MOUNT TO BRACKET

FOTOFACADE - LASER-CUT PERFORATED METAL IMAGING PANELS

APPLICATIONS

LANDSCAPE SCREENS

DIVIDER WALLS

FACADE SCREENS

WALL CLADDING

GARAGE SCREENS

FOTOFACADE

Available in FLAT or FOLD

We deliver on your vision, laser-cut to perfection. Modern design requires modern solutions, ones that fit into contemporary architectural design considerations.

FotoFacade is laser-cut perforated metal imaging solution. These panels are created by halftone dot patterns using laser cut technology, and integrates photographs or graphics into the panel design. The final result is a unique and eye-catching architectural application adds visual interest and depth to spaces.

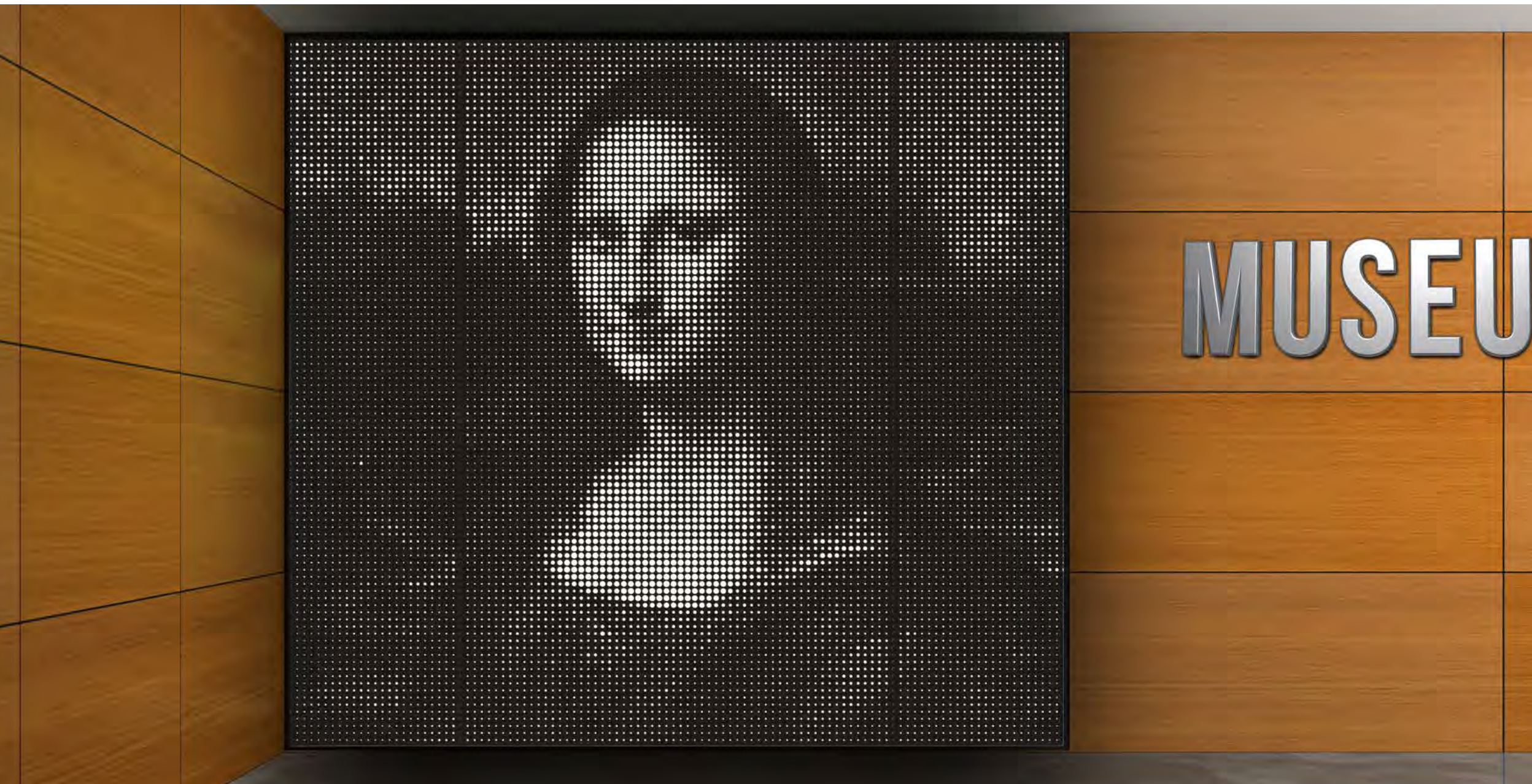



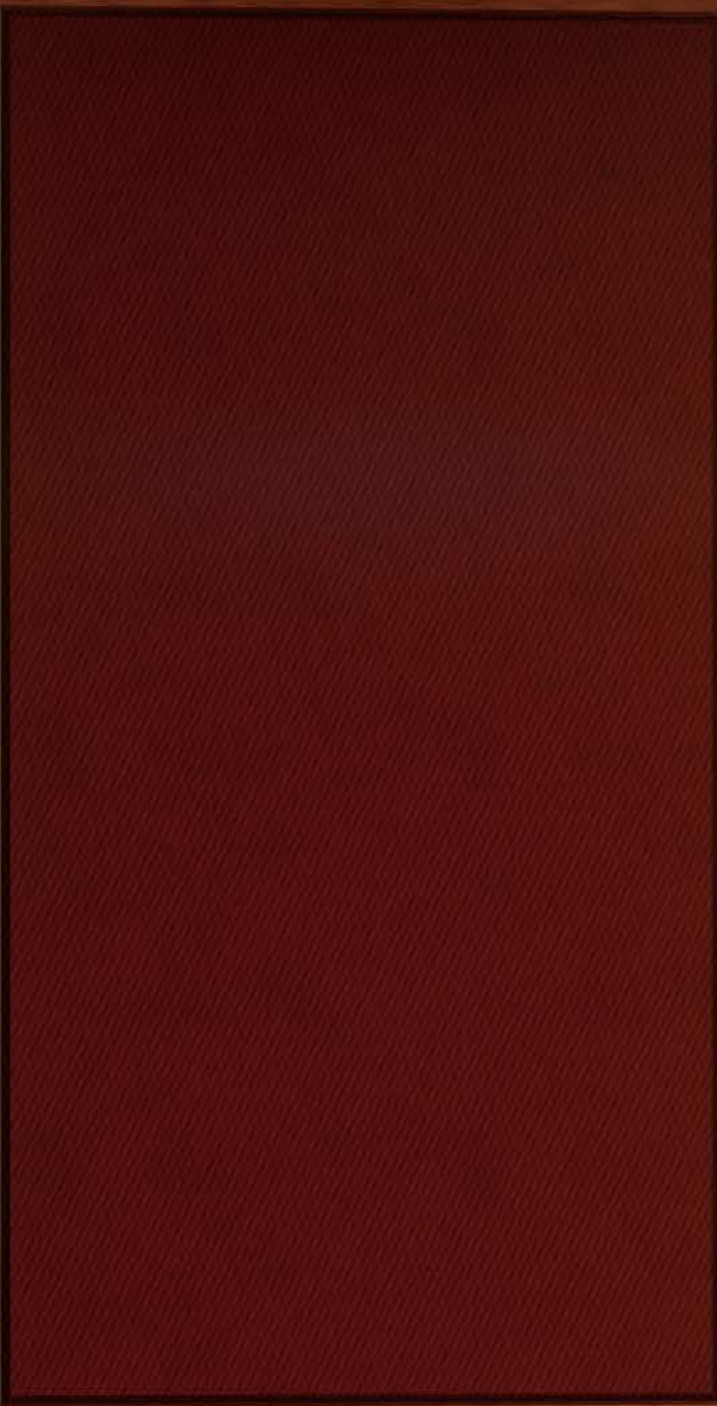

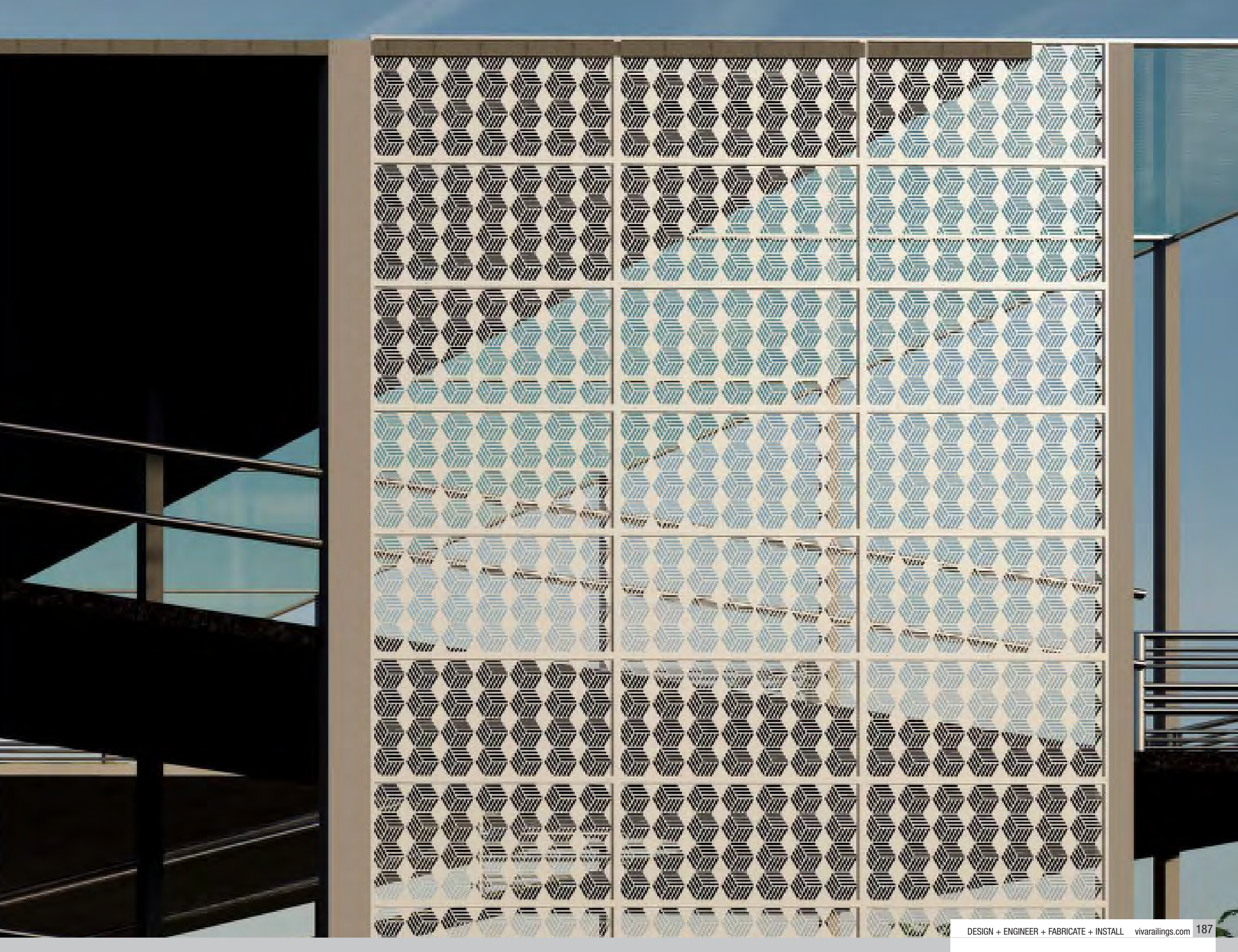

SUN CONTROL SYSTEM LASER CUT PANELS

TYPES	APPLICATIONS	FEATURES	OPTION (SHAPES)
BROW	WINDOW CANOPIES	EASY TO INSTALL	VERTICAL PANEL
WING	SUN BAFFLES	FRONT LOADING	HORIZONTAL PANEL
VERTICAL	VERTICAL SUN CONTROL		
SHADOW BOX			

Laser cut sun control and shade structures are fast becoming the ideal choice for commercial spaces and applications, with a range of choices in both design and material. These systems aid in controlling sunlight in architectural spaces and are precise, functional and durable. Our MetalSpaces range of products offer comprehensive and quality architectural solutions for laser-cut metal panels, from custom space dividers and lighting panels to sun control and shade structures.



BROW (TYPE B) - TECHNICAL DATA

BROW (TYPE B) - TECHNICAL DATA

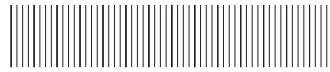

	MATERIAL	FINISH	WIDTH / LENGTH
BROW SYSTEM TYPE B	Aluminum: 1/8", 3/16" & 1/4"	Powder Coat, PVDF	2'-0" wide x 6'-0" long max 3'-0" wide x 4'-0" long max
	Stainless Steel: 14GA	Brushed Satin	

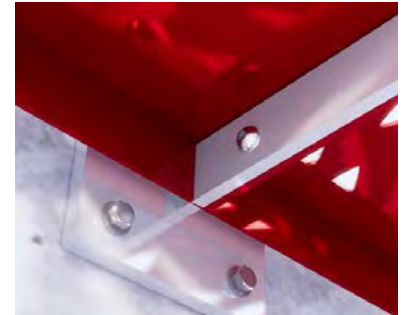
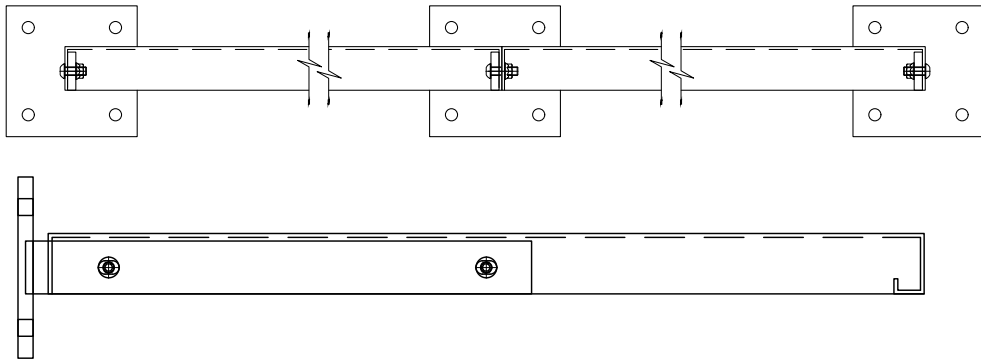

WING (TYPE W) - TECHNICAL DATA

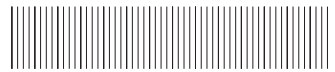

	MATERIAL	FINISH	WIDTH / LENGTH
WING SYSTEM TYPE W	Aluminum: 1/8", 3/16" & 1/4"	Powder Coat, PVDF	1'-6" 2'-0" 3'-0" max
	Stainless Steel: 14GA	Brushed Satin	

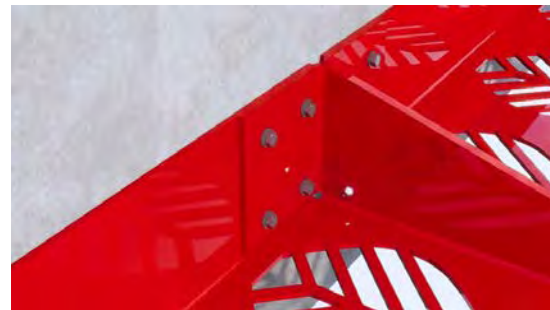
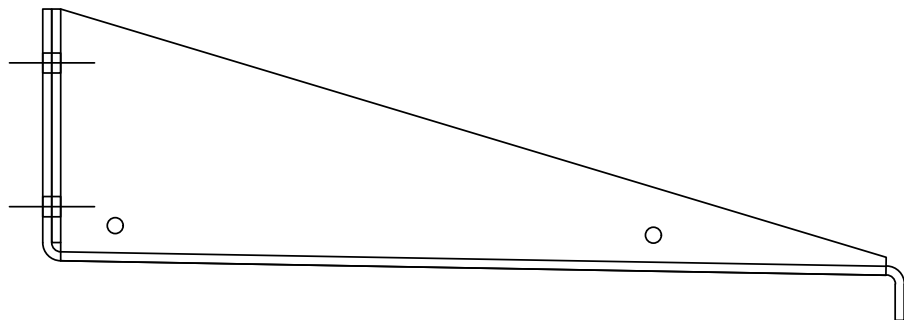

Available Standard and Premium powder coat colors on Pg 197-199

Above options are available in any of our Standard Patterns (pg xx), FotoFacade (pg xx) or Custom Pattern

VERTICAL (TYPE V) - TECHNICAL DATA

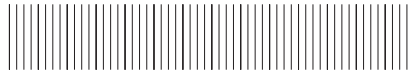

	MATERIAL	FINISH	WIDTH / LENGTH	
VERTICAL SYSTEM TYPE V	Aluminum: 1/8", 3/16" & 1/4"	Powder Coat, PVDF	1'-0"	4'-6"
	Stainless Steel: 14GA	Brushed Satin	1'-6" 2'-0" max.	7'-6" 9'-6"

Above options are available in any of our Standard Patterns, FotoFacade or Custom Pattern
Standard cost-effective sizes shown, custom sizes available at a premium cost add.

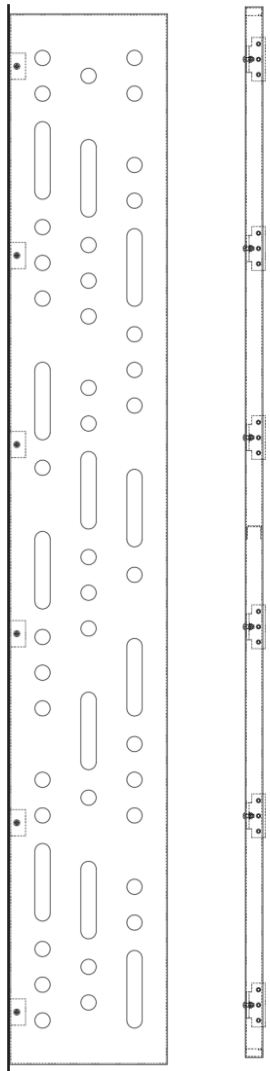

SHADOW BOX (TYPE SB) - TECHNICAL DATA

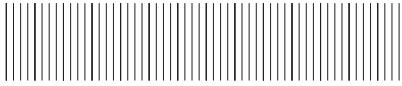

MATERIAL

FINISH

WIDTH

HEIGHT

LENGTH

SHADE BOX

Aluminum: 1/8", 3/16" & 1/4"
Stainless Steel: 14GA

Powder Coat, PVDF
Brushed Satin

1'-0"	5'-0"	4'-0"
1'-6"	8'-0"	5'-0"
2'-0" max.	10'-0"	6'-0"
		8'-0"
		10'-0"



Type SB-300: One Vertical Side



Type SB-301: Two Vertical Sides

SHADE STRUCTURE - TECHNICAL DATA

APPLICATIONS	FEATURES	OPTION (SHAPES)
OUTDOOR SEATING	SUN CONTROL	SQUARE
PARKS AND PLAYGROUNDS	EASE OF INSTALL	RECTANGULAR
GAZEBO	PRE-ENGINEERED SYSTEMS	ROUND
PARKING		
COVERED WALKWAYS		

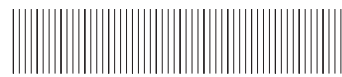
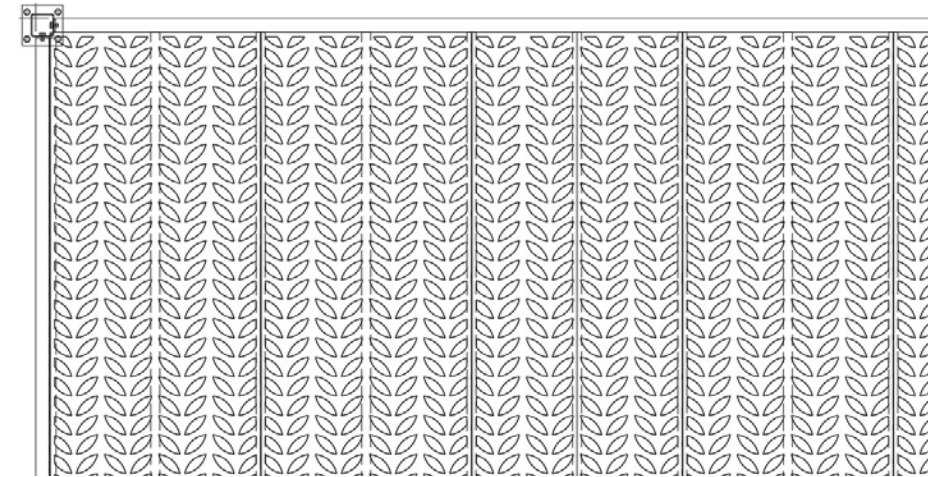

	MATERIAL	FINISH	FRAMING MATERIAL	FRAMING FINISH	SIZE
SQUARE SHAPE	Aluminum: 1/8", 3/16" & 1/4" Stainless Steel: 14GA Steel: 14GA , 11GA	Powder Coat, PVDF Brushed Satin Powder Coat, Weathered, Mill	Steel columns and Steel beams	Zinc Primer and Powder Coat Red Oxide Primer	10'-0" x 10'-0"
RECTANGULAR SHAPE	Aluminum: 1/8", 3/16" & 1/4" Stainless Steel: 14GA Steel: 14GA , 11GA	Powder Coat, PVDF Brushed Satin Powder Coat, Weathered, Mill	Steel columns and Steel beams	Zinc Primer and Powder Coat Red Oxide Primer	12'-0" x 15'-0" 16'-0" x 20'-0"
ROUND SHAPE	Aluminum: 1/8", 3/16" & 1/4" Stainless Steel: 14GA Steel: 14GA , 11GA	Powder Coat, PVDF Brushed Satin Powder Coat, Weathered, Mill	Steel columns and Steel beams	Zinc Primer and Powder Coat Red Oxide Primer	12'-0" O.D. 16'-0" O.D.

Above options are available in any of our Standard Patterns, FotoFacade or Custom Pattern
Standard cost-effective sizes shown, custom sizes available at a premium cost add.

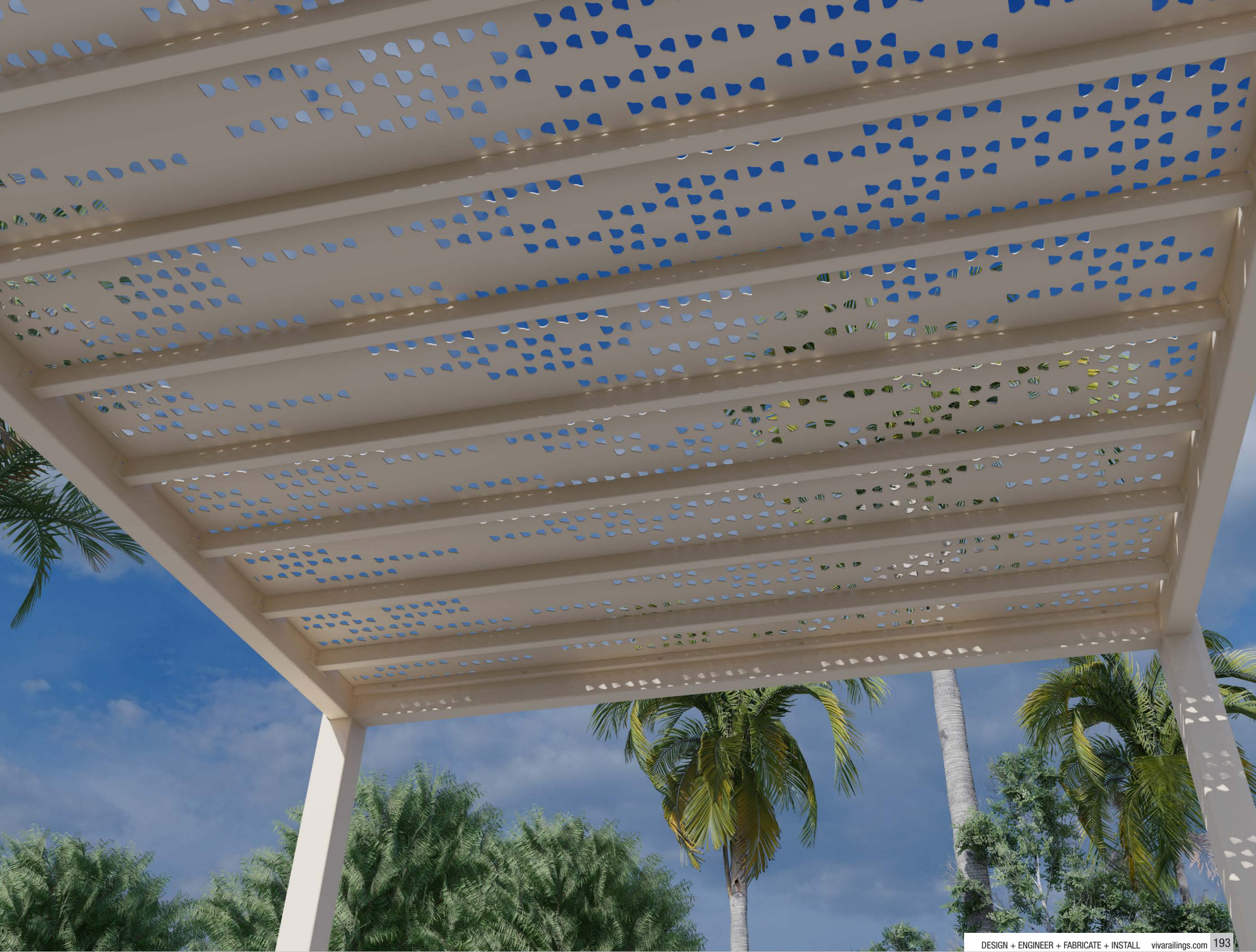





DECORATIVE CEILING SYSTEM

TYPES

HOK / CABLE

CABLE

TEE

APPLICATIONS

CONFERENCE ROOM

RECEPTION

OFFICE

LOBBIES

Laser-cut decorative ceiling systems offer both functionality and ornamentation. Customizable with a wide range of designs, materials, color and functionality, laser-cut ceiling systems are a modern-day architectural decor solution.

These systems can be finished in a variety of colors and styles to match the architecture of the surroundings.

High-quality materials, including stainless steel, aluminum, and steel, are used in the fabrication of panelled ceiling systems.

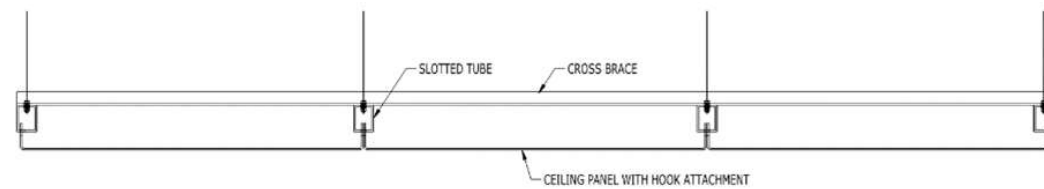

SECTION - HOOK SYSTEM, SLIDE AND LOCK

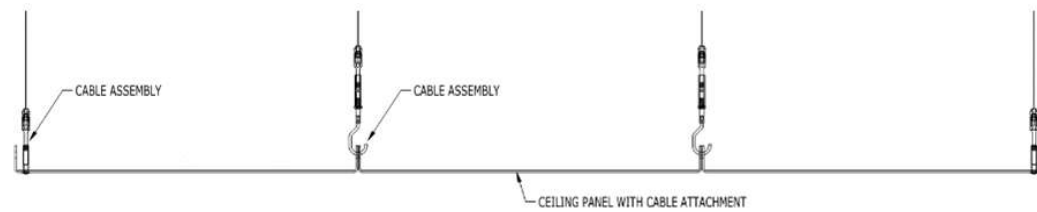

SECTION - CABLE SYSTEM, LIFT AND TENSION

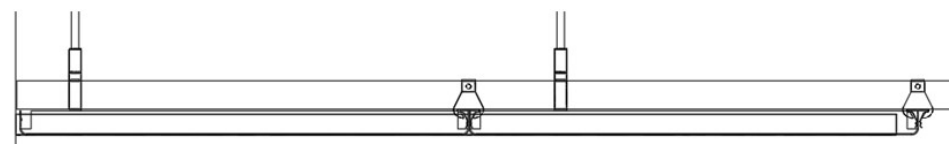

SECTION - TEE SNAP-IN



DECORATIVE CEILING SYSTEMS - TECHNICAL DATA



	MATERIALS	FINISH	STANDARD DIMENSIONS	
			WIDTH"	LENGTH"
HOOK AND CABLE SYSTEM	Aluminum: 1/8", 3/16" & 1/4"	Powder Coat, PVDF	44 32 26 20	116
	Stainless Steel: 14GA	Brushed Satin		92
	Steel: 14GA & 11GA	Powder Coat, Weathered, Mill		56 44 32
TEE SYSTEM	Aluminum	Powder Coat, PVDF	23 5/8	47 1/4
	Stainless Steel	Brushed Satin		23 5/8
	Steel	Powder Coat, Weathered, Mill		

Above options are available in any of our Standard Patterns, FotoFacade or Custom Pattern
Standard cost-effective sizes shown, custom sizes available at a premium cost add.

DECORATIVE CEILING SYSTEMS - APPLICATIONS



All LED LINEAR products are ETL certified; ETL mark is proof of product compliance to North American safety standard.









ARCHITECTURAL PANELS

APPLICATIONS

WALL SYSTEMS

CEILING SYSTEMS

SUN CONTROL

SHADE STRUCTURES

Architectural Laser Cut Panels are highly versatile panels that offer several benefits for commercial applications. They can be modified and used for Flat Wall Panel Systems, Ceiling Systems, Sun Control and for Shade Structures. One of the primary benefits of using these panels is their aesthetic appeal. They can add a unique, modern look to any project and are available in a variety of colors, finishes, and patterns. Additionally, architectural panels are durable and low maintenance, making them ideal for commercial applications where long-term durability is essential. The fabrication of architectural panels is a critical process that requires precision and accuracy. These panels are typically cut to precision by advanced fiber laser cutting machines that use state-of-the-art technology to achieve the desired results. The machines can be programmed to cut complex shapes and designs, allowing for a high degree of customization.

We have a range of Primary, Organic and Geometric Patterns available.

Custom patterns can be created and designed to fit the specific needs of a project, whether it's creating a unique look or adding functionality to the panel. The design can be as simple or as complex as needed. Custom patterns can also be used to incorporate branding or logos into the panel design, making it a perfect fit for corporate or commercial applications.

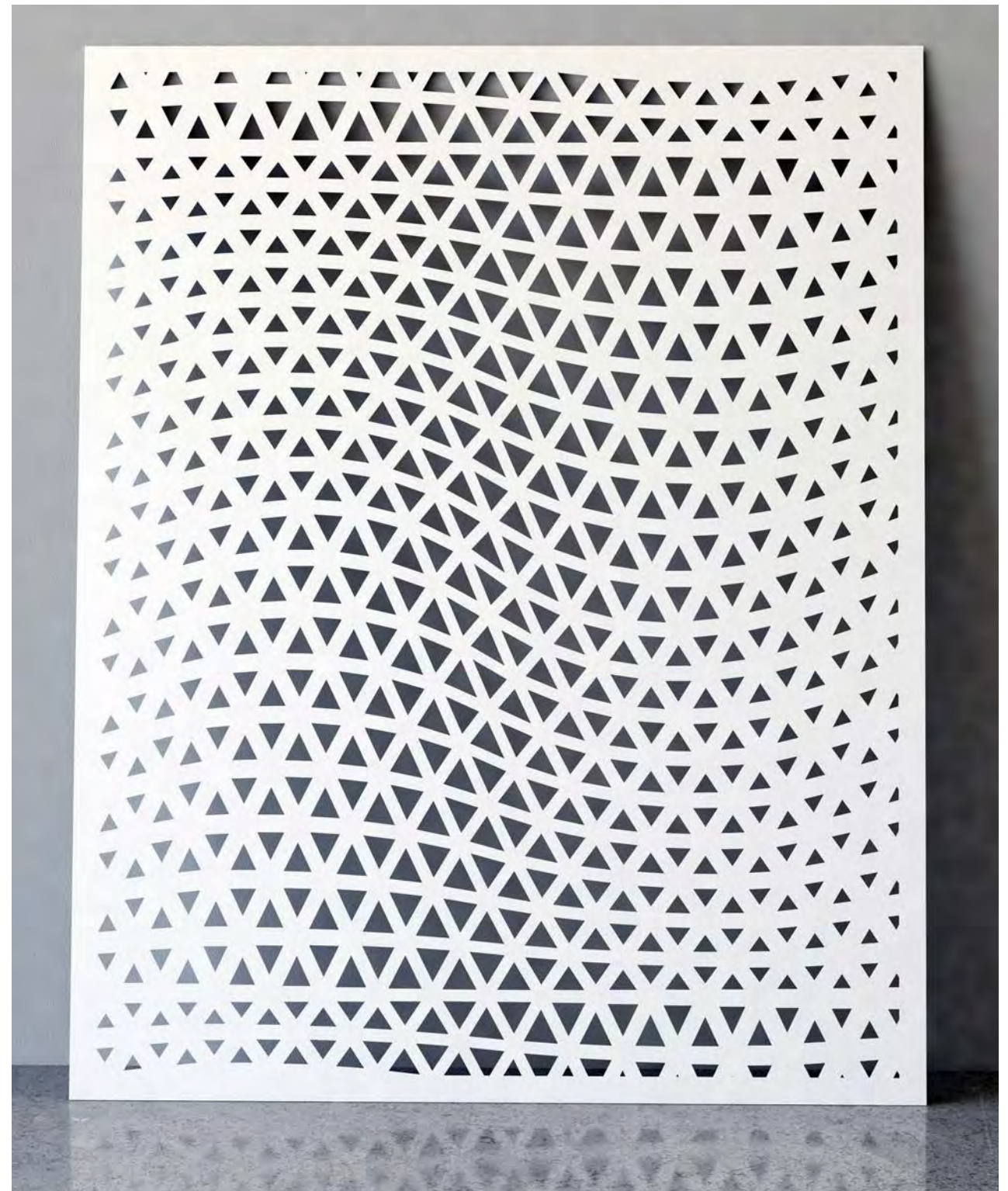

ARCHITECTURAL PANELS - TECHNICAL DATA

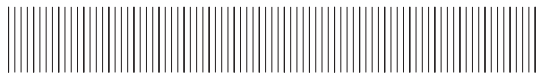

FLAT PANEL WIDTH AND HEIGHT FOR TYPE (HC), (TS) & (US)

MATERIALS	FINISH	WIDTH"	HEIGHT"
Aluminum: 1/8", 3/16" & 1/4"	Powder Coat, PVDF	48 36 24	120 96 60 48 24
Stainless Steel: 14GA	Brushed Satin		
Steel: 14GA & 11GA	Powder Coat, Weathered, Mill		

Above options are available in any of our Standard Patterns as shown, FotoFacade or Custom Pattern
Standard cost-effective sizes shown, custom sizes available at a premium cost add.

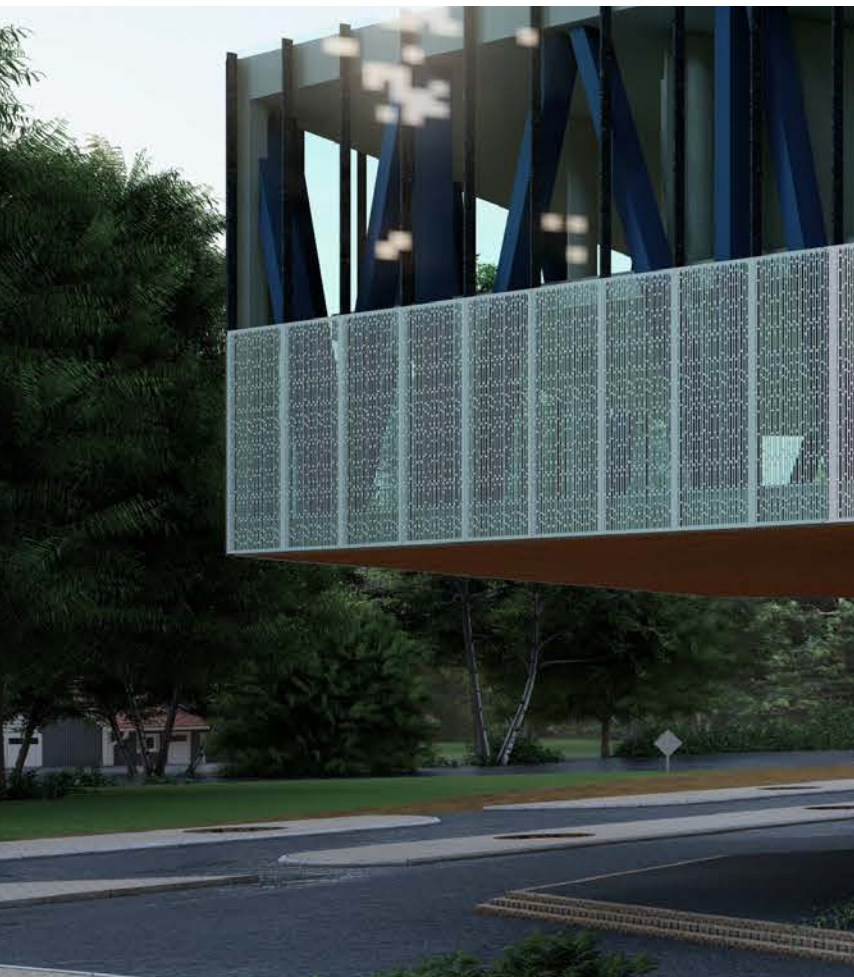

PRIMARY PATTERNS

PP - 01 PALLADIAN



PP - 02 RAMIE



PP - 03 SCHOTTISCHE

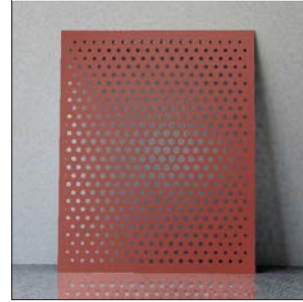

PP - 04 KALYPTRA



PP - 05 OCTAN



PP - 06 RIQQ



PP - 07 LATTEN

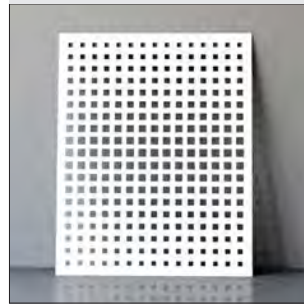

PP - 08 MASCLE



PP - 09 LENO



PP - 10 LACIS



PP - 11 NEXAL



PP - 12 NOEMA



PP - 13 NOVALIA



PP - 14 DAGERAAD



PP - 15 DARBY



PP - 16 RADIX



PP - 17 HASTATE



PP - 18 QUADRAL



PP - 19 FAVIFORM



PP - 20 HALITOUS

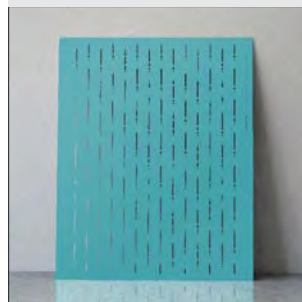

PP - 21 ONDOYANT



PP - 22 CABAS



PP - 23 GRAMARIE



ORGANIC PATTERNS

PO - 01 BICCHIERE



PO - 02 HANKEI



PO - 03 BLOEMEN



PO - 04 NOKTALI



PO - 05 TOPOGRAF



PO - 06 SHIRUDO



PO - 07 RENA



PO - 08 VINDMOLLE



PO - 09 VEVA



PO - 10 OBLAZ

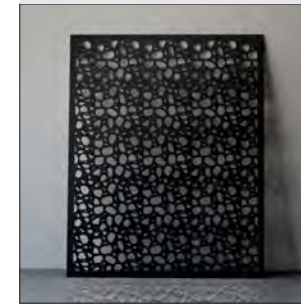

PO - 11 FYLLO



PO - 12 VERGANO



PO - 13 KIRIK

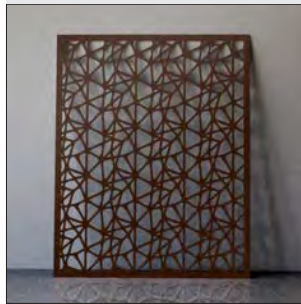

PO - 14 WERAQ

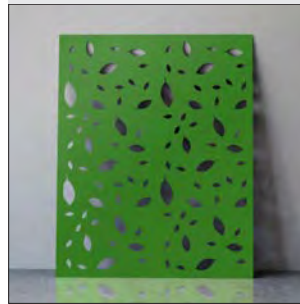

PO - 15 TULBI



PO - 16 AIKASA



PO - 17 HAUST



PO - 18 FRONS

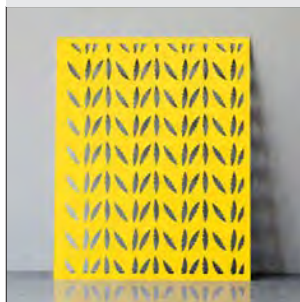

PO - 19 PETALO



PO - 20 FOLGIA

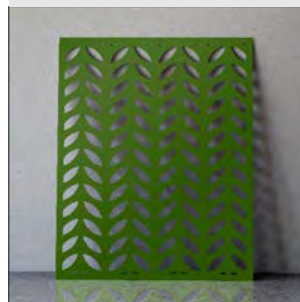

GEOMETRIC PATTERNS

PG - 01 CESTA



PG - 02 XIRIIR



PG - 03 VESPER



PG - 04 NAVETTE



PG - 05 MAKAF



PG - 06 TROKUT



PG - 07 STRALEND



PG - 08 CHRILI



PG - 09 HANZAT



PG - 10 ESAGANO



PG - 11 BINYA



PG - 12 MACKSA



PG - 13 IBBANG



PG - 14 GARIS



PG - 15 MUNJA



PG - 16 SKAYARA

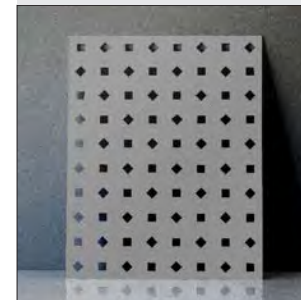

PG - 17 XAROMAR



PG - 18 BIXAR



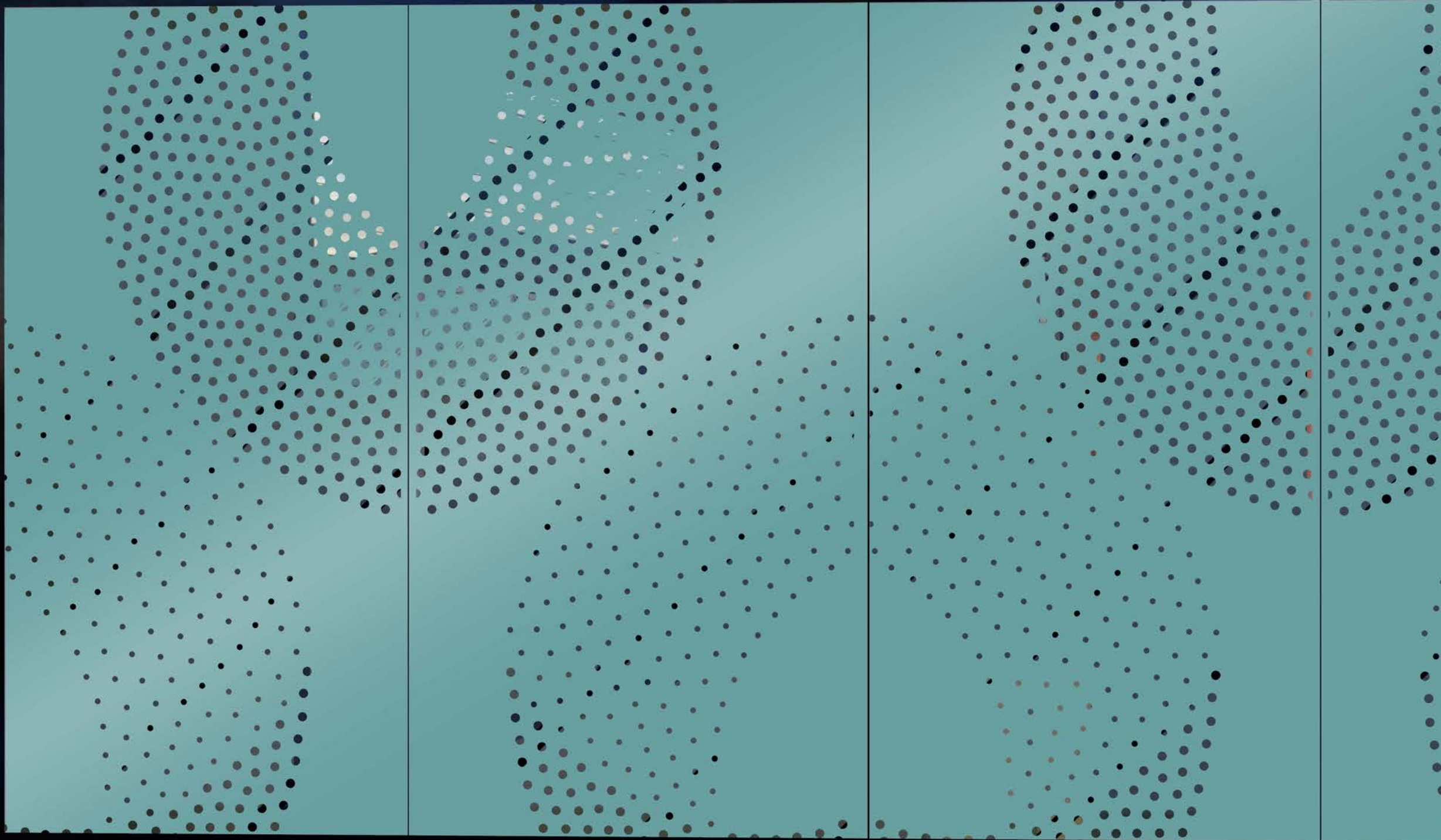

CERASHIELD - STANDARD COLORS

VIVA Railings leverages the advanced technology of CERASHIELD, a world-renowned coating technology celebrated for its superior durability, corrosion resistance, and aesthetic versatility. By integrating CERASHIELD'S proven methods, VIVA Railings ensures that our coating delivers unmatched performance and aesthetic excellence. Visit Cerakote for more information.



CS-102 GRAPHITE BLACK



CS-112 COBALT



CS-124 SATIN NICKEL



CS-129 STAINLESS



CS-138 JET BLACK



CS-143 STOPLIGHT RED

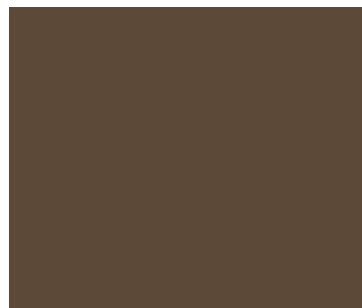

CS-148 BURNT BRONZE



CS-158 BLUE FLAME



CS-163 LOLLYPOP PURPLE



CS-186 PISTON COAT (AIR CURE)



CS-187 TRANSFER GREY



CS-190 20150 COYOTE

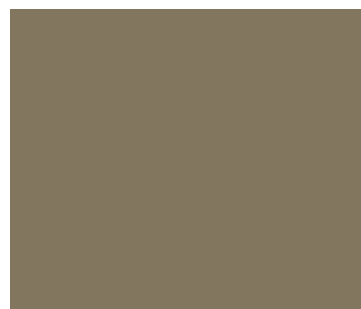

CS-211 DESERT SAND



CS-215 HIGHLAND GREEN

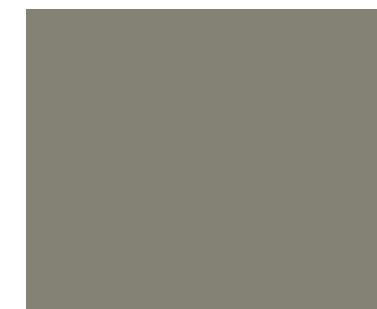

CS-219 GUN METAL GREY

CERASHIELD - STANDARD COLORS

CERASHIELD stands out with its exceptional color consistency. Every CERASHIELD color adheres to a strict standard of Delta E ≤ 1 , ensuring minimal perceptible variance



CS-226 PATRIOT BROWN



CS-231 MAGPUL FOLIAGE GREEN



CS-232 MAGPUL O.D. GREEN



CS-239 SNIPER GREY



CS-240 COYOTE TAN



CS-241 O.D. GREEN



CS-244 MIL SPECS O.D. GREEN



CS-267 MAGPUL FDE



CS-7300 BLACK VELVET



CS-7800 GLACIER GOLD



CS-7900 GLACIER TITANIUM



CS-30118 FS FIELD DRAB

FRAME RAILING SYSTEM | INFILL: LASER CUT PANELS

LAKE POINTE CHURCH - DALLAS, TX

General Contractor: Talley Riggins Construction

Architect: BECK



Visit the
project gallery.



CIRCA RAILING SYSTEM | INFILL: TEMPERED GLASS

PROSPER CENTRAL FIRE STATION - PROSPER, TX

General Contractor: Pogue Construction

Architect: Brown Reynolds Watford Architects



Visit the
project gallery.



WIRE MESH STANDARD PATTERN OPTIONS



WM-10

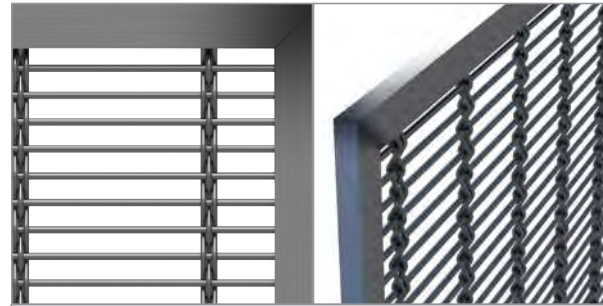

WM-11

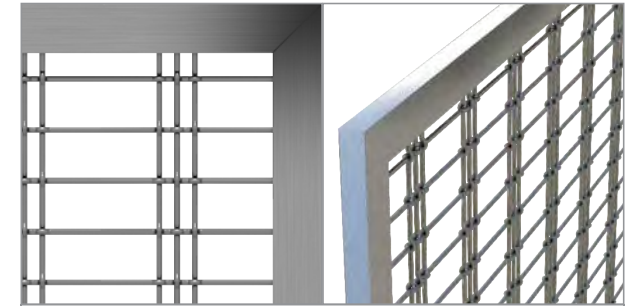

WM-12

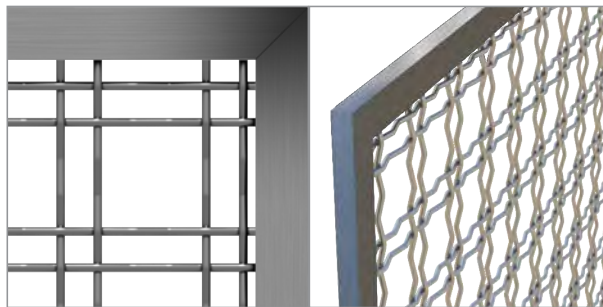

WM-13

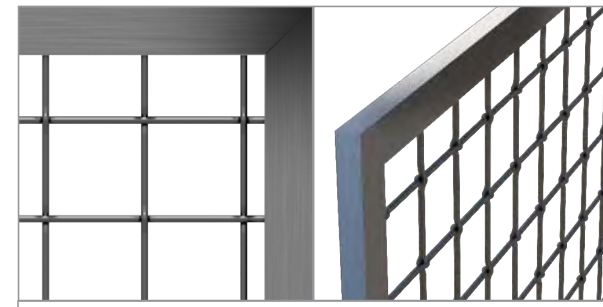

WM-14

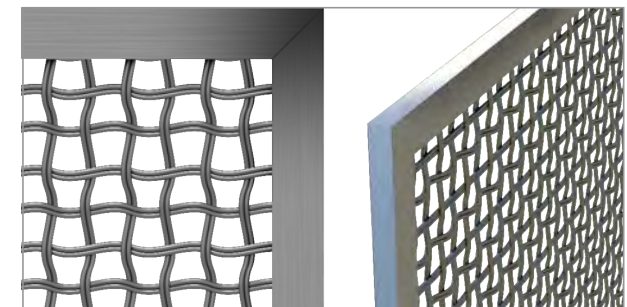

WM-15

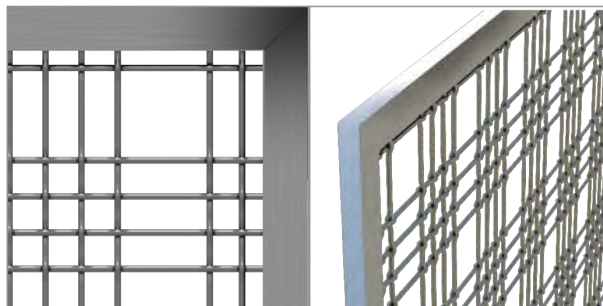

WM-17

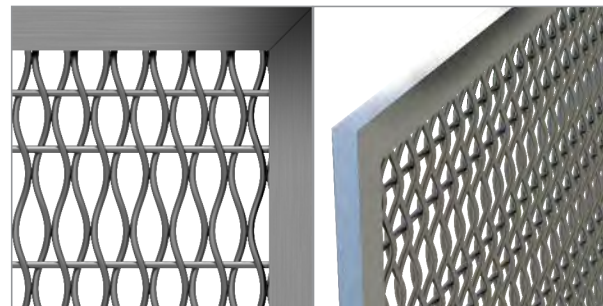

WM-19

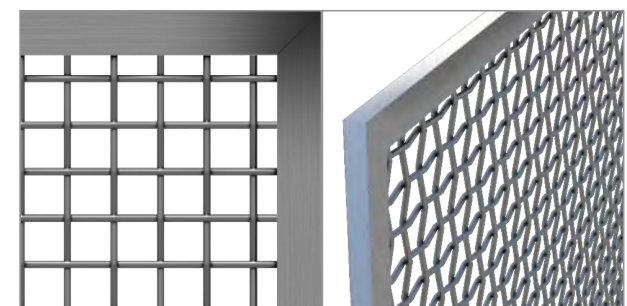

WM-20

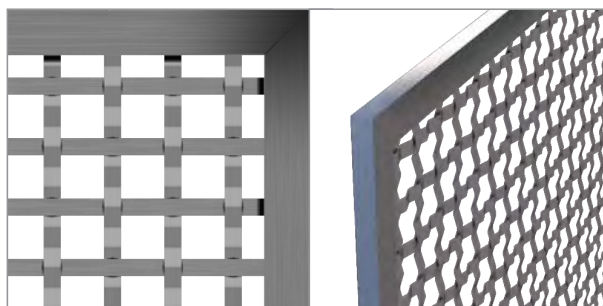

WM-21

PERFORATED METAL STANDARD PATTERN OPTIONS

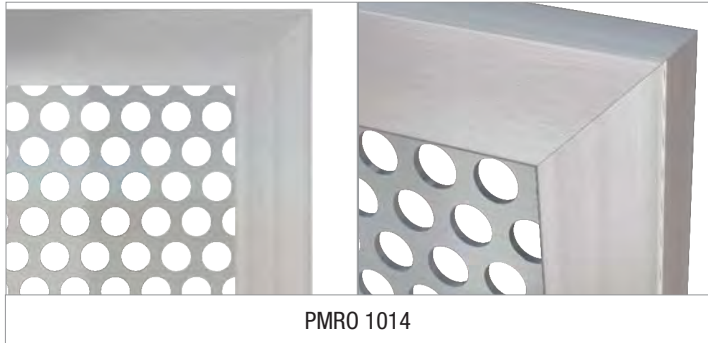
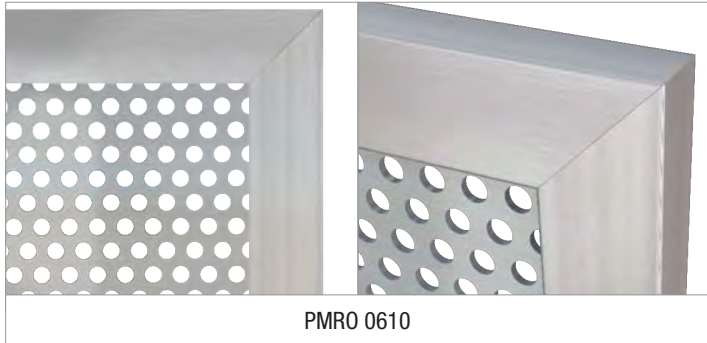

DECO GLASS SYSTEM

Decorative glass options provide both functional and aesthetic benefits to commercial railing applications, such as, increased privacy, reduced glare and heat gain, enhanced safety through tempered and laminated glass options and customized aesthetics to match the interiors and branding

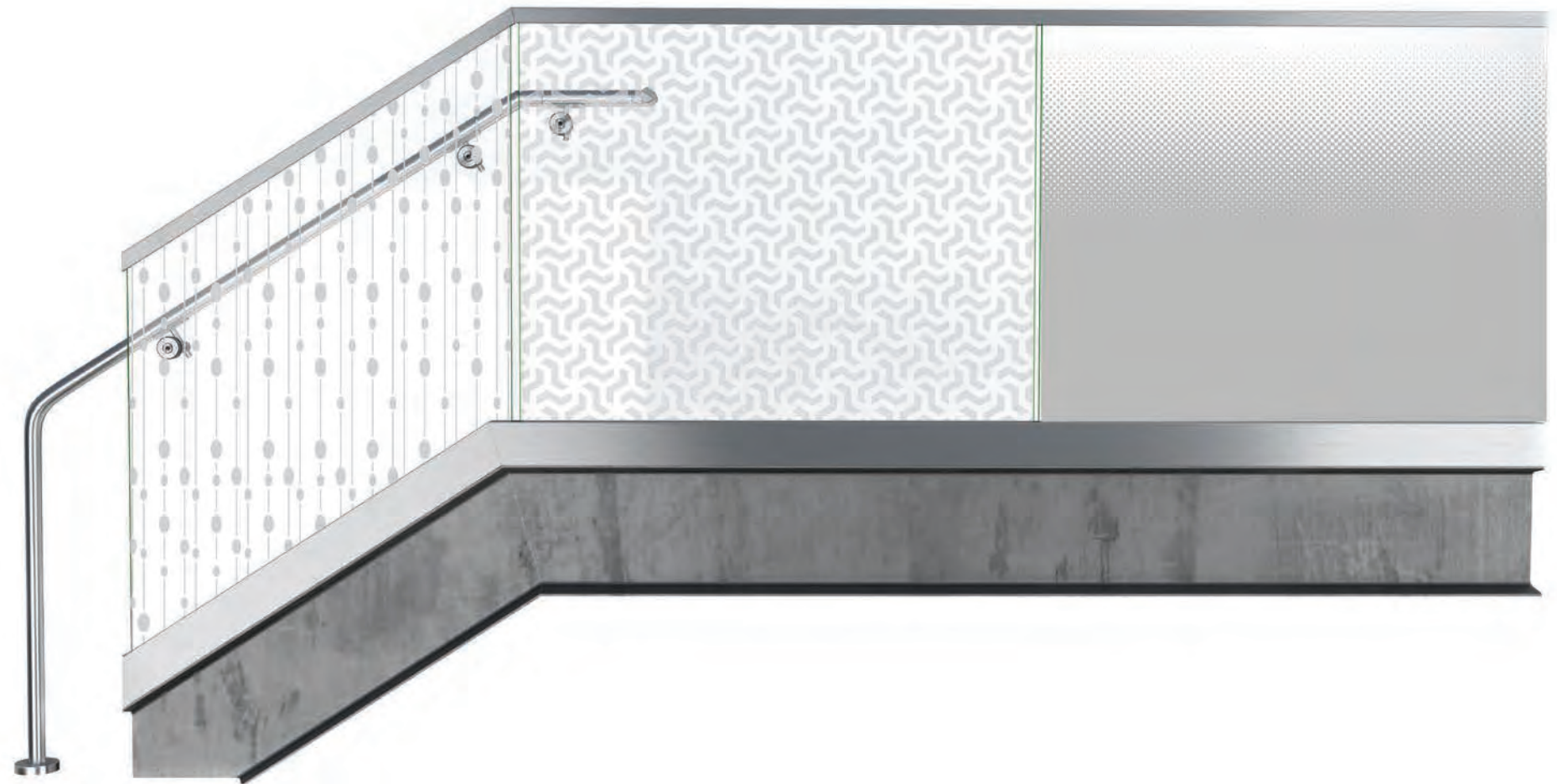

Scan the QR code to check out the BLADE system on our website and the interactive 3D viewport

SOLO™ RAILING SYSTEM | INFILL: GLASS

NORMAN CENTRAL LIBRARY - NORMAN, OK

General Contractor: Flintco, LLC

Architect: The McKinney Partnership Architects

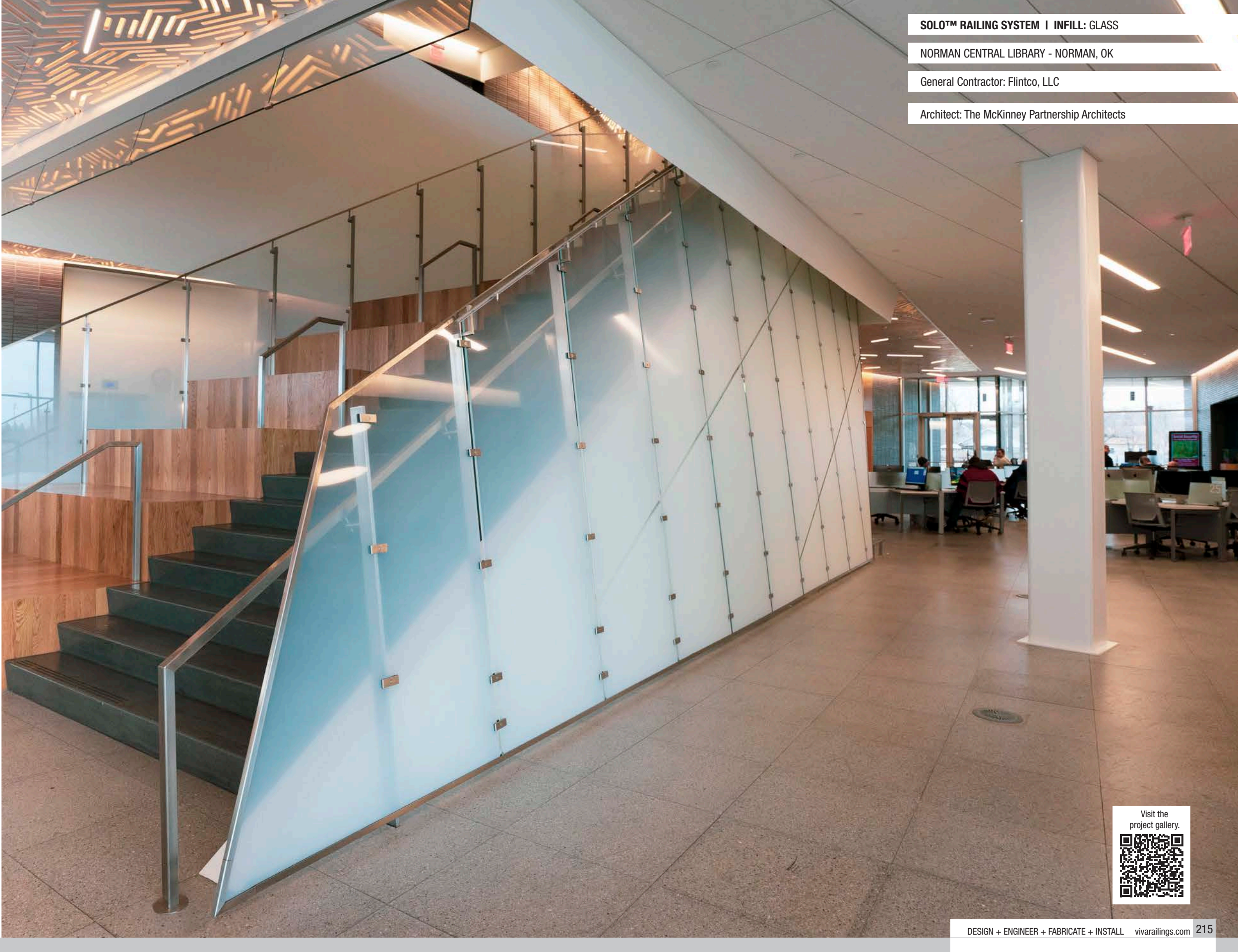

Visit the
project gallery.



DECO GLASS PATTERN OPTIONS

DOT GRADIENT PATTERNS



LINE GRADIENT PATTERNS

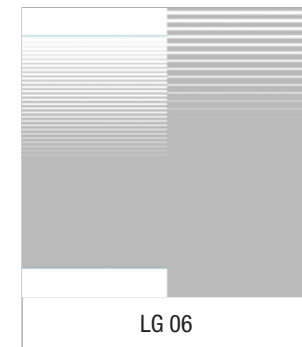
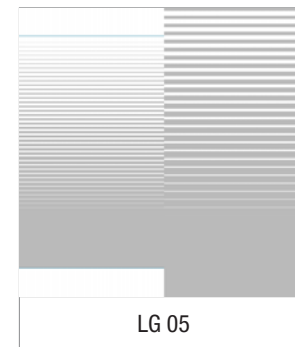
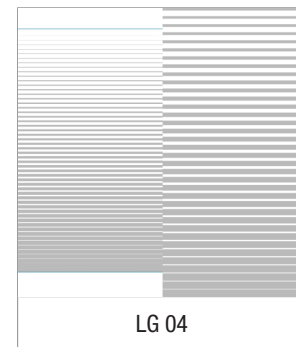
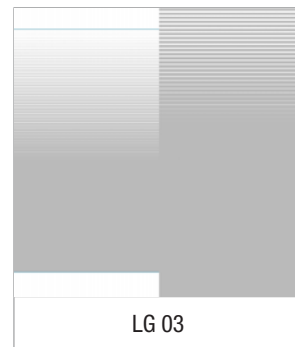
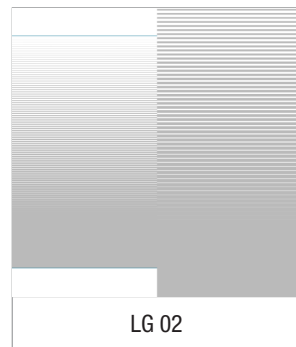
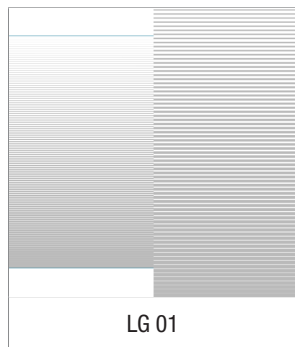

SQUARE GRADIENT PATTERNS

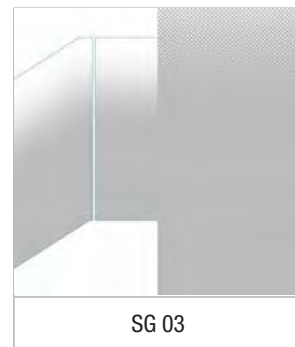
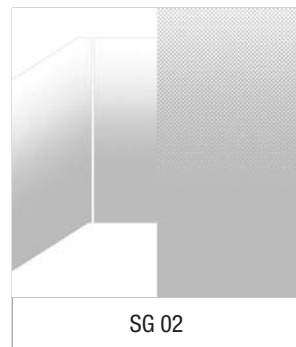

DECO GLASS PATTERNS

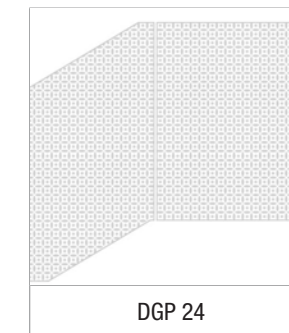
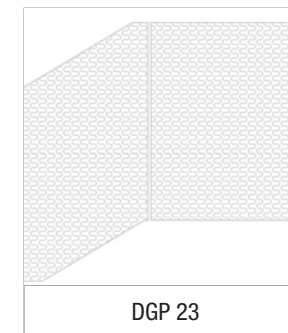
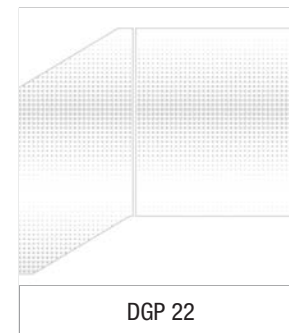
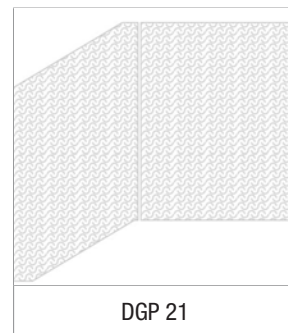
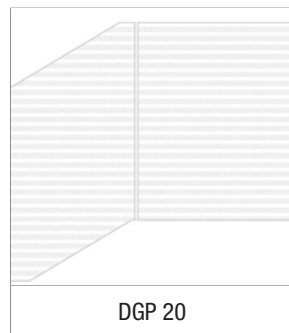
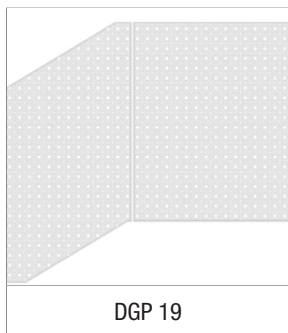
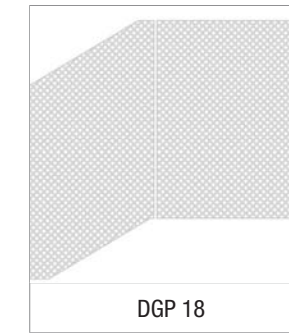
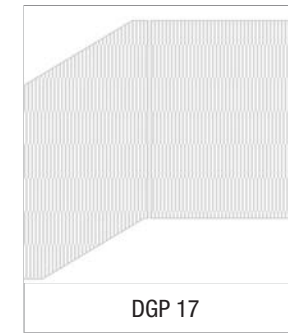
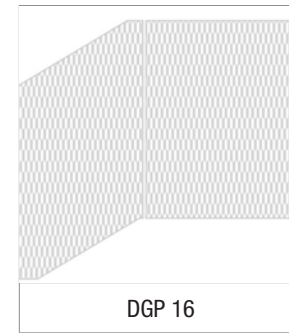
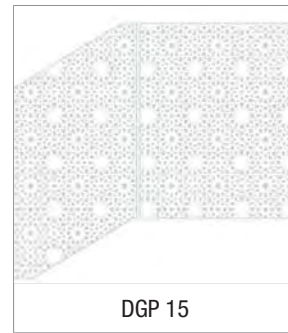
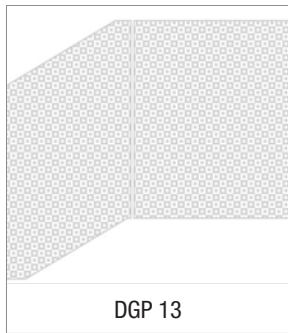
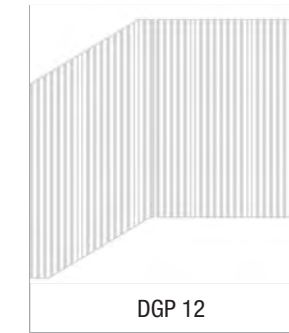
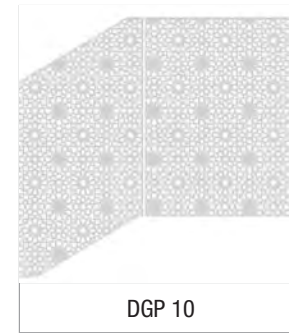
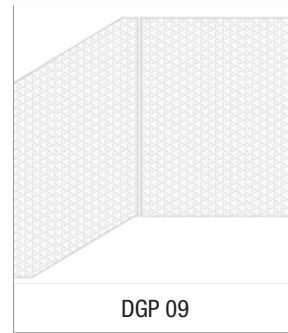
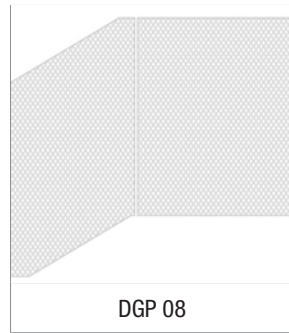
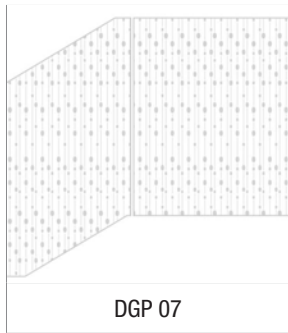
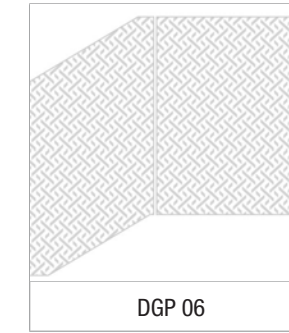
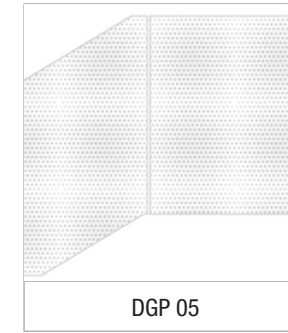
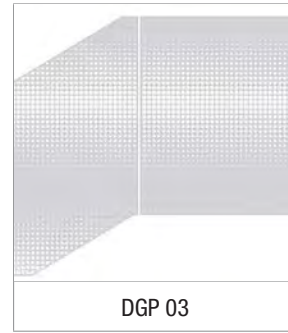
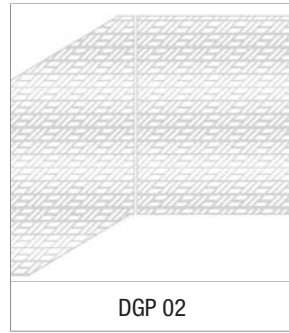
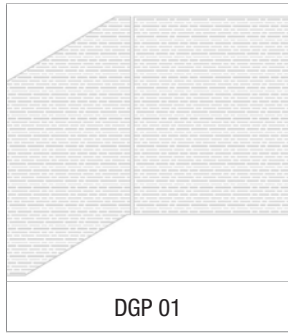

VIEW™ RAILING SYSTEM | INFILL: GLASS

WEST COAST UNIVERSITY - RICHARDSON, TX

General Contractor: HRNCIR Construction

Architect: Gensler

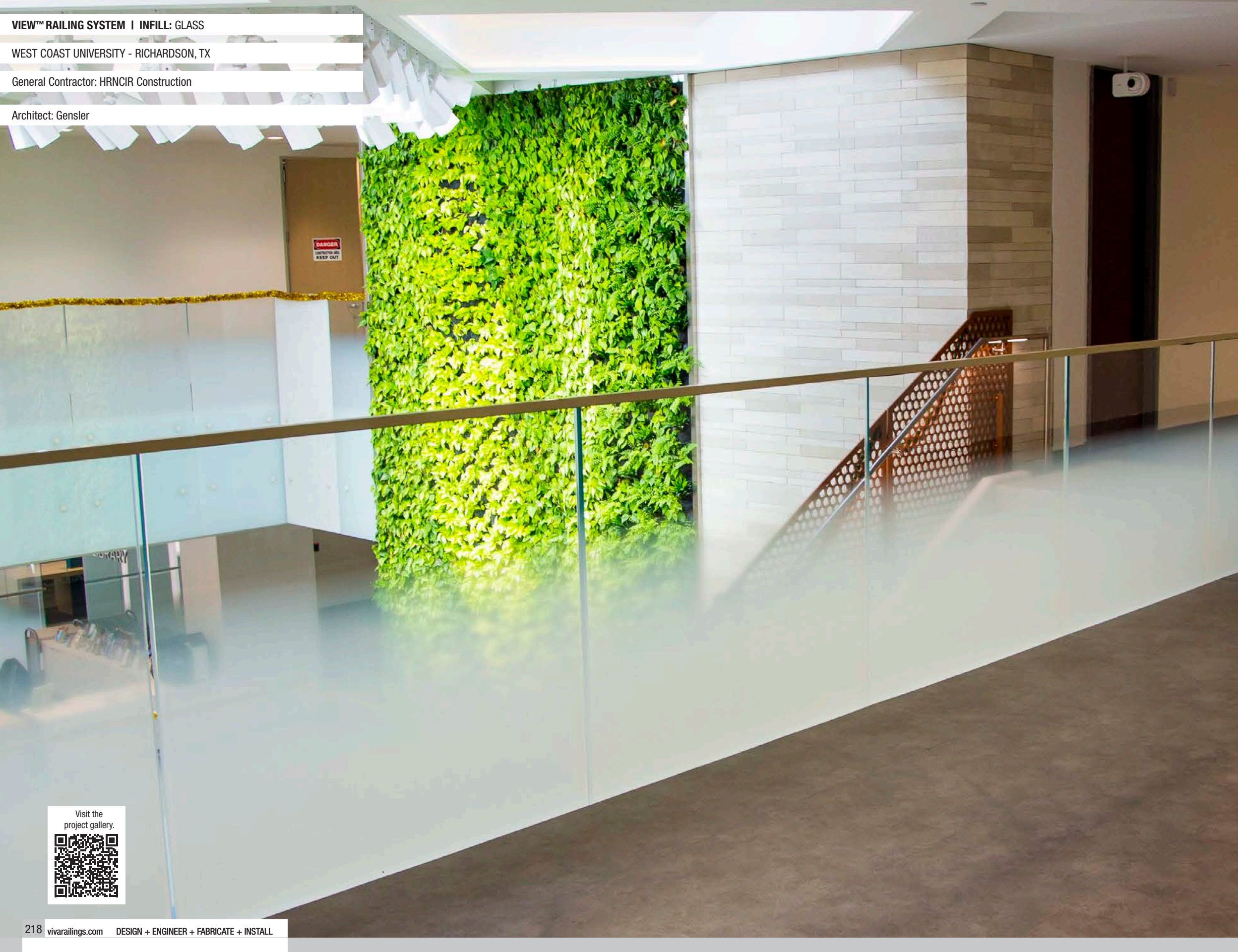

Visit the
project gallery.



VIEW™ RAILING SYSTEM | INFILL: GLASS

UNIVERSITY OF NEBRASKA-KEARNEY - KEARNEY, NE

General Contractor: Kearney Glass, Inc.

Architect: RDG Planning & Design



Visit the
project gallery.



Meet the Viva Railings Family: Passionate, Professional, and Dedicated

At Viva Railings, we take pride in our team of over 140 skilled team members who are committed to delivering a world-class client experience. Our leadership is hands-on and approachable, engaging with customers every day to ensure that we are meeting their needs. Our team members are experts in their fields, with years of experience and a dedication to excellence that is unparalleled. We believe that our employees are our greatest asset, and we are committed to

providing a top-notch working environment that fosters growth and development. When you work with Viva Railings, you can rest assured that you are working with a team of professionals who are passionate about what they do, our expert team is here to ensure that your project is a success.



NORTH AMERICA OPERATIONS



DESIGN + ENGINEER + FABRICATE + INSTALL

151 W. Vista Ridge Mall Dr. Lewisville, TX 75067

(Dallas/Fort Worth Metroplex)

PH: 972.353.8482 | info@vivarailings.com

vivarailings.com

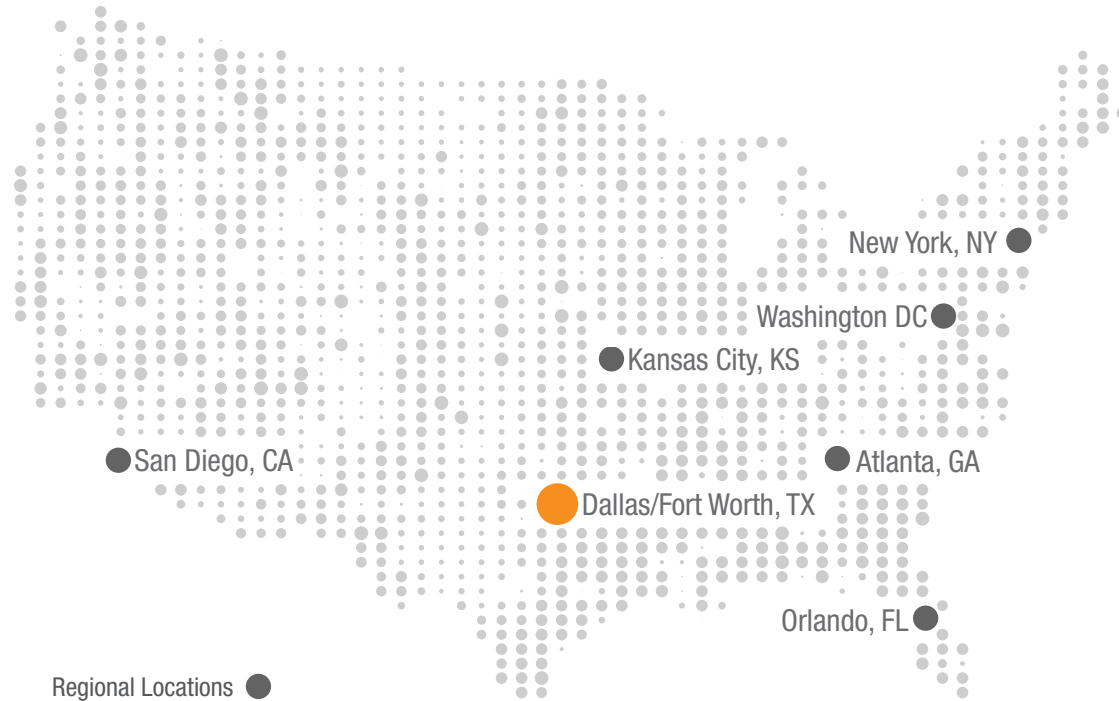

Inc. Magazine 500 | 5000
VIVA RAILINGS, LLC.
Among The Fastest Growing
US Companies
Eight Years in a Row
2012-2019



Inc. Magazine 500 | 5000
VIVA RAILINGS, LLC.
Among The Fastest Growing
Texas Companies
#211



ICC-ES 4405 Certified
SHOE™
Structural Glass Railing System



LEED
Material & Resources Credits 4.1 and 4.2



The American Institute of Architects



The California Contractors State License
Board Certified





Specification tools, product data's, CAD files, BIM objects, AIA CEU Course and other resources are also available on these portals:

