

Product overview

Stainless steel



Expertise in stainless steel

Ferrofix drainage solutions



 Made in Germany

Leading in drainage

Safe and innovative solutions from a single source



"As a premium manufacturer of innovative products for drainage technology, we regard ourselves as a partner for investors, planners and tradespeople who place value on top quality, integrated system solutions for their individual requirements and a comprehensive service that is geared to the needs of our customers."

A handwritten signature in blue ink, appearing to read 'Alexander Kessel'.

Alexander Kessel, Executive Board

KESSEL is your reliable partner and offers you a full service package.

Quality

Own development and production with a world-wide sales network.

Innovation

We are synonymous with innovative products that set standards in the field of drainage technology.

Safety

Customer-oriented brand products and individual solutions to suit your requirements.

Service

Benefit from our services.

KESSEL AG

- More than 50 years of innovation
- More than 600 employees in Lenting and other international locations
- Sustainability for our employees, the environment, the market and the community



Mitglied der
DGNB

Deutsche Gesellschaft für Nachhaltiges Bauen
German Sustainable Building Council

Leading in drainage

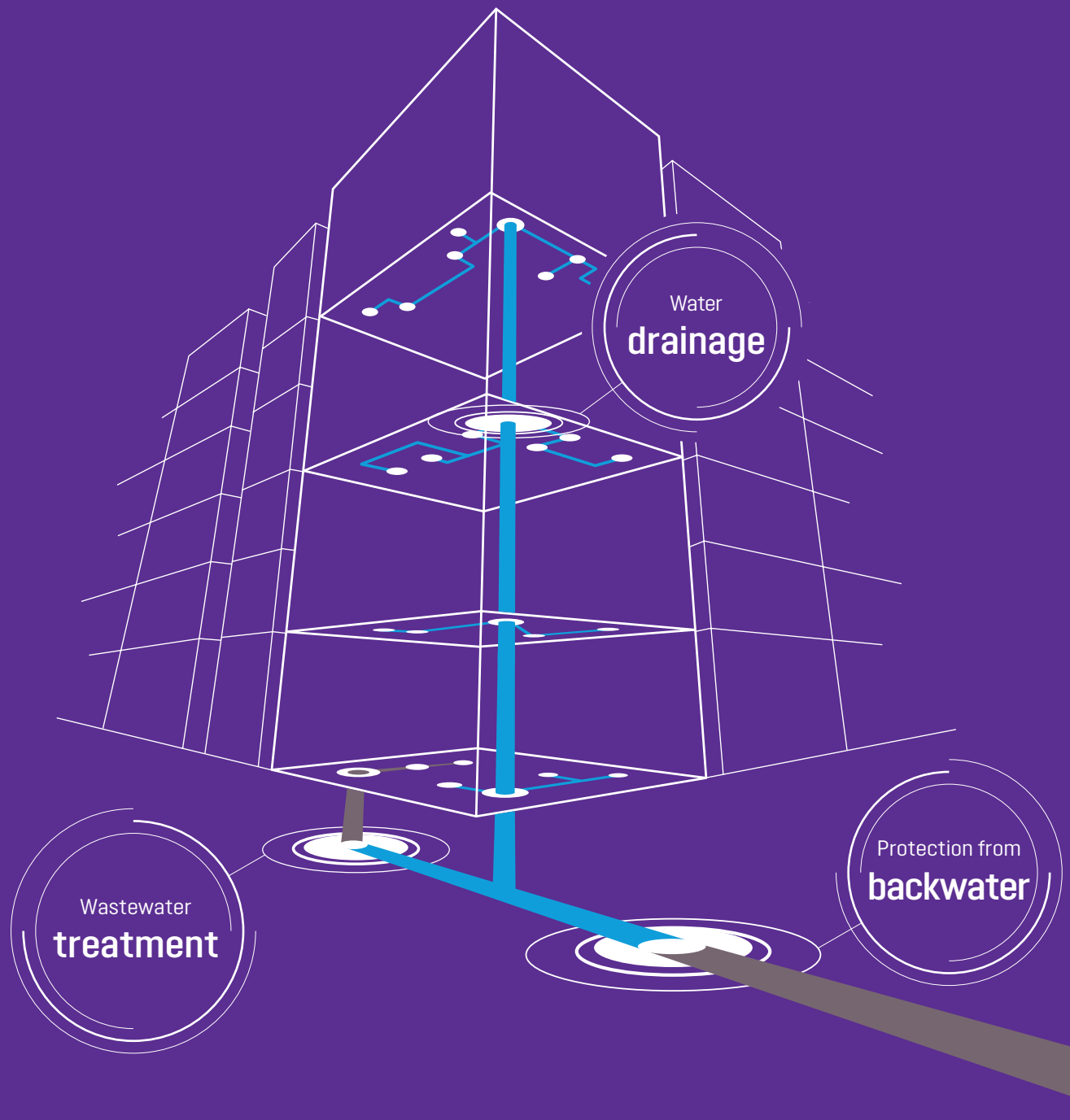

The drinking water supply and discharge of wastewater are comparable with a circulation system in a modern building. Drainage technology that doesn't work can lead to serious water

seepage in buildings, business interruptions and costly consequential damage. There is a risk of massive damage to the building.

The KESSEL full service package

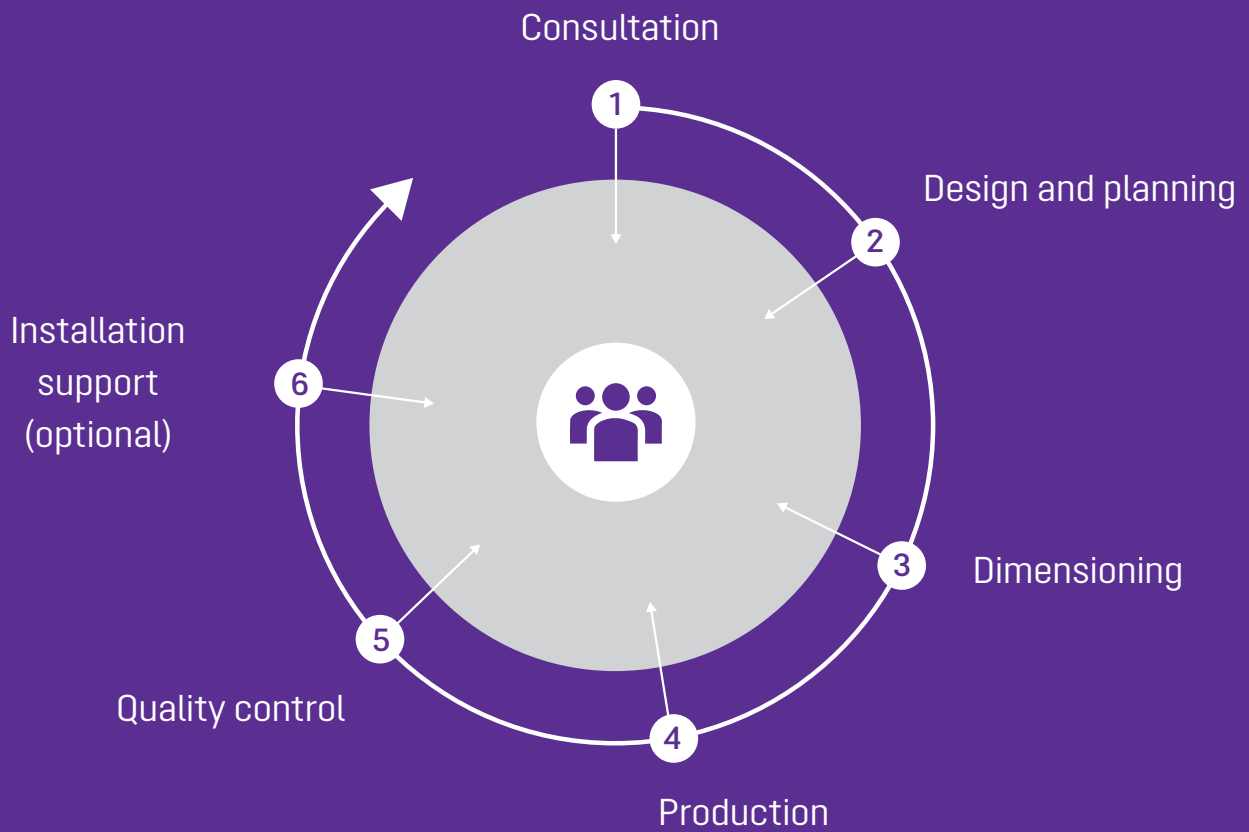



Expertise in **stainless steel!**

Professional kitchens need professional solutions.

For more than 30 years, KESSEL AG has been synonymous with state-of-the-art technology in the field of stainless steel drainage. Our aim is to provide customer-specific solutions with a high level of safety and craftsmanship. This means that we can offer you an almost unlimited variety of products.

We support you with integrated solutions as well as the best service in the industry. From the planning to the installation.

Ferrofix

The steel solution for commerce and industry.

Our *Ferrofix* stainless steel drains are particularly durable solutions for drainage in commercial areas, in which particular hygiene requirements apply. The stainless steel grade 1.4301 (1.4571 on request) used makes the drain suitable for use in areas with the highest standards, for example, in food processing companies or swimming pools.

Our box and slotted channels and floor trays are available as modular versions in various lengths. In general, the length is up to 3 metres, but we're also happy to offer you lengths and dimensions specific to the project. On request, we also develop individual solutions, which we also tailor to your functional requirements in addition to the necessary size.

Application

Safe drainage from large kitchens

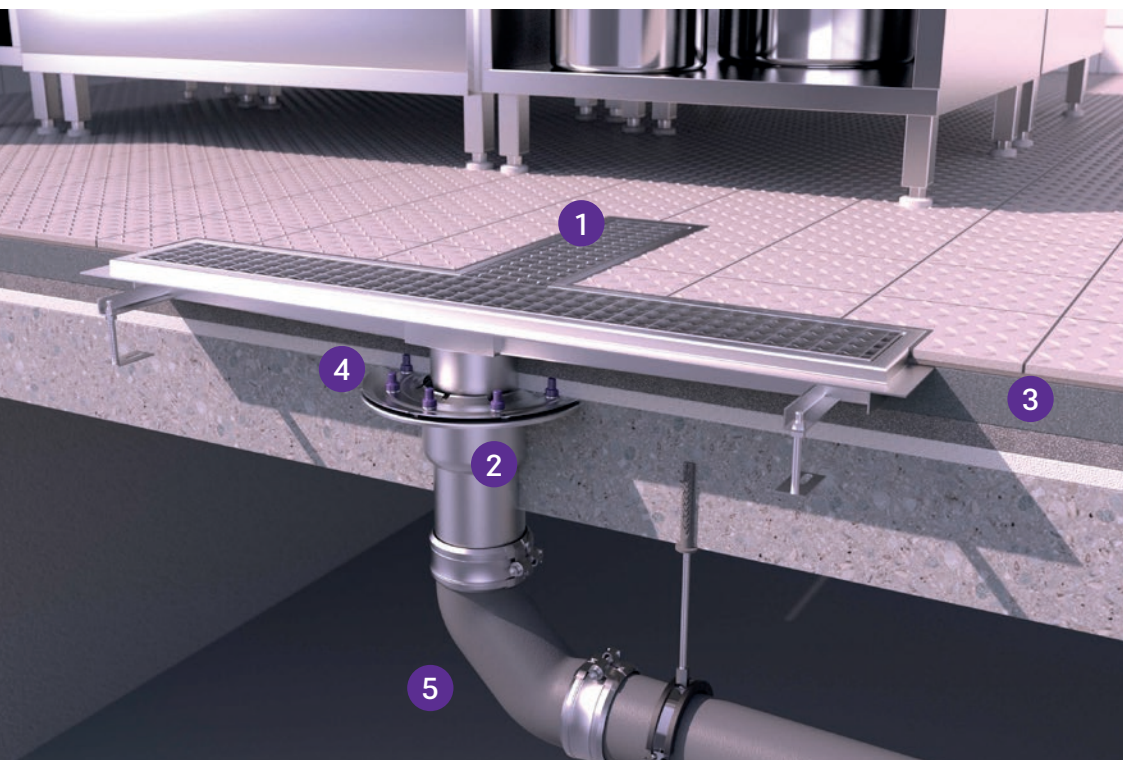

- 1 Drainage channel
- 2 Drain body with *Fire-Kit* fire protection
- 3 Upper waterproofing layer
- 4 Lower waterproofing layer
- 5 Drain pipe

The *Ferrofix* modular system

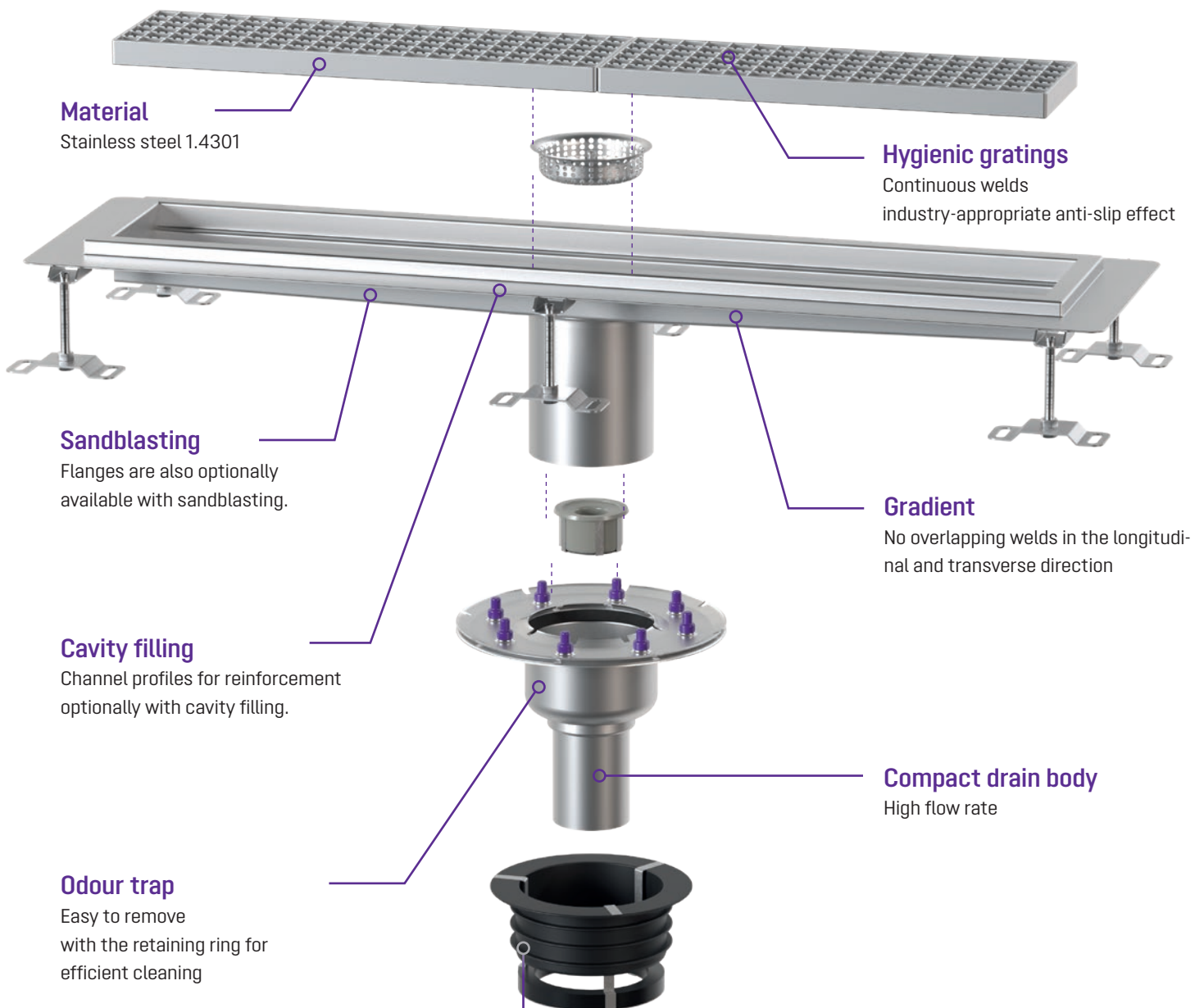

Material

Stainless steel 1.4301

Hygienic gratings

Continuous welds
industry-appropriate anti-slip effect

Sandblasting

Flanges are also optionally available with sandblasting.

Gradient

No overlapping welds in the longitudinal and transverse direction

Cavity filling

Channel profiles for reinforcement optionally with cavity filling.

Compact drain body

High flow rate

Odour trap

Easy to remove with the retaining ring for efficient cleaning

Highest fire protection standards

- Protection in the event of fire with the *Fire-Kit* fire and smoke protection insert or the *Quick-Fit* pipe penetration seal
- Highest fire resistance class R 120

Ferrofix drainage solutions

For further information about our stainless steel drains have a look in our catalogue chapter 4.2.



Your individual channel in just 4 steps

1. Drain body



➤ Page 8 (System 125)

2. Sizes and shapes



➤ Page 10

3. Profiles

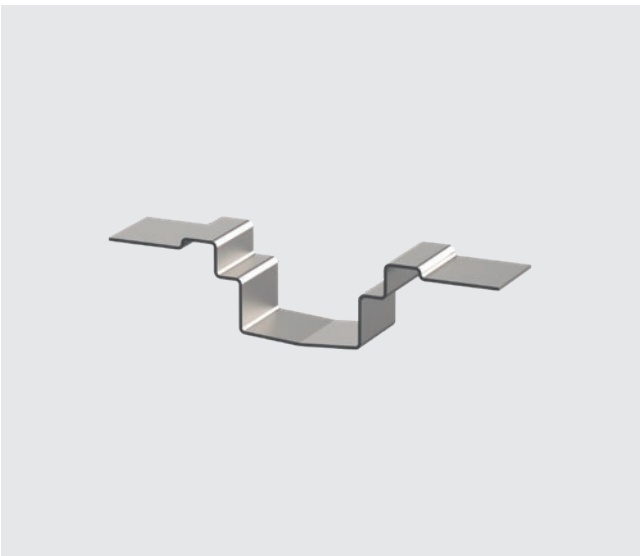

➤ Page 11 – 13

4. Covers

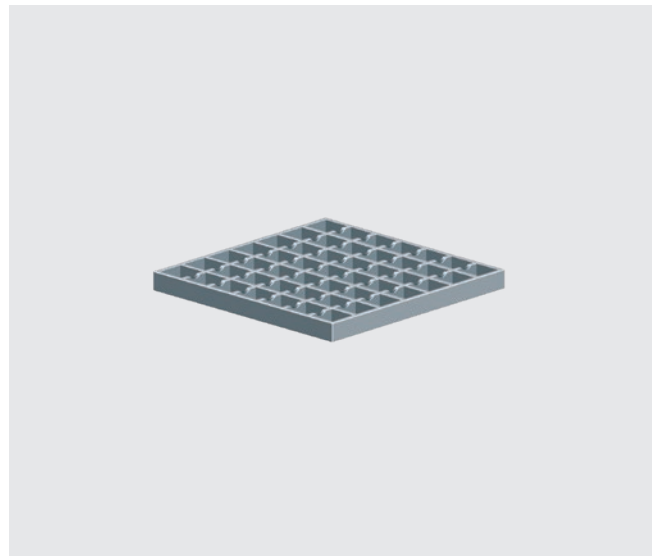

➤ Page 14

1. Drain body

KESSEL Ferrofix floor drains in the System 125



The drain bodies in the *Ferrofix* range set new standards

Our drains meet the highest demands on drainage components in the professional sector. Despite their high flow rate and the possibility of integrated fire protection, they impress with their installation-friendly dimensions. Our extensive accessories allow you to adapt the drain body to your individual needs and simplify installation. Depending on the type of waterproofing layer required, the drain bodies made of 304 stainless steel are available with a connection rim, glued flange or pressure sealing flange.

Ferrofix floor drains offer a high flow rate of up to 2.4 l/s and are available in nominal sizes of DN 70 / OD 78 and DN 100 / OD 110, with a vertical or horizontal outlet.

On request, the Ferrofix is also available as an extremely flat customised version made of 304 stainless steel – ideal for renovation projects. With low overall heights ranging from 100 to 107 mm, the renovation versions are particularly compact. The one-piece drains are supplied with an optional connection rim or glued flange.

2. Sizes and shapes

KESSEL *Ferrofix* box and slotted channels made of stainless steel

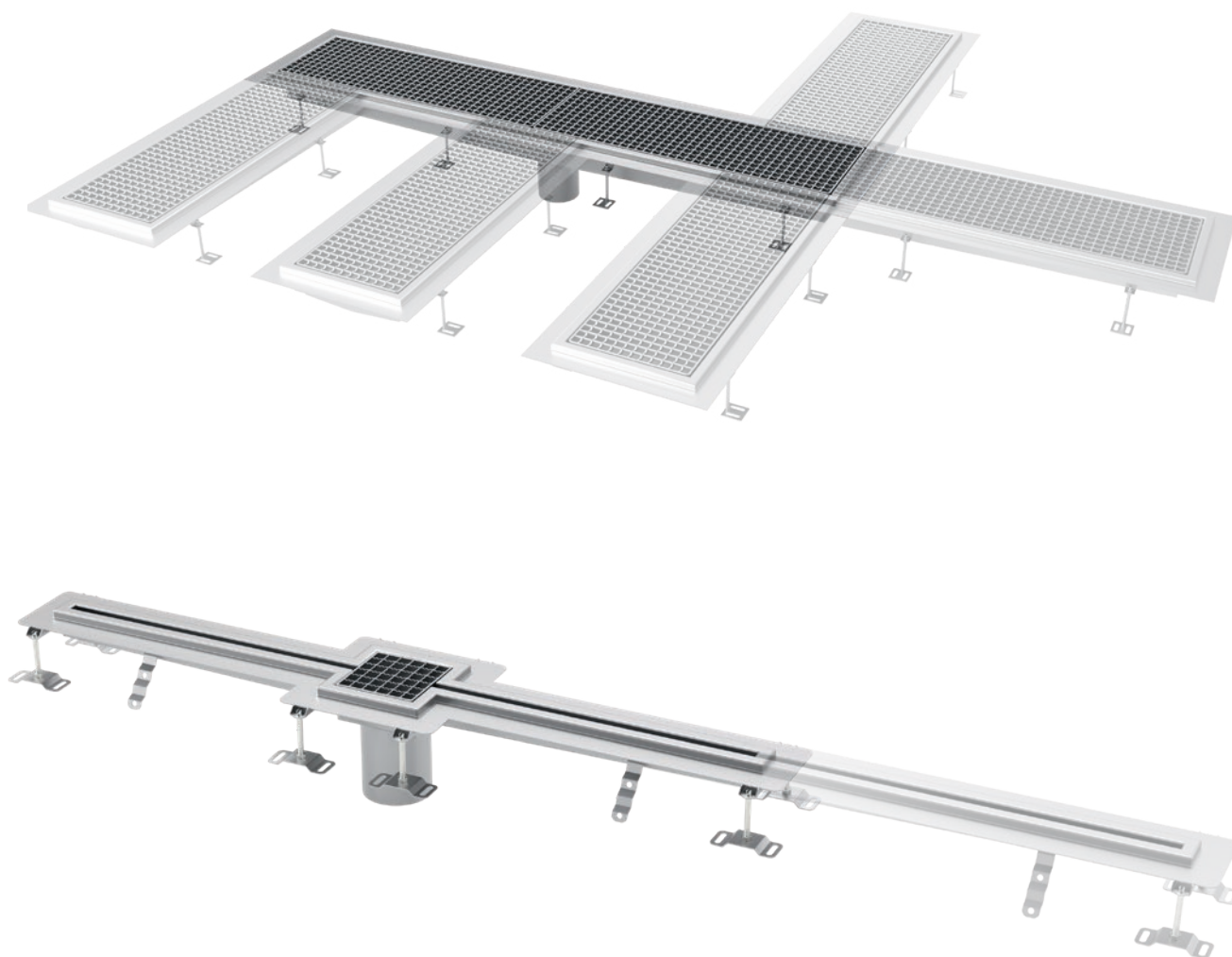

Floor trays, box and slotted channels

On request, we supply the *Ferrofix* as ready-to-install complete channels and trays with pre-assembled outlet spigots, anti-slip gratings and channel profiles with a glued flange for joint sealing. The channels and floor trays are combined with the matching *Ferrofix* or *Ecoguss* drain bodies as well as optional accessories.

3. Profiles

Overview – Different profiles

Flange variants

for floor trays, box and slotted channels

Also with cavity filling and sandblasting on request.
individual@kessel.de

When planning the drainage components in large kitchens, special attention must be paid to the interface between the waterproofing layer and the floor channel. At KESSEL you can obtain solutions that meet the requirements of interfaces and standards with different flange variants, which are tailored to your individual floor covering.

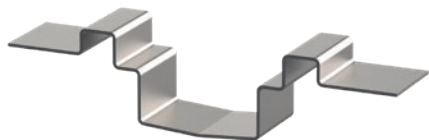

Glued flange, flange height 15 mm

For connection to waterproofing systems with panels and tiles.
(With a 50 mm flange according to DIN 18534).

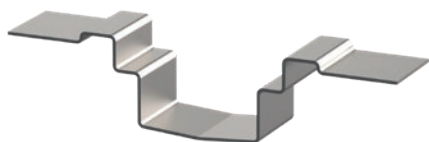

Glued flange, flange height 6 mm

For connection to floor coating systems (e.g. epoxy resin).



Tile connection angle profile

For use in the case of thermal stress on the channel.

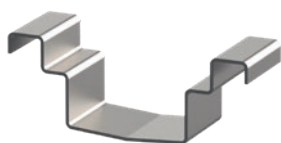

With no flange

Stainless steel channel with a 15 mm glued flange for a tiled floor covering

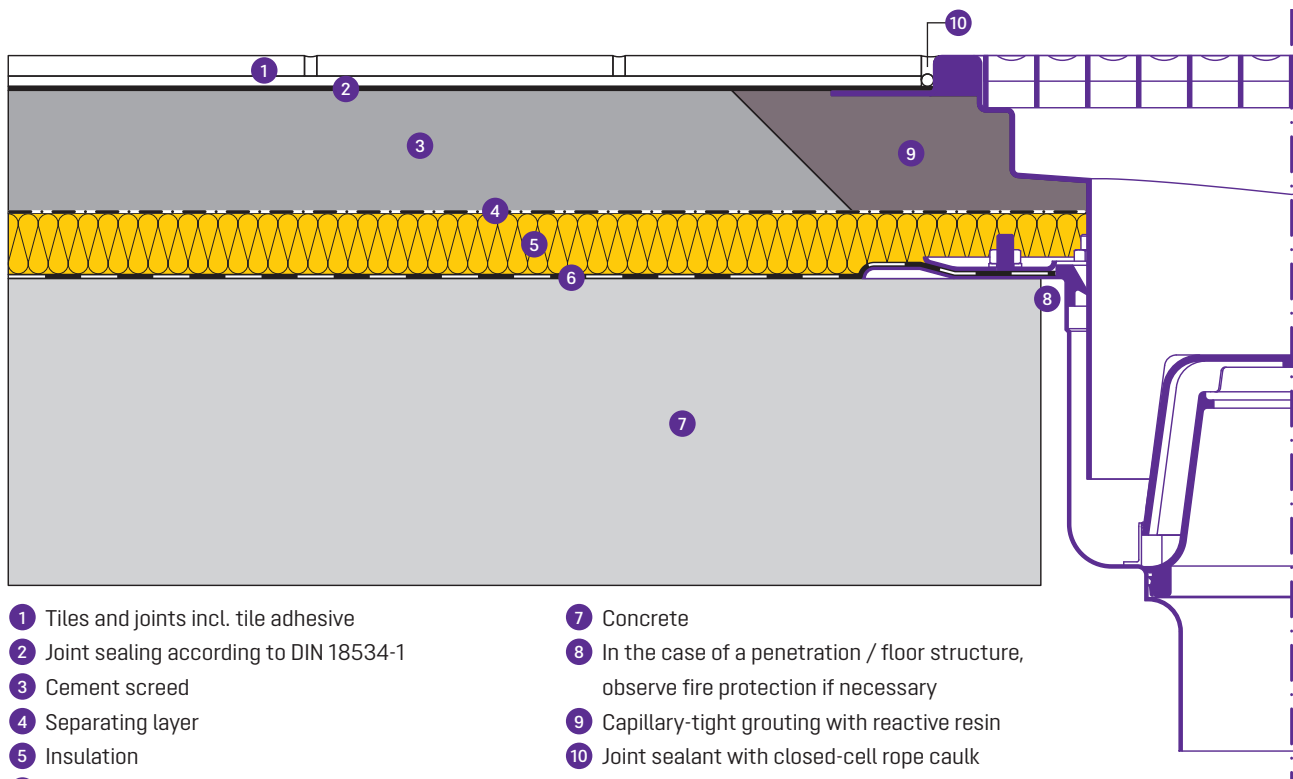

- | | |
|--|--|
| 1 Tiles and joints incl. tile adhesive | 7 Concrete |
| 2 Joint sealing according to DIN 18534-1 | 8 In the case of a penetration / floor structure, observe fire protection if necessary |
| 3 Cement screed | 9 Capillary-tight grouting with reactive resin |
| 4 Separating layer | 10 Joint sealant with closed-cell rope caulk |
| 5 Insulation | |
| 6 Waterproofing foil / separating layer ≥ 1.5 mm according to DIN 18534-2 | |

Stainless steel channel with a 6 mm glued flange for a reactive resin floor covering

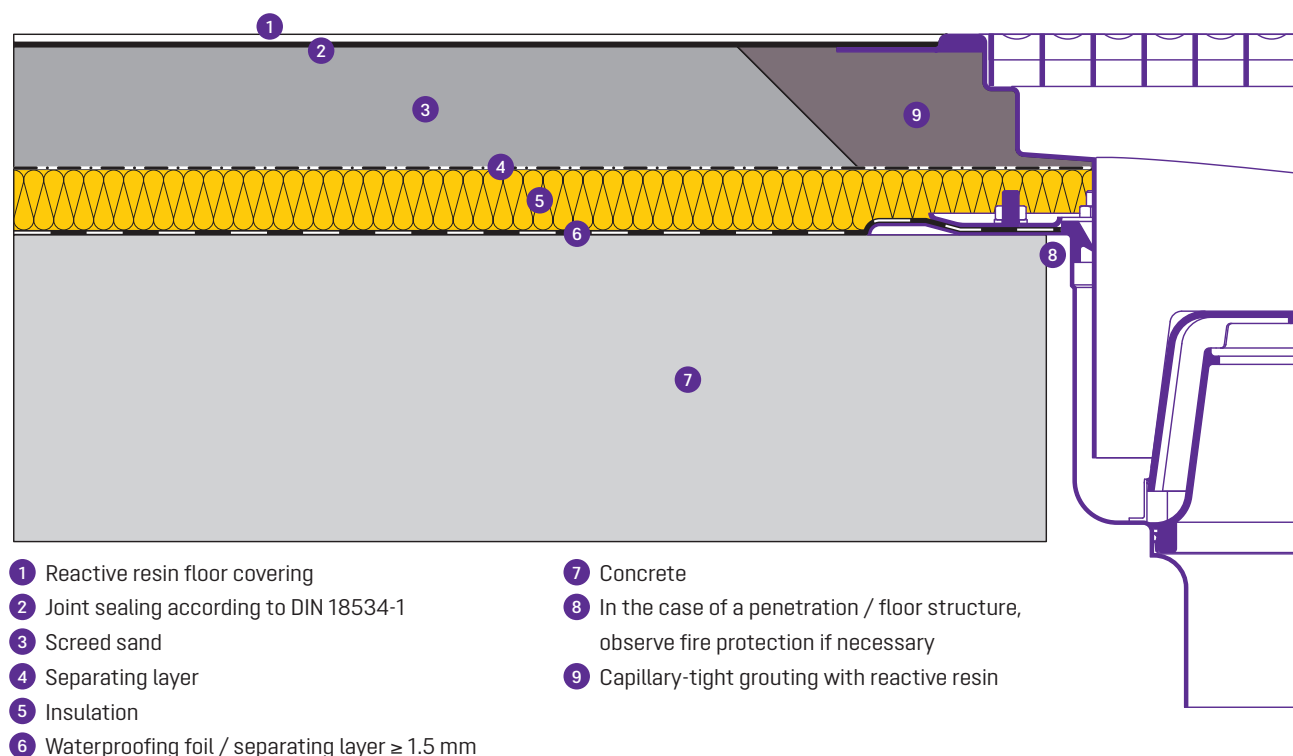

- | | |
|--|--|
| 1 Reactive resin floor covering | 7 Concrete |
| 2 Joint sealing according to DIN 18534-1 | 8 In the case of a penetration / floor structure, observe fire protection if necessary |
| 3 Screed sand | 9 Capillary-tight grouting with reactive resin |
| 4 Separating layer | |
| 5 Insulation | |
| 6 Waterproofing foil / separating layer ≥ 1.5 mm according to DIN 18534-2 | |

Stainless steel channel with thermal stress

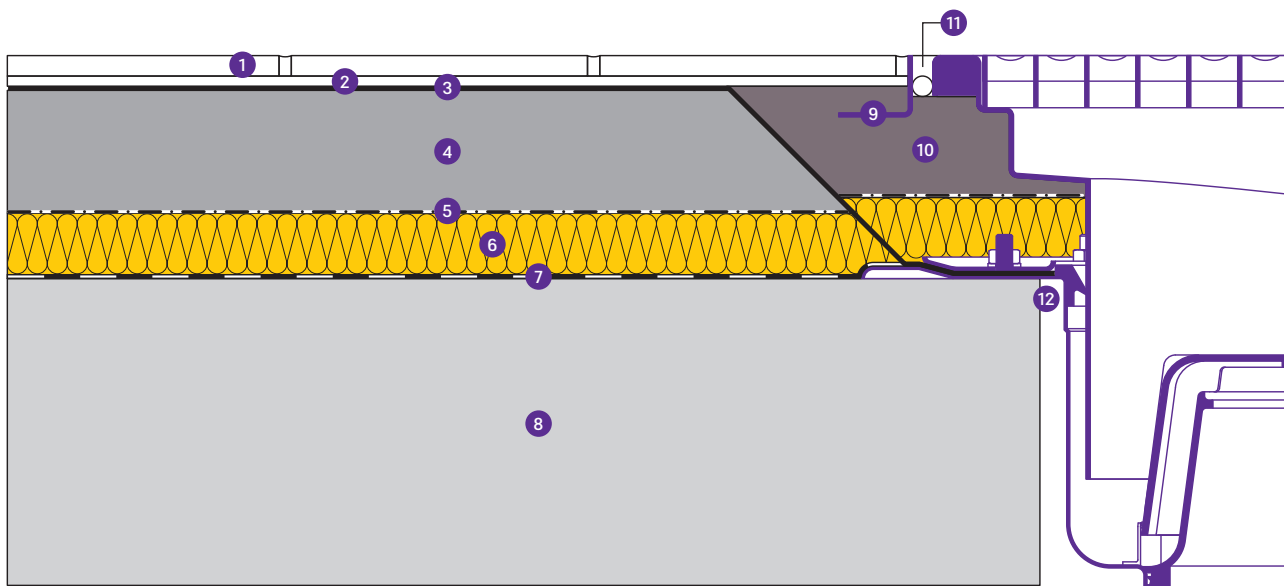

- 1 Tiles and joints
- 2 Tile adhesive
- 3 Joint sealing according to DIN 18534-1
- 4 Cement screed
- 5 Separating layer
- 6 Insulation
- 7 Waterproofing foil / separating layer ≥ 1.5 mm according to DIN 18534-2
- 8 Concrete
- 9 Tile connection angle profile
- 10 Capillary-tight grouting with reactive resin
- 11 Joint sealant with closed-cell rope caulk
- 12 In the case of a penetration / floor structure, observe fire protection if necessary



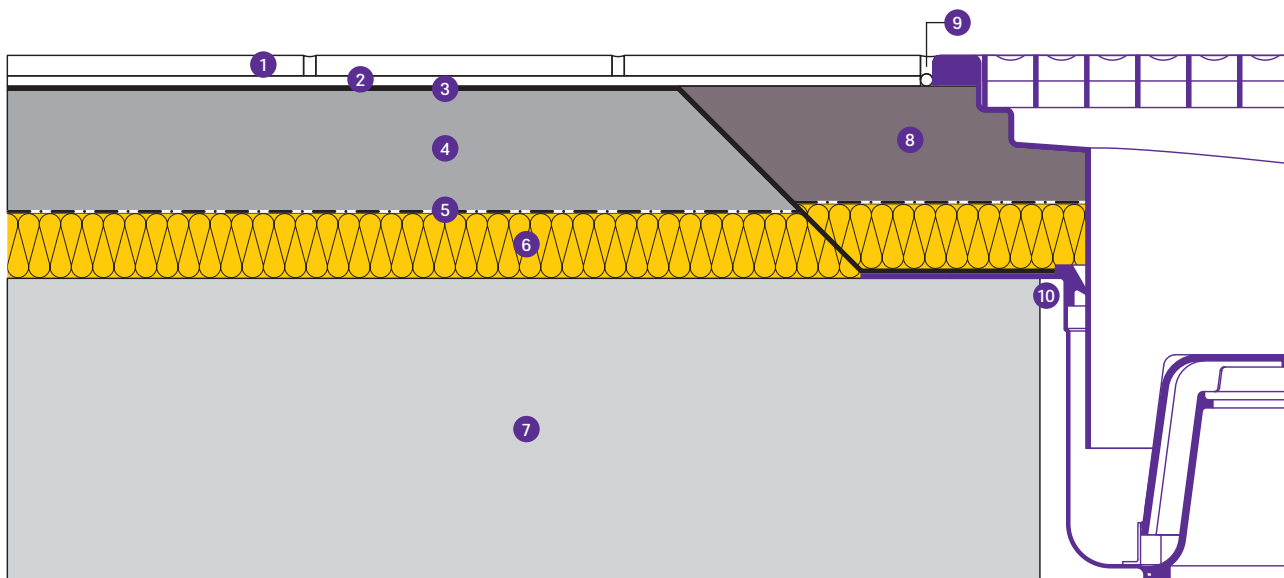





Stainless steel channel with no glued flange for a tiled floor covering

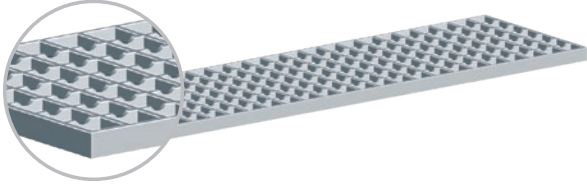

- 1 Tiles and joints
- 2 Tile adhesive
- 3 Joint sealing according to DIN 18534-1
- 4 Cement screed
- 5 Separating layer
- 6 Insulation
- 7 Concrete
- 8 Capillary-tight grouting made of construction resin and quartz sand
- 9 Filling with a flexible or rigid sealant depending on the component dimension requirements
- 10 In the case of a penetration / floor structure, observe fire protection if necessary

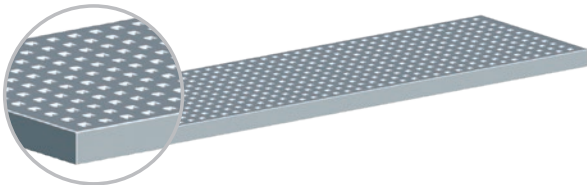
4. Covers

Overview – Channel covers / gully covers

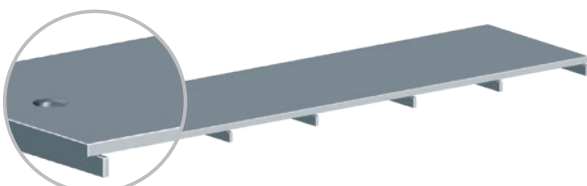
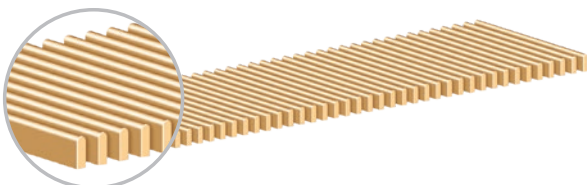
| Designation | Different covers for any channel / gully | Properties |
|--|--|--|
| Stainless steel grating  |  | Load class L 15 or M 125 Anti-slip R 12, pickled in a dip tank Mesh width: 23×23 mm or 30×30 mm or |
| Bar grating  |  | Load class M 125 Not anti-slip, pickled in a dip tank, bar spacing 18 mm, supporting bar 25×8 mm |
| Bathroom grating Stainless steel  |  | Load class K 3 Suitable for barefoot areas, brushed surface, insertion depth: variable Perforation 8×8 mm |
| Plate cover ribbed  |  | Load class M 125 Anti-slip R 11, pickled in a dip tank, inlet with 8 mm circumference, material thickness 10 mm |
| Plate cover  |  | Load class M 125 Anti-slip, glass bead blasted, inlet with 8 mm circumference, material thickness 10 mm |
| Bathroom grating polymer |  | Load class K 3 Suitable for barefoot areas, with a rounded or flat profile top, colours white, grey, beige or yellow (other RAL colours as well as roll-up grille versions on request), insertion depth 25 mm |

At the plate covers,
the wastewater is discharged
via a double-sided inlet
slot (8 mm).



The length
of the segments
is customer-
specific.

Regulations and standards

Safety through correct installation

Areas in commercial kitchens are generally classified in water exposure class W2-I or W3-I with additional chemical stress. The versions of DIN 18534 "Interior waterproofing" are the basis for the execution of the waterproofing work. With this in mind, it is a basic requirement that there are only moisture-resistant surfaces here (e.g. a cement screed on the floor and cement drywall panels). Plasterboard is not permitted. Penetrations, especially in the floor area, are assumed to have corresponding flange options for joint sealing. Channels exposed to high thermal stresses must be prepared in such a way that the waterproofing layer can be run under them, i.e. the screed must be cut out accordingly. If a waterproofing layer is arranged under the screed in accordance with DIN 18534-2, the connection details, especially in the wall area, must be planned correctly.

Relevant regulations and standards

- Interior waterproofing according to DIN 18534 (version 07-2018)
- ZDB information sheet: Joint sealing, 08/2019
- ZVSHK technical information, Interface coordination for wet rooms 12/2018
- Drains and channels in accordance with the ZDB technical information / guidelines 08/2012
- IVD information sheet no. 3 "Design and waterproofing of joints in washrooms / wet rooms"
- Installation instructions according to DIN 1986-100 (waterproofing of buildings, surfaces and walls)
- Sound and fire protection requirements of the states – noise levels to be observed are regulated in DIN 4109 or VDI 4100.

Principles of joint sealing

- The choice of waterproofing layer and surfaces is made in accordance with the requirements of DIN 18534 – Interior waterproofing – from 07/2017
- The surface must be suitable (appropriate building material, flat, dry, load-bearing and crack-free; the surface must provide good adhesion for the layers to be applied)
- All materials must be acclimatised to the ambient temperatures and the processing temperatures must be maintained
- Use only approved sealants (approvals according to the Ü-mark, abP, ETA and / or DIN EN 12004)
- Floor and wall surfaces must always be waterproofed directly in the stressed area (such as the walls in a shower area and shower areas with the same floor level)
- Suitable sealants must be selected depending on the existing surfaces and water exposure classes (see also: DIN 18534)
- Apply the waterproofing layer without any imperfections according to the manufacturer's specifications (at least two steps / layers)
- Observe the minimum drying times of the individual layers
- Only floor drains with a glued flange should be used to connect to the joint sealing

Waterproofing of expansion joints / edge joints

- Use an inlay made of fleece, fabric or foil in such a way that planned component movements can be absorbed.
- Only use approved sealing tapes / collars

Drain technology and fire protection

Why a fire-resistant material alone is not enough

Fire protection is probably the most important safety requirement that drainage technology has to meet. Many planners are misled into believing that only drains made of a non-combustible material (such as cast iron or *Ecoguss*) are required. The actual hazards posed by floor drains in the event of a fire require other solutions:

Danger

Smoke/gas emission

through leaks in and around the floor drain

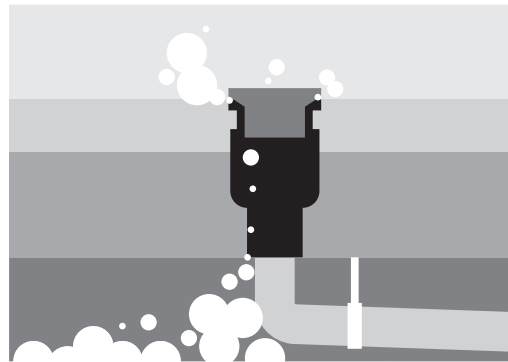

Solution

→ Air-tight closure of the drain

Fire spreading

to other rooms due to the draining system "burning away"



→ Fire protection elements with a high fire resistance class

Heat transmission

and ignition of combustible materials through non-combustible draining objects

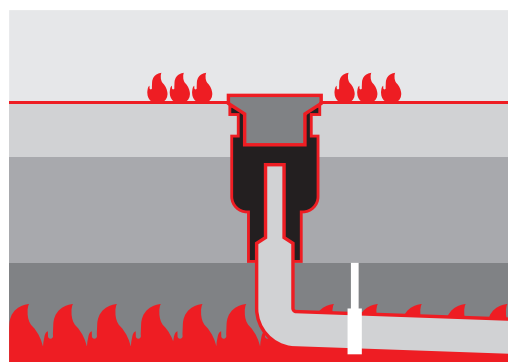

→ Non-heat conducting drain material

Guaranteed in accordance with the regulations

Fire protection for *Ferrofix* drains

The odour traps of *Ferrofix* drains ensure that in the event of a fire neither heat nor toxic gases are transferred from the floor below the drain. With fire protection elements such as the *Fire-Kit* fire protection insert, the drain is sealed as prescribed as soon as the fire reaches the drain.

How does the *Fire-Kit* fire protection insert work?

Pipe loosens due to the extreme heat

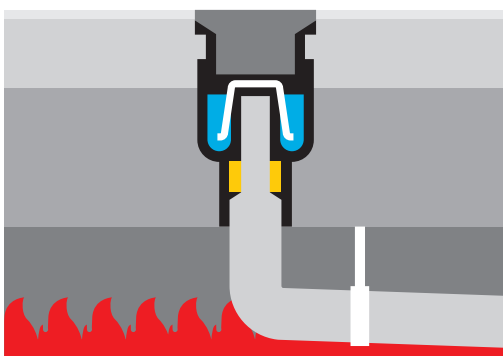

Fire protection insert swells up as soon as it comes into contact with fire

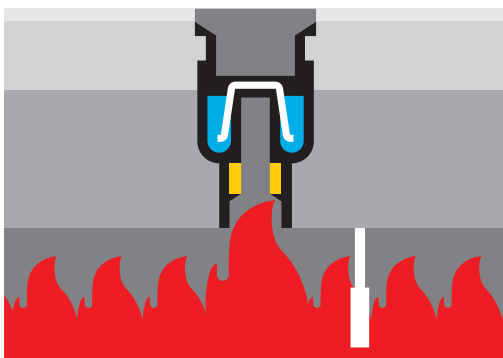

Drain is sealed, thus preventing further fire damage



Expertise in stainless steel

Building examples



Tucherbräu am Opernhaus,
Nuremberg, restaurant, 2021



Audi Sportpark,
Ingolstadt, sports stadium, 2010



Oberlahnbad,
Weilburg, sports centre, 2017



Spitalgarten,
Regensburg, hotel and restaurant, 2017



For further
information visit

www.kessel.com



Subject to technical modifications.

KESSEL AG

Bahnhofstraße 31 • 85101 Lenting (Germany)

www.kessel.com