



Natural wood
Made to last

Product Guide



Sustainable
wood cladding &
decking for long-
lasting projects.



Content

Decking	04
Kebony Deck Board	06
Boardwalk Decking	08
Cladding	10
Passive Rainscreen System	13
Kebony Clear Cladding	14
Kebony Character Cladding	16
Millwork	19
About Kebony	20
The Modification Process	24
Performance	26
Kebony vs. Ipé	28
How to Buy	30

Decking

Sourced from FSC®-Certified forests, our Kebony® Clear decking is engineered to handle the harshest of conditions. The rich brown color and clear grain are designed to impress, while hardwood-like durability and a 30-year warranty provide supreme peace of mind. Whether you maintain the original color or let Kebony Clear naturally patina, your project will amaze for decades to come.

Decking Products

- Kebony Deck Board
- Boardwalk Decking

ZILKER DECK

Austin, TX

Product: Kebony Deck Board with Step-Clip
for Kebony Fasteners (#2637, #2638)

Builder: FIA Homes

Photography: James Burniston







The Kebony Deck Board

The Only 4-in-1 Wood Decking Profile

The Kebony Deck Board is the most versatile wood decking profile on the market. We've engineered a profile that can be fastened in four different ways, making it easy to secure your surface decking according to your needs without added milling or lead time. Whether you want to fasten through the face of the board, plug, use hidden fasteners or the patented Step-Clip™ for Kebony system, the Kebony Deck Board is ready to go.

- 30-year, non-prorated warranty against rot
- 50-75 year expected life span as decking
- No maintenance required

- Evenly fades to silver-gray patina when left unfinished
- End-seal wax not needed or recommended

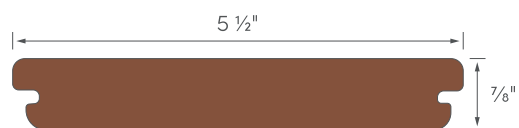

5/4x6 Clear Kebony Deck Board (INNER BOARD - #2637)

Actual Dimensions: 7/8" x 5 1/2"

Lengths: 10', 12', 14', 16'

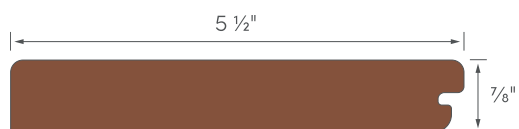

5/4x6 Clear Kebony Deck Board (OUTER BOARD - #2638)

Actual Dimensions: 7/8" x 5 1/2"

Lengths: 14'



In Stock in the USA

Step-Clip® for Kebony

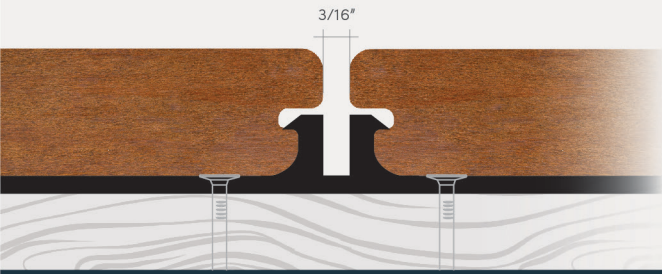

HIGHLIGHTS

- Fastest of the four install options
- Step-Clip® strip doubles as joist protection
- Automatic and consistent deck board spacing
- Easy board replacement

Step-Clip® Is A Registered Trademark Of Barrette Outdoor Living, Inc., Used With Permission By Kebony

Fastenator™ Hidden Fasteners

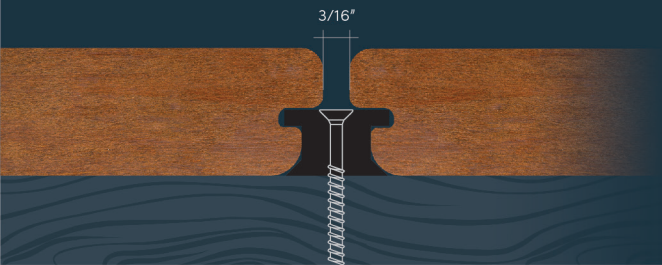

HIGHLIGHTS

- Automatic and consistent deck board spacing
- Works great for diagonal and herringbone deck patterns
- Ideal for resurfacing and/or out of square framing
- Stainless steel screws are pre-loaded in clip for quick and easy fastening

Pro Plug® System for Kebony

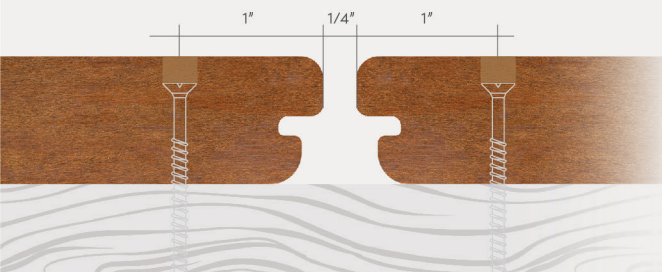

HIGHLIGHTS

- Hidden fasteners with face fastened strength
- Plugs made from actual Kebony face grain, so they perfectly match the surface
- Patented Pro Plug® Tool pre-drills and counterbores simultaneously for a perfect fit
- Kebony Kits include screws, plugs, glue nozzle and drill bit (Pro Plug® Tool and glue sold separately)

PRO TIP: Keep screws at least 1" from the end and edges of the boards.

Face Fastened

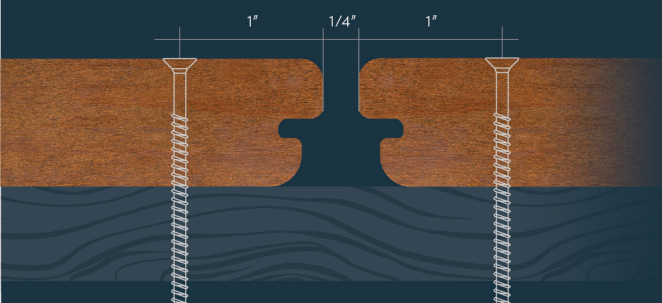

HIGHLIGHTS

- Ensures a secured board to the joist

PRO TIPS

- Pre-drill holes prior to fastening
- Use Stainless Steel Screws
- Keep screws at least 1" from the end and edges of the boards.
- Make sure screws are flush with top of the deck board to maintain a smooth and safe surface

Boardwalk Decking

Kebony Clear is perfect for high traffic areas like boardwalks and docks. With larger available dimensions and enhanced stability, choosing Kebony will ensure your project will withstand heavy use and retain beauty as it patinas to a silver-gray over time. Kebony's boardwalk product is the go-to for award-winning outdoor spaces across the country, including The Wharf in Washington D.C. and New York City's Hunter's Point South.

Available Profile



2x6 Clear Square S4S E2E (#2522)

Actual Dimensions: 1 1/2" x 5 1/2"

Lengths: 10', 12', 14', 16'

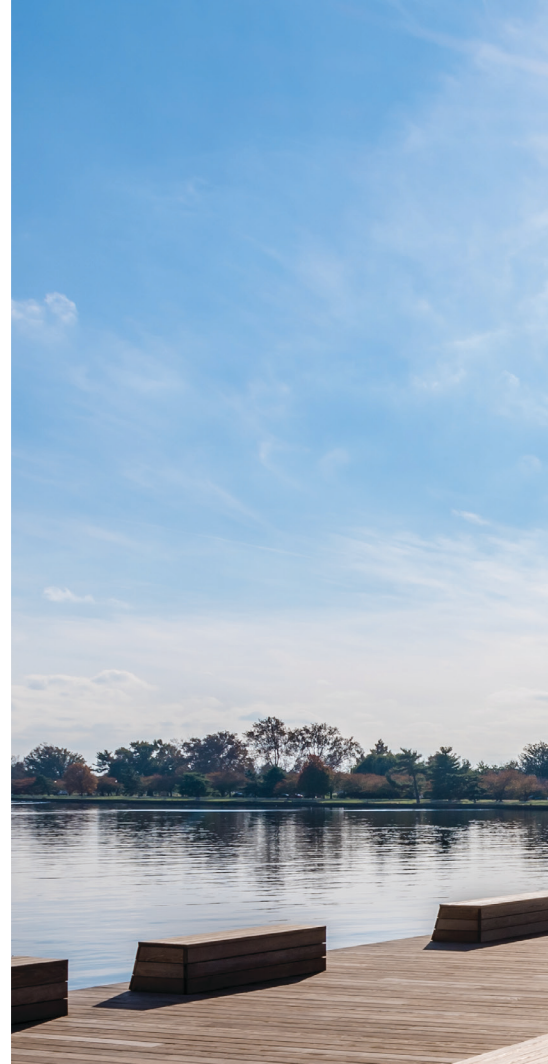

Get more information and installation guides at www.kebony.us.



THE WHARF DC

Washington, DC

Product: Kebony Clear Boardwalk (#2522)

Architect: Hoffman-Madison Waterfront

Builder: Clark Construction Group

Photography: Sean O'Rourke Photography

Cladding

Kebony is leading the way in sustainable and long-lasting real wood cladding. Our award-winning cladding projects have solidified Kebony as the go-to for America's top architects. Kebony cladding is unmatched in beauty, durability, and sustainability.

Cladding Products

- Passive Rainscreen System
- Kebony Clear Cladding
- Kebony Character Cladding





EDMONDS HOUSE

Animas Valley, NM

Product: Kebony Clear Rough Sawn
(#1935 Machined to T&G Nickel Gap)

Architect: Jim Rothwell

Millwork: Delta Millworks

Photography: Marona Photography



FULSHEAR HOUSE

Fulshear, TX

Product: Kebony Character 90 Degree Shiplap (#2216)

Architect: Tammy Hodgeson

Photography: Kristian Alveo

Passive Rainscreen System

The Passive Rainscreen System (PRS) goes beyond a traditional rainscreen to deliver maximum performance and aesthetics. A combination of marine-grade aluminum clips and perfectly matched Kebony Clear cladding, the PRS replaces common wood furring strips to create passive air flow between the cladding and sheathing. Its unique cladding profile creates a gap while providing increased protection from the elements, leading to a longer-lasting project all while hiding the fastener from view.

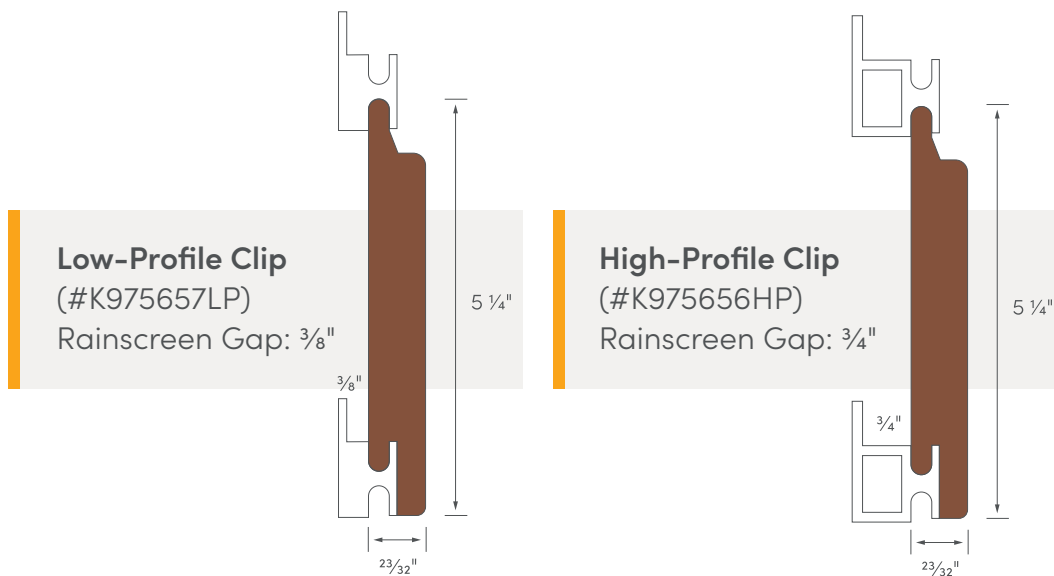

1x6 Clear Rainscreen Cladding (#KPRS1X6)

Actual Dimensions: 23/32" x 5 1/4"
 Face: 4 9/16"
 Gap: 3/8"
 Lengths: 10', 12', 14', 16'

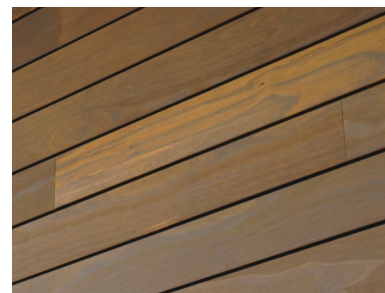

Passive Rainscreen cladding is special order, which may result in a longer lead time. Get more information and installation guides at www.kebonny.us.

Kebony Clear Cladding



SILVERNAILS HOUSE

Rhinebeck, NY

Product: Kebony Clear Square S4S E2E (#2226)

Architect: Amalgam Studio

Photography: Oliver Mint, Jesse Turnquist

Kebony Clear cladding is a perfect fit for residential and commercial siding applications. The uniform color will naturally patina over time like Brazilian Hardwoods, but without the instability and inconsistent color or grain. Our cladding also comes with a 30 warranty against rot, ensuring the beauty of your best projects for decades to come.

1x6 Clear Rough Sawn (#1935)

Actual Dimensions: 1" x 6"

Lengths: 10', 12', 14', 16'

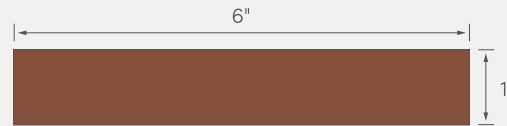

CAN BE MILLED TO ANY PROFILE

Available Profiles



1x6 Clear T&G w/Nickel Gap (#KTGNG)

Face: 5 1/4" Gap: 1/8"

Actual Dimensions: 3/4" x 5 1/2"

Lengths: 10', 12', 14', 16'

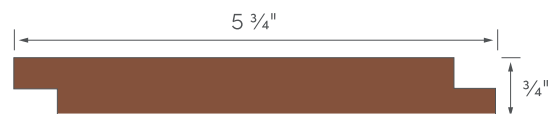

1x6 Clear 90 Degree Shiplap (#K90XX514)

Face: 5 1/4"

Actual Dimensions: 3/4" x 5 3/4"

Lengths: 10', 12', 14', 16'

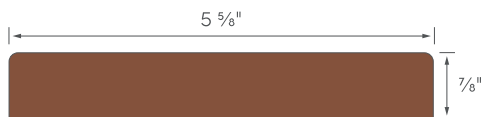

5/4x6 Clear Square S4S E2E (#2226)

Actual Dimensions: 7/8" x 5 5/8"

Lengths: 10' 12', 14', 16'



1x6 Clear Rhombus (#2436)

Actual Dimensions: 3/4" x 4 3/4"

Lengths: 10', 12', 14', 16'

All profiles are special order, which may result in a longer lead time. Get more information and installation guides at www.kebonny.us.

Kebony Character Cladding

The knotty grain of Kebony Character cladding gives your project a rustic feel at a value-conscious price. Kebony Character goes through the same modification process and comes with the same 30-year warranty as Kebony Clear.



BURKE MUSEUM

Seattle, WA

Product: Kebony Character Cladding

Architect: Olson Kundig

Photography: Ben Roberts & James Burniston

Available Dimensions

1x3 Character Square (#2335)

Actual Dimensions: 21 x 73 mm
Lengths: 3 m, 3.6 m, 4.2 m, 4.8 m

1x4 Character Square (#1407)

Actual Dimensions: 21 x 98 mm
Lengths: 3 m, 3.6 m, 4.2 m, 4.8 m

1x5 Character Square (#2336)

Actual Dimensions: 21 x 123 mm
Lengths: 3 m, 3.6 m, 4.2 m, 4.8 m

1x8 Character Square (#2338)

Actual Dimensions: 21 x 198 mm
Lengths: 3 m, 3.6 m, 4.2 m, 4.8 m

Available Profiles

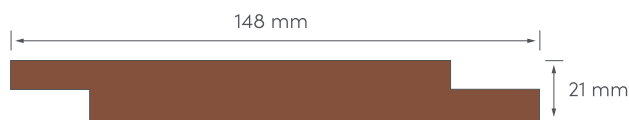

1x6 Character 90 Degree Shiplap (#2216)

Actual Dimensions: 21 x 148 mm
Lengths: 3 m, 3.6 m, 4.2 m, 4.8 m

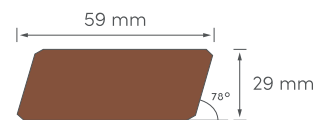

Character 70 Degree Rhombus (#2168)

Actual Dimensions: 29 x 59 mm
Lengths: 3 m, 3.6 m, 4.2 m, 4.8 m

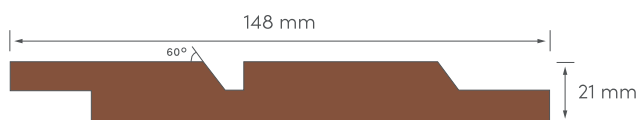

1x6 Character 60 Degree Shiplap w/Shadow (#2242)

Actual Dimensions: 21 x 148 mm
Lengths: 3 m, 3.6 m, 4.2 m, 4.8 m

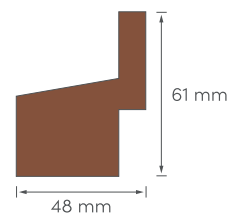

Character Melsomslat (#1217)

Actual Dimensions: 61 x 48 mm
Lengths: 3 m, 3.6 m, 4.2 m, 4.8 m

All profiles are special order, which may result in a longer lead time. Get more information and installation guides at www.kebony.us.

Millwork

Our Kebony Clear lumber has tremendous versatility compared to tropical hardwoods. Not only is our FSC®-Certified wood easy to work, it is dimensionally stable. The modification process changes the cell structure of the wood without harsh additives or glues to get in the way. For this reason, Kebony can handle heavy use on commercial benches, create stunningly intricate outdoor sculptures, or get milled down for wooden guitar picks and silverware handles.



EDMONTON FUNICULAR
Edmonton, AB, Canada
Product: Kebony Clear 2x8
Architect: Dialog Design
Photography: Brock Kryton



2019 Winner



Available Dimensions in Kebony Clear

2x3 Clear Beam S4S E4E (#2480)

Actual Dimensions: 1 1/2" x 2 17/25"

Lengths: 10', 12', 14', 16'

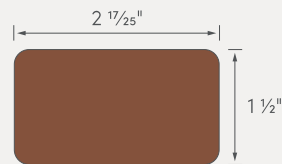

1x4 Clear Rough Sawn (#2535)

Actual Dimensions: 1" x 4"

Lengths: 10', 12', 14', 16'

1x6 Clear Rough Sawn (#1935)

Actual Dimensions: 1" x 6"

Lengths: 10', 12', 14', 16'

2x4 Clear Rough Sawn (#2423)

Actual Dimensions: 2" x 4"

Lengths: 10', 12', 14', 16'

1x8 Clear Rough Sawn (#1931)

Actual Dimensions: 1" x 8"

Lengths: 10', 12', 14', 16'

2x6 Clear Rough Sawn (#2489)

Actual Dimensions: 2" x 6"

Lengths: 10', 12', 14', 16'

2x8 Clear Rough Sawn (#2537)

Actual Dimensions: 2" x 8"

Lengths: 10', 12', 14', 16'

All profiles are special order, which may result in a longer lead time. Get more information and installation guides at www.kebony.us.

About Kebony

Natural wood made to last.

Headquartered in Oslo, Norway, Kebony is the leading global modified wood brand. Underpinned by proven and patented timber modification technologies, it produces an enhanced wood of superior quality that is both environmentally friendly and cost-effective.

From its production facilities located in Skien, Norway, and Flanders, Belgium, Kebony redefines standards in the timber industry and new possibilities for wood as a sustainable construction material. Kebony has sales and distribution across Europe spanning into North America and the rest of the world.

The company has received numerous awards and accolades for its environmentally friendly technology and innovation, including being named a World Economic Forum Technology Pioneer, repeated recognition as a Global Cleantech 100 company, and a 2019 Building, Design + Construction Top 101 Products Reader's Choice Winner.

Kebony Technology

Fully compliant with EU Timber Legislation, Kebony technology permanently transforms sustainable wood species such as pine into finished products with characteristics comparable to and, in some cases, better-performing than tropical hardwoods. This unique, patented technology is a process whereby sustainably sourced wood species are impregnated with furfuryl alcohol, which is derived from agricultural crop waste. With the addition of heat, the furfuryl polymer is permanently grafted into the wood cell wall, resulting in greatly improved durability and dimensional stability, making the wood strong and resistant to biological decay and harsh weather conditions.

FSC®-certified, Kebony wood provides architects and specifiers with a product that is unrivalled in its performance, delivering aesthetic value and durability.



Kebony's mission

Through active innovation and forward thinking, we will continue to produce beautiful, long-lasting and environmentally friendly wood products. The company will promote and practice social responsibility to improve the environment in a way that builds a better future.



UNIVERSITY OF MIAMI B.E. & W.R. MILLER BUILDLAB

Miami, FL

Product: Kebony Clear Cladding (#2436, #K90, #2522, #2226)

Architect/Builder: Rocco Ceo - University of Miami

Department of Architecture

Photography: Herman Schumacher Photography



The Modification Process

Developed in Norway, Kebony is an environmentally friendly, patented process that enhances the properties of sustainable softwood with a bio-based liquid. The process permanently modifies the wood cell walls, giving Kebony premium hardwood characteristics and a rich brown color throughout in two basic steps.

Step 1: Impregnation

Impregnation is the process in which the wood is infused with furfuryl alcohol (FA) produced from a bio-based liquid to make it dimensionally stable.

Step 2: Curing and Drying

After impregnation, the wood is heated, also known as curing. The resulting polymer, which is now permanently locked into the wood cells, is stable and will not disintegrate or leach out of the wood.

Result: Kebony Wood

After modification, the wood cell walls are 50 percent thicker due to the stable, locked-in polymers. This permanent modification of the wood cell walls gives the final wood product outstanding stability, the maximum amount of hardness and a guaranteed long life. Kebony wood also provides a high level of safety as the wood does not splinter and contains no toxins or chemicals, as well as staying cooler in the summer.

Because Kebony permanently changes the wood's behaviors as compared to natural woods, there is no need to consistently maintain the surface for longevity; you can simply let the wood naturally gray like Ipé or other Brazilian hardwoods.

Steps

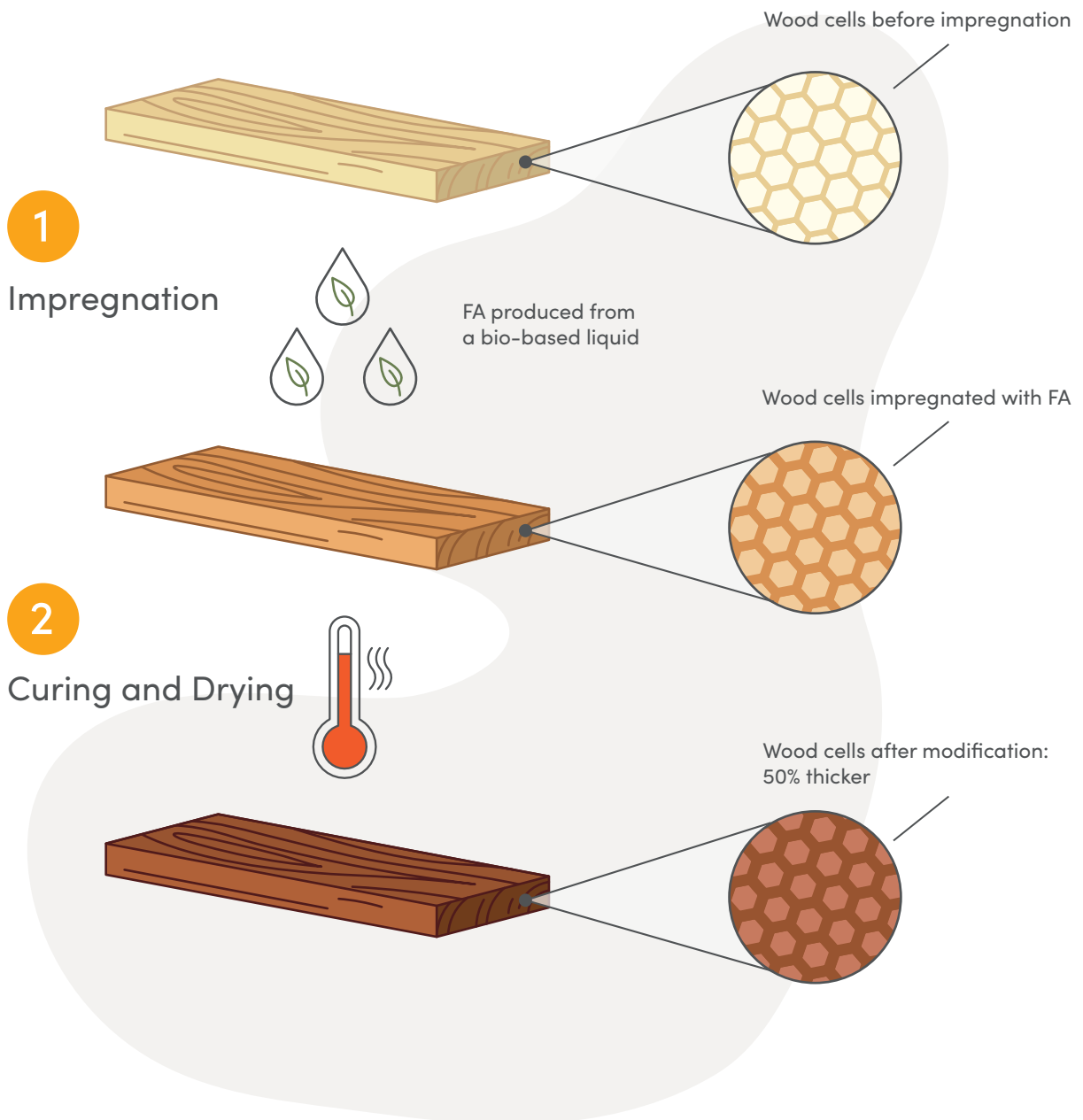

Stable, locked-in furan polymers in the wood cell walls give:
 Outstanding stability • Maximum hardness • Guaranteed long life

Performance

Appearance

All Kebony woods have a deep brown color that will turn to a silver-gray patina over time. The speed of this graying process depends on the intensity of exposure to environmental elements like the sun and rain combined with the type of application.



Kebony Clear RAP products are produced from FSC®-certified *Pinus Radiata*, they have a clear front surface and are treated through the board. They can be further machined as any other hardwood.

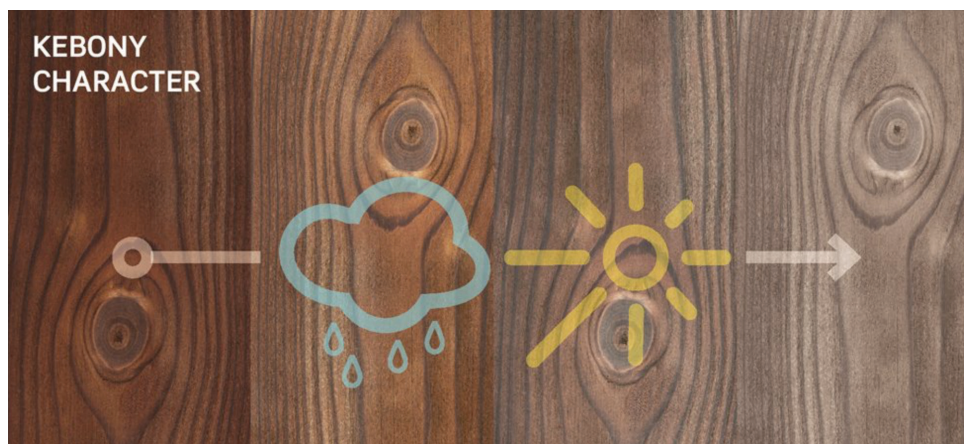

Kebony Character products are produced from FSC®-certified *Pinus Sylvestris* and contain knots and untreated heartwood. They should not be further machined or split as untreated heartwood will be exposed. Kebony Character products can be cross-cut to length. Exposed end grain after cross-cutting must be treated with a wood preservative.



Durability, Hardness & Maximum Movement

Wood species	Durability 1=best EN 350	Hardness Janka (lbf)	Swelling Dry to wet in tangential direction (%)
Ipe	1	3510	6
Kebony Clear RAP	1	1618	4
Teak	1	1070	3 - 4
Thermo Ash	1 - 2	900	5
Kebony Character	1 - 2*	630	6
Thermo Pine	2	600	4
Western Red Cedar	2 - 3	350	5

*Heartwood

Kebony vs. Ipe

Whether you call it epay, ipe, or I.P.E. (the correct pronunciation is ee-pay, FYI), the Brazilian Hardwood known as Ipe is starting to come under fire; literally and figuratively. Between increased fires in the Amazon Basin and illegal harvesting, it's time to start looking for Alternatives for Ipe.

So, how does Kebony stack up against Ipe and other Brazilian hardwoods? We are going to look at 5 main characteristics.

Durability

Ipe has always been known for its strength, being branded as “Iron Wood” by some importers. There's no doubt Ipe is extremely durable, in terms of hardness, the Brazilian Hardwood is more than twice as hard as Kebony Clear on the Janka hardness test. Ipé is also touted as lasting 75-100 years; that's a long time!

How strong is too strong?

Keconomy is not as hard as Ipe, but does it need to be? Kebony does come with a 30-year warranty and is still as hard as other Brazilian Hardwoods. Ipe's density makes it extremely hard to work with, so be prepared to pre-drill and buy extra carbide-tipped saw blades. The biggest advantage Kebony has over Ipe is in stability. Kebony's modification process makes it very resistant to warping, cupping and splintering, which is a common problem with any tropical hardwood that leads to added waste.

Winner: Ipe for density, Kebony for stability and warranty

Appearance

Keconomy Clear and Ipe are very similar in appearance. Both have a rich brown color, and both will naturally fade to a nice light gray unless regularly oiled. Both products also have a clear and straight grain pattern. The difference in Kebony and Ipe is the consistency. Kebony has a very uniform color and grain pattern, where Ipé will have variations in color and grain. Ipé has varying grades as well, so know what you are getting before it arrives.

Winner: Kebony for its uniformity

Maintenance

Both products have nearly identical maintenance routines. If you would like Kebony or Ipe to patina to a silver/gray, then little to no maintenance is required. Just let nature run its course. If you would like to keep the lustrous brown color of either product, regularly use a UV inhibiting Hardwood Oil. With Ipe, the extreme density of the wood means the Hardwood Oil won't soak into the wood, so be sure to back wipe excess oil within 15 minutes of application. Kebony will require some back wiping, but the oil will also soak into the wood.

Winner: Tie

Environmental Impact

This area is where Kebony and Ipe differ the most. Kebony is sustainably harvested from FSC®-certified forests. Because Kebony uses responsibly managed lumber and eco-friendly chemicals, it is an incredible green product: perfect for gaining LEED points for a project. Ipe? Well, that all depends on the mill. Unless the importer visits the sawmills personally, it's hard to know whether or not your Ipe was illegally harvested. Even when the rainforest is properly managed, Ipe trees take 80-100 years to mature. One thing is certain: Ipe is not sustainable and the supply of Ipe in the Amazon will eventually run out in the distant future. Ipe could even end up on the CITES Appendix II List in the next several years, making it very hard to harvest.

Obvious Winner: Kebony

Value

A price comparison will vary depending on region. Generally speaking, 5/4x6 Kebony Clear decking is priced right in between 1x6 Ipe and 5/4x6 Ipe. The added benefit of Kebony is it comes in premium lengths like 12' and 16' at no additional charge, so you can get the best lengths for your project without paying extra. For most of the country, Ipe will have a 10-20% upcharge for 12', 16' and 20' lengths, and many retailers will steer you towards shorter or random lengths to keep your cost down. For exact numbers you can consult your local lumberyard.

Winner: Kebony for price consistency

The Verdict

It's time to rethink whether you REALLY need Ipe on your next project, because there is a clear-cut alternative: Kebony.

How to Buy

Whether you order through your local lumberyard or buy direct, Kebony products are available anywhere in the United States & Canada from our Regional Distribution Centers (RDC) and trusted partners.

Call Us: 855.230.5656

Email Us: info@kebony.us



Offices

St Clair, MI (Headquarters)
Providence, RI
Austin, TX
Orange County, CA
Seattle, WA

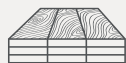

Regional Distribution Centers

Lansing, MI
Toronto, ON, Canada
North Kingston, RI
Baltimore, MD
Atlanta, GA
Austin, TX
Long Beach, CA
Oakland, CA
Seattle, WA
Calgary, AB, Canada



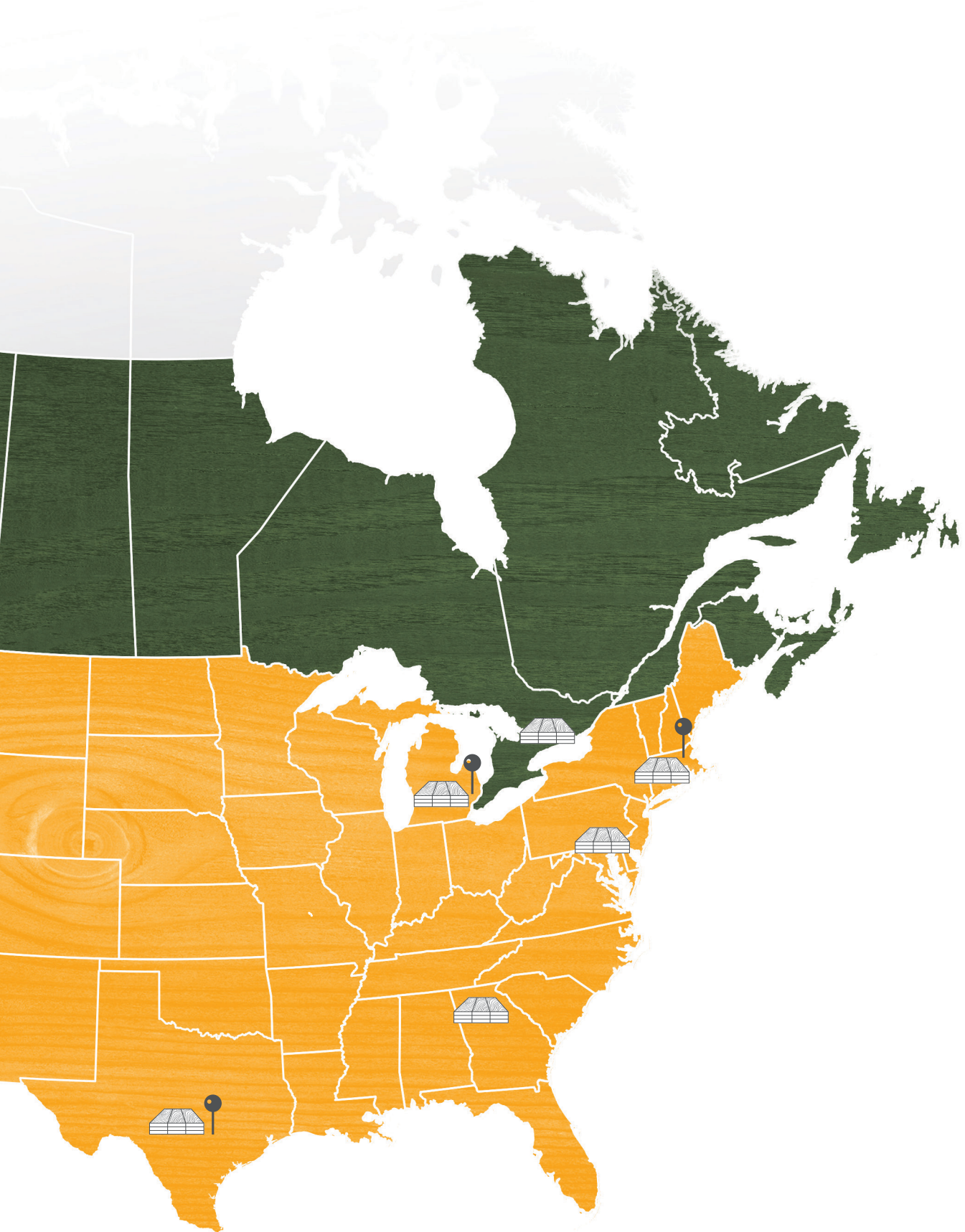



Natural wood
Made to last



More Resources

To get the latest information on new products, projects or other valuable resources visit our website and subscribe to our monthly newsletter.

www.kebonny.us
855.230.5656
info@kebonny.us



PRINT-PG-85X11-6-2020
8.5 x 11 Product Guide - 6/2020 Ed. (75 per box)

   @kebonnyusa