

AIRZONE

RadianT365

HVAC Control Solutions



Airzone Control Solutions

Leaders in smart control solutions for HVAC systems



The wide range of Airzone systems **is developed using the latest technology on the market**. Our products can control all types of installations and adapt to users' needs, at any time and in any place.

Airzone offers a single control for the entire installation

Unified and simplified control of both heating and air conditioning.

atlantic BAXI De Dietrich DAIKIN FUJITSU Fuji Electric GENERAL
 GREE Haier HITACHI Hisense HIYASU Kaysun LG
 Midea MITSUBISHI ELECTRIC MITSUBISHI HEAVY INDUSTRIES LTD. Panasonic SAMSUNG TOSHIBA



Air conditioning control solutions

Airzone enables smart **control of the centralized AC unit** or individual AC units.



Control solutions for heating

Whether yours is an installation with underfloor heating or one with radiators, **Airzone gives you zoned control of your heating**.

A fully integrated installation

Airzone is compatible with **the main BMS, home automation and IoT technologies**. Integration paths: gateways, Modbus, drivers, local API and Cloud API. In addition, with the Airzone Cloud app, you can manage your installation remotely, or by voice with the Amazon Alexa and Google Assistant wizards.

BACnet Control4 CRESTRON eedomus fhe
 FIBARO EEDOM KNX LUTRON Modbus
 RTI WAGO amazon alexa works with the Google Assistant



Heating with Airzone



ENJOY MAXIMUM COMFORT

Get the perfect temperature in every room with independent control of each zone. Change the temperature or switch the system off/on as required and without affecting the other zones.



OPTIMIZE MAINTENANCE

Extend the useful life of your installation with the anti-freezing function, which prevents the freezing of pipes, and the anti-scale function, which prevents obstruction or the accumulation of residues in the valves.

Zoned control of your heating with RadianT365



Underfloor heating and cooling

Customized and **zoned control of heating** with underfloor heating and cooling.

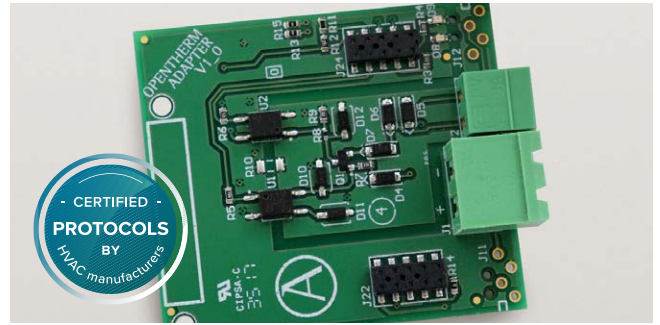

MANAGE PRODUCTION

Manage the production unit and recirculation pumps efficiently and adapted to the needs of the installation. Achieve perfect integration with the communication gateways.



COMMITMENT TO SUSTAINABILITY

Thanks to Airzone control solutions, you can get better ratings for your projects in certifications such as BREEAM, LEED and WELL, and it will help meet the requirements of the Passivhaus standard.



Radiators

Wireless Plug&Play solution for connected radiator control.

Airzone Interfaces

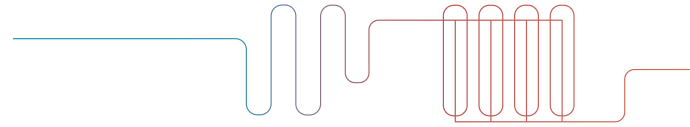

Airzone Blueface



Color:  Finish: Zamak and glass
Connection: Wired

The Airzone Blueface thermostat, with color graphic touchscreen interface, is the main thermostat and offers all the possibilities of control and configuration of the Airzone systems.

- On/Off
- Temperature control
- Humidity reading
- Selection of mode*
- Advanced settings
- Zone navigation
- Eco-Adapt function*
- Sleep mode

Airzone Think

The Airzone Think thermostat includes an electronic ink screen and capacitive buttons, and enables control of all the necessary features of an installation with very low energy consumption.

- On/Off
- Temperature control
- Humidity reading
- Selection of mode*
- Basic settings
- Zone navigation
- Sleep mode



Color:  Finish: Zamak and glass
Connection: Wireless



Color:  Finish: Zamak and glass
Connection: Wired and wireless

Airzone Lite

The Airzone Lite thermostat allows basic control of the installation using capacitive buttons and status LEDs, offering the possibility of modifying the temperature within +/-3 degrees.

- On/Off
- Temperature control
- Humidity and temperature sensor
- LED lights

Discover all the technical features at airzonecontrol.com/support.

*Available if the thermostat is configured as Master.

Airzone Cloud

The Airzone Cloud Webserver completes the installation, allowing you to **remotely control all connected systems through the free Airzone Cloud application.**

- On/Off
- Temperature control
- Selection of mode
- Advanced settings
- Zone navigation
- Time schedules
- Eco-Adapt function
- Weather information



REMOTE UPDATES

Our Technical **Support team can connect remotely to provide support** when starting up and to update the system, configure the operating parameters and perform a diagnosis of the installation.

Discover all the possibilities offered by Airzone Cloud by accessing the demo at:

airzonecloud.com



Play Store



App Store



Demo



1 MORE YEAR OF WARRANTY

By adding an Airzone Cloud Webserver to the installation, **the user can obtain an extra year of warranty** for the RadianT365 system.



VOICE CONTROL

Now it's possible to control the temperature using **voice commands thanks to Airzone's integration with Alexa and Google***.



*Integration applicable if the system has Airzone Cloud Webserver.

Solution for underfloor heating

With RadianT365 you can **control zoned hydronic heating installations with underfloor heating and cooling**. Take advantage of the floor's thermal inertia to create the perfect comfort by zones and achieve the greatest savings with the management of the production temperature by integrating the unit with our communication gateways. In addition, extend the useful life of the installation with the safety functions that the system incorporates.



Anti-condensation



Anti-freezing

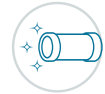

Anti-scale

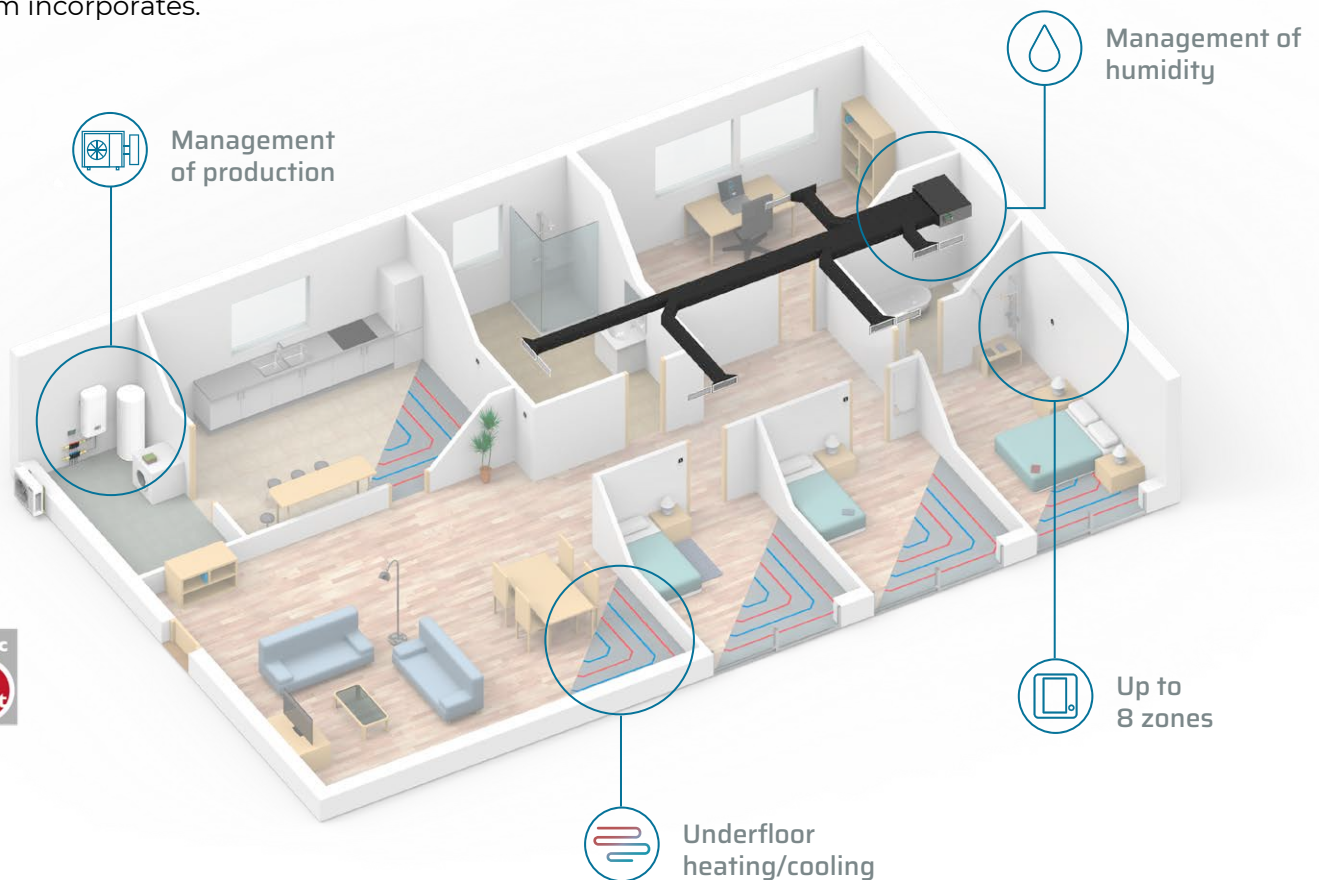

Advantages

- Control of heating/cooling **operation mode**.
- Control of **the comfort temperature** in each zone.
- **Optimization of comfort** with smart control of the floor's thermal inertia.
- **Anti-condensation** control with **measurement of humidity** in the zone, supply temperature and control of the dehumidifier.
- **Anti-freezing** and **anti-scale** functions.
- **Limitation of minimum and maximum temperatures** for efficient control through the Eco-Adapt function.
- **Management of production** by means of communication gateways and action on recirculation pumps.
- **Airzone thermostatic heads** supplied at 230 Vac for managing the valves in each zone*.

For more information visit airzonecontrol.com

*External power heads can be used at 110/230 Vac (50/60HZ).

Solution for underfloor heating

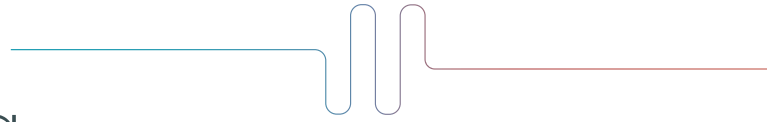

MAIN CONTROL BOARD

Reference	Description
AZRA6RADIANT	Airzone RadianT365 main control board - 8 zones

CONTROL MODULES

Reference	Description
AZRA6CM1VALC	Airzone RadianT365 control module of 110/230V wired valves - 8 zones
AZRA6CMOD3V	Airzone RadianT365 control module - 3 speed/stage dehumidifier

ZONE USER INTERFACES

Reference	Description
AZRA6BLUEZEROC [B/N]	Airzone RadianT365 Blueface Zero thermostat wired [black/white]
AZRA6THINKR [B/N]	Airzone RadianT365 Think monochrome thermostat wireless [black/white]
AZRA6LITEC [B/N]	Airzone RadianT365 Lite simplified thermostat wired [black/white]
AZRA6LITER [B/N]	Airzone RadianT365 Lite simplified thermostat wireless [black/white]

CENTRALIZED CONTROL

Reference	Description
AZX6WSPHUB	Webserver HUB Airzone Cloud Wi-Fi Dual 2,4-5 GHz
AZX6WSC5GER	Airzone Cloud Webserver Wi-Fi Dual 2.4-5GHz
AZX6CCP	Airzone production control board
AZX6CCPGAWI	Airzone hydronic production control board
AZX6KNXGTWAY	Airzone - KNX integration gateway

AIRZONE® COMMUNICATION GATEWAY

Reference	Description
AZX6GAWDA2	Airzone - Daikin Altherma 3 aerothermal gateway
AZX6GAWOTH	Airzone - OpenTherm aerothermal gateway
AZX6GAWME2	Pasarela de aerotermita Airzone - Mitsubishi Electric Ecodan
AZX6GAWHI4	Pasarela de aerotermita Airzone - Hitachi Yutaki
AZX6GAWMD3	Pasarela de aerotermita Airzone - Midea/Kaysun M-Thermal

Consult availability of Airzone gateways and their compatibility with manufacturers' AC units on airzonecontrol.com/support.

Visit airzonecontrol.com/support to consult the product's technical information.

ACCESSORIES

Reference	Description
AZX6ACTVALC	Airzone wired thermostatic head 110/230V VALC for radiant elements
AZX6SONDPROTEC	Airzone temperature metallic probe in sheath
AZX6POWER	Airzone 12V power supply unit
AZX6CABLEBUS15	Airzone bus cable (2x0.5 + 2x0.22) 15 m
AZX6CABLEBUS100	Airzone bus cable (2x0.5 + 2x0.22) 100 m
AZX6CABLEBUS500	Airzone bus cable (2x0.5 + 2x0.22) 500 m
AZX6CABLEBUSHF	Airzone halogen-free bus cable (2x0.5 + 2x0.22) 100 m

RADIANT365 PACK FOR UNDERFLOOR HEATING



Main control board



Airzone thermostats



Wired valve control module



Airzone bus cable

Example of reference number: **AZRA6PBLRBVALC4**.

Includes: 1 wired Airzone Blueface thermostat (white), 3 wireless Airzone Lite thermostats (white), 1 RadiantT365 main control board, 1 Airzone RadiantT365 control module of 110/230V VALC wired valves and Airzone bus cable.

Reference	Thermostat connection	Zones	Colors
AZRA6PBL [C/R] [B/N] VALC2	1 wired Airzone Blueface 1 [wired/wireless] Airzone Lite	2	White/black
AZRA6PBL [C/R] [B/N] VALC3	1 wired Airzone Blueface 2 [wired/wireless] Airzone Lite	3	White/black
AZRA6PBL [C/R] [B/N] VALC4	1 wired Airzone Blueface 3 [wired/wireless] Airzone Lite	4	White/black
AZRA6PBL [C/R] [B/N] VALC5	1 wired Airzone Blueface 4 [wired/wireless] Airzone Lite	5	White/black
AZRA6PBL [C/R] [B/N] VALC6	1 wired Airzone Blueface 5 [wired/wireless] Airzone Lite	6	White/black
AZRA6PBL [C/R] [B/N] VALC7	1 wired Airzone Blueface 6 [wired/wireless] Airzone Lite	7	White/black
AZRA6PBL [C/R] [B/N] VALC8	1 wired Airzone Blueface 7 [wired/wireless] Airzone Lite	8	White/black



Complete your pack, with as many Airzone thermostatic Heads as there are valves to control.



Add the Webserver HUB Airzone Cloud: an Internet connection is required to operate it.

Solution for radiators

Discover the simplest **Plug&Play solution for zoned control of radiators**. Now, RadianT365 is also suitable for buildings' central heating. Furthermore, you can benefit from the use of anti-freezing and anti-scale security and maintenance functions to guarantee an extension in the useful life of the installation.

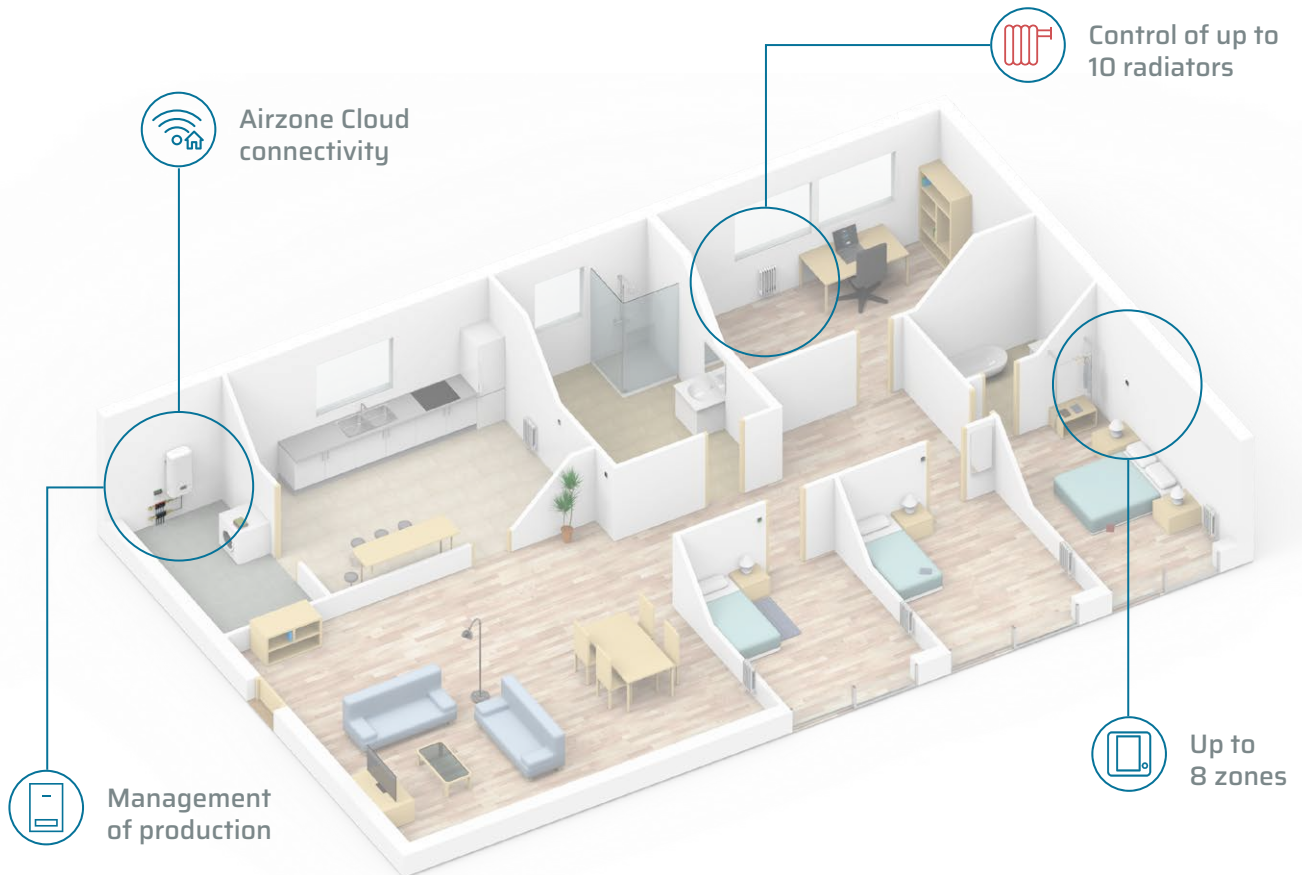

Advantages

- Control of **the comfort temperature** in each zone.
- **Optimization of comfort** with proportional control of the opening of the radiator valve depending on room temperature.
- **Airzone wireless thermostatic** heads with comfort temperature display and temperature control in each zone.
- **Limitation of minimum and maximum temperatures** for efficient control through the Eco-Adapt function.
- **Anti-freezing** and **anti-scale** functions.
- **Child lock function** to prevent accidental activation of any function.
- Improved control of the installation and **reduced energy consumption** thanks to production management via communication gateways and action on recirculation pumps.
- **Adapters for connecting the wireless** head with valves of different diameters.
- **Includes Airzone Cloud Webserver Wi-Fi Dual 2.4-5GHz**. With the connected Webserver, you will enjoy a 3 year warranty.

For more information visit airzonecontrol.com

Electronic elements and architecture

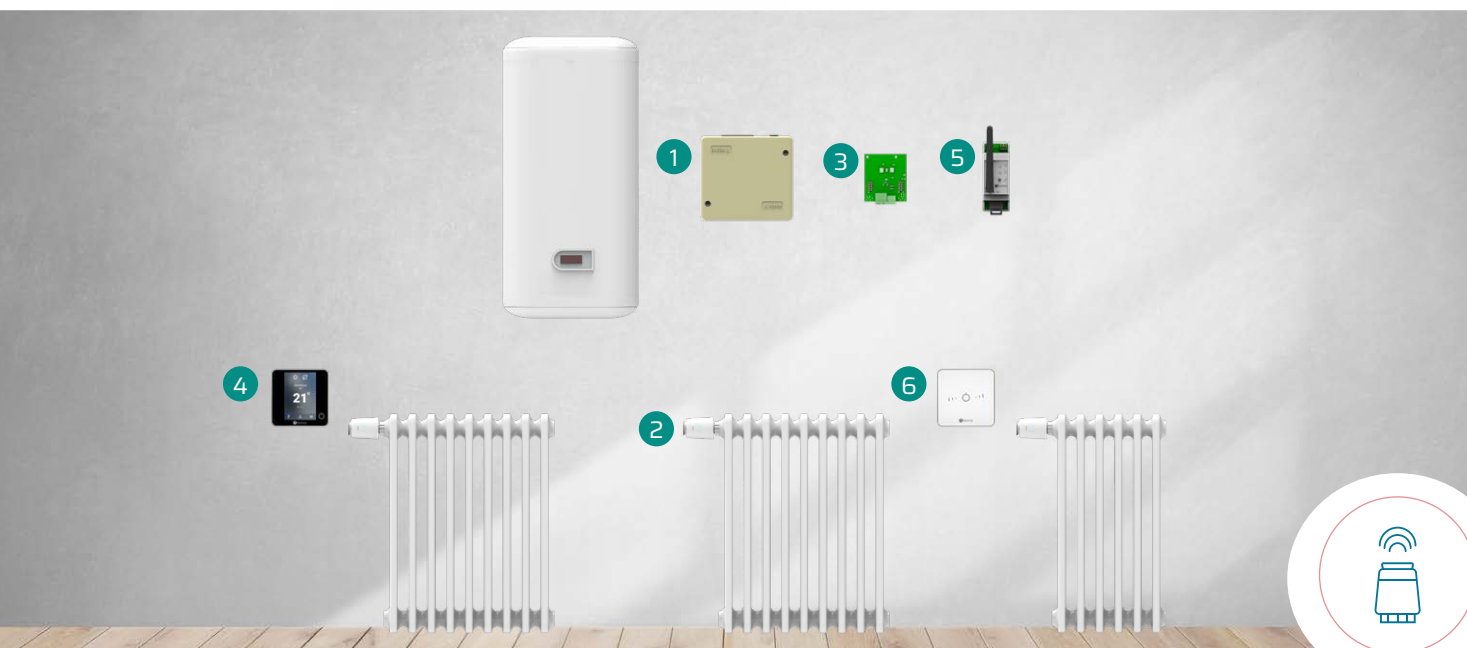

① **Main control board with connectivity**
System management and connection with Airzone Cloud.

② **Wireless thermostatic head**
Head with probe for radiator control.

③ **Communication gateway**
Communication with the production unit to optimize the control and management of DHW.

④ **Airzone Blueface**
Interface for centralized control of installation.

⑤ **Wireless valve control module**
Communication with wireless thermostatic heads.

⑥ **Zone interfaces**
Optionally a user interface can be added for each zone.

Architecture

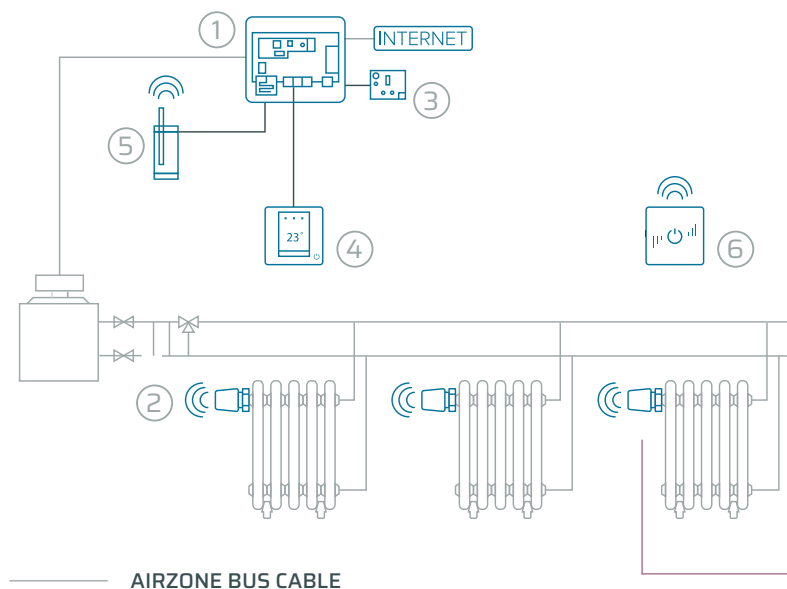

We adapt to your radiator model!



Thanks to the adapters **included for the different valves available** on the market you will be able to adapt the system to different radiators.

Solution for radiators

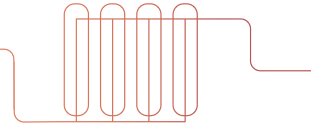

MAIN CONTROL BOARD

Reference	Description
AZRA6CB1RADW	Airzone RadiantT365 VALR Cloud Wi-Fi Dual 2.4-5GHz main control board for radiators

CONTROL MODULES

Reference	Description
AZX6CM1VALR	Airzone 10 wireless valve control module - 8 zones

ZONE USER INTERFACES

Reference	Description
AZRA6BLUEFACEC [B/N]	Airzone RadiantT365 Blueface thermostat wired [black/white]
AZRA6THINKR [B/N]	Airzone RadiantT365 Think monochrome thermostat wireless [black/white]
AZRA6LITEC [B/N]	Airzone RadiantT365 Lite simplified thermostat wired [black/white]
AZRA6LITER [B/N]	Airzone RadiantT365 Lite simplified thermostat wireless [black/white]

CENTRALIZED CONTROL

Reference	Description
AZX6WSPHUB	Webserver HUB Airzone Cloud Wi-Fi Dual 2,4-5 GHz
AZX6CCPGAWI	Airzone hydronic production control board

AIRZONE® COMMUNICATION GATEWAY

Reference	Description
AZX6GAWDA2	Airzone - Daikin Altherma 3 aerothermal gateway
AZX6GAWOTH	Airzone - OpenTherm aerothermal gateway
AZX6GAWME2	Pasarela de aeroterminia Airzone - Mitsubishi Electric Ecodan
AZX6GAWHI4	Pasarela de aeroterminia Airzone - Hitachi Yutaki
AZX6GAWMD3	Pasarela de aeroterminia Airzone - Midea/Kaysun M-Thermal

Compatible only with AZX6CCPGAWI.

Consult availability of Airzone gateways and their compatibility with manufacturers' AC units on airzonecontrol.com/support.

ACCESSORIES

Reference	Description
AZX6AC1VALR*	Airzone VALR wireless thermostatic head for radiators
AZX6CABLEBUS15	Airzone bus cable (2x0.5 + 2x0.22) 15 m
AZX6CABLEBUS100	Airzone bus cable (2x0.5 + 2x0.22) 100 m
AZX6CABLEBUS500	Airzone bus cable (2x0.5 + 2x0.22) 500 m
AZX6CABLEBUSHF	Airzone halogen-free bus cable (2x0.5 + 2x0.22) 100 m
AZX6POWER	Airzone 12V power supply unit

Only compatible with AZX6CM1VALR.

PACK ELEMENTS



Main control board with connectivity



Airzone Blueface thermostats



Wireless thermostatic head for radiators



Wireless valve control module



Airzone bus cable

RADIANT365 PACK FOR RADIATORS

Example: **AZRA6PBFCBVALR3**.

Includes: 1 Airzone Radiant365 VALR Cloud Wi-Fi dual 2.4-5GHz main control board for radiators, 1 Airzone Radiant365 Blueface wired thermostat (white), 1 x 10 wireless valve control module for 8 zones, 3 Airzone VALR wireless thermostatic heads for radiators and Airzone bus cable.

Reference	Description	Radiators	Colors
AZRA6PBFC [B/N] VALR2	1 wired Airzone Blueface 2 wireless thermostatic heads	2	White/black
AZRA6PBFC [B/N] VALR3	1 wired Airzone Blueface 3 wireless thermostatic heads	3	White/black
AZRA6PBFC [B/N] VALR4	1 wired Airzone Blueface 4 wireless thermostatic heads	4	White/black
AZRA6PBFC [B/N] VALR5	1 wired Airzone Blueface 5 wireless thermostatic heads	5	White/black
AZRA6PBFC [B/N] VALR6	1 wired Airzone Blueface 6 wireless thermostatic heads	6	White/black
AZRA6PBFC [B/N] VALR7	1 wired Airzone Blueface 7 wireless thermostatic heads	7	White/black
AZRA6PBFC [B/N] VALR8	1 wired Airzone Blueface 8 wireless thermostatic heads	8	White/black



Add **one head for each additional** radiator to any pack AZX6AC1VALR.



Possibility of adding a **Lite thermostat** to the pack AZRA6LITER.

Airzone by your side

We are **at your side to offer you the best service.** Whether it's face-to-face or online, you can always count on Airzone for your project.



Get trained at Airzone Academy now!
airzonecontrol.com/academy

Projects

Our team of engineers who are **specialists in HVAC and control projects** will advise you during every phase of your project regarding:

- Design and sizing of HVAC projects.
- Budget of the installation.
- Products modeled in BIM.
- Connection schemes.

Take advantage of our tools!

Airzone offers products in BIM format, connection schemes for our systems, Easyzone Packs configurator and Ductzone software. Go to: airzonecontrol.com

Training

Airzone's online training platform allows professionals to manage all their training, see upcoming courses and track their progress while completing a module.

Choose the course topic

Check the list of courses and register for free on the one you are most interested in. You can do all the courses you want.

Fits your schedule

We have different training modalities available to adapt to your schedule: webinars, online or face-to-face courses.

Become a pro

Follow a training program made up of different courses and become an Airzone Pro Installer or Specifier.



Wherever you are,
#AirzoneByYourSide



Contact Airzone

If you have any questions, you can contact us using the form at:

airzonecontrol.com/contact

Customer service and support

At Airzone we incorporate various engineering programs into our projects, and we have developed our own **custom-made software, Ductzone**, to easily calculate and design HVAC applications.

Our experts provide **personalized technical assistance wherever and whenever requested**. Our after sales department attend requests of warranty and returns promptly.





Parque Tecnológico de Andalucía
Marie Curie, 21 · 29590 Málaga (Spain)

Platform for professionals airzonecontrol.com/support

+34 900 400 445

airzonecontrol.com



Airzone distributor