

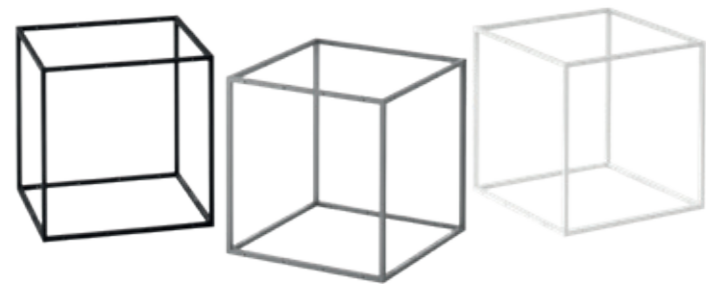

## Product Guide



Adaptable. Durable. Elegant.

## MAKING SPACE WORK

GRID is the ultimate modular interior system.

With its unprecedented flexibility, components from the GRID collection can be combined and adapted in countless ways. Whether you are designing larger or smaller spaces, the GRID system creates a customised interior that is both functional and beautiful.

Using carefully selected colours and materials, we work closely with you to design flexible configurations that meet your needs. This can include everything from coat racks to room dividers, benches and so much more.

Welcome to GRID - a world of possibilities.



## CONTENT

THE GRID SYSTEM	6
PETER J. LASSEN	8
SUSTAINABILITY	10
THE ORIGINAL GRID	
GRID MODULES AND CROSS BRACES	12
SHELVES/SIDES	14
TOP/BASE/SIDE PANELS	16
PLINTHS	20
CASTORS AND LEGS	22
STORAGE	24
WHITEBOARD PANELS	32
CORK PANELS	34
FELT PANELS	36
FELT SIDE PANELS AND DOUBLE SIDE PANELS	38
BOX SIDE PANELS AND TOP BOXES	40
MOSS PANELS	42
MAGAZINE SHELVES	44
DIVIDER INSERTS	46
SEATS	48
HANGERS	52
SUPPORT BEAMS	54
SCREWS, BITS AND MORE	56
THE HALF SIZE GRID	
HALF GRID MODULES	60
HALF SHELVES/SIDES	62
HALF TOP/BASE/SIDE PANELS	64
COLOURS AND MATERIALS	66
DELIVERY AND HANDLING	68

# THE GRID SYSTEM

Based on the iconic cube – the GRID module – and its many accessory components, GRID is the ultimate flexible interior system.

GRID is industrial and elegant with a distinctly minimalist design.

Each GRID module measures 40 x 40 x 40 cm with a frame of 12 x 12 mm. Mounting holes in the frame make it easy to assemble countless modules to fit your needs – in any height, width or depth.

The GRID module also fits shelves and side, top and base panels in different materials. In addition to these, you can add cross braces, hangers, planters, upholstered seats, magazine shelves, cabinets, drawers, whiteboards, felt panels and cork panels. All of these components make it possible to create a design solution that meets your needs.

Build a room divider, display wall, storage unit, counter, wardrobe, window display, podium, seating landscape or art installation - and reuse components in new design solutions.

## MODULAR AND MULTIFUNCTIONAL

The GRID modules are the building blocks and create the framework for the system. Once the foundational structure is in place, you can add countless functions, features and designs.

When new needs arise, existing components can be removed and new functions can be added and adapted for a new design. With its durable modularity, GRID provides the unique freedom to reconfigure and match your changing interior design needs.



# PETER J. LASSEN

***“Through the user’s creative application, the product becomes something truly unique.” - Peter J. Lassen***

Peter J. Lassen (1930-2019) designed GRID in 2004, where he pursued his vision of creating an interior design system with unprecedented freedom. With an open and modular structure that can be expanded in all directions, Peter J. Lassen succeeded in developing a GRID system that is designed for users to adapt and realise designs based on their unique needs.

GRID’s geometric structure reflects Peter J. Lassen’s artistic inspiration.

*“Good art never fully reveals itself. There is always another layer, another interpretation – we never become tired of nature or art because there is always another angle.”*

GRID combines simplicity and flexibility in one system. The components are building blocks with countless possibilities and provide an opportunity to play with dimensions and combine different functions, colours and materials. It also allows you to rethink and reconfigure existing designs.



# SUSTAINABILITY

At GRID, we focus on sustainability. We know it is important that your interior system can develop with you. That is why we take great pride in GRID's core concepts: durability and recyclability.

GRID units can be disassembled and components can be reused for new interior design solutions. For example, you can transform your room divider into seating or your storage into a display. GRID modules also work for outdoor use. After many years of use, GRID modules can be converted into granules and included in the production of new items.

It is important to us that the materials and production process have the least possible environmental impact, and this is reflected in our choice of partners and subcontractors. All components are produced in Denmark, and we always strive towards developing and optimising our modular GRID system.

We continuously test our products according to current environmental standards and to ensure strength and durability.

Feel free to contact us for more information.



## GRID MODULES AND CROSS BRACES



### GRID MODULE

H x D x W: 40 x 40 x 40 cm  
 Frame: 1.2 x 1.2 cm  
 Weight: 0.8 kg  
 Material: Nylon (PA6) reinforced with glass fibre

**Black**     **G.NB**  
**Grey**     **G.NG**  
**White**    **G.NW**



### CROSS BRACE

H x D x W: 37.6 x 37.6 x 1.2 cm  
 Frame: 1.2 x 1.2 cm  
 Weight: 0.2 kg  
 Material: Nylon (PA6) reinforced with glass fibre

**Black**     **CB.NB**  
**Grey**     **CB.NG**  
**White**    **CB.NW**



## GRID MODULES AND CROSS BRACES

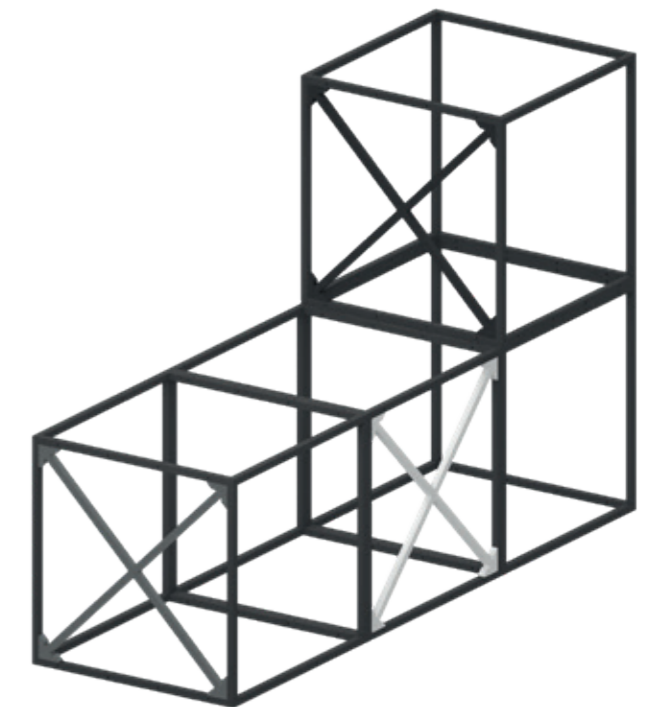
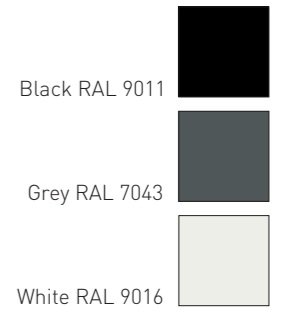

### GRID MODULES AND CROSS BRACES

GRID modules are the system's building blocks. The lightweight modules are produced in one piece. With visible mounting holes, you can easily combine two, three, hundreds or thousands of modules in all three dimensions. Assembled modules are easy to reconfigure and can always be taken apart and built again in new ways.

Build custom furniture or create artistic installations. Customise your design using other GRID components and combine multiple functions in the same unit.

Cross braces can be used to stabilise and reinforce freestanding and heavily loaded components or beams. Cross braces can also be added as a visual element.

## SHELVES/SIDES

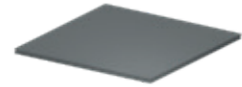

### SHELF/SIDE, MDF

H x D x W: 1.2 x 37.6 x 37.6 cm  
 Weight: 1.3 kg  
 Material: MDF, lacquered or veneered

**Black**      **SS.MB**  
**Grey**       **SS.MG**  
**White**      **SS.MW**  
**Oak**         **SS.MO**



### SHELF/SIDE, ACRYLIC

H x D x W: 1 x 37.6 x 37.6 cm  
 Weight: 1.6 kg  
 Material: Acrylic

**Clear**        **SS.AC**  
**Frosted**    **SS.AF**  
**Mirror**      **SS.MA**

## SHELVES/SIDES

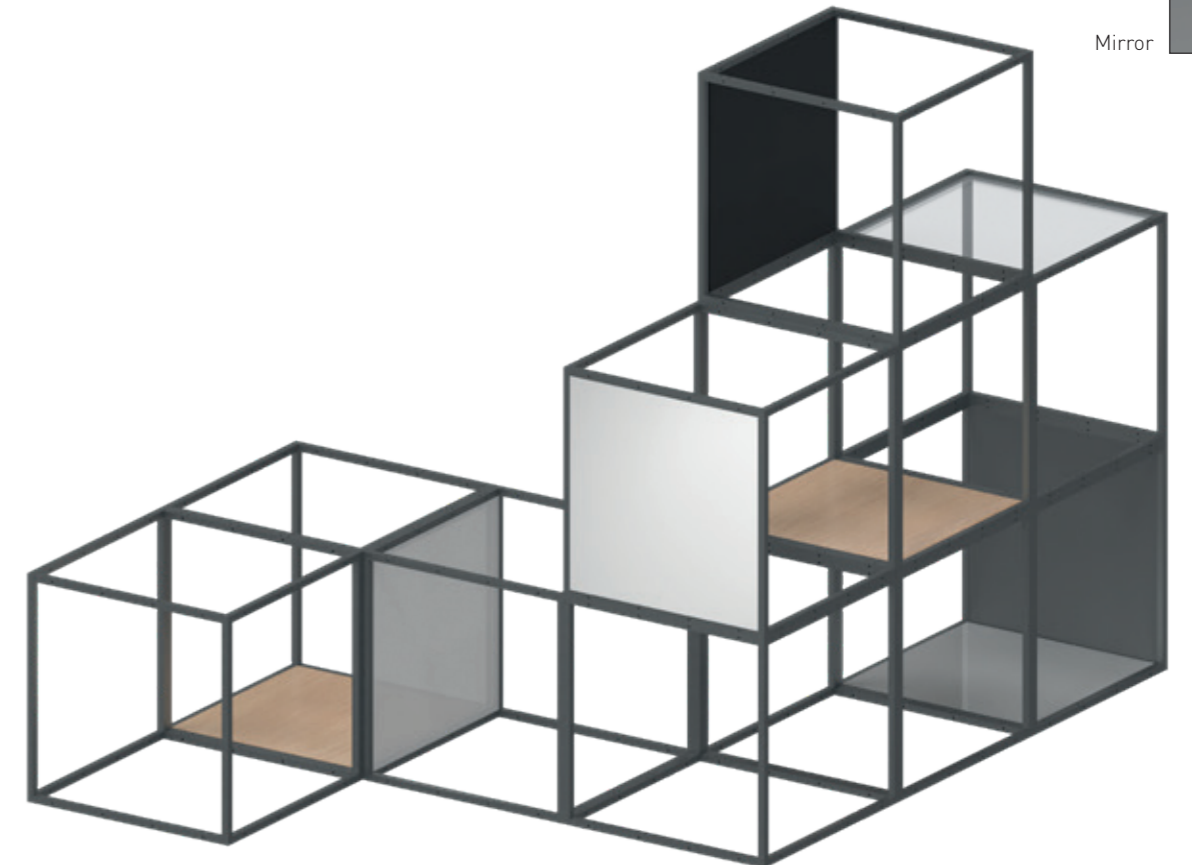
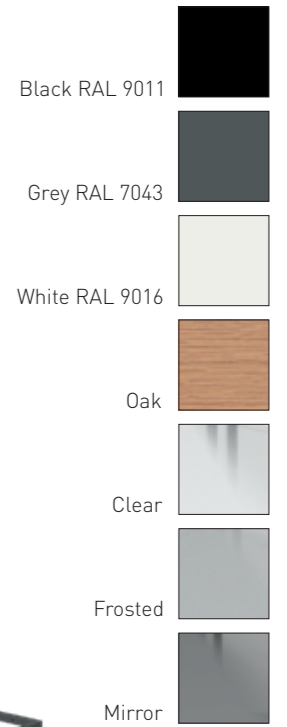

### SHELVES/SIDES

The shelves/sides are flush with the module's frame and can be used as a shelf or on the side, top, base, front or back of the module. Choose lacquered MDF or oak veneer for a solid shelf/side, clear acrylic for transparency, frosted acrylic for white translucency and mirror acrylic for a clear mirrored surface.





## TOP/BASE/SIDE PANELS

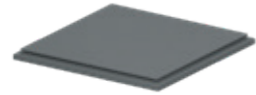

### TOP/BASE/SIDE PANEL, 1X1

H x D x W: 2.5 x 40 x 40 cm  
 Weight: Lacquered 2.7 kg / veneered 2.9 kg  
 Material: MDF, lacquered or veneered

**Black** P1.1.MB  
**Grey** P1.1.MG  
**White** P1.1.MW  
**Oak** P1.1.MO

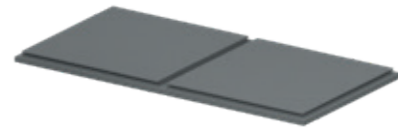

### TOP/BASE/SIDE PANEL, 1X2

H x D x W: 2.5 x 40 x 80 cm  
 Weight: Lacquered 5.5 kg / veneered 5.8 kg  
 Material: MDF, lacquered or veneered

**Black** P1.2.MB  
**Grey** P1.2.MG  
**White** P1.2.MW  
**Oak** P1.2.MO

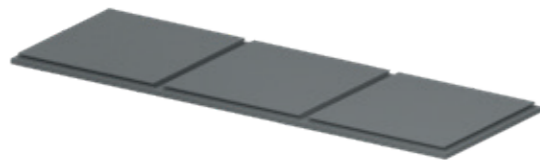

### TOP/BASE/SIDE PANEL, 1X3

H x D x W: 2.5 x 40 x 120 cm  
 Weight: Lacquered 8.3 kg / veneered 8.7 kg  
 Material: MDF, lacquered or veneered

**Black** P1.3.MB  
**Grey** P1.3.MG  
**White** P1.3.MW  
**Oak** P1.3.MO

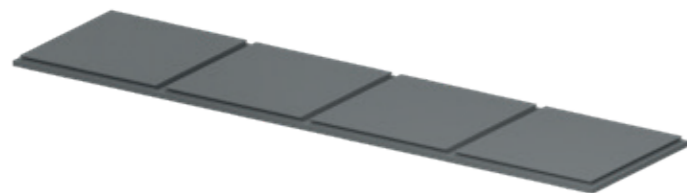

### TOP/BASE/SIDE PANEL, 1X4

H x D x W: 2.5 x 40 x 160 cm  
 Weight: Lacquered 11.3 kg / veneered 11.6 kg  
 Material: MDF, lacquered or veneered

**Black** P1.4.MB  
**Grey** P1.4.MG  
**White** P1.4.MW  
**Oak** P1.4.MO

## TOP/BASE/SIDE PANELS

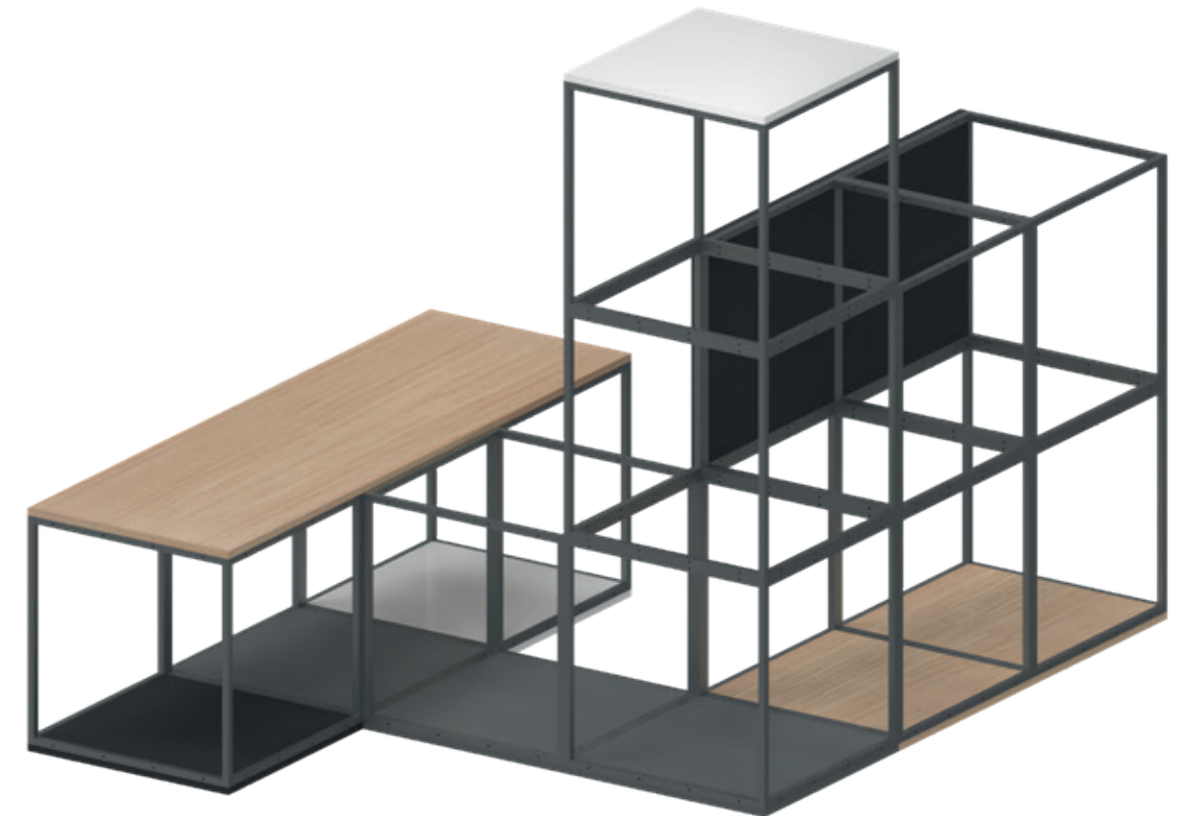
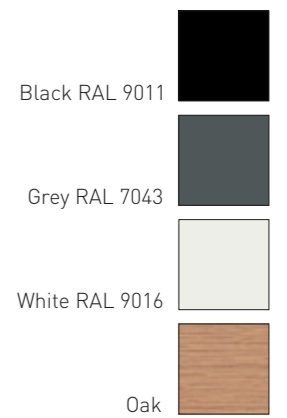

### TOP/BASE/SIDE PANELS

Can be used as a top, base, side, front or back panel. These panels rest on the outside of the module's frame and can be used for tables, podiums, seating arrangements and heavier loads.



## TOP/BASE/SIDE PANELS

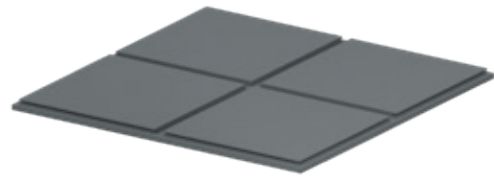

### TOP/BASE/SIDE PANEL, 2X2

H x D x W: 2.5 x 80 x 80 cm  
Weight: 11.3 kg  
Material: MDF, lacquered

**Black** P2.2.MB  
**Grey** P2.2.MG  
**White** P2.2.MW

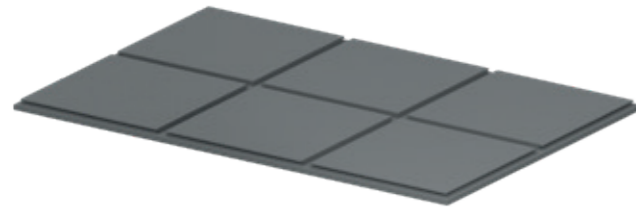

### TOP/BASE/SIDE PANEL, 2X3

H x D x W: 2.5 x 80 x 120 cm  
Weight: 16.6 kg  
Material: MDF, lacquered

**Black** P2.3.MB  
**Grey** P2.3.MG  
**White** P2.3.MW

## TOP/BASE/SIDE PANELS

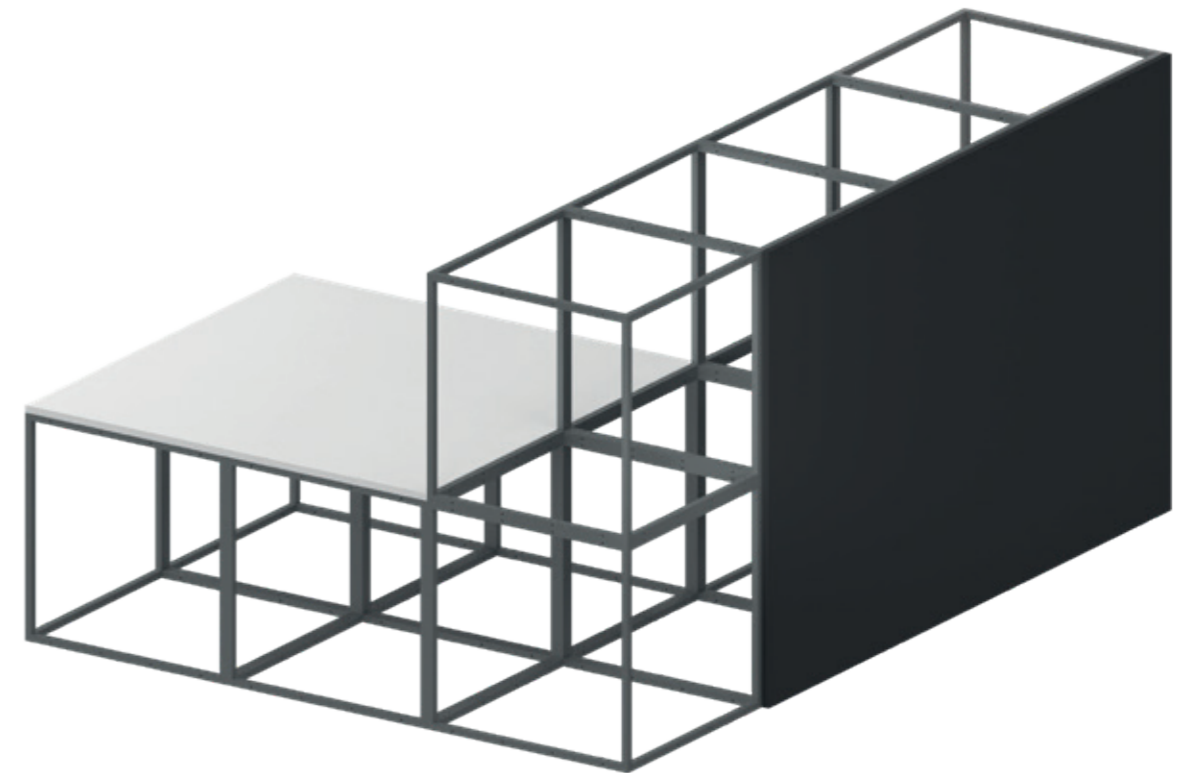
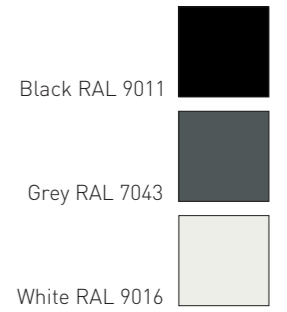

### TOP/BASE/SIDE PANELS

Can be used as a top, base, side, front or back panel. These panels rest on the outside of the module's frame and can be used for tables, podiums, seating arrangements and heavier loads.

## PLINTHS



### PLINTH, 1X1

H x D x W: 6.5 x 40 x 40 cm  
 Weight: 1.7 kg  
 Material: MDF, lacquered

**Black**    **PL1.1.MB**  
**Grey**    **PL1.1.MG**  
**White**   **PL1.1.MW**



### PLINTH, 1X2

H x D x W: 6.5 x 40 x 80 cm  
 Weight: 2.3 kg  
 Material: MDF, lacquered

**Black**    **PL1.2.MB**  
**Grey**    **PL1.2.MG**  
**White**   **PL1.2.MW**

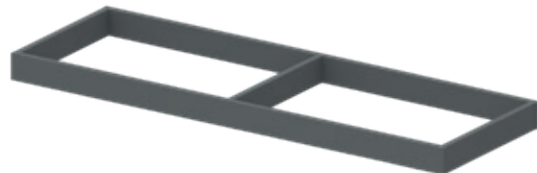

### PLINTH, 1X3

H x D x W: 6.5 x 40 x 120 cm  
 Weight: 3.5 kg  
 Material: MDF, lacquered

**Black**    **PL1.3.MB**  
**Grey**    **PL1.3.MG**  
**White**   **PL1.3.MW**

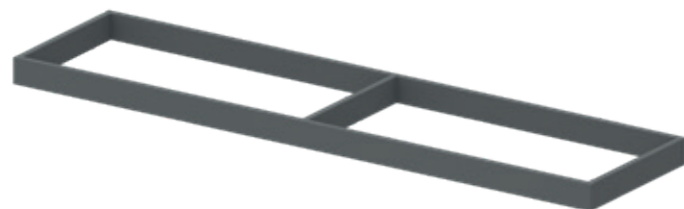

### PLINTH, 1X4

H x D x W: 6.5 x 40 x 160 cm  
 Weight: 4.4 kg  
 Material: MDF, lacquered

**Black**    **PL1.4.MB**  
**Grey**    **PL1.4.MG**  
**White**   **PL1.4.MW**

## PLINTHS

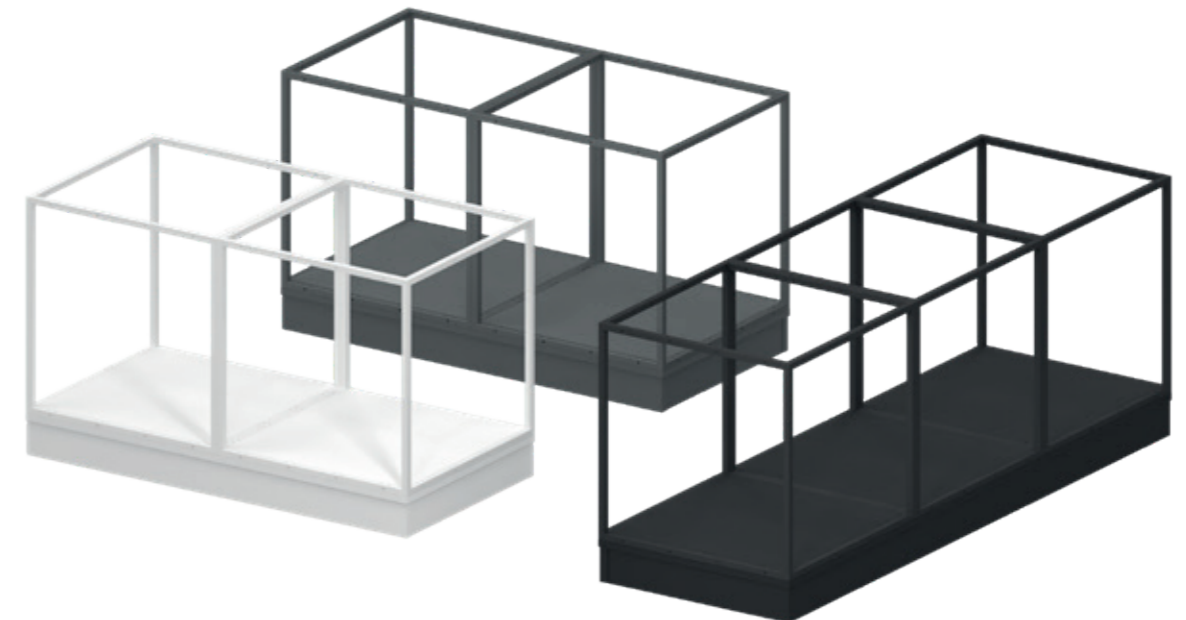
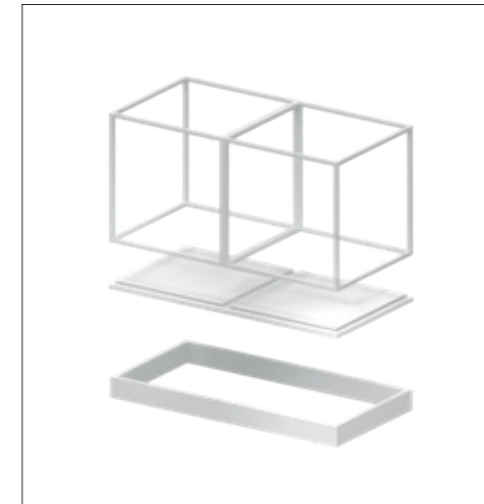
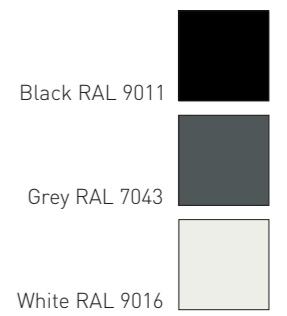

### PLINTHS

Plinths can be added to provide extra height with a solid look. Plinths are mounted under a base panel. The base panel must be ordered separately.



## CASTORS AND LEGS



### CASTOR

Set of four castors.

H: 6.5 cm

Material: Steel and transparent PU

Weight: 0.7 kg for 1 GRID module

1.7 kg for 2 GRID modules

2.4 kg for 3 GRID modules

3 kg for 4 GRID modules

**For 1 GRID module W1.1.4**

**For 2 GRID modules W1.2.4**

**For 3 GRID modules W1.3.4**

**For 4 GRID modules W1.4.4**

### ADJUSTABLE LEG

Set of four legs.

H: 5.8 - 7 cm

Material: Aluminium

Weight: 0.3 kg for 1 GRID module

1.3 kg for 2 GRID modules

2 kg for 3 GRID modules

2.6 kg for 4 GRID modules

**For 1 GRID module L1.1.4**

**For 2 GRID modules L1.2.4**

**For 3 GRID modules L1.3.4**

**For 4 GRID modules L1.4.4**

## CASTORS AND LEGS

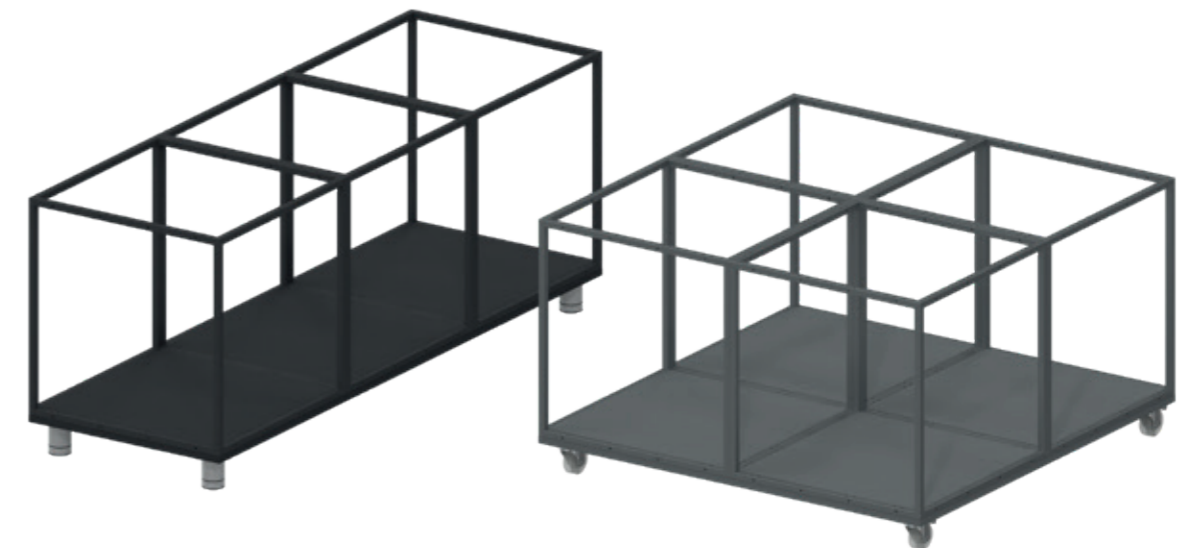
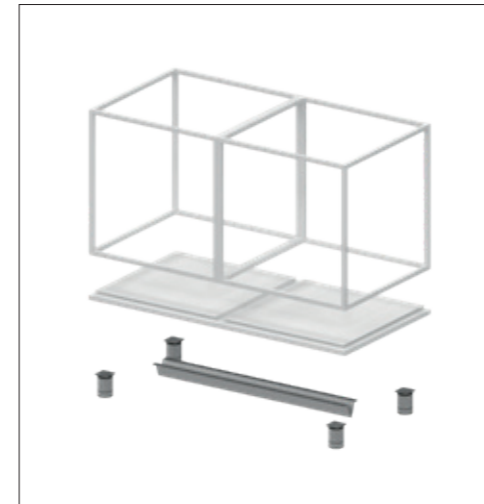

### CASTORS AND ADJUSTABLE LEGS

Castors provide easy mobility. A set of castors consists of four castors, all of which can be locked. Adjustable legs allow for 12 mm of height adjustment, which can be used, for example, to level the unit on sloping floors. Castors or legs for two, three or four GRID modules include a reinforcement frame for the base panel. The base panel must be ordered separately.

## STORAGE

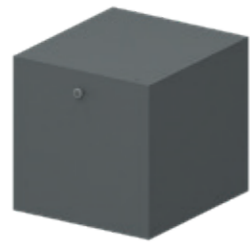

### DRAWER INSERT, 1 DRAWER

H x D x W: 37.6 x 41.2 x 37.6 cm  
 Internal: 31.5 x 34 x 31 cm  
 Weight: 11.7 kg  
 Material: MDF, lacquered

**Black** SM1.MB  
**Grey** SM1.MG  
**White** SM1.MW



### HANGING FILE INSERT

Set of 2 brackets for drawer insert, 1 drawer.

H x D x W: 15.8 x 0.15 x 30.6 cm  
 Weight: 0.7 kg  
 Material: Metal, lacquered

**White** HFI.W



### DRAWER INSERT, 2 DRAWERS

H x D x W: 37.6 x 41.2 x 37.6 cm  
 Internal: 11.8 x 34 x 31 cm  
 Weight: 14 kg  
 Material: MDF, lacquered

**Black** SM2.MB  
**Grey** SM2.MG  
**White** SM2.MW

## STORAGE

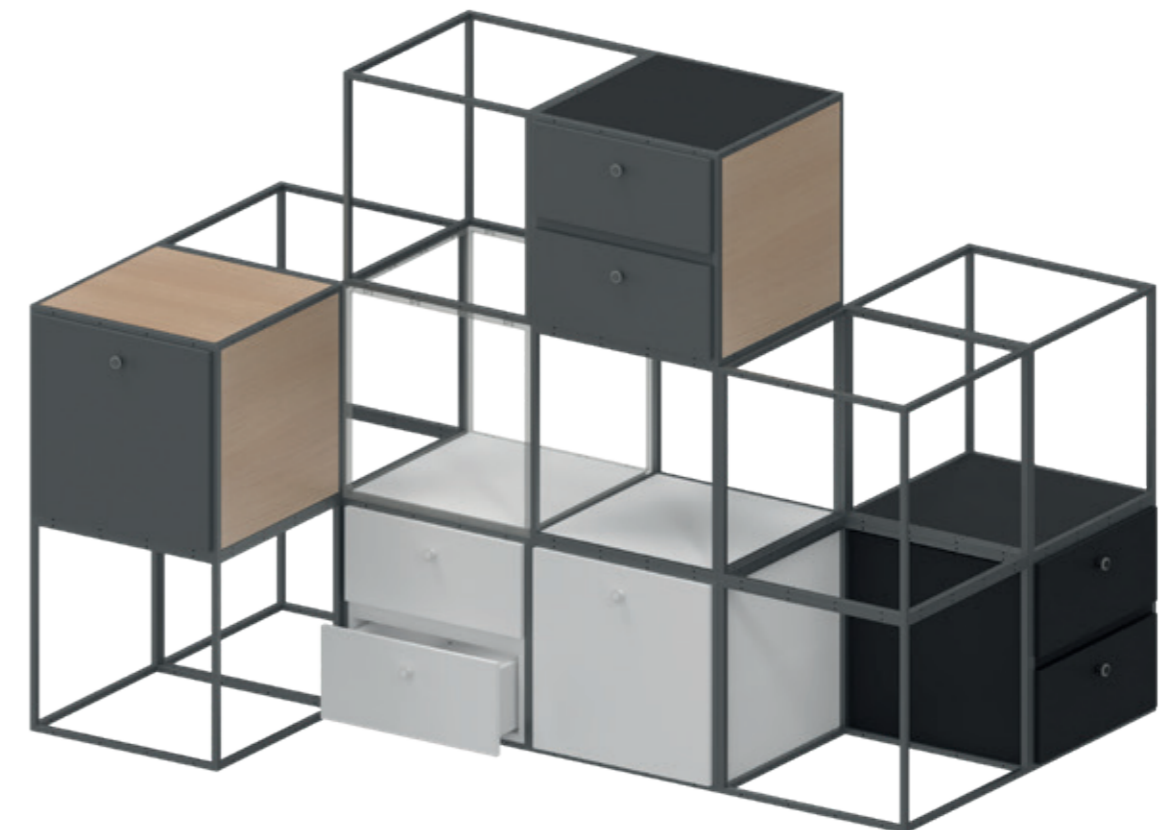
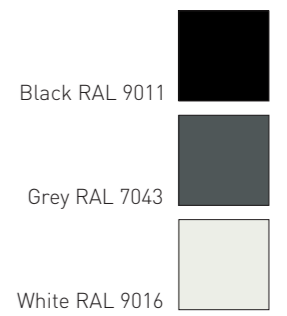

### DRAWER INSERTS

Drawer inserts fit directly into the GRID module. Set into the module, they are fixed into place using GRID screws and mounting holes inside the insert. The cut-out at the top makes mounting easy, and shelves/sides are used to ensure a smooth finish. GRID modules, additional side panels and shelves for covering the insert must be ordered separately.



## STORAGE

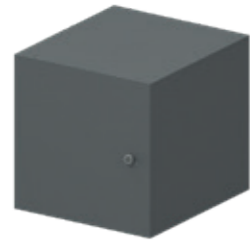

### CUPBOARD INSERT

H x D x W: 37.6 x 41.2 x 37.6 cm  
 Internal: 35.2 x 39 x 35.2 cm  
 Weight: 8.2 kg  
 Material: MDF, lacquered or veneered

<b>Black</b>	<b>SM3.MB</b>
<b>Grey</b>	<b>SM3.MG</b>
<b>White</b>	<b>SM3.MW</b>
<b>Black with oak front</b>	<b>SM3.MB01</b>
<b>Black with oak front and backside</b>	<b>SM3.MB02</b>
<b>Grey with oak front</b>	<b>SM3.MG01</b>
<b>Grey with oak front and backside</b>	<b>SM3.MG02</b>
<b>White with oak front</b>	<b>SM3.MW01</b>
<b>White with oak front and backside</b>	<b>SM3.MW02</b>

### CUPBOARD INSERT, TALL

H x D x W: 77.7 x 41.2 x 37.6 cm  
 Internal: 75.3 x 39 x 35.2 cm  
 Weight: 15.2 kg  
 Material: MDF, lacquered or veneered

<b>Black</b>	<b>SM4.MB</b>
<b>Grey</b>	<b>SM4.MG</b>
<b>White</b>	<b>SM4.MW</b>
<b>Black with oak front</b>	<b>SM4.MB01</b>
<b>Black with oak front and backside</b>	<b>SM4.MB02</b>
<b>Grey with oak front</b>	<b>SM4.MG01</b>
<b>Grey with oak front and backside</b>	<b>SM4.MG02</b>
<b>White with oak front</b>	<b>SM4.MW01</b>
<b>White with oak and backside</b>	<b>SM4.MW02</b>

### SHELF FOR CUPBOARD INSERT

H x D x W: 1.2 x 35.2 x 38.9 cm  
 Weight: 1.4 kg  
 Material: MDF, lacquered

<b>Black</b>	<b>SM.MSB</b>
<b>Grey</b>	<b>SM.MSG</b>
<b>White</b>	<b>SM.MSW</b>

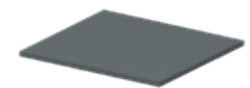

## STORAGE

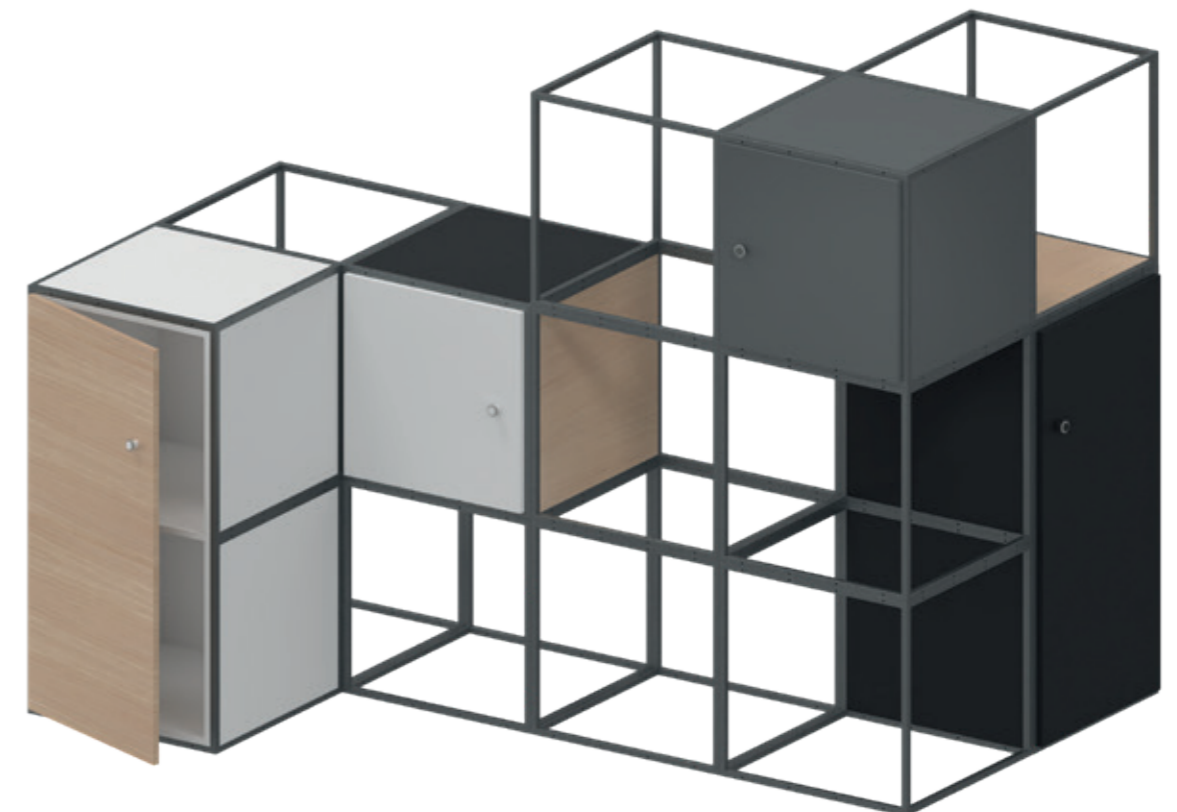
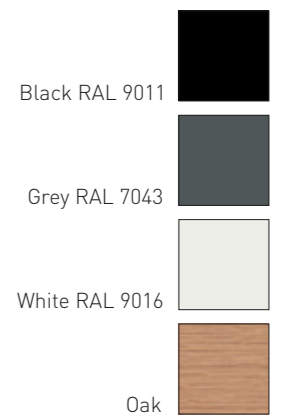
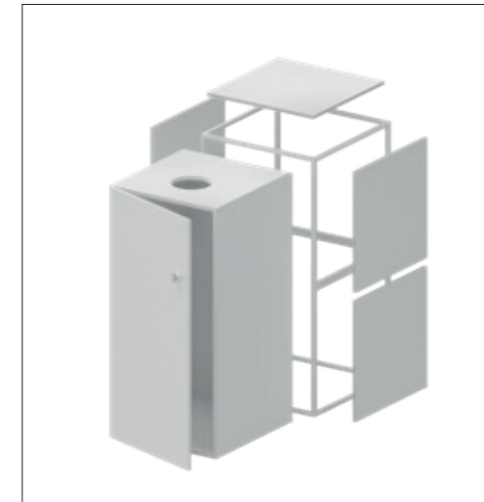

### CUPBOARD INSERTS

Cupboard inserts fit into one or two GRID modules. Placed into the module, they are affixed using GRID screws inserted into the mounting holes. The cut-out at the top makes mounting easy, and shelves/sides are used to ensure a smooth finish. In small cupboards, it is possible to add one or two shelves. In tall cupboards, one, two or three shelves can be inserted. Choose between right- and left-hinged cupboard doors. Extra GRID modules and shelves/sides used to close off side and top sections must be ordered separately. Loose shelves must be ordered separately.

## STORAGE



### KEY LOCK

Weight: 0.1 kg  
Material: Metal  
Lock for SM1, SM2, SM3 and SM4

Key lock LOCK.1



### CODE LOCK

Weight: 0.1 kg  
Material: Metal/black plastic  
Lock for SM1, SM3 and SM4

Code lock LOCK.2



### CHIP LOCK

Weight: 0.1 kg  
Material: Metal/black plastic  
Lock for SM3 and SM4

Chip lock LOCK.5



## STORAGE

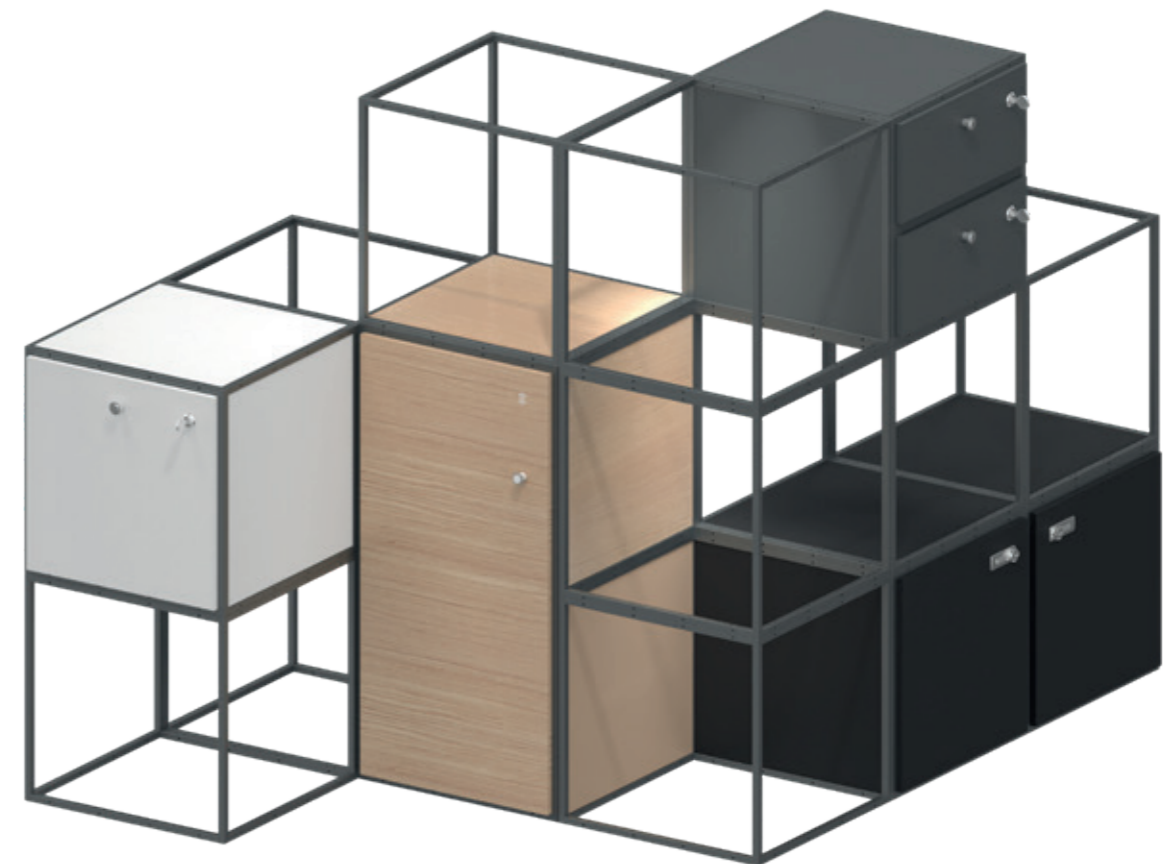

### KEY LOCKS, CODE LOCKS AND CHIP LOCKS

Locks are mounted in a drawer or cupboard insert. Unless otherwise specified, the lock is placed in the upper right corner of the drawer insert and in the upper corner above the handle in the cupboard insert. A key lock can be ordered with the same or different keys. Master keys for locks can also be ordered. Chip locks are MiFare RFID locks and include a chip/key tag. Add locks if you want to create personal and private storage space.

## STORAGE



### DOOR KIT

H x D x W: 37.2 x 0.4 x 37.2 cm

Weight: 1.3 kg

Material: Glass, clear

Door Kit **D.GC**

### DOOR KIT WITH LOCK

H x D x W: 37.2 x 0.4 x 37.2 cm

Weight: 1.3 kg

Material: Glass, clear

Door with Lock **D.GCL**

## STORAGE

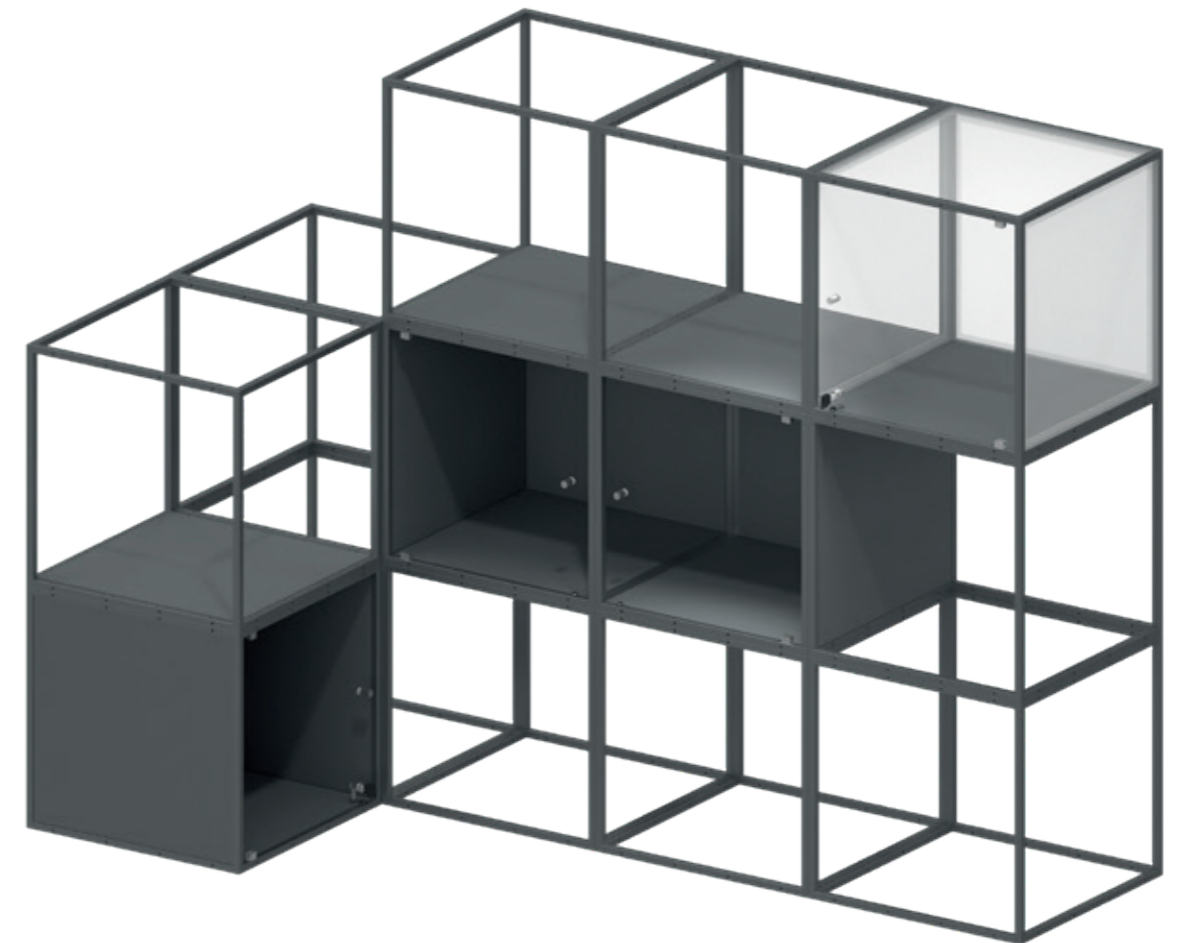

### DOOR KIT

Door kits are glass doors that are mounted directly in the GRID module. Shelves/sides are used to close off the module. Door kits can be mounted on the right or left side. Shelves/sides for the base, side and top panels must be ordered separately.



## WHITEBOARD PANELS



### WHITEBOARD PANEL, 1X1

H x D x W: 40 x 2.1 x 40 cm  
Weight: 2.7 kg  
Material: Whiteboard and MDF, lacquered

**Whiteboard/black** PW1.1.B-W  
**Whiteboard/grey** PW1.1.G-W  
**Whiteboard/white** PW1.1.W-W

### WHITEBOARD PANEL, 1X2

H x D x W: 40 x 2.1 x 80 cm  
Weight: 5.4 kg  
Material: Whiteboard and MDF, lacquered

**Whiteboard/black** PW1.2.B-W  
**Whiteboard/grey** PW1.2.G-W  
**Whiteboard/white** PW1.2.W-W

### WHITEBOARD PANEL, 2X2

H x D x W: 80 x 2.1 x 80 cm  
Weight: 10.8 kg  
Material: Whiteboard and MDF, lacquered

**Whiteboard/black** PW2.2.B-W  
**Whiteboard/grey** PW2.2.G-W  
**Whiteboard/white** PW2.2.W-W

## WHITEBOARD PANELS

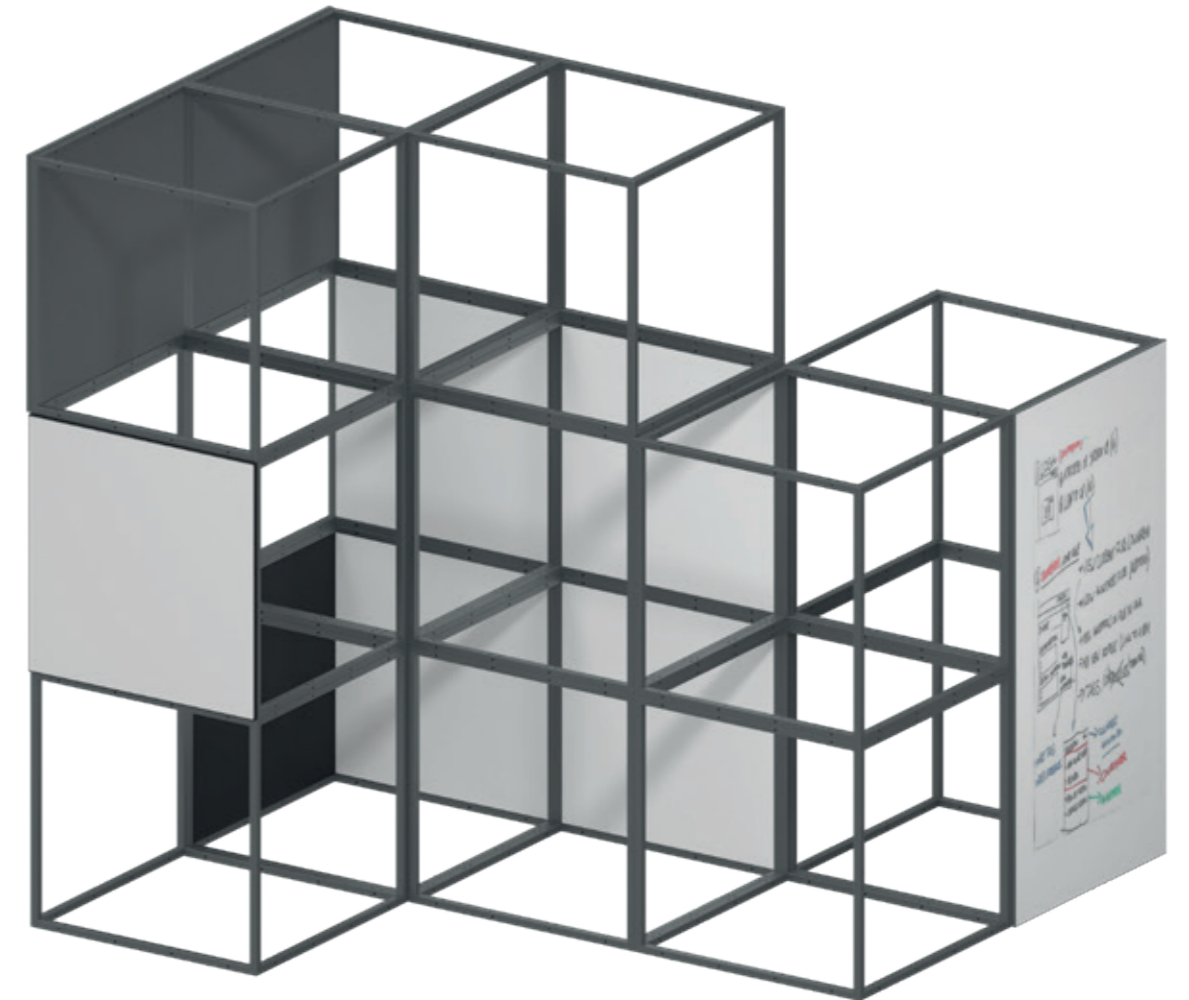
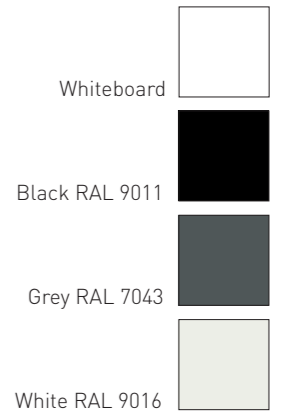

### WHITEBOARD PANELS

Whiteboard panels fit one, two or four [2 x 2] GRID modules. Whiteboard panels are made with a magnetic ceramic material that is glued onto a lacquered MDF panel. Choose between a black, grey or white backside.



## CORK PANELS



### CORK PANEL, 1X1

H x D x W: 40 x 2.4 x 40 cm  
Weight: 2.4 kg  
Material: Natural cork and MDF, lacquered

**Cork/black** PC1.1.B-C  
**Cork/grey** PC1.1.G-C  
**Cork/white** PC1.1.W-C

### CORK PANEL, 1X2

H x D x W: 40 x 2.4 x 80 cm  
Weight: 4.8 kg  
Material: Natural cork and MDF, lacquered

**Cork/black** PC1.2.B-C  
**Cork/grey** PC1.2.G-C  
**Cork/white** PC1.2.W-C

### CORK PANEL, 2X2

H x D x W: 80 x 2.4 x 80 cm  
Weight: 9.6 kg  
Material: Natural cork and MDF, lacquered

**Cork/black** PC2.2.B-C  
**Cork/grey** PC2.2.G-C  
**Cork/white** PC2.2.W-C

## CORK PANELS

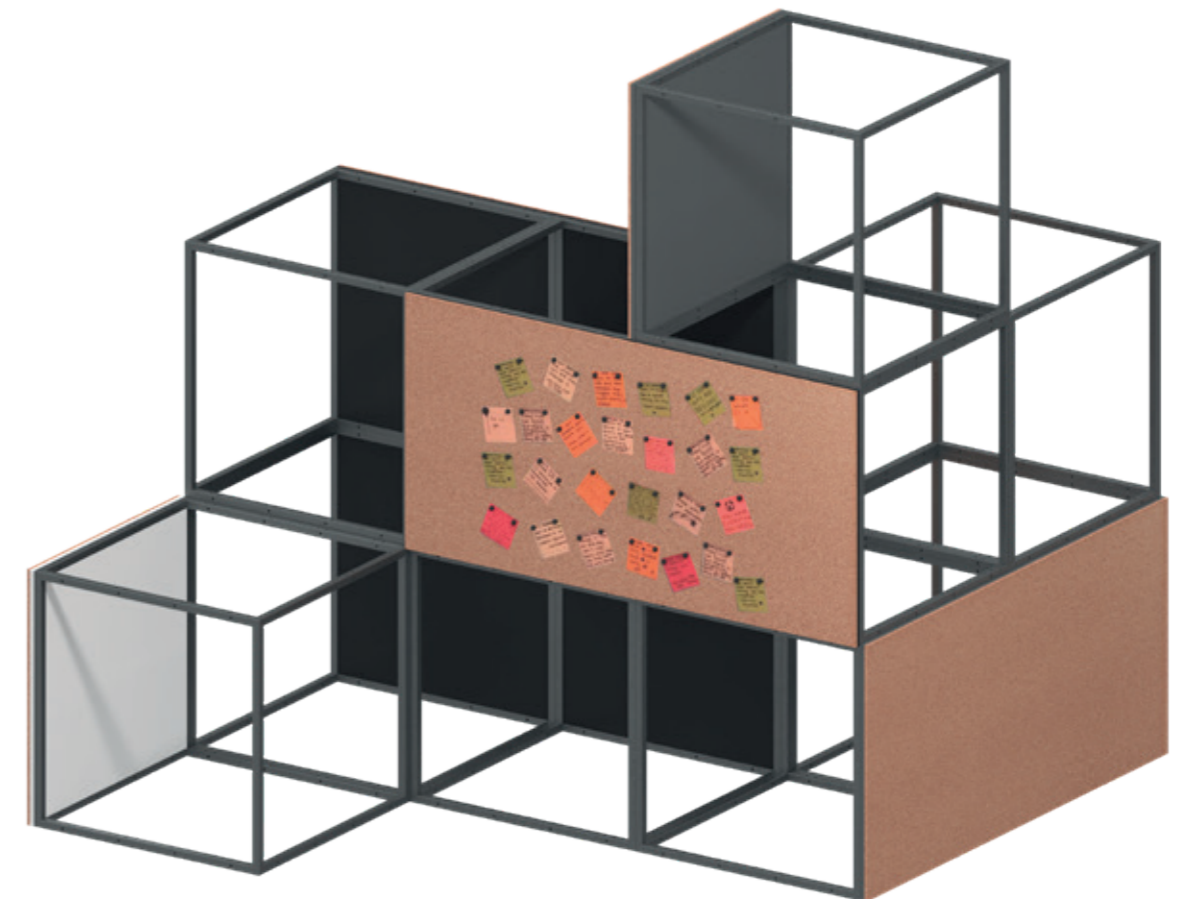

### CORK PANELS

Cork panels fit one, two or four (2 x 2) GRID modules and can be used as a pinboard. The cork is middle-grained natural cork that is glued onto a lacquered MDF panel. Choose between a black, grey or white backside.

## FELT PANELS



### FELT PANEL, 1X1

H x D x W: 40 x 2.4 x 40 cm  
 Weight: 2.3 kg  
 Material: Felt and MDF, lacquered

Off-White/black	PF1.1.B-63
Off-White/grey	PF1.1.G-63
Off-White/white	PF1.1.W-63
Stone Grey/black	PF1.1.B-67
Stone Grey/grey	PF1.1.G-67
Stone Grey/white	PF1.1.W-67
Anthracite/black	PF1.1.B-68
Anthracite/grey	PF1.1.G-68
Anthracite/white	PF1.1.W-68

### FELT PANEL, 1X2

H x D x W: 40 x 2.4 x 80 cm  
 Weight: 4.6 kg  
 Material: Felt and MDF, lacquered

Off-White/black	PF1.2.B-63
Off-White/grey	PF1.2.G-63
Off-White/white	PF1.2.W-63
Stone Grey/black	PF1.2.B-67
Stone Grey/grey	PF1.2.G-67
Stone Grey/white	PF1.2.W-67
Anthracite/black	PF1.2.B-68
Anthracite/grey	PF1.2.G-68
Anthracite/white	PF1.2.W-68

### FELT PANEL, 2X2

H x D x W: 80 x 2.4 x 80 cm  
 Weight: 9.2 kg  
 Material: Felt and MDF, lacquered

Off-White/black	PF2.2.B-63
Off-White/grey	PF2.2.G-63
Off-White/white	PF2.2.W-63
Stone Grey/black	PF2.2.B-67
Stone Grey/grey	PF2.2.G-67
Stone Grey/white	PF2.2.W-67
Anthracite/black	PF2.2.B-68
Anthracite/grey	PF2.2.G-68
Anthracite/white	PF2.2.W-68

## FELT PANELS

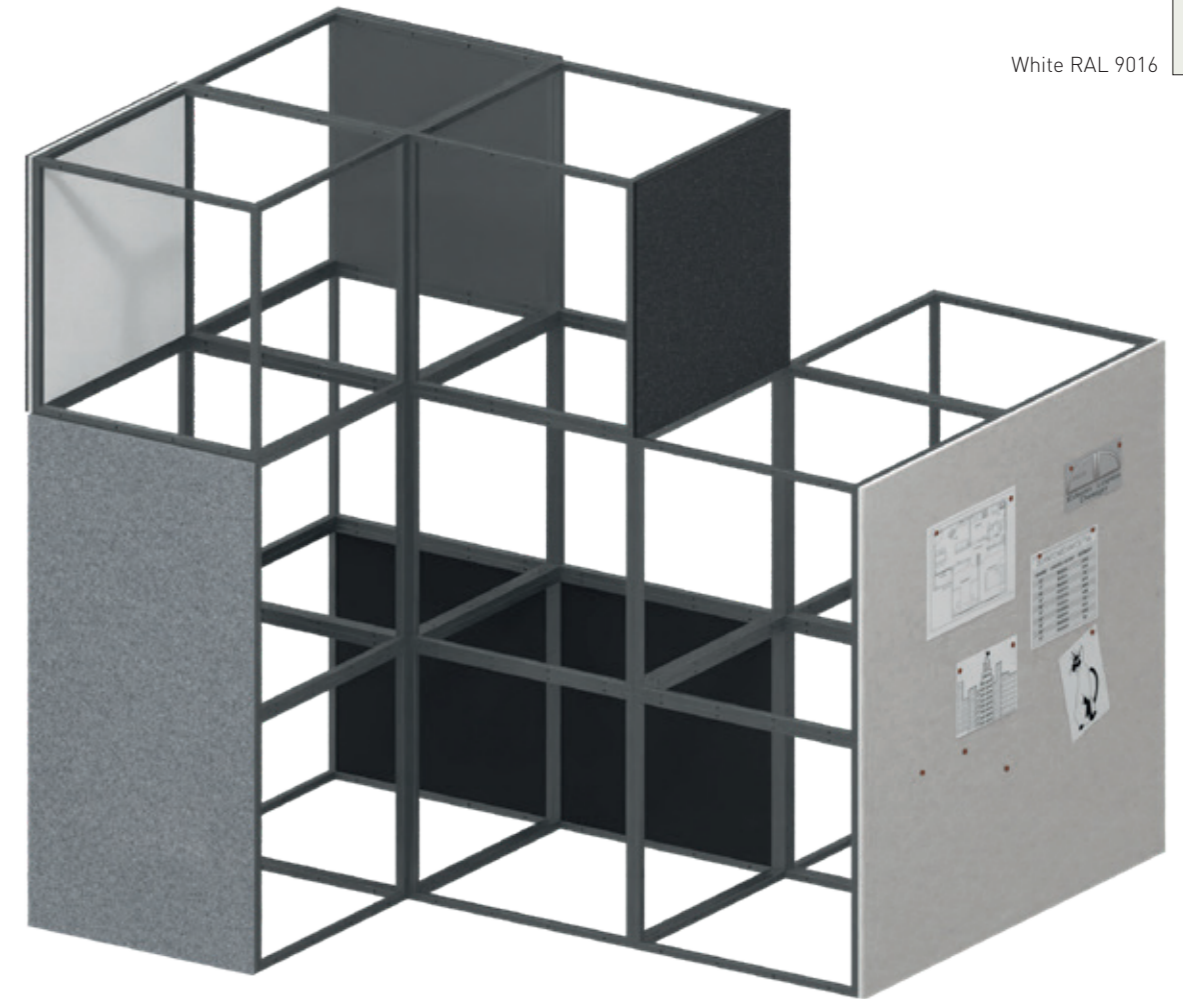

### FELT PANELS

Felt panels fit one, two or four [2 x 2] GRID modules and can be used as a pinboard and an acoustic-regulating element. The felt is glued onto a lacquered MDF panel. Choose between a black, grey or white backside.



## FELT SIDE PANELS AND DOUBLE SIDE PANELS



### FELT SIDE PANEL

H x D x W: 37.6 x 37.6 x 1.2 cm  
 Weight: 1.4 kg  
 Material: Felt-coated steel

**Off-White** SF.63  
**Stone Grey** SF.67  
**Anthracite** SF.68



### DOUBLE SIDE PANEL

H x D x W: 37.6 x 37.6 x 2.2 cm  
 Weight: 2.3 kg  
 Material: MDF, lacquered

**Black** DS.MB  
**Grey** DS.MG  
**White** DS.MW

## FELT SIDE PANELS AND DOUBLE SIDE PANELS

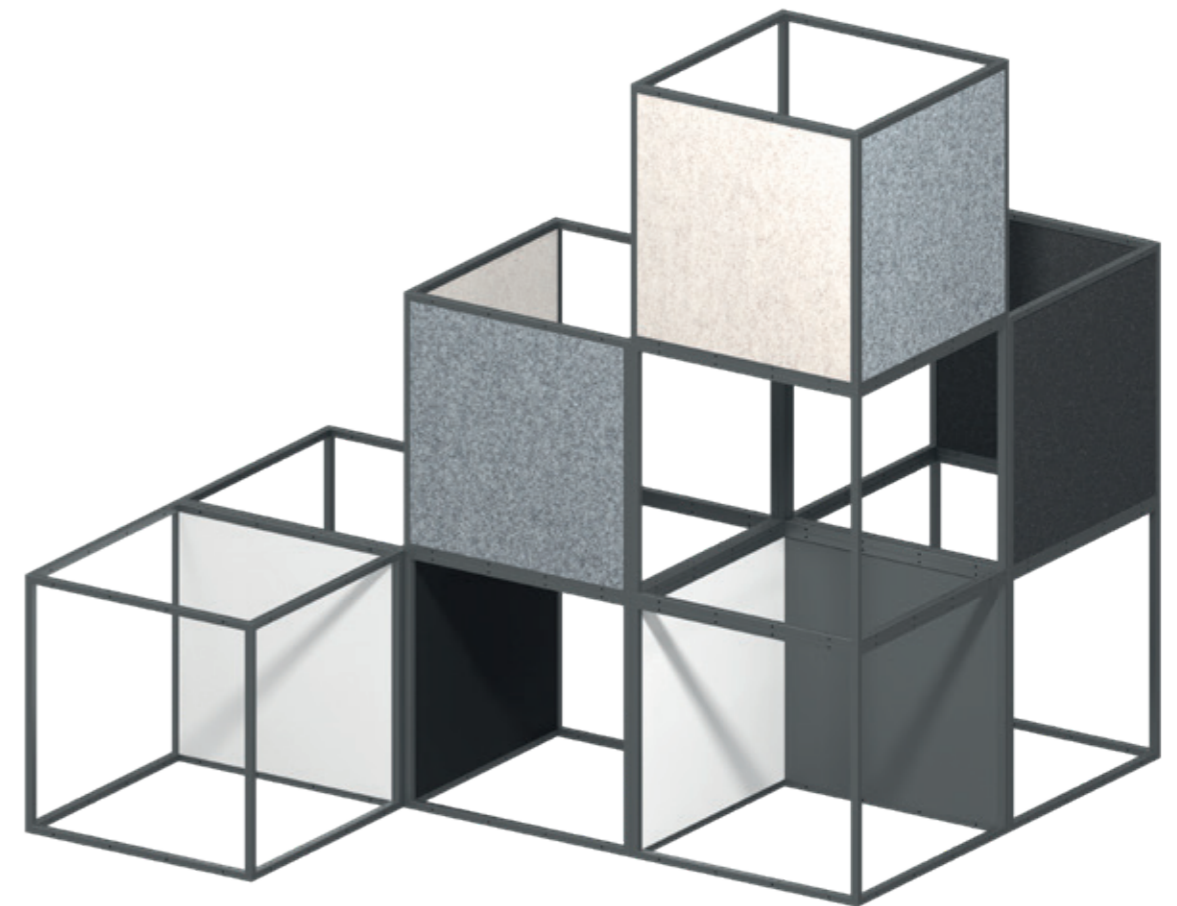
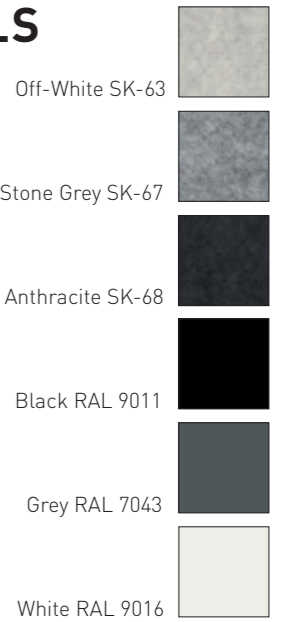

### FELT SIDE PANELS AND DOUBLE SIDE PANELS

Felt side panels fit one GRID module and can only be used for vertical mounting and function as a pinboard and an acoustic-regulating element. Felt side panels are magnetic and have felt on both sides. The felt side panels can simply be clicked into the module.

Double side panels fit one GRID module and can be used as a middle section when two GRID modules are placed together.



## BOX SIDE PANELS AND TOP BOXES



### BOX SIDE PANEL

H x D x W: 15 x 37.6 x 1.2 cm  
 Weight: 0.5 kg  
 Material: MDF, lacquered or veneered

**Black**      **PB.MB**  
**Grey**        **PB.MG**  
**White**       **PB.MW**  
**Oak**         **PB.MO**



### TOP BOX, 1X1

H x D x W: 16.2 x 40 x 40 cm  
 Weight: 3.3 kg  
 Material: MDF, lacquered or veneered

**Black**      **TB.MB**  
**Grey**        **TB.MG**  
**White**       **TB.MW**  
**Oak**         **TB.MO**



### PLANT BOX INSERT

H x D x W: 14.5 x 37.6 x 37.6 cm  
 Weight: 1 kg  
 Material: ABS

**Black**      **PBI.B**  
**Grey**        **PBI.G**  
**White**       **PBI.W**

## BOX SIDE PANELS AND TOP BOXES



### BOX SIDE PANELS AND TOP BOXES

Box side panels can be used to build a box in one or more GRID modules. Box side panels can be mounted inside a GRID module with shelves/sides as a base. In combination with plant box inserts, box side panels can also function as planters. Shelves/sides used as a base must be ordered separately.

A top box fits a single GRID module and is a combined unit with sides and a base. The top box is mounted on the top of the module and sits above the module's frame. In combination with plant box inserts, top boxes can be used as plant holders.

Plant box inserts fit down into a GRID module mounted with box sides or in a top box. The insert is waterproof and has a loose drainage base. The GRID module, box sides and top boxes must be ordered separately.



## MOSS PANELS



### MOSS PANEL

H x D x W: 37.6 x 37 x 37.6 cm  
Weight: 1.7 kg  
Material: Moss, ABS and MDF, lacquered

**Black**      **MP.B**  
**Grey**      **MP.G**  
**White**     **MP.W**

## MOSS PANELS

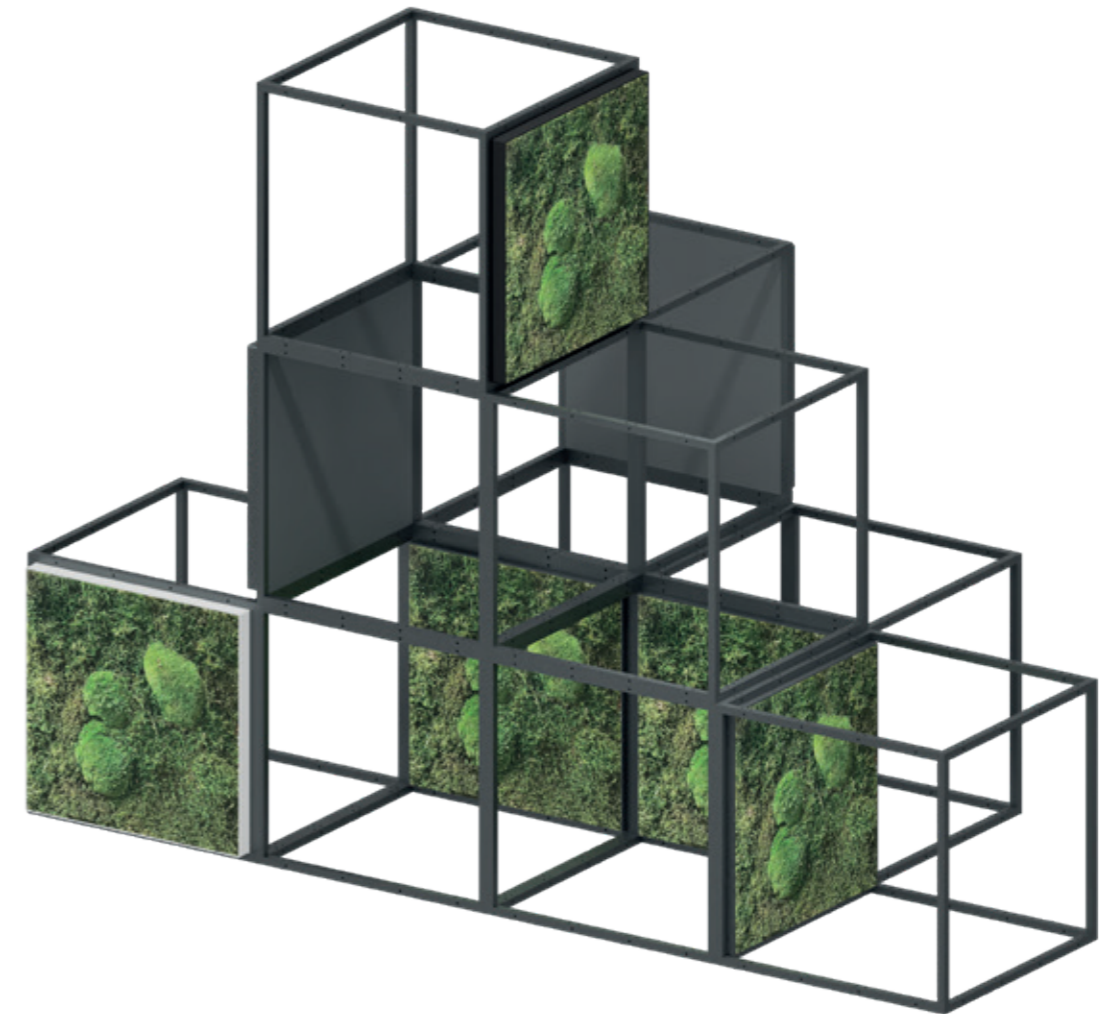
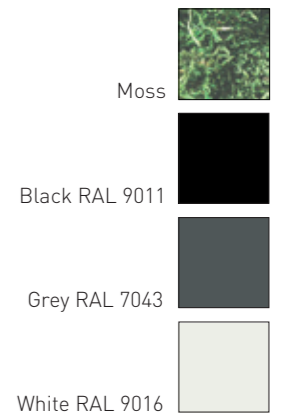

### MOSS PANELS

Moss panels fit one GRID module and can be used for vertical or horizontal mounting. The moss is preserved with natural plant substances. Each panel is a mix of turf and cushion moss and each panel is unique. Choose between black, grey or white for the frame and backside.



## MAGAZINE SHELVES

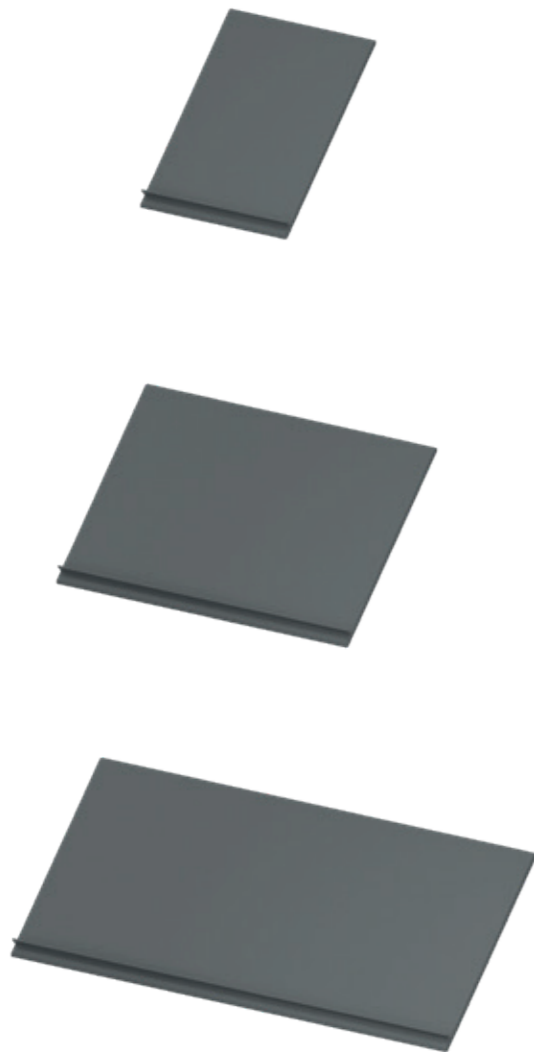

### MAGAZINE SHELF, 1X1

H x D x W: 3.2 x 53 x 40 cm  
Weight: 2.1 kg  
Material: MDF, lacquered

**Black** MS1.1.MB  
**Grey** MS1.1.MG  
**White** MS1.1.MW

### MAGAZINE SHELF, 1X2

H x D x W: 3.2 x 53 x 80 cm  
Weight: 4.1 kg  
Material: MDF, lacquered

**Black** MS1.2.MB  
**Grey** MS1.2.MG  
**White** MS1.2.MW

### MAGAZINE SHELF, 1X3

H x D x W: 3.2 x 53 x 120 cm  
Weight: 6.2 kg  
Material: MDF, lacquered

**Black** MS1.3.MB  
**Grey** MS1.3.MG  
**White** MS1.3.MW

## MAGAZINE SHELVES

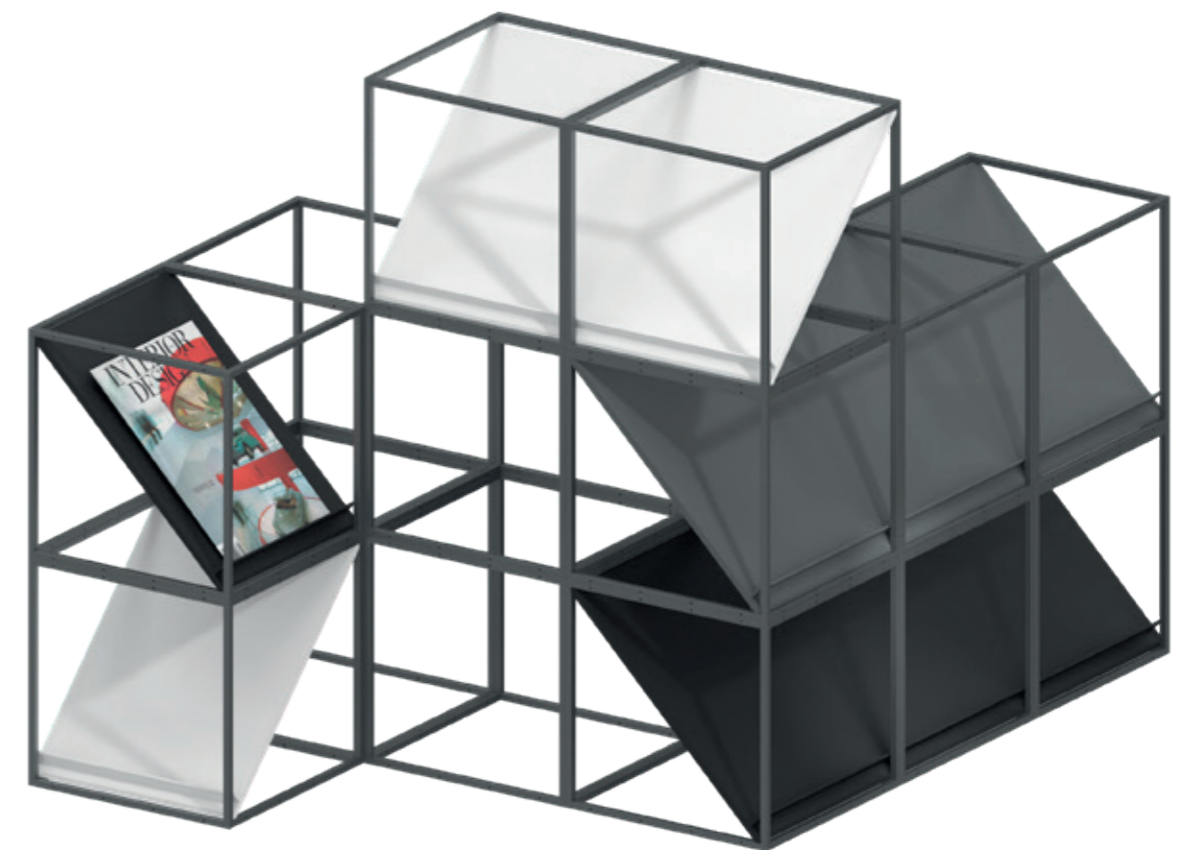
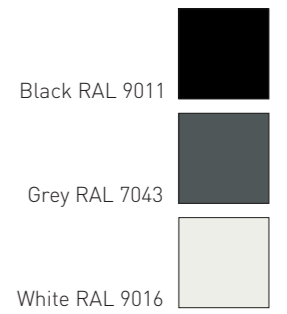

### MAGAZINE SHELVES

Magazine shelves fit into one, two or three GRID modules and are inserted through the side of the module.

## DIVIDER INSERTS

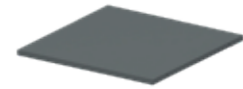

### DIVIDER INSERT

H x D x W: 37.6 x 37.6 x 40 cm  
 Weight: 3.6 kg  
 Material: MDF, lacquered or veneered

**Black** DI.MB  
**Grey** DI.MG  
**White** DI.MW  
**Oak** DI.MO

### SHELF/SIDE FOR DIVIDER INSERT

H x D x W: 1.2 x 37.6 x 37.6 cm  
 Weight: 1.2 kg  
 Material: MDF, lacquered or veneered

**Black** DIS.MB  
**Grey** DIS.MG  
**White** DIS.MW  
**Oak** DIS.MO

## DIVIDER INSERTS

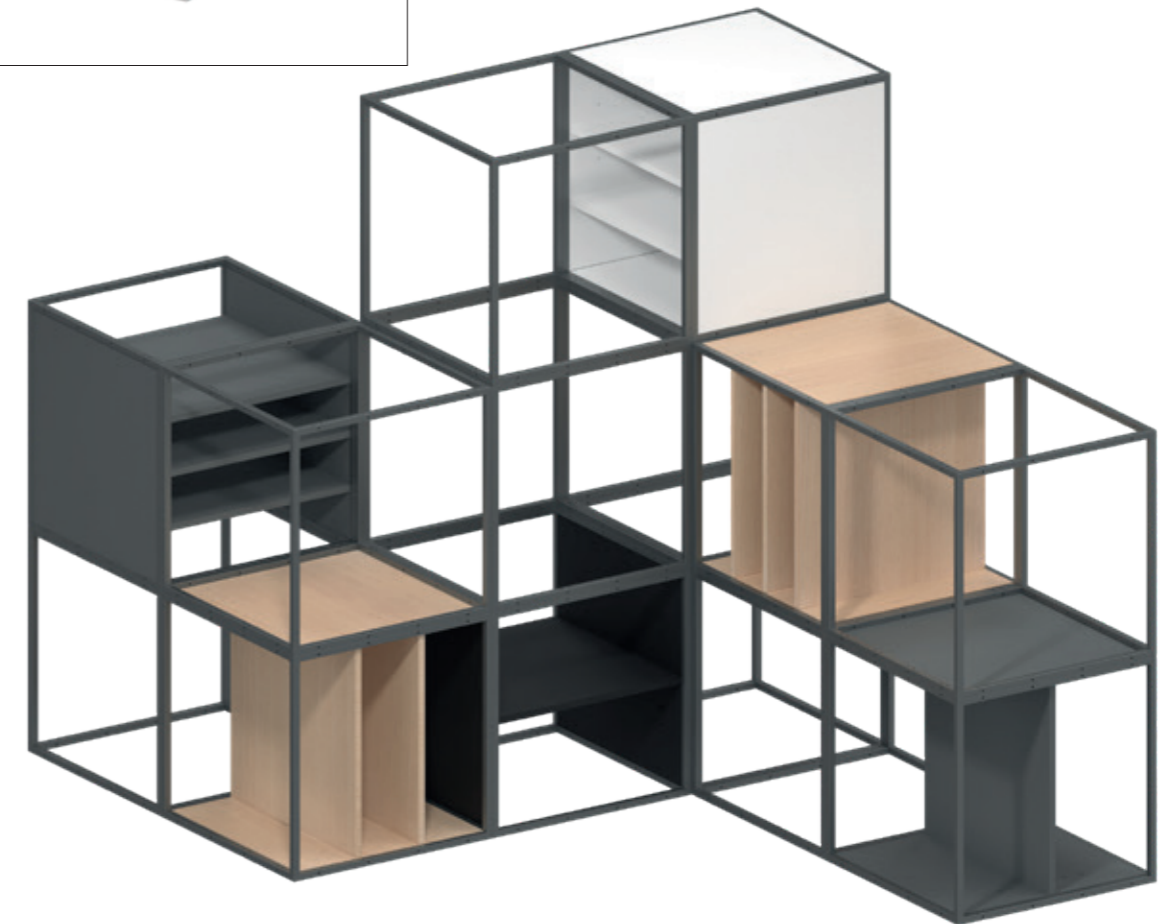
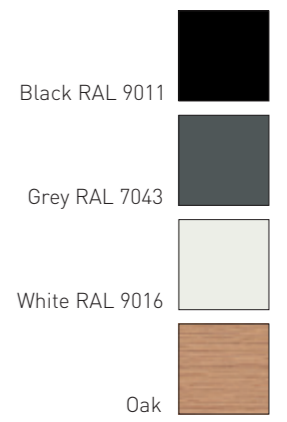
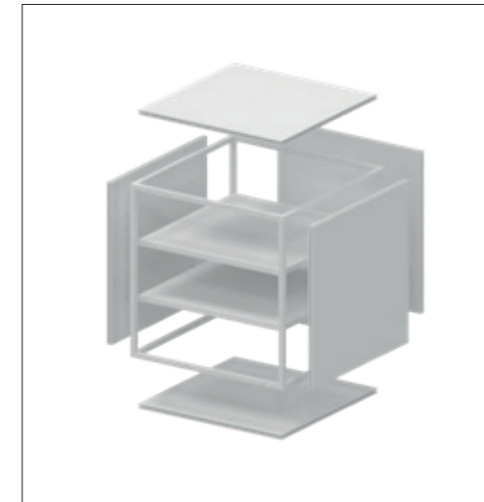

### DIVIDER INSERTS

Divider inserts fit into one GRID module and are a set that consists of two end-boards and a shelf/side. Divider inserts can be mounted vertically or horizontally in the GRID module. Extra shelves/sides for the divider inserts can be added to create additional vertical or horizontal space. Shelves and sides for closing off sides or top sections must be ordered separately.



## SEATS

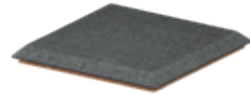

### SEAT, 1X1

H x D x W: 4.4 x 40 x 40 cm

Weight: 2.4 kg

Material: MDF, upholstered foam with fabric or leather

<b>Messenger, light grey</b>	<b>SE1.1.UM031</b>
<b>Messenger, dark grey</b>	<b>SE1.1.UM008</b>
<b>Messenger, black</b>	<b>SE1.1.UM029</b>
<b>Remix, light grey</b>	<b>SE1.1.UR123</b>
<b>Remix, dark grey</b>	<b>SE1.1.UR163</b>
<b>Remix, black</b>	<b>SE1.1.UR183</b>
<b>Leather, black</b>	<b>SE1.1.UL1599</b>



### SEAT, 1X2

H x D x W: 4.4 x 40 x 80 cm

Weight: 4.8 kg

Material: MDF, upholstered foam with fabric or leather

<b>Messenger, light grey</b>	<b>SE1.2.UM031</b>
<b>Messenger, dark grey</b>	<b>SE1.2.UM008</b>
<b>Messenger, black</b>	<b>SE1.2.UM029</b>
<b>Remix, light grey</b>	<b>SE1.2.UR123</b>
<b>Remix, dark grey</b>	<b>SE1.2.UR163</b>
<b>Remix, black</b>	<b>SE1.2.UR183</b>
<b>Leather, black</b>	<b>SE1.2.UL1599</b>



### SEAT, 1X3

H x D x W: 4.4 x 40 x 120 cm

Weight: 7.2 kg

Material: MDF, upholstered foam with fabric or leather

<b>Messenger, light grey</b>	<b>SE1.3.UM031</b>
<b>Messenger, dark grey</b>	<b>SE1.3.UM008</b>
<b>Messenger, black</b>	<b>SE1.3.UM029</b>
<b>Remix, light grey</b>	<b>SE1.3.UR123</b>
<b>Remix, dark grey</b>	<b>SE1.3.UR163</b>
<b>Remix, black</b>	<b>SE1.3.UR183</b>
<b>Leather, black</b>	<b>SE1.3.UL1599</b>

## SEATS



Light Grey Messenger 031



Dark Grey Messenger 008



Black Messenger 029



Light Grey Remix 123



Dark Grey Remix 163



Black Remix 183



Black Leather Ultra 1599

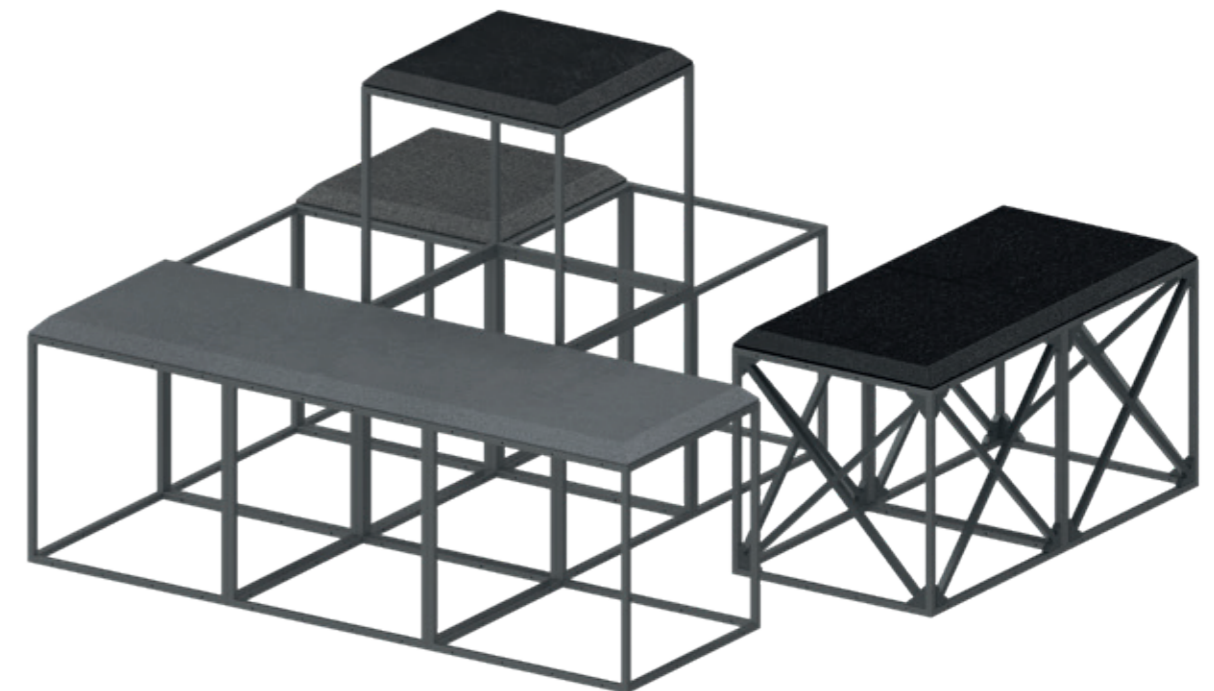

### SEATS

Upholstered seats can be used for large seating arrangements, benches or stools. The fabric is Messenger from Maharam or Remix from Kvadrat and the leather is Ultra from Sørensen Leather. Cross braces or side panels are necessary for reinforcement. The number and placement of these are dependent on the specific arrangement of the unit. Please contact us for assistance.

## SEATS



### SEAT, 1X4

H x D x W: 4.4 x 40 x 160 cm  
 Weight: 9.6 kg  
 Material: MDF, upholstered foam with fabric or leather

<b>Messenger, light grey</b>	<b>SE1.4.UM031</b>
<b>Messenger, dark grey</b>	<b>SE1.4.UM008</b>
<b>Messenger, black</b>	<b>SE1.4.UM029</b>
<b>Remix, light grey</b>	<b>SE1.4.UR123</b>
<b>Remix, dark grey</b>	<b>SE1.4.UR163</b>
<b>Remix, black</b>	<b>SE1.4.UR183</b>
<b>Leather, black</b>	<b>SE1.4.UL1599</b>

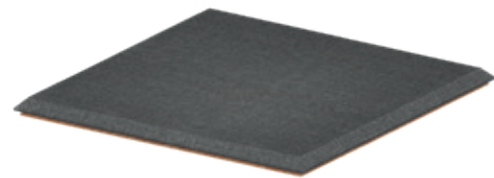

### SEAT, 2X2

H x D x W: 4.4 x 80 x 80 cm  
 Weight: 9.6 kg  
 Material: MDF, upholstered foam with fabric or leather

<b>Messenger, light grey</b>	<b>SE2.2.UM031</b>
<b>Messenger, dark grey</b>	<b>SE2.2.UM008</b>
<b>Messenger, black</b>	<b>SE2.2.UM029</b>
<b>Remix, light grey</b>	<b>SE2.2.UR123</b>
<b>Remix, dark grey</b>	<b>SE2.2.UR163</b>
<b>Remix, black</b>	<b>SE2.2.UR183</b>
<b>Leather, black</b>	<b>SE2.2.UL1599</b>

## SEATS



Light Grey Messenger 031	
Dark Grey Messenger 008	
Black Messenger 029	
Light Grey Remix 123	
Dark Grey Remix 163	
Black Remix 183	
Black Leather Ultra 1599	

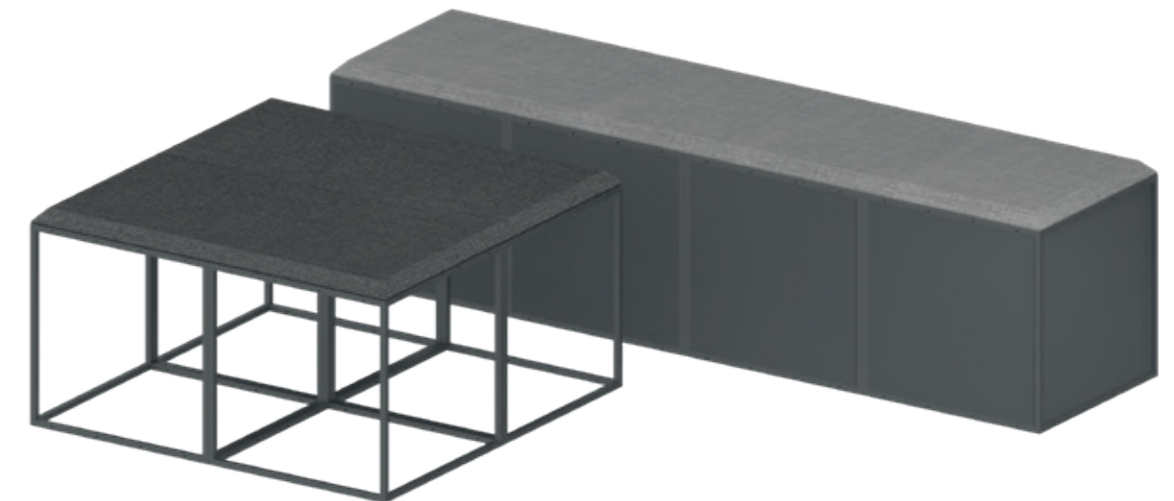

### SEATS

Upholstered seats can be used for large seating arrangements, benches or stools. The fabric is Messenger from Maharam or Remix from Kvadrat and the leather is Ultra from Sørensen Leather. Cross braces or side panels are necessary for reinforcement. The number and placement of these are dependent on the specific arrangement of the unit. Please contact us for assistance.

## HANGERS



### HANGING RAIL, 1X1

D x W: Diam. 2.5 x 40 cm  
Weight: 0.4 kg  
Material: Stainless steel, brushed

**Hanging Rail, 1x1 HA1.1.SS**



### HANGING RAIL, 1X2

D x W: Diam. 2.5 x 80 cm  
Weight: 0.8 kg  
Material: Stainless steel, brushed

**Hanging Rail, 1x2 HA1.2.SS**



### HANGER KIT, 1X1

H x D x W: 7.7 x 9.5 x 40 cm  
Weight: 0.3 kg  
Material: Stainless steel, brushed

**Hanger Kit, 1x1 HB1.1.SS**



## HANGERS

Stainless Steel, Brushed

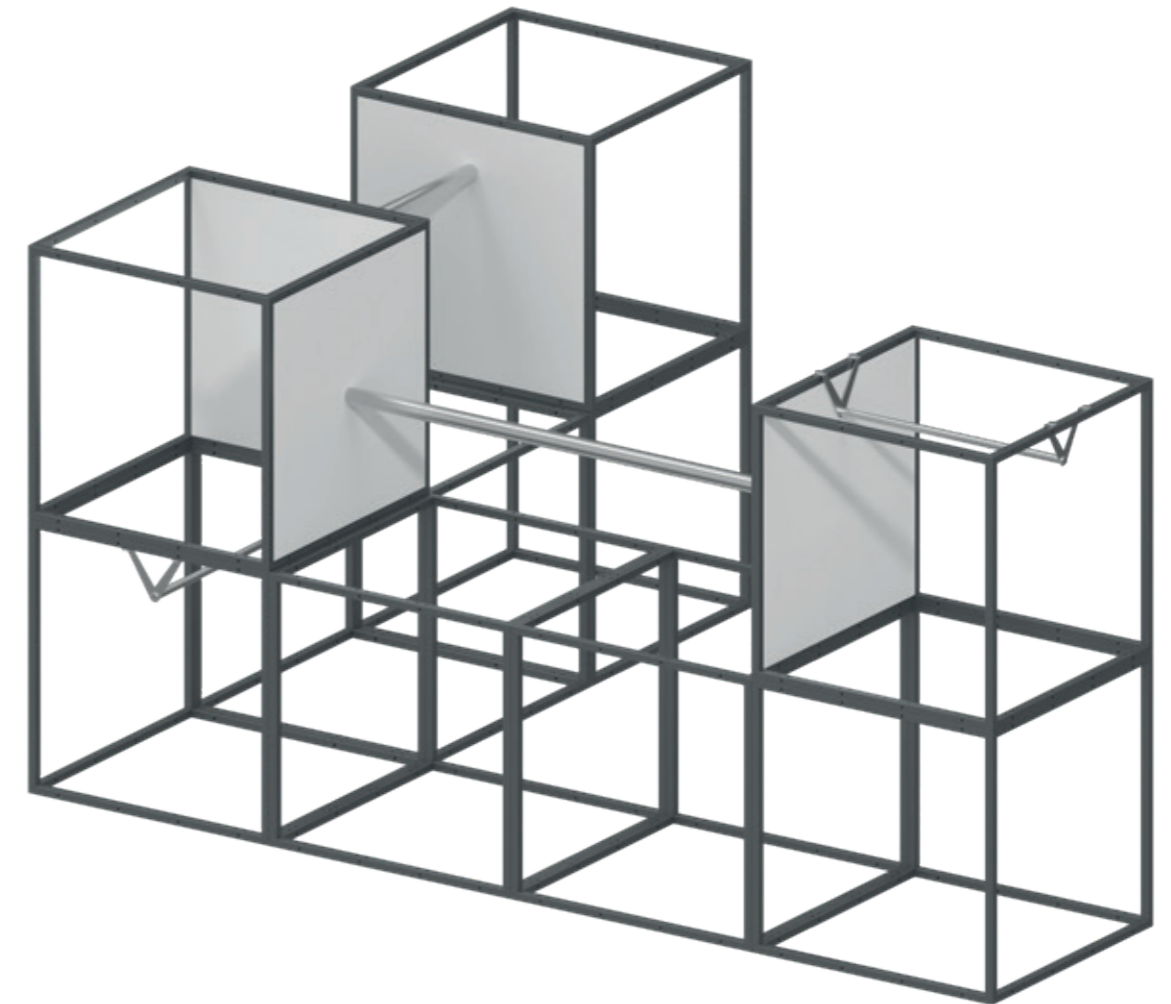

### HANGING RAIL AND HANGER KIT

Hanging rails are mounted between two GRID modules on their side panels. Unless otherwise specified, the hanging rail will be placed in the centre of the side panels. The hanger kit is mounted inside one GRID module. Shelves/sides must be ordered separately.

## SUPPORT BEAMS



### SUPPORT BEAM, 3

W: 120 cm  
 Weight: 2.0 kg  
 Material: Steel, lacquered

**Black** SB.3.B  
**Grey** SB.3.G  
**White** SB.3.W



### SUPPORT BEAM, 4

W: 160 cm  
 Weight: 2.7 kg  
 Material: Steel, lacquered

**Black** SB.4.B  
**Grey** SB.4.G  
**White** SB.4.W



### SUPPORT BEAM, 5

W: 200 cm  
 Weight: 3.4 kg  
 Material: Steel, lacquered

**Black** SB.5.B  
**Grey** SB.5.G  
**White** SB.5.W

## SUPPORT BEAMS

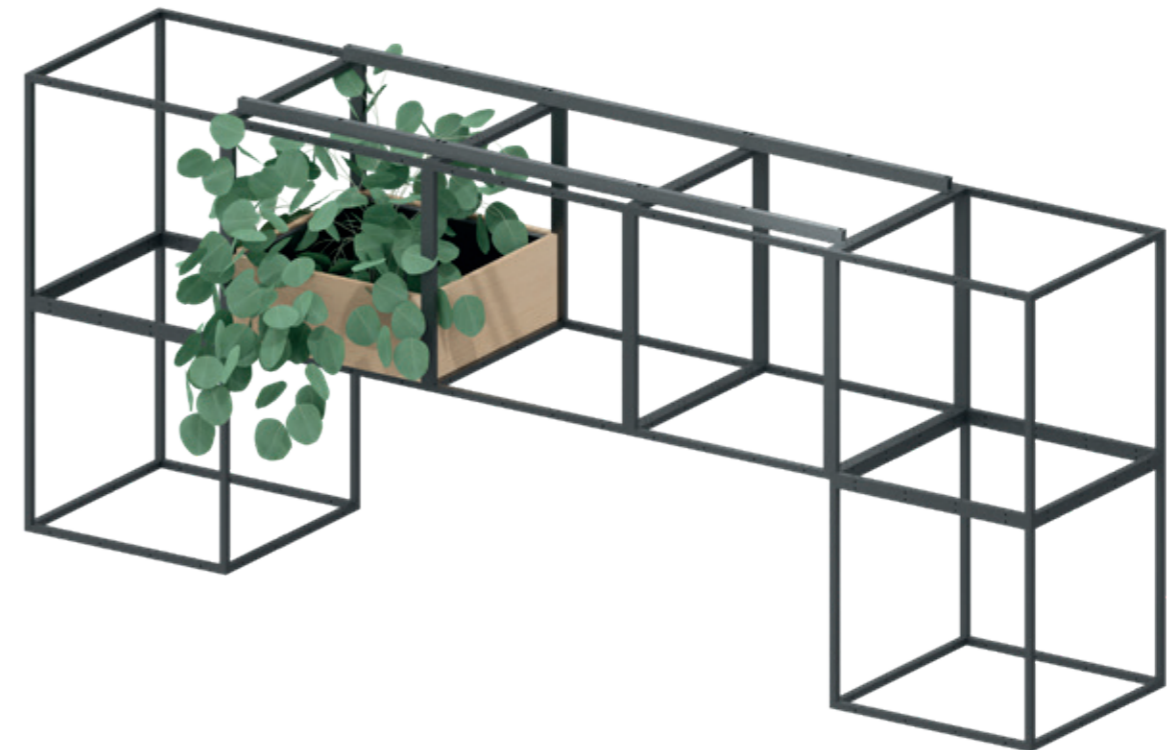
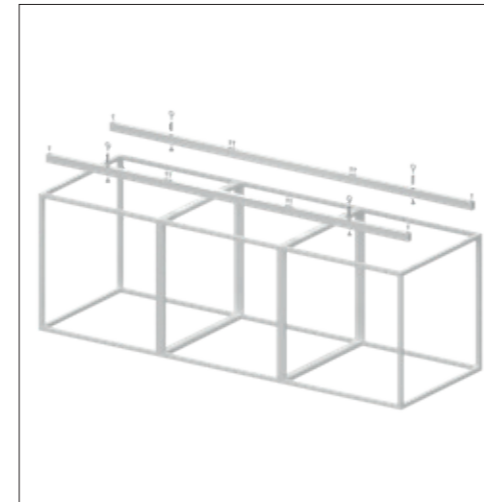
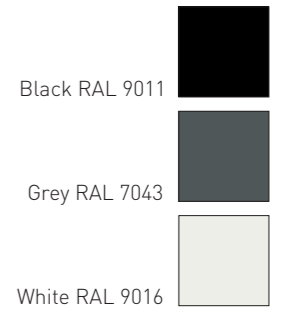

### SUPPORT BEAMS

Support beams can be used to reinforce and strengthen configurations and can be integrated using free-hanging GRID modules and archway constructions. Support brackets are available for 3, 4 or 5 GRID modules and can be mounted inside or on top of the modules. A set of support beams consist of two beams with eye bolts. When needed, the support beams can be mounted directly into the ceiling or hung by wires.



## SCREWS, BITS AND MORE



### GRID SCREWS, 50 PCS.

Standard: M4 x 20 mm  
 Short: M4 x 12 mm  
 (use for acrylic shelves/sides)  
 Material: Stainless steel

**Standard PS20.50**  
**Short PS12.50**



### GRID BIT, 5 PCS.

Size: 2 mm, 50 mm length  
 Material: Steel

**Bit B2.5**



### FLEXIBLE BIT HOLDER

Size: Diam. 15 mm, 275 mm length  
 Weight: 50 g  
 Material: Metal and plastic

**Flexible Bit Holder FBH1**



### SUCTION DISC

Size: Diam. 118 mm, 100 mm height  
 Weight: 170 g  
 Material: Plastic

**Suction Disc SD1**



### SPACERS, 10 PCS.

Size: Diam. 10 mm, 12 mm / 24 mm length  
 Material: Plastic

**Black 12 mm S12.B.10**  
**Black 24 mm S24.B.10**  
**Grey 12 mm S12.G.10**  
**Grey 24 mm S24.G.10**  
**White 12 mm S12.W.10**  
**White 24 mm S24.W.10**



### COUNTERWEIGHT

H x D x W: 11 x 376 x 376 mm  
 Weight: 10.2 kg  
 Material: Steel

**Black CW.B**  
**Grey CW.G**  
**White CW.W**

## SCREWS, BITS AND MORE

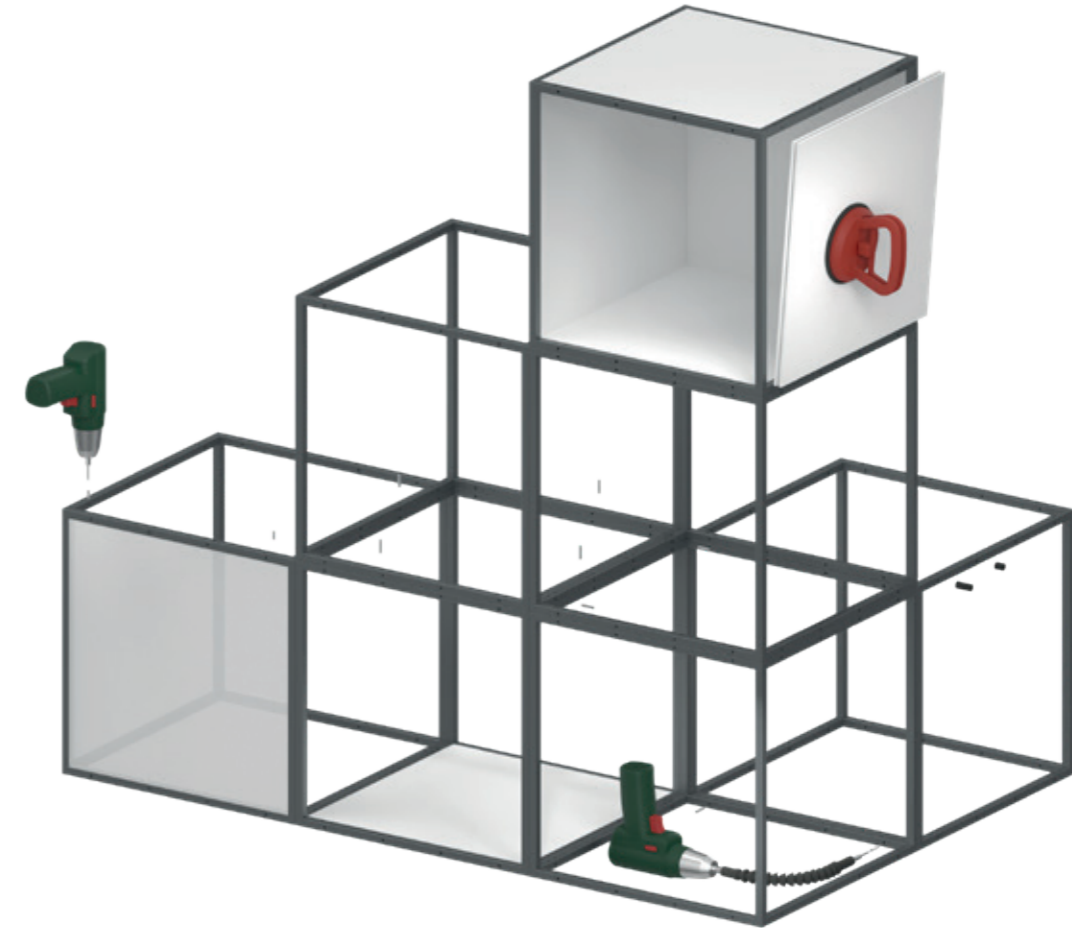

### SCREWS, BITS AND MORE

The GRID screws are used for all installation of GRID modules and accessories. For disassembly and reconfiguration, it is always possible to unscrew the GRID screws again.

The screws are inserted using a small power tool and the GRID bit.

A flexible bit holder is recommended in areas with limited space, for example close to the floor at the bottom of the module.

A suction disc can be useful for holding shelves and side panels in place in more enclosed units when reaching is difficult.

Spacers can ensure correct distance and create a smooth finish when larger units are affixed to the wall.

Counterweights can be used at the base of large and tall units to provide extra stability and balance. Counterweights can either be visible and function as a lower shelf area, or can be hidden within closed GRID modules.

Please refer to the GRID assembly instructions for more detailed guidance.





## HALF GRID MODULES



### HALF GRID MODULE

H x D x W: 40 x 20 x 40 cm  
Frame: 1.2 x 1.2 cm  
Weight: 0.7 kg  
Material: Nylon (PA6) reinforced with glass fibre

**Black**     **HG.NB**  
**Grey**     **HG.NG**  
**White**    **HG.NW**

## HALF GRID MODULES

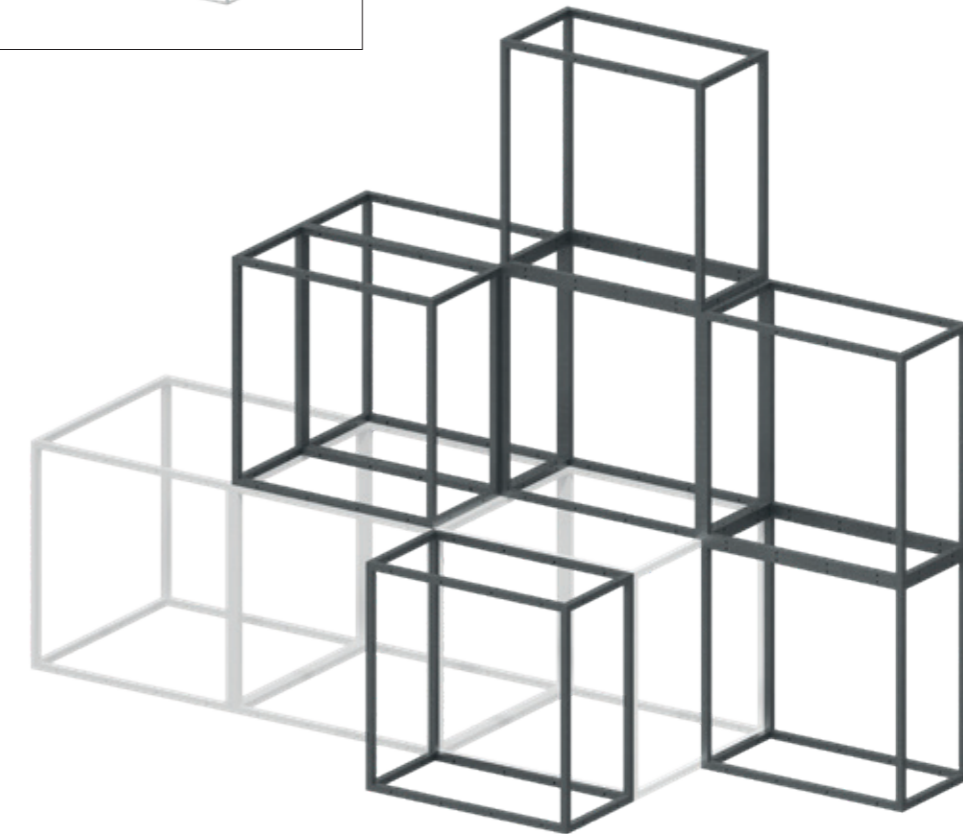
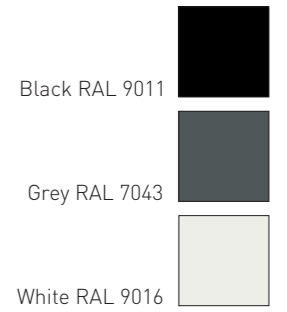
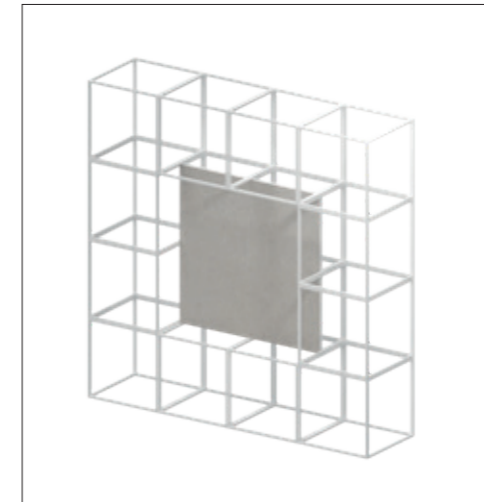

### HALF GRID MODULES

Half GRID modules are the system's resized building blocks, perfect for narrow spaces and niche areas. The half GRID modules can be used for TV screens, graphics, felt, cork, whiteboard panels and more. The lightweight modules are produced in one piece. With visible mounting holes, you can easily combine two, three, hundreds or thousands of modules in all three dimensions. You can also combine these half-sized modules with the original GRID modules. Assembled modules are easy to reconfigure and can always be taken apart and built again in new ways.

A selection of GRID components are designed to fit these half size modules. Add half shelves/sides and half top/base/side panels to create the function and look that matches your space needs.



## HALF SHELVES/SIDES



### HALF SHELF/SIDE, MDF

H x D x W: 1.2 x 17.6 x 37.6 cm  
Weight: 0.7 kg  
Material: MDF, lacquered

**Black** HSS.MB  
**Grey** HSS.MG  
**White** HSS.MW



### HALF SHELF/SIDE, ACRYLIC

H x D x W: 1 x 17.6 x 37.6 cm  
Weight: 0.8 kg  
Material: Acrylic

**Clear** HSS.AC  
**Frosted** HSS.AF

## HALF SHELVES/SIDES

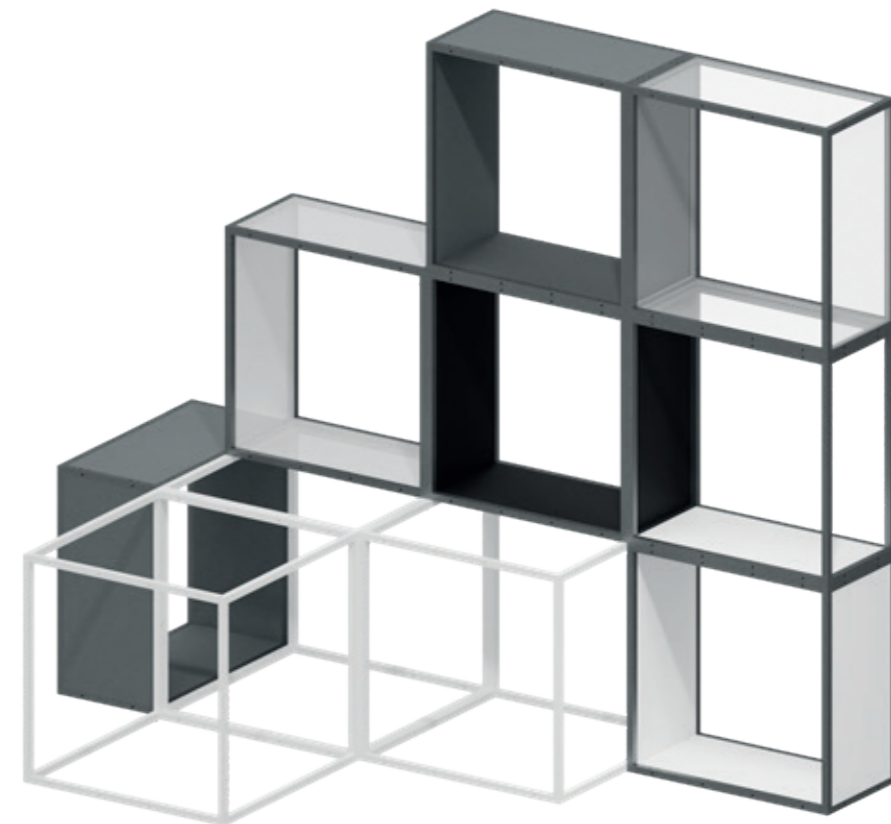
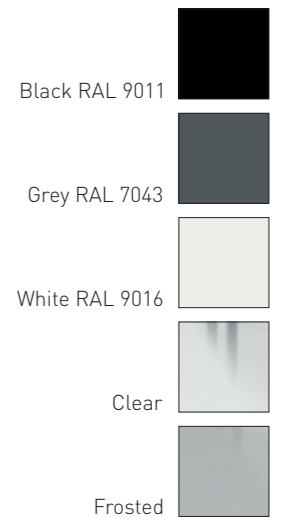

### HALF SHELVES/SIDES

The half shelves/sides fit half GRID modules and are flush with the module's frame. Half shelves/sides can be used as shelves or side panels. Choose lacquered MDF for a solid shelf/side, clear acrylic for transparency and frosted acrylic for white translucency.





## HALF TOP/BASE/SIDE PANELS



### HALF TOP/BASE/SIDE PANEL, 1X1

H x D x W: 2.5 x 20 x 40 cm  
 Weight: 1.4 kg  
 Material: MDF, lacquered

**Black**      **HP1.1.MB**  
**Grey**        **HP1.1.MG**  
**White**       **HP1.1.MW**

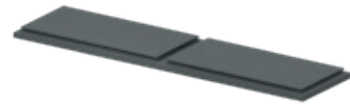

### HALF TOP/BASE/SIDE PANEL, 1X2

H x D x W: 2.5 x 20 x 80 cm  
 Weight: 2.8 kg  
 Material: MDF, lacquered

**Black**      **HP1.2.MB**  
**Grey**        **HP1.2.MG**  
**White**       **HP1.2.MW**

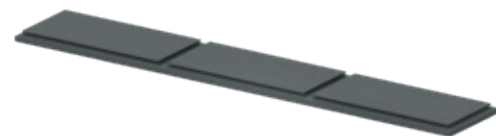

### HALF TOP/BASE/SIDE PANEL, 1X3

H x D x W: 2.5 x 20 x 120 cm  
 Weight: 4.3 kg  
 Material: MDF, lacquered

**Black**      **HP1.3.MB**  
**Grey**        **HP1.3.MG**  
**White**       **HP1.3.MW**

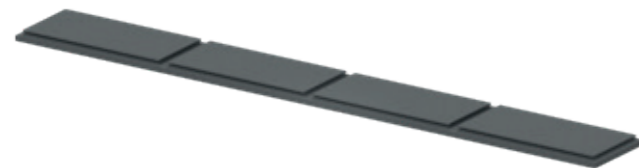

### HALF TOP/BASE/SIDE PANEL, 1X4

H x D x W: 2.5 x 20 x 160 cm  
 Weight: 5.7 kg  
 Material: MDF, lacquered

**Black**      **HP1.4.MB**  
**Grey**        **HP1.4.MG**  
**White**       **HP1.4.MW**

## HALF TOP/BASE/SIDE PANELS

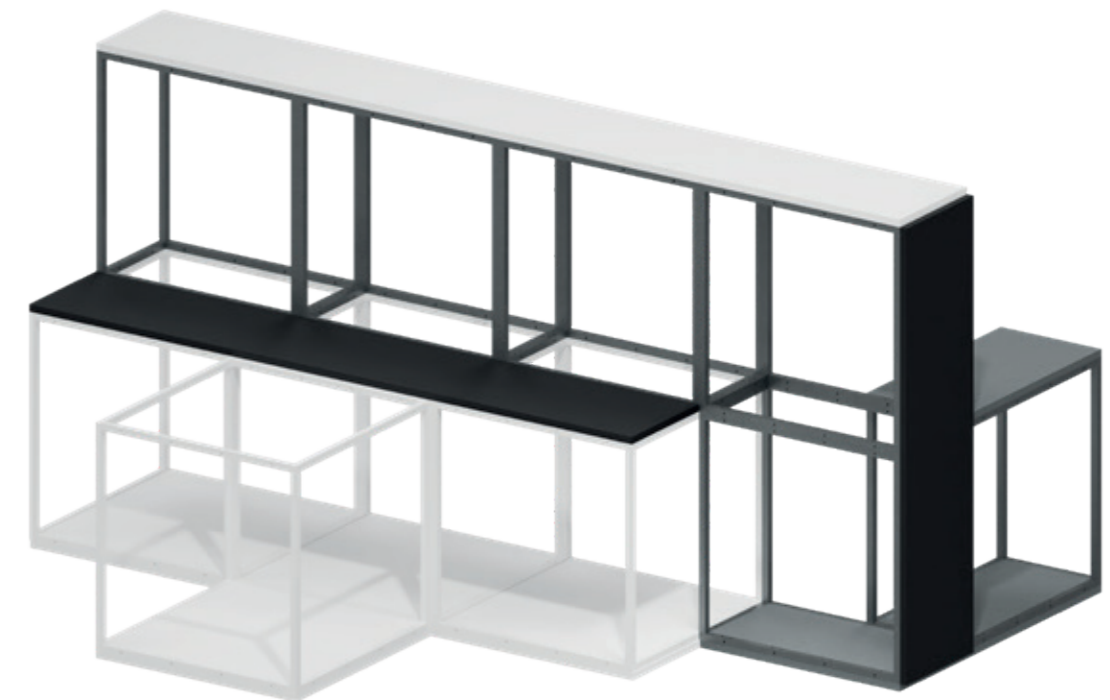
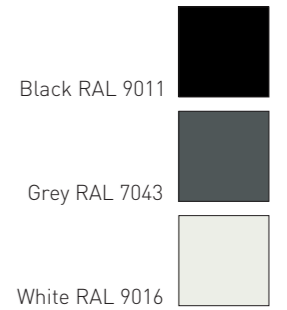

### HALF TOP/BASE/SIDE PANELS

Half top, base or side panels can be used on half GRID modules. These panels rest on the outside of the module's frame and can be used for tables, podiums, seating arrangements and heavier loads.



# COLOURS AND MATERIALS

The GRID module is made of fibreglass-reinforced nylon (PA6, 30% glass), which can be converted into granules and recycled. The GRID module is available in black (RAL 9011), grey (RAL 7043) and white (RAL 9016). No need for repaint or repair, the frame holds the same solid colour throughout the material. It is also UV and heat resistant.

Shelves/sides and top/base/side panels are made of 12 or 25 mm MDF (Medium Density Fiberboard).

As standard, shelves/sides and top/base/side panels are lacquered with black (RAL 9011), grey (RAL 7043) and white (RAL 9016) gloss 20 textured lacquer or veneered with a white-pigmented oak veneer. Shelves/sides are also available in clear acrylic, mirror acrylic or frosted acrylic. Use of other materials, such as stainless steel or glass, is specified in product descriptions of individual components. More information about materials and surfaces can be obtained upon request.

All references to standard RAL colours are subject to variations.

Other materials, colours and textiles can be ordered upon request.

Contact us to explore more options.



Black RAL 9011

Grey RAL 7043

White RAL 9016

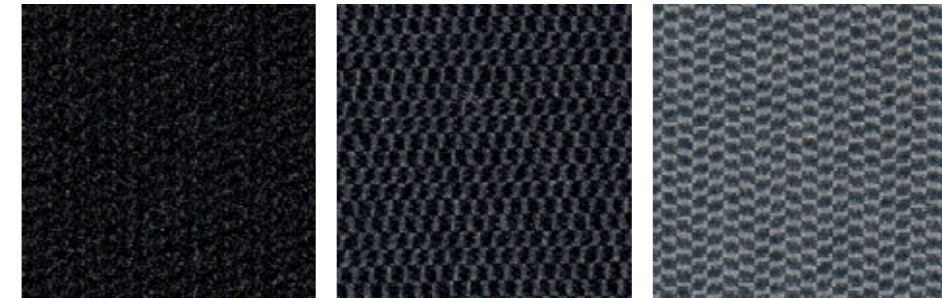

Messenger 029, Black

Messenger 008, Dark Grey

Messenger 031, Light Grey

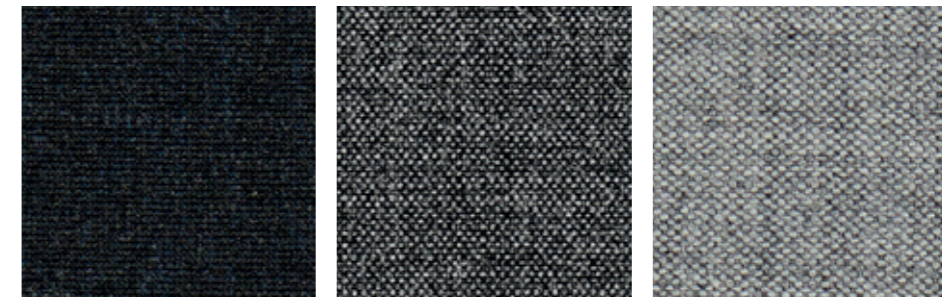

Remix 183, Black

Remix 163, Dark Grey

Remix 123, Light Grey

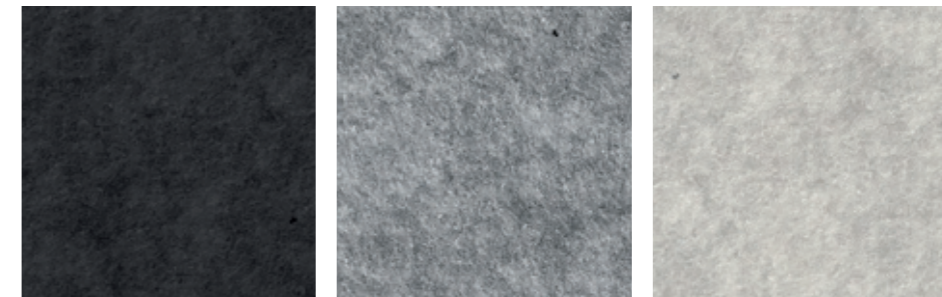

Felt, Anthracite SK-68

Felt, Stone Grey SK-67

Felt, Off-White SK-63



Leather Ultra 1599, Black

Cork

Oak



Acrylic, Clear

Acrylic, Frosted

Acrylic, Mirror



# DELIVERY AND HANDLING

## ASSEMBLY

As standard, GRID arrives with all components ready to assemble. All necessary screws and bits and assembly instructions are included in the shipment. Please refer to the GRID Assembly Instructions for further information on assembly, installation and disassembly of the GRID system.

Upon request, GRID can be pre-assembled before arrival. Please contact us for an individual quote.

## DELIVERY AND HANDLING

GRID is carefully packaged for easy and secure handling that avoids unnecessary package waste. It is the responsibility of the recipient to assess the delivery for any potential defects. Instances of damaged, defected or missing parcels must be handled immediately. Transport damage and defects are only covered when marked on the carrier's shipment note.

## GUARANTEE

On standard products, GRID System ApS provides a 5-year guarantee against manufacturing defects. Natural wear on surfaces and upholstery is not covered by the guarantee. All consumer complaints must be placed immediately. Return of goods may only occur upon prior arrangement.

## MAINTENANCE

GRID components are best cleaned using a damp cloth with a mild detergent. Components can be removed to allow damaged parts to be replaced.

Please note: GRID reserves the right to make ongoing changes and improvements to the product range. This product guide replaces all previous product guides. GRID is not responsible for printing errors.





RE  
NE

**GRID**  
**Product Guide**  
January 2023

**GRID System ApS**

Smedevangen 2  
DK-3540 Lyngø  
Denmark

+45 7262 6575  
grid@gridssystem.dk

gridssystem.dk  
instagram.com/gridssystem.dk  
facebook.com/gridssystem  
pinterest.com/gridssystemdk  
linkedin.com/company/gridssystem  
youtube.com/@gridssystemdk  
twitter.com/gridssystemdk