



PRODUCT GUIDE

Pavers That Elevate™

Tile Tech®. The leader in unforgettable outdoor experiences.

In the world of architectural hardscape systems, Tile Tech® emerges as a true leader. From coast to coast, our company has revolutionized the industry with a passion for innovation to redefine outdoor spaces. Specializing in a European-style of architectural paving products, Tile Tech® brings decades of experience in the production and distribution of premium porcelain pavers, wood deck tiles, versatile snow melt systems, synthetic turf, and living plant systems for both elevated deck and on-grade applications.

What sets Tile Tech® apart is not just our products, but our visionary approach within the industry. Our patented adjustable pedestal system is just one example of our commitment to innovation, reimagining the standards to deliver new products resulting in cost savings for architects and design professionals.

At Tile Tech®, our dedication to innovation and customer satisfaction has established us as a leader within the industry. With every endeavor, we push the boundaries of what's possible, continually striving to surpass the needs and dreams of each and every one of our clients.



**'ALOHI LANI RESORT
HONOLULU**
Quartzite White

Take our **Interactive 3D Models** for a spin.

360°

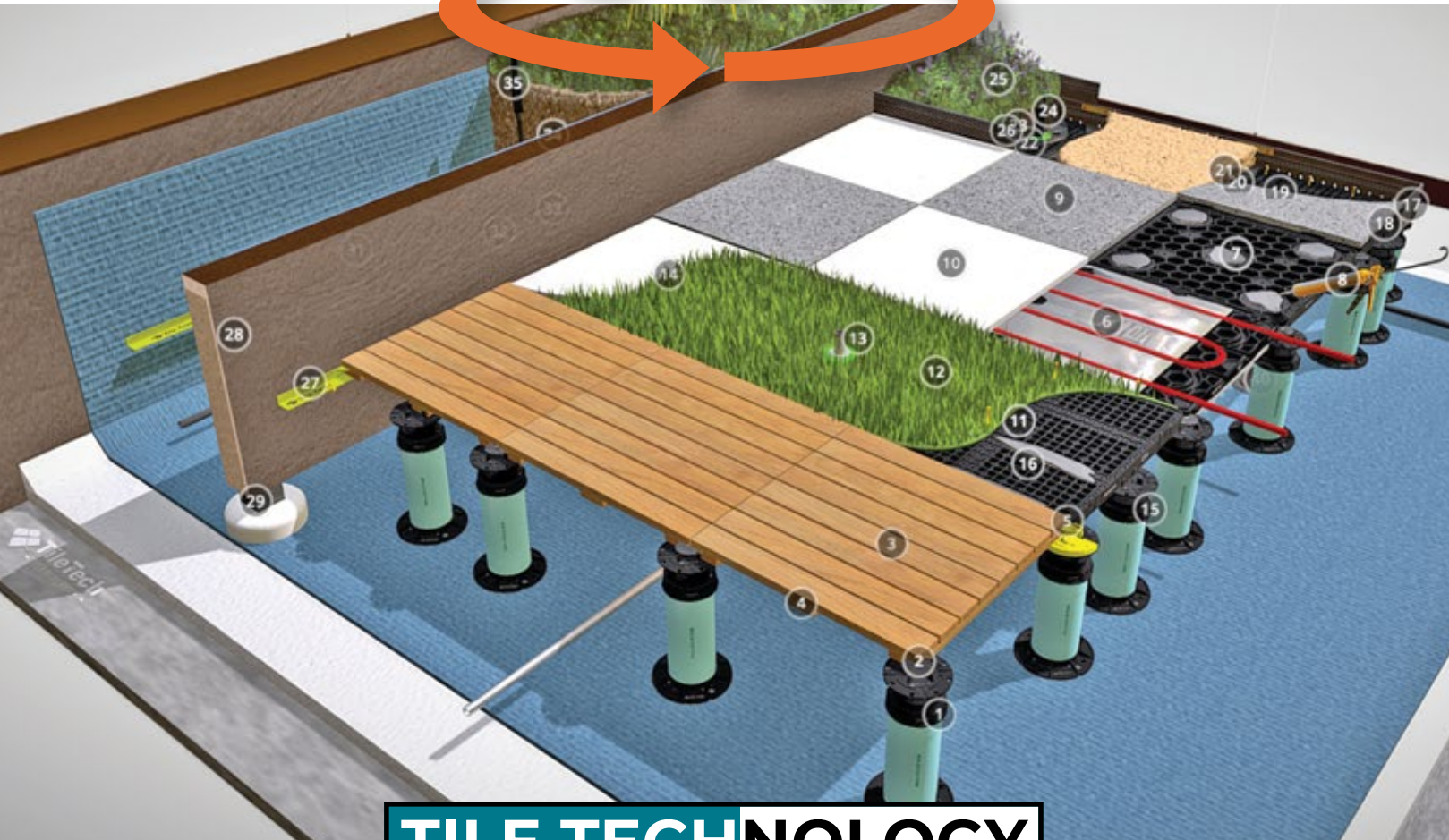

TILE TECHNOLOGY

Game-changing innovation.

If a picture is worth a thousand words, then our **360° interactive models** are priceless. Take our products for a spin—zoom in for details, zoom out to see the big picture.

Sequentially numbered pop-up boxes describe features & specifications in precise detail.



Interactive 3D models

BIM-powered tools available 24/7.

We're helping architects and designers build faster, smarter, and greener with **bimobject**. The platform allows you to better understand the design and make critical decisions resulting in accurate cost estimates, schedules, and successful completion of your unique project.



Powered by bimobject

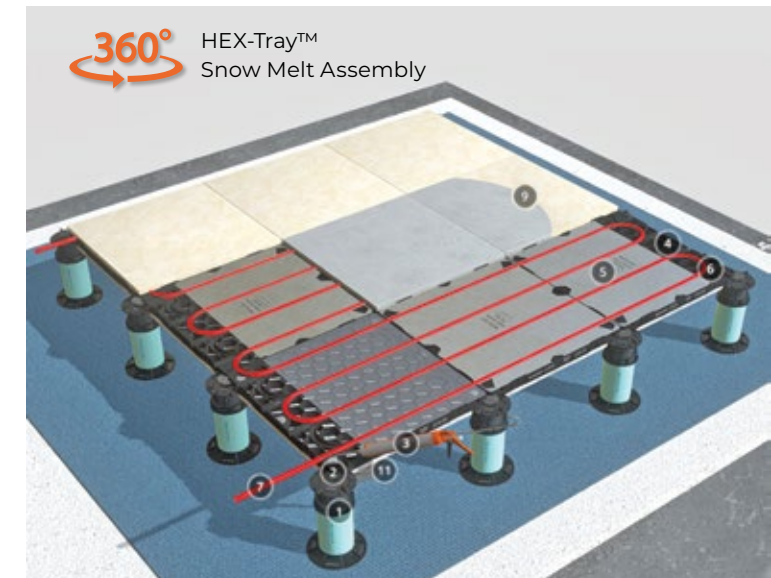
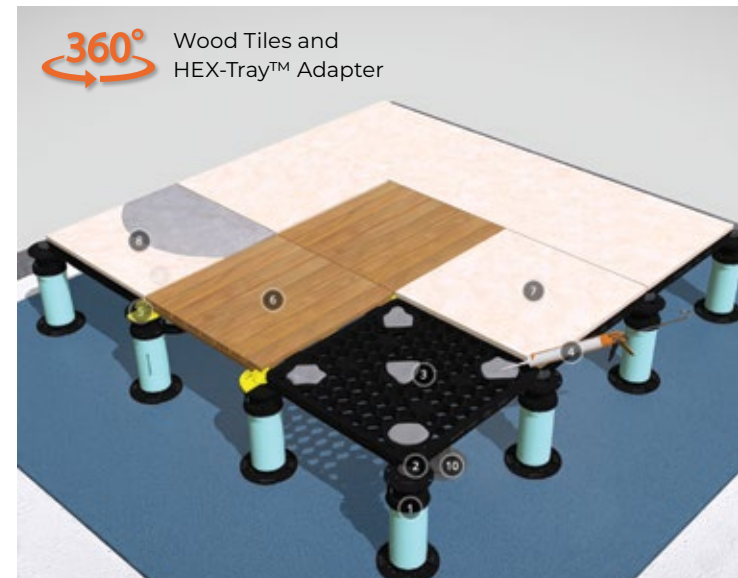

414 LIGHT STREET BALTIMORE

Travertine Pearl and Tan



Table of Contents



Porcelain Pavers™
..... 06-101



Wood Deck Tiles
..... 102-111



**Adjustable Pedestal
Systems & Components**
..... 112-127

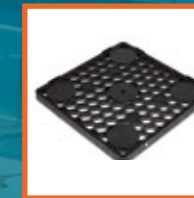

**Hex-Tray™ Wind Uplift
System**
..... 128-133



**Hex-Tray™ Snow Melt
System**
..... 134-139



Turf-Tray™ System
..... 140-147



Plant-Tray™ System
..... 148-153

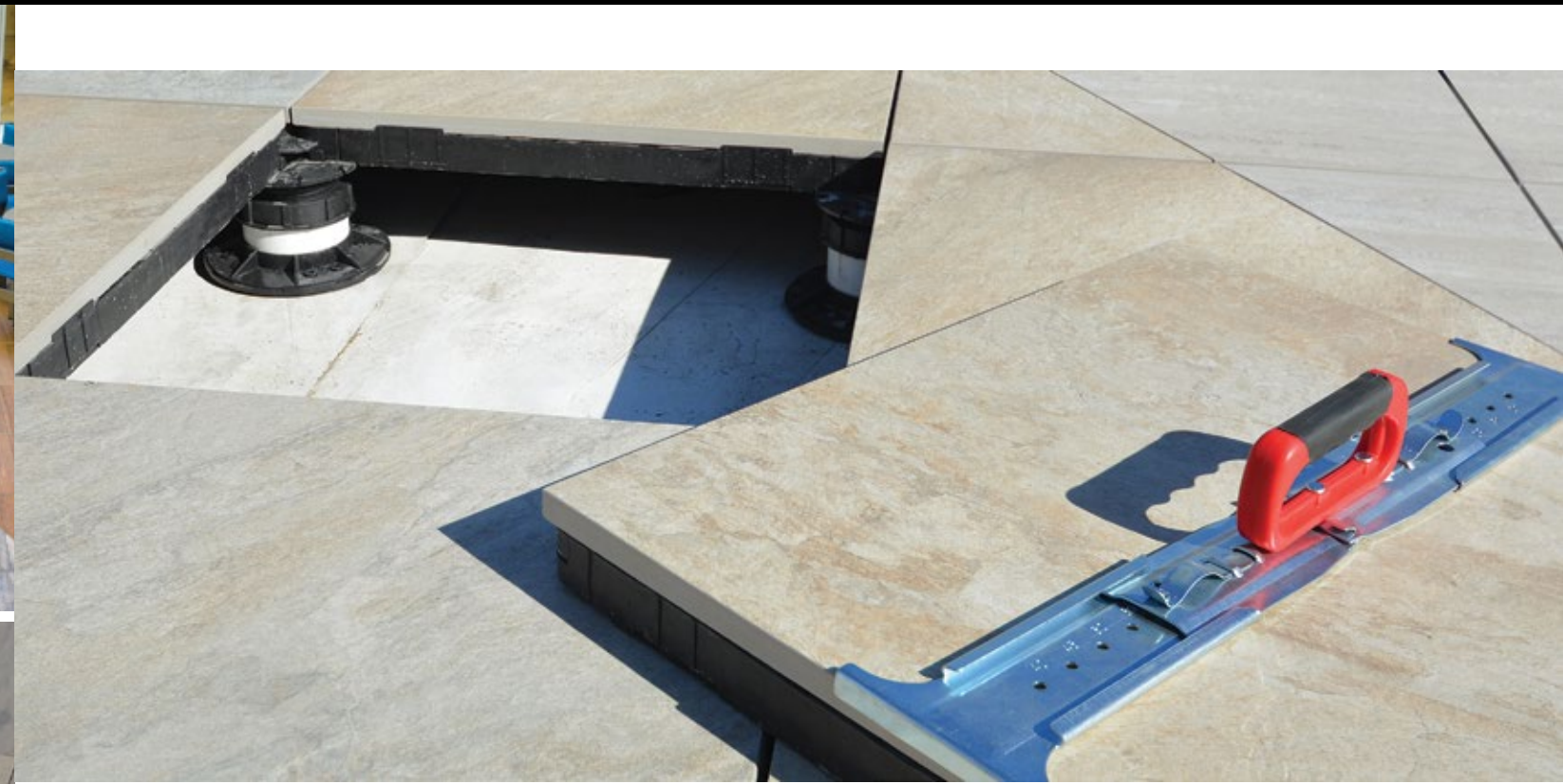

PAVERS THAT ELEVATE™



Tile Tech® hardscape systems provide architects and design professionals with a complete solution to transform any roof deck, walkway, driveway, courtyard or patio into beautiful, useful spaces.

At Tile Tech®, it's all about choice. Our patented Hybrid Adjustable Pedestal System was specifically designed to incorporate standard, off-the-shelf PVC pipe for sturdy support for pavers, deck tiles, synthetic turf and living green roof applications. Alternately, you can choose our coordinated Adjustable Pedestal and Coupler System - both offering an array of unique components resulting in fine-tuned, self-leveling surfaces. Whatever system you choose, our raised deck applications offer:

Concealment of utilities, pipes, and drains. The void between the pavers and roof membrane can be used to

accommodate pipes and services including drains, while retaining easy access for maintenance and repair.

Quick water drainage. The gap between and under Tile Tech® pavers allows for rapid water discharge on to substrate surface.

Thermal insulation and protection. The void between the paving and membrane encourages constant air circulation, extending the life of the waterproofing and improving heat insulation, in addition to protecting the substrate surface from ultraviolet (UV) degradation.

Level paving and less weight. With no requirement for special surface preparations, such as sand or bedding, our float system provides a level, lightweight solution, allowing decks to be built with less load on the structure and at substantially lower costs.



TILE TECH®
PORCELAIN PAVERS



FAIRMONT CENTURY PLAZA
LOS ANGELES

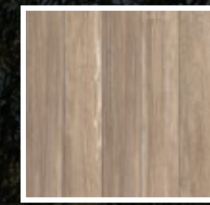

Wood-Plank Series™
Natural Plank
Mocha Plank
..... 10-13

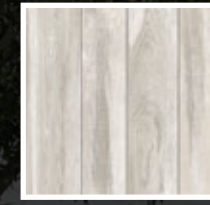

Wood-Rustic Series™
Rustic Maple
Rustic Oak
Rustic Gray
..... 14-19



Wood-Chevron Series™
Chevron Maple
Chevron Oak
Chevron Nut
..... 20-25

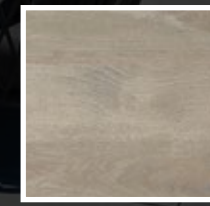

Solid Wood-Series™
Solid Maple
Solid Oak
Solid Nut
..... 26-31

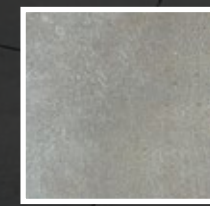

Stone-Series™
Sand Stone Gray Stone
Black Stone Multicolor Stone
Terracotta Stone
..... 32-41

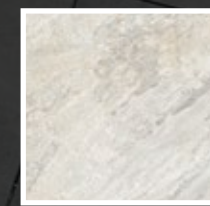

Quartzite Slate-Series™
Quartzite White Quartzite Sandy
Quartzite Cloud Quartzite Laguna
Quartzite Pennsylvania Bluestone
..... 42-51

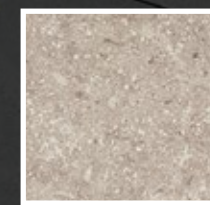

Seashell-Series™
Seashell Cool
Seashell Black
Seashell Tan
..... 52-55

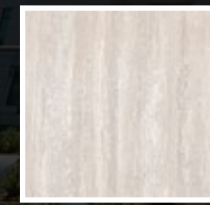

Travertine Series™
Travertine Pearl
Travertine Tan
..... 56-59

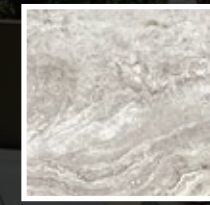

Travertine Cross Series™
Travertine Cross Shell
Travertine Cross Silver
Travertine Cross Walnut
..... 60-65

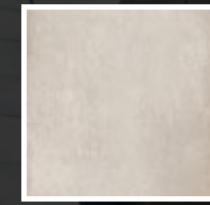

Cement Series™
Cenere
Cemento
Sandalo
..... 66-71

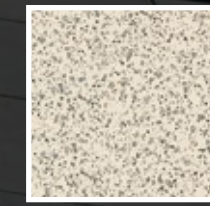

Terrazzo Series™
White Cool Gray
Charcoal Gray Black
White Black Straw
Cream Black Mocha Gold
Leather Gold Verde Green
..... 72-87



Earth-Tone Series™
Flat Bone Flat Ash
Flat Smoke Flat Desert
Flat Cognac Flat Tan
..... 88-95

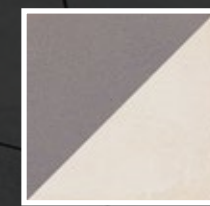

Trellis Series™
Bone & Smoke
Leather & Sand
..... 96-97

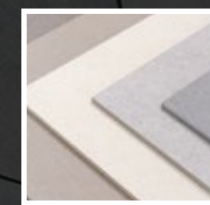

Colors & Specifications
..... 98-101

Note: Due to the inherent characteristics of porcelain pavers, slight color variations may occur between batches or individual pieces. These variations are a natural aspect of the manufacturing process and add to the unique charm of your outdoor space.

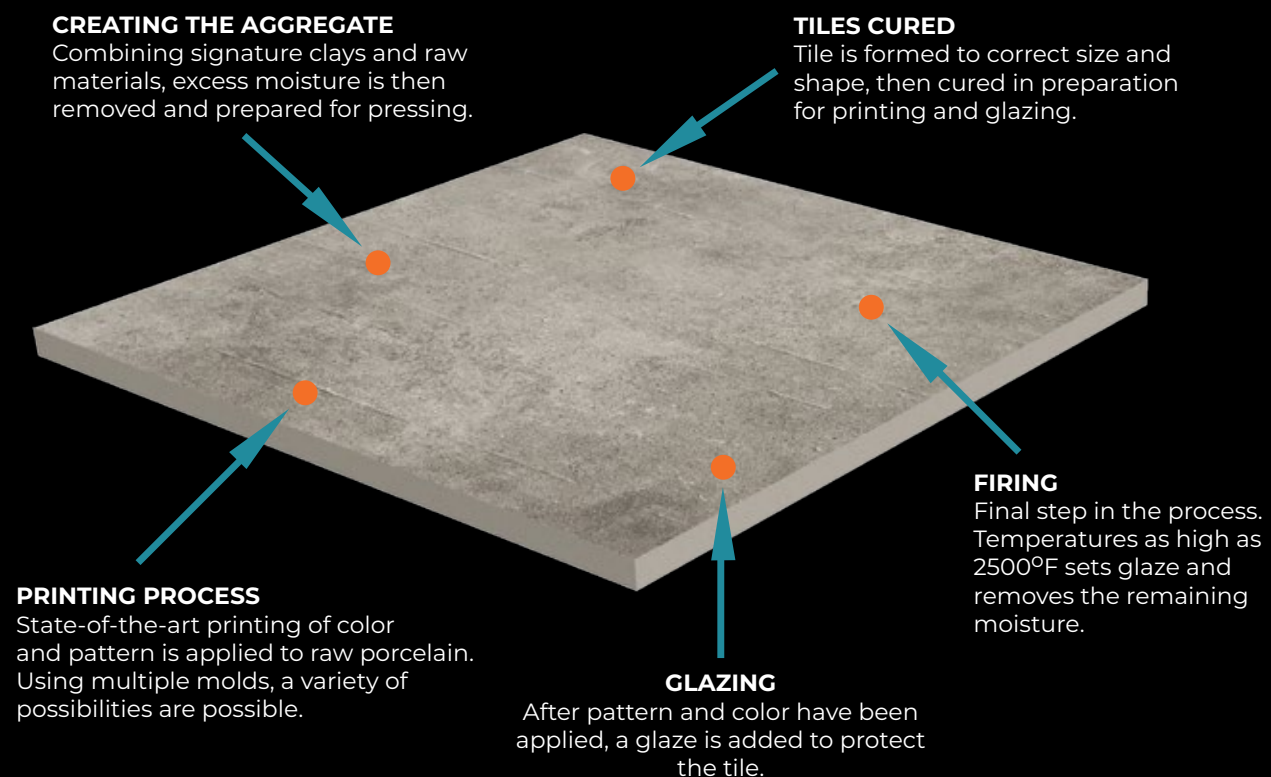

Exceptional strength, safety, and beauty.

Porcelain pavers have revolutionized exterior paving with their cutting edge manufacturing techniques and technological advancements. Manufacturers can now produce porcelain paver tiles in greater thickness and size, making them ideal for structural paving applications in outdoor spaces. This increased size and thickness not only enhances their durability but also opens up new possibilities for creative and functional design in areas like balconies, plazas, walkways, and pool deck areas.

The high-tech manufacturing processes involved in crafting porcelain pavers contribute to their exceptional strength and hardness. These tiles are remarkably resistant to external abrasion and can withstand scratching even with steel tools. This unique combination of durability and toughness makes porcelain pavers a superior choice for outdoor applications.

In addition to its technical and aesthetic properties, our porcelain pavers range can meet a number of important safety requirements for exterior floor paving in public places, combining an anti-slip surface with extreme wear and weather resistance. Additionally we also provide a wind uplift resistant system and a snow melting system coupled to our patented Hex-Tray™ system, which will also provide a safety system that will prevent from breaking and falling through.

Embracing USGBC LEED standards, our paving products boast a composition that includes 35% pre-consumer recycled materials. Not only do they minimize environmental impact, but they also contribute to sustainable building practices. With no traces of Volatile Organic Compounds (VOC) and a Solar Reflectance Index (SRI) of ≥ 32 , porcelain pavers emerge as an eco-friendly choice from conventional paving solutions.

PERFORMANCE & FUNCTIONALITY



RESISTANT TO FROST



RESISTANT TO FIRE



RESISTANT TO THERMAL SHOCK
From -58°F to +140°F.



HIGH BREAKING LOAD
More than 2,200 lbs. per slab.



RESISTANT TO ATTACK FROM mold, moss and verdigris treatments.



RESISTANT TO CORROSION FROM SALT



RESISTANT TO STAINS, ACIDS AND CHEMICALS



RESISTANT TO FLORESCENCE AND FORMATION OF DARK HALOS

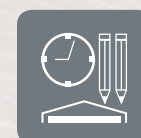

COLOR REMAINS UNCHANGED OVER TIME



LIGHT WEIGHT
Only 9 lb per Sq.Ft.



EASY TO INSTALL
Rectified and single work-size.



EASY TO REMOVE, INSPECT AND REINSTALL
Only 36 lb per 24" x 24" slab.



LOAD BEARING
19mm single layer structural porcelain.



VERSATILE INSTALLATION
Various installation methods including pedestal set, mortar set, and sand set.



ANTI-SLIP SURFACE FINISH



EASY TO CLEAN
With or without use of pressure washers.



NO SPECIAL TREATMENTS REQUIRED



OUTDOOR APPLICATION + COORDINATED INDOORS
Available in standard thickness for indoor use.

OUTRIGGER REEF RESORT WAIKIKI



WOOD-PLANK SERIES™

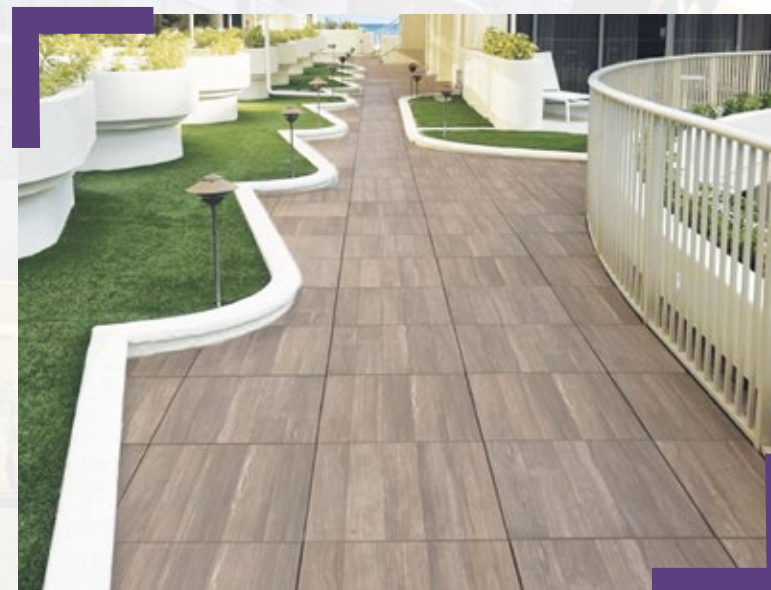

Natural Plank

Our Natural Plank in a popular medium-brown offers a porcelain paver solution that can illuminate and enhance any space. This series is designed to simulate the appearance of weathered natural wood planks, providing a warm and inviting Old World charm that enriches contemporary outdoor areas.

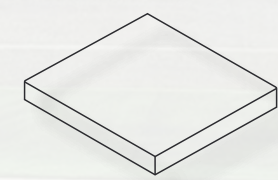
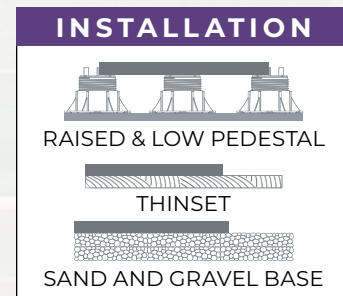

24"x24"x3/4"

ARMORY SQUARE APARTMENTS BUFFALO



WOOD-PLANK SERIES™



Mocha Plank

Mocha Plank creates a rich coffee-brown aesthetic that complements outdoor areas with a rustic natural beauty. It replicates the appearance of natural wood but without the disadvantages of fading, twisting, warping, decay, and poor fire resistance inherent in real wood.

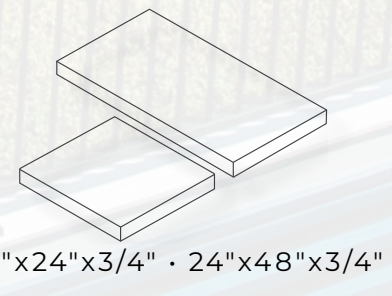
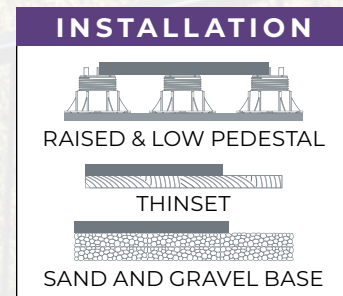

THE MAYFAIR HOTEL LOS ANGELES



WOOD-RUSTIC SERIES™



Rustic Maple

With an off-white rough-sawn look, Rustic Maple adds warmth and natural charm to outdoor spaces, creating a feel reminiscent of traditional plank flooring. These porcelain pavers typically feature a textured surface that replicates the grain and texture of natural wood, providing an authentic look and feel.

INSTALLATION

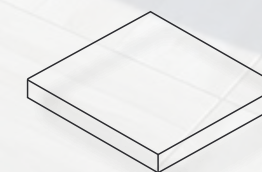
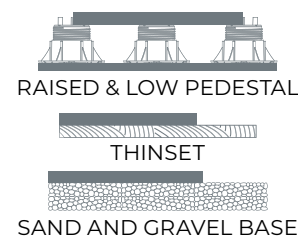

24"x24"x3/4"

**HOTEL NIKKO
SAN FRANCISCO**



WOOD-RUSTIC SERIES™

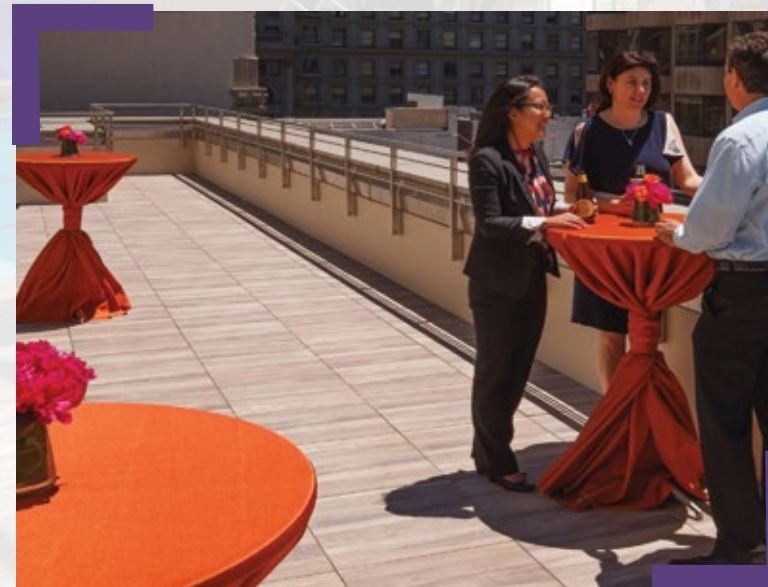

Rustic Oak

With shades of warm golden beige with rosy undertones, Rustic Oak mimics a hardwood prized for its strength. These porcelain pavers typically feature a textured surface that replicates the grain and texture of reclaimed wood, providing a touch of natural warmth and elegance to any space.

INSTALLATION

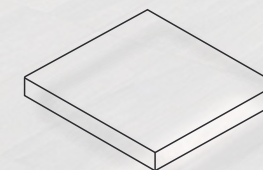
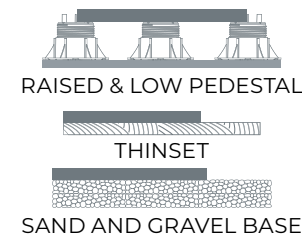

24"x24"x3/4"



WOOD-RUSTIC SERIES™



Rustic Gray

Our Rustic Gray paver reflects a beautiful ashen finish with soft undertones to satisfy traditional and classic tastes. Weathered wood finishes replicate the appearance of natural reclaimed wood but without the disadvantages of fading, twisting, warping, decay, and poor fire resistance inherent in real wood.

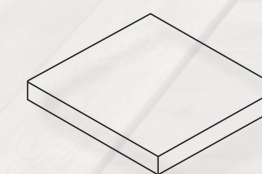
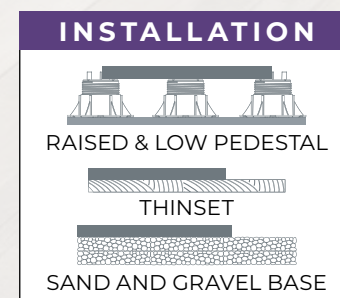

24"x24"x3/4"



WOOD CHEVRON SERIES™

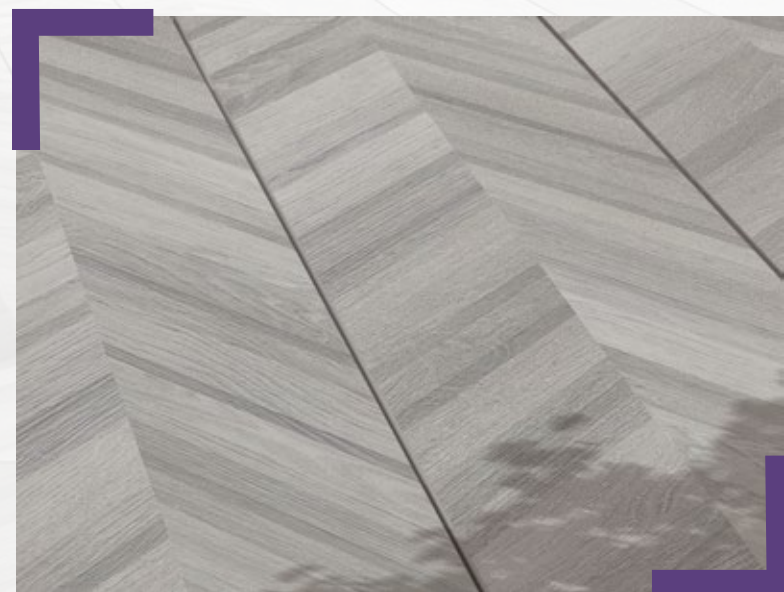

Chevron Maple

A delicate woodgrain with contrasting shades of gray, Chevron Maple porcelain pavers feature an elegant and classic herringbone design, a high-tech alternative to reclaimed natural wood. It replicates the appearance of maple but without the disadvantages of fading, twisting, warping, and poor fire resistance inherent in real wood.

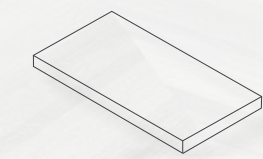
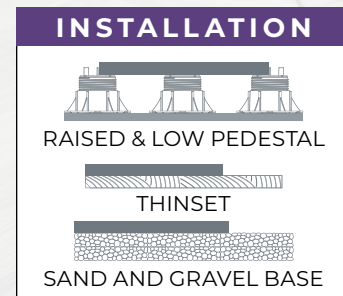

16"x48"x3/4"



WOOD CHEVRON SERIES™

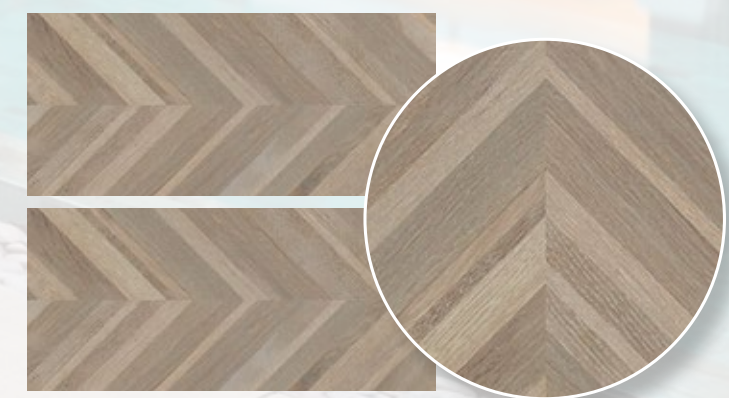

Chevron Oak

Chevron Oak porcelain pavers are a sophisticated outdoor decking option characterized by delicate brown and tan zig-zag graining. These pavers showcase an elegant and classic chevron design, offering a timeless aesthetic that adds a touch of luxury to outdoor spaces.

INSTALLATION

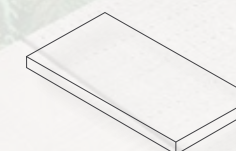
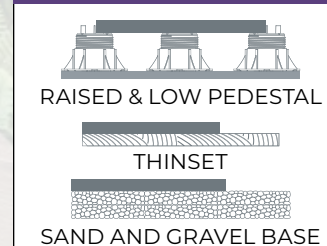

16"x48"x3/4"



WOOD CHEVRON SERIES™

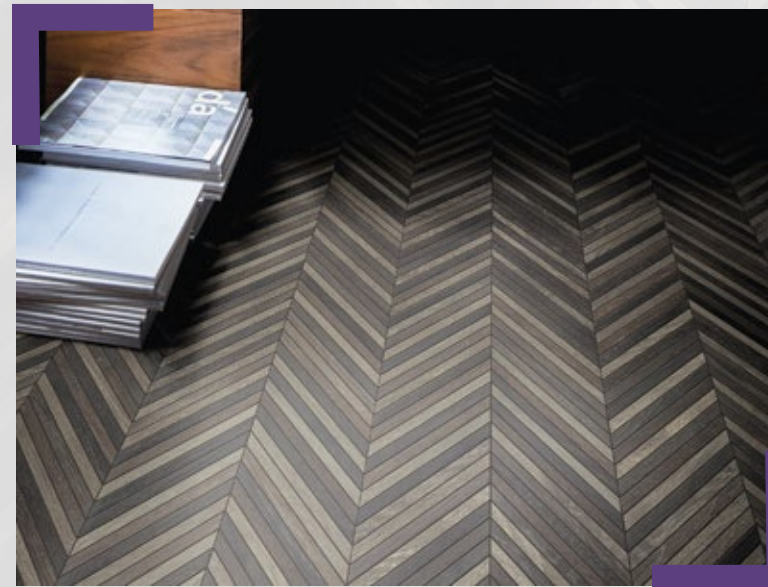

Chevron Nut

Our Chevron Nut porcelain pavers present a sophisticated and striking appearance for outdoor spaces, characterized by deep, rich cocoa coloring in a traditional V-shape design. These pavers feature an elegant and classic chevron design, adding a touch of refinement to various outdoor settings.

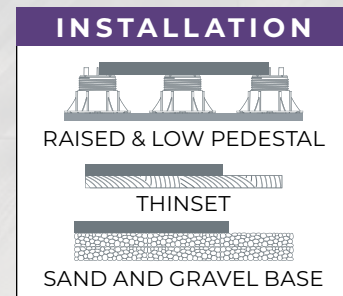



SOLID WOOD SERIES™

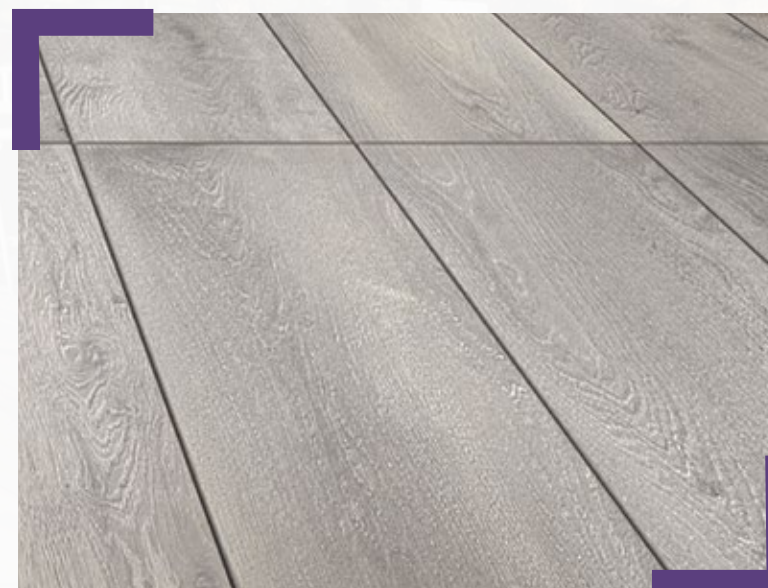

Solid Maple

Solid Maple pavers provide a high-tech solution to reclaimed natural wood, resulting in a skillful coupling of porcelain paver technology with timeless elegance. The resulting beauty creates both a durable, fade, stain, slip, and fire-resistant paving material with a weathered gray wood-grain finish.

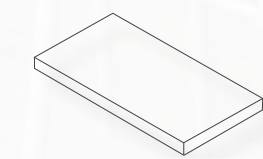
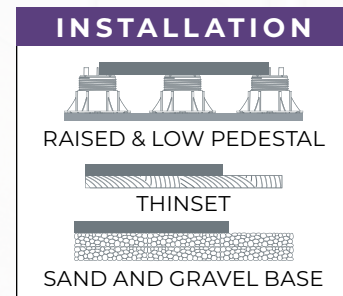

16"x48"x3/4"



SOLID WOOD SERIES™



Solid Oak

The natural hardwood taupe hues of the Solid Oak porcelain paver mimics a western plank aesthetic for your unique project. The result is a skillful coupling of porcelain paver technology with the timeless elegance and beauty of reclaimed wood that is both durable and fade, stain, slip, and fire-resistant.

INSTALLATION

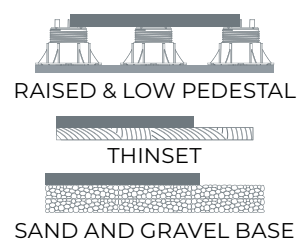

16"x48"x3/4"



SOLID WOOD SERIES™



Solid Nut

Solid Nut porcelain pavers provide a refined statement; a skillful coupling of rustic wood grain in an deep, earthy taupe. Porcelain offers a high-tech alternative to rustic wood and timber decking without the disadvantages of fading, twisting, warping, decay, and poor fire resistance inherent in real wood.

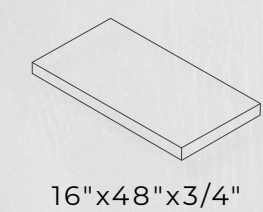
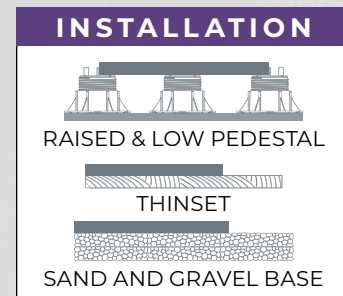

ANN ARBOR MAIN STREET
MICHIGAN



STONE SERIES™

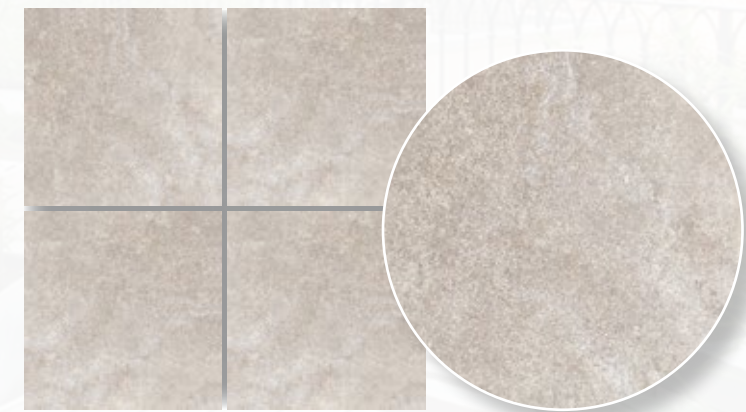

Sand Stone

Characteristically glassy and bisque-white in color, Sand Stone porcelain pavers offer the delicate beauty and aesthetics of stone with an enhanced durability and low-maintenance qualities of porcelain pavers. A durable and resilient choice for outdoor applications, ensuring a long-lasting and attractive surface.

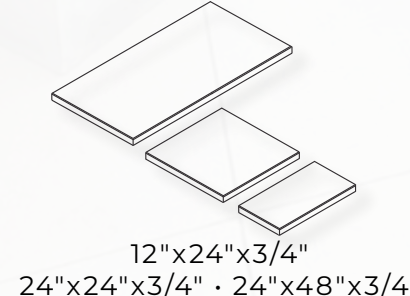
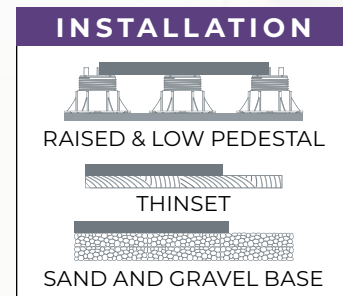

LA ATHLETIC CLUB LOS ANGELES

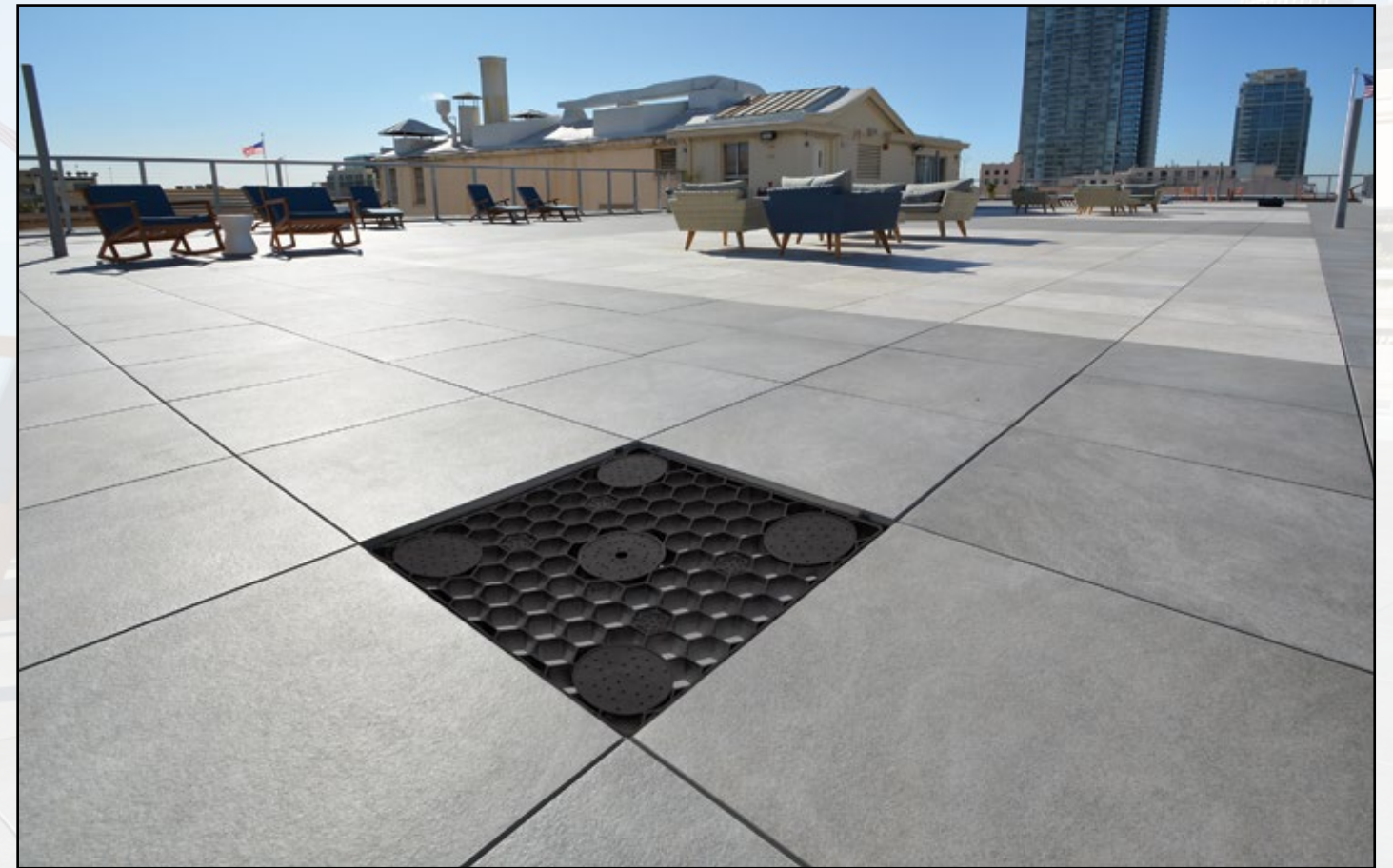

STONE SERIES™

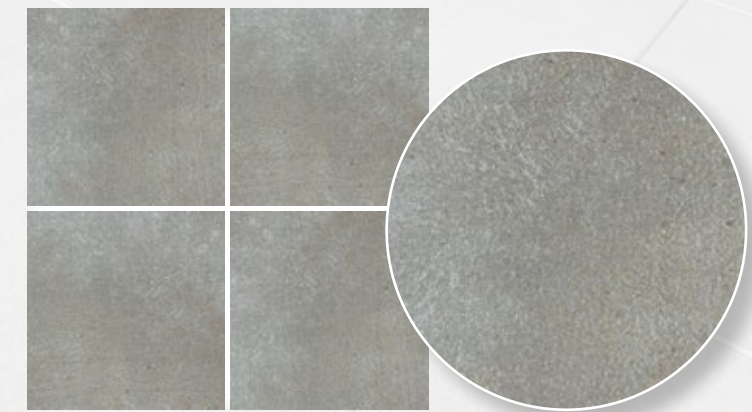
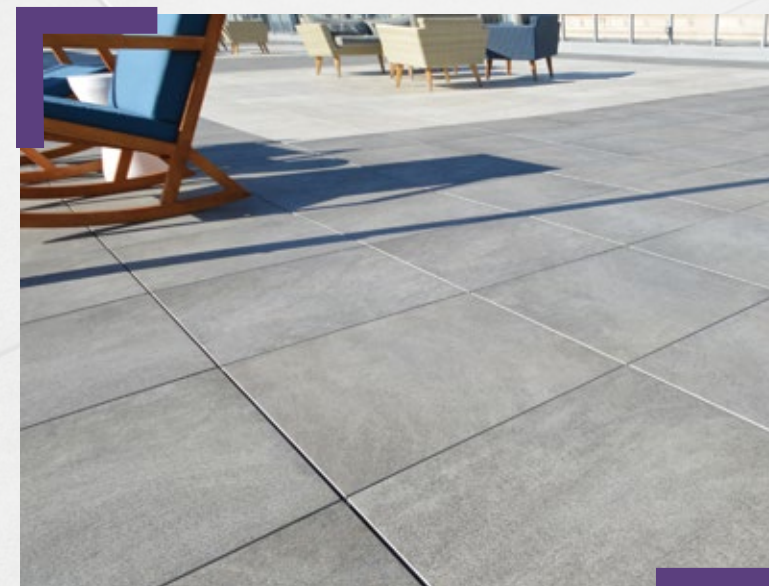

Gray Stone

With a swirl of warm, stormy hues, our Gray Stone porcelain pavers offer the beauty and aesthetics of stone, without the maintenance and upkeep required for natural stone materials. Completely nonporous, they will not stain and require no sealing. Extremely high slip resistance for all finishes and ensures a safe floor area wet or dry.

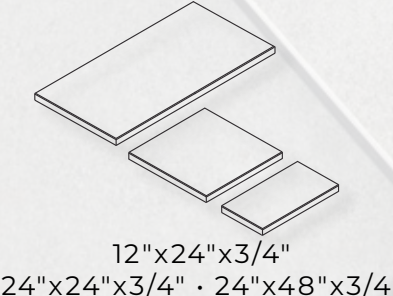
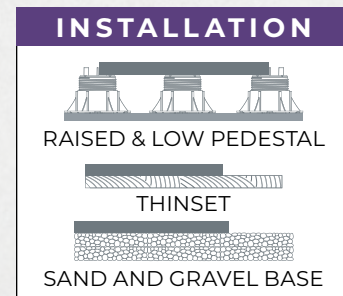

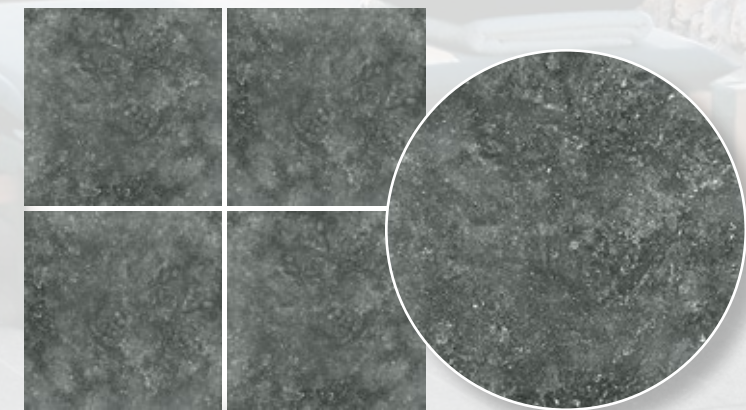
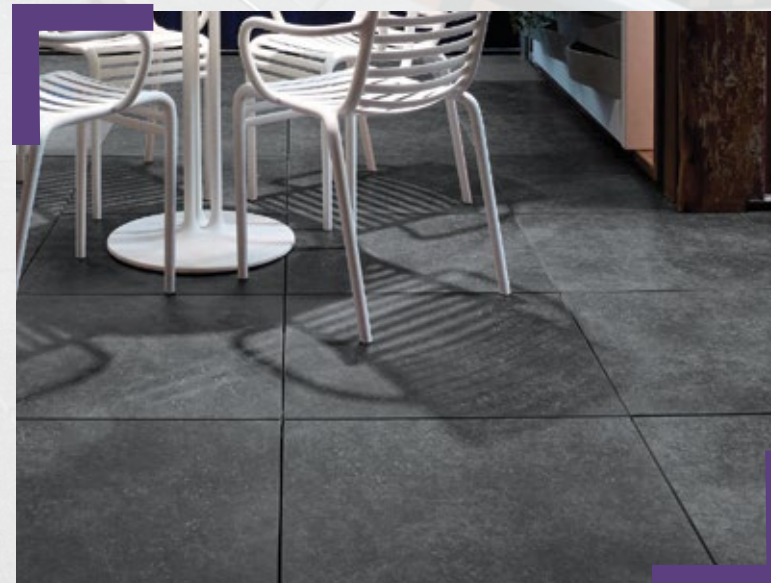

Black Stone

Our Black Stone porcelain paver presents a gorgeous statement with understated charcoal variations for a bold look for any project. Porcelain offers great strength and visual performance, are slip resistant, completely nonporous, and requires no sealing.

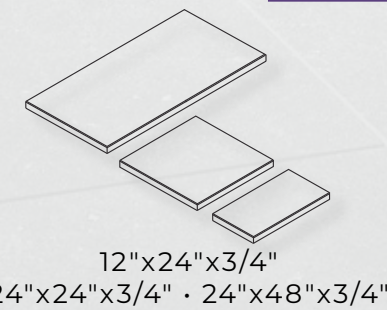
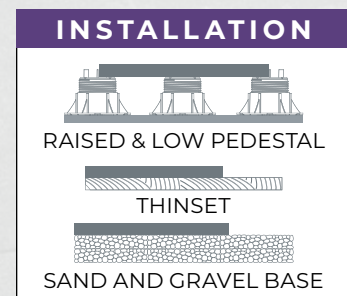



STONE SERIES™

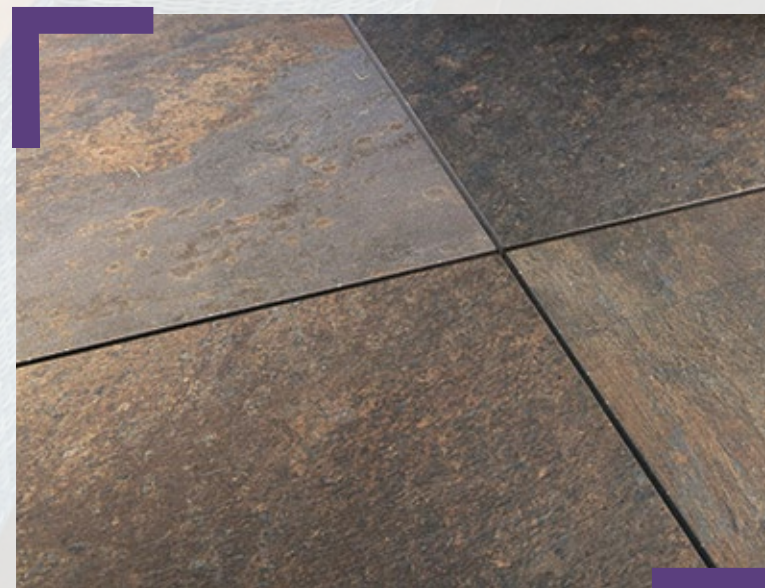

Multicolor Stone

Our Multicolor Stone pavers are a modern take on a timeless rustic paver. Visually striking with accent streaks of oxidized color but without the maintenance required for natural stone, they are completely nonporous, will not stain, and requires no sealing.

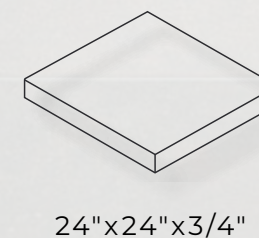
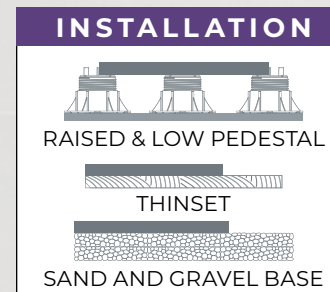



Terracotta Stone

With rich and warm earthy tones, our Terracotta Stone offers a deep burnt-orange with a touch of brown, adding warmth and more than a touch of character to outdoor environments. A durable and resilient choice for outdoor applications, it ensures a long-lasting and attractive surface.

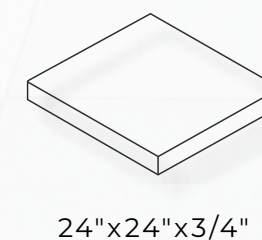
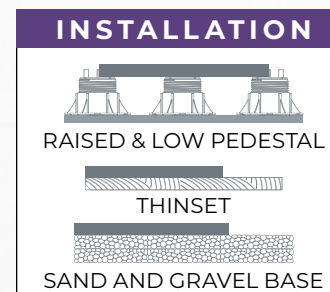

77 DEGREES ROOFTOP DALLAS



SLATE SERIES™



Quartzite White

Quartzite White porcelain pavers feature the beauty and aesthetics of a bright and off-white slate look with a distinct quartzite split-rock appearance. Completely nonporous, they will not stain and require no sealing. Extremely high slip resistance whether wet or dry.

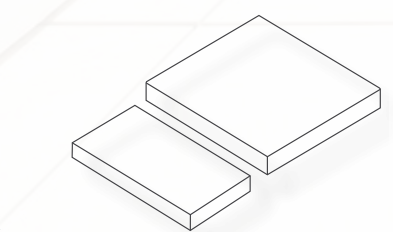
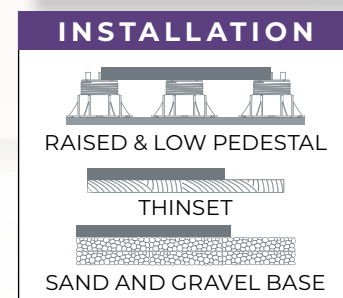

12"x24"x3/4" · 24"x24"x3/4"

ONE CULVER LOS ANGELES



SLATE SERIES™

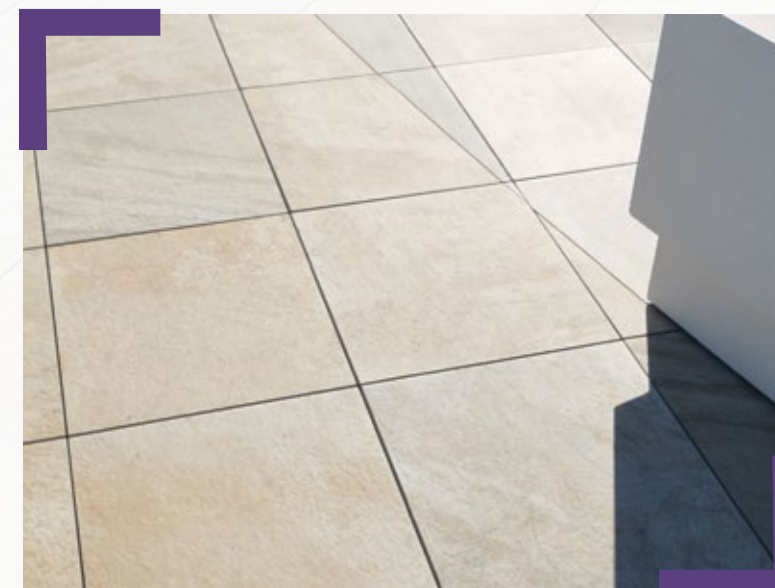

Quartzite Sandy

With the color of pale yellowish-brown sandstone, our Quartzite Sandy porcelain paver features the beauty and aesthetics of quartzite with a distinct and moderately textured split-rock appearance. Completely nonporous, they will not stain and require no sealing. Extremely high slip resistance whether wet or dry.

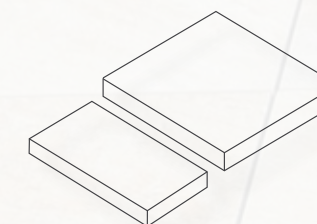
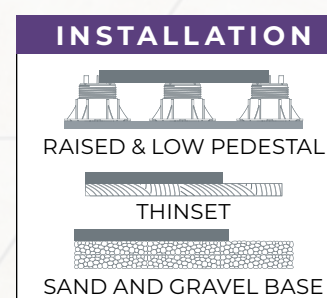

12"x24"x3/4" · 24"x24"x3/4"

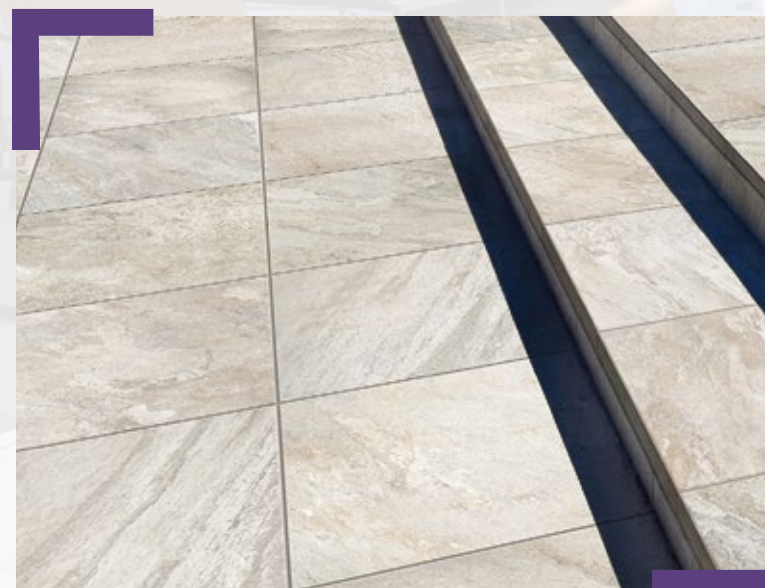

Quartzite Cloud

Variegated white to gray, Quartzite Cloud infuses subtle tones of rose and beige, with a distinct look and a moderately textured split-rock appearance. Completely nonporous, they are a durable and resilient choice for outdoor applications, ensuring a long-lasting and attractive surface.

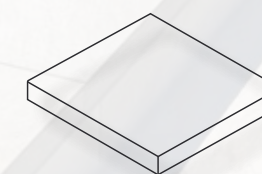
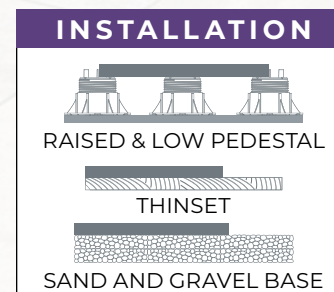

24"x24"x3/4"



SLATE SERIES™



Quartzite Laguna

Our Quartzite Laguna porcelain paver presents a visually striking option for outdoor spaces, a celestial feel in a silver-gray coloring. A distinctive textured finish, it features a split-rock appearance which contributes to its visual appeal. Completely nonporous, they will not stain, does not require sealing, and are slip-resistant.

INSTALLATION

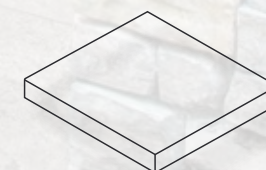
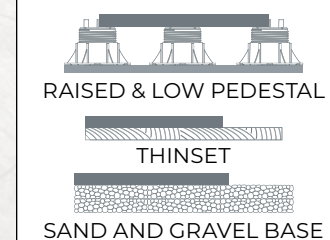

24"x24"x3/4"

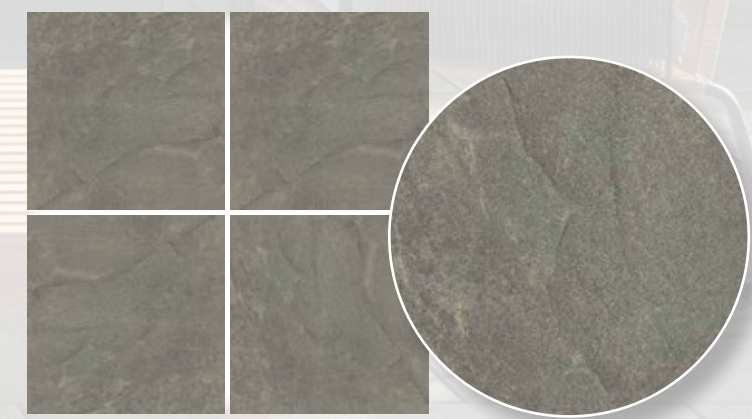

Pennsylvania Bluestone

Muted-gray hues with gorgeous combinations of rust, tan, brown, and green, the popular Pennsylvania Bluestone porcelain pavers offer the beauty and aesthetics of split stone. With durability and ease of maintenance, it's a practical choice for your unique project.

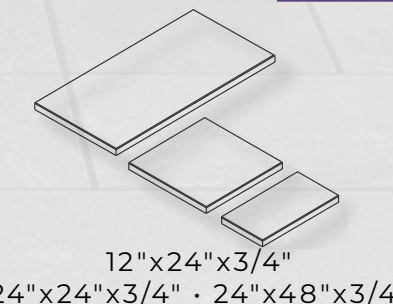
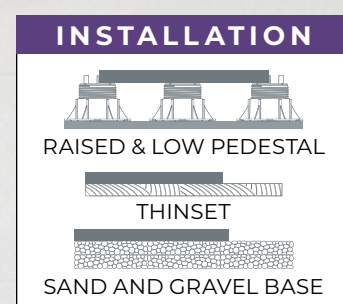



SEASHELL SERIES™



**Seashell
Cool and Black**

The contrasting colors of Seashell Cool and Black porcelain pavers infuses the look and texture of fossilized seashells. Reflecting an attractive and elegant primordial appearance, they are completely nonporous, they will not stain or require sealing, and are slip-resistant.

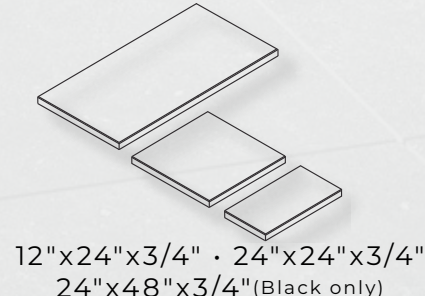
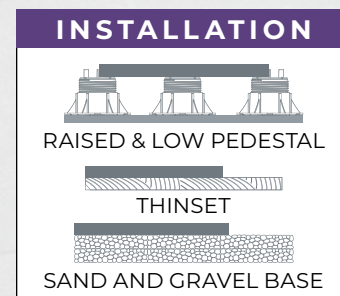



SEASHELL SERIES™



Seashell Tan

Our Seashell Tan porcelain paver combines the look and texture of fossilized seashells in an elegant buff undertone. This unique paver enhances any project design, both commercial and residential. Completely nonporous, they will not stain, require no sealing, and are slip-resistant.

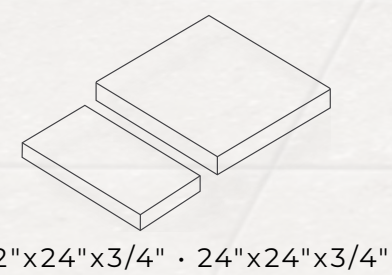
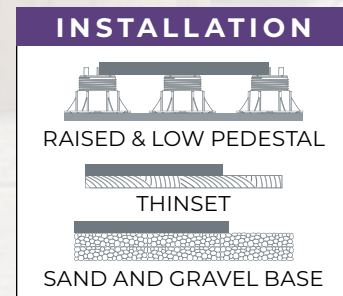



TRAVERTINE SERIES™

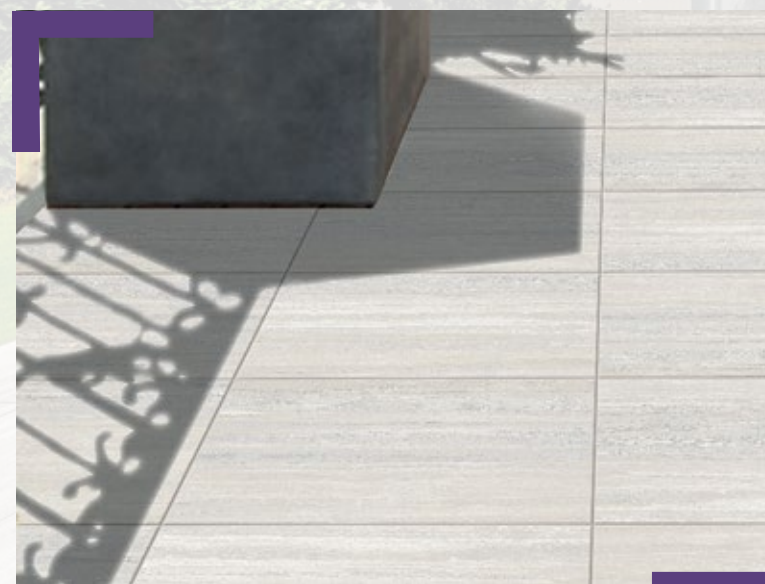

Travertine Pearl

Our Travertine Pearl porcelain paver perfectly replicates the soft, light, and sophisticated appearance of a natural travertine stone without the maintenance and upkeep required for a natural stone. Completely nonporous, they will not stain, do not require sealing, and are extremely slip resistant.

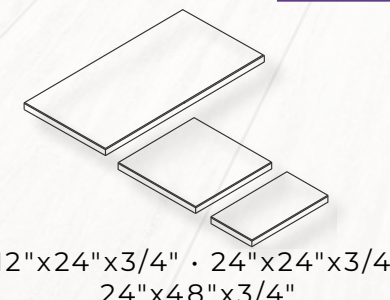
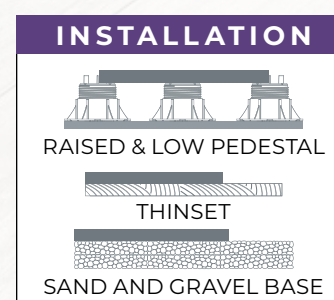

EATALY RESTAURANT LOS ANGELES



TRAVERTINE SERIES™



Travertine Tan

Our Travertine Tan porcelain paver perfectly replicates the natural and light saltwater appearance of a natural travertine stone without the maintenance and upkeep required for a natural stone travertine. Completely nonporous, they will not stain and require no sealing. Extremely high slip resistance ensures a safe floor area wet or dry.

INSTALLATION

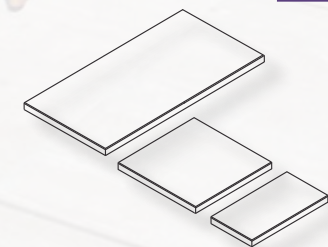
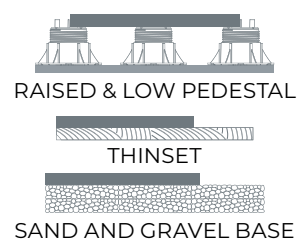

12"x24"x3/4" • 24"x24"x3/4"
24"x48"x3/4"



TRAVERTINE SERIES™



Travertine Cross Shell

Our Travertine Cross Shell porcelain paver perfectly replicates a muted beige abalone swirl within the cross-cut of natural travertine, without the maintenance and upkeep. Completely nonporous, they will not stain and require no sealing, and are extremely slip resistant.

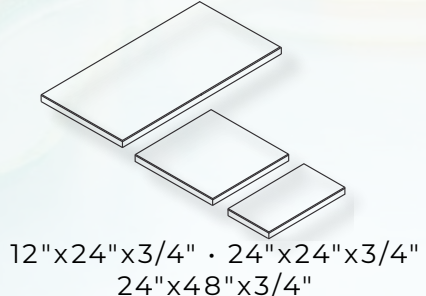
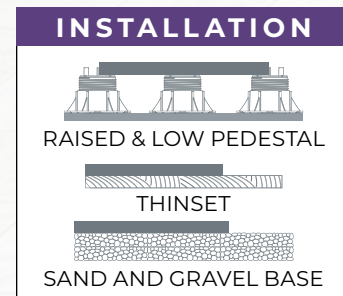



TRAVERTINE SERIES™

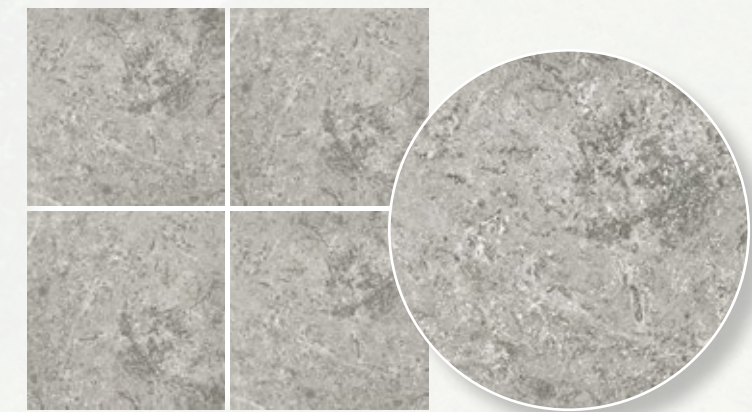
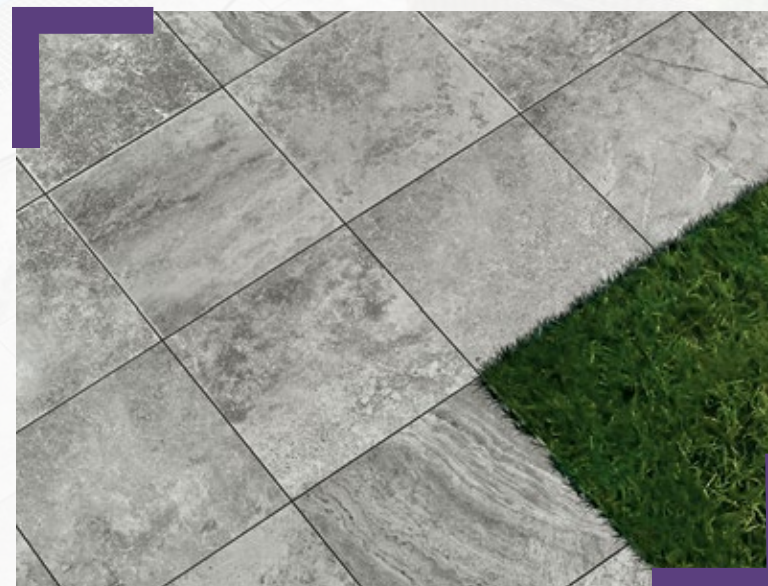

Travertine Cross Silver

Our Travertine Cross Silver perfectly replicates the muted pewter and gray cross-cut found in natural travertine without the maintenance and upkeep. Completely nonporous, they will not stain and require no sealing. Extremely high slip resistance ensures a safe floor area wet or dry.

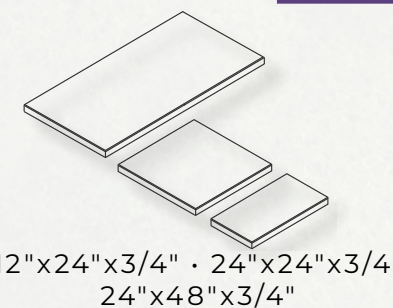
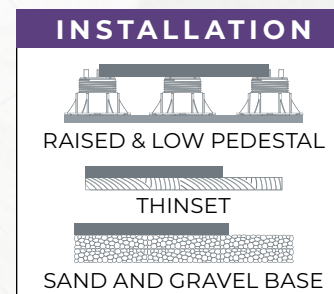



TRAVERTINE SERIES™

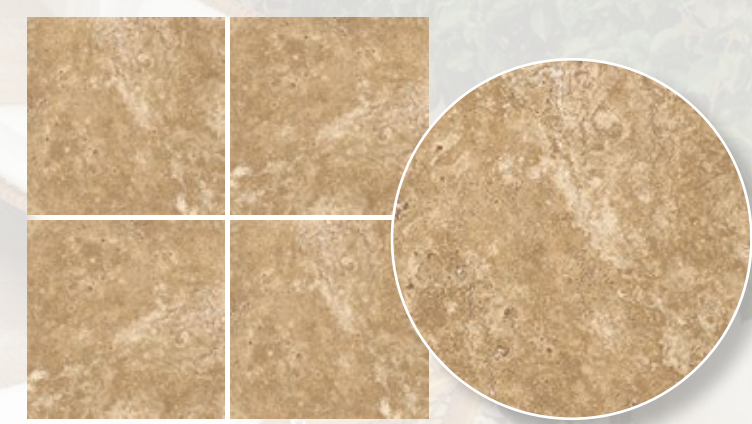

Travertine Cross Walnut

Our Travertine Cross Walnut porcelain paver perfectly replicates the shades of ochre found within a natural travertine without the maintenance and upkeep for a natural stone. Completely nonporous, they will not stain and require no sealing.

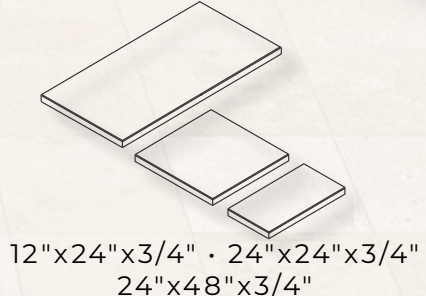
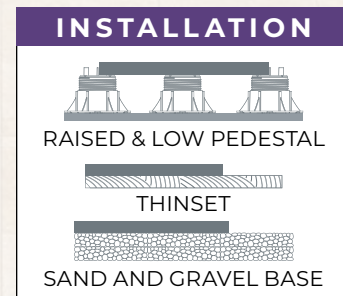



CEMENT SERIES™

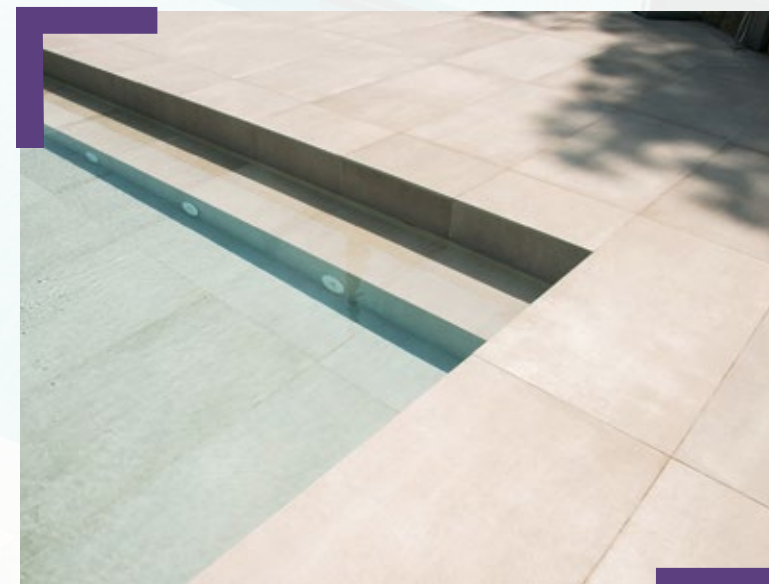

Cenere Cement

Our Cenere Cement reflects a smooth, matte, neutral gray with a hand-troweled finish, all without the stains, scratches, and efflorescence (crystalline deposit of salts formed on the surface of fresh concrete) of actual cement. Completely nonporous, they will not stain and require no sealing.

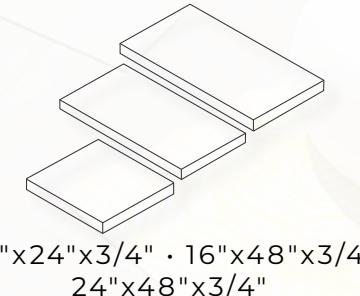
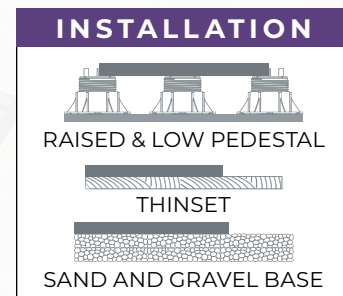



CEMENTO SERIES™

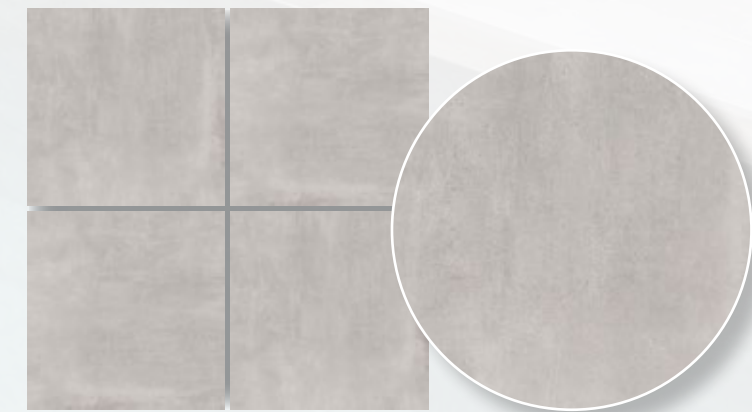
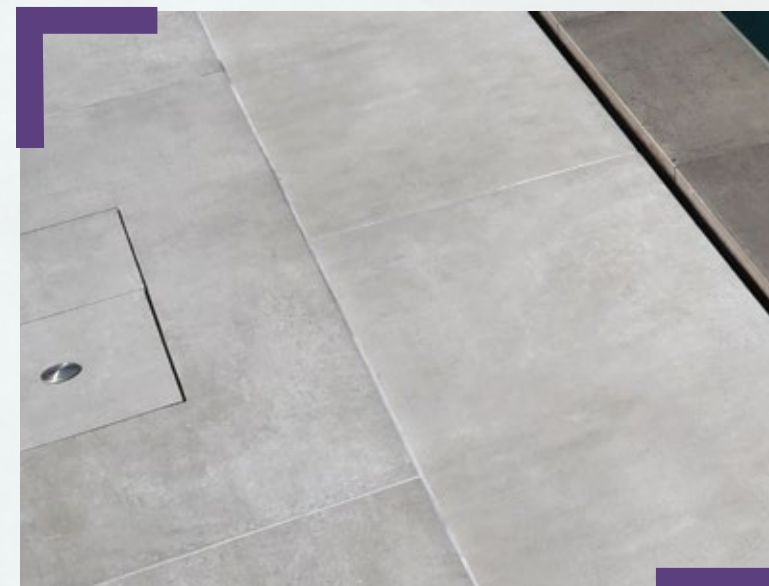

Cemento Cement

Our Cemento Cement paver reflects a smooth, matte, cool gray with the hand-troweled look of actual cement without the stains, scratches, and efflorescence (crystalline deposit of salts formed on the surface of fresh concrete) concerns with actual concrete. Nonporous, they will not stain and require no sealing.

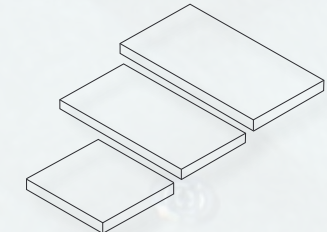
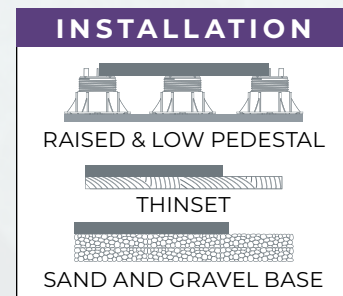

24"x24"x3/4" · 16"x48"x3/4"
24"x48"x3/4"

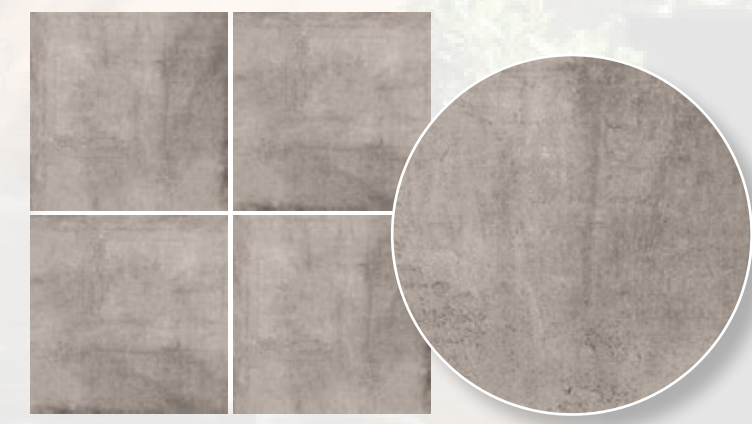

Sandalo Cement

Sandalo Cement

Our Sandalo Cement paver reflects a smooth, matte, medium-gray with the hand-troweled look of actual cement without the stains, scratches, and efflorescence (crystalline deposit of salts formed on the surface of fresh concrete) issues with actual concrete. They will not stain and require no sealing.

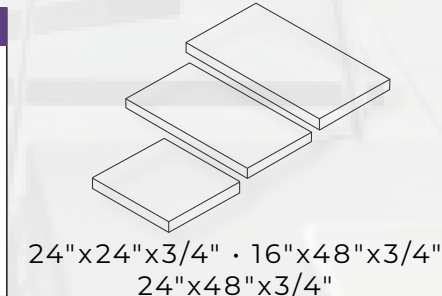
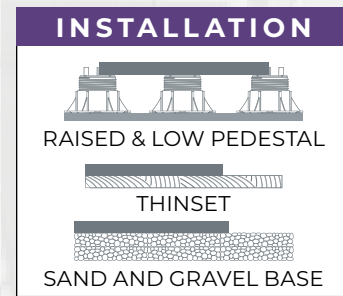

JW MARRIOTT L.A. LIVE LOS ANGELES



TERRAZZO SERIES™

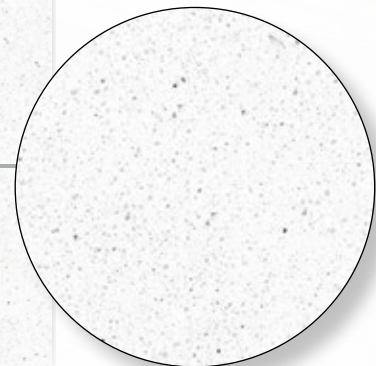
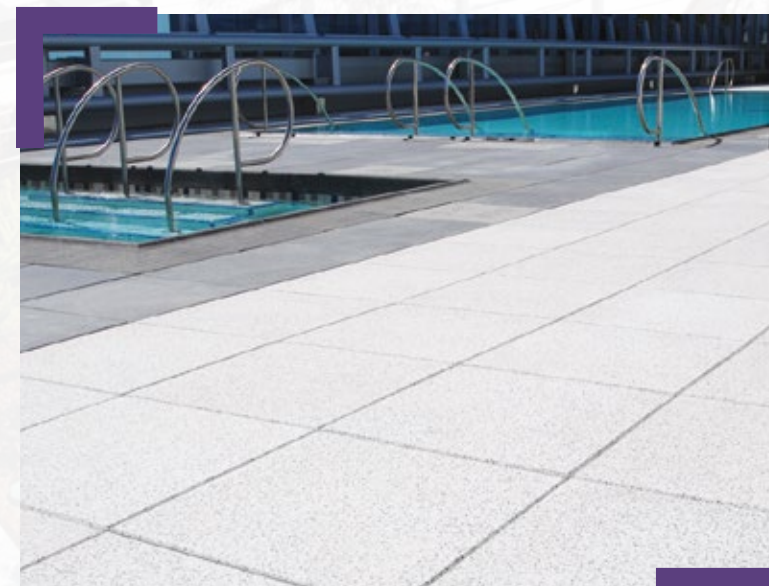

Terrazzo White

Terrazzo White porcelain pavers feature a bright, inviting, crushed-limestone appearance. Use this artisanal look to beautify floors, pool decks, roof decks, patios, walkways, and other features throughout commercial and residential properties. Stunningly elegant, porcelain pavers are impressively durable, stain and frost resistant, and do not require sealing.

INSTALLATION

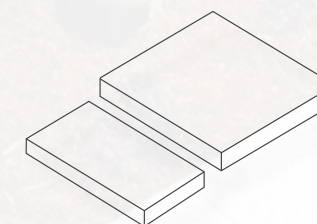
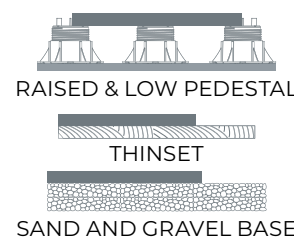

12"x24"x3/4" · 24"x24"x3/4"



Terrazzo Cool Gray

Terrazzo Cool Gray porcelain pavers feature a subtle gray crushed-limestone look and feel. Use this popular color to beautify floors, pool decks, roof decks, patios, walkways, and other features throughout commercial and residential properties. Subtly elegant, porcelain pavers are impressively durable, stain and frost resistant, and do not require sealing.

INSTALLATION

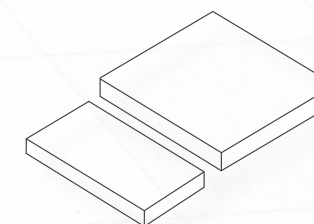
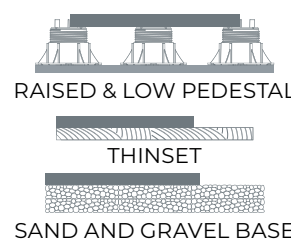

12"x24"x3/4" · 24"x24"x3/4"

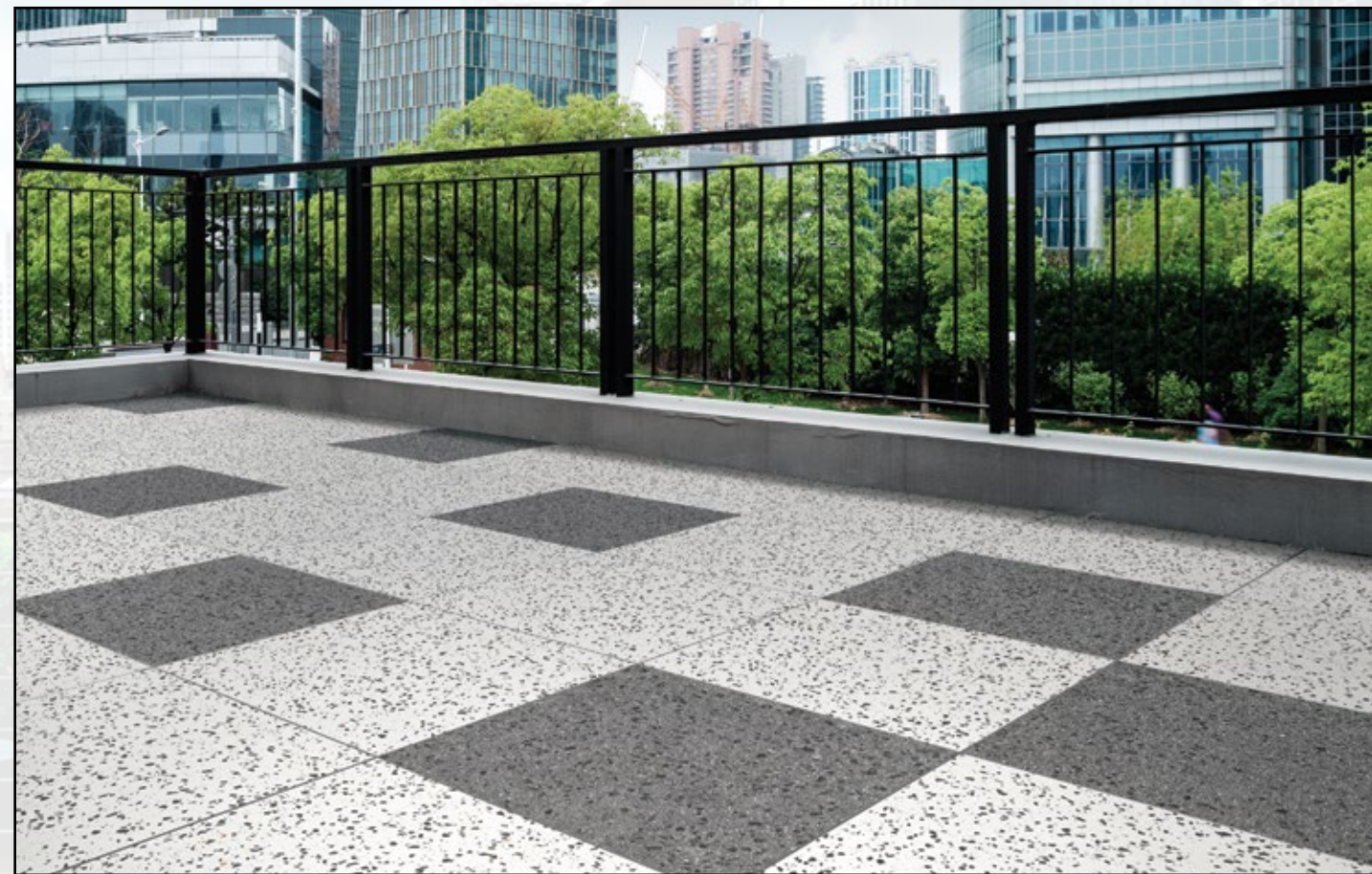

Terrazzo Charcoal, Gray Black, White Black

These harmonious pavers in Terrazzo Charcoal, Gray Black, and White Black incorporate an elegantly textured finish for a modern design on a timeless classic. These pavers are impressively durable, stain and frost resistant, and have high slip resistance.

INSTALLATION

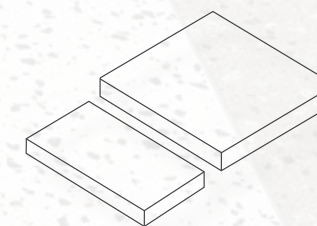
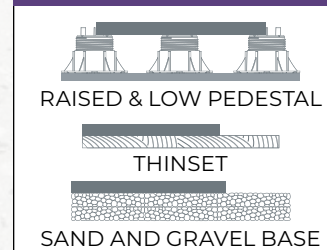

12"x24"x3/4" • 24"x24"x3/4"

GRANDMASTER RECORDERS ROOFTOP LOS ANGELES



TERRAZZO SERIES™

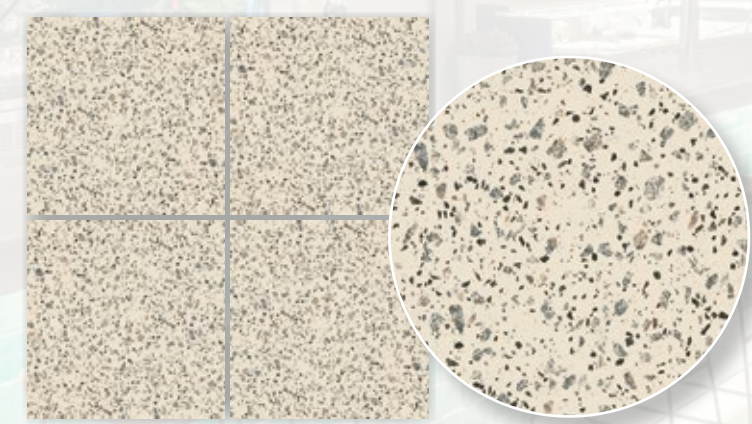
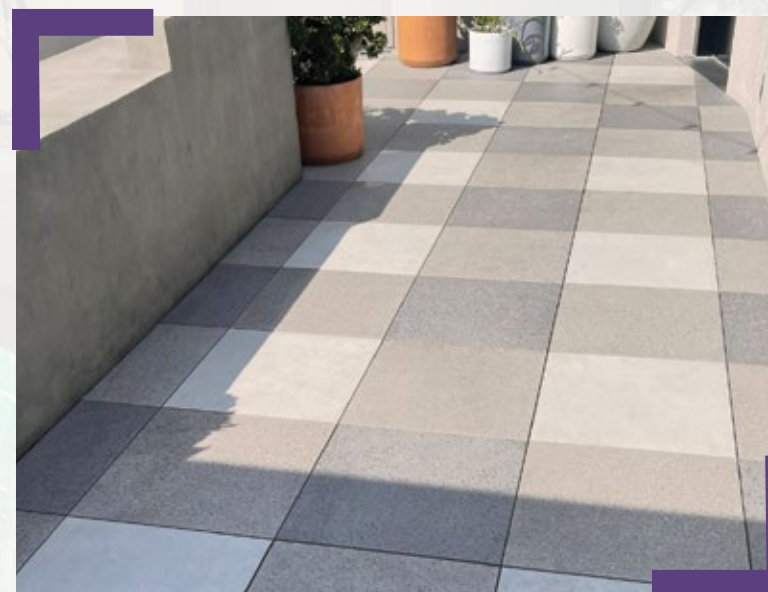

Terrazzo Straw

Terrazzo Straw porcelain pavers feature a vanilla white background with flecks of salt and pepper granite. The aggregate incorporates a moderately textured finish with a split-rock appearance. These porcelain pavers have high slip-resistance, and remain barefoot comfortable even in hot climates.

INSTALLATION

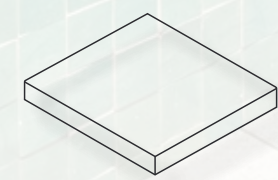
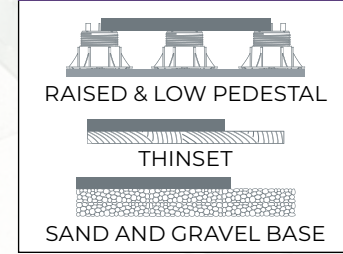

24"x24"x3/4"

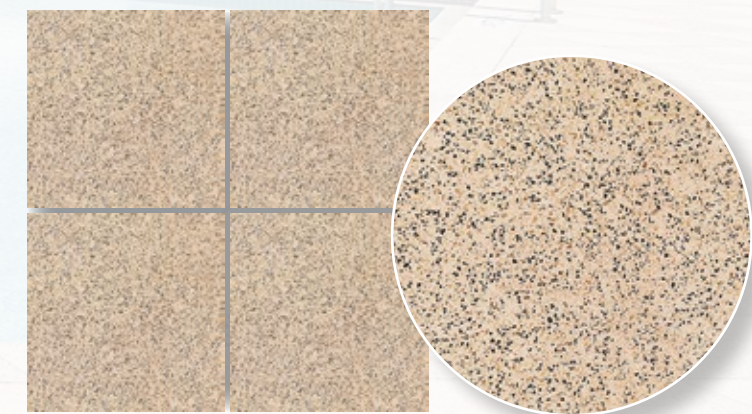

Terrazzo Cream Black

Terrazzo Cream Black porcelain pavers feature a beige-yellow background with flecks of black and gold aggregate. Incorporating a moderately textured finish with a split-rock appearance, these porcelain pavers are also impressively durable, and stain and frost resistant.

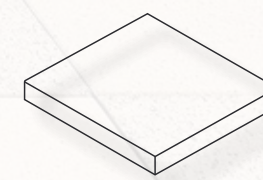
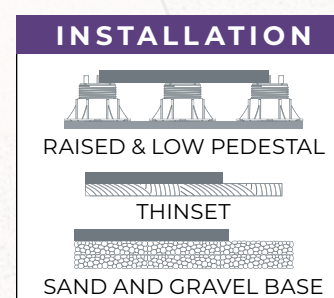

24"x24"x3/4"



TERRAZZO SERIES™

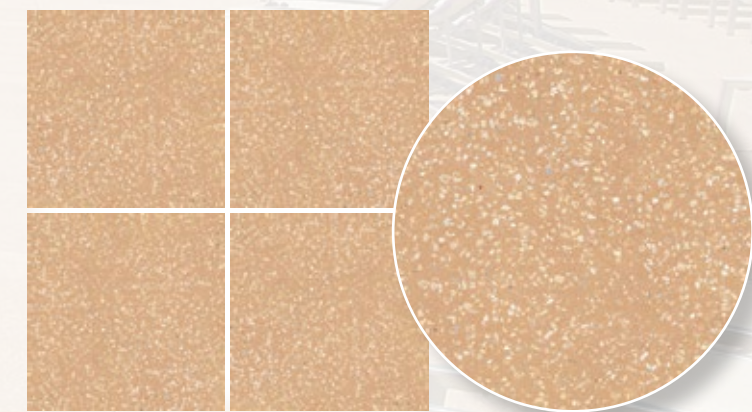

Terrazzo Mocha Gold

Terrazzo Mocha Gold porcelain pavers feature a creamy mocha background with flecks of gold aggregate. Incorporating a moderately textured finish for a timeless classic, these porcelain pavers are also impressively durable, stain and frost resistant, do not require sealing, and have high slip resistance.

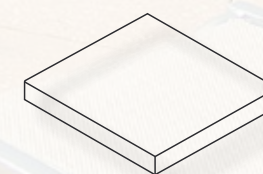
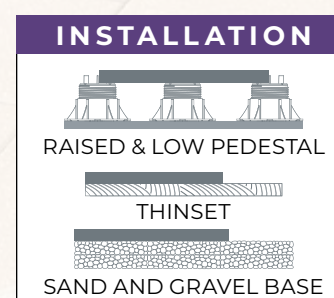

24"x24"x3/4"



TERRAZZO SERIES™

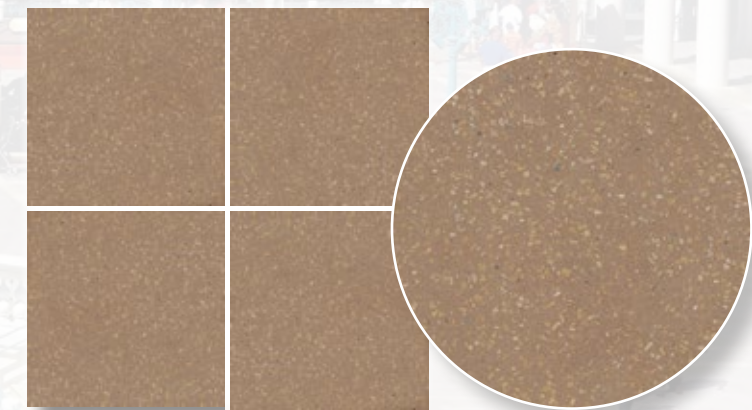
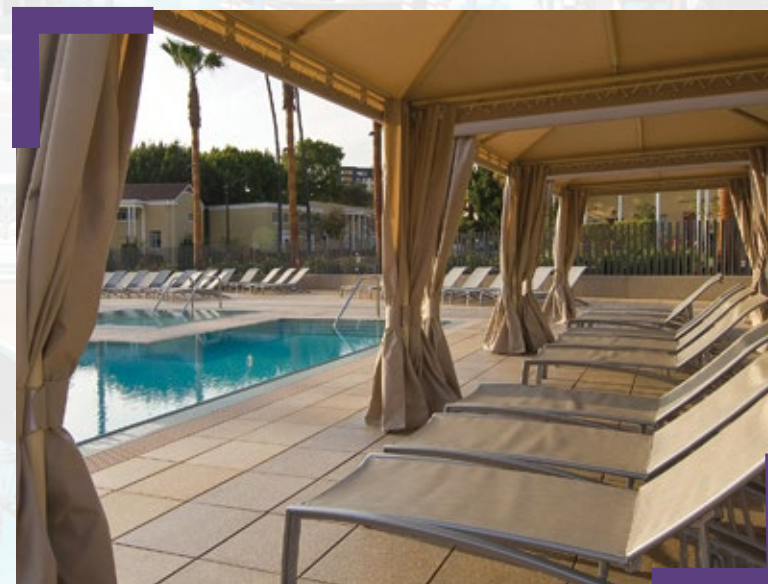

Terrazzo Leather Gold

Terrazzo Leather Gold porcelain pavers feature a creamy brown background with flecks of gold, reflecting a moderately textured finish. A modern take on a timeless classic, these porcelain pavers are also impressively durable, stain and frost resistant. Like all our porcelain pavers, they do not require sealing, and have high slip resistance.

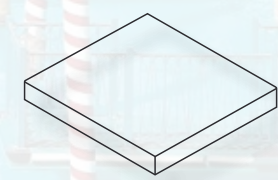
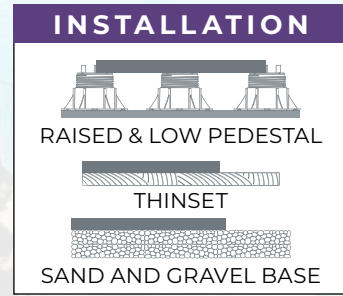

24"x24"x3/4"

THE HOXTON CHICAGO



TERRAZZO SERIES™

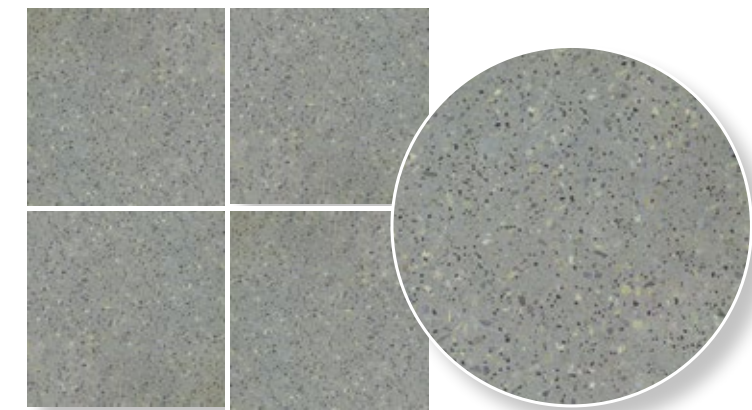
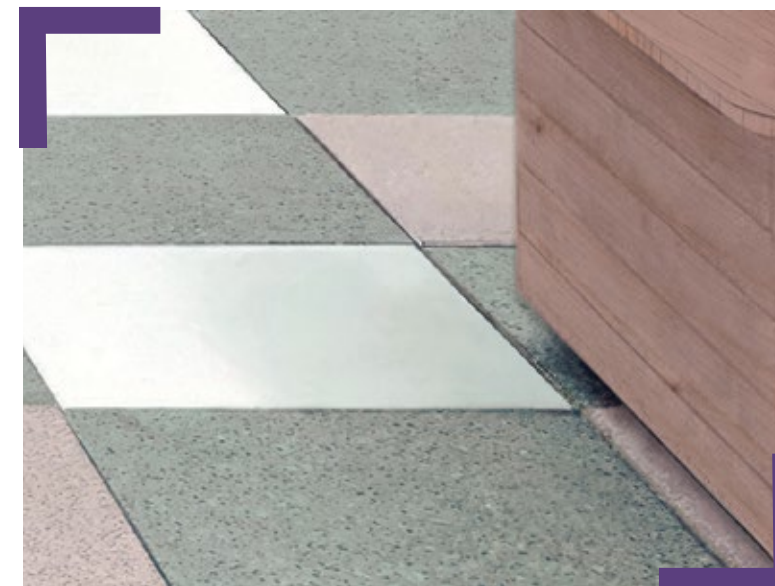

Terrazzo Verde Green

Terrazzo Verde Green porcelain pavers feature a mid-tone green background with flecks of black and green aggregate. With a moderately textured finish and exceptional color, it lends itself to patterning for a unique commercial or residential visual statement. These porcelain pavers are impressively durable, and stain and frost resistant.

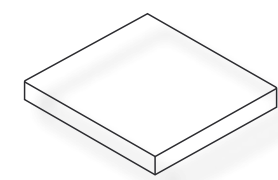
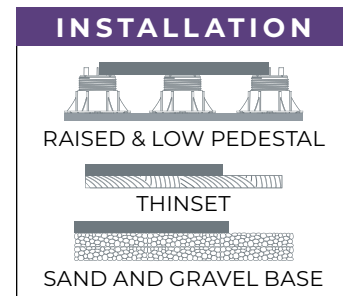

24"x24"x3/4"

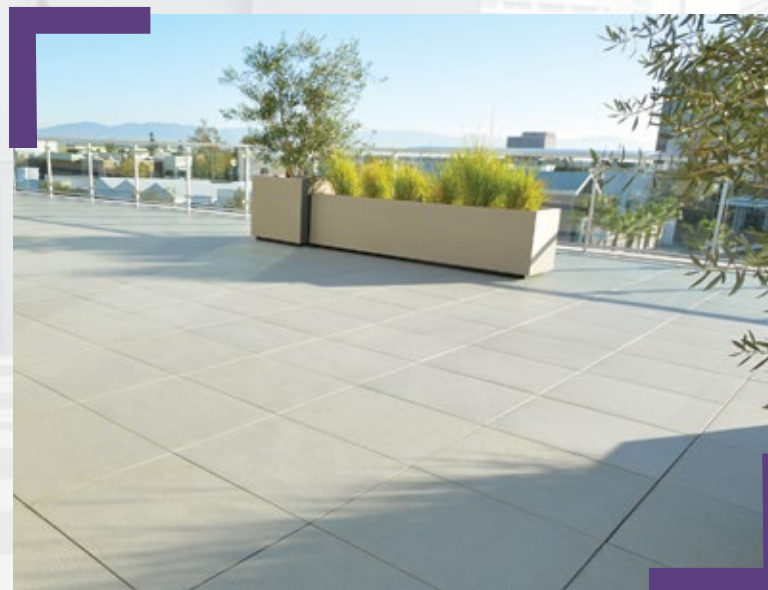

Flat Bone Flat Smoke

Our Flat Bone is a neutral off-white organic stone look, while dramatic gunmetal gray of Flat Smoke provides an understated elegance for your unique project. The pavers are completely nonporous, stain resistant, and require no sealing.

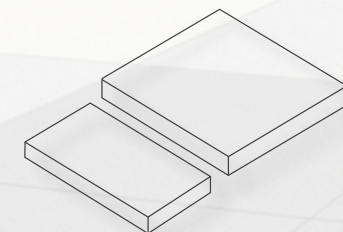
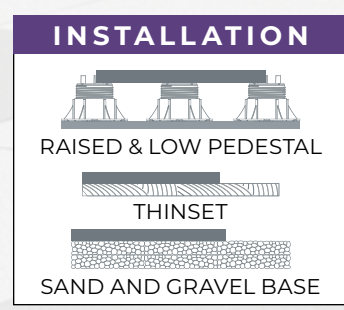

12"x24"x3/4" · 24"x24"x3/4"



EARTH-TONE SERIES™

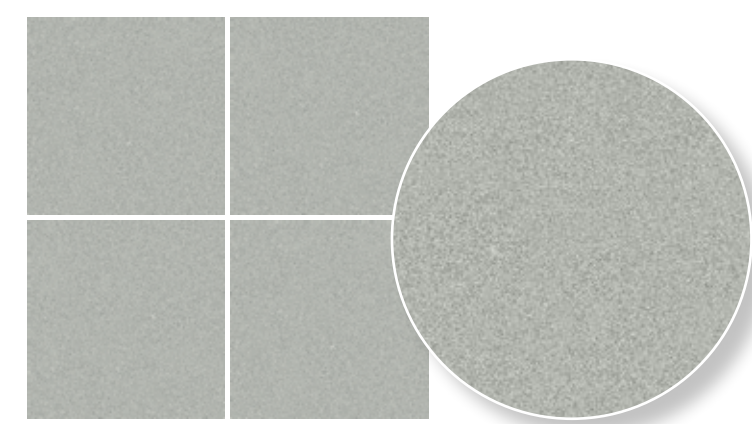
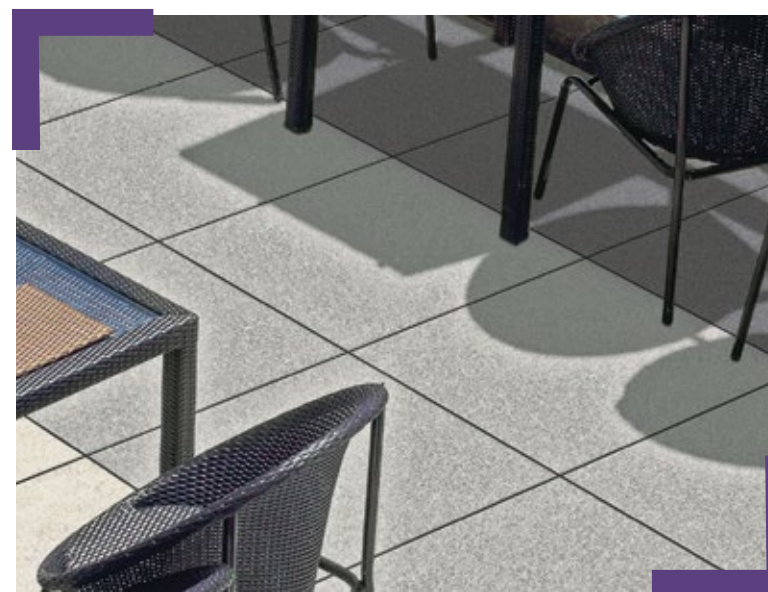

Flat Ash

The restrained neutral gray of Flat Ash provides an understated elegance for your project. Tile Tech® Flat Series range of porcelain pavers reflect a monochromatic beauty providing a natural, organic look and feel. Impressively durable, stain and frost resistant, our pavers do not require sealing, and have high slip resistance.

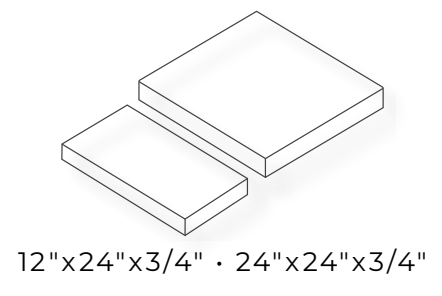
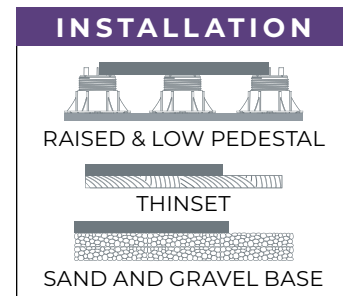

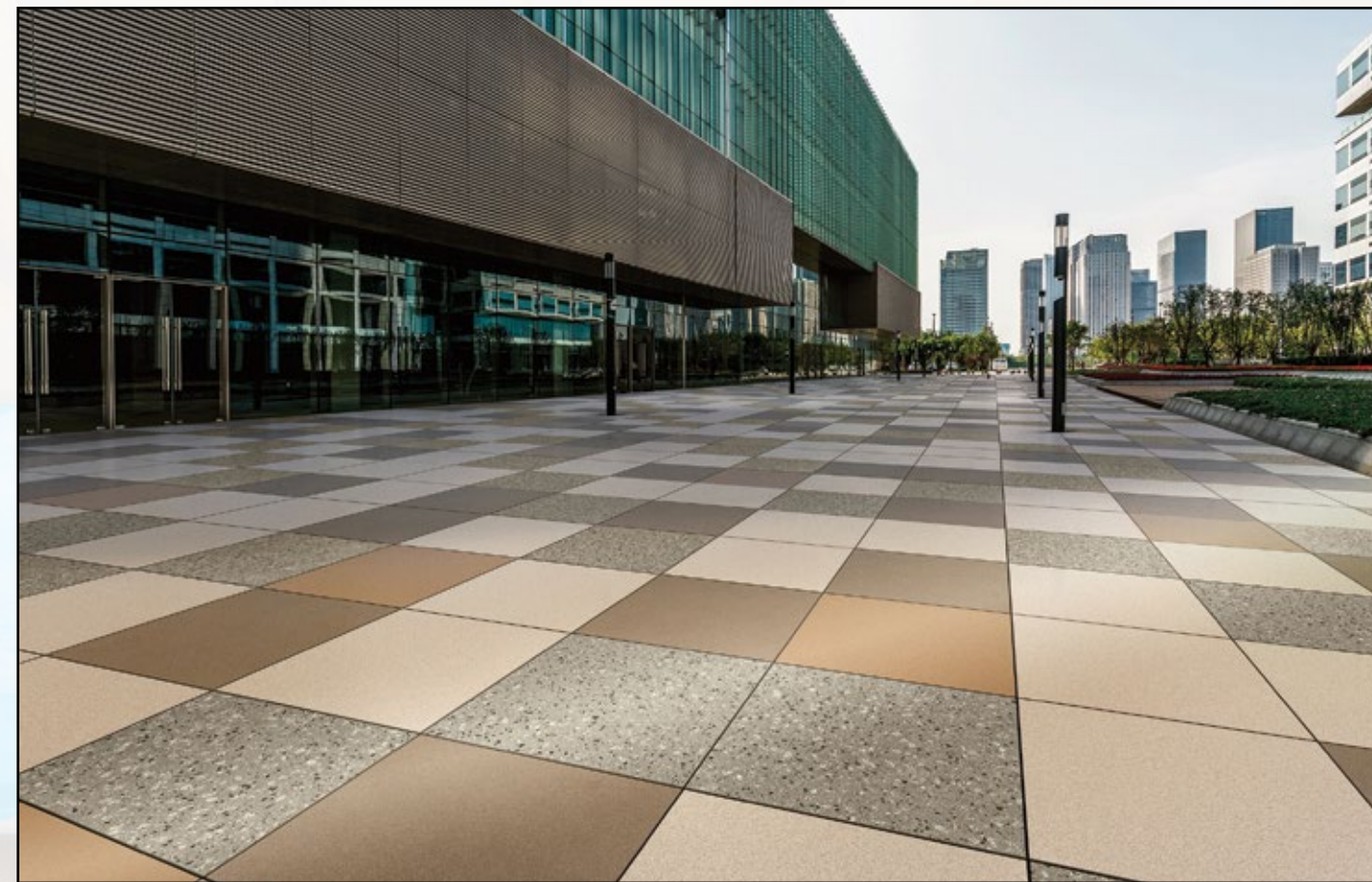

Flat Desert

Tile Tech® Flat Series range of porcelain pavers reflect a monochromatic beauty which provides a natural, organic look and feel. The spirit and allure Flat Desert provides the perfect backdrop for your project, while offering durability, stain and frost resistance, and requires no sealing.

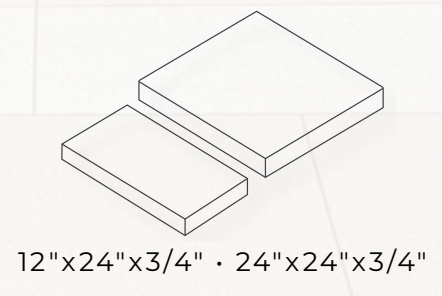
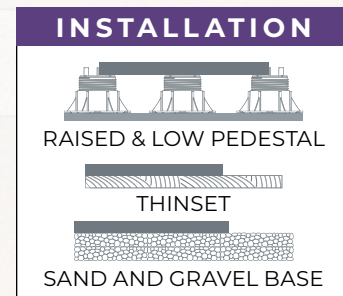



EARTH-TONE SERIES™

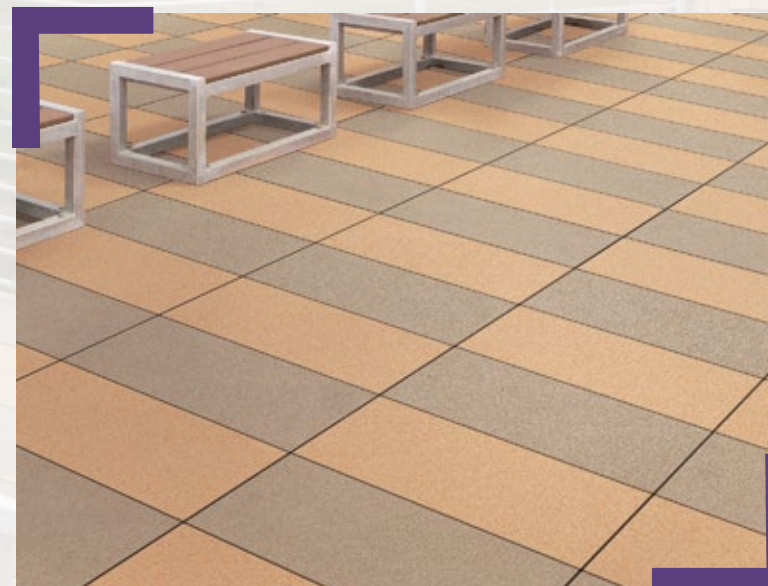

Flat Cognac Flat Tan

Our Earth-Tone Series porcelain pavers reflect nature-inspired palette for your project. Flat Cognac is a richly spiced tone of monochromatic, while Flat Tan is a muted suede hue, sand-blasted concrete without the efflorescence and maintenance required. The pavers require no sealing, and are completely non-porous, and stain resistant.

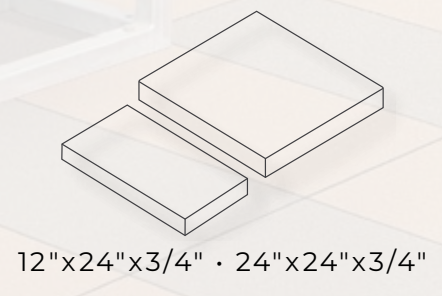
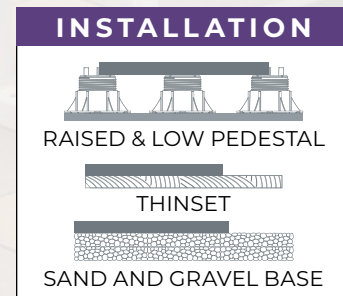

525 MARKET STREET
SAN FRANCISCO



TRELLIS SERIES™



Bone & Smoke
Leather & Sand

INSTALLATION

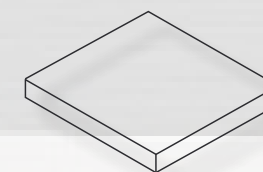
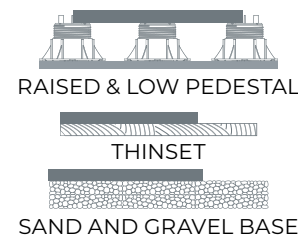

24"x24"x3/4"

The Trellis color palette is a distinctive combination of stoneware shades and a bold choice for residential and commercial environments. Free-style composition offers creative opportunities for a unique and exciting contrasts.

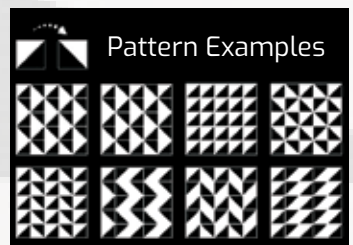

Pattern Examples

The Tile Tech Porcelain Collection faithfully captures and recreates the essence of wood, natural stone, and hand-troweled concrete, allowing you to transform any space in both high-traffic commercial and high-end residential applications.

Made in the USA, our porcelain paving products are resistant to frost, fire, thermal shock, mold, moss, stains, salt corrosion, acids, efflorescence, and UV fading. They're extremely hard wearing and load-bearing, making them suitable for virtually any outdoor use.

Wood Plank™ Series Nominal Sizes: 24" x 24" x 3/4" *24" x 48" x 3/4"



Natural Plank *Mocha Plank

Wood Rustic™ Series Nominal Size: 24" x 24" x 3/4"

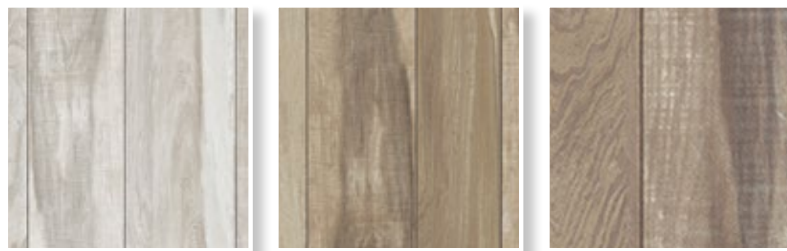

Rustic Maple Rustic Oak Rustic Gray

Wood Chevron™ Series Nominal Size: 16" x 48" x 3/4"

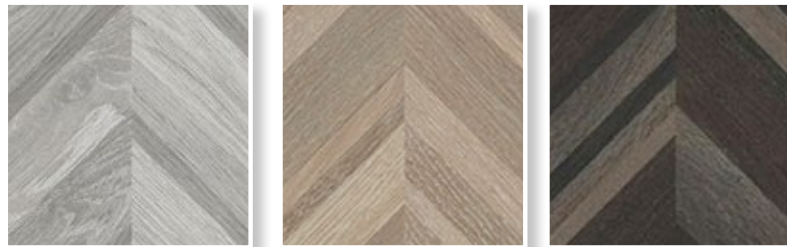

Chevron Maple Chevron Oak Chevron Nut

Wood Solid™ Series Nominal Size: 16" x 48" x 3/4"



Solid Maple Solid Oak Solid Nut

Stone Series™ Nominal Sizes: *12" x 24" x 3/4" 24" x 24" x 3/4" *24" x 48" x 3/4"

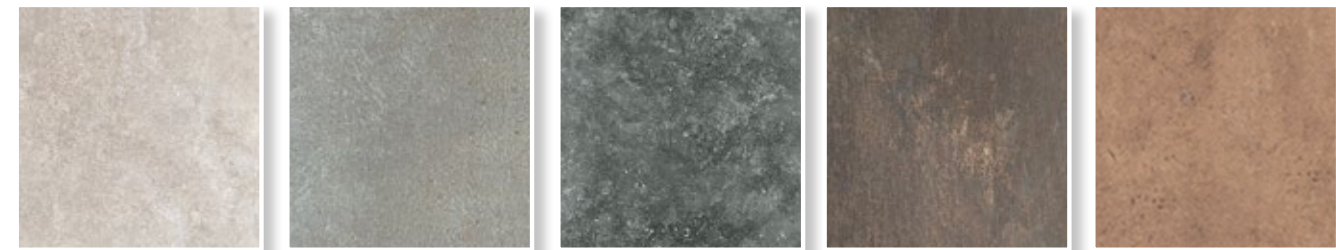

*Sand Stone *Gray Stone *Black Stone Multicolor Terracotta

Quartzite Slate Series™ Nom. Sizes: 12" x 24" x 3/4" 24" x 24" x 3/4" *24" x 48" x 3/4"

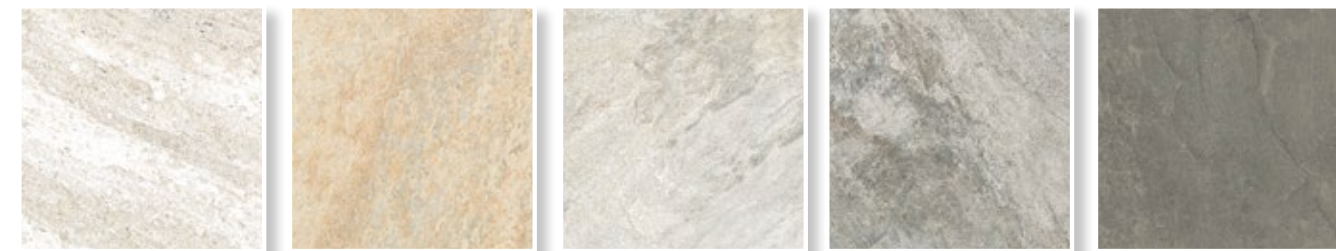

White Sandy Cloud Laguna *PA Bluestone

Seashell Series™ Nominal Sizes: 12" x 24" x 3/4" 24" x 24" x 3/4" *24" x 48" x 3/4"

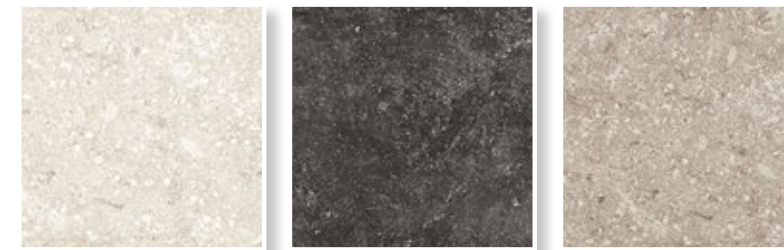

Cool *Black Tan

Travertine Series™ Nominal Sizes: 12" x 24" x 3/4" 24" x 24" x 3/4" 24" x 48" x 3/4"



Pearl Tan Cross Shell Cross Silver Cross Walnut

Cement Series™ Nominal Sizes: 24" x 24" x 3/4" 16" x 48" x 3/4" 24" x 48" x 3/4"



Cenere Cemento Sandalo

Terrazzo Series™ Nominal Sizes: *12" x 24" x 3/4" 24" x 24" x 3/4"



Earth Tone Series™ Nominal Sizes: 12" x 24" x 3/4" 24" x 24" x 3/4"



Trellis Series™ Nominal Size: 24" x 24" x 3/4"

Cool-Roof™ Series Solar Reflectance Index (SRI)

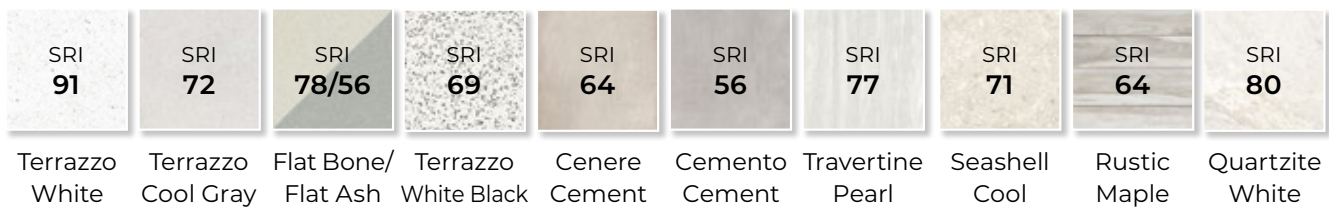

Dimensional Specifications	Size (Rectified)	Depth	Weight /Sq.Ft.	Weight/Unit	Units/Pallet
24" x 24"	23-1/2" x 23-1/2" 596mm x 596mm	3/4" 19mm	9 lbs.	36 lbs.	30 pcs.
24" x 48"	23-1/2" x 47-1/2" 596mm x 1206mm	3/4" 19mm	9 lbs.	72 lbs.	30 pcs.
16" x 48"	15-1/2" x 47-1/2" 393mm x 1206 mm	3/4" 19mm	9 lbs.	48 lbs.	30 pcs.

Note: Porcelain Pavers may be special ordered in 12" x 24". Please call our Sales Department for more details.

Technical Specifications	Test Method	Test Results	Appearance
Bending Strength	ASTM C-648 ISO 10545-4	3,300 lbs.	Tests the tiles resistance to heavy loads. The flexural/breaking strength is the force needed to break the tile.
Distributed Load	ASTM (N/A) EN 12825	2,500 lbs.	
Concentrated Load	ASTM (N/A) EN 12825	Center 2,160 lbs. Center of sides 1,460 lbs. Diagonal 1,840 lbs.	
Coefficient of Friction	ASTM C-1028 ISO (N/A)	Wet >0.60 Dry >0.60	This standard tests the anti-slip properties by determining the coefficient of friction between the paver and a body with a rubber surface.
Water Absorption	ASTM C-373 ISO 10545-3	Max 0.05%	Absorption is the product capacity for water penetration. Porcelain pavers are impervious, very dense product with a very low absorbency rate.
Frost Resistance	ASTM C-1026 ISO 10545-12	RESISTANT	Frost resistance is directly related to water absorption. If tiles absorb water and freeze, the tile may fracture as the tile expands. Tiles may be rated as frost resistant or not.
Abrasion Resistance	ASTM C-1027 ISO 10545-6	RESISTANT Class 5	Abrasion resistance is the capacity of the surface to resistant the wear caused by foot traffic or the abrasion caused by mechanical equipment.
Stain Resistance	ASTM C-1378 ISO 10545-14	RESISTANT Class 5	Method applicable to all working surface of ceramic tiles to determine their resistance to stains. Each staining agent must remain on at least 5 testing samples, for at least 24 hours.
Chemical Resistance	ASTM C-650 ISO 10545-13	RESISTANT UA ULA UHA	Resistant against household chemicals, swimming pool chemicals, acids and alkalis at low and high concentrations.

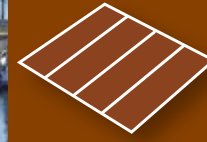

TILE TECH[®]
WOOD DECK TILES

PRINCE WAIKIKI HOTEL
HONOLULU

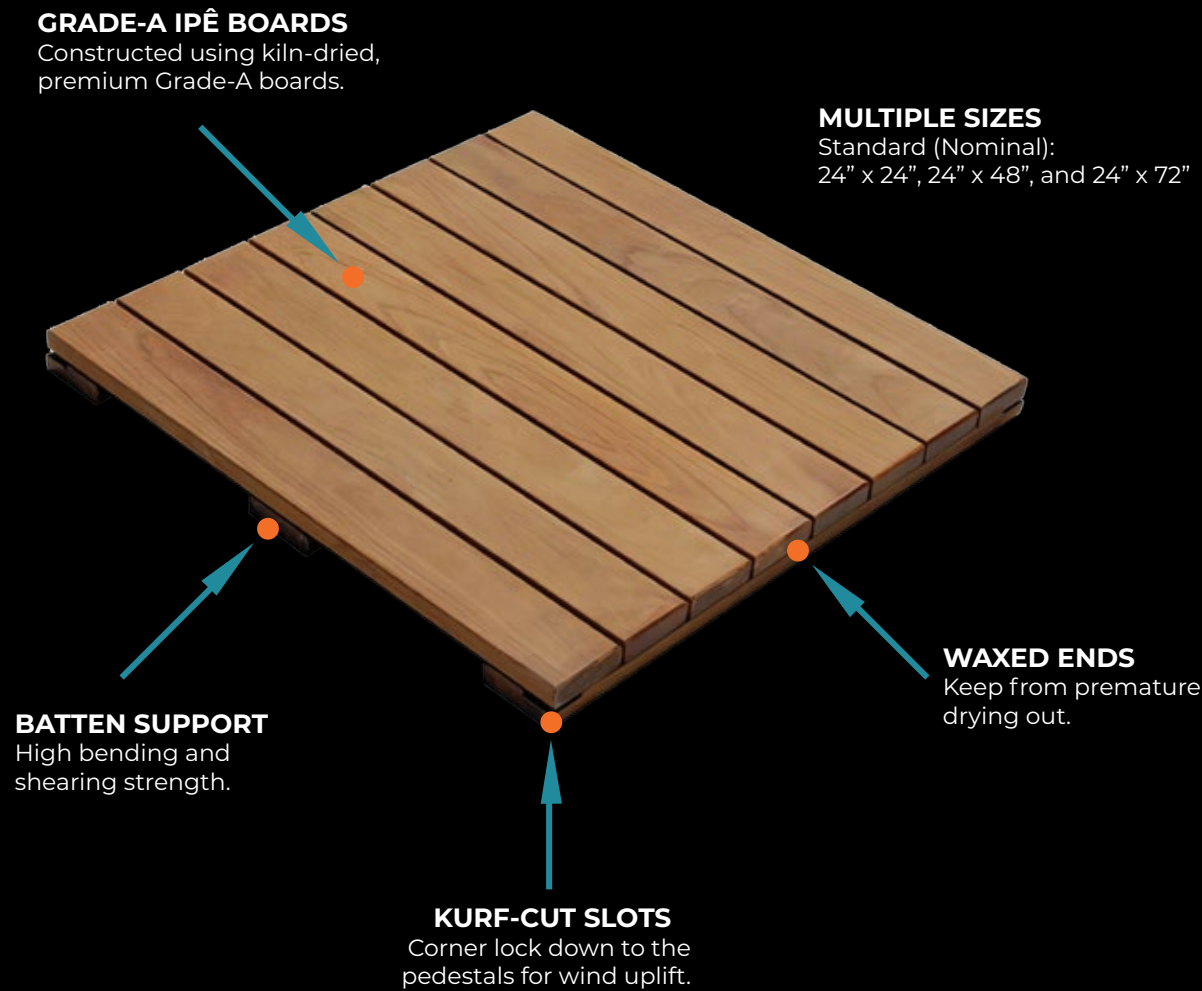

Responsibly harvested hardwoods.

Tile Tech's Wood Deck Tiles are designed for elevated decks over exterior surfaces such as rooftops, terraces, and plazas, in both residential and commercial applications.

Our standard tiles are constructed from kiln-dried IPÊ wood face slats secured to IPÊ wood support runners (battens) using corrosion-resistant screws, resulting in high structural strength, dimensional stability, low flexing, and unmatched beauty.

Additionally, IPÊ Wood Tiles are available as FSC® Certified (FSC-C113128), assuring your materials have positive environmental attributes and are backed by a global system

of verification, contributing to LEED points and SITES criteria.

These wood tiles are commercial grade and constructed from responsibly harvested Forest Stewardship Council® certified hardwood, meeting their high global standards for forest sustainability. Please ask us about the availability of FSC® products and applicable LEED credits i.e. Materials Reuse (3.1, 3.2), and Heat Island Effect (SS 7, 7.1, 7.2).

With 3-5 times the lifespan of other decking materials, renewable finish, along with stronger resistance to fire, weather, and insects, Tile Tech® Wood Deck Tiles are an environmentally sound choice.

PERFORMANCE & FUNCTIONALITY



RESISTANT TO FIRE
Meets Class A Flame Spread Requirement.



HIGH BREAKING LOAD
3,000 concentrated.
15,000 lbs uniform.



RESISTANT TO ATTACK FROM mold, moss and verdigris treatments.



RESISTANT TO THERMAL SHOCK
Dense hardwoods offer high resistance.



LIGHT WEIGHT
Only 6 lbs. per Sq.Ft.



EASY TO INSTALL
Rectified and single work-size.



EASY TO REMOVE, INSPECT AND REINSTALL
Only 24 lbs. per 24" x 24" tile.



ANTI-SLIP SURFACE FINISH

Introducing Tile Tech® IPÊ Wood Deck Tiles.

● Durability

IPÊ wood is renowned for its exceptional durability. It is a dense and hardwood species, making it resistant to scratches, dents, and general wear and tear. This durability is especially beneficial in commercial settings where high foot traffic and heavy deck furnishings may be common.

● Weather Resistance

IPÊ wood is naturally resistant to various weather conditions, including rain, sunlight, and extreme temperatures. It doesn't easily warp, crack or rot, making it an ideal material for outdoor applications. This weather resistance ensures that the deck tiles maintain their integrity over time, reducing maintenance costs and effort.

● Slip Resistance:

The texture of IPÊ wood provides a natural slip resistance, making it a safer option for outdoor spaces where moisture or rain may be present. This is particularly important for commercial areas where safety is a priority, such as restaurants, hotels, or public spaces.

● Longevity and Investment:

Due to its durability and resistance to environmental factors, IPÊ wood deck tiles have a longer lifespan compared to many other decking materials. IPÊ wood deck tiles offer a combination of durability, weather resistance, low maintenance, aesthetic appeal, slip resistance, and long-term investment value, making them a preferred choice for commercial outdoor spaces.

THE WESTIN MAUI RESORT AND SPA KA'ANAPALI

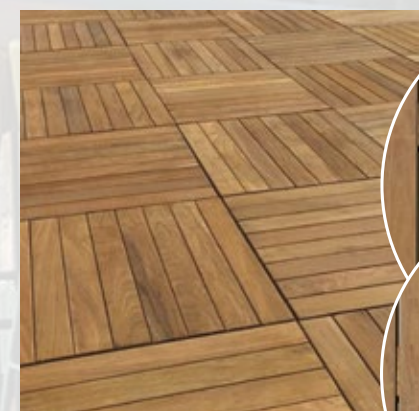

IPÊ Wood / IPÊ Wood FSC

IPÊ Wood

Tile Tech's IPÊ Wood Tiles are constructed from kiln-dried IPÊ wood face slats secured to IPÊ wood support runners (battens) using corrosion-resistant screws. With their high structural strength, dimensional stability, and low flexing, combined with our pedestals, our IPÊ wood tiles create a luxurious feature for any project.

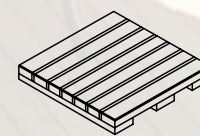

24" x 24"

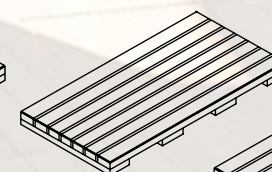

24" x 48"

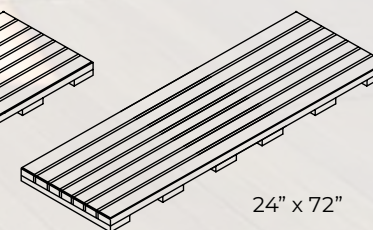

24" x 72"

BEVERLY WILSHIRE HOTEL BEVERLY HILLS

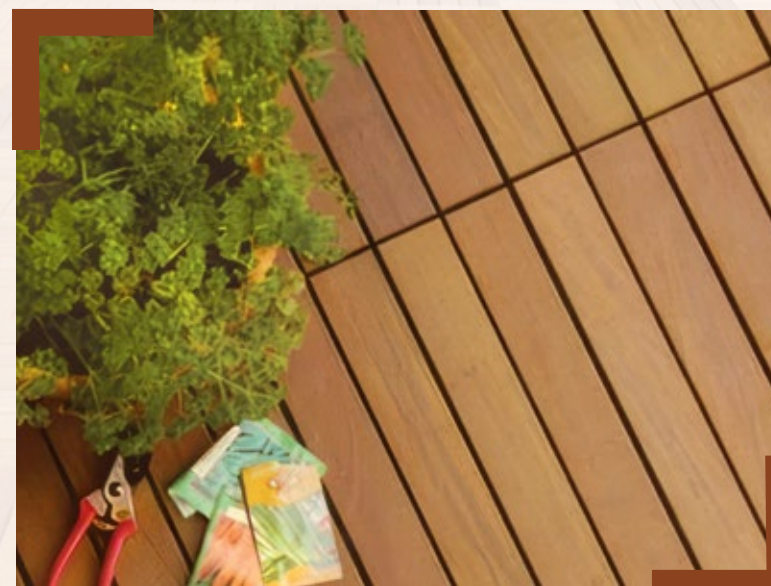

Cumaru Wood, Cumaru Wood FSC & Tigerwood

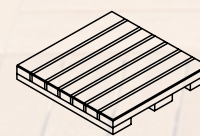

24" x 24"

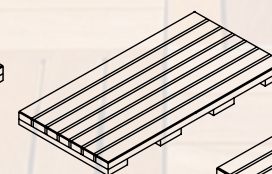

24" x 48"

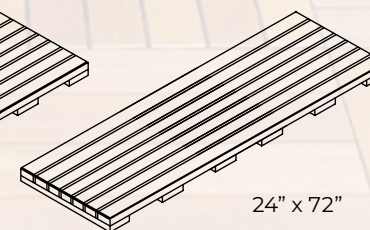

24" x 72"

Cumaru & Tigerwood

Discover the beauty and benefits of Cumaru and Tigerwood, a striking and resilient exotic hardwood perfect for your flooring and decking needs. With its unique blend of strength and patterning, these hardwoods provide visual and cost-friendly alternative for your decking project.

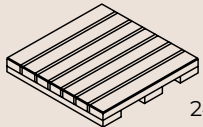
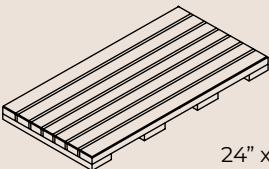
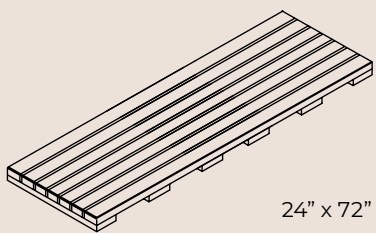
Nominal Size	Actual Size	Depth	Weight Sq. Ft.	Unit Weight	Sq.Ft./Pallet Units/Pallet
 24" x 24"	23-5/8" x 23-5/8" 600mm x 600mm	1-5/8" 41mm	6 lbs.	24 lbs.	400 Sq.Ft. 100 Units
 24" x 48"	23-5/8" x 47-5/8" 600mm x 1209mm	1-5/8" 41mm	6 lbs.	48 lbs.	400 Sq.Ft. 50 Units
 24" x 72"	23-5/8" x 71-5/8" 600mm x 1819mm	1-5/8" 41mm	6 lbs.	72 lbs.	384 Sq.Ft. 32 Units

Slat dimensions:
Width: 2-61/64 (75mm), Depth: 53/64" (21mm)
Slats per tile: 8

Type	Result
Durability	Class 1 (min. 25-year life)
Density	12% Moisture
Hardness (Janka)	3700 (very hard)
Modulus of Elasticity	21 GPa
Fire Rating	Class A



Top View



Bottom View

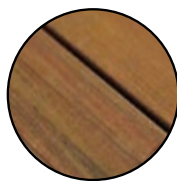

Smooth Surface Structural IPÊ deck tiles are our most popular tile and exceeds the ADA requirements for Static Coefficient of Friction in a wet environment (ASTM-C1028-89).

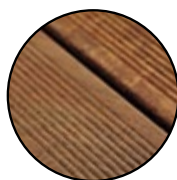

Grooved Surface While structural IPÊ deck tiles provide the highest slip resistance for wet climates, the grooved finish offers additional slip resistance when desired. Please call for assistance in ordering.

IMPORTANT! Our IPÊ deck tiles are shipped in their natural, unfinished state. Applying a quality deck oil with UV protection at regular intervals helps maintain color and preserves the appearance of the wood.



Installation of Tile Tech's IPÊ deck tiles are similar to steps for our porcelain pavers on pedestal systems. Like our Hex-Tray™ System, IPÊ deck tiles have a slot cut in each corner enabling a deck screw and Lock Disk™ component to be inserted. The screw is invisibly inserted into the pedestal head with the Lock-Disk™ holding down the corner of the pedestals to "lock down" the tiles onto the pedestal ensuring a safe, secure and level surface.

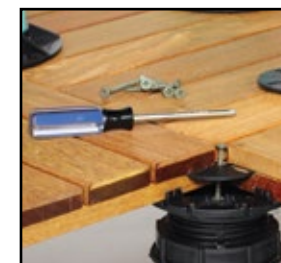

Our Lock Disk™ system allows lock down using a standard Phillips bit or adjustment tool (shown left), allowing you to fasten the screw into the hole in the center of the pedestal until the washer is level with the slot cut in the tile.

Push the pedestal back towards the tiles so the tab nests firmly against the tiles and the washer engages the slots. Install the other two tiles on the pedestal head, then tighten the screw with the screwdriver to secure the corners of all four tiles.



Tile Tech® IPÊ deck tile installation requires a Pedestal Buffer Pad, providing protection to waterproofing membrane from wear, and slip resistance to pedestal.



TILE TECH®
ADJUSTABLE PEDESTAL SYSTEM

BUDOKAN LITTLE TOKYO
LOS ANGELES



Our unique and flexible pedestal system.

Elevate your design projects with the Tile Tech® Pedestal System, expertly designed for porcelain pavers, concrete pavers, and wood deck tiles, ensuring a perfectly level surface on raised platforms.

Revolutionizing the industry with our PATENTED Hybrid screw-jack pedestal support system, this innovation offers unparalleled versatility. With a single model suited for all height applications, our system is easily adjustable through screw and PVC pipe mechanisms.

Further, it is stackable, providing flexible solutions for your project.

Compatible with both concrete and wood structures, our system seamlessly integrates with roof membranes, making it a versatile choice for design professionals.

Tile Tech® Pedestal systems are the go-to choice for an array of raised

decking applications. Whether it's elevated decks, tile decks, wood decks, porcelain decking, sloped or level rooftops, our system shines. Our system is ideal for balconies, patios, urban parks, plaza decks, rooftop terraces, water features, walkways, and general landscaping projects where precision is paramount.

While primarily designed for unit pavers such as porcelain, concrete, stone, or structural wood pavers, our system extends its support to wood joists, enabling the construction of traditional wood plank decks.

For projects involving modular pavers on elevated decks, our system offers unparalleled support. Pavers are anchored at each corner, with the option to add extra pedestals beneath the center or midway along the edge, ensuring stability and load distribution.

PERFORMANCE & FUNCTIONALITY



LIGHT WEIGHT



EASY TO INSTALL



EASY TO REMOVE AND INSPECT



LOAD BEARING



VERSATILE INSTALLATION



RESISTANT TO FROST



FIRE TESTED & APPROVED



RESISTANT TO THERMAL SHOCK

Introducing the Tile Tech® Adjustable Pedestal System.

Flexible Pedestal Design

Allows for all height applications from low as 5/8" and as high as 54" with Lateral Bracing and Tray System, resulting in reduced labor and material costs, while eliminating leftover parts and pieces.

PVC Pipe Adjustment

Allows the pedestal system to vary in heights up to 54" by using off-the-shelf 4"ø SDR-35 PVC pipe. Eliminates material and shipping costs.

Screw Adjustment

Allows for quick and easy fine-height tuning for an additional 3/4", 1-1/2" and 4" depending on the model size of Uni-Insert™ used. Eliminates having to cut pipe exactly.

Self-Leveling Head

Allows for slope compensation of 0% to 4% in any direction. A T-Handle tool allows for raising and leveling while loaded with pavers. Eliminates having to remove pavers to make adjustments.

Stackable Caps

Allows for minor height adjustments from 5/8" up to 2-1/4" and can compensate for slopes of 0% to 3% by aligning the built-in slope compensation of one cap relative to another. Simple, easy, and affordable!

Hybrid or Standard Pedestals. It's Your Choice.

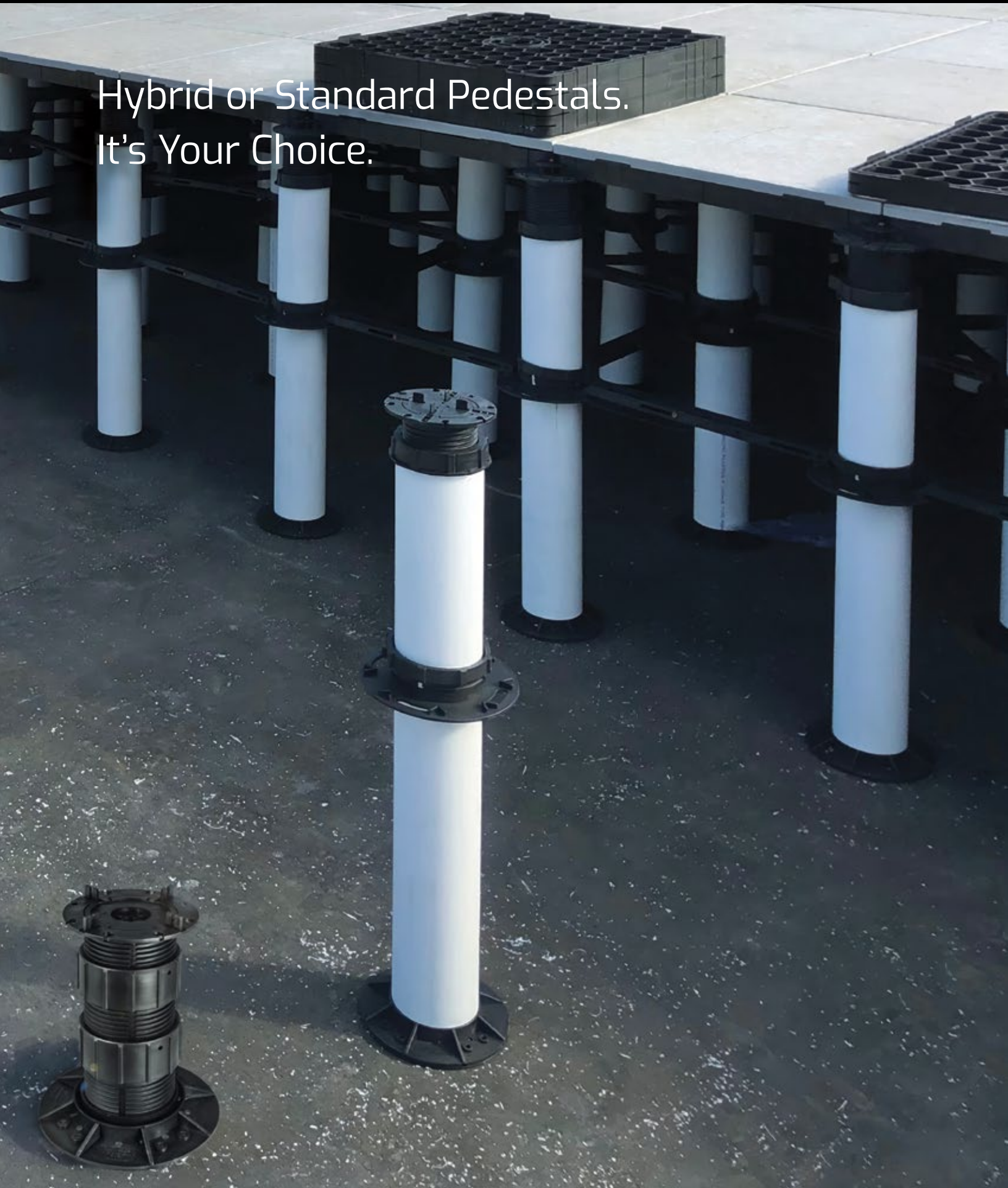

Our patented hybrid screw-jack pedestal support system can be configured to be used with off-the-shelf PVC pipe or special 4" male/female couplers or stackable caps.

The off-the-shelf, 4" diameter SDR-35 PVC sewer pipe allows the pedestal system to vary in height up to 54" (with Lateral Bracing and Tray System) and is cut to the desired height using a 12" chop saw. The screw

adjustable 4" Uni-Coupler™ can also be used in lieu of any PVC pipe and will allow a height build-up of 24".

Additional low-height stackable caps with built-in slope compensation are available for height ranges of 5/8" to 2-1/4" high.

Our pedestals paver system includes built-in self-leveling with additional slope compensation plates at the bottom of the pedestal system.



Adjustable Pedestals + PVC Pipe



Adjustable Pedestals + Couplers



Deck Pedestals + Joist Cap



Low-Height Pedestals + Stack-Cap™

Pedestal Components.

Tile Tech's component system provides precision placement for porcelain pavers and wood tiles on raised decks applications.

Both our PATENTED hybrid pedestals and Standard support systems are adjustable, self-leveling and designed for your height applications.



Uni-Base™: Used as base of pedestal system. "Press fits" on to end of PVC pipe. May be used with Uni-Insert™ for low height applications. Large surface area provides stability.



Uni-Collar™: Used for screw height adjustability of pedestal system. "Press fits" on to top end of PVC pipe.



Uni-Insert™ 3/4", 1-1/2" and 4": Used for screw height adjustment of pedestals. Screws into Uni-Collar™, providing an additional height adjustment as needed to PVC pipe.



Uni-Cap™: Self-leveling and adjustable in any direction from 0% to 4% slope. Aligns and locks to Uni-Insert™.



Lock Ring: Inserts into Uni-Cap™ and Joist Cap to keep pavers from pivoting.



Stack Cap™: Used when low height are required. May be rotated and stacked for slope and height adjustment.



Uni-Coupler™ 4": Screws on Uni-Base™ for incremental height adjustments. Use additional Uni-Couplers for incremental height adjustments.

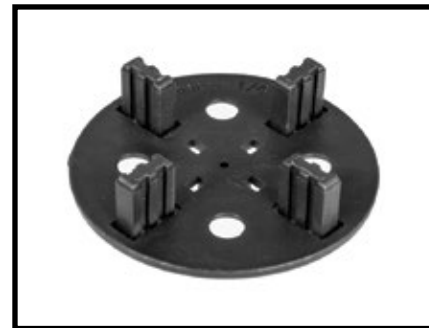

Spacer 1/4" (6mm): Allows for 1/4" spacing gap between pavers for drainage. Tabs are perforated for easy removal.



Spacer 1/16" (2mm): Used with Hex and Turf-Trays. Allows for 1/16" spacing gap between pavers for drainage. Tabs are perforated for easy removal.



Spacer 1/8" (3mm): Used with wood deck tiles or porcelain pavers without trays. Allows for 1/8" spacing gap between pavers for drainage. Tabs are perforated for easy removal.



Uni-Shim™ 1/8" and 1/16": Allow for fine tuning of individual pavers. Can be broken into quarters or halves and stacked on top or bottom of pedestals.



Base Slope Plate: Used for slope compensation at base of pedestals. Each plate compensates for 1/4" per foot (2%) slope and adds 3/8" to the overall height of pedestal. Maximum of four plates may be stacked for compensation of up to 1" per foot (0-8%) slope.



Pedestal Buffer Pad: Provides protection to waterproofing membrane from wear and provides slip resistance to pedestal. Attaches to bottom of Uni-Base™.



Rubber Shim: Ensures flush and level pavers while preventing rocking. Dampens sound.



Joist Cap: Wood joist self-leveling head for use on adjustable pedestal supports.



Spacer Plate/Joist Plate: Levels and provides 1/8" or 1/16" uniform spacing between pavers.

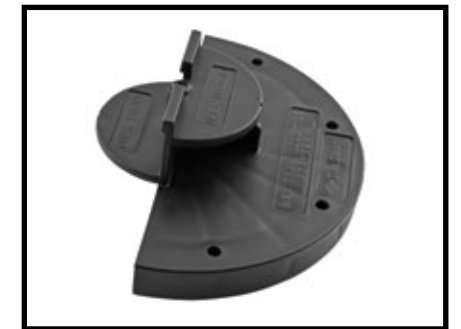

Wood Tile & Tray Adapter: Designed to raise and lock wood deck tiles to the Turf-Tray when combining wood and porcelain pavers.



Hex-Lock Disk: Used to secure Hex-Trays to prevent wind uplift by inserting disk into kerf-cut and then securing with 1-1/4" deck screw.

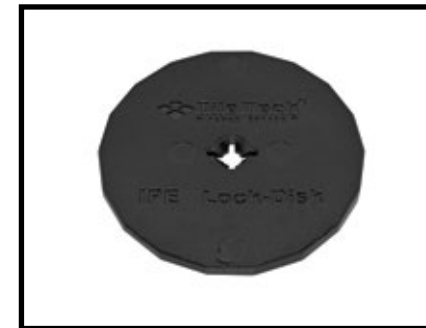

IPÊ Lock Disk: Used to secure wood tiles by inserting disk into kerf-cut between the upper slat and bottom rail, adding the 4th tile and securing with 1-1/4" deck screw.



Lateral Bracing System: Used for stabilizing and reinforcing pedestals, ensuring their structural integrity in the face of pronounced lateral forces such as wind, seismic activity, or other external pressures.



Fascia Clip: Designed to work with lateral bracing flange unit to allow 2x4 wood to be mounted to pedestals for perimeter enclosure. See page 126 for more information.

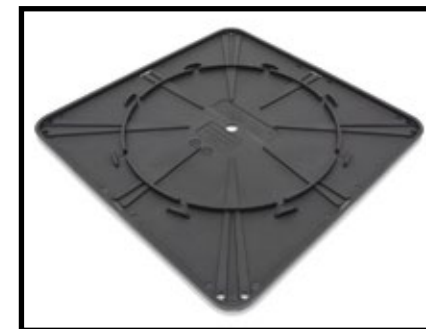

Foundation Pad: Used under pedestals for on-grade applications. Provides a 10" x 10" larger load bearing surface area to protect base from sinking into compact gravel base.

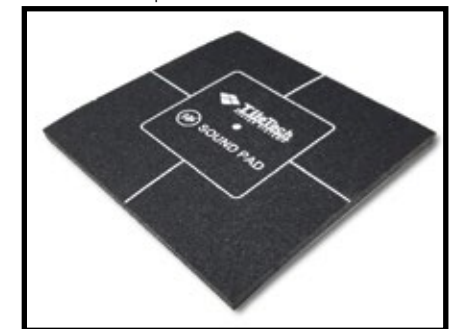

Sound Pad: Used directly under our adjustable pedestals systems and on top of the waterproofing membrane yielding exceptional impact/shock resistance and sound/vibration dampening.

Our Hybrid Pedestal System.

The beauty of our hybrid system is surprisingly simple. It's designed for use with off-the-shelf SDR-35 PVC pipe. Easily cut with a standard 12" chop saw, allowing the pedestal system to vary in height up to 54", (with Lateral Bracing and Tray System).

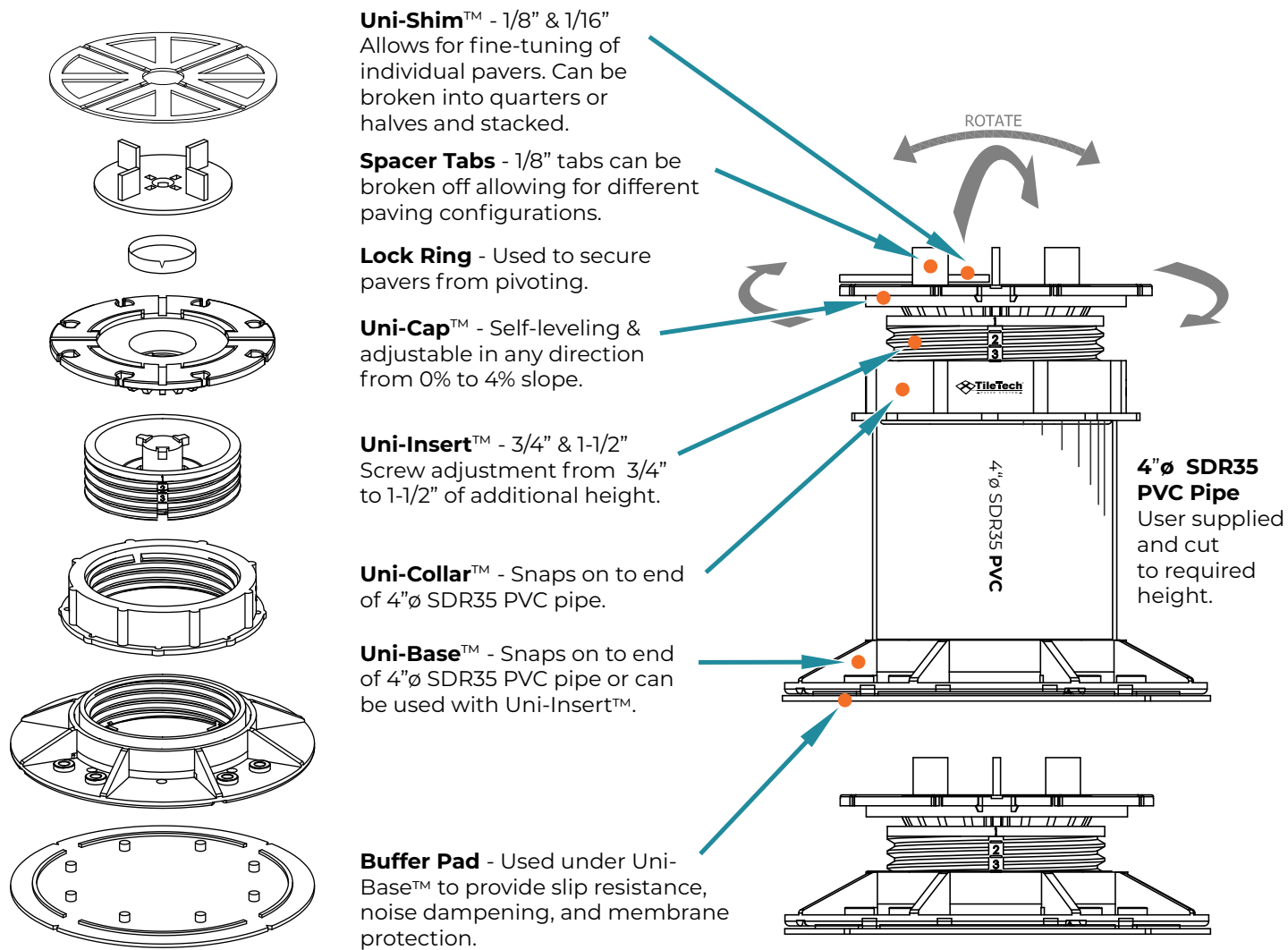

Pedestal Properties	Test Method	Results
Axial Load without PVC pipe	ASTM C-293	10,000 lbs.
Axial Load with PVC pipe	ASTM C-293	2,000 lbs.
Self-Ignition Temperature	ASTM D-1929	800° F (427° C)
Softening Point	ASTM C-1525	226° F
Freeze Thaw	ASTM C-1645	Unaffected
Material	HDPP - High Density Polypropylene * Resistant to oils, acids, alkalis, bitumen, mold, and algae.	



For complete material & installation specifications, please visit our website or contact us.

Our Standard Pedestal System.

Adjust your height from 2-1/4" to 24" with our 4" Uni-Coupler™ from Tile Tech®. A convenient solution providing durable support for a raised surface.

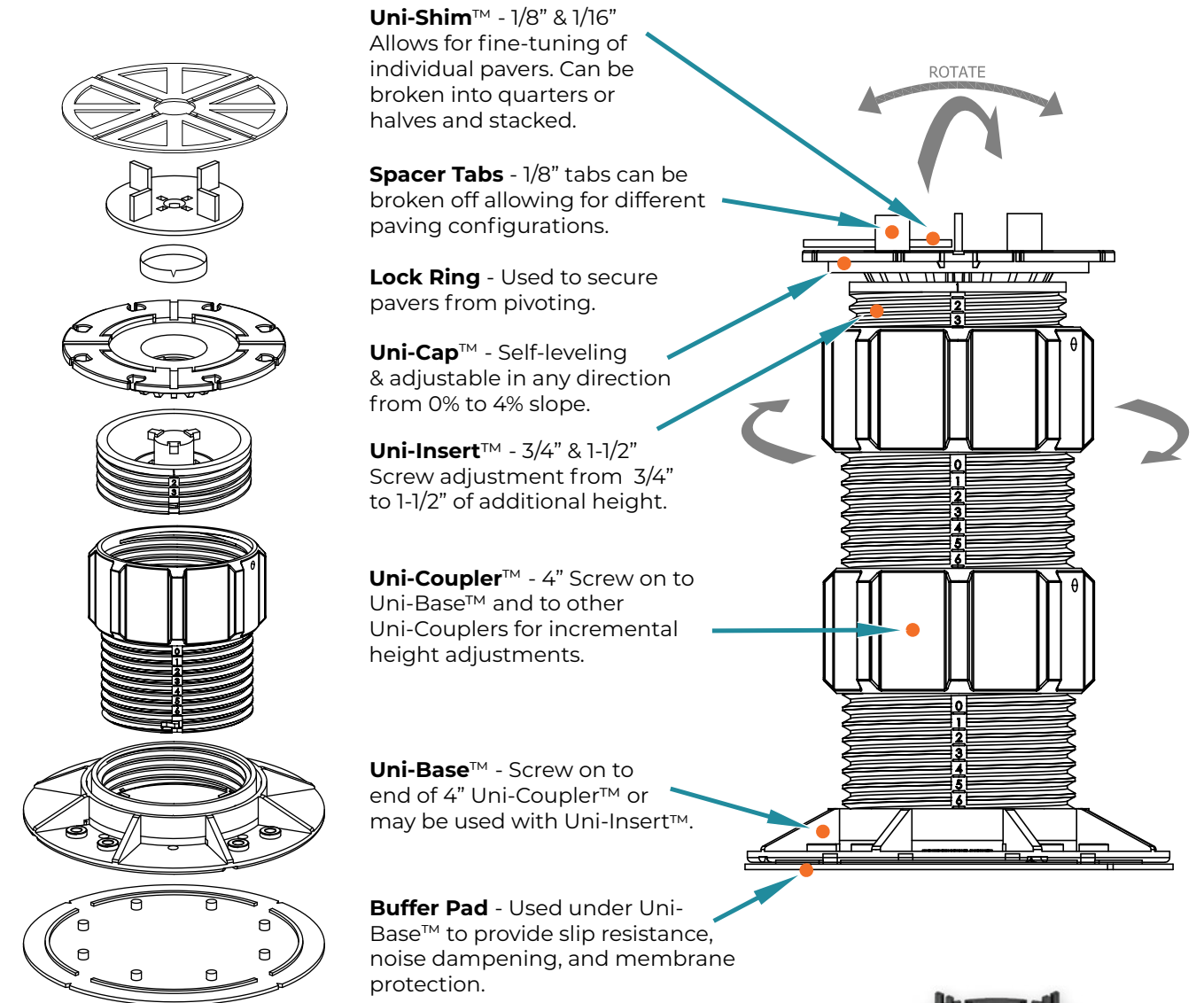

Pedestal Properties	Test Method	Results
Axial Load	ASTM C-638	10,000 lbs.
Self-Ignition Temperature	ASTM D-1929	800° F (427° C)
Softening Point	ASTM C-1525	226° F
Freeze Thaw	ASTM C-1645	Unaffected
Material	HDPP - High Density Polypropylene * Resistant to oils, acids, alkalis, bitumen, mold, and algae.	



For complete material & installation specifications, please visit our website or contact us.

Calculating pavers and pedestals.

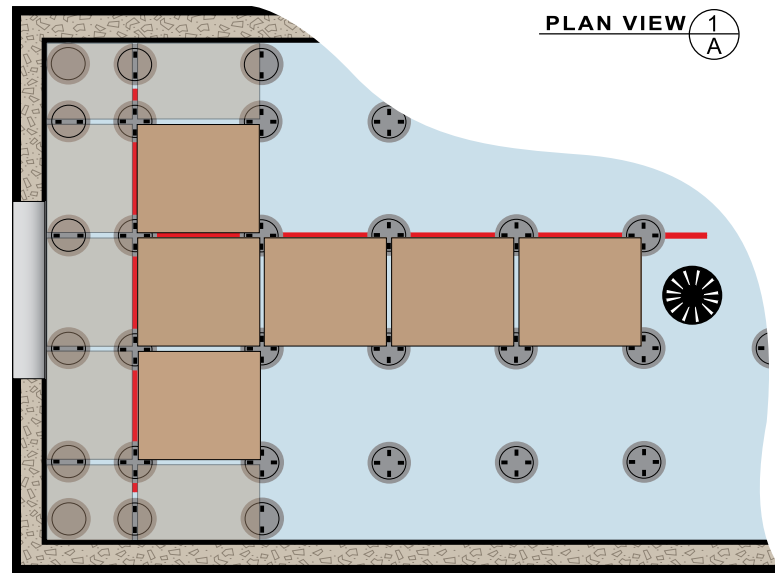

Please note, the formulas below are general calculations. Irregular shaped patios or rectangular pavers will increase the quantity of pavers and pedestals required for your project.

Estimates should include a 10% waste factor for pavers and 5% waste for pedestals.

Questions? Representatives are available to discuss your needs and provide a quote upon request.

Quantities of Pavers and Pedestals for a 20' x 50' deck:

Paver Size	# of Pavers	# of Pedestals
12" x 24"	500 (525 recommended)	1,140 (1,150 recommended)
24" x 24"	250 (300 recommended)	320 (325 recommended)
16" x 48"	188 (213 recommended)	481 (500 recommended)
24" x 48"	125 (150 recommended)	320 (325 recommended)

EXAMPLE: 24" x 24" Pavers and Pedestals for a 20' x 50' deck:

Part 1 - Pavers

Determine the number of pavers needed.

First, determine the square feet of the deck:

Multiply the width by the length of the area: $20 \text{ feet} \times 50 \text{ feet} = 1,000 \text{ Sq.Ft.}$

Next, determine the number of pavers needed:

Divide the total Sq.Ft. by the paver Sq.Ft.: $1,000 \text{ Sq.Ft.} / 4 \text{ Sq.Ft.} = 250 \text{ pavers.}$

Part 2 - Pedestals

Determine the number of pedestals needed.

First, determine the perimeter by adding all dimensions of the area: $20 \text{ feet} + 50 \text{ feet} + 20 \text{ feet} + 50 \text{ feet} = 140 \text{ feet.}$

Multiply the perimeter by 12 to determine square inches: $140 \text{ feet} \times 12 = 1,680 \text{ Sq.In.}$

Divide the square inches by the width of the paver in inches: $1,680 \text{ Sq.In.} / 24 \text{ inches} = 70$

Add the number of pavers + number of pedestals. $250 + 70 = 320 \text{ pedestals.}$

(It is recommended to round up to the nearest 25)

Level your pedestal with precision.

Precision leveling is paramount for ensuring the structural integrity, safety, and aesthetic appeal of elevated outdoor spaces. Achieving precision leveling prevents issues such as uneven settling, potential tripping hazards, and structural stress points.

It's also fundamental for efficient water drainage that could lead to damage over time. Our precision leveling pedestal system recommendations are an essential step toward creating a durable, safe, and visually pleasing outdoor environment.

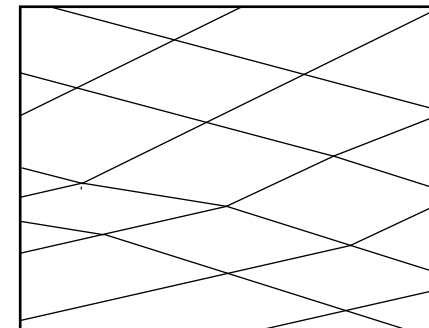

1. Chalk grid lines starting from door threshold based on paver size plus 1/8" gap.

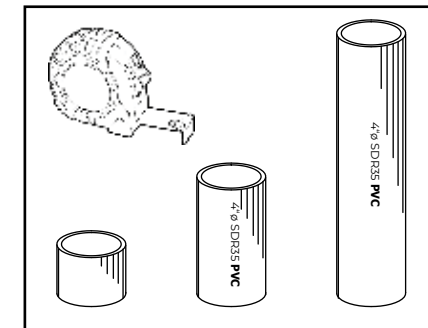

2. Using a laser, determine final height of pedestals. Deduct 1/4" for base & cap assembly. Measure & mark PVC pipe to be cut.

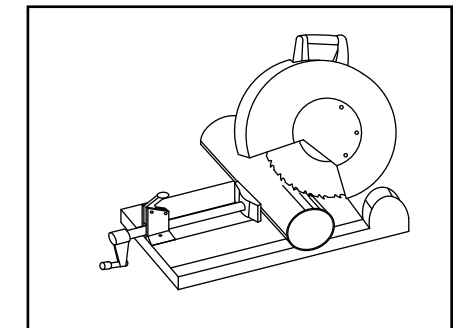

3. Cut PVC pipe to required height with a 12" chop saw. Using sand paper, remove any burrs from cut ends.

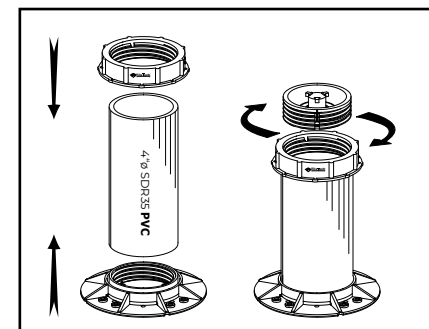

4. Assemble by inserting cut PVC pipe in to Uni-Base™ and Uni-Collar™ in to other end of PVC pipe. Screw Uni-Insert™ in to Uni-Collar™ minimum of 2 threads.

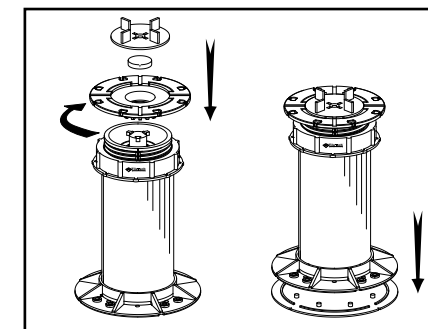

5. Complete assembly by rotating and aligning Uni-Cap™ with Uni-Insert™ and Lock Ring. Align & attach Buffer Pad to Uni-Base™.

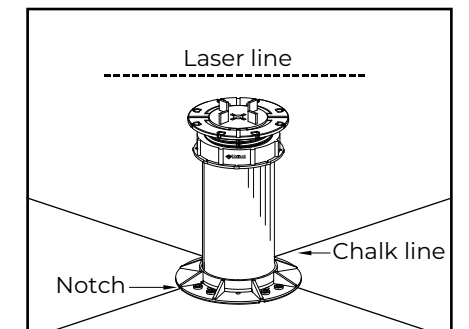

6. Position pedestal under laser line and align Buffer Pad notch with chalk line.

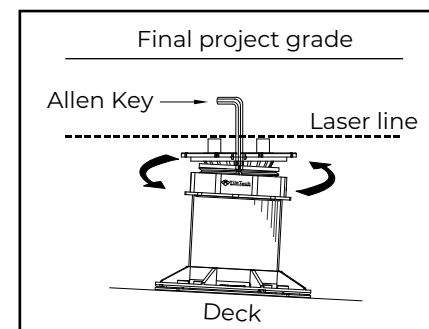

7. Adjust final pedestal height by using Allen Key from top to screw up or down Uni-Insert™.

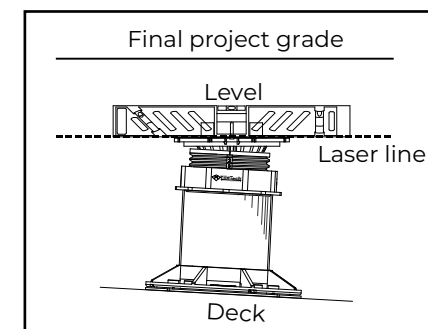

8. Use a spirit level to level Uni-Cap™ in any direction.

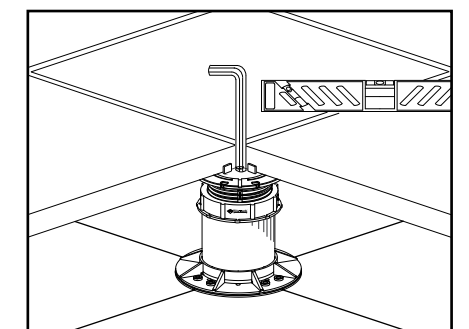

9. Use Allen Key to fine tune loaded pedestal for a perfect level & height.

From low to high, Tile Tech® components rise to every occasion.

For areas with minimal height requirements, our Stack Cap™ and Uni-Just™ components are ideal. They are adjustable to heights from 5/8" to 54" (with Lateral Bracing and Tray System), and our self-leveling cap automatically adjusts slopes from 0% to 5%.

May be screw-adjusted while pedestals are loaded for final height adjustment of 1-1/2".

Components are resistant to freeze-thaw, water, mold, acid and ultraviolet deterioration.

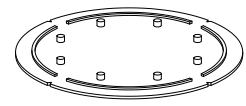

Buffer Pad (Mandatory)
Fixed Height: 1/8"
Used under base to provide slip resistance, noise dampening & membrane protection.



Spacer
Fixed Height: 1/8"



Stack Cap™ x 1 + Buffer Pad + Spacer
Height: 3/4"
Slope: 1% Max

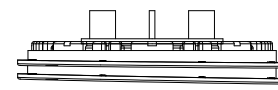

Stack Cap™ x 2 + Buffer Pad + Spacer
Height: 1-1/4"
Slope: 2% Max



Stack Cap™ x 3 + Buffer Pad + Spacer
Height: 1-3/4"
Slope: 3% Max

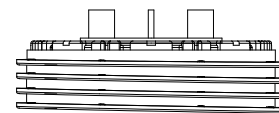

Stack Cap™ x 4 + Buffer Pad + Spacer
Height: 2-1/4"
Slope: 4% Max

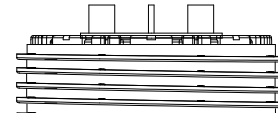

Stack Cap™ x 5 + Buffer Pad + Spacer
Height: 2-1/4"
Slope: 5% Max

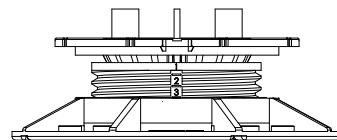

Uni-Just™ w/o PVC Pipe
Height: 2-1/4" To 3"
Slope: 0% To 4%

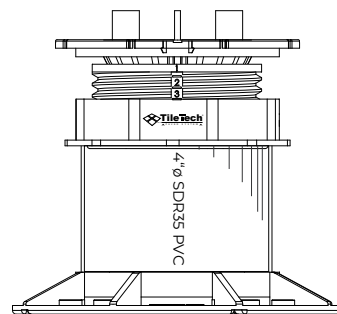

Uni-Just™ w/ PVC Pipe
Height: 3" To 3-3/4"
Slope: 0% To 4%

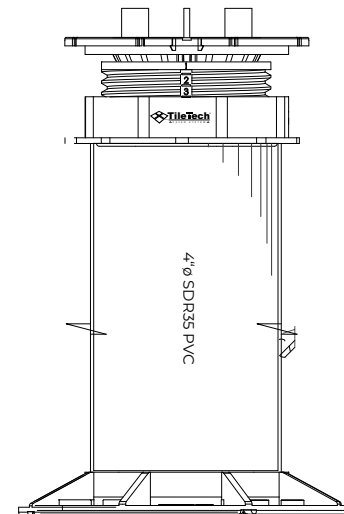

Uni-Just™ w/ PVC Pipe
Height: "Variable" Max 54" (with Lateral Bracing and Tray System).
Slope: 0% TO 4%

Deck support made easy with Joist Cap and Joist Plate.

For beam support Tile Tech® has you covered. Our Joist Caps and Joist Plates are adjustable in height from 2" to 24" (up to 54" with lateral bracing system). Height can be increased by using one or more of our Uni-Shim™

components. **NOTE:** Joist on-center spacing must be 11-7/8" or 301mm to properly support our Hex-Tray™ systems. Buffer pads are required to assist in reducing noise and vibration, and improving stability and protection.

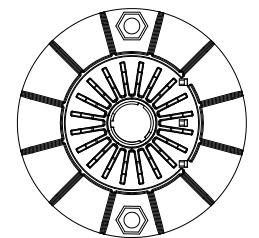
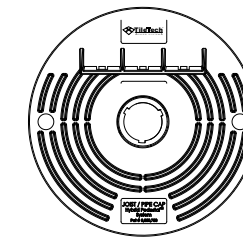
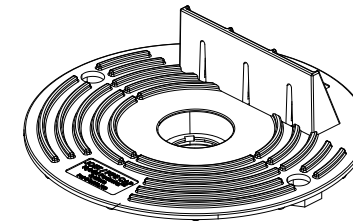
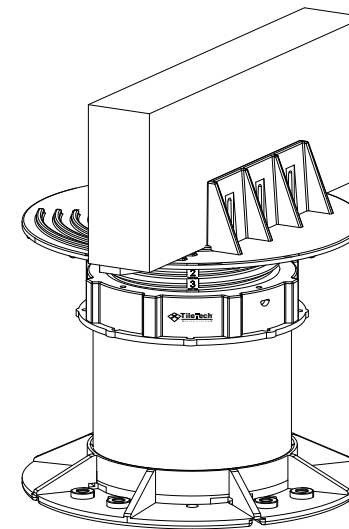

Tile Tech® Joist Cap

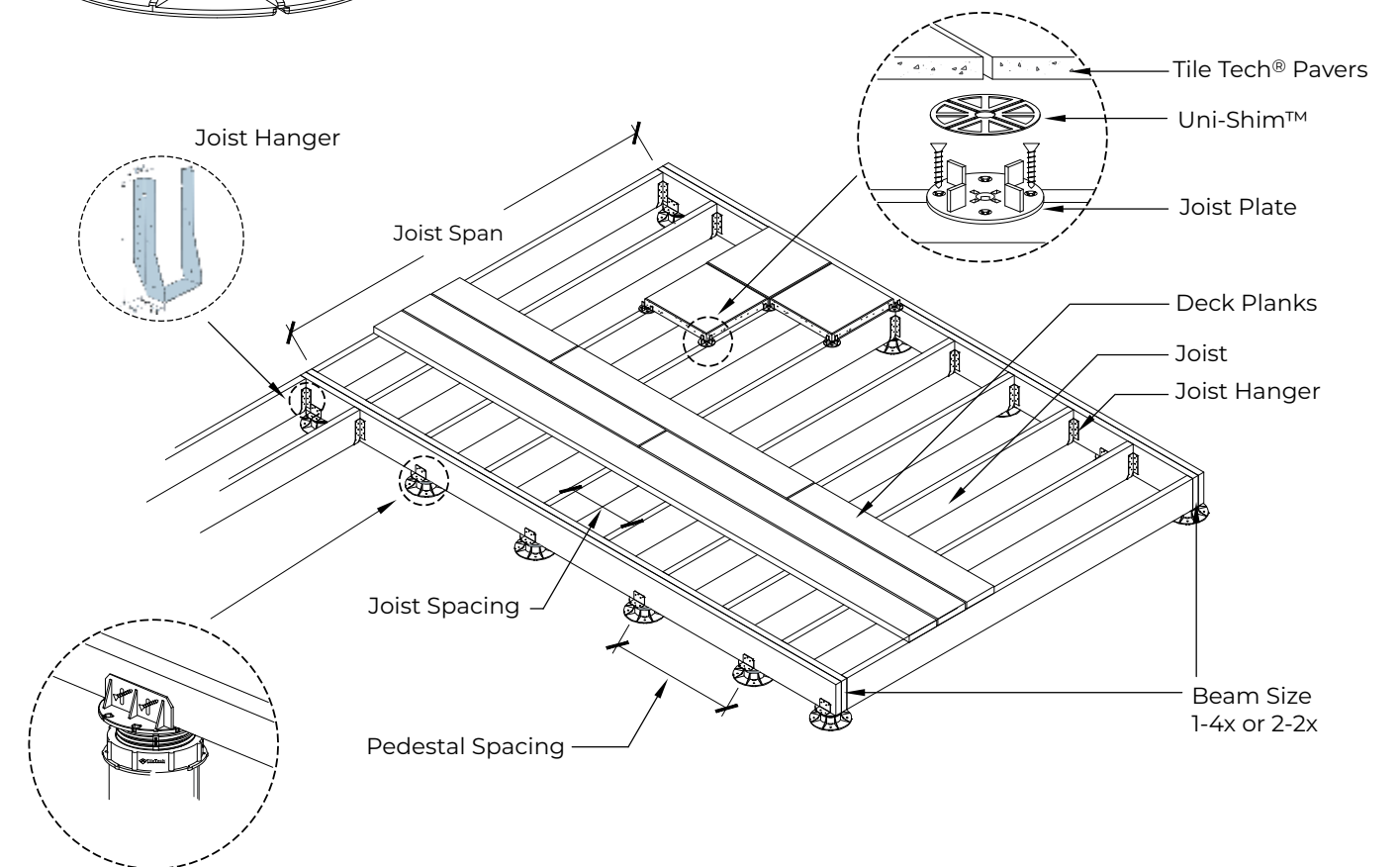

Our lateral bracing system provides you with rock-solid support.

Lateral bracing systems for pedestals are essential components for rooftop applications and elevated platforms.

Recommended for heights exceeding 24" and up to 54", these systems play a crucial role in stabilizing and reinforcing pedestals, ensuring their structural

integrity in the face of pronounced lateral forces such as wind, seismic activity, or other external pressures.

Whether used for rooftop gardens, outdoor terraces, or other large areas, lateral bracing is key to optimizing the performance of elevated structures.

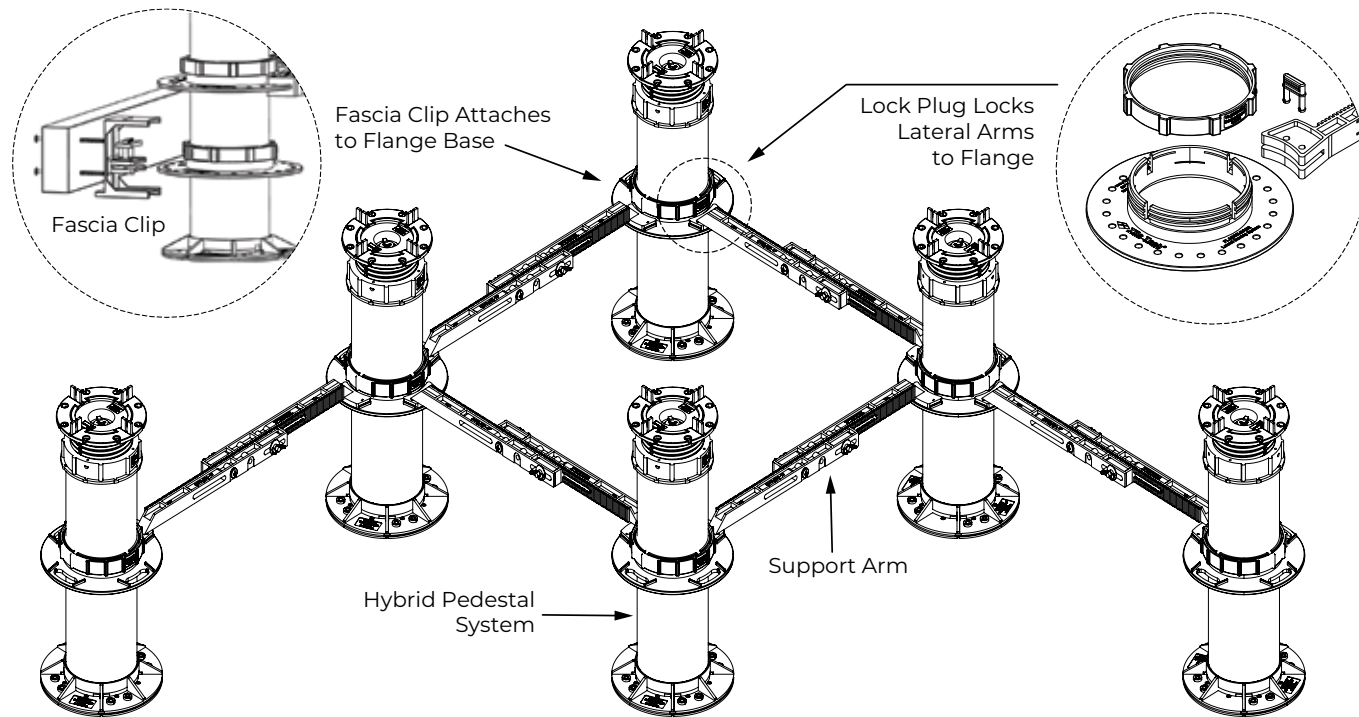

L-Metal Hidden Channel Lock

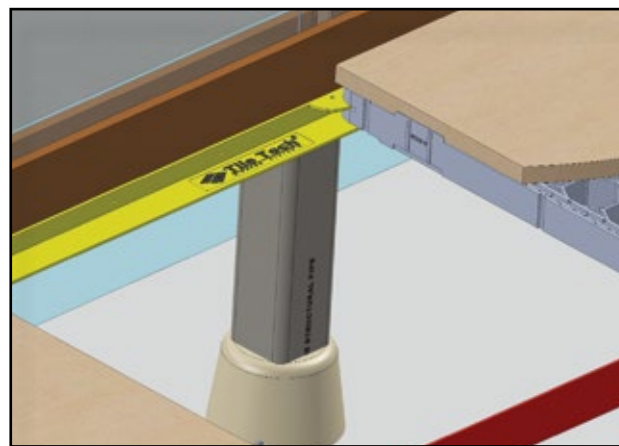

Tile Tech's Hidden Channel Lock performs as a "final pedestal" for perimeters with narrow cut pavers. Made of 6061 aluminum alloy powder coated black, half-circular tabs act as a continuous lip for hidden tray lock down.



Dimensions:
Length 71" (1803mm)
Depth 1-5/8" (41mm)
Height 7/8" (22mm)

Overcoming obstacles with Span Bridge™



Dimensions: Length 32" (812mm)
Width 8-5/16" (210mm) Height 3-1/2" (88mm)

One of the basic functions of a roof is to protect the building from the elements. Drainage systems and drain strainers, while necessary, often present unexpected layout issues for pedestal systems on rooftop decks. The two examples below show ped-

to pass over rooftop drains or other obstacles with ease. When presented with a rooftop drain/dome strainer, Span Bridge simply straddles the issue, creating a sturdy platform for pedestals. Simply slide two adjustable pedestals with Uni-Caps™ into lower



estals placed inappropriately, creating hazardous conditions. Tile Tech® has solved this problem with Span Bridge. Manufactured from corrosion resistant 6061 aluminum in a anodized black color, Span Bridge is designed



track to form a base, next slide the top pedestal's Uni-Base™ into the upper track.

NOTE: Minimum heights from top of water proofing to top of span bridge is 4" with a 0.25" gap under span bridge for drainage.

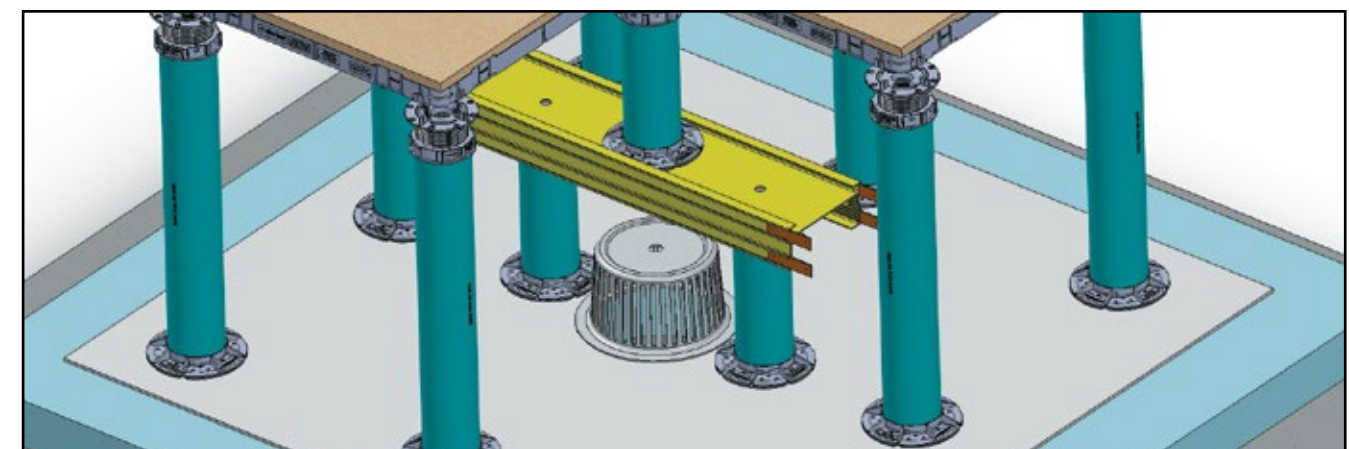

CITYFRONT PLAZA CHICAGO

Rustic Oak



TILE TECH[®]
WIND UPLIFT SYSTEM



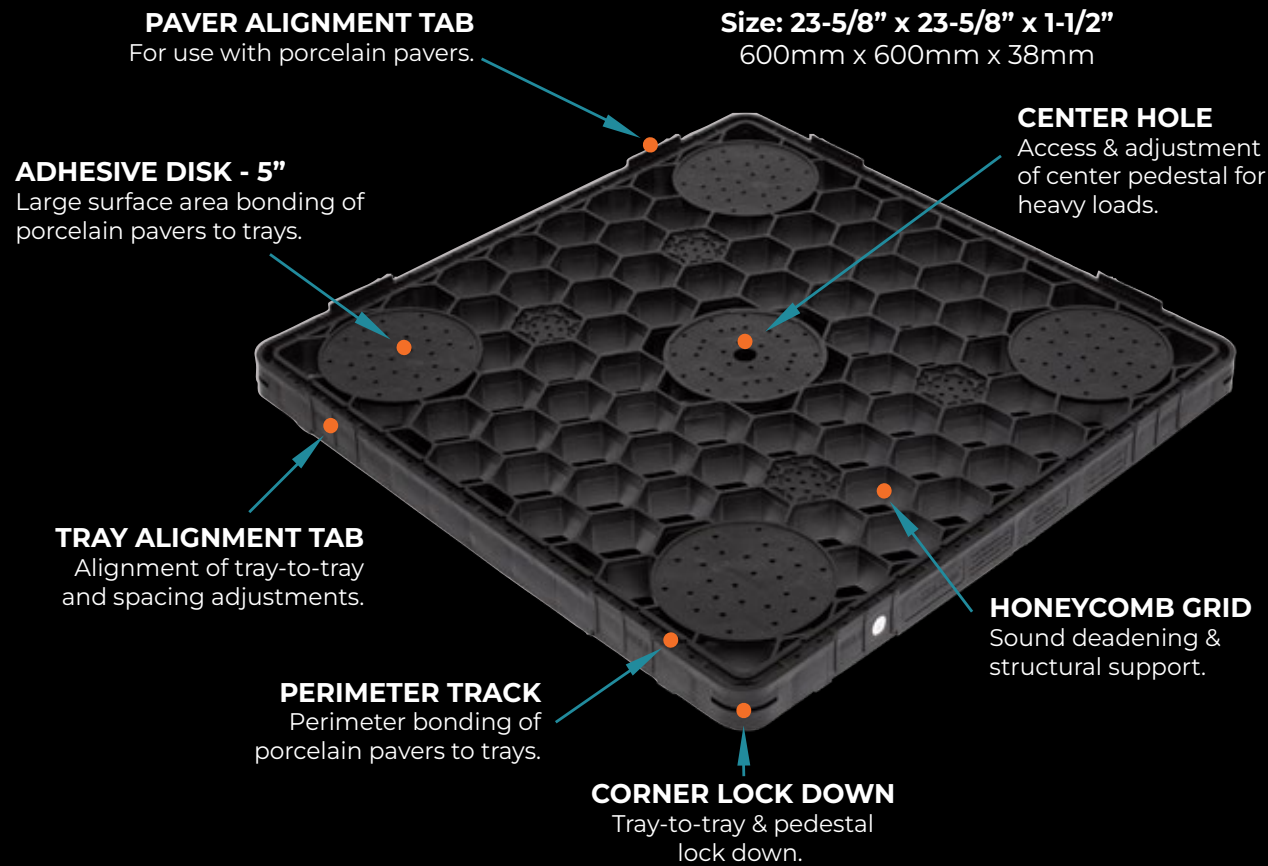

Wind Uplift and Safety with Hex-Tray™.



Tile Tech® was chosen as the company to work with a leading academic institution for an research study and a large-scale test on wind uplift of roof pavers, published in the Journal of Wind Engineering and Industrial Aerodynamics.

Florida International University researchers investigated the wind loading on concrete roof pavers on the flat roof of a low-rise building. Wind blow-off and pressure measurement tests

were conducted on top and bottom surfaces of roof pavers using the 12-fan Wall of Wind (WOW). Wind blow-off tests and pressure measurements were performed, focusing on net pressure distributions and an examination of the ratio of the spacing between pavers. A constant gap of 1/8" was maintained between the pavers while pedestal heights were varied from 1-1/4" to 4-1/2".

Based on the experimental results, simplified guidelines were developed for the design of loose-laid roof pavers against wind uplift. The guidelines are formatted so that the existing information in codes and standards such as the American Society of Civil Engineering (ASCE) 7-10 standard's pressure coefficients for components and cladding can be accurately calculated for code and standards development.

PERFORMANCE & FUNCTIONALITY

- LIGHT WEIGHT
- EASY TO INSTALL
- EASY TO REMOVE AND INSPECT
- LOAD BEARING
- VERSATILE INSTALLATION
- RESISTANT TO FROST
- RESISTANT TO FIRE
- RESISTANT TO THERMAL SHOCK

Introducing the Tile Tech® Wind Uplift System.

- **Hex-Tray™**
Nominal Size: 24" x 24"
 (609mm x 609mm)
Actual Size: 23-5/8" x 23-5/8"
 (600mm x 600mm)
Depth: 1-1/2" (38mm)
 3/4" (19mm)
- **Nominal Size:** 32" x 48"
 (812mm x 1219mm)
Actual Size: 31-1/2" x 47-1/4"
 (800mm x 1200mm)
Depth: 1-1/2" (38mm)
Weight: 1.5 lbs./Sq.Ft.

Material: High Density Polypropylene (HDPP). Complies with ASTM F2806.

● System Components

Tile Tech's Hex-Tray™ Wind Uplift System components include a honeycomb structural tray with 3 adhesive tracks (perimeter, center and auxiliary zones), a Hex-Lock Disk, 2mm Spacer, user supplied 1-1/4" rust-proof screws and Chem Link M-1 roofing adhesive.

● Installation

Pre-assemble and adhere the porcelain pavers to the Hex-Tray™ using Chem Link M-1 applied to the adhesive tracks on the Hex-Tray™. The perimeter zone is the most common adhesive track. Position and level hybrid pedestal system on to grid/chalk lines and place assembled Hex-Tray™ on to pedestal system. Level and secure four adjacent corners to pedestal system using Hex-Lock Disk and secure with screw. At termination points and walls, the Hex-Tray™ may be cut to match the porcelain pavers.

Hex-Tray™ Wind Uplift System Specifications.

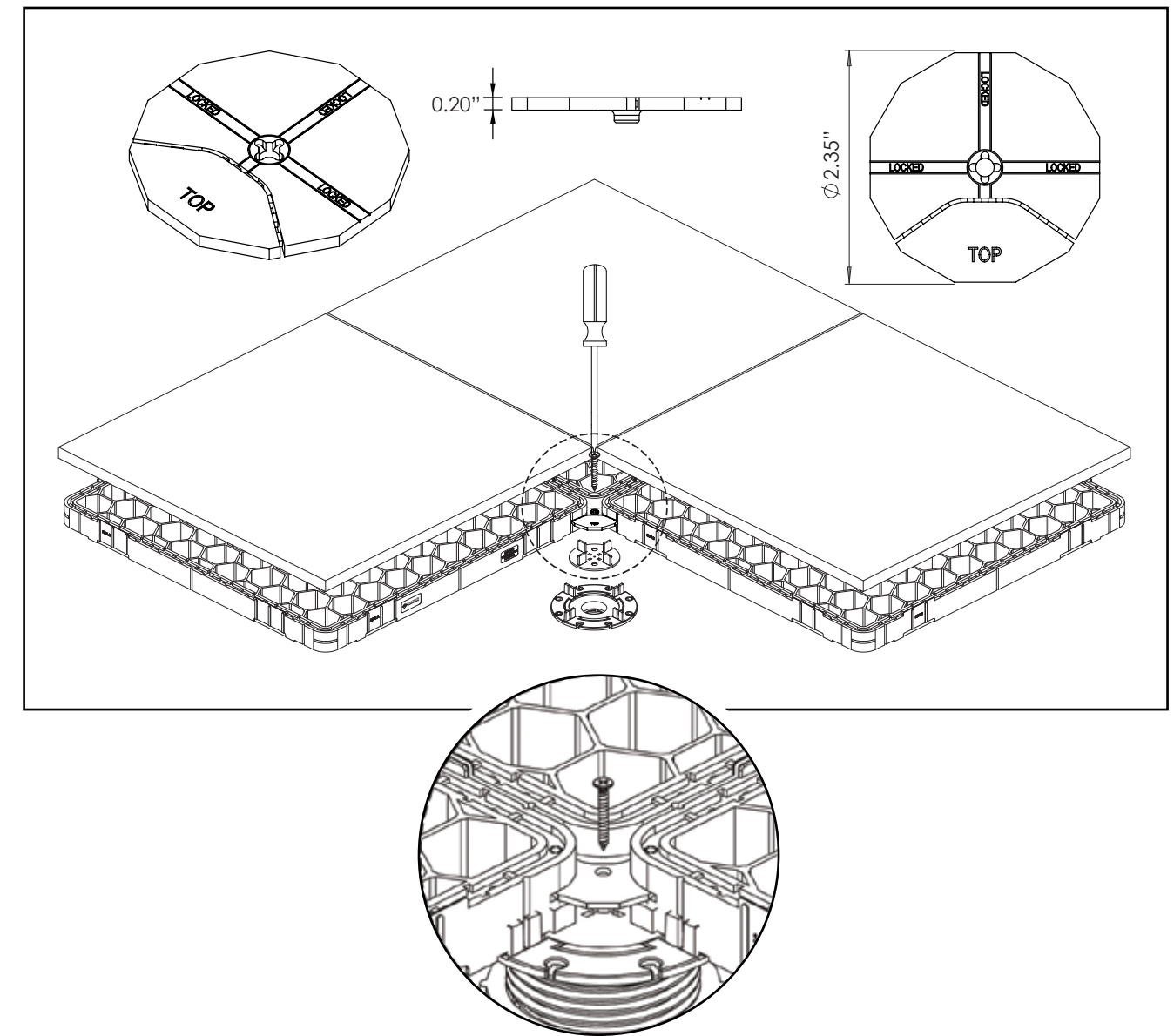
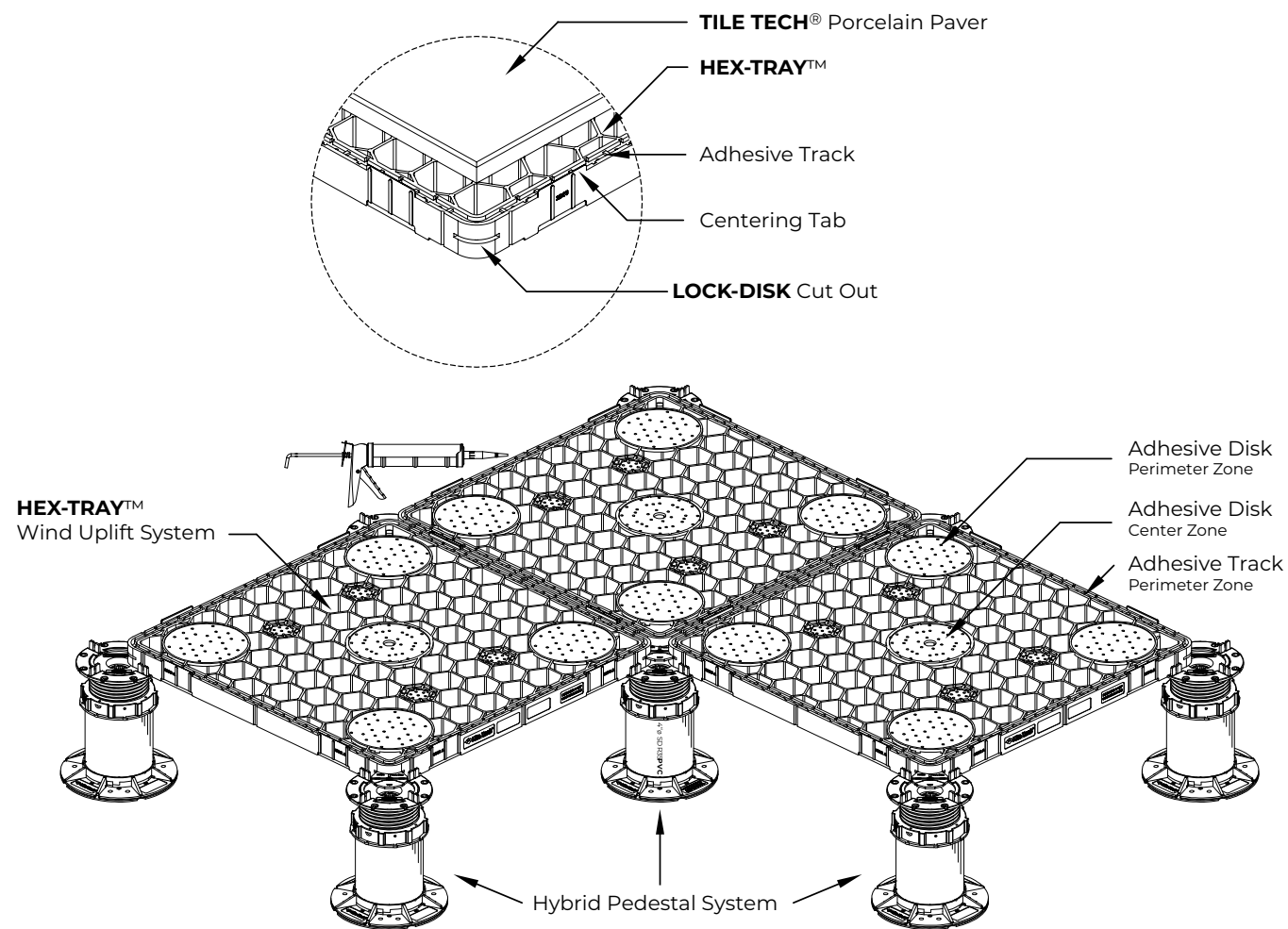

HEX-TRAY™ WIND UPLIFT - PROFILE VIEW

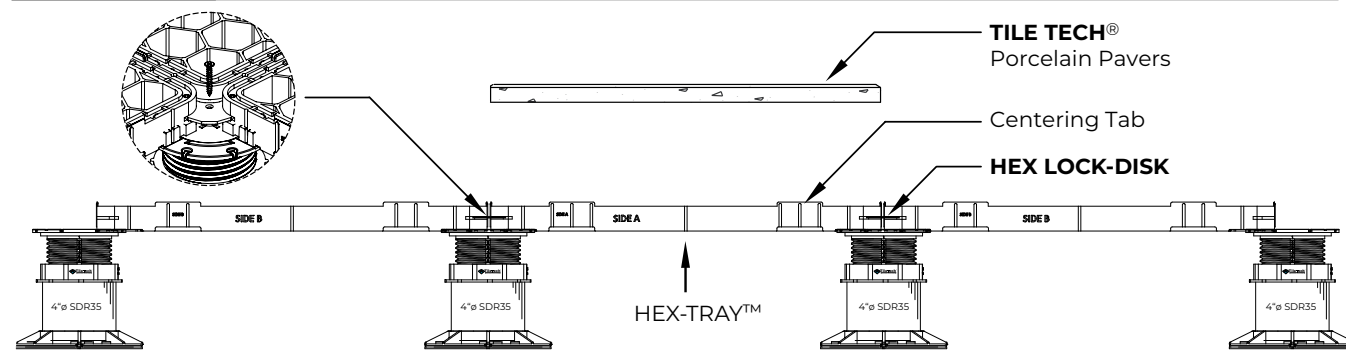

A simple solution to keep you grounded.

High wind uplift conditions can potentially impact rooftop decks, causing damage and endangering people's safety. Porcelain pavers, known for their resistance to many environmental factors, can be subject to the forces exerted by strong winds. Tile Tech's Hex-Tray™ system creates a solid paver surface tested to meet stringent building code requirements.

Our system locks down tight, utilizing the entire roof paver surface, preventing horizontal and vertical movement. Utilizing our Hex-Lock Disk and Chem Link M-1 applied to the Adhesive Disk regions on the Hex-Tray™, along with a 1-1/4" screw is inserted into Hex-Lock Disk, wind uplift is stabilized in elevated applications in both moderate and extreme weather conditions.

MT. VAN HOEVENBERG
NEW YORK



TILE TECH[®]
HEX-TRAY[™] SNOW MELT SYSTEM



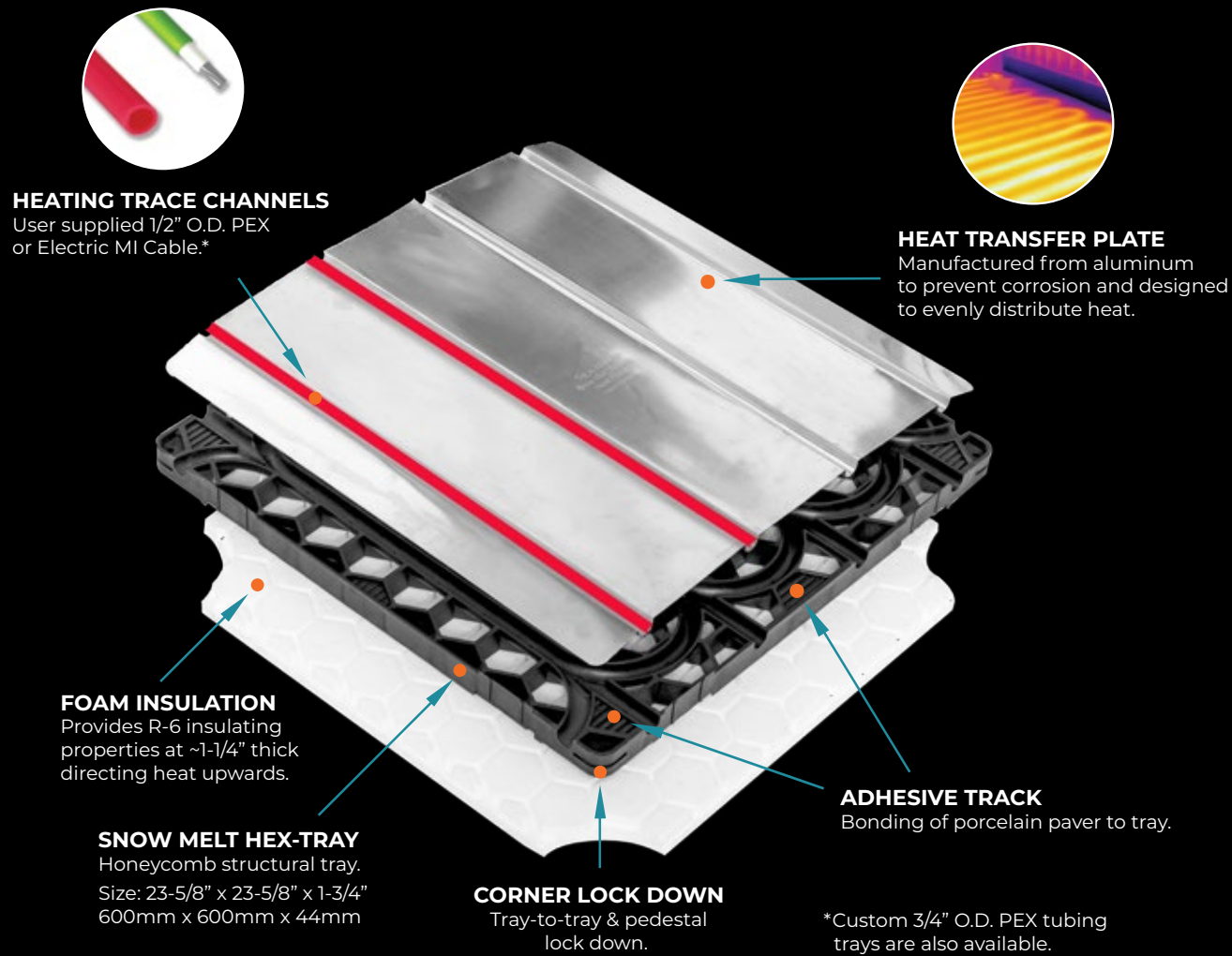

Electric or Hydronic? At Tile Tech®, you can have both!







Tile Tech® Hex-Tray™ Snow Melt design is the most economical, versatile, and efficient system for snow-free surfaces. Applications include elevated rooftop decks, terraces, plazas, or walkways in both residential and commercial settings prone to icy build-up.

It may be used with both ELECTRIC and HYDRONIC heating systems, engineered to be used in conjunction with our porcelain roof deck pavers

and adjustable pedestals. Heat trace channels accommodate either insulated electric MI heating cable or hydronic PEX tubing along channels below aluminum heat plates, installed under the paving slabs to keep decks and walkways free of snow and ice.

Additional wind uplift prevention mechanisms are available for our Snow Melt System, preventing horizontal and vertical movement in inclement weather.

PERFORMANCE & FUNCTIONALITY

-  LIGHT WEIGHT
-  EASY TO INSTALL
-  EASY TO REMOVE AND INSPECT
-  LOAD BEARING
-  VERSATILE INSTALLATION
-  RESISTANT TO FROST
-  FIRE TESTED & APPROVED
-  RESISTANT TO THERMAL SHOCK

Introducing the Tile Tech® Snow Melt System.

- **Single Model Design**

Nominal Size: 24" x 24"
(609mm x 609mm)
Actual Size: 23-5/8" x 23-5/8"
(600mm x 600mm)
Depth: 1-3/4" (44mm)
Weight: 2 lbs./Sq.Ft.

Materials: Aluminum sheet with polyurethane foam insulation.

Hex-Tray™: High Density Polypropylene (HDPP). Complies with ASTM F2806.

Foam Insulation: Provides R-6 insulating properties at ~1-1/4" thickness which directs heat upward.

- **Arrives Fully Assembled.**

Our Snow Melt System comes fully assembled, saving you time and effort.

- **Configurable with PEX or Electric MI cable.**

Cross-linked polyethylene (PEX) pipe is one of the most cost-effective piping solutions. It will expand if frozen and contract to its original shape when thawed.

Mineral Insulated Cable (MI) provides high-temperature capability, exceptional electrical isolation, and physical protection for the conductors when subjected to harsh environments.

- **LEED Standards.**

Tile Tech's Snow Melt products provide credit opportunities under LEED Energy and Atmosphere (EA) and LEED Indoor Environmental Quality (IEQ) and Innovation and Design Process (ID) categories. Refer to the USGBC website for more information.

Tile Tech® Snow Melt System Recommendations

The Hex-Tray™ Snow Melt System can efficiently melt snow on 24" x 24" elevated pedestal-supported porcelain pavers on terraces, patios, roof decks, walkways, or exterior paved areas.

For successful installation, please observe the following recommendations:

System requires a minimum of 2-3/4" finished clearance, including the paver, aluminum heat plate, Hex-Tray™, insulation, and low-height pedestal.

- Maximum system pressure should not exceed 40 PSI.
- Maximum system supply temperature should not exceed 175°F.
- It is recommended that hydronic or electric systems be installed by qualified plumbing/electrical professionals.

The heated section can easily be confined to specific zones within a paved area, or a section of a 24" wide paver if required.

There are no restrictions on the minimum or maximum area for installation.

Not recommended for use with our Wood Deck Series.

Hex-Tray™ Snow Melt System.

The Hex-Tray™ Snow Melt system, used in conjunction with fixed-height or adjustable pedestals provides snow and ice-free amenity spaces or egress for commercial and residential buildings.

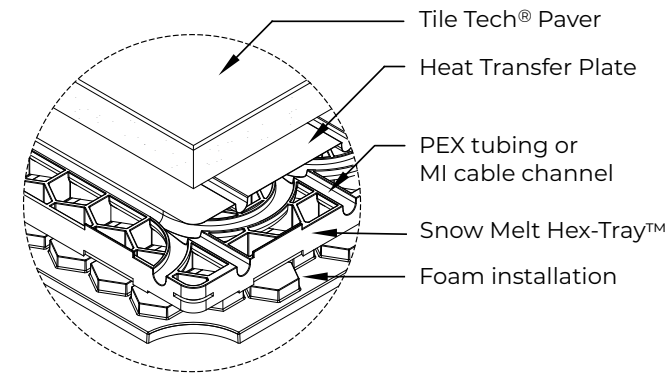

Hex-Tray™ Snow Melt System components includes a honeycomb structural tray with channels for either PEX tubing or MI cable, a foam insulation panel, and aluminum heat transfer plate.

Position and level hybrid pedestal system on to grid lines. Place pre-assembled Snow Melt Hex-Tray™ on to pedestal system.

Level the four adjacent corners to pedestal system using perforated Lock Disk and secure with screw.

At termination points and walls, cut back heat transfer plate to expose the "U" shaped channels in order to loop back PEX tubing or MI cable.

Install PEX tubing or MI cable, and test for leaks.

Install pavers.

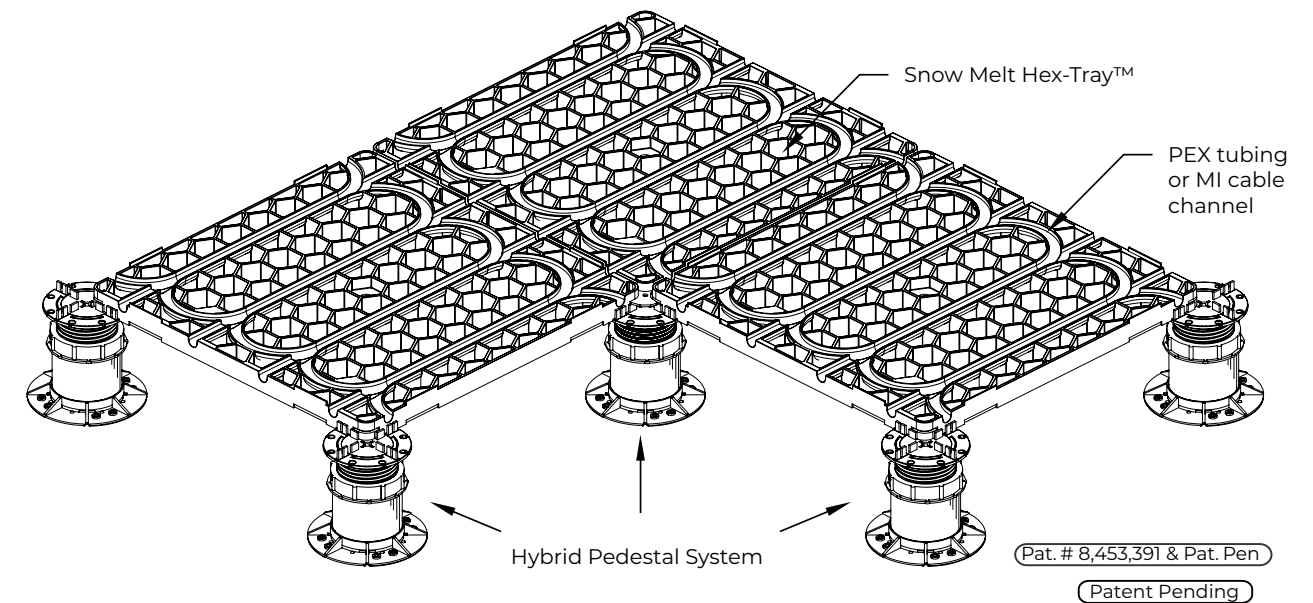

Hex-Tray™ Snow Melt - PROFILE VIEW

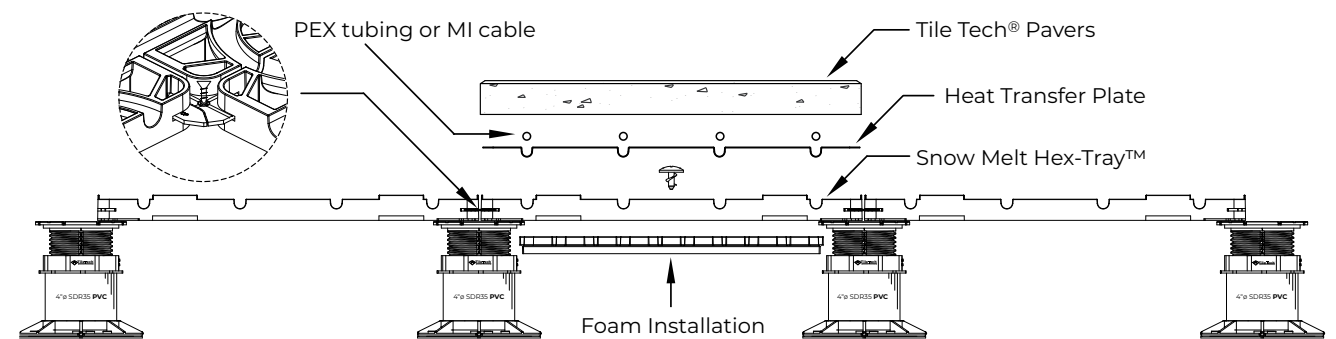

**SWIG OFFICE BUILDING
LOS ANGELES**

Diamond Pro Turf



TILE TECH[®]
TURF-TRAY[™] SYSTEM



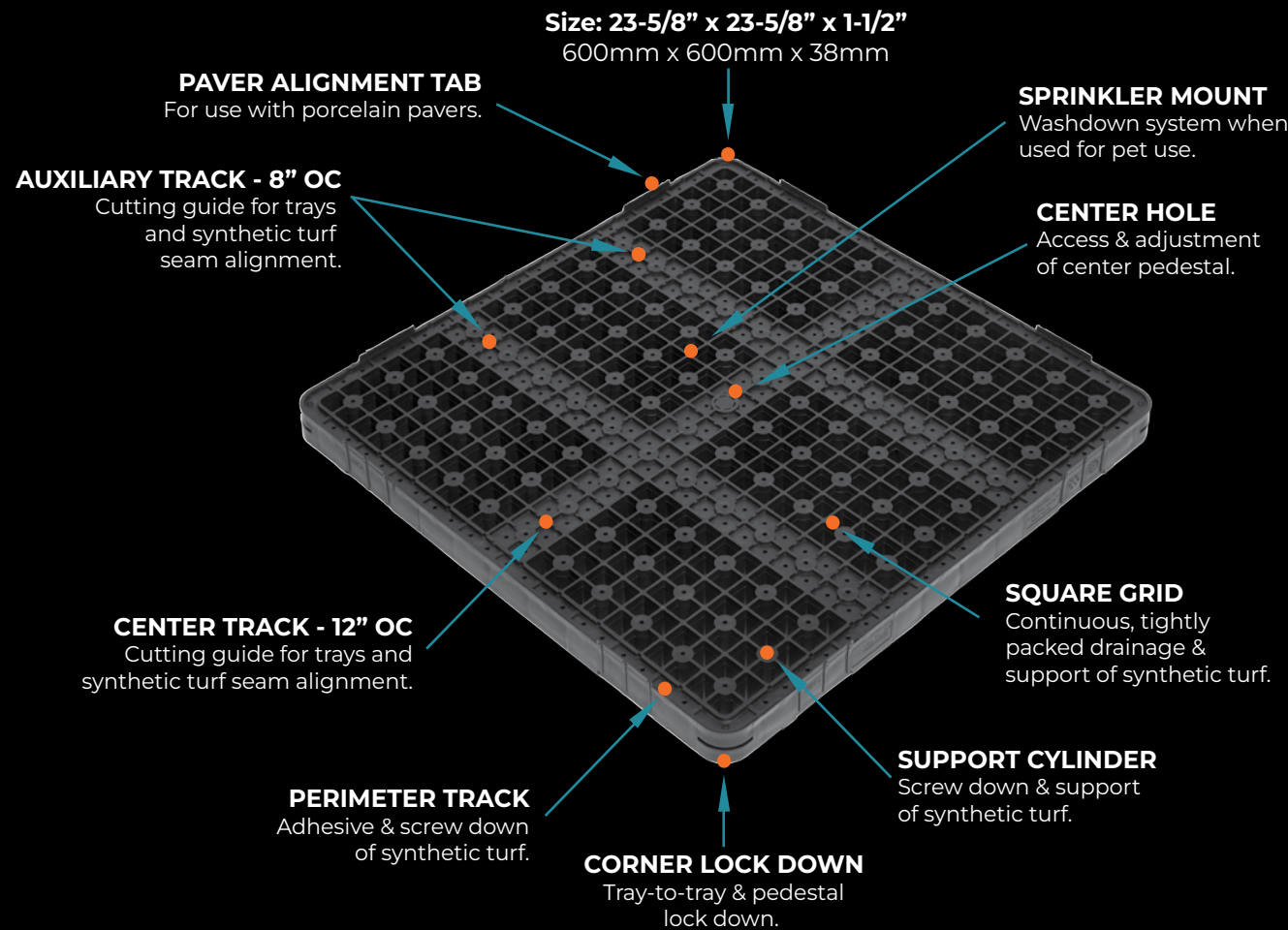

Turf-Tray™ A durable, low maintenance landscape solution.

Elevate your rooftop decks to new heights with our Turf-Tray™ system, a unique engineering solution designed



to seamlessly integrate with artificial turf and adjustable pedestals. Experience the charm, texture, and functionality of natural grass without the burden of soil or the demanding upkeep that it entails,

including invasive bugs and persistent weeds that often accompany traditional grass on projects.

Our Turf-Tray™ system allows you to infuse a lush aesthetic into your project designed specifically for landscape applications for commercial and residential clientele.

Incorporate porcelain pavers, IPÊ wood deck tiles, and living vegetation – precisely installed on adjustable pedestals – to create a level, elevated, and usable surface that is as functional as it is visually striking.

PERFORMANCE & FUNCTIONALITY



LIGHT WEIGHT



EASY TO INSTALL



EASY TO REMOVE AND INSPECT



LOAD BEARING



VERSATILE INSTALLATION



RESISTANT TO FROST



RESISTANT TO FIRE



RESISTANT TO THERMAL SHOCK

Introducing the Tile Tech® Turf-Tray™ System.

- **Single Model Design**

Nominal Size: 24" x 24" (609mm x 609mm)
 Actual Size: 23-5/8" x 23-5/8" (600mm x 600mm)
 Depth: 1-1/2" (38mm)
 Weight: 3 lbs./Sq.Ft.

Material: High Density Polypropylene (HDPP). Complies with ASTM F2806.

- **Synthetic Turf Dimensions**

Synthetic turf is manufactured in 15 foot widths. Please contact our sales experts for ordering.

- **Design Flexibility**

Modular Turf-Trays are fully customizable to your specific roof contours. Trays incorporate Tile Tech's pedestal system, guaranteeing seamless integration for your landscaping needs.

- **Configurable with artificial turf, monolithic green roof, and gravel applications.**

Turf-Tray™ systems lock together, allowing for porcelain paver and green roof design integration.

Tile Tech's aluminum milled-finish edging creates a customizable perimeter for living plants and gravel applications.

- **LEED Standards**

Artificial turf products provide credit opportunities under *LEED New Construction* and *LEED of Existing Buildings - Water Efficiency Landscaping, and Materials and Resources* categories. Refer to the USGBC website for more information on how Turf-Tray™ can assist with your sustainable efforts.



Our deck systems help you roll out the green carpet.



Synthetic Turf

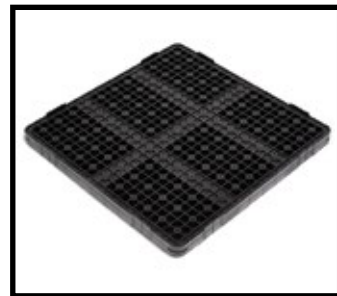

Turf Trays



Adjustable Pedestals

Easy Installation!

Turf-Tray™ synthetic turf system components includes a square-grid structural tray with adhesive and screw tracks anchoring for the artificial turf.

NOTE: Artificial turf size: 15' x 100'. Minimum order size: 15' x 2'.

Step 1: A pedestal grid is laid out and pedestals are assembled and tuned to the correct heights using string lines and laser level.

Step 2: Turf-Trays are then installed on

top of the leveled pedestals.

Step 3: After 3 Turf-Trays are installed, the Hex-Lock Disk is inserted into the kerf-cut corners of the 3 trays. Then the 4th Turf-Tray™ may be installed.

Step 4: User-supplied 1-1/4" screw is inserted into Hex-Lock Disk and secured

That's it! The turf is now rolled out, cut to the correct size and secured using 1-1/4" deck screws and Chem Link M-1 adhesive to perimeter zones. See page 146 for more details.



Diamond Pro 75-ounce face weight
Tile Tech's Diamond Pro roof deck turf features a 1.875" pile, polyethylene monofilament with thatch construction in dual shades of field and olive green tones complimented by a brown thatch. Designed specifically for moderate to heavy traffic on commercial and residential landscapes. Roll size: 15' x 100', Shipping weight: 1,065 lbs. (approx).



Diamond Light 60-ounce face weight
Tile Tech's Diamond Light roof deck turf features a 1.875" pile, polyethylene monofilament in field and mid-olive green. Designed specifically for moderate traffic on commercial and residential landscapes. Roll size: 15' x 100', Shipping weight: 910 lbs. (approx).



Everglade 60-ounce face weight
Tile Tech's Everglade roof deck turf features a 1.75" pile, polyethylene monofilament with field and olive green colors that remarkably mimic natural turf. Roll size: 15' x 100', Shipping weight: 1,065 lbs. (approx).



Pet Turf 60-ounce face weight
Tile Tech's Pet Turf roof deck turf features a 1" field green and clover green blade color, polyethylene monofilament with thatch construction, designed for moderate to heavy traffic. Non-toxic and safe for animals. Roll size: 15' x 100', Shipping weight: 928 lbs. (approx).



Tacoma 90-ounce face weight
Tile Tech's Tacoma roof deck turf features a 1.75 inch pile, polyethylene monofilament with thatch construction. Perforated backing allows for easy drainage, making it the ideal product for pets or dog runs. Designed for extra durability and for moderate to heavy traffic. Roll size: 15' x 100', Shipping weight: 1,333 lbs. (approx).



Sure Putt 45-ounce face weight
Tile Tech's Sure Putt roof deck putting turf features a 0.50 inch pile, polyethylene monofilament with thatch construction. A dual field and forest green blades provide a beautiful and responsive putting experience for the avid golfer. Roll size: 15' x 100', Shipping weight: 647 lbs. (approx).

A lead-free product, made in America.
All of our turf products undergo rigorous stringent testing to ensure safety, non-toxicity and contain NO detectable traces of lead or hazardous waste heavy metals.

Turf-Tray™ Artificial Green Roof System.

The advantage of our hybrid system is its seamless integration with our pedestal system. Designed for use with off-the-shelf SDR-35 PVC pipe, our pedestals may be cut to heights up to 54", providing a secure foundation for our structural tray.

Turf-Tray™ Artificial Turf System components includes a square grid structural tray with adhesive tracks and screw anchoring for securing artificial turf. The trays are locked together using the 2mm spacer tabs and user-supplied 1-1/4" rust-proof screws in addition to CHEM LINK M1 adhesive.

Position and level Hybrid Pedestal System onto grid/chalk lines and place Turf-Tray™ onto pedestal system including center pedestals. Level and secure four adjacent corners to pedestal system using Lock Disk and secure with rust-proof screw. At termination points and wall the Turf-Tray™ can be cut to fit. Stretch and secure artificial turf to Turf-Tray™ using adhesive applied to adhesive track and fasten to screw track with screws.

NOTE: Synthetic turf is manufactured in 15 foot widths. Please contact our sales experts for ordering.

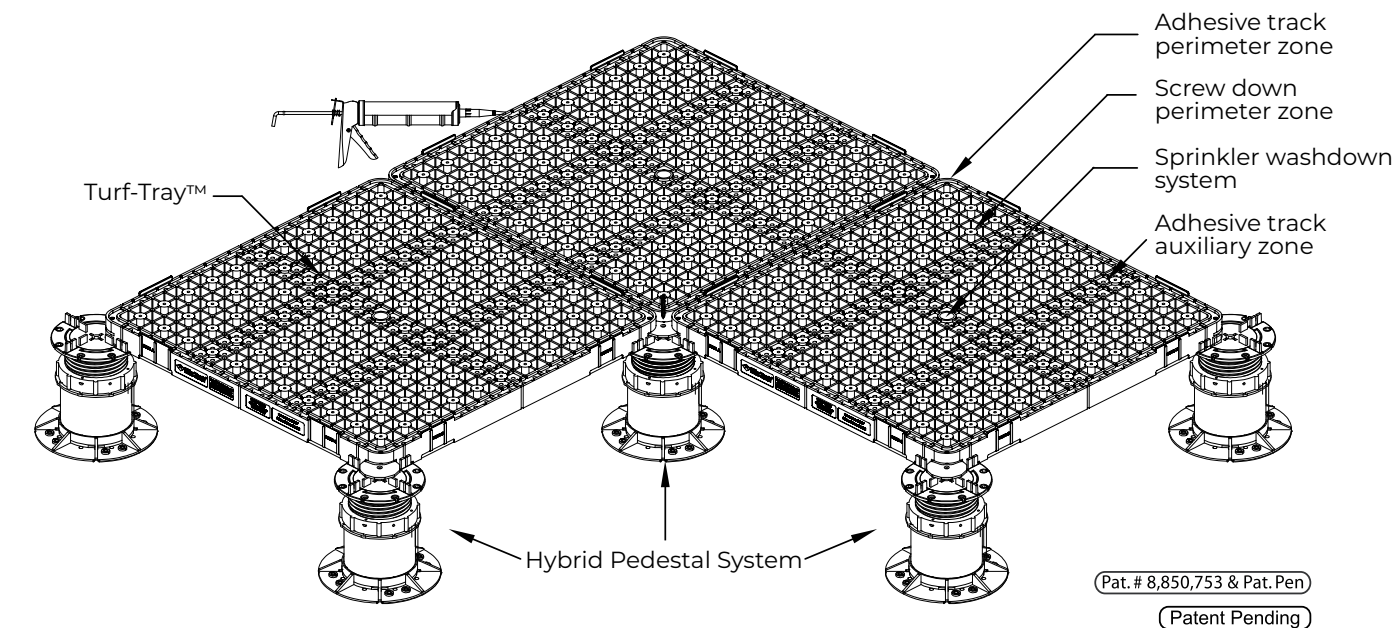
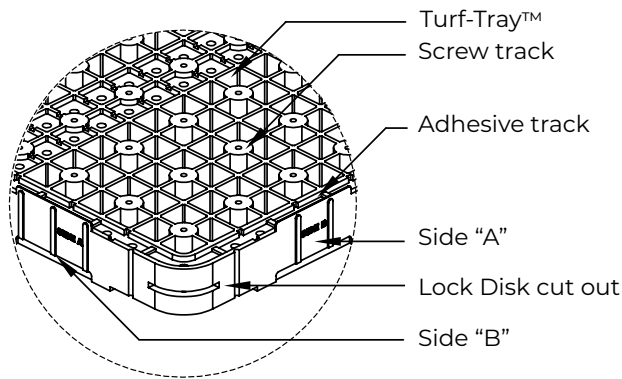

Turf-Tray™ Artificial Turf - Profile View

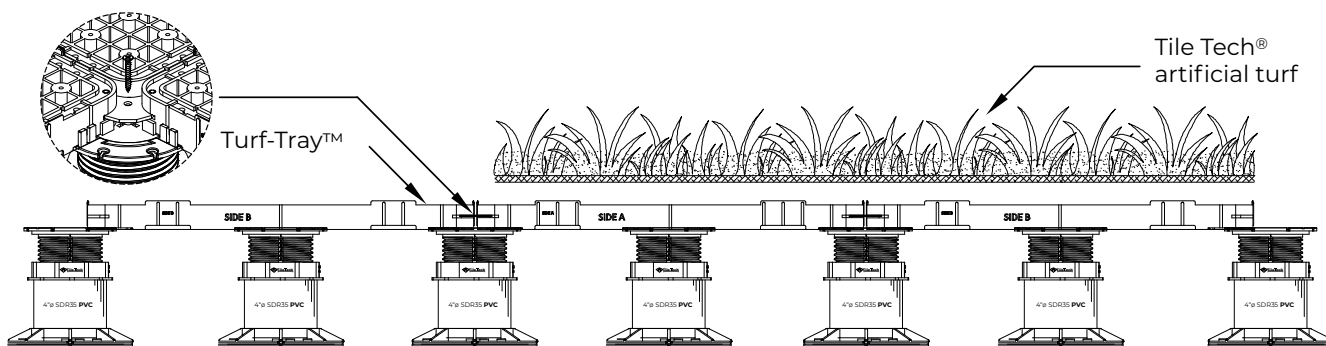

- **Turf-Tray™ Monolithic Green Roof.** Designed to accommodate live plants, gravel, as well as porcelain and wood tiles. These modular trays seamlessly integrate a secondary rooftop deck, significantly enhancing the structural strength of your building.

Available in anodized black or silver finish.

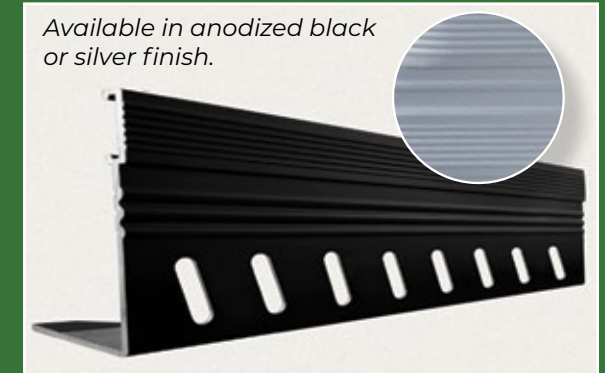

- **Aluminum L-Edging & Corners.** Define clear boundaries with our landscape edging system. Made of 6061 aluminum in either anodized black or silver finish, horizontal leg is notched for easy bending.

L-Edging Dimensions:

4-1/2" x 83", 6-1/2" x 83", and 8-1/2" x 83". (custom sizes are also available).

L-Corner Dimensions:

4-1/2" x 6"
6-1/2" x 6"

Available in both inner and outer configurations.

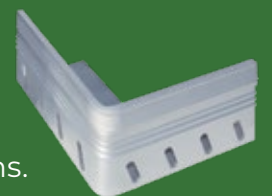



TILE TECH[®]
PLANT-TRAY[™] SYSTEM

JW MARRIOTT AT LA LIVE
LOS ANGELES

Terrazzo White

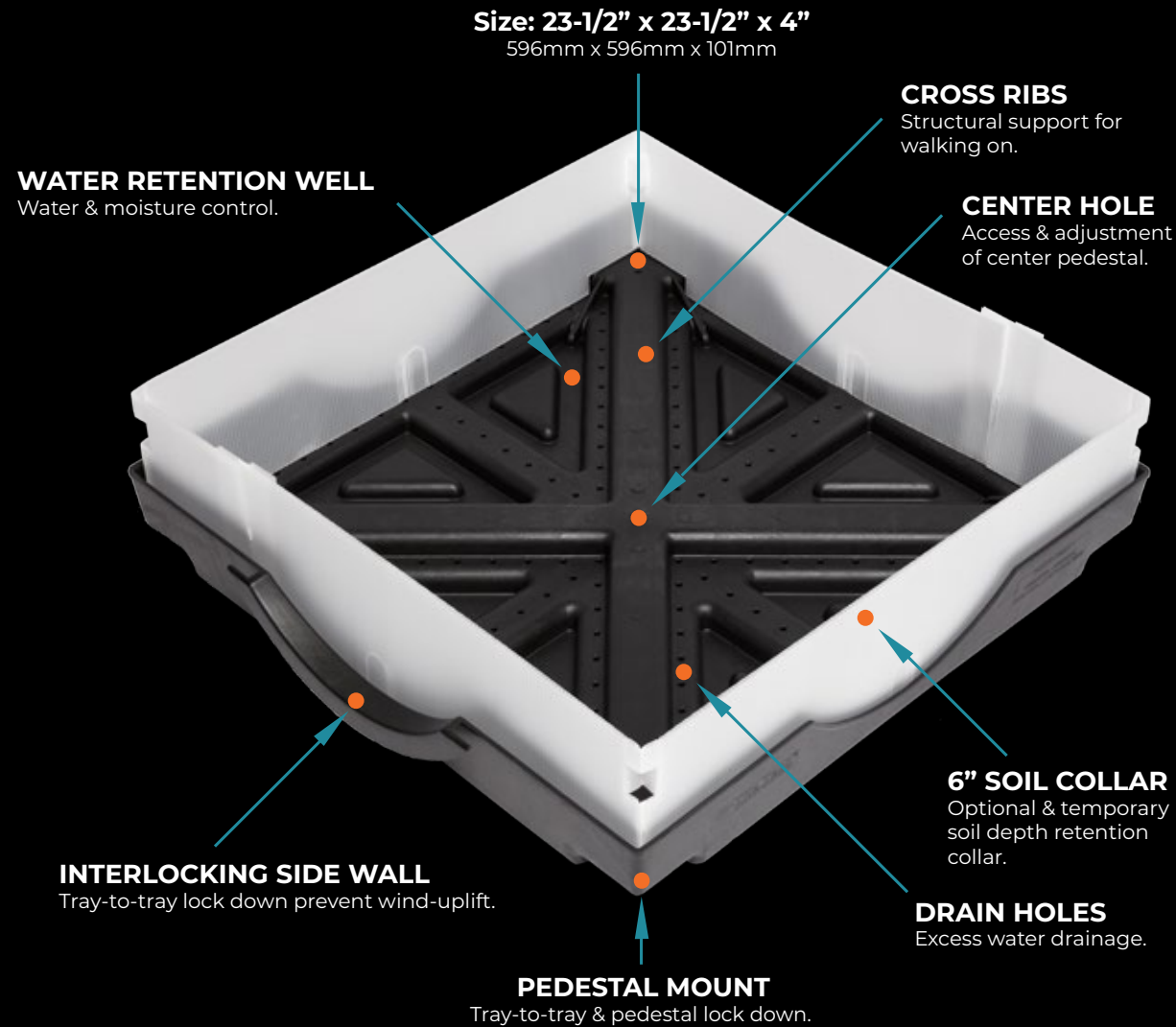

Plant-Tray™ Engineered for long-term growth.



Tile Tech's Plant-Tray™ Systems have made rooftop gardens easier than ever. Not only are they a beautiful addition to typically underutilized space, green roofs provide cost savings, environmental public health benefits.

Our systems are designed with interlocking side walls to prevent wind uplift, while cross ribs add structural support for easy access. Otherwise known as modular living roof or green

roof system, our engineered trays, used in conjunction with our adjustable pedestals on roof decks, can integrate seamlessly with our elevated paver and wood deck tiles products resulting in a stunning and versatile green rooftop setting.

Plant-Tray™ Systems can be utilized with various plant assortments to meet your specific design needs and climate, resulting in the natural beauty of living plants and long-term growth.

PERFORMANCE & FUNCTIONALITY

-  LIGHT WEIGHT
-  EASY TO INSTALL
-  EASY TO REMOVE AND INSPECT
-  LOAD BEARING
-  VERSATILE INSTALLATION
-  RESISTANT TO FROST
-  RESISTANT TO FIRE.
-  RESISTANT TO THERMAL SHOCK

Introducing the Tile Tech® Plant-Tray™ System.

- **Single Model Design**

Nominal Size: 24" x 24"
 Actual Size: 23-1/2" x 23-1/2"
 (596mm x 596mm)
 Depth: 4" (101mm)
 Weight: 3 lbs./Sq.Ft.

- **Design Flexibility**

Modular plant trays are designed as a "Plug and Play" to the rest of the Tile Tech systems. Use our Aluminum L-Metal Edging to create an integrated plant and paver design!

- **Sustainability and Energy Performance**

Plant-Tray™ systems reduce roof temperatures, helping to cool buildings and reduce heating and cooling bills.
 Reduced and regulated rainfall runoff into stormwater drains.
 Increased plant biodiversity that provides a habitat for insects and birds.
 Protection of the roof membrane, which increases the life of the roof.
 Lowered local air temperature through evapotranspiration, which reduces the urban heat island effect.

- **Interlocking Side Walls**

Tile Tech's unique "lock down" design prevents wind uplift on rooftop applications.



Landscape systems flourish with Plant-Tray.™

Welcome to Tile Tech's latest evolution of multi-layered landscaped systems. These cutting-edge systems are meticulously crafted to be seamlessly integrated into your rooftop, extending from wall-to-wall to provide optimal protection and functionality.

Platform-Based Landscape Systems ingeniously introduces a secondary rooftop deck, enhancing the structural strength of your building. Once in place, this platform provides a solid foundation for a variety of designs, accommodating both single and combined landscape options within a single area.

Monolithic Platform-Based Landscape Systems offer exceptional flexibility for both live plants or decorative aggregate alongside porcelain and wood tiles, seamlessly adapting to changes in roof pitches, and capable of working on both flat and sloped roofs, ranging from 0 to 30 degrees.

Their adaptability to shifting climate conditions ensures a lasting and sustainable solution for the lifespan of your structure.



Plant-Tray™

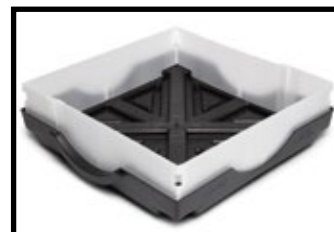

Plant-Tray™ with collar



Tray configuration

Plant-Tray™ Green Roof System.

Tile Tech's Plant-Tray™ Green Roof System is an innovative solution that brings nature to urban environments. Offering a range of advantages for both the building and the surrounding ecosystem, they are designed to support the growth of vegetation as well as provide numerous environmental and aesthetic benefits.

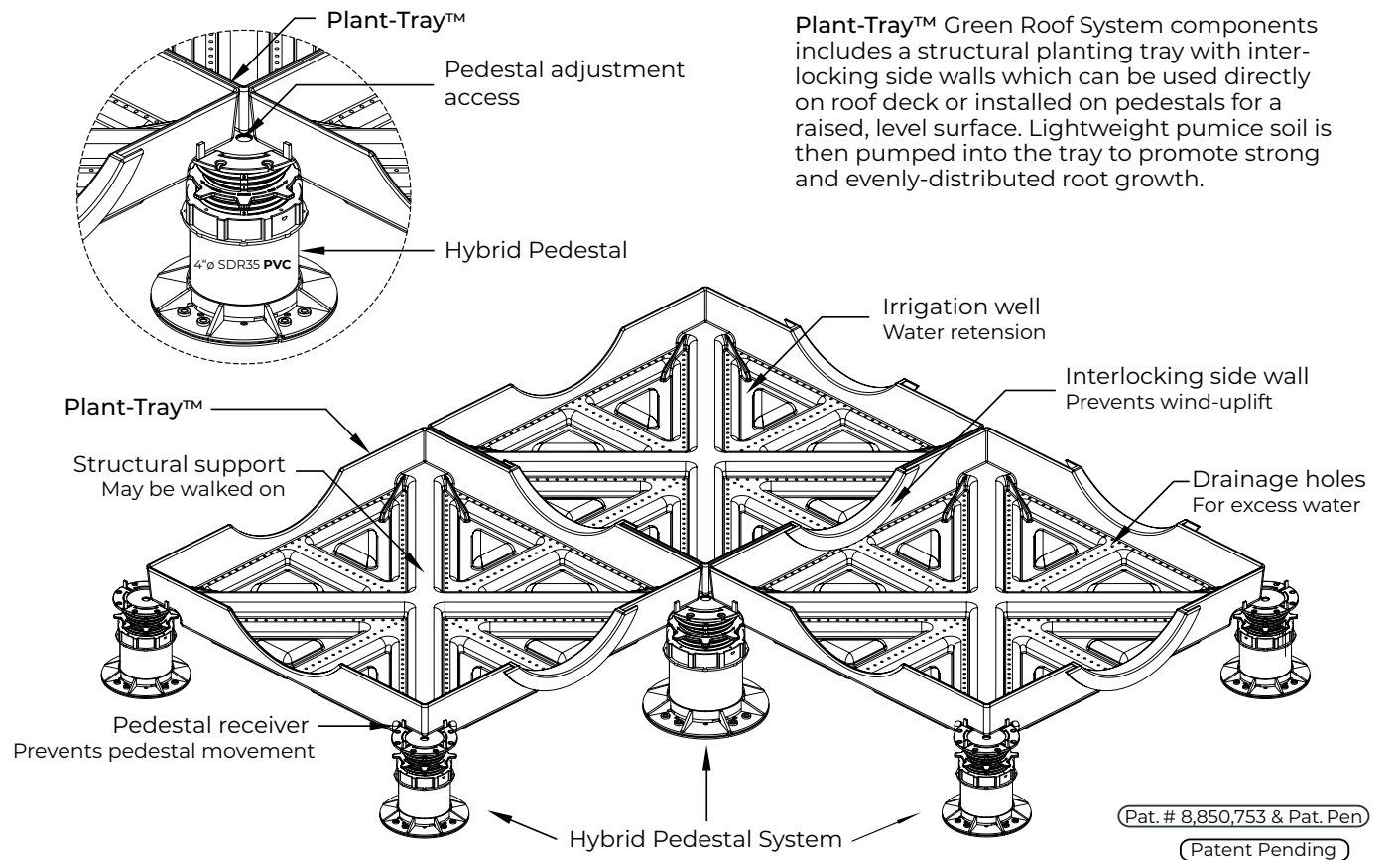

Plant-Tray™ Wind Uplift - Profile View

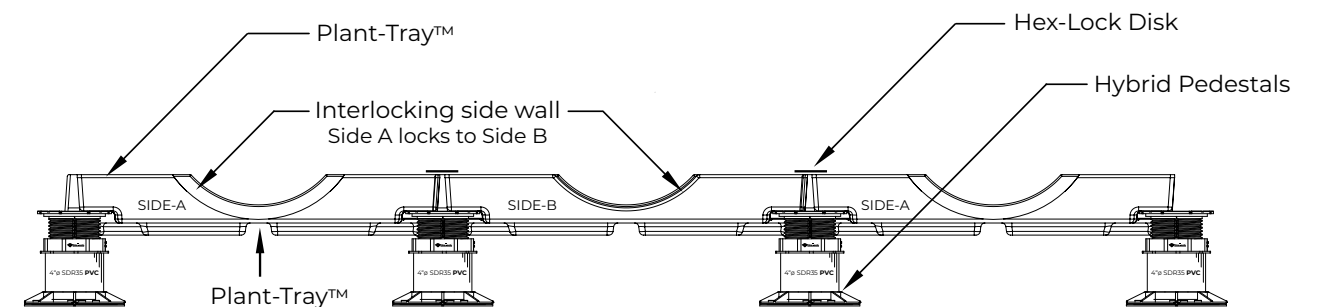

**PORCELAIN PAVERS FAQ'S**

What are the actual dimensions of our paver tiles? The **nominal sizes** of standard pavers are 24" x 24" x 3/4", 16" x 48" x 3/4", 24" x 48" x 3/4", depending on the finish. The **rectified (actual) size** of a paver is 1/2" +/- to accommodate a grout joint between the pavers. Ex: 24" x 24" = 23-1/2" x 23-1/2" +/-.

What is the weight per Sq.Ft. of a standard paver? 9 lbs. per Sq.Ft. Ex: 24" x 24" x 9 lbs. = 36 lbs.

What is the estimated lifespan of paver tiles? Paver tiles can last 20-25 years without any major issues with proper care and maintenance. Please see Tile Tech's website Download Center for cleaning and maintenance recommendations.

Are pavers fire-resistant? Yes. Our porcelain pavers meets the Class A Spread of Flame requirements when tested in accordance with ASTM-E108-11.

Are paver tiles scratch-resistant? One of the main advantages of porcelain tile is its durability. It is much denser than standard ceramic tile as it is fired at higher temperatures and made from more refined clay. This makes them tremendously hard and resistant to scratching.

What is the minimum height with a pedestal? Porcelain paver and Stack Cap™ = 1-3/8" total.

**WOOD DECK TILES FAQ'S**

What are the dimensions of our wood deck tiles? The **nominal sizes** of our wood tiles are: 24" x 24" x 1-5/8", 24" x 48" x 1-5/8", 24" x 72" x 1-5/8" (Special order). The **actual size** of a tile is 3/8" smaller than the nominal size in order to accommodate the gap/spacers between the tiles.

What is the weight per Sq.Ft. of a wood deck tile? 6 lbs. per Sq.Ft. Ex: 24" x 24" x 6 lbs. = 24 lbs.

What is the estimated lifespan of our wood deck tiles? IPÊ wood can last for up to 30+ years with proper care and maintenance.

What is the maximum load for IPÊ deck tiles? Wood tiles performed to ASTM-C293 Concentrated Load Testing Average of ~3,148 lbs. max. load and a uniform load of ~15,000 lbs.

Do the wood deck tiles arrive stained or finished? Because of the variety of finishes from which to choose, our wood tiles will arrive in their natural, unfinished condition. They may be sealed or varnished, or allowed to weather to a beautiful silver gray.

**WIND UPLIFT SYSTEM FAQ'S**

How does our Wind Uplift System lock together? Our Hex-Tray™ Lock-Disk (porcelain) or IPÊ Lock-Disk (wood) is used to secure trays and wood tiles to either Hybrid or Standard pedestals. The Lock-Disk is inserted into kerf-cut/slot, and securing with 1-1/4" rust-proof screw.

How is our system stronger than competitors metal trays? Our Hex-Tray™ is made of High Density Polypropylene (HDPP) which is extremely strong. Our unique honeycomb-grid design is engineered not deform in a wind event.

Does a perimeter need to be build around our trays? Any area of the pedestal deck that is not restrained by a parapet or foundation wall must be 'boxed-in' and contained. The deck panels will move if all sides are not adequately constrained.

Do the porcelain pavers need to be glued to the tray? Yes. Adhere the porcelain pavers to the adhesive track on the Hex-Tray™.

What glue is recommended? Chem Link M-1 is a moisture cure, multi-purpose structural adhesive/sealant designed for bonding and sealing a wide range of construction materials, including tile.

**SNOW MELT SYSTEM FAQ'S**

Can wood tiles be used with the Snow Melt System? Because of the deck tile design and inherent degree of permeability of wood, it is not recommended for snow melt installations.

What type of electric wiring is used? Heating Cable: Mineral Insulated (MI) Heat Trace Cable. This cable can withstand temperatures up to 175°F (79°C), thanks to its mineral insulation, which offers excellent thermal stability. Always refer to the manufacturer's specifications for detailed properties.

What voltage is used for the electric installation? Depending on the system design and the size of application, 120 V, 208-277 V, 347 V, 480 V, or 600 V may be appropriate. Any heating cable must be part of a UL Listed and CSA Certified system.

What size of the PEX tubing is recommended? PEX tubing should be 1/2" OD.

Is it recommended that a professional install this system? Snow Melt Systems are not difficult to install, but in order to ensure that the warranty remains valid, it is vital to have a qualified electrician or plumber to oversee installation.

**TURF AND PLANT TRAY FAQ'S**

What dimensions of our Turf-Tray and Plant-Tray? Turf-Tray™ dimensions are 23-5/8" x 23-5/8" x 1-1/2" (600mm x 600mm x 38mm). Plant-Tray™ dimensions are 23-1/2" x 23-1/2" x 4" (596mm x 596mm x 101mm). **NOTE:** Artificial turf roll size: 15' x 100'. Minimum order size: 15' x 2'.

How do you affix artificial turf onto the Turf-Tray? We recommend Chem Link M-1 Universal Adhesive or Surebond SB-10 Paver Bond Adhesive, along with 1-1/4" rust-proof screws along the perimeter zone of the Turf-Tray™.

Do you recommend infill sand on artificial turf applications? Infill sand is used to support turf fibers, add weight, and reduce rippling. Silica sand is recommended for its durability and availability, and may be applied by a drop spreader and push broom. Although there are pros and cons to adding infill sand, it can add fire resistance and prevent weed growth.

**PEDESTAL SYSTEM FAQ'S**

What is the lowest height of a pedestal? 1-3/8". (Stack Cap™ = 5/8" + Porcelain paver = 3/4").

What is the maximum height of a pedestal? The off-the-shelf, 4.215" diameter SDR-35 PVC sewer pipe allows the pedestal system to vary in height up to 54" with our Lateral Bracing and Tray System.

What are the advantages of using PVC pipe? Our patented design utilizes off-the-shelf SDR-35 PVC pipe. Easily cut with a standard 12" chop saw, with "press fit" ease of assembly, it provides significant cost savings for your project.

What is the diameter of a pedestal? Our Uni-Base™ measures 7.5" in diameter.

What is the maximum load of a pedestal? Average Maximum Load is 10,000 lbs.

What is the weight of a pedestal? Weight is dependent upon the height and components used. A standard pedestal with PVC pipe weights approximately 3/4 lb.

Can a pedestal be used against a wall? Yes! Our self-leveling Uni-Cap™, used in conjunction with our 1/8" (3mm) Spacer, allows for proper paver spacing and joint alignment. If a pedestal is adjacent to a wall, simply "snap off" extra tabs from the Spacer to nest pedestal underneath the porcelain paver or wood deck tile.

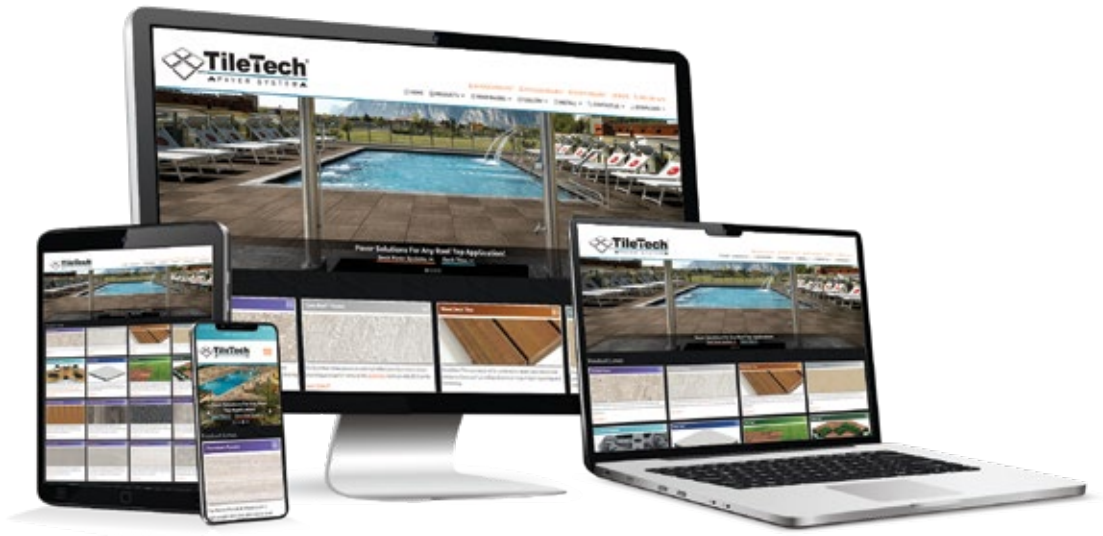

Pavers That Elevate™

For FREE quotes or sample requests, visit our website at <https://tiletechpavers.com>

