



iN

UR BAN

PERFORMANCE
iN LIGHTING

powered by
GEWISS

PERFORMANCE
in LIGHTING | powered by
GEWISS

A tailor-made lighting solution for each urban area: streets, parking areas, squares, green areas, playgrounds, bridges, pedestrian streets. We create versatile urban lighting systems that combine collective and individual interests. We want to offer urban spaces a new identity, and improve the perception of those who live in and use them.

AREA LIGHTING

HEDO+



HEDO+
12

HEDO+ FT
12

SPILLO



SPILLO MINI
POST
24

SPILLO MINI
24

SPILLO
24

AMON

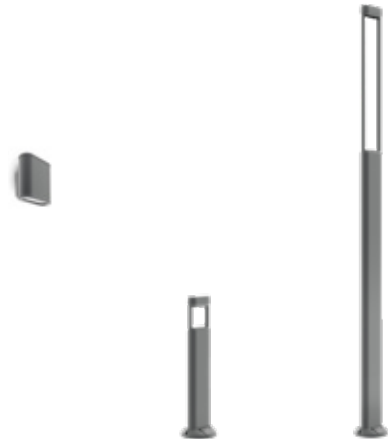

AMON WALL
36

AMON MINI
36

AMON MAXI
36

STREET LIGHTING

KREOS



KREOS
70

THEOS



THEOS GLASS
MINI
78

THEOS GLASS
78

KYRO+

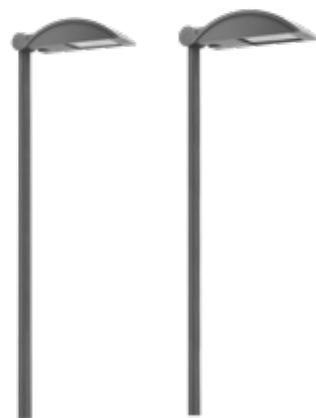

KYRO+ 1
90

KYRO+ 2
90

SYSTEMPARK



SYSTEMPARK
SQUARE+ 1/2
48



SYSTEMPARK
SQUARE+ 1/2
48



SYSTEMPARK
LINE+
48

SPIDER+ POST



SPIDER+ POST
100

ITALY: PUBLIC LIGHTING CAMs

The CAMs (Italian acronym for “Minimum Environmental Criteria”) are a set of legislative acts passed by the Italian government. They set the minimum mandatory requirements that goods and services must have in order to guarantee to be purchasable by the public administrations, giving particular attention to sustainability and energy savings. The “Public Lighting CAM”, approved by the ministerial decree of the 27th September 2017, regulate the purchasing of lighting sources and fixtures, as well as the procurement of design services in public lighting installations. In addition to minimum requirements, CAMs also assign rewarding requirements which allow to obtain a higher score during the award of the tender. According to CAMs, lighting fixtures are classified in relation to five different system installation types, with common and specific requirements.



Road lighting luminaires



Luminaires for area lighting, roundabouts, parking lots

Luminaire type

Parameters with common requirements for all luminaire types

LEDs life at 60000 hours
Warranty (years)

Parameters with specific requirements for each luminaire type

Optic compartment IP
Connection compartment IP
Luminous intensity class
Impacts protection (optic compartment)
Surge protection

IPEA*

From	To
2017	2019
2020	2021
2020	2024
2020	2025
2022	2023
2024	---
2025	---
2026	---

IPEI*

2017	2020
2021	2025
2026	---

Requirement	
Minimum	Rewarding
L80B10	---
5	> 5

IP 65	IP66
IP 55	IP65
≥ G*2	≥ G*3
IK06	IK07
4 kV	6 kV

B	B
A+	
	A
A++	
A3+	
	A+

B	A
A	A+
A+	A++

Requirement	
Minimum	Rewarding
L80B10	---
5	> 5

IP55	IP65
IP55	IP65
≥ G*2	≥ G*3
IK06	IK07
4 kV	6 kV

B	B
A+	
	A
A++	
A3+	
	A+

B	A
A	A+
A+	A++



Luminaires for pedestrian areas, pedestrian pathways, cycling pathways, cycle-pedestrian areas



Luminaires for green areas



Artistic luminaires for historic city centers

Requirement	
Minimum	Rewarding
L80B10	---
5	>5

Requirement	
Minimum	Rewarding
L80B10	---
5	>5

Requirement	
Minimum	Rewarding
L80B10	---
5	>5

IP55	IP65
IP55	IP65
≥ G*2	≥ G*3
IK07	IK08
4 kV	6 kV

IP55	IP65
IP55	IP65
≥ G*3	≥ G*4
IK07	IK08
4 kV	6 kV

IP55	---
IP43	---
≥ G*2	---
---	---
4 kV	---

C	B
	A
B	
	A+
A	
B	A
A	A+
A+	A++

C	B
	A
B	
	A+
A	
B	A
A	A+
A+	A++

C	B
	A
B	
	A+
A	
B	A
A	A+
A+	A++



IPEA* - IPEI*

The ever-growing attention given by institutions and public opinion to environment related issues, has led also the lighting industry to a profound renovation.

This process was brought forth not only by the diffusion of LED technology, but also by important regulatory evolutions, which have redefined the criteria to be used to evaluate efficacy and sustainability of lighting fixtures and systems. Lighting fixture efficacy (lm/W), in particular, has been understood to not be enough to obtain effective lighting systems, if considered alone.



To achieve effectiveness, indeed, the lumen/Watt ratio has to be considered together with the system lighting requirements; the lighting fixtures have to be evaluated for their capacity to light up “only where is needed”, without exceeding the light levels prescribed by the regulations.

Italy has given a strong contribution to this paradigmatic change by introducing, with CAM, two new energy indexes: IPEA* for fixtures and IPEI* for systems.

IPEA* (Italian acronym for “Parametric Fixture Efficacy Index”) is an alphanumeric value (ex. A++), similar to the energy class of household appliances. Is given by the result of the following ratio:

$$\text{IPEA}^* = \eta_a / \eta_r$$

In which:

η_a (lm/W): fixture efficacy

η_r (lm/W): reference efficacy, dependent on fixture type and power range

IPEI* (Italian acronym for “Parametric System Efficacy Index”) is an alphanumeric value too, similar to the energy class of buildings. Is given by the result of the following ratio:

$$\text{IPEI}^* = D_p / D_{p,R}$$

In which:

D_p : project power density, calculated according to EN 13201-5 regulation

$D_{p,R}$: reference power density, dependent on project type and lighting class.

FRANCE: LIGHT POLLUTION LAW

DECREE OF 27 DECEMBER 2018

The French government, with the law decree of 27 December 2018, has adopted a legislative provision for the reduction and limitation of light pollution, aimed at night skies preservation, intrusive light limitation, protection of biodiversity and increase of energy savings. These goals are reached through the regulation of four features of lighting fixtures and systems, which are: ULR (Uplight Lighting Ratio), CIE flux code n°3, colour temperature and light flux density.

In addition, specific requirements are prescribed for astronomical observation areas, national parks and nature reserves.

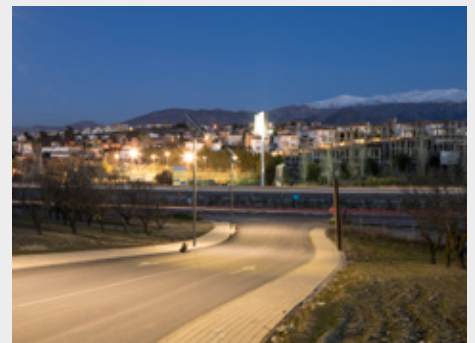

Polanco Road | Otura - Granada | Spain



ULR

ULR (Uplight Lighting Ratio) represents the percentage of light flux emitted upwards by a lighting fixture.

Limiting the ULR value allows to protect night skies, which observation is in fact compromised by upward directed light, detrimental for astronomical observatories and amateur astronomers.

	Fixture position	
	Horizontal	Tilted
- Lighting installations (both public and private) as roads, which assure drivers, cyclists and pedestrians' safety. - Outdoor and semi-indoor parking lots.	< 1%	< 4%
- Lighting installations of any kind, if located within a 10 km radius from an astronomic observatory or inside a nature reserve or a national park.	= 0%	= 0%
- Architectural lighting of cultural assets. - Architectural and landscape lighting of parks and gardens, both public and private. - Sport venues. - Temporary light installations for shows and events.	---	---



Navile public park | Bologna | Italy



CIE N°3

CIE flux codes are a photometric parameter made up of five integers (e.g. 32 74 97 100 100), which define the light distribution of a lighting fixture within certain angles. The third integer denotes the percentage of light flux emitted within an opening semi-angle of 75,5°.

Limiting the flux emitted above 70 ÷ 75° contributes to reduce glare and intrusive light, that is the fraction of light flux directed outside the areas which need to be lit.

- Lighting installations (both public and private) as roads, which assure drivers, cyclists and pedestrians' safety. > 95%
 - Outdoor and semi-indoor parking lots.

- Architectural lighting of cultural assets. ---
 - Architectural and landscape lighting of parks and gardens, both public and private. ---
 - Sport venues. ---
 - Temporary light installations for shows and events.

FRANCE: LIGHT POLLUTION LAW

DECREE OF 27 DECEMBER 2018

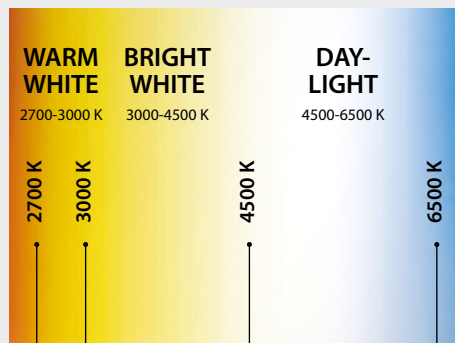

Alhambra | Granada | Spain

COLOUR TEMPERATURE (K)

Some features of the artificial light spectrum can affect biological cycles of flora and fauna.

To preserve biodiversity, the decree sets the maximum colour temperature of the light sources to be used.

	Colour temperature (K)	
	Urban areas	Extra-urban areas
<ul style="list-style-type: none"> - Lighting installations (both public and private) as roads, which assure drivers, cyclists and pedestrians' safety. - Non-residential buildings (e.g. commercial and industrial facilities), included indoor lighting which is emitted outdoor. - Outdoor and semi-indoor parking lots. 	≤ 3000 K	≤ 3000 K
<ul style="list-style-type: none"> - Architectural lighting of cultural assets. - Architectural and landscape lighting of parks and gardens, both public and private. - Sport venues. - Temporary light installations for shows and events. 	---	---
<ul style="list-style-type: none"> - Lighting installations of any kind inside nature reserves. 	≤ 2400 K	≤ 2400 K
<ul style="list-style-type: none"> - Lighting installations of any kind inside national parks. 	≤ 2700 K	≤ 2400 K

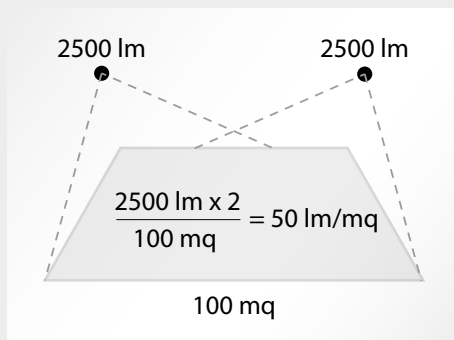

Tank storage Standic B.V. | Dordrecht | Netherlands

LIGHT FLUX DENSITY (lm/m²)

Light flux density is the ratio between the summation of the fluxes of all the lighting fixtures which light up a certain area and the surface of the area itself; its measure unit is lm/m².

It allows to evaluate if an installation lights up only where it's needed without wastes, so to increase energy savings.

	Light flux density (lm/m ²)	
	Urban areas	Extra-urban areas
- Lighting installations (both public and private) as roads, which assure drivers, cyclists and pedestrians' safety.	< 35 lm/m ²	< 25 lm/m ²
- Architectural and landscape lighting of parks and gardens, both public and private.	< 25 lm/m ²	< 10 lm/m ²
- Non-residential buildings (e.g. commercial and industrial facilities), included indoor lighting which is emitted outdoor.	< 25 lm/m ²	< 20 lm/m ²
- Outdoor and semi-indoor parking lots.	< 25 lm/m ²	< 20 lm/m ²

HEDO+

design Roberto Fiorato

Subtraction adds value

The new HEDO+ series is the latest restyling of an iconic product, aesthetically unique, characterized by minimalistic and pure design. The extensive use of voids subordinates HEDO+ to the environment: a crystal clear example where subtraction of matter adds value to the contest.

The HEDO+ transforms traditional lighting by blending contemporary designs with urban styles. This minimalistic look delivers a powerful creative statement with a low environmental impact. Its exceptional design will meld into most surroundings.

With proprietary optics and various lumen options, the HEDO+ FT offers precise and superb cylindrical and semi-cylindrical illumination.

The discreet, clean form of HEDO+ is an architectural solution for practically every project you design in both residential and urban contests.

The series meets the needs of the future cities through NEMA and Zhaga Book 18 protocols and interfaces for wireless remote control systems, opening to all future developments of the Internet of Things (IoT) and connected cities.





Jumeirah Lakes Towers | Dubai | EAU

HEDO+

design Roberto Fiorato

Area and site lighting series. Fixtures consist of:

Construction

- Die-cast aluminium housing, powder-polyester coated ISO 9227
- High resiliency anti-ageing silicone gasket with high elastic return capacity
- Stainless steel external screws
- Painted die-cast aluminium pole-top adaptor for pole Ø 60 / 76 mm

Electrical

- Integral surge protection device (SPD) against mains overvoltages up to 10 kV
- NEMA versions are complete with NEMA SOCKET connected to DALI drivers and a waterproof short-circuit cap allowing the on-off operation of the luminaire. These versions are designed for mounting SMART-compatible solutions

Installation

- IP66 quick connector allows electrical connection to mains without opening the fitting. Made in PA66 with silver-plated brass contacts, for cables of Ø 9 - Ø 12 mm

Variants

- For other colour temperatures and different colour rendering index consult factory

Listings

- CE
- EAC
- RCM
- ENEC pending
- Compliant with the UNI 10819 standards on light pollution
- Complies with CAM for public lighting fixtures
- Made in Italy

Warranty

- 5-year limited warranty. Complete warranty terms located at www.performanceinlighting.com
- Registered trademark ®
- Registered design ®





HEDO+

HEDO+ FT

CONSTRUCTION		HEDO+	HEDO+ FT
IP		IP65	IP66
IK		IK09 17J xx7	IK08 5J xx5
Dimensions (mm)		H 475 x Ø 330	H 565 (625 NEMA) x Ø 450
Windage area	EPA - front	0,0069 m ²	0,086 m ² (0,09 m ² NEMA)
	EPA - side	0,006 m ²	0,159 m ²
	EPA - top	-	-
Weight		Max 4 kg	Max 8 kg
Colour		●	●
INSTALLATION			
Pre-wired		-	-
Quick		✓	✓
Continuous mounted luminaire		-	-
LED			
Lightsource lumen output	3000 K	3150 lm ÷ 5894 lm	2026 lm ÷ 6837 lm
	4000 K	3247 lm ÷ 6140 lm	2094 lm ÷ 7181 lm
Luminaire lumen output	3000 K	2080 lm ÷ 3710 lm	1591 lm ÷ 4924 lm
	4000 K	2145 lm ÷ 3865 lm	1697 lm ÷ 5189 lm
CCT - Correlated Color Temperature		3000 K - 4000 K (2700 K on request)	3000 K - 4000 K (2700 K on request)
CRI / SDCM (macadam step)		80/5	70/3
Lifetime		L80B10@100000h	L90B10@100000h
ULR<1		✓	✓
CIEn ³ >95		✓	✓
OPTIC			
C/EW extra wide circle reflector		C/EW	C/EW
SR/075 road reflector		-	SR/075
ELECTRICAL			
Wattage		23 W - 42 W	14 W - 18 W - 19 W - 25 W - 27 W 34 W - 36 W - 40 W - 43 W
Class		I	II
EEL		-	-
Ta MAX° luminaire		50°C	55°C ÷ 45°C
Ta MIN° luminaire		-20°C	-20°C
Dimmable 1-10V		-	-
Dimmable DALI		✓	✓
COSφ ≥ 0,9		✓	✓
SPD (10kV)		✓	✓
CONTROL SYSTEMS			
Automatic derating		(on request)	✓
Pilot wire command derating		(on request)	(on request)
Constant light output		-	(on request)
NEMA socket		-	✓

● AN-96 / Anthracite gray / Textured



Jumeirah Lakes Towers | Dubai | EAU



Flat microprismatic glass diffuser internally pattern



Electrical connection with outdoor rated plug & socket quick connector (IP66) that allows connection to mains without opening the luminaire



Painted die-cast aluminium pole-top adaptor for pole Ø 60 / 76 mm



Integral surge protection device (SPD) against mains overvoltages up to 10 kV



Compliant with the UNI 10819 Standard and with the Italian regional laws on light pollution

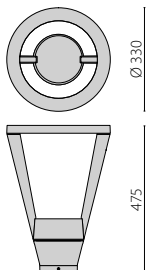

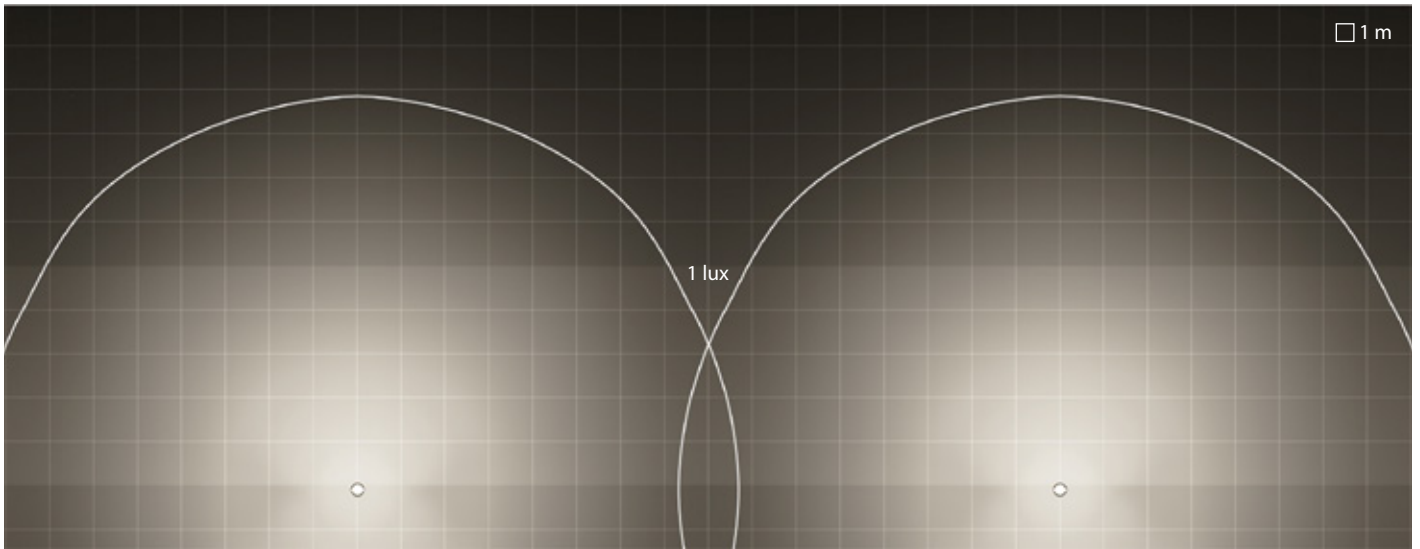

HEDO+ | C/EW | linear

Luminaire spacing = 16m
 Path depth = 5m
 Mounting height = 3m

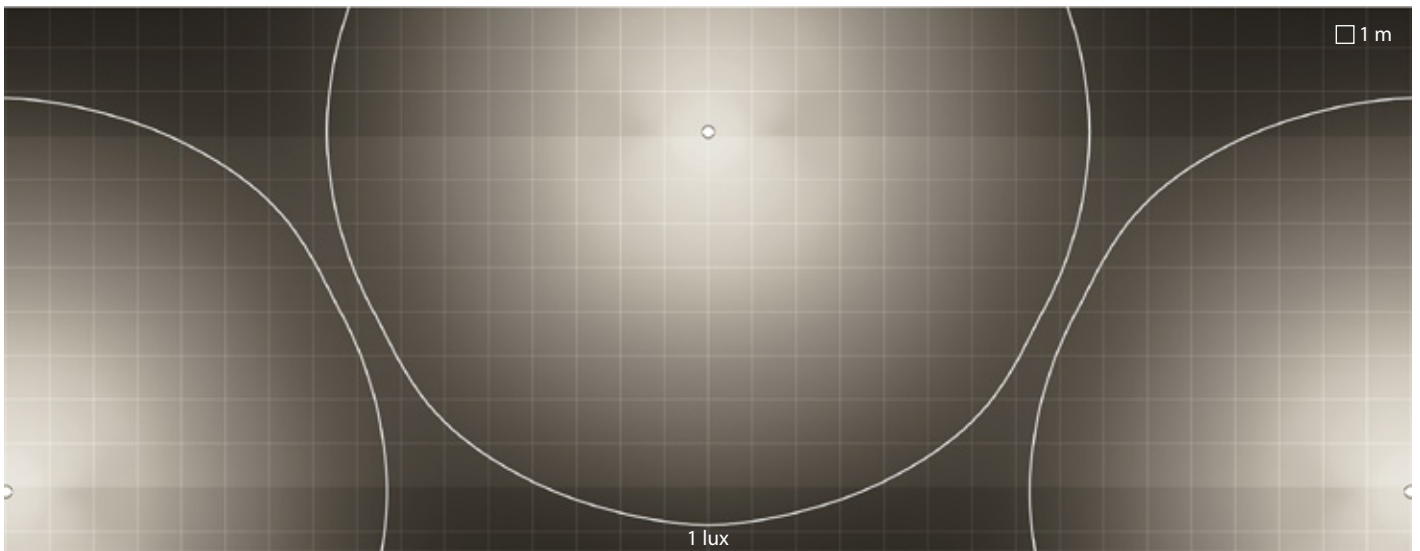

HEDO+ | C/EW | qunconce

Luminaire spacing = 16m
 Path depth = 8m
 Mounting height = 3m

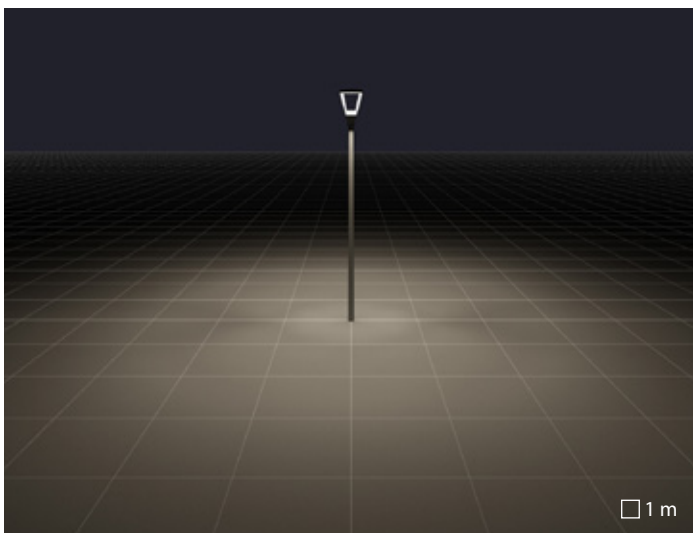

C/EW extra wide circle reflector

HEDO+ FT



NEMA versions are complete with NEMA SOCKET connected to DALI dimmer capable drivers and a watertight short-circuit cap that allows the on-off operation of the luminaire. These versions are designed for mounting SMART-compatible solutions.



Extra-clear flat tempered glass diffuser



Electrical connection with outdoor rated plug & socket quick connector (IP66) that allows connection to mains without opening the luminaire



Painted die-cast aluminium pole-top adaptor for pole Ø 60 / 76 mm



Integral surge protection device (SPD) against mains overvoltages up to 10 kV



Compliant with the UNI 10819 Standard and with the Italian regional laws on light pollution

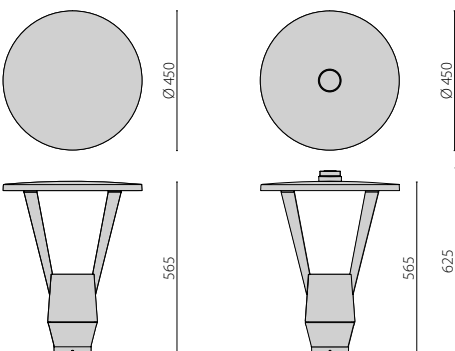



Jumeirah Lakes Towers | Dubai | EAU

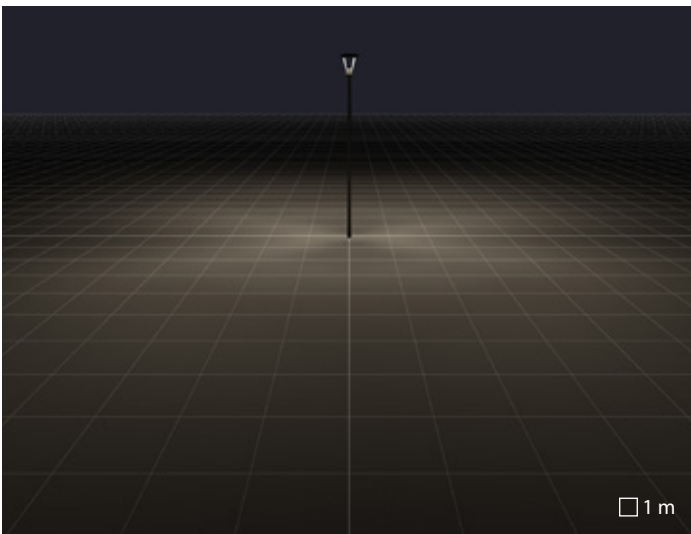

C/EW extra wide circle reflector

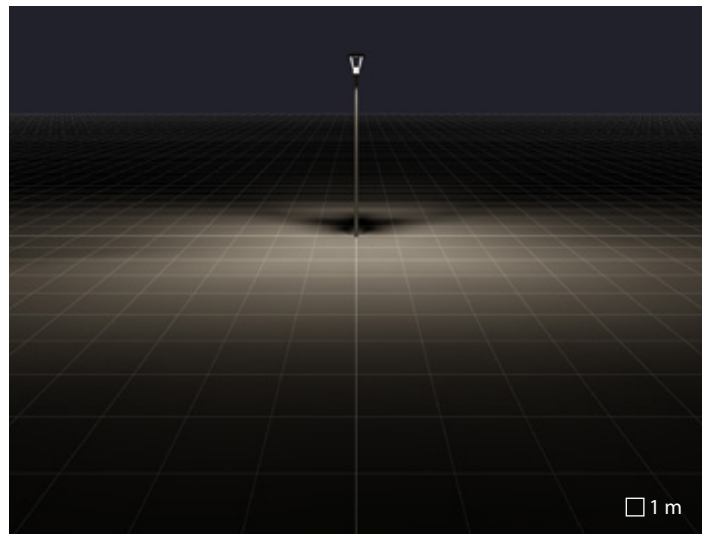

SR/075 road reflector



SECURE LIGHTING SOLUTION



In professional, urban and street lighting, lightning and overvoltages are significant risks for LED luminaires.

There is the risk of breakdowns and high repair costs, which prolong the amortisation times. In this sector replacement, in addition to hardware costs, also involves high expenses through the use of lifting platforms and qualified personnel.

A suitable protection device upstream of the electronic LED drivers is a safe barrier against overvoltages. The overvoltage protection devices upstream of the driver reduce the pulses and protect the equipment. Substantial cost savings are possible despite the increase in

the initial supply price. For this reason, PERFORMANCE IN LIGHTING offers a wide range of luminaires with standard SPD (Surge Protection Device) security system solutions up to a peak of 10kV. It is advised to set up a secure system adding centralised protection devices to avoid dangerous overvoltages.

SPILLO

design Alessandro Pedretti

Starry light

SPILLO is at the forefront of the technology and image of new generation lighting fixtures, transmitting a message of quality and "comfort" of the urban environment; be it of a historical or contemporary nature, for green areas of traffic.

SPILLO MINI and SPILLO are innovative alternatives for the enhancement of the national heritage in public and private parks, cycle-pedestrian walkways, gardens, paths, commercial complexes of municipalities, towns, and cities.

Offering various optical distributions, the SPILLO is not only the most beautiful exterior fixture available, but it's also the smartest. With a complimentary bollard in the form of the SPILLO MINI, the SPILLO series is the new standard in urban lighting.

In compliance with the international light pollution/dark sky requirements, this product series is the perfect choice for your residential, urban and commercial projects.

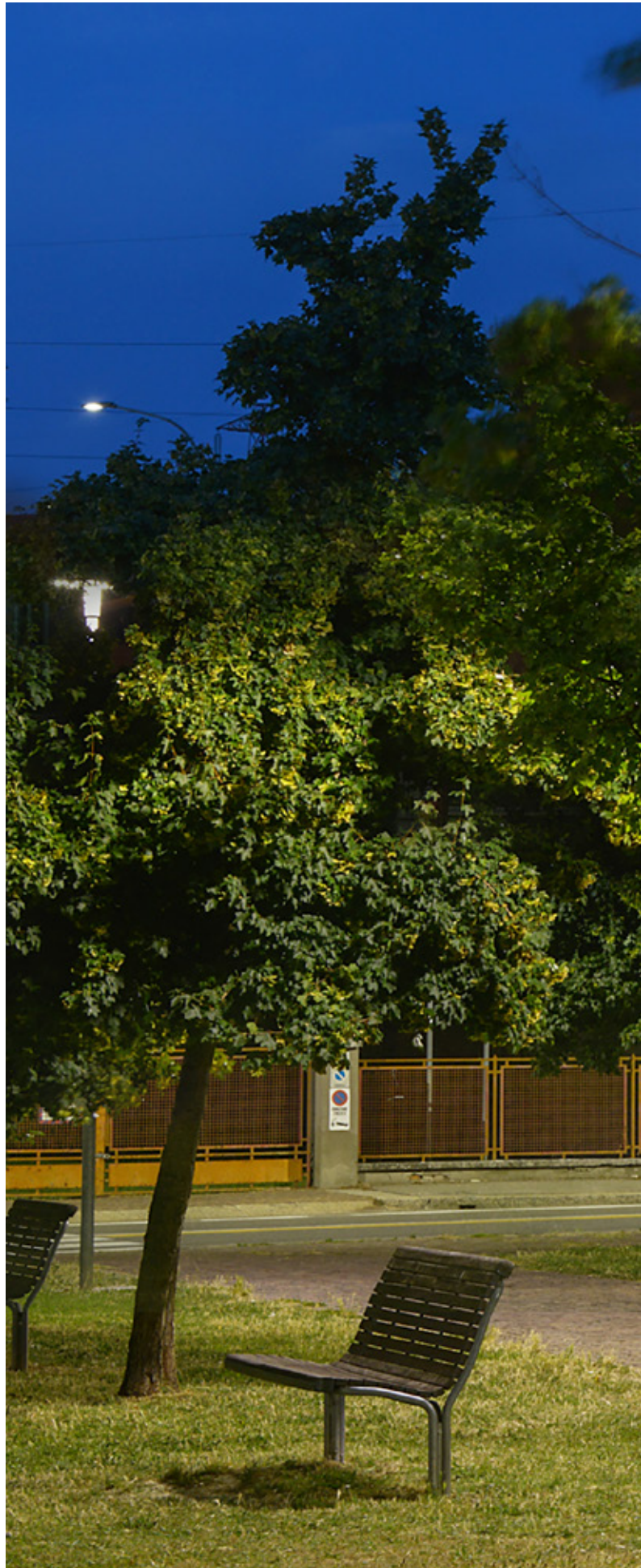



Navile public park | Bologna | Italy

SPILLO

design Alessandro Pedretti

Design-coordinated area/site lighting (SPILLO) and bollard (SPILLO MINI) series. Fixtures consist of:

Construction

- ISO 9227 painted die-cast aluminium housing
- Anti-ageing silicone gasket
- Stainless steel external screws

Electrical

- Supplied complete with 220/240 V 50/60 Hz power supply unit.
- Analogue dimmable HF ballast, 1-10 V
- The "SECURE LIGHT DISTRIBUTION" system guarantees uniform light distribution even in the remote case of LED failures
- Each LED is coupled with an electronic safety device (NUD) that can by-pass it in case of failure
- It is possible to replace the LED boards to keep the luminaire technologically updated through the years (consult factory).

Installation

- Suitable for pole-tops Ø 60 / 76 mm or on SPILLO pole Ø 90 mm
- Waterproof cable gland M25x1.5 for cables Ø 9- Ø 14 mm
- Supplied with 1m pre-wired HORN5 cable
- External electrical connection with sealed plug-socket QUICK, complete with cable

Listings

- CE
- EAC
- RCM
- ENEC
- Complies with CAM for public lighting fixtures
- Made in Italy

Warranty

- 5-year limited warranty. Complete warranty terms located at www.performanceinlighting.com



SPILLO



SPILLO MINI

SPILLO MINI POST

SPILLO

CONSTRUCTION		SPILLO MINI	SPILLO MINI POST	SPILLO
IP		IP65	IP65	IP65
IK		IK10 20J xx9	IK10 20J xx9	IK10 20J xx9
Dimensions (mm)		H 187 x Ø 360	H 1187 x Ø 360	H 187 x Ø 587
Windage area	EPA - front	0,0047 m ²	0,081 m ²	0,0062 m ²
	EPA - side	0,101 m ²	0,101 m ²	0,264 m ²
	EPA - top	-	-	-
Weight		Max 3,21 kg	Max 5,11 kg	Max 7,59 kg
Colour		●	●	●
INSTALLATION				
Pre-wired		✓	✓	✓
Quick		✓	✓	✓
Continuous mounted luminaire		-	-	-
LED				
Lightsource lumen output	4000 K	1500 lm ÷ 2240 lm	1450 lm ÷ 2240 lm	3485 lm ÷ 6970 lm
Luminaire lumen output	4000 K	867 lm ÷ 1237 lm	867 lm ÷ 1237 lm	1767 lm ÷ 3998 lm
CCT - Correlated Color Temperature		4000 K (3000 K on request)	4000 K (3000 K on request)	4000 K (3000 K on request)
CRI / SDCM (macadam step)		70/3	70/3	70/3
Lifetime		L80B10@60000h	L80B10@60000h	L80B10@60000h
ULR<1		✓	✓	✓
CIEn°3>95		✓	✓	✓
OPTIC				
C/EW extra wide circle reflector		C/EW	C/EW	C/EW
CP pedestrian and cycle reflector		-	-	CP
ELECTRICAL				
Wattage		11 W - 16 W	11 W - 16 W	24 W - 44 W
Class		II	II	II
EEl		-	-	-
Ta MAX° luminaire		45°	45°	35° ÷ 25°
Ta MIN° luminaire		-25°	-25°	-25°
Dimmable 1-10V		✓	✓	✓
Dimmable DALI		-	-	-
COSφ ≥ 0,9		-	-	-
SPD (10kV)		(on request)	(on request)	(on request)
CONTROL SYSTEMS				
Automatic derating		-	-	✓
Pilot wire command derating		(on request)	(on request)	(on request)
Constant light output		-	-	-

● AN-96 / Anthracite gray / Textured



FINSTRAL | Gochsheimt | Germany

SPILLO MINI / SPILLO

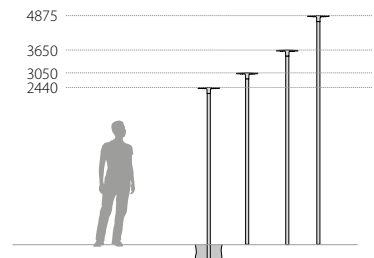
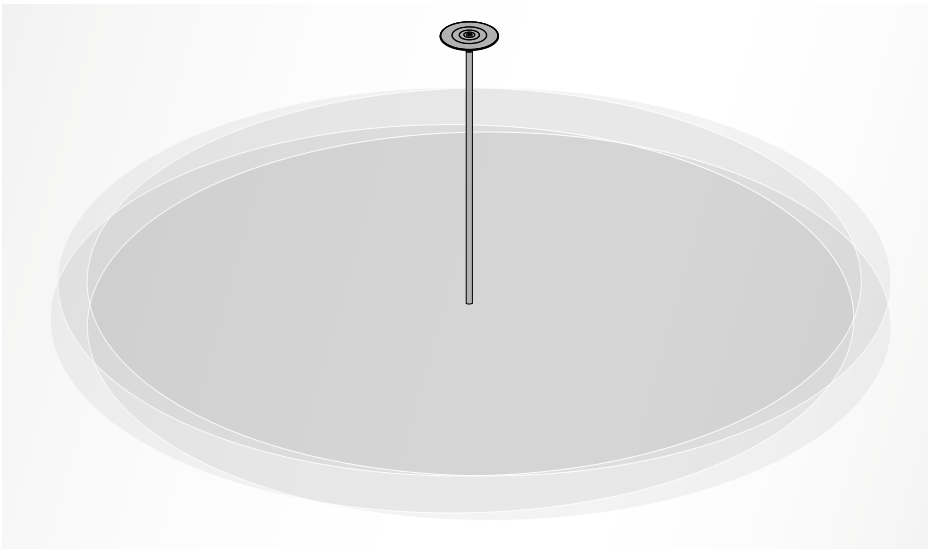

The "SECURE LIGHT DISTRIBUTION" system guarantees uniform light distribution even in the remote case of LED failures



Each LED is coupled with an electronic safety device (NUD) that can by-pass it in case of failure



Future proof. It is possible to replace the LED boards to keep the luminaire technologically updated through the years (consult factory)



Supplied with 1m pre-wired HORN5-5 cable



Suitable for pole-tops Ø 60 / 76 mm or on SPILLO pole Ø 90 mm



Complete with supplementary device for protection against network surges of up to 10 kV (DM)



External electrical connection with sealed plug-socket QUICK, complete with cable

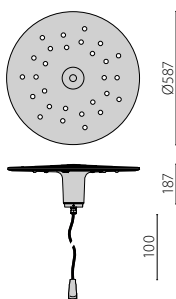
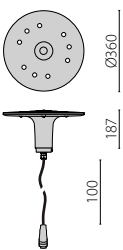

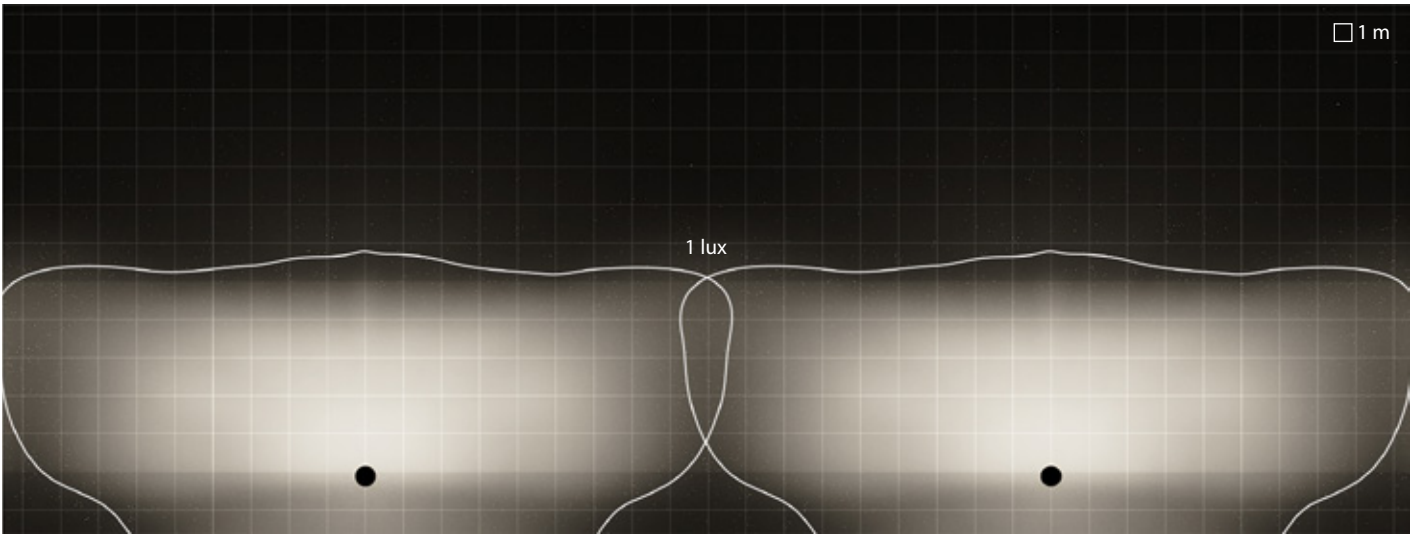

SPILLO | CP | linear

Luminaire spacing = 18m
 Path depth = 5m
 Mounting height = 3m

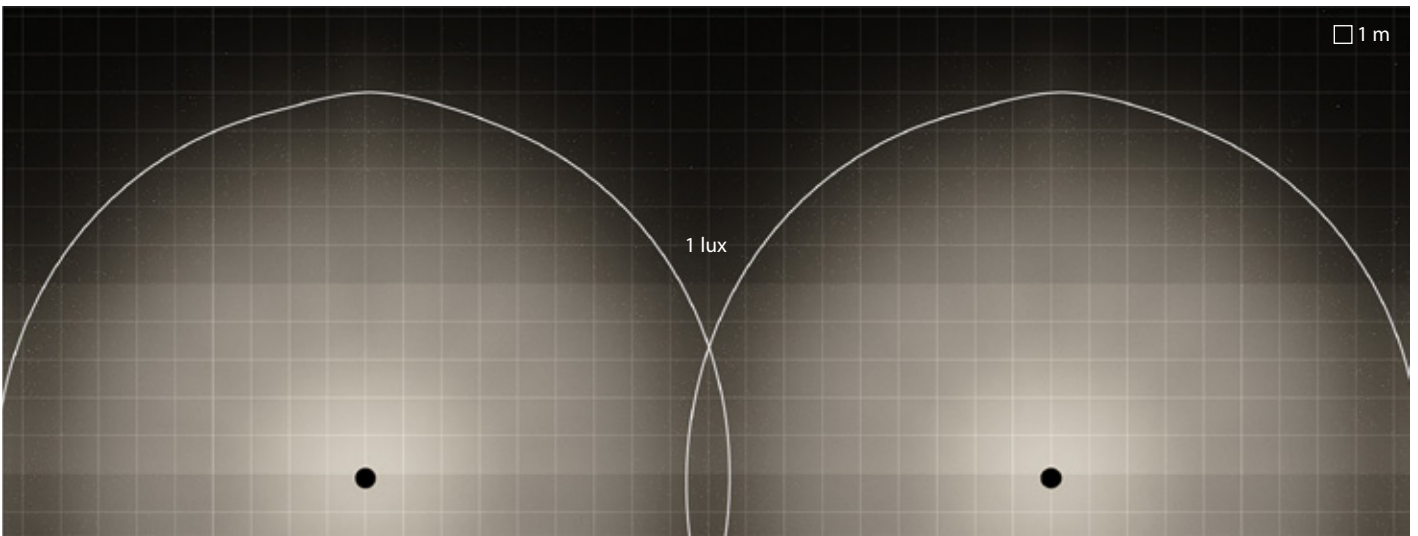

SPILLO | C/EW | linear

Luminaire spacing = 18m
 Path depth = 5m
 Mounting height = 3m

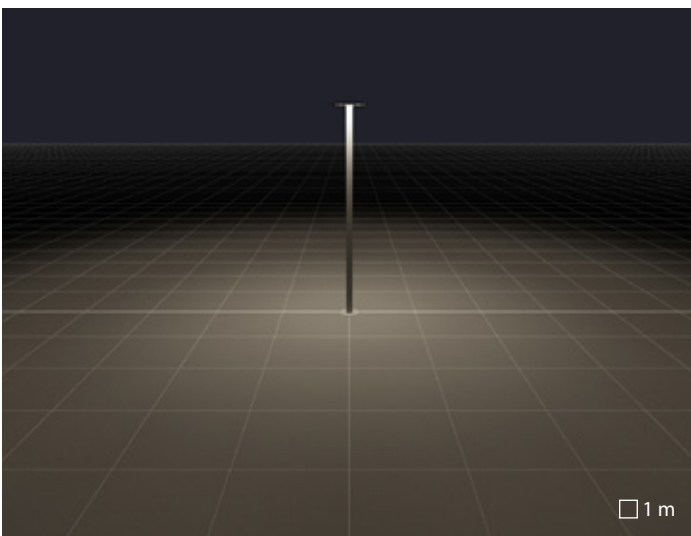

C/EW extra wide circle reflector

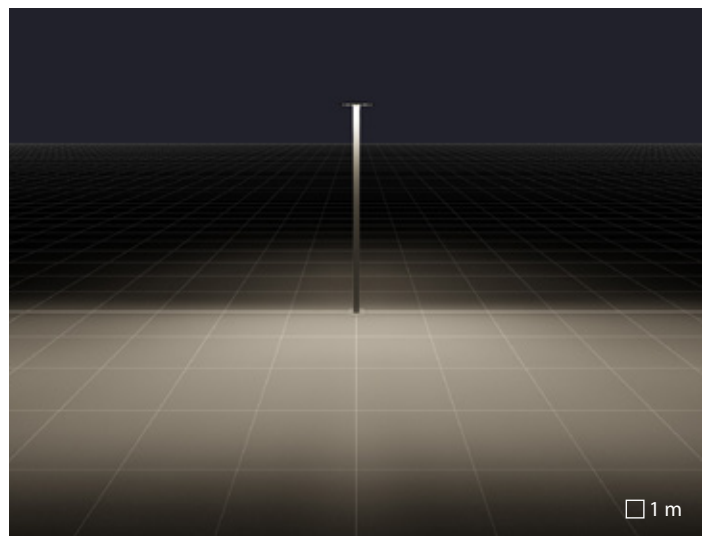

CP pedestrian and cycle reflector





Mitsui outlet park | Taichung | Taiwan

SILLO MINI POST

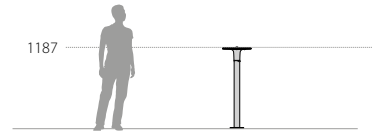
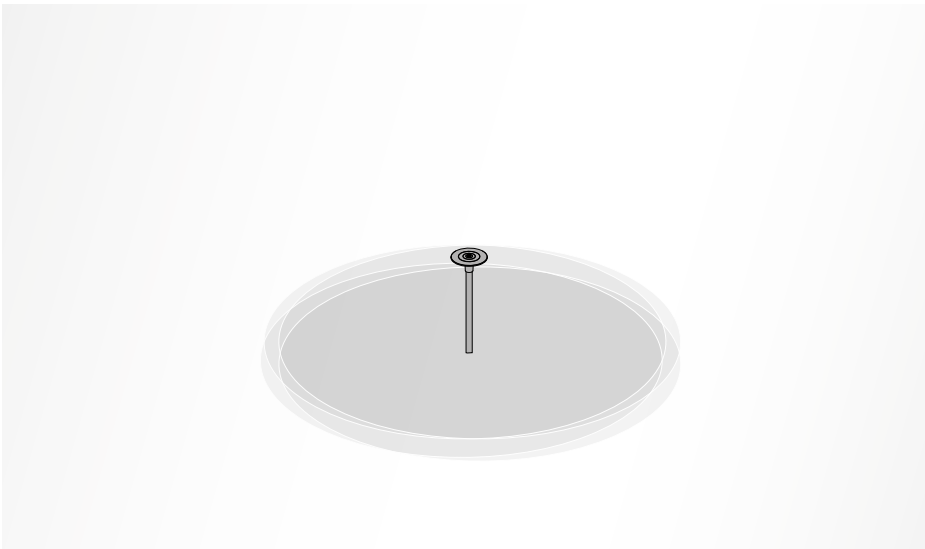

The "SECURE LIGHT DISTRIBUTION" system guarantees uniform light distribution even in the remote case of LED failures



Each LED is coupled with an electronic safety device (NUD) that can by-pass it in case of failure



Future proof. It is possible to replace the LED boards to keep the luminaire technologically updated through the years (consult factory)



External electrical connection with sealed plug-socket QUICK, complete with cable

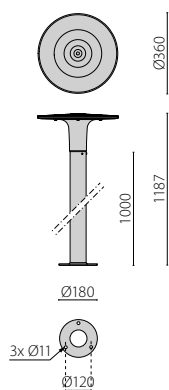

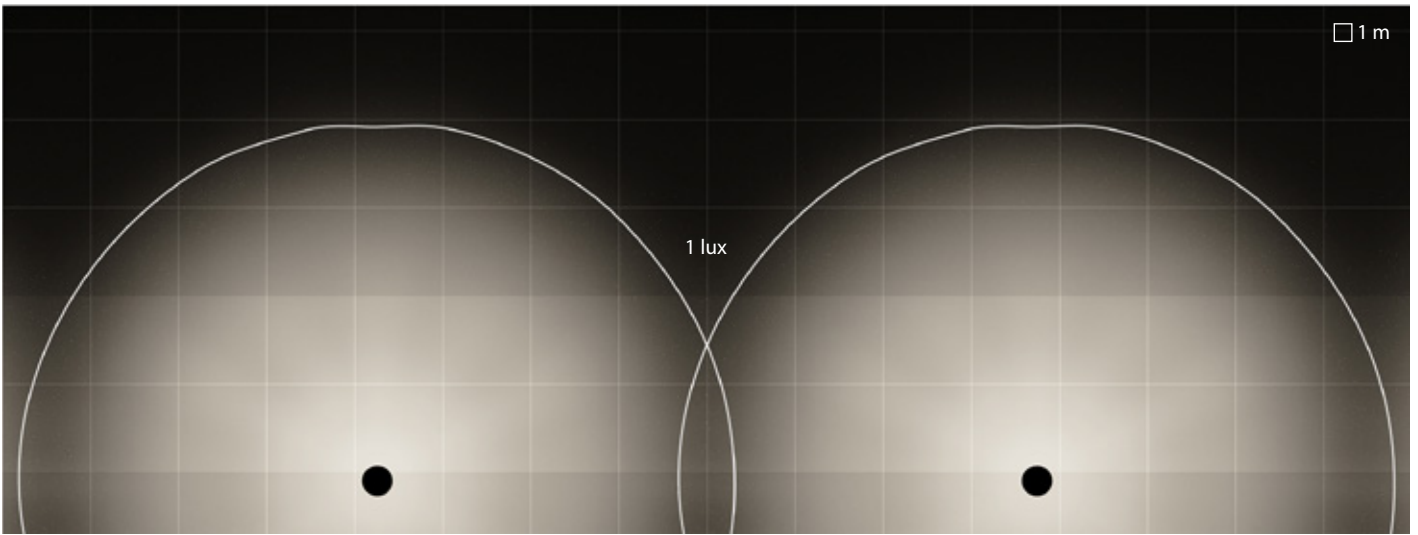

SPILLO MINI | C/EW | linear

Luminaire spacing = 7.5m
 Path depth = 2m
 Mounting height = 0m

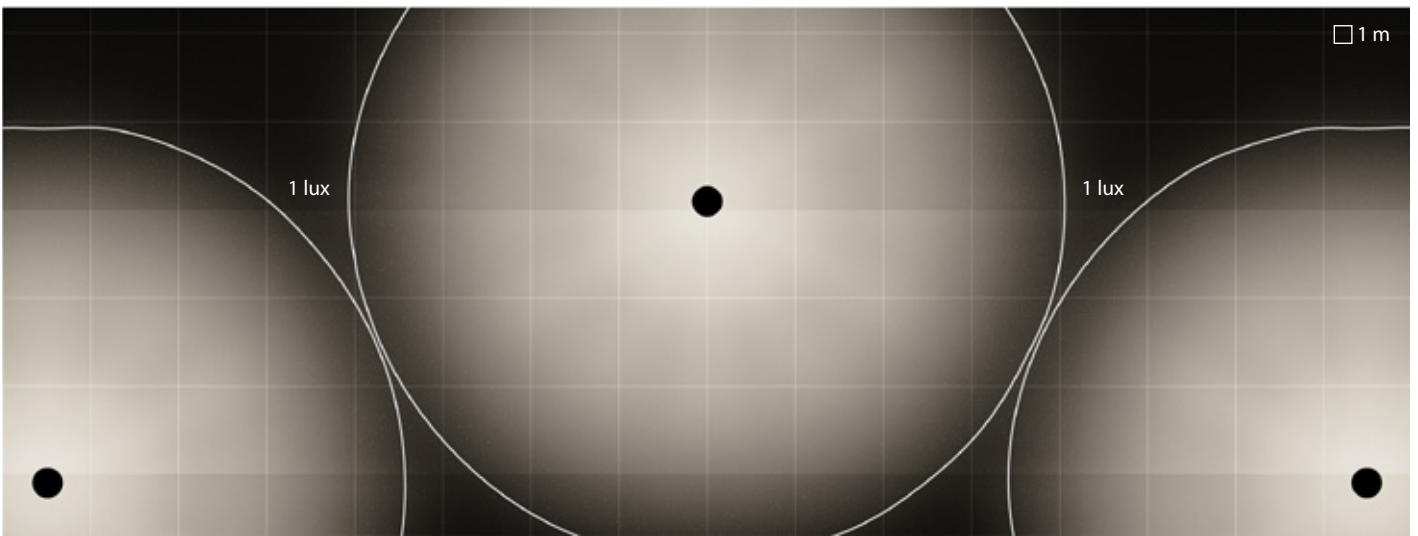

SPILLO MINI | C/EW | qunconce

Luminaire spacing = 7.5m
 Path depth = 3m
 Mounting height = 0m

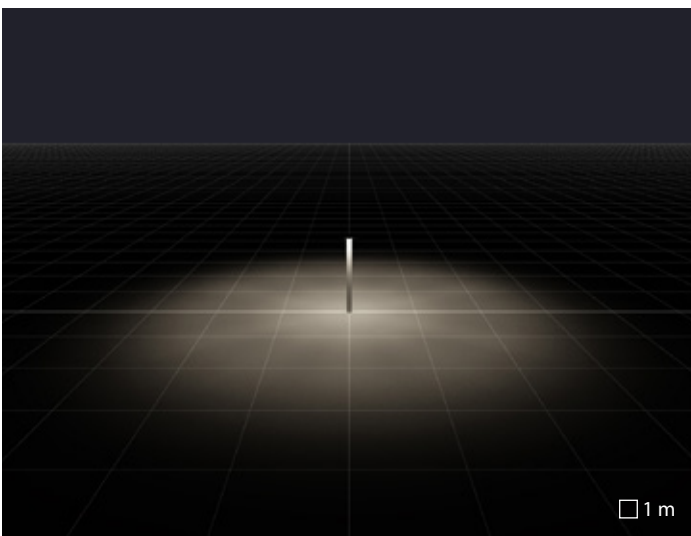

C/EW extra wide circle reflector

AMON

Build to last

The name AMON, King of Gods in ancient Egypt, also meant “mysterious in shape”. From this concept, our team designed a robust, yet at the same time classy and elegant unique oval-shaped luminaire.

This series provides the project designer with versatile lighting solutions while ensuring reduced installation and maintenance costs. AMON is the perfect solution for tomorrow’s city due to the variety of product options and light distributions.

From zero light pollution, glare-free options to the “soft/comfortable” light using our UV stabilized polycarbonate option, the AMON is the versatile option for virtually any project.





New building electrical wholesaler Robri | Wekerom | Netherlands

AMON

Design-coordinated lighting column (AMON MAXI), bollard (AMON MINI) and wall pack (AMON WALL) series. Fixtures consist of:

Construction

- Extruded aluminium profile housing, painted ISO 9227
- Powder polyester painting process optimised against UV rays in 13 different steps guaranteed ISO9227 against salt spray 1000 hours
- Anti-ageing silicone gasket
- Extra-clear, tempered, flat glass diffuser, screen-printed inside
- Stainless steel external screws
- Painted die cast aluminium bracket for wall mounted (WALL) applications, for easy installation

Electrical

- Built-in driver

Installation

- The bracket for wall mounting simplifies maintenance and installation, by making it possible to complete the wiring on the ground and then hang the fixture body without the need for special tools (wall version).
- Stainless steel base plate to anchor the fitting to concrete available as an accessory

Variants

- DALI dimmable ballast available. Consult factory
- For other colour temperatures and different colour rendering index consult factory

Listings

- CE
- EAC
- RCM
- Made in Italy

Warranty

- 5-year limited warranty. Complete warranty terms located at www.performanceinlighting.com





		AMON WALL	AMON MINI	AMON MAXI
CONSTRUCTION				
IP		IP65	IP65	IP65
IK		IK08 5J xx5	IK07 2J xx5 IK09 10J xx7	IK07 2J xx5 IK08 5J xx5
Dimensions (mm)		L 238 x H 270 x D 173	L 238 x H 1200 x D 97	L 238 x H 3933 x D 97
Windage area	EPA - front	0,065 m ²	0,29 m ²	0,96 m ²
	EPA - side	0,026 m ²	0,117 m ²	0,38 m ²
	EPA - top	0,023 m ²	0,023 m ²	0,023 m ²
Weight		Max 6 kg	Max 22 kg	Max 36 kg
Colour		●	●	●
INSTALLATION				
Pre-wired		-	-	-
Quick		-	-	-
Continuous mounted luminaire		-	✓	✓
LED				
Lightsource lumen output	4000 K	3120 lm ÷ 6240 lm	5046 lm	3120 lm ÷ 10092 lm
Luminaire lumen output	4000 K	1786 lm ÷ 3622 lm	1900 lm ÷ 2024 lm	1514 lm ÷ 4144 lm
CCT - Correlated Color Temperature		4000 K (3000 K on request)	4000 K (3000 K on request)	4000 K (3000 K on request)
CRI / SDCM (macadam step)		80/3	80/3	80/3
Lifetime		L70B10@80000h	L70B10@150000h	L70B10@50000h L70B10@80000h
ULR<1		✓	-	-
CIEn°3>95		✓	-	-
OPTIC				
A15/M asymmetric medium reflector		A15/M	-	-
A17/M asymmetric medium reflector		-	-	A17/M
A30/M asymmetric medium reflector		A30/M	-	A30/M
S/EW symmetric extra wide reflector		-	S/EW	S/EW
S/W symmetric wide reflector		-	S/W	S/W
ELECTRICAL				
Wattage		28 W - 37 W - 56 W	41 W	29 W - 42 W - 81 W - 85 W
Class		I	I	I
EEl		-	-	-
Ta MAX° luminaire		30°C	30°C	25°C
Ta MIN° luminaire		-20°C	-20°C	-20°C
Dimmable 1-10V		✓	✓	✓
Dimmable DALI		-	-	-
COSφ ≥ 0,9		✓	✓	✓
SPD (10kV)		-	✓	✓
CONTROL SYSTEMS				
Automatic derating		-	-	-
Pilot wire command derating		-	-	-
Constant light output		-	-	-

● AN-96 / Anthracite gray / Textured



New building electrical wholesaler Robri | Wekerom | Netherlands

AMON WALL

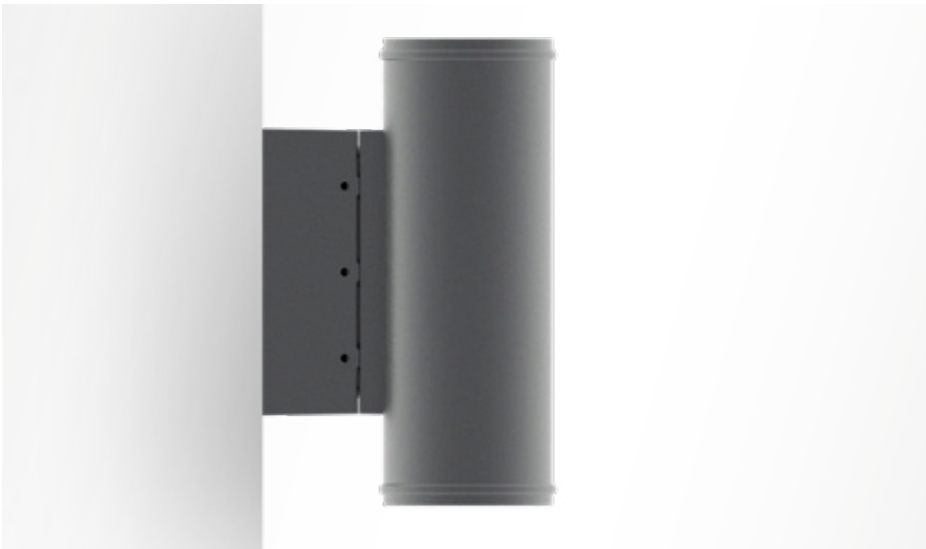

The bracket for wall mounting simplifies maintenance and installation, by making it possible to complete the wiring on the ground and then hang the fixture body without the need for special tools (wall version).



Diffuser in internally frosted extra clear, tempered, flat glass

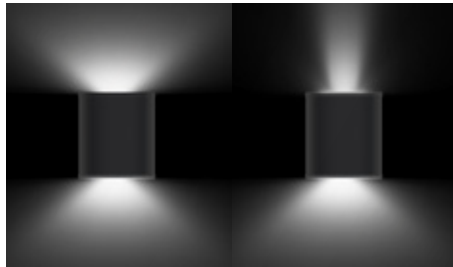

Double-emission (B) versions are equipped with two separate switches in order to provide upward and downward emission (DA)

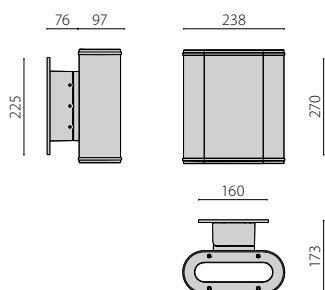

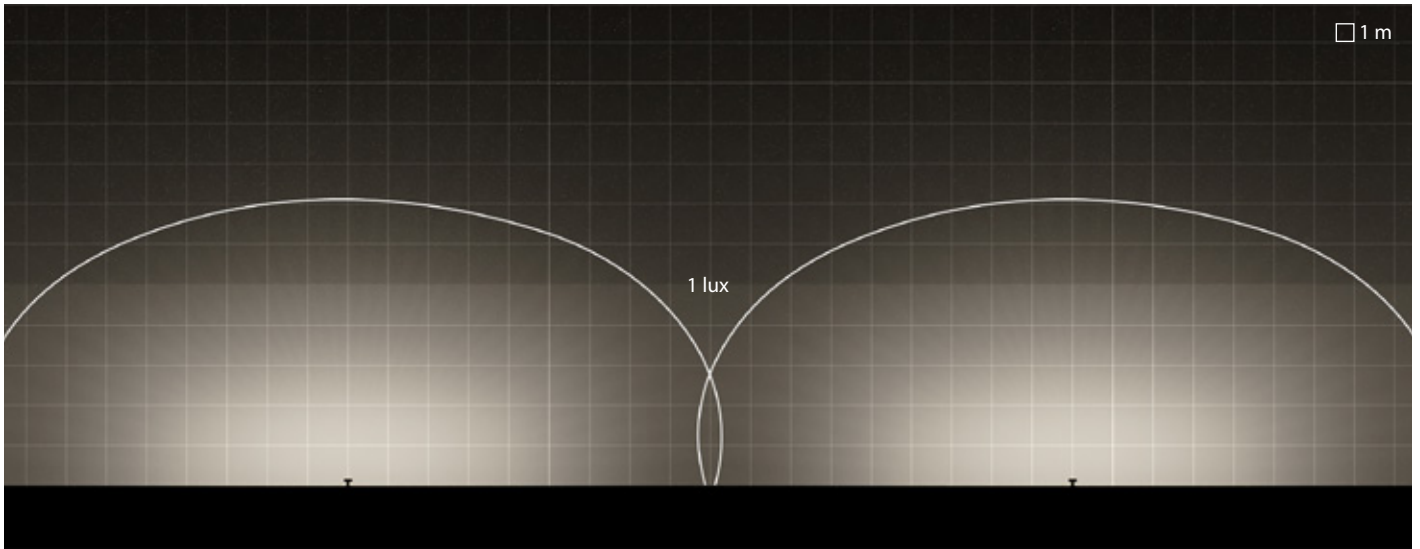

AMON WALL | A15/M | linear

Luminaire spacing = 18m
 Path depth = 5m
 Mounting height = 4m

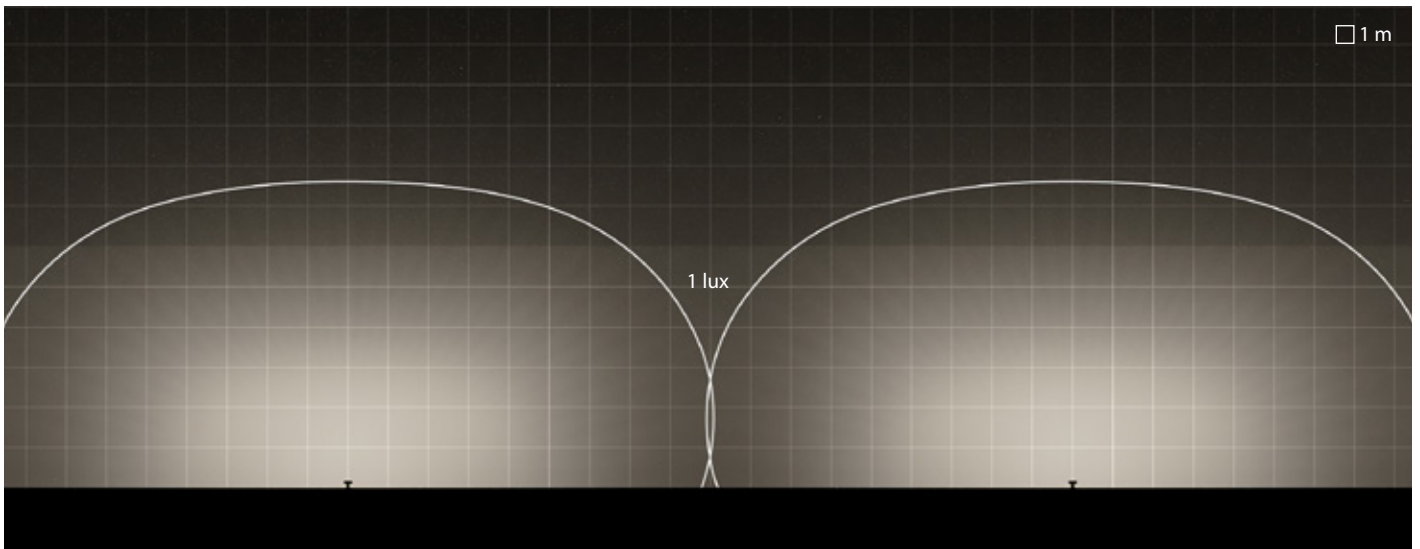

AMON WALL | A30/M | linear

Luminaire spacing = 18m
 Path depth = 6m
 Mounting height = 4m

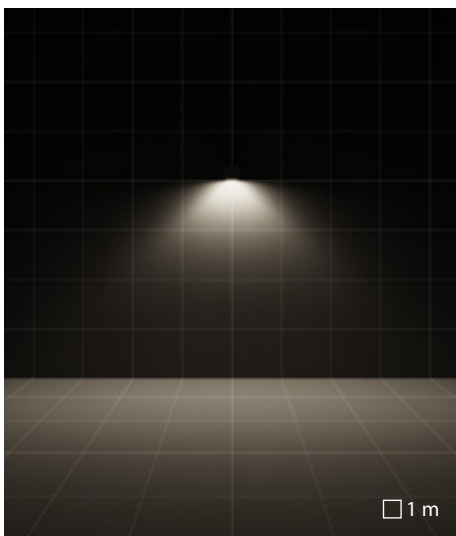

A15/M asymmetric medium reflector

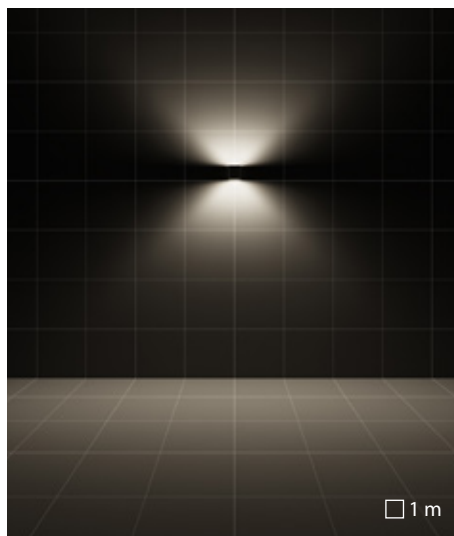

A15/M asymmetric medium reflector

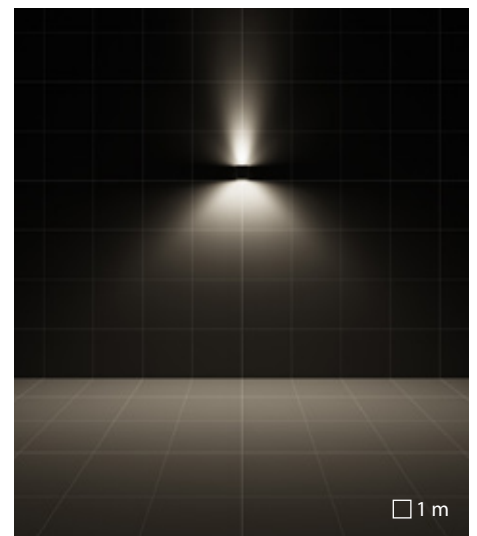

A15/M asymmetric medium reflector + S/I symmetric narrow reflector

AMON MINI

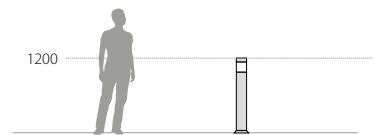

The SOFT version comes complete with satinized UV stabilized polycarbonate diffuser



Diffuser in internally frosted extra clear, tempered, flat glass



Complete with supplementary device for protection against network surges of up to 10 kV (DM)



Aesthetic painted die-cast aluminium flange cover for the base plate, available as accessory



Installation can make use of the accessory stainless steel ground plate to anchor the device to cement

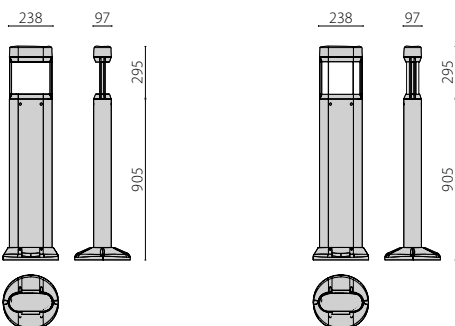

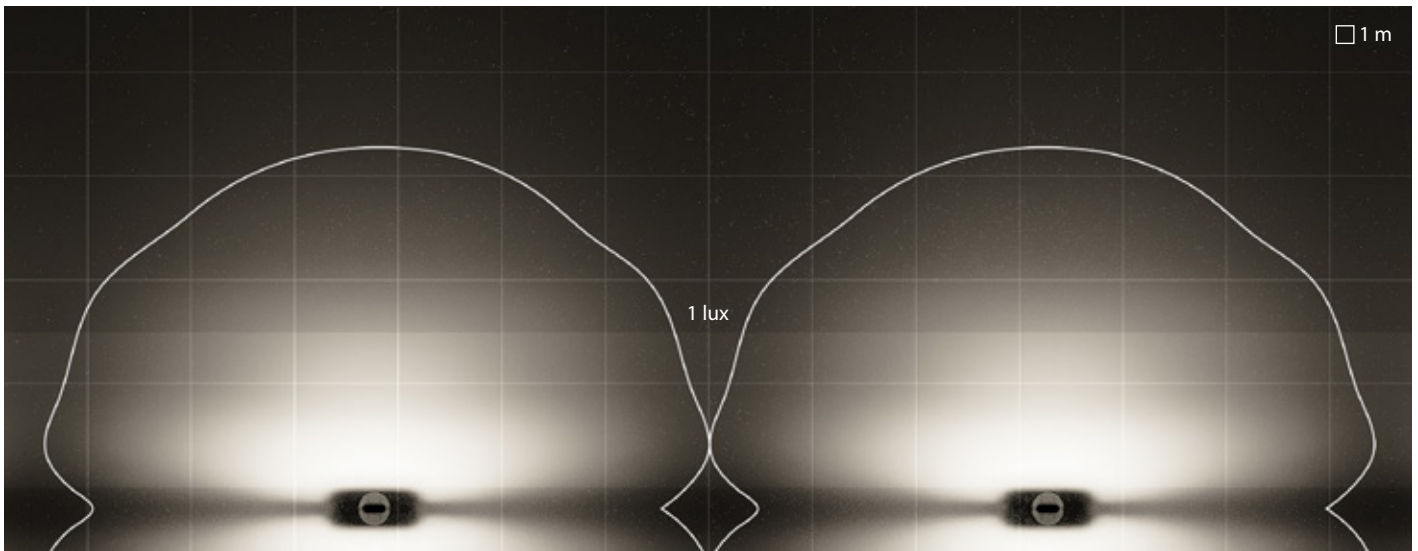

AMON MINI | S/W | linear

Luminaire spacing = 6.5m
 Path depth = 1.5m
 Mounting height = 0m

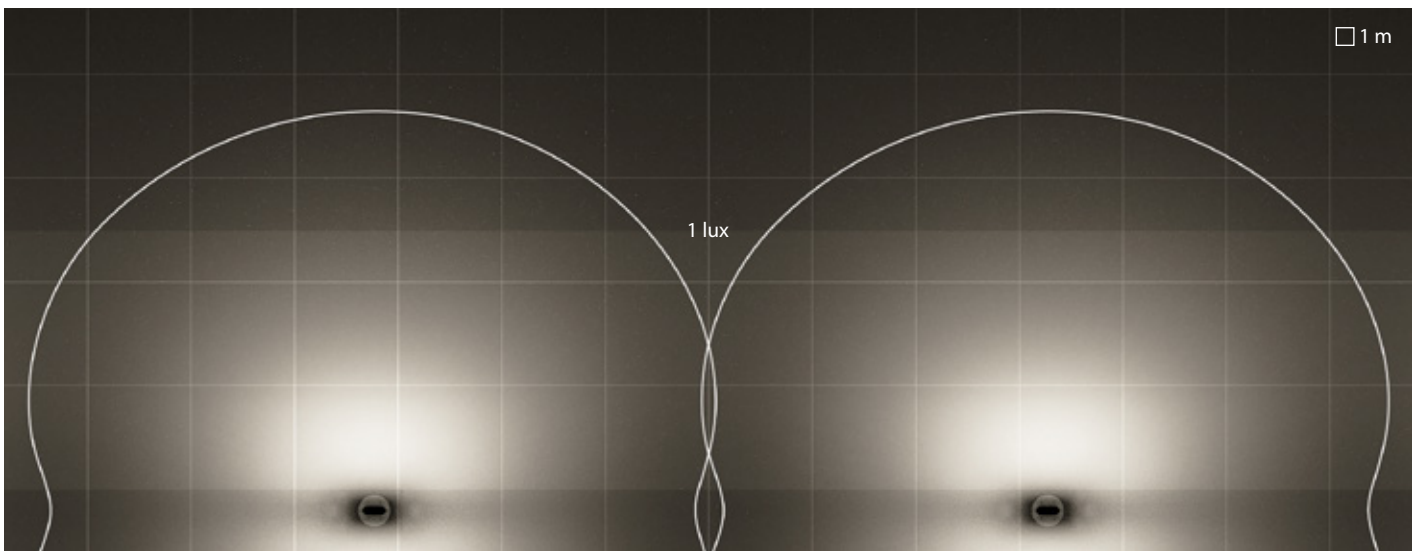

AMON MINI | SOFT S/EW | linear

Luminaire spacing = 6.5m
 Path depth = 2.5m
 Mounting height = 0m

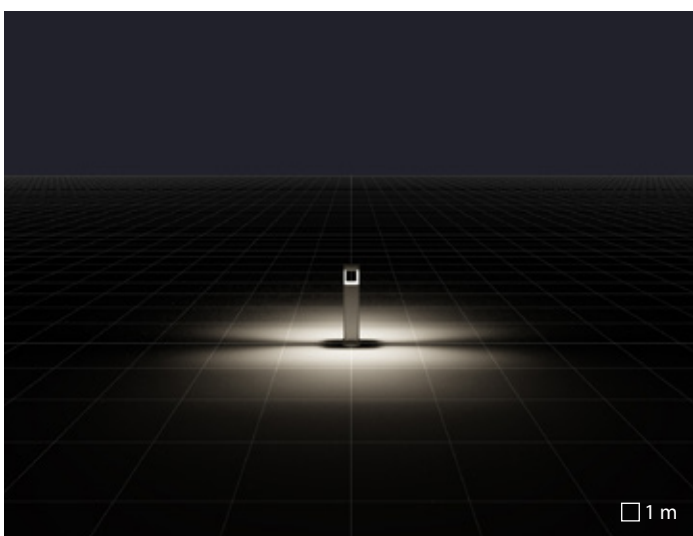

S/W symmetric wide reflector

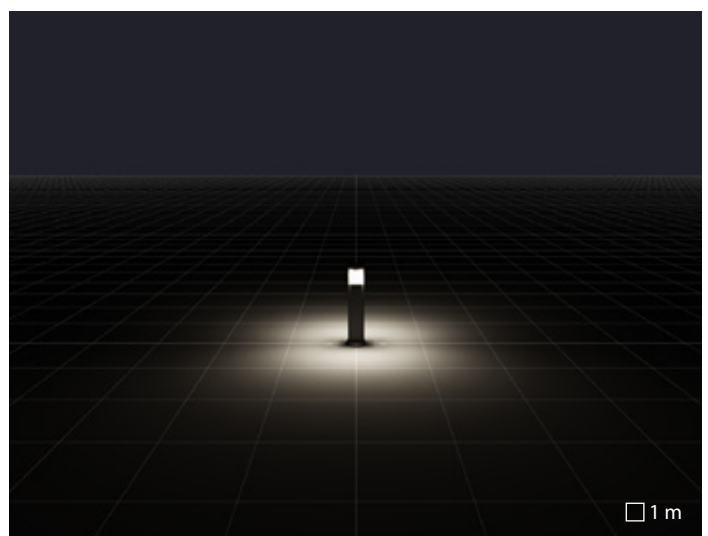

S/EW symmetric extra wide reflector

AMON MAXI



The SOFT version comes complete with opal UV stabilized polycarbonate diffuser

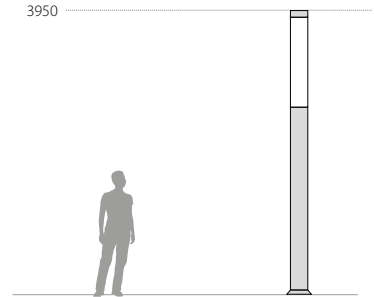

Diffuser in internally frosted extra clear, tempered, flat glass



Complete with supplementary device for protection against network surges of up to 10 kV (DM)



Aesthetic painted die-cast aluminium flange cover for the base plate, available as accessory



Installation can make use of the accessory stainless steel ground plate to anchor the device to cement



Handhole made of painted die-cast aluminium

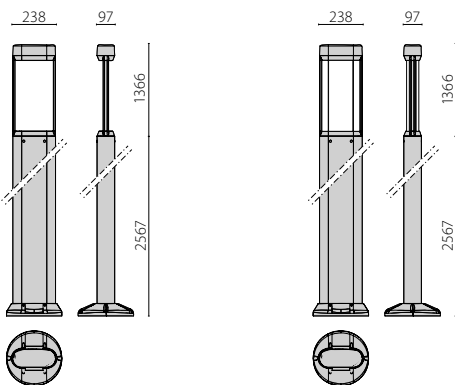

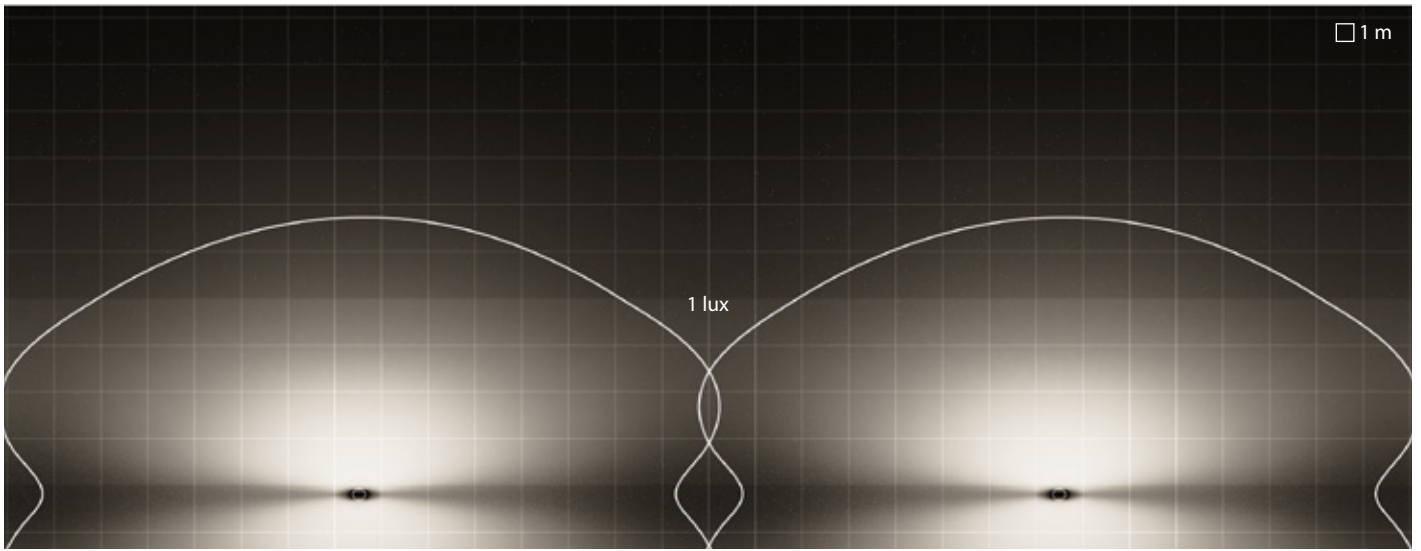

AMON MAXI | S/W | linear

Luminaire spacing = 15m
 Path depth = 4m
 Mounting height = 0m

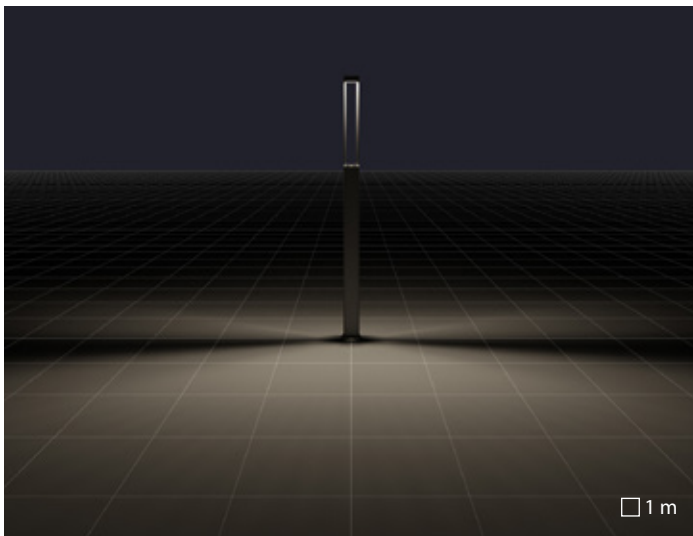

A17/M asymmetric medium reflector

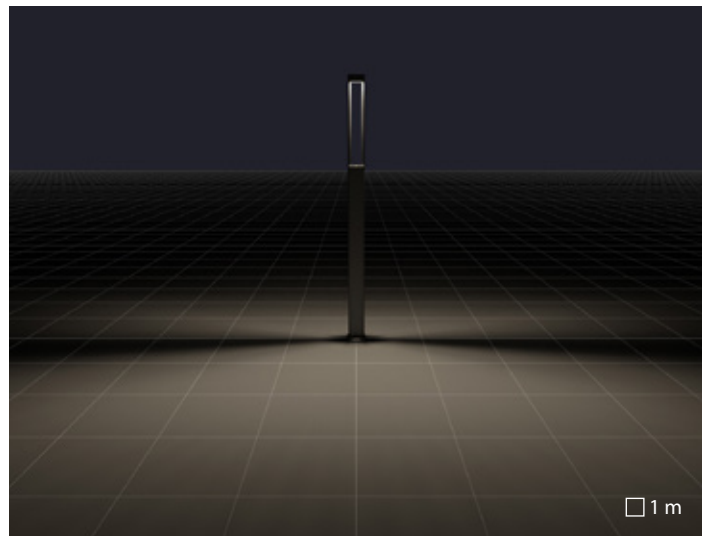

A30/M asymmetric medium reflector

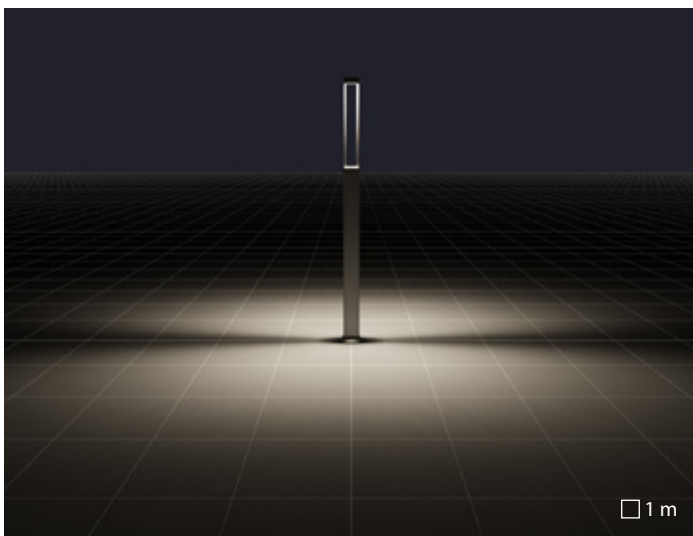

S/W symmetric wide reflector

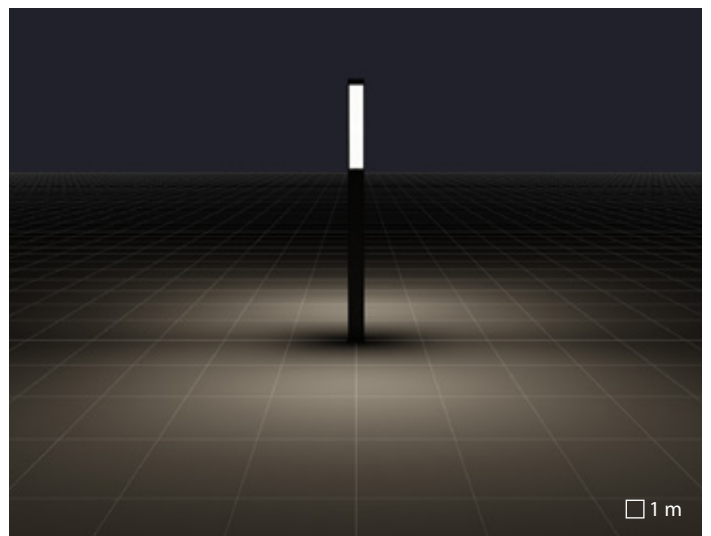

S/EW symmetric extra wide reflector

SYSTEMPARK

Lighting for pathways of all shapes and sizes

We have regenerated the SYSTEMPARK series due to overwhelming specifications and we have upgraded it to perform even better.

The distinctly designed slip fitters allow the different fixtures to be installed using various combinations of heights, angles, and light distributions.

A unique joint system allows different combinations of luminaires to be installed on different heights, including a variety of two different types of fixtures on the same post.

The extremely versatile and diverse system of accessories provided for this product family offers a wide range of lighting solutions for pedestrian areas, city streets, parking lots, and urban areas.

The aesthetics and functionality, economic saving and safeguard of sources, allow sustainable lighting that makes areas more alluring and comfortable without waste or light pollution.





"Città di Lombardia" square | Milan | Italy

SYSTEMPARK

Area and site lighting series. Fixtures consist of:

Construction

- Housing made of extruded aluminium profile or die-cast aluminium, powder coated
- Powder polyester painting process optimised against UV rays in 13 different steps guaranteed ISO9227 against salt spray 1000 hours
- High-transparency polycarbonate lenses grant an optimized light transmission
- Anti-ageing silicone gasket
- Extra clear, tempered, flat glass diffuser
- Stainless steel external screws

Electrical

- Integral surge protection device (SPD) against mains overvoltages up to 10 kV

Installation

- A wide range of accessories are available for floodlight installation in various configurations, ex. wall and post
- For the 210 W versions, "uplight" installation is permitted outdoors only.

Variants

- For other colour temperatures and different colour rendering index consult factory

Listings

- CE
- EAC
- RCM
- Made in Italy

Warranty

- 5-year limited warranty. Complete warranty terms located at www.performanceinlighting.com
- Registered design ®





SQUARE+ 1

SQUARE+ 2

CONSTRUCTION		SQUARE+ 1	SQUARE+ 2
IP		IP66	IP66
IK		IK07 2.4J xx5	IK07 2.4J xx5
Dimensions (mm)		L 267 - H 324 - D 68	L 411 - H 491 - D 95
Windage area	EPA - front	0,013 m ²	0,030 m ²
	EPA - side	0,019 m ²	0,037 m ²
	EPA - top	0,077 m ²	0,177 m ²
Weight		Max 3,71 kg	Max 8,93 kg
Colour		●	●
INSTALLATION			
Pre-wired		✓	✓
Quick		✓	✓
Continuous mounted luminaire		-	-
LED			
Lightsource lumen output	3000 K	-	-
	4000 K	4450 lm ÷ 8900 lm	17800 lm ÷ 26700 lm
Luminaire lumen output	3000 K	-	-
	4000 K	3672 lm ÷ 7545 lm	15013 lm ÷ 22999 lm
CCT - Correlated Color Temperature		4000 K	4000 K
CRI / SDCM (macadam step)		70/3	70/3
Lifetime		L70B10@55000h	L70B10@55000h
ULR<1		✓	✓
CIEn ³ >95		✓	✓
OPTIC			
S/M symmetric medium reflector		S/M	S/M
A50/W asymmetric wide reflector		-	-
A55/W asymmetric wide reflector		A55/W	A55/W
SR/T1 road reflector		SR/T1	-
SR/T2 road reflector		-	SR/T2
SR/T3 road reflector		-	SR/T3
Z/R crosswalks right reflector		Z/R	-
ELECTRICAL			
Wattage		38 W - 73 W	139 W - 210 W
Class		II	II
EEl		-	-
Ta MAX° luminaire		50°C ÷ 40°C	35°C ÷ 25°C
Ta MIN° luminaire		-40°C	-40°C
Dimmable 1-10V		-	-
Dimmable DALI		-	-
COSφ ≥ 0,9		✓	✓
SPD (10kV)		✓	✓
CONTROL SYSTEMS			
Automatic derating		✓	✓
Pilot wire command derating		(on request)	(on request)
Constant light output		(on request)	(on request)

● AN-96 / Anthracite gray / Textured



LINE+ 100

LINE+ 130

LINE+ 160

LINE+ 100	LINE+ 130	LINE+ 160
IP66	IP66	IP66
IK07 3J xx5	IK07 3J xx5	IK07 3J xx5
L 1063 - H 89 - D 90	L 1363 - H 89 - D 90	L 1663 - H 89 - D 90
0,006 m ²	0,006 m ²	0,006 m ²
0,085 m ²	0,116 m ²	0,143 m ²
0,083 m ²	0,114 m ²	0,139 m ²
Max 4,93 kg	Max 5,68 kg	Max 6 kg
●	●	●
-	-	-
-	-	-
-	-	-
4650 lm	6650 lm	8500 lm
4900 lm	7000 lm	8900 lm
2974 lm ÷ 3462 lm	4411 lm ÷ 5300 lm	5141 lm ÷ 5972 lm
3238 lm ÷ 3770 lm	4643 lm ÷ 5579 lm	5462 lm ÷ 6345 lm
3000 K - 4000 K	3000 K - 4000 K	3000 K - 4000 K
70/5	70/5	70/5
L80B10@50000h	L80B10@50000h	L80B10@50000h
✓	✓	✓
✓	✓	✓
-	-	-
A50/W	A50/W	A50/W
-	-	-
-	-	-
SR/T1	SR/T1	SR/T1
SR/T2	SR/T2	SR/T2
-	-	-
34 W	54 W	68 W
II	II	II
-	-	-
40°	35°	30°
-25°	-25°	-25°
-	-	-
-	-	-
✓	✓	✓
✓	✓	✓
-	-	-
-	-	-
-	-	-

SQUARE+ 1



A wide range of accessories are available for floodlight installation in various configurations, ex. wall and post

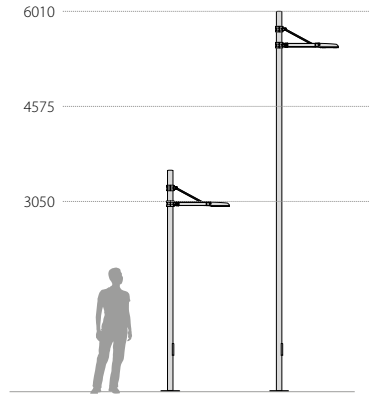

Electrical connection through an IP66 quick external socket-plug connector that makes it possible to connect it to the network without opening the lighting element, made of technopolymer



Complete with supplementary device for protection against network surges of up to 10 kV (DM)

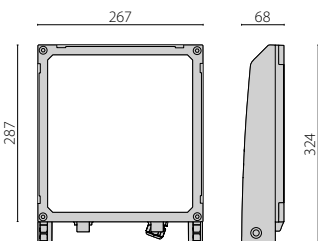

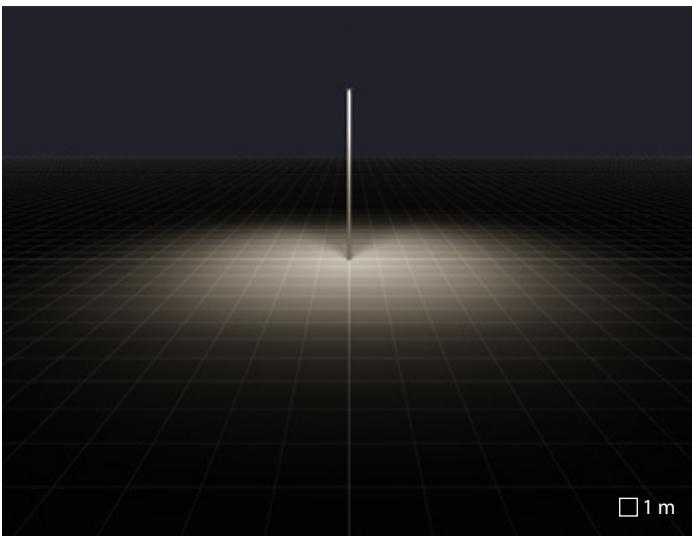

S/M symmetric medium reflector

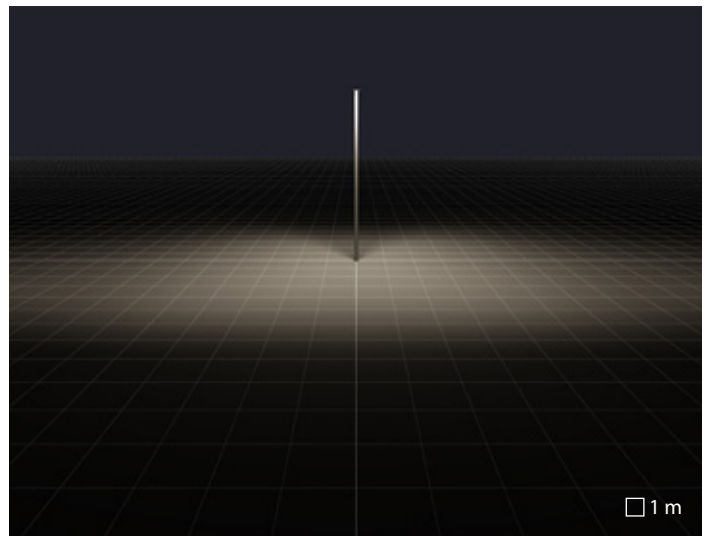

SR/T1 road reflector

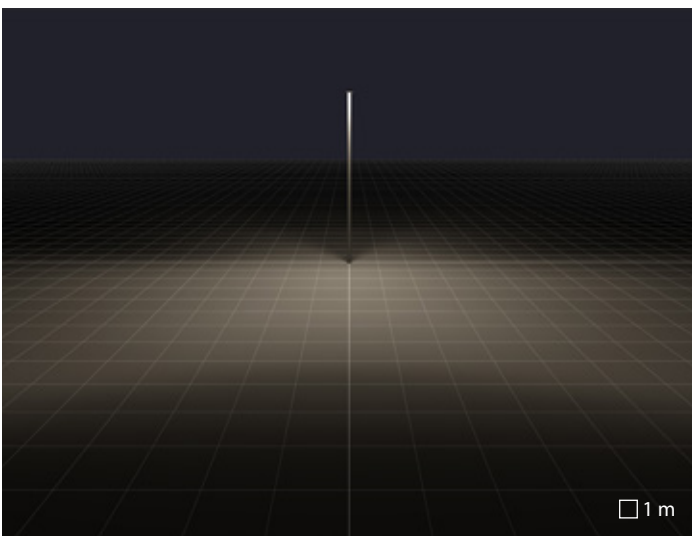

A55/W asymmetric wide reflector

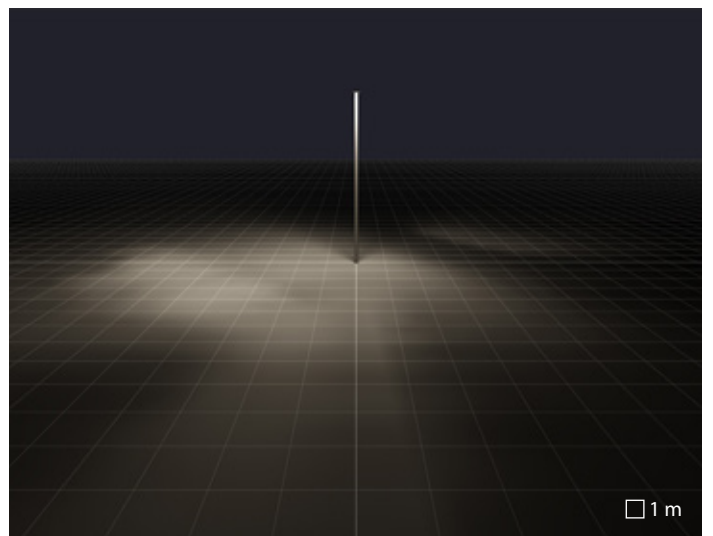

Z/R crosswalks right reflector



"Città di Lombardia" square | Milan | Italy

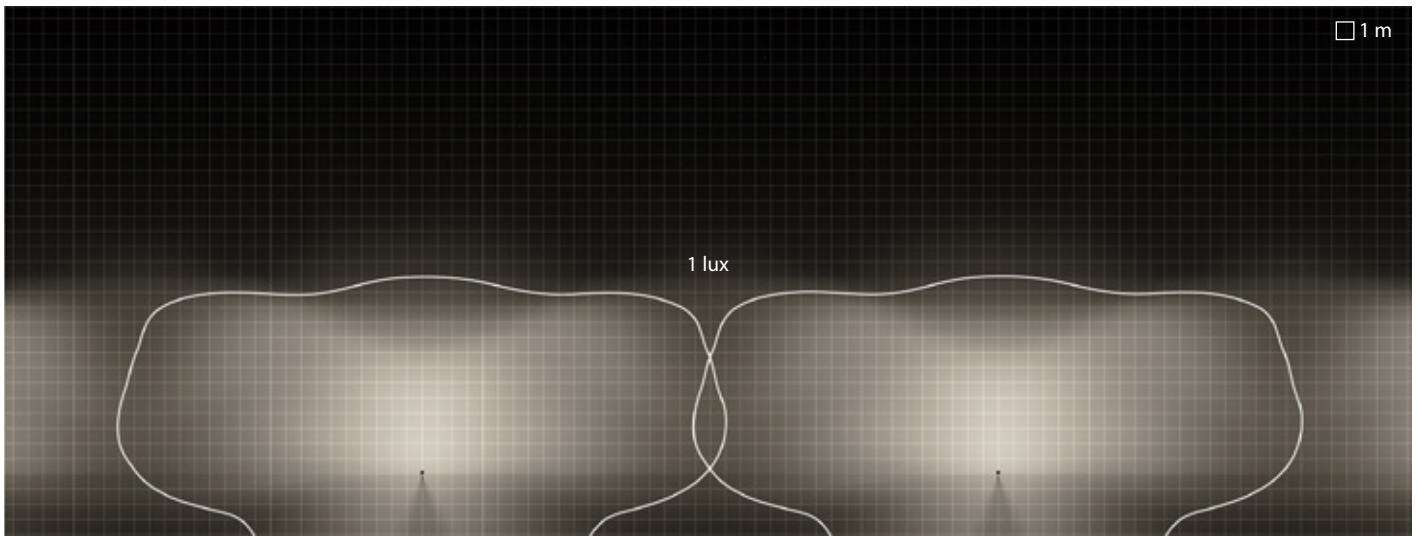

SQUARE+ 1 (73 W) | A55/W | linear

Luminaire spacing = 38m
 Path depth = 13m
 Mounting height = 6m

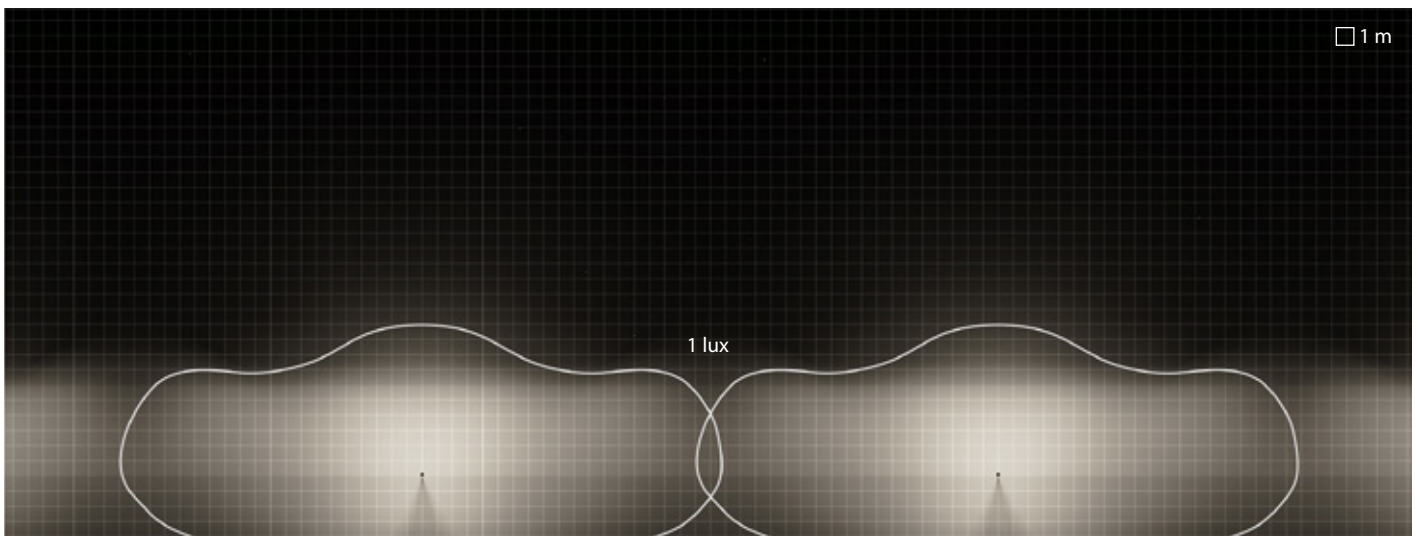

SQUARE+ 1 (73 W) | SR/T1 | linear

Luminaire spacing = 38m
 Path depth = 6m
 Mounting height = 6m

SQUARE+ 2



A wide range of accessories are available for floodlight installation in various configurations, ex. wall and post

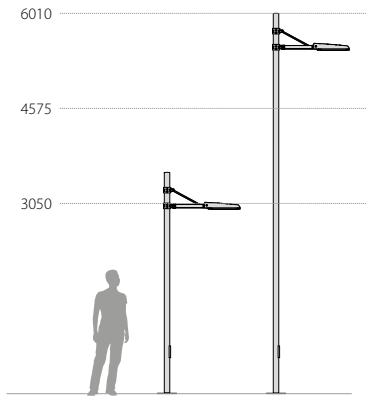

Electrical connection through an IP66 quick external socket-plug connector that makes it possible to connect it to the network without opening the lighting element, made of technopolymer



Complete with supplementary device for protection against network surges of up to 10 kV (DM)

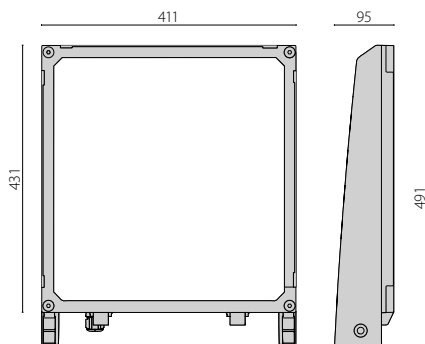

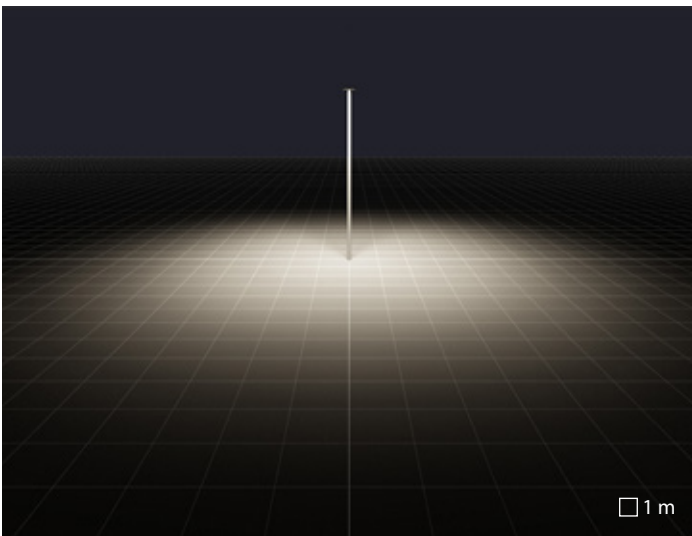

S/M symmetric medium reflector

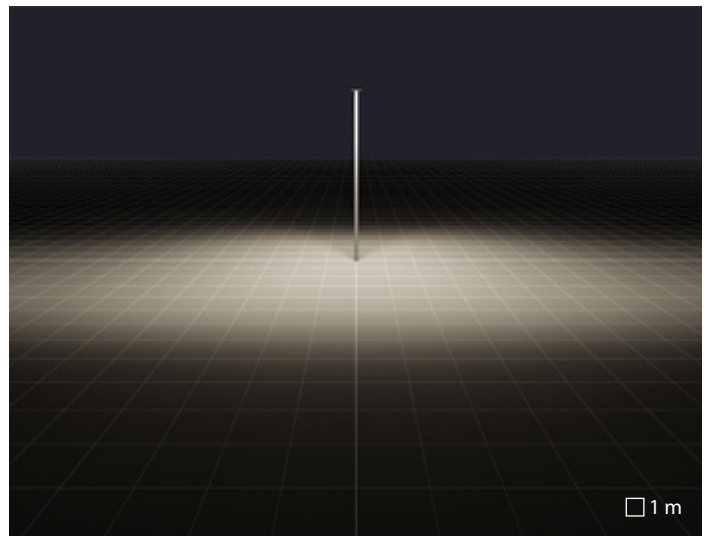

SR/T2 road reflector

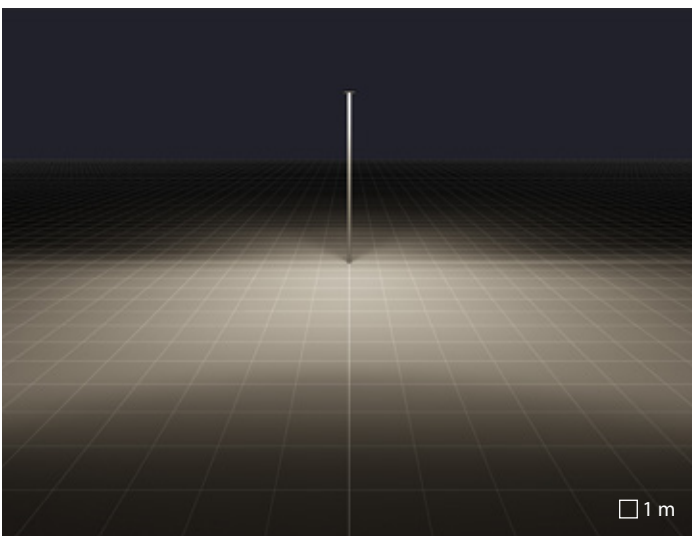

A55/W asymmetric wide reflector

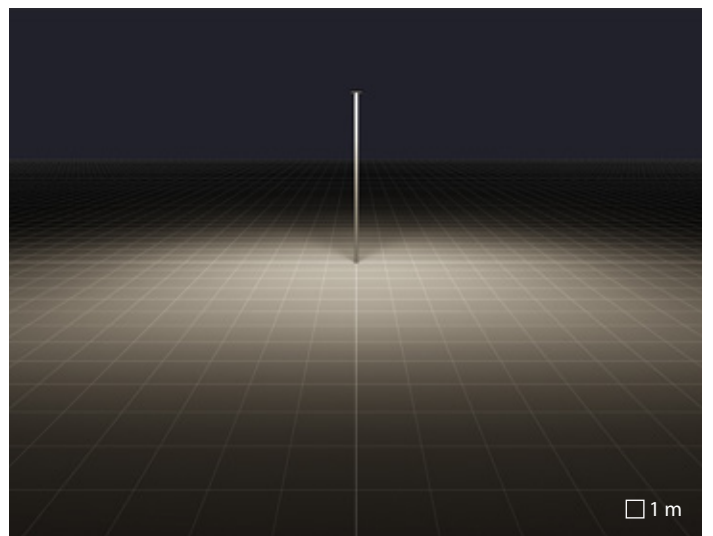

SR/T3 road reflector



"Città di Lombardia" square | Milan | Italy

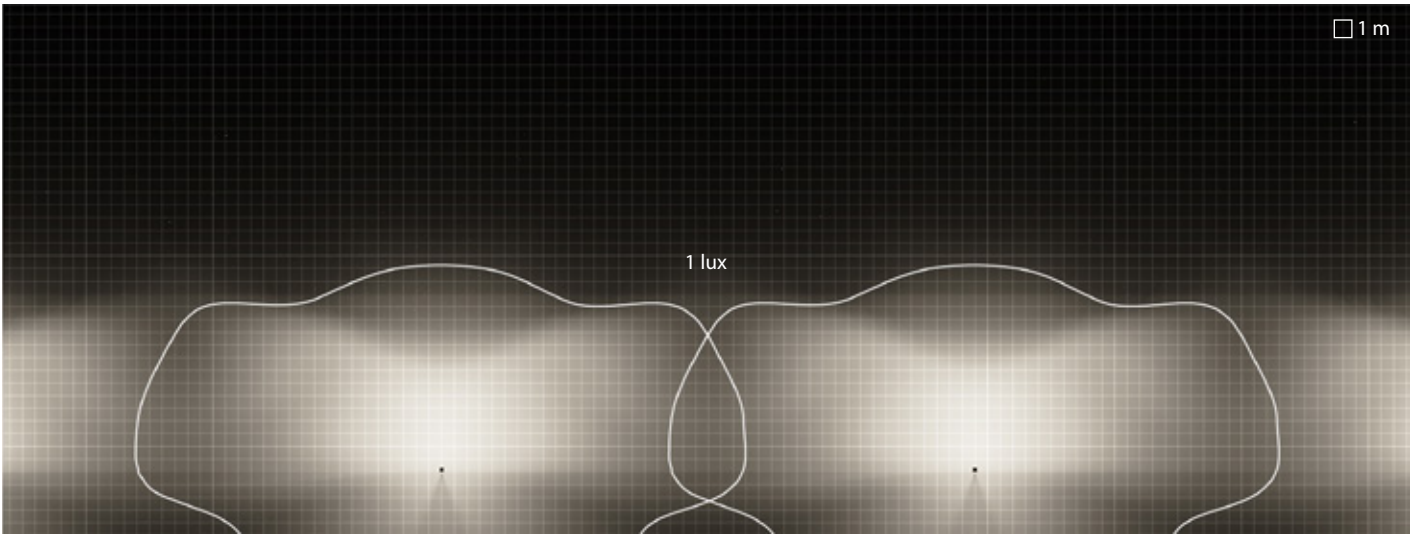

SQUARE+ 2 (210 W) | A55/W | linear

Luminaire spacing = 42m
 Path depth = 14m
 Mounting height = 6m

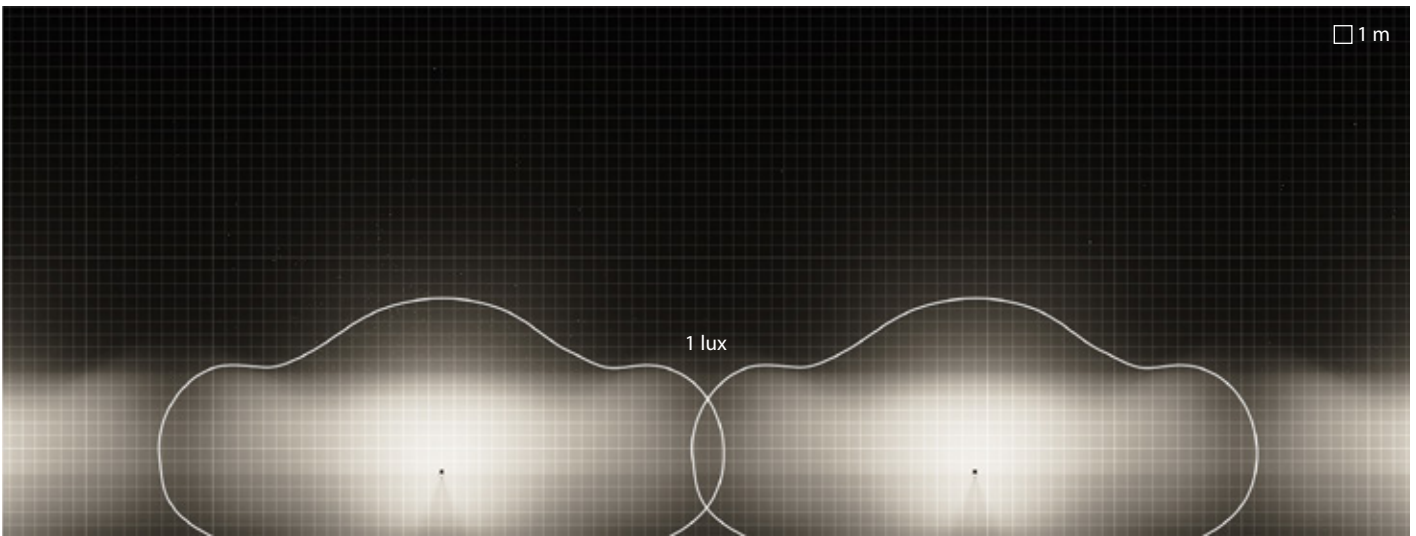

SQUARE+ 2 (210 W) | SR/T2 | linear

Luminaire spacing = 42m
 Path depth = 8m
 Mounting height = 6m

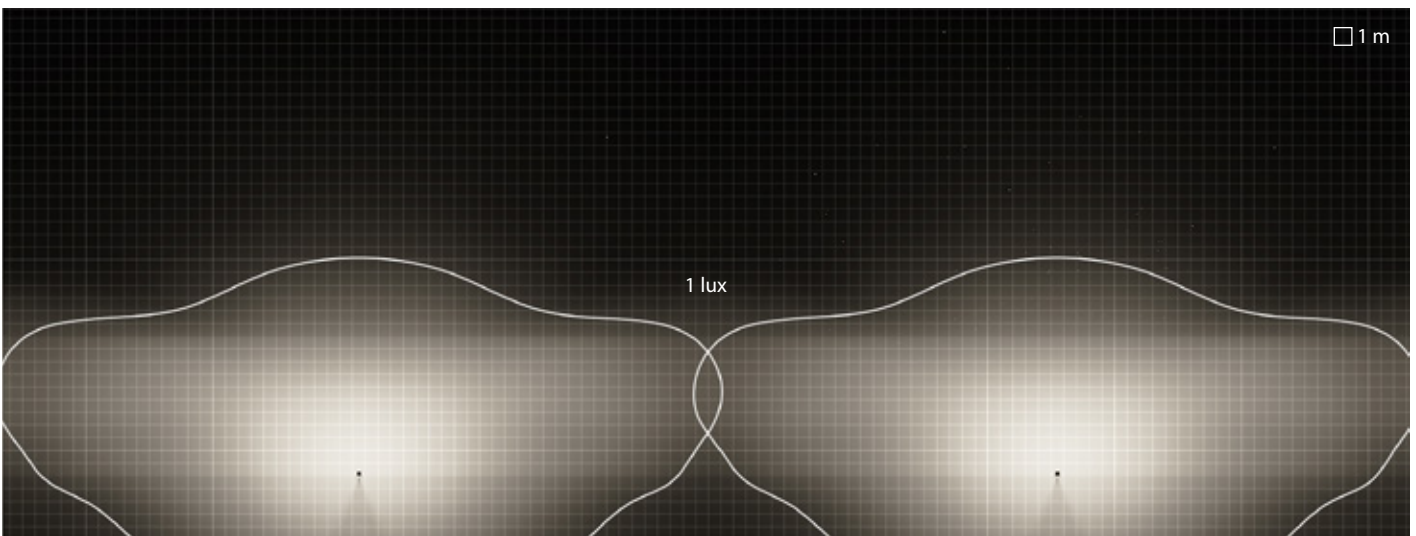

SQUARE+ 2 (210 W) | SR/T3 | linear

Luminaire spacing = 55m
 Path depth = 11m
 Mounting height = 6m

SQUARE+ | SYSTEMPARK

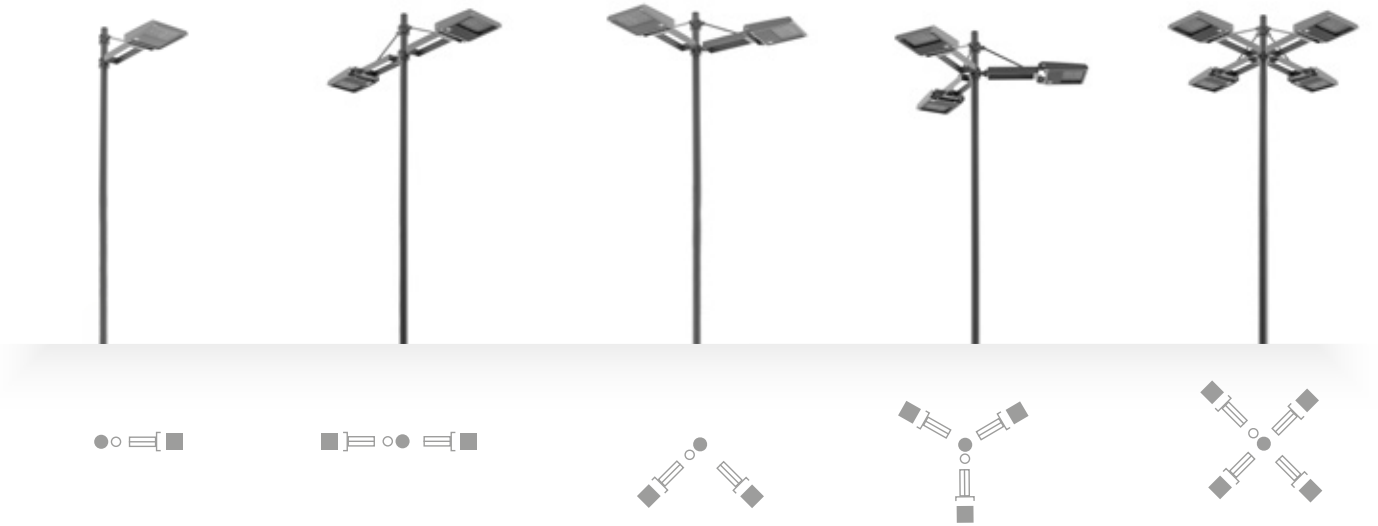

SQUARE+ 1 / 2 SYSTEMPARK

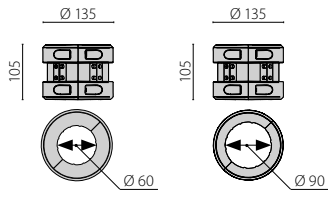

SQUARE+ 1

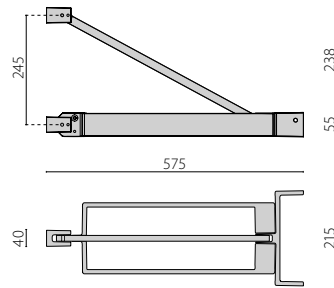

SQUARE+ 2

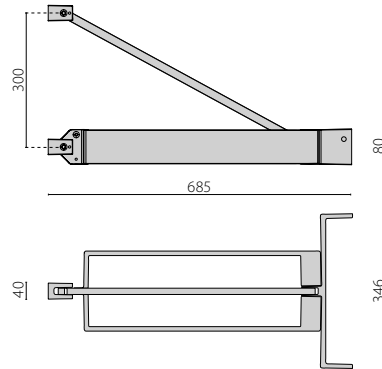

In order to allow for the use of lenses in typical urban settings (parks, gardens, pedestrian areas, squares, parking areas, etc.), the SYSTEMPARK+ range of accessories is available. They offer a range of stainless steel posts and painted aluminium arms that make it possible to solve a variety of installation requirements

SQUARE+ | SOLUTION

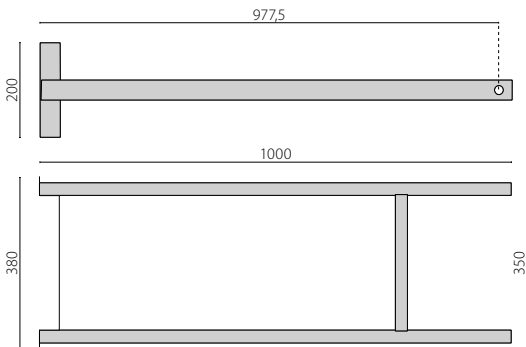
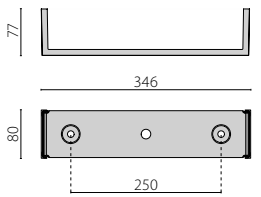
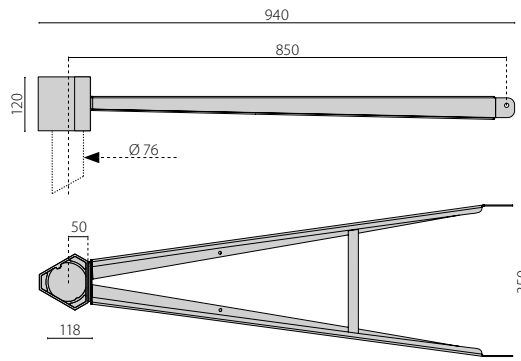
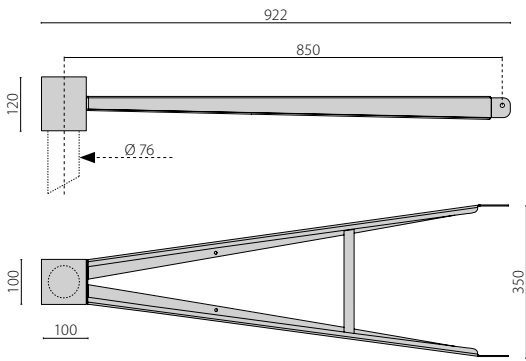
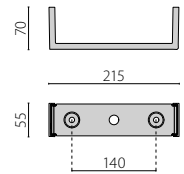
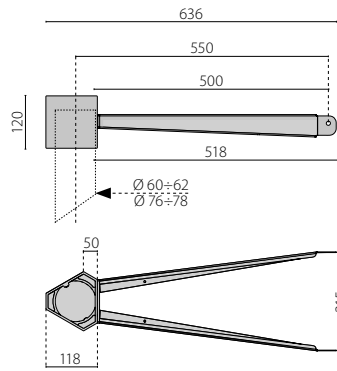
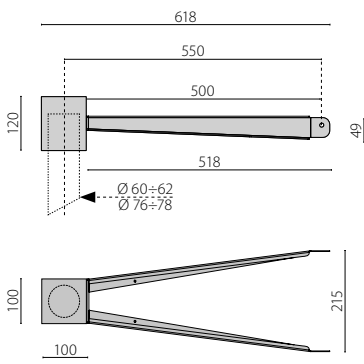
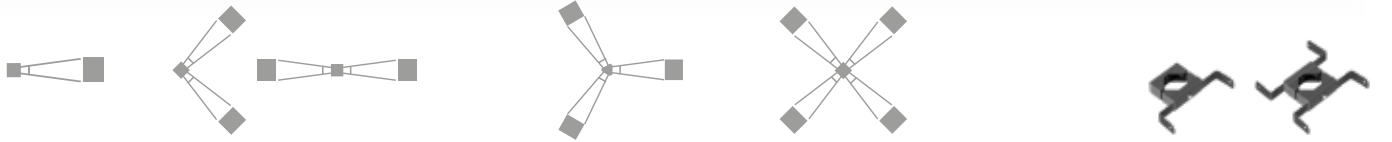
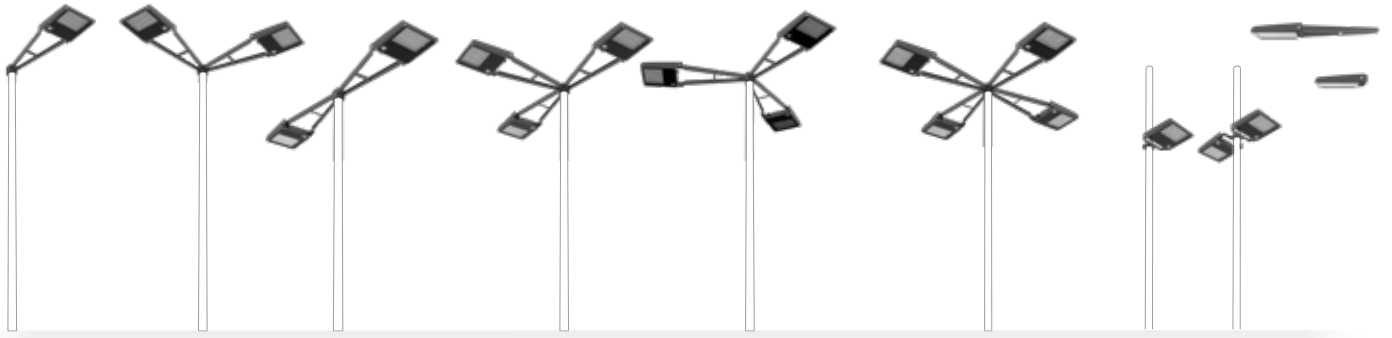

LINE+



Specially designed slip fitters allow different combinations of height and angle on post up to four different configurations at one level



LINE+ is available in three different lengths, slim in profile to provide a clean, minimal visual impact

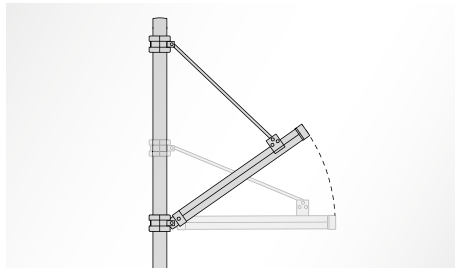

LINE+ can be tilted at various angles after installation by simply changing the location of the top collar

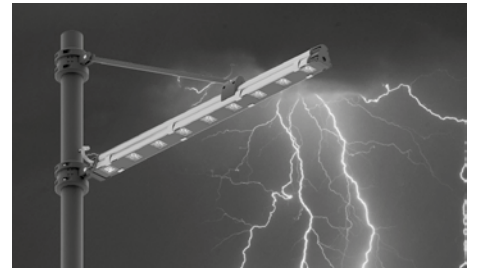

Complete with supplementary device for protection against network surges of up to 10 kV (DM)



A wide range of accessories are available for floodlight installation in various configurations, ex. wall and post

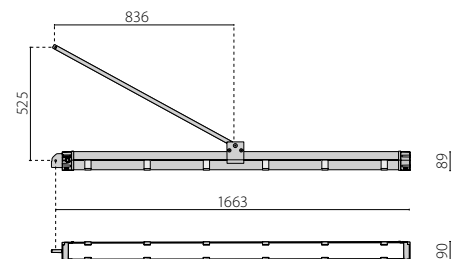
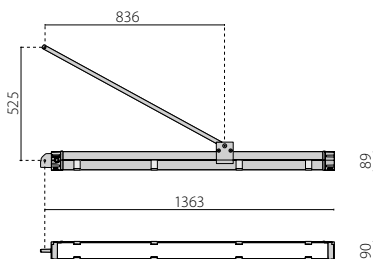
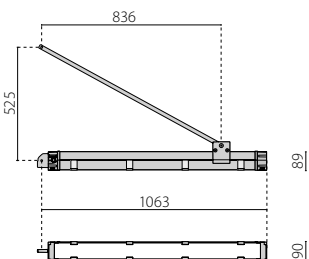

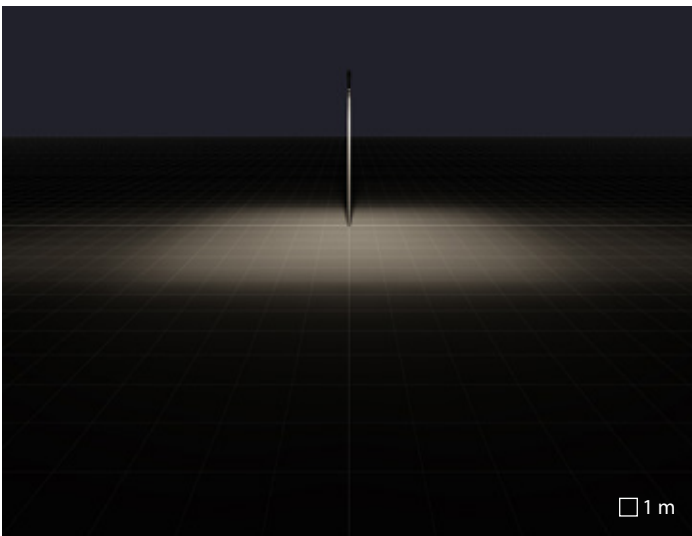

SR/T1 road reflector

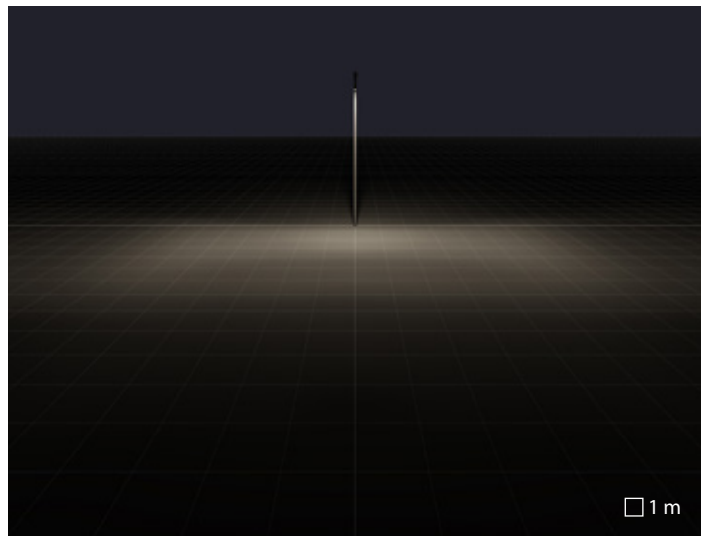

SR/T2 road reflector

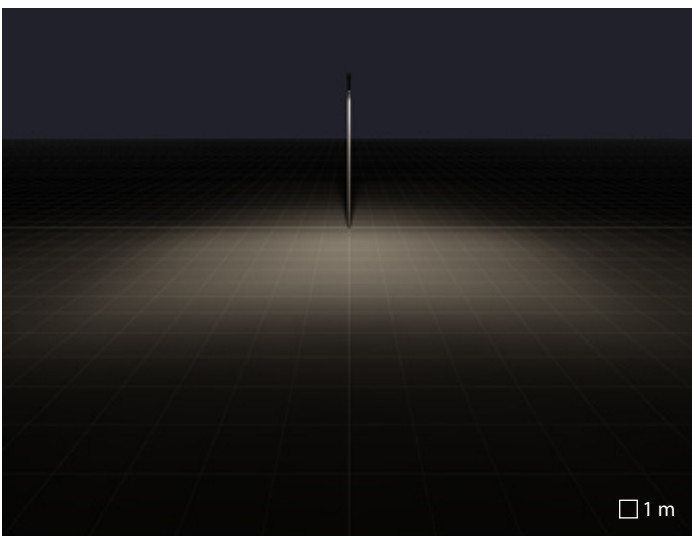

A50/W asymmetric wide reflector



Stone italiana headquarters | Verona | Italy

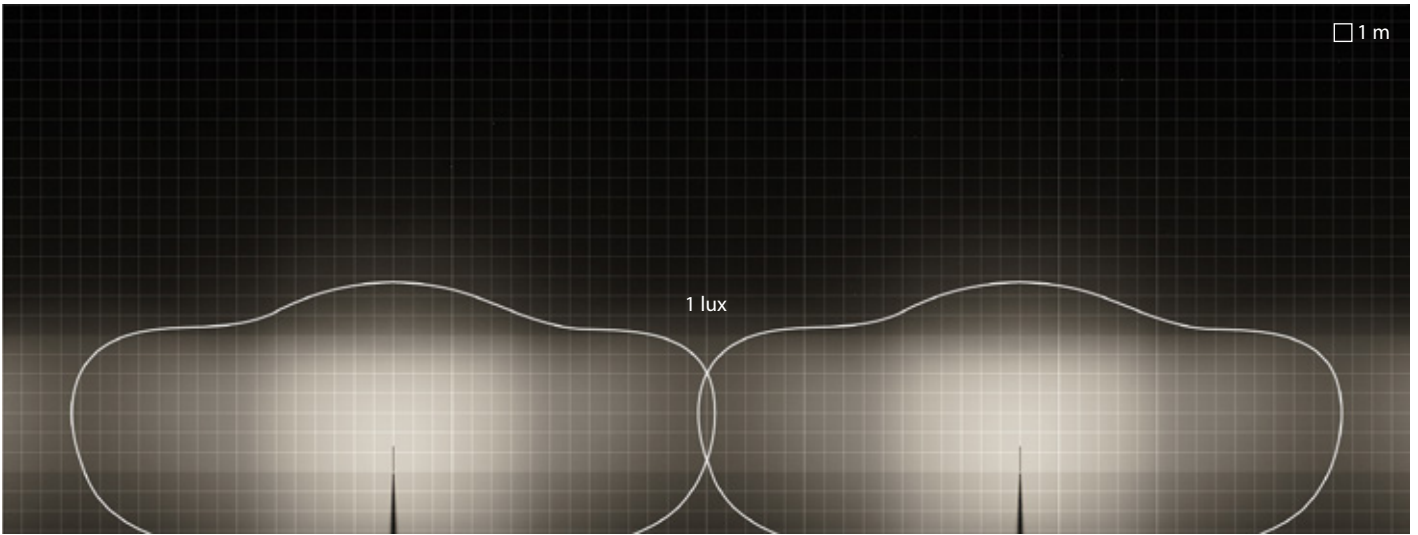

LINE+ | A50/W | linear

Luminaire spacing = 31m
 Path depth = 10m
 Mounting height = 5.5m

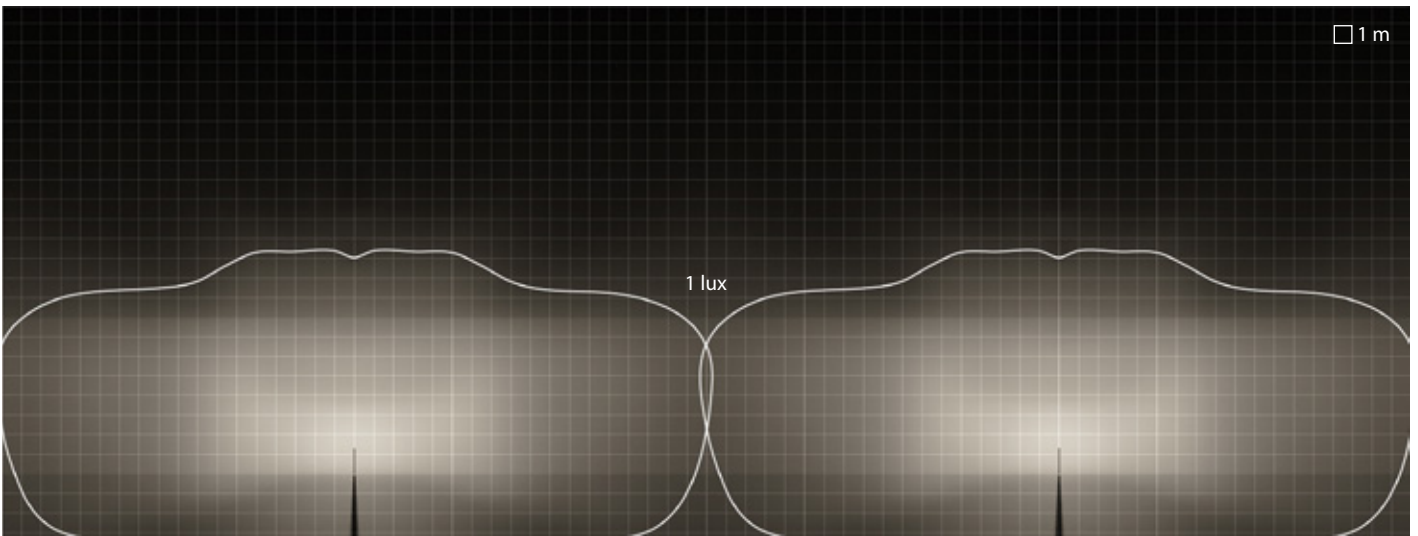

LINE+ | SR/T1 | linear

Luminaire spacing = 32m
 Path depth = 7m
 Mounting height = 5.5m

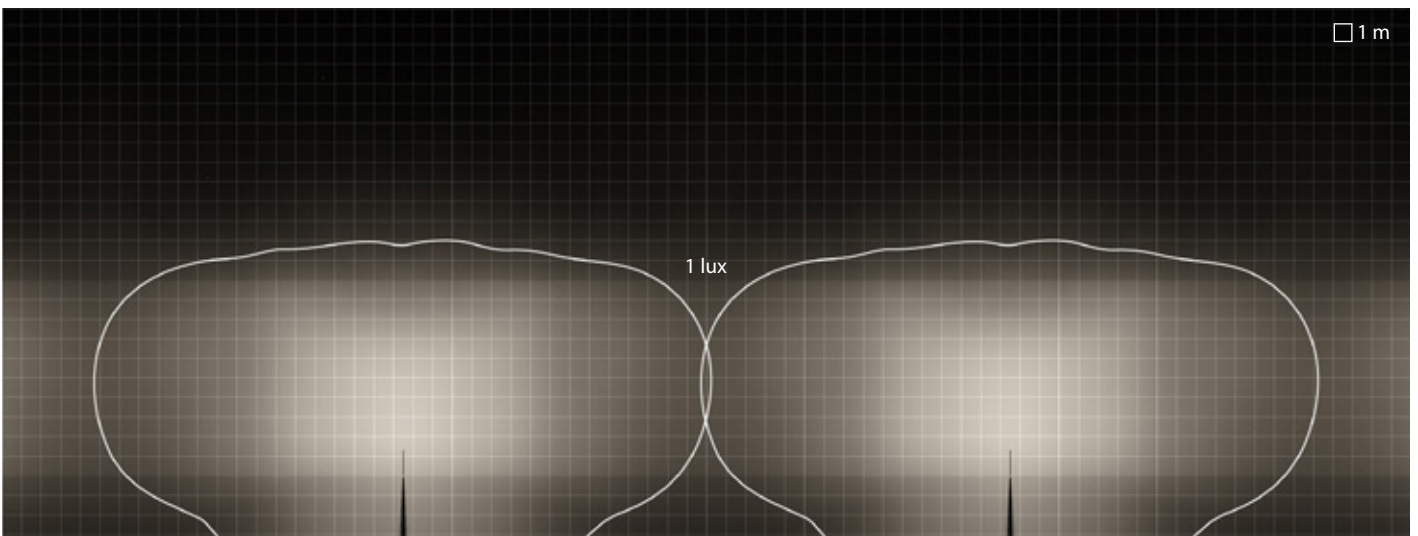

LINE+ | SR/T2 | linear

Luminaire spacing = 36m
 Path depth = 8m
 Mounting height = 5.5m

LIGHT ONLY WHERE NEEDED

PERFORMANCE IN LIGHTING designs and produces unique street optics to match the latest legislative and regulatory developments. The primary objective of these optics is to use the light only where needed. These optics, based on field experience, are based on the central feature that differentiates all the projects: the ratio between luminaire installation height (H) and the distance between the centre of gravity of the same and the limit of the roadway (L). The name of the different street optics (SR), therefore expresses this ratio (L/H).

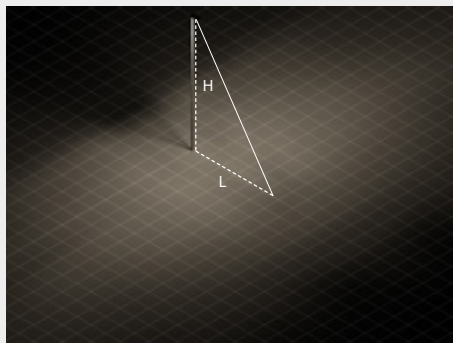

SR/075
 $L/H = 0.75$ ($0.5 \leq L/H \leq 0.875$)

Cycle and pedestrian pathways

This type of path, often not adjacent to a road, requires dedicated lighting. The width is between 1.5 and 3 meters, and the height of the supports is between 3 and 4 meters. In this type of high plant ratios between distance and height of the poles are required. Given the low L/H ratio, the SR/075 optics are the most suitable. They are designed to guarantee, in pedestrian and cycle applications, relationships between distance and height up to seven with consequent cost reduction.

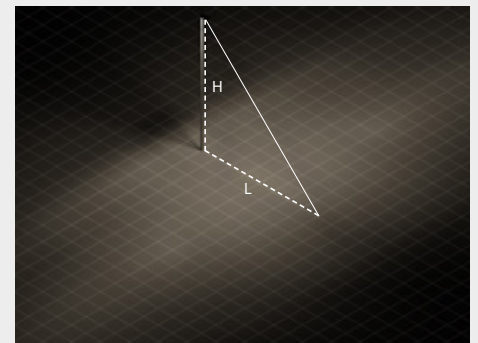

SR/100
 $L/H = 1.00$ ($0.875 \leq L/H \leq 1.125$)

New installations

The choice for the appropriate optics for improving the efficiency of an old plant is limited by the existing supports that are generally maintained. They are constrained to the height and distance. On the other hand, in new installations, it is possible to optimise the system parameters containing the number of light points. In these cases, the most indicated optics is the SR/100. Given that in such systems it is good practice to choose the height of the poles to obtain an L/H ratio of about 1 and because it allows reaching an inter-distance up to 4.5 times the height of the supports.

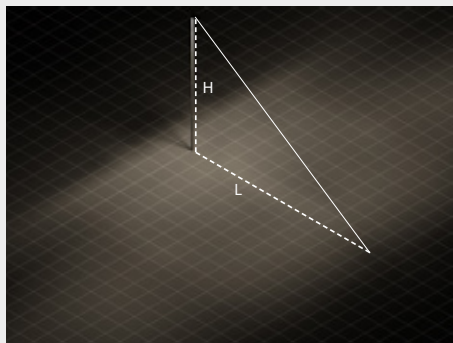

SR/125
 $L/H = 1.25$ ($1.125 \leq L/H \leq 1.375$)

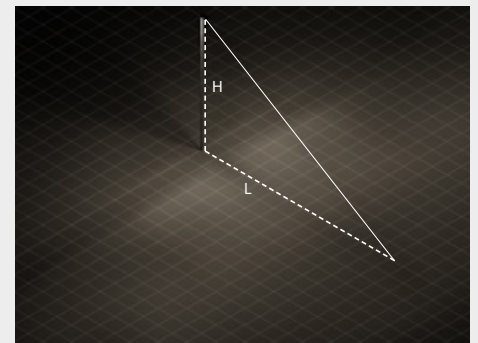

SR/150
 $L/H = 1.50$ ($1.375 \leq L/H \leq 1.625$)

Crossings and intersections

Even if the width of the roadway is higher supports of the same height of the road are typically used for crossroads and intersections. Statistically, this is the places where street accidents happen most often and therefore, the current regulations, in these types of plant, provide additional requirements. These plants have a medium-high L/H ratio, and the SR/125 is the best solution. The type of emission with functional frontal asymmetry ensures the vertical illuminance values required to increase driver safety.

Large areas

In the lighting of large areas, the positioning of the poles is very restricted. Luminaires in car parks, for example, can only be installed at the intersections of the lines delimiting the parking spaces or, in some cases, exclusively along the perimeter. SR/150, with high frontal emission, is the most suitable solution for this type of application. It guarantees the levels of uniformity required by the regulations in force using a reduced number of poles.

KREOS

The quality light smart cities deserve

KREOS, future of “krei” (to create) in the Esperanto language, is a desire to quickly construct from ground up today the smart city of tomorrow. Thanks to the experience gained with projects worldwide, PERFORMANCE iN LIGHTING developed this series with new proprietary optics, made with premium silver-plated reflectors. Three crucial criteria were considered when designing the KREOS: energy saving, by distributing light “only where needed”; visual comfort, guaranteed by reduced level of glare and intrusive light; versatility, met with a set of lighting solutions to adapt to the diverseness of existing plants. On new projects, an optimized inter-distance allows fewer luminaires to be used, thus reducing installation, maintenance and operating costs.

The series meets the needs of future cities through NEMA and Zhaga Book 18 protocols and interfaces for wireless remote control systems, opening to all future developments of the Internet of Things (IoT) and connected cities. Hence, each public administration can use its management system and platforms to forecast additional expansions in smart cities.





Polanco Road | Otura - Granada | Spain

KREOS

Street light series. Fixtures consist of:

Construction

- Die-cast aluminium housing and cap, chemical pre-treated and painted polyester powder coating ISO 9227
- Removable galvanized sheet metal gear tray
- Pure aluminium high-performance reflectors, polished, oxidised, PVD 99.99% silver treated. This treatment creates a surface with greater than 97% reflectance and iridescence-free
- High resiliency anti-ageing silicone gasket with high elastic return capacity
- Extra clear, tempered, flat glass diffuser
- Stainless steel external screws
- Painted die-cast aluminium pole-top adaptor for pole Ø 60 / 76 mm

Electrical

- Integral surge protection device (SPD) against mains overvoltages up to 10 kV
- NEMA versions are complete with NEMA SOCKET connected to DALI drivers and a waterproof short-circuit cap allowing the on-off operation of the luminaire. These versions are designed for mounting SMART-compatible solutions
- The ZHAGA versions are complete with ZHAGA SOCKET positioned on the upper part of the fixture (UP position) and D4i driver. They are installation ready for "Radio Frequency node" solutions, twilight sensors and other types of compatible sensors.

Installation

- Switch splitter automatically disconnects the power supply when the cable cover is opened
- Die-cast aluminium retaining clip with stainless steel spring allows quick and tool-free access to the fixture for extraordinary maintenance
- Complete with 1 meter H07RN-F 2x1.5 mm² or H07RN-F 4x1.5 mm² cable for dimmable versions, which allows connection to the mains without opening the luminaire
- Suitable for pole-tops Ø 60 / 76 mm

Variants

- For other colour temperatures and different colour rendering index consult factory
- CLO (Constant light output) option available. Consult factory
- Upon request, fixtures can be provided with ZHAGA SOCKET positioned in the lower part of the fixture (DOWN position) or mixed (UP position + DOWN position) to be able to connect presence and/or motion detectors or combined solutions

Listings

- CE
- EAC
- RCM
- ENEC pending
- Compliant with the UNI 10819 standards on light pollution
- Complies with CAM for public lighting fixtures
- Made in Italy

Warranty

- 5-year limited warranty. Complete warranty terms located at www.performanceinlighting.com
- Registered trademark ®
- Registered design ®





KREOS

CONSTRUCTION		
IP		IP66
IK		IK08 9J xx5
Dimensions (mm)		L 536 x H 229 (268 NEMA) x D 300
Windage area	EPA - front	0,0147 m ²
	EPA - side	0,047 m ²
	EPA - top	0,022 m ²
Weight		Max 6,45 kg
Colour		●
INSTALLATION		
Pre-wired		✓
Quick		✓
Continuous mounted luminaire		-
LED		
Lightsource lumen output	3000 K	1875 lm ÷ 12125 lm
	4000 K	1965 lm ÷ 12707 lm
Luminaire lumen output	3000 K	1417 lm ÷ 9410 lm
	4000 K	1485 lm ÷ 9862 lm
CCT - Correlated Color Temperature		3000 K - 4000 K (2700 K on request)
CRI / SDCM (macadam step)		70/5
Lifetime		L90B10@100000h
ULR<1		✓
CIEn ³ >95		✓
OPTIC		
SR/075 road reflector		SR/075
SR/100 road reflector		SR/100
SR/125 road reflector		SR/125
SR/150 road reflector		SR/150
ELECTRICAL		
Wattage		12 W - 16 W - 24 W - 34 W - 35 W 44 W - 53 W - 63 W - 82 W
Class		II
EEL		-
Ta MAX° luminaire		40° C ÷ 50° C
Ta MIN° luminaire		-40°C
Dimmable 1-10V		(on request)
Dimmable DALI		✓
COSφ ≥ 0,9		✓
SPD (10kV)		✓
CONTROL SYSTEMS		
Automatic derating		✓
Pilot wire command derating		(on request)
Constant light output		(on request)
NEMA socket		✓
ZHAGA book 18 socket		✓

● AN-96 / Anthracite gray / Textured



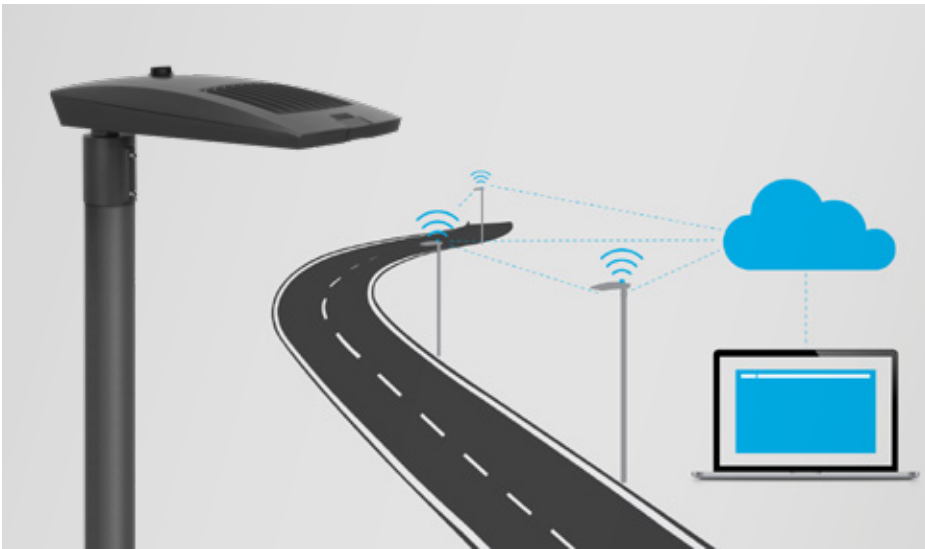

The ZHAGA versions are complete with ZHAGA SOCKET positioned on the upper part of the fixture (UP position) and D4i driver. They are installation ready for "Radio Frequency node" solutions, twilight sensors and other types of compatible sensors



Flat extra clear tempered glass diffuser



Removable galvanized sheet metal gear tray



Painted die-cast aluminium pole-mounting joint for pole Ø 60 mm or 76 mm

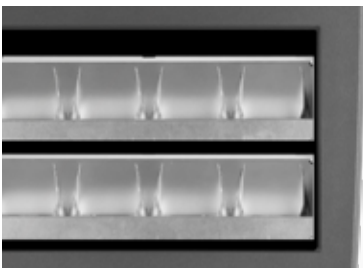

Very high performance reflectors made of very pure aluminium, polished and oxidized with successive PVD 99.99% silver treatment. This creates a surface with greater than 97% reflectance and free of iridescence



Complete with supplementary device for protection against network surges of up to 10 kV (DM)



NEMA versions are complete with NEMA SOCKET connected to DALI dimmer capable drivers and a watertight short-circuit cap that allows the on-off operation of the luminaire. These versions are designed for mounting SMART-compatible solutions.

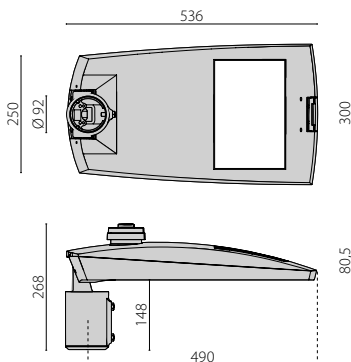
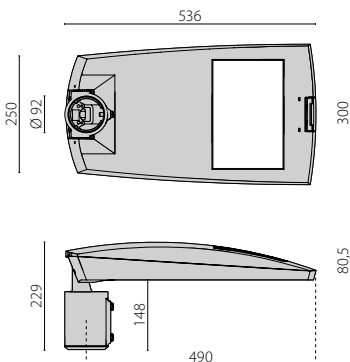

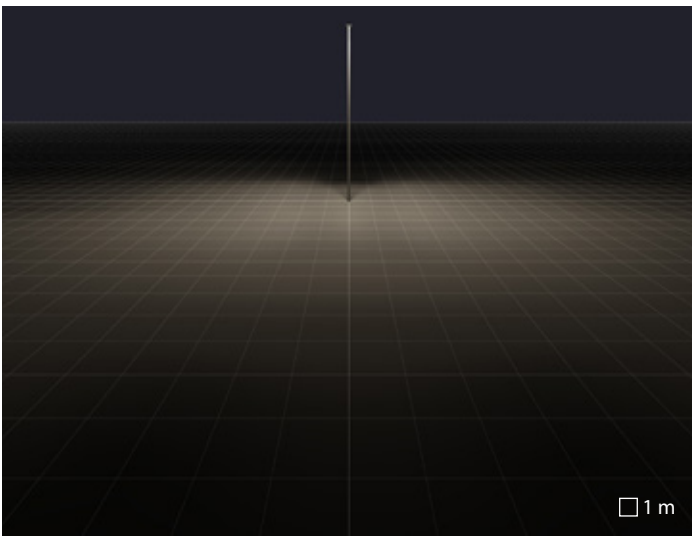

SR/075 road reflector

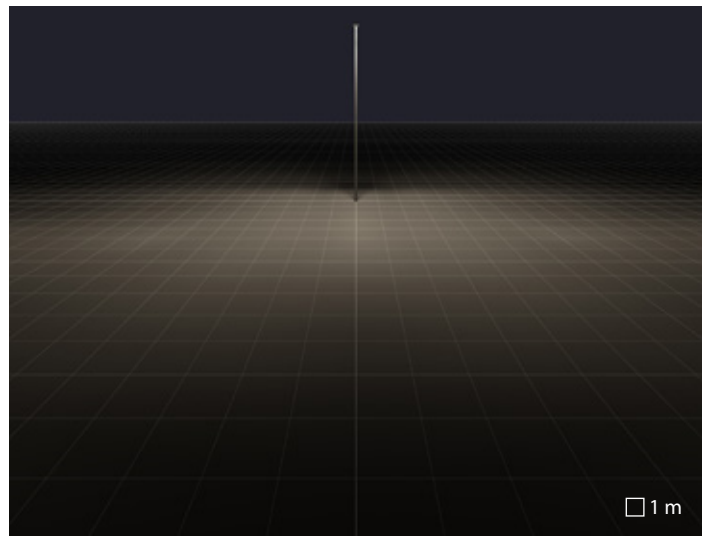

SR/100 road reflector

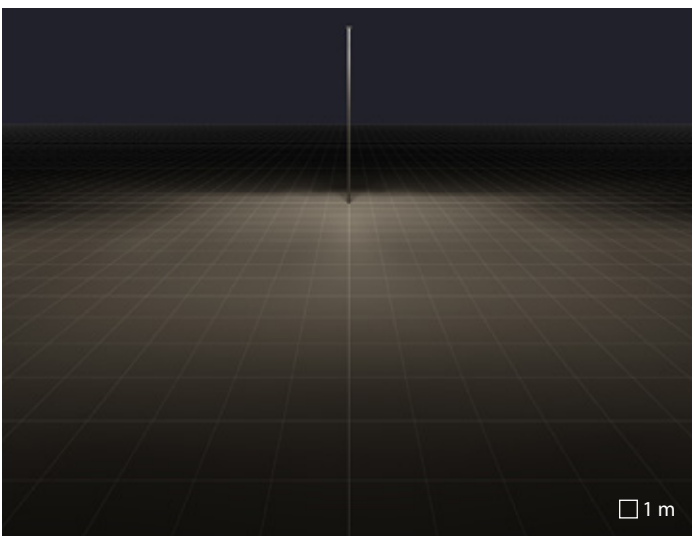

SR/125 road reflector

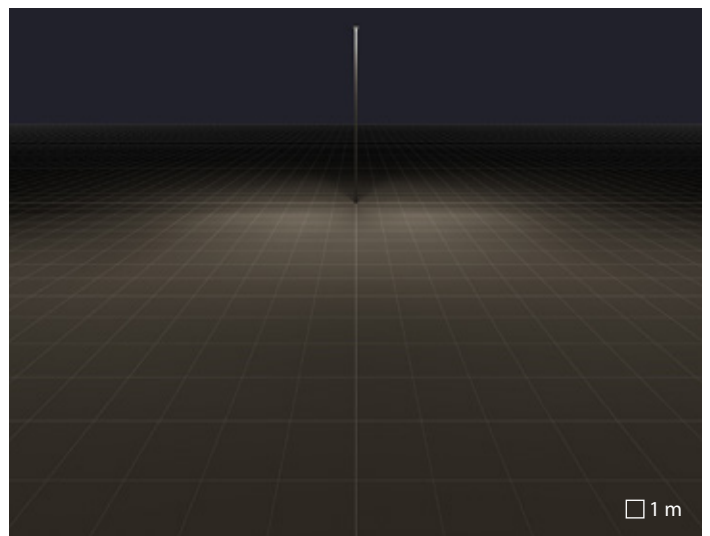

SR/150 road reflector

THEOS

design Silvia Paola Pennacchio

Exceptional, that's it!

The base of every being and happening. The principle that shines through with necessary clarity in all things and world facts. "It is theós!", Euripides wrote more than two thousand years ago. So, from these distant roots, a concept for the design is given birth to satisfy the most different requirements, going from the illumination of a great metropolis to the development of a small town.

The large dorsal fins optimize the heat exchange with the surrounding environment, favoring their dissipation. Moreover, their arrangement, combined with the geometry of the body, support the outflow of rainwater avoiding dangerous stagnation and dirt receptacles that could, over time, affect its thermal performance.

THEOS GLASS provides the city light designer versatile lighting solutions while it ensures at the same time reduced costs of installation and maintenance. The availability of different light distribution and installation types, of an array of materials and sizes of luminaires, makes this series a comprehensive tool to plan the illumination of the city of tomorrow.





Avenida de Andalucía Road | Málaga | Spain

THEOS

design Silvia Paola Pennacchio

Series of LED street lighting luminaires, in two sizes, comprising:

Construction

- Die-cast aluminium housing, powder-polyester coated ISO 9227
- High-transparency polycarbonate lenses grant an optimized light transmission
- High resiliency anti-ageing silicone gasket with high elastic return capacity
- Extra clear, tempered, flat glass diffuser
- Die-cast aluminium trim ring, polyester-powder painted after chemical surface treatment, fully integrated and hinged to the housing
- Stainless steel external screws
- Painted die-cast aluminium pole-top adaptor for pole Ø 60 / 76 mm

Electrical

- Integral surge protection device (SPD) against mains overvoltages up to 10 kV
- The "SECURE LIGHT DISTRIBUTION" system guarantees uniform light distribution even in the remote case of LED failures
- NEMA versions are complete with NEMA SOCKET connected to DALI dimmer capable drivers and a watertight short-circuit cap that allows the on-off operation of the luminaire. These versions are designed for mounting SMART-compatible solutions

Installation

- Complete with 1 meter H07RN-F 2x1.5 mm² or H07RN-F 4x1.5 mm² cable for dimmable versions, which allows connection to the mains without opening the luminaire
- Suitable for pole-tops Ø 60 / 76 mm.
- It is possible to replace the LED boards to keep the luminaire technologically updated through the years (consult factory).

Variants

- Dimmable ballast available. Consult factory
- For other colour temperatures and different colour rendering index consult factory
- Consult factory for 7-pin NEMA socket options for external control systems connection
- CLO (Constant light output) option available. Consult factory

Listings

- CE
- EAC
- RCM
- ENEC
- Compliant with the UNI 10819 standards on light pollution
- Complies with CAM for public lighting fixtures
- Made in Italy

Warranty

- 5-year limited warranty. Complete warranty terms located at www.performanceinlighting.com
- Registered trademark ®
- Registered design ®





THEOS GLASS MINI

THEOS GLASS

CONSTRUCTION			
IP		IP66	IP66
IK		IK08 6J xx5	IK08 9J xx5
Dimensions (mm)		L 506 x H 193 x D 280	L 696 x H 193 x D 315
Windage area	EPA - front	0,020 m ²	0,023 m ²
	EPA - side	0,039 m ²	0,063 m ²
	EPA - top	0,109 m ²	0,173 m ²
Weight		Max 6,68 kg	Max 9,55 kg
Colour		●	●
INSTALLATION			
Pre-wired		✓	✓
Quick		-	-
Continuous mounted luminaire		-	-
LED			
Lightsource lumen output	3000 K	2806 lm ÷ 10182 lm	15273 lm ÷ 20364 lm
	4000 K	2940 lm ÷ 10863 lm	16294 lm ÷ 21726 lm
Luminaire lumen output	3000 K	2570 lm ÷ 9328 lm	13586 lm ÷ 19284 lm
	4000 K	2656 lm ÷ 9635 lm	14034 lm ÷ 19920 lm
CCT - Correlated Color Temperature		3000 K - 4000 K	3000 K - 4000 K
CRI / SDCM (macadam step)		70/3	70/3
Lifetime		L90B10@100000h	L90B10@100000h
ULR<1		✓	✓
CIEn ³ >95		✓	✓
OPTIC			
SR/075 road reflector		SR/075	SR/075
SR/100 road reflector		SR/100	SR/100
SR/125 road reflector		SR/125	SR/125
SR/150 road reflector		SR/150	SR/150
ELECTRICAL			
Wattage		19 W - 35 W - 46 W - 58 W - 71 W	104 W - 136 W
Class		II	II
EEL		-	-
Ta MAX° luminaire		55°	55° ÷ 50°
Ta MIN° luminaire		-40°	-40°
Dimmable 1-10V		-	-
Dimmable DALI		✓	✓
COSφ ≥ 0,9		✓	✓
SPD (10kV)		✓	✓
CONTROL SYSTEMS			
Automatic derating		✓	✓
Pilot wire command derating		(on request)	(on request)
Constant light output		(on request)	(on request)
NEMA socket		✓	✓

● AN-96 / Anthracite gray / Textured



Parking + Street | Pedrengo | Italy

THEOS GLASS MINI / THEOS GLASS

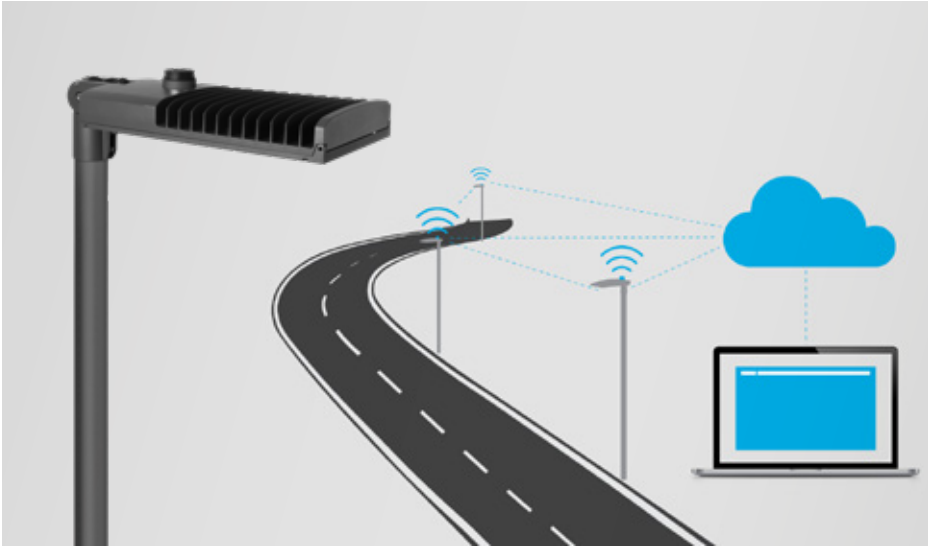

NEMA versions are complete with NEMA SOCKET connected to DALI dimmer capable drivers and a watertight short-circuit cap that allows the on-off operation of the luminaire. These versions are designed for mounting SMART-compatible solutions.

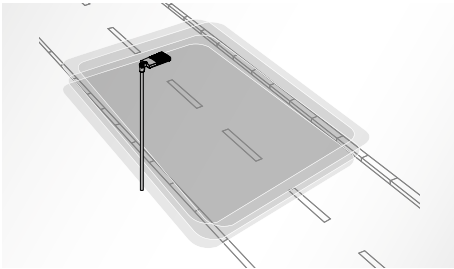

The "SECURE LIGHT DISTRIBUTION" system guarantees uniform light distribution even in the remote case of LED failures



Complete with 1 meter H07RN-F 2x1.5 mm² or H07RN-F 4x1.5 mm² cable for dimmable versions, which allows connection to the network without opening the luminaire



Painted die-cast aluminium pole-mounting joint for pole Ø 60 mm or 76 mm



Flat extra clear tempered glass diffuser



Complete with supplementary device for protection against network surges of up to 10 kV (DM)

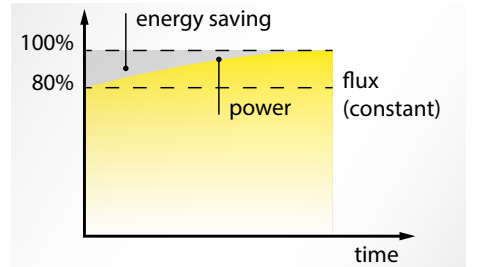

CLO (Constant light output) option available. Consult Factory

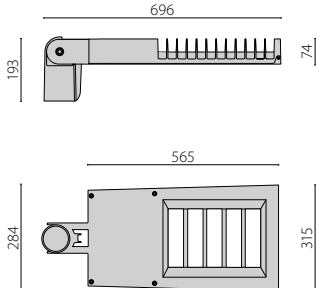
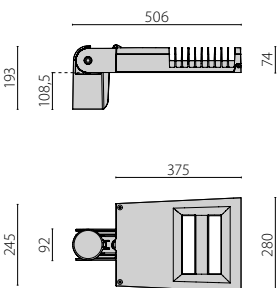

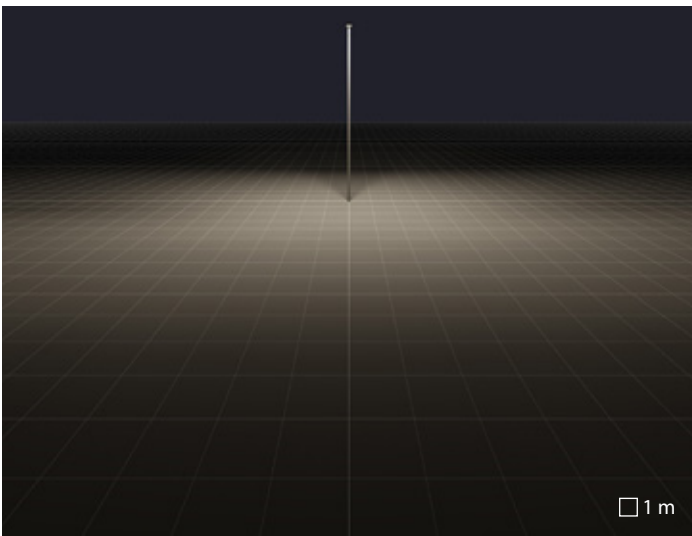

SR/075 road reflector

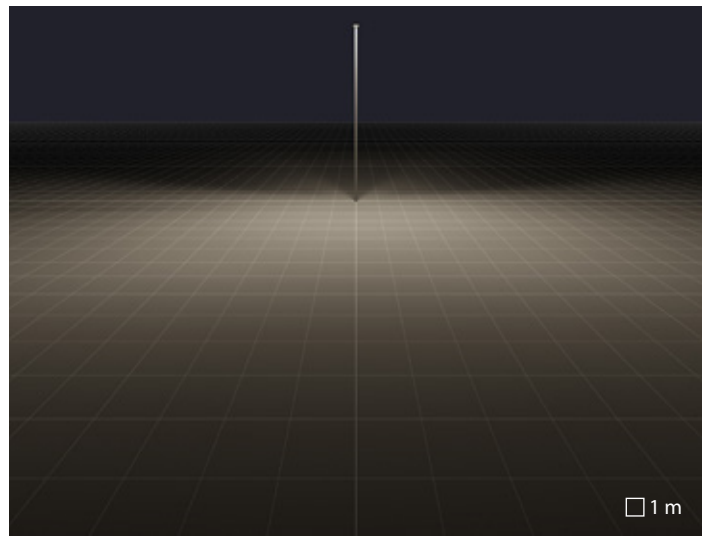

SR/100 road reflector

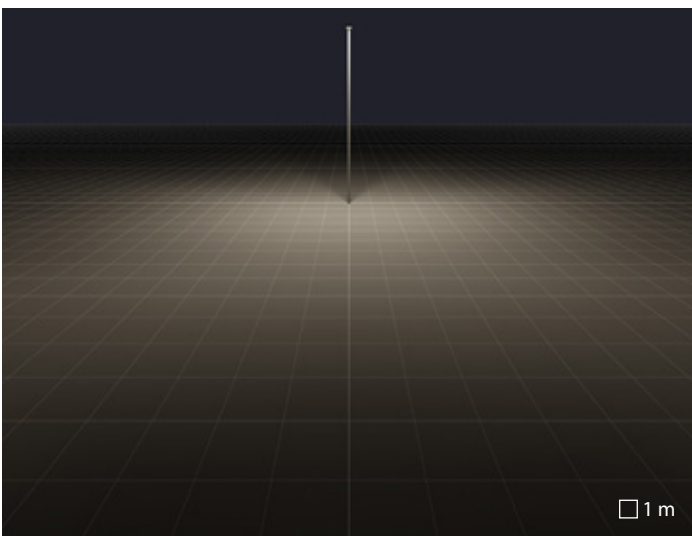

SR/125 road reflector

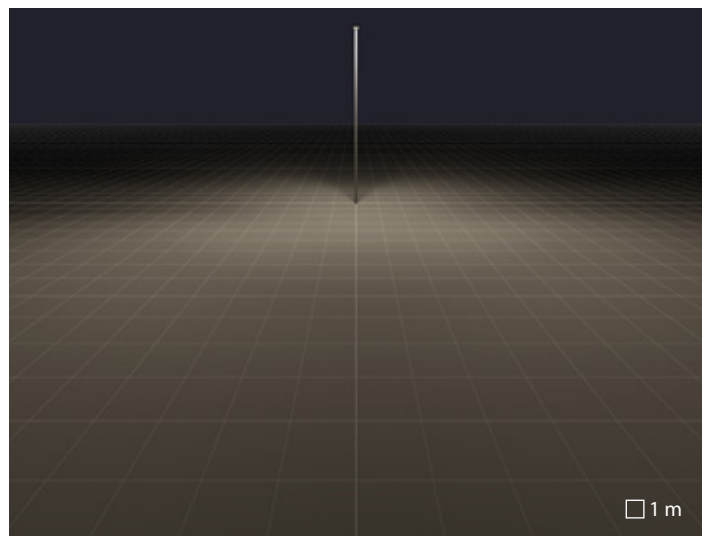

SR/150 road reflector





Train station Rockbank | Melbourne | Australia



SMART LIGHTING SOLUTIONS



The concept of “smart city” has different meanings in different cultures and can sound elusive until you break it down into practical terms. Therefore, in a short time, smart LED lights could use fifty per cent less power than traditional lights. Soon, as poles become “smart”, they could form the digital backbone of a city, giving citizens – and officials – real-time, accurate information on anything from rush hour delays to air quality. In this perspective, PERFORMANCE IN LIGHTING offers single luminaire controls: Time switches, dimmable and sensor versions. These simple controls offer reliable savings with little effort. Solutions give the option of dimming by fifty per cent at

night without requiring external control wiring where settings can be easily customised or deactivated. Respectively, RPA (Automatic Power Reduction) and RPP (Pilot Power Reduction) are some examples. For that reason, PERFORMANCE IN LIGHTING offers SMART fixtures suitable for ZHAGA and NEMA socket seven-pin for external remote-control systems and group connection. In this way, every city could use their management system and platforms waiting for further developments on this imaginative thematic.

KYRO+

design Silvia Paola Pennacchio

Value, Style, Performance

KYRO+, or Kairos, is the definition in Greek for “quality time”: this definition gave the inspiration and birth to this iconic, elegant, design-balanced series.

Lighting fixtures with an unmistakable curved design offer added value for urban centres, architectural contests and area lighting. They combine aesthetics with functionality along with cost saving LED sources.

The installation and maintenance of this street luminaire is extremely simplified thanks to the tool-less opening of the fixture. The mechanism also allows quick maintenance of the wiring plate.

To redesign this series, PERFORMANCE iN LIGHTING has united a timeless design with the know-how on LED and lenses acquired in decades of experience. The result is this high-tech product in an iconic shape.





Avenida Antonio Machado | Málaga | Spain

KYRO+

design Silvia Paola Pennacchio

Street light series. Fixtures consist of:

Construction

- Die-cast aluminium housing and cap, chemical pre-treated and painted polyester powder coating ISO 9227
- Technopolymer component holder bracket reinforced with fiberglass
- Aluminium heat sink
- High-transparency polycarbonate lenses grant an optimized light transmission
- High resiliency anti-ageing silicone gasket with high elastic return capacity
- Extra clear, tempered, flat glass diffuser
- Fully integrated stainless steel aluminium spring clips
- Stainless steel external screws
- Painted die-cast aluminium pole clamp

Electrical

- Integral surge protection device (SPD) against mains overvoltages up to 10 kV
- The "SECURE LIGHT DISTRIBUTION" system guarantees uniform light distribution even in the remote case of LED failures
- Provided complete with 1 m cable H07RN-F 2 x 1.5 mm² and IP66 plug-socket, produced in polyamide with silver-plated brass contacts, for cables Ø 9 - Ø14 mm, that allows connection to the mains without opening the luminaire.

Installation

- KYRO+1 versions are suitable for installation on Ø 42 - Ø 60/62 mm poles, KYRO+1-D76 versions on Ø 76 mm poles, and KYRO+2 versions on Ø 60/62 - Ø 76 mm poles
- Gear tray removable without tools
- Switch splitter automatically disconnects the power supply when the cable cover is opened
- Waterproof cable gland M25x1.5 for cables Ø 9- Ø 14 mm
- Suitable for pole-tops Ø 60 / 76 mm.

Variants

- Versions with automatic power reduction available (RPA)
- CLO (Constant light output) option available. Consult factory

Listings

- CE
- EAC
- RCM
- Compliant with the UNI 10819 standards on light pollution
- Complies with CAM for public lighting fixtures
- Made in Italy

Warranty

- 5-year limited warranty. Complete warranty terms located at www.performanceinlighting.com
- Registered trademark®





KYRO+ 1

KYRO+ 2

CONSTRUCTION		KYRO+ 1	KYRO+ 2
IP		IP66	IP66
IK		IK09 10J xx9	IK08 7J xx5
Dimensions (mm)		L 690 x H 131 x D 275	L 835 x H 155 x D 330
Windage area	EPA - front	0,036 m ²	0,051 m ²
	EPA - side	0,068 m ²	0,095 m ²
	EPA - top	0,170 m ²	0,245 m ²
Weight		Max 8,19 kg	Max 12,62 kg
Colour		●	●
INSTALLATION			
Pre-wired		-	-
Quick		-	-
Continuous mounted luminaire		-	-
LED			
Lightsource lumen output	3000 K	5291 lm ÷ 10182 lm	15273 lm ÷ 20364 lm
	4000 K	5431 lm ÷ 10863 lm	16294 lm ÷ 21726 lm
Luminaire lumen output	3000 K	4709 lm ÷ 9280 lm	13670 lm ÷ 18757 lm
	4000 K	4898 lm ÷ 9528 lm	14035 lm ÷ 19257 lm
CCT - Correlated Color Temperature		3000 K - 4000 K	3000 K - 4000 K
CRI / SDCM (macadam step)		70/3	70/3
Lifetime		L90B10@100000h	L90B10@100000h
ULR<1		✓	✓
CIEn ³ >95		✓	✓
OPTIC			
SR/075 road reflector		SR/075	SR/075
SR/100 road reflector		SR/100	SR/100
SR/125 road reflector		SR/125	SR/125
SR/150 road reflector		SR/150	SR/150
ELECTRICAL			
Wattage		36 W - 70 W	103 W - 136 W
Class		II	II
EEL		-	-
Ta MAX° luminaire		50° ÷ 35°	40° ÷ 30°
Ta MIN° luminaire		-40°	-40°
Dimmable 1-10V		-	-
Dimmable DALI		✓	✓
COSφ ≥ 0,9		✓	✓
SPD (10kV)		✓	✓
CONTROL SYSTEMS			
Automatic derating		✓	✓
Pilot wire command derating		(on request)	(on request)
Constant light output		(on request)	(on request)

● AN-96 / Anthracite gray / Textured

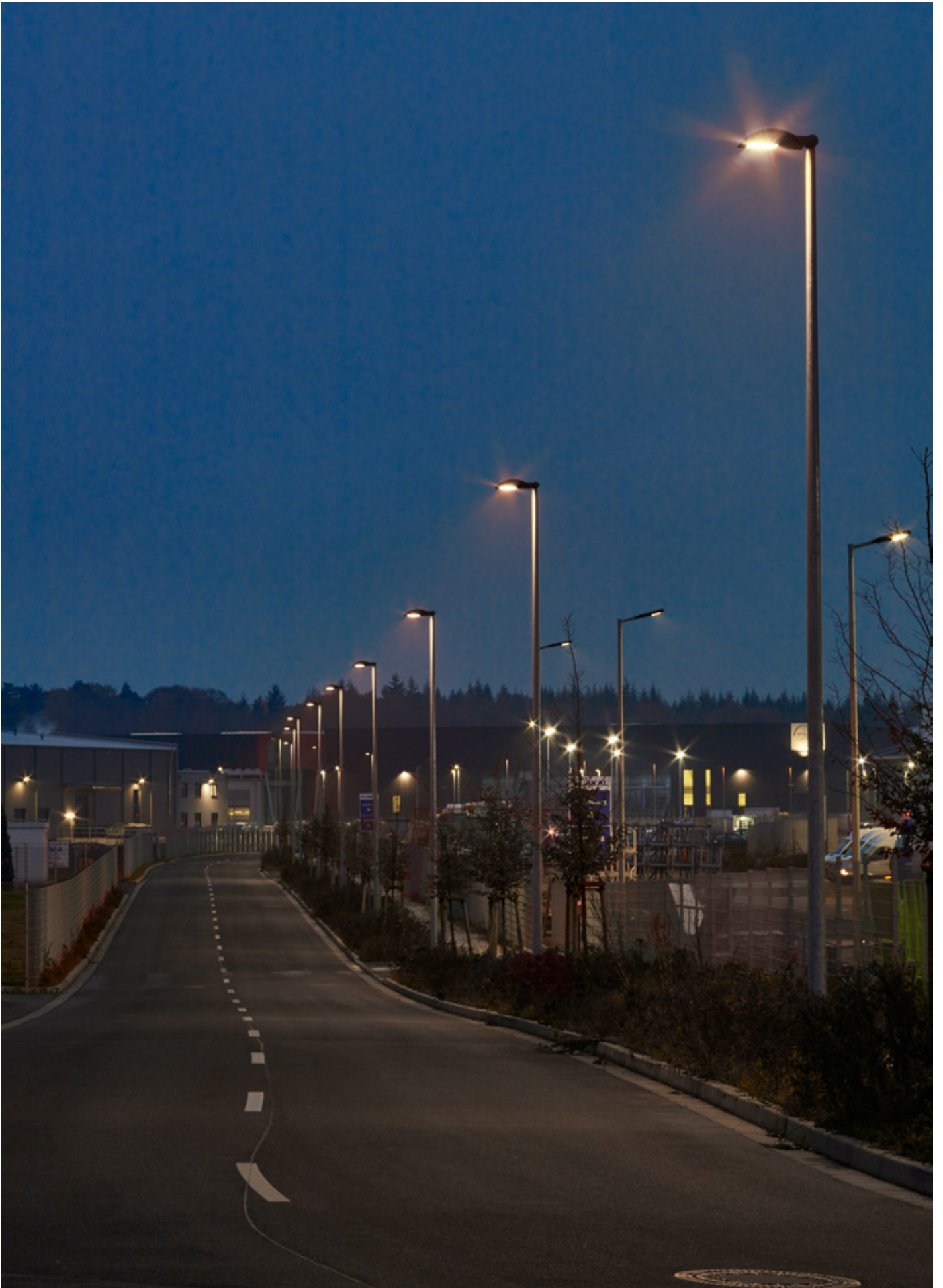

Urban street | Saarlouis | Germany

KYRO+ 1 / 2

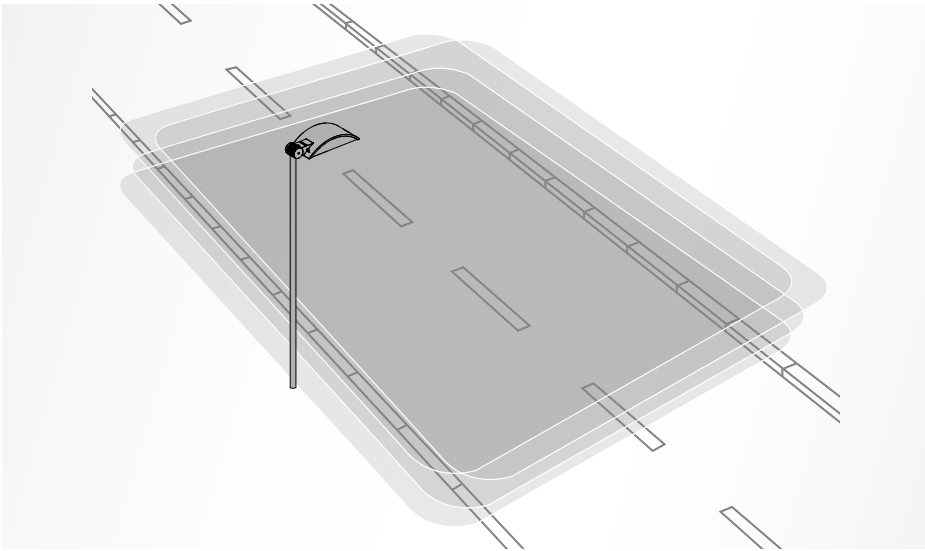

The "SECURE LIGHT DISTRIBUTION" system guarantees uniform light distribution even in the remote case of LED failures



Flat extra clear tempered glass diffuser

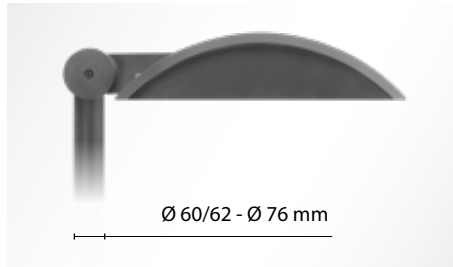

KYRO+2 versions on Ø 60/62 - Ø 76 mm poles



Fully integrated stainless steel aluminium spring clips



Complete with supplementary device for protection against network surges of up to 10 kV (DM)

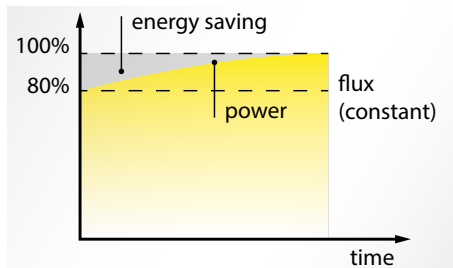

CLO (Constant light output) option available. Consult Factory



Painted die-cast aluminium pole clamp

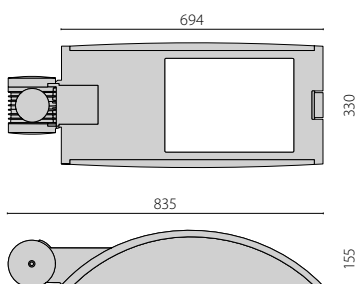
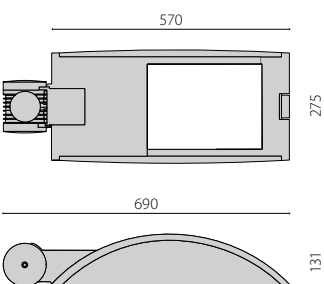

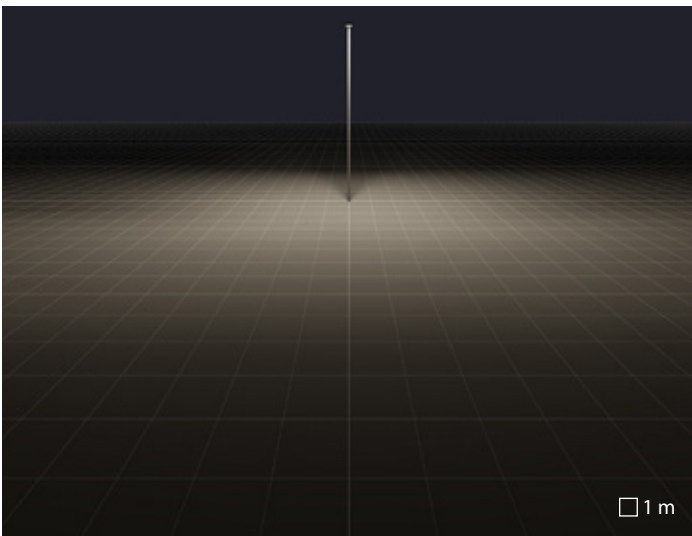

SR/075 road reflector

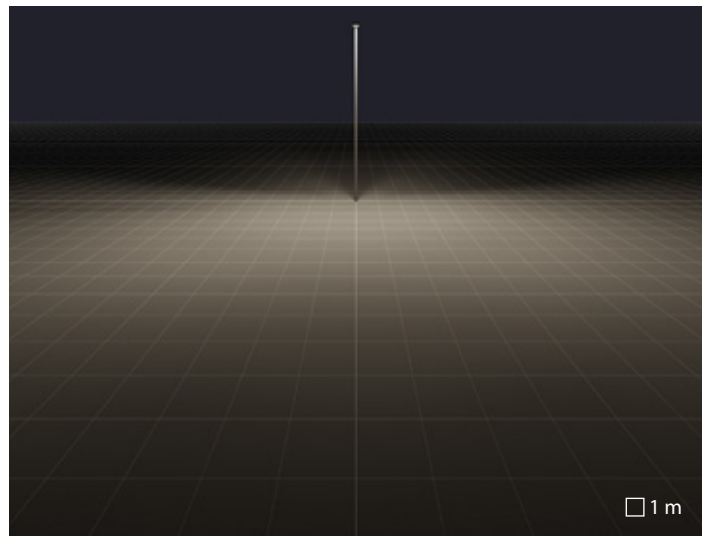

SR/100 road reflector

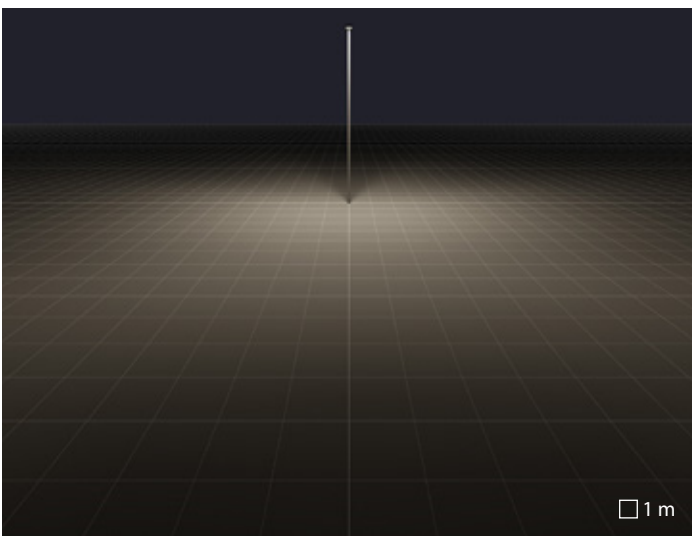

SR/125 road reflector

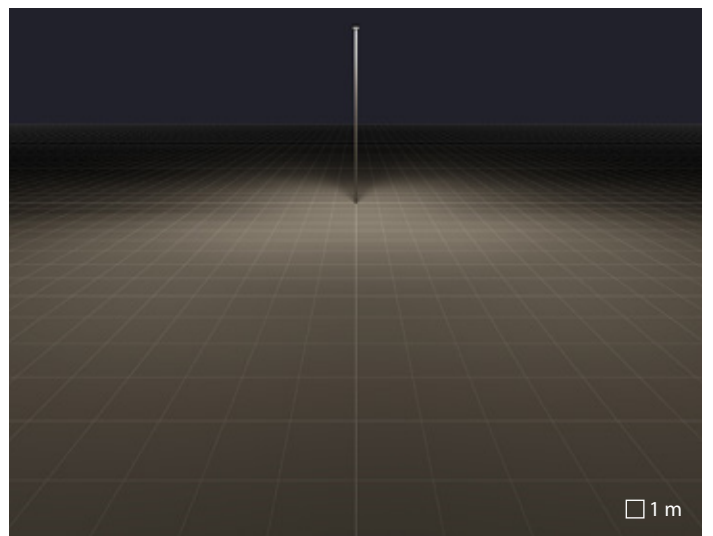

SR/150 road reflector

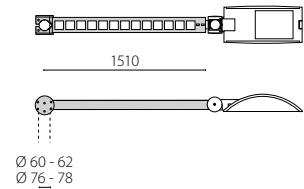
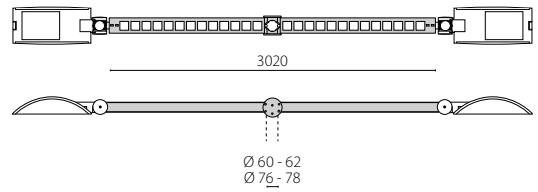
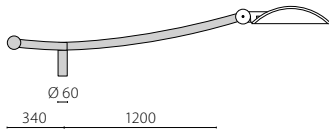
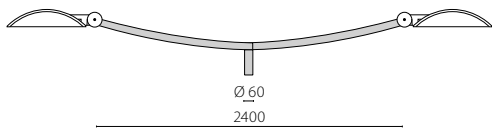

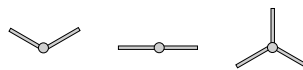
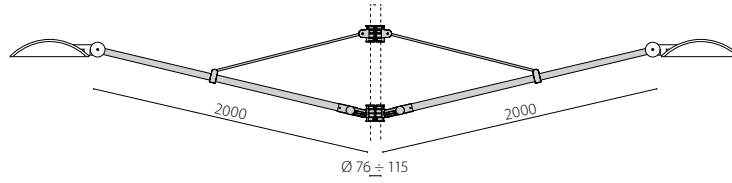
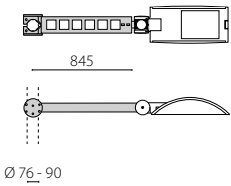
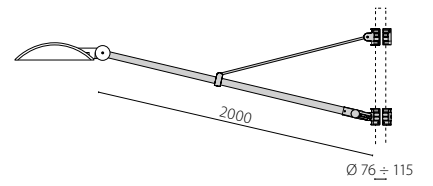
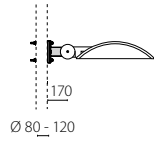
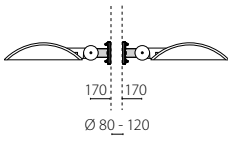
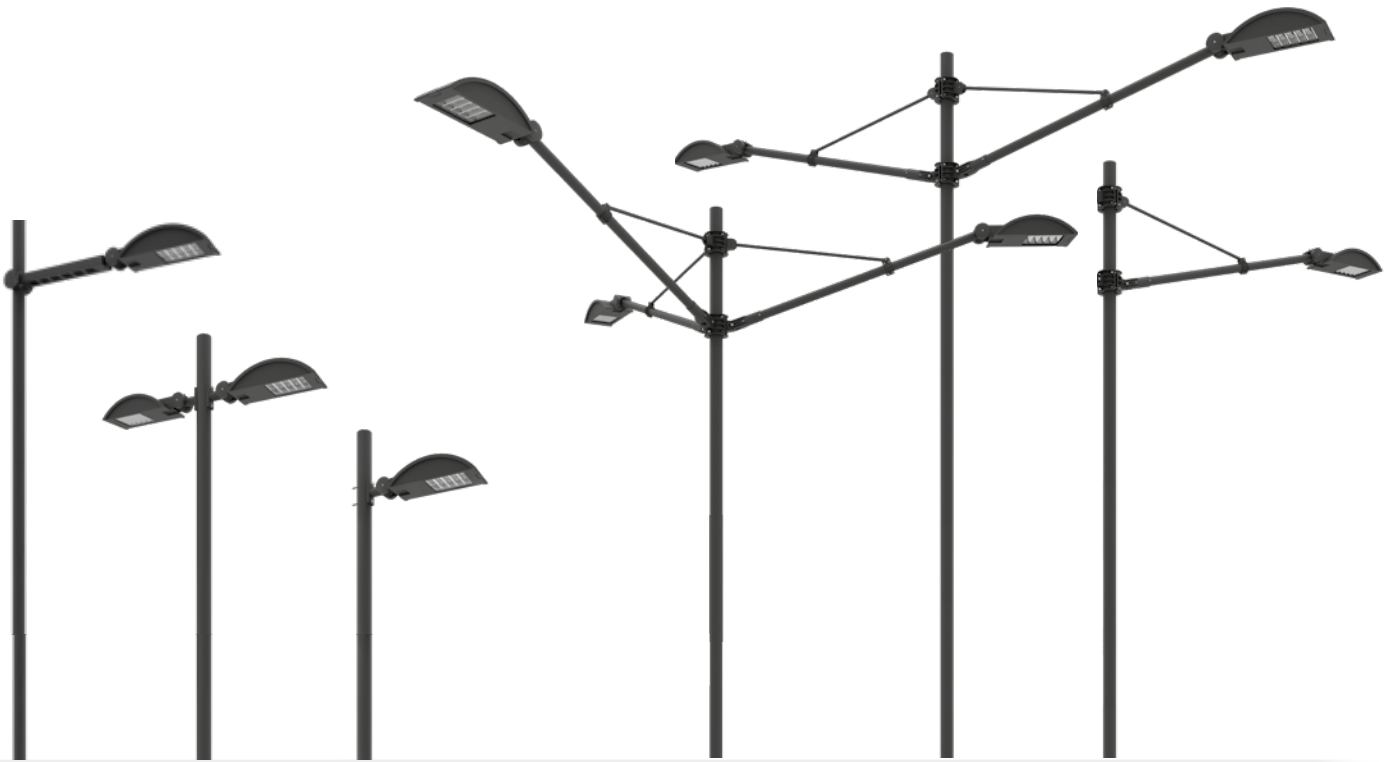

SPIDER+ POST

design Giorgio Lodi

Simplicity, flexibility
and functionality

It is not always easy to design a simple fixture that encompasses all the latest technical requirements in a simple, but captivating shape. PERFORMANCE IN LIGHTING managed to do so by designing this one-of-a-kind street luminaire that can be used in every residential and urban contest. The simplicity of the installation process is guaranteed by the IP68 waterproof fast connector that allows the fixture to remain sealed at all times. The newest LEDs light sources with dedicated optics and the possibility of orienting the fixture angle on site provide the ultimate solution for any project at the best value.





SPIDER+ POST

design Giorgio Lodi

LED floodlight for indoor and outdoor lighting, comprising:

Construction

- Die-cast aluminium housing, powder-polyester coated ISO 9227
- Extra pure polished aluminium reflector
- Anti-ageing silicone gasket
- Extra-clear, tempered, flat glass diffuser, screen-printed inside
- Diffuser permanently sealed to the housing through a high-temperature resistant silicone
- Stainless steel external screws

Electrical

- Built-in driver

Installation

- Luminaire designed to operate with two predetermined power levels that can be selected by the user acting on the specific cable in the quick connector
- Pole clamp for Ø 76 mm poles is available as an accessory

Listings

- CE
- EAC
- RCM

Warranty

- 5-year limited warranty. Complete warranty terms located at www.performanceinlighting.com
- Registered trademark ®
- Registered design ®



SPIDER+ POST



SPIDER+ POST

CONSTRUCTION		
IP		IP66
IK		IK06 1J xx3
Dimensions (mm)		L 350 x H 220 x D 180
Windage area	EPA - front	0,024 m ²
	EPA - side	0,036 m ²
	EPA - top	0,063 m ²
Weight		Max 3,5 kg
Colour		●
INSTALLATION		
Pre-wired		✓
Quick		✓
Continuous mounted luminaire		-
LED		
Lightsource lumen output	3000 K	6677 lm
	4000 K	6967 lm
Luminaire lumen output	3000 K	5754 lm
	4000 K	6005 lm
CCT - Correlated Color Temperature		3000 K - 4000 K
CRI / SDCM (macadam step)		80/3
Lifetime		L70B10@70000h
ULR<1		✓
CIE ⁿ 3>95		✓
OPTIC		
A35/EW asymmetric extra wide reflector		A35/EW
ELECTRICAL		
Wattage		37/51 W
Class		II
EEl		-
Ta MAX° luminaire		30°
Ta MIN° luminaire		-20°
Dimmable 1-10V		-
Dimmable DALI		-
COSφ ≥ 0,9		✓
SPD (10kV)		✓
CONTROL SYSTEMS		
Automatic derating		-
Pilot wire command derating		-
Constant light output		-

● AN-96 / Anthracite gray / Textured



SPIDER+ POST



Electrical connection with outdoor rated plug & socket quick connector (IP66), complete with cable, that allows connection to mains without opening the luminaire. Made in PA66 with brass contacts, for cables Ø 6.5 - Ø 12 mm



Die-cast aluminium pole clamp with polyester powder coating after surface chemical conversion treatment, for Ø 60 mm poles



Pole clamp for Ø 76 mm poles is available as an accessory

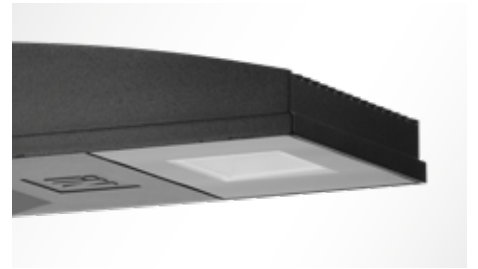

Extra-clear flat tempered glass diffuser internally screen-printed



Extra pure polished aluminium reflectors

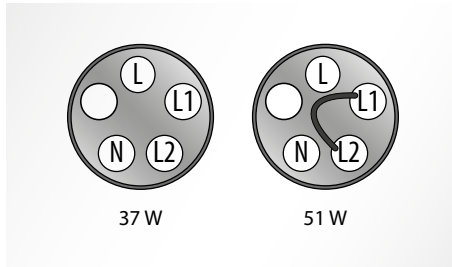

Luminaire designed to operate with two predetermined power levels that can be selected by the user acting on the specific cable in the quick connector



SPIDER+ series

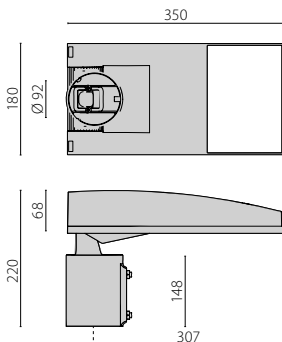

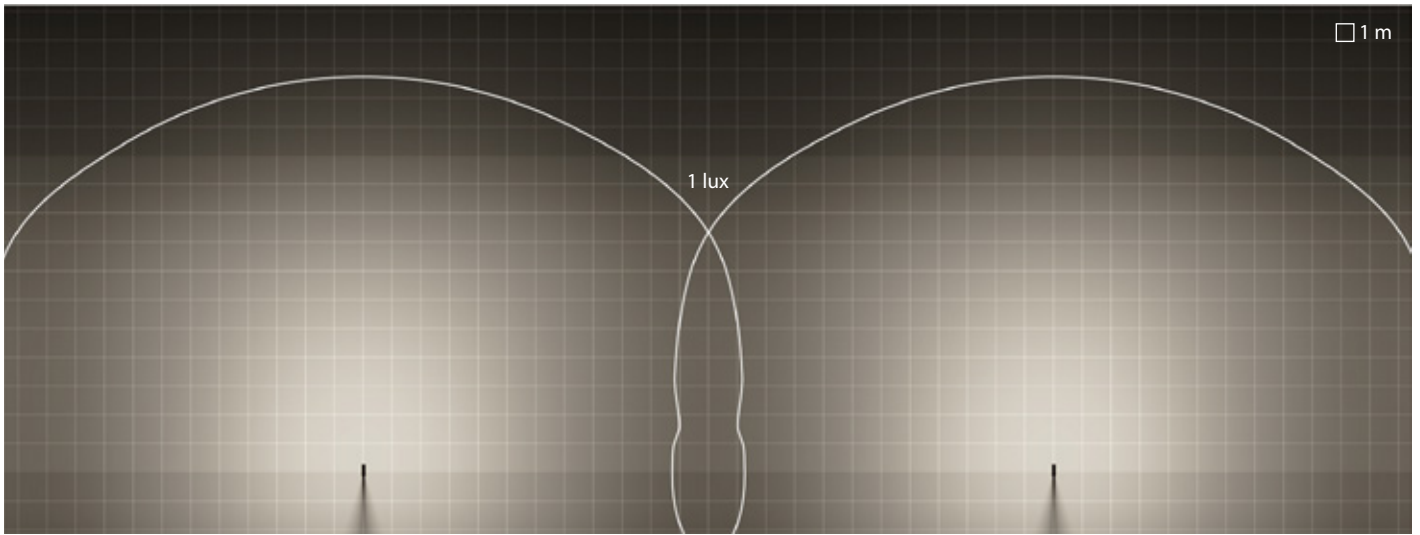

SPIDER+ POST | A35/EW | linear

Luminaire spacing = 24m
 Path depth = 11m
 Mounting height = 6m

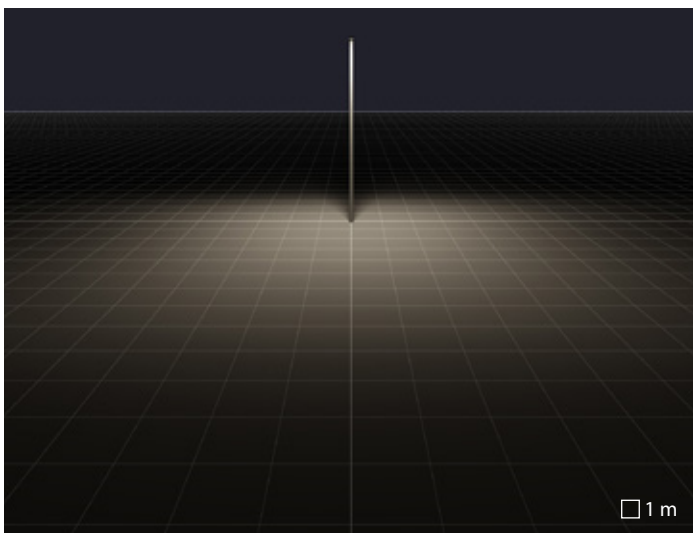

A35/EW asymmetric extra wide reflector

LIGHT ONLY WHEN NEEDED

The technical and conceptual changes that have taken place in the public lighting sector to achieve greater energy savings have also included the concept of “light only when needed”. In fact, the standards establish that the technical lighting levels must adapt to the traffic changes during night hours, implementing reductions of the luminous flux if necessary.

To meet these needs, Performance iN Lighting offers a complete range of flux regulation systems, both standalone and for centralized systems, which can be configured in relation to the customer’s needs.

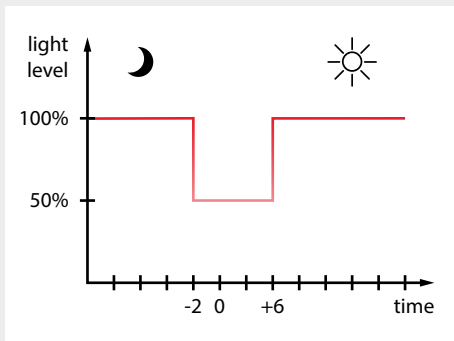

The fixtures equipped with RPA (automatic power reducer) power supply feature a standalone flux regulator since no additional wiring is required and the dimming profiles (up to five) are pre-programmed in relation to “virtual midnight”, in other words, the intermediate time between the switching on and switching off of the fixtures, calculated during the first three days the system is in operation.

Example: let’s suppose that, during a certain period of the year, a system is on from 5:00 pm to 6:00 am the following day for a total of 13 hours. The virtual midnight will coincide with 11:30 pm ($13 \text{ hours} \div 2 = 6.5 \text{ hours}$, therefore $5:00 \text{ pm} + 6.5 \text{ hours} = 11:30 \text{ pm}$). The Performance iN Lighting factory setting provides 50% dimming from two hours before to six hours after virtual midnight. Considering these parameters, the fixtures will be dimmed 50% from 9:30 pm ($11:30 \text{ pm} + 2 \text{ hours}$) to 5:30 am ($11:30 \text{ pm} + 6 \text{ hours}$) on the following day.

Virtual midnight is periodically updated to adapt to the seasonal changes of how long day and night last, allowing the system to be switched on and off with a twilight switch.

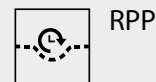
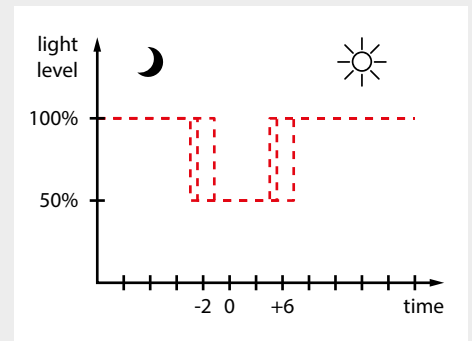

The fixtures equipped with RPP (power reduction with pilot command) power supply have a feature which, using dedicated wiring (the “pilot wire”), allows the flux to be reduced to a pre-programmed level (the factory setting is 50%).

Applying mains voltage to the pilot wire, the fixture is dimmed to the preset value, otherwise it operates at 100% of the luminous flux. By changing the fixture’s programming, this operating logic can be inverted. The product will operate at 100% when the pilot wire is powered and dimmed when it is not.

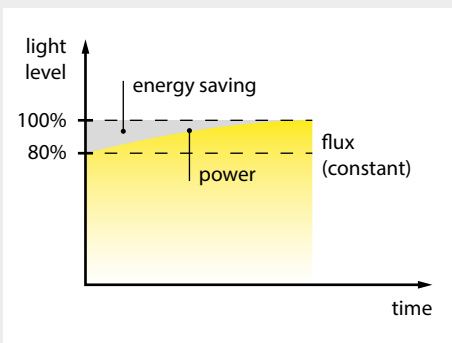

CLO

Fixtures equipped with CLO (Constant Light Output) power supply have a feature that maintains the flux constant for the entire life of the system. In fact, like all lighting sources, LED undergo a deterioration in performance that must be considered in the maintenance factor calculation. This means that the fixtures must be used with a flux (and therefore consumption) that is initially greater, since the luminous levels must be guaranteed for the entire life of the system.

For example, in a fixture with a flux deterioration of L80, the CLO will be configured so that the flux is reduced to 80% of the rated value and maintained constant, thanks to the progressive increase of the LED power supply voltage to compensate for the performance deterioration. This implies that a fixture with CLO will always operate with a flux lower than the rated value, which typically coincides with the end-of-life value. By using products with CLO, since there is no flux deterioration, a greater maintenance coefficient can be used, thereby achieving energy savings.

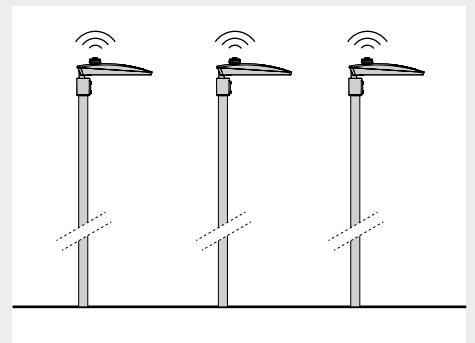

POINT-TO-POINT DIMMING

In some installations, the system may need to be managed centrally to modify the dimming profiles, create personalised scenes in relation to the technical lighting requirements or carry out diagnostics on the individual light points. To satisfy these needs, fixtures are available in DALI 1-10V version, or equipped with NEMA or Zhaga Book 18 socket. Performance iN Lighting can also assess the installation inside its fixtures of remote management modules (Wi-Fi, power line communication) based on the customer's needs.

EN 13201-2-2015

PERFORMANCE REQUIREMENTS

The standard defines, using photometric requirements, the performance needed by classes for street lighting. EN1301-2-2015 considers the vision needs of road users and covers the environmental aspects of street lighting. The norm takes into consideration relevant areas for groups of lighting situations, conflict areas, calming traffic measures and pedestrian crossing. Moreover, it provides information about glare control, color rendering, night-time use and visual guidance.

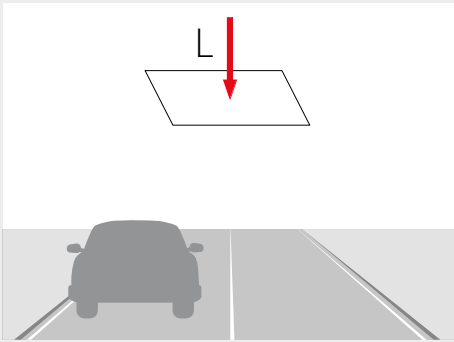

M

Classes for roads with motor powered vehicles other than slow-moving vehicle. The considered lighting size is the average horizontal luminance.

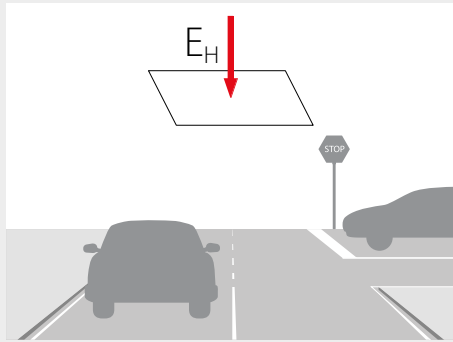

C

Classes for roads with reduced travel speed and conflict zones such as intersections, roundabouts, etc. The lighting size considered is the average horizontal illuminance.

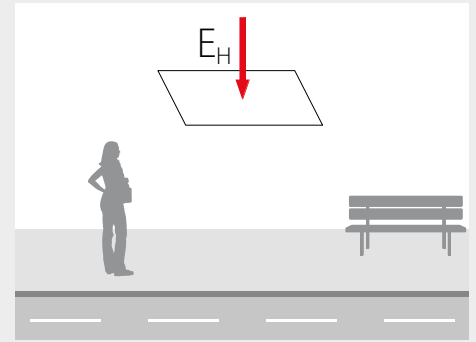

P

Classes for pedestrian and/or pedal cyclist areas, residential streets, emergency lanes, parking lots and sidewalks. The lighting size considered is the average horizontal illuminance.

	L (cd/m ²) (≥)	U ₀ (≥)	U ₁ (≥)	fT _i (%) (≤)	R _g (≥)
M1	2,00	0,40	0,70	10	0,35
M2	1,50	0,40	0,70	10	0,35
M3	1,00	0,40	0,60	15	0,30
M4	0,75	0,40	0,60	15	0,30
M5	0,50	0,35	0,40	15	0,30
M6	0,30	0,35	0,40	20	0,30

	Ē (lx) (≥)	U ₀ (≥)	fT _i (%) (≤)
C0	50,0	0,40	10
C1	30,0	0,40	10
C2	20,0	0,40	15
C3	15,0	0,40	15
C4	10,0	0,40	15
C5	7,50	0,40	20

	Ē (lx) (≥)	E _{min} (lx) (≥)	fT _i (%) (≤)
P1	15,0	3,00	20
P2	10,0	2,00	25
P3	7,50	1,50	25
P4	5,00	1,00	30
P5	3,00	0,60	30
P6	2,00	0,40	35
P7	-	-	-

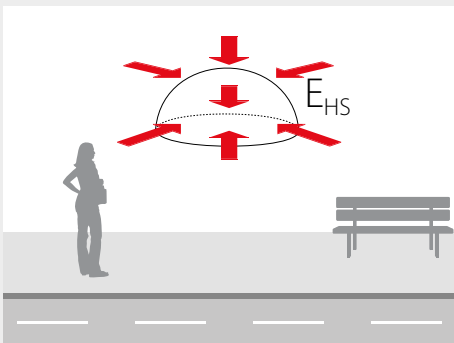

HS

Classes for pedestrian and cycle areas, residential streets, emergency lanes, parking lots and sidewalks. The considered lighting size is the average hemispherical illuminance.

	$E_{hs} (lx) (\geq)$	$U_0 (\geq)$
HS1	5,00	0,15
HS2	2,50	0,15
HS3	1,50	0,15
HS4	-	-

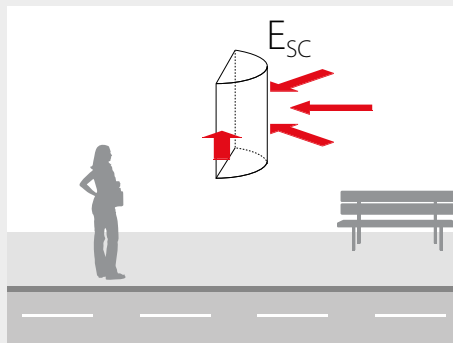

SC

Additional classes in pedestrian areas where face recognition is required for safety reasons. The lighting size considered is the minimum punctual semi-cylindrical illuminance.

	$E_{sc,min} (lx) (\geq)$
SC1	10,0
SC2	7,50
SC3	5,00
SC4	3,00
SC5	2,00
SC6	1,50
SC7	1,00
SC8	0,75
SC9	0,50

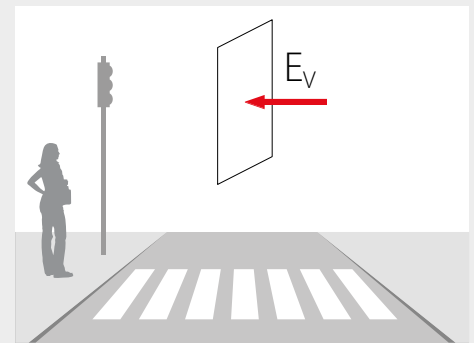

EV

Additional category in areas where it is necessary to pay attention to vertical elements, such as pedestrian crossings and conflict areas. The lighting size considered is the minimum punctual vertical illuminance.

	$E_{v,min} (lx) (\geq)$
EV1	50,00
EV2	30,00
EV3	10,00
EV4	7,50
EV5	5,00
EV6	0,50

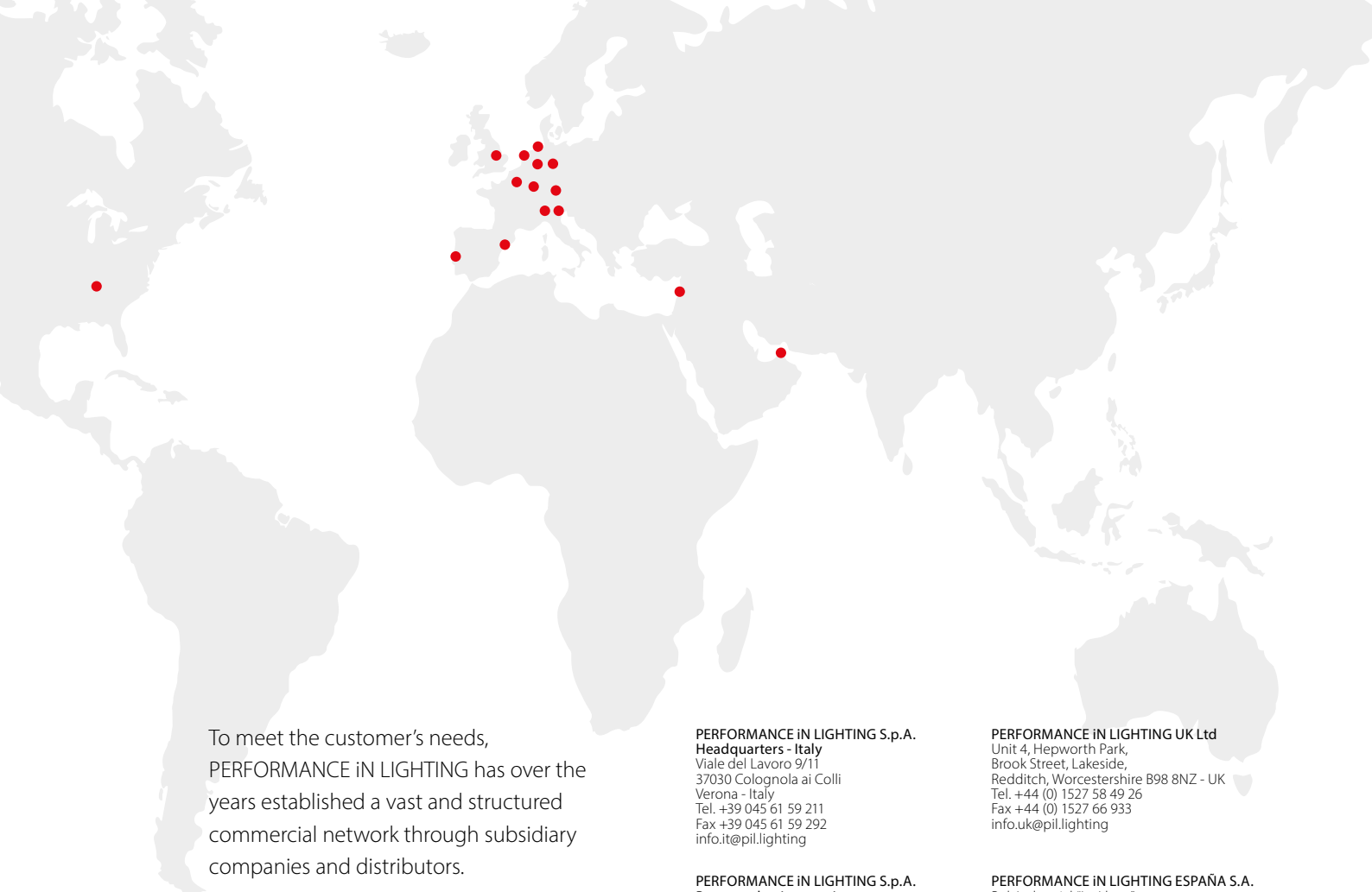

To meet the customer's needs, PERFORMANCE iN LIGHTING has over the years established a vast and structured commercial network through subsidiary companies and distributors.

The Group now exports to more than 100 countries worldwide.

PERFORMANCE iN LIGHTING S.p.A.
Headquarters - Italy
Viale del Lavoro 9/11
37030 Colognola ai Colli
Verona - Italy
Tel. +39 045 61 59 211
Fax +39 045 61 59 292
info.it@pil.lighting

PERFORMANCE iN LIGHTING S.p.A.
Bergamo business unit
Via Provinciale 57
24050 Ghisalba
Bergamo - Italy
Tel. +39 0363 94 06 11
Fax +39 0363 94 06 90
info.it@pil.lighting

PERFORMANCE iN LIGHTING GmbH
Headquarters - Germany
Stapelner Str. 1+3
38644 Goslar - Germany
Tel. +49 (0) 5321 3777 0
Fax +49 (0) 5321 3777 99
info.de@pil.lighting

PERFORMANCE iN LIGHTING GmbH
München business unit
Hauptstraße 27
82008 Unterhaching - Germany
Tel. +49 (0) 89/66 54 76 87 230
Fax +49 (0) 89/66 54 76 87 19
info.de@pil.lighting

PERFORMANCE iN LIGHTING GmbH
Düsseldorf business unit
Leichlinger Str. 14
40764 Langenfeld - Germany
Tel. +49 (0) 21 73/2 71 99 10
Fax +49 (0) 21 73/2 71 99 29
info.de@pil.lighting

PERFORMANCE iN LIGHTING BE
Chaussée de Haecht, 1880
Haachtsesteenweg, 1880
1130 Bruxelles / Brussel - Belgium
Tel. + 32 2 705 51 51
Fax + 32 2 705 12 87
info.be@pil.lighting

PERFORMANCE iN LIGHTING NEDERLAND
Ronde Tocht 1 C
1507 CC Zaandam - The Netherlands
Tel. + 31 75 6708 706
info.nl@pil.lighting

PERFORMANCE iN LIGHTING FRANCE S.A.S.
Parc d'Activités de la Couronne des Prés
107 Avenue des Pâtis - CS 50608 Epône
78417 Aubergenville Cedex - France
Tel. +33 1 3090 5360
Fax +33 1 3090 1681
info.fr@pil.lighting

PERFORMANCE iN LIGHTING UK Ltd
Unit 4, Hepworth Park,
Brook Street, Lakeside,
Redditch, Worcestershire B98 8NZ - UK
Tel. +44 (0) 1527 58 49 26
Fax +44 (0) 1527 66 933
info.uk@pil.lighting

PERFORMANCE iN LIGHTING ESPAÑA S.A.
Pol. Industrial "La Llana"
c/Pont de Can Claverí, 58
08191 Rubí (Barcelona) - Spain
Tel. +34 93 699 5554
Fax +34 93 699 5045
info.es@pil.lighting

PERFORMANCE iN LIGHTING PORTUGAL
Estrada da Circunvalação 3558 / 3560
4435-186 Porto - Portugal
Tel. +351 229 770 624
Fax +351 229 770 699
info.pt@pil.lighting

PERFORMANCE iN LIGHTING FINLAND Oy
Tikkurikuja 1
00750 Helsinki - Finland
Tel. +358 10422 1860
Fax +358 10422 1861
info.fi@pil.lighting

PERFORMANCE iN LIGHTING USA, Inc.
2621 Keys Pointe
Conyers GA 30013 - USA
Phone +1 770 822 2115
Fax +1 770 822 9925
info.usa@pil.lighting

PERFORMANCE iN LIGHTING - ISRAEL
Moshav Hagar Meshke 401, P.O.B. 9102 P.T.
Tel. +972 3 93 40 350
Fax +972 3 93 40 350
Mob +972 53 2280477

PERFORMANCE iN LIGHTING MIDDLE EAST
Dubai Airport Free Zone
P.O.Box. 371818, Dubai, U.A.E.
Tel. +971 4 2395146
info.me@pil.lighting



PERFORMANCE iN LIGHTING S.p.A

Viale del Lavoro 9/11

37030 Colognola ai Colli (VR) - Italy

T +39 045 61 59 211

F +39 045 61 59 393

www.performanceinlighting.com