



FOR MASTERS OF ALL FIXATIONS.

No matter what you build – wood, metal, façade or frame – we have the screw to match your precision.

OVERVIEW

It all began with screws – the foundation of our craft. From there, we built a legacy of fastening expertise that now spans every material, every challenge, every connection. Whether it's anchoring steel to concrete, securing wood to metal, or sealing a frame in place, our fixation solutions are designed to perform where precision matters most.

Reliable. Durable. Effortless to use. Because true masters know: strength isn't just in what you build — it's in how you fix it.

Discover the complete range of screws, dowels, and anchors made to keep every project solid from start to finish.

1	WOODEN STRUCTURE	4
2	FURNITURE ASSEMBLY	8
3	TERRACE BUILDING	10
4	WINDOW MOUNTING	12
5	VENTILATED FACADE & FACADE INSULATION	14
6	EXTERIOR INSTALLATION	16
7	HVAC AND ELECTRICAL INSTALLATIONS	18
8	METAL SHEETS AND STEEL FRAME	20
9	DRYWALLING	22
	ASSORTMENT TABLES	24



1. WOODEN STRUCTURE

1

Option A



NEW

Timber construction screw EASYtimberPRO TPN TZ
Art. 1014429

Option B



NEW

Timber construction screw EASYtimberPRO RPN TZ
Art. 1014375

2



NEW

Timber construction screw EASYtimber TOP RFD TZ
Art. 1014682

3



Timber construction screw EASYfast ISO, cylinder head, TX®, DUO thread, steel zinc plated
Art. 188968

4



NEW

Timber construction screw EASYtimber, washer head
Art. 1006423

8



Angle Connector KR
Art. 213657



Anchoring Nail zinc plated
Art. 18927

Option A



MMS-plus SS hexagon zinc plated
Art. 341208

Option B



Simplex anchor BAZ+
Art. 80592

5



Chipboard screw EASYtopCUT, countersunk head milling ribs, TX®, part thread, CUT (notch), steel zinc plated
Art. 412930



Integral connector
Art. 99122



Rod Plugs
Art. 187554

7



Joint Hangers Outside
Art. 99485

Option A



Wood screw DIN 571 PT ZP
Art. 103713

Option B



Timber construction screw EASYtimber, countersunk head
Art. 1006414

6

Option A



Compound mortar MCS Uni Plus
Art. 180983

Anchor rod MCS Plus A ZI
Art. 80554

Option B



Compound mortar MCS Protect Plus 300ml
Art. 1014819

NEW

Through-Hole Perforated Sleeve MCS Plus H
Art. 80619

Option C



SCREWanchor MMS-plus S hexagon zinc plated, with additional washer DIN 440
Art. 341216

EASYTIMBER PRO

- Faster grip
- Reduced screwing time
- Higher performance
- ETA 12/0280 certified
- Patent pending

EASYtimber PRO TPN Art. 1014423
EASYtimber PRO RPN Art. 1014369

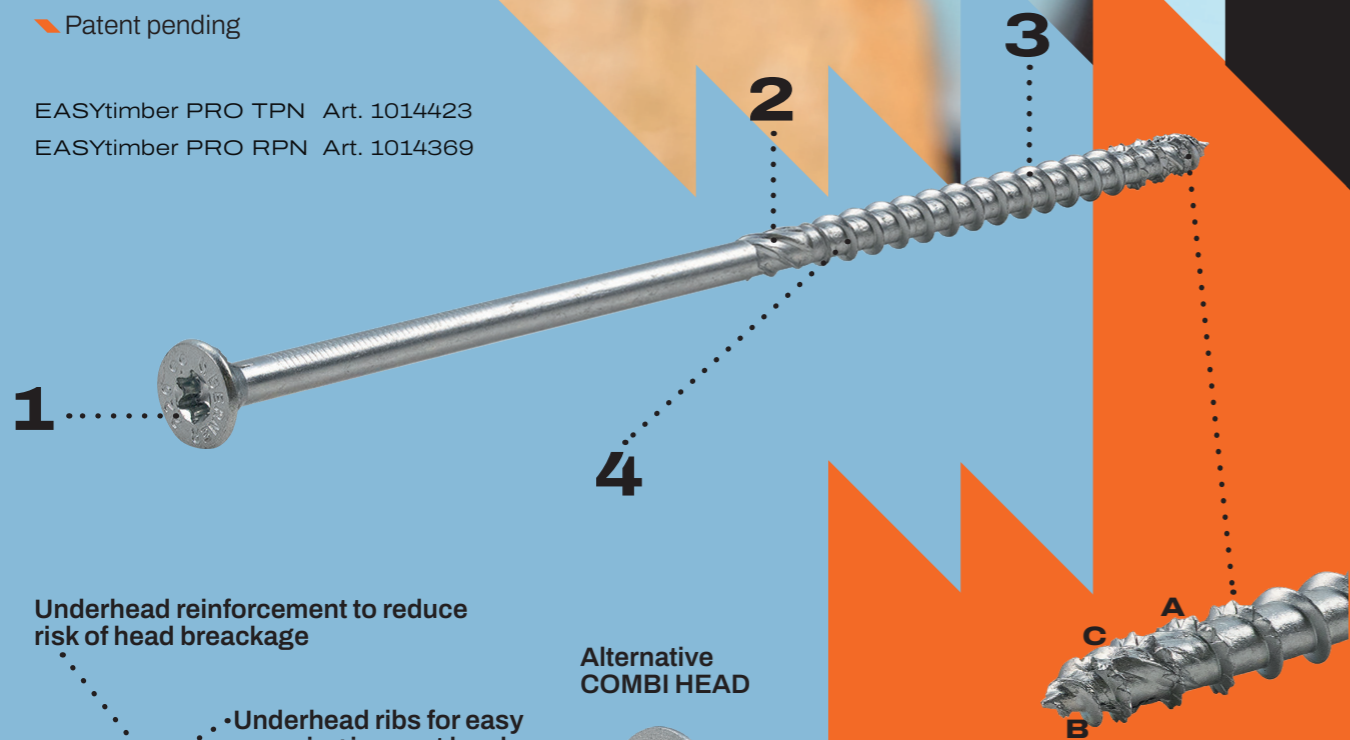

Underhead reinforcement to reduce risk of head breakage

Underhead ribs for easy screwing in exact level

Alternative COMBI HEAD



- Screw head with precise drive to match bit tolerances and reduce wobble behaviour
- Milling ribs with special design to round off and easing insertion
- Anti friction coating for lower torque and smoother insertion
- High pitch thread with thick diameter for higher load capacity

Multifunctional tip

- Special BERNER designed tip with ballistic shape and double HiLo thread for quick grip
- Sawtooth thread that cuts the wood fibers and reduces tension (A)
- Second thread for a fast grip (B)

Chip breaker

- Chip breaker to lower the spinning effect on wood (C)
- Parallel ribs compress the wood fibers
- Pre-drilling is not necessary

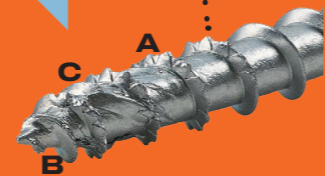

EASYTIMBER TOP

- High load-bearing capacity
- High-tensile steel for increased breaking torque resistance
- ETA 25/0719 certified

EASYtimber TOP RFD Art. 1014675
EASYtimber TOP ZFD Art. 1014640

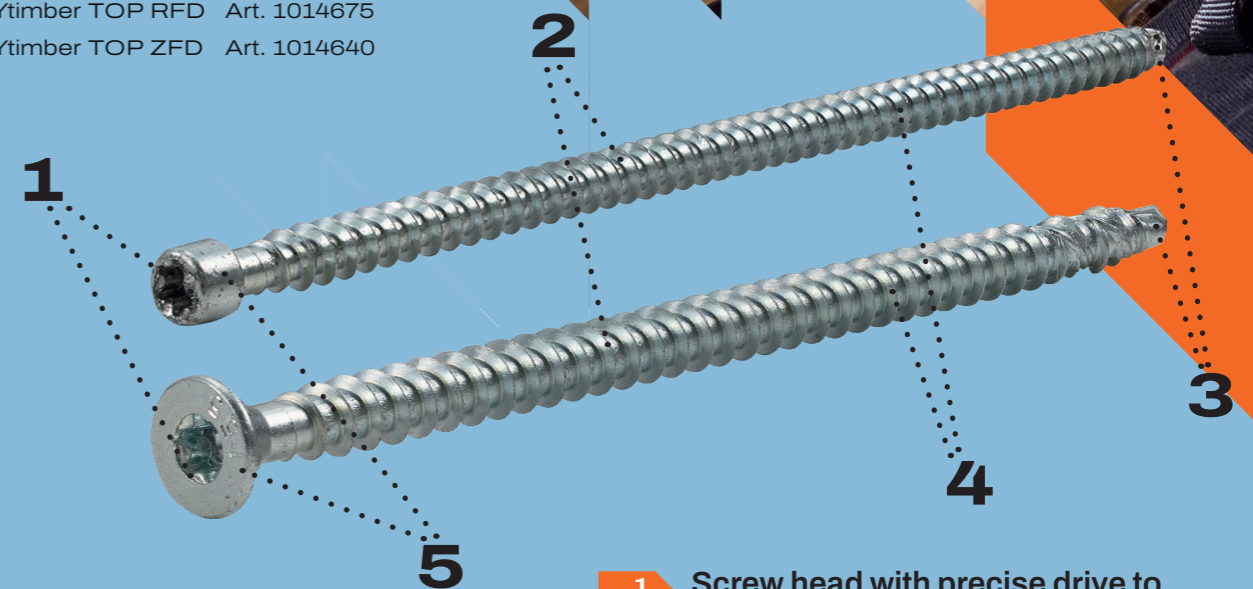

Underhead reinforcement to reduce risk of head breakage

Underhead ribs for easy screwing in exact level

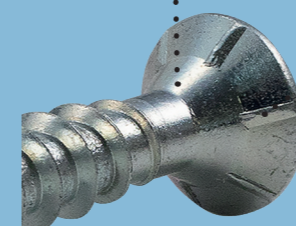

- Screw head with precise drive to match bit tolerances and reduce wobble behaviour
- Anti friction coating for lower torque and smoother insertion
- Drill tip shape to cut wood fibers and to work also in hard wood
- High pitch thread with thick diameter for higher load capacity
- Different heads for different use cases

ONLINE PRODUCT FINDER FOR WOOD SCREWS

Your digital shopping guide

Scan QR-Code

QR-CODE



2. FURNITURE ASSEMBLY

1



Chipboard screw EASYfastWAVE plus, countersunk head milling pockets, TX®, full thread, rib, steel zinc plated
Art. 410156

Option A



Art. 135184

Option B



Art. 1004342

8



Back Wall Screw, zinc plated PZD
Art. 434893

7



EASYclassic CPS FT CSK PZ Black
Art. 1002309

5



Furniture Handle Screws, Zinc plated Pozidriv
Art. 164655

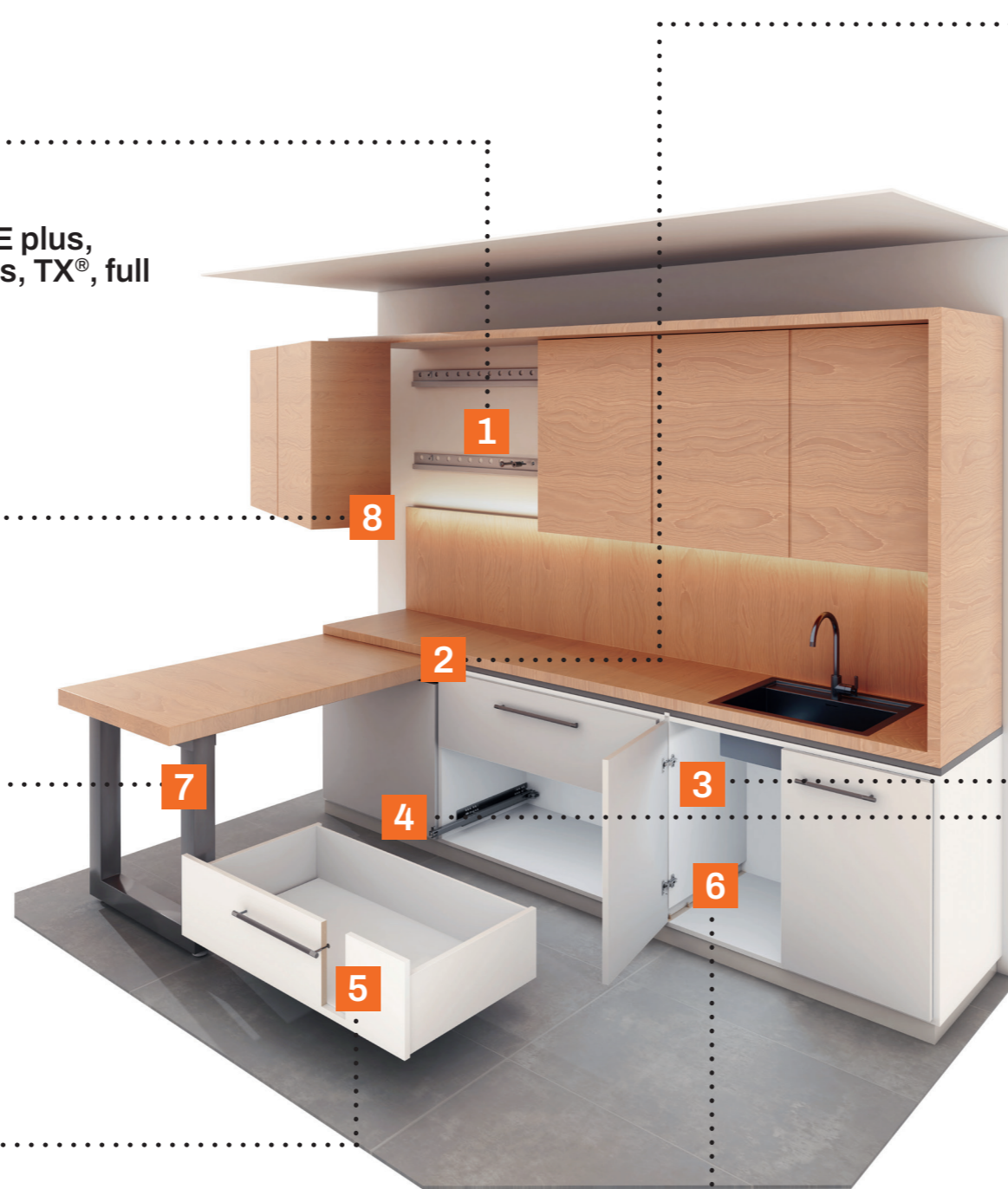

2



Chipboard screw EASYfast PRESS, countersunk head milling pockets, TX®, DUO thread, steel zinc plated
Art. 332298

3



Euro Screws, PZD, Pan Head 9 mm, Galvanized
Art. 91286

4



Chipboard screw, countersunk head, TX®, full thread, ZP
Art. 86768

6



Wood dowel
Art. 419691

3. TERRACE BUILDING

1



Terrace construction screw EASY-pat, flanged cylinder head, TX®, part thread, CUT (notch), martensitic stainless steel

Art. 34163



Terrace construction screw "TER-Tec", flanged cylinder head, TX®, DUO thread, martensitic stainless steel

Art. 60849

4

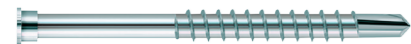

Profile drilling screw C1

Art. 1023193

2



Wood drilling screw EASYtop, countersunk head, TX®, part thread, drill-tip, martensitic stainless steel

Art. 372042

3



Joist plot

Art. 1014822



M-Clip

Art. 1014772

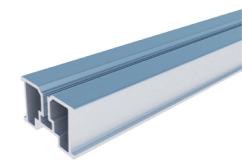

Deck Alu profile H24 4m

Art. 1014743

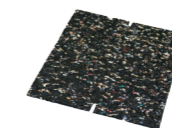

Isolation mat

Art. 1014820



DON'T FORGET



Terrace drill and senk bit 4.8 mm

Art. 82840

4. WINDOW MOUNTING

1

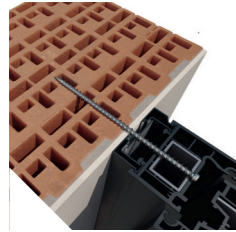

BETOfix Ø 7,5 mm cylindric head, zinc plated

Art. 186404



Frame screw BETOfix Ø 7,5 mm CSH zinc plated

Art. 186406



Frame screw BETOfix Ø 7,5 mm pan head H13 zinc plated

Art. 336712

4



FBS, Coarse thread, TX, martensitic Stainless steel A2, White lacquered RAL 9010

Art. 1578

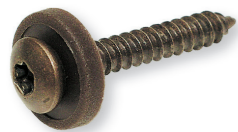
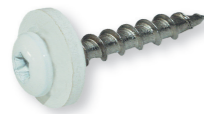

FBS, sheet metal screw thread, TX, martensitic stainless steel, old-German Copper

Art. 52468

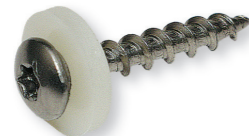

Window sill screw, coarse thread, pan head with polyamide disc, stainless steel A2

Art. 409191

2

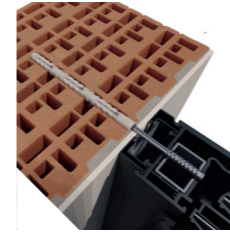

Universal dowel CLAS-SICfix

Art. 157201



Hollow brick dowel HOLLOWFRAMEfix

Art. 286443



Spacer screw DISTAfix

20/10 Ø 6.0 mm Torx®, zinc plated
45/10 Ø 6.0 mm Torx®, zinc plated
60/11.5 Ø 7.0 mm Torx®, zinc plated

Art. 368333
Art. 170063
Art. 213768

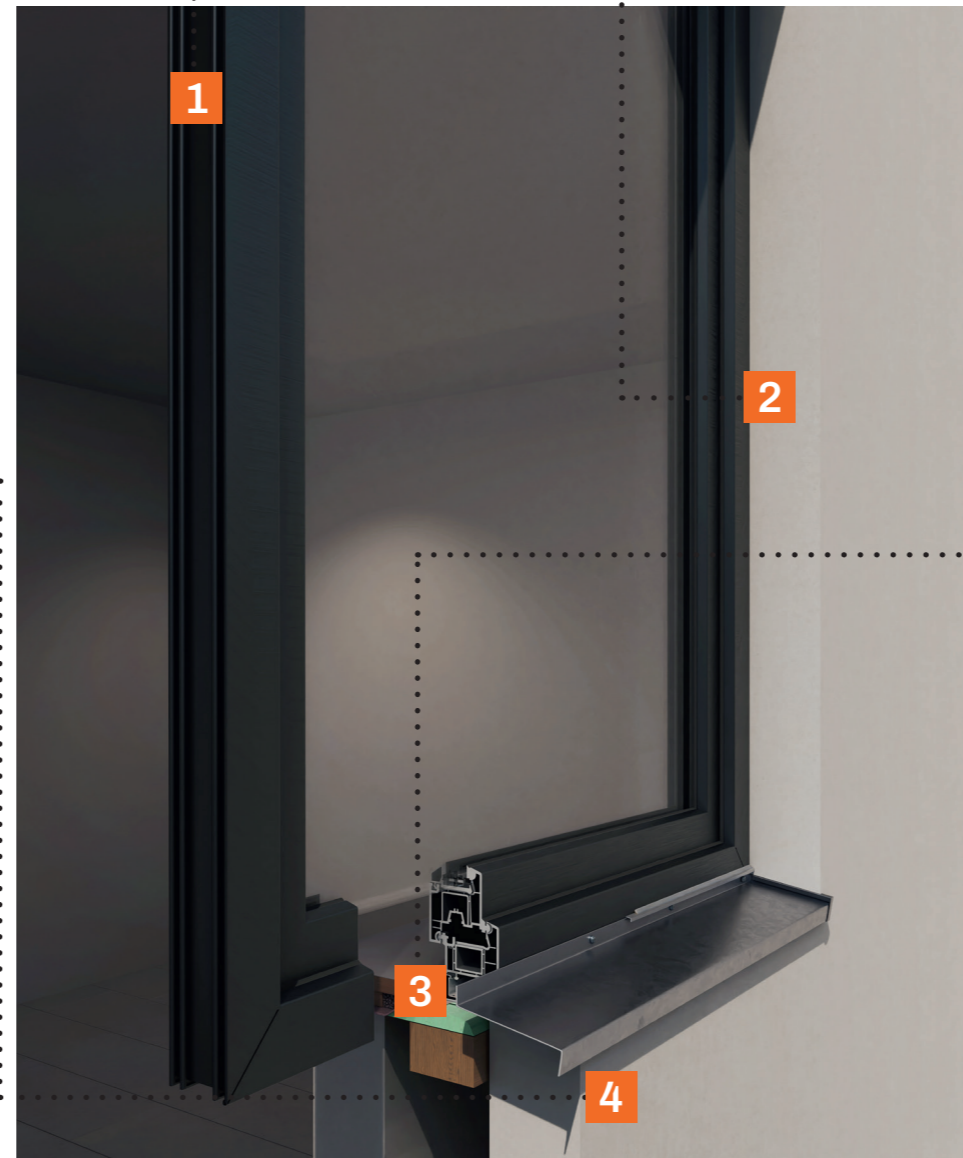

3

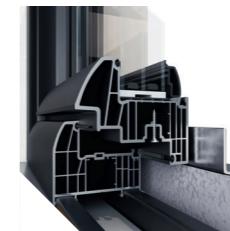

Option A – PVC PROFILE FIXATION



Window construction screw, countersunk head, full thread, double thread, PH, steel, zinc plated

Art. 61528



Option B – WOODEN WINDOW



Wood drilling screw, countersunk head milling ribs, TX®, part thread, drill-tip, steel zinc plated

Art. 144889

5. VENTILATED FACADE & FACADE INSULATION

1



Ventilated facade substructure self-drilling screw for fixed and sliding points, stainless steel A4

Art. 424677

6



Wood drilling screw EASYtop, ornamental head 60°, TX®, part thread, drill-tip, martensitic stainless steel

Art. 20898

5

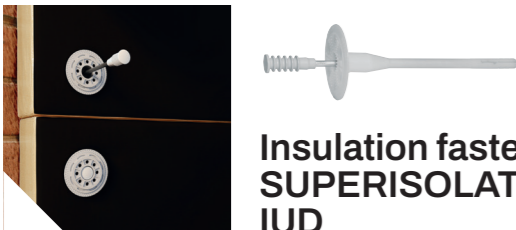

Insulation fastener SUPERISOLATEfix IUD

Art. 40373



Plug ISOLATEfix LTX

Art. 216567

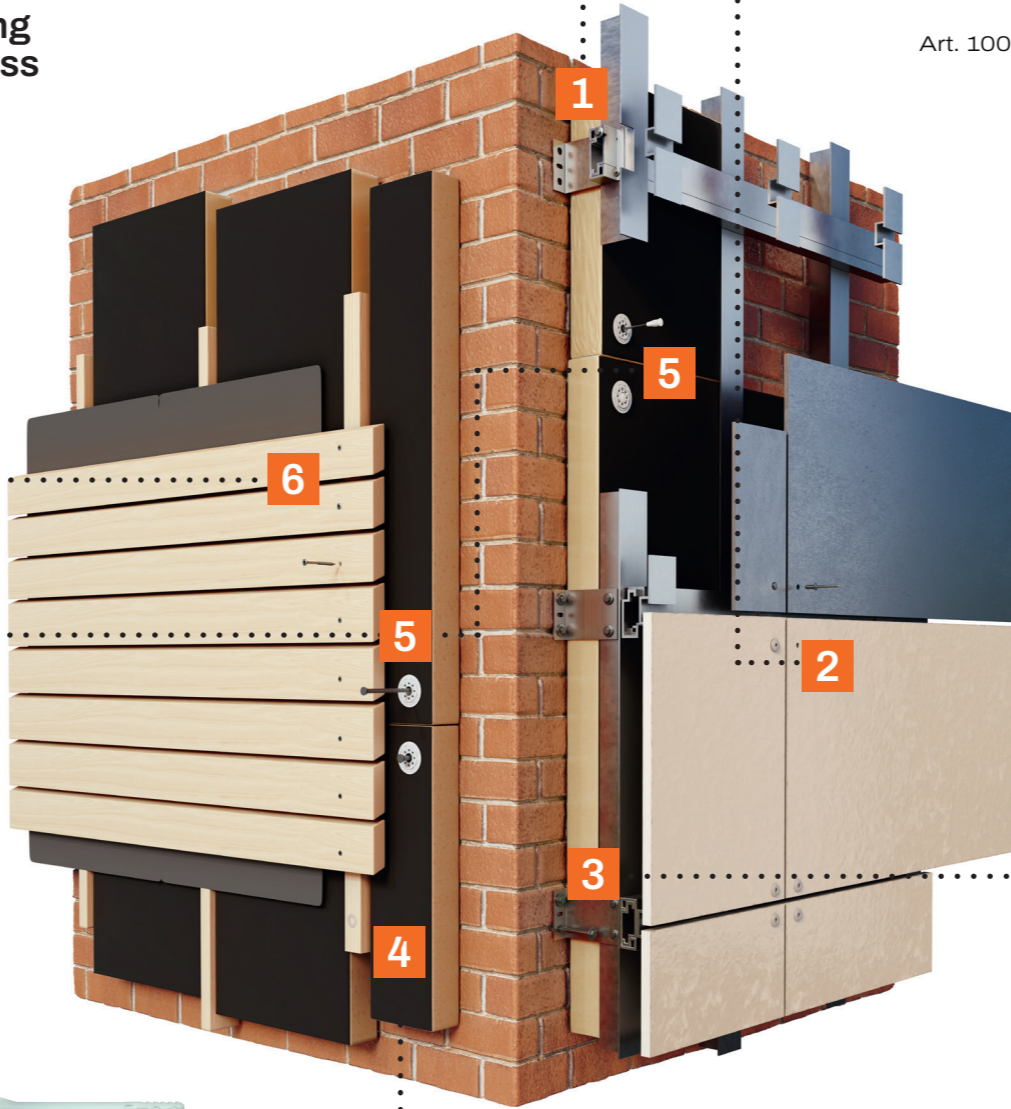

2

Option A



Facade ACM panel self-drilling screw pan head TX A2/plain

Art. 1002729

Option B



Facade rivet S11, AL/A2, colored

Art. 1002747

3



MMS-plus P panhead zinc plated, with TX drive

Art. 341241

Option A



Universal frame plug BXRfix 6KT ZI

Art. 113875

Option B



Simplex anchor BAZ+

Art. 114095

Option C



MMS-plus SS hexagon zinc plated

Art. 341205

4

Option A



Universal frame plug BXRLfix countersunk head ZP

Art. 251316

Option B



Universal frame dowel BXRfix countersunk head ZI

Art. 113830

6. EXTERIOR INSTALLATION

1



Tinsmith screw DIN 7995, raised countersunk head with washer, six lobe (TX), stainless steel A2/plain

Art. 14959

6



Insulation plug ISOdrill with thread rod

Art. 243745

5



Option A



NEW
Simplexanchor B-SN stainless steel A4

Art. 1012998

Option B



NEW
Simplex anchor BAZ+ R

Art. 114065

2

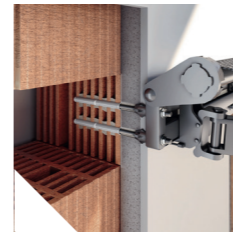

Spaced Installation System TMfix 16 M12

Art. 114057



Compound mortar MCS Uni Plus

Art. 200634

3



MMS-plus F countersunk A4

Art. 418709



4



Option A

Insulation plug direct 80

Art. 344186



Tinsmith screw DIN 7995, colored raised countersunk head with washer 15 mm, (TX), stainless steel A2/plain

Art. 167275

Option B



Iso plug ISOdrill TOP

Art. 174830

Option C



Distance Assembly System TMfix Mini

Art. 113983

7. HVAC AND ELECTRICAL INSTALLATIONS

1



MMS-plus I internal thread zinc plated

Art. 341255



Threaded rod DIN 976-1, shape A, steel 4.8, zinc plated, 1 meter

Art. 165697

2



Self-drilling screw DIN 7504-K / EN-ISO 15480, hexagon washer head, steel zinc plated

Art. 113357

9



MMS-plus SS hexagon zinc plated

Art. 341203

3



Quick sliding bolt

Art. 1001106

8

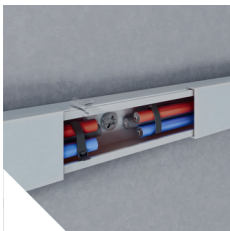

Universal dowel

Art. 108054

4



Hinged pipe clamp Quick M8/M10

Art. 82698

7



Self-tapping screw DIN 7981 / EN-ISO 7049, form C, pan head, cross recess (PH), steel zinc plated

Art. 182044

6



Round Clip NS-R

Art. 11173

5



Option A – IN AERATED CONCRETE



Gas concrete anchor BPX-I

Art. 207810

Option B – IN CONCRETE



NEW

Simplex anchor BAZ+

Art. 114095



Hanger Bolt with key flats, six lobe drive, steel zinc plated

Art. 117996



Universal plug BXfix II

Art. 1004342

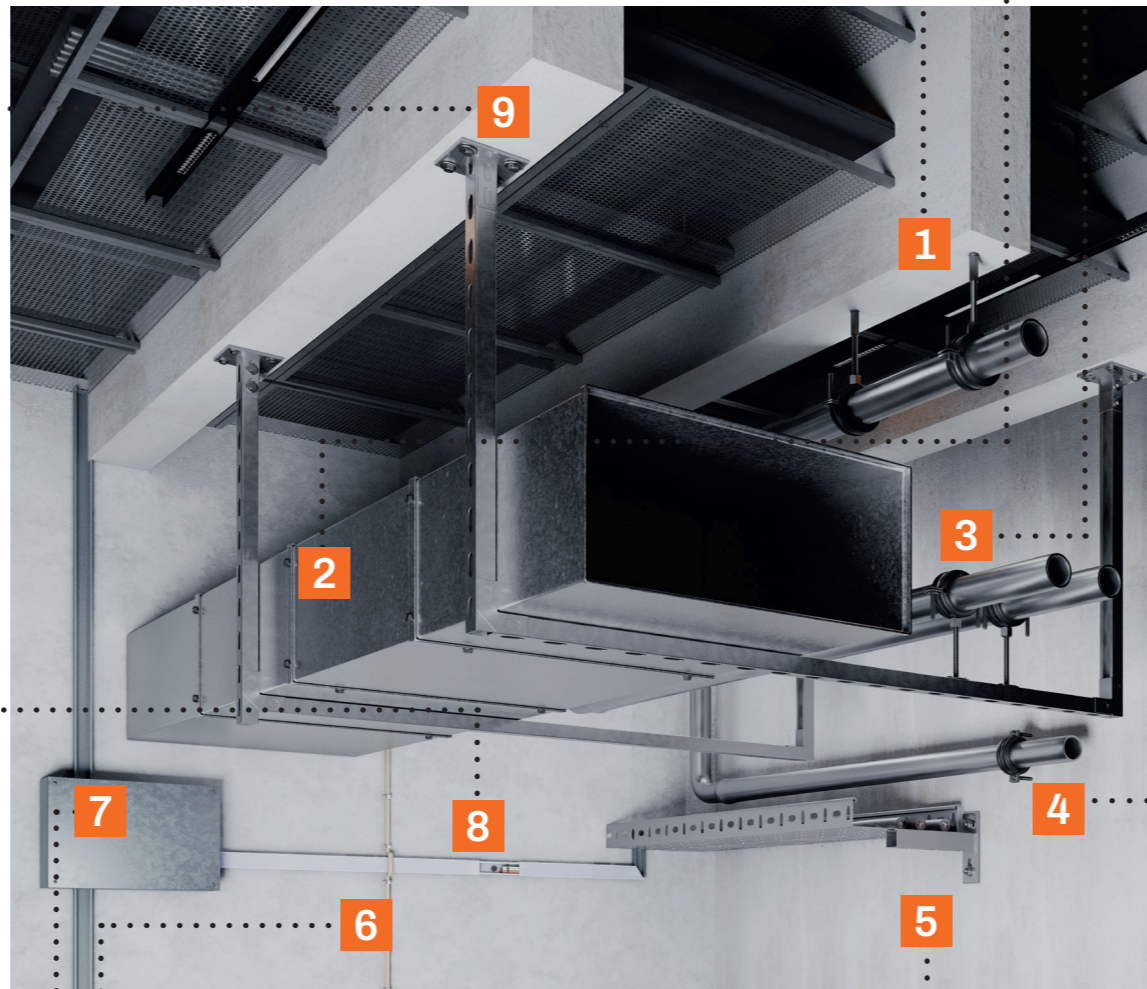

8. METAL SHEETS AND STEEL FRAME

1

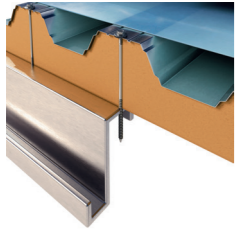

Self-drilling screw for sandwich panels, hexagon washer head, high thread, bi-metal stainless steel A2, w/ washer

Drill capacity 5 mm Art. 180385
 Drill capacity 12.5 mm Art. 180364

6

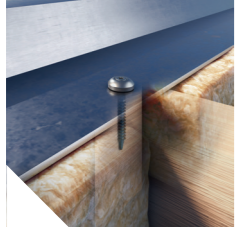

Self-drilling screw, hexagon washer head, bi-metal stainless steel A2, for wood substrate, w/ washer

Art. 54531

5

Option A



Injection mortar MCS Diamond
 Art. 180905



Anchor rod MCS Plus A ZI
 Art. 80544

Option B

NEW



Simplex anchor BAZ+
 Art. 114095

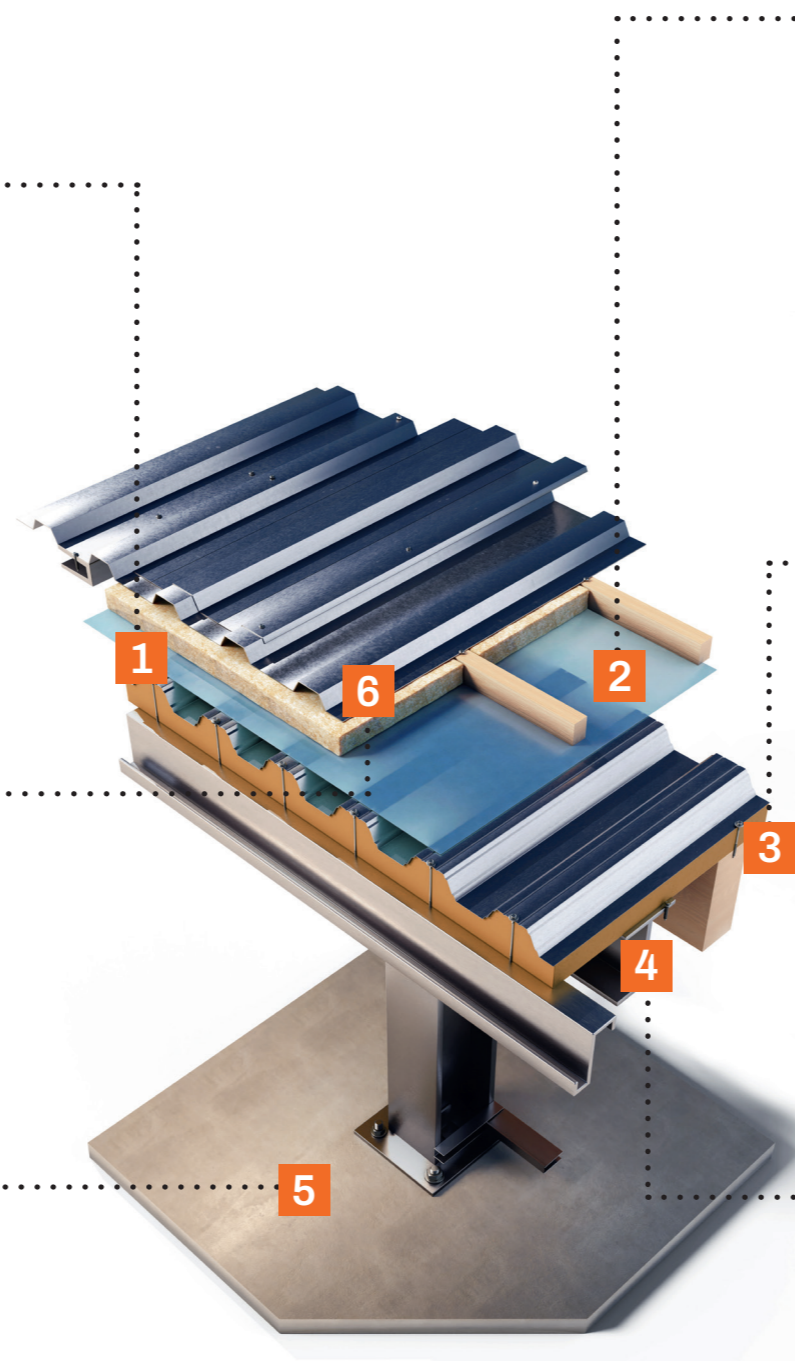

2



Stitching screw w/ chip-less forming bi-metal stainless steel A2 w/ washer

Art. 424617

3



Self-drilling screw for sandwich panels, hexagon head, high thread, bi-metal stainless steel A2 w/ hardened steel drill tip, chipless forming, for wood substrate, w/ washer

Art. 424610

4

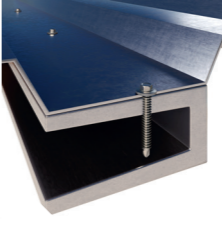

Self-drilling screw, hexagon washer head, bi-metal stainless steel A2, w/ washer

Drill capacity 3.5 mm Art. 103267



Drill capacity 6 mm Art. 54527
 Drill capacity 12.5 mm Art. 103290

9. DRYWALLING

1



Option A



Metal anchor CAVITYfix with screw

Art. 404465

Option B



Toggle plug BSTfix

Art. 10031

2



Drywall Screw, Fine double thread (metal), black phosphated

Art. 165855

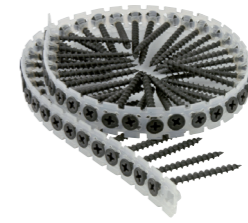

Drywall Screw, Coarse thread (wood), black phosphated, belted

Art. 154809

6

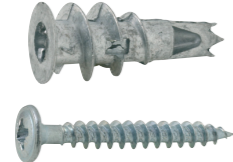

Plasterboard plug EXPRESSdrill 13x30 with screw

Art. 5205

5



Nail plug FLASHfix II flat collar with zinc plated screwnail

Art. 215677



DON'T FORGET



Cordless dry wall driver BACDWD BL & magazine BACM, 18 V, 2.0 Ah, BC+

Art. 366310

3

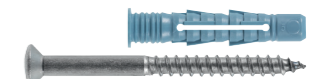

Sealing plug SEALfix with A2 screw

Art. 1006367

Watch the video

4



Fabric Assembly Tape

Art. 158867



Profi Fixing Pin

Art. 802718



Single clamp B-ESH

Art. 767298

DON'T FORGET



Fixing Pin Placement Iron Uni

Art. 802974

CARPENTRY/STRUCTURAL WOOD



	EASYtimber				EASYfast		EASYtop
	EASYtimber Pro TPN	EASYtimber Pro RNP	EASYtimber TOPRFD	EASYtimber TOP ZFD +	EASYfast WAVE plus	EASYfast ISO	EASYtop CUT
Article	1014423	1014369	1014675	1014640	410013	188966	412938
QR code							
Coating	ZP*	ZP*	ZP*	ZP*	ZP*	ZP*	ZP*
Drive type	TX®	TX®	TX®	TX®	TX®	TX®	TX®
Thread type	Partial	Partial	Full	Full	Partial	DUO	Partial
Ø (mm)	6 – 8 – 10	8 & 10	6,5 – 8 – 10	6,5 – 8 – 10	5 & 6	8	5 & 6
Total length (mm)	60 – 440	80 – 440	80 – 1000	80 – 1000	30 – 260	230 – 440	50 – 180
Shaft milling ribs	✓	✓	-	-	✓	-	✓
Screw tip	CUT	CUT	Drill	Drill	Chipbreaker rib	normal	CUT
Head shape	Washer (Plate)	Countersunk (Milling ribs)	Countersunk (Milling ribs)	Cylinder	Countersunk (Milling pockets)	Cylinder	Countersunk (Milling ribs)
ETA	✓	✓	✓	✓	✓	✓	✓
Application							
Wood joints structural (prefabricated) timber constructions: Timber (frame) constructions, formworks, on-roof insulations, rafter and shifter attachments	✓	✓	-	-	-	-	-
Fixing on-roof and facade insulation with pressure-resistant or pressure-soft materials	-	-	-	-	-	✓	-
For fastening structural wooden beams/purlins, lateral pressure and shear reinforcement, hall construction, ceiling renovation, roof insulation	-	-	✓	✓	-	-	-
For fixing woodenslats or OSB panels in wooden frame constructions	-	-	-	-	✓	-	✓
For fastening metal-wood (beam/purlin) connections: E.g. joist hangers (multiple screwings per metal sheet)	-	-	-	-	-	-	-

- no ✓ yes *ZP – Blue zinc-plated

WINDOW SCREWS



	BETOfix			DISTAfix	
	Cylindric head 7/8 mm	Countersunk head 11 mm	Pan head 13 mm	Notching 22 mm	Notching 45 mm
Art.	6470	169891	336712	368334	170063
QR code					
Coating material	ZP	ZP	ZP	ZP	ZP
Thread	Full	Full	Full	Partial	Partial
Drive	Tx	Tx	Tx	Tx	Tx
Head	Cylindric	Countersunk	Pan head	without head	without head
Ø (mm)	7,5 mm	7,5 mm	7,5 mm	6 mm	6 mm
Length	60 – 302 mm	60 – 302 mm	100 – 212 mm	60 – 180 mm	100 – 180 mm
Cutting	No	No	No	No	No
Ribs	No	Yes	No	No	No
Application					
Fixing aluminum, wood and PVC frames directly in concrete or hollow brick	✓	✓	✓	-	-
Frame fixation with adjustment on wooden support or other support with a dowel	-	-	-	✓	✓
Product advantages					
Discreet narrow head and aesthetics	✓	-	-	-	-
Direct fixing in the concrete after pre-drilling	✓	✓	✓	-	-
High and optimum load-bearing capacity pan n for an appealing look	-	-	✓	-	-
Superfluous wedging: time saving up to 60%	-	-	-	✓	✓
Reinforced version	-	-	-	✓	✓

WOOD/CHIPBOARD SCREWS

Chipboard Screws



Cabinet / Furniture



	EASYfast WAVEplus			EASYfast PRESS	EASYtop							EA-SYtop CUT	EASYclassic											Back Panel Screw	Euro Screw	Furniture Handle-screw	Furniture Connector		
Norm (CPR)	ETA *			ETA *	ETA *							ETA *	EN 14592																
Art.	409965	410100	410152	332297	370972	371015	411374	370993	370998	7027	370950	412937		TX: 87057 PZ: 86899	86938	87119	A2: 115901 A4: 142821	TX: 86765 PZ: 86577	TX: 86848 PZ: 86664	86723	1002310	TX: 149678 PZ: 281077	TX: 85474 PZ: 85428	TX: 879533 PZ: 936724	15829	TX: 421297 PZ: 115326	571377	23047	
QR Code																													
Applications																													
Cabinets / Furniture	•••	•	•••	•••	•••	•••	•••	•••	•••	•••	•••	••		•••	•••	•••	•••	•••	•••	•••	•••	•••	•••	•••	•••	-	-	•••	
Hinges / Fittings	•	•	-	•••	-	-	-	-	-	-	-	••	-	•	-	•	•••	•••	•••	•••	•••	•••	•	•	-	•••	-	-	
Furniture handles	-	-	-	-	-	-	-	-	-	-	-	-	-	-	-	-	-	-	-	-	-	-	-	-	-	-	•••	-	
(Acoustic) Panelling	••	••	•	-	••	••	••	••	••	••	•	•••		•••	-	•••	•••	•••	•••	•••	•••	•••	-	-	-	-	-	-	
Wooden stairs (e.g. cheek fastening)	-	-	-	-	-	-	-	-	-	-	-	-		-	-	-	-	-	-	-	-	-	-	-	-	-	-	-	
Suitable substructure(s)																													
Solid soft wood	✓	✓	✓	✓	✓	✓	✓	✓	✓	✓	✓	✓		✓	✓	✓	✓	✓	✓	✓	✓	✓	✓	✓	✓	✓	✓	✓	
Solid hard wood (pre-drilling)	✓	✓	✓	✓	✓	✓	✓	✓	✓	✓	✓	✓		✓	✓	✓	✓	✓	✓	✓	✓	✓	✓	✓	✓	✓	✓	✓	
Melamine-coated boards	✓	✓	✓	✓	✓	✓	✓	✓	✓	✓	✓	✓		✓	✓	✓	✓	✓	✓	✓	✓	✓	✓	✓	✓	✓	✓	✓	
(MDF)	✓	✓	✓	✓	✓	✓	✓	✓	✓	✓	✓	✓		✓	✓	✓	✓	✓	✓	✓	✓	✓	✓	✓	✓	✓	✓	✓	
Wood-core plywood	✓	✓	✓	✓	✓	✓	✓	✓	✓	✓	✓	✓		✓	✓	✓	✓	✓	✓	✓	✓	✓	✓	✓	✓	✓	✓	✓	
(OSB)	✓	✓	✓	✓	✓	✓	✓	✓	✓	✓	✓	✓		✓	✓	✓	✓	✓	✓	✓	✓	✓	✓	✓	✓	✓	✓	✓	
Screw tip	Thread + rib			normal	Drill	Drill	Drill	Drill	Drill	Drill	Drill	Cut		-	normal											normal			
Suitable with plastic dowels*	✓													✓	-	✓	✓	✓	✓	✓	✓	✓	✓	✓	✓	-	-	-	-

*safety-relevant fastenings (= risk of significant damage to property or persons in case of fastening failure) should always be mounted with ETA-systems (dowel+screw)

Available Dimensions

Ø [mm]	3.0-6.0			3.0 / 4.0	3.5-6.0	4.0-5.0	3.5-6.0	3.2	3.2	3.2-5.0	4.0	4.0-6.0		3.5-6.0	4.5	4.0-6.0	A2: 4.0-6.0 A4: 5.0	3.0-6.0	3.0-6.0	3.5-5.0	3.5 / 4.0	3.0-6.0	3.0-7.0	4.0-7.0	3.0 / 3.5	6.2	4.0	6.3
L [mm]	20-260	20-200	17-120	30-60	25-120	40-100	25-160	20-60	30-60	30-100	30-40	40-180		20-300	30-60	40-200	A2: 25-140 A4: 60-80	12-100	17-70	20-80	16-60	16-100	12-85	20-70	25-35	10.5 / 13.5	25	50

Ambient conditions – Material suitability

Dry (No direct moisture contact): ZP / YZP / BR / BLK / NP

Humid (No direct weathering / constant moisture or tannin contact): MAR

Wet (Direct moisture contact / no acids or tannins): A2

Inshore / Industry (Salty or moderately polluted or chemicals containing air / no direct seawater contact): A4/RUS

ZP = Zinc plated

YZP = Yellow zinc plated

MAR = Stainless Steel martensitic

BR = Bronzed / Burnished

A2 = Stainless Steel A2

RUS = Ruspert-coated (Alu-Zinc-Flake coat)

A4 = Stainless Steel A4 (tannin-resistant)

BLK = Black coated

NP = Nickel plated

- no ✓ yes • conditionally suitable •• suitable ••• especially suitable

METAL SCREWS



SELF-DRILLING METAL SCREWS											
Art.	909769	134404	828473	6706	57076	828701	540811	170536	54528	18038w	
Product name	DIN 7504-M self-drilling scr pan head BLKZP	DIN 7504-O self-drilling csk BLKZP	Screw Round-Head DIN 7504-M zinc plated	Self-drill screw sim. ~ DIN 7504-M	~ DIN 7504 self-drilling flat head flange ZP	DIN 7504-O self-drilling screw csk ZP	DIN 7504-K self-drilling screw	Wing-tip self-drilling screw UNC head Ø15 ZP	Facade self-drilling screw S6 bi-metal A2	Sandwich self-drilling screw S5 bi-metal A2	
Coating material			ZP	ZP	ZP	ZP	ZP	ZP	A2	A2	
Drive	PH	PH	PH	TX	PH	PH	6KT	TX	6KT	6KT	
Head shape			Pan	Pan		counter-sunk	6KT	counter-sunk	6KT	6KT	
Tip	Drill	Drill		Drill		Drill	Drill		Drill		
Pre-Drilling	not necessary			not necessary					not necessary		
Application											
steel	-	-	✓	✓	-	✓	✓	-	✓	✓	
Alu	-	-	✓	✓	-	✓	✓	-	-	-	
plastics	-	-	✓	✓	-	✓	✓	-	-	-	
wood/steel connections	-	-	-	-	-	-	-	✓	-	-	
Facade and roof cladding	-	-	✓	✓	-	-	-	-	-	-	
Roofing membranes on steel structures	-	-	-	-	-	-	-	-	✓	-	
Sandwich panels on metal substructures up to 5 mm	-	-	-	-	-	-	-	-	-	✓	
Plumbing and heating installation	-	-	✓	✓	-	✓	✓	-	-	-	
Window and door mounting	-	-	✓	✓	-	✓	✓	-	-	-	
Indoor (no wet areas)	-	-	✓	✓	-	✓	✓	✓	-	-	
Outdoor (no direct weather areas)	-	-	✓	✓	-	✓	✓	✓	-	-	
Outdoor (high humidity areas)	-	-	-	-	-	-	-	-	✓	✓	
Vehicle interior fittings	-	-	-	-	-	-	-	-	-	-	
Without centre punching	-	-	possible	possible	-	possible	possible	possible	-	possible	



SELF-TAPPING METAL SCREWS									
Art.	225851	632562	83242	723871	6670	535753	239267	724905	725854
Product name	DIN 7981-C self-tapping scr. pan head BLKZP	DIN 968-C self-tapp. pan head flange BLKZP	DIN 7982-C CSK PH BLK ZP	DIN 7981-C self-tapping screw pan head ZP	DIN 7981-C self-tapping screw pan head ZP	DIN 7982-C CSK PH ZP	DIN 7981 self-tapping screw pan head A2	DIN 7982 self-tapping screw CSK head A2	Window self-tapping screw cylinder head ZP
Coating material	ZP black	ZP black	ZP black	ZP	ZP	ZP	A2	A2	
Drive	PH	PH	PH	PH	TX	PH	PH	PH	
Head shape	Pan	flat Pan head		Pan			Pan	countersunk	
Tip	normal	normal		normal			normal	normal	
Pre-Drilling									
Application									
steel	✓	-	-	✓	-	-	✓	✓	-
Alu	✓	-	-	✓	-	-	✓	✓	-
plastics	✓	✓	-	✓	-	-	✓	✓	-
wood/steel connections	-	-	-	-	-	-	✓	✓	-
Facade and roof cladding	✓	-	-	-	-	-	-	-	-
Roofing membranes on steel structures	-	-	-	-	-	-	-	-	-
Sandwich panels on metal substructures up to 5 mm	-	-	-	-	-	-	-	-	-
Plumbing and heating installation	✓	-	-	✓	-	-	✓	✓	-
Window and door mounting	✓	-	-	✓	-	-	✓	✓	-
Indoor (no wet areas)	✓	-	-	✓	-	-	-	-	-
Outdoor (no direct weather areas)	✓	-	-	✓	-	-	-	-	-
Outdoor (high humidity areas)	-	-	-	-	-	-	✓	✓	-
Vehicle interior fittings	-	✓	-	-	-	-	-	-	-
Without centre punching	-	-	-	possible	-	-	-	-	-

STANDARD FIXING



	Universal plugs			Metal plugs	Rivet plugs		Express plugs	Brass plugs	Noise insulation plug	Gas concrete plugs	Universal plugs
	CLASSICfix	UNIVERSALfix	Bxfix II	EXPANDfix	RIVERfix		TURBOfix	BRASSfix	SSD	PBfix	PERFECTfix
Article	141153	135182	1004343	170895	364185		544779	42692	218330	113778	30680
QR code											
Base material											
Concrete	●●●	●●	●●●	●●●	●●		●●●	●●●	●●	-	●●●
Solid brick	●●●	●●	●●●	●●●	●●		●●●	●●●	●●	-	●●●
Sand-lime brick	●●●	●●	●●●	●●●	●		●●	●●●	●●	-	●●●
Lightweight concrete	●●●	●●	●●●	●●●	●		●●	-	●●	-	●●●
Aerated concrete	●●	●	●●	●●●	-		●	-	-	●●●	●●
Gypsum boards	●●	●	●●	●●●	-		-	-	-	●●	●●●
Perforated bricks	-	●●●	●●●	●●●	-		-	-	●	-	●●
Sand-lime perforated brick	-	●●●	●●●	●●●	-		-	-	●	-	●●
Hollow block	-	●●●	●●●	●	-		-	-	●	-	●●
Plaster boards	-	●●●	●●●	-	-		-	-	-	-	●

- no ● conditionally suitable ●● suitable ●●● especially suitable

CAVITY FIXING

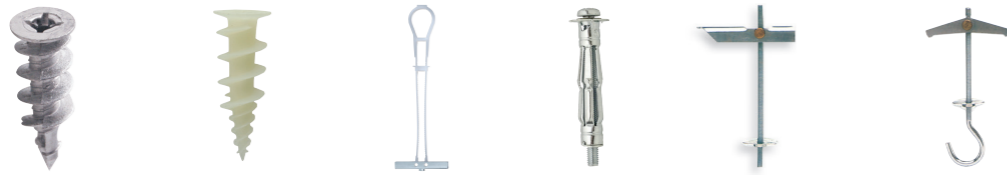

	Plasterboard plugs		Hollow wall plugs	Cavity fixing	Toggle fixing	
	EXPRESSdrill	SPEEDdrill	B-STfix	CAVITifix	FLIPfix	KLAPfix
Article	101625	113556	10031	404465	184136	42820
QR code						
Base material						
Concrete	-	-	-	-	-	-
Solid brick	-	-	-	-	-	-
Sand-lime brick	-	-	-	-	-	-
Lightweight concrete	-	-	-	-	-	-
Aerated concrete	-	-	-	-	-	-
Gypsum boards	•	-	-	-	-	-
Perforated bricks	-	-	-	-	-	-
Sand-lime perforated brick	-	-	-	-	-	-
Hollow block	-	-	•	••	•	•
Pre-stressed hollow core slabs	-	-	•	•	•	•
Plaster boards	•••	•••	•••	•••	•••	•••
Insulation boards	-	-	-	-	-	-
Wood-fibre insulation boards	-	-	-	-	-	-

FRAME FIXING



	FLASHfix II	HOLLOWFRAMEfix	BXRfix	BXRLfix	GERUSTfix
	Article	215665 215695	480531 400882	201152 113841	251325 251328
QR code					
Base material					
Concrete	••	-	•••	•••	•••
Solid brick	••	-	•••	••	•••
Sand-lime brick	••	-	•••	••	•••
Lightweight concrete	••	•	•••	••	•••
Aerated concrete	•	••	•	•••	••
Gypsum boards	•	••	•	••	••
Perforated bricks	-	•••	••	•••	-
Sand-lime perforated brick	-	•••	••	•••	-
Hollow block	-	••	••	•••	-
Assessment / approval					
Uncracked concrete	-	-	X	X	-
cracked concrete	-	-	X	X	-
Solid bricks	-	-	X	X	-
Hollow bricks	-	-	X	X	-
Aerated concrete	-	-		X	-
Fire resistance	-	-	(X)	(X)	-

- no • conditionally suitable •• suitable ••• especially suitable X Assessment available (X) See assessment

INSULATION FIXING



Article	Insulation plugs						Stand-off installation			Insulation panel holders			
	ISOdrill	ISOdrill TOP	ISOdrill 95D	ISOdrill direct	ISOdrill direct H-55		TMfix MINI	TMfix M12/16	ISOdistance block	SUPER ISOLATEfix	ISOLATEfix LTX	Insulation pin TID-S	ISOLATEfix LFM
	197289	174830	243746	344188 367957	420540 420541		113983	114046	1014090	40371	216571	399431	216566
Base material													
Concrete	-	-	-	-	-		•••	•••	•••	•••	••	•••	•••
Solid brick	-	-	-	-	-		•••	•••	•••	•••	••	••	•••
Sand-lime brick	-	-	-	-	-		•••	•••	•••	•••	••	••	•••
Lightweight concrete	-	-	-	-	-		••	•••	•••	••	••	•	••
Aerated concrete	-	-	-	-	-		••	•••	•••	••	••	-	••
Gypsum boards	-	-	-	-	-		••	••	•••	••	•	-	••
Perforated bricks	-	-	-	-	-		•••	•••	•••	•••	••	-	•••
Sand-lime perforated brick	-	-	-	-	-		•••	•••	•••	•••	••	-	•••
Hollow block	-	-	-	-	-		•••	•••	•••	•••	••	-	•••
Insulation boards	••	•••	•••	•••	-		-	-	-	-	-	-	-
Wood-fibre insulation boards	-	••	••	••	••		-	-	-	-	-	-	-
Assessment / approval													
Uncracked concrete	-	-	-	-	-		-	X	-	X	X	X	X
cracked concrete	-	-	-	-	-		-	X	-	X	X	-	X
Solid bricks	-	-	-	-	-		-	X	-	X	X	X	X
Hollow bricks	-	-	-	-	-		-	X	-	X	X	-	X
Aerated concrete	-	-	-	-	-		-	X	-	-	X	-	X
Fire resistance	-	-	-	-	-		-	-	-	-	-	X	-

- no • conditionally suitable •• suitable ••• especially suitable X Assessment available (X) See assessment

MECHANICAL ANCHORS

Mechanical anchors

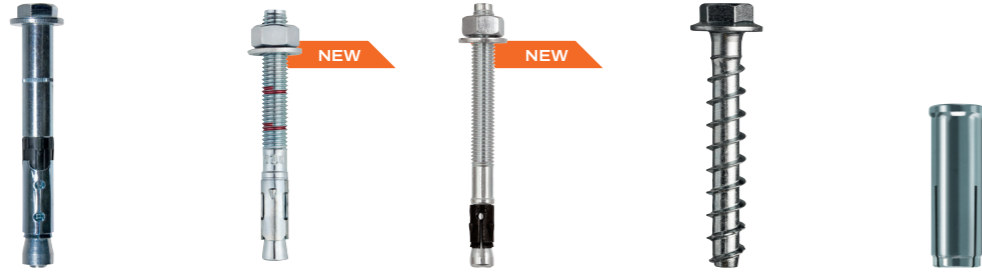

	High Performance anchor	SIMPLEXanchor		SCREWanchor	Drop-in anchor
	BHA	B-SN	BAZ+	MMS-plus	BE
Art.	80469	1012958	80589	341203	80384
QR code (all article numbers)					
Materials					
ETA cracked concrete	✓	-	✓	✓	-
ETA non-cracked concrete	✓	✓	✓	✓	✓
ETA redundant systems	-	-	-	✓	✓
ETA masonry	-	-	-	✓	-
ETA autoclaved aerated concrete	-	-	-	-	-
Prestressed hollow core slabs	-	-	-	✓	✓
Properties					
Seismic performance	C1/C2	-	C1/C2	C1/C2	-
Fire resistance	✓	-	✓	✓	✓
Usable in					
Concrete	●●●	●●	●●●	●●●	●●●
Solid brick	●●	●	●	●●●	-
Perforated bricks	-	-	-	-	-
Autoclaved aerated concrete	-	-	-	-	-

- no ✓ yes ● limited useable ●● good performance ●●● high performance

Mechanical anchors







	Drop-in anchor	SHIELDanchor	Gas concrete anchor	Nail anchor	Ceiling nail
	ES	-	BPX	BNA	TMH
Art.	408551	154902	207810	114545	1007289
QR code (all article numbers)					
Materials					
ETA cracked concrete	-	-	-	-	-
ETA non-cracked concrete	-	-	-	-	-
ETA redundant systems	✓	-	-	✓	✓
ETA masonry	-	-	-	-	-
ETA autoclaved aerated concrete	-	-	✓	-	-
Prestressed hollow core slabs	✓	-	-	-	-
Properties					
Seismic performance	-	-	-	-	-
Fire resistance	✓	-	✓	✓	✓
Usable in					
Concrete	●●●	●●	-	●●	●●
Solid brick	-	●●	-	●	●
Perforated bricks	-	●	-	-	-
Autoclaved aerated concrete	-	●	●●●	-	-

CHEMICAL ANCHORS

Chemical anchors



	MCS Protect Plus	MCS Uni Plus	MCS Uni Plus/WE	MCS Universal	MCS Diamond
Art.	1014819	114865 300 ml 175111 410 ml	422494 300 ml 175109 410 ml	367136	114861
QR code (to webshop)					
Cartridge size	300 ml	300 ml / 410 ml	300 ml / 410 ml	300 ml	390 ml
Special features	Declaration-free universal mortar for highest user and environment protection	Allround mortar with highest no. of approved applications	Express mortar with reduced curing time in low temperatures	Economic universal mortar with standard assessments	Premium mortar for highest performance in concrete
Chemical base	Vinylester Hybrid	Vinylester Hybrid	Vinylester Hybrid	Polyester	Pure epoxy
Materials					
ETA cracked concrete	✓	✓	✓	–	✓
ETA non-cracked concrete	✓	✓	✓	✓	✓
ETA masonry	b, c, d	b, c, d	b, c, d	c	–
ETA post-installed rebar	Ø 8 - 25 mm	Ø 8 - 28 mm	–	–	Ø 8 - 40 mm
Properties					
Seismic performance	–	C1/C2	C1/C2	–	C1/C2
Fire resistance	–	R120	R120	–	R120
Installation temperature	-10°C – +40°C	-5°C – +40°C	-10°C – +20°C	-5°C – +40°C	+5°C – +40°C
Max. processing time +15°C	5 min	5 min	1 min	9 min	30 min
Min. hardening time +15°C	2 h	1 h	30 min	1 h	18 h
Max. shelf life	18 months	15 months	15 months	18 months	36 months



– no ✓ yes





For detailed information please consider the assessment document of the anchoring system

CALCULATION SOFTWARE



Our fantastic four in one package

We at BERNER support our customers in calculating their projects with our smart and user-friendly calculation software with four modules covering all your requirements.

-  Dowel design
-  Reinforcement connections
-  Mortar calculator
-  Railing fasteners

Download for free



ONLINE PRODUCT FINDER FOR CHEMICAL ANCHORS

Your digital shopping guide



Scan QR-Code

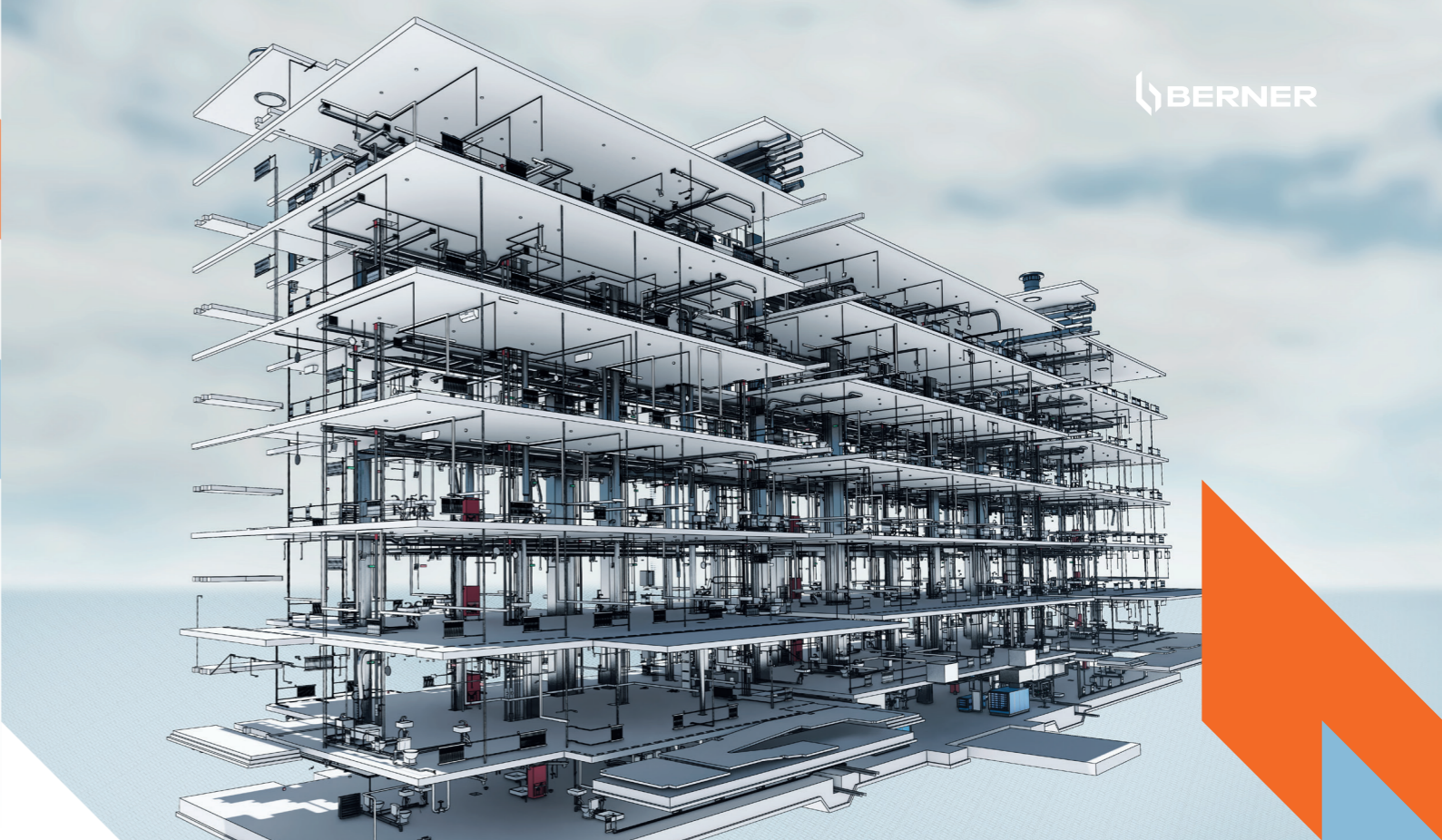

BIM - BUILDING INFORMATION MODELING

BIM creates smart 3D models that include not just the physical aspects of a structure, but also its functional characteristics—like materials, costs, timelines, and energy use. BIM is now compulsory for certain public projects, especially those above specific budget thresholds. BIM helps designers, engineers, architects visualize ideas in 3D, test materials and lighting and catch design issues.

BERNER LIBRARY

Berner provides a large library of products, such as screws and anchors, with BIM attributes that can be inserted into projects in just a few clicks. Integrates directly into AutoCAD®, Revit, ARCHICAD®, BricsCAD and similar software our RFA files. These documents are available and can be downloaded as well as Technical Data Sheets and ETA certifications in Berner webshop, under the product page.

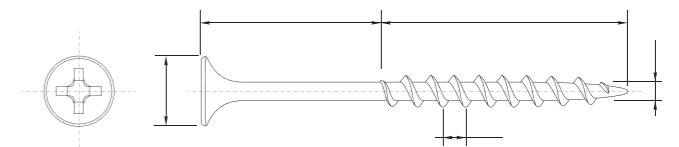



BERA MOBIL

Tailor-made for your van

Are you still looking for the tools in your vehicle? Do you still rearrange utensils senselessly? You could have it so much easier! Together with our strong partner Sortimo, we have the perfect solution for you to avoid clutter and wasted time: get the most out of the cargo space in your vehicle and ensure even more efficiency in your everyday work life with structure and order! Individual and tailor-made – just the way you need it.

YOUR BENEFITS:

- Order and availability of materials and tools at all times
- Maximum productivity and more efficient workflows
- Optimal load utilization through customized solutions
- Fulfillment of all legal requirements for load securing
- With installation service for immediate applicability

BERNER PAYS OFF

Benefit from our attractive refinancing model! Buy your individual in-vehicle equipment through BERNER and receive the purchase price back as a merchandise credit when reaching a predefined product turnover. Zero risk and no additional burden for your business.

INTRIGUED?

Find out more about BERA mobil from your sales rep or online:

QR-CODE

Find out more about our responsible products:

YOUR ANCHOR FOR ANY CONSTRUCTION.

Rock-solid heavy duty fastening solutions – safe, sustainable, and built for the toughest jobs.

You don't have time for second guesses. That's why our fastening systems are built to deliver: full holding power, smart certifications, and performance that holds up in any condition. Especially under pressure.

With BERNER, your work gets easy. No compromises, no overthinking. Whether chemical, mechanical, or a more sustainable option – we provide you with safe, efficient, and reliable solutions for every heavy-duty job.



Find out more





BERNER CONSTRUCTION APPLICATIONS

We have the right product portfolio for every challenge in construction to expand your expertise and drive your business even further!

ROOF EXTENSION

Create more space, more light, more energy efficiency, and more freedom to live and enjoy life with BERNER's efficient and smart solutions.

QR
CODE

See the full
portfolio here

FIRESTOP

Eliminate weak spots with ease and help your customers achieve an increased feeling of safety by sending a clear message to fire: no entry.

QR
CODE

See the full
portfolio here

BATHROOM RENOVATION

Whether it's a new build, a renovation, or a clever option for quick results: BERNER has the perfect solution for any bathroom!

QR
CODE

See the full
portfolio here

FOLLOW US ONLINE



QR
CODE

QR
CODE

QR
CODE

Berner Omnichannel Trading Holding SE

Bernerstr. 6
D-74653 Künzelsau

T +49 (0) 7940 120-0
F +49 (0) 7940 121-203
Info@berner-group.com

berner-group.com

