

Lumenwerx 

Evoq

ADAPTABLE COVE
LIGHTING SYSTEM

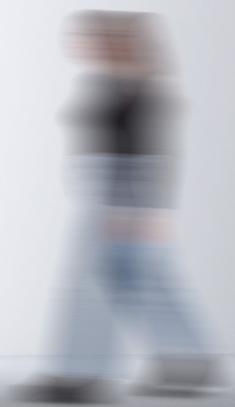

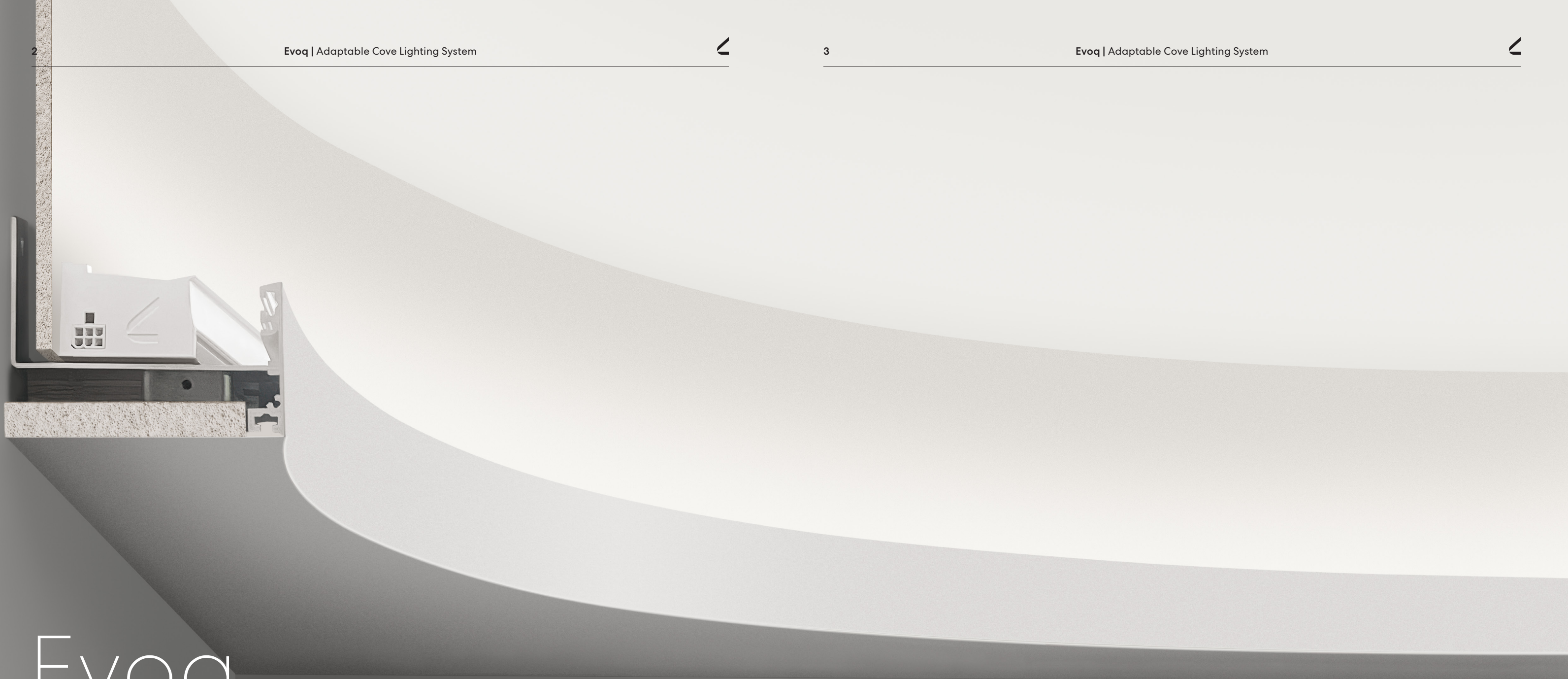

Evoq

Adaptable Cove Lighting System

Plug & Play Design

Soft & Uniform Illumination

2 Asymmetric Optics

10+ Mounting Options

Field-Curvable Mounting

Curved, Straight, One-of-a-kind Corners & Patterns



Evoq The System

Meet Evoq, the adaptable cove lighting system that utilizes cutting-edge technology to offer unparalleled customizability. With its prebuilt cove mounting ramps, Evoq provides easy solutions for seamlessly integrating cove lighting into a wide variety of interior designs.



Specify your Fixture

- Select your Options
(Optic, CCT, CRI, Lumen Package, etc.)



Define your Configuration

- Linear Cove
- Curved Patterns
- Straight Patterns



Select your Mounting

- 10+ Ramp Profiles
- Field-Curvable Ramps
- Use Pre-existing Cove





Evoq: Limitless Possibilities for Cove Design





Declare



Evoq The Fixture

Evoq fixtures are powerful, emitting up to 1200 lm/ft with a range from 3W to 12W. With integrated drivers, they maximize performance without compromising aesthetics. With two optic options available—the Asymmetric Narrow Optic (ANO) or Asymmetric Wide Optic (AWO)—Evoq fixtures offer a variety of mountings, including Mud-In, Direct Mount, or Field-Curvable ramp profiles, ensuring compatibility with any architectural cove design. Additionally, they can be used in pre-existing coves as standalone luminaires or installed with adjustable mounting brackets and rails.

SIZES

12", 18", 48"

UP TO

1200 lm/ft

2 OPTICS

Asymmetric Narrow Optic
Asymmetric Wide Optic

UP TO

95 CRI

10+
Mountings

Multiple
Control Options



Design & Options

The Fixture

Evoq luminaires are compact and versatile, seamlessly integrating into deep or shallow coves with plug-and-play 12", 18", and 48" fixtures. With two optic choices delivering true asymmetric uniform distribution, they excel in providing soft, even illumination for both shallow and deep cove applications. Fixtures can be spaced up to 0.5" without creating socket shadows or dark spots on the ceiling or walls.

Their quick, cost-effective installation with 10+ ramp options, along with adjustable options, makes them ideal for any cove application. Evoq fixtures are offered with multiple control options and provides smooth dimming up to 0.1%.

COMPACT SIZE (SIDE VIEW)

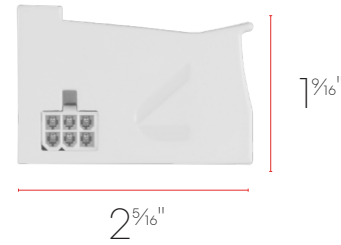

3 LENGTHS



PLUG & PLAY DESIGN

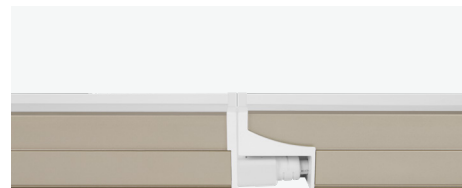

- Quick Connection
- 200 ft Max Run Length

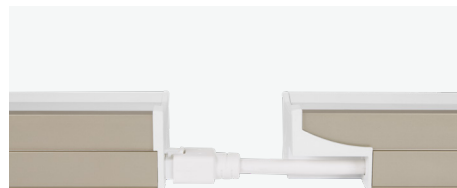

- Retractable Cable for Easy Installation
- Recommended Fixture Spacing Up to 0.5"



- Flexible Connection for Curved Cove



- Jumper Cable for Sharp-Angled Cove Design



- Adjustable Option with Brackets and Mounting Rail





Evoq Optics

Evoq utilizes true asymmetric optics that are precision-engineered to control the horizontal and vertical distribution, ensuring optimal illumination with clean beams and no light spill. The optics' indirect, asymmetric distribution creates visual comfort and ample footcandles on the work plane.

The optics deliver impressive color-over-angle uniformity with striation-free distribution.

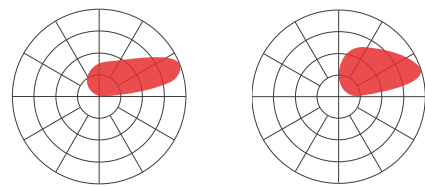

ANO

AWO

ASYMMETRIC NARROW OPTIC

Our Asymmetric Narrow Optic (ANO) is designed specifically for shallow coves with optimal performance achieved with fixture placement at 6"-12" from the ceiling. Its precise projection of light along ceilings and walls is evenly distributed with a soft, homogeneous gradient effect. The ANO peak intensity angle from nadir is at 110°, making it a true asymmetric optic that directs the light where it is intended.

ASYMMETRIC WIDE OPTIC

The Asymmetric Wide Optic (AWO) excels at maximizing light projection even farther to create a soft gradient illumination with remarkable uniformity in deeper coves. The AWO's optimal performance is achieved with fixture placement at 10"-36" from the ceiling. Its peak intensity angle from nadir is at 107°, creating a true asymmetric optic that aims light exactly where needed.

True Asymmetric Optics

Impressive Ceiling Uniformity

Precision-Engineered Optic Design

No Shadows
No Dark Spots





Color Temperatures & Static Colors

Evoq offers a versatile range of standard color temperatures, spanning from 2700K to 4000K. This range ensures that our lighting solutions cater to various environments and moods, providing options suitable for cozy warm spaces, at 2200K to crisp, clear lighting at 5000K. Evoq provides the flexibility of custom color temperatures or static colors, allowing you to precisely tailor the cove lighting to your space. Moreover, Evoq has optimal color consistency with 2-Step white binning.

Customizable CCT Options

2-Step White Binning

COLOR TEMPERATURES

- 2200K
- 2700K
- 3000K
- 3500K
- 4000K
- 5000K
- 6500K
- Static Colors

Chromawerx

Whether you prefer custom CCT ranges or our preset selections, you're in control. Choose the perfect color temperature for your space, crafting an ambiance that's captivating and tailored to your needs. Our tunable white lighting enhances visual comfort, functionality, and the well-being of occupants, making it lighting that's both effective and comfortable.

Custom CCT Ranges

Dynamic Adaptability

HEALTH & WELL-BEING
High EML/CS Options

TUNABLE WHITE (DUO) CUSTOM RANGE SELECTION



DIM TO WARM (SOLA) CUSTOM RANGE SELECTION





Colorful Ambiance

Sculpting Spaces with Cove Light



Evoq's static color option can transform ambiance, serving both functional and aesthetic purposes. Using colors for cove lighting is an elegant and subtle way to add a layer of accent lighting.

Warm hues create a cozy atmosphere, while cool colors give the illusion of more spacious environment.

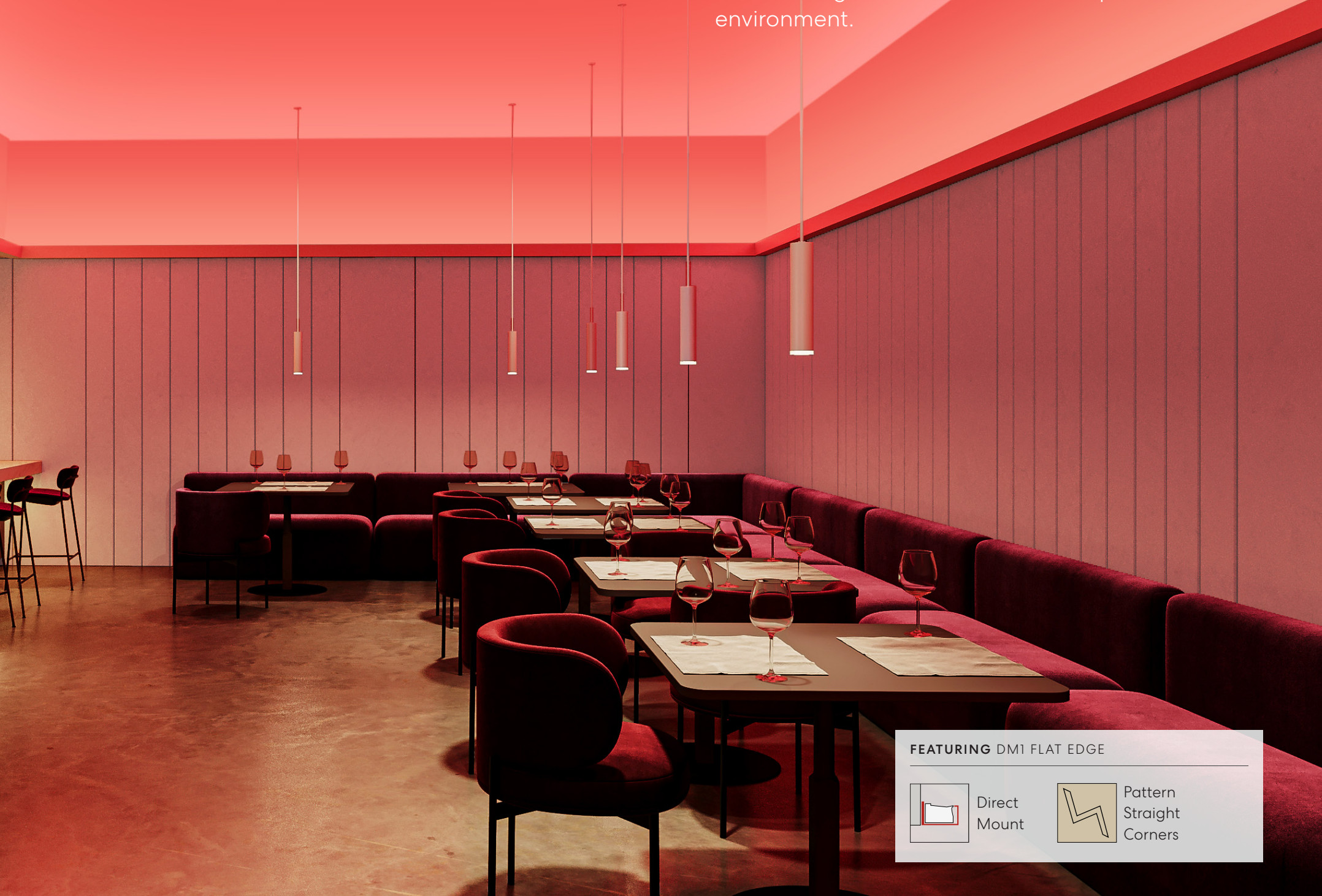

FEATURING DM1 FLAT EDGE

	Direct Mount		Pattern Straight Corners
--	--------------	--	--------------------------



Evoq Configurations

The Evoq Cove System is designed to be configured as linear runs or straight and curved patterns. Curved Configurations offer the flexibility to create captivating curved shapes and patterns with integrated corners. Equally versatile, Straight Configurations offer the possibility of creating simple geometric shapes and complex patterns with integrated corners.

Countless
Cove
Shapes

Patterns
With
Curved
Corners

Patterns
With
Straight
Corners





Curved Cove Configurations

Evoq's innovative curved cove configurations offer the flexibility to create captivating curved shapes and patterns and integrated corners. Three mounting options are available for curved configurations: two preset factory curved ramp options and one field-curvable ramp option. The Evoq System empowers you to bring your vision to life with precision and ease using curved corners with a minimal 15" radius.

Simple & Complex Patterns

Inside & Outside Curved Corners

Factory-Built Curved Mountings

Field-Curvable Mounting



PATTERNS WITH CURVED CORNERS

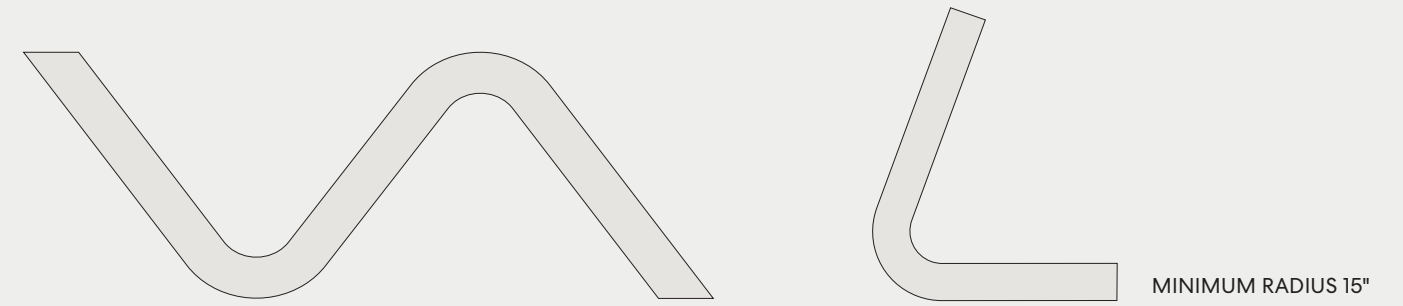

CURVED CONFIGURATIONS, OUTSIDE CORNERS (COMMON SHAPE EXAMPLES)

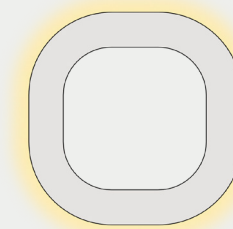

CURVED SQUARE

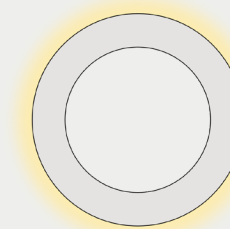

CIRCLE¹

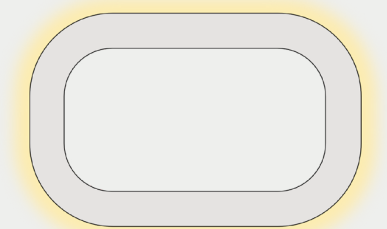

CURVED RECTANGLE

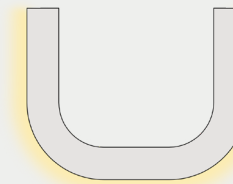

CURVED U-SHAPE

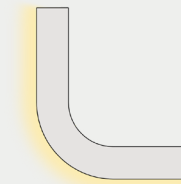

CURVED L-SHAPE



ARC²

CURVED CONFIGURATIONS, INSIDE CORNERS (COMMON SHAPE EXAMPLES)

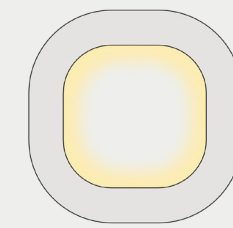

CURVED SQUARE

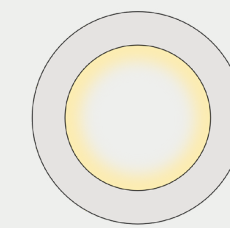

CIRCLE¹

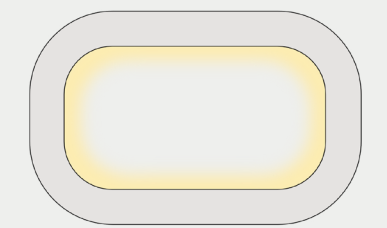

CURVED RECTANGLE

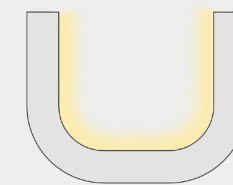

CURVED U-SHAPE

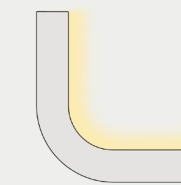

CURVED L-SHAPE



ARC²

¹ Minimum Ø 48"

² Minimum radius 24"



Straight Coves

Configuration

The cutting-edge Evoq Cove System enables seamless cove pattern integration effortlessly and maneuvering around corners with precision. For Straight Configurations and Linear Runs, over eight preset Factory Mounting options are offered.

Simple & Complex Patterns

Inside & Outside Corners

Linear Runs



PATTERNS WITH STRAIGHT CORNERS

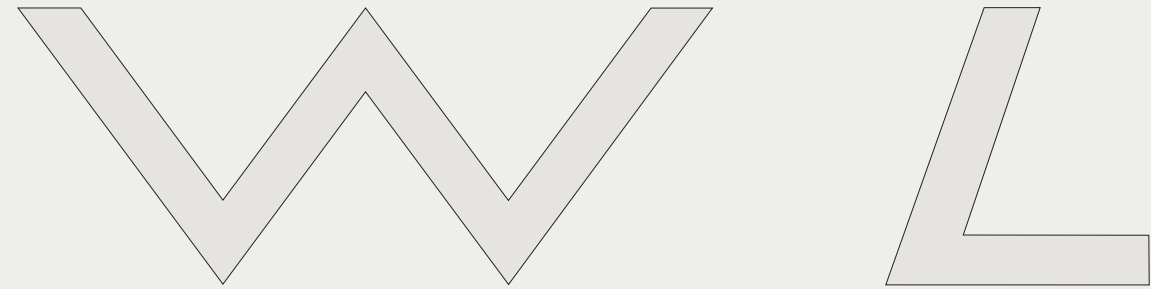

STRAIGHT CONFIGURATIONS, OUTSIDE CORNERS (COMMON SHAPE EXAMPLES)

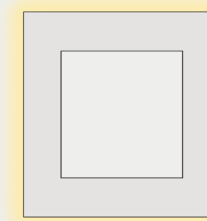

SQUARE

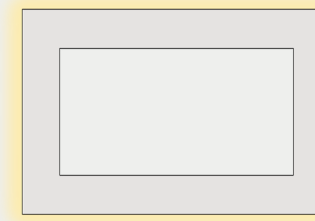

RECTANGLE

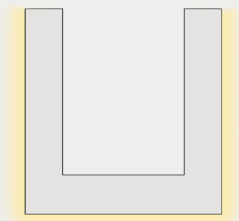

U-SHAPE



L-SHAPE

STRAIGHT CONFIGURATIONS, INSIDE CORNERS (COMMON SHAPE EXAMPLES)



SQUARE

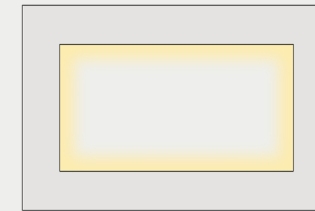

RECTANGLE

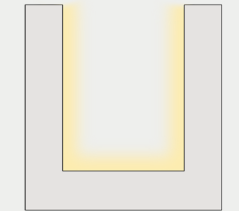

U-SHAPE



L-SHAPE



Evoq Mountings

Evoq ramps serve as prebuilt cove structures that can be easily integrated into ceilings or walls. All ramp options are field-cutttable and meticulously fit various designs of all shapes and patterns - straight, curved, or linear. They come in Mud-in, Direct Mount, or Field-Curvable options and they ensure quick and cost-effective cove installation. Evoq can also be integrated into existing coves as standalone fixtures.

Mud-In Ramps

Air Return
Integration Option

Direct Mount Ramps

Gasketed Clear
Cover Option

Field-Curvable Ramps





10+ Mounting Options

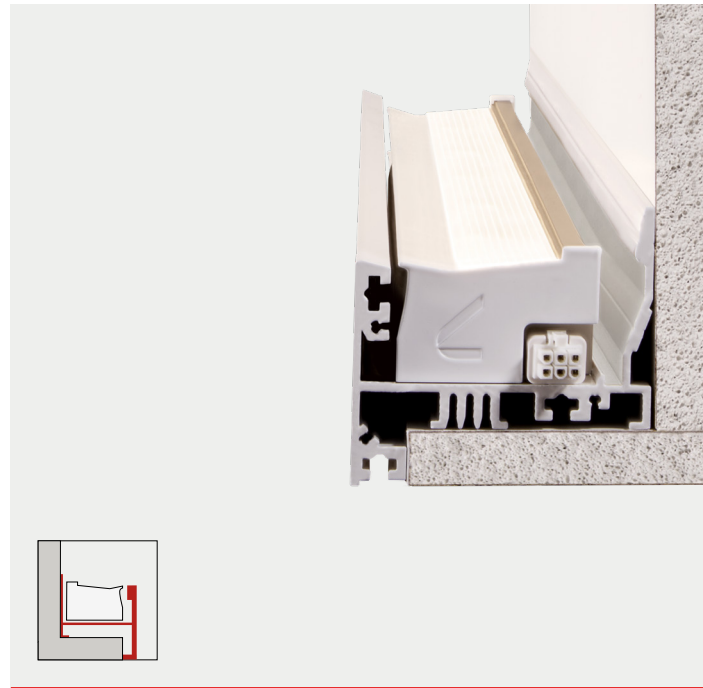

Mud-in Ramps

6 RAMP OPTIONS

Evoq Mud-in ramps seamlessly integrate cove lighting into ceilings or walls they serve as prebuilt cove structures. The ramp profiles are plastered-in and painted for a clean, polished ceiling appearance. The ramps are field-cutttable to ensure a perfect fit.

RAMP PROFILES

- **FE1** Flat Edge
- **FE2** Flat Edge with Air Return
- **KE1** Knife Edge 35°
- **WCA** Wall Cove with Adjustable Brackets
- **CRV1** Curved Ramp Flat Edge: Straight Structures
- **CRV2** Curved Ramp Flat Edge: Curved Structures

Field-Curvable Ramps

2 RAMP OPTIONS (MUD-IN)

The Field-Curvable ramps are the most flexible and customizable mud-in mounting options within the Evoq family. They are adjustable on-site to match the curved or straight contours of the wall/ceiling structure. The FC1 ramp includes field-curvable corner sections and non-field-curvable straight sections. The FC2 ramp option comes in 6' sections and is fully field-curvable for curved or straight structures. Both options are field-cutttable and require plastering and painting.

RAMP PROFILES

- **FC1** Field-Curvable Corners with Non-Field-Curvable Sections
- **FC2** Field-Curvable Ramp

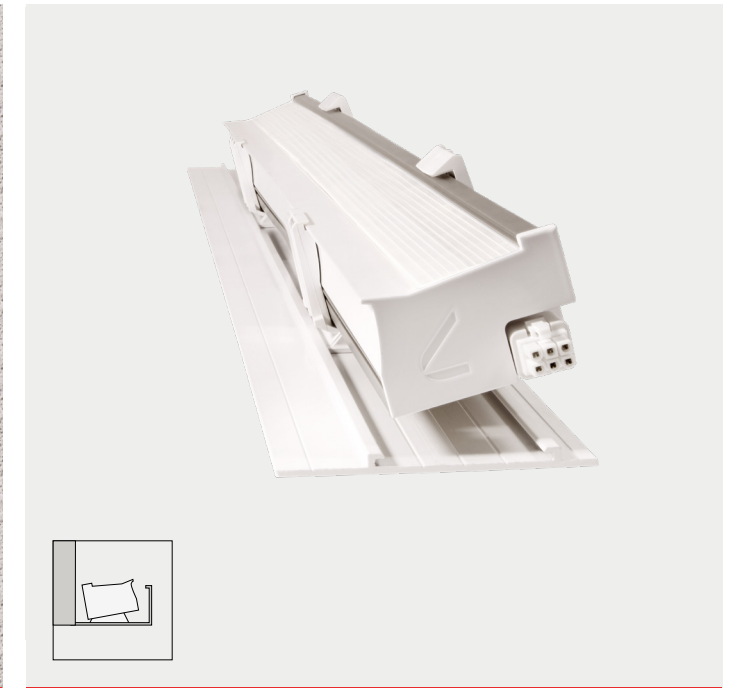

Direct Mount Ramps

3 RAMP OPTIONS

Evoq Direct Mount ramp options provide hassle-free, cost-effective cove lighting installations with prebuilt profiles that serve as stunning architectural cove details. The ramps are field-cutttable to ensure a perfect fit. Their streamlined finish elevates spaces and create a clean ceiling aesthetic.

RAMP PROFILES

- **DM1** Flat Edge
- **DM2** Flat Edge with Gasketed Clear Cover
- **DM3** Flat Edge with Adjustable Brackets

Additional Options

(COVE BY OTHERS)

Evoq can be integrated into existing coves as standalone fixtures or using the Adjustable Brackets with Mounting Rail option (ADJ).

OPTIONS

- **EVOQ** Evoq Fixture
- **ADJ** Adjustable Brackets with Mounting Rail



Softening Edges: Transforming Workspaces



FEATURING CRV2 RAMP



Mud-in Ramp



Patterns Curved Corners



Mud-in Ramp Options

Evoq mud-in ramps serve as prebuilt cove structures that can be easily integrated into ceilings or walls. The ramps are field-cutable to ensure a perfect fit and for a non-visible cove detail that blends seamlessly into the space, the final step is to plaster and paint the exposed part of the ramp. This creates a polished, built-in finish that blends into ceilings and walls.

6 Ramp Options

Linear Runs

Curved & Straight Patterns

Air Return Integration Option



FE1 - Flat Edge Ramp



FE1 is included in the mud-in offering, designed to be field-cutable, plastered-in, and painted. It seamlessly creates a cove space integrated into the architecture, allowing for linear or straight pattern coves with illuminated corners.



FE2 - Flat Edge + Air Return Ramp



FE2 is included in the mud-in offering, designed to be field-cutable, plastered-in, and painted. FE2 create a cove space that integrated air return vent in the cove architecture. The ramp can be use to create linear cove or straight patterns with illuminated corners.



KE1 - Knife Edge 35° Ramp



KE1 is included in the mud-in offering, designed to be field-cutable, plastered-in, and painted. Offering a sharp architectural cove detail and it seamlessly creates a cove space integrated into the architecture at a 35° angle, allowing for linear or straight pattern coves with illuminated corners.



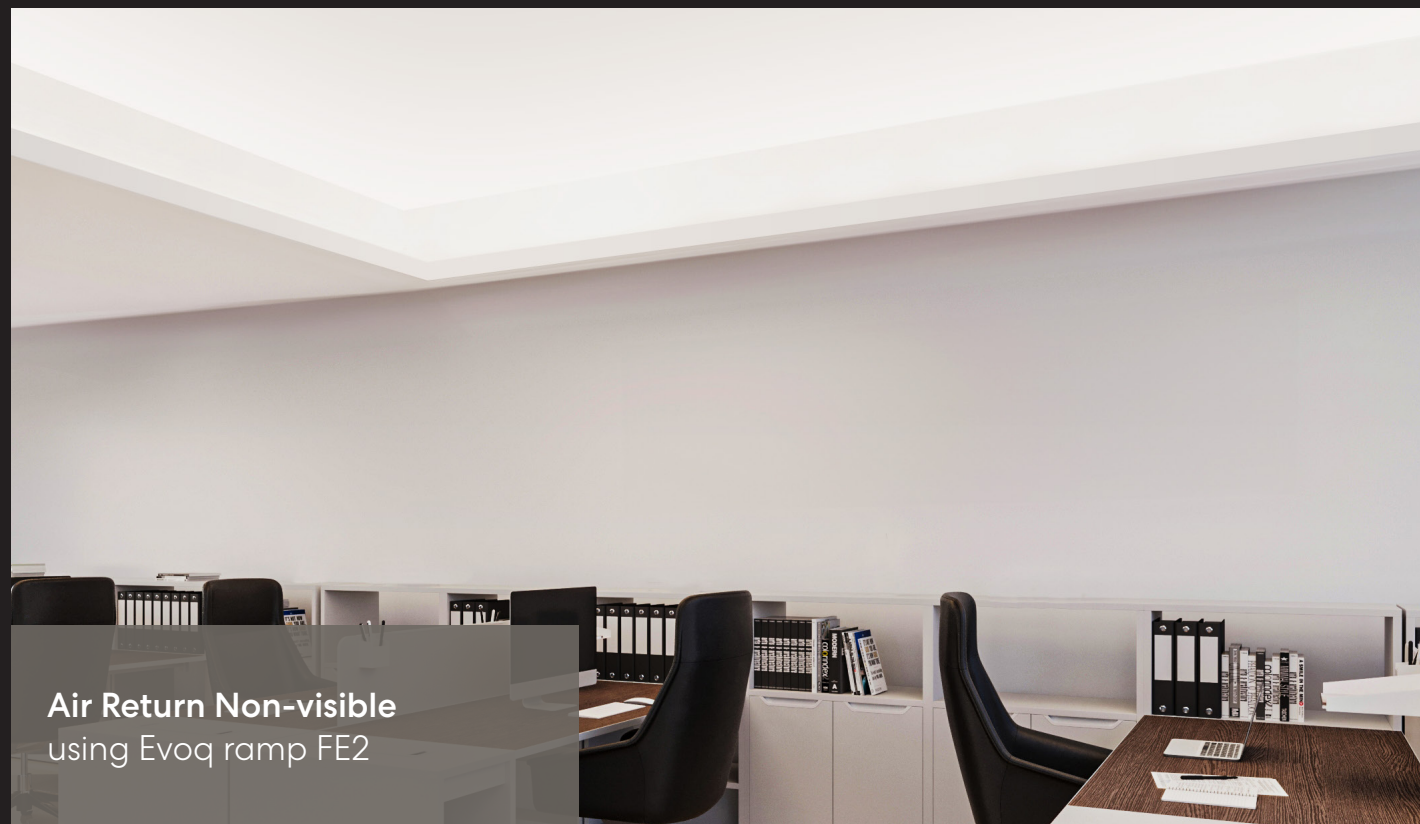

Air Return Visible

Air Return Non-visible
using Evoq ramp FE2

FE2 Ramp Option Concealed Air Return

Evoq's air return FE2 ramp solution eliminates the need for creating ventilation opening, saving on installation costs and effort.

The FE2 ramp effectively integrates air circulation into the cove ramp profile, concealing the air returns opening while delivering smooth, evenly distributed light. The ramp profile is a flat edge and is designed to be mud-in, and painted on site. The cove detail and air return disappear in the architecture resulting in a clean ceiling.

Mud-In
Cove Ramp

Clean Ceiling

Easy
Installation

Eliminate the
Cost of Air Vent
Installation

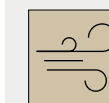
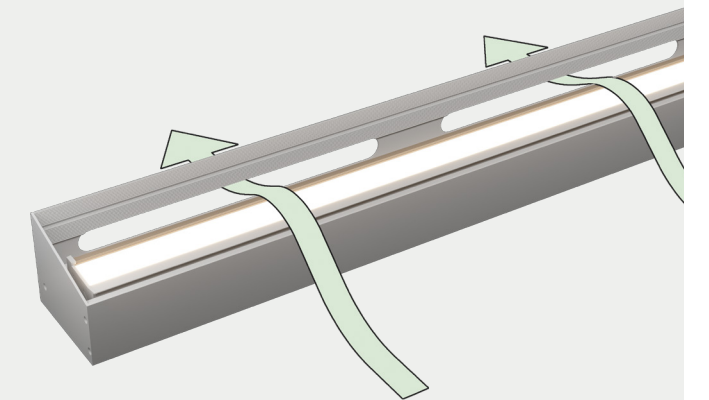
Air Return
Cove Ramp Integration



Mud-in Ramps

Patterns with Curved Corners

CRV1- Curved Ramp Flat Edge for Straight Structure

CRV1 is included in the mud-in offering, designed for **straight structure** and to be field-cuttable, plastered-in, and painted. The ramp is factory-built with preset curved corners and seamlessly creates a cove space allowing for curved pattern covers with illuminated corners.

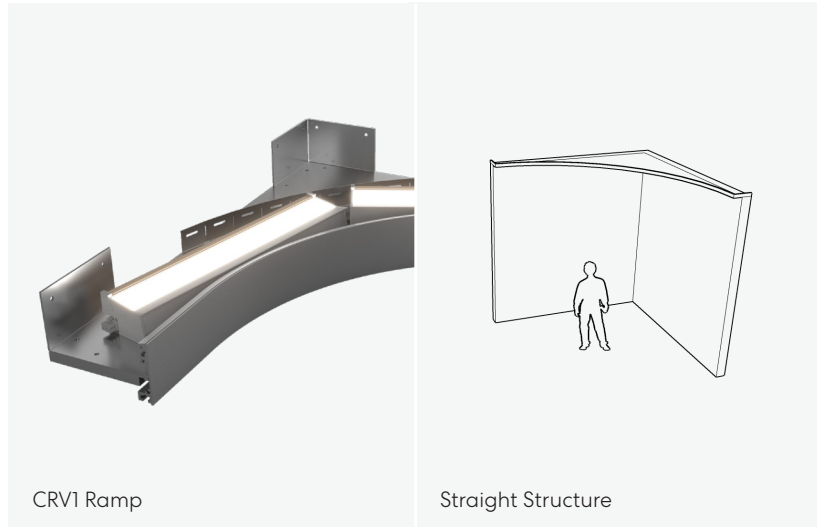

CRV2 - Curved Ramp Flat Edge for Curved Structure

CRV2 is included in the mud-in offering, designed for **curved structure** and to be field-cuttable, plastered-in, and painted. The ramp is factory-built with preset curved corners and seamlessly creates a cove space allowing for curved pattern covers with illuminated corners.

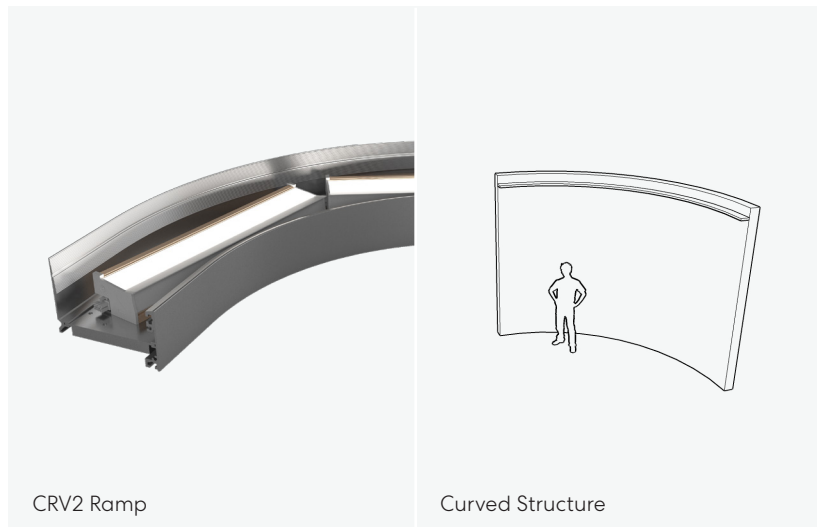

CRV1 RAMP
Straight Structure



CRV2 RAMP
Curved Structure



The Art of Curved Cove Design



FEATURING CRV2 RAMP

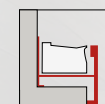

Mud-in Ramp



Patterns Curved Corners



Mud-in Ramps

Wall Cove Ramp (with Adjustable Brackets)

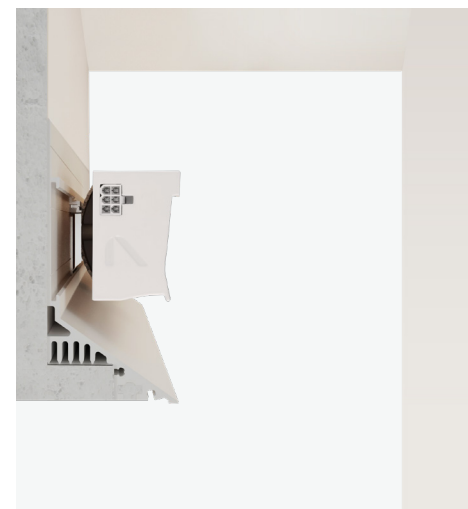

WCA

- Wall Cove with Adjustable Brackets

WCA is included in the mud-in offering, designed to be field-cuttable, plastered-in, and painted. The ramp is factory-built and creates a cove space allowing for straight patterns with factory preset illuminated corners. Its adjustable feature simplifies directing light towards your wall at the desired angle, without any pixelation on the surfaces. For optimal illumination, the ideal minimal distance from the wall is 6" for the Asymmetric Narrow Optic (ANO) and 12" for the Asymmetric Wide Optic (AWO).



Linear Run

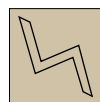

Pattern Straight Corners





Direct Mount

Ramp Options

Evoq Direct Mount ramp options provide hassle-free, cost-effective cove installations with prebuilt profiles that serve as stunning architectural details. Their streamlined finish elevates spaces, creating comfortable indirect illumination and a clean ceilings. Available in Lumenwerx's standard white, the Direct Mount option can also be tailored with custom colors.

3 Ramp Options

Straight Patterns Configurations

Adjustable Option

Gasketed Clear Cover Option



DM1 - Flat Edge

DM1 is included in the Direct Mount offering as prebuilt cove profiles that serve as stunning architectural cove detail. Designed for installation as a finished cove, it requires no additional plastering or painting. DM1 is field-cuttable and allows for linear or straight pattern coves with illuminated corners.



DM2 - Flat Edge with Gasketed Clear Cover

DM2 is included in the Direct Mount offering as prebuilt cove profiles that serve as stunning architectural cove details. Its gasketed clear cover makes it easy to clean, and it can also be finished with our Silverwerx antimicrobial finish. Designed for installation as a finished cove, it requires no additional plastering or painting. DM2 is field-cuttable and allows for linear or straight pattern coves with illuminated corners.



DM3 - Flat Edge with Adjustable Brackets

DM3 is included in the Direct Mount offering as prebuilt cove profiles that serve as stunning architectural cove detail. Its adjustable feature simplifies directing light towards your surface at a desired angle. Designed for installation as a finished cove, it requires no additional plastering or painting. DM3 is field-cuttable and allows for linear or straight pattern coves with illuminated corners.



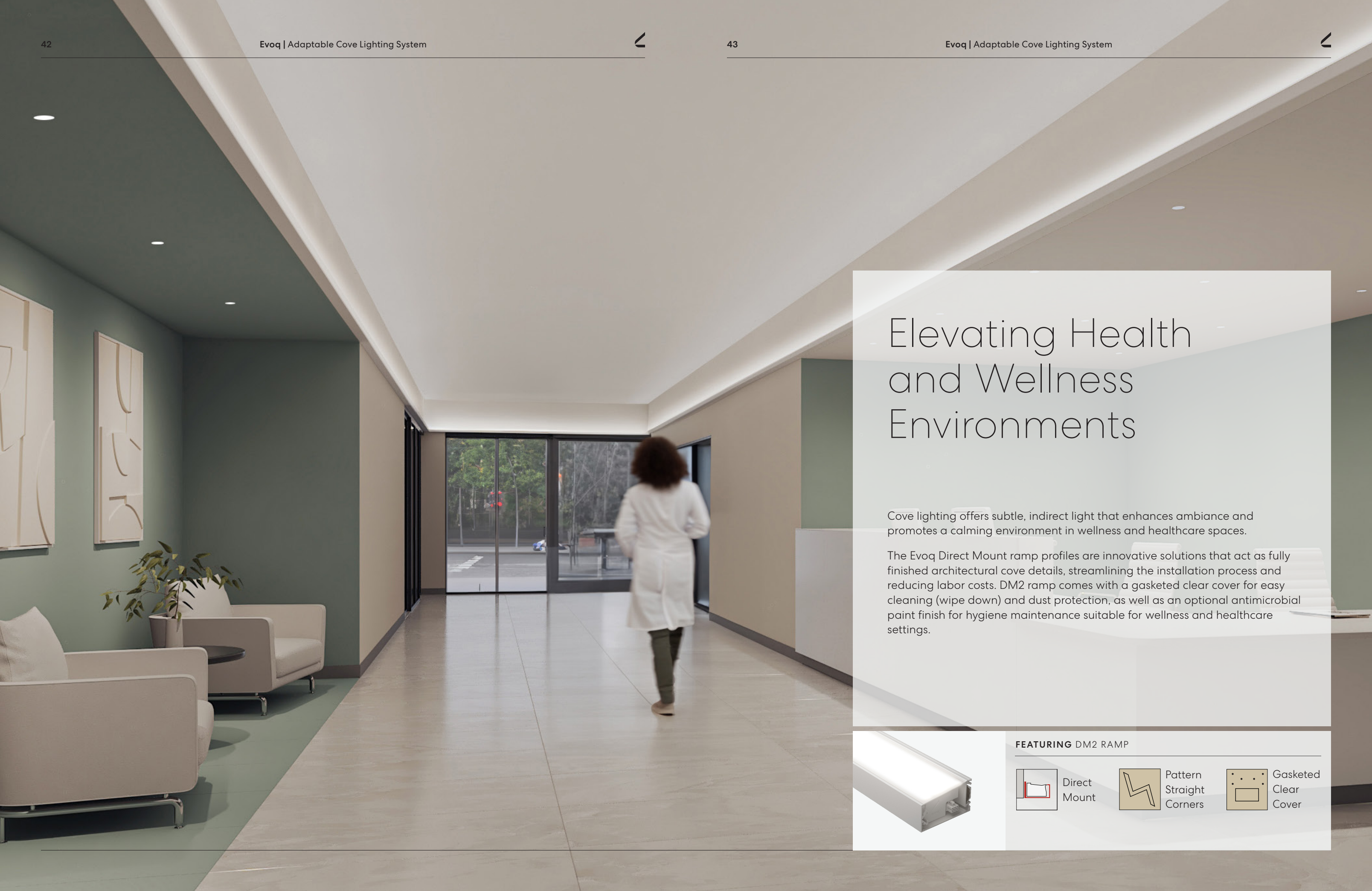

Elevating Health and Wellness Environments

Cove lighting offers subtle, indirect light that enhances ambiance and promotes a calming environment in wellness and healthcare spaces.

The Evoq Direct Mount ramp profiles are innovative solutions that act as fully finished architectural cove details, streamlining the installation process and reducing labor costs. DM2 ramp comes with a gasketed clear cover for easy cleaning (wipe down) and dust protection, as well as an optional antimicrobial paint finish for hygiene maintenance suitable for wellness and healthcare settings.

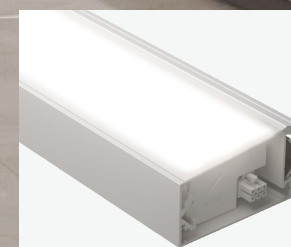

FEATURING DM2 RAMP

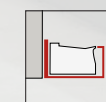

Direct Mount



Pattern Straight Corners

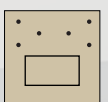

Gasketed Clear Cover



Innovative Field-Curvable Mounting



Field-Curvable Ramps

The Field-Curvable ramps (FC1 and FC2) are the most flexible and customizable mud-in mounting options within the Evoq family. The ramps are adjustable on-site to match the curved or straight contours of the wall/ceiling structure. They provide a streamlined and uniform architectural cove design suitable for new construction or remodeling projects.

The FC1 ramp includes field-curvable corner sections and non-field-curvable straight sections. The FC2 ramp option comes in 6' sections and is fully field-curvable for curved or straight structures. Both options are field cuttable and require plastering and painting.

COVE CONFIGURATIONS

Linear runs, straight patterns, curved patterns, corners with minimal radius of 15 in.



Patterns
Curved Corners



Pattern
Straight Corners

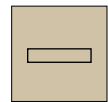

Linear
Run

Adjustable
for Complex
Cove Design

Easy
Installation

Follows your
Architecture

Minimal
Radius 15"



















Overview

Evoq Adaptable Cove Lighting System

FIXTURE OPTIONS

LENGTHS	COLOR RENDERINGS	OPTICS
12", 18", 48"	80+, 90+, 95+	 Asymmetric Narrow Optic  Asymmetric Wide Optic
COLOR TEMPERATURES	CONTROLS	LUMEN PACKAGES
<ul style="list-style-type: none">  2200K  2700K  3000K  3500K  4000K  5000K  6500K 	<ul style="list-style-type: none">  Sola  Duo  Static Colors  Full Spectrum LED 	<ul style="list-style-type: none"> 0-10V ELV TRIAC Lutron EcoSystem DALI DMX
		<ul style="list-style-type: none"> 350 lm/ft 500 lm/ft 750 lm/ft 1000 lm/ft 1200 lm/ft

MOUNTING OPTIONS

RAMPS		ADDITIONAL OPTIONS
 Mud-In Ramps	 Field-Curvable Ramps	 Adjustable Brackets with Mounting Rail
 Direct Mount Ramps		

RATINGS & CERTIFICATIONS

 L Dry, Damp locations	 D Declare label	 5 5-year warranty
 W WELL		



ALWAYS LIGHT
RIGHT

lumenwerx.com