

Zero



CATALANO

Zero



Zero 100x50 – Lavabo / Washbasin / Waschbecken

Ita Zero è il risultato dell'approccio innovativo di Catalano, finalizzato alla messa a punto di prodotti ineccepibili in termini di funzionalità, estetica e sostenibilità. Peculiarità grazie alle quali, Zero trova perfetta collocazione sia in ambienti d'hôtellerie che residenziali di alto profilo. La collezione è stata concepita per essere uno strumento di progettazione versatile e trasversale. L'ampia gamma di tipologie, dimensioni e le linee essenziali le permettono di aderire ai diversi bisogni arredativi. Il sistema si compone di ventitré lavabi da 150 a 32 cm e comprende versioni a tutto bacino, a doppio bacino o caratterizzate da piani polifunzionali da appoggio simmetrici o asimmetrici. I lavabi sono installabili a sospensione, ad appoggio, a semincasso e su mobile; alcuni anche ad incasso o sottopiano. Selezionati prodotti sono disponibili anche nelle Tonalità satinata bianco, cemento, nero e tortora. La collezione comprende un'ampia offerta di vasi sospesi e traslati a terra, tutti con l'innovativo sistema di scarico brevettato Silentech e rivestimento antibatterico Cataglaze+ con ioni d'argento e di titanio, per una brillantezza senza eguali e massima igiene garantita.

Deu Zero ist das Ergebnis des innovativen Ansatzes von Catalano, der darauf abzielt, Produkte in Bezug auf Funktionalität, Ästhetik und Nachhaltigkeit zu perfektionieren. Besonderheiten, dank derer sich Zero sowohl in der Gastronomie als auch in gehobenen Wohnumgebungen perfekt einfügt. Die Kollektion ist als vielseitiges und übergreifendes Tool in der Badezimmerplanung konzipiert. Die breite Auswahl an Modellen und Abmessungen sowie ihre essentiellen Formen ermöglichen es, den unterschiedlichsten Einrichtungsanforderungen gerecht zu werden. Das System besteht aus dreiundzwanzig Waschtischen von 150 bis 32 cm und umfasst verschiedene Lösungen mit Einzel- und Doppelwaschtischen sowie symmetrischen oder aber asymmetrischen Mehrzweckflächen. Die Waschtische können als Aufsatz-, Halbeinbau- und Schrankwaschtischen ausgeführt werden; einige sind auch als Einbau- oder Unterbauwaschtischen erhältlich. Ausgewählte Produkte sind auch in satinierten Farbtönen wie Weiß, Zement, Schwarz und Taubengrau erhältlich. Die Kollektion umfasst eine große Auswahl an wandhängenden und bodenstehenden WCs, alle mit dem innovativen, patentierten Silentech-Abflusssystem und der antibakteriellen Beschichtung Cataglaze+ mit Silber- und Titan-Ionen für unvergleichlichen Glanz und garantiert maximale Hygiene.

Eng Zero is the result of Catalano's innovative approach aimed at crafting products that are flawless for their performance, design and sustainability – features that make Zero the perfect choice for hospitality environments and prestige residences. The collection is intended to be showcased in a variety of different settings. The wide selection of types, sizes and its spare lines suit it for different decorating needs. The system comprises twenty-three washbasins ranging from 150 to 32 cm and includes models with a single basin, double basin or featuring multifunctional storage spaces that are either symmetrical or asymmetrical. Washbasins may be installed as wall-hung, countertop, built-in or resting on a unit; some may also be inset or under-counter. Selected products are also available in the Tonalitàs satined bianco, cemento, nero and tortora. The collection includes a wide selection of wall-hung or floor mounted wc's, all with the innovative patented Silentech flushing system and the antibacterial coating Cataglaze+ with silver and titanium ions for an unparalleled gloss and guaranteed maximum hygiene.



Zero 55x35 – Wc e bidet / Wc and Bidet / Wc und Bidet



Zero 150x50 – Lavabo / Washbasin / Waschbecken



Zero 55x35 – Wc e bidet / Wc and Bidet / Wc und Bidet



Zero 150x50 – Lavabo / Washbasin / Waschbecken



Zero 100x50 – Lavabo / Washbasin / Waschbecken



Zero 75x50 – Lavabo / Washbasin / Waschbecken



Zero 50x35 – Wc e bidet / Wc and Bidet / Wc und Bidet

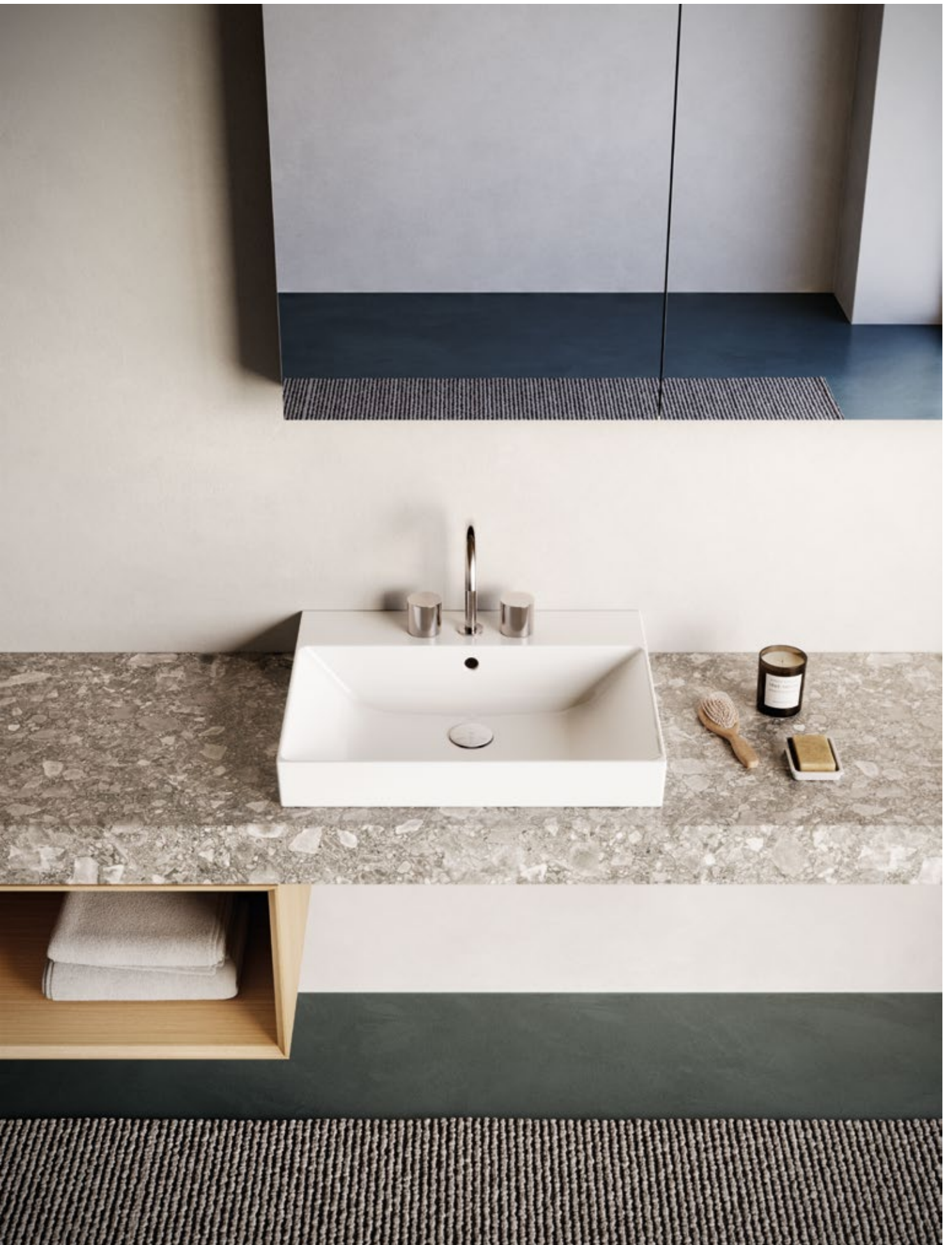

Zero 60x50 – Lavabo / Washbasin / Waschbecken



Zero 60x37 – Lavabo / Washbasin / Waschbecken



Zero 60x37 – Lavabo / Washbasin / Waschbecken



Zero 55x47 – Lavabo / Washbasin / Waschbecken



Zero 55x35 – Wc e bidet / Wc and Bidet / Wc und Bidet



Zero Ø45 h13 – Lavabo / Washbasin / Waschbecken

Zero 55x35 – Wc



Zero 50x35 h12 – Lavabo / Washbasin / Waschbecken
Ceramic top 150x50



Zero Ø32 h12 – Lavabo / Washbasin / Waschbecken
Zero 46x35 – Wc



Zero Ø32 h12 – Lavabo / Washbasin / Waschbecken
Zero 46x35 – Wc

Zero

Lavabi sospesi
Wall-hung Washbasins
Wandhängende Waschbecken

150x50
012152 2001



125x50
012126 1001



75x50
012078 1001



Lavabi appoggio
Countertop Washbasins
Aufsatzwaschbecken

70x35 h12
012270 0001

NEW



Tonalità collection
Gold&Silver

125x50
012127 2001

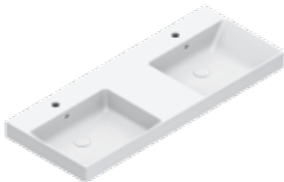

100x50
0121011001



100x50
012100 1001

p. 70



60x35 h12
012260 0001

p. 71

NEW



Tonalità collection
Gold&Silver

100x50
012104 1001



75x50
012075 1001

p. 70



50x35 h12
012250 0001

p. 71

NEW



Tonalità collection
Gold&Silver

100x50
012103 1001



60x50
012060 1001



Ø45 h13
012345 0001

Tonalità collection
Gold&Silver



75x50
012079 1001



50x50
012050 1001



Ø40 h13
012340 0001

Tonalità collection



Lavabi incasso
Built-in Washbasins
Einlegewaschbecken

Lavabi incasso e sottopiano
Built-in, under-counter Washbasins
Einlege- und Unterbauwaschbecken

Ø32 h12
01 2232 0001

NEW



60×37
01 2460 0001



80×37
01 2481 0001



Tonalità collection

50×37
01 2450 0001

p. 72



60×37
01 2461 0001



55×47
01 2655 1001

p. 73



Zero

Wc e Bidet sospesi
Wall-hung Wc and Bidet
Wandhängende Wcs und Bidets

55x35 Wc
011155 0001



Tonalità collection
Gold&Silver

50x35 Wc
011150 0001



46x35 Wc
011146 0001



55x35 Bidet
011855 1001



Tonalità collection
Gold&Silver

50x35 Bidet
011850 1001



Wc e Bidet terra
Floorstanding Wc and Bidet
Bodenstehende Wcs und Bidets

55x35 Wc
011455 0001



Tonalità collection

55x35 Bidet
011955 1001



Tonalità collection

Zero 150x50**01 2152 2001**

- Ita Lavabo con 1 foro, predisposto per 3 fori rubinetteria sui due bacini, con troppopieno. Installazione sospeso, incasso o su mobile.
- Eng Washbasin with 1 taphole, prearranged for 3 tapholes on both bowls, with overflow. Wall-hung, built-in or on furniture installation.
- Deu Waschbecken mit 1 Bohrung, vorbereitet mit 3 Bohrungen für Armaturen auf den zwei Waschschüsseln, mit Überlauf. Installation wandhängend, eingelegt oder auf Möbel.

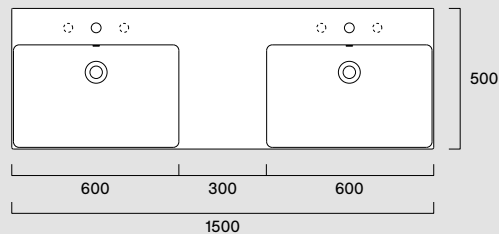

- Bianco lucido /
Glossy / Glänzend

Disponibile anche senza foro rubinetteria.
Also available without tap hole.
Auch ohne Armaturenbohrung erhältlich.

Zero 125x50**01 2127 2001**

- Ita Lavabo con 1 foro, predisposto per 3 fori rubinetteria sui due bacini, con troppopieno. Installazione sospeso, incasso o su mobile.
- Eng Washbasin with 1 taphole, prearranged for 3 tapholes on both bowls, with overflow. Wall-hung, built-in or on furniture installation.
- Deu Waschbecken mit 1 Bohrung, vorbereitet mit 3 Bohrungen für Armaturen auf den zwei Waschschüsseln, mit Überlauf. Installation wandhängend, eingelegt oder auf Möbel.

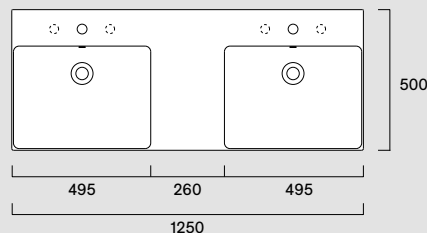

- Bianco lucido /
Glossy / Glänzend

Disponibile anche senza foro rubinetteria.
Also available without tap hole.
Auch ohne Armaturenbohrung erhältlich.

Zero 125x50**01 2126 1001**

- Ita Lavabo con 1 foro, predisposto per 3 fori rubinetteria, con troppopieno. Installazione sospeso, incasso o su mobile.
- Eng Washbasin with 1 taphole, prearranged for 3 tapholes, with overflow. Wall-hung, built-in or on furniture installation.
- Deu Waschbecken mit 1 Bohrung, vorbereitet mit 3 Bohrungen für Armaturen, mit Überlauf. Installation wandhängend, eingelegt oder auf Möbel.

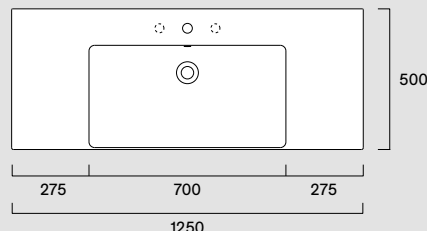

- Bianco lucido /
Glossy / Glänzend

Disponibile anche senza foro rubinetteria.
Also available without tap hole.
Auch ohne Armaturenbohrung erhältlich.

Zero 100x50**01 2101 1001**

- Ita Lavabo con 1 foro, predisposto per 3 fori rubinetteria, con troppopieno. Installazione sospeso, incasso o su mobile.
- Eng Washbasin with 1 taphole, prearranged for 3 tapholes, with overflow. Wall-hung, built-in or on furniture installation.
- Deu Waschbecken mit 1 Bohrung, vorbereitet mit 3 Bohrungen für Armaturen, mit Überlauf. Installation wandhängend, eingelegt oder auf Möbel.

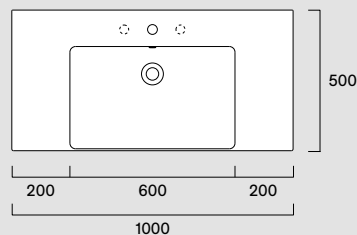

- Bianco lucido /
Glossy / Glänzend

Disponibile anche senza foro rubinetteria.
Also available without tap hole.
Auch ohne Armaturenbohrung erhältlich.

Zero 100x50**01 2104 1001**

- Ita Lavabo con 1 foro, predisposto per 3 fori rubinetteria, con troppopieno. Installazione sospeso, incasso o su mobile.
- Eng Washbasin with 1 taphole, prearranged for 3 tapholes, with overflow. Wall-hung, built-in or on furniture installation.
- Deu Waschbecken mit 1 Bohrung, vorbereitet mit 3 Bohrungen für Armaturen, mit Überlauf. Installation wandhängend, eingelegt oder auf Möbel.

- Bianco lucido /
Glossy / Glänzend

Disponibile anche senza foro rubinetteria.
Also available without tap hole.
Auch ohne Armaturenbohrung erhältlich.

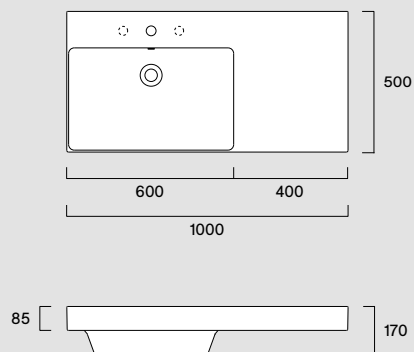
**Zero 100x50****01 2103 1001**

- Ita Lavabo con 1 foro, predisposto per 3 fori rubinetteria, con troppopieno. Installazione sospeso, incasso o su mobile.
- Eng Washbasin with 1 taphole, prearranged for 3 tapholes, with overflow. Wall-hung, built-in or on furniture installation.
- Deu Waschbecken mit 1 Bohrung, vorbereitet mit 3 Bohrungen für Armaturen, mit Überlauf. Installation wandhängend, eingelegt oder auf Möbel.

- Bianco lucido /
Glossy / Glänzend

Disponibile anche senza foro rubinetteria.
Also available without tap hole.
Auch ohne Armaturenbohrung erhältlich.

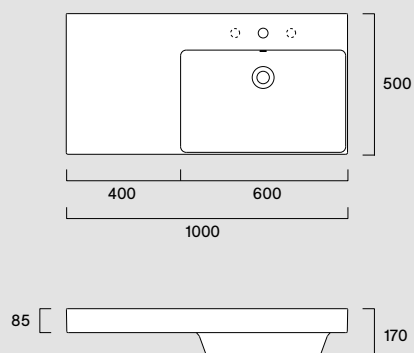
**Zero 75x50****01 2079 1001**

- Ita Lavabo con 1 foro, predisposto per 3 fori rubinetteria, con troppopieno. Installazione sospeso, incasso o su mobile.
- Eng Washbasin with 1 taphole, prearranged for 3 tapholes, with overflow. Wall-hung, built-in or on furniture installation.
- Deu Waschbecken mit 1 Bohrung, vorbereitet mit 3 Bohrungen für Armaturen, mit Überlauf. Installation wandhängend, eingelegt oder auf Möbel.

- Bianco lucido /
Glossy / Glänzend

Disponibile anche senza foro rubinetteria.
Also available without tap hole.
Auch ohne Armaturenbohrung erhältlich.

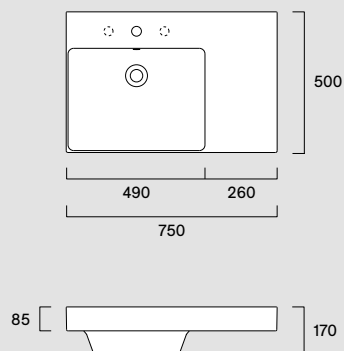
**Zero 75x50****01 2078 1001**

- Ita Lavabo con 1 foro, predisposto per 3 fori rubinetteria, con troppopieno. Installazione sospeso, incasso o su mobile.
- Eng Washbasin with 1 taphole, prearranged for 3 tapholes, with overflow. Wall-hung, built-in or on furniture installation.
- Deu Waschbecken mit 1 Bohrung, vorbereitet mit 3 Bohrungen für Armaturen, mit Überlauf. Installation wandhängend, eingelegt oder auf Möbel.

- Bianco lucido /
Glossy / Glänzend

Disponibile anche senza foro rubinetteria.
Also available without tap hole.
Auch ohne Armaturenbohrung erhältlich.

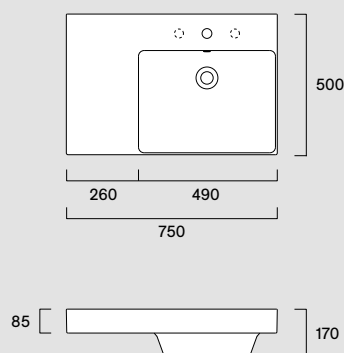

Zero 100x50**01 2100 1001**

- Ita Lavabo con 1 foro, predisposto per 3 fori rubinetteria, con troppopieno. Installazione sospeso, incasso o su mobile.
- Eng Washbasin with 1 taphole, prearranged for 3 tapholes, with overflow. Wall-hung, built-in or on furniture installation.
- Deu Waschbecken mit 1 Bohrung, vorbereitet mit 3 Bohrungen für Armaturen, mit Überlauf. Installation wandhängend, eingelegt oder auf Möbel.

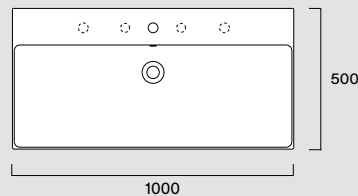

- Bianco lucido /
Glossy / Glänzend



Disponibile anche senza foro rubinetteria e con 2 fori rubinetteria laterali aperti.
Also available without tap hole and two opened lateral holes.
Auch ohne Armaturenbohrung und mit 2 offenen seitlichen Armaturenbohrungen erhältlich.

Zero 75x50**01 2075 1001**

- Ita Lavabo con 1 foro, predisposto per 3 fori rubinetteria, con troppopieno. Installazione sospeso, incasso o su mobile.
- Eng Washbasin with 1 taphole, prearranged for 3 tapholes, with overflow. Wall-hung, built-in or on furniture installation.
- Deu Waschbecken mit 1 Bohrung, vorbereitet mit 3 Bohrungen für Armaturen, mit Überlauf. Installation wandhängend, eingelegt oder auf Möbel.

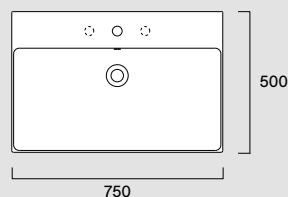

- Bianco lucido /
Glossy / Glänzend

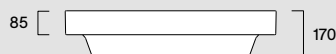

Disponibile anche senza foro rubinetteria.
Also available without tap hole.
Auch ohne Armaturenbohrung erhältlich.

Zero 60x50**01 2060 1001**

- Ita Lavabo con 1 foro, predisposto per 3 fori rubinetteria, con troppopieno. Installazione sospeso, incasso o su mobile.
- Eng Washbasin with 1 taphole, prearranged for 3 tapholes, with overflow. Wall-hung, built-in or on furniture installation.
- Deu Waschbecken mit 1 Bohrung, vorbereitet mit 3 Bohrungen für Armaturen, mit Überlauf. Installation wandhängend, eingelegt oder auf Möbel.

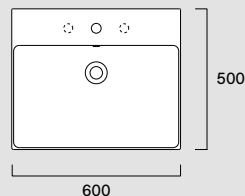

- Bianco lucido /
Glossy / Glänzend



Disponibile anche senza foro rubinetteria.
Also available without tap hole.
Auch ohne Armaturenbohrung erhältlich.

Zero 50x50**01 2050 1001**

- Ita Lavabo con 1 foro, predisposto per 3 fori rubinetteria, con troppopieno. Installazione sospeso, incasso o su mobile.
- Eng Washbasin with 1 taphole, prearranged for 3 tapholes, with overflow. Wall-hung, built-in or on furniture installation.
- Deu Waschbecken mit 1 Bohrung, vorbereitet mit 3 Bohrungen für Armaturen, mit Überlauf. Installation wandhängend, eingelegt oder auf Möbel.

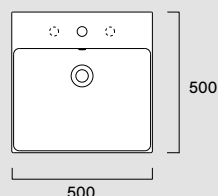

- Bianco lucido /
Glossy / Glänzend



Disponibile anche senza foro rubinetteria.
Also available without tap hole.
Auch ohne Armaturenbohrung erhältlich.

Zero 70x35 h12**01 2270 0001**

Ita Lavabo senza troppopieno. Installazione ad appoggio.

Eng Washbasin without overflow. Countertop installation.

Deu Waschbecken ohne Überlauf. Installation aufliegend.

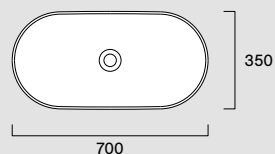

- Bianco lucido /
Glossy / Glänzend
- Argento-Bianco /
Silver-White / Silber-Weiss
- Oro-Bianco /
Gold-White / Gold-Weiss

- Bianco satinato / satin
- Nero satinato / satin
- Cemento satinato / satin
- Tortora satinato / satin

**Zero 60x35 h12****01 2260 0001**

Ita Lavabo senza troppopieno. Installazione ad appoggio.

Eng Washbasin without overflow. Countertop installation.

Deu Waschbecken ohne Überlauf. Installation aufliegend.

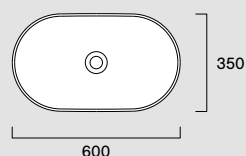

- Bianco lucido /
Glossy / Glänzend
- Argento-Bianco /
Silver-White / Silber-Weiss
- Oro-Bianco /
Gold-White / Gold-Weiss

- Bianco satinato / satin
- Nero satinato / satin
- Cemento satinato / satin
- Tortora satinato / satin

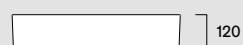
**Zero 50x35 h12****01 2250 0001**

Ita Lavabo senza troppopieno. Installazione ad appoggio.

Eng Washbasin without overflow. Countertop installation.

Deu Waschbecken ohne Überlauf. Installation aufliegend.

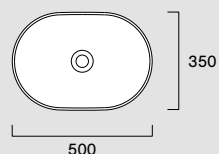

- Bianco lucido /
Glossy / Glänzend
- Argento-Bianco /
Silver-White / Silber-Weiss
- Oro-Bianco /
Gold-White / Gold-Weiss

- Bianco satinato / satin
- Nero satinato / satin
- Cemento satinato / satin
- Tortora satinato / satin

**Zero Ø45 h13****01 2345 0001**

Ita Lavabo senza troppopieno. Installazione ad appoggio.

Eng Washbasin without overflow. Countertop installation.

Deu Waschbecken ohne Überlauf. Installation aufliegend.

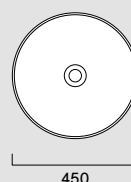

- Bianco lucido /
Glossy / Glänzend
- Argento-Bianco /
Silver-White / Silber-Weiss
- Oro-Bianco /
Gold-White / Gold-Weiss

- Bianco satinato / satin
- Nero satinato / satin
- Cemento satinato / satin
- Tortora satinato / satin



Zero Ø40 h13**01 2340 0001**

Ita Lavabo senza troppopieno. Installazione ad appoggio.

Eng Washbasin without overflow. Countertop installation.

Deu Waschbecken ohne Überlauf. Installation aufliegend.

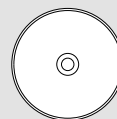

400

 Bianco lucido /
Glossy / Glänzend

 Bianco satinato / satin
 Nero satinato / satin
 Cemento satinato / satin
 Tortora satinato / satin

130

Zero Ø32 h12**01 2232 0001**

Ita Lavabo senza troppopieno. Installazione ad appoggio.

Eng Washbasin without overflow. Countertop installation.

Deu Waschbecken ohne Überlauf. Installation aufliegend.



320

 Bianco lucido /
Glossy / Glänzend

 Bianco satinato / satin
 Nero satinato / satin
 Cemento satinato / satin
 Tortora satinato / satin



120

Zero 60x37**01 2460 0001**

Ita Lavabo con troppopieno. Installazione ad incasso.

Eng Washbasin with overflow. Built-in installation.

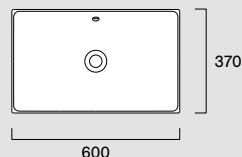
Deu Waschbecken mit Überlauf. Installation eingelegt.



370

600

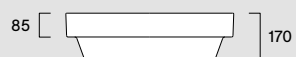
 Bianco lucido /
Glossy / Glänzend

170

85

Zero 50x37**01 2450 0001**

Ita Lavabo con troppopieno. Installazione ad incasso.

Eng Washbasin with overflow. Built-in installation.

Deu Waschbecken mit Überlauf. Installation eingelegt.

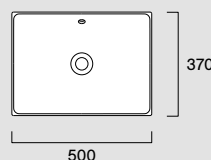

370

500

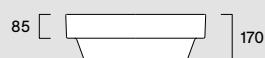
 Bianco lucido /
Glossy / Glänzend

170

85

Zero 55x47**01 2655 1001**

- Ita Lavabo con 1 foro, predisposto per 3 fori rubinetteria, con troppopieno. Installazione a semincasso.
- Eng Washbasin with 1 taphole, prearranged for 3 tapholes, with overflow. Semirecessed installation.
- Deu Waschbecken mit 1 Bohrung, vorbereitet mit 3 Bohrungen für Armaturen, mit Überlauf. Installation halb eingelegt.

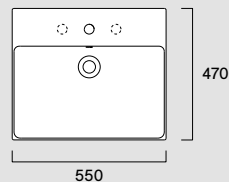

- Bianco lucido /
Glossy / Glänzend



Disponibile anche senza foro rubinetteria.
Also available without tap hole.
Auch ohne Armaturenbohrung erhältlich.

Zero 80x37**01 2481 0001**

- Ita Lavabo con troppopieno. Installazione ad incasso o sottopiano.
- Eng Washbasin with overflow. Built-in or under-counter installation.
- Deu Waschbecken mit Überlauf. Installation eingelegt oder Unterbau.

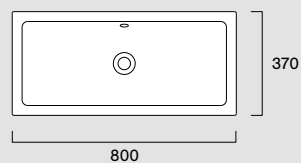

- Bianco lucido /
Glossy / Glänzend

**Zero 60x37****01 2461 0001**

- Ita Lavabo con troppopieno. Installazione ad incasso o sottopiano.
- Eng Washbasin with overflow. Built-in or under-counter installation.
- Deu Waschbecken mit Überlauf. Installation eingelegt oder Unterbau.

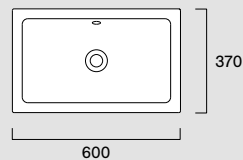

- Bianco lucido /
Glossy / Glänzend



Zero 55x35 Wc**01 1155 0001**

- Ita Wc sospeso con sistema di scarico Silentech e sistema di fissaggio a scomparsa dal basso.
- Eng Wall-hung Wc with Silentech flushing system and hidden fixing from the bottom.
- Deu Wandhängendes WC mit Silentech-Abflusssystem und verdecktem Bodenbefestigungssystem.

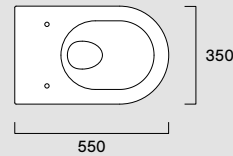

- | | |
|---|--|
| <input type="radio"/> Bianco lucido /
Glossy / Glänzend | <input type="radio"/> Bianco satinato / satin |
| <input type="radio"/> Argento-Bianco /
Silver-White / Silber-Weiss | <input checked="" type="radio"/> Nero satinato / satin |
| <input type="radio"/> Oro-Bianco /
Gold-White / Gold-Weiss | <input type="radio"/> Cemento satinato / satin |
| | <input type="radio"/> Tortora satinato / satin |

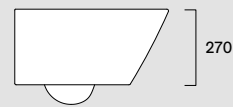
**Zero 55x35 Bidet****01 1855 1001**

- Ita Bidet sospeso monoforo con troppopieno e sistema di fissaggio a scomparsa dal basso.
- Eng Wall-hung bidet one taphole with overflow and hidden fixing from the bottom.
- Deu Wandhängendes Einloch-Bidet mit Überlauf und verdecktem Bodenbefestigungssystem.

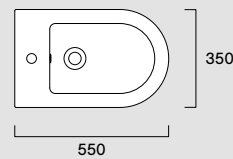

- | | |
|---|--|
| <input type="radio"/> Bianco lucido /
Glossy / Glänzend | <input type="radio"/> Bianco satinato / satin |
| <input type="radio"/> Argento-Bianco /
Silver-White / Silber-Weiss | <input checked="" type="radio"/> Nero satinato / satin |
| <input type="radio"/> Oro-Bianco /
Gold-White / Gold-Weiss | <input type="radio"/> Cemento satinato / satin |
| | <input type="radio"/> Tortora satinato / satin |

**Zero 50x35 Wc****01 1150 0001**

- Ita Wc sospeso con sistema di scarico Silentech e sistema di fissaggio a scomparsa dal basso.
- Eng Wall-hung Wc with Silentech flushing system and hidden fixing from the bottom.
- Deu Wandhängendes WC mit Silentech-Abflusssystem und verdecktem Bodenbefestigungssystem.

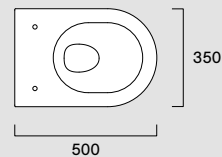

- | |
|--|
| <input type="radio"/> Bianco lucido /
Glossy / Glänzend |
|--|

**Zero 50x35 Bidet****01 1850 1001**

- Ita Bidet sospeso monoforo con troppopieno e sistema di fissaggio a scomparsa dal basso.
- Eng Wall-hung bidet one taphole with overflow and hidden fixing from the bottom.
- Deu Wandhängendes Einloch-Bidet mit Überlauf und verdecktem Bodenbefestigungssystem.

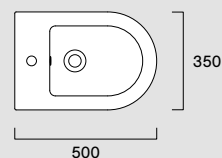

- | |
|--|
| <input type="radio"/> Bianco lucido /
Glossy / Glänzend |
|--|



Zero 46x35 Wc**01 1146 0001**

- Ita Wc sospeso con sistema di scarico Silentech e sistema di fissaggio a scomparsa dal basso.
- Eng Wall-hung Wc with Silentech flushing system and hidden fixing from the bottom.
- Deu Wandhängendes WC mit Silentech-Abflusssystem und verdecktem Bodenbefestigungssystem.

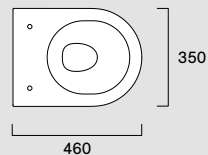

- Bianco lucido /
Glossy / Glänzend

**Zero 55x35 Wc****01 1455 0001**

- Ita Wc traslato filo parete con sistema di scarico Silentech e fissaggio a parete nascosto.
- Eng Floorstanding Wc with adjustable inlet/outlet, Silentech flushing system and hidden wall fixing
- Deu Wandhängendes Flachspül-WC mit Silentech-Abflusssystem und verdeckter Wandbefestigung.

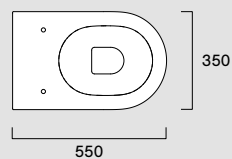

- Bianco lucido /
Glossy / Glänzend

- Bianco satinato / satin
- Nero satinato / satin
- Cemento satinato / satin
- Tortora satinato / satin

**Zero 55x35 Bidet****01 1955 1001**

- Ita Bidet filo parete monoforo con troppopieno e sistema di fissaggio a parete nascosto.
- Eng Floorstanding bidet one taphole with overflow and hidden fixing.
- Deu Einloch-Bidet mit Überlauf und verdecktem Wandbefestigungssystem.

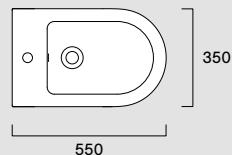

- Bianco lucido /
Glossy / Glänzend

- Bianco satinato / satin
- Nero satinato / satin
- Cemento satinato / satin
- Tortora satinato / satin



© 2024 Ceramica Catalano SpA
SP Falerina Km 7,2
01034 Fabbrica di Roma (VT)
Italia
T +39 0761 5661
F +39 0761 574304
catalano.it

Art direction and graphic design:
Studio CCRZ
CGI:
Studio 9010: Zero, Premium, Green,
Sfera, Alvea, Bianco, Nero, Cemento,
Tortora, Sabbia, Seta, Acqua,
Gold&Silver
Catalano: Italy, Comfort, Lino
Printed by:
Intese Grafiche



Ceramica Catalano support
UN global Sustainable Development Goals

Le immagini presenti in questo volume sono puramente indicative ed i prodotti possono subire lievi variazioni anche senza nessun preavviso, le tonalità di colore sono suscettibili di variazioni. I riferimenti colore mostrati, per effetto del tempo o del supporto di stampa, potrebbero non coincidere con le tonalità di colore dei prodotti ceramici finiti.

Die Abbildungen in diesem Band sind rein indikativ und die Produkte können ohne vorherige Ankündigung geringfügig variieren, die Farbtöne können sich ändern. Die gezeigten Farbreferenzen stimmen möglicherweise aufgrund der Witterung oder des Druckmediums nicht mit den Farbtönen der fertigen Keramikprodukte überein.

The images contained in this volume are for illustrative purposes only and products may be subject to slight variations without notice, the color tones may also vary. The colors shown, either due to the effects of time or the print medium, may not coincide exactly with the shade of color of the finished ceramic products.

