



Architectural  
solutions  
in zinc

Designing with elZinc®

elZinc®

Because **zinc** doesn't  
have to be **grey...**





# Prologue

Many years ago, when I visited the coal mine at Arnao (Avilés), I found that the most important buildings were roofed in zinc. The domes and cornices of the old headquarters of the Royal Company in the Spanish Square in Madrid that were covered in zinc over a century ago also made a strong impression on me.

To personally promote the numerous advantages of zinc in architecture, I had a dream: to create the largest and most modern zinc rolling mill in the world, able to offer the highest quality and widest range of finishes to architects wishing to use zinc, or rather, **elZinc®**.

Dear architects, partners and clients... thanks to you all this dream is becoming a reality.



Macario Fernández Fernández  
Chief Executive Officer - Asturiana de Laminados S.A.

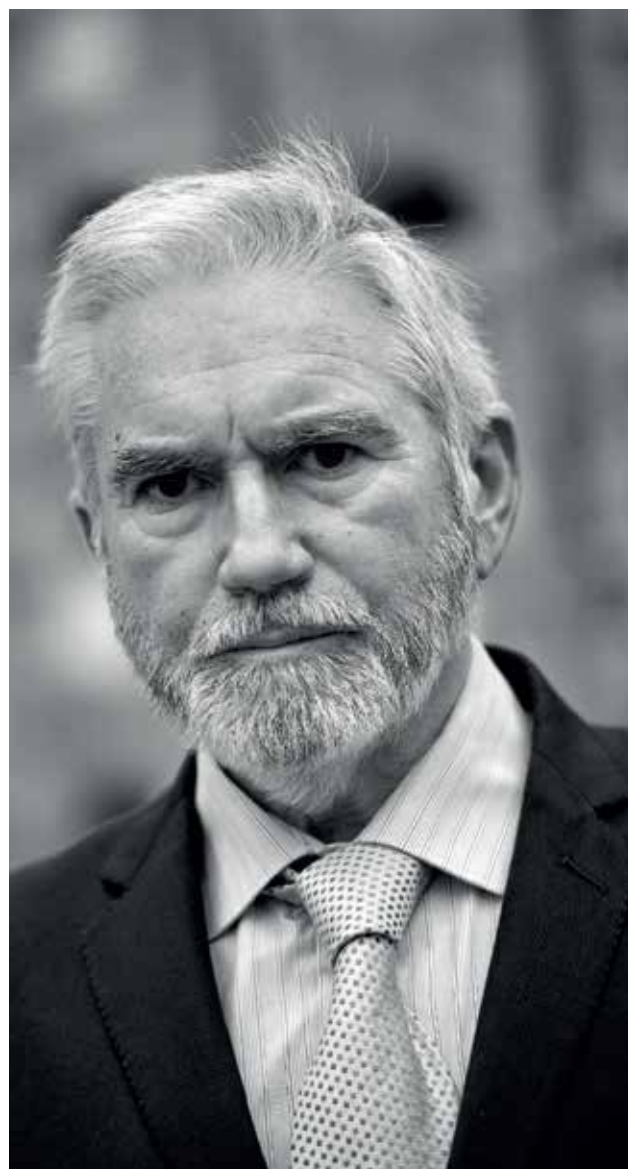

# Index

■ Why choose elZinc® for your projects?	<b>Pag. 8</b>
■ elZinc®: a sustainable building material	<b>Pag. 10</b>
■ The Company	<b>Pag. 13</b>
■ Quality	<b>Pag. 14</b>
Our quality assurance	Pag. 14
Lifetime Warranty	Pag. 16
Product properties	Pag. 18
■ Finishes and formats:	<b>Pag. 20</b>
elZinc Alkimi®	Pag. 22
- elZinc Astur®	Pag. 24
- elZinc Slate®	Pag. 26
- elZinc Graphite®	Pag. 28
- elZinc Crystal®	Pag. 30
- elZinc Oliva®	Pag. 32
- elZinc Lava®	Pag. 33
elZinc Rainbow®	Pag. 34
elZinc Advance®	Pag. 36
elZinc Protect+®	Pag. 38
elZinc Wide	Pag. 40
Delivery Program for coils and sheets	Pag. 42
Perforated zinc	Pag. 44
elZinc® Tiles	Pag. 46
elZinc® Honeycomb panel	Pag. 48
elZinc® Composite panel	Pag. 50
■ Systems:	<b>Pag. 52</b>
Traditional systems	Pag. 55
- Double lock standing seam	Pag. 60
- Angle standing seam	Pag. 66

Flat lock shingles	Pag. 70
<b>- elZinc® Tiles</b>	Pag. 74
Engineered façades	Pag. 81
- Façade panel	Pag. 84
<b>- elZinc® Composite material</b>	<b>Pag. 88</b>
<b>- elZinc® Honeycomb panel</b>	<b>Pag. 90</b>
<b>■ Envelope construction</b>	<b>Pag. 92</b>
Traditional systems	Pag. 95
- Underlays generally	Pag. 96
- The substrates	Pag. 97
- Compatibility with other building materials	Pag. 99
- Thermal design	Pag. 102
- Examples of roof types	Pag. 104
- Examples of unvented roofs	Pag. 108
- Examples of ventilated façades	Pag. 112
<b>■ Rainwater Systems</b>	<b>Pag. 120</b>
Eaves gutters rainwater systems	Pag. 124
Parapet and internal gutters	Pag. 128
<b>■ Services</b>	<b>Pag. 130</b>
Technical and comercial assistance	Pag. 132
Appendix	Pag. 134

# Why choose elZinc® for your projects?

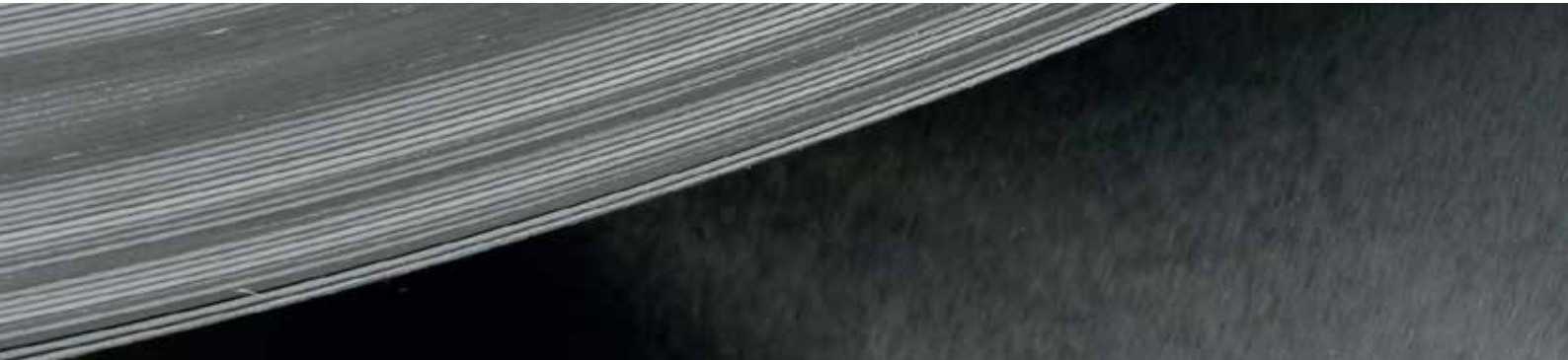

## Designing in zinc frees your imagination

Zinc has been used as a roofing and façade cladding material since the 19th century thanks to the numerous esthetic and functional qualities it possesses and which allow its adaptation to all architectural styles.

Its natural surface and changing reflections make it an extraordinarily versatile material.

Titanium-zinc from **elZinc®** can blend into its surroundings or, on the contrary, highlight the unique character of a facade, depending on the intended effect. Its excellent malleability and the adaptability of the systems used to install it enable **elZinc®** to conform to the most complex and unusual geometries.

It can be installed both on low pitched roofs (with a minimum of 3°) as well as on façades.

The wide range of surface finishes produced by **elZinc®** and the numerous possible combinations, as well as the many types of installation systems available nowadays, offer a host of possibilities for the inside and outside of buildings.

510 West Building, New York, USA - Cook Fox



## Building with elZinc® guarantees exceptional durability

Designed to endure, titanium-zinc from **elZinc®** is a long-lasting material that maintains its initial properties intact over the lifetime of the building.

One of most significant properties of zinc is its high corrosion resistance. In rural areas (where pollution is low) its service life can be well in excess of a hundred years.

Titanium-zinc is a living material, and develops a self-healing patina throughout its lifetime that continually protects it and confers to it a characteristically unique appearance.

Once in place, the result is a durable, resilient external building skin practically impervious to the worst the weather can throw at it.

The combination of just a few of the advantages of zinc - its long life service, lack of special maintenance and its lightness (between 7 and 10kg/m<sup>2</sup> which can help reduce the costs of the building's structure) - makes zinc a sound economical choice.

## Safer with elZinc®

Fire safety of buildings depends on several factors, including the fire resistance of the materials used. For this reason, **elZinc®** titanium zinc is an ideal material for projects that require an exterior cladding that is functional, attractive and also non-combustible.

All our aesthetic zinc finishes (**elZinc Alkimi®** and **elZinc Rainbow®**) and our technical finishes (**elZinc Advance®** and **elZinc Protect+®**) have the best reaction to fire. They are classified as A1, which corresponds to 'no contribution to fire' - the highest level.



**UNE - EN13501 - 1**

Choosing **elZinc®** as the building envelope's skin is not only selecting a natural and attractive material, but also ensuring long term protection.



# elZinc®: a sustainable building material



## elZinc®: a sustainable material

Zinc is a natural element which is found throughout the earth's crust in plentiful supply.

Zinc is essential for the survival of any living organism. Its use in construction is environmentally-friendly.

Zinc is one of the few building materials that are 100% reusable and recyclable for an unlimited number of times. Each recycling process takes away none of the mechanical and chemical properties that make it such a high-quality material.

Zinc is primarily mined in China, Peru and Australia. However, more than 30% of world production comes from recycled material. In this way, its use contributes to preserving other natural resources, saving energy consumption, reducing greenhouse gas emissions, whilst the exploitation of existing zinc reserves is kept to a minimum.

Note: All by-products and zinc waste generated during the elZinc® production process are reused and recycled. Having gone through the required quality controls, the scrap zinc is re-melted and rolled again in the same productive process. Regarding alternative byproducts, such as zinc oxide, they are used for other industrial applications.

Once installed, elZinc® doesn't need any special maintenance, therefore reducing its ecological impact.

The production process is less energy intensive than other metals used in construction. Indeed, it is significantly less than that of aluminium and copper:

Aluminum 255 MJ/kg – 482 MJ/m <sup>2</sup>	0.7mm thick aluminum
Copper 70 MJ/kg – 375 MJ/m <sup>2</sup>	0.6mm thick copper
Zinc 51 MJ/kg – 238 MJ/m <sup>2</sup>	0.65mm thick zinc

Source: 'Sustainable Construction: Green Building Design and Delivery'

## Our ecological footprint: Environment product declaration

Building professionals that intend to carry out an evaluation of the environmental impact of their building need an Environmental Product Declaration of the products they plan to use, that recognizes and proves their environmental credentials.

To this end, elZinc® has put at your disposal Environmental Product Declarations «EPD» for its elZinc Alkimi® range which includes elZinc Astur®, elZinc Slate®, elZinc Graphite®, elZinc Crystal®, elZinc Oliva® and elZinc Lava®, calculated in accordance with the International standard ISO14025.

The analysis of the life cycle of elZinc® products is the cornerstone of this project, putting at the fingertips of experts who pursue a policy of sustainable building management all the relevant information regarding the environmental impact of its products, in a broken down and verifiable manner.



The natural advantages of the material together with the productive intelligence of **elZinc®** offer many different and interesting solutions for sustainable building projects, both for new-build and refurbishment.

The ISO14001 certification guarantees that **elZinc®** manages its processes within a production model oriented towards total compatibility with the environment. Thanks to our continuous improvement system, we develop technical solutions that lead our transformation processes to excellence in terms of performance in resource usage.

Obtaining the ISO50001 Energy Efficiency certification means that we have implemented an energy management system. This sets the foundation for enabling us to achieve various goals in the future, including using energy more efficiently for example by implementing improvements to our facilities, conserving natural resources and addressing climate change by reducing our carbon footprint.

Asturiana de Laminados, S.A., manufacturer of **elZinc®**, has implemented a comprehensive performance programme for the optimization of consumption and the reduction of waste, based on the following elements:

- A sustainable purchasing policy and the location of our main supplier of raw materials located in the same region (Asturias) as our facilities ensure minimal environmental impact from transport.
- The use of the latest generation of manufacturing technology which gives the most efficient use of raw materials and reduces energy consumption even further.

**If you need more information regarding the implications of choosing an elZinc® product on the environmental certification process LEED, don't hesitate to consult our technical department and/or visit our webpage.**

## Resource-optimising management

	1 kg elZinc® Astur®	1 kg elZinc Slate®
GWP1 (kg CO2-Eq)	3,5	3,7
ODP2 (kg CFC11-Eq)	3,3 x 10 <sup>-7</sup>	3,3 x 10 <sup>-7</sup>
AP3 (kg SO2-Eq)	2,3 x 10 <sup>-2</sup>	2,3 x 10 <sup>-2</sup>

1. Global warming potential.
2. Ozone-depleting potential.
3. Acidification potential





# The company

Established in 2006, Asturiana de Laminados, S.A. by virtue of its **elZinc®** brand, has become one of the world's main producers of rolled zinc products.

The use of the latest technologies in casting, rolling, slitting and cutting coupled with the implementation of the most rigorous quality control protocols, allows **elZinc®** to better the tolerances established in the current European and American standards, namely EN988 and ASTM B-69.

Our success is founded upon a constant drive to progress and to satisfy the most demanding of market needs. Thanks to the work carried out in R&D&I, we offer a wide range of roofing and cladding products and finishes, and are already present in more than 50 countries.

More than a 165 professionals place their expertise at your disposal, providing customized technical and commercial assistance aimed at construction professionals that may require it in any part of the world.



## Our quality assurance



Using elZinc® in your projects guarantees a long lasting result and an impeccable finish

Our commitment to our customers and the constant strive to improve our products and services is one of the pillars of our Quality Policy.

Our experience together with the use of cutting edge technology allows us to offer quality products that exceed the requirements established by standards **EN 988 and ASTM-B69**, zinc alloys for use in construction are defined.

Through the optimization of the rolling process's operating parameters and meticulous temperature control during all of the various production stages, **elZinc®** has developed a product of excellent quality suitable for different applications in building.

The rigorous Quality Controls continuously conducted by our own laboratories and by prestigious independent experts maintain and attest to the Quality of our material.

### elZinc®'s products are characterized by:

- Very good workability irrespective of the direction of rolling.
- High resistance to creep (creep strain limit).
- Low cold brittleness.
- Optimal electro-welding performance due to its low surface oil content.



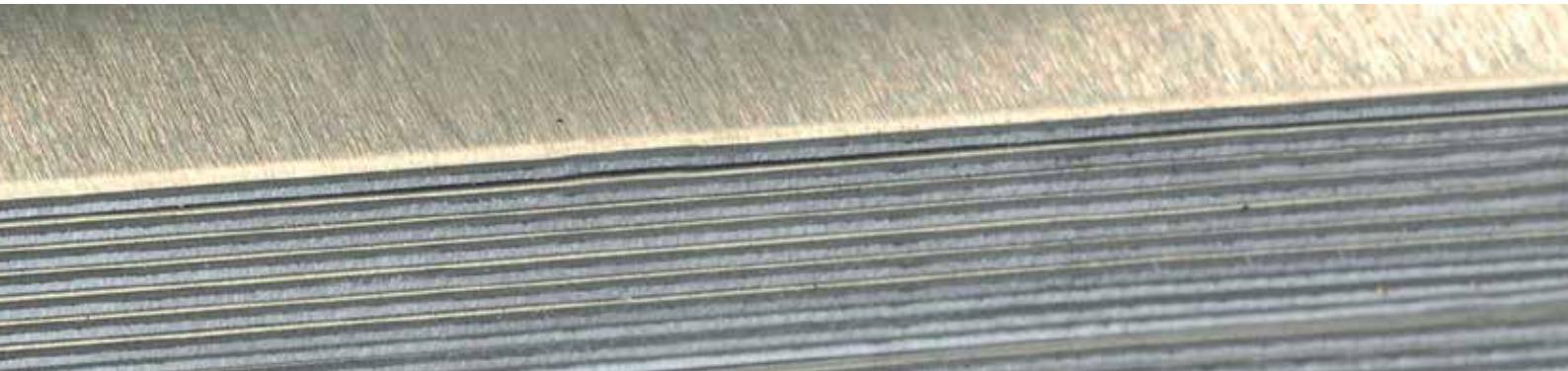

eZinc® has put into place numerous management tools that reinforce this quality guarantee:

■ **Quality certificate according to standard UNE-EN ISO 9001:2008**

From its origins, Asturiana de Laminados, SA - eZinc® - has submitted itself to an ongoing process of improvement that has been accredited and endorsed by the internationally recognized standard for quality management UNE-EN ISO 9001.

■ **Internal and external quality controls.**

The rigorous Controls continuously conducted by our own laboratories and by prestigious independent experts maintain and attest to the quality of our material.

■ **The identification of our products.**

All eZinc® sheets and coils are identified with a serial number to ensure traceability. This automatic marking on the inside surface of the metal guarantees product traceability and the identification of the material.

■ **Komo Certificate.**

eZinc® has been awarded the prestigious Komo Certification for the eZinc Astur®, eZinc Slate®, eZinc Graphite® and eZinc Rainbow® range of products. This document certifies, having undergone the thorough examination associated with the Komo mark, that the rigorous quality control procedures established by eZinc® in all of its industrial procedures ensure the highest possible quality of products.



TÜV SUD Quality Management System



KOMO Certificate



CE Certificate

# Lifetime Warranty



## elZinc Lifetime Warranty: A lifetime warranty for long-lasting cladding

One of the main characteristics of titanium zinc is its high corrosion resistance. As a living material, it will naturally develop a patina that will protect it during its entire life. Its remarkable properties make it a waterproof and weather-resistant building skin. Produced with the most advanced technology and according to a rigorous quality protocol, **elZinc**<sup>®</sup> zinc-titanium is of exceptional quality.

The lifetime guarantee we offer – unique in the sector – reflects the reliability of our **elZinc Astur**<sup>®</sup> and **elZinc Slate**<sup>®</sup> finishes. With more than a decade on the market, we have accredited their quality, solidifying our commitment to our customers.

## What do we guarantee?

- The manufacture of our **elZinc Astur**<sup>®</sup> and **elZinc Slate**<sup>®</sup> finishes is in accordance with the requirements set out in EN 988 and EN 1179, as well as with **elZinc**<sup>®</sup> technical specifications, for the duration of the product's service life.
- That the surface of **elZinc Astur**<sup>®</sup> and **elZinc Slate**<sup>®</sup> will not crack, blister, peel, flake or chalk.
- That during their service life, **elZinc Astur**<sup>®</sup> and **elZinc Slate**<sup>®</sup> will not discolour or fade to a colour that is not characteristic of zinc, or that cannot be associated with naturally aged zinc or naturally weathering zinc.

In the unlikely event that your **elZinc**<sup>®</sup> product has a manufacturing defect, **elZinc**<sup>®</sup> will replace or repair it in accordance with the terms of the warranty.

\* read terms and conditions on [www.elzinc.es](http://www.elzinc.es)



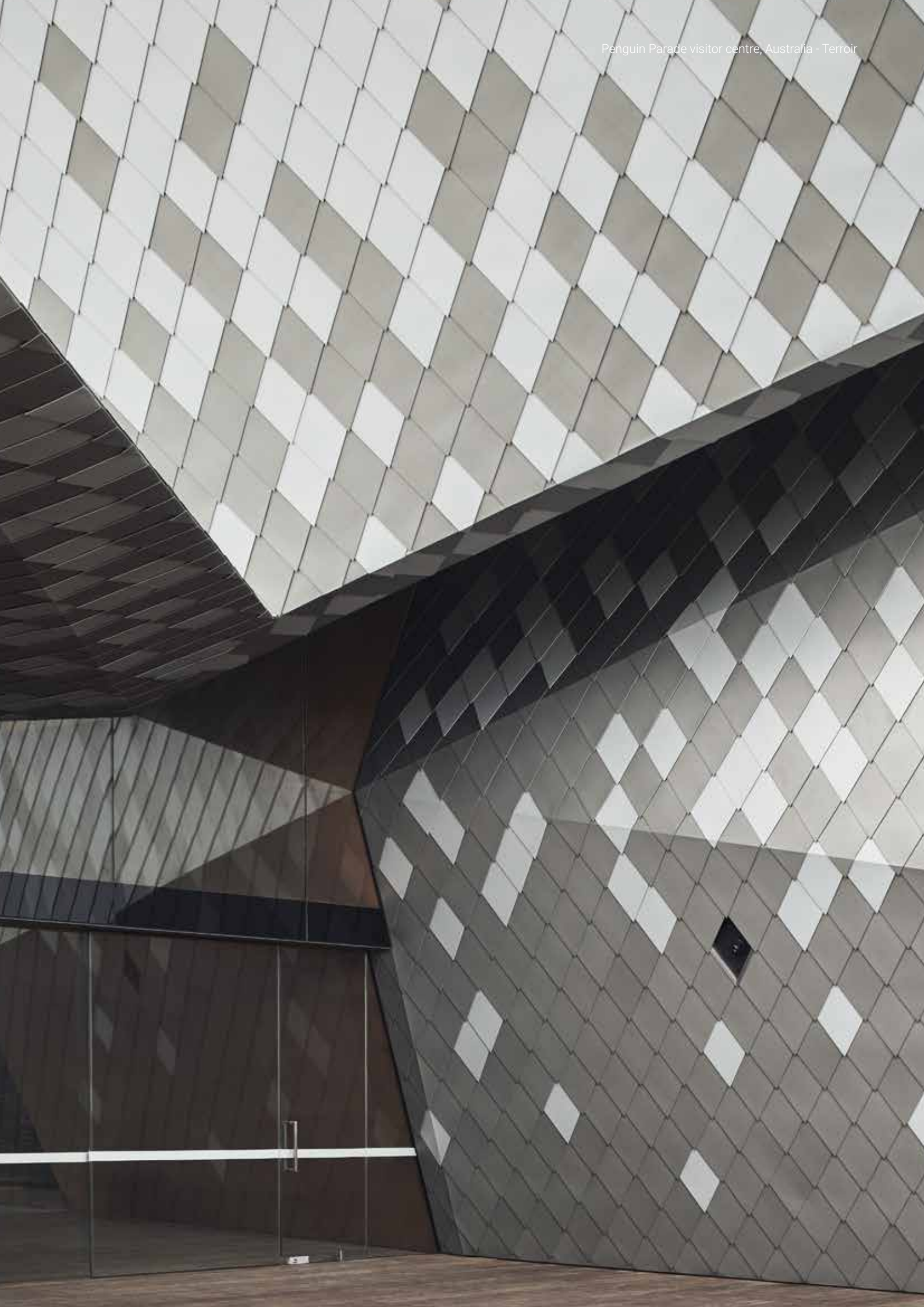



# Product properties

## Test criteria for elZinc's standard rolled zinc:

PARAMETER	CRITERIA elZinc®	CRITERIA EN988	CRITERIA ASTM B-69
<b>CHEMICAL COMPOSITION</b>			
Zinc	Zn 99,995 (Z1 according to EN 1179)	Zn 99,995 (Z1 according to EN 1179)	-
Pb, Fe, Cd, Sn, Mn and Mg	-	-	Max. 0,005 %
Copper	0,08-0,2%	0,08-1,0%	0,08-0,2%
Titanium	0,07-0,12%	0,06-0,2%	0,07-0,12%
Aluminium	≤0,015%	≤0,015%	0,001-0,015 %
<b>DIMENSIONS / TOLERANCES FOR STANDARD PRODUCTS</b>			
Thickness of sheets/coils	± 0,01mm	± 0,03mm	±0,0254 mm* ±0,0508 mm**
Width of sheets/coils	+ 1/-0mm	+ 2/-0mm	±1,575 mm
Length	+2/-0mm	+10/-0mm	±5 mm
Edgewise bow	≤1,0 mm/m	≤1,5 mm/m	25,4 mm/3048 mm (arc radius 45,7 m)
Flatness	≤2 mm	≤2 mm	-
<b>MECHANICAL AND TECHNOLOGICAL PROPERTIES IN THE DIRECTION OF ROLLING</b>			
Yield strength elasticity 0,2 % (Rp 0,2)	>110 N/mm <sup>2</sup>	>110 N/mm <sup>2</sup>	-
Tensile strength (Rm)	>150N/mm <sup>2</sup>	>150N/mm <sup>2</sup>	96 - 262N/mm <sup>2</sup>
Breaking elongation (A50)	≥40%	≥35%	10-70 %
Vickers hardness (HV3)	≥45	-	-
HR15T hardness	-	-	54-74
Bending test	No cracks at the edge of fold	No cracks at the edge of fold	-
Bending back after folding test	No cracks	-	-
Erichsen test	Min.7,5mm	-	-
Deformation after yield strength test (Rp0, 1)	≤0,1%	≤0,1%	-

\*for thicknesses between 0,254 y 0,762mm

\*\*for thicknesses between 0,762 y 1,524 mm



### 3. Finishes and formats





# elZinc Alkimi®

## Pure elegance

Zinc cladding and roofing allows a great deal of freedom when designing. The **elZinc Alkimi®** aesthetic finishes give character and authenticity to your architectural projects.

Manufactured from **elZinc Astur®**, according to EN988 and ASTM B-69 standards, through a unique surface treatment carried out with elZinc technology and know-how, the **elZinc Alkimi®** range respects and maintains intact the zinc's original properties.

**Zinc cladding and roofing contributes to create a unique style and confers undeniable aesthetic value to buildings.**

Used alone or combined, the shades that compose **elZinc Alkimi®** - currently the widest on the market - reveal the shapes, the volumes and the textures of architecture.

## elZinc Alkimi® finishes range:

**elZinc Astur®**



**elZinc Slate®**



**elZinc Graphite®**



**elZinc Crystal®**



**elZinc Oliva®**



**elZinc Lava®**



**elZinc Astur® and elZinc Slate® are guaranteed for life. See conditions.**

Tongliao Arts Center, Neimenggu, China.





# elZinc Astur®



## Product description:

**elZinc Astur®** is the original metallic grey finish produced by our manufacturing process.

Once exposed to the elements, **elZinc®** Naturally develops a compact protective layer called "patina". This patina provides exceptional resistance to corrosion, resulting in the gradual loss of its metallic luster until it takes on its characteristic matt grey colour.

The final shade of the colour largely depends on the environmental conditions to which it is exposed, as particulate matter and dust in the air are drawn into the patina.

Casa Priscos, Braga, Portugal  
Marco Ivan Architects







# eZinc Slate®



## Product description:

**eZinc Slate®** is a pre-patinated matt grey zinc having a very similar appearance to naturally weathered zinc.

The pre-weathering is performed using a non-polluting phosphate treatment that gives it a uniform appearance that would have been achieved after several years of exposure to the open air, whilst preserving its initial properties.

**eZinc Slate®** is used in roofing and cladding, where it harmonizes perfectly with other traditional building materials, or indoors, where a natural patina would take much longer to form. It is also especially appreciated in restoration and renovation since its initial colour allows it to blend in easily with existing weathered zinc.

Its attractive texture combines perfectly with most building materials (wood, stone, slate), giving rise to a long lasting harmonious appearance.

Madreselva house, Asturias, Spain  
David Olmos Architects





# elZinc Graphite®

## Product description:

**elZinc Graphite®** is architectural zinc pre-weathered to a very dark, almost black shade of grey.

The pre-weathered finish is achieved using a non-polluting phosphate treatment that preserves and respects the initial properties of zinc.

Bringing to the fore the cladding's lines in a refined fashion, it is appreciated for its purity and sobriety.

Combined with other traditional materials such as wood or glass, it allows the creation of stylish and long-lasting façades which maintain their original elegance as time passes by.

Single family house Harskamp, Netherlands  
Studio C Marcellis





# elZinc Crystal®

## Product description:

**elZinc Crystal®** is a new pearl grey pre-patinated zinc. Its changing reflections play with light and give it a different look depending on its exposure. It creates striking effects that personalize your façades.

The pre-weathered finish is achieved using a non-polluting treatment that preserves and respects the base properties of zinc.

Modern yet timeless, **elZinc Crystal®** helps you to create truly unique architecture.

Bitgaram Funeral Hall, Naju, South Korea





# elZinc Oliva®

## Product description:

**elZinc Oliva®** is a dark grey pre-weathered zinc with subtle greenish and bluish hues. These contemporary tones guarantee a natural and balanced contrast with the surrounding environment.

The pre-weathered finish is created using a surface treatment that maintains intact the zinc's original properties.

Subtle and sophisticated, **elZinc Oliva®** enhances any building's appearance with unique and personalized aesthetics.

Lydia residence, Luxembourg



# elZinc Lava®

## Product description:

**elZinc Lava®** is a charcoal grey pre-weathered zinc. Its colour sits perfectly amongst the other nishes in the elZinc range and thus allows a greyscale gradient design that can add dynamism to façades in a strikingly unique way.

The pre-weathered finish is created using a surface treatment that maintains intact the zinc's original properties.

Resistant and good looking, it can be incorporated into both contemporary and traditional architecture.

Private house, Chaves, Portugal





# elZinc Rainbow®

## Product description:

**elZinc Rainbow®** is available in a range of natural, warm and attractive graded colours.

It is rolled titanium zinc which complies with the European standard UNE-EN 988. **elZinc Rainbow®** is achieved by applying mineral pigments to our pre-treated zinc. The 35µm organic coating is a very attractive and durable finish that provides additional protection against corrosion.

Its subtle, versatile shades are suitable for all types of architecture, opening up exciting opportunities for designers. The shimmering, iridescent effects of **elZinc Rainbow®** combine modernity and tradition, to be enjoyed by all.

Like all **elZinc®** products, the **elZinc Rainbow®** range ensures high quality, lasting results.

**elZinc® has developed a process which allows it to offer custom colours\*. Don't hesitate to ask about personalized finishes - contact us!**

\*Conditions apply.

## elZinc Rainbow® range:

**elZinc Rainbow® Red**



**elZinc Rainbow® Blue**



**elZinc Rainbow® Green**



**elZinc Rainbow® Brown**



**elZinc Rainbow® Ebony**



**elZinc Rainbow® Gold**



Blunham Private Residence, United Kingdom  
David Coles Architects.



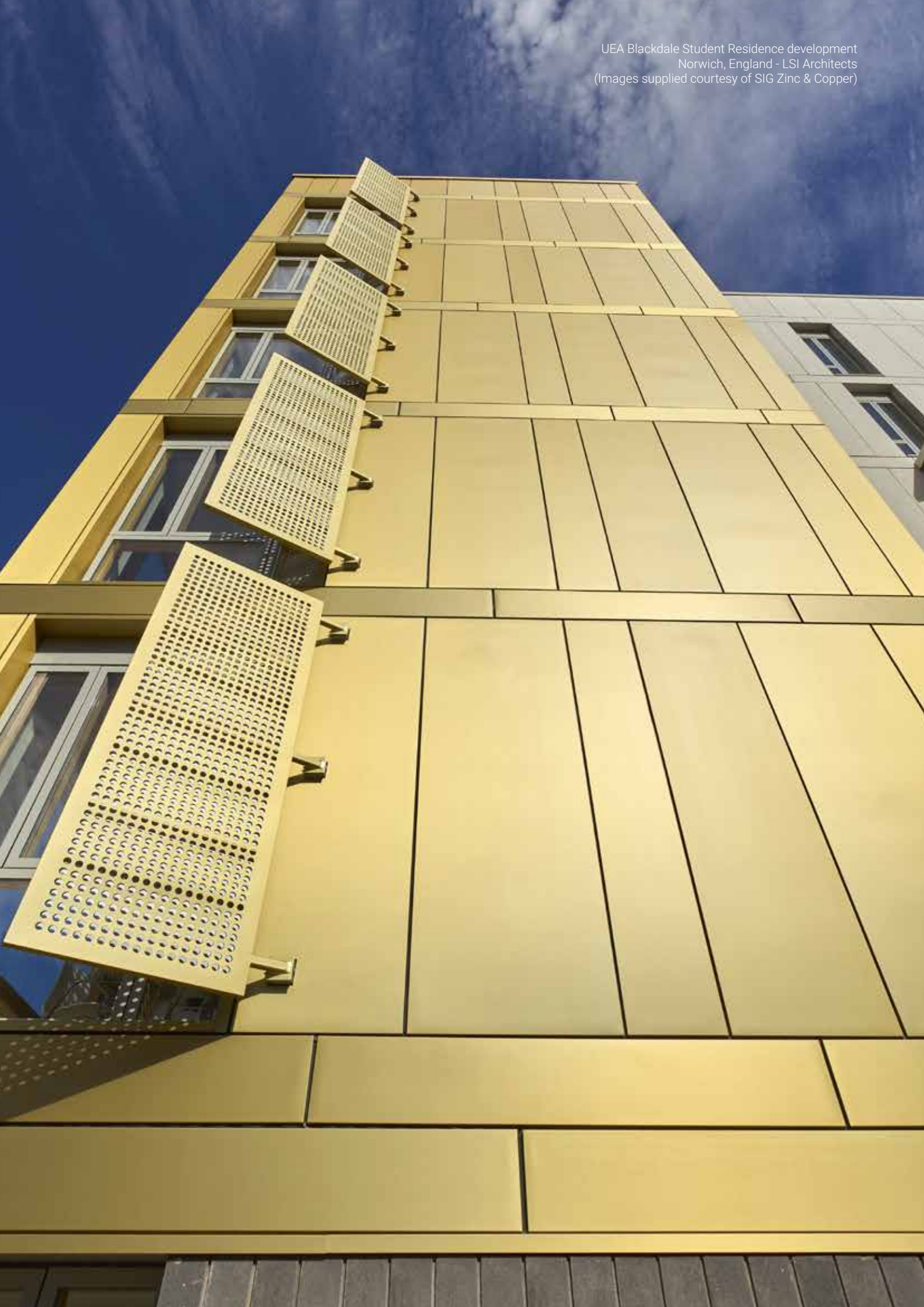

# elZinc Advance®

## Product description:

**elZinc Advance®** provides additional protection for **elZinc Slate®** and **elZinc Graphite®** roofs and façades situated in locations with especially corrosive atmospheres (for example located near to the sea) and that also have areas of cladding that are not frequently washed by rainwater.

The **elZinc Advance®** technology is available for **elZinc Slate®**, **elZinc Graphite®**, **elZinc Lava®**, **elZinc Crystal®** and **elZinc Oliva®** finishes.

**elZinc Advance®** is rolled architectural titanium-zinc manufactured according to the requirements established by EN988, which is then coated on its outside face with an organic layer.

- **Barrier effect:** It is impermeable to corrosive atmospheric elements.

- **Inhibitor:** It minimizes adhesion of salt and inorganic substances which may cause white oxidation in coastal areas.

**elZinc®** recommends its application for projects that have areas of cladding protected from the washing effect of rain in:

- Highly polluted areas
- Coastal areas
- Other aggressive climates (check with our Technical Department)

## Available in:

**elZinc Slate®**



**elZinc Crystal®**



**elZinc Graphite®**



**elZinc Oliva®**



**elZinc Lava®**



Penguin Parade Visitor Centre, Phillip Island, Australia  
Terroir





# elZinc Protect+®

## Product description:

**elZinc Protect+®** is a rolled zinc-titanium alloy produced according to the European Standards EN1179 and EN988 and American Standard ASTM B-69, which is then coated on its backside surface by a protective layer of 60 microns.

This protective white layer allows the zinc to be installed over otherwise incompatible substrates, avoiding its corrosion.

The **elZinc Protect+®** technology is available for all the aesthetic finishes manufactured by elZinc.

## Main applications:

- Installation on incompatible substrates.
- Installation on roofs which require a greater level of protection against underside corrosion of the zinc.

## Available in:

**elZinc Astur®**



**elZinc Graphite®**

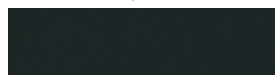

**elZinc Oliva®**



**elZinc Slate®**



**elZinc Crystal®**



**elZinc Lava®**



**elZinc Rainbow® red**



**elZinc Rainbow® green**

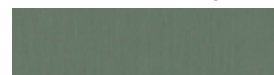

**elZinc Rainbow® ebony**



**elZinc Rainbow® blue**



**elZinc Rainbow® brown**



**elZinc Rainbow® gold**



Curtin University Research Facility, WA, Australia  
Silver Thomas Hanley Architects





# elZinc® Wide

All our finishes are also available in format unique on the market: up to a width of 1340 mm.

## Main advantages:

- Making internal gutters and other flashing wider than ever (>1000mm)
- Wider solutions which improve efficiency and reduce installation time for sinusoidal, trapezoidal and other systems.
- Material high performance thanks to the optimization of slitting.
- Wider composite and honeycomb panels according to market standards.

## Standard sizes of sheets and coils

- Widths: up to 1340-mm.
- Thicknesses: from 0.3mm up to 2,5mm.
- Sheets: up to 1340mm x 6000mm.

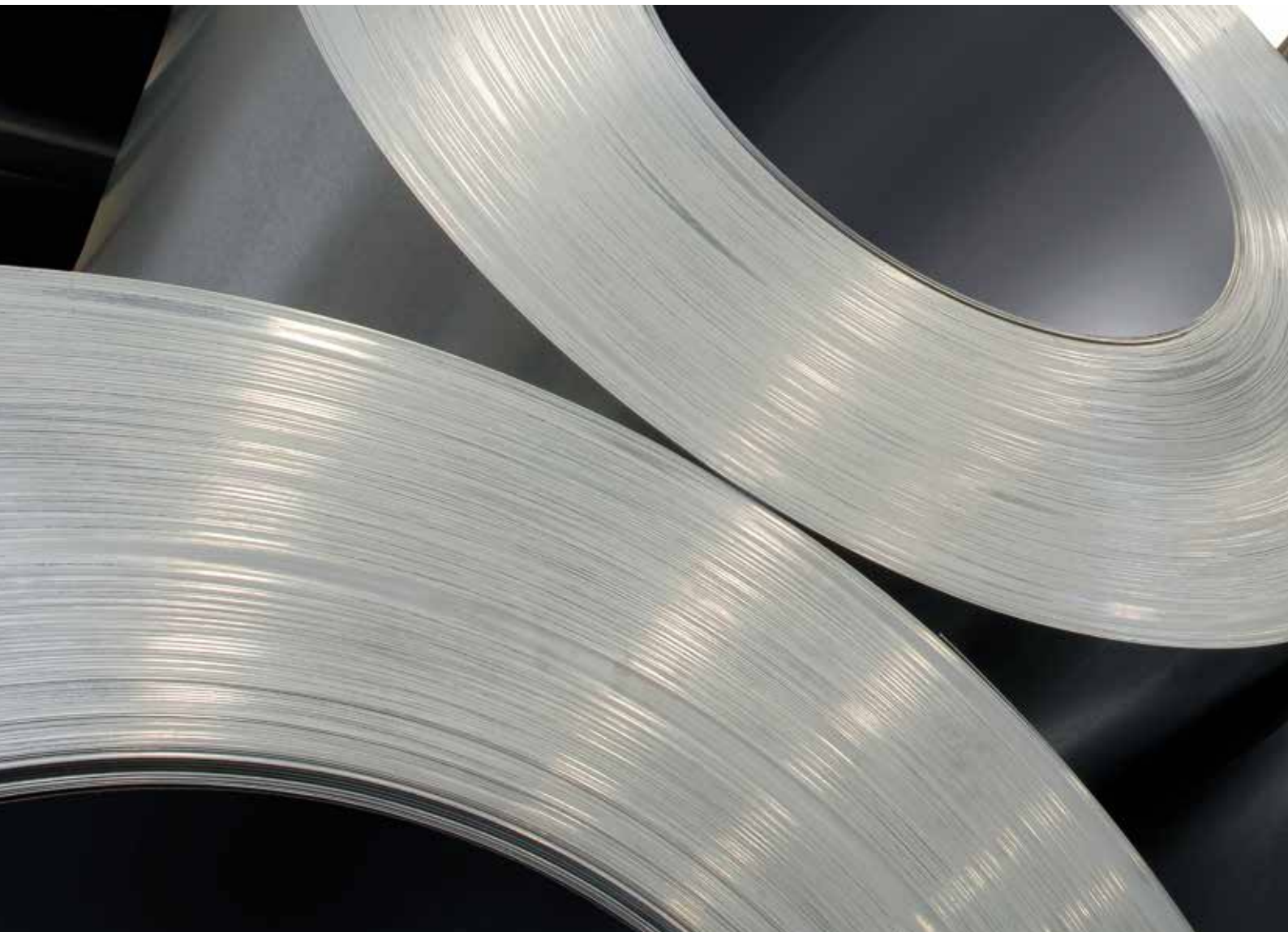

Table 1

		elZinc® Wide					
		1 coil per pallet		Sheets ( 1000kg* pallet)			
				2000x1000mm		3000x1000mm	
Thickness mm	Width mm	Approx. Length m	Theoretical Weight kg	Weight* / Sheet kg	Sheets / Pallet	Weight* / Sheet kg	Sheets / Pallet
0,5	1219	228	1000	7,2	139	10,8	93
0,5	1250	222	1000	7,2	139	10,8	93
0,5	1340	207	1000	7,2	139	10,8	93
0,65*	1219	175	1000	9,3	107	14,0	71
0,65*	1250	171	1000	9,3	107	14,0	71
0,65*	1340	159	1000	9,3	107	14,0	71
0,7	1219	163	1000	10,1	99	15,1	66
0,7	1250	159	1000	10,1	99	15,1	66
0,7	1340	148	1000	10,1	99	15,1	66
0,8	1219	142	1000	11,5	87	17,3	58
0,8	1250	139	1000	11,5	87	17,3	58
0,8	1340	130	1000	11,5	87	17,3	58
1	1219	114	1000	14,4	70	21,6	46
1	1250	111	1000	14,4	70	21,6	46
1	1340	104	1000	14,4	70	21,6	46
1,2	1219	95	1000	17,3	58	25,9	39
1,2	1250	93	1000	17,3	58	25,9	39
1,2	1340	86	1000	17,3	58	25,9	39
1,5	1219	76	1000	21,6	46	32,4	31
1,5	1250	74	1000	21,6	46	32,4	31
1,5	1340	69	1000	21,6	46	32,4	31
2	1219	57	1000	28,8	35	43,1	23
2	1250	56	1000	28,8	35	43,1	23
2	1340	52	1000	28,8	35	43,1	23
2,5	1219	46	1000	Consult availability and possible sizes			
2,5	1250	44	1000	Consult availability and possible sizes			
2,5	1340	41	1000	Consult availability and possible sizes			
3	1219	38	1000	Consult availability and possible sizes			
3	1250	37	1000	Consult availability and possible sizes			
3	1340	35	1000	Consult availability and possible sizes			

\* consult availability for elZinc Rainbow® range  
\*theoretical weights



# Delivery Program for coils and sheets

		elZinc Alkimi® (elZinc Astur®, elZinc Slate®, elZinc Graphite®, elZinc Lava®, elZinc Crystal® and elZinc Oliva®)							
		1 coil per pallet		6 small coils per pallet		Sheets (1000kg / 2205lb pallet)			
						2000 x 1000mm		3000 x 1000mm	
Thickness mm	Width mm	Aprox. Length m.	Theoretical weight kg	Aprox. Length m.	Theoretical weight kg	Weight* / Sheet kg	Sheets / Pallet	Weight* / Sheet kg	Sheets / Pallet
0,50	1000	278	1000	-	-	-	-	-	-
0,65	500	428	1000	31	73	-	-	-	-
0,65	650	329	1000	31	94	-	-	-	-
0,65	1000	214	1000	21	98	-	-	-	-
0,7	500	397	1000	40	100	-	-	-	-
0,7	600	331	1000	34	100	-	-	-	-
0,7	650	305	1000	31	101	-	-	-	-
0,7	670	305	1000	30	101	-	-	-	-
0,7	1000	198	1000	20	101	10,08	102	15,12	66
0,8	500	347	1000	34	101	-	-	-	-
0,8	600	289	1000	30	100	-	-	-	-
0,8	670	267	1000	30	100	-	-	-	-
0,8	1000	174	1000	17	98	11,52	89	17,28	58
1	500	277	1000	28	101	-	-	-	-
1	600	231	1000	23	99	-	-	-	-
1	670	214	1000	21	99	-	-	-	-
1	1000	138	1000	14	101	14,4	69	21,6	46
1,2	500	231	1000	-	-	-	-	-	-
1,2	600	193	1000	-	-	-	-	-	-
1,2	670	173	1000	-	-	-	-	-	-
1,2	1000	116	1000	-	-	17,28	58	25,9	39
1,5	500	185	1000	-	-	-	-	-	-
1,5	600	154	1000	-	-	-	-	-	-
1,5	670	138	1000	-	-	-	-	-	-
1,5	1000	93	1000	-	-	21,6	46	32,4	31
2	500	139	1000	-	-	-	-	-	-
2	600	116	1000	-	-	-	-	-	-
2	670	104	1000	-	-	-	-	-	-
2	1000	69	1000	-	-	28,8	35	43,2	23

\*theoretical weights

elZinc Slate®, elZinc Graphite®, elZinc Lava®, elZinc Crystal® and elZinc Oliva® sheets and coils are delivered with a protective film.

Other sizes and thicknesses are available upon request.

Coil inside dimension: coils ≥ 1T = 508 mm - Small coils = 300mm

Correct behaviour of the film on removal cannot be guaranteed beyond 8 months after dispatch from elZinc, and the film should be immediately removed after installation.

Table 3

		elZinc Rainbow®, elZinc Advance® and elZinc Protect+®							
		1 coil per pallet		6 small coils per pallet		2000 x 1000 mm Sheets			
						Approx. 200kg / pallet*		Approx. 500kg / pallet*	
Thickness mm	Width mm	Approx. Length m.l.	Theoretical Weight kg	Approx. Length m.l.	Theoretical Weight kg	Weight*/ Sheet kg	Sheets / Pallet	Weight*/ Sheet kg	Sheets / Pallet
0,50	1000	278	1000	-	-	-	-	-	-
0,7	500	397	1000	10	100	-	-	-	-
0,7	600	331	1000	34	100	-	-	-	-
0,7	650	305	1000	31	101	-	-	-	-
0,7	670	296	1000	31	104	-	-	-	-
0,7	1000	198	1000	28	101	10,08	20	10,8	50
0,8	500	347	1000	35	101	-	-	-	-
0,8	600	289	1000	30	103	-	-	-	-
0,8	650	267	1000	26	98	-	-	-	-
0,8	670	259	1000	26	100	-	-	-	-
0,8	1000	174	1000	17	98	11,52	17	11,52	43
1	500	277	1000	28	101	-	-	-	-
1	600	231	1000	23	99	-	-	-	-
1	650	214	1000	21	98	-	-	-	-
1	670	207	1000	21	101	-	-	-	-
1	1000	138	1000	14	101	14,4	14	14,4	35
1,2	500	231	1000	-	-	-	-	-	-
1,2	600	193	1000	-	-	-	-	-	-
1,2	650	178	1000	-	-	-	-	-	-
1,2	670	173	1000	-	-	-	-	-	-
1,2	1000	116	1000	-	-	17,3	14	14,4	29
1,5	500	185	1000	-	-	-	-	-	-
1,5	600	154	1000	-	-	-	-	-	-
1,5	650	142	1000	-	-	-	-	-	-
1,5	670	138	1000	-	-	-	-	-	-
1,5	1000	93	1000	-	-	21,6	9	21,6	23
2	500	139	1000	-	-	-	-	-	-
2	600	116	1000	-	-	-	-	-	-
2	650	107	1000	-	-	-	-	-	-
2	670	104	1000	-	-	-	-	-	-
2	1000	69	1000	-	-	28,8	7	43,2	17

\*theoretical weights

elZinc Rainbow®, elZinc Advance® and elZinc Protect+® sheets and coils are delivered with a protective film.

Other sizes and thicknesses are available upon request.

Coil inside dimension : coils ≥ 1 T = 508mm - Small coils = 300mm

Correct behaviour of the film on removal cannot be guaranteed beyond 8 months after dispatch from elZinc, and the film should be immediately removed after installation

# Perforated zinc solutions for façades

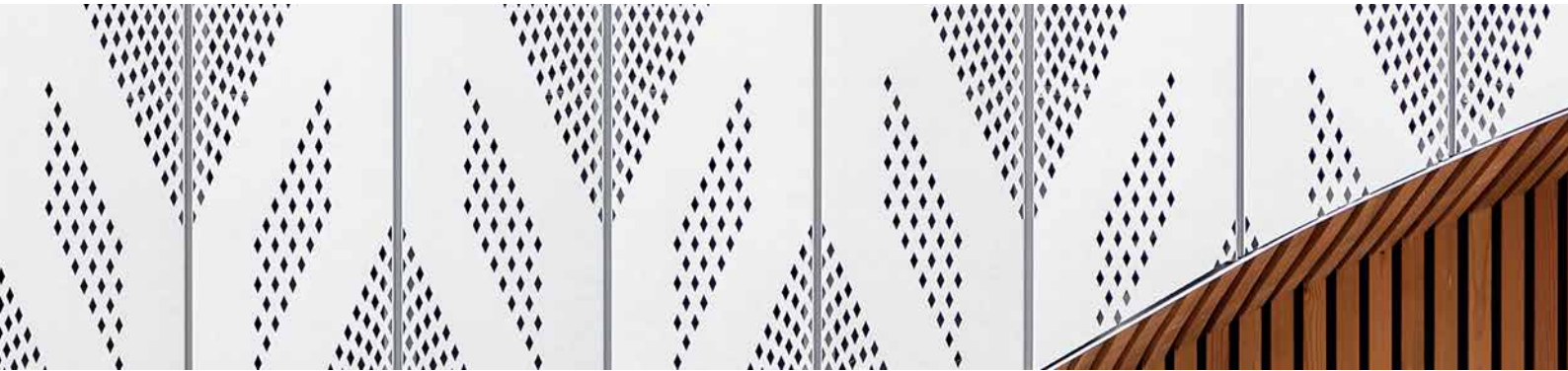

## Key Points

- Controlled transparency.
- Singularity and character.
- Versatility.
- Proven durability.
- Thermal comfort.
- Doesn't require post-painting treatment.

## | Standard Perforation

With its ten standard patterns and three different layouts, the standard perforated range of standard patterns provides aesthetic and functional cladding for your façades.

### Delivery formats:

#### - Coil:

Width (mm): 500 - 1000 - 1330

Length (mm): Depends on thickness

Thickness (mm): 0.7 - 0.8 - 1.00 - 1.50

#### - Sheet:

Width (mm): 500 - 1000 - 1330

Length (mm): 2000 & 3000

Thickness (mm): 0.7 - 0.8 - 1.00 - 1.50

### Formats:

- RWTP

- RWMP

- RWUP

## | eZinc 3D

By combining perforation technology with pressing processes, it is possible to create screens with a three-dimensional structure.

### Delivery formats:

#### - Rounded 3D Design

Width (mm): 1000

Length (mm): 1000 & 2000

Thickness (mm): 1 or 1.5 on request

#### - Square 3D Design

Width (mm): 1000

Length (mm): 1000 & 2000

Thickness (mm): 1 or 1.5 on request

## | elZinc image

By interpreting the images and converting them into perforation patterns of different densities and sizes, the architect can "draw" on the entire façade and fully customise it.

### Delivery formats:

#### - Sheet:

Width (mm): 1000 - 1250 - 1330

Length (mm): Project defined, up to a maximum of 6000

Thickness (mm): According to project

## | Standard perforations

In collaboration with Atelier d'architecture Janez Nguyen Architectes, authors of the St-Louis Hospital nursery (Paris), we have created three exclusive perforated designs.

### Delivery formats:

#### - St-Louis:

Width (mm): 250 panel face width

Length (mm): Up to 4000

Thickness (mm): 1.00

#### - St-Michel:

Width (mm): 250 panel face width

Length (mm): Up to 4000

Thickness (mm): 1.00

#### - St-Germain:

Width (mm): According to the tile

Length (mm): According to the tile

Thickness (mm): 1.00

## | elZinc expanded

Stylish and robust, these panels are ideal for areas requiring good aeration such as multi-storey car parks, plant rooms or industrial facilities.

### Delivery formats:

#### - Large format architectural panels

Width (mm): 1000 - 1250 - 1330

Length (mm): 2000 - 3000

Thickness (mm): 1,5

#### - Coil:

Width (mm): 1000 - 1250 - 1330

Length (mm): According to project requirements

Thickness (mm): 0,7

#### - Sheet

Width (mm): 500 - 1000 - 1250 - 1330

Length (mm): 2000 - 3000

Thickness (mm): 0,7



# elZinc® Tiles

## Product description:

Whether for new-build or refurbishment projects, prefabricated **elZinc®** tiles are a great solution for wall cladding and for weathering roofs pitched over either 25° or 45° (depending on the type of tile used).

Our five types of shingles, made of **elZinc®** zinc-titanium (EN988 standard), lend themselves to all architectural styles, in perfect harmony with the surrounding materials.

**elZinc Slate®**, **elZinc Graphite®** and **elZinc Astur®** are available in 0,65mm and 0,7mm. The rest of elZinc finishes are only available in 0,7mm.

**In addition to their ecological and aesthetic qualities, elZinc® tiles are:**

- Easy to install
- Suitable for most projects
- Highly corrosion resistant
- Virtually maintenance free

## Square tile:

**elZinc®**'s square tile with polystyrene reinforcement is notable for its ease of installation. Its clean design gives the cladding an elegantly neat appearance.

- **Elements number/m<sup>2</sup>:** 9
- **Approx. weight/m<sup>2</sup> (in 0,7 mm):** 7,3 kg
- **Dimensions:** 400 x 400 mm (parallel edges)  
512 x 555 mm (height x width)
- **Tiles/box:** 24



## Rhomboid tile:

The **elZinc®** rhomboid tile gives a stylised look to roofs and façades. The sleek interlocking tile highlights verticality, and is suited to both modern and traditional architecture.

- **Elements number/m<sup>2</sup>:** 14
- **Approx. weight/m<sup>2</sup> (in 0,7 mm):** 7,8 kg
- **Dimensions:** 260 x 260 mm (parallel edges)  
560 x 280 mm (height x width)
- **Tiles/box:** 35



### Pointed fish scale tile:

This **elZinc®** tile brings to mind images of baroque architecture. It provides, in its simplicity, a discreet, traditional feel to the building.

- Elements number/m<sup>2</sup>: 72
- Approx. weight/m<sup>2</sup> (in 0,7 mm): 10,9 kg
- Dimensions: 240 x 142 mm
- Tiles/box: 144



### Rounded fish scale tile:

A new twist on a classic model. **elZinc®**'s rounded fish scale tile is inspired by a shape commonly used in traditional European architecture.

- Elements number/m<sup>2</sup>: 41
- Approx. weight/m<sup>2</sup> (in 0,7 mm): 7,4 kg
- Dimensions: 280 x 200 mm
- Tiles/box: 104



### Diamond tile:

The diamond tile **elZinc®** offers the architect a modern and attractive option. A larger format tile suitable for a wide range of applications.

- Elements number/m<sup>2</sup>: 9,12
- Approx. weight/m<sup>2</sup> (in 0,7 mm): 7,2 kg
- Dimensions: 340 mm (perpendicular to hemmed edges)  
611 x 415 mm (height x width)
- Tiles/box: 20

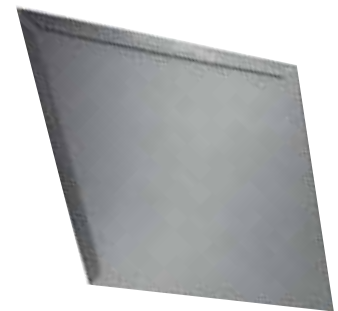

**elZinc®**'s range of tiles are available in every **elZinc®** aesthetic surface finish

**elZinc Astur®**



**elZinc Slate®**

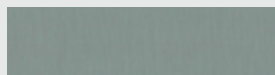

**elZinc Rainbow® Red**

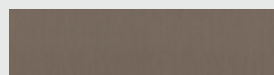

**elZinc Rainbow® Blue**



**elZinc Graphite®**

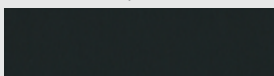

**elZinc Crystal®**

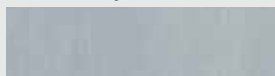

**elZinc Rainbow® Green**

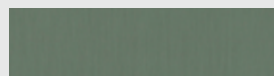

**elZinc Rainbow® Brown**

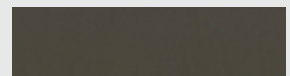

**elZinc Oliva®**



**elZinc Lava®**

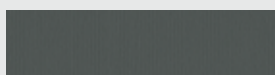

**elZinc Rainbow® Ebony**

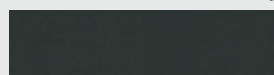

**elZinc Rainbow® Gold**

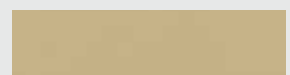

# elZinc® Honeycomb panel

An ideal architectural solution for wall cladding:

The **elZinc® honeycomb panel**, manufactured in a continuous production process, is a new generation material and represents the perfect integration of technology, safety, durability and natural beauty.

**elZinc® A2** fire-rated panels are formed by two **elZinc®** skins bonded to both faces of an aluminium honeycomb core, making an extremely light, yet exceedingly flat and ridged architectural cladding material.

The ample range of combinations and colours available enables the use of **elZinc®** to create innovative designs both in new-build and in refurbishment projects.

**A bespoke supporting system – HideTech® PLUS -, the world's first perimeter point-fixing system for architectural panels, takes advantage of the excellent rigidity of elZinc® panels.**

**Very easy to install, it also allows:**

- Cost and weight reduction.
- Easy panel replacement (no need to dismantle surrounding panels)
- Vertical and horizontal installation orientation
- Free but controlled thermal expansion and contraction
- Wall brackets that are fully adjustable in three directions
- Total security.

## System basic information

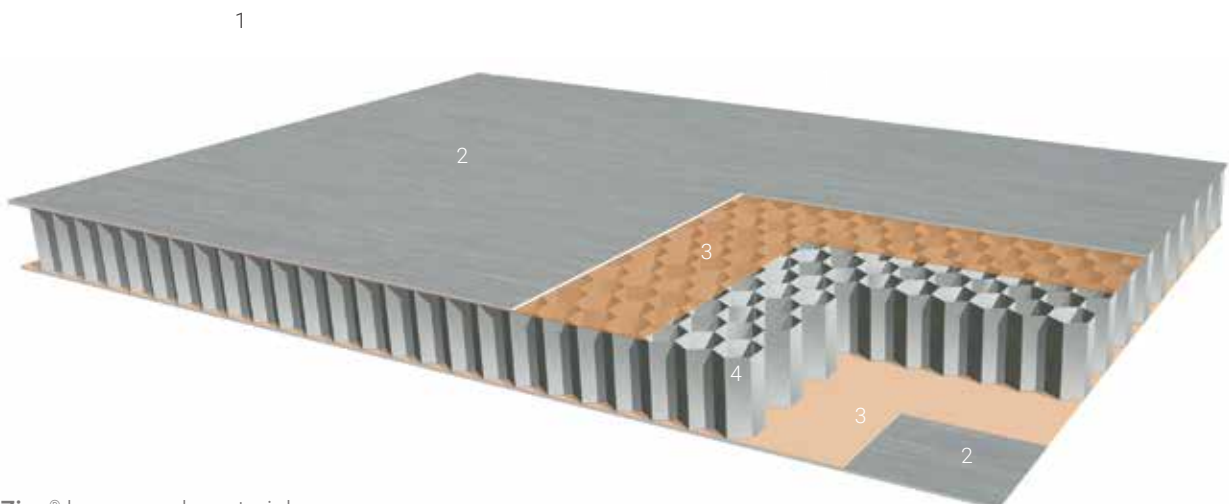

1. **elZinc®** honeycomb material
2. 0.5mm **elZinc®** panel skin
3. Adhesive
4. 14mm aluminium honeycomb core

Main features:

- Minimum/maximum length: 2.000 / 8.000 mm
- Standard width: 1.000 mm
- Total thickness: 15 mm
- Internal skin thickness: 0,5 mm
- External skin thickness: 0,5 mm
- Panel weight: 8,6 kg/m<sup>2</sup>



European Technical Assessment:  
ETA 16/0415 of 23/05/2016

Available in every el Zinc® aesthetic surface finish and in elZinc Advance®:

elZinc Astur®



elZinc Slate®



elZinc Rainbow® Red



elZinc Rainbow® Blue



elZinc Graphite®



elZinc Crystal®



elZinc Rainbow® Green

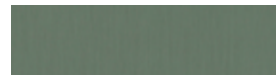

elZinc Rainbow® Brown



elZinc Oliva®



elZinc Lava®



elZinc Rainbow® Ebony



elZinc Rainbow® Gold

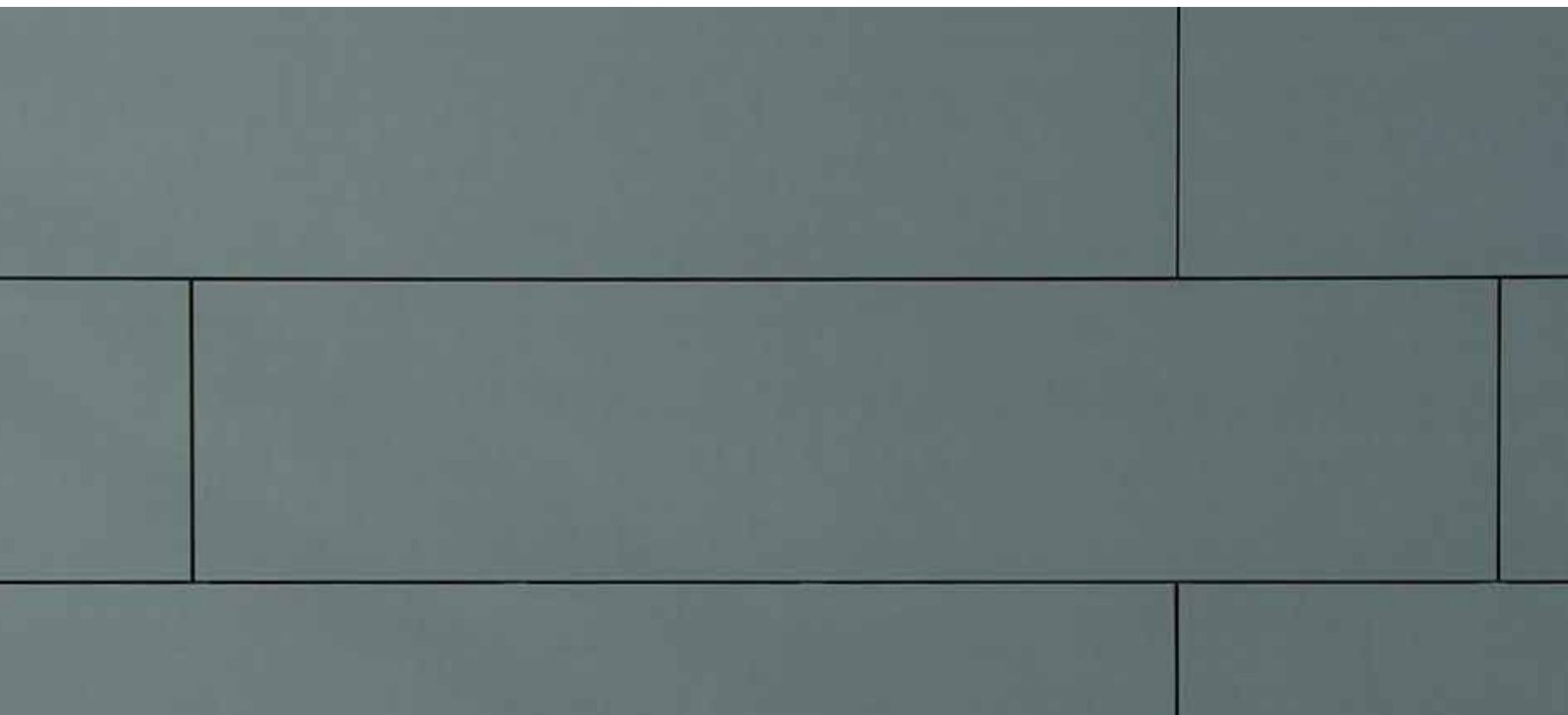



# elZinc® Composite panel

## Main applications:

**elZinc®** composite material is a high quality wall cladding material, providing long-term performance and flexibility of design for the most demanding of projects.

It consists of two **elZinc®** sheets continuously bonded to a ridged core made of either low-density polyethylene (PE) or of mineral filled Fire Resistant resin (FR) to provide flatness and lightness. The FR core material is defined as providing very little contribution to a fire by Euroclass fire classification.

The advanced production process ensures excellent bonding, achieving twice the recommended delamination values.

**elZinc®** composite panel will enhance your most creative project with its range of finishes (**elZinc Alkimi®** and **elZinc Rainbow®**).

### Basic system information

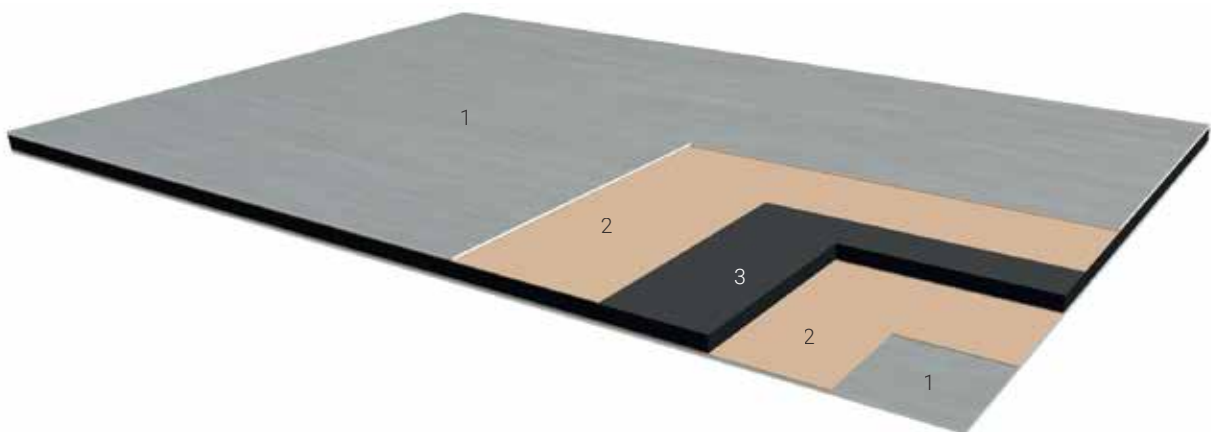

- 1. **elZinc®** skin
- 2. Adhesive
- 3. FR or PE core

Product characteristics:

**elZinc® PE composite panel**

- Length: up to 8.000 mm
- Standard width: 1.000 mm
- Total thickness: 4 mm
- Internal skin thickness: 0,5 mm
- External skin thickness: 0,5 mm
- Weight: 10,06 kg/m<sup>2</sup>

Reaction to fire test: M1 acc. to UNE23727: 1990

**elZinc® FR composite panel**

- Length: up to 8.000 mm
- Standard width: 1.000 mm
- Total thickness: 4 mm
- Internal skin thickness: 0,5 mm
- External skin thickness: 0,5 mm
- Weight: 12,2 kg/m<sup>2</sup>

Reaction to fire test: B-s1, d0



Available in every elZinc® aesthetic surface finish and in elZinc Advance®:

elZinc Astur®



elZinc Slate®



elZinc Rainbow® Red



elZinc Rainbow® Blue



elZinc Graphite®



elZinc Crystal®



elZinc Rainbow® Green



elZinc Rainbow® Brown



elZinc Oliva®



elZinc Lava®



elZinc Rainbow® Ebony



elZinc Rainbow® Gold



## 4. Systems







# Traditional systems

Traditional systems are fully supported metal coverings that employ tried and tested hard metal seaming and fixing techniques which have been used for centuries.

The most noteworthy are:

- Double lock standing seam
- Angle standing seam
- Flat lock shingles
- elZinc® tiles

Party Hall, Berstett, France  
Larche & Metzger



Botanical Garden, South Korea



# Traditional systems

The complete **elZinc®** range of finishes can be installed using these systems. They have several characteristics in common:

## **Light, timeless, artisan appearance:**

These systems are installed by specialist hard metal roofing contractors giving a hand crafted, made-to-measure feel. The subtle quilting that can become apparent naturally under different light conditions introduces a bit of visual 'vibration' and 'energy' to the building.

## **Adaptable and architecturally flexible:**

Making use of the malleability of **elZinc®**, the panels can be curved, tapered, formed and folded to conform to almost any geometric design. Intelligent use of the joints can convey interesting effects.

## **Proven durability:**

Zinc standing seam roofs have been known to last for well over half a century, and traditional zinc cladding lasts even longer.

## **Economical:**

The thin gauge of **elZinc®** used (0.65 to 0.8mm – only 5,6 to 7 kgs/m<sup>2</sup>) coupled with modern bending and profiling technology keeps costs more affordable than most architects appreciate.

## **Installation:**

They should be installed by experienced fully supported metal roofing specialists. Contact **elZinc®** for a list of reputable firms for your project.

Hallym University, Korea



Technically, they share the following features:

#### **Use of thin gauge zinc:**

Zinc between 0.65 and 0.8 mm is normally used since these systems require ease of hand forming on site to execute the joints and details. In countries new to this type of cladding, there is a temptation on occasion to use heavier gauge material to eliminate oil canning, but this should only be done after consultation – many traditional joint details cannot be executed in material thicker than 0,8 mm.

#### **Folded and welted joints to connect panels:**

These joints create protruding seams or small steps between the panels. They are either simply interconnected or welted together on site. The seams are not watertight, and their weathertightness varies, so each type of joint has its own pitch-related limits. Optically, these joints interact with the light generating interesting effects which can influence our perception of the façade at different times of the day and year.

#### **Fully supporting substrate:**

Due to the thin gauge of the zinc used, they require a fully supporting substrate (or partially supporting substrate for façades). This can either be of a vented or unventilated design, and helps reduce rain drumming especially if combined with structural underlays.

#### **Indirect fixing using stainless steel clips:**

These fixings are hidden by being overlapped by the next panel in the sequential installation of the covering. They hold the cladding down to the substrate whilst ensuring it can expand and contract freely as it warms up or cools down.

#### **Governed by national norms and codes of practice:**

These systems should be installed according to national standards and codes of practice. Independent system certification should not be required since they employ tried and tested techniques and methods.

Office building, France - Jean-Paul Faure





# Traditional systems

## Panel widths and clip centers in traditional systems

The standing seam, angle seam and flat lock panel systems all use the same set of seam centers, which are tied into commercially available coil widths.

Therefore, the following table can be used to determine the bay widths, thicknesses, and also to specify the number of fixings per m<sup>2</sup> for each of these systems.

**Table 2**

System dimensioning		FIXING REQUIREMENTS – NUMBER OF CLIPS PER M <sup>2</sup> / CLIP CENTRES IN CMS RELATED TO BUILDING HEIGHT (H)								
		<8m			8m<H≤20m			8m<H≤100m		
Thickness	Bay width	Center	Edge	Corner	Center	Edge	Corner	Center	Edge	Corner
0,7	430	3,9 / 48	3,9 / 48	6,4 / 29	3,9 / 48	5,5 / 34	9,6 / 20	3,9 / 48	7,7 / 25	12,8 / 15
0,7	530	3,9 / 48	3,9 / 48	6,4 / 29	3,9 / 48	5,5 / 34	9,6 / 20	3,9 / 48	7,7 / 25	12,8 / 15
0,7	600	3,9 / 43	3,9 / 43	6,4 / 26	3,9 / 43	5,5 / 30	9,6 / 17	3,9 / 43	8,5 / 20	12,8 / 13
0,7	600	4 / 40	4 / 40	6,4 / 25	4 / 40	5,4 / 29	10 / 16			

Notes: Assumes a nominal clip pull out load of 560N. Valid for non-exposed locations.

Various factors affect wind uplift - (location, exposure, orientation and roof geometry) and advice should be sought from **eZinc**<sup>®</sup> when determining tray widths for projects in exposed locations.

This is not only to ensure that the cladding does not suffer during storms, it is also to avoid fluttering of the trays during periods of continuously windy weather.

Bay widths may be narrowed to the next standard width in order to reduce quilting in the sheets if a flatter appearance to the cladding is required, especially for wall cladding or steeply pitched roofs.



# Double lock standing seam

## Key points

- **Proven, versatile system** for roofing flat, curved and 'free-form' roofs.
- **Weather-tight down** to 7° of pitch, 3° if seams are sealed.
- **Discrete joints** give a light, elegant appearance.
- **Modern profiling and seaming machines** facilitate short installation times.
- **On-the-roof detailing** uses folding techniques or soldered joints – no mastic!
- **Items** such as snow guards and life line attachments are readily available.

## Basic system information

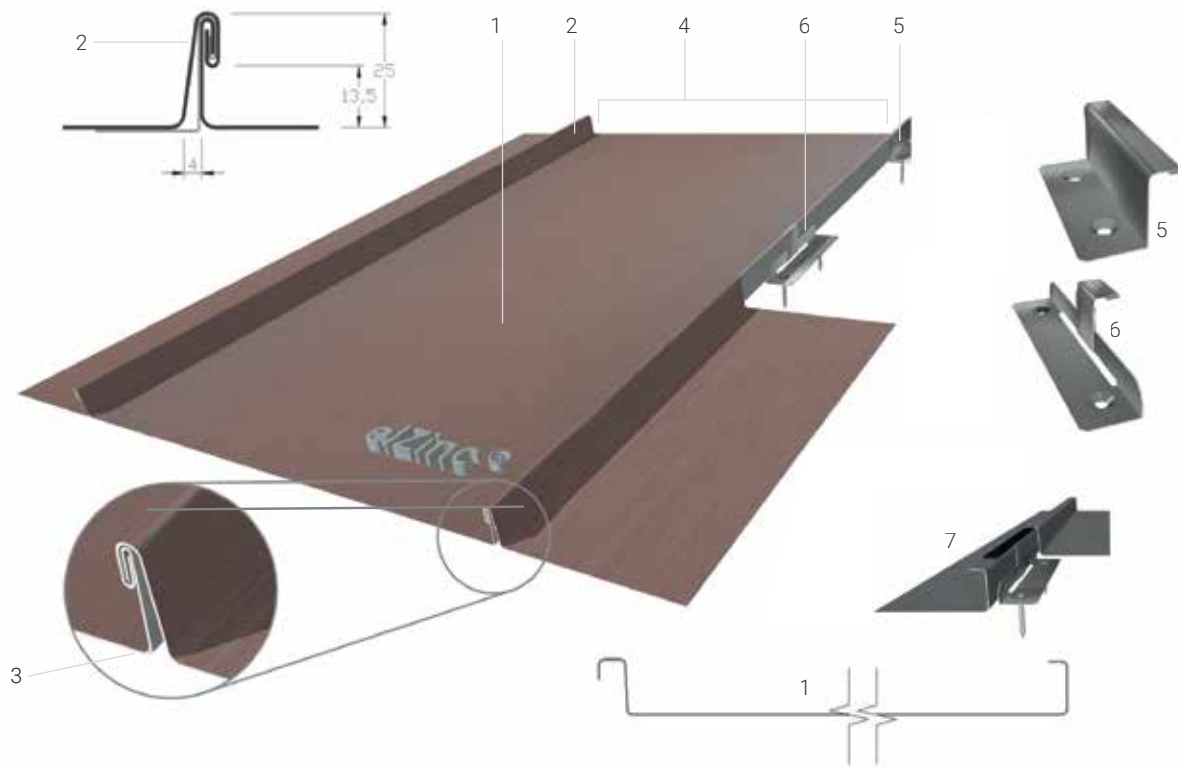

1. **elZinc®** Standing seam roofing tray, nominal max. length 10m
2. Standing seam joint (normally follow line of maximum pitch)
3. Expansion gap at seam base

4. Seam centres dimension. Normally from 430 to 600mm
5. Stainless steel 'fixed' clip – anchors the tray in position
6. Stainless steel 'sliding' clip - allows longitudinal expansion
7. Self-expanding sealing strip for roofs pitched under 7°

## The joint

The joint requires 70mm of material to make. It is formed by seaming together profiled trays of zinc as illustrated on the right.



## Seaming process



Standing seam tray



Clipped undercloak and the overcloak



Small gap at base forms automatically and allows for lateral thermal expansion



First turn completes angle standing seam joint



Double lock welt, second turn completes double lock standing seam joint

# Double lock standing seam

## Cross joints

Transverse joints vary according to roof pitch. They are needed to introduce expansion joints on large roofs or around details.

### Basic system information

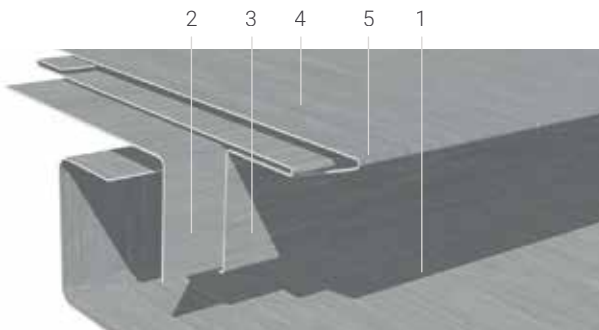

**Step**

**Pitch:** 3° and above

**Height:** 60mm

Often used as an expansion joint on long, low pitched roofs. The step in the substrate can be formed using a fillet.

1. Lower roofing tray
2. Continuous fixing strip
3. 'T' plate with folded back edge
4. Upper roofing tray
5. Expansion/contraction gap

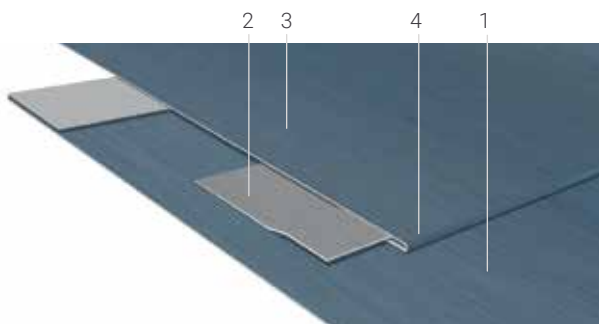

**Lap lock**

**Pitch:** 10° and above

**Lap:** Approx. 180mm

Often used as an expansion joint on long roofs.

1. Lower roofing tray
2. Soldered continuous cleat
3. Upper tray
4. Expansion/contraction gap



**Double lock cross welt**

**Pitch:** 7° and above

**Width:** Approx. 20mm

The preformed 'slide in' type (shown here) allows for perfect rainwater drainage.

**Does not function as an expansion joint.**

1. Lower roofing tray
2. Upper tray

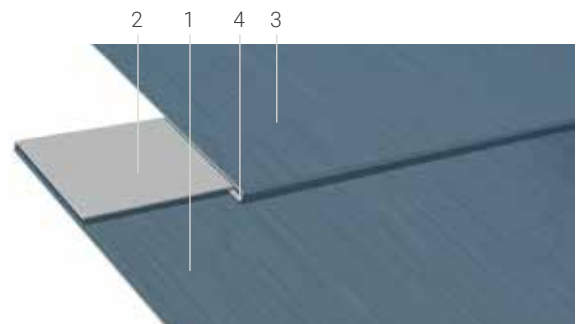

**Single lock cross welt**

**Pitch:** 25° and above

**Width:** 40mm fold on lower tray, 30mm on upper tray.

Can be used as an expansion joint on long roofs.

1. Lower roofing tray
2. 40mm fold
3. Upper tray
4. Expansion/contraction gap

## Dimensioning and fixing

The width of the trays should be dimensioned using the information in table 2, page 42. If the length of the roofing trays is over 1,5m the clips used to secure them to the substrate must allow the zinc to expand and contract, and these trays use a combination of fixed clips and sliding clips to accomplish this.

The position of the fixed clip zone depends on roof pitch – to avoid the trays from buckling when expanding up the roof from the fixed zone, the steeper the pitch, the higher the anchoring band of fixed clips is positioned. The thermal movement generated in the trays is accommodated by a gap introduced in the detail at the foot and at the head of the trays.

## Installation

The system is installed across the roof in either direction, or preferably outwards from a centrally placed undercloak – undercloak tray that ensures trays of equal width (and therefore symmetry) at both ends of the roof.

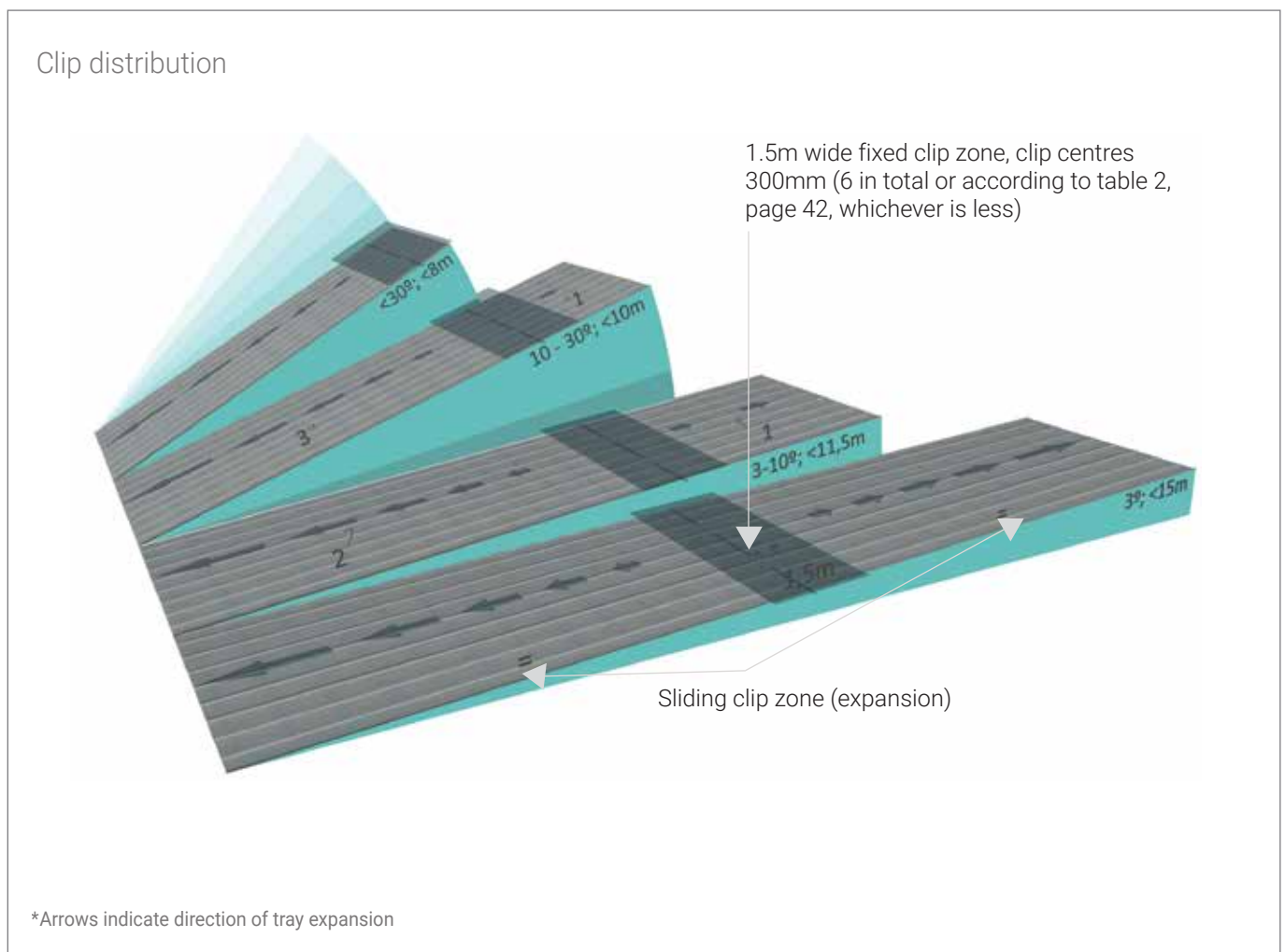

# Double lock standing seam

## Examples of typical details

Below are some examples of typical details. These and others, are available from our website. **elZinc®** also develops project specific details if required. For more detailed information on this system, please download the System Drawings pdf available from our website.

Details

The image contains nine technical drawings of roof details:

- Eaves – Half-round gutter over zinc apron:** Shows a half-round gutter installed over a zinc apron at the eaves.
- Eaves – Hidden boxed-gutter over zinc fascia:** Shows a hidden boxed-gutter system over a zinc fascia.
- Eaves - Hidden-boxed eaves gutter over angle seam cladding:** Shows a hidden boxed-gutter system over angle seam cladding.
- Flat vented ridge:** Shows a flat vented ridge detail.
- Unvented square batten ridge:** Shows an unvented square batten ridge detail.
- Vented abutment to brick wall:** Shows a vented abutment detail to a brick wall.
- Standing seam Verge - deep:** Shows a standing seam verge detail with a deep profile.
- Vented transition mansard roof:** Shows a vented transition detail for a mansard roof.
- Boxed valley gutter:** Shows a boxed valley gutter detail.





# Angle standing seam

## Key points

- **Traditional cladding system** based on the double lock standing seam

- **Principally used** in façade cladding, on flat or curved areas

- **Weather-tight** from 25° of pitch and above if used in roofing. 35° in regions with heavy snowfall

- **Attractive design layouts** complement different architectural styles

- **Suitable** for ventilated façade designs

- **Can use semi continuous substrate**

### Basic system information

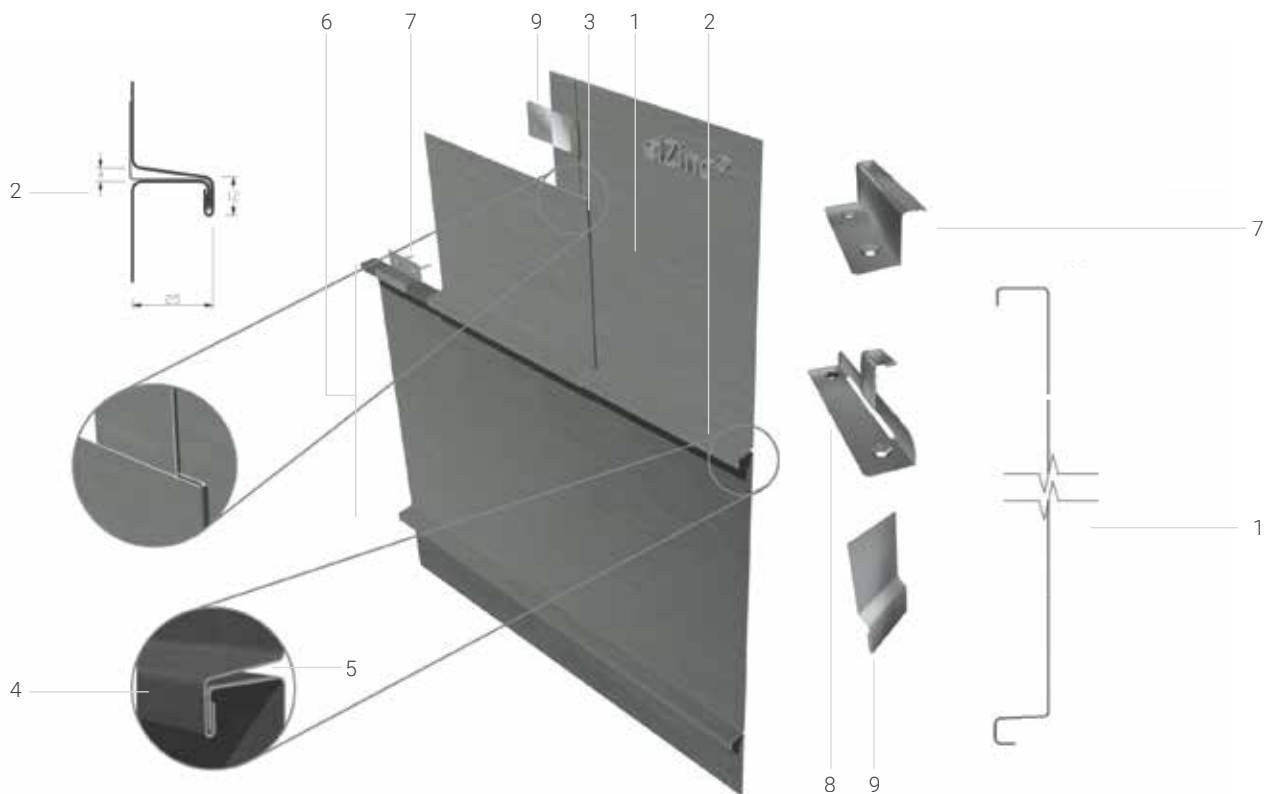

1. elZinc® angle standing seam roofing tray.

2. Angle Standing seam joint (horizontal, vertical or set at an angle).

3. Flat lock transversal joint.

4. Welt of angle seam.

5. Expansion gap at seam base.

6. Seam centres dimension, normally from 430 to 600mm.

7. Stainless steel 'fixed' clip – anchors the tray in position.

8. Stainless steel 'sliding' clip

9. Stainless steel flat lock clip

## Appearance

Angle seam façades exhibit fairly pronounced directionality – the longitudinal angle seam is more visible than the flat lock cross joints and so it dominates the aesthetic. The thin gauge zinc used can produce some degree of oil canning adding character to the façade. If desired, this can be minimised by using 0.8 mm **elZinc**<sup>®</sup> in narrower panel widths of 430 mm.

## Fixing and dimensioning

The width of the trays should be dimensioned using the information in table 2, page 42.

Aesthetic considerations sometimes mean narrower trays than those required to resist wind loading are chosen.

Art du Toit, Quebriac, France - Quinze Architecture



# Angle standing seam

## Design possibilities

The angle seam system offers the architect the opportunity to get creative with seam centers and cross joint placement to complement or enhance certain aspects of the overall design of the project.

A few of the more common designs are shown here. The horizontal designs can also be used vertically. Long strip horizontal cladding is not recommended due to site handling difficulties.

### Examples



#### Long strip vertical or near vertical

Not recommended for horizontal formats due to site handling issues

**Seam centres:** 430, 530, 580 and 600mm

**Panel length:** Maximum of 10000mm recommended

**Effect:** Clean and elegant



The cross joints can be set at an angle if desired to create other visual effects. No extra material is needed.



#### Staggered

**Seam centres:** 430, 530, 580, and 600mm

**Panel length:** Maximum of 3000mm recommended.

**Effect:** The cross joints will create some verticality as they line up



#### Staggered

**Seam centres:** 430, 530, 580, and 600mm

**Panel length:** Maximum of 3000mm recommended

**Effect:** The stepped cross joints impart a sense of movement



#### Varying panel widths

**Seam centres:** 263, 430, 600mm shown

**Panel length:** Maximum of 3000mm recommended

**Effect:** Very longitudinal and very distinctive. Gives the façade a very individual feeling

## Examples of typical details

Below are some examples of typical details of horizontal cladding. These and others, as well as their equivalents for vertical cladding, are available from our website.

**elZinc®** also develops project specific details if required. For more detailed information on this system, please download the System Drawings pdf available from our website.

### Details



Ground level foot

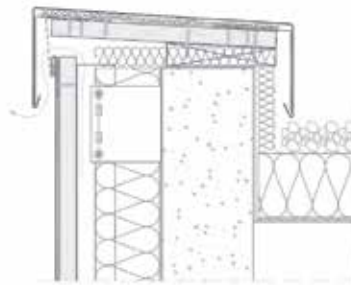

Front vented capping

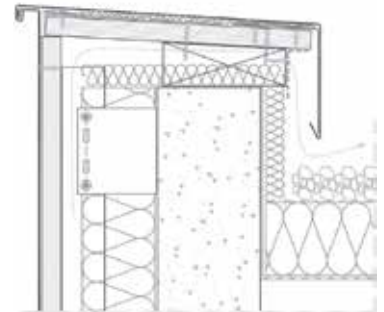

Rear vented capping

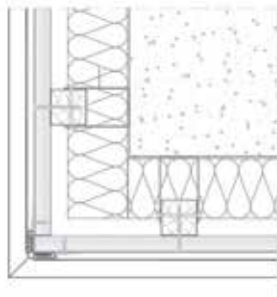

Continuous seam external corner

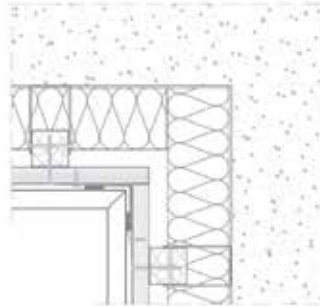

Continuous seam internal corner

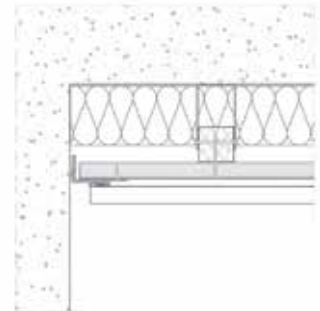

Reverse corner abutment

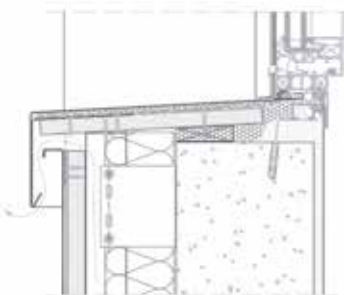

Vented window sill

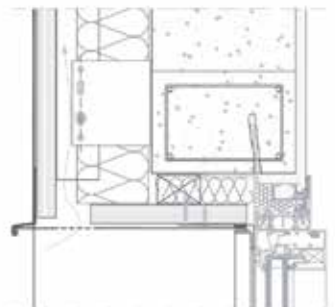

Vented window lintel

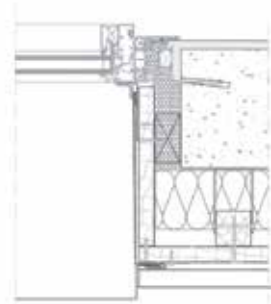

Window jamb

# Flat lock shingles

## Key points

- **Traditional cladding system** using interlocking panels
- **Principally used** in façade cladding, on flat or curved areas
- **Weather-tight** from 25° of pitch and above if used in roofing
- **Attractive design** layouts complement different architectural styles
- **Suitable for** ventilated façade designs
- **Can use semi continuous substrate**

## Basic system information

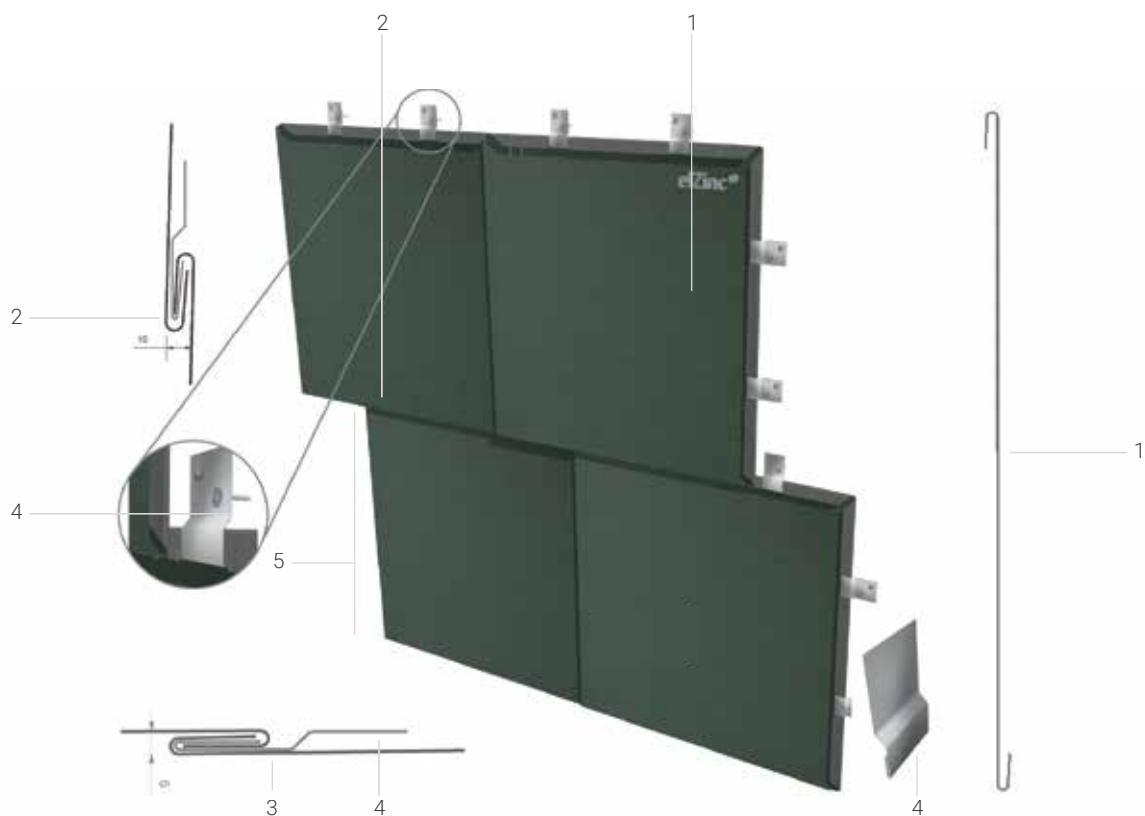

1. elZinc® flat lock shingle tray.

2. Flat lock dominant joint.

3. Flat lock transversal joint.

4. Stainless steel clip (can also be made of the same zinc as the cladding).

5. Seam centres dimension, normally 430 to 600mm.

## Key points

Depending on the layout of the joints, the system can either be directional or not. The seams themselves are very discrete, but they are highlighted by the shadows they cast in sunny weather, making them clearly visible especially on lighter finishes where the contrast is greatest.

This system is not profiled, so oil canning is normally less apparent than with the angle seam system.

## Fixing and dimensioning

The width of the shingles should be dimensioned using the information in table 2, page 42.

Each flat lock shingle is indirectly fixed along both outturned folds (undercloaks) using stainless (or zinc) clips. The number of clips per m<sup>2</sup> should be according to table 2, page 42.

Camp Southern Ground, Georgia, USA



# Flat lock shingles

## Design possibilities

As well as those designs shown for the angle seam for which rectangular shingles are employed, square flat lock shingles are often used but set at 45°. This arrangement can be either fully interlocked or set to leave a small overlap giving a more traditional artisan feel to the cladding.

Other designs are possible of course, as long as the shapes tessellate and the joints shed water correctly. As an example, a rhomboid design is illustrated below. Note how the same façade will change its appearance according to the shadows cast by the flat lock joints at different times of the day.

### Examples



**Fully interlocked shingles at 45°**

**Seam centres:** 430, 530, 580 and 600 mm

**Effect:** Visually 'disconnects' cladding from openings and the contours of the façade, so no care need be taken to coordinate opening positions with seam centres.



**40mm free edge interlocked shingles at 45°**

**Seam centres:** 430, 530, 580 and 600 mm

**Effect:** Has a more artisan feel than fully interlocked shingles. Also sets the cladding apart from other elements of the façade (openings, corners etc).



**Rhomboid shingles in a vertical design**

**Seam centres:** 430, 530, 580 and 600mm

**Effect:** Dependent on sun direction. The sun will highlight the cross joints more when full on the façade, when at an angle it will highlight the vertical joints more.



## Examples of typical details

Below are some examples of typical details. These and others are available from our website. **elZinc®** also develops project specific details if required.

For more detailed information on this system, please download the System Drawings pdf available from our website.

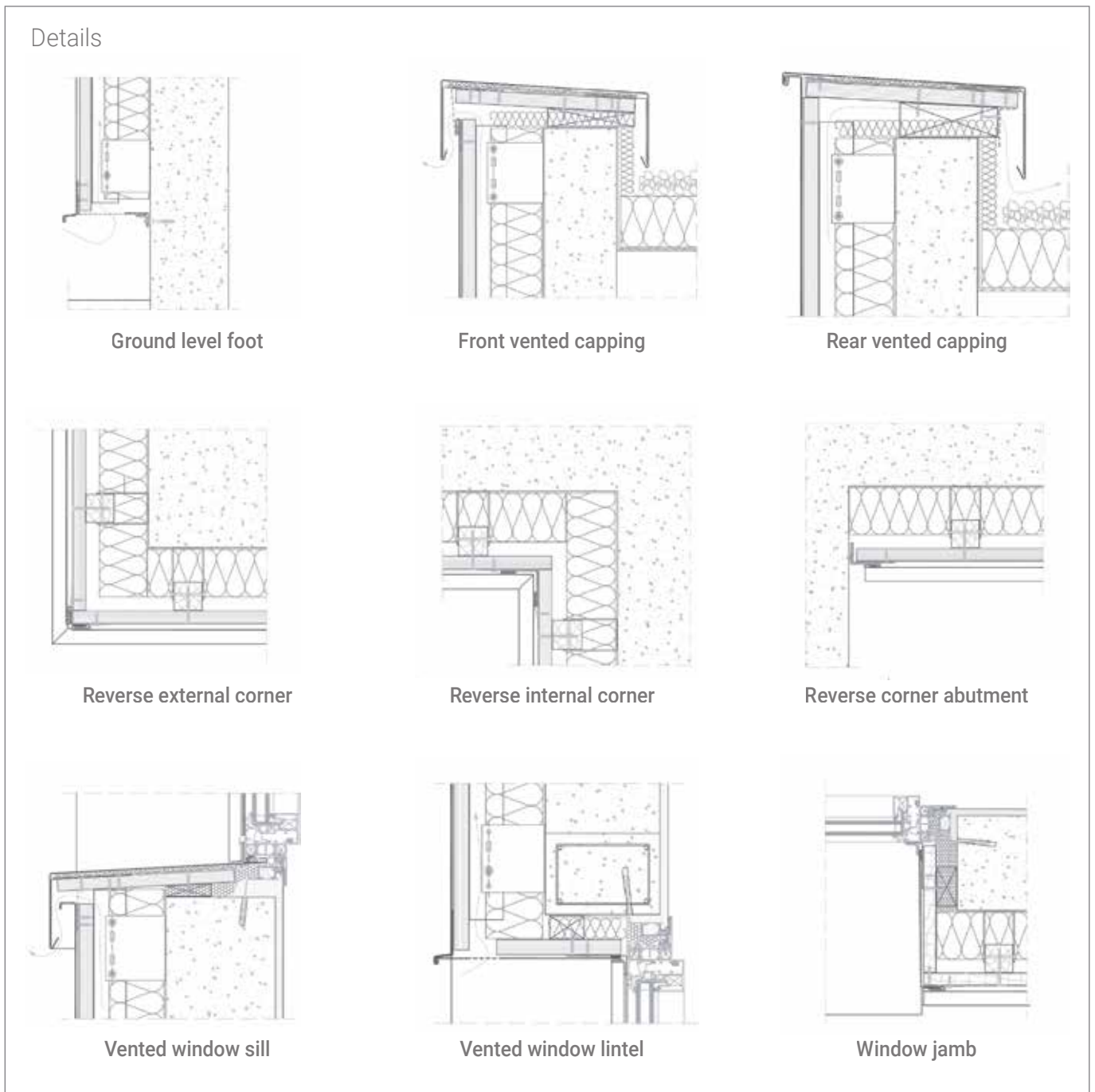



# elZinc® Tiles

## Key points

- **Pre-fabricated elements** directly fixed to substrate
- **For wall cladding and roofing** (subject to roof pitch)
- **5 different designs**
- **Easy to install** – can be cut, edged and folded as required
- **Require fully supporting substrate**
- **Available** in the full range of **elZinc®** finishes

Arzak Restaurant, San Sebastian, Spain  
Estudio LYMA Arquitectura



## Five different designs

Square tile

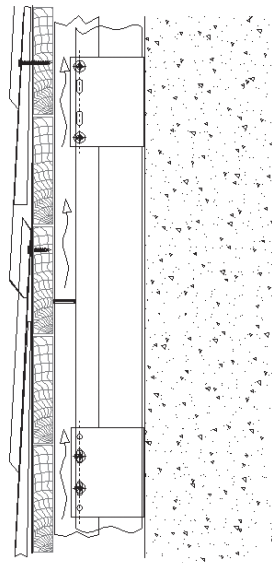

Robust, clean appearance  
Rigid backing dampens rain drumming  
Good rigidity, flat finish  
Weather-tight at 25° and above

elZinc® Rhomboid tile

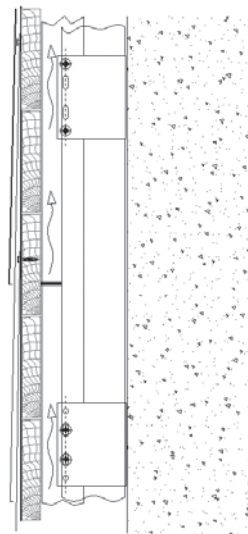
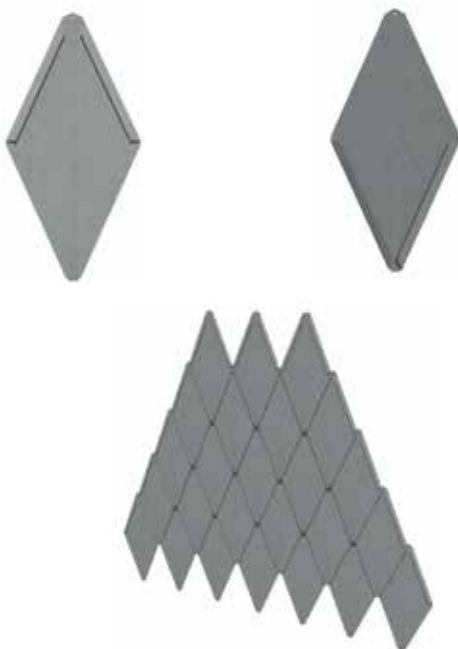

Elegant and artisan aesthetic  
Installation on curved surfaces possible  
Weather-tight at 25° and above

# elZinc® Tiles

Five different designs

## elZinc® Fish scale tiles

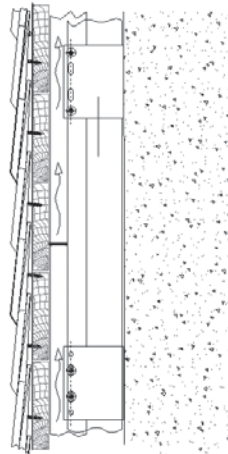

Classic, traditional appearance  
Weather-tight at 45° and above  
Quick and easy installation

## Pointed fish scale tile

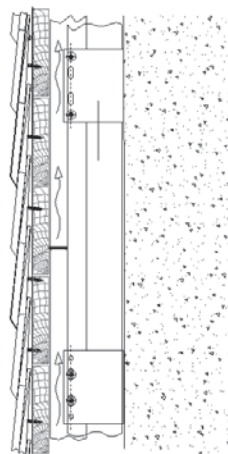

Classic, traditional appearance  
Weather-tight at 45° and above  
Quick and easy installation

## Five different designs



### elZinc® Rhomboid tile

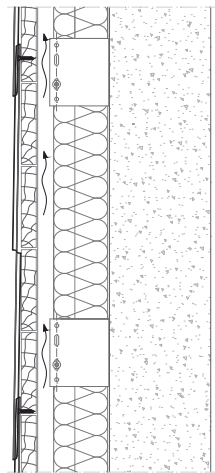
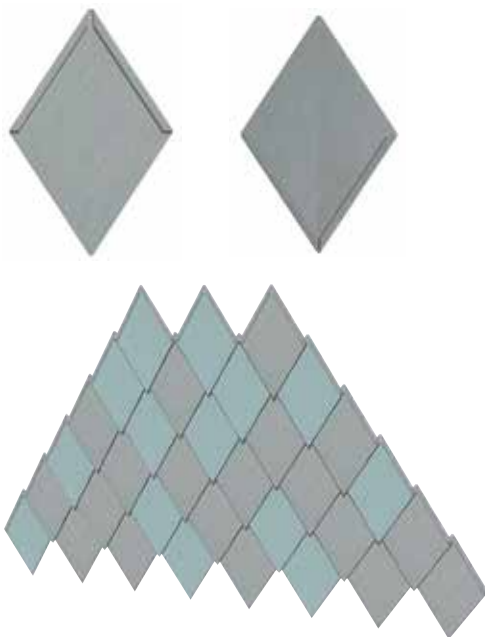

Elegant and modern aesthetic  
Weather-tight at 25° and above  
With additional clips provides  
greater resistance to wind loading.



## Examples of typical details

Below are some examples of typical details. These and others, are available from our website. **eZinc®** also develops project specific details if required.

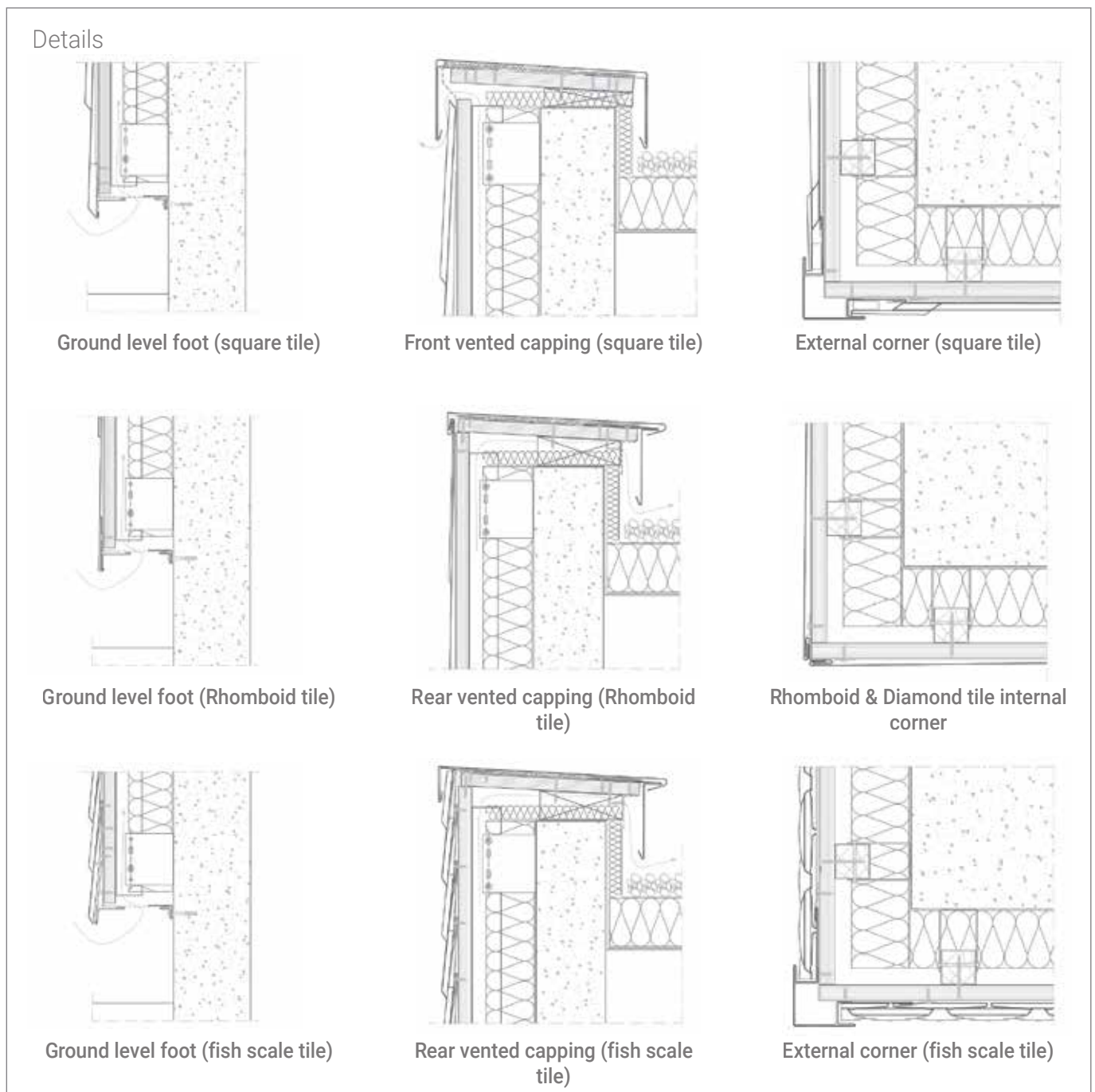



# Engineered façades

These are façades that are constructed using self-supporting panels fixed or attached back to metal rails.

The principal systems are:

- Façade panel
- elZinc® composite material
- elZinc® honeycomb panel

Individual residence, Cape Town, South Africa  
BjK Architectural Technologist



Vogue Building, Meudon, France





# Engineered façades

## Common characteristics

They include single skin **elZinc®** panels such as slot-in façade panels and cassette panels, and also **elZinc®** composite material and honeycomb material. They share the following characteristics.

### Rainscreen design

The joints between the panels are not 100% weather-tight, allowing some rainwater to drain down the backside of the panels during windy and rainy weather. A vented cavity behind the panels allows any moisture to evaporate and keeps the insulation dry. It also dissipates any moisture vapor that has penetrated through the insulation from the inside of the building.

### Recessed joints

Shadow joints are normally used between the panels. The façade panel system uses a tongue and groove joint, but cassette panels (whether single skin or composite) are not physically connected together and sit independently on the façade, as do face-fixed composite panels. Hidden fix systems work by hanging the panels onto the supporting substructure.

Private residence, Bondi, Australia  
Lend Lease Design



### Use of a metal supporting system

The system will usually allow for adjustment in two or three directions, depending on the structure behind. Most panel types fit back to a metal rail sub-construction.

### Robust aesthetics

The joints between the panels create strong lines over the façade. The panel faces are flat (with none of the oil canning associated with traditional systems) and so create a solid look to the façade.

Residence North Melbourne, Melbourne, Australia  
Jesse Judd



# Façade panel

## Key points

- **Single skin self-supporting panels** with tongue and groove joint
- **Narrow aspect ratio** – length up to a nominal 4m, width up to 300mm
- **Suitable** for flat or gently curved façades and soffits
- **Panels** are normally installed in either a horizontal or vertical direction
- **Uses 1mm thick elZinc®**
- **Direct fixing** using screws or rivets to metal rail substructure

## Basic system information

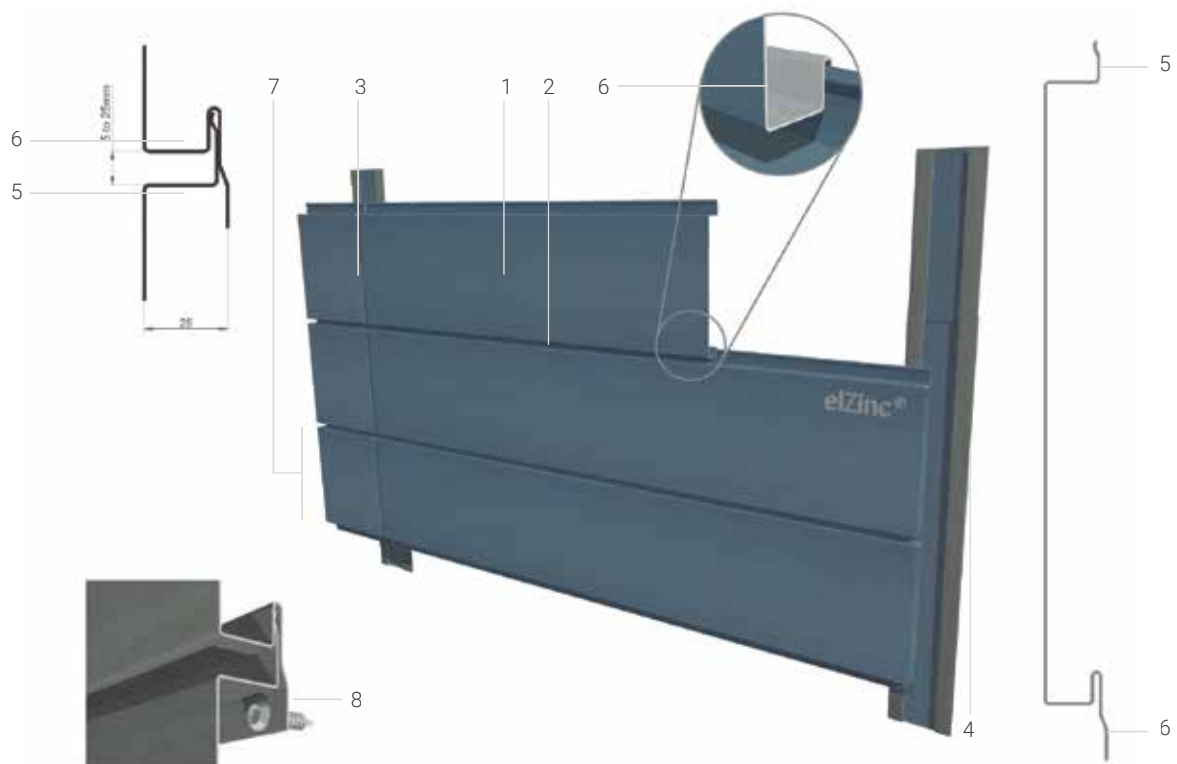

1. elZinc® profiled Façade panel. Maximum length nominally 4m.
2. Tongue and groove joint, can be varied from 5 to 25mm wide.
3. Transversal shadow joint.

4. Vertical weathering strip.
5. Tongue profile. Adjusts in length to vary joint width.
6. Groove profile

7. Joint centres dimension.
8. Direct fixing using self-drilling screws or rivets to rail profile substructure (not shown).

## Transverse joints

In a horizontal design, the cross joints can be achieved either by a reveal joint and weathering strip or by a sleeved joint, depending on the desired visual effect.

In a vertical design, the cross joints are normally achieved using an apron that weathers the joint.

### Transverse joints

#### Horizontal panels - shadow joint with weathering strip.

Creates a shadow joint in the vertical and therefore establishes a grid pattern across the façade.

The width of the joint can vary from the minimums given below (to allow for thermal movement) up to 25mm.

- 1m panel – 4mm min.
- 2m panel – 5mm min.
- 3m panel – 7mm min.
- 4m panel – 8mm min

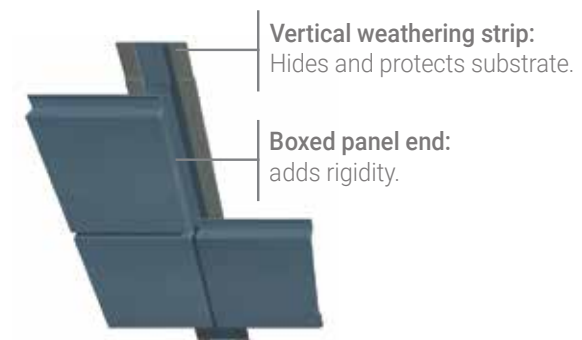

#### Horizontal - sleeved joint

A short sleeve is fixed to one end of the panel, over which the adjoining panel is slid.

Very discrete joint resulting in a completely horizontal design.- The same dimensions given above for the joint width apply here too.



#### Vertical panels - Aproned joint

Weather-secure joint.

Visually robust (can be adjusted by modifying the face of the profile)

Divides the façade into horizontal segments.

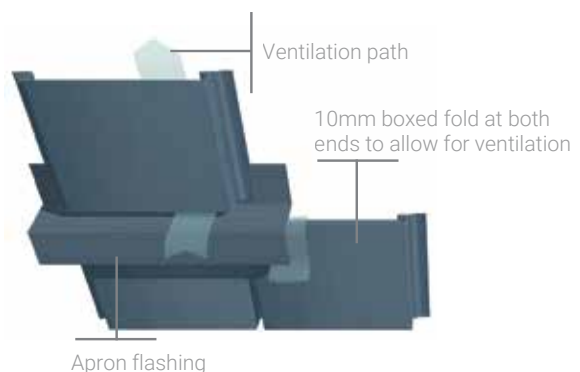

# Façade panel

## Appearance and layout options

The panels combine a flat solid feel with a certain delicacy due to their slim dimensions.

The panel joint's visual impact can be subdued or accentuated by the architect by varying its width from 5 to 25mm. If combined in the same façade, blocks of panels can be created to visually modulate the façade at greater intervals.

## Fixing

The panels are screwed or riveted to the metal profiles behind. The spacing of the profiles should not exceed 60cm (where wind loading is high it should be reduced).

### Examples

#### Uniform joint widths



#### 'Blocking' of panels by using different joints widths

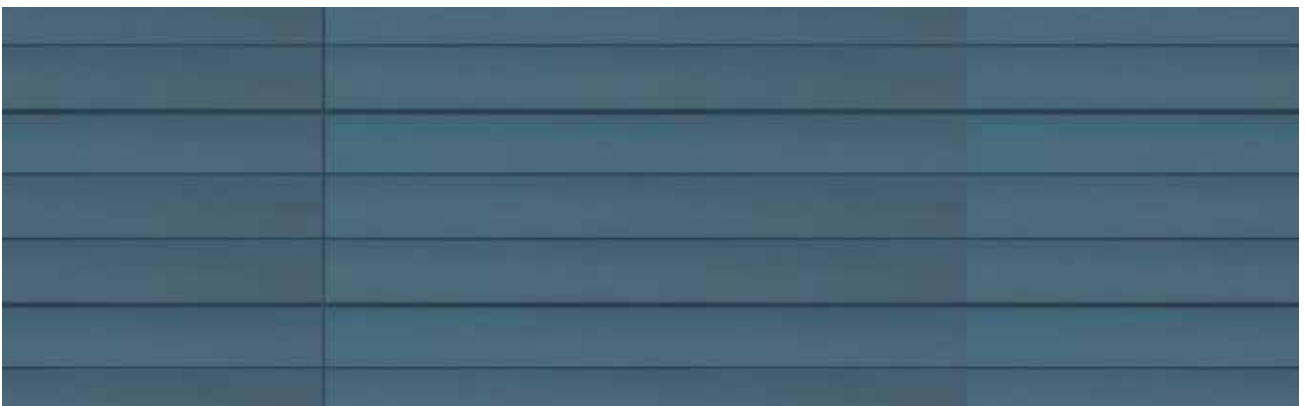

## Examples of typical details

Below are some examples of typical details. These and others are available from our website. **elZinc®** also develops project specific details if required. For more detailed information on this system, please download the System Drawings pdf available from our website.

### Details

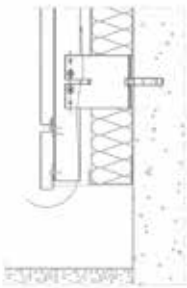

Ground level foot

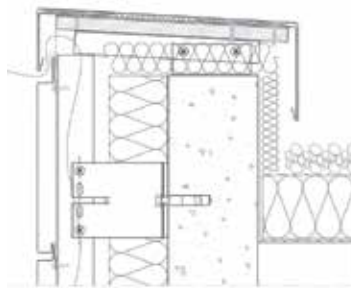

Front vented capping

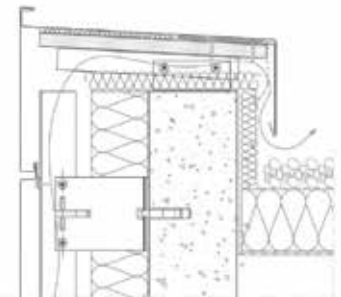

Rear vented capping

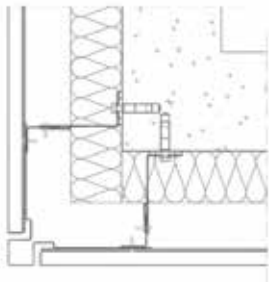

External corner with corner piece

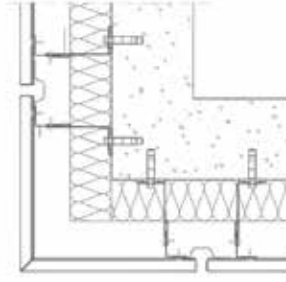

Internal corner with corner piece

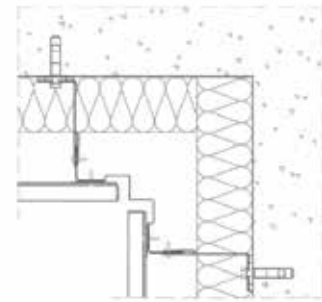

Reverse corner with corner piece



Vented window sill

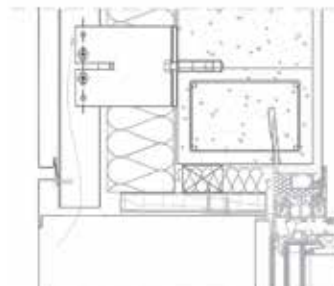

Vented window lintel

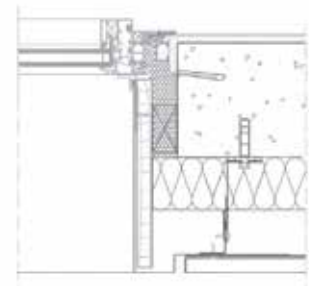

Window jamb

# elZinc® Composite material

## Key points

- **elZinc®** faced composite material
- Excellent **flatness and rigidity**
- **Large panel sizes** possible (1000mm x 8000mm max.) depending on installation system
- **PE** (B-s 1, d0 according to EN13501) and **FR** (A2-s1, d0) cores available.
- **Can be curved**
- **Various fixing options** and sub structure types available

### Hung cassettes

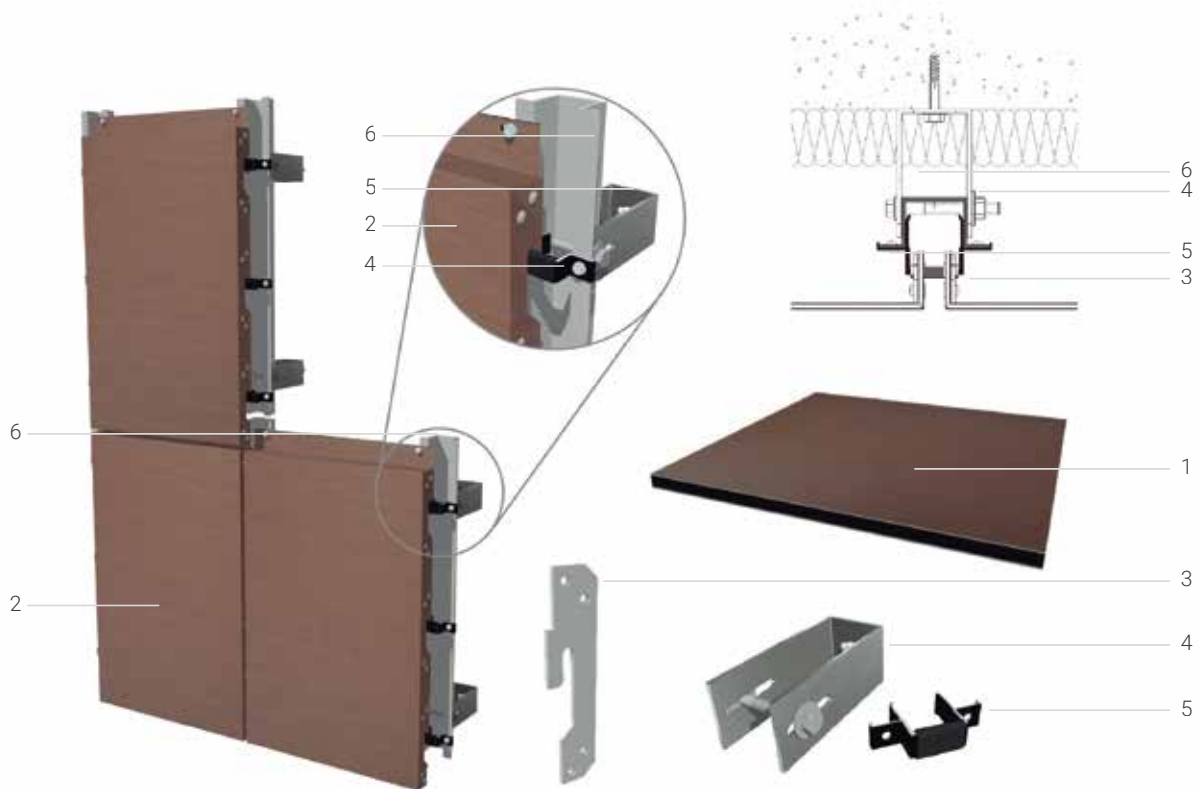

- 1. elZinc® composite material
- 2. elZinc® composite panel

- 3. Flange reinforcement
- 4. Adjustable wall bracket

- 5. Panel support with anti-vibration sleeve
- 6. Top hat profile

### Tongue and groove system



1. elZinc® composite panel
2. Extruded aluminium profiles
3. Adjustable wall bracket
4. Top hat profile

#### Cassette system with simplified panel preparation:

Best in horizontal layouts - vertical panel edges are un-supported so panel height is limited – consult elZinc® for maximum panel height.

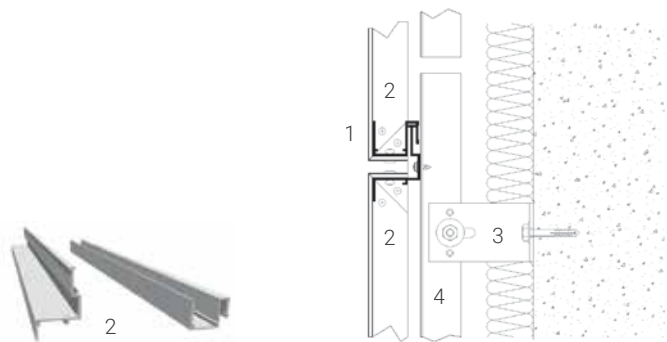

#### Maximum panel sizes:

**Horizontal layouts:** height 932 mm, length 7932 mm\*

**Vertical layouts:** consult elZinc® for panel height, width 932 mm

### Riveted system

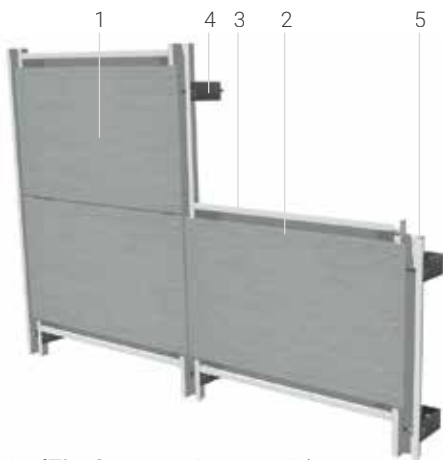

1. elZinc® composite material
2. Rivet fixing around elZinc® composite
3. Transome fixing bracket
4. Adjustable wall bracket
5. Top hat profile

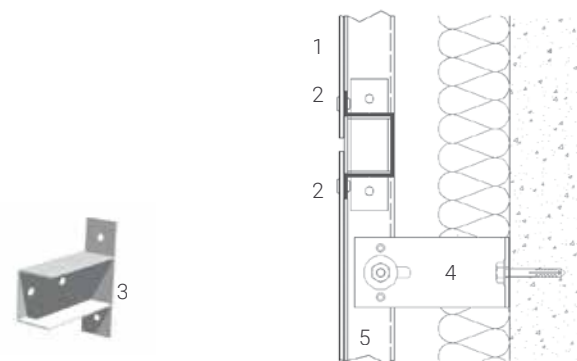

#### Simple and economical.

#### Maximum panel sizes:

**Horizontal layouts:** height 1000mm, length 8000mm\*

**Vertical layouts:** height 8000mm, width 1000mm



# elZinc® Honeycomb panel

## Key points

- **elZinc®** faced aluminium honeycomb panel
- **Perfect flatness**
- **Extremely rigid**, very large panel sizes possible
- **A2 fire rating** (A2-s1, d0)
- **Bespoke**, point fixing system reduces sub structure costs
- **Quick and easy** precision installation
- **100% recyclable**
- Wrap around edges for **added safety**

## Basic system information

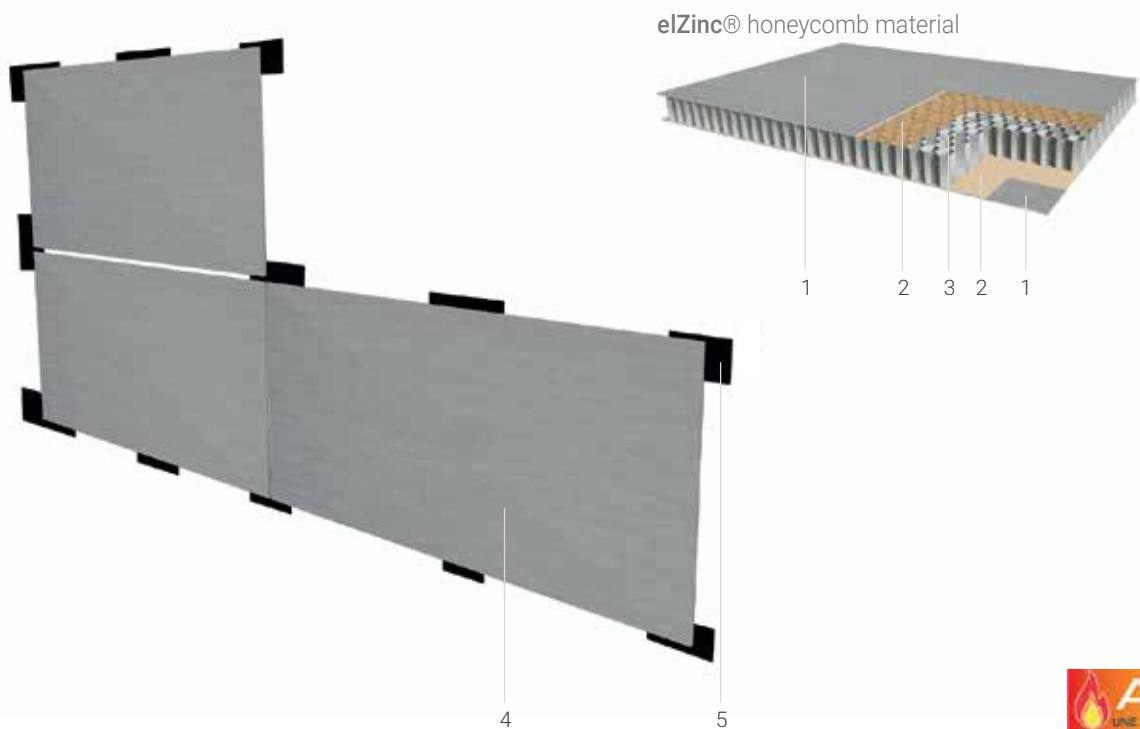

EAD Number: ETE 16/0415

23/05/2016

1. 0.5mm **elZinc®** panel skin

2. Adhesive

3. 14mm aluminium honeycomb core

4. **elZinc®** honeycomb panel

5. Point fixing system

## Appearance

The rigidity of the **elZinc®** honeycomb material allows for very large panel sizes to be installed, either horizontally or vertically. At the time of going to press, finished panels of 936mm x 8000mm are possible, but the width will soon increase to around 1220mm. This makes for a very bold statement across the façade, with a minimum number of joints. The perfect flatness of the panels contributes to a sensation of solidity and robustness.

## Certification

The entire system (panel + fixing system) is certified under the European Technical Assessment, part of the European Commission. The product has European Assessment Document (EAD) number ETA 16/0415 OF 23/05/2016. EAD's in the UK are recognized by BBA as being equivalent to BBA certificates.

## Installation

The panels are installed on a bespoke point fixing system, specially designed to make the most of the extreme rigidity of the panel, eliminating the need for metal rails and reducing costs as a consequence. The fixing system is fully adjustable in three directions, facilitating perfect alignment of the panels. Its design also compensates for the thermal expansion and contraction of the panels.

The system also allows for easy panel replacement without having to disturb adjoining panels, including corner panels. This feature permits easy future periodic inspections behind the panels, to determine the condition of the thermal insulation for example.

## Joints

The 20mm reveal joints can be left open or alternatively can be closed from the inside if desired. The outside **elZinc®** skin wraps around the edges and laps back onto the inside skin, where the two sheets are riveted together, producing a fail-safe fixing method of the panels to the supporting structure.

## Panel Fabrication

Fabrication of the panels is carried out by standard CNC milling machines and a specially modified edging machine. This can be done either to order by **elZinc®** or by the cladding contractor.

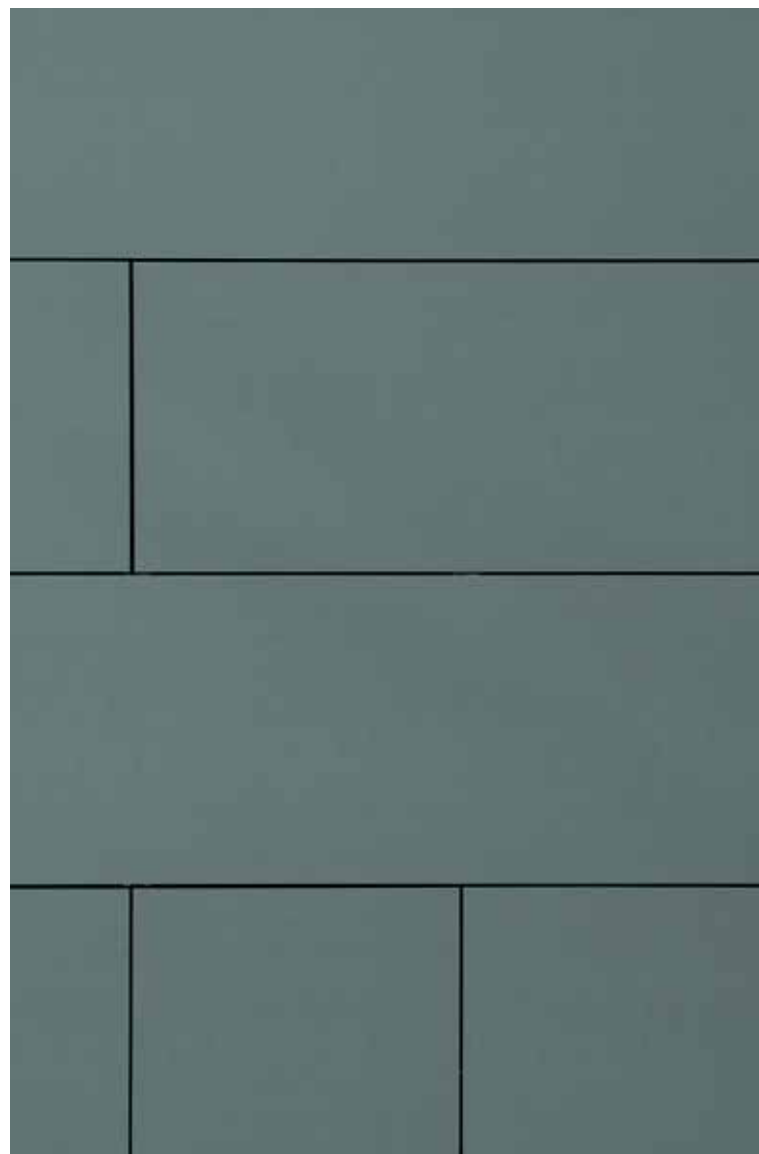

## 5. Envelope construction







### Layers in a traditional ventilated build up

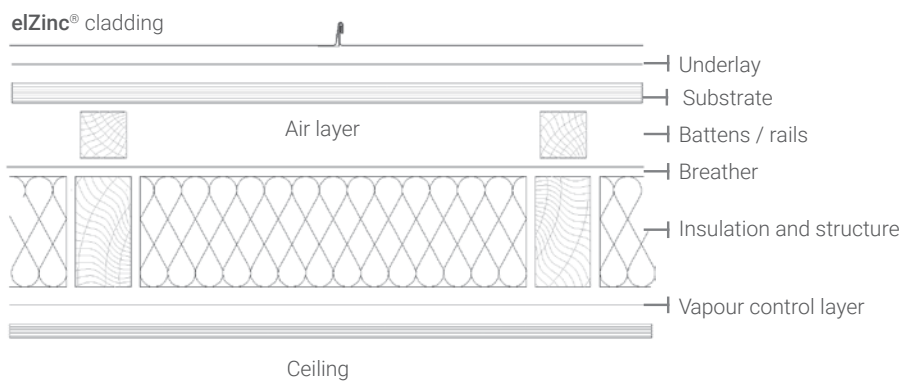

# Envelope construction

Zinc is an excellent roofing and cladding material which will give long and almost maintenance-free service if installed properly. Proper installation means not only the correct fixing of the zinc itself, but also the correct design and installation of the supporting structure.

In traditional roofing and cladding this structure provides a continuous support for the zinc, whereas in engineered façades, metal railing and point fixing systems are employed. The information provided in this section can be used as a guide to the basics of zinc roof construction.

The building envelope is built up in a series of different layers on site. Depending on the design of the roof, **it can include, from outside to inside:**

- elZinc® cladding
- Underlay
- Substrate
- Air layer (ventilated roofs and walls only)
- Insulation
- Battens or metal rails and wall brackets
- Vapor control layer / vapor barrier
- Principal load bearing structure

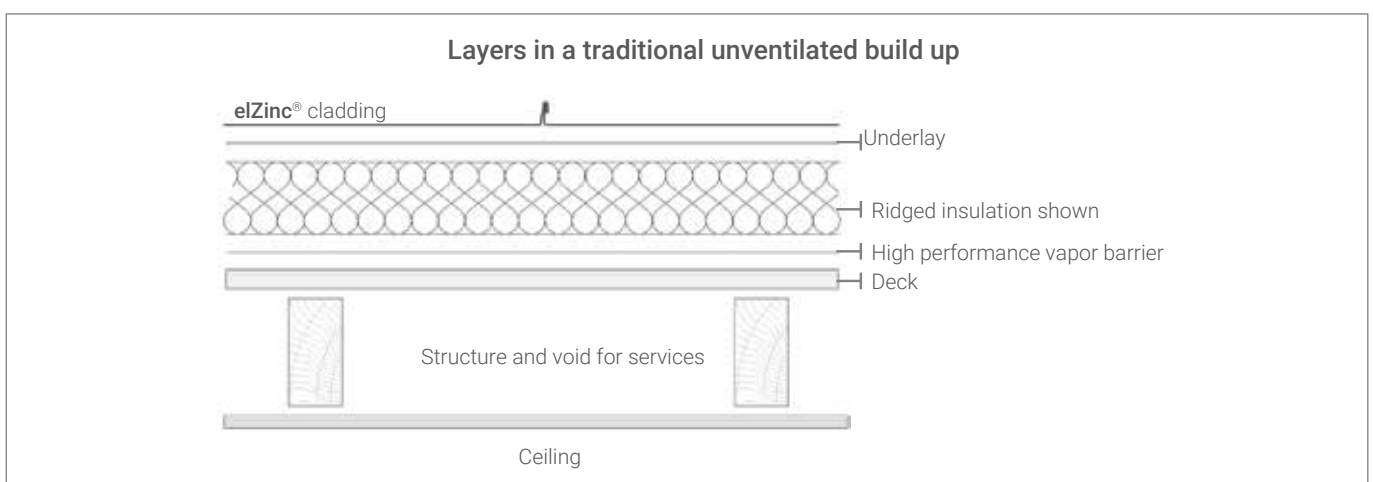

# Underlays generally



**An underlay is installed directly under the zinc. The underlay should be:**

- Stable between -20°C and +80°C
- Not stick to the zinc
- Stable for up to 3 months outside in the sun
- Conform to EN 13859: 1 and 2

**Its functions can include:**

- Acting as a separating layer
- Acting as a slip layer
- Substrate protection during construction
- Draining condensate from the underside of the zinc

**Structural underlays** are commonly made of an air-permeable, fibrous mat, and are installed directly over the substrate or over a membrane. This mat lifts the zinc off the membrane or substrate below, providing a thin air layer (~8mm) which allows air to get to the underside of the zinc, drying out any condensed water vapour and preventing possible underside corrosion problems. If the mat is combined with a breather membrane (some types are available loosely bonded to a breather membrane) or other type of waterproofing membrane, it also facilitates drainage of condensate (or indeed any rainwater that penetrated the zinc in heavy weather) to the gutter.

Structural underlays are recommended by **elZinc®** on most roof types as they have proved beneficial to the longevity of zinc roofs.

**They also:**

- Reduce friction between the zinc and the membrane
- Reduce rain drumming noise by up to 8 dB
- Even out slight unevenness in the substrate

Higher standing seam clips must be used to compensate for the height of the mat. It is also important that operatives use a piece of plywood or similarly stiff board when kneeling on the zinc to spread the load and prevent the zinc from denting. The same applies to any other point loads.

Breather membranes that are used on **elZinc®** roofs and façades should have a maximum Sd value of 0.04m. Sd is the symbol for the Equivalent Air Layer Thickness, in m. The smaller the Equivalent Thickness, the less the resistance to moisture vapour transmission. There is a table in the appendix that relates Sd to MNS/g to Perms.

**Peel and stick self-adhering waterproofing** membranes with rubberized asphalt adhesive are commonly used on warm roof applications over metal, plywood, OSB, etc. substrates. The underlayment must self-seal around punctures such as nails, screws and staples and have a non-slip surface. Asphalt membranes are ideal for warm roof underlayment and are waterproof, protecting the roof from the weather until the zinc is installed. This can be especially important in countries with cold winters (such as Canada) where zinc work stops during the winter months, and in general in markets where commonly some time elapses between substrate completion and zinc work commencement.

# The substrates

The substrate provides the structural support for the zinc, and generally the standing seam or flat lock clips are fixed to it. It should provide a minimum clip pull-out value of 560N. Surfaces that are single plane in geometry are simple to construct, curved surfaces can require a multi-layer approach of curvable thinner sheathing. Double curved geometry is best achieved by layers of softwood boarding.

## Open gap boarding



This is formed from solid softwood boards of zinc compatible species fixed to wooden supports:

### It should:

- Be fixed parallel to eaves, with a 2-3mm gap between boards, using countersunk screws or nails driven to just below the surface
- Use rough sawn boards 80 to 140mm wide, conforming to EN12775-2, with a moisture content of 18% or less
- Be treated with zinc-compatible wood preservatives
- Should have a max. difference of 2mm (+/-1mm) in height, both between boards and over the width of each board.

## Sheathing

Plywood, OSB or particle board sheathing is fixed using countersunk screws or nails to wooden or metal supports, driven just below the surface. The boards should be fixed as shown in the drawings on the following page.

### It should:

- Have a 2-3mm gap between them
- Be protected from the rain before the elZinc® trays are installed
- Be supported at ≈600mm centres

Sheathing board thickness is generally around 18 to 24mm, and the boards themselves are 1200 – 1250mm wide by 2400 – 2500mm long.

Plywood should be specified as structural plywood according to EN 636:2003, class 2. This is suitable for external protected applications.

Orientated strand board (OSB) should be specified as complying with EN 300:2006 OSB/3 load bearing boards for use in humid conditions.

If using nails to fix the clips, we recommend using OSB/4 as it takes a nail better than OSB/3.

Particle boards should be specified as complying to EN 312:2010 class P5: load-bearing boards for use in humid conditions.

## Insulating boards

Factory bonded insulation boards made of plywood and rigid insulation are used on warm roof designs. They avoid cold bridges and are quick to install, and provide a plywood or OSB deck for the elZinc® trays to be fitted to.

## Rigid insulation

Rigid insulation is used on warm roofs and obviates the need for a timber substrate. The elZinc® trays are fixed through it to a deck below using a special clip.

### The insulation should be able to:

- Remain stable at temperatures of up to 100°C
- Resist the compressive loads of foot traffic and kneeling operatives such that the elZinc® trays are not deformed



## Sandwich panels

Metal skinned rigid insulation panels can be used as a substrate in warm roof construction. Their outer skin should be thick enough to ensure minimum clip pull-out values of 560N. They have good spanning properties making them useful on steel structures, and they eliminate cold bridges. The inner skin acts as a vapour barrier, and so the joints between the panels must be effectively sealed.

## SIPs (Structural insulating panels)

Normally used on warm roofs over laminated wooden structures which take advantage of their spanning capabilities. The exterior wooden skin should be made of suitable grades of plywood, OSB or particle board and a minimum of 18mm thick.

Consult SIP's manufactures for advice regarding vapour control.

Open gap boarding laid in a staggered configuration



Sheathing laid in a straggered configuration

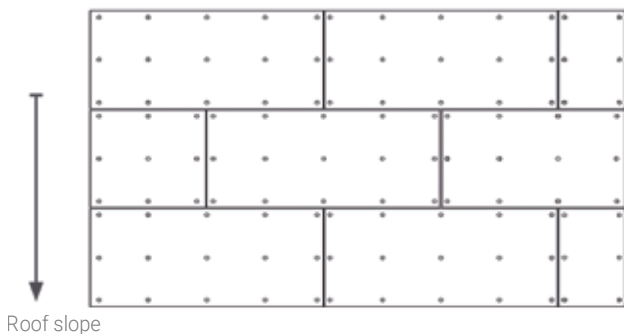

## Profiled metal decking

Installed to support traditional façades where its non-combustibility allows it to be used on taller buildings where fire regulations prohibit the use of wooden boards or sheathing. It is always installed 'façade side outwards' to give the zinc cladding the most support, and perpendicular to the longitudinal seams of the cladding. Its fixing must allow for thermal expansion and contraction. It should be thick enough to ensure a minimum clip pull-out value of 560N.

## Wooden battens and blocks for zinc work

Wooden battens, blocks etc. should be treated with zinc-compatible preservatives, and have a moisture content less than 22% at the moment of zinc installation.

## Substrate supporting materials: Metal profiles

Made of either extruded aluminium profiles or galvanised sheet, they are recommended to have a fixing face of 60mm. When supporting sheathing, they are set at centres of around 600 to 625mm, tying in with commercially available sheathing board widths and lengths.

## Substrate supporting materials: Wooden lathes

Used more commonly to support soft wood open gap boarding, they should be regularised and appropriately treated with preservatives.



# Compatibility with other building materials

Not all building materials are compatible with one another and care needs to be taken when selecting material to be in contact with, or draining onto, zinc roofing or cladding. The ill effects of not doing this can vary from light staining of the surface of the zinc to corrosion, so it is important that these potential hazards are designed out from the beginning. Note – the following is applicable to **elZinc Astur®** and **elZinc Alkimi®**. **elZinc Rainbow®** and **elZinc Advance®** products are undergoing testing at the time of writing and may be compatible under certain conditions with some of the materials or situations listed below – consult **elZinc®** in these cases.

## Metals

Different metals placed in contact with each other on the exterior of buildings must be compatible in order to avoid galvanic corrosion (also known as bi-metallic corrosion). Compatible metals with which **elZinc®** roofing and cladding can be placed in contact, with no effect on either metal: Aluminium, lead, stainless steel, galvanised steel. Incompatible metals with which **elZinc Astur®** and **elZinc Alkimi®** roofing and cladding should never be placed in contact with, or drain rainwater from: Un-protected steel, Iron, cast iron, copper, brass, bronze.

The more conductive the water (electrolyte) the faster the zinc will be affected. Salt water conducts electricity better than rainwater, so should galvanic corrosion occur it will be more serious in coastal environments than inland. If in doubt, seek the advice of your **elZinc®** distributor or contact **elZinc®** direct.

## Timber

Timber combines well aesthetically with zinc on façades. However, many species of timber are used in building and those that have a low pH value, such as hardwoods and tropical woods can cause staining of zinc, or in some severe cases, corrosion.

Compatible timber with which all **elZinc** products can be used without reservation: Pine (Norway pine, Scots pine, European Silver Fir, Spruce, Fir (red and white) Poplar. These would be typically used as the timber in open gap boarding substrates, without a separation layer between the zinc and the.

Additionally, all **elZinc®** products can be used without reservation with softwood plywood and OSB, which would be used as the sheathing substrate with a breather membrane (and possibly a structural mat) placed between the zinc and the sheathing.

Incompatible timber which should not be in contact with or shed run-off onto **elZinc Astur®** or **elZinc Alkimi®**: Tropical woods, Douglas pine, Larch, Oak, Chestnut, White and red Cedar.

## Wood preservatives

Nowadays wood preservatives pose few problems for zinc roofing and cladding. Organic products and emulsions can be used. Non-fixed metal salts are incompatible as the release of the metals they use (such as copper) can harm the zinc.

For more information, contact **elZinc®**.



## Bituminous products, sealants and adhesives

Bituminous membranes breakdown on exposure to the sun, releasing compounds that can harm zinc. Zinc should therefore be separated from bitumen membranes by appropriate means, and bitumen membranes draining rainwater onto zinc products should be protected from sunlight by at least 5cm of gravel.

Two component acid system sealants can potentially cause corrosion and staining of **elZinc®** products and should not be used. Neutral curing mastics and silicones are fine, as are Polyurethane based sealants and MS polymer sealants.

Sometimes an adhesive is required to attach accessories (such as the bird spikes below). Neutral curing silicones, MS polymers and polyurethane based adhesives are all compatible with **elZinc®** products.

Consult **elZinc®** for the compatibility of adhesive tapes.

## Cement

Amongst other ingredients, cement contains lime (calcium oxide - CaO) and calcium silicate (Ca<sub>2</sub>SiO<sub>4</sub>) that can react with zinc when fresh. Once cured, no reaction occurs, but the zinc should be separated from it by a breather membrane.

### Plaster of Paris

Generally does not pose a problem to zinc due to its fast curing time.

### Fibre cement boards

Cutting fibre cement boards produces cement dust that if allowed to settle onto zinc roofs in humid conditions, or it rains afterwards, can cause lasting staining.

### Magnesium oxide boards

Pending study – contact **elZinc®** for more information.



Bird spikes attached using neutral curing silicone



Aluminium window frame sealed against the **elZinc Rainbow®** Brown sill using brown neutral curing silicone



# Thermal design

## Roofing

Two designs are commonly used with **elZinc®** – the ventilated roof and the unventilated roof, also known respectively as the cold roof and warm roof.

Choosing which design is the most appropriate for a particular project depends on many factors such as roof form, available height, cost, and aesthetics.

This is best discussed on a project by project basis with our technical department. However, as a guide the following general comments are made below.

### **Ventilated (cold) roofs work best with:**

- A decent pitch
- Simple geometry
- Adequately dimensioned air gap

### **They are not so appropriate for:**

- Low pitched roofs (unless good cross ventilation can be provided, which limits the rafter length)
- Roofs where the required height of the air layer is problematic
- Geometrically complicated roofs (where it is difficult to achieve enough drive to get the air moving through the layer)
- Where ridge details are required to be as discreet as possible
- Where the cost is prohibitive

### **Unventilated (Warm) designs are more sensitive to the construction process itself:**

- Installation over humid substrates which traps moisture
- Improper installation of the vapour barrier which allows moisture migrating through the roof to condense (in cold weather) on the rear face of the zinc

### **However, their effectiveness is not dependent on:**

- The pitch of the roof
- The complexity of the roof's geometry

A warm roof also allows for a slimmer roof construction which can be important visually on some projects

Day care center, South Korea



## Façades

Traditional façades are generally ventilated, with an inlet at the foot of the cladding and an outlet at the head. This is because the vertical nature of vented façades means the air layer is working at its best and dissipates diffused moisture vapour effectively. This keeps the building envelope dry in the winter months and helps to cool the building in the summer.

Kyungpook University, South Korea



# Examples of roof types

## Ventilated (cold) roofs

These designs introduce an air layer under the substrate which draws warmed, moist air out from under the zinc. This layer also helps to dissipate heat in the summer months, keeping the building cooler.

Air inlets and outlets are created at the eaves and ridge of the roof, using perforated **elZinc®** material as an insect mesh. The net area required depends on roof pitch and is given opposite.

If a structural underlay is required, any draining membrane installed below it should be a breather membrane, since any condensate will evaporate down through it and the substrate into the air layer, where it is drawn out from the roof via the outlet.

Vented roof on sheathing

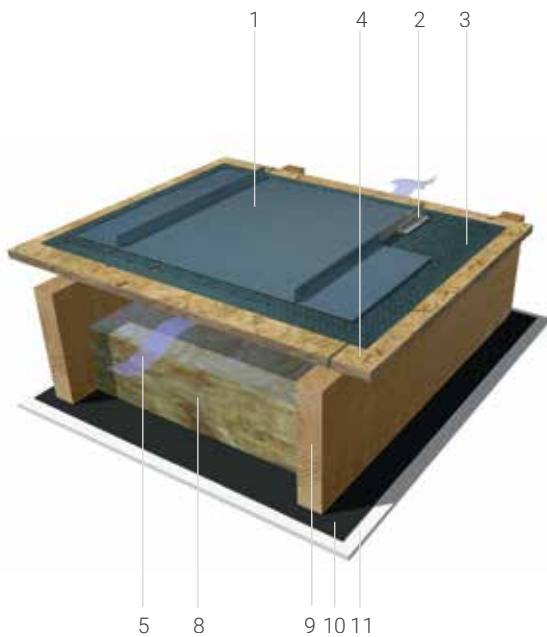

- 1. **elZinc®** standing seam tray
- 2. Standing seam clip
- 3. Underlay (structural underlay + breather)
- 4. Substrate
- 5. Ventilation path / air gap
- 6. Air layer batten (height = air layer thickness)

Vented roof on softwood boarding

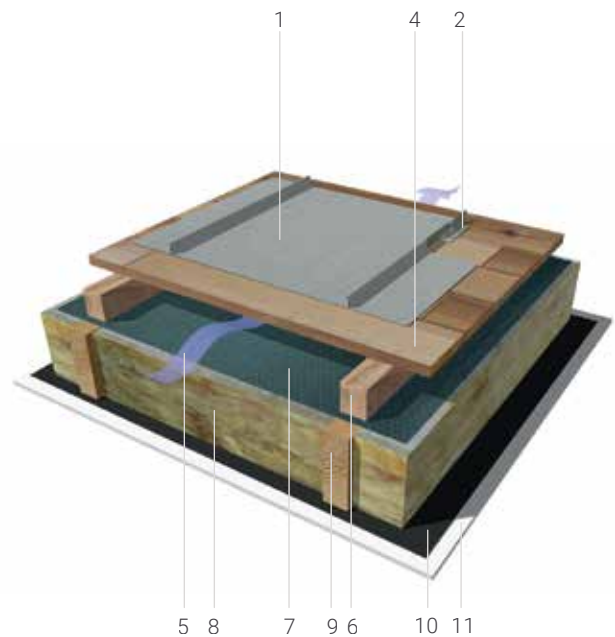

- 7. Breather membrane over insulation,  $sd < 0,04m$
- 8. Insulation
- 9. Wooden rafter
- 10. Vapour control layer with sealed laps
- 11. Ceiling finish

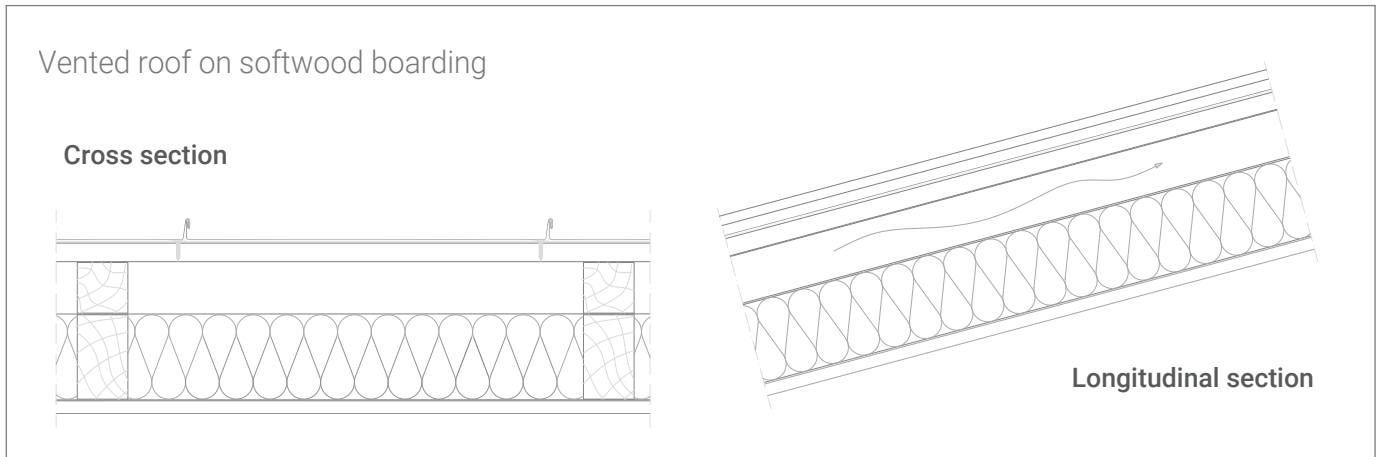

## Details:

### Underlays:

Open gap boarding  $\leq 15^\circ$ : Structural underlay optional  
 Open gap boarding  $>15^\circ$ : None required  
 Sheathed boarding all pitches: Structural underlay + breather.

### Air gap:

Ventilating layer height is varied according to its length and its pitch. The greater of the two values is taken.

Rafter length  $<10\text{m}$  : 5cms  
 Rafter length  $>10\text{m}$  : 10cms  
 Pitch  $< 20^\circ$  : 8cms  
 $20^\circ < \text{pitch} < 60^\circ$  : 5cms  
 Pitch  $> 60^\circ$  : 4cms

### Air inlets and outlets:

Net air inlet:  $3^\circ < \text{pitch} < 20^\circ$ : 1/500th of roof area  
 Pitch  $>20^\circ$ : 1/1000th of roof area.  
 Net air outlet:  $3^\circ < \text{pitch} < 20^\circ$ : 1/400th of roof area  
 Pitch  $> 20^\circ$ : 1/800th of roof area.

### Mesh:

Round holes or slots, approx. 5mm diameter /width.

### Vapour control layers:

These are used to limit the moisture being drawn into the air layer, and are more important nowadays since ever increasing insulation requirements weaken the air drive through the layer. Typical Sd values should be  $> 100\text{m}$ .

### Substrate:

Fixed perpendicular to the direction of the standing seams with a 2-3mm gap between boards.

Substrate options (in decreasing quality):

- Open gap softwood boarding
- EN 636 class 2 plywood
- EN300 class 3 OSB
- EN312 class P5 particle board

### Breather membrane over insulation:

Recommended for roofs on softwood boarding and pitched below  $30^\circ$ . Its principal function is to protect the insulation from the possibility of condensate dripping onto it in adverse climatic conditions.



# Examples of roof types

## Unventilated (warm) roofs

These designs incorporate a high performance, and when required, self-sealing vapour barrier on the warm side of the insulation. The effectiveness of this vapour barrier is of paramount importance to the roof, so:

- Its installation should be carefully controlled on site
- All joints and penetrations should be sealed
- It should wrap around all edges of the insulation

- It should always be installed over a structural deck

Any membranes used under the structural underlay mat are either breather membranes, peel and stick type membranes or bitumenous waterproofing type membranes, depending on climate, market and local building practices. Contact **elZinc®** or you local representative for specific information.

Ridged insulation substrate

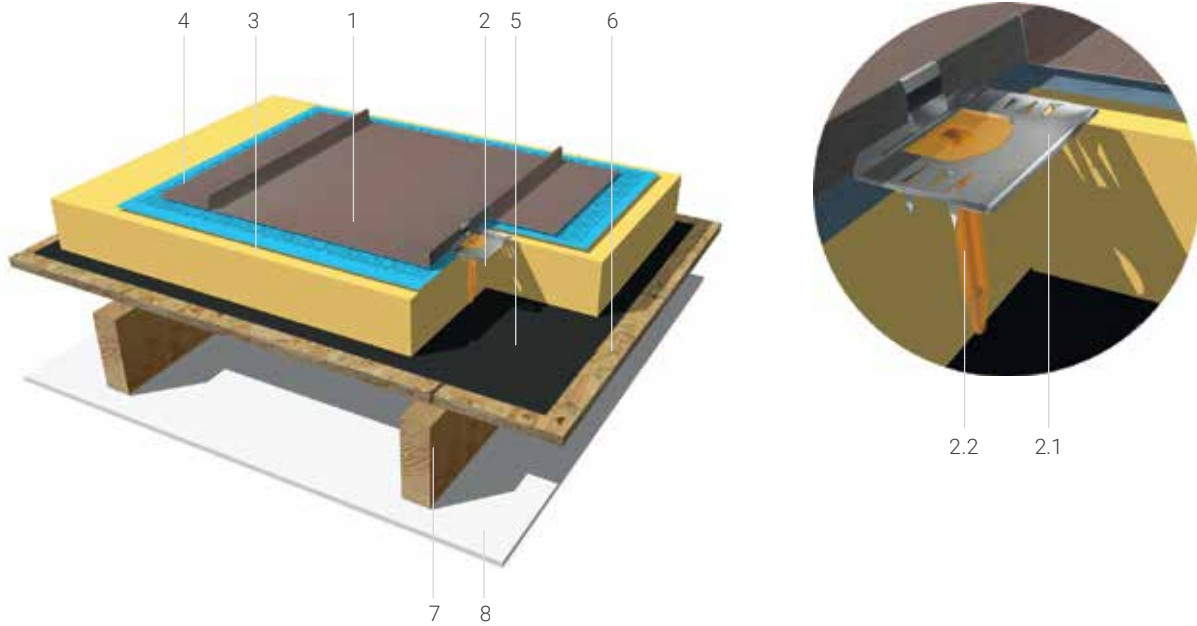

1. **elZinc®** standing seam tray (elZinc Protect+ recommended)
2. Standing seam 'warm-fast' clip
  - 2.1. Stainless steel grip plate
  - 2.2. Spacer plug
3. Structural underlay with water proof membrane
4. Rigid insulation
5. Self-sealing high performance vapour barrier
6. Decking (plywood, OSB).
7. Wooden rafter
8. Ceiling finish.

**Substrate:**

The insulation should be stable up to 100°C, and not permanently depress under foot traffic or kneeling operatives.

**Vapour barrier:**

Typical Sd values should be  $\geq 1500m$ .

**Decking:**

Plywood or similar can be used. Only one screw is used per clip, so pull-out values and clip centres should be checked, and deck thickness adjusted.

## Foamglas warm roof

Other supporting structures are possible – please contact  
Foamglas for more information

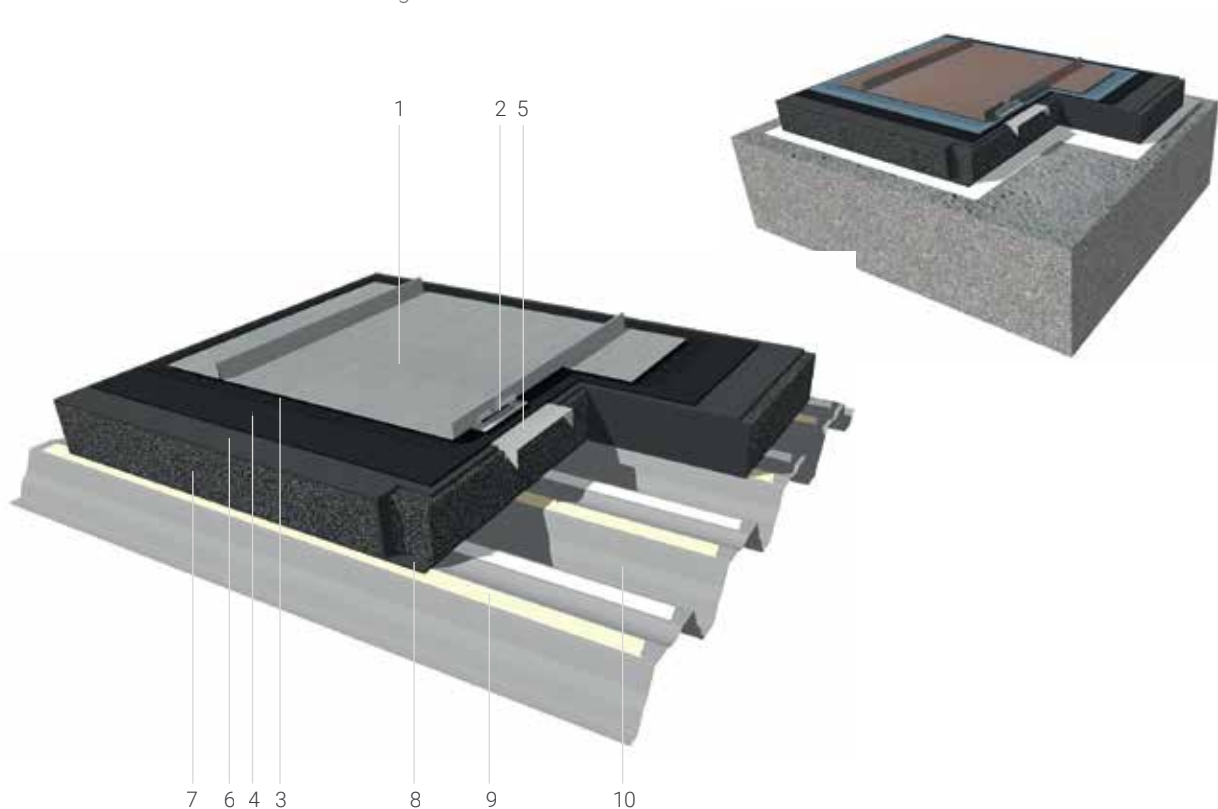

1. elZinc® standing seam tray (elZinc Protect+ recommended)
2. Standing seam clip
3. Structural underlay
4. Bitumenous waterproofing membrane
5. Serrated fixing plate
6. Hot bitumen top coat
7. Foamglas closed cell insulation (previously dipped in hot bitumen)
8. Hot bitumen bottom coat (from dipping insulation boards)
9. Self adhesive layer
10. Trapezoidal roof deck

**Substrate - Foamglas insulation:**

All information given here is indicative. The system itself is the insulation and the vapour barrier. Contact the manufacturer for project advice.

**Trapezoidal metal deck:**

Foamglas should be contacted to verify the validity of the trapezoidal deck, as deflection limits are imposed on it by the insulation system.

## Examples of unvented types

### Insulation boards

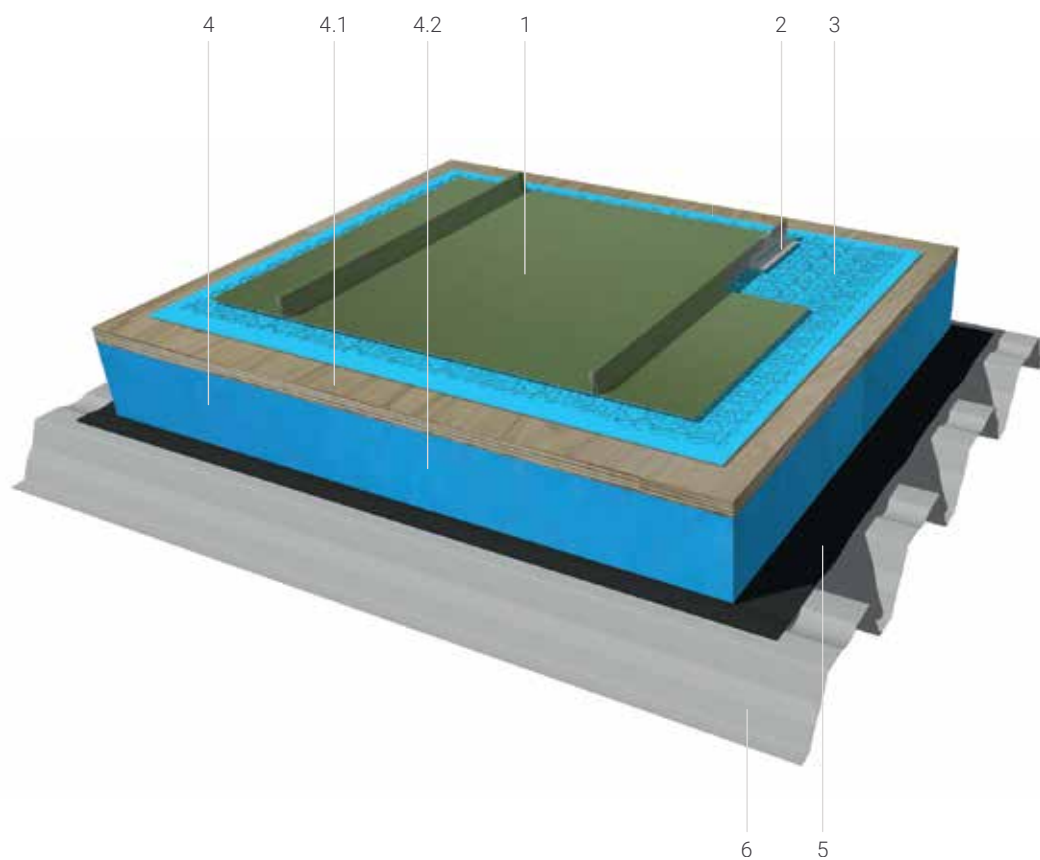

1. elZinc® standing seam tray (elZinc Protect+ recommended)
2. Standing seam clip
3. Structural underlay with waterproof membrane
4. Rigid insulation board
  - 4.1. Plywood decking
  - 4.2. Insulation
5. Self-sealing high performance vapour barrier
6. Metal trapezoidal deck

**Substrate:**

To be fixed according to the manufacturers' instructions

**Vapour barrier:**

Typical Sd values should be  $\geq 1500\text{m}$ .

Must be suitable for laying over a trapezoidal deck

## Carrier panel warm roof

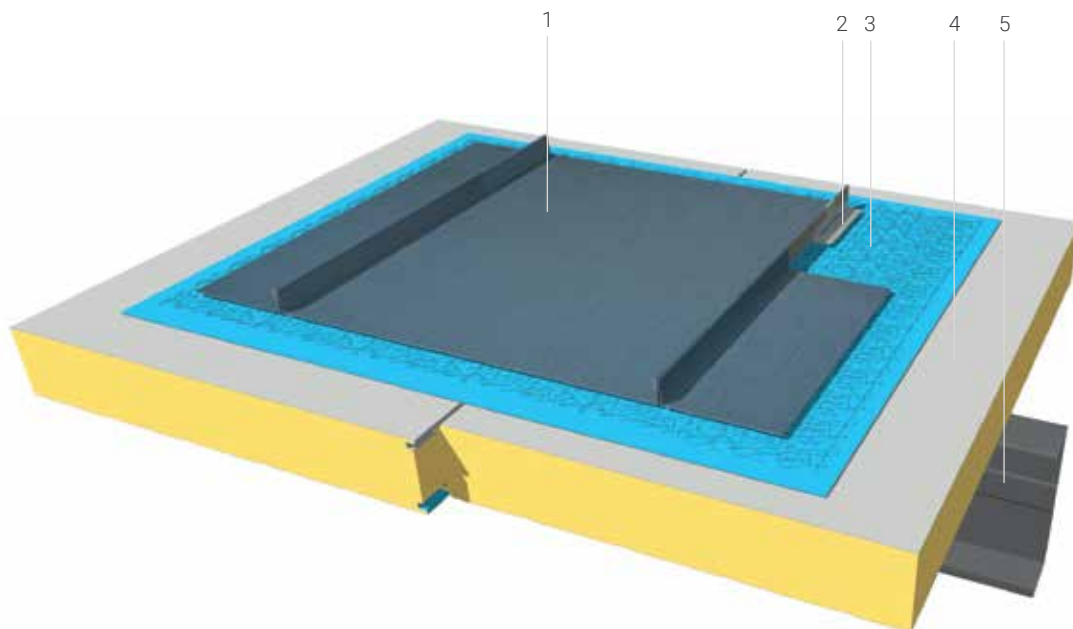

1. elZinc® standing seam tray (elZinc Protect+ recommended)
2. Standing seam clip
3. Structural underlay with waterproof membrane
4. Metal sandwich carrier panel
5. Structure

**Standing seam clips:**

These should be fixed using fasteners able to achieve a pull out value of 560N or greater per clip.

**Carrier panel:**

Carrier panels have a thicker outside skin ( $\geq 0,7\text{mm}$ ) to ensure pullout values for the clips are maintained at 560N per clip or more. Installation should be according to the manufacturer's instructions. It is vitally important that all panel joints are vapour-tight, the same is true for all perimeters of the panel installation.

The fixings of the carrier panel to the steel structure are normally visible from the inside..

# Examples of ventilated façades

## Ventilated façades fixed to wooden substrates

The ventilated façade incorporates an air gap behind the substrate which is connected to the outside air via an inlet at the foot and an outlet at the head of the cladding, and also at window sills and lintels.

Perforated zinc is used to provide an insect mesh along these openings. Structures that are not airtight may need an airtight membrane installed.

Façade on open gap boarding

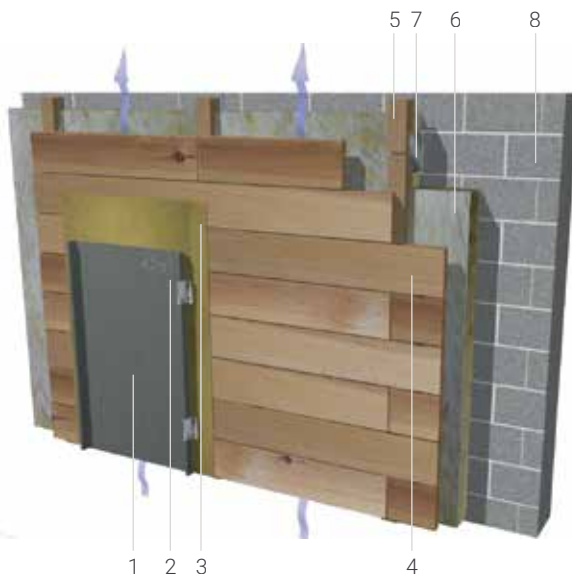

Sheathed vented façade

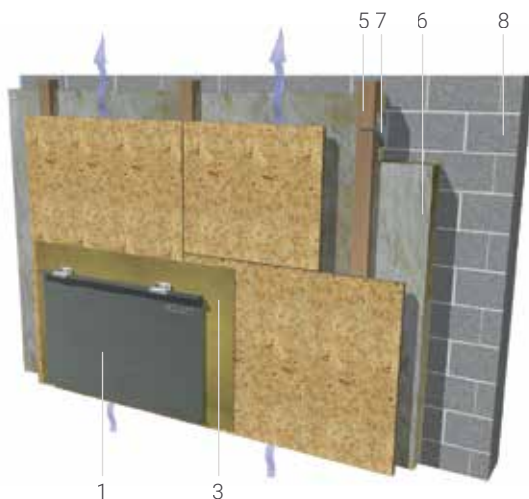

1. elZinc® traditional cladding (angle standing seam shown)
2. Seam clip
3. Breather membrane underlay
4. Substrate
5. Wooden battens @ ≈600mm centres
6. Insulation between battens
7. Wall bracket
8. Solid wall

## Vented façade on softwood boarding

Horizontal section

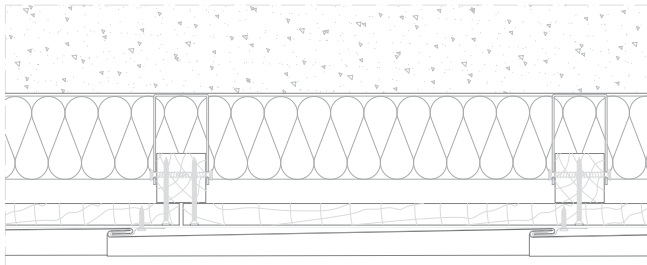

Vertical section

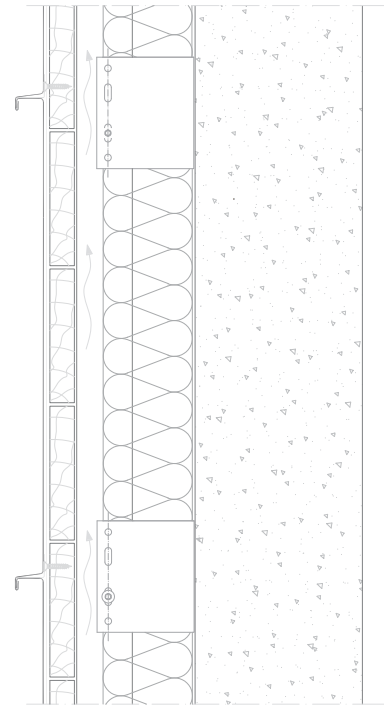

## Details:

**Substrate:**

Fixed perpendicular to the direction of the seams with a 2-3mm gap between boards.

Substrate options (in decreasing quality):

- Open gap soft wood boarding
- EN 636 class 2 plywood
- EN300 class 3 OSB
- EN312 class P5 particle board

**Air gap:**

20mm minimum, some countries require more, usually up to 40mm (eg. residential projects in UK generally require 38mm).

**Underlay:**

Underlays are optional with open gap boarding, (for weather protection before zinc installation for example). With other substrates a breather membrane is used as a separation layer.

**Supporting battens or rails:**

Plumbed and even to create a flat plane for the fixing of the substrate. They are fixed back to the main structure by means of adjustable wall brackets.

# Ventilated façades

## Ventilated façades fixed to trapezoidal substrates

In many countries, façades over a certain height are required to be constructed of non-combustible materials. In these cases, trapezoidal metal decking is commonly used instead of wooden substrates.

Profiled metal decking on blockwork

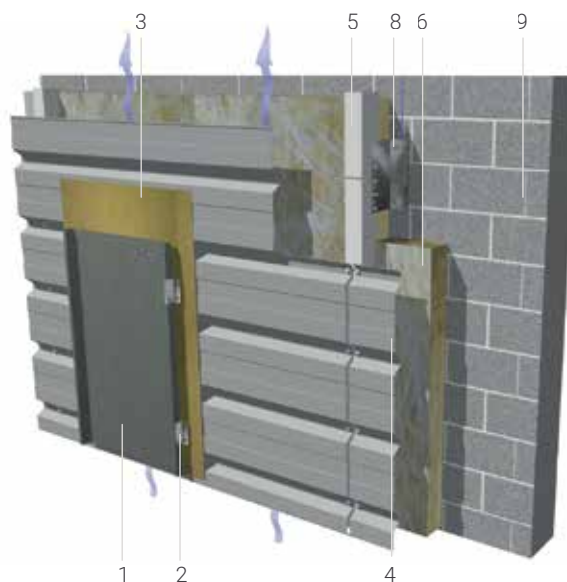

Profiled metal decking on steel structure

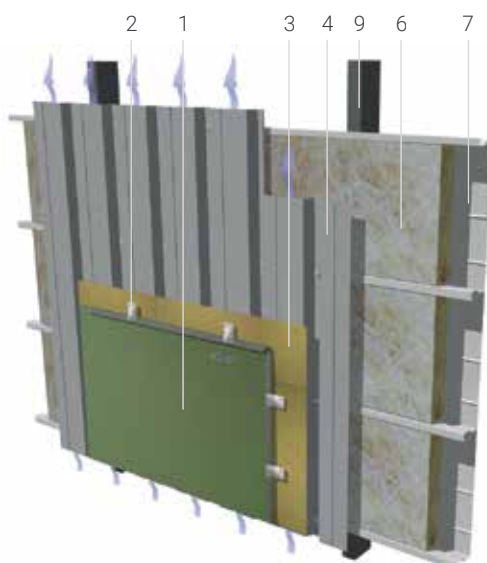

1. **elZinc®** traditional cladding (angle standing seam and flat lock panels shown)
2. Seam clip
3. Breather membrane underlay
4. Profiled metal decking
5. Metal profiles
6. Insulation
7. Structural liner tray
8. Adjustable wall bracket
9. Structure

## Façade on trapezoidal metal decking

Horizontal section

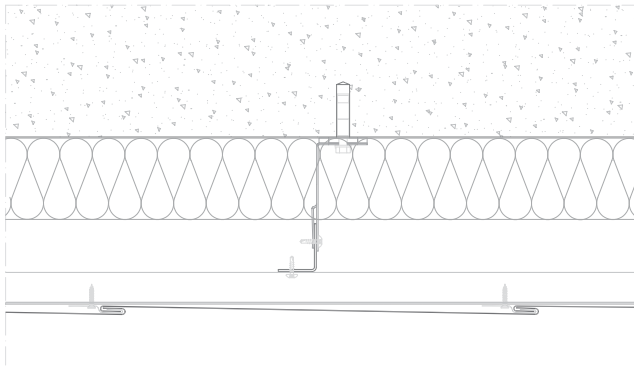

Vertical section

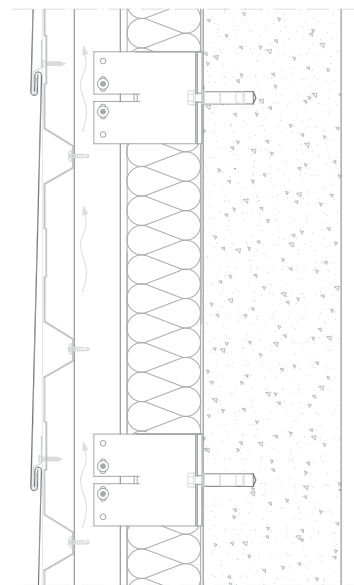

## Details:

**Underlay:**

A breather membrane is used as a separation layer.

**Metal decking:**

It is fixed perpendicular to the direction of the seams. Vertically fixed decking ventilates through its own section.

**Air gap:**

20mm minimum, some countries require more, usually up to 40mm (eg. residential projects in UK require 38mm).

**Wall brackets:**

'Helping hand' type wall brackets are adjustable and allow for thermal movement of the metal profiles. **A range of bracket depths** allows for varying insulation thicknesses and structure unevenness. A thermal break can be inserted **between the bracket and the wall** if required.

**Structural liner trays:**

These products have good spanning characteristics and can be micro-perforated for acoustic purposes.





# Engineered façades

Zinc is an excellent roofing and cladding material which will give long and almost maintenance-free service if installed properly. Proper installation means not only the correct fixing of the zinc itself, but also the correct design and installation of the supporting structure.

In engineered façades, metal railing and point fixing systems are employed.

Offices High Valley, Meylan, France



Multifamily development, Australia SJB



# Engineered façades

## Single skin façade panels

**elZinc®** façade panels are installed in rear-ventilated rainscreen systems. Since they are self-supporting they do not require a continuous substrate, and so are fixed back to metal rails. There is an air gap between the back of the panels and the insulation.

Thermal expansion and contraction of the **elZinc®** panels is allowed for by the gentle flexing of the metal rail – wall bracket assembly. At the end of each panel, there are two metal profiles fixed next to each other which act as an expansion joint – see diagrams opposite.

Vertical metal profiles fixed with helping hand brackets

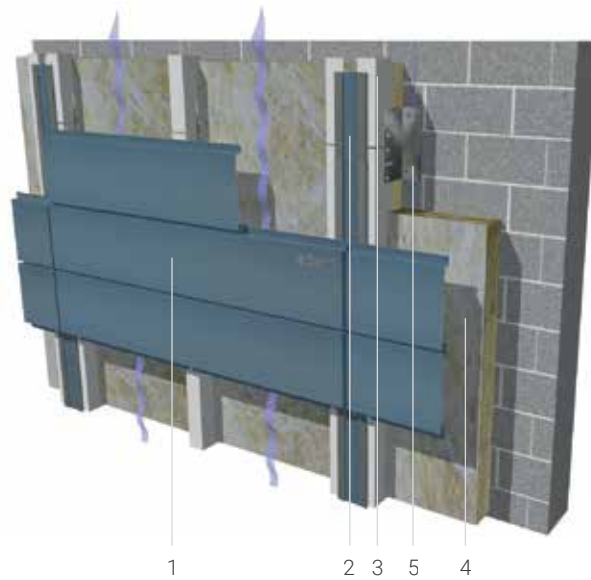

Horizontal metal profiles fixed with helping hand brackets

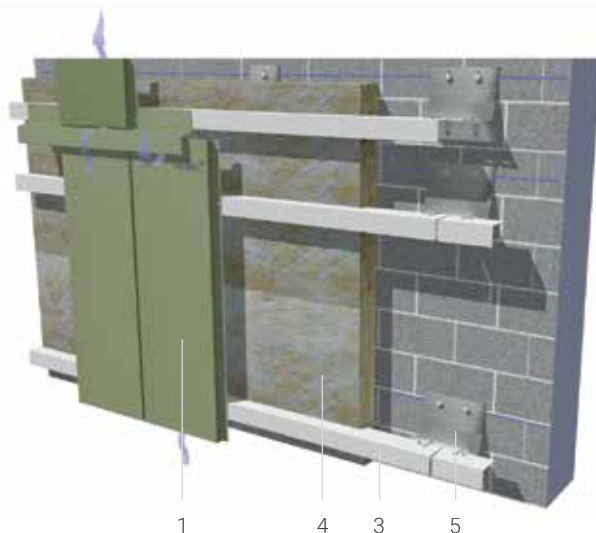

- 1. **elZinc®** façade panel
- 2. Vertical joint liner
- 3. Metal rails
- 4. Insulation between rails
- 5. Adjustable wall bracket

## Façade panels on metal rails

Horizontal section

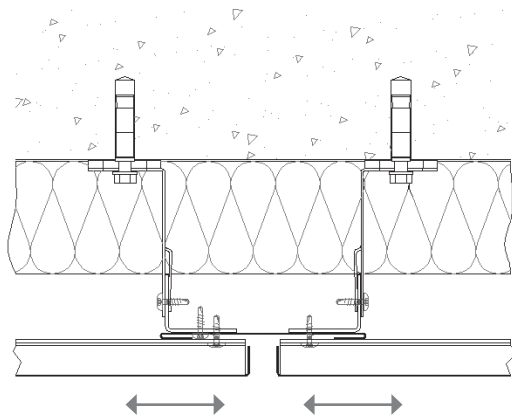

Vertical section

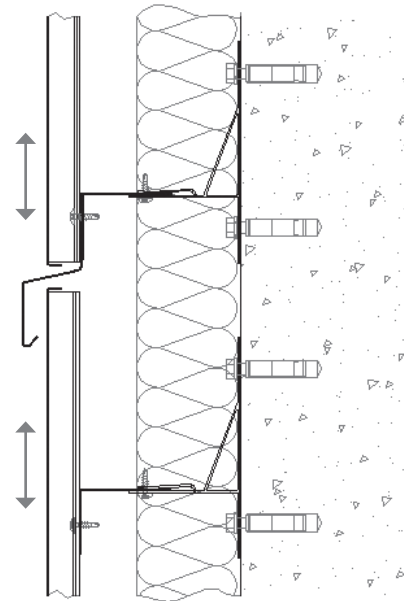

## Details:

**Air gap:**

20mm minimum, some countries require more, usually up to 40mm (ex. residential projects in UK require 38mm). Vertically installed panels ventilate through their sections.

**Metal rails:**

Extruded aluminium or galvanized steel. Fixed at centres according to wind loading which normally comes out at between 500 and 600mm. They should have a front face of at least 50mm.

**Wall brackets:**

'Helping hand' type wall brackets are adjustable and allow for thermal movement of the metal profiles by flexing slightly. A range of bracket depths allows for varying insulation thicknesses and structure unevenness. A thermal break can be inserted between the bracket and the wall if required.

# Engineered façades

## elZinc® Composite material

These systems have bespoke installation solutions specially designed for the **elZinc®** composite material. They are all rainscreen systems (rear vented and drained) and have open joints.

Every project is calculated according to its design wind loading which gives the maximum panel sizes possible, the panel reinforcements required (if any and depending on system) and the centres of the supporting profiles.

Hung cassettes, tongue and groove and riveted systems

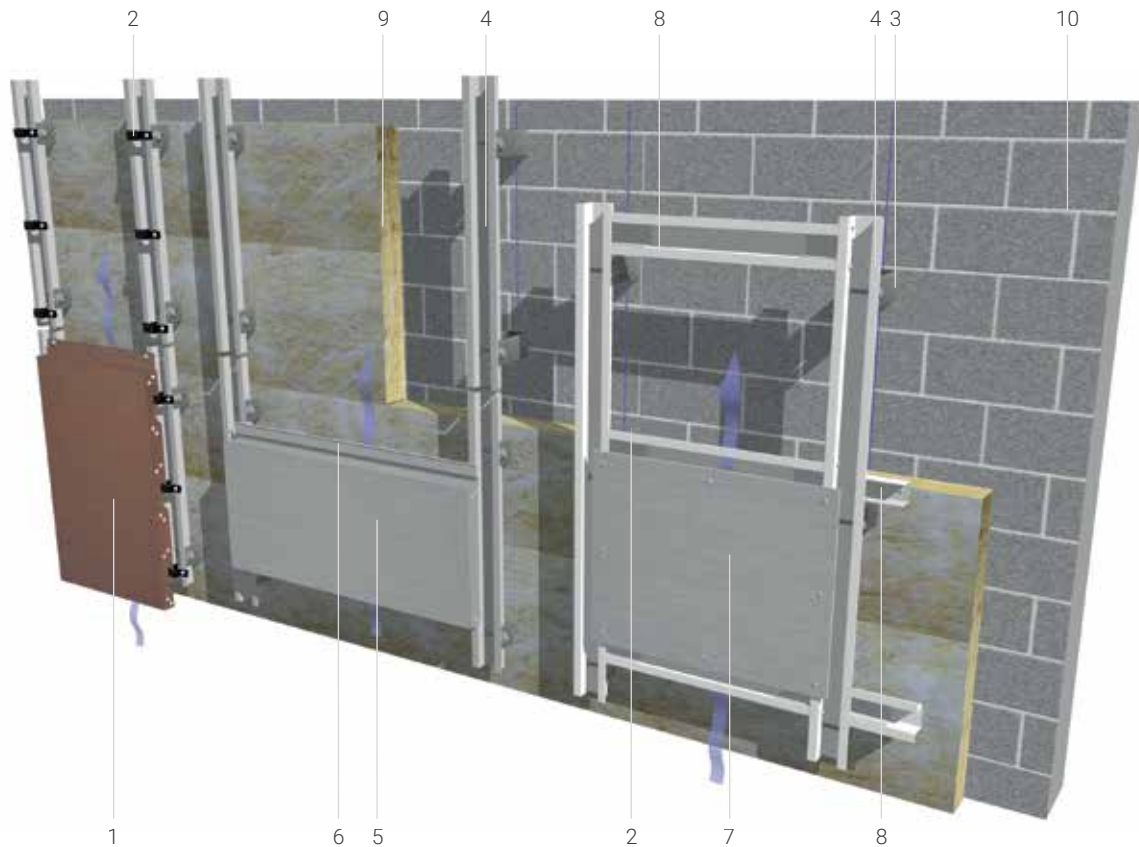

- 1. **elZinc®** hung composite cassette panel
- 2. Hung panel support with anti-vibration sleeve
- 3. Adjustable wall bracket common to all systems
- 4. Top hat aluminium mullion common to all systems
- 5. **elZinc®** tongue and groove composite cassette panel

- 6. Aluminium tongue profile
- 7. **elZinc®** riveted composite material
- 8. Mullion-transome bracket
- 9. Insulation between mullions
- 10. Structural support

## Cladding zones for the different systems

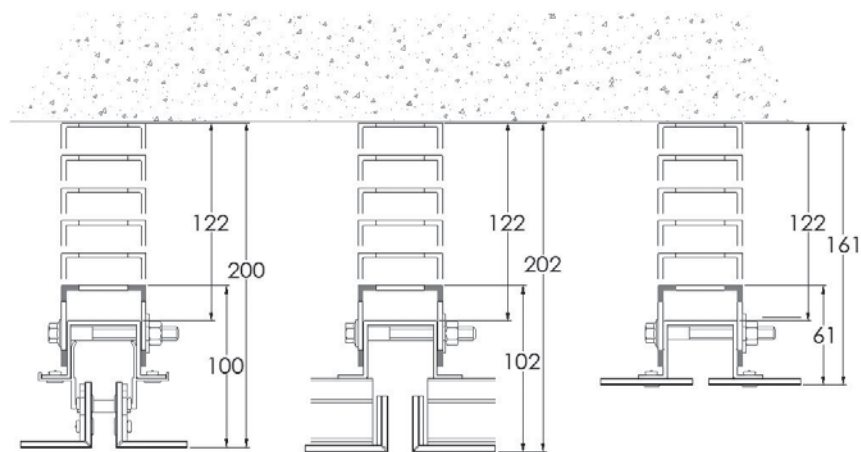

## Details:

**Air gap:**

20mm minimum, some countries require more, usually up to 40mm (eg. residential projects in UK require 38mm). The riveted system's transoms limit the insulation depth to  $\approx 100\text{mm}$  (with a 20mm air gap).

**Metal rails (mullions):**

Extruded aluminium.

**Wall brackets:**

Wall brackets are adjustable. A range of bracket depths allows for different insulation thicknesses and structure unevenness. A thermal break can be inserted between the bracket and the wall if required.

## 6. Rainwater systems









# Introduction

Zinc rainwater systems collect rainwater from the eaves of the roof and channel it to the ground rainwater management system.

Having a long history, over the decades national and regional variations have developed producing different designs, which likewise have to conform to varying national and regional codes of practice. Rainwater goods made from **elZinc®** are available that can satisfy these variations – read about them in the following sections.

## **Rainwater systems are dividing into two types:**

- Eaves gutters rainwater systems
- Parapet and internal gutters



# Eaves gutters rainwater systems

## Key points

- **Tried and tested systems** used for generations
- **Does not deteriorate** due to UV radiation
- **Attractive designs** in half round, box section and cornice styles
- Available in **elZinc Astur®**, **elZinc Slate®**, **elZinc Graphite®** and **elZinc Crystal®**
- **Very long lasting** and maintenance free
- **Fully recyclable**

## Basic system information

01. Half round eaves gutter

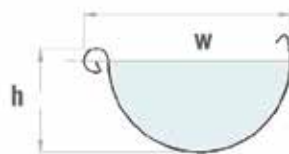

02. Box section gutter



03. Moulded gutter

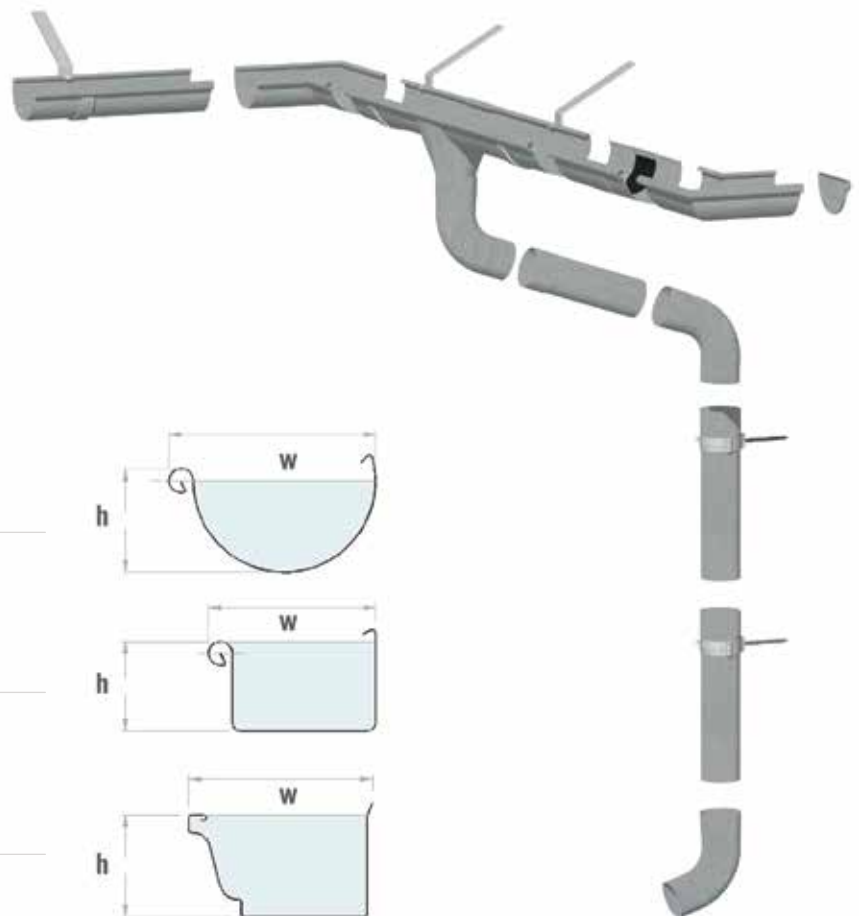

## Installation

Eaves gutters should be installed to a slight fall to aid their self-cleaning. Ideally 3 – 5mm / m but at least 1mm / m. This also gives them added flow capacity.

## Thermal expansion and contraction

Gutters are installed to allow for thermal movement and the entire system is designed taking this into account. The gutter brackets allow the gutter to slide over them and expansion joints are placed every 15m maximum (7,5m maximum from corners or running outlets) to keep expansion within limits.

HANGING GUTTER AND ASSOCIATED DOWNPIPE SIZES					
Gutter Girth	Width (w), depth (h) in mm, section (cm <sup>2</sup> )			Corresponding downpipe	
	Half round	Box section	Cornice	Round	Square
200	96, 40, 25	86, 42, 29	-	60	60 x 60
250	123, 53, 43	103, 55, 47	-	80	80 x 80
280	145, 63, 63	-	-	80 / 87	-
333	173, 77, 92	140, 75, 90	150, 98, 110	100	95 x 95
400	214, 96, 145	172, 90, 135	-	120	120 x 120
500	272, 125, 245	222, 110, 220	-	120 / 150	120 x 120

# Eaves gutters rainwater systems

## Supports

Gutter brackets that conform to DIN norms should be fixed at centers varying from 700mm to 900mm according to the expected snow loads, or can be fixed to line up with standing seam centers (more expensive than the former but generally it looks much better).

Two main types of bracket exist:

- Roof fitted
- Fascia fitted

Roof fitted brackets must be rebated into the substrate to fit flush with the surface. They should be securely fitted, which means they should be either nailed or screw fixed through to the rafters (which in turn means they will not line up with standing seam centers) or alternatively fitted to an eaves board made of solid softwood which allows the brackets to be fixed independently of rafter positions and thus to line up with seam centers – see drawings.

## Cold climates

In cold climates, snow retention systems should be installed to prevent snow slipping onto the gutters from the roof. This can quickly overload the brackets and damage the gutter – local regulations may apply. If this is not possible for any reason, then the gutter’s front edge should not be higher than the projected line of the roof.

## Connections

Gutters lengths are joined end to end and connected to corners and expansion joints using soft soldered joints.

## Outlets

- **Universal outlets.** There are various standard dimensions to provide a number of gutter / outlet combinations. The outlet is hooked around the gutter and is free to move so it does not limit thermal movement.
- **Running (spigot) outlets** are soldered to the gutter, so they do limit thermal movement and therefore an expansion joint must be placed a maximum of 7,5m from them.

It is good practice to provide an outlet next to internal angles to deal with the extra flow at that point from the valley gutter. Depending on the size of the roof, a corner hopper may be beneficial.

## Downpipe assembly

Downpipes are fixed to the wall at centers not exceeding 3m using downpipe brackets. These are positioned at the top of each pipe, just below the sleeved end to end downpipe joint (which is slightly wider) and therefore cannot slip through the bracket. The downpipes should be lapped 50mm within each sleeved joint. The pipes should be fixed at least 20mm away from the wall.

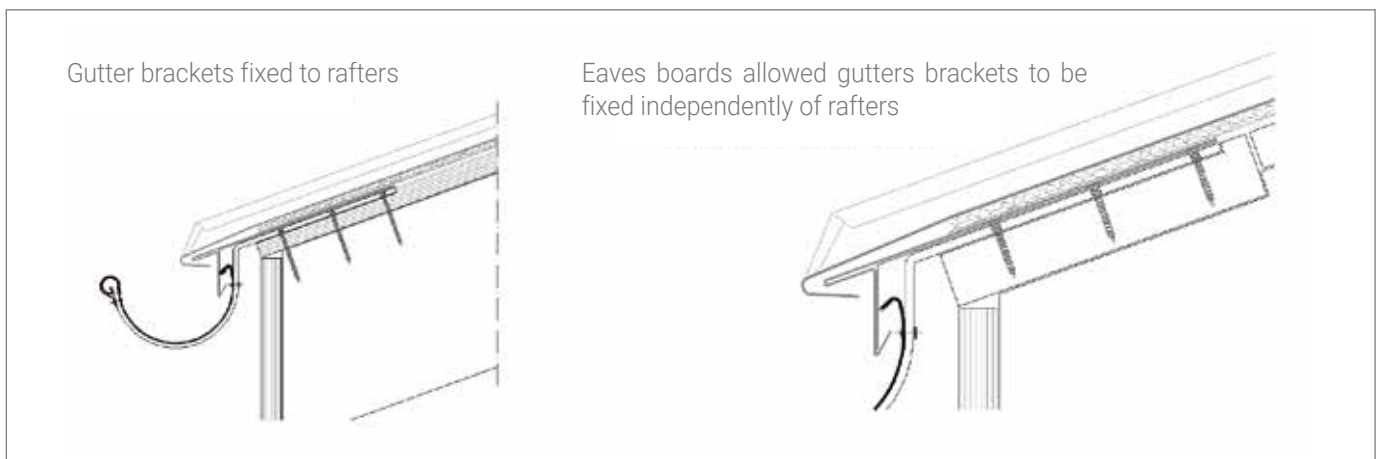

## Gutter sizing

The drainage capacity of the rainwater system is affected by the capacity of the gutter to carry rainwater to the outlet, and the capacity of the outlet and rain water pipe to drain that water. In normalized eaves gutter systems, outlets, downpipes and gutters are designed to create free discharge conditions, meaning that only the gutter run needs to be calculated.

Using EN 12056-3, which assumes free discharge conditions, the following tables giving gutter flow capacity and the effective roof area able to be drained by a gutter run is shown. These figures assume nominally level gutters and no wind effect on the effective catchment area.

### Half round gutter capacity table

Gutter run	250 mm girth			333 mm girth			400 mm girth			500 mm girth		
	Q	Effective catchment area in r= l/s ha		Q	Effective catchment area in r= l/s ha		Q	Effective catchment area in r= l/s ha		Q	Effective catchment area in r= l/s ha	
	[l/s]	300	400	[l/s]	300	400	[l/s]	300	400	[l/s]	300	400
<5	1,07	36 m <sup>2</sup>	27 m <sup>2</sup>	2,64	88 m <sup>2</sup>	66 m <sup>2</sup>	4,63	154 m <sup>2</sup>	116 m <sup>2</sup>	8,66	289 m <sup>2</sup>	217 m <sup>2</sup>
7,5	1,02	35 m <sup>2</sup>	26 m <sup>2</sup>	2,54	84 m <sup>2</sup>	63 m <sup>2</sup>	4,48	149 m <sup>2</sup>	112 m <sup>2</sup>	8,59	286 m <sup>2</sup>	214 m <sup>2</sup>
10	0,97	32 m <sup>2</sup>	24 m <sup>2</sup>	2,45	82 m <sup>2</sup>	61 m <sup>2</sup>	4,35	145 m <sup>2</sup>	109 m <sup>2</sup>	8,35	278 m <sup>2</sup>	209 m <sup>2</sup>
15	0,88	29 m <sup>2</sup>	22 m <sup>2</sup>	2,28	76 m <sup>2</sup>	57 m <sup>2</sup>	4,10	137 m <sup>2</sup>	103 m <sup>2</sup>	7,97	266 m <sup>2</sup>	199 m <sup>2</sup>
20	0,80	27 m <sup>2</sup>	20 m <sup>2</sup>	2,12	71 m <sup>2</sup>	53 m <sup>2</sup>	3,87	129 m <sup>2</sup>	97 m <sup>2</sup>	7,60	253 m <sup>2</sup>	190 m <sup>2</sup>

### Box section gutter capacity table

Gutter run	250 mm girth			333 mm girth			400 mm girth			500 mm girth		
	Q	Effective catchment area in r= l/s ha		Q	Effective catchment area in r= l/s ha		Q	Effective catchment area in r= l/s ha		Q	Effective catchment area in r= l/s ha	
	[l/s]	300	400	[l/s]	300	400	[l/s]	300	400	[l/s]	300	400
<5	1,02	34 m <sup>2</sup>	26 m <sup>2</sup>	2,38	79 m <sup>2</sup>	59 m <sup>2</sup>	3,96	132 m <sup>2</sup>	99 m <sup>2</sup>	7,23	241 m <sup>2</sup>	181 m <sup>2</sup>
7,5	0,97	32 m <sup>2</sup>	24 m <sup>2</sup>	2,28	76 m <sup>2</sup>	56 m <sup>2</sup>	3,83	127 m <sup>2</sup>	95 m <sup>2</sup>	7,02	234 m <sup>2</sup>	175 m <sup>2</sup>
10	0,82	30 m <sup>2</sup>	23 m <sup>2</sup>	2,18	73 m <sup>2</sup>	55 m <sup>2</sup>	3,63	121 m <sup>2</sup>	91 m <sup>2</sup>	6,82	227 m <sup>2</sup>	172 m <sup>2</sup>
15	0,82	28 m <sup>2</sup>	20 m <sup>2</sup>	2,01	67 m <sup>2</sup>	50 m <sup>2</sup>	3,44	115 m <sup>2</sup>	86 m <sup>2</sup>	6,43	214 m <sup>2</sup>	161 m <sup>2</sup>
20	0,74	25 m <sup>2</sup>	19 m <sup>2</sup>	1,85	62 m <sup>2</sup>	46 m <sup>2</sup>	3,21	107 m <sup>2</sup>	80 m <sup>2</sup>	6,07	202 m <sup>2</sup>	152 m <sup>2</sup>

'r' is rainfall in l/s ha. 300l/s ha is equivalent to 108mm/h, 400l/s ha is 144mm/h. For other rainfall intensities, please contact **elZinc®**.

It should be noted that for each corner within the run with a change in direction greater than 10°, both the discharge capacity of the gutter and the roof area it can drain must be reduced by 15%. Further reductions are needed if the outlet is fitted with a leaf guard.

For more information on the dimensioning of hanging gutters, please consult our technical department.

# Parapet and internal gutters

## Key points

- **Long lasting** and maintenance free
- **Lightweight** and sustainable
- Available in **elZinc Astur®**, **elZinc Slate®**, **elZinc Graphite®** and **elZinc Crystal®**
- **Matches the elZinc® roof**
- Must be **carefully designed** and installed

### Basic system information

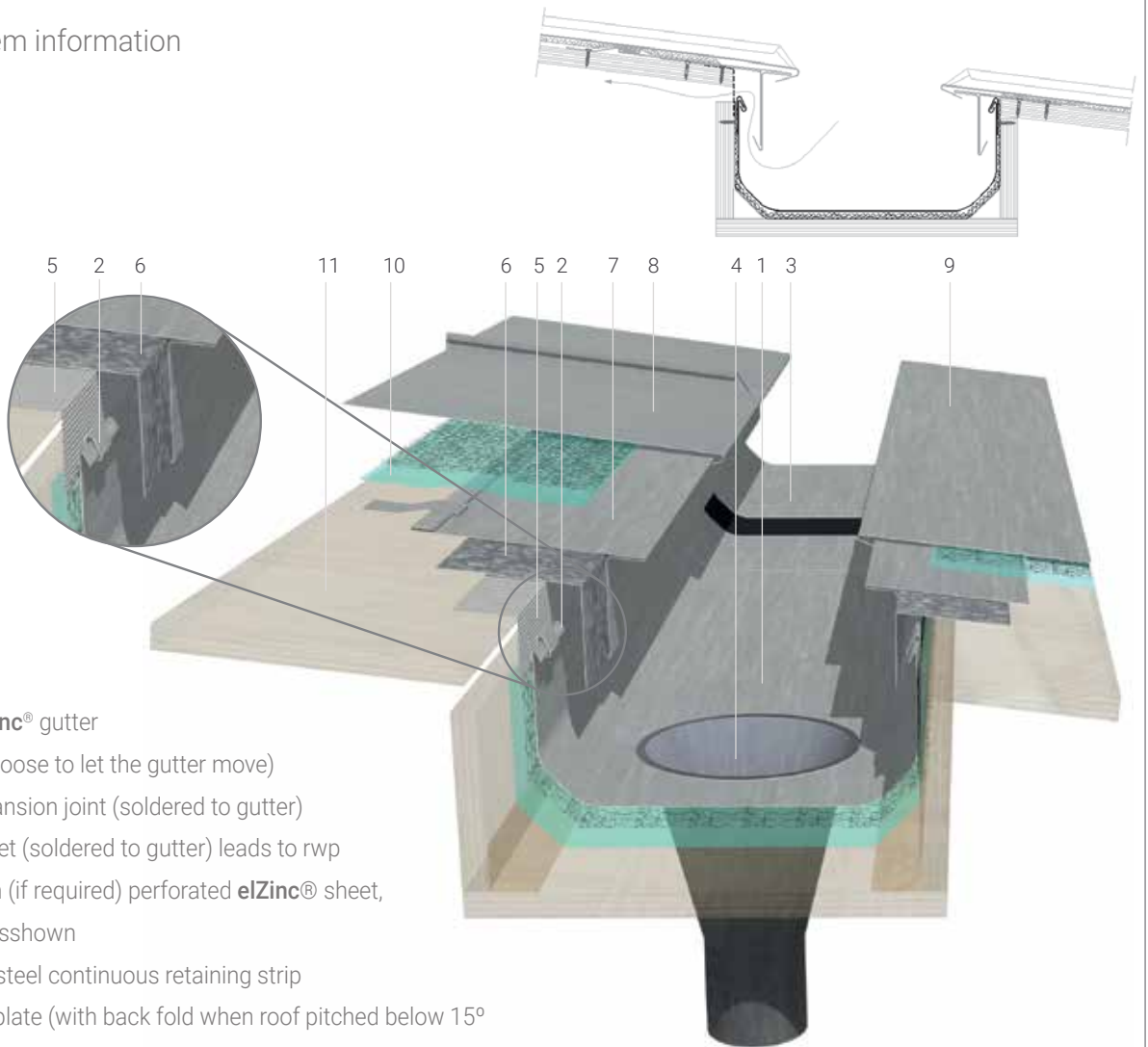

1. Internal **elZinc®** gutter
2. Gutter clip (loose to let the gutter move)
3. 'T-Pren' expansion joint (soldered to gutter)
4. Conical outlet (soldered to gutter) leads to rwp
5. Insect mesh (if required) perforated **elZinc®** sheet, 5mm dia. holeshown
6. Galvanised steel continuous retaining strip
7. **elZinc®** 'T' plate (with back fold when roof pitched below 15°)
8. Standing seam trays
9. Cladding below gutter
10. Underlay and membrane (if required – mat and breather shown)
11. Substrate (varies according to roof design and country)

## Installation

Internal gutters are folded to shape either on site or in the workshop. The gutter sections are joined end to end with soft soldered joints. They should be laid to a fall if possible to promote self-cleaning and increase flow capacity.

## Thermal expansion

Thermal expansion and contraction is accommodated for by inserting 'T'-Pren type expansion joints within the gutter run, and ensuring that the gutter is loosely clipped along its sides so it can move freely.

Location of expansion joints		
Gutter girth (mm)	Exp. Jt. centres (m)	Max. distance from outlet, corners etc. (m)
≤500	<8	<4
>500	<15	<7,5

## Outlets and overflows

Due to the consequences of internal gutters overflowing being much more serious than in the case of hung gutters, at least two outlets should be used to drain each run, each able to take the design flow if the other blocks. If this is not possible, then an overflow should be incorporated to prevent flooding of the gutter in case of outlet blockage. Conical outlets are much more effective at draining gutters – their top width should be  $\frac{3}{4}$  that of the gutter sole for maximum effectiveness.

## Snow and ice protection

In cold climates, thermostatically controlled trace heating cables should be installed in gutters where there is a risk of snow and ice build-up blocking the water flow. In addition, snow retention systems should be installed to prevent snow from the roof from sliding into the gutter and blocking it – local regulations may apply.

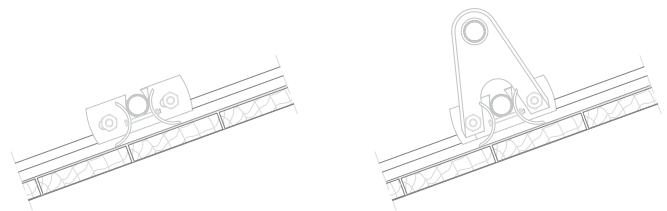

## Additional overflow protection

Buildings which require very high protection from water ingress may need a second gutter under the zinc gutter, to act as a back-up system. This secondary gutter must drain into an outlet into which the zinc outlet sits.

## Flow capacity

Internal gutter capacity is also calculated using EN 12056-3. However, guidance on calculating the required capacity of the system is beyond the scope of this media. Please contact **elZinc®** for assistance in this regard if required.



## 7. Services





# Technical and commercial assistance

## One priority: Your satisfaction

Your project not only requires the best product but also personalized technical advice. To the end, **elZinc®** has made available a wide network of technical advisers.

### a) Comprehensive project consultation service

- Selection of suitable products and system. We will help you to choose the product/system combination that is best suited to your architectural vision
- Ideas on the layout design, especially important on façades, with the aid of 3D rendered models. Advice, tips and ideas in order to reflect the message that you want the design to communicate through the 'face' of the façade
- Cladding build-up design, in order to ensure an effective building envelope
- Detail development. We help you choose the details that best suit the project
- Specification writing, in order to ensure that what has been designed will be faithfully carried out on-site
- A cost estimate, including the installation and supporting materials, for budgetary purposes
- A list of specialist hard metal roofing contractors in your area in order to ensure the material is in good hands on the building site

To ensure a smooth process from start to finish, we also make our experience available to the Project Manager, Main Contractor and/or the Installer, advising on:

- Cladding component manufacturing
- Setting out the layout design
- Correct handling and care of the material on site
- Correct forming of details

### b) Technical training days aimed at architects

**elZinc®** organizes technical training days and presentations at Colleges of Architecture and architectural offices covering available finishes, surface weathering, system selection, design, and installation of zinc cladding, including maintenance and approximate installed prices.

### c) Technical training days for installers

**elZinc®** also offers training courses covering the various techniques and methods **elZinc®** recommends for its zinc-titanium cladding.

- Theoretical guidance
- Various levels of practical training courses carried out at the Installers workshop
- On site support

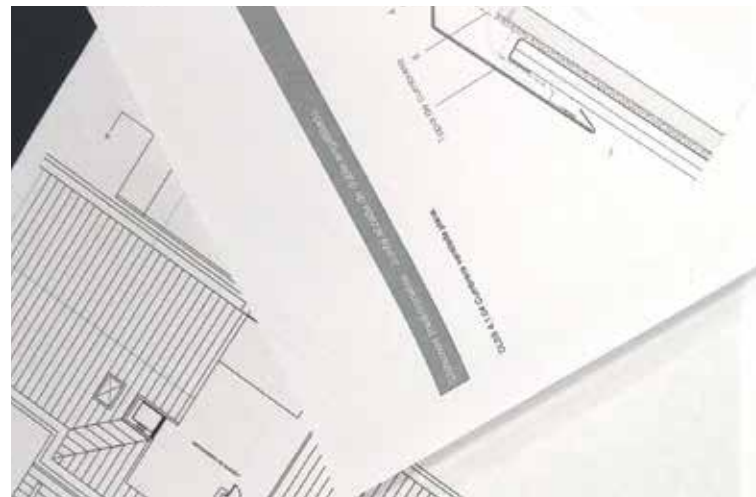

Our top priority is our client's interests and our service quality!



## d) Documentation



- **elZinc BIM Objects:** To help you to design your elZinc facade or roof project in **BIM**, we have developed a series of BIM objects with the most representative installation systems available on the BIMObject® platform and on our webpage. Easy to use, our objects contain detailed technical information and high quality textures of all our finishes. In addition, if you work in Autodesk Revit you can visualize your projects even more realistically by using our pattern-based surfaces.

- **elZinc 3D Models:** In addition to the more than 500 Architectural Details available in pdf and autocad for facades and roofs in zinc available to you from **elZinc®**, you can check out our 3D Models.

- Technical booklet
- AutoCad details Library
- 3D models
- Specifications Templates
- Product quality certificates (of zinc, finishes EPD etc..)
- Maintenance requirements

## e) Wide international comercial network

Apart from its internal customer's service, **elZinc®** also has an extensive external collaborators network. From its origins, **elZinc®** has been building an international network of professionals, which includes agents and distributors in more than 45 countries. They will advise you on the selection, purchase and installation of its **elZinc®** products.



DLSS 6.1.01 – Vented abutment (under window).

All our documentation is available on our webpage  
[www.elzinc.es](http://www.elzinc.es)

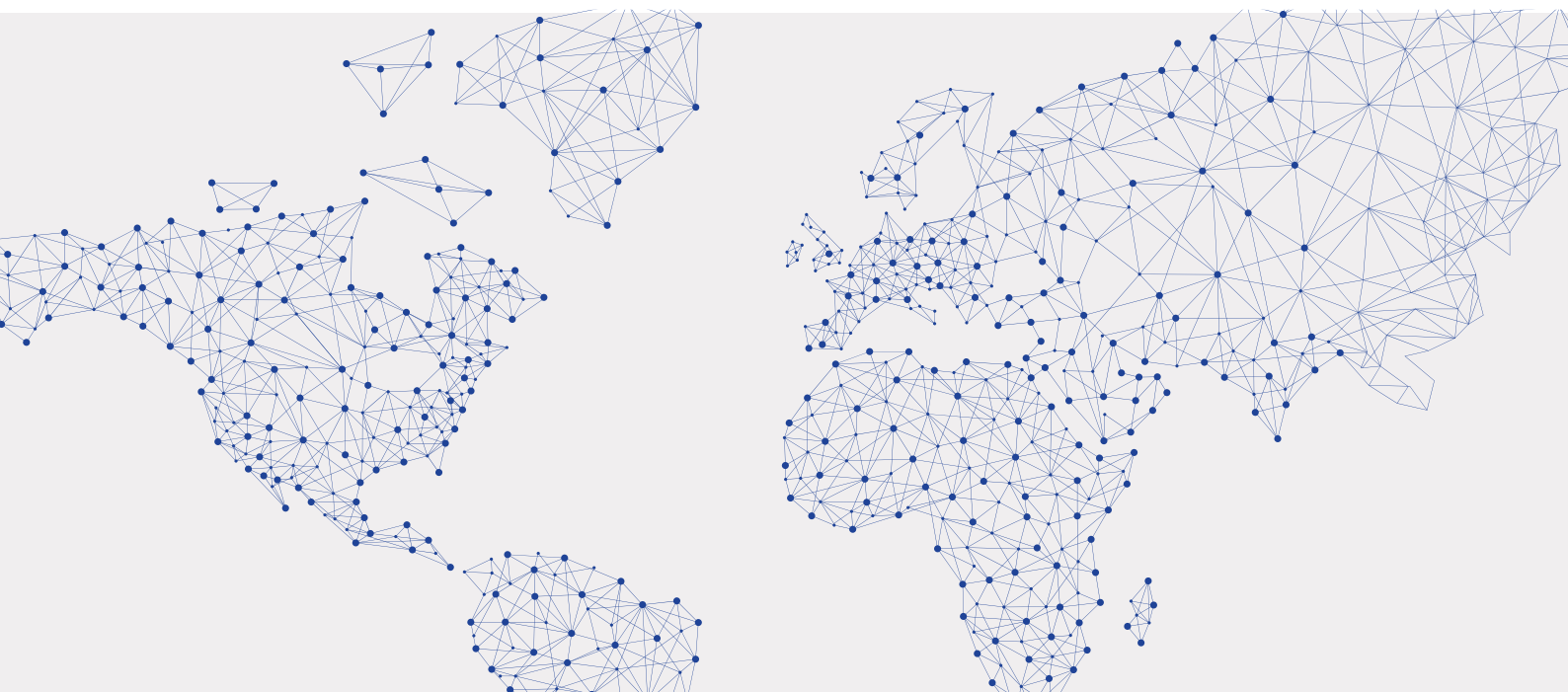

# Appendix

Roof pitch conversion table, degrees to %.											
Degrees	%	Imperial	Degrees	%	Imperial	Degrees	%	Imperial	Degrees	%	Imperial
1	2	0,21	26	49	5,85	51	123	14,82	76	401	48,13
2	3	0,42	27	51	6,11	52	128	15,36	77	433	51,98
3	5	0,63	28	53	6,38	53	133	15,92	78	470	56,46
4	7	0,84	29	55	6,65	54	138	16,52	79	514	61,73
5	9	1,05	30	58	6,93	55	143	17,14	80	567	68,06
6	11	1,26	31	60	7,21	56	148	17,79	81	631	75,77
7	12	1,47	32	62	7,50	57	154	18,48	82	712	85,38
8	14	1,69	33	65	7,79	58	160	19,20	83	814	97,73
9	16	1,90	34	67	8,09	59	166	19,97	84	951	114,17
10	18	2,12	35	70	8,40	60	173	20,78	85	1143	137,16
11	19	2,33	36	73	8,72	61	180	21,65	86	1430	171,61
12	21	2,55	37	75	9,04	62	188	22,57	87	1908	228,97
13	23	2,77	38	78	9,38	63	196	23,55	88	2864	343,64
14	25	2,99	39	81	9,72	64	205	24,60	89	5729	687,48
15	27	3,22	40	84	10,07	65	214	25,73	90	Infinite	
16	29	3,44	41	87	10,43	66	255	26,95			
17	31	3,67	42	90	10,80	67	236	28,27			
18	32	3,90	43	93	11,19	68	248	29,70			
19	34	4,13	44	97	11,59	69	261	31,26			
20	36	4,37	45	100	12,00	70	275	32,97			
21	38	4,61	46	104	12,43	71	290	34,85			
22	40	4,85	47	107	12,87	72	308	36,93			
23	42	5,09	48	111	13,33	73	327	39,25			
24	45	5,34	49	115	13,80	74	349	41,85			
25	47	5,60	50	119	14,30	75	373	44,78			

Vapour resistance		Vapour transmission		
sd value (UK)	MNs/g	g/(MNs)	US Perm	Metric Perm
0,02	0,1	10	174,8	115,2
0,04	0,2	5	87,4	57,60
1	5	0,2	3,50	2,30
20	100	0,01	0,175	0,115
100	500	0,002	0,035	0,023
400	2000	0,0005	0,009	0,006
800	4000	0,0003	0,004	0,003

Weight to area conversion table, flat sheet.

Thickness (mm)	kgs/m <sup>2</sup>	kgs/100m <sup>2</sup>	kgs/1000m <sup>2</sup>	m <sup>2</sup> /kg	m <sup>2</sup> /t
0,7	5,04	504	5040	0,198	198,4
0,8	5,76	576	5760	0,174	173,6
1	7,2	720	7200	0,139	138,9
1,2	8,64	864	8640	0,116	115,7
1,5	10,8	1080	10800	0,093	92,6

Multifunctional room, Lucinges, France  
AER Architectes







**Asturiana de Laminados, S.A.**  
Polígono Industrial de Villana,  
Parcela 1  
33695 Pola de Lena - Spain  
Tel (0034) 98 410 60 00  
Fax (0034) 985 49 32 02

June 2024  
[www.elzinc.co.uk](http://www.elzinc.co.uk)  
[elzinc@aslazinc.com](mailto:elzinc@aslazinc.com)