

HYGEA

The smart toilet evolution



INDEX

INDICE

HYGEA SMART TOILET HYGEA SMART TOILET	6
THE INNOVATIVE SYSTEM IL SISTEMA INNOVATIVO	10
MAIN FEATURES FUNZIONI PRINCIPALI	18
CERAMIC VASO	22
COLORS COLORI	26
TECHNICAL DETAILS CARATTERISTICHE TECNICHE	30



WHY HYGEA?

PERCHÉ HYGEA?

In Greek as well as Roman mythology, Hygea was the goddess/personification of health, cleanliness and sanitation. She was associated with the prevention of sickness and the continuation of good health. Her name is the source of the word "igiene".

Nella mitologia greca e successivamente in quella romana, Hygea era la dea della salute e dell'igiene. Veniva associata alla prevenzione di malattie e danni fisici. Il suo nome è l'origine della parola "igiene".

HYGEA SMART TOILET

Hygea is a new concept of smart toilet... its natural evolution. The electronic bidet module, that can be installed or replaced very easily like a cartridge, is inserted into the toilet bowl from above and is completely disconnected from its casing and from the seat. This hygienic and innovative modular system can be easily updated with new electronic bidet models we will develop in the future, without necessarily having to replace the seat as well as the toilet. This is our vision of the future of smart toilets.

Hygea è un nuovo concetto di smart toilet... la sua naturale evoluzione. Il modulo bidet elettronico, che può essere installato o sostituito molto facilmente come una cartuccia, viene inserito nel sanitario dall'alto ed è completamente scollegato dal suo involucro e dal sedile. Questo igienico e innovativo sistema modulare può essere facilmente aggiornato con nuovi modelli di bidet elettronici che verranno da noi realizzati in futuro, senza dover necessariamente sostituire il sedile e il WC. E' questa la nostra visione del futuro delle smart toilet.







THE INNOVATIVE SYSTEM

IL SISTEMA INNOVATIVO

We have developed a new system consisting of five elements: the toilet bowl, the fixing plate, the electronic bidet, the casing that contains it and the seat. 26 months of work, 7 teams, 54 people involved in the creation of what we believe is the most functional and hygienic of smart toilets on the market. A simple product, revolutionary and particularly attentive to the environmental impact.

Abbiamo sviluppato un nuovo sistema composto da cinque elementi: il sanitario, la piastra di fissaggio, il bidet elettronico, il coperchio che lo contiene ed il sedile. 26 mesi di lavoro, 7 squadre, 54 persone coinvolte per la realizzazione di quella che riteniamo sia la più funzionale ed igienica tra le smart toilet in commercio. Un prodotto semplice, rivoluzionario e particolarmente attento all'impatto ambientale.

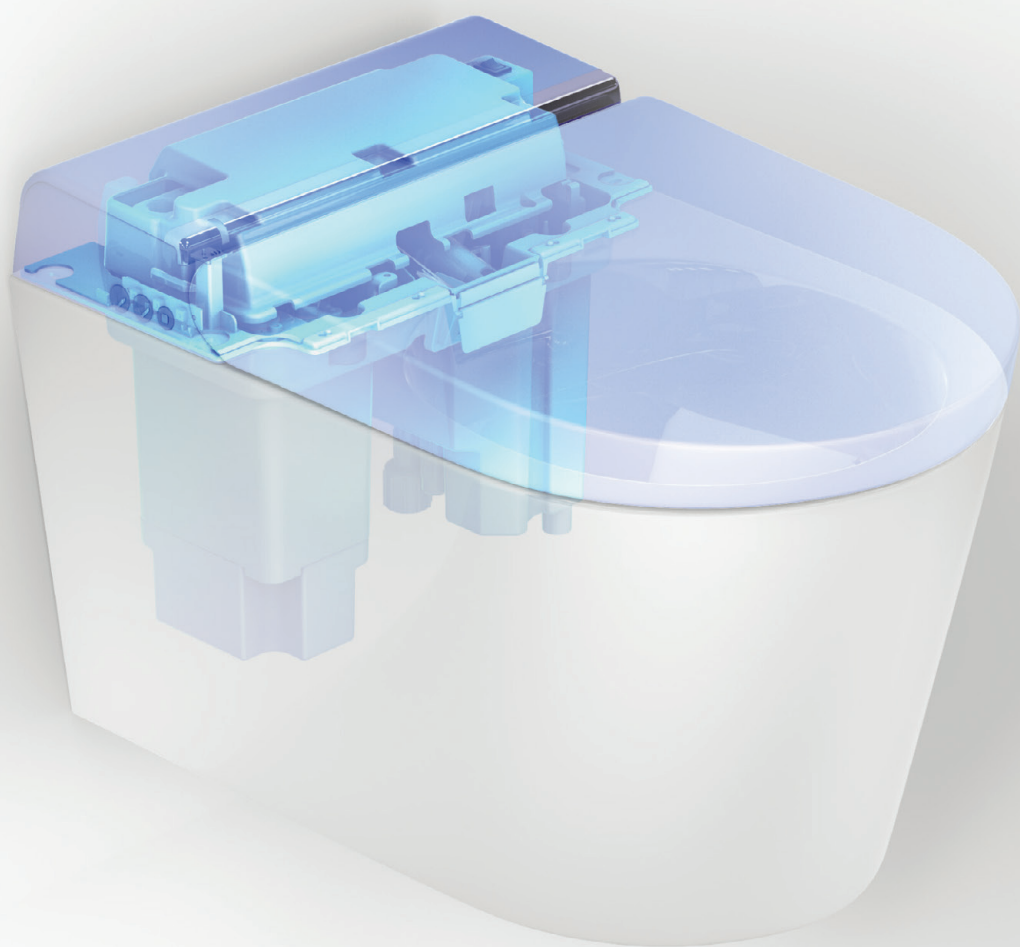

THE COMPONENTS

I COMPONENTI













MAIN FEATURES

FUNZIONI PRINCIPALI

The electronic bidet is Hygea's beating heart. Made with the best Korean technology, it has been designed to meet the needs of the most demanding customers. The functions have been carefully selected and optimized in order to provide the best possible experience.

A stainless-steel nozzle provides intimate hygiene, while drying is performed by a high efficiency device. The self-draining and anti-lime buildup functions ensure greater hygiene and reliability.









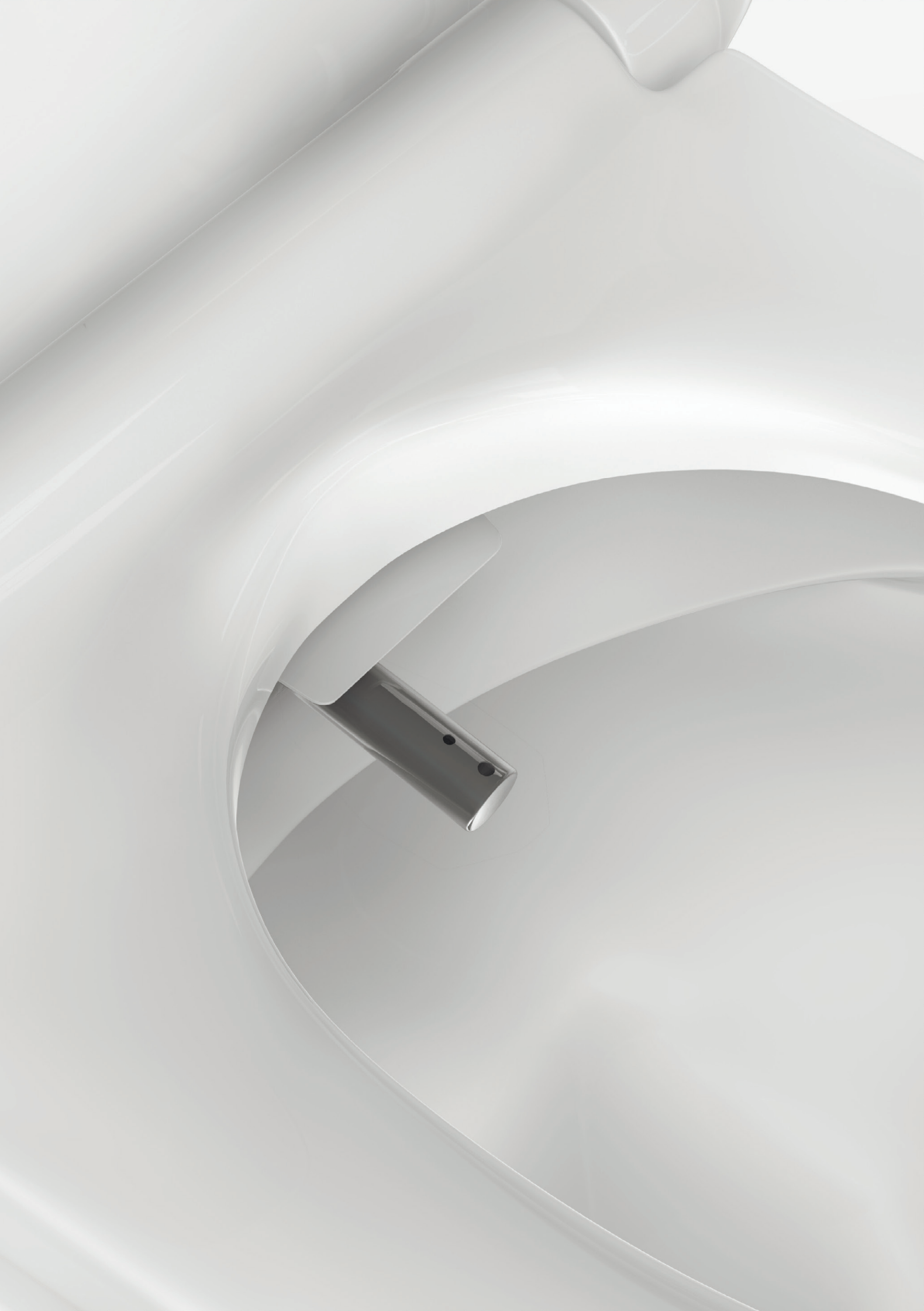

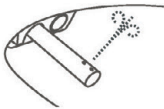
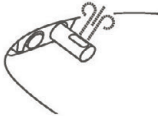
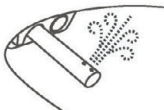

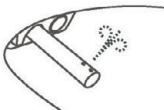
Il bidet elettronico è il cuore pulsante di Hygea. Realizzato con la migliore tecnologia coreana, è stato studiato per soddisfare le richieste dei clienti più esigenti. Le funzioni sono state accuratamente selezionate ed ottimizzate per fornire la miglior esperienza possibile.

Un ugello in acciaio inossidabile provvede all'igiene intima, mentre l'asciugatura viene effettuata da un dispositivo ad alta efficienza.

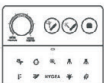
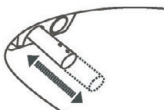
La funzione "svuotamento automatico della tanica" e il programma anticalcare assicurano maggior igiene ed affidabilità.

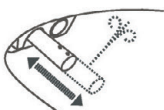
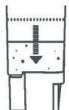

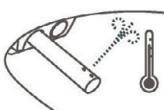
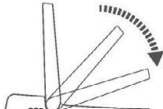

 <p>Posterior cleansing Igiene posteriore</p>	 <p>Air drying: 2 intensities 5 temperature levels Asciugatura: 2 intensità 5 livelli di temperatura</p>
 <p>Feminine cleansing Igiene femminile</p>	 <p>User's memories: 2 2 Memorie utente</p>
 <p>"Kids" function Igiene bambini</p>	 <p>Dimmering courtesy light Luce di cortesia ad intensità variabile</p>
 <p>"Auto" function (hygiene + dryer) Funzione "Auto" (igiene + asciugatura)</p>	 <p>Operational LED LED di notifica</p>
 <p>Variable spray Getto ad intensità variabile</p>	 <p>Remote control Telecomando</p>
 <p>Position of the nozzle variable Posizione dell'ugello regolabile</p>	 <p>Anti-lime program Programma anticalcare</p>
 <p>Oscillating nozzle Movimento oscillante dell'ugello</p>	 <p>Automatic draining of the tank Svuotamento automatico della tanica</p>
 <p>Automatic cleansing of the nozzle Pulizia automatica dell'ugello</p>	 <p>Radar sensor Sensore radar</p>
 <p>Warm water with variable temperature setting Temperatura dell'acqua regolabile</p>	 <p>Soft closing Chiusura rallentata</p>
 <p>Water renewal Rinnovo dell'acqua</p>	 <p>Eco function Risparmio energetico</p>

CERAMIC

VASO

Hygea is made of Vitreous China, a material with a reduced environmental impact and has been conceived while paying particular attention to water saving: its flushing system uses only 3.5 liters of water. The plaster molds that shape the toilet bowl are made by hand. Higherglaze enamel guarantees a perfectly smooth and easy to clean surface.

Hygea è stata concepita ponendo particolare attenzione al risparmio idrico, il suo sistema di scarico utilizza solamente 3,5 litri di acqua. Gli stampi in gesso che plasmano la forma del vaso sono realizzati manualmente. Lo smalto Higherglaze garantisce una superficie perfettamente liscia e facile da pulire.



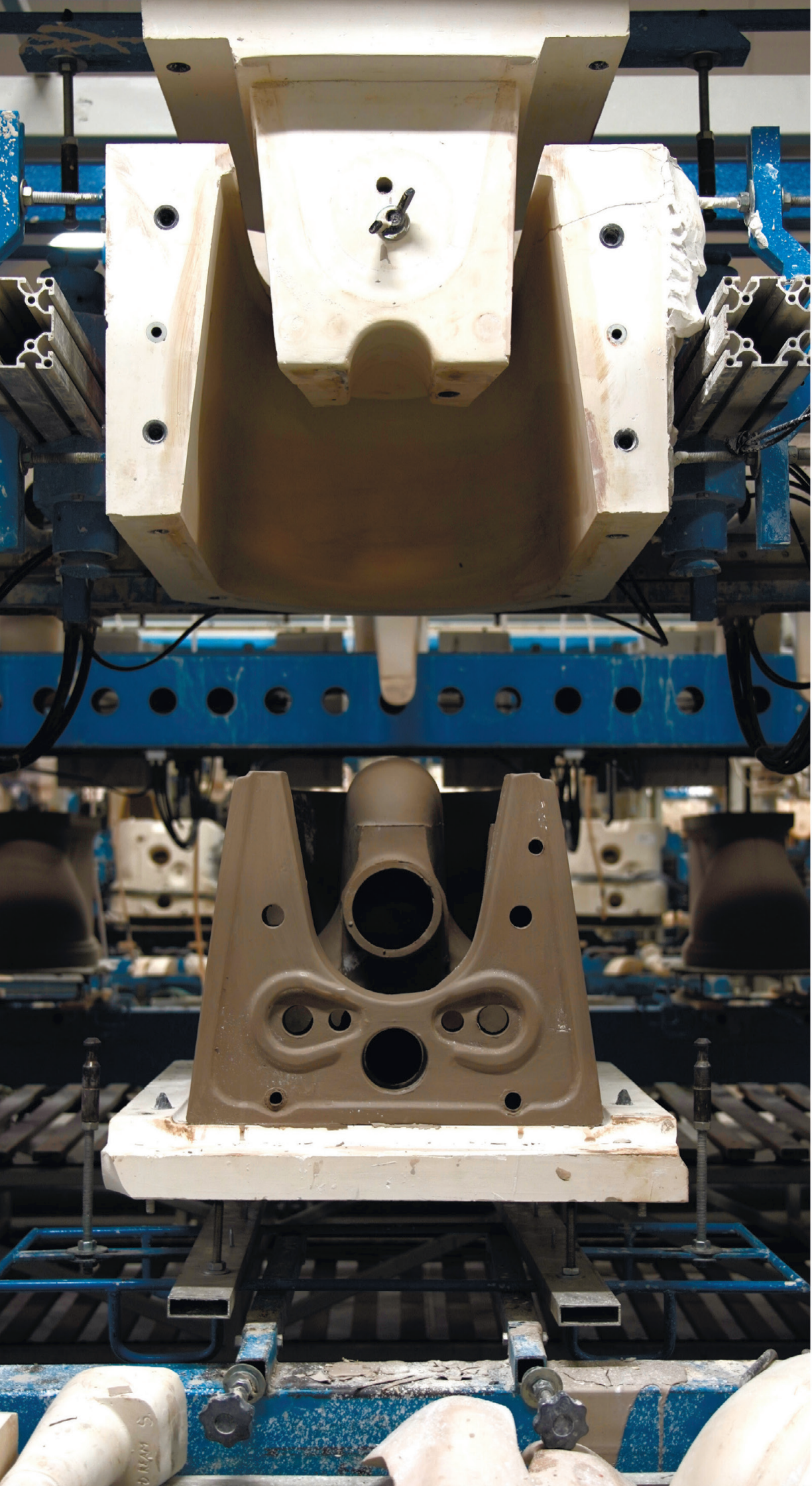

HIGHERGLAZE

Superior quality for Hygea. Its surface is perfectly smooth and does not allow dirt and scale to settle. This guarantees lasting shine, pleasant touch, high protection against scratches, abrasions and external agents.

The extreme ease of cleaning also allows a lower consumption of water and detergents in respect of the environment.

HIGHERGLAZE

Qualità senza compromessi per Hygea. La superficie del vaso risulta essere perfettamente liscia non permettendo allo sporco e al calcare di depositarsi. Questo smalto garantisce durevole brillantezza, piacevolezza al tatto, alta protezione da graffi, abrasioni e agenti esterni. L'estrema facilità di pulizia inoltre permette un minor consumo di acqua e detersivi nel rispetto dell'ambiente.

RIMLESS SENZA BRIDA

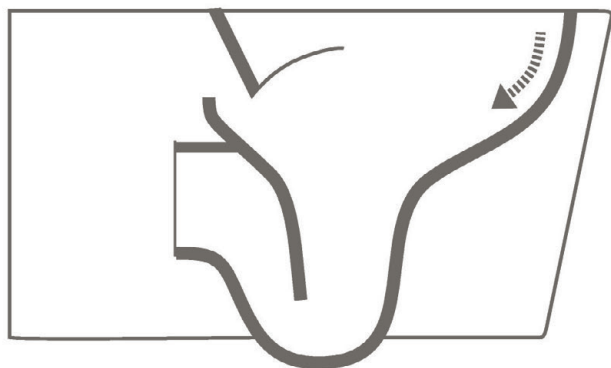

ANTIBACTERIAL ACTIVITY ATTIVITA' ANTIBATTERICA

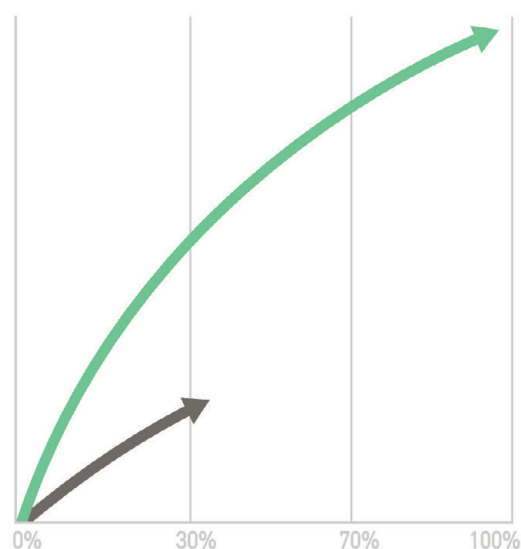

 zerobact®

ZEROBACT®

The innovative ZEROBACT® glaze is a total barrier against germs and bacteria. Integrated into the glaze and fired with the sanitary, it grants a lasting and limitless protection over time. This glaze has a certified effectiveness equal to 99,9%.

Iso 22196:2011 Certification.

ZEROBACT® glaze is supplied upon request.

ZEROBACT®

L'innovativo smalto ZEROBACT® è una barriera totale contro germi e batteri. Integrato nello smalto e cotto con il vaso, garantisce una protezione duratura e illimitata nel tempo. Questo smalto ha un'efficacia antibatterica certificata pari al 99,9%. Certificazione ISO 22196: 2011.

Lo smalto ZEROBACT® viene fornito su richiesta.

COLORS

COLORI

Who ever said that a smart toilet has to be white or only one color? Our modular system allows us to customize Hygea according to our customers' tastes and needs. The 4 elements that make up the aesthetics are available also in white, grey, sand and black with satin glaze that is very pleasant to the touch... any kind of mixed color customization is possible.

Chi ha mai detto che una smart toilet debba essere bianca oppure di un solo colore? Il nostro sistema modulare ci permette di personalizzare Hygea in base ai gusti e alle esigenze dei nostri clienti. I 4 elementi che ne costituiscono l'estetica possono essere di colore bianco, nero, grigio o sabbia, a smalto lucido o satinato... ogni personalizzazione è possibile.



▼ **White**
Bianco



▼ **Matt white**
Bianco satinato



▲ **Matt sand**
Sabbia satinato

▲ **Matt grey**
Grigio satinato

▲ **Matt black**
Nero satinato



TECHNICAL DETAILS

CARATTERISTICHE TECNICHE

Power supply Alimentazione	Rated voltage Tensione	AC 230 V AC 230 V
	Rated frequency Frequenza	50 Hz - 60 Hz 50 Hz - 60 Hz
Tap water pressure Pressione mandata acqua	Working pressure Pressione di esercizio	0.5 ~ 10 bar 0.5 ~ 10 bar
Hygiene Igiene	Water temperature Temperatura acqua	OFF, 33 °C, 36 °C, 39 °C OFF, 33 °C, 36 °C, 39 °C
	Nozzle type Materiale ugello	Stainless steel Acciaio inossidabile
	Motor Motore	DC 12 V, step motor DC 12 V, passo-passo
	Position of the nozzle Posizione dell'ugello	5 levels 5 livelli
	Water spray Getto ad intensità variabile	5 levels 5 livelli
Dryer Asciugatura	Operating time Tempo di funzionamento	180 sec. 5 temp. levels - 2 intensities 180 sec. 5 livelli di temperatura - 2 intensità
User detection Rilevazione utente	Radar sensor Sensore radar	
Personalized controls Controllo funzioni	Wireless remote control Telecomando	RF (2.4 GHz) - Batteries AAA x 3 RF (2.4 GHz) - Batterie AAA x 3
	Side buttons Pulsanti laterali	3 3
Toilet bowl Vaso	Material Materiale	Vitreous China Vitreous China
	Glaze Smalto	4 colors - 2 types 4 colori - 2 tipi
	Type Tipo	Rimless Rimless
Toilet Seat and lid Sedile	Material Materiale	UREA UREA
	Glaze Smalto	4 colors - 2 types 4 colori - 2 tipi
	Type Tipo	Easily detachable Sganciamento rapido
	Soft close system Sistema di chiusura rallentata	Oil pressure damper Ammortizzatore ad olio

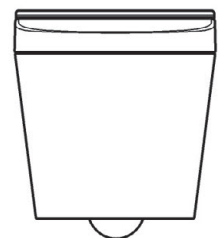
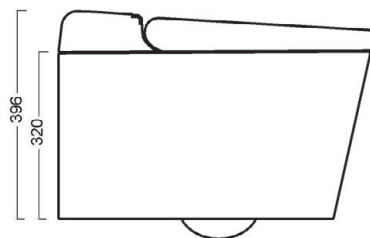
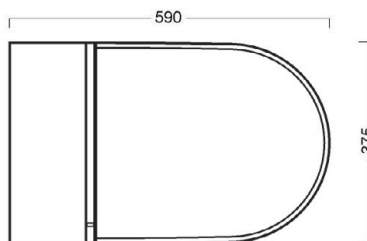

PUBLISHED BY

USPA EUROPE S.R.L.
CORSO DELLA VITTORIA 14
28100 NOVARA
ITALY

T: +39 0321 030449

F: +39 0321 031648

info@uspa.eu

www.uspa.eu

COPYRIGHT

USPA EUROPE S.R.L.

CONCEPTION

USPA EUROPE S.R.L.

EDITING AND DESIGN

CREOVISUALDESIGN

USPA EUROPE S.R.L. reserves the right to change products shown in this catalogue at any time without prior notice.

The figures and data quoted are intended as guidance only.

USPA EUROPE S.R.L. si riserva il diritto di apportare in qualsiasi momento modifiche o variazioni ai prodotti presenti in questo catalogo senza preavviso.

I dati e le raffigurazioni riportate sono da intendersi come indicativi.