



Design

Steel profile systems –
created to shape the face of a city

JANSEN



Design – the harmony between function and aesthetics

For Jansen, design means striking the harmony between function and aesthetics. We combine well-engineered function with practical handling of the products in order to create an appealing visual effect. A building should offer residents and users the greatest possible comfort and protection, but should also fit well into its surroundings, illustrate a certain concept and be convincing in terms of form.

When it comes to product development, a holistic design aspiration means thinking about aesthetics as well as covering all the necessary standards. This approach is reflected across the entire product range of steel windows, doors and facades and includes a variety of handles, opening shapes, special shapes and details such as edge radii.





Transparency | Page 8
Presenting a transparent view



Operation | Page 28
Easy to use



Material | Page 15
Representing materials



Opening variants | Page 30
Developing creativity



Variants | Page 16
Defining shapes



Sun protection | Page 34
Can be used individually



Longevity | Page 37
Thinking sustainably



Fittings | Page 22
Designing the function



Docu Center | Page 41
Virtual database



Jansen | Page 42
Complete solutions as a system provider



BIM models | Page 40
Product twin



JANIssoft | Page 40
Product configuration



Processing | Page 41
Automation and precision



System overview | Page 44
for aesthetes, users and practitioners

Design for aesthetes – Generating enthusiasm

Jansen strives to inspire, exceeding the functional requirements. After all, good design fulfils sensual demands in addition to the intended function. It guarantees a perceptible harmony by ensuring that a component perfectly fulfils its functional purpose. In addition, it should also enable the optimal combination of partial aspects: Then the element serves, for example, to emphasise or optimally set the scene for something – a fantastic view, the incident sunlight or an architectural feature.

Windows, doors and – even more – complete facades make a significant contribution to modern architecture: In the various variants, they help to achieve the desired effects. Sometimes they blend in as discreetly as possible, sometimes they take on a leading role as a striking design element. Dealing with their form and colour is just as much a part of the planning process as the question of how the element fits into the building: Should it be straightforward modern or playful baroque? How much light should it provide inside and how much of a view outside? – Jansen allows designers to choose which style they would like to follow.

“ Being an architect means you need to enjoy life, respect life and respect people. ”

Daide Macullo



Transparency – Presenting a transparent view

When light and gaze can glide freely back and forth between inside and outside, this visually eliminates the boundaries of a building. These are replaced by the staging of the surroundings and the bright, open space. With different sizes, fillings and profile views, highly individual effects and impressions can be achieved. How much of a view, how much insight and how much face width should there be?

Element sizes

Element sizes play a key role in ensuring that daylight and the environment are incorporated into the design in a targeted manner. In the case of doors and windows, the leaf respectively sash size, i.e. the element that can be opened, also has a major influence. In the case of facades and fixed parts, such as partition walls or skylights, the element size is generally the maximum glass surface area that can be positioned within a profile frame. A further size indication is given for the total area of individual components when these are lined up. Details of the sizes of the individual elements, i.e. the leaves/sashes and overall dimensions, can be found at the end of the brochure.

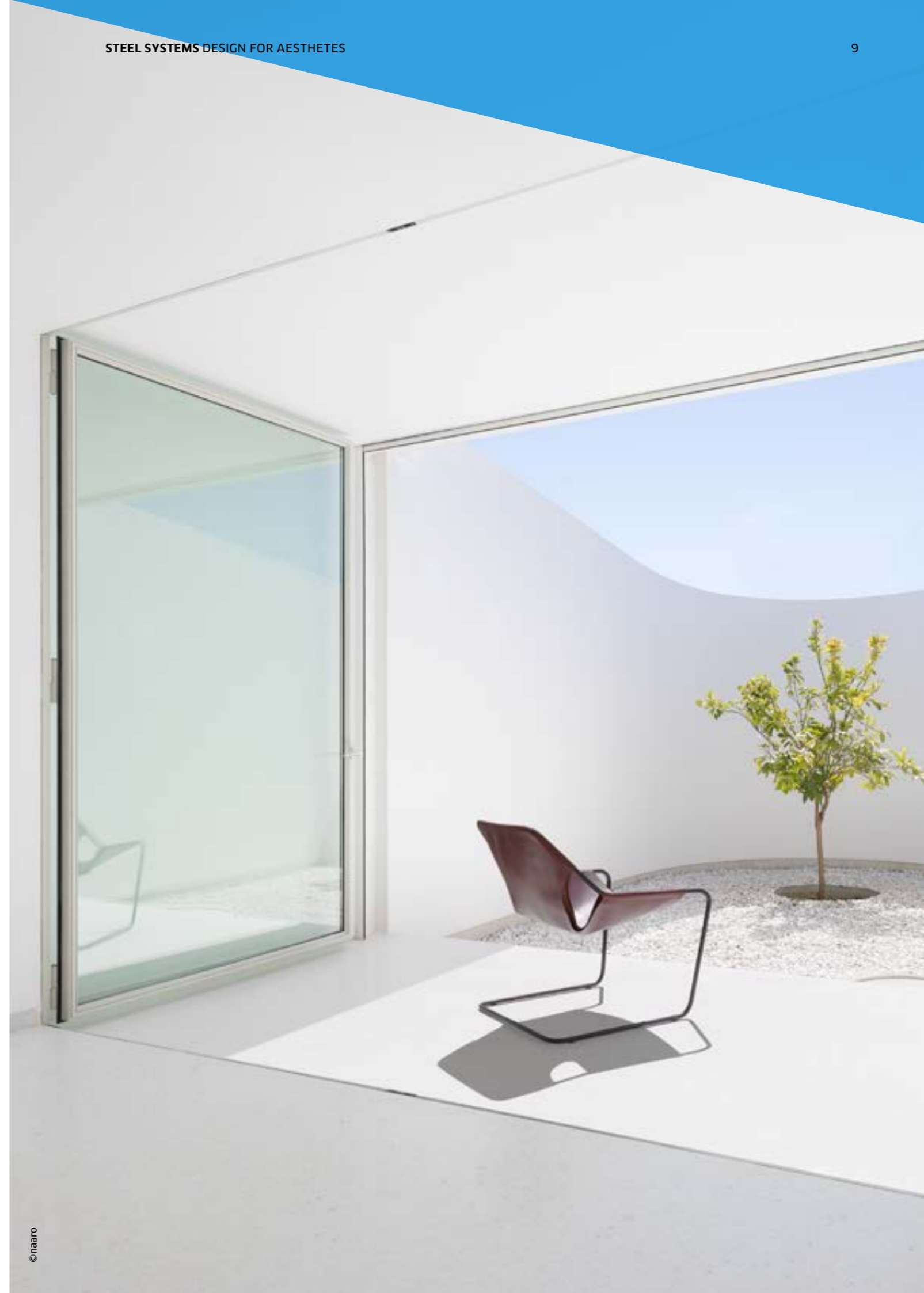
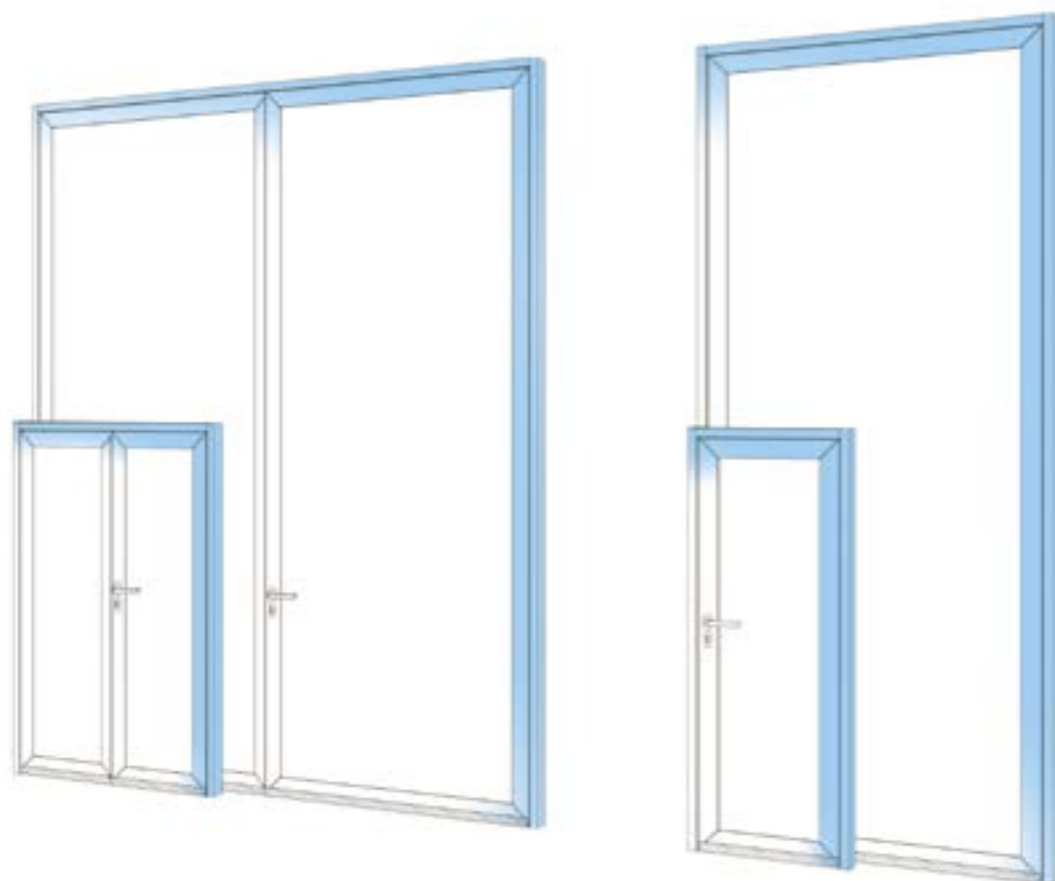

Fillings

It is the choice of filling that decides whether an element as a whole permits or limits the view. In addition to glass, plates or other insert elements that are placed into the surrounding profiles are also referred to as filling.

The filling is an important design element in that glass can be used to create a consistent transparency, for example, while a combination of a plate with cut-outs for glass achieves completely different impressions and effects. As a change or alternative to transparent areas, plate fillings in a wide range of colours can be used.

(Note: Fire and burglar resistance tests are always carried out on the completed element. The certificates issued apply only to the element tested in this form, including the filling used in the test.)

Narrow face widths

The slimmer a profile can be designed, the more design freedom remains in the filling area. Slim profiles make it possible to visually shift functional elements into the background and thus, for example, emphasise the lightness of the object or maximise the incidence of light and transparency.

Sample selection of various fillings for doors.

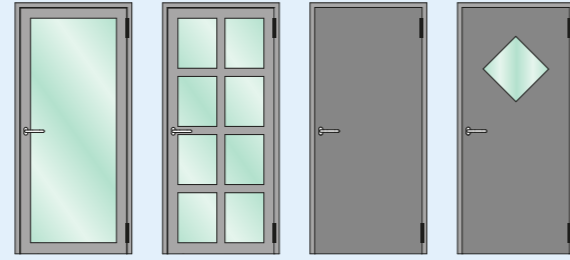

The functional elements can thus help to select the possible opening for glass to be as large as possible. Due to its strength, steel in particular is predestined to ensure very narrow face widths with maximum stability.



Both windows and doors with a face width of 45 mm can be implemented in the Janisol Arte system.

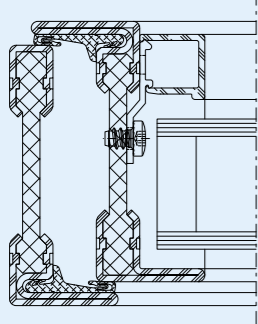

Jansen facade systems have face widths of 50 mm or 60 mm.

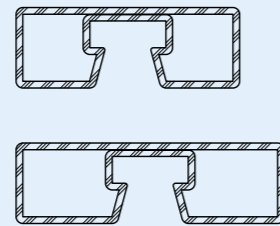

Profile design

The profile design is an essential design element and can either help to make the surrounding visible surfaces appear even further into the background or to emphasise them more strongly. In order to hold the glass, glazing beads are installed on the inside of doors and windows, which are produced in different forms; they blend visually with the casement frame or create their own accents. Especially on facades, the cover profiles intensify certain effects. This occurs either due to their surface design or their shape. Conical profiles or attached outriggers can be used, for example, to create an interplay of light and shadow or to create a similar look with the blinds.

The design configurator in our virtual showroom helps to display, compare and evaluate such design options.



jansen.com/virtualshowroom



Accents with different shapes of glazing bead

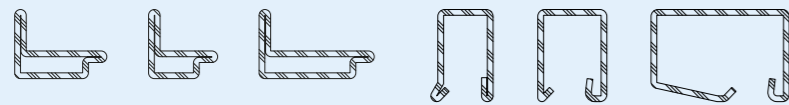

Light effects on the facade through facade cover profiles

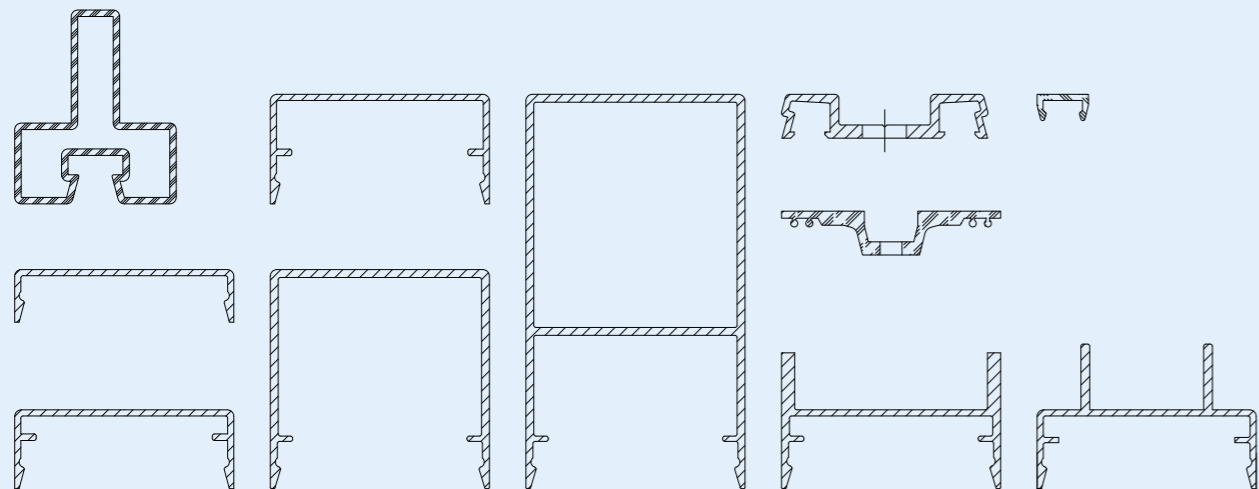



Material – Representing materials

The choice of materials makes it possible to choose a combination of properties. These relate to functional aspects such as the visual appearance and possible forms of processing. From the raw form to chemically or mechanically modified materials, colours and surfaces vary and open up a wide range of design options.

Steel / stainless steel / Corten

Steel, stainless steel and Corten offer universal design options combined with high stability and ease of use. There are differences: While steel is protected from corrosion through pretreatment with stove enamelling, galvanizing, powder coating or wet painting, stainless steel features material properties that do not require further treatment. The high-quality alloy is resistant to corrosion and contributes to its elegant appearance thanks to its characteristic colour and structure. Pre-rusted steel, Corten, is particularly suitable for visual accents in an industrial look, while retaining all the static properties of steel as a base material.

In our virtual showroom, we offer a design configurator that allows you to vary the material and colour of doors or windows in different environments.

You can find more detailed information in our 'Coating Guidelines' brochure. Jansen steel profiles bear the GSB seal of quality, which is recertified and confirmed annually by independent testing institutes.



Surface treatment

When it comes to surface treatment, colour design and mechanical treatment of the profiles or fittings come into play. Each material brings with it different basic requirements and may produce different results. Different colours are possible depending on the method used. The colour may contain different gloss levels as well as metallic components. Mechanical processes such as grinding, brushing, and polishing can also achieve various effects.

The surface treatment has long been fulfilling not only visual demands, but also functional tasks. It protects the material and the resulting properties can also contribute to heat absorption or reflect the sun's rays. Certain integrated components mean that it can even help to destroy germs. When it comes to choosing a colour, the key question is where that colour is used: In areas heavily exposed to the weather, 'highly weatherproof' paints, for example, protect against premature fading.

Colour selection in our virtual showroom

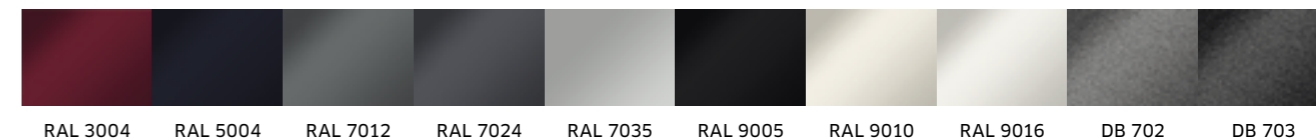

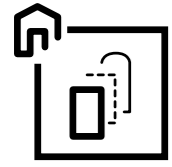

Variants – Defining shapes

Building elements can be designed in different variants. Whether for practical or aesthetic reasons, when it comes to the shape of an element, there is scope for achieving the ideal result. With this in mind, steel and glass can be designed in many ways.

Special shapes: Round arch, trapeze / studio

Steel is exceptionally malleable and retains its stability and elasticity like no other material. This allows profiles to be bent to a radius of up to 200 millimetres (Janisol Arte) or 600 millimetres (VISS facade). The material properties of the integrated thermal insulation bars are also suitable for the bending process. With this flexibility, there are virtually no limits to your imagination when it comes to round and rounded door, window and facade design.

These special shapes are offered in-house at Jansen, which guarantees their continued function. Since 2020, Jansen's special shapes have also been approved for CE marking. The same applies to the stable and permanent connection of steel profiles for unusual angles, such as those found in trapezoidal or studio windows.

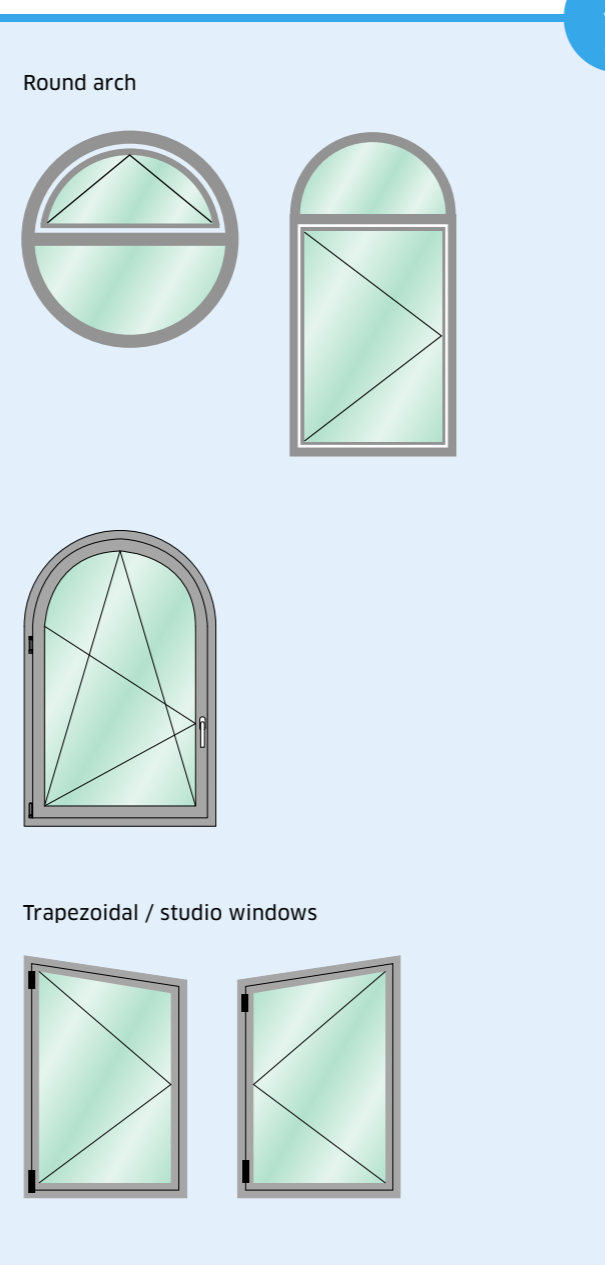
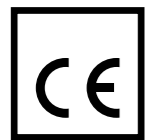

Connection: Transom windows, side sections

Transom windows are positioned above a window or door element, side panels at the side and lower lights below. They create additional visual and functional aspects in the interplay between shape, opening function and light; they can be adjusted in size, can be angled, curved or trapezoidal and can be fixed or opening. They offer design options in inaccessible and under-appreciated places.

Thanks to the compatibility of the various Jansen systems, different requirements can be combined with the same face widths – such as fixed glazing next to doors that have to meet the most stringent fire and smoke protection requirements, if necessary.



Transom windows

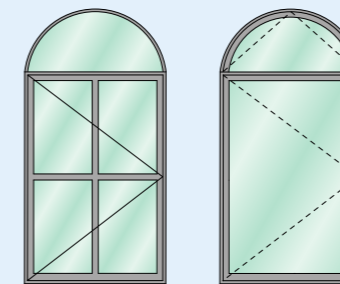

Windows

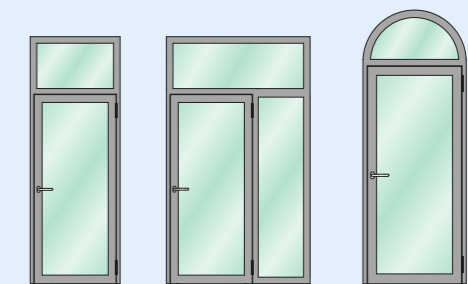

Doors

Side panels and transom windows fixed or for opening

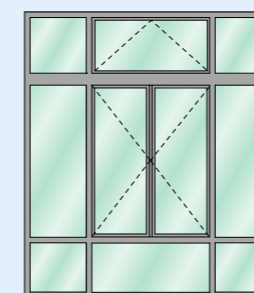

Windows

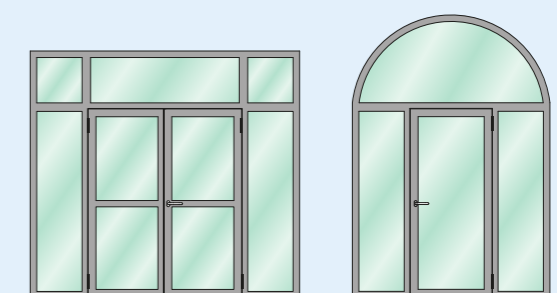

Doors



WERK 12

AAH HH

OH

PUH

“ It should also become a multifunctional facade which should be able to adapt to changing uses. ”

Christoph von Oefele

Roof: Pyramid, dome, gable, mono-pitch roof

The shapeability and stability of steel form the basis for the design of a wide range of roof shapes. Here, the maximum possible sizes and the feasible transparency of structures with a span width of up to 4.3 metres are impressive (fire-resistant roof glazing). In a construction with a VISS roof standard, the size depends on the statics and is calculated on a case-by-case basis.

For example, the 'high wall' of a mono-pitch roof can be elegantly designed using Jansen facade profiles. In this way, the wall becomes the design part of the roof and offers the opportunity to shed more light on the interior in a sophisticated way. Other options include ornate glass domes or pyramids that allow daylight to enter the rooms below or provide a view of the sky in the opposite direction.

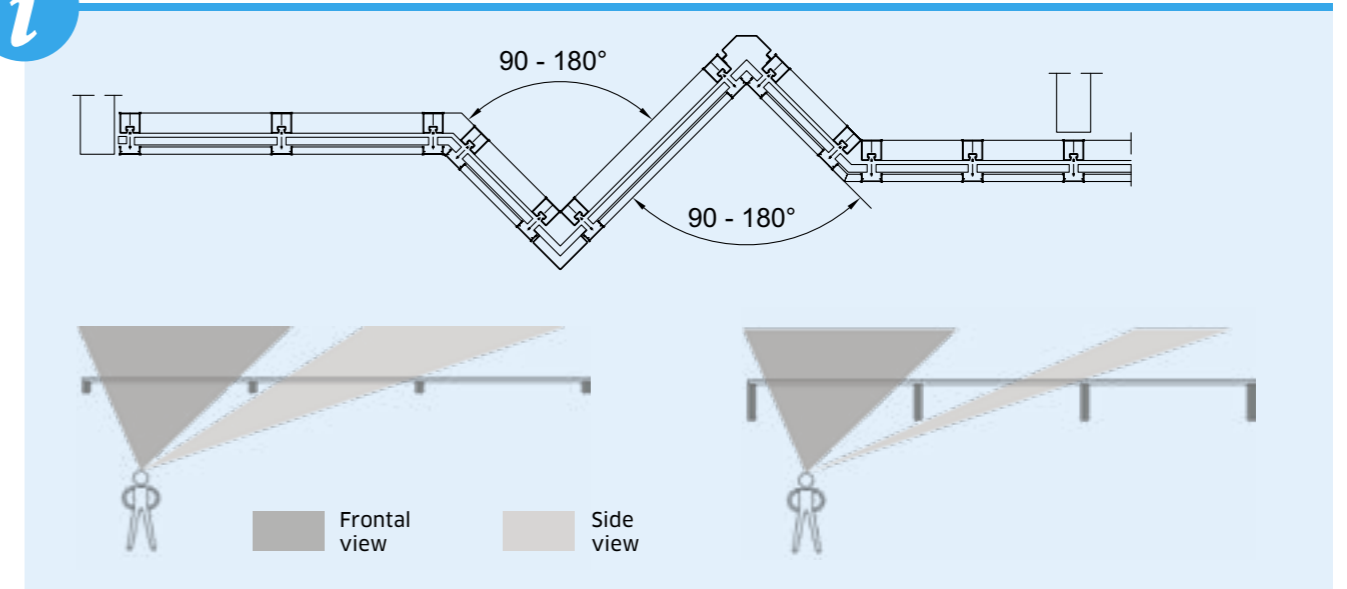
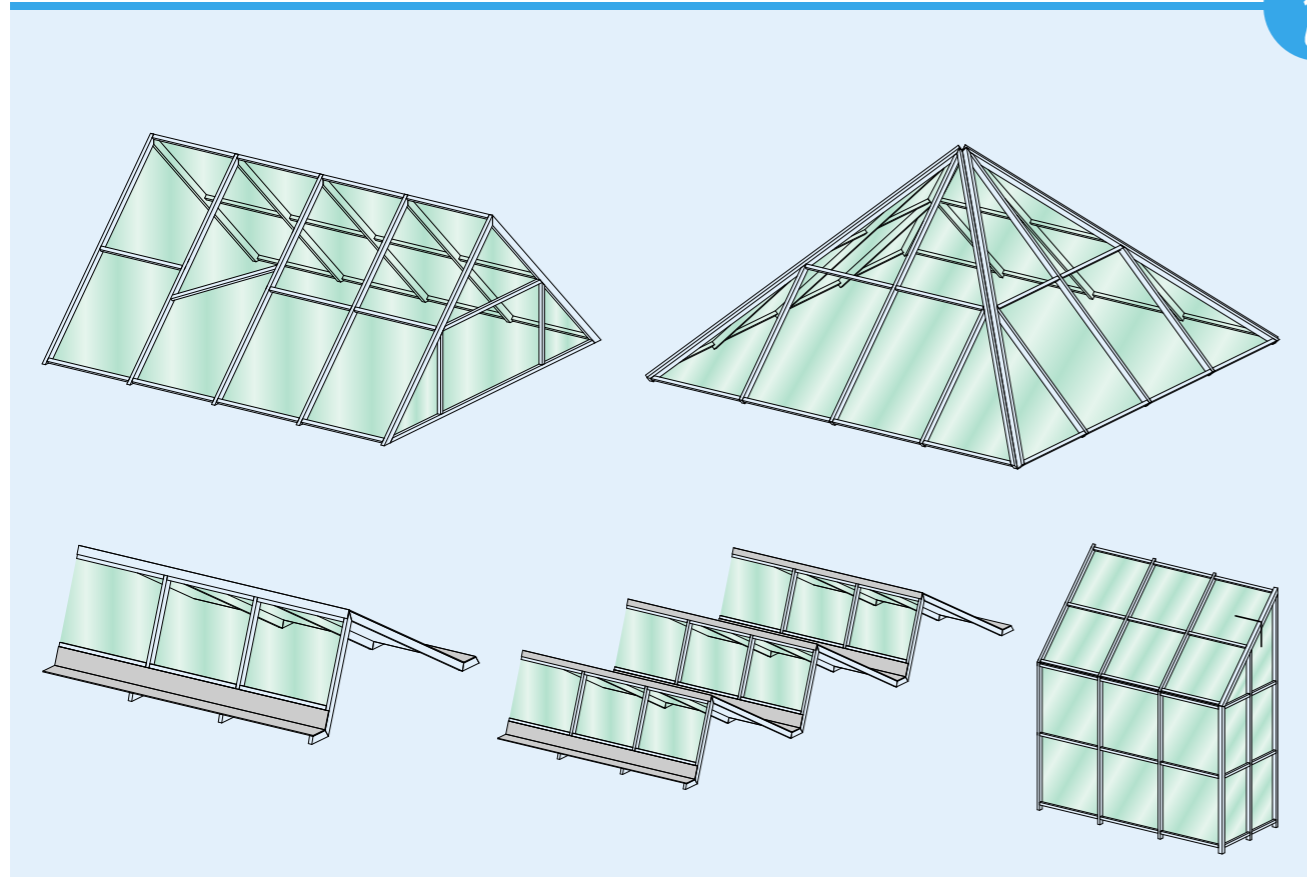
**Facade: Profile design, roof connection, polygon glazing**

As a rule, the design of the facade generally plays a key role in the appearance of a building. Add-on profiles, roof connections or polygon glazing can provide very individual facets here. The width and depth of profiles also play a decisive role, depending on whether generous insights and outlooks are to be provided. With different add-on profiles, an individual look can be achieved and the interplay of light and shadows can be varied depending on the viewing angle.

The roof connection, i.e. the transition from the vertical to the inclined roof surface, can be designed using Jansen systems, for example, with a discreet transom. The systems of the facade and roof are coordinated in such a way that the elegant line continues.

With the broken surface of polygon glazing, on the other hand, the vertical as well as the sloping roof surface is an eye-catcher. It also makes it possible to reject light and wind in a targeted manner or to capture them at specific angles. VISS facades or roof glazing allow for various angled connections and are tested against fire as VISS Fire. VISS can also be offered in a curved form.

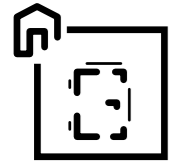

Fittings – Designing the function

Fittings play a central role in the functional process of opening and closing windows and doors. While some parts are invisibly concealed between or within the frame and sash, others are prominently positioned and thus represent an essential link between the visual appearance and ease of operation. The fittings must be able to withstand different stresses, such as the hinge withstanding the weight of the sash or the handle withstanding operation by the user.

Here a renovation of an old building, a puristic reconstruction – the fittings can underline a certain stylistic direction or skilfully emphasize the key features.

Locking elements hidden / visible

Locking elements that lock the sash towards the frame may be located in different parts of the door or window. Locking takes place via a key or automated.

Locking with a key is available in a wide range of variants; there may be a visible lock or a barely visible solution, e.g. on the handle. Automated locking mechanisms or the locking sequence of the lock can be triggered by fingerprint, remote control or programming, for example. As a rule, the specific requirements in the area of the element to be locked are decisive. Another component of a lock can be a door closer. An automatic door closer is mandatory in many countries if the automatic closing of a door is required under building law due to increased risk of fire or smoke. Door closers are available surface-mounted or integrated between the sash and frame, so they are either visible or not.

The samples are taken from the virtual showroom.
For your own access, get in touch with us.



Door closer
surface-mounted



Door closer
concealed



Door with
2-barrel hinge,
powdercoated.



Door with 3-barrel
aluminium
screw-on hinge,
anodised



Door with
concealed
hinge

Hinges concealed/visible

The hinges that allow a door or window to rotate and ensure fine adjustment in relation to the frame are partly located on the element, partly on the frame. The choice of these functional parts also contributes to the overall impression. Hinges can be prominent or delicate. Painted in the colour of the door or window, they are barely visible or can even be mounted in a concealed location between the moving elements. On the other hand, they can also be highlighted in colour to emphasise the technical aspect or add stylistic accents, for example.

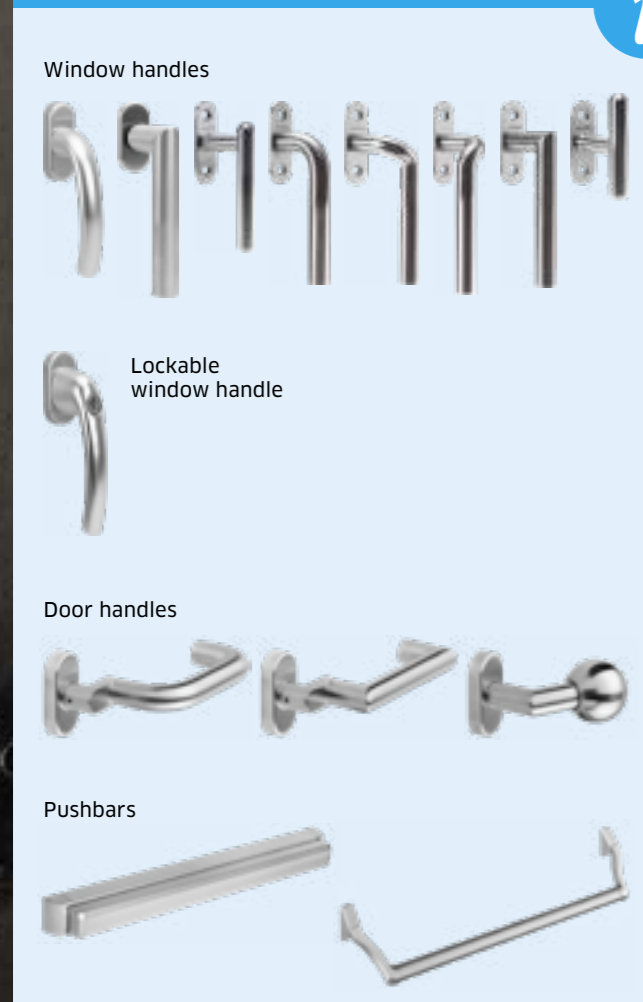

Handles

The handles are the most exposed parts of the fittings. These should be positioned in an easily accessible position, but can be positioned in an eye-catching and restrained way, e.g. in recessed grips. As a rule, visually appealing specimens are desired. It is important to ensure that the handles are used all the time and are designed to ensure different functions. They have to be permanently usable and easy to operate and also withstand the forces of the leaf. In public buildings, the anti-panic regulations must be observed, among other things, which are intended to ensure rapid departure and require the appropriate type of fittings. Handles should be comfortable to grip and should not be sharp-edged or attached too close to the profile, ensuring that they are easy to grip.

In highly frequented areas, the decision may be taken not to use handles in order to prevent germs from being passed on from one hand to another. Automatic doors that open without contact or corresponding coatings on the handles, which themselves have an antimicrobial effect, are useful here.

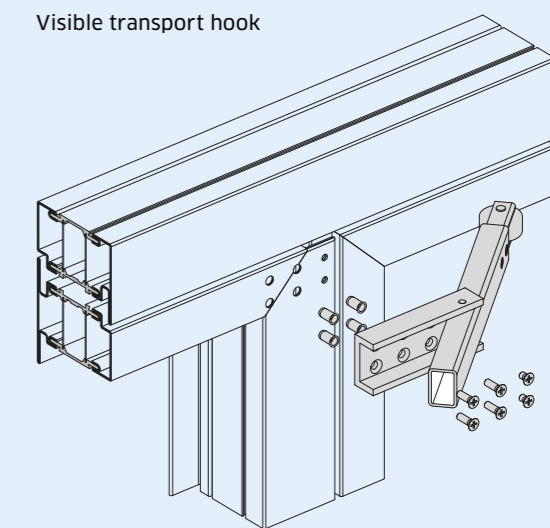
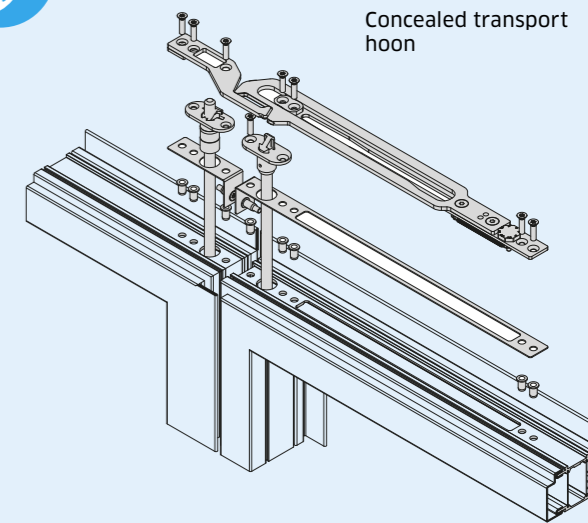

Transport hooks/selector bars

Simultaneous opening of double-leaf doors in the event of an escape is ensured by means of transport hooks and selector bars. These are mandatory for designated escape doors. In addition to visible selector bars, which often have a negative effect on the appearance of the elements due to their mechanics, there are concealed transport hooks. These retain the elegant overall appearance of the door and also serve to open both leaves at the same time in an emergency.

Design for users – Make wishes come true

At Jansen, the focus is always on the users. The first questions to ask are therefore related to their needs and requirements: How does the product fulfil the desired functions? Does it fit with the rest of the design concept and other components? Is it intuitive and comfortable to use? What visual effect should it have?

In order to simplify the respective development process, Jansen distinguishes between the user of the end product and the user during the construction phase of a building, i.e. the architect/planner/metalworker. The following is about the needs of the end user, while the chapter 'Design for Practitioners' is dedicated to the various users involved in the implementation.

“ First of all, it must be functional, because otherwise it will not exist for very long. So for me, it is very important that a design is easy to use in the first place. ”

Philippe Depotter



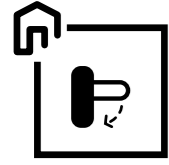

Operation – Easy to use

High-quality windows and doors are expected to be easy, pleasant and self-explanatory to use, without neglecting aesthetics. For this reason, Jansen tests handles, hinges and opening sequences for ease of movement and durability. Only high-quality products which, unless tested by Jansen itself, already meet the necessary requirements from the supplier's side are used. Intuitive operation should appeal to the user, but also be a matter of course.

Easy movement

Ease of movement is a verifiable variable and is defined by standards. DIN EN 12217, for example, regulates the operating forces on doors. This includes the force that has to be used to make a door move. The force is expressed in newtons and can therefore be easily converted to a standard measurement such as kilograms.

Motorisation

Smooth operation can also be achieved by means of motorisation. In this case, windows, doors or sliding doors are actuated by means of motion detectors, fingerprint or push buttons to initiate an automatic opening. These elements support barrier-free and contact-free passage and allow fresh air to be supplied by means of building automation or windows that are difficult to access.

Smart connections

Whether it's an office, administrative or private building, there are many ways to connect windows, doors and facades to a smart central building control system. For example, a smart system can be used to regulate the ventilation or automatically close a skylight using a rain sensor. Solar protection can also be controlled using smart systems. We go even further with a centrally scanned fingerprint that opens the front door.

Windows, doors, facades and glass panes can be controlled electronically and connected to a BUS-system. Compatibility and knowledge of the exact requirements of the residents as well as the possibility of installing the respective connections or data carriers in the element are crucial.

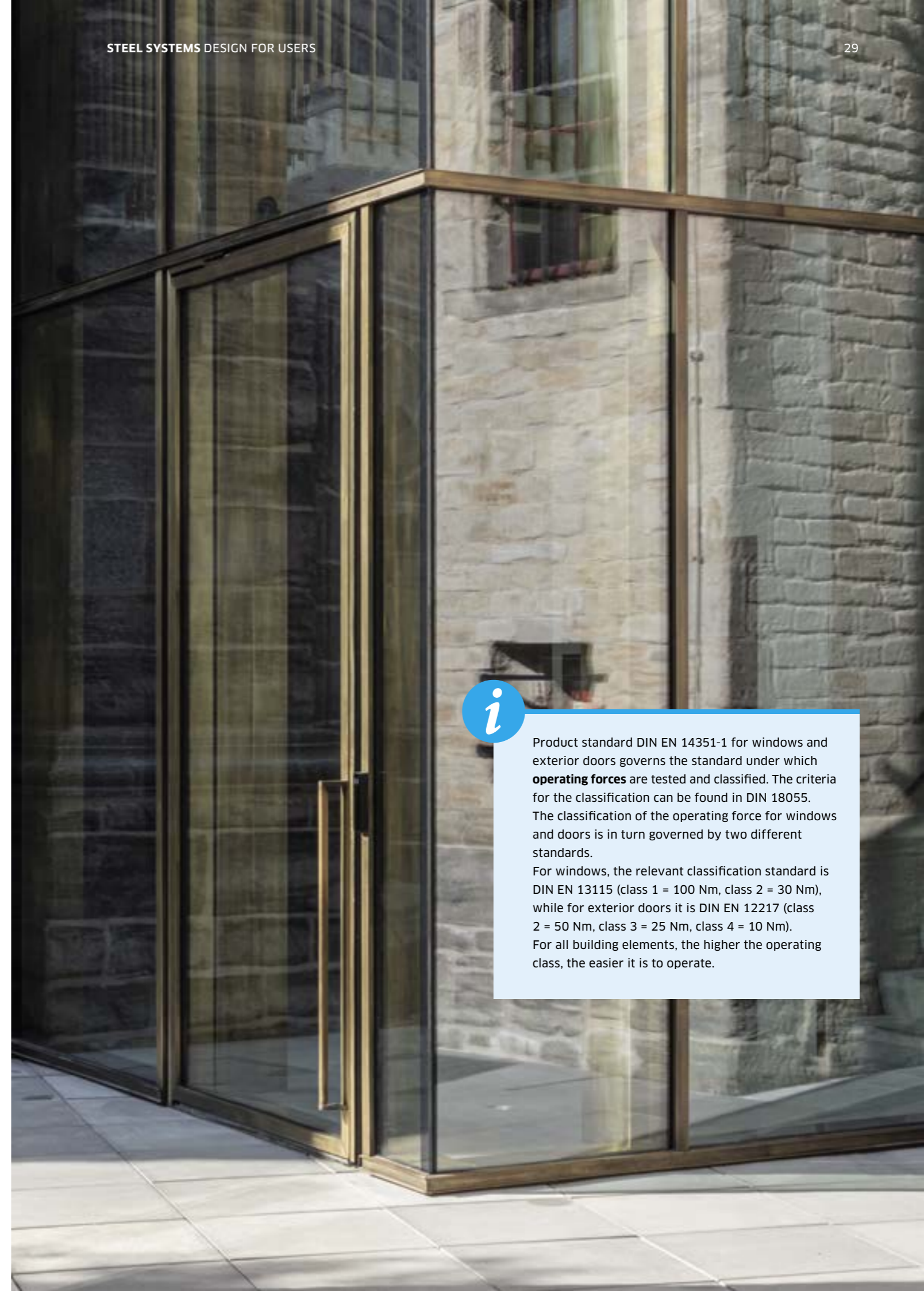

Product standard DIN EN 14351-1 for windows and exterior doors governs the standard under which **operating forces** are tested and classified. The criteria for the classification can be found in DIN 18055. The classification of the operating force for windows and doors is in turn governed by two different standards. For windows, the relevant classification standard is DIN EN 13115 (class 1 = 100 Nm, class 2 = 30 Nm), while for exterior doors it is DIN EN 12217 (class 2 = 50 Nm, class 3 = 25 Nm, class 4 = 10 Nm). For all building elements, the higher the operating class, the easier it is to operate.

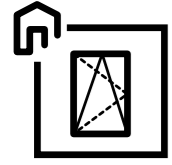

Opening variants – Developing creativity

The respective functional and aesthetic design requirements can be met by means of the different opening types of the windows and doors. Depending on the situation, special conditions in the building structure or legal regulations require certain types of opening. Elsewhere, the user is free to use elements according to their own wishes and needs.

Windows

Historically, windows have always had the largest variety of opening types. These are influenced by the position of the window, the amount of space available and the use of the building. In times of increasing density, for example, it is important that as little space as possible is lost due to the type of opening. This is why sliding elements, for example, are becoming increasingly popular.

1. Tilt-and-turn windows

Tilt-and-turn windows are the most widely used variants in Europe. They are usually used to open a window inwards, the whole sash to one side or the other, and by moving the handle further, to tilt the window with an opening at the top.

2. Top-hung window

With a top-hung window, only the flap opening type is possible. In contrast to a bottom-hung window, the resulting opening is always at the bottom of a top-hung window.

3. Vertical pivot window

With a pivot window, the window only rotates on its own vertically mounted axis of rotation when opened.

4. Projected top-hung windows

Projected top-hung windows are top-hung windows that can be opened outwards. The window sash sinks slightly when opened and can then be folded outwards.

5. Horizontal pivot window

With a horizontal pivot window, the sash rotates on its own axis when opened, with a horizontal axle bearing.

6. Sliding windows / lift-and-slide windows

With sliding windows, one or more window sashes are movable and can be moved to the side or upwards within the frame. With a lift-and-slide window, the sash is first lifted, then pushed to the side.

7. Folding sliding window

The folding sliding window consists of several window sashes, which are connected to each other by hinges. They allow the window to be opened almost across the entire width.

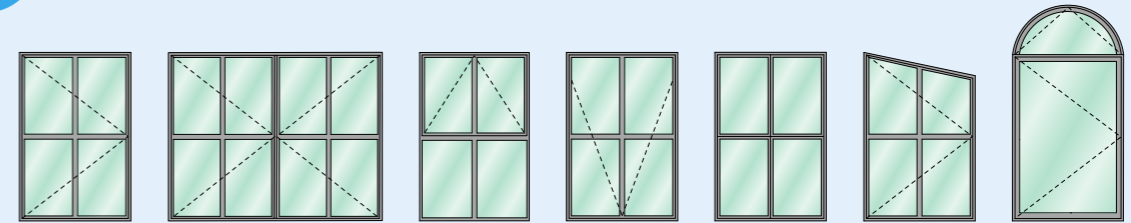

Tilt-and-turn windows

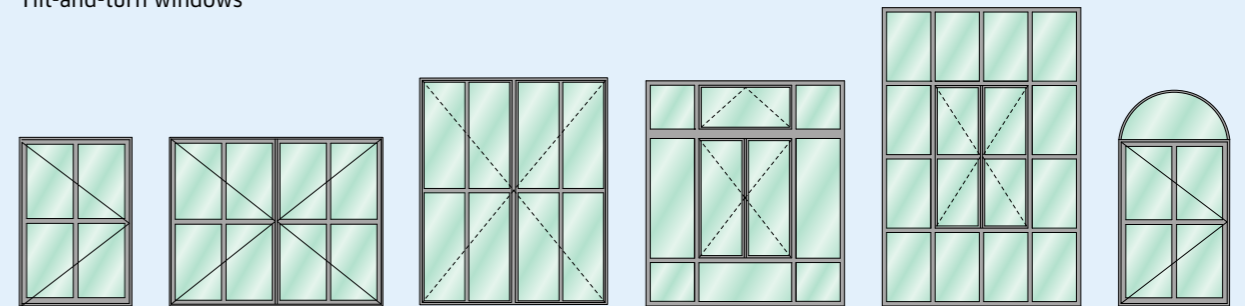

Tilt-and-turn windows

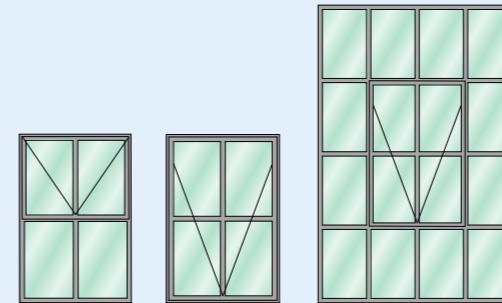

Top-hung window

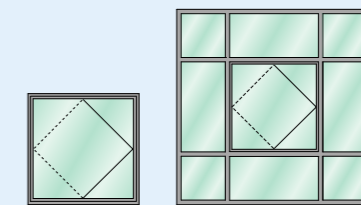

Vertical pivot window

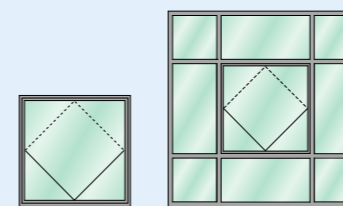

Horizontal pivot windows

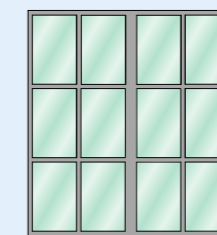

Fixed glazing

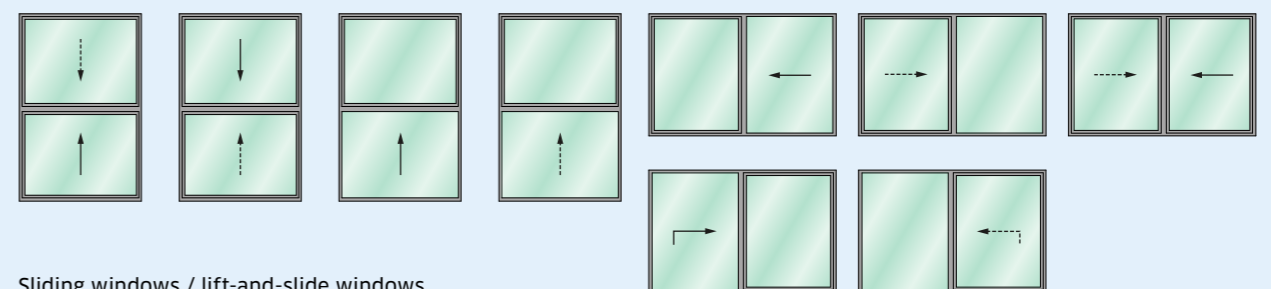

Sliding windows / lift-and-slide windows

Doors

Doors are functional interfaces that simultaneously separate what they connect. They can give entrances and passageways their own face and, depending on how they work, shape the type of passageway. In addition to the various materials and fillings, the opening types, which are differentiated by Jansen as follows, contribute to this:

1. Side-hung doors

The side-hung door is the most common door. It is attached to the side and can be swivelled inwards or outwards from the normal position (closed).

2. Swing doors

Swing door hinges on special frames make it possible to swing these doors both inwards and outwards. They are particularly suitable for high-frequency passageways.

3. Pivot doors

Pivot doors differ from the classic side door hinges, replacing the standard fastenings with pivot hinges. The wing axle has been offset and the pivot hinges are arranged on the upper and lower frame. The doors can be mounted centrally or off-centre and can be pivoted. This means that even very large door leaves can be used.

4. Sliding doors

For sliding doors, there are various more detailed designations depending on the opening option, such as lift-and-slide doors, slide-and-lift doors and parallel tilt-and-slide doors. Sliding doors may consist only of movable elements or also of fixed and movable elements. Depending on the type of arrangement, a distinction is made between different schemes (A, B, C etc.).

5. Folding sliding doors

Folding sliding doors generally run along rails and can result in very large openings due to the fact that the folding elements can be pushed together on one side of the opening and can be stowed away at the side to save space. The more leaves that can be assembled together, the larger the openings that can be created. However, ease of movement and safety have to be guaranteed.

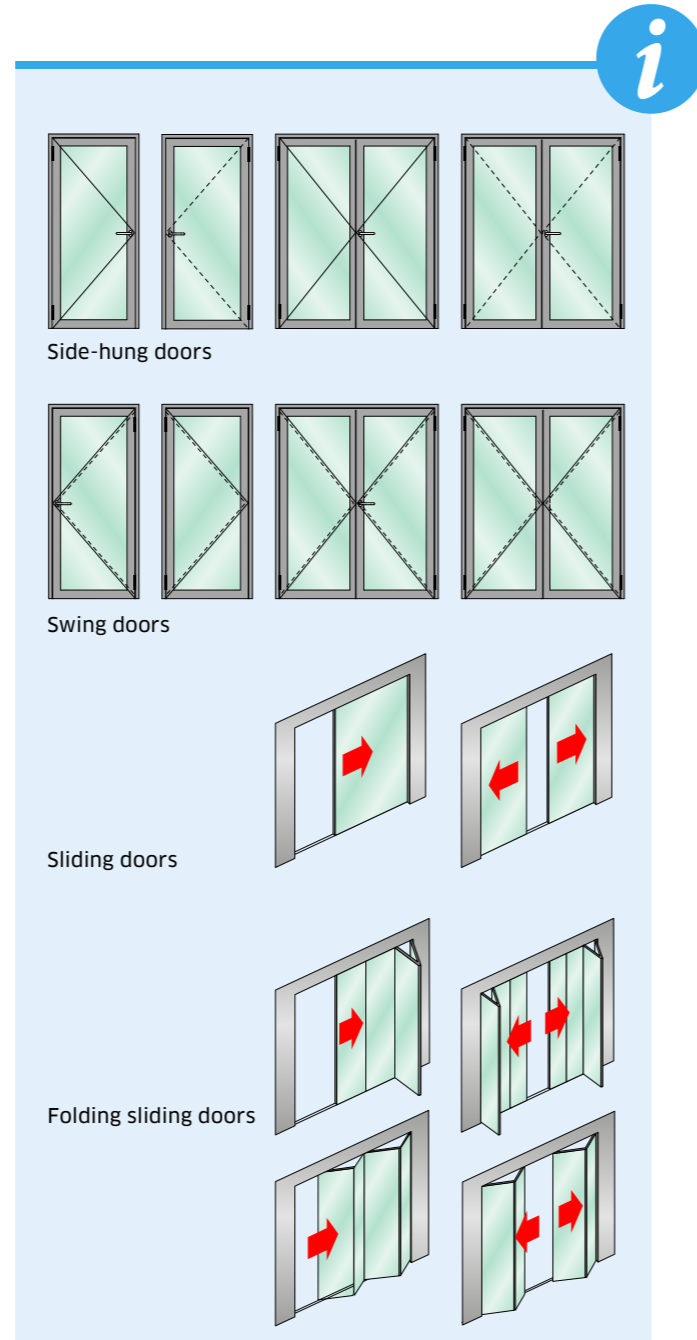

6. Anti-finger-trap doors

Anti-finger-trap doors offer no alternative opening variant other than the one mentioned above; their specific function also refers to the opening and closing of the doors: With anti-finger-trap doors, protection in the gap between the frame and leaf minimises the risk of fingers getting trapped there. This is particularly relevant in kindergartens and schools, for example. Jansen offers this function in various systems and with additional properties such as fire protection.

Fixed glazing / partition wall

Glass partition walls are strong design elements that visually connect rooms that need to be separated due to sounds, smells or functions. At the same time, they create transparency that ensures brightness and openness in the interior. For external walls, fixed glazing offers comparable possibilities with simultaneous consideration of heat insulation values and other safety features. They are also accompanying elements on doors or windows – at the side, top or bottom.

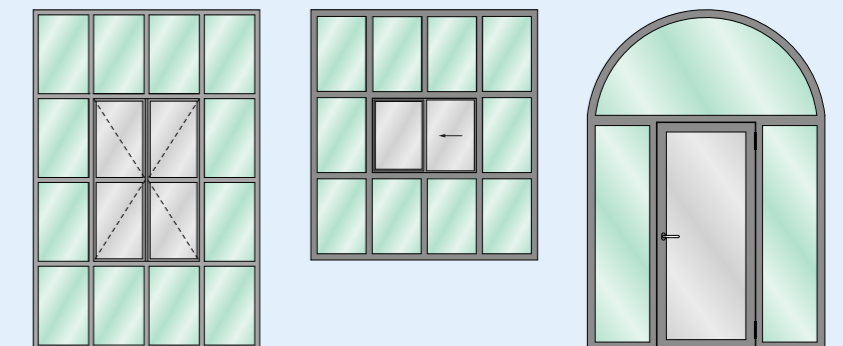



Sun protection – Can be used individually

In times of climate change, sun protection is becoming increasingly important. This involves both protection from light and thermal insulation. In this respect, careful consideration is required in the planning stage, as the orientation and use of a space are also critical. Mechanical sun protection, either continuous or with lamellae, can be installed inside or outside. Alternatively, it can also be integrated between two panes of multi-pane glass, protected from wind and weather. The various variants can also be controlled automatically or manually. If, on the other hand, you want to dispense with physical sun protection altogether, special, self-dimming glass can perform this task.

The steel systems for windows and facades from Jansen offer comprehensive flexibility for both architects and users, as the installation of third-party systems is completely open.





Longevity – Thinking sustainably

Sustainability is a decisive factor for contemporary building design in addition to function and appearance. This is why the durability of the materials also plays a major role in windows, doors and facades. Steel brings a great deal of added value here. Its material substance makes it extremely durable and weather-resistant. For building certifications, which are becoming increasingly important, the durability of steel systems is assessed with a lifespan of up to 100 years, depending on the country in Europe.

Jansen steel elements are also durable when it comes to handling and maintenance: Due to their load-bearing capacity, which has been proven in durability tests, these are predestined for heavily frequented buildings such as public buildings. Steel, a solid material, helps to ensure that long-lasting doors and windows can be used for many years, even with frequent use. Maintenance intervals are less frequent, but this also depends on the area of use. Maintenance intervals for fire doors, for example, are regulated by law rather than prescribed by the element or system provider.

Design for practitioners – Implementing planning security

When developing its products, Jansen involves all users who come into contact with the product – including those who are involved in the planning and realisation of buildings. This also includes the architect as a designer, who is the first to think intensively about windows, doors and facades during the planning phase.

Thanks to end-to-end digital data preparation for BIM applications, architects and planners already benefit from cooperation with Jansen at this early stage. Jansen also provides preproduced texts for calls for tenders which, depending on the intended purpose, only require minor adaptations or additions, e.g. in terms of size specifications. The planners deal with buildings in particular detail. They are the ones who need to be familiar with BIM and the standard calculation tools. Jansen offers software and training courses on both the program and its possibilities as well as on the technical details of the products relating to safety. Our commercial office provides comprehensive support with conceptual planning or required special solutions.

“ From the very beginning, we wanted to have a very filigree steel facade. Jansen also provided this in the form of a product which matches these specifications. ”

Christoph von Oefele



BIM models – Product twin

A BIM model is the digital twin of a product. Planners and architects can pull individual elements from central BIM libraries directly into the building they are planning. A building designed entirely in BIM makes the work of the architect easier and also offers decisive advantages for investors and building owners. This is because all transitions and interfaces between the trades are already defined exactly as they will be implemented later on on the construction site. In this way, inaccuracies and gaps can be avoided from the outset, thus limiting annoyance, time delays and cost jumps.

European guidelines already stipulate that the planning of public buildings must be carried out using BIM data in order to ensure transparency and to map interfaces neatly. Some of these guidelines have already been incorporated into the legal bases of individual countries, making BIM an obligation for the planning of all public buildings.

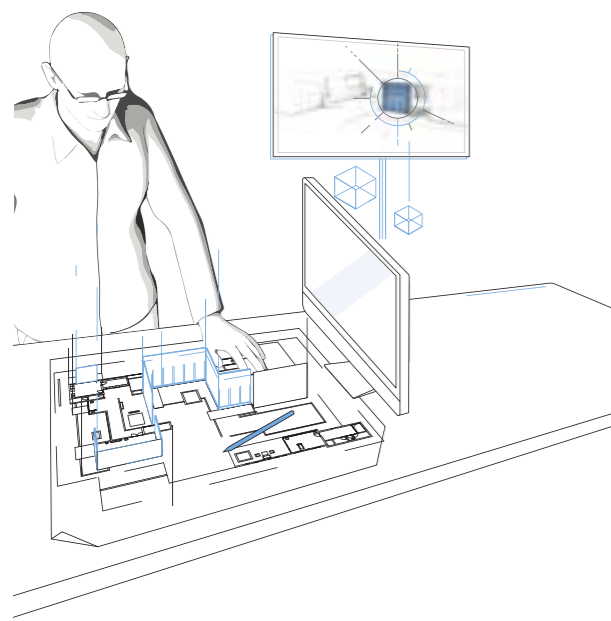

JANIssoft – Product configuration

The JANIssoft tool provided by Jansen allows, in particular, planners and metalworkers to make detailed plans. With JANIssoft, doors, windows and facades can be configured based on specifications. The system also offers the ability to generate order lists or cutting lists directly from these configurations. Consistent planning can prevent excess quantities and excess waste, which also leads to a reduction in costs. JANIssoft also includes interfaces for connecting machines, so that the exact data for recesses such as locks can be transferred directly from planning to the machine. This eliminates the source of errors resulting from manual data entry, thus removing the need for the metal fabricator to set up the machine.



Docu Center – Virtual database

The Jansen Docu Center is a virtual database in which Jansen collects all of its product support and makes it available to customers. There you can always find the latest versions of the delivery programmes or processing documents via the search function. Thanks to its simple structure, the Jansen Docu Center is self-explanatory and can be accessed from anywhere by anyone after registering. The relevant certificates and evidence required by the metal fabricator for declarations of performance and CE markings are also stored here. Jansen also uses the platform to explain how certain products are processed step by step using video tutorials.

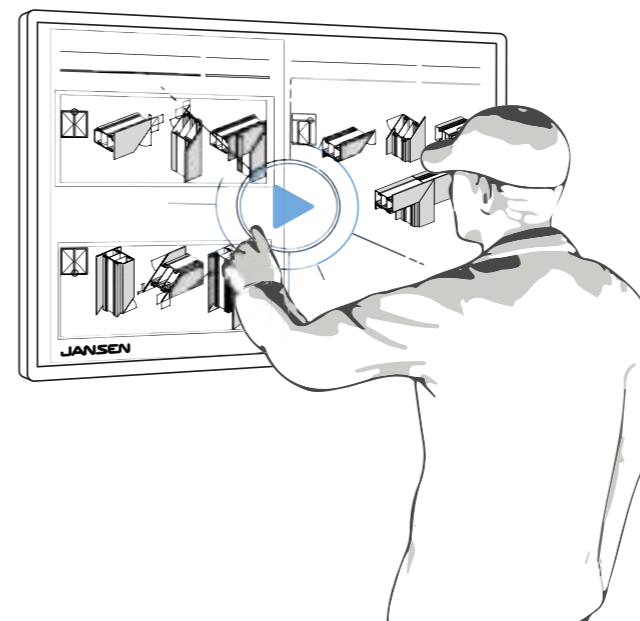

Processing – Automation and precision

Simple processing offers significant advantages for the metal fabricator, as it considerably reduces potential sources of error. Automation is supported by software and machine connection, and sources of error are avoided. Furthermore, in contrast to many other materials, the processing of steel also allows the production of continuous faces without mitre cuts for frames and sash profiles. The subsequent welding and grinding of the edges after composition of the workpiece is genuine craftsmanship. An aesthetically pleasing product is thus created at the highest level of precision.

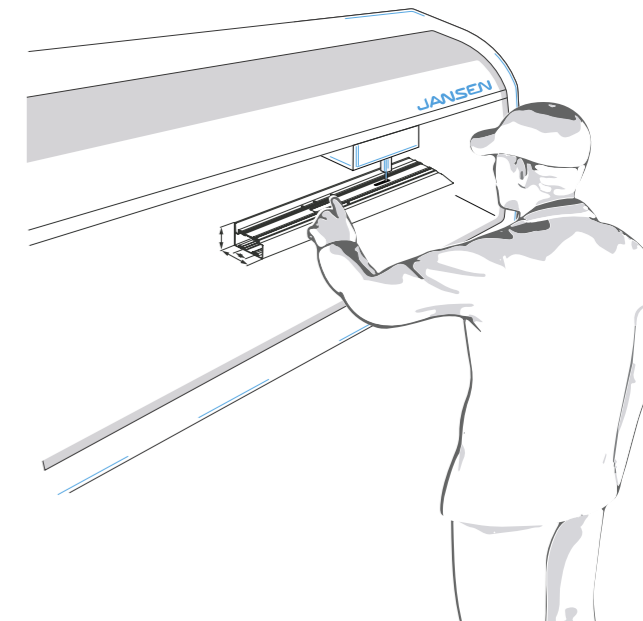

JANSEN – Complete solutions as a system provider

At Jansen, we see it as our duty as a system provider to offer comprehensive consistency. All components build on or complement each other. Processing guidelines with step-by-step explanations are available for the documented elements, sophisticated software support for system solutions and specialists for consulting on commercial solutions. The documented elements have been checked by us and the test results can be found in our respective delivery programme. At the same time, we aspire to provide a system guarantee for the elements manufactured according to our specifications, which even extends to the elements curved by us in house. Jansen is the only system provider in this sense to be able to offer a CE marking for special shapes. Details can be found in our brochure [Special geometry](#).



Design

			Windows								
			Arte 2.0	Arte 66	Art'System	Janisol	Janisol 1	Janisol Primo	Janisol HI	Economy 50	
For aesthetes Steel systems from Jansen open up the world of imagination in form, colour and expression	Transparency - Presenting a transparent view	Size specification for one leaf	min. (W x H)	370 x 370	480 x 470	310 x 310	370 x 575	330 x 535	370 x 575	600 x 600	370 x 575
			max. (W x H)	970 x 2370	1400 x 2300	872 x 2072	1475 x 2300	1225 x 2260	1475 x 2300	1435 x 2760	1475 x 2300
		Total element size	max. (W x H)				-		-	-	-
		Filling	Glass	x	x	x	x	x	x	x	x
			metal-clad	x	x	-	-	-	-	-	-
			metal-clad with glass cut-out	x	x	-	-	-	-	-	-
		SG solution		-	-	-	-	-	-	-	-
		Narrow face width	Narrowest face width of frame/leaf	45	53	55	82.5	-	82.5	90	82
	Designer glazing beads		x	x	x	x	-	x	x	x	
	Material / Surface finish - Representing materials	Steel	x	x	x	x	x	x	x	x	
		Stainless steel	x	-	-	x	-	-	-	-	x
		Corten steel	x	x	-	-	-	-	-	-	-
		Powder coating	x	x	x	x	x	x	x	x	x
		Wet paint	x	x	x	x	x	x	x	x	x
	Fittings - Designing the function	Hinges	concealed	-	x	-	x	-	x	x	x
			visible	x	-	x	x	-	x	x	x
		Door/window closer	concealed	-	-	-	-	-	-	-	-
			visible	-	-	-	-	-	-	-	-
		Handles	Knob	-	-	-	-	-	-	-	-
			Push-bar	-	-	-	-	-	-	-	-
			Pushbar	-	-	-	-	-	-	-	-
			Handle	x	x	x	-	-	x	x	x
	Transport hook	concealed	-	-	-	-	-	-	-	-	
		visible	-	-	-	-	-	-	-	-	
	Variants - Defining shapes	Round arch		x	-	x	x	-	x	-	x
		Trapezoidal windows/studio windows		x	-	x	x	-	x	x	x
		Fixed glazing		x	x	x	x	x	x	x	x
		Transom windows		x	x	x	x	x	x		x
		Side panels		x	x	x	x	x	x	x	x
		Pyramid		-	-	-	-	-	-	-	-
Domes			-	-	-	-	-	-	-	-	
Gable glazing			-	-	-	-	-	-	-	-	
Mono-pitch roof glazing			-	-	-	-	-	-	-	-	
Polygon glazing			-	-	-	-	-	-	-	-	
Design profiles			x	x	-	-	x	-	-	-	

Design

(**) for escape doors

			Façade			Roof glazing		Folding and sliding systems				
			VISS	VISS Basic	VISS SG/ Semi SG	VISS	VISS Basic	Janisol 2 E130	Janisol lift-and-slide doors	Janisol Arte 2.0 sliding doors	Janisol folding wall	
For aesthetes Steel systems from Jansen open up the world of imagination in form, colour and expression	Transparency - Presenting a transparent view	Size specification for one leaf	min. (W x H)	-	-	-	-	-	700 x 625	855 x 2090		600 (min. W)
			max. (W x H)	-	-	-	-	-	1400 x 2500	3310 x 3200	3000 x 2500	1000 x 2900
		Total element size	max. (W x H)	-	-	-	-	-	5900 x 4040	-	-	-
		Filling	Glass	x	x	x	x	x	x	x	x	x
			metal-clad	-	-	-	-	-	-	-	-	-
			metal-clad with glass cut-out	-	-	-	-	-	-	-	-	-
		SG solution		x	x	-	-	-	-	-	-	-
		Narrow face width	Narrowest face width of frame/leaf	-	-	-	-	-	70	113.5	x	82.5
	Designer glazing beads		-	-	-	-	-	-	-	x	x	
	Material / Surface finish - Representing materials	Steel		x	x	x	x	x	x	x	x	x
		Stainless steel	Glazing bead	-	-	-	Cover profiles	-	x	-	-	-
		Corten steel		-	-	-	-	-	-	-	-	-
		Powder coating		x	x	x	x	x	x	x	x	x
		Wet paint		x	x	x	x	x	x	x	x	x
	Fittings - Designing the function	Hinges	concealed	-	-	-	-	-	-	-	-	-
			visible	-	-	-	-	-	x (**)	-	-	x
		Door/window closer	concealed	-	-	-	-	-	x (**)	-	-	-
			visible	-	-	-	-	-	-	-	-	-
		Handles	Knob	-	-	-	-	-	-	-	-	-
			Push-bar	-	-	-	-	-	x (**)	-	-	-
			Pushbar	-	-	-	-	-	x (**)	-	-	-
			Handle	-	-	-	-	-	x (**)	x	x	x
	Transport hook	concealed	-	-	-	-	-	-	-	-	-	
		visible	-	-	-	-	-	-	-	-	-	
	Variants - Defining shapes	Round arch		-	-	-	-	-	-	-	-	-
		Trapezoidal windows/studio windows		-	-	-	-	-	-	-	-	-
		Fixed glazing		-	-	-	-	-	x	x	-	-
		Transom windows		-	-	-	-	-	x	-	-	-
		Side panels		-	-	-	-	-	x	x	-	-
		Pyramid		-	-	-	x	x	-	-	-	-
		Domes		-	-	-	x	x	-	-	-	-
		Gable glazing		-	-	-	x	x	-	-	-	-
Mono-pitch roof glazing			-	-	-	-	x	-	-	-	-	
Polygon glazing			-	-	-	x	x	-	-	-	-	
Design profiles			-	-	-	-	-	-	-	-	-	
Awards						Passive House certification	-	-	-	-		

Design

			Doors										
			Janisol	Janisol HI	Economy 50	Economy 60	Janisol 2 EI30	Janisol 2 EI30 70mm	Janisol C4 EI60/EI90	Arte 2.0 doors	Jansen Art'15	VISS side-hung doors	
For Users Jansen steel systems combine flexibility, security and practical functions	Operation - Easy to use	Easy movement	X	X	-	X	X	X	X	X	X	X	-
		motorized	-	-	-	X	X	X	X	X	-	-	-
	Longevity - Thinking sustainably	Total element size	-	-	X		X	X	X	X	X	-	-
		2-sash	X	X	X		X	X	X	X	X	X	X
	Opening variants - Developing creativity	Partition wall	X	X	X		X	X	X	X	X	X	-
		French doors	-	-	-		-	-	-	-	X	-	-
		Swing doors	-	-	X	-	X	-	-	-	-	-	-
		Pivot doors	-	-	-		-	-	-	-	-	-	-
		Sliding doors	-	-	-		X	-	-	-	-	-	-
		Folding sliding doors	-	-	-	X	-	-	-	-	-	-	-
		Anti-finger-trap doors	-	-	X		X	-	X	-	-	-	-
		Side-hung window	-	-	-		-	-	-	-	-	-	-
		Turn and tilt window	-	-	-		-	-	-	-	-	-	-
		Bottom-hung window	-	-	-		-	-	-	-	-	-	-
		Top-hung window	-	-	-		-	-	-	-	-	-	-
		Projected top-hung window	-	-	-		-	-	-	-	-	-	-
	Vertical pivot window	-	-	-		-	-	-	-	-	-	-	
Horizontal pivot window	-	-	-		-	-	-	-	-	-	-		
Sun protection - Can be used individually		X	X	-		X	X	X	X	X	X	-	
For practitioners Design means freedom in the composition by means of safety in the technical documentation and processing	JANISOFT - Product configuration		X	X	X		X	X	X	-	-	-	
	BIM models - Product twin		X	X	X		X	X	X	-	-	-	
	Processing - Automation and precision		simple	simple	-		X	X	X	X	X	-	

Design

			Windows							
			Arte 2.0	Arte 66	Art'System	Janisol	Janisol 1	Janisol Primo	Janisol HI	Economy 50
For Users Jansen steel systems combine flexibility, security and practical functions	Operation - Easy to use	Easy movement	X	X	-	X	-	X	X	X
		motorized	X	X	-	X	-	X	X	X
	Longevity - Thinking sustainably	Total element size	-	-	-	-	-	-	-	-
		2-sash	X	X	X	X	X	X	X	X
	Opening variants - Developing creativity	Partition wall	-	-	-	-	-	-	-	X
		French doors	X	-	-	-	-	-	-	-
		Swing doors	-	-	-	-	-	-	-	-
		Pivot doors	-	-	-	-	-	-	-	-
		Sliding doors	-	-	-	-	-	-	-	-
		Folding sliding doors	-	-	-	-	-	-	-	-
		Anti-finger-trap doors	-	-	-	-	-	-	-	-
		Side-hung window	X	X	X	X	X	X	X	X
		Turn and tilt window	-	X	-	X	X	X	X	X
		Bottom-hung window	X	X	X	X	X	X	X	X
		Top-hung window	X	-	-	-	-	-	-	-
	Projected top-hung window	X	-	-	-	-	-	-	-	
Vertical pivot window	X	-	-	X	-	X	X	-		
Horizontal pivot window	X	-	-	X	-	-	-	-		
Sun protection - Can be used individually		-	-	-	-	-	-	-	-	
For practitioners Design means freedom in the composition by means of safety in the technical documentation and processing	JANIssoft - Product configuration		X	X	X	X	X	X	X	
	BIM models - Product twin		X	X	X	X	X	-	X	
	Processing - Automation and precision		medium	medium	simple	medium	simple	medium	-	medium

Design

			Façade			Roof glazing		Folding and sliding systems			
			VISS	VISS Basic	VISS SG/ Semi SG	VISS	VISS Basic	Janisol 2 EI30	Janisol lift-and-slide doors	Janisol Arte 2.0 Sliding doors	Janisol folding wall
For Users Jansen steel systems combine flexibility, security and practical functions	Operation - Easy to use	Easy movement	-	-	-	-	-	X	X	X	X
		motorized	-	-	-	-	-	X	-	-	-
	Longevity - Thinking sustainably	Total element size	-	-	-	-	-	-	X	-	-
		2-sash	-	-	-	-	-	X	Up to 4 sashes	X	Up to 6 sashes
	Opening variants - Developing creativity	Partition wall	-	-	-	-	-	-	-	X	-
		French doors	-	-	-	-	-	-	-	-	-
		Swing doors	-	-	-	-	-	-	-	-	-
		Pivot doors	-	-	-	-	-	-	-	-	-
		Sliding doors	-	-	-	-	-	X	X	X	-
		Folding sliding doors	-	-	-	-	-	-	-	-	X
		Anti-finger-trap doors	-	-	-	-	-	-	-	-	-
		Side-hung window	-	-	-	-	-	-	-	-	-
		Turn and tilt window	-	-	-	-	-	-	-	-	-
		Bottom-hung window	-	-	-	-	-	-	-	-	-
	Sun protection - Can be used individually	Top-hung window	-	-	-	-	-	-	-	-	-
		Projected top-hung window	-	-	-	-	-	-	-	-	-
For practitioners Design means freedom in the composition by means of safety in the technical documentation and processing	JANISOFT - Product configuration	Horizontal pivot window	-	-	-	-	-	-	-	-	-
		X X -	X X -	- - -	Easy to connect	-	-	-	-		
		X X -	X X -	X X -	X X -	X X -	X X -	X X -			
BIM models - Product twin	X - -	- - -	- - -	- - -	- - -	- - -	X - -	X - -	X - -	X - -	
											X - -
Processing - Automation and precision	X - -	- - -	- - -	- - -	- - -	- - -	X - -	X - -	- - -	- - -	

If there are any differences between this document and the current German version (Jansen item no. K1219744), the applicable version of the original German text in the Jansen Docu Center shall prevail.

K1219745 | Steel Systems 1.06.2022 | Subject to change without notice

Jansen AG

Steel Systems
Industriestrasse 34
9463 Oberriet
Switzerland
jansen.com

JANSEN