



MODULAR and  
COMPACT SOLUTIONS

# E-LINENDK

Modular and Compact Solutions for Under floor and Raised Flooring

# EAE GROUP IN NUMBERS



## Since 1973

EAE Group of Companies started its journey in the electrical sector in 1973 with the establishment of EAE Elektrik. Since its founding, EAE has grown rapidly, expanding its production and areas of operation by incorporating EAE Lighting in 1983, EAE Machinery in 1996, EAE Electrotechnics in 2004, and EAE Technology in 2009.

EAE carries out its production activities in accordance with ISO 9001 Quality Management, ISO 14001 Environmental Management, ISO 14064-1 Greenhouse Gas Management System, ISO 45001 Occupational Health and Safety Management, ISO 10002 Customer Satisfaction Management, ISO 50001 Energy Management System, and ISO 27001 Information Security Management System standards.



**50+**  
Years Experience



**8**  
Active Factories



**370.000m<sup>2</sup>**  
Enclosed Space



**3**  
R&D Centers



**150+**  
Countries Exported To

# CONTENTS

---

E-LINE NDK MX 1 Floor Socket Box.....	2
E-LINE NDK MX 2 Floor Socket Box.....	3
E-LINE NDK-MX 1 and E-LINE NDK-MX 2 Underfloor Application .....	4
E-LINE NDK-MX 1 and E-LINE NDK-MX 2 Raised Floor Application .....	5
E-LINE NDK-F Screed and Raised Flooring Solutions .....	6
E-LINE NDK CX1 - CX2 Compact Solutions Floor Socket Box .....	7
E-LINE NDK-CX Mini Compact Solutions Floor Socket Box.....	8
E-LINE DK Locked CX-1 Lockable Floor Socket Box.....	9
E-LINE NDK-CX Stainless Steel Covered Compact Socket Box and Order Codes .....	10
E-LINE NDK-GRM DK Grommet 6 Modules .....	11
E-LINE DK-GRM DK Grommet 3 Modules.....	13
E-LINE NDK-SM FLEX Cable Organizer and Cable Pass-Through Modules .....	15
E-LINE NDK-MINI IP-66 C-Box Socket Box (6 Modules).....	16
E-LINE NDK-MINI IP-66 R-Box Socket Box (6 Modules).....	17
E-LINE NDK-MINI IP-40 P-Box Socket Box .....	18
E-LINE DB-DKL Exit and Pull Box Solutions.....	19
Outlets / Accessories Order Codes .....	20
Old Generation Junction Box Order Codes .....	23
E-LINE NDK General Product Features .....	24
Certificates .....	25
CE Declaration of Conformity .....	26

# E-LINE NDK-MX

## Floor Socket Boxes

### Under-Screed and Raised Flooring Solutions



**E-LINE NDK-MX1**; The new series of socket boxes, with two different models, offers rich, comfortable, and aesthetic options for both screed and raised flooring applications.

It offers practical solutions with a box body and a cover compatible with the filling plastic or stainless filling plate, suitable for the floor.

- **NDK-MX 1**; 250x250mm (16 and 24 Modules)

(Minimum Screed Height; 70mm)

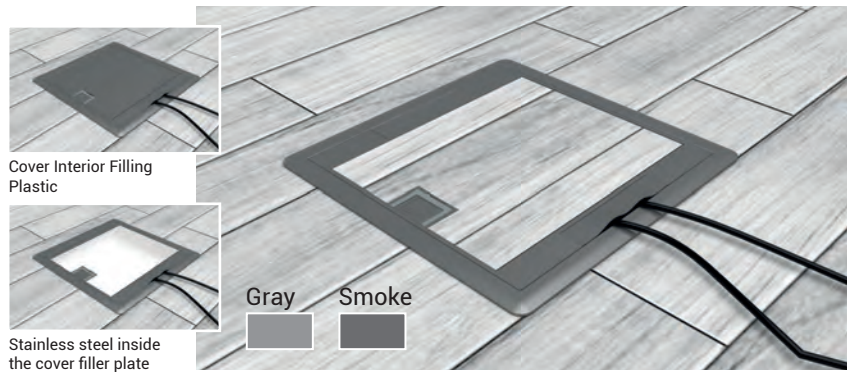

### General Construction

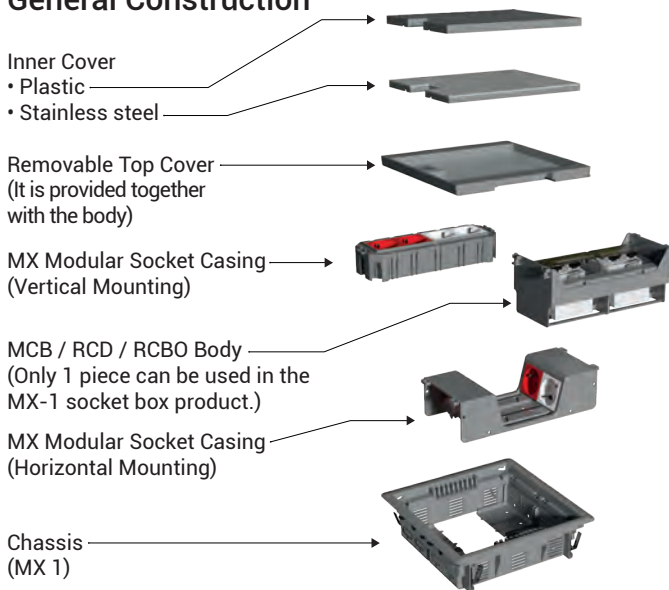

Order Codes		
Description	Gray	Smoke
NDK-MX 1 Socket Box, 16 Modules, Complete	3122702	3122703
NDK-MX 1 Socket Box, 24 Modules, Complete	3122704	3122705
NDK-MX 1 Cover Interior Filling Plastic	2057342	2057345
NDK-MX 1 Stainless Steel Cover Inner Filling Plate	2057339	
DB-MX1 (360X360) Under-screed Junction Box	3082311	

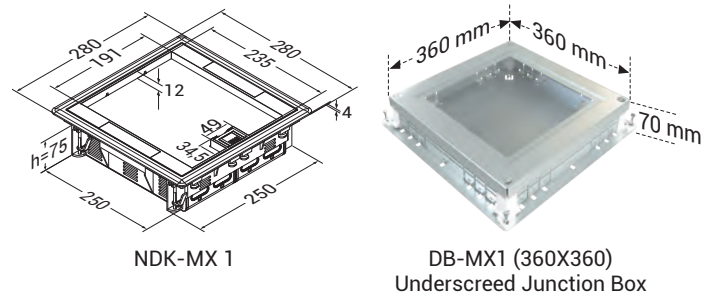

### Flexibility of Use



### Floor Cutting Dimension

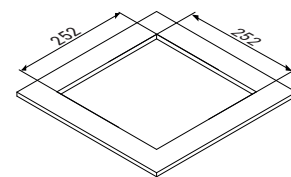

#### NDK-MX 1 (24 Modules) Vertical Mount Usage



Using 3 vertical-type socket enclosures, a total capacity of 24 modules is achieved through 'vertical' socket installation.

#### NDK-MX 1 (16 Modules) Horizontal Mount Usage



Using 2 modular socket enclosures, a total capacity of 16 modules is achieved through 'horizontal' socket installation.

#### NDK-MX 1 (16 and 24 Modules) Inner Cover

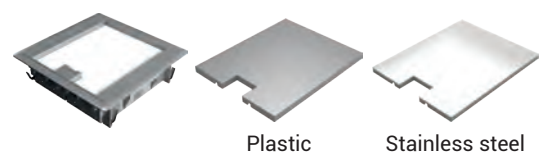

The inside depth of the cover is 12 mm, and the flooring material can be cut to fit within these dimensions for use as cover interior filling. If needed, stainless steel or plastic cover filling plates can also be ordered and used.

- The plastic material is "Halogen-free".
- Except for all kinds of sockets. Determine your needs from pages 23, 24 and 25 and place a separate order.
- Except for all kinds of junction boxes and channels. Determine your needs from pages 20,21 and 22 and place a separate order.

Dimensions are in millimeters.

# E-LINE NDK-MX

## Floor Socket Boxes

### Under-Screed and Raised Flooring Solutions



**E-LINE NDK-MX2;** The new series of socket boxes offers rich, comfortable, and aesthetic options for both subfloor and raised floor applications with its two different models.

It offers practical solutions that are compatible with the box body and the flooring, using cover interior filling plastic or stainless steel filling plates.

• **NDK-MX 2;** 146x250mm (8 Modules)

(Minimum Screed Height; 70mm)

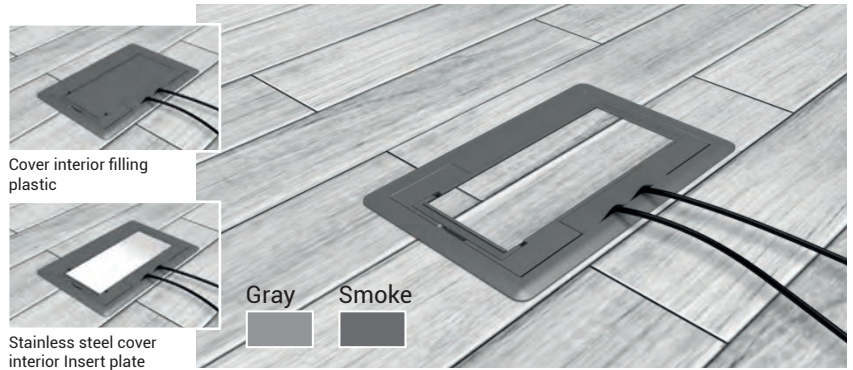

### General Construction

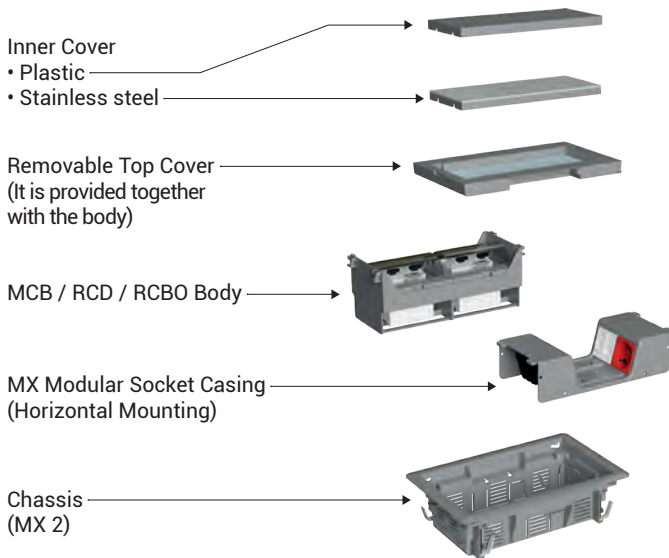

Order Codes		
Description	Gray	Smoke
NDK-MX 2 Socket Box, 8 Modules, Complete	3122709	3122711
NDK-MX 2 MCB/RCD/RCBO Casing Complete	3336231	3336232
NDK-MX 2 Cover Interior Filling Plastic	2065384	2065387
NDK-MX 2 Stainless Steel Cover Inner Filling Plate	2065388	
DB-MX2 (360X360) Under-screed Junction Box	3082312	

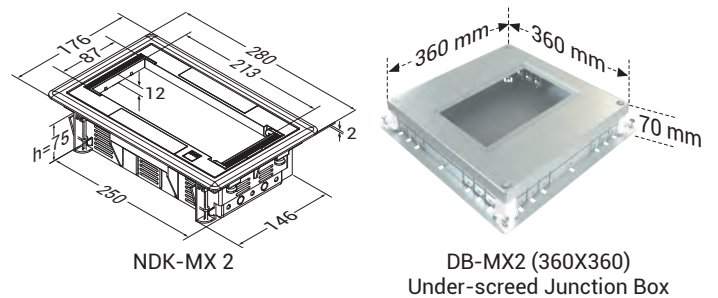

### Flexibility of Use

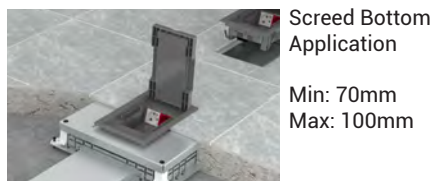

### Floor Cutting Dimension

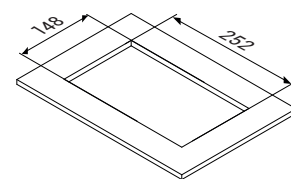

### Elevated Flooring Thicknesses

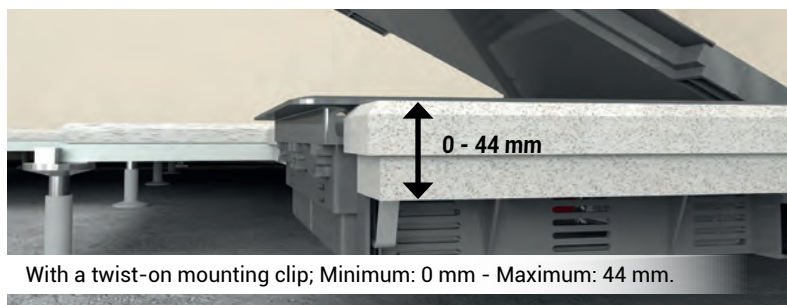

### NDK-MX 2 (8 Modules) Inner Cover



- Please specify your mounting clip option according to the floor thickness exceeding 44 mm. Otherwise, a twist-on type mounting clip will be provided.
- The plastic material is "Halogen-free".
- Except for all kinds of sockets. Determine your needs from pages 23, 24 and 25 and place a separate order.
- Except for all kinds of junction boxes and channels. Determine your needs from pages 20,21 and 22 and place a separate order.

Dimensions are in millimeters.

# E-LINE NDK-MX

## Floor Socket Boxes

### NDK-MX Underfloor Application

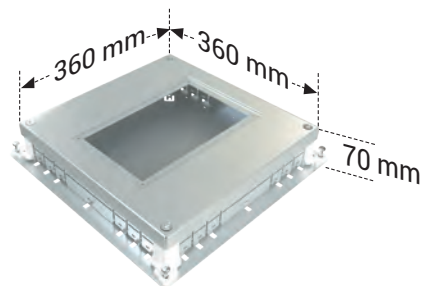
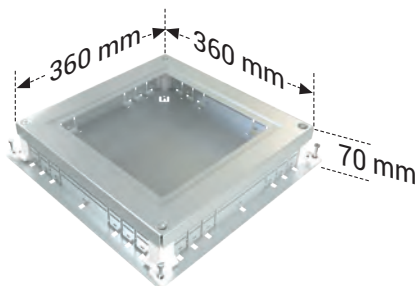
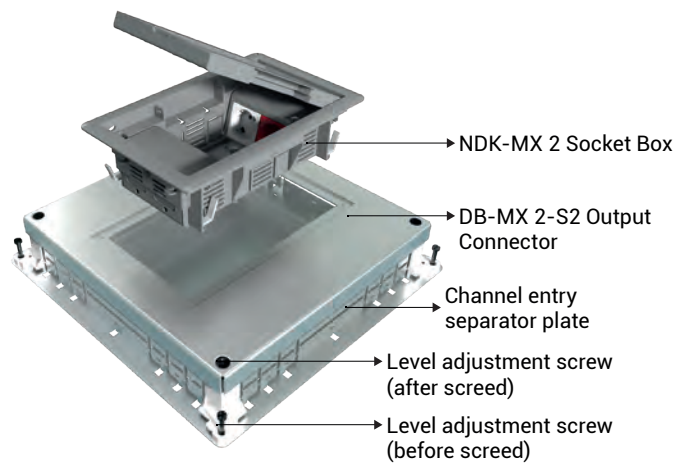
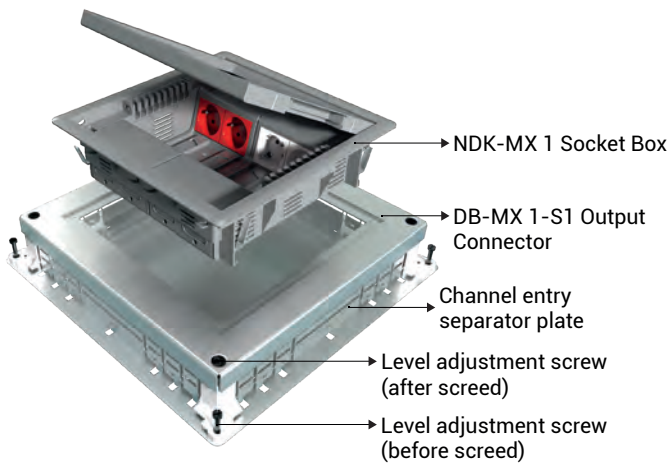

All busbar units allow cable tray entry from four sides, and the junction box can be mounted from any of the four directions. The cable tray entry separators made from galvanized sheet metal on all four sides of the busbars enable the use of cable trays with four different sizes under the modular design.

(\*1) A cover plate must be ordered separately for socket busbars that do not contain junction box.

(\*2) The visuals are provided for the MX-1 junction box and the internal space of the busbar is 252x252mm. For the MX-2 junction box the internal space of the busbar is 148x252mm.

Junction Box Cover Plate		
	DB-MX1 BK	DB-MX2 BK
	280x280mm	176x280mm
Order Code	<b>3082317</b>	<b>3082318</b>

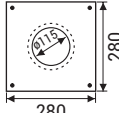
Grommet Special Junction Box Cover Plate	
	DK Grommet 3 Modules
	ø115mm
Order Code	<b>3126734</b>

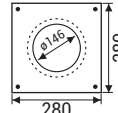
Grommet Special Junction Box Cover Plate	
	DK Grommet 6 Modules
	ø146mm
Order Code	<b>3126735</b>

### NDK-MX 1 Underfloor Application Example

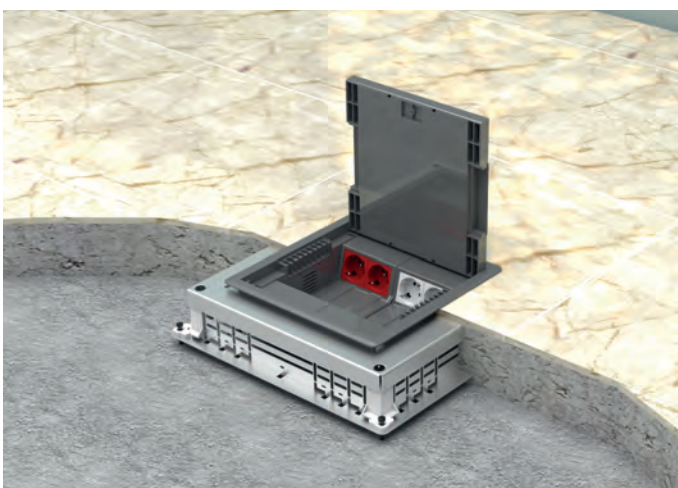

### NDK-MX 2 Underfloor Application Example

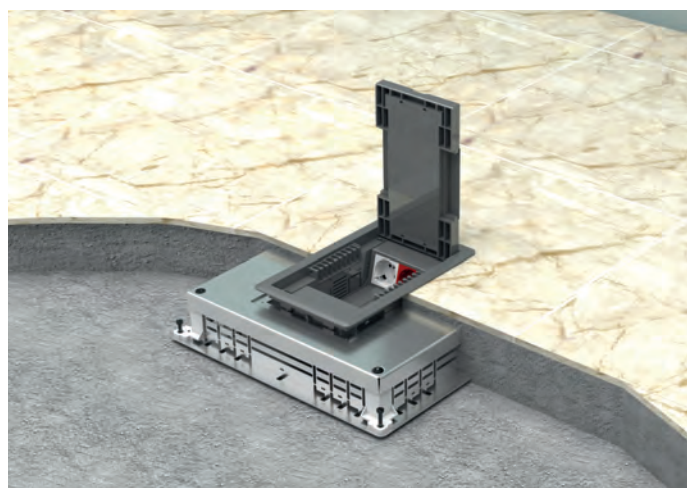

# E-LINE NDK-MX

## Floor Socket Boxes

### NDK-MX Raised Floor Application



**NDK-MX 1**  
Raised Floor Application Example

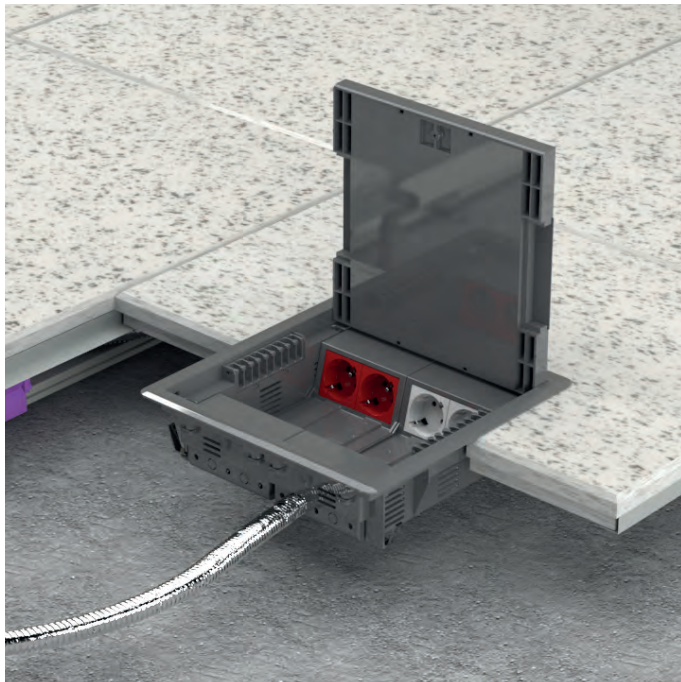

**NDK-MX 2**  
Raised Floor Application Example



Raised floor thickness (h);

- With twist-on mounting clip; min: 0 - max: 44mm.
- With flat mounting clip; it can be between min: 25mm and max: 65mm. Please specify this detail in your order.

### E-LINE NDK-MX (Raised Floor Usage)

The NDK-MX series socket boxes can be easily used for raised floor applications. There is no need for a connector or housing. They can be easily mounted using metal fixing clips.

### Two-Way Cover Installation

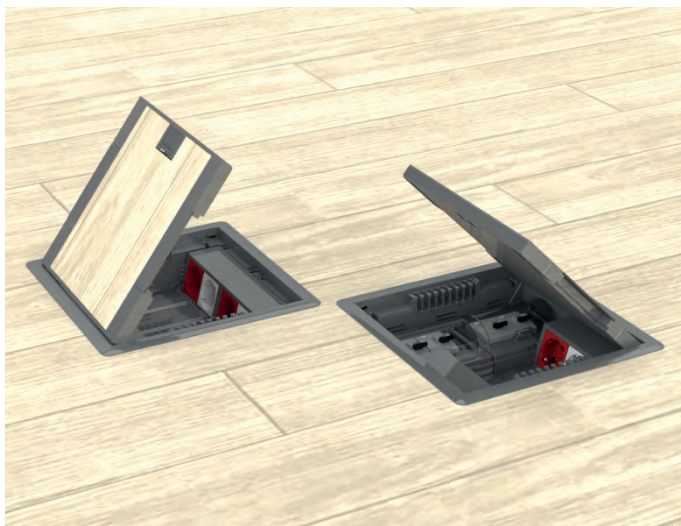

### Use with MCB or RCBO Housing



# E-LINE NDK-F

## Floor Socket Boxes

### Under-Screed and Raised Flooring Solutions



**E-LINE NDK-F;** The new series floor socket boxes offers rich, comfortable, and aesthetic options for both under screed and raised floor applications.

The cover insert plastic or stainless steel filling plate, along with the box body, offers practical solutions that are compatible with the floor and provide convenience.

- **NDK-F 7;** 250x250mm (16 Modules), 70mm min. screed height

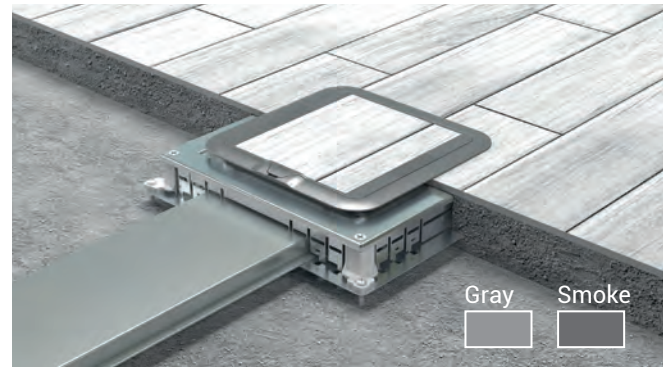

### General Construction

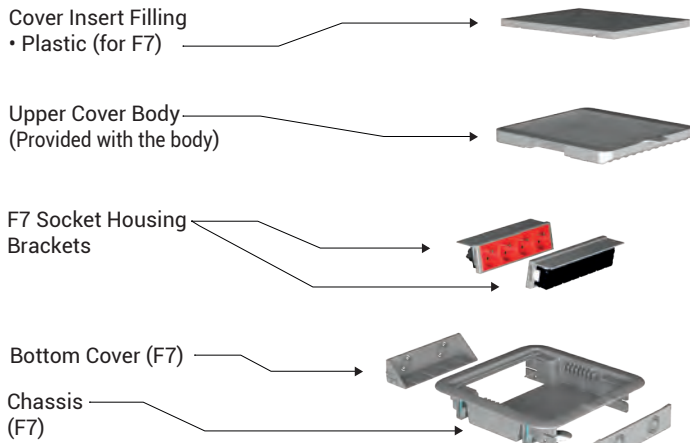

Order Codes		
Description	Gray	Smoke
NDK-F 7 Compact Socket Box, 16 Modules, Complete	3137282	3137285
NDK-F 7 Cover Interior Filling Plastic	2067319	2067322
DB-F7 (360X360) Under Screed Junction Box	3082311	

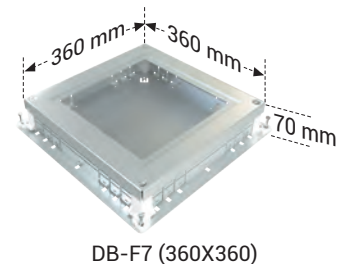
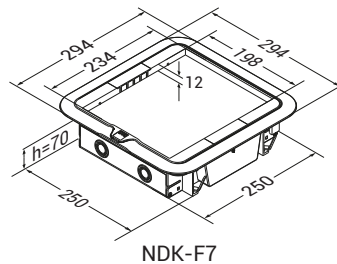

- Except for all kinds of sockets. Determine your needs from pages 23, 24 and 25 and place a separate order.

### Flexibility of Use



### Floor Cut Measurement

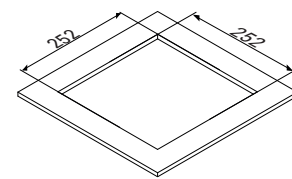

### 180° Degree Opening Top Lid



### Aesthetic Socket Window

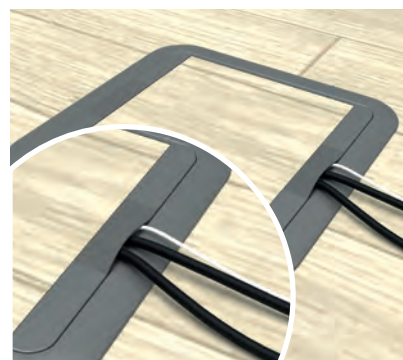

### Mounting Clips

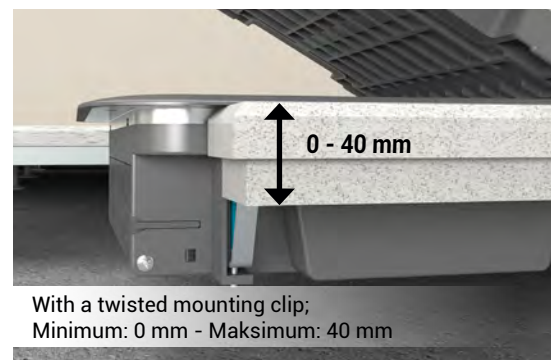

- The plastic material is "Halogen-free".
- Except for all kinds of junction boxes and channels. Determine your needs from pages 20, 21 and 22 and place a separate order. Dimensions are in millimeters.

# E-LINE NDK-CX

## Stainless Steel Covered Compact Socket Boxes

### Compact Solutions for Underfloor and Raised Flooring



**E-LINE NDK-CX;** The new series of compact socket boxes offers heavy-duty and alternative solution options for both underfloor and raised flooring applications with its galvanized steel body and reinforced stainless steel cover structure.

It provides practical solutions that are compatible with the box body thanks to the stainless steel filler plate inside the cover.

- **NDK-CX Mini;** 140x140x96mm (8 Modules)
- **NDK-CX 1;** 244x244x96mm (16 Modules)
- **NDK-CX 2;** 320x244x96mm (24 Modules)

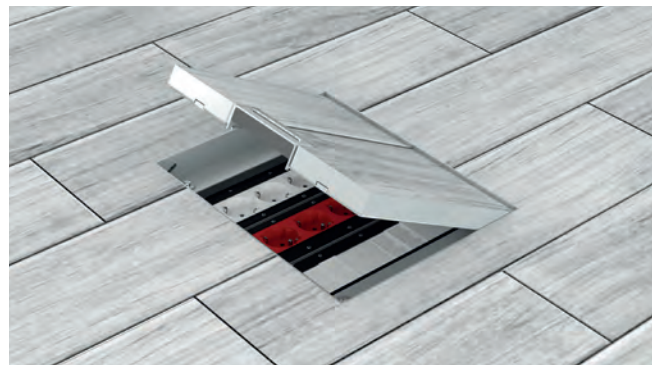

### General Construction

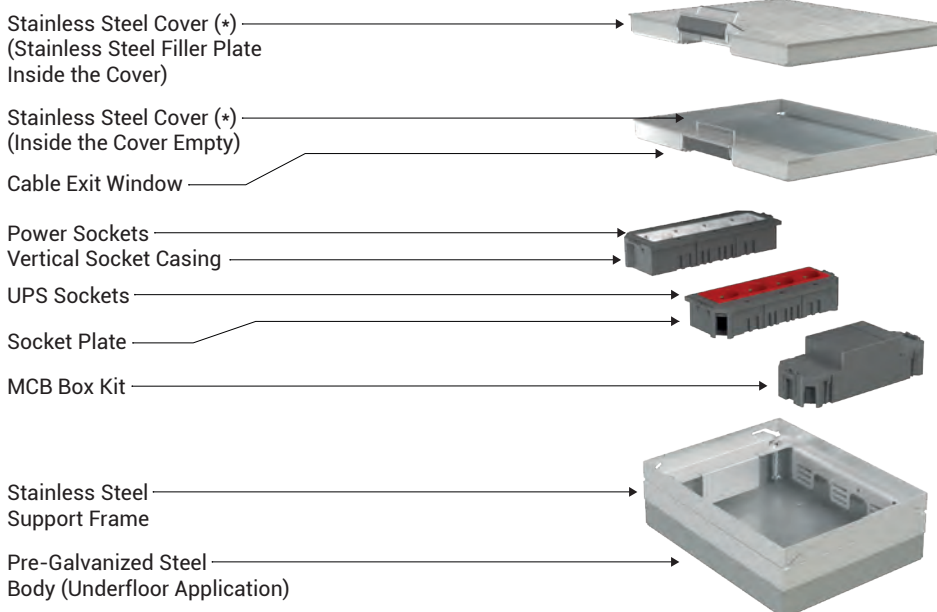

• Except for all kinds of sockets. Determine your needs from pages 23, 24 and 25 and place a separate order.

### 3 Different Capacity Options

**NDK-CX Mini (8 Module)**  
Floor Cut Size

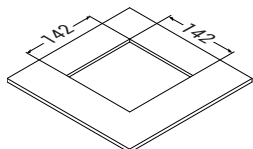

**NDK-CX 1 (16 Module)**  
Floor Cut Size

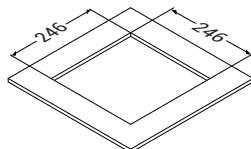

**NDK-CX 2 (24 Module)**  
Floor Cut Size

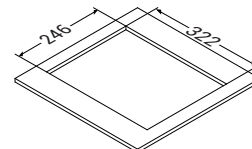

### Height Adjustment



The minimum screed height should be determined taking into account the thickness of the top covering material.

The total height of the top covering, together with the screed, cannot exceed the maximum heights provided on page 13. NDK-CX type compact socket boxes, thanks to their height adjustment screws, offer adjustment options at a single point both before and after screeding.

### Inside Cover Height



The inside cover height of NDK-CX type compact socket boxes is a standard 20mm.

(\*) It can be manufactured in the desired dimensions according to the type and thickness of the floor.

• The plastic material is "Halogen-free".

Dimensions are in millimeters.

# E-LINE NDK-CX

## Floor Socket Boxes

### NDK-CX Mini

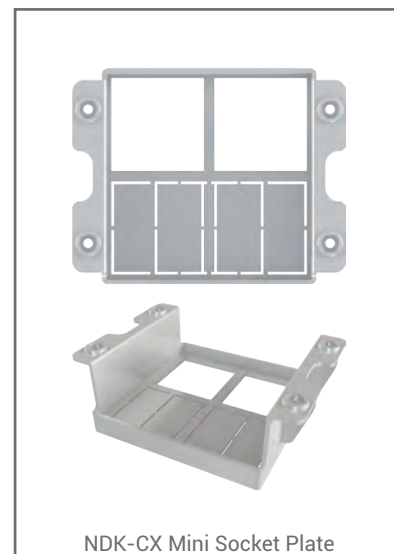
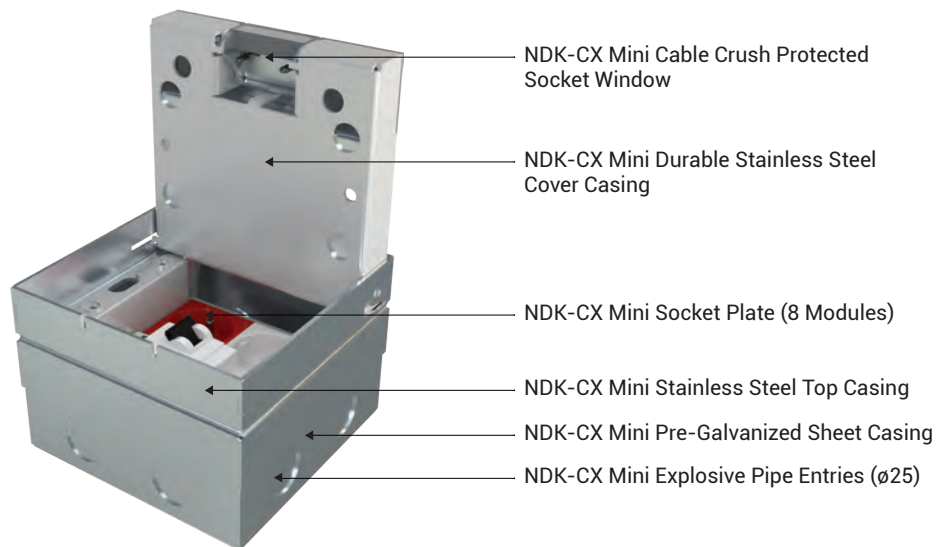

### Other Features

#### Fuse Module

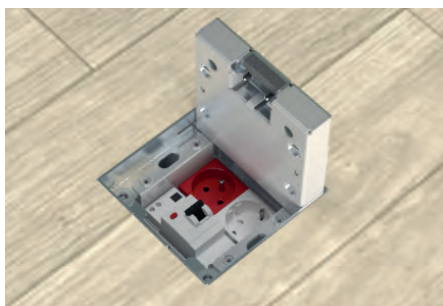

#### Different Unbreakable Cover Options & Protected Cable Socket Window

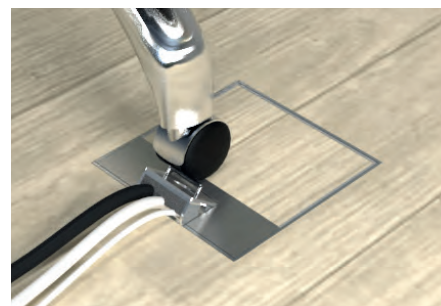

#### NDK-CX Mini Under-Screed Application Example

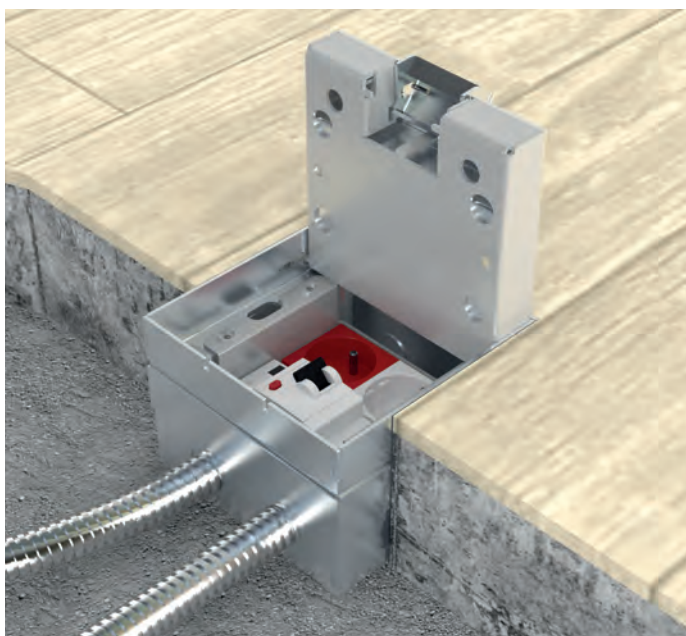

#### NDK-CX Mini Raised Floor Application Example

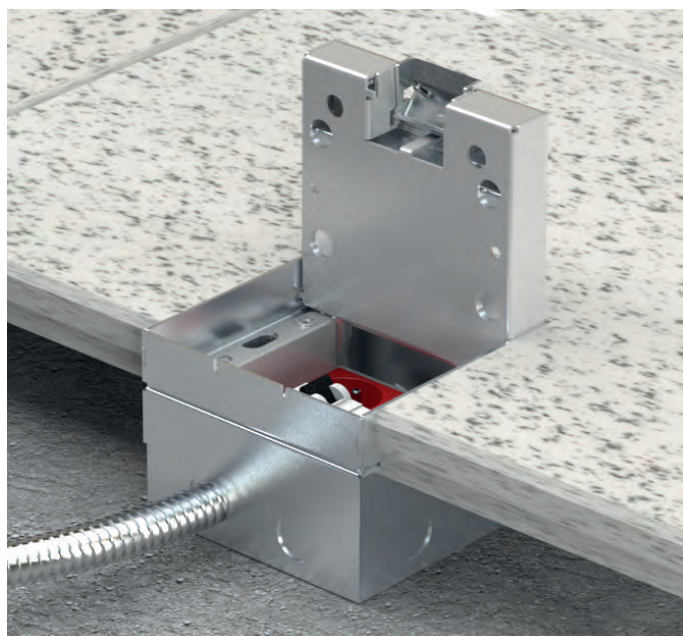

# E-LINE DK-LOCKABLE CX

## Lockable Floor Socket Boxes

### NDK-Lockable CX-1

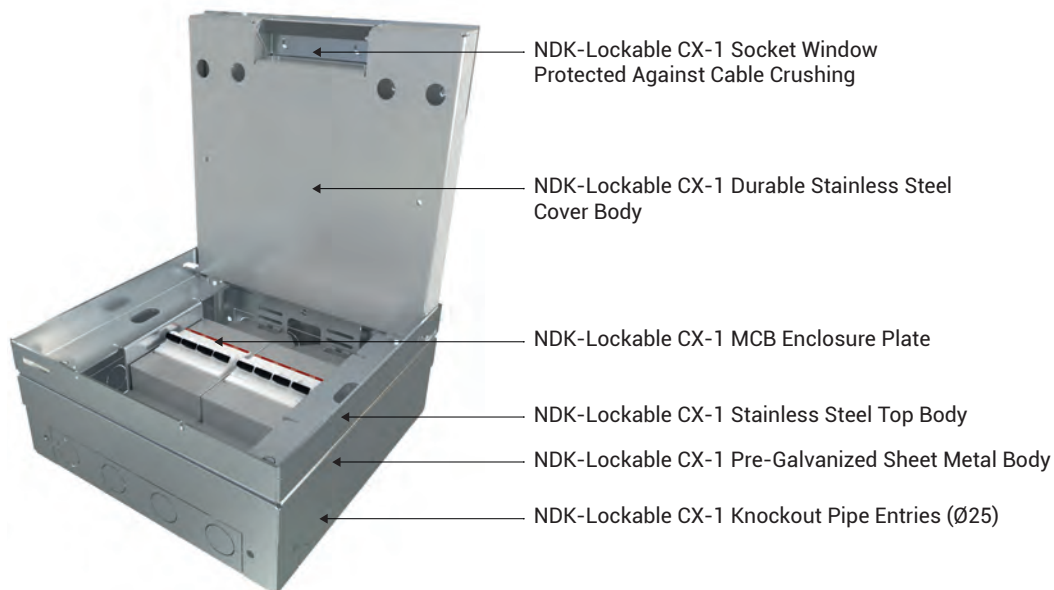

### Other Features

#### Fuse Module



#### 16 Module Socket Plate



#### Different Unbreakable Cover Options & Protected Cable Socket Window



#### NDK Lockable CX-1 Under-Screed Application Example

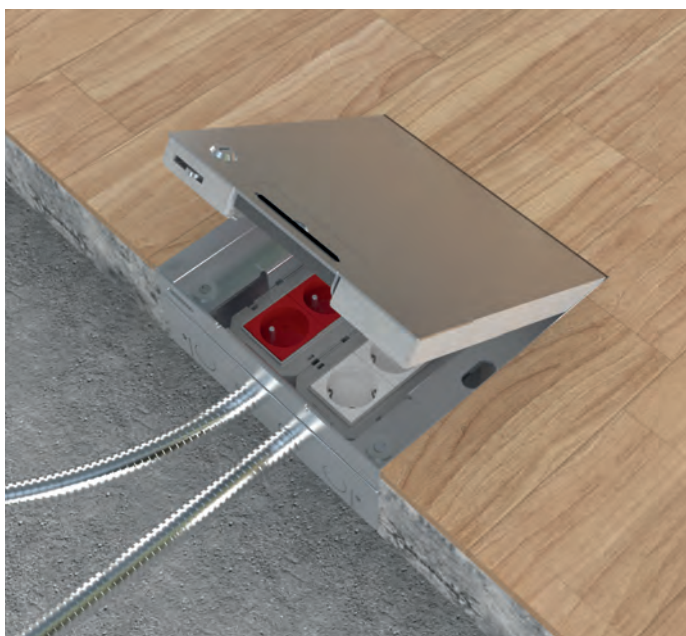

#### NDK Lockable CX-1 Raised Floor Application Example



# E-LINE NDK-CX

## Floor Socket Boxes

### CX Stainless Steel Cover Compact Socket Box and Ordering Codes



#### NDK-CX Mini D

Stainless Steel Filling Cover,  
Compact, Socket Box, Under-Screed

8 Modules, 140x140x96mm

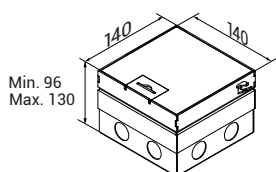

**Order Code** 3136718

#### NDK-CX 1D

Stainless Steel Filling Cover,  
Compact, Socket Box, Under-Screed

16 Modules, 244x244x96mm

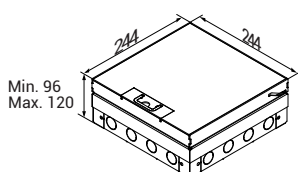

**Order Code** 3122682

#### NDK-CX 2D

Stainless Steel Filling Cover,  
Compact, Socket Box, Under-Screed

24 Modules, 320x244x96mm

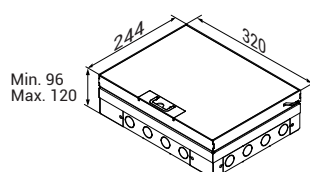
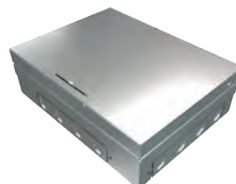

**Order Code** 3122686

#### NDK-Lockable-CX 1D

Stainless Steel Filling Cover,  
Compact, Socket Box, Under-Screed

16 Modules, 244x244x96mm

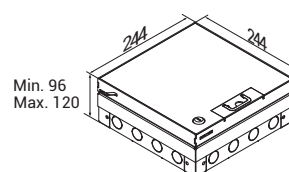
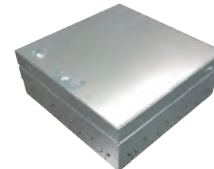

**Order Code** 3377669

#### NDK-CX Mini

Stainless Steel Cover, Compact,  
Socket Box, Under-Screed

8 Modules, 140x140x96mm

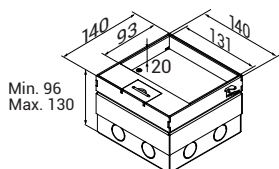

**Order Code** 3133897

#### NDK-CX 1

Stainless Steel Cover, Compact,  
Socket Box, Under-Screed

16 Modules, 244x244x96mm

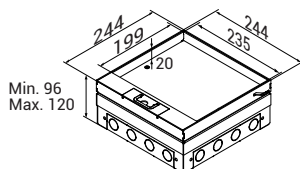
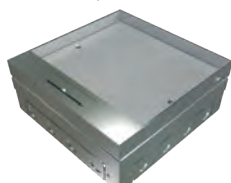

**Order Code** 3122681

#### NDK-CX 2

Stainless Steel Cover, Compact,  
Socket Box, Under-Screed

24 Modules, 320x244x96mm

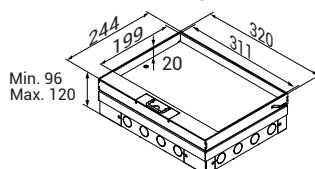
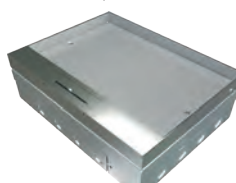

**Order Code** 3122685

#### NDK-Lockable-CX 1

Stainless Steel Cover, Compact,  
Socket Box, Under-Screed

16 Modules, 244x244x96mm

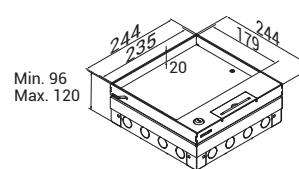
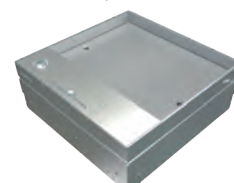

**Order Code** 3376003

### NDK-CX Under-Screed Application Example

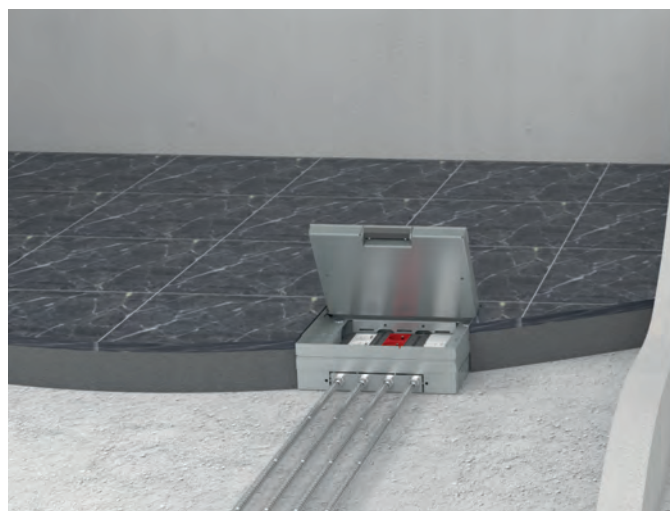

### NDK-CX Raised Floor Application Example



- NDK-CX 1 and NDK-CX 2 compact socket boxes have explosive side walls compatible with both pipe (ø25) and duct (180x25mm) entries.
- In your orders, please specify the finished floor heights for under-screed or raised floor applications.
- The socket box and socket plates are included, except for all types of sockets.  
Please choose the sockets you need and place a separate order from the relevant page.

Dimensions are  
in millimeters.

# E-LINE NDK-GRM

## DK Grommet 6 Modules

### Multi-Function Socket Box



- 6 Module Socket Capacity
- h=75mm/ø180
- Raised Floor and Screed Underfloor Usage Options

The plastic material is 'halogen-free'

Used as a small and compact 6-module socket box, it can also be used for cable passages from under the floor, on top of the floor, or on the table with a socket plate compatible with MCB, RCD, or RCBO when desired.



### General Structure

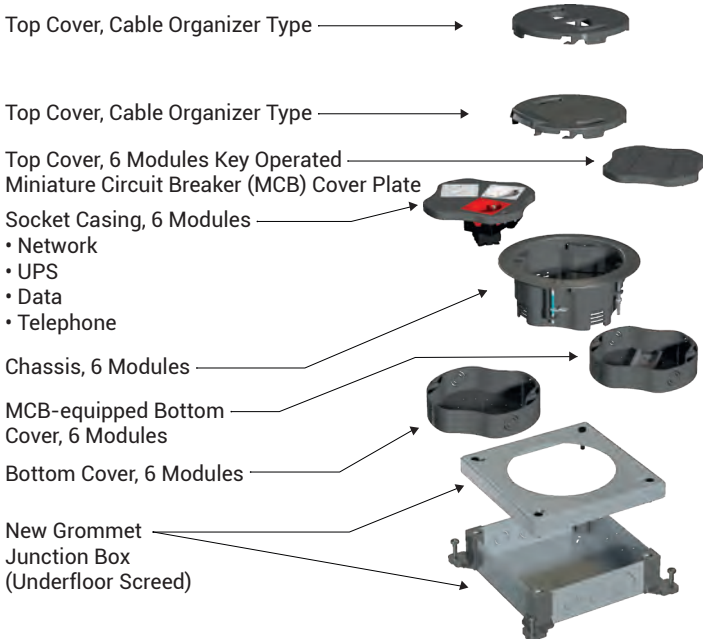

Order Codes		
Description	Gray	Smoke
Grommet, 6 Modules, with Socket Plate, Complete	3159337	3159340
Grommet, 6 Modules with, MCB Plate, Complete	3159341	3159344
Grommet, 6 Modules, with Socket Plate, Backbone Cover, Complete	3210162	3210165
Grommet, Underfloor Junction Box, 6 Modules	3159345	

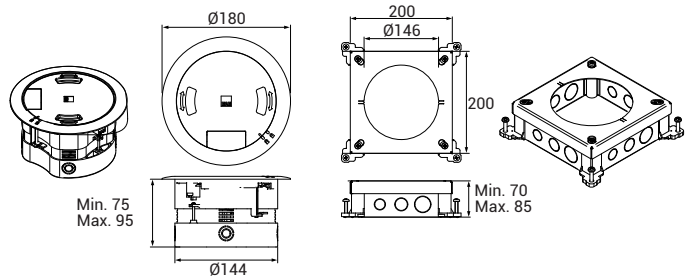

### Multi-Purpose Building

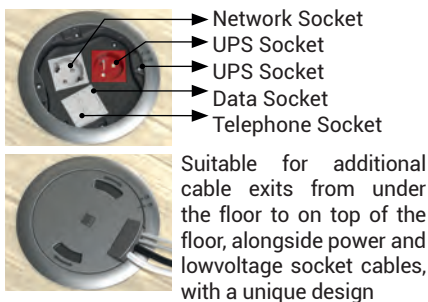

### Usage with MCB

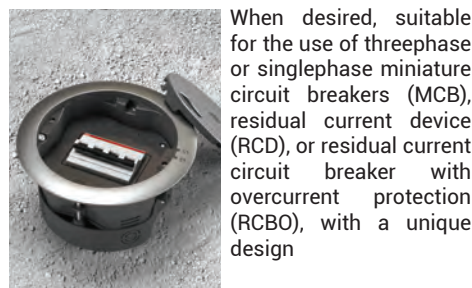

### Integrated Usage with Cable Organizer



### Mounting Clips

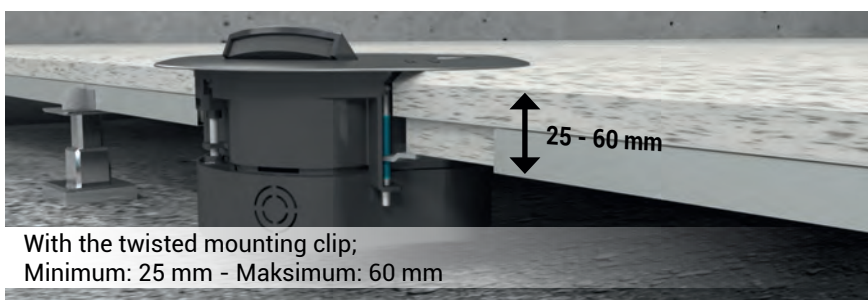

### Floor Cutting Dimension

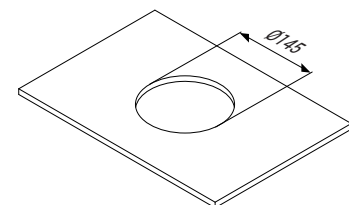

Dimensions are in millimeters.

# E-LINE NDK-GRM

## DK Grommet 6 Modules

### Multi-Function Socket Box



Raised Floor Application Example



Under Floor Application Example



Application Example with Cable Organizer



### Protected Exit Window

A structure with gasket protected windows that allows for easy and secure exit with multiple cables.



### Ergonomic Cover Structure

A perforated and locking cover structure with a practical grip feature that facilitates opening and closing.



### Socket Capacity

A small-sized DK Grommet 6 Modules that meets network, UPS, data, and telephone needs. It offers versatility in usage with a capacity of 6 modules and an ergonomic interior design.



### Under Floor Application

DK Grommet 6 Modules should be used in conjunction with the Underlayment Box. The minimum underlayment height is 75mm.



### Height Adjustment

Before the Screed

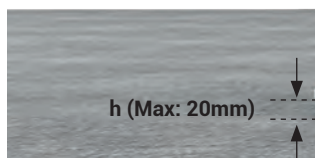

After the Screed



# E-LINE DK-GRM

## DK Grommet 3 Modules



### Socket Box

**DKY Grommet Socket Box**, meets your needs. It provides a 3-module output capacity. Its ergonomic interior design ensures ease of use.

The plastic material is 'halogen-free'.

With its floor depth and various color options, it can easily be used in a variety of different decoration applications.

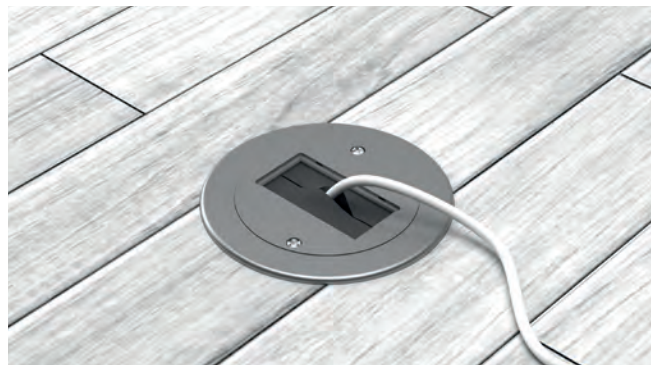

### General Construction

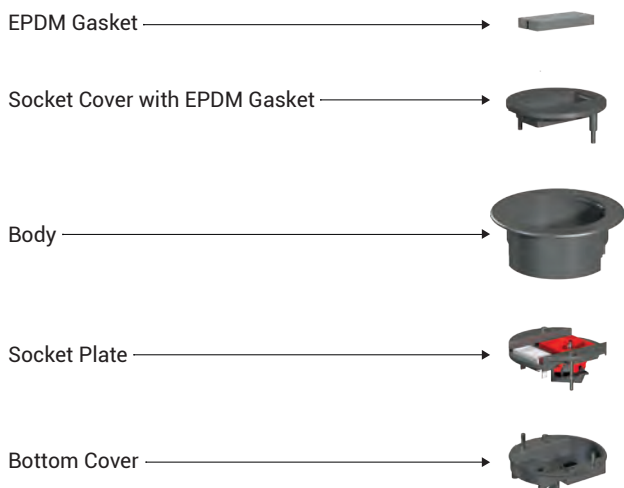

Order Codes		
Description	Gray	Smoke
Grommet, 3 Module, with Socket Plate, Complete	3377123	3377125
Grommet, Empty, Complete	3377124	3377126
Grommet Under Screed Junction box 3 Module	3122081	

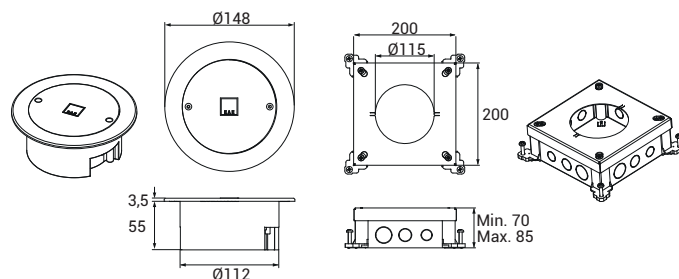

Dimensions are in millimeters.

### Mounting Clips

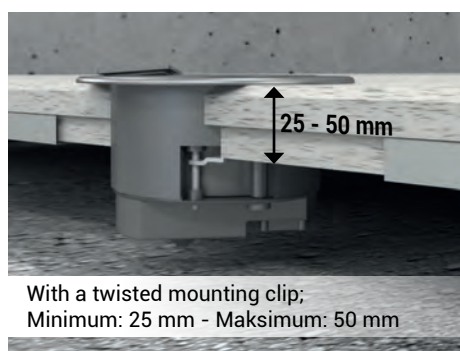

### Raised Floor Application



### Floor Cutting Dimension

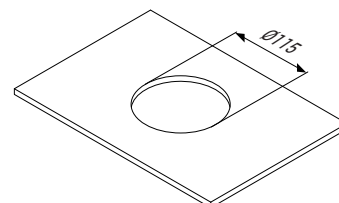

### Height Adjustment

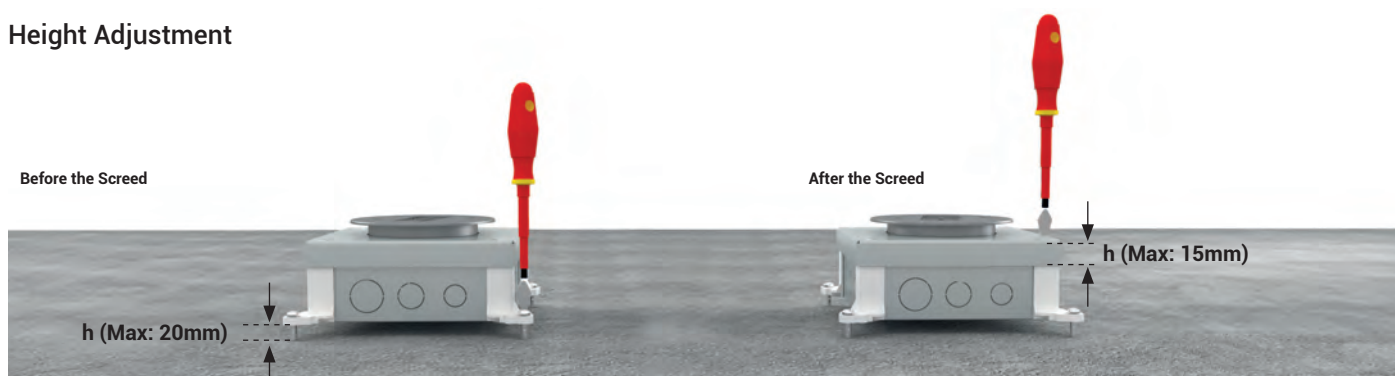

# E-LINE DK-GRM

## DK Grommet 3 Modules

### Socket Cover with EPDM Gasket

Thanks to its EPDM gasket protected socket, it offers aesthetic and secure usage. It has a structure that can be integrated with a cable organizer if needed.

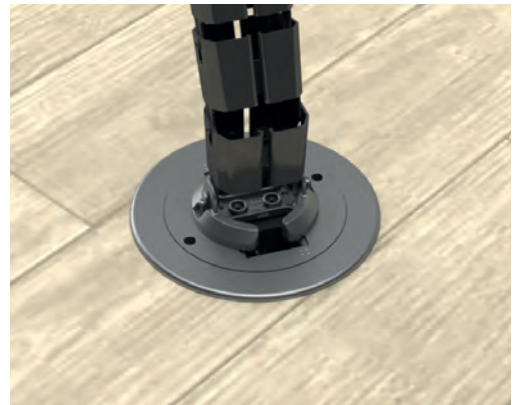
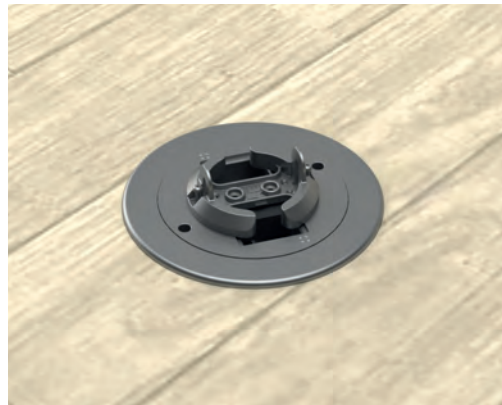
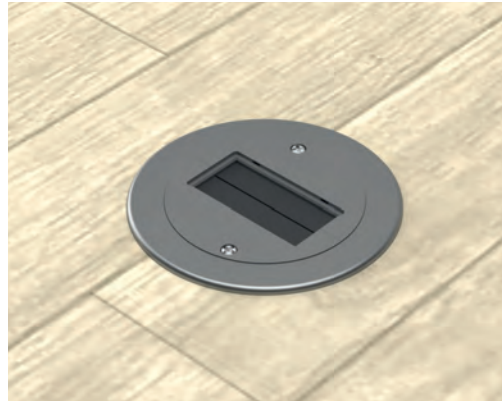

### Raised Floor Application Example



### Under Floor Application Example



### Application Example with Cable Organizer



• Except for all kinds of sockets. Please order the sockets separately by selecting the ones you need from the relevant page.

# E-LINE NDK-SM FLEX

## Cable Organizer and Cable Pass-Through Modules



Designed to deliver power, low current, and multimedia cables from the floor to desks or work environments  
Provides a flexible and aesthetic solution  
Manufactured with PC/ABS material, V2 (Fire Retardant Class), and HF (Halogen Free) properties  
Production using high-quality materials  
Standard length: 750 mm

Order Codes		
Description	Gray	Smoke
SM-FLEX Cable Organizer Collector	5000363	5001022



(Gri)



(Füme)

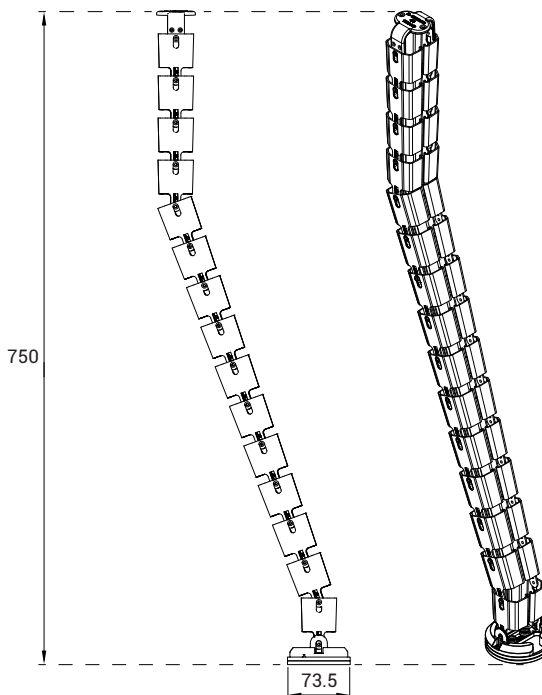

Dimensions are in millimeters.

# E-LINE NDK-MINI

## IP-66 Series Products

### IP66 C-Box, 6 Modules Socket Box



**C-Box** socket box, thanks to its zinc alloy cast body, has an elegant and durable structure. It provides protection against water and dust with an IP-66 protection level.

You can safely use the two-stage hinged cover C-Box series products in your living space to prevent cable crushes. With a capacity of 6 modules, it offers the opportunity for customization to meet your needs with its circular structure



### General Construction

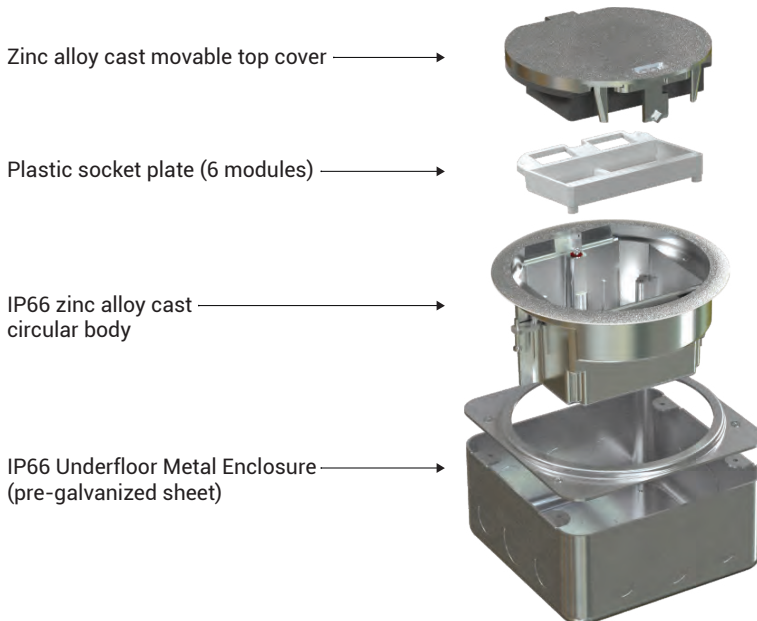

Order Codes	
Description	
IP-66 C-Box (6 Modules)	1022597

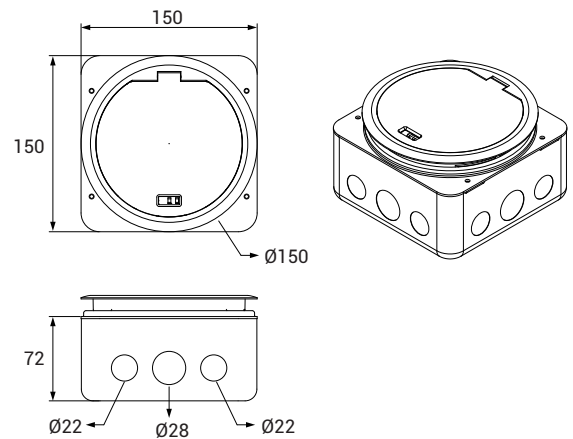

• Sockets are not included. They should be selected and ordered from the table on the back page as per the requirement.

### Raised Floor Hole Diameter

IP66-C BOX raised floor hole diameter is 130mm.

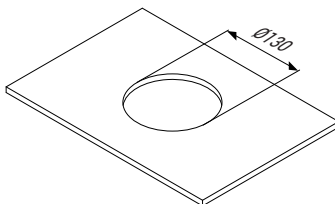

- Two-tiered hinged cover structure
- Modular type (45x45mm and 22.5x45mm) suitable for energy, data, telephone, and multimedia sockets with compatible plastic socket plates
- Body suitable for underfloor screed and raised floor usage, along with pipe-connected underfloor metal casing
- Capacity for up to six (4) modular sockets
- Special locking mechanism on the cover to prevent cable crushing

### Points to Consider in Usage Areas

- This product is suitable for indoor use only.
- Do not expose it directly to sunlight.
- Do not use the product in areas close to water. For example, near a bathroom or kitchen sink.
- Do not insert objects into the openings of the product. Do not spill liquids on the product.
- Keep the product away from radiators, stoves, or any heat sources.
- The product should not be subjected to impacts or have heavy loads placed on it.
- Ensure that the cover is completely closed to maintain the IP rating of the product.

### Areas of Use



- Please review the "User Manual" included in the product box.
- Except for all kinds of sockets. Please order the sockets separately by selecting the ones you need from the relevant page.

# E-LINE NDK-MINI

## IP-66 Series Products

### IP66 R-Box, 6 Modules Socket Box



**R-Box**, The socket box with an IP-66 protection level is resistant to water and dust. It offers safe usage with its two-stage hinged cover, which prevents cable damage.

R-Box, offering the possibility of use either on the desktop, under the counter, or on raised flooring, features a rectangular structure with a capacity of 6 modules, allowing you to personalize it according to your needs.



### General Construction

Plastic top cover (stainless steel filler inside the cover)

Plastic socket plate (6 modules)

IP66 Stainless steel-framed, plastic rectangular body

IP66 Underfloor Plastic Enclosure

Pre-handle level adjustment screw (0-50mm)



Order Codes	
Description	
IP-66 R-Box (6 Modules)	1022596

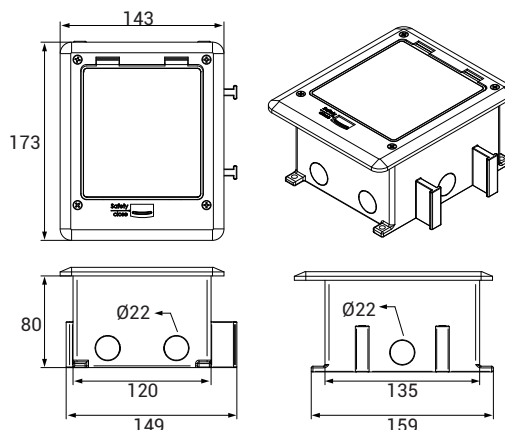

• Sockets are not included. They should be selected and ordered from the table on the back page as per the requirement.

### Raised Floor Hole Diameter

IP66-R BOX raised floor hole diameter is 119x134mm.

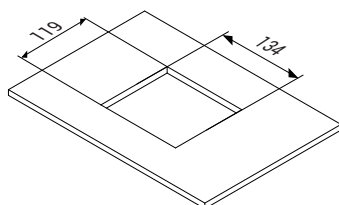

- Two-tiered hinged cover structure
- Modular type (45x45mm and 22.5x45mm) suitable for energy, data, telephone, and multimedia sockets with compatible plastic socket plates
- Body suitable for underfloor screed and raised floor usage, along with pipe-connected underfloor plastic casing
- Capacity for up to six (4) modular sockets
- Special locking mechanism on the cover to prevent cable crushing

### Points to Consider in Usage Areas

- This product is suitable for indoor use only.
- Do not expose it directly to sunlight.
- Do not use the product in areas close to water. For example, near a bathroom or kitchen sink.
- Do not insert objects into the openings of the product. Do not spill liquids on the product.
- Keep the product away from radiators, stoves, or any heat sources.
- The product should not be subjected to impacts or have heavy loads placed on it.
- Ensure that the cover is completely closed to maintain the IP rating of the product.

### Areas of Use

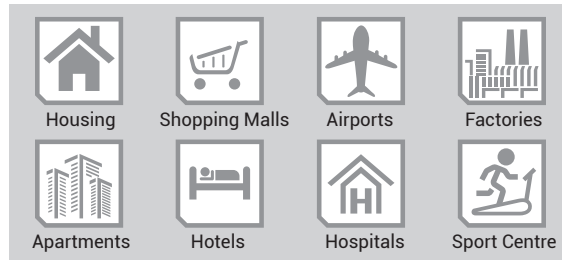

- Please review the "User Manual" included in the product box.
- Except for all kinds of sockets. Please order the sockets separately by selecting the ones you need from the relevant page.

# E-LINE NDK-MINI

## IP-40 Series Products

### P Box 3M / P Box 6M



**Pop-up** Enhance your living space with the Pop-up series products. With their elegant and user-friendly design, you can easily access power from the nearest point.

It offers the possibility of use on the desktop, under the floor, or on a raised floor, whichever you prefer.

You can personalize the sockets inside by choosing the module that suits your needs (3 / 6 modules).



### General Construction

Swinging stainless steel cover

Plastic socket plate (3 modules)

Semi-Fixed Frame (stainless steel)

Desk connecting part (stainless steel)

Metal enclosure suitable for underfloor and raised floor applications (pregalvanized sheet)

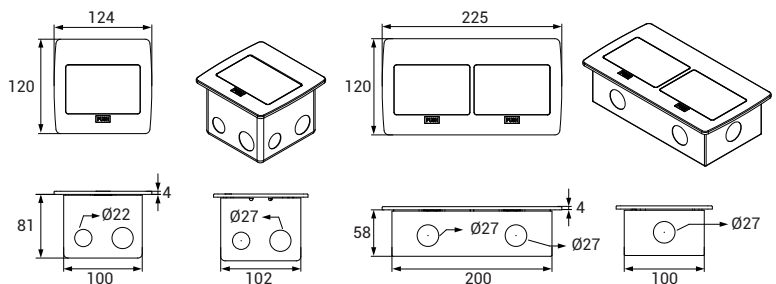

Order Codes	
Description	
P-Box 3M (3 Modules)	1022598
P-Box 6M (6 Modules)	1022599
P-Box 3M Desk Connection Part (Stainless steel)	2086156
P-Box 6M Desk Connection Part (Stainless steel)	2086157

- Soft-opening covers
- Suitable for modular type (45x45mm and 22.5x45mm) plastic socket plates for power, data, telephone, and multimedia sockets
- Suitable for use on desks, raised floors, and underfloor applications
- 3 Module and 6-Module options

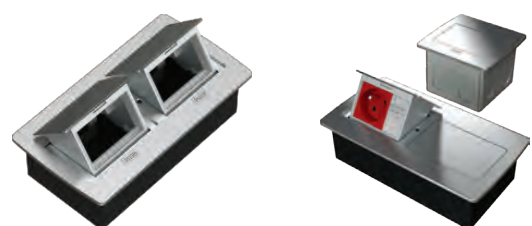

- Desk connecting part; should be ordered separately for in-desk and raised floor (flush) applications.

### Table and Floor Cutting Dimension

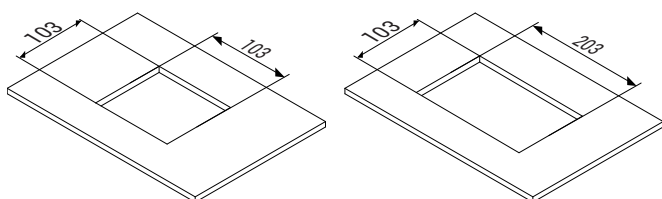

The raised floor hole measurement for P-Box 3M is 102x105 mm

The raised floor hole measurement for P-Box 6M is 202x105 mm

### Areas of Use

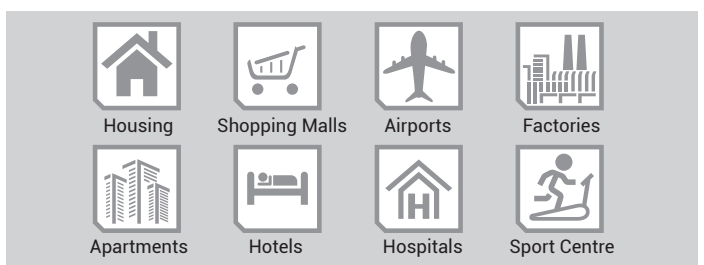

- Except for all kinds of sockets. Please order the sockets separately by selecting the ones you need from the relevant page.

# E-LINE DB-DKL

## Underfloor Socket Boxes

Exit and Pull Box Solutions

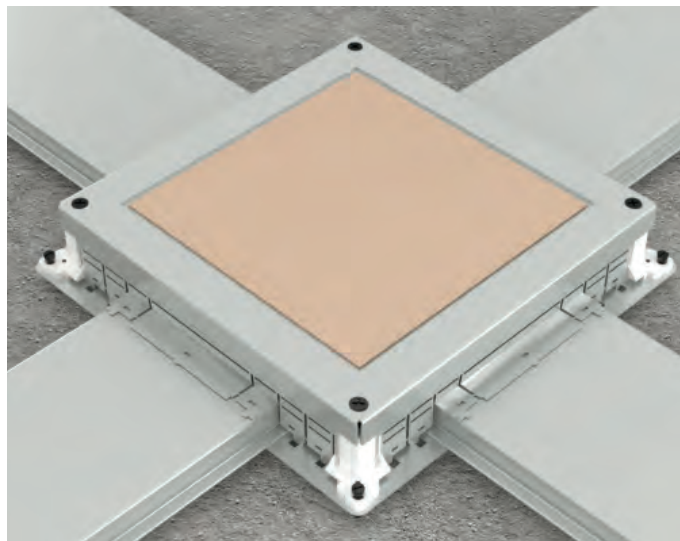
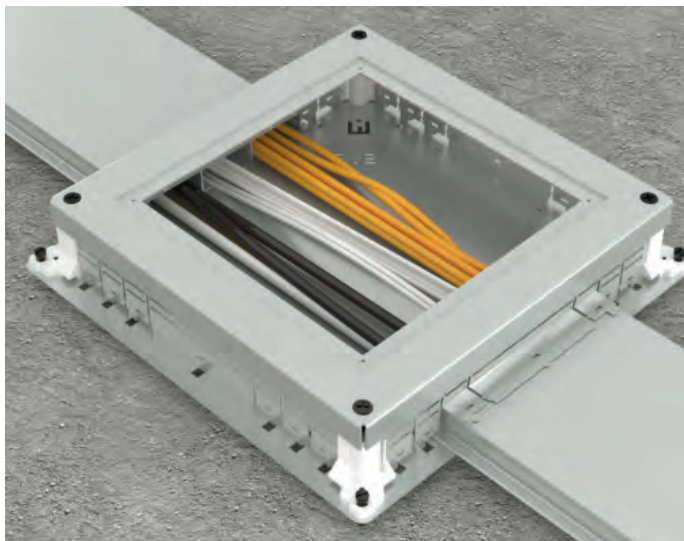

### Socket Boxes

#### Pull Box (DB-SK)

It includes a hinged access window that is necessary for pulling electrical installation cables (power and low-current).

#### Exit Box (DB-S)

It is used for the installation of socket boxes and does not include a cover.

### S Type Clamps

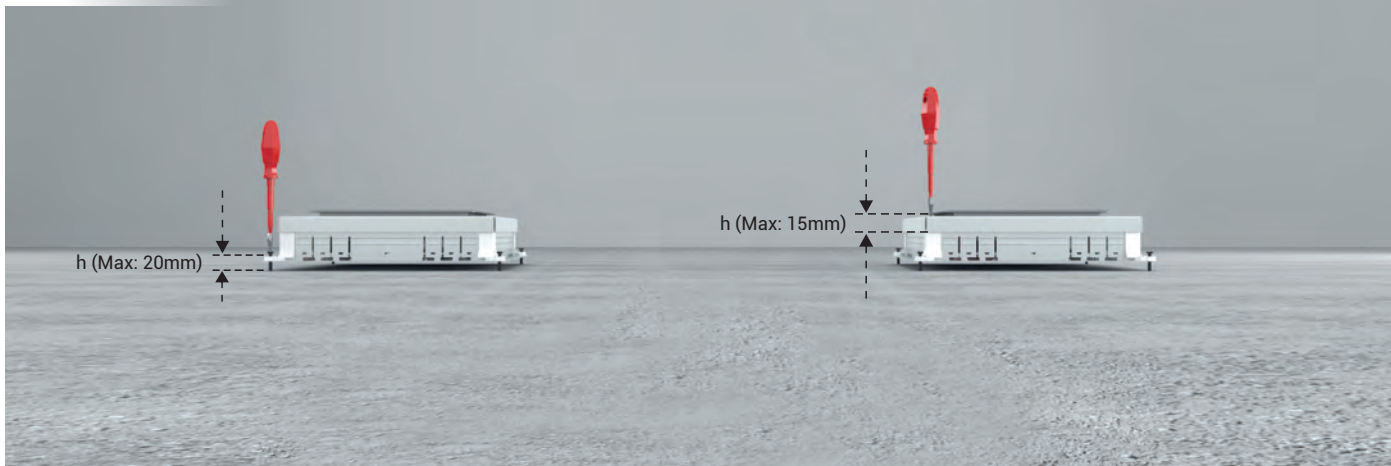

#### Before Floor Height Adjustment (20mm)

S Type Clamps, with its corner piece and special design, provides adjustment options before and after the screed. The maximum adjustment height before screed is 20mm. The minimum screed height is 70mm

#### After Floor Height Adjustment (15mm)

S Type Clamps can be adjusted smoothly after the screed, in a range of 0-15mm for the height (h). Precise adjustment after the screed should be done using a 'spirit level'

(\*) The impedance (Z) at the additional points meets the standard-specified value of 5mΩ, and test certificates are available.

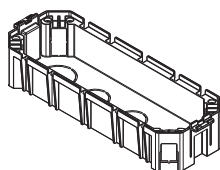

(0,085 kg/pcs)

### Socket Casing (Vertical)

Description	Order Code
Socket Casing (Vertical)	3135639

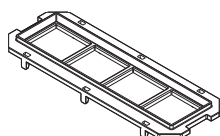

(0,030 kg/pcs)

### Socket Plate (3)

Description	Order Code
Socket Plate (3) 8 Modules	1020401

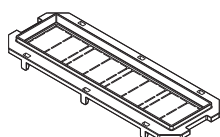

(0,028 kg/pcs)

### Socket Plate (4)

Description	Order Code
Socket Plate (4)	1020403

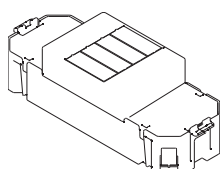

(0,192 kg/pcs)

### MCB / RCD / RCBO Casing (1)

Description	Order Code
MCB / RCD / RCBO Mounting Box / 4 Module-Open (**)	3181231

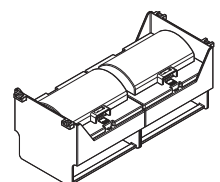

(0,220 kg/pcs)

### MCB / RCD / RCBO Casing (2)

Description	Order Code
MCB / RCD / RCBO Mounting Box / 8 Module-Covered (***)	3275397

- When a 24-Module MX-1 Socket Box is ordered, 3 vertical socket casing and 3 triple socket plates are supplied as standard inside the box. There is no need to order these separately. However, in case of loss, breakage, or functional change, you should place a separate order.
- Products marked with (\*\*), (\*\*\*) must be ordered separately when required.
- Product images are schematic and may vary.
- Sockets are not included with the product and must be ordered separately according to project requirements.
- Only 1 piece can be used in the MX-1 socket box product. (\*\*\*)



1

### Power Socket (1)

Description	Order Code
Power Socket (1)-(230 V/16 A)	1023438



1

### UPS Socket (1)

Description	Order Code
UPS Socket (1)-(230 V/16 A)	1023439

- Product images are schematic and subject to change.
- Sockets are not included with the product and should be ordered separately according to your needs.
- (\*) Marked group sockets can only be used with the appropriate socket plates. Please confirm before placing an order.



### Phone / Data Cover

Description	Order Code
Phone / Data Cover with Transparent Lid and Label Space, White	1076956
Phone / Data Cover with Transparent Lid and Label Space, Black	1076957



### Phone Socket

Description	Order Code
White Phone Socket (RJ11) Faceplate-Mounted	1075116
Black Phone Socket (RJ11) Faceplate-Mounted	1075817



### Data Socket

Description	Order Code
White Data Socket (RJ45) Faceplate-Mounted	1075115
Black Data Socket (RJ45) Faceplate-Mounted	1075816



### Single Cover Plate

Description	Order Code
Single Cover Plate (1 Modules)	1073620



### Double Cover Plate

Description	Order Code
Double Cover Plate (2 Modules)	1002612



### USB Adapter

Description	Order Code
USB 3.0 Adapter, 22.5x45mm, Female-Female, 90° Angled, White	1016318
USB 3.0 Adapter, 22.5x45mm, Female-Female, 90° Angled, Black	1053875



### HDMI Adapter

Description	Order Code
HDMI Adapter, 22.5x45mm, Female-Female, 90° Angled, White	1016317
HDMI Adapter, 22.5x45mm, Female-Female, 90° Angled, Black	1053871
HDMI Adapter, 22,5x45mm Female-Female (Straight Type - Non-Angled) White	1020060
HDMI Adapter, 22,5x45mm Female-Female (Straight Type - Non-Angled) Black	1075123



### VGA Adapter

Description	Order Code
VGA Adapter, 22.5x45mm, Female-Female, White	1075135
VGA Adapter, 22.5x45mm, Female-Female, Black	1075136



### USB Charging Unit

Description	Order Code
Dual USB Charger Adapter White, 1 Port Type A, 1 Port Type C, Total Output Power Max 20W	1046296
Dual USB Charger Adapter Black, 1 Port Type A, 1 Port Type C, Total Output Power Max 20W	1075818

# E-LINE NDK

## Old Generation Junction Boxes

### Technical Specifications and Order Codes

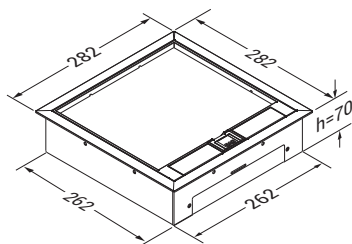

(3,17 kg/pcs)

#### E-Line Easybox (Sheet Metal) Junction and Socket Boxes

Description	Order Code
E-Line Easybox Junction Kit (Gray)	3006342

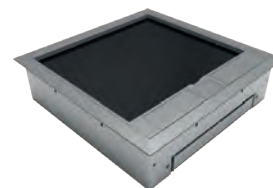

#### 1- SCOPE:

This section is used in electrical installation designs;  
This section covers the details related to the production of various parts, including underfloor cable ducts, conduits, elbows, connecting components, underfloor junction boxes, bases, socket boxes, casings, and more, used in electrical installation designs.

#### 2- STANDARDS:

The underfloor cable ducts and conduits within the scope of this specification are produced, manufactured, assembled, and tested in accordance with the latest editions of the following standards.

STANDARD NUMBER	STANDARD NAME
TS EN 50085-2-2 EN 50085-2-2	Equipped Cable Duct Systems and Cable Duct Systems - Part 2-2 for Electrical Installations. It specifies requirements and guidelines for these cable channel systems in various installation scenarios

#### 3- TECHNICAL SPECIFICATIONS:

##### 3.1-Underfloor Cable Duct:

The underfloor cable duct system is designed to be used in areas where the floor and covering are at a sufficient height. It consists of three units: underfloor cable duct, floor conduit, and socket box. These units are manufactured to be completely embedded within the floor. The underfloor cable duct is used for energy, data, and other connection lines. It comes in two different heights: 25mm and 35mm, and five different widths: 120mm, 180mm, 215mm, 240mm, and 300mm. The 120mm width channels have two compartments, while the others have three compartments. The channels consist of two parts: a lower body and an upper cover. They are assembled using a "roll-form" machine, without any welding or spot welding due to their corrosive properties. These cable ducts are manufactured in standard lengths of 2000mm, and special channel joint elements are used for channel connections. Special corner turn elements are used when the channels need to turn upward or downward, and special termination elements are available at the channel endpoints. The underfloor cable ducts use level adjustable legs for different height settings. These cable ducts have been tested and certified by an accredited laboratory in accordance with the EN 50085-2-2 standard. They meet the requirements for electrical continuity and can be used for equipotential bonding and protective grounding, as specified in the standard. The system includes grounding elements for electrical continuity, as required by the standard. This information provides a detailed overview of the underfloor cable duct system's technical characteristics and its compliance with relevant standards.

##### 3.2-Underfloor Connection and Socket Conduit:

Underfloor Connection and Socket Conduit Underfloor connection conduit boxes and socket conduit boxes are produced to meet various needs, such as changing the direction of the underfloor cable duct or mounting network (power), UPS socket, data, and telephone socket sockets. These boxes are manufactured from 2mm thick pre-galvanized steel with a special form. They feature perforated cover plates on all four sides, designed to adapt to various sizes of underfloor cable duct installations. These cover plates also prevent the entry of foreign materials like mortar or plaster. Heavy-duty conduit boxes are available for areas with heavy loads, constructed with aluminum bodies and special corner blocks. The top cover plate of heavy-duty models is 4mm thick. Transparent plastic protective covers are included in underfloor conduit boxes to prevent the entry of mortar and foreign materials during floor construction. After installation and floor work are completed, these protective covers can be cut and removed, and the box can be sealed with a socket cover plate. Underfloor conduit boxes have adjustable screws on their bottom bases and corner elements, allowing for height adjustments before and after floor application. These screws work in conjunction with standard nuts embedded in the corner pieces. All metal components used in underfloor conduit boxes are manufactured from galvanized steel. The conduit boxes have been tested and certified by an accredited laboratory in compliance with the EN 50085-2-2 standard. This information provides a comprehensive overview of the technical features and construction of underfloor connection and socket conduit boxes, as well as their compliance with the relevant standard.

##### 3.3- Socket Boxes:

In underfloor cable duct systems, socket boxes used for power (grid + UPS), data, and telephone sockets, which are placed inside the underfloor socket box, are designed to meet different capacity requirements and can accommodate a maximum of 24 module sockets. The direction of the socket box cover can be changed by 180°, and the cover is reinforced with a suitable thickness of sheet metal to increase its strength. The bodies and plastic parts used in the socket boxes for underfloor and/or raised floor applications are made from PC, PC/ABS, and PA6 "halogen free" plastic raw materials that meet at least the "V2" flame resistance class according to the UL94 standard and have passed the "glow wire" test conditions of at least 650°C according to the IEC 60965 standard. Underfloor socket boxes have been tested and certified by an accredited laboratory under the EN 50085-2-2 standard.



# TEST CERTIFICATE

**Issued to:** EAE Elektrik Asansör Endustrisi Insaat San. ve Tic. A.S.  
Akçaburgaz Mahallesi 3114  
Sokak No: 10  
34510 Esenyurt / İstanbul  
Turkey

**For the product:** Cable trunking and cable ducting systems intended for mounting underfloor, flushfloor or onfloor.

**Trade name:** EAE

**Type/Model:** E-LINE DK...

**Ratings:** See for the product information the annex of this DEKRA Test Certificate.

**Manufactured by:** EAE Elektrik Asansör Endustrisi Insaat San. ve Tic. A.S.  
Akçaburgaz Mahallesi 3114  
Sokak No: 10  
34510 Esenyurt / İstanbul  
Turkey

**Requirements:** EN 50085-1:2005/A1:1998  
EN 50085-2-2:2008  
BS EN 50085-1:2005/A1:1998  
BS EN 50085-2-2:2008

**Remarks:** The products meet the requirements.

This DEKRA Test Certificate is based on and replaced certificate no. 2198073.01, dated 9 March 2017.

This Test Certificate is granted on account of an examination by DEKRA, the results of which are laid down in a confidential file no. 225928300.

The examination has been carried out on one single specimen of the product, submitted by the manufacturer. The Attestation does not include an assessment of the manufacturer's production. Conformity of his production with the specimen tested by DEKRA is not the responsibility of DEKRA.

Arnhem, 2 September 2021

Number: 2259283.01-DTC

DEKRA Certification B.V.



H.R.M. Barends  
Certification Manager

© Integral publication of this certificate and adjoining reports is allowed

DEKRA Certification B.V. Meander 1051, 6825 MJ Arnhem P.O. Box 5185, 6802 ED Arnhem, The Netherlands  
T +31 88 96 83000 F +31 88 96 83100 www.dekra-certification.com Company registration 09085396

## CE DECLARATION OF CONFORMITY

**Product Group** E-Line NDK Modular and Compact Solutions for Under floor and Raised Flooring

**Manufacturer** EAE Elektrik Asansor End. Insaat San. ve Tic. A.S.  
Akcaburgaz Mahallesi, 3114. Sokak,  
No:10 34522 Esenyurt-Istanbul

This declaration is a formal acknowledgment of the manufacturer's responsibility for ensuring their products are in compliance with the applicable European laws and standards.

**Standard:**

**EN 50085-1 / EN 50085-2-2**

Equipped Cable Duct Systems,Cable Channel Systems,Part 1: General Specifications

**CE - Regulation:**

2014/35/EU "Low Voltage Directive"

**Technical Document Preparation Authorized Person**

EAE Elektrik Asansor End. Insaat San. ve Tic. A.S.  
Akcaburgaz Mahallesi, 3114. Sokak, No:10 34522 Esenyurt-Istanbul

Mustafa AKCELIK

**Date**

08.03.2025

**Document Signing Authority**

Elif Gamze KAYA OK  
Deputy General Manager



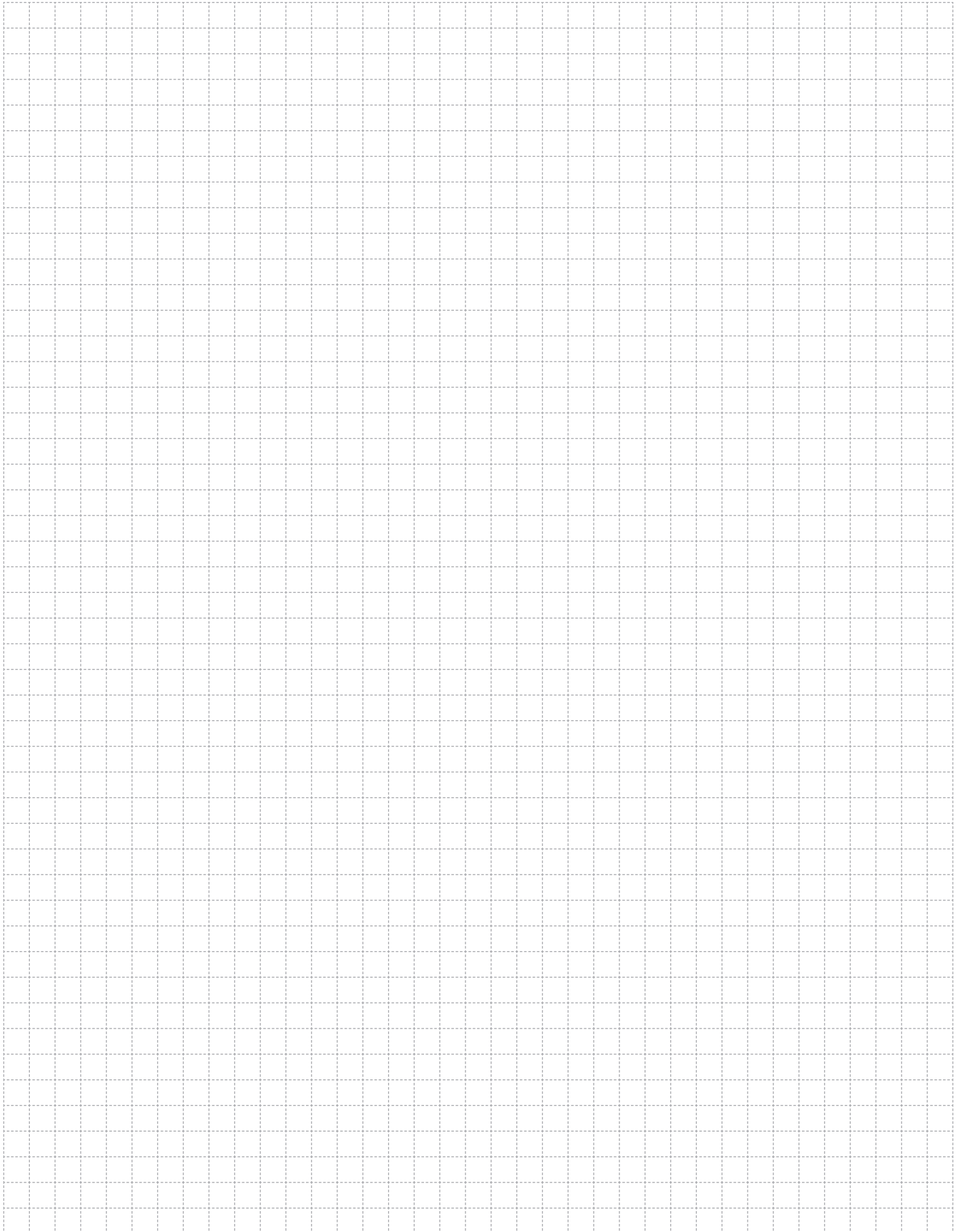

A large grid area for taking notes, consisting of a fine grid of small squares.

---

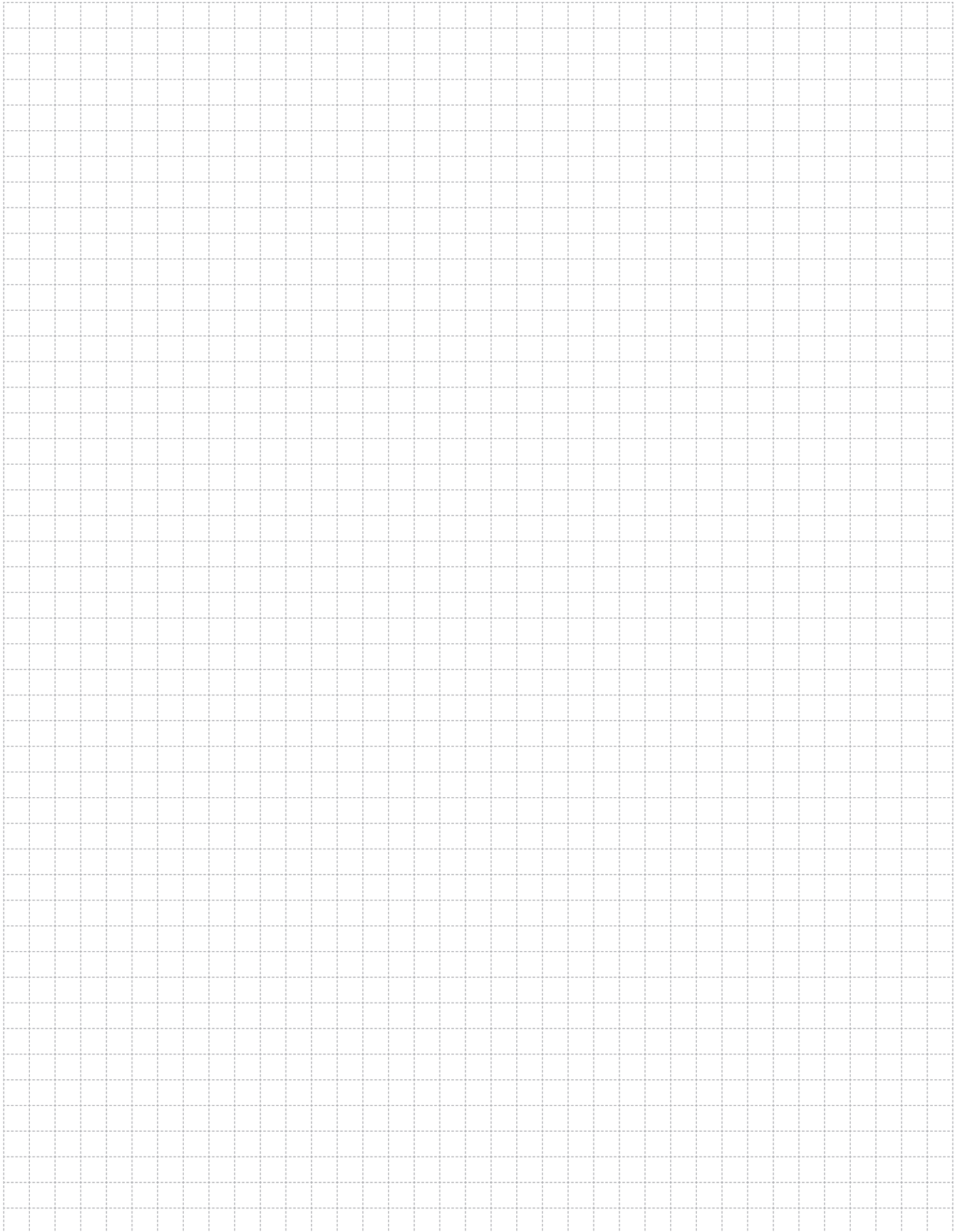

# SUSTAINABLE FUTURE

## Sustainability Management at EAE Elektrik



As part of our goal to support sustainable development and green transformation, measuring, evaluating, and managing all economic, environmental, and social impacts resulting from our sustainability practices is a key governance priority for EAE Elektrik. We act with great care in analyzing, monitoring, and managing the economic, environmental, and social impacts and risks that arise throughout our value chain in both our national and global operations.

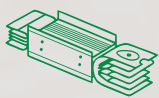

Busbar Systems

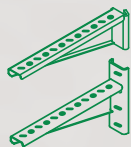

Support Systems



Cable Tray Systems

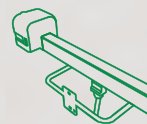

Trolley Busbar Systems



Fit-Out Solutions

*"We are working together with all our stakeholders to develop the electrical technologies that will build the future."*

You can visit our sustainability website at [sustainability.eaeelectric.com](https://sustainability.eaeelectric.com)



#FutureTogether

**EAE Elektrik**

**Head Office**

Akcaburgaz Mahallesi,  
3114. Sokak, No: 10 34522  
Esenyurt - Istanbul - Turkiye  
Tel: +90 (212) 866 20 00  
Fax: +90 (212) 886 24 20

**EAE DL 4 Factory**

**Busbar 2**

Organize Sanayi Bolgesi Mahallesi,  
6. Cadde, No: 14/10, 41455  
Dilovasi - Kocaeli - Turkiye  
Tel: +90 (262) 999 05 55  
Fax: +90 (262) 502 01 45



Please visit our website for the updated  
version of our catalogues.  
[www.eaelectric.com](http://www.eaelectric.com)



Catalogue 33 - En. / Rev. 12 1000 Pcs. 22/04/2026  
N.G.

EAE has full right to make any revisions or changes on this catalogue without any prior notice.