

# HOTEL COLLECTION

THE ITALIAN STYLE DOOR



YOUR HOME, YOUR LIFE



IL VIAGGIO È UNA PORTA  
ATTRAVERSO LA QUALE SI ESCE  
DALLA REALTÀ E SI ENTRA  
IN UN'ALTRA REALTÀ  
INESPLORATA, CHE SOMIGLIA  
AL SOGNO.

THE JOURNEY IS A KIND OF DOOR THROUGH WHICH ONE  
LEAVES REALITY AS IF TO ENTER AN UNEXPLORED REALITY  
THAT SEEMS LIKE A DREAM.

GUY DE MAUPASSANT

# HOTEL COLLECTION

MODELLO OPERA OPERA MODELS	DESTINAZIONE DESTINATION	PAG. P.
PARODI [AIDA]	NEW YORK <b>N</b>	20
PARODI [PARSIFAL]	PARIGI <b>P 1</b>	32
PARODI [NABUCCO]	LISBONA <b>L 1</b>	44
ISY [AIDA]	SYDNEY <b>S</b>	56
FORTE [TURANDOT]	TOKYO <b>T</b>	66
FORTE [MANON]	ISTANBUL <b>I</b>	76
LIGHT [OTELLO]	ZAGABRIA <b>Z</b>	96
DANIELI [TOSCA]	LONDRA <b>L 2</b>	110
FREESTYLE [MEDEA]	COPENAGHEN <b>C</b>	140
D-METRIA [NORMA]	DUBAI <b>D</b>	156
BELLINI [FALSTAFF]	BERLINO <b>B</b>	166
BELLINI WOOD [TRAVIATA]	BUDAPEST <b>B</b>	196
LUCCHINI [ORFEO]	ROMA <b>R</b>	208
JUVARRA [RIGOLETTO]	MOSCA <b>M</b>	218
BONAPARTE [CARMEN]	PECHINO <b>P 2</b>	240
SPECIFICHE TECNICHE	TECHNICAL INFORMATION	250

IT Dietro ogni porta c'è una storia che aspetta di essere raccontata. Hotel Collection è un viaggio attraverso le città che amiamo: quindici tappe per guardare ogni luogo con uno sguardo nuovo. Ma anche per sentirsi a casa, ovunque. Scopri Opera, la nostra selezione di porte dedicata all'hôtellerie.

EN Behind every door, there's a story waiting to be told. Hotel Collection is a journey across the cities we love: fifteen destinations for you to explore with new eyes while feeling at home, wherever you go. Discover Opera: our door selection dedicated to the hotel industry.



**PARODI**  
AIDA

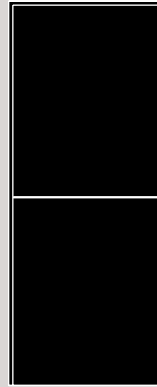

IN ESSENZA LISCIA O CON INSERTI  
VENEERED SMOOTH OR WITH INSERTS

**PARODI**  
PARSIFAL

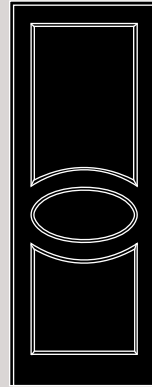

IN ESSENZA SOLO CORNICI APPLICATE  
VENEERED ONLY APPLIED MOLDINGS

**PARODI**  
NABUCCO

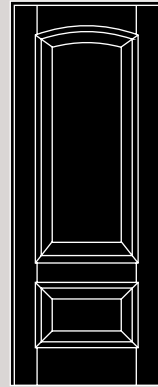

IN ESSENZA CON CORNICI APPLICATE  
E BUGNE  
VENEERED WITH APPLIED MOLDINGS  
AND RELIEF

**ISY**  
AIDA



IN LAMINATO LISCIA O CON INSERTI  
IN SMOOTH LAMINATE OR WITH INSERTS

**FORTE**  
TURANDOT

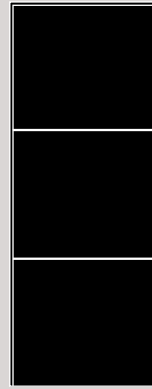

LACCATA LISCIA CON INSERTI  
SMOOTH LACQUERED WITH INSERTS

**FORTE**  
MANON

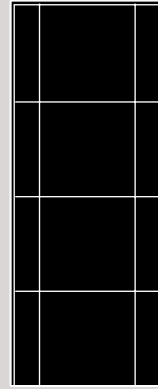

LACCATA INCISA PROFILO 1  
LACQUERED ENGRAVED PROFILE 1

**LIGHT**  
OTELLO

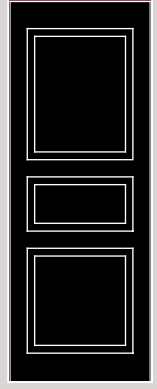

LACCATA PANTOGRAFATA PIANA  
FLAT PANTOGRAPHED LACQUERED

**DANIELI**  
TOSCA

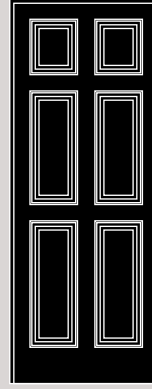

LACCATA PANTOGRAFATA  
CON PIATTABANDA SAGOMATA  
LACQUERED PANTOGRAPHED  
WITH SHAPED PLATBAND

**FREESTYLE**  
MEDEA

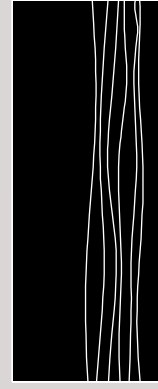

LACCATA INCISA PROFILO 2  
LACQUERED ENGRAVED PROFILE 2

**D-METRIA**  
NORMA

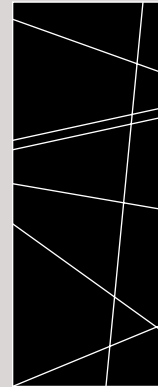

LACCATA INCISA PROFILO 1  
LACQUERED ENGRAVED PROFILE 1

**BELLINI**  
FALSTAFF

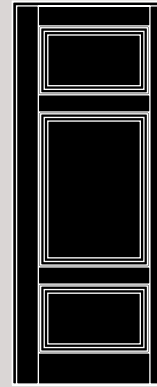

LACCATA PANTOGRAFATA CON  
PIATTABANDA SAGOMATA E  
CON RASAMENTO / LACQUERED  
PANTOGRAPHED WITH SHAPED  
PLATBAND AND WITH SHAVING

**BELLINI WOOD**  
TRAVIATA

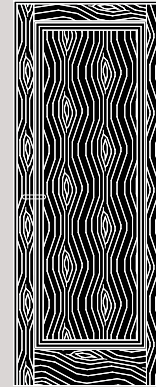

LACCATA PANTOGRAFATA CON PIATTABANDA  
SAGOMATA E CON RASAMENTO SU TRANCIATO  
IMPIALLACCIATO / LACQUERED PANTOGRAPHED  
WITH SHAPED PLATBAND AND WITH SHAVING ON  
VENEERED BASIS

**LUCCHINI**  
ORFEO

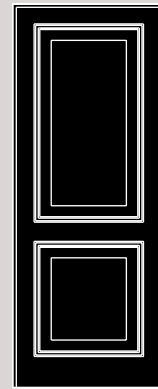

LACCATA BUGNATA CON CORNICE IN  
RILIEVO - BREVETTO DIERRE  
RELIEFED LACQUERED WITH RELIEF  
MOLDINGS - DIERRE PATENT

**JUVARRA**  
RIGOLETTO



LACCATA BUGNATA CON CORNICE IN  
RILIEVO - BREVETTO DIERRE  
RELIEFED LACQUERED WITH RELIEF  
MOLDINGS - DIERRE PATENT

**BONAPARTE**  
CARMEN

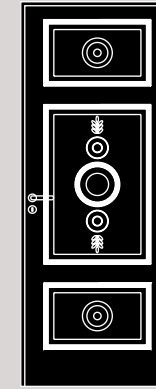

LACCATA BUGNATA CON CORNICE IN  
RILIEVO - BREVETTO DIERRE  
RELIEFED LACQUERED WITH RELIEF  
MOLDINGS - DIERRE PATENT

NOTA: I MODELLI DELLE PORTE RAPPRESENTANO LE FAMIGLIE DI APPARTENENZA.  
NOTE: THE MODELS OF THE DOORS SHOW THE BELONGED FAMILIES.







# DIERRE, THE ITALIAN STYLE DOOR

<sup>IT</sup> Siamo italiani ma ci sentiamo a casa in tutto il mondo. Dierre nasce nel 1975 e, da allora, distribuiamo le nostre porte in oltre 30 paesi. Siamo stati i primi a industrializzare il processo di costruzione di una porta blindata, personalizzando colori, decorazioni e finiture. Lo stesso approccio ci guida anche nella progettazione delle nostre porte da interni, in cui ogni aspetto può essere disegnato su misura per dare stile e personalità all'ambiente. Per noi, i risultati migliori nascono quando le lavorazioni artigianali incontrano l'innovazione tecnologica: ecco perché non smettiamo mai di fare ricerca. Le nostre porte garantiscono il massimo livello di isolamento acustico esistente sul mercato per dare a tutti la possibilità di godersi il silenzio, a casa e in hotel.

<sup>EN</sup> We are Italian, but we feel at home everywhere in the world. Dierre was born in 1975 and, since then, we have distributed our doors to over 30 countries. We were the first to industrialise the construction process of the security door, allowing clients to personalise colours, decorations and finishings. We apply the same approach when designing our interior doors, as every feature can be tailored to convey style and personality to any given space. In our opinion, the best results come to life when artisanal processing meets technological innovation: this is why we never stop conducting research. Our doors guarantee the maximum level of acoustic isolation on the market, giving people the chance to enjoy silence, both at home and in the hotel.

# INNOVATORI PER TRADIZIONE

INNOVATORS BY TRADITION

<sup>IT</sup> Da 45 anni creiamo progetti che migliorano la vita delle persone, rendendola più semplice e sicura. Nelle nostre porte, ciascun dettaglio parla dell'incontro esclusivo tra artigianalità e innovazione, cura e sperimentazione. Perché per noi, puntare sulla tecnologia più avanzata significa non rinunciare alla tradizione, alla personalizzazione e all'amore per le cose fatte bene.

<sup>EN</sup> For 45 years we have been creating projects that improve people's life making it simpler and safer. Every detail of our doors reveals the exclusive meeting between craftsmanship and innovation, special care and constant research. Because to us, focusing on the most advanced technology does not mean giving up tradition, customization and love for things made just as they should be.

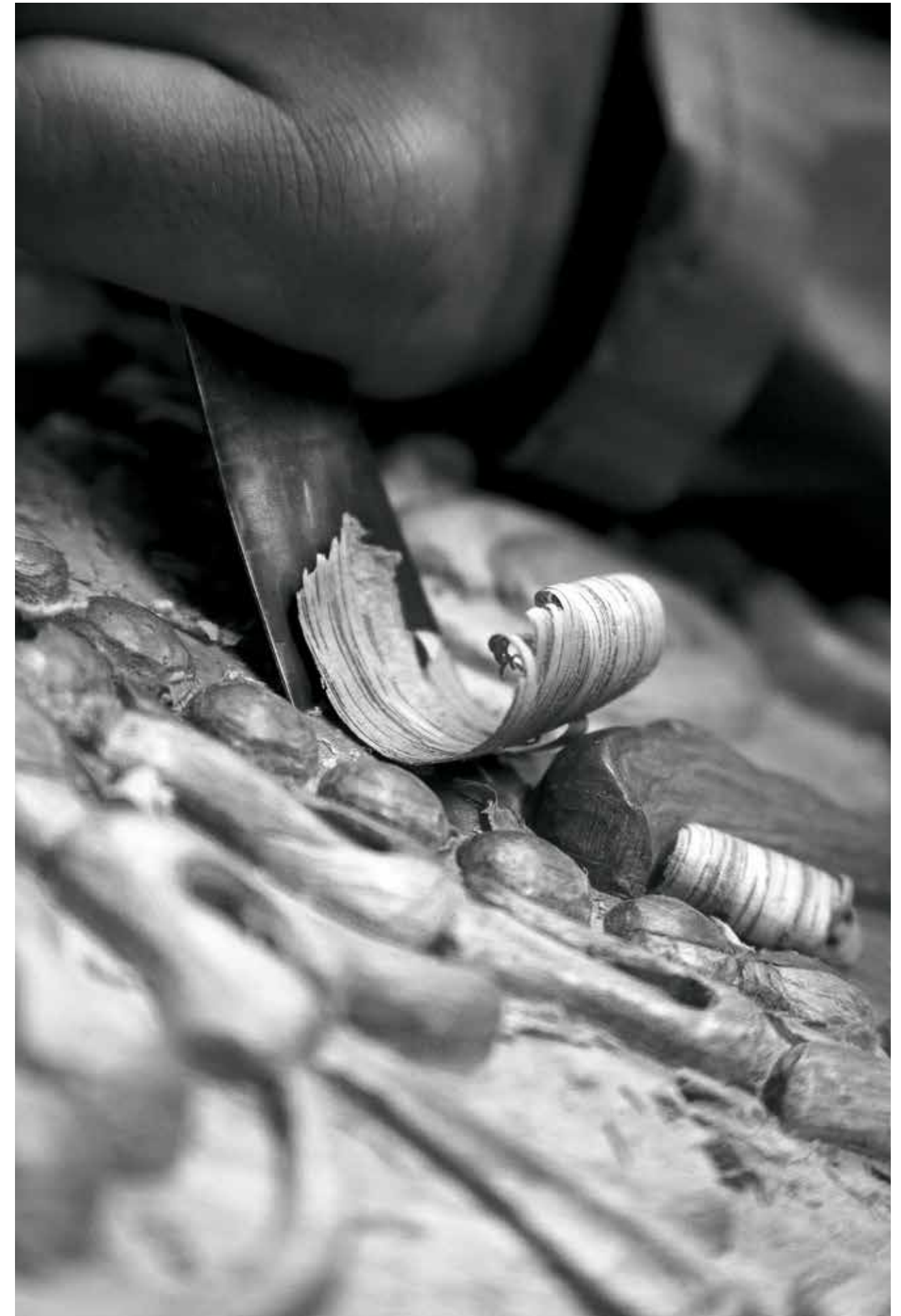



# OPERA: UN VIAGGIO NEL DESIGN

OPERA: A JOURNEY THROUGH DESIGN

IT Opera è una collezione di porte in grado di adattarsi a ogni cultura, città, esigenza. Un viaggio alla scoperta di stili e visioni diverse per creare ambienti personalizzati, esprimersi e migliorare la vita delle persone. Che si tratti di un grande albergo o di un raccolto bed and breakfast, con Opera puoi offrire ai tuoi ospiti la cosa più preziosa: un'esperienza di puro relax.

EN Opera is a door collection adaptable to any culture, city or requirement. It is a journey upon the discovery of different styles and visions to personalise and tailor spaces, and improve people's lives. Whether it's a spacious hotel or a cosy bed and breakfast, thanks to Opera, you can offer your clients the most precious thing there is: total relaxation.



Hotel Mystery ★★★★★ - Budapest



# OPERA DISUPER

SPECIFICHE TECNICHE / TECHNICAL INFORMATION

IT / EN

## PORTE O BATTENTE SINGOLO CIECO / SINGLE BLIND DOOR

- spessore anta da 64 mm  
*leaf thickness from 64 mm*
- intelaiatura perimetrale in legno massello su quattro lati, copertura con MDF  
*perimeter frame in solid wood on four sides with MDF sheets*
- speciale riempimento interno in più strati di vari materiali per garantire alte prestazioni in termini di taglio fuoco e alto isolamento acustico  
*special internal filling in several layers of various materials to ensure high performance in terms of firecut and high sound insulation*

## ALTE PRESTAZIONI / HIGH PERFORMANCE

- **Dati trasmittanza termica: Ud DI-SUPER30: 1,15 W/m<sup>2</sup>K / Ud D-SUPER60: 1,1 W/m<sup>2</sup>K**  
**Thermal transmittance data: Ud DI-SUPER30: 1,15 W/m<sup>2</sup>K / Ud D-SUPER60: 1,1 W/m<sup>2</sup>K**
- DISUPER 30: resistenza al fuoco 30 minuti abbattimento **acustico 42 dB**  
*DISUPER 30: fire resistance 30 minutes, **soundproof 42 dB***
- DISUPER 60: resistenza al fuoco 60 minuti abbattimento **acustico 47 dB**  
*DISUPER 60: fire resistance 60 minutes, **soundproof 47 dB***
- **cerniere a scomparsa regolabili su 3 assi** il cui numero garantisce alta portata di peso  
**hidden adjustable hinges on 3 axes** whose number guarantees high weight capacity
- **doppia soglia mobile inferiore / double lower mobile threshold**
- **guarnizione termoespandente** sul telaio e anta **fumi caldi / fumi freddi Sa norma EN 1634-3**  
**thermo-expanding gasket on the frame and door hot fumes / cold fumes Sa norma EN 1634-3**
- **rostro ad espansione DISUPER 60 / expansion rostrum DISUPER 60**
- rostro fisso DISUPER 60 / *fixed rostrum DISUPER 60*
- serratura versione cilindro Yale / *lock with Yale cylinder version*
- chiudiporta a slitta esterno o a scomparsa  
*external folding door closer or retractable*
- telaio in legno listellare / *blockboard wooden frame*
- doppia guarnizione di battuta / *double stop gasket*
- coprifili in varie dimensioni e profili e taglio con intestatura 45° o 90° disponibile  
*architraves in various sizes and profiles and cutting with butting 45° or 90° available*

## VARIANTI / VARIANTS

- vasta gamma di finiture: dal laccato, all'essenza, al laminato, al laminato  
*wide range of finishes: from lacquered, to essence, to laminated*

## MISURE / SIZES

- dimensioni standard passaggio / *standard passage dimensions*
- altezza netta passaggio / *clear passage height: 1970 / 2000 / 2070 / 2090 / 2100mm*
- larghezza netta passaggio / *clear passage width: 680 / 700 / 780 / 800 / 880 / 900mm*
- telaio spessore parete configurabile alle richieste per quantitativi  
*frame wall thickness configurable to requests for quantities*

## EXTRA

- varie soluzioni di serratura / *various lock solutions*
- sblocco elettrico / *electrical release*
- chiudiporta a scomparsa / *hidden door closer*

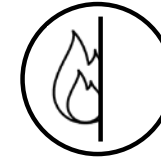
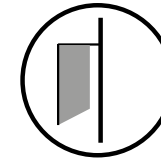
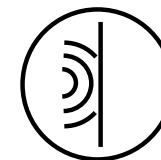
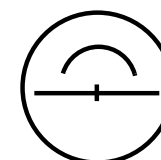
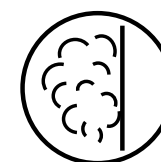

**01** Porte o battente singolo cieco  
Blind door, single leaf

**02** Cerniere a scomparsa regolabili su 3 assi di serie  
Hidden adjustable hinges on 3 axes as standard

**03** Serratura versione cilindro Yale  
Lock with Yale cylinder version

**04** Telaio in legno listellare  
Frame in blockboard wood

# OPERA EI 30 EI 60

SPECIFICHE TECNICHE / TECHNICAL INFORMATION

IT / EN

## PORTE O BATTENTE SINGOLO CIECO / SINGLE BLIND DOOR

- spessore anta da 44 mm (per EI 30 modello base) a 54 mm (per EI 60 modello base)  
*leaf thickness from 44 mm (for EI 30 basic model) to 54 mm (for EI 60 basic model)*
- intelaiatura perimetrale in legno massello su quattro lati, copertura con MDF  
*perimeter frame in solid wood on four sides with MDF sheets*
- speciale riempimento interno per garantire alte prestazioni in termini di tagliofuoco e isolamento acustico  
*special internal filling to ensure high performance in terms of firecut and sound insulation*

## ALTE PRESTAZIONI / HIGH PERFORMANCE

- EI 30: resistenza al fuoco 30 minuti abbattimento acustico 34 dB (configurazione R31)  
*EI 30: fire resistance 30 minutes, soundproof 34 dB (configuration R31)*
- EI 60: resistenza al fuoco 60 minuti abbattimento acustico 37 dB (configurazione R61)  
*EI 60: fire resistance 60 minutes, soundproof 37 dB (configuration R61)*
- **EI 30 disponibile con cerniere a scomparsa regolabili su 3 assi per anta singola**  
il cui numero garantisce alta portata di peso  
**EI 30 available hidden adjustable hinges on 3 axes for single door** whose number guarantees high weight capacity
- **soglia mobile inferiore a richiesta / lower mobile threshold on request**
- **guarnizione termoespandente sul telaio e anta fumi caldi / fumi freddi Sa norma EN 1634-3**  
**thermo-expanding gasket on the frame and door hot fumes / cold fumes Sa norma EN 1634-3**
- serratura versione cilindro Yale / lock with Yale cylinder version
- chiudiporta a slitta esterno o a scomparsa / external folding door closer or retractable
- telaio in legno listellare / blockboard wooden frame
- guarnizione di battuta / stop gasket
- coprifili in varie dimensioni e profili e taglio con intestatura 45° o 90° disponibile  
*architraves in various sizes and profiles and cutting with butting 45° or 90° available*

## VARIANTI / VARIANTS

- vasta gamma di finiture: dal laccato, all'essenza, al laminatino, al laminato  
*wide range of finishes: from lacquered, to essence, to laminated*

## MISURE / SIZES

- dimensioni standard passaggio / standard passage dimensions
- altezza netta passaggio / clear passage height: 1970 / 2000 / 2070 / 2090 / 2100mm
- larghezza netta passaggio / clear passage width: 680 / 700 / 780 / 800 / 880 / 900mm
- telaio spessore parete configurabile alle richieste per quantitativi  
*frame wall thickness configurable to requests for quantities*

## EXTRA

- varie soluzioni di serratura / various lock solutions
- sblocco elettrico / electrical release
- chiudiporta a scomparsa / hidden door closer

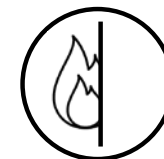
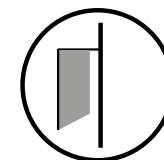
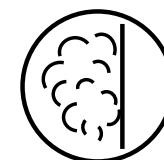

**01** Porte o battente singolo cieco  
Blind door, single leaf

**02** Cerniere a bandella e a scomparsa  
Hidden and flat adjustable hinges

**03** Serratura versione cilindro Yale  
Lock with Yale cylinder version

**04** Telaio in legno listellare  
Frame in blockboard wood



# IL SUONO DELLA TRANQUILLITÀ

THE SOUND OF SERENITY

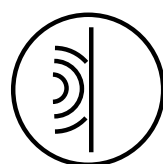

<sup>IT</sup> Un momento per te, uno spazio privato in cui fare entrare solo quello che ti fa stare bene. Grazie alle porte Opera nella versione DiSuper puoi avere, oltre a un'elevata sicurezza antincendio, il più alto livello di abbattimento acustico e far assaporare ai tuoi ospiti la calma di cui hanno bisogno. Scopri il suono della tranquillità.

<sup>EN</sup> A moment for you, a private space where you let in only what makes you feel good. Thanks to Opera collection's DiSuper doors, in addition to better fire protection safety, you can get the best soundproofing, allowing your guests to experience the peacefulness they need. Discover the sound of serenity.



Hotel Mystery ★★★★★ - Budapest



# NEW YORK

IT A New York non c'è tempo per dormire. Le strade sono fiumi in piena, in cui milioni di persone passano l'una accanto all'altra, milioni di storie si incontrano. Ogni scorcio parla di un film che abbiamo visto. E, all'angolo tra la Fifth Avenue e la West 34th Street, guardare la città dall'Empire State Building è l'unico modo per rendersi davvero conto di quanto sia immensa.

EN New York truly is the city that never sleeps. The streets are rivers in which millions of people flow and millions of stories meet. Every corner tells the story of a movie we've watched at the cinema. And, on the corner of 5th Avenue and West 34th St, you really get a sense of how big New York is by looking at the city from the Empire State Building rooftop.





# OPERA PARODI

[AIDA]



IT **OPERA PARODI ESPRIME CON NATURALITÀ IL CALORE DEL LEGNO: ELEGANTE, ESSENZIALE, SOBRIA ANCHE NELLA RICERCA FORMALE.**

Una collezione dal gusto lineare, classico, progettata per incontrare espressioni diverse dell'interior design. Ricercate nei dettagli e nei disegni, le porte Parodi si trasformano in veri elementi di arredo, ricchi di personalità. **Disponibile anche nella versione ad elevato abbattimento acustico Disuper30 e Disuper60.**

EN **OPERA PARODI NATURALLY EXPRESSES THE WARMTH OF WOOD: ELEGANT, ESSENTIAL, SOBER ALSO IN THE SEARCH FOR FORMALISM.**

A collection having a linear, classic taste, designed to meet the different expressions of interior design. Precious in their details and patterns, the Parodi doors turn into true furnishing items, rich in personality. **Also available in the high soundproof "Disuper30" and "Disuper60" version.**



[AIDA 1]



**OPERA PARODI S**

Versione cieca a trancia orizzontale  
Essenza rovere sbiancato  
Coprifilo disponibile M60

Version blank with horizontal grain  
Essence whitened oak  
Cover mould available M60

[AIDA 2]



**OPERA PARODI A**

Versione cieca  
Essenza noce nazionale tinto  
Coprifilo disponibile M60

Version blank  
Essence italian stained walnut  
Cover mould available M60

[AIDA 3]



**OPERA PARODI C**

Versione cieca a trancia orizzontale  
con 3 riquadri e profili in inox  
Essenza tanganika medio scuro  
Coprifilo disponibile M60

Version blank with horizontal grain  
with 3 panels and stainless steel profiles  
Essence medium dark tanganika  
Cover mould available M60

[AIDA 3]



**OPERA PARODI C**

Versione cieca a trancia orizzontale  
con 4 riquadri e profili in inox  
Essenza rovere grey  
Coprifilo disponibile M60

Version blank with horizontal grain  
with 4 panels and stainless steel profiles  
Essence grey oak  
Cover mould available M60



[AIDA 3]



**OPERA PARODI C**

Versione cieca a trancia orizzontale  
con 5 riquadri e profili in inox  
Essenza rovere grey  
Coprifilo disponibile M60

Version blank with horizontal grain  
with 5 panels and stainless steel profiles  
Essence grey oak  
Cover mould available M60

[AIDA 3]



**OPERA PARODI C**

Versione cieca a trancia orizzontale  
con riquadro e profili in inox  
Essenza noce nazionale tinto  
Coprifilo disponibile M60

Version blank with horizontal grain  
with panel and stainless steel profile  
Essence italian stained walnut  
Cover mould available M60

[AIDA 3]



**OPERA PARODI C**

Versione cieca a trancia orizzontale  
con 2 riquadri e profili in inox  
Essenza rovere grey  
Coprifilo disponibile M60

Version blank with horizontal grain  
with 2 panels and stainless steel profiles  
Essence grey oak  
Cover mould available M60

ESSENZE STANDARD / STANDARD ESSENCES

	TANGANIKA MEDIO SCURO MEDIUM DARK TANGANIKA		FRASSINO LACCATO NERO ASH LACQUERED BLACK
	NOCE NAZIONALE TINTO ITALIAN STAINED WALNUT		FRASSINO LACCATO CAFFÈ ASH LACQUERED COFFEE
	SHERRY		FRASSINO LACCATO BIANCO ASH LACQUERED WHITE
	ROVERE SBIANCATO WHITENED OAK		FRASSINO LACCATO PANNA B003 ASH LACQUERED CREAM B003
	ROVERE TINTO WENGÉ WENGÉ STAINED OAK		FRASSINO LACCATO AVORIO ASH LACQUERED IVORY
	ROVERE GREY GREY OAK		

ATTENZIONE: I COLORI SONO PURAMENTE INDICATIVI.  
CONSULTARE IL CAMPIONARIO COLORI.

LE IMMAGINI RAPPRESENTATE NEL CATALOGO SONO A SCOPO  
ILLUSTRATIVO.

ULTERIORI ALTRE ESSENZE SU RICHIESTA VERRANNO  
ANALIZZATE SINGOLARMENTE PER STABILIRNE LA FATTIBILITÀ,  
IL PREZZO E I TEMPI DI CONSEGNA.

ATTENTION: THE COLORS ARE PURELY INDICATIVE.  
CONSULT THE COLOR SAMPLE.

ALL IMAGES SHOWN IN THE CATALOG ARE FOR ILLUSTRATIVE  
PURPOSES ONLY.

FURTHER OTHER ESSENCES ON REQUEST WILL BE ANALYZED  
INDIVIDUALLY TO DETERMINE THE FEASIBILITY, PRICE AND  
DELIVERY TIMES.



Hotel CampZero ★★★★★ - Champoluc (AO)  
Porte interne in abbinamento / Interior doors in combination



Hotel CampZero ★★★★★ - Champoluc (AO)  
Lato interno Opera EI 30 in larice spazzolato tinta a campione con porte interne in abbinamento  
Opera EI 30 internal side in brushed stained larch as per sample with matching internal doors



# PARIGI

PARIS

IT È lei, Parigi. Senti la sua voce quando entri in un bistrot, quando cammini sugli Champs-Élysées con il vento in faccia, quando attraversi un ponte di notte. Ogni boulevard racconta una storia diversa e, guardando la città riflessa nella Senna, ti sembra di vivere in un quadro impressionista. È lei, Parigi. A ogni angolo, ti sussurra che sei nel posto giusto.

EN Paris is unmistakable. You know you are in Paris when you enter a bistrot, when you walk along the Champs-Élysées with the wind blowing in your face, and when you stroll across a bridge at night. Every boulevard tells a different story and, when you see the city reflected in the Seine, you feel like you're in an impressionist painting. Paris is unmistakable and, at every corner, she reminds you that you're in the right place.

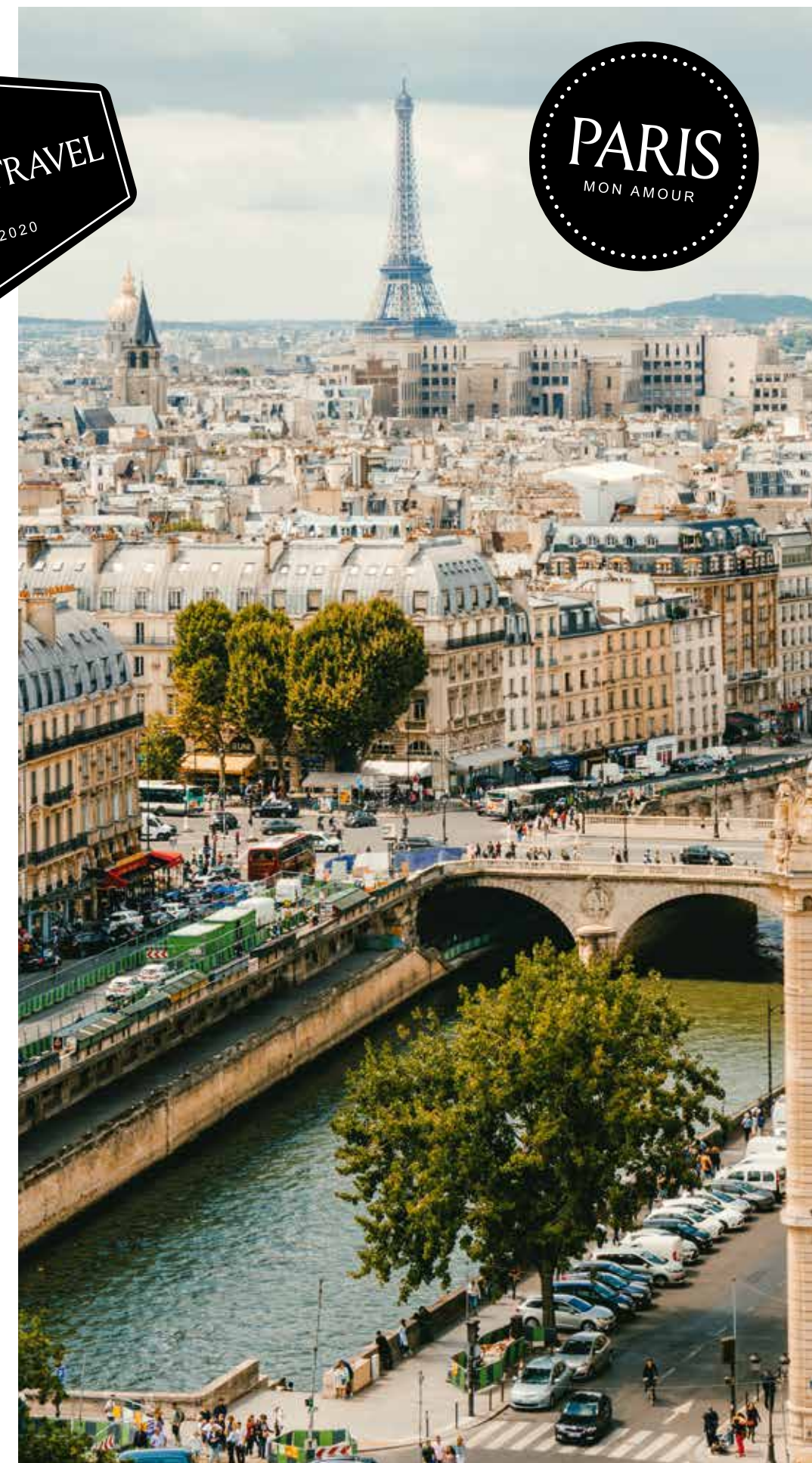



# OPERA PARODI

[PARSIFAL]



Coprifilo standard disponibile  
Standard cover mould available

IT **LA SUGGERIONE DI ANTICHE ATMOSFERE, IL PREGIO DI FORME E MATERIALI NATI PER VINCERE IL TEMPO.**

Raffinate cornici applicate, in legno e delicatamente sagomate, arricchiscono la superficie del battente impiallacciato a fiamma verticale in essenza dichiarata. È possibile scegliere fra svariati modelli la composizione di riquadri preferita, così come il tipo di legno: tanganika tinto, noce nazionale tinto, rovere tinto, ciliegio tinto o frassino biondo. **Disponibile anche nella versione ad elevato abbattimento acustico Disuper30 e Disuper60.**

EN **THE SUGGESTIVE ANTIQUE ATMOSPHERE, THE PRESTIGIOUS SHAPE AND MATERIALS CREATED TO OUTDISTANCE TIME.**

Refined and delicately fashioned applied wooden mouldings enrich the surface of the door, vertically veneered in the stated woods. The arrangement of the panels can be chosen from the various models, as well as the type of wood: stained Tanganyika, stained Italian walnut, stained oak, stained cherry wood or light ash. **Also available in the high soundproof "Disuper30" and "Disuper60" version.**

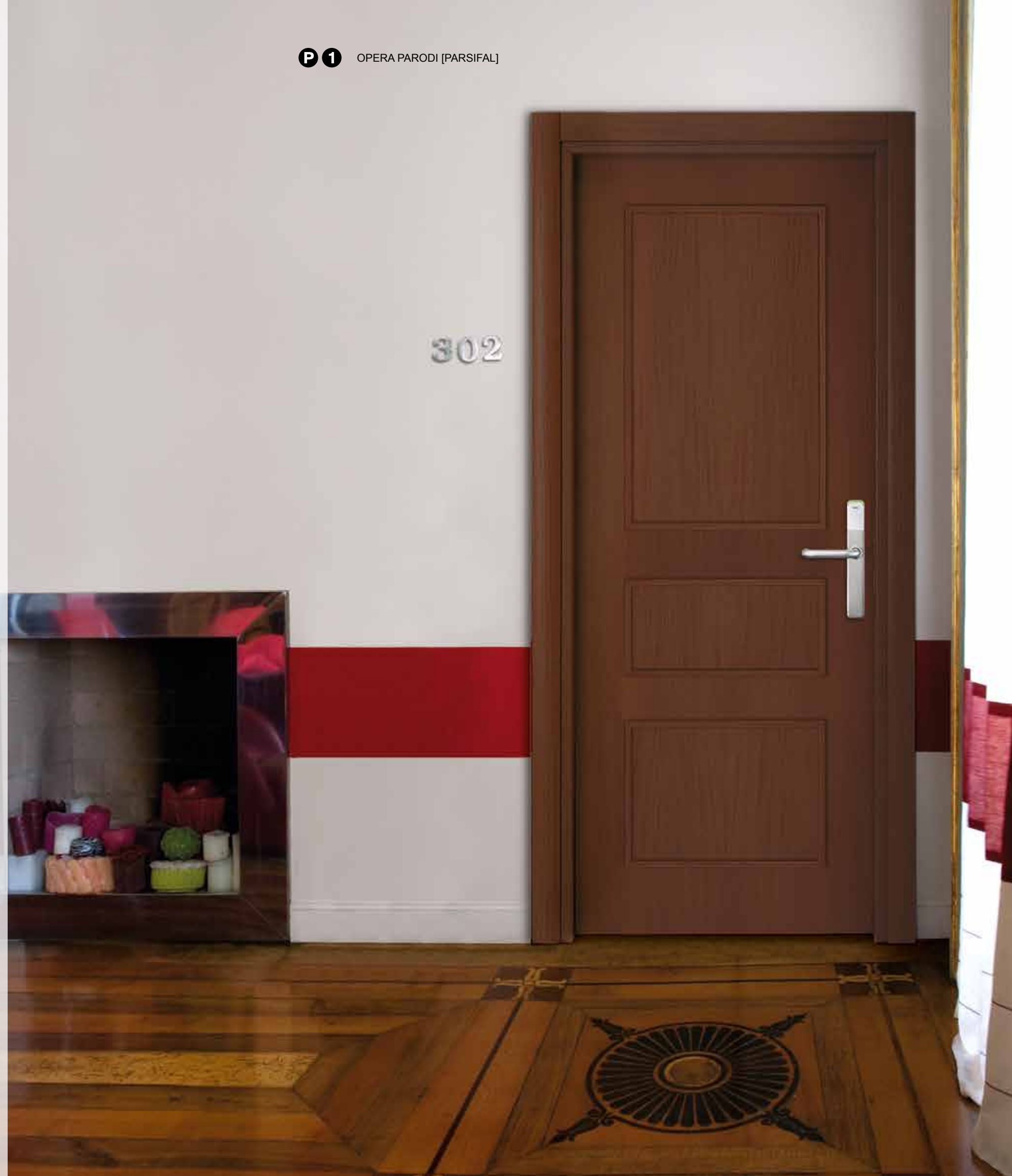

[PARSIFAL 1]



OPERA PARODI 1

Versione cieca  
Essenza sherry  
Coprifilo disponibile M60

Version blank  
Essence sherry  
Cover mould available M60

[PARSIFAL 2]



OPERA PARODI 2

Versione cieca  
Essenza sherry  
Coprifilo disponibile M60

Version blank  
Essence sherry  
Cover mould available M60

[PARSIFAL 3]



OPERA PARODI 3

Versione cieca  
Essenza noce nazionale tinto  
Coprifilo disponibile M60

Version blank  
Essence stained Italian walnut  
Cover mould available M60

[PARSIFAL 4]



OPERA PARODI 4

Versione cieca  
Essenza tanganika medio scuro  
Coprifilo disponibile M60

Version blank  
Essence medium dark tanganika  
Cover mould available M60



[PARSIFAL 5]



# OPERA PARODI 5

Versione cieca  
Essenza sherry  
Coprifilo disponibile M60

Version blank  
Essence sherry  
Cover mould available M60

[PARSIFAL 6]



# OPERA PARODI 6

Versione cieca  
Essenza tanganika medio scuro  
Coprifilo disponibile M60

Version blank  
Essence medium dark tanganika  
Cover mould available M60

[PARSIFAL 7]



# OPERA PARODI 7

Versione cieca  
Essenza tanganika medio scuro  
Coprifilo disponibile M60

Version blank  
Essence medium dark tanganika  
Cover mould available M60

[PARSIFAL B]



# OPERA PARODI B

Versione cieca  
Essenza tanganika medio scuro  
Coprifilo disponibile M60

Version blank  
Essence medium dark tanganika  
Cover mould available M60

[PARSIFAL D]



[PARSIFAL G]



OPERA PARODI D

Versione cieca  
Essenza tanganika medio scuro  
Coprifilo disponibile M60

Version blank  
Essence medium dark tanganika  
Cover mould available M60

OPERA PARODI G

Versione cieca  
Essenza sherry  
Coprifilo disponibile M60

Version blank  
Essence sherry  
Cover mould available M60

ESSENZE STANDARD / STANDARD ESSENCES

	TANGANIKA MEDIO SCURO MEDIUM DARK TANGANIKA
	NOCE NAZIONALE TINTO ITALIAN STAINED WALNUT
	SHERRY
	TANGANIKA GREZZO RAW TANGANIKA
	NOCE NAZIONALE GREZZO RAW ITALIAN WALNUT
	CILIEGIO GREZZO RAW CHERRY

ATTENZIONE: I COLORI SONO PURAMENTE INDICATIVI.  
CONSULTARE IL CAMPIONARIO COLORI.  
LE IMMAGINI RAPPRESENTATE NEL CATALOGO SONO A SCOPO  
ILLUSTRATIVO.

ULTERIORI ALTRE ESSENZE SU RICHIESTA VERRANNO  
ANALIZZATE SINGOLARMENTE PER STABILIRNE LA FATTIBILITÀ,  
IL PREZZO E I TEMPI DI CONSEGNA.

ATTENTION: THE COLORS ARE PURELY INDICATIVE.  
CONSULT THE COLOR SAMPLE.  
ALL IMAGES SHOWN IN THE CATALOG ARE FOR ILLUSTRATIVE  
PURPOSES ONLY.

FURTHER OTHER ESSENCES ON REQUEST WILL BE ANALYZED  
INDIVIDUALLY TO DETERMINE THE FEASIBILITY, PRICE AND  
DELIVERY TIMES.





# LISBONA

LISBON

IT Lisbona è un tagliente alternarsi di luce e ombra, bellezza e decadenza. Da un lato, i bianchi edifici di Belém, spruzzati di salsedine. Dall'altro il dedalo di strade di Alfama, con le salite ripide e i tram sferraglianti. Bellezza e malinconia, azulejos e rovine: a Lisbona, la saudade ha il sapore dei pastel de nata e la melodia del fado.

EN Lisbon is a stark alternation of light and shade, of beauty and decadence. On the one side, you have the white buildings of Belém, with the sweet scent of salt in the air; on the other, there's Alfama, with its labyrinth of streets, steep inclines and clanking trams. Beauty and melancholy, azulejos and ruins: in Lisbon, melancholy tastes like pastel de nata and sounds like the melody of fado.

WELCOME TO  
LISBON  
ENJOY YOUR JOURNEY

EXPLORING  
THE WORLD  
SINCE 1975





# OPERA PARODI

[NABUCCO]



**IT IL PERFETTO EQUILIBRIO TRA RIGORE ED ELEGANZA, TRA FASTO E SEMPLICITÀ, CHE SOLO IL GUSTO PIÙ SQUISITO SA CREARE.**

Il fascino del legno è reso ancora più ricercato da un gioco di riquadri su più livelli, proposti in ben 8 varianti. A cornici in essenza si affiancano pannellotti spessi 10 mm, contornati da bisellatura a effetto rilievo e impiallacciati in essenza dichiarata. La scelta può spaziare fra tanganyika tinto, noce nazionale tinto, rovere tinto, ciliegio tinto, frassino biondo. **Disponibile anche nella versione ad elevato abbattimento acustico Disuper30 e Disuper60.**

**EN THE PERFECT BALANCE BETWEEN PRECISION AND ELEGANCE, SPLENDOUR AND SIMPLICITY, THAT ONLY THE MOST SOPHISTICATED OF TASTES CAN CREATE.**

The charm of wood is made even more elaborate with the proposal of 8 variations of multilevel panels. Bevelled 10 mm thick panels, veneered in the stated wood types, stained Tanganyika, stained Italian walnut, stained oak, stained cherry wood and light ash, are combined to the wooden mouldings to give an effective raised appearance. **Also available in the high soundproof "Disuper30" and "Disuper60" version.**



[NABUCCO 1]



OPERA PARODI 1-B

Versione cieca  
Essenza sherry  
Coprifilo disponibile  
M60 a 90°

Version blank  
Essence sherry  
Cover mould available  
M60 at 90°

[NABUCCO 2]



OPERA PARODI 2-B

Versione cieca  
Essenza sherry  
Coprifilo disponibile  
M60 a 90°

Version blank  
Essence sherry  
Cover mould available  
M60 at 90°

[NABUCCO 3]



OPERA PARODI 3-B

Versione cieca  
Essenza noce nazionale tinto  
Coprifilo disponibile  
M60 a 90°

Version blank  
Essence stained Italian walnut  
Cover mould available  
M60 at 90°

[NABUCCO 4]



OPERA PARODI 4-B

Versione cieca  
Essenza tanganika medio scuro  
Coprifilo disponibile  
M60 a 90°

Version blank  
Essence medium dark tanganika  
Cover mould available  
M60 at 90°

[NABUCCO 5]



OPERA PARODI 5-B

Versione cieca  
Essenza sherry  
Coprifilo disponibile  
M60 a 90°

Version blank  
Essence sherry  
Cover mould available  
M60 at 90°

[NABUCCO 6]



OPERA PARODI 6-B

Versione cieca  
Essenza tanganika medio scuro  
Coprifilo disponibile  
M60 a 90°

Version blank  
Essence medium dark tanganika  
Cover mould available  
M60 at 90°

[NABUCCO 7]



OPERA PARODI 7-B

Versione cieca  
Essenza tanganika medio scuro  
Coprifilo disponibile  
M60 a 90°

Version blank  
Essence medium dark tanganika  
Cover mould available  
M60 at 90°

[NABUCCO B]



OPERA PARODI B-B

Versione cieca  
Essenza noce nazionale tinto  
Coprifilo disponibile  
M60 a 90°

Version blank  
Essence stained Italian walnut  
Cover mould available  
M60 at 90°



[NABUCCO D]



[NABUCCO G]



OPERA PARODI D-B

Versione cieca  
Essenza tanganka medio scuro  
Coprifilo disponibile  
M60 a 90°

Version blank  
Essence medium dark tanganka  
Cover mould available  
M60 at 90°

OPERA PARODI G-B

Versione cieca  
Essenza sherry  
Coprifilo disponibile  
M60 a 90°

Version blank  
Essence sherry  
Cover mould available  
M60 at 90°

ESSENZE STANDARD / STANDARD ESSENCES



ATTENZIONE: I COLORI SONO PURAMENTE INDICATIVI.  
CONSULTARE IL CAMPIONARIO COLORI.  
LE IMMAGINI RAPPRESENTATE NEL CATALOGO SONO A SCOPO  
ILLUSTRATIVO.

ULTERIORI ALTRE ESSENZE SU RICHIESTA VERRANNO  
ANALIZZATE SINGOLARMENTE PER STABILIRNE LA FATTIBILITÀ,  
IL PREZZO E I TEMPI DI CONSEGNA.

ATTENTION: THE COLORS ARE PURELY INDICATIVE.  
CONSULT THE COLOR SAMPLE.  
ALL IMAGES SHOWN IN THE CATALOG ARE FOR ILLUSTRATIVE  
PURPOSES ONLY.

FURTHER OTHER ESSENCES ON REQUEST WILL BE ANALYZED  
INDIVIDUALLY TO DETERMINE THE FEASIBILITY, PRICE AND  
DELIVERY TIMES.



# SIDNEY

<sup>IT</sup> Sul Sydney Harbour Bridge, all'alba, il tempo si ferma. L'odore dell'Oceano si mescola a quello della città e i pappagalli si affacciano sulla baia. A Sydney non c'è contraddizione tra grattacieli e libellule, tra strade e fiori profumati. A Sydney la natura è viva. E quando si alzano le onde, non resta che andare in spiaggia e iniziare a surfare.

<sup>EN</sup> Time stands still at dawn on Sydney Harbour Bridge. The scent of the ocean meets the smell of the city as the parrots look out onto the bay. In Sydney, there's no contradiction between skyscrapers and dragonflies, roads and scented flowers. Nature is alive in Sydney. And when the waves are high, there's nowhere else to be but the beach and nothing better to do but surf.

DON'T STOP  
EXPLORING  
SYDNEY

HOTEL  
COLLECTION  
EDITION  
2020





# OPERA ISY

[AIDA]



IT **VERSATILE, ORIGINALE, CONTEMPORANEA: CON OPERA ISY, IL DESIGN ESPRIME LA FORZA ESPRESSIVA DEL LEGNO, CON FINITURE IN LAMINATINO CHE INCONTRANO TUTTI GLI STILI DI DESIGN.**

Opera Isy è una porta per interni particolarmente facile da collocare in ogni spazio della casa grazie all'ampia gamma di colorazioni e sfumature disponibili. La struttura in listellare del telaio e il particolare coprifilo in multistrato mettono in risalto la forza espressiva del legno che, come una volta, ritorna ad essere il protagonista della porta moderna. **Disponibile anche nella versione ad elevato abbattimento acustico Disuper30 e Disuper60.**

EN **VERSATILE, ORIGINAL, AND CONTEMPORARY: OPERA ISY SHOWCASES THE EXPRESSIVE POWER OF WOOD, WITH LAMINATE FINISHES THAT MERGE ALL THE DESIGNER STYLES.**

Opera Isy is a door for interiors particularly easy to fit within every space of the house thanks to the wide range of available colors and shades. The structure of the slat frame and the particular multilayer casing make the expressive strength of wood stand out that - as it used to be - comes to be the star of modern doors. **Also available in the high soundproof "Disuper30" and "Disuper60" version.**





[AIDA 1]



OPERA ISY I

Versione cieca  
Colore marmorizzato beton maloja  
Coprifilo disponibile M90/T90

Version blank  
Colour marbled beton maloja  
Cover mould available M90/T90

[AIDA 3]



OPERA ISY I

Versione 3 riquadri e profili in inox  
Colore bianco B011  
Coprifilo disponibile M90/T90

Version 3 panels and stainless steel  
profiles  
Colour white B011  
Cover mould available M90/T90

[AIDA 1]



OPERA ISY I

Versione 4 riquadri e profili in inox  
Colore matrix palissandro grigio  
Coprifilo disponibile M90/T90

Version 4 panels and stainless steel  
profiles  
Colour matrix grey rosewood  
Cover mould available M90/T90

[AIDA 3]



OPERA ISY I

Versione 5 riquadri e profili in inox  
Colore marmorizzato beton maloja  
Coprifilo disponibile M90/T90

Version 5 panels and stainless steel  
profiles  
Colour marbled beton maloja  
Cover mould available M90/T90

[AIDA 1]



OPERA ISY 1

Versione con riquadro centrale e profili in inox  
Colore marmorizzato beton maloja  
Coprifilo disponibile M90/T90

Version con central panel and stainless steel profiles  
Colour marbled beton maloja  
Cover mould available M90/T90

[AIDA 3]



OPERA ISY 1

Versione 2 riquadri e profili in inox  
Colore bianco B011  
Coprifilo disponibile M90/T90

Version 2 panels and stainless steel profiles  
Colour white B011  
Cover mould available M90/T90

FINITURE LAMINATINO / LAMINATE FINISHES

	MATRIX BIANCO WHITE MATRIX		MARMORIZZATO BETON MALOJA MARBLED BETON MALOJA
	MATRIX PALISSANDRO BIANCO MATRIX WHITE ROSEWOOD		BIANCO B011 WHITE B011
	MATRIX PALISSANDRO GRIGIO MATRIX GREY ROSEWOOD		BIANCO PANNA B003 WHITE CREAM B003
	MATRIX PALISSANDRO BLU MATRIX BLUE ROSEWOOD		BIANCO AZIMUT WHITE AZIMUTH
	ALTER NOCE TABACCO ALTER TOBACCO WALNUT		LACCATO RAL E/O NCS SPAZZOLATO MILLECOLORI BRUSHED LACQUERED AND/OR NCS RAL MILLECOLORI
	ROVERE GRIGIO TRANCHÉ GREY OAK TRANCHÉ		LACCATO RAL E/O NCS SFUMATO MILLECOLORI SHADED LACQUERED RAL AND/OR NCS MILLECOLORI
	ROVERE SBIANCATO TRANCHÉ WHITENED OAK TRANCHÉ		LACCATO RAL E/O NCS LISCIIO MILLECOLORI LACQUERED RAL AND/OR NCS SMOOTH MILLECOLORI

ATTENZIONE: I COLORI SONO PURAMENTE INDICATIVI. CONSULTARE IL CAMPIONARIO COLORI.

LE IMMAGINI RAPPRESENTATE NEL CATALOGO SONO A SCOPO ILLUSTRATIVO.

ULTERIORI ALTRE ESSENZE SU RICHIESTA VERRANNO ANALIZZATE SINGOLARMENTE PER STABILIRNE LA FATTIBILITÀ, IL PREZZO E I TEMPI DI CONSEGNA.

ATTENTION: THE COLORS ARE PURELY INDICATIVE. CONSULT THE COLOR SAMPLE.

ALL IMAGES SHOWN IN THE CATALOG ARE FOR ILLUSTRATIVE PURPOSES ONLY.

FURTHER OTHER ESSENCES ON REQUEST WILL BE ANALYZED INDIVIDUALLY TO DETERMINE THE FEASIBILITY, PRICE AND DELIVERY TIMES.





Hotel Carlton Riviera ★★★ - Cefalù (PA)  
DISUPER EI 30 - Palissandro bianco / White rosewood



Hotel Carlton Riviera ★★★ - Cefalù (PA)  
DISUPER EI 30 - Palissandro bianco / White rosewood



# TOKYO

IT Le luci al neon, i colori, i grattacieli: Tokyo non sa stare ferma, è una città di eterni contrasti in cui si annulla ogni opposizione. Uno spazio sospeso tra Oriente e Occidente, tradizione e futuro. Proprio lì, dove la megalopoli cede il passo ai giardini, natura e cultura si mescolano nella bellezza di un gesto: alzare lo sguardo e guardare i ciliegi in fiore.

EN Neon lights, colours and skyscrapers: Tokyo doesn't know how to stand still. It's a city of eternal contrasts which cancel out every opposition. It is a space suspended between East and West, tradition and future. Right there, where the megalopolis gives way to gardens, nature and culture, is where beauty meets: look up and you'll see cherry trees in bloom.

DIERRE  
BORN TO TRAVEL  
EDITION 2020

WELCOME TO  
TOKYO  
ENJOY YOUR JOURNEY





# OPERA FORTE

[TURANDOT]



IT **IL CULTO DEL COLORE TINGE GLI AMBIENTI DI FORTE PERSONALITÀ, SPAZIANDO FRA LE PIÙ MODERNE ESPRESSIONI ARTISTICHE.**

L'assoluta semplicità dell'anta, esaltata da colorazioni brillanti e luminose, è la soluzione ideale sia per gli ambienti di carattere moderno che per i contesti più informali. La linearità della superficie permette di apprezzare appieno la perfezione della laccatura, disponibile in tinta bianca, verde, celeste o avorio oltre che, a richiesta, in qualsiasi colore RAL e /o NCS esistente. **Disponibile anche nella versione ad elevato abbattimento acustico Disuper30 e Disuper60.**

EN **THE COLOUR TREND TINGES THE SURROUNDINGS WITH INTENSE PERSONALITY, ROAMING THROUGH THE LATEST ARTISTIC EXPRESSIONS.**

The absolute simplicity of the door, exalted by bright and luminous colours, is the ideal solution for both modern and informal surroundings. The lacquered finishes, in white, green, sky-blue or ivory as well as any existing RAL e/or NCS or sample colour on request, can be appreciated to their fullest through the linearity of the surfaces. **Also available in the high soundproof "Disuper30" and "Disuper60" version.**





[TURANDOT 1]



# OPERA FORTE 6

Versione cieca  
Colore laccata RAL 7047  
Coprifilo disponibile M60 a 45°

Version blank  
Colour lacquered RAL 7047  
Cover mould available M60 at 45°

[TURANDOT 3]



# OPERA FORTE 9

Versione 3 riquadri e profili in cromo  
satinato  
Colore laccata terre d'argilla  
Coprifilo disponibile M60 a 45°

Version 3 panels and satin chrome profiles  
Colour lacquered clay dirt  
Cover mould available M60 at 45°

[TURANDOT 3]



# OPERA FORTE 9

Versione 4 riquadri e profili in cromo  
satinato  
Colore laccata RAL 9003  
Coprifilo disponibile M60 a 45°

Version 4 panels and satin chrome profiles  
Colour lacquered RAL 9003  
Cover mould available M60 at 45°

[TURANDOT 3]



# OPERA FORTE 9

Versione 5 riquadri e profili in cromo  
satinato  
Colore laccata ghiaccio  
Coprifilo disponibile M60 a 45°

Version 5 panels and satin chrome profiles  
Colour lacquered ice  
Cover mould available M60 at 45°

[TURANDOT 3]



OPERA FORTE 9

Versione riquadro centrale con profili in cromo satinato  
Colore laccata RAL 7003  
Coprifilo disponibile M60 a 45°

Version central panel with satin chrome profiles  
Colour lacquered RAL 7003  
Cover mould available M60 at 45°

[TURANDOT 3]



OPERA FORTE 9

Versione 2 riquadri e profilo in cromo satinato  
Colore laccata RAL 9018  
Coprifilo disponibile M60 a 45°

Version 2 panels and satin chrome profile  
Colour lacquered RAL 9018  
Cover mould available M60 at 45°

DISPONIBILITÀ LACCATURE / LACQUER AVAILABILITY

	LACCATO BIANCO B011 WHITE LACQUERED B011		GRIGIO SATURNO SATURN GREY
	LACCATO PANNA B003 CREAM LACQUERED B003		GHIACCIO ICE
	TERRE D'ARGILLA CLAY DIRT		GRIGIO TORTORA DOVE GREY
	CORDA ROPE		VIOLETTA VIOLET

RAL E/O NCS / RAL AND/OR NCS



ATTENZIONE: I COLORI SONO PURAMENTE INDICATIVI. CONSULTARE IL CAMPIONARIO COLORI.

LE IMMAGINI RAPPRESENTATE NEL CATALOGO SONO A SCOPO ILLUSTRATIVO.

ULTERIORI ALTRE ESSENZE SU RICHIESTA VERRANNO ANALIZZATE SINGOLARMENTE PER STABILIRNE LA FATTIBILITÀ, IL PREZZO E I TEMPI DI CONSEGNA.

ATTENTION: THE COLORS ARE PURELY INDICATIVE. CONSULT THE COLOR SAMPLE.

ALL IMAGES SHOWN IN THE CATALOG ARE FOR ILLUSTRATIVE PURPOSES ONLY.

FURTHER OTHER ESSENCES ON REQUEST WILL BE ANALYZED INDIVIDUALLY TO DETERMINE THE FEASIBILITY, PRICE AND DELIVERY TIMES.





# ISTANBUL

IT Quella di Istanbul è una sinfonia magica, in cui i suoni si amalgamano nel vociare caotico del Gran Bazar e i muezzin si fanno eco l'un l'altro dai minareti. Le ampie gonne dei dervisci rotanti si gonfiano e, dietro ogni angolo, c'è qualcosa di straordinario. A Istanbul Oriente e Occidente si incontrano. A Istanbul, tra cupole e minareti, tutto è possibile.

EN Istanbul is a magical symphony which blends the chaotic clamour of the Gran Bazar with the echoing of the muezzins from the minarets. The large rotating dervishes twirl all around and, behind every corner, something extraordinary awaits. Istanbul is where East and West converge. With its domes and minarets, everything is possible here.





# OPERA FORTE

[MANON]



IT **ESPRESSIONE DI UN'ELEGANZA SONTUOSA E IMPONENTE, PER RIVIVERE QUI E ADESSO IDEALI DI BELLEZZA PREZIOSI E LONTANI.**

Classico o decisamente moderno? La versatilità della tecnica di incisione, consente di comporre riquadri linee e greche e di realizzare porte dal carattere unico. Autentici capolavori di uno stile eclettico e estremamente personale, declinabile in infinite varianti di colore, grazie alla laccatura bianco, verde, celeste, avorio e qualsiasi colore RAL e/o NCS. **Disponibile anche nella versione ad elevato abbattimento acustico Disuper30 e Disuper60.**

EN **THE EXPRESSION OF A RICH AND FORMIDABLE ELEGANCE, TO LIVE AGAIN, HERE AND NOW, THE IDEALS OF A PRECIOUS AND FAR-OFF BEAUTY.**

Classic or decidedly modern? From the versatility of the carving techniques, doors with fretted and linear panels and a unique character are created. Authentic works of art with a versatile and extremely personal style, available in an infinite variation of colours, thanks to the white, green, sky-blue and ivory lacquering and in any RAL and/or NCS colour. **Also available in the high soundproof "Disuper30" and "Disuper60" version.**



[MANON 1]



OPERA FORTE 1

Versione cieca  
Colore laccata RAL 1034  
Coprifilo disponibile M60 e M20 a 45°

Version blank  
Colour lacquered RAL 1034  
Cover mould available M60 and M20 at 45°

[MANON 2]



OPERA FORTE 2

Versione cieca  
Colore laccata bianco B011  
Coprifilo disponibile M60 e M20 a 45°

Version blank  
Colour white lacquered B011  
Cover mould available M60 and M20 at 45°

[MANON 3]



OPERA FORTE 3

Versione cieca  
Colore laccata RAL 7044  
Coprifilo disponibile M60 e M20 a 45°

Version blank  
Colour lacquered RAL 7044  
Cover mould available M60 and M20 at 45°

[MANON 4]



OPERA FORTE 4

Versione cieca  
Colore laccata RAL 3031  
Coprifilo disponibile M60 e M20 a 45°

Version blank  
Colour lacquered RAL 3031  
Cover mould available M60 and M20 at 45°



[MANON 5]



OPERA FORTE 5

Versione cieca  
Colore laccata RAL 6003  
Coprifilo disponibile M60 e M20 a 45°

Version blank  
Colour lacquered RAL 6003  
Cover mould available M60 and M20 at 45°

[MANON 7]



OPERA FORTE 7

Versione cieca  
Colore laccata RAL 1001  
Coprifilo disponibile M60 e M20 a 45°

Version blank  
Colour lacquered RAL 1001  
Cover mould available M60 and M20 at 45°

[MANON 8]



OPERA FORTE 8

Versione cieca  
Colore laccata RAL 6021  
Coprifilo disponibile M60 e M20 a 45°

Version blank  
Colour lacquered RAL 6021  
Cover mould available M60 and M20 at 45°

[MANON A]



OPERA FORTE A

Versione cieca  
Colore laccata RAL 7001  
Coprifilo disponibile M60 e M20 a 45°

Version blank  
Colour lacquered RAL 7001  
Cover mould available M60 and M20 at 45°

[MANON B]



[MANON C]



OPERA FORTE B

Versione cieca  
Colore laccata RAL 7044  
Coprifilo disponibile M60 e M20 a 45°

Version blank  
Colour lacquered RAL 7044  
Cover mould available M60 and M20 at 45°

OPERA FORTE C

Versione cieca  
Colore laccata RAL 7037  
Coprifilo disponibile M60 e M20 a 45°

Version blank  
Colour lacquered RAL 7037  
Cover mould available M60 and M20 at 45°

[MANON D]



[MANON E]



OPERA FORTE D

Versione cieca  
Colore laccata RAL 1001  
Coprifilo disponibile M60 e M20 a 45°

Version blank  
Colour lacquered RAL 1001  
Cover mould available M60 and M20 at 45°

OPERA FORTE E

Versione cieca  
Colore laccata RAL 1013  
Coprifilo disponibile M60 e M20 a 45°

Version blank  
Colour lacquered RAL 1013  
Cover mould available M60 and M20 at 45°



[MANON F]



[MANON G]



# OPERA FORTE F

Versione cieca  
Colore laccata RAL 7036  
Coprifilo disponibile M60 e M20 a 45°

Version blank  
Colour lacquered RAL 7036  
Cover mould available M60 and M20 at 45°

# OPERA FORTE G

Versione cieca  
Colore laccata RAL 7035  
Coprifilo disponibile M60 e M20 a 45°

Version blank  
Colour lacquered RAL 7035  
Cover mould available M60 and M20 at 45°

[MANON H]



[MANON I]



# OPERA FORTE G

Versione cieca  
Colore laccata RAL 1013  
Coprifilo disponibile M60 e M20 a 45°

Version blank  
Colour lacquered RAL 1013  
Cover mould available M60 and M20 at 45°

# OPERA FORTE G

Versione cieca  
Colore laccata grigio saturno  
Coprifilo disponibile M60 e M20 a 45°

Version blank  
Colour lacquered saturn grey  
Cover mould available M60 and M20 at 45°

[MANON F]



OPERA FORTE H

Versione cieca  
Colore laccata RAL 9018  
Coprifilo disponibile M60 e M20 a 45°

Version blank  
Colour lacquered RAL 9018  
Cover mould available M60 and M20 at 45°

[MANON G]



OPERA FORTE H

Versione cieca  
Colore laccata violetta  
Coprifilo disponibile M60 e M20 a 45°

Version blank  
Colour lacquered violet  
Cover mould available M60 and M20 at 45°

[MANON H]



OPERA FORTE H

Versione cieca  
Colore laccata RAL 7031  
Coprifilo disponibile M60 e M20 a 45°

Version blank  
Colour lacquered RAL 7031  
Cover mould available M60 and M20 at 45°

[MANON I]



OPERA FORTE I

Versione cieca  
Colore laccata RAL 7035  
Coprifilo disponibile M60 e M20 a 45°

Version blank  
Colour lacquered RAL 7035  
Cover mould available M60 and M20 at 45°



[MANON L]



OPERA FORTE L

Versione cieca  
Colore laccata RAL 7040  
Coprifilo disponibile M60 e M20 a 45°

Version blank  
Colour lacquered RAL 7040  
Cover mould available M60 and M20 at 45°

[MANON M]



OPERA FORTE M

Versione cieca  
Colore laccata RAL 1019  
Coprifilo disponibile M60 e M20 a 45°

Version blank  
Colour lacquered RAL 1019  
Cover mould available M60 and M20 at 45°

[MANON N]



OPERA FORTE N

Versione cieca  
Colore laccata RAL 1001  
Coprifilo disponibile M60 e M20 a 45°

Version blank  
Colour lacquered RAL 1001  
Cover mould available M60 and M20 at 45°

[MANON P]



OPERA FORTE P

Versione cieca  
Colore laccato bianco B011  
Coprifilo disponibile M60 e M20 a 45°

Version blank  
Colour white lacquered B011  
Cover mould available M60 and M20 at 45°

[MANON P1]



OPERA FORTE P1

Versione cieca  
 Colore laccato bianco B011  
 Coprifilo disponibile M60 e M20 a 45°

Version blank  
 Colour white lacquered B011  
 Cover mould available M60 and M20 at 45°

DISPONIBILITÀ LACCATURE / LACQUER AVAILABILITY

	LACCATO BIANCO B011 WHITE LACQUERED B011		GRIGIO SATURNO SATURN GREY
	LACCATO PANNA B003 CREAM LACQUERED B003		GHIACCIO ICE
	TERRE D'ARGILLA CLAY DIRT		GRIGIO TORTORA DOVE GREY
	CORDA ROPE		VIOLETTA VIOLET

RAL E/O NCS / RAL AND/OR NCS



ATTENZIONE: I COLORI SONO PURAMENTE INDICATIVI.  
 CONSULTARE IL CAMPIONARIO COLORI.

ATTENTION: THE COLORS ARE PURELY INDICATIVE.  
 CONSULT THE COLOR SAMPLE.

LE IMMAGINI RAPPRESENTATE NEL CATALOGO SONO A SCOPO ILLUSTRATIVO.

ALL IMAGES SHOWN IN THE CATALOG ARE FOR ILLUSTRATIVE PURPOSES ONLY.

ULTERIORI ALTRE ESSENZE SU RICHIESTA VERRANNO ANALIZZATE SINGOLARMENTE PER STABILIRNE LA FATTIBILITÀ, IL PREZZO E I TEMPI DI CONSEGNA.

FURTHER OTHER ESSENCES ON REQUEST WILL BE ANALYZED INDIVIDUALLY TO DETERMINE THE FEASIBILITY, PRICE AND DELIVERY TIMES.





# ZAGABRIA

ZAGREB

IT Zagabria è fatta di contrasti. È dall'armonia stridente tra i palazzi barocchi e gli edifici austeri che nasce la sua bellezza. Passeggiare per le vie della Città Alta, vagare senza meta per le strade, entrare nei caffè e sentire il profumo delle erbe aromatiche al mercato: per capire Zagabria bisogna immergersi completamente.

EN Zagreb is all about contrasts. Its beauty is born from the striking harmony between the Baroque palaces and the austere buildings. Strolling through the streets of the Upper Town, wandering aimlessly through the streets, entering cafés, and smelling the scent of aromatic herbs at the market - to understand Zagreb you have to immerse yourself completely.

DON'T STOP  
EXPLORING  
ZAGREB

HOTEL  
COLLECTION  
EDITION  
2020





# OPERA LIGHT

[OTELLO]

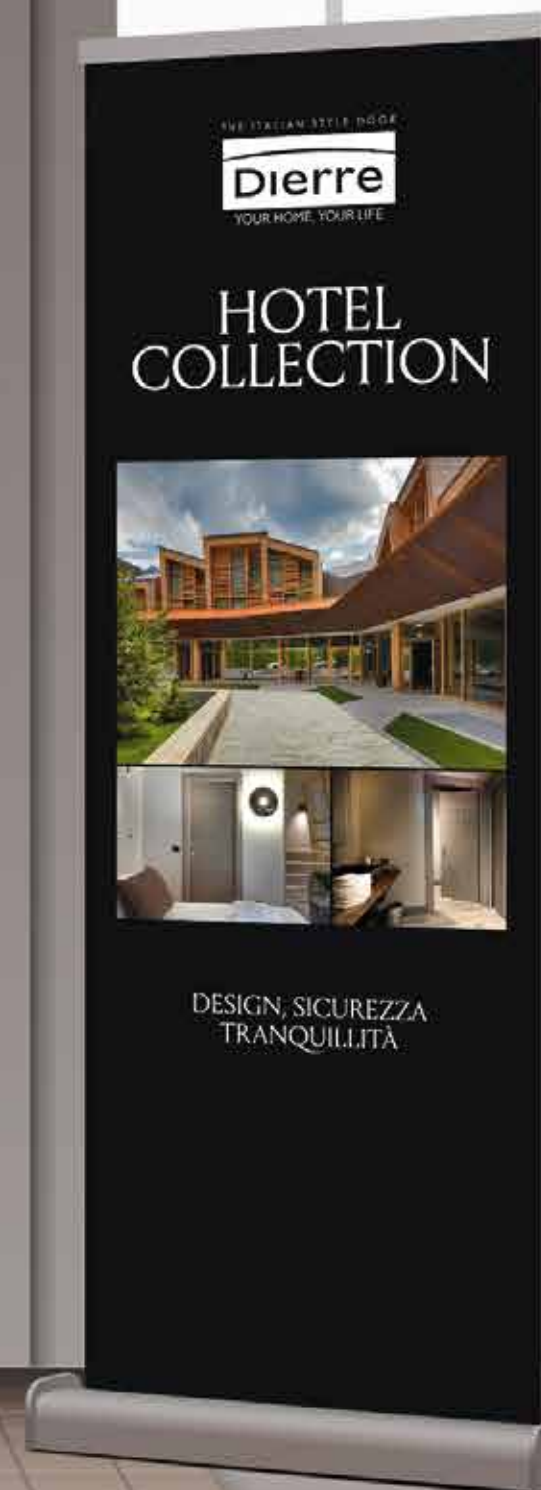

**IT LINEE SEMPLICI E DESIGN ESSENZIALE: OPERA LIGHT DÀ FORMA ALL'ELEGANZA SENZA TEMPO.**

La collezione Opera Light ripropone in chiave moderna le linee classiche delle porte tradizionali a bugna con una pantografatura quadrata piana. Segno delicato che si abbina alla perfezione con le nuove finiture d'arredo, offrendo superfici morbide e caldi riflessi. Disponibili in qualsiasi colore RAL e/o NCS.

**EN SIMPLE LINES AND ESSENTIAL DESIGN: OPERA LIGHT GIVES SHAPE TO TIMELESS ELEGANCE.**

The Light collection presents a more modern version of classic lines found in traditional raised panel doors with a flat square pantographing. A delicate touch that perfectly matches with the new furnishing finishes, offering soft surfaces and warm reflections. Available in any RAL and/or NCS color.

[OTELLO]



OPERA LIGHT 1

Versione cieca  
Colore laccato terre d'argilla  
Coprifilo disponibile M60

Version blank  
Colour lacquered clay dirt  
Cover mould available M60

[OTELLO]



OPERA LIGHT 2

Versione cieca  
Colore laccato grigio tortora  
Coprifilo disponibile M60

Version blank  
Colour lacquered dove grey  
Cover mould available M60

[OTELLO]



OPERA LIGHT Y

Versione cieca  
Colore laccato grigio saturno  
Coprifilo disponibile M60

Version blank  
Colour lacquered saturn gray  
Cover mould available M60

[OTELLO]



OPERA LIGHT J

Versione cieca  
Colore laccato corda  
Coprifilo disponibile M60

Version blank  
Colour lacquered rope  
Cover mould available M60



[OTELLO]



**OPERA LIGHT L**

Versione cieca  
Colore laccato grigio tortora  
Coprifilo disponibile M60

Version blank  
Colour lacquered dove grey  
Cover mould available M60

[OTELLO]



**OPERA LIGHT J**

Versione cieca  
Colore laccato corda  
Coprifilo disponibile M60

Version blank  
Colour lacquered rope  
Cover mould available M60

[OTELLO]



**OPERA LIGHT L**

Versione cieca  
Colore laccato grigio saturno  
Coprifilo disponibile M60

Version blank  
Colour lacquered saturn gray  
Cover mould available M60

[OTELLO]



**OPERA LIGHT 1 R**

Versione cieca  
Colore laccato terre d'argilla  
Coprifilo disponibile M60

Version blank  
Colour lacquered clay dirt  
Cover mould available M60

[OTELLO]



OPERA LIGHT 2 R

Versione cieca  
Colore laccato terre d'argilla  
Coprifilo disponibile M60

Version blank  
Colour lacquered clay dirt  
Cover mould available M60

[OTELLO]



OPERA LIGHT J R

Versione cieca  
Colore laccato corda  
Coprifilo disponibile M60

Version blank  
Colour lacquered rope  
Cover mould available M60



[OTELLO]

OPERA LIGHT L R

Versione cieca  
Colore laccato grigio tortora  
Coprifilo disponibile M60

Version blank  
Colour lacquered dove grey  
Cover mould available M60



[OTELLO]



OPERA LIGHT JR

Versione cieca  
Colore laccato ghiaccio  
Coprifilo disponibile M60

Version blank  
Colour lacquered ice  
Cover mould available M60

[OTELLO]



OPERA LIGHT LR

Versione cieca  
Colore laccato grigio saturno  
Coprifilo disponibile M60

Version blank  
Colour lacquered saturn grey  
Cover mould available M60

DISPONIBILITÀ LACCATURE / LACQUER AVAILABILITY

	LACCATO BIANCO B011 WHITE LACQUERED B011		GRIGIO SATURNO SATURN GREY
	LACCATO PANNA B003 CREAM LACQUERED B003		GHIACCIO ICE
	TERRE D'ARGILLA CLAY DIRT		GRIGIO TORTORA DOVE GREY
	CORDA ROPE		VIOLETTA VIOLET

RAL E/O NCS / RAL AND/OR NCS

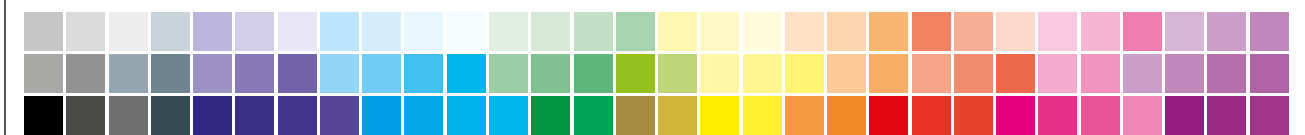

ATTENZIONE: I COLORI SONO PURAMENTE INDICATIVI.  
CONSULTARE IL CAMPIONARIO COLORI.

LE IMMAGINI RAPPRESENTATE NEL CATALOGO SONO A SCOPO ILLUSTRATIVO.

ULTERIORI ALTRE ESSENZE SU RICHIESTA VERRANNO ANALIZZATE SINGOLARMENTE PER STABILIRNE LA FATTIBILITÀ, IL PREZZO E I TEMPI DI CONSEGNA.

ATTENTION: THE COLORS ARE PURELY INDICATIVE.  
CONSULT THE COLOR SAMPLE.

ALL IMAGES SHOWN IN THE CATALOG ARE FOR ILLUSTRATIVE PURPOSES ONLY.

FURTHER OTHER ESSENCES ON REQUEST WILL BE ANALYZED INDIVIDUALLY TO DETERMINE THE FEASIBILITY, PRICE AND DELIVERY TIMES.

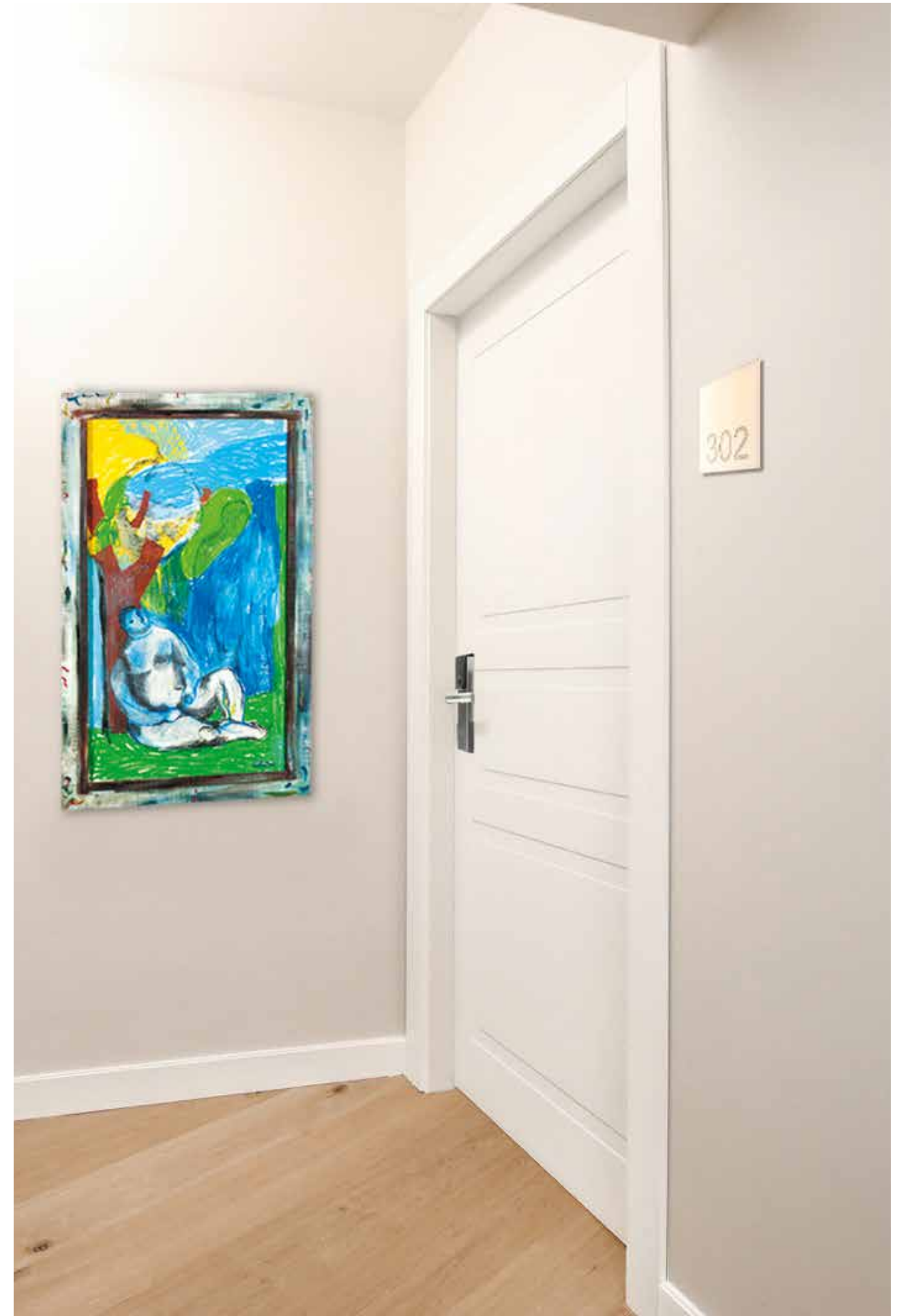



# LONDRA

LONDON

IT Londra è la storia impressa nei monumentali edifici del West End. Londra è la città delle idee e dell'innovazione. Londra è l'energia che attraversa le strade, passa sul Millennium bridge e scorre sottoterra, lungo le linee della metropolitana. Londra è tante culture e ha il sapore del mondo intero.

EN London is history, etched in the monumental buildings of the West End. But London is also ideas and innovation. It is energy in the streets, on the Millennium Bridge and underground on the lines of the Tube. It is a melting pot of cultures where the flavours of the whole world meet.

LONDON  
HAVE A NICE TRIP

HOTEL  
COLLECTION  
EDITION  
2020





# OPERA DANIELI

[TOSCA]



IT **RAFFINATE ARCHITETTURE FIORISCONO DI DECORAZIONI FANTASIOSE, VALORIZZATE DALLA GRAZIA LINEARE DEGLI ELEMENTI D'ARREDO.**

La versatile tecnica della pantografatura trasforma il battente in una superficie aperta alla fantasia e agli stili più svariati, dal classico all'ultramoderno. Attraverso la diversa composizione di riquadri, archi, linee, si crea un effetto di particolare originalità che arricchisce la brillantezza della laccatura: bianco, verde, celeste, avorio, oltre a qualsiasi colore RAL e/o NCS. **Disponibile anche nella versione ad elevato abbattimento acustico Disuper30 e Disuper60.**

EN **REFINED ARCHITECTURE FLOURISHING WITH IMAGINATIVE DECORATIONS, ENHANCED BY THE LINEAR ELEGANCE OF THE FURNISHINGS.**

The versatile pantographing technique transforms the door into a surface open to fantasy and a variety of styles, from the classic to the ultra-modern. Through the varying square, arched and linear compositions a particularly original effect is created which enriches the brilliance of the lacquering: white, green, sky-blue and ivory in addition to any RAL and/or NCS colour. **Also available in the high soundproof "Disuper30" and "Disuper60" version.**



[TOSCA 1]



OPERA DANIELI 1

Versione cieca  
Colore laccata RAL 9002  
Coprifilo disponibile M60

Version blank  
Colour lacquered RAL 9002  
Cover mould available M60

[TOSCA 2]



OPERA DANIELI 2

Versione cieca  
Colore laccata RAL 7015  
Coprifilo disponibile M60

Version blank  
Colour lacquered RAL 7015  
Cover mould available M60

[TOSCA 3]



OPERA DANIELI 3

Versione cieca  
Colore laccata RAL 7039  
Coprifilo disponibile M60

Version blank  
Colour lacquered RAL 7039  
Cover mould available M60

[TOSCA 4]



OPERA DANIELI 4

Versione cieca  
Colore laccata grigio tortora  
Coprifilo disponibile M60

Version blank  
Colour lacquered dove grey  
Cover mould available M60

[TOSCA 5]



OPERA DANIELI 5

Versione cieca  
Colore laccata RAL 6013  
Coprifilo disponibile M60

Version blank  
Colour lacquered RAL 6013  
Cover mould available M60

[TOSCA 6]



OPERA DANIELI 6

Versione cieca  
Colore laccato bianco B011  
Coprifilo disponibile M60

Version blank  
Colour white lacquered B011  
Cover mould available M60

[TOSCA 7]



OPERA DANIELI 7

Versione cieca  
Colore laccata RAL 7016  
Coprifilo disponibile M60

Version blank  
Colour lacquered RAL 7016  
Cover mould available M60

[TOSCA 8]



OPERA DANIELI 8

Versione cieca  
Colore laccata RAL 7001  
Coprifilo disponibile M60

Version blank  
Colour lacquered RAL 7001  
Cover mould available M60



[TOSCA 9]



OPERA DANIELI 9

Versione cieca  
Colore laccata RAL 7032  
Coprifilo disponibile M60

Version blank  
Colour lacquered RAL 7032  
Cover mould available M60

[TOSCA A]



OPERA DANIELI A

Versione cieca  
Colore laccata RAL 2004  
Coprifilo disponibile M60

Version blank  
Colour lacquered RAL 2004  
Cover mould available M60

[TOSCA B]



OPERA DANIELI B

Versione cieca  
Colore laccata RAL 5023  
Coprifilo disponibile M60

Version blank  
Colour lacquered RAL 5023  
Cover mould available M60

[TOSCA C]



OPERA DANIELI C

Versione cieca  
Colore laccata RAL 6013  
Coprifilo disponibile M60

Version blank  
Colour lacquered RAL 6013  
Cover mould available M60

[TOSCA D]



OPERA DANIELI D

Versione cieca  
Colore laccata RAL 7001  
Coprifilo disponibile M60

Version blank  
Colour lacquered RAL 7001  
Cover mould available M60

[TOSCA E]



OPERA DANIELI E

Versione cieca  
Colore laccata RAL 1011  
Coprifilo disponibile M60

Version blank  
Colour lacquered RAL 1011  
Cover mould available M60

[TOSCA F]



OPERA DANIELI F

Versione cieca  
Colore laccata RAL 3020  
Coprifilo disponibile M60

Version blank  
Colour lacquered RAL 3020  
Cover mould available M60

[TOSCA G]



OPERA DANIELI G

Versione cieca  
Colore laccata RAL 7006  
Coprifilo disponibile M60

Version blank  
Colour lacquered RAL 7006  
Cover mould available M60



[TOSCA H]



OPERA DANIELI H

Versione cieca  
Colore laccata RAL 5015  
Coprifilo disponibile M60

Version blank  
Colour lacquered RAL 5015  
Cover mould available M60

[TOSCA I]



OPERA DANIELI I

Versione cieca  
Colore laccata RAL 6018  
Coprifilo disponibile M60

Version blank  
Colour lacquered RAL 6018  
Cover mould available M60

[TOSCA J]



OPERA DANIELI J

Versione cieca  
Colore laccata violetta  
Coprifilo disponibile M60

Version blank  
Colour lacquered violet  
Cover mould available M60

[TOSCA K]



OPERA DANIELI J

Versione cieca  
Colore laccata RAL 6003  
Coprifilo disponibile M60

Version blank  
Colour lacquered RAL 6003  
Cover mould available M60

[TOSCA H]



**OPERA DANIELI J**

Versione cieca  
Colore laccata grigio saturno  
Coprifilo disponibile M60

Version blank  
Colour lacquered saturn grey  
Cover mould available M60

[TOSCA K]



**OPERA DANIELI K**

Versione cieca  
Colore laccata RAL 7045  
Coprifilo disponibile M60

Version blank  
Colour lacquered RAL 7045  
Cover mould M60 at 90°

[TOSCA L]



**OPERA DANIELI L**

Versione cieca  
Colore laccata RAL 1013  
Coprifilo disponibile M60

Version blank  
Colour lacquered RAL 1013  
Cover mould available M60

[TOSCA L]



**OPERA DANIELI L**

Versione cieca  
Colore laccata RAL 1017  
Coprifilo disponibile M60

Version blank  
Colour lacquered RAL 1017  
Cover mould available M60



[TOSCA L]



OPERA DANIELI L

Versione cieca  
Colore laccata RAL 4002  
Coprifilo disponibile M60

Version blank  
Colour lacquered RAL 4002  
Cover mould available M60

[TOSCA M]



OPERA DANIELI M

Versione cieca  
Colore laccata RAL 1013  
Coprifilo disponibile M60

Version blank  
Colour lacquered RAL 1013  
Cover mould available M60

[TOSCA N]



OPERA DANIELI N

Versione cieca  
Colore laccata RAL 3015  
Coprifilo disponibile M60

Version blank  
Colour lacquered RAL 3015  
Cover mould available M60

[TOSCA O]



OPERA DANIELI O

Versione cieca  
Colore laccata RAL 7004  
Coprifilo disponibile M60

Version blank  
Colour lacquered RAL 7004  
Cover mould available M60

[TOSCA P]



OPERA DANIELI P

Versione cieca  
Colore laccata RAL 3007  
Coprifilo disponibile M60

Version blank  
Colour lacquered RAL 3007  
Cover mould available M60

[TOSCA Q]



OPERA DANIELI Q

Versione cieca  
Colore laccata RAL 3001  
Coprifilo disponibile M60

Version blank  
Colour lacquered RAL 3001  
Cover mould available M60

[TOSCA R]



OPERA DANIELI R

Versione cieca  
Colore laccata RAL 6013  
Coprifilo disponibile M60

Version blank  
Colour lacquered RAL 6013  
Cover mould available M60

[TOSCA S]



OPERA DANIELI S

Versione cieca  
Colore laccata panna B003  
Coprifilo disponibile M60

Version blank  
Colour cream lacquered B003  
Cover mould available M60

[TOSCA T]



OPERA DANIELI T

Versione cieca  
Colore laccata RAL 3020  
Coprifilo disponibile M60

Version blank  
Colour lacquered RAL 3020  
Cover mould available M60

[TOSCA V]



OPERA DANIELI V

Versione cieca  
Colore laccata RAL 5014  
Coprifilo disponibile M60

Version blank  
Colour lacquered RAL 5014  
Cover mould available M60

[TOSCA X]



OPERA DANIELI X

Questo modello non può essere utilizzato sulle D-SUPER / This model cannot be used on the D-SUPER version

Versione cieca  
Colore laccata RAL 9005  
Coprifilo disponibile M60

Version blank  
Colour lacquered RAL 9005  
Cover mould available M60

[TOSCA Y]



OPERA DANIELI Y

Versione cieca  
Colore laccata bianco B001  
Coprifilo disponibile M60

Version blank  
Colour white lacquered B001  
Cover mould available M60



[TOSCA Z]



OPERA DANIELI Z

Versione cieca  
Colore laccata RAL 7004  
Coprifilo disponibile M60

Version blank  
Colour lacquered RAL 7004  
Cover mould available M60

[TOSCAA1]



OPERA DANIELI A1

Versione cieca  
Colore laccata RAL 8017  
Coprifilo disponibile M60

Version blank  
Colour lacquered RAL 8017  
Cover mould available M60

[TOSCAA2]



OPERA DANIELI A2

Versione cieca  
Colore laccata panna B003  
Coprifilo disponibile M60

Version blank  
Colour cream lacquered B003  
Cover mould available M60

[TOSCAA3]



OPERA DANIELI A3

Versione cieca  
Colore laccata RAL 1001  
Coprifilo disponibile M60

Version blank  
Colour lacquered RAL 1001  
Cover mould available M60

[TOSCAA4]



OPERA DANIELI A4

Versione cieca  
Colore laccata bianco B011  
Coprifilo disponibile M60

Version blank  
Colour white lacquered B011  
Cover mould available M60

[TOSCAA5]



OPERA DANIELI A5

Versione cieca  
Colore laccata RAL 7047  
Coprifilo disponibile M60

Version blank  
Colour lacquered RAL 7047  
Cover mould available M60

[TOSCAA6]



OPERA DANIELI A6

Versione cieca  
Colore laccata RAL 1015  
Coprifilo disponibile M60

Version blank  
Colour lacquered RAL 1015  
Cover mould available M60

[TOSCAA7]



OPERA DANIELI A7

Versione cieca  
Colore laccata RAL 1013  
Coprifilo disponibile M60

Version blank  
Colour lacquered RAL 1013  
Cover mould available M60

DISPONIBILITÀ LACCATURE / LACQUER AVAILABILITY

	LACCATO BIANCO B011 WHITE LACQUERED B011		GRIGIO SATURNO SATURN GREY
	LACCATO PANNA B003 CREAM LACQUERED B003		GHIACCIO ICE
	TERRE D'ARGILLA CLAY DIRT		GRIGIO TORTORA DOVE GREY
	CORDA ROPE		VIOLETTA VIOLET

RAL E/O NCS / RAL AND/OR NCS



ATTENZIONE: I COLORI SONO PURAMENTE INDICATIVI.  
CONSULTARE IL CAMPIONARIO COLORI.

LE IMMAGINI RAPPRESENTATE NEL CATALOGO SONO A SCOPO  
ILLUSTRATIVO.

ULTERIORI ALTRE ESSENZE SU RICHIESTA VERRANNO  
ANALIZZATE SINGOLARMENTE PER STABILIRNE LA FATTIBILITÀ,  
IL PREZZO E I TEMPI DI CONSEGNA.

ATTENTION: THE COLORS ARE PURELY INDICATIVE.  
CONSULT THE COLOR SAMPLE.

ALL IMAGES SHOWN IN THE CATALOG ARE FOR ILLUSTRATIVE  
PURPOSES ONLY.

FURTHER OTHER ESSENCES ON REQUEST WILL BE ANALYZED  
INDIVIDUALLY TO DETERMINE THE FEASIBILITY, PRICE AND  
DELIVERY TIMES.





# COPENAGHEN

COPENHAGEN

IT A Copenaghen, il vento freddo culla le barche a vela nel loro lento rollio, mentre le biciclette attraversano le strade lastricate e le persone si scaldano nei caffè. A Copenaghen, il cielo è terso. I colori delle case che si riflettono nelle acque scintillanti di Nyhavn sono i colori della felicità.

EN In Copenhagen, the cold wind cradles the sailboats as they gently rock, bicycles zip across the paved streets and people warm up in cafes. In Copenhagen, the sky is clear and the joyful colours of the houses reflect in the sparkling waters of the Nyhavn.

DIERRE  
BORN TO TRAVEL  
EDITION 2020



WELCOME TO  
COPENHAGEN  
ENJOY YOUR JOURNEY



# OPERA FREESTYLE

[MEDEA]

**IT FREESTYLE DÀ PERSONALITÀ A OGNI AMBIENTE, CON SUPERFICI DISEGNATE E PROFONDE INCISIONI PANTOGRAFATE CHE SEMBRANO REALIZZATE A MANO LIBERA.**

Porta laccata dal disegno deciso e contemporaneo, Freestyle si distingue come vero e proprio elemento di arredo. Il suo carattere si definisce scegliendo a piacimento nel catalogo delle incisioni disponibili e abbinandole alla gamma delle laccature, fino ad affiancarle a vetri con disegno analogo. Disponibile anche nelle nuove finiture d'arredo Portedi, selezionate NCS STD: terre d'argilla, violetta, grigio saturno, grigio tortora, ghiaccio, corda e colori RAL e NCS a scelta.

**EN FREESTYLE CONVEYS PERSONALITY TO EACH SPACE, WITH PATTERNED SURFACES AND DEEP PANTOGRAPHED INCISIONS WHICH LOOK LIKE FREE-HAND DESIGNS.**

Lacquered door with a marked and contemporary pattern, Freestyle stands out as a true piece of furniture. Its character is defined by choosing the available engravings from the catalogue and combining them to the range of lacquering, up to matching them to glasses with similar design. Available in the new Portedi furnishing finishes, NCS STD selected: clay soils, violet, Saturn grey, dove grey, ice, cord and RAL and NCS colors of your choice.





[SEQUOIA]



OPERA FRE 001

Versione sequoia  
Colore laccato bianco B011  
Coprifilo disponibile M60

Version sequoia  
Colour white lacquered B011  
Cover mould available M60

[CASCATA]



OPERA FRE 002

Versione cascata  
Colore laccato violetta  
Coprifilo disponibile M60

Version cascata  
Colour lacquered violet  
Cover mould available M60

[RICCIO]



OPERA FRE 004

Versione riccio  
Colore laccato panna B003  
Coprifilo disponibile M60

Version riccio  
Colour cream lacquered B003  
Cover mould available M60

[CLESSIDRA]



OPERA FRE 005

Versione clessidra  
Colore laccato ghiaccio  
Coprifilo disponibile M60

Version clessidra  
Colour lacquered ice  
Cover mould available M60

[TAGLIO]



OPERA FRE 006

Versione taglio  
Colore laccato terre d'argilla  
Coprifilo disponibile M60

Version taglio  
Colour lacquered clay dirt  
Cover mould available M60

[PIANETI]



OPERA FRE 007

Versione pianeti  
Colore laccato violetta  
Coprifilo disponibile M60

Version pianeti  
Colour lacquered violet  
Cover mould available M60

[ESSE]



OPERA FRE 008

Versione esse  
Colore laccato panna B003  
Coprifilo disponibile M60

Version esse  
Colour cream lacquered B003  
Cover mould available M60

[SAETTE]



OPERA FRE 010

Versione saette  
Colore laccato grigio tortora  
Coprifilo disponibile M60

Version saette  
Colour lacquered dove grey  
Cover mould available M60

[NVAE]



OPERA FRE 012

Versione nave  
Colore laccato terre d'argilla  
Coprifilo disponibile M60

Version nave  
Colour lacquered clay dirt  
Cover mould available M60

[GIRANDOLE]



OPERA FRE 016

Versione girandole  
Colore laccato grigio tortora  
Coprifilo disponibile M60

Version girandole  
Colour lacquered dove grey  
Cover mould available M60

[QUADRI]



OPERA FRE 017

Versione quadri  
Colore laccato corda  
Coprifilo disponibile M60

Version quadri  
Colour lacquered rope  
Cover mould available M60

[SUN]



OPERA FRE 023

Versione hertz  
Colore laccato bianco B011  
Coprifilo disponibile M60

Version hertz  
Colour white lacquered B011  
Cover mould available M60



[SUNRISE]



# OPERA FRE 024

Versione sunrise  
Colore laccato grigio saturno  
Coprifilo disponibile M60

Version sunrise  
Colour lacquered saturn grey  
Cover mould available M60

[OLIVO]



# OPERA FRE 026

Versione olivo  
Colore laccato terre d'argilla  
Coprifilo disponibile M60

Version olivo  
Colour lacquered clay dirt  
Cover mould available M60

[SOFFIONI]



# OPERA FRE 027

Versione soffioni  
Colore laccato grigio saturno  
Coprifilo disponibile M60

Version soffioni  
Colour lacquered saturn grey  
Cover mould available M60

DISPONIBILITÀ LACCATURE / LACQUER AVAILABILITY

	LACCATO BIANCO B011 WHITE LACQUERED B011		GRIGIO SATURNO SATURN GREY
	LACCATO PANNA B003 CREAM LACQUERED B003		GHIACCIO ICE
	TERRE D'ARGILLA CLAY DIRT		GRIGIO TORTORA DOVE GREY
	CORDA ROPE		VIOLETTA VIOLET

RAL E/O NCS / RAL AND/OR NCS



ATTENZIONE: I COLORI SONO PURAMENTE INDICATIVI.  
CONSULTARE IL CAMPIONARIO COLORI.

LE IMMAGINI RAPPRESENTATE NEL CATALOGO SONO A SCOPO ILLUSTRATIVO.

ULTERIORI ALTRE ESSENZE SU RICHIESTA VERRANNO ANALIZZATE SINGOLARMENTE PER STABILIRNE LA FATTIBILITÀ, IL PREZZO E I TEMPI DI CONSEGNA.

ATTENTION: THE COLORS ARE PURELY INDICATIVE.  
CONSULT THE COLOR SAMPLE.

ALL IMAGES SHOWN IN THE CATALOG ARE FOR ILLUSTRATIVE PURPOSES ONLY.

FURTHER OTHER ESSENCES ON REQUEST WILL BE ANALYZED INDIVIDUALLY TO DETERMINE THE FEASIBILITY, PRICE AND DELIVERY TIMES.





# DUBAI

IT Dubai cresce, si allarga, ruba spazio al deserto. Il brusio dei suq si mescola a quello delle feste, dei grandi centri commerciali e degli hotel di lusso. Tra le terrazze panoramiche e i grattacieli avveniristici, il vento caldo racconta le storie dei beduini e soffia nella direzione del futuro.

EN Dubai is growing, expanding and stealing space from the desert. The hustle and bustle of the souq meets the commotion of the parties, the big shopping malls and luxury hotels. From panoramic terraces to pioneering skyscrapers, the warm wind tells the stories of bedouins and blows in the direction of the future.



HOTEL  
COLLECTION  
EDITION  
2020



# OPERA D-METRIA

[NORMA]

**IT SPAZIO AL COLORE, ALLE TRAME ORIGINALI E AI LAYER SOVRAPPONIBILI: CON LE SUE FORME ASTRATTE E GEOMETRICHE, OPERA D-METRIA ISPIRA LA CREATIVITÀ.**

Porta laccata di stile contemporaneo arreda con eleganza offrendo al cliente la possibilità di combinare tre livelli di pantografatura e due disegni alternativi: la linearità delle "strade" o la morbidezza dei "fiumi". Abbinata al nuovo telaio minimale rasé, grazie alla perfetta complanarità di anta e telaio, garantisce un risultato di sicura eleganza. Disponibile anche nelle nuove finiture d'arredo Portedi selezionate NCS STD: terre d'argilla, violetta, grigio saturno, grigio tortora, ghiaccio, corda e colori RAL e NCS a scelta.

**EN GIVE SPACE TO COLOURS, ORIGINAL PATTERNS AND OVERLAPPING LAYERS: WITH ITS ABSTRACT SHAPES AND FORMS, OPERA D-METRIA INSPIRES CREATIVITY.**

Contemporary style lacquered door, its elegant features give the customer the possibility to combine three pantographing levels and two alternative patterns: the linearity of "roads" or the softness of "rivers". Combined with the new minimal rasé frame, thanks to the perfect flushness of door and frame, it guarantees the utmost elegant touch. Available in the new Portedi furnishing finishes, NCS STD selected: clay soils, violet, Saturn grey, dove grey, ice, cord and RAL and NCS colors of your choice.





[STRADE SHANGAI BASE]



OPERA FRE 037

Versione strade shangai base  
Colore laccato grigio saturno  
Coprifilo disponibile M60

Version strade shangai base  
Colour lacquered saturn grey  
Cover mould available M60

[STRADE SHANGAI LAYER 1]



OPERA FRE 038

Versione strade shangai layer 1  
Colore laccato violetta  
Coprifilo disponibile M60

Version strade shangai layer 1  
Colour lacquered violet  
Cover mould available M60

[STRADE SHANGAI LAYER 2]



OPERA FRE 039

Versione strade shangai layer 2  
Colore laccato ghiaccio  
Coprifilo disponibile M60

Version strade shangai layer 2  
Colour lacquered ice  
Cover mould available M60

[FIUMI BASE]



OPERA FRE 041

Versione fiumi base  
Colore laccato grigio tortora  
Coprifilo disponibile M60

Version fiumi base  
Colour lacquered dove grey  
Cover mould available M60



[FIUMI LAYER 1]



[FIUMI LAYER 2]



OPERA FRE 042

Versione fiumi layer 1  
Colore laccato ghiaccio  
Coprifilo disponibile M60

Version fiumi layer 1  
Colour lacquered ice  
Cover mould available M60

OPERA FRE 043

Versione fiumi layer 2  
Colore laccato panna B003  
Coprifilo disponibile M60

Version fiumi layer 2  
Colour cream lacquered B003  
Cover mould available M60

DISPONIBILITÀ LACCATURE / LACQUER AVAILABILITY

	LACCATO BIANCO B011 WHITE LACQUERED B011		GRIGIO SATURNO SATURN GREY
	LACCATO PANNA B003 CREAM LACQUERED B003		GHIACCIO ICE
	TERRE D'ARGILLA CLAY DIRT		GRIGIO TORTORA DOVE GREY
	CORDA ROPE		VIOLETTA VIOLET

RAL E/O NCS / RAL AND/OR NCS



ATTENZIONE: I COLORI SONO PURAMENTE INDICATIVI. CONSULTARE IL CAMPIONARIO COLORI.

LE IMMAGINI RAPPRESENTATE NEL CATALOGO SONO A SCOPO ILLUSTRATIVO.

ULTERIORI ALTRE ESSENZE SU RICHIESTA VERRANNO ANALIZZATE SINGOLARMENTE PER STABILIRNE LA FATTIBILITÀ, IL PREZZO E I TEMPI DI CONSEGNA.

ATTENTION: THE COLORS ARE PURELY INDICATIVE. CONSULT THE COLOR SAMPLE.

ALL IMAGES SHOWN IN THE CATALOG ARE FOR ILLUSTRATIVE PURPOSES ONLY.

FURTHER OTHER ESSENCES ON REQUEST WILL BE ANALYZED INDIVIDUALLY TO DETERMINE THE FEASIBILITY, PRICE AND DELIVERY TIMES.



# BERLINO

BERLIN

IT Berlino ha un fascino ruvido e un'energia contagiosa. Li senti nelle strade, nei caffè, nei locali. Li respiri nelle feste sfrenate e quando passeggi nel Mauerpark. Berlino cambia, si evolve, crea nuove architetture e porta le tracce tangibili della sua storia. Passato, presente e futuro sono tutti lì, vicino a te.

EN You can sense Berlin's rugged appeal and contagious energy in its streets, cafes and bars. You can feel its energy at wild parties and when you stroll across Mauerpark. Berlin is changing, evolving, and creating new architecture while bearing the tangible traces of its history. Past, present and future are all there, within your reach.





# OPERA BELLINI

[FALSTAFF]



IT **UNO STILE CHE NASCE DALL'ARMONIA DI CONTENUTI ED EMOZIONI E VIVE NELLA SOBRIA ELEGANZA DI LINEE E ORNAMENTI.**

La brillantezza della laccatura bianco, verde, celeste, avorio e di qualsiasi colore RAL e/o NCS, si arricchisce di riquadri e linee ottenuti mediante pantografatura. Si crea così un effetto originale che veste il battente di fantasia, carattere e personalità. Un risultato che può abbracciare i più diversi stili, dal classico al contemporaneo. **Disponibile anche nella versione ad elevato abbattimento acustico Disuper30 e Disuper60.**

EN **THE FASCINATION OF THE PAST, THE PRECIOUSNESS OF THE ORNAMENTS, THE MAGNIFICENT ELEGANCE OF A STYLE WITH A NEVER ENDING EMOTION.**

The brilliance of the white, green, sky-blue and ivory lacquering in addition to any RAL and/or NCS colour, is enriched through the varying square and linear pantograph compositions. Through this, an original effect is created that envelops the leaf with fantasy, character and personality, a result that can unite numerous styles, from the classic to the contemporary. **Also available in the high soundproof "Disuper30" and "Disuper60" version.**

[FALSTAFF 1]



**OPERA BELLINI 1**

Versione cieca  
Colore laccata bianco B011  
Coprifilo disponibile M60 a 45°

Version blank  
Colour white lacquered B011  
Cover mould available M60 at 45°

[FALSTAFF 2]



**OPERA BELLINI 2**

Versione cieca  
Colore laccata RAL 7039  
Coprifilo disponibile M60 a 45°

Version blank  
Colour lacquered RAL 7039  
Cover mould available M60 at 45°

[FALSTAFF 3]



**OPERA BELLINI 3**

Versione cieca  
Colore laccata RAL 7005  
Coprifilo disponibile M60 a 45°

Version blank  
Colour lacquered RAL 7005  
Cover mould available M60 at 45°

[FALSTAFF 4]



**OPERA BELLINI 4**

Versione cieca  
Colore laccata RAL 7024  
Coprifilo disponibile M60 a 45°

Version blank  
Colour lacquered RAL 7024  
Cover mould available M60 at 45°

[FALSTAFF 5]



**OPERA BELLINI 5**

Versione cieca  
Colore laccata RAL 8016  
Coprifilo disponibile M60 a 45°

Version blank  
Colour lacquered RAL 8016  
Cover mould available M60 at 45°

[FALSTAFF 6]



**OPERA BELLINI 6**

Versione cieca  
Colore laccata violetta  
Coprifilo disponibile M60 a 45°

Version blank  
Colour lacquered violet  
Cover mould available M60 at 45°

[FALSTAFF 7]



**OPERA BELLINI 7**

Versione cieca  
Colore laccata bianco B011  
Coprifilo disponibile M60 a 45°

Version blank  
Colour white lacquered B011  
Cover mould available M60 at 45°

[FALSTAFF 8]



**OPERA BELLINI 8**

Versione cieca  
Colore laccata RAL 3002  
Coprifilo disponibile M60 a 45°

Version blank  
Colour lacquered RAL 3002  
Cover mould available M60 at 45°



[FALSTAFF 9]



[FALSTAFF A]



**OPERA BELLINI 9**

Versione cieca  
Colore laccata panna B003  
Coprifilo disponibile M60 a 45°

Version blank  
Colour cream lacquered B003  
Cover mould available M60 at 45°

**OPERA BELLINI A**

Versione cieca  
Colore laccata RAL 7003  
Coprifilo disponibile M60 a 45°

Version blank  
Colour lacquered RAL 7003  
Cover mould available M60 at 45°

[FALSTAFF B]



[FALSTAFF C]



**OPERA BELLINI B**

Versione cieca  
Colore laccata RAL 5022  
Coprifilo disponibile M60 a 45°

Version blank  
Colour lacquered RAL 5022  
Cover mould available M60 at 45°

**OPERA BELLINI C**

Versione cieca  
Colore laccata RAL 7015  
Coprifilo disponibile M60 a 45°

Version blank  
Colour lacquered RAL 7015  
Cover mould available M60 at 45°

[FALSTAFF D]



**OPERA BELLINI D**

Versione cieca  
Colore laccata violetta  
Coprifilo disponibile M60 a 45°

Version blank  
Colour lacquered violet  
Cover mould available M60 at 45°

[FALSTAFF E]



**OPERA BELLINI E**

Versione cieca  
Colore laccata RAL 6028  
Coprifilo disponibile M60 a 45°

Version blank  
Colour lacquered RAL 6028  
Cover mould available M60 at 45°

[FALSTAFF F]



**OPERA BELLINI F**

Versione cieca  
Colore laccata RAL 1000  
Coprifilo disponibile M60 a 45°

Version blank  
Colour lacquered RAL 1000  
Cover mould available M60 at 45°

[FALSTAFF G]



**OPERA BELLINI G**

Versione cieca  
Colore laccata RAL 7024  
Coprifilo disponibile M60 a 45°

Version blank  
Colour lacquered RAL 7024  
Cover mould available M60 at 45°

[FALSTAFF H]



[FALSTAFF I]



**OPERA BELLINI H**

Versione cieca  
Colore laccata bianco B001  
Coprifilo disponibile M60 a 45°

Version blank  
Colour white lacquered B001  
Cover mould available M60 at 45°

**OPERA BELLINI I**

Versione cieca  
Colore laccata RAL 1002  
Coprifilo disponibile M60 a 45°

Version blank  
Colour lacquered RAL 1002  
Cover mould available M60 at 45°

[FALSTAFF J]



[FALSTAFF J]



**OPERA BELLINI J**

Versione cieca  
Colore laccata RAL 5015  
Coprifilo disponibile M60 a 45°

Version blank  
Colour lacquered RAL 5015  
Cover mould available M60 at 45°

**OPERA BELLINI J**

Versione cieca  
Colore laccata bianco B001  
Coprifilo disponibile M60 a 45°

Version blank  
Colour white lacquered B001  
Cover mould available M60 at 45°



[FALSTAFF J]



[FALSTAFF K]



**OPERA BELLINI J**

Versione cieca  
Colore laccata bianco B001  
Coprifilo disponibile M60 a 45°

Version blank  
Colour white lacquered B001  
Cover mould available M60 at 45°

**OPERA BELLINI K**

Versione cieca  
Colore laccata RAL 8017  
Coprifilo disponibile M60 a 45°

Version blank  
Colour lacquered RAL 8017  
Cover mould available M60 at 45°

[FALSTAFF L]



[FALSTAFF L]



**OPERA BELLINI L**

Versione cieca  
Colore laccata RAL 3015  
Coprifilo disponibile M60 a 45°

Version blank  
Colour lacquered RAL 3015  
Cover mould available M60 at 45°

**OPERA BELLINI L**

Versione cieca  
Colore laccata RAL 6005  
Coprifilo disponibile M60 a 45°

Version blank  
Colour lacquered RAL 6005  
Cover mould available M60 at 45°

[FALSTAFF L]



**OPERA BELLINI L**

Versione cieca  
Colore laccata grigio tortora  
Coprifilo disponibile M60 a 45°

Version blank  
Colour lacquered dove grey  
Cover mould available M60 at 45°

[FALSTAFF M]



**OPERA BELLINI M**

Versione cieca  
Colore laccata RAL 4009  
Coprifilo disponibile M60 a 45°

Version blank  
Colour lacquered RAL 4009  
Cover mould available M60 at 45°

[FALSTAFF N]



**OPERA BELLINI N**

Versione cieca  
Colore laccata RAL 7010  
Coprifilo disponibile M60 a 45°

Version blank  
Colour lacquered RAL 7010  
Cover mould available M60 at 45°

[FALSTAFF O]



**OPERA BELLINI O**

Versione cieca  
Colore laccata panna B003  
Coprifilo disponibile M60 a 45°

Version blank  
Colour cream lacquered B003  
Cover mould available M60 at 45°

[FALSTAFF P]



[FALSTAFF Q]



OPERA BELLINI P

Versione cieca  
Colore laccata RAL 6025  
Coprifilo disponibile M60 a 45°

Version blank  
Colour lacquered RAL 6025  
Cover mould available M60 at 45°

OPERA BELLINI Q

Versione cieca  
Colore laccata RAL 8014  
Coprifilo disponibile M60 a 45°

Version blank  
Colour lacquered RAL 8014  
Cover mould available M60 at 45°

[FALSTAFF R]



[FALSTAFF S]



OPERA BELLINI R

Versione cieca  
Colore laccata RAL 7036  
Coprifilo disponibile M60 a 45°

Version blank  
Colour lacquered RAL 7036  
Cover mould available M60 at 45°

OPERA BELLINI S

Versione cieca  
Colore laccata RAL 5012  
Coprifilo disponibile M60 a 45°

Version blank  
Colour lacquered RAL 5012  
Cover mould available M60 at 45°



[FALSTAFF T]



[FALSTAFF V]



**OPERA BELLINI T**

Versione cieca  
Colore laccata RAL 6003  
Coprifilo disponibile M60 a 45°

Version blank  
Colour lacquered RAL 6003  
Cover mould available M60 at 45°

**OPERA BELLINI V**

Versione cieca  
Colore laccata RAL 3007  
Coprifilo disponibile M60 a 45°

Version blank  
Colour lacquered RAL 3007  
Cover mould available M60 at 45°

[FALSTAFF X]



[FALSTAFF Y]



**OPERA BELLINI X**

Versione cieca  
Colore laccata panna B003  
Coprifilo disponibile M60 a 45°

Version blank  
Colour cream lacquered B003  
Cover mould available M60 at 45°

**OPERA BELLINI Y**

Versione cieca  
Colore laccata RAL 8016  
Coprifilo disponibile M60 a 45°

Version blank  
Colour lacquered RAL 8016  
Cover mould available M60 at 45°

[FALSTAFF Z]



[FALSTAFF A1]



**OPERA BELLINI Z**

Versione cieca  
Colore laccata RAL 3001  
Coprifilo disponibile M60 a 45°

Version blank  
Colour lacquered RAL 3001  
Cover mould available M60 at 45°

**OPERA BELLINI A1**

Versione cieca  
Colore laccata ghiaccio  
Coprifilo disponibile M60 a 45°

Version blank  
Colour lacquered ice  
Cover mould available M60 at 45°

[FALSTAFF A2]



[FALSTAFF A3]



**OPERA BELLINI A2**

Versione cieca  
Colore laccata panna B003  
Coprifilo disponibile M60 a 45°

Version blank  
Colour cream lacquered B003  
Cover mould available M60 at 45°

**OPERA BELLINI A3**

Versione cieca  
Colore laccata RAL 1002  
Coprifilo disponibile M60 a 45°

Version blank  
Colour lacquered RAL 1002  
Cover mould available M60 at 45°

[FALSTAFF A4]



**OPERA BELLINI A4**

Versione cieca  
Colore laccata RAL 8019  
Coprifilo disponibile M60 a 45°

Version blank  
Colour lacquered RAL 8019  
Cover mould available M60 at 45°

[FALSTAFF A5]



**OPERA BELLINI A5**

Versione cieca  
Colore laccata bianco B001  
Coprifilo disponibile M60 a 45°

Version blank  
Colour white lacquered B001  
Cover mould available M60 at 45°

[FALSTAFF A6]



**OPERA BELLINI A6**

Versione cieca  
Colore laccata bianco B001  
Coprifilo disponibile M60 a 45°

Version blank  
Colour white lacquered B001  
Cover mould available M60 at 45°

[FALSTAFF A7]



**OPERA BELLINI A7**

Versione cieca  
Colore laccata RAL 1013  
Coprifilo disponibile M60 a 45°

Version blank  
Colour lacquered RAL 1013  
Cover mould available M60 at 45°



DISPONIBILITÀ LACCATURE / LACQUER AVAILABILITY

	LACCATO BIANCO B011  WHITE LACQUERED B011		GRIGIO SATURNO SATURN GREY
	LACCATO PANNA B003  CREAM LACQUERED B003		GHIACCIO ICE
	TERRE D'ARGILLA CLAY DIRT		GRIGIO TORTORA DOVE GREY
	CORDA ROPE		VIOLETTA VIOLET

RAL E/O NCS / RAL AND/OR NCS



ATTENZIONE: I COLORI SONO PURAMENTE INDICATIVI.  
CONSULTARE IL CAMPIONARIO COLORI.

LE IMMAGINI RAPPRESENTATE NEL CATALOGO SONO A SCOPO  
ILLUSTRATIVO.

ULTERIORI ALTRE ESSENZE SU RICHIESTA VERRANNO  
ANALIZZATE SINGOLARMENTE PER STABILIRNE LA FATTIBILITÀ,  
IL PREZZO E I TEMPI DI CONSEGNA.

ATTENTION: THE COLORS ARE PURELY INDICATIVE.  
CONSULT THE COLOR SAMPLE.

ALL IMAGES SHOWN IN THE CATALOG ARE FOR ILLUSTRATIVE  
PURPOSES ONLY.

FURTHER OTHER ESSENCES ON REQUEST WILL BE ANALYZED  
INDIVIDUALLY TO DETERMINE THE FEASIBILITY, PRICE AND  
DELIVERY TIMES.



# BUDAPEST

IT Il Danubio, i parchi, i viali: dalle colline si vede tutta Budapest. Tra i palazzi, le strade e le stazioni della metropolitana aleggia un'atmosfera fin de siècle, in cui si intrecciano storie diverse. Maestosa e imponente, è una perla tra oriente e occidente.

EN The Danube, the parks, the avenues: you can see all of Budapest from the hills. Among the buildings, streets and underground stations lingers a fin de siècle atmosphere, where a variety of stories intertwine. Majestic and imposing, it is a gem between the east and the west.





# OPERA BELLINI WOOD

[TRAVIATA]



IT **UNA COLLEZIONE DAL FASCINO INTRAMONTABILE CHE CONIUGA SEMPLICITÀ ED ELEGANZA.**

La finitura venata effetto legno si accompagna a una bugnatura asciutta e moderna. Il risultato è una porta dall'eleganza misurata che si armonizza al gusto delle nuove tendenze di arredo e design.

EN **A COLLECTION WITH LASTING CHARM THAT COMBINES SIMPLICITY AND ELEGANCE.**

The grained finish is accompanied by a modern and dry raised panel. The result is an elegant door that harmonizes with the taste of new trends in furniture and design.

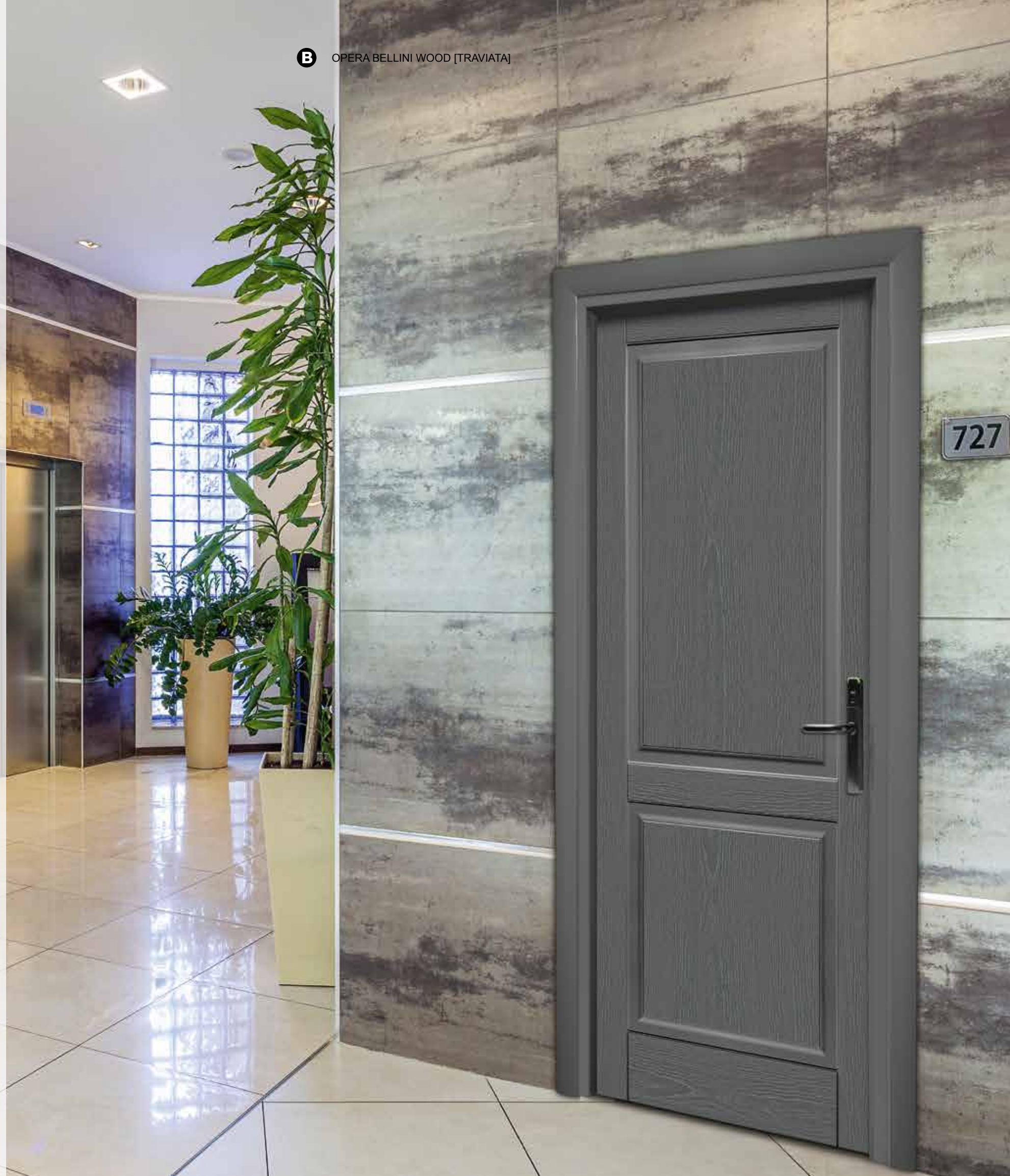



[TRAVIATA]



OPERA BELLINI WOOD 1

Versione cieca  
Colore laccato frassino caffè  
Coprifilo disponibile M60 a 45°

Version blank  
Colour lacquered coffee ash  
Cover mould available M60 at 45°

[TRAVIATA]



OPERA BELLINI WOOD 2

Versione cieca  
Colore laccato RAL 7012  
Coprifilo disponibile M60 a 45°

Version blank  
Colour lacquered RAL 7012  
Cover mould available M60 at 45°

[TRAVIATA]



OPERA BELLINI WOOD 3

Versione cieca  
Colore laccato frassino nero  
Coprifilo disponibile M60 a 45°

Version blank  
Colour lacquered black ash  
Cover mould available M60 at 45°

[TRAVIATA]



OPERA BELLINI WOOD K

Versione cieca  
Colore laccato RAL 8012  
Coprifilo disponibile M60 a 45°

Version blank  
Colour lacquered RAL 8012  
Cover mould available M60 at 45°

[TRAVIATA]



OPERA BELLINI WOOD L

Versione cieca  
Colore laccato RAL 1019  
Coprifilo disponibile M60 a 45°

Version blank  
Colour lacquered RAL 1019  
Cover mould available M60 at 45°

[TRAVIATA]



OPERA BELLINI WOOD J

Versione cieca  
Colore laccato frassino panna B003  
Coprifilo disponibile M60 a 45°

Version blank  
Colour lacquered cream ash B003  
Cover mould available M60 at 45°

[TRAVIATA]



OPERA BELLINI WOOD V

Versione cieca  
Colore laccato frassino bianco B011  
Coprifilo disponibile M60 a 45°

Version blank  
Colour lacquered white ash B011  
Cover mould available M60 at 45°

[TRAVIATA]



OPERA BELLINI WOOD Y

Versione cieca  
Colore laccato RAL 1019  
Coprifilo disponibile M60 a 45°

Version blank  
Colour lacquered RAL 1019  
Cover mould available M60 at 45°



[TRAVIATA]



OPERA BELLINI WOOD Z

Versione cieca  
 Colore laccato frassino nero  
 Coprifilo disponibile M60 a 45°

Version blank  
 Colour lacquered black ash  
 Cover mould available M60 at 45°

DISPONIBILITÀ LACCATURE / LACQUER AVAILABILITY

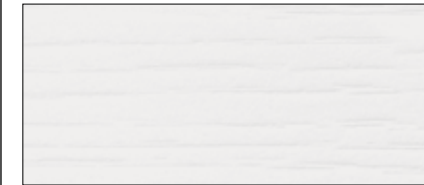

FRASSINO  
LACCATO  
BIANCO B011  
LACQUERED  
WHITE ASH B011



FRASSINO  
LACCATO  
PANNA B003  
LACQUERED  
CREAM ASH B003



FRASSINO  
LACCATO AVORIO  
LACQUERED  
IVORY ASH



FRASSINO  
LACCATO CAFFÈ  
LACQUERED  
COFFEE ASH



FRASSINO  
LACCATO NERO  
LACQUERED  
BLACK ASH

RAL E/O NCS / RALAND/OR NCS



ATTENZIONE: I COLORI SONO PURAMENTE INDICATIVI.  
 CONSULTARE IL CAMPIONARIO COLORI.

LE IMMAGINI RAPPRESENTATE NEL CATALOGO SONO A SCOPO  
 ILLUSTRATIVO.

ULTERIORI ALTRE ESSENZE SU RICHIESTA VERRANNO  
 ANALIZZATE SINGOLARMENTE PER STABILIRNE LA FATTIBILITÀ,  
 IL PREZZO E I TEMPI DI CONSEGNA.

ATTENTION: THE COLORS ARE PURELY INDICATIVE.  
 CONSULT THE COLOR SAMPLE.

ALL IMAGES SHOWN IN THE CATALOG ARE FOR ILLUSTRATIVE  
 PURPOSES ONLY.

FURTHER OTHER ESSENCES ON REQUEST WILL BE ANALYZED  
 INDIVIDUALLY TO DETERMINE THE FEASIBILITY, PRICE AND  
 DELIVERY TIMES.

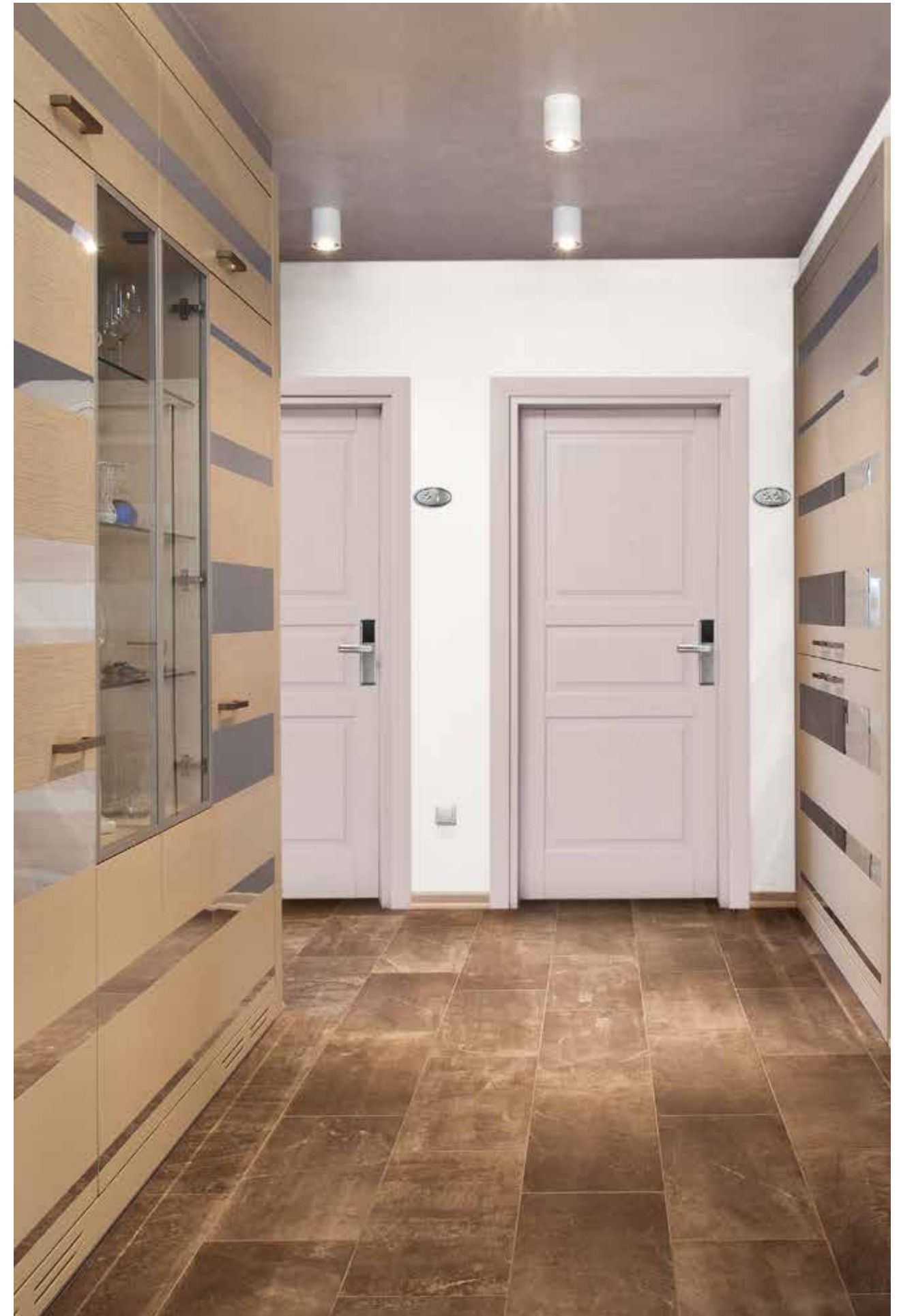

# ROMA

ROME

IT Roma, accogliente e caotica, incoraggia tutti a prendersela comoda. Seduti al tavolino di un bar o sulle scalinate di Piazza di Spagna, quello che conta è godersi la vita. Chiese accanto a negozi di lusso, resti archeologici vicino a motorini fermi al semaforo: a ogni angolo, la grandezza dell'antichità si mescola con la vita vera.

EN Rome is welcoming and chaotic and it invites everyone to 'take it easy'. Whether you're sat at a table outside a bar or on the Spanish steps, what really matters is enjoying life. Rome is churches, luxury shops, archaeological ruins, and motorbikes at traffic lights, all juxtaposed: around every corner, the greatness of antiquity blends with everyday life.



ROME  
HAVE A NICE TRIP

HOTEL  
COLLECTION  
EDITION  
2020



# OPERA LUCCHINI

BREVETTO DIERRE / DIERRE PATENT

[ORFEO]

IT **GUSTO E PERSONALITÀ, NATE PER ESSERE LE UNICHE, VERE PROTAGONISTE NEGLI AMBIENTI PIÙ PRESTIGIOSI.**

Stile, fantasia e abile progettazione. Conoscenza delle materie prime con infinite possibilità realizzative. Ogni particolare rivela la classe inconfondibile con cui ogni porta è stata realizzata. **Non disponibile nella versione Disuper. Sistema di pantografatura brevettato Dierre.**

EN **TASTE AND PERSONALITY, CONCEIVED TO BE UNIQUE, THE TRUE PROTAGONISTS WITHIN THE MOST PRESTIGIOUS SETTINGS.**

Style, imagination and clever design. Knowledge of the raw materials with endless creation possibilities. The unmistakable class each door has been made with is unveiled by each single detail. **Not available in the Disuper version. Pantographing system patented by Dierre.**



[ORFEO 1]



[ORFEO 2]



[ORFEO 3]



[ORFEO 4]



OPERA LUCCHINI 1

Versione cieca  
Colore laccato panna B003  
Coprifilo disponibile M60 e M80 a 45° e 90°

Version blank  
Colour *cream* lacquered B003  
Cover mould available M60 and M80 at 45° and 90°

OPERA LUCCHINI 2

Versione cieca  
Colore laccato bianco B011  
Coprifilo disponibile M60 e M80 a 45° e 90°

Version blank  
Colour white lacquered B011  
Cover mould available M60 and M80 at 45° and 90°

OPERA LUCCHINI 3

Versione cieca  
Colore laccata RAL 2001  
Coprifilo disponibile M60 e M80 a 45° e 90°

Version blank  
Colour lacquered RAL 2001  
Cover mould available M60 and M80 at 45° and 90°

OPERA LUCCHINI 4

Versione cieca  
Colore laccata RAL 6013  
Coprifilo disponibile M60 e M80 a 45° e 90°

Version blank  
Colour lacquered RAL 6013  
Cover mould available M60 and M80 at 45° and 90°

[ORFEO 5]



OPERA LUCCHINI 5

Versione cieca  
Colore laccata RAL 7037  
Coprifilo disponibile M60 e M80 a 45° e 90°

Version blank  
Colour lacquered RAL 7037  
Cover mould available M60 and M80 at 45° and 90°

[ORFEO 6]



OPERA LUCCHINI 6

Versione cieca  
Colore laccata RAL 7003  
Coprifilo disponibile M60 e M80 a 45° e 90°

Version blank  
Colour lacquered RAL 7003  
Cover mould available M60 and M80 at 45° and 90°

DISPONIBILITÀ LACCATURE / LACQUER AVAILABILITY

	LACCATO BIANCO B011 WHITE LACQUERED B011		GRIGIO SATURNO SATURN GREY
	LACCATO PANNA B003 CREAM LACQUERED B003		GHIACCIO ICE
	TERRE D'ARGILLA CLAY DIRT		GRIGIO TORTORA DOVE GREY
	CORDA ROPE		VIOLETTA VIOLET

RAL E/O NCS / RAL AND/OR NCS



ATTENZIONE: I COLORI SONO PURAMENTE INDICATIVI.  
CONSULTARE IL CAMPIONARIO COLORI.

LE IMMAGINI RAPPRESENTATE NEL CATALOGO SONO A SCOPO ILLUSTRATIVO.

ULTERIORI ALTRE ESSENZE SU RICHIESTA VERRANNO ANALIZZATE SINGOLARMENTE PER STABILIRNE LA FATTIBILITÀ, IL PREZZO E I TEMPI DI CONSEGNA.

ATTENTION: THE COLORS ARE PURELY INDICATIVE.  
CONSULT THE COLOR SAMPLE.

ALL IMAGES SHOWN IN THE CATALOG ARE FOR ILLUSTRATIVE PURPOSES ONLY.

FURTHER OTHER ESSENCES ON REQUEST WILL BE ANALYZED INDIVIDUALLY TO DETERMINE THE FEASIBILITY, PRICE AND DELIVERY TIMES.



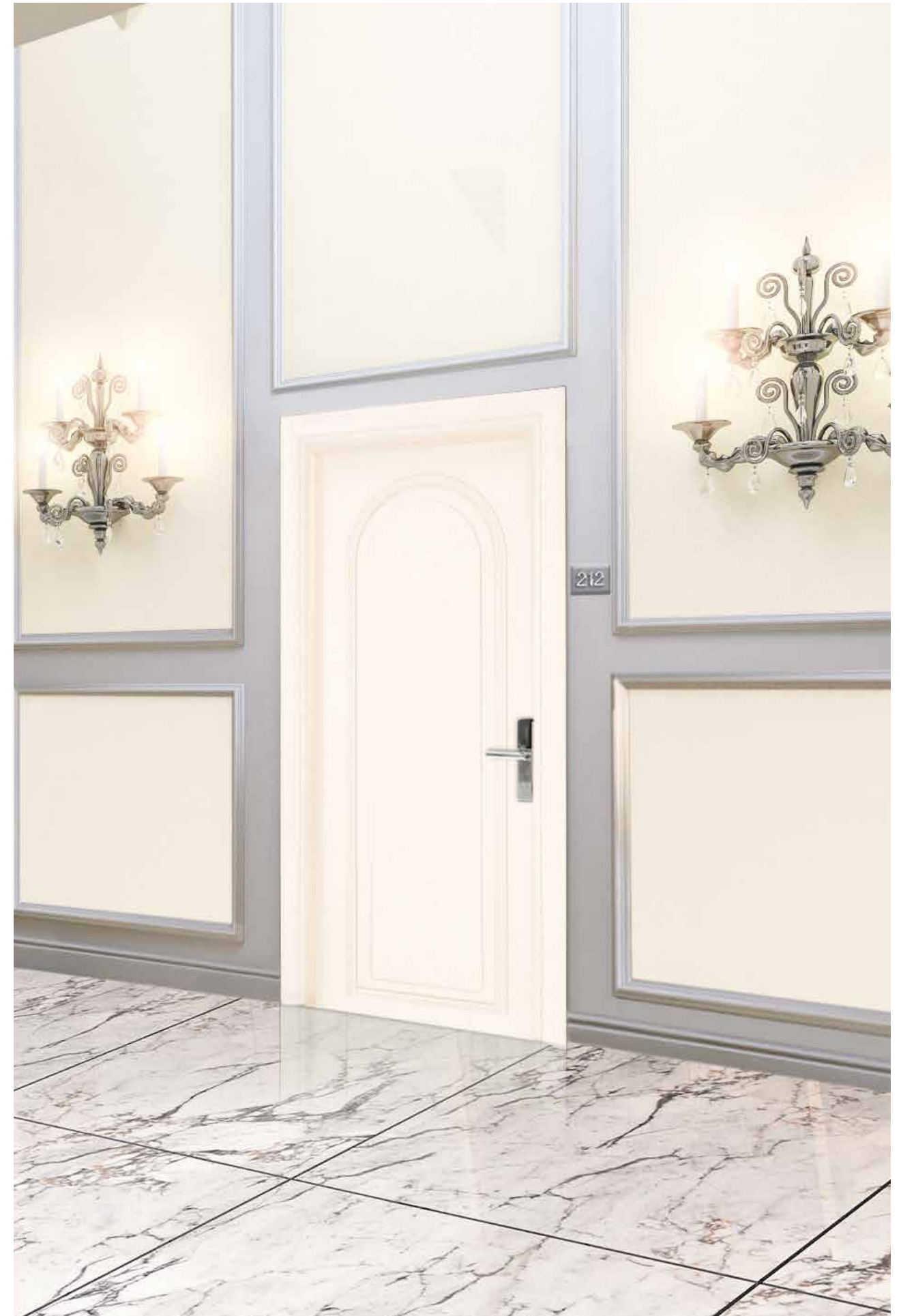



# MOSCA

MOSCOW

IT I palazzi raccontano storie antiche, le mura del Cremlino custodiscono il cuore della città, la piazza Rossa affascina per la sua imponenza. Mosca è un gioiello prezioso che nasconde la bellezza nei suoi angoli più remoti: dalle stazioni della metropolitana ai grandi magazzini, tutto sembra una grande opera d'arte.

EN Its palaces tell ancient stories, the walls of the Kremlin guard the heart of the city, and the Red Square impresses with its imposing beauty. Moscow is a precious jewel which conceals beauty even behind its remotest corners: from its subway stations to its huge department stores, everything feels like a work of art.





# OPERA JUVARRA

BREVETTO DIERRE / DIERRE PATENT

[RIGOLETTO]



IT **LA DECORAZIONE D'INTERNI COME VERA E PROPRIA ARTE, RICCA DI ORNAMENTI E DI PREZIOSE LAVORAZIONI.**

Lo stile intramontabile di un classico, in un battente ricco di pregio e di personalità. La pantografatura e la cornice, con una particolare tecnica produttiva, sono ottenute integralmente dal supporto dell'anta. Le possibilità di colore partono da bianco, verde, celeste o avorio, per arrivare a qualsiasi colore RAL su richiesta. **Non disponibile nella versione Disuper. Sistema di pantografatura brevettato Dierre.**

EN **THE INTERNAL DÉCOR JUST LIKE REAL ART, RICH IN ORNAMENTS AND VALUED WORKMANSHIP.**

The timeless style of a classic, in a door rich in prestige and personality. The pantograph and mouldings are completely obtained from the leaf support thanks to a particular manufacturing technique. The possible colours include white, green, sky-blue and ivory as well as any RAL or requested colour. **Not available in the Disuper version. Pantographing system patented by Dierre.**



[RIGOLETTO 1]



# OPERA JUVARRA 1

Versione cieca  
Colore laccata RAL 3005  
Coprifilo disponibile M60 e M80

Version blank  
Colour lacquered RAL 3005  
Cover mould available M60 and M80

[RIGOLETTO 2]



# OPERA JUVARRA 2

Versione cieca  
Colore laccata RAL 1002  
Coprifilo disponibile M60 e M80

Version blank  
Colour lacquered RAL 1002  
Cover mould available M60 and M80

[RIGOLETTO 3]



# OPERA JUVARRA 3

Versione cieca  
Colore laccata RAL 5012  
Coprifilo disponibile M60 e M80

Version blank  
Colour lacquered RAL 5012  
Cover mould available M60 and M80

[RIGOLETTO 4]



# OPERA JUVARRA 4

Versione cieca  
Colore laccatao RAL 1015  
Coprifilo disponibile M60 e M80

Version blank  
Colour lacquered RAL 1015  
Cover mould available M60 and M80

[RIGOLETTO 5]



OPERA JUVARRA 5

Versione cieca  
Colore laccata RAL 1013  
Coprifilo disponibile M60 e M80

Version blank  
Colour lacquered RAL 1013  
Cover mould available M60 and M80

[RIGOLETTO 6]



OPERA JUVARRA 6

Versione cieca  
Colore laccata RAL 1015  
Coprifilo disponibile M60 e M80

Version blank  
Colour lacquered RAL 1015  
Cover mould available M60 and M80

[RIGOLETTO 7]



OPERA JUVARRA 7

Versione cieca  
Colore laccata RAL 6013  
Coprifilo disponibile M60 e M80

Version blank  
Colour lacquered RAL 6013  
Cover mould available M60 and M80

[RIGOLETTO 8]



OPERA JUVARRA 8

Versione cieca  
Colore laccata RAL 7001  
Coprifilo disponibile M60 e M80

Version blank  
Colour lacquered RAL 7001  
Cover mould available M60 and M80

[RIGOLETTO 9]



OPERA JUVARRA 9

Versione cieca  
Colore laccata RAL 9005  
Coprifilo disponibile M60 e M80

Version blank  
Colour lacquered RAL 9005  
Cover mould available M60 and M80

[RIGOLETTO A]



OPERA JUVARRA A

Versione cieca  
Colore laccata RAL 8012  
Coprifilo disponibile M60 e M80

Version blank  
Colour lacquered RAL 8012  
Cover mould available M60 and M80

[RIGOLETTO B]



OPERA JUVARRA B

Versione cieca  
Colore laccata RAL 1013  
Coprifilo disponibile M60 e M80

Version blank  
Colour lacquered RAL 1013  
Cover mould available M60 and M80

[RIGOLETTO C]



OPERA JUVARRA C

Versione cieca  
Colore laccato bianco B011  
Coprifilo disponibile M60 e M80

Version blank  
Colour white lacquered B011  
Cover mould available M60 and M80



[RIGOLETTO D]



OPERA JUVARRA D

Versione cieca  
Colore laccata RAL 7040  
Coprifilo disponibile M60 e M80

Version blank  
Colour lacquered RAL 7040  
Cover mould available M60 and M80

[RIGOLETTO E]



OPERA JUVARRA E

Versione cieca  
Colore laccata RAL 1013  
Coprifilo disponibile M60 e M80

Version blank  
Colour lacquered RAL 1013  
Cover mould available M60 and M80

[RIGOLETTO F]



OPERA JUVARRA F

Versione cieca  
Colore laccata RAL 9018  
Coprifilo disponibile M60 e M80

Version blank  
Colour lacquered RAL 9018  
Cover mould available M60 and M80

[RIGOLETTO G]



OPERA JUVARRA G

Versione cieca  
Colore laccata RAL 9001  
Coprifilo disponibile M60 e M80

Version blank  
Colour lacquered RAL 9001  
Cover mould available M60 and M80

[RIGOLETTO H]



OPERA JUVARRA H

Versione cieca  
Colore laccata RAL 8015  
Coprifilo disponibile M60 e M80

Version blank  
Colour lacquered RAL 8015  
Cover mould available M60 and M80

[RIGOLETTO H]



OPERA JUVARRA H

Versione cieca  
Colore laccata RAL 1013  
Coprifilo disponibile M60 e M80

Version blank  
Colour lacquered RAL 1013  
Cover mould available M60 and M80

[RIGOLETTO L]



OPERA JUVARRA L

Versione cieca  
Colore laccatao panna B003  
Coprifilo disponibile M60 e M80

Version blank  
Colour cream lacquered B003  
Cover mould available M60 and M80

[RIGOLETTO M]



OPERA JUVARRA M

Versione cieca  
Colore laccata RAL 7001  
Coprifilo disponibile M60 e M80

Version blank  
Colour lacquered RAL 7001  
Cover mould available M60 and M80

[RIGOLETTO N]



OPERA JUVARRA N

Versione cieca  
Colore laccata RAL 7043  
Coprifilo disponibile M60 e M80

Version blank  
Colour lacquered RAL 7043  
Cover mould available M60 and M80

[RIGOLETTO O]



OPERA JUVARRA O

Versione cieca  
Colore laccata RAL 1013  
Coprifilo disponibile M60 e M80

Version blank  
Colour lacquered RAL 1013  
Cover mould available M60 and M80

[RIGOLETTO P]



OPERA JUVARRA P

Versione cieca  
Colore laccata RAL 8015  
Coprifilo disponibile M60 e M80

Version blank  
Colour lacquered RAL 8015  
Cover mould available M60 and M80

[RIGOLETTO Q]



OPERA JUVARRA Q

Versione cieca  
Colore laccata RAL 1013  
Coprifilo disponibile M60 e M80

Version blank  
Colour lacquered RAL 1013  
Cover mould available M60 and M80



[RIGOLETTO R]



OPERA JUVARRA R

Versione cieca  
Colore laccata RAL 1001  
Coprifilo disponibile M60 e M80

Version blank  
Colour lacquered RAL 1001  
Cover mould available M60 and M80

[RIGOLETTO S]



OPERA JUVARRA S

Versione cieca  
Colore laccata RAL 1013  
Coprifilo disponibile M60 e M80

Version blank  
Colour lacquered RAL 1013  
Cover mould available M60 and M80

[RIGOLETTO T]



OPERA JUVARRA T

Versione cieca  
Colore laccata RAL 1015  
Coprifilo disponibile M60 e M80

Version blank  
Colour lacquered RAL 1015  
Cover mould available M60 and M80

[RIGOLETTO U]



OPERA JUVARRA U

Versione cieca  
Colore laccata RAL 6003  
Coprifilo disponibile M60 e M80

Version blank  
Colour lacquered RAL 6003  
Cover mould available M60 and M80

DISPONIBILITÀ LACCATURE / LACQUER AVAILABILITY

	LACCATO BIANCO B011 WHITE LACQUERED B011		GRIGIO SATURNO SATURN GREY
	LACCATO PANNA B003 CREAM LACQUERED B003		GHIACCIO ICE
	TERRE D'ARGILLA CLAY DIRT		GRIGIO TORTORA DOVE GREY
	CORDA ROPE		VIOLETTA VIOLET

RAL E/O NCS / RAL AND/OR NCS



ATTENZIONE: I COLORI SONO PURAMENTE INDICATIVI.  
CONSULTARE IL CAMPIONARIO COLORI.

LE IMMAGINI RAPPRESENTATE NEL CATALOGO SONO A SCOPO  
ILLUSTRATIVO.

ULTERIORI ALTRE ESSENZE SU RICHIESTA VERRANNO  
ANALIZZATE SINGOLARMENTE PER STABILIRNE LA FATTIBILITÀ,  
IL PREZZO E I TEMPI DI CONSEGNA.

ATTENTION: THE COLORS ARE PURELY INDICATIVE.  
CONSULT THE COLOR SAMPLE.

ALL IMAGES SHOWN IN THE CATALOG ARE FOR ILLUSTRATIVE  
PURPOSES ONLY.

FURTHER OTHER ESSENCES ON REQUEST WILL BE ANALYZED  
INDIVIDUALLY TO DETERMINE THE FEASIBILITY, PRICE AND  
DELIVERY TIMES.



Dogana Resort ★★★★★ - Molfetta (BA)  
porte personalizzate di / customized doors by Infissiarredo S.r.l. - Altamura (BA)





# PECHINO

BEIJING

IT Palazzi imperiali e grattacieli, pagode e autostrade, antichi templi e architetture avveniristiche: a Pechino le glorie del passato incontrano l'energia del presente. E, tra i suoi vicoli pieni di fascino, le persone trovano ancora il tempo per rallentare, giocare a scacchi e osservare la gente che passa.

EN Imperial buildings and skyscrapers, pagodas and highways, ancient temples and pioneering architecture: in Beijing, the glory of the past meets the energy of the present. And along its fascinating narrow streets, people still find the time to slow down, play chess and people-watch.

WELCOME  
TO BEIJING

EXPLORING  
THE WORLD  
SINCE 1975





# OPERA BONAPARTE

BREVETTO DIERRE / DIERRE PATENT

[CARMEN]

IT **VIVERE IL CALORE DEL LEGNO, DELLE FORME, DEI DETTAGLI, NELL'INTIMITÀ DI INTERNI NATI PER ACCOGLIERE ATMOSFERE RARE E AFFASCINANTI.**

La miscela delle tecniche di lavorazione utilizzate, che comprende incisioni, pantografatura e l'applicazione di cornici, trasforma il battente in una raffinata espressione di stile. Creando soluzioni ed effetti assolutamente inaspettati, che arricchiscono di nuove suggestioni le laccature bianco e avorio. **Non disponibile nella versione Disuper. Sistema di pantografatura brevettato Dierre.**

EN **CREATED TO WELCOME RARE AND ENCHANTING MOODS, TO LIVE THE WARMTH OF THE WOOD, THE SHAPE AND THE DETAILS IN THE INTIMACY OF ONE'S HOME.**

The door is transformed into a refined expression of style through the combination of production techniques, which include carving, pantographing and the application of moulds, creating unexpected solutions and effects that enrich the white and ivory lacquering with new charm. **Not available in the Disuper version. Pantographing system patented by Dierre.**



[CARMEN 1]



# OPERA BONAPARTE 1

Versione cieca  
Colore laccata RAL 7040  
Coprifilo disponibile M100 lato esterno/  
M60 lato interno

Version blank  
Colour lacquered RAL 7040  
Cover mould available M100 external side/  
M60 internal side

[CARMEN 2]



# OPERA BONAPARTE 2

Versione cieca  
Colore laccata RAL 8014  
Coprifilo disponibile M50 lato esterno/  
M60 lato interno

Version blank  
Colour lacquered RAL 8014  
Cover mould available M50 external side/  
M60 internal side

[CARMEN 3]



# OPERA BONAPARTE 3

Versione cieca  
Colore laccata bianco B011  
Coprifilo disponibile M100 lato esterno/  
M60 lato interno

Version blank  
Colour white lacquered B011  
Cover mould available M100 external side/  
M60 internal side

[CARMEN 4]



# OPERA BONAPARTE 4

Versione cieca  
Colore laccata antichizzato bianco con  
filetti in oro  
Coprifilo disponibile M100 lato esterno  
con filetti in oro/ M60 lato interno

Version blank  
Colour lacquered aged white with gold trim  
Cover mould available M100 external side  
with gold trim/M60 internal side



[CARMEN 5]



OPERA BONAPARTE 5

Versione cieca  
 Colore laccata RAL 1011  
 Coprifilo disponibile M100 lato esterno/  
 M60 lato interno

Version blank  
 Colour lacquered RAL 1011  
 Cover mould available M100 external side/  
 M60 internal side

[CARMEN 6]



OPERA BONAPARTE 6

Versione cieca  
 Colore laccato panna B003  
 Coprifilo disponibile M100 lato esterno/  
 M60 lato interno

Version blank  
 Colour cream lacquered B003  
 Cover mould available M100 external side/  
 M60 internal side

DISPONIBILITÀ LACCATURE / LACQUER AVAILABILITY

	LACCATO BIANCO B011 WHITE LACQUERED B011		GRIGIO SATURNO SATURN GREY
	LACCATO PANNA B003 CREAM LACQUERED B003		GHIACCIO ICE
	TERRE D'ARGILLA CLAY DIRT		GRIGIO TORTORA DOVE GREY
	CORDA ROPE		VIOLETTA VIOLET

RAL E/O NCS / RAL AND/OR NCS



ATTENZIONE: I COLORI SONO PURAMENTE INDICATIVI.  
 CONSULTARE IL CAMPIONARIO COLORI.

LE IMMAGINI RAPPRESENTATE NEL CATALOGO SONO A SCOPO ILLUSTRATIVO.

ULTERIORI ALTRE ESSENZE SU RICHIESTA VERRANNO ANALIZZATE SINGOLARMENTE PER STABILIRNE LA FATTIBILITÀ, IL PREZZO E I TEMPI DI CONSEGNA.

ATTENTION: THE COLORS ARE PURELY INDICATIVE.  
 CONSULT THE COLOR SAMPLE.

ALL IMAGES SHOWN IN THE CATALOG ARE FOR ILLUSTRATIVE PURPOSES ONLY.

FURTHER OTHER ESSENCES ON REQUEST WILL BE ANALYZED INDIVIDUALLY TO DETERMINE THE FEASIBILITY, PRICE AND DELIVERY TIMES.

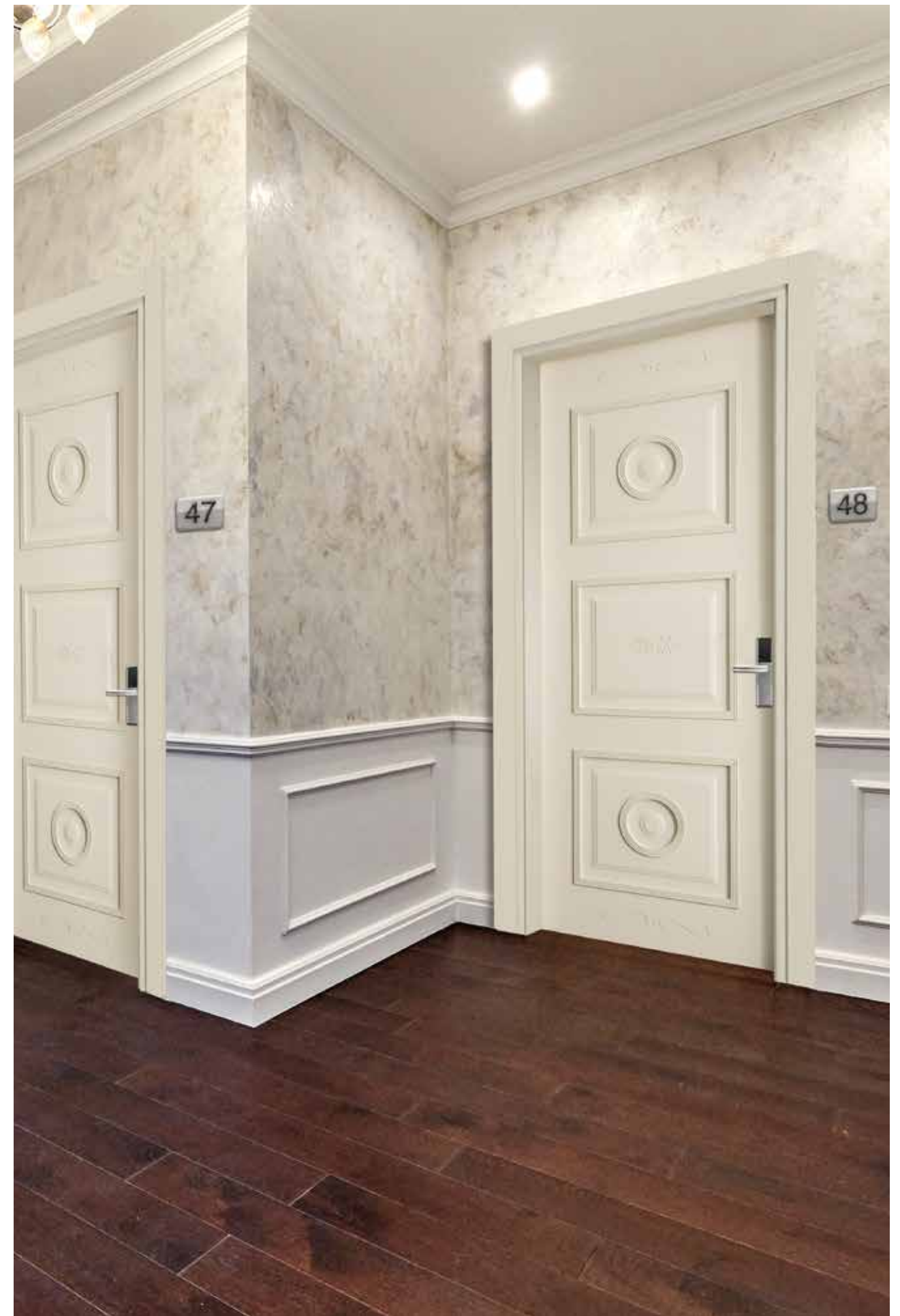

# SPECIFICHE TECNICHE

TECHNICAL INFORMATION



# OPERA VERSIONE DISUPER30 UN BATTENTE 42dB

CERNIERE A SCOMPARSA E CHIUDIPIORTA A VISTA

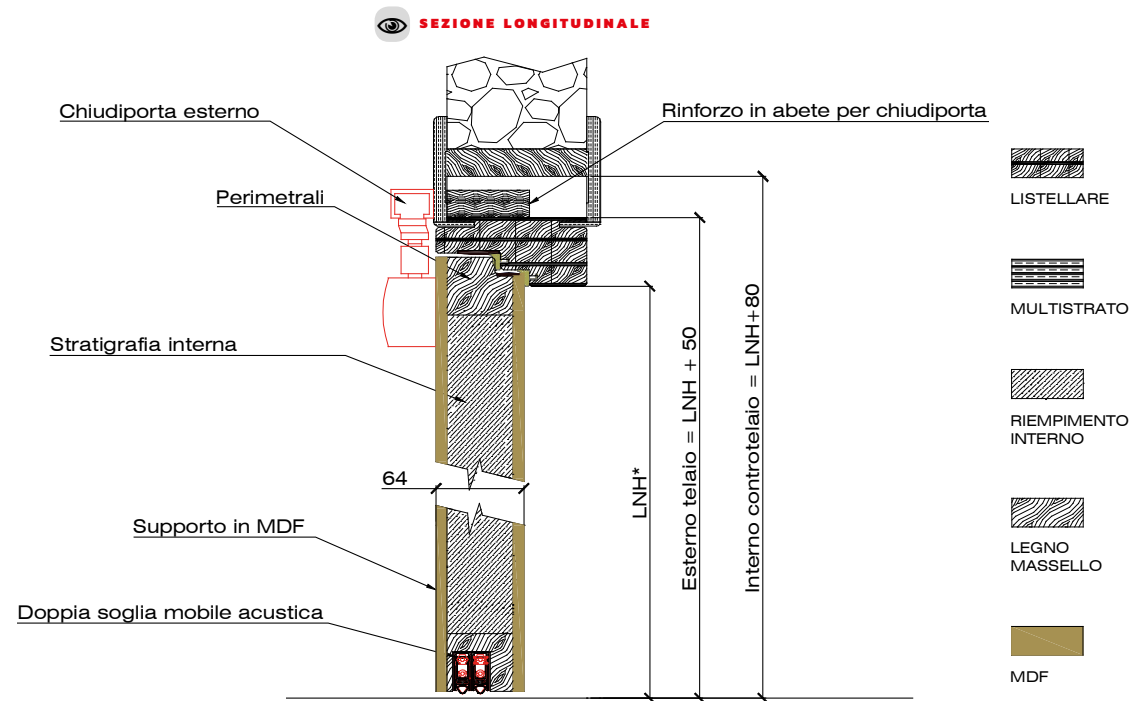
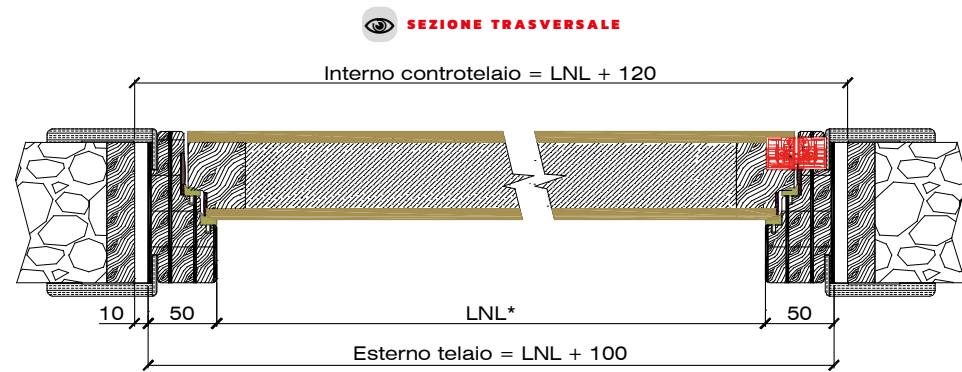

codice ordine **D30**

# OPERA VERSIONE DISUPER30 UN BATTENTE 42dB

CERNIERE E CHIUDIPIORTA A SCOMPARSA

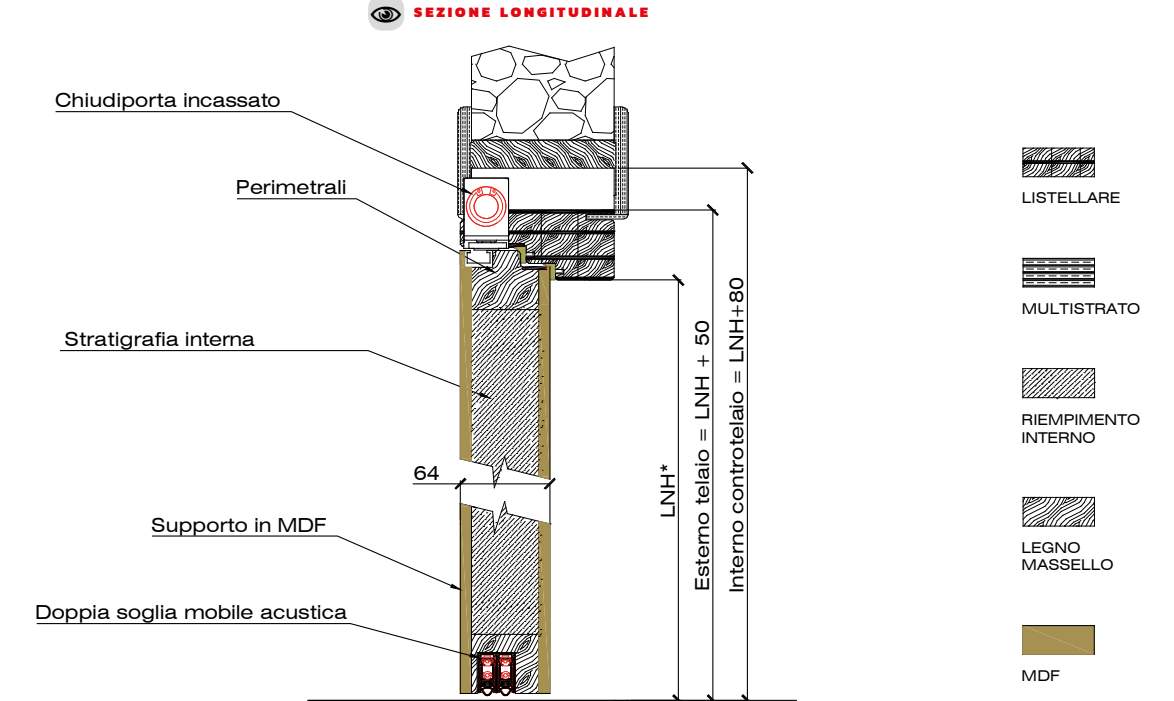
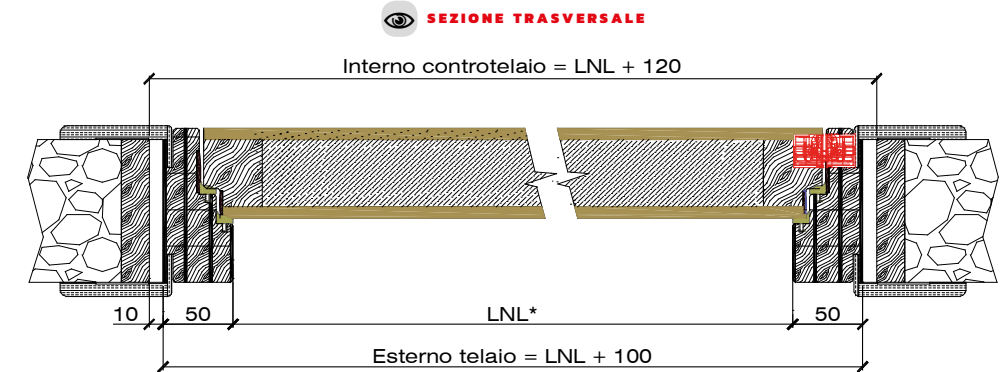

codice ordine **D31**

# OPERA VERSIONE DISUPER60 UN BATTENTE 47dB

CERNIERE A SCOMPARSA E CHIUDIPIORTA A VISTA

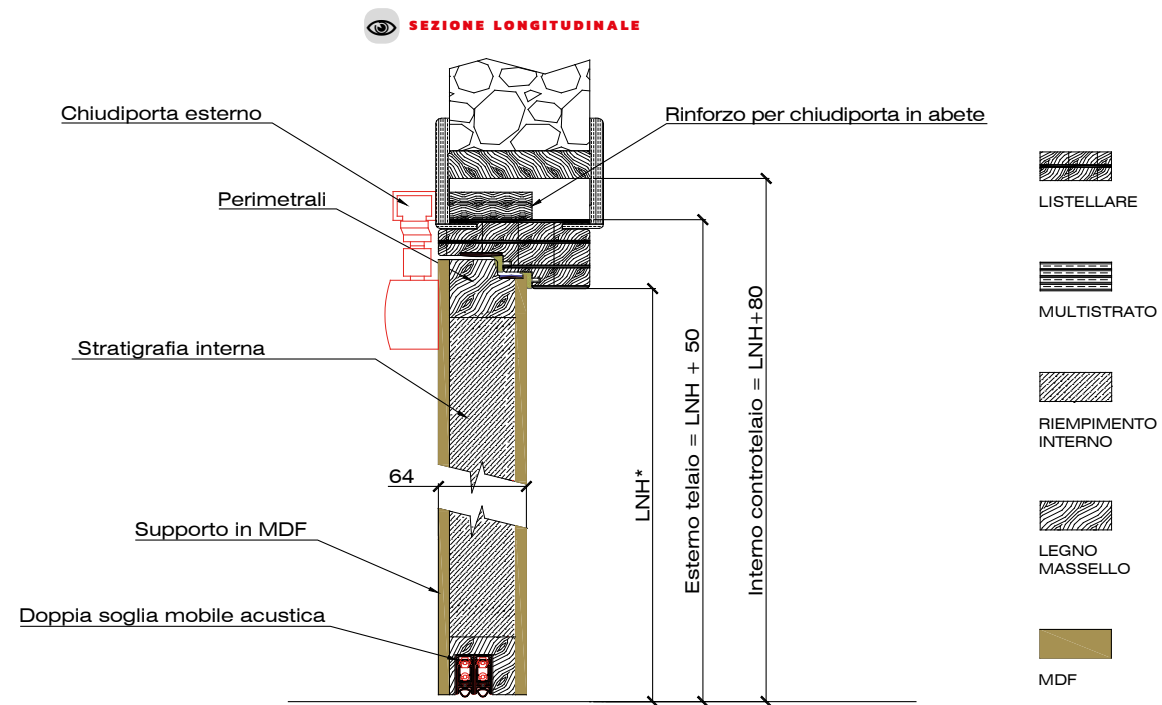
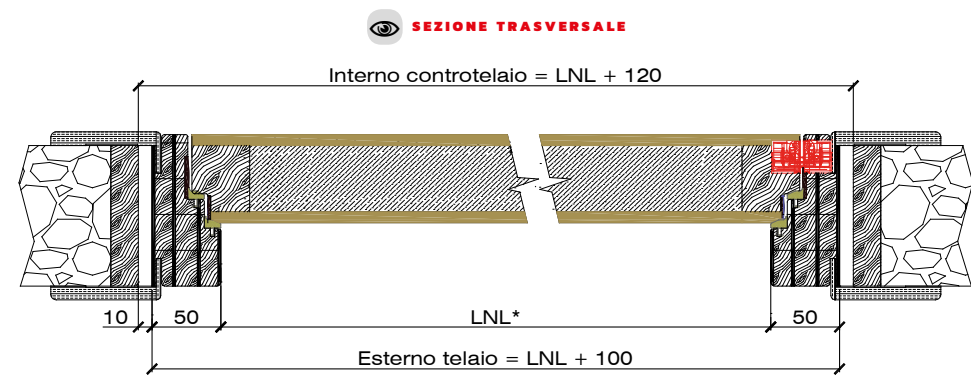

codice ordine **D60**

# OPERA VERSIONE DISUPER60 UN BATTENTE 47dB

CERNIERE E CHIUDIPIORTA A SCOMPARSA

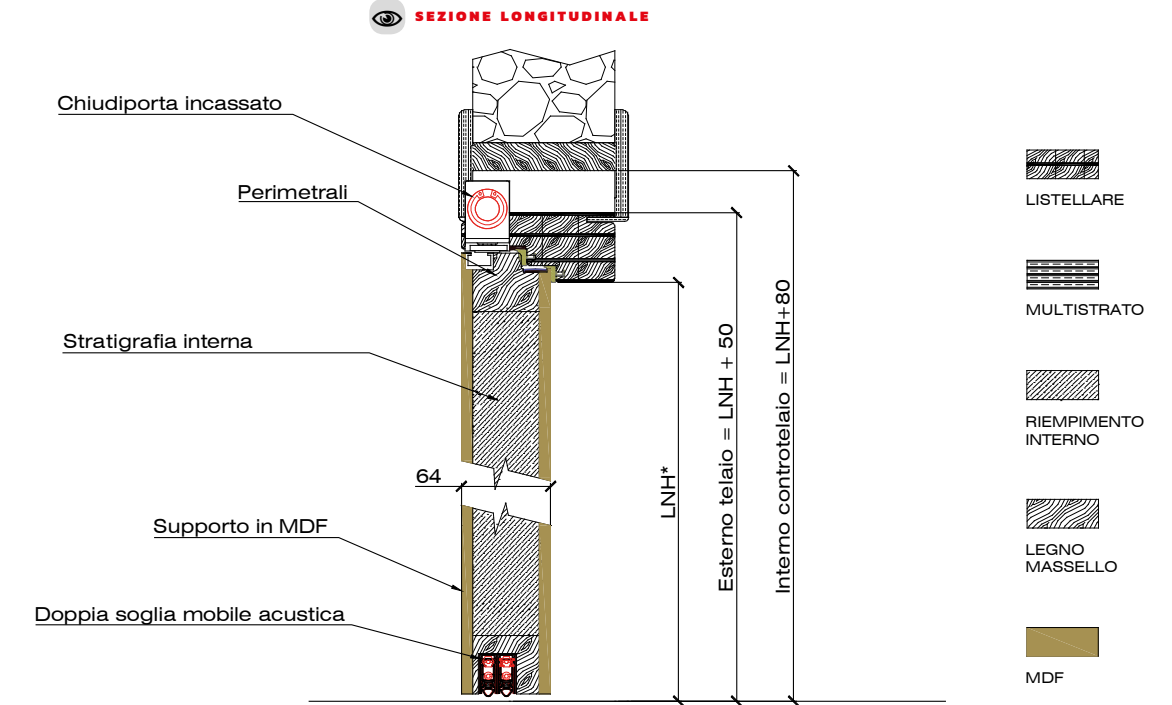
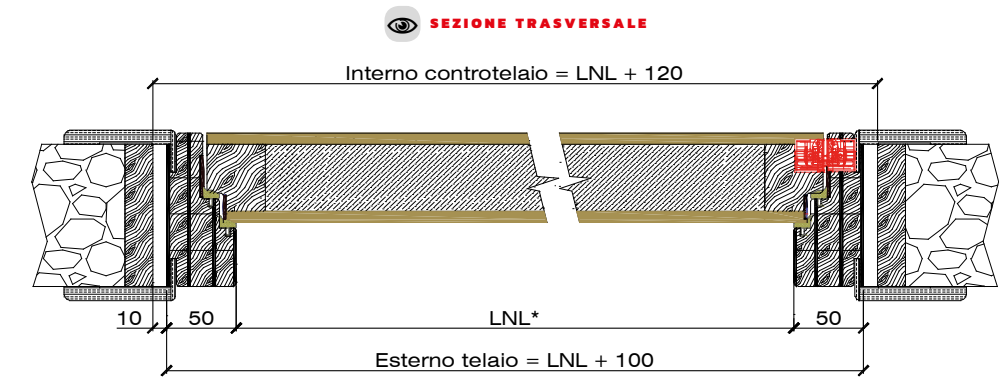

codice ordine **D61**

# OPERA EI30

## UN BATTENTE DISPONIBILE 34dB

CERNIERE E CHIUDIPIORTA A VISTA

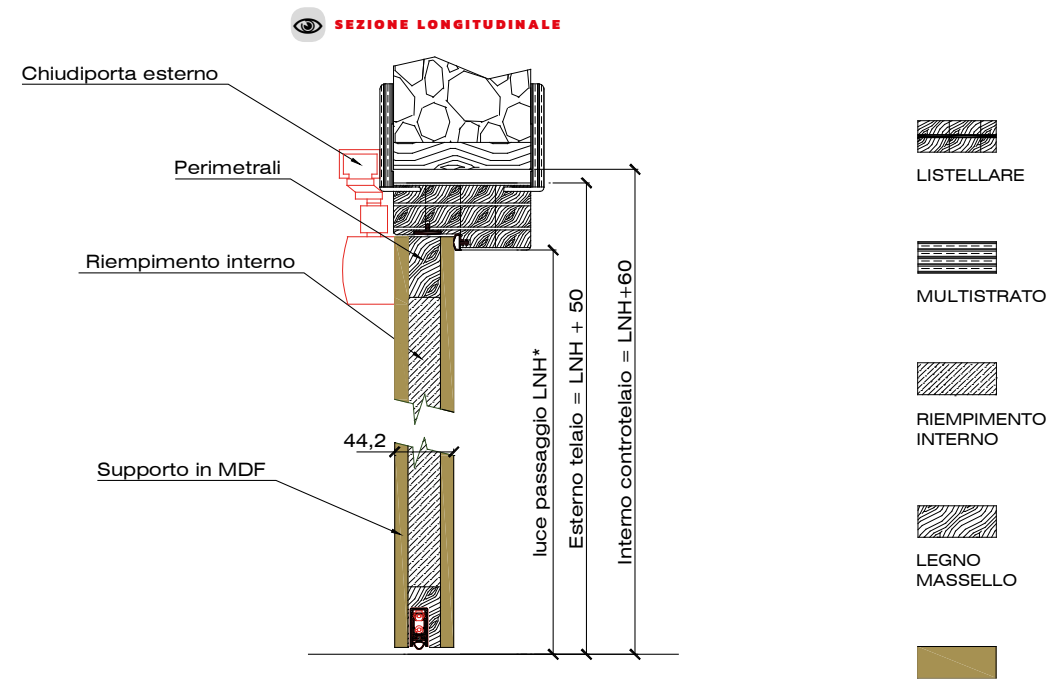
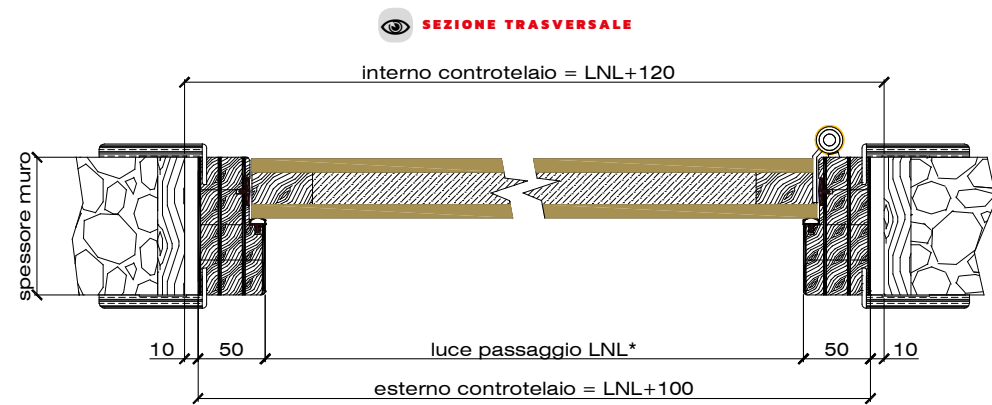

codice ordine **R31**

# OPERA EI30

## UN BATTENTE DISPONIBILE 34dB

CERNIERE E CHIUDIPIORTA A SCOMPARSA

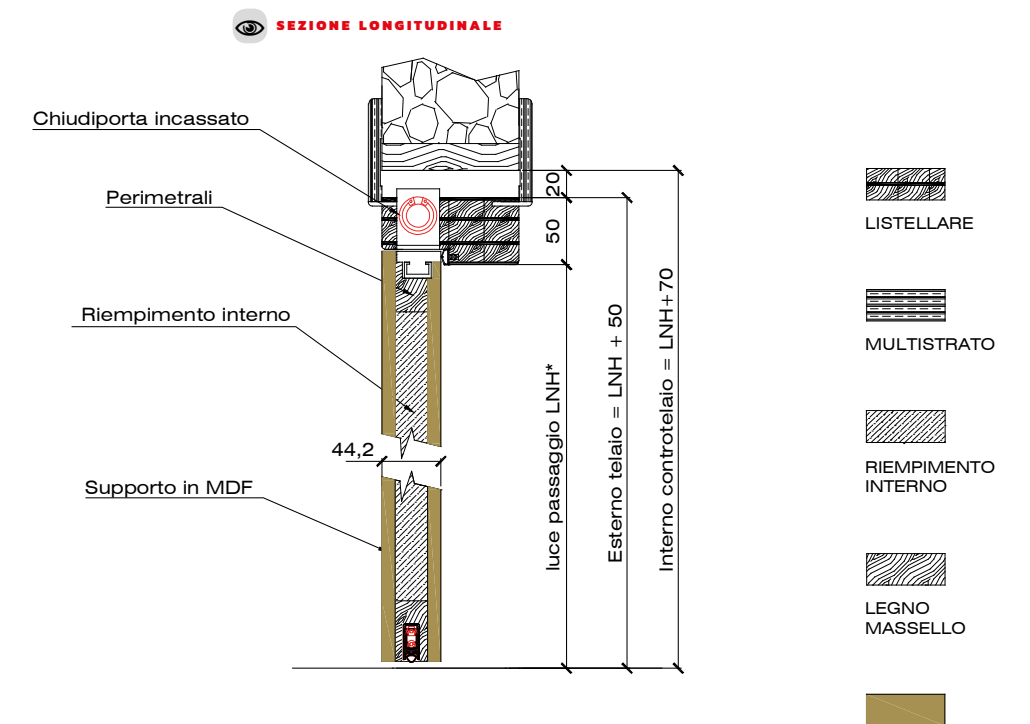
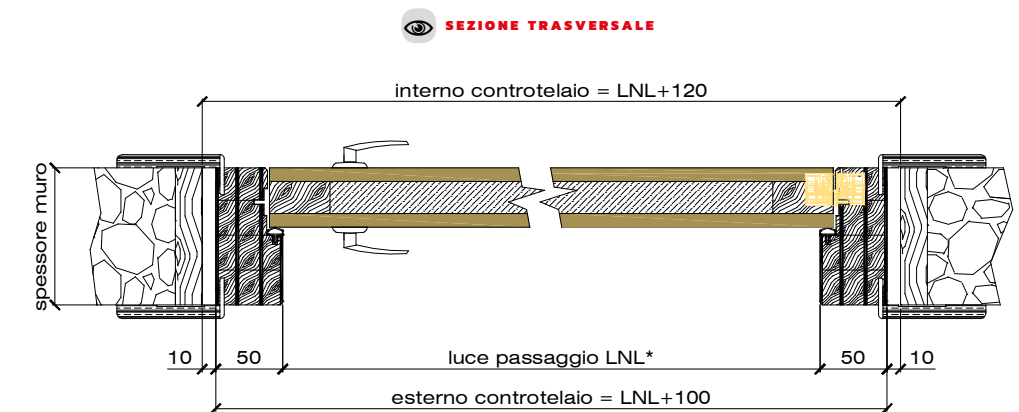

codice ordine **R35**



# OPERA EI30 UN BATTENTE

CERNIERE E CHIUDIPIORTA A SCOMPARSA

SEZIONE TRASVERSALE

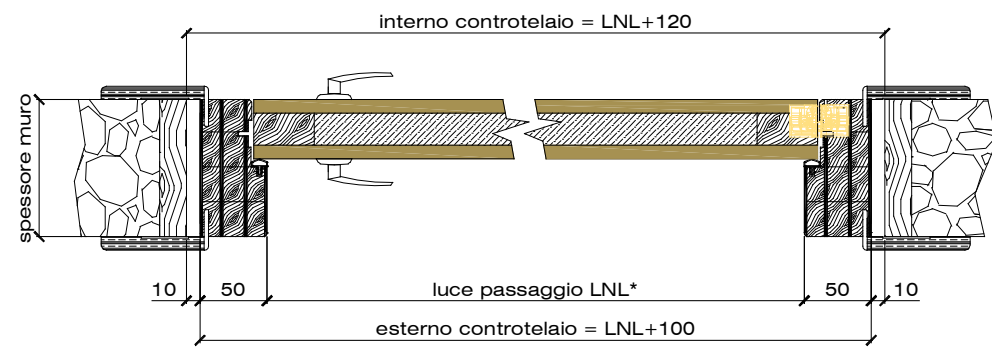

SEZIONE LONGITUDINALE

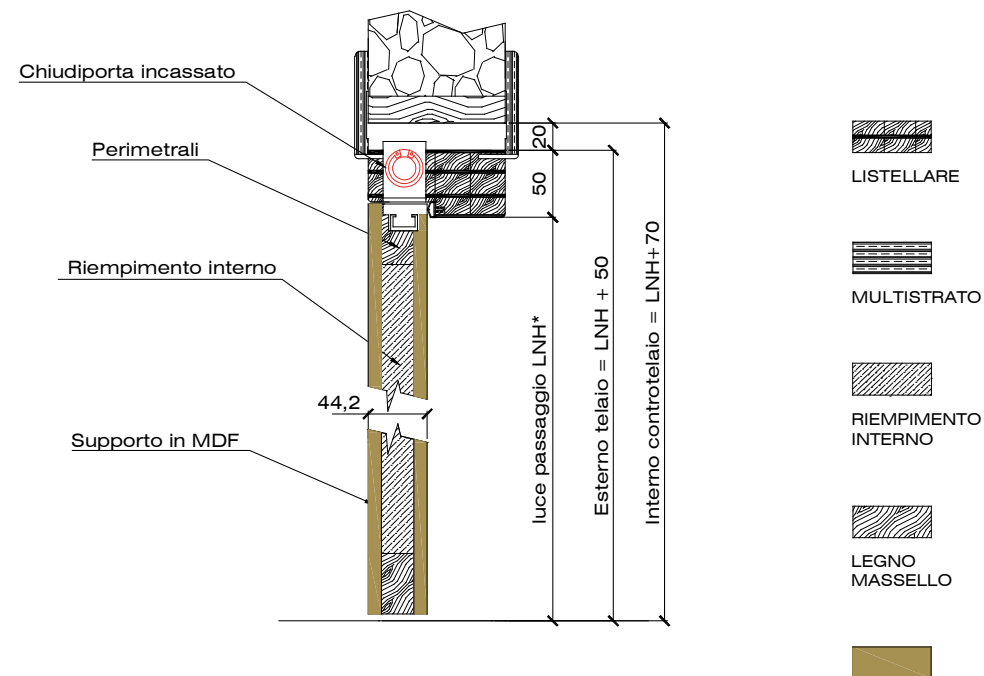

codice ordine R35

# OPERA EI30 UN BATTENTE

CERNIERE E CHIUDIPIORTA A SCOMPARSA  
FILO COPRIFILO

SEZIONE TRASVERSALE

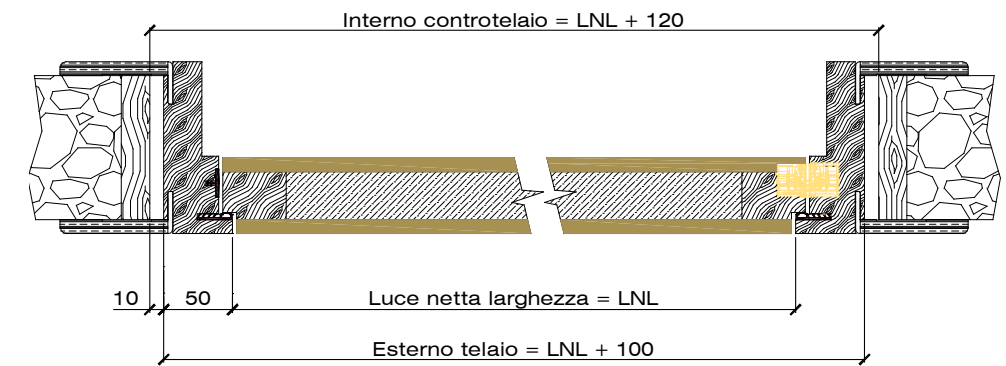

SEZIONE LONGITUDINALE

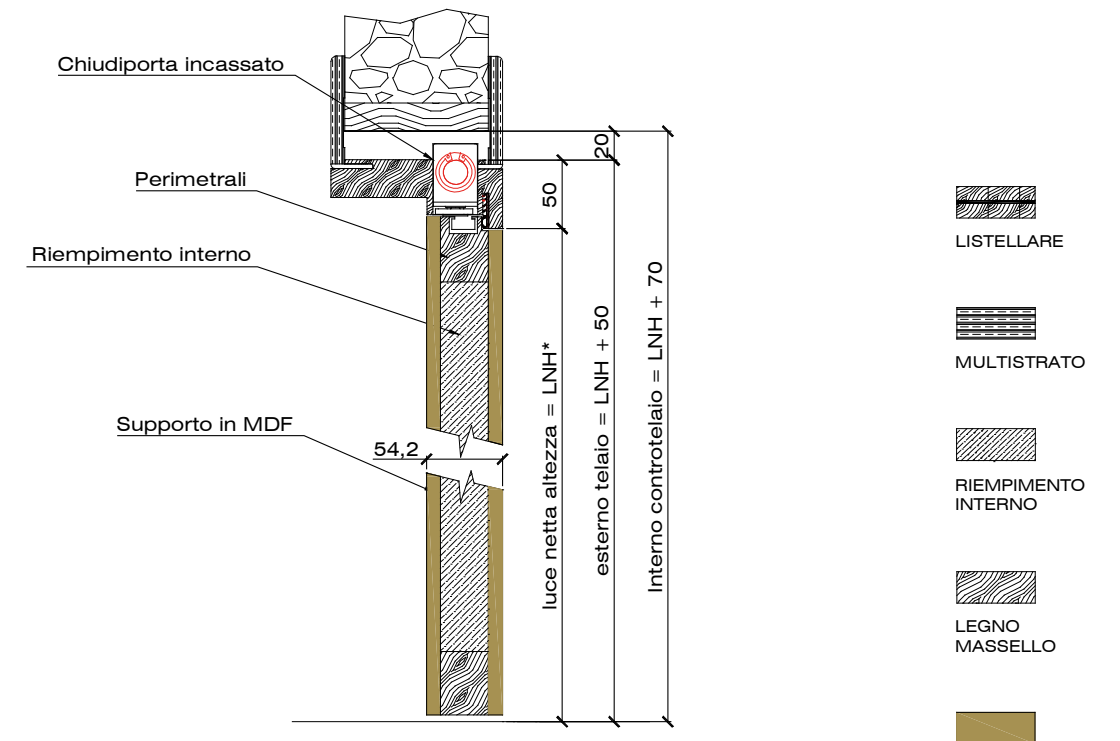

codice ordine R37

# OPERA EI30 DOPPIO BATTENTE

CERNIERE E CHIUDIORTA A VISTA

SEZIONE TRASVERSALE

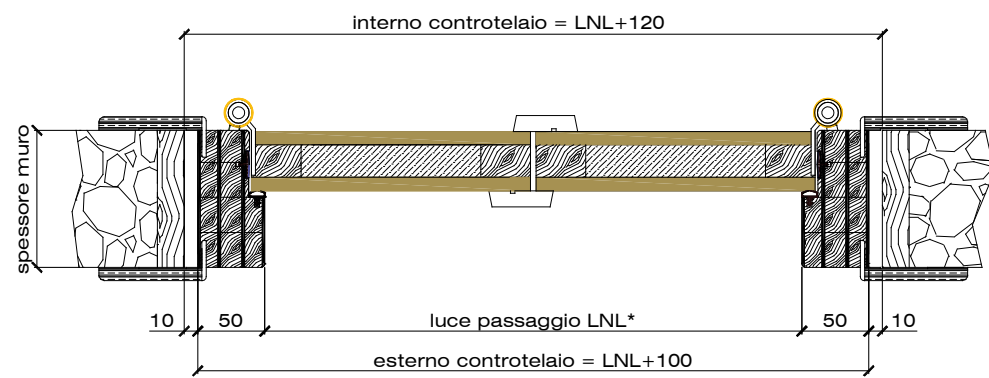

SEZIONE LONGITUDINALE

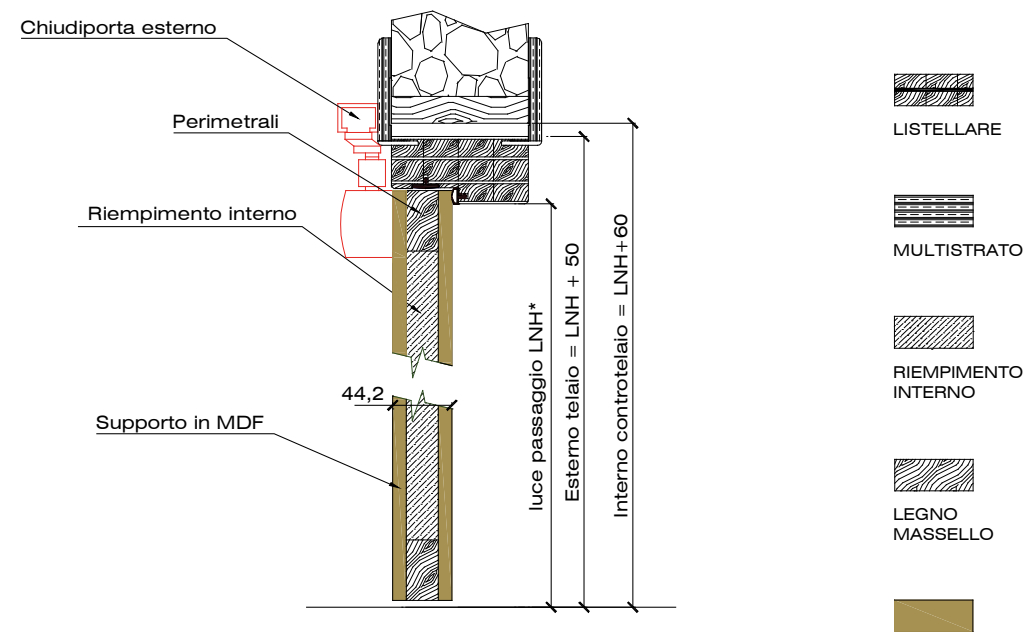

codice ordine **R32**

# OPERA EI60

## UN BATTENTE DISPONIBILE 37dB

CERNIERE E CHIUDIPIORTA A VISTA

SEZIONE TRASVERSALE

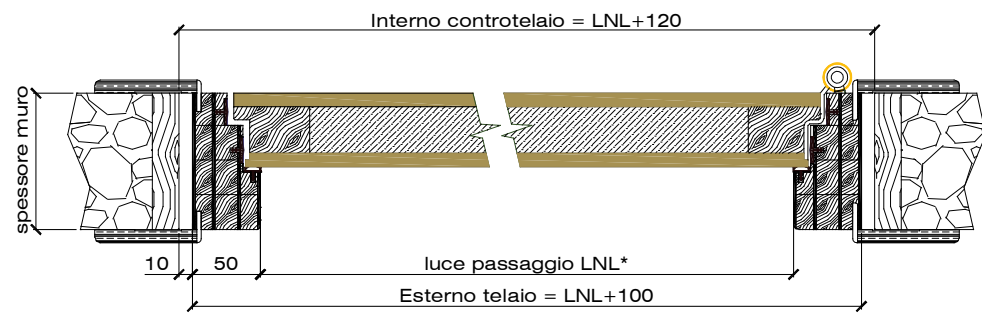

SEZIONE LONGITUDINALE

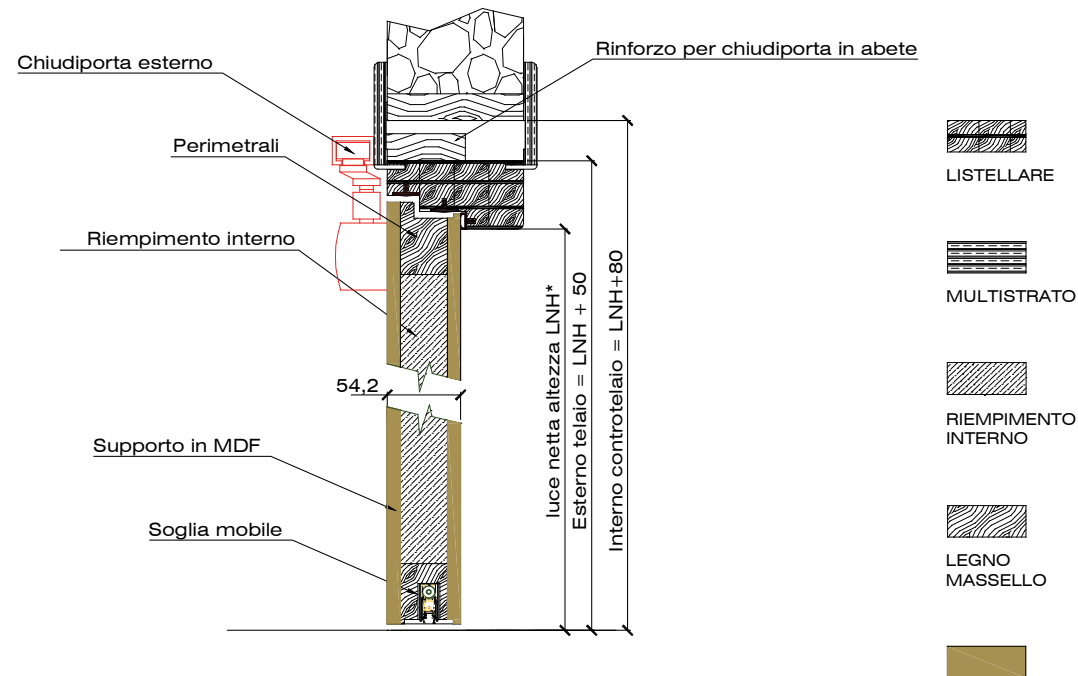

codice ordine **R61**

# OPERA EI60

## DOPPIO BATTENTE

CERNIERE E CHIUDIPIORTA A VISTA

SEZIONE TRASVERSALE

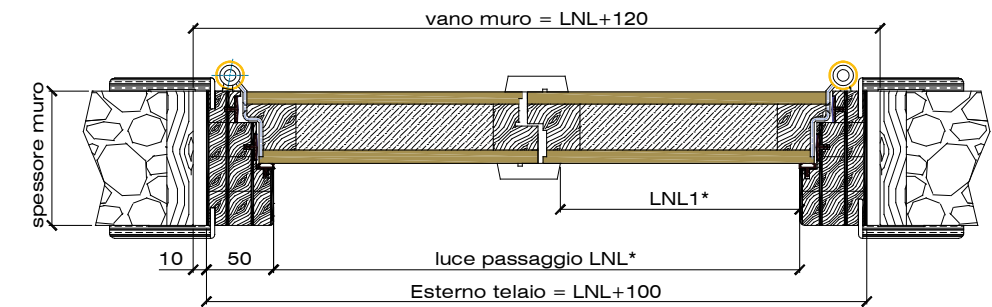

SEZIONE LONGITUDINALE

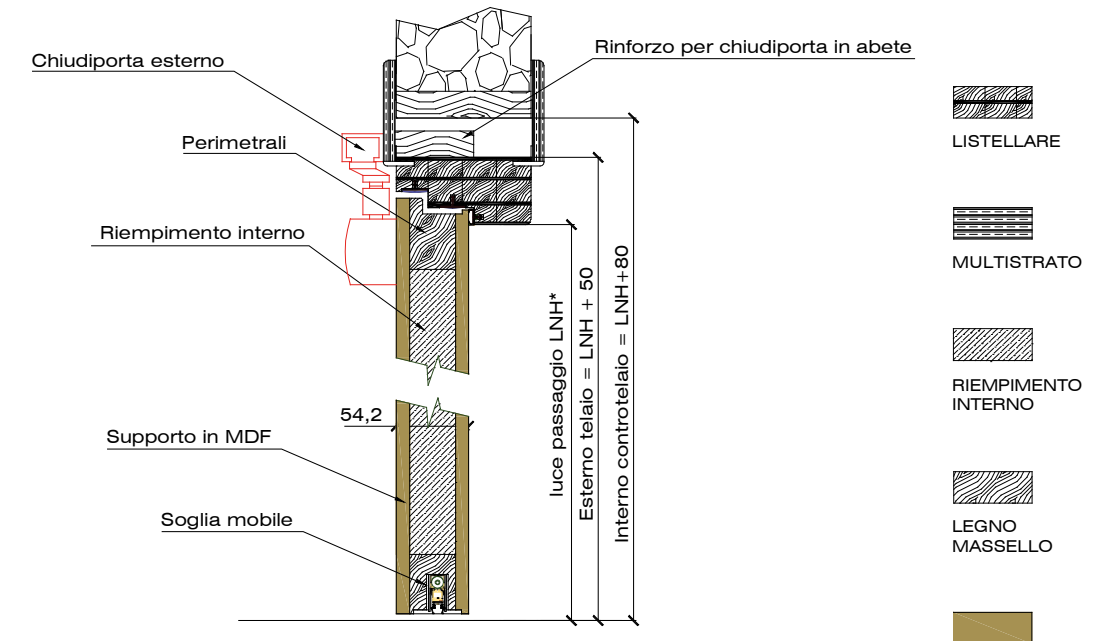

codice ordine **R62**



# TELAIO OPERA

SOLUZIONI PER PORTE TAGLIAFUOCO  
TENUTA FUMI CALDI E FREDDI  
SOLUTIONS FOR FIRE-RATED DOORS  
COLD AND HOT SMOKE SEALS



**TELAIO EI 30**  
con cerniera a scomparsa  
e/o a bandella  
posa su cartongesso e/o muratura

**EI 30 FRAME**  
with flap concealed hinge  
and / or a strip  
installation on plasterboard and /  
or masonry

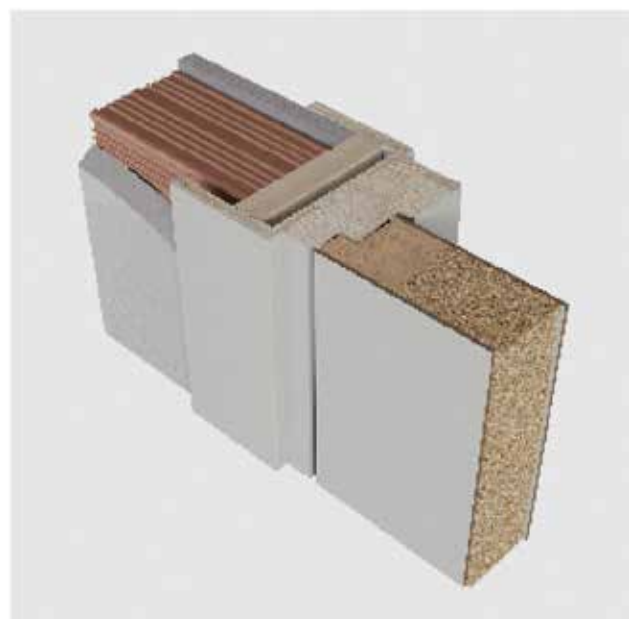

**TELAIO EI 60 - 37 dB\***  
con cerniera a bandella

**EI 60 FRAME 37 dB\***  
with flap zipper

\* Con allestimento acustico (solo anta singola)  
With sound-proofing fitting (single door only)

# TELAIO OPERA DISUPER

SISTEMA DI ABBATTIMENTO ACUSTICO FINO A 47 dB  
TENUTA FUMI CALDI E FREDDI  
SOUND-PROOF UP TO 47 DB COLD  
AND HOT SMOKE SEALS

\* Con allestimento acustico / With sound-proofing fitting

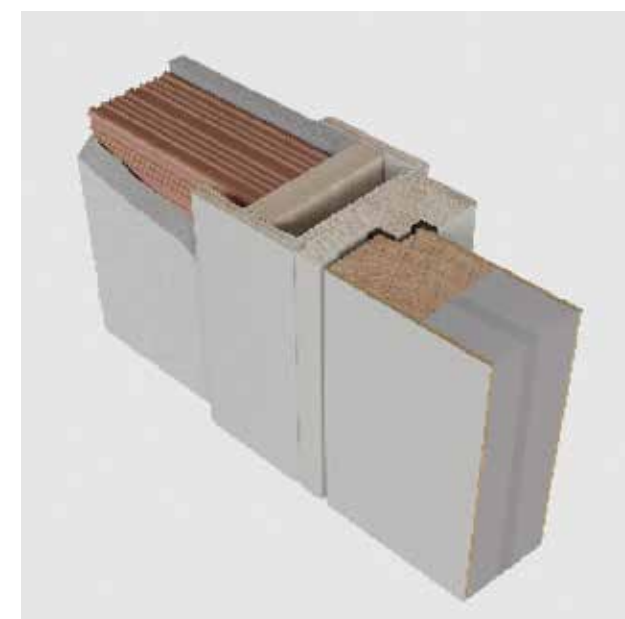

**TELAIO D SUPER EI 30 - 42 dB\***  
con cerniera a scomparsa

**EI 30 D SUPER FRAME 42 dB\***  
with concealed hinge

NON DISPONIBILE / NOT AVAILABLE  
SU OPERA OTELLO, OPERA TRAVIATA,  
OPERA CARMEN, OPERA RIGOLETTO,  
OPERA ORFEO.

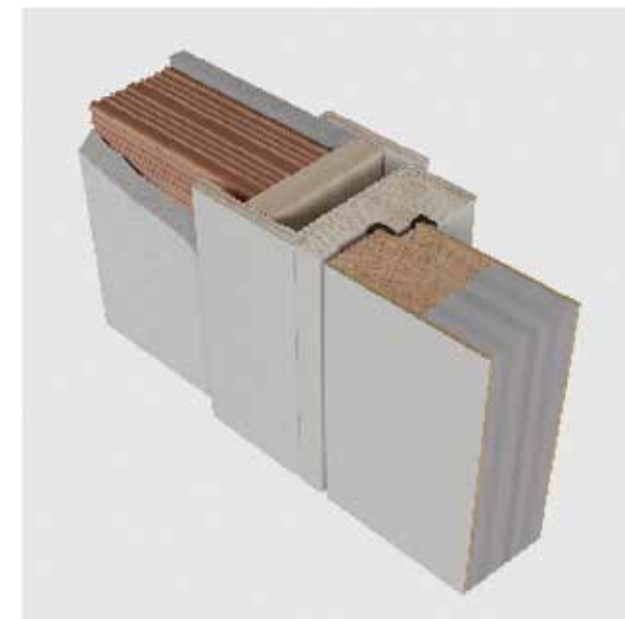

**TELAIO D SUPER EI 60 - 47 dB\***  
con cerniera a scomparsa

**EI 60 D SUPER FRAME 47 dB\***  
with concealed hinge

NON DISPONIBILE / NOT AVAILABLE  
SU OPERA OTELLO, OPERA TRAVIATA,  
OPERA CARMEN, OPERA RIGOLETTO,  
OPERA ORFEO.

# KIT TELAIO EI 30

misura telaio:  
 nomin. 80 - reale 82 - coprifili fino a 98  
 nomin. 100 - reale 102 - coprifili fino a 118  
 nomin. 120 - reale 122 - coprifili fino a 138  
 nomin. 140 - reale 142 - coprifili fino a 158

frame size:  
 nominal 80 - real 82 - cover mould up to 98  
 nominal 100 - real 102 - cover mould up to 118  
 nominal 120 - real 122 - cover mould up to 138  
 nominal 140 - real 142 - cover mould up to 158

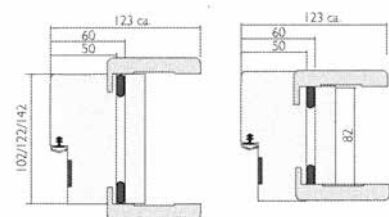

## KIT TELAIO EI 30 A DUE ANTE

Tipologia ed essenza:  
 tanganika medio scuro, noce nazionale tinto, sherry, rovere sbiancato, rovere tinto wengè, rovere grey, tanganika grezzo, noce nazionale grezzo, laccato bianco B011, terre d'argilla, corda, grigio saturno, ghiaccio, grigio tortora, violetta, laccato avorio, laccato RAL, laccato RAL scuro, grezzo per laccato



## FRAME KIT EI 30 WITH TWO DOORS

Type and essence:  
 medium dark tanganika, italian stained walnut, sherry, whitened oak, wengè stained oak, grey oak, raw tanganika, raw italian walnut, white lacquered B011, clay dirt, rope, saturn grey, ice, dove grey, violet, ivory lacquered, RAL lacquered, dark RAL lacquered, raw for lacquered

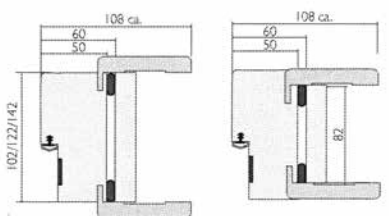

## KIT TELAIO EI 30 A DUE ANTE

Tipologia ed essenza in frassino laccato:  
 bianco, avorio, panna, caffè, nero, RAL chiaro, RAL scuro, con mano di fondo



## FRAME KIT EI 30 WITH TWO DOORS

Type and essence in lacquered ash:  
 white, ivory, cream, coffee, black, light RAL, dark RAL, primed

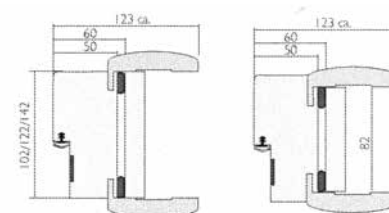

## KIT TELAIO EI 30 A UN'ANTA

Tipologia ed essenza:  
 laccato bianco B011, terre d'argilla, corda, grigio saturno, ghiaccio, grigio tortora, violetta, laccato avorio, laccato RAL, laccato RAL scuro, grezzo per laccato

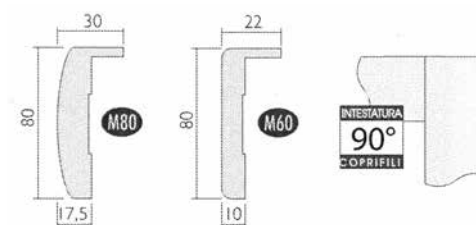

## FRAME KIT EI 30 WITH ONE DOOR

Type and essence:  
 white lacquered B011, clay dirt, rope, saturn grey, ice, dove grey, violet, ivory lacquered, RAL lacquered, dark RAL lacquered, raw for lacquered

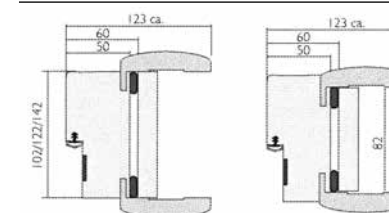

## KIT TELAIO EI 30 A DUE ANTE

Tipologia ed essenza:  
 laccato bianco B011, terre d'argilla, corda, grigio saturno, ghiaccio, grigio tortora, violetta, laccato avorio, laccato RAL, laccato RAL scuro, grezzo per laccato

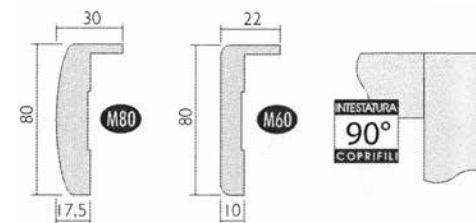

## FRAME KIT EI 30 WITH TWO DOORS

Type and essence:  
 white lacquered B011, clay dirt, rope, saturn grey, ice, dove grey, violet, ivory lacquered, RAL lacquered, dark RAL lacquered, raw for lacquered

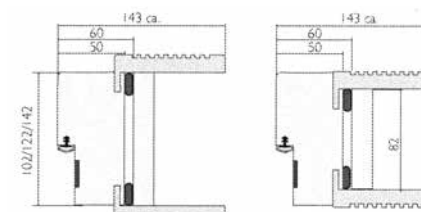

## KIT TELAIO EI 30 A UN'ANTA

Tipologia ed essenza:  
 laccato bianco B011, terre d'argilla, corda, grigio saturno, ghiaccio, grigio tortora, violetta, laccato avorio, grezzo per laccato

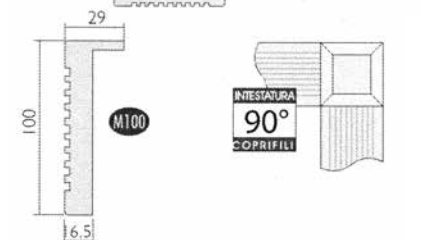

## FRAME KIT EI 30 WITH ONE DOOR

Type and essence:  
 white lacquered B011, clay dirt, rope, saturn grey, ice, dove grey, violet, ivory lacquered, raw for lacquered

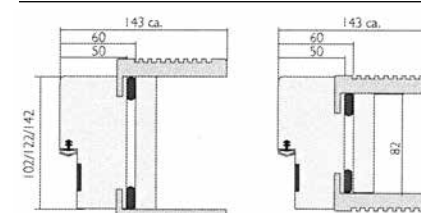

## KIT TELAIO EI 30 A DUE ANTE

Tipologia ed essenza:  
 laccato bianco B011, terre d'argilla, corda, grigio saturno, ghiaccio, grigio tortora, violetta, laccato avorio, grezzo per laccato

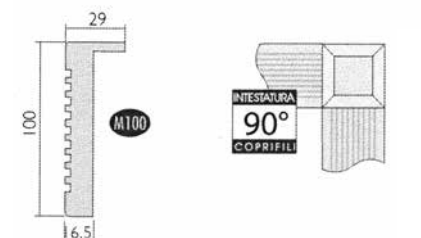

## FRAME KIT EI 30 WITH TWO DOORS

Type and essence:  
 white lacquered B011, clay dirt, rope, saturn grey, ice, dove grey, violet, ivory lacquered, raw for lacquered

# MANIGLIE

**PER PORTE EI30-EI60-DSUPER30-DSUPER60  
DOOR HANDLES EI30-EI60-DSUPER30-DSUPER60**



Maniglia + maniglia DESY  
Handle + DESY handle



Maniglia + maniglia DESY  
senza libero/occupato su placca  
esterna  
Handle + DESY handle  
without free / occupied on external  
plate



Maniglia + maniglia CURVA  
senza libero/occupato su placca  
esterna  
Handle + CURVA handle  
without free / occupied on external  
plate

**POMOLI + MANIGLIE PER PORTE EI30/EI60  
KNOBS + HANDLES FOR DOORS EI30 / EI60**



Pomolo fisso OTELLO  
e maniglia DESY  
con/senza segnale  
libero/occupato su placca  
esterna  
Fixed knob OTELLO  
and DESY handle  
with/without  
free/busy signal  
on external plate



Pomolo fisso OTELLO  
+ maniglia CURVA  
su rosetta  
Fixed knob OTELLO  
+ CURVA handle on rose  
Pomolo fisso QUADRO  
+ maniglia TIME su rosetta  
Fixed knob QUADRO  
+ TIME handle on rose

**POMOLI + MANIGLIE PER PORTE DISUPER  
KNOBS + HANDLES FOR DOORS DISUPER**



Pomolo fisso decentrato  
LEON e maniglia DESY  
con/senza segnale  
libero/occupato su placca  
esterna  
Fixed decentralized knob  
LEON and DESY handle  
with/without  
free/busy signal  
on external plate



Pomolo fisso decentrato  
LEON + maniglia  
su rosetta YALE  
Fixed decentralized knob  
LEON + YALE handle  
on rose





Maniglia + maniglia ALASKA  
(compatibile con serratura  
standard e serratura AGB DQ)

Handle + ALASKA handle  
(compatible with standard lock  
and AGB DQ lock)



Maniglia + maniglia ALASKA  
senza libero/occupato su placca  
esterna (compatibile con serratura  
standard e serratura AGB DQ)

Handle + ALASKA handle  
without free / occupied on external  
plate (compatible with standard  
lock and AGB DQ lock)



Maniglia + maniglia GALLEN  
senza libero/occupato su placca  
esterna (compatibile con serratura  
standard e serratura AGB DQ)

Handle + GALLEN handle  
without free / occupied on external  
plate (compatible with standard  
lock and AGB DQ lock)



Pomolo fisso GALENA  
e maniglia ALASKA  
senza segnale  
libero/occupato su placca esterna  
(compatibile con serratura AGB)

Fixed knob GALENA  
and ALASKA handle  
without free/busy signal  
on external plate  
(compatible with AGB lock)



Pomolo fisso GALENA  
e maniglia ALASKA  
con segnale  
libero/occupato su placca esterna  
(compatibile con serratura CISA)

Fixed knob GALENA  
and ALASKA handle  
with free/busy signal  
on external plate  
(compatible with CISA lock)



Pomolo fisso SFERA + maniglia  
GALLEN su rosetta  
(compatibile con serratura AGB)

Fixed knob SFERA + GALLEN  
handle on rose  
(compatible with AGB lock)



Serratura elettronica Gaudi 2 Free  
Turn di Omnitec abbinata  
a maniglia interna

Electronic lock Gaudi 2 Free Turn  
di Omnitec combined with internal  
handle



NO-PANIC interno con barra rossa e maniglia o pomolo fisso su placca con foro Yale sul lato esterno (completo di serratura di sicurezza antipanico e mezzo cilindro)

NO-PANIC internal side with red bar and handle or fixed knob on plate with Yale hole on the external side (complete with anti-panic safety lock and half cylinder)

Disponibile soluzione per abbinamento con qualsiasi maniglia su rosetta  
Solution available for combination with any handle on plate.



NO-PANIC interno con barra rossa e maniglia o pomolo fisso su placca con foro Yale sul lato esterno (completo di serratura di sicurezza antipanico e mezzo cilindro)

NO-PANIC internal side with red bar and handle or fixed knob on plate with Yale hole on the external side (complete with anti-panic safety lock and half cylinder)



NO-PANIC con barra rossa per anta secondariaa (compreso di controserratura a chiusura alto/basso - larghezza minima mm 400)

NO-PANIC with red bar for secondary leaf (including top / bottom locking safety lock - minimum width 400 mm)



Cilindro masterizzato solo per serratura standard

Master cylinder for standard lock only



Serratura tipo patent predisposta per cilindro Yale

Patent type lock prepared for Yale cylinder



Serratura antipanico AGB sistema Opera  
Cilindro masterizzato AGB per sistema Opera con indicatore di libero/occupato esterno e nottolino privacy interno a goccia

AGB panic lock  
Opera system  
AGB mastered cylinder for Opera system with external free / busy indicator and internal privacy lock with dropped knob



Serratura antipanico AGB sistema Opera DQ  
Cilindro masterizzato AGB per sistema Opera DQ senza indicatore di libero/occupato esterno e nottolino privacy interno a goccia

AGB panic lock  
DQ Opera system  
AGB mastered cylinder for Opera DQ system without external free / busy indicator and internal privacy lock with dropped knob



Serratura antipanico CISA  
Cilindro masterizzato con nottolino privacy interno a goccia

CISA panic lock  
Master cylinder with internal privacy latch



# UN PARTNER UNICO PER IL TUO HOTEL

A UNIQUE PARTNER FOR YOUR HOTEL

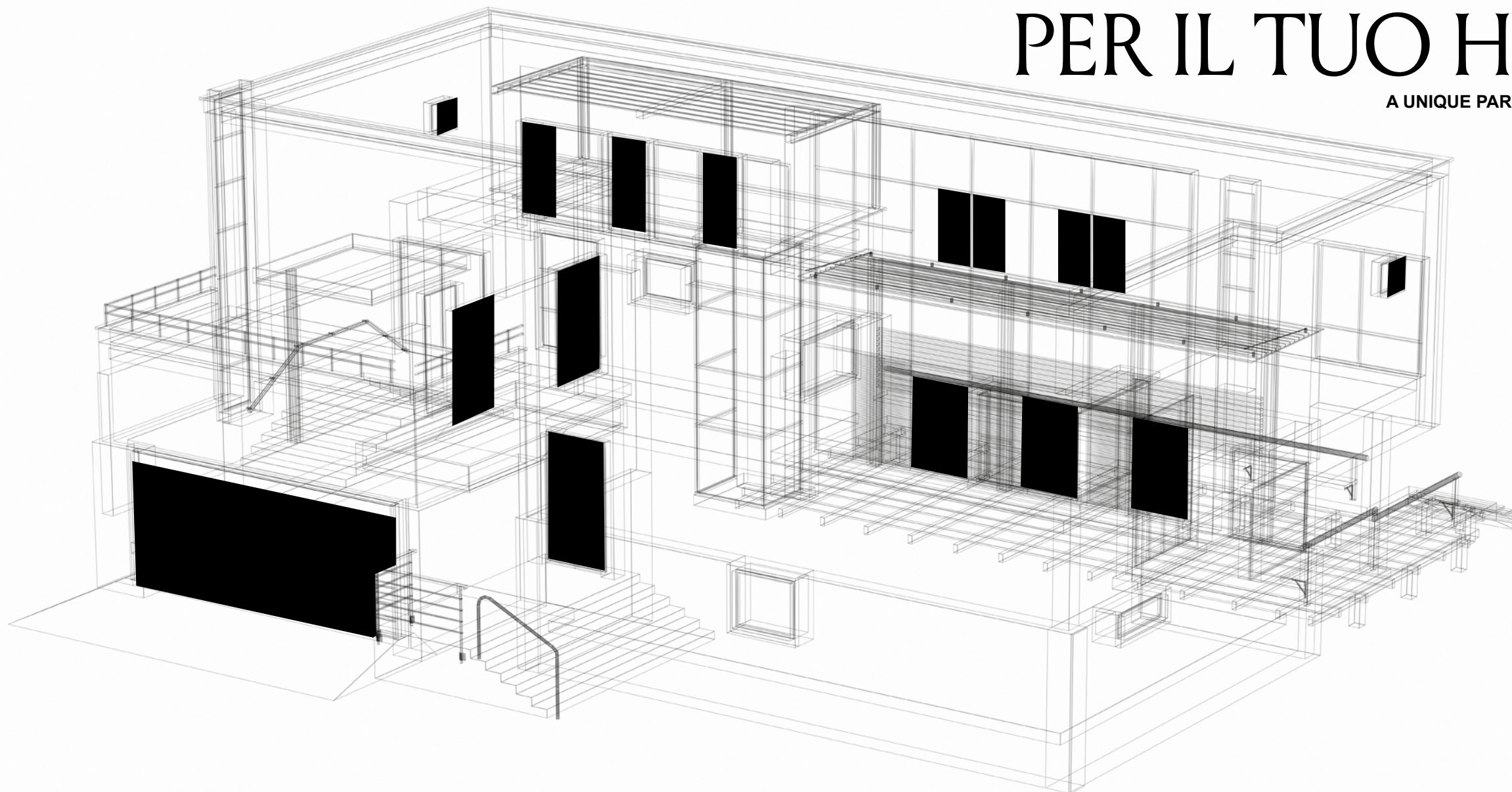

- PORTE E PORTONI SCORREVOLI  
TAGLIAFUOCO IN ACCIAIO  
FIRE-RATED SLIDING DOORS AND GATES  
IN STEEL

- PORTE TAGLIAFUOCO IN LEGNO  
FIRE-RATED WOODEN DOORS

- PORTE INTERNE IN ESSENZA, LACCATE,  
INCISE, PANTOGRAFATE; IN LAMINATINO;  
IN VETRO E IN LEGNO MASSELLO  
INTERIOR DOORS IN WOOD, LACQUERED,  
ENGRAVED, PANTOGRAPHED; LAMINATED;  
GLAZED AND IN SOLID WOOD

- CASSEFORTI DI SICUREZZA / SAFETY SAFES

- BASCULANTI E SEZIONALI PER GARAGE  
UP-AND-OVER AND SECTIONAL FOR GARAGE

- PORTE BLINDATE EI30 e EI60  
EI30 and EI60 ARMoured DOORS

- PORTE MULTIFUNZIONE  
MULTIFUNCTIONAL DOORS

- PORTE TECNICHE CON TELAIO IN ALLUMINIO /  
TECHNICAL DOORS WITH ALUMINIUM FRAME

<sup>IT</sup> Sicurezza, stile e innovazione hanno tante forme; noi di Dierre le conosciamo tutte. Porte tagliafuoco, portoni per garage, porte interne, casseforti: mettiamo a disposizione della tua struttura alberghiera una vasta gamma di prodotti in grado di arrearla e proteggerla, senza rinunciare al design, con soluzioni di chiusura prodotte industrialmente ma con un livello di personalizzazione quasi artigianale, una qualità unica, i massimi standard nei test di sicurezza e sempre il meglio che la tecnologia mette a disposizione.

<sup>EN</sup> Safety, style, and innovation take on many shapes: here at Dierre, we know them all. Standard doors, fire doors, garage doors, internal doors, and safes: we offer a wide range of products for your accommodation facility which provide furnishing and protection, accompanied by design, capable of providing industrially-produced closure systems but with an almost craftsmanship customization level, a unique quality, the highest standards in security tests and always the best that technology makes available.



# CERTIFICAZIONI

TUTTI I PRODOTTI SONO CERTIFICATI PER LA NORMATIVA FUMI CALDI E FREDDI  
ALL PRODUCTS ARE CERTIFIED FOR HOT AND COLD SMOKE SEALS

<b>DENOMINAZIONE MANUFATTO</b>	<b>Opera 1B 30-C</b>
<b>DESCRIZIONE</b>	Porta opera EI30 configurazione anta singola con chiudiporta a slitta esterno con cerniere a bandella. Massime dimensioni nette passaggio: mm 2420x1000.
<b>ENTE DI PROVA</b>	RINA
<b>DESCRIZIONE</b>	Configurazione disponibile anche con abbattimento acustico 34dB.
<b>ENTE DI PROVA</b>	CSI
<b>DENOMINAZIONE MANUFATTO</b>	<b>Opera 2B 30-C</b>
<b>DESCRIZIONE</b>	Porta opera EI30 configurazione doppio battente con chiudiporta a slitta esterno con cerniere a bandella. Massime dimensioni nette passaggio, divisione simmetrica: mm 2200 x 1600. L'anta singola non può avere dimensioni maggiori di mm 2200 x 800.
<b>ENTE DI PROVA</b>	RINA
<b>DENOMINAZIONE MANUFATTO</b>	<b>Opera 1B 60-C</b>
<b>DESCRIZIONE</b>	Porta opera EI60 configurazione anta singola con chiudiporta a slitta esterno con cerniere a bandella. Massime dimensioni nette passaggio: mm 2420x1000.
<b>ENTE DI PROVA</b>	RINA
<b>DESCRIZIONE</b>	Configurazione disponibile anche con abbattimento acustico 37dB.
<b>ENTE DI PROVA</b>	ISTITUTO GIORDANO
<b>DENOMINAZIONE MANUFATTO</b>	<b>Opera 2B 60-C</b>
<b>DESCRIZIONE</b>	Porta opera EI60 configurazione doppio battente con chiudiporta a slitta esterno con cerniere a bandella. Massime dimensioni nette passaggio, divisione simmetrica: mm 2200 x 1600. L'anta singola non può avere dimensioni maggiori di mm 2200 x 800.
<b>ENTE DI PROVA</b>	RINA

<b>DENOMINAZIONE MANUFATTO</b>	<b>Opera DISUPER 1B30-FP</b>
<b>DESCRIZIONE</b>	Porta opera EI30 configurazione anta singola con chiudiporta e cerniere a scomparsa. Massime dimensioni nette passaggio: mm 2200 x 900.
<b>ENTE DI PROVA</b>	RINA
<b>DENOMINAZIONE MANUFATTO</b>	<b>Opera DISUPER 1B30-FK</b>
<b>DESCRIZIONE</b>	Porta opera EI30 configurazione anta singola raso telaio e coprifilo con cerniere e chiudiporta a scomparsa. Massime dimensioni nette passaggio: mm 2200 x 900.
<b>ENTE DI PROVA</b>	RINA
<b>DENOMINAZIONE MANUFATTO</b>	<b>Opera DISUPER 1B30-42A</b>
<b>DESCRIZIONE</b>	Porta opera DISUPER 30 (EI30) configurazione anta singola con cerniere a scomparsa e chiudiporta a slitta esterno. Massime dimensioni nette passaggio: mm 2350 x 1000.
<b>ENTE DI PROVA</b>	RINA
<b>DESCRIZIONE ENTE DI PROVA</b>	Abbattimento acustico (conf. STD) 42dB. CSI
<b>DENOMINAZIONE MANUFATTO</b>	<b>Opera DISUPER 1B30-42B</b>
<b>DESCRIZIONE</b>	Porta opera DISUPER 30 (EI30) configurazione anta singola con cerniere e chiudiporta a scomparsa. Massime dimensioni nette passaggio: mm 2350x1000.
<b>ENTE DI PROVA</b>	RINA
<b>DESCRIZIONE ENTE DI PROVA</b>	Abbattimento acustico (conf.STD) 42dB. CSI
<b>DENOMINAZIONE MANUFATTO</b>	<b>Opera DISUPER 1B60-47A</b>
<b>DESCRIZIONE</b>	Porta opera DISUPER 60 (EI60) configurazione anta singola con cerniere e chiudiporta a scomparsa. Massime dimensioni nette passaggio: mm 2350x1000.
<b>ENTE DI PROVA</b>	RINA
<b>DESCRIZIONE ENTE DI PROVA</b>	Abbattimento acustico (conf.STD) 47dB (solo con versione chiudiporta a slitta esterno). Massime dimensioni nette passaggio: mm 2350x1000.
<b>ENTE DI PROVA</b>	CSI

# I MIGLIORI PARTNER PER UN MERCATO MIGLIORE

THE BEST PARTNERS FOR A BETTER MARKET

<sup>IT</sup> Ad agosto 2019 Dierre è diventata partner di Gabetti Lab, il nuovo progetto del Gruppo Gabetti dedicato alle attività di riqualificazione sostenibile degli edifici, attraverso un percorso formativo promosso da Gabetti. Infatti, uno dei nostri obiettivi più importanti, è la formazione di tutti i professionisti che contribuiscono a migliorare la qualità del costruire e dell'abitare. Il 30 e 31 Gennaio 2020 abbiamo partecipato insieme a **Home Together - Il futuro dell'abitare**: il più grande evento di settore sul tema della sostenibilità, in tutte le sue sfaccettature: sociale, ambientale ed economica. Obiettivo dell'evento è stato di riunire la filiera del sistema immobiliare per promuovere stili di vita e comportamenti sostenibili; migliorare l'impatto ambientale degli edifici; rendere le città accessibili sul piano sociale, ambientale ed economico.

<sup>EN</sup> In August 2019 Dierre became a Gabetti Lab partner, the new project of the Gabetti Group devoted to the activities of sustainable redevelopment of buildings, through a training program promoted by Gabetti. In fact, one of our most important objectives is to train all the professionals that contribute to improving the quality of building and living. We all attended **Home Together** on 30th and 31st January 2020 - **The future of living**: the largest industry event on sustainability in all its aspects: social, environmental and economical. The aim of the event was to bring together the real estate system world to promote sustainable lifestyles and behaviours; to improve the environmental impact of buildings; make the cities accessible on the social, economic and environmental point of view.

## BUILDING INFORMATION MODELLING PER I PRODOTTI TAGLIAFUOCO

<sup>IT</sup> BIM è una piattaforma software dedicata al mondo delle costruzioni, una tecnologia mirata alla condivisione di elementi grafici 3D e caratteristiche tecniche degli oggetti. Si applica a edifici, costruzioni in genere e infrastrutture. Dierre ha pianificato per il 2017 la condivisione dei prodotti tagliafuoco in formato BIM utilizzabile dai progettisti, un primo passo fondamentale per un'azienda leader del settore. In seguito è prevista la conversione dell'intera gamma Dierre in oggetti BIM.

## BUILDING INFORMATION MODELLING FOR FIRE-RATED PRODUCTS

<sup>EN</sup> BIM is a software platform dedicated to the world of construction, a technology designed to share 3D elements and technical characteristics of the objects. It applies to buildings, buildings in general and infrastructure. Dierre started in 2017 to convert of BIM format fire-rated products usable by designers, a first fundamental step for a leading company in the sector. The conversion of the whole Dierre range in BIM objects has been planned for the future.

## ASSOCIAZIONE MAIA

<sup>IT</sup> L'esperienza internazionale di Dierre nel comparto tagliafuoco ha fatto di Dierre il partner privilegiato di grandi imprese di costruzioni di importanza globale. L'obiettivo oggi è quello di trasferire queste professionalità anche in Italia. Da qui nasce la partnership con Maia (Associazione italiana specializzata nella formazione di Manutentori, Assemblatori, Installatori associati per la sicurezza antincendio) che si concretizza con l'organizzazione di seminari formativi in sede Dierre e in tutta Italia e con la messa a disposizione gratuita dei prodotti tagliafuoco Dierre.

## MAIA ASSOCIATION

<sup>EN</sup> Dierre's international experience in the fire-rated sector has turned Dierre into the privileged partner of worldwide known large construction companies. The objective is currently that of transferring these high professional roles also in Italy. Here is where the partnership with Maia (Italian Association specializing in the training of maintainers, assemblers, fitters for fire safety) which is achieved with the organization of training seminars at Dierre's and throughout Italy and with the free supply of Dierre fire-rated products.

Gabetti-lab

bim object  
BIM.archiproducts



Hotel CampZero ★★★★★ - Champoluc (AO)





Hotel CampZero ★★★★★ - Champoluc (AO)





ELEMENTAL  
CHLORINE  
**FREE**  
GUARANTEED



Carta naturale realizzata con cellulosa di eucalipto, prodotta impiegando fibre vergini certificate FSC. Il suo intero ciclo di vita ha un ridotto impatto ambientale, così come certificato dal marchio Ecolabel. Inoltre la foresta di provenienza è un importante deposito di carbonio che permette di contribuire alla riduzione delle emissioni di gas serra nell'atmosfera.

THE ITALIAN STYLE DOOR



### Dierre Spa

Strada statale per Chieri 66/15  
14019 Villanova D'Asti (AT)  
Tel 0141.949411  
Fax 0141.946427  
info@dierre.it  
www.dierre.com



NEW YORK

PARIGI

LISBONA

SYDNEY

TOKYO

ISTANBUL

ZAGABRIA

LONDRA

COPENAGHEN

DUBAI

BERLINO

BUDAPEST

ROMA

MOSCA

PECHINO