

**Compact**<sup>®</sup>

FOLDING DOOR



**Product Information**  
2022 - nr 23

# Rolflex Netherlands



## 1. Space-saving design

The panels fold into a compact package above the door opening when the door is opened. The door does not need rails or a structural frame on the ceiling. As a result, the ceiling can be kept clear for installations or other items.

### Well-suited for:

- Renovations, especially when replacing roller shutters or sliding doors
- Doors in corners
- Sloped roofs
- Sprinkler- heating or airconditioning installations
- Narrow spaces
- Crane tracks
- Car workshops

## 2. Design that blends in

As there are no overhead rails, the door package can be fully integrated in the ceiling, providing a nice clean finish without bulky tracks in sight. In addition, panels and nearly all door parts can be manufactured in any colour you desire. A door that blends in!

- Commercial areas
- Interior flexible walls
- Car Showrooms
- Larger residential projects



### 3. Low maintenance

The Compact door has a unique folding system without balance springs. Designed for a longer life and less maintenance.

All parts of the door have been developed with durability in mind. We aim for a long and carefree lifespan of our doors.

- Industrial areas with frequent usage
- Commercial spaces

View all applications and reference projects on our website  
[www.rolflex.com](http://www.rolflex.com)



### 4. Innovative options

#### External installation

The Compact door is one of the few sectional doors that can be installed outside of a room or building. The panels and motor will be mounted outside a building or space. This type of installation is frequently used in:

- Car wash booths
- Spray booths
- Car or Freight Elevators
- Damp indoor environments

#### Wicket door

The Compact door is the only folding door where a wicket door can be installed. Even more unique is that this door can be adapted to open to the inside or to the outside.

# The Compact industrial door

## Safety

Slack cable device



Fall safety device



Light curtain safety

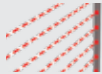

Automatic lock



## Function

Electrical operation



Remote control



Control box with push buttons

















Key switch



# Table of contents



	Chapter	1	Page	6	Sandwich panels
	Chapter	2	Page	7	Standard colours
	Chapter	3	Page	8 - 9	Windows
	Chapter	4	Page	10 - 11	Full vision panels
	Chapter	5	Page	12 - 13	Full light panels
	Chapter	6	Page	14 - 15	Ventilation grating
	Chapter	7	Page	16 - 19	Wicket door
	Chapter	8	Page	20 - 21	Standard safety features
	Chapter	9	Page	22 - 25	Operation
	Chapter	10	Page	26 - 29	Dimensions and details
	Chapter	11	Page	30	Sealings
	Chapter	12	Page	31 - 45	Accessories
	Chapter	13	Page	46 - 47	The problem-solving door
	Chapter	14	Page	50	References
	Chapter	15	Page	51	Notes

# 1 Sandwich panels



## Panel materials

The insulated sandwich panels consist of a CFC-free polystyrene foam (expanded, EPS SE) covered with aluminum stucco finished cladding.

Aluminium U-profiles on top and bottom of the sandwich panels provide extra strength and stability.

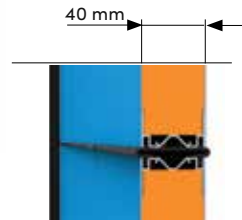

## Specifications

Top panel height can be adapted to fit the door opening

Insulation value EN12428	Wind resistance EN12424	Water penetration EN12425	Air permeability EN12426	Noise reduction ISO140-3
Panel: $U = 0,76$ $W/m^2K$	Class 2 – 5	Class 2	Class 2	Panel 20 dB (A)

# Standard colours 2



The panels are available in 10 standard colours as shown below. Optionally, the door can be painted in any RAL colour of choice.



**Ral 3002**  
Carmine red



**Ral 5010**  
Gentian blue



**Ral 5017**  
Traffic blue



**Ral 6005**  
Moss green



**Ral 7016**  
Anthracite grey



**Ral 7032**  
Pebble grey



**Ral 9002**  
Grey white



**Ral 9006**  
White aluminium



**Ral 9007**  
Grey aluminium



**Ral 9016**  
Traffic white

Printing colours can deviate and are just a guide

# 3 Windows rectangular



## Specifications

Window insulated acrylate with black plastic cover.

- Net glass surface:  $0.18 \text{ m}^2$
- Insulation value:  $U = 1.38 \text{ W/m}^2\text{K}$
- One window per meter panel

## Dimensions

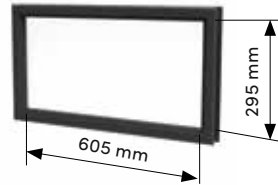
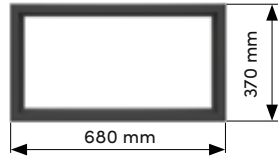



## Specifications

Window insulated acrylate with black plastic cover.

- Net glass surface:  $0.17 \text{ m}^2$
- Insulation value:  $U=2.8 \text{ W/m}^2\text{K}$
- One window per meter panel

## Dimensions

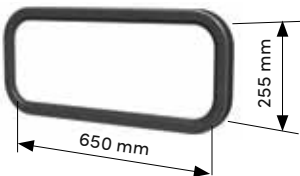
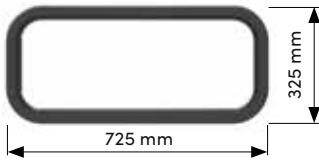

## 4 Full vision panels



### Panel specifications

Aluminium profiles with vertical sections

- Standard colours: anodized aluminium or RAL 9002
- Other RAL colours possible
- Thickness: 40 mm
- Height: 610 mm
- Top panel height variable, minimum 135 mm
- Fillings of choice
- Number of sections can be varied

### Dimensions

- For door blades wider than 6000 mm a maximum of two full vision panels can be used.
- The maximum width for a full vision panel is 7000 mm



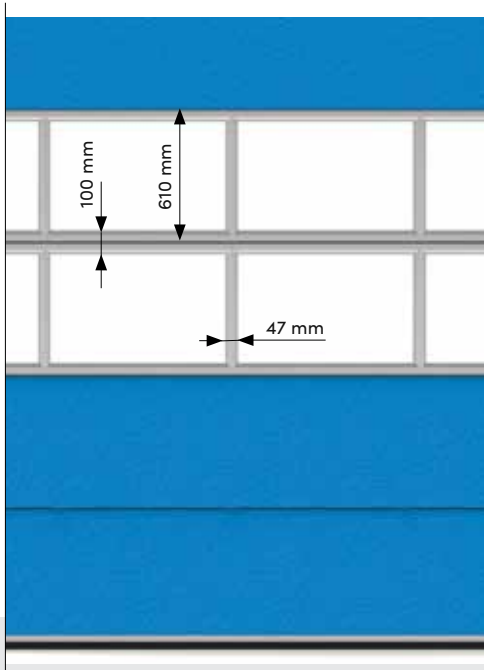

## Product details

- Full vision panels with fillings of choice.
- On the inside of the door blade white plastic click frames with rubber seals are used to fix the fillings in place.
- These click frames are suitable for fillings of +/- 4 or 17 mm thickness.
- Standard in anodized aluminum or RAL 9002.  
Other RAL colours optional.
- Click frames can be painted in RAL colour of choice.



## Single fillings

- Single Acrylic
- Single Polycarbonate
- Single Safety glass
- Aluminum Expanded Metal
- Perforated aluminum



## Double fillings

- Insulated acrylic
- Insulated polycarbonate
- Insulated polycarbonate twin-wall
- Insulated sandwich panel



## Delivery of plastic click-frames

- For single-wall filling from 3-4 mm
- For double-walled filling from 17-18 mm

## 5 Full light panels



### Product details

Aluminium profiles without vertical sections

- Full Light panels without vertical center posts, filled with multi wall sheet
- Translucent, but not transparent. Made of impact resistant, lightweight polycarbonate
- The fillings are clamped in the profiles with white plastic clickframes and rubbers.
- Standard in anodized aluminum or RAL 9002. Other RAL colours optional
- Click frames can be made in any RAL colour of your choice

Panels can be combined with sandwich panels or full vision panels as well.

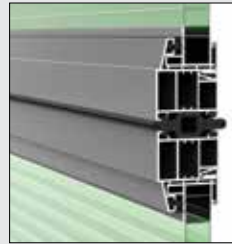

### Colour options



Natural



Opal

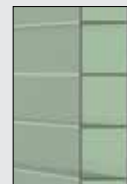

Green

# Full light panels 5



## 6 Ventilation grating



### Ventilation grating 452 cm<sup>2</sup>

- Anodized aluminium
- Air permeability net 452 cm<sup>2</sup>

### Dimensions

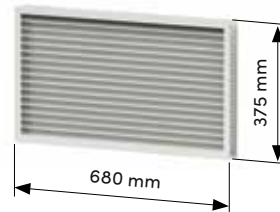

### Ventilation grating 215 cm<sup>2</sup>

- Black plastic
- Air permeability net 215 cm<sup>2</sup>

### Dimensions

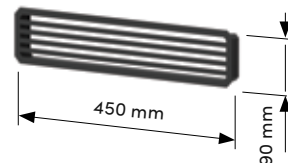



## Ventilation grating 185 cm<sup>2</sup>

- Aluminium RAL 9010 (white)
- Lockable
- Air permeability net 185 cm<sup>2</sup>

## Dimensions

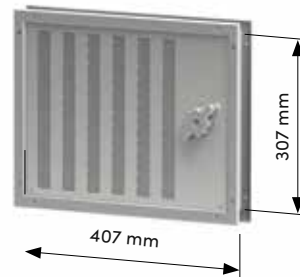

## Ventilation grating 45 cm<sup>2</sup>

- Aluminium RAL 9010 (white)
- Lockable
- Air permeability net 45 cm<sup>2</sup>

## Dimensions

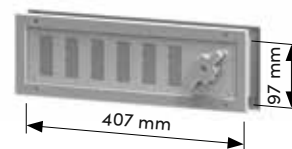

# 7 Wicket door



## Specifications

The wicket door aluminium profiles will be delivered in anodized aluminium.

## Dimensions

- Net opening width 850 mm
- Height (from floor level) 2100 mm
- Threshold  $\pm 120$  mm

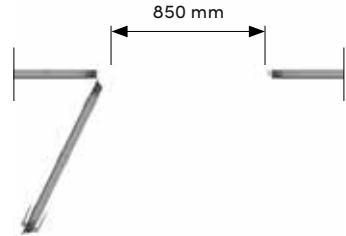

## Closure

- Door closer on bottom panel
- Door catcher on top panel
- Lock in the second panel
- Rubber seal in door frame

## Safety

Electrical safety switch integrated in the door frame prevents the door from running automatically when the wicket door is open.

## Position wicket door

Specify hinge side, opening side and position of the wicket door when ordering (see page 17).

## Position Full vision panels

Doors with an opening width from 4000 to 6000 mm: full vision possible only from panel number 3.



### Wicket door options

1. Hinge left / opening to the outside

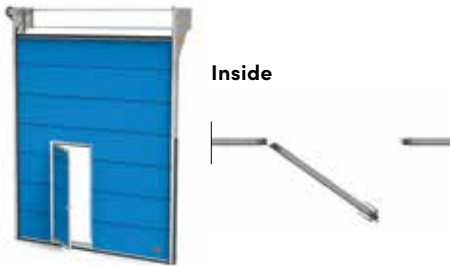

2. Hinge left / opening to the inside

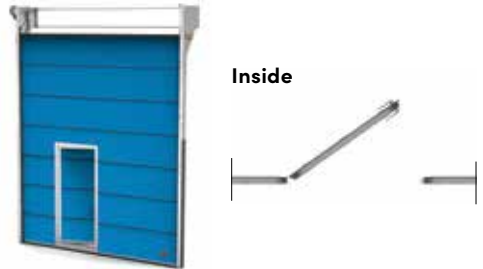

3. Hinge right / opening to the outside

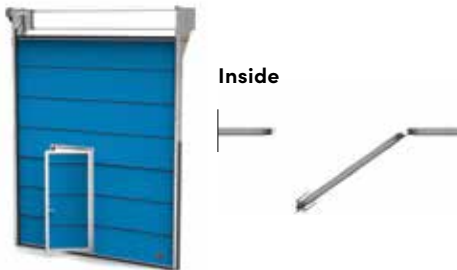

4. Hinge right / opening to the inside

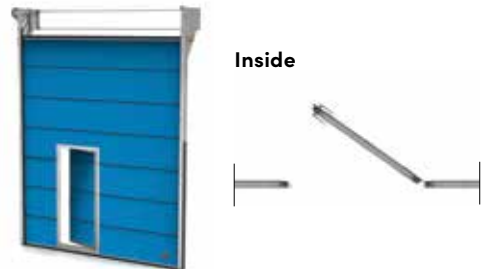

### Wicket door positions

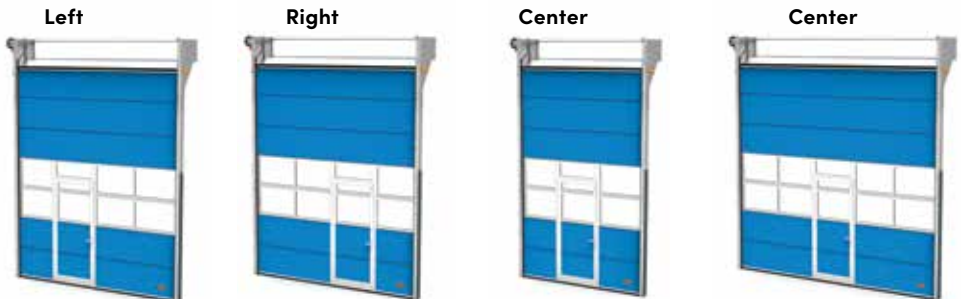

# 7 Wicket door (detail)

**Door catch (top panel)**



**Door lock and handle**



**Safety switch**

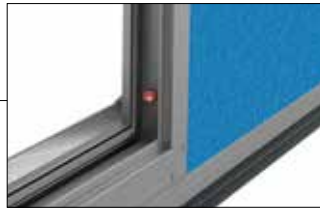

**Door closer  
(bottom panel)**



**90 mm extra top space required for:**

- 50 mm due to the application of the special bottom profile
- 40 mm due to of the application of the door closer

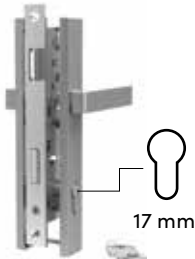

**Euro cylinder lock**

Cylinder 30/35 with 3 keys.  
Door handle inside and outside.



**Panic lock (option)**

Always open from the inside  
in case of an emergency.

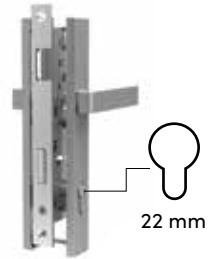

**KABA Lock (Option)**

# Wicket door 7



## 8 Standard safety features



### General

Safety regulations and norms EN12604 en EN12453 Delivery according EURO norm EN 13 241-1 and CE-certificate.

### Slack cable device

Motor shuts off if the tension on the steel cable is gone.



### Side rail covers

Plastic covers to protect the holes in the side rails and to avoid injury.

### Front rail covers

Safety covers with warning tape to prevent injury to fingers and hands.

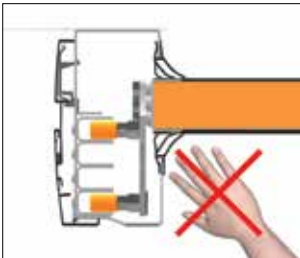

## Fall safety device



## Function

The fall safety device prevents the door blade from falling down in case the steel cables break. The bottom brackets will catch in the side rail holes.

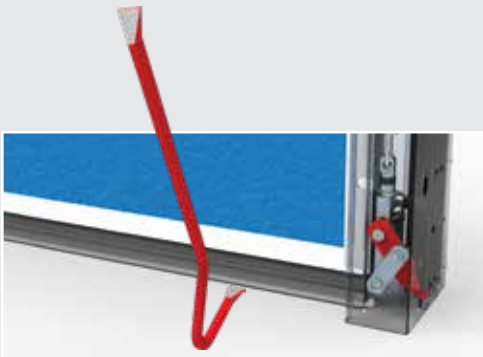

## Anti-lift system, burglar-resistant

The door blade will lock automatically when lifted.

# 9 Operation (control)

## Electrical operation with control box CS320

## Opening of the door

After an impulse the door will completely open automatically.

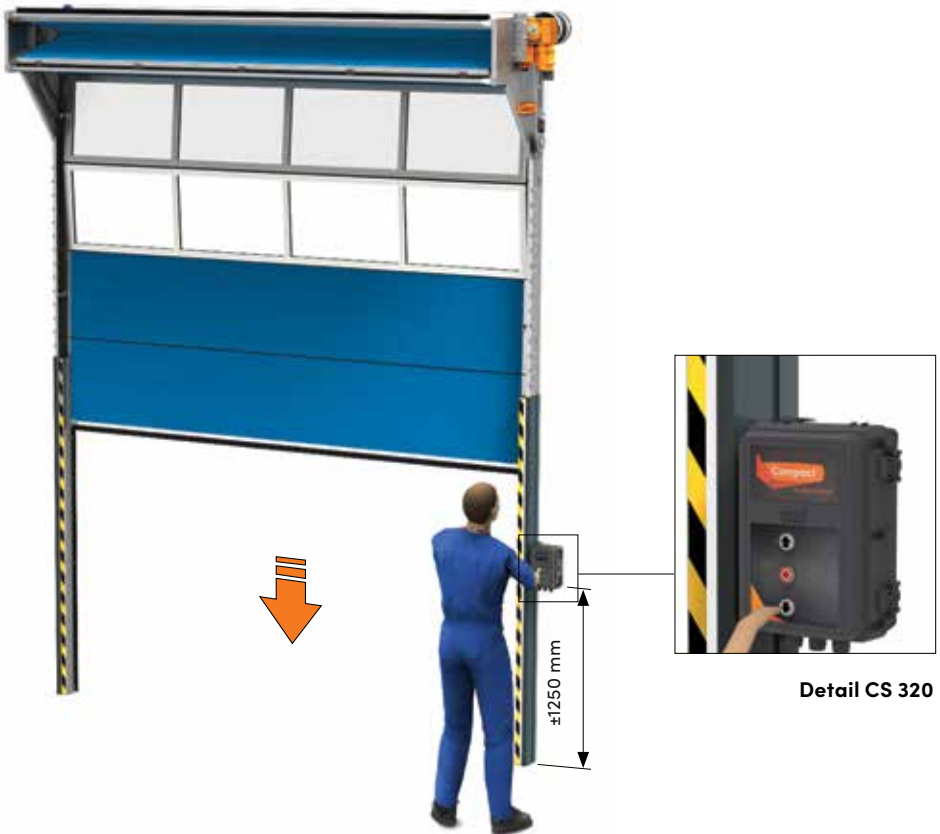

## Closing the door with dead-man operation

When closing the door, keep the "down" button pressed until the door is closed. The person operating the door controls the closing movement. When a dangerous situation arises, the door can be stopped immediately by releasing the button.

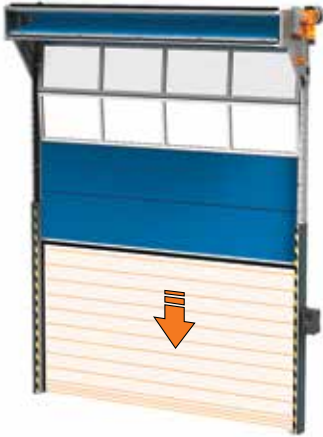

## Light curtain protection (option)

This security allows the door to close automatically, for example with a remote control.

The light curtain monitors the doorway to a height of 2500 mm and signals obstacles.

When activated, the closing movement will stop and the door opens automatically so that the door blade poses no danger to materials or persons.

All Compact doors with automatic closing (for example a remote control) are equipped with a light curtain.

## Remote control



### 4-Channel transmitter

Transmitter for maximum operation of 4 doors.

- Frequency 433 MHz
- Clip holder inclusive



### Multi-Channel transmitter

Transmitter for maximum operation of 99 doors.

- Frequency 433 MHz



### Remote control receiver

Receiver suitable for 4-channel or multi-channel hand transmitter.

- Operation till  $\pm 20$  meter.
- Frequency 433 MHz.

## ATTENTION

Remote control only in combination with light curtain security.

## 9 Operation (motor)



### MOTOR AND SPECIFICATIONS

Motor	RC150	RC175 <sup>3</sup>	RC250 <sup>3</sup>	RC300 <sup>3</sup>	RC300T <sup>3</sup>	RC500
Speed (cm/sec)	19 cm/sec	19 cm/sec	19 cm/sec	19 cm/sec	15 cm/sec	max 60 cm/sec <sup>4</sup>
Voltage (volt)	1 x 230 V	3 x 400 V	3 x 400 V	3 x 400 V	3 x 400V	3 x 400V
Power (ampere)	6,5 A	2,8 A	3,3 A	3,3 A	3,3 A	6,5 A
Power (kilowatt)	0,75 kW	0,65 kW	1,1 kW	1,3 kW	1,3 kW	3 kW
Frequency (hertz)	50 Hz	50 Hz	50 Hz	50 Hz	50 Hz	50 Hz
Plug (neutral not necessary)	2- pin, 16A	5- pin, 16A	5- pin, 16A	5- pin, 16A	5- pin, 16A	5- pin, 16A
Potential free contact	4	4	4	4	4	4
Duration (%) <sup>1</sup>	25%	60%	60%	60%	60%	80%
Cycles open/close per hour	12x	20x	20x	20x	20x	30x
Protection class <sup>2</sup>	IP54	IP54	IP54	IP54	IP54	IP65
Max. weight doorblade (kilogram)	140 kg	190 kg	275 kg	389 kg	455 kg	190 kg

<sup>1</sup> The duty cycle is an indication of how often the door can be opened. In case of intensive usage, you can choose for an 80% engine.

<sup>2</sup> The motors have a standard protection against dust and water ingress (IP54). In a moist environment, you can opt for an IP65 version.

<sup>3</sup> These motors are also available in an 80% version with IP65 ranking.

<sup>4</sup> Closing speed 30 cm/sec.





The motor position is universal, left or right.  
Various installation positions are possible (front, top, side)  
(see page 28-29).

Each motor is equipped with a hand crank, positioned near the motor, as standard to open the door manually. Optionally, a hand chain hoist is available to manually open the door from the floor.

Standard cable length between motor and control box is 7 meter.  
Optionally, a cable length of 15 meters is possible.

Plug at 3 x 400 V > 5- pin, 16 A.  
Plug at 1 x 230 V > 5- pin, 16 A.  
Other motor types on request (1x230 V, 3x230 V or 60 Hz).

Standard turning direction pre-set right.

Trafo in control 24 V DC, maximum 500 mA.

Recommended position of the wall socket.

# 10 Dimensions and details (measurements)

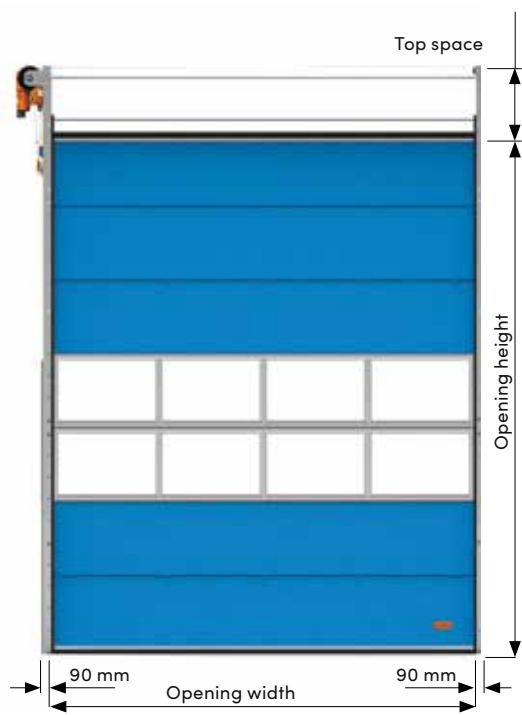

## Side view

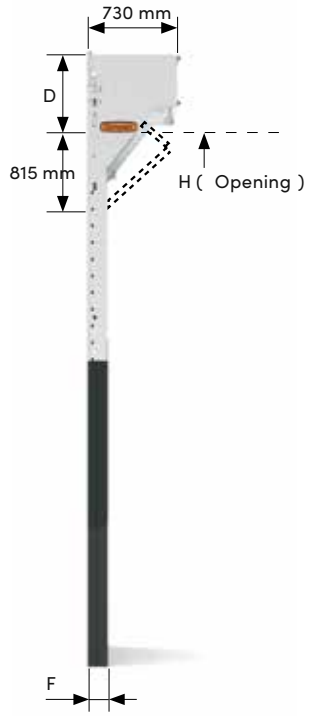

## Top view

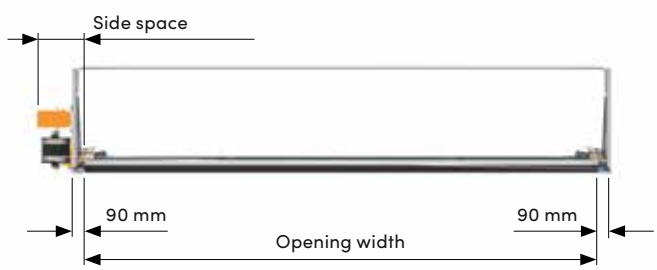

Extra space required for  
 Top motor – Front motor –  
 Protection shield – Wicket door –  
 Storm profiles

## Measurements

H (Door height) (mm) min.(<) - max.(>)	D (top space) (mm)	F (rail depth) (mm)
$0 < h \leq 3080$	420	140
$3081 < h \leq 4300$	520	160
$4301 < h \leq 5520$	630	180
$5521 < h \leq 6740$	770	200
$6741 < h \leq 7960$	890	220

# Dimensions and details (installation frame)

10

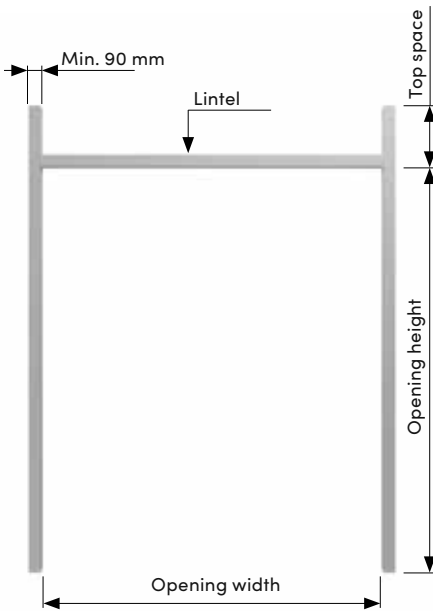

## Detail

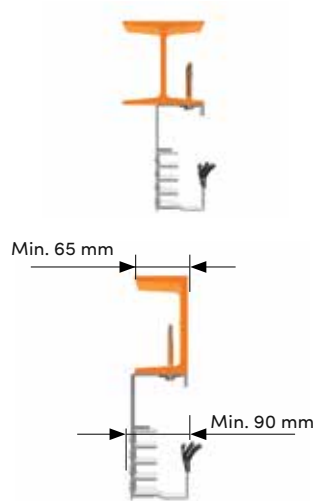

## Installation frame

Installation frame has to be stable, flat and square. Installation on steel, stone, concrete or wood is possible.

## Lintel

A lintel is not necessary for constructional reasons. However, the top rubber needs a vertical surface to close and provide sealing.

## Threshold

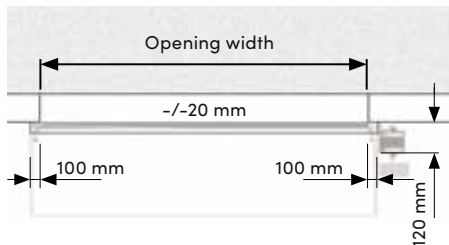

## Side view



## Specifications

We advise a threshold on the bottom to prevent water going into the building.

# 10 Dimensions and details (motor)

## Side motor

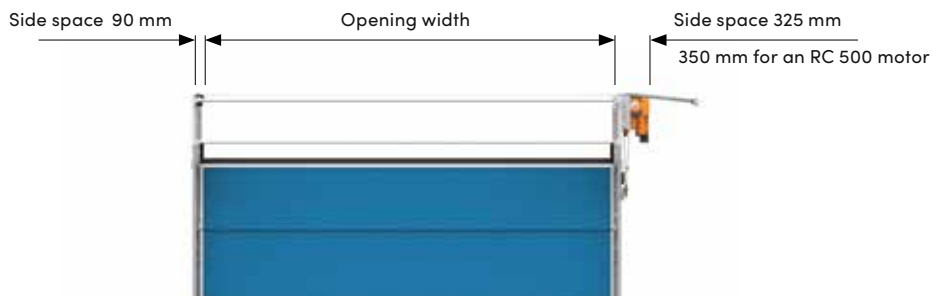

## Top motor

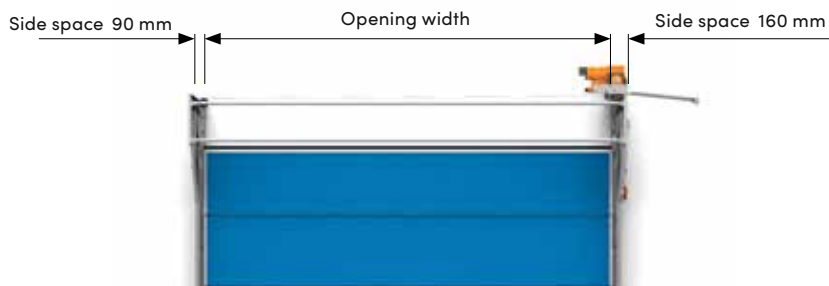

## Front motor

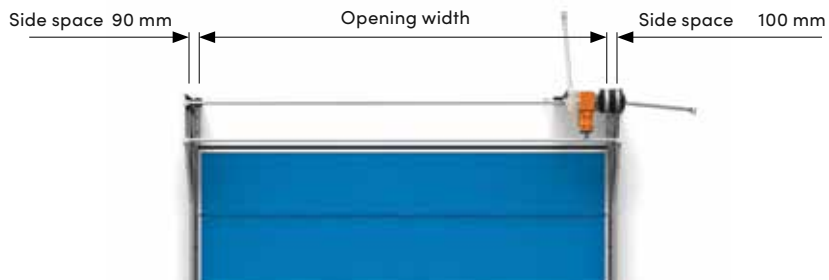

## Side motor (standard)

### Detail



### Side motor

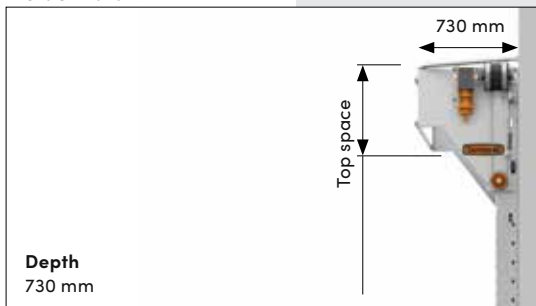

## Top motor

### Detail



### Top motor

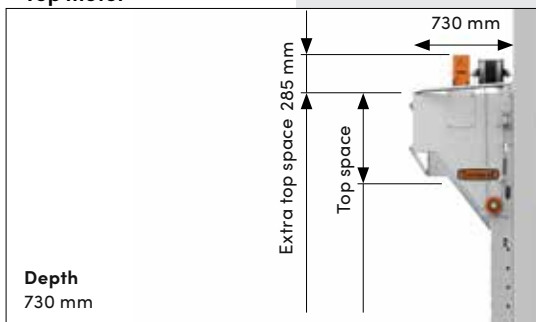

## Front motor

### Limits

- Maximum weight of the door blade is 275 kg
- Maximum door height is 5520 mm

### Detail



### Front motor

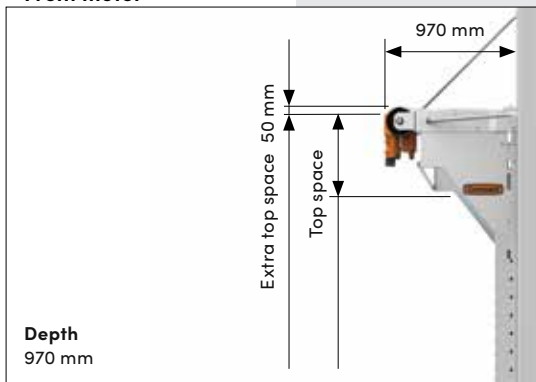

# 11 Sealings

## Optimum closing and insulation

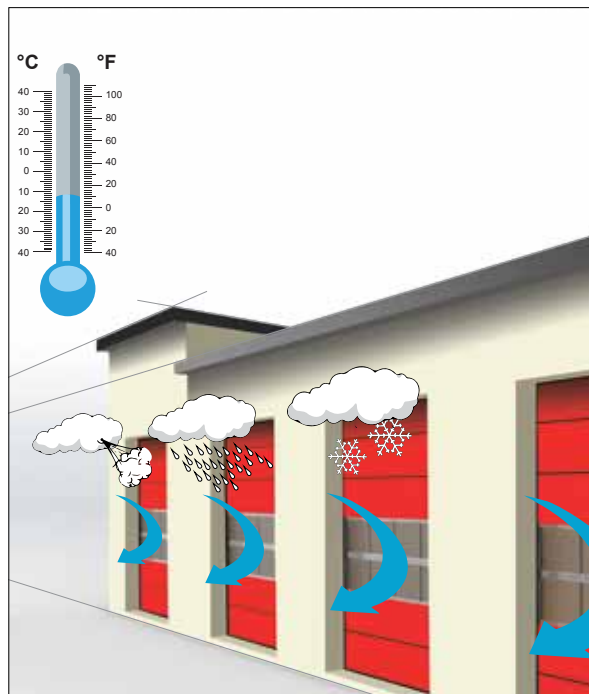

## Top rubber



## Bottom rubber

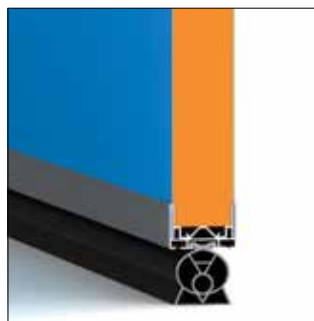

## Intermediate seal



## Intermediate seal

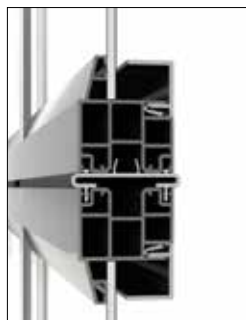

## Side seal

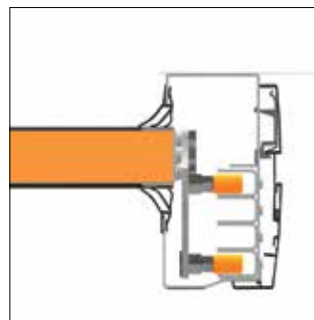



## Storm/Rigidity profiles

The anodized aluminium profiles are positioned between the panels and make the door blade extra strong. With these profiles the Compact door is extra protected against high wind loads.

Compact doors from 6000 mm and wider are provided with storm profiles as standard.

For other dimensions the storm profiles are available on demand. This could be necessary in high wind areas like in coastal areas or mountains.

## Side view



## Stormprofiles in RAL colour

For aesthetic reasons, profiles can optionally be painted in any RAL colour of choice.

## 12 Accessories (fascia panels)

Fascia door panel sandwich (fixed panel)

Side view



Fascia door panel Full vision (fixed panel)

Side view





## Fascia door panel - Sandwich

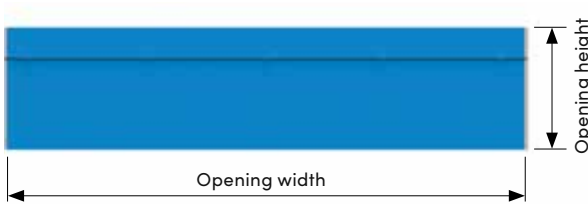

## Specifications

This insulated fixed fascia door panel is composed of the same sandwich panels as used for the door blade.

Available in **10 standard RAL colours** or in a RAL colour to choice.

Anodized aluminum U-profiles all around.

## Fascia door panel - Full Vision

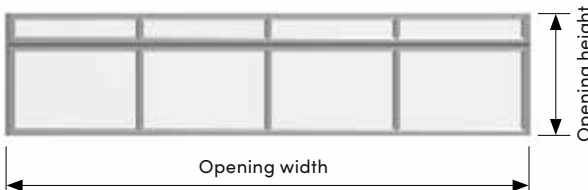

## Specifications

This full vision fascia panel is composed of the same full vision panels that are used for the door blade.

Delivery in 2 standard colours (anodized aluminium or RAL 9002) or in a RAL colour of choice. Filling of choice.

Anodized aluminum U-profiles all around.

## Top view fascia panel

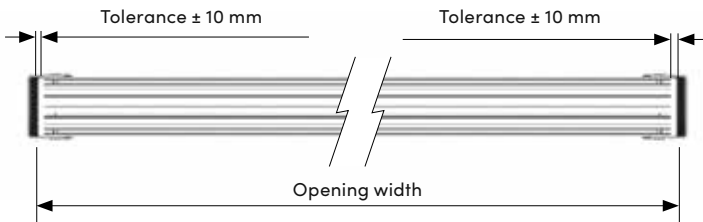

## 12 Accessories (external installation)



### Door package cover

The Compact door package (panels) can be protected by a cover. Available in any RAL colour of choice.

- Protective cover not available with a **top motor**.
- Extra required top space 85 mm.
- Max clear width 5860 mm.



### Side motor cover

The side motor of the Compact door can be fitted with a protective cover. Available in any RAL colour of choice. Motor side is universal (left or right).

- Protective cover is not available with **top motor**.
- Minimum required side space is 350 mm.



### Front motor cover (only in combination with door package cover)

The door package and the front motor of the Compact door can be protected from the elements with a protective cover. Powder coated in RAL colour of your choice. Motor side is universal for left or right.

- Protective cover is not available with **top engine**.
- Extra required top space 10 mm.
- Max. clear width 5860 mm.
- Total installation depth including is 1085 mm.

## External installation

Due to the smart folding system, the Compact door can be installed on both the inside and the outside of a building or space. When the door is installed on the outside of the building, the door package and the motor must be additionally protected.

Additional weather protection when mounted on the outside of the building

- Emergency manual operation secured by a lock
- Click frames for glazing on the inside
- Protective covers for panels and motor
- Powder coated rails and hardware
- Motor with additional protection (IP65)
- Stainless steel coated fasteners



## 12 Accessories (powder coating)

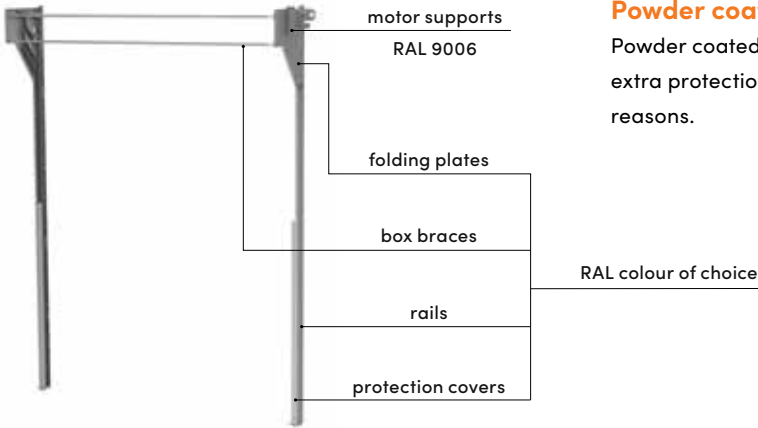

### Powder coated rails

Powder coated parts for extra protection or aesthetic reasons.

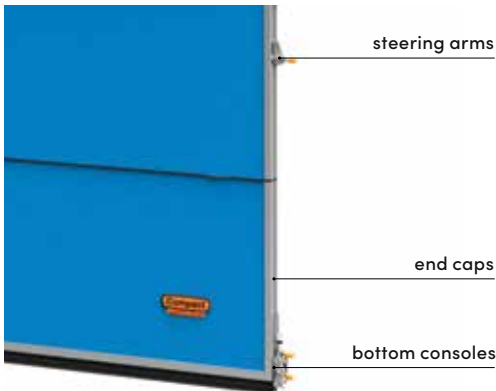

### Powder coated hardware

Powder coated parts in RAL colour 9006 for extra protection or aesthetic reasons.

## Top - bottom profile in RAL colour

Profiles in the same colour as the door blade for aesthetic reasons.



## Stainless steel coated fasteners

Optimum protection against damp and weather influences.

For use in damp spaces such as car washes or for external installation.



# 12 Accessories (control box)

## Control box CS320 Class IP65



### LCD monitor

To adjust end switches for open and close position and to program the control functions.

### Emergency button

In case of an emergency the door can be stopped immediately.



### Lock control box

Switch off the controls to avoid unwilling operation of the door.



### Summer/winter switch

Half open function for summer and winter. Also to switch off automatic time closure.



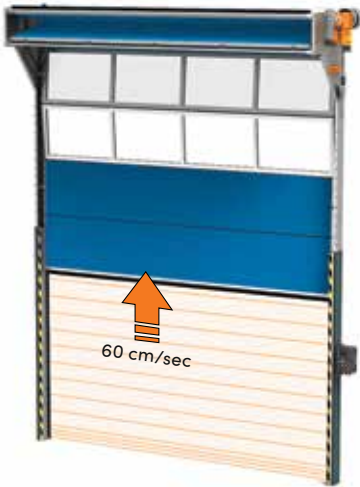

## Control box CS maxi class IP65

## High speed motor with frequency control system

The Compact door can be delivered as a high speed door.

Note: A high speed motor cannot be combined with a wicket door.

- Opening speed adjustable up to maximum 60 cm/sec
- Closing speed 30 cm/sec

## Specifications high speed motor RC500R

- 3 x 400 V
- 4,7 A
- 2,2 kW
- 50 Hz
- 5-pin, 16A

## This motor will be delivered with the following options:

- LCD monitor for programming the control system
- Emergency chain opener in case of power failure
- Light curtain safety
- Switch duration 80%
- Safety class IP65 (dust and water protected)
- Emergency button on control box

## Limits

- Maximum dimensions 5000 x 5000 mm (WxH)
- Maximum weight of door blade is 190 kg
- Only available at side motor position (minimum side space required is 350 mm)



## 12 Accessories (extra controls)



### Emergency chain opener

In case of a power failure the door can be operated by hand from floor level.



### Additional push button

Push button  
OPEN – STOP – CLOSE,  
Class IP65.



### Pull switch

Operation of the door from lift truck and other vehicles.  
Class IP65.





### Key switch

Key switch with Euro Cylinder and 3 keys.

Operation by key movement.



### Key switch UP-STOP-DOWN

Key switch with Euro Cylinder and 3 keys.

Operation by push buttons.

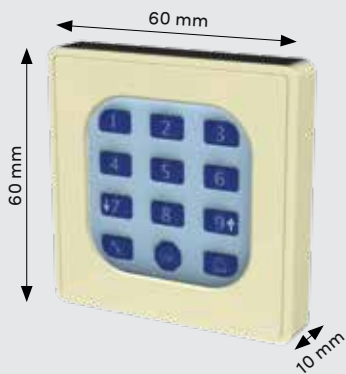

### Pin code unit

With a personal pin code the door can be operated.

## 12 Accessories (remote control)

### Photocell

For extra security to signal an obstacle in the doorway or as an extra impulse to open or close the door. A photocell in combination with a reflector is used as standard.

For heavy use or car wash booths we advise a transmitter and receiver photocell.

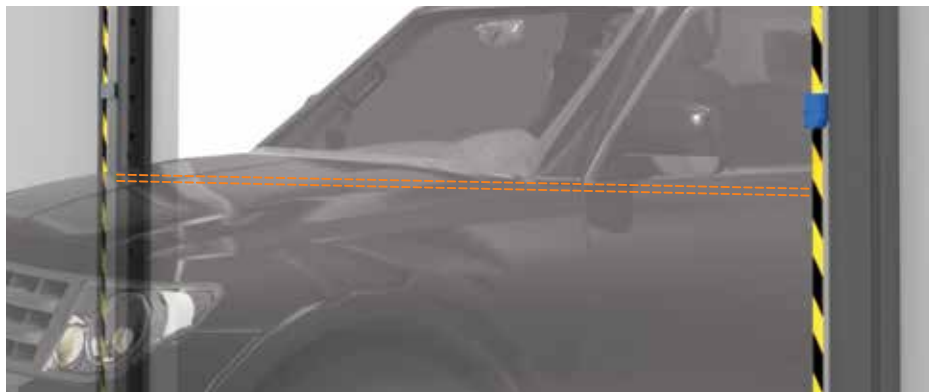

### Radar

Infrared adjustable radar.

- Range up to approximately 5 meters



## Warning light

Flashing warning light, Class IP65.

Combine multiple lights for a traffic light function.

Glass colour choices are green, orange and red.

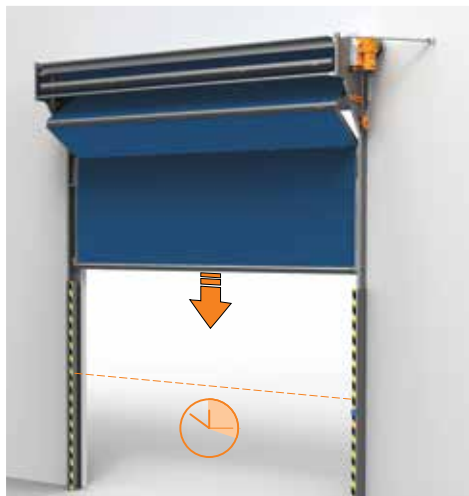

## Automatic time closure

After the door is opened, it will close automatically after a preset time. Adjustable from 0 to 600 seconds.

## Attention

Automatic time closure only in combination with light curtain security.

## 12 Accessories (options)



### Extended track set

Delivery of additional vertical rails for increasing the installation height of the door package and motor.

In some cases it may be desirable to increase the height of the folding system and side rails. For example, when using a crane track or mezzanine floor.

## ATEX

(For Compact doors in potentially explosive environments).

There are two ATEX models possible: Mechanical and Electrical.

### Mechanical ATEX for Compact folding doors

The mechanical elements of the Compact folding door comply with:

#### Directive 2014/34/EU (ATEX 114)

Directive 2014/34/EU reference II 3 GD T6

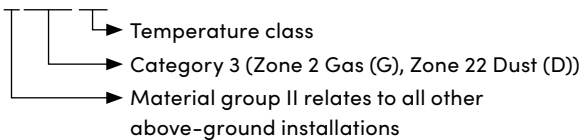

### Adjustments to Compact folding door with Mechanical ATEX

- Automatic static discharge of the door
- Transformer for slack rope guard including blue ATEX cables

### Allowance must also be made for a few aspects:

- The motor must be fitted outside the explosive area, this may mean that adjustments have to be made to the motor, e.g. an extended shaft, possibly in combination with a front-fitted motor.
- The control box must be fitted outside the explosive area.
- The Compact folding door is only available with a “deadman’s control” in ATEX-compatible models.

### ATEX for electrical components of the Compact folding door

The motor and the controls can also be offered in ATEX-compatible models. Combinations are possible that allow positioning the motor or the controls outside the explosive zone. This is on request.



# 13 The problem-solving door

The **Compact** door:  
The **space-saving**  
sectional door without  
overhead rails.

Unique folding  
system

Pipes and  
installations

Storage

Tailor-made

Room for light

Sprinklers

Ceiling integration

Crane tracks

Maximum use of space

Sloping roofs

Narrow spaces

External installation

Low maintenance

Corner solution

Well insulated

Mezzanines



Wicket door  
possible



### Compact Academy

In our Compact Academy we train professionals from all over the world, both online and in person.



### Sales support

Our sales team is available for all your questions about the Compact door. They are in daily contact with Compact resellers and clients from all over the world.

Request a quote!



### Online configurator

Would you like to receive a quote or drawing? Go to [rolflex.com](http://rolflex.com) and use the online configurator. On the website you will also find brochures and technical information about the Compact door.



## The Compact door configurator

Design your door yourself

### Design your door online

Enter dimensions and choose your glazing, colours and other options. This creates your unique Compact door.

### Open for everyone

The configurator is available 24/7 for everyone. Are you a dealer or a returning customer? Our system recognizes your email address and ensures the correct handling. Try it now!

### Receive a quote and drawings

You will receive a quote and technical drawings (and/or DWG files) from your design in your email.



Go to [visulator.rolflex.com](https://visulator.rolflex.com)





Resellers  
only

## The Compact parts webshop

Ready when you are

### No login, easy access

The webshop can be used by all Compact resellers. There is no login required, we recognize you by your contact details.

### Available 24/7

You can now request prices for parts via the webshop 24/7. Normally, you will receive an answer within one business day. If you have an urgent question, please let us know in the comments.

### Door number as reference

To make sure you get the right item, you may need to enter your door number in the webshop.



Go to [shop.rolflex.com](https://shop.rolflex.com)

# 14 References



---

---

---

---

---

---

---

---

---

---

---

---

---

---

---

---

---

---

---

---

---

---

---

---

---

---

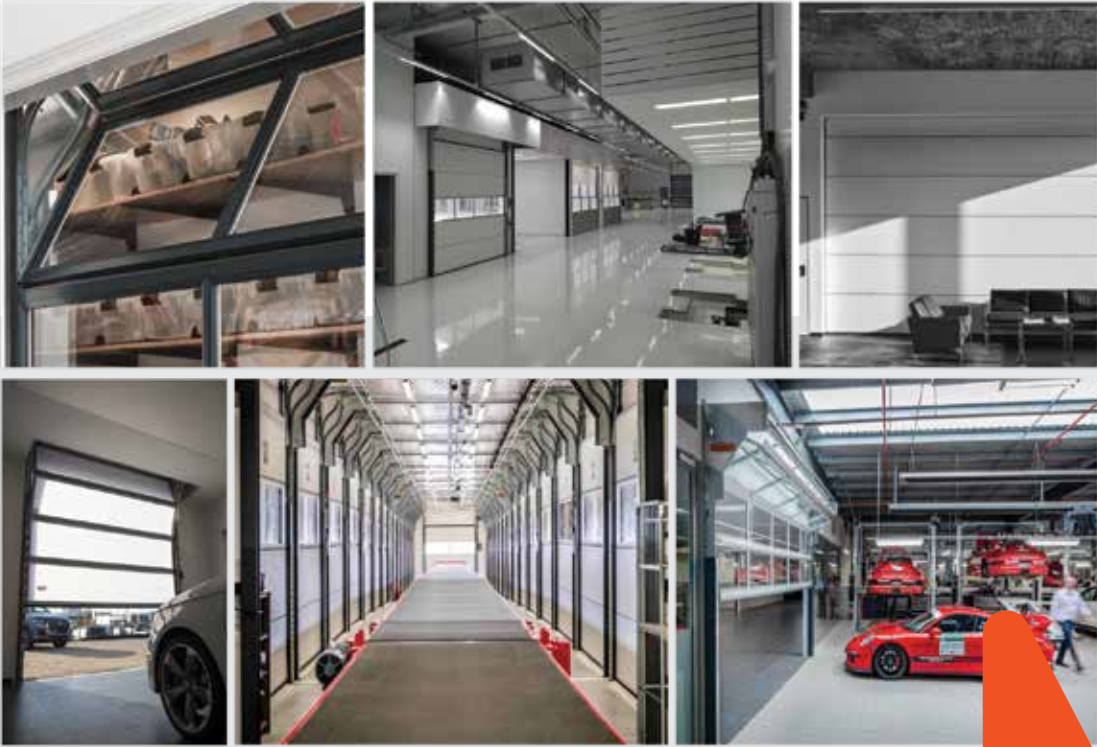

**Rolflex®**

MANUFACTURER OF  
THE COMPACT DOOR

**Rolflex Nederland BV**  
Nijverheidsweg 23

NL-7081 AE Uift  
Netherlands

+ 31 (0)315 69 59 54  
info@rolflex.com

**[www.rolflex.com](http://www.rolflex.com)**