

NEOREST®



TOTO

Life Anew

TOTO

Life Anew

To create a culture of comfortable, healthy living.

Since our founding, we have continuously pursued innovations that offer greater wellness and comfort to daily life.

Honoring the trust that our customers and society place in us, TOTO remains dedicated to delivering products that offer inclusive functionality and respect for the environment.

We embrace these values every day to create a future that surpasses all expectations.

NEOREST®



CONTENTS

ICONS

- 4 Icon Guide
- 6 Comparison Chart
- 8 Product Dimensions

TECHNOLOGIES

- 12 Cycle of Cleanliness and Comfort
- 14 TOTO CLEANOVATION
- 16 Clean Synergy
- 18 EWATER+®
- 22 CEFIONTECT®
- 24 TORNADO FLUSH®
- 26 1 Gallon Technology
- 28 ACTILIGHT®
- 30 Cleansing Functions
- 32 Auto Flush
- 32 PREMIST®
- 32 Deodorizer
- 33 Heated Seat
- 33 Auto Open/Close Lid
- 33 Dryer
- 34 NEOREST® Features

TOILET

- 37 NEOREST NX2
- 37 NEOREST NX1
- 39 NEOREST AC®
- 39 NEOREST EW®

TOILET (CONTINUED)

- 41 NEOREST 750H
- 41 NEOREST 700H
- 43 NEOREST AH
- 43 NEOREST RH
- 44 Remote Control Stand
- 46 How The Remote Control Works

FAUCET

- 49 ZN

LAVATORY

- 51 Kiwami® Asymmetrical
- 51 Kiwami® Oval
- 53 NEOREST Kiwami Semi-Recessed

ACCESSORY

- 53 NEOREST Bath Towel Holder
- 53 NEOREST Hand Towel Holder
- 53 NEOREST Paper Holder
- 53 NEOREST Robe Hook

BATHTUB

- 56 Zero Dimension®
- 59 Flotation Tub with Zero Dimension
- 61 NEOREST Freestanding Tub

TUB FILLER

- 61 ZN Freestanding Tub Filler

TOTO
Life Anew

ICON GUIDE

TOILET & LAVATORY



1.0 GPF

Using only 1 gallon per flush, 1G toilets provide the most efficient flush in the industry.



TORNADO FLUSH®

A state-of-the-art, hole-free rim design that offers dual-nozzle bowl cleansing, creating a centrifugal rinsing action that cleans the bowl more efficiently.



3D TORNADO FLUSH®

Three powerful nozzles create a powerful centrifugal rinsing action and combines it with the conservation of 0.9 or 1.28 GPF.



DUAL-MAX®

A dual flushing system that optimizes conservation by selecting the preferred flush volume.



CEFIONTECT®

Ultra-smooth ceramic glaze leaves nowhere for waste to cling.



UNIVERSAL HEIGHT

Toilet height that allows for a more comfortable height position across a wide range of users.



SKIRTED DESIGN

The trapway is concealed by smooth porcelain, making the toilet easier to clean.



LINEARCERAM®

Material used for lavatories that achieves an extremely thin design yet two times as strong as standard fireclay.



LUMINIST®

An epoxy resin material that combines the translucence of glass with exceptional impact and heat resistance.

WASHLET®



**TOTO .
washLÈT**

An electronic bidet seat featuring adjustable warm water cleansing, heated seat, dryer, deodorizer and much more.

washLÈT® +

WASHLET and toilet set with a concealed connection that is specially designed for a seamless installation.



ACTILIGHT®

Special glaze combined with ultraviolet light work together to break down waste in the toilet bowl.



EWATER+®

Mists the bowl with electrolyzed water, keeping the wand and toilet bowl clean to reduce the need for harsh chemicals.



PREMIST®

Using the incoming water supply, PREMIST sprays the toilet bowl surface aiding in the elimination of waste approximately 80 percent better than a dry bowl.

FAUCET



COMFORT WAVE®

A mix of large droplets and standard spray creates a shower with moderate intensity and just the right amount of stimulation.



COMFORT GLIDE®

Precise and easy flow control of water based on user's touch.



SOFT FLOW

Keeps splashing to a minimum for comfortable use and soft to the touch water.



SAFETY THERMO®

Shape Memory Alloy (SMA) thermostatic valve that prevents a sudden, unwanted increase in water temperature.

TUB



ZERO DIMENSION®

A zero-gravity bathing experience, letting the body float in a completely tension-free state, creating absolute relaxation for the body and mind.



HYDROHANDS

Deeply stimulating water massage gives the feeling of real hands kneading tired muscles.

GENERAL FEATURES



AUTO FUNCTIONS

Product featuring an integrated, automatic, sensor activated function.



ADA

Product complies with Americans with Disabilities Act guidelines.



WATERSENSE®

Product that meets EPA standards for water efficiency and performance criteria.



CEC

Product meets California Energy Commission requirements.

CALGreen

Product meets CalGreen Water Regulations for new construction and permitted remodel.

DESIGN AWARDS



**reddot award
winner**

The Red Dot is the award for high design quality. The international jury only awards this sought-after seal of quality to products that feature an outstanding design.



IF AWARD













The IF DESIGN AWARD has long become a symbol for excellent form, for aesthetic quality, and for user-focused, ergonomic and efficient design in all disciplines, by companies around the world.







GOOD DESIGN

The Good Design Award is the world's oldest and most important industrial design program organized annually by the Chicago Athenaeum Museum. Awarded to our EWATER+ products.

NEOREST[®] COMPARISON CHART

		NX2	NX1	AC [®]	EW [®]
		MS901CUMFX	MS900CUMFG	CWT996CEMFX	CWT994CEMFG
					
		SEE PAGE 37	SEE PAGE 37	SEE PAGE 39	SEE PAGE 39
	COLOR:	#01			
CLEANSE	REAR CLEANSE				
	SOFT REAR CLEANSE				
	FRONT CLEANSE				
	WIDE FRONT CLEANSE				
	OSCILLATING CLEANSE				
	PULSATING CLEANSE				
	INSTANTANEOUS WATER HEATING				
	WATER PRESSURE CONTROL	5 SETTINGS			
	WATER TEMPERATURE CONTROL				
	WAND POSITION ADJUSTMENT				
AIR	AIR PURIFIER (DEODORIZER)				
	AIR DRYER				
	AIR TEMPERATURE CONTROL	5 SETTINGS			
SEAT	HEATED SEAT				
	HEATED SEAT TEMPERATURE CONTROL	5 SETTINGS			
	SoftClose [®] SEAT AND LID				
SENSOR	SEAT SENSOR				
	 AUTOMATIC OPEN AND CLOSE LID				
	 AUTOMATIC FLUSH				
	NIGHT LIGHT				
REMOTE CONTROL	REMOTE CONTROL				
	REMOTE CONTROLLED SEAT				
	REMOTE CONTROLLED FLUSH				
HYGIENE	 ACTILIGHT [®]	•	-	•	-
	 CEFIONTECT [®]				
	 EWATER+ [®]				
	 PREMIST [®]				
	BOWL CLEANING MODE				
	WAND CLEANING MODE				
	SELF-CLEANING WAND				
FLUSH SYSTEM	FLUSHING TYPE	TORNADO		3D TORNADO	
	GALLONS PER FLUSH	1.0 & 0.8 GPF		1.28 & 0.9 GPF	
ENERGY SAVING	ENERGY-SAVE TIMER	3, 6, 9 HOURS			
	AUTO ENERGY SAVER				
	ON / OFF BUTTON				
USABILITY	INSTALLATION	FLOOR MOUNT		WALL-HUNG	
	 ADA				
	 UNIVERSAL HEIGHT				

750H	700H	AH	RH
MS993CUMFX	MS992CUMFG	MS989CUMFG	MS988CUMFG
 SEE PAGE 41	 SEE PAGE 41	 SEE PAGE 43	 SEE PAGE 43
#01		#01, #12	
<ul style="list-style-type: none"> • 			
5 SETTINGS			
<ul style="list-style-type: none"> • 			
5 SETTINGS			
<ul style="list-style-type: none"> • 			
5 SETTINGS			
<ul style="list-style-type: none"> • 			
<ul style="list-style-type: none"> • 			
<ul style="list-style-type: none"> • 	-		
<ul style="list-style-type: none"> • 			
TORNADO			
1.0 & 0.8 GPF			
3, 6, 9 HOURS			
<ul style="list-style-type: none"> • 			
FLOOR MOUNT			
<ul style="list-style-type: none"> • 			

**NEOREST® NX2
NEOREST NX1**



L x W x H (in)

31-1/2" L x 18-7/16" W x 23-5/8" H

Material

Bowl: Vitreous china
Seat and cover: Plastic

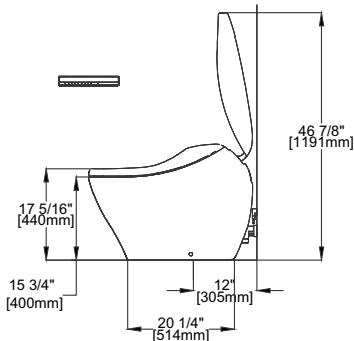
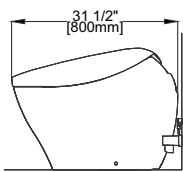
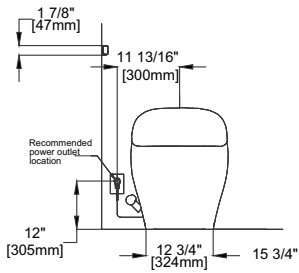
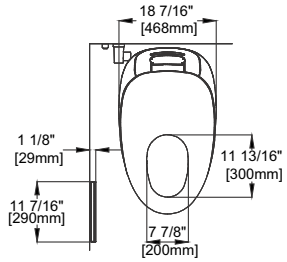

**NEOREST AC®
NEOREST EW®**



L x W x H (in)

26-9/16" L x 16-5/8" W x 16-1/16" H

Material

Bowl: Vitreous china
Seat: Plastic
Cover: Urea-Resin

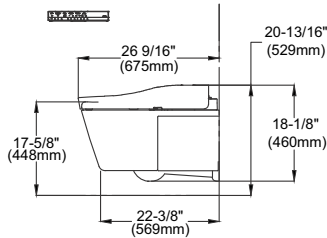
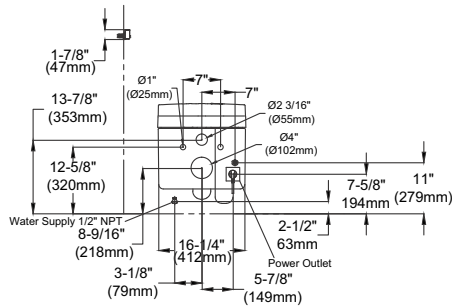
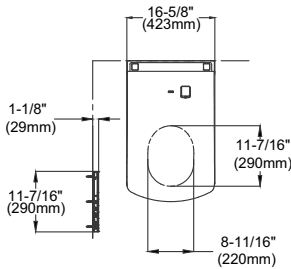

**NEOREST 750H
NEOREST 700H**



L x W x H (in)

32-5/16" L x 17-5/8" W x 20-3/4" H

Material

Bowl: Vitreous china
Seat and cover: Plastic

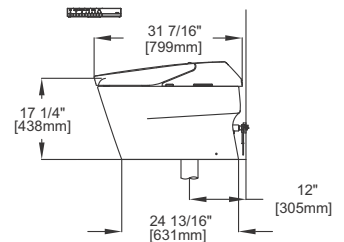
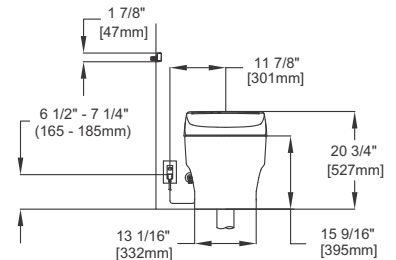
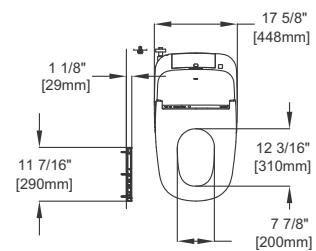

NEOREST AH



L x W x H (in)

27-1/8"L x 15-3/16"W x 21-1/16"H

Material

Bowl: Vitreous china
Seat and cover: Plastic

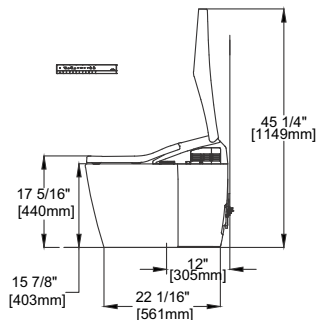
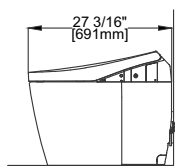
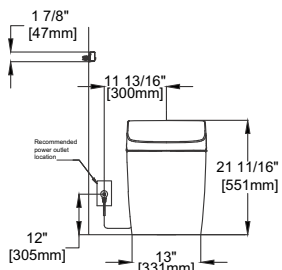
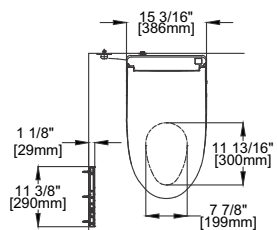

NEOREST RH



L x W x H (in)

27-3/16"L x 15-3/16"W x 21-5/8"H

Material

Bowl: Vitreous china
Seat and cover: Plastic

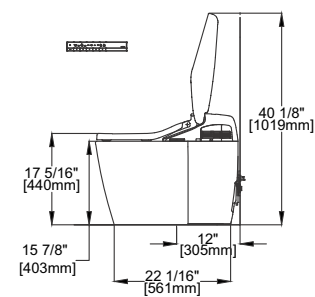
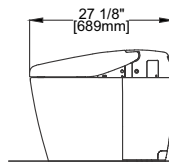
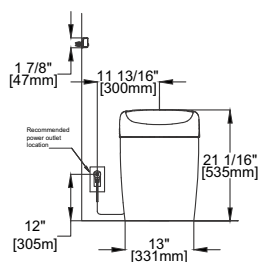
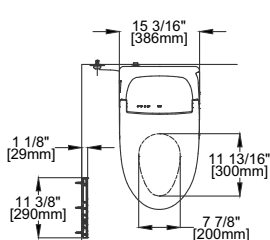

NEOREST®



NEOREST® NX2
NEOREST NX1



NEOREST 750H
NEOREST 700H



NEOREST AC®
NEOREST EW®

NEOREST AH

NEOREST RH

NEOREST®

Every moment of every day, the experience of life arising clean, comfortable and always inviting.

Constantly at work, automated technologies maintain hygienic conditions keeping surfaces clean and providing a place that is inviting and comfortable.

Cycle of Cleanliness and Comfort





TOTO CLEA

Enriching lives with inno



NOVATION

vative clean technology



CLEAN SYNERGY

Technology & Design



CLEAN SYNERGY



EWATER+[®]
For BOWL

Prevents the accumulation of waste on bowl.

EWATER+ reduces waste and dirt you can't see.

EWATER+®

WASHES THE WAND AND TOILET BOWL WHERE WASTE TENDS TO ACCUMULATE AND PRODUCE STAINS THAT CAN BECOME PERMENANT.

Using no chemicals or cleaning agents, EWATER+ provides peace of mind every day that microscopic waste has no place to hide.



How EWATER+ Cleans

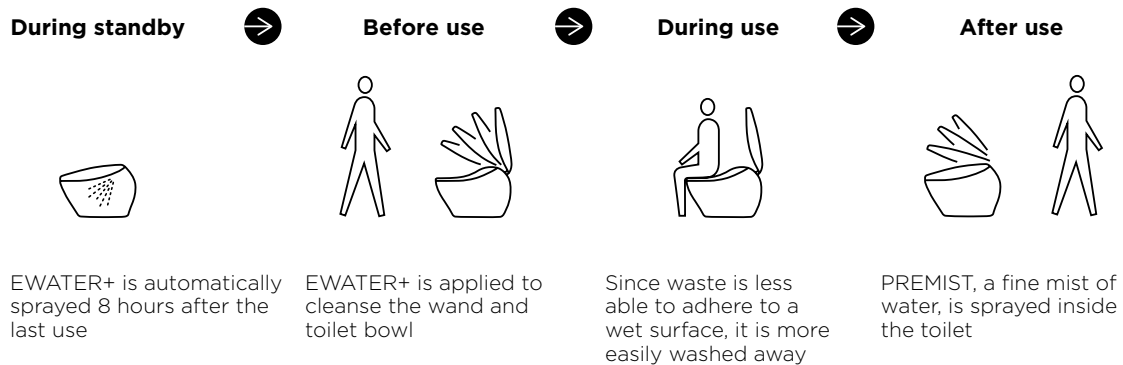

CLEAN SYNERGY



EWATER+[®]
For WAND

Prevents the accumulation of waste on wand.

The wand washes itself inside and out with EWATER+ to maintain clean conditions.

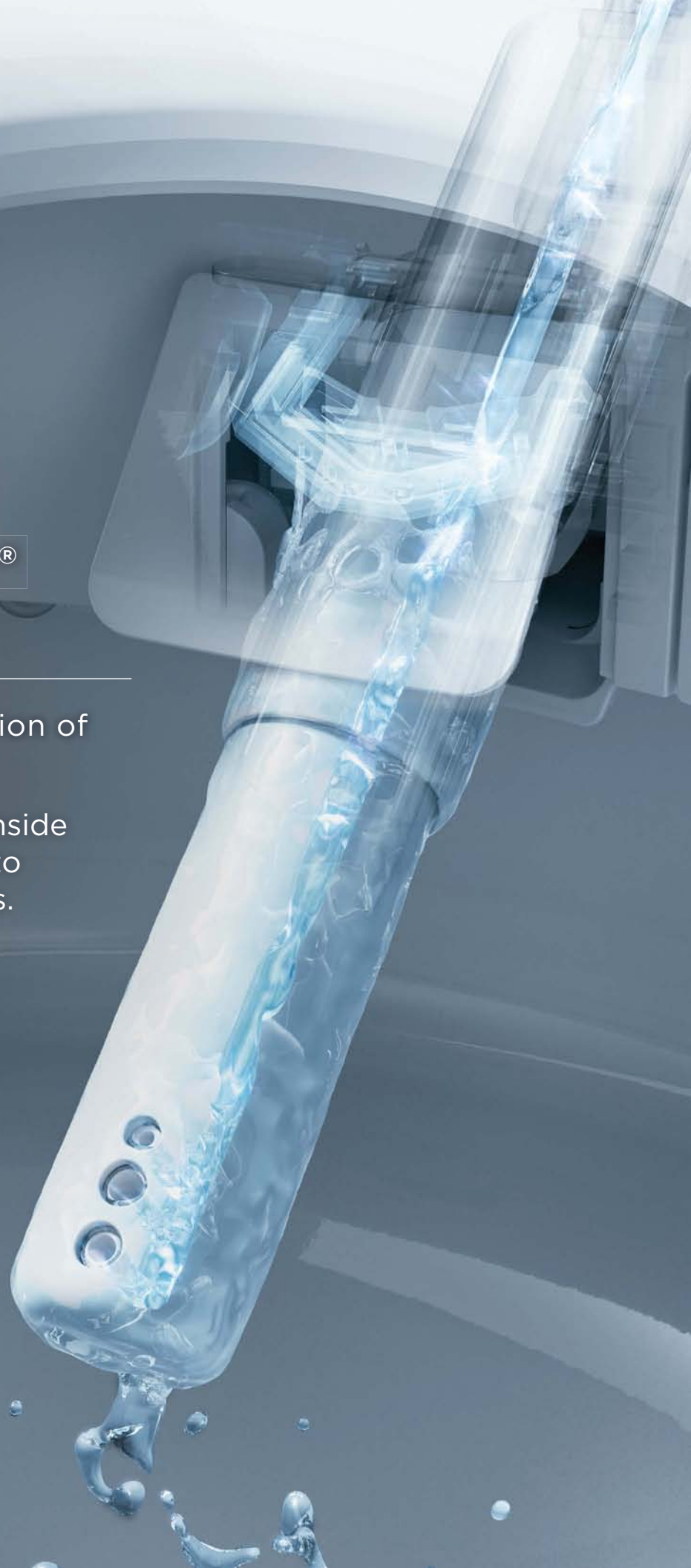

EWATER+®

BEFORE AND AFTER EACH USE, THE WAND AUTOMATICALLY WASHES ITSELF WITH EWATER+.

This thorough cleaning occurs inside the wand as well as all around the exterior. Even when the toilet is not being used, the wand periodically washes itself to ensure constant clean conditions.

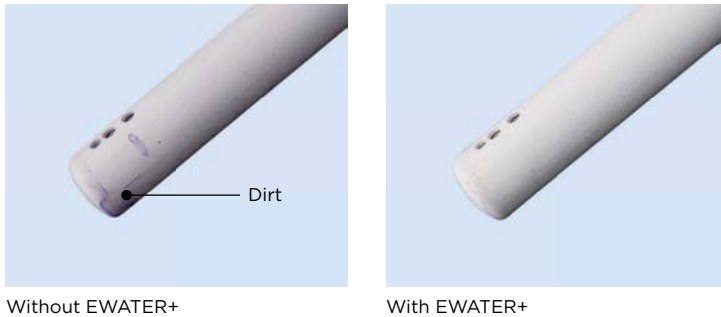

Without EWATER+

With EWATER+

Self-Cleaning Inside the Mechanism



Always Keeping Conditions Clean

Made of high-quality, waste-resistant resin and automatically sprayed with EWATER+ after each use, the wand is extremely resistant to waste and stains. What's more, the wand attaches to the seat, not the bowl, so waste is less likely to even reach it. Though the wand is self-cleaning, you will appreciate how easily you can reach it and wipe it spotless.

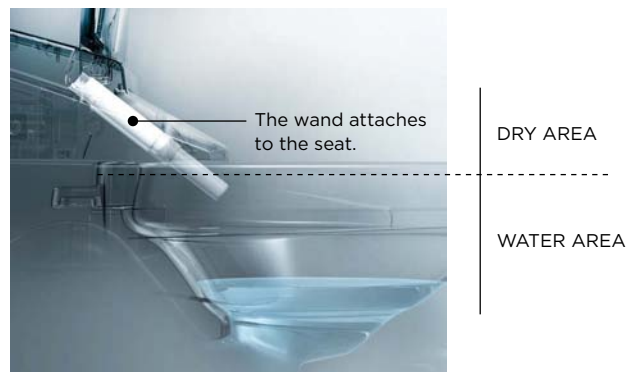

CLEAN SYNERGY



CEFIONTECT®

Forces waste to slide down.
Ultra-smooth ceramic leaves
nowhere for waste to cling.



PREMIST®

Prevents waste from clinging.
A film of water keeps waste
from clinging.

CEFIONTECT® IS AN ULTRA-SMOOTH CERAMIC GLAZE THAT COATS THE TOILET BOWL.

Its microscopic surface ridges are far smaller than waste particles, leaving no place for waste to gain a foothold. Extremely durable, CEFIONTECT is designed for enduring beauty and cleanliness.

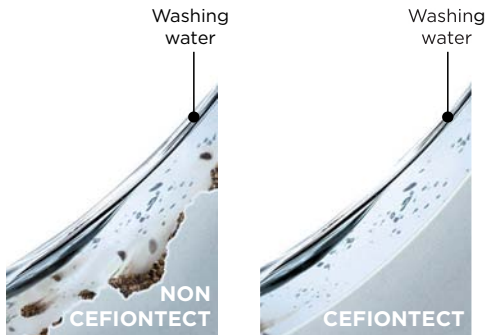

Eliminating the microscopic gaps where waste hides

Conventional ceramic may appear perfectly smooth to the eyes, but has gaps where waste particles hide. At just one millionth of a millimeter, CEFIONTECT's surface ridges are much tinier than waste particles.

What makes CEFIONTECT so durable?

Glass layers are burned onto conventional glaze, making CEFIONTECT an extremely durable material.

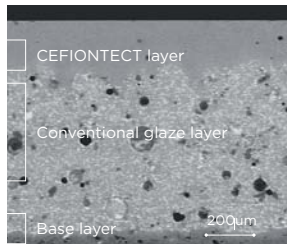

CEFIONTECT toilet micrograph *1Qm=0.001mm

Water has a strong affinity to CEFIONTECT

The term hydrophilic describes matter that is attracted to water. Due to the hydrophilic nature of CEFIONTECT, water spreads easily over the toilet bowl, effortlessly washing waste particles away.

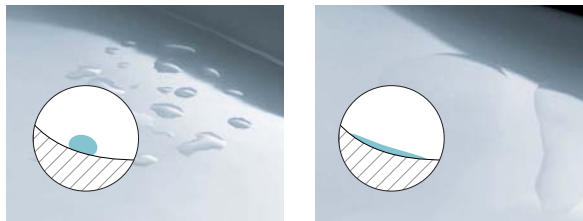

Water hydrophobic

Water hydrophilic



PREMIST®

To ensure waste washes away easily, a film of water keeps waste from clinging to the toilet bowl.

PREMIST automatically sprays water over the surface of the inner toilet bowl before every use. Due to the ceramic's hydrophilic nature, waste washes away more easily.



CLEAN SYNERGY



**TORNADO
FLUSH®**

Swirls and eliminates waste entirely.
360° cleaning power reaches
every spot using less water.

DYNAMAX TORNADO FLUSH®

USES 100% OF WATER TO CLEAN AND RINSE BOWL.



DYNAMAX combines powerful bowl cleaning and waste evacuation using water that is 100% projected from the rim creating 360° cleaning power. Using only 1.0/0.8 or 1.28/0.8 gallons per flush, coupled with a 25% larger trapway diameter, this high-efficiency system uses 20% less water with improved performance while also creating a quieter flush. With a modern rimless design, it performs more consistently and is easy to clean.

TORNADO FLUSH® NOT ONLY CLEANS MORE EFFECTIVELY, IT DOES SO QUIETLY USING LESS WATER.

Powerful streams of water merge and swirl 360 degrees, washing every spot inside the RIMLESS toilet bowl.



Powerful washing where waste accumulates most easily

TORNADO FLUSH's dynamic waterjet discharges from near the front of the toilet bowl, travels in a narrow channel along a hairpin curve, and with sustained water pressure thoroughly cleanses the areas where waste accumulates most easily - and then washes the entire bowl clean. Exquisitely high-quality ceramic makes this innovative design possible.



The RIMLESS design not only leaves no place for waste and germs to hide, it also makes for a much easier to clean toilet.





1 GALLON TECHNOLOGY (1.0 GPF)

Reduces water use by 35% or more on average
over a standard 1.6 gpf toilet.



35%
WATER
SAVINGS
PER YEAR*



VS.



TOTO® 1G
TOILETS

5,840 GALLONS
Used in Flushing

\$175 Operation
Cost

PER YEAR

STANDARD 1.6 GPF
TOILETS

9,344 GALLONS
Used in Flushing

\$280 Operation
Cost

PER YEAR

**The average American flushes five times a day at home. Assuming an average household of 3.2 people over 365 days @ 3¢ per gallon.*



ACTILIGHT®

Innovative glaze, the ultimate cleaning technology, has extreme hydrophilic power to easily wash waste away.

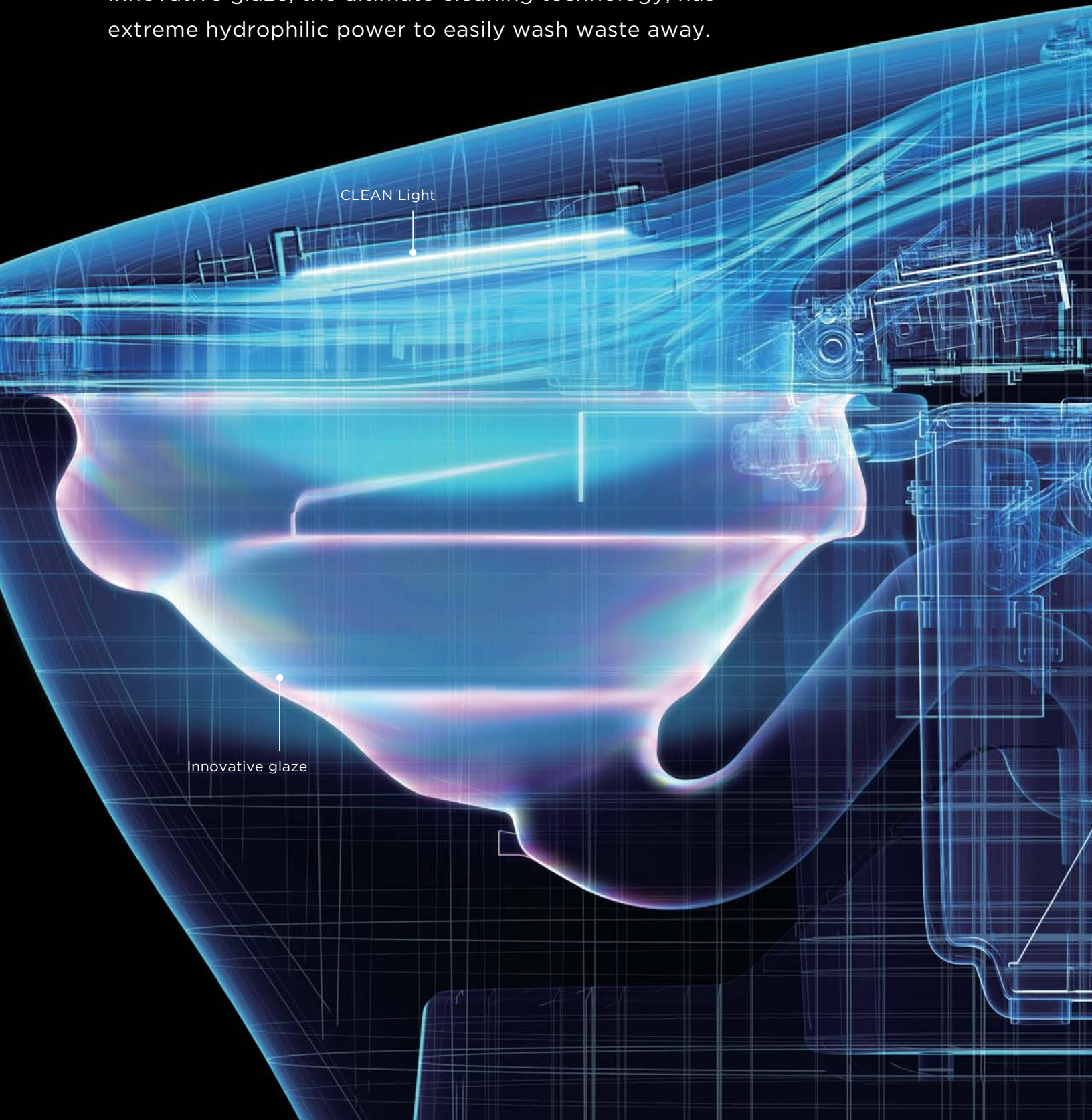

CLEAN Light

Innovative glaze

CLEAN Light and the extraordinary surface treatment enable easy removal of even microscopic debris and particles.

State-of-the-art materials

CLEAN Light and the extreme hydrophilic surface of the toilet bowl combine to attract water to the surface and keep the surface clean after use.

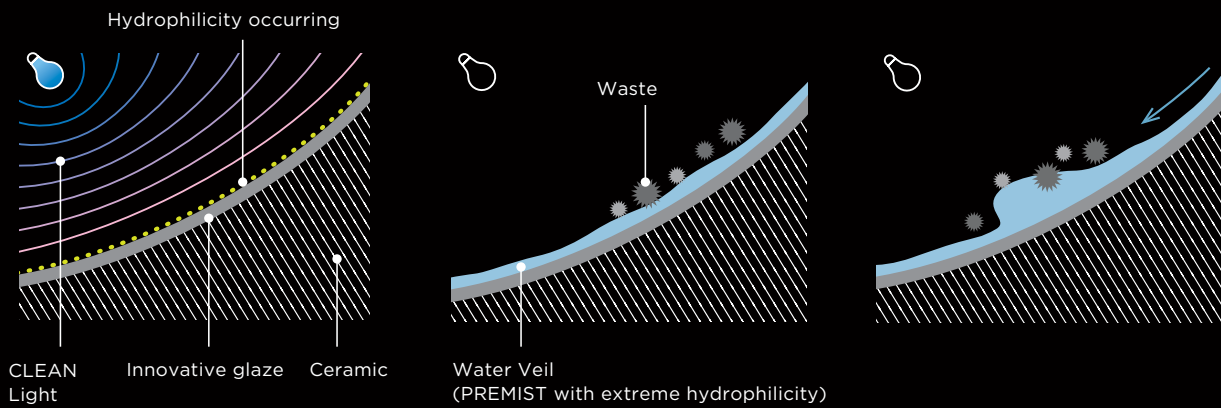

Operates 24 hours a day to maintain clean conditions

CLEAN Light and the extreme hydrophilic surface of the toilet bowl combine to make it easy to wash waste away and keep the toilet bowl surface clean.

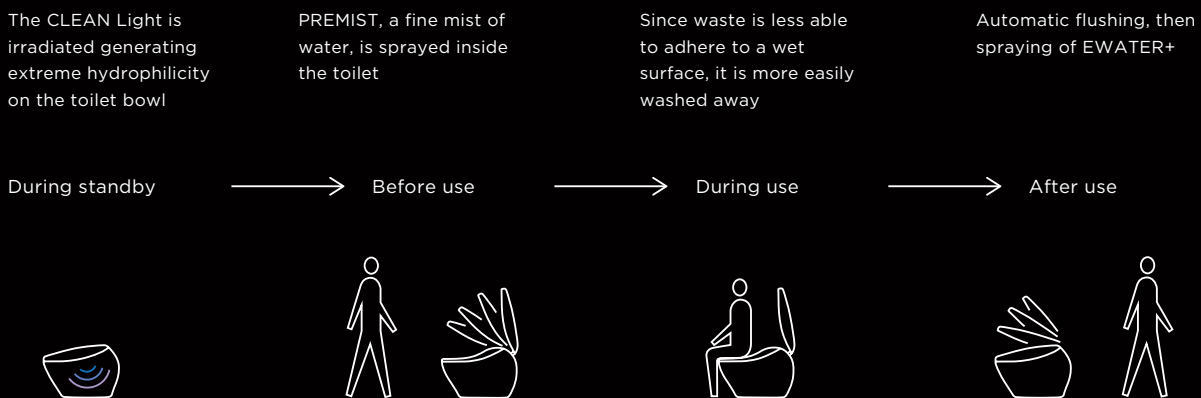



NEOREST®

CLEANSING FUNCTIONS



CLEANSING FUNCTIONS

WITH THE TOUCH OF A BUTTON, A WAND EXTENDS FROM UNDER THE SEAT FOR SOOTHING WARM-WATER CLEANSING.

How WASHLET® works

AIR-IN WONDER-WAVE® technology is the precise, pleasant, air rich stream that keeps you clean. As water is fired at different speeds, small droplets collide with larger ones, combining and expanding as the droplets fill with more air. The injection of air enlarges water droplets around 30%.

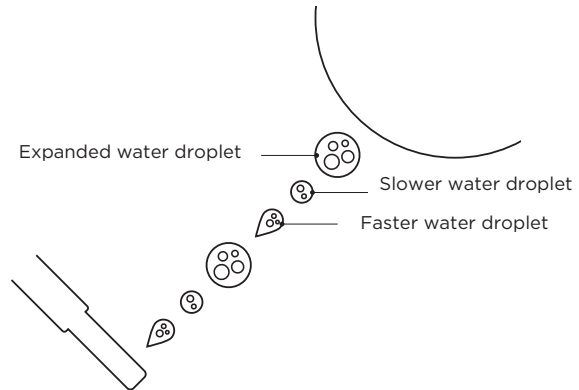

Select the type of cleansing you desire each time.



NEOREST® NX2, NX1, AH, and RH Remote Control



REAR SPRAY

The rear spray is designed to clean the rear intimate area. It features pleasant, yet strong water pressure to target this specific area.



REAR SOFT SPRAY

It has a larger radius to cover more area. Lower water pressure makes for a soft, comfortable spray.



FRONT SPRAY

The front wash consists of large, soft drops for comfortable intimate cleansing – for a clean, fresh feeling.



WIDE FRONT SPRAY

It has a larger radius to cover more area. Lower water pressure makes for a soft, comfortable spray.

NEOREST® TECHNOLOGIES

For greater performance and hygiene in the bathroom.



AUTO FLUSH



PREMIST®



DEODORIZER

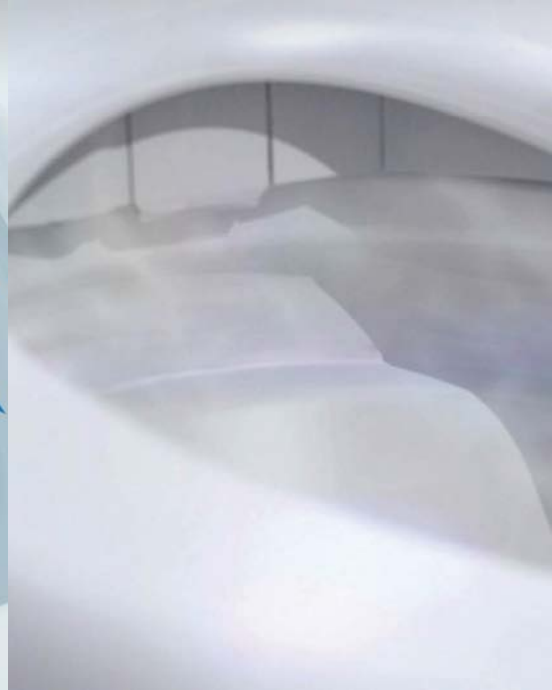

No need to touch buttons or handles and never worry about someone forgetting to flush — it's automatic after each use

**Auto Flush models only*

Using the incoming water supply, PREMIST wets the toilet bowl surface aiding in the elimination of waste approximately 80% better than a dry bowl.

Highly effective deodorizing automatically takes places inside the toilet bowl both during and immediately after use, leaving no disturbing odors.



HEATED SEAT

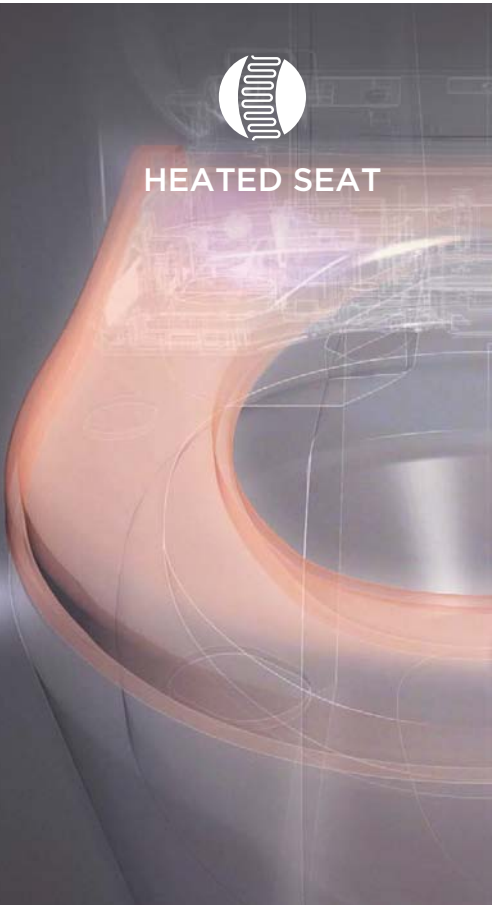

The moment you approach the toilet, the seat begins rapidly warming to a comfortable temperature.



AUTO OPEN / CLOSE LID



Eliminating the need to touch the toilet surfaces, the lid automatically opens and closes when the toilet is approached and departed.



DRYER



Enjoy the ease and comfort of drying with the temperature-adjustable warm-air dryer.

NEOREST® FEATURES



**SoftClose®
LID**

The SoftClose lid automatically closes gently to eliminate seat slamming.

PREMIST®

PREMIST wets the surface of the toilet bowl, aiding in the removal of waste and resulting in a better clean.

HEATED SEAT

The contoured seat has five temperature settings for maximum comfort.

EWATER+®

After each flush, EWATER+® mists on the wand and toilet bowl, reducing the need for harsh cleaning chemicals.

**SELF-CLEANING
WAND**

The self-cleaning function cleans the entire wand with EWATER+ before and after each use.

DRYER

Enjoy the ease and comfort of drying with the temperature-adjustable warm-air dryer.

ACTILIGHT®

Uses a special light-reactive glaze and CLEAN Light technology inside the lid to get rid of both visible and invisible waste. Available on NEOREST models NX2, AC, and 750H.

**AUTOMATIC
DEODORIZER**

The deodorizer cleans the air around the toilet using powerful filters. Air is drawn in, passing through an ionized carbon filter to reduce unpleasant odors.



NEOREST® NX2

MS901CUMFX (With ACTILIGHT)



Remote (Front View)



Remote (Top View)

NEOREST® NX1

MS900CUMFG



Remote (Front View)



Remote (Top View)



CALGreen

- ACTILIGHT® Clean light technology built in lid (*NEOREST NX2 only*)
- TORNADO FLUSH® system, ultra-high efficiency
- Dual flush function (1.0 GPF/3.8 LPF and 0.8 GPF/3.0 LPF)
- CEFIONTECT® ceramic glaze minimizes waste from sticking to porous, ceramic surfaces
- WASHLET® with three wash modes (front, rear, soft)
- Skirted Design - Concealed trapway for easy cleaning
- Auto open/close lid, auto flush
- EWATER+® keeps the wand and toilet bowl clean
- PREMIST® of bowl before each use
- Universal Height
- ADA compliant
- Meets WaterSense efficiency and performance standards

AVAILABLE
COLOR



#01
Cotton



NEOREST® AC;
CWT996CEMFX

NEOREST®

AC/EW

CWT996CEMFX/CWT994CEMFG



- *ACTILIGHT® Clean light technology built into lid
- 3D TORNADO FLUSH® system, ultra-high efficiency (1.28 GPF/4.8 LPF and 0.9 GPF/3.4 LPF)
- CEFIONTECT® ceramic glaze minimizes waste from sticking to porous, ceramic surfaces
- WASHLET® with three wash modes (front, rear, soft)
- Skirted Design - Concealed trapway for easy cleaning
- Auto open/close lid, auto flush
- EWATER+® keeps the wand and toilet bowl clean
- PREMIST® of bowl before each use
- Universal Height
- ADA compliant
- Meets WaterSense efficiency and performance standards



Remote (Front View)



Remote (Top View)

*ACTILIGHT only available on NEOREST AC

**AVAILABLE
COLOR**



#01
Cotton

NEOREST IN-WALL TANK UNIT - 1.28/0.9 GPF

WT174M (Copper supply line)
2" x 6" installation
2" x 4" outlet kit available
Push plates sold separately



PUSH PLATE YT994#WH

Glass/White plastic





NEOREST® 750H

MS993CUMFX (With ACTILIGHT)

NEOREST® 700H

MS992CUMFG



Remote (Front View)



Remote (Front View)



Remote (Top View)



Remote (Top View)



CALGreen

- ACTILIGHT® Clean light technology built in lid (*NEOREST 750H only*)
- TORNADO FLUSH® system, ultra-high efficiency (1.0GPF/3.8LPF and 0.8GPF/3.0LPF)
- CEFIONTECT® ceramic glaze minimizes waste from sticking to porous, ceramic surfaces
- WASHLET® with three wash modes (front, rear, soft)
- Skirted Design - Concealed trapway for easy cleaning
- Auto open/close lid, auto flush
- EWATER+® keeps the wand and toilet bowl clean
- PREMIST® of bowl before each use
- Universal Height
- ADA compliant
- Meets WaterSense efficiency and performance standards

AVAILABLE
COLOR



#01
Cotton



**NEOREST.
AH**
MS989CUMFG



Remote (Front View)



Remote (Top View)

**NEOREST.
RH**
MS988CUMFG



Remote (Front View)



Remote (Top View)



CALGreen

- TORNADO FLUSH® system, ultra-high efficiency (1.0GPF/3.8LPF and 0.8GPF/3.0LPF)
- CEFIONTECT® ceramic glaze minimizes waste from sticking to porous, ceramic surfaces
- WASHLET® with three wash modes (front, rear, soft)
- Skirted Design - Concealed trapway for easy cleaning
- Auto open/close lid, auto flush
- EWATER+® keeps the wand and toilet bowl clean
- PREMIST® of bowl before each use
- Meets WaterSense efficiency and performance standards
- Universal Height
- ADA compliant

**AVAILABLE
COLORS**



#01 Cotton

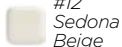

#12 Sedona Beige

NEOREST® REMOTE CONTROL STAND

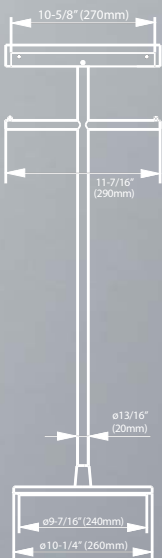

NEOREST REMOTE CONTROL STAND;
YS990

NEOREST®

YS990

- Versatile design with removable remote control plate for a stand alone toilet paper holder
- Solid brass construction weighing 22 lbs.
- Designed to hold two rolls of toilet paper and one remote control
- Remote control not included



AVAILABLE
FINISH



#CP
Polished
Chrome

REMOTE CONTROL HOW IT WORKS

Easy and Convenient to Use.

NEOREST®

NX2, NX1, AH, and RH models

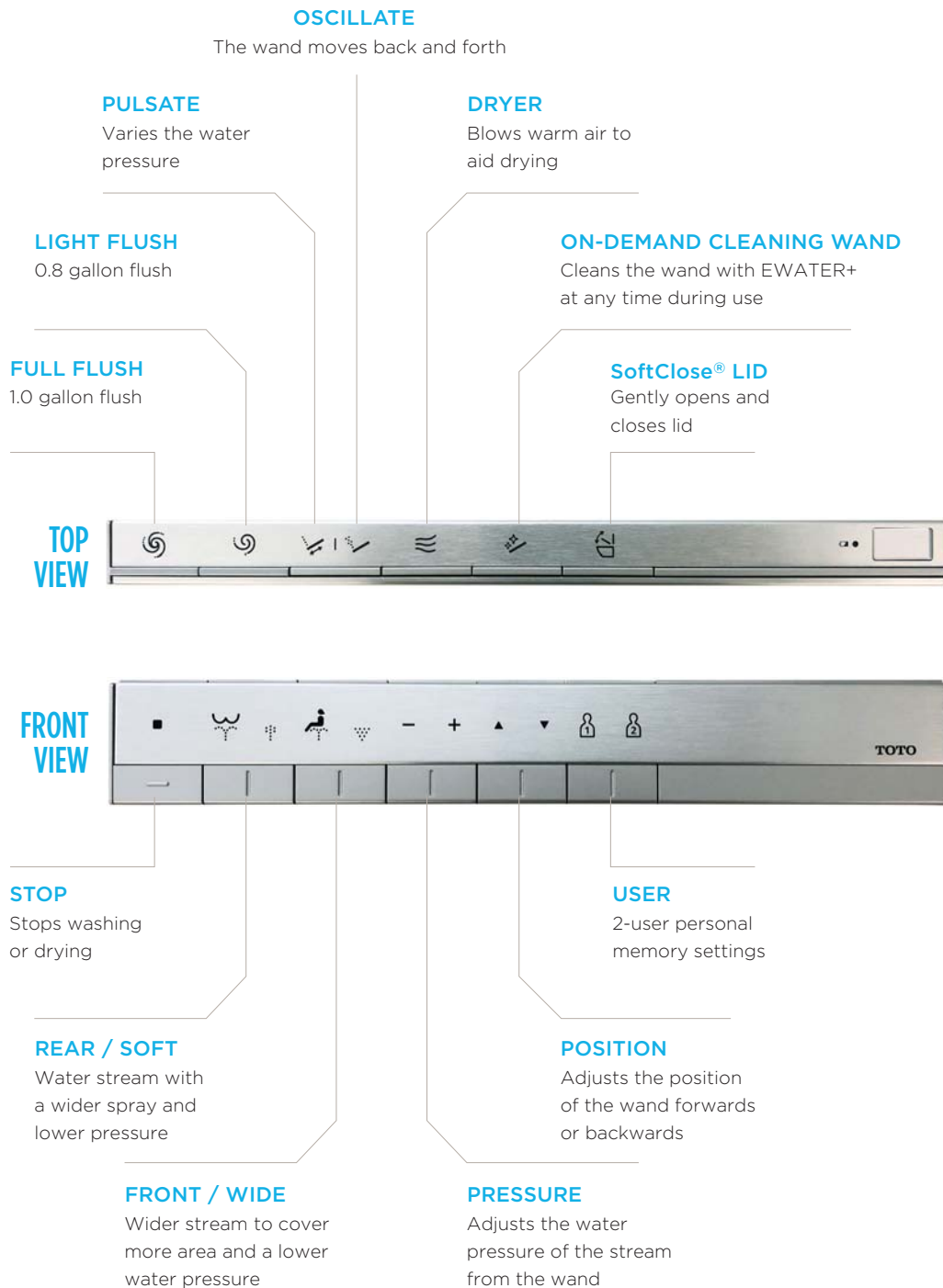

INTERFACE OF THE REMOTE CONTROL IS SUBJECT TO CHANGE.

NEOREST®

AC, EW, 750H, and 700H models

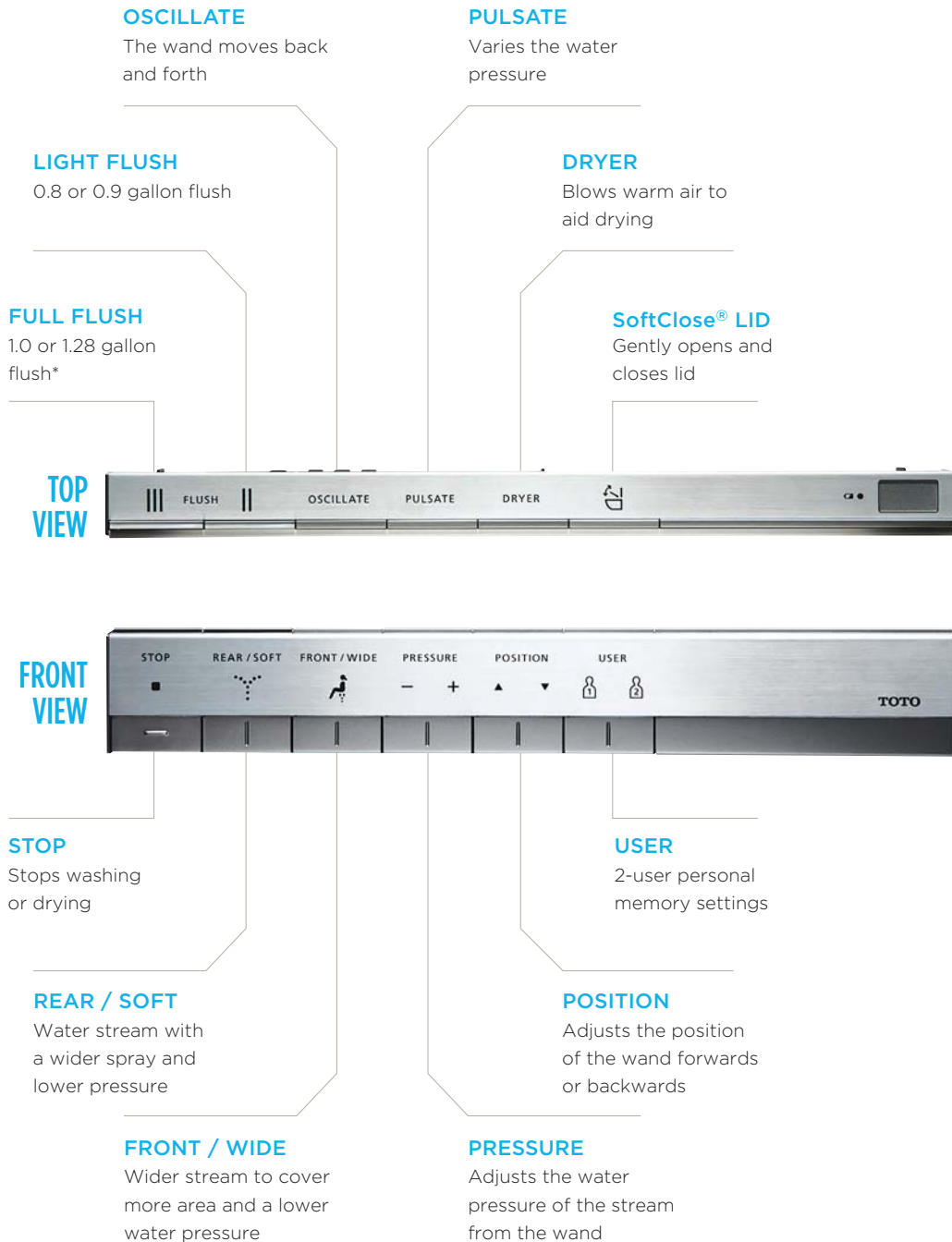

*1.0 GPF available on NEOREST 750H and 700H
1.28 GPF available on NEOREST AC and EW



ZN LAVATORY FAUCET;
TLP01701U

ZN FAUCET

The ZN Faucet features a beautiful design inspired by graceful flowing water. The precisely balanced streams of water from SOFT FLOW touches the skin gently, causing almost no splatter as you wash your hands. The feeling is soft, yet strong and enriching. Sensor-operation eliminates the need for levers or buttons to touch.

ZN LAVATORY FAUCET

TLP01701U

Requires TLP01702U Controller sold separately



Polished Chrome



Brushed Nickel



SPLASH-FREE HANDWASHING

SOFT FLOW technology creates little to no splashing, enveloping your hands in warmth and comfort.



HANDS-FREE OPERATION

The ZN Faucet has sensors both for opening and closing the spout and for switching between hot and cold water. Simply waving the hand over each sensor operates it.

CLEAN MATTE

An elegant texture you'll want to touch.

With CLEAN MATTE, we achieved a smooth texture that had been impossible with ordinary ceramics, while at the same time, enhancing the design to give off a gentle, silky light unlike ordinary gloss ceramics.



KIWAMI ASYMMETRICAL
VESSEL LAVATORY;
LT477MT

KIWAMI® VESSEL LAVATORIES

NEW

KIWAMI ASYMMETRICAL VESSEL LAVATORY

**LT477(G)(MT)

W 8-1/8" x D 16-1/2" x H 5-1/8"

Basin W 20" x D 18"



NEW

KIWAMI OVAL VESSEL LAVATORY

**LT473(G)(MT)

W 15-3/4" x D 10-1/4" x H 3-1/8"

Basin W 15-7/16" x D 9-15/16"



NEW

KIWAMI OVAL VESSEL LAVATORY

**LT474(G)(MT)

W 23-5/8" x D 16-9/16" x H 3-9/16"

Basin W 23-5/16" x D 16-1/4"



A Matte Finish with Outstanding Cleanability

Ordinary matte ceramics have a reputation for hanging on to dirt, but the unique way CLEAN MATTE ceramics from TOTO are processed means that any clinging dirt can be easily washed away.

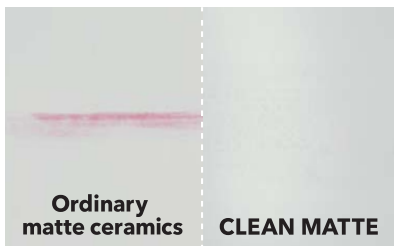

About CLEAN MATTE Technology

Compressed air is used to blast the glaze-covered surface of the ceramic with a slurry of water and abrasive material - an advanced technology that enables microscale processing.

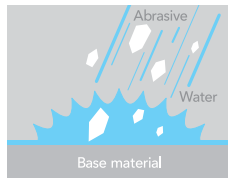

Ordinary matte ceramics have a jagged surface that tends to retain dirt. CLEAN MATTE achieves uniform, micro-level undulations for a smoother surface that makes dirt removal easier while also improving design.

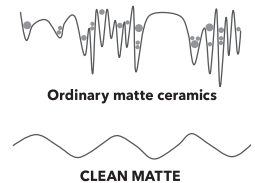

*Tests were conducted using a water-dampened sponge to wipe away oily grime applied to the ceramic surface.

**CLEAN MATTE (MT) available Q4 2019



LAVATORY

**NEOREST® KIWAMI®
SEMI-RECESSED**

LT994G (Shown)
W 29-3/8" x D 17-5/8"
Basin W 28-7/16" x D 16-15/16"

LT995G
W 23-7/16" x D 15-5/8"
Basin W 22-1/2" x D 15"



**AVAILABLE
COLOR**



ACCESSORIES

BATH TOWEL HOLDER, 26"
YB990
#CP only



HAND TOWEL HOLDER, 14"
YC990
#CP only



PAPER HOLDER
YP990
#CP only



ROBE HOOK
YH990
#CP only



**AVAILABLE
FINISH**



#CP
Polished
Chrome

FLOTATION TUB





ICONS

CHARTS

TECHNOLOGIES

TOILET

FAUCET

LAVATORY

ACCESSORY

BATHTUB

TUB FILLER



ZERO DIMENSION®

Immersed in the meditative moment of relaxation.



THE POSTURE OF AN ASTRONAUT RESTING IN SPACE

ZERO DIMENSION bathing brings freedom from gravity, releasing stress on joints and encouraging ultimate relaxation.

After more than a decade of research on body positioning, bathing and neurological relaxation, TOTO developed the Flotation Tub. Its design simulates zero gravity by offering bathers the experience of total weightlessness. By releasing the bather from the bonds of gravity to float in a tension-free state, deep muscle relaxation occurs that calms the body, mind and spirit creating a sanctuary from the physical and mental fatigue today's world brings.



ICONS

CHARTS

TECHNOLOGIES

TOILET

FAUCET

LAVATORY

ACCESSORY

BATHTUB

TUB FILLER



Graphic Image

THE BRAIN IN A STATE OF TRANQUILITY

Research has shown that the ZERO DIMENSION bathing posture reduces activity in the part of the brain that houses the language function. This is the reason ZERO DIMENSION bathing feels calming and relaxing.

ADVANCED TECHNOLOGY ENCOURAGES RELAXATION

Exclusive features that make every bath a luxurious occasion.



NECK BATH

With variable pillow positions ensuring stability, people of all body shapes can enjoy the warmth of the bath from above the shoulders to the neck.

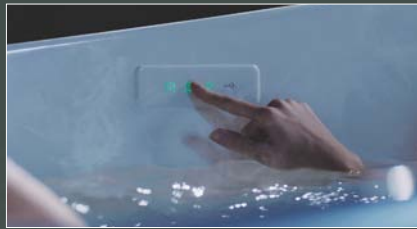

CONTROLLER

The electrostatic controller is operated by the slightest touch.



LED LIGHTING

In the outer perimeter of the tub's base, LED lighting supplies a dream-like ambience.

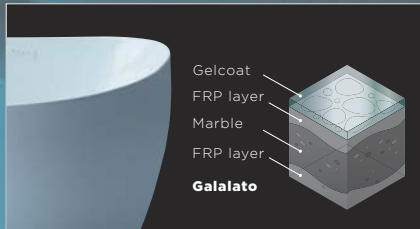

GALALATO® MATERIAL

Offering outstanding durability, the tub is made of Galalato artificial marble and constructed using TOTO's innovative sandwich configuration.



HYDROHANDS

Deeply stimulating water massage gives the feeling of real hands kneading tired muscles.



AIR-JET

Fluctuating streams of air bubbles rise from below and envelop the body with a soothing sensation.



FLOTATION TUB WITH
ZERO DIMENSION®
PJYD2200PWEU
(86-5/8" x 41-5/16" x 30-7/8")



NECK BATH

GALALATO®
MATERIAL

CONTROLLER

HYDROHANDS

LED LIGHTING

AIR-JET

ICONS

CHARTS

TECHNOLOGIES

TOILET

FAUCET

LAVATORY

ACCESSORY

BATHTUB

TUB FILLER



NEOREST® FREESTANDING TUB; ABF992X,
ZN FREESTANDING TUB FILLER; TBP01301U

FREESTANDING BATHTUB

NEOREST®
FREESTANDING TUB
ABF992X
(70-7/8" x 37-3/8" x 23-5/8")



**AVAILABLE
COLOR**



TUB FILLER

**ZN FREESTANDING
TUB FILLER**
TBP01301U

Requires TBN01105U Tub Filler Base sold separately
#CP and #BN only



**AVAILABLE
FINISHES**

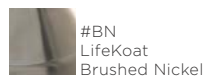
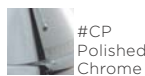

ICONS

CHARTS

TECHNOLOGIES

TOILET

FAUCET

LAVATORY

ACCESSORY

BATHTUB

TUB FILLER

SCAN CODE NOW
FOR DIGITAL NEOREST BROCHURE



TOTO USA, INC.
1155 SOUTHERN ROAD
MORROW, GA 30260
800-350-8686

www.totousa.com

#KO-102019-NB
Printed in the U.S.A. 10/19