



LAMIERE GRECATE

Catalogo Prodotti | Product Catalogue





*Non puntiamo al meglio:
puntiamo oltre.*

*We are not simply aiming for the top:
we are going above and beyond.*

Nazareno Sandrini

Fondata dal Presidente Nazareno Sandrini, da oltre 70 anni Sandrini Metalli opera nel settore delle coperture.

Nata come azienda artigiana, ha assunto crescendo un assetto decisamente più industriale, sempre tenendo come principale obiettivo il raggiungimento dei massimi livelli di qualità nel prodotto e nel servizio offerto al cliente.

Oggi Sandrini Metalli opera con tre differenti divisioni:

- Divisione Building, che si occupa della produzione di lamiere grecate destinate ad ogni tipologia di utilizzo;
- Divisione Coils, che si occupa del taglio e della commercializzazione di laminati metallici;
- Divisione Architecture, che offre prodotti destinati a rivestimenti e coperture dall'alto valore architettonico.

Sandrini Metalli è un partner rapido, affidabile, competitivo e tecnologicamente avanzato per tutti gli operatori del settore nella fornitura di prodotti e servizi per il sistema tetto.

Sandrini Metalli was founded by Nazareno Sandrini in the 1950s and has become a leader in the market of corrugated and trapezoidal sheets.

What starting out as a small company has become an industrial leader with the main purpose of providing the highest quality products and the best customer service.

Sandrini Metalli has expanded its activities into 3 different branches:

- Building Division, which is dedicated to the production of corrugated and trapezoidal sheets for all kinds of use;
- Coils Division, which is dedicated to the supply of strips and sheets in several materials, thicknesses and widths, with a wide range of colours available;
- Architecture Division, which is dedicated to roofing and cladding to enhance buildings with high architectural value.

Sandrini Metalli is a responsive, reliable, competitive and technologically advanced partner for all companies dealing with products and services for the roofing system.

L'esperienza maturata nel settore dei laminati metallici rende Sandrini Metalli un fornitore ideale, poiché più di chiunque altro conosce i requisiti fondamentali che il mercato oggi richiede:

The Sandrini Metalli experience in the metal-rolled sector makes it the ideal partner. It knows better than anyone else the essential requirements of the current market:



ELEVATA QUALITÀ DEL MATERIALE
HIGH QUALITY MATERIALS



CONSEGNA IN TEMPI RAPIDI
RAPID DELIVERY



VASTA GAMMA DI PRODOTTI
WIDE RANGE OF PRODUCTS



PREZZI COMPETITIVI
COMPETITIVE PRICES

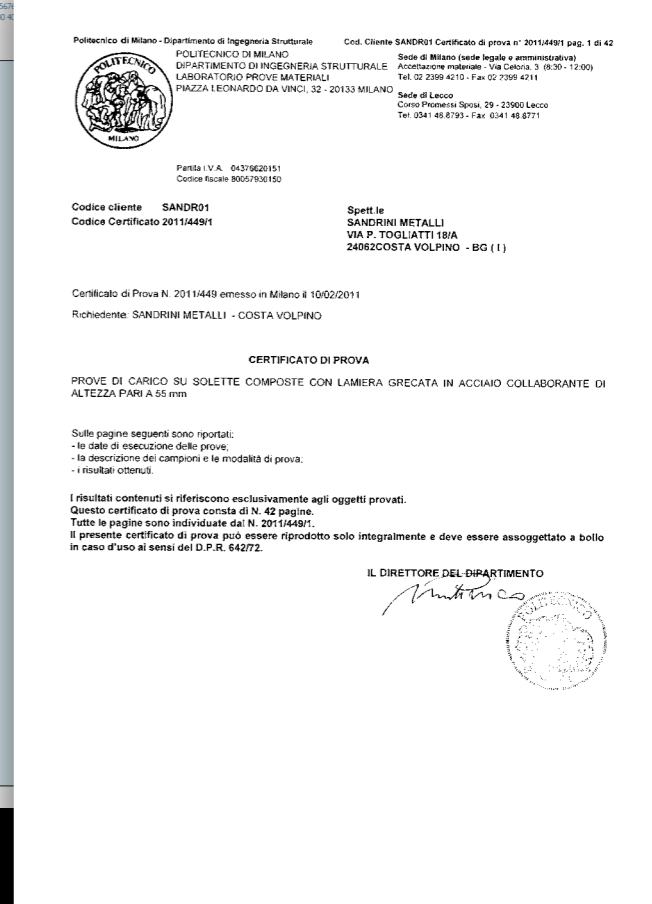
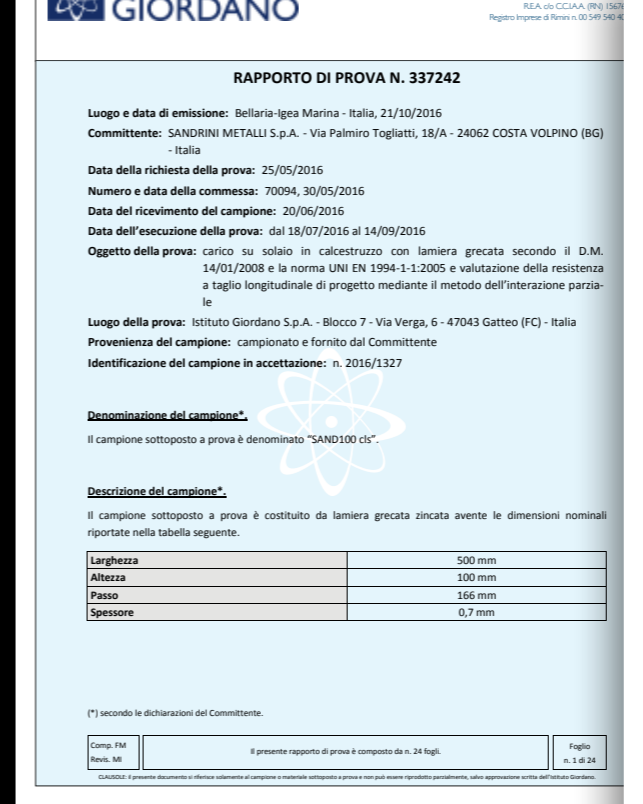
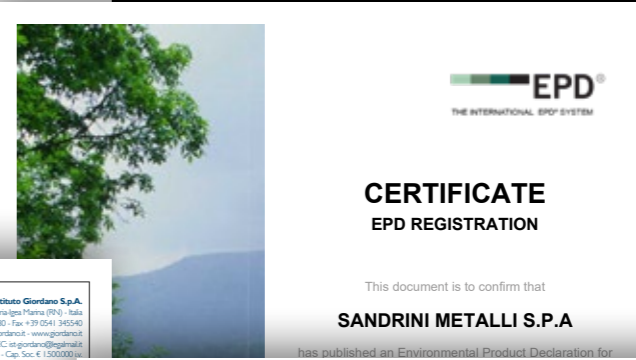
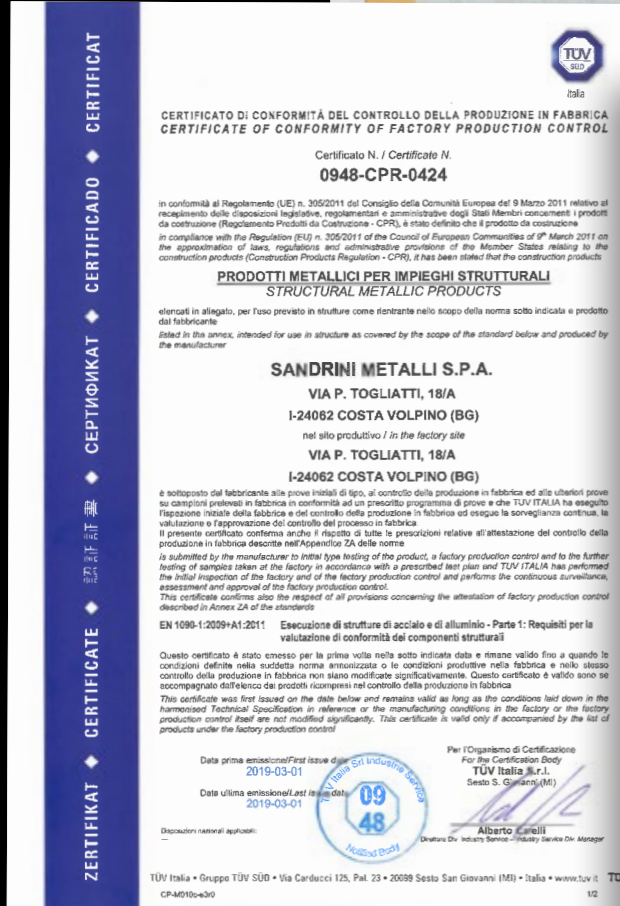

LE NOSTRE CERTIFICAZIONI OUR CERTIFICATIONS

Centro di trasformazione lamiera grecate

Transformation center for metal sheets
Consiglio Superiore dei LLPP Servizio Tecnico Centrale - Attestato nr. 1437/11 del 26/05/2011

Conformità del controllo della produzione in fabbrica EN 1090 - C €

Conformity of factory production control EN 1090 TÜV ITALIA - Certificato nr. 0948-CPR-0424

Sistema Qualità Certificato ISO 9001:2015

ISO 9001:2015 Quality management system certification - TÜV ITALIA - Certificato nr. 50 100 14090

Certificato prove di carico soletta in C.A. con lamiera collaborante SAND75

Load test certificate of composite floor with profiled metal sheet SAND75
Politecnico di Milano Dipartimento di Ingegneria Strutturale - Certificato Nr. 2011/23

Dichiarazione ambientale di prodotto EPD

Environmental Product Declaration EPD
The International EPD System - Numero di registrazione S-P-02159

Certificato prove di carico soletta in C.A. con lamiera collaborante SAND100

Load test certificate of composite floor with profiled metal sheet SAND100
ISTITUTO GIORDANO - Certificato Nr. 337242

Certificato prove di carico soletta in C.A. con lamiera collaborante SAND55

Load test certificate of composite floor with profiled metal sheet SAND55
Politecnico di Milano Dipartimento di Ingegneria Strutturale - Certificato Nr. 2011/449



DIVISIONE BUILDING

Sandrini Metalli rappresenta l'azienda di riferimento nella produzione di lamiere grecate, disponendo di una gamma completa di prodotti destinata ad ogni tipologia di utilizzo.

L'azienda dispone di 28 profili differenti, disponibili in ogni materiale e colorazione, con la possibilità di eseguire qualsiasi tipo di lavorazione di curvatura.

La flessibilità e l'attenzione al servizio, che da sempre ci contraddistinguono, rendono l'azienda il partner ideale per sviluppare e realizzare piccoli e grandi progetti.

La vicinanza ai principali nodi stradali del Nord Italia fa sì che Sandrini Metalli possa rappresentare un partner affidabile e facilmente raggiungibile sia per i clienti italiani che per quelli esteri.

Sandrini Metalli can be considered a market leader in the production of corrugated and trapezoidal sheets due to a complete range of 28 several corrugated and trapezoidal sheets for all kinds of use.

A wide assortment of products with different thicknesses, materials, colours and finishing available on stock. Specific customized products obtained through the bending process of the corrugated sheets.

The flexibility and dedication of customer service, which have always distinguished us, make Sandrini Metalli an ideal partner for big and small projects.

Thanks to the proximity to the main highways in Northern Italy, Sandrini Metalli can be easily reached by clients both in Italy and abroad.

PER RIVESTIMENTI, COPERTURE, SOLAI FOR FACADES, ROOFS, FLOORS		P.10
SAND 18		P.12
SAND 20		P.14
SAND 27		P.16
SAND 28		P.18
SAND 35		P.20
SAND 38		P.22
SAND 40/100		P.24
SAND 40/200		P.26
SAND 40/250		P.28
SAND 40/300		P.30
SAND 41		P.32
SAND 42		P.34
SAND A55 P600		P.36
SAND A55 P750		P.38
SAND A55 P800		P.40
SAND 59		P.42
SAND 65		P.44
SAND A75 P570		P.46
SAND A75 P760		P.48
SAND 100		P.50
PER SOLAI GRANDI LUCI FOR LARGE SPAN FLOORS		P.52
SAND 105 positive		P.54
SAND 105 negative		P.56
SAND 105 perforated		P.58
SAND 110 positive		P.60
SAND 110 negative		P.62
SAND 110 perforated		P.64
SAND 115 positive		P.66
SAND 115 negative		P.68
SAND 115 perforated		P.70
SAND 135 positive - end support width 100 mm - internal support width 200 mm		P.72
SAND 135 positive - end support width 225 mm - internal support width 450 mm		P.74
SAND 135 negative		P.76
SAND 135 perforated		P.78
SAND 145 positive - end support width 100 mm - internal support width 200 mm		P.80
SAND 145 positive - end support width 225 mm - internal support width 450 mm		P.82
SAND 145 negative		P.84
SAND 145 perforated		P.86
SAND 151 positive - end support width 100 mm - internal support width 200 mm		P.88
SAND 151 positive - end support width 225 mm - internal support width 450 mm		P.90
SAND 151 negative		P.92
SAND 151 perforated		P.94
SAND 153 positive - end support width 100 mm - internal support width 200 mm		P.96
SAND 153 positive - end support width 225 mm - internal support width 450 mm		P.98
SAND 153 negative		P.100
SAND 153 perforated		P.102
SAND 160 positive - end support width 100 mm - internal support width 200 mm		P.104
SAND 160 positive - end support width 225 mm - internal support width 450 mm		P.106
SAND 160 negative		P.108
SAND 160 perforated		P.110
LAVORAZIONI	PROCESSING	P.112
APPLICAZIONI	APPLICATIONS	P.114
ACCESSORI	ACCESSORIES	P.116
MATERIALI E COLORAZIONI	MATERIALS AND COLOURS	P.118

PER RIVESTIMENTI, COPERTURE, SOLAI

Nelle pagine seguenti vengono presentate, per ogni prodotto, le schede tecniche riportanti i dati geometrici e statici del profilo e le relative tabelle di portata.

The following pages present, for each product, the technical data sheets showing the geometric and static data of the profile and the relative load tables.

DATI GEOMETRICI GEOMETRIC DATA

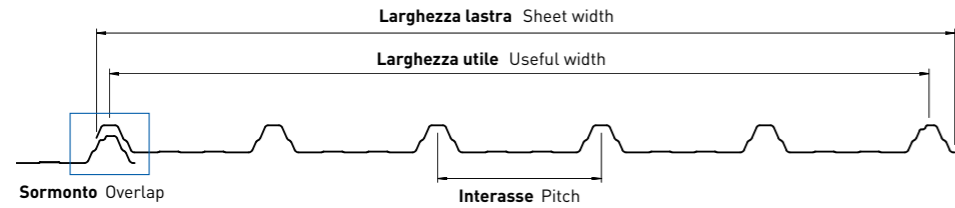

Interasse = distanza tra il centro di una greca e il centro della greca successiva;
Larghezza utile = larghezza effettiva coperta, al netto dei sormonti;
Larghezza lastra = larghezza complessiva della lastra, comprensiva delle parti di sormonto.
Per ogni profilo vengono date indicazioni sui possibili sormonti realizzabili.

Pitch = distance between the center of a rib and the center of the next rib;
 Useful width = effective covered width, net of overlaps;
 Sheet width = overall Sheet width, including Overlap parts.
 For each profile, indications are given on possible overlaps.

TABELLE DI PORTATA LOAD TABLES

Le tabelle di portata sono state calcolate in ottemperanza alla normativa EUROCODICE 3 (EN1993-1-3) per i tre schemi statici tipo: a singola campata, a campata doppia ed a campata multipla.
 I valori riportati in nero rappresentano il carico caratteristico in esercizio, con coefficiente di sicurezza applicato pari a $\gamma_q = 1,50$.
 I valori riportati in blu rappresentano il carico caratteristico in esercizio limitato da inflessione pari a 1/200 della luce "L".
NB: Le tabelle di portata fanno riferimento a materiale standard, non sottoposto a lavorazioni speciali, quali, ad esempio, la foratura.

Load tables have been calculated in compliance with the standard legislation EUROCODE 3 (EN1993-1-3) for the three static type schemes: single span, double span and multiple span.
 The values reported in black represent the serviceability load value with safety coefficient applied equal to $\gamma_q = 1,50$.
 The values reported in blue represent the serviceability load value referred at deflection limit equal to 1/200 of span "L".
 NB: The load tables refer to the standard material, not subjected to special processes, such as, for example, perforation.

TABELLE DI PORTATA – SOLAI COLLABORANTI LOAD TABLES – COMPOSITE STRUCTURAL SYSTEMS

Per le tabelle di carico relative ai solai collaboranti viene sempre considerato lo schema statico a singola campata.
 Per ogni profilo vengono riportate tre diverse tabelle, calcolate considerando tre diverse altezze del getto collaborante in cls. L'altezza H riportata in tabella è intesa come altezza totale del solaio, somma dell'altezza della lastra grecata (h_g) e di quella della cappa in cls (h_{cls}).

For the load tables related to the composite floors, the single-span static scheme is always considered. For each profile there are three different tables, calculated considering three different heights of the concrete casting.
 The height H shown in the table refers to the total height of the floor, as the sum of the metal profile's height (h_g) and the concrete hood ones (h_{cls}).

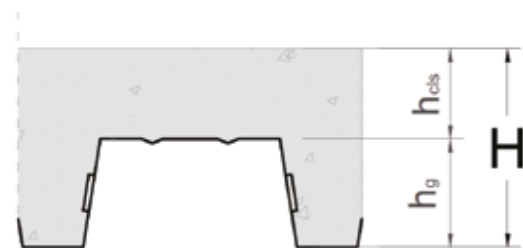

Per maggiori informazioni e dettagli su lavorazioni e applicazioni speciali consultare le pagine 112 e 114.
 For more information and details on special processes and applications, see pages 112 and 114.

FOR FACADES, ROOFS, FLOORS

Per garantire la qualità del prodotto e dell'installazione, alcuni tipi di profilo presentano due sistemi particolari:
 To guarantee the quality of the product and its installation, some types of profile have two particular systems:

SANDdry: esclusivo sistema di drenaggio rappresentato da una canaletta sulla cresta della greca, che consente di evitare eventuali infiltrazioni d'acqua anche in caso di basse pendenze.
SANDdry: an exclusive drainage system represented by a channel on the ridge of the metal sheet, which allows to avoid any water infiltration even in case of low slopes.

SANDsupport: particolare configurazione della parte terminale della lamiera, che funge da supporto per la lamiera successiva in fase di sormonto.
SANDsupport: particular configuration of the end part of the sheet, which supports the next sheet during the Overlap phase.

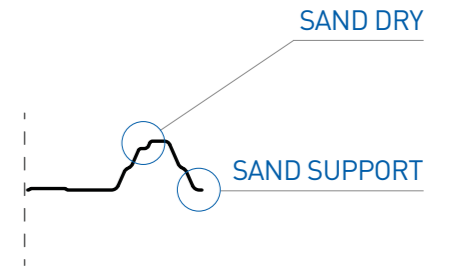

Per tutti i prodotti possono essere previste una serie di lavorazioni ed applicazioni speciali al fine di assicurare l'adattabilità a qualsiasi tipo di struttura e il raggiungimento delle prestazioni ricercate e necessarie. In particolare:
 For all products, a series of special processes and applications can be provided in order to ensure adaptability to any type of structure and the achievement of the required and necessary performance. In particular:

CURVATURA BENDING

In base alla tipologia di lamiera è possibile prevedere bending a raggio fisso, a raggio variabile (raggi di curvatura differenti, ed eventualmente intervallati da parti rette, sulla stessa lamiera) o lavorazioni a shed.
 Depending on the type of the metal sheet, it is possible to provide for fixed radius, variable radius bends (different radiuses of bending, and possibly interspersed with straight parts, on the same sheet) or shed machining.



APPLICAZIONI APPLICATIONS

È possibile prevedere applicazioni specifiche per migliorare le prestazioni del prodotto a livello igrometrico e acustico:
 It is possible to foresee specific applications to improve the product performance at hygrometric and acoustic level:

- SANDnodrip** Particolare tessuto non tessuto che permette di rendere la superficie interna della lastra molto porosa e con eccellenti proprietà di assorbimento dell'umidità, impedendo così eventuali problematiche di condensa e sgocciolamento;
 Particular non-woven felt that makes it possible to make the internal surface of the sheet very porous and with excellent moisture absorption properties, thus preventing any problems of condensation and dripping;
- SANDcontrol** Speciale tessuto non tessuto a maggiorata densità che, oltre ad evitare problematiche di condensa e sgocciolamento, consente anche di attenuare sensibilmente il rumore provocato dagli agenti atmosferici esterni.
 Special non-woven felt with higher density which, in addition to avoid condensation and dripping problems, also allows to significantly attenuate the noise caused by external atmospheric agents.

FORATURE PERFORATIONS

Tutti i profili possono essere forniti nella versione forata. La lavorazione standard prevede una foratura completa (su tutta la superficie della lastra) con la possibilità di scegliere due tipologie di foratura:
 All profiles can be supplied in the perforated version. The standard processing involves a complete perforation (on the whole surface of the slab) with the possibility of choosing two types of perforation:

- F3 P5 60°** Diametro del foro pari a 3 mm, distanza tra i centri dei fori di 5 mm ed angolo di 60°;
 Hole diameter of 3 mm, distance between the centers of the holes of 5 mm and angle of 60°;
- F5 P8 60°** Diametro del foro pari a 5 mm, distanza tra i centri dei fori di 8 mm ed angolo di 60°.
 Hole diameter of 5 mm, distance between the centers of the holes of 8 mm and angle of 60°.

Su richiesta è possibile prevedere soluzioni customizzate, quali forature regolari o irregolari, complete o parziali e con diverse tipologie di foro.
 On request it is possible to provide customized solutions, such as regular or irregular, complete or partial perforation and with different types of holes.

SAND 18

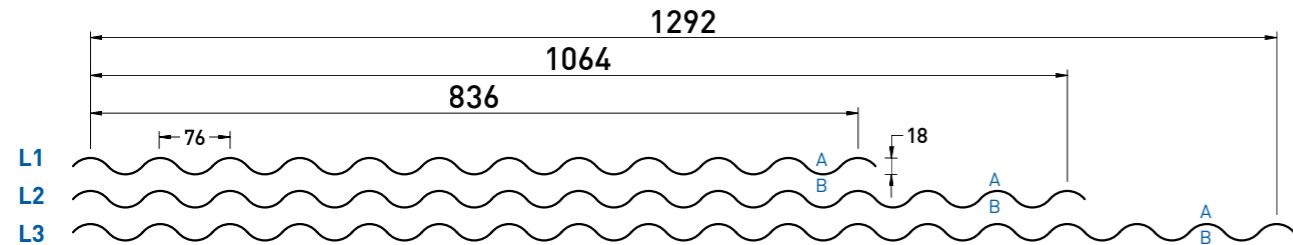

A: lato a vista - front side
B: lato non a vista - back side

	Reazione al fuoco Fire reaction CLASS A1	Comportamento al fuoco dall'esterno External fire performance Broof (t1,t2,t3)
	Senza necessità di sottoporre a prova secondo la norma UNI EN 14782:2006. No lab test is required as per UNI EN 14782:2006.	

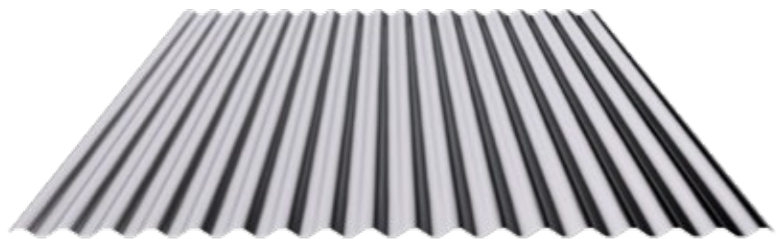

Sp. Th. (mm)	Jy (cm ² /m)	DATI STATICI		PESO		WEIGHT	
		We inf (cm ³ /m)	We sup (cm ³ /m)	Steel Kg/m ²	Aluminium Kg/m ²		
0,50	1,87	2,08	2,08	4,35	1,50		
0,60	2,24	2,49	2,49	5,22	1,80		
0,70	2,61	2,90	2,90	6,09	2,10		
0,80	3,00	3,33	3,33	6,96	2,40		
1,00	4,13	4,59	4,59	8,70	3,00		
1,20	4,83	5,37	5,37	10,44	3,59		

CURVATURA BENDING

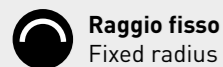

Raggio fisso
Fixed radius

APPLICAZIONI APPLICATIONS

- SANDnodrip**
Class A2 - s1, d0 Broof (t1,t2,t3)
- SANDcontrol**
Class C - s1, d0 Broof (t1,t2,t3)

FORATURE PERFORATION

- F3 P5 60°**
- F5 P8 60°**

Per maggiori dettagli consultare pagine 112-114

For more details see pages 112-114

PROFILO PROFILE	NR. GRECHE RIBS NO.	INTERASSE (mm) PITCH (mm)	LARGH. UTILE (mm) USEFUL WIDTH (mm)	LARGH. LASTRA (mm) SHEET WIDTH (mm)	SORMONTO OVERLAP	TIPO SORMONTO KIND OF OVERLAP
L1	SAND 18	12	76	836	900	7.66 %
L2	SAND 18	15	76	1064	1128	6.02 %
L3	SAND 18	18	76	1292	1356	4.95 %

Accessori, materiali e colorazioni sono consultabili alle pagine 116-118

Accessories, materials and colors are available on pages 116-118

SAND 18

Tabelle di portata (daN/m²) Load tables (daN/sqm)

steel S250GD

Sp. Th. mm	Larghezza appoggio: 100 mm Support width: 100 mm																				
	L=m	CAMPATA SINGOLA									SINGLE SPAN										
q=daN/m ²	0,80	1,00	1,20	1,40	1,60	1,80	2,00	2,20	2,40	2,60	2,80	3,00	3,20	3,40	3,60	3,80	4,00	4,20	4,40	4,60	
0,50	285	140	80																		
0,60	340	170	95	55																	
0,70	390	195	110	65																	
0,80	470	235	135	80	50																
1,00	635	315	175	105	65																
1,20	735	365	210	125	80	50															
1,50																					

Sp. Th. mm	Larghezza appoggio: 100 mm Support width: 100 mm																				
	L=m	CAMPATA DOPPIA									DOUBLE SPAN										
q=daN/m ²	0,80	1,00	1,20	1,40	1,60	1,80	2,00	2,20	2,40	2,60	2,80	3,00	3,20	3,40	3,60	3,80	4,00	4,20	4,40	4,60	
0,50	260	180	130	100	75	55															
0,60	350	240	175	130	95	65															
0,70	430	295	210	160	110	75	55														
0,80	550	375	260	190	135	90	65														
1,00	790	510	350	255	185	125	90	65													
1,20	920	600	410	300	225	155	110	80	60												
1,50																					

Sp. Th. mm	Larghezza appoggio: 100 mm Support width: 100 mm																				
	L=m	CAMPATA MULTIPLA									MULTIPLE SPAN										
q=daN/m ²	0,80	1,00	1,20	1,40	1,60	1,80	2,00	2,20	2,40	2,60	2,80	3,00	3,20	3,40	3,60	3,80	4,00	4,20	4,40	4,60	
0,50	300	205	155	100	65																
0,60	400	275	200	125	80	55															
0,70	490	340	230	145	95	65															
0,80	635	425	280	175	115	75	55														
1,00	920	595	375	235	155	105	75	50													
1,20	1080	700	420	260	170	120	80	60													
1,50																					

In azzurro i carichi limitati da freccia 1/200 L. Values in blue show load limited by vertical deflection 1/200 L.

Calcoli eseguiti in ottemperanza alla normativa EUROCODICE 3 (EN 1993-1-3). Il carico riportato va inteso come valore caratteristico di portata, con coefficiente di combinazione applicato $\gamma_f=1,5$. I valori riportati in tabella sono da considerarsi come indicativi, è competenza del progettista procedere per i singoli casi di verifica al relativo calcolo. Calculations are made in accordance with EUROCODE 3 (EN 1993-1-3). The load reported shall be understood as the characteristic load value, with the coefficient of combination applied $\gamma_f=1,5$. The values shown in the table must be considered as indicative, the designer has the responsibility to proceed with the relative calculation in any individual cases.

aluminium series 3000

Sp. Th. mm	Larghezza appoggio: 100 mm Support width: 100 mm																				
	L=m	CAMPATA SINGOLA									SINGLE SPAN										
q=daN/m ²	0,80	1,00	1,20	1,40	1,60	1,80	2,00	2,20	2,40	2,60	2,80	3,00	3,20	3,40	3,60	3,80	4,00	4,20	4,40	4,60	
0,50	95	50																			
0,60	115	60																			
0,70	135	70																			
0,80	155	80																			
1,00	215	110	60																		
1,20	250	130	75																		
1,50																					

Sp. Th. mm	Larghezza appoggio: 100 mm Support width: 100 mm																				
	L=m	CAMPATA DOPPIA									DOUBLE SPAN										
q=daN/m ²	0,80	1,00	1,20	1,40	1,60	1,80	2,00	2,20	2,40	2,60	2,80	3,00	3,20	3,40	3,60	3,80	4,00	4,20	4,40	4,60	
0,50	230	120	70																		
0,60	245	145	80	50																	
0,70	305	170	95	60																	
0,80	375	190	110	70																	
1,00	520	265	150	95	65																
1,20	605	310	180	110	75																
1,50																					

Sp. Th. mm	Larghezza appoggio: 100 mm Support width: 100 mm																				
	L=m	CAMPATA MULTIPLA									MULTIPLE SPAN										
q=daN/m ²	0,80	1,00	1,20	1,40	1,60	1,80	2,00	2,20	2,40	2,60	2,80	3,00	3,20	3,40	3,60	3,80	4,00	4,20	4,40	4,60	
0,50	190	95	55																		
0,60	225	115	65																		
0,70	255	135	75																		
0,80	300	155	90	55																	
1,00	410	210	120	75	55																
1,20	480	250	145	90	60																
1,50																					

In azzurro i carichi limitati da freccia 1/200 L. Values in blue show load limited by vertical deflection 1/200 L.

Calcoli eseguiti in ottemperanza alla normativa EUROCODICE 3 (EN 1993-1-3). Il carico riportato va inteso come valore caratteristico di portata, con coefficiente di combinazione applicato $\gamma_f=1,5$. I valori riportati in tabella sono da considerarsi come indicativi, è competenza del progettista procedere per i singoli casi di verifica al relativo calcolo. Calculations are made in accordance with EUROCODE 3 (EN 1993-1-3). The load reported shall be understood as the characteristic load value, with the coefficient of combination applied $\gamma_f=1,5$. The values shown in the table must be considered as indicative, the designer has the responsibility to proceed with the relative calculation in any individual cases.

SAND 20

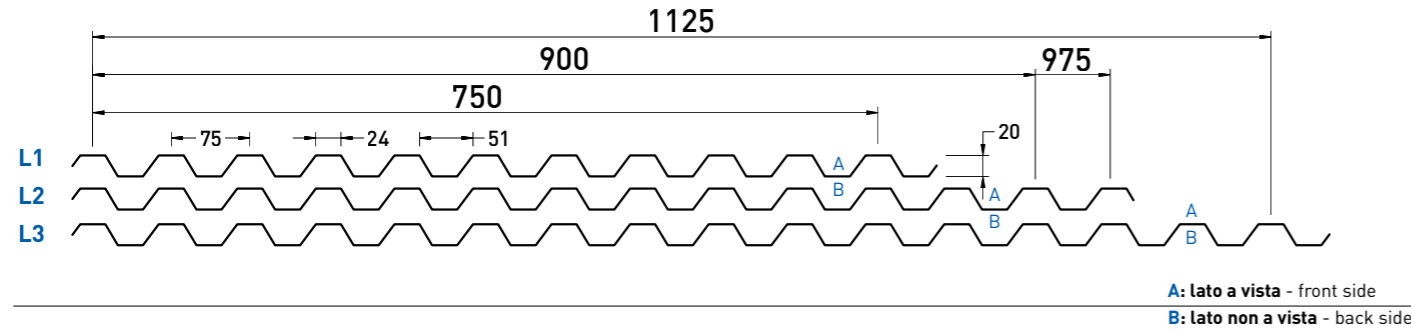

Reazione al fuoco Fire reaction CLASS A1 **Comportamento al fuoco dall'esterno External fire performance Broof (t1,t2,t3)**

Senza necessità di sottoporre a prova secondo la norma UNI EN 14782:2006. No lab test is required as per UNI EN 14782:2006.



Sp. Th. (mm)	DATI STATICI / STATIC DATA			PESO / WEIGHT	
	Jy (cm ² /m)	We inf (cm ³ /m)	We sup (cm ³ /m)	Steel Kg/m ²	Aluminium Kg/m ²
0,50	3,69	3,69	3,69	4,84	1,67
0,60	4,30	4,30	4,30	5,81	2,00
0,70	4,86	4,86	4,86	6,78	2,33
0,80	5,38	5,38	5,38	7,75	2,67
1,00	6,30	6,30	6,30	9,69	3,33
1,20	7,06	7,06	7,06	11,62	4,00

CURVATURA BENDING

- Raggio fisso / Fixed radius
- Variabile / Variable
- Shed / Shed

APPLICAZIONI APPLICATIONS

- SANDnodrip**
Class A2 - s1, d0 🔥 Broof (t1,t2,t3)
- SANDcontrol**
Class C - s1, d0 🔥 Broof (t1,t2,t3)

FORATURE PERFORATION

- F3 P5 60°**
- F5 P8 60°**

Per maggiori dettagli consultare pagine 112-114

For more details see pages 112-114

PROFILO / PROFILE	NR. GRECHE / RIBS NO.	INTERASSE (mm) / PITCH (mm)	LARGH. UTILE (mm) / USEFUL WIDTH (mm)	LARGH. LASTRA (mm) / SHEET WIDTH (mm)	SORMONTO / OVERLAP	TIPO SORMONTO / KIND OF OVERLAP
L1	SAND 20	11	75	750	8.00%	
			900	12.56%		
L2	SAND 20	14	75	937*	8.11%	
			75	975**	3.90%	
L3	SAND 20	16	75	1125	7.73%	

Accessori, materiali e colorazioni sono consultabili alle pagine 116-118

Accessories, materials and colors are available on pages 116-118

* Particolare sormonto ottenuto in fase d'opera alterando l'installazione di una lamiera grecata normale ad una capovolta. Consigliato solo per materiali con la stessa finitura su entrambi i lati.
** Sormonto che non svolge funzione di tenuta all'acqua.

* Particular overlap obtained during the lay by alternating the installation of a normal profiled sheet with an inverted one. Recommended only for materials with the same finish on both sides.
** Overlap that does not perform a water-tight function.

SAND 20

Tabelle di portata (daN/m²) Load tables (daN/sqm)

steel S250GD

Sp. Th. (mm)	Larghezza appoggio: 100 mm / Support width: 100 mm																						
	L=m	0,80	1,00	1,20	1,40	1,60	1,80	2,00	2,20	2,40	2,60	2,80	3,00	3,20	3,40	3,60	3,80	4,00	4,20	4,40	4,60		
0,50	583	294	166	102	64																		
0,60	706	358	203	123	80	54																	
0,70	808	407	230	144	91	64																	
0,80	893	455	257	161	102	70																	
1,00	1049	530	300	187	118	80	54																
1,20	1177	594	337	209	134	91	59																
1,50																							

Sp. Th. (mm)	Larghezza appoggio: 100 mm / Support width: 100 mm																						
	L=m	0,80	1,00	1,20	1,40	1,60	1,80	2,00	2,20	2,40	2,60	2,80	3,00	3,20	3,40	3,60	3,80	4,00	4,20	4,40	4,60		
0,50	642	423	310	225	171	118	80	59															
0,60	797	524	385	284	203	139	102	75	54														
0,70	920	605	492	358	235	161	118	86	64														
0,80	1022	669	551	396	262	182	128	96	70	54													
1,00	1198	786	663	465	305	209	150	107	80	59													
1,20	1343	883	760	519	342	235	166	123	91	70	54												
1,50																							

Sp. Th. (mm)	Larghezza appoggio: 100 mm / Support width: 100 mm																						
	L=m	0,80	1,00	1,20	1,40	1,60	1,80	2,00	2,20	2,40	2,60	2,80	3,00	3,20	3,40	3,60	3,80	4,00	4,20	4,40	4,60		
0,50	803	530	321	198	134	91	64																
0,60	995	653	391	241	161	107	75	54															
0,70	1156	760	449	278	182	128	91	64															
0,80	1279	840	498	310	203	139	96	70	54														
1,00	1498	984	583	364	235	161	118	86	59														
1,20	1685	1107	653	407	268	182	128	91	70														
1,50																							

In azzurro i carichi limitati da freccia 1/200 L. Values in blue show load limited by vertical deflection 1/200 L. Calcoli eseguiti in ottemperanza alla normativa EUROCODICE 3 (EN 1993-1-3). Il carico riportato va inteso come valore caratteristico di portata, con coefficiente di combinazione applicato $\gamma_c=1.5$. I valori riportati in tabella sono da considerarsi come indicativi, è competenza del progettista procedere per i singoli casi di verifica al relativo calcolo. Calculations are made in accordance with EUROCODE 3 (EN 1993-1-3). The load reported shall be understood as the characteristic load value, with the coefficient of combination applied $\gamma_c=1.5$. The values shown in the table must be considered as indicative, the designer has the responsibility to proceed with the relative calculation in any individual cases.

aluminium alloy 3003

Sp. Th. (mm)	Larghezza appoggio: 100 mm / Support width: 100 mm																						
	L=m	0,80	1,00	1,20	1,40	1,60	1,80	2,00	2,20	2,40	2,60	2,80	3,00	3,20	3,40	3,60	3,80	4,00	4,20	4,40	4,60		
0,50	198	96	54																				
0,60	230	118	64																				
0,70	262	134	75																				
0,80	294	150	86																				
1,00	342	171	96	59																			
1,20	391	198	112	70																			
1,50																							

Sp. Th. (mm)	Larghezza appoggio: 100 mm / Support width: 100 mm																						
	L=m	0,80	1,00	1,20	1,40	1,60	1,80	2,00	2,20	2,40	2,60	2,80	3,00	3,20	3,40	3,60	3,80	4,00	4,20	4,40	4,60		
0,50	417	241	139	86	59																		
0,60	519	284	161	102	64																		
0,70	626	321	187	118	75	54																	
0,80	706	358	209	128	86	59																	
1,00	835	428	246	150	102	70																	
1,20	947	482	273	171	112	75	54																
1,50																							

Sp. Th. (mm)	Larghezza appoggio: 100 mm / Support width: 100 mm																						
	L=m	0,80	1,00	1,20	1,40	1,60	1,80	2,00	2,20	2,40	2,60	2,80	3,00	3,20	3,40	3,60	3,80	4,00	4,20	4,40	4,60		
0,50	369	187	107	64																			
0,60	433	225	128	80	54																		
0,70	498	251	144	91	59																		
0,80	556	284	161	102	64																		
1,00	658	332	193	118	75	54																	
1,20	744	375	214	134	86	59																	
1,50																							

In azzurro i carichi limitati da freccia 1/200 L. Values in blue show load limited by vertical deflection 1/200 L. Calcoli eseguiti in ottemperanza alla normativa EUROCODICE 3 (EN 1993-1-3). Il carico riportato va inteso come valore caratteristico di portata, con coefficiente di combinazione applicato $\gamma_c=1.5$. I valori riportati in tabella sono da considerarsi come indicativi, è competenza del progettista procedere per i singoli casi di verifica al relativo calcolo. Calculations are made in accordance with EUROCODE 3 (EN 1993-1-3). The load reported shall be understood as the characteristic load value, with the coefficient of combination applied $\gamma_c=1.5$. The values shown in the table must be considered as indicative, the designer has the responsibility to proceed with the relative calculation in any individual cases.

SAND 27

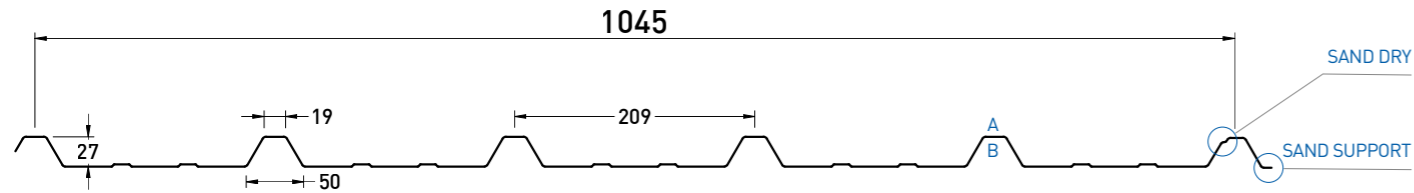

A: lato a vista - front side
B: lato non a vista - back side

Reazione al fuoco Fire reaction CLASS A1 **Comportamento al fuoco dall'esterno External fire performance Broof (t1,t2,t3)**

Senza necessità di sottoporre a prova secondo la norma UNI EN 14782:2006. No lab test is required as per UNI EN 14782:2006.



Sp. Th. (mm)	Jy (cm ² /m)	STATI STATICI / STATIC DATA		PESO / WEIGHT	
		We inf (cm ³ /m)	We sup (cm ³ /m)	Steel Kg/m ²	Aluminium Kg/m ²
0,50	4,02	7,10	1,98	4,38	1,51
0,60	4,70	8,26	2,31	5,26	1,81
0,70	5,33	9,34	2,63	6,13	2,11
0,80	5,92	10,34	2,92	7,01	2,41
1,00	6,99	12,11	3,46	8,76	3,01
1,20	7,91	13,60	3,92	10,51	3,62

CURVATURA BENDING

- Raggio fisso**
Fixed radius
- Variabile**
Variable

APPLICAZIONI APPLICATIONS

- SANDnodrip**
Class A2 - s1, d0 Broof (t1,t2,t3)
- SANDcontrol**
Class C - s1, d0 Broof (t1,t2,t3)

FORATURE PERFORATION

- F3 P5 60°**
- F5 P8 60°**

Per maggiori dettagli consultare pagine 112-114

For more details see pages 112-114

PROFILO / PROFILE	NR. GRECHE / RIBS NO.	INTERASSE (mm) / PITCH (mm)	LARGH. UTILE (mm) / USEFUL WIDTH (mm)	LARGH. LASTRA (mm) / SHEET WIDTH (mm)	SORMONTO / OVERLAP	TIPO SORMONTO / KIND OF OVERLAP
SAND 27	6	209	1045	1120	7.18%	

Accessori, materiali e colorazioni sono consultabili alle pagine 116-118

Accessories, materials and colors are available on pages 116-118

SAND 27

Tabelle di portata (daN/m²) Load tables (daN/sqm)

steel S250GD

Sp. Th. (mm)	Larghezza appoggio: 100 mm / Support width: 100 mm																				
	L=m	0,80	1,00	1,20	1,40	1,60	1,80	2,00	2,20	2,40	2,60	2,80	3,00	3,20	3,40	3,60	3,80	4,00	4,20	4,40	4,60
0,50	404	257	173	116	74	53															
0,60	520	331	221	137	89	58															
0,70	599	383	252	158	100	68															
0,80	677	431	278	173	110	74	53														
1,00	824	525	331	205	131	89	63														
1,20	935	593	373	231	152	100	68														
1,50																					

Sp. Th. (mm)	Larghezza appoggio: 100 mm / Support width: 100 mm																				
	L=m	0,80	1,00	1,20	1,40	1,60	1,80	2,00	2,20	2,40	2,60	2,80	3,00	3,20	3,40	3,60	3,80	4,00	4,20	4,40	4,60
0,50	368	263	200	152	126	100	84	68	53												
0,60	473	336	252	200	158	131	105	84	63												
0,70	562	404	305	236	189	152	126	95	68	53											
0,80	651	467	352	273	215	173	142	105	79	58											
1,00	824	588	436	336	268	215	168	121	89	68	53										
1,20	992	688	509	389	310	252	189	137	105	79	58										
1,50																					

Sp. Th. (mm)	Larghezza appoggio: 100 mm / Support width: 100 mm																				
	L=m	0,80	1,00	1,20	1,40	1,60	1,80	2,00	2,20	2,40	2,60	2,80	3,00	3,20	3,40	3,60	3,80	4,00	4,20	4,40	4,60
0,50	452	320	242	189	147	100	74	53													
0,60	572	410	310	242	173	121	84	63													
0,70	683	494	373	294	200	137	100	74	53												
0,80	793	572	431	336	221	152	110	79	58												
1,00	1013	725	546	394	263	179	126	95	68	53											
1,20	1218	866	641	446	294	205	147	105	79	58											
1,50																					

In azzurro i carichi limitati da freccia 1/200 L. Values in blue show load limited by vertical deflection 1/200 L. Calcoli eseguiti in ottemperanza alla normativa EUROCODICE 3 (EN 1993-1-3). Il carico riportato va inteso come valore caratteristico di portata, con coefficiente di combinazione applicato $\gamma_f=1.5$. I valori riportati in tabella sono da considerarsi come indicativi, è competenza del progettista procedere per i singoli casi di verifica al relativo calcolo. Calculations are made in accordance with EUROCODE 3 (EN 1993-1-3). The load reported shall be understood as the characteristic load value, with the coefficient of combination applied $\gamma_f=1.5$. The values shown in the table must be considered as indicative, the designer has the responsibility to proceed with the relative calculation in any individual cases.

aluminium alloy 3003

Sp. Th. (mm)	Larghezza appoggio: 100 mm / Support width: 100 mm																				
	L=m	0,80	1,00	1,20	1,40	1,60	1,80	2,00	2,20	2,40	2,60	2,80	3,00	3,20	3,40	3,60	3,80	4,00	4,20	4,40	4,60
0,50	205	105	58																		
0,60	247	126	68																		
0,70	284	142	79																		
0,80	315	158	89	58																	
1,00	378	189	110	68																	
1,20	431	215	121	74																	
1,50																					

Sp. Th. (mm)	Larghezza appoggio: 100 mm / Support width: 100 mm																				
	L=m	0,80	1,00	1,20	1,40	1,60	1,80	2,00	2,20	2,40	2,60	2,80	3,00	3,20	3,40	3,60	3,80	4,00	4,20	4,40	4,60
0,50	252	173	131	89	58																
0,60	315	221	163	110	74																
0,70	383	268	200	126	84	58															
0,80	452	315	226	142	95	63															
1,00	567	399	268	168	110	74	53														
1,20	672	467	305	189	126	84	63														
1,50																					

Sp. Th. (mm)	Larghezza appoggio: 100 mm / Support width: 100 mm																				
	L=m	0,80	1,00	1,20	1,40	1,60	1,80	2,00	2,20	2,40	2,60	2,80	3,00	3,20	3,40	3,60	3,80	4,00	4,20	4,40	4,60
0,50	305	200	116	74																	
0,60	389	236	137	84	58																
0,70	473	273	158	95	63																
0,80	557	305	173	110	74																
1,00	704	368	210	131	84	58															
1,20	819	415	236	147	95	68															
1,50																					

In azzurro i carichi limitati da freccia 1/200 L. Values in blue show load limited by vertical deflection 1/200 L. Calcoli eseguiti in ottemperanza alla normativa EUROCODICE 3 (EN 1993-1-3). Il carico riportato va inteso come valore caratteristico di portata, con coefficiente di combinazione applicato $\gamma_f=1.5$. I valori riportati in tabella sono da considerarsi come indicativi, è competenza del progettista procedere per i singoli casi di verifica al relativo calcolo. Calculations are made in accordance with EUROCODE 3 (EN 1993-1-3). The load reported shall be understood as the characteristic load value, with the coefficient of combination applied $\gamma_f=1.5$. The values shown in the table must be considered as indicative, the designer has the responsibility to proceed with the relative calculation in any individual cases.

SAND 28

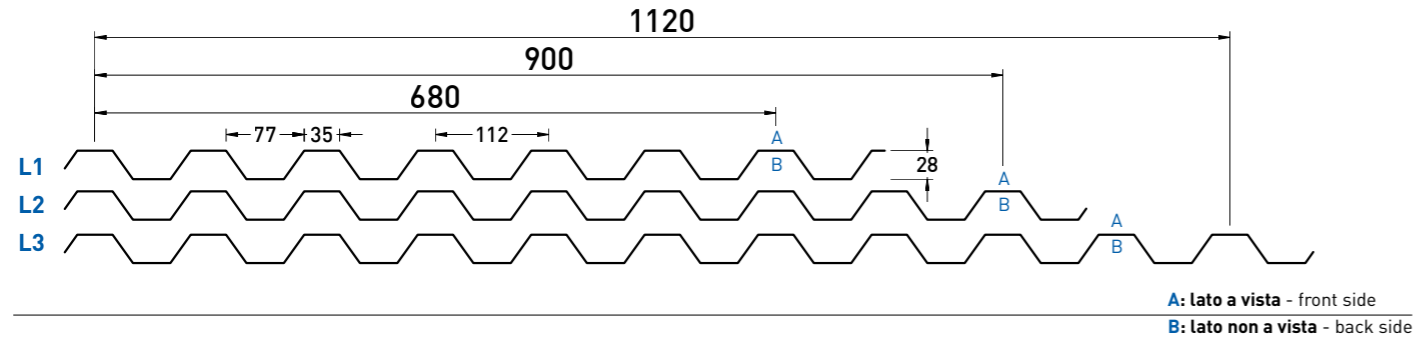

Reazione al fuoco Fire reaction CLASS A1 **Comportamento al fuoco dall'esterno External fire performance Broof (t1,t2,t3)**

Senza necessità di sottoporre a prova secondo la norma UNI EN 14782:2006. No lab test is required as per UNI EN 14782:2006.



Sp. Th. (mm)	DATI STATICI		STATIC DATA		PESO		WEIGHT	
	Jy (cm ² /m)	We inf (cm ³ /m)	We sup (cm ³ /m)	Steel Kg/m ²	Aluminium Kg/m ²			
0,50	7,57	5,32	5,32	4,86	1,67			
0,60	9,22	6,22	6,22	5,83	2,00			
0,70	10,70	7,08	7,08	6,80	2,34			
0,80	12,35	7,89	7,89	7,77	2,67			
1,00	15,64	9,36	9,36	9,72	3,34			
1,20	18,12	10,65	10,65	11,66	4,01			

CURVATURA BENDING

- Raggio fisso**
Fixed radius
- Variabile**
Variable
- Shed**
Shed

APPLICAZIONI APPLICATIONS

- SANDnodrip**
Class A2 - s1, d0 Broof (t1,t2,t3)
- SANDcontrol**
Class C - s1, d0 Broof (t1,t2,t3)

FORATURE PERFORATION

- F3 P5 60°**
- F5 P8 60°**

Per maggiori dettagli consultare pagine 112-114

For more details see pages 112-114

PROFILO PROFILE	NR. GRECHE RIBS NO.	INTERASSE (mm) PITCH (mm)	LARGH. UTILE (mm) USEFUL WIDTH (mm)	LARGH. LASTRA (mm) SHEET WIDTH (mm)	SORMONTO OVERLAP	TIPO SORMONTO KIND OF OVERLAP
L1 SAND 28	7	112	680	810	19,12%	
L2 SAND 28	9	112	900	1010	12,22%	
L3 SAND 28	11	112	1120	1231	9,91%	

Accessori, materiali e colorazioni sono consultabili alle pagine 116-118

Accessories, materials and colors are available on pages 116-118

SAND 28

Tabelle di portata (daN/m²) Load tables (daN/sqm)

steel S250GD

Sp. Th. mm	Larghezza appoggio: 100 mm Support width: 100 mm																					
	L=m	0,80	1,00	1,20	1,40	1,60	1,80	2,00	2,20	2,40	2,60	2,80	3,00	3,20	3,40	3,60	3,80	4,00	4,20	4,40	4,60	
0,50	800	510	300	185	120	85	60															
0,60	1010	630	360	225	145	100	70	50														
0,70	1225	735	425	265	175	120	85	60														
0,80	1440	845	485	300	200	135	95	70	50													
1,00	1840	1045	600	375	245	170	120	85	65	50												
1,20	2090	1190	680	425	280	190	135	100	75	55												
1,50																						

Sp. Th. mm	Larghezza appoggio: 100 mm Support width: 100 mm																					
	L=m	0,80	1,00	1,20	1,40	1,60	1,80	2,00	2,20	2,40	2,60	2,80	3,00	3,20	3,40	3,60	3,80	4,00	4,20	4,40	4,60	
0,50	615	425	315	240	185	145	120	100	85	65	50											
0,60	785	545	400	300	235	195	155	125	100	80	60	50										
0,70	960	665	485	365	285	235	190	155	120	95	70	55										
0,80	1135	785	575	430	330	280	225	185	140	105	85	65	50									
1,00	1485	1025	730	545	425	390	305	225	170	130	105	80	65	50								
1,20	1755	1165	830	620	480	450	345	255	195	150	115	95	75	60	50							
1,50																						

Sp. Th. mm	Larghezza appoggio: 100 mm Support width: 100 mm																					
	L=m	0,80	1,00	1,20	1,40	1,60	1,80	2,00	2,20	2,40	2,60	2,80	3,00	3,20	3,40	3,60	3,80	4,00	4,20	4,40	4,60	
0,50	803	556	412	316	251	177	128	91	70	54												
0,60	1022	712	524	401	305	214	150	112	86	64												
0,70	1252	867	642	492	358	251	177	133	102	75	59											
0,80	1487	1033	760	572	412	284	203	150	112	86	70	54										
1,00	1947	1348	979	733	508	353	257	187	139	107	86	64	54									
1,20	2306	1562	1113	835	578	401	289	214	161	123	96	75	59									
1,50																						

In azzurro i carichi limitati da freccia 1/200 L. Values in blue show load limited by vertical deflection 1/200 L.

Calcoli eseguiti in ottemperanza alla normativa EUROCODICE 3 (EN 1993-1-3). Il carico riportato va inteso come valore caratteristico di portata, con coefficiente di combinazione applicato $\gamma_f=1,5$. I valori riportati in tabella sono da considerarsi come indicativi, è competenza del progettista procedere per i singoli casi di verifica al relativo calcolo. Calculations are made in accordance with EUROCODE 3 (EN 1993-1-3). The load reported shall be understood as the characteristic load value, with the coefficient of combination applied $\gamma_f=1,5$. The values shown in the table must be considered as indicative, the designer has the responsibility to proceed with the relative calculation in any individual cases.

aluminium alloy 3003

Sp. Th. mm	Larghezza appoggio: 100 mm Support width: 100 mm																					
	L=m	0,80	1,00	1,20	1,40	1,60	1,80	2,00	2,20	2,40	2,60	2,80	3,00	3,20	3,40	3,60	3,80	4,00	4,20	4,40	4,60	
0,50	360	185	105	65																		
0,60	425	220	125	80	50																	
0,70	485	250	145	90	60																	
0,80	545	280	160	100	65																	
1,00	660	335	195	120	80	55																
1,20	755	385	220	140	90	60																
1,50																						

Sp. Th. mm	Larghezza appoggio: 100 mm Support width: 100 mm																					
	L=m	0,80	1,00	1,20	1,40	1,60	1,80	2,00	2,20	2,40	2,60	2,80	3,00	3,20	3,40	3,60	3,80	4,00	4,20	4,40	4,60	
0,50	420	285	205	155	105	75	55															
0,60	530	360	260	190	125	90	65															
0,70	645	435	315	220	145	100	75	55														
0,80	760	510	370	245	165	115	80	60														
1,00	990	665	470	295	195	135	100	70	55													
1,20	1210	815	540	340	225	155	110	85	60	50												
1,50																						

Sp. Th. mm	Larghezza appoggio: 100 mm Support width: 100 mm																					
	L=m	0,80	1,00	1,20	1,40	1,60	1,80	2,00	2,20	2,40	2,60	2,80	3,00	3,20	3,40	3,60	3,80	4,00	4,20	4,40	4,60	
0,50	541	368	210	131	89	63																
0,60	683	431	252	158	105	74	53															
0,70	830	494	289	179	121	84	58															
0,80	977	557	320	205	137	95	68															
1,00	1281	672	389	242	163	110	79	58														
1,20	1502	772	446	278	184	126	89	68	53													
1,50																						

In azzurro i carichi limitati da freccia 1/200 L. Values in blue show load limited by vertical deflection 1/200 L.

Calcoli eseguiti in ottemperanza alla normativa EUROCODICE 3 (EN 1993-1-3). Il carico riportato va inteso come valore caratteristico di portata, con coefficiente di combinazione applicato $\gamma_f=1,5$. I valori riportati in tabella sono da considerarsi come indicativi, è competenza del progettista procedere per i singoli casi di verifica al relativo calcolo. Calculations are made in accordance with EUROCODE 3 (EN 1993-1-3). The load reported shall be understood as the characteristic load value, with the coefficient of combination applied $\gamma_f=1,5$. The values shown in the table must be considered as indicative, the designer has the responsibility to proceed with the relative calculation in any individual cases.

SAND 35

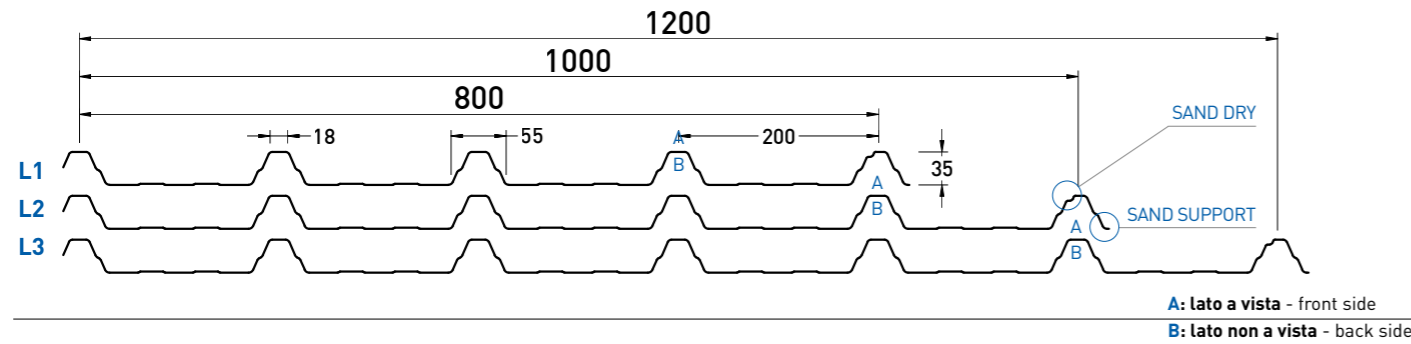

Reazione al fuoco Fire reaction CLASS A1 **Comportamento al fuoco dall'esterno External fire performance Broof (t1,t2,t3)**

Senza necessità di sottoporre a prova secondo la norma UNI EN 14782:2006. No lab test is required as per UNI EN 14782:2006.

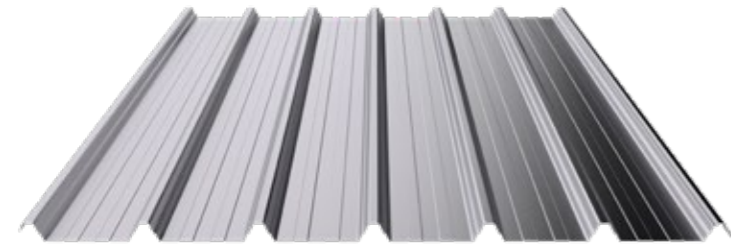

Sp. Th. (mm)	Jy (cm ² /m)	STATI STATICI		Steel Kg/m ²	Aluminium Kg/m ²
		We inf (cm ³ /m)	We sup (cm ³ /m)		
0,50	7,89	9,34	3,09	4,69	1,61
0,60	9,24	10,92	3,62	5,62	1,93
0,70	10,52	12,41	4,12	6,56	2,26
0,80	11,72	13,81	4,59	7,50	2,58
1,00	13,93	16,35	5,47	9,37	3,22
1,20	15,86	18,56	6,23	11,25	3,87

CURVATURA BENDING

- Raggio fisso**
Fixed radius
- Variabile**
Variable

APPLICAZIONI APPLICATIONS

- SANDnodrip**
Class A2 - s1, d0 Broof (t1,t2,t3)
- SANDcontrol**
Class C - s1, d0 Broof (t1,t2,t3)

FORATURE PERFORATION

- F3 P5 60°**
- F5 P8 60°**

Per maggiori dettagli consultare pagine 112-114

For more details see pages 112-114

PROFILO PROFILE	NR. GRECHE RIBS NO.	INTERASSE (mm) PITCH (mm)	LARGH. UTILE (mm) USEFUL WIDTH (mm)	LARGH. LASTRA (mm) SHEET WIDTH (mm)	SORMONTO OVERLAP	TIPO SORMONTO KIND OF OVERLAP
L1	SAND 35	5	200	800	836	4,50%
L2	SAND 35	6	200	1000	1047	4,70%
L3	SAND 35	7	200	1200	1253	4,42%

Accessori, materiali e colorazioni sono consultabili alle pagine 116-118

Accessories, materials and colors are available on pages 116-118

SAND 35

Tabelle di portata (daN/m²) Load tables (daN/sqm)

steel S250GD

Sp. Th. mm	Larghezza appoggio: 100 mm Support width: 100 mm																			
	L=m	CAMPATA SINGOLA SINGLE SPAN																		
0,50	595	380	260	190	145	100	70	50												
0,60	1095	700	425	265	175	120	85	60												
0,70	1265	805	480	300	200	135	95	70	50											
0,80	1425	910	535	335	220	150	110	80	60											
1,00	1735	1110	640	395	260	180	130	95	70	50										
1,20	2030	1265	725	450	300	205	145	105	80	60										
1,50																				

Sp. Th. mm	Larghezza appoggio: 100 mm Support width: 100 mm																			
	L=m	CAMPATA DOPPIA DOUBLE SPAN																		
0,50	462	330	253	198	160	132	110	94	77	66	55									
0,60	578	413	314	248	198	160	132	110	94	83	72	61								
0,70	699	501	374	297	237	193	160	132	110	94	83	72	61							
0,80	820	583	440	347	270	220	182	149	127	110	94	83	66	55						
1,00	1062	759	561	429	336	275	226	187	160	138	121	99	77	61						
1,20	1304	902	660	506	402	325	270	226	193	165	138	110	88	72	55					
1,50																				

Sp. Th. mm	Larghezza appoggio: 100 mm Support width: 100 mm																			
	L=m	CAMPATA MULTIPLA MULTIPLE SPAN																		
0,50	612	444	336	264	210	174	150	126	96	72										
0,60	768	552	420	330	264	216	186	150	114	84	66									
0,70	930	666	504	396	318	264	216	168	126	96	78	60								
0,80	1092	780	588	462	372	300	246	192	144	108	84	66								
1,00	1422	1014	762	588	462	378	306	228	168	132	102	78	66							
1,20	1752	1230	906	696	546	444	348	258	192	150	114	90	72	60						
1,50																				

In azzurro i carichi limitati da freccia 1/200 L. Values in blue show load limited by vertical deflection 1/200 L.

Calcoli eseguiti in ottemperanza alla normativa EUROCODICE 3 (EN 1993-1-3). Il carico riportato va inteso come valore caratteristico di portata, con coefficiente di combinazione applicato $\gamma_f=1,5$. I valori riportati in tabella sono da considerarsi come indicativi, è competenza del progettista procedere per i singoli casi di verifica al relativo calcolo. Calculations are made in accordance with EUROCODE 3 (EN 1993-1-3). The load reported shall be understood as the characteristic load value, with the coefficient of combination applied $\gamma_f=1,5$. The values shown in the table must be considered as indicative, the designer has the responsibility to proceed with the relative calculation in any individual cases.

aluminium alloy 3003

Sp. Th. mm	Larghezza appoggio: 100 mm Support width: 100 mm																			
	L=m	CAMPATA SINGOLA SINGLE SPAN																		
0,50	352	200	116	74																
0,60	462	236	137	84	58															
0,70	541	278	163	100	63															
0,80	620	315	184	110	74	53														
1,00	756	383	221	137	89	63														
1,20	861	441	252	158	100	68														
1,50																				

Sp. Th. mm	Larghezza appoggio: 100 mm Support width: 100 mm																			
	L=m	CAMPATA DOPPIA DOUBLE SPAN																		
0,50	320	231	168	131	105	79	58													
0,60	389	273	205	158	126	100	68	53												
0,70	462	326	242	184	147	116	84	58												
0,80	536	378	278	215	168	126	95	68	53											
1,00	683	478	352	268	215	158	110	84	63											
1,20	824	572	420	320	252	179	126	95	74	53										
1,50																				

Sp. Th. mm	Larghezza appoggio: 100 mm Support width: 100 mm																			
	L=m	CAMPATA MULTIPLA MULTIPLE SPAN																		
0,50	389	278	210	137	89	63														
0,60	467	336	252	163	110	74	53													
0,70	567	399	299	189	126	89	63													
0,80	656	462	347	215	142	100	74	53												
1,00	845	588	420	263	173	121	84	63												
1,20	1019	709	483	299	200	137	100	74	53											
1,50																				

In azzurro i carichi limitati da freccia 1/200 L. Values in blue show load limited by vertical deflection 1/200 L.

Calcoli eseguiti in ottemperanza alla normativa EUROCODICE 3 (EN 1993-1-3). Il carico riportato va inteso come valore caratteristico di portata, con coefficiente di combinazione applicato $\gamma_f=1,5$. I valori riportati in tabella sono da considerarsi come indicativi, è competenza del progettista procedere per i singoli casi di verifica al relativo calcolo. Calculations are made in accordance with EUROCODE 3 (EN 1993-1-3). The load reported shall be understood as the characteristic load value, with the coefficient of combination applied $\gamma_f=1,5$. The values shown in the table must be considered as indicative, the designer has the responsibility to proceed with the relative calculation in any individual cases.

SAND 38

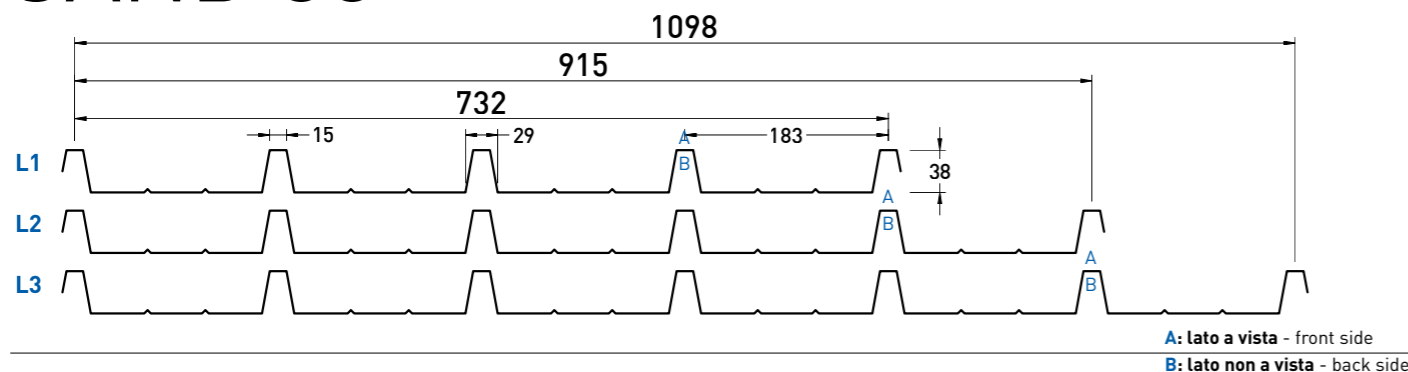

Reazione al fuoco Fire reaction CLASS A1 **Comportamento al fuoco dall'esterno External fire performance Broof (t1,t2,t3)**

Senza necessità di sottoporre a prova secondo la norma UNI EN 14782:2006. No lab test is required as per UNI EN 14782:2006.



Sp. Th. (mm)	Jy (cm ² /m)	STATI STATICI		Steel Kg/m ²	Aluminium Kg/m ²
		We inf (cm ³ /m)	We sup (cm ³ /m)		
0,50	10,77	12,92	3,63	5,36	1,84
0,60	12,71	15,22	4,29	6,43	2,21
0,70	14,59	17,45	4,92	7,51	2,58
0,80	16,40	19,58	5,54	8,58	2,95
1,00	19,83	23,60	6,70	10,72	3,69
1,20	23,01	27,28	7,78	12,87	4,43

CURVATURA BENDING

- Raggio fisso**
Fixed radius
- Variabile**
Variable

APPLICAZIONI APPLICATIONS

- SANDnodrip**
Class A2 - s1, d0 Broof (t1,t2,t3)
- SANDcontrol**
Class C - s1, d0 Broof (t1,t2,t3)

FORATURE PERFORATION

- F3 P5 60°**
- F5 P8 60°**

Per maggiori dettagli consultare pagine 112-114

For more details see pages 112-114

PROFILO PROFILE	NR. GRECHE RIBS NO.	INTERASSE (mm) PITCH (mm)	LARGH. UTILE (mm) USEFUL WIDTH (mm)	LARGH. LASTRA (mm) SHEET WIDTH (mm)	SORMONTO OVERLAP	TIPO SORMONTO KIND OF OVERLAP
L1	SAND 38	5	183	732	732	-
L2	SAND 38	6	183	915	915	-
L3	SAND 38	7	183	1098	1098	-

Accessori, materiali e colorazioni sono consultabili alle pagine 116-118

Accessories, materials and colors are available on pages 116-118

SAND 38

Tabelle di portata (daN/m²) Load tables (daN/sqm)

steel S250GD

Sp. Th. mm	Larghezza appoggio: 100 mm Support width: 100 mm																					
	L=m	0,80	1,00	1,20	1,40	1,60	1,80	2,00	2,20	2,40	2,60	2,80	3,00	3,20	3,40	3,60	3,80	4,00	4,20	4,40	4,60	
0,50	685	435	300	220	165	130	100	75	55													
0,60	1035	660	455	335	240	165	120	85	65	50												
0,70	1485	945	655	420	275	190	135	100	75	55												
0,80	1685	1075	745	470	310	215	155	115	85	65	50											
1,00	2070	1320	915	570	375	260	185	135	105	80	60											
1,20	2445	1560	1060	660	440	305	215	160	120	90	70	55										
1,50																						

Sp. Th. mm	Larghezza appoggio: 100 mm Support width: 100 mm																					
	L=m	0,80	1,00	1,20	1,40	1,60	1,80	2,00	2,20	2,40	2,60	2,80	3,00	3,20	3,40	3,60	3,80	4,00	4,20	4,40	4,60	
0,50	609	436	331	257	210	173	147	126	105	95	79	68	58									
0,60	777	562	425	336	273	226	189	163	137	121	105	84	68	58								
0,70	950	688	520	410	331	273	231	200	168	147	126	100	79	63	53							
0,80	1124	809	614	483	394	326	273	231	194	168	142	110	89	74	58							
1,00	1470	1055	803	630	515	420	352	294	252	215	168	137	110	89	74	58						
1,20	1811	1302	987	777	620	504	420	352	299	252	200	158	126	105	84	68	58					
1,50																						

Sp. Th. mm	Larghezza appoggio: 100 mm Support width: 100 mm																					
	L=m	0,80	1,00	1,20	1,40	1,60	1,80	2,00	2,20	2,40	2,60	2,80	3,00	3,20	3,40	3,60	3,80	4,00	4,20	4,40	4,60	
0,50	730	530	404	315	257	215	173	142	116	89	68	58										
0,60	940	683	520	410	331	278	231	184	137	105	84	68	53									
0,70	1155	835	635	504	410	341	284	210	158	121	95	79	63									
0,80	1360	982	751	593	483	399	315	236	179	137	110	84	68	58								
1,00	1785	1292	982	777	630	520	383	284	215	168	131	105	84	68	53							
1,20	2205	1591	1208	956	772	614	446	331	252	194	152	121	95	79	63	53						
1,50																						

In azzurro i carichi limitati da freccia 1/200 L. Values in blue show load limited by vertical deflection 1/200 L.

Calcoli eseguiti in ottemperanza alla normativa EUROCODICE 3 (EN 1993-1-3). Il carico riportato va inteso come valore caratteristico di portata, con coefficiente di combinazione applicato $\gamma_f=1,5$. I valori riportati in tabella sono da considerarsi come indicativi, è competenza del progettista procedere per i singoli casi di verifica al relativo calcolo. Calculations are made in accordance with EUROCODE 3 (EN 1993-1-3). The load reported shall be understood as the characteristic load value, with the coefficient of combination applied $\gamma_f=1,5$. The values shown in the table must be considered as indicative, the designer has the responsibility to proceed with the relative calculation in any individual cases.

aluminium alloy 3003

Sp. Th. mm	Larghezza appoggio: 100 mm Support width: 100 mm																					
	L=m	0,80	1,00	1,20	1,40	1,60	1,80	2,00	2,20	2,40	2,60	2,80	3,00	3,20	3,40	3,60	3,80	4,00	4,20	4,40	4,60	
0,50	520	275	160	100	65																	
0,60	640	330	190	120	80	55																
0,70	750	385	220	135	90	60																
0,80	855	435	250	155	100	70	50															
1,00	1035	525	300	190	125	85	60															
1,20	1200	610	350	220	145	100	70	50														
1,50																						

Sp. Th. mm	Larghezza appoggio: 100 mm Support width: 100 mm																					
	L=m	0,80	1,00	1,20	1,40	1,60	1,80	2,00	2,20	2,40	2,60	2,80	3,00	3,20	3,40	3,60	3,80	4,00	4,20	4,40	4,60	
0,50	400	285	215	165	135	110	80	60														
0,60	515	365	275	215	170	135	95	70	55													
0,70	630	450	335	260	210	155	110	85	65	50												
0,80	750	535	400	310	250	175	125	95	70	55												
1,00	995	705	525	410	305	215	155	115	85	65	50											
1,20	1225	870	650	505	355	250	180	135	100	80	60	50										
1,50																						

Sp. Th. mm	Larghezza appoggio: 100 mm Support width: 100 mm																					
	L=m	0,80	1,00	1,20	1,40	1,60	1,80	2,00	2,20	2,40	2,60	2,80	3,00	3,20	3,40	3,60	3,80	4,00	4,20	4,40	4,60	
0,50	480	350	265	190	125	85	65															
0,60	620	445	335	225	150	105	75	55														
0,70	765	545	410	265	175	120	85	65	50													
0,80	910	650	475	300	200	135	100	75	55													
1,00	1210	865	575	360	240	165	120	90	65	50												
1,20	1500	1065	670	420	280	195	140	105	80	60												
1,50																						

In azzurro i carichi limitati da freccia 1/200 L. Values in blue show load limited by vertical deflection 1/200 L.

Calcoli eseguiti in ottemperanza alla normativa EUROCODICE 3 (EN 1993-1-3). Il carico riportato va inteso come valore caratteristico di portata, con coefficiente di combinazione applicato $\gamma_f=1,5$. I valori riportati in tabella sono da considerarsi come indicativi, è competenza del progettista procedere per i singoli casi di verifica al relativo calcolo. Calculations are made in accordance with EUROCODE 3 (EN 1993-1-3). The load reported shall be understood as the characteristic load value, with the coefficient of combination applied $\gamma_f=1,5$. The values shown in the table must be considered as indicative, the designer has the responsibility to proceed with the relative calculation in any individual cases.

SAND 40/100

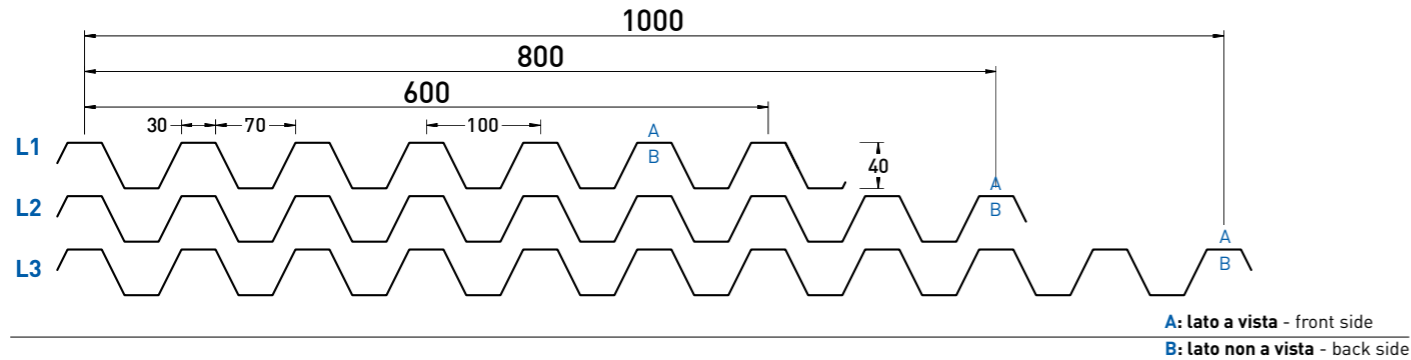

Reazione al fuoco Fire reaction CLASS A1 **Comportamento al fuoco dall'esterno External fire performance Broof (t1,t2,t3)**

Senza necessità di sottoporre a prova secondo la norma UNI EN 14782:2006. No lab test is required as per UNI EN 14782:2006.

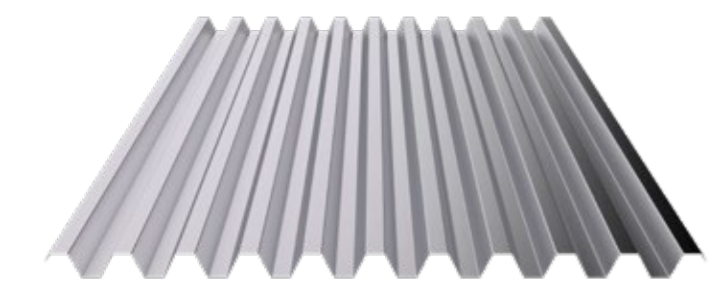

Sp. Th. (mm)	DATI STATICI		STATIC DATA		PESO		WEIGHT	
	Jy (cm ² /m)	We inf (cm ³ /m)	We sup (cm ³ /m)	Steel Kg/m ²	Aluminium Kg/m ²			
0,50	16,25	8,12	8,12	5,64	1,94			
0,60	19,09	9,55	9,55	6,77	2,33			
0,70	21,81	10,90	10,90	7,90	2,72			
0,80	24,39	12,20	12,20	9,02	3,10			
1,00	29,18	14,59	14,59	11,28	3,88			
1,20	33,47	16,74	16,74	13,53	4,66			

CURVATURA BENDING

- Raggio fisso**
Fixed radius
- Variabile**
Variable

APPLICAZIONI APPLICATIONS

- SANDnodrip**
Class A2 - s1, d0 Broof (t1,t2,t3)
- SANDcontrol**
Class C - s1, d0 Broof (t1,t2,t3)

FORATURE PERFORATION

- F3 P5 60°**
- F5 P8 60°**

Per maggiori dettagli consultare pagine 112-114

For more details see pages 112-114

PROFILO PROFILE	NR. GRECHE RIBS NO.	INTERASSE (mm) PITCH (mm)	LARGH. UTILE (mm) USEFUL WIDTH (mm)	LARGH. LASTRA (mm) SHEET WIDTH (mm)	SORMONTO OVERLAP	TIPO SORMONTO KIND OF OVERLAP
L1 SAND 40/100	7	100	600	694	15,67%	
L2 SAND 40/100	9	100	800	860	7,50%	
L3 SAND 40/100	10	100	1000	1045	4,50%	

Accessori, materiali e colorazioni sono consultabili alle pagine 116-118 Accessories, materials and colors are available on pages 116-118

SAND 40/100

Tabelle di portata (daN/m²) Load tables (daN/sqm)

steel S250GD

Sp. Th. mm	Larghezza appoggio: 100 mm Support width: 100 mm																
	L=m	CAMPATA SINGOLA SINGLE SPAN															
0,50	1375	880	605	430	285	200	140	105	80	60							
0,60	1720	1100	760	525	345	240	175	130	95	75	55						
0,70	2065	1320	910	615	410	285	205	150	115	85	65	55					
0,80	2400	1535	1060	705	470	325	235	175	130	100	80	60	50				
1,00	2885	1840	1275	845	560	390	280	205	155	120	95	75	60				
1,20	3305	2110	1460	970	645	445	320	235	180	135	105	85	65	55			
1,50																	

Sp. Th. mm	Larghezza appoggio: 100 mm Support width: 100 mm																
	L=m	CAMPATA DOPPIA DOUBLE SPAN															
0,50	955	670	500	385	315	255	210	175	145	125	105	90	80	65	55		
0,60	1220	855	635	490	400	325	265	220	185	155	135	115	100	80	65	55	
0,70	1490	1045	775	600	490	395	320	265	220	185	160	140	115	95	80	65	55
0,80	1770	1235	915	705	575	465	375	310	260	220	185	160	130	110	90	75	60
1,00	2250	1560	1150	880	710	560	450	370	310	260	225	195	160	130	105	90	75
1,20	2700	1860	1365	1020	815	640	515	425	355	300	255	220	180	150	125	100	85
1,50																	

Sp. Th. mm	Larghezza appoggio: 100 mm Support width: 100 mm																
	L=m	CAMPATA MULTIPLA MULTIPLE SPAN															
0,50	1208	851	635	494	404	326	268	215	163	126	100	79	63	53			
0,60	1544	1087	809	630	515	415	347	263	200	158	121	100	79	63	53		
0,70	1890	1328	992	767	630	509	415	310	236	184	142	116	95	74	63	53	
0,80	2247	1575	1171	908	740	599	473	352	268	210	163	131	105	89	74	58	
1,00	2867	2000	1475	1139	929	735	567	425	326	252	200	158	126	105	84	68	58
1,20	3455	2394	1759	1344	1076	845	651	488	373	289	226	184	147	121	100	79	68
1,50																	

In azzurro i carichi limitati da freccia 1/200 L. Values in blue show load limited by vertical deflection 1/200 L. Calcoli eseguiti in ottemperanza alla normativa EUROCODICE 3 (EN 1993-1-3). Il carico riportato va inteso come valore caratteristico di portata, con coefficiente di combinazione applicato $\gamma_f=1,5$. I valori riportati in tabella sono da considerarsi come indicativi, è competenza del progettista procedere per i singoli casi di verifica al relativo calcolo. Calculations are made in accordance with EUROCODE 3 (EN 1993-1-3). The load reported shall be understood as the characteristic load value, with the coefficient of combination applied $\gamma_f=1,5$. The values shown in the table must be considered as indicative, the designer has the responsibility to proceed with the relative calculation in any individual cases.

aluminium alloy 3003

Sp. Th. mm	Larghezza appoggio: 100 mm Support width: 100 mm																
	L=m	CAMPATA SINGOLA SINGLE SPAN															
0,50	785	405	235	150	100	70	50										
0,60	935	480	280	175	115	80	60										
0,70	1080	555	320	200	135	95	65	50									
0,80	1220	625	360	225	150	105	75	55									
1,00	1485	760	440	275	180	125	90	65	50								
1,20	1725	880	510	320	210	145	105	75	60								
1,50																	

Sp. Th. mm	Larghezza appoggio: 100 mm Support width: 100 mm																
	L=m	CAMPATA DOPPIA DOUBLE SPAN															
0,50	655	470	345	265	210	165	120	90	70	55							
0,60	845	595	435	335	265	200	145	105	80	65	50						
0,70	1035	720	530	405	325	230	165	125	95	75	60						
0,80	1230	855	625	475	370	255	185	140	105	80	65	50					
1,00	1625	1120	815	620	445	310	225	170	130	100	80	65	50				
1,20	2015	1380	1000	760	515	360	260	195	150	115	90	70	60	50			
1,50																	

Sp. Th. mm	Larghezza appoggio: 100 mm Support width: 100 mm																
	L=m	CAMPATA MULTIPLA MULTIPLE SPAN															
0,50	795	565	420	280	190	130	95	70	55								
0,60	1020	720	530	335	225	155	115	85	65	50							
0,70	1250	880	610	385	255	180	130	95	75	55							
0,80	1490	1040	685	430	290	200	145	110	80	65	50						
1,00	1975	1370	835	525	350	245	175	130	100	75	60	50					
1,20	2460	1670	965	605	405	280	205	150	115	90	70	55					
1,50																	

In azzurro i carichi limitati da freccia 1/200 L. Values in blue show load limited by vertical deflection 1/200 L. Calcoli eseguiti in ottemperanza alla normativa EUROCODICE 3 (EN 1993-1-3). Il carico riportato va inteso come valore caratteristico di portata, con coefficiente di combinazione applicato $\gamma_f=1,5$. I valori riportati in tabella sono da considerarsi come indicativi, è competenza del progettista procedere per i singoli casi di verifica al relativo calcolo. Calculations are made in accordance with EUROCODE 3 (EN 1993-1-3). The load reported shall be understood as the characteristic load value, with the coefficient of combination applied $\gamma_f=1,5$. The values shown in the table must be considered as indicative, the designer has the responsibility to proceed with the relative calculation in any individual cases.

SAND 40/200

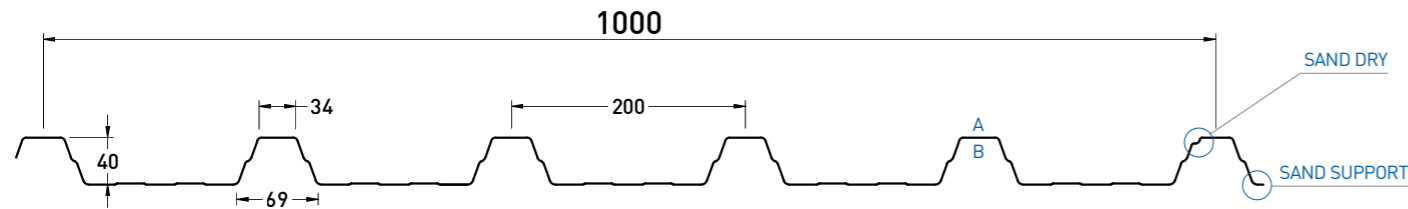

A: lato a vista - front side
B: lato non a vista - back side

Reazione al fuoco Fire reaction CLASS A1 **Comportamento al fuoco dall'esterno External fire performance Broof (t1,t2,t3)**

Senza necessità di sottoporre a prova secondo la norma UNI EN 14782:2006. No lab test is required as per UNI EN 14782:2006.

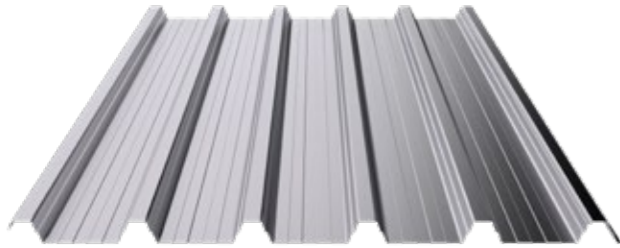

Sp. Th. (mm)	DATI STATICI		STATIC DATA		PESO		WEIGHT	
	Jy (cm ² /m)	We inf (cm ³ /m)	We sup (cm ³ /m)	Steel Kg/m ²	Aluminium Kg/m ²			
0,50	13,88	11,08	5,05	4,99	1,72			
0,60	16,30	13,00	5,94	5,99	2,06			
0,70	18,61	14,84	6,78	6,98	2,40			
0,80	20,81	16,58	7,58	7,98	2,75			
1,00	24,87	19,79	9,07	9,98	3,43			
1,20	28,50	22,64	10,40	11,97	4,12			

CURVATURA BENDING

- Raggio fisso Fixed radius
- Variabile Variable

APPLICAZIONI APPLICATIONS

- SANDnodrip Class A2 - s1, d0 Broof (t1,t2,t3)
- SANDcontrol Class C - s1, d0 Broof (t1,t2,t3)

FORATURE PERFORATION

- F3 P5 60°
- F5 P8 60°

Per maggiori dettagli consultare pagine 112-114

For more details see pages 112-114

PROFILO PROFILE	NR. GRECHE RIBS NO.	INTERASSE (mm) PITCH (mm)	LARGH. UTILE (mm) USEFUL WIDTH (mm)	LARGH. LASTRA (mm) SHEET WIDTH (mm)	SORMONTO OVERLAP	TIPO SORMONTO KIND OF OVERLAP
SAND 40/200	6	200	1000	1070	7,00%	

Accessori, materiali e colorazioni sono consultabili alle pagine 116-118

Accessories, materials and colors are available on pages 116-118

SAND 40/200

Tabelle di portata (daN/m²) Load tables (daN/sqm)

steel S250GD

Sp. Th. (mm)	Larghezza appoggio: 100 mm Support width: 100 mm																			
	L=m	CAMPATA SINGOLA SINGLE SPAN																		
	0,80	1,00	1,20	1,40	1,60	1,80	2,00	2,20	2,40	2,60	2,80	3,00	3,20	3,40	3,60	3,80	4,00	4,20	4,40	4,60
0,50	810	520	355	260	200	155	115	85	65	50										
0,60	1015	650	450	330	250	195	140	105	80	60										
0,70	1225	785	540	395	300	235	165	125	95	70	55									
0,80	1430	915	635	465	350	270	195	145	105	80	65	50								
1,00	1785	1740	1150	720	475	330	240	175	135	100	80	60	50							
1,20	2045	2060	1315	825	545	380	275	200	150	115	90	70	55							
1,50																				

Sp. Th. (mm)	Larghezza appoggio: 100 mm Support width: 100 mm																			
	L=m	CAMPATA DOPPIA DOUBLE SPAN																		
	0,80	1,00	1,20	1,40	1,60	1,80	2,00	2,20	2,40	2,60	2,80	3,00	3,20	3,40	3,60	3,80	4,00	4,20	4,40	4,60
0,50	500	360	275	215	175	145	120	100	85	75	65	60	50							
0,60	630	455	345	270	215	180	150	125	110	95	80	70	60	50						
0,70	765	550	415	325	260	215	180	155	130	110	95	85	75	65	60	50				
0,80	905	645	490	380	310	255	210	175	150	130	110	95	85	75	65	60	50			
1,00	1190	850	640	500	395	320	265	220	185	160	140	120	105	95	85	75	65	55		
1,20	1480	1050	785	600	475	380	315	265	225	195	170	145	130	115	100	85	70	60	50	
1,50																				

Sp. Th. (mm)	Larghezza appoggio: 100 mm Support width: 100 mm																			
	L=m	CAMPATA MULTIPLA MULTIPLE SPAN																		
	0,80	1,00	1,20	1,40	1,60	1,80	2,00	2,20	2,40	2,60	2,80	3,00	3,20	3,40	3,60	3,80	4,00	4,20	4,40	4,60
0,50	600	435	330	260	210	175	145	125	110	95	75	60	50							
0,60	760	550	415	330	265	220	185	160	135	120	95	75	60	50						
0,70	925	670	505	400	320	265	225	190	165	140	110	90	70	60	50					
0,80	1100	790	595	470	380	310	260	220	190	160	130	105	85	70	55					
1,00	1450	1035	780	615	495	400	330	280	235	205	160	130	105	85	70	55				
1,20	1810	1290	970	750	595	480	400	335	285	235	185	145	120	95	80	65	55			
1,50																				

In azzurro i carichi limitati da freccia 1/200 L. Values in blue show load limited by vertical deflection 1/200 L. Calcoli eseguiti in ottemperanza alla normativa EUROCODICE 3 (EN 1993-1-3). Il carico riportato va inteso come valore caratteristico di portata, con coefficiente di combinazione applicato $\gamma_f=1,5$. I valori riportati in tabella sono da considerarsi come indicativi, è competenza del progettista procedere per i singoli casi di verifica al relativo calcolo. Calculations are made in accordance with EUROCODE 3 (EN 1993-1-3). The load reported shall be understood as the characteristic load value, with the coefficient of combination applied $\gamma_f=1,5$. The values shown in the table must be considered as indicative, the designer has the responsibility to proceed with the relative calculation in any individual cases.

aluminium alloy 3003

Sp. Th. (mm)	Larghezza appoggio: 100 mm Support width: 100 mm																			
	L=m	CAMPATA SINGOLA SINGLE SPAN																		
	0,80	1,00	1,20	1,40	1,60	1,80	2,00	2,20	2,40	2,60	2,80	3,00	3,20	3,40	3,60	3,80	4,00	4,20	4,40	4,60
0,50	425	270	185	115	80	55														
0,60	575	365	225	140	95	65														
0,70	730	445	260	165	110	75	55													
0,80	885	510	295	185	125	85	60													
1,00	1185	625	365	230	150	105	75	55												
1,20	1420	730	425	265	175	120	90	65	50											
1,50																				

Sp. Th. (mm)	Larghezza appoggio: 100 mm Support width: 100 mm																			
	L=m	CAMPATA DOPPIA DOUBLE SPAN																		
	0,80	1,00	1,20	1,40	1,60	1,80	2,00	2,20	2,40	2,60	2,80	3,00	3,20	3,40	3,60	3,80	4,00	4,20	4,40	4,60
0,50	345	250	190	150	120	95	80	70	55											
0,60	445	320	240	190	150	125	100	85	65	50										
0,70	555	395	295	230	185	150	125	100	75	60										
0,80	660	465	350	270	215	175	145	115	85	70	55									
1,00	860	605	445	345	275	220	185	140	105	85	65	50								
1,20	990	690	510	390	310	250	205	165	125	95	75	60	50							
1,50																				

Sp. Th. (mm)	Larghezza appoggio: 100 mm Support width: 100 mm																			
	L=m	CAMPATA MULTIPLA MULTIPLE SPAN																		
	0,80	1,00	1,20	1,40	1,60	1,80	2,00	2,20	2,40	2,60	2,80	3,00	3,20	3,40	3,60	3,80	4,00	4,20	4,40	4,60
0,50	415	300	230	180	145	105	75	55												
0,60	535	390	295	230	180	125	90	70	50											
0,70	665	480	360	280	210	145	105	80	60											
0,80	795	570	425	330	235	165	120	90	70	55										
1,00	1050	740	550	425	290	205	145	110	85	65	50									
1,20	1220	850	630	485	340	235	170	125	95	75	60									
1,50																				

In azzurro i carichi limitati da freccia 1/200 L. Values in blue show load limited by vertical deflection 1/200 L. Calcoli eseguiti in ottemperanza alla normativa EUROCODICE 3 (EN 1993-1-3). Il carico riportato va inteso come valore caratteristico di portata, con coefficiente di combinazione applicato $\gamma_f=1,5$. I valori riportati in tabella sono da considerarsi come indicativi, è competenza del progettista procedere per i singoli casi di verifica al relativo calcolo. Calculations are made in accordance with EUROCODE 3 (EN 1993-1-3). The load reported shall be understood as the characteristic load value, with the coefficient of combination applied $\gamma_f=1,5$. The values shown in the table must be considered as indicative, the designer has the responsibility to proceed with the relative calculation in any individual cases.

SAND 40/250

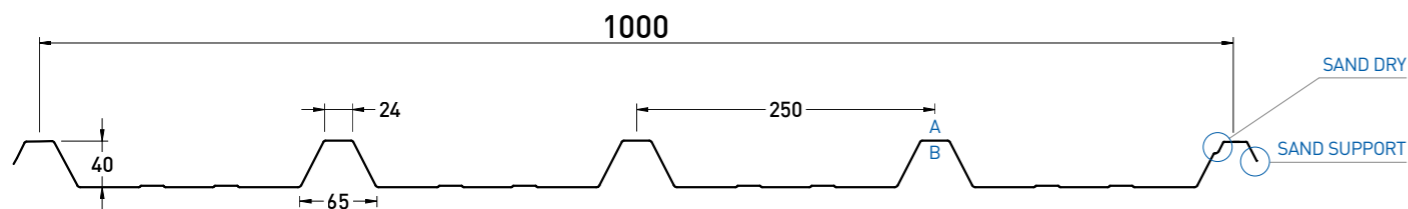

A: lato a vista - front side
B: lato non a vista - back side

Reazione al fuoco Fire reaction
CLASS A1

Comportamento al fuoco dall'esterno External fire performance
Roof (t1,t2,t3)

Senza necessità di sottoporre a prova secondo la norma UNI EN 14782:2006. No lab test is required as per UNI EN 14782:2006.

Sp. Th. (mm)	DATI STATICI			PESO	
	Jy (cm ² /m)	We inf (cm ³ /m)	We sup (cm ³ /m)	Steel Kg/m ²	Aluminium Kg/m ²
0,50	10,72	11,71	3,59	4,67	1,61
0,60	12,68	13,83	4,25	5,61	1,93
0,70	14,59	15,88	4,89	6,54	2,25
0,80	16,44	17,85	5,52	7,48	2,57
1,00	19,97	21,60	6,71	9,35	3,21
1,20	23,28	25,09	7,83	11,21	3,86

CURVATURA BENDING

Raggio fisso
Fixed radius

Variabile
Variable

APPLICAZIONI APPLICATIONS

SANDnodrip
Class A2 - s1, d0 Broof (t1,t2,t3)

SANDcontrol
Class C - s1, d0 Broof (t1,t2,t3)

FORATURE PERFORATION

F3 P5 60°

F5 P8 60°

Per maggiori dettagli consultare pagine 112-114

For more details see pages 112-114

PROFILO PROFILE	NR. GRECHE RIBS NO.	INTERASSE (mm) PITCH (mm)	LARGH. UTILE (mm) USEFUL WIDTH (mm)	LARGH. LASTRA (mm) SHEET WIDTH (mm)	SORMONTO OVERLAP	TIPO SORMONTO KIND OF OVERLAP
SAND 40/250	5	250	1000	1050	5,00%	

Accessori, materiali e colorazioni sono consultabili alle pagine 116-118

Accessories, materials and colors are available on pages 116-118

SAND 40/250

Tabelle di portata (daN/m²) Load tables (daN/sqm)

steel S250GD

Sp. Th. mm	Larghezza appoggio: 100 mm Support width: 100 mm																			
	L=m	CAMPATA SINGOLA									SINGLE SPAN									
q=daN/m ²	0,80	1,00	1,20	1,40	1,60	1,80	2,00	2,20	2,40	2,60	2,80	3,00	3,20	3,40	3,60	3,80	4,00	4,20	4,40	4,60
0,50	600	380	260	190	145	115	90	65	50											
0,60	810	515	355	260	195	155	115	85	65	50										
0,70	1290	825	570	415	280	195	140	100	75	60										
0,80	1595	1015	705	475	315	215	155	115	85	65	50									
1,00	1965	1255	865	575	380	265	190	140	105	80	60	50								
1,20	2325	1485	1025	670	445	310	220	165	120	95	70	55								
1,50																				

Sp. Th. mm	Larghezza appoggio: 100 mm Support width: 100 mm																			
	L=m	CAMPATA DOPPIA									DOUBLE SPAN									
q=daN/m ²	0,80	1,00	1,20	1,40	1,60	1,80	2,00	2,20	2,40	2,60	2,80	3,00	3,20	3,40	3,60	3,80	4,00	4,20	4,40	4,60
0,50	522	378	288	222	180	150	126	108	90	78	72	60								
0,60	672	480	366	288	234	192	162	138	120	102	90	78	66	60						
0,70	816	582	444	348	282	234	192	168	144	126	108	96	84	72	60					
0,80	966	690	522	414	330	276	228	198	168	144	126	108	96	84	72	60				
1,00	1272	912	690	540	438	360	300	252	216	186	162	138	126	102	84	72	60			
1,20	1590	1140	858	678	546	450	372	312	264	228	192	174	150	120	102	84	66			
1,50																				

Sp. Th. mm	Larghezza appoggio: 100 mm Support width: 100 mm																			
	L=m	CAMPATA MULTIPLA									MULTIPLE SPAN									
q=daN/m ²	0,80	1,00	1,20	1,40	1,60	1,80	2,00	2,20	2,40	2,60	2,80	3,00	3,20	3,40	3,60	3,80	4,00	4,20	4,40	4,60
0,50	630	456	348	276	222	186	156	132	114	96	72	60								
0,60	804	582	444	348	282	234	198	168	144	120	96	72	60							
0,70	984	708	540	426	342	288	240	204	174	144	108	90	72	60						
0,80	1164	840	636	504	408	336	282	240	204	162	126	102	78	66						
1,00	1542	1110	840	660	534	444	372	318	252	192	150	120	96	78	66					
1,20	1932	1386	1050	828	672	552	468	384	294	228	180	144	114	90	72	60				
1,50																				

In azzurro i carichi limitati da freccia 1/200 L. Values in blue show load limited by vertical deflection 1/200 L.

Calcoli eseguiti in ottemperanza alla normativa EUROCODICE 3 (EN 1993-1-3). Il carico riportato va inteso come valore caratteristico di portata, con coefficiente di combinazione applicato $\gamma_f=1,5$. I valori riportati in tabella sono da considerarsi come indicativi, è competenza del progettista procedere per i singoli casi di verifica al relativo calcolo. Calculations are made in accordance with EUROCODE 3 (EN 1993-1-3). The load reported shall be understood as the characteristic load value, with the coefficient of combination applied $\gamma_f=1,5$. The values shown in the table must be considered as indicative, the designer has the responsibility to proceed with the relative calculation in any individual cases.

aluminium alloy 3003

Sp. Th. mm	Larghezza appoggio: 100 mm Support width: 100 mm																			
	L=m	CAMPATA SINGOLA									SINGLE SPAN									
q=daN/m ²	0,80	1,00	1,20	1,40	1,60	1,80	2,00	2,20	2,40	2,60	2,80	3,00	3,20	3,40	3,60	3,80	4,00	4,20	4,40	4,60
0,50	467	273	158	100	68															
0,60	583	331	189	121	79	53														
0,70	698	383	221	142	95	63														
0,80	819	441	252	158	105	74	53													
1,00	1061	546	315	194	131	89	63													
1,20	1271	646	373	236	152	105	74	53												
1,50																				

Sp. Th. mm	Larghezza appoggio: 100 mm Support width: 100 mm																			
	L=m	CAMPATA DOPPIA									DOUBLE SPAN									
q=daN/m ²	0,80	1,00	1,20	1,40	1,60	1,80	2,00	2,20	2,40	2,60	2,80	3,00	3,20	3,40	3,60	3,80	4,00	4,20	4,40	4,60
0,50	331	242	179	137	110	89	74	63												
0,60	420	299	221	173	142	116	95	74	58											
0,70	509	362	273	210	168	137	116	84	63											
0,80	599	425	320	247	200	163	131	95	74	58										
1,00	793	562	420	326	257	210	163	121	89	68	58									
1,20	987	693	520	399	320	263	189	142	105	84	63	53								
1,50																				

Sp. Th. mm	Larghezza appoggio: 100 mm Support width: 100 mm																			
	L=m	CAMPATA MULTIPLA									MULTIPLE SPAN									
q=daN/m ²	0,80	1,00	1,20	1,40	1,60	1,80	2,00	2,20	2,40	2,60	2,80	3,00	3,20	3,40	3,60	3,80	4,00	4,20	4,40	4,60
0,50	394	294	215	168	126	89	63													
0,60	504	362	273	210	152	105	79	58												
0,70	609	436	331	257	179	126	89	68												
0,80	719	520	389	305	205	142	105	74	58											
1,00	956	683	515	378	252	173	126	95	68	53										
1,20	1197	851	635	446	294	205	147	110	84	63										
1,50																				

In azzurro i carichi limitati da freccia 1/200 L. Values in blue show load limited by vertical deflection 1/200 L.

Calcoli eseguiti in ottemperanza alla normativa EUROCODICE 3 (EN 1993-1-3). Il carico riportato va inteso come valore caratteristico di portata, con coefficiente di combinazione applicato $\gamma_f=1,5$. I valori riportati in tabella sono da considerarsi come indicativi, è competenza del progettista procedere per i singoli casi di verifica al relativo calcolo. Calculations are made in accordance with EUROCODE 3 (EN 1993-1-3). The load reported shall be understood as the characteristic load value, with the coefficient of combination applied $\gamma_f=1,5$. The values shown in the table must be considered as indicative, the designer has the responsibility to proceed with the relative calculation in any individual cases.

SAND 40/300

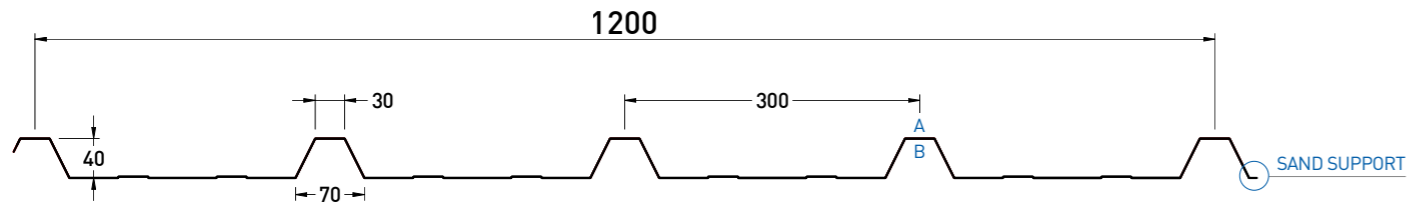

A: lato a vista - front side
B: lato non a vista - back side

Reazione al fuoco Fire reaction CLASS A1 **Comportamento al fuoco dall'esterno External fire performance Broof (t1,t2,t3)**

Senza necessità di sottoporre a prova secondo la norma UNI EN 14782:2006. No lab test is required as per UNI EN 14782:2006.



Sp. Th. (mm)	Jy (cm ² /m)	STATI STATICI		Steel Kg/m ²	Aluminium Kg/m ²
		We inf (cm ³ /m)	We sup (cm ³ /m)		
0,50	11,00	12,72	3,51	4,58	1,58
0,60	13,04	15,05	4,16	5,50	1,89
0,70	15,03	17,30	4,80	6,41	2,21
0,80	16,97	19,48	5,42	7,33	2,52
1,00	20,68	23,65	6,62	9,16	3,15
1,20	24,20	27,54	7,75	11,00	3,78

CURVATURA BENDING

Su richiesta
On request

APPLICAZIONI APPLICATIONS

- SANDnodrip**
Class A2 - s1, d0 Broof (t1,t2,t3)
- SANDcontrol**
Class C - s1, d0 Broof (t1,t2,t3)

FORATURE PERFORATION

- F3 P5 60°**
- F5 P8 60°**

Per maggiori dettagli consultare pagine 112-114

For more details see pages 112-114

PROFILO PROFILE	NR. GRECHE RIBS NO.	INTERASSE (mm) PITCH (mm)	LARGH. UTILE (mm) USEFUL WIDTH (mm)	LARGH. LASTRA (mm) SHEET WIDTH (mm)	SORMONTO OVERLAP	TIPO SORMONTO KIND OF OVERLAP
SAND 40/300	5	300	1200	1285	7,08%	

Accessori, materiali e colorazioni sono consultabili alle pagine 116-118

Accessories, materials and colors are available on pages 116-118

SAND 40/300

Tabelle di portata (daN/m²) Load tables (daN/sqm)

steel S250GD

Sp. Th. mm	Larghezza appoggio: 100 mm Support width: 100 mm																				
	L=m	CAMPATA SINGOLA SINGLE SPAN																			
q=daN/m ²	0,80	1,00	1,20	1,40	1,60	1,80	2,00	2,20	2,40	2,60	2,80	3,00	3,20	3,40	3,60	3,80	4,00	4,20	4,40	4,60	
0,50	535	340	235	170	130	100	80	65	50												
0,60	730	465	320	235	175	140	110	85	65	50											
0,70	905	580	400	290	220	175	140	100	75	60											
0,80	1065	680	470	340	260	205	160	120	90	70	50										
1,00	1865	1190	825	595	395	275	195	145	110	85	65	50									
1,20	2220	1415	980	700	465	320	230	170	130	100	75	60									
1,50																					

Sp. Th. mm	Larghezza appoggio: 100 mm Support width: 100 mm																				
	L=m	CAMPATA DOPPIA DOUBLE SPAN																			
q=daN/m ²	0,80	1,00	1,20	1,40	1,60	1,80	2,00	2,20	2,40	2,60	2,80	3,00	3,20	3,40	3,60	3,80	4,00	4,20	4,40	4,60	
0,50	300	210	155	120	95	80	65	55													
0,60	380	270	200	155	125	100	85	70	60	50											
0,70	465	330	245	190	155	125	105	85	70	60	50										
0,80	560	395	295	230	185	150	125	100	85	75	65	55	50								
1,00	750	530	400	310	250	205	165	140	120	100	85	75	65	60	50						
1,20	950	675	510	400	320	260	215	180	150	130	110	100	85	75	65	60	55	50			
1,50																					

Sp. Th. mm	Larghezza appoggio: 100 mm Support width: 100 mm																				
	L=m	CAMPATA MULTIPLA MULTIPLE SPAN																			
q=daN/m ²	0,80	1,00	1,20	1,40	1,60	1,80	2,00	2,20	2,40	2,60	2,80	3,00	3,20	3,40	3,60	3,80	4,00	4,20	4,40	4,60	
0,50	360	255	190	150	120	95	80	65	55	50											
0,60	460	325	245	190	150	125	105	85	75	65	55										
0,70	565	400	300	235	190	155	130	110	90	80	65	60	50								
0,80	675	480	360	280	225	185	155	130	110	95	80	70	60	55							
1,00	910	650	490	385	310	255	210	175	150	130	110	95	85	70	55						
1,20	1160	825	625	490	395	325	270	225	190	165	145	125	100	80	65	55					
1,50																					

In azzurro i carichi limitati da freccia 1/200 L. Values in blue show load limited by vertical deflection 1/200 L.

Calcoli eseguiti in ottemperanza alla normativa EUROCODICE 3 (EN 1993-1-3). Il carico riportato va inteso come valore caratteristico di portata, con coefficiente di combinazione applicato $\gamma_f=1,5$. I valori riportati in tabella sono da considerarsi come indicativi, è competenza del progettista procedere per i singoli casi di verifica al relativo calcolo. Calculations are made in accordance with EUROCODE 3 (EN 1993-1-3). The load reported shall be understood as the characteristic load value, with the coefficient of combination applied $\gamma_f=1,5$. The values shown in the table must be considered as indicative, the designer has the responsibility to proceed with the relative calculation in any individual cases.

aluminium alloy 3003

Sp. Th. mm	Larghezza appoggio: 100 mm Support width: 100 mm																				
	L=m	CAMPATA SINGOLA SINGLE SPAN																			
q=daN/m ²	0,80	1,00	1,20	1,40	1,60	1,80	2,00	2,20	2,40	2,60	2,80	3,00	3,20	3,40	3,60	3,80	4,00	4,20	4,40	4,60	
0,50	400	255	150	95	65																
0,60	505	315	185	115	75	55															
0,70	610	370	215	135	90	60															
0,80	720	420	245	155	100	70	50														
1,00	940	525	305	190	125	85	60														
1,20	1160	630	365	225	150	105	75	55													
1,50																					

Sp. Th. mm	Larghezza appoggio: 100 mm Support width: 100 mm																				
	L=m	CAMPATA DOPPIA DOUBLE SPAN																			
q=daN/m ²	0,80	1,00	1,20	1,40	1,60	1,80	2,00	2,20	2,40	2,60	2,80	3,00	3,20	3,40	3,60	3,80	4,00	4,20	4,40	4,60	
0,50	210	150	110	85	65	55															
0,60	270	190	140	105	85	65	55														
0,70	330	230	170	130	100	80	65	55													
0,80	395	275	200	155	120	100	80	65	55	50											
1,00	525	365	265	205	160	130	105	90	75	65	55										
1,20	660	455	335	260	205	165	135	115	95	80	65	50									
1,50																					

Sp. Th. mm	Larghezza appoggio: 100 mm Support width: 100 mm																				
	L=m	CAMPATA MULTIPLA MULTIPLE SPAN																			
q=daN/m ²	0,80	1,00	1,20	1,40	1,60	1,80	2,00	2,20	2,40	2,60	2,80	3,00	3,20	3,40	3,60	3,80	4,00	4,20	4,40	4,60	
0,50	255	180	135	105	80	65	55														
0,60	325	230	170	130	105	85	70	55													
0,70	400	280	210	160	125	100	85	65	50												
0,80	480	335	250	190	150	120	100	75	55												
1,00	640	445	330	255	200	165	120	90	70	55											
1,20	805	560	415	320	255	200	145	110	80	65	50										
1,50																					

In azzurro i carichi limitati da freccia 1/200 L. Values in blue show load limited by vertical deflection 1/200 L.

Calcoli eseguiti in ottemperanza alla normativa EUROCODICE 3 (EN 1993-1-3). Il carico riportato va inteso come valore caratteristico di portata, con coefficiente di combinazione applicato $\gamma_f=1,5$. I valori riportati in tabella sono da considerarsi come indicativi, è competenza del progettista procedere per i singoli casi di verifica al relativo calcolo. Calculations are made in accordance with EUROCODE 3 (EN 1993-1-3). The load reported shall be understood as the characteristic load value, with the coefficient of combination applied $\gamma_f=1,5$. The values shown in the table must be considered as indicative, the designer has the responsibility to proceed with the relative calculation in any individual cases.

SAND 41

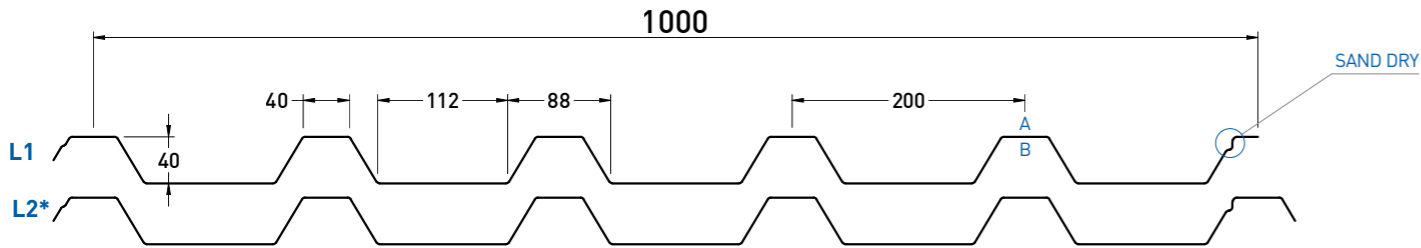

A: lato a vista - front side
B: lato non a vista - back side

Reazione al fuoco Fire reaction CLASS A1 **Comportamento al fuoco dall'esterno External fire performance Broof (t1,t2,t3)**

Senza necessità di sottoporre a prova secondo la norma UNI EN 14782:2006. No lab test is required as per UNI EN 14782:2006.



Sp. Th. (mm)	Jy (cm ² /m)	STATIC DATA		PESO Steel Kg/m ²	WEIGHT Aluminium Kg/m ²
		We inf (cm ³ /m)	We sup (cm ³ /m)		
0,50	15,23	10,74	5,90	4,91	1,69
0,60	18,04	12,73	6,99	5,89	2,03
0,70	20,79	14,65	8,05	6,87	2,36
0,80	23,46	16,52	9,09	7,85	2,70
1,00	28,58	20,11	11,08	9,81	3,38
1,20	33,41	23,48	12,97	11,78	4,05

CURVATURA BENDING

- Raggio fisso**
Fixed radius
- Variabile**
Variable

APPLICAZIONI APPLICATIONS

- SANDnodrip**
Class A2 - s1, d0 Broof (t1,t2,t3)
- SANDcontrol**
Class C - s1, d0 Broof (t1,t2,t3)

FORATURE PERFORATION

- F3 P5 60°**
- F5 P8 60°**

Per maggiori dettagli consultare pagine 112-114

For more details see pages 112-114

PROFILO PROFILE	NR. GRECHE RIBS NO.	INTERASSE (mm) PITCH (mm)	LARGH. UTILE (mm) USEFUL WIDTH (mm)	LARGH. LASTRA (mm) SHEET WIDTH (mm)	SORMONTO OVERLAP	TIPO SORMONTO KIND OF OVERLAP
L1	SAND 41	6	200	1000	1035	3,50%
L2*	SAND 41	6	200	1070	1070	7,00%

Accessori, materiali e colorazioni sono consultabili alle pagine 116-118

Accessories, materials and colors are available on pages 116-118

SAND 41

Tabelle di portata (daN/m²) Load tables (daN/sqm)

steel S250GD

Sp. Th. mm	Larghezza appoggio: 100 mm Support width: 100 mm																			
	L=m	CAMPATA SINGOLA SINGLE SPAN																		
	0,80	1,00	1,20	1,40	1,60	1,80	2,00	2,20	2,40	2,60	2,80	3,00	3,20	3,40	3,60	3,80	4,00	4,20	4,40	4,60
0,50	830	530	365	265	205	160	125	90	70	55										
0,60	1120	715	495	360	275	215	155	115	85	65	50									
0,70	1365	875	605	440	335	255	180	135	100	80	60									
0,80	1620	1035	715	525	400	295	210	155	120	90	70	55								
1,00	2130	1365	945	690	525	375	270	200	150	115	90	70	55							
1,20	2550	1735	1200	880	645	450	325	240	180	140	110	85	70	55						
1,50																				

Sp. Th. mm	Larghezza appoggio: 100 mm Support width: 100 mm																			
	L=m	CAMPATA DOPPIA DOUBLE SPAN																		
	0,80	1,00	1,20	1,40	1,60	1,80	2,00	2,20	2,40	2,60	2,80	3,00	3,20	3,40	3,60	3,80	4,00	4,20	4,40	4,60
0,50	490	345	260	200	160	130	110	90	80	65	55	50								
0,60	625	445	330	255	205	170	140	120	100	85	75	65	55	50						
0,70	775	545	410	320	255	210	175	145	125	105	90	80	70	60	55					
0,80	925	655	490	385	305	250	210	175	150	125	110	95	85	75	65	60	50			
1,00	1255	890	670	520	420	345	285	235	200	170	150	130	115	100	90	80	70	60	50	
1,20	1605	1140	855	670	535	440	360	305	255	220	190	165	145	130	115	105	90	85	75	60
1,50																				

Sp. Th. mm	Larghezza appoggio: 100 mm Support width: 100 mm																			
	L=m	CAMPATA MULTIPLA MULTIPLE SPAN																		
	0,80	1,00	1,20	1,40	1,60	1,80	2,00	2,20	2,40	2,60	2,80	3,00	3,20	3,40	3,60	3,80	4,00	4,20	4,40	4,60
0,50	590	420	315	245	195	160	135	115	95	85	70	65	55							
0,60	755	535	405	315	250	205	175	145	125	110	95	80	65	55						
0,70	935	665	500	390	315	255	215	180	155	135	115	100	80	65	55					
0,80	1120	800	600	470	375	310	260	220	185	160	140	115	90	75	60	50				
1,00	1520	1085	815	640	515	420	355	300	255	220	185	145	120	95	80	70	60	50		
1,20	1945	1390	1045	820	660	545	455	380	325	275	220	175	140	115	95	80	65	55		
1,50																				

In azzurro i carichi limitati da freccia 1/200 L. Values in blue show load limited by vertical deflection 1/200 L. Calcoli eseguiti in ottemperanza alla normativa EUROCODICE 3 (EN 1993-1-3). Il carico riportato va inteso come valore caratteristico di portata, con coefficiente di combinazione applicato $\gamma_f=1,5$. I valori riportati in tabella sono da considerarsi come indicativi, è competenza del progettista procedere per i singoli casi di verifica al relativo calcolo. Calculations are made in accordance with EUROCODE 3 (EN 1993-1-3). The load reported shall be understood as the characteristic load value, with the coefficient of combination applied $\gamma_f=1,5$. The values shown in the table must be considered as indicative, the designer has the responsibility to proceed with the relative calculation in any individual cases.

aluminium alloy 3003

Sp. Th. mm	Larghezza appoggio: 100 mm Support width: 100 mm																			
	L=m	CAMPATA SINGOLA SINGLE SPAN																		
	0,80	1,00	1,20	1,40	1,60	1,80	2,00	2,20	2,40	2,60	2,80	3,00	3,20	3,40	3,60	3,80	4,00	4,20	4,40	4,60
0,50	590	360	210	135	90	60														
0,60	735	435	255	160	105	75	55													
0,70	895	505	295	185	125	85	60													
0,80	1055	575	335	210	140	100	70	50												
1,00	1380	715	415	260	175	120	85	65	50											
1,20	1650	850	495	310	205	145	105	75	55											
1,50																				

Sp. Th. mm	Larghezza appoggio: 100 mm Support width: 100 mm																			
	L=m	CAMPATA DOPPIA DOUBLE SPAN																		
	0,80	1,00	1,20	1,40	1,60	1,80	2,00	2,20	2,40	2,60	2,80	3,00	3,20	3,40	3,60	3,80	4,00	4,20	4,40	4,60
0,50	340	245	180	140	110	90	75	60	50											
0,60	440	310	230	175	140	110	90	75	65	55										
0,70	540	380	280	215	170	135	115	95	80	70	55									
0,80	645	450	335	255	200	165	135	110	95	75	60	50								
1,00	865	605	445	340	270	220	180	150	125	95	75	60	50							
1,20	1095	765	565	430	340	275	230	190	145	115	90	70	60	50						
1,50																				

Sp. Th. mm	Larghezza appoggio: 100 mm Support width: 100 mm																			
	L=m	CAMPATA MULTIPLA MULTIPLE SPAN																		
	0,80	1,00	1,20	1,40	1,60	1,80	2,00	2,20	2,40	2,60	2,80	3,00	3,20	3,40	3,60	3,80	4,00	4,20	4,40	4,60
0,50	410	295	220	170	135	110	85	65	50											
0,60	525	375	280	215	170	140	105	75	60											
0,70	650	460	345	265	210	165	120	90	70	55										
0,80	780	550	410	315	250	190	135	100	80	60										
1,00	1050	740	545	420	335	235	170	125	95	75	60									
1,20	1335	935	690	535	395	275	200	150	115	90	70	55								
1,50																				

In azzurro i carichi limitati da freccia 1/200 L. Values in blue show load limited by vertical deflection 1/200 L. Calcoli eseguiti in ottemperanza alla normativa EUROCODICE 3 (EN 1993-1-3). Il carico riportato va inteso come valore caratteristico di portata, con coefficiente di combinazione applicato $\gamma_f=1,5$. I valori riportati in tabella sono da considerarsi come indicativi, è competenza del progettista procedere per i singoli casi di verifica al relativo calcolo. Calculations are made in accordance with EUROCODE 3 (EN 1993-1-3). The load reported shall be understood as the characteristic load value, with the coefficient of combination applied $\gamma_f=1,5$. The values shown in the table must be considered as indicative, the designer has the responsibility to proceed with the relative calculation in any individual cases.

SAND 42

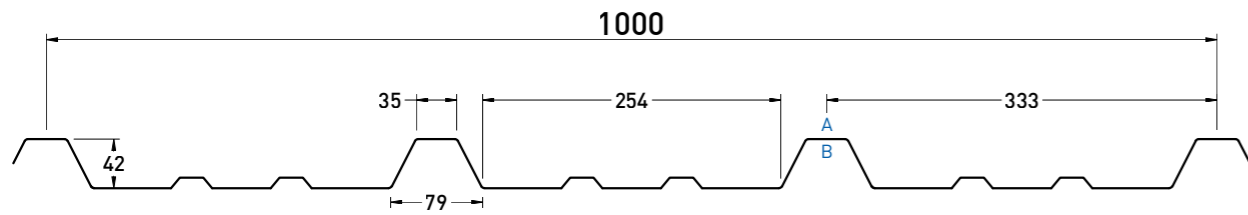

A: lato a vista - front side
B: lato non a vista - back side

Reazione al fuoco Fire reaction CLASS A1 **Comportamento al fuoco dall'esterno External fire performance Broof (t1,t2,t3)**

Senza necessità di sottoporre a prova secondo la norma UNI EN 14782:2006. No lab test is required as per UNI EN 14782:2006.



Sp. Th. (mm)	Jy (cm ² /m)	DATI STATICI		STATIC DATA		PESO Steel Kg/m ²	WEIGHT Aluminium Kg/m ²
		We inf (cm ³ /m)	We sup (cm ³ /m)	We inf (cm ³ /m)	We sup (cm ³ /m)		
0,50	11,61	11,57	3,63	4,91	1,69		
0,60	13,79	13,70	4,32	5,89	2,03		
0,70	15,92	15,78	4,99	6,87	2,36		
0,80	18,00	17,80	5,65	7,85	2,70		
1,00	22,03	21,68	6,92	9,81	3,38		
1,20	25,89	25,34	8,14	11,78	4,05		

CURVATURA BENDING

- Raggio fisso
Fixed radius
- Variabile
Variable

APPLICAZIONI APPLICATIONS

- SANDnodrip
Class A2 - s1, d0 Broof (t1,t2,t3)
- SANDcontrol
Class C - s1, d0 Broof (t1,t2,t3)

FORATURE PERFORATION

- F3 P5 60°
- F5 P8 60°

Per maggiori dettagli consultare pagine 112-114

For more details see pages 112-114

PROFILO PROFILE	NR. GRECHE RIBS NO.	INTERASSE (mm) PITCH (mm)	LARGH. UTILE (mm) USEFUL WIDTH (mm)	LARGH. LASTRA (mm) SHEET WIDTH (mm)	SORMONTO OVERLAP	TIPO SORMONTO KIND OF OVERLAP
SAND 42	4	333	1000	1000	-	

Accessori, materiali e colorazioni sono consultabili alle pagine 116-118

Accessories, materials and colors are available on pages 116-118

SAND 42

Tabelle di portata (daN/m²) Load tables (daN/sqm)

steel S250GD

Sp. Th. mm	Larghezza appoggio: 100 mm Support width: 100 mm																			
	L=m	CAMPATA SINGOLA SINGLE SPAN																		
	0,80	1,00	1,20	1,40	1,60	1,80	2,00	2,20	2,40	2,60	2,80	3,00	3,20	3,40	3,60	3,80	4,00	4,20	4,40	4,60
0,50	520	330	230	165	125	95	75	65	50											
0,60	705	450	310	225	170	135	105	85	65	50										
0,70	895	570	395	285	220	170	135	105	75	60										
0,80	1055	675	465	340	260	200	160	120	90	70	55									
1,00	1360	1475	1015	635	420	290	210	155	115	90	70	55								
1,20	1600	1830	1195	745	495	345	245	180	135	105	80	65	50							
1,50																				

Sp. Th. mm	Larghezza appoggio: 100 mm Support width: 100 mm																			
	L=m	CAMPATA DOPPIA DOUBLE SPAN																		
	0,80	1,00	1,20	1,40	1,60	1,80	2,00	2,20	2,40	2,60	2,80	3,00	3,20	3,40	3,60	3,80	4,00	4,20	4,40	4,60
0,50	360	260	195	150	120	100	80	70	60	50										
0,60	460	325	245	195	160	130	110	95	80	70	60	55	50							
0,70	560	405	310	245	200	165	140	120	105	90	80	70	60	55	50					
0,80	670	490	375	300	245	205	170	145	125	110	100	85	80	70	60	50				
1,00	905	665	510	410	335	280	235	205	175	155	135	120	110	95	80	65	55			
1,20	1165	855	665	530	440	370	315	270	235	210	185	165	140	115	95	75	65	55		
1,50																				

Sp. Th. mm	Larghezza appoggio: 100 mm Support width: 100 mm																			
	L=m	CAMPATA MULTIPLA MULTIPLE SPAN																		
	0,80	1,00	1,20	1,40	1,60	1,80	2,00	2,20	2,40	2,60	2,80	3,00	3,20	3,40	3,60	3,80	4,00	4,20	4,40	4,60
0,50	435	310	235	185	145	120	100	85	75	65	55									
0,60	555	395	300	235	195	160	135	115	100	90	75	60	50							
0,70	675	485	375	300	245	205	170	150	130	110	95	75	60	50						
0,80	805	590	455	360	295	250	210	180	160	140	110	85	70	55						
1,00	1090	800	620	495	410	340	290	250	220	180	140	110	90	75	60	50				
1,20	1405	1040	805	650	535	450	385	335	270	210	165	130	105	85	70	55				
1,50																				

In azzurro i carichi limitati da freccia 1/200 L. Values in blue show load limited by vertical deflection 1/200 L.

Calcoli eseguiti in ottemperanza alla normativa EUROCODICE 3 (EN 1993-1-3). Il carico riportato va inteso come valore caratteristico di portata, con coefficiente di combinazione applicato $\gamma_f=1,5$. I valori riportati in tabella sono da considerarsi come indicativi, è competenza del progettista procedere per i singoli casi di verifica al relativo calcolo. Calculations are made in accordance with EUROCODE 3 (EN 1993-1-3). The load reported shall be understood as the characteristic load value, with the coefficient of combination applied $\gamma_f=1,5$. The values shown in the table must be considered as indicative, the designer has the responsibility to proceed with the relative calculation in any individual cases.

aluminium alloy 3003

Sp. Th. mm	Larghezza appoggio: 100 mm Support width: 100 mm																			
	L=m	CAMPATA SINGOLA SINGLE SPAN																		
	0,80	1,00	1,20	1,40	1,60	1,80	2,00	2,20	2,40	2,60	2,80	3,00	3,20	3,40	3,60	3,80	4,00	4,20	4,40	4,60
0,50	385	250	155	100	65															
0,60	490	310	190	120	80	55														
0,70	590	375	220	140	90	65														
0,80	695	430	250	160	105	70	50													
1,00	910	540	310	195	130	90	65													
1,20	1130	645	370	235	155	105	75	55												
1,50																				

Sp. Th. mm	Larghezza appoggio: 100 mm Support width: 100 mm																			
	L=m	CAMPATA DOPPIA DOUBLE SPAN																		
	0,80	1,00	1,20	1,40	1,60	1,80	2,00	2,20	2,40	2,60	2,80	3,00	3,20	3,40	3,60	3,80	4,00	4,20	4,40	4,60
0,50	260	195	150	120	95	80	65	55												
0,60	335	245	190	150	120	95	80	70	55											
0,70	415	300	230	180	145	115	95	80	65	50										
0,80	495	355	270	210	165	135	110	95	75	55										
1,00	655	465	345	265	215	175	145	120	90	70	55									
1,20	820	575	430	340	270	225	185	145	110	85	65	55								
1,50																				

Sp. Th. mm	Larghezza appoggio: 100 mm Support width: 100 mm																			
	L=m	CAMPATA MULTIPLA MULTIPLE SPAN																		
	0,80	1,00	1,20	1,40	1,60	1,80	2,00	2,20	2,40	2,60	2,80	3,00	3,20	3,40	3,60	3,80	4,00	4,20	4,40	4,60
0,50	300	225	175	140	115	85	65													
0,60	390	290	225	180	145	105	75	55												
0,70	485	360	275	215	175	125	90	65	50											
0,80	585	425	325	255	200	140	100	75	55											
1,00	780	560	420	325	250	175	125	95	70	55										
1,20	985	695	525	415	295	205	150	110	85	65	50									
1,50																				

In azzurro i carichi limitati da freccia 1/200 L. Values in blue show load limited by vertical deflection 1/200 L.

Calcoli eseguiti in ottemperanza alla normativa EUROCODICE 3 (EN 1993-1-3). Il carico riportato va inteso come valore caratteristico di portata, con coefficiente di combinazione applicato $\gamma_f=1,5$. I valori riportati in tabella sono da considerarsi come indicativi, è competenza del progettista procedere per i singoli casi di verifica al relativo calcolo. Calculations are made in accordance with EUROCODE 3 (EN 1993-1-3). The load reported shall be understood as the characteristic load value, with the coefficient of combination applied $\gamma_f=1,5$. The values shown in the table must be considered as indicative, the designer has the responsibility to proceed with the relative calculation in any individual cases.

SAND A55 P600

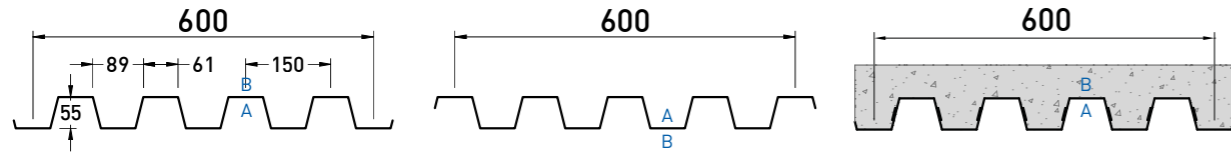

POSITIVE

NEGATIVE

CLS

A: lato a vista - front side
B: lato non a vista - back side

Reazione al fuoco Fire reaction CLASS A1

Comportamento al fuoco dall'esterno External fire performance Broof (t1,t2,t3)

Senza necessità di sottoporre a prova secondo la norma UNI EN 14782:2006. No lab test is required as per UNI EN 14782:2006.



POSITIVE

immagine a scopo illustrativo - image as example

DATI STATICI				STATIC DATA				PESO		WEIGHT	
Sp. Th. (mm)	Jy (cm ² /m)	We inf (cm ³ /m)	We sup (cm ³ /m)	Steel Kg/m ²							
0,50	38,58	14,03	14,03	6,54							
0,60	45,89	16,69	16,69	7,85							
0,70	53,07	19,30	19,30	9,16							
0,80	60,12	21,86	21,86	10,47							
1,00	73,82	26,84	26,84	13,08							
1,20	87,00	31,64	31,64	15,70							
1,50	105,83	38,48	38,48	19,63							

POSITIVE NEGATIVE

CURVATURA BENDING

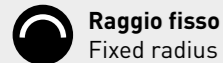

Raggio fisso
Fixed radius



Variabile
Variable

APPLICAZIONI APPLICATIONS

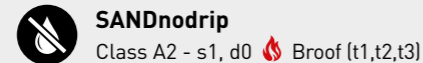

SANDnodrip
Class A2 - s1, d0 Broof (t1,t2,t3)

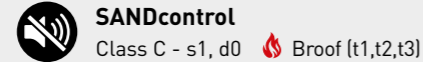

SANDcontrol
Class C - s1, d0 Broof (t1,t2,t3)

FORATURE PERFORATION



F3 P5 60°



F5 P8 60°

Per maggiori dettagli consultare pagine 112-114

For more details see pages 112-114

PROFILO PROFILE	NR. GRECHE RIBS NO.	INTERASSE (mm) PITCH (mm)	LARGH. UTILE (mm) USEFUL WIDTH (mm)	LARGH. LASTRA (mm) SHEET WIDTH (mm)	SORMONTO OVERLAP	TIPO SORMONTO KIND OF OVERLAP
SAND A55 P600 POSITIVE						
SAND A55 P600 NEGATIVE	5	150	600	600	-	
SAND A55 P600 CLS						

Accessori, materiali e colorazioni sono consultabili alle pagine 116-118

Accessories, materials and colors are available on pages 116-118

SAND A55 P600

Tabelle di portata (daN/m²) Load tables (daN/sqm)

POSITIVE

NEGATIVE

steel S250GD

Sp. Th. mm	Larghezza appoggio: 100 mm Support width: 100 mm																					
	CAMPATA SINGOLA SINGLE SPAN																					
	L=m	1,50	1,75	2,00	2,25	2,50	2,75	3,00	3,25	3,50	3,75	4,00	4,25	4,50	4,75	5,00	5,25	5,50	5,75	6,00	6,25	
0,50	482	353	268	209	166	123	91	70	54													
0,60	663	482	369	284	203	150	112	86	70	54												
0,70	813	599	455	332	241	177	134	102	80	64												
0,80	979	717	546	385	278	203	155	118	91	75	59											
1,00	1321	968	706	492	353	262	198	155	118	96	75	59										
1,20	1685	1231	861	599	433	321	241	187	144	118	91	75	59									
1,50	2231	1637	1097	765	551	407	310	241	187	150	118	96	75	64								

Sp. Th. mm	Larghezza appoggio: 100 mm Support width: 100 mm																					
	CAMPATA DOPPIA DOUBLE SPAN																					
	L=m	1,50	1,75	2,00	2,25	2,50	2,75	3,00	3,25	3,50	3,75	4,00	4,25	4,50	4,75	5,00	5,25	5,50	5,75	6,00	6,25	
0,50	385	297	237	193	160	132	116	99	83	72	61	55										
0,60	506	391	314	259	215	182	154	138	116	99	88	77	66	61	55							
0,70	627	490	391	319	264	226	193	171	143	127	110	94	83	72	66	55						
0,80	754	589	473	385	319	270	231	204	176	149	132	116	99	88	77	66	55					
1,00	1029	803	644	523	440	369	330	281	237	204	182	160	138	116	99	83	72	61				
1,20	1326	1029	825	677	561	473	418	358	303	264	231	204	171	143	121	99	88	72	61			
1,50	1788	1386	1111	908	754	627	561	473	407	352	308	264	220	182	154	132	110	94	83			

Sp. Th. mm	Larghezza appoggio: 100 mm Support width: 100 mm																					
	CAMPATA MULTIPLA MULTIPLE SPAN																					
	L=m	1,50	1,75	2,00	2,25	2,50	2,75	3,00	3,25	3,50	3,75	4,00	4,25	4,50	4,75	5,00	5,25	5,50	5,75	6,00	6,25	
0,50	452	347	278	226	189	158	137	116	100	89	74	58										
0,60	583	457	368	299	252	215	184	163	137	110	89	68	58									
0,70	725	567	457	373	315	263	226	200	158	126	105	84	68	58								
0,80	877	683	551	452	378	320	273	231	184	147	121	95	79	68	53							
1,00	1197	935	751	614	515	436	383	299	236	189	152	126	100	84	68	58						
1,20	1538	1197	961	793	662	562	467	362	289	231	189	152	126	105	89	74	63	53				
1,50	2079	1617	1297	1066	893	756	593	462	368	294	236	194	163	131	110	95	79	68	58			

In azzurro i carichi limitati da freccia 1/200 L. Values in blue show load limited by vertical deflection 1/200 L.

Calcoli eseguiti in ottemperanza alla normativa EUROCODICE 3 (EN 1993-1-3). Il carico riportato va inteso come valore caratteristico di portata, con coefficiente di combinazione applicato $\gamma_c=1.5$. I valori riportati in tabella sono da considerarsi come indicativi, è competenza del progettista procedere per i singoli casi di verifica al relativo calcolo. Calculations are made in accordance with EUROCODE 3 (EN 1993-1-3). The load reported shall be understood as the characteristic load value, with the coefficient of combination applied $\gamma_c=1.5$. The values shown in the table must be considered as indicative, the designer has the responsibility to proceed with the relative calculation in any individual cases.

CLS

steel S280GD

H mm	S mm	peso soletta Kg/m ²	Larghezza appoggio: 100 mm Support width: 100 mm																			
			CAMPATA SINGOLA SINGLE SPAN																			
			L=m	1,50	1,75	2,00	2,25	2,50	2,75	3,00	3,25	3,50	3,75	4,00	4,25	4,50	4,75	5,00	5,25	5,50	5,75	6,00
100	0,70*	185,9	2030	1715	1480	1270	1045	875	740	635	550	475	415	350	260	190	135					
	0,80	187,1	2030	1715	1480	1295	1130	945	800	685	590	515	450	365	275	200	140					
	1,00	189,3	2030	1715	1480	1295	1150	1030	910	775	670	580	510	390	295	220	155	105				
	0,169	191,4	2030	1715	1480	1295	1150	1030	930	845	730	635	540	415	315	235	170	115				
	1,50	194,7	2030	1715	1480	1295	1150	1030	930	845	775	700	585	450	340	255	190	130				

H mm	S mm	peso soletta Kg/m ²	Larghezza appoggio: 100 mm Support width: 100 mm																			
			CAMPATA SINGOLA SINGLE SPAN																			
			L=m	1,50	1,75	2,00	2,25	2,50	2,75	3,00	3,25	3,50	3,75	4,00	4,25	4,50	4,75	5,00	5,25	5,50	5,75	6,00
110	0,70*	210,4	2315	1955	1690	1430	1180	995	845	725	630	550	485	415	350	290	215	155	100			
	0,80	211,6	2315	1955	1690	1480	1270	1065	905	780	675	590	520	460	400	305	225	160	110			
	1,00	213,8	2315	1955	1690	1480	1310	1175	1020	875	760	660	580	515	430	325	245	180	125			
	0,169	215,9	2315	1955	1690	1480	1310	1175	1060	950	820	715	625	555	455	350	265	195	135			
	1,50	219,2	2315	1955	1690	1480	1310	1175	1060	965	880	790	690	605	590	380	290	215	155	105		

H mm	S mm	peso soletta Kg/m ²	Larghezza appoggio: 100 mm Support width: 100 mm																			
			CAMPATA SINGOLA SINGLE SPAN																			
			L=m	1,50	1,75	2,00	2,25	2,50	2,75	3,00	3,25	3,50	3,75	4,00	4,25	4,50	4,75	5,00	5,25	5,50	5,75	6,00
120	0,70*	234,9	2595	2195	1895	1585	1315	1110	950	820	715	625	550	480	405	340	290	240	175	120		
	0,80	236,1	2595	2195	1895	1660	1405	1185	1010	875	760	665	585	520	460	410	335	250	185	125		
	1,00	238,3	2595	2195	1895	1660	1475	1320	1130	970	845	740	650	575	515	460	360	275	200	140		
	0,169	240,4	2595	2195	1895	1660	1475	1320	1190	1050	910	795	700	620	550	490	385	295	220	155	105	
	1,50	243,7	2595	2195	1895	1660	1475	1320	1190	1085	99											

SAND A55 P750

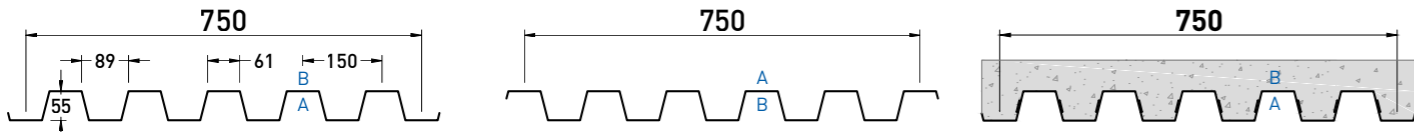

POSITIVE

NEGATIVE

CLS

A: lato a vista - front side
B: lato non a vista - back side

Reazione al fuoco Fire reaction CLASS A1

Comportamento al fuoco dall'esterno External fire performance Broof (t1,t2,t3)

Senza necessità di sottoporre a prova secondo la norma UNI EN 14782:2006. No lab test is required as per UNI EN 14782:2006.



POSITIVE

immagine a scopo illustrativo - image as example

DATI STATICI				STATIC DATA				PESO		WEIGHT	
Sp. Th. (mm)	Jy (cm ² /m)	We inf (cm ³ /m)	We sup (cm ³ /m)	Steel Kg/m ²							
0,50	38,58	14,03	14,03	6,54							
0,60	45,89	16,69	16,69	7,85							
0,70	53,07	19,30	19,30	9,16							
0,80	60,12	21,86	21,86	10,47							
1,00	73,82	26,84	26,84	13,08							
1,20	87,00	31,64	31,64	15,70							
1,50	105,83	38,48	38,48	19,63							

CURVATURA BENDING

- Raggio fisso Fixed radius
- Variabile Variable

APPLICAZIONI APPLICATIONS

- SANDnodrip**
Class A2 - s1, d0 Broof (t1,t2,t3)
- SANDcontrol**
Class C - s1, d0 Broof (t1,t2,t3)

FORATURE PERFORATION

- F3 P5 60°**
- F5 P8 60°**

Per maggiori dettagli consultare pagine 112-114

For more details see pages 112-114

PROFILO PROFILE	NR. GRECHE RIBS NO.	INTERASSE (mm) PITCH (mm)	LARGH. UTILE (mm) USEFUL WIDTH (mm)	LARGH. LASTRA (mm) SHEET WIDTH (mm)	SORMONTO OVERLAP	TIPO SORMONTO KIND OF OVERLAP
SAND A55 P750 POSITIVE						
SAND A55 P750 NEGATIVE	6	150	750	750	-	
SAND A55 P750 CLS						

Accessori, materiali e colorazioni sono consultabili alle pagine 116-118 Accessories, materials and colors are available on pages 116-118

SAND A55 P750 Tabelle di portata (daN/m²) Load tables (daN/sqm) POSITIVE NEGATIVE steel S250GD

Sp. Th. mm	Larghezza appoggio: 100 mm Support width: 100 mm																						
	CAMPATA SINGOLA SINGLE SPAN																						
	L=m	1,50	1,75	2,00	2,25	2,50	2,75	3,00	3,25	3,50	3,75	4,00	4,25	4,50	4,75	5,00	5,25	5,50	5,75	6,00	6,25		
0,50	482	353	268	209	166	123	91	70	54														
0,60	663	482	369	284	203	150	112	86	70	54													
0,70	813	599	455	332	241	177	134	102	80	64													
0,80	979	717	546	385	278	203	155	118	91	75	59												
1,00	1321	968	706	492	353	262	198	155	118	96	75	59											
1,20	1685	1231	861	599	433	321	241	187	144	118	91	75	59										
1,50	2231	1637	1097	765	551	407	310	241	187	150	118	96	75	64									

Sp. Th. mm	Larghezza appoggio: 100 mm Support width: 100 mm																						
	CAMPATA DOPPIA DOUBLE SPAN																						
	L=m	1,50	1,75	2,00	2,25	2,50	2,75	3,00	3,25	3,50	3,75	4,00	4,25	4,50	4,75	5,00	5,25	5,50	5,75	6,00	6,25		
0,50	385	297	237	193	160	132	116	99	83	72	61	55											
0,60	506	391	314	259	215	182	154	138	116	99	88	77	66	61	55								
0,70	627	490	391	319	264	226	193	171	143	127	110	94	83	72	66	55							
0,80	754	589	473	385	319	270	231	204	176	149	132	116	99	88	77	66	55						
1,00	1029	803	644	523	440	369	330	281	237	204	182	160	138	116	99	83	72	61					
1,20	1326	1029	825	677	561	473	418	358	303	264	231	204	176	154	132	110	94	83	72	61			
1,50	1788	1386	1111	908	754	627	561	473	407	352	308	264	220	182	154	132	110	94	83				

Sp. Th. mm	Larghezza appoggio: 100 mm Support width: 100 mm																						
	CAMPATA MULTIPLA MULTIPLE SPAN																						
	L=m	1,50	1,75	2,00	2,25	2,50	2,75	3,00	3,25	3,50	3,75	4,00	4,25	4,50	4,75	5,00	5,25	5,50	5,75	6,00	6,25		
0,50	452	347	278	226	189	158	137	116	100	89	74	58											
0,60	583	457	368	299	252	215	184	163	137	110	89	68	58										
0,70	725	567	457	373	315	263	226	200	158	126	105	84	68	58									
0,80	877	683	551	452	378	320	273	231	184	147	121	95	79	68	53								
1,00	1197	935	751	614	515	436	383	299	236	189	152	126	100	84	68	58							
1,20	1538	1197	961	793	662	562	467	362	289	231	189	152	126	105	89	74	63	53					
1,50	2079	1617	1297	1066	893	756	593	462	368	294	236	194	163	131	110	95	79	68	58				

In azzurro i carichi limitati da freccia 1/200 L. Values in blue show load limited by vertical deflection 1/200 L.
Calcoli eseguiti in ottemperanza alla normativa EUROCODICE 3 (EN 1993-1-3). Il carico riportato va inteso come valore caratteristico di portata, con coefficiente di combinazione applicato γ_c=1.5. I valori riportati in tabella sono da considerarsi come indicativi, è competenza del progettista procedere per i singoli casi di verifica al relativo calcolo. Calculations are made in accordance with EUROCODE 3 (EN 1993-1-3). The load reported shall be understood as the characteristic load value, with the coefficient of combination applied γ_c=1.5. The values shown in the table must be considered as indicative, the designer has the responsibility to proceed with the relative calculation in any individual cases.

CLS steel S280GD

H mm	S mm	peso soletta Kg/m ²	Larghezza appoggio: 100 mm Support width: 100 mm																				
			CAMPATA SINGOLA SINGLE SPAN																				
			L=m	1,50	1,75	2,00	2,25	2,50	2,75	3,00	3,25	3,50	3,75	4,00	4,25	4,50	4,75	5,00	5,25	5,50	5,75	6,00	
100	0,70*	185,9	2030	1715	1480	1270	1045	875	740	635	550	475	415	350	260	190	135						
	0,80	187,1	2030	1715	1480	1295	1130	945	800	685	590	515	450	365	275	200	140						
	1,00	189,3	2030	1715	1480	1295	1150	1030	910	775	670	580	510	390	295	220	155	105					
	0,169	191,4	2030	1715	1480	1295	1150	1030	930	845	730	635	540	415	315	235	170	115					
	1,50	194,7	2030	1715	1480	1295	1150	1030	930	845	775	700	585	450	340	255	190	130					

H mm	S mm	peso soletta Kg/m ²	Larghezza appoggio: 100 mm Support width: 100 mm																				
			CAMPATA SINGOLA SINGLE SPAN																				
			L=m	1,50	1,75	2,00	2,25	2,50	2,75	3,00	3,25	3,50	3,75	4,00	4,25	4,50	4,75	5,00	5,25	5,50	5,75	6,00	
110	0,70*	210,4	2315	1955	1690	1430	1180	995	845	725	630	550	485	415	350	290	215	155	100				
	0,80	211,6	2315	1955	1690	1480	1270	1065	905	780	675	590	520	460	400	305	225	160	110				
	1,00	213,8	2315	1955	1690	1480	1310	1175	1020	875	760	660	580	515	430	325	245	180	125				
	0,169	215,9	2315	1955	1690	1480	1310	1175	1060	950	820	715	625	555	455	350	265	195	135				
	1,50	219,2	2315	1955	1690	1480	1310	1175	1060	965	880	790	690	605	590	380	290	215	155	105			

H mm	S mm	peso soletta Kg/m ²	Larghezza appoggio: 100 mm Support width: 100 mm																				
			CAMPATA SINGOLA SINGLE SPAN																				
			L=m	1,50	1,75	2,00	2,25	2,50	2,75	3,00	3,25	3,50	3,75	4,00	4,25	4,50	4,75	5,00	5,25	5,50	5,75	6,00	
120	0,70*	234,9	2595	2195	1895	1585	1315	1110	950	820	715	625	550	480	405	340	290	240	175	120			
	0,80	236,1	2595	2195	1895	1660	1405	1185	1010	875	760	665	585	520	460	410	335	250	185	125			
	1,00	238,3	2595	2195	1895	1660	1475	1320	1130	970	845	740	650	575	515	460	360	275	200	140			
	0,169	240,4	2595	2195	1895	1660	1475	1320	1190	1050	910	795	700	620	550	490	385	295	220	155	105		
	1,50	243,7	2595	2195	1895	1660	1475	1320	1190	1085	990	870	765	675	600	530	415	320	240	175	120		

In rosso i carichi limitati da freccia 1/350 L. Values in red show load limited by vertical deflection 1/350 L.
Armatura minima di ripartizione da posizionare all'estradosso della soletta. (NTC 18 § 4.3.6.3.1 - EN 1994-1-1 § 9.8.1(2))
0,2% A Ø5 150x150 costruzioni non puntellate in fase di getto.
0,4% A Ø6 150x150 costruzioni puntellate in fase di getto (H 100mm).
0,4% A Ø6 100x100 costruzioni puntellate in fase di getto (H 110mm e H

SAND A55 P800

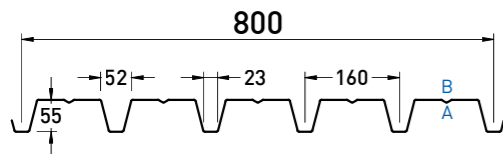

POSITIVE

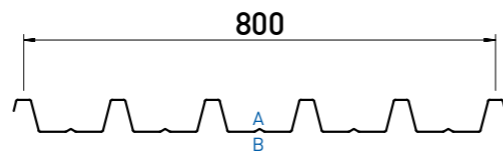

NEGATIVE

A: lato a vista - front side
B: lato non a vista - back side

Reazione al fuoco Fire reaction
CLASS A1

Comportamento al fuoco dall'esterno External fire performance
Roof (t1,t2,t3)

Senza necessità di sottoporre a prova secondo la norma UNI EN 14782:2006. No lab test is required as per UNI EN 14782:2006.



POSITIVE

immagine a scopo illustrativo - image as example

Sp. Th. (mm)	Jy (cm ² /m)	DATI STATICI		STATIC DATA		PESO		WEIGHT	
		We inf (cm ³ /m)	We sup (cm ³ /m)	Steel Kg/m ²	Aluminium Kg/m ²				
0,50	31,17	8,45	17,22	6,13	2,11				
0,60	36,94	10,01	20,40	7,36	2,53				
0,70	42,55	11,53	23,49	8,59	2,95				
0,80	48,01	13,02	26,50	9,81	3,38				
1,00	58,48	15,86	32,26	12,27	4,22				
1,20	68,36	18,54	37,69	14,72	5,06				
1,50	82,10	22,28	45,23	18,40	6,33				

POSITIVE

per versione negative invertire We inf e We sup
for negative version, invert We inf and We sup

CURVATURA BENDING



Su richiesta
On request

APPLICAZIONI APPLICATIONS



SANDnodrip
Class A2 - s1, d0 🔥 Broof (t1,t2,t3)



SANDcontrol
Class C - s1, d0 🔥 Broof (t1,t2,t3)

FORATURE PERFORATION



F3 P5 60°



F5 P8 60°

Per maggiori dettagli consultare pagine 112-114

For more details see pages 112-114

PROFILO PROFILE	NR. GRECHE RIBS NO.	INTERASSE (mm) PITCH (mm)	LARGH. UTILE (mm) USEFUL WIDTH (mm)	LARGH. LASTRA (mm) SHEET WIDTH (mm)	SORMONTO OVERLAP	TIPO SORMONTO KIND OF OVERLAP
SAND A55 P800 POSITIVE	6	160	800	800	-	
SAND A55 P800 NEGATIVE						

Accessori, materiali e colorazioni sono consultabili alle pagine 116-118

Accessories, materials and colors are available on pages 116-118

SAND A55 P800 Tabelle di portata (daN/m²) Load tables (daN/sqm)

POSITIVE

steel S250GD

Sp. Th. mm	Larghezza appoggio: 100 mm Support width: 100 mm																					
	CAMPATA SINGOLA SINGLE SPAN										CAMPATA SINGOLA SINGLE SPAN											
	L=m	0,80	1,00	1,20	1,40	1,60	1,80	2,00	2,20	2,40	2,60	2,80	3,00	3,20	3,40	3,60	3,80	4,00	4,20	4,40	4,60	
0,50	q=daN/m ²	1715	1150	800	585	445	350	280	210	160	125	95	80	60	50							
0,60		2260	1450	1010	740	565	445	340	255	195	150	120	95	75	60	50						
0,70		2760	1775	1230	905	690	545	400	300	225	175	140	110	90	75	60	50					
0,80		3270	2100	1460	1075	820	635	460	340	260	200	160	125	105	85	70	55					
1,00		4290	2760	1920	1410	1080	790	575	425	325	255	200	160	130	105	85	70	60	50			
1,20		5200	3350	2330	1715	1310	930	670	500	380	295	235	185	150	125	100	85	70	60	50		
1,50		6500	4185	2915	2145	1595	1115	805	600	460	355	280	225	180	150	120	100	85	70	60		

Sp. Th. mm	Larghezza appoggio: 100 mm Support width: 100 mm																					
	CAMPATA DOPPIA DOUBLE SPAN										CAMPATA DOPPIA DOUBLE SPAN											
	L=m	0,80	1,00	1,20	1,40	1,60	1,80	2,00	2,20	2,40	2,60	2,80	3,00	3,20	3,40	3,60	3,80	4,00	4,20	4,40	4,60	
0,50	q=daN/m ²	875	620	470	360	285	235	190	160	135	120	100	90	80	70	60	55					
0,60		1140	820	630	485	385	315	260	220	185	160	140	120	105	95	80	75	65	60	50		
0,70		1395	995	805	625	500	410	340	290	245	215	185	160	140	120	105	95	85	75	70		
0,80		1645	1170	1075	845	680	555	465	395	340	295	255	225	200	180	160	145	130	110	95		
1,00		2155	1520	1535	1200	965	790	665	560	485	420	365	325	285	255	230	190	160	140	120		
1,20		2665	1865	1915	1490	1195	980	815	690	590	515	450	395	350	310	265	225	190	160	140		
1,50		3425	2380	2500	1935	1540	1260	1045	880	755	650	570	495	430	380	320	270	230	195	165		

Sp. Th. mm	Larghezza appoggio: 100 mm Support width: 100 mm																					
	CAMPATA MULTIPLA MULTIPLE SPAN										CAMPATA MULTIPLA MULTIPLE SPAN											
	L=m	0,80	1,00	1,20	1,40	1,60	1,80	2,00	2,20	2,40	2,60	2,80	3,00	3,20	3,40	3,60	3,80	4,00	4,20	4,40	4,60	
0,50	q=daN/m ²	1050	745	565	440	350	285	235	200	170	145	125	110	100	85	75	70	60	50			
0,60		1360	980	755	590	470	385	320	270	230	195	170	150	135	120	105	85	75	60	55		
0,70		1665	1195	970	760	610	500	420	355	305	265	230	200	175	145	120	100	85	75	60		
0,80		1970	1410	1290	1015	820	675	565	480	415	360	310	250	205	170	140	120	100	85	70		
1,00		2590	1835	1840	1445	1165	960	800	685	590	490	390	315	255	210	175	150	125	105	90		
1,20		3215	2260	2305	1800	1450	1190	1120	845	725	575	460	370	300	250	205	175	145	125	105		
1,50		4145	2890	3015	2345	1875	1535	1280	1080	885	690	550	445	360	300	250	210	175	150	125		

In azzurro i carichi limitati da freccia 1/200 L. Values in blue show load limited by vertical deflection 1/200 L.

Calcoli eseguiti in ottemperanza alla normativa EUROCODICE 3 (EN 1993-1-3). Il carico riportato va inteso come valore caratteristico di portata, con coefficiente di combinazione applicato γ_f=1,5. I valori riportati in tabella sono da considerarsi come indicativi, è competenza del progettista procedere per i singoli casi di verifica al relativo calcolo. Calculations are made in accordance with EUROCODE 3 (EN 1993-1-3). The load reported shall be understood as the characteristic load value, with the coefficient of combination applied γ_f=1,5. The values shown in the table must be considered as indicative, the designer has the responsibility to proceed with the relative calculation in any individual cases.

NEGATIVE

steel S250GD

Sp. Th. mm	Larghezza appoggio: 100 mm Support width: 100 mm																					
	CAMPATA SINGOLA SINGLE SPAN										CAMPATA SINGOLA SINGLE SPAN											
	L=m	0,80	1,00	1,20	1,40	1,60	1,80	2,00	2,20	2,40	2,60	2,80	3,00	3,20	3,40	3,60	3,80	4,00	4,20	4,40	4,60	
0,50	q=daN/m ²	1365	870	605	440	335	265	210	175	145	120	95	80	65	50							
0,60		1835	1170	810	595	450	355	285	235	195	155	125	100	80	65	55						
0,70		2365	1510	1045	765	585	460	370	305	235	185	145	115	95	75	65	50					
0,80		3495	2230	1545	1135	865	650	470	350	270	210	165	130	105	85	70	60	50				
1,00		4965	3170	2200	1610	1135	795	575	430	325	255	200	160	130	105	85	70	60	50			
1,20		5870	3750	2600	1905	1330	930	670	500	380	295	235	185	150	125	100	85	70	60	50		
1,50																						

Sp. Th. mm	Larghezza appoggio: 100 mm Support width: 100 mm																					
	CAMPATA DOPPIA DOUBLE SPAN										CAMPATA DOPPIA DOUBLE SPAN											
	L=m	0,80	1,00	1,20	1,40	1,60	1,80	2,00	2,20	2,40	2,60	2,80	3,00	3,20	3,40	3,60	3,80	4,00	4,20	4,40	4,60	
0,50	q=daN/m ²	865	630	480	380	310	255	215	185	160	140	125	110	95	85	80	70	65	60	55		
0,60		1115	810	620	490	400	330	280	240	205	180	160	140	125	115	100	90	85	75	70		
0,70		1400	1015	780	615	500	415	350	300	260	230	200	180	160	145	130	115	105	95	85		
0,80		1705	1240	950	755	615	510	430	370	320	280	245	220	195	175	160	145	130	115	95		
1,00		2350	1710	1310	1040	845	705	595	510	445	390	345	305	275	245	220	190	165	140	120		
1,20		2965	2160	1655	1315	1070	890	755	645	560	490	435	385	345	310	265	225	190	160	140		
1,50																						

Sp. Th. mm	Larghezza appoggio: 100 mm Support width: 100 mm																				
	CAMPATA MULTIPLA MULTIPLE SPAN										CAMPATA MULTIPLA MULTIPLE SPAN										
	L=m	0,80	1,00	1,20	1,40	1,60	1,80	2,00	2,20	2,40	2,60	2,80	3,00	3,20	3,40	3,60	3,80	4,00	4,20	4,40	4,60
0,50	q=daN/m ²	1035	755																		

SAND 59

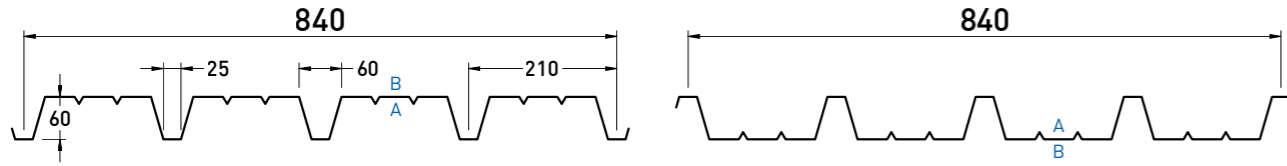

POSITIVE

NEGATIVE

A: lato a vista - front side
B: lato non a vista - back side

Reazione al fuoco Fire reaction
CLASS A1

Comportamento al fuoco dall'esterno External fire performance
Roof (t1,t2,t3)

Senza necessità di sottoporre a prova secondo la norma UNI EN 14782:2006. No lab test is required as per UNI EN 14782:2006.

DATI STATICI				PESO		WEIGHT	
Sp. Th. (mm)	Jy (cm ⁴ /m)	We inf (cm ³ /m)	We sup (cm ³ /m)	Steel Kg/m ²	Aluminium Kg/m ²		
0,50	32,20	7,49	18,89	5,84	2,01		
0,60	38,70	9,01	22,70	7,01	2,41		
0,70	44,37	10,33	26,01	8,18	2,81		
0,80	50,53	11,77	29,6	9,35	3,21		
1,00	61,72	14,38	36,12	11,68	4,02		
1,20	72,29	16,85	42,25	14,02	4,82		
1,50	87,55	20,43	51,08	17,52	6,03		



POSITIVE

immagine a scopo illustrativo - image as example

POSITIVE

per versione negative invertire We inf e We sup
for negative version, invert We inf and We sup

CURVATURA BENDING



Su richiesta
On request

APPLICAZIONI APPLICATIONS



SANDnodrip
Class A2 - s1, d0 🔥 Roof (t1,t2,t3)



SANDcontrol
Class C - s1, d0 🔥 Roof (t1,t2,t3)

FORATURE PERFORATION



F3 P5 60°



F5 P8 60°

Per maggiori dettagli consultare pagine 112-114

For more details see pages 112-114

PROFILO PROFILE	NR. GRECHE RIBS NO.	INTERASSE (mm) PITCH (mm)	LARGH. UTILE (mm) USEFUL WIDTH (mm)	LARGH. LASTRA (mm) SHEET WIDTH (mm)	SORMONTO OVERLAP	TIPO SORMONTO KIND OF OVERLAP
SAND 59 POSITIVE	5	210	840	840	-	
SAND 59 NEGATIVE						

Accessori, materiali e colorazioni sono consultabili alle pagine 116-118

Accessories, materials and colors are available on pages 116-118

SAND 59

Tabelle di portata (daN/m²) Load tables (daN/sqm)

POSITIVE

steel S250GD

Sp. Th. mm	Larghezza appoggio: 100 mm Support width: 100 mm																					
	CAMPATA SINGOLA SINGLE SPAN										CAMPATA SINGOLA SINGLE SPAN											
	L=m	0,80	1,00	1,20	1,40	1,60	1,80	2,00	2,20	2,40	2,60	2,80	3,00	3,20	3,40	3,60	3,80	4,00	4,20	4,40	4,60	
0,50	q=daN/m ²	1180	945	785	575	440	345	280	225	175	135	105	85	70	55							
0,60		1625	1295	1035	760	580	460	370	275	210	165	130	105	85	65	55						
0,70		2060	1650	1265	930	710	560	425	320	245	190	150	120	95	80	65	55					
0,80		2600	2080	1510	1110	850	670	490	365	280	215	170	135	110	90	75	60	50				
1,00		3755	2785	1945	1435	1100	830	605	450	340	265	210	170	135	110	90	75	60	50			
1,20		5070	3380	2360	1740	1335	980	710	530	405	315	250	200	160	130	105	90	75	60	50		
1,50		6465	4200	2940	2165	1660	1190	860	645	490	380	300	240	195	160	130	110	90	75	60	50	

Sp. Th. mm	Larghezza appoggio: 100 mm Support width: 100 mm																					
	CAMPATA DOPPIA DOUBLE SPAN										CAMPATA DOPPIA DOUBLE SPAN											
	L=m	0,80	1,00	1,20	1,40	1,60	1,80	2,00	2,20	2,40	2,60	2,80	3,00	3,20	3,40	3,60	3,80	4,00	4,20	4,40	4,60	
0,50	q=daN/m ²	650	465	345	275	215	175	145	125	105	90	75	65	60	50							
0,60		895	640	480	375	300	245	205	170	145	125	110	95	85	75	65	60	50				
0,70		1100	795	605	465	380	310	260	215	185	160	140	120	105	95	85	75	65	60	55		
0,80		1325	950	720	660	535	430	345	285	235	200	170	150	130	115	105	90	80	75	65		
1,00		1755	1250	940	990	805	665	560	475	410	360	315	280	250	220	200	175	160	140	125		
1,20		2195	1555	1190	1250	1005	830	695	590	510	445	390	345	305	270	245	220	200	170	145		
1,50		2885	2020	1510	1655	1330	1090	910	775	665	575	505	445	395	350	315	280	245	210	180		

Sp. Th. mm	Larghezza appoggio: 100 mm Support width: 100 mm																					
	CAMPATA MULTIPLA MULTIPLE SPAN										CAMPATA MULTIPLA MULTIPLE SPAN											
	L=m	0,80	1,00	1,20	1,40	1,60	1,80	2,00	2,20	2,40	2,60	2,80	3,00	3,20	3,40	3,60	3,80	4,00	4,20	4,40	4,60	
0,50	q=daN/m ²	775	555	420	330	265	215	180	150	130	110	95	85	75	65	60	50					
0,60		1065	765	580	455	365	300	250	210	180	155	135	120	105	90	80	75	65	60	55		
0,70		1310	950	725	560	465	380	315	265	230	195	170	150	135	120	105	95	85	75	65		
0,80		1575	1140	865	790	640	530	435	355	300	250	215	185	165	145	130	115	105	90	75		
1,00		2100	1505	1135	1185	965	800	675	580	500	435	385	330	270	225	185	155	130	110	95		
1,20		2635	1875	1390	1500	1215	1005	845	720	620	540	475	390	320	265	220	185	155	130	110		
1,50		3470	2445	1795	1995	1605	1325	1110	940	810	705	590	475	385	320	265	225	190	160	135		

In azzurro i carichi limitati da freccia 1/200 L. Values in blue show load limited by vertical deflection 1/200 L.

Calcoli eseguiti in ottemperanza alla normativa EUROCODICE 3 (EN 1993-1-3). Il carico riportato va inteso come valore caratteristico di portata, con coefficiente di combinazione applicato $\gamma_f=1,5$. I valori riportati in tabella sono da considerarsi come indicativi, è competenza del progettista procedere per i singoli casi di verifica al relativo calcolo. Calculations are made in accordance with EUROCODE 3 (EN 1993-1-3). The load reported shall be understood as the characteristic load value, with the coefficient of combination applied $\gamma_f=1,5$. The values shown in the table must be considered as indicative, the designer has the responsibility to proceed with the relative calculation in any individual cases.

NEGATIVE

steel S250GD

Sp. Th. mm	Larghezza appoggio: 100 mm Support width: 100 mm																					
	CAMPATA SINGOLA SINGLE SPAN										CAMPATA SINGOLA SINGLE SPAN											
	L=m	0,80	1,00	1,20	1,40	1,60	1,80	2,00	2,20	2,40	2,60	2,80	3,00	3,20	3,40	3,60	3,80	4,00	4,20	4,40	4,60	
0,50	q=daN/m ²	1095	695	480	350	270	210	170	140	115	95	80	70	60	50							
0,60		1505	960	665	485	370	290	235	190	160	135	115	100	80	65	55						
0,70		1900	1210	840	615	465	365	295	240	200	170	145	120	95	80	65	55					
0,80		2300	1470	1015	745	565	445	360	295	245	210	175	140	110	90	75	60	50				
1,00		3755	2730	1895	1385	1060	835	605	455	345	270	210	170	135	110	90	75	65	50			
1,20		5070	3490	2420	1775	1355	980	710	530	405	315	250	200	160	130	110	90	75	60	50		
1,50																						

Sp. Th. mm	Larghezza appoggio: 100 mm Support width: 100 mm																					
	CAMPATA DOPPIA DOUBLE SPAN										CAMPATA DOPPIA DOUBLE SPAN											
	L=m	0,80	1,00	1,20	1,40	1,60	1,80	2,00	2,20	2,40	2,60	2,80	3,00	3,20	3,40	3,60	3,80	4,00	4,20	4,40	4,60	
0,50	q=daN/m ²	675	500	385	310	255	215	180	155	135	120	105	95	85	75	60	55	50				
0,60		905	670	520	415	345	290	245	210	185	160	145	130	115	105	95	85	80	70	65		
0,70		1130	835	650	520	430	360	310	265	230	205	180	160	145	130	120	110	100	90	85		
0,80		1390	1030	800	645	530	445	380	330	285	255	225	200	180	165	150	135	125	115	100		
1,00		1910	1415	1100	885	730	615	525	455	395	350	310	275	250	225	205	185	170	145	125		
1,20		2455	1815	1410	1135	935	790	675	580	510	450	400	355	320	290	265	240	200	170	145		
1,50																						

Sp. Th. mm	Larghezza appoggio: 100 mm Support width: 100 mm																				
	CAMPATA MULTIPLA MULTIPLE SPAN										CAMPATA MULTIPLA MULTIPLE SPAN										
	L=m	0,80	1,00	1,20	1,40	1,60	1,80	2,00	2,20	2,40	2,60	2,80	3,00	3,20	3,40	3,60	3,80	4,00	4,20	4,40	4,60
0,50	q=daN/m ²	800	595	460	370	305	255	220	190	165	145	130	115	100	85						

SAND 65

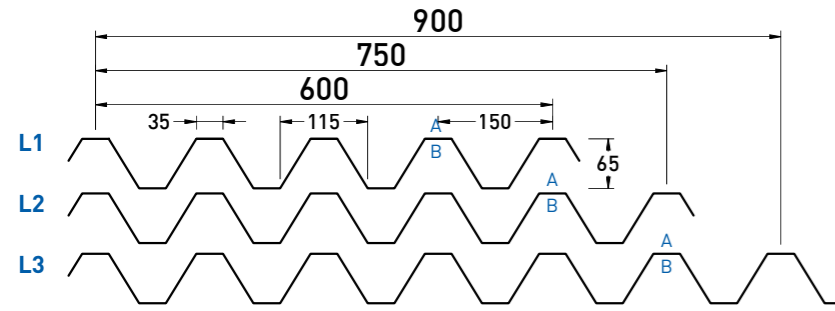

A: lato a vista - front side
B: lato non a vista - back side

Reazione al fuoco Fire reaction CLASS A1 **Comportamento al fuoco dall'esterno External fire performance Broof (t1,t2,t3)**

Senza necessità di sottoporre a prova secondo la norma UNI EN 14782:2006. No lab test is required as per UNI EN 14782:2006.

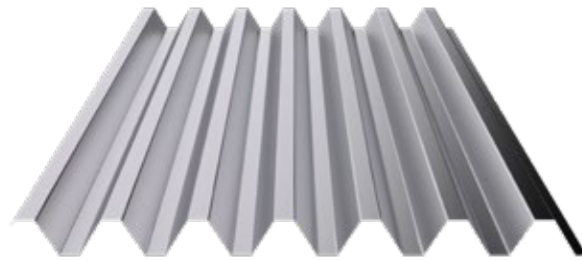

Sp. Th. (mm)	Jy (cm ² /m)	STATIC DATA		Steel Kg/m ²	Aluminium Kg/m ²
		We inf (cm ³ /m)	We sup (cm ³ /m)		
0,50	39,77	12,24	12,24	5,84	2,01
0,60	47,07	14,48	14,48	7,01	2,41
0,70	54,15	16,66	16,66	8,18	2,81
0,80	61,02	18,77	18,77	9,35	3,21
1,00	74,11	22,80	22,80	11,68	4,02
1,20	86,38	26,58	26,58	14,02	4,82
1,50	103,23	31,76	31,76	17,52	6,03

CURVATURA BENDING

Su richiesta
On request

APPLICAZIONI APPLICATIONS

- SANDnodrip**
Class A2 - s1, d0 Broof (t1,t2,t3)
- SANDcontrol**
Class C - s1, d0 Broof (t1,t2,t3)

FORATURE PERFORATION

- F3 P5 60°**
- F5 P8 60°**

Per maggiori dettagli consultare pagine 112-114

For more details see pages 112-114

PROFILO PROFILE	NR. GRECHE RIBS NO.	INTERASSE (mm) PITCH (mm)	LARGH. UTILE (mm) USEFUL WIDTH (mm)	LARGH. LASTRA (mm) SHEET WIDTH (mm)	SORMONTO OVERLAP	TIPO SORMONTO KIND OF OVERLAP
L1	SAND 65	5	150	600	13,33%	
L2	SAND 65	6	150	750	12,00%	
L3	SAND 65	7	150	900	13,33%	

Accessori, materiali e colorazioni sono consultabili alle pagine 116-118

Accessories, materials and colors are available on pages 116-118

SAND 65

Tabelle di portata (daN/m²) Load tables (daN/sqm)

steel S250GD

Sp. Th. mm	Larghezza appoggio: 100 mm Support width: 100 mm															
	L=m	1,50	1,75	2,00	2,25	2,50	2,75	3,00	3,25	3,50	3,75	4,00	4,25	4,50	4,75	5,00
0,50	495	360	275	215	170	125	95	75	60							
0,60	670	490	375	295	215	160	120	95	75	60						
0,70	860	630	480	355	255	190	145	110	85	70	55					
0,80	1005	735	560	410	295	220	165	130	100	80	65	50				
1,00	1345	985	735	510	370	275	205	160	125	100	80	65	50			
1,20	1585	1160	855	595	430	320	240	185	145	115	95	75	60	50		
1,50	1925	1410	1020	710	515	380	290	225	175	140	110	90	70	60		

Sp. Th. mm	Larghezza appoggio: 100 mm Support width: 100 mm															
	L=m	1,50	1,75	2,00	2,25	2,50	2,75	3,00	3,25	3,50	3,75	4,00	4,25	4,50	4,75	5,00
0,50	365	285	230	185	155	130	110	95	80	70	60	55	50			
0,60	490	385	310	250	205	175	150	130	110	95	85	75	65	60	50	
0,70	605	480	385	315	265	220	190	165	145	125	110	100	85	75	70	60
0,80	720	575	460	375	315	265	225	195	170	150	130	115	105	90	80	70
1,00	955	790	630	515	430	360	310	265	230	205	180	155	140	120	100	85
1,20	1175	975	775	630	525	440	375	325	280	240	210	185	165	140	120	100
1,50	1490	1250	990	805	665	555	470	395	340	295	255	225	200	165	140	120

Sp. Th. mm	Larghezza appoggio: 100 mm Support width: 100 mm															
	L=m	1,50	1,75	2,00	2,25	2,50	2,75	3,00	3,25	3,50	3,75	4,00	4,25	4,50	4,75	5,00
0,50	440	345	275	225	190	160	135	115	100	90	75	60	50			
0,60	590	470	375	305	255	215	185	160	140	120	95	80	65	55		
0,70	725	580	465	385	320	270	235	200	175	140	115	90	75	65	50	
0,80	870	695	560	460	380	325	275	240	200	160	130	105	90	75	60	50
1,00	1155	960	765	630	525	445	380	315	250	200	165	135	110	90	75	65
1,20	1425	1185	945	770	640	540	465	365	290	235	190	155	130	105	90	75
1,50	1815	1525	1210	985	815	685	565	440	350	280	225	185	155	125	105	90

In azzurro i carichi limitati da freccia 1/200 L. Values in blue show load limited by vertical deflection 1/200 L.

Calcoli eseguiti in ottemperanza alla normativa EUROCODICE 3 (EN 1993-1-3). Il carico riportato va inteso come valore caratteristico di portata, con coefficiente di combinazione applicato $\gamma_f=1,5$. I valori riportati in tabella sono da considerarsi come indicativi, è competenza del progettista procedere per i singoli casi di verifica al relativo calcolo. Calculations are made in accordance with EUROCODE 3 (EN 1993-1-3). The load reported shall be understood as the characteristic load value, with the coefficient of combination applied $\gamma_f=1,5$. The values shown in the table must be considered as indicative, the designer has the responsibility to proceed with the relative calculation in any individual cases.

aluminium 3003 alloy

Sp. Th. mm	Larghezza appoggio: 100 mm Support width: 100 mm															
	L=m	0,80	1,00	1,20	1,40	1,60	1,80	2,00	2,20	2,40	2,60	2,80	3,00	3,20	3,40	3,60
0,50	795	635	525	360	240	170	125	90	70	55						
0,60	1065	850	675	430	290	200	145	110	85	65	50					
0,70	1365	1090	785	500	335	234	170	125	95	75	60					
0,80	1690	1350	895	565	380	265	195	145	110	85	65	55				
1,00	2430	1900	1105	695	465	325	235	175	135	105	85	65	55			
1,20	3270	2250	1305	820	550	385	280	210	160	125	95	80	65	50		
1,50																

Sp. Th. mm	Larghezza appoggio: 100 mm Support width: 100 mm															
	L=m	0,80	1,00	1,20	1,40	1,60	1,80	2,00	2,20	2,40	2,60	2,80	3,00	3,20	3,40	3,60
0,50	570	435	345	280	230	195	165	140	120	105	95	80	70	60	50	
0,60	755	570	450	360	300	250	210	180	155	135	120	105	85	70	60	
0,70	950	715	560	450	370	310	260	220	190	165	145	120	100	80	70	
0,80	1155	865	675	540	440	370	310	265	225	195	170	135	110	90	75	
1,00	1605	1190	920	730	595	495	415	350	300	260	205	165	135	115	95	
1,20	2085	1535	1175	925	750	630	520	440	375	305	245	195	160	135	110	
1,50																

Sp. Th. mm	Larghezza appoggio: 100 mm Support width: 100 mm															
	L=m	0,80	1,00	1,20	1,40	1,60	1,80	2,00	2,20	2,40	2,60	2,80	3,00	3,20	3,40	3,60
0,50	660	510	405	330	275	230	200	170	135	105	85	65	55			
0,60	875	665	530	430	355	300	255	210	160	125	100	80	65	55		
0,70	1100	835	660	535	440	370	315	245	185	145	115	95	75	65	50	
0,80	1345	1020	800	645	530	445	365	275	210	165	130	105	85	70	60	
1,00	1875	1405	1095	875	715	600	450	340	260	205	160	130	105	90	75	
1,20	2450	1820	1405	1115	905	730	530	400	305	240	190	155	125	105	85	
1,50																

In azzurro i carichi limitati da freccia 1/200 L. Values in blue show load limited by vertical deflection 1/200 L.

Calcoli eseguiti in ottemperanza alla normativa EUROCODICE 3 (EN 1993-1-3). Il carico riportato va inteso come valore caratteristico di portata, con coefficiente di combinazione applicato $\gamma_f=1,5$. I valori riportati in tabella sono da considerarsi come indicativi, è competenza del progettista procedere per i singoli casi di verifica al relativo calcolo. Calculations are made in accordance with EUROCODE 3 (EN 1993-1-3). The load reported shall be understood as the characteristic load value, with the coefficient of combination applied $\gamma_f=1,5$. The values shown in the table must be considered as indicative, the designer has the responsibility to proceed with the relative calculation in any individual cases.

SAND A75 P570

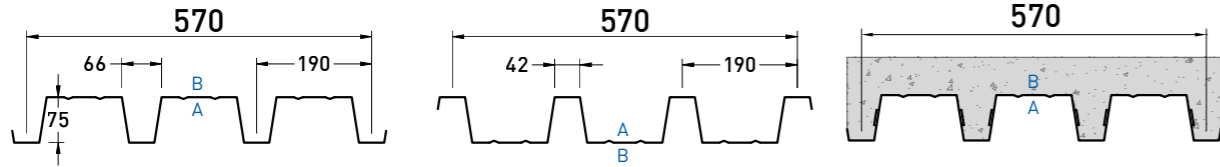

POSITIVE

NEGATIVE

CLS

A: lato a vista - front side
B: lato non a vista - back side

Reazione al fuoco Fire reaction CLASS A1

Comportamento al fuoco dall'esterno External fire performance Broof (t1,t2,t3)

Senza necessità di sottoporre a prova secondo la norma UNI EN 14782:2006. No lab test is required as per UNI EN 14782:2006.



POSITIVE

immagine a scopo illustrativo - image as example

DATI STATICI				STATIC DATA				PESO		WEIGHT	
Sp. Th. (mm)	Jy (cm ² /m)	We inf (cm ³ /m)	We sup (cm ³ /m)	Steel Kg/m ²							
0,50	67,80	14,30	24,59	6,89							
0,60	80,48	16,97	29,18	8,26							
0,70	92,87	19,58	33,67	9,64							
0,80	104,98	22,14	38,06	11,02							
1,00	128,34	27,07	46,52	13,77							
1,20	150,58	31,76	54,58	16,53							
1,50	181,87	38,37	65,90	20,66							

POSITIVE

per versione negative invertire We inf e We sup
for negative version, invert We inf and We sup

CURVATURA BENDING



Su richiesta
On request

APPLICAZIONI APPLICATIONS



SANDnodrip
Class A2 - s1, d0 🔥 Broof (t1,t2,t3)



SANDcontrol
Class C - s1, d0 🔥 Broof (t1,t2,t3)

FORATURE PERFORATION



F3 P5 60°



F5 P8 60°

Per maggiori dettagli consultare pagine 112-114

For more details see pages 112-114

PROFILO PROFILE	NR. GRECHE RIBS NO.	INTERASSE (mm) PITCH (mm)	LARGH. UTILE (mm) USEFUL WIDTH (mm)	LARGH. LASTRA (mm) SHEET WIDTH (mm)	SORMONTO OVERLAP	TIPO SORMONTO KIND OF OVERLAP
SAND A75 P570 POSITIVE						
SAND A75 P570 NEGATIVE	4	190	570	570	-	
SAND A75 P570 CLS						

Accessori, materiali e colorazioni sono consultabili alle pagine 116-118

Accessories, materials and colors are available on pages 116-118

SAND A75 P570 Tabelle di portata (daN/m²) Load tables (daN/sqm)

POSITIVE

steel S250GD

Sp. Th. mm	Larghezza appoggio: 100 mm Support width: 100 mm																					
	CAMPATA SINGOLA SINGLE SPAN																					
	L=m	1,50	1,75	2,00	2,25	2,50	2,75	3,00	3,25	3,50	3,75	4,00	4,25	4,50	4,75	5,00	5,25	5,50	5,75	6,00	6,25	
0,50	831	611	462	363	292	242	204	165	127	105	83	66	55									
0,60	1018	743	567	446	363	297	248	198	154	121	99	83	66	55								
0,70	1205	886	677	534	429	352	292	226	176	143	116	94	77	66	55							
0,80	1397	1023	781	616	495	407	330	259	204	160	132	105	88	72	61							
1,00	1782	1309	1001	787	633	523	402	314	248	198	160	132	110	88	72	61						
1,20	2211	1623	1238	979	787	622	473	369	292	231	187	154	127	105	88	72	61					
1,50	2882	2118	1617	1276	1007	748	572	446	352	281	226	187	154	127	105	88	72	61				

Sp. Th. mm	Larghezza appoggio: 100 mm Support width: 100 mm																					
	CAMPATA DOPPIA DOUBLE SPAN																					
	L=m	1,50	1,75	2,00	2,25	2,50	2,75	3,00	3,25	3,50	3,75	4,00	4,25	4,50	4,75	5,00	5,25	5,50	5,75	6,00	6,25	
0,50	368	289	231	189	158	131	110	95	84	74	63	58										
0,60	499	389	310	257	215	179	152	131	116	100	89	79	68	63	53							
0,70	709	504	404	336	278	236	200	173	147	131	116	100	89	84	74	63	58	53				
0,80	777	614	499	415	347	294	252	215	189	163	147	126	116	105	95	84	74	68	58			
1,00	1055	830	688	562	467	399	341	294	257	226	200	179	158	142	126	116	100	95	84			
1,20	1328	1040	919	751	625	530	457	394	341	305	268	236	215	189	168	152	137	126	116			
1,50	1717	1339	1149	919	751	625	530	457	394	341	305	268	236	215	189	168	152	137	126	116		

Sp. Th. mm	Larghezza appoggio: 100 mm Support width: 100 mm																					
	CAMPATA MULTIPLA MULTIPLE SPAN																					
	L=m	1,50	1,75	2,00	2,25	2,50	2,75	3,00	3,25	3,50	3,75	4,00	4,25	4,50	4,75	5,00	5,25	5,50	5,75	6,00	6,25	
0,50	446	347	278	231	194	163	137	121	105	89	79	68	63	58	53							
0,60	604	473	378	315	263	221	189	163	142	126	110	100	89	79	68	63	58	53				
0,70	777	609	488	410	341	289	247	210	184	163	142	126	116	105	95	84	74	68	58			
0,80	935	740	599	504	425	357	310	268	231	205	179	163	142	131	116	100	89	74	63			
1,00	1271	1003	830	683	572	483	415	362	315	278	247	221	200	173	147	126	105	89	79			
1,20	1601	1260	1108	914	761	646	557	483	425	373	331	294	247	205	173	147	126	110	95			
1,50	2074	1622	1343	1113	913	777	656	530	431	357	294	247	210	179	152	131	110					

In azzurro i carichi limitati da freccia 1/200 L. Values in blue show load limited by vertical deflection 1/200 L.

Calcoli eseguiti in ottemperanza alla normativa EUROCODICE 3 (EN 1993-1-3). Il carico riportato va inteso come valore caratteristico di portata, con coefficiente di combinazione applicato γ_f=1.5. I valori riportati in tabella sono da considerarsi come indicativi, è competenza del progettista procedere per i singoli casi di verifica al relativo calcolo. Calculations are made in accordance with EUROCODE 3 (EN 1993-1-3). The load reported shall be understood as the characteristic load value, with the coefficient of combination applied γ_f=1.5. The values shown in the table must be considered as indicative, the designer has the responsibility to proceed with the relative calculation in any individual cases.

CLS

steel S280GD

H mm	S mm	peso soletta Kg/m ²	Larghezza appoggio: 100 mm Support width: 100 mm																			
			CAMPATA SINGOLA SINGLE SPAN																			
			L=m	1,50	1,75	2,00	2,25	2,50	2,75	3,00	3,25	3,50	3,75	4,00	4,25	4,50	4,75	5,00	5,25	5,50	5,75	6,00
120	0,70*	170,7	980	815	695	600	525	460	410	365	330	295	265	240	220	200	180	165	120			
	0,80	171,9	980	815	695	600	525	460	410	365	330	295	265	240	220	200	180	165	130			
	1,00	174,4	980	815	695	600	525	460	410	365	330	295	265	240	220	200	180	165	145	100		
	1,20	176,8	980	815	695	600	525	460	410	365	330	295	265	240	220	200	180	165	150	110		
	1,50	180,5	980	815	695	600	525	460	410	365	330	295	265	240	220	200	180	165	150	125		

H mm	S mm	peso soletta Kg/m ²	Larghezza appoggio: 100 mm Support width: 100 mm																			
			CAMPATA SINGOLA SINGLE SPAN																			
			L=m	1,50	1,75	2,00	2,25	2,50	2,75	3,00	3,25	3,50	3,75	4,00	4,25	4,50	4,75	5,00	5,25	5,50	5,75	6,00
130	0,70*	195,2	1115	930	790	680	595	525	465	415	375	335	305	275	250	230	210	190	175	130		
	0,80	196,4	1115	930	790	680	595	525	465	415	375	335	305	275	250	230	210	190	175	135		
	1,00	198,9	1115	930	790	680	595	525	465	415	375	335	305	275	250	230	210	190	175	150	105	
	1,20	201,3	1115	930	790	680	595	525	465	415	375	335	305	275	250	230	210	190	175	155	120	
	1,50	205,0	1115	930	790	680	595	525	465	415	375	335	305	275	250	230	210	190	175	155	135	

H mm	S mm	peso soletta Kg/m ²	Larghezza appoggio: 100 mm Support width: 100 mm																			
			CAMPATA SINGOLA SINGLE SPAN																			
			L=m	1,50	1,75	2,00	2,25	2,50	2,75	3,00	3,25	3,50	3,75	4,00	4,25	4,50	4,75	5,00	5,25	5,50	5,75	6,00
140	0,70*	219,7	1250	1040	885	765	670	590	525	470	420	380	340	310	280	255	235	215	195	175	135	
	0,80	220,9	1250	1040	885	765	670	590	525	470	420	380	340	310	280	255	235	215	195	175	145	
	1,00	223,4	1250	1040	885	765	670	590	525	470	420	380	340	310	280	255	235	215	195	175	160	
	1,20	225,8	1250	1040	885	765	670	590	525	470	420	380	340	310	280	255	235	215	195	175	160	
	1,50	229,5	1250	1040																		

SAND A75 P760

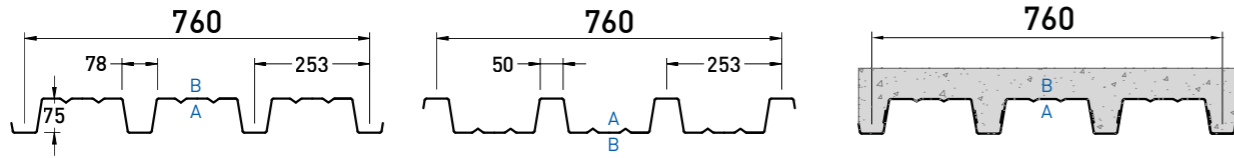

POSITIVE

NEGATIVE

CLS

A: lato a vista - front side
B: lato non a vista - back side

Reazione al fuoco Fire reaction CLASS A1 **Comportamento al fuoco dall'esterno External fire performance Broof (t1,t2,t3)**

Senza necessità di sottoporre a prova secondo la norma UNI EN 14782:2006. No lab test is required as per UNI EN 14782:2006.



POSITIVE

immagine a scopo illustrativo - image as example

DATI STATICI				STATIC DATA				PESO		WEIGHT	
Sp. Th. (mm)	Jy (cm ² /m)	We inf (cm ³ /m)	We sup (cm ³ /m)	Steel Kg/m ²							
0,50	62,11	12,47	24,65	6,46							
0,60	73,78	14,82	29,28	7,75							
0,70	85,21	17,11	33,80	9,04							
0,80	96,39	19,36	38,23	10,33							
1,00	118,03	23,71	46,79	12,91							
1,20	138,71	27,88	54,96	15,49							
1,50	167,96	66,50	33,70	19,37							

POSITIVE

per versione negative invertire We inf e We sup
for negative version, invert We inf and We sup

CURVATURA BENDING

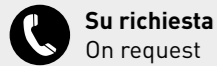

APPLICAZIONI APPLICATIONS

- SANDnodrip**
Class A2 - s1, d0 🔥 Broof (t1,t2,t3)
- SANDcontrol**
Class C - s1, d0 🔥 Broof (t1,t2,t3)

FORATURE PERFORATION

- F3 P5 60°**
- F5 P8 60°**

Per maggiori dettagli consultare pagine 112-114

For more details see pages 112-114

PROFILO PROFILE	NR. GRECHE RIBS NO.	INTERASSE (mm) PITCH (mm)	LARGH. UTILE (mm) USEFUL WIDTH (mm)	LARGH. LASTRA (mm) SHEET WIDTH (mm)	SORMONTO OVERLAP	TIPO SORMONTO KIND OF OVERLAP
SAND A75 P760 POSITIVE						
SAND A75 P760 NEGATIVE	4	253	760	760	-	
SAND A75 P760 CLS						

Accessori, materiali e colorazioni sono consultabili alle pagine 116-118

Accessories, materials and colors are available on pages 116-118

SAND A75 P760

Tabelle di portata (daN/m²) Load tables (daN/sqm)

POSITIVE

steel S250GD

Sp. Th. mm	Larghezza appoggio: 100 mm Support width: 100 mm																					
	CAMPATA SINGOLA SINGLE SPAN																					
mm	L=m	1,50	1,75	2,00	2,25	2,50	2,75	3,00	3,25	3,50	3,75	4,00	4,25	4,50	4,75	5,00	5,25	5,50	5,75	6,00	6,25	
0,50	q=daN/m ²	575	490	385	305	245	200	165	130	100	80	65	55									
0,60		770	645	490	385	310	255	205	160	125	100	80	65	55								
0,70		985	785	600	470	380	315	240	185	145	115	95	75	65	50							
0,80		1225	930	710	560	455	360	275	215	170	135	110	90	75	60	50						
1,00		1680	1235	945	745	595	440	335	260	205	165	135	110	90	75	60	50					
1,20		2075	1525	1170	920	700	520	395	310	245	195	160	130	105	90	75	60	50				
1,50		2645	1945	1490	1170	845	630	480	375	295	235	190	155	130	105	90	75	60	50			

Sp. Th. mm	Larghezza appoggio: 100 mm Support width: 100 mm																					
	CAMPATA DOPPIA DOUBLE SPAN																					
mm	L=m	1,50	1,75	2,00	2,25	2,50	2,75	3,00	3,25	3,50	3,75	4,00	4,25	4,50	4,75	5,00	5,25	5,50	5,75	6,00	6,25	
0,50	q=daN/m ²	260	200	160	130	110	95	80	65	60	50											
0,60		350	275	220	180	150	130	110	95	80	70	60	55	50								
0,70		455	355	285	235	195	165	140	125	105	95	80	70	65	55	50						
0,80		560	440	355	295	245	210	180	155	135	120	105	90	80	75	65	60	55	50			
1,00		760	600	485	400	340	295	250	220	190	165	150	130	120	105	95	85	75	70	65		
1,20		980	770	620	515	430	375	320	280	245	215	190	170	150	135	120	110	95	90	80		
1,50		1305	1020	825	680	570	520	445	385	335	295	260	235	210	185	165	150	135	120	110		

Sp. Th. mm	Larghezza appoggio: 100 mm Support width: 100 mm																					
	CAMPATA MULTIPLA MULTIPLE SPAN																					
mm	L=m	1,50	1,75	2,00	2,25	2,50	2,75	3,00	3,25	3,50	3,75	4,00	4,25	4,50	4,75	5,00	5,25	5,50	5,75	6,00	6,25	
0,50	q=daN/m ²	310	245	195	160	135	115	100	85	75	65	55	50									
0,60		425	330	265	220	185	155	135	115	100	90	80	70	60	55	50						
0,70		550	430	345	285	240	205	175	150	130	115	100	90	80	75	65	60	55	50			
0,80		670	530	430	355	300	260	220	190	165	145	130	115	105	90	85	75	70	60	55		
1,00		915	725	590	490	410	360	310	270	235	205	185	165	145	130	120	110	95	80	70		
1,20		1175	930	755	625	525	460	395	345	300	265	235	210	190	170	150	130	110	95	80		
1,50		1570	1240	1000	830	695	635	545	475	415	365	325	290	260	220	185	155	135	115	100		

In azzurro i carichi limitati da freccia 1/200 L. Values in blue show load limited by vertical deflection 1/200 L.

Calcoli eseguiti in ottemperanza alla normativa EUROCODICE 3 (EN 1993-1-3). Il carico riportato va inteso come valore caratteristico di portata, con coefficiente di combinazione applicato γ_f=1.5. I valori riportati in tabella sono da considerarsi come indicativi, è competenza del progettista procedere per i singoli casi di verifica al relativo calcolo. Calculations are made in accordance with EUROCODE 3 (EN 1993-1-3). The load reported shall be understood as the characteristic load value, with the coefficient of combination applied γ_f=1.5. The values shown in the table must be considered as indicative, the designer has the responsibility to proceed with the relative calculation in any individual cases.

CLS

steel S280GD

H mm	S mm	peso soletta Kg/m ²	Larghezza appoggio: 100 mm Support width: 100 mm																				
			CAMPATA SINGOLA SINGLE SPAN																				
mm	mm	Kg/m ²	L=m	1,50	1,75	2,00	2,25	2,50	2,75	3,00	3,25	3,50	3,75	4,00	4,25	4,50	4,75	5,00	5,25	5,50	5,75	6,00	
120	0,70*	165,5	q=daN/m ²	915	760	645	560	485	430	380	340	305	275	245	225	200	185	165	150	105			
	0,80	166,7		915	760	645	560	485	430	380	340	305	275	245	225	200	185	165	150	110			
	1,00	169,0		915	760	645	560	485	430	380	340	305	275	245	225	200	185	165	150	125			
	0,112	171,3		915	760	645	560	485	430	380	340	305	275	245	225	200	185	165	150	135			
	1,50	174,7		915	760	645	560	485	430	380	340	305	275	245	225	200	185	165	150	135	110		

H mm	S mm	peso soletta Kg/m ²	Larghezza appoggio: 100 mm Support width: 100 mm																				
			CAMPATA SINGOLA SINGLE SPAN																				
mm	mm	Kg/m ²	L=m	1,50	1,75	2,00	2,25	2,50	2,75	3,00	3,25	3,50	3,75	4,00	4,25	4,50	4,75	5,00	5,25	5,50	5,75	6,00	
130	0,70*	190,0	q=daN/m ²	1045	870	740	640	555	490	435	390	350	315	280	255	230	210	190	175	160	110		
	0,80	191,2		1045	870	740	640	555	490	435	390	350	315	280	255	230	210	190	175	160	115		
	1,00	193,5		1045	870	740	640	555	490	435	390	350	315	280	255	230	210	190	175	160	130		
	0,112	195,8		1045	870	740	640	555	490	435	390	350	315	280	255	230	210	190	175	160	145		
	1,50	199,2		1045	870	740	640	555	490	435	390	350	315	280	255	230	210	190	175	160	145	100	

H mm	S mm	peso soletta Kg/m ²	Larghezza appoggio: 100 mm Support width: 100 mm																				
			CAMPATA SINGOLA SINGLE SPAN																				
mm	mm	Kg/m ²	L=m	1,50	1,75	2,00	2,25	2,50	2,75	3,00	3,25	3,50	3,75	4,00	4,25	4,50	4,75	5,00	5,25	5,50	5,75	6,00	
140	0,70*	214,5	q=daN/m ²	1175	980	835	720	625	550	490	435	390	350	320	290	260	235	215	195	180	160	115	
	0,80	215,7		1175	980	835	720	625	550	490	435	390	350	320	290	260	235	215	195	180	160	125	
	1,00	218,0		1175	980	835	720	625	550	490	435	390	350	320	290	260	235	215	195	180	160	140	
	0,112	220,3		1175	980	835	720	625	550	490	435	390	350	320	290	260	235	215	195	180	160	140	
	1,50	223,7		1175	980	835	720	625	550	490	435	390	350	320	290	260	235	215	195	180	160	145	

In rosso i carichi limitati da freccia 1/350 L. Values in red show load limited by vertical deflection 1/350 L.

P

SAND 100

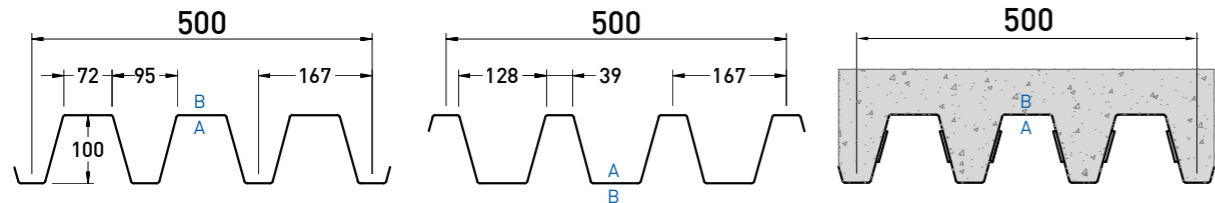

POSITIVE

NEGATIVE

CLS

A: lato a vista - front side
B: lato non a vista - back side

Reazione al fuoco Fire reaction CLASS A1

Comportamento al fuoco dall'esterno External fire performance Broof (t1,t2,t3)

Senza necessità di sottoporre a prova secondo la norma UNI EN 14782:2006. No lab test is required as per UNI EN 14782:2006.



POSITIVE

immagine a scopo illustrativo - image as example

DATI STATICI				STATIC DATA				PESO		WEIGHT	
Sp. Th. (mm)	Jy (cm ² /m)	We inf (cm ³ /m)	We sup (cm ³ /m)	Steel Kg/m ²							
0,50	125,76	27,25	23,36	7,85							
0,60	149,59	32,41	27,78	9,42							
0,70	172,98	37,48	32,12	10,99							
0,80	195,93	42,45	36,39	12,56							
1,00	240,54	52,12	44,67	15,70							
1,20	283,43	61,41	52,64	18,84							
1,50	344,59	63,99	74,66	23,55							

POSITIVE

per versione negative invertire We inf e We sup
for negative version, invert We inf and We sup

CURVATURA BENDING



Su richiesta
On request

APPLICAZIONI APPLICATIONS



SANDnodrip
Class A2 - s1, d0 🔥 Broof (t1,t2,t3)



SANDcontrol
Class C - s1, d0 🔥 Broof (t1,t2,t3)

FORATURE PERFORATION



F3 P5 60°



F5 P8 60°

Per maggiori dettagli consultare pagine 112-114

For more details see pages 112-114

PROFILO PROFILE	NR. GRECHE RIBS NO.	INTERASSE (mm) PITCH (mm)	LARGH. UTILE (mm) USEFUL WIDTH (mm)	LARGH. LASTRA (mm) SHEET WIDTH (mm)	SORMONTO OVERLAP	TIPO SORMONTO KIND OF OVERLAP
SAND 100 POSITIVE						
SAND 100 NEGATIVE	4	167	500	500	-	
SAND 100 CLS						

Accessori, materiali e colorazioni sono consultabili alle pagine 116-118

Accessories, materials and colors are available on pages 116-118

SAND 100

Tabelle di portata (daN/m²) Load tables (daN/sqm)

POSITIVE

steel S250GD

Sp. Th. mm	Larghezza appoggio: 100 mm Support width: 100 mm																					
	CAMPATA SINGOLA SINGLE SPAN																					
	L=m	1,50	1,75	2,00	2,25	2,50	2,75	3,00	3,25	3,50	3,75	4,00	4,25	4,50	4,75	5,00	5,25	5,50	5,75	6,00	6,25	
0,50	775	570	435	340	275	225	190	160	135	115	100	90	75	65	55							
0,60	1060	775	590	465	375	310	255	220	185	160	140	115	95	80	70	60	50					
0,70	1375	1010	770	605	490	400	335	285	245	210	170	140	120	100	85	70	60	50				
0,80	1720	1265	965	760	610	505	420	355	305	245	200	165	140	115	95	80	70	60	50			
1,00	2425	1780	1360	1070	865	710	595	495	395	315	260	215	175	145	125	105	90	75	65			
1,20	2970	2185	1670	1315	1060	875	730	605	480	385	315	260	215	180	150	130	110	95	80			
1,50	3755	2760	2105	1660	1340	1105	925	760	605	490	400	330	270	230	190	160	140	120	100			

Sp. Th. mm	Larghezza appoggio: 100 mm Support width: 100 mm																					
	CAMPATA DOPPIA DOUBLE SPAN																					
	L=m	1,50	1,75	2,00	2,25	2,50	2,75	3,00	3,25	3,50	3,75	4,00	4,25	4,50	4,75	5,00	5,25	5,50	5,75	6,00	6,25	
0,50	465	365	295	225	210	175	150	130	115	100	90	80	70	65	60	50						
0,60	625	495	400	335	280	240	205	180	155	140	125	110	100	90	80	70	65	60	55			
0,70	805	635	520	435	365	310	265	230	205	180	160	140	130	115	105	95	85	80	70			
0,80	990	790	645	540	455	385	335	290	255	225	200	180	160	145	130	120	110	100	90			
1,00	1350	1080	885	745	630	540	465	405	360	320	285	255	230	210	190	170	155	145	135			
1,20	1725	1375	1120	1035	875	750	650	570	500	445	400	355	320	290	265	245	225	205	190			
1,50	2280	1805	1465	1355	1140	975	840	735	645	570	510	455	410	375	340	310	285	260	240			

Sp. Th. mm	Larghezza appoggio: 100 mm Support width: 100 mm																					
	CAMPATA MULTIPLA MULTIPLE SPAN																					
	L=m	1,50	1,75	2,00	2,25	2,50	2,75	3,00	3,25	3,50	3,75	4,00	4,25	4,50	4,75	5,00	5,25	5,50	5,75	6,00	6,25	
0,50	555	440	360	300	250	215	185	160	140	125	110	100	90	80	70	65	60	55	50			
0,60	745	595	485	405	340	290	250	220	195	170	150	135	120	110	100	90	85	75	70			
0,70	960	765	625	525	440	375	325	285	250	220	195	175	160	145	130	120	110	100	90			
0,80	1170	940	775	650	550	470	405	355	310	275	245	220	200	180	165	150	135	125	110			
1,00	1605	1285	1055	895	760	650	565	495	435	390	345	310	280	255	235	215	185	160	135			
1,20	2060	1645	1345	1240	1050	905	785	690	610	540	485	435	395	355	305	260	225	195	165			
1,50	2730	2165	1765	1630	1380	1180	1020	895	785	700	625	560	505	450	385	330	285	245	210			

In azzurro i carichi limitati da freccia 1/200 L. Values in blue show load limited by vertical deflection 1/200 L.

Calcoli eseguiti in ottemperanza alla normativa EUROCODICE 3 (EN 1993-1-3). Il carico riportato va inteso come valore caratteristico di portata, con coefficiente di combinazione applicato $\gamma_c=1.5$. I valori riportati in tabella sono da considerarsi come indicativi, è competenza del progettista procedere per i singoli casi di verifica al relativo calcolo. Calculations are made in accordance with EUROCODE 3 (EN 1993-1-3). The load reported shall be understood as the characteristic load value, with the coefficient of combination applied $\gamma_c=1.5$. The values shown in the table must be considered as indicative, the designer has the responsibility to proceed with the relative calculation in any individual cases.

CLS

steel S280GD

H mm	S mm	peso soletta Kg/m ²	Larghezza appoggio: 100 mm Support width: 100 mm																		
			CAMPATA SINGOLA SINGLE SPAN																		
			L=m	1,50	1,75	2,00	2,25	2,50	2,75	3,00	3,25	3,50	3,75	4,00	4,25	4,50	4,75	5,00	5,25	5,50	5,75
140	0,70*	212,8	1370	1150	980	850	745	660	590	525	475	430	390	355	325	275	235	200	170	145	120
	0,80	214,1	1370	1150	980	850	745	660	590	525	475	430	390	355	325	300	275	250	220	190	160
	1,00	216,8	1370	1150	980	850	745	660	590	525	475	430	390	355	325	300	275	250	230	215	195
	1,20	219,5	1370	1150	980	850	745	660	590	525	475	430	390	355	325	300	275	250	230	215	195
	1,50	223,5	1370	1150	980	850	745	660	590	525	475	430	390	355	325	300	275	250	230	215	195

H mm	S mm	peso soletta Kg/m ²	Larghezza appoggio: 100 mm Support width: 100 mm																		
			CAMPATA SINGOLA SINGLE SPAN																		
			L=m	1,50	1,75	2,00	2,25	2,50	2,75	3,00	3,25	3,50	3,75	4,00	4,25	4,50	4,75	5,00	5,25	5,50	5,75
150	0,70*	237,3	1530	1280	1095	950	830	735	655	590	530	480	440	400	350	300	260	220	190	160	135
	0,80	238,6	1530	1280	1095	950	830	735	655	590	530	480	440	400	365	335	310	270	235	205	175
	1,00	241,3	1530	1280	1095	950	830	735	655	590	530	480	440	400	365	335	310	285	260	240	220
	1,20	244,0	1530	1280	1095	950	830	735	655	590	530	480	440	400	365	335	310	285	260	240	220
	1,50	248,0	1530	1280	1095	950	830	735	655	590	530	480	440	400	365	335	310	285	260	240	220

H mm	S mm	peso soletta Kg/m ²	Larghezza appoggio: 100 mm Support width: 100 mm																		
			CAMPATA SINGOLA SINGLE SPAN																		
			L=m	1,50	1,75	2,00	2,25	2,50	2,75	3,00	3,25	3,50	3,75	4,00	4,25	4,50	4,75	5,00	5,25	5,50	5,75
160	0,70*	261,8	1695	1415	1210	1050	920	815	725	655	590	535	485	440	380	325	280	240	205	175	150
	0,80	263,1	1695	1415	1210	1050	920	815	725	655	590	535	485	445	405	370	335	290	255	220	190
	1,00	265,8	1695	1415	1210	1050	920	815	725	655	590	535	485	445	405	370	340	315	290	265	240
	1,20	268,5	1695	14																	

PER SOLAI GRANDI LUCI

Nelle pagine successive vengono riportate le schede tecniche dei prodotti concepiti per la realizzazione di coperture e solai su grandi luci. Per ogni profilo vengono previste più schede tecniche, considerando tre diverse configurazioni di posa: positive, negative e perforated.

TABELLE DI PORTATA

Le tabelle di portata sono state calcolate in ottemperanza alla normativa EUROCODICE 3 (EN1993-1-3) per i tre schemi statici tipo: a singola campata, a campata doppia e a campata multipla.

Relativamente ai valori di portata, vengono rappresentati i valori di portata allo stato limite ultimo e d'esercizio:

- SLU = stato limite ultimo, nessun coefficiente di sicurezza applicato;
- SLE = stato limite d'esercizio, con coefficiente di sicurezza applicato $\gamma_q = 1,40$.

In blu sono riportati i valori con limite di deformazione imposta raggiunto, ovvero 1/150, 1/200, 1/250 o 1/300 della luce "L".

NB: Per la configurazione positive dei prodotti SAND 135, SAND 145, SAND 151, SAND 153, SAND 160 vengono riportate due diverse serie di tabelle di portata in base alla larghezza dei supporti:

- appoggio esterno 100 mm, appoggio intermedio 200 mm;
- appoggio esterno 225 mm, appoggio intermedio 450 mm.

Le tabelle di portata delle versioni PERFORATED sono state calcolate considerando una foratura di tipo F5 P8 60°, eseguita a fasce di altezza 35 mm, posizionate sui lati obliqui delle greche, come rappresentato dai dettagli grafici presenti sulle schede di prodotto.

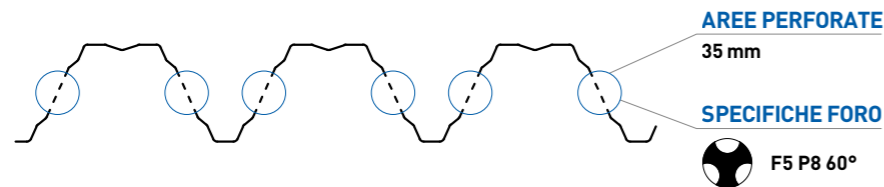

Le lamiere grecate devono essere adeguatamente vincolate alla struttura portante mediante idonei fissaggi, e deve essere eseguita una congrua cucitura reciproca fra le lastre lungo i sormonti longitudinali delle stesse.

Per tutte le prescrizioni relative alla scelta dei dispositivi di fissaggio, e al numero minimo di ancoraggi da effettuare, si rimanda alla consultazione della normativa di riferimento UNI EN 1090-4:2018, paragrafo 8. Si ricorda che è altresì onere del progettista la verifica della resistenza e del numero minimo dei fissaggi necessari in funzione delle sollecitazioni previste nel sito di installazione, in accordo alle disposizioni normative vigenti.

APPLICAZIONI

Per tutti i prodotti possono essere previste una serie di lavorazioni ed applicazioni speciali al fine di assicurare l'adattabilità a qualsiasi tipo di struttura e il raggiungimento delle prestazioni ricercate e necessarie. In particolare:

È possibile prevedere applicazioni specifiche per migliorare le prestazioni del prodotto a livello igrometrico e acustico:

SANDnodrip: particolare tessuto non tessuto che permette di rendere la superficie interna della lastra molto porosa e con eccellenti proprietà di assorbimento dell'umidità, impedendo così eventuali problematiche di condensa e gocciolamento;



SANDnodrip

SANDcontrol: speciale tessuto non tessuto a maggiorata densità che, oltre ad evitare problematiche di condensa e sgocciolamento, consente anche di attenuare sensibilmente il rumore provocato dagli agenti atmosferici esterni.



SANDcontrol

Per maggiori informazioni e dettagli su lavorazioni e applicazioni speciali consultare le pagine 112 - 114.

Su richiesta è possibile prevedere soluzioni customizzate, quali forature regolari o irregolari, complete o parziali e con diverse tipologie di foratura.

FOR LARGE SPAN FLOORS

The following pages show the technical data sheets of the products usually used for large-span floors. For each profile there are several technical data sheets, considering three different laying configurations: positive, negative and perforated.

LOAD TABLES

Load tables have been calculated in compliance with the standard legislation EUROCODE 3 (EN1991-1-3) for the three static type schemes: single span, double span and multiple span.

In the tables are reported two type of load values: ultimate limit state (ULS) and serviceability limit state (SLS):

- ULS = ultimate limit state, no security coefficient applied;
- SLS = serviceability limit state, security coefficient applied $\gamma_q = 1,40$.

The values indicated in blue represent the load capacity with the limit inflection reached, or rather 1/150, 1/200, 1/250 or 1/300 of span "L".

NB: For the positive configuration of SAND 135, SAND 145, SAND 151, SAND 153, SAND 160 products, two different series of load tables are reported according to the width of the supports:

- external support 100 mm, intermediate support 200 mm;
- external support 225 mm, intermediate support 450 mm.

PERFORATED versions' loads tables have been calculated taking into consideration a perforation type F5 P8 60°, done with height bends of 35 mm, positioned on the oblique sides of the sheets as per illustrations and graphic details present in the technical sheets of the products.

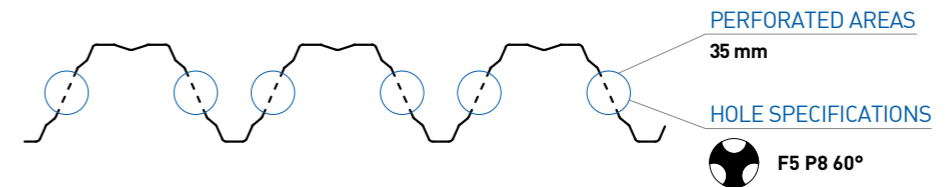

The corrugated sheets must be correctly fixed to the supporting structure by adequate fasteners, and it is necessary to make a fair reciprocal sewing between the sheets along their longitudinal overlaps.

For all the requirements inherent to the choice of fasteners, and the minimum number of anchors to be made please follow all the regulations and prescriptions contained inside the standard legislation EN 1090-4:2018, paragraph 8. Remember that it is a burden of the designer the one of verifying the resistance and the minimum number of fastenings necessary according to the stresses provided on the installation site, in accordance with the current legislation.

APPLICATIONS

For all products, a series of special processes and applications can be provided in order to ensure adaptability to any type of structure and the achievement of the required and necessary performance. In particular:

It is possible to foresee specific applications to improve the product performance at hygrometric and acoustic level:

SANDnodrip: particular non-woven felt that makes it possible to make the internal surface of the slab very porous and with excellent moisture absorption properties, thus preventing any problems of condensation and dripping;



SANDnodrip

SANDcontrol: special non-woven felt with higher density which, in addition to avoid condensation and dripping problems, also allows to significantly attenuate the noise caused by external atmospheric agents.



SANDcontrol

For more information and details on special processes and applications, see pages 112 - 114.

On request it is possible to provide customized solutions, such as regular or irregular, complete or partial perforation and with different types of holes.

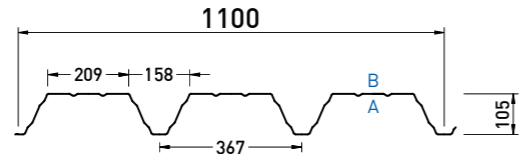

A: lato a vista - front side
B: lato non a vista - back side

POSITIVE

Reazione al fuoco Fire reaction
CLASS A1

Comportamento al fuoco dall'esterno External fire performance
Broof (t1,t2,t3)

Senza necessità di sottoporre a prova secondo la norma UNI EN 14782:2006. No lab test is required as per UNI EN 14782:2006.

Sp. Th. (mm)	DATI STATICI / STATIC DATA			PESO / WEIGHT Steel Kg/m ²
	Jy (cm ² /m)	We inf (cm ³ /m)	We sup (cm ³ /m)	
0,75	127,74	19,23	42,41	8,03
0,80	138,00	20,78	45,39	8,56
0,88	154,69	23,29	50,18	9,42
1,00	180,23	27,13	57,38	10,70
1,15	212,83	31,99	66,37	12,31
1,25	234,88	34,84	72,10	13,38
1,50	290,71	41,74	86,21	16,06

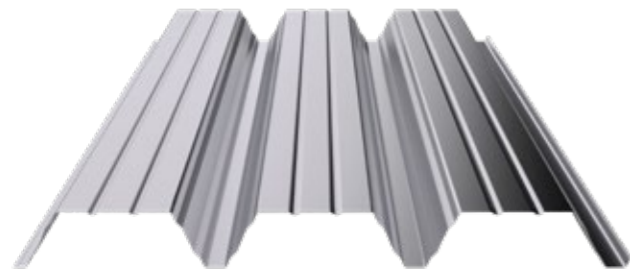

APPLICAZIONI
APPLICATIONS

SANDnodrip
Class A2 - s1, d0 Broof (t1,t2,t3)

SANDcontrol
Class C - s1, d0 Broof (t1,t2,t3)

Tabelle di portata (daN/m²) Load tables (daN/sqm)

* Valori di portata caratteristici con coefficiente di sicurezza applicato pari a: $\gamma_f = 1,40$. Characteristic load with an applied safety coefficient equal to: $\gamma_f = 1,40$.
In azzurro i valori rappresentativi della portata con inflessione limite raggiunta. The values indicated in blue are representative of the load capacity with the limit inflection reached.

Larghezza appoggio esterno: 100 mm End support width: 100 mm

Sp. Th. mm	Interasse appoggi (m) / Carico uniformemente distribuito (daN/m ²)																		Span (m) / Uniformly distributed load (daN/sqm)																			
	CAMPATA SINGOLA																		SINGLE SPAN																			
	Stato limite Limit state	2,60	2,80	3,00	3,20	3,40	3,60	3,80	4,00	4,20	4,40	4,60	4,80	5,00	5,20	5,40	5,60	5,80	6,00	2,60	2,80	3,00	3,20	3,40	3,60	3,80	4,00	4,20	4,40	4,60	4,80	5,00	5,20	5,40	5,60	5,80	6,00	
0,75	SLU	ULS	603	542	468	409	360	319	284	255	221	200	182	166	146	134	124	114	106	98	603	542	468	409	360	319	284	255	221	200	182	166	146	134	124	114	106	98
	SLE* SLS*	1/150	387	335	292	257	228	203	182	158	143	121	106	87	76	67	60	53	47	42	387	335	292	257	228	203	182	158	143	121	106	87	76	67	60	53	47	
		1/200	431	387	335	292	257	209	176	149	120	103	89	78	64	56	49	43	38	34	431	387	335	292	257	209	176	149	120	103	89	78	64	56	49	43	38	34
		1/250	431	370	297	242	199	166	139	118	95	81	70	61	50	43	38	33	29	26	431	370	297	242	199	166	139	118	95	81	70	61	50	43	38	33	29	26
0,80	SLU	ULS	679	581	502	438	386	342	305	273	237	214	195	178	157	144	133	123	114	106	679	581	502	438	386	342	305	273	237	214	195	178	157	144	133	123	114	106
	SLE* SLS*	1/150	485	415	359	313	275	244	218	195	169	153	131	114	94	83	73	65	57	51	485	415	359	313	275	244	218	195	169	153	131	114	94	83	73	65	57	51
		1/200	485	415	359	313	275	226	190	161	130	112	97	84	69	60	53	47	41	37	485	415	359	313	275	226	190	161	130	112	97	84	69	60	53	47	41	37
		1/250	485	399	321	261	215	179	151	127	103	88	76	66	54	47	41	36	32	28	485	399	321	261	215	179	151	127	103	88	76	66	54	47	41	36	32	28
0,88	SLU	ULS	752	643	556	486	427	379	338	303	262	238	216	197	181	166	153	141	131	122	752	643	556	486	427	379	338	303	262	238	216	197	181	166	153	141	131	122
	SLE* SLS*	1/150	537	460	397	347	305	271	241	217	187	170	147	128	112	99	87	77	68	61	537	460	397	347	305	271	241	217	187	170	147	128	112	99	87	77	68	61
		1/200	537	460	397	347	305	253	213	181	146	125	108	94	82	72	63	56	49	44	537	460	397	347	305	253	213	181	146	125	108	94	82	72	63	56	49	44
		1/250	537	460	360	293	241	201	169	143	115	99	85	74	64	56	49	43	38	33	537	460	360	293	241	201	169	143	115	99	85	74	64	56	49	43	38	33
1,00	SLU	ULS	863	738	638	557	490	435	388	348	314	284	258	236	216	199	183	169	157	145	863	738	638	557	490	435	388	348	314	284	258	236	216	199	183	169	157	145
	SLE* SLS*	1/150	616	527	456	398	350	310	277	248	224	203	172	150	123	108	96	85	75	67	616	527	456	398	350	310	277	248	224	203	172	150	123	108	96	85	75	67
		1/200	616	527	456	398	350	295	249	211	170	146	127	110	90	79	70	61	54	48	616	527	456	398	350	295	249	211	170	146	127	110	90	79	70	61	54	48
		1/250	616	527	419	342	282	234	197	167	134	115	99	86	71	62	54	47	42	37	616	527	419	342	282	234	197	167	134	115	99	86	71	62	54	47	42	37
1,15	SLU	ULS	1002	857	741	647	570	505	450	404	350	317	288	263	241	222	204	189	175	162	1002	857	741	647	570	505	450	404	350	317	288	263	241	222	204	189	175	162
	SLE* SLS*	1/150	716	612	530	462	407	361	322	289	250	226	206	177	146	128	113	100	89	79	716	612	530	462	407	361	322	289	250	226	206	177	146	128	113	100	89	79
		1/200	716	612	530	462	407	361	294	249	201	173	150	130	107	94	82	73	64	57	716	612	530	462	407	361	294	249	201	173	150	130	107	94	82	73	64	57
		1/250	716	612	496	404	333	277	233	197	159	136	118	102	84	73	64	56	50	44	716	612	496	404	333	277	233	197	159	136	118	102	84	73	64	56	50	44
1,25	SLU	ULS	1096	937	810	707	623	552	492	442	382	346	315	288	253	233	215	198	184	171	1096	937	810	707	623	552	492	442	382	346	315	288	253	233	215	198	184	171
	SLE* SLS*	1/150	783	669	579	505	445	394	352	315	273	247	225	195	161	142	125	111	98	88	783	669	579	505	445	394	352	315	273	247	225	195	161	142	125	111	98	88
		1/200	783	669	579	505	445	394	325	275	222	191	165	144	118	104	91	80	71	63	783	669	579	505	445	394	325	275	222	191	165	144	118	104	91	80	71	63
		1/250	783	669	547	446	367	306	257	218	176	151	130	113	92	81	71	62	55	48	783	669	547	446	367	306	257	218	176	151	130	113	92	81	71	62	55	48
1,50	SLU	ULS	1329	1137	983	858	755	669	597	536	464	420	382	349	307	283	260	241	223	207	1329	1137	983	858	755	669	597	536	464	420	382	349	307	283	260	241	223	207
	SLE* SLS*	1/150	949	812	702	613	539	478	427	383	331	300	273	249	200	176	155	138	122	109	949	812	702	613	539	478	427	383	331	300	273	249	200	176	155	138	122	109
		1/200	949	812	702	613	539	478	402	341	276	237	205	178	147	129	113	100	88	79	949	812	702	613	539	478	402	341	276	237	205	178	147	129	113	100	88	79
		1/250	949	812	702	552	455	379	319	270	218	187	161	140	115	100	88	77	68	60	949	812	702	552	455	379	319	270	218	187	161	140	115	100	88	77	68	60

I valori riportati in tabella sono da considerarsi come indicativi, è competenza del progettista procedere per i singoli casi di verifica al relativo calcolo.

SANDRINI metalli S.p.A. si riserva di variare in qualsiasi momento e senza preavviso le caratteristiche dei prodotti. Tutti i diritti riservati: vietata la riproduzione.

Tabelle di portata (daN/m²) Load tables (daN/sqm)

Larghezza appoggio intermedio: 200 mm - Larghezza appoggio esterno: 100 mm Internal support width: 200 mm - End support width: 100 mm

Sp. Th. mm	Interasse appoggi (m) / Carico uniformemente distribuito (daN/m ²)																		Span (m) / Uniformly distributed load (daN/sqm)																			
	CAMPATA DOPPIA																		DOUBLE SPAN																			
	Stato limite Limit state	2,60	2,80	3,00	3,20	3,40	3,60	3,80	4,00	4,20	4,40	4,60	4,80	5,00	5,20	5,40	5,60	5,80	6,00	2,60	2,80	3,00	3,20	3,40	3,60	3,80	4,00	4,20	4,40	4,60	4,80	5,00	5,20	5,40	5,60	5,80	6,00	
0,75	SLU	ULS	440	391	350	316	286	261	238	219	193	178	166	154	138	129	121	113	107	100	440	391	350	316	286	261	238	219	193	178	166	154	138	129	121	113	107	100
	SLE* SLS*	1/150	314	280	250	226	204	186	170	156	138	127	118	110	98	92	86	81	76	72	314	280	250	226	204	186	170	156	138	127	118	110	98	92	86	81	76	72
		1/200	314	280	250	226	204	186	170	156	138	127																										

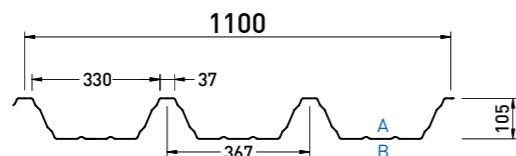

A: lato a vista - front side
B: lato non a vista - back side

NEGATIVE

Reazione al fuoco Fire reaction
CLASS A1

Comportamento al fuoco dall'esterno External fire performance
Broof (t1,t2,t3)

Senza necessità di sottoporre a prova secondo la norma UNI EN 14782:2006. No lab test is required as per UNI EN 14782:2006.

Sp. Th. (mm)	DATI STATICI / STATIC DATA			PESO / WEIGHT Steel Kg/m ²
	Jy (cm ² /m)	We inf (cm ³ /m)	We sup (cm ³ /m)	
0,75	127,74	42,41	19,23	8,03
0,80	138,00	45,39	20,78	8,56
0,88	154,69	50,18	23,29	9,42
1,00	180,23	57,38	27,13	10,70
1,15	212,83	66,37	31,99	12,31
1,25	234,88	72,10	34,84	13,38
1,50	290,71	86,21	41,74	16,06

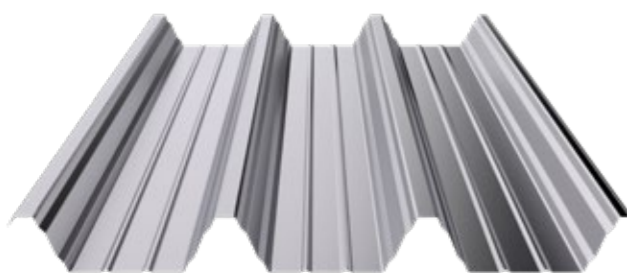

APPLICAZIONI
APPLICATIONS



SANDnodrip
Class A2 - s1, d0 🔥 Broof (t1,t2,t3)



SANDcontrol
Class C - s1, d0 🔥 Broof (t1,t2,t3)

Tabelle di portata (daN/m²) Load tables (daN/sqm)

* Valori di portata caratteristici con coefficiente di sicurezza applicato pari a: $\gamma_f = 1,40$. Characteristic load with an applied safety coefficient equal to: $\gamma_f = 1,40$.
In azzurro i valori rappresentativi della portata con inflessione limite raggiunta. The values indicated in blue are representative of the load capacity with the limit inflection reached.

Larghezza appoggio esterno: 100 mm End support width: 100 mm

Sp. Th. mm	Interasse appoggi (m) / Carico uniformemente distribuito (daN/m ²)																		Span (m) / Uniformly distributed load (daN/sqm)																					
	CAMPATA SINGOLA / SINGLE SPAN																		CAMPATA SINGOLA / SINGLE SPAN																					
	Stato limite / Limit state	2,60	2,80	3,00	3,20	3,40	3,60	3,80	4,00	4,20	4,40	4,60	4,80	5,00	5,20	5,40	5,60	5,80	6,00	Stato limite / Limit state	2,60	2,80	3,00	3,20	3,40	3,60	3,80	4,00	4,20	4,40	4,60	4,80	5,00	5,20	5,40	5,60	5,80	6,00		
0,75	SLU	ULS	573	515	445	388	342	303	270	242	210	190	173	158	139	128	118	109	101	93	SLU	ULS	499	444	398	360	326	298	272	251	221	205	190	177	158	148	139	131	123	116
	SLE*	1/150	409	368	318	277	244	216	193	173	150	136	115	100	83	73	64	57	50	45	SLE*	1/150	356	317	285	257	233	213	195	179	158	146	136	126	113	106	99	93	88	83
	SLS*	1/200	409	368	318	277	244	199	167	142	114	98	85	74	60	53	47	41	36	32	SLS*	1/200	356	317	285	257	233	213	195	179	158	146	136	126	113	106	99	93	88	83
	SLS*	1/250	409	351	282	230	189	158	132	112	90	77	67	58	47	41	36	32	28	24	SLS*	1/250	356	317	285	257	233	213	195	179	158	146	136	126	113	106	94	83	74	66
0,80	SLU	ULS	645	552	477	416	366	325	290	260	225	204	185	169	149	137	126	117	108	100	SLU	ULS	579	515	462	417	378	344	315	289	255	236	219	204	182	170	159	150	141	133
	SLE*	1/150	461	394	341	297	262	232	207	186	161	145	125	109	89	79	69	61	54	48	SLE*	1/150	414	368	330	298	270	246	225	207	182	168	156	145	130	121	114	107	101	95
	SLS*	1/200	461	394	341	297	262	215	181	153	124	106	92	80	65	57	50	44	39	35	SLS*	1/200	414	368	330	298	270	246	225	207	182	168	156	145	130	121	114	107	101	95
	SLS*	1/250	461	379	305	248	205	170	143	121	97	84	72	62	51	45	39	34	30	26	SLS*	1/250	414	368	330	298	270	246	225	207	182	168	156	145	130	115	101	90	80	71
0,88	SLU	ULS	715	611	529	461	406	360	321	288	249	226	205	187	172	158	145	134	124	116	SLU	ULS	707	628	562	506	458	417	381	350	307	284	263	245	218	204	191	179	169	159
	SLE*	1/150	510	437	378	330	290	257	229	206	178	161	140	122	107	94	83	73	65	58	SLE*	1/150	505	448	401	362	327	298	272	250	219	203	188	175	156	146	136	128	120	114
	SLS*	1/200	510	437	378	330	290	241	203	172	139	119	103	89	78	68	60	53	47	41	SLS*	1/200	505	448	401	362	327	298	272	250	219	203	188	175	156	146	136	128	114	102
	SLS*	1/250	510	437	342	278	229	191	160	136	109	94	81	70	61	53	47	41	36	32	SLS*	1/250	505	448	401	362	327	298	272	250	219	203	188	167	146	129	114	101	90	80
1,00	SLU	ULS	820	701	606	529	466	413	368	330	298	270	245	224	205	189	174	161	149	138	SLU	ULS	860	763	682	613	555	504	460	422	388	359	332	309	288	269	252	236	222	209
	SLE*	1/150	586	501	433	378	333	295	263	236	213	193	163	142	117	103	91	80	71	64	SLE*	1/150	614	545	487	438	396	360	329	301	277	256	237	221	205	192	180	169	158	149
	SLS*	1/200	586	501	433	378	333	281	236	200	162	139	120	104	86	75	66	58	52	46	SLS*	1/200	614	545	487	438	396	360	329	301	277	256	237	221	205	192	180	149	133	119
	SLS*	1/250	586	501	398	325	268	223	187	158	128	109	94	82	67	59	51	45	40	35	SLS*	1/250	614	545	487	438	396	360	329	301	277	256	237	194	170	150	133	118	105	93
1,15	SLU	ULS	952	815	704	615	541	480	428	384	332	301	274	250	229	210	194	179	166	154	SLU	ULS	1061	939	838	752	679	616	562	515	473	437	404	375	349	326	305	286	268	251
	SLE*	1/150	680	582	503	439	387	343	306	274	237	215	196	168	139	122	107	95	85	75	SLE*	1/150	758	671	598	537	485	440	402	368	338	312	289	268	249	233	218	204	192	179
	SLS*	1/200	680	582	503	439	387	343	279	237	191	164	142	124	102	89	78	69	61	54	SLS*	1/200	758	671	598	537	485	440	402	368	338	312	289	268	249	233	199	177	158	141
	SLS*	1/250	680	582	471	384	316	263	221	187	151	130	112	97	79	69	61	53	47	41	SLS*	1/250	758	671	598	537	485	440	402	368	338	312	264	230	202	177	157	139	124	110
1,25	SLU	ULS	1041	890	770	672	591	524	468	420	363	329	299	273	241	221	204	188	175	162	SLU	ULS	1190	1053	938	841	759	688	627	574	527	486	449	417	388	362	338	317	294	273
	SLE*	1/150	743	636	550	480	422	374	334	300	259	235	214	186	153	135	119	105	94	83	SLE*	1/150	850	752	670	601	542	491	448	410	376	347	321	298	277	258	242	226	210	195
	SLS*	1/200	743	636	550	480	422	374	308	262	211	182	157	137	112	98	87	76	68	60	SLS*	1/200	850	752	670	601	542	491	448	410	376	347	321	298	277	258	220	195	174	156
	SLS*	1/250	743	636	520	423	349	291	244	207	167	143	124	107	88	77	67	59	52	46	SLS*	1/250	850	752	670	601	542	491	448	410	376	347	291	254	223	196	173	154	137	122
1,50	SLU	ULS	1262	1080	934	815	717	636	567	509	441	399	363	332	292	268	247	229	212	197	SLU	ULS	1517	1338	1189	1063	957	866	788	720	660	608	561	520	483	445	411	380	352	327
	SLE*	1/150	902	771	667	582	512	454	405	364	315	285	259	237	190	167	147	131	116	104	SLE*	1/150	1084	955	849	760	684	619	563	514	471	434	401	371	345	318	293	271	252	234
	SLS*	1/200	902	771	667	582	512	454	382	324	262	225	195	169	139	122	108	95	84	75	SLS*	1/200	1084	955	849	760	684	619	563	514	471	434	401	371	345	318	272	242	216	193
	SLS*	1/250	902	771	667	525	433	360	303	257	207	178	153	133	109	95	84	74	65	57	SLS*	1/250	1084	955	849	760	684	619	563	514	471	434	361	315	276	243	215	191	170	152
1,50	SLU	ULS	842	665	534	435	358	298	250	212	170	146	126	109	89	77	68	59	52	46	SLU	ULS	1084	955	849	760	684	619	563	466	399	344	298	260	228	200	177	156	139	124

I valori riportati in tabella sono da considerarsi come indicativi, è competenza del progettista procedere per i singoli casi di verifica al relativo calcolo.

SANDRINI metalli S.p.A. si riserva di variare in qualsiasi momento e senza preavviso le caratteristiche dei prodotti. Tutti i diritti riservati: vietata la riproduzione.

Tabelle di portata (daN/m²) Load tables (daN/sqm)

Larghezza appoggio intermedio: 200 mm - Larghezza appoggio esterno: 100 mm Internal support width: 200 mm - End support width: 100 mm

Sp. Th. mm	Interasse appoggi (m) / Carico uniformemente distribuito (daN/m ²)																		Span (m) / Uniformly distributed load (daN/sqm)																	
	CAMPATA DOPPIA / DOUBLE SPAN																		CAMPATA DOPPIA / DOUBLE SPAN																	
	Stato limite / Limit state	2,60	2,80	3,0																																

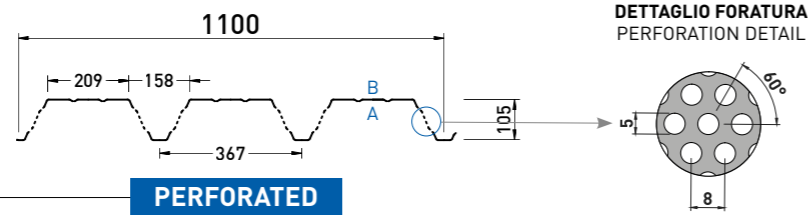

A: lato a vista - front side
B: lato non a vista - back side

PERFORATED

Reazione al fuoco Fire reaction
CLASS A1

Comportamento al fuoco dall'esterno External fire performance
Broof (t1,t2,t3)

Senza necessità di sottoporre a prova secondo la norma UNI EN 14782:2006. No lab test is required as per UNI EN 14782:2006.

Sp. Th. (mm)	DATI STATICI / STATIC DATA			PESO / WEIGHT Steel Kg/m ²
	Jy (cm ² /m)	We inf (cm ³ /m)	We sup (cm ³ /m)	
0,75	124,94	17,14	31,65	7,63
0,80	134,88	18,54	33,87	8,14
0,88	151,00	20,84	37,43	8,96
1,00	175,62	24,34	42,79	10,18
1,15	206,98	28,78	49,48	11,70
1,25	228,16	31,36	53,76	12,72
1,50	281,68	37,56	64,30	15,27

Valori riferiti alla versione | Values referred to version **PERFORATED**

APPLICAZIONI
APPLICATIONS

SANDnodrip
Class A2 - s1, d0 Broof (t1,t2,t3)

SANDcontrol
Class C - s1, d0 Broof (t1,t2,t3)

Tabelle di portata (daN/m²) Load tables (daN/sqm)

* Valori di portata caratteristici con coefficiente di sicurezza applicato pari a: $\gamma_f = 1,40$. Characteristic load with an applied safety coefficient equal to: $\gamma_f = 1,40$.
In azzurro i valori rappresentativi della portata con inflessione limite raggiunta. The values indicated in blue are representative of the load capacity with the limit inflection reached.

Sp. Th.		Interasse appoggi (m) / Carico uniformemente distribuito (daN/m ²)																Span (m) / Uniformly distributed load (daN/sqm)		
mm		CAMPATA SINGOLA / SINGLE SPAN																CAMPATA SINGOLA / SINGLE SPAN		
		Stato limite / Limit state	2,60	2,80	3,00	3,20	3,40	3,60	3,80	4,00	4,20	4,40	4,60	4,80	5,00	5,20	5,40	5,60	5,80	6,00
0,75	SLU	ULS	471	422	365	319	281	249	222	199	172	156	142	129	114	105	97	89	83	77
	SLE*	1/150	336	302	261	228	200	178	158	142	123	111	95	82	68	60	53	47	41	37
		1/200	336	302	261	228	200	163	137	116	94	81	70	60	50	43	38	34	30	26
		1/250	336	288	232	189	155	129	109	92	74	63	55	47	39	34	30	26	23	20
0,80	SLU	ULS	529	453	392	342	301	267	238	213	185	167	152	139	122	112	104	96	89	82
	SLE*	1/150	378	324	280	244	215	190	170	152	132	119	102	89	73	64	57	50	45	40
		1/200	378	324	280	244	215	176	148	126	101	87	75	65	54	47	41	36	32	28
		1/250	378	312	250	204	168	140	117	99	80	69	59	51	42	37	32	28	25	22
0,88	SLU	ULS	587	502	434	379	333	295	264	236	205	185	169	154	141	130	119	110	102	95
	SLE*	1/150	419	359	310	271	238	211	188	169	146	132	115	100	88	77	68	60	53	47
		1/200	419	359	310	271	238	198	166	141	114	98	85	73	64	56	49	43	38	34
		1/250	419	359	281	229	188	157	132	112	90	77	66	58	50	44	38	34	30	26
1,00	SLU	ULS	673	576	498	435	383	339	302	271	245	222	202	184	169	155	143	132	122	113
	SLE*	1/150	481	411	356	310	273	242	216	194	175	158	134	117	96	85	75	66	59	52
		1/200	481	411	356	310	273	230	194	165	133	114	99	86	70	62	54	48	42	38
		1/250	481	411	327	266	220	183	154	130	105	90	78	67	55	48	42	37	33	29
1,15	SLU	ULS	782	669	578	505	444	394	351	315	273	247	225	205	188	173	159	147	136	127
	SLE*	1/150	558	478	413	361	317	281	251	225	195	177	161	138	114	100	88	78	69	62
		1/200	558	478	413	361	317	281	229	195	157	135	117	101	83	73	64	57	50	44
		1/250	558	478	387	315	260	216	182	154	124	106	92	80	65	57	50	44	39	34
1,25	SLU	ULS	854	731	632	552	486	430	384	344	298	270	246	224	198	182	167	155	143	133
	SLE*	1/150	610	522	452	394	347	307	274	246	213	193	176	152	126	110	98	86	77	68
		1/200	610	522	452	394	347	307	253	215	173	149	129	112	92	81	71	63	56	49
		1/250	610	522	427	348	287	239	201	170	137	118	101	88	72	63	55	49	43	38
1,50	SLU	ULS	1036	887	767	669	589	522	466	418	362	328	298	272	240	220	203	188	174	162
	SLE*	1/150	740	633	548	478	421	373	333	299	258	234	213	194	156	137	121	107	95	85
		1/200	740	633	548	478	421	373	314	266	215	185	160	139	114	100	88	78	69	61
		1/250	740	633	548	431	355	296	249	211	170	146	126	109	89	78	69	60	53	47

I valori riportati in tabella sono da considerarsi come indicativi, è competenza del progettista procedere per i singoli casi di verifica al relativo calcolo.

SANDRINI metalli S.p.A. si riserva di variare in qualsiasi momento e senza preavviso le caratteristiche dei prodotti. Tutti i diritti riservati: vietata la riproduzione.

Tabelle di portata (daN/m²) Load tables (daN/sqm)

Sp. Th.		Interasse appoggi (m) / Carico uniformemente distribuito (daN/m ²)																Span (m) / Uniformly distributed load (daN/sqm)		
mm		CAMPATA DOPPIA / DOUBLE SPAN																CAMPATA DOPPIA / DOUBLE SPAN		
		Stato limite / Limit state	2,60	2,80	3,00	3,20	3,40	3,60	3,80	4,00	4,20	4,40	4,60	4,80	5,00	5,20	5,40	5,60	5,80	6,00
0,75	SLU	ULS	343	305	273	246	223	203	186	171	151	139	129	120	107	100	94	88	83	78
	SLE*	1/150	245	218	195	176	159	145	133	122	108	99	92	86	77	72	67	63	59	56
		1/200	245	218	195	176	159	145	133	122	108	99	92	86	77	72	67	63	59	56
		1/250	245	218	195	176	159	145	133	122	108	99	92	86	77	72	67	63	59	56
0,80	SLU	ULS	398	354	317	285	258	235	215	197	173	160	148	138	123	115	108	101	95	90
	SLE*	1/150	285	253	226	204	184	168	153	141	124	114	106	99	88	82	77	72	68	64
		1/200	285	253	226	204	184	168	153	141	124	114	106	99	88	82	77	72	68	64
		1/250	285	253	226	204	184	168	153	141	124	114	106	99	88	82	77	72	68	64
0,88	SLU	ULS	485	430	384	346	313	284	260	238	209	193	178	166	147	138	129	121	114	107
	SLE*	1/150	346	307	275	247	223	203	185	170	149	138	127	118	105	98	92	86	81	76
		1/200	346	307	275	247	223	203	185	170	149	138	127	118	105	98	92	86	81	76
		1/250	346	307	275	247	223	203	185	170	149	138	127	118	105	98	92	86	81	76
1,00	SLU	ULS	589	522	465	418	377	343	312	286	263	243	225	209	194	181	170	159	148	137
	SLE*	1/150	421	373	332	299	270	245	223	204	188	173	161	149	139	129	121	114	106	98
		1/200	421	373	332	299	270	245	223	204	188	173	161	149	139	129	121	114	106	98
		1/250	421	373	332	299	270	245	223	204	188	173	161	149	139	129	121	114	106	98
1,15	SLU	ULS	725	641	571	511	461	418	381	348	320	295	273	253	235	219	204	189	175	162
	SLE*	1/150	518	458	408	365	329	299	272	249	229	211	195	181	168	157	146	135	125	116
		1/200	518	458	408	365	329	299	272	249	229	211	195	181	168	157	146	135	125	116
		1/250	518	458	408	365	329	299	272	249	229	211	195	181	168	157	146	135	125	116
1,25	SLU	ULS	812	717	638	571	514	466	424	388	356	328	303	281	261	241	222	206	190	177
	SLE*	1/150	580	512	455	408	367	333	303	277	254	234	216	200	186	172	159	147	136	126
		1/200	580	512	455	408	367	333	303	277	254	234	216	200	186	172	159	147	136	126
		1/250	580	512	455	408	367	333	303	277	254	234	216	200	186	172	159	147	136	126
1,50	SLU	ULS	1031	908	805	720	647	585	531	485	444	409	376	343	314	289	266	246	228	212
	SLE*	1/150	737	648	575	514	462	418	379	346	317	292	268	245	225	206	190	176	163	151
		1/200	737	648	575	514	462	418	379	346	317	292	268	245	225	206	190	176	163	151
		1/250	737	648	575	514	462	418	379	346	317	292	268	245	225	206	190	176	163	151

The values shown in the table must be considered as indicative, the designer has the responsibility to proceed with the relevant calculation in any individual cases.

SANDRINI metalli S.p.A. reserves the right to change the characteristics of the products at any time and without prior notice. All rights reserved: reproduction is prohibited.

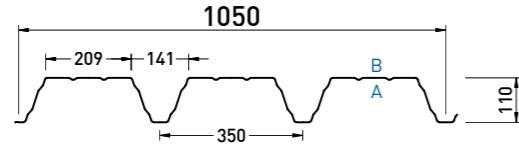

A: lato a vista - front side
B: lato non a vista - back side

POSITIVE

Reazione al fuoco Fire reaction
CLASS A1

Comportamento al fuoco dall'esterno External fire performance
Broof (t1,t2,t3)

Senza necessità di sottoporre a prova secondo la norma UNI EN 14782:2006. No lab test is required as per UNI EN 14782:2006.

Sp. Th. (mm)	DATI STATICI / STATIC DATA			PESO / WEIGHT Steel Kg/m ²
	Jy (cm ² /m)	We inf (cm ³ /m)	We sup (cm ³ /m)	
0,75	146,22	21,04	46,52	8,41
0,80	157,97	22,73	49,80	8,97
0,88	177,07	25,49	55,06	9,87
1,00	206,31	29,71	62,97	11,21
1,15	243,64	35,05	72,86	12,90
1,25	268,89	38,31	79,23	14,02
1,50	332,83	45,90	94,75	16,82

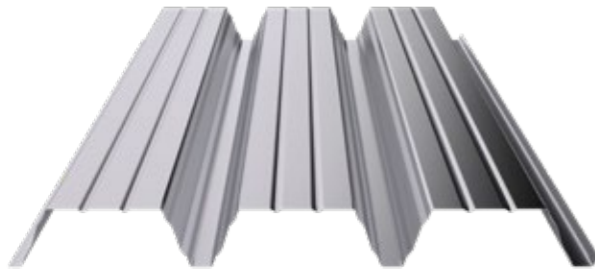

APPLICAZIONI
APPLICATIONS

SANDnodrip
Class A2 - s1, d0 Broof (t1,t2,t3)

SANDcontrol
Class C - s1, d0 Broof (t1,t2,t3)

Tabelle di portata (daN/m²) Load tables (daN/sqm)

* Valori di portata caratteristici con coefficiente di sicurezza applicato pari a: $\gamma_f = 1,40$. Characteristic load with an applied safety coefficient equal to: $\gamma_f = 1,40$.
In azzurro i valori rappresentativi della portata con inflessione limite raggiunta. The values indicated in blue are representative of the load capacity with the limit inflection reached.

Sp. Th. mm	Larghezza appoggio esterno: 100 mm / End support width: 100 mm																			
	Interasse appoggi (m) / Carico uniformemente distribuito (daN/m ²) / Span (m) / Uniformly distributed load (daN/sqm)																			
	CAMPATA SINGOLA / SINGLE SPAN																			
	Stato limite / Limit state	2,60	2,80	3,00	3,20	3,40	3,60	3,80	4,00	4,20	4,40	4,60	4,80	5,00	5,20	5,40	5,60	5,80	6,00	
0,75	SLU	ULS	632	585	515	450	396	351	313	281	243	220	200	183	161	148	137	126	117	109
	SLE* SLS*	1/150	452	418	368	321	283	251	224	201	174	157	131	114	100	88	78	69	62	54
		1/200	452	418	368	321	283	251	224	171	138	119	103	89	73	64	57	50	44	39
		1/250	452	418	368	277	229	190	160	136	109	94	81	70	57	50	44	39	34	30
0,80	SLU	ULS	727	639	552	482	424	376	336	301	261	236	215	196	173	159	146	135	125	116
	SLE* SLS*	1/150	519	456	395	344	303	269	240	215	186	169	151	131	108	95	84	75	66	59
		1/200	519	456	395	344	303	269	218	185	150	129	111	97	79	70	61	54	48	42
		1/250	519	456	368	300	247	206	173	147	118	101	87	76	62	54	48	42	37	33
0,88	SLU	ULS	828	708	612	534	470	417	372	334	289	262	238	217	192	176	162	150	139	129
	SLE* SLS*	1/150	591	506	437	382	336	298	266	238	206	187	170	155	122	107	94	84	74	66
		1/200	591	506	437	382	336	298	245	208	168	144	125	109	89	78	69	61	54	48
		1/250	591	506	413	336	277	231	194	164	133	114	98	85	70	61	54	47	41	37
1,00	SLU	ULS	949	812	702	613	540	478	427	383	332	300	273	250	220	202	186	172	160	148
	SLE* SLS*	1/150	678	580	502	438	385	342	305	274	237	215	195	178	142	125	110	98	87	77
		1/200	678	580	502	438	385	342	286	242	196	168	146	127	104	91	80	71	63	56
		1/250	678	580	481	392	323	269	226	192	155	133	115	99	82	71	63	55	49	43
1,15	SLU	ULS	1103	943	816	712	627	556	496	445	385	349	317	290	266	244	225	208	193	179
	SLE* SLS*	1/150	788	674	583	509	448	397	354	318	275	249	227	207	168	148	130	116	103	92
		1/200	788	674	583	509	448	397	338	287	231	199	172	150	123	108	95	84	75	66
		1/250	788	674	583	463	382	318	268	227	183	157	136	118	97	84	74	65	58	51
1,25	SLU	ULS	1205	1031	892	778	685	607	542	486	421	381	347	317	279	257	237	219	203	188
	SLE* SLS*	1/150	861	736	637	556	489	434	387	347	301	272	248	226	199	163	144	128	114	101
		1/200	861	736	637	556	489	434	373	316	256	220	190	166	136	120	105	93	82	73
		1/250	861	736	637	511	422	352	296	251	202	174	150	130	107	93	82	72	64	56
1,50	SLU	ULS	1462	1251	1082	944	831	737	657	590	511	463	421	384	339	311	287	265	246	228
	SLE* SLS*	1/150	1044	893	773	674	594	526	470	421	365	331	301	275	242	202	179	159	141	126
		1/200	1044	893	773	674	594	526	470	392	317	273	236	205	169	148	131	116	103	91
		1/250	1044	893	773	634	523	436	366	311	251	215	186	162	133	116	102	90	79	70
1/300	1018	803	645	525	433	360	303	256	206	177	153	132	108	94	83	73	64	56		

I valori riportati in tabella sono da considerarsi come indicativi, è competenza del progettista procedere per i singoli casi di verifica al relativo calcolo.

SANDRINI metalli S.p.A. si riserva di variare in qualsiasi momento e senza preavviso le caratteristiche dei prodotti. Tutti i diritti riservati: vietata la riproduzione.

Tabelle di portata (daN/m²) Load tables (daN/sqm)

Sp. Th. mm	Larghezza appoggio intermedio: 200 mm - Larghezza appoggio esterno: 100 mm / Internal support width: 200 mm - End support width: 100 mm																			
	Interasse appoggi (m) / Carico uniformemente distribuito (daN/m ²) / Span (m) / Uniformly distributed load (daN/sqm)																			
	CAMPATA DOPPIA / DOUBLE SPAN																			
	Stato limite / Limit state	2,60	2,80	3,00	3,20	3,40	3,60	3,80	4,00	4,20	4,40	4,60	4,80	5,00	5,20	5,40	5,60	5,80	6,00	
0,75	SLU	ULS	471	420	376	339	307	280	256	236	208	192	178	166	148	139	130	122	115	109
	SLE* SLS*	1/150	337	300	269	242	220	200	183	168	148	137	127	119	106	99	93	87	82	78
		1/200	337	300	269	242	220	200	183	168	148	137	127	119	106	99	93	87	82	78
		1/250	337	300	269	242	220	200	183	168	148	137	127	119	106	99	93	87	82	78
0,80	SLU	ULS	547	487	436	393	356	324	296	272	239	221	205	191	170	159	149	140	132	124
	SLE* SLS*	1/150	391	348	311	280	254	231	212	194	171	158	147	136	122	114	107	100	94	89
		1/200	391	348	311	280	254	231	212	194	171	158	147	136	122	114	107	100	94	89
		1/250	391	348	311	280	254	231	212	194	171	158	147	136	122	114	107	100	94	89
0,88	SLU	ULS	667	592	530	477	431	392	358	329	288	266	247	230	204	191	179	168	158	149
	SLE* SLS*	1/150	477	423	378	340	308	280	256	235	206	190	176	164	146	136	128	120	113	106
		1/200	477	423	378	340	308	280	256	235	206	190	176	164	146	136	128	120	113	106
		1/250	477	423	378	340	308	280	256	235	206	190	176	164	146	136	128	120	113	106
1,00	SLU	ULS	812	719	642	577	521	474	432	396	364	336	311	289	269	251	235	221	207	194
	SLE* SLS*	1/150	580	514	459	412	372	338	309	283	260	240	222	207	192	180	168	158	148	138
		1/200	580	514	459	412	372	338	309	283	260	240	222	207	192	180	168	158	148	138
		1/250	580	514	459	412	372	338	309	283	260	240	222	207	192	180	168	158	148	138
1,15	SLU	ULS	1000	884	788	707	638	579	527	483	444	409	378	351	327	305	285	266	246	229
	SLE* SLS*	1/150	714	632	563	505	456	413	377	345	317	292	270	251	233	218	204	190	176	163
		1/200	714	632	563	505	456	413	377	345	317	292	270	251	233	218	204	190	176	163
		1/250	714	632	563	505	456	413	377	345	317	292	270	251	233	218	204	190	176	163
1,25	SLU	ULS	1123	992	883	792	714	647	589	539	495	456	421	391	363	339	314	291	269	250
	SLE* SLS*	1/150	802	709	631	566	510	462	421	385	353	326	301	279	260	242	225	208	192	179
		1/200	802	709	631	566	510	462	421	385	353	326	301	279	260	242	225	208	192	179
		1/250	802	709	631	566	510	462	421	385	353	326	301	279	260	242	225	208	192	179
1,50	SLU	ULS	1429	1259	1118	999	899	813	739	675	619	569	526	485	444	408	377	348	323	300
	SLE* SLS*	1/150	1021	899	798	714	642	581	528	482	442	407	375	346	317	292	269	249	230	214
		1/200	1021	899	798	714	642	581	528	482	442	407	375	346	317	292	269	249	230	214
		1/250	1021	899	798	714	642	581	528	482	442	407	375	346	317	292	269	249	230	214
1/300	1021																			

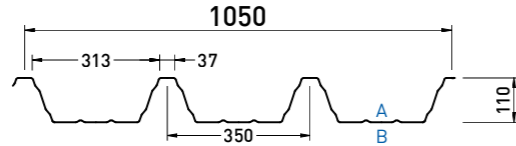

A: lato a vista - front side
B: lato non a vista - back side

NEGATIVE

Reazione al fuoco Fire reaction
CLASS A1

Comportamento al fuoco dall'esterno External fire performance
Broof (t1,t2,t3)

Senza necessità di sottoporre a prova secondo la norma UNI EN 14782:2006. No lab test is required as per UNI EN 14782:2006.

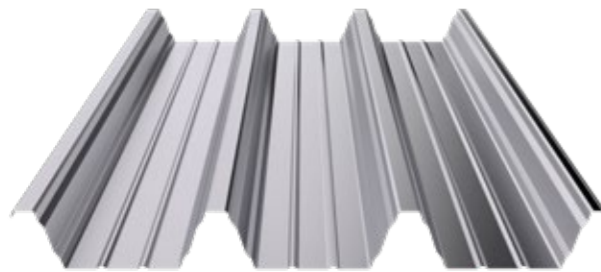

Sp. Th. (mm)	DATI STATICI / STATIC DATA			PESO / WEIGHT Steel Kg/m ²
	Jy (cm ² /m)	We inf (cm ³ /m)	We sup (cm ³ /m)	
0,75	146,22	46,52	21,04	8,41
0,80	157,97	49,80	22,73	8,97
0,88	177,07	55,06	25,49	9,87
1,00	206,31	62,97	29,71	11,21
1,15	243,64	72,86	35,05	12,90
1,25	268,89	79,23	38,31	14,02
1,50	332,83	94,75	45,90	16,82

APPLICAZIONI
APPLICATIONS

SANDnodrip
Class A2 - s1, d0 Broof (t1,t2,t3)

SANDcontrol
Class C - s1, d0 Broof (t1,t2,t3)

Tabelle di portata (daN/m²) Load tables (daN/sqm)

* Valori di portata caratteristici con coefficiente di sicurezza applicato pari a: $\gamma_q = 1,40$. Characteristic load with an applied safety coefficient equal to: $\gamma_q = 1,40$.
In azzurro i valori rappresentativi della portata con inflessione limite raggiunta. The values indicated in blue are representative of the load capacity with the limit inflection reached.

Larghezza appoggio esterno: 100 mm End support width: 100 mm

Sp. Th. mm	Interasse appoggi (m) / Carico uniformemente distribuito (daN/m ²)																	Span (m) / Uniformly distributed load (daN/sqm)																					
	CAMPATA SINGOLA / SINGLE SPAN																	CAMPATA SINGOLA / SINGLE SPAN																					
Stato limite / Limit state	2,60	2,80	3,00	3,20	3,40	3,60	3,80	4,00	4,20	4,40	4,60	4,80	5,00	5,20	5,40	5,60	5,80	6,00	2,60	2,80	3,00	3,20	3,40	3,60	3,80	4,00	4,20	4,40	4,60	4,80	5,00	5,20	5,40	5,60	5,80	6,00			
0,75	SLU	601	556	490	427	376	333	297	267	231	209	190	174	153	141	130	120	111	103	601	556	490	427	376	333	297	267	231	209	190	174	153	141	130	120	111	103		
	SLE*	429	397	350	305	269	238	212	191	165	149	124	108	95	84	74	66	59	51	429	397	350	305	269	238	212	191	165	149	124	108	95	84	74	66	59	51		
	SLS*	1/200	429	397	350	305	269	238	212	191	165	149	124	108	95	84	74	66	59	51	1/200	429	397	350	305	269	238	212	191	165	149	124	108	95	84	74	66	59	51
	SLS*	1/250	429	397	350	264	217	181	152	129	104	89	77	67	55	48	42	37	32	29	1/250	429	397	350	264	217	181	152	129	104	89	77	67	55	48	42	37	32	29
0,80	SLU	429	334	268	218	180	150	126	106	85	73	63	54	44	39	34	30	26	23	429	334	268	218	180	150	126	106	85	73	63	54	44	39	34	30	26	23		
	SLE*	690	607	525	458	403	357	319	286	248	224	204	186	164	151	139	129	119	111	690	607	525	458	403	357	319	286	248	224	204	186	164	151	139	129	119	111		
	SLE*	1/150	493	433	375	327	288	255	228	204	177	160	143	125	103	91	80	71	63	56	1/150	493	433	375	327	288	255	228	204	177	160	143	125	103	91	80	71	63	56
	SLS*	1/200	493	433	375	327	288	255	228	204	177	160	143	125	103	91	80	71	63	56	1/200	493	433	375	327	288	255	228	204	177	160	143	125	103	91	80	71	63	56
0,88	SLU	1/250	493	433	350	285	235	196	164	139	112	96	83	72	59	52	45	40	35	31	1/250	493	433	350	285	235	196	164	139	112	96	83	72	59	52	45	40	35	31
	SLE*	1/150	562	480	415	363	319	283	233	197	159	137	119	103	85	74	65	58	51	45	1/150	562	480	415	363	319	283	233	197	159	137	119	103	85	74	65	58	51	45
	SLE*	1/200	562	480	415	363	319	283	233	197	159	137	119	103	85	74	65	58	51	45	1/200	562	480	415	363	319	283	233	197	159	137	119	103	85	74	65	58	51	45
	SLS*	1/250	562	480	392	319	263	219	184	156	126	108	93	81	66	58	51	45	39	35	1/250	562	480	392	319	263	219	184	156	126	108	93	81	66	58	51	45	39	35
1,00	SLU	1/300	513	405	325	265	218	181	152	129	104	89	76	66	54	47	41	36	32	28	1/300	513	405	325	265	218	181	152	129	104	89	76	66	54	47	41	36	32	28
	SLU	902	772	667	583	513	455	405	364	315	285	260	237	209	192	177	164	152	141	902	772	667	583	513	455	405	364	315	285	260	237	209	192	177	164	152	141		
	SLE*	1/150	644	551	477	416	366	325	290	260	225	204	185	169	135	119	105	93	83	74	1/150	644	551	477	416	366	325	290	260	225	204	185	169	135	119	105	93	83	74
	SLE*	1/200	644	551	477	416	366	325	271	230	186	160	138	120	99	87	76	67	60	53	1/200	644	551	477	416	366	325	271	230	186	160	138	120	99	87	76	67	60	53
1,15	SLU	1/250	644	551	457	372	307	256	215	182	147	126	109	94	77	68	59	52	46	41	1/250	644	551	457	372	307	256	215	182	147	126	109	94	77	68	59	52	46	41
	SLE*	1/150	1047	896	775	677	596	528	471	423	366	331	302	275	252	232	214	198	183	170	1/150	1047	896	775	677	596	528	471	423	366	331	302	275	252	232	214	198	183	170
	SLE*	1/200	748	640	554	483	425	377	321	272	220	189	164	142	117	103	91	80	71	63	1/200	748	640	554	483	425	377	321	272	220	189	164	142	117	103	91	80	71	63
	SLS*	1/250	748	640	554	440	363	302	254	216	174	149	129	112	92	80	70	62	55	48	1/250	748	640	554	440	363	302	254	216	174	149	129	112	92	80	70	62	55	48
1,25	SLU	1/300	706	558	448	365	301	250	210	178	143	123	106	91	75	65	57	50	44	39	1/300	706	558	448	365	301	250	210	178	143	123	106	91	75	65	57	50	44	39
	SLU	1145	979	847	740	651	577	515	462	400	362	330	301	265	244	225	208	193	179	1145	979	847	740	651	577	515	462	400	362	330	301	265	244	225	208	193	179		
	SLE*	1/150	818	700	605	528	465	412	368	330	286	259	235	215	189	155	137	121	108	96	1/150	818	700	605	528	465	412	368	330	286	259	235	215	189	155	137	121	108	96
	SLE*	1/200	818	700	605	528	465	412	354	301	243	209	181	157	129	114	100	88	78	70	1/200	818	700	605	528	465	412	354	301	243	209	181	157	129	114	100	88	78	70
1,50	SLU	1/250	818	700	605	486	401	334	281	238	192	165	142	124	101	89	78	69	61	54	1/250	818	700	605	486	401	334	281	238	192	165	142	124	101	89	78	69	61	54
	SLU	1389	1188	1028	897	790	700	625	560	485	440	400	365	322	296	273	252	234	217	1389	1188	1028	897	790	700	625	560	485	440	400	365	322	296	273	252	234	217		
	SLE*	1/150	992	849	734	641	564	500	446	400	347	314	286	261	230	192	170	151	134	120	1/150	992	849	734	641	564	500	446	400	347	314	286	261	230	192	170	151	134	120
	SLE*	1/200	992	849	734	641	564	500	446	373	301	259	224	195	161	141	124	110	97	87	1/200	992	849	734	641	564	500	446	373	301	259	224	195	161	141	124	110	97	87

I valori riportati in tabella sono da considerarsi come indicativi, è competenza del progettista procedere per i singoli casi di verifica al relativo calcolo.

SANDRINI metalli S.p.A. si riserva di variare in qualsiasi momento e senza preavviso le caratteristiche dei prodotti. Tutti i diritti riservati: vietata la riproduzione.

Tabelle di portata (daN/m²) Load tables (daN/sqm)

Larghezza appoggio intermedio: 200 mm - Larghezza appoggio esterno: 100 mm Internal support width: 200 mm - End support width: 100 mm

Sp. Th. mm	Interasse appoggi (m) / Carico uniformemente distribuito (daN/m ²)																	Span (m) / Uniformly distributed load (daN/sqm)																			
	CAMPATA DOPPIA / DOUBLE SPAN																	CAMPATA DOPPIA / DOUBLE SPAN																			
Stato limite / Limit state	2,60	2,80	3,00	3,20	3,40	3,60	3,80	4,00	4,20	4,40	4,60	4,80	5,00	5,20	5,40	5,60	5,80	6,00	2,60	2,80	3,00	3,20	3,40	3,60	3,80	4,00	4,20	4,40	4,60	4,80	5,00	5,20	5,40	5,60	5,80	6,00	
0,75	SLU	448	399	357	322	292	266	244	224	197	183	169	158	141	132	124	116	109	103	448	399	357	322	292	266	244	224	197	183	169	158	141	132	124	116	109	103
	SLE*	1/150	320	285	255	230	209	190	174	160	141	130	121	113	101	94	88	83	78	74	1/150																

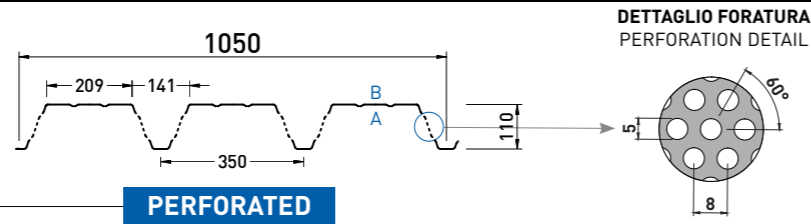

A: lato a vista - front side
B: lato non a vista - back side

PERFORATED

Reazione al fuoco Fire reaction
CLASS A1

Comportamento al fuoco dall'esterno External fire performance
Broof (t1,t2,t3)

Senza necessità di sottoporre a prova secondo la norma UNI EN 14782:2006. No lab test is required as per UNI EN 14782:2006.

Sp. Th. (mm)	DATI STATICI / STATIC DATA			PESO / WEIGHT Steel Kg/m ²
	Jy (cm ² /m)	We inf (cm ² /m)	We sup (cm ² /m)	
0,75	143,08	18,75	34,75	8,00
0,80	154,46	20,30	37,19	8,53
0,88	172,92	22,81	41,11	9,38
1,00	201,12	26,66	47,00	10,66
1,15	237,05	31,56	54,36	12,26
1,25	261,31	34,51	59,11	13,33
1,50	322,63	41,34	70,72	15,99

Valori riferiti alla versione | Values referred to version **PERFORATED**

APPLICAZIONI
APPLICATIONS



SANDnodrip
Class A2 - s1, d0 🔥 Broof (t1,t2,t3)



SANDcontrol
Class C - s1, d0 🔥 Broof (t1,t2,t3)

Tabelle di portata (daN/m²) Load tables (daN/sqm)

* Valori di portata caratteristici con coefficiente di sicurezza applicato pari a: $\gamma_q = 1,40$. Characteristic load with an applied safety coefficient equal to: $\gamma_q = 1,40$.
In azzurro i valori rappresentativi della portata con inflessione limite raggiunta. The values indicated in blue are representative of the load capacity with the limit inflection reached.

Sp. Th. mm	Larghezza appoggio esterno: 100 mm / End support width: 100 mm																			
	Interasse appoggi (m) / Carico uniformemente distribuito (daN/m ²) / Span (m) / Uniformly distributed load (daN/sqm)																			
	CAMPATA SINGOLA / SINGLE SPAN		2,60	2,80	3,00	3,20	3,40	3,60	3,80	4,00	4,20	4,40	4,60	4,80	5,00	5,20	5,40	5,60	5,80	6,00
0,75	SLU	ULS	493	457	402	351	309	274	244	219	190	172	156	143	126	116	106	98	91	85
	SLE* SLS*	1/150	352	326	287	251	221	196	174	156	135	123	102	89	78	69	61	54	48	42
		1/200	352	326	287	251	221	196	174	156	135	123	102	89	78	69	61	54	48	42
		1/250	352	326	287	251	221	196	174	156	135	123	102	89	78	69	61	54	48	42
0,80	SLU	ULS	567	498	431	376	331	293	262	235	203	184	168	153	135	124	114	106	98	91
	SLE* SLS*	1/150	405	356	308	269	236	210	187	168	145	132	118	103	85	74	66	58	52	46
		1/200	405	356	308	269	236	210	187	168	145	132	118	103	85	74	66	58	52	46
		1/250	405	356	287	234	193	161	135	114	92	79	68	59	48	42	37	33	29	25
0,88	SLU	ULS	645	552	478	417	367	325	290	260	225	204	186	170	149	137	127	117	108	101
	SLE* SLS*	1/150	461	394	341	298	262	232	207	186	161	146	133	121	95	83	74	65	58	52
		1/200	461	394	341	298	262	232	207	186	161	146	133	121	95	83	74	65	58	52
		1/250	461	394	322	262	216	180	151	128	103	89	77	66	54	48	42	37	32	29
1,00	SLU	ULS	741	634	548	478	421	373	333	299	259	234	213	195	171	158	145	134	124	116
	SLE* SLS*	1/150	529	453	391	342	301	267	238	213	185	167	152	139	111	97	86	76	68	60
		1/200	529	453	391	342	301	267	238	213	185	167	152	139	111	97	86	76	68	60
		1/250	529	453	375	306	252	210	177	150	121	104	89	78	64	56	49	43	38	33
1,15	SLU	ULS	860	736	636	556	489	433	387	347	300	272	248	226	207	190	176	162	150	140
	SLE* SLS*	1/150	614	526	455	397	349	310	276	248	215	194	177	162	131	115	102	90	80	72
		1/200	614	526	455	397	349	310	276	248	215	194	177	162	131	115	102	90	80	72
		1/250	614	526	455	361	298	248	209	177	143	123	106	92	75	66	58	51	45	40
1,25	SLU	ULS	940	804	695	607	534	474	423	379	328	298	271	247	218	200	185	171	158	147
	SLE* SLS*	1/150	671	574	497	434	382	338	302	271	235	213	193	177	156	127	112	100	89	79
		1/200	671	574	497	434	382	338	291	247	199	172	148	129	106	93	82	73	64	57
		1/250	671	574	497	399	329	274	231	195	158	135	117	102	83	73	64	56	50	44
1,50	SLU	ULS	1140	975	844	737	648	575	513	460	398	361	328	300	264	243	224	207	192	178
	SLE* SLS*	1/150	814	697	603	526	463	411	366	329	285	258	235	214	189	158	140	124	110	98
		1/200	814	697	603	526	463	411	366	329	285	258	235	214	189	158	140	124	110	98
		1/250	814	697	603	494	408	340	286	242	195	168	145	126	103	91	80	70	62	55

I valori riportati in tabella sono da considerarsi come indicativi, è competenza del progettista procedere per i singoli casi di verifica al relativo calcolo.

SANDRINI metalli S.p.A. si riserva di variare in qualsiasi momento e senza preavviso le caratteristiche dei prodotti. Tutti i diritti riservati: vietata la riproduzione.

Tabelle di portata (daN/m²) Load tables (daN/sqm)

Sp. Th. mm	Larghezza appoggio intermedio: 200 mm - Larghezza appoggio esterno: 100 mm / Internal support width: 200 mm - End support width: 100 mm																			
	Interasse appoggi (m) / Carico uniformemente distribuito (daN/m ²) / Span (m) / Uniformly distributed load (daN/sqm)																			
	CAMPATA DOPPIA / DOUBLE SPAN		2,60	2,80	3,00	3,20	3,40	3,60	3,80	4,00	4,20	4,40	4,60	4,80	5,00	5,20	5,40	5,60	5,80	6,00
0,75	SLU	ULS	368	327	293	264	240	218	200	184	162	150	139	129	116	108	102	95	90	85
	SLE* SLS*	1/150	263	234	209	189	171	156	143	131	116	107	99	92	83	77	73	68	64	60
		1/200	263	234	209	189	171	156	143	131	116	107	99	92	83	77	73	68	64	60
		1/250	263	234	209	189	171	156	143	131	116	107	99	92	83	77	73	68	64	60
0,80	SLU	ULS	427	380	340	306	277	253	231	212	187	173	160	149	133	124	116	109	103	97
	SLE* SLS*	1/150	305	271	243	219	198	180	165	151	133	123	114	106	95	89	83	78	73	69
		1/200	305	271	243	219	198	180	165	151	133	123	114	106	95	89	83	78	73	69
		1/250	305	271	243	219	198	180	165	151	133	123	114	106	95	89	83	78	73	69
0,88	SLU	ULS	520	462	413	372	336	306	280	257	225	208	193	179	159	149	139	131	123	116
	SLE* SLS*	1/150	372	330	295	266	240	219	200	183	161	148	138	128	114	106	100	93	88	83
		1/200	372	330	295	266	240	219	200	183	161	148	138	128	114	106	100	93	88	83
		1/250	372	330	295	266	240	219	200	183	161	148	138	128	114	106	100	93	88	83
1,00	SLU	ULS	633	561	501	450	407	369	337	309	284	262	243	226	210	196	183	172	162	151
	SLE* SLS*	1/150	452	401	358	321	290	264	241	221	203	187	173	161	150	140	131	123	115	108
		1/200	452	401	358	321	290	264	241	221	203	187	173	161	150	140	131	123	115	108
		1/250	452	401	358	321	290	264	241	221	203	187	173	161	150	140	131	123	115	108
1,15	SLU	ULS	780	690	615	551	498	451	411	377	346	319	295	274	255	238	222	207	192	178
	SLE* SLS*	1/150	557	493	439	394	355	322	294	269	247	228	211	196	182	170	159	148	137	127
		1/200	557	493	439	394	355	322	294	269	247	228	211	196	182	170	159	148	137	127
		1/250	557	493	439	394	355	322	294	269	247	228	211	196	182	170	159	148	137	127
1,25	SLU	ULS	876	774	689	618	557	505	459	420	386	356	329	305	283	264	245	227	210	195
	SLE* SLS*	1/150	626	553	492	441	398	360	328	300	276	254	235	218	202	189	175	162	150	139
		1/200	626	553	492	441	398	360	328	300	276	254	235	218	202	189	175	162	150	139
		1/250	626	553	492	441	398	360	328	300	276	254	235	218	202	189	175	162	150	139
1,50	SLU	ULS	1115	982	872	780	701	634	577	526	483	444	410	378	347	319	294	272	252	234
	SLE* SLS*	1/150	796	701	623	557	501	453	412	376	345	317	293	270	248	228	210	194	180	167
		1/200	796	701	623	557	501	453	412	376	345	317	293	270	248	228	210	194	180	167
		1/250	796	701	623	557	501	453	412	376	345	317	293	270	248	228	210	194	180	167

Sp. Th. mm	Larghezza appoggio intermedio: 200 mm - Larghezza appoggio esterno: 100 mm / Internal support width: 200 mm - End support width: 100 mm																
	Interasse appoggi (m) / Carico uniformemente distribuito (daN/m ²) / Span (m) / Uniformly distributed load (daN/sqm)																
	CAMPATA MULTIPLA / MULTIPLE SPAN		2,60	2,80	3,00</												

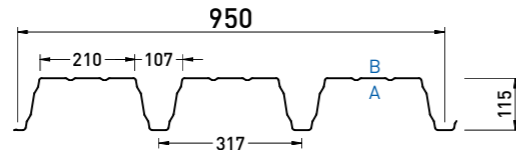

A: lato a vista - front side
B: lato non a vista - back side

POSITIVE

Reazione al fuoco Fire reaction
CLASS A1

Comportamento al fuoco dall'esterno External fire performance
Broof (t1,t2,t3)

Senza necessità di sottoporre a prova secondo la norma UNI EN 14782:2006. No lab test is required as per UNI EN 14782:2006.



Sp. Th. (mm)	DATI STATICI / STATIC DATA			PESO / WEIGHT Steel Kg/m ²
	Jy (cm ² /m)	We inf (cm ³ /m)	We sup (cm ³ /m)	
0,75	183,12	24,70	54,89	9,30
0,80	197,84	26,70	58,77	9,92
0,88	221,77	29,96	64,98	10,91
1,00	258,4	34,95	74,34	12,39
1,15	305,18	41,29	86,05	14,25
1,25	336,83	45,46	93,79	15,49
1,50	417,01	54,47	112,21	18,59

APPLICAZIONI
APPLICATIONS

SANDnodrip
Class A2 - s1, d0 Broof (t1,t2,t3)

SANDcontrol
Class C - s1, d0 Broof (t1,t2,t3)

Tabelle di portata (daN/m²) Load tables (daN/sqm)

* Valori di portata caratteristici con coefficiente di sicurezza applicato pari a: $\gamma_q = 1,40$. Characteristic load with an applied safety coefficient equal to: $\gamma_q = 1,40$.
In azzurro i valori rappresentativi della portata con inflessione limite raggiunta. The values indicated in blue are representative of the load capacity with the limit inflection reached.

Larghezza appoggio esterno: 100 mm End support width: 100 mm

Sp. Th. mm	Interasse appoggi (m) / Carico uniformemente distribuito (daN/m ²)																		Span (m) / Uniformly distributed load (daN/sqm)																			
	CAMPATA SINGOLA																		SINGLE SPAN																			
	Stato limite Limit state	2,60	2,80	3,00	3,20	3,40	3,60	3,80	4,00	4,20	4,40	4,60	4,80	5,00	5,20	5,40	5,60	5,80	6,00	2,60	2,80	3,00	3,20	3,40	3,60	3,80	4,00	4,20	4,40	4,60	4,80	5,00	5,20	5,40	5,60	5,80	6,00	
0,75	SLU	ULS	699	647	602	534	470	417	372	334	289	262	238	218	192	176	163	150	139	129	699	647	602	534	470	417	372	334	289	262	238	218	192	176	163	150	139	129
	SLE* SLS*	1/150	499	462	430	382	336	298	266	238	206	187	170	155	126	111	98	87	78	69	499	462	430	382	336	298	266	238	206	187	170	155	126	111	98	87	78	69
		1/200	499	462	430	382	336	298	254	216	174	150	130	113	93	82	72	64	56	50	499	462	430	382	336	298	254	216	174	150	130	113	93	82	72	64	56	50
		1/250	499	462	430	349	287	240	202	171	138	118	102	89	73	64	56	49	44	39	499	462	430	349	287	240	202	171	138	118	102	89	73	64	56	49	44	39
0,80	SLU	ULS	803	744	656	573	504	447	399	358	310	281	256	233	206	189	174	161	149	139	803	744	656	573	504	447	399	358	310	281	256	233	206	189	174	161	149	139
	SLE* SLS*	1/150	574	531	469	409	360	319	285	256	221	201	183	167	137	120	106	94	84	75	574	531	469	409	360	319	285	256	221	201	183	167	137	120	106	94	84	75
		1/200	574	531	469	409	360	319	285	256	221	162	140	122	101	88	78	69	61	54	574	531	469	377	311	259	218	185	149	128	111	96	79	69	61	53	47	42
		1/250	574	531	469	377	311	259	218	185	149	128	111	96	79	69	61	53	47	42	574	477	384	312	257	214	180	152	123	105	91	79	64	56	49	43	38	33
0,88	SLU	ULS	982	841	727	635	559	495	442	397	343	311	283	259	228	210	193	179	166	154	982	841	727	635	559	495	442	397	343	311	283	259	228	210	193	179	166	154
	SLE* SLS*	1/150	702	600	519	453	399	354	316	283	245	222	202	185	154	135	119	106	94	84	702	600	519	453	399	354	316	283	245	222	202	185	154	135	119	106	94	84
		1/200	702	600	519	453	399	354	316	261	211	182	158	137	113	99	87	77	69	61	702	600	519	422	348	290	244	207	167	144	124	108	89	78	68	60	53	47
		1/250	702	600	519	422	348	290	244	207	167	144	124	108	89	78	68	60	53	47	702	535	430	350	289	240	202	171	138	118	102	88	72	63	55	49	43	38
1,00	SLU	ULS	1127	964	834	728	641	568	507	455	394	357	325	297	262	241	222	205	190	177	1127	964	834	728	641	568	507	455	394	357	325	297	262	241	222	205	190	177
	SLE* SLS*	1/150	805	689	596	520	458	406	362	325	282	252	232	212	179	158	139	124	110	98	805	689	596	520	458	406	362	325	282	252	232	212	179	158	139	124	110	98
		1/200	805	689	596	520	458	406	362	305	246	212	184	160	132	116	102	90	80	71	805	689	596	492	406	339	285	242	195	168	145	126	103	91	80	70	62	55
		1/250	805	689	596	492	406	339	285	242	195	168	145	126	103	91	80	70	62	55	805	624	501	409	337	280	236	200	161	138	119	103	85	74	65	57	50	44
1,15	SLU	ULS	1309	1120	969	846	745	660	589	529	458	415	378	345	304	279	258	238	221	205	1309	1120	969	846	745	660	589	529	458	415	378	345	304	279	258	238	221	205
	SLE* SLS*	1/150	935	800	692	604	532	472	421	378	327	296	270	246	217	186	165	146	130	116	935	800	692	604	532	472	421	378	327	296	270	246	217	186	165	146	130	116
		1/200	935	800	692	604	532	472	421	361	291	251	217	189	156	137	121	107	95	84	935	800	692	604	480	400	337	286	231	198	172	149	122	107	94	83	74	65
		1/250	935	800	692	604	480	400	337	286	231	198	172	149	122	107	94	83	74	65	935	737	593	483	398	332	279	236	190	163	141	122	100	88	77	67	59	52
1,25	SLU	ULS	1430	1224	1059	924	814	722	644	578	500	453	413	377	346	318	293	271	251	233	1430	1224	1059	924	814	722	644	578	500	453	413	377	346	318	293	271	251	233
	SLE* SLS*	1/150	1022	874	756	660	581	515	460	413	357	324	295	269	247	206	182	162	144	129	1022	874	756	660	581	515	460	413	357	324	295	269	247	206	182	162	144	129
		1/200	1022	874	756	660	581	515	460	413	322	277	240	209	172	151	134	118	105	93	1022	874	756	660	530	442	372	316	255	219	189	165	135	119	104	92	81	72
		1/250	1022	874	756	660	530	442	372	316	255	219	189	165	135	119	104	92	81	72	1022	814	654	533	440	366	308	261	210	180	156	135	111	97	85	75	66	58
1,50	SLU	ULS	1735	1485	1284	1121	987	875	781	701	607	550	501	457	403	371	342	316	293	272	1735	1485	1284	1121	987	875	781	701	607	550	501	457	403	371	342	316	293	272
	SLE* SLS*	1/150	1239	1061	917	801	705	625	558	501	434	393	358	327	288	255	226	201	179	160	1239	1061	917	801	705	625	558	501	399	344	298	259	214	188	166	147	130	116
		1/200	1239	1061	917	801	657	548	461	391	316	272	235	204	168	147	130	114	101	90	1239	1061	917	801	657	548	461	391	316	272	235	204	168	147	130	114	101	90
		1/250	1239	1061	917	801	657	548	461	391	316	272	235	204	168	147	130	114	101	90	1239	1008	811	661	545	454	382	323	261	224	193	168	138	120	106	93	82	72

I valori riportati in tabella sono da considerarsi come indicativi, è competenza del progettista procedere per i singoli casi di verifica al relativo calcolo.

SANDRINI metalli S.p.A. si riserva di variare in qualsiasi momento e senza preavviso le caratteristiche dei prodotti. Tutti i diritti riservati: vietata la riproduzione.

Tabelle di portata (daN/m²) Load tables (daN/sqm)

Larghezza appoggio intermedio: 200 mm - Larghezza appoggio esterno: 100 mm Internal support width: 200 mm - End support width: 100 mm

Sp. Th. mm	Interasse appoggi (m) / Carico uniformemente distribuito (daN/m ²)																		Span (m) / Uniformly distributed load (daN/sqm)																			
	CAMPATA DOPPIA																		DOUBLE SPAN																			
	Stato limite Limit state	2,60	2,80	3,00	3,20	3,40	3,60	3,80	4,00	4,20	4,40	4,60	4,80	5,00	5,20	5,40	5,60	5,80	6,00	2,60	2,80	3,00	3,20	3,40	3,60	3,80	4,00	4,20	4,40	4,60	4,80	5,00	5,20	5,40	5,60	5,80	6,00	
0,75	SLU	ULS	537	478	429	387	352	321	294	270	238	221	205	191	171	160	150	141	133	125	537	478	429	387	352	321	294	270	238	221	205	191	171	160	150	141	133	125
	SLE* SLS*	1/150	384	342	307	277	251	229	210	193	170	158	146	136	122	114	107	101	95	89	384	342	307	277	251	229	210	193	170	158	146	13						

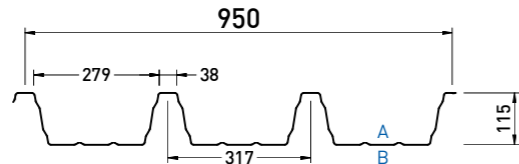

A: lato a vista - front side
B: lato non a vista - back side

NEGATIVE

Reazione al fuoco Fire reaction
CLASS A1

Comportamento al fuoco dall'esterno External fire performance
Broof (t1,t2,t3)

Senza necessità di sottoporre a prova secondo la norma UNI EN 14782:2006. No lab test is required as per UNI EN 14782:2006.

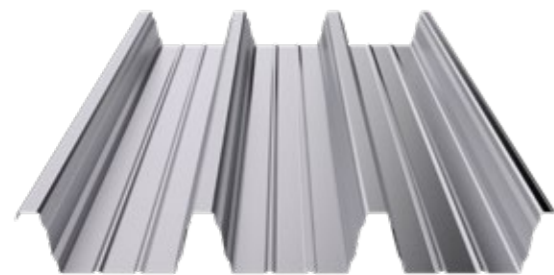

Sp. Th. (mm)	DATI STATICI / STATIC DATA			PESO / WEIGHT Steel Kg/m ²
	Jy (cm ² /m)	We inf (cm ³ /m)	We sup (cm ³ /m)	
0,75	183,12	54,89	24,70	9,30
0,80	197,84	58,77	26,70	9,92
0,88	221,77	64,98	29,96	10,91
1,00	258,40	74,34	34,95	12,39
1,15	305,18	86,05	41,29	14,25
1,25	336,83	93,79	45,46	15,49
1,50	417,01	112,21	54,47	18,59

APPLICAZIONI
APPLICATIONS



SANDnodrip
Class A2 - s1, d0 🔥 Broof (t1,t2,t3)



SANDcontrol
Class C - s1, d0 🔥 Broof (t1,t2,t3)

Tabelle di portata (daN/m²) Load tables (daN/sqm)

* Valori di portata caratteristici con coefficiente di sicurezza applicato pari a: $\gamma_q = 1,40$. Characteristic load with an applied safety coefficient equal to: $\gamma_q = 1,40$.
In azzurro i valori rappresentativi della portata con inflessione limite raggiunta. The values indicated in blue are representative of the load capacity with the limit inflection reached.

Sp. Th.		Interasse appoggi (m) / Carico uniformemente distribuito (daN/m ²)																Span (m) / Uniformly distributed load (daN/sqm)				
mm		CAMPATA SINGOLA																SINGLE SPAN				
		Stato limite	Limit state	2,60	2,80	3,00	3,20	3,40	3,60	3,80	4,00	4,20	4,40	4,60	4,80	5,00	5,20	5,40	5,60	5,80	6,00	
0,75	SLU	ULS	664	615	572	508	447	396	353	317	275	249	226	207	182	168	154	143	132	123		
	SLE*	1/150	474	439	409	363	319	283	252	227	196	178	162	148	120	106	93	83	74	66		
		SLS*	1/200	474	439	409	331	273	228	191	162	131	112	97	84	69	61	53	47	41	37	
		SLS*	1/250	474	439	409	331	273	228	191	162	131	112	97	84	69	61	53	47	41	37	
0,80	SLU	ULS	763	707	623	544	479	425	379	340	294	267	243	222	195	180	166	153	142	132		
	SLE*	1/150	545	505	445	389	342	303	271	243	210	191	173	158	130	114	101	90	80	71		
		SLS*	1/200	545	505	445	389	342	303	271	243	210	191	173	158	130	116	96	84	74	65	51
		SLS*	1/250	545	505	445	358	295	246	207	175	142	122	105	91	75	66	58	51	45	40	
0,88	SLU	ULS	933	799	691	603	531	471	420	377	326	296	269	246	217	199	184	170	157	146		
	SLE*	1/150	667	570	493	431	379	336	300	269	233	211	192	176	146	128	113	101	90	80		
		SLS*	1/200	667	570	493	431	379	336	300	248	201	173	150	130	107	94	83	73	65	58	
		SLS*	1/250	667	570	493	401	331	276	232	197	159	136	118	102	84	74	65	57	50	45	
1,00	SLU	ULS	1071	916	792	692	609	540	482	432	374	339	309	282	249	229	211	195	181	168		
	SLE*	1/150	765	654	566	494	435	386	344	309	267	242	221	201	170	150	132	117	105	93		
		SLS*	1/200	765	654	566	494	435	386	344	290	234	202	175	152	125	110	97	86	76	68	
		SLS*	1/250	765	654	566	468	386	322	271	230	185	159	138	120	98	86	76	67	59	52	
1,15	SLU	ULS	1243	1064	920	804	707	627	560	502	435	394	359	328	289	265	245	226	210	195		
	SLE*	1/150	888	760	657	574	505	448	400	359	311	282	256	234	206	177	157	139	124	111		
		SLS*	1/200	888	760	657	574	505	448	400	343	277	238	207	180	148	130	115	102	90	80	
		SLS*	1/250	888	760	657	574	456	380	320	272	219	188	163	142	116	102	90	79	70	62	
1,25	SLU	ULS	1359	1163	1006	878	773	686	612	549	475	431	392	358	328	302	278	257	239	222		
	SLE*	1/150	971	831	718	627	552	490	437	392	340	308	280	256	234	196	173	154	137	122		
		SLS*	1/200	971	831	718	627	552	490	437	392	306	263	228	199	164	144	127	112	100	89	
		SLS*	1/250	971	831	718	627	504	420	354	300	242	208	180	156	129	113	99	87	77	69	
1,50	SLU	ULS	1648	1410	1220	1065	938	832	742	666	577	523	476	435	383	352	325	300	278	259		
	SLE*	1/150	1177	1007	871	761	670	594	530	476	412	373	340	310	274	243	215	191	170	152		
		SLS*	1/200	1177	1007	871	761	670	594	530	476	379	326	283	246	203	179	158	139	124	110	
		SLS*	1/250	1177	1007	871	761	624	521	438	372	300	258	223	194	160	140	123	109	96	85	
SLS*	1/300	1177	958	770	627	517	431	362	307	248	213	184	159	131	114	100	88	78	69			

I valori riportati in tabella sono da considerarsi come indicativi, è competenza del progettista procedere per i singoli casi di verifica al relativo calcolo.

SANDRINI metalli S.p.A. si riserva di variare in qualsiasi momento e senza preavviso le caratteristiche dei prodotti. Tutti i diritti riservati: vietata la riproduzione.

Tabelle di portata (daN/m²) Load tables (daN/sqm)

Sp. Th.		Interasse appoggi (m) / Carico uniformemente distribuito (daN/m ²)																Span (m) / Uniformly distributed load (daN/sqm)			
mm		CAMPATA DOPPIA																DOUBLE SPAN			
		Stato limite	Limit state	2,60	2,80	3,00	3,20	3,40	3,60	3,80	4,00	4,20	4,40	4,60	4,80	5,00	5,20	5,40	5,60	5,80	6,00
0,75	SLU	ULS	510	455	408	368	334	305	279	257	226	210	195	181	162	152	142	134	126	119	
	SLE*	1/150	364	325	291	263	239	218	199	183	162	150	139	130	116	108	102	96	90	85	
		SLS*	1/200	364	325	291	263	239	218	199	183	162	150	139	130	116	108	102	96	90	85
		SLS*	1/300	364	325	291	263	239	218	199	183	162	150	139	130	116	108	102	96	90	85
0,80	SLU	ULS	593	528	473	427	387	352	323	296	261	242	224	209	186	174	163	153	144	136	
	SLE*	1/150	423	377	338	305	276	252	230	212	186	173	160	149	133	124	117	110	103	97	
		SLS*	1/200	423	377	338	305	276	252	230	212	186	173	160	149	133	124	117	110	103	97
		SLS*	1/300	423	377	338	305	276	252	230	212	186	173	160	149	133	124	117	110	103	97
0,88	SLU	ULS	724	643	576	519	470	428	391	359	315	291	270	251	224	209	196	184	173	163	
	SLE*	1/150	517	459	411	371	336	306	279	256	225	208	193	180	160	149	140	131	124	117	
		SLS*	1/200	517	459	411	371	336	306	279	256	225	208	193	180	160	149	140	131	124	117
		SLS*	1/300	517	459	411	371	336	306	279	256	225	208	193	180	160	149	140	131	124	117
1,00	SLU	ULS	882	783	699	629	569	517	472	433	399	368	341	317	295	276	258	242	228	215	
	SLE*	1/150	630	559	500	449	406	369	337	309	285	263	244	227	211	197	185	173	163	153	
		SLS*	1/200	630	559	500	449	406	369	337	309	285	263	244	227	211	197	185	173	163	153
		SLS*	1/300	630	559	500	449	406	369	337	309	285	263	244	227	211	197	185	173	163	153
1,15	SLU	ULS	1089	965	861	773	698	634	578	529	487	449	416	386	359	335	314	294	276	257	
	SLE*	1/150	778	689	615	552	499	453	413	378	348	321	297	276	257	240	224	210	197	184	
		SLS*	1/200	778	689	615	552	499	453	413	378	348	321	297	276	257	240	224	210	197	184
		SLS*	1/250	778	689	615	552	499	453	413	378	348	321	297	276	257	240	224	210	197	184
1,25	SLU	ULS	1230	1088	970	870	785	712	649	594	546	504	466	432	402	375	351	329	305	283	
	SLE*	1/150	879	777	693	622															

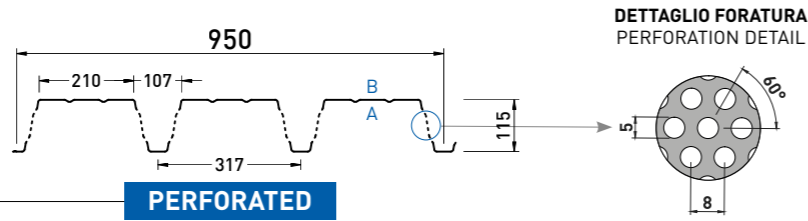

A: lato a vista - front side
B: lato non a vista - back side

Reazione al fuoco Fire reaction CLASS A1
Comportamento al fuoco dall'esterno External fire performance Broof (t1,t2,t3)
Senza necessità di sottoporre a prova secondo la norma UNI EN 14782:2006. No lab test is required as per UNI EN 14782:2006.

Sp. Th. (mm)	DATI STATICI / STATIC DATA			PESO / WEIGHT (Steel Kg/m ²)
	Jy (cm ² /m)	We inf (cm ³ /m)	We sup (cm ³ /m)	
0,75	165,89	22,06	41,07	8,84
0,80	178,97	23,89	43,96	9,43
0,88	200,19	26,06	48,60	10,37
1,00	232,53	31,43	55,57	11,78
1,15	273,53	37,25	64,30	13,55
1,25	300,52	41,06	70,07	14,73
1,50	360,63	49,19	83,84	17,68

Valori riferiti alla versione | Values referred to version **PERFORATED**

APPLICAZIONI / APPLICATIONS

SANDnodrip
Class A2 - s1, d0 Broof (t1,t2,t3)

SANDcontrol
Class C - s1, d0 Broof (t1,t2,t3)

Tabelle di portata (daN/m²) Load tables (daN/sqm)

* Valori di portata caratteristici con coefficiente di sicurezza applicato pari a: $\gamma_q = 1,40$. Characteristic load with an applied safety coefficient equal to: $\gamma_q = 1,40$.
In azzurro i valori rappresentativi della portata con inflessione limite raggiunta. The values indicated in blue are representative of the load capacity with the limit inflection reached.

Sp. Th. (mm)	Larghezza appoggio esterno: 100 mm / End support width: 100 mm																			
	Interasse appoggi (m) / Carico uniformemente distribuito (daN/m ²) / Span (m) / Uniformly distributed load (daN/sqm)																			
	Stato limite / Limit state	2,60	2,80	3,00	3,20	3,40	3,60	3,80	4,00	4,20	4,40	4,60	4,80	5,00	5,20	5,40	5,60	5,80	6,00	
0,75	SLU	ULS	545	505	470	417	367	325	290	260	225	204	186	170	150	138	127	117	109	101
	SLE* SLS*	1/150	389	360	336	298	262	232	207	186	161	146	133	121	99	87	77	68	61	54
		1/200	389	360	336	298	262	232	198	168	136	117	101	88	73	64	56	50	44	39
		1/250	389	360	336	272	224	187	157	133	107	92	80	69	57	50	44	38	34	30
0,80	SLU	ULS	626	580	512	447	393	349	311	279	242	219	199	182	160	147	136	126	117	108
	SLE* SLS*	1/150	447	414	366	319	281	249	222	199	173	156	142	130	107	94	83	74	65	58
		1/200	447	414	366	319	281	249	222	199	173	126	109	95	78	69	61	54	48	42
		1/250	447	414	366	294	242	202	170	144	116	100	86	75	61	54	47	42	37	33
0,88	SLU	ULS	766	656	567	495	436	386	345	309	268	243	221	202	178	163	151	139	129	120
	SLE* SLS*	1/150	547	468	405	354	311	276	246	220	191	173	158	144	120	105	93	83	74	66
		1/200	547	468	405	329	272	227	191	162	130	112	97	84	69	60	53	47	41	37
		1/250	547	468	405	329	272	227	191	162	130	112	97	84	69	60	53	47	41	37
1,00	SLU	ULS	879	752	651	568	500	443	396	355	307	279	253	232	204	188	173	160	148	138
	SLE* SLS*	1/150	628	537	465	406	357	317	283	254	220	199	181	165	140	123	109	96	86	77
		1/200	628	537	465	406	357	317	283	238	192	166	143	125	103	90	80	70	62	56
		1/250	628	537	465	384	317	264	222	189	152	131	113	98	81	71	62	55	48	43
1,15	SLU	ULS	1021	874	756	660	581	515	460	412	357	324	294	269	237	218	201	186	172	160
	SLE* SLS*	1/150	729	624	540	471	415	368	328	295	255	231	210	192	169	145	129	114	102	91
		1/200	729	624	540	471	415	368	328	281	227	196	170	148	122	107	94	83	74	66
		1/250	729	624	540	471	375	312	263	223	180	155	134	116	96	84	74	65	57	51
1,25	SLU	ULS	1116	955	826	721	635	563	502	451	390	354	322	294	270	248	229	211	196	182
	SLE* SLS*	1/150	797	682	590	515	453	402	359	322	279	253	230	210	193	161	142	126	112	100
		1/200	797	682	590	515	453	402	359	322	251	216	187	163	134	118	104	92	82	73
		1/250	797	682	590	515	414	345	290	246	199	171	148	128	106	93	81	72	64	56
1,50	SLU	ULS	1353	1158	1002	875	770	683	609	547	474	429	391	357	314	289	267	247	229	212
	SLE* SLS*	1/150	967	827	716	625	550	488	435	391	338	307	279	255	225	199	176	157	139	125
		1/200	967	827	716	625	550	488	435	391	311	268	232	202	167	147	129	114	102	91
		1/250	967	827	716	625	512	427	360	305	246	212	183	159	131	115	101	89	79	70

I valori riportati in tabella sono da considerarsi come indicativi, è competenza del progettista procedere per i singoli casi di verifica al relativo calcolo.

SANDRINI metalli S.p.A. si riserva di variare in qualsiasi momento e senza preavviso le caratteristiche dei prodotti. Tutti i diritti riservati: vietata la riproduzione.

Tabelle di portata (daN/m²) Load tables (daN/sqm)

Sp. Th. (mm)	Larghezza appoggio intermedio: 200 mm - Larghezza appoggio esterno: 100 mm / Internal support width: 200 mm - End support width: 100 mm																			
	Interasse appoggi (m) / Carico uniformemente distribuito (daN/m ²) / Span (m) / Uniformly distributed load (daN/sqm)																			
	Stato limite / Limit state	2,60	2,80	3,00	3,20	3,40	3,60	3,80	4,00	4,20	4,40	4,60	4,80	5,00	5,20	5,40	5,60	5,80	6,00	
0,75	SLU	ULS	419	373	335	302	274	250	229	211	186	172	160	149	133	125	117	110	103	98
	SLE* SLS*	1/150	299	267	239	216	196	179	164	150	133	123	114	106	95	89	84	78	74	70
		1/200	299	267	239	216	196	179	164	150	133	123	114	106	95	89	84	78	74	70
		1/250	299	267	239	216	196	179	164	150	133	123	114	106	95	89	84	78	74	70
0,80	SLU	ULS	487	433	388	350	318	289	265	243	214	198	184	171	153	143	134	126	119	112
	SLE* SLS*	1/150	348	309	277	250	227	207	189	174	153	142	131	122	109	102	96	90	85	80
		1/200	348	309	277	250	227	207	189	174	153	142	131	122	109	102	96	90	85	80
		1/250	348	309	277	250	227	207	189	174	153	142	131	122	109	102	96	90	85	80
0,88	SLU	ULS	594	528	473	426	386	351	321	295	259	239	222	206	184	172	161	151	142	134
	SLE* SLS*	1/150	424	377	338	304	276	251	229	211	185	171	158	147	131	123	115	108	101	96
		1/200	424	377	338	304	276	251	229	211	185	171	158	147	131	123	115	108	101	96
		1/250	424	377	338	304	276	251	229	211	185	171	158	147	131	123	115	108	101	96
1,00	SLU	ULS	724	643	574	516	467	425	388	356	327	302	280	260	243	227	212	199	187	176
	SLE* SLS*	1/150	517	459	410	369	334	303	277	254	234	216	200	186	173	162	152	142	134	126
		1/200	517	459	410	369	334	303	277	254	234	216	200	186	173	162	152	142	134	126
		1/250	517	459	410	369	334	303	277	254	234	216	200	186	173	162	152	142	134	126
1,15	SLU	ULS	894	792	707	634	573	520	475	435	400	369	341	317	295	275	258	241	227	211
	SLE* SLS*	1/150	639	566	505	453	409	372	339	310	285	263	244	226	211	197	184	172	162	151
		1/200	639	566	505	453	409	372	339	310	285	263	244	226	211	197	184	172	162	151
		1/250	639	566	505	453	409	372	339	310	285	263	244	226	211	197	184	172	162	151
1,25	SLU	ULS	1010	894	796	714	645	585	533	488	448	413	382	355	330	308	288	270	250	233
	SLE* SLS*	1/150	722	638	569	510	461	418	381	349	320	295	273	253	236	220	206	193	179	166
		1/200	722	638	569	510	461	418	381	349	320	295	273	253	236	220	206	193	179	166
		1/250	722	638	569	510	461	418	381	349	320	295	273	253	236	220	206	193	179	166
1,50	SLU	ULS	1289	1137	1010	904	814	737	670	613	562	517	478	443	412	379	350	324	300	279
	SLE* SLS*	1/150	920	812	722	646	582	526	479	438	401	370	341	316	294	271	250	231	214	199
		1/200	920	812	722	646	582	526	479	438	401	370	341	316	294	271	250	231	214	199
		1/250	920	812	722	646	582	526	479	438	401	370	341	316	294	271	250	231	214	199

Sp. Th. (mm)	Larghezza appoggio intermedio: 200 mm - Larghezza appoggio esterno: 100 mm / Internal support width: 200 mm - End support width: 100 mm																	
	Interasse appoggi (m) / Carico uniformemente distribuito (daN/m ²) / Span (m) / Uniformly distributed load (daN/sqm)																	
	Stato limite / Limit state	2,60	2,80	3,00	3,20	3,40	3,60	3,80	4,00	4,20	4,40	4,60	4,80	5,00	5,20	5,40	5,60	5,80
0,75	SLU	ULS	498	445														

Larghezza appoggi: intermedio = 200 mm | esterno = 100 mm

Support width: Internal = 200 mm | End = 100 mm

Tabelle di portata (daN/m²) Load tables (daN/sqm)

steel s320GD

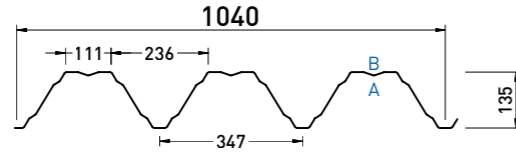

A: lato a vista - front side
B: lato non a vista - back side

POSITIVE

Reazione al fuoco Fire reaction
CLASS A1

Comportamento al fuoco dall'esterno External fire performance
Broof (t1,t2,t3)

Senza necessità di sottoporre a prova secondo la norma UNI EN 14782:2006. No lab test is required as per UNI EN 14782:2006.

Sp. Th. (mm)	DATI STATICI / STATIC DATA			PESO / WEIGHT Steel Kg/m ²
	Jy (cm ² /m)	We inf (cm ² /m)	We sup (cm ² /m)	
0,75	236,25	29,45	41,69	8,49
0,80	253,71	31,69	44,61	9,06
0,88	281,78	35,31	49,27	9,96
1,00	322,19	40,63	56,21	11,32
1,15	370,52	46,69	64,56	13,02
1,25	402,74	50,72	70,11	14,15
1,50	483,30	60,76	83,95	16,98

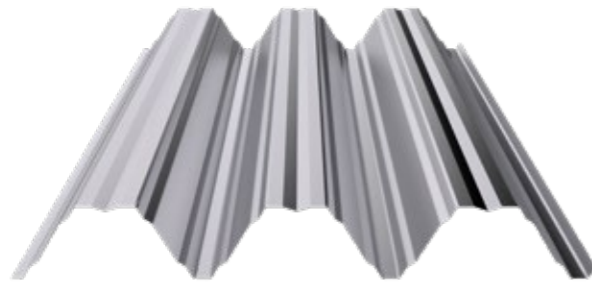

APPLICAZIONI
APPLICATIONS

SANDnodrip
Class A2 - s1, d0 Broof (t1,t2,t3)

SANDcontrol
Class C - s1, d0 Broof (t1,t2,t3)

Tabelle di portata (daN/m²) Load tables (daN/sqm)

steel s320GD

* Valori di portata caratteristici con coefficiente di sicurezza applicato pari a: $\gamma_q = 1,40$. Characteristic load with an applied safety coefficient equal to: $\gamma_q = 1,40$.
In azzurro i valori rappresentativi della portata con inflessione limite raggiunta. The values indicated in blue are representative of the load capacity with the limit inflection reached.

Larghezza appoggio esterno: 100 mm End support width: 100 mm

Sp. Th. mm	Interasse appoggi (m) / Carico uniformemente distribuito (daN/m ²)																	Span (m) / Uniformly distributed load (daN/sqm)																					
	CAMPATA SINGOLA																	SINGLE SPAN																					
	Stato limite Limit state	4,40	4,60	4,80	5,00	5,20	5,40	5,60	5,80	6,00	6,20	6,40	6,60	6,80	7,00	7,20	7,40	7,60	7,80	4,40	4,60	4,80	5,00	5,20	5,40	5,60	5,80	6,00	6,20	6,40	6,60	6,80	7,00	7,20	7,40	7,60	7,80		
0,75	SLU	ULS	287	261	239	219	202	186	172	160	149	138	129	121	113	106	100	94	89	84	287	261	239	219	202	186	172	160	149	138	129	121	113	106	100	94	89	84	
	SLE*	1/150	205	187	171	156	144	133	123	114	106	93	84	76	69	62	56	51	47	43	205	187	171	156	144	133	123	114	106	93	84	76	69	62	56	51	47	43	
		SLS*	1/200	205	187	158	138	122	108	96	85	76	68	61	55	50	45	40	37	30	205	187	158	138	122	108	96	85	76	68	61	55	50	45	40	37	30		
		SLS*	1/250	165	143	125	109	96	85	75	67	59	53	47	42	38	34	31	28	25	23	165	143	125	109	96	85	75	67	59	53	47	42	38	34	31	28	25	23
0,80	SLU	ULS	329	299	274	251	231	213	197	183	170	159	148	139	130	122	115	108	102	96	329	299	274	251	231	213	197	183	170	159	148	139	130	122	115	108	102	96	
	SLE*	1/150	235	214	196	179	165	152	141	125	112	100	90	81	74	67	61	55	50	46	235	214	196	179	165	152	141	125	112	100	90	81	74	67	61	55	50	46	
		SLS*	1/200	224	194	169	149	131	116	103	91	82	73	66	59	53	48	43	39	36	32	224	194	169	149	131	116	103	91	82	73	66	59	53	48	43	39	36	32
		SLS*	1/250	177	154	134	117	103	91	81	72	64	57	51	46	41	37	33	30	27	24	177	154	134	117	103	91	81	72	64	57	51	46	41	37	33	30	27	24
0,88	SLU	ULS	381	347	318	291	268	247	229	213	198	184	172	161	151	142	133	125	118	112	381	347	318	291	268	247	229	213	198	184	172	161	151	142	133	125	118	112	
	SLE*	1/150	272	248	227	208	192	177	164	146	131	118	106	96	86	78	71	65	59	54	272	248	227	208	192	177	164	146	131	118	106	96	86	78	71	65	59	54	
		SLS*	1/200	262	228	199	174	153	136	120	107	96	86	77	69	62	56	51	46	42	38	262	228	199	174	153	136	120	107	96	86	77	69	62	56	51	46	42	38
		SLS*	1/250	208	180	157	137	121	107	95	84	75	67	60	54	48	43	39	35	32	29	208	180	157	137	121	107	95	84	75	67	60	54	48	43	39	35	32	29
1,00	SLU	ULS	435	396	362	332	305	282	261	242	225	210	196	183	172	161	152	143	135	127	435	396	362	332	305	282	261	242	225	210	196	183	172	161	152	143	135	127	
	SLE*	1/150	310	283	258	237	218	201	186	173	161	142	127	115	104	94	86	78	71	65	310	283	258	237	218	201	186	173	161	142	127	115	104	94	86	78	71	65	
		SLS*	1/200	310	283	239	210	185	163	145	129	115	103	93	83	75	68	61	56	50	46	310	283	239	210	185	163	145	129	115	103	93	83	75	68	61	56	50	46
		SLS*	1/250	250	217	189	166	146	128	114	101	90	80	72	65	58	52	47	42	38	34	250	217	189	166	146	128	114	101	90	80	72	65	58	52	47	42	38	34
1,15	SLU	ULS	499	455	416	381	351	324	300	278	259	241	225	211	197	185	174	164	155	146	499	455	416	381	351	324	300	278	259	241	225	211	197	185	174	164	155	146	
	SLE*	1/150	357	325	297	272	251	231	214	199	185	163	147	132	120	108	99	90	82	74	357	325	297	272	251	231	214	199	185	163	147	132	120	108	99	90	82	74	
		SLS*	1/200	357	325	275	241	212	188	167	149	133	119	107	96	87	78	71	64	58	53	357	325	275	241	212	188	167	149	133	119	107	96	87	78	71	64	58	53
		SLS*	1/250	288	250	217	190	167	148	131	116	104	93	83	74	67	60	54	49	44	40	288	250	217	190	167	148	131	116	104	93	83	74	67	60	54	49	44	40
1,25	SLU	ULS	542	494	451	414	381	352	326	302	281	262	245	229	215	201	189	178	168	159	542	494	451	414	381	352	326	302	281	262	245	229	215	201	189	178	168	159	
	SLE*	1/150	387	353	322	296	272	251	233	216	201	177	159	144	130	118	107	97	89	81	387	353	322	296	272	251	233	216	201	177	159	144	130	118	107	97	89	81	
		SLS*	1/200	387	353	299	262	231	204	181	161	144	129	116	104	94	85	77	70	63	57	387	353	299	262	231	204	181	161	144	129	116	104	94	85	77	70	63	57
		SLS*	1/250	313	271	236	207	182	161	142	126	113	101	90	81	72	65	59	53	48	43	313	271	236	207	182	161	142	126	113	101	90	81	72	65	59	53	48	43
1,50	SLU	ULS	650	592	541	496	457	421	390	362	337	314	293	274	257	241	227	214	201	190	650	592	541	496	457	421	390	362	337	314	293	274	257	241	227	214	201	190	
	SLE*	1/150	464	423	386	354	326	302	281	262	245	229	215	201	189	178	168	159	147	137	464	423	386	354	326	302	281	262	245	229	215	201	189	178	168	159	147	137	
		SLS*	1/200	464	423	359	315	277	245	218	194	173	155	139	125	113	102	92	84	76	69	464	423	359	315	277	245	218	194	173	155	139	125	113	102	92	84	76	69
		SLS*	1/250	375	325	284	248	218	193	171	152	135	121	108	97	87	78	70	63	57	52	375	325	284	248	218	193	171	152	135	121	108	97	87	78	70	63	57	52

I valori riportati in tabella sono da considerarsi come indicativi, è competenza del progettista procedere per i singoli casi di verifica al relativo calcolo.

SANDRINI metalli S.p.A. si riserva di variare in qualsiasi momento e senza preavviso le caratteristiche dei prodotti. Tutti i diritti riservati: vietata la riproduzione.

Larghezza appoggio intermedio: 200 mm - Larghezza appoggio esterno: 100 mm Internal support width: 200 mm - End support width: 100 mm

Sp. Th. mm	Interasse appoggi (m) / Carico uniformemente distribuito (daN/m ²)																	Span (m) / Uniformly distributed load (daN/sqm)																				
	CAMPATA MULTIPLA																	MULTIPLE SPAN																				
	Stato limite Limit state	4,40	4,60	4,80	5,00	5,20	5,40	5,60	5,80	6,00	6,20	6,40	6,60	6,80	7,00	7,20	7,40	7,60	7,80	4,40	4,60	4,80	5,00	5,20	5,40	5,60	5,80	6,00	6,20	6,40	6,60	6,80	7,00	7,20	7,40	7,60	7,80	
0,75	SLU	ULS	260	242	227	212	199	188	177	167	158	150	142	135	128	122	117	111	107	102	260	242	227	212	199	188	177	167	158	150	142	135	128	122	117	111	107	102
	SLE*	1/150	186	173	162	152	142	134	126	119	113	107	101	96	92	87	83	80	76	73	186	173	162	152	142	134	126	119	113	107	101	96	92	87	83	80	76	73
		SLS*	1/250	186	173	162	152	142	134	126	119	113</																										

Larghezza appoggi: intermedio = 450 mm | esterno = 225 mm

Support width: Internal = 450 mm | End = 225 mm

Tabelle di portata (daN/m²) Load tables (daN/sqm)

steel s320GD

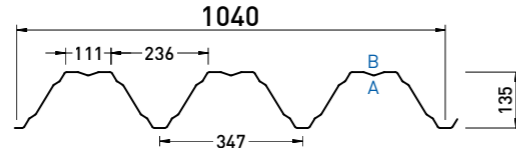

A: lato a vista - front side
B: lato non a vista - back side

POSITIVE

Reazione al fuoco Fire reaction
CLASS A1

Comportamento al fuoco dall'esterno External fire performance
Broof (t1,t2,t3)

Senza necessità di sottoporre a prova secondo la norma UNI EN 14782:2006. No lab test is required as per UNI EN 14782:2006.

Sp. Th. (mm)	DATI STATICI / STATIC DATA			PESO / WEIGHT Steel Kg/m ²
	Jy (cm ² /m)	We inf (cm ² /m)	We sup (cm ² /m)	
0,75	236,25	29,45	41,69	8,49
0,80	253,71	31,69	44,61	9,06
0,88	281,78	35,31	49,27	9,96
1,00	322,19	40,63	56,21	11,32
1,15	370,52	46,69	64,56	13,02
1,25	402,74	50,72	70,11	14,15
1,50	483,30	60,76	83,95	16,98

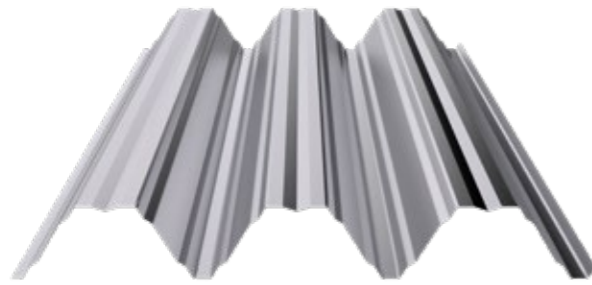

APPLICAZIONI
APPLICATIONS

SANDnodrip
Class A2 - s1, d0 Broof (t1,t2,t3)

SANDcontrol
Class C - s1, d0 Broof (t1,t2,t3)

Tabelle di portata (daN/m²) Load tables (daN/sqm)

steel s320GD

* Valori di portata caratteristici con coefficiente di sicurezza applicato pari a: $\gamma_f = 1,40$. Characteristic load with an applied safety coefficient equal to: $\gamma_f = 1,40$.
In azzurro i valori rappresentativi della portata con inflessione limite raggiunta. The values indicated in blue are representative of the load capacity with the limit inflection reached.

Larghezza appoggio esterno: 225 mm End support width: 225 mm

Sp. Th. mm	Interasse appoggi (m) / Carico uniformemente distribuito (daN/m ²)																	Span (m) / Uniformly distributed load (daN/sqm)																						
	CAMPATA SINGOLA																	SINGLE SPAN																						
	Stato limite / Limit state	4,40	4,60	4,80	5,00	5,20	5,40	5,60	5,80	6,00	6,20	6,40	6,60	6,80	7,00	7,20	7,40	7,60	7,80	4,40	4,60	4,80	5,00	5,20	5,40	5,60	5,80	6,00	6,20	6,40	6,60	6,80	7,00	7,20	7,40	7,60	7,80			
0,75	SLU	ULS	301	274	251	230	212	195	181	168	156	145	136	127	119	112	105	99	93	88	301	274	251	230	212	195	181	168	156	145	136	127	119	112	105	99	93	88		
	SLE*	1/150	215	196	179	164	151	140	129	120	111	98	88	80	72	65	59	54	49	45	215	196	166	145	128	113	100	89	80	71	64	58	52	47	42	38	35	32		
		SLS*	1/200	215	196	166	145	128	113	100	89	80	71	64	58	52	47	42	38	35	32	1/250	173	150	131	115	101	89	79	70	62	56	50	45	40	36	32	29	26	24
		SLS*	1/300	143	124	108	94	83	73	64	57	51	45	40	36	32	29	26	23	21	18	1/300	143	124	108	94	83	73	64	57	51	45	40	36	32	29	26	23	21	18
0,80	SLU	ULS	345	314	287	264	243	224	207	192	179	167	156	146	137	128	121	114	107	101	345	314	287	264	243	224	207	192	179	167	156	146	137	128	121	114	107	101		
	SLE*	1/150	247	225	205	188	173	160	148	131	117	105	95	85	77	70	64	58	53	48	1/150	247	225	205	188	173	160	148	131	117	105	95	85	77	70	64	58	53	48	
		SLE*	1/200	235	204	178	156	137	121	108	96	86	77	69	62	56	50	46	41	37	34	1/200	235	204	178	156	137	121	108	96	86	77	69	62	56	50	46	41	37	34
		SLS*	1/250	186	161	141	123	108	95	85	75	67	60	53	48	43	39	35	31	28	25	1/250	186	161	141	123	108	95	85	75	67	60	53	48	43	39	35	31	28	25
0,88	SLU	ULS	401	365	333	306	282	260	240	223	208	193	181	169	158	149	140	132	124	117	401	365	333	306	282	260	240	223	208	193	181	169	158	149	140	132	124	117		
	SLE*	1/150	286	261	238	218	201	186	172	153	137	123	111	100	91	82	75	68	62	56	1/150	286	261	238	218	201	186	172	153	137	123	111	100	91	82	75	68	62	56	
		SLE*	1/200	275	239	209	183	161	142	126	113	101	90	81	73	66	59	54	49	44	40	1/200	275	239	209	183	161	142	126	113	101	90	81	73	66	59	54	49	44	40
		SLS*	1/250	218	189	165	144	127	112	99	88	79	70	63	56	51	45	41	37	33	30	1/250	218	189	165	144	127	112	99	88	79	70	63	56	51	45	41	37	33	30
1,00	SLU	ULS	456	415	380	348	321	296	274	254	236	220	206	193	180	169	159	150	141	134	456	415	380	348	321	296	274	254	236	220	206	193	180	169	159	150	141	134		
	SLE*	1/150	326	297	271	249	229	211	196	182	169	149	134	121	109	99	90	82	75	68	1/150	326	297	271	249	229	211	196	182	169	149	134	121	109	99	90	82	75	68	
		SLE*	1/200	326	297	251	220	194	172	152	136	121	109	97	88	79	71	65	58	53	48	1/200	326	297	251	220	194	172	152	136	121	109	97	88	79	71	65	58	53	48
		SLS*	1/250	263	228	199	174	153	135	120	106	95	84	76	68	61	55	49	44	40	36	1/250	263	228	199	174	153	135	120	106	95	84	76	68	61	55	49	44	40	36
1,15	SLU	ULS	524	477	436	400	368	340	315	292	272	253	236	221	207	195	183	172	163	153	524	477	436	400	368	340	315	292	272	253	236	221	207	195	183	172	163	153		
	SLE*	1/150	374	341	312	286	263	243	225	209	194	171	154	139	126	114	103	94	86	78	1/150	374	341	312	286	263	243	225	209	194	171	154	139	126	114	103	94	86	78	
		SLE*	1/200	374	341	289	253	223	197	175	156	139	125	112	101	91	82	74	67	61	55	1/200	374	341	289	253	223	197	175	156	139	125	112	101	91	82	74	67	61	55
		SLS*	1/250	302	262	228	200	176	155	137	122	109	97	87	78	70	63	57	51	46	42	1/250	302	262	228	200	176	155	137	122	109	97	87	78	70	63	57	51	46	42
1,25	SLU	ULS	569	519	474	435	400	369	342	317	295	275	257	240	225	211	199	187	177	167	569	519	474	435	400	369	342	317	295	275	257	240	225	211	199	187	177	167		
	SLE*	1/150	407	370	339	311	286	264	244	227	211	186	167	151	137	124	112	102	93	85	1/150	407	370	339	311	286	264	244	227	211	186	167	151	137	124	112	102	93	85	
		SLE*	1/200	407	370	314	275	242	214	190	170	151	136	122	110	99	89	81	73	66	60	1/200	407	370	314	275	242	214	190	170	151	136	122	110	99	89	81	73	66	60
		SLS*	1/250	329	285	248	217	191	169	149	133	118	106	95	85	76	68	62	56	50	45	1/250	329	285	248	217	191	169	149	133	118	106	95	85	76	68	62	56	50	45
1,50	SLU	ULS	682	621	568	521	479	443	410	380	353	329	308	288	270	253	238	224	211	200	682	621	568	521	479	443	410	380	353	329	308	288	270	253	238	224	211	200		
	SLE*	1/150	487	444	406	372	342	349	310	277	248	223	201	181	164	149	135	123	112	102	1/150	487	444	406	372	342	349	310	277	248	223	201	181	164	149	135	123	112	102	
		SLE*	1/200	487	444	377	330	291	257	228	203	182	163	146	131	119	107	97	88	79	72	1/200	487	444	377	330	291	257	228	203	182	163	146	131	119	107	97	88	79	72
		SLS*	1/250	394	342	298	261	229	202	179	159	142	127	113	102	91	82	74	67	60	54	1/250	394	342	298	261	229	202	179	159	142	127	113	102	91	82	74	67	60	54
1,50	SLU	ULS	682	621	568	521	479	443	410	380	353	329	308	288	270	253	238	224	211	200	682	621	568	521	479	443	410	380	353	329	308	288	270	253	238	224	211	200		
	SLE*	1/150	487	444	406	372	342	349	310	277	248	223	201	181	164	149	135	123	112	102	1/150	487	444	406	372	342	349	310	277	248	223	201	181	164	149	135	123	112	102	
		SLE*	1/200	487	444	377	330	291	257	228	203	182	163	146	131	119	107	97	88	79	72	1/200	487	444	377	330	291	257	228	203	182	163	146	131	119	107	97	88	79	72
		SLS*	1/250	394	342	298	261	229	202	179	159	142	127	113	102	91	82	74	67	60	54	1/250	394	342	298	261	229	202	179											

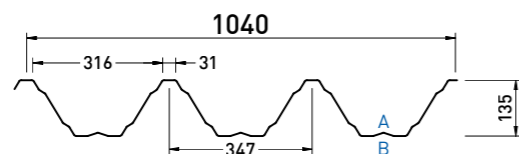

A: lato a vista - front side
B: lato non a vista - back side

NEGATIVE

Reazione al fuoco Fire reaction
CLASS A1

Comportamento al fuoco dall'esterno External fire performance
Broof (t1,t2,t3)

Senza necessità di sottoporre a prova secondo la norma UNI EN 14782:2006. No lab test is required as per UNI EN 14782:2006.

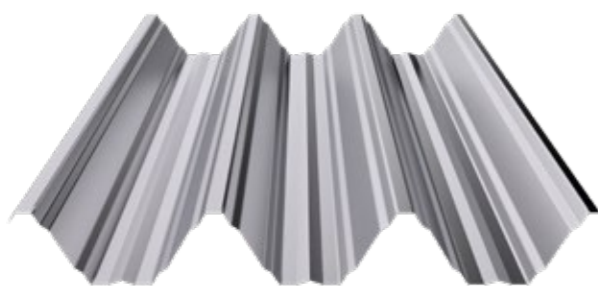

Sp. Th. (mm)	DATI STATICI / STATIC DATA			PESO / WEIGHT Steel Kg/m ²
	Jy (cm ² /m)	We inf (cm ³ /m)	We sup (cm ³ /m)	
0,75	236,25	41,69	29,45	8,49
0,80	253,71	44,61	31,69	9,06
0,88	281,78	49,27	35,31	9,96
1,00	322,19	56,21	40,63	11,32
1,15	370,52	64,56	46,69	13,02
1,25	402,74	70,11	50,72	14,15
1,50	483,30	83,95	60,76	16,98

APPLICAZIONI
APPLICATIONS



SANDnodrip
Class A2 - s1, d0 🔥 Broof (t1,t2,t3)



SANDcontrol
Class C - s1, d0 🔥 Broof (t1,t2,t3)

Tabelle di portata (daN/m²) Load tables (daN/sqm)

* Valori di portata caratteristici con coefficiente di sicurezza applicato pari a: $\gamma_f = 1,40$. Characteristic load with an applied safety coefficient equal to: $\gamma_f = 1,40$.
In azzurro i valori rappresentativi della portata con inflessione limite raggiunta. The values indicated in blue are representative of the load capacity with the limit inflection reached.

Larghezza appoggio esterno: 100 mm End support width: 100 mm

Sp. Th. mm	Interasse appoggi (m) / Carico uniformemente distribuito (daN/m ²)																	Span (m) / Uniformly distributed load (daN/sqm)																						
	CAMPATA SINGOLA																	SINGLE SPAN																						
	Stato limite Limit state	4,40	4,60	4,80	5,00	5,20	5,40	5,60	5,80	6,00	6,20	6,40	6,60	6,80	7,00	7,20	7,40	7,60	7,80	Stato limite Limit state	4,40	4,60	4,80	5,00	5,20	5,40	5,60	5,80	6,00	6,20	6,40	6,60	6,80	7,00	7,20	7,40	7,60	7,80		
0,75	SLU	ULS	272	248	227	208	191	177	164	152	141	132	123	115	108	101	95	90	84	80	SLU	ULS	247	230	215	202	189	178	168	159	150	142	135	128	122	116	111	106	101	97
	SLE*	1/150	195	177	162	149	137	126	117	108	101	89	80	72	65	59	54	49	44	40	SLE*	1/150	176	164	154	144	135	127	120	113	107	102	96	92	87	83	79	76	72	69
	SLS*	1/200	195	177	150	131	116	102	91	81	72	65	58	52	47	42	38	35	31	29	SLS*	1/200	176	164	154	144	135	127	120	113	107	102	96	92	87	83	79	76	72	69
	SLS*	1/250	157	136	118	104	91	80	71	63	56	50	45	40	36	33	29	26	24	21	SLS*	1/250	176	164	154	144	135	127	120	113	107	102	96	92	87	77	70	64	58	53
0,80	SLU	ULS	312	284	260	239	220	203	188	174	162	151	141	132	124	116	109	103	97	91	SLU	ULS	296	276	258	242	227	213	201	190	179	170	161	153	146	139	132	126	121	115
	SLE*	1/150	223	203	186	170	157	145	134	118	106	95	86	77	70	63	58	52	48	43	SLE*	1/150	212	197	184	173	162	152	143	135	128	121	115	109	104	99	94	90	86	82
	SLS*	1/200	212	184	161	141	124	110	98	87	78	69	62	56	51	46	41	37	34	31	SLS*	1/200	212	197	184	173	162	152	143	135	128	121	115	109	104	99	94	90	80	73
	SLS*	1/250	168	146	127	111	98	86	77	68	61	54	48	43	39	35	31	28	26	23	SLS*	1/250	212	197	184	173	162	152	143	135	128	121	115	100	91	83	75	68	62	57
0,88	SLU	ULS	362	330	302	277	255	235	218	202	188	175	163	153	143	135	127	119	112	106	SLU	ULS	375	349	325	304	286	268	253	238	225	213	202	192	182	174	166	158	151	144
	SLE*	1/150	259	236	215	198	182	168	155	139	124	112	101	91	82	74	68	61	56	51	SLE*	1/150	268	249	232	217	204	192	180	170	161	152	144	137	130	124	118	113	108	103
	SLS*	1/200	249	216	189	165	146	129	114	102	91	82	73	66	59	54	48	44	40	36	SLS*	1/200	268	249	232	217	204	192	180	170	161	152	144	137	130	117	107	97	89	82
	SLS*	1/250	198	171	149	131	115	101	90	80	71	63	57	51	46	41	37	33	30	27	SLS*	1/250	268	249	232	217	204	192	180	170	161	152	144	137	124	112	101	92	83	76
1,00	SLU	ULS	413	376	344	315	290	268	248	230	214	199	186	174	163	153	144	136	128	121	SLU	ULS	473	440	410	384	359	337	317	299	282	267	253	240	228	217	207	197	188	180
	SLE*	1/150	295	269	245	225	207	191	177	164	153	134	121	109	99	90	81	74	67	62	SLE*	1/150	338	314	293	274	257	241	227	214	202	191	181	171	163	155	148	141	134	128
	SLS*	1/200	295	269	227	199	176	155	138	123	110	98	88	79	72	65	58	53	48	44	SLS*	1/200	338	314	293	274	257	241	227	214	202	191	181	171	147	134	122	111	102	93
	SLS*	1/250	238	206	180	157	138	122	108	96	86	76	68	61	55	50	45	40	36	33	SLS*	1/250	338	314	293	274	257	241	227	214	202	191	181	171	147	134	122	111	102	93
1,15	SLU	ULS	474	432	395	362	333	308	285	264	246	229	214	200	188	176	166	156	147	139	SLU	ULS	572	531	494	461	432	405	380	358	338	319	302	286	272	258	246	234	224	212
	SLE*	1/150	339	308	282	259	238	220	203	189	176	155	139	126	114	103	94	85	78	71	SLE*	1/150	408	379	353	330	308	289	272	256	241	228	216	205	194	185	176	167	160	152
	SLS*	1/200	339	308	261	229	202	179	158	141	126	113	101	91	82	74	67	61	55	50	SLS*	1/200	408	379	353	330	308	289	272	256	241	228	216	187	169	154	140	128	117	107
	SLS*	1/250	273	237	207	181	159	140	124	110	98	88	79	71	63	57	51	46	42	38	SLS*	1/250	408	379	353	330	308	289	272	256	241	228	216	187	169	154	140	128	117	107
1,25	SLU	ULS	515	469	429	393	362	334	309	287	267	249	232	217	204	191	180	169	160	151	SLU	ULS	638	592	551	514	480	450	423	398	375	354	335	318	301	286	272	258	244	231
	SLE*	1/150	368	335	306	281	259	239	221	205	191	168	151	137	124	112	102	93	84	77	SLE*	1/150	456	423	393	367	343	322	302	284	268	253	239	227	215	205	195	185	174	165
	SLS*	1/200	368	335	284	249	219	194	172	153	137	123	110	99	89	81	73	66	60	54	SLS*	1/200	456	423	393	367	343	322	302	284	268	253	239	203	184	167	153	139	127	117
	SLS*	1/250	297	258	225	197	173	153	135	120	107	96	86	77	69	62	56	50	45	41	SLS*	1/250	456	423	393	367	343	322	272	243	218	196	177	160	145	131	119	109	99	91
1,50	SLU	ULS	617	562	514	471	434	400	371	344	320	298	278	260	244	229	216	203	191	181	SLU	ULS	807	747	694	647	604	565	530	498	469	443	418	396	371	349	328	310	292	276
	SLE*	1/150	441	401	367	337	310	286	265	246	225	202	182	164	148	134	122	111	101	92	SLE*	1/150	576	534	496	462	431	404	379	356	335	316	299	283	265	249	235	221	209	197
	SLS*	1/200	441	401	341	299	263	233	207	184	164	147	132	119	107	97	88	79	72	65	SLS*	1/200	576	534	496	462	431	404	379	356	335	316	269	243	221	201	183	167	153	140
	SLS*	1/250	357	309	269	236	207	183	162	144	128	115	103	92	83	74	67	60	54	49	SLS*	1/250	576	534	496	462	431	404	379	356	335	316	269	243	221	201	183	167	153	140
SLS*	1/300	295	255	222	194	170	150	133	117	104	93	83	74	66	59	53	48	43	38	SLS*	1/300	576	534	441	388	342	303	269	240	215	193	174	157	142	129	117	106	97	88	

I valori riportati in tabella sono da considerarsi come indicativi, è competenza del progettista procedere per i singoli casi di verifica al relativo calcolo.

SANDRINI metalli S.p.A. si riserva di variare in qualsiasi momento e senza preavviso le caratteristiche dei prodotti. Tutti i diritti riservati: vietata la riproduzione.

Tabelle di portata (daN/m²) Load tables (daN/sqm)

Larghezza appoggio intermedio: 200 mm - Larghezza appoggio esterno: 100 mm Internal support width: 200 mm - End support width: 100 mm

Sp. Th. mm	Interasse appoggi (m) / Carico uniformemente distribuito (daN/m ²)																	Span (m) / Uniformly distributed load (daN/sqm)																
	CAMPATA DOPPIA																	DOUBI E SPAN																
	Stato limite Limit state	4,40	4,60	4,80	5,00	5,20	5,40	5,60	5,80	6,00	6,20	6,40	6,60	6,80	7,00	7,20	7,40	7,																

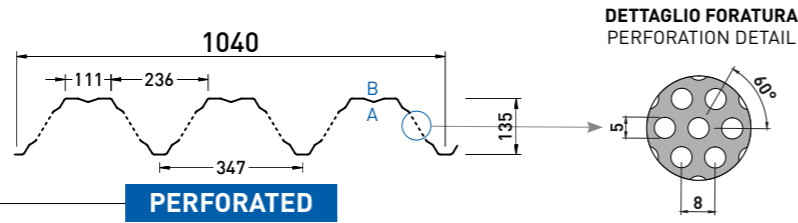

A: lato a vista - front side
B: lato non a vista - back side

Reazione al fuoco Fire reaction CLASS A1
Comportamento al fuoco dall'esterno External fire performance Broof (t1,t2,t3)
Senza necessità di sottoporre a prova secondo la norma UNI EN 14782:2006. No lab test is required as per UNI EN 14782:2006.

Sp. Th. (mm)	DATI STATICI / STATIC DATA			PESO / WEIGHT (Steel Kg/m ²)
	Jy (cm ² /m)	We inf (cm ² /m)	We sup (cm ² /m)	
0,75	224,01	27,05	41,84	8,07
0,80	240,07	29,15	44,75	8,61
0,88	267,77	32,54	49,40	9,47
1,00	307,68	37,53	56,31	10,76
1,15	353,84	43,13	64,67	12,38
1,25	384,61	46,85	70,23	13,45
1,50	461,54	56,14	84,09	16,15

Valori riferiti alla versione | Values referred to version **PERFORATED**

APPLICAZIONI / APPLICATIONS
SANDnodrip Class A2 - s1, d0 Broof (t1,t2,t3)
SANDcontrol Class C - s1, d0 Broof (t1,t2,t3)

Tabelle di portata (daN/m²) Load tables (daN/sqm)

* Valori di portata caratteristici con coefficiente di sicurezza applicato pari a: $\gamma_q = 1,40$. Characteristic load with an applied safety coefficient equal to: $\gamma_q = 1,40$.
In azzurro i valori rappresentativi della portata con inflessione limite raggiunta. The values indicated in blue are representative of the load capacity with the limit inflection reached.

Larghezza appoggio esterno: 100 mm End support width: 100 mm

Sp. Th. (mm)	Interasse appoggi (m) / Carico uniformemente distribuito (daN/m ²)																	Span (m) / Uniformly distributed load (daN/sqm)																
	CAMPATA SINGOLA / SINGLE SPAN		4,40	4,60	4,80	5,00	5,20	5,40	5,60	5,80	6,00	6,20	6,40	6,60	6,80	7,00	7,20	7,40	7,60	7,80														
0,75	SLU	ULS	224	204	186	171	157	145	134	125	116	108	101	94	88	83	78	74	69	65														
	SLE*	1/150	160	146	133	122	112	104	96	89	83	73	65	59	53	48	44	40	36	33														
		1/200	160	146	123	108	95	84	75	66	59	53	48	43	39	35	32	29	26	23														
		1/250	129	112	97	85	75	66	58	52	46	41	37	33	30	27	24	22	20	18														
0,80	SLU	ULS	256	234	214	196	180	166	154	143	133	124	116	108	101	95	90	84	80	75														
	SLE*	1/150	183	167	153	140	129	119	110	97	87	78	70	63	57	52	47	43	39	36														
		1/200	174	151	132	116	102	90	80	71	64	57	51	46	42	37	34	31	28	25														
		1/250	138	120	104	91	80	71	63	56	50	44	40	36	32	29	26	23	21	19														
0,88	SLU	ULS	298	271	248	227	209	193	179	166	154	144	134	126	118	110	104	98	92	87														
	SLE*	1/150	213	194	177	162	149	138	128	114	102	92	83	74	67	61	55	50	46	42														
		1/200	205	178	155	136	120	106	94	84	75	67	60	54	49	44	40	36	33	30														
		1/250	162	141	122	107	94	83	74	65	58	52	47	42	38	34	30	27	25	22														
1,00	SLU	ULS	339	309	282	259	238	220	204	189	176	164	153	143	134	126	118	111	105	99														
	SLE*	1/150	242	220	202	185	170	157	145	135	125	110	99	90	81	74	67	61	55	51														
		1/200	242	220	187	164	144	127	113	101	90	81	72	65	59	53	48	43	39	36														
		1/250	195	169	147	129	114	100	89	79	70	63	56	50	45	41	37	33	30	27														
1,15	SLU	ULS	389	355	324	297	274	253	234	217	202	188	176	164	154	145	136	128	121	114														
	SLE*	1/150	278	253	232	212	195	180	167	155	144	127	114	103	93	85	77	70	64	58														
		1/200	278	253	215	188	166	147	130	116	104	93	83	75	68	61	55	50	45	41														
		1/250	225	195	170	149	131	115	102	91	81	72	65	58	52	47	42	38	34	31														
1,25	SLU	ULS	423	385	352	323	297	274	254	236	219	204	191	179	167	157	148	139	131	124														
	SLE*	1/150	302	275	252	231	212	196	181	168	157	138	124	112	101	92	84	76	69	63														
		1/200	302	275	233	204	180	159	141	126	113	101	90	81	73	66	60	54	49	45														
		1/250	244	212	184	161	142	125	111	99	88	78	70	63	57	51	46	41	37	34														
1,50	SLU	ULS	507	461	422	387	356	329	304	282	263	245	229	214	200	188	177	167	157	148														
	SLE*	1/150	362	330	301	276	254	235	217	202	184	166	149	135	122	110	100	91	83	76														
		1/200	362	330	280	245	216	191	170	151	135	121	109	98	88	80	72	65	59	54														
		1/250	293	254	221	194	170	150	133	118	105	94	84	76	68	61	55	50	45	40														

I valori riportati in tabella sono da considerarsi come indicativi, è competenza del progettista procedere per i singoli casi di verifica al relativo calcolo.
SANDRINI metalli S.p.A. si riserva di variare in qualsiasi momento e senza preavviso le caratteristiche dei prodotti. Tutti i diritti riservati: vietata la riproduzione.

Tabelle di portata (daN/m²) Load tables (daN/sqm)

Larghezza appoggio intermedio: 200 mm - Larghezza appoggio esterno: 100 mm Internal support width: 200 mm - End support width: 100 mm

Sp. Th. (mm)	Interasse appoggi (m) / Carico uniformemente distribuito (daN/m ²)																	Span (m) / Uniformly distributed load (daN/sqm)																
	CAMPATA DOPPIA / DOUBLE SPAN		4,40	4,60	4,80	5,00	5,20	5,40	5,60	5,80	6,00	6,20	6,40	6,60	6,80	7,00	7,20	7,40	7,60	7,80														
0,75	SLU	ULS	169	158	147	138	129	122	115	108	102	97	92	87	83	79	75	72	69	66														
	SLE*	1/150	121	113	105	98	92	87	82	77	73	69	66	62	59	56	54	51	49	47														
		1/200	121	113	105	98	92	87	82	77	73	69	66	62	59	56	54	51	49	47														
		1/250	121	113	105	98	92	87	82	77	73	69	66	62	59	56	54	51	49	47														
0,80	SLU	ULS	203	189	176	165	155	145	137	129	122	115	109	104	99	94	90	85	82	78														
	SLE*	1/150	145	135	126	118	110	104	98	92	87	82	78	74	70	67	64	61	58	56														
		1/200	145	135	126	118	110	104	98	92	87	82	78	74	70	67	64	61	58	56														
		1/250	145	135	126	118	110	104	98	92	87	82	78	74	70	67	64	61	58	56														
0,88	SLU	ULS	256	238	222	208	194	183	172	162	153	145	137	130	123	117	112	107	102	97														
	SLE*	1/150	183	170	159	148	139	130	123	116	109	103	98	93	88	84	80	76	73	70														
		1/200	183	170	159	148	139	130	123	116	109	103	98	93	88	84	80	76	73	70														
		1/250	183	170	159	148	139	130	123	116	109	103	98	93	88	84	80	76	73	70														
1,00	SLU	ULS	323	300	279	261	244	229	215	203	191	181	171	162	154	146	139	133	126	119														
	SLE*	1/150	231	214	199	186	174	164	154	145	137	129	122	116	110	105	100	95	90	85														
		1/200	231	214	199	186	174	164	154	145	137	129	122	116	110	105	100	95	90	85														
		1/250	231	214	199	186	174	164	154	145	137	129	122	116	110	105	100	95	90	85														
1,15	SLU	ULS	389	361	335	313	292	274	257	242	228	216	204	193	183	174	163	154	145	137														
	SLE*	1/150	278	258	240	223	209	196	184	173	163	154	146	138	131	124	117	110	103	98														
		1/200	278	258	240	223	209	196	184	173	163	154	146	138	131	124	117	110	103	98														
		1/250	278	258	240	223	209	196	184	173	163	154	146	138	131	124	117	110	103	98														
1,25	SLU	ULS	433	401	373	348	325	304	286	269	253	239	226	214	201	188	177	167	157	149														
	SLE*	1/150	309	287	267	248	232	217	204	192	181	171	161	153	143	135	127	119	112	106														
		1/200	309	287	267	248	232	217	204	192	181	171	161	153	143	135	127	119	112	106														
		1/250	309	287	267	248	232	217	204	192	181	171	161	153	143	135	127	119	112	106														
1,50	SLU	ULS	546	505	469	436	407	381	357	335	315	294	274	257	241	226	212	200	189	178														
	SLE*	1/150	390	361	335	312	291	272	255	240	225	210	196	183	172	161	152	143	135	127														
		1/200	390	361	335	312	291	272	255	240	225	210	196	183	172	161	152	143	135	127														
		1/250	390	361	335	312	291	272	255	240	225	210	196	183	172	161	152	143	135	127														

Larghezza appoggio intermedio: 200 mm - Larghezza appoggio esterno: 100 mm Internal support width: 200 mm - End support width: 100 mm

Sp. Th. (mm)	Interasse appoggi (m) / Carico uniformemente distribuito (daN/m ²)																	Span (m) / Uniformly distributed load (daN/sqm)																
	CAMPATA MULTIPLA / MULTIPLE SPAN		4,40	4,60	4,80	5,00	5,20	5,40	5,60	5,80	6,00	6,20	6,40	6,60	6,80	7,00	7,20	7,40	7,60	7,80														
0,75	SLU	ULS	203	189	177	166	155	146	138	130	123	117	111	105	100	95	91	87	83	80														
	SLE*	1/150	145	135	126	118	111	104	99	93	88	83	79	75	72	68	65	62	59	57														
		1/200	145	135	126	118	111	104	99	93	8																							

Larghezza appoggi: intermedio = 200 mm | esterno = 100 mm

Support width: Internal = 200 mm | End = 100 mm

Tabelle di portata (daN/m²) Load tables (daN/sqm)

steel s320GD

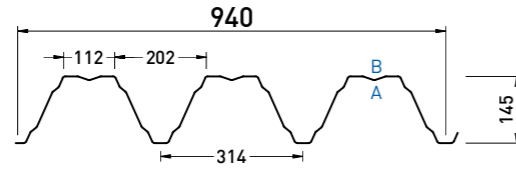

A: lato a vista - front side
B: lato non a vista - back side

POSITIVE

Reazione al fuoco Fire reaction
CLASS A1

Comportamento al fuoco dall'esterno External fire performance
Broof (t1,t2,t3)

Senza necessità di sottoporre a prova secondo la norma UNI EN 14782:2006. No lab test is required as per UNI EN 14782:2006.

DATI STATICI STATIC DATA **PESO** WEIGHT

Sp. Th. (mm)	Jy (cm²/m)	We inf (cm³/m)	We sup (cm³/m)	Steel Kg/m²
0,75	307,90	35,36	50,27	9,39
0,80	330,70	38,06	53,79	10,02
0,88	367,35	42,43	59,43	11,02
1,00	420,82	49,03	67,90	12,53
1,15	483,95	56,42	78,03	14,41
1,25	526,03	61,29	84,75	15,66
1,50	631,24	73,44	101,49	18,79

APPLICAZIONI
APPLICATIONS

SANDnodrip
Class A2 - s1, d0 Broof (t1,t2,t3)

SANDcontrol
Class C - s1, d0 Broof (t1,t2,t3)

Tabelle di portata (daN/m²) Load tables (daN/sqm)

steel s320GD

* Valori di portata caratteristici con coefficiente di sicurezza applicato pari a: $\gamma_q = 1,40$. Characteristic load with an applied safety coefficient equal to: $\gamma_q = 1,40$.
In azzurro i valori rappresentativi della portata con inflessione limite raggiunta. The values indicated in blue are representative of the load capacity with the limit inflection reached.

Larghezza appoggio esterno: 100 mm End support width: 100 mm

Sp. Th. mm	Interasse appoggi (m) / Carico uniformemente distribuito (daN/m²)																	Span (m) / Uniformly distributed load (daN/sqm)																					
	CAMPATA SINGOLA																	SINGLE SPAN																					
Stato limite Limit state	4,40	4,60	4,80	5,00	5,20	5,40	5,60	5,80	6,00	6,20	6,40	6,60	6,80	7,00	7,20	7,40	7,60	7,80	4,40	4,60	4,80	5,00	5,20	5,40	5,60	5,80	6,00	6,20	6,40	6,60	6,80	7,00	7,20	7,40	7,60	7,80			
0,75	SLU	ULS	347	316	289	265	244	225	209	194	180	168	157	147	138	129	122	115	108	102	347	316	289	265	244	225	209	194	180	168	157	147	138	129	122	115	108	102	
	SLE* SLS*	1/150	248	226	206	189	174	161	149	138	129	120	112	100	91	82	75	68	62	57	248	226	206	182	160	142	126	112	100	90	81	73	66	60	54	49	45	41	
		1/200	248	226	206	182	160	142	126	112	100	90	81	73	66	60	54	49	45	41	217	188	164	144	126	112	99	88	79	70	63	57	51	46	42	38	34	31	
		1/250	217	188	164	144	126	112	99	88	79	70	63	57	51	46	42	38	34	31	179	155	135	118	104	92	81	72	64	57	51	46	41	37	33	30	27	24	
0,80	SLU	ULS	398	362	331	304	280	258	239	222	207	193	180	168	158	148	139	131	124	117	398	362	331	304	280	258	239	222	207	193	180	168	158	148	139	131	124	117	
	SLE* SLS*	1/150	284	259	237	217	200	185	171	159	148	132	119	108	98	89	81	73	67	61	284	259	237	215	192	172	152	135	121	108	97	87	79	71	64	58	53	48	44
		1/200	284	259	237	215	192	172	152	135	121	108	97	87	79	71	64	58	53	48	44	233	202	176	154	136	120	107	95	85	76	68	61	55	50	45	40	37	33
		1/250	233	202	176	154	136	120	107	95	85	76	68	61	55	50	45	40	37	33	192	167	145	127	112	99	87	78	69	62	55	49	44	40	36	32	29	26	
0,88	SLU	ULS	462	420	384	353	325	300	278	258	240	223	209	195	183	172	162	152	144	136	462	420	384	353	325	300	278	258	240	223	209	195	183	172	162	152	144	136	
	SLE* SLS*	1/150	330	300	275	252	232	214	198	184	171	160	140	126	114	104	95	86	79	72	330	300	261	229	202	179	159	142	127	114	102	92	83	75	68	62	56	51	
		1/200	330	300	261	229	202	179	159	142	127	114	102	92	83	75	68	62	56	51	273	237	207	181	159	141	125	111	99	89	80	72	65	58	53	48	43	39	
		1/250	273	237	207	181	159	141	125	111	99	89	80	72	65	58	53	48	43	39	226	196	170	149	131	116	102	91	81	72	65	58	52	47	42	38	34	31	
1,00	SLU	ULS	526	479	438	402	370	342	316	294	273	255	238	223	209	196	185	174	164	155	526	479	438	402	370	342	316	294	273	255	238	223	209	196	185	174	164	155	
	SLE* SLS*	1/150	376	342	313	287	264	244	226	210	195	182	170	152	138	125	114	104	95	87	376	342	313	276	243	216	192	171	153	137	123	111	100	91	82	75	68	62	
		1/200	376	342	313	276	243	216	192	171	153	137	123	111	100	91	82	75	68	62	329	286	249	218	192	170	151	134	120	107	96	87	78	70	64	57	52	47	
		1/250	329	286	249	218	192	170	151	134	120	107	96	87	78	70	64	57	52	47	272	236	206	180	158	140	124	110	98	87	78	70	63	57	51	46	41	37	
1,15	SLU	ULS	605	551	504	462	425	393	364	337	314	293	273	256	240	225	212	200	188	178	605	551	504	462	425	393	364	337	314	293	273	256	240	225	212	200	188	178	
	SLE* SLS*	1/150	432	393	360	330	304	281	260	241	224	209	195	175	159	144	131	120	109	100	432	393	360	318	280	248	220	197	176	158	142	128	116	105	95	86	78	71	
		1/200	432	393	360	318	280	248	220	197	176	158	142	128	116	105	95	86	78	71	378	328	287	251	221	196	173	154	138	123	111	99	90	81	73	66	60	54	
		1/250	378	328	287	251	221	196	173	154	138	123	111	99	90	81	73	66	60	54	313	271	236	207	182	161	142	126	112	100	90	81	72	65	59	53	47	43	
1,25	SLU	ULS	657	598	547	502	462	427	395	367	341	318	297	278	261	245	230	217	205	193	657	598	547	502	462	427	395	367	341	318	297	278	261	245	230	217	205	193	
	SLE* SLS*	1/150	469	427	391	359	330	305	282	262	244	227	212	191	173	157	143	130	119	108	469	427	391	345	304	270	240	214	191	171	154	139	126	114	103	94	85	77	
		1/200	469	427	391	345	304	270	240	214	191	171	154	139	126	114	103	94	85	77	411	357	311	273	240	213	189	168	150	134	120	108	97	88	79	72	65	59	
		1/250	411	357	311	273	240	213	189	168	150	134	120	108	97	88	79	72	65	59	340	295	257	225	198	175	155	137	122	109	98	88	79	71	64	57	52	47	
1,50	SLU	ULS	787	717	655	601	554	511	473	439	409	381	356	333	312	293	276	260	245	232	787	717	655	601	554	511	473	439	409	381	356	333	312	293	276	260	245	232	
	SLE* SLS*	1/150	562	512	468	430	395	365	338	314	292	272	254	229	207	188	171	156	142	130	562	512	468	414	365	323	287	256	229	206	185	167	151	136	124	112	102	93	
		1/200	562	512	468	414	365	323	287	256	229	206	185	167	151	136	124	112	102	93	494	428	374	328	285	226	201	180	161	144	130	117	105	95	86	78	71		
		1/250	494	428	374	328	285	226	201	180	161	144	130	117	105	95	86	78	71	408	354	308	270	237	209	185	165	147	131	117	105	94	85	76	69	62	56		

I valori riportati in tabella sono da considerarsi come indicativi, è competenza del progettista procedere per i singoli casi di verifica al relativo calcolo.

SANDRINI metalli S.p.A. si riserva di variare in qualsiasi momento e senza preavviso le caratteristiche dei prodotti. Tutti i diritti riservati: vietata la riproduzione.

Larghezza appoggio intermedio: 200 mm - Larghezza appoggio esterno: 100 mm Internal support width: 200 mm - End support width: 100 mm

Sp. Th. mm	Interasse appoggi (m) / Carico uniformemente distribuito (daN/m²)																	Span (m) / Uniformly distributed load (daN/sqm)																				
	CAMPATA MULTIPLA																	MULTIPLE SPAN																				
Stato limite Limit state	4,40	4,60	4,80	5,00	5,20	5,40	5,60	5,80	6,00	6,20	6,40	6,60	6,80	7,00	7,20	7,40	7,60	7,80	4,40	4,60	4,80	5,00	5,20	5,40	5,60	5,80	6,00	6,20	6,40	6,60	6,80	7,00	7,20	7,40	7,60	7,80		
0,75	SLU	ULS	313	292	273	256	245	232	221	202	191	181	172	164	156	149	142	136	130	124	313	292	273	256	245	232	221	202	191	181	172	164	156	149	142	136	130	124
	SLE* SLS*	1/150	223	208	195	183	175	166	158	144	137	130	123	117	111	106	101	97	93	89	223	208	195	183	175	166	158	144	137	130	123	117	111	106	101	97	93	89
		1/200	223	208	195	183	175	166	158	144	137	130	123	117	111	106</																						

Larghezza appoggi: intermedio = 450 mm | esterno = 225 mm

Support width: Internal = 450 mm | End = 225 mm

Tabelle di portata (daN/m²) Load tables (daN/sqm)

steel s320GD

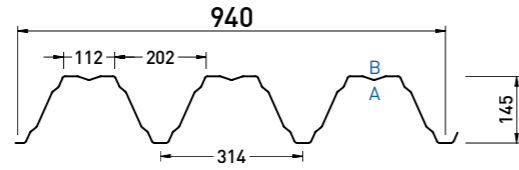

A: lato a vista - front side
B: lato non a vista - back side

POSITIVE

Reazione al fuoco Fire reaction
CLASS A1

Comportamento al fuoco dall'esterno External fire performance
Broof (t1,t2,t3)

Senza necessità di sottoporre a prova secondo la norma UNI EN 14782:2006. No lab test is required as per UNI EN 14782:2006.

Sp. Th. (mm)	DATI STATICI / STATIC DATA			PESO / WEIGHT Steel Kg/m ²
	Jy (cm ² /m)	We inf (cm ³ /m)	We sup (cm ³ /m)	
0,75	307,90	35,36	50,27	9,39
0,80	330,70	38,06	53,79	10,02
0,88	367,35	42,43	59,43	11,02
1,00	420,82	49,03	67,90	12,53
1,15	483,95	56,42	78,03	14,41
1,25	526,03	61,29	84,75	15,66
1,50	631,24	73,44	101,49	18,79

APPLICAZIONI
APPLICATIONS

SANDnodrip
Class A2 - s1, d0 Broof (t1,t2,t3)

SANDcontrol
Class C - s1, d0 Broof (t1,t2,t3)

Tabelle di portata (daN/m²) Load tables (daN/sqm)

steel s320GD

* Valori di portata caratteristici con coefficiente di sicurezza applicato pari a: $\gamma_q = 1,40$. Characteristic load with an applied safety coefficient equal to: $\gamma_q = 1,40$.
In azzurro i valori rappresentativi della portata con inflessione limite raggiunta. The values indicated in blue are representative of the load capacity with the limit inflection reached.

Larghezza appoggio esterno: 225 mm End support width: 225 mm

Sp. Th. mm	Interasse appoggi (m) / Carico uniformemente distribuito (daN/m ²)																	Span (m) / Uniformly distributed load (daN/sqm)																				
	CAMPATA SINGOLA																	SINGLE SPAN																				
	Stato limite Limit state	4,40	4,60	4,80	5,00	5,20	5,40	5,60	5,80	6,00	6,20	6,40	6,60	6,80	7,00	7,20	7,40	7,60	7,80	4,40	4,60	4,80	5,00	5,20	5,40	5,60	5,80	6,00	6,20	6,40	6,60	6,80	7,00	7,20	7,40	7,60	7,80	
0,75	SLU	ULS	364	332	303	278	256	237	219	203	189	176	165	154	145	136	128	120	113	107	364	332	303	278	256	237	219	203	189	176	165	154	145	136	128	120	113	107
	SLE*	1/150	260	237	217	199	183	169	156	145	135	126	118	105	95	86	79	72	65	60	260	237	217	199	183	169	156	145	135	126	118	105	95	86	79	72	65	60
		1/200	260	237	217	191	168	149	132	118	106	95	85	77	69	63	57	52	47	43	260	237	217	191	168	149	132	118	106	95	85	77	69	63	57	52	47	43
		SLS*	1/250	227	197	172	151	133	117	104	93	83	74	66	60	54	48	44	40	36	32	227	197	172	151	133	117	104	93	83	74	66	60	54	48	44	40	36
0,80	SLU	ULS	418	380	348	319	294	271	251	233	217	202	189	177	166	156	146	138	130	123	418	380	348	319	294	271	251	233	217	202	189	177	166	156	146	138	130	123
	SLE*	1/150	298	272	248	228	210	194	179	167	155	139	125	113	102	93	85	77	70	64	298	272	248	228	210	194	179	167	155	139	125	113	102	93	85	77	70	64
		1/200	298	272	233	205	181	160	142	127	113	102	91	82	74	67	61	55	50	46	298	272	233	205	181	160	142	127	113	102	91	82	74	67	61	55	50	46
		SLS*	1/250	244	212	185	162	143	126	112	100	89	79	71	64	58	52	47	42	38	35	244	212	185	162	143	126	112	100	89	79	71	64	58	52	47	42	38
0,88	SLU	ULS	485	441	404	370	341	315	291	270	252	235	219	205	192	181	170	160	151	143	485	441	404	370	341	315	291	270	252	235	219	205	192	181	170	160	151	143
	SLE*	1/150	346	315	288	265	244	225	208	193	180	168	147	133	120	109	99	90	83	75	346	315	288	265	244	225	208	193	180	168	147	133	120	109	99	90	83	75
		1/200	346	315	274	240	212	188	167	149	133	119	107	97	87	79	72	65	59	54	346	315	274	240	212	188	167	149	133	119	107	97	87	79	72	65	59	54
		SLS*	1/250	287	249	217	190	167	148	131	117	104	93	84	75	68	61	55	50	45	41	287	249	217	190	167	148	131	117	104	93	84	75	68	61	55	50	45
1,00	SLU	ULS	579	527	482	442	407	376	348	323	301	280	262	245	230	216	203	191	180	170	579	527	482	442	407	376	348	323	301	280	262	245	230	216	203	191	180	170
	SLE*	1/150	413	377	344	316	291	269	249	231	215	200	187	168	152	138	125	114	104	95	413	377	344	316	291	269	249	231	215	200	187	168	152	138	125	114	104	95
		1/200	413	377	344	304	268	237	211	188	168	151	136	122	111	100	91	82	75	68	413	377	344	304	268	237	211	188	168	151	136	122	111	100	91	82	75	68
		SLS*	1/250	362	314	274	240	212	187	166	148	132	118	106	95	86	77	70	63	57	52	362	314	274	240	212	187	166	148	132	118	106	95	86	77	70	63	57
1,15	SLU	ULS	665	606	554	508	468	432	400	371	345	322	301	282	264	248	233	220	207	196	665	606	554	508	468	432	400	371	345	322	301	282	264	248	233	220	207	196
	SLE*	1/150	475	433	396	363	334	309	286	265	247	230	215	193	175	159	144	132	120	110	475	433	396	363	334	309	286	265	247	230	215	193	175	159	144	132	120	110
		1/200	475	433	396	349	308	273	242	216	193	174	156	141	127	115	104	95	86	78	475	433	396	349	308	273	242	216	193	174	156	141	127	115	104	95	86	78
		SLS*	1/250	416	361	315	276	243	215	191	170	152	136	122	109	99	89	80	73	66	60	416	361	315	276	243	215	191	170	152	136	122	109	99	89	80	73	66
1,25	SLU	ULS	722	658	602	552	508	469	434	403	375	350	327	306	287	269	253	239	225	213	722	658	602	552	508	469	434	403	375	350	327	306	287	269	253	239	225	213
	SLE*	1/150	516	470	430	394	363	335	310	288	268	250	233	210	190	172	157	143	131	119	516	470	430	394	363	335	310	288	268	250	233	210	190	172	157	143	131	119
		1/200	516	470	430	380	335	296	263	235	210	189	170	153	138	125	113	103	94	85	516	470	430	380	335	296	263	235	210	189	170	153	138	125	113	103	94	85
		SLS*	1/250	453	393	343	300	264	234	207	185	165	147	132	119	107	97	87	79	72	65	453	393	343	300	264	234	207	185	165	147	132	119	107	97	87	79	72
1,50	SLU	ULS	866	789	721	662	609	562	521	483	449	419	392	366	344	323	304	286	270	255	866	789	721	662	609	562	521	483	449	419	392	366	344	323	304	286	270	255
	SLE*	1/150	618	563	515	473	435	402	372	345	321	299	280	252	228	207	188	172	157	143	618	563	515	473	435	402	372	345	321	299	280	252	228	207	188	172	157	143
		1/200	618	563	515	456	402	356	316	282	252	226	204	184	166	150	136	124	112	102	618	563	515	456	402	356	316	282	252	226	204	184	166	150	136	124	112	102
		SLS*	1/250	543	471	411	360	317	281	249	222	198	177	159	143	129	116	105	95	86	78	543	471	411	360	317	281	249	222	198	177	159	143	129	116	105	95	86

I valori riportati in tabella sono da considerarsi come indicativi, è competenza del progettista procedere per i singoli casi di verifica al relativo calcolo.

SANDRINI metalli S.p.A. si riserva di variare in qualsiasi momento e senza preavviso le caratteristiche dei prodotti. Tutti i diritti riservati: vietata la riproduzione.

Larghezza appoggio intermedio: 450 mm - Larghezza appoggio esterno: 225 mm Internal support width: 450 mm - End support width: 225 mm

Sp. Th. mm	Interasse appoggi (m) / Carico uniformemente distribuito (daN/m ²)																	Span (m) / Uniformly distributed load (daN/sqm)																				
	CAMPATA MULTIPLA																	MULTIPLE SPAN																				
	Stato limite Limit state	4,40	4,60	4,80	5,00	5,20	5,40	5,60	5,80	6,00	6,20	6,40	6,60	6,80	7,00	7,20	7,40	7,60	7,80	4,40	4,60	4,80	5,00	5,20	5,40	5,60	5,80	6,00	6,20	6,40	6,60	6,80	7,00	7,20	7,40	7,60	7,80	
0,75	SLU	ULS	375	350	328	307	298	278	265	245	232	220	207	196	187	178	170	163	156	149	375	350	328	307	298	278	265	245	232	220	207	196	187	178	170	163	156	149
	SLE*	1/150	268	250	234	219	213	199	189	175	166	157	148	140	134	127	122	116	111	106	268	250	234	219	213	199	189	175	166	157	148	140	134	127	122	116	111	

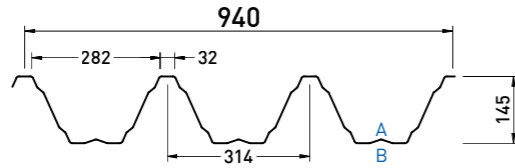

A: lato a vista - front side
B: lato non a vista - back side

NEGATIVE

Reazione al fuoco Fire reaction CLASS A1	Comportamento al fuoco dall'esterno External fire performance Broof (t1,t2,t3)
Senza necessità di sottoporre a prova secondo la norma UNI EN 14782:2006. No lab test is required as per UNI EN 14782:2006.	



Sp. Th. (mm)	DATI STATICI / STATIC DATA			PESO / WEIGHT Steel Kg/m ²
	Jy (cm ² /m)	We inf (cm ³ /m)	We sup (cm ³ /m)	
0,75	307,90	50,27	35,36	9,39
0,80	330,70	53,79	38,06	10,02
0,88	367,35	59,43	42,43	11,02
1,00	420,82	67,90	49,03	12,53
1,15	483,95	78,03	56,42	14,41
1,25	526,03	84,75	61,29	15,66
1,50	631,24	101,49	73,44	18,79

APPLICAZIONI
APPLICATIONS

SANDnodrip
Class A2 - s1, d0 Broof (t1,t2,t3)

SANDcontrol
Class C - s1, d0 Broof (t1,t2,t3)

Tabelle di portata (daN/m²) Load tables (daN/sqm)



* Valori di portata caratteristici con coefficiente di sicurezza applicato pari a: $\gamma_q = 1,40$. Characteristic load with an applied safety coefficient equal to: $\gamma_q = 1,40$.
In azzurro i valori rappresentativi della portata con inflessione limite raggiunta. The values indicated in blue are representative of the load capacity with the limit inflection reached.

Sp. Th. mm		Interasse appoggi (m) / Carico uniformemente distribuito (daN/m ²)																Span (m) / Uniformly distributed load (daN/sqm)		
		CAMPATA SINGOLA / SINGLE SPAN																		
		Stato limite / Limit state	4,40	4,60	4,80	5,00	5,20	5,40	5,60	5,80	6,00	6,20	6,40	6,60	6,80	7,00	7,20	7,40	7,60	7,80
0,75	SLU	ULS	330	300	275	252	232	214	198	184	171	160	149	139	131	123	116	109	103	97
	SLE* SLS*	1/150	235	214	196	180	166	153	142	131	122	114	106	95	86	78	71	65	59	54
		1/200	235	214	196	173	152	135	120	107	95	86	77	69	63	57	51	47	42	39
		1/250	206	178	156	140	120	106	94	84	75	67	60	54	49	44	40	36	32	29
0,80	SLU	ULS	378	344	315	289	266	245	227	211	196	183	171	160	150	141	132	125	118	111
	SLE* SLS*	1/150	270	246	225	206	190	175	162	151	140	126	113	102	93	84	77	70	64	58
		1/200	270	246	211	185	163	145	129	115	103	92	83	75	67	61	55	50	46	42
		1/250	221	192	167	151	132	115	101	90	80	72	65	58	52	47	43	38	35	32
0,88	SLU	ULS	438	399	365	335	308	285	264	245	228	212	198	186	174	163	154	145	137	129
	SLE* SLS*	1/150	313	285	261	239	220	203	188	175	163	152	133	120	109	99	90	82	75	68
		1/200	313	285	248	220	192	170	151	135	120	108	97	88	79	72	65	59	54	49
		1/250	259	225	196	172	151	134	122	110	95	84	76	68	61	55	50	45	41	37
1,00	SLU	ULS	500	455	416	382	352	325	301	279	260	242	226	212	198	186	175	165	156	147
	SLE* SLS*	1/150	357	325	297	273	251	232	215	199	185	173	162	145	131	119	108	99	90	82
		1/200	357	325	297	262	231	205	182	162	145	130	117	106	95	86	78	71	65	59
		1/250	313	271	237	210	183	162	143	128	114	102	91	82	74	67	60	55	49	45
1,15	SLU	ULS	574	523	478	439	404	373	345	321	298	278	260	243	228	214	201	190	179	169
	SLE* SLS*	1/150	410	374	342	314	289	266	247	229	213	199	186	167	151	137	125	114	104	95
		1/200	410	374	342	302	266	236	209	187	167	150	135	122	110	99	90	82	74	68
		1/250	360	312	272	239	210	186	165	147	131	117	105	95	85	77	69	63	57	51
1,25	SLU	ULS	624	568	520	477	439	405	375	348	324	302	282	264	248	233	219	206	194	184
	SLE* SLS*	1/150	446	406	371	341	314	289	268	249	231	216	202	181	164	149	135	123	113	103
		1/200	446	406	371	328	289	256	228	203	182	163	147	132	119	108	98	89	81	74
		1/250	391	339	296	259	228	202	179	159	142	127	114	103	93	83	75	68	62	56
1,50	SLU	ULS	748	681	623	571	526	486	450	417	388	362	338	316	297	279	262	247	233	220
	SLE* SLS*	1/150	534	486	445	408	376	347	321	298	277	259	242	217	197	179	163	148	135	124
		1/200	534	486	445	393	347	307	273	244	218	195	176	159	143	130	118	107	97	88
		1/250	469	407	355	311	274	242	215	191	171	153	137	123	111	100	91	82	74	67
1,50	SLU	ULS	388	336	293	256	225	199	176	157	139	124	111	100	90	81	72	65	59	53

I valori riportati in tabella sono da considerarsi come indicativi, è competenza del progettista procedere per i singoli casi di verifica al relativo calcolo.

SANDRINI metalli S.p.A. si riserva di variare in qualsiasi momento e senza preavviso le caratteristiche dei prodotti. Tutti i diritti riservati: vietata la riproduzione.

Tabelle di portata (daN/m²) Load tables (daN/sqm)

Sp. Th. mm		Interasse appoggi (m) / Carico uniformemente distribuito (daN/m ²)																Span (m) / Uniformly distributed load (daN/sqm)		
		CAMPATA DOPPIA / DOUBLE SPAN																		
		Stato limite / Limit state	4,40	4,60	4,80	5,00	5,20	5,40	5,60	5,80	6,00	6,20	6,40	6,60	6,80	7,00	7,20	7,40	7,60	7,80
0,75	SLU	ULS	249	232	217	205	198	185	173	161	151	143	136	129	123	117	111	106	102	97
	SLE* SLS*	1/150	178	166	155	146	141	132	124	115	108	102	97	92	88	83	80	76	73	70
		1/200	178	166	155	146	141	132	124	115	108	102	97	92	88	83	80	76	73	70
		1/250	178	166	155	146	141	132	124	115	108	102	97	92	88	83	80	76	73	70
0,80	SLU	ULS	286	267	249	233	222	210	198	185	173	164	156	148	140	134	128	122	116	111
	SLE* SLS*	1/150	205	191	178	167	159	150	141	132	124	117	111	106	100	96	91	87	83	80
		1/200	205	191	178	167	159	150	141	132	124	117	111	106	100	96	91	87	83	80
		1/250	205	191	178	167	159	150	141	132	124	117	111	106	100	96	91	87	83	80
0,88	SLU	ULS	369	344	321	300	284	272	249	235	222	210	199	189	180	171	163	155	148	142
	SLE* SLS*	1/150	264	245	229	214	203	194	178	168	158	150	142	135	128	122	116	111	106	101
		1/200	264	245	229	214	203	194	178	168	158	150	142	135	128	122	116	111	106	101
		1/250	264	245	229	214	203	194	178	168	158	150	142	135	128	122	116	111	106	101
1,00	SLU	ULS	459	426	397	371	348	327	307	290	273	259	245	232	221	210	200	191	182	174
	SLE* SLS*	1/150	328	305	284	265	249	233	219	207	195	185	175	166	158	150	143	136	130	124
		1/200	328	305	284	265	249	233	219	207	195	185	175	166	158	150	143	136	130	124
		1/250	328	305	284	265	249	233	219	207	195	185	175	166	158	150	143	136	130	124
1,15	SLU	ULS	554	514	479	447	418	392	369	347	327	309	293	277	263	250	238	227	215	203
	SLE* SLS*	1/150	396	367	342	319	299	280	263	248	234	221	209	198	188	179	170	162	153	145
		1/200	396	367	342	319	299	280	263	248	234	221	209	198	188	179	170	162	153	145
		1/250	396	367	342	319	299	280	263	248	234	221	209	198	188	179	170	162	153	145
1,25	SLU	ULS	618	574	534	498	466	436	410	386	364	343	325	308	292	277	263	247	233	220
	SLE* SLS*	1/150	442	410	381	356	333	312	293	275	260	245	232	220	208	198	188	177	167	157
		1/200	442	410	381	356	333	312	293	275	260	245	232	220	208	198	188	177	167	157
		1/250	442	410	381	356	333	312	293	275	260	245	232	220	208	198	188	177	167	157
1,50	SLU	ULS	782	724	673	626	585	548	514	483	455	429	405	380	356	334	315	296	280	264
	SLE* SLS*	1/150	558	517	480	447	418	391	367	345	325	306	290	271	254	239	225	212	200	189
		1/200	558	517	480	447	418	391	367	345	325	306	290	271	254	239	225	212	200	189
		1/250	558	517	480	447	418	391	367	345	325	306	290	271	254	239	225	212	200	189

Sp. Th. mm	
---------------	--

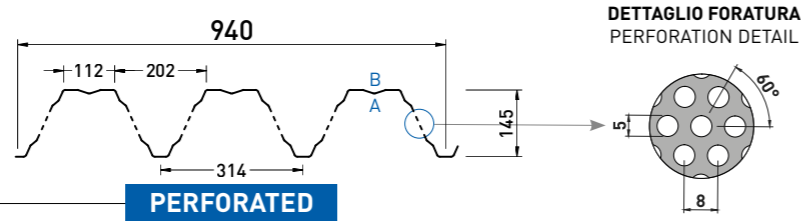

A: lato a vista - front side
B: lato non a vista - back side

Reazione al fuoco Fire reaction CLASS A1
Comportamento al fuoco dall'esterno External fire performance Broof (t1,t2,t3)
Senza necessità di sottoporre a prova secondo la norma UNI EN 14782:2006. No lab test is required as per UNI EN 14782:2006.

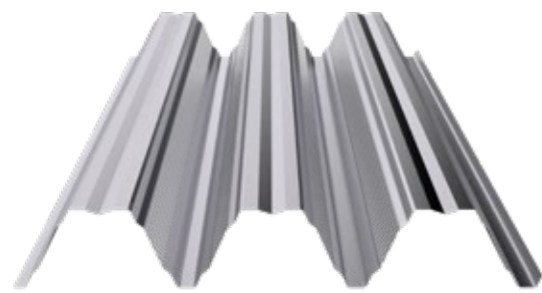

Sp. Th. (mm)	DATI STATICI / STATIC DATA			PESO / WEIGHT (Steel Kg/m ²)
	Jy (cm ² /m)	We inf (cm ³ /m)	We sup (cm ³ /m)	
0,75	291,46	32,48	50,53	8,93
0,80	313,36	35,02	54,04	9,53
0,88	348,65	39,19	59,67	10,48
1,00	401,91	45,34	68,11	11,91
1,15	462,75	52,19	78,26	13,70
1,25	502,99	56,69	85,00	14,89
1,50	603,59	67,94	101,78	17,86

Valori riferiti alla versione | Values referred to version **PERFORATED**

APPLICAZIONI
APPLICATIONS

SANDnodrip
Class A2 - s1, d0 Broof (t1,t2,t3)

SANDcontrol
Class C - s1, d0 Broof (t1,t2,t3)

Tabelle di portata (daN/m²) Load tables (daN/sqm)

* Valori di portata caratteristici con coefficiente di sicurezza applicato pari a: $\gamma_f = 1,40$. Characteristic load with an applied safety coefficient equal to: $\gamma_f = 1,40$.
In azzurro i valori rappresentativi della portata con inflessione limite raggiunta. The values indicated in blue are representative of the load capacity with the limit inflection reached.

Larghezza appoggio esterno: 100 mm End support width: 100 mm

Sp. Th. (mm)	Interasse appoggi (m) / Carico uniformemente distribuito (daN/m ²)																	Span (m) / Uniformly distributed load (daN/sqm)																						
	CAMPATA SINGOLA / SINGLE SPAN																	CAMPATA SINGOLA / SINGLE SPAN																						
mm	Stato limite / Limit state	4,40	4,60	4,80	5,00	5,20	5,40	5,60	5,80	6,00	6,20	6,40	6,60	6,80	7,00	7,20	7,40	7,60	7,80	Stato limite / Limit state	4,40	4,60	4,80	5,00	5,20	5,40	5,60	5,80	6,00	6,20	6,40	6,60	6,80	7,00	7,20	7,40	7,60	7,80		
0,75	SLU	ULS	278	253	231	212	195	180	167	155	144	134	126	117	110	103	97	92	86	82	ULS	278	253	231	212	195	180	167	155	144	134	126	117	110	103	97	92	86	82	
	SLE* SLS*	1/150	198	181	165	152	139	129	119	111	103	96	90	80	73	66	60	55	50	46	1/150	198	181	165	150	132	115	101	90	80	72	65	58	53	48	43	39	36	32	
		1/200	198	181	165	150	132	115	101	90	80	72	65	58	53	48	43	39	36	32	1/200	198	181	165	150	132	115	101	90	80	72	65	58	53	48	43	39	36	32	
		1/250	173	150	131	115	101	93	81	71	63	56	51	45	41	37	33	30	27	25	1/250	173	150	131	115	101	93	81	71	63	56	51	45	41	37	33	30	27	25	
0,80	SLU	ULS	318	290	265	243	224	207	191	178	165	154	144	135	126	119	112	105	99	94	ULS	318	290	265	243	224	207	191	178	165	154	144	135	126	119	112	105	99	94	
	SLE* SLS*	1/150	227	207	189	174	160	148	137	127	118	106	95	86	78	71	64	59	54	49	1/150	227	207	189	174	160	148	137	127	118	106	95	86	78	71	64	59	54	49	
		1/200	227	207	189	174	160	148	137	127	118	106	95	86	78	71	64	59	54	49	1/200	227	207	189	174	160	148	137	127	118	106	95	86	78	71	64	59	54	49	
		1/250	186	161	141	123	112	100	85	76	68	61	54	49	44	40	36	32	29	27	1/250	186	161	141	123	112	100	85	76	68	61	54	49	44	40	36	32	29	27	
0,88	SLU	ULS	369	336	308	282	260	240	222	206	192	179	167	156	147	138	129	122	115	109	ULS	369	336	308	282	260	240	222	206	192	179	167	156	147	138	129	122	115	109	
	SLE* SLS*	1/150	264	240	220	202	186	171	159	147	137	128	112	101	92	83	76	69	63	58	1/150	264	240	220	202	186	171	159	147	137	128	112	101	92	83	76	69	63	58	
		1/200	264	240	209	183	161	143	127	113	101	91	82	74	67	60	55	50	45	41	1/200	264	240	209	183	161	143	127	113	101	91	82	74	67	60	55	50	45	41	
		1/250	218	189	165	145	130	116	102	90	81	71	64	57	52	47	42	38	34	31	1/250	218	189	165	145	130	116	102	90	81	71	64	57	52	47	42	38	34	31	
1,00	SLU	ULS	421	383	351	322	296	273	253	235	219	204	190	178	167	157	148	139	131	124	ULS	421	383	351	322	296	273	253	235	219	204	190	178	167	157	148	139	131	124	
	SLE* SLS*	1/150	301	274	250	230	212	195	181	168	156	146	136	122	110	100	91	83	76	69	1/150	301	274	250	230	212	195	181	168	156	146	136	122	110	100	91	83	76	69	
		1/200	301	274	250	230	212	195	181	168	156	146	136	122	110	99	89	80	73	66	50	1/200	301	274	250	230	212	195	181	168	156	146	136	122	110	99	89	80	73	66
		1/250	263	228	199	175	154	136	121	110	100	88	77	69	62	56	51	46	42	38	1/250	263	228	199	175	154	136	121	110	100	88	77	69	62	56	51	46	42	38	
1,15	SLU	ULS	484	441	403	370	340	314	291	270	251	234	219	205	192	180	170	160	151	142	ULS	484	441	403	370	340	314	291	270	251	234	219	205	192	180	170	160	151	142	
	SLE* SLS*	1/150	345	315	288	264	243	224	208	193	179	167	156	140	127	115	105	96	87	80	1/150	345	315	288	264	243	224	208	193	179	167	156	140	127	115	105	96	87	80	
		1/200	345	315	288	254	224	201	180	161	141	126	114	102	92	84	76	69	63	57	1/200	345	315	288	254	224	201	180	161	141	126	114	102	92	84	76	69	63	57	
		1/250	303	263	229	203	180	160	143	125	110	100	89	80	72	65	58	53	48	43	1/250	303	263	229	203	180	160	143	125	110	100	89	80	72	65	58	53	48	43	
1,25	SLU	ULS	525	479	438	402	370	341	316	293	273	254	238	222	209	196	184	174	164	155	ULS	525	479	438	402	370	341	316	293	273	254	238	222	209	196	184	174	164	155	
	SLE* SLS*	1/150	375	342	313	287	264	244	226	209	195	182	170	152	138	125	114	104	95	87	1/150	375	342	313	287	264	244	226	209	195	182	170	152	138	125	114	104	95	87	
		1/200	375	342	313	276	243	216	192	171	153	137	123	111	100	91	82	75	68	62	1/200	375	342	313	276	243	216	192	171	153	137	123	111	100	91	82	75	68	62	
		1/250	329	286	249	218	192	170	151	134	120	107	96	87	78	70	64	57	52	47	1/250	329	286	249	218	192	170	151	134	120	107	96	87	78	70	64	57	52	47	
1,50	SLU	ULS	630	573	524	481	443	409	379	351	327	305	285	267	250	235	221	208	196	185	ULS	630	573	524	481	443	409	379	351	327	305	285	267	250	235	221	208	196	185	
	SLE* SLS*	1/150	450	410	375	344	316	292	270	251	234	218	203	183	166	150	137	125	114	104	1/150	450	410	375	344	316	292	270	251	234	218	203	183	166	150	137	125	114	104	
		1/200	450	410	375	331	292	259	230	205	183	165	148	133	121	109	99	90	82	74	1/200	450	410	375	331	292	259	230	205	183	165	148	133	121	109	99	90	82	74	
		1/250	395	343	299	262	231	204	181	161	144	129	115	104	94	84	76	69	62	57	1/250	395	343	299	262	231	204	181	161	144	129	115	104	94	84	76	69	62	57	

I valori riportati in tabella sono da considerarsi come indicativi, è competenza del progettista procedere per i singoli casi di verifica al relativo calcolo.

SANDRINI metalli S.p.A. si riserva di variare in qualsiasi momento e senza preavviso le caratteristiche dei prodotti. Tutti i diritti riservati: vietata la riproduzione.

Tabelle di portata (daN/m²) Load tables (daN/sqm)

Larghezza appoggio intermedio: 200 mm - Larghezza appoggio esterno: 100 mm Internal support width: 200 mm - End support width: 100 mm

Sp. Th. (mm)	Interasse appoggi (m) / Carico uniformemente distribuito (daN/m ²)																	Span (m) / Uniformly distributed load (daN/sqm)																					
	CAMPATA DOPPIA / DOUBLE SPAN																	CAMPATA DOPPIA / DOUBLE SPAN																					
mm	Stato limite / Limit state	4,40	4,60	4,80	5,00	5,20	5,40	5,60	5,80	6,00	6,20	6,40	6,60	6,80	7,00	7,20	7,40	7,60	7,80	Stato limite / Limit state	4,40	4,60	4,80	5,00	5,20	5,40	5,60	5,80	6,00	6,20	6,40	6,60	6,80	7,00	7,20	7,40	7,60	7,80	
0,75	SLU	ULS	209	195	182	174	169	156	146	135	127	120	114	109	103	98	94	90	86	82	ULS	209	195	182	174	169	156	146	135	127	120	114	109	103	98	94	90	86	82
	SLE* SLS*	1/150	150	139	130	124	121	111	104	97	91	86	82	78	74	70	67	64	61	59	1/150																		

Larghezza appoggi: intermedio = 200 mm | esterno = 100 mm

Support width: Internal = 200 mm | End = 100 mm

Tabelle di portata (daN/m²) Load tables (daN/sqm)

steel s320GD

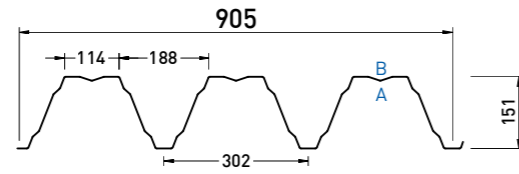

A: lato a vista - front side
B: lato non a vista - back side

POSITIVE

Reazione al fuoco Fire reaction
CLASS A1

Comportamento al fuoco dall'esterno External fire performance
Broof (t1,t2,t3)

Senza necessità di sottoporre a prova secondo la norma UNI EN 14782:2006. No lab test is required as per UNI EN 14782:2006.

DATI STATICI STATIC DATA **PESO** WEIGHT

Sp. Th. (mm)	Jy (cm ² /m)	We inf (cm ³ /m)	We sup (cm ³ /m)	Steel Kg/m ²
0,75	335,24	37,62	53,56	9,76
0,80	360,08	40,50	57,31	10,41
0,88	400,02	45,16	63,33	11,45
1,00	458,58	52,20	72,36	13,01
1,15	527,37	60,16	83,21	14,96
1,25	573,23	65,36	90,37	16,26
1,50	687,88	78,32	108,23	19,52

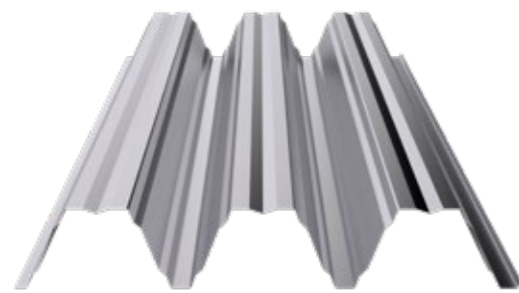

APPLICAZIONI
APPLICATIONS

SANDnodrip
Class A2 - s1, d0 Broof (t1,t2,t3)

SANDcontrol
Class C - s1, d0 Broof (t1,t2,t3)

Tabelle di portata (daN/m²) Load tables (daN/sqm)

steel s320GD

* Valori di portata caratteristici con coefficiente di sicurezza applicato pari a: $\gamma_q = 1,40$. Characteristic load with an applied safety coefficient equal to: $\gamma_q = 1,40$.
In azzurro i valori rappresentativi della portata con inflessione limite raggiunta. The values indicated in blue are representative of the load capacity with the limit inflection reached.

Larghezza appoggio esterno: 100 mm End support width: 100 mm

Sp. Th. mm	Interasse appoggi (m) / Carico uniformemente distribuito (daN/m ²)																	Span (m) / Uniformly distributed load (daN/sqm)																							
	CAMPATA SINGOLA																	SINGLE SPAN																							
mm	Stato limite	Limit state	4,40	4,60	4,80	5,00	5,20	5,40	5,60	5,80	6,00	6,20	6,40	6,60	6,80	7,00	7,20	7,40	7,60	7,80	Stato limite	Limit state	4,40	4,60	4,80	5,00	5,20	5,40	5,60	5,80	6,00	6,20	6,40	6,60	6,80	7,00	7,20	7,40	7,60	7,80	
0,75	SLU	ULS	437	398	363	334	307	284	263	244	227	211	197	185	173	163	153	144	137	129	ULS	437	398	363	334	307	284	263	244	227	211	197	185	173	163	153	144	137	129		
		1/150	312	284	260	238	219	203	188	174	152	139	128	115	104	95	86	78	72	65	1/150	312	284	260	238	219	203	188	174	152	139	128	115	104	95	86	78	72	65		
		SLE*	1/200	312	284	260	208	183	162	144	130	115	103	93	84	75	68	62	57	51	47	SLE*	1/200	312	284	260	208	183	162	144	130	115	103	93	84	75	68	62	57	51	47
		SLS*	1/250	248	215	187	164	145	130	114	102	90	81	73	65	59	53	48	43	39	35	SLS*	1/250	248	215	187	164	145	130	114	102	90	81	73	65	59	53	48	43	39	35
0,80	SLU	ULS	481	438	400	367	338	312	289	269	249	233	217	203	190	179	169	159	149	142	ULS	481	438	400	367	338	312	289	269	249	233	217	203	190	179	169	159	149	142		
		1/150	344	313	286	262	241	223	206	192	169	152	137	123	112	102	92	84	77	70	1/150	344	313	286	262	241	223	206	192	169	152	137	123	112	102	92	84	77	70		
		SLE*	1/200	344	313	279	223	201	181	160	142	125	113	100	90	81	74	67	61	55	50	SLE*	1/200	344	313	279	223	201	181	160	142	125	113	100	90	81	74	67	61	55	50
		SLS*	1/250	266	231	202	177	160	143	122	111	100	92	78	70	63	57	51	47	42	38	SLS*	1/250	266	231	202	177	160	143	122	111	100	92	78	70	63	57	51	47	42	38
0,88	SLU	ULS	542	494	452	414	381	352	326	303	282	262	245	230	215	202	190	179	169	160	ULS	542	494	452	414	381	352	326	303	282	262	245	230	215	202	190	179	169	160		
		1/150	387	353	323	296	272	252	233	216	191	175	155	141	127	115	105	96	88	80	1/150	387	353	323	296	272	252	233	216	191	175	155	141	127	115	105	96	88	80		
		SLE*	1/200	387	353	316	254	224	204	182	163	141	132	114	103	93	84	76	69	63	57	SLE*	1/200	387	353	316	254	224	204	182	163	141	132	114	103	93	84	76	69	63	57
		SLS*	1/250	303	263	229	201	183	161	140	124	111	101	89	80	72	65	59	53	48	44	SLS*	1/250	303	263	229	201	183	161	140	124	111	101	89	80	72	65	59	53	48	44
1,00	SLU	ULS	619	564	515	473	436	402	373	346	322	300	280	262	246	231	217	204	193	182	ULS	619	564	515	473	436	402	373	346	322	300	280	262	246	231	217	204	193	182		
		1/150	442	403	368	338	311	287	266	247	219	200	184	165	150	136	124	113	103	94	1/150	442	403	368	338	311	287	266	247	219	200	184	165	150	136	124	113	103	94		
		SLE*	1/200	442	403	368	299	264	234	208	185	166	151	134	121	109	99	90	81	74	67	SLE*	1/200	442	403	368	299	264	234	208	185	166	151	134	121	109	99	90	81	74	67
		SLS*	1/250	357	309	270	240	212	185	163	151	135	120	105	94	85	77	69	63	57	52	SLS*	1/250	357	309	270	240	212	185	163	151	135	120	105	94	85	77	69	63	57	52
1,15	SLU	ULS	711	648	592	544	501	462	428	397	369	344	322	301	283	266	250	235	222	209	ULS	711	648	592	544	501	462	428	397	369	344	322	301	283	266	250	235	222	209		
		1/150	508	463	423	388	358	330	306	284	252	230	211	190	172	157	143	130	119	108	1/150	508	463	423	388	358	330	306	284	252	230	211	190	172	157	143	130	119	108		
		SLE*	1/200	508	463	423	382	304	269	239	213	191	171	154	139	126	114	103	94	85	78	SLE*	1/200	508	463	423	382	304	269	239	213	191	171	154	139	126	114	103	94	85	78
		SLS*	1/250	410	356	310	272	240	212	188	168	150	134	120	108	97	88	80	72	65	59	SLS*	1/250	410	356	310	272	240	212	188	168	150	134	120	108	97	88	80	72	65	59
1,25	SLU	ULS	772	704	644	591	544	502	465	432	402	374	350	327	307	288	271	255	241	228	ULS	772	704	644	591	544	502	465	432	402	374	350	327	307	288	271	255	241	228		
		1/150	552	503	460	422	388	359	332	308	287	267	250	230	213	170	155	141	129	118	1/150	552	503	460	422	388	359	332	308	287	267	250	230	213	170	155	141	129	118		
		SLE*	1/200	552	503	460	415	330	292	260	232	208	186	168	151	136	124	112	102	93	84	SLE*	1/200	552	503	460	415	330	292	260	232	208	186	168	151	136	124	112	102	93	84
		SLS*	1/250	446	387	338	296	261	230	205	182	163	146	131	118	106	96	87	78	71	64	SLS*	1/250	446	387	338	296	261	230	205	182	163	146	131	118	106	96	87	78	71	64
1,50	SLU	ULS	926	844	771	708	652	601	557	517	481	448	418	392	368	345	324	306	289	272	ULS	926	844	771	708	652	601	557	517	481	448	418	392	368	345	324	306	289	272		
		1/150	661	603	551	506	466	430	398	370	343	320	299	275	255	204	186	169	155	142	1/150	661	603	551	506	466	430	398	370	343	320	299	275	255	204	186	169	155	142		
		SLE*	1/200	661	603	551	498	450	351	312	278	249	223	201	181	164	148	134	122	111	101	SLE*	1/200	661	603	551	498	450	351	312	278	249	223	201	181	164	148	134	122	111	101
		SLS*	1/250	535	464	405	355	313	277	246	219	195	175	157	141	127	115	104	94	85	77	SLS*	1/250	535	464	405	355	313	277	246	219	195	175	157	141	127	115	104	94	85	77

I valori riportati in tabella sono da considerarsi come indicativi, è competenza del progettista procedere per i singoli casi di verifica al relativo calcolo.

SANDRINI metalli S.p.A. si riserva di variare in qualsiasi momento e senza preavviso le caratteristiche dei prodotti. Tutti i diritti riservati: vietata la riproduzione.

Larghezza appoggio intermedio: 200 mm - Larghezza appoggio esterno: 100 mm Internal support width: 200 mm - End support width: 100 mm

Sp. Th. mm	Interasse appoggi (m) / Carico uniformemente distribuito (daN/m ²)																	Span (m) / Uniformly distributed load (daN/sqm)																						
	CAMPATA MULTIPLA																	MULTIPLE SPAN																						
mm	Stato limite	Limit state	4,40	4,60	4,80	5,00	5,20	5,40	5,60	5,80	6,00	6,20	6,40	6,60	6,80	7,00	7,20	7,40	7,60	7,80	Stato limite	Limit state	4,40	4,60	4,80	5,00	5,20	5,40	5,60	5,80	6,00	6,20	6,40	6,60	6,80	7,00	7,20	7,40	7,60	7,80
0,75	SLU	ULS	371	346	323	304	285	269	258	245	234	214	2																											

Larghezza appoggi: intermedio = 450 mm | esterno = 225 mm

Support width: Internal = 450 mm | End = 225 mm

Tabelle di portata (daN/m²) Load tables (daN/sqm)

steel s320GD

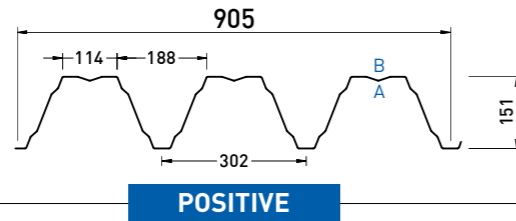

A: lato a vista - front side
B: lato non a vista - back side

Reazione al fuoco Fire reaction CLASS A1
Comportamento al fuoco dall'esterno External fire performance Broof (t1,t2,t3)
Senza necessità di sottoporre a prova secondo la norma UNI EN 14782:2006. No lab test is required as per UNI EN 14782:2006.

Sp. Th. (mm)	DATI STATICI / STATIC DATA			PESO / WEIGHT (Steel Kg/m ²)
	Jy (cm ² /m)	We inf (cm ³ /m)	We sup (cm ³ /m)	
0,75	335,24	37,62	53,56	9,76
0,80	360,08	40,50	57,31	10,41
0,88	400,02	45,16	63,33	11,45
1,00	458,58	52,20	72,36	13,01
1,15	527,37	60,16	83,21	14,96
1,25	573,23	65,36	90,37	16,26
1,50	687,88	78,32	108,23	19,52

APPLICAZIONI / APPLICATIONS
 SANDnodrip Class A2 - s1, d0 Broof (t1,t2,t3)
 SANDcontrol Class C - s1, d0 Broof (t1,t2,t3)

Tabelle di portata (daN/m²) Load tables (daN/sqm)

* Valori di portata caratteristici con coefficiente di sicurezza applicato pari a: $\gamma_q = 1,40$. Characteristic load with an applied safety coefficient equal to: $\gamma_q = 1,40$.
In azzurro i valori rappresentativi della portata con inflessione limite raggiunta. The values indicated in blue are representative of the load capacity with the limit inflection reached.

Larghezza appoggio esterno: 225 mm | End support width: 225 mm

Sp. Th. (mm)	Interasse appoggi (m) / Carico uniformemente distribuito (daN/m ²)																	Span (m) / Uniformly distributed load (daN/sqm)																						
	CAMPATA SINGOLA / SINGLE SPAN																	CAMPATA SINGOLA / SINGLE SPAN																						
mm	Stato limite / Limit state	4,40	4,60	4,80	5,00	5,20	5,40	5,60	5,80	6,00	6,20	6,40	6,60	6,80	7,00	7,20	7,40	7,60	7,80	4,40	4,60	4,80	5,00	5,20	5,40	5,60	5,80	6,00	6,20	6,40	6,60	6,80	7,00	7,20	7,40	7,60	7,80			
0,75	SLU	ULS	459	418	382	350	323	298	276	256	238	222	207	194	181	171	160	151	143	135	459	418	382	350	323	298	276	256	238	222	207	194	181	171	160	151	143	135		
	SLE* SLS*	1/150	328	299	273	250	230	213	197	183	160	146	134	120	109	99	90	82	75	69	328	299	273	250	230	213	197	183	160	146	134	120	109	99	90	82	75	69		
		1/200	328	299	273	218	192	171	152	140	123	112	98	88	79	72	65	59	54	49	328	299	273	218	192	171	152	140	123	112	98	88	79	72	65	59	54	49		
		1/250	260	226	197	173	152	134	121	106	95	85	76	69	61	56	50	45	41	37	260	226	197	173	152	134	121	106	95	85	76	69	61	56	50	45	41	37		
0,80	SLU	ULS	505	460	420	386	355	328	304	282	262	244	228	213	200	188	177	167	157	149	505	460	420	386	355	328	304	282	262	244	228	213	200	188	177	167	157	149		
	SLE* SLS*	1/150	361	328	300	275	253	234	217	201	177	159	143	129	117	107	97	88	81	74	361	328	300	275	253	234	217	201	177	159	143	129	117	107	97	88	81	74		
		1/200	361	328	293	234	207	183	161	150	140	120	105	95	86	77	70	64	58	53	361	328	293	234	207	183	161	150	140	120	105	95	86	77	70	64	58	53		
		1/250	280	242	212	185	163	144	130	114	102	91	82	74	66	60	54	49	44	40	280	242	212	185	163	144	130	114	102	91	82	74	66	60	54	49	44	40		
0,88	SLU	ULS	569	518	474	435	400	370	343	318	296	275	258	241	226	212	200	188	178	168	569	518	474	435	400	370	343	318	296	275	258	241	226	212	200	188	178	168		
	SLE* SLS*	1/150	407	370	339	311	286	264	245	227	201	184	163	148	134	121	111	101	92	84	407	370	339	311	286	264	245	227	201	184	163	148	134	121	111	101	92	84		
		1/200	407	370	332	267	236	209	185	165	152	132	121	108	97	88	80	72	66	60	407	370	332	267	236	209	185	165	152	132	121	108	97	88	80	72	66	60		
		1/250	318	276	241	211	186	164	146	130	115	104	93	84	75	68	62	56	50	46	318	276	241	211	186	164	146	130	115	104	93	84	75	68	62	56	50	46		
1,00	SLU	ULS	681	620	567	521	479	442	410	380	354	330	308	288	271	254	239	225	212	201	681	620	567	521	479	442	410	380	354	330	308	288	271	254	239	225	212	201		
	SLE* SLS*	1/150	487	443	405	372	342	316	293	272	241	221	202	182	165	150	136	124	113	104	487	443	405	372	342	316	293	272	241	221	202	182	165	150	136	124	113	104		
		1/200	487	443	405	329	290	260	229	204	183	164	148	133	120	109	99	90	81	74	487	443	405	329	290	260	229	204	183	164	148	133	120	109	99	90	81	74		
		1/250	392	340	297	260	230	203	180	160	145	132	115	104	93	84	76	69	63	57	392	340	297	260	230	203	180	160	145	132	115	104	93	84	76	69	63	57		
1,15	SLU	ULS	782	713	652	598	551	508	471	437	406	379	354	331	311	292	275	259	244	230	782	713	652	598	551	508	471	437	406	379	354	331	311	292	275	259	244	230		
	SLE* SLS*	1/150	559	509	465	427	393	363	336	312	277	253	232	209	190	172	157	143	130	119	559	509	465	427	393	363	336	312	277	253	232	209	190	172	157	143	130	119		
		1/200	559	509	465	420	334	296	263	235	210	189	169	153	138	125	114	103	94	85	559	509	465	420	334	296	263	235	210	189	169	153	138	125	114	103	94	85		
		1/250	451	391	341	299	264	233	207	184	165	148	132	119	107	97	87	79	72	65	451	391	341	299	264	233	207	184	165	148	132	119	107	97	87	79	72	65		
1,25	SLU	ULS	850	775	708	650	598	552	512	475	442	411	384	360	338	317	298	281	265	250	850	775	708	650	598	552	512	475	442	411	384	360	338	317	298	281	265	250		
	SLE* SLS*	1/150	607	553	506	464	427	394	366	339	315	294	275	253	234	187	170	155	142	130	607	553	506	464	427	394	366	339	315	294	275	253	234	187	170	155	142	130		
		1/200	607	553	506	457	363	321	286	255	228	205	184	166	150	136	123	112	102	93	607	553	506	457	363	321	286	255	228	205	184	166	150	136	123	112	102	93		
		1/250	490	426	371	326	287	253	225	201	179	160	144	129	117	106	95	86	78	71	490	426	371	326	287	253	225	201	179	160	144	129	117	106	95	86	78	71		
1,50	SLU	ULS	1019	928	848	779	717	661	613	569	529	493	460	431	404	380	357	337	318	300	1019	928	848	779	717	661	613	569	529	493	460	431	404	380	357	337	318	300		
	SLE* SLS*	1/150	728	663	606	548	496	386	343	306	274	246	221	200	180	163	148	134	122	112	728	663	606	548	496	386	343	306	274	246	221	200	180	163	148	134	122	112		
		1/200	728	663	606	548	496	391	344	304	270	241	215	192	172	156	140	126	114	103	94	728	663	606	548	496	391	344	304	270	241	215	192	172	156	140	126	114	103	94
		1/250	588	511	445	391	344	304	270	241	215	192	172	156	140	126	113	102	91	83	75	588	511	445	391	344	304	270	241	215	192	172	156	140	126	113	102	91	83	75

I valori riportati in tabella sono da considerarsi come indicativi, è competenza del progettista procedere per i singoli casi di verifica al relativo calcolo.
SANDRINI metalli S.p.A. si riserva di variare in qualsiasi momento e senza preavviso le caratteristiche dei prodotti. Tutti i diritti riservati: vietata la riproduzione.

Larghezza appoggio intermedio: 450 mm - Larghezza appoggio esterno: 225 mm | Internal support width: 450 mm - End support width: 225 mm

Sp. Th. (mm)	Interasse appoggi (m) / Carico uniformemente distribuito (daN/m ²)																	Span (m) / Uniformly distributed load (daN/sqm)																				
	CAMPATA DOPPIA / DOUBLE SPAN																	CAMPATA DOPPIA / DOUBLE SPAN																				
mm	Stato limite / Limit state	4,40	4,60	4,80	5,00	5,20	5,40	5,60	5,80	6,00	6,20	6,40	6,60	6,80	7,00	7,20	7,40	7,60	7,80	4,40	4,60	4,80	5,00	5,20	5,40	5,60	5,80	6,00	6,20	6,40	6,60	6,80	7,00	7,20	7,40	7,60	7,80	
0,75	SLU	ULS	340	318	297	281	271	254	235	222	208	196	186	177	168	160	153	146	140	134	340	318	297	281	271	254	235	222	208	196	186	177	168	160	153	146	140	134
	SLE* SLS*	1/150	243	227	212	199	194	181	168	159	149	140	133	126	120	115	109	104	100	96	243	227	212	199	194	181	168	159	149	140	133	126	120	115	109	104	100	96
		1/200	243	227	212	199	194	181	168	159	149	140	133	126	120	115	109	104	100	96	243	2																

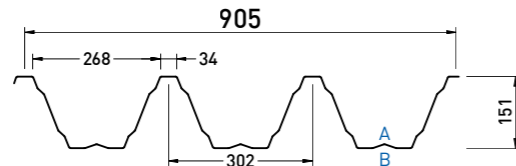

A: lato a vista - front side
B: lato non a vista - back side

NEGATIVE

Reazione al fuoco Fire reaction
CLASS A1

Comportamento al fuoco dall'esterno External fire performance
Broof (t1,t2,t3)

Senza necessità di sottoporre a prova secondo la norma UNI EN 14782:2006. No lab test is required as per UNI EN 14782:2006.

DATI STATICI STATIC DATA **PESO** WEIGHT

Sp. Th. (mm)	Jy (cm ² /m)	We inf (cm ³ /m)	We sup (cm ³ /m)	Steel Kg/m ²
0,75	335,24	53,56	37,62	9,76
0,80	360,08	57,31	40,50	10,41
0,88	400,02	63,33	45,16	11,45
1,00	458,58	72,36	52,20	13,01
1,15	527,37	83,21	60,16	14,96
1,25	573,23	90,37	65,36	16,26
1,50	687,88	108,23	78,32	19,52



APPLICAZIONI
APPLICATIONS



SANDnodrip
Class A2 - s1, d0 🔥 Broof (t1,t2,t3)



SANDcontrol
Class C - s1, d0 🔥 Broof (t1,t2,t3)

Tabelle di portata (daN/m²) Load tables (daN/sqm)



* Valori di portata caratteristici con coefficiente di sicurezza applicato pari a: $\gamma_f = 1,40$. Characteristic load with an applied safety coefficient equal to: $\gamma_f = 1,40$.
In azzurro i valori rappresentativi della portata con inflessione limite raggiunta. The values indicated in blue are representative of the load capacity with the limit inflection reached.

Larghezza appoggio esterno: 100 mm End support width: 100 mm

Sp. Th. mm	Interasse appoggi (m) / Carico uniformemente distribuito (daN/m ²)																	Span (m) / Uniformly distributed load (daN/sqm)						
	CAMPATA SINGOLA																	SINGLE SPAN						
	Stato limite Limit state	4,40	4,60	4,80	5,00	5,20	5,40	5,60	5,80	6,00	6,20	6,40	6,60	6,80	7,00	7,20	7,40	7,60	7,80					
0,75	SLU	ULS	418	381	349	320	294	272	251	234	218	203	189	177	166	156	147	138	130	103				
	SLE* SLS*	1/150	299	272	249	229	210	194	180	167	149	136	124	112	101	92	84	76	70	64				
		1/200	299	272	249	202	181	162	143	125	112	105	90	82	74	67	61	55	50	45				
		1/250	241	209	183	160	141	125	111	102	91	80	71	63	57	51	47	42	38	35				
0,80	SLU	ULS	462	421	385	354	325	300	278	258	240	223	209	195	183	172	162	152	144	136				
	SLE* SLS*	1/150	330	301	275	253	232	215	198	184	164	147	133	120	109	99	90	82	75	69				
		1/200	330	301	268	218	203	180	160	142	124	113	97	88	79	72	65	59	54	49				
		1/250	259	225	196	172	152	134	119	106	95	84	76	68	62	56	50	45	41	37				
0,88	SLU	ULS	524	478	437	401	369	340	316	293	272	254	237	222	209	196	184	173	163	155				
	SLE* SLS*	1/150	375	341	312	286	263	243	225	209	186	170	151	137	124	113	102	93	85	78				
		1/200	375	341	305	252	222	201	180	161	143	125	111	100	91	82	74	67	61	56				
		1/250	295	256	224	196	173	152	135	120	108	96	86	78	70	63	57	52	47	43				
1,00	SLU	ULS	603	549	502	461	424	392	363	337	313	295	284	256	239	225	211	200	188	178				
	SLE* SLS*	1/150	431	392	359	329	303	280	259	241	213	195	179	161	146	133	121	110	101	92				
		1/200	431	392	359	291	261	230	203	181	162	145	131	118	106	96	87	80	72	66				
		1/250	347	301	263	231	203	180	160	142	127	113	102	92	83	74	67	61	55	50				
1,15	SLU	ULS	696	634	580	532	490	452	419	389	361	337	315	295	277	260	245	230	217	205				
	SLE* SLS*	1/150	497	453	414	380	350	323	299	278	246	225	206	186	168	153	139	127	116	106				
		1/200	497	453	414	374	297	263	234	208	187	167	150	136	123	111	101	91	83	76				
		1/250	400	348	303	266	234	207	184	164	146	131	118	106	95	86	78	70	64	58				
1,25	SLU	ULS	756	689	630	578	532	491	455	422	393	366	342	320	301	282	265	250	236	223				
	SLE* SLS*	1/150	540	492	450	413	380	351	325	302	281	261	244	225	208	186	161	138	126	115				
		1/200	540	492	450	407	322	286	254	226	203	182	164	148	133	121	109	99	90	82				
		1/250	435	378	330	289	255	225	200	178	159	142	128	115	104	94	85	77	69	63				
1,50	SLU	ULS	906	826	755	693	638	589	545	506	471	439	410	384	360	338	318	299	283	267				
	SLE* SLS*	1/150	647	590	539	495	456	420	389	362	336	314	293	270	249	199	182	166	151	138				
		1/200	647	590	539	488	441	343	305	272	243	218	196	177	160	145	131	119	109	99				
		1/250	523	453	396	347	306	270	240	214	191	171	153	138	125	112	101	92	83	76				

I valori riportati in tabella sono da considerarsi come indicativi, è competenza del progettista procedere per i singoli casi di verifica al relativo calcolo.

SANDRINI metalli S.p.A. si riserva di variare in qualsiasi momento e senza preavviso le caratteristiche dei prodotti. Tutti i diritti riservati: vietata la riproduzione.

Tabelle di portata (daN/m²) Load tables (daN/sqm)

Larghezza appoggio intermedio: 200 mm - Larghezza appoggio esterno: 100 mm Internal support width: 200 mm - End support width: 100 mm

Sp. Th. mm	Interasse appoggi (m) / Carico uniformemente distribuito (daN/m ²)																	Span (m) / Uniformly distributed load (daN/sqm)						
	CAMPATA DOPPIA																	DOUBLE SPAN						
	Stato limite Limit state	4,40	4,60	4,80	5,00	5,20	5,40	5,60	5,80	6,00	6,20	6,40	6,60	6,80	7,00	7,20	7,40	7,60	7,80					
0,75	SLU	ULS	300	279	261	245	234	221	208	195	183	173	165	156	148	142	135	129	124	118				
	SLE* SLS*	1/150	214	200	187	175	167	158	149	139	131	123	118	111	106	101	97	92	88	85				
		1/200	214	200	187	175	167	158	149	139	131	123	118	111	106	101	97	92	88	85				
		1/250	214	200	187	175	167	158	149	139	131	123	118	111	106	101	97	92	88	85				
0,80	SLU	ULS	337	313	293	274	261	245	232	221	208	195	184	174	165	158	151	143	138	131				
	SLE* SLS*	1/150	240	224	210	196	186	175	166	158	149	139	131	125	118	113	108	102	98	94				
		1/200	240	224	210	196	186	175	166	158	149	139	131	125	118	113	108	102	98	94				
		1/250	240	224	210	196	186	175	166	158	149	139	131	125	118	113	108	102	98	94				
0,88	SLU	ULS	407	380	354	331	311	292	275	260	245	234	220	209	199	189	180	172	164	157				
	SLE* SLS*	1/150	291	271	253	237	222	208	197	186	175	167	157	149	142	135	129	123	117	112				
		1/200	291	271	253	237	222	208	197	186	175	167	157	149	142	135	129	123	117	112				
		1/250	291	271	253	237	222	208	197	186	175	167	157	149	142	135	129	123	117	112				
1,00	SLU	ULS	499	464	433	404	379	355	334	315	298	282	266	253	240	229	218	208	198	190				
	SLE* SLS*	1/150	356	331	309	289	271	254	239	225	213	201	190	180	172	163	156	148	142	136				
		1/200	356	331	309	289	271	254	239	225	213	201	190	180	172	163	156	148	142	136				
		1/250	356	331	309	289	271	254	239	225	213	201	190	180	172	163	156	148	142	136				
1,15	SLU	ULS	607	564	524	490	458	429	404	380	359	338	320	304	288	274	261	249	235	222				
	SLE* SLS*	1/150	434	403	375	350	327	307	289	271	256	242	229	217	206	196	186	178	168	159				
		1/200	434	403	375	350	327	307	289	271	256	242	229	217	206	196	186	178	168	159				
		1/250	434	403	375	350	327	307	289	271	256	242	229	217	206	196	186	178	168	159				
1,25	SLU	ULS	678	629	585	546	510	478	449	422	399	376	356	337	320	304	287	271	255	241				
	SLE* SLS*	1/150	484	449	418	390	364	342	321	302	285	269	254	241	229	217	205	193	182	172				
		1/200	484	449	418	390	364	342	321	302	285	269	254	241	229	217	205	193	182	172				
		1/250	484	449	418	390	364	342	321	302	285	269	254	241	229	217	205	193	182	172				
1,50	SLU	ULS	856	792	736	686	640	599	562	529	497	469	443	416	390	366	344	324	306	289				
	SLE* SLS*	1/150	611	566	526	490	457	428	401	378	355	335	317	297	278	261	246	232	219	206				
		1/200	611	566	526	490	457	428	401	378	355	335	317	297	278	261	246	232	219	206				
		1/250	611	566	526	490	457	428	401	378	355	335	317	297	278	261	246	232	219	206				

The values shown in the table must be considered as indicative, the designer has the responsibility to proceed with the relevant calculation in any individual cases.

SANDRINI metalli S.p.A. reserves

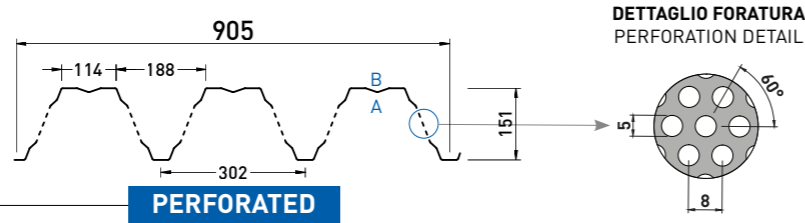

A: lato a vista - front side
B: lato non a vista - back side

Reazione al fuoco Fire reaction CLASS A1
Comportamento al fuoco dall'esterno External fire performance Broof (t1,t2,t3)
Senza necessità di sottoporre a prova secondo la norma UNI EN 14782:2006. No lab test is required as per UNI EN 14782:2006.

Sp. Th. (mm)	DATI STATICI / STATIC DATA			PESO / WEIGHT (Steel Kg/m ²)
	Jy (cm ² /m)	We inf (cm ³ /m)	We sup (cm ³ /m)	
0,75	317,16	34,56	53,86	9,28
0,80	341,02	37,27	57,61	9,90
0,88	379,49	41,68	63,61	10,89
1,00	437,57	48,28	72,62	12,37
1,15	504,46	55,68	83,48	14,23
1,25	548,35	60,48	75,67	15,46
1,50	658,03	72,48	108,58	18,55

APPLICAZIONI / APPLICATIONS

- SANDnodrip** Class A2 - s1, d0 Broof (t1,t2,t3)
- SANDcontrol** Class C - s1, d0 Broof (t1,t2,t3)

Tabelle di portata (daN/m²) Load tables (daN/sqm)

* Valori di portata caratteristici con coefficiente di sicurezza applicato pari a: $\gamma_q = 1,40$. Characteristic load with an applied safety coefficient equal to: $\gamma_q = 1,40$.
In azzurro i valori rappresentativi della portata con inflessione limite raggiunta. The values indicated in blue are representative of the load capacity with the limit inflection reached.

Larghezza appoggio esterno: 100 mm End support width: 100 mm

Sp. Th. (mm)	Interasse appoggi (m) / Carico uniformemente distribuito (daN/m ²)																	Span (m) / Uniformly distributed load (daN/sqm)																						
	CAMPATA SINGOLA / SINGLE SPAN																	CAMPATA SINGOLA / SINGLE SPAN																						
mm	Stato limite / Limit state	4,40	4,60	4,80	5,00	5,20	5,40	5,60	5,80	6,00	6,20	6,40	6,60	6,80	7,00	7,20	7,40	7,60	7,80	4,40	4,60	4,80	5,00	5,20	5,40	5,60	5,80	6,00	6,20	6,40	6,60	6,80	7,00	7,20	7,40	7,60	7,80			
0,75	SLU	ULS	295	275	258	243	229	217	205	195	186	177	169	162	154	145	136	128	121	114	295	275	258	243	229	217	205	195	186	177	169	162	154	145	136	128	121	114		
	SLE*	1/150	210	197	184	173	164	155	147	139	133	126	116	104	94	86	78	71	65	60	210	197	184	170	161	150	131	120	104	94	84	76	69	63	57	52	47	43		
	SLS*	1/200	198	182	167	155	143	131	116	103	92	82	74	66	60	54	49	44	40	36	33	198	182	167	155	143	131	116	103	92	82	74	66	60	54	49	44	40	36	33
	SLS*	1/250	183	161	140	123	108	95	85	75	67	60	54	48	44	39	35	32	29	26	26	183	161	140	123	108	95	85	75	67	60	54	48	44	39	35	32	29	26	26
0,80	SLU	ULS	338	316	297	279	263	249	236	224	213	203	192	180	169	159	149	141	133	125	338	316	297	279	263	249	236	224	213	203	192	180	169	159	149	141	133	125		
	SLE*	1/150	242	226	212	199	188	178	169	160	152	137	124	112	101	92	84	77	70	64	242	226	212	199	188	178	169	160	152	137	124	112	101	92	84	77	70	64		
	SLS*	1/200	242	226	206	190	180	162	140	125	112	101	91	82	74	67	61	56	51	46	242	226	206	190	180	162	140	125	112	101	91	82	74	67	61	56	51	46		
	SLS*	1/250	221	203	188	160	141	125	111	102	90	81	71	64	58	52	47	43	39	35	221	203	188	160	141	125	111	102	90	81	71	64	58	52	47	43	39	35		
0,88	SLU	ULS	405	379	355	334	315	299	283	266	248	231	216	202	190	178	168	158	149	141	405	379	355	334	315	299	283	266	248	231	216	202	190	178	168	158	149	141		
	SLE*	1/150	289	270	254	239	225	213	202	190	177	157	140	127	115	105	95	87	80	73	289	270	254	239	225	213	202	190	177	157	140	127	115	105	95	87	80	73		
	SLS*	1/200	289	270	248	230	202	181	160	142	130	114	111	93	84	76	69	63	57	52	289	270	248	230	202	181	160	142	130	114	111	93	84	76	69	63	57	52		
	SLS*	1/250	266	245	207	181	160	141	126	112	100	90	81	73	66	59	54	49	44	40	266	245	207	181	160	141	126	112	100	90	81	73	66	59	54	49	44	40		
1,00	SLU	ULS	499	467	439	414	382	353	327	304	283	264	246	231	216	203	191	180	170	161	499	467	439	414	382	353	327	304	283	264	246	231	216	203	191	180	170	161		
	SLE*	1/150	356	334	314	296	273	252	234	217	202	180	165	149	135	123	112	102	93	85	356	334	314	296	273	252	234	217	202	180	165	149	135	123	112	102	93	85		
	SLS*	1/200	356	334	314	291	236	210	186	166	151	134	121	109	99	89	81	74	67	61	356	334	314	291	236	210	186	166	151	134	121	109	99	89	81	74	67	61		
	SLS*	1/250	319	277	242	212	187	166	147	131	120	105	94	85	77	69	63	57	52	47	319	277	242	212	187	166	147	131	120	105	94	85	77	69	63	57	52	47		
1,15	SLU	ULS	624	569	520	477	439	406	376	349	325	303	283	265	249	234	220	207	196	185	624	569	520	477	439	406	376	349	325	303	283	265	249	234	220	207	196	185		
	SLE*	1/150	446	406	371	341	314	290	269	249	232	207	189	171	155	141	128	117	107	98	446	406	371	341	314	290	269	249	232	207	189	171	155	141	128	117	107	98		
	SLS*	1/200	446	406	371	336	272	241	214	191	171	154	139	125	113	103	93	85	77	71	446	406	371	336	272	241	214	191	171	154	139	125	113	103	93	85	77	71		
	SLS*	1/250	367	319	278	244	215	190	169	151	135	121	109	98	88	80	72	66	60	54	367	319	278	244	215	190	169	151	135	121	109	98	88	80	72	66	60	54		
1,25	SLU	ULS	678	618	565	518	477	441	408	379	353	329	308	288	270	254	239	225	213	201	678	618	565	518	477	441	408	379	353	329	308	288	270	254	239	225	213	201		
	SLE*	1/150	484	441	403	370	341	315	292	271	252	225	206	186	169	153	140	127	116	107	484	441	403	370	341	315	292	271	252	225	206	186	169	153	140	127	116	107		
	SLS*	1/200	484	441	403	365	296	262	233	208	186	167	151	136	123	112	101	92	84	77	484	441	403	365	296	262	233	208	186	167	151	136	123	112	101	92	84	77		
	SLS*	1/250	399	346	302	265	234	207	184	164	147	131	118	106	96	87	79	71	65	59	399	346	302	265	234	207	184	164	147	131	118	106	96	87	79	71	65	59		
1,50	SLU	ULS	812	740	677	621	572	528	489	454	423	394	369	345	324	304	286	270	255	241	812	740	677	621	572	528	489	454	423	394	369	345	324	304	286	270	255	241		
	SLE*	1/150	580	529	483	444	409	377	350	325	302	270	247	223	202	184	167	153	140	128	580	529	483	444	409	377	350	325	302	270	247	223	202	184	167	153	140	128		
	SLS*	1/200	580	529	483	438	397	314	280	250	224	201	181	163	148	134	122	111	101	92	580	529	483	438	397	314	280	250	224	201	181	163	148	134	122	111	101	92		
	SLS*	1/250	479	416	363	318	281	248	221	197	176	158	142	128	115	104	94	86	78	71	479	416	363	318	281	248	221	197	176	158	142	128	115	104	94	86	78	71		

I valori riportati in tabella sono da considerarsi come indicativi, è competenza del progettista procedere per i singoli casi di verifica al relativo calcolo.

SANDRINI metalli S.p.A. si riserva di variare in qualsiasi momento e senza preavviso le caratteristiche dei prodotti. Tutti i diritti riservati: vietata la riproduzione.

Tabelle di portata (daN/m²) Load tables (daN/sqm)

Larghezza appoggio intermedio: 200 mm - Larghezza appoggio esterno: 100 mm Internal support width: 200 mm - End support width: 100 mm

Sp. Th. (mm)	Interasse appoggi (m) / Carico uniformemente distribuito (daN/m ²)																	Span (m) / Uniformly distributed load (daN/sqm)																				
	CAMPATA DOPPIA / DOUBLE SPAN																	CAMPATA DOPPIA / DOUBLE SPAN																				
mm	Stato limite / Limit state	4,40	4,60	4,80	5,00	5,20	5,40	5,60	5,80	6,00	6,20	6,40	6,60	6,80	7,00	7,20	7,40	7,60	7,80	4,40	4,60	4,80	5,00	5,20	5,40	5,60	5,80	6,00	6,20	6,40	6,60	6,80	7,00	7,20	7,40	7,60	7,80	
0,75	SLU	ULS	230	215	202	192	182	169	159	153	143	136	129	123	117	112	107	102	98	94	230	215	202	192	182	169	159	153	143	136	129	123	117	112	107	102	98	94
	SLE*	1/150	165	154	144	137	130	121	114	109	102	97	92	88	84	80	76	73	70	67	165	154	144	137	130	121	114	109	102	97	92	88	84	80	76	73	70	67
	SLS*	1/200	165	154	144	137	130	121	114	109	102	97	92	88	84	80	76	73	70	67	165	154	144	137	130	121	114	109	102	97	92	88	84	80	76	73	70	67

Larghezza appoggi: intermedio = 200 mm | esterno = 100 mm

Support width: Internal = 200 mm | End = 100 mm

Tabelle di portata (daN/m²) Load tables (daN/sqm)

steel s320GD

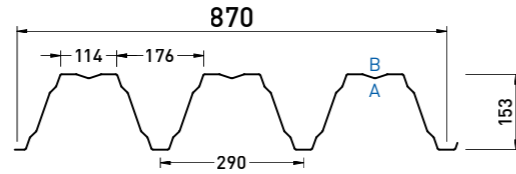

A: lato a vista - front side
B: lato non a vista - back side

POSITIVE

Reazione al fuoco Fire reaction
CLASS A1

Comportamento al fuoco dall'esterno External fire performance
Broof (t1,t2,t3)

Senza necessità di sottoporre a prova secondo la norma UNI EN 14782:2006. No lab test is required as per UNI EN 14782:2006.

Sp. Th. (mm)	DATI STATICI / STATIC DATA			PESO / WEIGHT (Steel Kg/m ²)
	Jy (cm ² /m)	We inf (cm ² /m)	We sup (cm ² /m)	
0,75	362,57	39,88	56,85	10,15
0,80	389,45	42,94	60,83	10,83
0,88	432,68	47,88	67,22	11,91
1,00	496,34	55,36	76,81	13,53
1,15	570,79	63,90	88,38	15,56
1,25	620,43	69,42	95,99	16,92
1,50	744,52	83,19	114,97	20,30

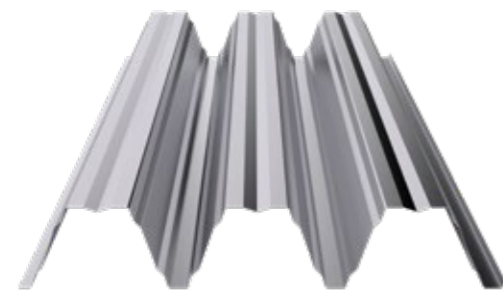

APPLICAZIONI / APPLICATIONS

SANDnodrip
Class A2 - s1, d0 🔥 Broof (t1,t2,t3)

SANDcontrol
Class C - s1, d0 🔥 Broof (t1,t2,t3)

Tabelle di portata (daN/m²) Load tables (daN/sqm)

steel s320GD

* Valori di portata caratteristici con coefficiente di sicurezza applicato pari a: $\gamma_g = 1,40$. Characteristic load with an applied safety coefficient equal to: $\gamma_g = 1,40$.
In azzurro i valori rappresentativi della portata con inflessione limite raggiunta. The values indicated in blue are representative of the load capacity with the limit inflection reached.

Larghezza appoggio esterno: 100 mm | End support width: 100 mm

Sp. Th. (mm)	Interasse appoggi (m) / Carico uniformemente distribuito (daN/m ²)																		Span (m) / Uniformly distributed load (daN/sqm)																					
	CAMPATA SINGOLA / SINGLE SPAN																		CAMPATA SINGOLA / SINGLE SPAN																					
	Stato limite / Limit state	5,00	5,20	5,40	5,60	5,80	6,00	6,20	6,40	6,60	6,80	7,00	7,20	7,40	7,60	7,80	8,00	8,20	8,40	Stato limite / Limit state	5,00	5,20	5,40	5,60	5,80	6,00	6,20	6,40	6,60	6,80	7,00	7,20	7,40	7,60	7,80	8,00	8,20	8,40		
0,75	SLU	ULS	402	371	342	317	294	273	255	238	223	208	196	184	174	165	156	147	139	132	SLU	ULS	402	371	342	317	294	273	255	238	223	208	196	184	174	165	156	147	139	132
	SLE*	1/150	287	265	244	226	210	176	159	143	129	117	107	97	88	81	74	68	62	57	SLE*	1/150	287	265	244	226	210	176	159	143	129	117	107	97	88	81	74	68	62	57
	SLS*	1/200	234	206	183	163	145	130	116	105	95	85	77	70	64	58	53	48	44	40	SLS*	1/200	234	206	183	163	145	130	116	105	95	85	77	70	64	58	53	48	44	40
	SLS*	1/250	185	163	144	128	114	102	91	82	74	66	60	54	49	44	40	37	33	30	SLS*	1/250	185	163	144	128	114	102	91	82	74	66	60	54	49	44	40	37	33	30
0,80	SLU	ULS	431	396	366	339	315	292	273	255	238	223	210	198	186	175	166	157	148	141	SLU	ULS	431	396	366	339	315	292	273	255	238	223	210	198	186	175	166	157	148	141
	SLE*	1/150	308	283	261	242	225	190	171	154	139	126	115	104	95	87	79	73	67	61	SLE*	1/150	308	283	261	242	225	190	171	154	139	126	115	104	95	87	79	73	67	61
	SLS*	1/200	251	222	197	175	156	140	125	113	102	92	83	76	69	62	57	52	47	43	SLS*	1/200	251	222	197	175	156	140	125	113	102	92	83	76	69	62	57	52	47	43
	SLS*	1/250	199	175	155	138	123	109	98	88	79	71	64	58	53	48	43	39	36	33	SLS*	1/250	199	175	155	138	123	109	98	88	79	71	64	58	53	48	43	39	36	33
0,88	SLU	ULS	476	438	405	375	348	324	301	282	264	247	232	219	205	195	184	174	165	156	SLU	ULS	476	438	405	375	348	324	301	282	264	247	232	219	205	195	184	174	165	156
	SLE*	1/150	340	313	289	268	249	211	190	171	155	140	127	116	106	97	88	81	74	68	SLE*	1/150	340	313	289	268	249	211	190	171	155	140	127	116	106	97	88	81	74	68
	SLS*	1/200	280	247	219	194	173	155	139	125	113	102	93	84	76	70	63	58	53	48	SLS*	1/200	280	247	219	194	173	155	139	125	113	102	93	84	76	70	63	58	53	48
	SLS*	1/250	221	195	172	153	136	122	109	98	88	79	72	65	59	53	48	44	40	36	SLS*	1/250	221	195	172	153	136	122	109	98	88	79	72	65	59	53	48	44	40	36
1,00	SLU	ULS	545	501	462	429	398	370	345	322	301	283	265	250	235	222	210	198	187	178	SLU	ULS	545	501	462	429	398	370	345	322	301	283	265	250	235	222	210	198	187	178
	SLE*	1/150	389	358	330	306	284	243	219	197	178	162	147	134	122	111	102	93	86	79	SLE*	1/150	389	358	330	306	284	243	219	197	178	162	147	134	122	111	102	93	86	79
	SLS*	1/200	322	284	252	224	200	179	161	145	130	118	107	97	88	80	73	67	61	56	SLS*	1/200	322	284	252	224	200	179	161	145	130	118	107	97	88	80	73	67	61	56
	SLS*	1/250	255	225	199	176	157	140	126	113	102	92	83	75	68	62	56	51	46	42	SLS*	1/250	255	225	199	176	157	140	126	113	102	92	83	75	68	62	56	51	46	42
1,15	SLU	ULS	626	576	531	492	458	424	396	370	346	325	306	288	271	255	241	228	213	205	SLU	ULS	626	576	531	492	458	424	396	370	346	325	306	288	271	255	241	228	213	205
	SLE*	1/150	447	411	379	351	327	279	251	227	205	186	169	154	140	128	117	107	99	91	SLE*	1/150	447	411	379	351	327	279	251	227	205	186	169	154	140	128	117	107	99	91
	SLS*	1/200	447	327	290	258	230	206	185	166	150	136	123	112	101	92	84	77	70	64	SLS*	1/200	447	327	290	258	230	206	185	166	150	136	123	112	101	92	84	77	70	64
	SLS*	1/250	293	258	229	203	181	162	145	130	117	105	95	86	78	71	64	58	53	48	SLS*	1/250	293	258	229	203	181	162	145	130	117	105	95	86	78	71	64	58	53	48
1,25	SLU	ULS	680	626	578	536	497	462	430	402	376	354	331	312	294	277	262	247	235	222	SLU	ULS	680	626	578	536	497	462	430	402	376	354	331	312	294	277	262	247	235	222
	SLE*	1/150	485	447	413	383	355	330	307	287	269	253	234	217	200	187	171	157	143	130	SLE*	1/150	485	447	413	383	355	330	307	287	269	253	234	217	200	187	171	157	143	130
	SLS*	1/200	485	355	315	280	250	224	201	181	163	147	134	121	110	100	91	83	76	70	SLS*	1/200	485	355	315	280	250	224	201	181	163	147	134	121	110	100	91	83	76	70
	SLS*	1/250	319	281	248	221	197	176	157	141	127	115	104	94	85	77	70	63	58	52	SLS*	1/250	319	281	248	221	197	176	157	141	127	115	104	94	85	77	70	63	58	52
1,50	SLU	ULS	815	750	692	641	596	553	516	481	451	423	397	373	352	333	313	297	282	267	SLU	ULS	815	750	692	641	596	553	516	481	451	423	397	373	352	333	313	297	282	267
	SLE*	1/150	582	536	494	458	425	395	369	344	322	302	220	201	183	167	153	140	129	118	SLE*	1/150	582	536	494	458	425	395	369	344	322	302	220	201	183	167	153	140	129	118
	SLS*	1/200	582	458	418	383	353	324	297	271	249	228	207	186	165	144	123	110	100	91	SLS*	1/200	582	458	418	383	353	324	297	271	249	228	207	186	165	144	123	110	100	91
	SLS*	1/250	383	337	298	265	236	211	189	169	153	138	124	112	102	92	84	76	69	63	SLS*	1/250	383	337	298	265	236	211	189	169	153	138	124	112	102	92	84	76	69	63

I valori riportati in tabella sono da considerarsi come indicativi, è competenza del progettista procedere per i singoli casi di verifica al relativo calcolo.

SANDRINI metalli S.p.A. si riserva di variare in qualsiasi momento e senza preavviso le caratteristiche dei prodotti. Tutti i diritti riservati: vietata la riproduzione.

Larghezza appoggio intermedio: 200 mm - Larghezza appoggio esterno: 100 mm | Internal support width: 200 mm - End support width: 100 mm

Sp. Th. (mm)	Interasse appoggi (m) / Carico uniformemente distribuito (daN/m ²)																		Span (m) / Uniformly distributed load (daN/sqm)																		
	CAMPATA MULTIPLA / MULTIPLE SPAN																		CAMPATA MULTIPLA / MULTIPLE SPAN																		
	Stato limite / Limit state	5,00	5,20	5,40	5,60	5,80	6,00	6,20	6,40	6,60	6,80	7,00	7,20	7,40	7,60	7,80	8,00	8,20	8,40	Stato limite / Limit state	5,00	5,20	5,40	5,60	5,80	6,00	6,20	6,40	6,60	6,80	7,00	7,20	7,40	7,60	7,80	8,00	8,20
0,75	SLU	ULS	346	323	306	292	271	256	243	231	219	208	198	18																							

Larghezza appoggi: intermedio = 450 mm | esterno = 225 mm

Support width: Internal = 450 mm | End = 225 mm

Tabelle di portata (daN/m²) Load tables (daN/sqm)

steel s320GD

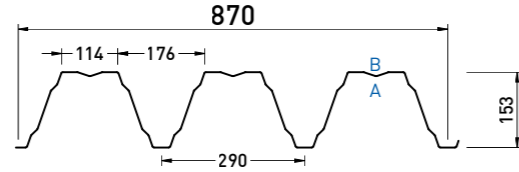

A: lato a vista - front side
B: lato non a vista - back side

POSITIVE

Reazione al fuoco Fire reaction
CLASS A1

Comportamento al fuoco dall'esterno External fire performance
Broof (t1,t2,t3)

Senza necessità di sottoporre a prova secondo la norma UNI EN 14782:2006. No lab test is required as per UNI EN 14782:2006.

Sp. Th. (mm)	DATI STATICI / STATIC DATA			PESO / WEIGHT Steel Kg/m ²
	Jy (cm ² /m)	We inf (cm ³ /m)	We sup (cm ³ /m)	
0,75	362,57	39,88	56,85	10,15
0,80	389,45	42,94	60,83	10,83
0,88	432,68	47,88	67,22	11,91
1,00	496,34	55,36	76,81	13,53
1,15	570,79	63,90	88,38	15,56
1,25	620,43	69,42	95,99	16,92
1,50	744,52	83,19	114,97	20,30

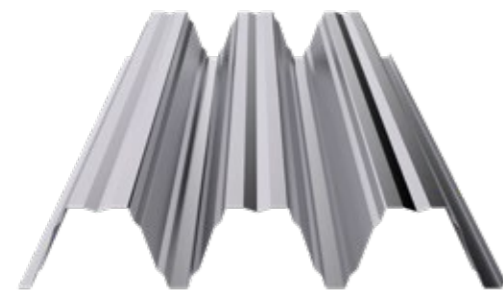

APPLICAZIONI
APPLICATIONS

SANDnodrip
Class A2 - s1, d0 Broof (t1,t2,t3)

SANDcontrol
Class C - s1, d0 Broof (t1,t2,t3)

Tabelle di portata (daN/m²) Load tables (daN/sqm)

steel s320GD

* Valori di portata caratteristici con coefficiente di sicurezza applicato pari a: $\gamma_q = 1,40$. Characteristic load with an applied safety coefficient equal to: $\gamma_q = 1,40$.
In azzurro i valori rappresentativi della portata con inflessione limite raggiunta. The values indicated in blue are representative of the load capacity with the limit inflection reached.

Larghezza appoggio esterno: 225 mm End support width: 225 mm

Sp. Th. mm	Interasse appoggi (m) / Carico uniformemente distribuito (daN/m ²)																	Span (m) / Uniformly distributed load (daN/sqm)																						
	CAMPATA SINGOLA																	SINGLE SPAN																						
	Stato limite Limit state	5,00	5,20	5,40	5,60	5,80	6,00	6,20	6,40	6,60	6,80	7,00	7,20	7,40	7,60	7,80	8,00	8,20	8,40	5,00	5,20	5,40	5,60	5,80	6,00	6,20	6,40	6,60	6,80	7,00	7,20	7,40	7,60	7,80	8,00	8,20	8,40			
0,75	SLU	ULS	422	389	359	332	309	287	268	250	234	218	206	193	183	173	164	154	146	139	422	389	359	332	309	287	268	250	234	218	206	193	183	173	164	154	146	139		
	SLE*	1/150	302	278	257	237	221	185	167	150	135	123	112	102	92	85	78	71	65	60	302	278	257	237	221	185	167	150	135	123	112	102	92	85	78	71	65	60		
		1/200	246	216	192	171	152	137	122	110	100	89	81	74	67	61	56	50	46	42	246	216	192	171	152	137	122	110	100	89	81	74	67	61	56	50	46	42		
		SLS*	1/250	194	171	151	134	120	107	96	86	78	69	63	57	51	46	42	39	35	32	194	171	151	134	120	107	96	86	78	69	63	57	51	46	42	39	35	32	
0,80	SLU	ULS	452	416	384	356	331	307	287	268	250	234	221	208	195	184	174	165	155	148	452	416	384	356	331	307	287	268	250	234	221	208	195	184	174	165	155	148		
	SLE*	1/150	323	297	275	254	236	200	180	162	146	132	121	109	100	91	83	77	70	64	323	297	275	254	236	200	180	162	146	132	121	109	100	91	83	77	70	64		
		1/200	264	233	207	184	164	147	131	119	107	97	87	80	72	65	60	55	49	45	264	233	207	184	164	147	131	119	107	97	87	80	72	65	60	55	49	45		
		SLS*	1/250	209	184	163	145	129	114	103	92	83	75	67	61	56	50	45	41	38	35	209	184	163	145	129	114	103	92	83	75	67	61	56	50	45	41	38	35	
0,88	SLU	ULS	499	460	425	394	365	340	316	296	277	259	244	230	215	205	193	183	173	164	499	460	425	394	365	340	316	296	277	259	244	230	215	205	193	183	173	164		
	SLE*	1/150	357	329	304	281	261	222	200	180	163	147	133	122	111	102	92	85	78	71	357	329	304	281	261	222	200	180	163	147	133	122	111	102	92	85	78	71		
		1/200	294	259	230	204	182	163	146	131	119	107	98	88	80	74	66	61	56	50	294	259	230	204	182	163	146	131	119	107	98	88	80	74	66	61	56	50		
		SLS*	1/250	232	205	181	161	143	128	114	103	92	83	76	68	62	56	50	46	42	38	232	205	181	161	143	128	114	103	92	83	76	68	62	56	50	46	42	38	
1,00	SLU	ULS	599	551	508	472	437	407	380	354	331	311	292	275	259	244	231	218	206	196	599	551	508	472	437	407	380	354	331	311	292	275	259	244	231	218	206	196		
	SLE*	1/150	428	394	363	337	312	267	241	217	196	178	162	147	134	122	112	102	95	87	428	394	363	337	312	267	241	217	196	178	162	147	134	122	112	102	95	87		
		1/200	354	312	277	246	220	197	177	160	143	130	118	107	97	88	80	74	67	62	354	312	277	246	220	197	177	160	143	130	118	107	97	88	80	74	67	62		
		SLS*	1/250	281	248	219	194	173	154	139	124	112	101	91	83	75	68	62	56	51	46	281	248	219	194	173	154	139	124	112	101	91	83	75	68	62	56	51	46	
1,15	SLU	ULS	688	634	584	541	503	466	436	407	381	358	337	317	298	281	265	251	234	226	688	634	584	541	503	466	436	407	381	358	337	317	298	281	265	251	234	226		
	SLE*	1/150	491	453	417	387	359	307	276	250	226	205	186	169	154	141	129	118	109	100	491	453	417	387	359	307	276	250	226	205	186	169	154	141	129	118	109	100		
		1/200	491	360	319	284	253	227	204	183	165	150	135	123	111	101	92	85	77	70	491	360	319	284	253	227	204	183	165	150	135	123	111	101	92	85	77	70		
		SLS*	1/250	322	284	252	223	199	178	160	143	129	116	105	95	86	78	70	64	58	53	322	284	252	223	199	178	160	143	129	116	105	95	86	78	70	64	58	53	
1,25	SLU	ULS	747	688	635	589	546	508	473	442	414	389	364	343	323	305	288	272	259	244	747	688	635	589	546	508	473	442	414	389	364	343	323	305	288	272	259	244		
	SLE*	1/150	534	491	454	421	390	363	338	316	295	278	202	184	167	153	140	129	118	108	534	491	454	421	390	363	338	316	295	278	202	184	167	153	140	129	118	108		
		1/200	534	391	347	308	275	246	221	199	179	162	147	133	121	110	100	91	84	77	534	391	347	308	275	246	221	199	179	162	147	133	121	110	100	91	84	77		
		SLS*	1/250	351	309	273	243	217	194	173	155	140	127	114	103	94	85	77	69	64	57	351	309	273	243	217	194	173	155	140	127	114	103	94	85	77	69	64	57	
1,50	SLU	ULS	896	825	761	705	655	608	568	529	496	465	437	410	387	366	344	327	310	294	896	825	761	705	655	608	568	529	496	465	437	410	387	366	344	327	310	294		
	SLE*	1/150	640	589	543	503	468	435	405	378	354	332	242	221	201	184	168	154	142	130	640	589	543	503	468	435	405	378	354	332	242	221	201	184	168	154	142	130		
		1/200	640	534	481	441	411	381	351	321	291	261	231	201	171	151	131	121	110	100	92	640	534	481	441	411	381	351	321	291	261	231	201	171	151	131	121	110	100	92
		SLS*	1/250	421	371	328	292	260	232	208	186	168	152	136	123	112	101	92	84	76	69	421	371	328	292	260	232	208	186	168	152	136	123	112	101	92	84	76	69	

I valori riportati in tabella sono da considerarsi come indicativi, è competenza del progettista procedere per i singoli casi di verifica al relativo calcolo.

SANDRINI metalli S.p.A. si riserva di variare in qualsiasi momento e senza preavviso le caratteristiche dei prodotti. Tutti i diritti riservati: vietata la riproduzione.

Larghezza appoggio intermedio: 450 mm - Larghezza appoggio esterno: 225 mm Internal support width: 450 mm - End support width: 225 mm

Sp. Th. mm	Interasse appoggi (m) / Carico uniformemente distribuito (daN/m ²)																	Span (m) / Uniformly distributed load (daN/sqm)																				
	CAMPATA MULTIPLA																	MULTIPLE SPAN																				
	Stato limite Limit state	5,00	5,20	5,40	5,60	5,80	6,00	6,20	6,40	6,60	6,80	7,00	7,20	7,40	7,60	7,80	8,00	8,20	8,40	5,00	5,20	5,40	5,60	5,80	6,00	6,20	6,40	6,60	6,80	7,00	7,20	7,40	7,60	7,80	8,00	8,20	8,40	
0,75	SLU	ULS	352	331	311	297	278	263	250	237	225	215	205	196	187	179	171	164	157	151	352	331	311	297	278	263	250	237	225	215	205	196	187	179	171	164	157	151
	SLE*	1/150	251	236	222	212	198	188	178	169	161	153	146	140	133	128	122	117	112	108	251	236	222	212	198	188	178	169	161	153	146	140	133					

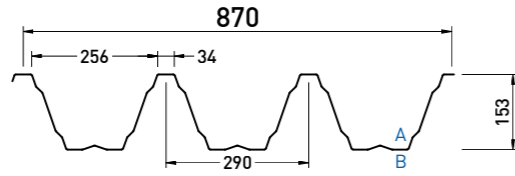

A: lato a vista - front side
B: lato non a vista - back side

Reazione al fuoco Fire reaction CLASS A1 **Comportamento al fuoco dall'esterno External fire performance Broof (t1,t2,t3)**

Senza necessità di sottoporre a prova secondo la norma UNI EN 14782:2006. No lab test is required as per UNI EN 14782:2006.



Sp. Th. (mm)	DATI STATICI / STATIC DATA			PESO / WEIGHT (Steel Kg/m²)
	Jy (cm²/m)	We inf (cm³/m)	We sup (cm³/m)	
0,75	362,57	56,85	39,88	10,15
0,80	389,45	60,83	42,94	10,83
0,88	432,68	67,22	47,88	11,91
1,00	496,34	76,81	55,36	13,53
1,15	570,79	88,38	63,90	15,56
1,25	620,43	95,99	69,42	16,92
1,50	744,52	114,97	83,19	20,30

APPLICAZIONI / APPLICATIONS

SANDnodrip
Class A2 - s1, d0 Broof (t1,t2,t3)

SANDcontrol
Class C - s1, d0 Broof (t1,t2,t3)

Tabelle di portata (daN/m²) Load tables (daN/sqm)

* Valori di portata caratteristici con coefficiente di sicurezza applicato pari a: $\gamma_q = 1,40$. Characteristic load with an applied safety coefficient equal to: $\gamma_q = 1,40$.
In azzurro i valori rappresentativi della portata con inflessione limite raggiunta. The values indicated in blue are representative of the load capacity with the limit inflection reached.

Sp. Th. (mm)	Larghezza appoggio esterno: 100 mm / End support width: 100 mm																			
	Interasse appoggi (m) / Carico uniformemente distribuito (daN/m²) / Span (m) / Uniformly distributed load (daN/sqm)																			
	Stato limite / Limit state	5,00	5,20	5,40	5,60	5,80	6,00	6,20	6,40	6,60	6,80	7,00	7,20	7,40	7,60	7,80	8,00	8,20	8,40	
0,75	SLU	ULS	389	357	330	305	284	264	246	229	214	201	189	178	168	157	109	141	133	126
	SLE* SLS*	1/150	278	255	236	218	203	175	158	142	128	116	106	96	88	80	73	67	62	57
		1/200	232	205	182	161	144	132	116	104	94	85	77	70	63	58	52	48	44	40
		1/250	184	162	143	130	113	101	91	81	73	66	59	54	49	44	40	36	33	30
0,80	SLU	ULS	419	384	356	329	305	283	264	247	231	217	204	192	180	171	160	151	144	136
	SLE* SLS*	1/150	299	274	254	235	218	188	169	153	138	125	114	103	94	86	79	72	66	61
		1/200	250	220	195	174	155	140	125	112	101	91	83	75	68	62	56	51	47	43
		1/250	200	174	154	140	122	110	100	87	79	71	64	58	52	47	43	39	35	32
0,88	SLU	ULS	467	429	396	368	341	316	295	276	258	243	228	214	201	190	180	169	160	153
	SLE* SLS*	1/150	333	306	283	263	243	209	188	170	154	139	127	115	105	96	88	80	74	68
		1/200	278	245	217	193	172	154	138	125	112	102	92	83	76	69	63	57	52	48
		1/250	220	194	171	152	135	121	108	97	88	79	71	64	58	53	48	44	40	36
1,00	SLU	ULS	540	497	459	425	395	367	342	320	280	264	247	234	220	208	196	186	177	177
	SLE* SLS*	1/150	386	355	328	303	282	241	217	196	177	161	146	133	121	111	101	93	85	78
		1/200	320	283	250	223	200	180	160	144	130	117	106	96	88	80	73	66	61	55
		1/250	254	223	201	175	156	140	125	112	101	91	82	74	67	61	55	50	46	42
1,15	SLU	ULS	626	576	531	492	458	424	396	370	346	325	306	288	271	255	241	228	213	205
	SLE* SLS*	1/150	447	411	379	351	327	279	251	227	205	186	169	154	140	128	117	107	99	91
		1/200	447	327	290	258	230	206	185	166	150	136	123	112	101	92	84	77	70	64
		1/250	293	258	229	203	181	162	145	130	117	105	95	86	78	71	64	58	53	48
1,25	SLU	ULS	680	626	578	536	497	462	430	402	376	354	331	312	294	277	262	247	235	222
	SLE* SLS*	1/150	485	447	413	383	355	330	307	287	269	253	234	217	201	187	171	157	143	133
		1/200	485	355	315	280	250	224	201	181	163	147	134	121	110	100	91	83	76	70
		1/250	319	281	248	221	197	176	157	141	127	115	104	94	85	77	70	63	58	52
1,50	SLU	ULS	815	750	692	641	596	553	516	481	451	423	397	373	352	333	313	297	282	267
	SLE* SLS*	1/150	582	536	494	458	425	395	369	344	322	302	280	261	243	226	210	194	179	164
		1/200	582	447	404	368	336	300	268	241	217	196	177	160	145	132	120	110	100	91
		1/250	383	337	298	265	236	211	189	169	153	138	124	112	102	92	84	76	69	63

I valori riportati in tabella sono da considerarsi come indicativi, è competenza del progettista procedere per i singoli casi di verifica al relativo calcolo.

SANDRINI metalli S.p.A. si riserva di variare in qualsiasi momento e senza preavviso le caratteristiche dei prodotti. Tutti i diritti riservati: vietata la riproduzione.

Tabelle di portata (daN/m²) Load tables (daN/sqm)

Sp. Th. (mm)	Larghezza appoggio intermedio: 200 mm - Larghezza appoggio esterno: 100 mm / Internal support width: 200 mm - End support width: 100 mm																			
	Interasse appoggi (m) / Carico uniformemente distribuito (daN/m²) / Span (m) / Uniformly distributed load (daN/sqm)																			
	Stato limite / Limit state	5,00	5,20	5,40	5,60	5,80	6,00	6,20	6,40	6,60	6,80	7,00	7,20	7,40	7,60	7,80	8,00	8,20	8,40	
0,75	SLU	ULS	287	271	254	240	227	215	205	194	183	174	167	159	152	146	140	134	128	123
	SLE* SLS*	1/150	205	194	181	171	162	153	146	138	131	124	119	114	108	104	100	95	91	88
		1/200	205	194	181	171	162	153	146	138	131	124	119	114	108	104	100	95	91	88
		1/250	205	194	181	171	162	153	146	138	131	124	119	114	108	104	100	95	91	88
0,80	SLU	ULS	315	297	279	263	249	236	222	212	201	191	182	174	165	159	152	146	140	134
	SLE* SLS*	1/150	225	212	199	188	178	168	159	151	144	136	130	124	118	114	108	104	100	95
		1/200	225	212	199	188	178	168	159	151	144	136	130	124	118	114	108	104	100	95
		1/250	225	212	199	188	178	168	159	151	144	136	130	124	118	114	108	104	100	95
0,88	SLU	ULS	363	341	320	302	285	269	255	242	230	218	207	198	189	180	173	165	159	152
	SLE* SLS*	1/150	259	243	228	215	204	192	182	173	164	155	148	141	135	129	123	118	114	108
		1/200	259	243	228	215	204	192	182	173	164	155	148	141	135	129	123	118	114	108
		1/250	259	243	228	215	204	192	182	173	164	155	148	141	135	129	123	118	114	108
1,00	SLU	ULS	437	410	384	362	341	323	305	288	273	260	248	236	225	215	206	197	188	179
	SLE* SLS*	1/150	312	293	274	258	243	230	218	206	195	185	177	168	161	153	147	140	134	128
		1/200	312	293	274	258	243	230	218	206	195	185	177	168	161	153	147	140	134	128
		1/250	312	293	274	258	243	230	218	206	195	185	177	168	161	153	147	140	134	128
1,15	SLU	ULS	533	498	467	440	413	390	368	348	330	314	299	284	270	255	242	228	216	206
	SLE* SLS*	1/150	380	356	333	314	295	279	263	249	236	224	213	203	193	182	173	163	154	147
		1/200	380	356	333	314	295	279	263	249	236	224	213	203	193	182	173	163	154	147
		1/250	380	356	333	314	295	279	263	249	236	224	213	203	193	182	173	163	154	147
1,25	SLU	ULS	594	555	521	489	459	434	410	387	366	348	330	312	294	278	263	248	236	222
	SLE* SLS*	1/150	424	396	372	349	328	310	293	276	261	249	236	223	210	198	188	177	168	159
		1/200	424	396	372	349	328	310	293	276	261	249	236	223	210	198	188	177	168	159
		1/250	424	396	372	349	328	310	293	276	261	249	236	223	210	198	188	177	168	159
1,50	SLU	ULS	746	696	651	611	575	540	510	482	452	423	398	374	353	333	314	297	282	267
	SLE* SLS*	1/150	533	497	465	436	410	386	364	344	323	302	284	267	252	238	224	212	201	191
		1/200	533	497	465	436	410	386	364	344	323	302	284	267	252	238	224	212	201	191
		1/250	533	497	465	436	410	386	364	344	323	302	284	267	252	238	224	212	201	191

The values shown in the table must be considered as indicative, the designer has the responsibility to proceed with the relevant calculation in any individual cases.

SANDRINI metalli S.p.A. reserves the right to change the characteristics of the products at any time and without prior notice. All rights reserved: reproduction is prohibited.

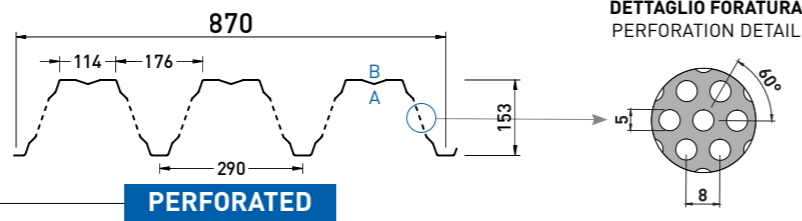

A: lato a vista - front side
B: lato non a vista - back side

Reazione al fuoco Fire reaction CLASS A1
Comportamento al fuoco dall'esterno External fire performance Broof (t1,t2,t3)
Senza necessità di sottoporre a prova secondo la norma UNI EN 14782:2006. No lab test is required as per UNI EN 14782:2006.

Sp. Th. (mm)	DATI STATICI / STATIC DATA			PESO / WEIGHT (Steel Kg/m ²)
	Jy (cm ² /m)	We inf (cm ³ /m)	We sup (cm ³ /m)	
0,75	342,86	36,64	57,19	9,65
0,80	368,68	39,52	61,17	10,29
0,88	410,32	44,17	67,55	11,32
1,00	473,22	51,22	77,12	12,87
1,15	546,16	59,16	88,70	14,80
1,25	593,71	64,27	66,34	16,08
1,50	712,46	77,02	115,37	19,30

APPLICAZIONI / APPLICATIONS
 SANDnodrip Class A2 - s1, d0 Broof (t1,t2,t3)
 SANDcontrol Class C - s1, d0 Broof (t1,t2,t3)

Tabelle di portata (daN/m²) Load tables (daN/sqm)

* Valori di portata caratteristici con coefficiente di sicurezza applicato pari a: $\gamma_q = 1,40$. Characteristic load with an applied safety coefficient equal to: $\gamma_q = 1,40$.
In azzurro i valori rappresentativi della portata con inflessione limite raggiunta. The values indicated in blue are representative of the load capacity with the limit inflection reached.

Larghezza appoggio esterno: 100 mm End support width: 100 mm

Sp. Th. (mm)	Interasse appoggi (m) / Carico uniformemente distribuito (daN/m ²)																	Span (m) / Uniformly distributed load (daN/sqm)																						
	CAMPATA SINGOLA / SINGLE SPAN																	CAMPATA SINGOLA / SINGLE SPAN																						
mm	Stato limite / Limit state	5,00	5,20	5,40	5,60	5,80	6,00	6,20	6,40	6,60	6,80	7,00	7,20	7,40	7,60	7,80	8,00	8,20	8,40	5,00	5,20	5,40	5,60	5,80	6,00	6,20	6,40	6,60	6,80	7,00	7,20	7,40	7,60	7,80	8,00	8,20	8,40			
0,75	SLU	ULS	274	263	253	244	235	227	220	213	206	198	186	175	165	156	147	139	132	125	274	263	253	244	235	227	220	213	206	198	186	175	165	156	147	139	132	125		
	SLE* SLS*	1/150	195	188	181	174	168	162	157	141	128	116	106	96	88	81	74	68	62	57	195	188	181	174	168	162	157	141	128	116	106	96	88	81	74	68	62	57		
		1/200	195	188	181	160	143	128	115	104	94	85	77	70	64	58	53	49	45	41	195	188	181	160	143	128	115	104	94	85	77	70	64	58	53	49	45	41		
		1/250	195	161	143	127	113	101	91	82	74	67	60	55	50	45	41	37	34	31	195	161	143	127	113	101	91	82	74	67	60	55	50	45	41	37	34	31		
0,80	SLU	ULS	315	302	291	280	271	261	253	240	225	211	199	187	176	166	157	149	141	134	315	302	291	280	271	261	253	240	225	211	199	187	176	166	157	149	141	134		
	SLE* SLS*	1/150	225	216	208	200	193	187	168	152	138	125	114	104	95	87	79	73	67	62	225	216	208	200	193	187	168	152	138	125	114	104	95	87	79	73	67	62		
		1/200	225	216	194	172	154	138	124	112	101	92	83	76	69	63	57	52	48	44	225	216	194	172	154	138	124	112	101	92	83	76	69	63	57	52	48	44		
		1/250	196	173	153	136	121	109	98	88	79	71	65	59	53	49	44	40	37	34	196	173	153	136	121	109	98	88	79	71	65	59	53	49	44	40	37	34		
0,88	SLU	ULS	386	371	357	344	327	304	284	265	249	233	219	206	195	184	174	164	156	148	386	371	357	344	327	304	284	265	249	233	219	206	195	184	174	164	156	148		
	SLE* SLS*	1/150	276	265	255	246	234	217	187	169	153	139	126	115	105	96	88	81	74	69	276	265	255	246	234	217	187	169	153	139	126	115	105	96	88	81	74	69		
		1/200	276	242	215	191	171	153	138	124	112	102	92	84	77	70	64	58	53	49	276	242	215	191	171	153	138	124	112	102	92	84	77	70	64	58	53	49		
		1/250	218	192	170	151	135	121	108	98	88	79	72	65	59	54	49	45	41	37	218	192	170	151	135	121	108	98	88	79	72	65	59	54	49	45	41	37		
1,00	SLU	ULS	506	469	433	401	373	347	324	302	283	266	250	235	222	209	198	187	178	168	506	469	433	401	373	347	324	302	283	266	250	235	222	209	198	187	178	168		
	SLE* SLS*	1/150	362	335	309	287	266	248	214	194	175	159	145	132	121	110	101	93	85	79	362	335	309	287	266	248	214	194	175	159	145	132	121	110	101	93	85	79		
		1/200	362	278	247	220	196	176	158	143	129	117	106	96	88	80	73	67	61	56	362	278	247	220	196	176	158	143	129	117	106	96	88	80	73	67	61	56		
		1/250	250	220	195	174	155	139	124	112	101	91	83	75	68	62	56	52	47	43	250	220	195	174	155	139	124	112	101	91	83	75	68	62	56	52	47	43		
1,15	SLU	ULS	585	539	498	461	428	398	372	348	326	305	287	270	255	241	227	215	204	193	585	539	498	461	428	398	372	348	326	305	287	270	255	241	227	215	204	193		
	SLE* SLS*	1/150	418	385	355	329	306	285	247	223	202	183	167	152	139	127	116	107	98	90	418	385	355	329	306	285	247	223	202	183	167	152	139	127	116	107	98	90		
		1/200	418	320	284	253	226	202	182	164	148	134	122	111	101	92	84	77	71	65	418	320	284	253	226	202	182	164	148	134	122	111	101	92	84	77	71	65		
		1/250	287	253	224	200	178	159	143	129	116	105	95	86	78	71	65	59	54	49	287	253	224	200	178	159	143	129	116	105	95	86	78	71	65	59	54	49		
1,25	SLU	ULS	635	585	541	501	465	433	404	378	354	332	312	294	277	261	247	234	222	210	635	585	541	501	465	433	404	378	354	332	312	294	277	261	247	234	222	210		
	SLE* SLS*	1/150	454	418	386	358	332	309	268	242	219	199	181	165	151	138	127	116	107	98	454	418	386	358	332	309	268	242	219	199	181	165	151	138	127	116	107	98		
		1/200	454	348	308	274	245	220	198	178	161	146	132	120	110	100	92	84	77	70	454	348	308	274	245	220	198	178	161	146	132	120	110	100	92	84	77	70		
		1/250	312	275	244	217	194	173	155	140	126	114	103	94	85	77	71	64	59	54	312	275	244	217	194	173	155	140	126	114	103	94	85	77	71	64	59	54		
1,50	SLU	ULS	761	701	648	600	557	519	484	452	424	398	374	352	332	313	296	280	265	252	761	701	648	600	557	519	484	452	424	398	374	352	332	313	296	280	265	252		
	SLE* SLS*	1/150	544	501	463	429	398	371	322	290	263	239	217	198	181	166	152	139	128	118	544	501	463	429	398	371	322	290	263	239	217	198	181	166	152	139	128	118		
		1/200	544	454	401	370	329	294	264	237	214	193	175	159	145	132	120	110	101	92	85	544	454	401	370	329	294	264	237	214	193	175	159	145	132	120	110	101	92	85
		1/250	375	331	293	260	232	208	187	168	151	137	124	112	102	93	85	77	71	64	375	331	293	260	232	208	187	168	151	137	124	112	102	93	85	77	71	64		

I valori riportati in tabella sono da considerarsi come indicativi, è competenza del progettista procedere per i singoli casi di verifica al relativo calcolo.
SANDRINI metalli S.p.A. si riserva di variare in qualsiasi momento e senza preavviso le caratteristiche dei prodotti. Tutti i diritti riservati: vietata la riproduzione.

Tabelle di portata (daN/m²) Load tables (daN/sqm)

Larghezza appoggio intermedio: 200 mm - Larghezza appoggio esterno: 100 mm Internal support width: 200 mm - End support width: 100 mm

Sp. Th. (mm)	Interasse appoggi (m) / Carico uniformemente distribuito (daN/m ²)																	Span (m) / Uniformly distributed load (daN/sqm)																				
	CAMPATA DOPPIA / DOUBLE SPAN																	CAMPATA DOPPIA / DOUBLE SPAN																				
mm	Stato limite / Limit state	5,00	5,20	5,40	5,60	5,80	6,00	6,20	6,40	6,60	6,80	7,00	7,20	7,40	7,60	7,80	8,00	8,20	8,40	5,00	5,20	5,40	5,60	5,80	6,00	6,20	6,40	6,60	6,80	7,00	7,20	7,40	7,60	7,80	8,00	8,20	8,40	
0,75	SLU	ULS	209	197	186	176	167	159	151	144	137	131	125	120	115	110	106	102	98	94	209	197	186	176	167	159	151	144	137	131	125	120	115	110	106	102	98	94
	SLE* SLS*	1/150	149	141	133	126	119	113	108	103	98	94	89	86	82	79	75	73	70	67	149	141	133	126	119	113	108	103	98	94	89	86	82	79	75	73	70	67
		1/200	149	141	133	126	119	113	108	103	98	94	89	86	82	79	75	73	70	67	149	141	133	126	119	113	108	103	98	94	89	86	82	79	75	73	70	67
		1/300	149	141	133	126	119	113	108	103	98</																											

Larghezza appoggi: intermedio = 200 mm | esterno = 100 mm

Support width: Internal = 200 mm | End = 100 mm

Tabelle di portata (daN/m²) Load tables (daN/sqm)

steel s320GD

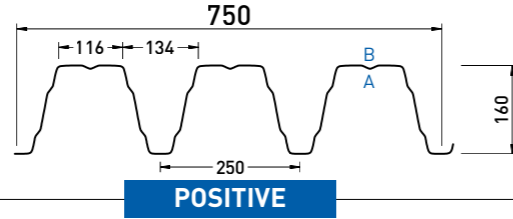

A: lato a vista - front side
B: lato non a vista - back side

Reazione al fuoco Fire reaction CLASS A1
Comportamento al fuoco dall'esterno External fire performance Broof (t1,t2,t3)
Senza necessità di sottoporre a prova secondo la norma UNI EN 14782:2006. No lab test is required as per UNI EN 14782:2006.

Sp. Th. (mm)	DATI STATICI / STATIC DATA			PESO / WEIGHT (Steel Kg/m ²)
	Jy (cm ² /m)	We inf (cm ³ /m)	We sup (cm ³ /m)	
0,75	469,04	48,83	69,92	11,78
0,80	503,89	52,60	74,83	12,56
0,88	559,96	58,70	82,71	13,82
1,00	643,91	67,94	94,54	15,70
1,15	740,5	78,90	109,02	18,06
1,25	804,89	85,71	118,41	19,63
1,50	965,88	102,72	141,83	23,55

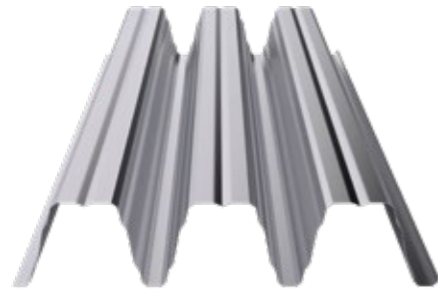

APPLICAZIONI / APPLICATIONS

SANDnodrip
Class A2 - s1, d0 🔥 Broof (t1,t2,t3)

SANDcontrol
Class C - s1, d0 🔥 Broof (t1,t2,t3)

Tabelle di portata (daN/m²) Load tables (daN/sqm)

steel s320GD

* Valori di portata caratteristici con coefficiente di sicurezza applicato pari a: $\gamma_q = 1,40$. Characteristic load with an applied safety coefficient equal to: $\gamma_q = 1,40$.
In azzurro i valori rappresentativi della portata con inflessione limite raggiunta. The values indicated in blue are representative of the load capacity with the limit inflection reached.

Sp. Th. (mm)	Larghezza appoggio esterno: 100 mm / End support width: 100 mm																		
	CAMPATA SINGOLA / SINGLE SPAN																		
	Stato limite / Limit state	5,00	5,20	5,40	5,60	5,80	6,00	6,20	6,40	6,60	6,80	7,00	7,20	7,40	7,60	7,80	8,00	8,20	8,40
0,75	SLU	418	384	355	329	305	284	265	248	232	217	204	192	181	171	162	153	145	137
	SLE*	298	275	254	235	218	203	189	177	155	140	128	116	106	97	89	82	75	69
	SLS*	221	195	172	153	137	122	109	98	89	80	72	66	60	54	49	45	41	37
		182	161	142	126	112	100	89	80	72	65	59	53	48	43	39	36	32	29
0,80	SLU	447	411	380	352	327	304	284	265	248	233	219	206	194	183	173	164	155	147
	SLE*	319	294	271	251	233	217	203	189	166	151	137	125	114	104	96	88	81	74
	SLS*	237	209	185	165	147	131	118	106	95	86	78	71	64	58	53	48	44	40
		196	173	153	135	120	108	96	86	78	70	63	57	51	47	42	38	35	31
0,88	SLU	494	455	420	389	361	336	313	293	274	257	242	227	214	202	191	181	171	162
	SLE*	353	325	300	278	258	240	224	209	196	184	161	147	134	123	112	103	95	87
	SLS*	279	246	218	194	173	155	139	126	113	103	93	85	77	70	64	59	54	49
		230	203	179	159	141	126	113	101	91	82	74	67	61	55	50	45	41	37
1,00	SLU	564	520	480	444	413	384	358	335	313	294	276	260	245	231	218	207	196	186
	SLE*	403	371	343	317	295	274	256	239	224	210	197	178	162	149	136	125	115	106
	SLS*	338	298	263	234	209	187	167	151	136	123	111	101	91	83	75	69	63	57
		279	245	217	193	171	153	137	123	110	100	90	81	73	66	60	55	50	45
1,15	SLU	648	597	551	511	474	441	411	385	360	338	317	299	281	266	251	237	225	213
	SLE*	463	426	394	365	339	315	294	275	257	241	227	205	187	171	157	144	132	121
	SLS*	388	342	303	269	240	215	193	173	156	141	128	116	105	95	87	79	72	66
		320	282	250	221	197	176	157	141	127	114	103	93	84	76	69	63	57	52
1,25	SLU	704	648	599	555	515	479	447	418	391	367	345	324	306	289	273	258	244	232
	SLE*	503	463	428	396	368	342	319	298	279	262	246	222	203	186	170	156	143	132
	SLS*	422	372	329	293	261	233	209	188	170	153	139	126	114	104	94	86	78	71
		348	307	271	241	214	191	171	154	138	124	112	101	92	83	75	68	62	56
1,50	SLU	844	777	718	665	617	574	536	501	469	440	413	389	366	346	327	309	293	278
	SLE*	603	555	513	445	397	356	320	288	260	236	214	194	177	161	147	135	123	113
	SLS*	506	446	395	351	313	280	251	226	204	184	166	151	137	124	113	103	94	86
		418	368	325	289	257	229	205	184	166	149	135	122	110	100	90	82	74	67

I valori riportati in tabella sono da considerarsi come indicativi, è competenza del progettista procedere per i singoli casi di verifica al relativo calcolo.

SANDRINI metalli S.p.A. si riserva di variare in qualsiasi momento e senza preavviso le caratteristiche dei prodotti. Tutti i diritti riservati: vietata la riproduzione.

Sp. Th. (mm)	Larghezza appoggio intermedio: 200 mm - Larghezza appoggio esterno: 100 mm / Internal support width: 200 mm - End support width: 100 mm																		
	CAMPATA DOPPIA / DOUBLE SPAN																		
	Stato limite / Limit state	5,00	5,20	5,40	5,60	5,80	6,00	6,20	6,40	6,60	6,80	7,00	7,20	7,40	7,60	7,80	8,00	8,20	8,40
0,75	SLU	295	277	261	246	233	220	209	198	189	180	171	163	156	149	143	137	131	126
	SLE*	211	198	186	176	166	157	149	142	135	128	122	117	112	107	102	98	94	90
	SLS*	211	198	186	176	166	157	149	142	135	128	122	117	112	107	102	98	94	90
		211	198	186	176	166	157	149	142	135	128	122	117	112	107	102	98	94	90
0,80	SLU	340	320	301	284	268	254	240	228	217	206	197	188	179	171	164	157	151	145
	SLE*	243	228	215	203	191	181	172	163	155	147	140	134	128	122	117	112	108	103
	SLS*	243	228	215	203	191	181	172	163	155	147	140	134	128	122	117	112	108	103
		243	228	215	203	191	181	172	163	155	147	140	134	128	122	117	112	108	103
0,88	SLU	411	386	363	342	323	306	289	275	261	248	236	225	215	206	197	188	181	173
	SLE*	294	276	259	245	231	218	207	196	186	177	169	161	154	147	140	135	129	124
	SLS*	294	276	259	245	231	218	207	196	186	177	169	161	154	147	140	135	129	124
		294	276	259	245	231	218	207	196	186	177	169	161	154	147	140	135	129	124
1,00	SLU	521	489	459	432	408	385	365	346	328	312	297	283	270	258	247	236	226	217
	SLE*	372	349	328	309	291	275	261	247	234	223	212	202	193	184	176	169	161	155
	SLS*	372	349	328	309	291	275	261	247	234	223	212	202	193	184	176	169	161	155
		372	349	328	309	291	275	261	247	234	223	212	202	193	184	176	169	161	155
1,15	SLU	633	593	556	523	493	466	440	417	396	376	357	340	324	310	296	283	270	256
	SLE*	452	423	397	374	352	333	314	298	283	268	255	243	232	221	211	202	193	183
	SLS*	452	423	397	374	352	333	314	298	283	268	255	243	232	221	211	202	193	183
		452	423	397	374	352	333	314	298	283	268	255	243	232	221	211	202	193	183
1,25	SLU	706	661	620	583	549	518	489	463	439	417	396	377	360	343	327	310	293	278
	SLE*	504	472	443	416	392	370	350	331	314	298	283	270	257	245	234	221	209	199
	SLS*	504	472	443	416	392	370	350	331	314	298	283	270	257	245	234	221	209	199
		504	472	443	416	392	370	350	331	314	298	283	270	257	245	234	221	209	199
1,50	SLU	892	834	781	733	690	650	614	580	550	521	495	466	440	415	392	371	351	333
	SLE*	637	596	558	524	493	464	438	415	393	372	354	333	314	296	280	265	251	238
	SLS*	637	596	558	524	493	464	438	415	393	372	354	333	314	296	280	265	251	238
		637	596	558	524	493	464	438	415	393	372	354	333	314	296	280	265	251	238

Sp. Th. (mm)	Larghezza appoggio intermedio: 200 mm - Larghezza appoggio esterno: 100 mm / Internal support width: 200 mm - End support width: 100 mm																		
	CAMPATA MULTIPLA / MULTIPLE SPAN																		
	Stato limite / Limit state	5,00	5,20	5,40	5,60	5,80	6,00	6,20	6,40	6,60	6,80	7,00	7,20	7,40	7,60	7,80	8,00	8,20	8,40
0,75	SLU	353	332	313	295	279	265	251	239	227	216	206	197	188	180	173	166	159	153
	SLE*	252	237	223	211	200	189	179	170	162	155	147	141	135	129	123	118	114	109
	SLS*	252	237	223	211	200	189	179	170	162	155	147	141	135	129	123	118	114	109
		252	237	223	211	200	189	179	170	162	155	147	141	135	129	123	118	114	109</

Larghezza appoggi: intermedio = 450 mm | esterno = 225 mm

Support width: Internal = 450 mm | End = 225 mm

Tabelle di portata (daN/m²) Load tables (daN/sqm)

steel s320GD

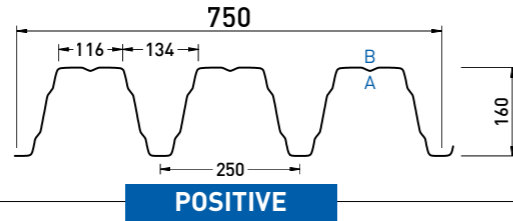

A: lato a vista - front side
B: lato non a vista - back side

Reazione al fuoco Fire reaction CLASS A1
Comportamento al fuoco dall'esterno External fire performance Broof (t1,t2,t3)
Senza necessità di sottoporre a prova secondo la norma UNI EN 14782:2006. No lab test is required as per UNI EN 14782:2006.

Sp. Th. (mm)	DATI STATICI / STATIC DATA			PESO / WEIGHT (Steel Kg/m ²)
	Jy (cm ² /m)	We inf (cm ³ /m)	We sup (cm ³ /m)	
0,75	469,04	48,83	69,92	11,78
0,80	503,89	52,60	74,83	12,56
0,88	559,96	58,70	82,71	13,82
1,00	643,91	67,94	94,54	15,70
1,15	740,5	78,90	109,02	18,06
1,25	804,89	85,71	118,41	19,63
1,50	965,88	102,72	141,83	23,55

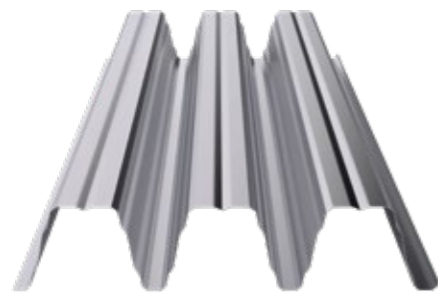

APPLICAZIONI / APPLICATIONS

SANDnodrip
Class A2 - s1, d0 🔥 Broof (t1,t2,t3)

SANDcontrol
Class C - s1, d0 🔥 Broof (t1,t2,t3)

Tabelle di portata (daN/m²) Load tables (daN/sqm)

steel s320GD

* Valori di portata caratteristici con coefficiente di sicurezza applicato pari a: $\gamma_f = 1,40$. Characteristic load with an applied safety coefficient equal to: $\gamma_f = 1,40$.
In azzurro i valori rappresentativi della portata con inflessione limite raggiunta. The values indicated in blue are representative of the load capacity with the limit inflection reached.

Larghezza appoggio esterno: 225 mm | End support width: 225 mm

Sp. Th. (mm)	Interasse appoggi (m) / Carico uniformemente distribuito (daN/m ²)																		Span (m) / Uniformly distributed load (daN/sqm)																					
	CAMPATA SINGOLA / SINGLE SPAN																		CAMPATA SINGOLA / SINGLE SPAN																					
	Stato limite / Limit state	5,00	5,20	5,40	5,60	5,80	6,00	6,20	6,40	6,60	6,80	7,00	7,20	7,40	7,60	7,80	8,00	8,20	8,40	Stato limite / Limit state	5,00	5,20	5,40	5,60	5,80	6,00	6,20	6,40	6,60	6,80	7,00	7,20	7,40	7,60	7,80	8,00	8,20	8,40		
0,75	SLU	ULS	438	404	373	345	321	298	278	260	243	228	215	202	190	180	170	160	152	144	SLU	ULS	409	385	363	343	324	307	291	277	263	251	239	229	219	209	200	192	184	177
	SLE*	1/150	313	288	266	247	229	213	199	186	163	147	134	122	111	102	93	86	79	72	SLE*	1/150	292	275	259	245	231	219	208	198	188	179	171	163	156	149	143	137	132	127
	SLS*	1/200	293	258	229	204	182	163	146	132	119	108	98	89	81	74	67	61	56	51	SLS*	1/200	292	275	259	245	231	219	208	198	188	179	171	163	156	149	143	137	132	127
	SLS*	1/250	232	205	181	161	143	128	115	103	93	84	76	69	62	57	52	47	43	39	SLS*	1/250	292	275	259	245	231	219	208	198	188	179	171	163	156	149	143	137	132	127
0,80	SLU	ULS	469	432	399	369	343	319	298	278	261	244	230	216	204	192	182	172	163	154	SLU	ULS	489	460	433	409	387	366	347	330	314	299	285	272	260	249	238	228	219	210
	SLE*	1/150	335	309	285	264	245	228	213	199	175	158	144	131	120	110	100	92	85	78	SLE*	1/150	349	328	309	292	276	261	248	236	224	213	203	194	186	178	170	163	156	150
	SLS*	1/200	315	278	246	219	196	175	157	142	128	116	105	96	87	79	72	66	60	55	SLS*	1/200	349	328	309	292	276	261	248	236	224	213	203	194	186	178	170	163	156	150
	SLS*	1/250	249	220	195	173	154	138	124	111	100	90	82	74	67	61	56	51	46	42	SLS*	1/250	349	328	309	292	276	261	248	236	224	213	203	194	178	163	149	137	126	116
0,88	SLU	ULS	519	477	441	408	379	353	329	308	288	270	254	239	225	212	201	190	180	171	SLU	ULS	592	556	524	494	467	442	419	398	378	360	343	327	312	299	286	274	263	252
	SLE*	1/150	370	341	315	292	271	252	235	220	206	193	169	154	141	129	118	108	99	91	SLE*	1/150	423	397	374	353	333	316	299	284	270	257	245	234	223	213	204	196	188	180
	SLS*	1/200	370	326	289	257	230	206	185	166	150	136	123	112	102	93	85	78	71	65	SLS*	1/200	423	397	374	353	333	316	299	284	270	257	245	234	223	213	204	196	188	180
	SLS*	1/250	293	258	228	203	181	162	145	130	118	106	96	87	79	72	65	59	54	49	SLS*	1/250	423	397	374	353	333	316	299	284	270	257	245	234	223	213	204	196	188	180
1,00	SLU	ULS	621	571	528	489	454	422	394	368	345	323	304	286	269	254	240	227	215	204	SLU	ULS	740	694	653	615	581	549	520	493	469	446	425	405	386	369	353	338	324	311
	SLE*	1/150	443	408	377	349	324	302	281	263	246	231	217	196	179	163	150	137	126	116	SLE*	1/150	528	496	466	439	415	392	371	352	335	318	303	289	276	264	252	242	232	222
	SLS*	1/200	443	408	377	326	291	261	235	211	191	173	157	142	130	118	108	99	90	83	SLS*	1/200	528	496	466	439	415	392	371	352	335	318	303	289	276	264	252	242	232	222
	SLS*	1/250	371	327	290	258	230	205	184	166	149	135	122	111	100	91	83	76	69	63	SLS*	1/250	528	496	466	439	415	392	371	352	335	318	303	289	276	264	252	242	232	222
1,15	SLU	ULS	713	657	606	562	521	485	453	423	396	371	349	328	310	292	276	261	247	235	SLU	ULS	842	790	742	698	659	622	589	558	530	503	479	456	435	416	398	381	365	350
	SLE*	1/150	509	469	433	401	372	347	323	302	283	265	249	225	205	188	172	158	145	133	SLE*	1/150	602	564	530	499	470	444	421	399	378	360	342	326	311	297	284	272	260	250
	SLS*	1/200	509	469	433	375	335	300	270	243	220	199	180	164	149	136	124	114	104	95	SLS*	1/200	602	564	530	499	470	444	421	399	378	360	342	326	311	297	284	272	260	250
	SLS*	1/250	427	376	333	296	264	236	212	190	172	155	140	127	115	105	95	87	79	72	SLS*	1/250	602	564	530	499	470	444	421	399	378	360	342	326	311	297	284	272	260	250
1,25	SLU	ULS	828	773	731	679	632	589	551	516	484	454	428	403	380	359	340	322	305	SLU	ULS	981	919	863	811	765	722	683	647	614	583	555	528	504	481	459	440	421	403	
	SLE*	1/150	553	510	471	436	405	377	351	328	307	288	271	245	223	204	187	172	158	145	SLE*	1/150	701	656	616	580	546	516	488	462	438	416	396	377	360	343	328	314	301	288
	SLS*	1/200	553	510	471	408	364	326	293	264	239	216	196	178	162	148	135	123	113	103	SLS*	1/200	701	656	616	580	546	516	488	462	438	416	396	377	360	343	328	314	301	288
	SLS*	1/250	464	409	362	322	287	257	230	207	187	169	152	138	125	114	104	94	86	79	SLS*	1/250	701	656	616	580	546	516	488	462	438	416	396	377	360	343	328	314	301	288
1,50	SLU	ULS	928	855	789	731	679	632	589	551	516	484	454	428	403	380	359	340	322	305	SLU	ULS	1243	1163	1090	1024	964	909	859	813	770	731	695	661	630	601	572	542	514	488
	SLE*	1/150	663	611	564	522	485	451	421	393	368	345	325	294	268	245	225	206	189	174	SLE*	1/150	888	831	779	732	689	649	614	581	550	522	496	472	450	429	409	387	367	348
	SLS*	1/200	663	611	564	489	437	391	352	317	286	259	235	214	195	177	162	148	136	124	SLS*	1/200	888	831	779	732	689	649	614	581	550	522	496	472	450	429	409	387	367	348
	SLS*	1/250	557	491	435	386	344	308	276	248	224	202	183	166	151	137	124	113	103	94	SLS*	1/250	888	831	779	732	689	649	614	581	550	522	496	472	450	429	409	387	367	348

I valori riportati in tabella sono da considerarsi come indicativi, è competenza del progettista procedere per i singoli casi di verifica al relativo calcolo.

SANDRINI metalli S.p.A. si riserva di variare in qualsiasi momento e senza preavviso le caratteristiche dei prodotti. Tutti i diritti riservati: vietata la riproduzione.

Larghezza appoggio intermedio: 450 mm - Larghezza appoggio esterno: 225 mm | Internal support width: 450 mm - End support width: 225 mm

Sp. Th. (mm)	Interasse appoggi (m) / Carico uniformemente distribuito (daN/m ²)																		Span (m) / Uniformly distributed load (daN/sqm)																		
	CAMPATA MULTIPLA / MULTIPLE SPAN																		CAMPATA MULTIPLA / MULTIPLE SPAN																		
	Stato limite / Limit state	5,00	5,20	5,40	5,60	5,80	6,00	6,20	6,40	6,60	6,80	7,00	7,20	7,40	7,60	7,80	8,00	8,20	8,40	Stato limite / Limit state	5,00	5,20	5,40	5,60	5,80	6,00	6,20	6,40	6,60	6,80	7,00	7,20	7,40	7,60	7,80	8,00	8,20
0,75	SLU	ULS	409	385	363	343	324																														

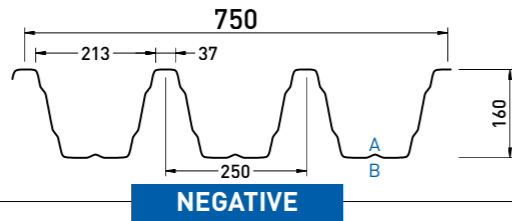

A: lato a vista - front side
B: lato non a vista - back side

Reazione al fuoco Fire reaction CLASS A1
Comportamento al fuoco dall'esterno External fire performance Broof (t1,t2,t3)
Senza necessità di sottoporre a prova secondo la norma UNI EN 14782:2006. No lab test is required as per UNI EN 14782:2006.



Sp. Th. (mm)	DATI STATICI / STATIC DATA			PESO / WEIGHT (Kg/m²)
	Jy (cm³/m)	We inf (cm³/m)	We sup (cm³/m)	
0,75	469,04	69,92	48,83	11,78
0,80	503,89	74,83	52,60	12,56
0,88	559,96	82,71	58,70	13,82
1,00	643,91	94,54	67,94	15,70
1,15	740,5	109,02	78,90	18,06
1,25	804,89	118,41	85,71	19,63
1,50	965,88	141,83	102,72	23,55

APPLICAZIONI / APPLICATIONS

SANDnodrip
Class A2 - s1, d0 Broof (t1,t2,t3)

SANDcontrol
Class C - s1, d0 Broof (t1,t2,t3)

Tabelle di portata (daN/m²) Load tables (daN/sqm)

* Valori di portata caratteristici con coefficiente di sicurezza applicato pari a: $\gamma_q = 1,40$. Characteristic load with an applied safety coefficient equal to: $\gamma_q = 1,40$.
In azzurro i valori rappresentativi della portata con inflessione limite raggiunta. The values indicated in blue are representative of the load capacity with the limit inflection reached.

Sp. Th. (mm)	Larghezza appoggio esterno: 100 mm / End support width: 100 mm																			
	CAMPATA SINGOLA / SINGLE SPAN																			
	Stato limite / Limit state	5,00	5,20	5,40	5,60	5,80	6,00	6,20	6,40	6,60	6,80	7,00	7,20	7,40	7,60	7,80	8,00	8,20	8,40	
0,75	SLU	ULS	397	365	337	312	290	270	252	235	220	207	194	183	172	162	153	145	138	130
	SLE* SLS*	1/150	283	261	241	223	207	193	180	168	147	133	121	110	101	92	84	77	71	65
		1/200	265	234	207	184	165	147	132	119	108	98	88	80	73	67	61	56	51	47
		1/250	210	185	164	146	130	116	104	93	84	76	69	62	57	51	47	42	39	35
0,80	SLU	ULS	425	391	361	334	310	289	269	252	236	221	208	195	184	174	164	155	147	140
	SLE* SLS*	1/150	303	279	258	239	222	206	192	180	158	143	130	119	108	99	91	83	77	70
		1/200	285	251	223	198	177	159	142	128	116	105	95	86	79	72	65	60	55	50
		1/250	226	199	176	156	139	125	112	101	91	82	74	67	61	55	50	46	42	38
0,88	SLU	ULS	469	432	399	369	343	319	298	278	261	244	230	216	204	192	182	172	163	154
	SLE* SLS*	1/150	335	309	285	264	245	228	213	199	186	175	153	139	127	116	107	98	90	83
		1/200	335	295	261	233	208	186	167	151	136	123	112	102	92	84	77	70	64	59
		1/250	265	233	207	184	164	146	131	118	106	96	87	79	71	65	59	54	49	45
1,00	SLU	ULS	536	494	456	422	392	365	340	318	298	279	262	247	233	220	208	196	186	176
	SLE* SLS*	1/150	383	353	326	302	280	261	243	227	213	199	187	169	154	141	129	119	109	100
		1/200	383	353	326	282	252	225	203	182	165	149	135	123	112	102	93	85	78	71
		1/250	321	283	250	222	198	177	159	143	129	116	105	95	87	79	72	65	59	54
1,15	SLU	ULS	616	567	524	485	450	419	391	365	342	321	301	284	267	252	238	226	214	203
	SLE* SLS*	1/150	440	405	374	346	322	299	279	261	244	229	215	194	177	162	149	136	125	115
		1/200	440	405	374	324	289	259	233	210	190	172	156	142	129	117	107	98	90	82
		1/250	369	325	288	256	228	204	183	165	148	134	121	110	100	91	82	75	68	62
1,25	SLU	ULS	669	616	569	527	489	455	425	397	372	349	327	308	290	274	259	245	232	220
	SLE* SLS*	1/150	478	440	406	376	349	325	303	283	265	249	234	211	193	176	162	148	136	125
		1/200	478	440	406	352	314	282	253	228	206	187	169	154	140	128	117	107	98	89
		1/250	401	353	313	278	248	222	199	179	161	146	132	119	108	98	90	82	74	68
1,50	SLU	ULS	802	738	682	631	586	546	509	476	445	418	392	369	348	328	310	294	278	264
	SLE* SLS*	1/150	573	527	487	451	419	390	363	340	318	298	280	253	231	212	194	178	163	150
		1/200	573	527	487	423	377	338	304	274	247	224	203	185	168	153	140	128	117	107
		1/250	481	424	375	334	297	266	239	215	193	175	158	143	130	118	107	98	89	81

I valori riportati in tabella sono da considerarsi come indicativi, è competenza del progettista procedere per i singoli casi di verifica al relativo calcolo.

SANDRINI metalli S.p.A. si riserva di variare in qualsiasi momento e senza preavviso le caratteristiche dei prodotti. Tutti i diritti riservati: vietata la riproduzione.

Tabelle di portata (daN/m²) Load tables (daN/sqm)

Sp. Th. (mm)	Larghezza appoggio intermedio: 200 mm - Larghezza appoggio esterno: 100 mm / Internal support width: 200 mm - End support width: 100 mm																			
	CAMPATA DOPPIA / DOUBLE SPAN																			
	Stato limite / Limit state	5,00	5,20	5,40	5,60	5,80	6,00	6,20	6,40	6,60	6,80	7,00	7,20	7,40	7,60	7,80	8,00	8,20	8,40	
0,75	SLU	ULS	280	263	248	234	221	209	198	188	179	171	163	155	148	142	136	130	125	120
	SLE* SLS*	1/150	200	188	177	167	158	150	142	135	128	122	116	111	106	101	97	93	89	86
		1/200	200	188	177	167	158	150	142	135	128	122	116	111	106	101	97	93	89	86
		1/250	200	188	177	167	158	150	142	135	128	122	116	111	106	101	97	93	89	86
0,80	SLU	ULS	323	304	286	270	255	241	228	217	206	196	187	178	170	163	156	149	143	137
	SLE* SLS*	1/150	231	217	204	193	182	172	163	155	147	140	133	127	122	116	111	107	102	98
		1/200	231	217	204	193	182	172	163	155	147	140	133	127	122	116	111	107	102	98
		1/250	231	217	204	193	182	172	163	155	147	140	133	127	122	116	111	107	102	98
0,88	SLU	ULS	391	367	345	325	307	290	275	261	248	236	224	214	204	195	187	179	172	165
	SLE* SLS*	1/150	279	262	246	232	219	207	196	186	177	168	160	153	146	140	133	128	123	118
		1/200	279	262	246	232	219	207	196	186	177	168	160	153	146	140	133	128	123	118
		1/250	279	262	246	232	219	207	196	186	177	168	160	153	146	140	133	128	123	118
1,00	SLU	ULS	495	464	436	411	387	366	347	328	312	296	282	269	256	245	234	224	215	206
	SLE* SLS*	1/150	354	332	312	293	277	262	248	235	223	212	201	192	183	175	167	160	153	147
		1/200	354	332	312	293	277	262	248	235	223	212	201	192	183	175	167	160	153	147
		1/250	354	332	312	293	277	262	248	235	223	212	201	192	183	175	167	160	153	147
1,15	SLU	ULS	601	563	529	497	469	442	418	396	376	357	339	323	308	294	281	269	256	243
	SLE* SLS*	1/150	430	402	378	355	335	316	299	283	268	255	242	231	220	210	201	192	183	174
		1/200	430	402	378	355	335	316	299	283	268	255	242	231	220	210	201	192	183	174
		1/250	430	402	378	355	335	316	299	283	268	255	242	231	220	210	201	192	183	174
1,25	SLU	ULS	671	628	589	554	521	492	465	440	417	396	377	359	342	326	311	294	279	264
	SLE* SLS*	1/150	479	449	421	395	372	351	332	314	298	283	269	256	244	233	222	210	199	189
		1/200	479	449	421	395	372	351	332	314	298	283	269	256	244	233	222	210	199	189
		1/250	479	449	421	395	372	351	332	314	298	283	269	256	244	233	222	210	199	189
1,50	SLU	ULS	847	792	742	697	655	618	583	551	522	495	470	443	418	394	372	352	334	317
	SLE* SLS*	1/150	605	566	530	498	468	441	416	394	373	354	336	317	298	282	266	252	238	226
		1/200	605	566	530	498	468	441	416	394	373	354	336	317	298	282	266	252	238	226
		1/250	605	566	530	498	468	441	416	394	373	354	336	317	298	282	266	252	238	226

Sp. Th. (mm)	Larghezza appoggio intermedio: 200 mm - Larghezza appoggio esterno: 100 mm / Internal support width: 200 mm - End support width: 100 mm																			
	CAMPATA MULTIPLA / MULTIPLE SPAN																			
	Stato limite / Limit state	5,00	5,20	5,40	5,60	5,80	6,00	6,20	6,40	6,60	6,80	7,00	7,20	7,40	7,60	7,80	8,00	8,20	8,40	
0,75	SLU	ULS	335	315	297	281	265	251	239	227	216	206	196	187	179	171	164	157	151	145
	SLE* SLS*																			

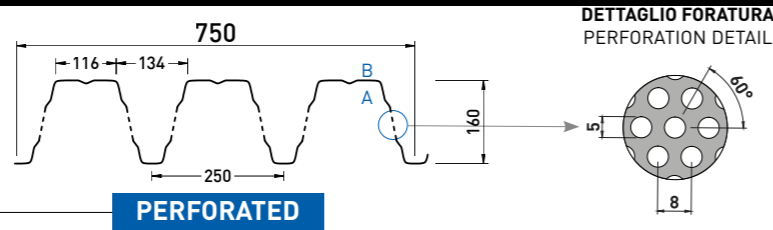

A: lato a vista - front side
B: lato non a vista - back side

Reazione al fuoco Fire reaction CLASS A1
Comportamento al fuoco dall'esterno External fire performance Broof (t1,t2,t3)
Senza necessità di sottoporre a prova secondo la norma UNI EN 14782:2006. No lab test is required as per UNI EN 14782:2006.

Sp. Th. (mm)	DATI STATICI / STATIC DATA			PESO / WEIGHT (Steel Kg/m ²)
	Jy (cm ² /m)	We inf (cm ² /m)	We sup (cm ² /m)	
0,75	442,47	44,89	70,43	11,19
0,80	475,93	48,44	75,34	11,94
0,88	529,94	54,18	83,2	13,13
1,00	611,67	62,89	95,02	14,93
1,15	709,50	73,16	109,5	17,16
1,25	771,19	79,48	118,93	18,66
1,50	925,44	95,25	142,45	22,39

APPLICAZIONI / APPLICATIONS

- SANDnodrip** Class A2 - s1, d0 Broof (t1,t2,t3)
- SANDcontrol** Class C - s1, d0 Broof (t1,t2,t3)

Tabelle di portata (daN/m²) Load tables (daN/sqm)

* Valori di portata caratteristici con coefficiente di sicurezza applicato pari a: $\gamma_f = 1,40$. Characteristic load with an applied safety coefficient equal to: $\gamma_f = 1,40$.
In azzurro i valori rappresentativi della portata con inflessione limite raggiunta. The values indicated in blue are representative of the load capacity with the limit inflection reached.

Larghezza appoggio esterno: 100 mm End support width: 100 mm

Sp. Th. (mm)	Interasse appoggi (m) / Carico uniformemente distribuito (daN/m ²)																	Span (m) / Uniformly distributed load (daN/sqm)																						
	Stato limite Limit state	5,00	5,20	5,40	5,60	5,80	6,00	6,20	6,40	6,60	6,80	7,00	7,20	7,40	7,60	7,80	8,00	8,20	8,40	Stato limite Limit state	5,00	5,20	5,40	5,60	5,80	6,00	6,20	6,40	6,60	6,80	7,00	7,20	7,40	7,60	7,80	8,00	8,20	8,40		
0,75	SLU	ULS	334	308	284	263	244	227	212	198	185	174	163	154	145	137	129	122	116	110	SLU	ULS	282	265	250	236	223	212	201	191	182	173	165	158	151	144	138	133	127	122
	SLE*	1/150	239	220	203	188	174	162	151	141	124	112	102	93	85	78	71	65	60	55	SLE*	1/150	202	190	179	169	160	151	143	136	130	124	118	113	108	103	99	95	91	87
	SLS*	1/200	223	197	175	155	139	124	112	101	91	82	74	68	62	56	51	47	43	39	SLS*	1/200	202	190	179	169	160	151	143	136	130	124	118	113	108	103	99	95	91	87
	SLS*	1/250	177	156	138	123	109	98	88	79	71	64	58	52	48	43	39	36	33	30	SLS*	1/250	202	190	179	169	160	151	143	136	130	124	118	113	108	103	99	95	91	87
0,80	SLU	ULS	357	329	304	282	261	243	227	212	198	186	175	165	155	146	138	131	124	118	SLU	ULS	326	307	289	273	258	244	231	220	209	199	190	181	173	166	159	152	146	140
	SLE*	1/150	255	235	217	201	187	174	162	151	133	121	110	100	91	84	76	70	64	59	SLE*	1/150	233	219	206	195	184	174	165	157	149	142	136	129	124	118	113	109	104	100
	SLS*	1/200	240	212	188	167	149	133	120	108	98	88	80	73	66	60	55	50	46	42	SLS*	1/200	233	219	206	195	184	174	165	157	149	142	136	129	124	118	113	109	104	100
	SLS*	1/250	190	167	148	132	117	105	94	85	76	69	62	56	51	47	42	39	35	32	SLS*	1/250	233	219	206	195	184	174	165	157	149	142	136	129	124	118	113	109	104	100
0,88	SLU	ULS	395	364	336	311	289	269	251	234	219	206	193	182	171	162	153	145	137	130	SLU	ULS	395	371	349	329	311	295	279	265	252	240	229	218	208	199	191	183	175	168
	SLE*	1/150	282	260	240	222	206	192	179	167	157	147	129	117	107	98	90	82	76	70	SLE*	1/150	282	265	249	235	222	210	199	189	180	171	163	156	149	142	136	130	125	120
	SLS*	1/200	282	248	220	196	175	157	141	127	115	104	94	85	78	71	65	59	54	50	SLS*	1/200	282	265	249	235	222	210	199	189	180	171	163	156	149	142	136	130	125	120
	SLS*	1/250	223	197	174	155	138	123	111	99	90	81	73	66	60	55	50	45	41	38	SLS*	1/250	282	265	249	235	222	210	199	189	180	171	163	156	149	142	136	130	125	120
1,00	SLU	ULS	451	416	384	355	330	307	286	268	251	235	221	208	196	185	175	165	157	149	SLU	ULS	501	471	443	417	394	372	353	334	318	302	288	274	262	250	240	229	220	211
	SLE*	1/150	322	297	274	254	236	219	205	191	179	168	158	142	130	119	109	100	92	84	SLE*	1/150	358	336	316	298	281	266	252	239	227	216	206	196	187	179	171	164	157	151
	SLS*	1/200	322	297	274	254	236	219	205	191	179	168	158	142	130	119	109	100	92	84	SLS*	1/200	358	336	316	298	281	266	252	239	227	216	206	196	187	179	171	164	157	151
	SLS*	1/250	270	238	211	187	167	149	134	120	109	98	89	80	73	66	60	55	50	46	SLS*	1/250	358	336	316	298	281	266	252	239	227	216	206	196	187	179	171	164	157	151
1,15	SLU	ULS	519	478	441	408	379	353	329	308	288	270	254	239	225	212	201	190	180	171	SLU	ULS	586	549	516	486	458	433	410	388	368	350	333	318	303	289	277	265	254	243
	SLE*	1/150	370	341	315	292	271	252	235	220	206	193	181	164	149	137	125	115	106	97	SLE*	1/150	419	392	369	347	327	309	293	277	263	250	238	227	216	207	198	189	181	174
	SLS*	1/200	370	341	315	292	271	252	235	220	206	193	181	164	149	137	125	115	106	97	SLS*	1/200	419	392	369	347	327	309	293	277	263	250	238	227	216	207	198	189	181	174
	SLS*	1/250	311	274	242	215	192	172	154	139	125	113	102	92	84	76	69	63	58	53	SLS*	1/250	419	392	369	347	327	309	293	277	263	250	238	227	216	207	198	189	181	174
1,25	SLU	ULS	563	519	479	444	412	383	358	334	313	294	276	260	245	231	218	206	195	185	SLU	ULS	682	639	600	564	532	502	475	450	427	406	386	367	350	334	320	306	293	281
	SLE*	1/150	402	371	342	317	294	274	255	239	224	210	197	178	162	149	136	125	115	106	SLE*	1/150	487	457	429	403	380	359	339	321	305	290	276	262	250	221	203	187	172	159
	SLS*	1/200	402	371	342	317	294	274	255	239	224	210	197	178	162	149	136	125	115	106	SLS*	1/200	487	457	429	403	380	359	339	321	305	290	276	262	250	221	203	187	172	159
	SLS*	1/250	338	298	263	234	209	187	167	151	136	123	111	101	91	83	75	69	63	57	SLS*	1/250	487	457	429	403	380	359	339	321	305	290	276	262	250	221	203	187	172	159
1,50	SLU	ULS	675	622	574	532	494	459	428	400	375	352	330	311	293	277	261	247	234	222	SLU	ULS	865	809	758	713	671	633	598	565	536	509	483	460	438	418	398	377	357	339
	SLE*	1/150	482	444	410	380	353	328	306	286	268	251	236	213	195	178	163	150	138	127	SLE*	1/150	618	578	542	509	479	452	427	404	383	363	345	328	289	265	244	224	207	191
	SLS*	1/200	482	444	410	380	353	328	306	286	268	251	236	213	195	178	163	150	138	127	SLS*	1/200	618	578	542	509	479	452	427	404	383	363	345	328	289	265	244	224	207	191
	SLS*	1/250	405	357	316	281	251	224	201	181	163	147	133	121	109	99	91	82	75	69	SLS*	1/250	618	578	542	509	479	452	427	404	383	363	345	328	289	265	244	224	207	191

Tabelle di portata (daN/m²) Load tables (daN/sqm)

Larghezza appoggio intermedio: 200 mm - Larghezza appoggio esterno: 100 mm Internal support width: 200 mm - End support width: 100 mm

Sp. Th. (mm)	Interasse appoggi (m) / Carico uniformemente distribuito (daN/m ²)																	Span (m) / Uniformly distributed load (daN/sqm)																						
	Stato limite Limit state	5,00	5,20	5,40	5,60	5,80	6,00	6,20	6,40	6,60	6,80	7,00	7,20	7,40	7,60	7,80	8,00	8,20	8,40	Stato limite Limit state	5,00	5,20	5,40	5,60	5,80	6,00	6,20	6,40	6,60	6,80	7,00	7,20	7,40	7,60	7,80	8,00	8,20	8,40		
0,75	SLU	ULS	236	222	209	197	186	176	167	159	151	144	137	131	125	119	114	110	105	101	SLU	ULS	272	256	241	227	214	203	192	183	173	165	157	150	143	137	131	126	121	116
	SLE*	1/150	169	158	149	141	133	126	119	113	108	103	98																											

LASTRE CURVE CON CALANDRATURA



CURVED METAL SHEETS WITH CALENDERING

La calandratura a microimpronte è una lavorazione di curvatura che consente di deformare in modo controllato la lamiera grecata fino ad ottenere il raggio di curvatura desiderato.

Le lastre curve a raggio costante vengono impiegate principalmente per la realizzazione di coperture curve (su strutture metalliche, su tegoli prefabbricati ad "Y", ecc.).

SPECIFICHE TECNICHE

Raggio di curvatura = min. 2000 mm

Lunghezza = min. 1000 mm

Passo impronte = 50 mm

Per progetti o richieste differenti, invitiamo a contattare il nostro Ufficio Tecnico per richiedere un'analisi di fattibilità.

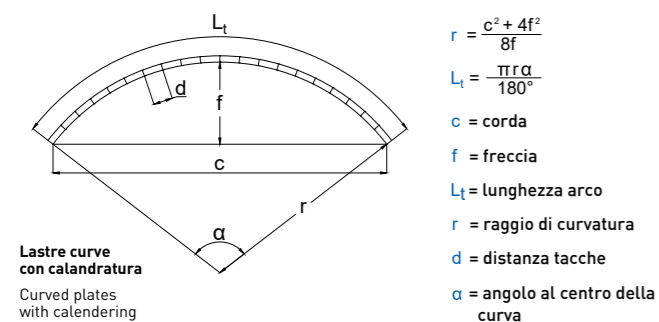

Lastre curve con calandratura
Curved plates with calendering

Micro-impression calendering is a bending process that allows to deform the profiled sheet in a controlled way until the desired bending radius is obtained.

Curved sheets with constant radius are mainly used for the construction of curved roofs (on metal structures, on prefabricated "Y" tiles, etc.).

TECHNICAL SPECIFICATIONS

Bending radius = min. 2000 mm

Length = min. 1000 mm

Footprint pitch = 50 mm.

For different projects or requests, please contact our Technical Office to require a feasibility analysis.



LASTRE CURVE CON TACCHETTATURA



CURVED METAL SHEETS WITH NOTCHING

La tacchettatura è una lavorazione meccanica che consiste nella realizzazione di una serie di impronte trasversali a passo costante e/o variabile che consente di deformare una lamiera grecata fino al raggiungimento della curvatura desiderata.

Grazie a questa lavorazione è possibile ottenere delle lastre grecate con bending irregolari, con tratti retti alternati a tratti curvi.

Le lastre curve così ottenute trovano principalmente impiego nella realizzazione di coperture a sezione curva regolare o irregolare, a cuspidi, con "travi ad Y", ecc.

SPECIFICHE TECNICHE

Raggio di curvatura = min. 500 mm

Lunghezza = min. 300 mm

Passo impronte = variabile

Per progetti o richieste differenti, invitiamo a contattare il nostro Ufficio Tecnico per richiedere un'analisi di fattibilità.

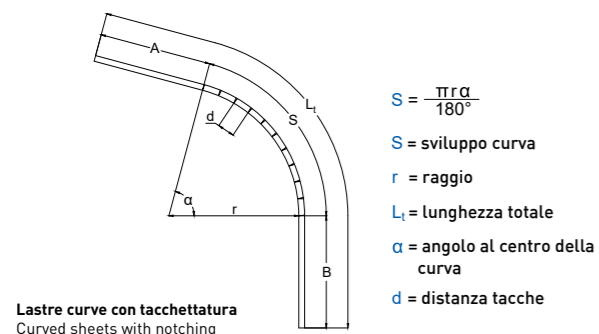

Lastre curve con tacchettatura
Curved sheets with notching

Notching is a mechanical process that consists in the realization of a series of transversal impressions with constant and / or variable pitch that allows to deform a corrugated sheet until the desired bending is reached.

Thanks to this process it is possible to obtain corrugated slabs with irregular curves, with straight sections alternating with curved sections.

The curved sheets thus obtained are mainly used in the construction of roofs with a regular or irregular curved section, with a cusp, with "Y beams", etc.

TECHNICAL SPECIFICATIONS

Bending radius = min. 500 mm

Length = min. 300 mm

Footprint = variabile

For different projects or requests, please contact our Technical Office to require a feasibility analysis.



LASTRE A SHED



SHED METAL SHEETS

Le lastre a shed vengono ottenute tramite una lavorazione speciale, chiamata maxipiega, che consiste in una piega trasversale della lastra grecata, eseguita tramite un'apposita attrezzatura dotata di uno speciale stampo sagomato.

Tutte le deformazioni generate vengono contenute e controllate dalla speciale conformazione dello stampo in modo da rendere i prodotti finiti perfettamente a misura, uguali ed accoppiabili tra loro nei vari sormonti laterali e longitudinali.

Una porzione laterale di lamiera viene infatti asportata direttamente in fase di lavorazione fornendo un prodotto finito immediatamente pronto ad essere installato.

Le lastre grecate così ottenute trovano impiego principalmente nella realizzazione di coperture a shed su strutture ad "Y" al fine di ottenere un ottimo piano di appoggio per l'installazione di un impianto fotovoltaico, oltre che eliminare l'applicazione della lattoneria di raccordo al colmo.

Tale lavorazione è disponibile per SAND 20 e SAND 28.

SPECIFICHE TECNICHE

Angolo minimo realizzabile = 87°

Lunghezza lato H = min. 200 mm

Lunghezza lato L = variabile, standard max 4000 mm

Per progetti specifici o richieste differenti, invitiamo a contattare il nostro Ufficio Tecnico per verificarne le fattibilità.

The shed sheets are obtained through a special process, called maxi fold, which consists of a transverse fold of the corrugated sheet, performed by means of a special folder equipped with a special shaped mold.

All the deformations generated are contained and controlled by the special shape of the mold in order to make the finished products perfectly made to measure, equal and combinable with each other in the various lateral and longitudinal overlaps.

A lateral portion of the sheet is indeed removed directly during the processing supplying a final product immediately ready to be installed.

The corrugated sheets thus obtained are mainly used in the construction of shed roofs on "Y" structures in order to obtain an excellent support surface for the installation of a photovoltaic system, as well as eliminating the application of the tinsmith connection to the ridge.

This processing is available for SAND 20 and SAND 28.

TECHNICAL SPECIFICATIONS

Minimum achievable angle = 87°

Length side A = min. 200 mm

Length of side B = variabile, standard max 4000 mm

For different projects or requests, please contact our Technical Office to require a feasibility analysis.

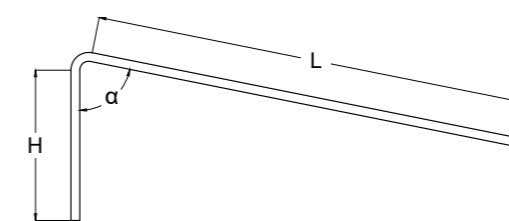

Lastre a shed
Shed plates



SANDnodrip



SANDnodrip

SANDnodrip è uno speciale panno in tessuto non tessuto composto al 100% in fibra di poliestere. Viene applicato, su richiesta, al lato interno delle lamiere grecate.

La sua speciale struttura e gli innovativi sistemi produttivi permettono di ottenere una perfetta adesione al supporto metallico.

La principale funzione del panno anticondensa è quella di trattenere l'acqua di condensazione che si viene a formare al lato interno delle lastre, per rilasciarla nell'aria sottoforma di normale umidità quando le condizioni climatiche lo consentono.

Al fine di evitare distaccamenti e/o alterazioni delle sue funzioni, è necessario prevedere un ponte non igroscopico di circa 20 cm sulle estremità delle lastre grecate in prossimità della gronda e in corrispondenza dei sormonti di testa.

I principali vantaggi dell'impiego di questa applicazione sono:

- nessun gocciolamento di acqua di condensa;
- attenuazione dell'intensità del rumore;
- protegge il supporto metallico dalla corrosione;
- rappresenta un'alternativa alla barriera al vapore.

SPECIFICHE TECNICHE

Materiale = TNT 100% fibra poliestere

Spessore nominale = < 1 mm

Colore = grigio

Classe di reazione al fuoco = A2 - s1, d0

SANDnodrip is a special non-woven felt made of 100% polyester fiber. It is applied, on request, on the internal side of the corrugated sheets.

Its special structure and innovative production systems allow perfect adhesion to the metal support.

The main function of the anti-condensation felt is retaining the condensation water that forms in the internal side of the sheet, to subsequently it in the air in the form of normal humidity when weather conditions permit.

It is necessary to provide a non-hygroscopic bridge of indicatively 20 cm on the ends of the corrugated sheets near the eaves and at the head overlaps in order to avoid detachments and / or alterations of its functions.

The main advantages of using this application are:

- no dripping of condensation water;
- attenuation of the intensity of the noise;
- protects the metal support from corrosion;
- represents an alternative to the vapor barrier.

TECHNICAL SPECIFICATIONS

Material = non-woven felt 100% polyester fiber

Nominal thickness = < 1 mm

Color = grey

Fire reaction class = A2 - s1, d0

Per maggiori informazioni, o per visionare i rapporti delle prove eseguite presso laboratorio accreditato, contattare il nostro Ufficio Tecnico.

For more information, or to view the reports of the tests performed in an accredited laboratory, contact our Technical Office.

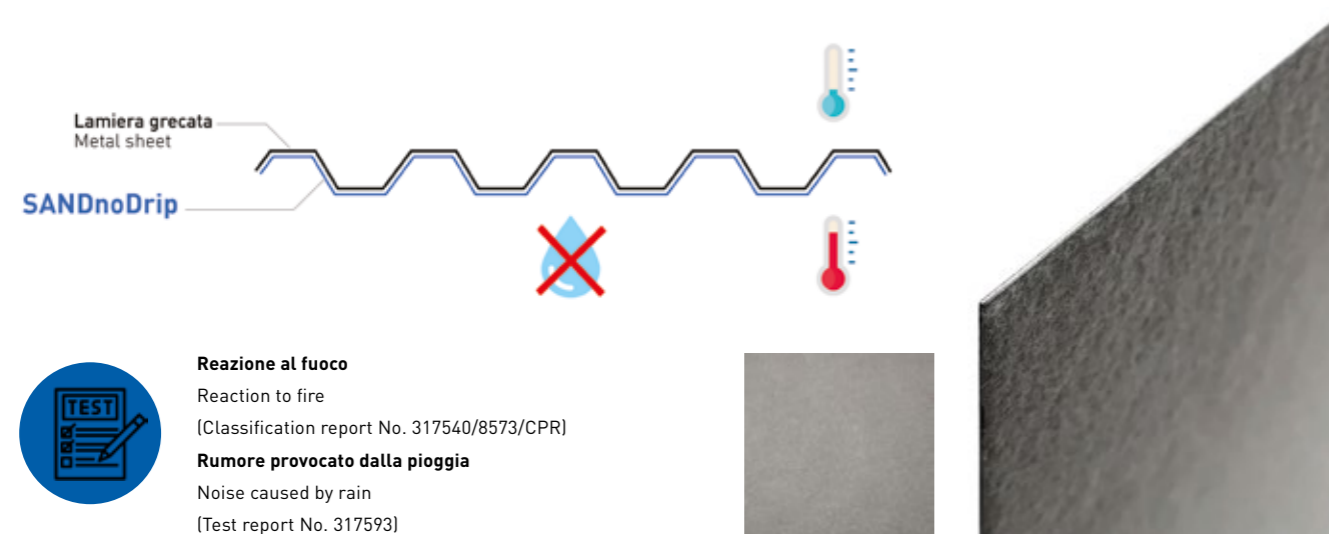

Reazione al fuoco

Reaction to fire

(Classification report No. 317540/8573/CPR)

Rumore provocato dalla pioggia

Noise caused by rain

(Test report No. 317593)

SANDcontrol



SANDcontrol

SANDcontrol è uno speciale panno in tessuto non tessuto composto al 100% in fibra di poliestere. Viene applicato, su richiesta, al lato interno delle lamiere grecate.

La sua speciale struttura e gli innovativi sistemi produttivi permettono di ottenere una perfetta adesione al supporto metallico.

SANDcontrol svolge due importanti funzioni:

- **antirumore, grazie alla consistente densità della quale è composto consente di attenuare notevolmente l'intensità del rumore generato dagli agenti atmosferici e dall'interno del fabbricato;**
- **anticondensa, permette di trattenere l'acqua di condensazione che si viene a formare al lato interno delle lastre, per rilasciarla nell'aria sottoforma di normale umidità quando le condizioni climatiche lo consentono.**

Al fine di evitare distaccamenti e/o alterazioni delle sue funzioni, è necessario prevedere un ponte non igroscopico di circa 20 cm sulle estremità delle lastre grecate in prossimità della gronda e in corrispondenza dei sormonti di testa.

I principali vantaggi dell'impiego di questa applicazione sono:

- nessun gocciolamento di acqua di condensa;
- attenuazione dell'intensità del rumore;
- protegge il supporto metallico dalla corrosione;
- rappresenta un'alternativa alla barriera al vapore.

SPECIFICHE TECNICHE

Materiale = TNT 100% fibra poliestere

Spessore nominale = 2-3 mm

Densità nominale = 200 g/m²

Colore = grigio

Classe di reazione al fuoco = C - s1, d0

SANDcontrol is a special non-woven felt made of 100% polyester fiber. It is applied, on request, on the internal side of the corrugated sheets.

Its special structure and innovative systems production allow to obtain a perfect adhesion to the metal support.

SANDcontrol performs two important functions:

- anti-noise, thanks to the consistent density of which it is composed of, it allows to significantly attenuate the intensity of the noise generated by the atmospheric agents and the one coming from inside the building;
- anti-condensation, it allows to retain the condensed water that can be formed on the internal inside sheets, to subsequently release it in the air in the form of normal humidity when weather conditions permit.

It is necessary to provide a non-hygroscopic bridge of indicatively 20 cm on the ends of the corrugated sheets near the eaves and at the head overlaps in order to avoid detachments and / or alterations of its functions.

The main advantages of using this application are:

- no dripping of condensation water;
- attenuation of the intensity of the noise;
- protects the metal support from corrosion;
- represents an alternative to the vapor barrier.

TECHNICAL SPECIFICATIONS

Material = non-woven felt 100% polyester fiber

Nominal thickness = 2-3 mm

Nominal density = 200 g/sqm

Color = grey

Fire reaction class = C - s1, d0

For more information, or to consult the reports of the tests performed in an accredited laboratory, contact our Technical Office.

Per maggiori informazioni, o per consultare i rapporti delle prove eseguite presso laboratorio accreditato, contattare il nostro Ufficio Tecnico.



Reazione al fuoco

Reaction to fire

(Classification report No. 357855/11999/CPR)

Rumore provocato dalla pioggia

Noise caused by rain

(Test report No. 358266)

Colmo dentellato
Notched ridge

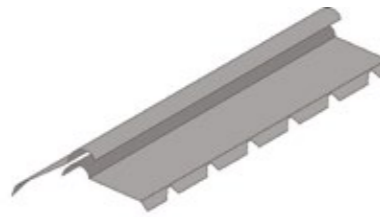

Colmo stampato
Corrugation shaped ridge



Raccordo dentellato
Notched endwall flashing

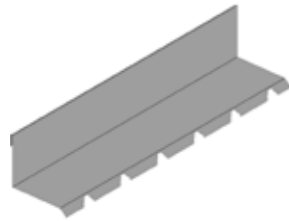

Raccordo stampato
Corrugation shaped endwall flashing



Chiudigreca metallica
Metal corrugated closure flashing



Chiudigreca in polietilene
Polyethylene corrugated closure strips



Fermaneve
Snowguard



Guarnizione antirisalita
Sealant tapes



Lastre grecate in policarbonato compatto
Compact polycarbonate corrugated sheets



Lastre grecate in policarbonato microalveolare
Multiwall polycarbonate corrugated sheets



Lastre in policarbonato alveolare
Multiwall polycarbonate sheets

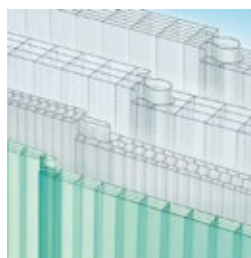

Lastre grecate in vetroresina
Fiberglass corrugated sheets



Profili metallici per orditura
Metal profiles for purlins

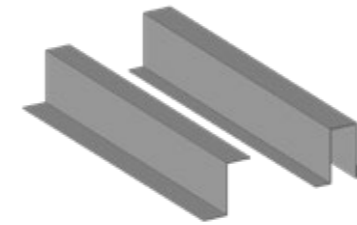

Rete anticaduta
Safety net



Piedini telescopici regolabili
Adjustable telescopic supports



Lana di vetro
Glasswool



Listelli di abete per orditura
Fir strips for purlins



Staffe per sovracoperture
Over-Coverage Brackets



Basamenti per lucernari
Skylight bases

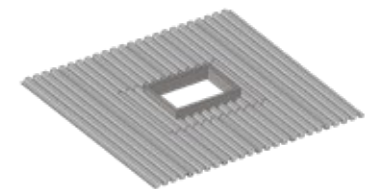

Lana di roccia
Rockwool



Silicone e vernice spray
Silicone and spray paint



Tappi chiudigreca per solai collaboranti
Containment caps for collaborating metal sheets



Sistemi di fissaggio
Fixing systems



Cappellotti
Caps for roofing



NATURAL



STANDARD

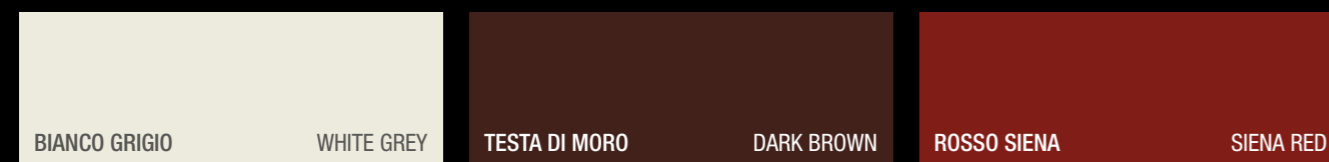

PREMIUM



Tutti i colori sono solo di riferimento.

All colors are for reference only.

LUXURY



STONE



Tutti i colori sono solo di riferimento.

All colors are for reference only.



**IL METALLO
CHE VESTE
IL MONDO** 



SANDRINI metalli S.p.A.
Via P. Togliatti, 18/A - 24062 Costa Volpino (BG)
+39 035 970 435
www.sandrinimetalli.it