

HEBESCHIEBETÜRSYSTEM SYNEGO[®]

TECHNISCHE INFORMATION

PROFILDRUCK

HEBESCHIEBETÜRSYSTEM SYNEGO®

PROFILDRUCK

Inhaltsverzeichnis

Flügelprofile	2
Zargenprofile	4
Leistenprofile	5
Sets Form- und Dichtteile	8
Formteile	9
Schrauben	10
Werkzeuge	11
Dichtungen	12
Glasleisten (schräg) mit anextrudierten Dichtlippen	13
Glasleisten (rund) und Glasleisten Softline mit anextrudierten Dichtlippen	15
Blendrahmenverbreiterungen	16
Eckpfostenprofile	20
Dehnstoßprofile	21
Abdeckprofile	22
Kopplungsprofile	23
Zusatzprofile / Zubehörteile	24
„Rund ums Fenster“	25
Zeichenerklärung	27
Variantensystematik	28
Artikelverzeichnis	29

HEBESCHIEBETÜRSYSTEM SYNEGO®

PROFILDRUCK

Flügelprofile

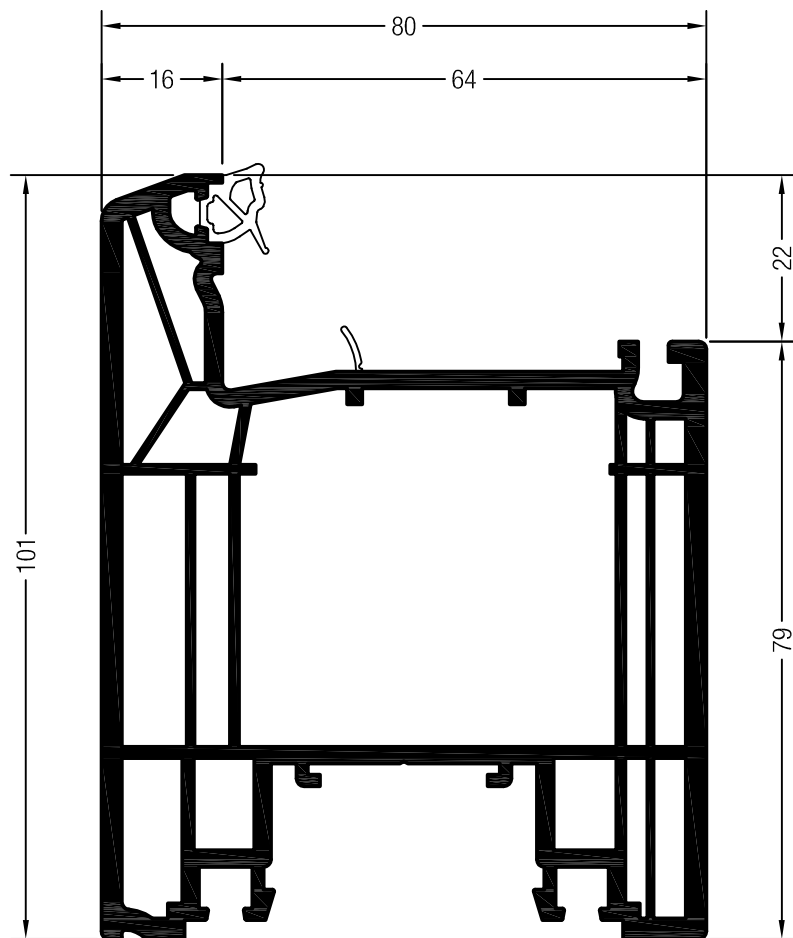

Flügel 101 HST SYNEGO®

1536545

12 (6)

1539545

12 (6)

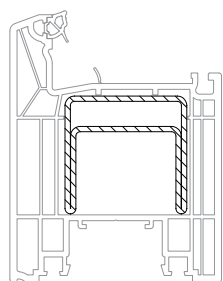

Armierung Flügel 101

	1398300
	2
lx	15,4
ly	8,1
	6

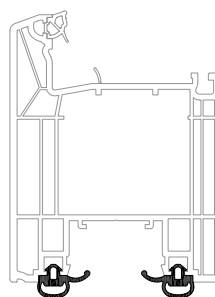

Dichtung Flügel

1398312

150

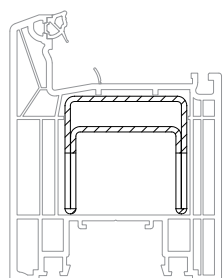

konf. Armierung Flügel 101

	1398350
	2
konfektioniert für Schlosseite	
	2,42

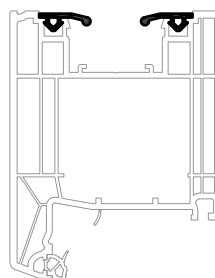

ISO - Dichtung HST SYNEGO®

1398316

100

HEBESCHIEBETÜRSYSTEM SYNEGO®

PROFILDRUCK

Flügelprofile

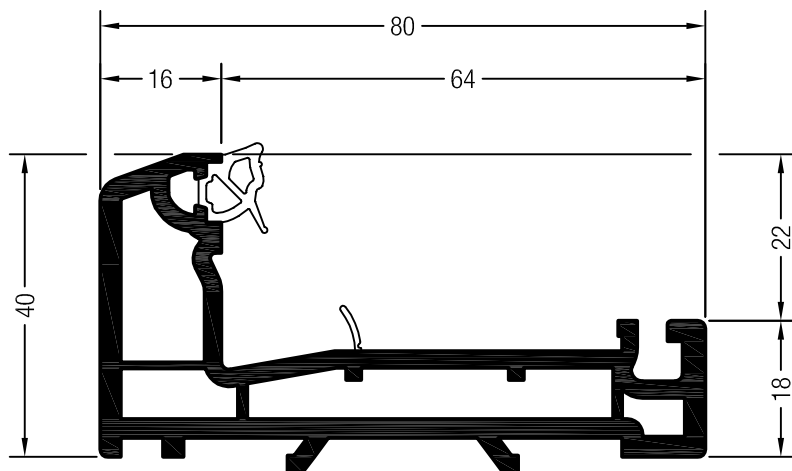

Flügel 40 HST SYNEGO®

1536585

24 (6)

1539585

12 (6)

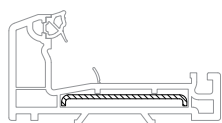

Armierung Flügel 40

	1398301
	1,5
lx	1,6
ly	-
	6

HEBESCHIEBETÜRSYSTEM SYNEGO®

PROFILDRUCK

Zargenprofile

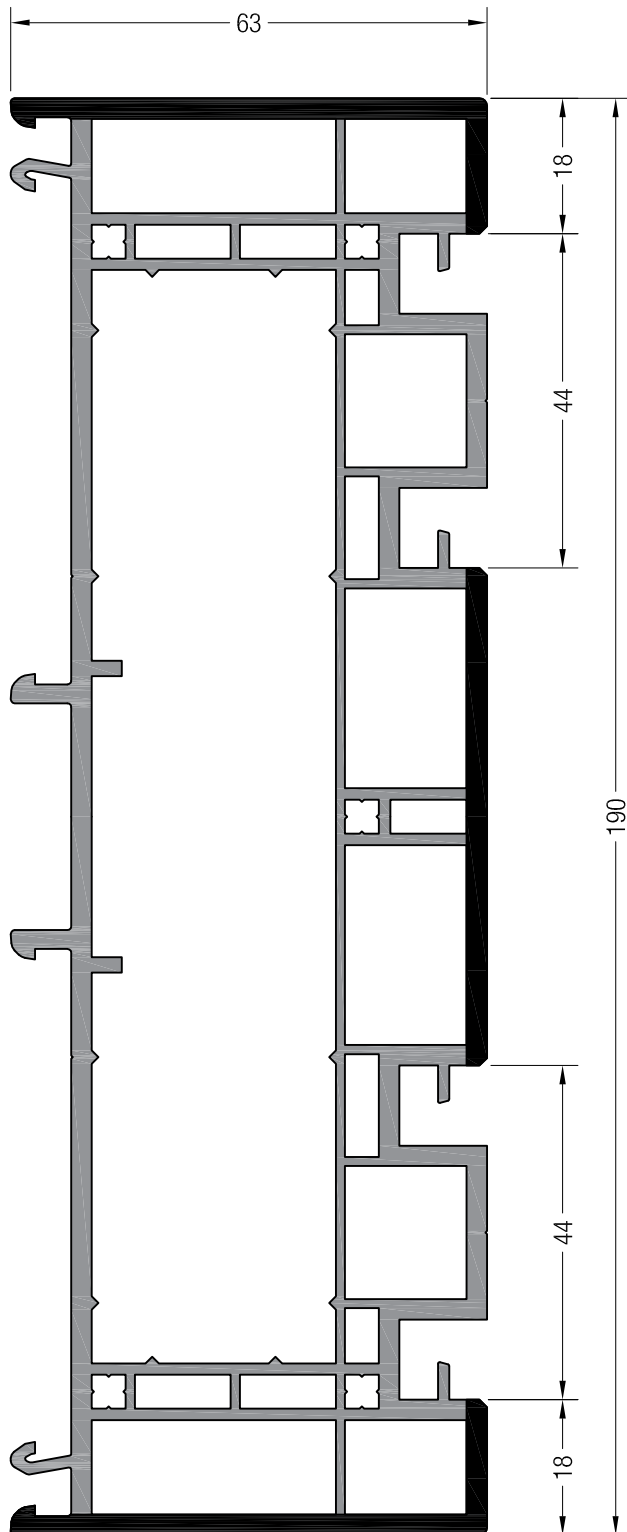

Zarge PULS HST SYNEGO®

1536570 





1539570 

 13,6 (6,8)



PULS (Profiles for Unique Living Solutions)

Profil in CoEx-Technologie hergestellt, im Kern Recycling-Material

Armierung Zarge Stahl

	1398303
	2
lx	9,6
ly	4,3
	6

Armierung Zarge Alu

	1398305
	2
lx	59,7*
ly	3,3*
	6,8

* Trägheitsmomente bezogen auf einen E-Modul von Stahl!

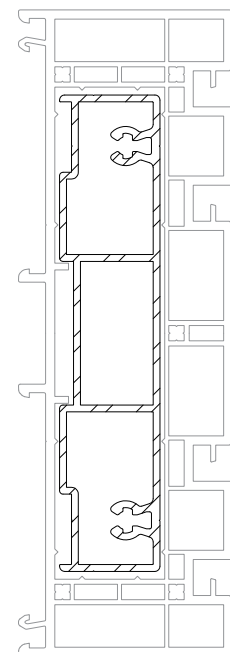
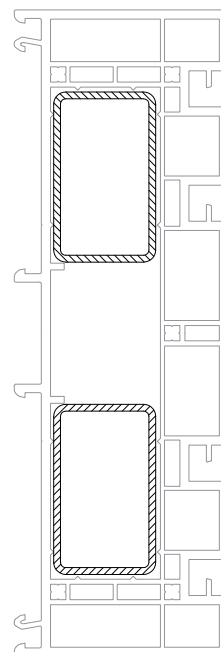

HEBESCHIEBETÜRSYSTEM SYNEGO®

PROFILDRUCK

Leistenprofile

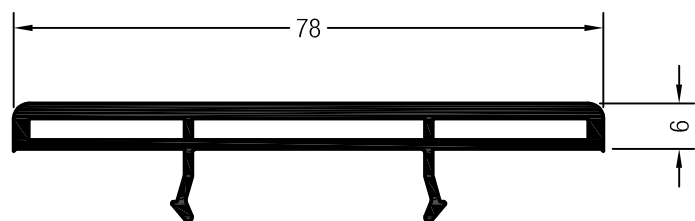

Abdeckprofil HST SYNEGO®

1536500 



1539500 

 30 (5)

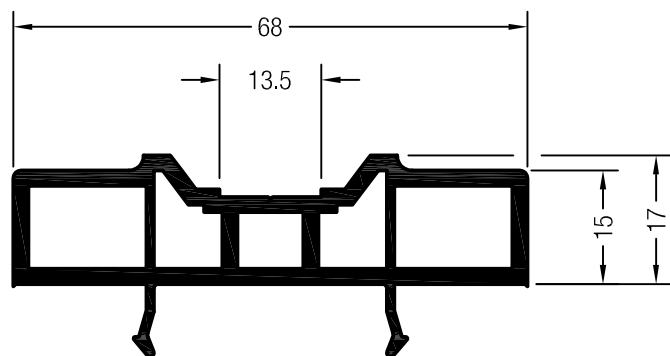
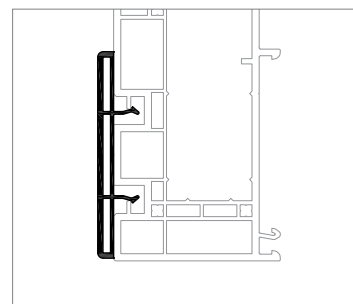
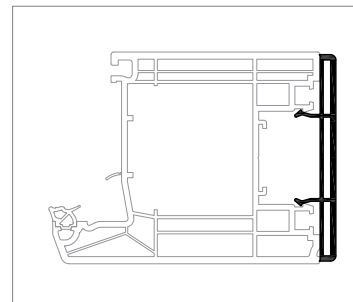

Anschlagleiste HST SYNEGO®

1536530 



 60 (6)

1539530 

 36 (6)

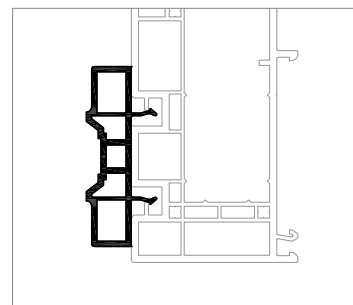
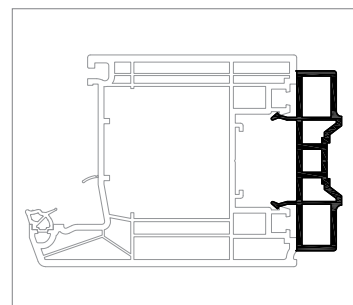

HEBESCHIEBETÜRSYSTEM SYNEGO®

PROFILDRUCK

Leistenprofile

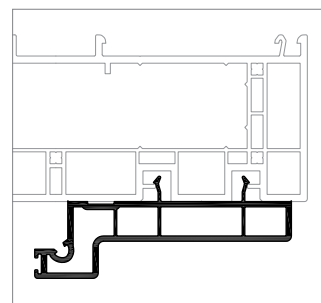
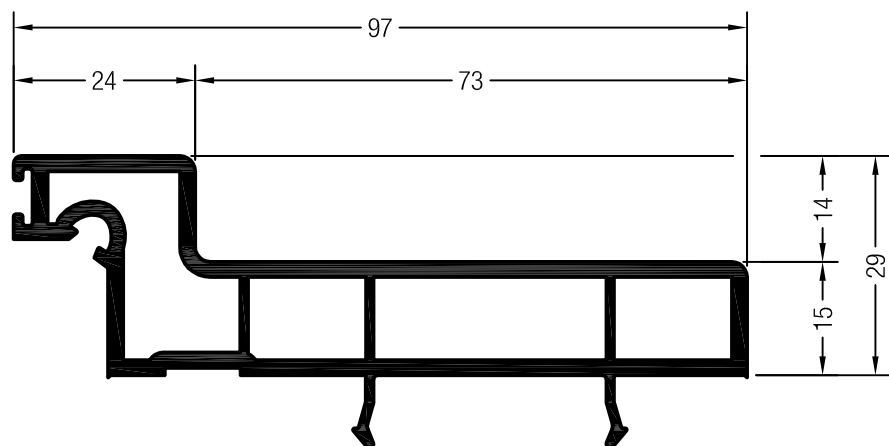

Zargenleiste HST SYNEGO®



1536520 



1539520 

 36 (6)

Dichtung Zargenleiste außen

	1354000
	1354001
	100

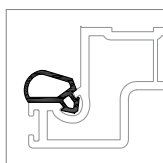

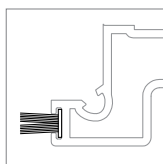

Bürstendichtung 6,7 x 12

	1246834
	100



Bürstendichtung 6,7 x 12 WF (für Schallschutzanforderung)

	1398599
	100

HEBESCHIEBETÜRSYSTEM SYNEGO®

PROFILDRUCK

Leistenprofile

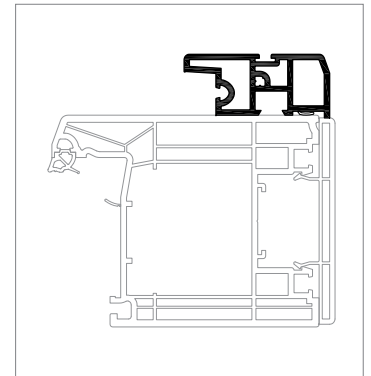
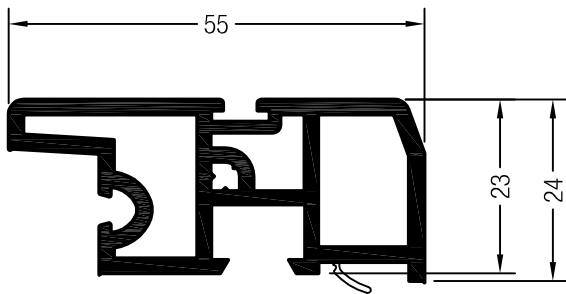

Mittelschluss HST SYNEGO®

- 1536550 40 (5)
- 40 (5)
- 1539550 30 (5)

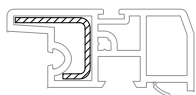

Armierung Mittelschluss

	1398302
	1,5
lx	0,3
ly	0,3
	5

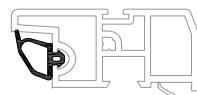

Dichtung Mittelschluss

	1398313
	100

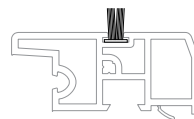

Bürstendichtung 6,7 x 12

	1246834
	100

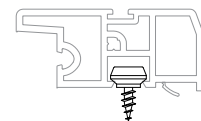

Nippelschraube

	1267669
	1000

Bürstendichtung 6,7 x 12 WF (für Schallschutzanforderung)

	1398599
	100

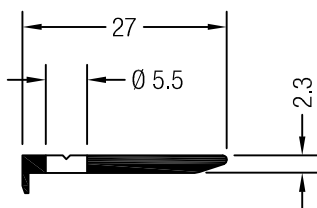

Dichtleiste Alu

- 1398307
- 6

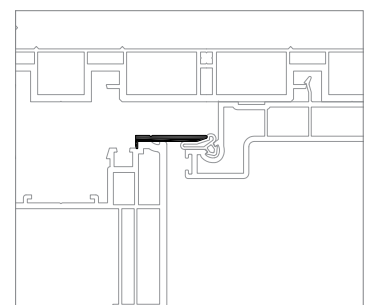

HEBESCHIEBETÜRSYSTEM SYNEGO®

PROFILDRUCK

Sets Form- und Dichtteile

Set Form- und Dichtstücke, Schema A

1398308



1

bestehend aus:

- 3 Stück - Dichtpad Anschlagleiste 1398321
- 1 Stück - Dichtpad MS oben innen 1398322
- 1 Stück - Dichtkissen Zargenleiste 1398324
- 1 Stück - Dichtstück MS unten 1398327
- 2 Stück - Distanzstück Flügel 1398332
- 1 Stück - Endstück Anschlagleiste 1398334
- 1 Stück - Endstück Abdeckprofil unten 1398338
- 1 Stück - Endstück Abdeckprofil oben 1398339
- 2 Stück - Dichtpad Zarge 1398370

Set Form- und Dichtstücke, Schema C

1398309



1

bestehend aus:

- 6 Stück - Dichtpad Anschlagleiste 1398321
- 2 Stück - Dichtpad MS oben innen 1398322
- 2 Stück - Dichtstück MS unten 1398327
- 1 Stück - Dichtpad Stulp oben 1398328
- 4 Stück - Distanzstück Flügel 1398332
- 1 Stück - Endstück Anschlagleiste 1398334
- 2 Stück - Endstück Abdeckprofil unten 1398338
- 2 Stück - Endstück Abdeckprofil oben 1398339
- 2 Stück - Dichtpad Zarge 1398370

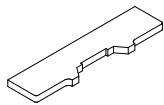

Dichtpad Anschlagleiste
PE

1398321 ■

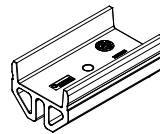

Distanzstück
ABS

1398332 ■

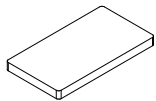

Dichtpad MS oben innen
PE

1398322 ■

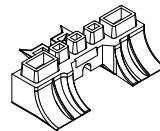

Endstück Anschlagleiste
TPE

1398334 ■

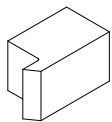

Dichtkissen Zargenleiste
Zellgummi

1398324 ■

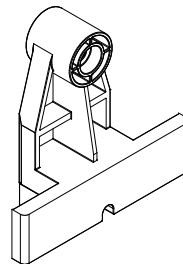

Endstück Abdeckprofil unten
ASA

1398338 ■

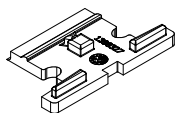

Dichtstück MS unten
TPE

1398327 ■

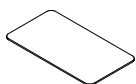

Dichtpad Stulp oben
PVC

1398328 □

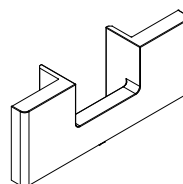

Endstück Abdeckprofil oben
ASA

1398339 ■

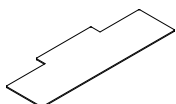

Dichtpad Zarge
PE

1398370 ■



HEBESCHIEBETÜRSYSTEM SYNEGO®

PROFILDRUCK

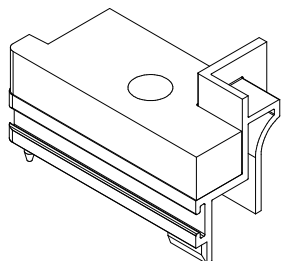
Formteile





Dichtstück MS oben
ASA - Zellgummi

1398325  

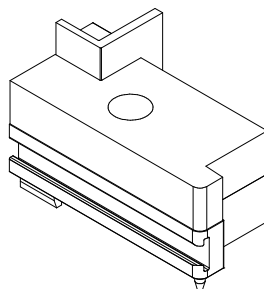
 50



Dichtstück MS oben
ASA - Zellgummi

1398326  

 50

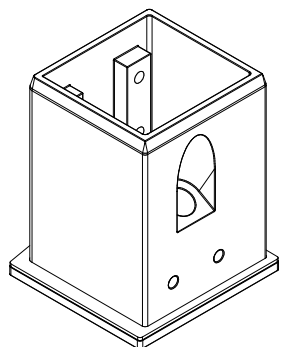

Verbinder FLG 101
PA - GF

1398341 

 10

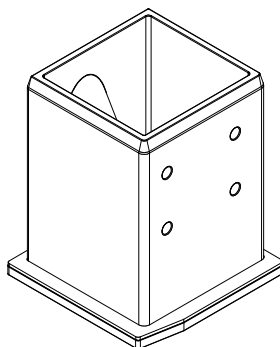

Verbinder FLG 101
PA - GF

1398351 

 10

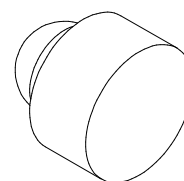

Anschlagstopfen
EPDM

1353685 

 50

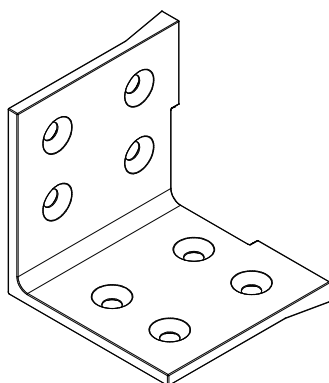

Falzeckverbinder
Zink-Druckguss

1398342

 20

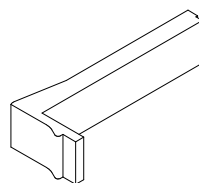

Dichtstück FLG 40
Zellgummi

1398340 

 20

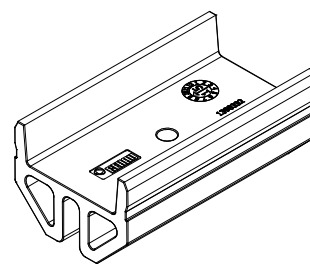

Distanzstück
ABS

1398332 

 50

HEBESCHIEBETÜRSYSTEM SYNEGO®

PROFILDRUCK

Formteile

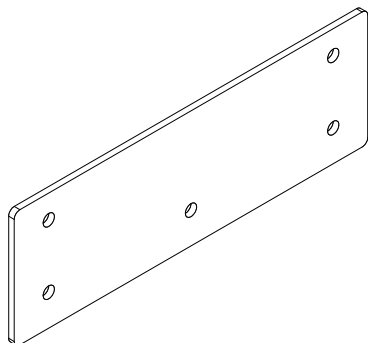

Abschluss Zarge

PVC

1398320 

 20

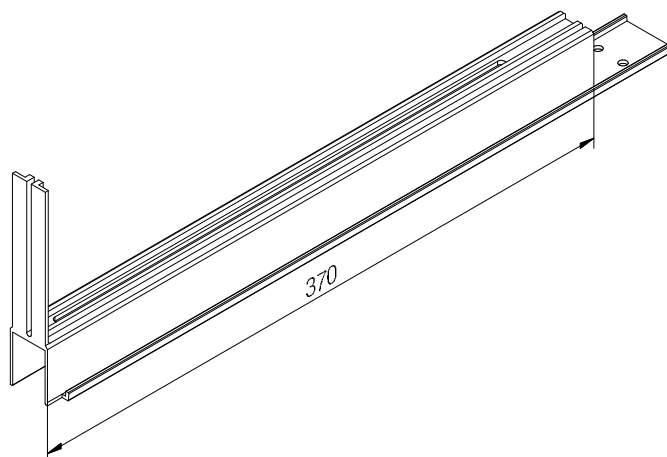

Laufwagengehäuse

Zink-Druckguss

1352849

 2

Schrauben

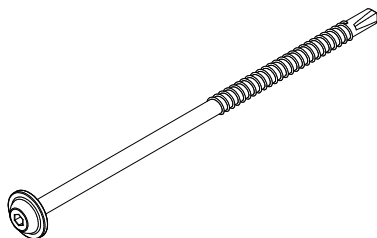

Bohrschraube 5,5 x 110

Stahl verzinkt

1357800

 50

Bohrschraube 5,5 x 130

Stahl verzinkt

1357900

 50

HEBESCHIEBETÜRSYSTEM SYNEGO®

PROFILDRUCK

Werkzeuge

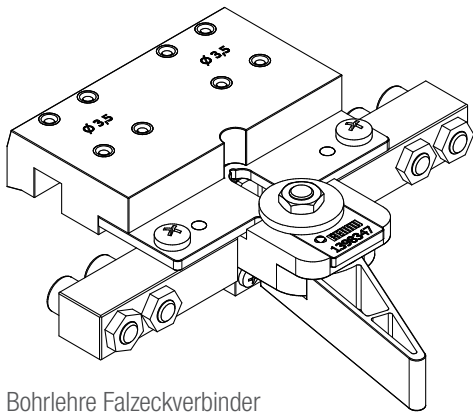

Bohrlehre Falzeckverbinder

1398347

 1

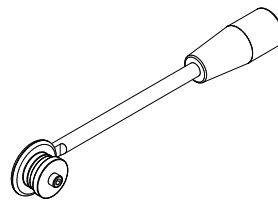

Handroller

1266828

 1

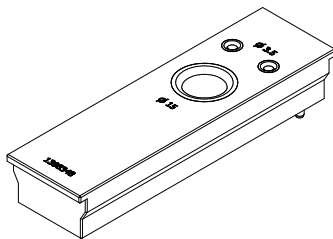

Bohrlehre FLG 101 Panorama

1398348

 1

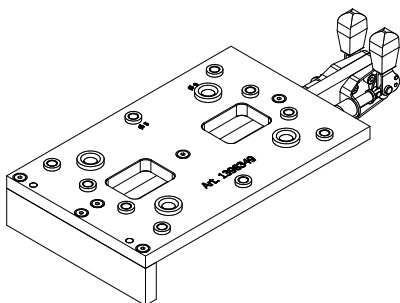

Bohrlehre Zarge

1398349

 1

HEBESCHIEBETÜRSYSTEM SYNEGO®

PROFILDRUCK

Dichtungen

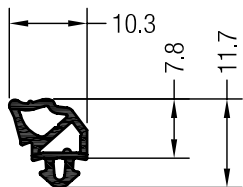

Universaldichtung

PREN

1607457 ■■■

250

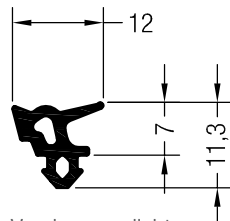

Verglasungsdichtung

EPDM

1357441 ■■■

200

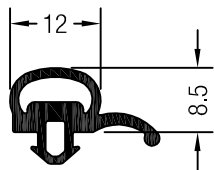

Dichtung Flügel

EPDM

1398312 ■■■

150

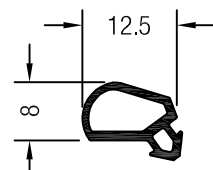

Dichtung Zargenleiste

EPDM

1354000 ■■■

1354001 ■■■

100

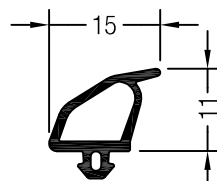

Dichtung Mittelschluss

EPDM

1398313 ■■■

100

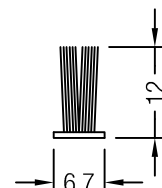

Bürstendichtung 6,7 x 12

PE

1246834 ■■■

100

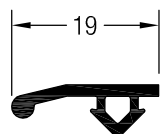

ISO - Dichtung HST SYNEGO®

EPDM

1398316 ■■■

100

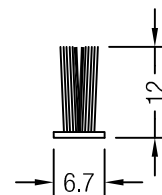

Bürstendichtung 6,7 x 12 WF
(für Schallschutzanforderung)

PE

1398599 ■■■

100

HEBESCHIEBETÜRSYSTEM SYNEGO®

PROFILDRUCK

Glasleisten (schräg) mit anextrudierten Dichtlippen

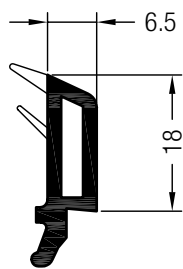

Glasleiste 6,5

1560580

144 (6)

1594330

72 (6)

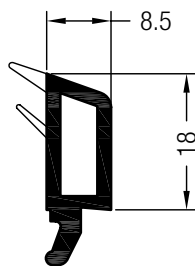

Glasleiste 8,5

1560281

144 (6)

1597008

72 (6)

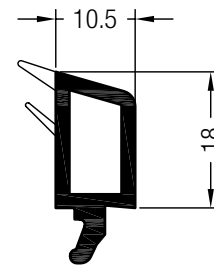

Glasleiste 10,5

1560590

144 (6)

1596910

72 (6)

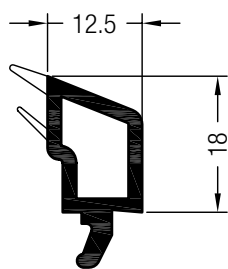

Glasleiste 12,5

1560311

144 (6)

1597009

72 (6)

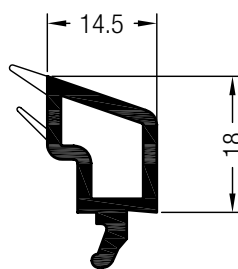

Glasleiste 14,5

1560600

144 (6)

1596660

72 (6)

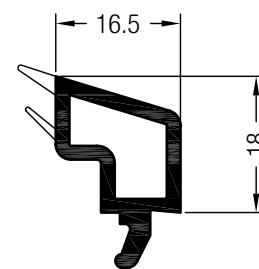

Glasleiste 16,5

1560321

144 (6)

1596001

72 (6)

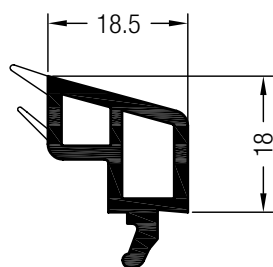

Glasleiste 18,5

1560610

144 (6)

1596260

72 (6)

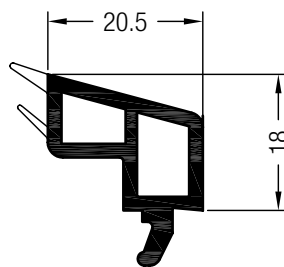

Glasleiste 20,5

1561063

144 (6)

1597063

72 (6)

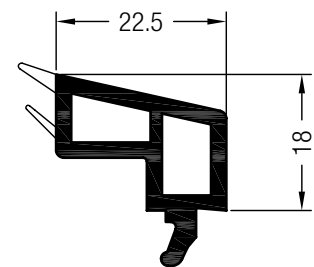

Glasleiste 22,5

1560510

144 (6)

1581441

72 (6)

HEBESCHIEBETÜRSYSTEM SYNEGO®

PROFILDRUCK

Glasleisten (schräg) mit anextrudierten Dichtlippen

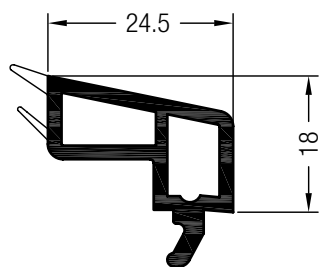

Glasleiste 24,5

1533040

144 (6)

1563040

72 (6)

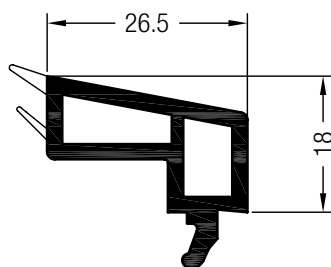

Glasleiste 26,5

1560620

144 (6)

1596920

72 (6)

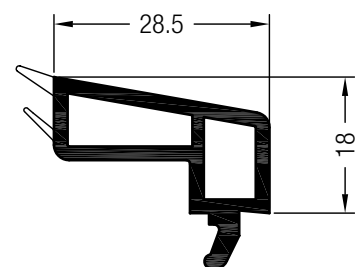

Glasleiste 28,5

1562000

72 (6)

1597005

72 (6)

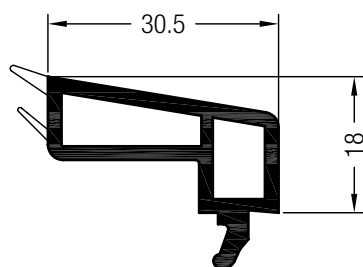

Glasleiste 30,5

1561520

144 (6)

1596600

72 (6)

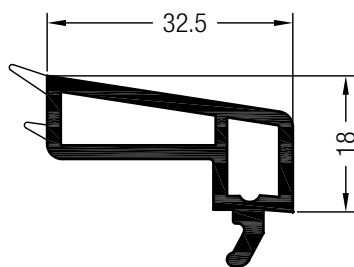

Glasleiste 32,5

1533100

144 (6)

1563100

72 (6)

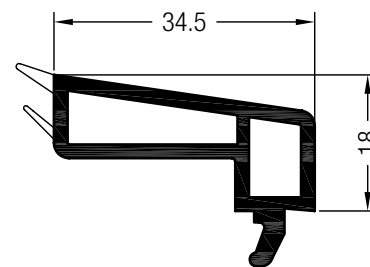

Glasleiste 34,5

1561530

144 (6)

1596630

72 (6)

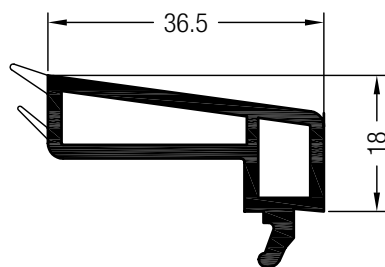

Glasleiste 36,5

1560660

1597660

72 (6)

HEBESCHIEBETÜRSYSTEM SYNEGO®

PROFILDRUCK

Glasleisten (rund) und Glasleisten Softline mit anextrudierten Dichtlippen

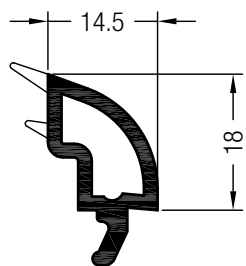

Glasleiste 14,5 rund
1550090
 144 (6)
1599090
 72 (6)

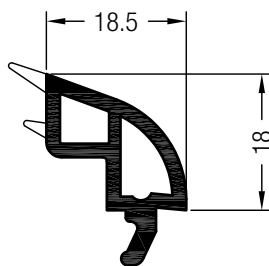

Glasleiste 18,5 rund
1550100
 144 (6)
1599100
 72 (6)

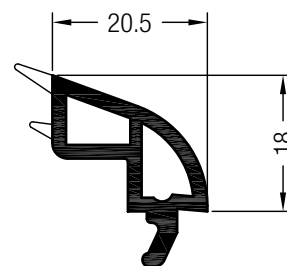

Glasleiste 20,5 rund
1550180
 144 (6)
1599360
 72 (6)

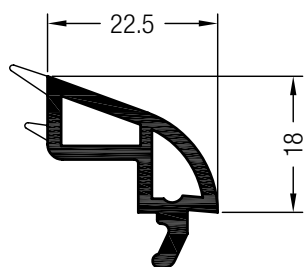

Glasleiste 22,5 rund
1550110
 144 (6)
1599110
 72 (6)

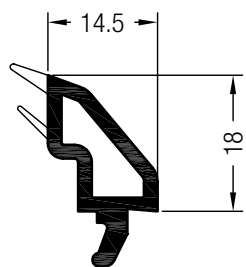

Glasleiste 14,5 Softline
1561145
 144 (6)
1597145
 72 (6)

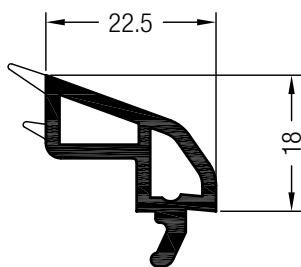

Glasleiste 22,5 Softline
1550120
 144 (6)
1599120
 72 (6)

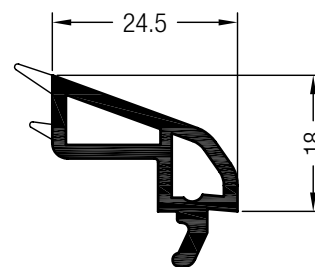

Glasleiste 24,5 Softline
1541043
 144 (6)

HEBESCHIEBETÜRSYSTEM SYNEGO®

PROFILDRUCK

Blendrahmenverbreiterungen

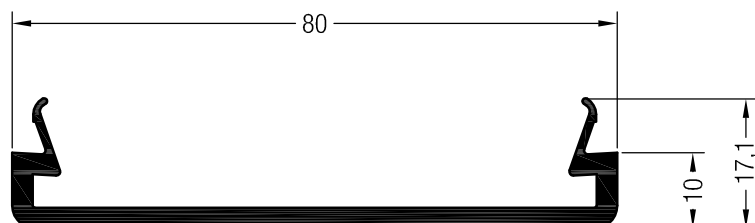

Blendrahmenverbreiterung 10/80



1538010 

1568010 

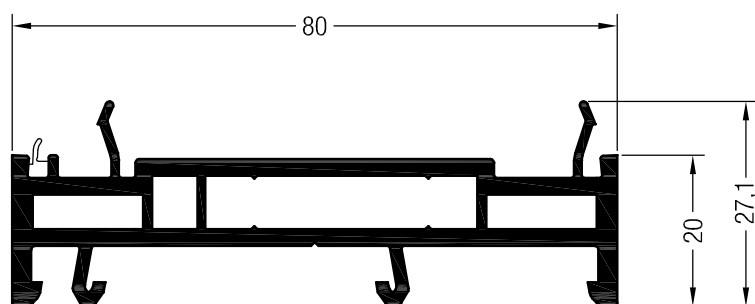
 36 (6)



Blendrahmenverbreiterung 20/80 mit IDS

1538025  

1568025  

 36 (6)

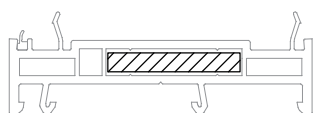

35 x 5

	1264306@
lx	1,8
ly	---
	6

HEBESCHIEBETÜRSYSTEM SYNEGO®

PROFILDRUCK

Blendrahmenverbreiterungen

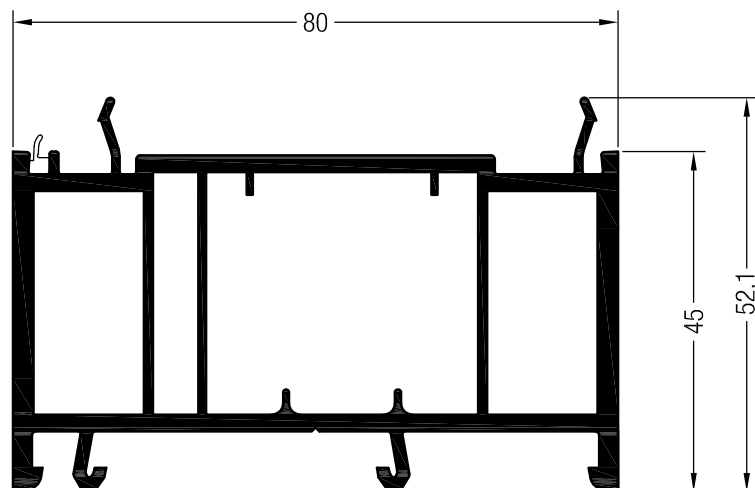

Blendrahmenverbreiterung 45/80 mit IDS



1538045   

1568045   

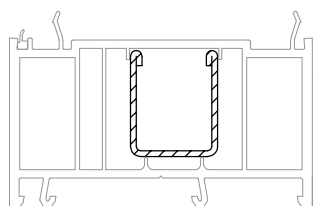
 36 (6)



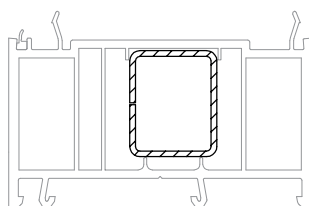

23 x 28

	1306619
	1,5
lx	1,1
ly	1,1
	6



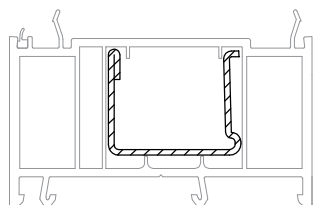

23 x 28

	1357540
	1,5
lx	1,1
ly	1,5
	6



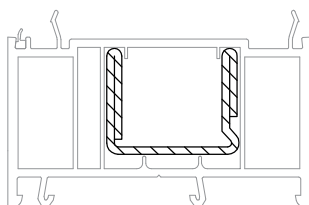

35 x 28

	1244516	1244526
	1,5	2
lx	2,7	3,5
ly	1,3	1,7
	6	6



35 x 28

	1244536
	2
lx	5
ly	2
	6

HEBESCHIEBETÜRSYSTEM SYNEGO®

PROFILDRUCK

Blendrahmenverbreiterungen

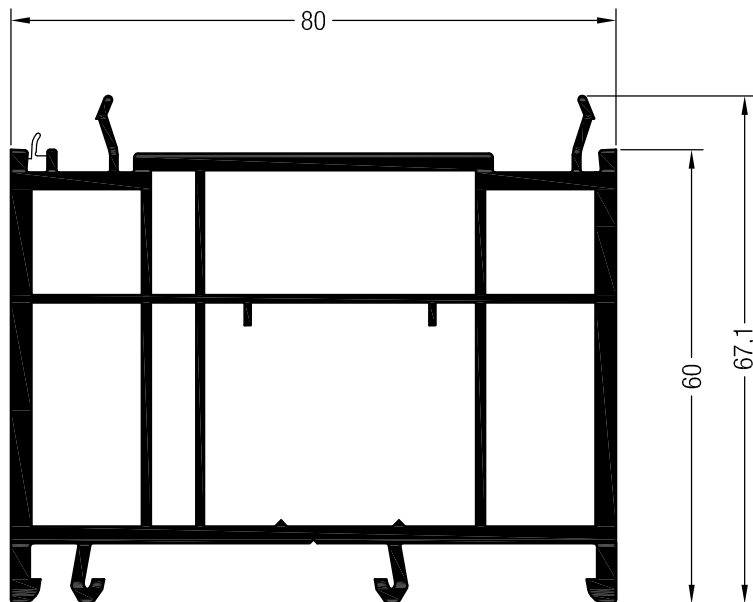

Blendrahmenverbreiterung 60/80 mit IDS

1538065  



 24 (6)

1568065  

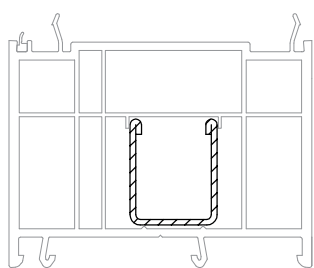
 36 (6)



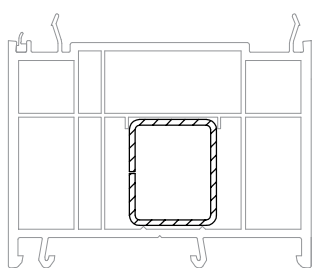

23 x 28

	1306619
	1,5
lx	1,1
ly	1,1
	6



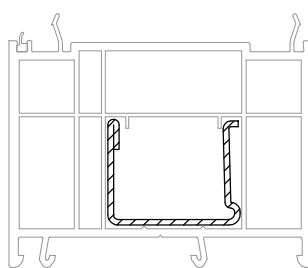

23 x 28

	1357540
	1,5
lx	1,1
ly	1,5
	6



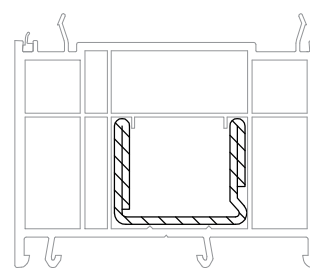

35 x 28

	1244516	1244526
	1,5	2
lx	2,7	3,5
ly	1,3	1,7
	6	6



35 x 28

	1244536
	2
lx	5
ly	2
	6

HEBESCHIEBETÜRSYSTEM SYNEGO®

PROFILDRUCK

Blendrahmenverbreiterungen

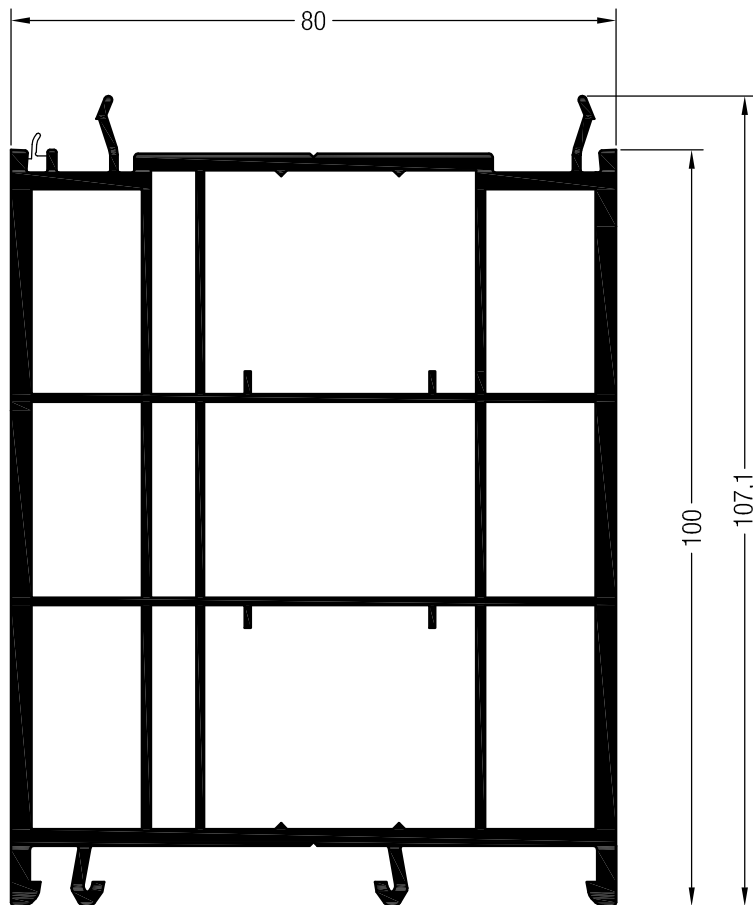

Blendrahmenverbreiterung 100/80 mit IDS



1538105 

1568105 

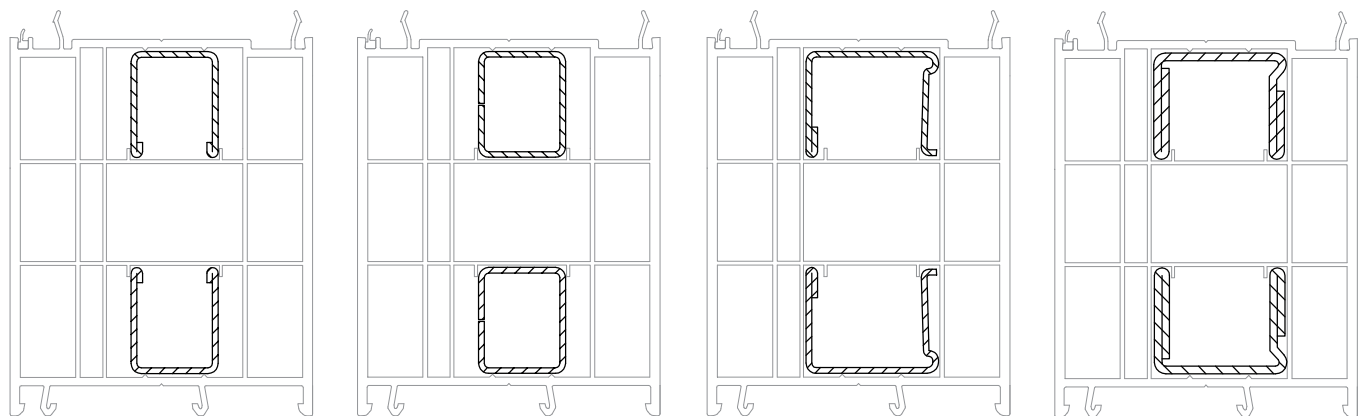

 12 (6)





23 x 28

	1306619
	1,5
lx	1,1
ly	1,1
	6



23 x 28

	1357540
	1,5
lx	1,1
ly	1,5
	6

35 x 28

	1244516	1244526
	1,5	2
lx	2,7	3,5
ly	1,3	1,7
	6	6

35 x 28

	1244536
	2
lx	5
ly	2
	6

HEBESCHIEBETÜRSYSTEM SYNEGO®

PROFILDRUCK

Eckpfostenprofile

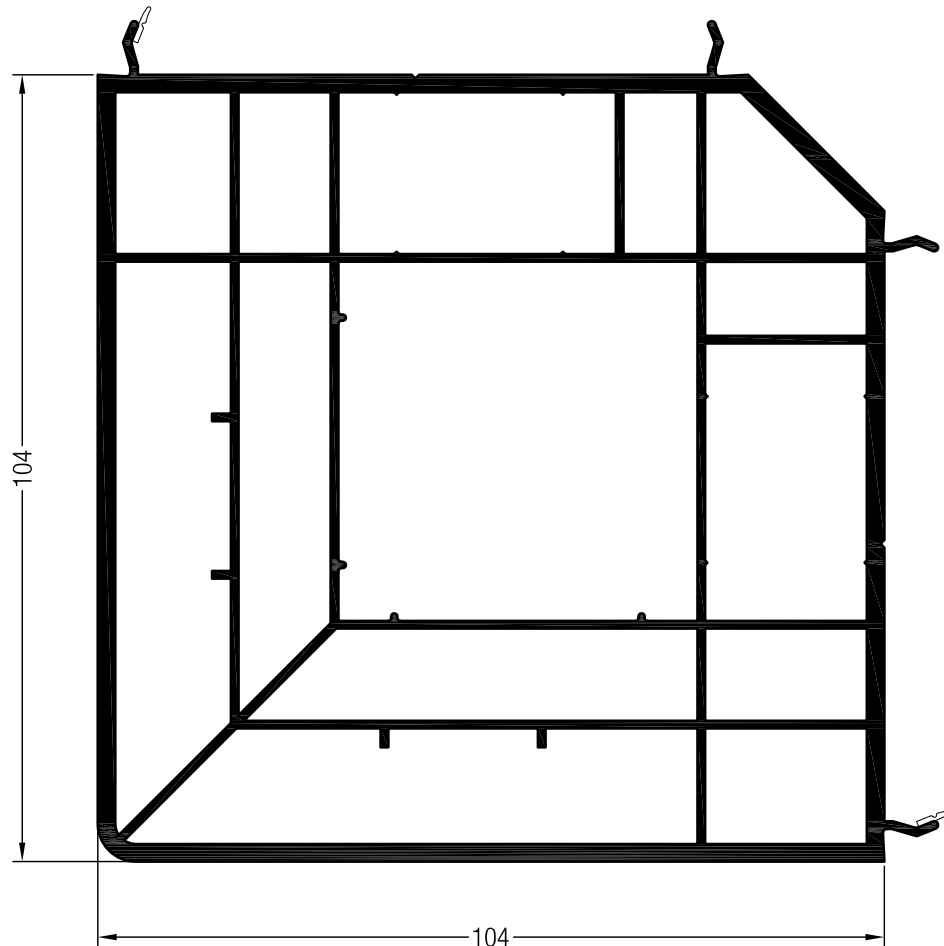

Eckpfosten 90°/86 mit IDS



1533235 

1563235 

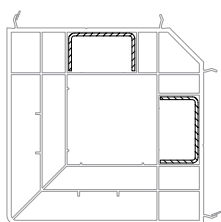
 24 (6)



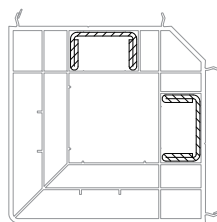

35 x 20

	1245536
	1,5
lx	2
ly	0,42
	6



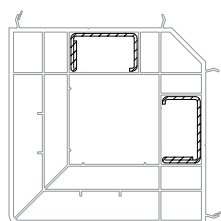

35 x 20

	1351893	1245526
	2	2,5
lx	3,7	4,2
ly	0,77	0,9
	6	6



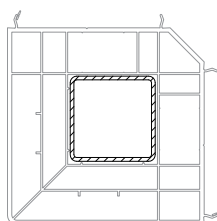

35 x 20

	1261831
	1,5
lx	2,5
ly	0,56
	6



45 x 45

	1259894	1221718@	1253147@	1259306@
	2	2,5	3	4
lx	10,2	12,1	13,8	16,6
ly	10,2	12,1	13,8	16,6
	6	6	6	6



Einsatz nur in Verbindung mit dem Adapterprofil 1538305 bzw. 1568305 möglich!

HEBESCHIEBETÜRSYSTEM SYNEGO®

PROFILDRUCK

Dehnstoßprofile

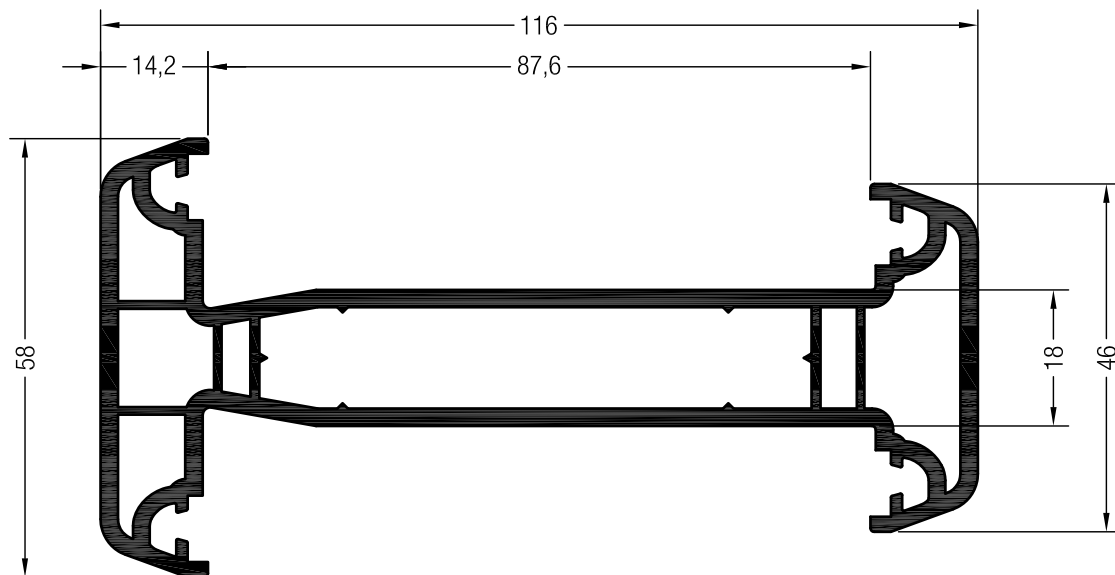

Dehnstoßprofil 2/86



1533070 

1563070 

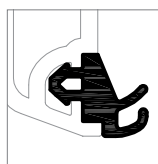
 24 (6)



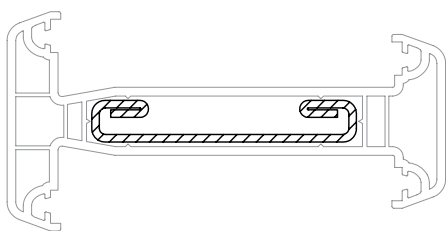

Anschlagdichtung Dehnstoß 

	1357448
	1357448
	200



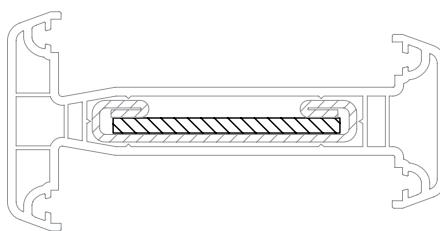

70 x 11

	1350286
	2
lx	15,1
ly	0,38
	6



60 x 3

	1350287@
	3
lx	5,4
ly	-
	6

 Nur in Verbindung mit 1350286 einsetzbar!

HEBESCHIEBETÜRSYSTEM SYNEGO®

PROFILDRUCK

Abdeckprofile

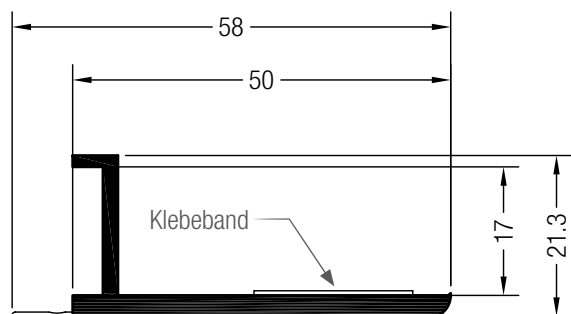

Deckleiste 50

1561660 ↺

144 (6)

1597060 @

72 (6)

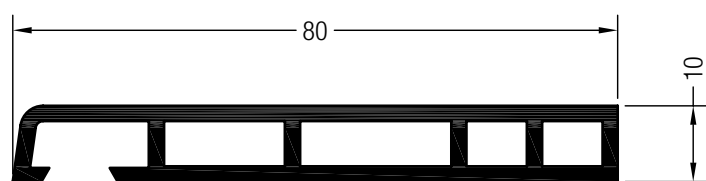

Deckleiste 80

1612762

72

1590260

36 (6)

HEBESCHIEBETÜRSYSTEM SYNEGO®

PROFILDRUCK

Kopplungsprofile

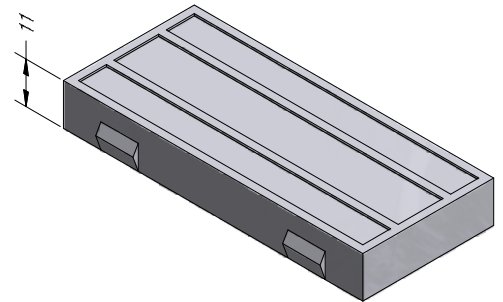
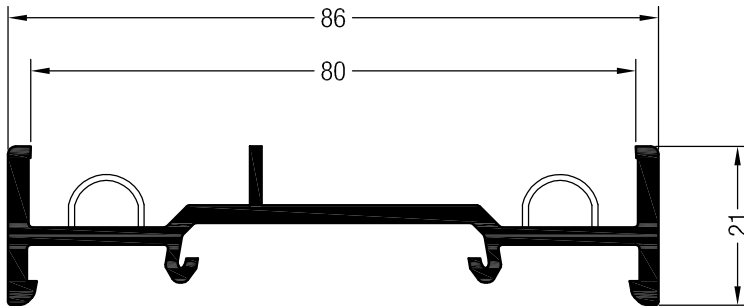

Adapterprofil

1538305  

1568305  

 36 (6)

Distanzklotz 11

RAU-PS

1246009 

 100

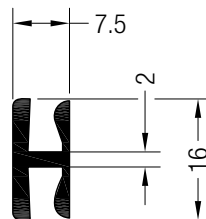
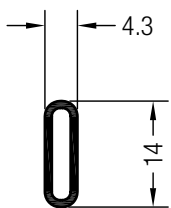

Verbindungsfeder

1561043 

 144 (6)

H-Verbindungsprofil Nr. 1

1732460 

 144 (6)

1590010 

 36 (6)

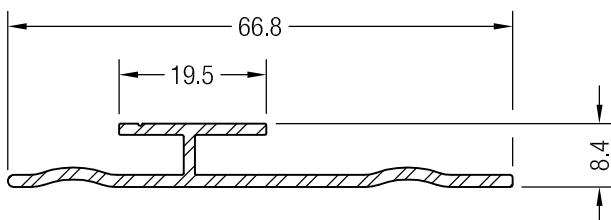

Verbindungsschiene HST SYNEGO

1320401 

 6 (6)

HEBESCHIEBETÜRSYSTEM SYNEGO®

PROFILDRUCK

Zusatzprofile / Zubehörteile

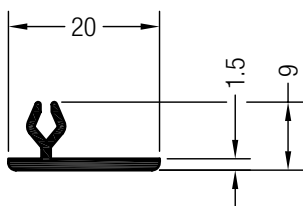

Füllprofil Nr. 2 für Silikonfuge

1561007   @

 144 (6)



Klotzbrücke 53 x 4

RAU-PP

1358049 

 500

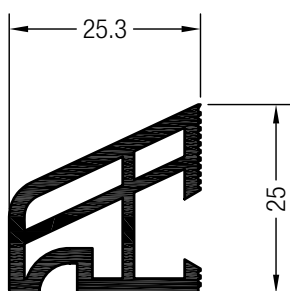

Wetterschenkel Nr. 2

1560720 



 144 (6)

1594140  @

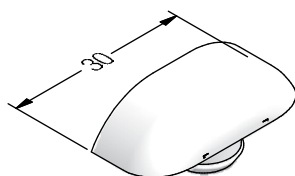
 36 (6)





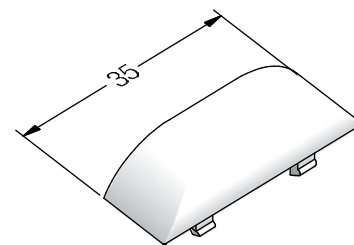

Abdeckkappe für Entwässerungsbohrungen

1645594   

 1000



Abdeckkappe für Entwässerungsschlitze

1261582    

 1000

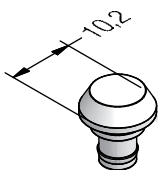

Nippel zum Einschlagen

RAU-PA

1253479 

 1000

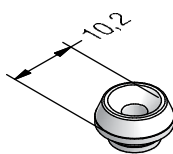

Nippel zum Anschrauben

RAU-PA

1264230  @

 1000

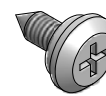

Nippelschraube 4 x 10

Stahl verzinkt

1267669  @

 1000

HEBESCHIEBETÜRSYSTEM SYNEGO®

PROFILDRUCK

„Rund ums Fenster“



EPDM-Kleber (20 g Flasche)

1251760 

 10



PVC-Pflegereiniger für weiße Profile
(500 ml)

1252280

PVC-Pflegereiniger für lackierte und
folienkaschierte Profile (500 ml)

1222660

 20

ohne Abbildung:

Glasreiniger Sprossenfest (1000 ml)

1246409  @

 1



PVC-Reiniger (Industrie, 1000 ml)

1252220 

 10



PVC-Kleber (200 ml)

1251660  

1251670 transparent 

 30

HEBESCHIEBETÜRSYSTEM SYNEGO®

PROFILDRUCK

„Rund ums Fenster“

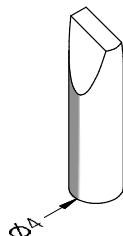



Lackstiftspitze schräg

1217581 

 100

Lackstift	Lack- fläschchen	Spray- dose	
			
1206920	---	---	Anthrazit Grau gebürstet
1206960@	---	---	Schwarzgrau
1207668@	---	---	Schiefergrau
1207673@	---	---	Winchester XA
1208794	---	---	Grau glatt
1209614@	---	---	Cherry Blossom
1209616@	---	---	Rustic Cherry
1215617@	---	---	Siena Rosso genarbt
1215825@	---	---	Siena Noce genarbt
1216873@	---	---	Schokobraum genarbt
1217792@	---	---	Schiefergrau genarbt
1217793@	---	---	Crown Platin
1223900	1209805@	---	Nussbaum
1225610	---	1205240@	Signalgrau
1224740	---	1205240@	BlackCherry
1224820@	---	1205240@	Hellelfenbein
1229450	---	---	Soft Cherry
1229460	---	---	Irish Oak
1229470	---	---	Golden Beech
1229690	---	---	Quarzgrau
1229700@	---	---	Achatgrau
1241212	1248561@	1205240@	Bergkiefer
1242523	1242533@	1205240@	Ultramarinblau
1242563	1242573@	1205240@	Lichtgrau
1246351	1248521@	---	Brillantblau
1246451	1248501@	1205240@	Verkehrsweiß RAL 9016
1246942	1246952@	---	Weinrot
1247018	---	---	Basaltgrau
1247033	---	---	Macore
1247241	1248571	1205240@	Golden Oak
1248310	---	---	Aluminium gebürstet

 5  3  3

































Lackstift	Lack- fläschchen	Spray- dose	
			
1252119	1263894@	---	Dunkelrot
1252224	1263744	1205240@	Braun
1252234	1263754	1205240@	Eiche
1252244	1263764	1205240@	Mahagoni
1257667	1263774@	---	Eiche hell
1258737	1263914	1205240@	Dunkelgrün
1259457	1263864	1205240@	Grau genarbt
1259795	1263794@	---	Mooreiche
1259825	1263884@	---	Rot
1259835	1263904@	---	Grün
1259845@	1263874@	---	Gelb
1260007	1248551@	---	Oregon
1260488	1263834	1205240@	Anthrazit
1260943	1263854@	1205240@	Cremeweiß
1261279	1263944@	1205240@	Stahlblau
1261570@	---	---	Weiß Struktur
1261818	1263824@	---	Douglasie
1263342	1263352@	---	Weiß RAL 9010
1268039	1243125	1205240@	Mooreiche 2
1269677	1248511@	---	Moosgrün
1283316	---	---	Sierra
1289880	---	---	Monumentengrün
1310770@	---	---	Betongrau
1310780@	---	---	Schwarzblau
1311000@	---	---	Walnuss Terra
1311010@	---	---	Walnuss Amaretto
1314576@	---	---	Alux Anthrazitgrau
1314577	---	---	Alux DB 703
1314981@	---	---	Alux Steingrau
1314982@	---	---	Alux Graualuminium
1314983@	---	---	Alux Weissaluminium

 5  3  3

HEBESCHIEBETÜRSYSTEM SYNEGO®

PROFILDRUCK

Zeichenerklärung

	Farbe Schwarz
	Farbe Anthrazitgrau
	Farbe Grau
	Farbe Weiß
	Weißer Deckschicht/bunter Kern
	Farbe Cremeweiß
	Farbe Braun
	Farbe Karamell
	Farbe Grün
	Farbe Rot
	Farbe Silber
	Farbe beliebig
	Aluminium natur eloxiert
	Aluminium pressblank
	Kaschierte Ausführung
	Lackierte Ausführung
	Verpackungseinheit [Gesamt (Profillänge)]
	Wanddicke in mm
	Mit verschweißbarer Dichtung
	Mit nicht verschweißbarer Dichtung
	Manuell einzuziehende Dichtung
	Rechte Ausführung
	Linke Ausführung
@	Außerstandard, Lieferzeit auf Anfrage
lx	Trägheitsmoment in X-Richtung in cm ⁴ , bezogen auf E-Modul von Stahl
ly	Trägheitsmoment in Y-Richtung in cm ⁴ , bezogen auf E-Modul von Stahl
	Mit PVC-Kleber verkleben, weiße Profile mit REHAU PVC-Kleber 1251660/1251670, kaschierte Profile mit lösemittelfreien Klebstoff (z.B. Cosmofen 515, Fa. Weiss).
	Mit Silikon abdichten
	Mit EPDM-Dichtmasse abdichten
	Mit EPDM-Kleber verkleben
	Linsenkopf-Blechschaube ISO 7049
	Senkkopf-Blechschaube ISO 7050
	Senkkopf-Bohrschraube ISO 15482
	Linsenkopf-Bohrschraube ISO 15481
	Bohrlehre
	Kennzeichnungspflichtig nach Gefahrstoffverordnung

HEBESCHIEBETÜRSYSTEM SYNEGO®

PROFILDRUCK

Variantensystematik

Weiß Profile:

Nach der Artikelnummer (z.B. 1598545) folgt eine 4-stellige Variante (z.B. 1701), die bei Haupt- und Zusatzprofilen gleichermaßen aufgebaut ist.

Die Variante besteht aus jeweils 4 Stellen:

- 1. und 2. Stelle: Verpackungsart
- 3. und 4. Stelle: Farbnummer



1. und 2. Stelle	Verpackungsart
17	Schlauch-Langgutpalette (LGP)
19	Schrumpf-Langgutpalette (LGP)

3. und 4. Stelle	Farbnummer	
	Profil	Profil/Dichtung
01	Weiß	Weiß/Schwarz
	159	159/601
05	Weiß	Weiß/Weiß
	159	159/159
15	-	Weiß/Grau 159/RAL 7001

Beispiele:

XXXXXXX  - Artikel in Weiß ohne Dichtung
 36
 kleinste Verpackungseinheit 36 m

Variante 1701: Schlauch-LGP
 Variante 1901: Schrumpf-LGP

XXXXXXX   - Artikel in Weiß mit weißer Dichtung
 24
 kleinste Verpackungseinheit 24 m





Variante 1705: Schlauch-LGP
 Variante 1905: Schrumpf-LGP

XXXXXXX   - Artikel in Weiß mit grauer Dichtung
 36
 kleinste Verpackungseinheit 36 m
 Variante 1715: Schlauch-LGP
 Variante 1915: Schrumpf-LGP

Kaschierte Profile:

Für kaschierte Profile ist abhängig von der gewünschten Farbkombination eine 4-stellige Farbvariante aus dem Tableau Standardfarben zu entnehmen. Kaschierte Profile werden generell in der Verpackungsart Schlauch-Langgutpalette geliefert.

Beispiele:

XXXXXXX    - Artikel kaschiert mit schwarzer Dichtung
 24
 kleinste Verpackungseinheit 24 m
 Verpackung generell in Schlauch-LGP
 Farbvariante nach Tableau Standardfarben.

Materialnummer

Die 7-stellige Artikelnummer (z.B. 1532015) wird mit der 4-stelligen Variante (z.B. 1701) zu einer 11-stelligen Materialnummer zusammengefasst (z.B. 15320151701).

 Achtung: Nicht alle Profile werden in allen oben gelisteten Varianten angeboten.

HEBESCHIEBETÜRSYSTEM SYNEGO®

PROFILDRUCK

Artikelverzeichnis

Art.-Nr.	Bezeichnung	Pack/Bündel in m	Karton/Beutel in Stück	Seite
1205240	Spraydose Farbe über Variante		3	26
1206920	Lackstift Anthrazitgrau gebürstet		5	26
1206960	Lackstift Schwarzgrau		5	26
1207668	Lackstift Schiefergrau		5	26
1207673	Lackstift Winchester XA		5	26
1208794	Lackstift Grau glatt		5	26
1209614	Lackstift Cherry blossom		5	26
1209616	Lackstift Rustic cherry		5	26
1209805	Lackfläschchen Nussbaum		5	26
1215617	Lackstift Siena Rosso genarbt		5	26
1215825	Lackstift Siena Noce genarbt		5	26
1216873	Lackstift Schokobraun genarbt		5	26
1217581	Lackstiftspitze schräg		100	26
1217792	Lackstift Schiefergrau genarbt		5	26
1217793	Lackstift Crown Platin		5	26
1221718	45 x 45	6		20
1222660	PVC-Pflegereiniger für folienkaschierte und lackierte Profile (500 ml)		20	25
1223900	Lackstift Nussbaum		5	26
1224740	Lackstift Black cherry		5	26
1224820	Lackstift Hellelfenbein		5	26
1225610	Lackstift Signalgrau		5	26
1229450	Lackstift Soft cherry		5	26
1229460	Lackstift Irish oak		5	26
1229470	Lackstift Golden beech		5	26
1229690	Lackstift Quarzgrau		5	26
1229700	Lackstift Achatgrau		5	26
1241212	Lackstift Bergkiefer		5	26
1242523	Lackstift Ultramarinblau		5	26
1242533	Lackfläschchen Ultramarinblau		1	26
1242563	Lackstift Lichtgrau		5	26
1242573	Lackfläschchen Lichtgrau		1	26
1243125	Lackfläschchen Mooreiche 2		1	24
1244516	35 x 28	6		21
1244526	35 x 28	6		21
1244536	35 x 28	6		21
1245526	35 x 20	6		21
1245536	35 x 20	6		21
1246009	Distanzklotz 11		100	23
1246351	Lackstift Brillantblau		5	26
1246409	Glasreiniger Sprossenfest (1000 ml)		1	9

HEBESCHIEBETÜRSYSTEM SYNEGO®

PROFILDRUCK

Artikelverzeichnis

Art.-Nr.	Bezeichnung	Pack/Bündel in m	Karton/Beutel in Stück	Seite
1246451	Lackstift Verkehrsweiß		5	26
1246834	Bürstendichtung 6,7x12		100	12
1246942	Lackstift Weinrot		5	26
1246952	Lackfläschchen Weinrot		1	26
1247018	Lackstift Basaltgrau		5	26
1247033	Lackstift Macore		5	26
1247241	Lackstift Golden oak		5	26
1248310	Lackstift Aluminium gebürstet		5	26
1248501	Lackfläschchen Verkehrsweiß		1	26
1248511	Lackfläschchen Moosgrün		1	26
1248521	Lackfläschchen Brillantblau		1	26
1248551	Lackfläschchen Oregon		1	26
1248561	Lackfläschchen Bergkiefer		1	26
1248571	Lackfläschchen Golden oak		1	26
1251660	PVC-Kleber (200 ml)		30	24
1251670	PVC-Kleber (200 ml)		30	25
1251760	EPDM-Kleber (20g Flasche)		10	24
1252119	Lackstift Dunkelrot		5	26
1252220	PVC-Reiniger (Industrie, 1000 ml)		10	25
1252224	Lackstift Braun		5	26
1252234	Lackstift Eiche dunkel 1		5	26
1252244	Lackstift Mahagoni		5	26
1252280	PVC-Pflegereiniger für weiße Profile (500 ml)		12	25
1253147	45 x 45	6		20
1253479	Nippel zum Einschlagen		1000	24
1257667	Lackstift Eiche hell		5	26
1258737	Lackstift Dunkelgrün		5	26
1259306	45 x 45	6		21
1259457	Lackstift Grau genarbt		5	26
1259795	Lackstift Mooreiche		5	26
1259825	Lackstift Rot		5	26
1259835	Lackstift Grün		5	26
1259845	Lackstift Gelb		5	26
1259894	45 x 45	6		21
1260007	Lackstift Oregon		5	26
1260488	Lackstift Anthrazit		5	26
1260943	Lackstift Cremeweiß		5	26
1261279	Lackstift Stahlblau		5	26
1261570	Lackstift Weiß struktur		5	26
1261582	Abdeckkappe für Entwässerungsschlitze		1000	9

HEBESCHIEBETÜRSYSTEM SYNEGO®

PROFILDRUCK

Artikelverzeichnis

Art.-Nr.	Bezeichnung	Pack/Bündel in m	Karton/Beutel in Stück	Seite
1261818	Lackstift Douglasie		5	26
1261831	35 x 20	6		21
1263342	Lackstift Weiß		5	26
1263352	Lackfläschchen Weiß		5	26
1263744	Lackfläschchen Braun		1	26
1263754	Lackfläschchen Eiche		1	26
1263764	Lackfläschchen Mahagoni		1	26
1263774	Lackfläschchen Eiche hell		1	26
1263794	Lackfläschchen Mooreiche		1	26
1263824	Lackfläschchen Douglasie		1	26
1263834	Lackfläschchen Anthrazit		1	26
1263854	Lackfläschchen Cremeweiß		1	26
1263864	Lackfläschchen Grau genarbt		1	26
1263874	Lackfläschchen Gelb		1	26
1263884	Lackfläschchen Rot		1	26
1263894	Lackfläschchen Dunkelrot		1	26
1263904	Lackfläschchen Grün		1	26
1263914	Lackfläschchen Dunkelgrün		1	26
1263944	Lackfläschchen Stahlblau		1	26
1264230	Nippel zum Anschrauben		1000	24
1264306	35 x 5	6		16
1266828	Handroller		1	11
1267669	Nippelschraube		1000	24
1268039	Lackstift Mooreiche 2		5	26
1269677	Lackstift Moosgrün		5	26
1283316	Lackstift Sierra		5	26
1289880	Lackstift Monumentengrün		5	26
1306619	28 x 28	6		21
1310770	Lackstift Betongrau		5	26
1310780	Lackstift Schwarzblau		5	26
1311000	Lackstift Walnuss Terra		5	26
1311010	Lackstift Walnuss Amaretto		5	26
1314576	Lackstift Alux Anthrazitgrau		5	26
1314577	Lackstift Alu DB 703		5	26
1314981	Lackstift Alu Steingrau		5	26
1314982	Lackstift Alu Graualuminium		5	26
1314983	Lackstift Alu Weissaluminium		5	26
1320401	Verbindungsschiene HST SYNEGO	6		23
1350287	60 x 3	6		21
1350286	70 x 11	6		21

HEBESCHIEBETÜRSYSTEM SYNEGO®

PROFILDRUCK

Artikelverzeichnis

Art.-Nr.	Bezeichnung	Pack/Bündel in m	Karton/Beutel in Stück	Seite
1351893	35 x 20	6		20
1352849	Laufwagengehäuse		2	10
1353685	Anschlagstopfen		50	9
1354000	Dichtung Zargenleiste außen (Schwarz)	100		24
1354001	Dichtung Zargenleiste außen (Grau)	100		12
1357441	Verglasungsdichtung	200		12
1357448	Anschlagdichtung Dehnstoß	200		12
1357540	23 x 28	6		21
1357800	Bohrschraube 5,5 x 110		50	10
1357900	Bohrschraube 5,5 x 130		50	10
1358049	Klotzbrücke 53 x 4		500	9
1398300	Armierung Flügel 101	6		2
1398301	Armierung Flügel 40	6		3
1398302	Armierung Mittelschluss	5		7
1398303	Armierung Zarge Stahl	6		4
1398305	Armierung Zarge Alu	6		4
1398307	Dichtleiste Alu	6		9
1398308	Set Form- und Dichtteile, Schema A	1		8
1398309	Set Form- und Dichtteile, Schema C	1		8
1398312	Dichtung Flügel	150		12
1398313	Dichtung Mittelschluss	100		12
1398316	ISO - Dichtung HST SYNEGO	100		12
1398320	Abschluss Zarge	20		24
1398321	Dichtpad Anschlagleiste			8
1398322	Dichtpad Mittelschluss oben innen			4
1398324	Dichtkissen Zargenleiste			5
1398325	Dichtstück Mittelschluss oben rechts		50	9
1398326	Dichtstück Mittelschluss oben links		50	9
1398327	Dichtstück Mittelschluss unten			8
1398328	Dichtpad Stulp oben			8
1398332	Distanzstück			9
1398334	Endstück Anschlagleiste			8
1398338	Endstück Abdeckprofil unten			8
1398339	Endstück Abdeckprofil oben			9
1398340	Dichtstück FLG 40		20	8
1398341	Verbinder FLG 101 rechts		10	8
1398342	Falzeckverbinder		20	9
1398347	Bohrlehre Falzeckverbinder		1	11
1398348	Bohrlehre FLG 101 Panorama		1	11
1398349	Bohrlehre Zarge		1	11

HEBESCHIEBETÜRSYSTEM SYNEGO®

PROFILDRUCK

Artikelverzeichnis

Art.-Nr.	Bezeichnung	Pack/Bündel in m	Karton/Beutel in Stück	Seite
1398350	konf. Armierung Flügel 101		1	2
1398351	Verbinder FLG 101 links		10	9
1398370	Dichtpad Zarge			8
1398599	Bürstendichtung 6,7 x 12 WF		100	12
1533040	Glasleiste 24,5	144		14
1533070	Dehnstoßprofil 2/86	24		24
1533100	Glasleiste 32,5	144		14
1533235	Eckpfosten 90°/86 mit IDS	24		23
1536500	Abdeckprofil HST SYNEGO	30		5
1536520	Zargenleiste HST SYNEGO	36		4
1536530	Anschlagleiste HST SYNEGO	60		5
1536545	Flügel 101 HST SYNEGO	12		2
1536550	Mittelschluss HST SYNEGO	40		7
1536570	Zarge HST SYNEGO	13,6		4
1536585	Flügel 40 HST SYNEGO	24		3
1538010	Blendrahmenverbreiterung 10/80	36		24
1538025	Blendrahmenverbreiterung 20/80	36		16
1538045	Blendrahmenverbreiterung 45/80	36		17
1538065	Blendrahmenverbreiterung 60/80	24		16
1538105	Blendrahmenverbreiterung 100/80	12		19
1538305	Adapterprofil	36		16
1539500	Adeckprofil HST SYNEGO (kaschiert)	30		4
1539520	Zargenleiste HST SYNEGO (kaschiert)	36		4
1539530	Anschlagleiste HST SYNEGO (kaschiert)	36		4
1539545	Flügel 101 HST SYNEGO (kaschiert)	12		2
1539550	Mittelschluss HST SYNEGO (kaschiert)	30		4
1539570	Zarge HST SYNEGO	13,6		4
1539585	Flügel 40 HST SYNEGO (kaschiert)	12		2
1541043	Glasleiste Softline 24,5	144		15
1550090	Glasleiste rund 14,5	144		15
1550100	Glasleiste rund 18,5	144		15
1550110	Glasleiste rund 22,5	144		15
1550120	Glasleiste Softline 22,5	144		15
1550180	Glasleiste rund 20,5	144		15
1560281	Glasleiste 8,5	144		13
1560311	Glasleiste 12,5	144		15
1560321	Glasleiste 16,5	72		15
1560510	Glasleiste 22,5	144		13
1560580	Glasleiste 6,5	144		13
1560590	Glasleiste 10,5	144		13

HEBESCHIEBETÜRSYSTEM SYNEGO®

PROFILDRUCK

Artikelverzeichnis

Art.-Nr.	Bezeichnung	Pack/Bündel in m	Karton/Beutel in Stück	Seite
1560600	Glasleiste 14,5	144		15
1560610	Glasleiste 18,5	144		15
1560620	Glasleiste 26,5	144		14
1560660	Glasleiste 36,5	72		15
1560720	Wetterschenkel Nr. 2	144		24
1561007	Füllprofil Nr. 2 für Silikonfuge	144		24
1561043	Verbindungsfeder	144		23
1561063	Glasleiste 20,5	144		15
1561145	Glasleiste Softline 14,5	144		15
1561520	Glasleiste 30,5	144		15
1561530	Glasleiste 34,5	144		15
1561660	Deckleiste 50	144		24
1562000	Glasleiste 28,5	72		15
1563040	Glasleiste 24,5 (kaschiert)	72		15
1563070	Dehnstoßprofil 2/86	24		24
1563100	Glasleiste 32,5 (kaschiert)	72		15
1563235	Eckpfosten 90°/86 mit IDS	24		24
1568010	Blendrahmenverbreiterung 10/80 (kaschiert)	36		24
1568025	Blendrahmenverbreiterung 20/80 (kaschiert)	36		24
1568045	Blendrahmenverbreiterung 45/80 (kaschiert)	36		23
1568065	Blendrahmenverbreiterung 60/80 (kaschiert)	36		23
1568105	Blendrahmenverbreiterung 100/80 (kaschiert)	12		24
1568305	Adapterprofil	36		24
1581441	Glasleiste 22,5 (kaschiert)	72		15
1590010	H-verbundungsprofil Nr. 1 (kaschiert)	36		24
1590260	Deckleiste 80 (kaschiert)	36		24
1594140	Wetterschenkel Nr. 2 (kaschiert)	36		24
1594330	Glasleiste 6,5 (kaschiert)	72		13
1596001	Glasleiste 16,5 (kaschiert)	72		15
1596260	Glasleiste 18,5 (kaschiert)	72		15
1596600	Glasleiste 30,5 (kaschiert)	72		15
1596630	Glasleiste 34,5 (kaschiert)	72		15
1596660	Glasleiste 14,5 (kaschiert)	72		13
1596910	Glasleiste 10,5 (kaschiert)	72		15
1596920	Glasleiste 26,5 (kaschiert)	72		15
1597005	Glasleiste 28,5 (kaschiert)	72		15
1597008	Glasleiste 8,5 (kaschiert)	72		15
1597009	Glasleiste 12,5 (kaschiert)	72		15
1597060	Deckleiste 50 (kaschiert)	72		16
1597063	Glasleiste 20,5 (kaschiert)	72		15

HEBESCHIEBETÜRSYSTEM SYNEGO®

PROFILDRUCK

Artikelverzeichnis

Art.-Nr.	Bezeichnung	Pack/Bündel in m	Karton/Beutel in Stück	Seite
1597145	Glasleiste Softline 14,5 (kaschiert)	72		13
1597660	Glasleiste 36,5 (kaschiert)	72		13
1599090	Glasleiste rund 14,5 (kaschiert)	72		15
1599100	Glasleiste rund 18,5 (kaschiert)	72		15
1599110	Glasleiste rund 22,5 (kaschiert)	72		15
1599120	Glasleiste Softline 22,5 (kaschiert)	72		15
1599360	Glasleiste rund 20,5 (kaschiert)	72		15
1607457	Universaldichtung	250		12
1612762	Deckleiste 80	72		24
1645594	Adeckkappe für Entwässerungsbohrung		1000	24
1732460	H-Verbindungsprofil Nr. 1	144		24

Die in dieser Drucksache angegebenen Maße sind ungefähre Angaben. Für Toleranzen gelten ausschließlich unsere Lieferungs- und Zahlungsbedingungen. Wir empfehlen daher zu prüfen, ob die in dieser Druckschrift genannten Angaben für Ihre vorgesehene technische Lösung geeignet sind.

Anwendung, Verwendung und Verarbeitung unserer Produkte erfolgen außerhalb unserer Kontrollmöglichkeiten und liegen daher ausschließlich in Ihrem Verantwortungsbereich. Unsere Gewährleistung bezieht sich daher in jedem Fall auf die

gleichbleibende Qualität unserer Produkte entsprechend unserer Spezifikation. Sollte eine Haftung in Frage kommen, so richtet sich diese nach unseren Ihnen bekannten allgemeinen Lieferungs- und Zahlungsbedingungen. Diese sind auch abrufbar unter <http://rehau.de/lzb> oder werden auf Anfrage zugesandt. Für Schäden, die aus der Verwendung von anderen als in unseren Unterlagen aufgeführten Original-System-Zubehörteilen herrühren, ist jede Gewährleistung und Haftung von REHAU ausgeschlossen.