

TRACKTRIM®

SOLUTIONS TO RECESS SOMFY DRAPERY TRACKS



DESIGNED TO DISAPPEAR

Tracktrim® by Blindspace is a perfect fit solution to recess manual and electric curtain tracks. The track and end set are installed flush with the ceiling during construction to form a cavity matching the drapery system and can be painted to match the ceiling. Standard curved sections are available to fit corners, curved walls, bay windows and other applications. When curtain tracks are installed, the result is a minimalist design where curtain tracks fully blend in, flush with the ceiling.

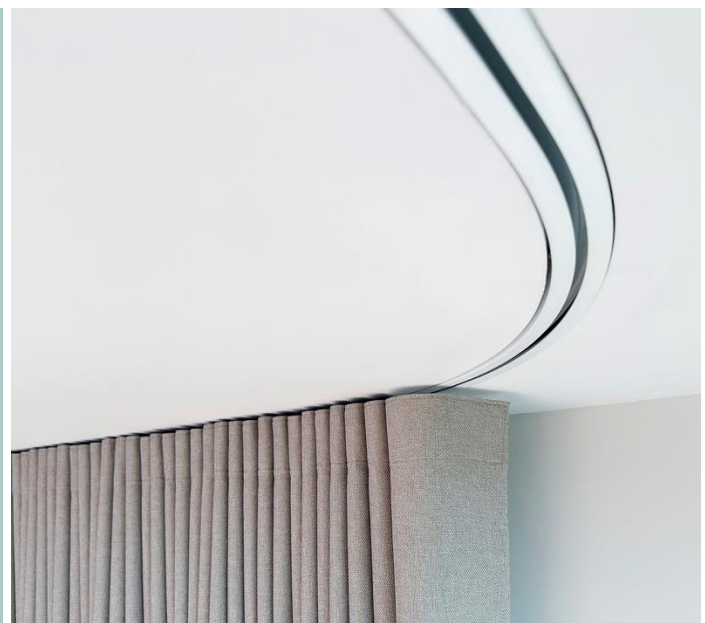

BLINDSPACE®

Track with Screw Channel (TT1F)

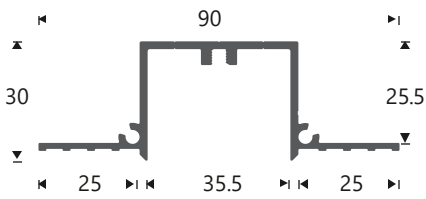

Curve Section

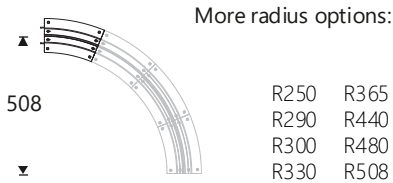

Track for Screw-Through Fixing (TT2F)



1-Piece Return Ends

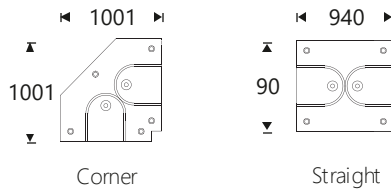

Fixing of Tracktrim (TT1F) & Curtain Track

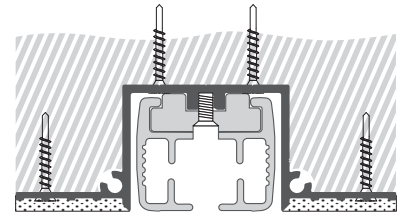

Accessories

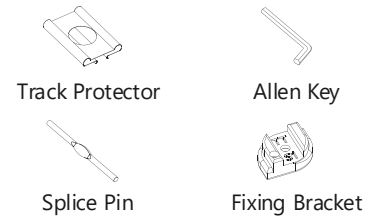

Motor End (TTSMB1F)

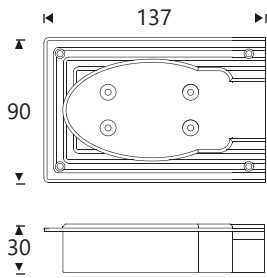

Inverted Motor End (TTSIMB1F)

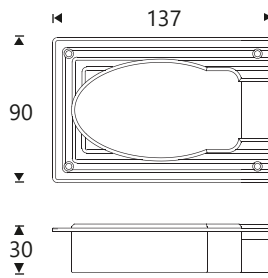

Return End (TTSRB1F)

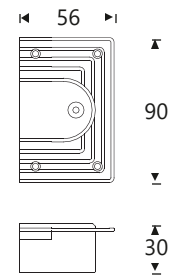

Manufacturer

Blindspace AB
Web: www.blindspace.com
Email: sales@blindspace.com
Tel: +44 20 8798 3945

Description

Solutions to recess manual and electric electric curtain tracks and end sets, with no visible bracketry.

Product Reference

Tracks: TT1F
End-sets: TTSMB1F/TTSIMB1F/TTSRB1F
1-Piece Return Ends: TTSCR1F & TTSSRB1F
Curve sections: TTCR508
Example: TTSMB1F, TTSIMB1F & TTSRB1F

Fixing

Anchoring with countersink screws through profile and flanges every 200mm. Finished plaster level flush with chamfered edge and ceiling.

Material

Tracks in Aluminium, EN 6060 T66
End-sets & curves in Plastic POM Polymer

Finish

White to be plastered in and decorated at site to match ceiling.

FEATURES

Centered curtain tracks with no visible fixing brackets

In contrast to solutions using a wedge along the side of the curtain track, TrackTrim® are fixed through the curtain track for minimum visual impact.

Perfect-fit end-set to match motor and return ends

End sets are designed and manufactured to perfectly fit with motor and belt return ends.

Seamless appearance after painting

Plaster is feathered over skim coat flanges to hide the track and end-set, leaving only an open cavity for installation of curtain system.

Splice Pins to connect different profiles

Splice Pins are used to connect the endsets to the main Tracktrim profile and also to the different curved sections.



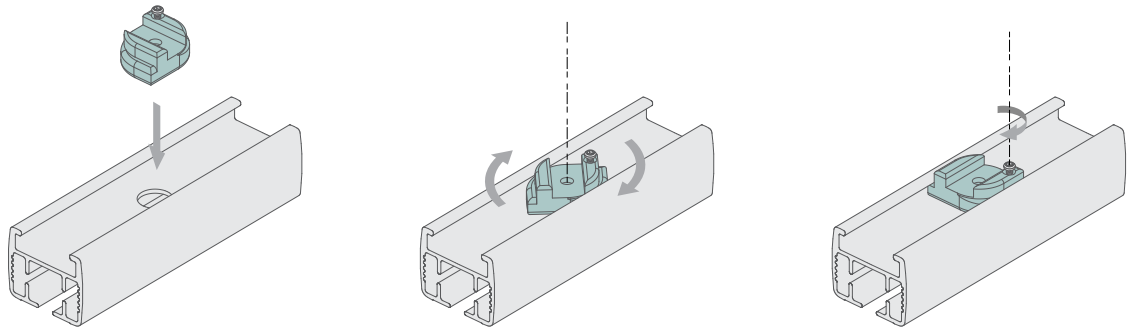

Fixing to TT1F

Fixing to TT2F, Optional Fixing to TT1F

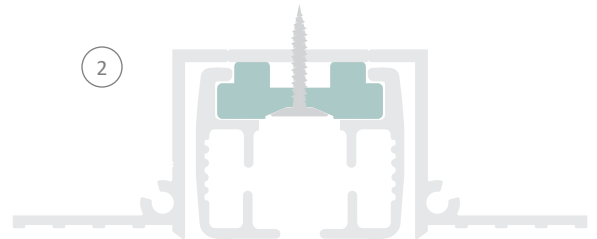
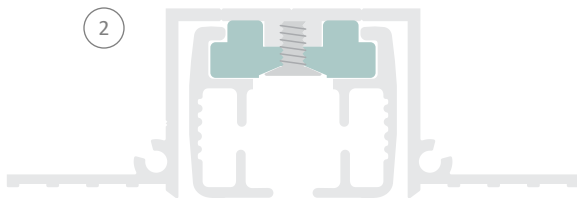
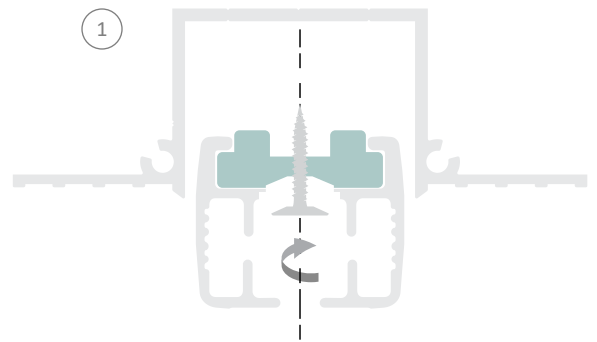
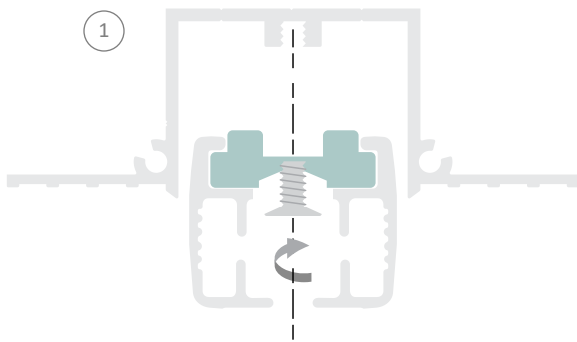

Connecting Sections using Splice Pins

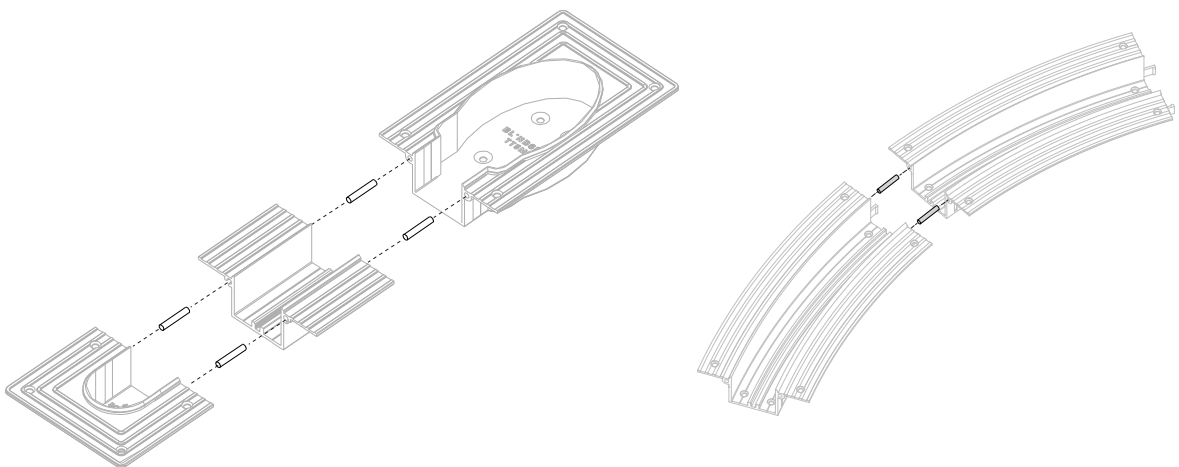



Dual TT1F with TTSMB1F and TTSRB1F, tracks with 180mm spacing.



TT1F with TTSMB1F and TTSRB1F



Trackrim® Curved Section finished installation.

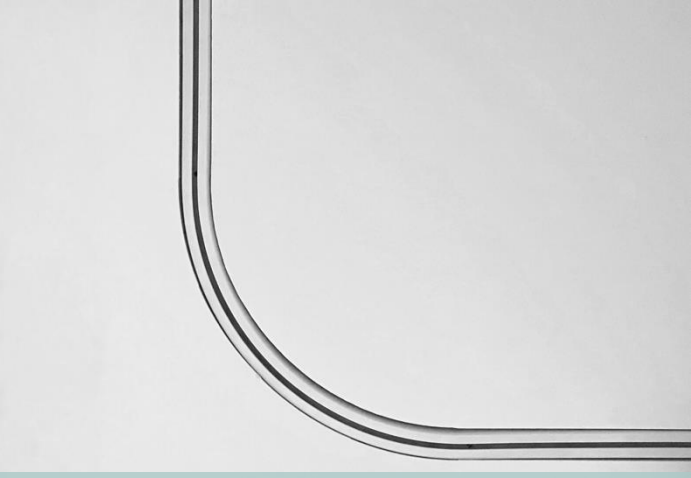

Trackrim® Curved Section finished installation.



TTCR300 Curved Section 300mm radius



TT1F with TTSMB1F and TTSRB1F.



TTSIMB1F, TTSMB1F and TTSRB1F Sample.

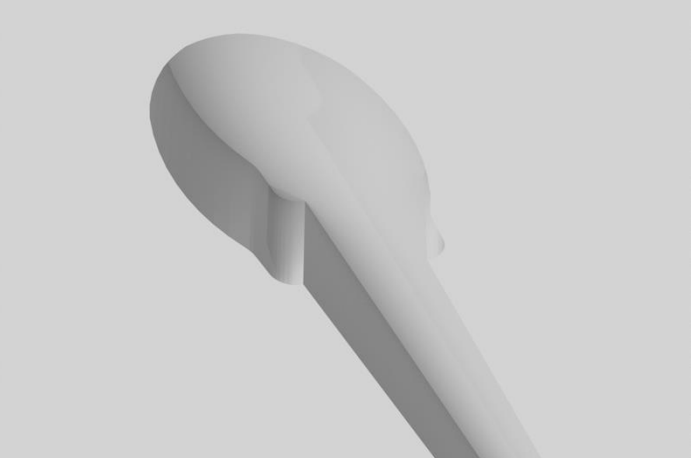

TT1F with TTSMB1F finished installation.