

TRACKTRIM®

SOLUTIONS TO RECESS SILENT GLASS 5600



DESIGNED TO DISAPPEAR

Tracktrim® by Blindspace is a perfect fit solution to recess manual and electric curtain tracks. The track and end set are installed flush with the ceiling during construction to form a cavity matching the drapery system and can be painted to match the ceiling. Standard curved sections are available to fit corners, curved walls, bay windows and other applications. When curtain tracks are installed, the result is a minimalist design where curtain tracks fully blend in, flush with the ceiling.

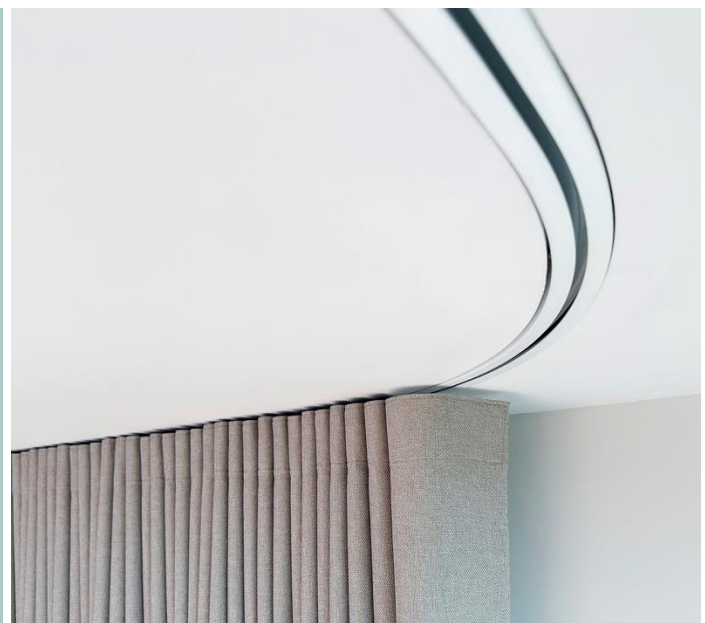

BLINDSPACE®

Track with Screw Channel (TT1F)

Track for Screw-Through Fixing (TT2F)

Fixing of Tracktrim (TT1F) & Curtain Track

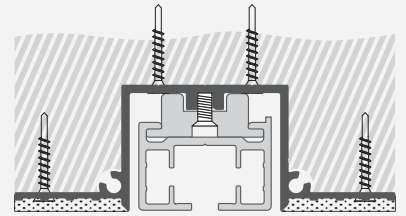
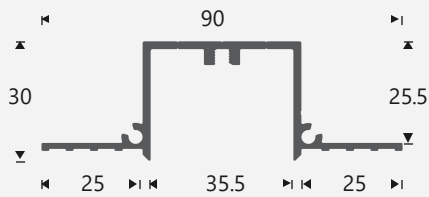

Curve Section

1-Piece Return Ends

Accessories

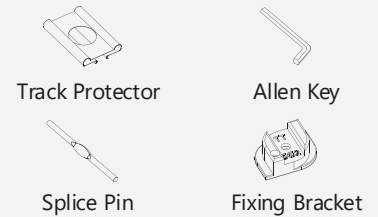
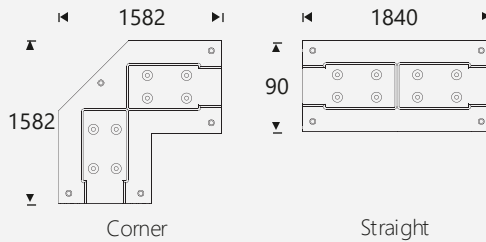
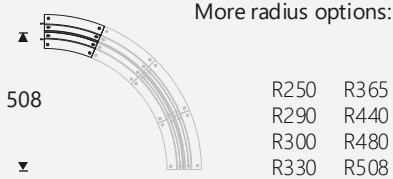

Motor End (TTSG56MB1F)

Track with Flanges (TT1F)

Return End (TTSG56RB1F)

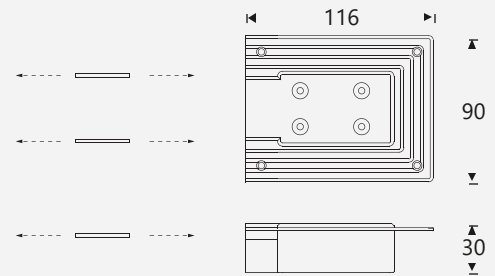
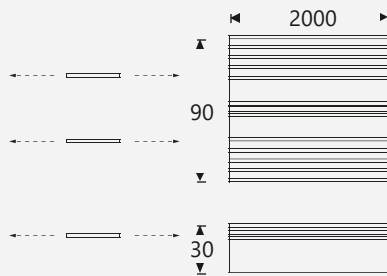
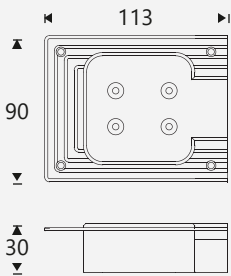

Manufacturer

Blindspace AB
Web: www.blindspace.com
Email: sales@blindspace.com
Tel: +44 20 8798 3945

Description

Solutions to recess manual and electric electric curtain tracks and end sets, with no visible bracketry.

Product Reference

Tracks: TT1F
End-sets: TTSG56MB1F/TTSG56RB1F
1-Piece Return Ends: TTSG56CRB1F & TTSG56SRB1F
Curve sections: TTCR508
Example: TT1F with TTSG56MB1F & TTSG56RB1F

Fixing

Anchoring with countersink screws through profile and flanges every 200mm. Finished plaster level flush with chamfered edge and ceiling.

Material

Tracks in Aluminium, EN 6060 T66
End-sets & curves in Plastic POM Polymer

Finish

White to be plastered in and decorated at site to match ceiling.

FEATURES

Centered curtain tracks with no visible fixing brackets

In contrast to solutions using a wedge along the side of the curtain track, Tracktrim® are fixed through the curtain track for minimum visual impact.

Perfect-fit end-set to match motor and return ends

End sets are designed and manufactured to perfectly fit with motor and belt return ends.

Seamless appearance after painting

Plaster is feathered over skim coat flanges to hide the track and end-set, leaving only an open cavity for installation of curtain system.

Splice Pins to connect different profiles

Splice Pins are used to connect the endsets to the main Tracktrim profile and also to the different curved sections.



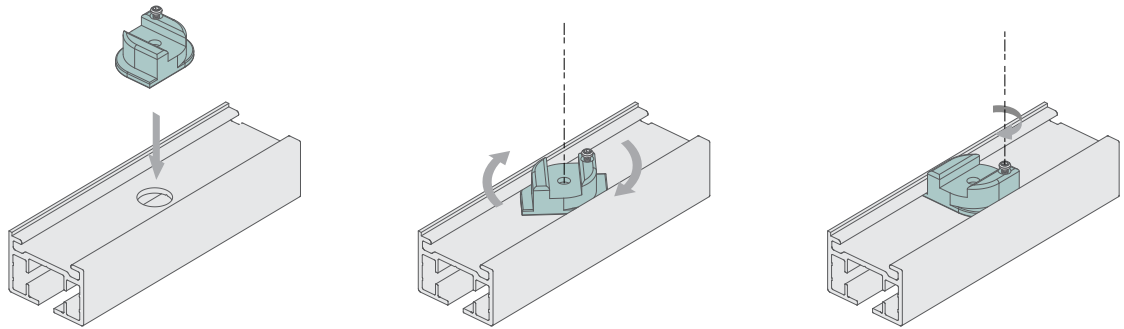

Fixing to TT1F

Fixing to TT2F, Optional Fixing to TT1F

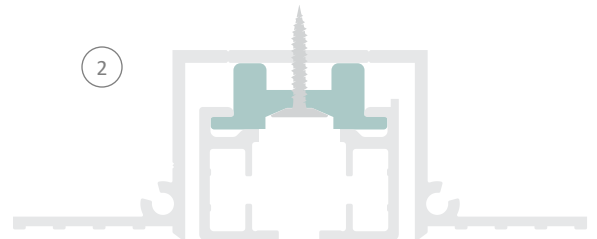
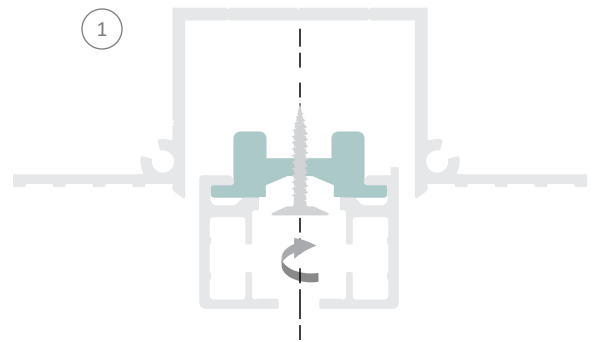
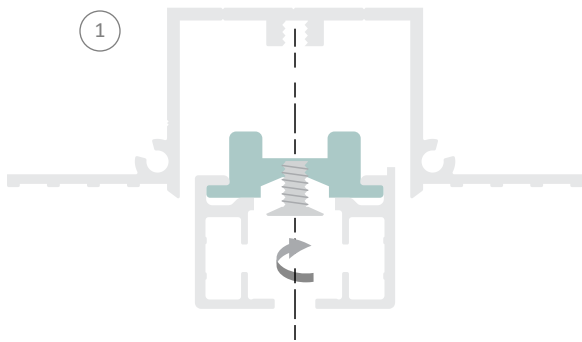

Connecting Sections using Splice Pins

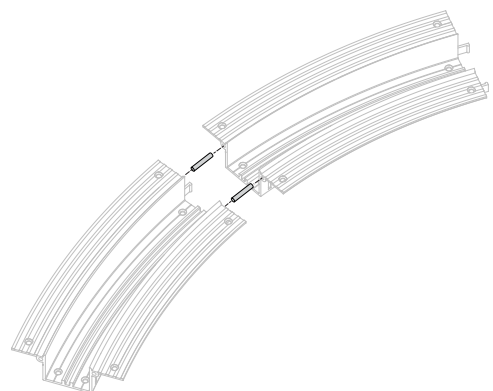
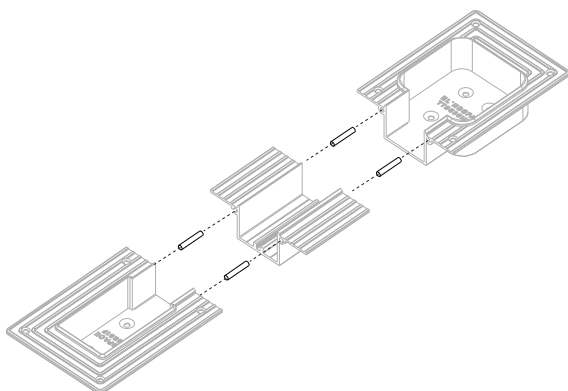



Dual TT1F with TTSG56MB1F and TTSG56RB1F, tracks with 180mm spacing.



TT1F with TTSG56MB1F and TTSG56RB1F



Tracktrim® Curved Section finished installation.

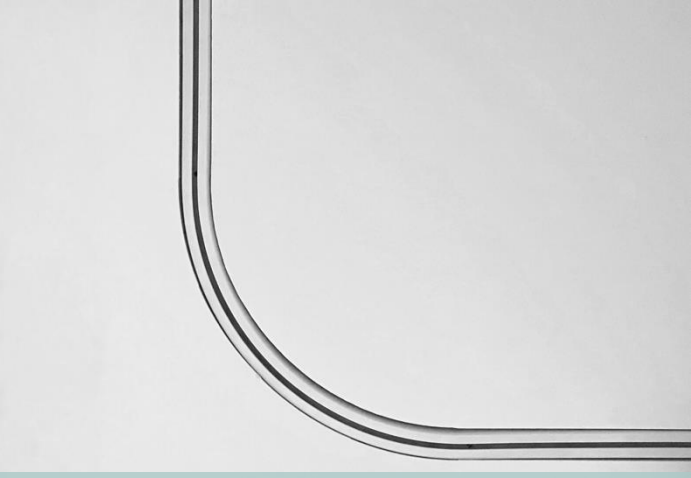

Tracktrim® Curved Section finished installation.

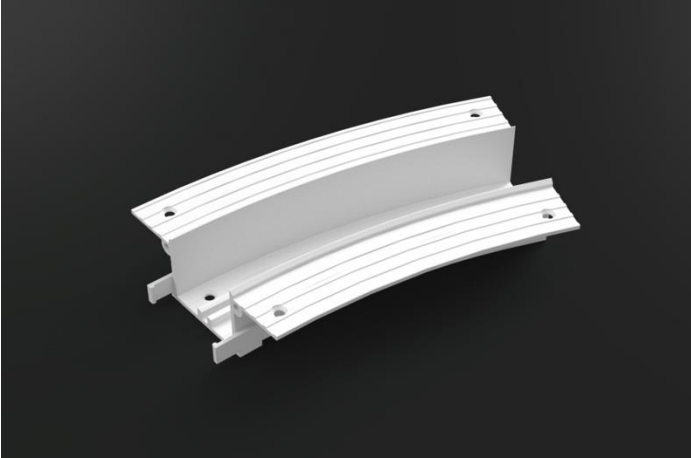

TTCR250 Curved Section 250mm radius



TTSG56MB1F and TTSG56LRB1F Sample.



TT1F with TTSG56MB1F and TTSG56RB1F.

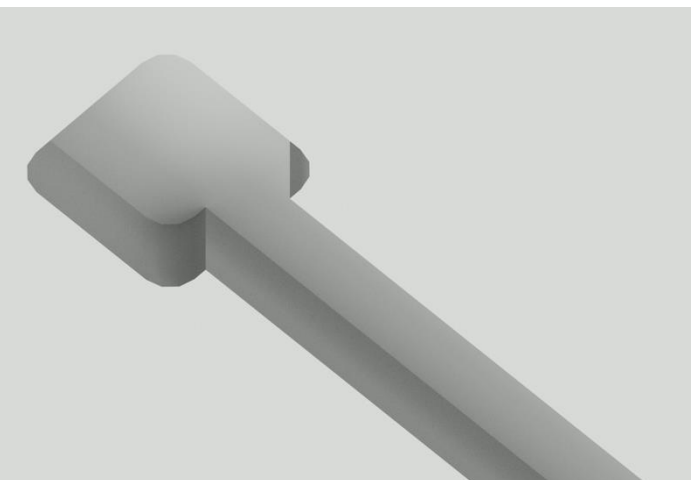

TT1F with TTSG56MB1F finished installation.