

OUTDOOR

Alias



Leggerezza tecnologica, trasversalità e innovazione sono dal 1979 i valori chiave di Alias, storico marchio del design Made in Italy. Valori dai quali prende avvio il forte legame dell'azienda con designer affermati attraverso i quali Alias ha saputo far emergere la peculiarità di ciascun progettista, in uno scambio continuo di stimoli e idee e con una costante apertura all'utilizzo inedito dei materiali e alla sperimentazione delle tecnologie.

Technological lightness, versatility, innovation. Since 1979 these have been the overriding values of Alias, one of the most consolidated names of Italian design. Values that have driven the firm's close association with some renowned designer signatures. Collaborations that have developed and grown through the years, and in the course of which, Alias has managed to reveal the peculiar talent of each designer. Conducted in an ongoing exchange of suggestions and ideas, and a constantly open-minded approach to the use of new materials and technological experimentation.

Technologische Leichtigkeit, Vielseitigkeit und Innovation, das sind seit 1979 die Schlüsselwerte von Alias, der historischen Marke für Design Made in Italy. Diese Werte verbinden das Unternehmen mit renommierten Designer. Mit diesen Kooperationen und durch einen konstanten Austausch von Anregungen und Ideen gelang es Alias, die Besonderheiten jedes einzelnen Designers hervorzuheben, und dem Einsatz ungewohnter Materialien und technologischen Experimenten besondere Bedeutung zu geben.

Légèreté technologique, transversalité et innovation sont depuis 1979 les valeurs clefs d'Alias, marque historique du design made in Italy. Des valeurs d'où il démarre le lien de l'entreprise avec des designers confirmés à travers lesquels Alias a su faire émerger l'originalité de chaque concepteur dans un échange continu de stimulations et d'idées et avec la volonté constante de détourner les matériaux et d'expérimenter les technologies.

Alias

Alias collections for outdoor transfer to open-air spaces transversal designs of chairs, tables, sofas, armchairs, lounges, poufs and sun loungers. They are designed to experience comfort and elegance in private terraces and gardens, as well as in public areas. Technology and materials research give the outdoor collections manageability and weatherproofness, without compromising their personality, attention to detail and comfort. In addition to the lightweight aluminium and the resistance of polyester mesh, for the outdoor collection Alias has chosen the appeal of wood, the practicality of steel, the elegance of fabric coverings and the simplicity of lines of ceramics. The whole outdoor project, organized by type and available in different colours and finishes, designs outdoor spaces and responds to the needs of public and private places with great versatility and functionality.

Pensati per vivere con comodità ed eleganza le terrazze e i giardini privati così come i dehor e gli spazi pubblici, le collezioni Alias per l'outdoor trasferiscono all'aperto progetti trasversali di sedute, tavoli, divani, poltrone, chaise longue, pouf e lettini. Tecnologia e ricerca dei materiali trasmettono alle collezioni per l'esterno maneggevolezza e resistenza ai fattori ambientali senza rinunciare a personalità, cura dei dettagli e comfort. Oltre alla leggerezza dell'alluminio e alla resistenza della rete di poliestere, Alias sceglie per il paesaggio outdoor il fascino del legno la praticità dell'acciaio, l'eleganza dei rivestimenti in tessuto e la pulizia formale delle ceramiche. L'insieme di progetti outdoor, tipologicamente articolato e disponibile in diversi colori e finiture, disegna gli spazi della vita all'aperto e risponde con grande versatilità e funzionalità alle esigenze di luoghi collettivi e privati.

Entwickelt um Terrassen, Privatgärten, Freigelände und öffentliche Plätze mit Komfort und Eleganz auszustatten und zu erleben, bringen die Alias Kollektionen für den Außenbereich neue Bewegung ins Freie mit ihrem transversalen Stühlen, Tischen, Sofas, Sesseln, Liegen, Chaise Longue und Hockern. Technologie- und Materialforschung verleihen der Outdoorkollektionen die erforderliche Witterungsbeständigkeit und Handlichkeit, ohne an Persönlichkeit, Liebe zum Detail und Komfort aufzugeben. Neben der Leichtigkeit des Aluminiums und der Beständigkeit des Polyesternetzes wählt Alias für die Outdoor-Landschaften den Charme des Holzes, die Handlichkeit des Stahls, die Eleganz von Stoffbezügen und die formelle Schlichtheit der Keramik. Die Gesamtheit der Outdoor-Projekte, die nach Typ gegliedert sind und in verschiedenen Farben und Ausführungen erhältlich sind, gestaltet den Raum und entspricht vielseitig und praktisch allen Ansprüchen von privaten und öffentlichen Bereichen.

Conçues pour vivre avec confort et élégance les terrasses et les jardins privés ainsi que les espaces ouverts et publics, les collections Alias pour l'outdoor transfèrent à l'extérieur de projets polyvalents de sièges, tables, canapes, fauteuils, chaises longues, poufs et transats. Technologie et recherche des matériaux transmettent aux collections d'extérieur maniabilité et résistance aux facteurs environnementaux sans renoncer à leur personnalité, au soin des détails ou au confort. Outre la légèreté de l'aluminium et la résistance du tissu polyester maillé, Alias choisit pour le paysage outdoor le charme du bois, l'aspect pratique de l'acier, l'élégance des revêtements en tissu et la propreté formelle de la céramique. La gamme des projets outdoor, articulée par catégories et disponible dans des finitions et coloris différents, dessine les espaces de la vie en plein air et fait rimer polyvalence et fonctionnalité avec les besoins des collectivités et des particuliers.

outdoor collection

06	FRAME OUTDOOR COLLECTION
18	FRAMETABLE OUTDOOR
26	BIPLANE OUTDOOR
32	TECH WOOD
42	DEHORS
50	GREEN
62	ALUZEN SOFT OUTDOOR
72	TEN SYSTEM OUTDOOR
82	SLIM CHAIR OUTDOOR
86	KOBI OUTDOOR COLLECTION
94	GRAN KOBI OUTDOOR
98	SAEN OUTDOOR
104	TAGLIATELLE OUTDOOR
110	SEGESTA OUTDOOR
114	CROSS TABLE OUTDOOR
117	MateriAlias



Frame outdoor collection

Alberto Meda



La rete di poliestere spalmata con PVC e la struttura in alluminio verniciato trattato rendono la collezione **frame** adatta ad un uso esterno. Confortevoli ed eleganti in un parco privato, funzionali in un dehor estivo, le sedute highframe, bigframe e frame 52, la poltroncina armframe (corredabile con poggiatesta) e la chaise longue longframe sono disponibili con o senza braccioli.

The PVC covered polyester mesh and the structure in treated lacquered aluminium, make the **frame** collection suitable for outdoor use. Comfortable and elegant in a private park, functional in a summer setting, the chairs highframe, bigframe, and frame 52, the armchair armframe (that can be equipped with footstool) and the chaise longue longframe are available with or without armrests.

Das PVC-beschichtete Polyesternetz und das Gestell aus lackiertem und behandeltem Aluminium ermöglichen die Anwendung der **frame** Kollektion auch im Außenbereich. Elegant und bequem in einem privaten Garten, zweckmäßig in einem Sommergarten sind die highframe, bigframe und frame 52 Stühle, der kleine Sessel armframe (verfügbar auch mit Hocker) und die Liege longframe mit und ohne Armlehnen verfügbar.

Le tissu maillé en polyester enduit de PVC et la structure en aluminium laqué traité rendent la collection **frame** adaptée à une utilisation à l'extérieur. Confortables et élégants dans un parc privé, fonctionnels dans un dehor d'été, les sièges highframe, bigframe et frame 52, le fauteuil armframe (disponible avec repose-pieds) et la chaise longue longframe sont disponibles avec ou sans accoudoirs.

FRAME OUTDOOR COLLECTION



HIGHFRAME 40 OUTDOOR

BIGFRAME 44 OUTDOOR



FRAME 52 OUTDOOR



FRAME 52 SOFT OUTDOOR

Frame 52 chairs are also available in a soft version characterised by a removable shaped cushion, padded with draining foam and covered with outdoor fabric or eco-leather.

Le sedute frame 52 sono disponibili anche nella versione soft, caratterizzata da un cuscino sagomato removibile, con imbottitura in espanso drenante e rivestimento in tessuto o ecopelle da esterno.



FRAME 52 SOFT OUTDOOR
ALUMINIUM (A019) FABRIC (TEMPOTEST® PT02)



HIGHFRAME 40 OUTDOOR
ALUMINIUM (A019) MESH (R003 / R009)
TECH WOOD TABLE FOLDING ALUMINIUM (A019) TEAK WOOD

FRAME LOUNGE OUTDOOR



LONGFRAME OUTDOOR



ARMFRAME / FEETFRAME OUTDOOR



LONGFRAME SOFT OUTDOOR



ARMFRAME SOFT OUTDOOR

La caratteristica struttura in alluminio estruso si allunga nella poltroncina armframe (corredabile con poggiatesta) fino a creare una sinuosa silhouette nella chaise longue longframe. Per i momenti di relax all'aperto, le due sedute regalano all'ambiente stile, armonia e bellezza, esprimendo un design pratico ed elegante rivolto al benessere e al comfort.

The distinctive structure in extruded aluminium of frame collection is extended to the armframe armchair (also available with footstool) up to create a sinuous silhouette in the chaise longue longframe. Ideal for relaxing moments in the open air, both seats enhance any environment with style, harmony and beauty, yet also providing wellbeing and comfort with a practical and elegant design.

Das kennzeichnende Aluminiumgestell der frame Familie wurde auch für den Sessel armframe (verfügbar auch mit Hocker) und für die elegante Liege longframe verwendet. Diese zwei Modelle sind ideal zum Ausruhen im Freien und sie vermitteln jedem Umfeld Stil, Harmonie und Eleganz. Sie haben ein praktisches und elegantes Design, welches Komfort und an Wohlbefinden ermöglicht.

La structure caractéristique en aluminium extrudé se prolonge dans le fauteuil armframe (disponible avec repose-pieds) jusqu'à créer une silhouette sinieuse dans la chaise longue longframe. Pour les moments de relax en plein air, les deux sièges donnent au milieu style, harmonie et charme en transmettant un design pratique et élégant visant au bien-être et au confort.



LONGFRAME OUTDOOR
ALUMINIUM (A019) MESH (R003)



LONGFRAME SOFT OUTDOOR
 ALUMINIUM (A047) FABRIC (TEMPOTEST® PT01)
 ARMFRAME SOFT OUTDOOR ALUMINIUM (A047) FABRIC (TEMPOTEST® PT03)

DIMENSIONS

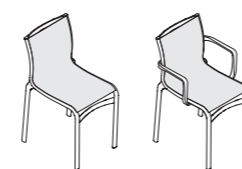

HIGHFRAME 40 OUTDOOR (416_O / 417_O)

cm 56x44 - h cm 82 - h seat 48
 cm 56x51 - h cm 82 - h seat 48

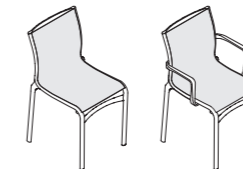

BIGFRAME 44 OUTDOOR (441_O / 440_O)

cm 61x48 - h cm 86 - h seat 47
 cm 61x55 - h cm 86 - h seat 47

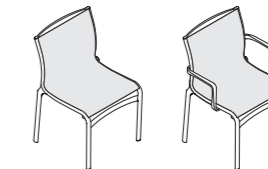

FRAME 52 OUTDOOR (458_O / 459_O)

cm 66x56,5 - h cm 83 - h seat 47
 cm 66x63 - h cm 83 - h seat 47

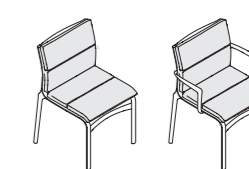

FRAME 52 SOFT OUTDOOR (408_O / 409_O)

cm 66x56,5 - h cm 83 - h seat 50
 cm 66x63 - h cm 83 - h seat 50

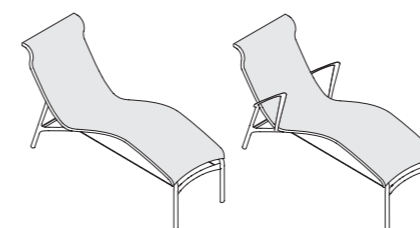

LONGFRAME OUTDOOR (419_O / 439_O)

cm 146x54 - h cm 82 - h seat 42
 cm 146x66 - h cm 82 - h seat 42

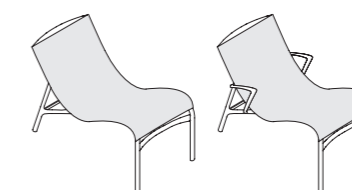

ARMFRAME OUTDOOR (418_O / 419_O)

cm 91x54 - h cm 73 - h seat 38
 cm 91x66 - h cm 73 - h seat 38

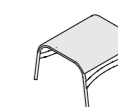

FEETFRAME OUTDOOR (431_O)

cm 55x54 - h cm 38

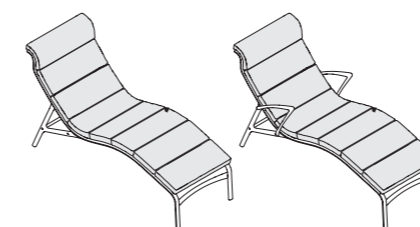

LONGFRAME SOFT OUTDOOR (414_O / 415_O)

cm 146x54 - h cm 82 - h seat 45
 cm 146x66 - h cm 82 - h seat 45

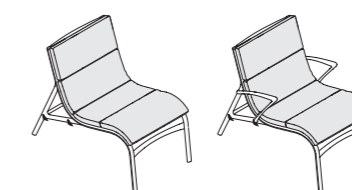

ARMFRAME SOFT OUTDOOR (462_O / 463_O)

cm 91x54 - h cm 73 - h seat 41
 cm 91x66 - h cm 73 - h seat 41

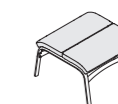

FEETFRAME SOFT OUTDOOR (464_O)

cm 55x54 - h cm 41

Longframe, armframe e feetframe outdoor si arricchiscono con la variante soft. Il cuscino removibile con imbottitura in espanso drenante e rivestimento in tessuto o ecopelle da esterno, apporta un ulteriore miglioramento di comfort che va a completare l'offerta di una collezione icona.

The outdoor longframe, armframe and feetframe are now joined by a soft version. The removable cushion with draining foam padding and outdoor fabric or eco-leather upholstery offers additional comfort, completing this iconic collection.

Longframe, armframe und feetframe outdoor werden mit der gepolsterten Version ergänzt. Das abnehmbare Kissen mit Polsterung aus entwässerndem geschäumtem Polyurethan kann mit Stoff oder Kunstleder für den Außenbereich bezogen werden; es verbessert somit die Bequemlichkeit weiter und vervollständigt das Angebot einer ikonischen Kollektion.

Longframe, armframe et feetframe outdoor s'enrichissent de la version soft. Le coussin amovible, avec rembourrage en mousse drainante et revêtement en tissu ou en similicuir pour un usage extérieur, apporte une amélioration supplémentaire en termes de confort et complète l'offre d'une collection icône.



FINISHES

Alluminio verniciato
Lacquered aluminium
Aluminium lackiert
Aluminium laqué

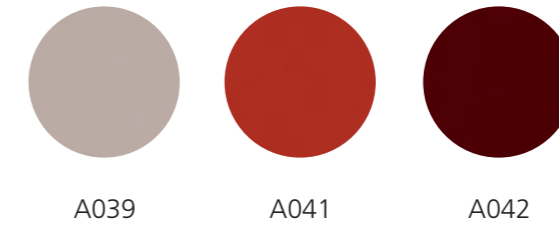
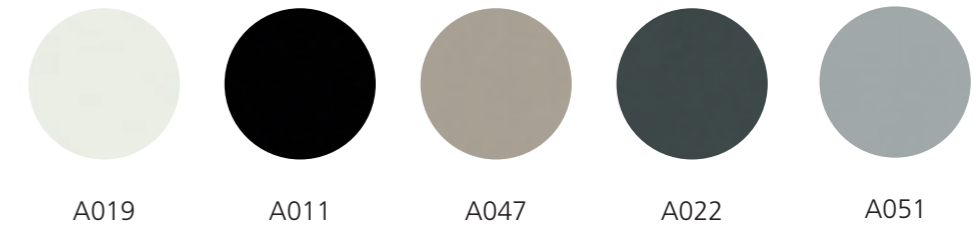

Rete (A)
Mesh (A)
Netzgewebe (A)
Maille (A)

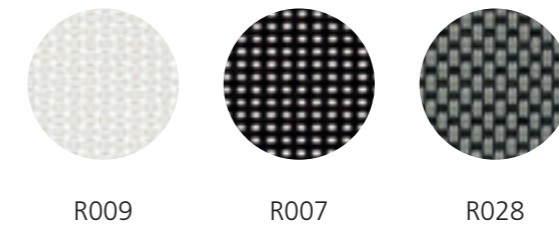

Rete (B)
Mesh (B)
Netzgewebe (B)
Maille (B)

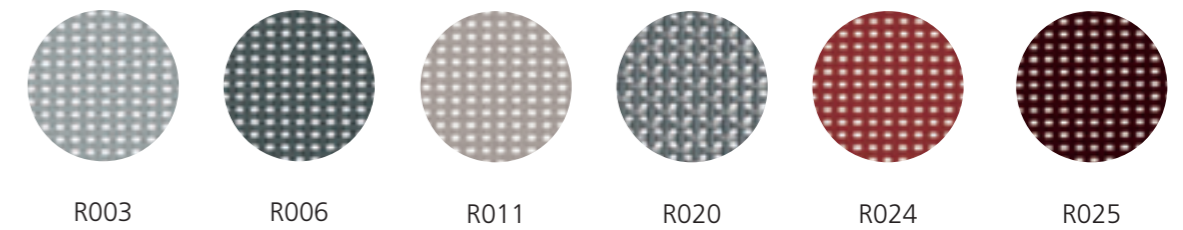

Tessuto
Fabric
Stoff
Tissu

Alias Living Outdoor (B) *
Tempotest® (A)

Ecopelle
Eco-leather
Kunstleder
Simili cuir

Serge Ferrari® (A)

MATERIAlias

* Per Frame soft collection Alias Living Outdoor (B) è disponibile nella selezione tessuti LK / LN.
* Only the fabrics LK/LN of Alias Living Outdoor (B) are available for Frame soft collection.
* Für die Frame soft Kollektion sind nur die Stoffe LK/LN vom Alias Living Outdoor (B) verfügbar.
* Pour Frame soft collection Alias Living Outdoor (B) est disponible dans la sélection de tissus LK / LN.



Frametable outdoor

Alberto Meda



Grazie alla ricerca tecnologica su cui Alias investe fin dalle sue origini, è stato sviluppato **frametable outdoor** caratterizzato da un sistema di piani in alluminio estruso che permettono di declinare lo storico progetto nella versione da esterni, senza comprometterne l'identità progettuale e l'immagine estetica. Un tavolo nuovo, tecnologico ed estremamente leggero che completa la proposta da esterno Alias.

Thanks to the technological research in which the company has been investing since its origins, it has been possible to develop **frametable outdoor** characterized by a new system of tops in extruded aluminium. This gave the opportunity to vary the historical project and to propose it in the outdoor version, without compromising its design identity and aesthetic image. A new, technological and extremely light table that completes Alias outdoor proposal.

Dank der technologischen Forschung, in die das Unternehmen seit seiner Gründung investiert hat, konnte **frametable outdoor** entwickelt werden, charakterisiert durch ein neues System von Platten aus stranggepresstem Aluminium, die den Einsatz des historischen Tisches im Außenbereich ermöglichen, ohne seine Designidentität und sein ästhetisches Erscheinungsbild zu beeinträchtigen. Ein neuer, technologischer und extrem leichter Tisch, der das Angebot von Alias für den Außenbereich vervollständigt.

La recherche technologique, dans laquelle Alias a investi dès sa création, a permis de développer **frametable outdoor** caractérisée par un nouveau système de plateaux en aluminium extrudé permettant de décliner le projet historique en version d'extérieur, en respectant son concept d'origine et son image esthétique. Une nouvelle table, technologique et extrêmement légère qui complète la proposition Alias pour l'extérieur.

FRAMETABLE OUTDOOR



FRAMETABLE 190 FOLDING OUTDOOR



FRAMETABLE 190 OUTDOOR



FRAMETABLE 240 OUTDOOR



FRAMETABLE 295XL OUTDOOR

The table tops of frametable outdoor are made of five extruded aluminium slats, which are as thin as possible and have a cross-section that allows them to be attached to the legs in a completely invisible manner, structurally increasing the load-bearing capacity of the table top.

I piani di frametable outdoor si compongono di cinque doghe in alluminio estruso, con spessore ridotto al minimo e con una sezione tale da consentire un sistema di fissaggio alle gambe completamente invisibile ed aumentare strutturalmente la portata del piano del tavolo.



FRAMETABLE OUTDOOR

ALUMINIUM (A047)

FRAME 52 OUTDOOR ALUMINIUM (A047) MESH (R011)



FRAMETABLE OUTDOOR
ALUMINIUM (A047)
FRAME 52 OUTDOOR ALUMINIUM (A047) MESH (R011)



FRAMETABLE OUTDOOR
 ALUMINIUM (A047)
 FRAME 52 OUTDOOR ALUMINIUM (A047) MESH (R011)

DIMENSIONS

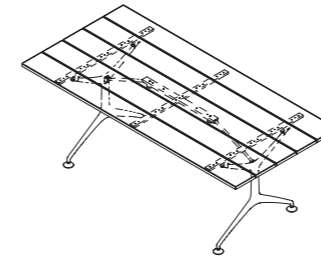

FRAMETABLE FOLDING (F02_190_O)
 cm 190x95 - h cm 75

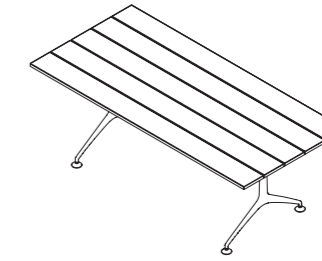

FRAMETABLE 190 OUTDOOR (F01_190_O)
 cm 190x95 - h cm 75

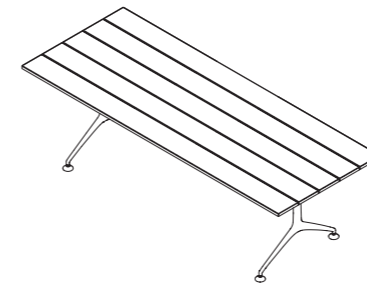

FRAMETABLE 240 OUTDOOR (F01_240_O)
 cm 240x95 - h cm 75

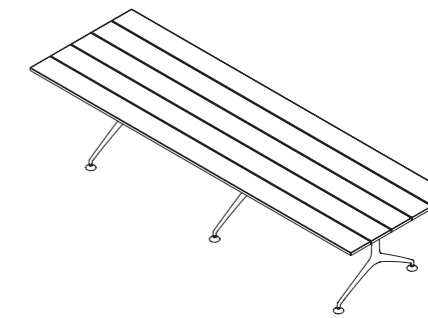

FRAMETABLE 295XL OUTDOOR (F01_295_O)
 cm 295x95 - h cm 75

FINISHES

Alluminio verniciato
 Lacquered aluminium
 Aluminium lackiert
 Aluminium laqué



A019



A011



A047



A022



A051



2022, Premio Red Dot Design Award: best of the best
 2022, Red Dot Design Award: best of the best
 2022, Prix Red Dot Design Award: best of the best
 2022, Preis Red Dot Design Award: best of the best

Biplane outdoor

Alberto Meda



Un'intuizione compositiva che dà vita ad un sistema di tavoli di grande duttilità nelle forme, nelle dimensioni e negli utilizzi. Il progetto **biplane** nasce dall'idea di ottenere una serie ampia e differenziata di modelli. Le gambe in alluminio pressofuso sono fissate ad un sottopiano centrale e al piano del tavolo, componendo così una solida struttura. Il numero delle gambe è variabile a seconda della dimensione del piano, proposto per l'esterno in pietra acrilica.

A strong grasp of form and composition has given life to a collection of tables characterized by great flexibility in terms of shape, size and range of uses. The project **biplane** derives from the idea of creating a broad and differentiated range of models. The legs in die-cast aluminium are fixed both to a central shelf and to the table top, creating a solid structure. The number of legs may vary depending on the dimensions of the top, available in acrylic stone for the outdoor version.

Eine kompositorische Intuition. Ein Tischsystem mit vielfältigen Formen, Größen und Verwendungsmöglichkeiten. Das Projekt **biplane** entsteht aus der Idee eine breitgefächerte und differenzierte Serie von Modellen anzubieten. Die Beine aus Aluminiumdruckguß sind an einem zentralen Tablar und an der Tischplatte befestigt, wodurch eine solide Struktur entsteht. Die Anzahl der Tischbeine variiert je nach der Größe der Tischplatte, die für die Außenbereich-Version aus Naturacrylstein angeboten wird.

Une intuition de composition qui donne vie à un système de tables d'une grande flexibilité dans leurs formes, leurs dimensions et leur utilisation. Le projet **biplane** a germé de l'idée d'obtenir une série vaste et différenciée de modèles. Les pieds en aluminium moulé sous pression sont fixés à un sous-plateau central ainsi qu'au plateau de la table pour former une structure solide. Le nombre des pieds varie selon la dimension du plateau qui est proposé pour l'extérieur en pierre acrylique.



BIPLANE OUTDOOR



BIPLANE XS OUTDOOR / h. cm 46



BIPLANE XS OUTDOOR / h. cm 35



BIPLANE OUTDOOR
ALUMINIUM (A019) ACRYLIC STONE (PR01)
KOBI SLEDGE OUTDOOR ALUMINIUM (A019) ECO LEATHER® (SERGE FERRARI SK14)



BIPLANE XS OUTDOOR
 ALUMINIUM (A019) ACRYLIC STONE (PR01)
 LONGFRAME OUTDOOR ALUMINIUM (A047) MESH (R011)

DIMENSIONS

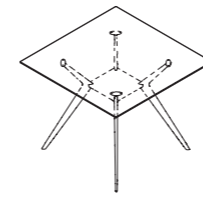

BIPLANE 90x90 OUTDOOR (400_O)
 cm 90x90 - h cm 72

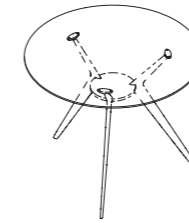

BIPLANE Ø90 OUTDOOR (401_O)
 Ø cm 90 - h cm 72

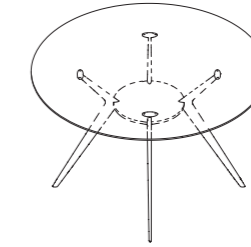

BIPLANE Ø90 OUTDOOR (402_O)
 Ø cm 120 - h cm 72

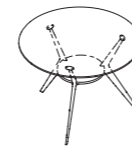

BIPLANE XS Ø62 OUTDOOR (B07_O)
 Ø cm 62 - h cm 46



BIPLANE XS TRIANGULAR OUTDOOR (B01_O)
 cm 62x57 - h cm 46



BIPLANE XS 60x60 OUTDOOR (B02_O)
 cm 60x60 - h cm 46



BIPLANE XS Ø80 OUTDOOR (B03_O)
 Ø cm 80 - h cm 35

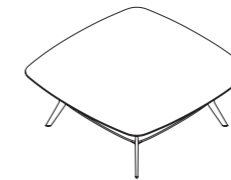

BIPLANE XS 95x95 OUTDOOR (B04_O)
 cm 95x95 - h cm 35

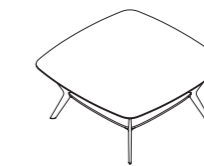

BIPLANE XS 80x80 OUTDOOR (B05_O)
 cm 80x80 - h cm 35

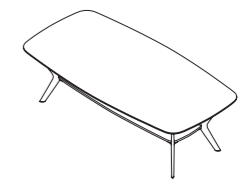

BIPLANE XS 60x120 OUTDOOR (B06_O)
 cm 60x120 - h cm 35

FINISHES

Alluminio verniciato
 Lacquered aluminium
 Aluminium lackiert
 Aluminium laqué



A019

Pietra acrilica
 Acrylic stone
 Naturacrylstein
 Pierre acrylique



PR01



Tech Wood

Alberto Meda



La collezione **tech wood** restituisce nei progetti di sedute, con e senza braccioli, e tavoli l'anima materica e formale della panchina setes, vincitrice del concorso "Una panchina per Milano" nel 2005. Realizzati con doghe di legno teak o frassino termotrattato su struttura in pressofusione di alluminio, i pezzi della collezione tech wood sono resistenti nel tempo e piacevoli al tatto. Ideale per gli spazi aperti, terrazze e giardini, i prodotti che compongono l'intera famiglia aggiungono solidità e cura dei dettagli al paesaggio outdoor.

The **tech wood** collection with its table models and the chairs with or without arms returns to the material essence of the setes bench, that won the contest "Una panchina per Milano" (A bench for Milan) in 2005. Manufactured with slats of teak wood or heat-treated ash-wood on a die-cast aluminium frame, the products of the tech wood collection are resistant through time and pleasing to the touch. Ideal for open spaces, terraces and gardens, the products that make up the entire family add solidity and attention to detail to the outdoor landscape.

Mit ihren Tischen und Stühlen mit und ohne Armlehnen gibt die Kollektion **tech wood** die materielle Essenz und die formelle Linie der Bank setes wieder, die im Jahr 2005 den Wettbewerb "Una panchina per Milano" (eine Bank für Mailand) gewonnen hat. Die Artikel der tech wood Kollektion sind mit Dauben aus Teak- oder wärmebehandeltem Eschenholz und einem Gestell aus Aluminiumdruckguss hergestellt; dank dieser sind sie im Laufe der Zeit besonders widerstandsfähig und fühlen sich angenehm an. Die Produkte der gesamten Serie sind für Freiflächen, Terrassen und Gärten ideal und verleihen der Außenlandschaft Kraft und Liebe zum Detail.

La collezione **tech wood** véhicule l'âme des matériaux et des formes du banc setes, gagnant du concours "Una panchina per Milano" en 2005, dans les projets de sièges avec et sans accoudoirs et tables. Réalisés en lattes de teak ou frêne thermotraité sur une structure en fonte d'aluminium, les articles de la collection tech wood sont résistants au temps et agréables au toucher. Parfaits pour les espaces ouverts, les terrasses et les jardins, les produits qui composent l'ensemble de la famille ajoutent au paysage extérieur solidité et attention aux détails.

TECH WOOD SEATS



TECH WOOD CHAIR



TECH WOOD ARMREST



TECH WOOD BENCH

L'intera collezione **tech wood** si arricchisce della finitura in frassino termotrattato. Questo legno dopo completa essiccazione, subisce un trattamento termico che lo porta a una temperatura di circa 200° e un'umidità finale attorno al 5%. A seguito della lavorazione il materiale assume una colorazione marrone e ottima stabilità dimensionale che lo rende molto più versatile e più sostenibile.

The entire **tech wood** collection is enriched with the new finish in heat-treated ash. After complete drying, this wood undergoes a heat treatment that brings it to a temperature of about 200°C and a final humidity of about 5%. After processing, the material takes on a brown colour and excellent dimensional stability which makes it much more versatile and sustainable.

Die gesamte Kollektion **tech wood** wurde mit der neuen Ausführung wärmebehandelte Esche erweitert. Nach vollständiger Trocknung wird dieses Holz einer Wärmebehandlung unterzogen, bei der eine Temperatur von etwa 200° C und eine Endfeuchtigkeit von etwa 5% erreicht wird. Nach der Verarbeitung erhält das Material eine braune Farbe und eine ausgezeichnete Formbeständigkeit, wodurch es vielseitiger und nachhaltiger als Teakholz ist.

La finition en frêne thermotraité a été ajoutée à l'ensemble de la collection **tech wood**. Après un séchage complet, ce bois subit un traitement thermique qui le porte à une température d'environ 200°C et à une humidité finale d'environ 5%. Après le traitement, le matériau assume une couleur brune et une excellente stabilité dimensionnelle, ce qui le rend beaucoup plus polyvalent et durable.



TECH WOOD ARMREST/TABLE
ALUMINIUM (A022) HEAT-TREATED ASH WOOD (FRTT)

TECH WOOD TABLES



TECH WOOD TABLE 200F



TECH WOOD TABLE 240



TECH WOOD TABLE 300



2012, Premio XVIII Compasso d'Oro ADI
 2012, XVIII Compasso d'Oro ADI Award
 2012, Prix XVIII Compasso d'Oro ADI
 2012, Preis XVIII Compasso d'Oro ADI



TECH WOOD ARMREST/TABLE
 ALUMINIUM (A022) HEAT-TREATED ASH WOOD (FRIT)



TECH WOOD CHAIR/TABLE
ALUMINIUM (A019) TEAK WOOD



MATERIAlias



DIMENSIONS



TECH WOOD CHAIR (M20_O)
cm 55x52 - h cm 81 - h seat cm 47



TECH WOOD ARMREST (M21_O)
cm 55x60 - h cm 81 - h seat cm 47

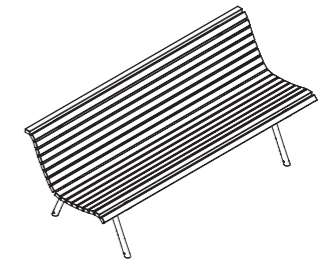

TECH WOOD BENCH (M22_O)
cm 199x75 - h cm 80 - h seat cm 42,5

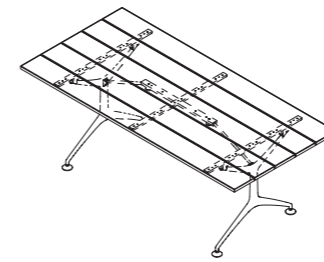

TECH WOOD TABLE 200F (M23_O)
cm 200x95 - h cm 75

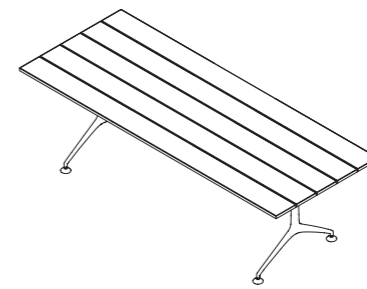

TECH WOOD TABLE 240 (M24_O)
cm 240x95 - h cm 75

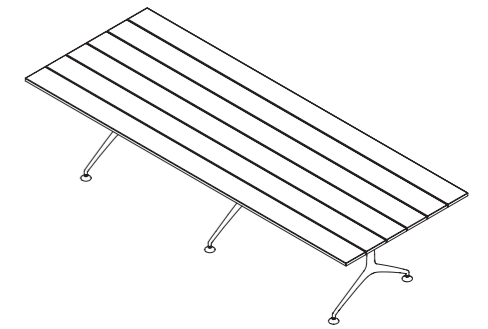

TECH WOOD TABLE 300 (M25_O)
cm 300x114 - h cm 75

FINISHES

Alluminio verniciato
Lacquered aluminium
Aluminium lackiert
Aluminium laqué



A019



A011



A047



A022



A051

Legno
Wood
Holz
Bois



TEAK



FRTT

It is a natural material and it could therefore be subject to colour changes, cracks and movements that may vary depending on the exposition to atmospheric agents and on the environment in which the product is placed.

Trattandosi di un materiale naturale, si possono verificare variazioni di colore, crepe e movimenti, che sono soggetti ad andamenti differenziati in funzione dell'esposizione agli agenti atmosferici e al tipo di ambiente in cui si trova il prodotto.

Es handelt sich um ein natürliches Material und deswegen könnten sich Farbwechsel, Risse und Bewegungen im Laufe der Zeit offenbaren. Diese variieren je nach der Exposition gegenüber Witterungseinflüssen und nach dem Umfeld, in dem das Produkt gestellt wird.

En tant que matériau naturel, des variations de couleur, des fissures et des mouvements peuvent se produire. Ceux-ci sont soumis à des tendances différenciées en fonction de l'exposition aux agents atmosphériques et du type d'environnement dans lequel le produit se trouve.



Dehors

Michele De Lucchi



La collezione **dehors**, progettata per un ideale “salotto da giardino”, si ispira coerentemente alla natura, all’irregolarità delle forme vegetali. I sostegni dei pezzi deviano dalle consuete linee verticali; il risultato è un insieme di strutture mosse, che si discostano da ogni rigore architettonico e offrono una inaspettata comodità. Un sistema di arredi aggregabili caratterizzati da una struttura in acciaio trattato per esterno e da cuscini resistenti agli agenti ambientali, grazie ad un’accurata selezione dei materiali per l’imbottitura e per i rivestimenti.

The **dehors** collection is designed to create an ideal “garden living-room”, inspired by nature and its irregular shapes. The structures of the products differ from the usual vertical lines. The result is a collection of wavy structures that divert from every architectural rigour and offer an unexpected degree of comfort. This is a combinable system characterized by a frame in steel treated for outdoor use and by the weather-resistant cushions, thanks to their carefully selected padding and covers.

Die Kollektion **dehors**, die für die Gestaltung eines authentischen “Salons im Garten” konzipiert ist, lässt sich zusammenhängend von der Natur und der unregelmäßigen Form von Pflanzen inspirieren. Die Trägerstrukturen weichen von den gewohnten vertikalen Linien ab. Das Ergebnis ist eine bewegte Struktur, die sich von jeder architektonischen Regel befreit und gleichzeitig eine unerwartete Bequemlichkeit bietet. Ein kombinierbares System charakterisiert durch ein Gestell aus Stahl behandelt für den Außenbereich und durch witterungsbeständige Kissen dank einer sorgfältigen Auswahl der Polstermaterialien und der Bezüge.

La collezione **dehors**, conçue pour un “salon de jardin” idéal, s’inspire en cohérence avec la nature et l’irrégularité des formes végétales. Les supports des articles s’éloignent des lignes verticales habituelles; le résultat est un ensemble de structures animées qui s’éloignent de toute rigueur architectonique et offrent un confort inattendu. Un système de meubles combinables caractérisés par une structure en acier traité pour l’extérieur et des coussins qui résistent aux agents atmosphériques grâce à la sélection rigoureuse des matériaux pour le rembourrage et les revêtements.

DEHORS



DEHORS ARMCHAIR



DEHORS SOFA 2



DEHORS SOFA 3



DEHORS DORMEUSE



DEHORS ARMCHAIR
ALUMINIUM (A019) FABRIC (TEMPOTEST ® PT01 / PT02)
CROSS LOW TABLE OUTDOOR STEEL (A019) ACRYLIC STONE (PR01)



DEHORS
ALUMINIUM (A019) FABRIC (TEMPOTEST® PT01 / PT02)
CROSS LOW TABLE OUTDOOR STEEL (A019) ACRYLIC STONE (PR01)

DIMENSIONS

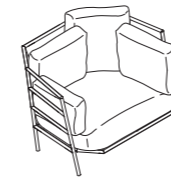

DEHORS ARMCHAIR (370_O)

cm 108x82,5 - h cm 68,7 - h seat cm 44

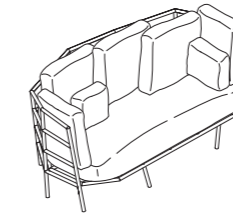

DEHORS SOFA 2 (371_O)

cm 173x90,3 - h cm 68,7 - h seat cm 44

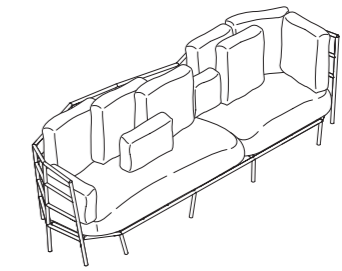

DEHORS SOFA 3 (372_O)

cm 253,8x89,5 - h cm 68,7 - h seat cm 44

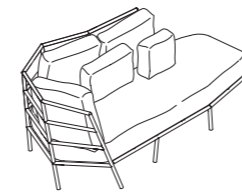

DEHORS DORMEUSE (373_O)

cm 166x90,5 - h cm 68,7 - h seat cm 44

Cover protettive disponibili.
Protective covers available.
Schutzhüllen verfügbar.
Couvertures de protection disponibles.

FINISHES

Alluminio verniciato
Lacquered aluminium
Aluminium lackiert
Aluminium laqué



A019

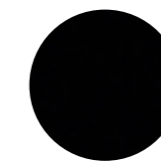

A011



A047



A022



A051

Tessuto
Fabric
Stoff
Tissu

Alias Living Outdoor (B)
Tempotest® (A)



Rete / Mesh
(R020)

Alluminio /
Aluminium
(A022)

Tessuto / Fabric
Tempotest® A
(PT03)

Frassino Termotrattato /
Heat-treated ash wood
(FRTT)

Tessuto / Fabric
Alias Living Outdoor
(LN08 / LN10)

Gres / Gres Stoneware
(CE12)

MATERIAlias



Green

Giandomenico Belotti



Resistenza, praticità e definizione di spazi aperti caratterizzano la collezione **green**. Strutture in acciaio inox spazzolato disegnano sedie, poltroncine, sgabelli e comode chaise longue, proposti con seduta e schienale in rete di poliestere spalmata di PVC o nella originale tessitura in tondino di PVC. Aggiungono forte identità all'insieme i tavoli disponibili in diverse dimensioni e finiture.

Resistance, practicality and definition of open spaces characterize the **green** collection. Frames in brushed stainless steel design chairs, small armchairs, stools and comfortable chaise longues with seat and back in PVC covered polyester mesh or with the original PVC strings available in different colours. Tables with different dimensions and finishes add a strong identity to the collection.

Festigkeit, Komfort und sinnvolle Raumaussnutzung sind die Stärken der Kollektion **green**. Die Gestellen aus gebürstetem Edelstahl zeichnen Stühle, Sessel, Hocker und bequeme Chaise Lounge bezogen mit einem aus feuerhemmendem PVC-beschichtetem Polyestergewebe oder mit der ursprünglicher PVC-Schnur. Die Tische in unterschiedlichen Abmessungen und Ausführungen verleihen der green Kollektion eine starke Persönlichkeit.

Résistance, praticité et définition d'espaces ouverts caractérisent la collection **green**. Des structures en inox brossé dessinent chaises, petits fauteuils, tabourets et transats confortables, proposés avec assise et dossier en tissu polyester maille enduit de PVC ou en fil PVC d'origine. Les tables disponibles avec plusieurs dimensions et finitions, ajoutent forte personnalité à l'ensemble.

GREEN



GREEN GEMINI



GREEN ARMREST



GREEN ARMCHAIR



GREEN STOOL



GREEN HIGH STOOL



GREEN SUN LOUNGER



GREEN SUN LOUNGER
STAINLESS STEEL (IS) MESH (R028)
CROSS TABLE XS OUTDOOR STEEL (A019) ACRYLIC STONE (PR01)

GREEN PVC



GREEN PVC ARMREST



GREEN PVC ARMCHAIR



GREEN PVC STOOLS



GREEN PVC ARMREST
STAINLESS STEEL (IS) PVC (P020)
GREEN TABLE STAINLESS STEEL (IS) DEKTON (DK01)

GREEN TABLE

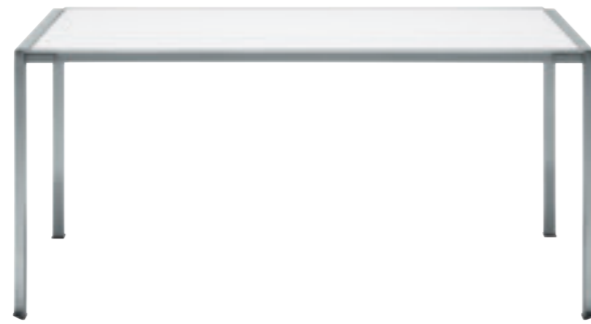

GREEN TABLE 160X80



GREEN TABLE 80X80



GREEN TABLE 135X135



GREEN TABLE 220X90



GREEN TABLE 220X90
STAINLESS STEEL (IS) DEKTON (DK01)
GREEN PVC ARMREST STAINLESS STEEL (IS) PVC (P020)



GREEN ARMCHAIR
STAINLESS STEEL (IS) MESH (R009)

DIMENSIONS

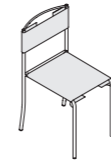

GREEN GEMINI (200_O)
cm 52x42 - h cm 83 - h seat cm 47

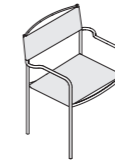

GREEN ARMREST (232_O)
cm 64x53 - h cm 84 - h seat cm 46



GREEN ARMCHAIR (209_O)
cm 59x68 - h cm 71 - h seat cm 42

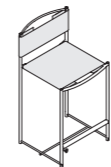

GREEN STOOL (224_O)
cm 49x45 - h cm 87 - h seat cm 64



GREEN HIGH STOOL (225_O)
cm 49x45 - h cm 102 - h seat cm 80

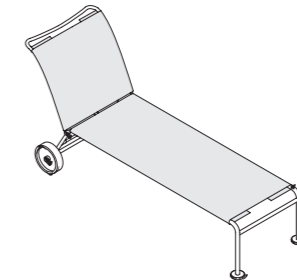

GREEN SUN LOUNGER (251_O)
cm 195x68 - h cm 96 - h seat cm 35

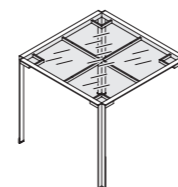

GREEN TABLE 80x80 (227_O)
cm 80x80 - h cm 73,5

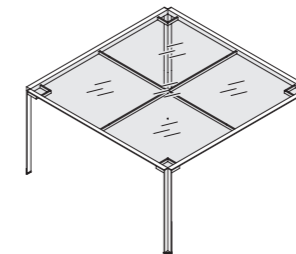

GREEN TABLE 135x135 (223_O)
cm 135x135 - h cm 73,5

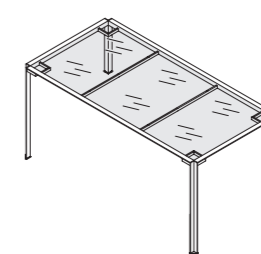

GREEN TABLE 160x80 (218_O)
cm 160x80 - h cm 73,5

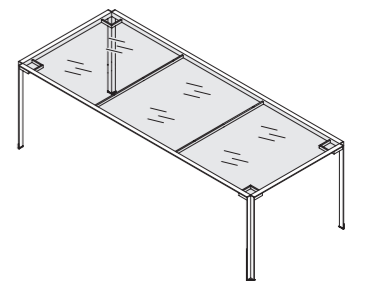

GREEN TABLE 220x90 (222_O)
cm 220x90 - h cm 73,5

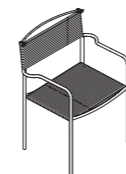

GREEN PVC ARMREST (201_O)
cm 53x64 - h cm 84 - h seat cm 46



GREEN PVC ARMCHAIR (202_O)
cm 59x68 - h cm 71 - h seat cm 42

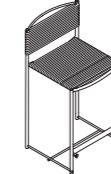

GREEN PVC STOOL (204_O)
cm 49x45 - h cm 87 - h seat cm 64

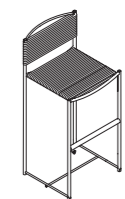

GREEN PVC HIGH STOOL (205_O)
cm 49x45 - h cm 102 - h seat cm 80

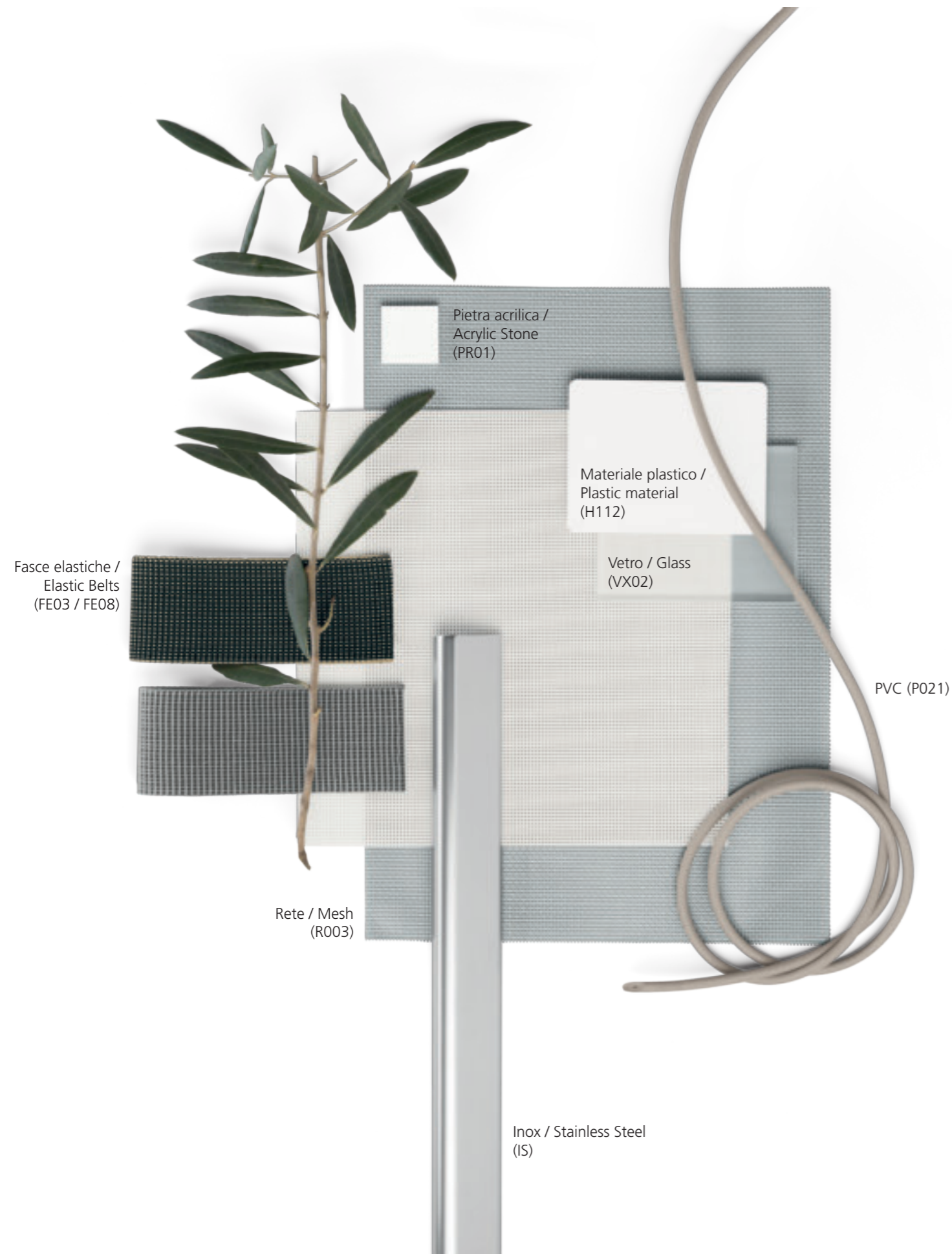

FINISHES

Acciaio Inox
Stainless Steel
Edelstahl
Acier Inox

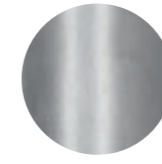

IS

Rete (A)
Mesh (A)
Netzgewebe (A)
Maille (A)



R009

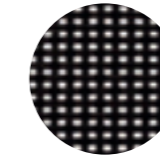

R007

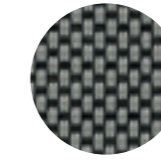

R028

Rete (B)
Mesh (B)
Netzgewebe (B)
Maille (B)

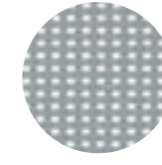

R003

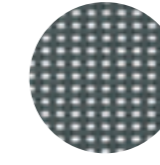

R006

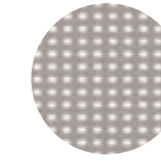

R011

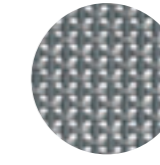

R020

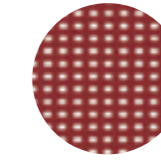

R024

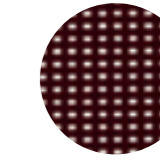

R025

Vetro
Glass
Glas
Verre



VX02

Dekton®
Dekton®
Dekton®
Dekton®



DK01

Tondino PVC
PVC
PVC-Schnur
fil PVC



P020

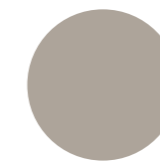

P021

MATERIAlias



AluZen soft outdoor

Ludovica & Roberto Palomba



Il segno elegante e leggero di Ludovica e Roberto Palomba reinterpreta le linee rigorose e geometriche del divano modulare aluZen in un'ottica di comfort e relax, dando vita ad **aluZen soft** che viene declinato nella versione per esterno, un'interessante new entry nel catalogo di Alias. Grazie alla sua spiccata e affascinante identità ibrida, Aluzen soft outdoor offre una risposta contemporanea al mondo dell'outdoor sempre più sofisticato e attento alle esigenze della vita all'aperto.

Ludovica and Roberto Palomba's elegant, light design reinterprets the rigorous, geometric lines of the aluZen modular sofa with a view to comfort and relaxation, giving life to **aluZen soft**, which is proposed in the outdoor version, an interesting new entry in the Alias catalogue. Thanks to its distinct and fascinating hybrid identity, Aluzen soft outdoor offers a contemporary response to the outdoor world, increasingly sophisticated and attentive to the needs of open-air life.

Das elegante und zugleich lässige Design von Ludovica und Roberto Palomba interpretiert die strengen und geometrischen Linien des modularen Sofas aluZen neu mit Blick auf Komfort und Entspannung und erweckt **aluZen soft** zum Leben, das jetzt in einer neuen Version für den Außenbereich erhältlich ist, eine interessante Neuheit im Katalog von Alias. Mit seiner ausgeprägten und faszinierenden hybriden Identität bietet Aluzen Soft Outdoor eine zeitgemäße Antwort auf die immer anspruchsvollere Outdoor-Welt.

Avec leur style élégant et léger Ludovica et Roberto Palomba réinterprètent les lignes rigoureuses et géométriques du canapé modulaire aluZen dans une optique de confort et de détente et créent **aluZen soft**, décliné dans la version pour l'extérieur, un nouvel ajout intéressant au catalogue Alias. Avec son identité hybride, particulière et fascinante, Aluzen soft outdoor offre une réponse contemporaine à l'univers de l'architecture d'extérieur, toujours plus sophistiqué et attentif aux exigences de la vie en plein air.

ALUZEN SOFT OUTDOOR



Modular system: P63_O / P70_O / P64_O / P73_O



Modular system: P64_O / P70_O



Modular system: P65_O / P66_O / P68_O



ALUZEN SOFT OUTDOOR

ALUMINIUM (A047) FABRIC ALIAS LIVING OUTDOOR LH04

ALUZEN LOW TABLE OUTDOOR ALUMINIUM (A047) SAEN XS OUTDOOR POLYURETHANE (V003) GLAZED CERAMIC (V003)



The minimal and geometric aluminium structure of Aluzen soft outdoor accommodates a system of soft, imposing cushions, designed to meet ergonomics and comfort requirements.

La struttura in alluminio di Aluzen soft outdoor, minimale e geometrica ospita un sistema di cuscini morbidi e importanti, disegnati per rispondere ai requisiti di ergonomia e comfort.

ALUZEN SOFT OUTDOOR

ALUMINIUM (A047) FABRIC ALIAS LIVING OUTDOOR LH04

ALUZEN LOW TABLE ALUMINIUM (A047) SAEN XS OUTDOOR POLYURETHANE (V003) GLAZED CERAMIC (V003)

DIMENSIONS

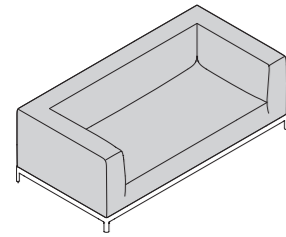

ALUZEN SOFT SOFA 2 OUTDOOR (P60_O)
cm 190x95 - h cm 65 - h seat cm 42

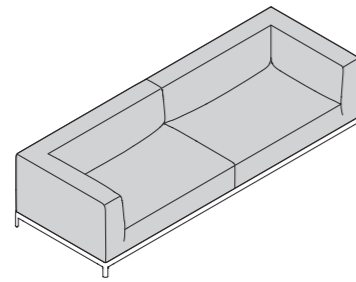

ALUZEN SOFT SOFA 3 OUTDOOR (P61_O)
cm 270x95 - h cm 65 - h seat cm 42

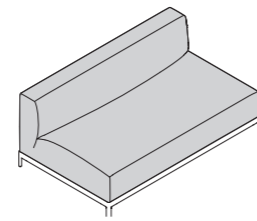

ALUZEN SOFT CENTRAL 160X95 OUTDOOR (P62_O)
cm 160x95 - h cm 65 - h seat cm 42

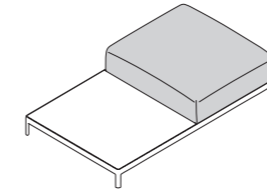

ALUZEN SOFT TOP 190X95 OUTDOOR (P72_O)
cm 190x95 - h seat cm 42

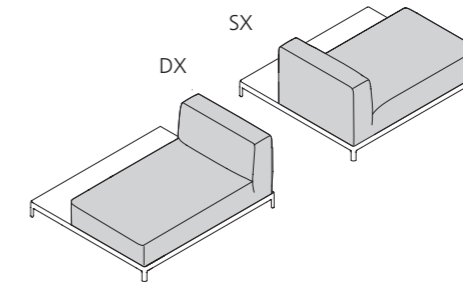

ALUZEN SOFT TOP 135X120 OUTDOOR (P68_O)
cm 135x120 - h cm 65 - h seat cm 42

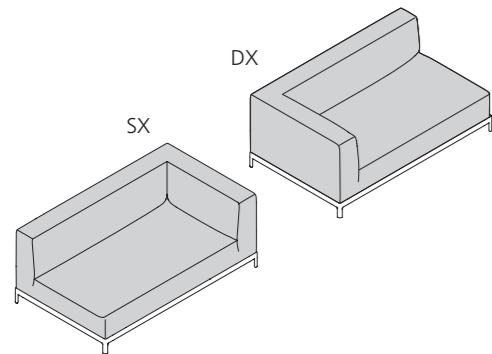

ALUZEN SOFT ANGULAR 160X95 OUTDOOR (P63_O)
cm 160x95 - h cm 65 - h seat cm 42

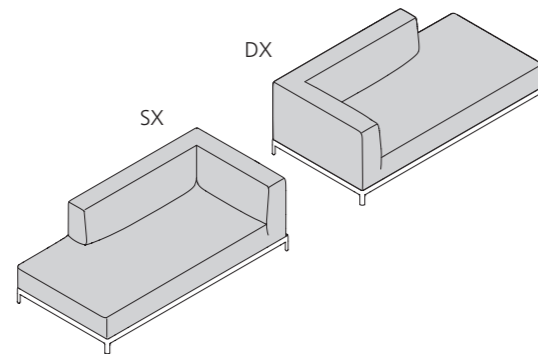

ALUZEN SOFT ANGULAR 190X95 OUTDOOR (P64_O)
cm 190x95 - h cm 65 - h seat cm 42

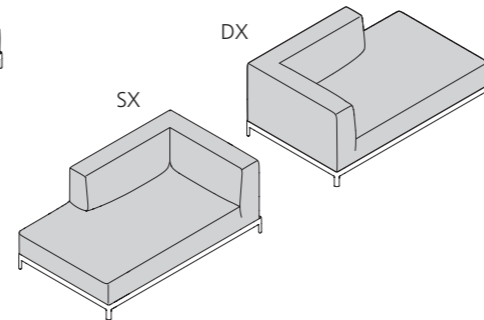

ALUZEN SOFT ENDING 160X95 OUTDOOR (P65_O)
cm 160x95 - h cm 65 - h seat cm 42

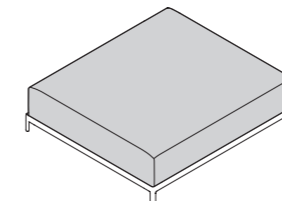

ALUZEN SOFT POUF 135X120 OUTDOOR (P69_O)
cm 135x120 - h seat cm 42

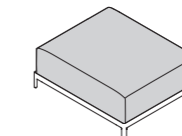

ALUZEN SOFT POUF 80X95 OUTDOOR (P70_O)
cm 80x95 - h seat cm 42

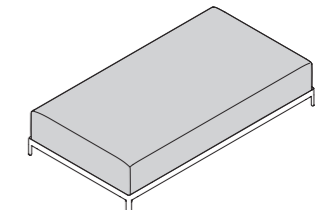

ALUZEN SOFT BENCH OUTDOOR (P71_O)
cm 175x95 - h seat cm 42

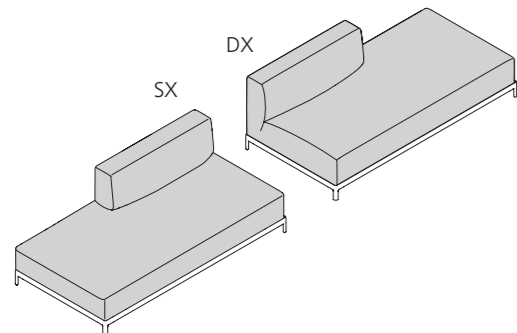

ALUZEN SOFT ENDING 190X95 OUTDOOR (P66_O)
cm 190x95 - h cm 65 - h seat cm 42

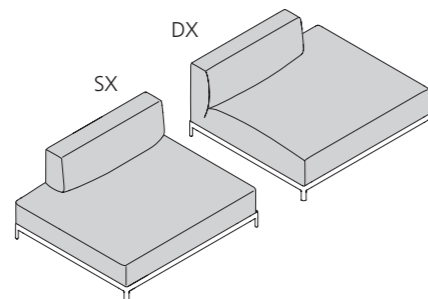

ALUZEN SOFT ENDING 135X120 OUTDOOR (P67_O)
cm 135x120 - h cm 65 - h seat cm 42

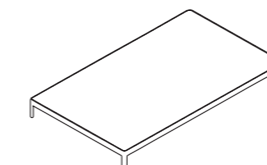

ALUZEN SOFT LOW TABLE 190X95 OUTDOOR (P73_O)
cm 190x95 - h cm 24

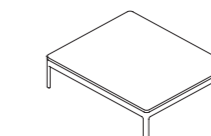

ALUZEN SOFT LOW TABLE 80X95 OUTDOOR (P74_O)
cm 80x95 - h cm 24



Scopri la collezione completa
Discover the complete collection

Cover protettive disponibili.
Protective covers available.
Schutzhüllen verfügbar.
Couvertures de protection disponibles.



FINISHES

Alluminio verniciato
Lacquered aluminium
Aluminium lackiert
Aluminium laqué

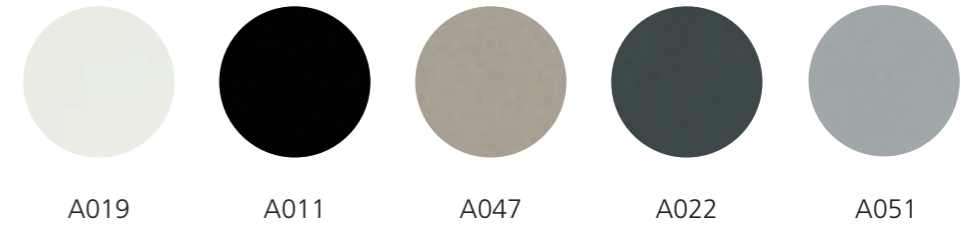

Gres
Gres stoneware
Feinsteinzeug
Grès

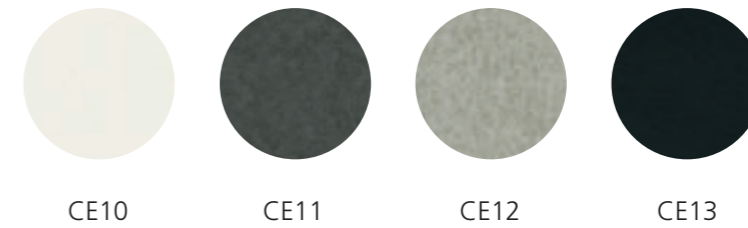

Tessuto
Fabric
Stoff
Tissu

Alias Living Outdoor (B)
Tempotest® (A)

Ecopelle
Eco-leather
Kunstleder
Simili cuir

Serge Ferrari® (A)

Schienale, seduta e braccioli di Aluzen soft outdoor si integrano in un blocco unico ed avvolgente, che sembra sfiorare il pavimento senza mai raggiungerlo. Il rivestimento, in tessuto o ecopelle, rivela raffinate caratteristiche artigianali tipiche della manifattura Alias, come la profilatura perimetrale dei cuscini che evidenzia l'ortogonalità dei piani ed esalta la purezza dei volumi.

The back, seat and arms of the Aluzen soft outdoor all coalesce into a single, enveloping shape, which seems to touch the floor but never reaches it. The fabric or leather upholstery features the handmade characteristics typically associated with Alias products, such as the piping around the perimeter of the cushions, which underscores the orthogonality of the flat surfaces and exalts the purity of the volumes.

Die Rückenlehne, Sitzfläche und Armlehnen von Aluzen soft outdoor integrieren sich in einer einzigen, umhüllenden Form, die den Fußboden zu berühren scheint, ohne mit ihm in Kontakt zu gelangen. Der Stoff- oder Lederbezug offenbart elegante, für Alias typisch handwerklichen Eigenschaften; zum Beispiel das Randprofil der Kissen, das die rechteckigen Ebenen betont und die Reinheit der Volumen hervorhebt.

Le dossier, l'assise et les accoudoirs de Aluzen soft s'intègrent dans un bloc unique et enveloppant, qui semble effleurer le sol sans jamais l'atteindre. Le revêtement, en tissu ou simili cuir, révèle des caractéristiques artisanales raffinées, typiques de la fabrication Alias, tout comme le profilage périmétrique des coussins qui met en évidence les plans orthogonaux et met en valeur la pureté des volumes.



Ten System Outdoor

PearsonLloyd

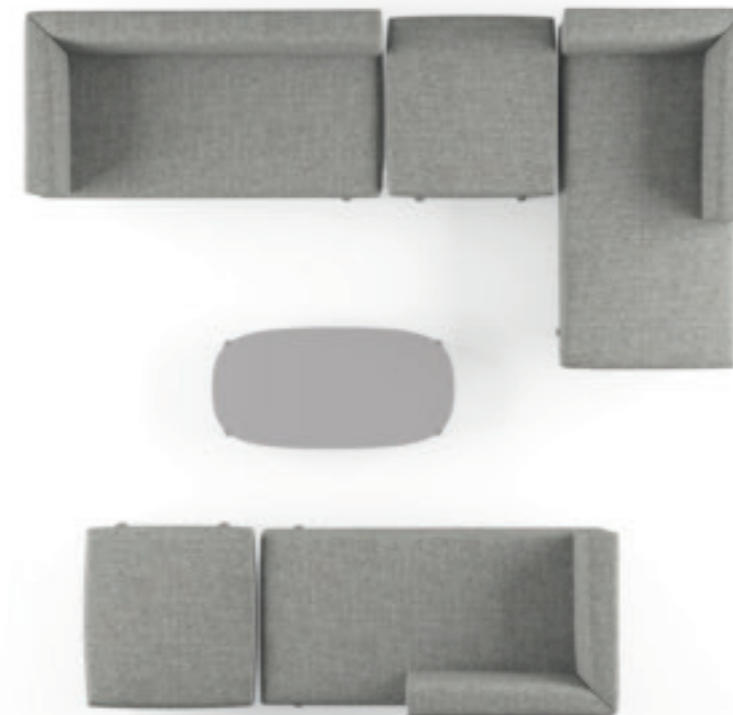

La collezione di imbottiti Eleven, disegnata dal duo britannico PearsonLloyd, si arricchisce della versione da esterno **ten system** caratterizzata da moduli che, abbinati tra loro, consentono di creare varie configurazioni dalle dimensioni generose. La modularità di **ten system** rispecchia i canoni di Alias attraverso pochi elementi, ben identificati. Combinando tra loro i diversi moduli è possibile creare svariate configurazioni, dalle più classiche a quelle più contemporanee.

The Eleven collection of upholstered furniture, designed by the British duo PearsonLloyd, is enriched with the outdoor version **ten system**, characterized by modules that, when combined, offer the possibility of creating various configurations with generous dimensions. The modularity of **ten system** reflects the standards of Alias through few well-identified elements. By combining the different modules it is possible to create various configurations, from the most classic to the most contemporary.

Die vom britischen Duo PearsonLloyd entworfene Polstermöbelkollektion Eleven, wird durch die Outdoor-Version **ten system** bereichert, die sich durch Module auszeichnet, die verschiedene Konfigurationen mit großzügigen Abmessungen ermöglichen. Die Modularität von **ten system** spiegelt den Kanon von Alias durch einige klar identifizierte Elemente wider. Durch die Kombination der verschiedenen Module ist es möglich, viele Konfigurationen zu schaffen, von der klassischsten bis zur modernsten.

La collection de meubles rembourrés Eleven, dessinée par le duo britannique PearsonLloyd, s'enrichit de la version pour l'extérieur **ten system**, caractérisée par des modules qui, une fois combinés, permettent de créer diverses configurations aux dimensions généreuses. La modularité de **ten system** reflète les standards d'Alias à travers peu d'éléments, clairement identifiés. La combinaison des différents modules permet de créer plusieurs configurations, des plus classiques aux plus contemporaines.

TEN SYSTEM OUTDOOR



Modular system: T06_O / T07_O / T05_O



Modular system: T05_O / T07_O



Modular system: T05_O / T04_O / T06_O / T10_O



TEN SYSTEM OUTDOOR
ALUMINIUM (A022) FABRIC ALIAS LIVING OUTDOOR LH23



Scopri la collezione completa
Discover the complete collection



TEN SYSTEM OUTDOOR
ALUMINIUM (A022) FABRIC ALIAS LIVING OUTDOOR LH23
GREEN PVC ARMCHAIR STAINLESS STEEL (IS) PVC (P021)



TEN SYSTEM OUTDOOR
 ALUMINIUM (A022) FABRIC ALIAS LIVING OUTDOOR LH23
 GREEN PVC ARMCHAIR STAINLESS STEEL (IS) PVC (P021)

DIMENSIONS

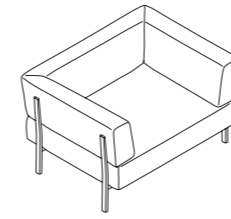

TEN ARMCHAIR (T01_O)
 cm 118x90 - h cm 72 - h seat cm 41

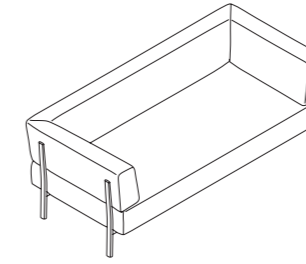

TEN SOFA 2 (T02_O)
 cm 194x90 - h cm 72 - h seat cm 41

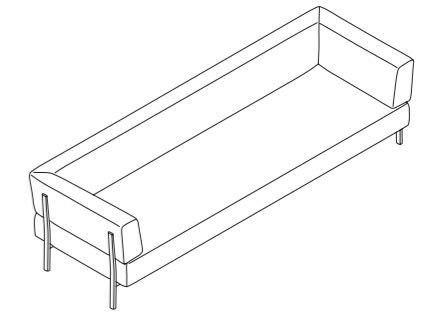

TEN SOFA 3 (T03_O)
 cm 270x90 - h cm 72 - h seat cm 41

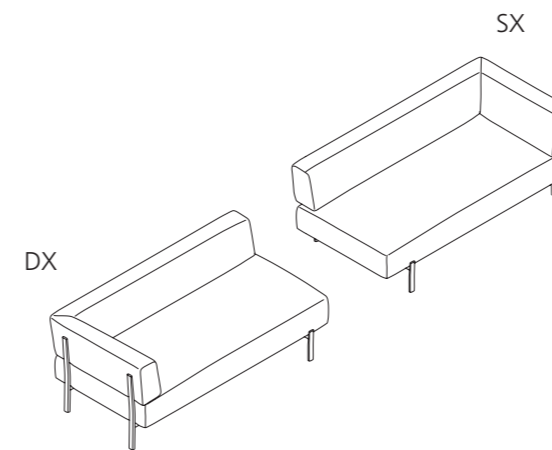

TEN ANGULAR (T05_O)
 cm 173x90 - h cm 72 - h seat cm 41

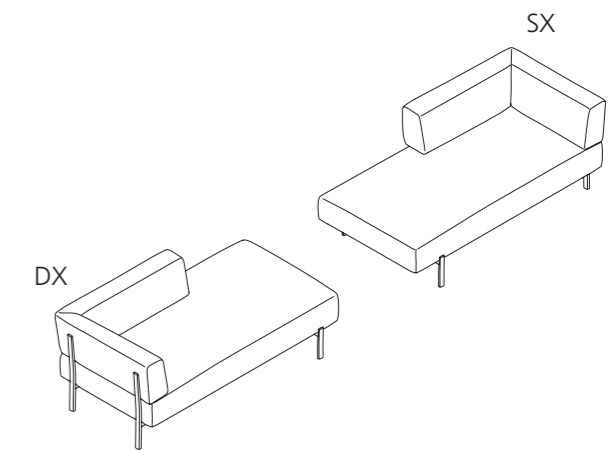

TEN DORMEUSE (T06_O)
 cm 173x90 - h cm 72 - h seat cm 41

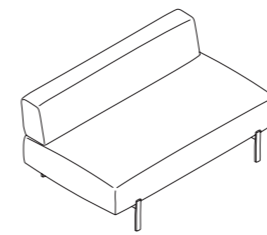

TEN CENTRAL (T04_O)
 cm 149x90 - h cm 72 - h seat cm 41

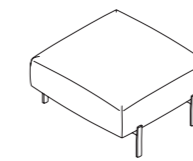

TEN POUF (T07_O)
 cm 90x85 - h seat cm 41



TEN LOW TABLE 60x60 (T09_O)
 cm 60x60 - h cm 37



TEN LOW TABLE 90x45 (T08_O)
 cm 90x45 - h cm 37

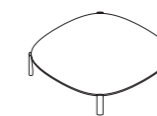

TEN LOW TABLE 80x80 (T11_O)
 cm 80x80 - h cm 22

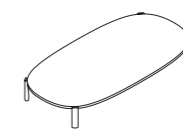

TEN LOW TABLE 120x60 (T10_O)
 cm 120x60 - h cm 22

FINISHES



Alluminio verniciato
Lacquered aluminium
Aluminium lackiert
Aluminium laqué



Ceramica smaltata
Glazed ceramic
Glasierete Keramik
Céramique émaillée



Tessuto
Fabric
Stoff
Tissu

Alias Living Outdoor (B) Tempotest® (A)	Ecopelle Eco-leather Kunstleder Simili cuir	Serge Ferrari® (A)
--	--	--------------------

Cover protettive disponibili.
Protective covers available.
Schutzhüllen verfügbar.
Couvertures de protection disponibles.

La collezione ten system outdoor comprende pratici tavolini che riprendono stilisticamente il design delle gambe degli imbottiti. I piani sono realizzati in ceramica stampata e smaltata, con proprietà superficiali e strutturali ideali per questo tipo di prodotto.

Ten system outdoor collection includes practical coffee tables that stylistically reflect the design of the legs of the upholstered furniture. The tops are made of pressed and glazed ceramic material, with surface and structural properties that are ideal for this type of product.

Die ten system Outdoor-Kollektion hat praktische Beistelltische, die stilistisch das Design der Beine der Polstermöbel übernehmen. Die Tischplatten bestehen aus geformter und glasierter Keramik, dessen Oberflächen- und Struktureigenschaften ideal für diese Art von Produkten sind.

La collection de plein air ten system comprend des tables pratiques basses, qui reprennent le style et la forme des pieds des meubles rembourrés. Les plateaux sont réalisés en céramique moulée et émaillée, dont les propriétés superficielles et structurelles sont idéales pour ce type de produit.

Ten system è perfetto per residenze private e situazioni contract, offrendo un sistema di imbottiti confortevole e dinamico che risponde alle esigenze contemporanee dell'abitare nelle quali le funzioni si sovrappongono e gli ambienti si trasformano.

Ten system is perfect for private residences and contract situations, offering a comfortable and dynamic upholstery system that responds to contemporary living needs in which functions overlap and environments are transformed.

Das ten system eignet sich perfekt für den privaten Wohnbereich und den Objektbereich und bietet ein komfortables und dynamisches Polstersystem, das den Bedürfnissen des modernen Wohnens entspricht, wo sich Funktionen überschneiden und Umgebungen verändert werden.

Ten system est parfait pour les résidences privées et les situations contrat, car il offre un système de meubles rembourrés confortable et dynamique, qui satisfait les exigences de l'habitat contemporain, où les fonctions se superposent et les cadres se transforment.

MATERIAlias



Slim Chair Outdoor

PearsonLloyd



Funzionalità e pulizia formale sono gli elementi che caratterizzano **slim chair outdoor**, la seduta in polipropilene firmata dallo studio PearsonLloyd.

Ideale per arredare giardini e terrazze, pubbliche e private, **slim chair outdoor** è formata da una struttura a 4 gambe in acciaio inox, verniciata a polvere in diversi colori, sul quale si fissa una scocca in polipropilene dal design minimale.

Semplice ed ergonomica, **slim chair outdoor** interpreta un tema peculiare del design contemporaneo: la seduta essenziale, in grado di soddisfare esigenze contract e residenziali.

Functionality and simple lines characterize the **slim chair outdoor**, a seat in polypropylene designed by PearsonLloyd.

Ideal to furnish gardens and public or private terraces, **slim chair outdoor** is created with a four legs steel structure, lacquered in various colours, on which a polypropylene minimal shell is fixed.

Simple and ergonomic, the **slim chair outdoor** embodies a unique topic of the contemporary design: the essential seat that can satisfy both contract and residential needs.

Funktionalität und reinen Linien kennzeichnen der vom britischen Duo PearsonLloyd entworfene Stuhl **slim chair outdoor**.

Ideal als Einrichtung für Gärten und private oder öffentliche Terrassen hat der **Slim chair outdoor** ein 4-Beinen Gestell aus Edelstahl, lackiert in verschiedenen Farben; darauf wird eine minimale Schale aus Polypropylen montiert.

Schlicht und ergonomisch präsentiert er ein Thema, das dem zeitgenössischen Design eigen ist: Der leichte Stuhl, der die Bedürfnisse von Contract- und Wohnbereichen erfüllen kann.

Fonctionnalité et propreté formelle sont les éléments qui caractérisent **slim chair outdoor**, la chaise en polypropylène dessinée par le studio PearsonLloyd.

Idéale pour meubler les jardins et les terrasses, publics ou privés, **slim chair outdoor** se compose d'une structure à 4 pieds en acier inoxydable, laquée en poudre en différentes couleurs, sur laquelle est fixée une coque en polypropylène au design minimaliste.

Simple et ergonomique, **slim chair outdoor** interprète un thème propre au design contemporain: le siège essentiel capable de satisfaire les besoins résidentiels et des collectivités.



With high structural strength and defined by minimum thickness, the shell of slim chair is made with a mould that allows the insertion of a minimum percentage of glass fibre reinforcement, thus ensuring an excellent surface quality.

Ad alta tenuta strutturale e definita da spessori ridotti al minimo, la scocca di Slim chair è realizzata con uno stampo che permette di inserire una minima percentuale di fibra di vetro di rinforzo, garantendo così un'ottima qualità superficiale.

SLIM CHAIR 4 OUTDOOR
ALUMINIUM (A022) POLYPROPYLENE (PP04)

SLIM CHAIR OUTDOOR



DIMENSIONS



SLIM CHAIR 4 OUTDOOR 89C_O
cm 56x53 - h cm 81 - h seat cm 46

FINISHES

Polipropilene
Polypropylene
Polypropylen
Polypropylène

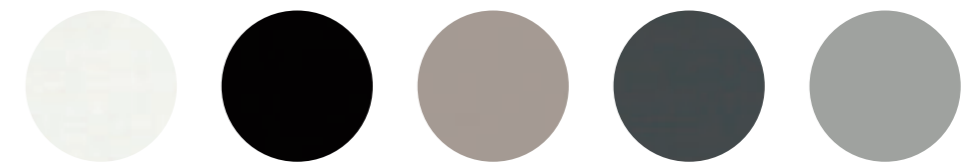

PP01 PP05 PP03 PP04 PP02

Alluminio verniciato
Lacquered aluminium
Aluminium lackiert
Aluminium laqué



A019 A011 A047 A022 A051



Kobi outdoor collection

Patrick Norguet



La passione per le tecnologie, la funzionalità e la leggerezza. Valori che uniscono il designer Patrick Norguet e Alias. Un'affinità da cui prende forma **kobi**. Norguet studia una nuova tipologia di seduta, ispirandosi alla tradizione delle sedie in filo di ferro, e progetta una struttura elegante e leggera: un'architettura sospesa di grande contemporaneità.

Passion for technology, functionality and lightness are the values shared by the designer Patrick Norguet and Alias. **Kobi** has taken shape as a result of this affinity. Norguet has developed a new type of chair, inspired by the tradition of iron wire chairs, coming up with an elegant and light-weight structure: a highly contemporary suspended architecture.

Leidenschaft für Technologie, Zweckmäßigkeit und Leichtigkeit. Diese sind die Werte, die den Stil des Designers Patrick Norguet und Alias vereinen. Aus dieser Gemeinsamkeit gestaltet sich der Stuhl **kobi**. Norguet entwickelt einen neuen Stuhltyp und er inspiriert sich an der Tradition des Drahtgeflechts und entwirft eine elegante, leichte Struktur: eine Architektur von höchster Aktualität, die frei im Raum zu schweben scheint.

La passion pour les technologies, la fonctionnalité et la légèreté. Des valeurs communes au designer Patrick Norguet et à Alias. Une affinité qui prend la forme de **kobi**. Norguet étudie un nouveau genre d'assise, s'inspirant de la tradition des chaises en fil de fer, et invente une structure élégante et légère: une architecture suspendue d'une grande modernité.

KOBI OUTDOOR



KOBI CHAIR + PAD SMALL OUTDOOR



KOBI SLEDGE OUTDOOR



KOBI STOOLS OUTDOOR

The shell is a sort of rigorous and enveloping basket, created by woven welded round steel wire. The support belt, made from cast aluminium, embraces the seat elegantly, totally enveloping the form. The seat cushions in eco leather guarantee a high seating comfort, ideal for outdoor settings.

La scocca è una sorta di canestro, rigoroso e avvolgente, creato dagli intrecci in tondino d'acciaio saldato. Il sostegno, in fusione di alluminio, abbraccia elegantemente la seduta, avvolgendone totalmente la forma. I cuscini nella variante solo seduta in pelle sintetica garantiscono un adeguato livello di comfort e sono ideali nelle situazioni outdoor.



KOBI STOOL OUTDOOR
ALUMINIUM (A011) ECO LEATHER (SERGE FERRARI® SK14)



Elegant, light and highly contemporary, the kobi sledge chair and stool collection draws its inspiration from the tradition of metal wire chairs, with a seat characterized by woven welded steel rods attached to the practical sledge frame.

Elegante, leggera e di grande contemporaneità, la collezione di sedute e sgabelli kobi sledge si ispira alla tradizione delle sedie in filo di ferro, con seduta caratterizzata da intrecci in tondino d'acciaio saldato che si fissano sulla pratica struttura a slitta.



KOBI SLEDGE OUTDOOR
 ALUMINIUM (A019) ECO LEATHER (SERGE FERRARI® SK14)
 BIPLANE OUTDOOR ALUMINIUM (A019) ACRYLIC STONE (PR01)



Ecopelle / Eco Leather
Serge Ferrari® Stamskin Top
F4340-20253

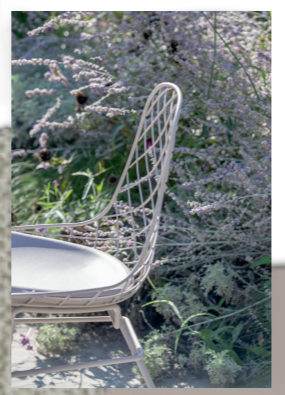

Alluminio / Aluminium
(A047)

Tessuti / Fabrics
Alias Living Outdoor
(LN06 / LK40)

MATERIAlias

DIMENSIONS



KOBI CHAIR OUTDOOR (040_O)
cm 56x64,5 - h cm 76 - h seat cm 42



KOBI PAD SMALL OUTDOOR (042_O)
cm 56x64,5 - h cm 76 - h seat cm 42



KOBI SLEDGE OUTDOOR (N01_O)
cm 52,5x48 - h cm 86,5 - h seat cm 49



KOBI STOOL OUTDOOR (N02_O)
cm 42x50,5 h cm 73 - h seat cm 63,5



KOBI HIGH STOOL OUTDOOR (N03_O)
cm 44x54 - h cm 89 - h seat cm 79,5

FINISHES

Alluminio/Acciaio
Aluminium/Steel
Aluminium/Stahl
Aluminium/Acier



A019 A011 A047 A022 A051

Tessuto
Fabric
Stoff
Tissu

Alias Living Outdoor (B)
Tempotest® (A)

Ecopelle
Eco-leather
Kunstleder
Simili cuir

Serge Ferrari®



Gran Kobi outdoor

Patrick Norguet



La collezione **gran kobi** si espande con l'introduzione della variante per esterno. Poltrona bassa dalle dimensioni generose, gran kobi outdoor è una seduta molto versatile che permette situazioni di relax, garantendo massimo comfort ed inserendosi armoniosamente negli spazi verdi. Come l'intera collezione, gran kobi outdoor riprende la stessa estetica della variante per interni: la scocca è un cesto, rigoroso e avvolgente, creato dagli intrecci in tondino d'acciaio saldato. Il sostegno, in fusione di alluminio, abbraccia elegantemente la seduta, avvolgendone totalmente la forma.

The **gran kobi** collection grows with the addition of an outdoor variant. A generously sized, low armchair, gran kobi outdoor is a highly versatile seat, suitable for relaxing situations and which ensures maximum comfort, as it fits harmoniously in green environments. As the entire collection, gran kobi outdoor retains the aesthetics of the indoor variant: the shell is a sort of rigorous and enveloping basket, created by woven welded steel rod. The support, made of die-cast aluminium, elegantly embraces the seat, totally enveloping its form.

Die Kollektion **gran kobi** outdoor erweitert sich mit der Einführung der Variante für den Außenbereich. Gran Kobi ist ein niedriger, großzügiger Sessel mit einer vielfältigen Sitzfläche zum Ausruhen, der höchsten Komfort anbietet und harmonisch in Grünanlagen einpasst. So wie die ganze Kollektion bietet gran kobi outdoor die gleiche Ästhetik der Variante für den Innenbereich: Die Sitzschale ähnelt einem rigorosen und komfortablem Korb, der aus einem geschweißten Rundstahlgeflecht besteht. Das Gestell besteht aus Aluminiumgusselementen und umarmt elegant und vollkommen die Sitzfläche.

La collezione **gran kobi** s'enrichit d'une variante destinée à l'extérieur. Avec ses dimensions généreuses, gran kobi outdoor est un fauteuil bas très polyvalent destiné à la détente et au repos. Très confortable, il s'intègre harmonieusement dans les espaces verts. A l'instar de toute la collection, gran kobi outdoor affiche la même esthétique que sa variante d'intérieur : sa coque est une sorte de corbeille, rigoureuse et enveloppante, créée par un tressage de ronds d'acier soudés. Le support, en fonte d'aluminium, embrasse élégamment l'assise en enveloppant totalement sa forme.



GRAN KOBI PAD OUTDOOR
 ALUMINIUM (A047) FABRIC LIVING OUTDOOR LN06
 ALUZEN LOW TABLE OUTDOOR ALUMINIUM (A022) GRES (CE13)

DIMENSIONS



GRAN KOBI + PAD OUTDOOR (035_0)
 cm 89x69 - h cm 96 - h seat cm 40

La struttura proposta prevede sostegno e gambe in alluminio verniciato con scocca in acciaio in tinta, disponibile in diversi colori. Il tutto trattato per resistere all'ambiente esterno.

The structure consists of a lacquered aluminium support, legs and a steel shell in the same tone, available in a variety of colours. Ad hoc treatments make the entire seat suitable to withstand outdoor conditions.

Das angebotene Gestell hat eine Sitzhalterung und Beine aus lackiertem Aluminium und die Schale ist aus gleichfarbigem lackiertem Stahl, verfügbar in verschiedenen Farben. Alles wird für den Außenbereich behandelt.

La structure proposée comprend un support et des pieds en aluminium laqué avec une coque en acier assortie, disponible en différentes couleurs. Tous traités pour résister à l'environnement extérieur.

FINISHES

Alluminio/Acciaio
 Aluminium/Steel
 Aluminium/Stahl
 Aluminium/Acier



A019

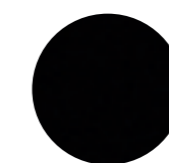

A011



A047



A022



A051

Tessuto
 Fabric
 Stoff
 Tissu

Alias Living outdoor (B)
 Tempotest® (A)

Ecopelle
 Eco-leather
 Kunstleder
 Simill cuir

Serge Ferrari® (A)



Saen Outdoor

Gabriele & Oscar Buratti



Saen arricchisce la collezione outdoor di Alias che si completa di tipologie inedite offrendo una risposta molto articolata al mondo della progettazione d'esterno. Fondendo l'eleganza del disegno alla ricercatezza materica, Gabriele e Oscar Buratti danno vita a Saen outdoor un tavolo caratterizzato da un basamento importante che in un disegno fluido, continuo e morbido diventa uno stelo esile e slanciato, un meraviglioso contrasto formale ideale per terrazze e dehors.

Saen expands Alias outdoor collection, which is now completed with new types and offers a highly varied response to the world of outdoor design. By combining the elegance of the design with the refinement of the material, Gabriele and Oscar Buratti create Saen outdoor, a table with an important base which, in a fluid, continuous and soft design, becomes a slender and slim stem, a wonderful formal contrast ideal for terraces and outdoor areas.

Saen bereichert die Alias Outdoor-Kollektion, die durch neue Modelle vervollständigt wird und dem Welt des Outdoor-Designs eine sehr differenzierte Antwort bietet. Gabriele und Oscar Buratti vereinen die Eleganz des Designs mit der Raffinesse des Materials und erwecken den Saen Tisch zum Leben. Charakteristisch ist die große Basis, die in einem fließenden, kontinuierlichen und weichen Design zu einem schlanken und schmalen Stiel übergeht, ein wunderbarer formaler Kontrast, ideal für Terrassen und Innenhöfe.

Saen enrichit la collection Alias pour l'extérieur, complétée par de nouvelles typologies inédites, qui offre une réponse très variée au monde de la décoration d'extérieur. Alliant l'élégance du design et le raffinement du matériau, Gabriele et Oscar Buratti ont créé Saen Outdoor une table caractérisée par un pied imposant qui, évoluant en une forme fluide, continue et douce, devient une tige fine et élancée, un merveilleux contraste de formes, idéal pour les terrasses et les patios.

SAEN OUTDOOR



SAEN OUTDOOR



SAEN XS OUTDOOR

Pensato per gli ambienti esterni, saen è proposto in diverse configurazioni: il tavolo da pranzo è caratterizzato da un top rotondo da 150 cm di diametro; i pratici coffee table sono disponibili in due altezze, con top di diametri da 50, 60 e 80 cm.

Designed for outdoor environments, saen is offered in different configurations: the dining table features a round top with a diameter of 150 cm; the practical coffee tables are available in two heights, with top diameters of 50, 60 and 80 cm.

Konzipiert für den Außenbereich, wird saen in verschiedenen Konfigurationen angeboten: Der Esstisch verfügt über eine runde Platte mit einem Durchmesser von 150 cm; die praktischen Couchtische sind in zwei Höhen und mit einem Plattendurchmesser von 50, 60 und 80 cm erhältlich.

Conçue pour les espaces extérieurs, saen est proposée en différentes configurations : la table à manger se distingue par un plateau rond de 150 cm de diamètre ; les tables basses pratiques sont disponibles en deux hauteurs, avec des plateaux de 50, 60 et 80 cm de diamètre.



SAEN OUTDOOR
POLYURETHANE (V007) CERAMIC (V007)
KOBI SLEDGE OUTDOOR ALUMINIUM (A047) ECO LEATHER (SERGE FERRARI® SK04)



SAEN XS OUTDOOR
 POLYURETHANE (V130) CERAMIC (V130)
 ALUZEN SOFT OUTDOOR ALUMINIUM (A047) ALIAS LIVING OUTDOOR LH04

DIMENSIONS

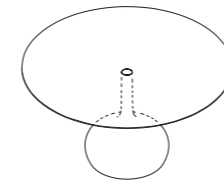

SAEN OUTDOOR 012_O
 Ø cm 150 - h cm 74.5 - base Ø 49 cm

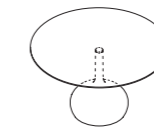

SAEN XS OUTDOOR SNS_O
 Ø cm 50/60 - h cm 50 - base Ø 35 cm

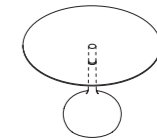

SAEN XS OUTDOOR SNS_O
 Ø cm 50/60 - h cm 63 - base Ø 35 cm

La base di saen outdoor è realizzata in poliuretano rigido compatto, un materiale dalle elevate prestazioni, ad alto contenuto tecnico ed estetico. Allo stelo rifinito con vernici goffrate vengono fissati piani realizzati in ceramica smaltata opaca, disponibili in vari colori.

The base is made of compact rigid polyurethane, a high performance material with advanced technical and aesthetic properties. Onto the stem, lacquered with textured paint, are placed tops in matt glazed ceramic, available in various colours.

Das Untergestell von saen outdoor besteht aus kompaktem, hartem Polyurethan, ein Hochleistungsmaterial mit hohem technischem und ästhetischem Gehalt. An dem mit gerauten Lacken beschichtetem Stiel werden Tischplatten aus glasierter Keramik befestigt, verfügbar in verschiedenen matten Farben.

La base de saen outdoor est réalisée en polyuréthane rigide compact, un matériau performant à fort contenu technique et esthétique. Sur la tige finie avec des laques granitées sont fixés des plateaux en céramique émaillée mate, disponibles en plusieurs couleurs.

FINISHES

Ceramica smaltata
 Glazed ceramic
 Glasierte Keramik
 Céramique émaillée



V001



V130



V007

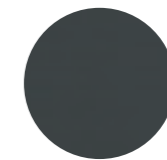

V003

Poliuretano
 Polyurethane
 Polyurethan
 Polyuréthane



V001

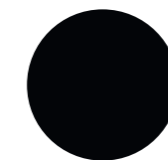

V130



V007

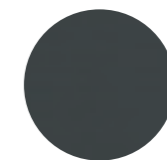

V003



Tagliatelle outdoor

Jasper Morrison



Il linguaggio diretto ed essenziale di Jasper Morrison incontra spaghetti chair; e di questa icona Alias, ne offre la sua originale reinterpretazione, citandone e riformulandone ogni elemento. La collezione **tagliatelle** prevede sedie impilabili, con e senza braccioli, comode poltroncine e pratici sgabelli. Grazie alla struttura in acciaio inox e alle fasce elastiche che compongono seduta e schienale, l'intera famiglia si inserisce armoniosamente negli spazi verdi, creando un'atmosfera di raffinato relax.

The direct and essential design of Jasper Morrison meets the spaghetti chair; Alias reinterprets this icon in an innovative way, redesigning each element. The **tagliatelle** collection is composed of stackable chairs, with or without arms, comfortable armchairs and practical stools. Thanks to its structure in stainless steel and the elastic belts covering the seat and the back, the whole collection harmoniously fits in green spaces, thus creating a relaxing and refined vibe.

Das direkte und unverkennbare Design von Jasper Morrison trifft den spaghetti chair und die Ikone von Alias wird neu interpretiert. Die **tagliatelle** Kollektion bietet stapelbare Stühle, mit oder ohne Armlehnen, bequeme Sessel und praktische Hocker. Dank dem Gestell aus Edelstahl und den Elastikbändern des Sitzes und der Rückenlehne integriert sich die ganze Kollektion harmonisch mit Grünflächen und erschafft eine entspannende und raffinierte Stimmung.

La langage direct et épuré de Jasper Morrison rencontre spaghetti chair; de cette icône Alias, il offre son réinterprétation originale, en citant et en reformulant chaque élément. La collection **tagliatelle** comprend des chaises empilables, avec et sans accoudoirs, des fauteuils confortables et des tabourets pratiques. Grâce à la structure en acier inoxydable et aux bandes élastiques qui constituent l'assise et le dossier, toute la famille s'intègre harmonieusement dans les espaces verts, créant une atmosphère de détente raffinée.

TAGLIATELLE OUTDOOR



TAGLIATELLE CHAIR OUTDOOR



TAGLIATELLE ARMREST OUTDOOR



TAGLIATELLE ARMCHAIR OUTDOOR



TAGLIATELLE STOOLS OUTDOOR



TAGLIATELLE HIGH STOOL OUTDOOR
STAINLESS STEEL (S) ELASTIC BELTS (FE10)

Polipropilene /
Polypropylene
(PP02)



Fasce elastiche / Elastic Belts
(FE06)



Rete / Mesh
(R003)

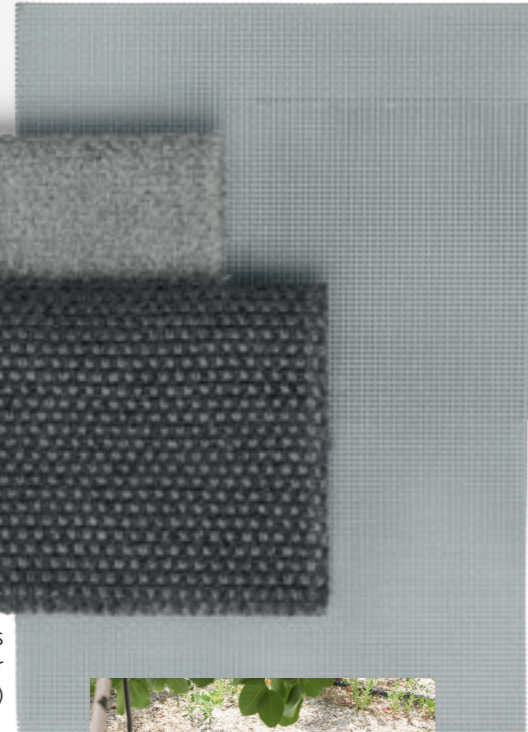

PVC (P020)



Alluminio / Aluminium
(A051)



Gres / Gres stoneware
(CE10)



Frassino Termotrattato /
Heat-treated ash wood
(FRTT)



Tessuti / Fabrics
Alias Living Outdoor
(LH24 / LK03)



Inox / Stainless Steel
(IS)



DIMENSIONS



TAGLIATELLE CHAIR OUTDOOR (715_O)
cm 48x42 - h cm 79,5 - h seat cm 45,5



TAGLIATELLE ARMREST OUTDOOR (716_O)
cm 48x50 - h cm 79,5 - h seat cm 45,5

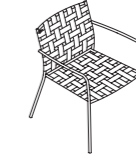

TAGLIATELLE ARMCHAIR OUTDOOR (717_O)
cm 58x55 - h cm 73 - h seat cm 39,5



TAGLIATELLE STOOL OUTDOOR (718_O)
cm 50x45 - h cm 96,5 - h seat cm 68,5



TAGLIATELLE HIGH STOOL OUTDOOR (719_O)
cm 52x46 - h cm 109,5 - h seat cm 81,5

FINISHES

Acciaio Inox
Stainless Steel
Stahl Inox
Acier Inox



IS

Fasce elastiche
Elastic belts
Elastichänder
Bandes élastiques

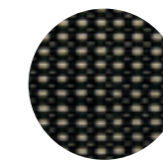

FE03

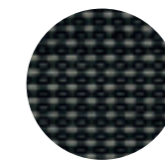

FE04



FE05

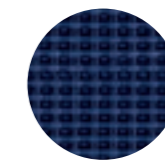

FE06

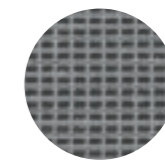

FE08

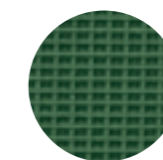

FE09

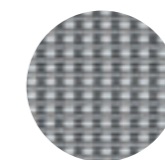

FE10

MATERIAlias



Segesta Outdoor

Alfredo Häberli



Le poltroncine **segesta** avvolgono senza essere ingombranti, offrendo un generoso bracciolo che nasce dal disegno dello schienale. Ampie e sinuose curve nella scocca ergonomiche e pratiche nell'utilizzo. La scocca è in tecnopolimero. La sua forma e le sue funzioni si prestano a interni o esterni d'immagine.

Segesta armchairs embrace without being cumbersome and offer a generous armrest that stems from the design of the backrest. A shell with smooth, flowing curves creates an ergonomic and practical chair. The shell is made of technopolymer. Its shape and functions are appropriate for prestigious indoor and outdoor environments.

Die Sessel **segesta** umschließen den Körper, ohne dabei sperrig zu wirken, und haben großzügige Armlehnen, die direkt aus der Rückenlehne entspringen. Die Sitzschale mit weiten, geschwungenen Kurven charakterisiert das Design der Stühle. Die Schale ist aus Technopolymer und ist sowohl ergonomisch als auch zweckmäßig. Dank ihrer Form sind die Stühle für den Wohnbereich genauso einsetzbar wie für den Außenbereich.

Les fauteuils **segesta** enveloppent sans encombrer et offrent un accoudoir généreux issu du design du dossier. Une coque aux courbes amples et sinueuses dessine les chaises ergonomiques et pratiques à utiliser. La coque est en technopolymère. Sa forme et ses fonctions se prêtent aussi bien aux intérieurs qu'aux extérieurs élégants.



Segesta chairs, in brushed stainless steel version, add practicality and identity to the outdoor landscape, by adorning gardens and terraces with simple shapes and refined details.

Le sedute segesta, nella versione con struttura in acciaio inox spazzolato, aggiungono praticità e identità al paesaggio outdoor, arricchendo e valorizzando con forme semplici e dettagli ricercati i giardini e le terrazze.

SEGESTA CHAIR OUTDOOR
STAINLESS STEEL (IS) PLASTIC MATERIAL (H112)

SEGESTA OUTDOOR



SEGESTA CHAIR OUTDOOR



SEGESTA SLEDGE OUTDOOR

DIMENSIONS



SEGESTA CHAIR OUTDOOR 500_O
cm 59x56 - h cm 80 - h seat cm 47



SEGESTA SLEDGE OUTDOOR 501_O
cm 59x56 - h cm 80 - h seat cm 47

FINISHES

Acciaio Inox
Stainless Steel
Edelstahl
Acier Inox



IS

Materiale plastico
Plastic material
Kunststoffmaterial
Matériau plastique



H112



Cross table outdoor

Alfredo Häberli



Un'ampia collezione di tavoli e tavolini, con piani in full color bianco disponibili in diverse forme e dimensioni, che poggiano sulla struttura cross: una base a croce, di diverse altezze, in acciaio verniciato. Raffinati e d'impatto i **cross table** arredano in modo riconoscibile e funzionale sia gli ambienti di casa che le situazioni outdoor.

A wide collection of tables and little tables, with a top in white full color available in different shapes and dimensions placed on the cross structure: a cross base available in different heights in lacquered steel. Refined and eye-catching, the **cross tables** furnish in a distinctive and functional manner both home environments and outdoor settings.

Eine breite Kollektion von Tischen und Beistelltischen mit Platten aus weißem Full Color in verschiedenen Formen und Größen, gestützt von einem kreuzförmigen Gestell: verschiedenen Höhen, aus lackiertem Stahl. Die raffinierten und als Blickfang dienende **cross** Tische eignen sich sowohl für die funktionelle Einrichtung von Wohn- als auch von Outdoor-Bereichen.

Une ample collection de tables et petites tables avec plateaux en full color blanc disponibles en différentes formes et dimensions qui posent sur la structure cross: une base à croix de différentes hauteurs en acier laqué. Raffinées et de fort impact, les **cross tables** meublent d'une façon reconnaissable et fonctionnelle soit les maisons soit les situations outdoor.



MATERIAlias

MATERIAlias is a project dedicated to gather all materials of our collection in a unique palette, organizing them according to the material, the colours and the finishes, in order to increasingly widen and simplify the choices of architects and interior designers. The project came up as an integrated material path where every colour, finish and material has been chosen to match with one another down to the smallest detail.

MATERIAlias è il progetto Alias dedicato a raccogliere in un'unica palette trasversale tutti i materiali in collezione secondo un ordine ragionato dal punto di vista materico, dei colori e delle finiture, per ampliare e facilitare sempre più le scelte di architetti e interior designer. Il progetto nasce come percorso materico integrato in cui ogni materiale, ogni finitura e ogni colore, sono stati scelti per dialogare bene gli uni con gli altri fino ai minimi dettagli, pur parlando lingue diverse.

METAL / TEXTURED LACQUERED METAL

METALLO / METALLO VERNICIATO GOFFRATO - METALL / METALL LACKIERT GERAUHT - MÉTAL / MÉTAL LAQUÉ GRNAITÉ

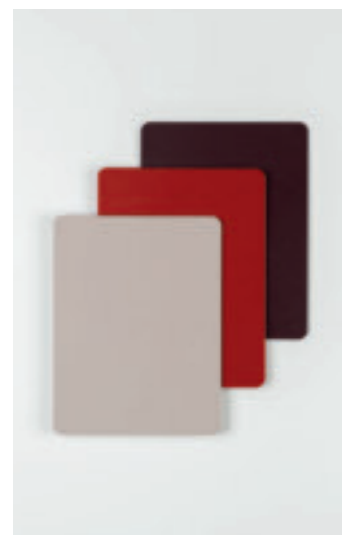

Brushed stainless steel
acciaio inox spazzolato /
Gebürsteter Inox Stahl /
acier inoxydable brossé



IS

MATT LACQUER

LACCATURA OPACA / MATTLACK / LAQUAGE OPAQUE



PLASTIC MATERIALS

MATERIALE PLASTICO / KUNSTSTOFFMATERIAL / MATÉRIAU PLASTIQUE

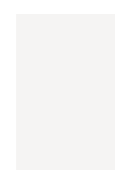

H112

Polypropylene
Polipropilene /
Polypropylen /
Polypropylene

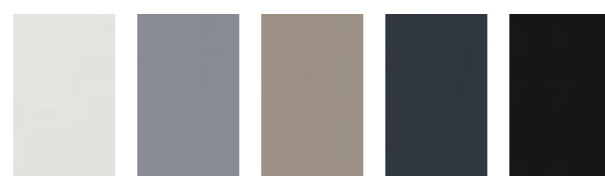

PP01 PP02 PP03 PP04 PP05

PVC

PVC / PVC-SCHNUR / FIL PVC



PVC FOR OUTDOOR (Ø 5mm)

P020 P021

WOOD

LEGNO / HOLZ / BOIS

Teak
Teak /
Teak /
Teak



TEAK

Frassino termotrattato
Heat-treated ash wood /
Wärmebehandeltes
Eschenholz /
Frêne Thermotraité



FRTT

It is a natural material and it could therefore be subject to colour changes, cracks and movements that may vary depending on the exposition to atmospheric agents and on the environment in which the product is placed.

Trattandosi di un materiale naturale, si possono verificare variazioni di colore, crepe e movimenti, che sono soggetti ad andamenti differenziati in funzione dell'esposizione agli agenti atmosferici e al tipo di ambiente in cui si trova il prodotto.

Es handelt sich um ein natürliches Material und deswegen könnten sich Farbwechsel, Risse und Bewegungen im Laufe der Zeit offenbaren. Diese variieren je nach der Exposition gegenüber Witterungseinflüssen und nach dem Umfeld, in dem das Produkt gestellt wird.

En tant que matériau naturel, des variations de couleur, des fissures et des mouvements peuvent se produire. Ceux-ci sont soumis à des tendances différenciées en fonction de l'exposition aux agents atmosphériques et du type d'environnement dans lequel le produit se trouve.

DEKTON®

DK01

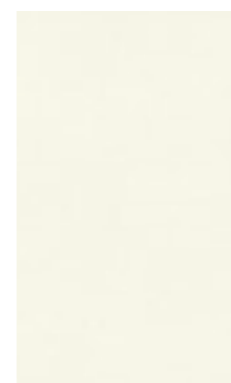

MESH
RETE / NETZGEWEBE / TISSU MAILLÉ

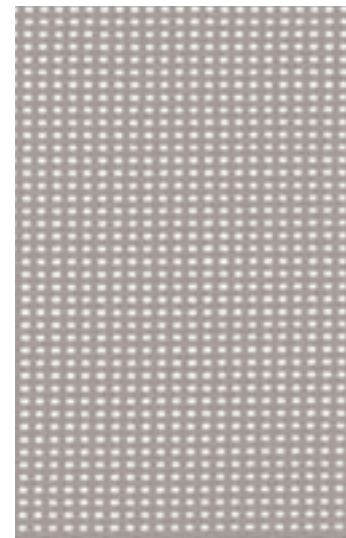

Mesh A
Rete A /
Netzgewebe A /
Tissu maillé A



R007 R009 R028

Mesh B
Rete B /
Netzgewebe B /
Tissu maillé B

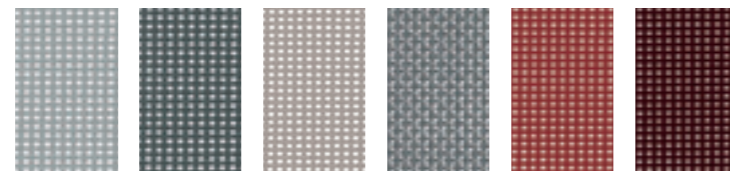

R003 R006 R011 R020 R024 R025

ELASTIC BELTS
FASCE ELASTICHE / ELASTIKBÄNDER / BANDES ÉLASTIQUES

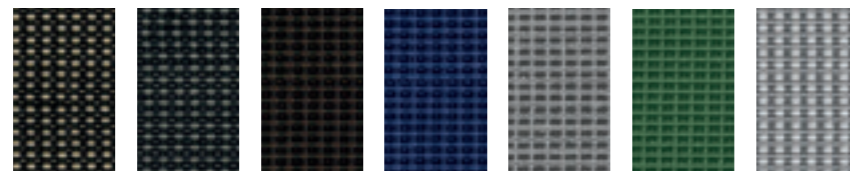

FE03 FE04 FE05 FE06 FE08 FE09 FE10

ACRYLIC STONE
PIETRA ACRILICA / NATURACRYLSTEIN / PIERRE ACRYLIQUE

PR01



GRES STONEWARE
GRES / FEINSTEINZEUG / GRÈS

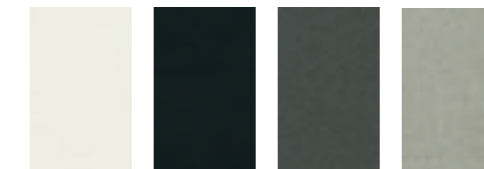

CE10 CE13 CE12 CE11

GLAZED CERAMIC
CERAMICA SMALTATA / GLASIERTE KERAMIK / CÉRAMIQUE ÉMAILLÉE



V001 V130 V003 V007

GLASS
VETRO / GLAS / VERRE

VX02

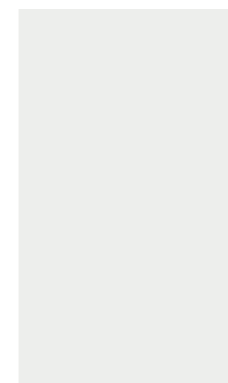

FABRIC ALIAS LIVING OUTDOOR COLLECTION (B)
 ALIAS LIVING OUTDOOR COLLEZIONE B / KOLLEKTION LIVING OUTDOOR B / LIVING OUTDOOR B COLLECTION

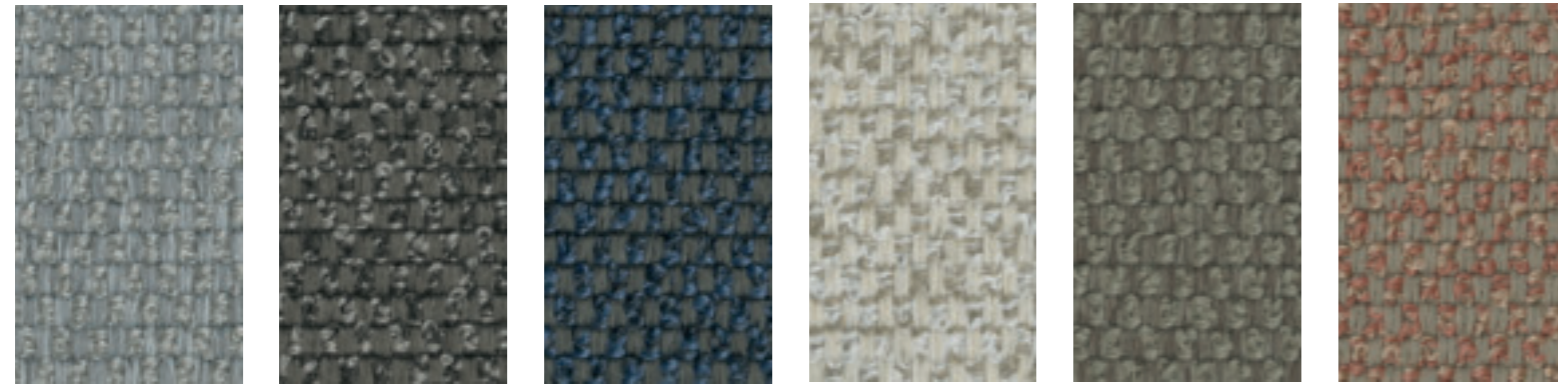

LN03 LN08 LN10 LN06 LN05 LN11

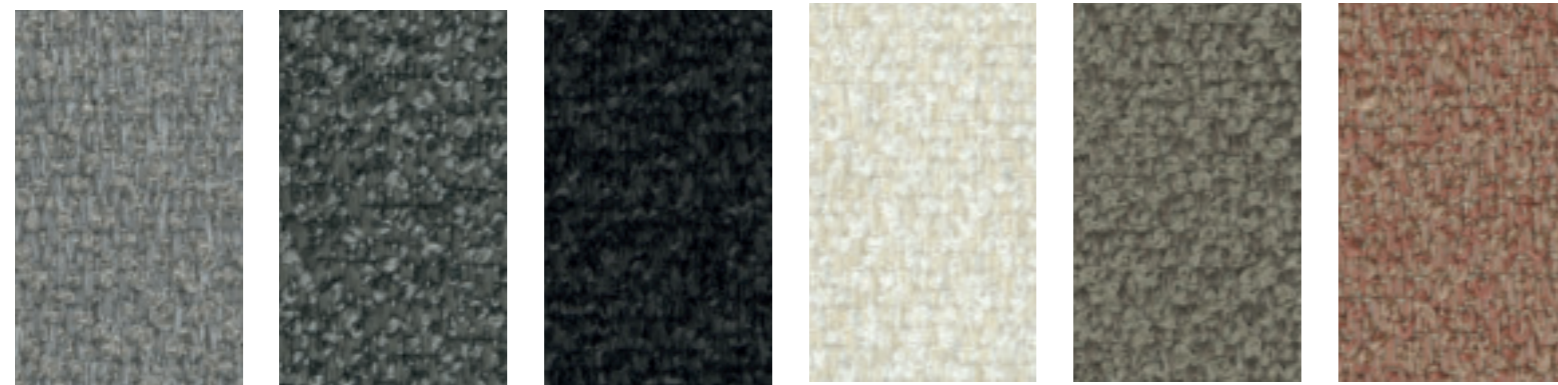

LK03 LK47 LK48 LK40 LK43 LK44

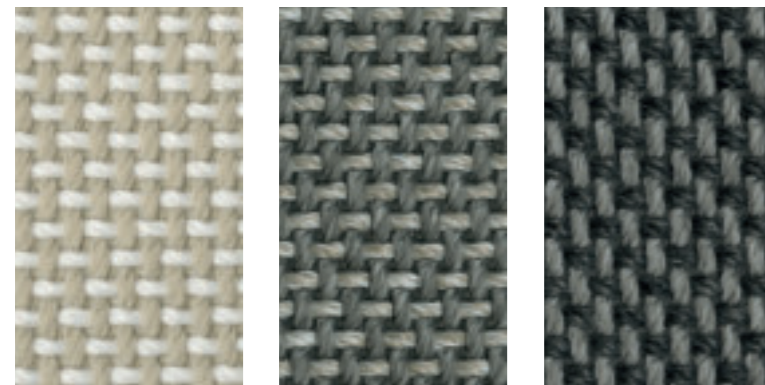

LH04 LH23 LH24

ECO-LEATHER Serge Ferrari® Stamskin Top (A)
 ECO PELLE / KUNSTLEDER / SIMILI CUIR

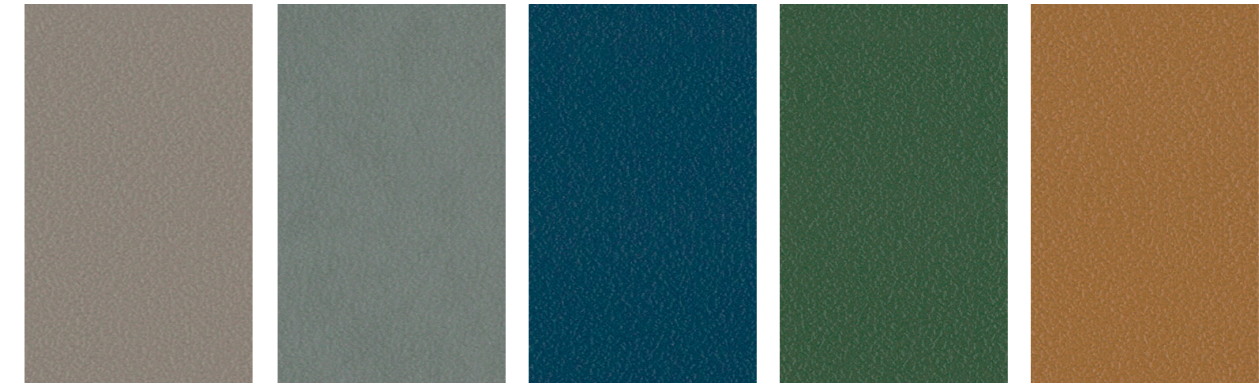

20237 07432 20284 20253 20286

Color example fabrics

OUTDOOR FABRIC Tempotest® (A)
 TESSUTO PER ESTERNI / STOFF FÜR OUTDOOR / TISSU POUR L'EXTÉRIEUR



PT01 PT02 PT03

The color samples are only indicative. Due to technical limits, samples in print cannot accurately reproduce the colour characteristics of the various materials.

I colori dei campioni sono da considerarsi puramente indicativi, non essendo tecnicamente possibile riprodurre fedelmente in stampa le caratteristiche cromatiche dei vari materiali.

Die Farbmuster sind nicht verbindlich. Es ist technisch nicht möglich, die Farbeigenschaften der verschiedenen Materialien im Druck originalgetreu zu reproduzieren.

Les couleurs des échantillons sont purement indicatives, car il n'est pas techniquement possible de reproduire fidèlement en impression les caractéristiques chromatiques des différents matériaux.

Design

Alias

Photography

Beppe Brancato

Still life

Studio Phototecnica

Digital Rendering

Archè Agency

Set and concept

Giulia Deitinge

Copywriting

Silvia Tiraboschi

Print in Italy

Grafiche Antiga

2022

Thanks to

Benedetto Fasciana

Galleria Altai

Maddalena Selvini

Ooniko manifattura vetro

Palermo Uno

Paola Paronetto

Produzione Privata

Riva 1920

Yali Glass

Alias

Alias S.r.l. a Socio Unico
via delle Marine 5
24064 Grumello del Monte, Italy
tel. +39 035 44 22 511
info@alias.design
alias.design

Each Alias product is made in Italy in accordance with a quality process meeting regulations 9001 ISO Policies have been put in place in order to minimize the environmental impact at every stage of production.

Ogni prodotto Alias viene realizzato in Italia all'interno di un processo di qualità rispondente alla norma 9001 ISO. Alias minimizza l'impatto ambientale attraverso politiche che coinvolgono ogni fase del suo operato.

Jedes Alias Produkt wird in Italien nach einem Qualitätsverfahren hergestellt, das der Norm 9001 ISO entspricht. Durch besondere Aufmerksamkeit auf jede Phase der Produktion minimiert Alias die Umweltbelastung.

Chaque produit Alias a été réalisé en Italie dans le cadre d'une procédure de qualité qui répond à la norme 9001 ISO. Alias minimise l'impact environnemental par une politique qui implique tous les stades de sa réalisation.

Certified Quality System ISO 9001



member of



follow us



Technological lightness, versatility and innovation are values of Alias since 1979. Alias has been able to establish prolific and prosper collaborations with some renowned designers throughout the years , revealing at the same time the peculiar talent of each designer. The story of the brand is an ongoing exchange of suggestions and ideas, and a constantly open-minded approach to the use of new materials and technological experimentation.