

Catalog

36

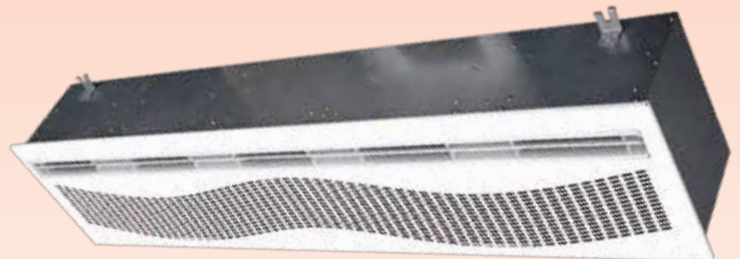

PRODUCTS INDEX

16

CENTRIFUGAL AIR CURTAIN WITH UPPER EXTRACTION WITH BUILT-IN LED BAR LIGHT "AIRJET"

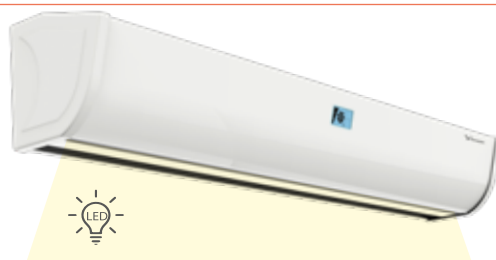

19

TANGENTIAL AIR CURTAIN WITH UPPER EXTRACTION "ARIA 3 SILENCE"



22

TANGENTIAL AIR CURTAIN WITH UPPER EXTRACTION WITH SINGLE OR DOUBLE ELECTRIC HEATING ELEMENTS "ARIA 3 SILENCE"



26

TANGENTIAL AIR CURTAIN WITH FRONT EXTRACTION "ARIA 3 SILENCE FRONT"



29

BUILT-IN TANGENTIAL AIR CURTAINS AT AMBIENT TEMPERATURE "ARIA 2 ELEGANCE T"

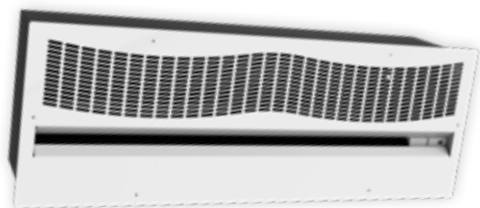

32

BUILT-IN TANGENTIAL AIR CURTAIN WITH ELECTRIC HEATING ELEMENT "ARIA 2 ELEGANCE TR"

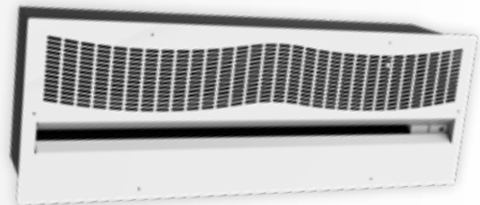

34

BUILT-IN CENTRIFUGAL AIR CURTAIN AT AMBIENT TEMPERATURE "ARIA 2 ELEGANCE"



36

BUILT-IN CENTRIFUGAL AIR CURTAIN WITH ELECTRIC HEATING ELEMENT "ARIA 2 ELEGANCE CR"



PRODUCTS INDEX

38

BUILT-IN CENTRIFUGAL AIR CURTAIN WITH HOT WATER COIL
"ARIA 2 ELEGANCE H2O"



HOT WATER COIL



40

CENTRIFUGAL AIR CURTAIN WITH UPPER EXTRACTION
"AIR FOR 3 UP"



AT AMBIENT TEMPERATURE



42

AIR CURTAIN WITH BODY IN CENTRIFUGAL "ABS" WITH UPPER EXTRACTION
"AIR FOR 3 STYLE"



AT AMBIENT TEMPERATURE



44

CENTRIFUGAL AIR CURTAIN WITH FRONT EXTRACTION
"AIR FOR 3 FRONT"



AT AMBIENT TEMPERATURE



46

CENTRIFUGAL AIR CURTAIN WITH UPPER EXTRACTION
"AIR FOR 3 WALL"



AT AMBIENT TEMPERATURE



48

CENTRIFUGAL AIR CURTAIN WITH FRONT EXTRACTION
HOT WATER COIL
"AIR FOR 3 H2O"



HOT WATER COIL



50

BUILT-IN CENTRIFUGAL AIR CURTAIN WITH ELECTRIC HEATING ELEMENT WITH FRONT AIR INTAKE
"AIR FOR 3 CR"



ELECTRIC HEATING ELEMENT

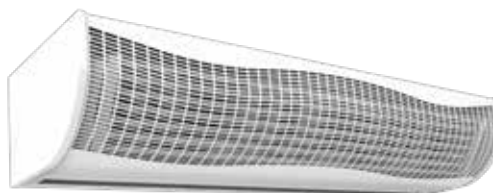

52

LARGE FLOW INDUSTRIAL CENTRIFUGAL AIR CURTAINS WITH FRONT AIR INTAKE
"ARIA 1 POTENZA"



AT AMBIENT TEMPERATURE

SPARE PARTS FOR AIR CURTAINS



CONFIGURE YOUR AIR BARRIER

CONFIGURE YOUR SYSTEM

ON THE WEBSITE WWW.TECNOSYSTEMI.COM

Generate automatically
QUOTE and **TECHNICAL DATA SHEETS**
of the chosen products

TRY IT

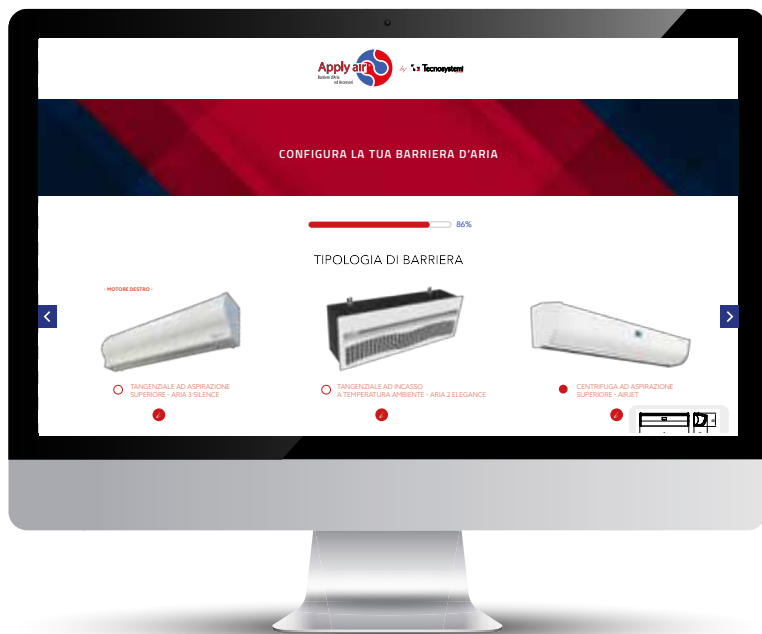

Also from Smartphone

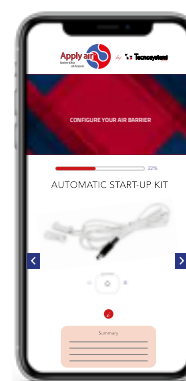
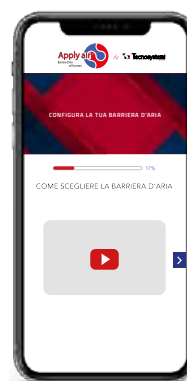

BIM TECHNOLOGY



Tecnosystemi provides professionals in the mechanical, architectural and structural design sector with all models of air barriers in 3D models to be used in BIM (Building Information Modeling).

Our air barriers can be downloaded for free on the BIMOBJECT platform

bimobject



WHY TO INSTALL AN AIR CURTAIN?

Air curtains allow to keep the doors opened, encouraging people to enter your sales outlet and enable customers to move around with ease, offering maximum freedom of movement and visibility by maintaining an ideal degree of comfort inside the premises.

Moreover, we guarantee an immediate reduction in heat loss of up to 80%. Your air-conditioning system will work better and consume less energy!

IT'S THE IDEAL CHOICE FOR:

All commercial undertakings where free access is an invitation to customers to enter

- Hospitals and laboratories
- Catering and reception facilities, offices
- Warehouses and manufacturing units
- Bars, restaurants, ice-cream parlours
- Shops in general
- Cold storage facilities (external installation)
- The food industry, where a separation between different areas is called for in terms of temperature and hygiene, and at the same time the quick, easy transit of goods and people is necessary



THE AIR CURTAINS GUARANTEE:

Simple rapid installation, extremely low energy consumption	its compact size and modular nature means that it fits perfectly into any kind of room
a factory-calibrated air flow	heating function heats the air flow in order to optimize energy saving in cold weather *
once installed maintains a perfectly balanced flow thanks to its patented aerodynamic shape	the system switches on/off automatically when the door opens/closes
3 speeds to regulate air flow according to your needs, by means of an easy to use remote control device	energy saving for heating, maintenance-free

**ONLY FOR MODELS WITH ELECTRIC RESISTANCE AND HOT WATER COIL*



The air curtains guarantee
a reduction in energetic consumption

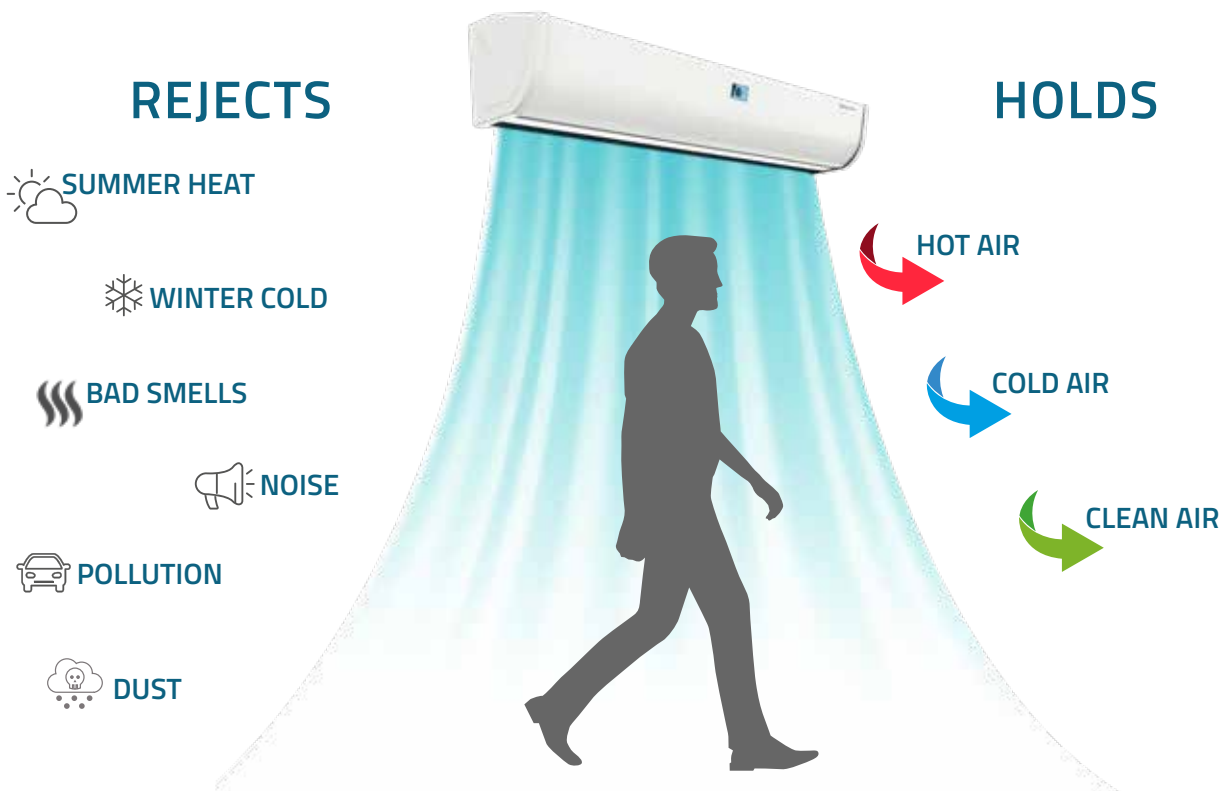



COMPARISON OF TEMPERATURE DISTRIBUTION

— SUMMER —



WITHOUT AIR CURTAIN



WITH AIR CURTAIN

— WINTER —

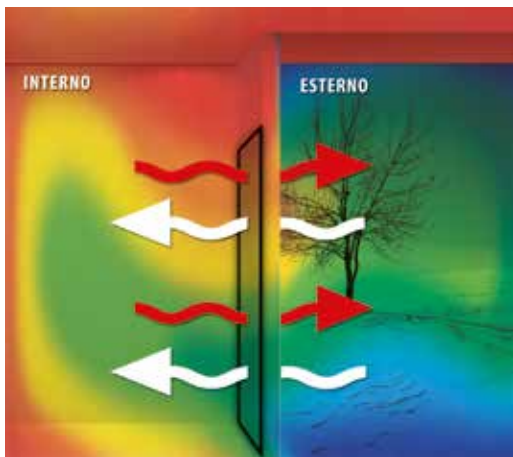

WITHOUT AIR CURTAIN



WITH AIR CURTAIN

TEMPERATURE CHART





GUIDE TO CHOOSE THE RIGHT AIR CURTAIN MODELS

QUESTIONS TO ASK BEFORE BUYING

- Where will the air curtain be mounted? (shop, bar, restaurant, office, shopping center, etc.)
- Do you need the air curtain to be in-built or wall mounted?
- Do you want it with tangential or centrifugal motors?
- Have you considered whether you want it with front or top air intake?
- Do you prefer the air to be at room temperature, heated with electrical resistance, or heated with battery?
- Do you need an automatic start on door opening? (not with electrical resistance)

Note: the “automatic start” kit block the functioning of all the air curtains with heating elements.

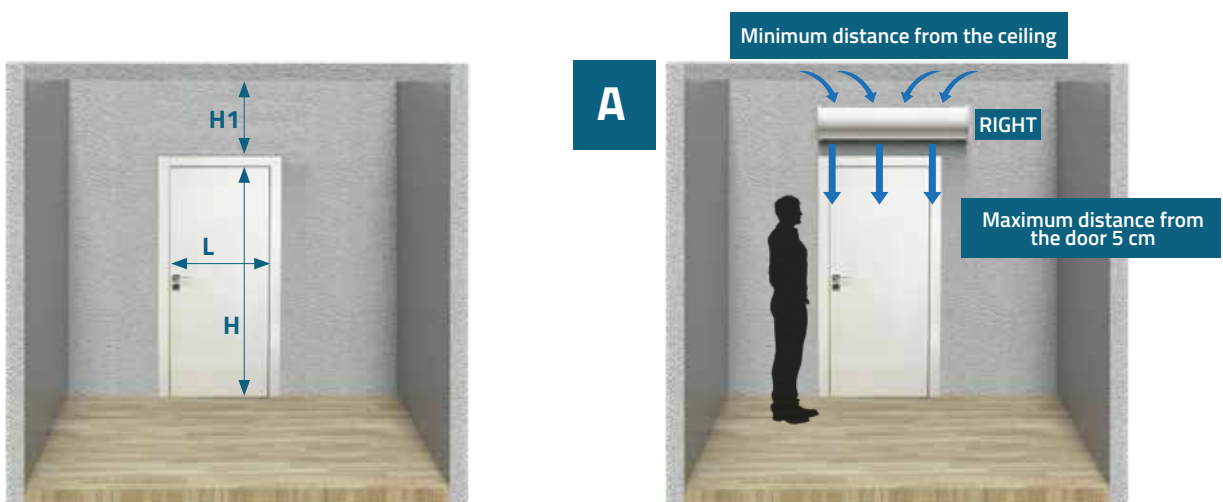

INFORMATION GATHERING: CHOICE OF THE AIR CURTAIN WITH LEFT, CENTRAL OR RIGHT WALL MOTOR.

The choice of the air curtain with left, right or cen (central) motor, refers to the motor position in the air curtain (which must correspond to the door opening).

The reference is considered in frontal position with respect to the air curtain (opposite).



CORRECT INSTALLATION OF AIR CURTAINS WITH FRONT AIR INTAKE RESPECTING THE DESCRIBED MEASUREMENTS.



VERY IMPORTANT:

A) To assemble the air curtains with top air intake, the distance between the curtains and ceiling must be minimum 15 cm, to allow the air suction through the upper grid.

the distance between the air curtain and the door must be of maximum 5 cm except aria3 silence front air curtain (see at pag. 18).

B) To assemble the air curtains with front air intake, the space above the unit and the ceiling is not considered, because the air suction comes from the front grid of the curtain.

the distance between the air curtain and the door must be maximum 25 cm

C) Air curtains with a central motor of 2 m - 1.5 m, and those with centrifugal motors, must always follow the instructions of (a) and (b) however they can be always be installed in the centre of the door.

FOR BOTH CASES, WE ALWAYS RECOMMEND CONSULTING THE TECHNICAL SPECIFICATIONS OF THE CATALOGUE AND THE INSTRUCTIONS SUPPLIED OR DOWNLOADABLE FROM THE SITE WWW.TECNOSYSTEMI.COM

AIR CURTAINS WITH ASSEMBLY OF TYPE A	AIR CURTAINS WITH ASSEMBLY OF TYPE B
AIR CURTAINS WITH TOP AIR INTAKE	AIR CURTAINS WITH FRONT AIR INTAKE
ARIA 3 SILENCE at room temperature	ARIA 3 SILENCE-FRONT at room temperature
ARIA 3 SILENCE at room temperature	AIRFOR 3 FRONT at room temperature
AIRFOR 3 UP at room temperature	AIRFOR3 H2O with hot water coil
AIRFOR 3 STYLE at room temperature	AIRFOR 3 CR with electrical resistance
AIRFOR 3 WALL at room temperature	ARIA 1 POTENZA at room temperature

VERY IMPORTANT:

BY ROOM-TEMPERATURE AIR CURTAINS, WE MEAN THAT **THE AIR IN THE INTERIOR IS TAKEN IN THROUGH THE UPPER GRID OR THE FRONT GRID** AND BLOWN DOWNWARDS TO THE GROUND SO **THE BLOWN AIR KEEPS THE INTERNAL ENVIRONMENT TEMPERATURE CONSTANT.**

VERY IMPORTANT:

FOR AIR CURTAINS WITH ELECTRICAL RESISTANCE OR WITH HOT WATER COIL WITH INTAKE FROM THE UPPER OR FRONT GRID, THE AIR IS HEATED AND BLOWN DOWNWARDS TO THE GROUND. THEREFORE THE BLOWN-AIR TEMPERATURE IS HIGHER THAN THAT OF THE INTERNAL ENVIRONMENT.

FOR NO REASON THIS CAN WARM UP THE ENVIRONMENT OR CAN BE CONFUSED WITH A HEATING APPLIANCE. ITS MAIN PURPOSE IS TO SUITABLY HEAT THE AIR FROM THE CURTAIN, MAKING THE ENTRANCE OF THE CUSTOMERS INTO THE ENVIRONMENT PLEASANT AND COMFORTABLE DURING WINTER.

WARNING: THE INSTALLATION OF THE AUTOMATIC START KIT PROVIDES THE START UP OF THE CURTAINS AT THE MAXIMUM SPEED, IGNORING OTHER SETTINGS. IN MODELS WITH ELECTRICAL RESISTANCE, THE RESISTANCE IS NOT ENABLED.



INFORMATION GATHERING:

CHOICE OF THE BUILT-IN AIR CURTAIN

This type of air curtain is ideal for all contexts with a false ceiling because it is installed into the false ceiling to fit flush, giving a very attractive aesthetic result. The built-in air curtain can have centrifugal or tangential motor, which operate either at room temperature or with electrical resistance. It must be always mounted at the centre of the doors.

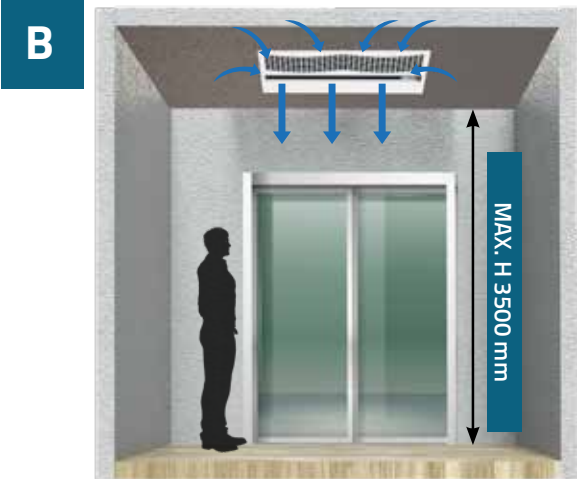
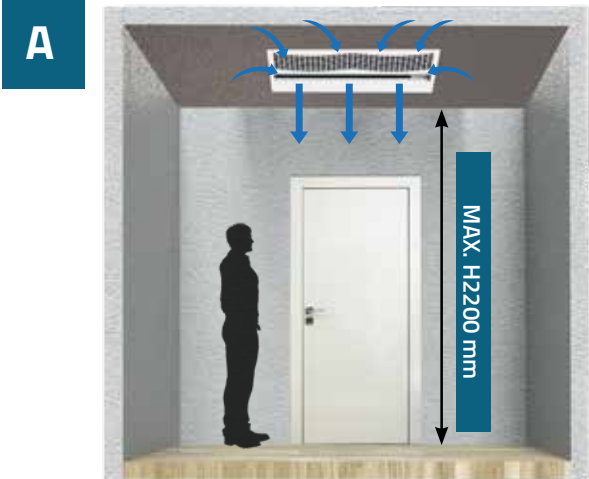

BUILT-IN TANGENTIAL AIR CURTAINS TYPE A	BUILT-IN TANGENTIAL AIR CURTAINS TYPE B
ARIA 2 ELEGANCE T at room temperature	ARIA 2 ELEGANCE at room temperature
ARIA 2 ELEGANCE TR with electrical resistance	ARIA 2 ELEGANCE CR with electrical resistance

VERY IMPORTANT: By built-in, room-temperature air curtains, we mean that the air in **the interior is taken in through the grid and blown downward to the ground**. So the blown air **keeps the internal environment temperature constant**.

VERY IMPORTANT: By built-in air curtains with electrical resistance we mean that **the air in the interior is taken in through the grid, heated by the resistance and blown downward to the ground**. So the blown-air temperature is higher than that of the internal environment.

For no reason can this warm up the environment or confused with a heating appliance. Its main purpose is to suitably **heat the air from the curtain**, making the entrance of the customers into the **environment pleasant and comfortable during winter**.

VERY IMPORTANT / ATTENTION: THE INSTALLATION OF THE AUTOMATIC START KIT PROVIDES THE STARTUP OF THE CURTAINS AT THE MAXIMUM SPEED, IGNORING OTHER SETTINGS. IN MODELS WITH ELECTRICAL RESISTANCE, THE RESISTANCE IS NOT TURNED ON.

FOR ALL THE BUILT-IN AIR CURTAIN MODELS, WE ALWAYS RECOMMEND CONSULTING THE TECHNICAL SPECIFICATIONS OF THE CATALOGUE AND THE INSTRUCTIONS SUPPLIED OR DOWNLOADABLE FROM THE SITE WWW.TECNOSYSTEMI.COM

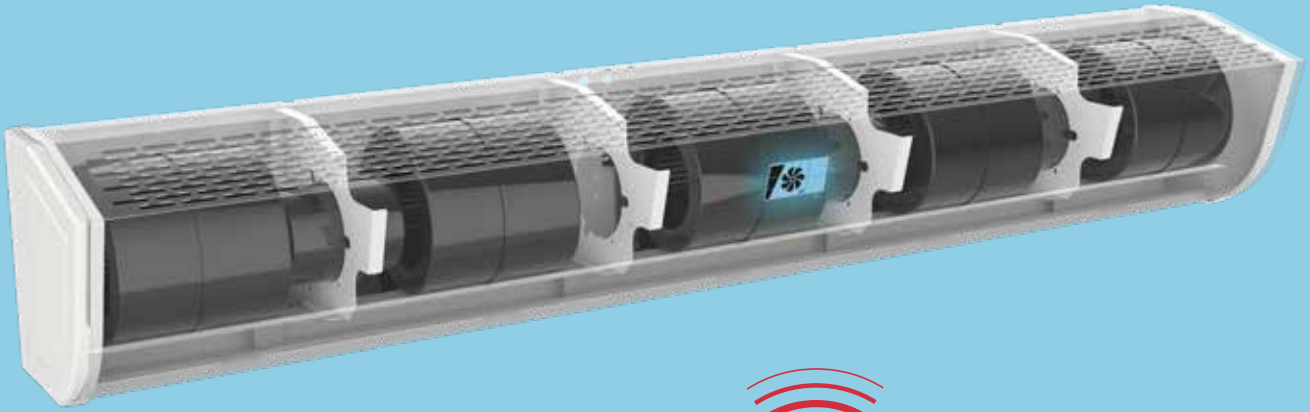

REMOTE CONTROL FUNCTIONS



Air curtain ON

Air curtain OFF

VENTILATION

Symbol of selected fan speed (green LED)

1/2 LOAD RESISTANCE

The electric resistances installed operate at half load. This function is available only on air curtains with electric resistances. (Yellow LED)

Cambio Velocità

Maximum speed

Medium speed

Low speed

Change mode

FULL LOAD RESISTANCE

The electric resistances installed operate at full load. This function is available only on air curtains with electric resistances. (Orange LED)

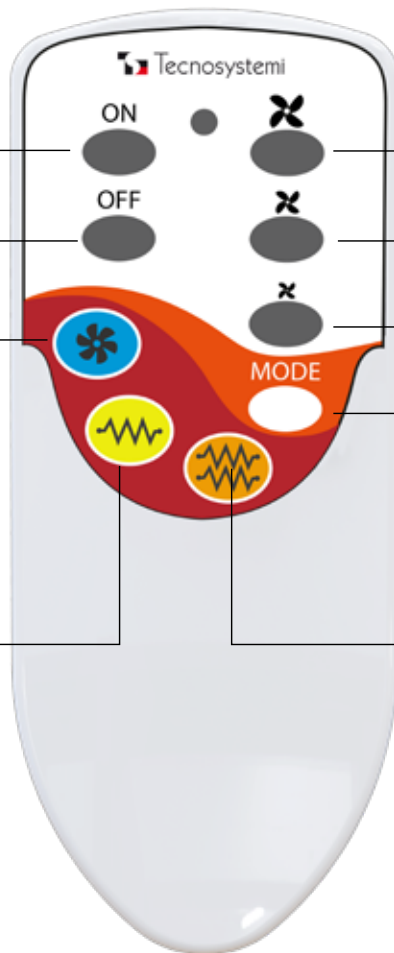

LOWER ENERGY COSTS

AirJET

THE ONLY ONE
WITH DISPLAY AND BUILT-IN
COURTESY LIGHT



LIGHT ON/OFF

Turns the LED bar on the Airjet air curtain on/off.



LUCE ON / OFF



AUTOMATICO

AUTOMATIC START.

Turns the "automatic starter kit" on or off. This function is used to automatically turn the air curtain on/off when the door is opened or closed.

ON/OFF SWITCH

Turns the air curtain on/off.



Low speed

Medium speed

Maximum speed



by Tecnosystemi



WATCH THE VIDEO



✓ SIMPLE

✓ QUICK

✓ INTUITIVE



AirJET

AIRJET



CENTRIFUGAL AIR CURTAIN WITH UPPER EXTRACTION WITH BUILT-IN LED BAR LIGHT



RIDEAU D'AIR CENTRIFUGE À ASPIRATION SUPÉRIEURE AVEC LUMIÈRE À BARRE LED INTÉGRÉE



LUFTSCHLEIER MIT ANSAUGUNG AN DER OBERSEITE MIT EIN-GEBAUTER LED-LEISTE

TECHNICAL FEATURES
<ul style="list-style-type: none"> • 4 MODELS IN WHITE • 3 SPEEDS SELECTABLE BY REMOTE CONTROL OR INTERFACE • AIR CURTAINS ARE DESIGNED FOR INDOOR USE • AUTOMATIC STARTER KIT ON REQUEST • LOWER BAR WITH LED LIGHT STRIP • BACKLIT LCD DISPLAY • UPPER AIR INTAKE • THE UNIT MUST BE INSTALLED HORIZONTALLY

CARACTÉRISTIQUES TECHNIQUES
<ul style="list-style-type: none"> • 4 MODÈLES BLANCS • 3 VITESSES SÉLECTIONNABLES PAR TÉLÉCOMMANDE OU INTERFACE • LES RIDEAU D'AIR SONT CONÇUES POUR UNE UTILISATION À L'INTÉRIEUR • KIT DE DÉMARRAGE AUTOMATIQUE SUR DEMANDE • BARRE INFÉRIEURE AVEC BANDE LUMINEUSE LED • ÉCRAN LCD RÉTROÉCLAIRÉ • ASPIRATION D'AIR SUPÉRIEURE • L'UNITÉ DOIT ÊTRE INSTALLÉE HORIZONTALEMENT

TECHNISCHE EIGENSCHAFTEN
<ul style="list-style-type: none"> • 4 MODELLE IN FARBE WEIßE • 3 GESCHWINDIGKEITEN MIT FERNBEDIENUNG ODER SCHNITTSTELLE WÄHLBAR • LUFTSCHLEIER SIND FÜR DIE VERWENDUNG IN INNENRÄUMEN BESTIMMT • AUTOMATISCHES STARTER-KIT AUF ANFRAGE • UNTERE STANGE MIT LED-STREIFEN • LCD-DISPLAY HINTERLEUCHTET • OBERE LUFTANSAUGUNG • DAS GERÄT MUSS HORIZONTAL MONTIERT WERDEN



ON ROOM TEMPERATURE



AirJET

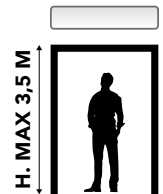

MADE IN ITALY

LCD DISPLAY

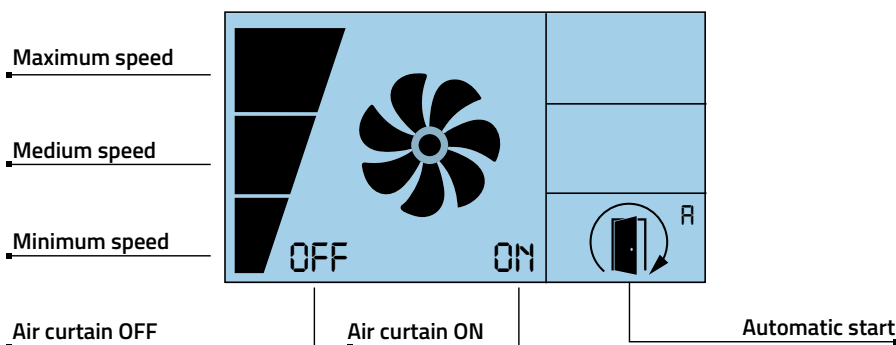

LED LIGHT BAR

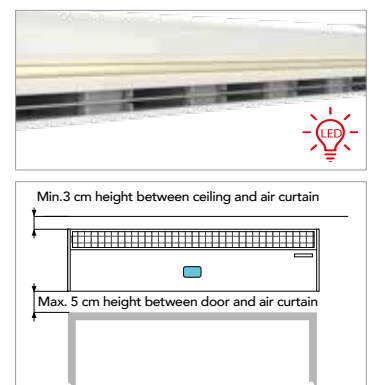

ACCESSORIES



REMOTE CONTROL INCLUDED

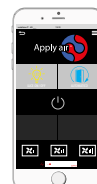

EASILY CONTROLLED CENTRIFUGAL MOTOR FROM SMARTPHONE OR TABLET



CENTRIFUGAL MOTOR

AIRJET



CODE	SUPPLY VOLTAGE [V]	FREQUENCY [Hz]	POWER CONSUMPTION [W]	AIR SPEED AT INLET [m/s]	AIR FLOW RATE [m³/h]	SOUND POWER LEVEL [dB(A)]	WEIGHT [kg]	SUITABLE FOR DOORS [mm]
CODE	TENSION [V] D'ALIMENTATION [V]	FRÉQUENCE [Hz]	PUISSANCE ABSORBÉE [W]	VITESSE DE L'AIR À LA GRILLE [m/s]	DÉBIT D'AIR [m³/h]	NIVEAU DE PUISSANCE ACOUSTIQUE [dB(A)]	POIDS [kg]	CONVIENT POUR PORTES [mm]
CODE	VERSOR- GUNGSSPAN- NUNG [V]	FREQUENZ [Hz]	LEISTUNGS- UFNAHME [W]	LUFTGE- SCHWIN- DIGKEIT AN DER ÖFFNUNG [m/s]	LUFTDUR- CHFLUSSRATE [m³/h]	SCHALLEI- STUNGSPEGEL [dB(A)]	GEWICHT [kg]	GEEIGNET FÜR TÜREN [mm] PER PORTE [mm]
AAD400001	230 ac	50	I:175 II:217 III:296	I:10 II:12,5 III:15	I:737 II:867 III:1020	I:50 II:52 III:53	12	L. 900 H. 3500
AAD400002	230 ac	50	I:235 II: 272 III:390	I:10 II:12,5 III:15	I:983 II:1156 III:1360	I:51 II:53 III:54	16	L. 1200 H. 3500
AAD400003	230 ac	50	I:272 II: 333 III:490	I:10 II:12,5 III:15	I:1225 II:1445 III:1700	I:53 II:54 III:56	20,6	L. 1500 H. 3500
AAD400004	230 ac	50	I:330 II: 393 III:590	I:10 II:12,5 III:15	I:1467 II:1734 III:2040	I:54 II:55 III:57	24,5	L. 2000 H. 3500

DIMENSIONS

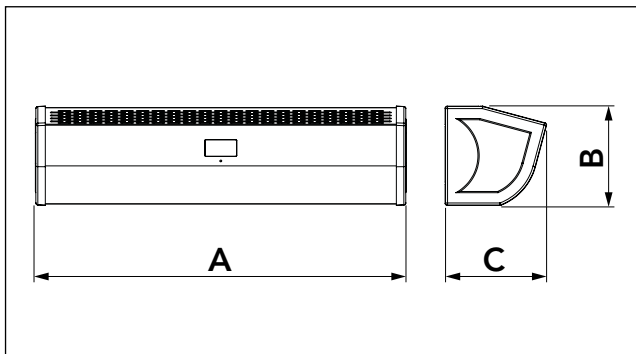

DIMENSIONS [mm]			
MODEL	A	B	C
900	900	240	250
1200	1200	240	250
1500	1500	240	250
2000	2000	240	250



DOWNLOAD DATASHEET

INSTALLATION EXAMPLE

EXAMPLE OF DAY



EXAMPLE AT NIGHT WITH LED AIR CURTAIN ON



CODE	DESCRIPTION
AAD400001	CENTRIFUGAL AIR CURTAIN WITH UPPER EXTRACTION WITH BUILT-IN LED BAR LIGHT "AIRJET 900"
AAD400002	CENTRIFUGAL AIR CURTAIN WITH UPPER EXTRACTION WITH BUILT-IN LED BAR LIGHT "AIRJET 1200"
AAD400003	CENTRIFUGAL AIR CURTAIN WITH UPPER EXTRACTION WITH BUILT-IN LED BAR LIGHT "AIRJET 1500"
AAD400004	CENTRIFUGAL AIR CURTAIN WITH UPPER EXTRACTION WITH BUILT-IN LED BAR LIGHT "AIRJET 2000"



Aria3 SILENCE

ARIA 3 SILENCE

 **TANGENTIAL AIR CURTAIN WITH UPPER EXTRACTION**

 **RIDEAU D'AIR TANGENTIELLE À ASPIRATION SUPÉRIEURE**

 **LUFTSCHLEIER MIT ANSAUGUNG AN DER OBERSEITE**

TECHNICAL FEATURES	CARACTÉRISTIQUES TECHNIQUES	TECHNISCHE EIGENSCHAFTEN
<ul style="list-style-type: none"> • 4 MODELS IN WHITE • 3 SPEEDS OPERATED BY REMOTE CONTROL • AIR CURTAINS ARE DESIGNED FOR INDOOR USE • PANEL WITH 3 LEDS • AUTOMATIC STARTER KIT ON REQUEST • UPPER AIR INTAKE • THE UNIT MUST BE INSTALLED HORIZONTALLY 	<ul style="list-style-type: none"> • 4 MODÈLES BLANCS • 3 VITESSES COMMANDÉES PAR TÉLÉCOMMANDE • LES RIDEAU D'AIR SONT CONÇUES POUR UNE UTILISATION À L'INTÉRIEUR • TABLEAU DE BORD AVEC 3 LED • KIT DE DÉMARRAGE AUTOMATIQUE SUR DEMANDE • ASPIRATION D'AIR SUPÉRIEURE • L'UNITÉ DOIT ÊTRE INSTALLÉE HORIZONTALEMENT 	<ul style="list-style-type: none"> • 4 MODELLE IN FARBE WEIßE • 3 GESCHWINDIGKEITEN, MIT FERNBEDIENUNG BETRIEBEN • LUFTSCHLEIER SIND FÜR DIE VERWENDUNG IN INNENRÄUMEN BESTIMMT • ARMATURENBRETT MIT 3 LEDS • AUTOMATISCHES STARTER-KIT AUF ANFRAGE • OBERE LUFTANSAUGUNG • DAS GERÄT MUSS HORIZONTAL MONTIERT WERDEN

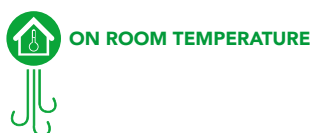

Aria3 SILENCE



 **MADE IN ITALY** 

ACCESSORIES



REMOTE CONTROL INCLUDED



TANGENTIAL MOTOR



PANEL WITH 3 COLOURED LEDS

APPLY AIR

ARIA 3 SILENCE



CODE	SUPPLY VOLTAGE [V]	FREQUENCY [Hz]	POWER CONSUMPTION [W]	AIR SPEED AT INLET [m/s]	AIR FLOW RATE [m³/h]	SOUND LEVEL [dB(A)]	WEIGHT [kg]	REMOTE CONTROL	SUITABLE FOR DOORS [mm]
CODE	TENSION D'ALIMENTATION [V]	FRÉQUENCE [Hz]	PUISSANCE ABSORBÉE [W]	VITESSE DE L'AIR À LA GRILLE [m/s]	DÉBIT D'AIR [m³/h]	NIVEAU SONORE [dB(A)]	POIDS [kg]	TÉLÉCOMMANDE	CONVIENT POUR PORTES [mm]
CODE	VERSORUNGSSPANNUNG [V]	FREQUENZ [Hz]	LEISTUNGS-AUFNAHME [W]	LUFTGESCHWINDIGKEIT AN DER ÖFFNUNG [m/s]	LUFTDURCHFLUSSRA-TE [m³/h]	SCHALL-PEGEL [dB(A)]	GEWICHT [kg]	FERNBEDIENUNGEN	GEEIGNET FÜR TÜREN [mm]
SINGLE-FAN TANGENTIAL AIR CURTAINS L: 1100 RIGHT - LEFT									
123000501	230 ac	50	75	I:8 II:9 III:10	765 846 918	61 64 66	13,3	ADJUSTMENT SPEED	L.1000 H.3000
12300051									
DUAL-FAN TANGENTIAL AIR CURTAINS L: 1500 - 2000 CENTRAL									
123000551	230 ac	50	190	I:8 II:9 III:10	1350 1458 1512	66 68 69	19,2	ADJUSTMENT SPEED	L.1500 H.3000
123000561					1494 1692 1818	64 66 68			27,5

DIMENSIONS

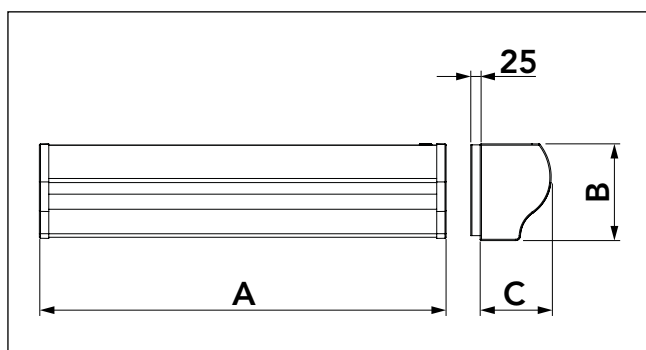

DIMENSIONS [mm]			
MODEL	A	B	C
1100 Right	1085	250	185
1100 Left	1085	250	185
1500 Central	1440	250	185
2000 Central	2040	250	185



DOWNLOAD DATASHEET

CODE	DESCRIPTION
123000501	SINGLE-FAN TANGENTIAL AIR CURTAIN "ARIA3 SILENCE" 1100 RIGHT WITH UPPER AIR INTAKE
123000511	SINGLE-FAN TANGENTIAL AIR CURTAIN "ARIA3 SILENCE" 1100 LEFT WITH UPPER AIR INTAKE
123000551	DUAL-FAN TANGENTIAL AIR CURTAIN "ARIA3 SILENCE" 1500 CENTRAL WITH UPPER AIR INTAKE
123000561	DUAL-FAN TANGENTIAL AIR CURTAIN "ARIA3 SILENCE" 2000 CENTRAL WITH UPPER AIR INTAKE



APPLY AIR

Aria³ SILENCE

ARIA 3 SILENCE

 **TANGENTIAL AIR CURTAIN WITH UPPER EXTRACTION WITH SINGLE OR DOUBLE ELECTRICAL HEATING ELEMENT**

 **RIDEAU D'AIR TANGENTIELLE À ASPIRATION SUPÉRIEURE AVEC 1 OU 2 RÉSISTANCE ÉLECTRIQUES**

 **EINGEBAUTE TANGENTIALLUFT MIT ANSAUGUNG AN DER OBERSEITE MIT 1 ODER 2 ELEKTRISCHEN HEIZKÖRPER**

TECHNICAL FEATURES	CARACTÉRISTIQUES TECHNIQUES	TECHNISCHE EIGENSCHAFTEN
<ul style="list-style-type: none"> • 8 MODELS IN WHITE • 3 SPEEDS OPERATED BY REMOTE CONTROL • AIR CURTAINS ARE DESIGNED FOR INDOOR USE • PANEL WITH COLOURED LEDS TO INDICATE OPERATING MODE • AUTOMATIC STARTER KIT ON REQUEST • UPPER AIR INTAKE • ELECTRIC HEATER OPERATED BY REMOTE CONTROL • OPERATION OF ELECTRIC HEATERS CAN BE PARTIALISED ON AIR CURTAINS WITH DOUBLE HEATING ELEMENTS • THE UNIT MUST BE INSTALLED HORIZONTALLY 	<ul style="list-style-type: none"> • 8 MODÈLES BLANCS • 3 VITESSES COMMANDÉES PAR TÉLÉCOMMANDE • LES RIDEAU D'AIR SONT CONÇUES POUR UNE UTILISATION À L'INTÉRIEUR • TABLEAU DE BORD AVEC LED COLORÉES POUR LE MODE DE FONCTIONNEMENT DE LA SIGNALISATION • KIT DE DÉMARRAGE AUTOMATIQUE SUR DEMANDE • ASPIRATION D'AIR SUPÉRIEURE • RÉSISTANCE ÉLECTRIQUE COMMANDÉE PAR TÉLÉCOMMANDE • DANS LES RIDEAU D'AIR À DOUBLE RÉSISTANCE, IL EST POSSIBLE DE PARTIALISER LE FONCTIONNEMENT DES RÉSISTANCES ÉLECTRIQUES • L'UNITÉ DOIT ÊTRE INSTALLÉE HORIZONTALEMENT 	<ul style="list-style-type: none"> • 8 MODELLE IN FARBE WEIßE • 3 GESCHWINDIGKEITEN, MIT FERNBEDIENUNG BETRIEBEN • LUFTSCHLEIER SIND FÜR DIE VERWENDUNG IN INNENRÄUMEN BESTIMMT • ARMATURENBRETT MIT FARBIGEN LEDS FÜR DIE SIGNALISIERUNG DER BETRIEBSART • AUTOMATISCHES STARTER-KIT AUF ANFRAGE • OBERE LUFTANSAUGUNG • ELEKTRISCHER HEIZKÖRPER, DER ÜBER EINE FERNBEDIENUNG GESTEUERT WERDEN KANN • BEI LUFTSCHLEIERN MIT 2 HEIZELEMENTEN KANN DER BETRIEB DER ELEKTRISCHEN HEIZELEMENTE TEILWEISE EINGESTELLT WERDEN • DAS GERÄT MUSS HORIZONTAL MONTIERT WERDEN



Aria3 SILENCE



CE

MADE IN ITALY

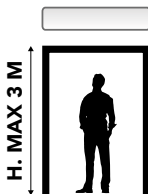

ACCESSORIES



REMOTE CONTROL INCLUDED



TANGENTIAL MOTOR

WITH 1 RESISTANCE



WITH 2 RESISTANCES

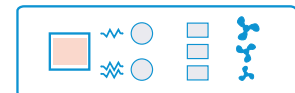

PANEL WITH 3 COLOURED LEDS

ARIA 3 SILENCE



CODE	SUPPLY VOLTAGE [V]	FREQUENCY [Hz]	POWER CONSUMPTION [W]	POWER ABSORBED WITH RESISTANCE [W]	AIR SPEED AT INLET [m/s]	AIR FLOW RATE [m³/h]	SOUND LEVEL [dB(A)]	ΔT AIR WITH HEATING ELEMENTS	WEIGHT [kg]	REMOTE CONTROL	SUITABLE FOR DOORS [mm]
CODE	TENSION D'ALIMENTATION [V]	FRÉQUENCE [Hz]	PUISSANCE ABSORBÉE [W]	PUISSANCE ABSORBÉE AVEC RÉSTANCE [W]	VITESSE DE L'AIR À LA GRILLE [m/s]	DÉBIT D'AIR [m³/h]	NIVEAU SONORE [dB(A)]	ΔT AIR AVEC RÉSTANCES	POIDS [kg]	TÉLÉCOMMANDE	CONVIENT POUR PORTES [mm]
CODE	VERSORUNGSSPANNUNG [V]	FREQUENZ [Hz]	LEISTUNGS-AUFNAHME [W]	MIT WIDERSTAND AUFGENOMMENE LEISTUNG [W]	LUFTGESCHWINDIGKEIT AN DER ÖFFNUNG [m/s]	LUFTDURCHFLUSSRATE [m³/h]	SCHALLPEGEL [dB(A)]	ΔT DER LUFT MIT WIDERSTÄNDEN	GEWICHT [kg]	FERNBEDIENUNGEN	FERNBEDIENUNGEN [mm]
SINGLE-FAN TANGENTIAL AIR CURTAINS WITH 1 RESISTANCE L: 1100 WITH UPPER AIR INTAKE											
12300050RI	230 ac	50	75	1900	I:7,5	693	65	12°	14.8	ADJUSTMENT SPEED ON/OFF resistant	L.1000 - H.3000
12300051RI					II:8						
12300051RI					III:9	783	68				
DUAL-FAN TANGENTIAL AIR CURTAINS WITH 2 RESISTANCES L: 1500 - 2000 WITH UPPER AIR INTAKE											
12300055RI	230 ac	50	190	3200	I:7,5	1161	68	12°	21.4	ADJUSTMENT SPEED ON/OFF resistant	L.1500 - H.3000
12300056RI					II:8						
12300056RI					III:9	1215	69				
12300056RI				3800	I:7,5	1332	67		28.6		L.2000 - H.3000
				II:8	1404						
					III:9	1458	70				

*THE INDICATED TEMPERATURE REFERS TO THE INCREASE IN TEMPERATURE BETWEEN THE ROOM AND THE AIR BEING DISCHARGED FROM THE AIR CURTAIN AT MINIMUM SPEED.

DIMENSIONS

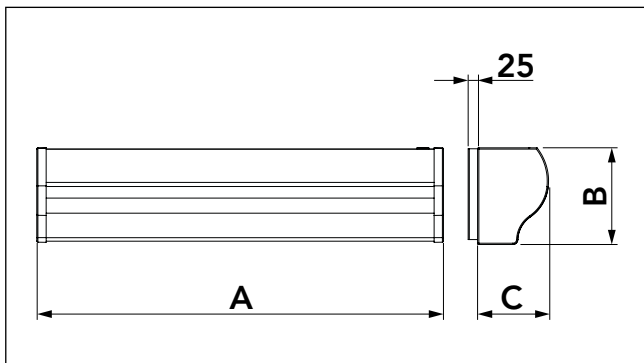

DIMENSIONS [mm]			
MODEL	A	B	C
1100 Right	1085	250	185
1100 Left	1085	250	185
1500 Central	1440	250	185
2000 Central	2040	250	185



DOWNLOAD DATASHEET

CODE	DESCRIPTION
12300050RI	SINGLE-FAN TANGENTIAL AIR CURTAIN "ARIA3 SILENCE" 1100 RIGHT WITH 1 RESISTANCE
12300051RI	SINGLE-FAN TANGENTIAL AIR CURTAIN "ARIA3 SILENCE" 1100 LEFT WITH 1 RESISTANCE
12300055RI	DUAL-FAN TANGENTIAL AIR CURTAIN "ARIA3 SILENCE" 1500 CENTRAL WITH 2 RESISTANCES
12300056RI	DUAL-FAN TANGENTIAL AIR CURTAIN "ARIA3 SILENCE" 2000 CENTRAL WITH 2 RESISTANCES

ARIA 3 SILENCE



CODE	SUPPLY VOLTAGE [V]	FREQUENCY [Hz]	POWER CONSUMPTION [W]	PARTIAL LOAD HEATING ELEMENT POWER [W]	TOTAL LOAD HEATING ELEMENT POWER [W]	AIR SPEED AT INLET [m/s]	AIR FLOW RATE [m³/s]	SOUND LEVEL [dB(A)]	ΔT AIR WITH HEATING ELEMENTS	WEIGHT [kg]	REMOTE CONTROL	SUITABLE FOR DOORS [mm]
CODE	TENSION D'ALIMENTATION [V]	FRÉQUENCE [Hz]	PUISSANCE ABSORBÉE [W]	PUISSANCE RÉSTANCES CHARGE PARTIELLE [W]	PUISSANCE RÉSTANCES CHARGE TOTALE [W]	VITESSE DE L'AIR À LA GRILLE [m/s]	DÉBIT D'AIR [m³/s]	NIVEAU SONORE [dB(A)]	ΔT AIR AVEC RÉSTANCES	POIDS [kg]	TÉLÉCOMMANDE	CONVIENT POUR PORTES [mm]
CODE	VERSORUNGSSPANNUNG [V]	FREQUENZ [Hz]	LEISTUNGS-AUFNAHME [W]	TEILLASTWIDERSTANDSLEISTUNG [W]	VOLLASTWIDERSTANDSLEISTUNG [W]	LUFTGESCHWINDIGKEIT AN DER ÖFFNUNG [m/s]	LUFTDURCHFLUSSRA-TE [m³/s]	SCHALL-PEGEL [dB(A)]	ΔT DER LUFT MIT WIDERSTÄNDEN	GEWICHT [kg]	FERNBEDIENUNGEN	GEEIGNET FÜR TÜREN [mm]
FAN TANGENTIAL AIR CURTAINS WITH 2 RESISTANCES L: 1100 WITH UPPER AIR INTAKE												
12300050RI2	230 ac	50	75	1900	3800	I:7,5	675	64	25°	15.7	Adjustment 3 Speed and On/off resistance	L.1000 - H.3000
12300051RI2						II:8		65				
12300051RI2						III:8,5	738	66				
DUAL-FAN TANGENTIAL AIR CURTAINS WITH 4 RESISTANCES L: 1500 - 2000 WITH UPPER AIR INTAKE												
12300055RI2	400 ac	50	190	3200	6400	I:7,5	1134	66	25°	22.3	3 Speed and On/off resistance	L.1500 - H.3000
12300056RI2				3800		7600		II:8				
12300056RI2						III:8,5	1188	67				
12300056RI2						I:7,5	1242	66,5		29.6		L.2000 - H.3000
12300056RI2						II:8	1278	67				
12300056RI2						III:8,5	1332	70				

* TEMPERATURE REFERS TO THE INCREASE IN TEMPERATURE BETWEEN THE ROOM AND THE AIR BEING DISCHARGED FROM THE AIR CURTAIN AT MINIMUM SPEED.

DIMENSIONS

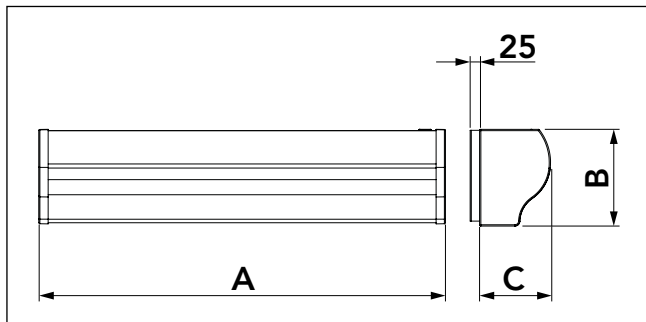

DIMENSIONS [mm]			
MODEL	A	B	C
1100 Right	1085	250	185
1100 Left	1085	250	185
1500 Central	1440	250	185
2000 Central	2040	250	185



DOWNLOAD DATASHEET

CODE	DESCRIPTION
12300050RI2	SINGLE-FAN TANGENTIAL AIR CURTAIN "ARIA3 SILENCE" 1100 RIGHT WITH 2 RESISTANCES
12300051RI2	SINGLE-FAN TANGENTIAL AIR CURTAIN "ARIA3 SILENCE" 1100 LEFT WITH 2 RESISTANCES
12300055RI2	DUAL-FAN TANGENTIAL AIR CURTAIN "ARIA3 SILENCE" 1500 CENTRAL WITH 4 RESISTANCES
12300056RI2	DUAL-FAN TANGENTIAL AIR CURTAIN "ARIA3 SILENCE" 2000 CENTRAL WITH 4 RESISTANCES



APPLY AIR

Aria3 SILENCE FRONT

ARIA 3 SILENCE FRONT



TANGENTIAL AIR CURTAIN WITH FRONT EXTRACTION



RIDEAU D'AIR TANGENTIELLE À ASPIRATION FRONTALE



TANGENTIALLUFT MIT FRONTANSAUGUNG

TECHNICAL FEATURES

- 4 MODELS IN WHITE
- 3 SPEEDS OPERATED BY REMOTE CONTROL
- AIR CURTAINS ARE DESIGNED FOR INDOOR USE
- PANEL WITH 3 LEDS
- AUTOMATIC START-UP KIT ON REQUEST
- THE UNIT MUST BE INSTALLED HORIZONTALLY

CARACTÉRISTIQUES TECHNIQUES

- 4 MODÈLES BLANCS
- 3 VITESSES COMMANDÉES PAR TÉLÉCOMMANDE
- LES RIDEAU D'AIR SONT CONÇUES POUR UNE UTILISATION À L'INTÉRIEUR
- TABLEAU DE BORD AVEC 3 LED
- KIT DE DÉMARRAGE AUTOMATIQUE SUR DEMANDE
- L'UNITÉ DOIT ÊTRE INSTALLÉE HORIZONTALEMENT

TECHNISCHE EIGENSCHAFTEN

- 4 MODELLE IN FARBE WEIßE
- 3 GESCHWINDIGKEITEN, MIT FERNBEDIENUNG BETRIEBEN
- LUFTSCHLEIER SIND FÜR DIE VERWENDUNG IN INNENRÄUMEN BESTIMMT
- ARMATURENBRETT MIT 3 LEDS
- AUTOMATISCHES STARTER-KIT AUF ANFRAGE
- DAS GERÄT MUSS HORIZONTAL MONTIERT WERDEN



ON ROOM TEMPERATURE

Aria3 SILENCE FRONT



CE

MADE IN ITALY

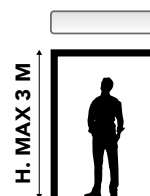

ACCESSORIES



REMOTE CONTROL INCLUDED DOTAZIONE



TANGENTIAL MOTOR

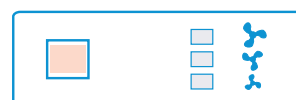

PANEL WITH 3 COLOURED LEDS

ARIA 3 SILENCE FRONT



CODE	SUPPLY VOLTAGE [V]	FREQUENCY [Hz]	POWER CONSUMPTION [W]	AIR SPEED AT INLET [m/s]	AIR FLOW RATE [m³/h]	SOUND POWER LEVEL [dB(A)]	WEIGHT [kg]	REMOTE CONTROL	SUITABLE FOR LARGE DOORS [mm]
CODE	TENSION D'ALIMENTATION [V]	FRÉQUENCE [Hz]	PUISSANCE ABSORBÉE [W]	VITESSE DE L'AIR À LA GRILLE [m/s]	DÉBIT D'AIR [m³/h]	NIVEAU DE PUISSANCE ACOUSTIQUE [dB(A)]	POIDS [kg]	TÉLÉCOMMANDE	CONVIENT POUR PORTAILS [mm]
CODE	VERSORUNGSSPANNUNG [V]	FREQUENZ [Hz]	LEISTUNGSABNAHME [W]	LUFTGESCHWINDIGKEIT AN DER ÖFFNUNG [m/s]	LUFTDURCHFLUSSRADE [m³/h]	SCHALLLEISTUNGSPEGEL [dB(A)]	GEWICHT [kg]	FERNBEDIENUNGEN	GEEIGNET FÜR TÜREN [mm]
SINGLE-FAN TANGENTIAL AIR CURTAINS: 1100 RIGHT - LEFT									
12400011	230 ac	50	75	I:9 II:10 III:11	963 1080 1152	50 53 55	11,2	ADJUSTMENT SPEED	L.1000 H.3000
12400013									
DUAL-FAN TANGENTIAL AIR CURTAINS L: 1500 - 2000									
12400021	230 ac	50	190	I:9 II:10 III:11	1416 1520 1550	54 55 56	14.7	ADJUSTMENT SPEED	L.1500 H.3000
12400031									

APPLY AIR

DIMENSIONS

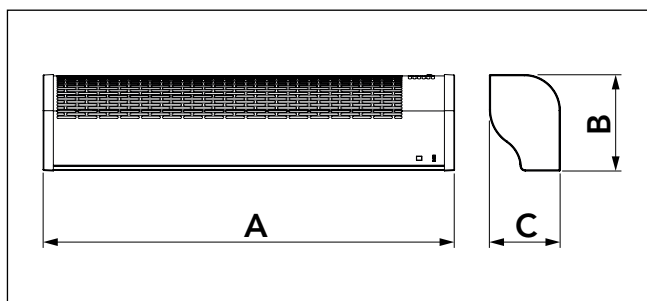

DIMENSIONS [mm]			
MODEL	A	B	C
1100 Right	1070	245	180
1100 Left	1070	245	180
1500 Central	1422	245	180
2000 Central	2032	245	180

BASIC PRINCIPLES OF THE INSTALLATION OF THE AIR CURTAINS WITH FRONTAL AIR INTAKE

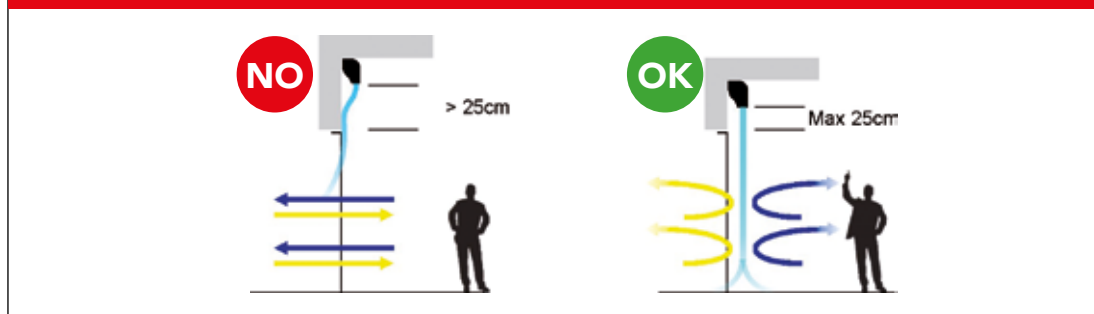

DOWNLOAD DATASHEET

CODE	DESCRIPTION
12400011	SINGLE-FAN TANGENTIAL AIR CURTAIN "ARIA3 SILENCE FRONT" 1100 RIGHT WITH FRONTAL AIR INTAKE
12400013	SINGLE-FAN TANGENTIAL AIR CURTAIN "ARIA3 SILENCE FRONT" 1100 LEFT WITH FRONTAL AIR INTAKE
12400021	DUAL-FAN TANGENTIAL AIR CURTAIN "ARIA3 SILENCE FRONT" 1500 CENTRAL WITH FRONTAL AIR INTAKE
12400031	DUAL-FAN TANGENTIAL AIR CURTAIN "ARIA3 SILENCE FRONT" 2000 CENTRAL WITH FRONTAL AIR INTAKE



ARIA2 ELEGANCE T

ARIA 2 ELEGANCE T

 **BUILT-IN TANGENTIAL AIR CURTAIN AT ROOM TEMPERATURE**

 **RIDEAU D'AIR TANGENTIELLE INTÉGRÉE À TEMPÉRATURE AMBIANTE**

 **EINGebaUTE TANGENTIALLUFT BEI RAUMTEMPERATUR**

TECHNICAL FEATURES

- 3 MODELS IN WHITE
- 3 SPEEDS OPERATED BY REMOTE CONTROL
- AIR CURTAINS ARE DESIGNED FOR INDOOR USE
- TOTAL INTEGRATION TO THE FALSE CEILING
- THE UNIT MUST BE INSTALLED HORIZONTALLY
- MAXIMUM INSTALLATION HEIGHT 2.2 m

CARACTÉRISTIQUES TECHNIQUES

- 3 MODÈLES BLANCS
- 3 VITESSES COMMANDÉES PAR TÉLÉCOMMANDE
- LES RIDEAU D'AIR SONT CONÇUES POUR UNE UTILISATION À L'INTÉRIEUR
- INTÉGRATION TOTALE AU FAUX PLAFOND
- L'UNITÉ DOIT ÊTRE INSTALLÉE HORIZONTALEMENT
- HAUTEUR MAXIMALE D'INSTALLATION 2,2 m

TECHNISCHE EIGENSCHAFTEN

- 3 MODELLE IN FARBE WEIßE
- 3 GESCHWINDIGKEITEN, MIT FERNBEDIENUNG BETRIEBEN
- LUFTSCHLEIER SIND FÜR DIE VERWENDUNG IN INNENRÄUMEN BESTIMMT
- VOLLSTÄNDIGE INTEGRATION IN DIE ZWISCHENDECKE
- DAS GERÄT MUSS HORIZONTAL INSTALLIERT WERDEN
- MAXIMALE EINBAUHÖHE 2,2 m



ON ROOM TEMPERATURE

ARIA2 ELEGANCE T

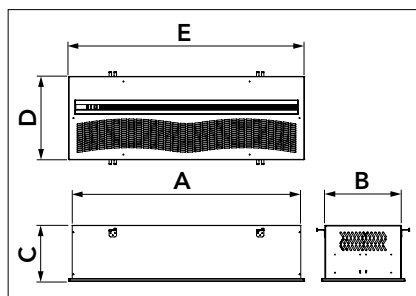
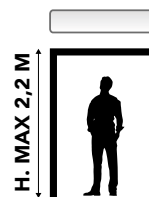

DIMENSIONS [mm]

MOD.	A	B	C	D	E
1100	1086	362	270	396	1120
1500	1440	362	270	396	1472
2000	2040	362	270	396	2072

ACCESSORIES



REMOTE CONTROL INCLUDED



TANGENTIAL MOTOR



PANEL WITH 3 COLOURED LEDS

MADE IN ITALY 

APPLY AIR



CODE	SUPPLY VOLTAGE [V]	FREQUENCY [Hz]	POWER CONSUMPTION [W]	AIR SPEED AT INLET [m/s]	AIR FLOW RATE [m³/s]	SOUND POWER LEVEL [dB(A)]	WEIGHT [kg]	SUITABLE FOR LARGE DOORS [mm]
12450014	230 ac	50	75	I:8 II:9 III:10	I:706 II:768 III:967	I:46 II:51 III:53	22	L.1000 H.Max.2200 H.Min.1800
12450024	230 ac	50	190	I:8 II:9 III:10	I:1135 II:1238 III:1289	I:50 II:53 III:54	33	L.1500 H.Max.2200 H.Min.1800
12450034	230 ac	50	190	I:8 II:9 III:10	I:1419 II:1560 III:1635	I:48 II:51 III:52	47	L.2000 H.Max.2200 H.Min.1800

CODE	DESCRIPTION
12450014	BUILT-IN TANGENTIAL AIR CURTAIN "ARIA2 ELEGANCE T" 1100
12450024	BUILT-IN TANGENTIAL AIR CURTAIN "ARIA2 ELEGANCE T" 1500
12450034	BUILT-IN TANGENTIAL AIR CURTAIN "ARIA2 ELEGANCE T" 2000



DOWNLOAD DATASHEET



ARIA² ELEGANCE TR

ARIA 2 ELEGANCE TR

 **BUILT-IN TANGENTIAL AIR CURTAIN WITH ELECTRICAL HEATING ELEMENT**

 **RIDEAU D'AIR TANGENTIELLE INTÉGRÉE À RÉISTANCE ÉLECTRIQUE**

 **EINGEBAUTE TANGENTIALE LUFTBARRIERE MIT ELEKTRISCHEM WIDERSTAND HEIZKÖRPER**

TECHNICAL FEATURES

- 6 MODELS IN WHITE
- 3 SPEEDS OPERATED BY REMOTE CONTROL
- AIR CURTAINS ARE DESIGNED FOR INDOOR USE
- AUTOMATIC START-UP KIT ON REQUEST
- TOTAL INTEGRATION IN THE FALSE CEILING
- OPTION TO PARTIALISE OPERATION OF ELECTRIC ELEMENTS
- THE UNIT MUST BE INSTALLED HORIZONTALLY
- INSTALLATION HEIGHT MAX. 2.2 m

CARACTÉRISTIQUES TECHNIQUES

- 6 MODÈLES BLANCS
- 3 VITESSES COMMANDÉES PAR TÉLÉCOMMANDE
- LES RIDEAU D'AIR SONT CONÇUES POUR UNE UTILISATION À L'INTÉRIEUR
- KIT DE DÉMARRAGE AUTOMATIQUE SUR DEMANDE
- INTÉGRATION TOTALE DANS LE FAUX PLAFOND
- POSSIBILITÉ DE PARTIALISER LE FONCTIONNEMENT DES RÉISTANCES ÉLECTRIQUES
- L'UNITÉ DOIT ÊTRE INSTALLÉE HORIZONTALEMENT
- HAUTEUR D'INSTALLATION MAX. 2,2 m

TECHNISCHE EIGENSCHAFTEN

- 6 MODELLE IN FARBE WEIßE
- 3 GESCHWINDIGKEITEN, MIT FERNBEDIENUNG BETRIEBEN
- LUFTSCHLEIER SIND FÜR DIE VERWENDUNG IN INNENRÄUMEN BESTIMMT
- AUTOMATISCHES STARTER-KIT AUF ANFRAGE
- VOLLSTÄNDIGE INTEGRATION IN DER ZWISCHENDECKE
- MÖGLICHKEIT DER EINSCHRÄNKUNG DES BETRIEBS VON ELEKTRISCHEN HEIZKÖRPER
- DAS GERÄT MUSS HORIZONTAL INSTALLIERT WERDEN



ARIA² ELEGANCE TR



 **MADE IN ITALY**



ACCESSORIES



REMOTE CONTROL INCLUDED



TANGENTIAL MOTOR



PANEL WITH 3 COLOURED LEDS

DIMENSIONS

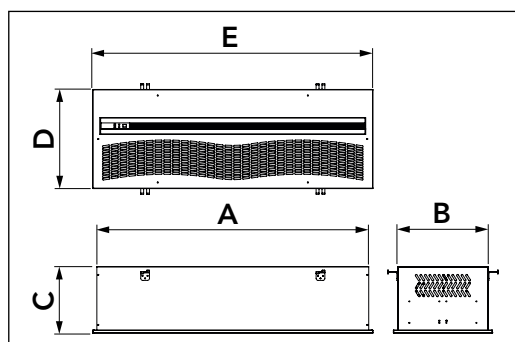

DIMENSIONS [mm]					
MODEL	A	B	C	D	E
1100	1086	362	270	396	1120
1500	1440	362	270	396	1472
2000	2040	362	270	396	2072

ARIA 2 ELEGANCE TR



CODE	SUPPLY VOLTAGE [V]	FREQUENCY [Hz]	POWER CONSUMPTION [W]	AIR SPEED AT INLET [m/s]	POWER CONSUMPTION WITH PARTIAL LOAD RESISTANCE [W]	POWER ABSORBED WITH FULL LOAD RESISTANCE [W]	AIR FLOW RATE [m³/s]	SOUND POWER LEVEL [dB(A)]	ΔT AIR WITH HEATING ELEMENTS [°C]	WEIGHT [kg]	SUITABLE FOR LARGE DOORS [mm]
CODE	TENSION D'ALIMENTATION [V]	FRÉQUENCE [Hz]	PUISSANCE ABSORBÉE [W]	VITESSE DE L'AIR À LA GRILLE [m/s]	PUISSANCE ABSORBÉE AVEC RÉSISTANCE DE CHARGE PARTIELLE [W]	PUISSANCE ABSORBÉE AVEC RÉSISTANCE À PLEINE CHARGE [W]	DÉBIT D'AIR [m³/s]	NIVEAU DE PUISSANCE ACOUSTIQUE [dB(A)]	ΔT AIR AVEC RÉSISTANCES [°C]	POIDS [kg]	CONVIENT POUR PORTAILS [mm]
CODE	VERSORGUNGSSPANNUNG [V]	FREQUENZ [Hz]	LEISTUNGSAUFNAHME [W]	LUFTGESCHWINDIGKEIT AN DER ÖFFNUNG [m/s]	LEISTUNGSAUFNAHME BEI TEILLASTWIDERSTAND [W]	LEISTUNGSAUFNAHME BEI VOLLASTWIDERSTAND [W]	LUFTDURCHFLOSSRATE [m³/s]	SCHALLLEISTUNGSPEGEL [dB(A)]	ΔT DER LUFT MIT WIDERSTÄNDEN [°C]	GEWICHT [kg]	GEEIGNET FÜR TÜREN [mm]
TANGENTIAL AIR CURTAINS WITH 2 ELECTRIC RESISTANCES											
12450014R2	220 ac	50	75	I:8 II:9 III:10	1900	3800	I:692 II:753 III:948	I:47 II:52 III:54	12	23	L.1000 H.Max.2200 H.Min.1800
TANGENTIAL AIR CURTAINS WITH 3 ELECTRIC RESISTANCES											
12450014R3	400 ac	50	75	I:8 II:9 III:10	3800	5700	I:678 II:738 III:929	I:47 II:52 III:54	15	24	L.1000 H.Max.2200 H.Min.1800
TANGENTIAL AIR CURTAINS WITH 4 ELECTRIC RESISTANCES											
12450024R2	400 ac	50	190	I:8 II:9 III:10	3200	6400	I:1112 II:1213 III:1263	I:51 II:54 III:55	19	35	L.1500 H.Max.2200 H.Min.1800
12450024R3	400 ac	50	190	I:8 II:9 III:10	3800	7600	I:1090 II:1189 III:1238	I:49 II:52 III:53	19	49	L.2000 H.Max.2200 H.Min.1800
TANGENTIAL AIR CURTAINS WITH 6 ELECTRIC RESISTANCES											
12450034R2	400 ac	50	190	I:8 II:9 III:10	6400	9600	I:1090 II:1189 III:1238	I:52 II:55 III:56	25	36	L.1500 H.Max.2200 H.Min.1800
12450034R3	400 ac	50	190	I:8 II:9 III:10	7600	11400	I:1068 II:1165 III:1213	I:50 II:53 III:54	25	50	L.2000 H.Max.2200 H.Min.1800



DOWNLOAD DATASHEET

CODE	DESCRIPTION
12450014R2	TANGENTIAL AIR CURTAIN WITH 2 ELECTRIC RESISTANCES "ARIA2 ELEGANCE TR" 1100
12450014R3	TANGENTIAL AIR CURTAIN WITH 3 ELECTRIC RESISTANCES "ARIA2 ELEGANCE TR" 1100
12450024R2	TANGENTIAL AIR CURTAIN WITH 4 ELECTRIC RESISTANCES "ARIA2 ELEGANCE TR" 1500
12450024R3	TANGENTIAL AIR CURTAIN WITH 6 ELECTRIC RESISTANCES "ARIA2 ELEGANCE TR" 1500
12450034R2	TANGENTIAL AIR CURTAIN WITH 4 ELECTRIC RESISTANCES "ARIA2 ELEGANCE TR" 2000
12450034R3	TANGENTIAL AIR CURTAIN WITH 6 ELECTRIC RESISTANCES "ARIA2 ELEGANCE TR" 2000



ARIA2 ELEGANCE

ARIA 2 ELEGANCE

 **BUILT-IN CENTRIFUGAL AIR CURTAIN AT ROOM TEMPERATURE**

 **RIDEAU D'AIR CENTRIFUGE ENCASTRÉE À TEMPÉRATURE AMBIANTE**

 **EINGebaute ZENTRIFUGALLUFT BEI RAUMTEMPERATUR**

TECHNICAL FEATURES

- 3 MODELS IN WHITE
- WITH SPEED CONTROLLER SUPPLIED
- AIR CURTAINS ARE DESIGNED FOR INDOOR USE
- FLOW ADJUSTMENT VIA FLAPS
- TOTAL INTEGRATION IN THE FALSE CEILING
- THE UNIT MUST BE INSTALLED HORIZONTALLY
- INSTALLATION HEIGHT MAX 3,5 m

CARACTÉRISTIQUES TECHNIQUES

- 3 MODÈLES BLANCS
- AVEC RÉGULATEUR DE VITESSE INCLUS
- LES RIDEAU D'AIR SONT CONÇUES POUR UNE UTILISATION À L'INTÉRIEUR
- RÉGLAGES DU DÉBIT VIA L'AILETTE
- INTÉGRATION TOTALE DANS LE FAUX PLAFOND
- L'UNITÉ DOIT ÊTRE INSTALLÉE HORIZONTALEMENT
- HAUTEUR D'INSTALLATION MAX. 3,5 m

TECHNISCHE EIGENSCHAFTEN

- 3 MODELLE IN FARBE WEIßE
- MIT MITGELIEFERTEM DREHZAHLEGLER
- LUFTSCHLEIER SIND FÜR DIE VERWENDUNG IN INNENRÄUMEN BESTIMMT
- DURCHFLUSSVERSTELLUNG ÜBER RIPPE
- VOLLSTÄNDIGE INTEGRATION IN DER ZWISCHENDECKE
- DAS GERÄT MUSS HORIZONTAL INSTALLIERT WERDEN
- EINBAUHÖHE MAX. 3,5 m



ON ROOM TEMPERATURE

ARIA2 ELEGANCE

 YouTube



VIDEO



DOWNLOAD DATASHEET

 **MADE IN ITALY** 

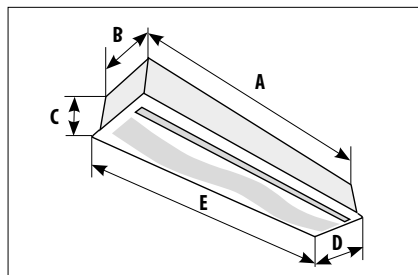

ACCESSORIES



SPEED CONTROLLER SUPPLIED



CENTRIFUGAL MOTOR

DIMENSIONS [mm]

MOD.	A	B	C	D	E
1000	1000	362	270	396	1034
1500	1500	362	270	396	1524
2000	2000	362	270	396	2034



CODE	SUPPLY VOLTAGE [V]	FREQUENCY [Hz]	POWER CONSUMPTION [W]	AIR SPEED AT INLET [m/s]	AIR FLOW RATE [m³/h]	SOUND POWER LEVEL [dB(A)]	WEIGHT [kg]	SUITABLE FOR LARGE DOORS [mm]
CODE	TENSION D'ALIMENTATION [V]	FRÉQUENCE [Hz]	PUISSANCE ABSORBÉE [W]	VITESSE DE L'AIR À LA GRILLE [m/s]	DÉBIT D'AIR [m³/h]	NIVEAU DE PUISSANCE ACOUSTIQUE [dB(A)]	POIDS [kg]	CONVIENT POUR PORTAILS [mm]
CODE	VERSORUNGSSPANNUNG [V]	FREQUENZ [Hz]	LEISTUNGSANNAHME [W]	LUFTGESCHWINDIGKEIT AN DER ÖFFNUNG [m/s]	LUFTDURCHFLOSSRATEGRADE [m³/h]	SCHALLLEISTUNGSPEGEL [dB(A)]	GEWICHT [kg]	GEEIGNET FÜR TÜREN [mm]
12300033	230 ac	50	225	12	1436	60	22	L1000 HMax.3500 HMin.1800
12300035	230 ac	50	300	12	2129	61	33	L1500 HMax.3500 HMin.1800
12450030	230 ac	50	450	12	3197	62	47	L2000 HMax.3500 HMin.1800

CODE	DESCRIPTION
12300033	BUILT-IN CENTRIFUGAL AIR CURTAIN AT ROOM TEMPERATURE "ARIA2 ELEGANCE" 1000
12300035	BUILT-IN CENTRIFUGAL AIR CURTAIN AT ROOM TEMPERATURE "ARIA2 ELEGANCE" 1500
12450030	BUILT-IN CENTRIFUGAL AIR CURTAIN AT ROOM TEMPERATURE "ARIA2 ELEGANCE" 2000



ARIA² ELEGANCE CR

ARIA 2 ELEGANCE CR



BUILT-IN CENTRIFUGAL AIR CURTAIN WITH ELECTRICAL HEATING ELEMENT



RIDEAU D'AIR CENTRIFUGE À ASPIRATION ENCASTRÉE AVEC RÉSISTANCE ÉLECTRIQUE



EINGebaUTE ZENTRIFUGALLUFT MIT ELEKTRISCHEM WIDERSTAND

TECHNICAL FEATURES

- 3 MODELS IN WHITE
- 3 SPEEDS OPERATED BY REMOTE CONTROL
- AIR CURTAINS ARE DESIGNED FOR INDOOR USE
- AUTOMATIC START-UP KIT ON REQUEST
- TOTAL INTEGRATION IN THE FALSE CEILING
- THE UNIT MUST BE INSTALLED HORIZONTALLY
- INSTALLATION HEIGHT MAX 3.5 m

CARACTÉRISTIQUES TECHNIQUES

- 3 MODÈLES BLANCS
- 3 VITESSES COMMANDÉES PAR TÉLÉCOMMANDE
- LES RIDEAU D'AIR SONT CONÇUES POUR UNE UTILISATION À L'INTÉRIEUR
- KIT DE DÉMARRAGE AUTOMATIQUE SUR DEMANDE
- INTÉGRATION TOTALE DANS LE FAUX PLAFOND
- L'UNITÉ DOIT ÊTRE INSTALLÉE HORIZONTALEMENT
- HAUTEUR D'INSTALLATION MAX. 3,5 m

TECHNISCHE EIGENSCHAFTEN

- 3 MODELLE IN FARBE WEISSE
- 3 GESCHWINDIGKEITEN, MIT FERNBEDIENUNG BETRIEBEN
- LUFTSCHLEIER SIND FÜR DIE VERWENDUNG IN INNENRÄUMEN BESTIMMT
- AUTOMATISCHES STARTER-KIT AUF ANFRAGE
- VOLLSTÄNDIGE INTEGRATION IN DER ZWISCHENDECKE
- DAS GERÄT MUSS HORIZONTAL MONTIERT WERDEN
- EINBAUHÖHE MAX. 3,5 m



WITH ELECTRIC RESISTANCE

ARIA2 ELEGANCE CR

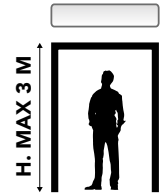
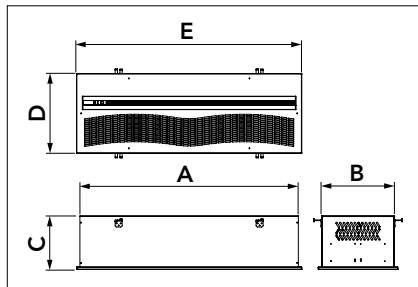

MADE IN ITALY

DIMENSIONS [mm]

MOD.	A	B	C	D	E
1000	1000	362	270	396	1034
1500	1500	362	270	396	1524
2000	2000	362	270	396	2034

ACCESSORIES



REMOTE CONTROL INCLUDED



CENTRIFUGAL MOTOR



PANEL WITH 3 COLOURED LEDS



CODE	SUPPLY VOLTAGE [V]	FREQUENCY [Hz]	POWER CONSUMPTION [W]	AIR SPEED AT INLET [m/s]	POWER CONSUMPTION WITH PARTIAL LOAD RESISTANCE [W]	POWER ABSORBED WITH FULL LOAD RESISTANCE [W]	AIR FLOW RATE [m³/h]	SOUND POWER LEVEL [dB(A)]	ΔT AIR WITH HEATING ELEMENTS [°C]	WEIGHT [kg]	SUITABLE FOR LARGE DOORS [mm]
CODE	TENSION D'ALIMENTATION [V]	FRÉQUENCE [Hz]	PUISSANCE ABSORBÉE [W]	VITESSE DE L'AIR À LA GRILLE [m/s]	PUISSANCE ABSORBÉE AVEC RÉSISTANCE DE CHARGE PARTIELLE [W]	PUISSANCE ABSORBÉE AVEC RÉSISTANCE À PLEINE CHARGE [W]	DÉBIT D'AIR [m³/h]	NIVEAU DE PUISSANCE ACOUSTIQUE [dB(A)]	ΔT AIR AVEC RÉSISTANCES [°C]	POIDS [kg]	CONVIENT POUR PORTAILS [mm]
CODE	VERSORGUNGSSPANNUNG [V]	FREQUENZ [Hz]	LEISTUNGSAUFNAHME [W]	LUFTGESCHWINDIGKEIT AN DER ÖFFNUNG [m/s]	LEISTUNGSAUFNAHME BEI TEILLASTWIDERSTAND [W]	LEISTUNGSAUFNAHME BEI VOLLASTWIDERSTAND [W]	LUFTDURCHFLOSSRATEGIE [m³/h]	SCHALLLEISTUNGSPEGEL [dB(A)]	ΔT DER LUFT MIT WIDERSTÄNDEN [°C]	GEWICHT [kg]	GEEIGNET FÜR TÜREN [mm]
CENTRIFUGAL AIR CURTAINS WITH 3 ELECTRIC RESISTANCES											
12300033R3	400 ac	50	180	I:1163 II:1242 III:1436	3800	5700	I:1163 II:1242 III:1436	I:54 II:57 III:60	20	23	L1000 H.Max.3000 H.Min.1800
CENTRIFUGAL AIR CURTAINS WITH 6 ELECTRIC RESISTANCES											
12300035R3	400 ac	50	240	I:1163 II:1242 III:1436	6400	9600	I:1724 II:1916 III:2129	I:55 II:58 III:61	20	36	L1500 HMax.3000 HMin.1800
12450030R3	400 ac	50	360	I:1163 II:1242 III:1436	7600	11400	I:2589 II:2877 III:3197	I:56 II:59 III:62	20	50	L2000 HMax.3000 HMin.1800

CODE	DESCRIPTION
12300033R3	BUILT-IN CENTRIFUGAL AIR CURTAIN WITH 3 ELECTRICAL RESISTANCES "ARIA2 ELEGANCE CR" 1000
12300035R3	BUILT-IN CENTRIFUGAL AIR CURTAIN WITH 6 ELECTRICAL RESISTANCES "ARIA2 ELEGANCE CR" 1500
12450030R3	BUILT-IN CENTRIFUGAL AIR CURTAIN WITH 6 ELECTRICAL RESISTANCES "ARIA2 ELEGANCE CR" 2000



DOWNLOAD DATASHEET



ARIA² ELEGANCE H2O

ARIA 2 ELEGANCE H2O



BUILT-IN CENTRIFUGAL AIR CURTAIN WITH HOT WATER COIL



RIDEAU D'AIR CENTRIFUGE ENCASTRÉE AVEC SERPENTIN D'EAU CHAUDE



ZENTRIFUGALLUFT FÜR DEN EINBAU MIT WARMWASSERBATTERIE

TECHNICAL FEATURES

- 3 MODELS IN WHITE
- 3 SPEEDS OPERATED BY REMOTE CONTROL
- AIR CURTAINS ARE DESIGNED FOR INDOOR USE
- TOTAL INTEGRATION IN THE FALSE CEILING
- THE UNIT MUST BE INSTALLED HORIZONTALLY
- INSTALLATION HEIGHT MAX. 3 m

CARACTÉRISTIQUES TECHNIQUES

- 3 MODÈLES BLANCS
- 3 VITESSES COMMANDÉES PAR TÉLÉCOMMANDE
- LES RIDEAU D'AIR SONT CONÇUES POUR UNE UTILISATION À L'INTÉRIEUR
- INTÉGRATION TOTALE DANS LE FAUX PLAFOND
- L'UNITÉ DOIT ÊTRE INSTALLÉE HORIZONTALEMENT
- HAUTEUR D'INSTALLATION MAX. 3 m

TECHNISCHE EIGENSCHAFTEN

- 3 MODELLE IN FARBE WEIßE
- 3 GESCHWINDIGKEITEN, MIT FERNBEDIENUNG BETRIEBEN
- LUFTSCHLEIER SIND FÜR DIE VERWENDUNG IN INNENRÄUMEN BESTIMMT
- VOLLSTÄNDIGE INTEGRATION IN DER ZWISCHENDECKE
- DAS GERÄT MUSS HORIZONTAL MONTIERT WERDEN
- EINBAUHÖHE MAX. 3 m



WITH HOT WATER COIL

MADE IN ITALY

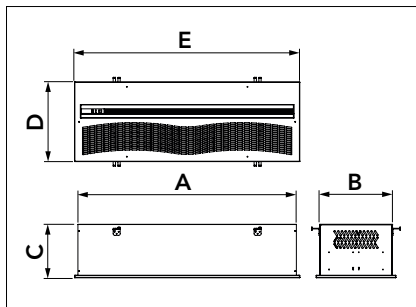

DIMENSIONS [mm]

MOD.	A	B	C	D	E
1000	1000	362	331	396	1034
1500	1500	362	331	396	1524
2000	2000	362	331	396	2034



ARIA 2 ELEGANCE H2O



ACCESSORIES



REMOTE CONTROL DEVICE



CENTRIFUGAL MOTOR

CODE	SUPPLY VOLTAGE [V]	FREQUENCY [Hz]	POWER CONSUMPTION [W]	AIR SPEED AT INLET [m/s]	AIR FLOW RATE [m³/h]	SOUND POWER LEVEL [dB(A)]	MEASUREMENT OF IN/OUT CONNECTIONS	AVERAGE TEMPERATURE IN/OUT [°C]	HEAT OUTPUT [kW]	AVERAGE WATER FLOW [m³/h]	WEIGHT [kg]	SUITABLE FOR LARGE DOORS [mm]
CODE	TENSION D'ALIMENTATION [V]	FRÉQUENCE [Hz]	PUISSANCE ABSORBÉE [W]	VITESSE DE L'AIR À LA GRILLE [m/s]	DÉBIT D'AIR [m³/h]	NIVEAU DE PUISSANCE ACOUSTIQUE [dB(A)]	MESURE CONNEXIONS ENTRÉE/SORTIE	TEMPÉRATURE MOYENNE ENTRÉE/SORTIE [°C]	RENDEMENT EN PUISSANCE THERMIQUE [kW]	DÉBIT D'EAU MOYEN [m³/h]	POIDS [kg]	CONVIENT POUR PORTAILS [mm]
CODE	VERSORUNGSSPANNUNG [V]	FREQUENZ [Hz]	LEISTUNGS-AUFNAHME [W]	LUFTGESCHWINDIGKEIT AN DER ÖFFNUNG [m/s]	LUFTDURCHFLUSSRA-TE [m³/h]	SCHALLLEI-STUNGSPEGEL [dB(A)]	ABMESSUNG ANSCHLÜSSE IN/OUT	DURCHSCHNITT- LICHE TEMPERATUR IN/OUT [°C]	THERMISCHE LEI- STUNGS-AU- SBEUTE [kW]	MIT- TLERER WAS- SERDURCHSATZ [m³/h]	GEWICHT [kg]	GEEIGNET FÜR TÜREN [mm]
12450092	230	50	180	I:8 II:10 III:12	1590	62	1/2"	70/60	11,4	1	31,9	L1000 H3000
12450102	230	50	240	I:8 II:10 III:12	2120	64	1/2"	70/60	16,1	1,42	45,1	L1500 H3000
12450112	230	50	360	I:8 II:10 III:12	3190	66	1/2"	70/60	24,1	2,12	64	L2000 H3000

CODE	DESCRIPTION
12450092	BUILT-IN CENTRIFUGAL AIR CURTAIN WITH HOT WATER COIL "ARIA2 ELEGANCE H2O" 1000
12450102	BUILT-IN CENTRIFUGAL AIR CURTAIN WITH HOT WATER COIL "ARIA2 ELEGANCE H2O" 1500
12450112	BUILT-IN CENTRIFUGAL AIR CURTAIN WITH HOT WATER COIL "ARIA2 ELEGANCE H2O" 2000



DOWNLOAD DATASHEET



APPLY AIR

AirFor3^{UP}

AIR FOR 3 UP

 **CENTRIFUGAL AIR CURTAIN WITH UPPER EXTRACTION**

 **RIDEAU D'AIR CENTRIFUGE À ASPIRATION SUPÉRIEURE**

 **ZENTRIFUGALLUFTSCHLEIER MIT ANSAUGUNG AN DER OBERSEITE**

TECHNICAL FEATURES

- 2 MODELS IN WHITE
- OPERATING TEMPERATURE: + 50°C TO -10°C
- 3 SPEEDS OPERATED BY REMOTE CONTROL OR MANUALLY
- AIR CURTAINS ARE DESIGNED FOR INDOOR USE.
- UPPER AIR INTAKE
- THE UNIT MUST BE INSTALLED HORIZONTALLY
- MAXIMUM INSTALLATION HEIGHT 3.5 m

CARACTÉRISTIQUES TECHNIQUES

- 2 MODÈLES BLANCS
- TEMPÉRATURE DE FONCTIONNEMENT : + 50°C À -10°C
- 3 VITESSES COMMANDÉES PAR TÉLÉCOMMANDE OU MANUELLEMENT
- LES RIDEAU D'AIR SONT CONÇUES POUR UNE UTILISATION À L'INTÉRIEUR.
- ASPIRATION D'AIR SUPÉRIEURE
- L'UNITÉ DOIT ÊTRE INSTALLÉE HORIZONTALEMENT
- HAUTEUR MAXIMALE D'INSTALLATION 3,5 m

TECHNISCHE EIGENSCHAFTEN

- 2 MODELLE IN FARBE WEIßE
- BETRIEBSTEMPERATUR: VON + 50°C BIS -10°C
- 3 GESCHWINDIGKEITEN, MIT FERNBEDIENUNG ODER MANUELL BETRIEBEN
- LUFTSCHLEIER SIND FÜR DIE VERWENDUNG IN INNENRÄUMEN BESTIMMT.
- OBERE LUFTANSAUGUNG
- DAS GERÄT MUSS HORIZONTAL INSTALLIERT WERDEN
- MAXIMALE EINBAUHÖHE 3,5 m

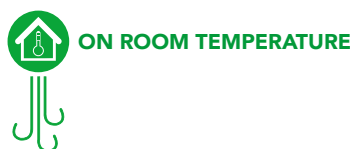
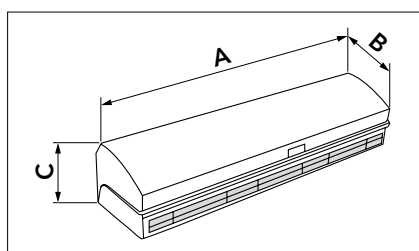

AirFor3^{UP}



DIMENSIONS [mm]

MOD.	A	B	C
1000	1000	230	212
1500	1500	230	212

ACCESSORIES



SPEED CONTROLLER SUPPLIED



CENTRIFUGAL MOTOR



CODE	SUPPLY VOLTAGE [V]	FREQUENCY [Hz]	POWER CONSUMPTION [W]	AIR SPEED AT INLET [m/s]	AIR FLOW RATE [m³/h]	SOUND POWER LEVEL [dB(A)]	REMOTE CONTROL	WEIGHT [kg]	SUITABLE FOR LARGE DOORS [mm]
CODE	TENSION D'ALIMENTATION [V]	FRÉQUENCE [Hz]	PUISSANCE ABSORBÉE [W]	VITESSE DE L'AIR À LA GRILLE [m/s]	DÉBIT D'AIR [m³/h]	NIVEAU DE PUISSANCE ACOUSTIQUE [dB(A)]	TÉLÉCOMMANDE	POIDS [kg]	CONVIENT POUR PORTAILS [mm]
CODE	VERSORGUNGSSPANNUNG [V]	FREQUENZ [Hz]	LEISTUNGS-AUFNAHME [W]	LUFTGESCHWINDIGKEIT AN DER ÖFFNUNG [m/s]	LUFTDURCHFLUSSRATE [m³/h]	SCHALLLEISTUNGSPEGEL [dB(A)]	FERNBEDIENUNGEN	GEWICHT [kg]	GEEIGNET FÜR TÜREN [mm]
12300038	230 ac	50	I:186 II:238 III: 322	I:9 II:11 III: 12,5	798	I:46 II:51 III:58	ADJUSTMENT SPEED	16,9	L 1000 H 3500
12300039	230 ac	50	I:291 II:381 III: 536	I:9 II:11 III: 12,5	1330	I:51 II:56 III: 62	ADJUSTMENT SPEED	22,6	L1500 H3500

CODE	DESCRIPTION
12300038	CENTRIFUGAL AIR CURTAIN WITH UPPER INTAKE "AIRFOR3 UP" 1000
12300039	CENTRIFUGAL AIR CURTAIN WITH UPPER INTAKE "AIRFOR3 UP" 1500



DOWNLOAD DATASHEET



AirFor3 ^{STYLE}

AIR FOR 3 STYLE

 **CENTRIFUGAL AIR CURTAIN WITH UPPER EXTRACTION WITH BODY IN ABS**

 **RIDEAU D'AIR CENTRIFUGE À ASPIRATION SUPÉRIEURE AVEC COQUE EN ABS**

 **ZENTRIFUGALLUFT MIT ANSAUGUNG AN DER OBERSEITE MIT GEHÄUSE AUS ABS**

TECHNICAL FEATURES

- 3 MODELS IN WHITE
- OPERATING TEMPERATURE: + 50°C TO -10°C
- 3 SPEEDS OPERATED BY REMOTE CONTROL OR MANUALLY
- AIR CURTAINS ARE DESIGNED FOR INDOOR USE.
- UPPER AIR INTAKE
- THE UNIT MUST BE INSTALLED HORIZONTALLY
- MAXIMUM INSTALLATION HEIGHT 4 m

CARACTÉRISTIQUES TECHNIQUES

- 3 MODÈLES BLANCS
- TEMPÉRATURE DE FONCTIONNEMENT : + 50°C À -10°C
- 3 VITESSES COMMANDÉES PAR TÉLÉCOMMANDE OU MANUELLEMENT
- LES RIDEAU D'AIR SONT CONÇUES POUR UNE UTILISATION À L'INTÉRIEUR.
- ASPIRATION D'AIR SUPÉRIEURE
- L'UNITÉ DOIT ÊTRE INSTALLÉE HORIZONTALEMENT
- HAUTEUR MAXIMALE D'INSTALLATION 4 m

TECHNISCHE EIGENSCHAFTEN

- 3 MODELLE IN FARBE WEIßE
- BETRIEBSTEMPERATUR: VON + 50°C BIS -10°C
- 3 GESCHWINDIGKEITEN, MIT FERNBEDIENUNG ODER MANUELL BETRIEBEN
- LUFTSCHLEIER SIND FÜR DIE VERWENDUNG IN INNENRÄUMEN BESTIMMT.
- OBERE LUFTANSAUGUNG
- DAS GERÄT MUSS HORIZONTAL INSTALLIERT WERDEN
- MAXIMALE EINBAUHÖHE 4 m

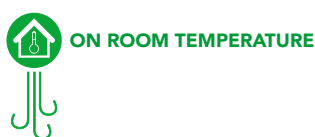

AirFor3^{STYLE}

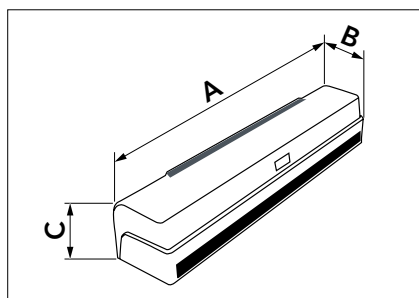

CE

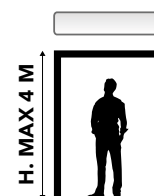

DIMENSIONS [mm]

MOD.	A	B	C
900	900	231	216
1200	1200	231	216
1500	1500	231	216

ACCESSORIES



REMOTE CONTROL INCLUDED

CENTRIFUGAL MOTOR

CODE	SUPPLY VOLTAGE [V]	FREQUENCY [Hz]	POWER CONSUMPTION [W]	AIR SPEED AT INLET [m/s]	AIR FLOW RATE [m³/h]	SOUND POWER LEVEL [dB(A)]	WEIGHT [kg]	REMOTE CONTROL	SUITABLE FOR LARGE DOORS [mm]
CODE	TENSION D'ALIMENTATION [V]	FREQUENCE [Hz]	PUISANCE ABSORBÉE [W]	VITESSE DE L'AIR À LA GRILLE [m/s]	DÉBIT D'AIR [m³/h]	NIVEAU DE PUISSANCE ACOUSTIQUE [dB(A)]	POIDS [kg]	TÉLÉCOMMANDE	CONVIENT POUR PORTAILS [mm]
CODE	VERSORGUNGSSPANNUNG [V]	FREQUENZ [Hz]	LEISTUNGS-AUFNAHME [W]	LUFTGESCHWINDIGKEIT AN DER ÖFFNUNG [m/s]	LUFTDURCHFLUSSRATE [m³/h]	SCHALLLEISTUNGSPPEL [dB(A)]	GEWICHT [kg]	FERNBEDIENUNGEN	GEEIGNET FÜR TÜREN [mm]
AAC100001	230 ac	50	I:175 II:217 III:296	I:10 II:12,5 III:15	I:737 II:867 III:1020	I:50 II:52 III:53	12	ADJUSTMENT SPEED	L900 H3000
12300044	230 ac	50	I:235 II:272 III:390	I:10 II:12,5 III:15	I:983 II:1156 III:1360	I:51 II:53 III:54	16	ADJUSTMENT SPEED	L1200 H4000
123000445	230 ac	50	I:272 II:333 III:490	I:10 II:12,5 III:15	I:1225 II:1445 III:1700	I:53 II:53 III:56	20,6	ADJUSTMENT SPEED	L1500 H4000

CODE	DESCRIPTION
AAC100001	CENTRIFUGAL AIR CURTAIN WITH ABS PLASTIC BODY AND UPPER AIR INTAKE "AIRFOR3 STYLE" 900
12300044	CENTRIFUGAL AIR CURTAIN WITH ABS PLASTIC BODY AND UPPER AIR INTAKE "AIRFOR3 STYLE" 1200
123000445	CENTRIFUGAL AIR CURTAIN WITH ABS PLASTIC BODY AND UPPER AIR INTAKE "AIRFOR3 STYLE" 1500



DOWNLOAD DATASHEET



APPLY AIR

AirFor3 FRONT

AIR FOR 3 FRONT

 **CENTRIFUGAL AIR CURTAIN WITH FRONT EXTRACTION**

 **RIDEAU D'AIR CENTRIFUGE D'ASPIRATION FRONTALE**

 **ZENTRIFUGALLUFT MIT FRONTANSAUGUNG**

TECHNICAL FEATURES

- 2 MODELS IN WHITE
- OPERATING TEMPERATURE + 50°C - 10°C
- 3 SPEEDS OPERATED BY REMOTE CONTROL OR MANUALLY
- AIR CURTAINS ARE DESIGNED FOR INDOOR USE
- THE UNIT MUST BE INSTALLED HORIZONTALLY
- MAXIMUM INSTALLATION HEIGHT 3.5 m

CARACTÉRISTIQUES TECHNIQUES

- 2 MODÈLES BLANCS
- TEMPÉRATURE DE FONCTIONNEMENT + 50°C - 10°C
- 3 VITESSES COMMANDÉES PAR TÉLÉCOMMANDE OU MANUELLEMENT
- LES RIDEAU D'AIR SONT CONÇUES POUR UNE UTILISATION À L'INTÉRIEUR
- L'UNITÉ DOIT ÊTRE INSTALLÉE HORIZONTALEMENT
- HAUTEUR MAXIMALE D'INSTALLATION 3,5 m

TECHNISCHE EIGENSCHAFTEN

- 2 MODELLE IN FARBE WEIßE
- BETRIEBSTEMPERATUR + 50°C - 10°C
- 3 GESCHWINDIGKEITEN, MIT FERNBEDIENUNG ODER MANUELL BETRIEBEN
- LUFTSCHLEIER SIND FÜR DIE VERWENDUNG IN INNENRÄUMEN BESTIMMT
- DAS GERÄT MUSS HORIZONTAL INSTALLIERT WERDEN
- MAXIMALE EINBAUHÖHE 3,5 m

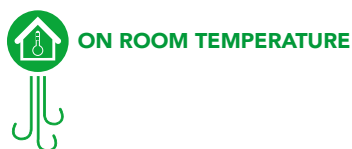

AirFor3 FRONT

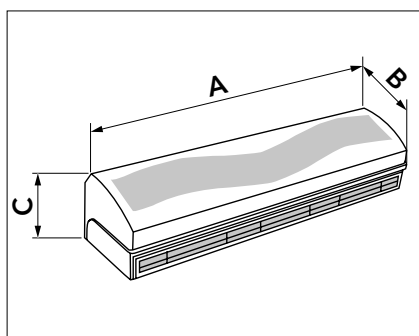

DIMENSIONS [mm]

MOD.	A	B	C
1000	1000	230	212
1500	1500	230	212

ACCESSORIES



REMOTE CONTROL INCLUDED

CENTRIFUGAL MOTOR

CODE	SUPPLY VOLTAGE [V]	FREQUENCY [Hz]	POWER CONSUMPTION [W]	AIR SPEED AT INLET [m/s]	AIR FLOW RATE [m³/h]	SOUND POWER LEVEL [dB(A)]	WEIGHT [kg]	REMOTE CONTROL	SUITABLE FOR LARGE DOORS [mm]
CODE	TENSION D'ALIMENTATION [V]	FRÉQUEN-CE [Hz]	PUISANCE ABSORBÉE [W]	VITESSE DE L'AIR À LA GRILLE [m/s]	DÉBIT D'AIR [m³/h]	NIVEAU DE PUISSANCE ACOUSTIQUE [dB(A)]	POIDS [kg]	TÉLÉCOMMANDE	CONVIENT POUR PORTAILS [mm]
CODE	VERSOR-GUNGSSPAN-NUNG [V]	FREQUENZ [Hz]	LEI-STUNGS-AUFNAHME [W]	LUFTGE-SCHWIN-DICKEIT AN DER ÖFFNUNG [m/s]	LUFTDUR-CHFLUSSRA-TE [m³/h]	SCHALLEI-STUNGSPE-GEL [dB(A)]	GEWICHT [kg]	FERNBEDIENUN-GEN	GEEIGNET FÜR TÜREN [mm]
12300036	230 ac	50	296	I:9 II:11 III:12,5	I:550 II:673 III:798	I:48 II:52 III:56	16,9	ADJUSTMENT SPEED	L.1000 H.3500
12300037	230 ac	50	490	I:9 II:11 III:12,5	I:939 II:1148 III:1330	I:52 II:57 III:62	22,6	ADJUSTMENT SPEED	L.1500 H.3500

CODE	DESCRIPTION
12300036	CENTRIFUGAL AIR CURTAIN WITH FRONT AIR INTAKE "AIRFOR3 FRONT" L1000
12300037	CENTRIFUGAL AIR CURTAIN WITH FRONT AIR INTAKE "AIRFOR3 FRONT" L1500



DOWNLOAD DATASHEET



APPLY AIR

AirFor3^{WALL}

AIR FOR 3 WALL

 CENTRIFUGAL AIR CURTAIN WITH UPPER EXTRACTION

 RIDEAU D'AIR CENTRIFUGE À ASPIRATION SUPÉRIEURE

 ZENTRIFUGAL-LUFTSCHLEIER MIT ANSAUGUNG AN DER OBERSEITE

TECHNICAL FEATURES

- 3 MODELS IN WHITE WITH SPEED CONTROLLER SUPPLIED
- AIR CURTAINS ARE DESIGNED FOR INDOOR USE
- UPPER AIR INTAKE
- THE UNIT MUST BE INSTALLED HORIZONTALLY.
- MAXIMUM INSTALLATION HEIGHT 3 m

CARACTÉRISTIQUES TECHNIQUES

- 3 MODÈLES BLANCS AVEC RÉGULATEUR DE VITESSE FOURNI
- LES RIDEAU D'AIR SONT CONÇUES POUR UNE UTILISATION À L'INTÉRIEUR
- ASPIRATION D'AIR SUPÉRIEURE
- L'UNITÉ DOIT ÊTRE INSTALLÉE HORIZONTALEMENT.
- HAUTEUR MAXIMALE D'INSTALLATION 3 m

TECHNISCHE EIGENSCHAFTEN

- 3 MODELLE IN FARBE WEIÙE MIT DREHZAHNREGLER IM LIEFERUMFANG ENTHALTEN
- LUFTSCHLEIER SIND FÜR DIE VERWENDUNG IN INNENRÄUMEN BESTIMMT
- OBERE LUFTANSAUGUNG
- DAS GERÄT MUSS HORIZONTAL MONTIERT WERDEN.
- MAXIMALE EINBAUHÖHE 3 m



ON ROOM TEMPERATURE

AirFor3^{WALL}

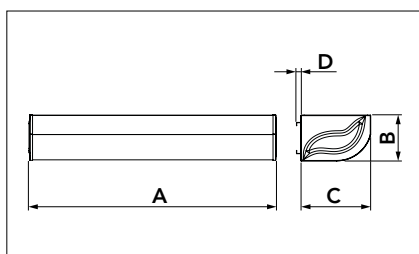

DIMENSIONS [mm]

MOD.	A	B	C
1000	1012	279	455
1500	1512	279	455
2000	2012	279	455

ACCESSORIES



SPEED CONTROLLER SUPPLIED



CENTRIFUGAL MOTOR

MADE IN ITALY



CODE	SUPPLY VOLTAGE [V]	FREQUENCY [Hz]	POWER CONSUMPTION [W]	AIR SPEED AT INLET [m/s]	AIR FLOW RATE [m³/h]	SOUND POWER LEVEL [dB(A)]	WEIGHT [kg]	SUITABLE FOR LARGE DOORS [mm]
12450050	230 ac	50	192	12	1596	58	23,8	L1000 H3000
12450060	230 ac	50	256	12.5	2125	60	32,8	L1500 H3000
12450070	230 ac	50	384	13	3195	62	48,2	L2000 H3000

CODE	DESCRIPTION
12450050	WALL-MOUNTED CENTRIFUGAL AIR CURTAIN "AIRFOR3 WALL" 1000 WITH UPPER AIR INTAKE
12450060	WALL-MOUNTED CENTRIFUGAL AIR CURTAIN "AIRFOR3 WALL" 1500 WITH UPPER AIR INTAKE
12450070	WALL-MOUNTED CENTRIFUGAL AIR CURTAIN "AIRFOR3 WALL" 2000 WITH UPPER AIR INTAKE



DOWNLOAD DATASHEET



APPLY AIR

AirFor3^{H20}

AIR FOR 3 H2O

 **CENTRIFUGAL AIR CURTAIN WITH FRONT EXTRACTION WITH HOT WATER COIL**

 **RIDEAU D'AIR CENTRIFUGE D'ASPIRATION FRONTALE AVEC BATTERIE A EAU CHAUDE**

 **ZENTRIFUGALLUFT MIT FRONTANSAUGUNG MIT WARMWASSER-BATTERIE**

TECHNICAL FEATURES

- 3 MODELS IN WHITE WITH SPEED CONTROLLER SUPPLIED
- 1/2" WATER EXCHANGER COUPLINGS
- AIR CURTAINS ARE DESIGNED FOR INDOOR USE
- THE UNIT MUST BE INSTALLED HORIZONTALLY MAXIMUM INSTALLATION HEIGHT 3 m

CARACTÉRISTIQUES TECHNIQUES

- 3 MODÈLES BLANCS AVEC RÉGULATEUR DE VITESSE FOURNI
- RACCORDS D'ÉCHANGEUR DE CHALEUR À EAU DE 1/2"
- LES RIDEAU D'AIR SONT CONÇUES POUR UNE UTILISATION À L'INTÉRIEUR
- L'UNITÉ DOIT ÊTRE INSTALLÉE HORIZONTALEMENT
- HAUTEUR MAXIMALE D'INSTALLATION 3 m

TECHNISCHE EIGENSCHAFTEN

- 3 MODELLE IN FARBE WEIÙE MIT DREHZAHLEGLER IM LIEFERUMFANG ENTHALTEN
- 1/2" WASSER-WÄRMETAUSCHER-ANSCHLÜÙE
- LUFTSCHLEIER SIND FÜR DIE VERWENDUNG IN INNENRÄUMEN BESTIMMT
- DAS GERÄT MUSS HORIZONTAL MONTIERT WERDEN
- MAXIMALE EINBAUHÖHE 3 m



WITH HOT WATER COIL

AirFor3^{H2O}

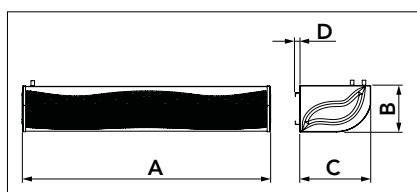

DIMENSIONS [mm]				
MODEL	A	B	C	D
1000	1010	280	425	25
1500	1510	280	425	27
2000	2010	280	425	27



ACCESSORIES



SPEED CONTROLLER SUPPLIED

CENTRIFUGAL MOTOR

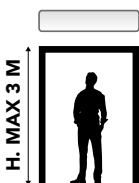

CODE	SUPPLY VOLTAGE [V]	FREQUENCY [Hz]	POWER CONSUMPTION [W]	AIR SPEED AT INLET [m/s]	AIR FLOW RATE [m³/h]	MEASUREMENT OF IN/OUT CONNECTIONS	AVERAGE WATER TEMPERATURE IN/OUT	HEAT OUTPUT [kW]	AVERAGE WATER FLOW [m³/h]	WEIGHT [kg]	SUITABLE FOR LARGE DOORS [mm]
CODE	TENSION D'ALIMENTATION [V]	FREQUEN-CE [Hz]	PUISSANCE ABSORBÉE [W]	VITESSE DE L'AIR À LA GRILLE [m/s]	DÉBIT D'AIR [m³/h]	MESURE CONNEXIONS ENTRÉE/SORTIE	TEMPÉRATURE MOYENNE DE L'EAU ENTRÉE/SORTIE	RENDEMENT EN PUISSANCE THERMIQUE [kW]	DÉBIT D'EAU MOYEN [m³/h]	POIDS [kg]	CONVIENT POUR PORTAILS [mm]
CODE	VERSOR-GUNGSSPAN-NUNG [V]	FREQUENZ [Hz]	LEISTUNGS-AUFNAHME [W]	LUFTGE-SCHWIN-DIGKEIT AN DER ÖFFNUNG [m/s]	LUFTDUR-CHFLUSSRATE [m³/h]	ABMES-SUNG AN-SCHLÜÙE IN/OUT	DURCHSCH-NITTLICHE WASSERTEM-PERATUR IN/OUT	THERMI-SCHE LEI-STUNGS-AU-SBEUTE [kW]	MITTLERER WASSER-DURCHSATZ [m³/h]	GEWICHT [kg]	GEEIGNET FÜR TÜREN [mm]
12450090	230 ac	50	192	13	1590	1/2"	70°C/60°C	11.4	1	31,9	L.1000 H.3000
12450100	230 ac	50	256	13	2120	1/2"	70°C/60°C	16.1	1,42	45,1	L.1500 H.3000
12450110	230 ac	50	384	13	3190	1/2"	70°C/60°C	24.1	2,12	64	L.2000 H.3000

CODE	DESCRIPTION
12450090	CENTRIFUGAL AIR CURTAIN WITH HOT WATER COIL AND FRONT AIR INTAKE "AIRFOR3 H2O" 1000
12450100	CENTRIFUGAL AIR CURTAIN WITH HOT WATER COIL AND FRONT AIR INTAKE "AIRFOR3 H2O" 1500
12450110	CENTRIFUGAL AIR CURTAIN WITH HOT WATER COIL AND FRONT AIR INTAKE "AIRFOR3 H2O" 2000



DOWNLOAD DATASHEET



APPLY AIR

*AirFor*3^{CR}

AIR FOR 3 CR

 **CENTRIFUGAL AIR CURTAIN WITH FRONT EXTRACTION WITH ELECTRIC HEATING ELEMENT**

 **RIDEAU D'AIR CENTRIFUGE À ASPIRATION FRONTALE AVEC RÉSISTANCE ÉLECTRIQUE**

 **ZENTRIFUGALLUFT MIT FRONTANSAUGUNG MIT ELEKTRISCHEM WIDERSTAND**

TECHNICAL FEATURES

- 3 MODELS IN WHITE WITH SPEED CONTROLLER SUPPLIED
- 3 SPEEDS OPERATED BY REMOTE CONTROL
- AIR CURTAINS ARE DESIGNED FOR INDOOR USE
- THE UNIT MUST BE INSTALLED HORIZONTALLY
- MAXIMUM INSTALLATION HEIGHT 3 m

CARACTÉRISTIQUES TECHNIQUES

- 3 MODÈLES BLANCS AVEC RÉGULATEUR DE VITESSE FOURNI
- 3 VITESSES COMMANDÉES PAR TÉLÉCOMMANDE
- LES RIDEAU D'AIR SONT CONÇUES POUR UNE UTILISATION À L'INTÉRIEUR
- L'UNITÉ DOIT ÊTRE INSTALLÉE HORIZONTALEMENT
- HAUTEUR MAXIMALE D'INSTALLATION 3 m

TECHNISCHE EIGENSCHAFTEN

- 3 MODELLE IN FARBE WEIÙE MIT DREHZAHLEGLER IM LIEFERUMFANG ENTHALTEN
- 3 GESCHWINDIGKEITEN, MIT FERNBEDIENUNG BETRIEBEN
- LUFTSCHLEIER SIND FÜR DIE VERWENDUNG IN INNENRÄUMEN BESTIMMT
- DAS GERÄT MUSS HORIZONTAL MONTIERT WERDEN
- MAXIMALE EINBAUHÖHE 3 m



AirFor3^{CR}

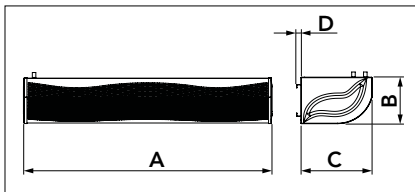

DIMENSIONS [mm]

MOD.	A	B	C	D
1000	1010	280	425	25
1500	1510	280	425	27
2000	2010	280	425	27

ACCESSORIES



REMOTE CONTROL INCLUDED

CENTRIFUGAL MOTOR

PANEL WITH 3 COLOURED LEDES

MADE IN ITALY 

CODE	SUPPLY VOLTAGE [V]	FREQUENCY [Hz]	POWER CONSUMPTION [W]	AIR SPEED AT INLET [m/s]	AIR FLOW RATE [m³/h]	SOUND POWER LEVEL [dB(A)]	ΔT AIR WITH HEATING ELEMENTS [°C]	POWER CONSUMPTION WITH PARTIAL LOAD RESISTANCE [W]	POWER ABSORBED WITH FULL LOAD RESISTANCE [W]	WEIGHT [kg]	SUITABLE FOR LARGE DOORS [mm]
CODE	TENSION D'ALIMENTATION [V]	FRÉQUENCE [Hz]	PUISSANCE ABSORBÉE [W]	VITESSE DE L'AIR À LA GRILLE [m/s]	DÉBIT D'AIR [m³/h]	NIVEAU DE PUISSANCE ACOUSTIQUE [dB(A)]	ΔT AIR AVEC RÉSISTANCES [°C]	PUISSANCE ABSORBÉE AVEC RÉSISTANCE DE CHARGE PARTIELLE [W]	PUISSANCE ABSORBÉE AVEC RÉSISTANCE À PLEINE CHARGE [W]	POIDS [kg]	CONVIENT POUR PORTAILS [mm]
CODE	VERSORUNGSSPANNUNG [V]	FREQUENZ [Hz]	LEISTUNGSAUFNAHME [W]	LUFTGESCHWINDIGKEIT AN DER ÖFFNUNG [m/s]	LUFTDURCHFLUSSRATE [m³/h]	SCHALLLEISTUNGSPEGEL [dB(A)]	ΔT DER LUFT MIT WIDERSTÄNDEN [°C]	LEISTUNGSAUFNAHME BEI TEILLASTWIDERSTAND [W]	LEISTUNGSAUFNAHME BEI VOLLASTWIDERSTAND [W]	GEWICHT [kg]	GEEIGNET FÜR TÜREN [mm]
CENTRIFUGAL AIR CURTAINS WITH 3 RESISTANCES L: 1000											
12450090R2	400 ac	50	180	I:10 II:11,5 III:12,5	I:1288 II:1430 III:1590	I:56 II:59 III:62	19	3800	5700	33	L.1000 H.3500
CENTRIFUGAL AIR CURTAINS WITH 6 RESISTANCES L: 1500 / 2000											
12450100R2	400 ac	50	240	I:10 II:11,5 III:12,5	I:1717 II:1908 III:2120	I:58 II:61 III:64	17	6400	9600	48	L.1500 H.3500
12450110R2	400 ac	50	360	I:10 II:11,5 III:12,5	I:2584 II:2870 III:3190	I:60 II:63 III:66	17	7600	11400	67	L.2000 H.3500

CODE	DESCRIPTION
12450090R2	CENTRIFUGAL AIR CURTAIN WITH 3 RESISTANCES AND FRONT AIR INTAKE "AIRFOR3 CR" 1000
12450100R2	CENTRIFUGAL AIR CURTAIN WITH 6 RESISTANCES AND FRONT AIR INTAKE "AIRFOR3 CR" 1500
12450110R2	CENTRIFUGAL AIR CURTAIN WITH 6 RESISTANCES AND FRONT AIR INTAKE "AIRFOR3 CR" 2000



DOWNLOAD DATASHEET



ARIA1 POTENZA

ARIA 1 POTENZA

INDUSTRIAL CENTRIFUGAL AIR CURTAIN LARGE FLOW RATES WITH FRONT EXTRACTION

THIS HIGH-PERFORMANCE AIR CURTAIN USES THREE-PHASE MOTORS TO PROVIDE MAXIMUM AIRFLOW.

ITS PERFORMANCE ALLOWS INSTALLATIONS UP TO HEIGHTS OF 5 M, CREATING ACTUAL BARRIERS ON LARGE GATES, SUCH AS INDUSTRIAL GATES, LEAVING FREE THE MANOEUVRING PASSAGE OF PERSONS OR VEHICLES. THE UNIT CAN BE PLACED ON THE CEILING AND MUST BE INSTALLED HORIZONTALLY.

RIDEAU CENTRIFUGE INDUSTRIELLE À GRAND DÉBIT AVEC ASPIRATION

CETTE RIDEAU À AIR HAUTE PERFORMANCE UTILISE DES MOTEURS TRIPHASÉS POUR FOURNIR UN DÉBIT D'AIR MAXIMAL. SES PERFORMANCES PERMETTENT DES INSTALLATIONS JUSQU'À DES HAUTEURS DE 5 M, CRÉANT DE VÉRITABLES BARRIÈRES SUR LES GRANDES PORTES, TELLES QUE LES PORTES INDUSTRIELLES, LAISSANT LIBRE LE PASSAGE DES PERSONNES OU DES VÉHICULES EN MANŒUVRE. L'APPAREIL PEUT ÊTRE PLACÉ AU PLAFOND ET DOIT ÊTRE INSTALLÉ HORIZONTALEMENT.

INDUSTRIELLE ZENTRIFUGALLUFTBARRIERE, GROSSE DURCHFLOUWMENGEN, FRONTABSAUGUNG

DIESE HOCHLEISTUNGS-LUFT VERWENDET DREHSTROMMOTOREN, UM EINEN MAXIMALEN LUFTSTROM ZU GEWÄHRLEISTEN.

SEINE LEISTUNG ERMÖGLICHT INSTALLATIONEN BIS ZU EINER HÖHE VON 5 M, WODURCH ECHE SPERREN AN GROSSEN TÖREN, WIE INDUSTRIETÖREN, ENTSTEHEN, DIE DEN DURCHGANG VON PERSONEN ODER FAHRZEUGEN IM MANÖVER FREILASSEN. DAS GERÄT KANN AN DER DECKE ANGEBRACHT WERDEN UND MUSS WAAGERECHT INSTALLIERT WERDEN.



ON ROOM TEMPERATURE

ARIA1 POTENZA

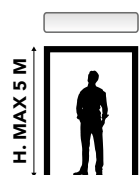

FIN TO REGULATE THE AIRFLOW DETAIL



DOWNLOAD DATASHEET



DIMENSIONS

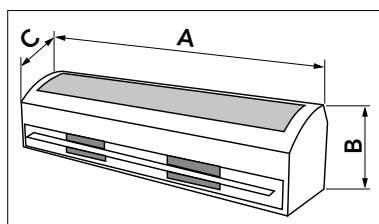

DIMENSIONS [mm]			
MOD	A	B	C
1000	1000	287	297
1500	1500	287	297

ACCESSORIES



CENTRIFUGAL MOTOR



CODE	SUPPLY VOLTAGE [V]	FREQUENCY [Hz]	POWER CONSUMPTION [W]	AIR SPEED AT INLET [m/s]	AIR FLOW RATE [m³/h]	SOUND POWER LEVEL [dB(A)]	WEIGHT [kg]	FOR DOORS WITH DIMENSIONS [mm]
CODE	TENSION D'ALIMENTATION [V]	FRÉQUENCE [Hz]	PUISSANCE ABSORBÉE [W]	VITESSE DE L'AIR À LA GRILLE [m/s]	DÉBIT D'AIR [m³/h]	NIVEAU DE PUISSANCE ACOUSTIQUE [dB(A)]	POIDS [kg]	POUR PORTES DE DIMENSIONS [mm]
CODE	VERSORUNGSSPANNUNG [V]	FREQUENZ [Hz]	LEISTUNGS-AUFNAHME [W]	LUFTGESCHWINDIGKEIT AN DER ÖFFNUNG [m/s]	LUFTDURCHFLOUSTRATE [m³/h]	SCHALLLEISTUNGSPEGEL [dB(A)]	GEWICHT [kg]	FÜR TÜREN MIT ABMESSUNGEN [mm]
12300042	380 ac	50	1100	28	3709	64	32,7	H MIN.3000 H MAX.5000
AAC400001	380 ac	50	1850	28	5563	68	52	H MIN. 3000 H.MAX. 5000



CODE	DESCRIPTION
12300042	HIGH PERFORMING AIR CURTAIN WITH FRONT EXTRACTION "ARIA1 POTENZA" 1000
AAC400001	HIGH PERFORMING AIR CURTAIN WITH FRONT EXTRACTION "ARIA1 POTENZA" 1500

SPARE PARTS FOR AIR CURTAINS



AUTOMATIC START KIT FOR AIR CURTAINS

THE KIT CAN BE USED IN THE FOLLOWING MODELS OF AIR CURTAINS:

- AIRJET
- ARIA 3 SILENCE (WITH RESISTANCE) *
- ARIA 3 SILENCE FRONT
- ARIA 2 ELEGANCE T
- ARIA 2 ELEGANCE TR *
- ARIA 2 ELEGANCE CR *
- AIR FOR 3 CR *



KIT DÉMARRAGE AUTOMATIQUE POUR BARRIÈRES D'AIR

LE KIT PEUT ÊTRE UTILISÉ DANS LES MODÈLES DE BARRIÈRES D'AIR SUIVANTS :

- AIRJET
- ARIA 3 SILENCE (WITH RESISTANCE) *
- ARIA 3 SILENCE FRONT
- ARIA 2 ELEGANCE T
- ARIA 2 ELEGANCE TR *
- ARIA 2 ELEGANCE CR *
- AIR FOR 3 CR *



AUTOMATISCHER STARTER-KIT FÜR LUFTSCHLEIER

DER BAUSATZ KANN IN DEN FOLGENDEN MODELLEN VON LUFTSCHLEIERN VERWENDET WERDEN:

- AIRJET
- ARIA 3 SILENCE (MIT HEIZKÖRPER) *
- ARIA 3 SILENCE FRONT
- ARIA 2 ELEGANCE T
- ARIA 2 ELEGANCE TR *
- ARIA 2 ELEGANCE CR *
- AIR FOR 3 CR *



DOWNLOAD DATASHEET

* FOR THE BUILT-IN MODELS "ARIA2 ELEGANCE TR - "ARIA2 ELEGANCE CR" - " ARIA3SILENCE" (WITH HEATING ELEMENT) PAY ATTENTION TO THE INSTALLATION METHODS OF THE AUTOMATIC STARTER KIT ILLUSTRATED IN THE USER MANUAL.

MADE IN ITALY

CODE	DESCRIPTION
12300058	AUTOMATIC START KIT FOR AIR CURTAIN



REMOTE CONTROL FOR AIR CURTAINS



TÉLÉCOMMANDE POUR BARRIÈRES D'AIR



FERNBEDIENUNG FÜR LUFTSCHLEIER

CE MADE IN ITALY

AVAILABLE FOR AIR CURTAINS UNTIL MARCH 2017



DOWNLOAD DATASHEET



CODE	DESCRIPTION
C3000039	REMOTE CONTROL FOR AIR CURTAIN WITH RESISTANCE



REMOTE CONTROL FOR AIR CURTAINS



TÉLÉCOMMANDE POUR RIDEAU D'AIR



FERNBEDIENUNG FÜR LUFTSCHLEIER

CE

AVAILABLE FOR AIR CURTAINS FROM APRIL 2017



DOWNLOAD DATASHEET



CODE	DESCRIPTION
C60000625	REMOTE CONTROL FOR AIR CURTAIN WITH RESISTANCE PARTIAL ELECTRIC LOAD
C60000626	REMOTE CONTROL DEVICE FOR AIR CURTAIN WITHOUT RESISTANCE
C60000631	REMOTE CONTROL DEVICE FOR AIR CURTAIN WITH RESISTANCE



CEILING WALL BRACKET
FOR AIR CURTAINS



SUPPORT AU PLAFOND
POUR BARRIÈRES D'AIR



DECKENKONSOLE FÜR
LUFTSCHLEIER

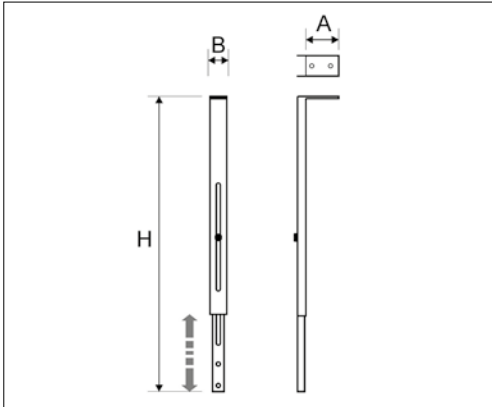

DIMENSIONS [mm]			
A	B	H.MIN.	H MAX.
120	45	450	770



MADE IN ITALY

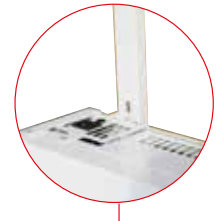

DOWNLOAD
DATASHEET

CODE	DESCRIPTION
12300057	CEILING WALL BRACKET FOR AIR CURTAINS



ELECTRIC MOTOR FOR AIR
CURTAINS



MOTEUR ÉLECTRIQUE
POUR RIDEAU D'AIR



ELEKTROMOTOR FÜR
LUFTSCHLEIERN

SINGLE
CAMSHAFT MOTOR

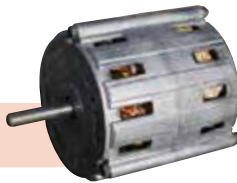

DOUBLE
CAMSHAFT MOTOR



CODE	DESCRIPTION	TIPO MOTORE
C60000097	ELECTRIC MOTOR FOR AIR CURTAIN MODEL T100 COMMERCIAL	M
C60000102	ELECTRIC MOTOR FOR AIR CURTAIN 1500/2000 RESIDENTIAL	B



DOWNLOAD
DATASHEET



ELECTRONIC BOARD FOR
AIR CURTAIN



CARTE ÉLECTRONIQUE
POUR RIDEAU D'AIR



ELEKTRONISCHE PLATINE
FÜR LUFTSCHLEIER

AVAILABLE FOR AIR CURTAINS FROM MARCH 2017

CODE	DESCRIPTION
C30000038	ELECTRONIC BOARD FOR AIR CURTAIN WITH RESISTANCE
C30000040	ELECTRONIC BOARD FOR AIR CURTAIN WITHOUT RESISTANCE

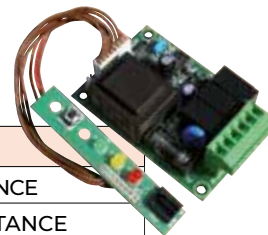

DOWNLOAD
DATASHEET



ELECTRONIC BOARD FOR
AIR CURTAIN



CARTE ÉLECTRONIQUE
POUR RIDEAU D'AIR



ELEKTRONISCHE PLATINE
FÜR LUFTSCHLEIER



MADE IN ITALY

AVAILABLE FOR AIR CURTAINS FROM APRIL 2017

CODE	DESCRIPTION
C60000623	ELECTRONIC BOARD FOR CENTRIFUGAL AIR CURTAIN DOUBLE RESISTANCE
C60000624	ELECTRONIC BOARD FOR TANGENTIAL AIR CURTAIN
C60000629	ELECTRONIC BOARD FOR AIR CURTAIN ONE RESISTANCE

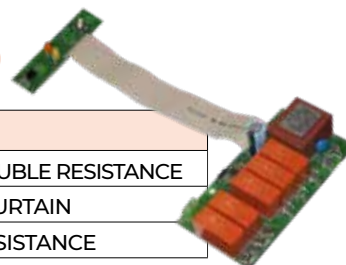

DOWNLOAD
DATASHEET



ALUMINIUM FAN FOR AIR CURTAIN



VENTILATEUR EN ALUMINIUM POUR RIDEAU D'AIR



ALUMINIUMVENTILATOR FÜR LUFTSCHLEIER



DOWNLOAD DATASHEET

CODE	DESCRIPTION
C60000053D	ALUMINIUM FAN FOR AIR CURTAIN 900DX WITH AND WITHOUT RESISTANCE
C60000053S	ALUMINIUM FAN FOR AIR CURTAIN 900DX WITH AND WITHOUT RESISTANCE
C60000058S	ALUMINIUM FAN FOR AIR CURTAIN 1100SX/2000 RESIDENTIAL WITH AND WITHOUT RESISTANCE
C60000048D	ALUMINIUM FAN FOR AIR CURTAIN 1500 DX RESIDENTIAL WITH AND WITHOUT RESISTANCE
C60000048S	ALUMINIUM FAN FOR AIR CURTAIN 1500 SX RESIDENTIAL WITH AND WITHOUT RESISTANCE
C60000057D	ALUMINIUM FAN FOR AIR CURTAIN 1100DX/2000 INDUSTRIAL WITH AND WITHOUT RESISTANCE
C60000057S	ALUMINIUM FAN FOR AIR CURTAIN 1100SX/2000 INDUSTRIAL WITH AND WITHOUT RESISTANCE
C60000047D	ALUMINIUM FAN FOR AIR CURTAIN 1500 DX INDUSTRIAL WITH AND WITHOUT RESISTANCE
C60000047S	ALUMINIUM FAN FOR AIR CURTAIN 1500 SX INDUSTRIAL WITH AND WITHOUT RESISTANCE



JACK FOR ELECTRONIC AIR CURTAIN BOARD



PRISE POUR CARTE ÉLECTRONIQUE RIDEAU D'AIR



BUCHSE FÜR ELEKTRONISCHE LUFTSCHLEIERPLATINE

FOR MODEL "ARIA3 SILENCE" - "ARIA3 SILENCE FRONT"

CODE	DESCRIPTION
C60000609	JACK FOR ELECTRONIC AIR CURTAIN BOARD



DOWNLOAD DATASHEET



220V SINGLE PHASE SPEED REGULATOR



RÉGULATEUR DE VITESSE MONOPHASÉ 220 V



DREHZAHLEGLER 220V EINPHASEN

THE ELECTRONIC SPEED REGULATOR MAKES IT POSSIBLE TO VARY THE AIR FLOW OF THE HEAT RECOVERY ELEMENT AND OF THE BARRIER FROM 30% TO 100% OF ITS PERFORMANCE.

LE RÉGULATEUR DE VITESSE ÉLECTRONIQUE PERMET DE FAIRE VARIER LE DÉBIT D'AIR DE L'UNITÉ DE RÉCUPÉRATION DE CHALEUR ET DE LA RIDEAU D'AIR DE 30% À 100% DE SES PERFORMANCES.

MIT DEM ELEKTRONISCHEN DREHZAHLEGLER KÖNNEN SIE DEN LUFTSTROM DER WÄRMERÜCKGEWINNUNGSEINHEIT UND DER BARRIERE VON 30 % BIS 100 % IHRER LEISTUNG VARIIEREN.



FOR CODES SEE AT APPLY.CO CATALOG

APPLY.AIR INDEX CATALOG 36

CODE	PAGE
12300033	34
12300033R3	36
12300035	34
12300035R3	36
12300036	44
12300037	44
12300038	40
12300039	40
12300042	52
12300044	42
123000445	42
12300050I	20
12300050RI	23
12300050RI2	24
12300051I	20
12300051RI	23
12300051RI2	24
12300055I	20
12300055RI	23
12300055RI2	24
12300056I	20
12300056RI	23
12300056RI2	24
12300057	54
12300058	53
12400011	27
12400013	27
12400021	27
12400031	27
12450014	29

CODE	PAGE
12450014R2	32
12450014R3	32
12450024	29
12450024R2	32
12450024R3	32
12450030	34
12450030R3	36
12450034	29
12450034R2	32
12450034R3	32
12450050	46
12450060	46
12450070	46
12450090	48
12450090R2	50
12450092	38
12450100	48
12450100R2	50
12450102	38
12450110	48
12450110R2	50
12450112	38
AAC100001	42
AAC400001	52
AAD400001	17
AAD400002	17
AAD400003	17
AAD400004	17
C30000038	54

CODE	PAGE
C30000039	53
C30000040	54
C60000047D	55
C60000047S	55
C60000048D	55
C60000048S	55
C60000053D	55
C60000053S	55
C60000057D	55
C60000057S	55
C60000058S	55
C60000097	54
C60000102	54
C60000609	55
C60000623	54
C60000624	54
C60000625	53
C60000626	53
C60000629	54
C60000631	53

NOTE

