

# GREENHOUSES, SUNROOMS & CONSERVATORIES

Blending Timeless Charm with American Innovation



# Content Guide



**RESIDENCE | TWIN FALLS, ID**  
Curved Eave Lean-To Sunroom with Awning Windows



**GLASS HOUSE WINERY | FREE UNION, VA**  
Straight Eave Double Pitch Greenhouse with Pivot Windows



**RESIDENCE | REDDING, CT**  
Straight Eave Lean-To Conservatory with Irregular Conservatory Nose Dormer

- 3** About Us
- 4** Why Solar Innovations®?
- 5** Functional Spaces
- 6** Design Considerations
- 8** Greenhouses
- 10** Conservatories
- 12** Sunrooms
- 14** Pool & Spa Enclosures
- 16** Residential Applications
- 18** Commercial Applications
- 20** Traditional vs. Contemporary
- 21** Restoration & Replacement
- 22** Configurations
- 26** Structural Details
- 28** Foundation Types
- 30** Ventilation
- 31** Dormers & Lanterns
- 32** Skylights
- 34** Door & Window Integration
- 36** Shade Options
- 37** Screen Options
- 38** Wood Interiors
- 40** Decorative Elements
- 42** Greenhouse Accessories
- 44** Performance
- 45** Glazing Options
- 46** Finish Options
- 47** Our Process

# About Us



As an industry leader for more than 20 years, Solar Innovations® has a long history that is rooted in the heart of manufacturing with a deep passion for the American dream. As a single source provider of custom glass structures, skylights, windows, doors, and more, Solar Innovations® strives to endlessly innovate and design custom products throughout the world. Our products continue to develop and grow as a direct result of our dedication to the industry and the creativity of our customers.

By investing in our team and customers, we are proud to turn dreams into reality. All of our American made products are designed and manufactured at our campus in Pine Grove, PA, allowing for more flexibility to provide superior products and services. In addition, most of our engineering, product testing, and product

designing take place within our facility. By producing as many components as possible in-house, we have greater control over quality, lead times, and cost, which ultimately achieves better results for our customers.

Although Solar Innovations® comes from small and humble beginnings, we now reside in a 400,000-square-foot corporate and manufacturing space. With a three-building campus located on over 36 acres of land, our company continues to develop and grow by creating innovative designs and engineering new product lines. The Solar Innovations® team strives to forge its path into the future by promoting a strong spirit of unity, with the desire to be better today than yesterday.



## INNOVATIVE

Solar Innovations® – it's in the name. By constantly introducing new ideas with creative ways of thinking, our decisions take standard products to the next level. No project is too big or too small for us to handle.



## DURABLE

The strength and durability of our products are a promise. The majority of our applications are impact tested in-house, ensuring that every project can withstand the test of time in any environment.



## HIGH-PERFORMING

At Solar Innovations®, we are about superior results. Our company currently offers the largest, impact rated folding glass walls on the market and constantly strives to create the highest quality product possible.



## EASY TO OPERATE

All of our applications are user-friendly and straightforward. No matter the shape, size, or type of project you may have, our products remain practical and manageable for the ultimate customer experience.

# Why Solar Innovations®?

## SINGLE SOURCE PROVIDER

We are a single source supplier of aluminum, wood, and vinyl-composite glazing systems which all help to create consistency throughout your project. Solar Innovations® provides all fasteners, silicone, sill flashings, and project specific shop drawings (unless stated otherwise on our proposal).

## IN-HOUSE TESTING

With two in-house test labs, the quality of our products is second to none and includes some of the highest ratings in class. Solar Innovations® offers a vast line of tested products that meet various certifications, including NFRC, AAMA, Florida Impact, Miami Dade, and TDI. Our products can be specifically designed and engineered to your project location.

## ECO-FRIENDLY PRODUCTS

We are proud that our materials are sourced from local suppliers; not only does this help boost our local economy, but it also reduces transportation times and fuel emissions to help lower the impact on the environment. Our products are designed for high thermal performance, making them an energy efficient option for homes and commercial spaces. Even more, our systems include recycled content and are LEED friendly. Possible LEED credits are available in the following categories: Materials & Resources (recycled content), Indoor Environmental Quality (daylight), Energy & Atmosphere (performance), and Regional Priority (within 500 miles of our facility). Depending on the application, other credits may also apply. Solar Innovations® is proud to be a LEED Gold certified manufacturing facility.

## COASTAL APPLICATIONS

Our systems have the ability to meet coastal requirements, limiting visible wear and tear. We have advanced aluminum finishes and stainless steel components in our hardware, making our materials durable against the corrosive effects of the elements in coastal regions.

## INSTALLATION

Whether a product is purchased directly from our manufacturing facility or through our dealer network, Solar Innovations® can provide installation and service for all of our products within a six-hour radius of Pine Grove, PA. Our expertly trained team is registered to complete installation and service work in an ever increasing number of states (consult our sales department for a current listing).

## REPAIR & REPLACEMENT SERVICES

Our team has the technical skill and experience to evaluate your situation and determine the most effective options for the repair, service, or replacement that is needed for your project. All drawings and information are saved for each project, so a site visit will not always be required.



**RESIDENCE | DENVER, CO**

Straight Eave Double Pitch Conservatory with G2 Terrace Door



**RESIDENCE | RIDGEFIELD, CT**

Straight Eave Lean-To Greenhouse

# Functional Spaces



RESIDENCE | NORTH SALEM, NY  
Straight Eave Double Pitch Sunroom

## What is the Difference Between a Conservatory, Greenhouse, and Sunroom?

Sunrooms, greenhouses, and conservatories are functionally very similar, but are differentiated by the level of stylistic decor present in the structures' design. For example, conservatories are typically highly decorative and period specific; they can feature window grids, finials, crown molding, Palladian arches, ridge cresting, and other decorative elements.

### CONSERVATORY

Conservatories are glazed structures that feature a glass roof and/or glass walls. These structures can be attached to existing construction or be manufactured as stand-alone units. The term "conservatory" is more commonly used in Europe, especially in England.

Conservatories originated in the 16<sup>th</sup> century as a way to preserve citrus and other plants brought back by explorers to Europe. The original purpose of the English conservatories was to protect plants from strong breezes, wind, and extreme cold weather.

While conservatories can house and even propagate plants, their primary function is the creation of additional living space. Conservatories serve as seating areas, dining rooms, living rooms, kitchen extensions, pool houses and more—the possibilities are endless.

### GREENHOUSE

A greenhouse is a structure in which plants are grown. It can be large or small and constructed out of various materials, such as glass, plastic, or aluminum. Greenhouses heat up by absorbing and retaining visible sunlight.

During the 13<sup>th</sup> century, greenhouses—called botanical gardens—were built in Italy to house the plants explorers brought back from the tropics. Charles Lucien Bonaparte, a French botanist and nephew of Napoléon Bonaparte, is credited with building the first modern greenhouse in Holland in the 1800s to grow medicinal tropical plants.

Greenhouses offer a wide variety of options to any level of gardener and can be used year-round.

### SUNROOM

Sunroom—also known as a solarium—is a term most commonly used in countries such as the United States, Australia, New Zealand, and Canada, and is typically less decorative than a conservatory. The room can either be added to a building or be attached to a pre-existing room that can then be modified to become a sunroom by replacing the roof with glass.

Grids can be integrated into windows, ridge cresting can adorn the structure's roof line, and/or a Palladian arch can be inserted into a gable end to provide stylistic accents.

Sunrooms can also create a unique focal point or blend seamlessly into the surrounding architecture.

# Design Considerations



**RESIDENCE | SOMERVILLE, MA**

Straight Eave Lean-To Sunroom with G2 Multi-Track Sliding Glass Doors

## **BUILDING IN REGULATED AREAS**

Townships and building developments have varying regulations associated with construction. It is important to adhere to municipal ordinances beginning with a project's development. We recommend you provide Solar Innovations® with a full set of regulations so we can assure your structure adheres to specifications. Renderings can be created for submission and approval before a project is finalized.

Historic districts may have specific requirements for all building alterations to ensure they match the aesthetic standard, so your structure may be subject to the same regulations. We can manufacture historically styled structures guaranteed to blend seamlessly with period homes. Profiled rafters are available, as well as cladding options, window grids, finials, and ridge cresting. We will work diligently to ensure your structure meets regulations.

## **SIZING**

Deciding on the size of your structure can be challenging, especially if you are not restricted by your property size. Before finalizing your plans, please consider the following tips to find an appropriate structure size:

- Identify the desired function of the structure.
- Account for the structures' required capacity for both people and/or plants.
- An interior floor plan—including walkways, windows, and doors—can be created on-site. Roughly 1 foot from each wall will be consumed by the foundation and framing. Take into account that a comfortable walking path is normally 36 inches wide.

## **GLAZING**

In most cases, clear glass is recommended as the best choice for your project if you intend on housing delicate plants that may be harmed by direct sunlight. If your structure is designed to be combined with your daily living space, Low-E glass may be a good choice. Low-E glass reduces the U-value of the glass, meaning it protects plants and helps maintain temperature.

## **LOCATION**

Structures should be positioned to receive maximum sunlight exposure. A southern facing structure will receive the most consistent amount of direct sunlight and passive heat gain. A northern facing structure receives the least amount of sunlight and may require a heating system during colder weather.

Your structure does not have to be limited to a ground floor installation. In urban areas, where vertical expansion may be the only option, rooftops and balconies provide creative solutions for entertainment and dining areas. Our in-house engineers ensure your project will meet specific wind and snow loads for elevated applications.

## **BASE WALL**

Solar Innovations® recommends a standard 33-inch base wall for any enclosure that will contain multiple furnishings. The reason for this is to conceal furniture backs, wires, or any other contents that are not visually pleasing from the outside. If a base wall is used, it can be constructed to match the existing design of the house and make the transition between structures uniform.

## NEARBY TREES

Many customers and clients become concerned with trees located on the property near their structure, specifically whether or not falling trees may break the glass. Should the structure actually suffer an impact, the use of tempered and laminated glass will reduce the risk of breakage or leaks. Trees can actually be beneficial to an enclosure. A deciduous tree will provide shade from summer heat and allow sunlight into the structure during the winter months. Solar does not recommend locating your structure near an evergreen tree since it can block winter sunlight. Keep in mind that large trees and buildings can hinder the light coming in during specific times of day.

## ELEVATION

While ground level structures may be the most common, second story or taller installations are also possible. In urban areas, a structure can provide extra space to entertain on rooftops. Other applications of second story installations can also include balconies and terraces. The installation of a structure on the second floor of a building allows the owner to take advantage of the scenic views of the city skyline or nearby mountains.

## ATTACHING TO AN EXISTING STRUCTURE

To make sure your project runs smoothly, you will need to provide all of the details that describe the surface which the enclosure will be attaching to. Also remember to consider window and door locations to allow for proper clearance.

The following options are recommendations by Solar Innovations®:

- A standard 33-inch base wall for any enclosure that will contain multiple furnishings.
- Allow at least 1 foot of clearance under any existing roof overhang to provide adequate space for flashing and other ridge connections.
- When furnishing your structure, be sure to consider the environment of the space—there is a lot of sunlight and the possibility of moisture may increase.

## HEATING

The best way to maximize the investment in a glass structure is to ensure it can be used year-round. Solar Innovations® offers customers both roof mounted and floor mounted heating units which can be powered by electricity, natural gas, or propane. If an alternative heating method is desired, like radiant floor heat, we can provide the heating load requirement for our glass structure in your location.

## COOLING

Cooling a glass structure is equally important for annual use. Solar Innovations® reduces the amount of mechanical cooling needed by recommending the best Low-E coated glass for your location. This minimizes solar heat gain while maximizing natural ventilation and shading in the design. If some mechanical cooling is needed, we can offer pad-mounted evaporative coolers. This method of cooling also provides fresh air exchanges, which are highly beneficial to plants.

## SECURITY

Solar Innovations® recognizes that security is a high priority when purchasing a glass structure. The use of tempered glass is a structure's main security feature—intruders cannot simply break a window with a blunt object. Structures also feature no exterior fasteners, and glazing bars cannot be unscrewed to gain access to the building since all screws are safely hidden behind a cap. For extra safety, doors feature semi-concealed hinges that cannot be removed from the exterior. Our doors can also include a two point locking system that deploys a bolt in the head and the sill.



**RESIDENCE | WESTPORT, CT**  
Straight Eave Lean-To Sunroom with Hip End



**RESIDENCE | MONUMENT, CO**  
Irregular Polygon Conservatory



**RESIDENCE | BLOOMINGTON, IN**  
Straight Eave Double Pitch Greenhouse

# Greenhouses



**RESIDENCE | MILL NECK, NY**  
Straight Eave Double Pitch Greenhouse with Dormer



**RESIDENCE | PHILADELPHIA, PA**  
Straight Eave Lean-To Greenhouse



**RESIDENCE | WARWICK, NY**  
Straight Eave Double Pitch Greenhouse with Straight Eave Double Pitch Dormers, Awning Windows, and G2 French Doors





**RESIDENCE | LARKSPUR, CO**  
Straight Eave Double Pitch Greenhouse

## Gardening Under Glass

Greenhouses can be designed to any specification you like—no two products are the same. Every greenhouse that leaves the Solar Innovations® facility is completely custom. From big to small, we can create the perfect greenhouse for you. Our design team will work with you on your wants and needs, while also recommending suggestions to help ensure you have a properly functioning greenhouse.

Every greenhouse Solar Innovations® manufactures is constructed out of durable aluminum. This means the frame will not rot, warp, rust or require constant finish maintenance. The aluminum is an excellent choice for greenhouses and will last for years to come. Snow, wind, hail, and rain do not typically cause damage to the frame's exterior. There are eight standard colors available, along with any custom color you may require.

### ACCESSORIES

A great benefit of a Solar Innovations® greenhouse is being able to complete your project all in one place. We offer a complete line of greenhouse accessories ensuring your project is consistent and cohesive:

- Benches
- Environmental Control Systems
- Plant Hangers
- Ridge & Eave Vents
- Heaters
- Evaporative Coolers
- Irrigation Systems
- Shelves
- Circulation Fans
- Humidifiers

More information available on page 42-43.

### DECORATIVE ELEMENTS

Many times a customer is looking for a greenhouse that is more than just the "run-of-the-mill" greenhouse. We have one of the largest selections of extruded aluminum decorative elements available in the industry:

- Corner Columns
- Ridge Cresting
- Gable Pediments
- Base Panels
- Appliqués
- Grids
- Gutters
- Ring & Collars
- Eave Spandrels
- King Posts
- Finials

More information available on page 40-41.

# Conservatories



RESIDENCE | DENVER, CO

Straight Eave Double Pitch Conservatory with G2 Terrace Door

# The Perfect Escape

Our classic conservatories are custom designed with elegant lines and superior detail. Solar Innovations® has the in-house manufacturing capabilities to create custom structures in any size or configuration with no limit to the amount of windows, doors, or decorative elements.

## RESIDENTIAL APPLICATIONS

Conservatories can be used in residential settings as a dining room, family room, or game room. They are perfect for entertaining guests, and the natural light makes them an ideal environment for growing plants.

## CLADDING

Copper, stainless steel, and lead coated copper cladding options are available for use on the interior or exterior of your conservatory.

## ORANGERIES

Our custom conservatories can also be adapted to a structure's traditional framing. This type of conservatory is known as an orangery. An orangery blends conventional construction—which includes cement, vinyl, stucco, or wood—with aluminum framed skylights, doors, and windows. Our aluminum system can easily match trims and grid styles in standard wood construction as well.

## ENGLISH & VICTORIAN CONSERVATORIES

The charm and beauty of classic conservatories cannot be surpassed. With elegant lines and exquisite detail, conservatories are the ultimate extension between your living space and the environment, providing a functional sanctuary with unparalleled beauty. English and Victorian styles are a common traditional look.

## DECORATIVE ELEMENTS

Solar Innovations® offers the most complete line of extruded aluminum decorative elements in the industry, including:

- Corner Columns
- Ridge Cresting
- Gable Pediments
- Base Panels
- Appliqués
- Grids
- Gutters
- Ring & Collars
- Eave Spandrels
- King Posts
- Finials

More information available on page 40-41.



RESIDENCE | MANHASSET, NY

Straight Eave Double Pitch Conservatory with Double Pitch Dormer



RESIDENCE | NEEDHAM, MA

Straight Eave Double Pitch Conservatory with Hip End



RESIDENCE | WEST CHESTER, PA

Bull Nose Conservatory

# Sunrooms



**RESIDENCE | SANTA CLARA, NY**

Straight Eave Lean-To Sunroom with G3 Outswing French Doors



**RESIDENCE | ATHERTON, CA**

Ogee Double Pitch Sunroom with G2 Outswing French Doors

## Outdoor Living...Indoors

A sunroom, solarium, or patio enclosure is the perfect four-season addition to increase surrounding views and to create a focal point for any home or business. While a sunroom may look the same as a conservatory, they are typically seen as an extra room as opposed to an extension of the home or business.

We can design aluminum structures with various options for solid wood or wood laminate interiors. Glazed structures combine the strength and quality that Solar Innovations® is known for with the warmth that makes a house a home. Our structures can also be outfitted with heating and cooling units, which will allow you to enjoy your addition year-round.

### ROOF TYPE

One of the first decisions you will face is what type of roof your sunroom will have. You will need to decide the architecture of the roof, of course, including whether you opt for a standard, straight eave roof, or the elegance and symmetry of the curved roof. Or, perhaps you prefer the classic, eye-catching style of a bull nose roof.

### DECORATIVE ELEMENTS

Sunrooms can be designed to fit any style. A traditional, classic feel is very easy to achieve with our decorative elements. Raised base panels with appliques and grids can be added to each glass panel in your sunroom as well.

### NATURAL LIGHT

Fill your home with natural light and add the space you have always wanted with one easy sunroom addition. Exposure to natural sunlight is proven to nourish your mental health and reduce stress.

### IMPROVE QUALITY OF LIFE

Sunrooms bring drama and sophistication into your home, as well as your lifestyle. Adding a sunroom addition opens the flow of your floor plan and lends easy elegance to your entertaining style. From breakfast to stargazing, bring family and friends together with a Solar Innovations® sunroom.

More information available on page 40-41.



**RESIDENCE | ANDOVER, MA**  
Straight Eave Lean-To Sunroom



**RESIDENCE | MIDDLEBURY, CT**  
Straight Eave Lean-To Sunroom



**RESIDENCE | SOUTH CHINA, ME**  
Straight Eave Lean-To Spa Enclosure



**RESIDENCE | WINSTON-SALEM, NC**  
Straight Eave Double Pitch Conservatory Pool House



**RESIDENCE | ROCHESTER, NY**  
Straight Eave Double Pitch Pool Enclosure



**RESIDENCE | LEBANON, PA**  
Straight Eave Double Pitch Pool Enclosure

# Pool & Spa Enclosures



RESIDENCE | IRVINGTON, VA

Straight Eave Lean-To Pool Enclosure with G2 Folding Glass Walls

## Soak Up the Sun Year-Round

People across the world spend countless hours opening, closing, and cleaning their pool or spa. You can devote more time to enjoying your pool or spa by surrounding it with an enclosure manufactured by Solar Innovations®.

Creating a custom enclosure allows you to enjoy your pool or spa during every season. The variety of glazing options we offer allows the charm and beauty of nature to enter, while keeping out the snow, wind, rain, leaves, and insects. We use a non-corrosive aluminum framework and stainless steel fasteners that will withstand the elements in the high humidity, chemical filled environment of a pool or spa enclosure.

### POOL HOUSES

A pool house—also known as a pool cabana—is an alternative to a pool enclosure. Generally, it is a small structure that sits near the pool and can serve as a multi-purpose space for users. Almost any of Solar Innovations® products can be incorporated into a pool house.

Our glazed structures can be used as free standing pool houses, or any operable door or window system can be added to a conventionally constructed pool house to enhance function and aesthetics.

### ENTERTAINING

A pool house can create a unique entertaining space. The implementation of a pool house allows you to keep the party out of your home and contained to the area surrounding the pool, while still providing a conventional space. Instead of people tracking water and debris into your home after swimming, they can utilize the pool house for drinks, food, a changing room, or as a restroom.

### GUEST LIVING SPACE

Including a bedroom and bathroom in a pool house is always an added bonus—not only will this increase your home's value, it will also provide you with a private area for visiting guests away from the main living area.

### TROPICAL OASIS

Even in blizzard conditions, our enclosures can provide comfortable protection from the elements. Thermal break technology in our aluminum profiles create a stable temperature, maintaining a tropical indoor atmosphere in any climate or weather condition.

# Residential Applications



RESIDENCE | MECHANICSBURG, PA  
Straight Eave Hip End Conservatory

## Perfect Blend of Function and Detail

With elegant lines and exquisite detail, a glass structure from Solar Innovations® can be the ultimate extension between your living space and the environment, providing a functional sanctuary with unparalleled beauty. These structures allow you to comfortably enjoy the changing seasons without the harsh elements.

### ENTERTAINING

During the holiday season, a structure can serve as a gathering place for families or coworkers to socialize. A structure from Solar Innovations® allows you to take pleasure in spring flowers, autumn leaves, and winter snow while being in a social setting. Parties can be hosted and will create a unique environment where you are able to view the outdoors. Structures can also be purpose-specific and they make great studios for artists, providing inspiration from nature. The possibilities are virtually limitless.

### KITCHEN

A kitchen structure is typically an extension of an existing room that provides flexibility and additional space for entertaining purposes. During most gatherings, the kitchen inevitably becomes a gathering point and a Solar Innovations® structure can act as an "overflow" space. Our structures also provide additional natural lighting which will help to heat your home in the winter months. Consider adding additional ventilation to a kitchen structure to reduce food odors and the build up of steam while cooking.

### OFFICE

A structure can provide a unique at home office space. Home offices are often afterthoughts and end up being located in a renovated closet or basement, but by creating an inviting office space at home, business transactions can be more organized and will seem more professional when vendors and customers visit. Regardless, the structure will provide the added benefit of the natural views and daylight.

### FAMILY SPACES

Glass structures can provide a useful space for growing families. Children's toys can quickly take over a home and an added glass structure can easily be transformed into a playroom where children can safely play. Tables and chairs can also be added to make space for homework and craft projects. As your family matures, the space can be transformed into a hangout for teenagers by adding lounge seating and regular sized tables.





**RESIDENCE | NORTH SALEM, NY**  
17-Sided Conservatory Nose



**RESIDENCE | WILLISTON, VT**  
Straight Eave Lean-To Greenhouse



**RESIDENCE | WARREN, NJ**  
Straight Eave Double Pitch Conservatory with Hip End and Dormers

# Commercial Applications



# Combine Indoor Comfort with Breathtaking Views

Businesses often find commercial structures useful, as their primary function is the generation of revenue. The purpose of the conservatory, greenhouse, or sunroom may vary between business outlets. Common applications include display areas, dining, event facilities, and workshop spaces. Other applications include boutiques and florists, which use the structure for retail display space.

## RESTAURANTS

Solar Innovations® structures will allow your restaurant to be a unique space when compared to the competition. Our products will help to provide your business with a beautiful space with an unparalleled view of the outdoors. Restaurants often use these structures as a dining room, where patrons can enjoy a view while also enjoying their meal.

## OFFICE SPACES

A glass structure can provide unique office space for many businesses. A business can add a structure for their employees to house desks, or even use it as a conference space. Regardless, the space will provide the added benefit of natural views and additional daylight proven to increase employee morale.

## EDUCATIONAL FACILITIES

Greenhouses provide students with a unique opportunity to study horticulture first hand. Universities often conduct studies on plant growth, pesticides, and genetics, while vocational schools may propagate plants for landscaping course work. Elementary schools often utilize greenhouses to expose students to starting seeds and raising butterflies.

## SENIOR LIVING & MEDICAL FACILITIES

Personal care facilities—such as continuing care retirement communities and hospitals—utilize structures as an area for residents and patients to complete therapy. Group sessions and recreational activities can easily be performed in the space. Patients in a hospital can recuperate and enjoy the outdoors without risking the onset of a new illness from extreme weather conditions.

## RESORTS

When incorporating a Solar Innovations® glass structure into a hotel or resort, businesses will get that "wow" factor that will have them standing apart from the competition. Whether your entryway or pool needs a glass structure, or even a light and inviting sitting area, the options for creativity remain virtually endless.



LEE'S DINER | YORK, PA  
Straight Eave Lean-To Sunroom



YALE UNIVERSITY | NEW HAVEN, CT  
Straight Eave Double Pitch Greenhouse



ST. IGNATIUS RETIREMENT HOME | PHILADELPHIA, PA  
Irregular Straight Eave Double Pitch Conservatory

# Traditional vs. Contemporary

## HISTORIC CHARM

Classically designed English structures are the epitome of style and tradition. Solar Innovations® offers glass structures constructed of aluminum framing that will not require constant maintenance or suffer termite damage. Cast aluminum profiled rafters, wood grids, raised base panels, Palladian arches, finials, and ridge crestings can be added to complete the traditional appeal. English structures feature strong architectural styling and light interior design. The structures showcase

layered, muted fabrics in a variety of pastel colors. Floral patterns and small print fabric are commonly combined with wicker or rattan furniture to add airiness to the conservatory. Pinoleum blinds, which consist of small strips of wood, are often used on the ceiling and windows to help reduce glares and heat gain.

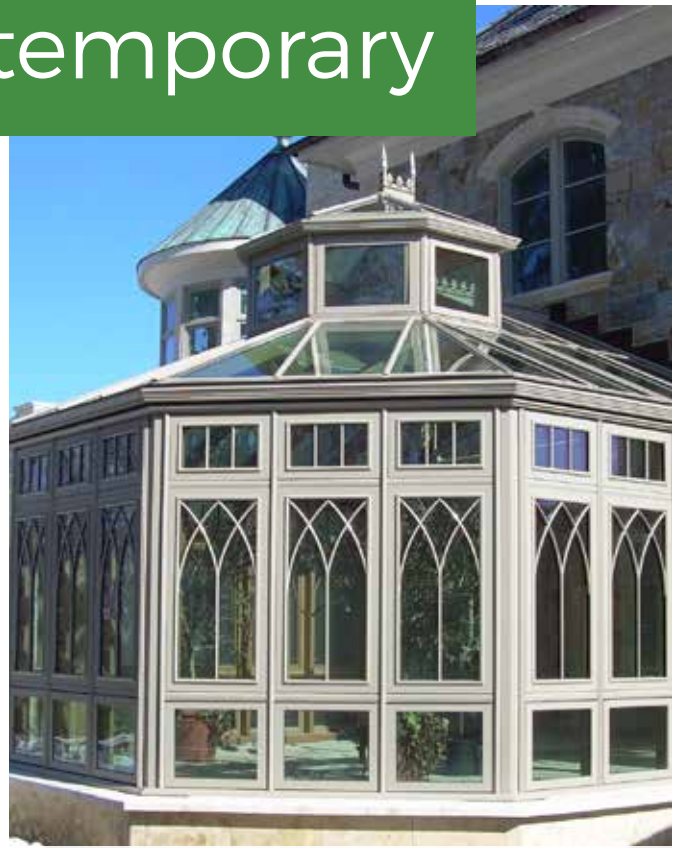
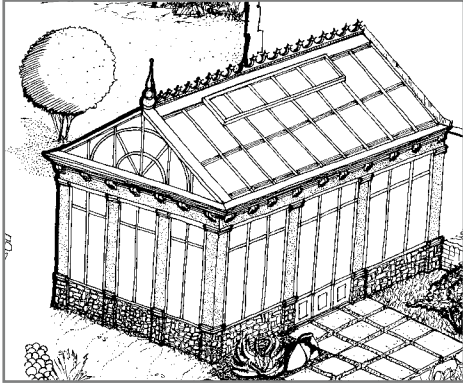

**RESIDENCE | MENDHAM, NJ**  
Straight Eave Double Pitch Conservatory

## MODERN INNOVATIONS

Modern style structures are often characterized by the simple forms and clean lines used to create their facades. These structures generally create a solid vs. void relationship by combining a variety of materials such as glass, concrete, and aluminum. The interior of a modern conservatory is usually minimalistic, clean, unadorned, and bold in color choice. Simple colors such as white, black, and gray are used throughout a modern space. Accents of bright colors such as red, blue, and yellow are used, but in moderation. Modern glass structures typically feature interior finishes that consist of natural looking materials like concrete, stainless steel, and wood. Sustainability is often a key factor in the selection of materials for modern styling.

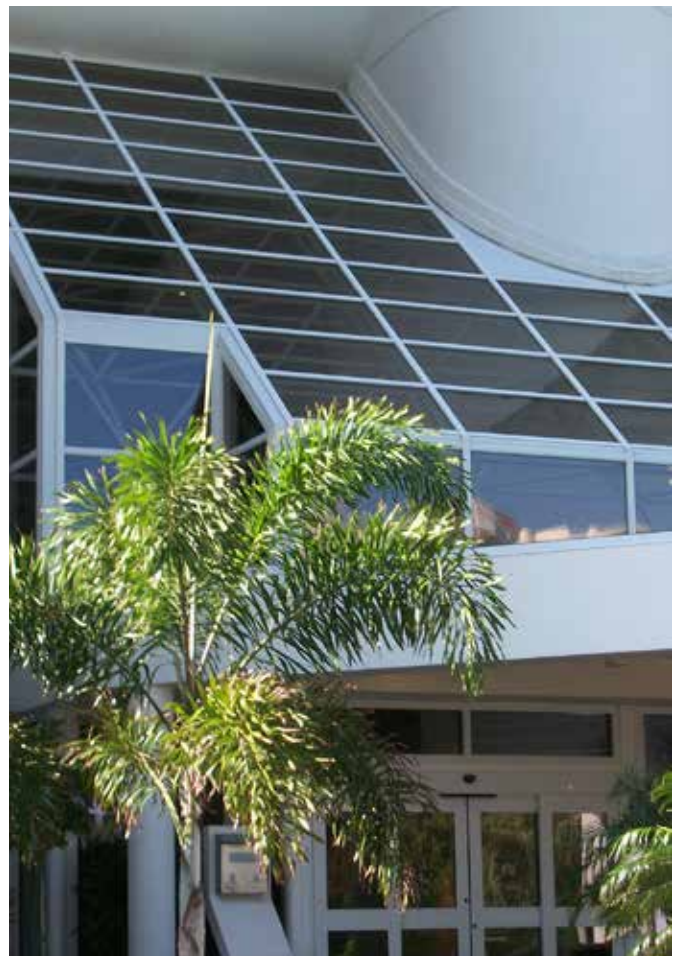
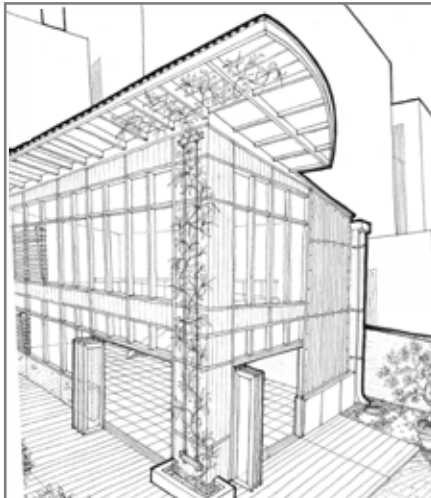

**CONDO COMPLEX | NAPLES, FL**  
Irregular Straight Eave Lean-To Sunroom

# Restoration & Replacement



BEFORE



AFTER

## Restoring Structures to Their Original Beauty

Antique conservatories and other glass structures can possess beautiful architecture, but require constant maintenance. Instead of removing these structures and destroying a piece of history, Solar Innovations® can restore these units to their original glory. Whether your structure requires a complete replacement or you are simply looking to restore certain aspects of your structure, we can provide the necessary services.

### **BUILDING REGULATIONS**

Historic districts often have specific requirements to ensure any building alterations adhere to the community's established aesthetic guidelines. A conservatory, be it new construction or a restoration project, may be subject to such regulations. Solar Innovations® manufactures historically styled conservatories that blend seamlessly with period specific homes. Historic elements such as profiled rafters, cladding options, window grids, finials, and ridge crestings are available.

### **MODERN ADDITIONS**

Although restorations are meant to maintain a structure's historic appeal, the addition of modern amenities—such as heating and cooling units, thermally-broken doors and windows, and insulated glazing—can provide your structure with added functionality. The addition of modern innovations to a classic structure will provide you with added comfort and flexibility.

### **GLAZING OPTIONS**

Many older structures are glazed with single-pane glass, which lacks insulation and the ability to deflect solar heat gain. Monolithic glass can allow the structure to become uncomfortable during extreme temperature fluctuations as well. Solar Innovations® can replace broken, missing, or even existing glass in your structure with high-performance, insulated glass to increase user comfort levels. Broken or aging capping and/or moldings can be updated with replacement aluminum parts that can be designed to look like their historic counterparts.

### **DOOR & WINDOW INTEGRATION**

We can also provide classically styled doors and windows that will seamlessly match your structure and retain its overall aesthetics. We make every effort to provide a structure with historic qualities that will not be compromised by its restoration.

# Configurations



RESIDENCE | MIDDLETOWN, RI

Straight Eave Double Pitch Greenhouse with Straight Eave Lean-To & Cold Frames

# Straight Eave Double Pitch

A straight eave double pitch configuration is the standard shape for free-standing structures. It provides a uniform space that is tallest along the center axis where the ridge runs directly overhead.

## GABLE ENDS

The pitch of the roof can be set at virtually any requested degree. Your structure will have either one or two gable ends depending upon its location in proximity to your home.

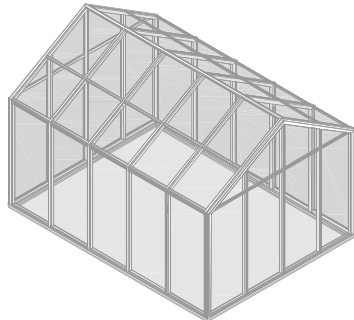

**RESIDENCE | GUILFORD, CT**

Straight Eave Double Pitch Conservatory with Casement Windows

# Straight Eave Lean-To

A straight eave lean-to structure tends to require a smaller investment. This structure style is directly attached to the building and allows for easy access during inclement weather. If you only have a small amount of space, this configuration is a great option and is equally impressive when used in large spans along a building.

## THERMAL ADVANTAGE

An advantage to this shape is the solid rear wall; the space acts as thermal storage for heat which helps to create a comfortable year-round environment.

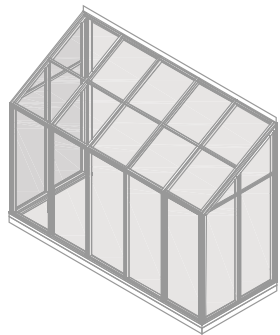

**RESIDENCE | MAMARONECK, NY**

Straight Eave Lean-To Conservatory

# Curved Eave Double Pitch

In a curved eave double pitch configuration, the structure's eaves—the point where the walls and roof meet—are curved as compared to straight. This style is often selected for the decorative elements. When no decorative elements are selected, it creates a modern appearance. The curve can begin high on the rafter to allow for more head room and furnishings, or lower for a more traditional look.

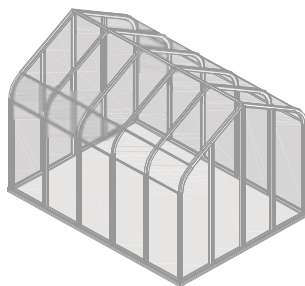

**RESIDENCE | SPRINGER, NM**

Curved Eave Double Pitch Greenhouse

# Curved Eave Lean-To

A curved eave lean-to has all the features of a straight eave lean-to with the difference being the point where the walls and roof meet are curved. These structures are usually attached to another facility where the existing structures can act as thermal storage for solar heat. They can also be utilized with large structures or along large lengths, such as a storefront.

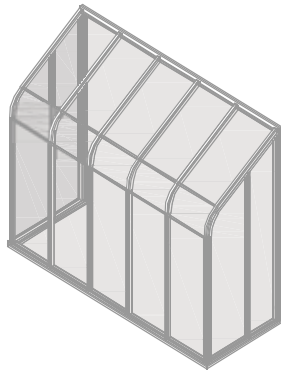

**RESIDENCE | HARRISBURG, PA**  
Curved Eave Lean-To Sunroom

# Hip End

The hip end roof is an attractive option and is typically selected for its aesthetic qualities. Each section of the roof slopes downward at a gentle pitch, eliminating gable ends. A hip end can easily be adapted to numerous design styles. This style is preferred in high wind areas due to the shape assisting with keeping wind flow to a minimum. The roof area will be smaller in scale than that of a double pitch, which can correlate to lower heating and cooling costs. Hip end structures can be attached to a building or be constructed as a freestanding unit.

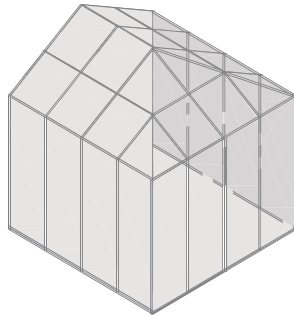

**RESIDENCE | WESTPORT, CT**  
Straight Eave Lean-To Conservatory with Hip End

# Ogee

Ogee configurations are named in reference to the inverted curved eaves that come to a peak at the roof. This shape is sometimes referred to as an "s-curve" or "ogee curve." Ogee style structures are a unique configuration that few manufacturers have the ability to properly execute, but our bending capabilities allow us to produce quality ogee curves in-house to minimize lead times.

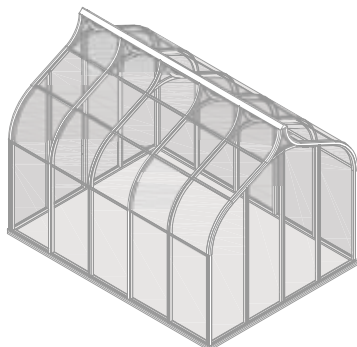

**RESIDENCE | NEW YORK, NY**  
Ogee Double Pitch Sunroom



# Bull Nose

Bull nose configurations are also commonly referred to as "conservatory nose" or "Victorian style". This design consists of a double pitch section that tapers into a "nose." The structure can also be designed as a lean-to where there is no double pitch section and the nose peak directly attaches to a house. Typically, the "nose" projects half the width of the structure and is comprised of 6 to 8 sections that form the radial shape. This is another style which can be easily equipped with accessories to achieve a traditional aesthetic.

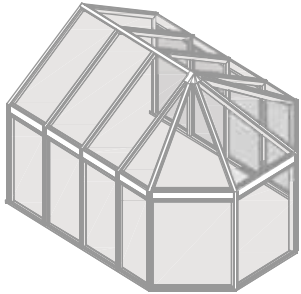

**RESIDENCE | CONCORD, MA**

Straight Eave Lean-To Conservatory with Bull Nose

# Custom Designs

Solar Innovations® specializes in custom structure configurations. If you have a uniquely shaped project in mind, you have come to the right place. No project is too small or too large; multiple turns, additional walls, and unique accessory operations are welcomed.

The structural accessories your project requires may need to be customized and we are capable of providing just that. Many manufacturers set a limit on the placement or number of windows allowed in a structure; Solar Innovations® allows you the freedom to incorporate as many windows as you see fit. The same is true for doors, ridge vents, and eave sashes.

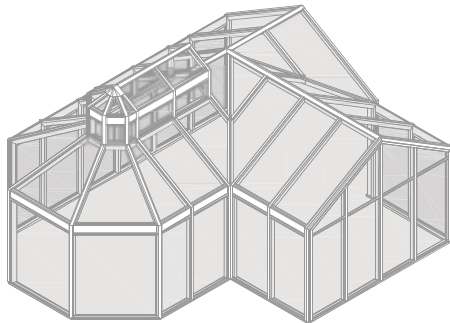

**RESIDENCE | FAR HILLS, NJ**

Straight Eave Pyramid Conservatory with Dormers & Lantern



**RESIDENCE | LOS RANCHOS, NM**

Straight Eave Lean-To Conservatory

# Structure Details

Solar Innovations® consistently works with customers, vendors, and dealers to achieve the best results possible for your structure. Below are a few details related to our glass structures to help you with the process. For further information or to download standard drawings, visit our website at [solarinnovations.com/information/downloads](http://solarinnovations.com/information/downloads). Proprietary details are only available upon request.

## SILL OPTIONS

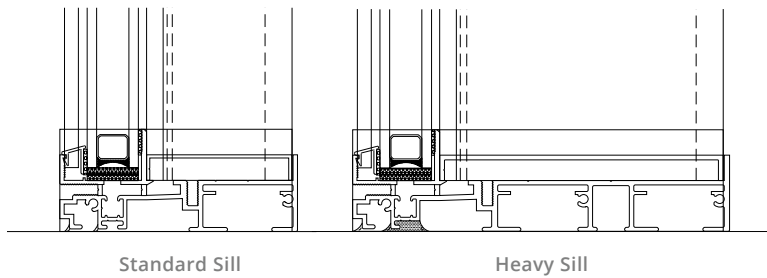

## MUNTIN OPTIONS

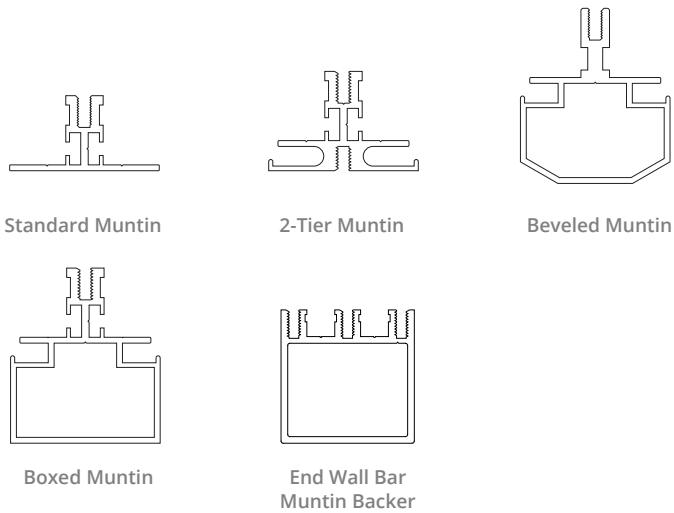

## COVER CAP OPTIONS

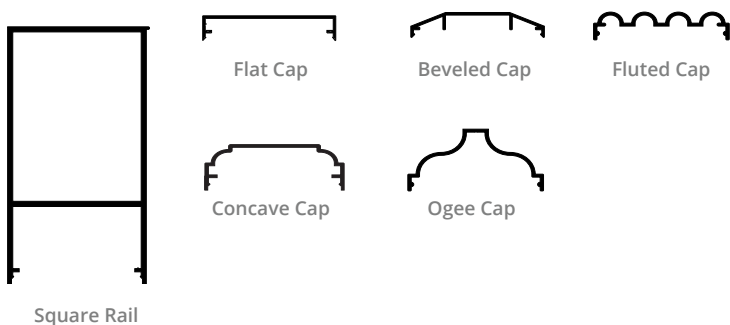

**RESIDENCE | MILLIS, MA**  
Irregular Pyramid Pool Enclosure



**RESIDENCE | AMHERST, MA**  
Straight Eave Lean-to Greenhouse with G2 Terrace Door



**RESIDENCE | GREENWICH, CT**  
Straight Eave Double Pitch Greenhouse

## Rafter Details

Solar Innovations® glazed structure rafters used in conservatories and sunrooms are available in two widths. Multiple length bars may be combined within one project to create a dynamic appearance while maintaining matching sightlines.

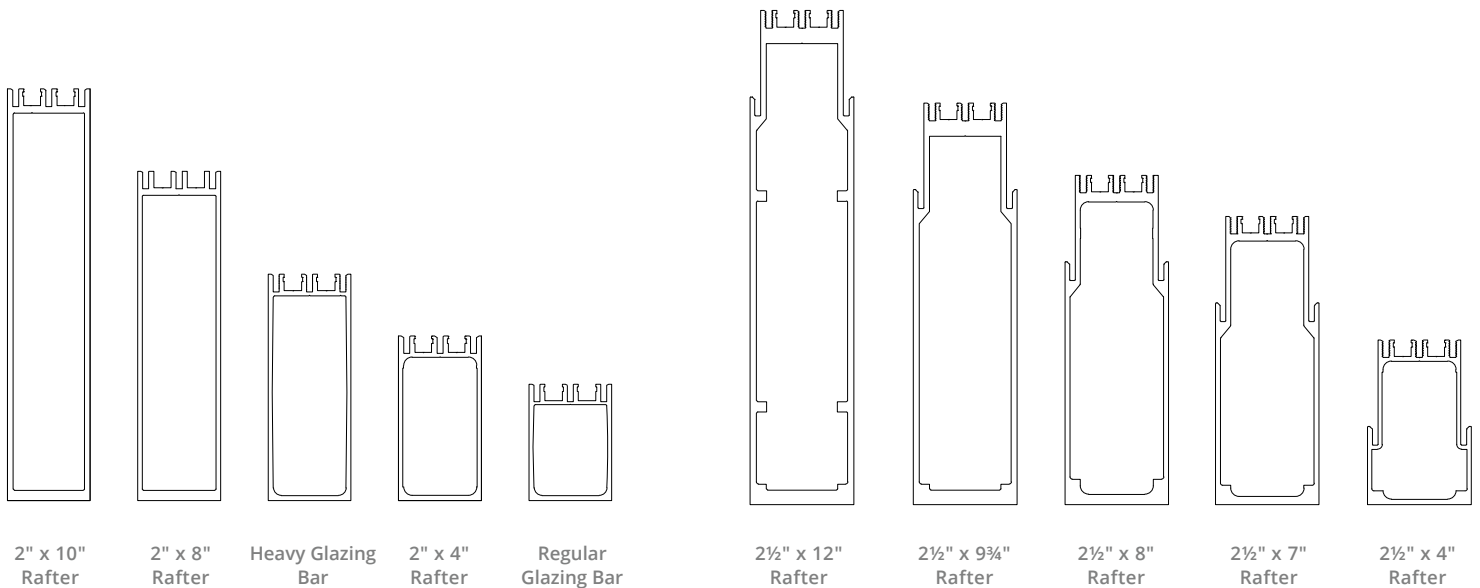

# Foundation Types

## Recommendations for a Stable Base

While Solar Innovations® does not provide labor or materials for base walls, floors, or foundations, we can make recommendations based on the function of the structure. We recommend referencing local building codes for more information on foundation requirements in your area.

### WOOD FOUNDATION

For structures under 200 square feet, pressure-treated lumber can be bolted together to form a foundation. Structures 6 by 8 feet can be constructed on one tier of lumber while a 10 by 12-foot structure will require two tiers of lumber to create a solid foundation. For added strength, 2-foot sections of rebar should be inserted into the ground and fastened to the lumber base.

### CONCRETE FOUNDATION

A stronger foundation is necessary with a structure larger than 200 square feet. Options include a concrete slab, a continuous concrete footing around the perimeter, or a concrete block footing. The concrete slab can be reinforced with wire mesh and it is suggested the concrete floor be at least 4 inches thick, and should be thicker around the perimeter to handle the load of the building. Footings should extend below the frost line to prevent damage to the structure's frame and glazing. If you are pouring concrete, the trench must be large enough to accommodate wooden forms.

Waterproofing can be achieved by coating the foundation in a waterproof compound or underlying the concrete slab with a polyethylene moisture barrier. Surrounding the foundation with insulation panels will aid in the retention of heat in the structure.

Remember to install necessary utility lines and be sure to excavate deep enough to bury plumbing and electrical conduit. A concrete block footing should extend a minimum of 6 inches above grade to form a knee wall. Tying a structure to a foundation or footing is crucial and achieved by embedding anchor bolts into concrete.

### KNEE WALLS

Knee walls—sometimes referred to as "base" or "pony" walls—are commonly featured in the construction of glass structures. Incorporating a knee wall is typically more cost effective than extending glass entirely to the ground. Applying a stone or brick veneer directly to a concrete knee wall will achieve the desired aesthetic in a cost efficient method. Solar Innovations® recommends insulating the knee wall to optimize heating and cooling. Knee walls are typically between 30 and 36 inches tall. Although knee walls can be used with any of our structures, if you decide to use one with your greenhouse, the benches, smaller plants, and garden tools can be hidden from external view. Another practical use of a knee wall in your greenhouse is shade—low-light plants can be grown underneath the benches, where they receive only filtered light.



**RESIDENCE | BEAVERTOWN, PA**

Straight Eave Double Pitch Sunroom with Projected Dormer



**RESIDENCE | RIDGEFIELD, CT**

Straight Eave Double Pitch Greenhouse with Walkway



**RESIDENCE | BUENA VISTA, VA**

Straight Eave Lean-To Greenhouse



**RESIDENCE | GREENWICH, CT**  
Straight Eave Double Pitch Greenhouse

# Ventilation



RESIDENCE | MYERSTOWN, PA  
Straight Eave Lean-To Greenhouse

## Breathe in the Fresh Air

After the configuration of your structure is selected, you should consider the fenestration and ventilation accessories that you desire. Operable accessories are the components which promote circular air ventilation. This could include doors, windows, ridge vents, and eave vents. With these options, your structure has the ability to achieve plant appropriate temperatures and circulation.

### RIDGE & EAVE VENTS

The use of ridge vents and eave vents in a Solar Innovations® structure will create a functional, passive ventilation system. A ridge vent is placed at the roof's highest point so that when hot air rises and becomes trapped in the peak of the roof, the ridge vent can be opened via a motor or a pole operator to allow the hot air to escape. Multiple bays can be joined together so the entire roof line can be opened.

An eave vent operates similarly to a ridge vent, except it is placed on a wall rather than the roof. This accessory is used in place of individual windows. Bays are joined together by a motorized arm and the entire section will open.

Without these systems, hot air becomes trapped at the top of the structure. By incorporating ridge and eave vents, natural air circulation can be achieved for a more comfortable environment.

Solar Innovations® ridge vents are typically manufactured to a 27-inch diagonal on the slope. They are available in various bay widths up to 48 inches wide with a total overall length up to 24 feet. Our eave vents are typically 27 inches high and are available in various bay widths of up to 48 inches with a total overall length up to 24 feet. Eave vents will match the bay widths of the structure, however, numerous custom designs are available.

### INTAKE LOUVERS

Intake louvers allow fresh air to flow into the structure while exhaust fans create a cross flow of air for adequate ventilation, minimizing hot spots, and assisting in maintaining a constant temperature inside the enclosure. Our intake louvers and exhaust fans are utilized most often in our sunrooms.

The motorized intake creates a seal against most rain, cold air, snow, and insects when closed and opens as the fan turns on to ventilate your structure. Exhaust fans can be used alone or combined with matching intake louvers to create a "cross flow" for increased air flow and circulation. The fans are placed in the upper section of the gable end of the structure to remove stale, hot air from the peak of the structure. For maximum efficiency, the operation of both intake vents and roof vents should be coordinated. The fans are made of white, industrial grade, corrosion proof PVC with UV inhibitors, but they can be custom painted to match your enclosure for an additional cost.

# Dormers & Lanterns

## DORMERS

Dormers are small structures which project from a roof and typically begin at the ridge line or in the middle of the roof. The gable side of the dormer can have an operable window, depending on the size.

A traditional appearance can be achieved by incorporating the following:

- Pilasters (set on either side of the gable)
- Grids (utilized on the gable with numerous "P-patterns" available)
- A Palladian arch (incorporated into the eave)
- Ridge cresting (adorns the ridge of the dormer, typically with a finial at the peak)



RESIDENCE | COTUIT, MA

Straight Eave Double Pitch Greenhouse with Dormer Entryway

### EXAMPLE CONFIGURATIONS



Flush Dormer



Extended Double Pitch Dormer

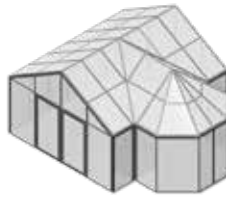

Bull Nose Dormer

## LANTERNS

The goal of the lantern is two fold: to allow additional light into the conservatory and to add a design element. A lantern is located on top of the roof and can span the entire length of the roof or occupy only a small section. It can feature a hip end conservatory nose or a double pitch configuration. If the eave is high enough, the glass can be operable to allow for ventilation.



RESIDENCE | PACIFIC GROVE, CA

Hip End Skylight with Lantern

### EXAMPLE CONFIGURATIONS



Full Lantern



Hip End Lantern



Bull Nose Lantern



RESIDENCE | COLUMBUS, OH

Polygonal Nose Lantern

# Skylights



RESIDENCE | NARBETH, PA

Straight Eave Double Pitch Skylight with Irregular Conservatory Nose



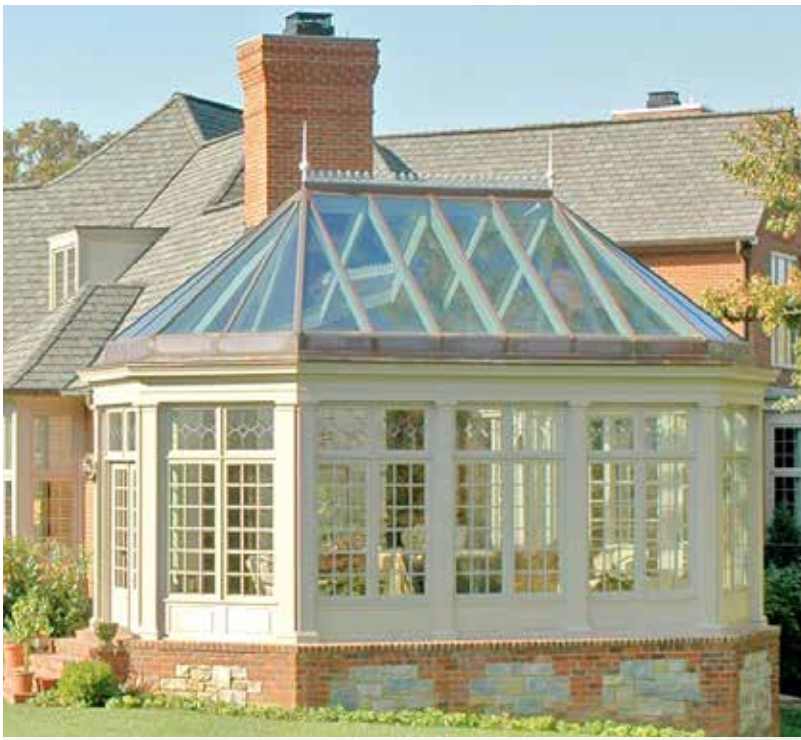

**RESIDENCE | LOUISVILLE, KY**  
Straight Eave Double Pitch Skylight



**RESIDENCE | STRATFORD, CT**  
Straight Eave Lean-To Retractable Skylight

## Boosted Sun Exposure

Skylights, or glass roofs, can be used in applications where additional daylight is desired and are the ideal choice when updating an existing structure.

### **FIXED SKYLIGHTS**

Fixed, or non-operable, skylights are comprised of panels that do not move. Fixed skylights can be built in nearly any size or configuration and can include custom shapes. With design opportunities that are nearly endless, the most common fixed skylights in structures are single slope and double pitch. Though fixed skylights do not open, they can include ridge vents to allow for air circulation and climate control.

### **OPERABLE SKYLIGHTS**

Operable skylights have the unique ability to open a structure to the outdoors. The most popular operable skylight for structures is the retractable skylight. Retractable skylights provide clear, unobstructed views and increased airflow for any structure.

### **DECORATIVE ACCESSORIES**

Finials and ridge cresting may be included in the skylight for a more decorative appearance. The structure's skylights can also incorporate a lantern into its design, creating a classic feel and drawing attention to the addition. If the lantern is large enough, operable windows can be added to assist in ventilation.

### **ATRIUM**

An atrium structure blends a glass roof and large windows with conventional construction walls. Various materials can be utilized to complement the framing, such as masonry, stucco, or siding.

Solar Innovations® can manufacture the glass roof, or skylight, of an atrium, which can incorporate windows and operable ridge vents to control the interior climate. Operable window choices include awning, casement, hopper, pivot, and tilt turn. Window grids further enhance a structure's classic aesthetic, while finials and ridge cresting create decorative accents. If desired, traditional walls can be designed or altered to include folding glass walls.

# Door & Window Integration



RESIDENCE | NEW CANAAN, CT  
G2 Folding Glass Walls & G1 International Fixed Windows

## Open Up the Possibilities

The use of operable windows in your structure allows for you to further enjoy the outdoors. Integrating these operable features will help to create cross ventilation and natural air flow, giving you more fresh air to enjoy on those beautiful days.

### AWNING

Awning windows hinge at the top of the frame, allowing the bottom to open outward. There is usually a cam lock on the interior, which can be unlocked, and the window will open. They are a popular choice for in-system windows in greenhouses, conservatories, sunrooms, and other glass structures. When the windows are open, rain water will flow off and away from your structure.

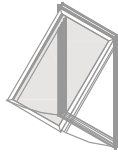

### HOPPER

Hopper windows are hinged at the bottom and tilt in to offer increased ventilation. They are often paired with other fixed or operable windows and doors or incorporated into transoms. These window systems are typically used in basements for light and ventilation where there is limited space.

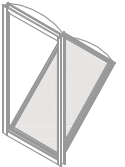

### CASEMENT

Casement windows are one of the most popular styles in the world. They are hinged at the side and swing outward when opened. Casement windows are excellent for natural ventilation strategies, especially in hot climates. Inswing casement windows are also available.



### TILT TURN

Tilt turn windows offer dual action with the turn of a handle. Turning the handle upward allows the window to open like a hopper, offering increased security. Turning the handle to the side opens it like an inswing casement, allowing for easy cleaning. Returning the handle downward engages the lock.

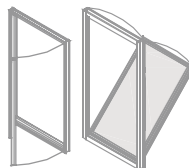

### FIXED

Fixed windows are non-operable, meaning they can't be opened. This type of window is often found in conjunction with the other types of windows in a Muled Window System or in areas where natural light is needed without the need for ventilation.



### PIVOT

Pivot windows project to the exterior and interior of a room, but require less space in one direction allowing for larger openings. Pivot windows can pivot from the left, right, or center, and can feature decorative interior and exterior grids.

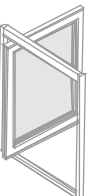

# Redefine Boundaries

Operable walls are an attractive and functional addition to a conservatory, sunroom, or greenhouse. Our selection of folding, stacking, swing, and sliding doors allow for the walls to be opened for occupants to bask in the outdoor climate when weather is pleasant. With operable walls, your structure can seamlessly become part of the outdoors for entertaining.

## TERRACE & FRENCH DOORS

Terrace doors are single swing door units, while French doors are a set of double doors. Units can be hinged left or right and swing in or out. Sizes are custom designed to suit your structure.

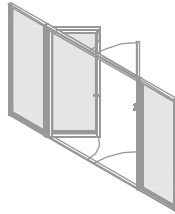

## FOLDING GLASS WALLS

Folding walls, also known as bi-fold doors or accordion-style doors, can accommodate an unlimited number of panels and configurations. These systems offer a flexible and customizable opening that can be incorporated into any residential or commercial project.



## SLIDING GLASS DOORS

Sliding glass door systems expand the view of any living space and can be used as external entryways or transitions between two interior spaces. Motorization options, pocketing possibilities, countless custom configurations, and expansive panel sizes make our sliding glass doors a flexible design element that complements any space.

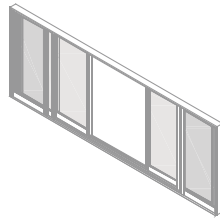

## SLIDE & STACK GLASS WALLS

Slide and stack glass wall systems feature individual panels that slide along a top hung track and stack to a remote location or into a pocketed space within a home. This system is designed to accommodate a large number of panels that open to provide unobstructed views.

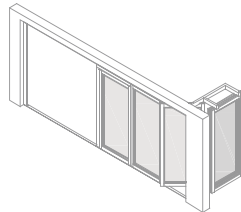

## LIFT SLIDE DOORS

Solar Innovations® Lift Slide Door Systems are a high-performance alternative to traditional sliding glass doors. Controlled with a simple turn of the wrist, the handle lifts the panels off the track to move with ease. This door can be opened with one hand and closed with even less resistance. Once the panels are in place, turning the handle reseals the door to provide security and superior air, water, and thermal performance.

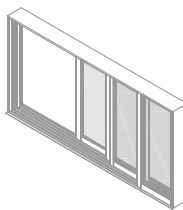

### RESIDENCE | KIRKWOOD, MO

Straight Eave Double Pitch Sunroom with G2 French Doors



### RESIDENCE | NEW YORK, NY

Straight Eave Lean-To Sunroom with G2 Folding Glass Walls



### RESIDENCE | JOHNSTOWN, OH

Conservatory Nose with Awning Windows

# Shade Options



Solar R Blinds

## MANUAL ROLLER SHADES

Manual roller shades are designed to be pulled by hand against the eave line. When pulled taut, the shade will click and hold in place. Effective for greenhouses and other applications that are used less frequently, the tension shade system is less expensive and easy to install.

## GRAVITY FED SHADES

Gravity fed shades, also known as Roman fold shades, are typically used on sloped roofs, but can also be utilized in vertical wall applications. These shades are individually sized to fit between the rafters of an interior glass roof and are operated with a motor or manual pull cord in a Roman fold style. Numerous materials and colors are available. Wide span—covering two to four bays—may be available depending on fabric, layout, and design. Gravity fed shades are operable in rectangular sections and fixed in angled corners. They are also mounted at the ridge, and roll down to the eave. Gravity fed shades can be used in moist environments and typically require a minimum 2/12 roof slope.

## WIDE SPAN SHADES

Wide span shades extend from eave to eave or follow the slope of a glass structure. The blinds are designed in a Roman fold style with various fabric, color, and texture options. When extended, the shades trap heat above them, allowing your living space to remain cooler. On cool days, the shades can be retracted to trap heat below the eave line of the structure.



Pleated Shades

## PLEATED SHADES

Pleated shades can be used in the roof and vertical walls of a glass structure. The pleats provide a visual pattern and soften daylight for interior spaces. These shades can be operated with manual pulls or motorized options, and each shade is operated independently.

## PINOLEUM BLINDS

Pinoleum blinds are traditionally used in conservatories, sunrooms, and skylights. The blinds are comprised of individual wooden reeds that are woven together to diffuse light. This shade system lets light in while still reducing heat and glare.

## SOLAR R BLINDS

Solar R blinds are typically used to increase energy efficiency and control temperature inside a space. The smooth shades have an aluminum backing which reflects solar rays away from the structure to limit solar heat gain. When operated, the shades move on a roller into a cassette via a pulley system. Motorized options are also available. Solar R blinds are suitable for sloped and vertical applications.

For additional information refer to our shades brochure or visit [solarinnovations.com/shades](http://solarinnovations.com/shades).

# Screen Options

## FOLDING SCREENS

Folding screens are hinged and fold in an accordion-style, mimicking the operation of folding glass walls. Folding screens can be used to create an outdoor screen room to enjoy nature without bothersome insects.

## SLIDING SCREENS

Sliding screens are generally used on large openings, most commonly on the exterior of sliding glass doors. The panels of this system can be pocketed into a wall cavity with either a center split, or stack to the left or right when fully open.

## SCREEN SWING DOORS

Screen swing doors are available for both terrace and French doors. The screen swing door is constructed from an aluminum frame that mimics the sightlines of our glazed swing doors.

## FIXED SCREENS

Fixed screens are used on casement, awning, hopper, tilt turn, and sliding glass windows. Fixed screens can easily be removed for cleaning.

## B SERIES RETRACTABLE SCREENS

B Series Screens are suited for large openings when a pleated screen option is preferred. These retractable screens can meet at a 90° corner to enclose a space with only one visible vertical division. This screen can be paired with folding glass walls, sliding glass doors, lift slide doors, French doors, screen rooms, and more.

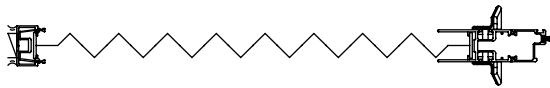
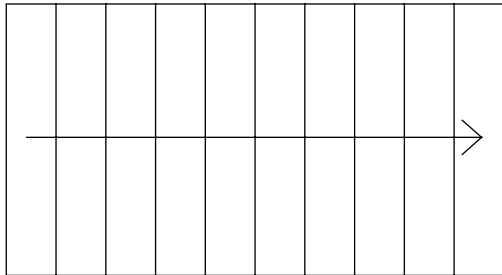

## S SERIES RETRACTABLE SCREENS

S Series Screens are vertically retractable screens that provide the ability to enjoy the outdoors while being protected from pests. S Series Screens feature a specialty zipper system which guides the fabric within the track and prevents insects from entering. This system can prevent sunlight from entering the room with the selection of black out fabric.

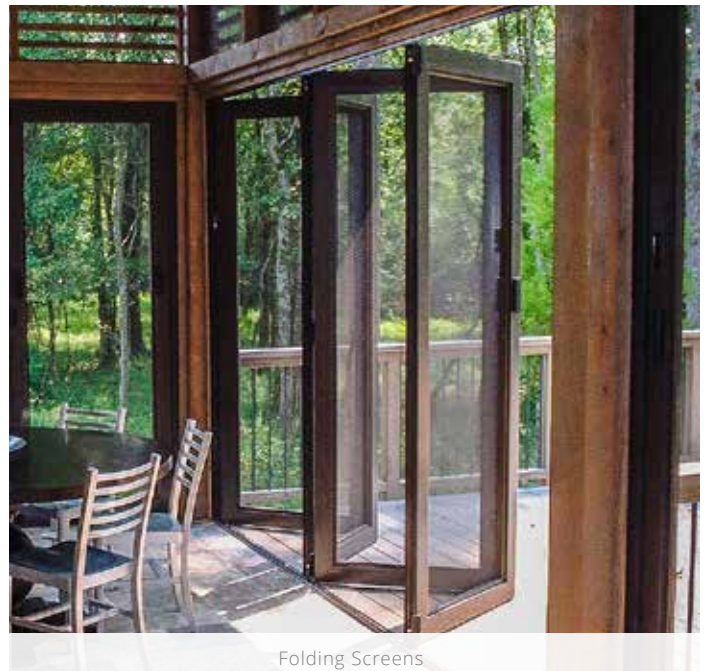
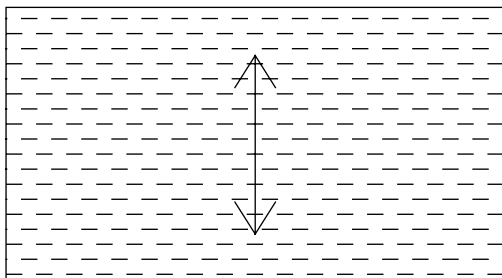

For additional information refer to our screens brochure or visit [solarinnovations.com/screens](http://solarinnovations.com/screens).

# Wood Interiors



RESIDENCE | SHAVERTOWN, PA  
Straight Eave Lean-To Conservatory with Skylight

## Bring Home the Timeless Beauty of Natural Wood

Solar Innovations® offers several elegantly designed products in custom wood systems. Thermal efficiency tends to be higher with a wooden structure as it allows for lower U-values. A lower U-value allows the room to maintain an even temperature throughout the year. When implemented correctly, a wooden interior can provide a structure with a traditional feel. A wood conservatory can be highly decorative and include traditional elements reminiscent of classic conservatories. Moldings and trims featured in the structure can be manufactured to mimic existing architectural elements within your home and the same is true for wood interior panels, which can be customized to fit virtually any design.

We do not recommend using wood in structures that have high moisture, such as greenhouses or pool enclosures—due to warping and aging of the wood—but for your conservatory or sunroom, this can be the perfect solution.

### FINISH OPTIONS



White Oak



Red Oak



Hard Maple



White Ash



Cherry



Douglas Fir



Sapele Mahogany



Walnut

**Please Note:** Depending upon color selection, extra cost and lead times may apply for all finishes other than Solar Innovations® stock standards. Color illustrations are shown as accurate as standard photography and printing processes allow. Final finish selection should be made from a physical sample; please contact Solar Innovations® to receive samples. All product and finish options are subject to vendor availability. Solar Innovations® reserves the right to discontinue any option at any time without notice. Additional options, including custom color matches, are available; contact a Solar Innovations® sales designer for details.



**RESIDENCE | MAMARONECK, NY**  
Straight Eave Lean-To Sunroom



**RESIDENCE | CHICAGO, IL**  
Straight Eave Double Pitch Conservatory

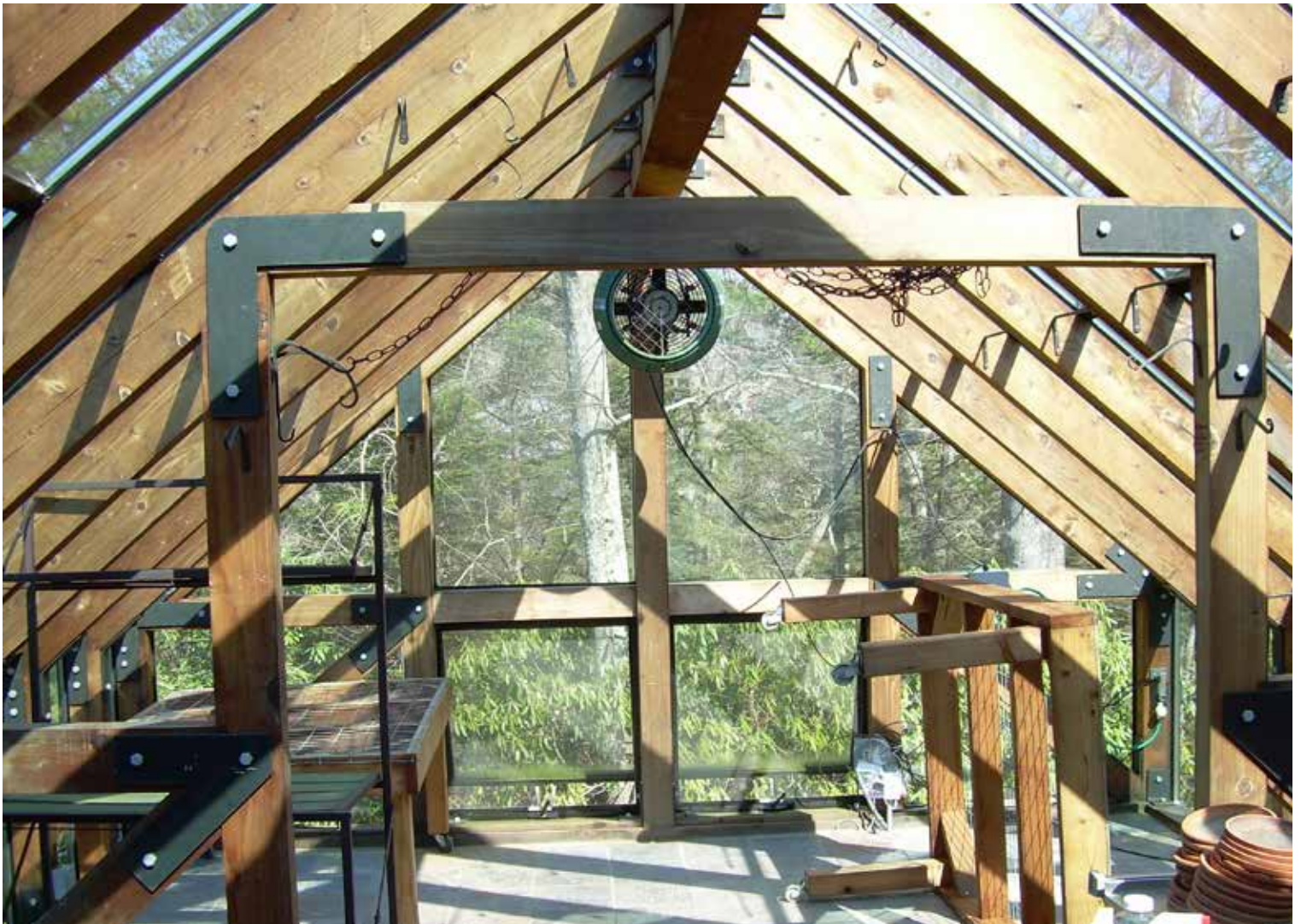

**RESIDENCE | CHAPEL HILL, NC**  
Straight Eave Double Pitch Greenhouse

# Decorative Elements



## FINIALS

A finial, also known as a spire, is typically located at the highest peak of a greenhouse's roof. Dormers, lanterns, ridges, and entryways can all utilize finials.

## APPLIQUÉS

Decorative appliques are elements that can add character to your structure. Each cast aluminium appliqué features one of two main motifs: the rosette or the fleur-de-lis.



## KING POST

King posts, similar to finials, are typically placed at the end of a structure's ridge cresting. The king post is made up of a hub with finials on the top and bottom to create a dramatic decorative finale to the roof line.

## BASE PANELS

Decorative base panels follow the Elizabethan form of raised grid design. We offer two standard models: a raised panel and a smooth panel.

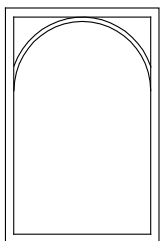

Arched Grid

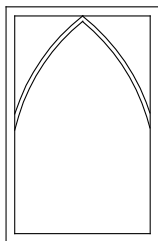

Gothic Grid

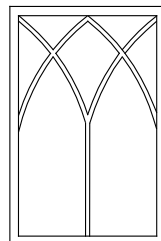

Double Gothic Grid

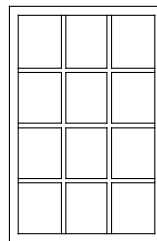

Traditional Grid

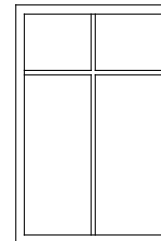

Cross Grid

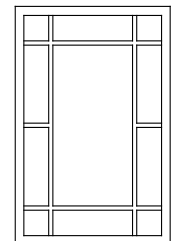

English Grid

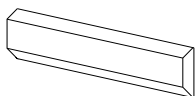

Low Profile Grid



Ogee Grid

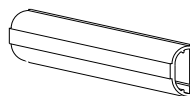

Colonial Grid



Traditional Grid

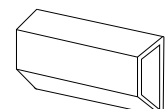

Large Traditional Grid

## GRIDS

Decorative grids enhance the look of any structure and are available in five standard types: Low Profile, Ogee, Colonial, Traditional, and Large Traditional. We also offer two types of grids: interior muntins and exterior grids combined with simulated divided lites (SDLs).



## GABLE PEDIMENTS

Gable pediments—commonly referred to as Palladian arches—are added to the triangular gable in a conservatory. Grid work can be used to simulate true pediments or mullions.

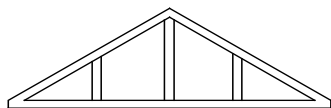

Traditional Gable End

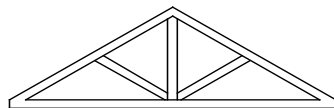

Straight Fan Light

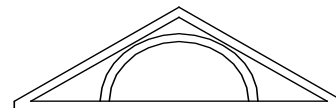

Open Radius Gable End

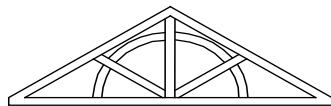

Arched Fan Light Option 1

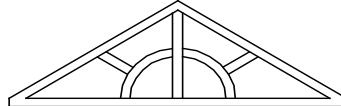

Arched Fan Light Option 2



Arched Fan Light Option 3

## RIDGE CRESTING

Ridge creasting is used to enhance the ridge line of a greenhouse, especially in classic English designs. Several styles of ridge creasting are available.



CA07



CA06



CA059



CA05



## EAVE SPANDRELS

Eave spandrels—or decorative corners—can be considered one of the oldest forms of decorative architecture. While eave spandrels are primarily decorative, they can also be used for shelf supports.



## RING & COLLARS

Ring and collar supports are decorative trusses that link two opposite rafters. These provide additional support to maintain the roof shape and structural integrity, while also adding unique architectural appeal.



## TRIMS

Solar Innovations® offers extruded decorative trims in durable aluminium, which will not warp, rot, rust, or require finish maintenance like traditional wooden trim.

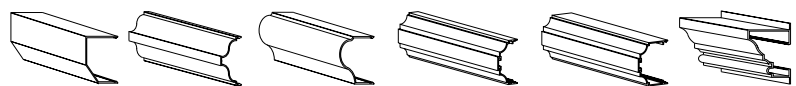

Beveled Nose

Ogee

Large Bulbous

Extended Ogee Horizontal

Extended Ogee Vertical

Gable Rake Crown Molding



Greenhouse Gutter



Decorative Gutter



Restoration Gutter



Box Gutter

## GUTTERS

Decorative gutters add an aesthetically appealing and functional element to any structure. Gutters are available in several styles and finishes.

# Greenhouse Accessories



## **BENCHES**

Benches greatly increase the amount of growing space in a greenhouse. Benches come in standard sizes from most manufacturers, but Solar Innovations® creates custom benches to fit any configuration, including fixed, tiered, rolling, and more.



## **ENVIRONMENTAL CONTROL SYSTEMS**

To ease the burden of greenhouse maintenance, an environmental control system can be installed. This system can automate accessories within the greenhouse, including heating, cooling, watering, lighting, shading, and more.



## **CIRCULATION FANS**

Circulation fans constantly move air within the greenhouse and are essential to the health of plants. These fans keep the temperature and humidity uniform while destratifying the air and reducing condensation.



## **PLANT HANGERS**

With our stationary and operable plant hanger options, plants can be grown year-round in baskets within the greenhouse or outdoor baskets can be brought inside during colder months.



## **HUMIDIFIERS**

Humidifiers are utilized to control moisture levels in the air for optimal plant growth. When humidity drops below a predetermined level, a sensor triggers the humidifier to activate. For more advanced applications, high pressure foggers are available.



## **GROW LIGHTS**

Supplemental lighting creates the potential for additional plant growth by providing the necessary hours of light when it is not naturally available. Most year-round greenhouses require lighting during the winter so that plants receive the necessary amount of light.



### **IRRIGATION SYSTEMS**

An automatic watering system can regulate the flow of water and nutrients to plants without the gardener being on-site. A Solar Innovations® greenhouse specialist can determine if misting and/or drip systems are correct for you.



### **HEATER**

A greenhouse specialist can evaluate the structure's location, size, shape, design, and plant types to provide the best heating solution for each project, including which fuel source to use. An optional vibration kit is also available.



### **SHELVES**

A greenhouse's growing area can be increased by installing shelving. We offer several variations of support brackets and shelf tops.



### **TRELLISES**

A trellis allows gardeners to utilize vertical space within the greenhouse for growing climbing plants. Solar Innovations® manufactures aluminium, single and stacking trellises that will not rot like their wooden counterparts.



### **EVAPORATIVE COOLERS**

The evaporative cooler draws air over a wet pad, by way of a fan. As the water passes over the pads, it evaporates and takes heat with it. The air then passes into the greenhouse and can be up to 30 degrees cooler.



### **COLD FRAMES**

A cold frame is essentially a glass box with aluminium framing and a lid. Its main function is to extend the growing season into early spring and late fall. It is placed directly above a section of soil where plants will be grown.

# Performance

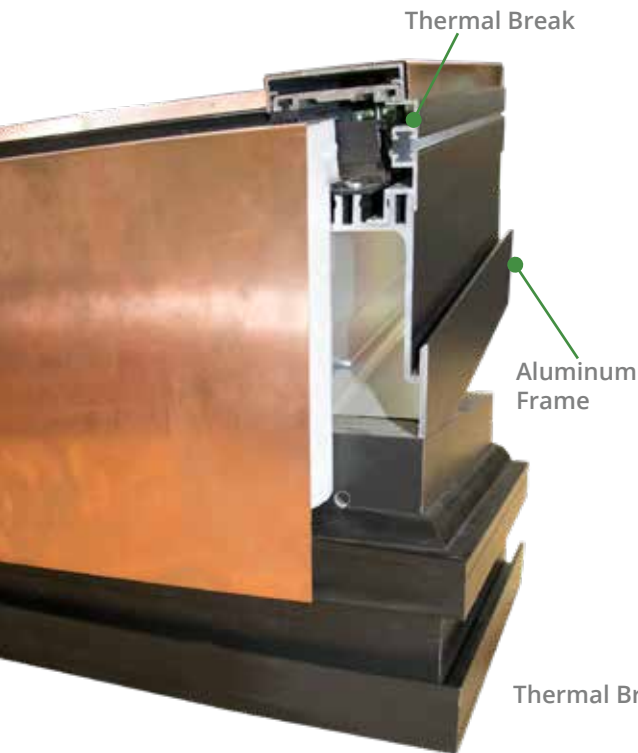

## Thermally Enhanced

The thermal break separates the aluminum and minimizes conductivity of heat and cold from the inside to the outside while ensuring the structure's interior remains more consistent all year long. One common strut construction method is threading a polyamide strut into the cavity between two aluminum profiles and crimping it into place. In the pour-and-debridge system, another thermally enhanced method, liquid polyurethane is poured into an aluminum cavity; once the polyurethane has hardened, the aluminum "bridge" around it is removed. Both methods improve thermal efficiency by breaking the continuous metal-to-metal contact of the highly conductive aluminum. Nonthermal aluminum frames should be used for interior applications or where thermal conductivity is not important.

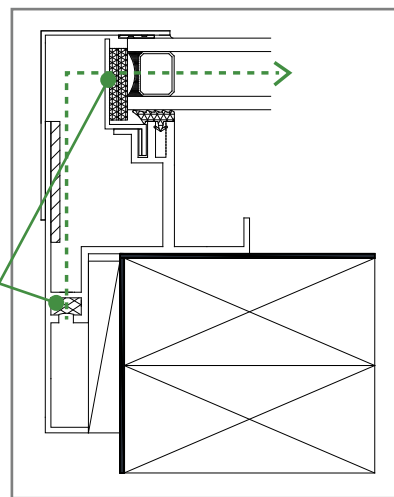

## Certified Products



### TESTING

We are dedicated to providing safe, quality products to customers. Our in-house test labs offer the unique opportunity to execute tests quickly and efficiently with certification by nationally-recognized third parties.



### HURRICANE IMPACT TESTED

We currently offer one of the largest selection of products tested for Florida ratings. They can withstand even the most extreme weather conditions.

### NFRC Approved

- G2 Folding Glass Walls
- G2 Sliding Glass Door
- G3 Sliding Glass Door
- G3 Lift Slide Door
- Vinyl-Composite Tilt Turn Window
- Vinyl-Composite Terrace Door
- G2 International Windows (Fixed, Casement, Awning, Tilt Turn)
- Vinyl-Composite Sliding Glass Door
- Pan Flushing Skylight
- Welded Curb Skylight

- G2 Terrace Door
- G3 Terrace Door
- G2 Folding Glass Walls
- G3 Folding Glass Walls
- G2 Sliding Glass Door
- G3 Sliding Glass Door
- G3 Lift Slide Door
- G2 Aluminum Curtain Wall
- Wood Curtain Wall
- G2 International Windows (Fixed, Casement, Awning, Tilt Turn, Hopper)
- Vinyl-Composite Tilt Turn Windows
- Vinyl-Composite Sliding Glass Door
- Fixed Skylights
- 90° Operable Skylight

Visit our website, [solarinnovations.com/testing](http://solarinnovations.com/testing) for a full list of our certified products.

# Glazing Options

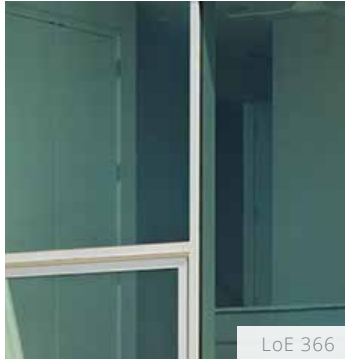

## LOW-E GLASS

Low-E glass includes microscopically thin transparent layers on the glass surfaces that reflect heat back to its source, keeping heat out in the summer, and warmth in during the winter. We offer several variations of tint intensity for the perfect selection in any climate.

- **LoE 272:** Our most common glazing, allows for clear views with the thermal benefits of Low-E glass.  
*72% VISIBLE LIGHT TRANSMITTANCE*  
*0.41 SOLAR HEAT GAIN COEFFICIENT*
- **LoE 366:** Increased performance with a slight tint, provides a comfortable space for both plants and people.  
*65% VISIBLE LIGHT TRANSMITTANCE*  
*0.27 SOLAR HEAT GAIN COEFFICIENT*
- **LoE 340:** Reduces solar heat gain drastically while allowing daylight to enter.  
*39% VISIBLE LIGHT TRANSMITTANCE*  
*0.18 SOLAR HEAT GAIN COEFFICIENT*

Other Low-E options are available from Guardian, PPG, and Viracon.



Pattern 62



Single Glue Chip



English Reeded



Satin Etch

## DECORATIVE GLAZING

Decorative glazing is a broad category consisting of art glass and other unique glazing options. Additional custom decorative options are also available.

- **Pattern 62:** Pattern 62 offers an attractive appearance, obscurity, and light transmission capabilities.
- **Single Glue Chip:** Single glue chip or glue chip is a texture that resembles frost on a window pane during the winter cold.
- **English Reeded:** English Reeded glass is a ribbed glass. The ribs of the glass run horizontally.
- **Satin/Acid Etch:** Satin etched adds the appearance of a 3-dimensional texture. It should be used on an unexposed surface in an IG unit.

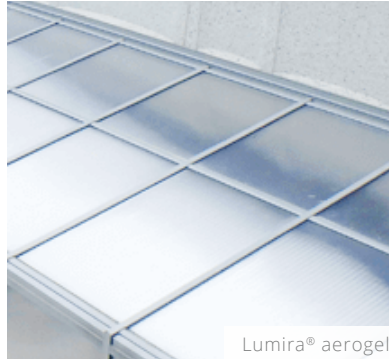

Lumira® aerogel

## POLYCARBONATE

Polycarbonate is a popular alternative to glass; it is lightweight, sustainable, incredibly strong, and easily transported.

- **Lumira® aerogel** can be used to fill the polycarbonate for increased thermal ratings, and greatly reducing sound transmission differences. Another benefit of incorporating Lumira® aerogel is glare reduction — the diffused daylight offered by polycarbonate creates bright, even lighting in any space. Sustainable purchasing, optimum energy efficiency, occupant comfort, low emissions, and daylighting are all possible points that Lumira® aerogel can assist with for LEED certification.



Electrochromic

## DYNAMIC GLASS

Dynamic glass can change automatically at specific temperatures, lighting conditions, or on demand. This allows for heat, light, and glare control any time of day.

- **Electrochromic** is highly energy efficient glass that switches between clear and tinted states on demand. In its tinted state, it blocks solar heat while controlling glare. In its clear state, it transmits more solar heat than typical Low-E glass.
- **Thermochromic** glazing darkens gradually and dynamically when heated by direct sunlight. The glass interlayer changes in reaction to ambient temperature and sunlight, managing a building's varied needs for passive solar heat gain, solar control, and natural daylight transmittance throughout the day.

# Finish Options



RESIDENCE | MECHANICSBURG, PA  
Bull Nose Conservatory



RESIDENCE | MAUI, HI  
Straight Eave Lean-To Sunroom

**Paint STANDARD** - AAMA 2603 (5 year warranty). Finishes available while in stock.

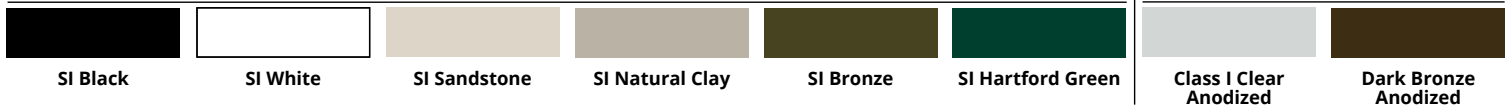

**Anodized** Additional cost

**Paint DESIGNER** - AAMA 2604 (5 year warranty), AAMA 2605 (10 year; up to 20 year warranty). Scratch & fade resistant; contains no VOCs.\*



**Powder Coat Solids** AAMA 2604 (10 year warranty), AAMA 2605 (10 year; up to 20 year warranty). Scratch & fade resistant; contains no VOCs.\*



**Powder Coat Metallics** AAMA 2604, AAMA 2605\*



**Metal Clad STANDARD\***



**Metal Clad DESIGNER\***



**Decoral Finishes (Powder Coat)\***

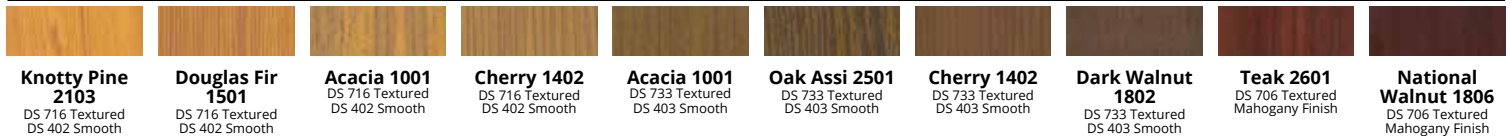

**Wood Veneering (Unfinished) STANDARD\***



**Wood Veneering (Unfinished) DESIGNER\***



**NOTE: WOOD VENEERING IS FOR INTERIOR APPLICATIONS ONLY. AVAILABLE ON A LIMITED BASIS DUE TO VENDOR SUPPLY.**

\*Adds one to three weeks to lead time.

Note: Depending upon color selection, additional charges and increased lead times may apply. Extended warranties and service plans are available for an additional charge. Examples are shown as accurate as photography and printing processes allow. Final finish selection should be made from a physical sample; contact Solar Innovations® for samples. Product and finish options are subject to vendor availability. Solar Innovations® reserves the right to discontinue any option at any time without notice. Additional options, including custom color match, are available; contact Solar Innovations® for details. FSC options available.

# Our Process

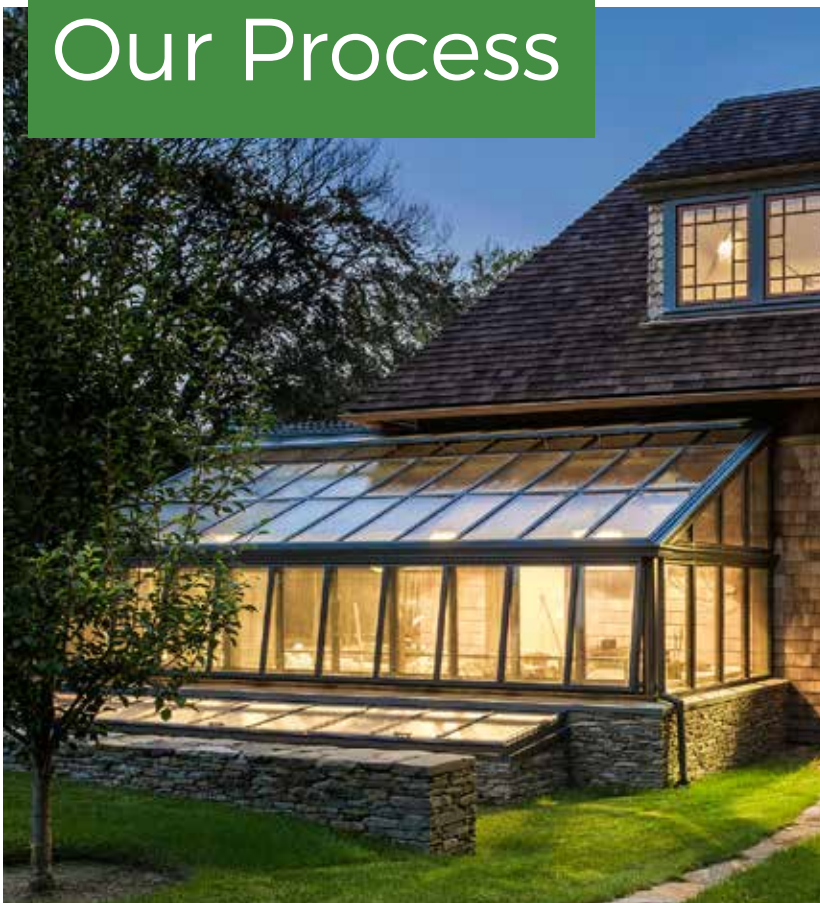

**RESIDENCE | MIDDLETOWN, RI**  
Straight Eave Lean-to Greenhouse with Cold Frames



**RESIDENCE | STOCKTON, NJ**  
Curved Eave Double Pitch Sunroom with G2 Terrace Door

## 1 Contact Us

There are three convenient ways to work with Solar Innovations®. If you aren't quite sure where to start, call us directly at (800) 618-0669.

### OUR DEALER NETWORK

Our extensive network of dealers throughout the United States have experience in the glazing industry and with our products. Dealers are frequently able to visit the job site and work one-on-one with the customer, aiding in design, local permits, and installation.

### ARCHITECTS, GLAZIERS OR CONTRACTORS

Your architect, glazier, or contractor can work with our inside sales designer to ensure you receive the best product information and communication experience possible. Specifications, quotes, and drawings can be directed to you to review.

### INSIDE SALES DESIGNER

Contact our inside sales designers directly to help plan and specify your project.

## 2 Planning & Quoting

There are various stages of planning due to the large variety of products, configurations, and options Solar Innovations® provides. Our in-house sales team can help coach you through the process and educate you on the differences between options. Whether you're a dealer, architect, business, or homeowner, we will help you achieve the best product results.

You can call us directly at (800) 618-0669 or complete an online quote form at [solarinnovations.com](http://solarinnovations.com). Our quotes have a quick turnaround time and we will work hard to give the most competitive pricing when quoting your project.

## 3 Place an Order

Our ordering process is streamlined and efficient, giving you all the requirements for your project, shop drawings, lead times, and shipment dates. Once your order is placed, you will be paired with a dedicated project manager to guide you throughout the process.

## 4 Installation

We can provide installation and service for all of our products within a six-hour radius of Pine Grove, PA. Our expertly trained team is registered to complete installation in over 16 states. When utilizing our installation services, an experienced team will be scheduled to install the project upon completion of shop fabrication. Our team is trained in the correct protocols to ensure safe, efficient, and accurate system installation.

# RESIDENTIAL & COMMERCIAL DOORS & WINDOWS | GLASS STRUCTURES | SKYLIGHTS

Folding Glass Walls  
Slide & Stack Glass Walls  
Clear Glass Walls  
Sliding Glass Doors  
Lift Slide Doors  
Swing Doors  
Pivot Doors

Casement Windows  
Awning Windows  
Tilt Turn Windows  
Mulled Windows  
Hopper Windows  
Fixed Windows  
Sliding Glass Windows

Folding Glass Windows  
Curtain Walls  
Wood Curtain Walls  
Greenhouses  
Conservatories  
Sunrooms  
Canopies

Pool Enclosures  
Pool Houses  
Walkways  
Glass Railings  
Fixed Skylights  
Curb Mount Skylights  
Barrel Vault Skylights

Double Pitch Skylights  
Dome Skylights  
Single Slope Skylights  
Pyramid Skylights  
Walkable Skylights  
Retractable Skylights  
90° Operable Skylights



31 Roberts Road, Pine Grove, PA 17963  
570 915 1500 | 800 618 0669  
[solarinnovations.com](http://solarinnovations.com)

 **SOLAR INNOVATIONS<sup>®</sup>**  
ARCHITECTURAL GLAZING SYSTEMS  
