

Installation Manual for All SMI Profiles: Wood Substrates



**Sheffield Metals
International**

A **MAZZELLA** COMPANY

50+ Years of SSMR, Installation & Technical Experience

www.sheffieldmetals.com

Table of Contents:

- General
- Safety Precautions
- Delivery & Storage
- Material Handling
- Pre-Installation
- System Installation Guidelines
- Clean Up
- Seaming the Panels
- Hemming
- Thermal Movement

E1	Eave Detail
EG1	Eave w/ Gutter Detail
ET1	Eave Transition Detail
RK1	Rake / Gable Detail
RK2	Rake / Gable Detail
SW1	Sidewall Detail
SW2	Sidewall Detail
SW3	Sidewall Detail
HW1	Headwall Detail
HW2	Headwall Detail
HW3	Headwall Detail
V1	Valley Detail
T1	Roof Transition Detail
PK1	Peak Detail
PK2	Peak "D Style" Detail
HR1	Standard Hip / Ridge Detail
VR1	Vented Ridge Detail
L1	Lightning Protection Detail
P1	Penetration Detail
P2	Large Penetration Detail
C1	Curb Detail

GENERAL

The following installation details are suggestions or guidelines for installing SMI panels over wood, metal, or open frame substrates. The installation details shown here are proven methods to ensure a watertight installation but they are not intended to cover all building designs and might require changes based on specific project conditions. It is the designer's/installer's responsibility to ensure the details meet the particular building requirements and that watertight integrity of the building is maintained. Also, ensure that all project requirements are met with the chosen panel system i.e. slope requirements, applicable testing, wind loads, snow loads or any other performance requirement.

SAFETY PRECAUTIONS

Follow all OSHA safety practices and regulations.

Never walk on sky lights, fiberglass type panels or any other component not designed for the weight of a person.

Extreme care should be taken when unloading, handling and installing metal roofs. Material may be heavy and bulky; metal edges may be sharp; and working at heights is dangerous.

The installer should wear heavy duty gloves and a long sleeve shirt when handling metal items as they may be sharp and can cause severe cuts. Safety goggles should be worn when cutting and drilling metal items or installing fasteners.

Installer should be trained and wear the appropriate fall protection and foot wear when working on the roof. Workers should not be on the roof when moisture or other substances may cause unsure footing.

DELIVERY & STORAGE

Unload and inspect the delivered materials for damage. Report any damaged materials promptly to the manufacturer.

The best way to reduce the possibility of damage during storage is to minimize the storage time. Other steps are designed to reduce the intrusion of water from rain, snow or condensation. A primary objective is to keep both painted and unpainted panels dry.

Storage under roof is always preferable.

Store away from materials that may contaminate the surface (such as diesel oil, paint, grease) and away from site traffic.

If panels must be stored outdoors:

Store panels in a level area away from construction activities in order to minimize the number of movements. Bundles stored on the ground must be raised several inches above a plastic ground cloth to avoid contact with puddles, allow for air circulation and to minimize condensation of water from the ground onto the panels.

Wet or treated lumber must not come in contact with the bundles.

The panels must be stored at an angle to promote drainage, taking care that the bundle is properly supported at each crosswise runner along its length.

The bundle must be completely sheltered with a loose-fitting, waterproof tarp to protect the bundle from rain or snow while allowing for air circulation and drying of condensed water. The tarp also shades the bundle from direct sunlight, which helps to moderate temperature extremes and UV damage to protective masking.

If bundles of nested panels become wet, the panel sheets should be separated, wiped with a clean cloth without delay and then placed so that air circulation completes the drying process. This is true for both painted and unpainted panels.

Avoid prolonged exposure of bundled, pre-painted panels to wet conditions which can cause paint blistering or substrate corrosion.

If panels are exposed to extreme heat or extensive solar radiation during storage or after installation, the strippable film may be very difficult to remove, and a residue may be left behind.

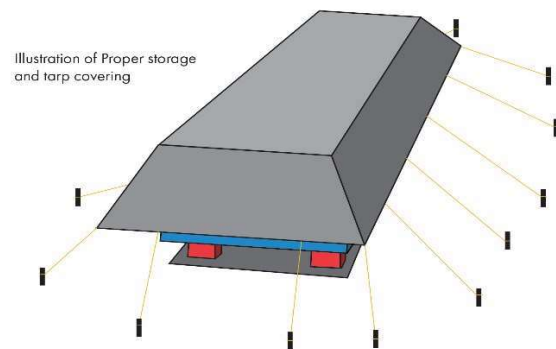
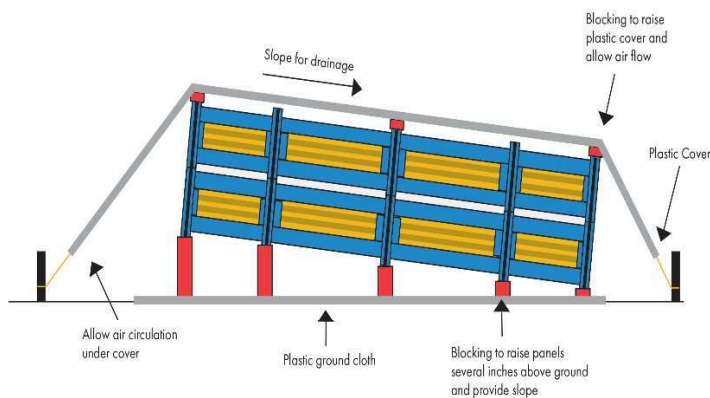

MATERIAL HANDLING

Handling of panels and the number of handlers required are determined by the panel length, width, experience of the handlers and the weather condition at the site. The final handling decision rests with the handlers themselves to ensure the metal panel does not bend or become distorted before the installation of the panel. Sheffield Metals suggests the following guidelines for handling procedures.

RIGHT WAY

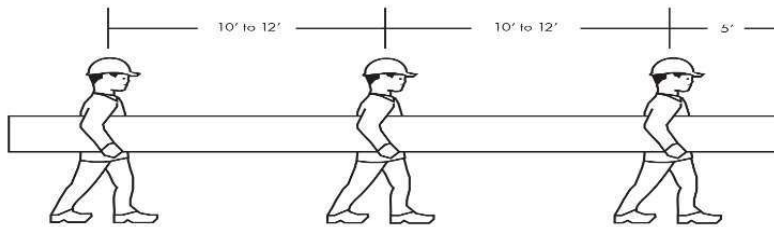

WRONG WAY

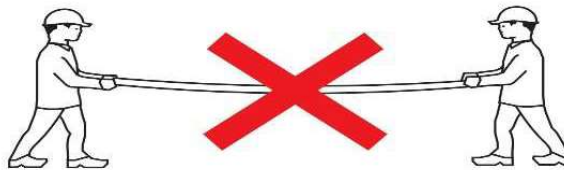

Panel Length	Less than 6'	7'-15'	16'-30'	31'-45'	>45'
# of Handlers	1	2-3	3-4	4-5	4 or more using extreme care

PRE-INSTALLATION

All projects should conform to applicable building codes

The building must be squared according to acceptable building practices. To check if the roof is square, measure diagonally across one slope of the roof from similar points at the eave and ridge and confirming the same dimension. The substructure (eave to ridge) must be on plane within a ¼" tolerance.

Provide a written report of discrepancies to the architect. Do not begin the installation until unsatisfactory conditions have been corrected as starting installation usually indicates acceptance of the substrate.

SYSTEM INSTALLATION GUIDELINES

Assure the supplied materials are as specified and meet the project guidelines.

Install the underlayment per the manufacturer's written installation instructions.

Install the roof system per the manufacturer's specified engineering reports or per wind load calculations specific to the project and installation details.

Use only approved clips, fasteners, and accessories per the manufacturers' direction.

Notify the Architect or General Contractor of any areas that do not allow for proper drainage of the roof system before the installation begins.

When panels are installed in coastal environments it is recommended that stainless steel clips and fasteners are used in conjunction with aluminum roof panels.

Inspect project to ensure that there are no areas where dissimilar metals will come into contact with each other. Separate areas with the appropriate barriers as needed. This is to include pressure/fire treated wood that is corrosive to some metals.

CLEAN UP

Peel off any strippable film from the flashings as they are installed.

Complete all items on punch list.

Touch-up minor scratches with appropriate paint or paint pen.

Remove all debris associated with the roof installation.

SEAMING THE PANELS (WHEN APPLICABLE)

Ensure panels are in tolerance before installation.

Ensure panels are fitted tightly together so there are no gaps between the panels at the eave.

Hand seam all clip locations to a 90° after panel installation.

When using an electric seamer if problems arise, stop the seaming process and contact the project manager

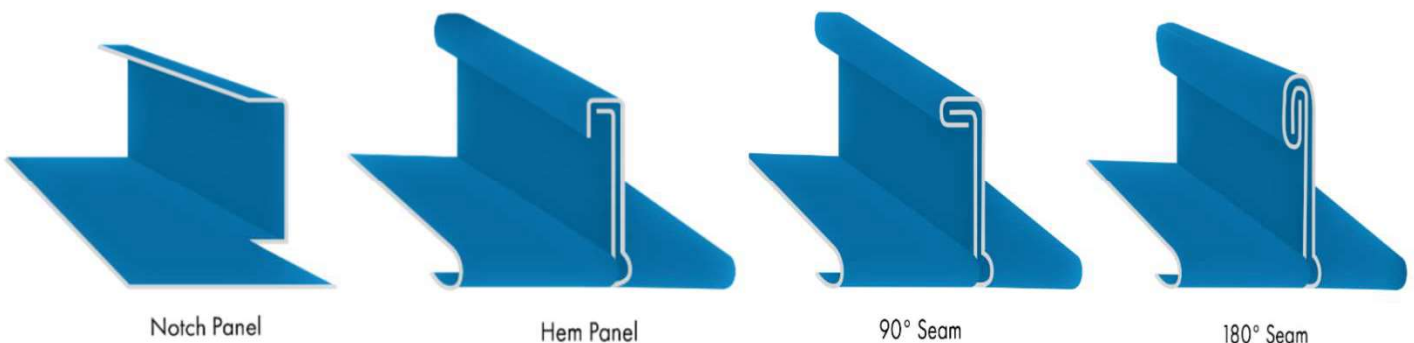

HEMMING THE PANEL

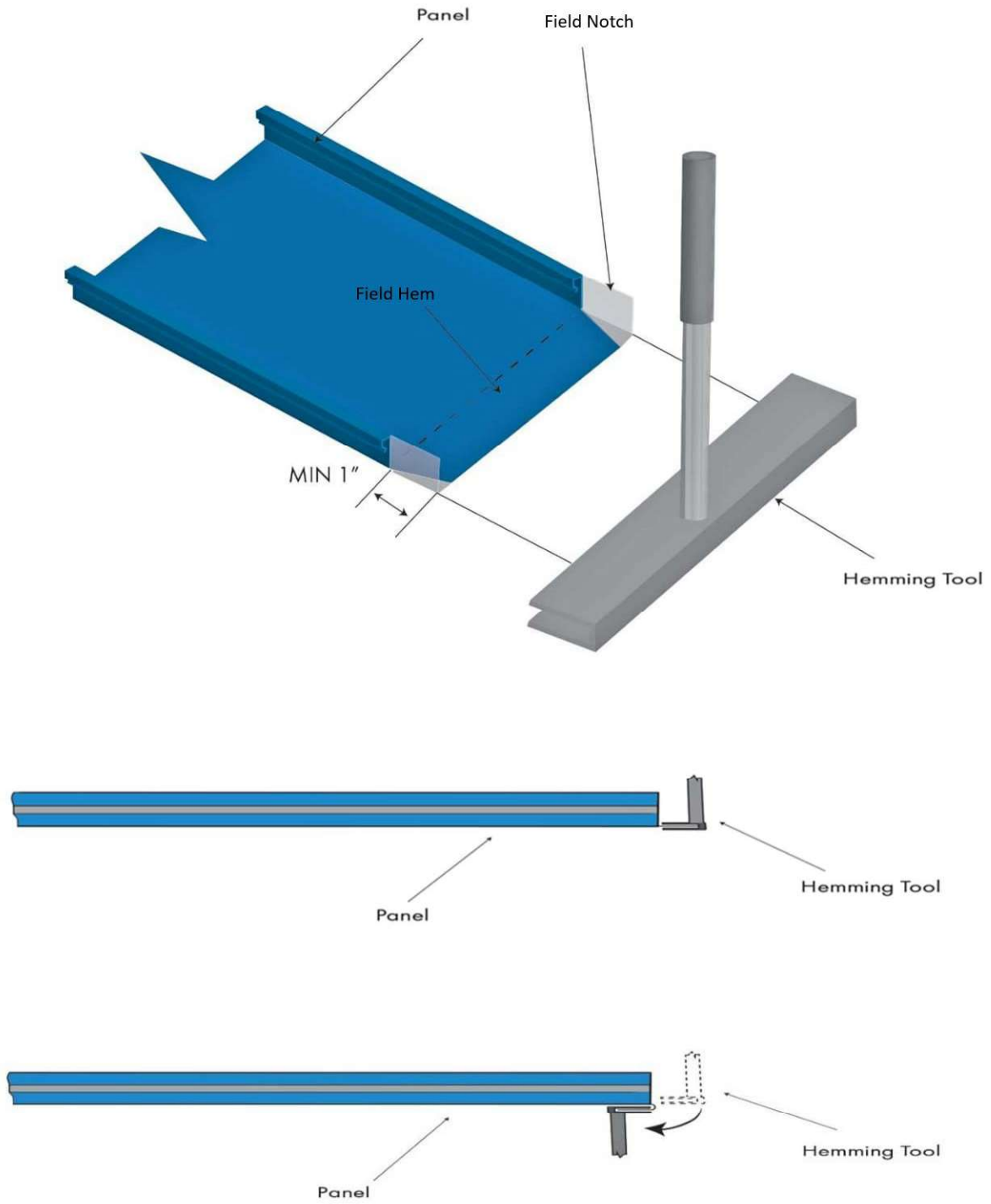

NOTES:

1. Cut through male and female legs/ribs 1" up from panel end as shown.
2. Then cut diagonally with metal shears as shown.
3. Place hemming tool over panel tab.
4. Bend down and under to 180° as shown.

THERMAL MOVEMENT

A standing seam roof panel experiences changes in panel length with changes in panel temperature. One end of the panel is fixed to the substrate while the other end is free to move. The panel end that is free to move requires a hem that engages a cleat that is fixed to the substrate. The hem and cleat permit the panel end to move along the plane of the roof while holding the panel flat.

The thermal movement also requires proper design of the hem and cleat. The length of the hem needed at the end of a panel will vary with the temperature range that the panel experiences and the length of the panel. Unless a more exact analysis of the temperature during installation compared to the anticipated temperature range is conducted, use the following equation and the Thermal Movement Table. When installing panels, be sure to leave room at the end of the panel that will experience movement for the “starting gap” which is the required air space (X) between the panel and cleat. Be sure that the hem is not tight against the cleat (unless the panels are being installed in the coldest temperatures the panel will experience). Also be sure that the lower edge of the hem will not be in contact with any flashings when the panels contract.

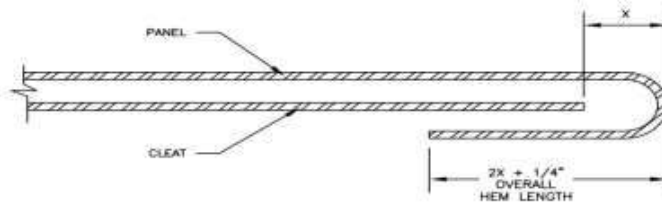

THERMAL MOVEMENT TABLE

PANEL AND SUBSTRATE MATERIALS	PANEL LENGTH (FT.)			REQUIRED AIR SPACE (X)
	10'	50'	100'	
Steel on Rigid Insulation	1/8"	1/2"	7/8"	
Steel on Wood	1/16"	3/8"	5/8"	
Steel on Steel	1/16"	3/8"	5/8"	
Steel on Concrete	1/16"	3/8"	1/2"	
Aluminum on Rigid Insulation	3/16"	7/8"	1 9/16"	
Aluminum on Wood	3/16"	11/16"	1 3/8"	
Aluminum on Steel	1/8"	5/8"	1 3/16"	
Aluminum on Concrete	1/8"	5/8"	1 1/4"	

This table assumes a temperature change of 100°F for the panel and 50°F for the substrate.

E1 - Eave Detail

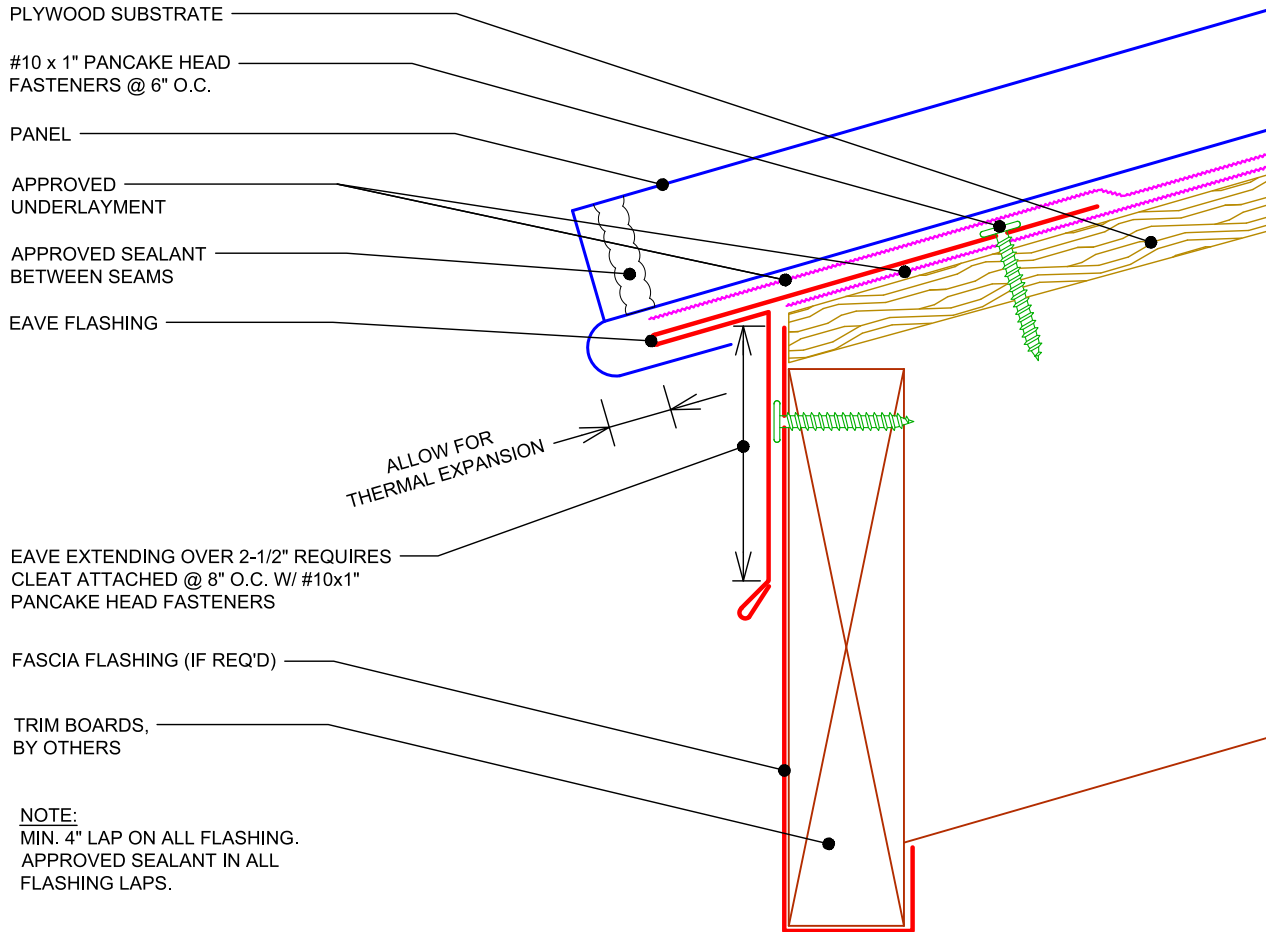

1. Make sure deck is clean and ready for installation. Install underlayment per manufacturer's instructions.
2. Place eave flashing onto roof deck and fasten with #10x1" pancake head fasteners at 6" O.C. Minimum 4" lap on eave flashings with approved sealant in-between laps. 24" minimum flashing length.
3. Strip in eave flashing with 8" roll of approved peel and stick underlayment.
4. Install panels and engage panel hem onto nose of eave flashing. Leave the required gap to allow for thermal expansion and contraction. Carefully crimp panel hem closed using hand seammers.
5. Apply a bead of approved sealant on the vertical seam of the panel before installing the next panel.

EG1 - Eave w/ Gutter Detail

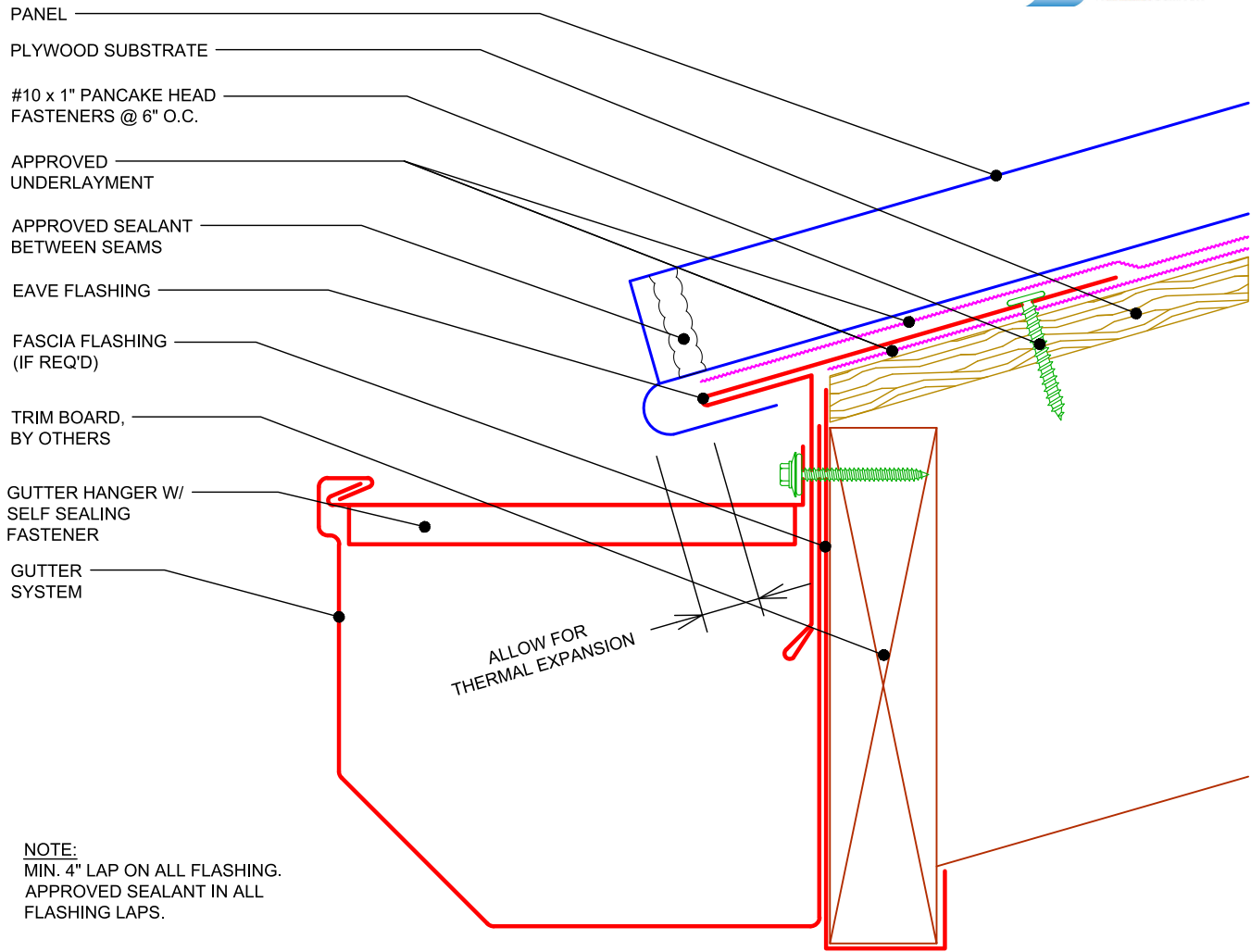

1. Make sure deck is clean and ready for installation. Install underlayment per manufacturer's instructions.
2. Place eave flashing onto roof deck and fasten with #10x1" pancake head fasteners at 6" O.C. Minimum 4" lap on eave flashings with approved sealant in-between laps. 24" minimum flashing length.
3. Strip in eave flashing with 8" roll of approved peel and stick underlayment.
4. Install panels and engage panel hem onto nose of eave flashing. Leave the required gap to allow for thermal expansion and contraction. Carefully crimp panel hem closed using hand seamers.
5. Apply a bead of approved sealant on vertical seam of panel before installing the next panel.
6. Install gutter behind face of the drip edge and fasten gutter hangers with self-sealing fasteners through eave flashing.

ET1 - Eave Transition Detail

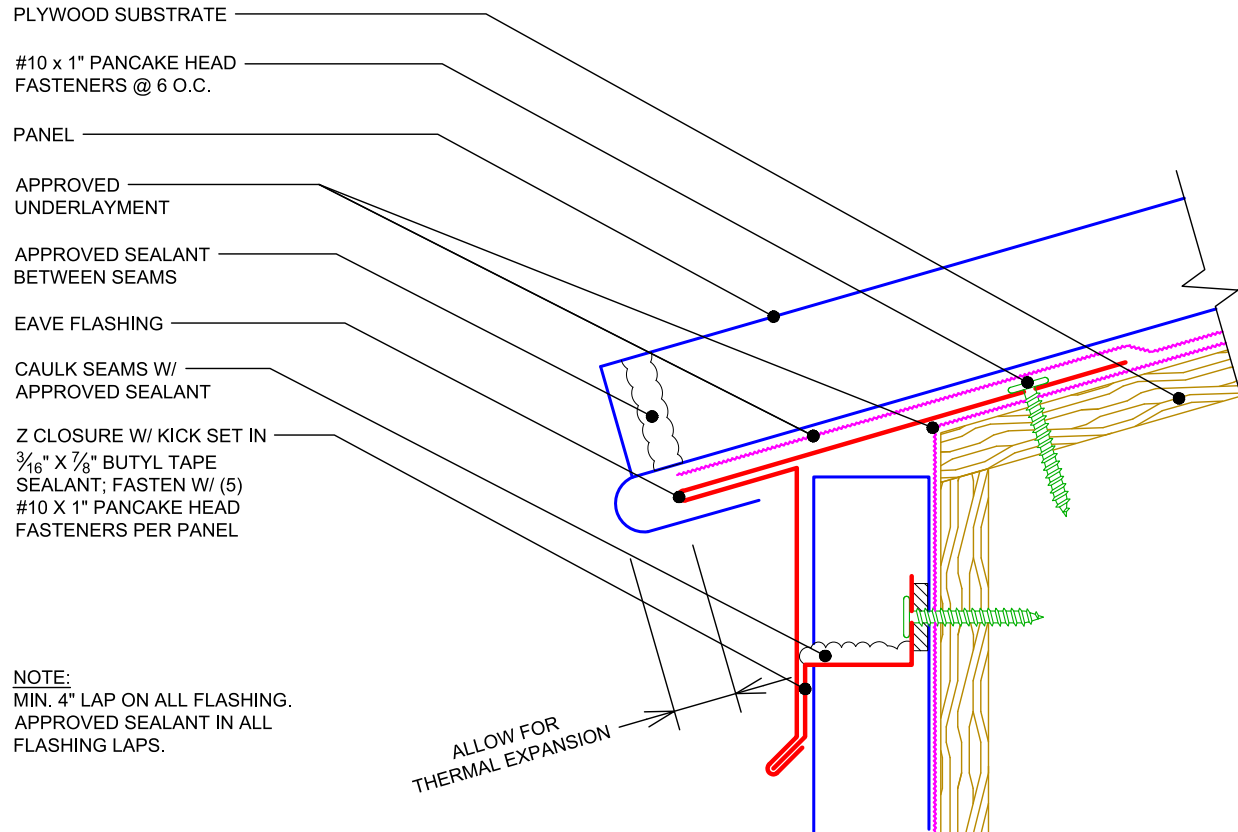

1. Make sure deck is clean and ready for installation. Install underlayment per manufacturer's instructions.
2. Install metal wall panel per manufacturer's instructions.
3. Apply 3/16"x7/8" butyl tape to Z closure with kick and install over wall panel using #10x1" SD pancake head fasteners at 4" O.C. through butyl tape. Minimum 5 fasteners per panel.
4. Apply a bead of approved sealant behind the Z closure with kick at wall panel rib and tool in.
5. Engage open hem of eave flashing onto wall panel Z closure and fasten with #10x1" SD pancake head fasteners at 6" O.C. Minimum 4" lap on eave flashings with approved sealant in-between laps. 24" minimum flashing length.
6. Strip in eave flashing with 8" roll of approved peel and stick underlayment.
7. Install panels and engage panel hem onto nose of eave flashing. Leave the required gap to allow for thermal expansion and contraction. Carefully crimp panel hem closed using hand seamers.
8. Apply a bead of approved sealant on vertical seam of panel before installing the next panel.

RK1 - Rake / Gable Detail

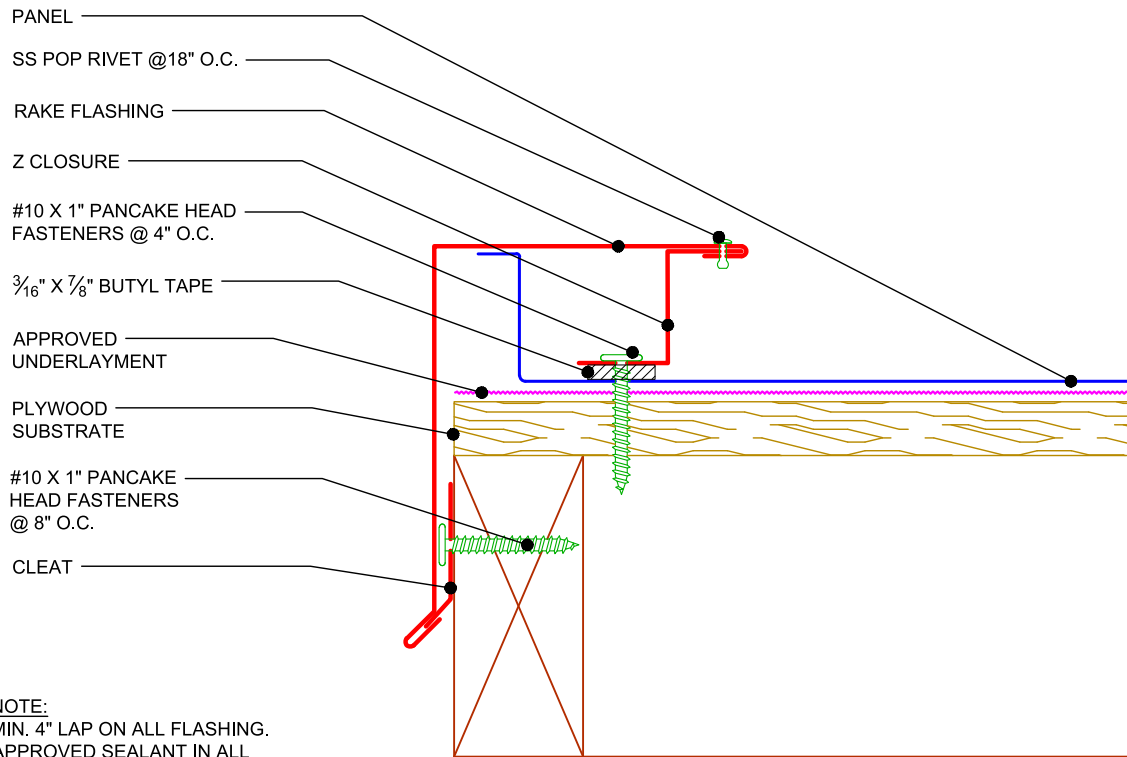

1. Make sure deck is clean and ready for installation. Install underlayment per manufacturer's instructions.
2. Install panel, field bend panel edge 90° to match Z closure height.
3. Install cleat on rake face and fasten with #10x1" pancake head fasteners at 8" O.C.
4. Apply 3/16"x7/8" butyl tape to Z closure and install over panel using #10x1" pancake head fasteners at 4" O.C. through butyl tape. Minimum 4" lap on Z closure with approved sealant in-between laps.
5. Install rake flashing by engaging onto cleat and Z closure. Minimum 4" lap on rake flashing with approved sealant in-between laps. Stagger laps between Z closure and rake flashings a minimum of 6". 24" minimum flashing length.
6. Drill holes in rake flashing hem and Z closure using the correct size drill bit at 18" O.C.
7. Install stainless steel pop rivets through hem of rake flashing, attaching to Z closure, at 18" O.C.
8. Remove all swarf, filings, and debris from drilling immediately upon completion.

RK2 - Rake / Gable Detail

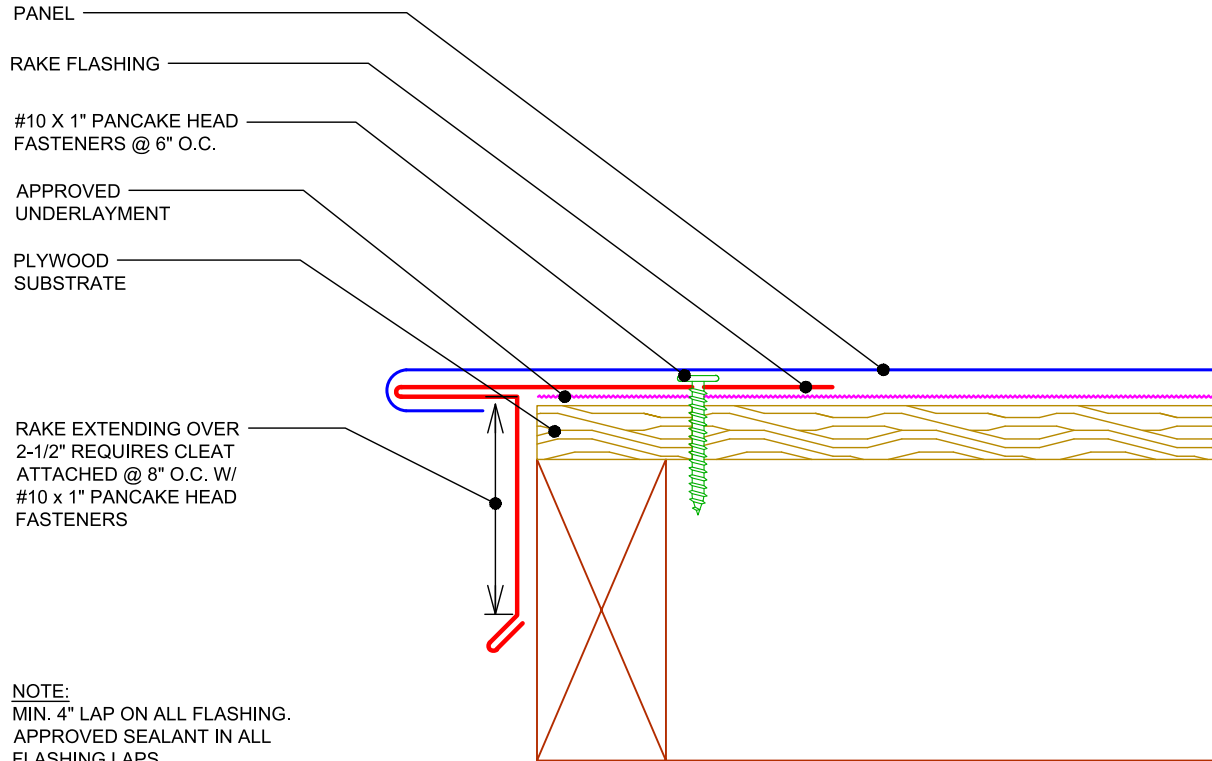

1. Make sure deck is clean and ready for installation. Install underlayment per manufacturer's instructions.
2. Place rake flashing onto roof deck and fasten with #10x1" pancake head fasteners at 6" O.C. Minimum 4" lap on rake flashings with approved sealant in-between laps. 24" minimum flashing length.
3. Fold panel edge using a WUKO bending tool (or similar) to create the open hem.
4. Install panel and engage panel hem onto nose of rake flashing.
5. Carefully crimp panel hem closed using hand seamers.

SW1 - Sidewall Detail

BACKER ROD & APPROVED SEALANT

THREADED FASTENERS @ 16" O.C.

$\frac{3}{16}$ " x $\frac{7}{8}$ " BUTYL TAPE

COUNTER FLASHING W/ REGLET

SIDEWALL FLASHING

FIELD BEND PANEL

SS POP RIVET, 18" O.C.

Z CLOSURE SET IN $\frac{3}{16}$ " x $\frac{7}{8}$ "
BUTYL TAPE

#10 x 1" PANCAKE HEAD
FASTENERS @ 4" O.C.

APPROVED UNDERLAYMENT

PLYWOOD SUBSTRATE

NOTE:
MINIMUM LAP ON ALL FLASHING
IS 4". APPROVED SEALANT IN
LAPS OF ALL FLASHING. TURN
APPROVED UNDERLAYMENT 3"
VERTICALLY MIN.

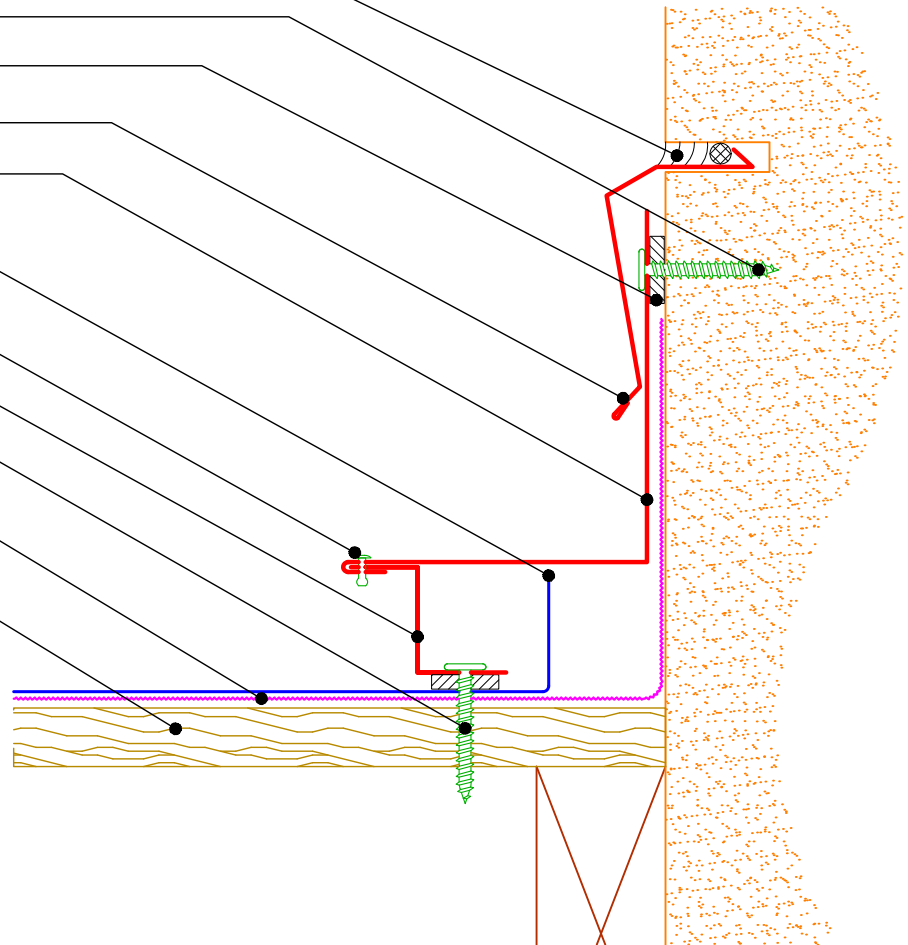

1. Make sure deck is clean and ready for installation. Install underlayment per manufacturer's instructions. Underlayment turns up wall a minimum of 3".
2. Install panel, field bend panel edge 90° to match Z closure height.
3. Apply $\frac{3}{16}$ "x $\frac{7}{8}$ " butyl tape to Z closure and install over panel using #10x1" pancake head fasteners at 4" O.C. through butyl tape.
4. Apply $\frac{3}{16}$ "x $\frac{7}{8}$ " butyl tape on backside vertical leg of sidewall flashing. Engage sidewall flashing over Z closure and attach to wall using threaded anchor screws at 16" O.C. through butyl tape.
5. Drill holes through sidewall flashing hem and Z closure using the correct size drill bit at 18" O.C.
6. Install stainless steel pop rivets through hem of sidewall flashing, attaching to Z closure, at 18" O.C.
7. Install reglet counter flashing into pre-cut reglet.
8. Apply backer rod and approved sealant, completely filling sawcut reglet, and tool in.
9. Remove all swarf, filings, and debris from area immediately upon completion.
10. Minimum 4" lap on all flashings with approved sealant in-between laps. 24" minimum flashing length.
11. Stagger laps between Z closure, sidewall, and counter flashings a minimum of 6".

SW2 - Sidewall Detail

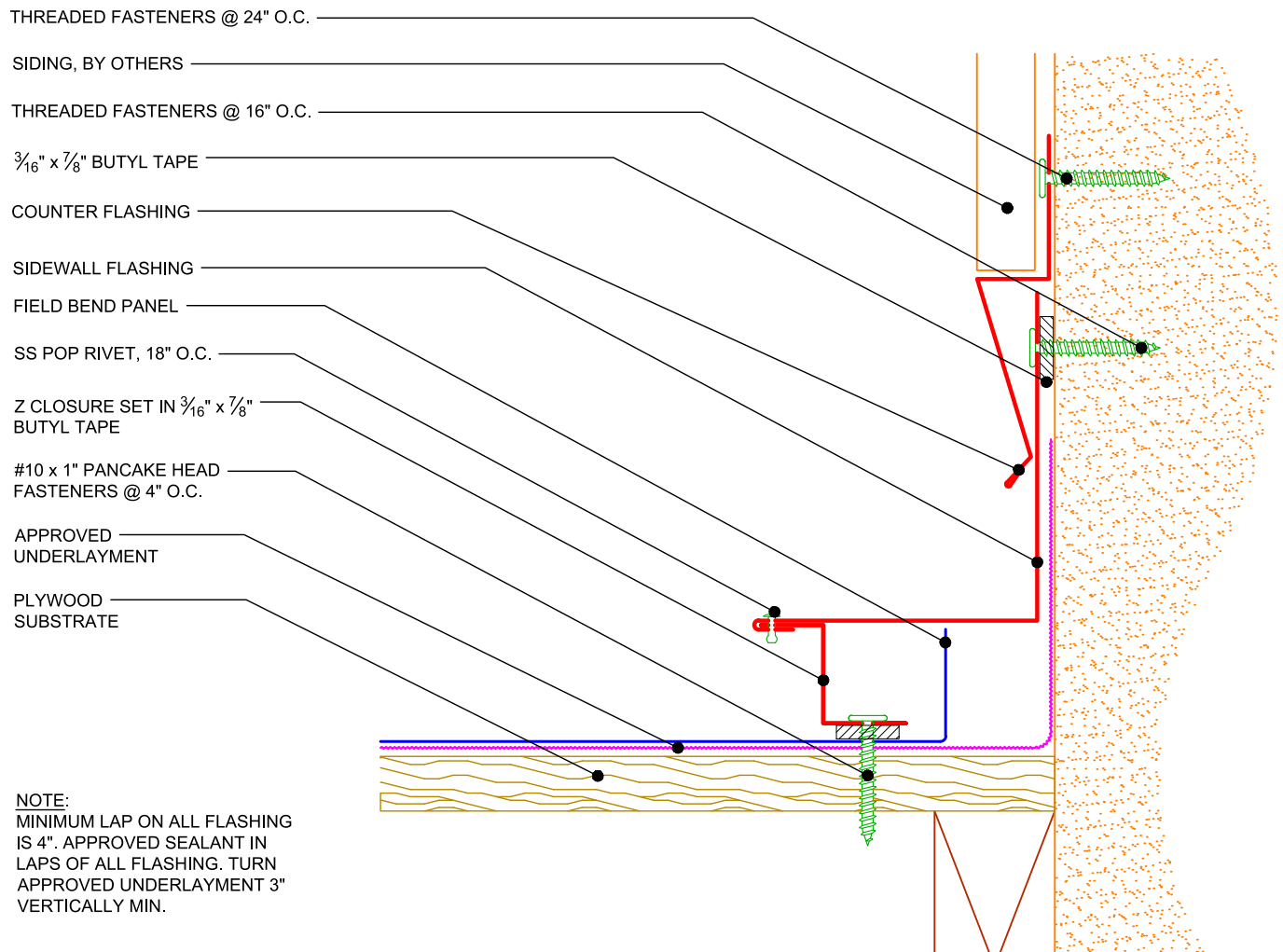

1. Make sure deck is clean and ready for installation. Install underlayment per manufacturer's instructions. Underlayment turns up wall a minimum of 3".
2. Install panel, field bend panel edge 90° to match Z closure height.
3. Apply 3/16"x7/8" butyl tape to Z closure and install over panel using #10x1" pancake head fasteners at 4" O.C. through butyl tape.
4. Apply 3/16"x7/8" butyl tape on backside vertical leg of sidewall flashing. Engage sidewall flashing over Z closure and attach to wall using threaded anchor screws at 16" O.C. through butyl tape.
5. Drill holes through sidewall flashing hem and Z closure using the correct size drill bit at 18" O.C.
6. Install stainless steel pop rivets through hem of sidewall flashing, attaching to Z closure, at 18" O.C.
7. Install counter flashing using threaded fasteners at 24" O.C.
8. Remove all swarf, filings, and debris from area immediately upon completion.
9. Minimum 4" lap on all flashings with approved sealant in-between laps. 24" minimum flashing length.
10. Stagger laps between Z closure, sidewall, and counter flashings a minimum of 6".

SW3 - Sidewall Detail

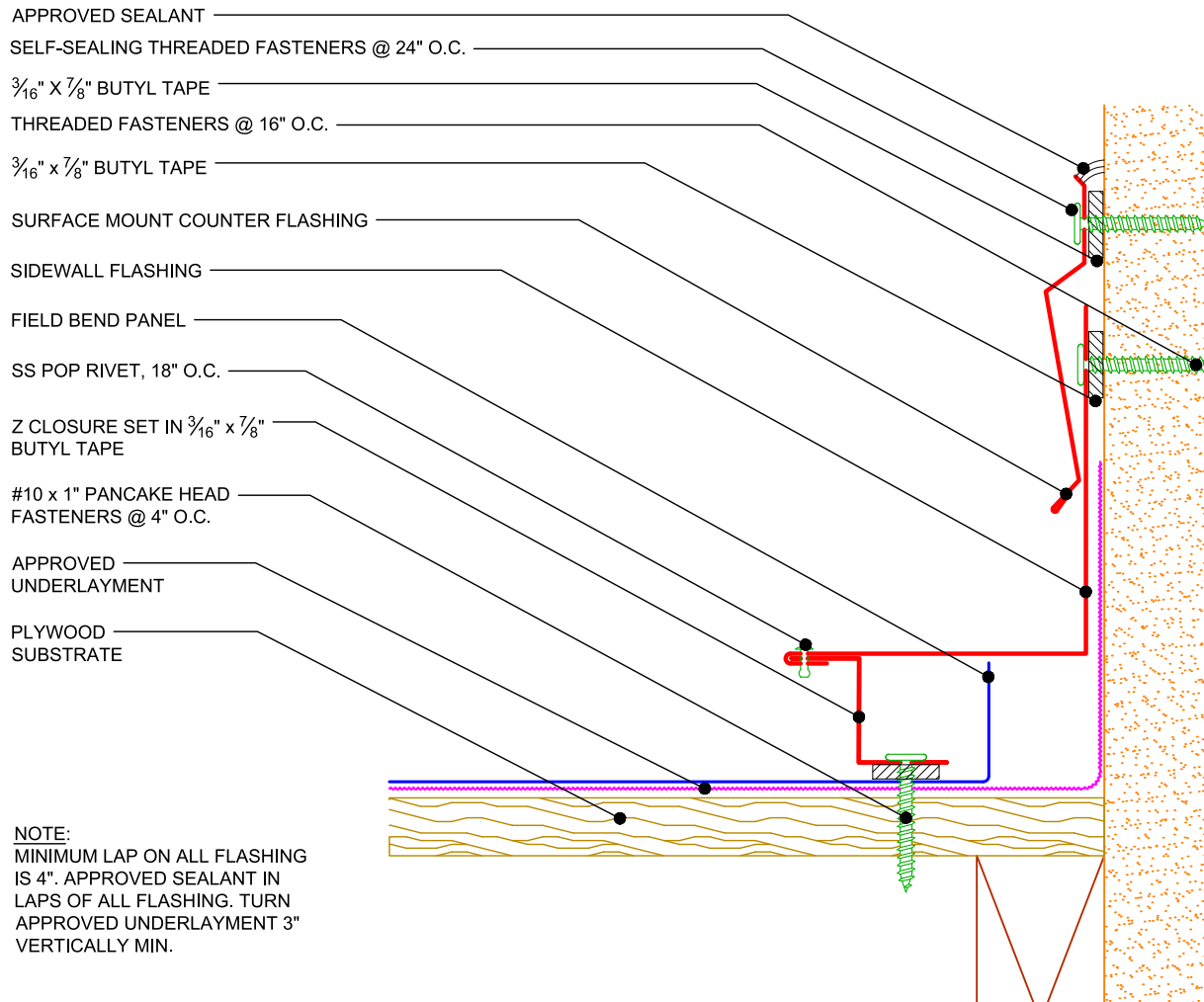

NOTE:
MINIMUM LAP ON ALL FLASHING IS 4". APPROVED SEALANT IN LAPS OF ALL FLASHING. TURN APPROVED UNDERLAYMENT 3" VERTICALLY MIN.

1. Make sure deck is clean and ready for installation. Install underlayment per manufacturer's instructions. Underlayment turns up wall a minimum of 3".
2. Install panel, field bend panel edge 90° to match Z closure height.
3. Apply 3/16"x7/8" butyl tape to Z closure and install over panel using #10x1" pancake head fasteners at 4" O.C. through butyl tape.
4. Apply 3/16"x7/8" butyl tape on backside vertical leg of sidewall flashing. Engage sidewall flashing over Z closure and attach to wall using threaded anchor screws at 16" O.C. through butyl tape.
5. Drill holes through sidewall flashing hem and Z closure using the correct size drill bit at 18" O.C.
6. Install stainless steel pop rivets through hem of sidewall flashing, attaching to Z closure, at 18" O.C.
7. Apply 3/16"x7/8" butyl tape on backside of counter flashing and attach using self-sealing threaded fasteners at 24" O.C.
8. Apply approved sealant above counter flashing caulk edge and tool in.
9. Remove all swarf, filings, and debris from area immediately upon completion.
10. Minimum 4" lap on all flashings with approved sealant in-between laps. 24" minimum flashing length.
11. Stagger laps between Z closure, sidewall, and counter flashings a minimum of 6".

HW1 - Headwall Detail

BACKER ROD & APPROVED SEALANT

THREADED FASTENERS @ 16" O.C.

$\frac{3}{16}$ " X $\frac{7}{8}$ " BUTYL TAPE

COUNTER FLASHING W/ REGLET

APPROVED UNDERLAYMENT

HEADWALL FLASHING

BOX END OF PANEL

Z CLOSURE SET IN $\frac{3}{16}$ " X $\frac{7}{8}$ "
BUTYL TAPE

SS POP RIVET @ 18" O.C.

CAULK SEAMS VERTICALLY
W/ APPROVED SEALANT

#10 X 1" PANCAKE HEAD
FASTENERS, (5) PER PANEL

PLYWOOD SUBSTRATE

PANEL

NOTE:

MINIMUM LAP ON ALL FLASHING IS 4". APPROVED SEALANT IN LAPS OF ALL FLASHING. TURN APPROVED UNDERLAYMENT 3" VERTICALLY MIN.

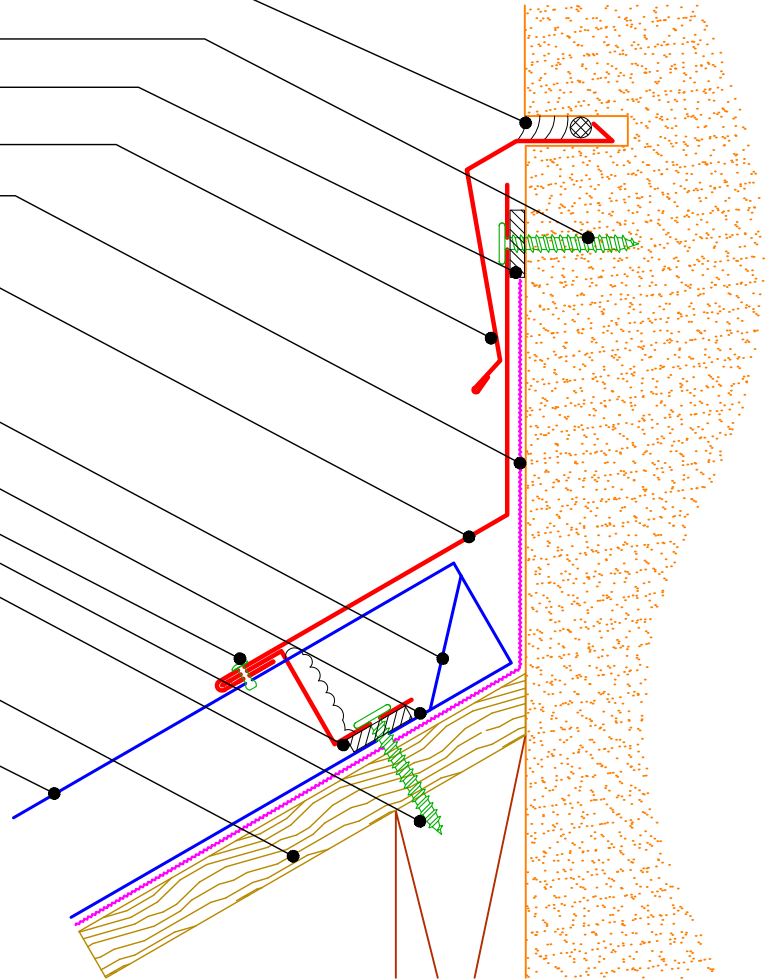

1. Make sure deck is clean and ready for installation. Install underlayment per manufacturer's instructions. Underlayment turns up wall a minimum of 3".
2. Install panel, field bend panel edge 45° to create box end. Do not cut panel ribs when folding box end.
3. Apply $\frac{3}{16}$ "x $\frac{7}{8}$ " butyl tape to Z closure and install over panel using #10x1" pancake head fasteners at 4" O.C. through butyl tape. Minimum 5 fasteners per panel.
4. Apply a vertical bead of approved sealant behind the Z closure at panel rib and tool in.
5. Apply $\frac{3}{16}$ "x $\frac{7}{8}$ " butyl tape on backside vertical leg of headwall flashing. Engage headwall flashing over Z closure and attach to wall using threaded anchor screws at 16" O.C. through butyl tape.
6. Drill holes through headwall flashing hem and Z closure using the correct size drill bit at 18" O.C.
7. Install stainless steel pop rivets through hem of headwall flashing, attaching to Z closure, at 18" O.C.
8. Install reglet counter flashing into pre-cut reglet.
9. Apply backer rod and approved sealant, completely filling sawcut reglet, and tool in.
10. Remove all swarf, filings, and debris from area immediately upon completion.
11. Minimum 4" lap on all flashings with approved sealant in-between laps. 24" minimum flashing length.
12. Stagger laps between headwall and counter flashings a minimum of 6".

HW2 - Headwall Detail

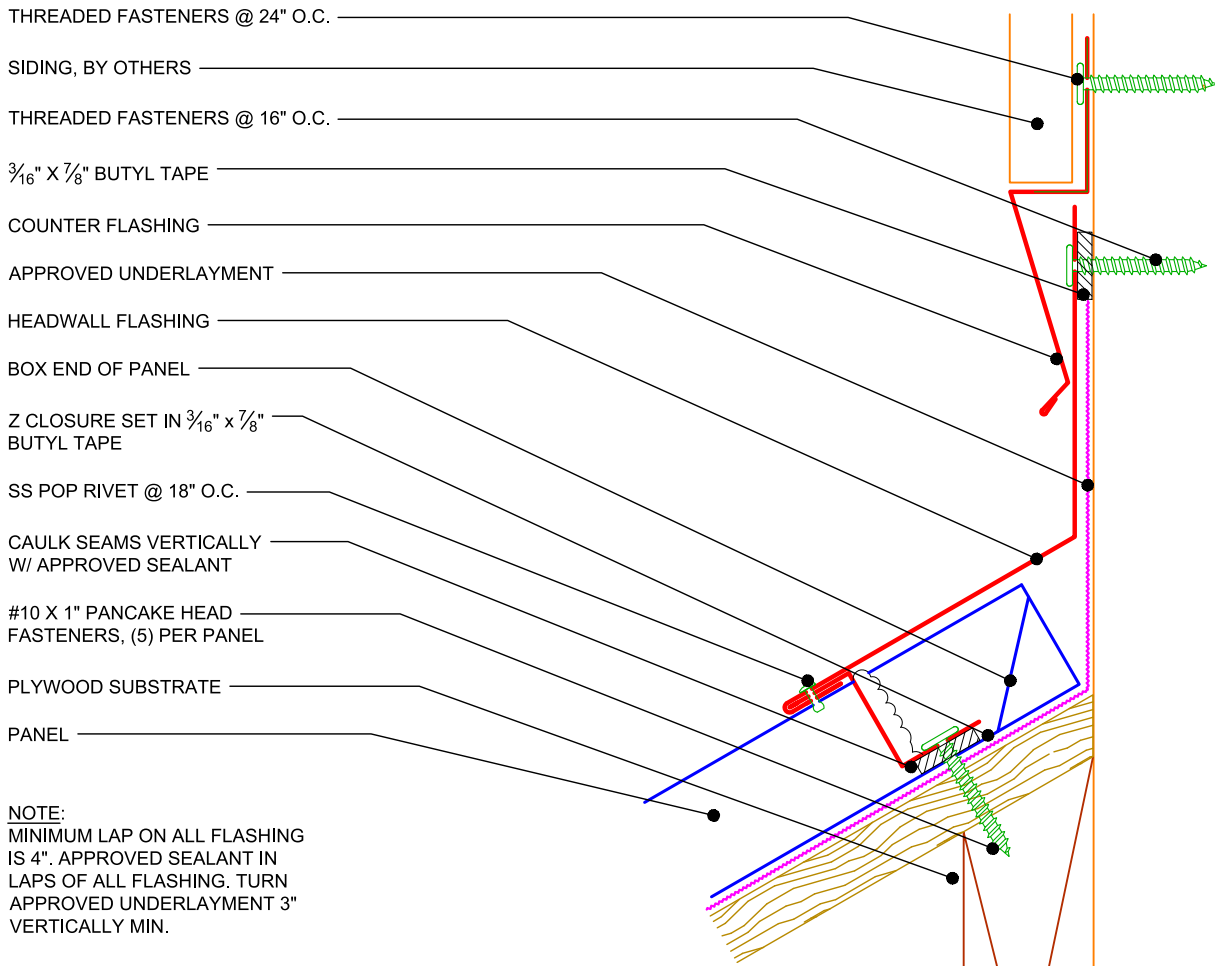

1. Make sure deck is clean and ready for installation. Install underlayment per manufacturer's instructions. Underlayment turns up wall a minimum of 3".
2. Install panel, field bend panel edge 45° to create box end. Do not cut panel ribs when folding box end.
3. Apply $\frac{3}{16}$ "x $\frac{7}{8}$ " butyl tape to Z closure and install over panel using #10x1" pancake head fasteners at 4" O.C. through butyl tape. Minimum 5 fasteners per panel.
4. Apply a vertical bead of approved sealant behind the Z closure at panel rib and tool in.
5. Apply $\frac{3}{16}$ "x $\frac{7}{8}$ " butyl tape on backside vertical leg of headwall flashing. Engage headwall flashing over Z closure and attach to wall using threaded anchor screws at 16" O.C. through butyl tape.
6. Drill holes through headwall flashing hem and Z closure using the correct size drill bit at 18" O.C.
7. Install stainless steel pop rivets through hem of headwall flashing, attaching to Z closure, at 18" O.C.
8. Install counter flashing using threaded fasteners at 24" O.C.
9. Remove all swarf, filings, and debris from area immediately upon completion.
10. Minimum 4" lap on all flashings with approved sealant in-between laps. 24" minimum flashing length.
11. Stagger laps between headwall and counter flashings a minimum of 6".

HW3 - Headwall Detail

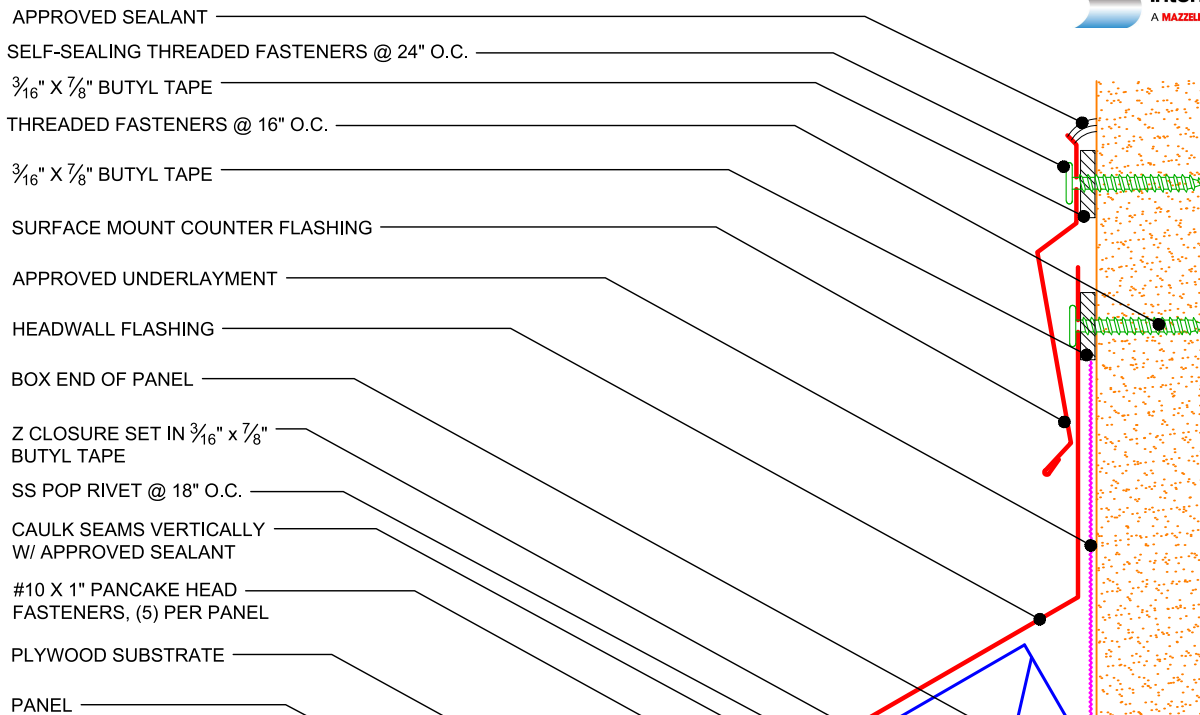

NOTE:
MINIMUM LAP ON ALL FLASHING IS 4". APPROVED SEALANT IN LAPS OF ALL FLASHING. TURN APPROVED UNDERLAYMENT 3" VERTICALLY MIN.

1. Make sure deck is clean and ready for installation. Install underlayment per manufacturer's instructions. Underlayment turns up wall a minimum of 3".
2. Install panel, field bend panel edge 45° to create box end. Do not cut panel ribs when folding box end.
3. Apply $\frac{3}{16}$ "x $\frac{7}{8}$ " butyl tape to Z closure and install over panel using #10x1" pancake head fasteners at 4" O.C. through butyl tape. Minimum 5 fasteners per panel.
4. Apply a vertical bead of approved sealant behind the Z closure at panel rib and tool in.
5. Apply $\frac{3}{16}$ "x $\frac{7}{8}$ " butyl tape on backside vertical leg of headwall flashing. Engage headwall flashing over Z closure and attach to wall using threaded anchor screws at 16" O.C. through butyl tape.
6. Drill holes through headwall flashing hem and Z closure using the correct size drill bit at 18" O.C.
7. Install stainless steel pop rivets through hem of headwall flashing, attaching to Z closure, at 18" O.C.
8. Apply $\frac{3}{16}$ "x $\frac{7}{8}$ " butyl tape on backside of counter flashing and attach using self-sealing threaded fasteners at 24" O.C.
9. Apply approved sealant above counter flashing caulk edge and tool in.
10. Remove all swarf, filings, and debris from area immediately upon completion.
11. Minimum 4" lap on all flashings with approved sealant in-between laps. 24" minimum flashing length.
12. Stagger laps between headwall and counter flashings a minimum of 6".

V1 - Valley Detail

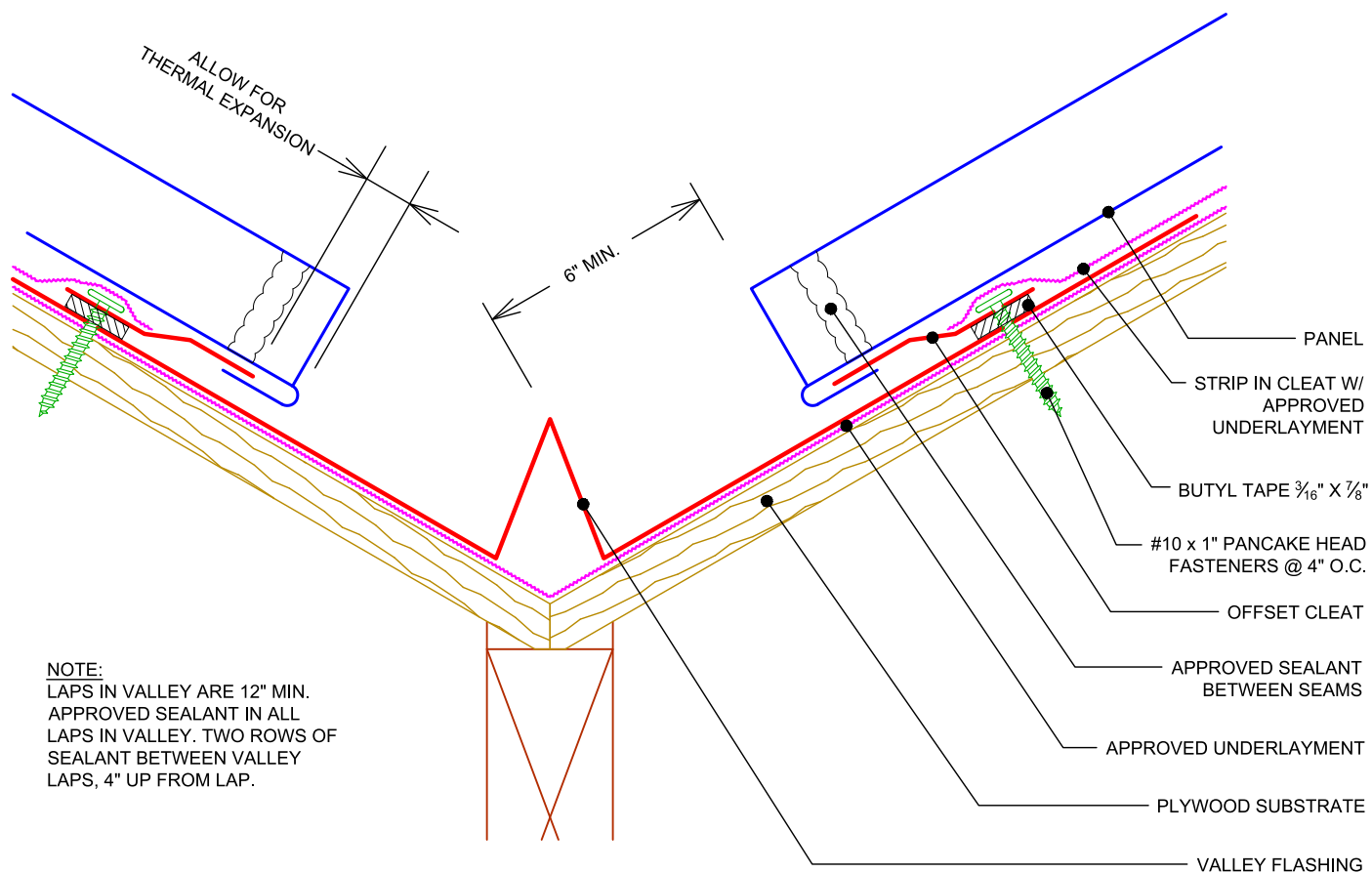

1. Make sure deck is clean and ready for installation. Install underlayment per manufacturer's instructions.
2. Place valley flashing, centered in valley, and tack in place using a #10x1" pancake head fastener at 3' O.C. Minimum valley lap is 12" with two rows of approved sealant in lap. 24" min. flashing length.
3. Apply 3/16"x7/8" butyl tape to offset cleat and install over valley flashing using #10x1" pancake head fasteners at 4" O.C. through butyl tape.
4. Minimum 6" clean out between the center of the valley and offset cleat.
5. Strip in offset cleat and edge of valley flashing with 8" roll of approved peel and stick underlayment.
6. Install panels and engage panel hem onto offset cleat. Leave the required gap to allow for thermal expansion and contraction. Carefully crimp panel hem closed using hand seamers.
7. Apply a bead of approved sealant on the vertical seam of the panel before installing the next panel.

T2 - Roof Transition Detail

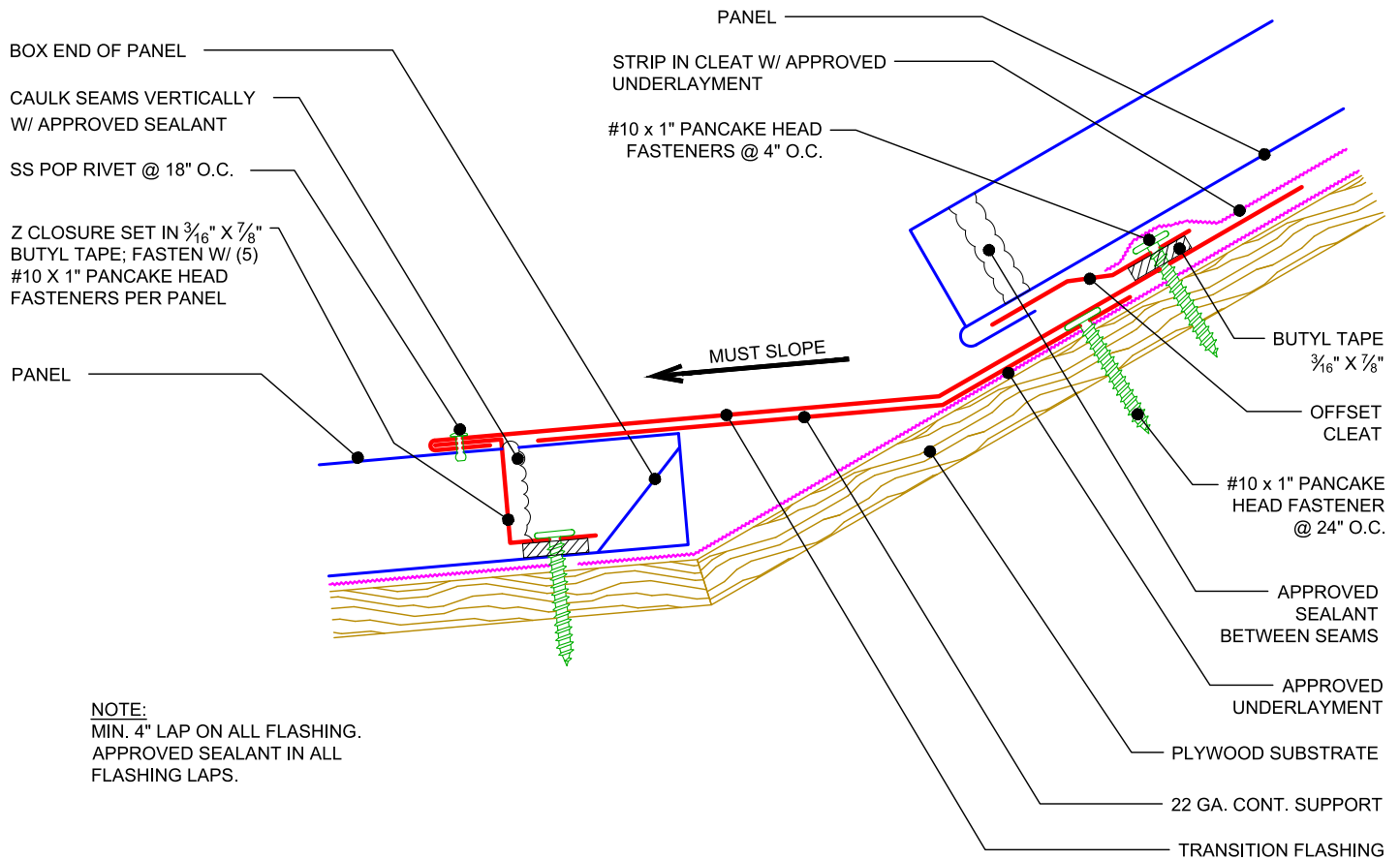

1. Make sure deck is clean and ready for installation. Install underlayment per manufacturer's instructions.
2. Install lower panel, field bend panel edge 45° to create box end. Do not cut panel ribs when folding.
3. Apply $\frac{3}{16}$ "x $\frac{7}{8}$ " butyl tape to Z closure and install over panel using #10x1" pancake head fasteners at 4" O.C. through butyl tape. Minimum 5 fasteners per panel.
4. Apply a vertical bead of approved sealant behind the Z closure at panel rib and tool in.
5. Place 22ga. continuous support flashing over lower panels and fasten to upper roof deck high flute with #10x1" pancake head fasteners at 12" O.C. Flashing must have slope.
6. Engage transition flashing onto Z closure and fasten with #10x1" pancake head fasteners at 6" O.C. Minimum 4" lap on transition flashings with approved sealant in-between laps. 24" min. flashing length.
7. Apply $\frac{3}{16}$ "x $\frac{7}{8}$ " butyl tape to offset cleat and install over transition flashing using #10x1" pancake head fasteners at 4" O.C. through butyl tape.
8. Strip in offset cleat and edge of transition flashing with 8" roll of approved peel and stick underlayment.
9. Install panels and engage panel hem onto offset cleat. Leave the required gap to allow for thermal expansion and contraction. Carefully crimp hem closed using hand seamers.
10. Drill holes through transition flashing hem and Z closure using the correct size drill bit at 18" O.C.
11. Install stainless steel pop rivets through hem of transition flashing, attaching to Z closure, at 18" O.C.
12. Remove all swarf, filings, and debris from area immediately upon completion.

PK1 - Peak Detail

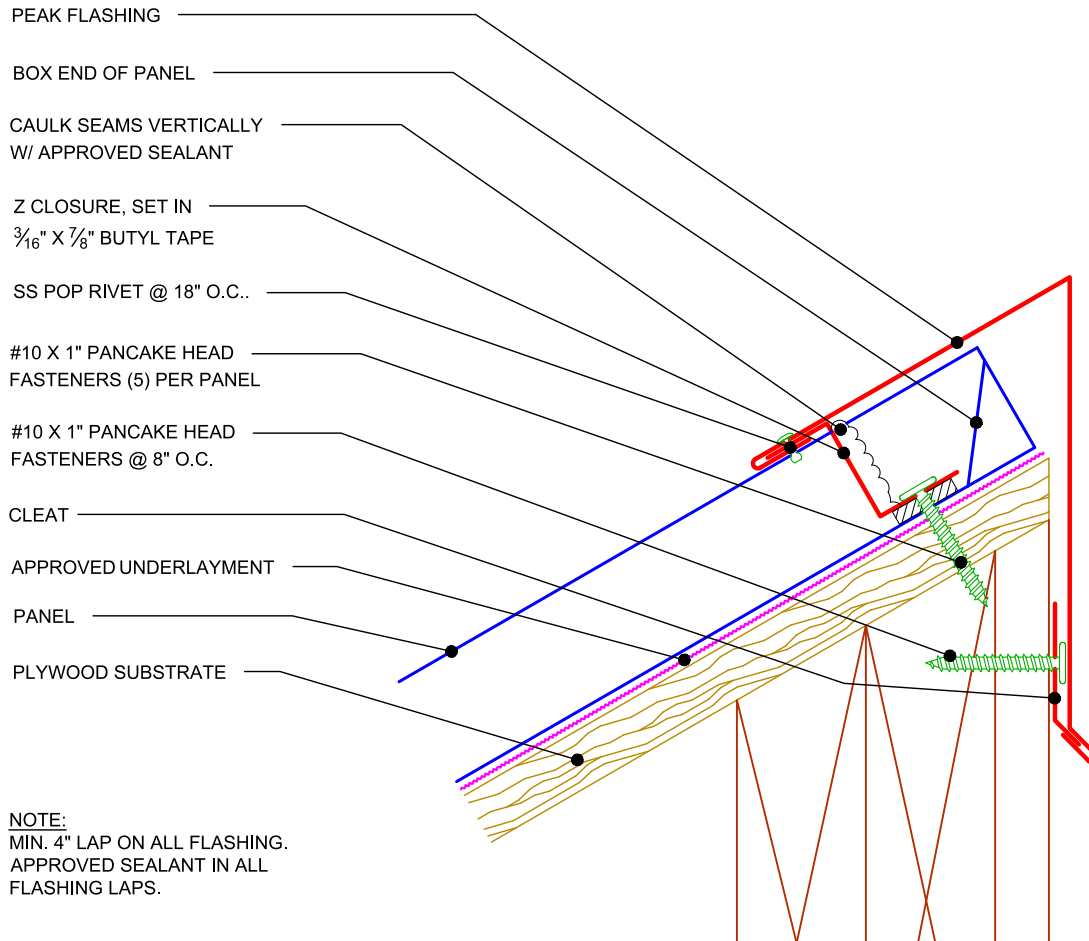

1. Make sure deck is clean and ready for installation. Install underlayment per manufacturer's instructions.
2. Install panel, field bend panel edge 45° to create box end. Do not cut panel ribs when folding box end.
3. Install cleat on peak face and fasten with #10x1" pancake head fasteners at 8" O.C.
4. Apply 3/16"x7/8" butyl tape to Z closure and install over panel using #10x1" pancake head fasteners at 4" O.C. through butyl tape. Minimum 5 fasteners per panel.
5. Apply a vertical bead of approved sealant behind the Z closure at panel rib and tool in.
6. Install peak flashing by engaging onto cleat and Z closure. Minimum 4" lap on peak flashing with approved sealant in-between laps. 24" min. flashing length.
7. Drill holes in rake flashing hem and Z closure using the correct size drill bit at 18" O.C.
8. Install stainless steel pop rivets through hem of rake flashing, attaching to Z closure, at 18" O.C.
9. Remove all swarf, filings, and debris from drilling immediately upon completion.

PK2 - Peak Detail

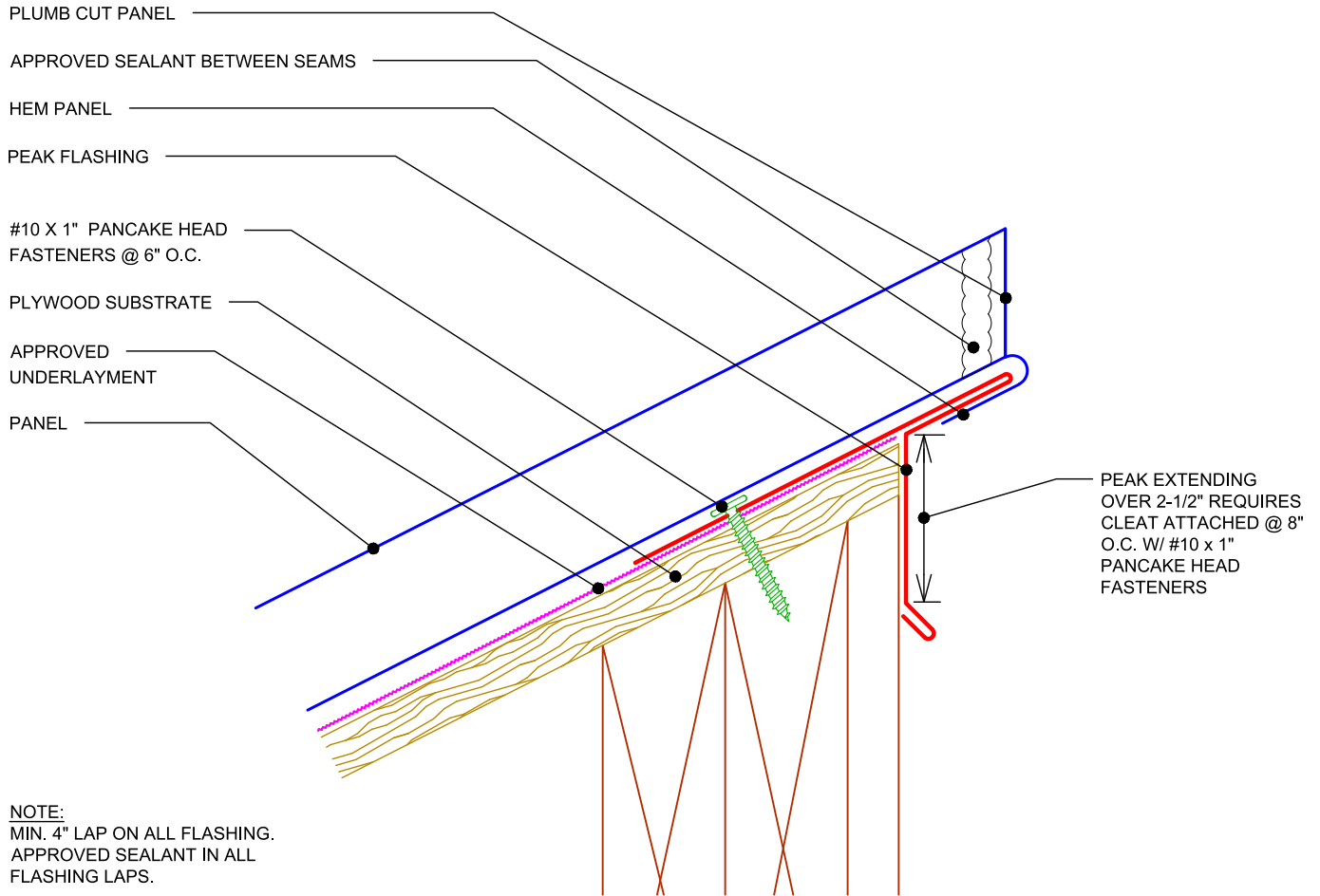

1. Make sure deck is clean and ready for installation. Install underlayment per manufacturer's instructions.
2. Place peak flashing onto roof deck and fasten with #10x1" pancake head fasteners at 6" O.C. Minimum 4" lap on peak flashings with approved sealant in-between laps. 24" minimum flashing length.
3. Install panels and engage panel hem onto nose of peak flashing.
4. Carefully crimp hem closed using hand seamers.
5. Apply a bead of approved sealant on the vertical seam of the panel before installing the next panel.

HR1 - Standard Hip / Ridge Detail

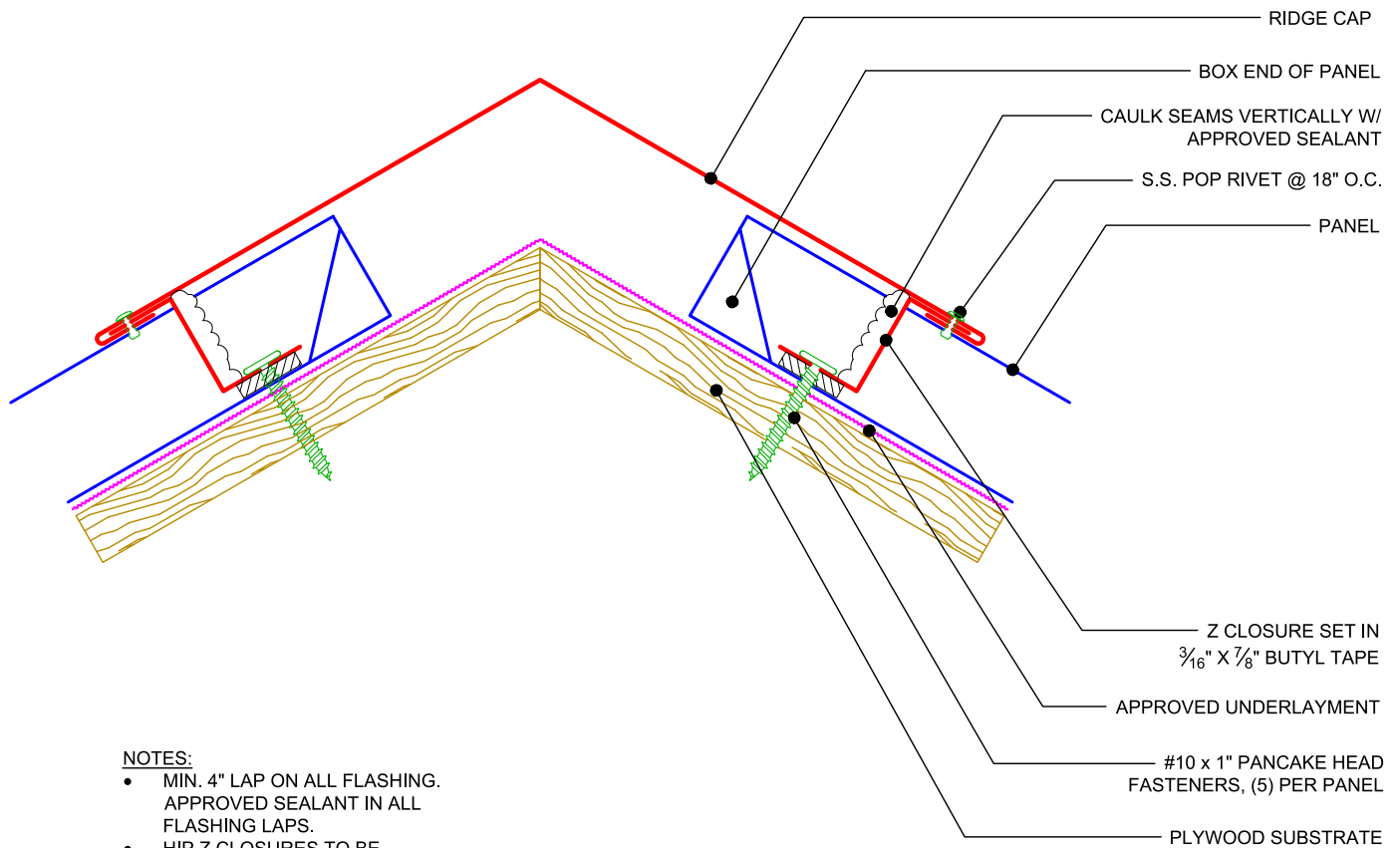

NOTES:

- MIN. 4" LAP ON ALL FLASHING. APPROVED SEALANT IN ALL FLASHING LAPS.
- HIP Z CLOSURES TO BE FASTENED @ 4" O.C.

1. Make sure deck is clean and ready for installation. Install underlayment per manufacturer's instructions.
2. Install panel, field bend panel edge 45° to create box end. Do not cut panel ribs when folding box end.
3. Apply 3/16" x 7/8" butyl tape to Z closure and install over panel using #10x1" pancake head fasteners at 4" O.C. through butyl tape. Minimum 5 fasteners per panel.
4. Apply a vertical bead of approved sealant behind the Z closure at panel rib and tool in.
5. Install hip or ridge cap by engaging onto Z closures. Minimum 4" lap on hip or ridge cap with approved sealant in-between laps. 24" min. flashing length.
6. Drill holes through hip or ridge cap hem and Z closure using the correct size drill bit at 18" O.C.
7. Install stainless steel pop rivets through hem of hip or ridge cap, attaching to Z closure, at 18" O.C.
8. Remove all swarf, filings, and debris from area immediately upon completion.

VR1 - Vented Ridge Detail

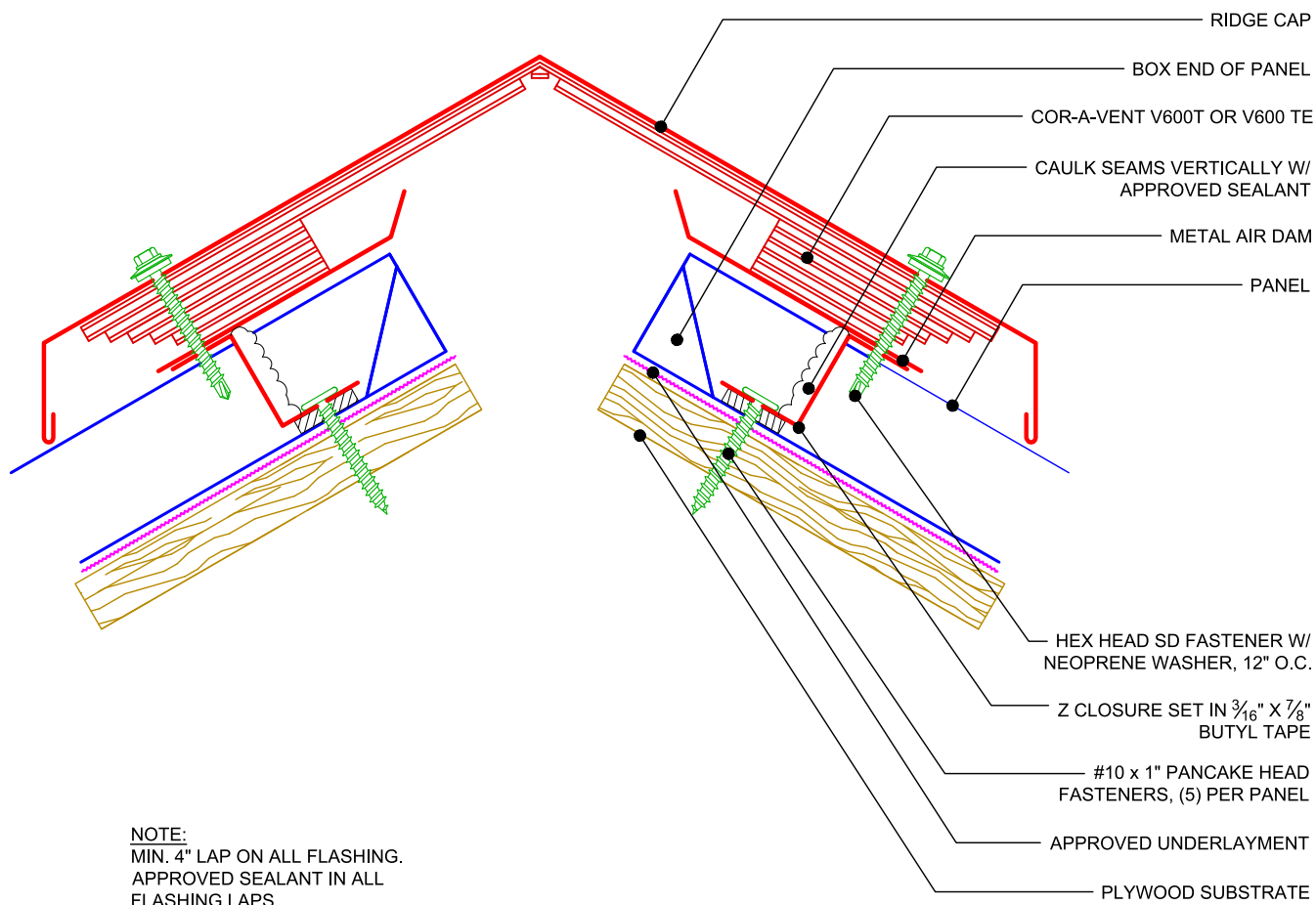

1. Make sure deck is clean and ready for installation. Install underlayment per manufacturer's instructions.
2. Install panel, field bend panel edge 45° to create box end. Do not cut panel ribs when folding box end.
3. Apply 3/16"x7/8" butyl tape to Z closure and install over panel using #10x1" pancake head fasteners at 4" O.C. through butyl tape. Minimum 5 fasteners per panel.
4. Apply a vertical bead of approved sealant behind the Z closure at panel rib and tool in.
5. Place metal air dam and Cor-A-Vent V600T or V600TE on top of Z closure. Tack in place using #10x1" pancake head fasteners at 3' O.C. through Z closure.
6. Place ridge cap over Cor-A-Vent and attach to Z closure using hex-head fasteners with neoprene washers at 12" O.C. Minimum 4" lap on ridge cap with approved sealant in-between laps. 24" min. flashing length.

L1 - Lightning Protection Detail

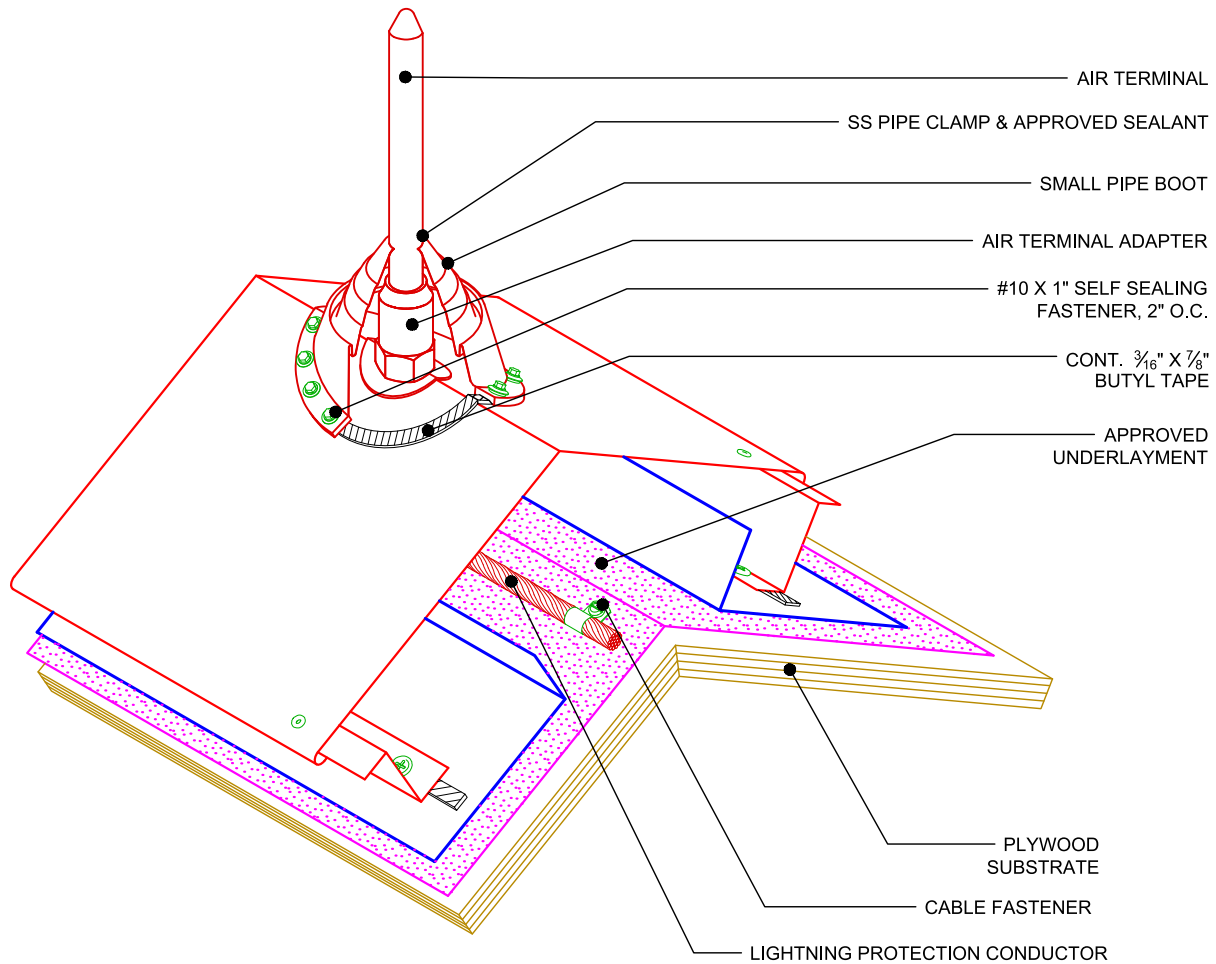

1. Make sure deck is clean and ready for installation. Install underlayment per manufacturer's instructions.
2. Install panel, field bend panel edge 45° to create box end. Do not cut panel ribs when folding box end.
3. Apply 3/16"x7/8" butyl tape to Z closure and install over panel using #10x1" pancake head fasteners at 4" O.C. through butyl tape. Minimum 5 fasteners per panel.
4. Apply a vertical bead of approved sealant behind the Z closure at panel rib and tool in.
5. Install aluminum lightning protection conductor using cable fasteners. Copper products cannot be used.
6. Locate air terminal locations and cut small hole in ridge cap.
7. Install ridge cap by engaging onto Z closures. Minimum 4" lap on ridge cap with approved sealant in-between laps. 24" min. flashing length.
8. Apply 3/16"x7/8" butyl tape to small pipe boot and install over air terminal, attach to ridge cap using #10x1" self-sealing fasteners at 2" O.C. through butyl tape.
9. Apply a bead of approved sealant above small pipe boot and tool in.
10. Drill holes through ridge cap hem and Z closure using the correct size drill bit at 18" O.C.
11. Install stainless steel pop rivets through hem of ridge cap, attaching to Z closure, at 18" O.C.
12. Remove all swarf, filings, and debris from area immediately upon completion.

P1 - Penetration Detail

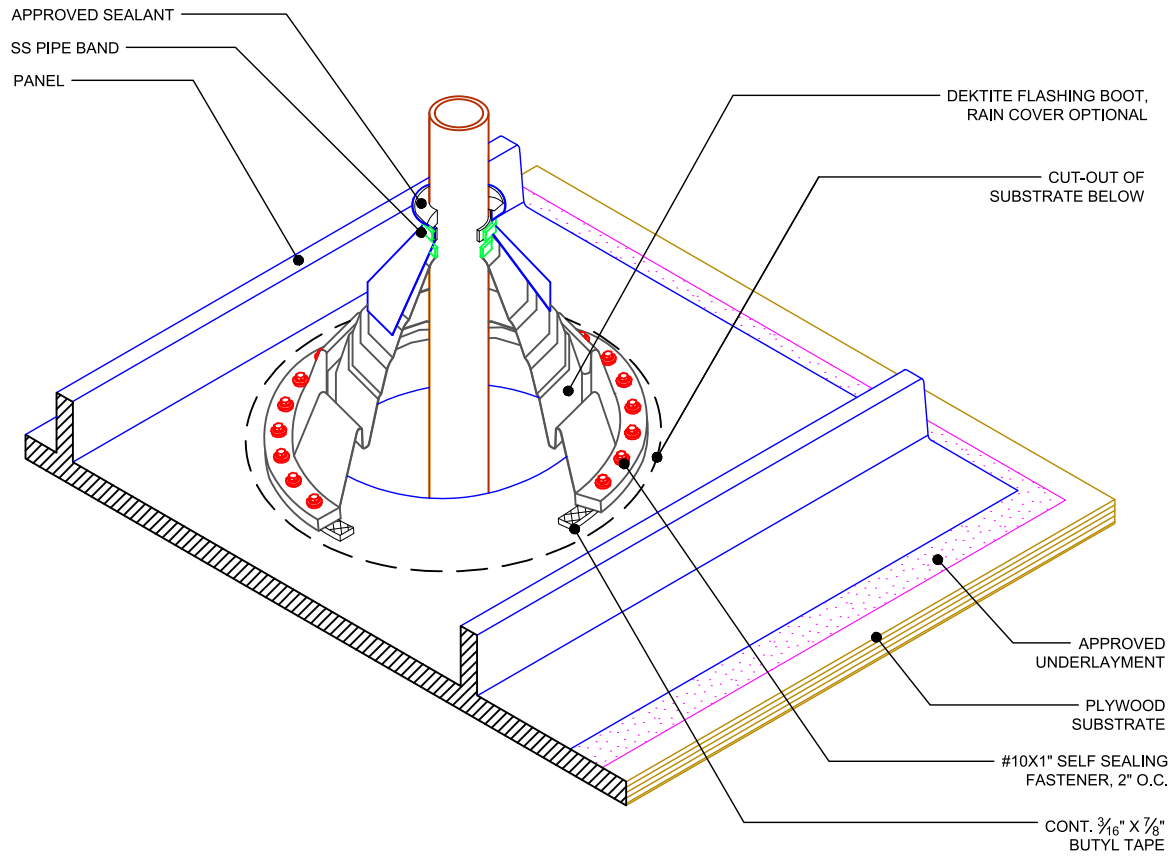

1. Make sure deck is clean and ready for installation; install underlayment per manufacturer's instructions.
2. Install panels across roof until a penetration occurs. Layout penetration location by measuring distance up from eave and distance over from last panel rib.
3. The Large Penetration Detail must be used if pipe boot flange is located within 1" of panel rib.
4. Cut a hole in the substrate that extends beyond the pipe boot being used.
5. Cut a hole in the panel that is 2" larger than the penetration and install panel.
6. Apply $\frac{3}{16}$ "x $\frac{7}{8}$ " butyl tape to pipe boot, cut to the correct size for penetration and slide over top of pipe. Attach to panel using #10x1" self-sealing fasteners at 2" O.C. through butyl tape.
7. Install stainless steel pipe clamp at top of pipe boot and tighten accordingly.
8. Apply a bead of approved sealant above pipe boot and tool in.

P2 - Large Penetration Detail

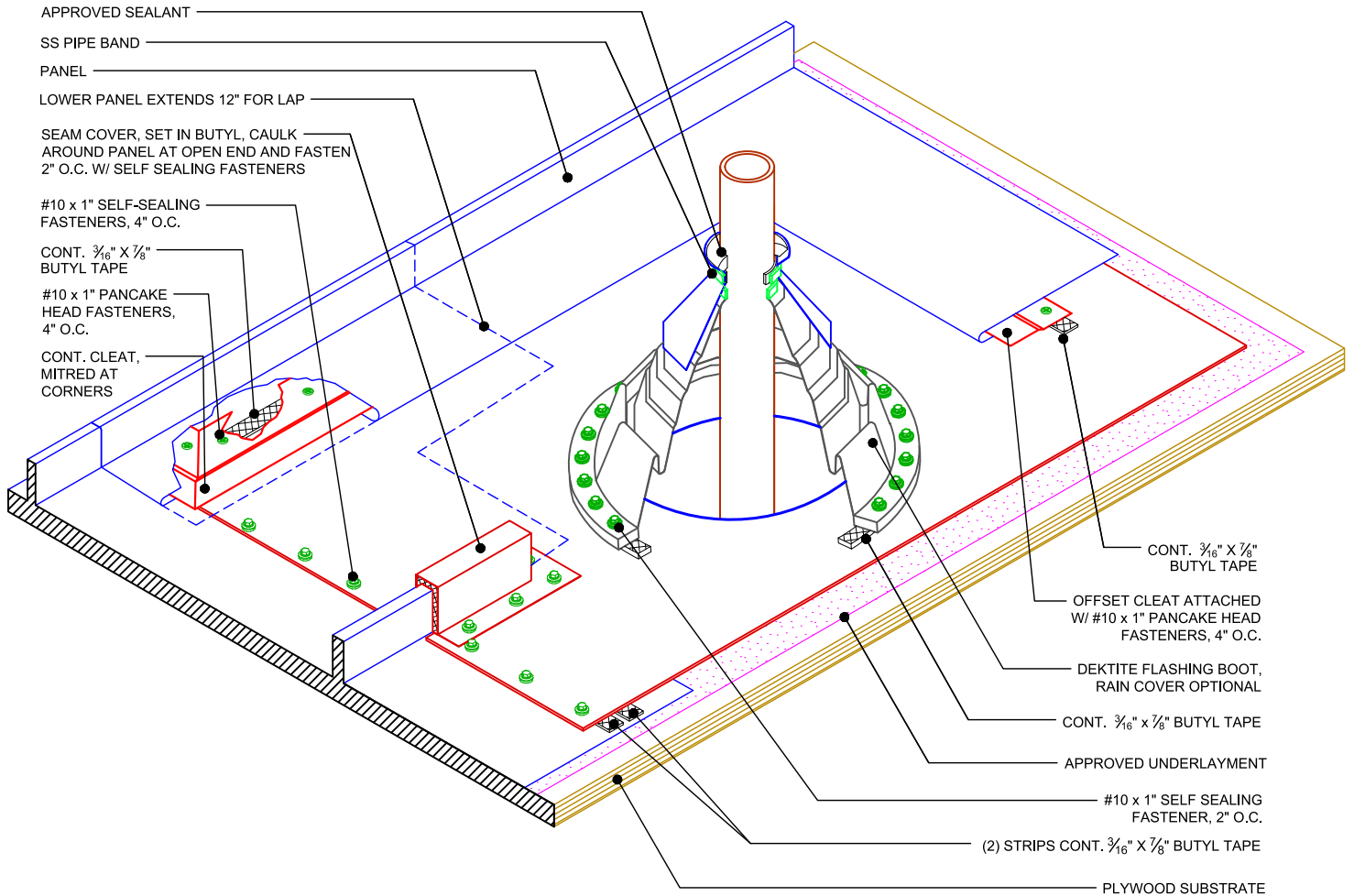

1. Make sure deck is clean and ready for installation; install underlayment per manufacturer's instructions.
2. Install panels across roof until a penetration occurs. Layout penetration location by measuring distance up from eave and distance over from last panel rib.
3. Cut a hole in the substrate that extends beyond the pipe boot being used.
4. Install lower panels, allow for a 12" panel lap on both sides of the penetration and 4" lap below.
5. Layout matching flat sheet material that laps over lower panels a minimum of 4" below the penetration and includes a minimum 4" lap for upper panels above the penetration. Cut hole in flat sheet material that is 2" larger than the penetration and notch out lower panel ribs.
6. Apply two rows $\frac{3}{16}$ "x $\frac{7}{8}$ " butyl tape to underside, lower edge, of flat sheet and set in place.
7. Apply $\frac{3}{16}$ "x $\frac{7}{8}$ " butyl tape to offset cleat and install over flat sheet using #10x1" pancake head fasteners at 4" O.C. through butyl tape with proper miters all corners.
8. Strip in offset cleat with 8" roll of approved peel and stick underlayment.
9. Install upper panels and engage panel hem onto offset cleat. Leave the required gap to allow for thermal expansion and contraction. Carefully crimp panel hem closed using hand seamers.
10. Apply $\frac{3}{16}$ "x $\frac{7}{8}$ " butyl tape to pipe boot, cut to the correct size for penetration and slide over top of pipe. Attach to panel using #10x1" self-sealing fasteners at 2" O.C. through butyl tape.
11. Install stainless steel pipe clamp at top of pipe boot and tighten accordingly.
12. Apply a bead of approved sealant above pipe boot and tool in.
13. Apply $\frac{3}{16}$ "x $\frac{7}{8}$ " butyl tape to seam cover and place over panel rib. Attach seam cover and lower edge of flat sheet to support flashing with #10x1" self-sealing fasteners at 4" O.C. through butyl tape.

C1 - Curb Detail

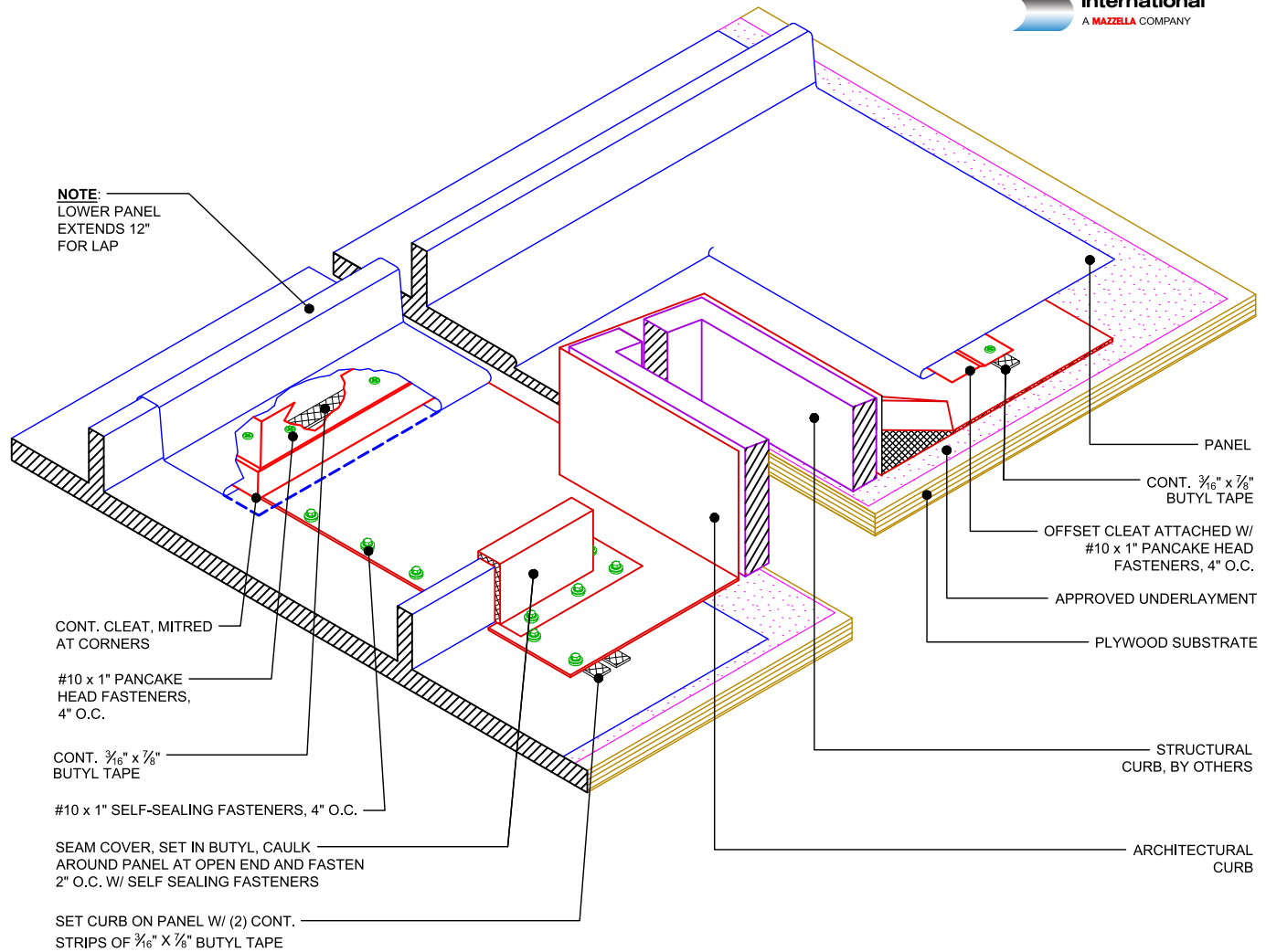

1. Make sure deck is clean and ready for installation; install underlayment per manufacturer's instructions.
2. Install panels across roof until a structural curb occurs. Panel around lower half of curb, with side panels extending 8" up slope from lower corner, and ending 1" away from curb, below curb.
3. Apply two rows $\frac{3}{16}$ "x $\frac{7}{8}$ " butyl tape to underside, lower edge, of architectural curb and set in place. Notch out architectural curb flange at panel rib locations using hand snips.
4. Apply $\frac{3}{16}$ "x $\frac{7}{8}$ " butyl tape to offset cleat and install over curb flange using #10x1" SD pancake head fasteners at 4" O.C. through butyl tape with proper miters all corners. Maintain a 4" cleanout between offset cleat and side of architectural curb.
5. Strip in offset cleat with 8" roll of approved peel and stick underlayment.
6. Install upper panels and engage panel hem onto offset cleat. Leave the required gap to allow for thermal expansion and contraction. Carefully crimp panel hem closed using hand seamers.
7. Apply $\frac{3}{16}$ "x $\frac{7}{8}$ " butyl tape to seam cover and place over panel ribs. Attach seam cover and lower edge of curb flange to panel using #10x1" self-sealing fasteners at 4" O.C. through butyl tape.