

Smart Building and Hybrid Work Solutions

Cisco Talent and Collaboration Centers



New York Look Book



New York Look Book



Designing the office for the Hybrid World

Spanning 59,000 square feet (5,481 square meters) in the heart of midtown Manhattan, Cisco's New York City Talent and Collaboration Center is designed specifically for the realities of hybrid work. Over 70% of the usable square footage is dedicated to collaboration, including over 90 video-enabled spaces specifically designed for collaboration, learning, and socializing.

Built on a Power over Ethernet (PoE) foundation, 100% of the lighting, shading, and environmental controls are connected to the network, allowing us to achieve new levels of manageability, breakthroughs in health and wellness, as well as contributing to Cisco's corporate goal of reaching net zero across all Scope 1, Scope 2, and Scope 3 emissions by 2040.

Most importantly, when combined with other technology elements, such as Cisco Catalyst networking solutions, Cisco collaboration devices, Meraki Cameras, and Cisco Smart Workspaces, the NYC Talent and Collaboration Center is a digital real estate platform that continues to delight employees and visitors alike.

| | |
|--|----|
| ▶ Key Design & Implementation Partners | 3 |
| ▶ Enabling Technology | 4 |
| ▶ Floor Plan | 11 |
| ▶ Hot Desk | 12 |
| ▶ Quiet Room (1 and 2 Person) | 14 |
| ▶ Traditional Huddle Room | 17 |
| ▶ Casual Huddle Room | 20 |
| ▶ Brainstorming Huddle Room | 23 |
| ▶ Small Collaboration Room | 26 |
| ▶ Medium Collaboration Room - Dual Display | 29 |
| ▶ Medium Collaboration Room - Single Display | 32 |
| ▶ Medium Collaboration Room - Video Centric | 35 |
| ▶ Medium Brainstorming Room | 38 |
| ▶ Large Collaboration Room | 41 |
| ▶ Innovation Suite | 44 |
| ▶ Training Room | 47 |
| ▶ Resources | 50 |

Key Design & Implementation Partners



Owners Representative
and Project Management



Architectural
Design Services



Construction
Management



Collaboration Design &
Implementation Services





Smart Building Design &
Implementation Services



Interiors and
Furnishings

Enabling Technology

Smart Building Components



Low Voltage 90W PoE Lighting
(employee zone), air quality /
CO2, Temp, Humidity, VOC



Intelligent automated
shading platform



Intelligent PoE VAV
controls for individual
collaboration rooms



Individual heat pumps in
customer zone meeting rooms,
providing customized climate
control and thermal comfort



Luminaries

Enabling Technology

Smart Cameras

High-definition Indoor Security Cameras

Providing local storage of video and advanced object detection to support people counting.



Cisco Meraki MV12 Compact Dome Camera



Cisco Meraki MV32 360° Birdseye Camera

Enabling Technology

Cisco Smart Workspaces



Workplace visualization tool, leveraging data sources across all technology platforms to help employees make better decisions within the work environment.



Overall floor occupancy from smart cameras at points of entry/exit

Indoor air quality from wired sensors in lighting platform, Cisco collaboration devices in collaboration spaces/individual spaces

Desk occupancy from Cisco Desk Series devices located at hotdesks

Collaboration space availability using presence and people counting data from Cisco collaboration devices

Enabling Technology

Networking Elements



The Cisco Catalyst 9400 Switch provides connectivity for IT elements (video devices, wireless APs, IP Phones, smart cameras, etc.).

The Cisco Catalyst 90 watt UPOE+ 9300 stackable switching platforms is used to connect and power OT/smart building components (lighting, shading, thermostats, sensors, etc.).



The Cisco Catalyst 6E-compliant Wireless Access Points (APs) provide secure network connectivity for employees and guests.

Built-in temperature, humidity, and air quality (VoC) sensors provide additional data on environmental performance.



Cisco Catalyst 9300 Switch



Cisco Catalyst 9400 Switch



Cisco Catalyst 9166 Access Point

Enabling Technology

Room Signage



Cisco Room Navigator for Wall

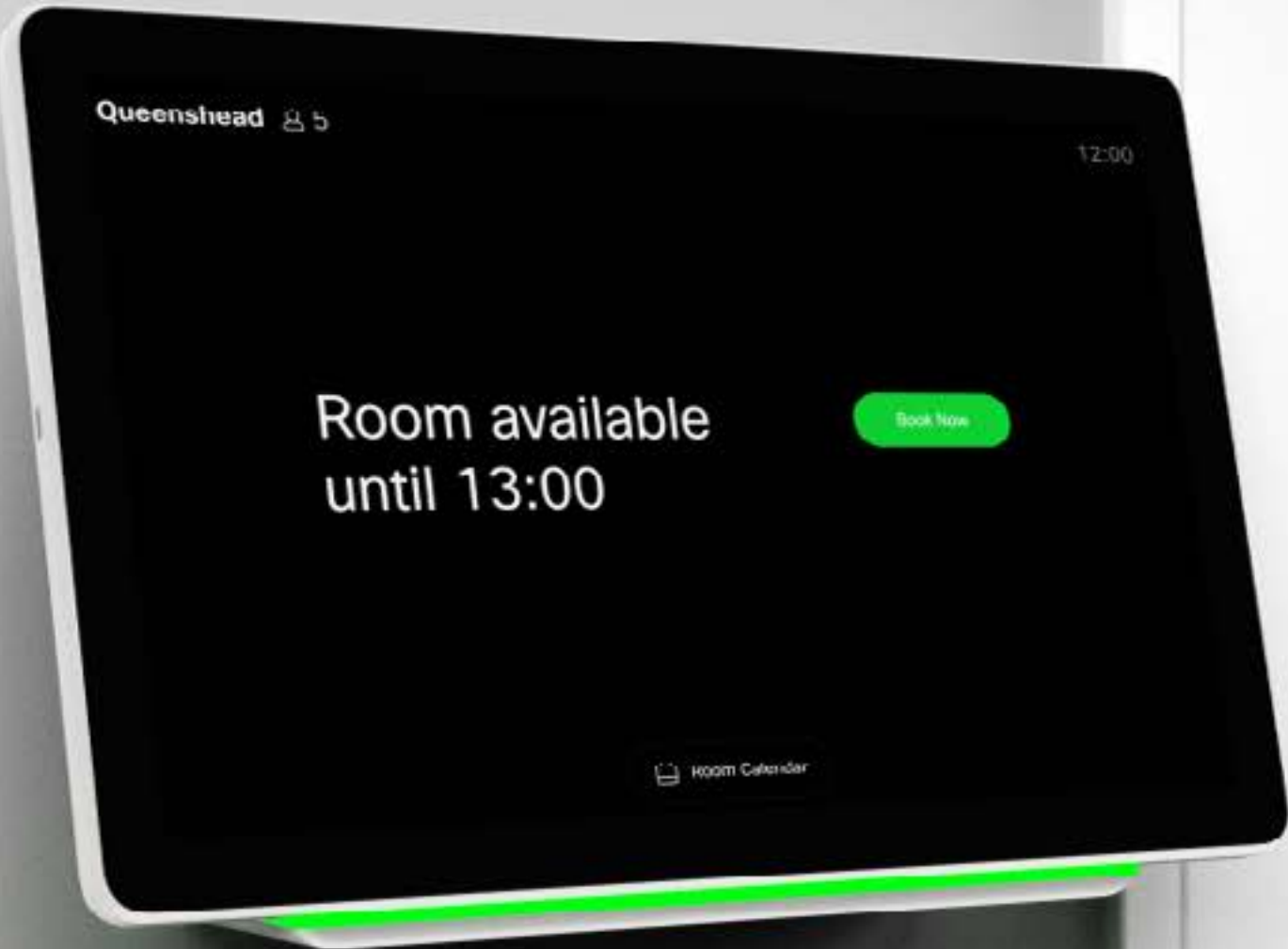

Bookable Rooms

Cisco Room Navigator for Wall – through its integration with O365, Exchange and Google Calendar – enables seamless room booking, calendar view, meeting information, and meeting extension with a few taps on the touch screen.

Adhoc Rooms

The Cisco Room Navigator for Wall uses an in-house developed web app to change the display and LED light based on occupancy, green available, and red for occupied.



Enabling Technology

Building System Integration



Leveraging the open APIs available from the smart building systems and the UI Extension feature within the Cisco collaboration devices, custom buttons are available on the Cisco Board Pros, Cisco Desk/Desk Pros, and the Cisco Room Navigator for Table to control lights and shades in the collaboration spaces.

These capabilities are also available via voice command in selected rooms using Webex Assistant (“Hey, Webex, tell the room to lower the shades”). The integrations leverage the openness of the smart building APIs and the Cisco collaboration devices and do not require using any third-party control systems (Crestron, AMX, etc.). They are now available on GitHub for download and use.

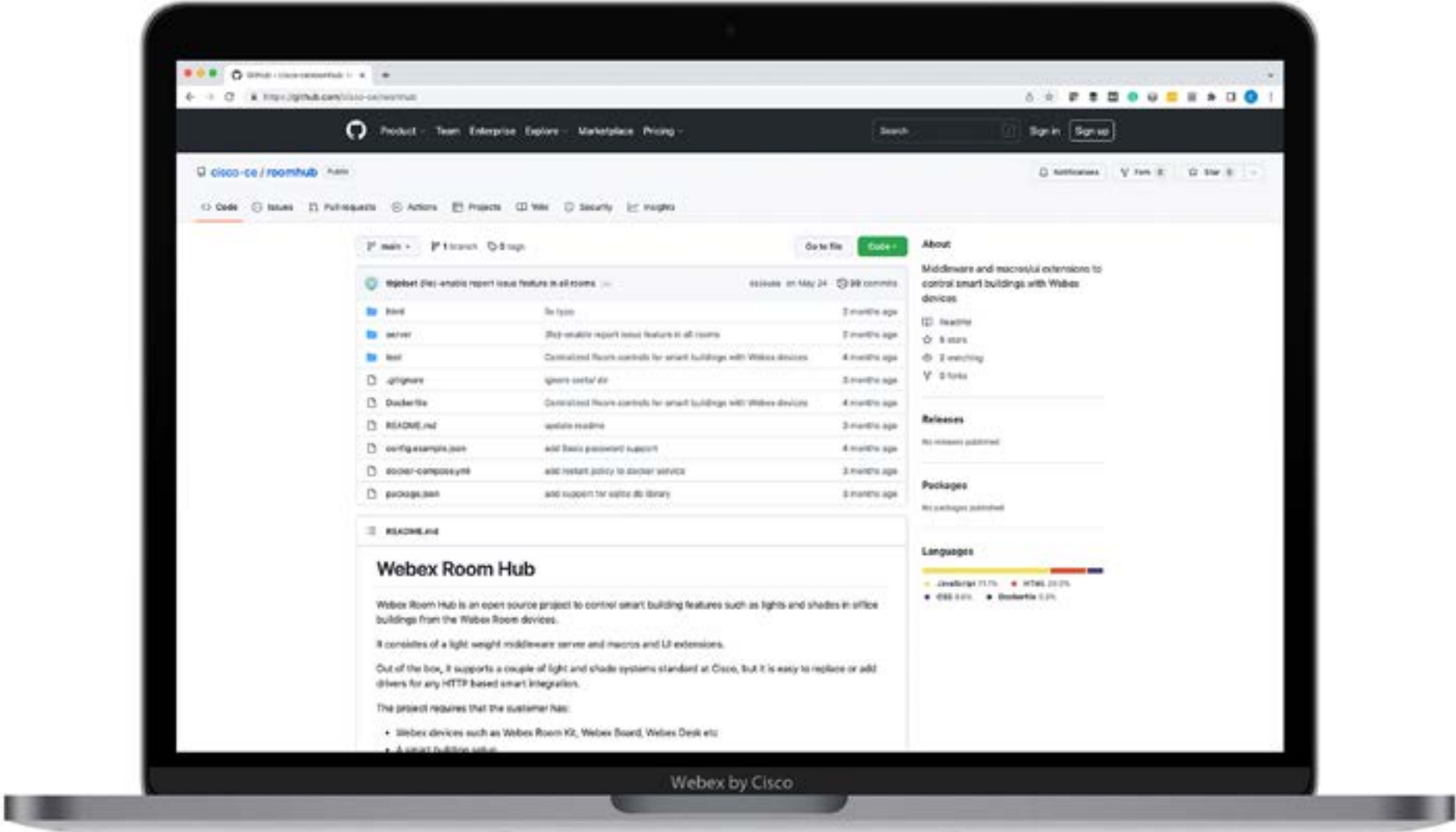

Enabling Technology

Digital Signage



Appspace Digital Signage on LG 55" Display

Simultaneous display of local office signage within the Webex app, via Appspace bot.

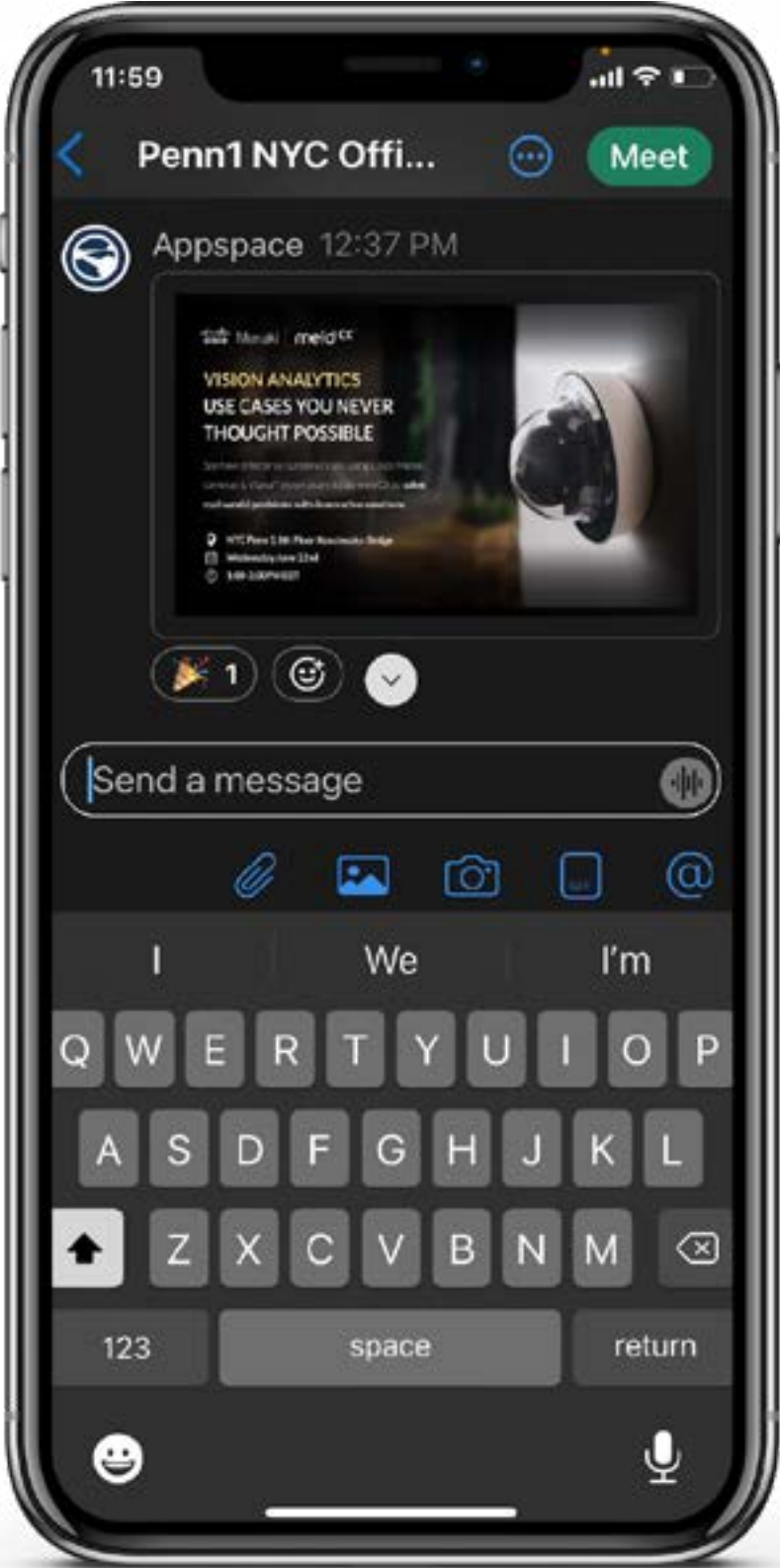

Floor Plan

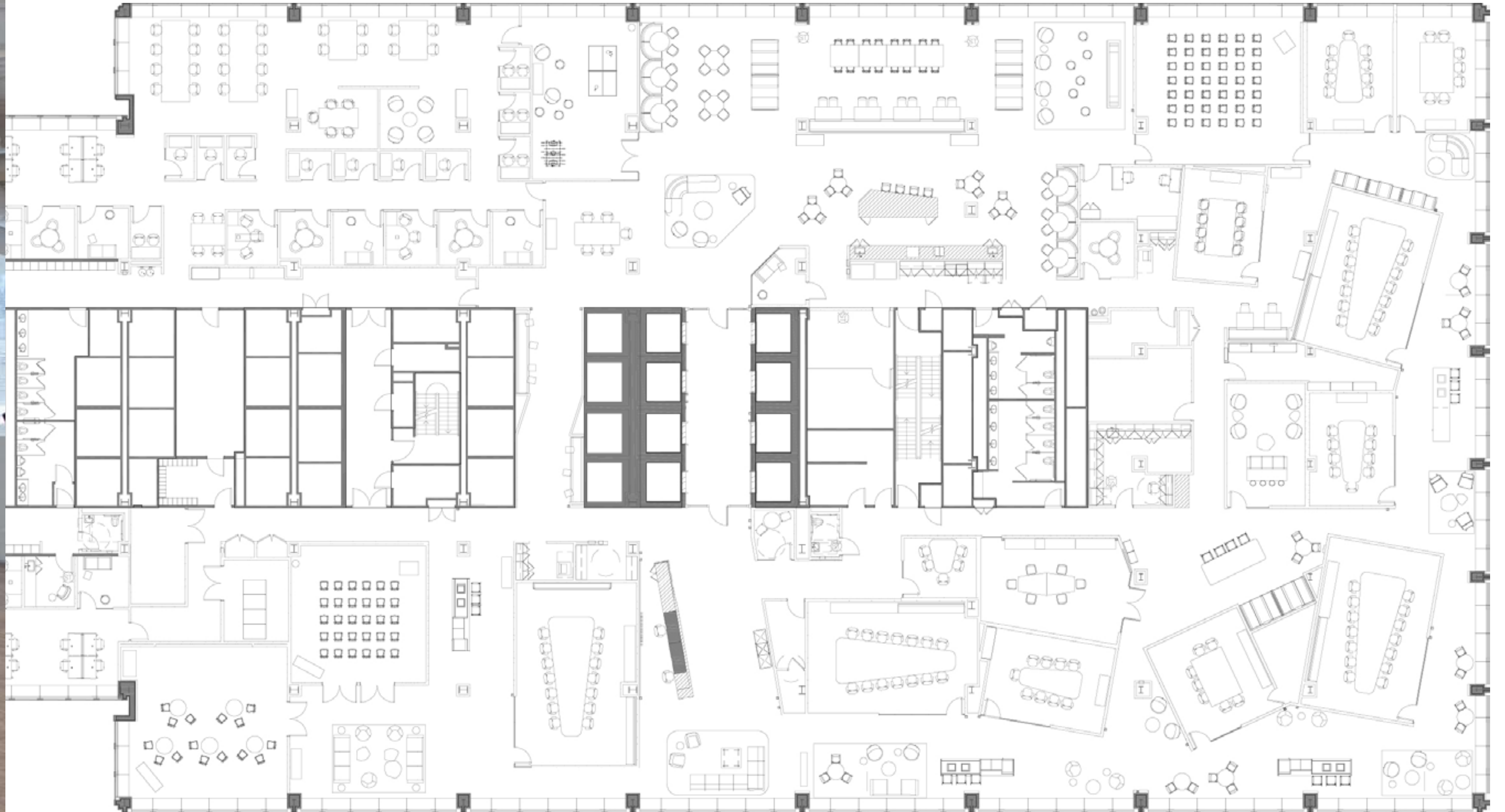

Hot Desk

Overview



Providing areas for people to do focus work or passively participate in a remote meeting is critical in the hybrid work environment, and the hot desk is the perfect space for these activities.

Features

- Cisco Desk or Cisco Desk Camera and 27" Display
- Teknion Navigate Height-Adjustable Table
- Humanscale Liberty Task chair



Hot Desk Components



Option 1

Cisco Desk



CISCO



Humanscale Liberty
Task Chair

Humanscale

Option 2



Cisco Desk Camera

CISCO



Single 27" Display
(LG, Panasonic, Samsung, or Sony)

LG Panasonic SAMSUNG SONY

Teknion Navigate
Height Adjustable Table
with PoE conversion kit

PoE Conversion
Kit by:  mht



teknion

Quiet Room (1 and 2 Person)

Overview



The one and two-person quiet rooms are the perfect space when you need privacy to take a video call, carry out focused work, collaborate with another individual, or simply need a bit more screen space to get your job done.

Features

- Cisco Desk (1 person) and Desk Pro (2 person)
- Teknion Navigate Height-Adjustable Table
- Allermuir Kin chair



Quiet Room (1 and 2 Person)

Components



Allermuir Kin CH-42B



Seat Upholstery
Maharam Manner - Dill

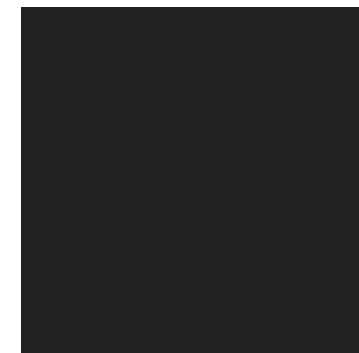

Base
Off Black Powder Coat



Teknion Navigate
Height-Adjustable Table



Cisco Deskpro



Cisco Desk



Quiet Room (1 and 2 Person)

Room Layout



1 Person Quiet Room

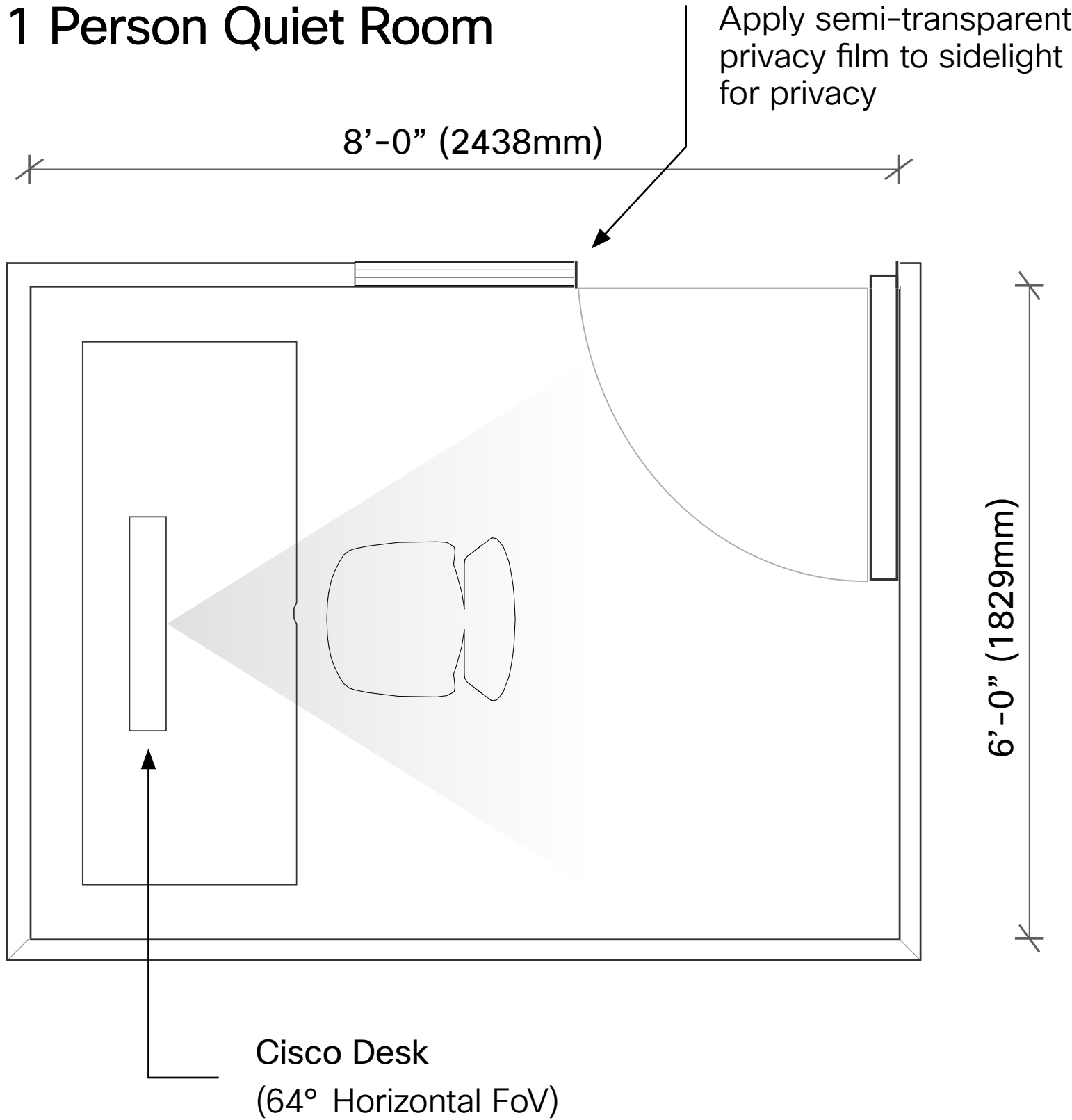

2 Person Quiet Room

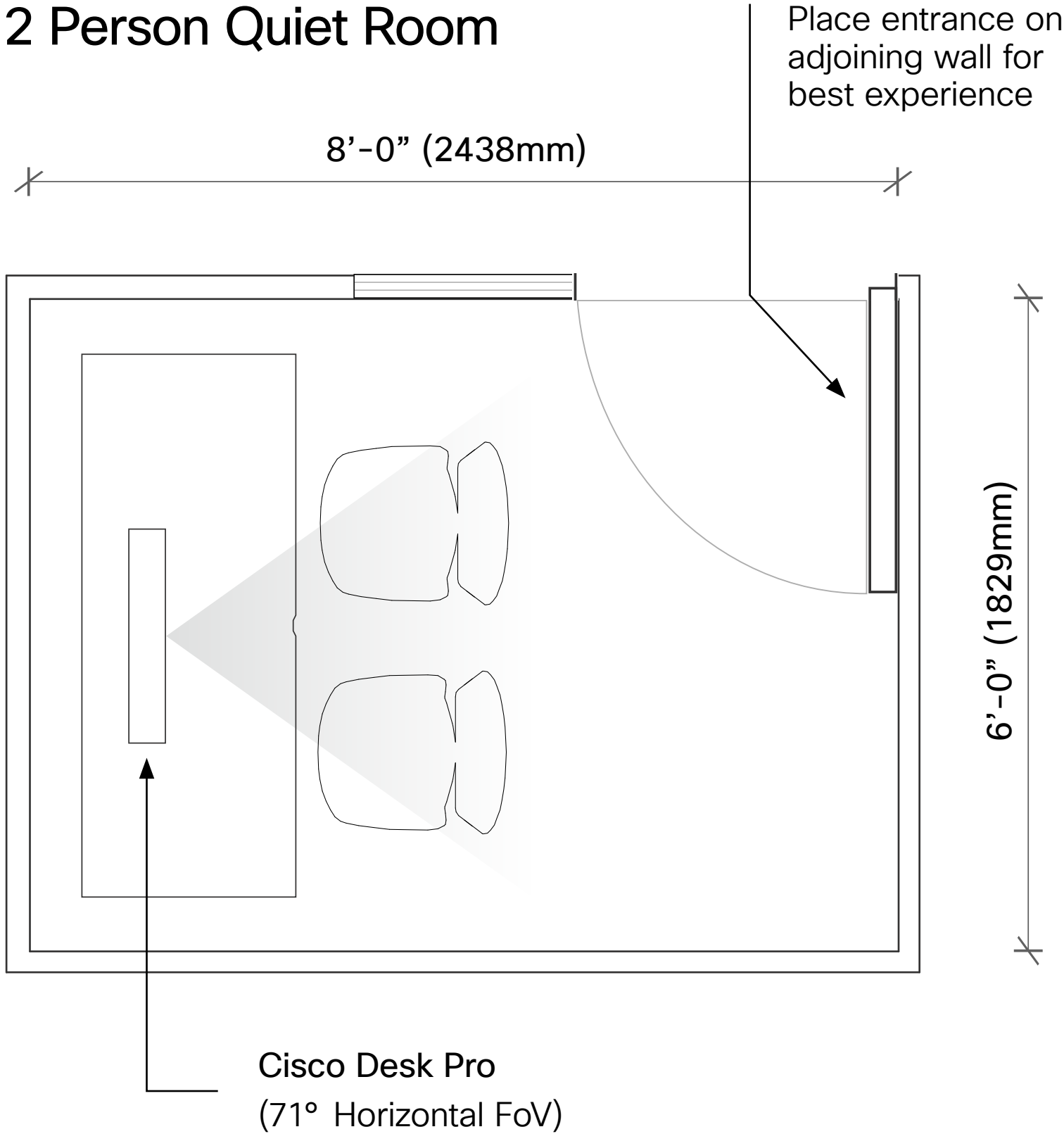

Note: Optimal size is nominal 8'x6' (2438mm x 1829mm), with a 5' (1524mm) table, 1 person room can go to 7'x5' (2134mm x 1524mm) with a 4' (1291mm) table if needed

Traditional Huddle Room

Overview



Making it easy for small groups to come together to share information, brainstorm, and solve problems is absolutely critical. In this office, we've replaced personal offices with dozens of huddle rooms and smaller collaboration spaces, each designed for this exact purpose. All of these spaces are video-enabled, ensuring the right resources can come together, regardless of where they are.

The Traditional Huddle Room is the perfect space for small group collaboration, especially when you need to bring in that important remote participant. Wireless sharing allows you to display content effortlessly in local and virtual meetings.

Features

- Cisco Room Bar
- Single 43" (3 person) or 50" (4 person) display
- Neinkamper Gateway table
- Teknion Zone chairs



Traditional Huddle Room

Components



Teknion Zones
Five-Star Caster Base



Seat Upholstery
Maharam Manner
Tidewater

teknion

Nienkamper Gateway Wall Mounted Half Round Table

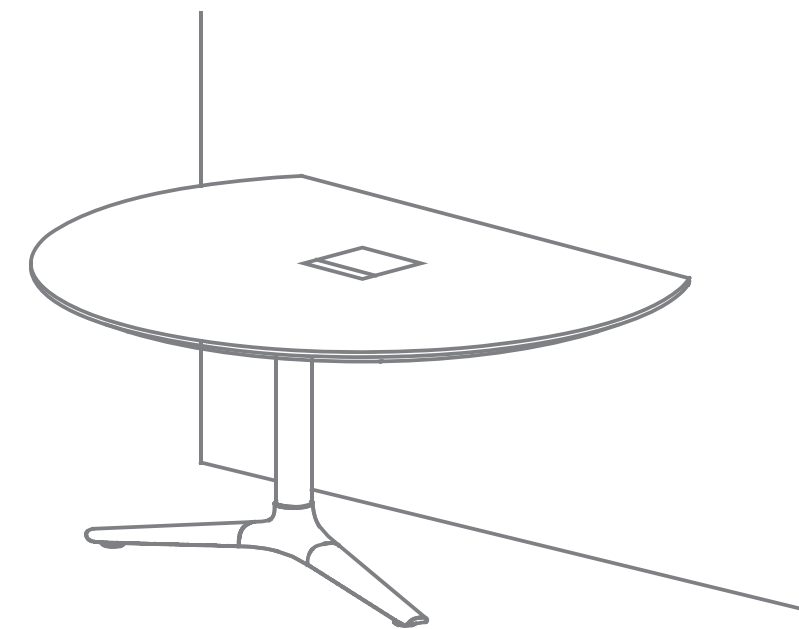

50" L X 58" D X 29" H
(1270mm L X 1473mm D X 737mm H)

Laminate top
Wilsonart-Natural Rift 7954-38, fine velvet finish

Base
Black



Power Forum finish
Black



Cisco Room Bar

CISCO



Single 43" or 50" Display
(LG, Panasonic, Samsung, or Sony)

LG Panasonic SAMSUNG SONY



nienkamper

Traditional Huddle Room

Room Layout



9' x 9' (2743mm x 2743mm)

Traditional Huddle Room

(3-Chairs)

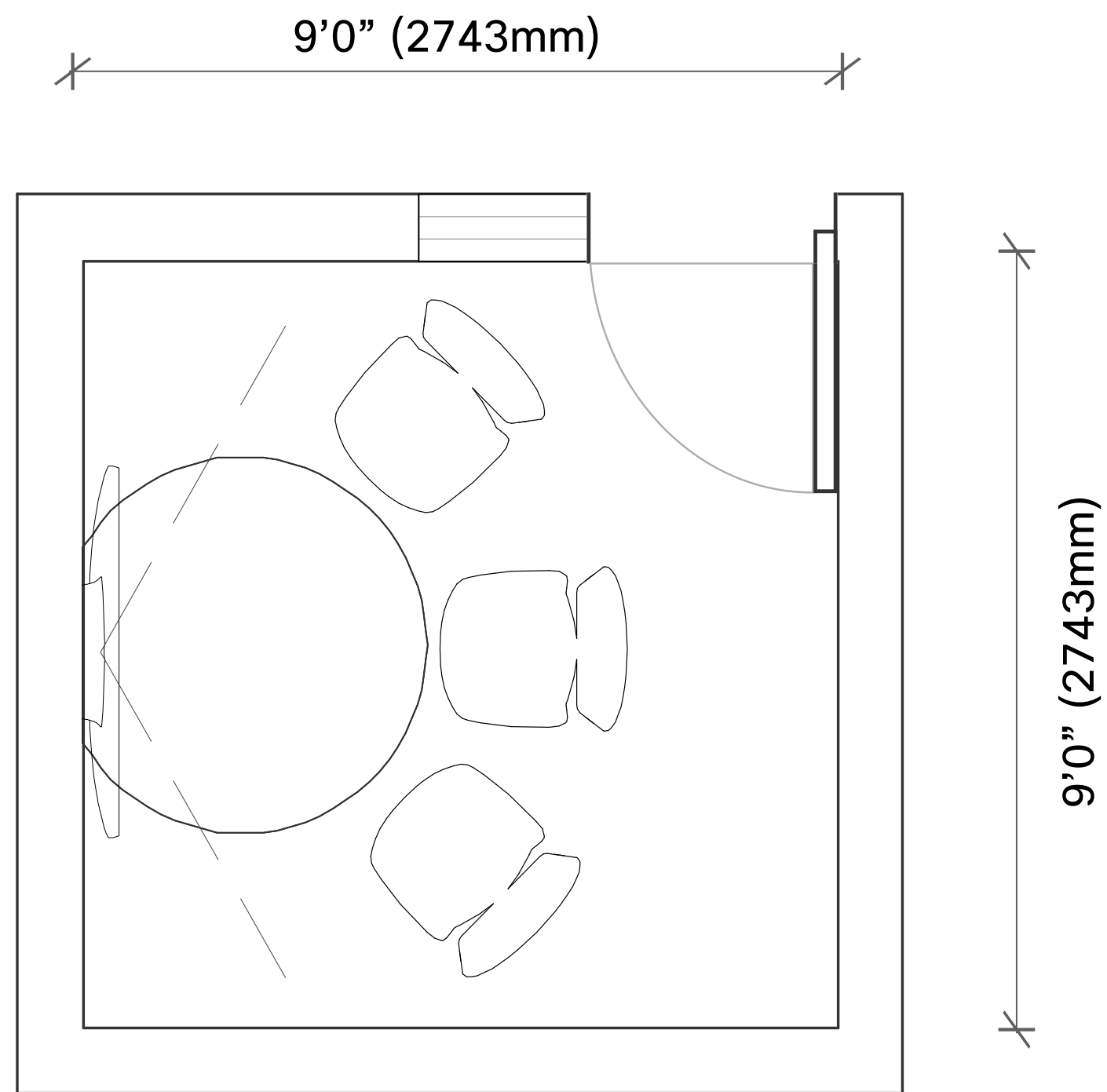

10' x 10' (3048mm x 3048mm)

Traditional Huddle Room

Optimal (4-Chairs)

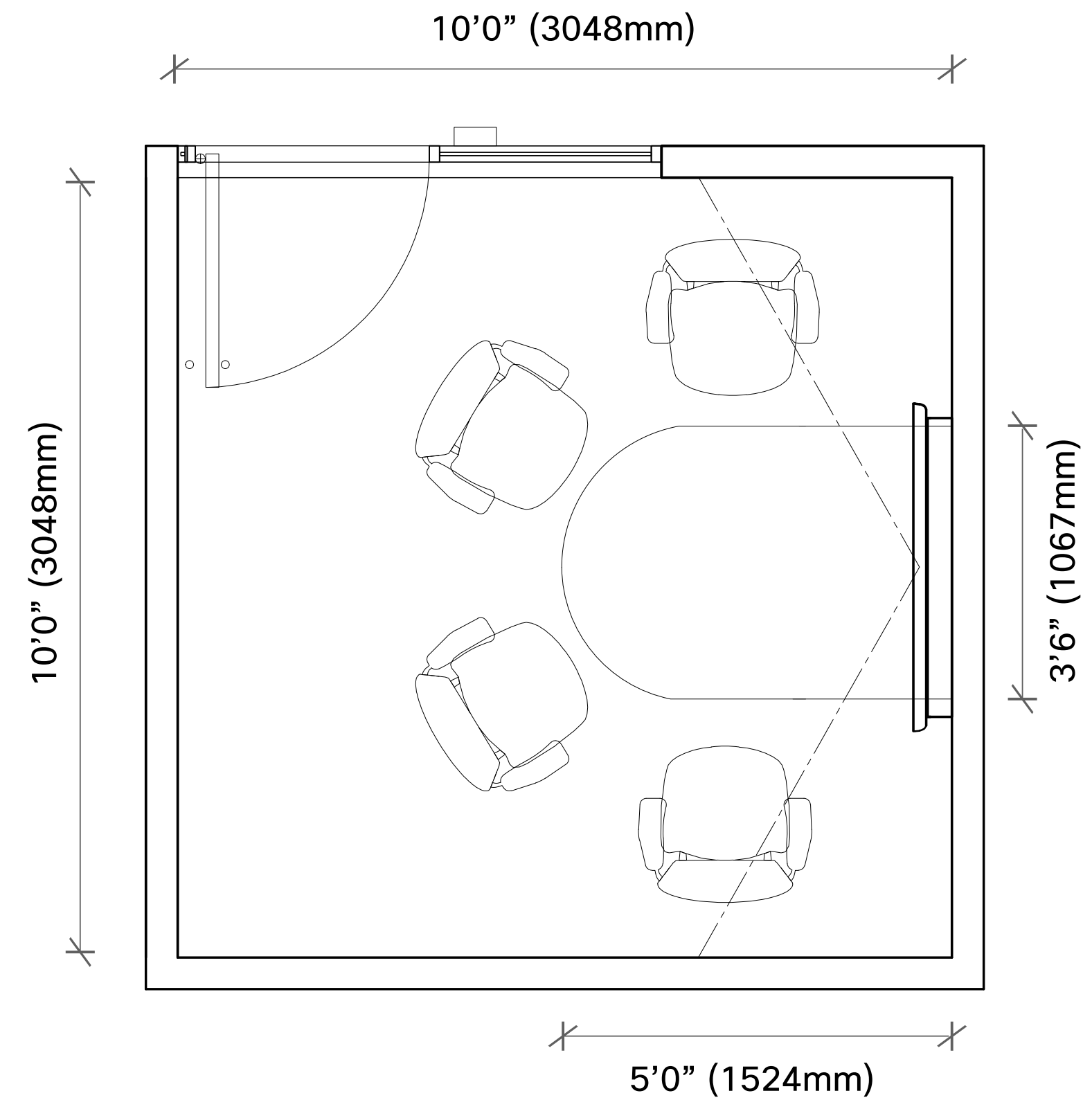

Casual Huddle Room

Overview



The Casual Huddle is specifically designed for that informal meeting with colleagues, even when some of those colleagues are remote. The soft seat is lightweight and highly flexible, allowing the space to adapt to any and all needs.

Features

- Cisco Room Bar with a single 55" display (LG, Panasonic, Samsung, or Sony) or Cisco Board Pro 55 on a Salamander EZ Touch Wall Mount
- Stylex Share sectional
- Bernhardt Tour Pouf
- Source International LT Laptop Table

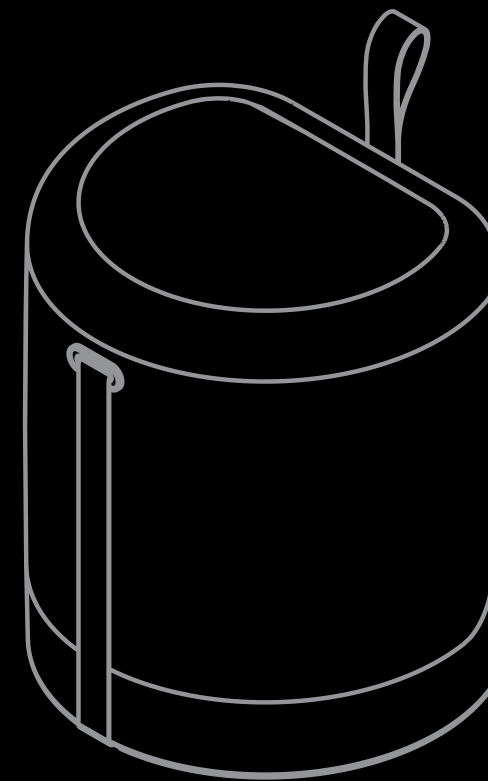

Casual Huddle Room

Components



Option 1



Cisco Room Bar

CISCO



Single 55" Display

LG Panasonic SAMSUNG SONY

Option 2



Cisco Board Pro 55

CISCO



Salamander
EZ Touch
Adjustable
Mount

SALAMANDER
DESIGNS



Stylex Share SO-10



Seat Upholstery
Maharam Mode Sycamore

STYLEX



Bernhardt Tour CH-36



Seat
Focus - Siren

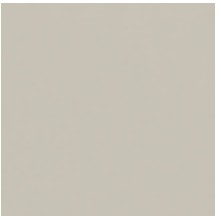

Base
Bernhardt Excel - Cloud



BERNHARDT | design



Source International LT Laptop Table

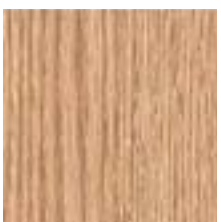

Top
Natural Rift 7954



Base
RI K



SOURCE

Casual Huddle Room

Room Layout

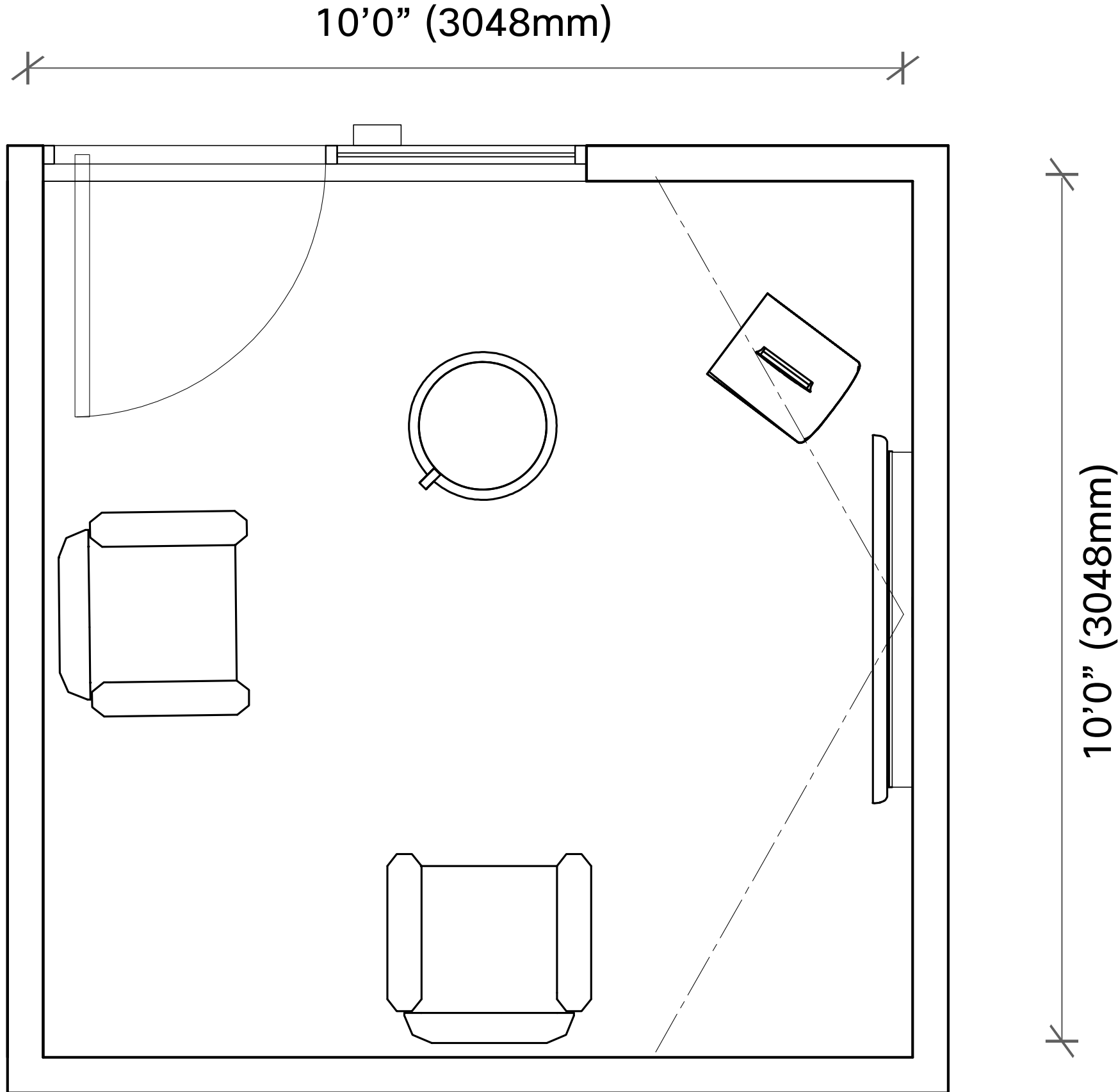

Brainstorming Huddle Room

Overview



A perfect space for an ad-hoc brainstorming session or when you want to co-create with a colleague on an important project. The Cisco Board Pro is mounted on an adjustable EZ Lift from Salamander Designs, allowing the device to be used both in a standing and seated position

Features

- Cisco Board Pro 55
- Neinkamper standard height cone table
- Allermuir Kin chairs
- Salamander EZ Touch Wall Mount (optional)



Brainstorming Huddle Room

Components



Allermuir Kin (CH-42A)

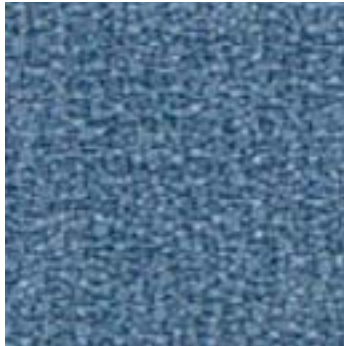

Upholstery
Maharam
Manner - Tidewater



Nienkamper | Cone Table



Round Table with Laminate Top
42" DIA X 29" H
(1067mm DIA X 737mm H)
Laminate top
Wilsonart-Frosty White #1573-60
Base
White cone



Power Forum
1 Power module w/3 ports
Finish
White



Cisco Board Pro 55



Salamander EZTouch Mount



Brainstorming Huddle Room

Room Layout

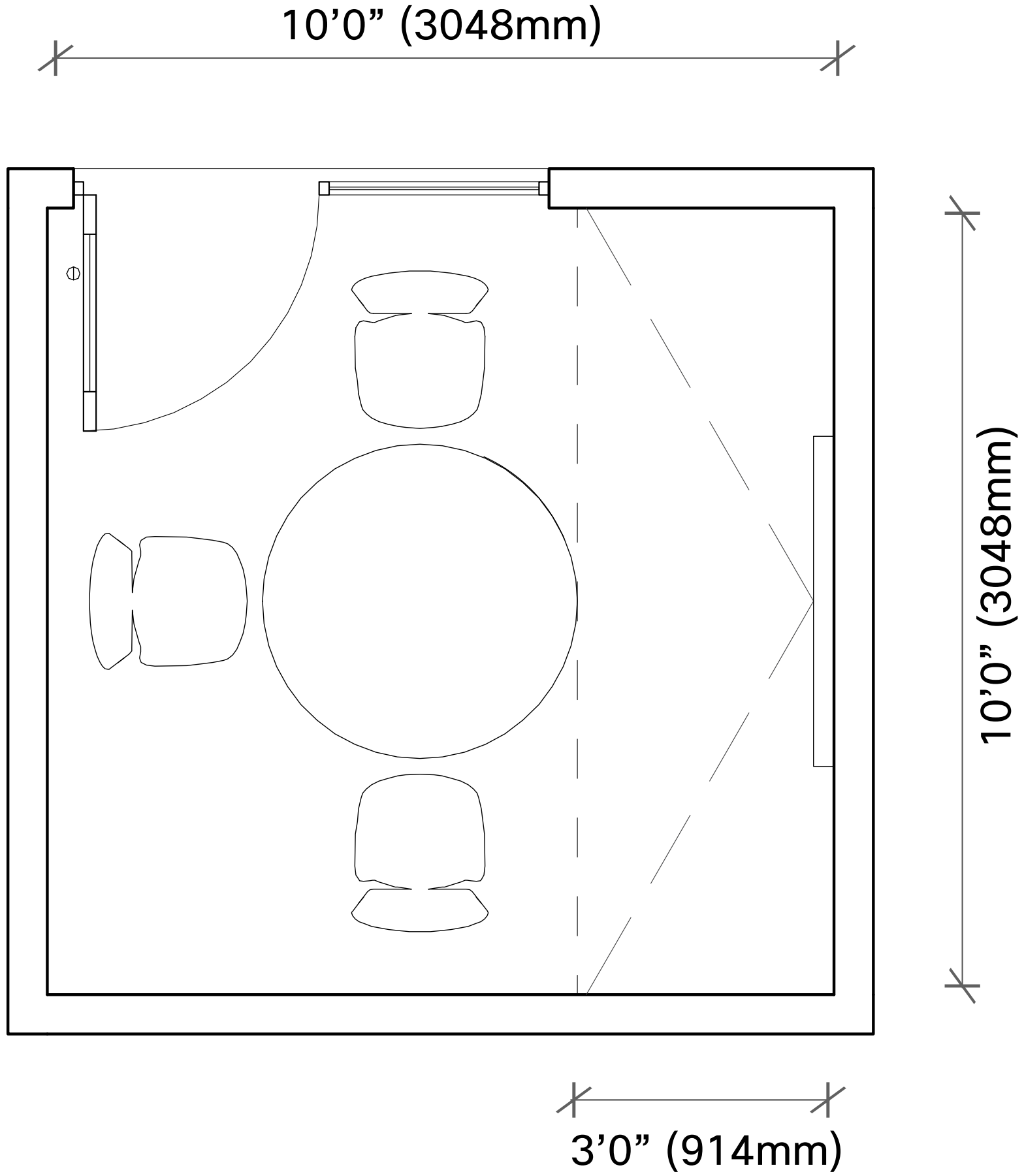

Small Collaboration Room

Overview



Small groups get work done. These small collaboration rooms are the perfect setting to bring in-person and remote colleagues together. The 120° field of view of the Cisco Room Bar camera ensures everyone is in view.

Features

- Cisco Room Bar
- Single 55" Display (LG, Panasonic, Samsung, or Sony)
- Neinkamper Gateway Table
- Humanscale Freedom Task Chair



Small Collaboration Room

Components



Humanscale Freedom Task Chair

Armrest/Armpad
Advanced Duron Arms with Textile

Frame Color
Polished aluminum with Graphite Trim

Seat Textile
Ticino (Color: Glacier / White)

Humanscale

Nienkamper Gateway TB-09

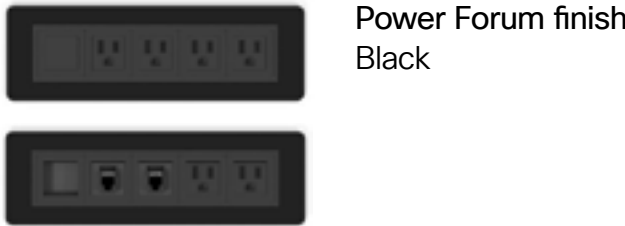

Table with Trapezoid Top, (1) simple forum with wood trough-6 ports

72" L x 32"/55" D x 28-1/2" H
(1829mm L x 813mm/1397mm D x 724mm H)

Wood finish top
#F18 Natural White Oak

Leg finish
Black



Power Forum finish
Black

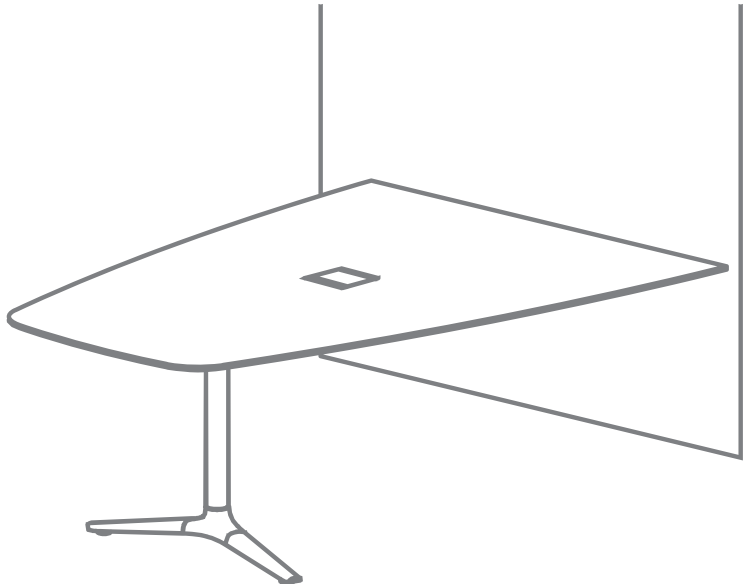

Cisco Room Bar

CISCO



Single 55" Display (LG, Panasonic, Samsung, or Sony)

LG Panasonic SAMSUNG SONY

nienkamper

Small Collaboration Room

Room Layout

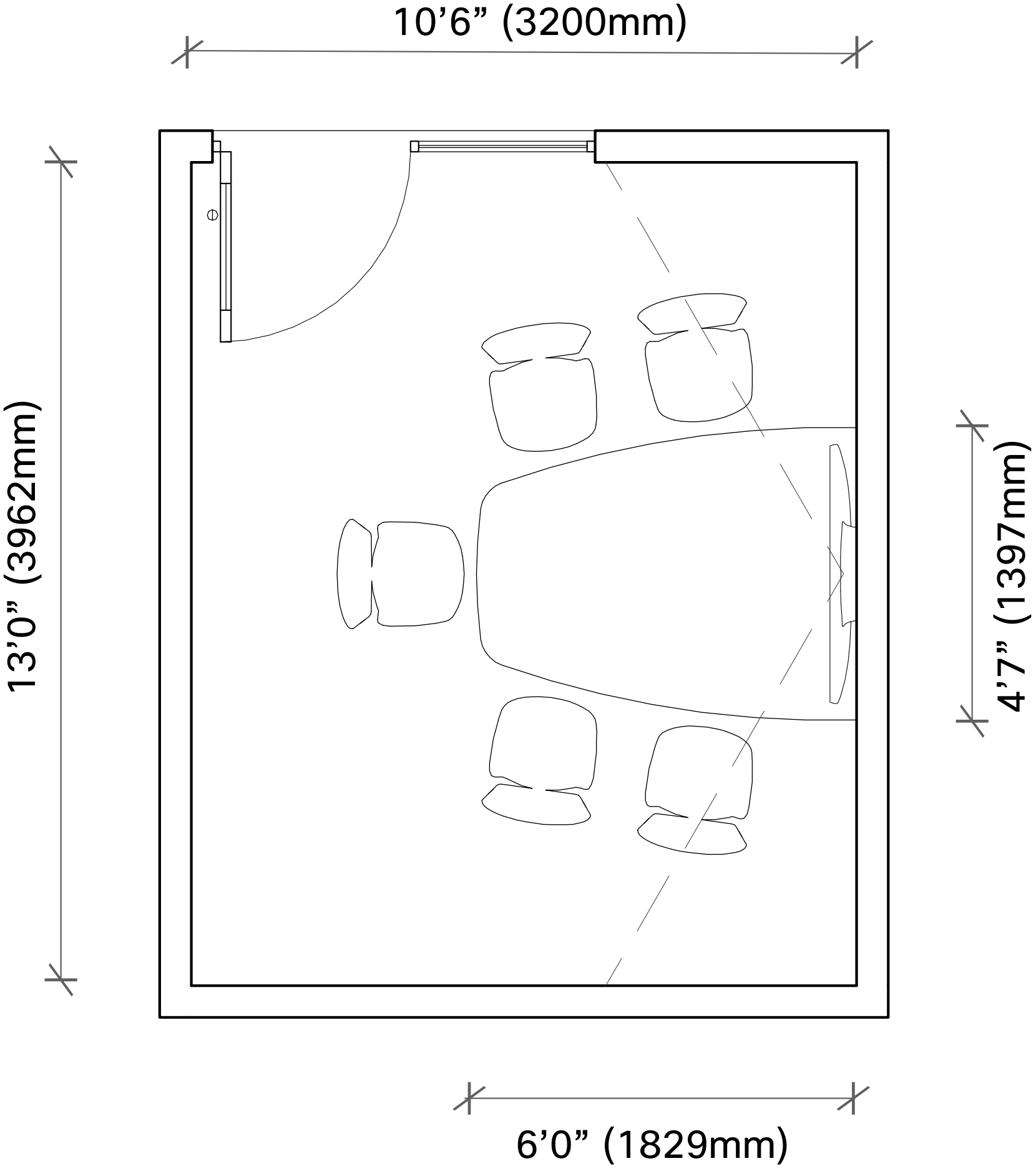

Medium Collaboration Room – Dual Display

Overview



The perfect space to bring people together for knowledge sharing or decision making, dual 65" displays allow you to see content and remote participants simultaneously. Trapezoid shaped table ensures everyone can be seen.

Features

- Cisco Room Kit EQX (or Room Bar Pro) with dual 65" Displays mounted on a Salamander Credenza
- Nienkamper Vox table
- Humanscale Freedom Task chairs



Medium Collaboration Room - Dual Display

Components



Option 1

Cisco Room Kit EQX

CISCO

Nienkamper Vox Table TB-15



Table with Trough: Rectangle Shape and Laminate Top
 Accessible Duo bases to conceal stub-up
 120" L x 48" D x 28-1/2" H
 (3048mm L x 1219mm D x 724mm H)
 Laminate top
 Wilsonart Natural Rift 7954-38, Fine Velvet Finish
 Base
 Black
 Two Power modules
 5 ports
 Power Forum finish
 Black



nienkamper

Option 2

Cisco Room Bar Pro

CISCO

Dual 65" Displays
 (LG, Panasonic, Samsung, or Sony)

LG Panasonic SAMSUNG SONY



Humanscale Freedom Task Chair

Armrest/Armpad
 Advanced Duron Arms with Textile
 Frame Color
 Polished aluminum with Graphite Trim
 Seat Textile
 Ticino (Color: Glacier / White)

Humanscale

Salamander Credenza



Medium Collaboration Room - Dual Display

Room Layout

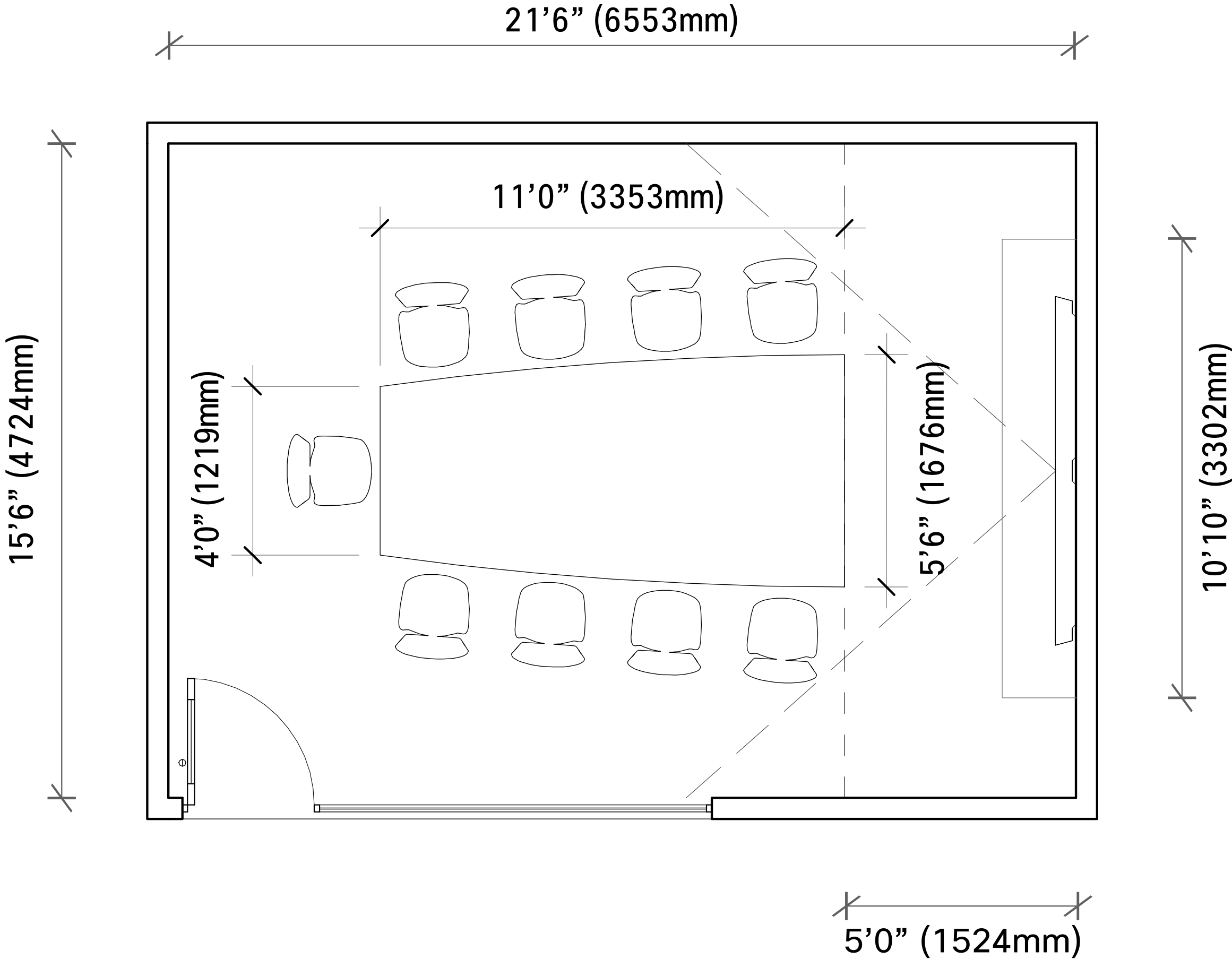

Medium Collaboration Room – Single Display

Overview



The Medium Collaboration Room with a single display is a great solution when wall space is at a premium. The large display provides ample screen space for both video and content, and when combined with a tapered table both in-person and remote participants are guaranteed to have a great experience.

Features

- Cisco Room 70 Single (or Room Bar Pro and 75" display) mounted on a Salamander Designs Credenza
- Nienkamper Vox table
- Humanscale Freedom Task chairs



Medium Collaboration Room - Single Display

Components



Option 1



Cisco Room 70 Single





Nienkamper Vox Table TB-15



Table with Trough: Rectangle Shape and Laminate Top
 Accessible Duo bases to conceal stub-up
 120" L x 48" D x 28-1/2" H
 (3048mm L x 1219mm D x 724mm H)
 Laminate top
 Wilsonart Natural Rift 7954-38, Fine Velvet Finish
 Base
 Black
 Two Power modules
 5 ports
 Power Forum finish
 Black

nienkämper

Option 2



Cisco Room Bar Pro





Single 75" Display
 (LG, Panasonic, Samsung, or Sony)







Humanscale Freedom Task Chair

Armrest/Armpad
 Advanced Duron Arms with Textile
 Frame Color
 Polished aluminum with Graphite Trim
 Seat Textile
 Ticino (Color: Glacier / White)

Humanscale

Salamander Credenza



Medium Collaboration Room - Single Display

Room Layout

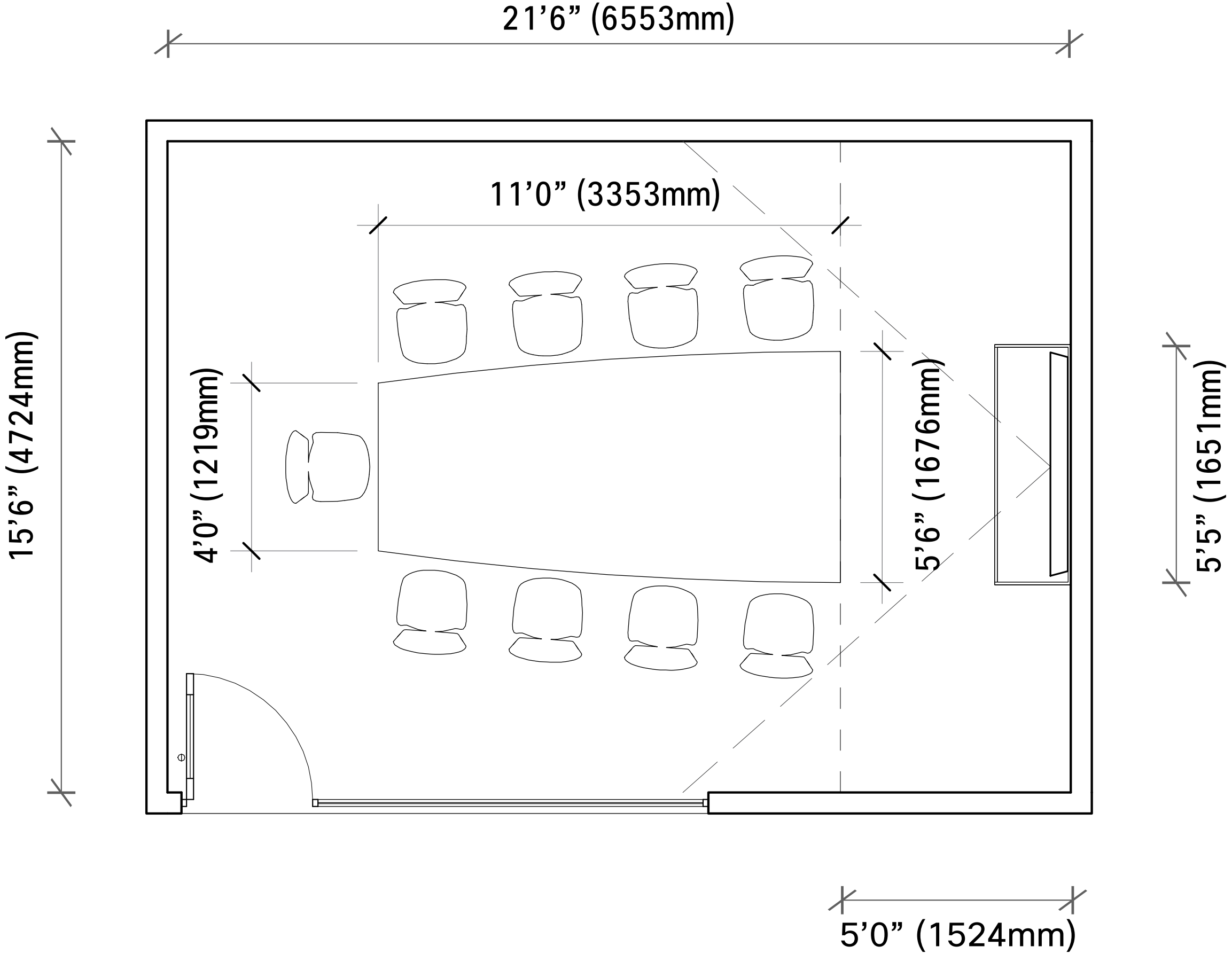

Medium Collaboration Room – Video Centric

Overview



The video-centric collaboration room is perfect for decision-making meetings. The horizontal table creates the effect of everyone sitting around a table. Dual 65" displays ensure that remote participants, as well as content, can be seen by all.

Features

- Cisco Room Kit EQX (or Room Bar Pro) with dual 65" Displays mounted on a Salamander Credenza
- Nienkamper Vox table
- Humanscale Freedom Task chairs



Medium Collaboration Room – Video Centric

Components



Option 1

Cisco Room Kit EQX



CISCO

Nienkamper Vox Table TB-15



Table with Trough: Rectangle Shape and Laminate Top
 Accessible Duo bases to conceal stub-up
 120" L x 48" D x 28-1/2" H
 (3048mm L x 1219mm D x 724mm H)
Laminate top
 Wilsonart Natural Rift 7954-38, Fine Velvet Finish
Base
 Black



Two Power modules
 5 ports
 Power Forum finish
 Black

nienkamper

Option 2



Cisco Room Bar Pro

CISCO



Dual 65" Displays
 (LG, Panasonic, Samsung, or Sony)

LG Panasonic SAMSUNG SONY



Humanscale Freedom Task Chair

Armrest/Armpad
 Advanced Duron Arms with Textile
Frame Color
 Polished aluminum with Graphite Trim
Seat Textile
 Ticino (Color: Glacier / White)

Humanscale

Salamander Credenza



Medium Collaboration Room – Video Centric

Room Layout

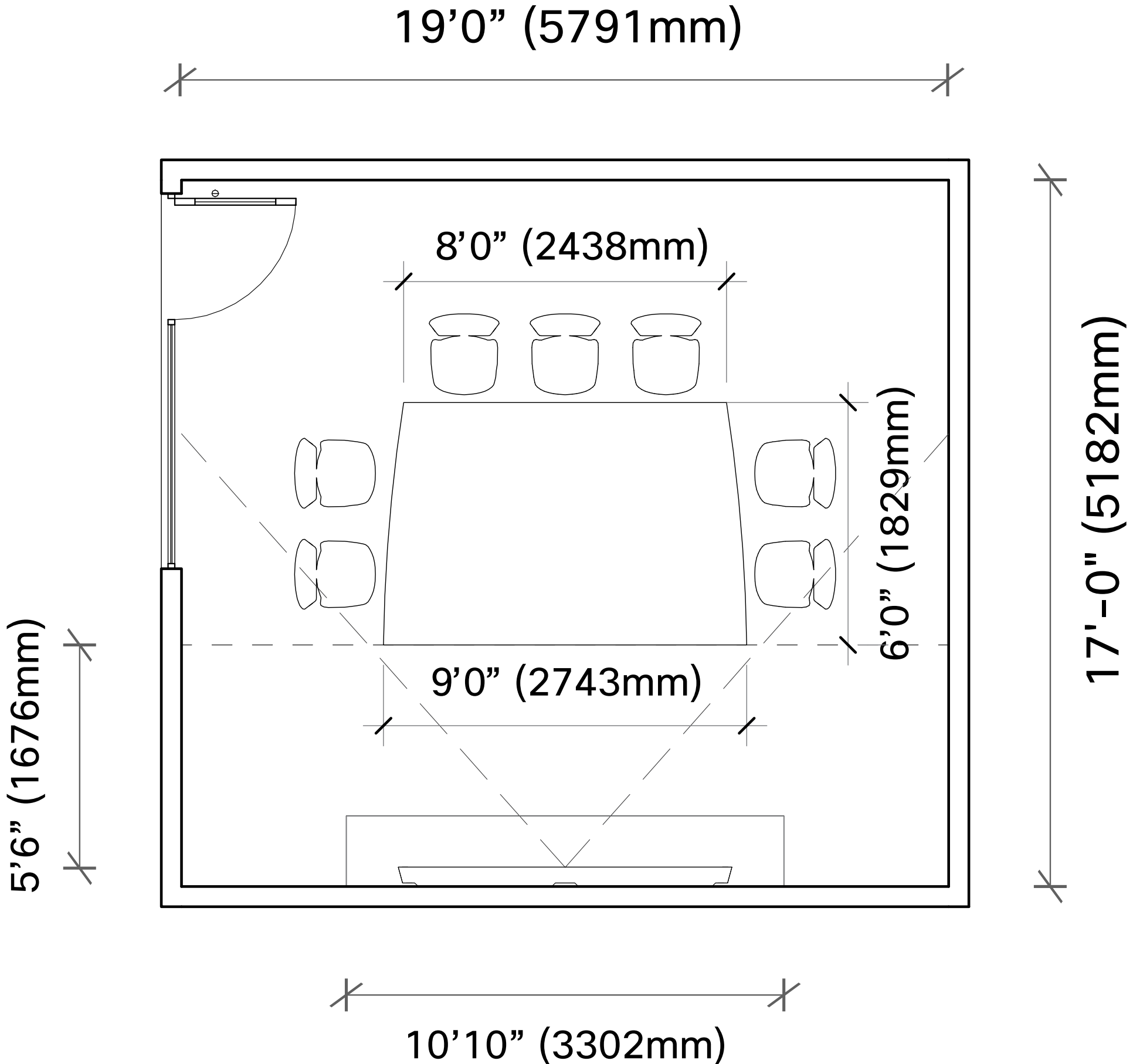

Medium Brainstorming Room

Overview



This brainstorming space is built for when larger groups need to ideate. The table orientation and shape ensure everyone can be seen and heard, and the density of the space is gracious, allowing ample space to move within the room. The Cisco Board is multi-functional, enabling video calls, content sharing, and whiteboarding.

Features

- Cisco Board Pro 75 wall mounted
- Nienkamper Vox table
- Humanscale Freedom Task Chairs



Medium Brainstorming Room

Components



Humanscale Freedom Task Chair

Armrest/Armpad
Advanced Duron Arms with Textile
Frame Color
Polished aluminum with Graphite Trim
Seat Textile
Ticino (Color: Glacier / White)

Humanscale

Cisco Board Pro 75



CISCO

Nienkamper Vox Table TB-15



Table with Trough: Rectangle Shape
Accessible Duo bases to conceal stub-up
120" L x 48" D x 28-1/2" H
(3048mm L x 1219mmz D x 724mm H)
Laminate top
Wilsonart Natural Rift 7954-38, Fine Velvet Finish
Base
Black



Two Power modules
5 ports
Power Forum finish
Black

nienkämper

Medium Brainstorming Room

Room Layout

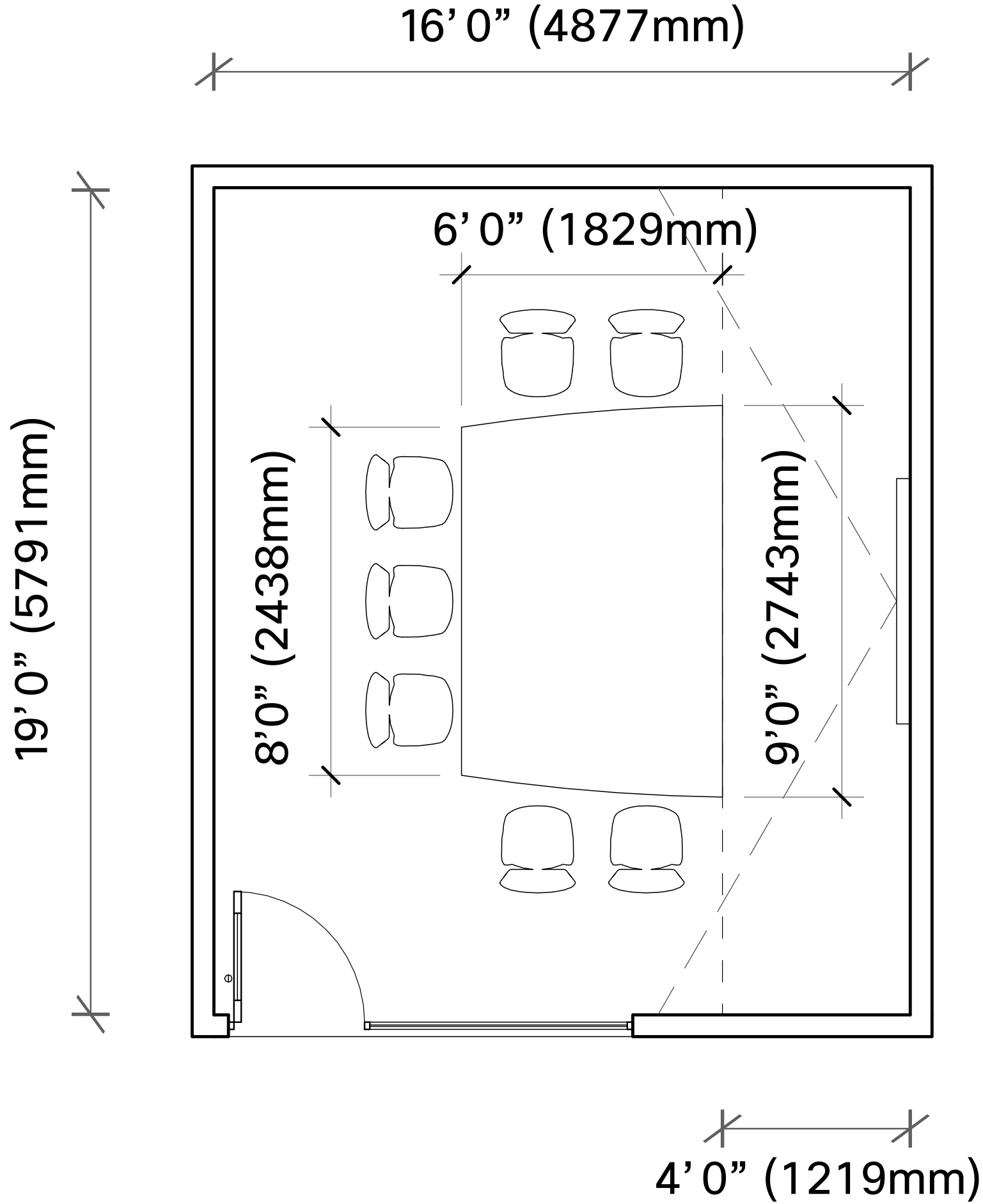

Large Collaboration Room

Overview



A collaboration space specifically designed for large groups, dual screens allow in-person attendees to see both remote participants and content, and the tapered table shape ensure remote participants can see everyone in the room. The rear-mounted Cisco TelePresence Precision 60 Camera automatically captures presenters as they move in the front of the room. The optional Cisco Board Pro, operating in companion mode, allows co-creation capabilities to be brought into a video meeting.

Features

- Cisco Room 70D G2 w/ Wall Stand or Cisco Room Kit EQX with dual 75" displays
- Cisco Board Pro 75 (In Companion Mode)
- Rear-mounted Cisco TelePresence Precision 60 Camera
- Salamander Infiniti Table
- Humanscale Freedom Task Chairs with headrests



Large Collaboration Room Components



Option 1

Cisco Room 70D G2 w/Wall Stand



CISCO

Cisco Board Pro 75



Cisco TelePresence Precision 60 Camera



CISCO

Option 2

Cisco Room Kit EQX

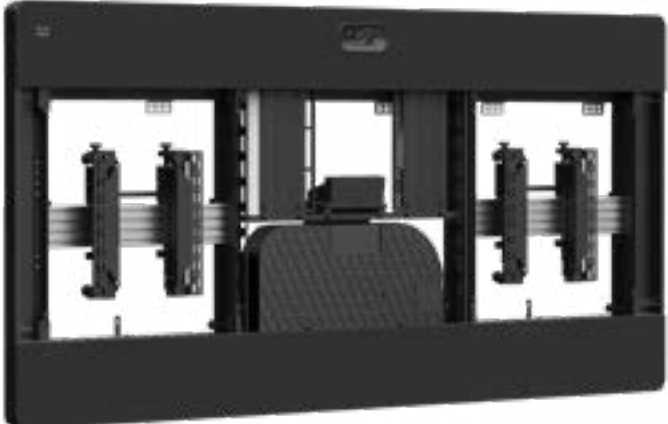

CISCO

Dual 75" Displays
(LG, Panasonic, Samsung, or Sony)



LG Panasonic SAMSUNG SONY



Humanscale Freedom Task Chair with Headrest

- Armrest/Armpad
Advanced Duron Arms with Textile
- Frame Color
Polished aluminum with Graphite Trim
- Seat Textile
Ticino (Color: Glacier / White)

Humanscale

Salamander Infiniti Table

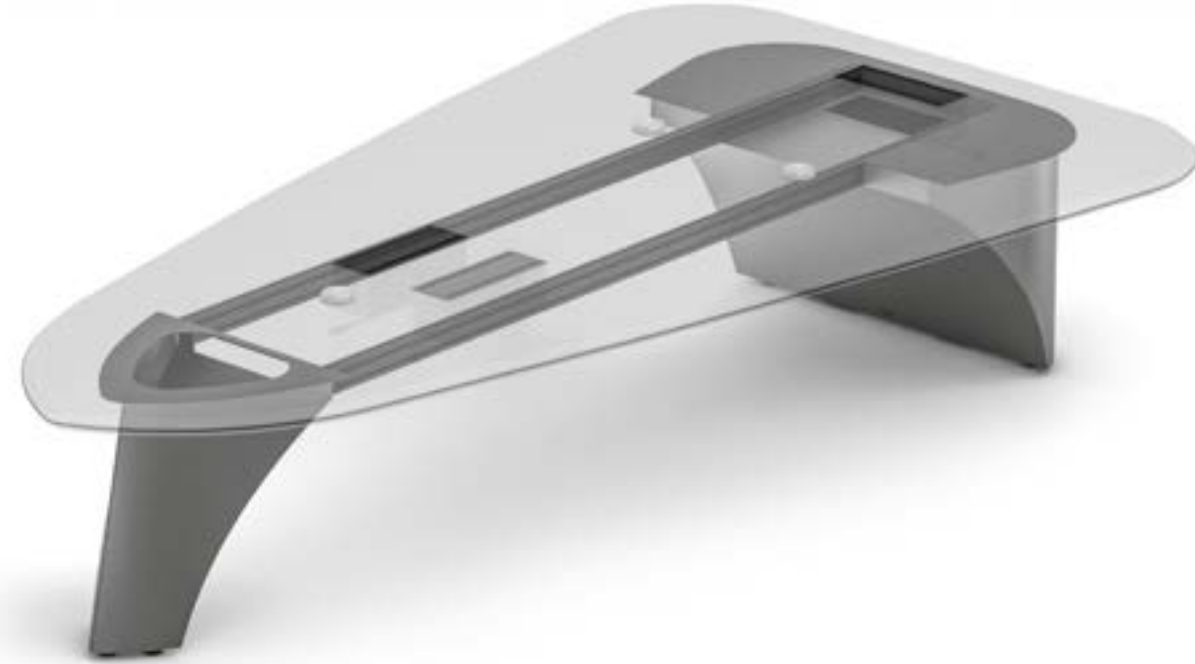

Large Collaboration Room

Room Layout

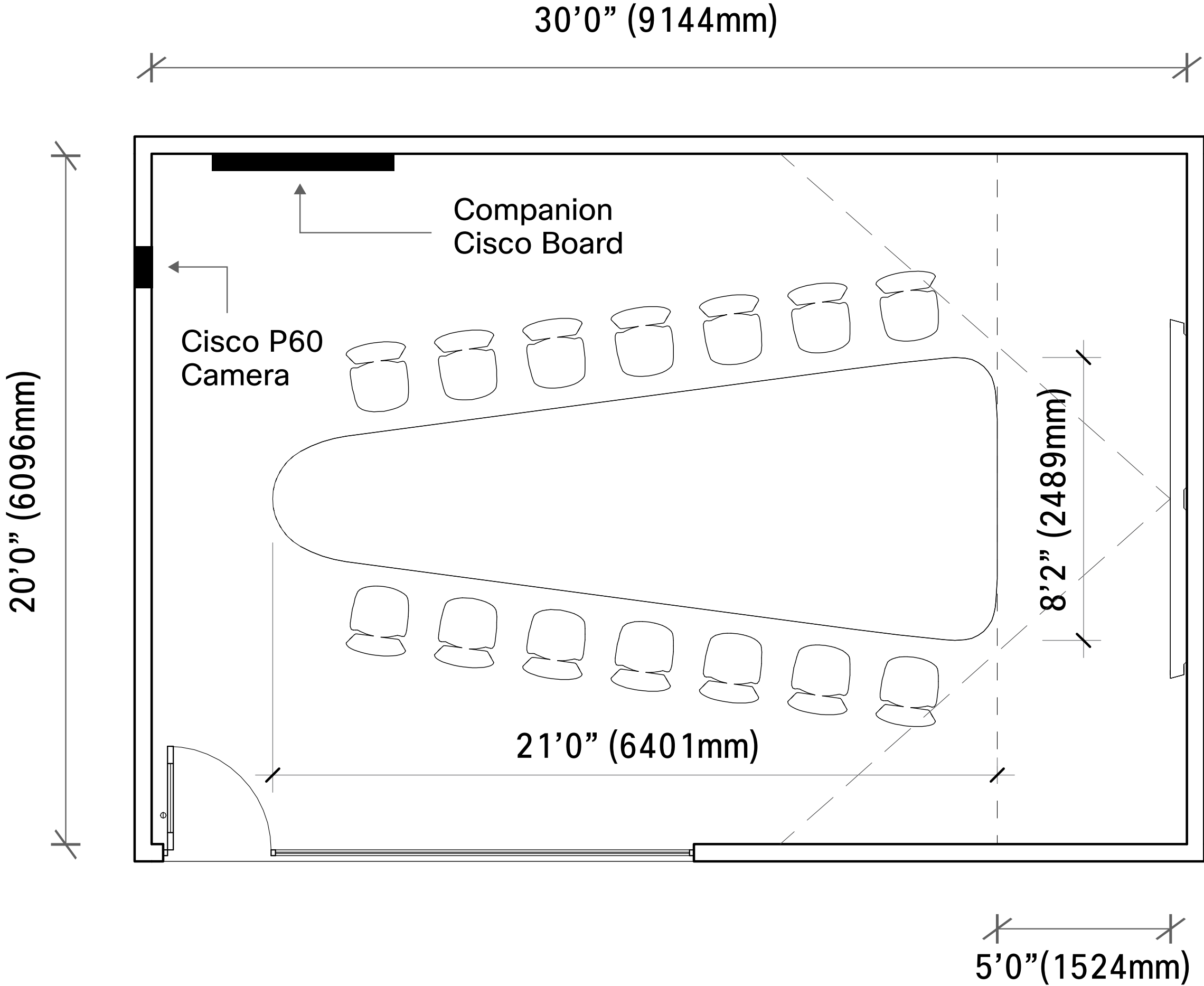

Innovation Suite

Overview



A perfect space for a team meeting or when colleagues want to get together to share ideas. The informal setting, the mix of seating types, and varying postures provide choice. The Cisco Board Pro 75 is the perfect multi-functional device for the space.

Features

- Cisco Board Pro 75
- National Strassa
- Bernhardt Chiara
- Bernhardt Chance
- Stylex Share 3-Seater
- Teknion Sprout Stool
- Bernhardt Clue



Innovation Suite

Components



Kimball Strassa Table



Dimensions:
84" W x 24" D x 41" H
(2134mm W x 610mm D
x 1041mm H)

Kimball International

Cisco Board Pro 75



CISCO

Teknion Sprout Stool



teknion

Stylex Share 3-Seater



STYLEX

Bernhardt Chiara



Bernhardt Chance



Bernhardt Clue



BERNHARDT | design

Innovation Suite

Room Layout

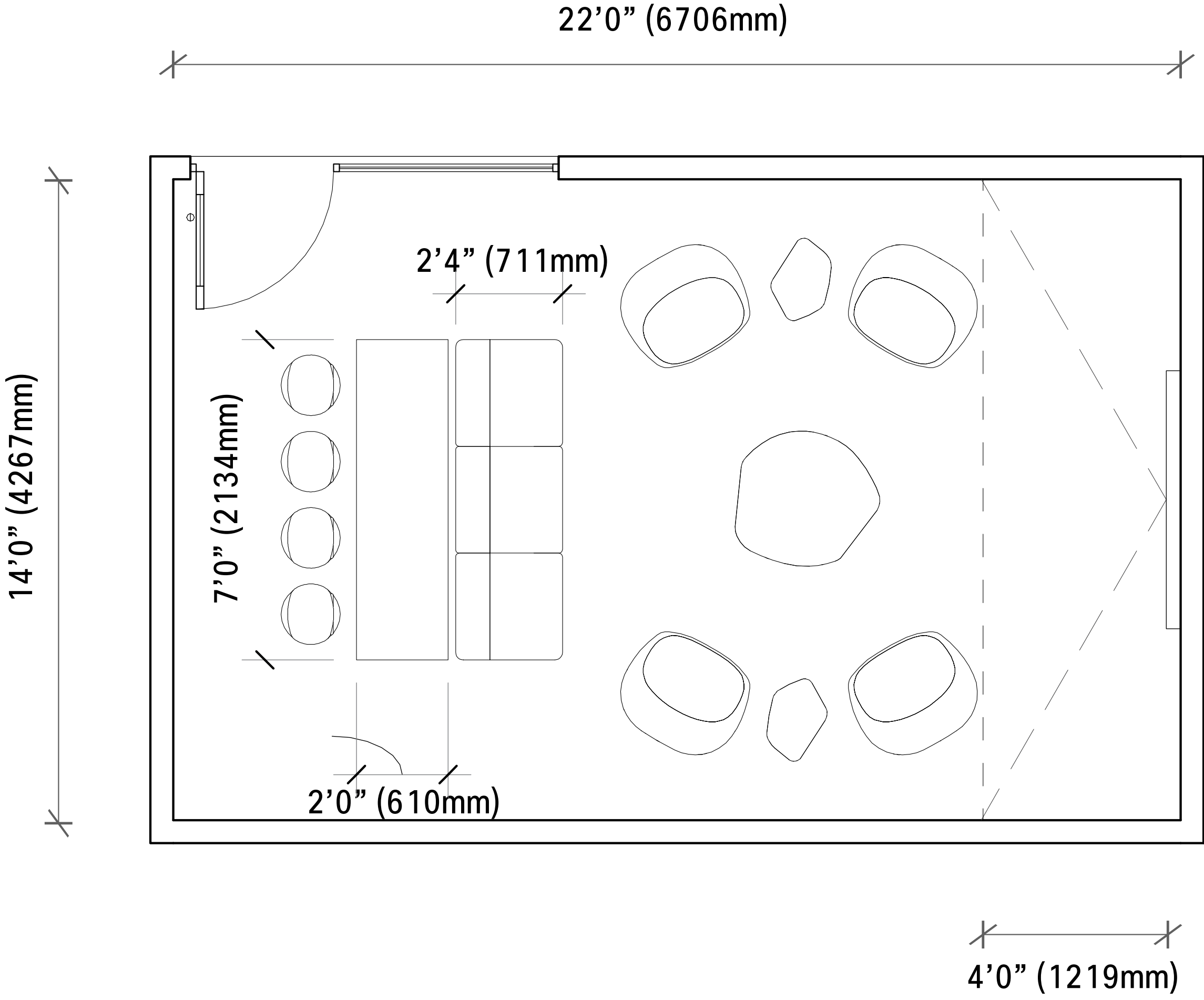

Training Room

Overview



Designed for delivering true hybrid learning events, this training room leverages three large displays, multiple cameras, and Cisco's "Classroom" mode to provide an unparalleled experience to all participants. The solution supports multiple learning scenarios, including local presenter to a local audience, local presenter to a local and remote audience, remote presenter to a local and remote audience, and discussion mode. In the meeting, whiteboarding and annotation are supported by the Cisco Board Pro operating in Companion Mode.

Features

- Cisco Room Kit Pro
- Wall mounted Cisco Quad Cam
- Triple 85" Displays (LG, Panasonic, Samsung, or Sony)
- Rear mounted 65" display (confidence monitor)
- Cisco Ceiling Microphones
- JBL or Extron Soundfield (26CT) ceiling speakers with amplifier
- Overhead mounted Cisco TelePresence Precision 60 Camera
- Wall mounted Cisco Board Pro 75
- Teknion Expansion Training tables
- National Jiminy Flip Nesting chairs



Training Room Components



Kimball Jiminy
Flip Nesting chair

Kimball International

Cisco Board Pro 75



Cisco Room Kit Codec Pro



Dual 75" Displays



(LG, Panasonic, Samsung, or Sony)

CISCO

LG Panasonic SAMSUNG SONY

Teknion Expansion Training table



teknion

Cisco Ceiling Microphones



Cisco TelePresence Precision 60 Camera



CISCO

Training Room

Room Layout

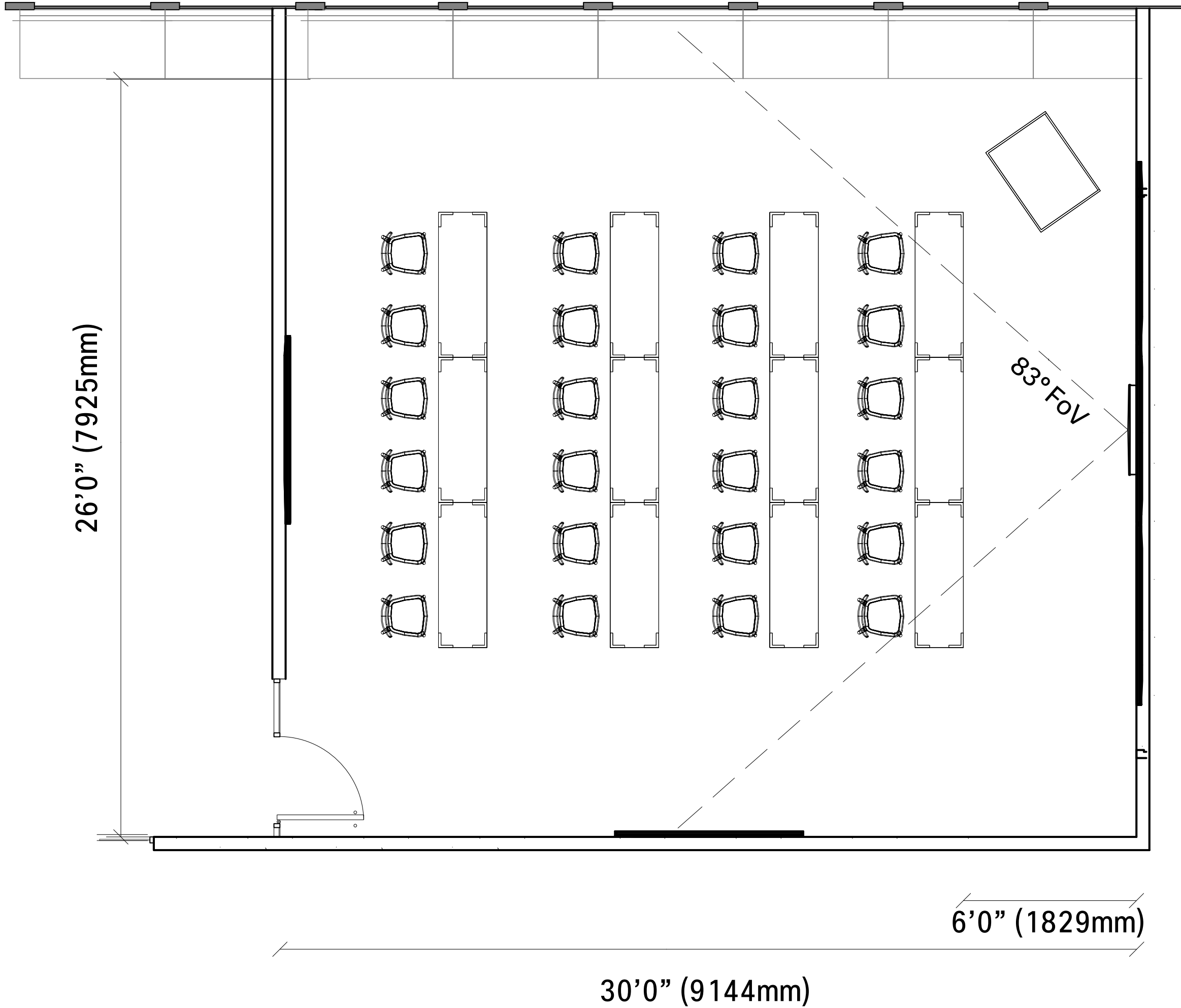

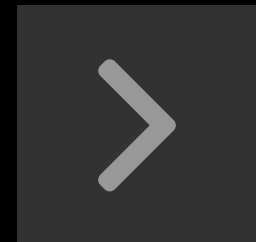

Resources

[Cisco.com](#)

[Cisco Workspaces](#)

[Best Practices for Creating Effective Video-enabled Rooms](#)

© 2024 Cisco and/or its affiliates. All rights reserved. Cisco, the Cisco logo, Webex by Cisco, and Webex are trademarks or registered trademarks of Cisco and/or its affiliates in the U.S. and other countries. To view a list of Cisco trademarks, see the Trademarks page on the Cisco website. Third-party trademarks mentioned are the property of their respective owners. The use of the word “partner” does not imply a partnership relationship between Cisco and any other company. (2106R)

The intent of this document is to highlight the details, components and partners used in the creation of New York Penn1. Any reference herein to any specific commercial products or service does not necessarily constitute or imply its endorsement or recommendation.