



Smart Building Technology
and Hybrid Work Solutions

Cisco Talent and Collaboration Centers

Medium Collaboration Room – Video Centric Design Guide

Cisco Room Kit EQX Option Shown

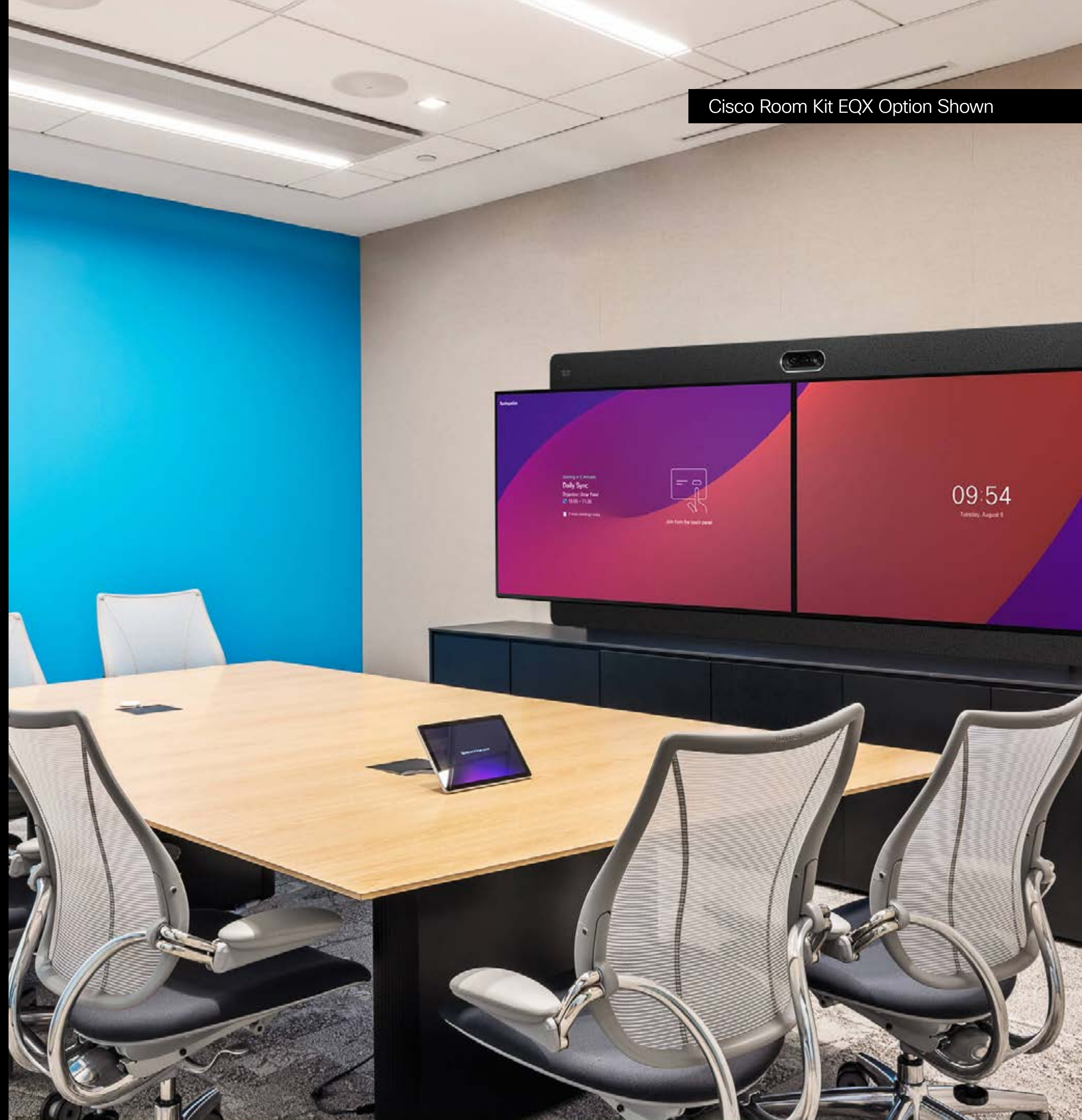



Design Guide

Table of Contents

▶ Introduction	3	▶ Option 2: Cisco Room Kit EQX	18
▶ Visualization of Key Cisco Elements	4	▶ Room Layout	19
▶ Certified Third Party Displays	5	▶ Composite Plan	20
		▶ Video Device Mounting Options	21
▶ Option 1: Cisco Room Bar Pro	6	▶ Room Elevations	22
▶ 7-Person Room Layout	7	▶ Reflective Ceiling Plan & Acoustical Treatment	26
▶ 8-Person Room Layout	8	▶ Power & Data	27
▶ Composite Plan	9	▶ Exploded IT Diagram	28
▶ Video Device Mounting Options	10	▶ Connectivity View	29
▶ Room Elevations	11	▶ IT/OT Bill of Material	30
▶ Reflective Ceiling Plan & Acoustical Treatment	13		
▶ Power & Data	14	▶ IT/OT Reference Architectures	31
▶ Exploded IT Diagram	15	▶ Commissioning-User Acceptance Testing Criteria	32
▶ Connectivity View	16	▶ Design Files & Resources	33
▶ IT/OT Bill of Material	17		



Introduction

Overview and Intent

This document provides guidance on how to effectively design a Medium Collaboration Room - Video Centric.

This design brings space layout, technology, and furnishings together to create an optimal experience for those present locally and for remote attendees.

Each project is unique; thus, it is important to involve internal facilities and IT teams, as well as an architect and/or space designer, furniture providers, and a Cisco-certified integrator, as early as possible. The goal is to thoroughly understand the needs of the end users and address any local concerns, including physical layout, wall, floor, and ceiling composition, electrical/mechanical integration, network and cabling considerations, and external environmental issues (lighting/noise/temperature) before the design is finalized.



Note: Links to key Cisco documentation, including product data sheets, room preparation guides and installation materials can be found at the last page of this Design Guide.

Room Description

The video-centric collaboration room is perfect for information sharing and decision-making meetings. The horizontal table creates the effect of everyone sitting around a table. Dual displays ensure that remote participants, as well as content can be seen by all. This room can be deployed in a 7 person configuration (2x3x2) or 8 person (2x4x2), depending on the width of the allocated space.

Supported Collaboration Activities

Information Sharing	✓
Brainstorming	
Team Building	
Decision Making	✓

Visualization of Key Cisco Elements



Cisco Room Navigator
for Wall



Cisco Room Navigator
for Table

Option 1

Cisco Room Bar Pro



Option 2

Cisco Room Kit EQX



Dual 65" displays
LG / Panasonic / Samsung / Sony

Microphone Options



Cisco Table Microphone Pro (x2)

- or -



Cisco Ceiling Microphone Pro (x1)

Certified Third Party Displays



Webex certified displays have been tested for compatibility and robustness of their video interfaces, optical characteristics, and basic security practices.

When connected to a Cisco collaboration device they will automatically reconfigure to the optimal configuration already tested and verified.

This list of verified devices was update on November 4, 2024. For up to date information on certified and compatible Cisco collaboration device partner offers, click on the link below.

Vendor	Product or Series	Firmware version
Samsung	QMB	1040.7
Samsung	QBB	1040.7
Samsung	QMC	1040.4
Panasonic	EQ2	2.40
LG	UL3J	03.08.41
LG	UH5J	03.24.01
LG	UR640S	03.17.00
LG	UM5K	3.70.30
Sony	BZ30J, BU30J, BZ35J, BU35J, BZ40H, BU40H, BZ40J, BU40J	6.5929
Sharp/NEC	M751, M861, M981	1.200
Sharp/NEC	MA431, MA491, MA551, P435, P495, P555	3.203
Sharp	PN-LA652, PN-LA752, PN-LA862	1.112

Option 1: Cisco Room Bar Pro



7-Person Room Layout

Wall Mount Option

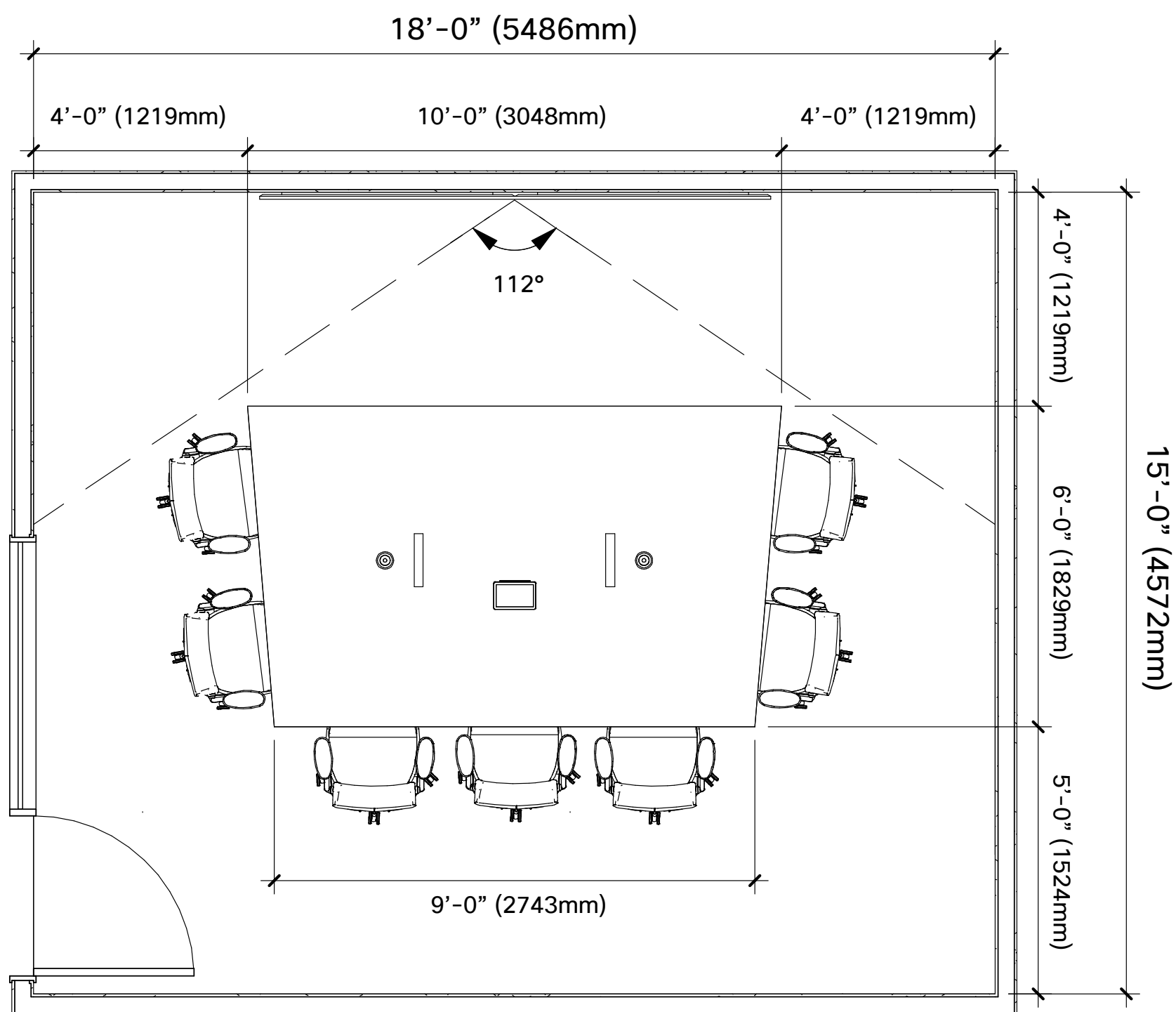

Credenza Mount Option

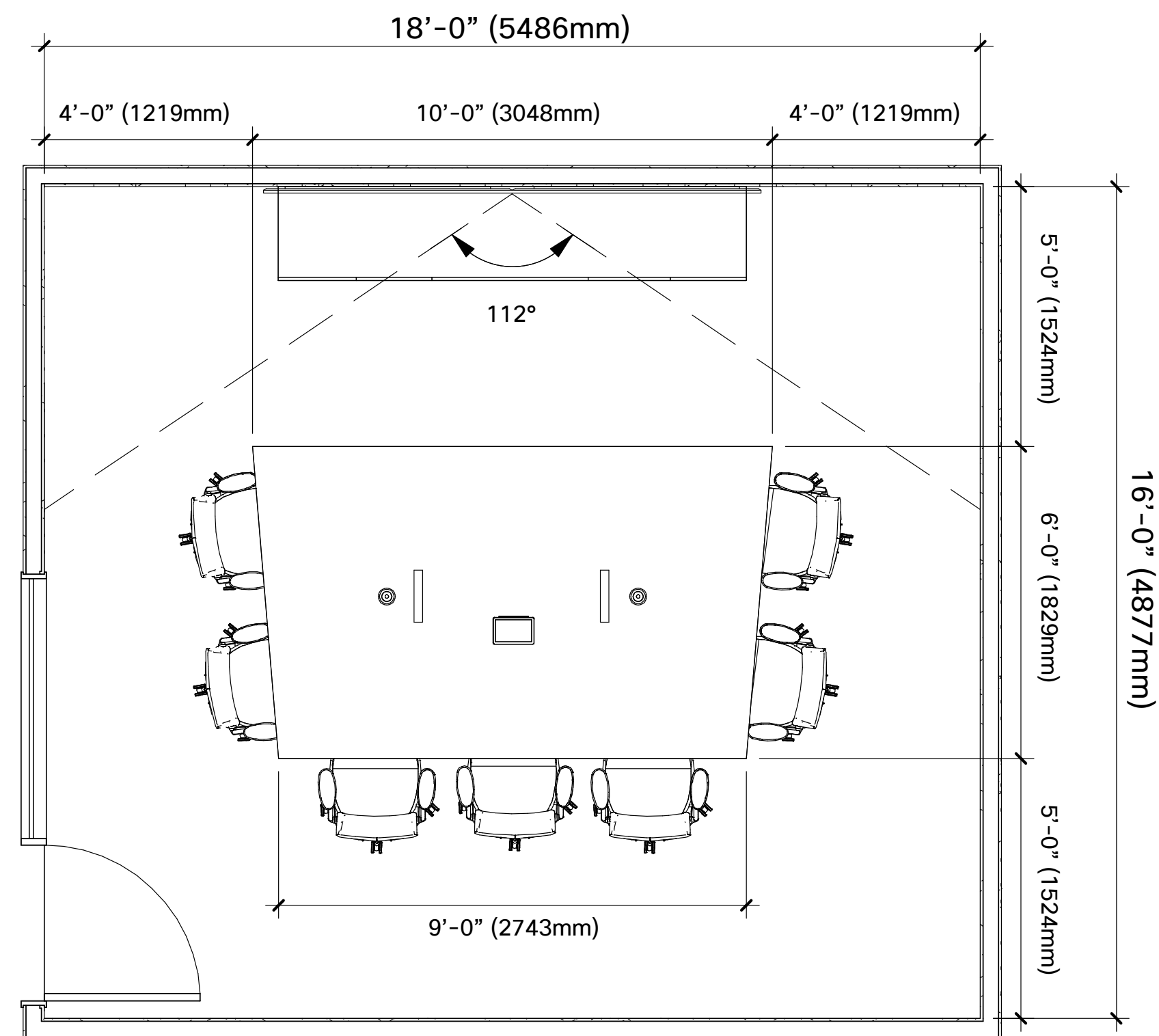

i Note: Room dimensions show are the minimal size, based on the technology and furniture options shown.

i With its 112 degree Field of View (FoV), the Cisco Room Bar Pro will also support an 8-person configuration (2-4-2). This is not recommended with the Cisco Room Kit EQX.

8-Person Room Layout

Wall Mount Option

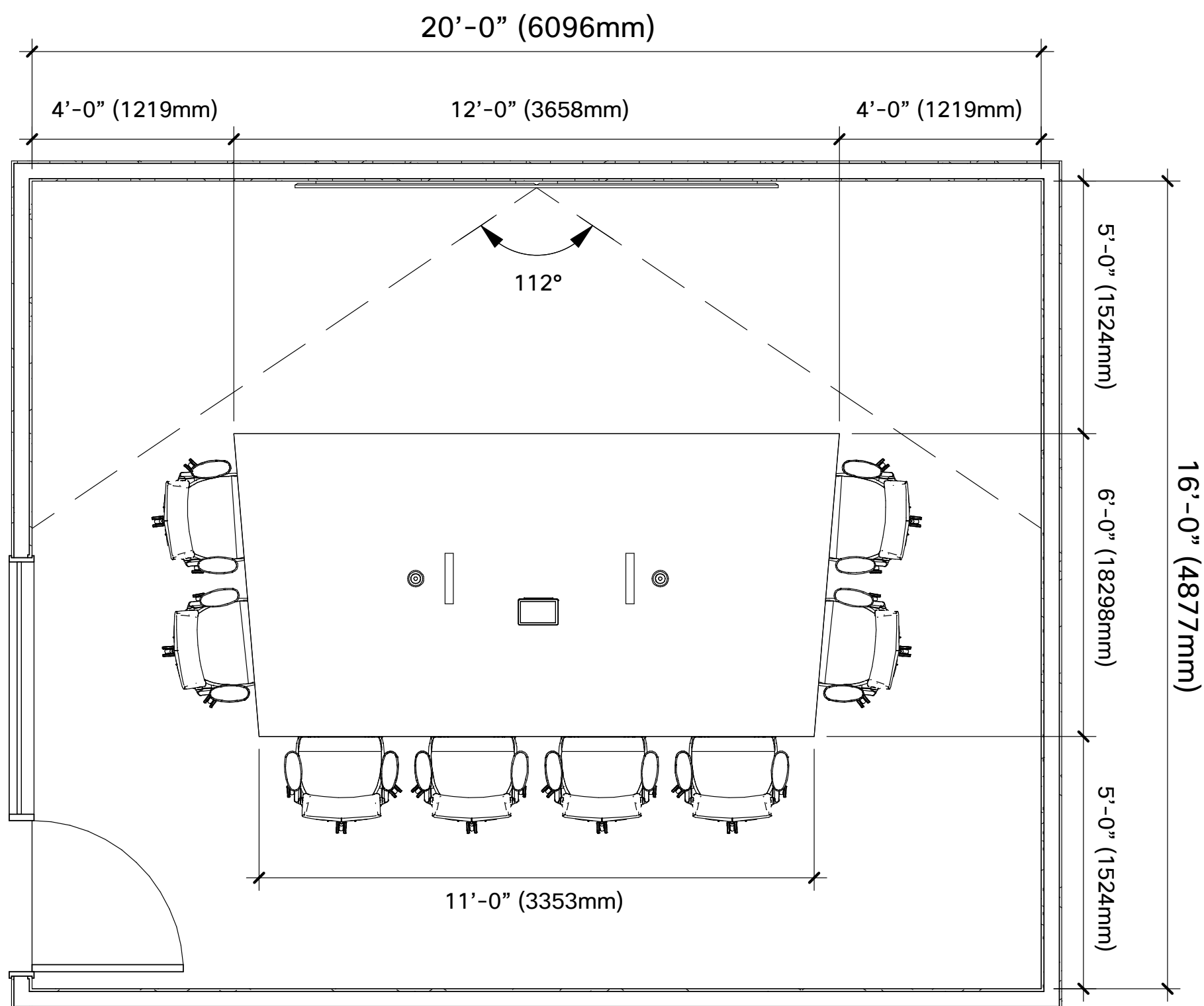

i Note: Room dimensions show are the minimal size, based on the technology and furniture options shown.

Credenza Mount Option

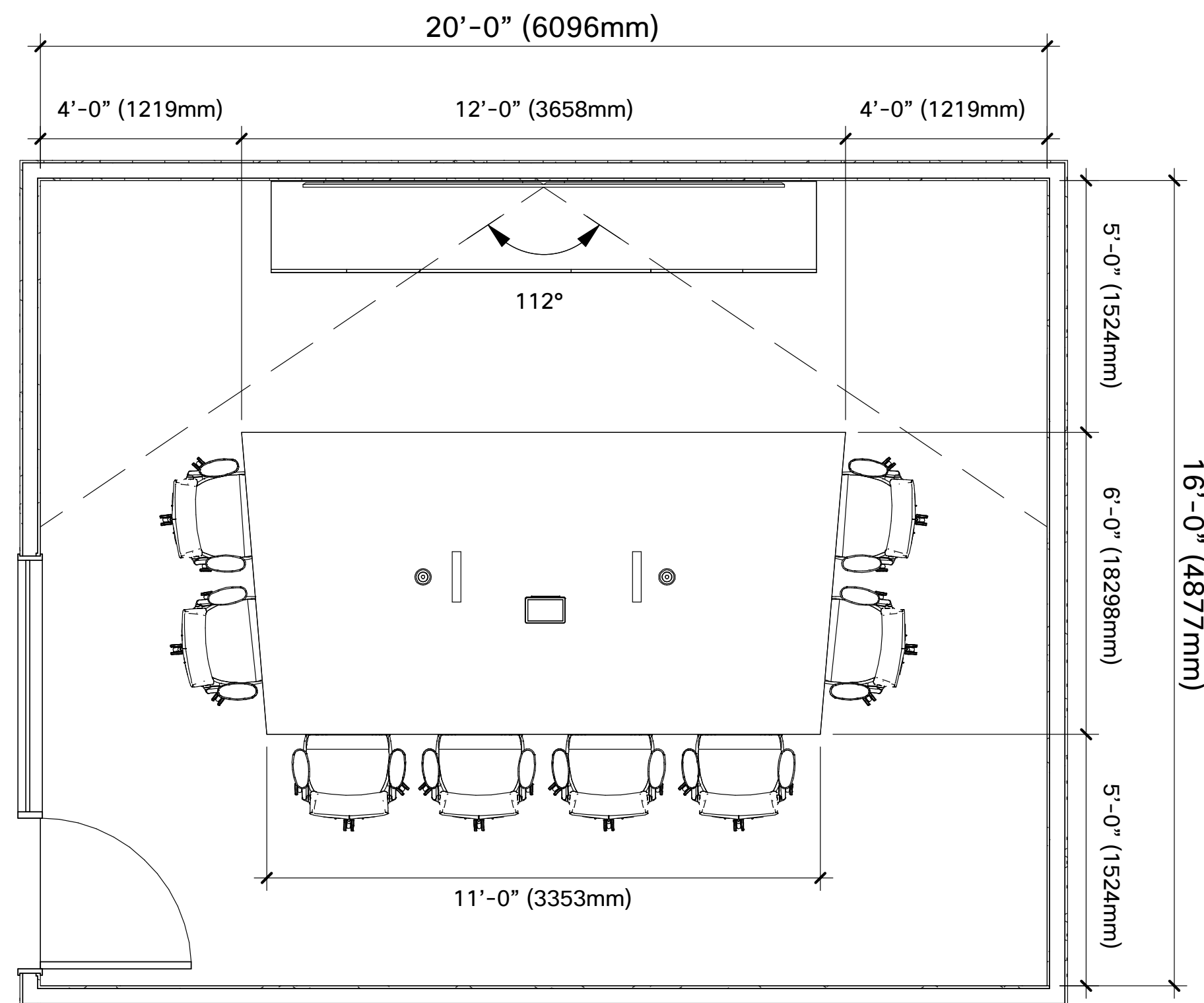

i With its 112 degree Field of View (FoV), the Cisco Room Bar Pro will also support an 8-person configuration (2-4-2). This is not recommended with the Cisco Room Kit EQX.

Composite Plan

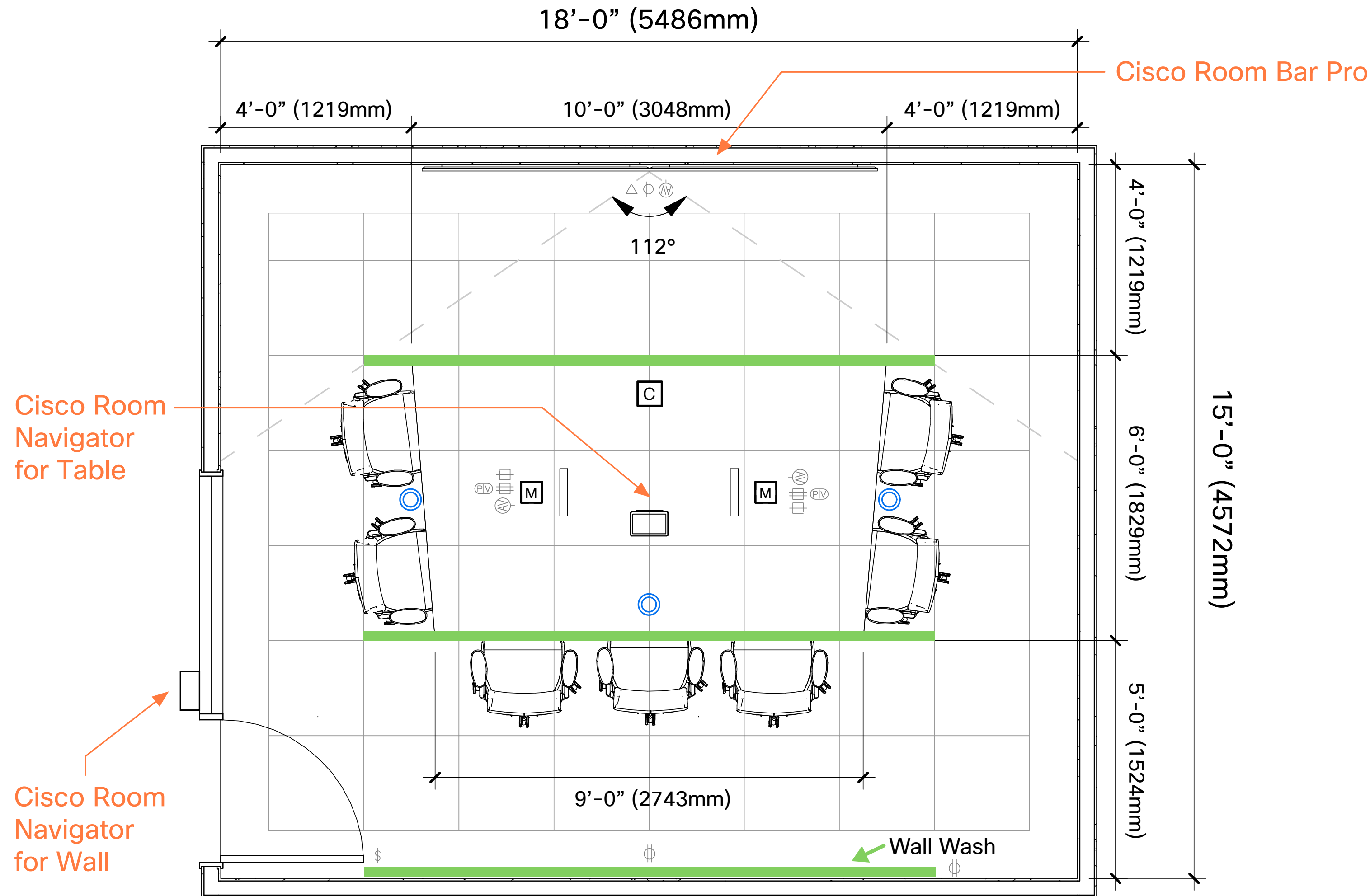

Graphics Symbols

- Acoustical Ceiling & Grid
 - HVAC Diffusers (T.B.D.)
Shown as Example Only
 - Light Fixtures
 - Acoustical Wall
- Furniture Systems Version Devices**
- Duplex Receptacle & Grid
 - Data Receptacle
- Power and Communication**
WALL / CEILING / FLOOR VERSION DEVICES
- Cisco Ceiling Microphone Pro
 - Third Party Speakers (Optional)
 - Duplex Receptacle
 - Data Receptacle
 - Light Switch
 - AV Receptacle
 - Table Microphone
 - Combination Power & Voice / Data Infeed

Video Device Mounting Options

Option 1 Cisco Room Bar Pro

There are two mounting options for the device when deploying the Cisco Room Bar Pro. Several factors will go into determining which option is best.

Option 1a Wall Mount

Wall Mounted – Requires wall to be blocked and electrical and data to be elevated. Specific wall mount hardware must be determined based on the weight of the displays that are selected.



Option 1b Credenza

A/V compatible credenza – Freestanding and fully integrated cabinets available from a number of specialized vendors eliminate the requirement for the wall to be blocked and electrical moved. Perfect for new and retrofit installations, allowing for quick and efficient installation.



Room Elevations

Option 1a Cisco Room Bar Pro - Wall Mount

Construction Elevation

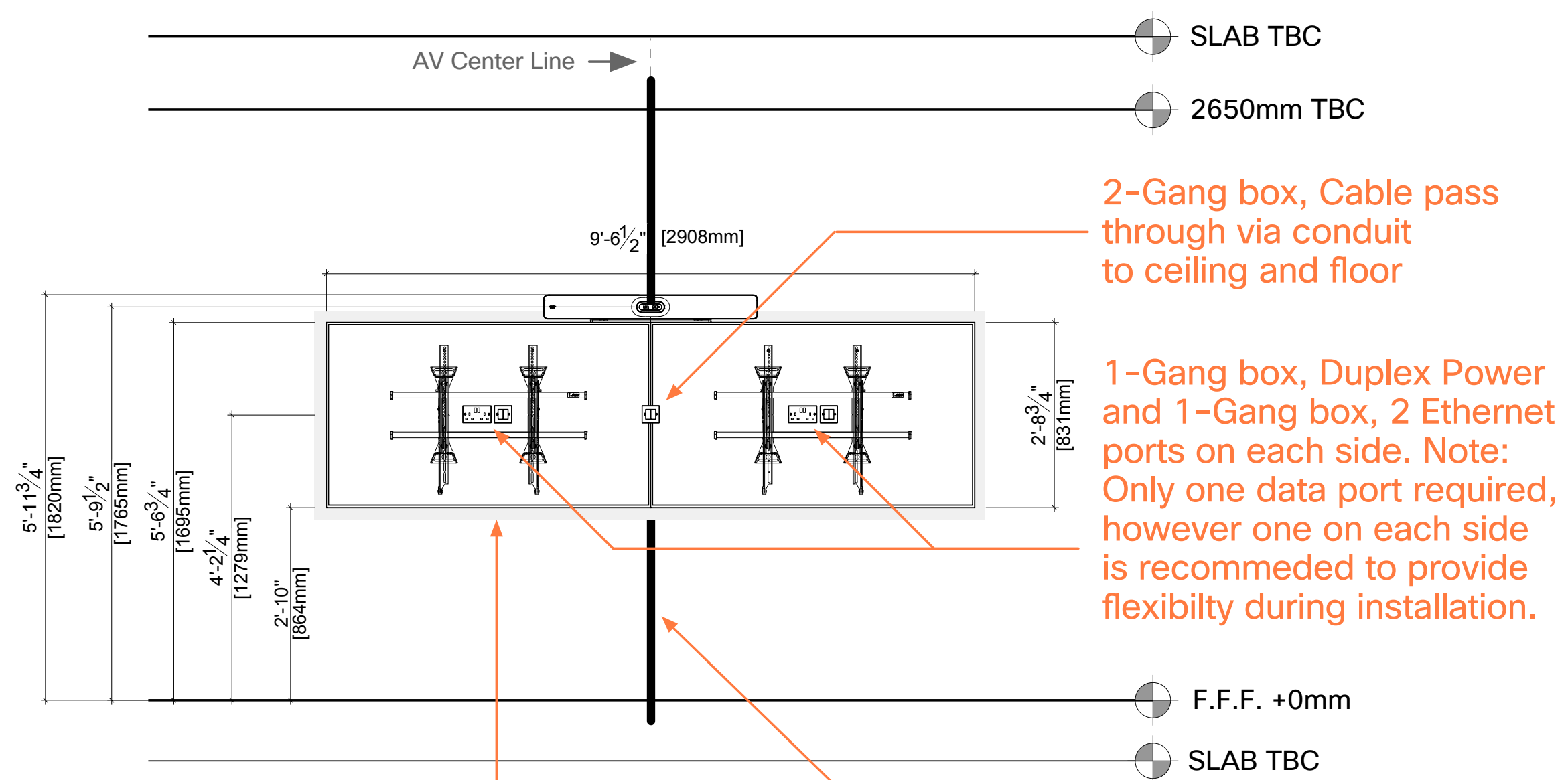

11-Ply (or similar approved), prior to screen installation. Steel fixings must be able to support screen specifications. Wall should be made-good to match existing wall finish.

Conduit to floor and ceiling for Cisco Room Navigator, A/V cables, table or ceiling microphones and/or secondary camera.

Side Elevation

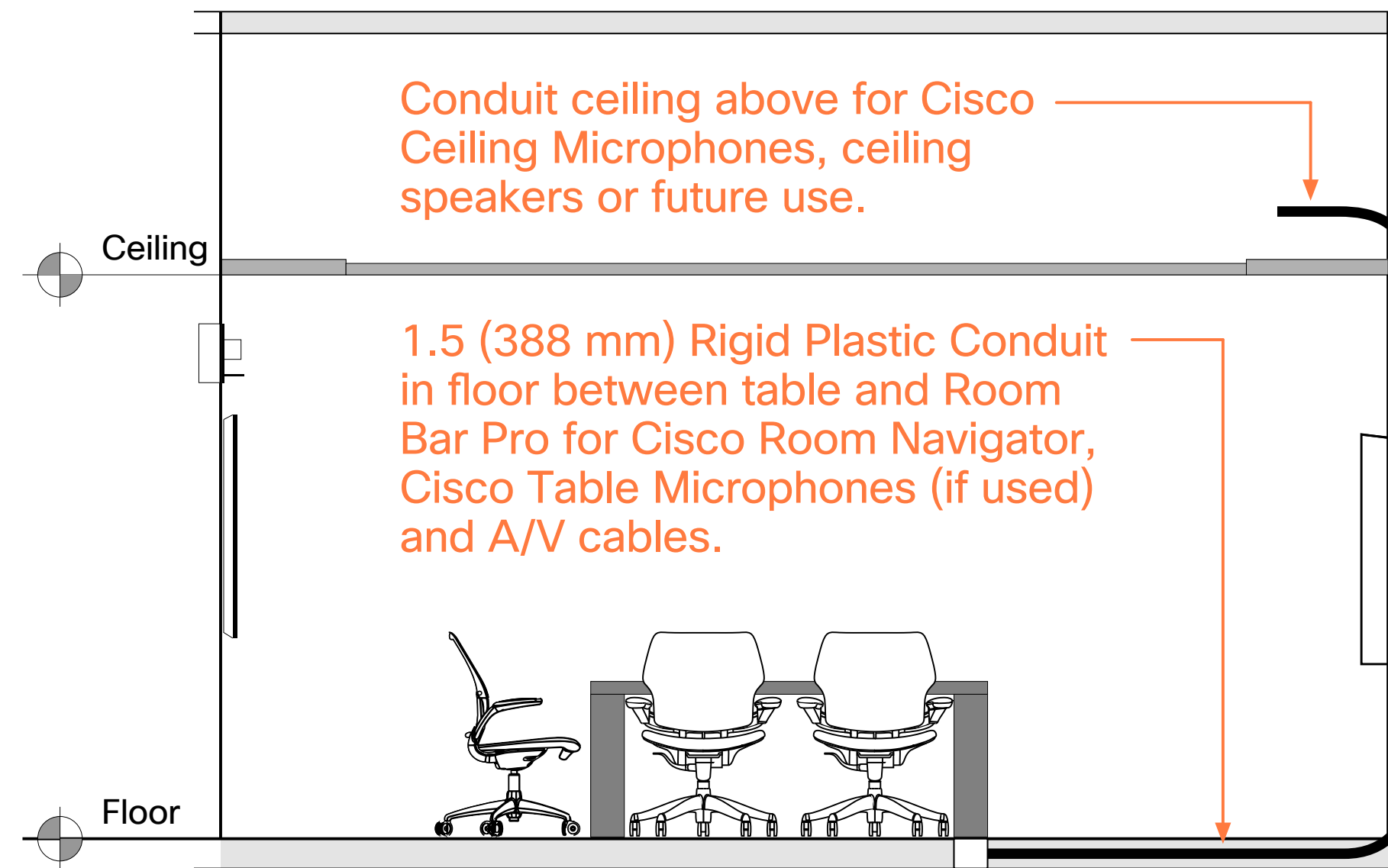

Room Elevations



Cisco Room Bar Pro - A/V Credenza

Construction Elevation

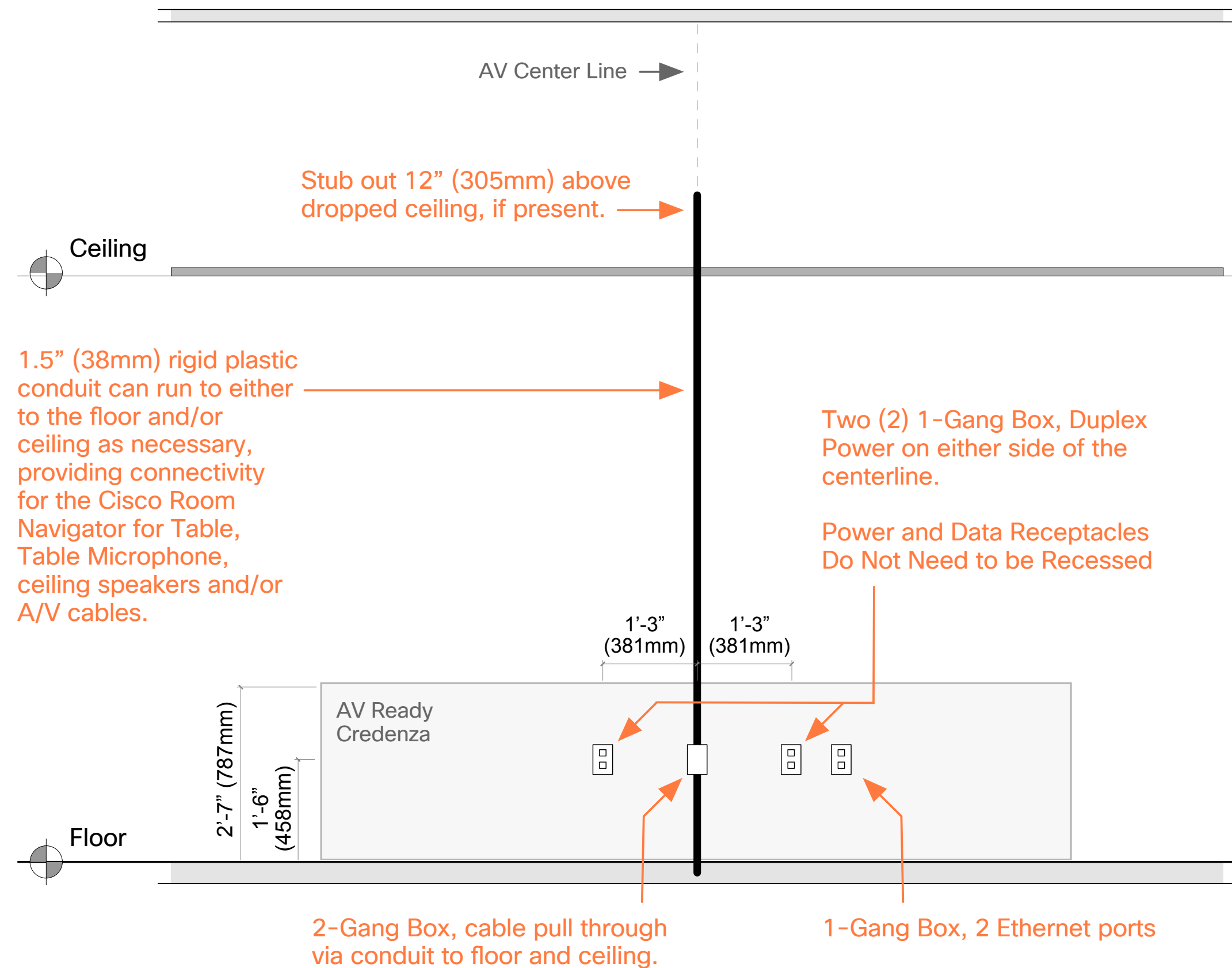

Finished Elevation

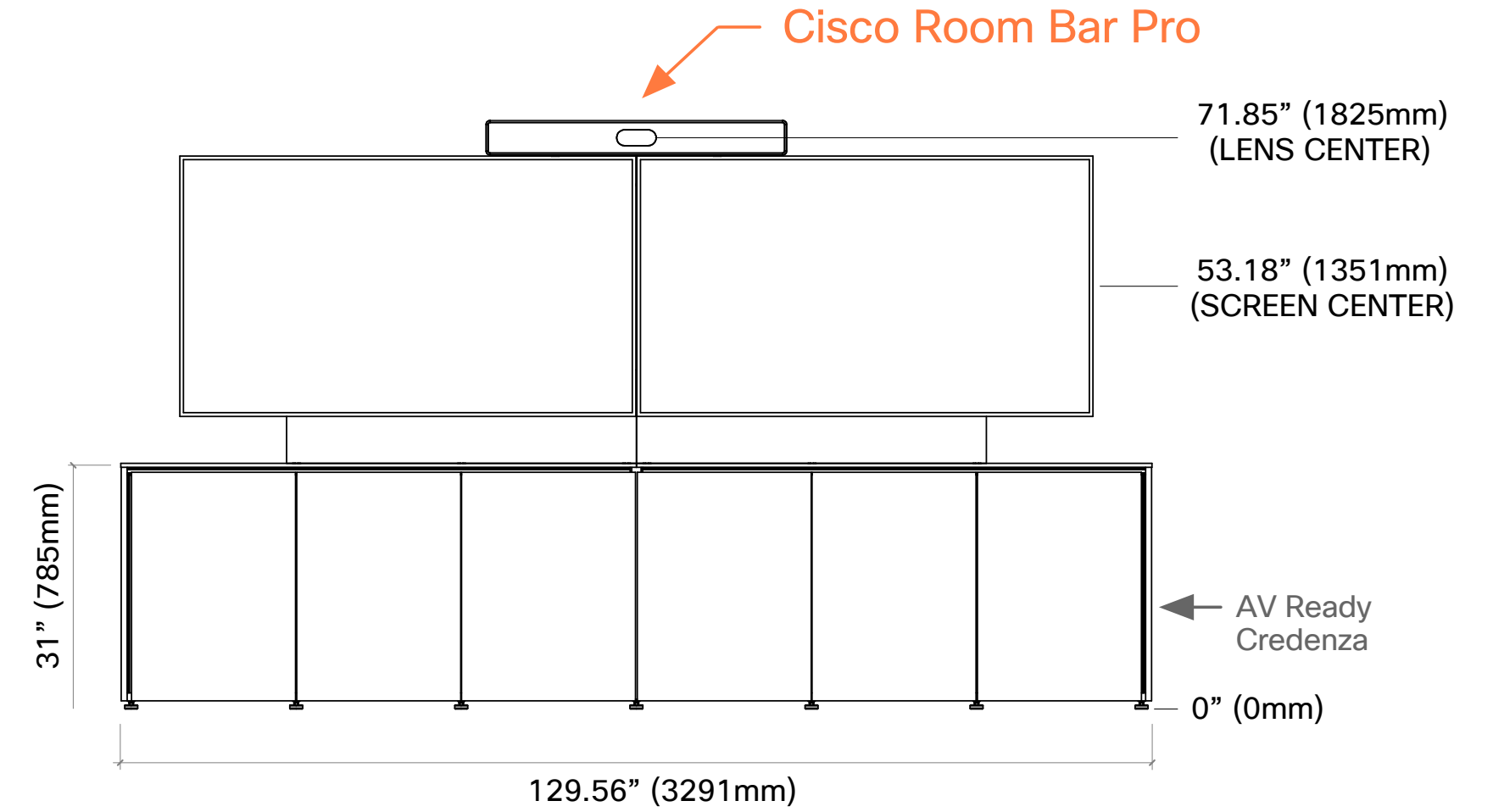

Side Elevation

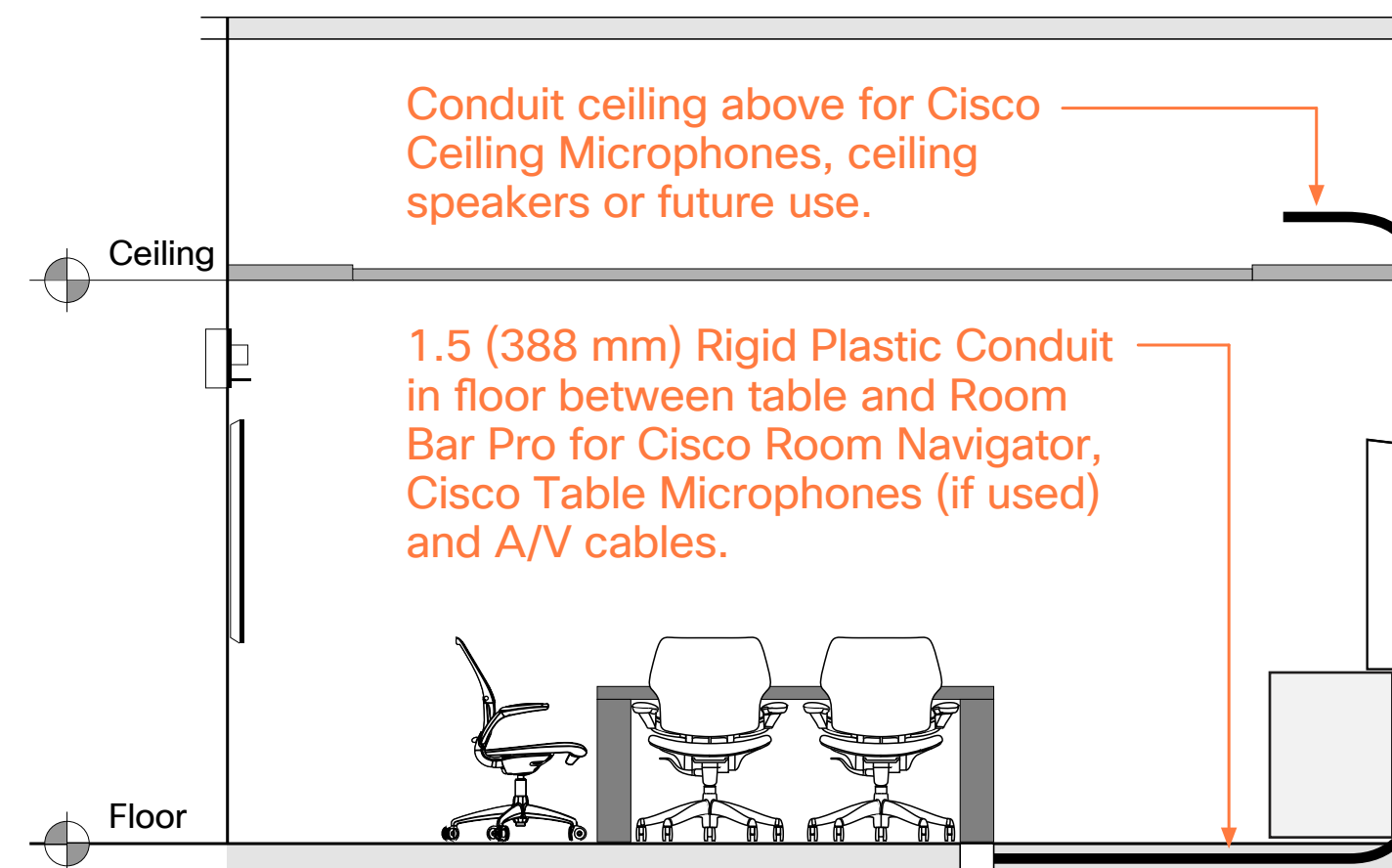

Reflective Ceiling Plan & Acoustical Treatment

Reflective Ceiling Plan

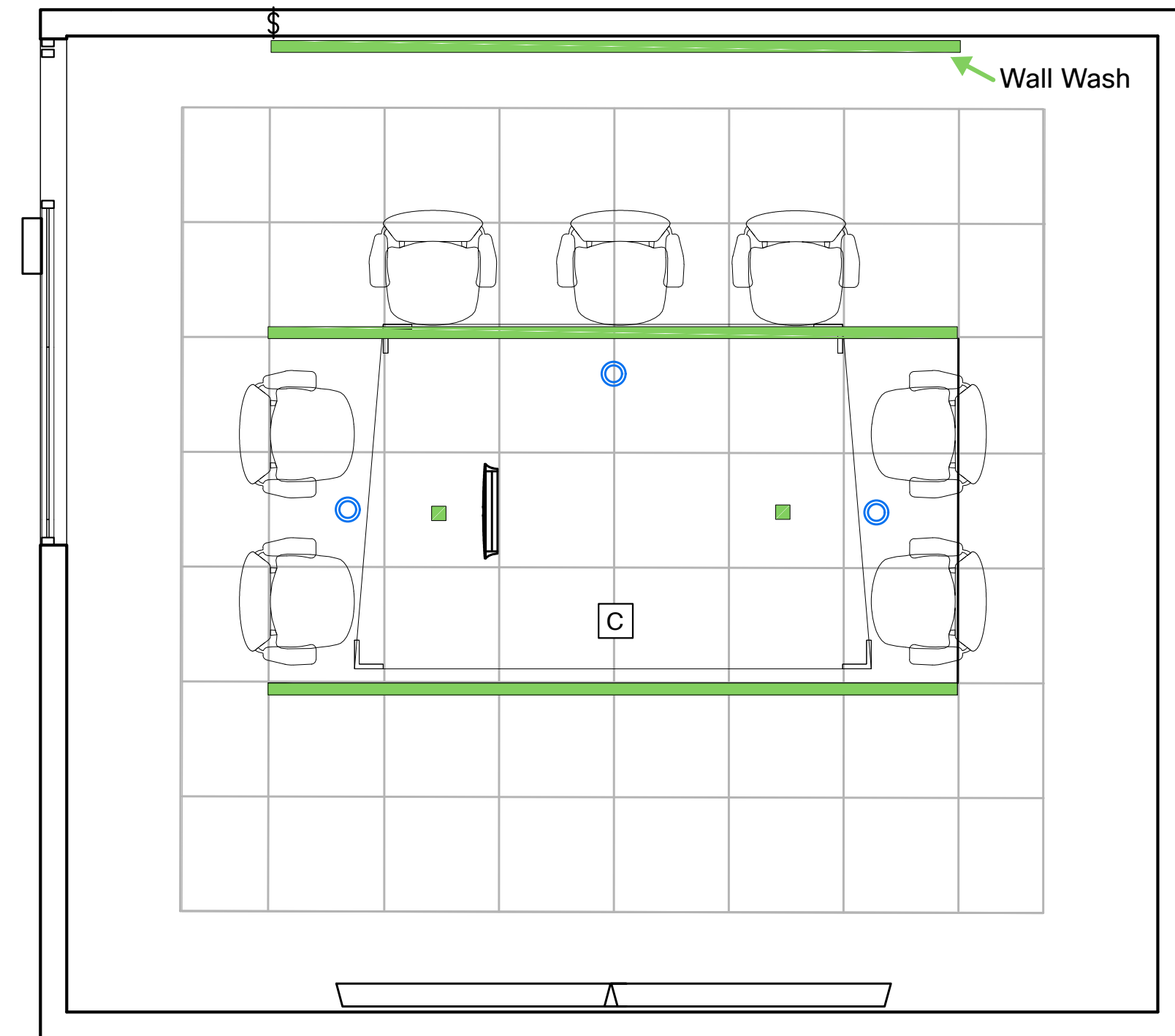





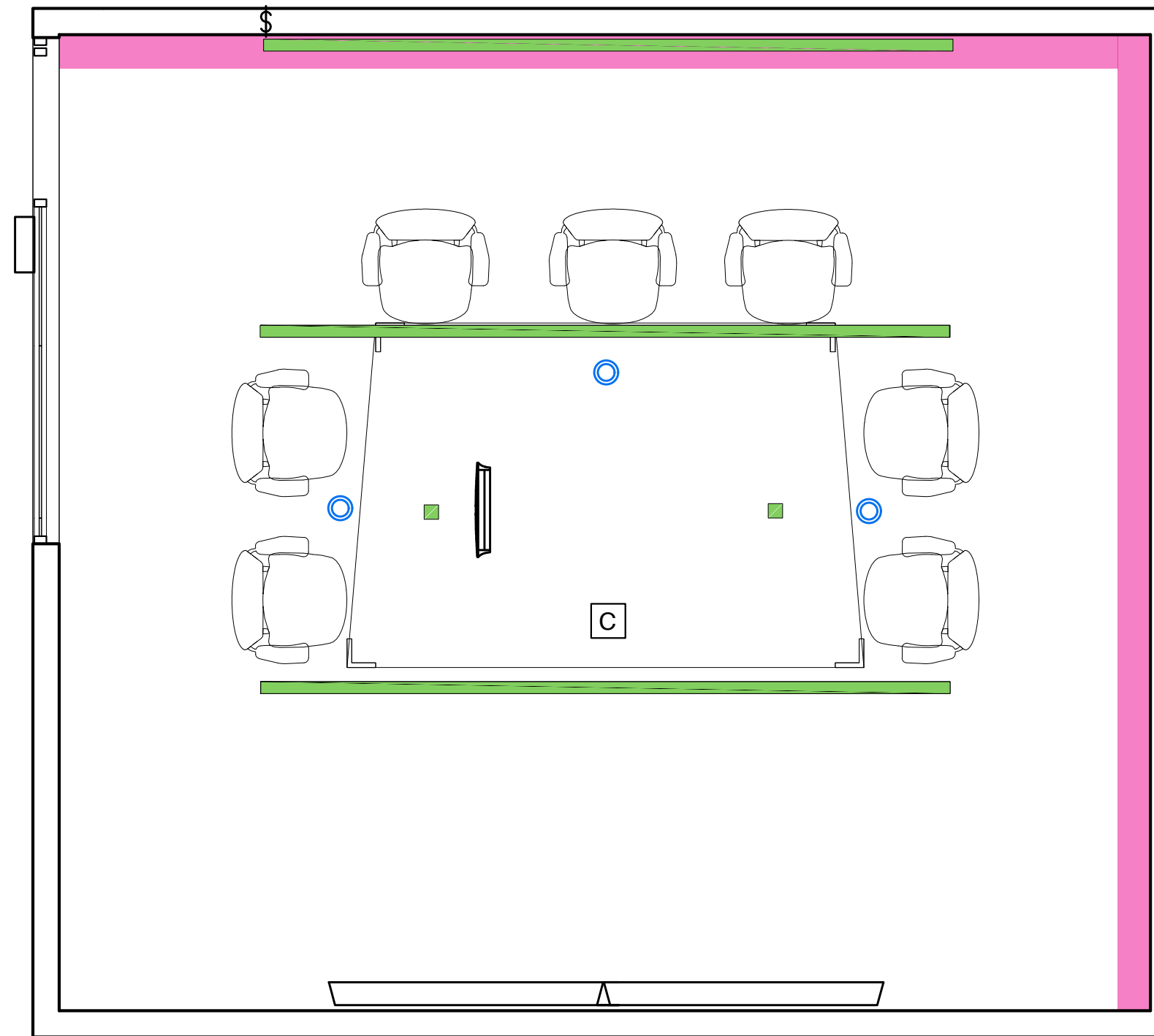





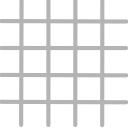



A glare-free luminary with a beam angle of 90° or wider is recommended. In addition, fixtures selected should have a color temperature of ~4000K and color rendering index (CRI) of 85 or better.

Acoustical Treatment

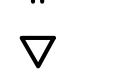

Two walls of acoustical wall treatment is optimal, preferred location is wall opposite device and then adjoining, away from entry location.

Graphics Symbols

-  Acoustical Ceiling & Grid
-  HVAC Diffusers (T.B.D.)
Shown as Example Only
-  Light Fixtures
-  Acoustical Wall
- Furniture Systems Version Devices**
-  Duplex Receptacle & Grid
-  Data Receptacle
- Power and Communication**
- WALL / CEILING / FLOOR VERSION DEVICES**
-  Cisco Ceiling Microphone Pro
-  Third Party Speakers (Optional)
-  Duplex Receptacle
-  Data Receptacle
-  Light Switch
-  AV Receptacle
-  Table Microphone
-  Combination Power & Voice / Data Infeed

Power & Data

General Specifications

Power/data requirements need to be verified for each project. Provide video device power/data even if the project plan does not include it on day one. Based on the design of this space, core drills and floor boxes will be required.

Power & Data

Provide two (2) duplex power outlets and one data receptacle with two ethernet ports on the wall behind the video device (a second data receptacle with either one or two ports can be added for redundancy and/or future use). The exact location for both will depend on the mounting option chosen. Suggested locations can be found in the elevations section of this document, but the exact location should be verified with the mount manufacturer or the A/V partner doing the installation. Additional power and data ports may also be required under the table, based on how the Cisco Room Navigator and/or Cisco Microphone Pros are deployed.

Power in Tabletop

User power should be surface mounted in the tabletop. If pop-ups or table wells are used, it is important to verify that they can accommodate all laptop power supplies. Provide shared power – 1 power port for every two seats.

Exploded IT Diagram



Cisco Room Navigator for Table (required)

The preferred method of connectivity for the Cisco Room Navigator for Table is directly to the designated PoE port on the back of the Cisco Bar Pro via an Ethernet cable. Alternatively, the Room Navigator can also be connected to a PoE compatible switch mounted under the table, which then connects directly back to the designated PoE port on the Room Bar Pro, or directly to the network switch via a Ethernet jack in the floor (hidden by the table leg).

Cisco Room Navigator for Wall

It is recommended to run the cable inside the wall or through the door frame directly back to a network switch.

Cisco Microphones

Although not technically required for a room of this size, either a single Cisco Ceiling Microphone Pro or two (2) Cisco Table Microphone Pros are highly recommended. The Room Bar Pro has two (2) general use PoE ports that can be used for either the Cisco Ceiling Microphone or Cisco Table Microphone Pros. If more than two (2) Cisco Table Microphone Pros are needed then an under-table mounted PoE compatible Switch will be required.

Third-party Speakers

Although not typically required for this space, they can be used if local conditions warrant. (Requires conduit behind device to ceiling.)

Table Top Charging

USB-C charging and convenience outlets on table top. Ensure the size of the trough and layout can accommodate a variety of laptop power supplies.

Wall Blocking

Required when the device is wall-mounted. The size and composition of blocking materials should be determined based on the overall weight of the solution deployed.

Core Drilling

Core Drill-Preferred method for providing connectivity between the table and the Cisco Room Bar Pro for the Cisco Room Navigator for Table, Cisco Table Microphones and/or A/V cables. If core drilling is not an option, a floor cable cover or wire concealer can be used.

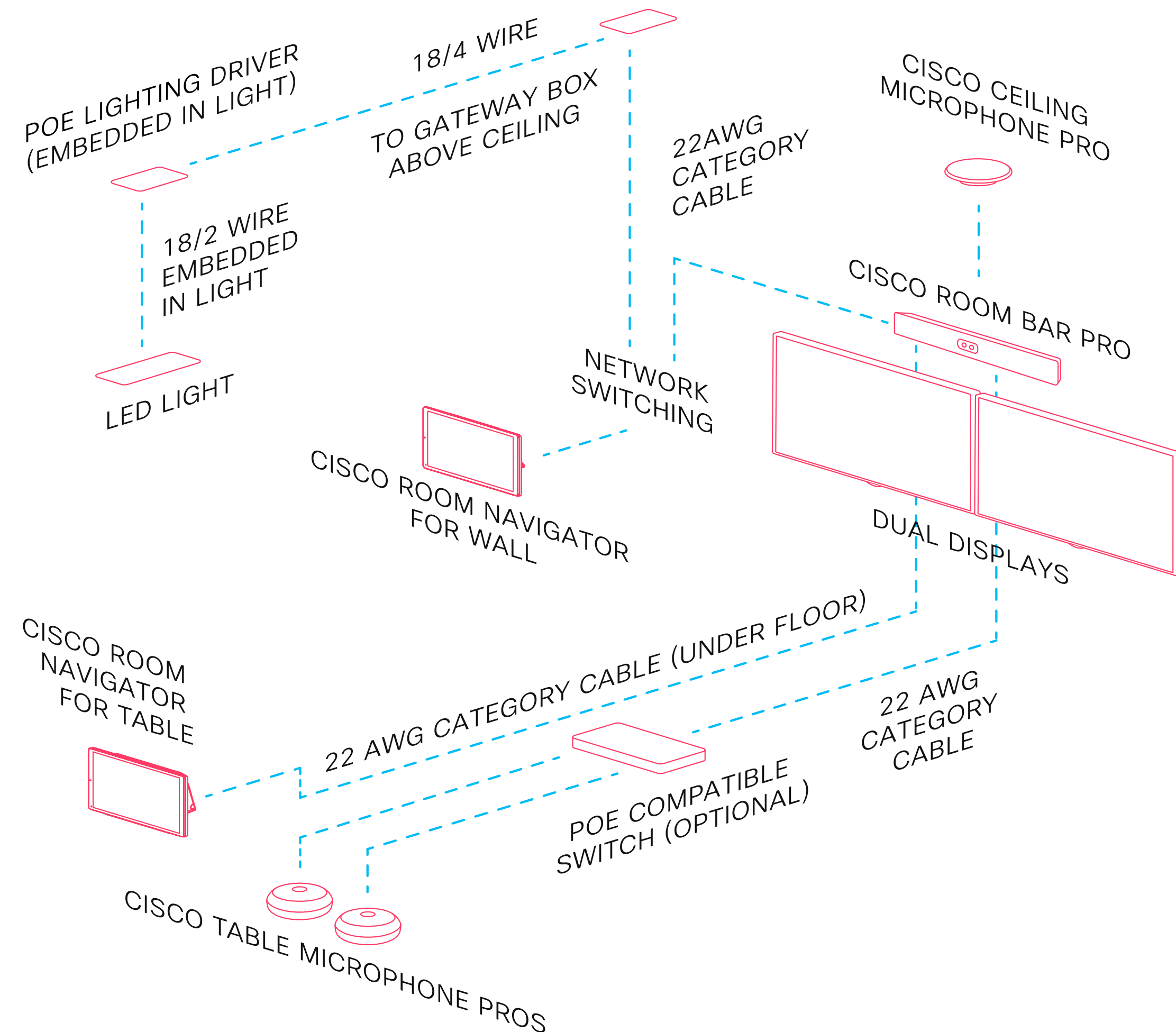

Connectivity View

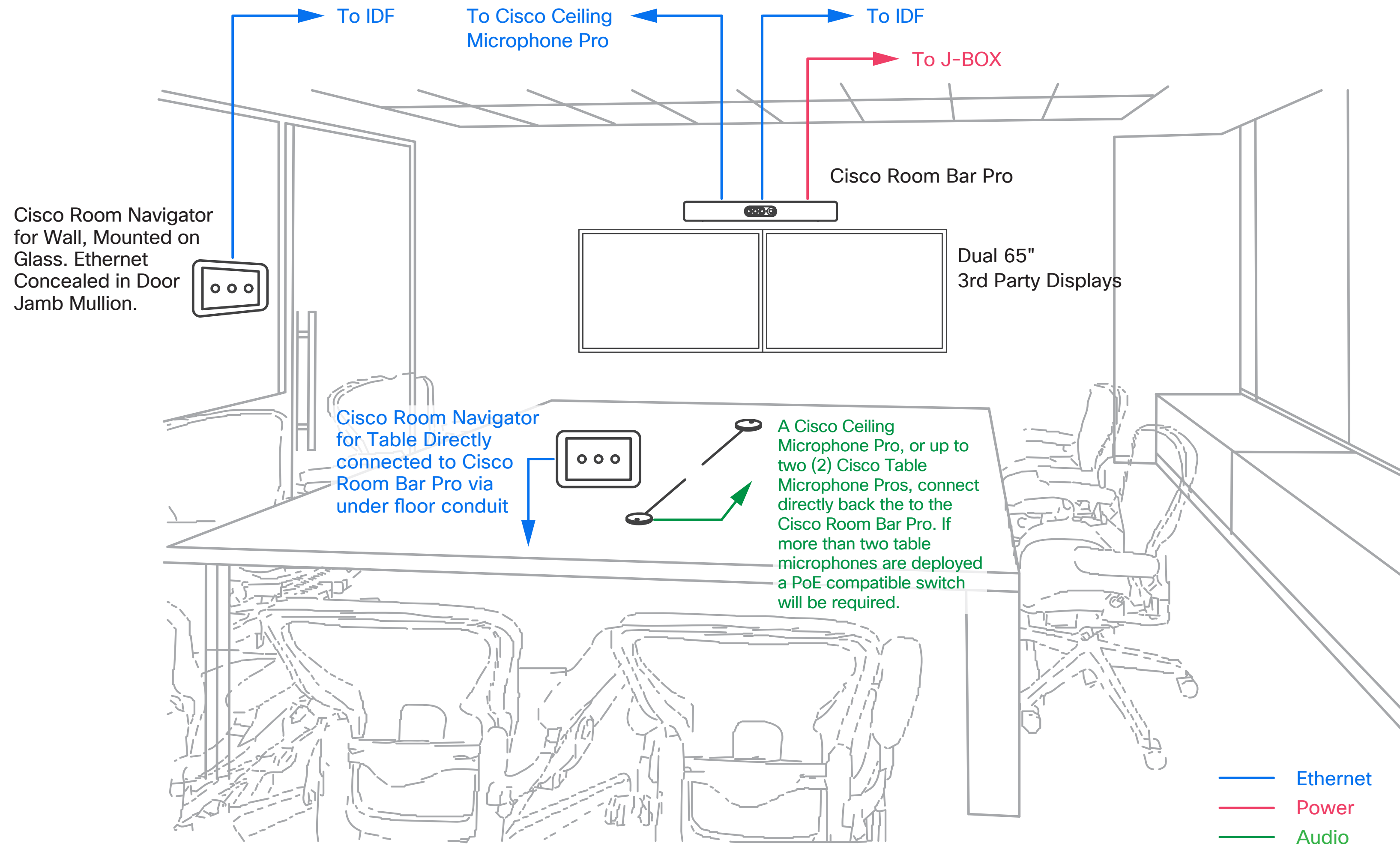

IT/OT Bill of Material

Cisco Products

Cisco Room Bar Pro Option:

- **CS-BARPRO-C-K9.** Cisco Room Bar Pro - Carbon Black (with Cisco Room Navigator for Table, mounting kit and accessories)
- **CS-MIC-ARRAY-T** Cisco Table Microphone Pro - First Light (Qty 2) - Optional
- **C1200-8FP-2G** Cisco Catalyst 1200 Series PoE Switch (or equivalent) - Optional
- **CS-MIC-CLGPRO** Cisco Ceiling Mic Pro Arctic White (Qty 1) - Optional
- **CS-T10-WM-K9=** Cisco Room Navigator for Wall

Non-Cisco peripherals

- Dual 65" Video Displays
- Third-party wall mount or AV-ready credenza

IOT Devices

- IAQ coming from the Cisco Room Navigator, No additional IoT IAQ
- Occupancy sensing is coming from the Cisco Endpoints
- Suggested lighting specifications: 220LPW raw, 140LPW delivered
- Each Medium Collaboration room POE lights being power by 4 ports on the ceiling
- Traditional DC Wall Switch
- Ensure device is not connected to ASHRAE 90.1 outlet

External microphones and speakers

- The Cisco Room Bar Pro is equipped with an internal microphone array and is optimized for small to medium sized collaboration spaces, thus external microphones are not technically required if people are seated within 13 feet (4 meters) from the device. That said, we do recommend adding two (2) Cisco Table Microphone Pros, or a Cisco Ceiling Microphone Pro to this space to ensure the best audio experience.
- The Cisco Room Bar Pro has a 3-channel loudspeakers embedded within, third-party external speakers are typically not needed unless room acoustic conditions warrant their use.

Option 2: Cisco Room Kit EQX



Room Layout

Layout Using Wall Mount, Wall Stand, or A/V Credenza

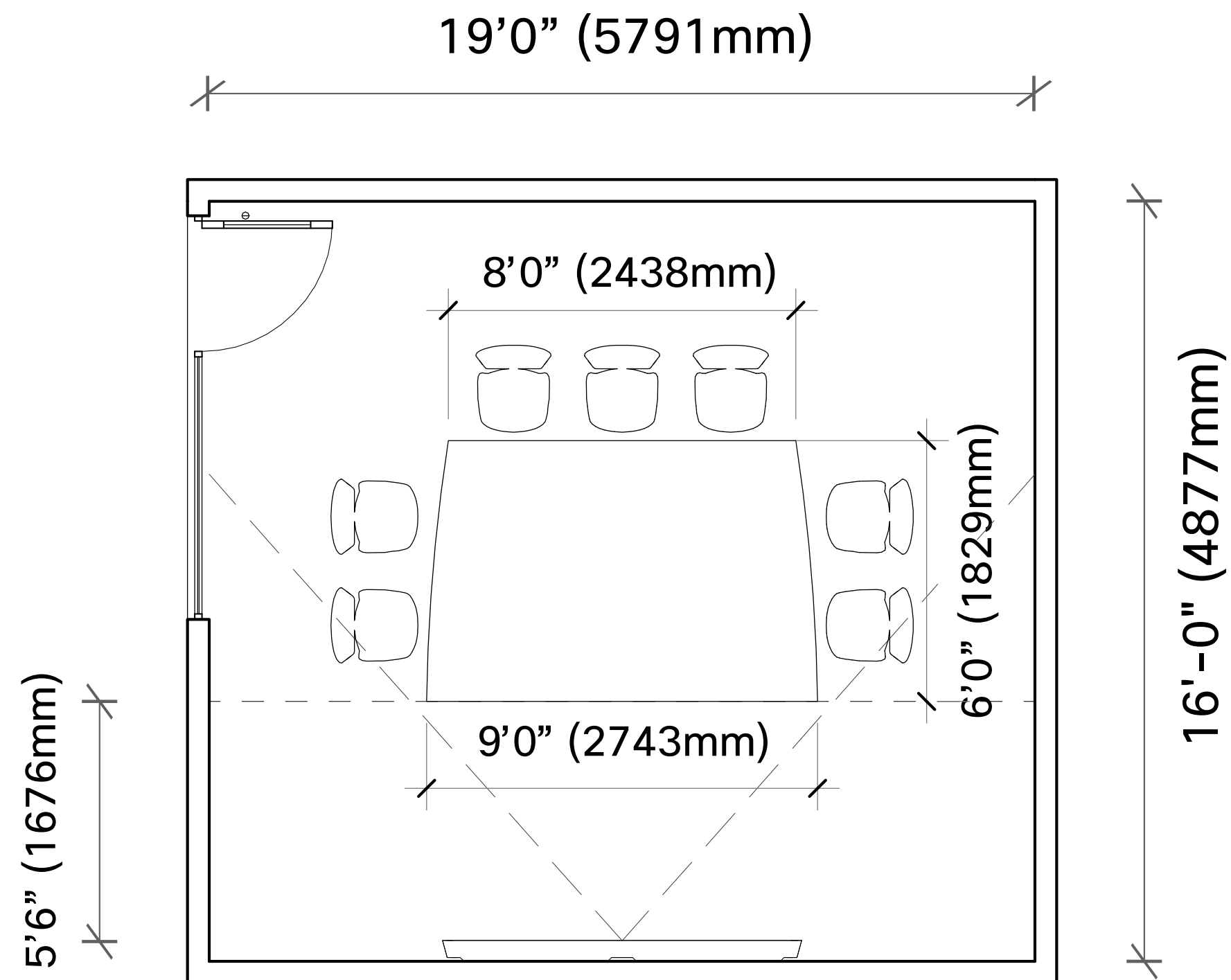

Layout Using the Cisco EQX Floor Stand

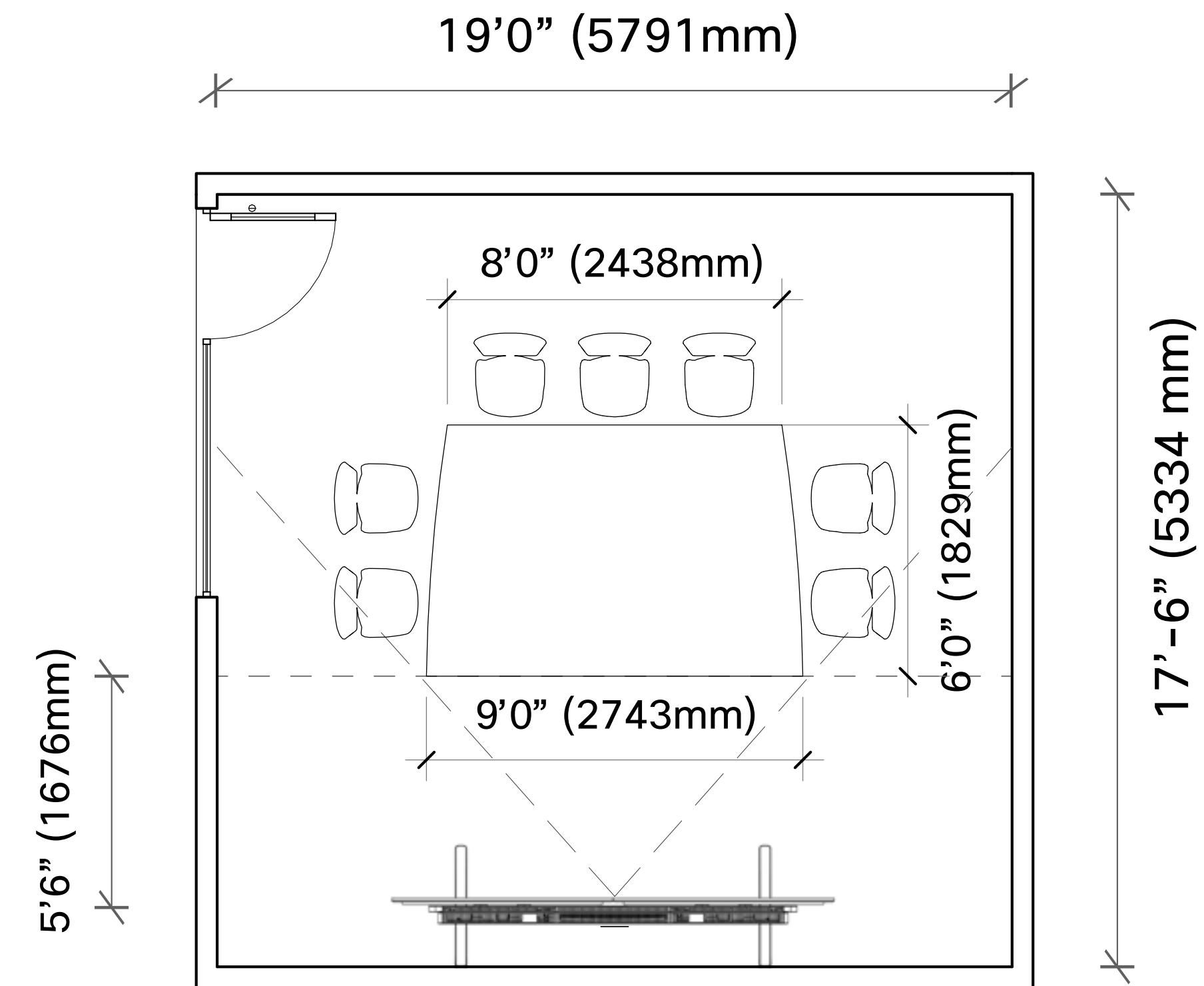

Note: Room dimensions shown are the minimal size, based on the technology and furniture options shown.



Note: Room dimensions shown are the minimal size, based on the technology and furniture options shown. The length of this space is slightly larger than what is shown for the Wall Mount, Credenza, and Wall Stand options due to the width of the legs on the Cisco EQX Floor Stand.

Composite Plan

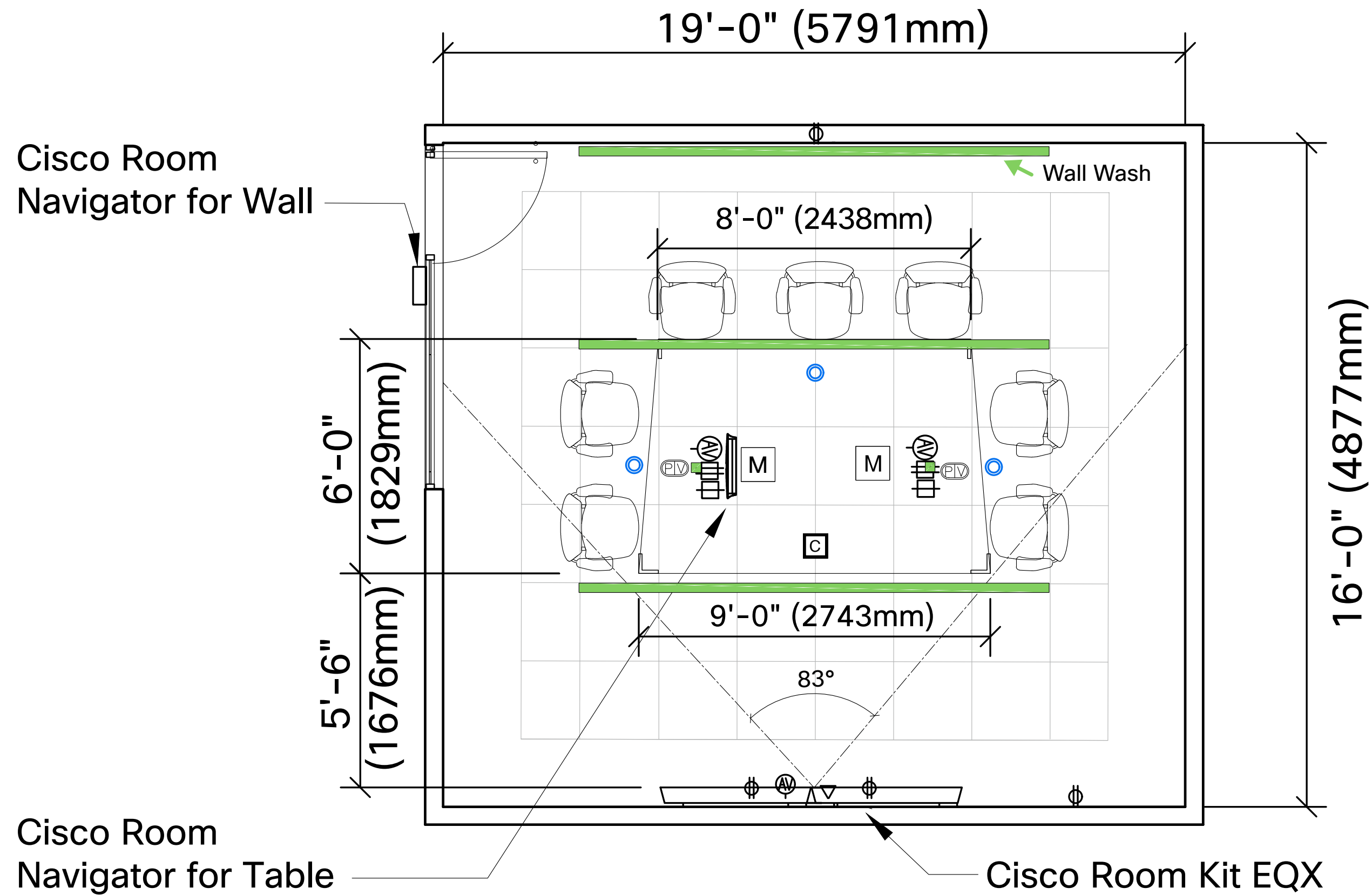

Graphics Symbols

- Acoustical Ceiling & Grid
 - HVAC Diffusers (T.B.D.)
Shown as Example Only
 - Light Fixtures
 - Acoustical Wall
- Furniture Systems Version Devices**
- Duplex Receptacle & Grid
 - Data Receptacle
- Power and Communication**
- WALL / CEILING / FLOOR VERSION DEVICES
- Cisco Ceiling Microphone Pro
 - Third Party Speakers (Optional)
 - Duplex Receptacle
 - Data Receptacle
 - Light Switch
 - AV Receptacle
 - Table Microphone
 - Combination Power & Voice / Data Infeed



Note: Setback from display to edge of table is greater than in the Room Bar Pro scenario due to 83 degree FoV of the EQX.

Video Device Mounting Options



Cisco Room Kit EQX

There are four mounting options for the device when using the Cisco Room Kit EQX in the Medium Collaboration Room - Video Centric. The physical conditions of the space, desired aesthetics, and required amenities will define which solution is most appropriate.



Wall Mount

Wall Mounted – Requires wall to be blocked and electrical and data to be elevated.



A/V Credenza

Freestanding – Does not require wall blocking. Perfect for retrofit installations, or when trash, recycling and/or extra storage is required.



Wall Stand

Wall tethered – An effective solution when the wall is not blocked, but still may require power and data to be relocated.



Floor Stand

Freestanding – A perfect for retrofits, open area deployments, or when video needs to be installed quickly.



Room Elevations

Option 2a Cisco Room Kit EQX with Wall Mount

Construction and Finished Elevation

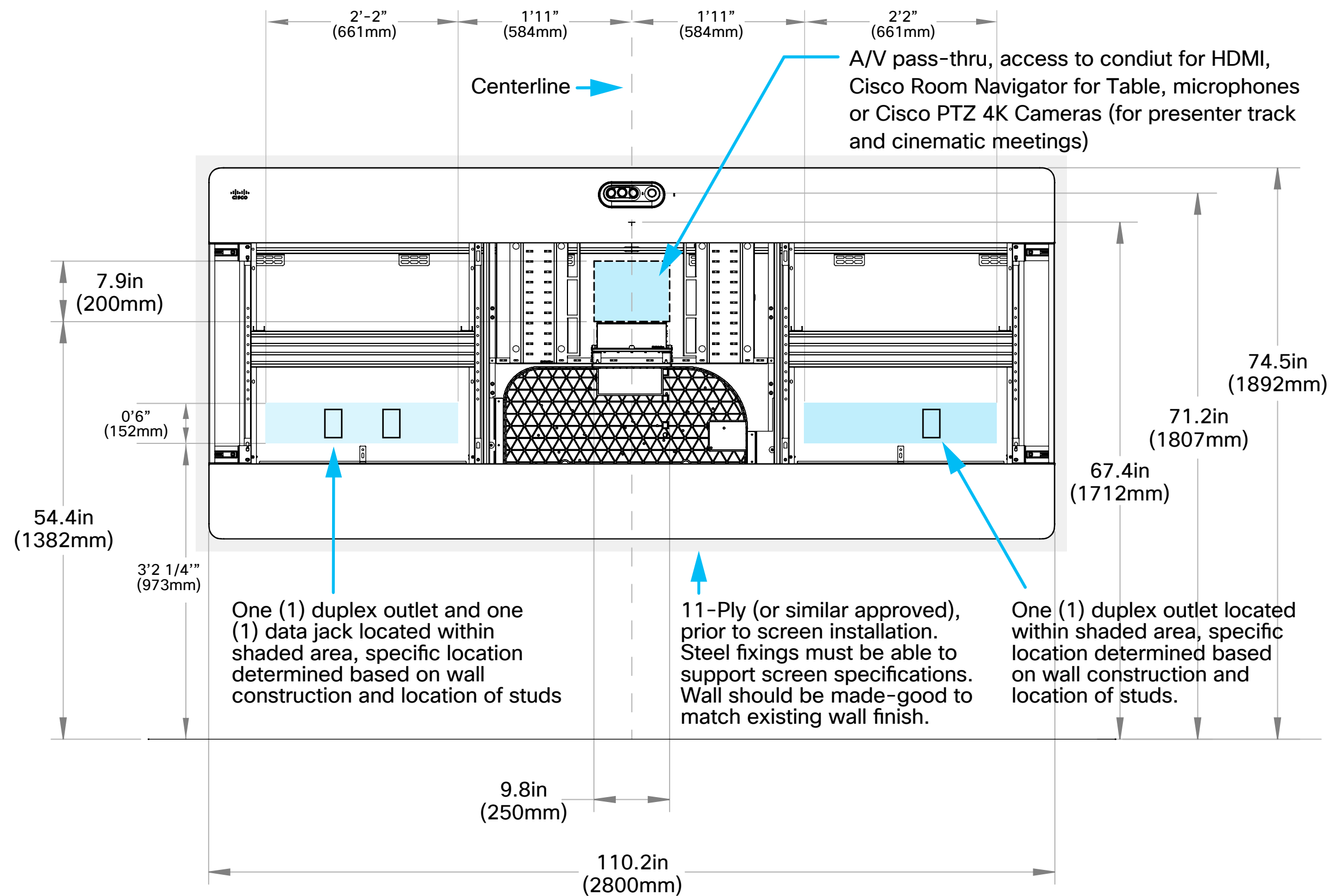

Side Elevation

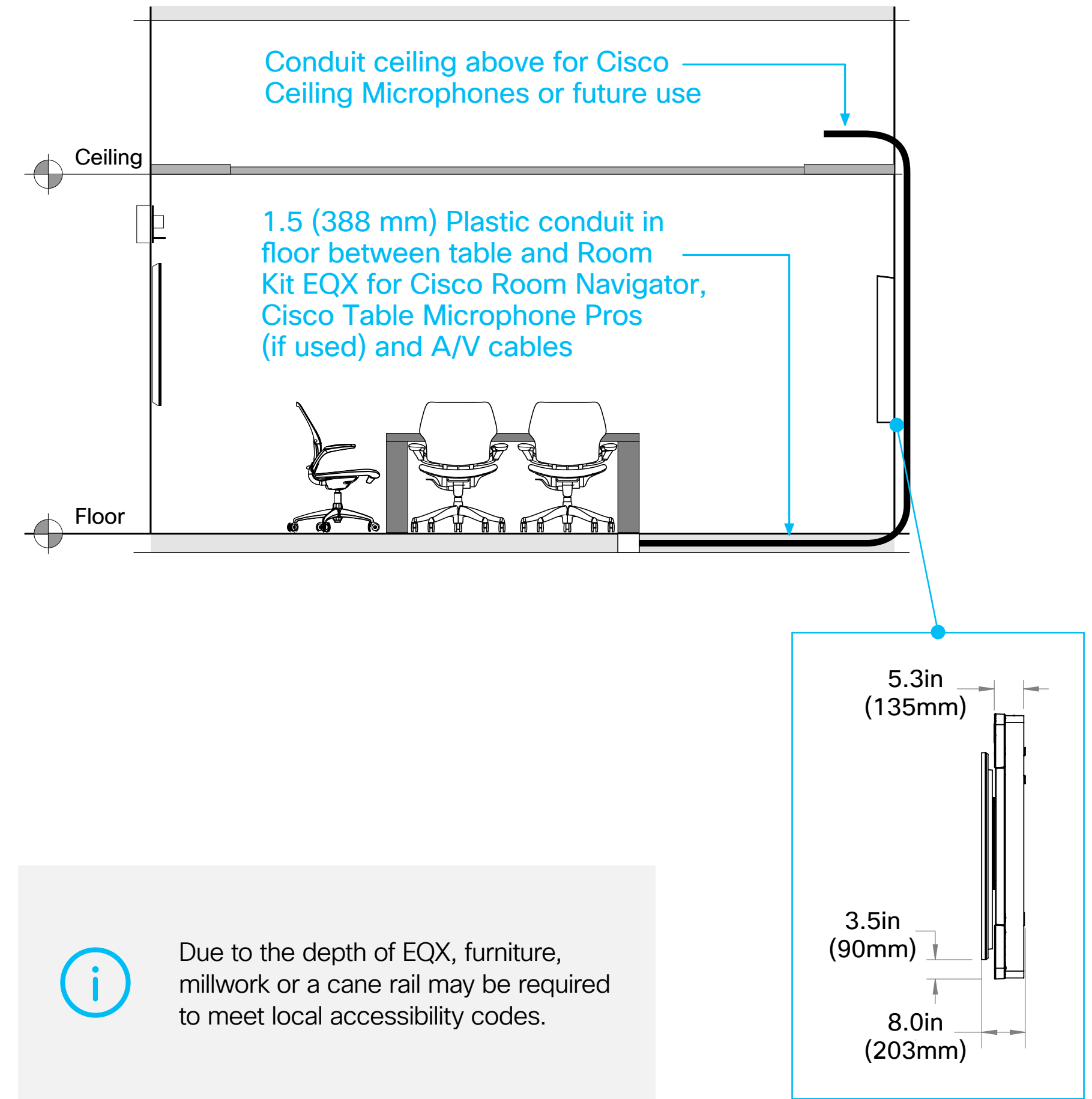

i Due to the depth of EQX, furniture, millwork or a cane rail may be required to meet local accessibility codes.

Room Elevations

Option 2b Cisco Room Kit EQX with A/V Credenza

Construction Elevation

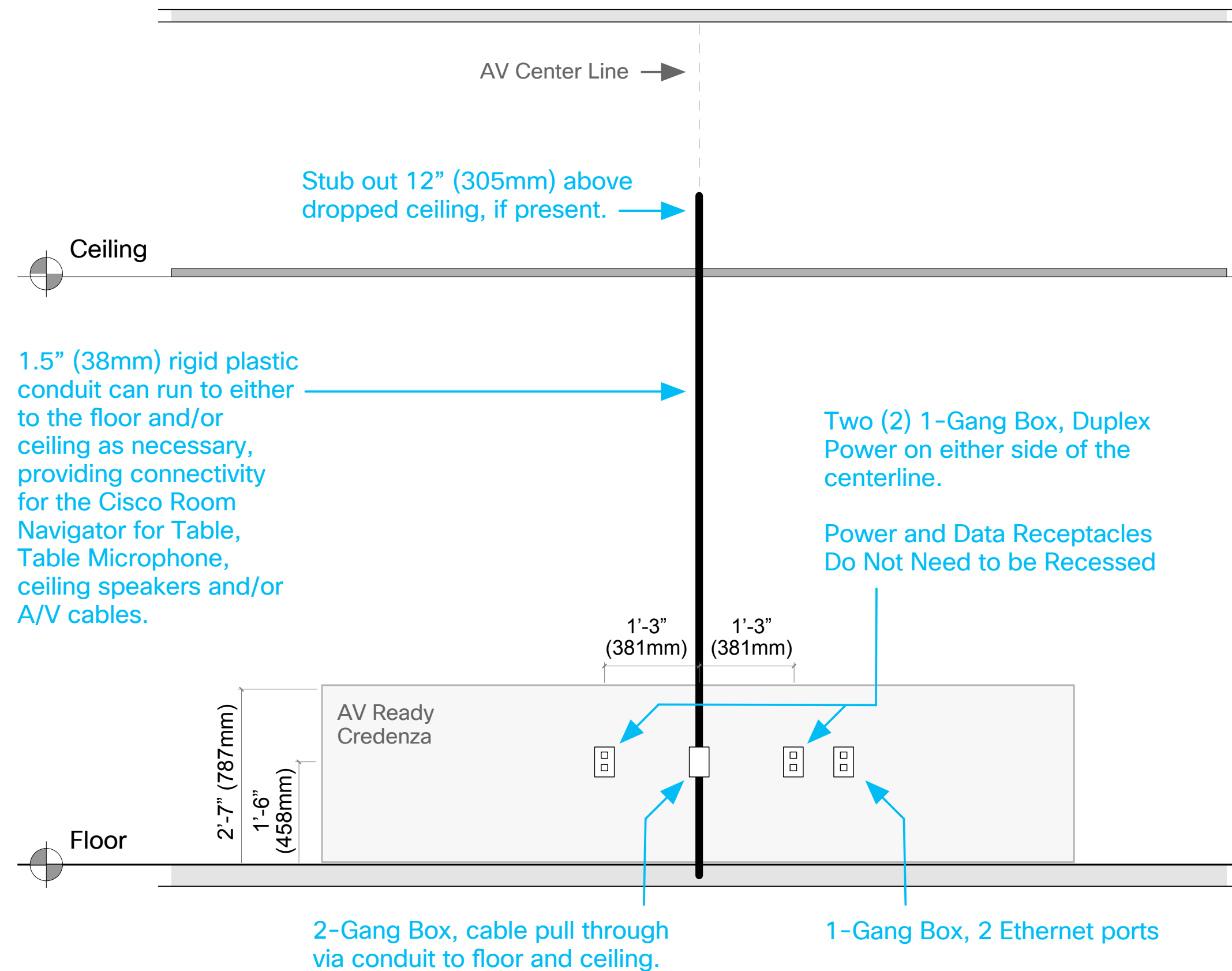

Finished Elevation

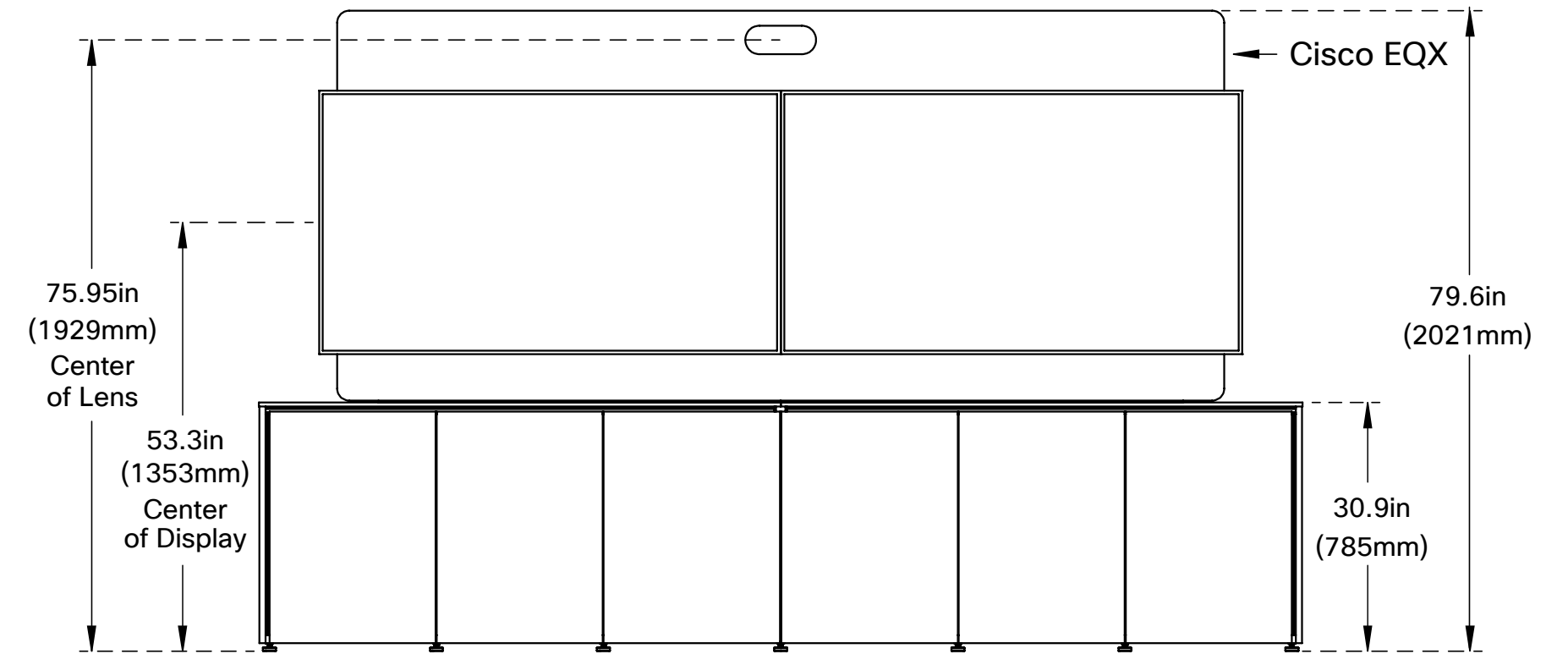

Side Elevation

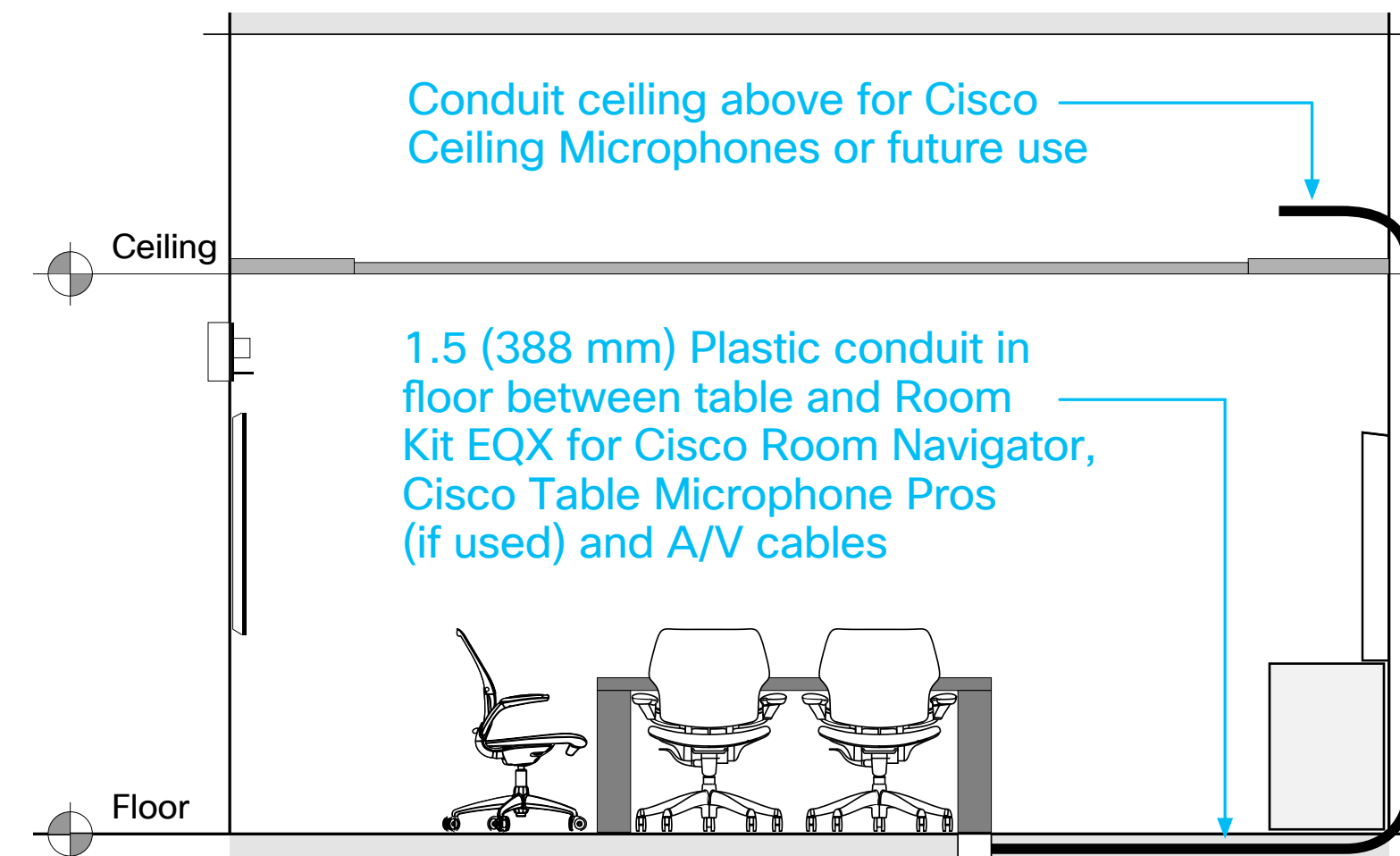

Room Elevations



Cisco Room Kit EQX with Wall Stand

Front Elevation

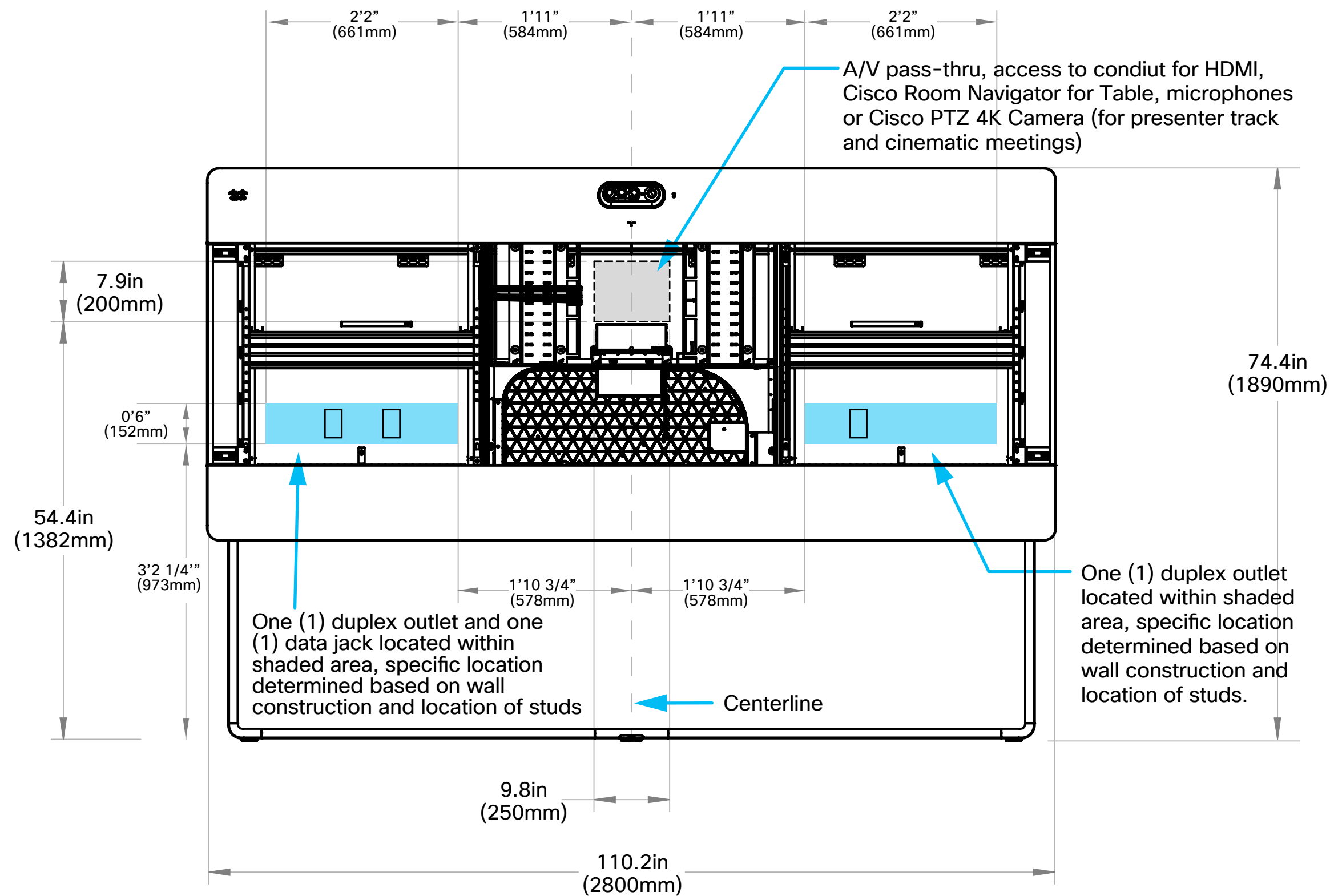

Side Elevation

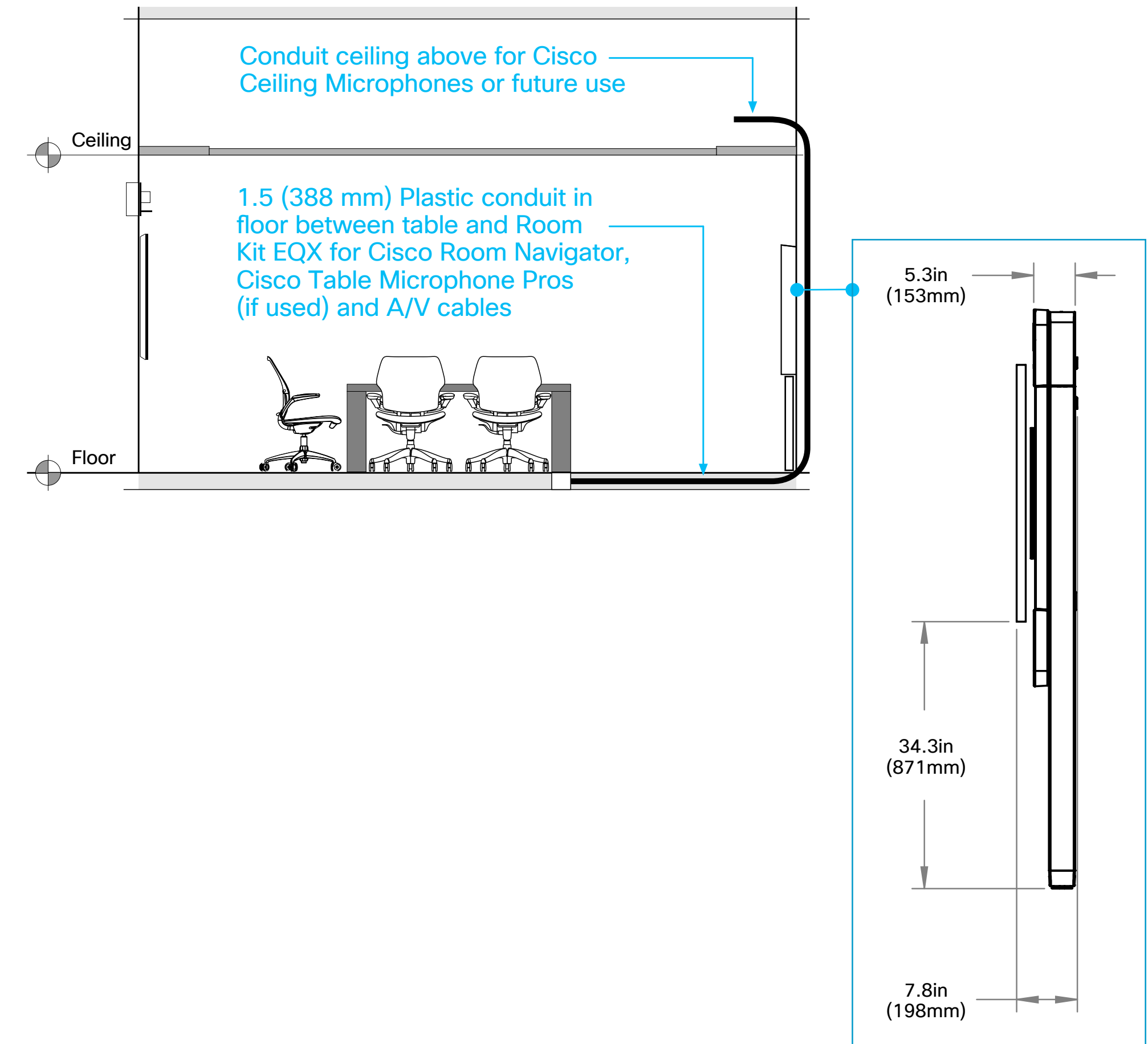

Room Elevations

Option
2d

Cisco Room Kit EQX with Floor Stand

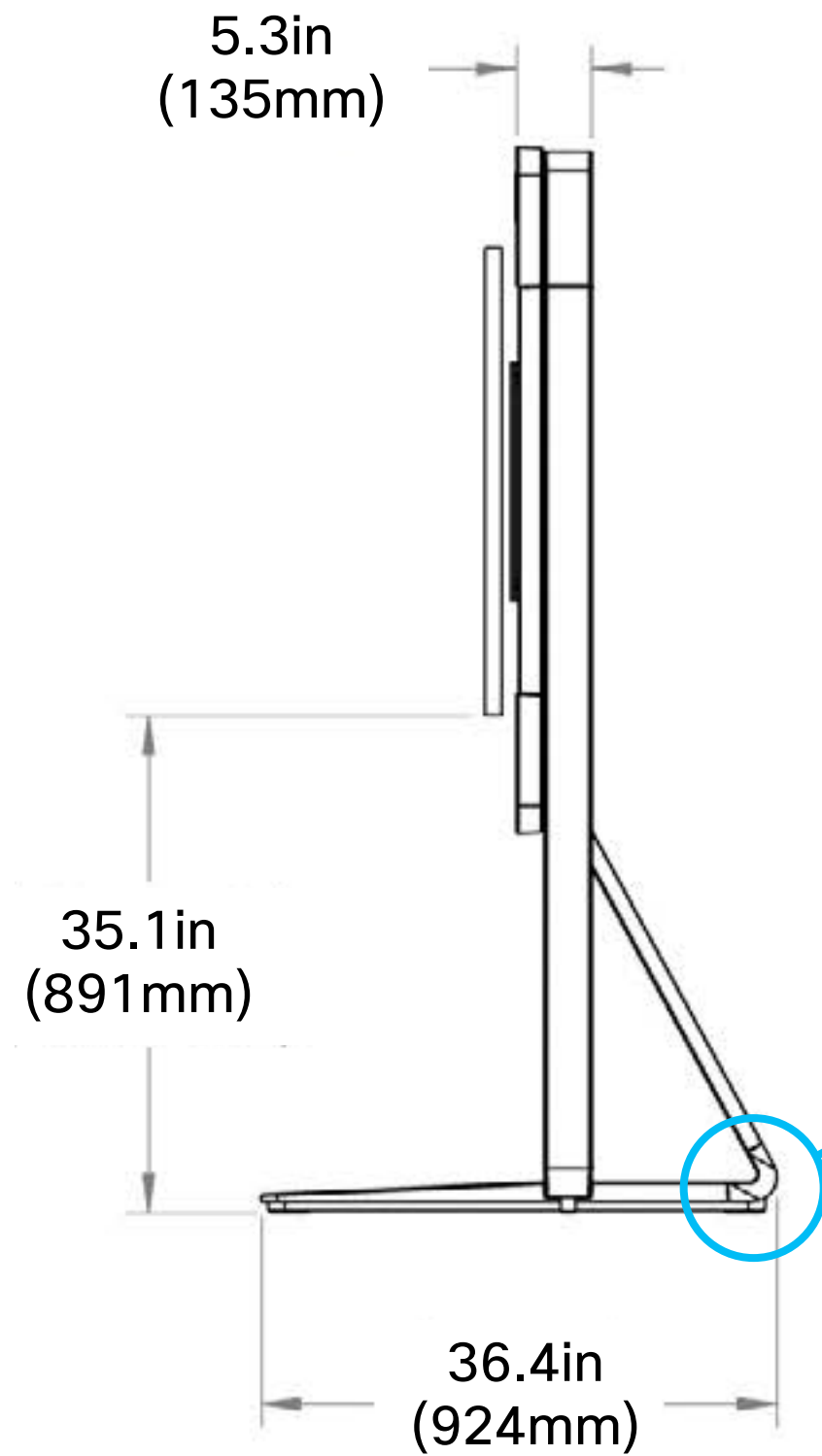

Location where power, data and microphone cables exit the floor stand

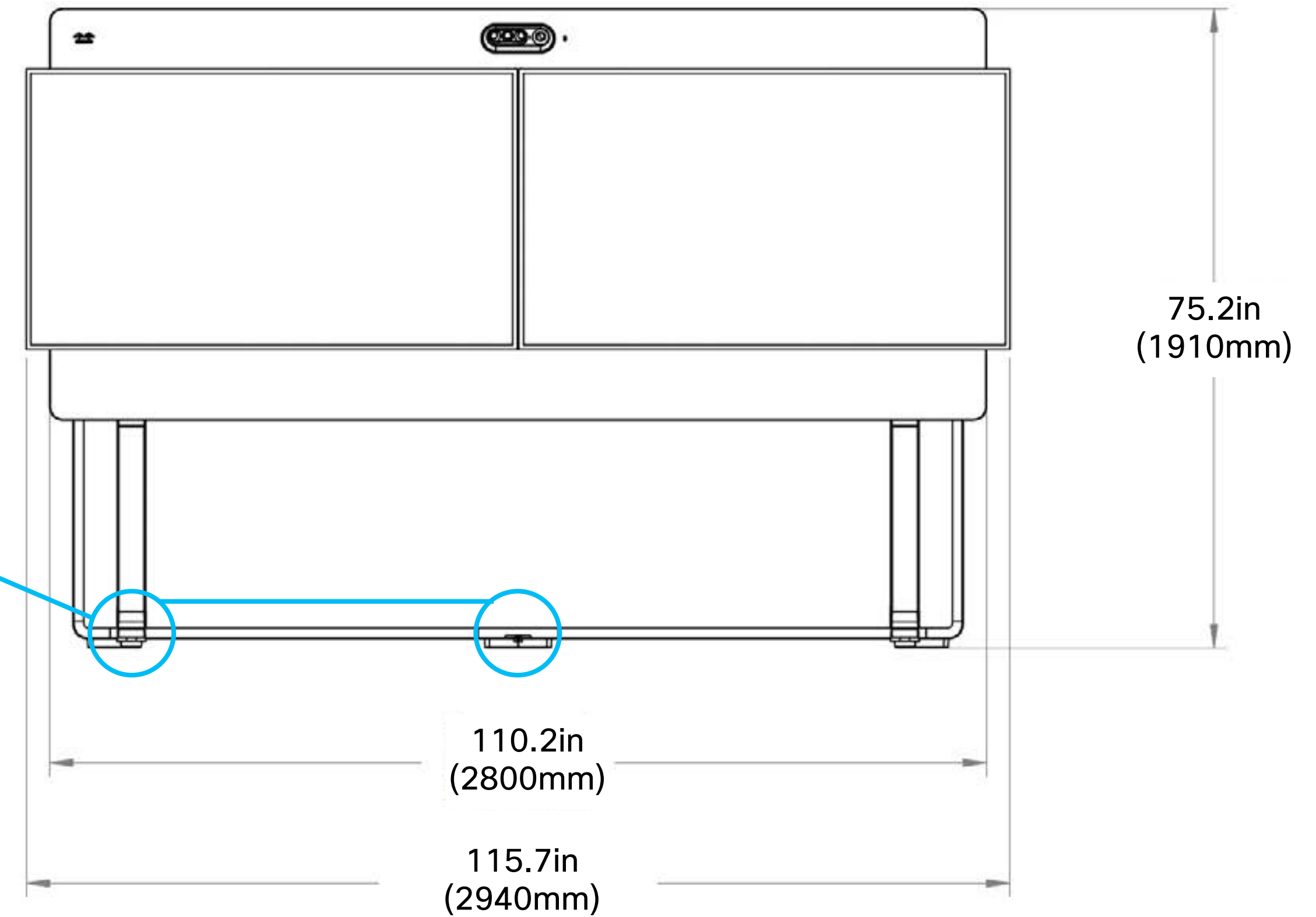

Note: For aesthetics purposes, the optimal location for power, data and A/V passthru is in floor boxes. Wall mounted outlets, either standard or elevated, can also be used.

Reflective Ceiling Plan & Acoustical Treatment



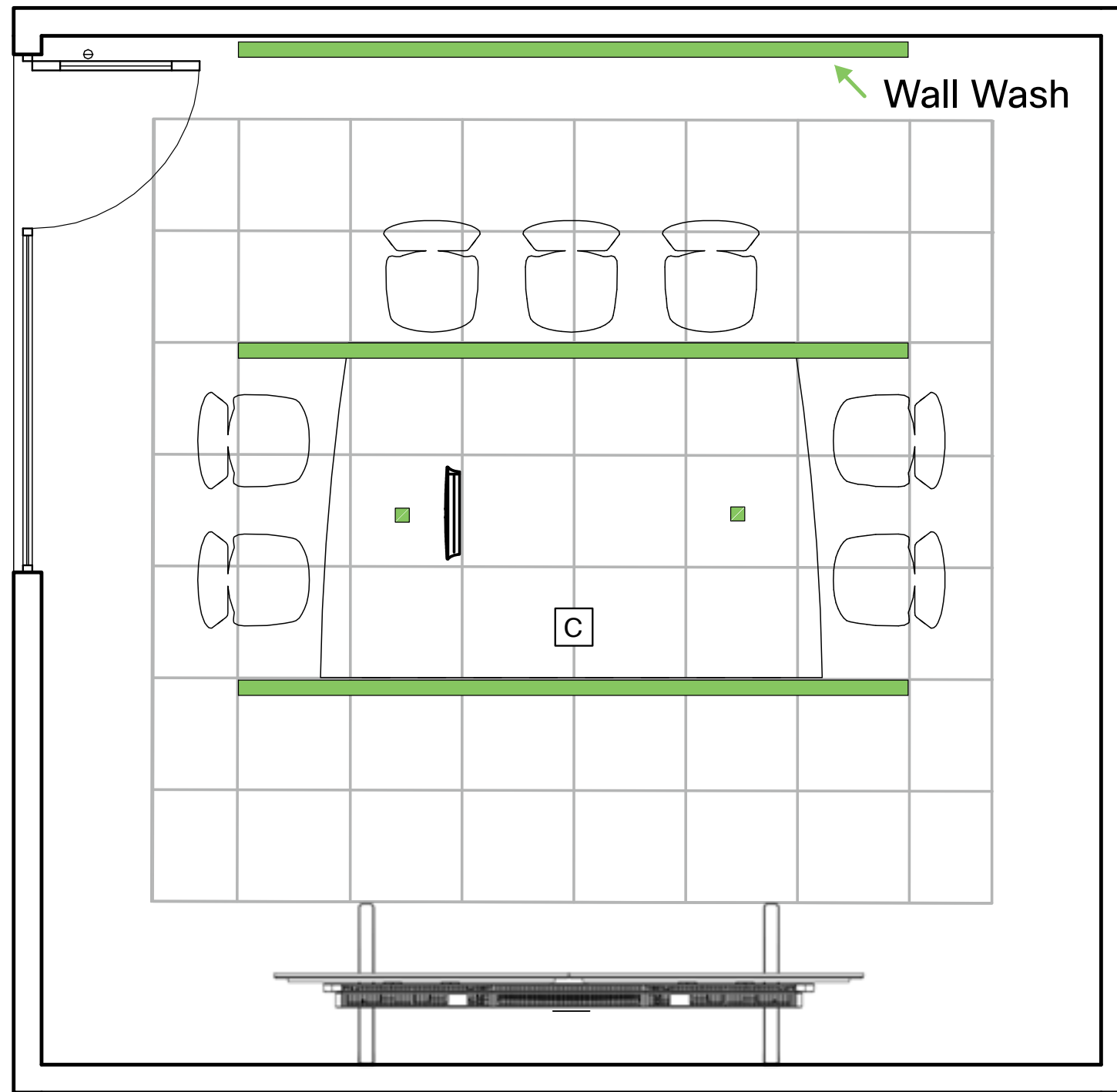



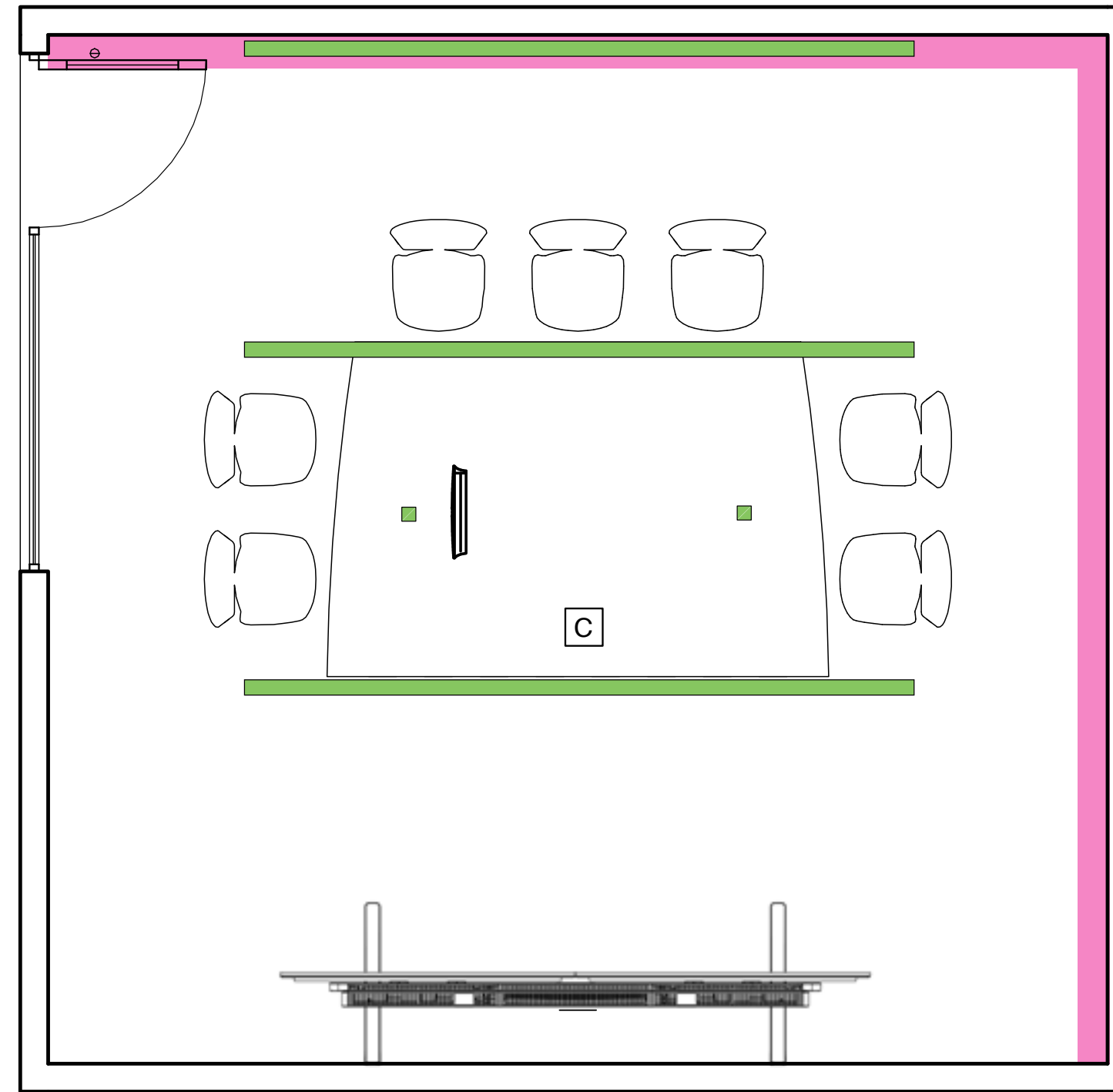



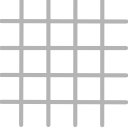



Reflective Ceiling Plan



Acoustical Treatment



Graphics Symbols

-  Acoustical Ceiling & Grid
-  HVAC Diffusers (T.B.D.)
Shown as Example Only
-  Light Fixtures
-  Acoustical Wall
- Furniture Systems Version Devices**
-  Duplex Receptacle & Grid
-  Data Receptacle
- Power and Communication**
- WALL / CEILING / FLOOR VERSION DEVICES**
-  Cisco Ceiling Microphone Pro
-  Third Party Speakers (Optional)
-  Duplex Receptacle
-  Data Receptacle
-  Light Switch
-  AV Receptacle
-  Table Microphone
-  Combination Power & Voice / Data Infeed

● A glare-free luminary with a beam angle of 90° or wider is recommended. In addition, fixtures selected should have a color temperature of ~4000K and color rendering index (CRI) of 85 or better.

● Two walls of acoustical wall treatment is optimal, preferred location is wall opposite device and then adjoining, away from entry location.

Power & Data

General Specifications

Power/data requirements need to be verified for each project. Provide video device power/data even if the project plan does not include it on day one. Based on the design of this space, core drills and floor boxes will be required.

Power & Data

The Cisco Room Kit EQX requires two (2) duplex outlets and one (1) LAN/Ethernet jack, located on the wall behind the device (a second Ethernet jack can also be added for redundancy/future use). Suggested locations for these services can be found in the “Elevations” section of this document. Exact location, however, should be verified with A/V consultants and installation personnel. In addition, power (1 outlet) must be available under the table for the network switch supporting the Cisco Microphone Pros.

Power in Tabletop

User power should be surface mounted in the tabletop. If pop-ups or table wells are used, it is important to verify that they can accommodate all laptop power supplies. Provide shared power – 1 power port for every two seats.

Exploded IT Diagram



Cisco Room Navigator for Table (required)

The preferred method of connectivity for the Cisco Room Navigator for Table is directly to one of the four (4) general use PoE ports on the Cisco Room Kit EQX. Alternatively, the Navigator can also be connected to a PoE compatible switch mounted under the table, which then connects back to a PoE port on the EQX, or directly to the network switch via a Ethernet port in the floor.

Cisco Room Navigator for Wall

It is recommended to run the cable inside the wall or through the door frame directly back to a network switch.

Cisco Microphones

External microphones are required, either a single Cisco Ceiling Microphone Pro or two (2) Cisco Table Microphone Pros (three, if Cinematic Cross view is enabled). Although the Cisco Room Kit EQX has four (4) general use PoE ports that can be used for connecting adjunct devices, two (2) of those are required to connect the camera and amplifier, and the third for the Cisco Room Navigator for

Table. Thus, the one remaining port can be used for the Ceiling Microphone Pro, or to connect a PoE compatible switch to support the Table Microphone Pros.

Third-party Speakers

Not required for a room of this size.

Table Top Charging

USB-C charging and convenience outlets on table top. Ensure the size of the trough and layout can accommodate a variety of laptop power supplies.

Wall Blocking

Required when the device is wall-mounted. The size and composition of blocking materials should be determined based on the overall weight of the solution deployed.

Core Drilling

Core Drill-Preferred method for providing connectivity between the table and the Cisco Room Kit EQX for the Cisco Room Navigator for Table, Cisco Table Microphone Pros and/or A/V cables. If core drilling is not an option, a floor cable cover or wire concealer can be used.

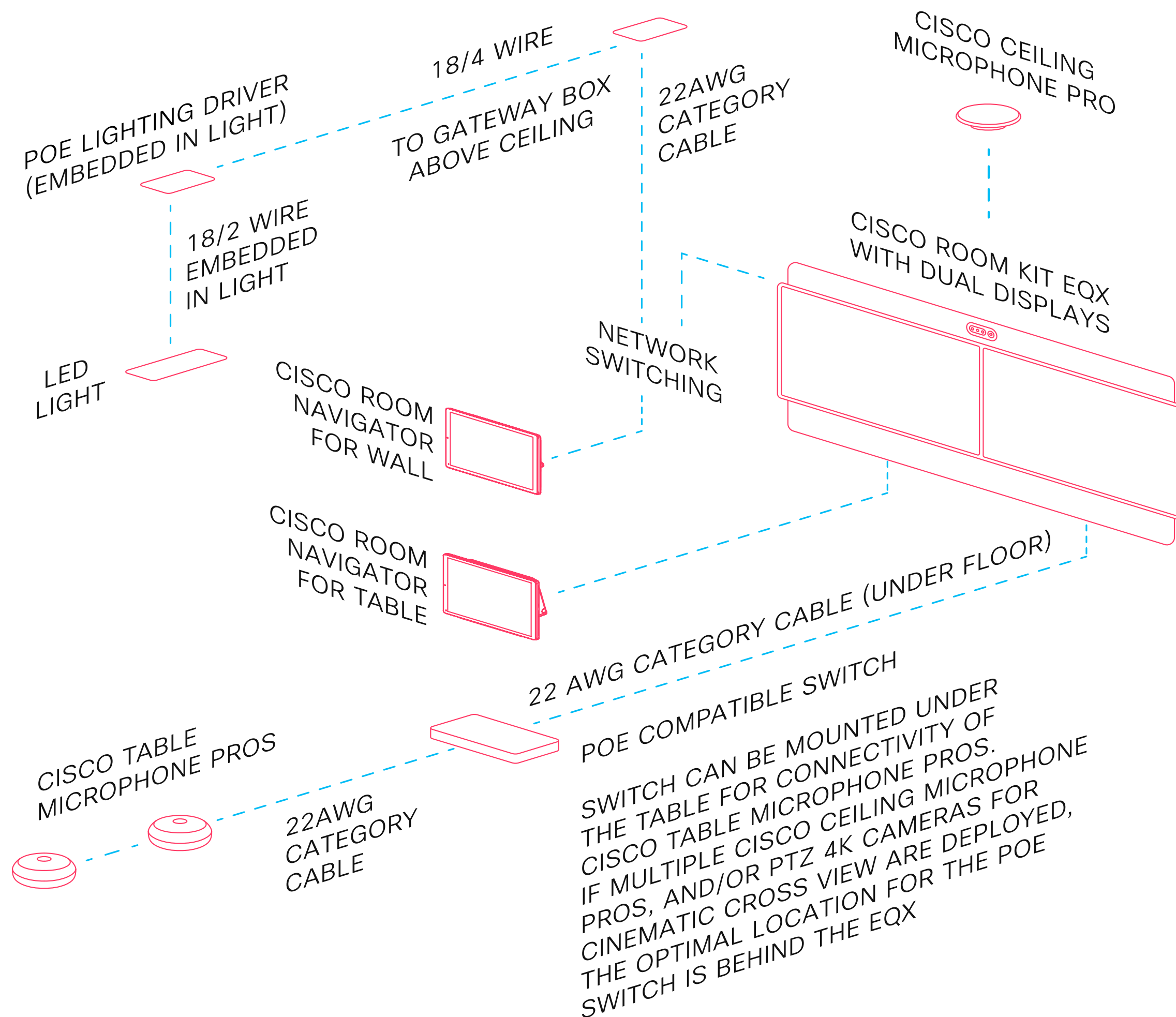

Connectivity View

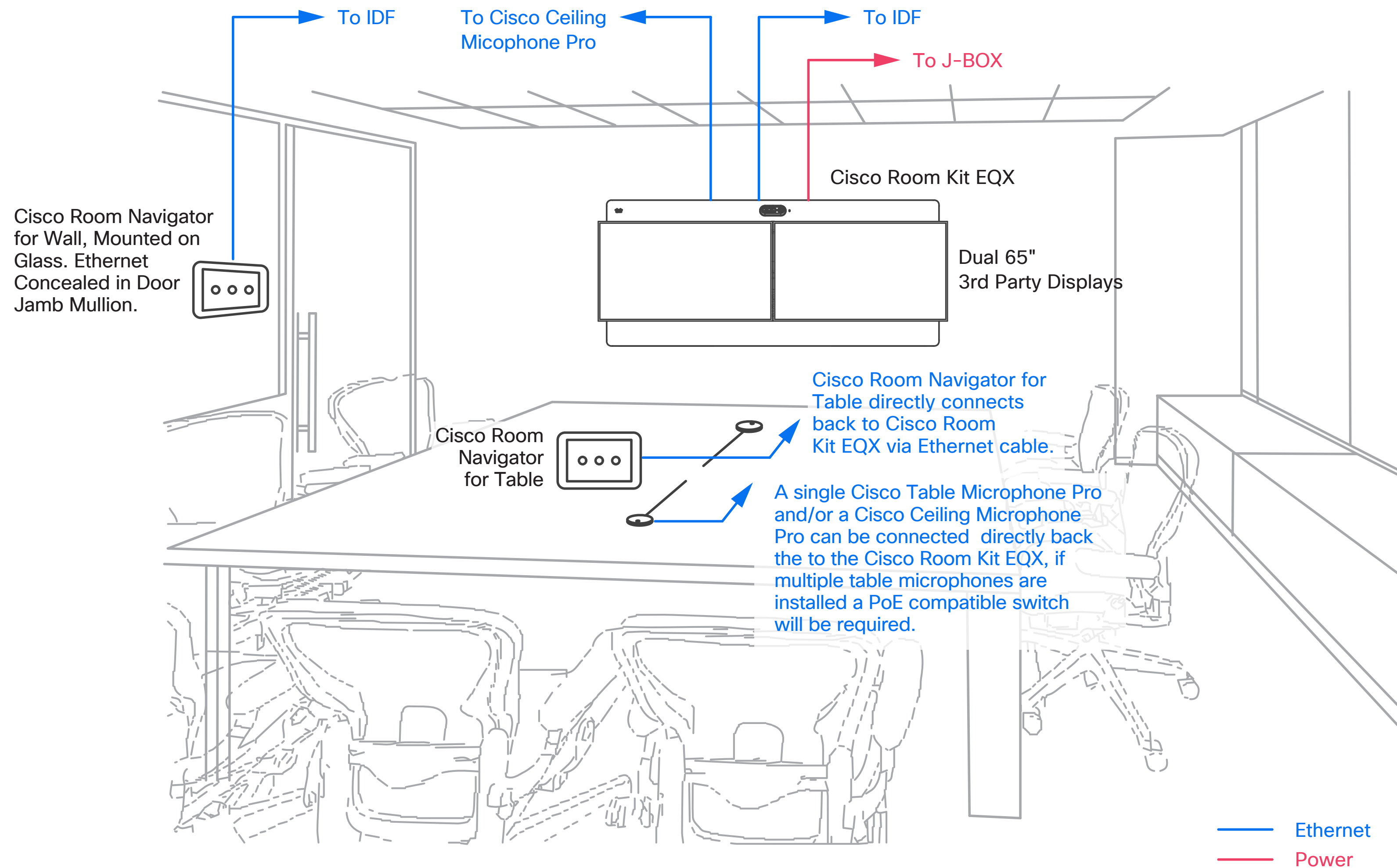

IT/OT Bill of Material

Cisco Products

Cisco Room Kit EQX Option:

- **CS-KIT-EQZX-C-K9.** Cisco Room Kit EQX, Carbon Black
- **CS-KIT-EQX-WMK-C** Cisco Room Kit EQX Wall Mount Carbon Black (Optional)
- **CS-KIT-EQX-WSK-C** Cisco Room Kit EQX Wall Stand Carbon Black (Optional)
- **CS-KIT-EQX-FSK-C** Cisco Room Kit EQX Floor Stand Carbon Black (Optional)
- **CS-MIC-ARRAY-T** Cisco Table Microphone Pro (Qty 2)
- **CS-MIC-CLGPRO** Cisco Ceiling Mic Pro Arctic White (Qty 1) (Optional)
- **C1200-8FP-2G** Cisco Catalyst 1200 Series PoE Switch
- **CS-T10-WM-K9=** Cisco Room Navigator for Wall

Non-Cisco peripherals

- Dual 65" Video Displays
- Cisco Wall Mount, Wall Stand, Floor Stand or 3rd party AV-ready credenza

IOT Devices

- IAQ coming from the Cisco Room Navigator, No additional IoT IAQ
- Occupancy sensing is coming from the Cisco Endpoints
- Suggested lighting specifications: 220LPW raw, 140LPW delivered
- Each Medium Collaboration room POE lights being power by 4 ports on the ceiling
- Traditional DC Wall Switch
- Ensure device is not connected to ASHRAE 90.1 outlet

External microphones and speakers

- External microphones are required for the Cisco Room Kit EQX installation. Third-party speakers are not typically required in a space of this size unless environmental conditions warrant their use.

IT/OT Reference Architectures

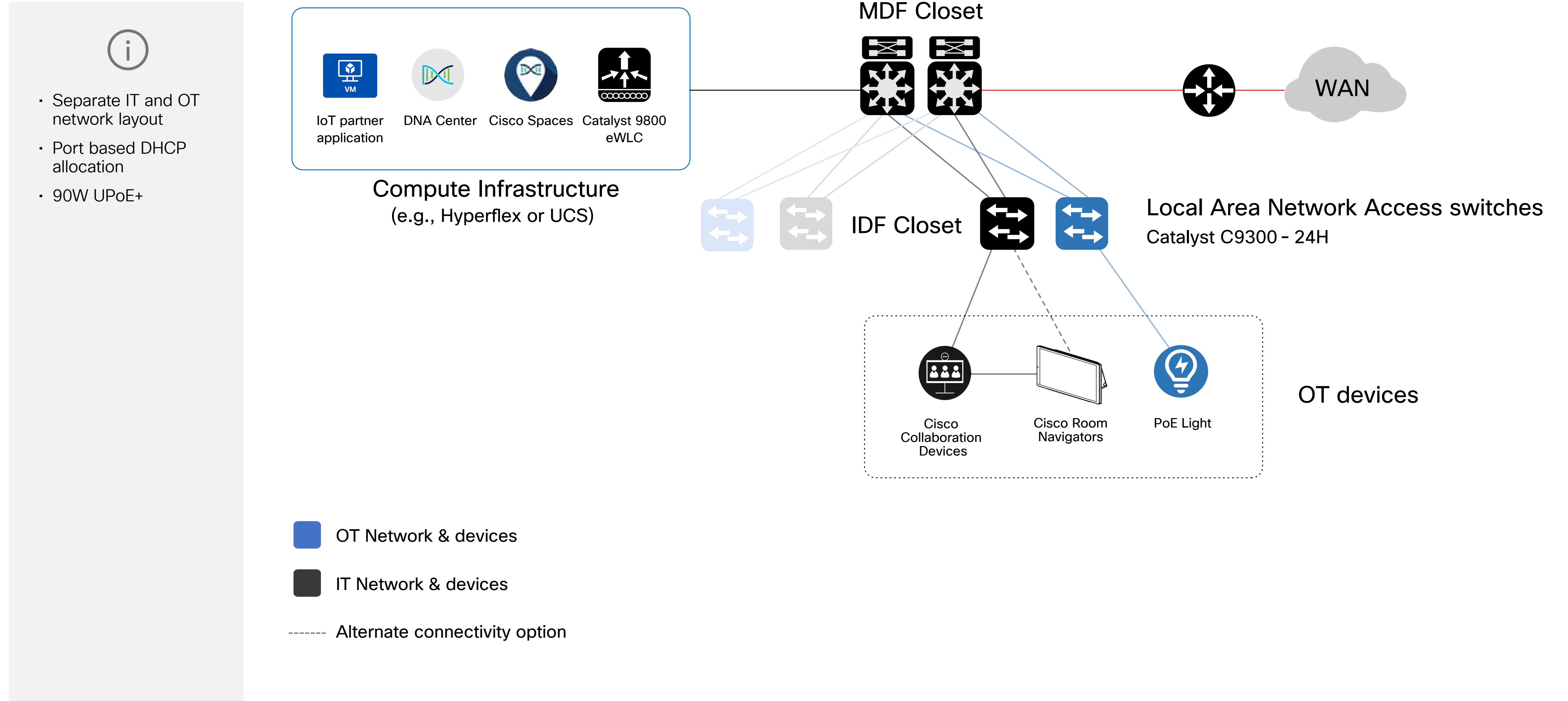

Commissioning-User Acceptance Testing (UAT) Criteria

OT/Space Testing

- Verify manual adjustment of lights, shades and environmental controls are operational from wall controls.
- Confirm lighting occupancy sensor is functional.
- Check any tabletop power and data functionality.
- Verify any smart buildings integrations are working properly.

IT Testing

- Internet connectivity of Cisco Collaboration device.
- Initiate test calls on video endpoint (via Room Navigator, Webex app and voice controls).
- Validate environmental metrics are being displayed on collaboration device and Room Navigator.
- Confirm help videos are loaded.
- Confirm that Room Navigator for Wall is powered and that booking function is working properly. Check that booking function is also available within the room via the Room Navigator for Table.
- Verify the Cisco Smart Workspaces display is showing proper presence status.



Design Files

Design files (Revit, AutoCAD, Sketch up, Rhino3D, etc.) for Cisco's collaboration devices, network switches, wireless access points and Meraki security cameras can be found at www.bimobjects.com, search "Cisco."

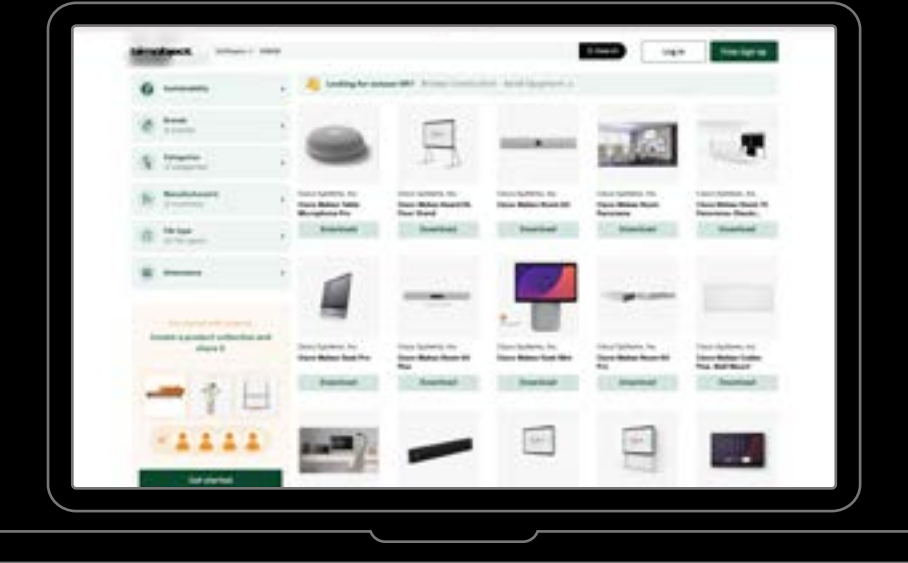

Resources

Guide: Best Practices for Creating Effective Video-enabled Rooms

Cisco Room Bar Pro Data Sheet

Cisco Room Kit EQX Data Sheet

Cisco Room Kit EQX Room Preparations Guide

Cisco Room Kit EQX Installation Guide

© 2025 Cisco and/or its affiliates. All rights reserved. Cisco, the Cisco logo, Webex by Cisco, and Webex are trademarks or registered trademarks of Cisco and/or its affiliates in the U.S. and other countries. To view a list of Cisco trademarks, see the Trademarks page on the Cisco website. Third-party trademarks mentioned are the property of their respective owners. The use of the word "partner" does not imply a partnership relationship between Cisco and any other company. (2106R)

The intent of this document is to highlight the details, components and partners used in the creation of a Medium Collaboration Room - Video Centric. Any reference herein to any specific commercial products or service does not necessarily constitute or imply its endorsement or recommendation.

