



Smart Building Technology
and Hybrid Work Solutions

Cisco Talent and Collaboration Centers

Traditional Huddle Room Design Guide



Introduction

Overview and Intent

This document provides guidance on how to effectively design the Traditional Huddle Room.

This design brings space layout, technology, and furnishings together to create an optimal experience for those present locally and for remote attendees.

Each customer project is unique. Thus, it is important to involve local facilities teams, workplace design resources, architects and space designers, IT, and a Cisco-certified integrator. The collective goal is to finalize the details of any design, verify the applicability and address any local concerns – electrical/mechanical, orientation and location of the room within the floor plan, accessibility, circulation, and external factors such as noise, light, and temperature.

Room Description

Making it easy for small groups to come together to share information, brainstorm, and solve problems is absolutely critical. In this office, we've replaced personal offices with dozens of huddle rooms and smaller collaboration spaces, each designed for this exact purpose. All of these spaces are video-enabled, ensuring the right resources can come together, regardless of where they are.

The Traditional Huddle Room is the perfect space for small group collaboration, especially when you need to bring in that important remote participant. Wireless sharing allows you to display content effortlessly in local and virtual meetings.

Supported Collaboration Activities

	3 Person	4 Person
Information Sharing	✓	✓
Brainstorming		
Team Building		
Decision Making	✓	✓

Table of Contents

- ▶ Introduction 2
- ▶ Visualization of key Cisco elements 3
- ▶ Certified Third Party Displays 4
- ▶ Video Device Mounting Options 5
- ▶ Composite Plans 6
- ▶ Room Layouts 7
- ▶ Reflective Ceiling Plans 8
- ▶ Room Elevations 9
- ▶ Acoustical Treatment 11
- ▶ Power & Data 12
- ▶ Exploded IT Diagram 13
- ▶ Connectivity View 14
- ▶ IT/OT Reference Architectures 15
- ▶ IT/OT Bill of Material 16
- ▶ Commissioning–User Acceptance Testing 17
- ▶ Design Files & Resources 18

Visualization of key Cisco elements



Single 43" or 50" Display and Display Mount

LG / Panasonic / Samsung / Sony



Cisco Room Bar



Cisco Room Navigator for Wall



Cisco Room Navigator for Table

Certified Third Party Displays



Webex certified displays have been tested for compatibility and robustness of their video interfaces, optical characteristics, and basic security practices.

When connected to a Cisco collaboration device they will automatically reconfigure to the optimal configuration already tested and verified.

This list of verified devices was update on August 21, 2024. For up to date information on certified and compatible Cisco collaboration device partner offers, click on the link below.

Vendor	Product or Series	Firmware version
Samsung	QMB	1040.7
Samsung	QBB	1040.7
Samsung	QMC	1040.4
Panasonic	EQ2	2.40
LG	UL3J	03.08.41
LG	UH5J	03.24.01
LG	UR640S	03.17.00
LG	UM5K	3.70.30
Sony	BZ30J, BU30J, BZ35J, BU35J, BZ40H, BU40H, BZ40J, BU40J	6.5929
Sharp/NEC	M751, M861, M981	1.200
Sharp/NEC	MA431, MA491, MA551, P435, P495, P555	3.203
Sharp	PN-LA652, PN-LA752, PN-LA862	1.112

Video Device Mounting Options

Cisco Room Bar

With the Cisco Room Bar, it is best that the display is mounted on the wall. If the wall mounting option is selected, the wall will need to be blocked, and power and data will need to be recessed into the wall. As with other small room applications, it is important to elevate power and data and locate it either in the center of the mount or offset. This will ensure that the electrical outlets and data jacks will not be seen from outside the room. The exact location of power and data should be made based on the specifications of the manufacturer of the mounting bracket.

If wall mounting is not an option, the display can also be free-standing on the table or mounted on a low-profile credenza unit that either tethers to the wall or is free-standing. In either of these scenarios, it is best to locate power and data at standard height, per local code, from the floor.

Wall Mounted Option



Credenza Option



Composite Plans

3 Person

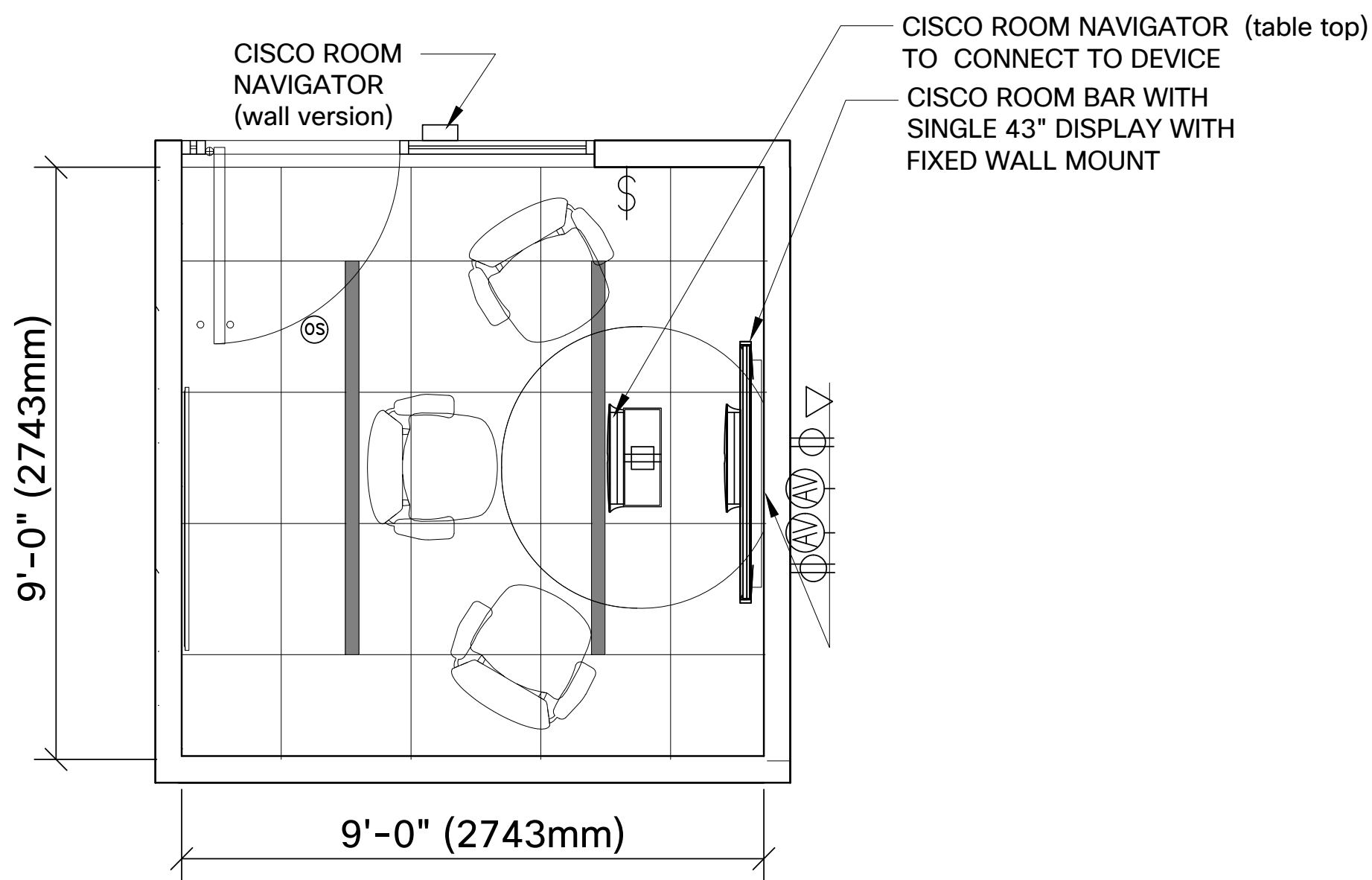

4 Person

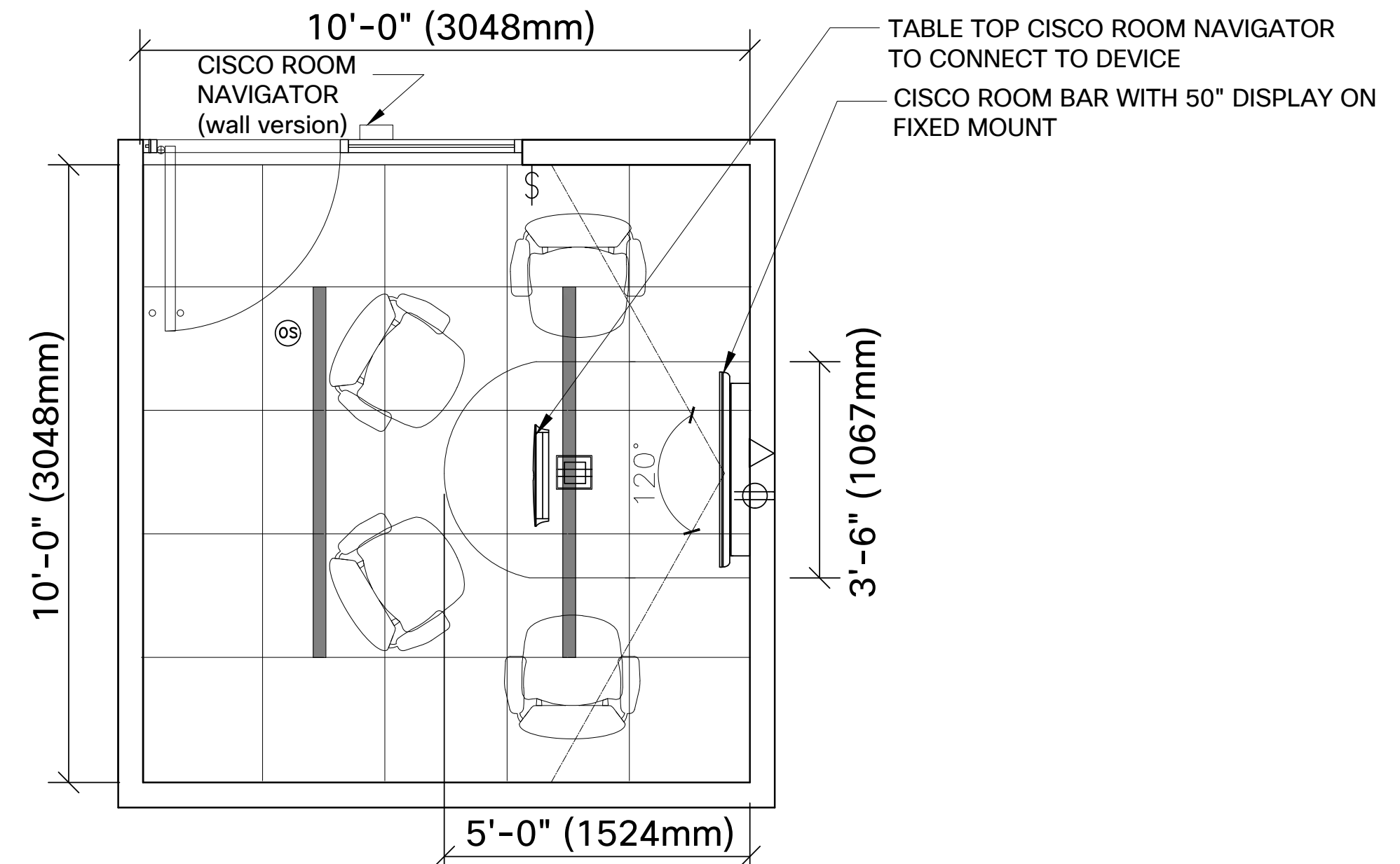

Graphics Symbols

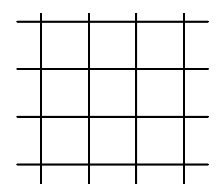

ACOUSTICAL CEILING AND GRID

LIGHT FIXTURES

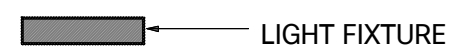

LIGHT FIXTURE

FURNITURE SYSTEMS MOUNTED DEVICES



DUPLEX RECEPTACLE



DATA RECEPTACLE

POWER AND COMMUNICATION

WALL MOUNTED DEVICES



DUPLEX RECEPTACLE



DATA RECEPTACLE



LIGHT SWITCH



AV RECEPTACLE

NOTE: PROVIDE SOLID BLOCKING IN WALLS FOR ALL WALL MOUNTED EQUIPMENT & DEVICES

FLUSH FLOOR MOUNTED DEVICES

Room Layouts



The furniture shown in this design is there to indicate the scale of the space. The selection of specific furniture elements should be based on local preference and how the room is planned to be used.

9' x 9' (2743mm x 2743mm)
Traditional Huddle Room
(3-Chairs)

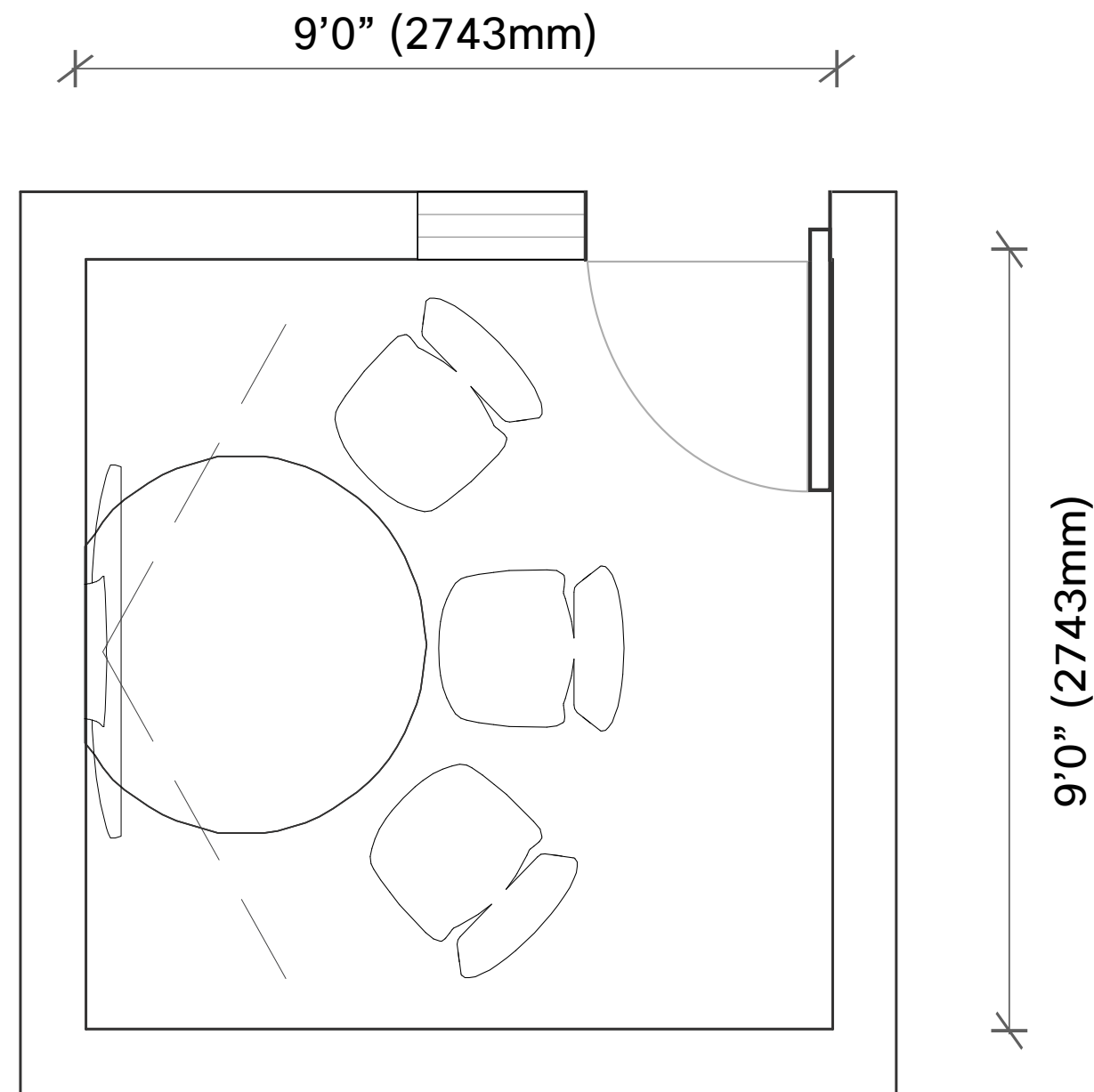

10' x 10' (3048mm x 3048mm)
Traditional Huddle Room
Optimal (4-Chairs)

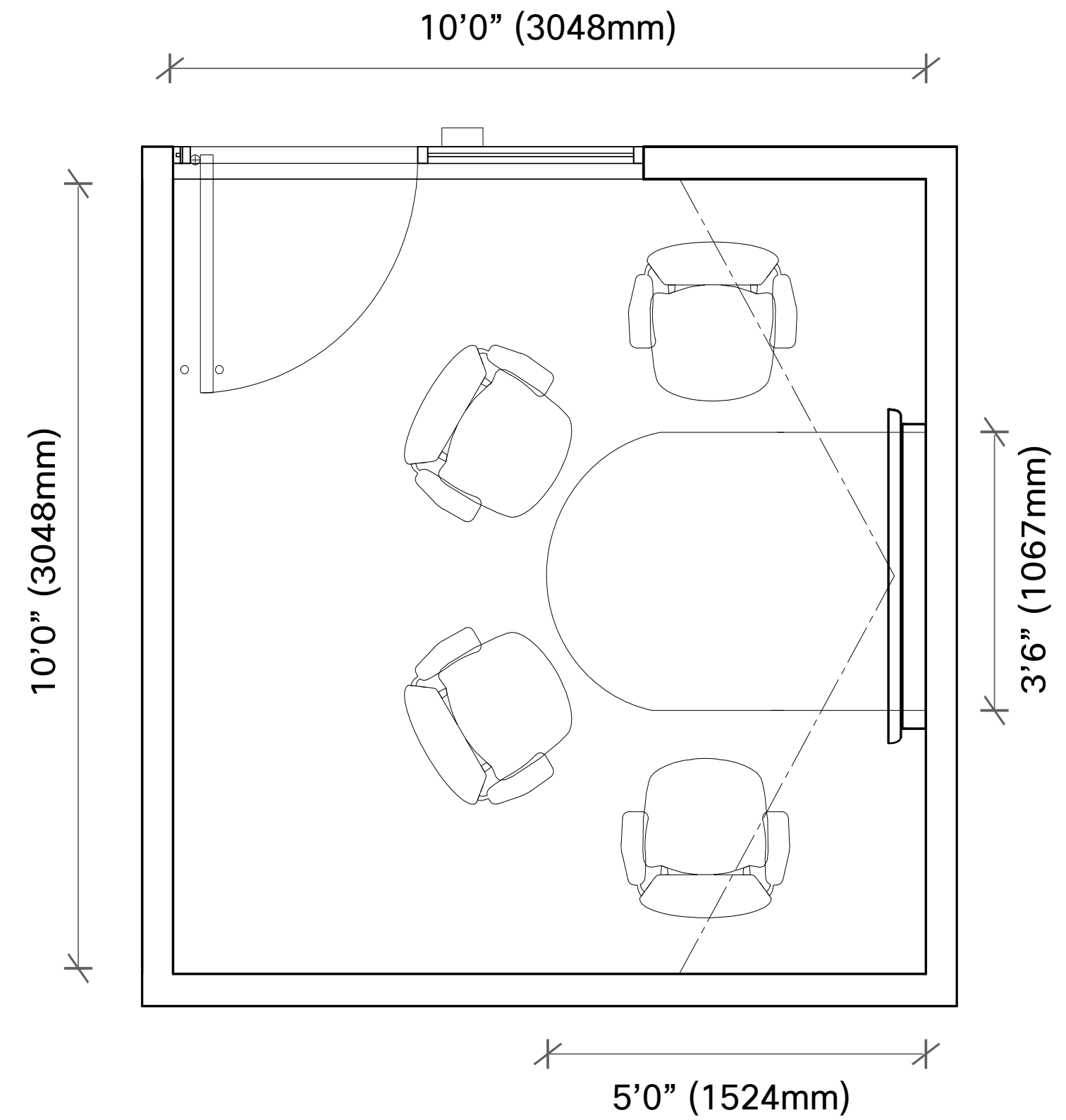

Reflective Ceiling Plans

3 Person

4 Person

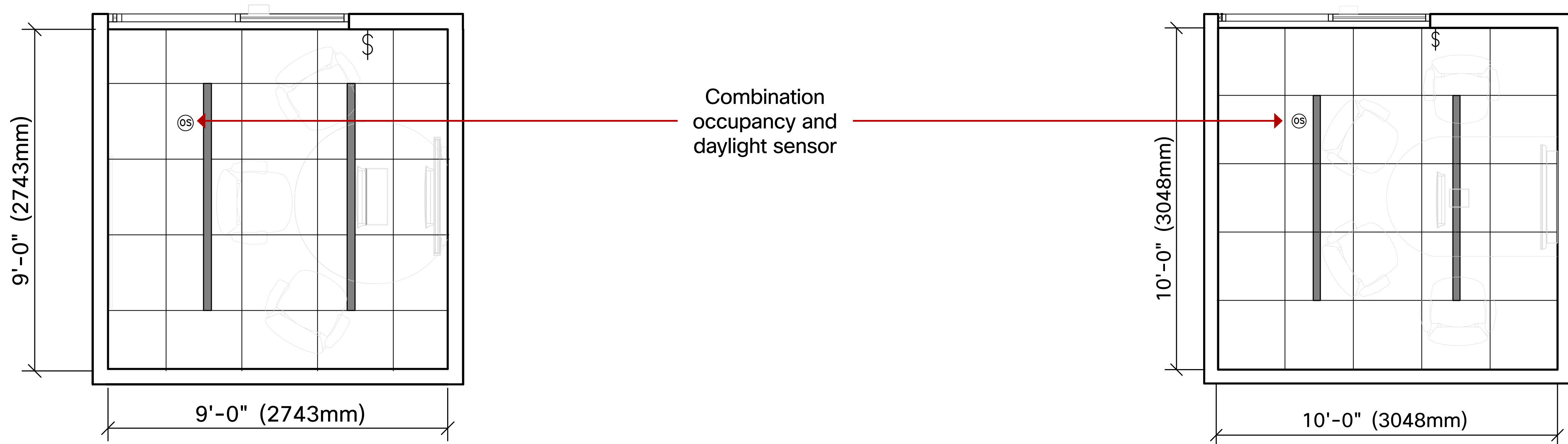

Graphics Symbols

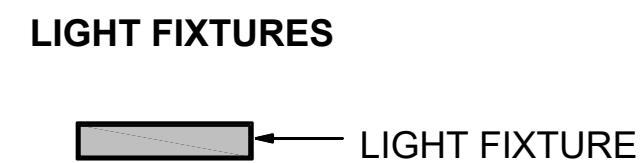
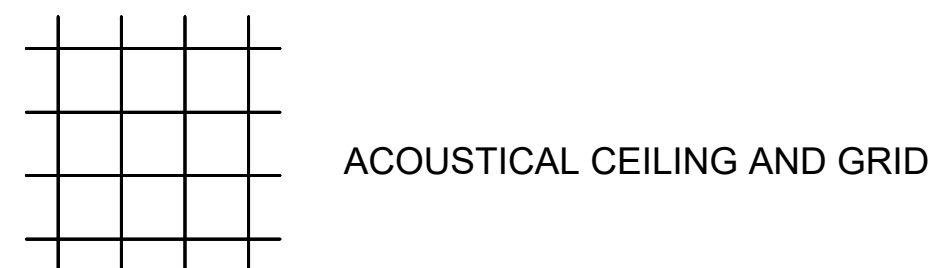

POWER AND COMMUNICATION

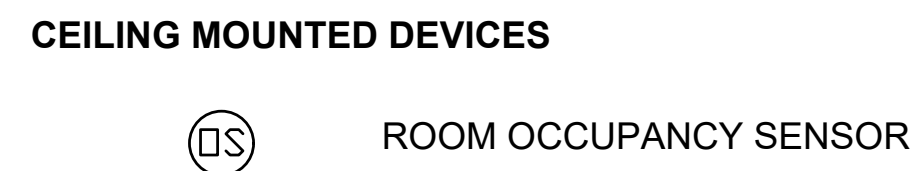

Room Elevations (3 Person)

Construction Elevation

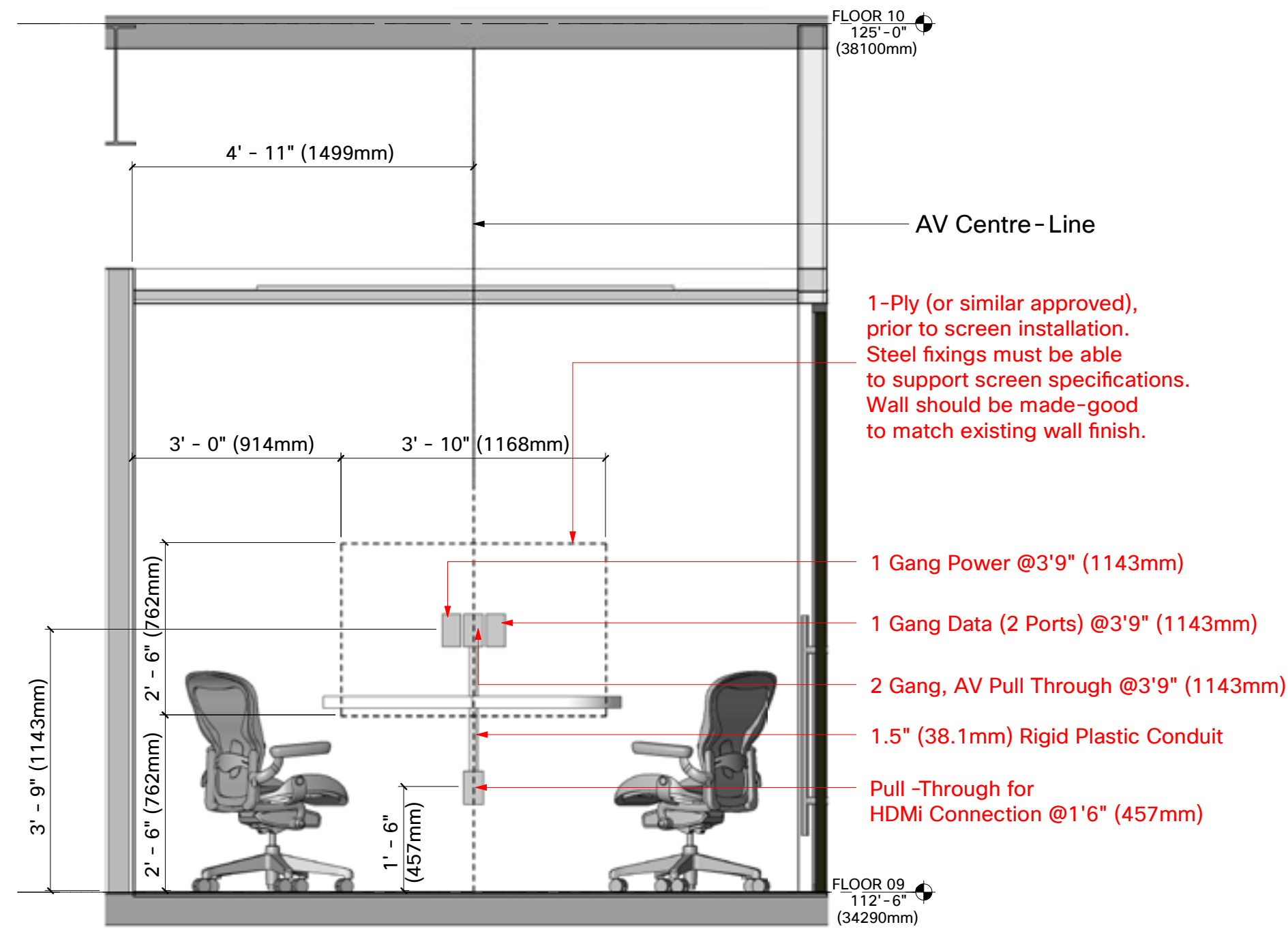

NOTE:
Power and Data need to be recessed

Front Elevation

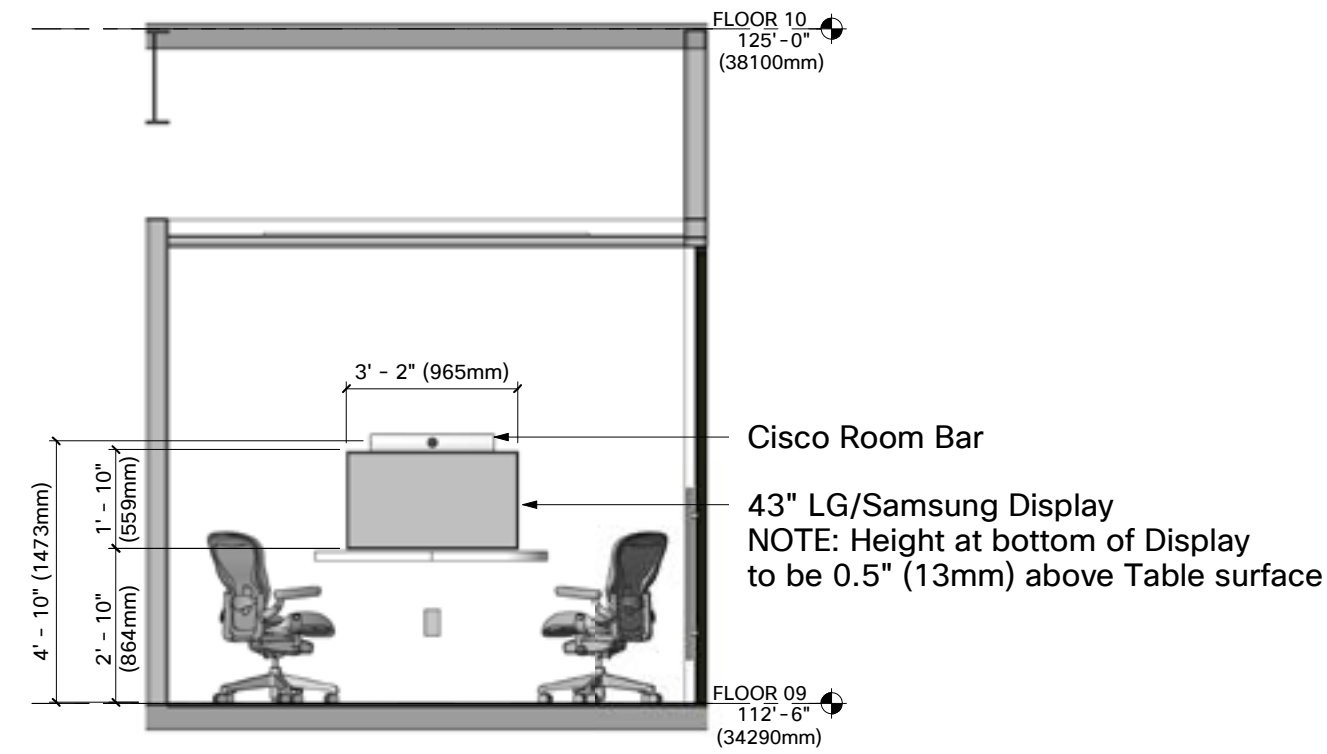

Side Elevation

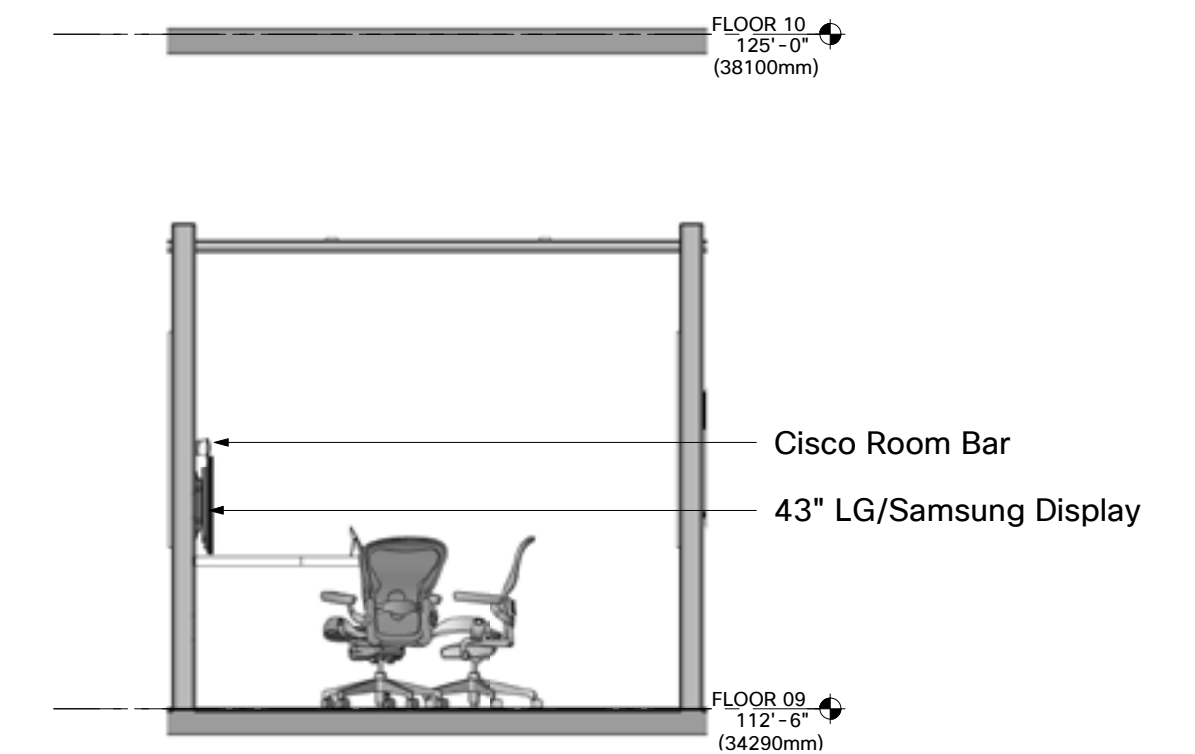

Perspective View

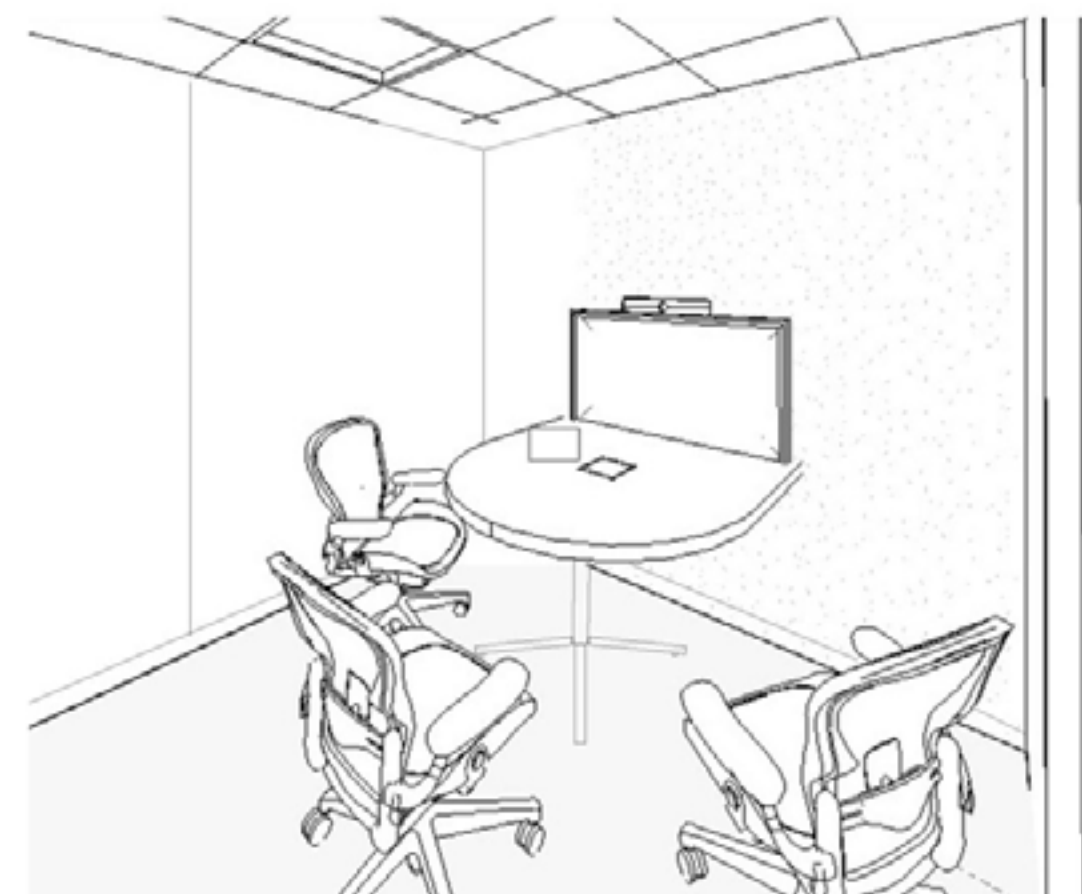

Room Elevations (4 Person)

Conduit Elevation

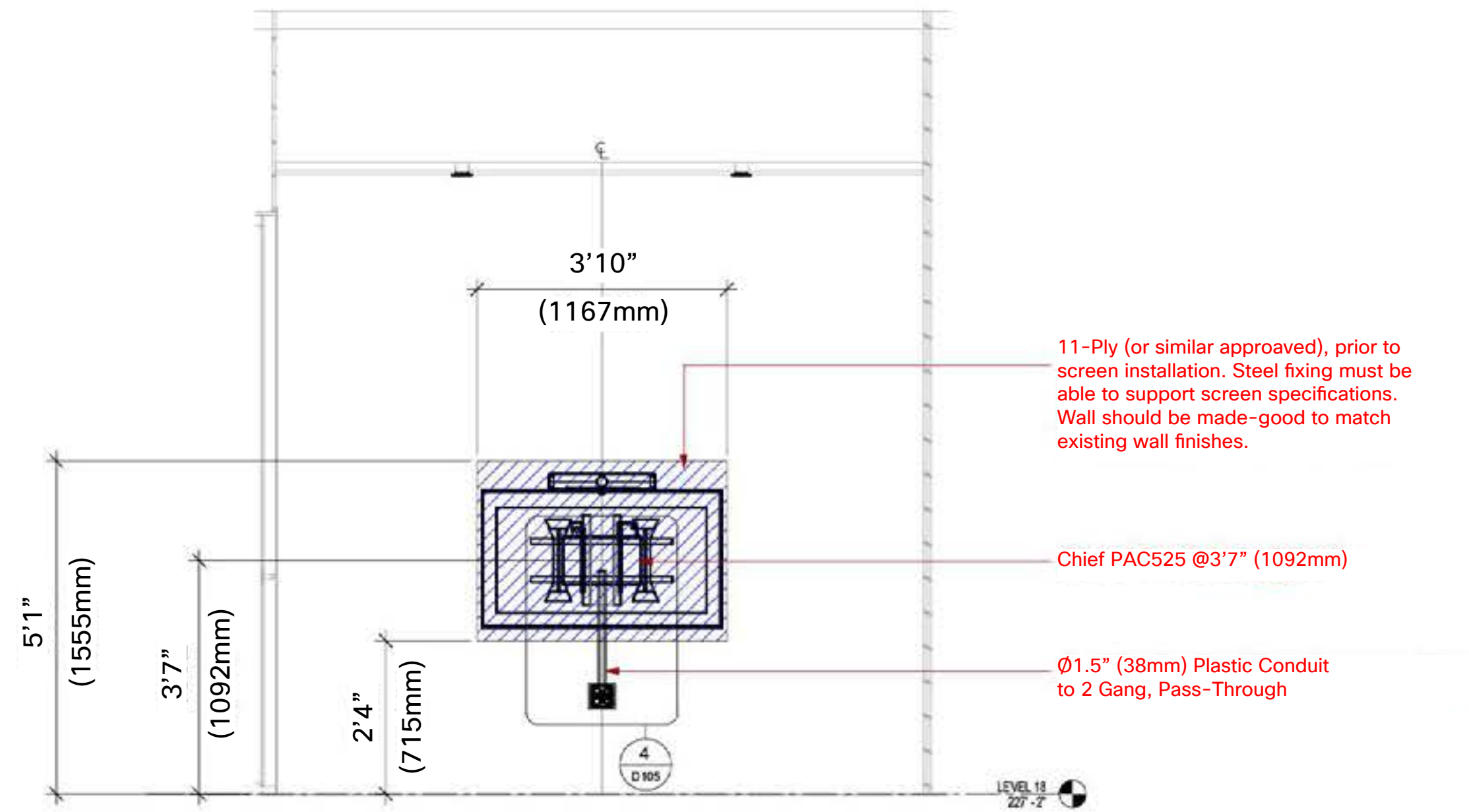

Front Elevation

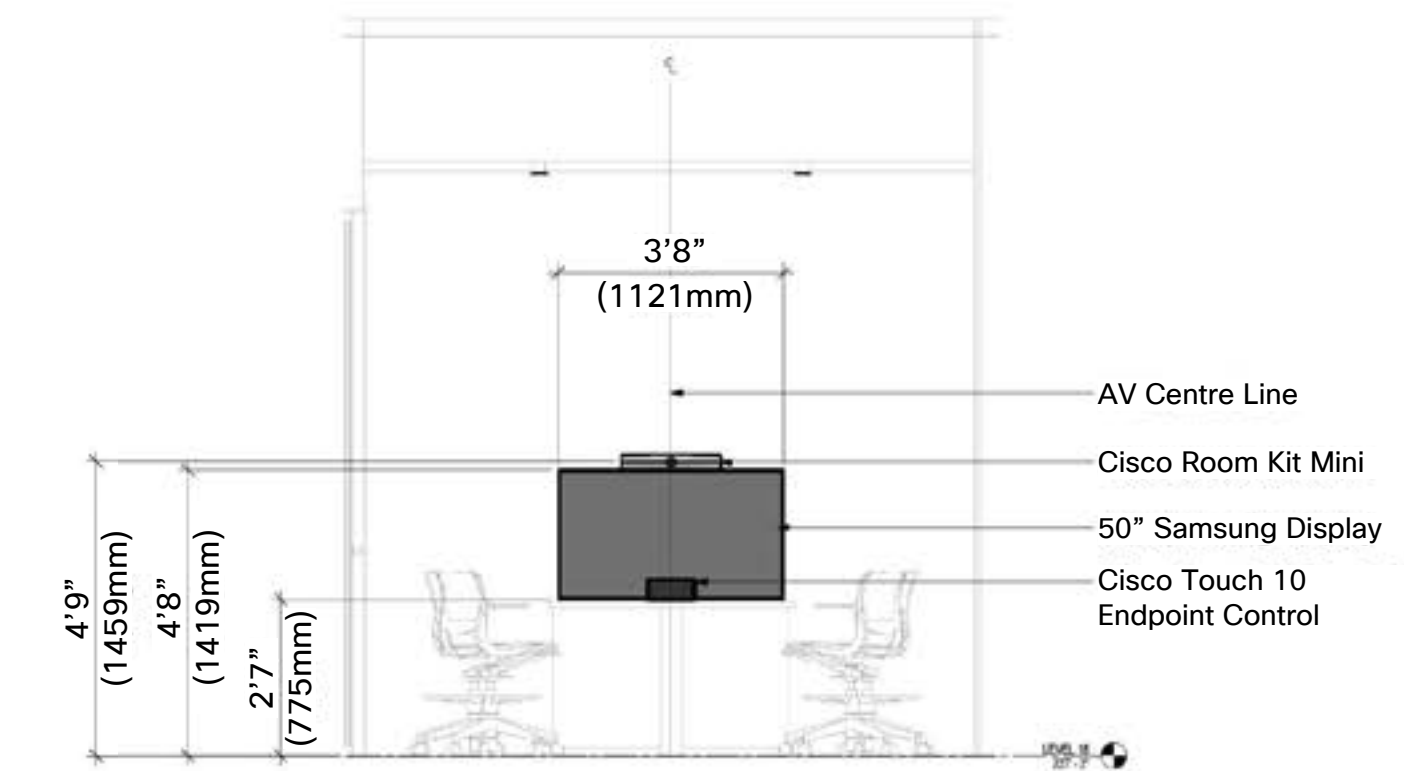

Side Elevation

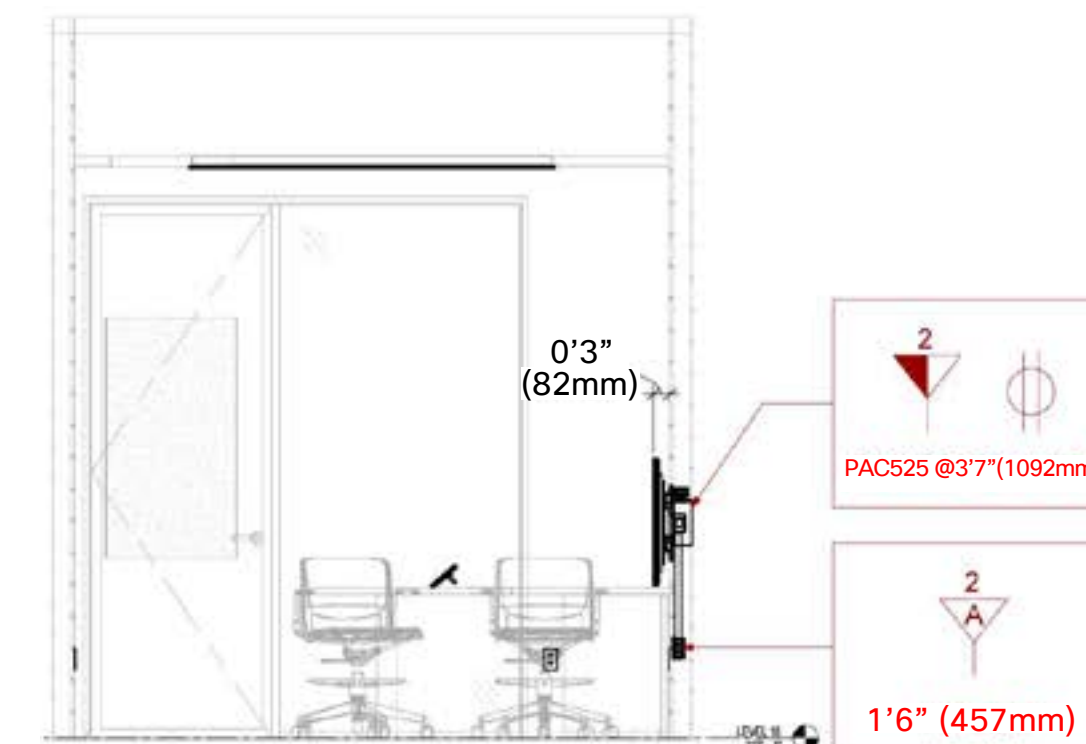

Acoustical Treatment

9' x 9' (2743mm x 2743mm)
Traditional Huddle Room
(3-Chairs)

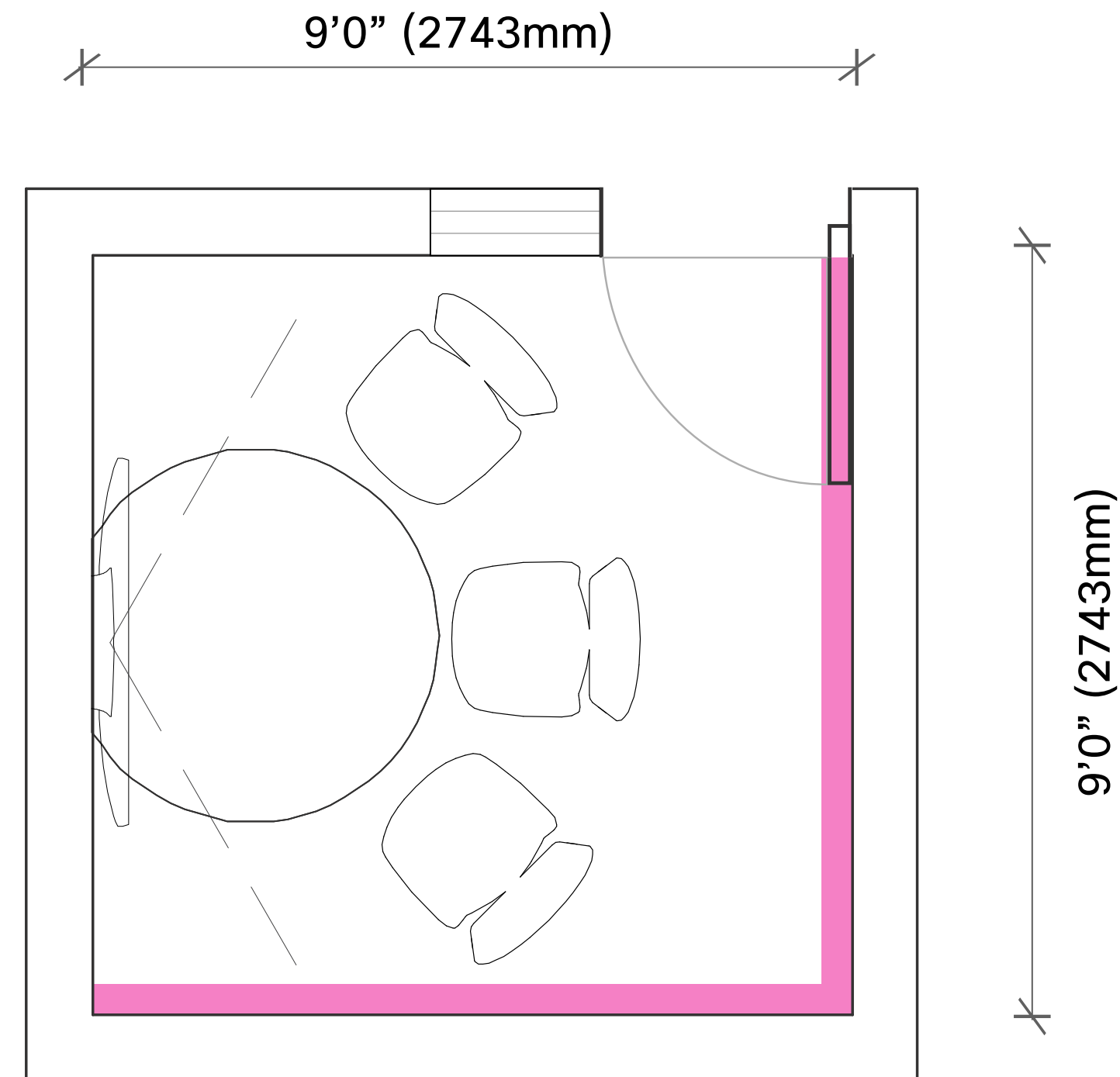

10' x 10' (3048mm x 3048mm)
Traditional Huddle Room
Optimal (4-Chairs)

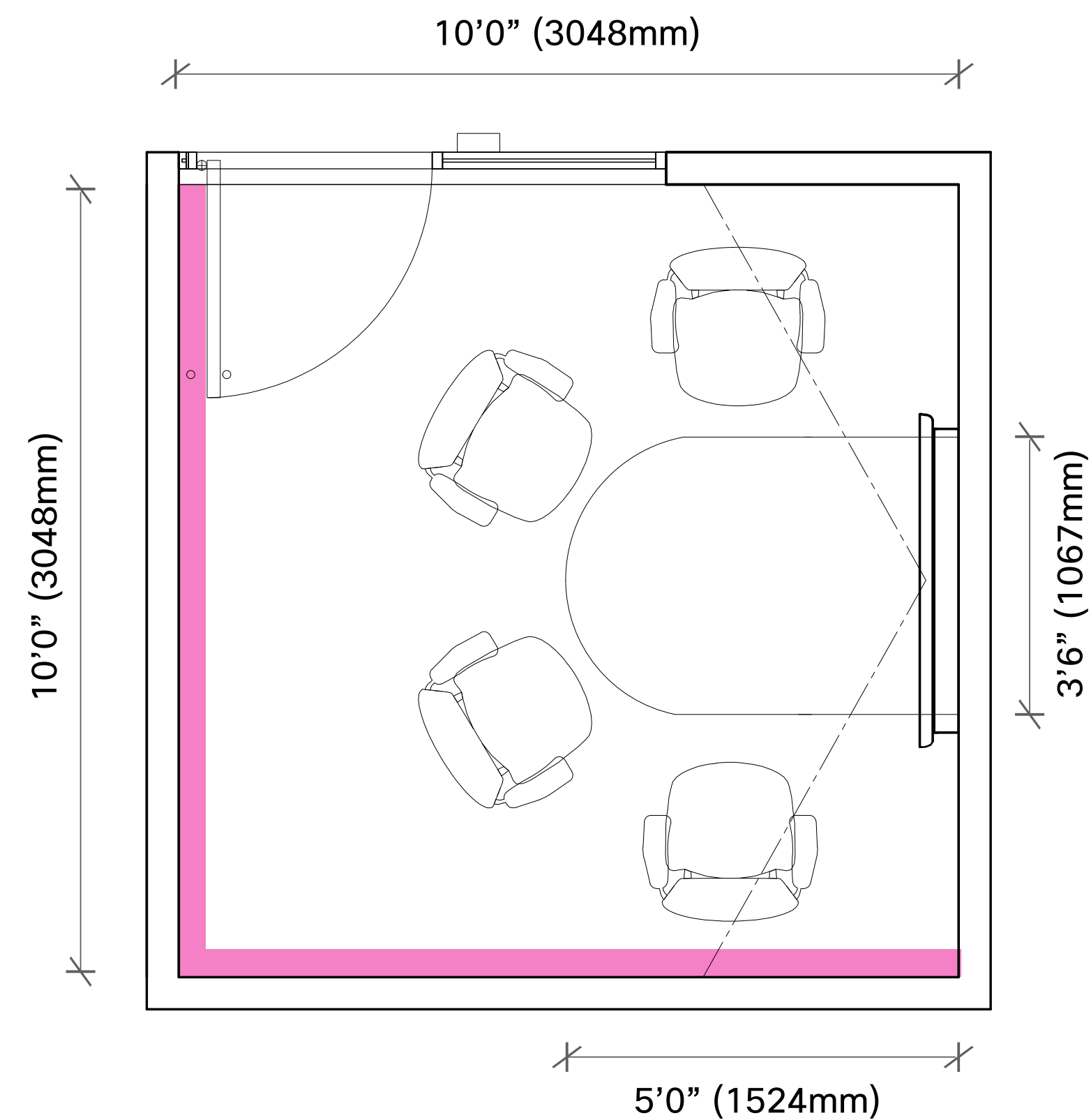

● Two walls of acoustical wall treatment is optimal, preferred location is wall opposite device and then adjoining, away from entry location.



Traditional Huddle Room

Power & Data

General Specifications

Power and data requirements need to be verified for each project. Provide video device power and data even if the project plan does not include it on day one. Based on the design of this space, core drills and floor boxes will not be required.

Power & Data

Provide one (1) duplex power outlet and one data receptacle with two (2) ethernet ports on the wall behind the video device. If wall mounted, both should be recessed, and the location should be either centered on the wall or off-center, away from the door and/or sidelight (so not visible). If a credenza/table unit is used, power and data can remain at standard height per code. In either case, please confirm with the provider.

Exploded IT Diagram



Cisco Room Navigator for Table

The recommended approach is to connect the table stand Cisco Room Navigator directly to the Cisco Room Bar using a network cable. The two can also be connected over the IT network if an ethernet port is available under the table.

Cisco Room Navigator for Wall

It is recommended to run the cable inside the wall or through the door frame directly back to a network switch.

Table Top Charging

USB-C charging and convenience outlets on table top. Ensure the size of the trough and layout can accommodate a variety of laptop power supplies.

Wall Blocking

Required when the device is wall-mounted. The size and composition of blocking materials should be determined based on the overall weight of the solution deployed.

Core Drilling

Not required, with the table connected to the wall, all cables can run on the underside of the table surface, passing to the top of the table through a table trough. Access to the underside of the table can be either a grommet behind the display or a wall conduit (as shown in elevation drawings).

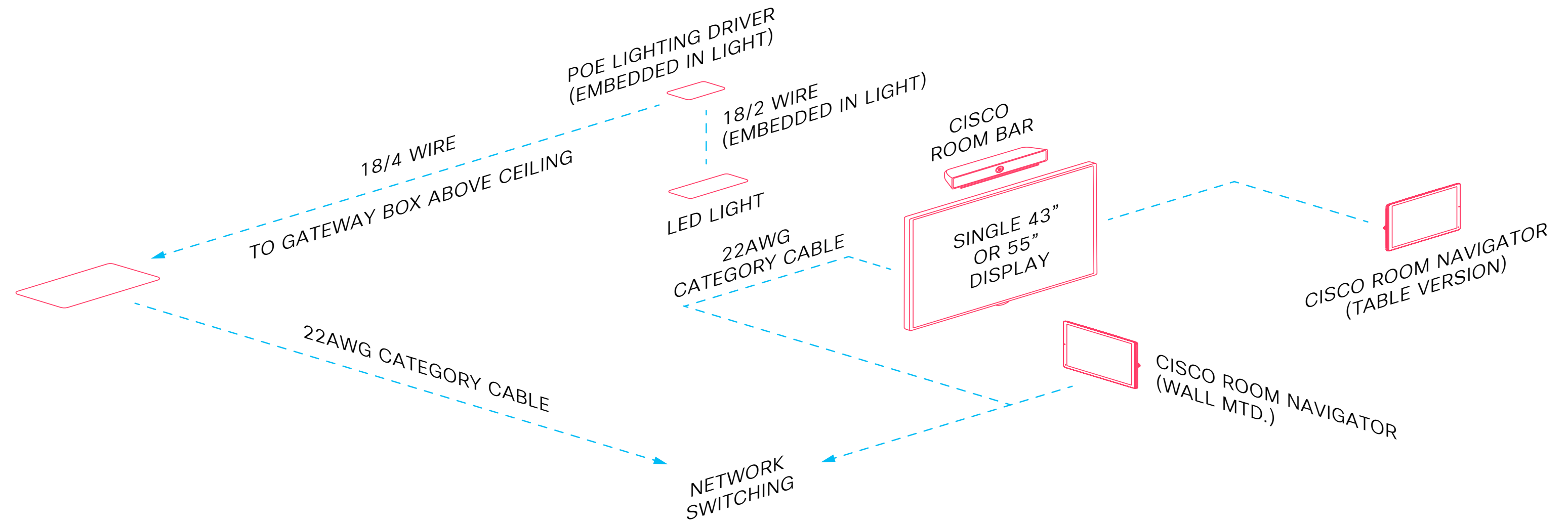

Connectivity View

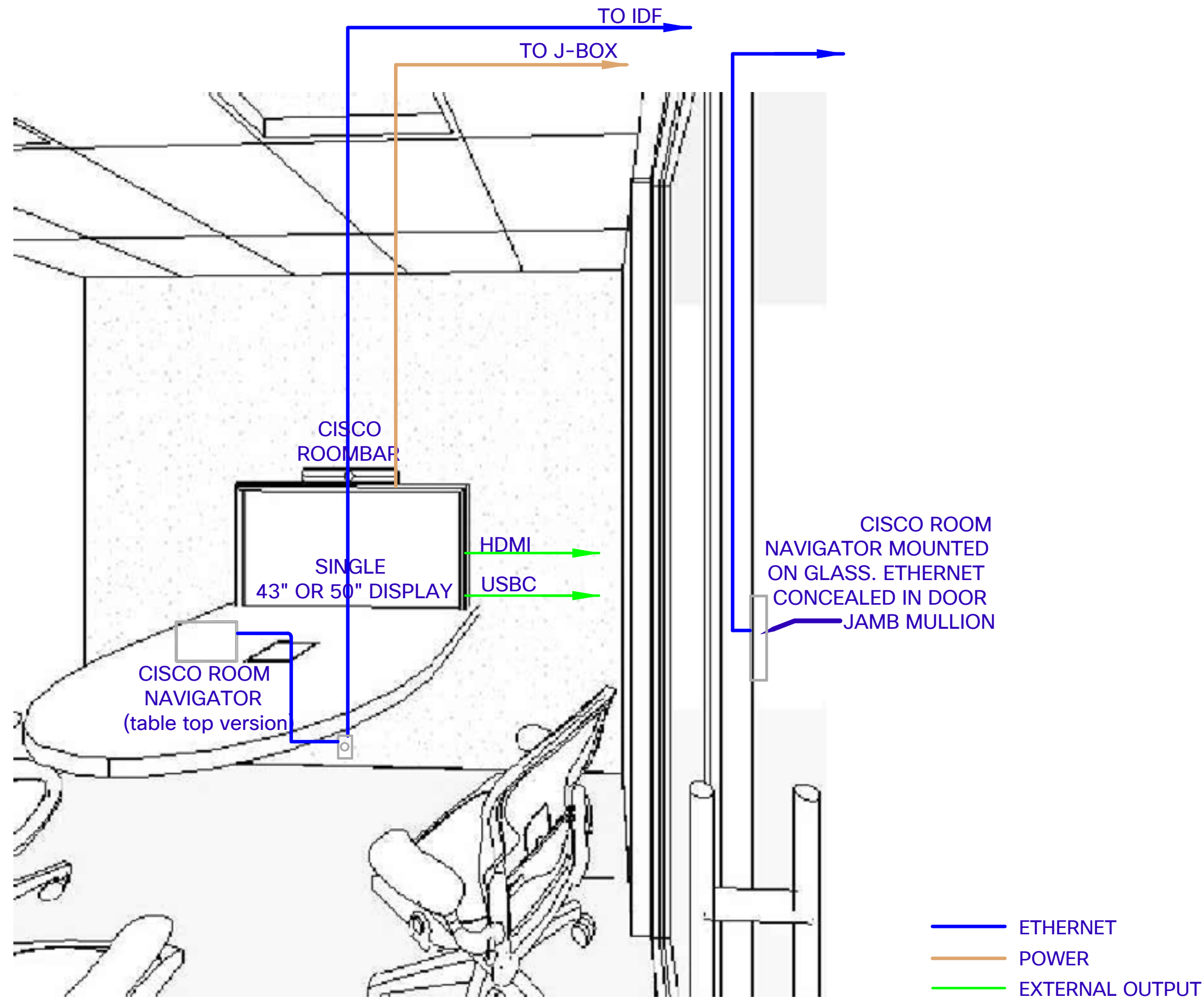

IT/OT Reference Architectures

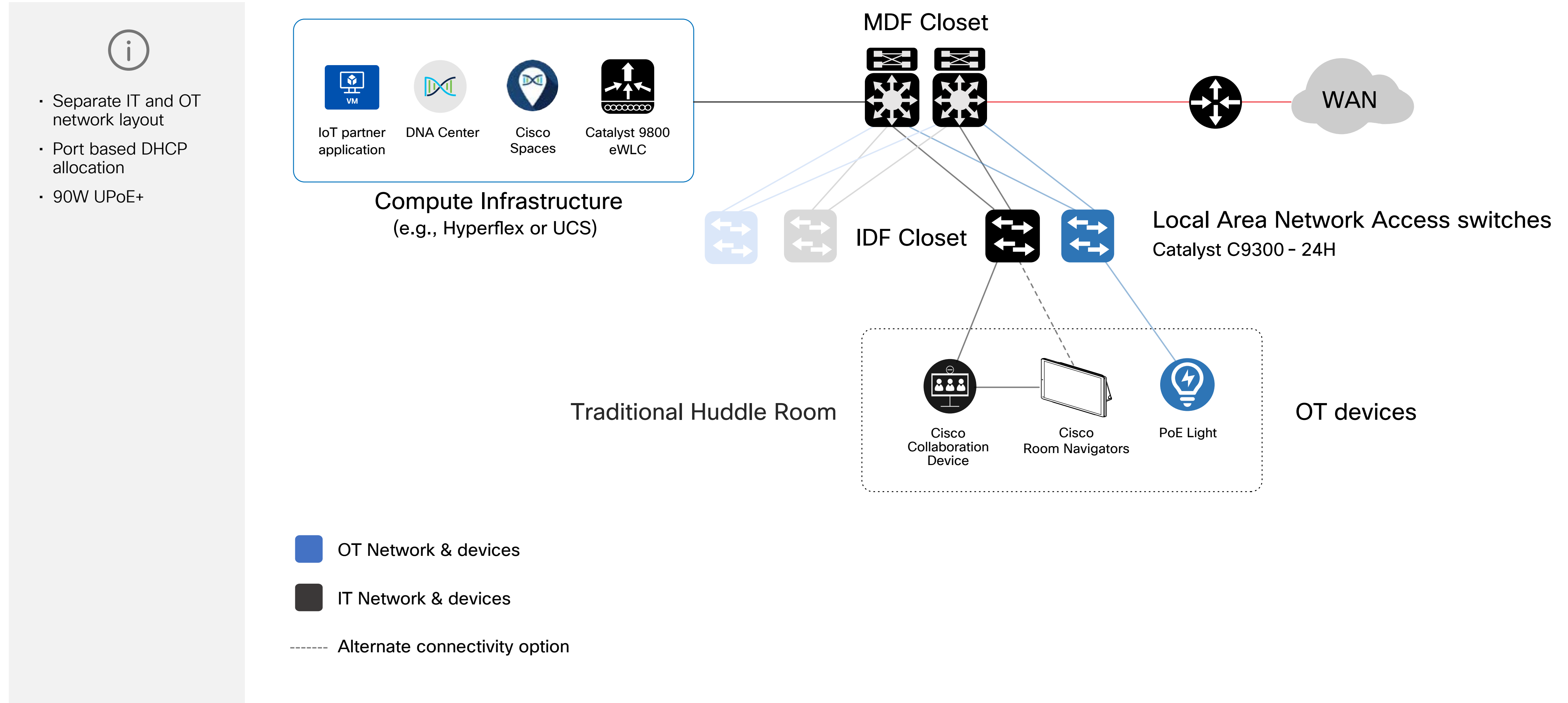

IT/OT Bill of Material

Cisco Products - Video Endpoint in Traditional Huddle rooms (3 or 4 occupancy)

- **CS-BAR-T-K9** Cisco Room Bar
 - **S-T10-TS+** Room Navigator for Table (included)
- **CS-T10-WM-K9=** Cisco Room Navigator for Wall

IOT Considerations

- IAQ coming from the Cisco Room Navigator or the Cisco Board Pro 55, No additional IoT IAQ
- Occupancy sensing is coming from the Cisco Endpoints
- Suggested lighting specifications: 220LPW raw, 140LPW delivered
- Each Huddle room PoE lights being power by a single port on the ceiling
- Traditional DC Wall Switch
- Ensure device is not connected to ASHRAE 90.1 outlet

External microphones and speakers

- Mic and speakers are embedded in the Cisco Endpoint, No additional mic or speakers required
-

Commissioning-User Acceptance Testing (UAT) Criteria (Sample)

OT/Space Testing

- Verify manual adjustment of lights, shades and environmental controls are operational from wall controls
- Confirm lighting occupancy sensor is functional
- Check any tabletop power and data functionality
- Verify any smart buildings integrations are working properly

IT Testing

- Internet connectivity of Cisco Collaboration device
- Initiate test calls on video endpoint (via Room Navigator, Webex app and voice controls)
- Validate environmental metrics are being displayed on video device and Room Navigator
- Confirm help videos are loaded
- Confirm occupancy beacon function is correctly working on Cisco Room Navigator for Wall
- Verify the Cisco Smart Workspaces display is showing proper presence status



Design Files

Design files (Revit, AutoCAD, Sketch up, Rhino3D, etc.) for Cisco's collaboration devices, network switches, wireless access points and Meraki security cameras can be found at www.bimobjects.com, search "Cisco."

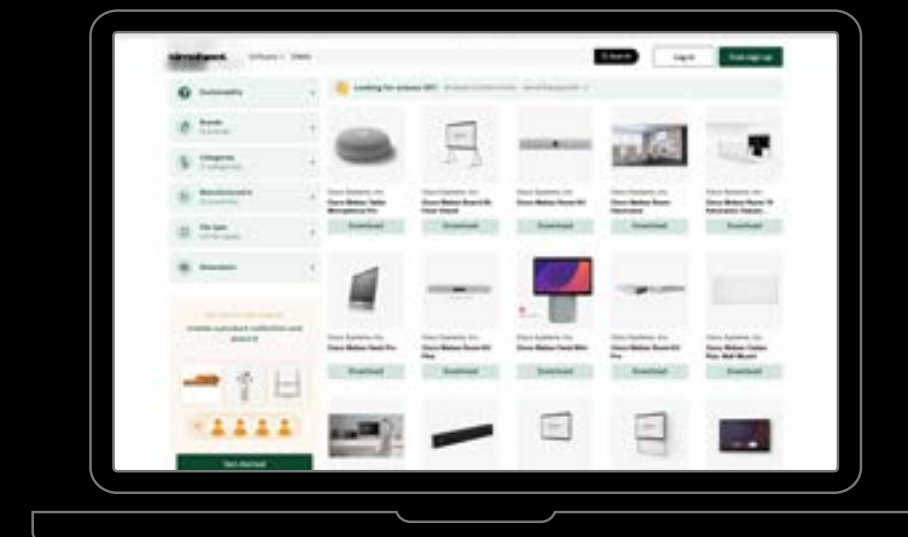

Resources

Guide: Best Practices for Creating Effective Video-enabled Rooms

Cisco Room Bar Data Sheet

© 2024 Cisco and/or its affiliates. All rights reserved. Cisco, the Cisco logo, Webex by Cisco, and Webex are trademarks or registered trademarks of Cisco and/or its affiliates in the U.S. and other countries. To view a list of Cisco trademarks, see the Trademarks page on the Cisco website. Third-party trademarks mentioned are the property of their respective owners. The use of the word "partner" does not imply a partnership relationship between Cisco and any other company. (2106R)

The intent of this document is to highlight the details, components and partners used in the creation of a Large Collaboration Room. Any reference herein to any specific commercial products or service does not necessarily constitute or imply its endorsement or recommendation.

