

# GYM and ATHLETIC LOCKERS

Salsbury Industries offers a complete line of quality lockers for gyms, athletic facilities and health clubs. Our lockers are made with premium-quality materials, and they are designed to withstand heavy usage in busy gyms and fitness clubs. They come in a variety of sizes, colors and configurations to suit your specific requirements. Our lockers are equipped with advanced locking features to ensure the safety and security of your customers' belongings. Salsbury lockers can be ordered by phone or online at [www.lockers.com](http://www.lockers.com).



People Committed to Quality Since 1936®

# GYM and ATHLETIC LOCKERS

## Designer Wood Series



**"S" Style displayed**



### DESIGNER WOOD LOCKERS

- Constructed of industrial grade particleboard and covered with durable high pressure laminate.
- Ideal for gyms, health clubs, locker rooms, country clubs, day spas, sports and athletic facilities or wherever a professional environment is desired.
- 1 wide units come fully assembled while 3 wide units require minor assembly.
- All locker doors include heavy duty concealed hinges and a lift up handle and recessed hasp for added security.

### CONFIGURATIONS

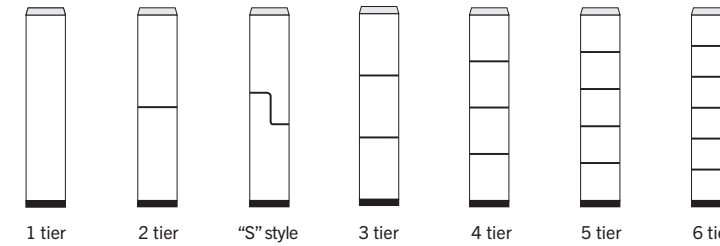

### TOP AND SIDE OPTIONS

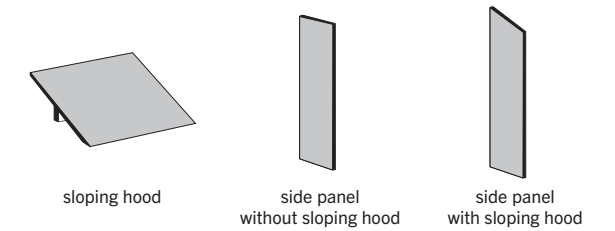

### COLOR OPTIONS

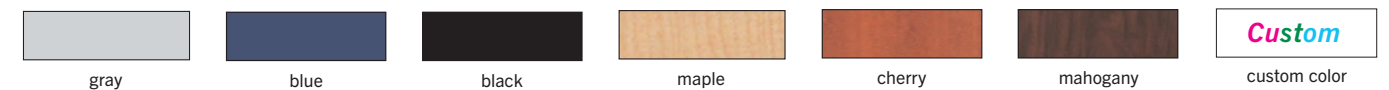

Custom colors - 25% upcharge (minimum fifteen (15) frames) To view all colors visit: [www.lockers.com/customdesignerlockers](http://www.lockers.com/customdesignerlockers)

### LOCK OPTIONS / NUMBER PLATES

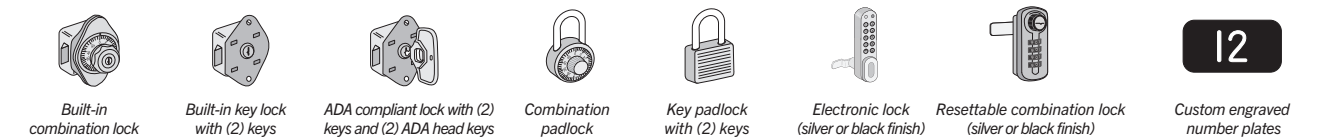

DISPLAYED WITH OPTIONAL SIDE PANEL AND SLOPING HOOD

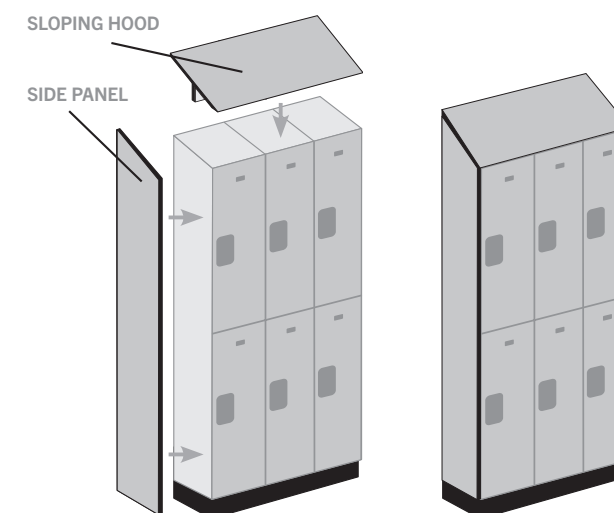

### Online Resources

- Product Information
- 3D Revit / BIM Models
- Detailed Specifications
- Technical Drawings
- Augmented Reality (AR) Models
- Installation Instructions
- AutoCAD Drawings



Visit: [www.lockers.com/Architectural-Resources](http://www.lockers.com/Architectural-Resources)

# GYM and ATHLETIC LOCKERS

## Designer Open Access Series



## DESIGNER OPEN ACCESS LOCKERS

- Constructed of industrial grade particleboard and covered with durable high pressure laminate.
- Ideal for gyms, health clubs, locker rooms, country clubs, day spas, sports and athletic facilities or wherever a professional environment is desired.
- 14" high foot locker provides comfortable seating and secure equipment storage.
- The top compartment features a 12" wide x 3/4" deep door with heavy duty concealed hinges and a lift up handle and recessed hasp for added security.

## TOP AND SIDE OPTIONS

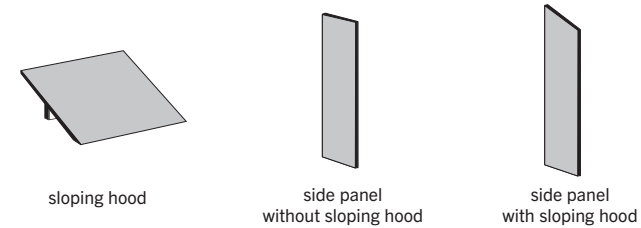

## COLOR OPTIONS



Custom colors - 25% upcharge (minimum fifteen (15) frames) To view all colors visit: [www.lockers.com/customdesignerlockers](http://www.lockers.com/customdesignerlockers)

## LOCK OPTIONS / NUMBER PLATES

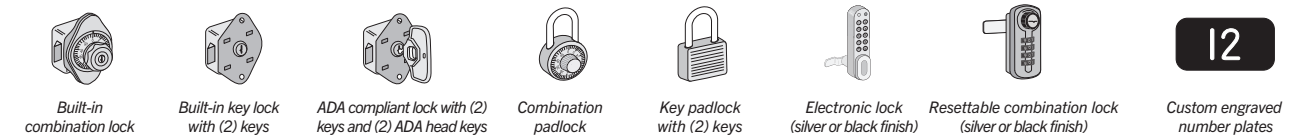

## DISPLAYED WITH OPTIONAL SIDE PANEL AND SLOPING HOOD

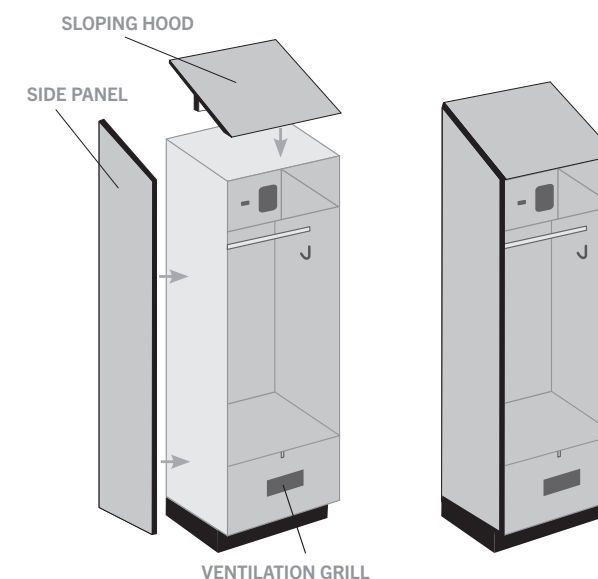

## Online Resources

- Product Information
- 3D Revit / BIM Models
- Detailed Specifications
- Technical Drawings
- Augmented Reality (AR) Models
- Installation Instructions
- AutoCAD Drawings



Visit: [www.lockers.com/Architectural-Resources](http://www.lockers.com/Architectural-Resources)

# GYM and ATHLETIC LOCKERS

## Designer Gear Series



## DESIGNER GEAR LOCKERS

- Constructed of industrial grade particleboard and covered with durable high pressure laminate.
- Ideal for gyms, health clubs, locker rooms, country clubs, day spas, sports and athletic facilities or wherever a professional environment is desired.
- Units feature a ventilated front door that opens from left to right with four (4) heavy duty concealed hinges.
- 14" high foot locker provides comfortable seating and secure equipment storage.
- The top compartment features a 12" wide x 3/4" deep door with heavy duty concealed hinges and a lift up handle and recessed hasp for added security.

## TOP AND SIDE OPTIONS

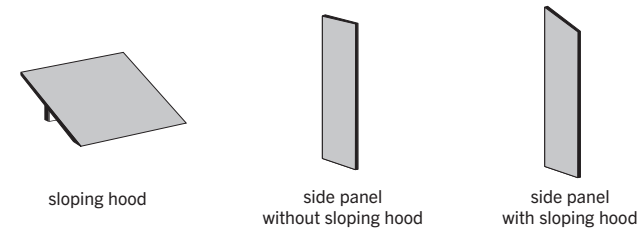

## COLOR OPTIONS

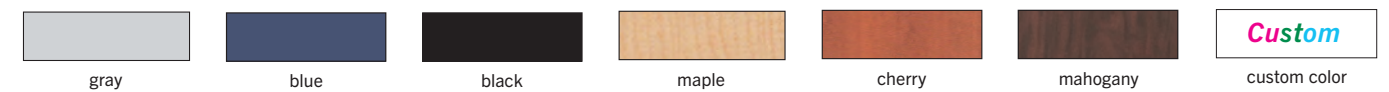

Custom colors - 25% upcharge (minimum fifteen (15) frames) To view all colors visit: [www.lockers.com/customdesignerlockers](http://www.lockers.com/customdesignerlockers)

## LOCK OPTIONS / NUMBER PLATES

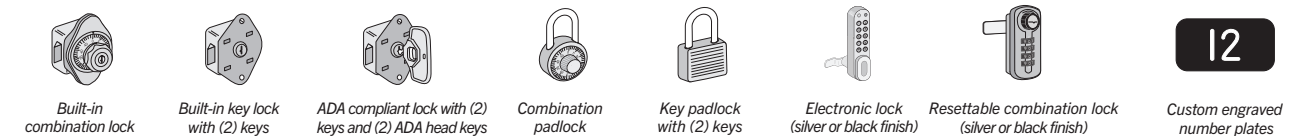

## DISPLAYED WITH OPTIONAL SIDE PANEL AND SLOPING HOOD

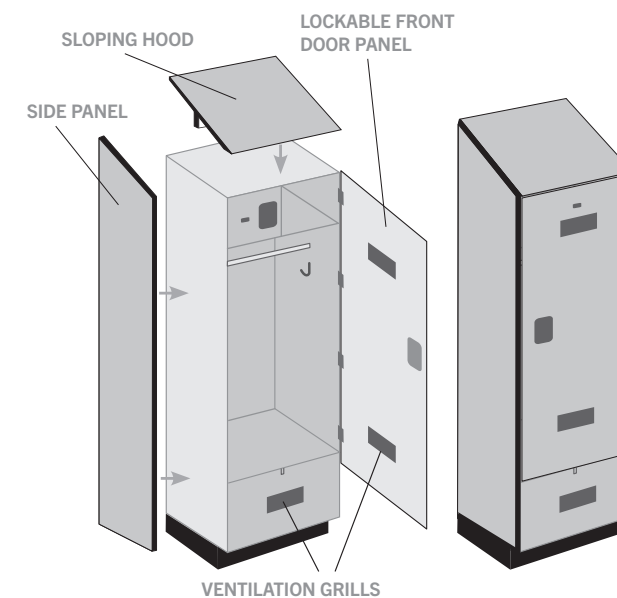

## Online Resources

- Product Information
- 3D Revit / BIM Models
- Detailed Specifications
- Technical Drawings
- Augmented Reality (AR) Models
- Installation Instructions
- AutoCAD Drawings



Visit: [www.lockers.com/Architectural-Resources](http://www.lockers.com/Architectural-Resources)

# GYM and ATHLETIC LOCKERS

## Open Access Metal Lockers

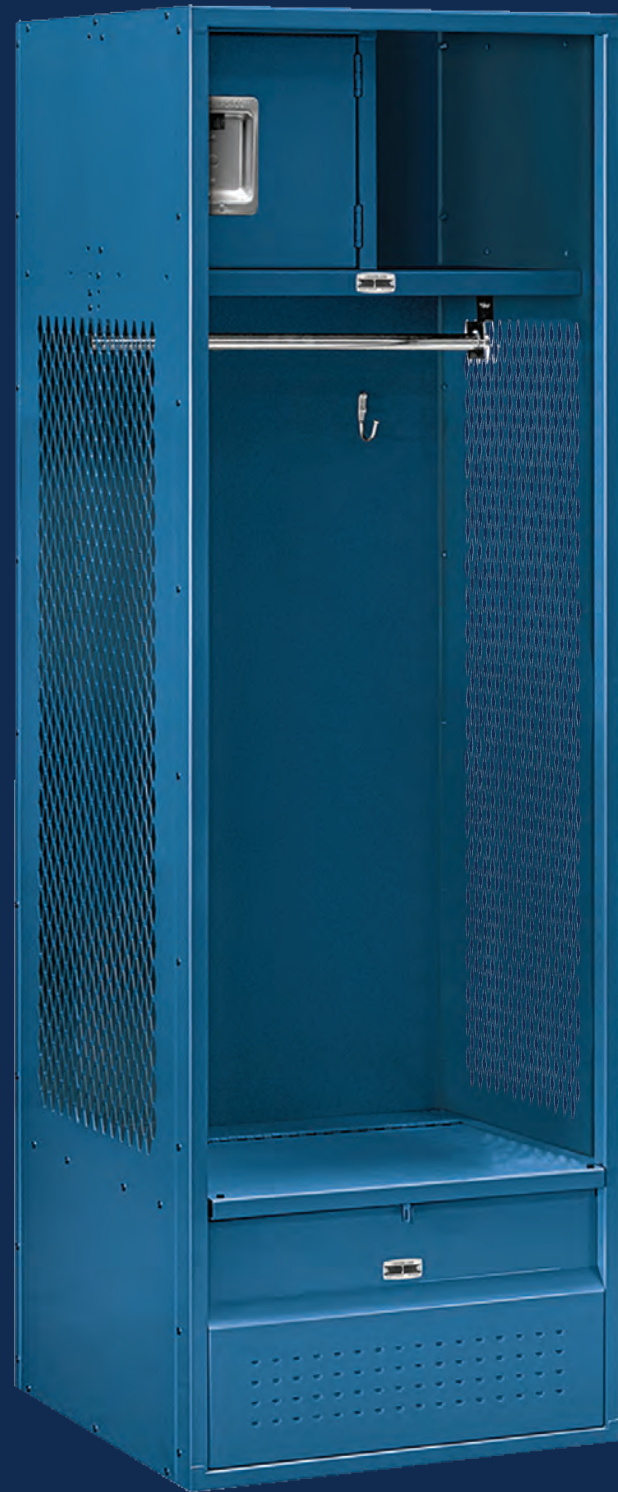

### OPEN ACCESS METAL LOCKERS

- Constructed of 16 gauge steel and feature a durable powder coated finish available in gray, tan or blue.
- Ideal for high schools, middle schools, colleges, locker rooms, sports facilities, police and fire stations and many other applications where visibility and maximum airflow is needed.
- Units are 2 feet wide, 6 feet high and 18" or 24" deep.
- Units also feature 2 steel coat hooks, a coat rod and a 14" high foot locker with a hinged lid and recessed padlock hasp for secure storage.

### COLOR OPTIONS



### LOCK OPTIONS / NUMBER PLATES



### LOCKER BENCHES

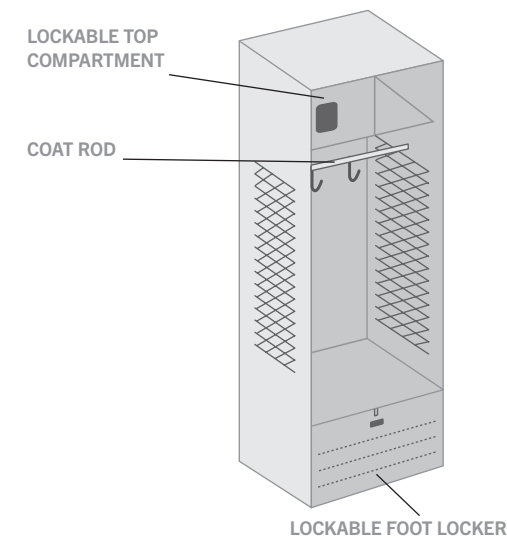
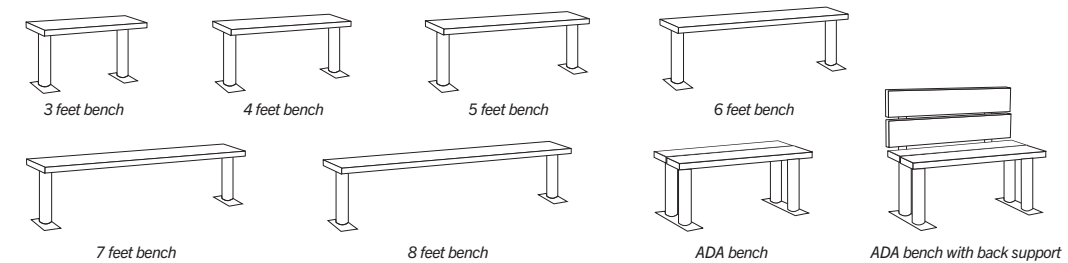

### Online Resources

- *Product Information*
- *3D Revit / BIM Models*
- *Detailed Specifications*
- *Technical Drawings*
- *Augmented Reality (AR) Models*
- *Installation Instructions*
- *AutoCAD Drawings*



Visit: [www.lockers.com/Architectural-Resources](http://www.lockers.com/Architectural-Resources)

# GYM and ATHLETIC LOCKERS

## Standard Metal Lockers



### STANDARD METAL LOCKERS

- Constructed of 16 gauge steel and feature a durable powder coated finish available in gray, tan or blue.
- Ideal for gyms, health clubs, locker rooms, country clubs, day spas, sports and athletic facilities or wherever a professional environment is desired.
- 5 and 6 foot high lockers have compartment sizes that are 12", 15" and 18" wide and 12", 15", 18" or 21" deep.
- Units include a lift up handle and recessed hasp for added security and can accommodate built-in combination or key locks and combination or key padlocks.

### CONFIGURATIONS

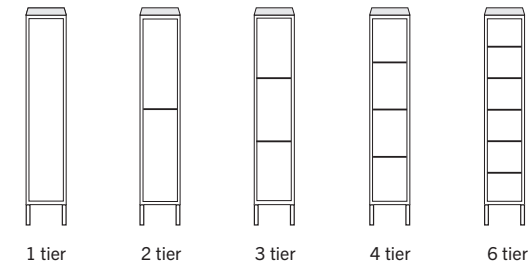

### LOCKER OPTIONS

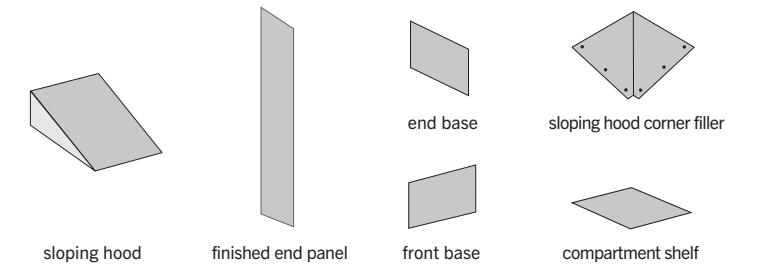

### COLOR OPTIONS



### LOCK OPTIONS / NUMBER PLATES

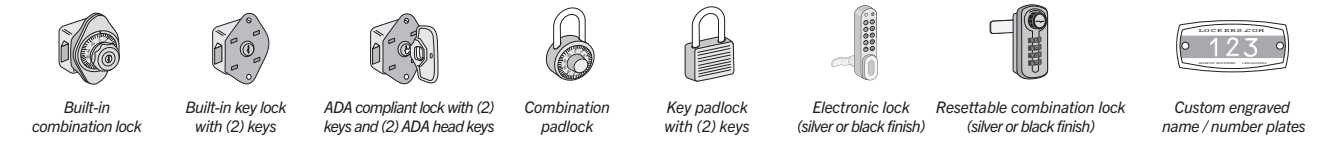

DISPLAYED WITH OPTIONAL SIDE PANEL, SLOPING HOOD, FRONT AND END BASES

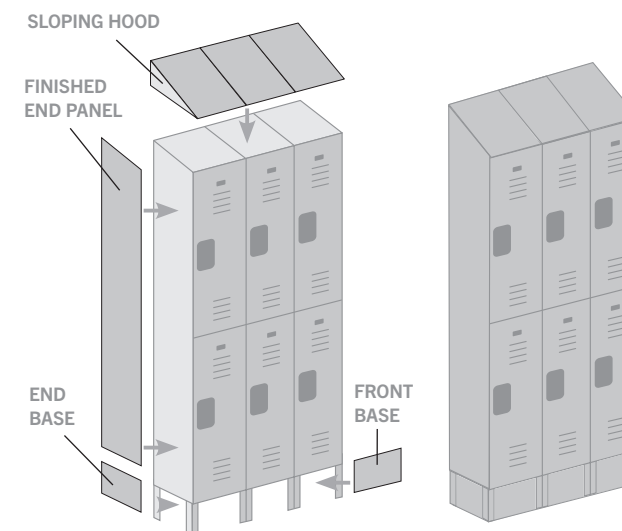

### Online Resources

- Product Information
- 3D Revit / BIM Models
- Detailed Specifications
- Technical Drawings
- Augmented Reality (AR) Models
- Installation Instructions
- AutoCAD Drawings

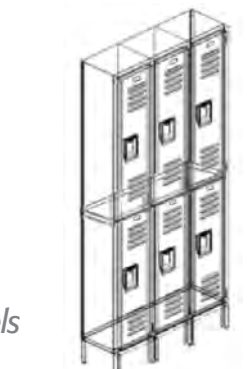

Visit: [www.lockers.com/Architectural-Resources](http://www.lockers.com/Architectural-Resources)

# GYM and ATHLETIC LOCKERS

## Vented Metal Lockers



### VENTED METAL LOCKERS

- Constructed of 16 gauge steel and feature a durable powder coated finish available in gray, tan or blue.
- Ideal for employee locker rooms, health clubs, gyms and many other applications where visibility and maximum airflow is needed.
- 5 and 6 foot high lockers have compartment sizes that are 12" and 15" wide, and 12", 15" or 18" deep.
- Units include a lift up handle and recessed hasp for added security and can accommodate built-in combination or key locks and combination or key padlocks.

### CONFIGURATIONS

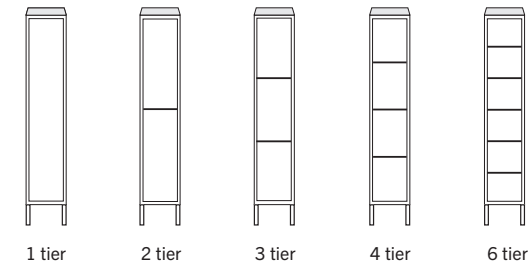

### LOCKER OPTIONS

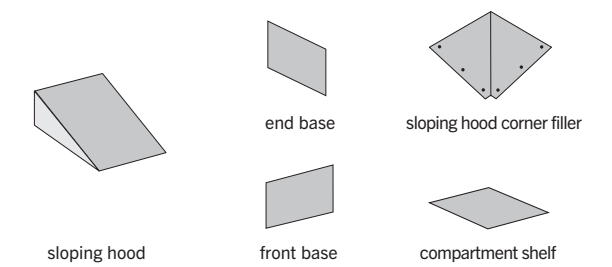

### COLOR OPTIONS



### LOCK OPTIONS / NUMBER PLATES

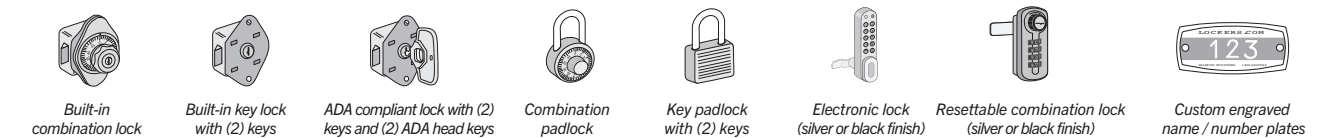

DISPLAYED WITH OPTIONAL SLOPING HOOD, FRONT AND END BASES

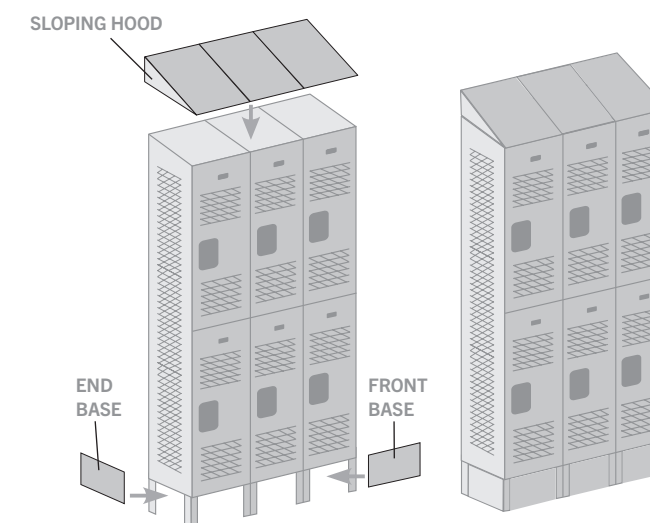

### Online Resources

- Product Information
- 3D Revit / BIM Models
- Detailed Specifications
- Technical Drawings
- Augmented Reality (AR) Models
- Installation Instructions
- AutoCAD Drawings

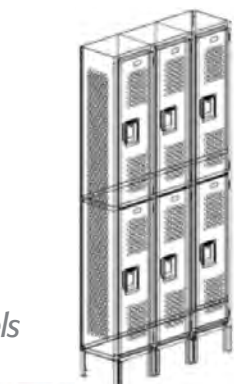

Visit: [www.lockers.com/Architectural-Resources](http://www.lockers.com/Architectural-Resources)

# GYM and ATHLETIC LOCKERS

## Cell Phone Lockers



### CELL PHONE LOCKERS

- Made entirely of heavy duty aluminum and feature a durable powder coated finish in a variety of colors.
- Ideal for gyms, health clubs, locker rooms, country clubs, day spas, sports and athletic facilities or wherever a professional environment is desired.
- Available in five (5) and seven (7) doors high and three (3), four (4) and five (5) doors wide with standard "A" size doors (6-1/2" W x 5-1/4" H) and larger "B" size doors (13" W x 5-1/4" H).
- Cell phone lockers are available with master keyed locks or resettable combination locks.

### STANDARD CONFIGURATIONS

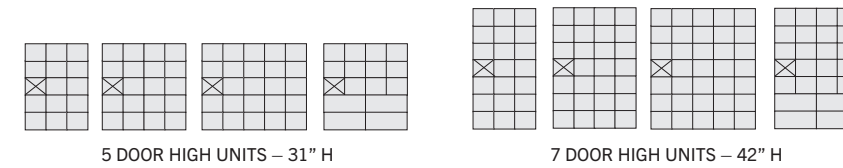

### OPTIONS



Custom configurations available (Minimum order of ten (10) units)

To view all custom cell phone lockers visit: [www.lockers.com/salsbury-custom-cell-phone-lockers/](http://www.lockers.com/salsbury-custom-cell-phone-lockers/)

### COLOR OPTIONS

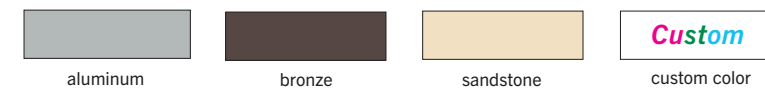

Custom colors available (Minimum order of ten (10) units)

To view all custom colors visit: [www.lockers.com/salsbury-custom-cell-phone-lockers/](http://www.lockers.com/salsbury-custom-cell-phone-lockers/)

### LOCK OPTIONS / NUMBER PLATES

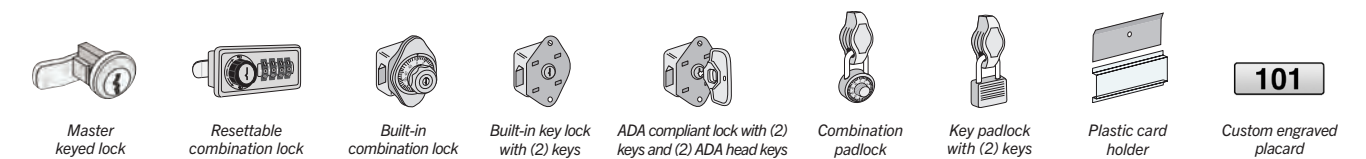

### CELL PHONE LOCKER INSTALLATIONS

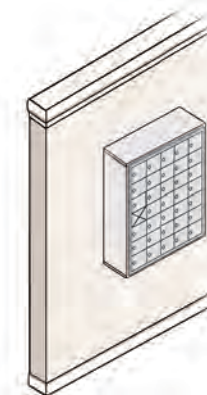

SURFACE MOUNTED

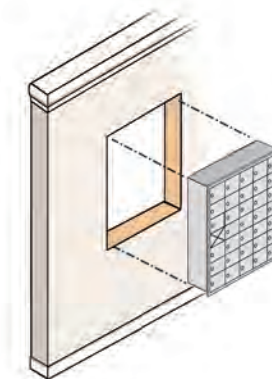

RECESSED MOUNTED

### Online Resources

- Product Information
- 3D Revit / BIM Models
- Detailed Specifications
- Technical Drawings
- Augmented Reality (AR) Models
- Installation Instructions
- AutoCAD Drawings

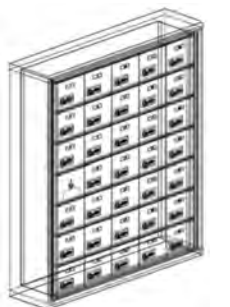

Visit: [www.lockers.com/Architectural-Resources](http://www.lockers.com/Architectural-Resources)



# MANUFACTURING SINCE 1936

*The Industry Leader in Quality Lockers*



# ORDER FACTORY DIRECT

*Large Inventory and Fast Shipping*



# SALSBURY INDUSTRIES

Contact us to learn more about  
Salsbury Gym and Athletic Lockers!

Discounts Available!  
Contact Us  
for a Quote Today!



People Committed to Quality Since 1936®

**Salsbury Industries**  
18300 Central Avenue  
Carson CA 90746-4008

phone: 1.800.562.5377

fax: 1.800.562.5399

phone: 1.323.846.6700

fax: 1.323.846.6800

email: [salsbury@lockers.com](mailto:salsbury@lockers.com)

website: [www.lockers.com](http://www.lockers.com)

