















FRAMES and SUBFRAMES SECURITY DOORS



















TECHNICAL DRAWINGS
rev. 2022.09.12

**FRAMES and SUBFRAMES
SECURITY DOORS**

TECHNICAL DRAWINGS

rev. 2022.09.12

1.0	PUSH/PULL DOOR ASSEMBLY SCHEMES	
1.1 - 1.3	THRESHOLDS SECTIONS – SUBFRAME INSTALLATION	
2.1 - 2.2 2.3 - 2.4 2.5 - 2.6	STANDARD SUBFRAME "CT1" SUBFRAME "CT1" with watertight/sound/thermal break threshold SUBFRAME "CT1" FOR "884" SECURITY DOOR	
3.1 - 3.2 3.3 - 3.6 3.7 - 3.8 3.9 - 3.12 3.13-3.14	STANDARD SUBFRAME "CT1" WITH STANDARD FRAME – Solution 1 sections with side windows and top window sections with watertight/sound/thermal break threshold arched top window schemes STANDARD SUBFRAME "CT1" WITH STANDARD FRAME, WITH CONCEALED HINGES – Solution 1a	
4.1 - 4.2	STANDARD SUBFRAME "CT1" WITH BICOLOUR ALUMINIUM FRAME – Sol. 8	
5.1 - 5.2	SUBFRAME WITH EXTENSION "CT2"	
6.1 - 6.2 6.3 - 6.6	SUBFRAME WITH EXTENSION "CT2" AND STANDARD FRAME – Solution 3 sections with side windows and top window	
7.1 - 7.2	SMALLER SUBFRAME "CT3"	
8.1 - 8.2 8.3 - 8.6	SMALLER SUBFRAME "CT3" WITH STANDARD FRAME – Solution 4 sections with side windows and top window	
8.7 - 8.10	SMALLER SUBFRAME "CT3.1" WITH STANDARD FRAME	
9.1 - 9.2 9.3 - 9.6	SMALLER SUBFRAME "CT3" WITH BICOLOUR ALUMINIUM FRAME sections with side windows and top window	
10.1 - 10.2	SUBFRAME "CT4" WITH REDUCED EXTENSION	
10.3 - 10.4	SUBFRAME AND FRAME WITH REDUCED EXTENSION "CT4" – Solution 5	
12.1 - 12.2	STEEL AND ALUMINIUM FRAME INSTALLATION SOLUTIONS	
14.1 - 14.2 14.3 - 14.6	ONE COLOUR ALUMINIUM FRAME FLUSH WITH THE WALL - Solution 11 sections with side windows and top window	

15.1 - 15.6	FRAME AND SUBFRAME WITH THERMAL BREAK - Solution 6	
16.1 - 16.2	BOX-SHAPED FRAME WITH EXTERNAL COVERING-FRAME PROFILE – Sol. 13	
16.3 - 16.4	BOX-SHAPED FRAME WITH EXT. COVERING-FRAME PROFILE, WITH CONCEALED HINGES – Sol.13a	
17.1 - 17.2	BOX-SHAPED FRAME WITH EXTENSION LINING – Solution 14	
17.3.- 17.4	BOX-SHAPED FRAME WITH EXTENSION LINING, WITH CONCEALED HINGES - Solution 14a	
18.1 - 18.2	SMALLER BOX-SHAPED FRAME WITH EXTERNAL COVERING-FRAME PROFILE– Sol. 15	
19.1 - 19.2	SMALLER BOX-SHAPED FRAME WITH EXTENSION LINING – Sol. 15 bis	
19.3 - 19.4	SMALLER WELDED BOX-SHAPED FRAME – Sol. 15 tris	
20.1 - 20.2	BOX-SHAPED FRAME FLUSH WITH THE WALL – Solution 16	
20.3 - 20.4	BOX-SHAPED FRAME FLUSH WITH THE WALL, WITH CONCEALED HINGES Solution 16a	
21.1 - 21.2	BOX-SHAPED FRAME WITH EXTRA THICKNESS ON STANDARD SUBFRAME – Sol. 17/A	
22.1 - 22.2	BOX-SHAPED FRAME WITH EXTRA THICKNESS – Sol. 17/B	
23.1 - 23.2	PAINTED STEEL FRAME WITH THERMAL BREAK – Sol. 19	
23.2 - 23.3	PAINTED STEEL FRAME AND SUBFRAME WITH THERMAL BREAK – Sol. 19 bis	
24.1 - 24.2	PAINTED STEEL FRAME WITH THERMAL BREAK FLUSH WITH THE WALL – Sol. 18	
25.1	PUSH DI.BIG DOOR ASSEMBLY SCHEMES	
25.2 - 25.3	STANDARD PANELS DI.BIG DOOR SCHEMES AND PANELS WITH GLASS INSERT. DOOR SCHEMES	
26.1 - 26.2	SUBFRAME AND FRAME FOR DI.BIG PIVOT SECURITY DOOR - SOL. 20	
26.3 - 26.4	SUBFRAME AND FRAME FOR DI.BIG PIVOT DOOR with interior wall finish - Sol. 21	
26.5 - 26.6	SUBFRAME AND FRAME FOR DI.BIG PIVOT DOOR with exterior wall finish - Sol. 22	
26.7 - 26.8	SUBFRAME AND FRAME FOR DI.BIG PIVOT DOOR with exterior and interior wall finish - Sol. 23	
26.9 - 26.10	SUBFRAME AND FRAME FOR DI.BIG PIVOT DOOR TUNNEL - Sol. 24	
27.1 - 27.4	SUBFRAME AND FRAME FOR DI.BIG PIVOT SECURITY DOOR WITH SIDE AND TOP WINDOWS	
28.1 - 28.4	SUBFRAME AND FRAME FOR DI.BIG PIVOT SECURITY DOOR WITH BLIND SIDE AND TOP WINDOWS	
29.1 - 29.2	SUBFRAME AND FRAME FOR RASOMURO SECURITY DOOR WITH INTERIOR WALL FINISH – Sol. 25	

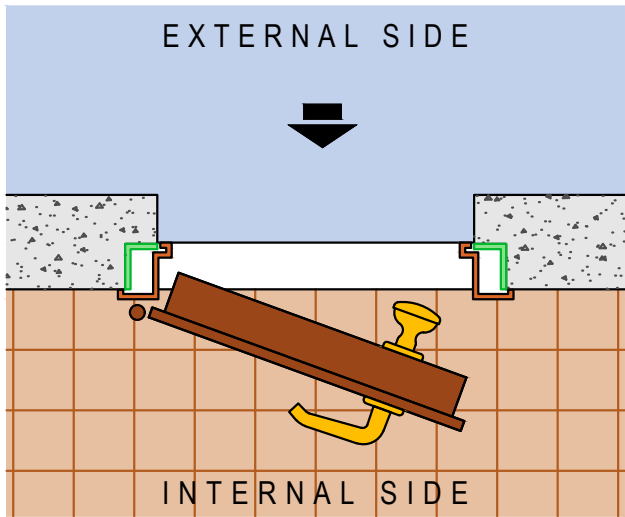

RH Push door

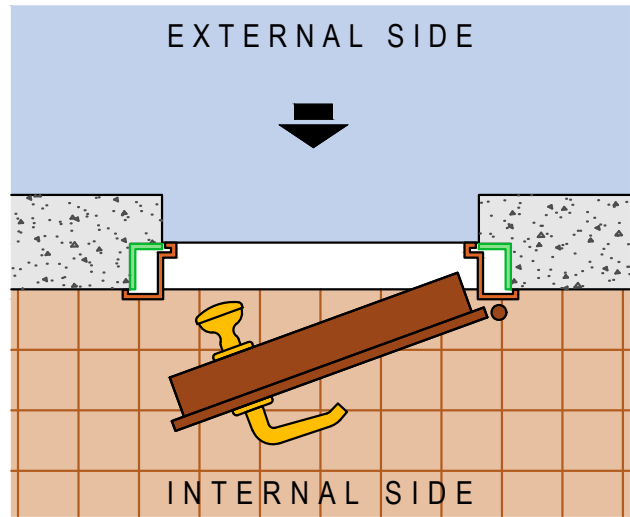

LH Push door

PUSH DOOR ASSEMBLY

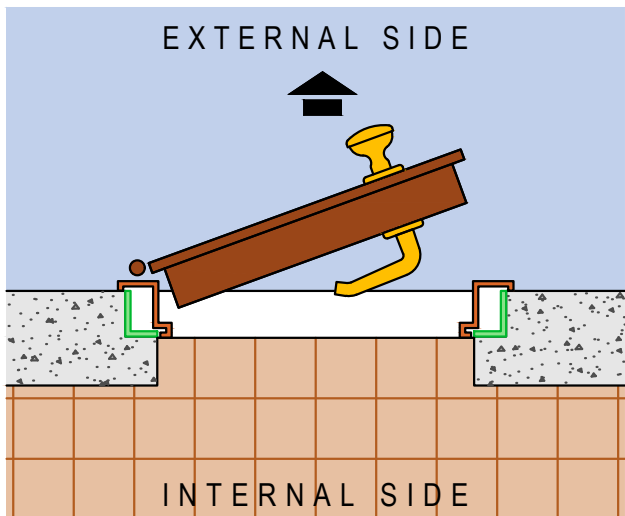

RH Pull door

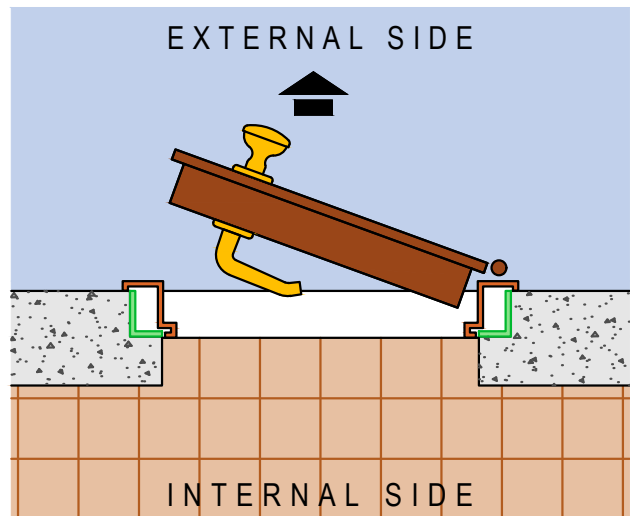

LH Pull door

PULL DOOR ASSEMBLY

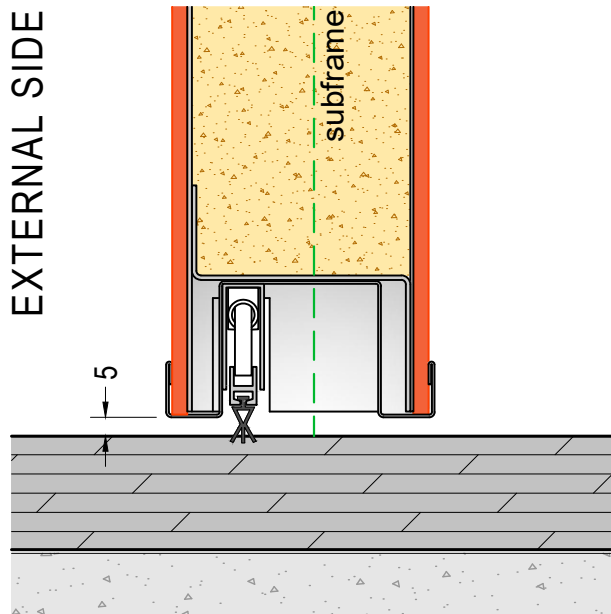

vertical section

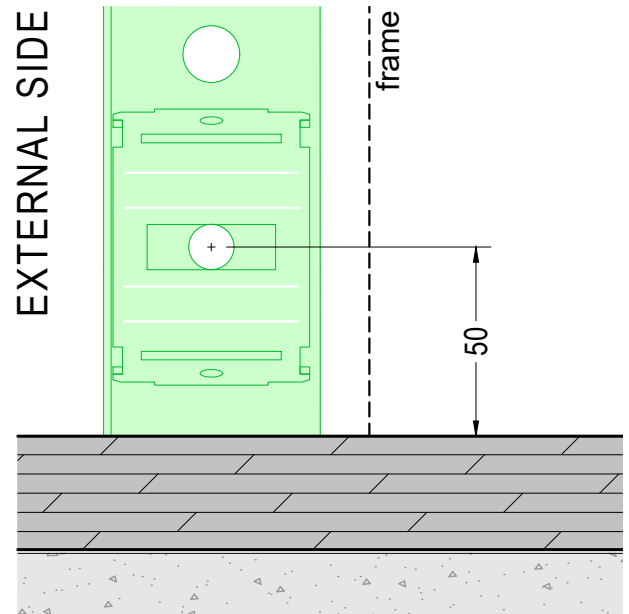

subframe installation

STANDARD DOOR WITH WEATHERSTRIP BAR ON CONTINUOUS FLOORING

SUBFRAME H =2159

ref. DOOR H=2100

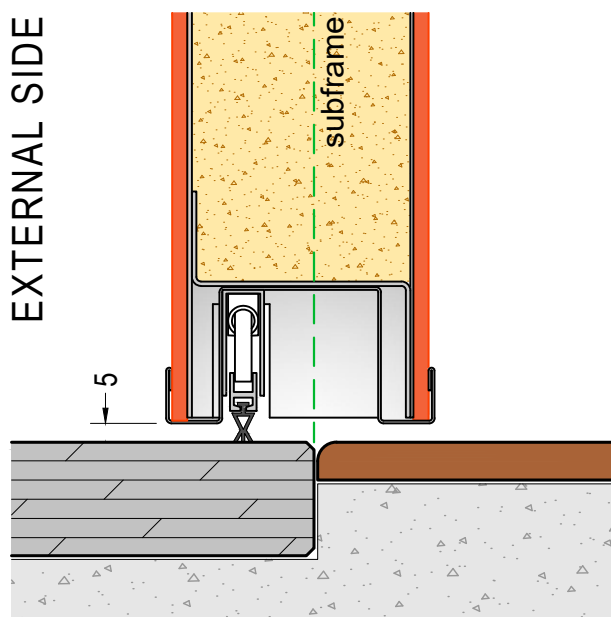

vertical section

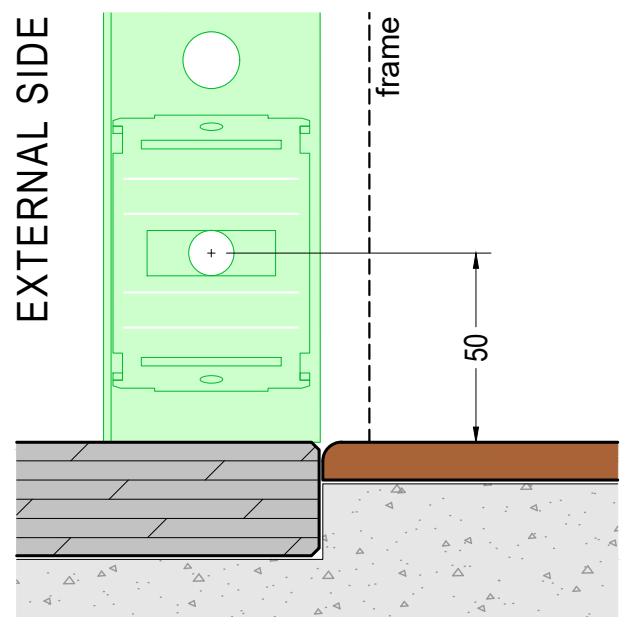

subframe installation

STANDARD DOOR WITH WEATHERSTRIP BAR ON TWO DIFFERENT FLOORINGS

SUBFRAME H =2159

ref. DOOR H=2100



**THRESHOLDS SECTIONS
SUBFRAME INSTALLATION**

1.1

VERTICAL SECTIONS

scale 1:2

v 1.2

DI.BI. PORTE BLINDATE Srl - Fano (PU) ITALY - www.dibigroup.com

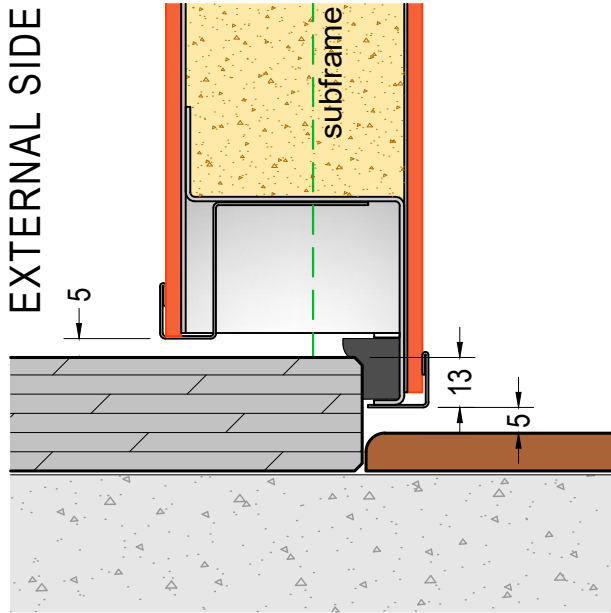

vertical section

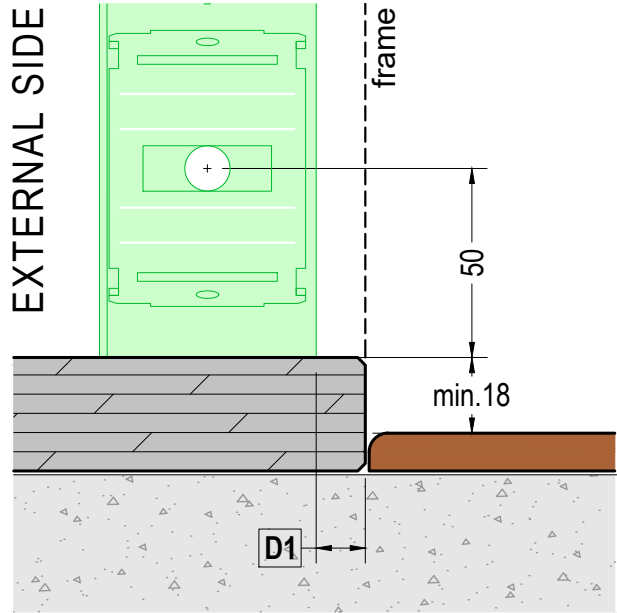

subframe installation

D1=13 mm for Steel Frame
D1=16 mm for Aluminium Frame

DOOR WITH THRESHOLD
SUBFRAME H=2159
ref. DOOR H=2100

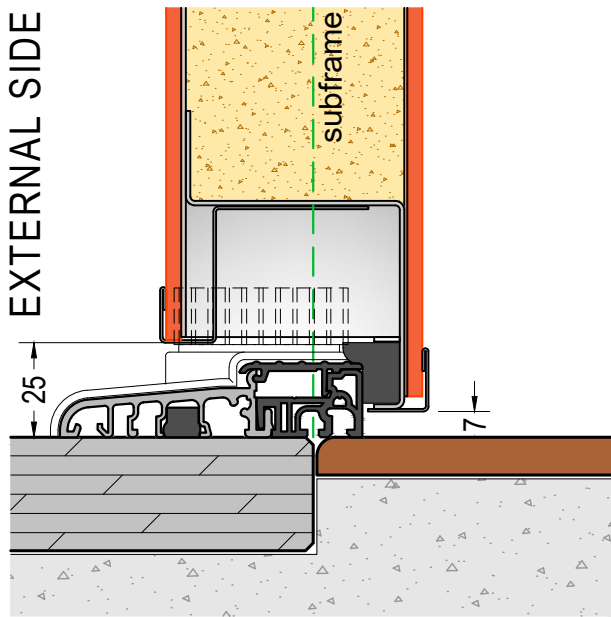

vertical section

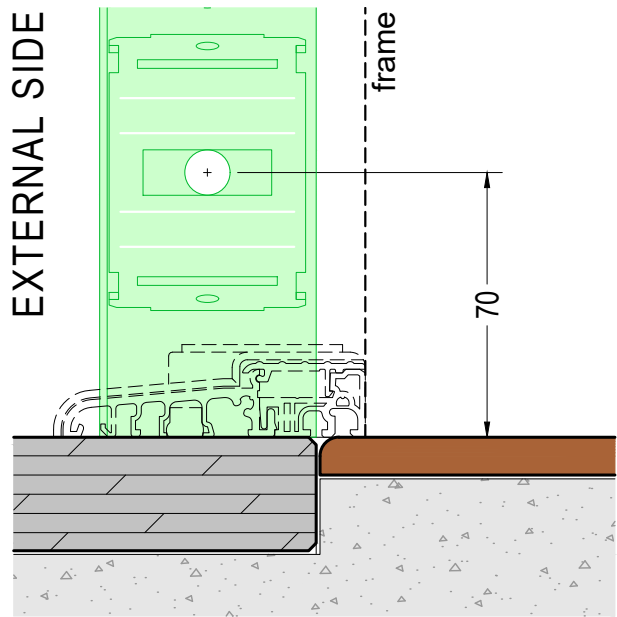

subframe installation

DOOR WITH WATERTIGHT/SOUND/THERMAL BREAK THRESHOLD
SUBFRAME H =2179
ref. DOOR H=2100



THRESHOLDS SECTIONS SUBFRAME INSTALLATION

1.2

VERTICAL SECTIONS
scale 1:2

v 2.3

DI.BI. PORTE BLINDATE Srl - Fano (PU) ITALY - www.dibigroup.com

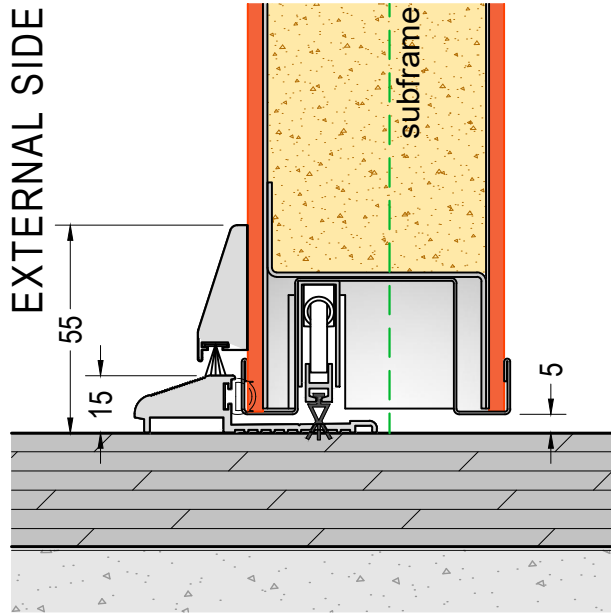

vertical section

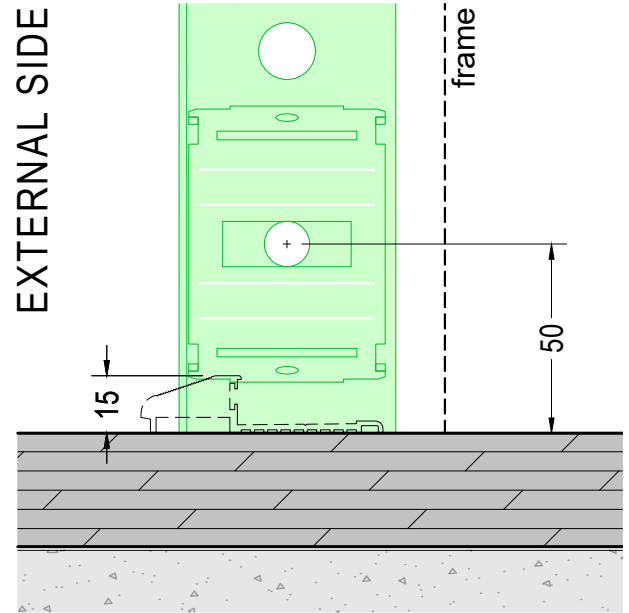

subframe installation

DOOR WITH THRESHOLD, WEATHERSTRIP BAR AND DRIP RAIL FOR STANDARD SUBFRAME ON CONTINUOUS FLOORING
 SUBFRAME H=2159 - ref. DOOR H=2100

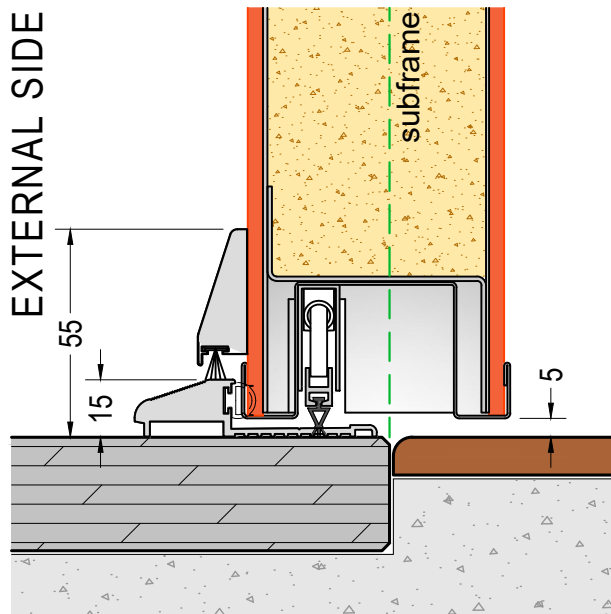

vertical section

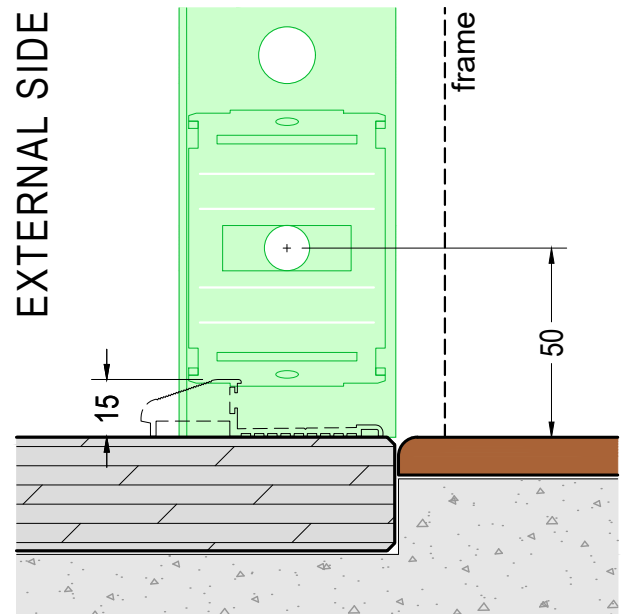

subframe installation

DOOR WITH THRESHOLD, WEATHERSTRIP BAR AND DRIP RAIL FOR STANDARD SUBFRAME ON TWO DIFFERENT FLOORINGS
 SUBFRAME H=2159 - ref. DOOR H=2100



THRESHOLDS SECTIONS
SUBFRAME INSTALLATION

1.3

VERTICAL SECTIONS
 scale 1:2

v 1.2

DI.BI. PORTE BLINDATE Srl - Fano (PU) ITALY - www.dibigroup.com

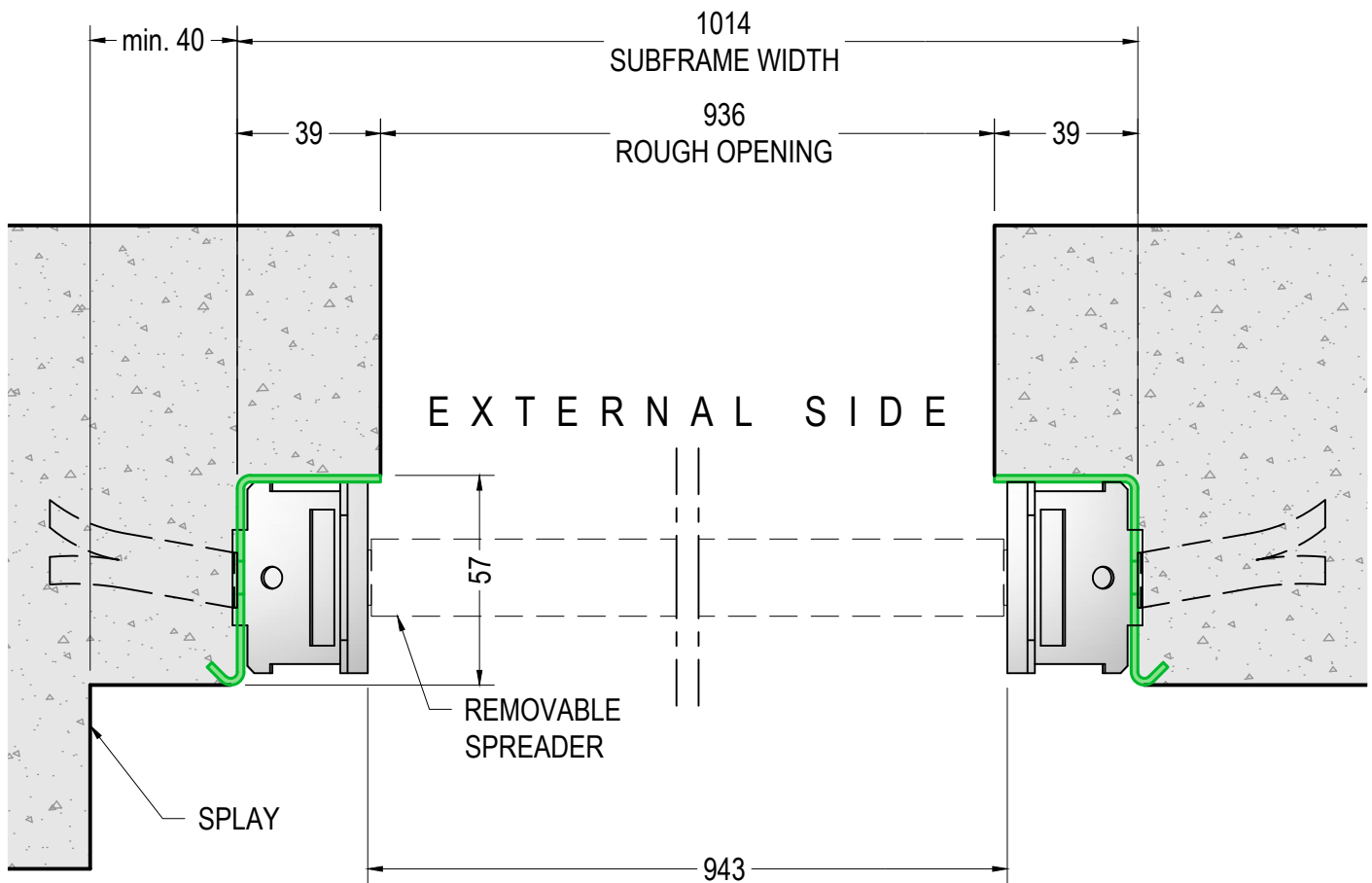

HORIZONTAL SECTION
ref. DOOR W=900

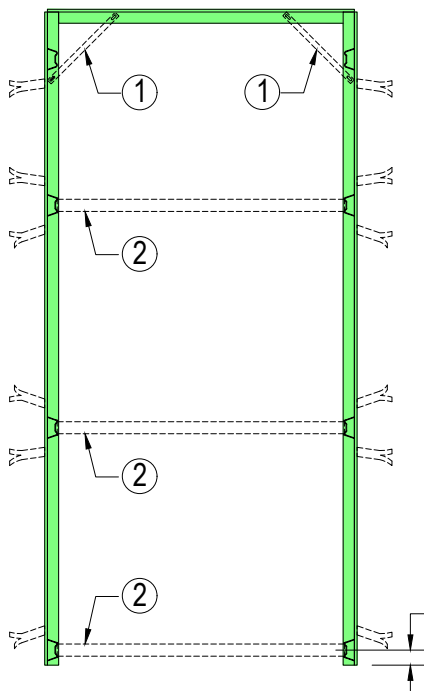

- ① Removable corner gussets
- ② Removable spreaders

INTERNAL SIDE VIEW

**STANDARD SUBFRAME
"CT1"**

2.1

HORIZONTAL SECTION - scale 1:2
INTERNAL SIDE VIEW - scale 1:25

v 4.2

DI.BI. PORTE BLINDATE Srl - Fano (PU) ITALY - www.dibigroup.com

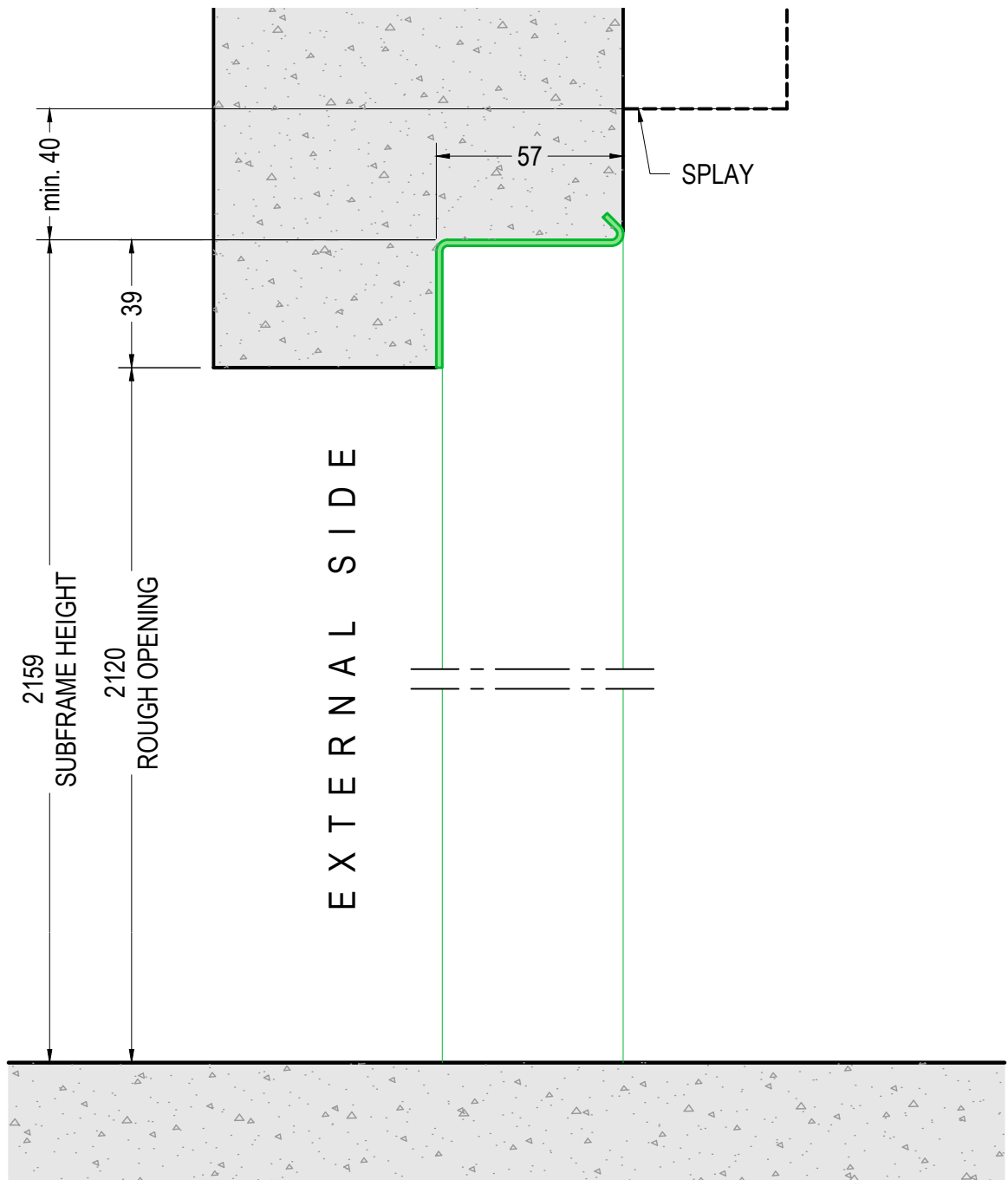

VERTICAL SECTION
ref. DOOR H=2100



**STANDARD SUBFRAME
"CT1"**

2.2

VERTICAL SECTION
scale 1:2

v 4.2

DI.BI. PORTE BLINDATE Srl - Fano (PU) ITALY - www.dibigroup.com

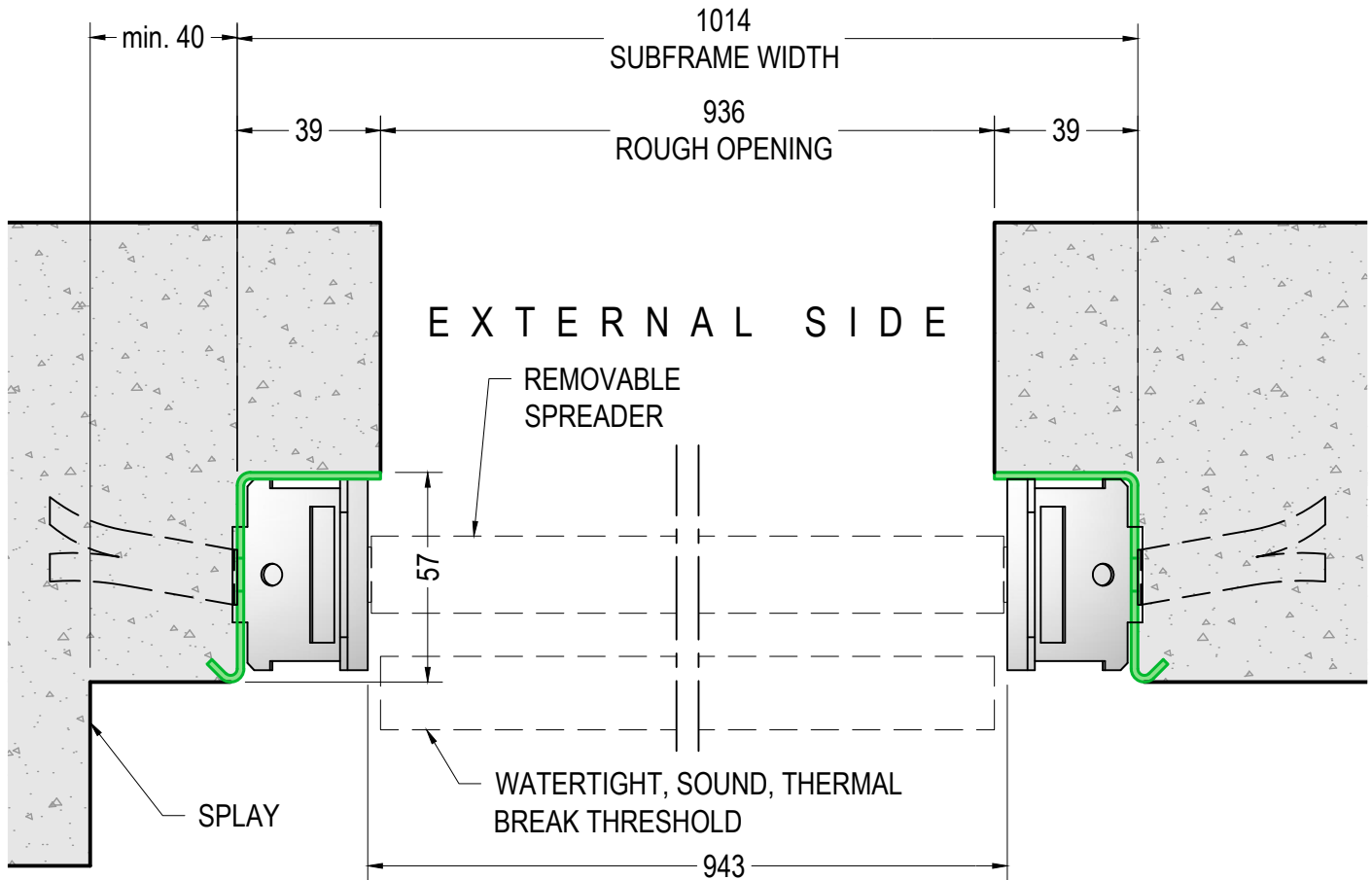

HORIZONTAL SECTION
ref. DOOR W=900

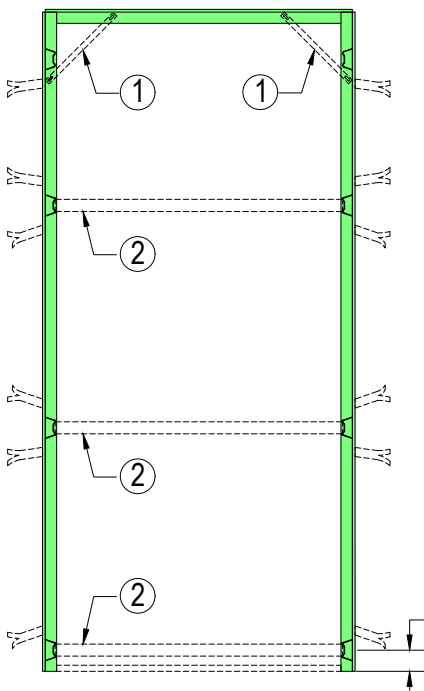

- ① Removable corner gussets
- ② Removable spreaders

70 (*) Verification of the measure for watertight, sound, thermal break threshold (with standard subframe "CT1" has to be 50mm)

INTERNAL SIDE VIEW



SUBFRAME "CT1" with watertight / sound / thermal break threshold

2.3

HORIZONTAL SECTION - scale 1:2
INTERNAL SIDE VIEW - scale 1:25

v 4.1

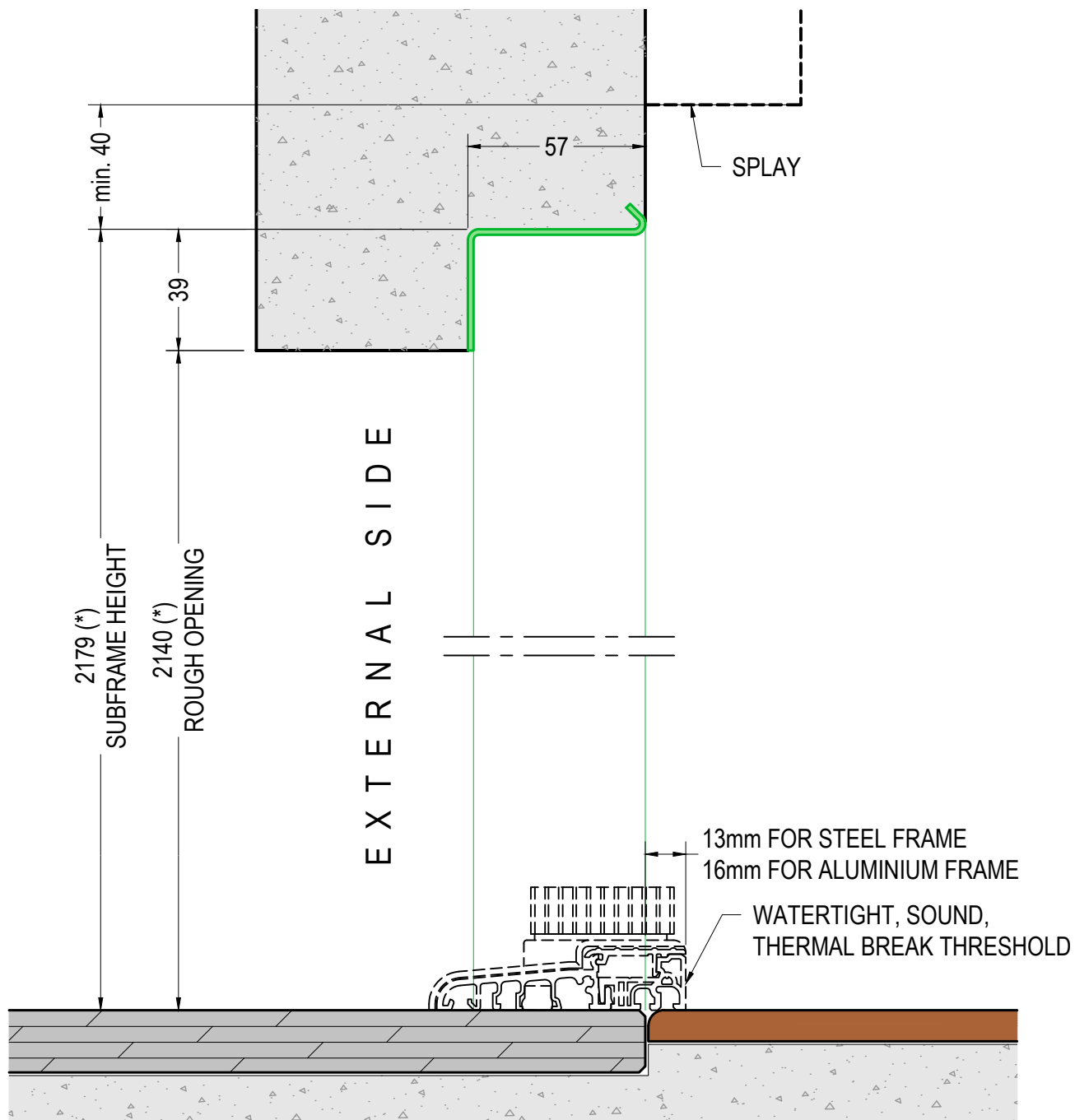

VERTICAL SECTION

ref. DOOR H=2100

* Standard subframe "CT1" dimensions increased by 20mm for watertight/sound threshold (see table 1.2 Thresholds Sections)



**SUBFRAME "CT1" with watertight/
sound/ thermal break threshold**

2.4

VERTICAL SECTION

scale 1:2

v 4.2

DI.BI. PORTE BLINDATE Srl - Fano (PU) ITALY - www.dibigroup.com

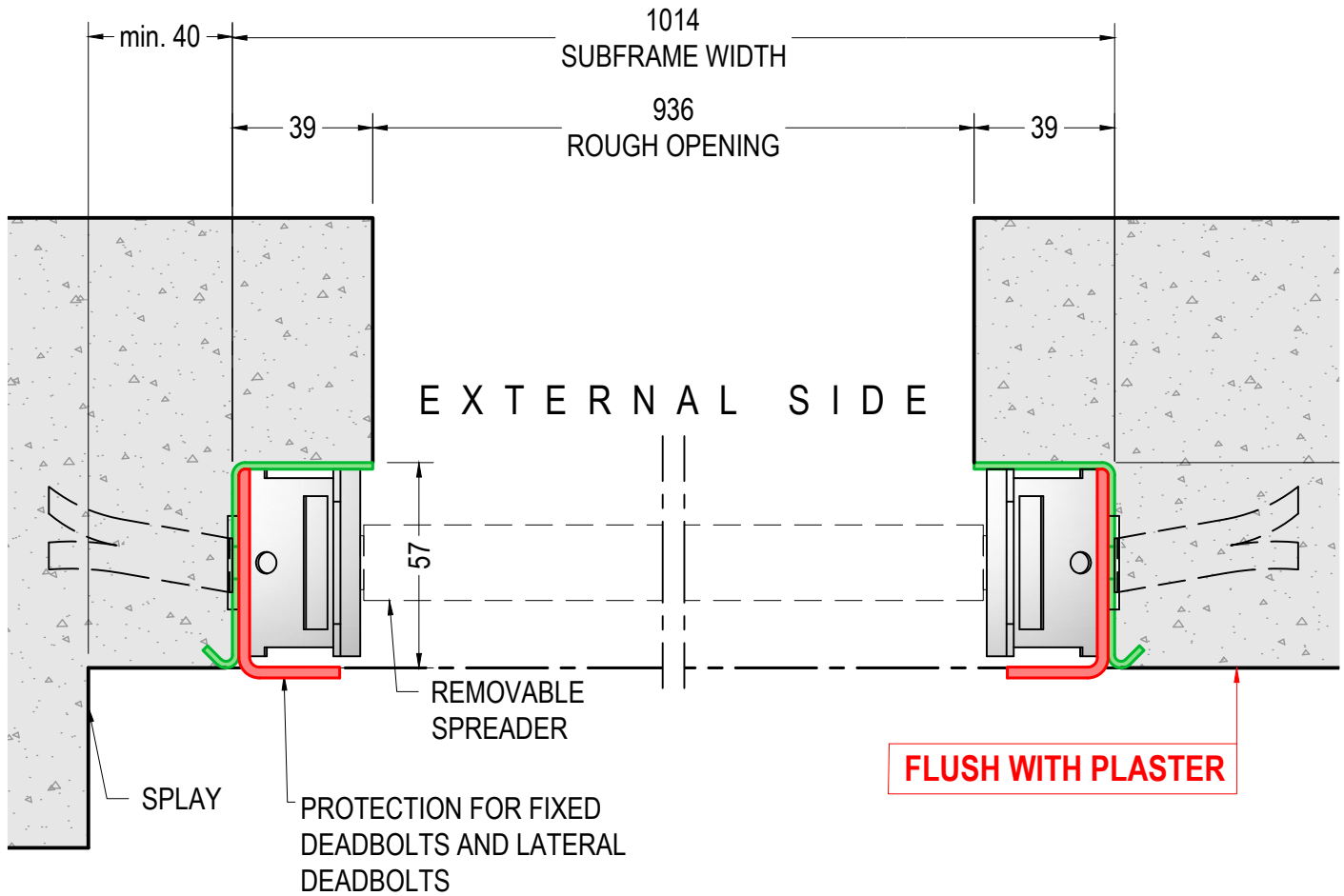

HORIZONTAL SECTION
ref. DOOR W=900

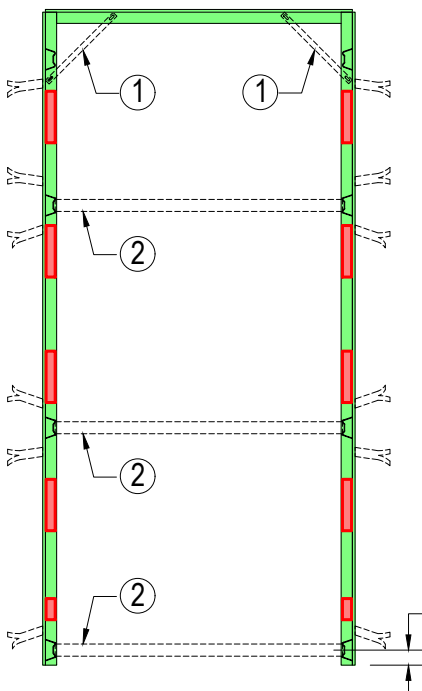

- ① Removable corner gussets
- ② Removable spreaders

**NOTICE! FLUSH WITH THE PLASTER
INSTALLATION AT 45° ANGLE EDGE
OF THE SUBFRAME**

INTERNAL SIDE VIEW



**SUBFRAME "CT1" FOR "884"
SECURITY DOOR**

2.5

HORIZONTAL SECTION - scale 1:2
INTERNAL SIDE VIEW - scale 1:25

v 4.3

DI.BI. PORTE BLINDATE Srl - Fano (PU) ITALY - www.dibigroup.com

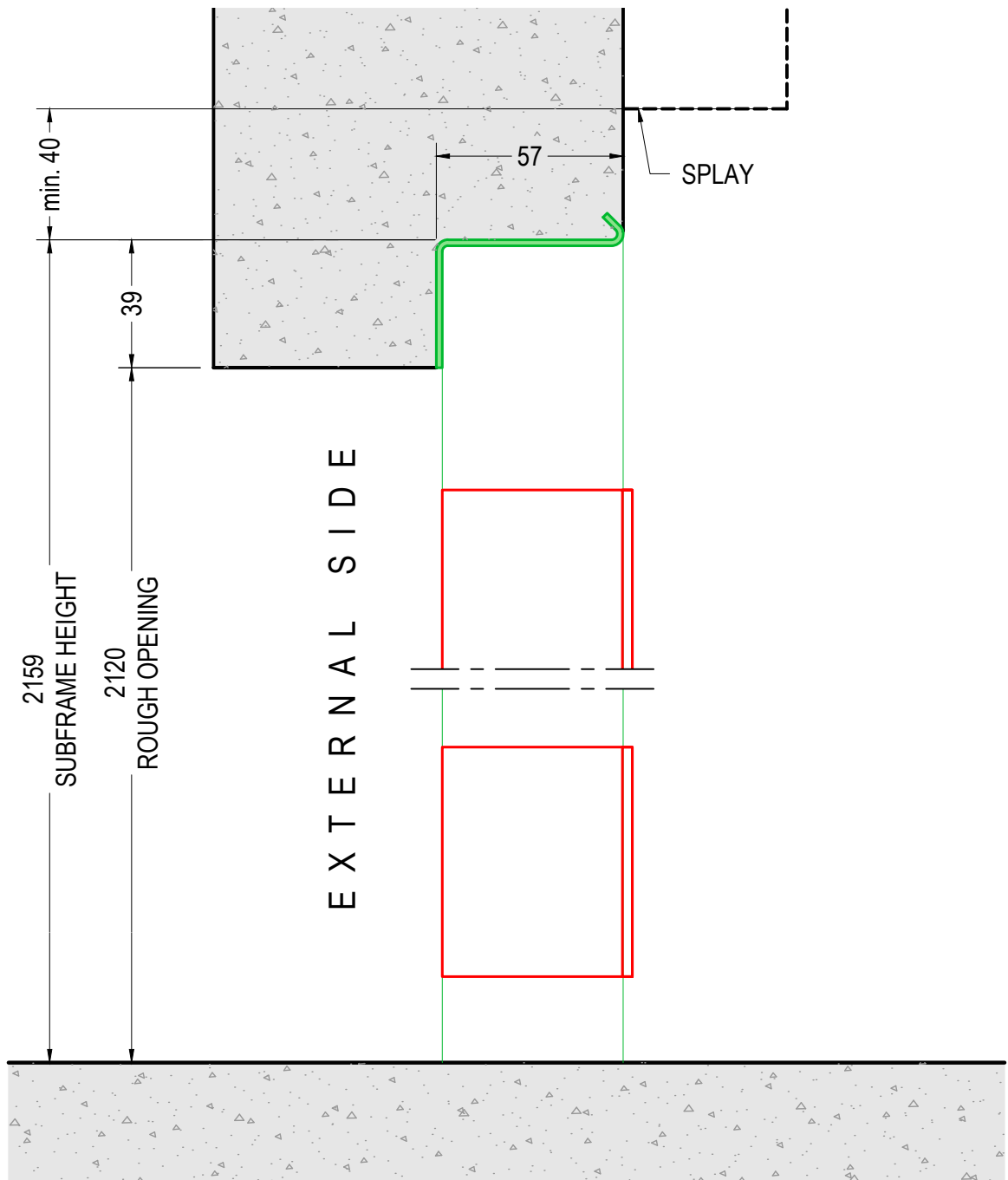

VERTICAL SECTION
ref. DOOR H=2100



**SUBFRAME "CT1" FOR "884"
SECURITY DOOR**

2.6

VERTICAL SECTION
scale 1:2

v 4.3

DI.BI. PORTE BLINDATE Srl - Fano (PU) ITALY - www.dibigroup.com

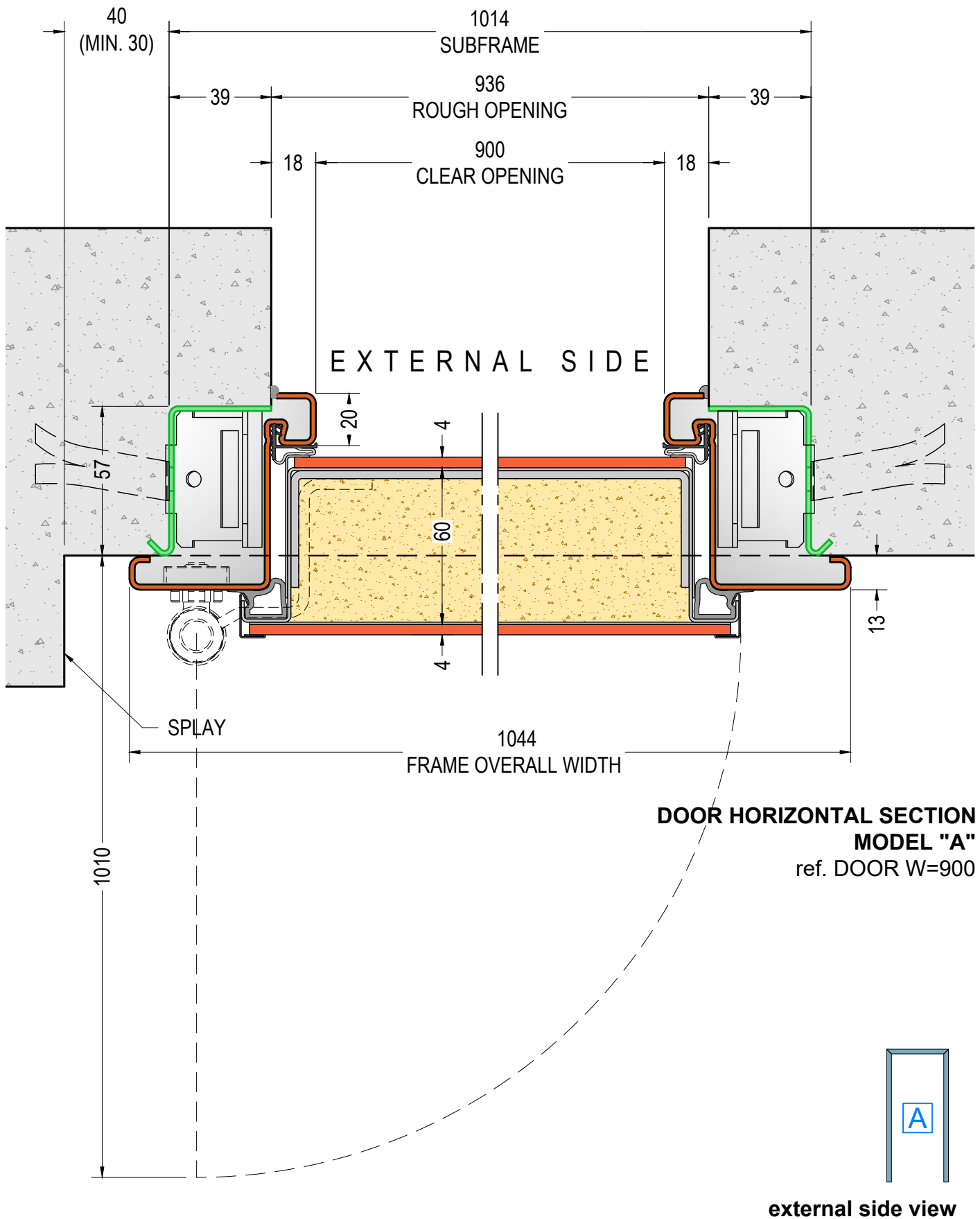

**STANDARD SUBFRAME "CT1" WITH
STANDARD FRAME – Solution 1**

3.1

HORIZONTAL SECTION
scale 1:2

v 4.3

DI.BI. PORTE BLINDATE Srl - Fano (PU) ITALY - www.dibigroup.com

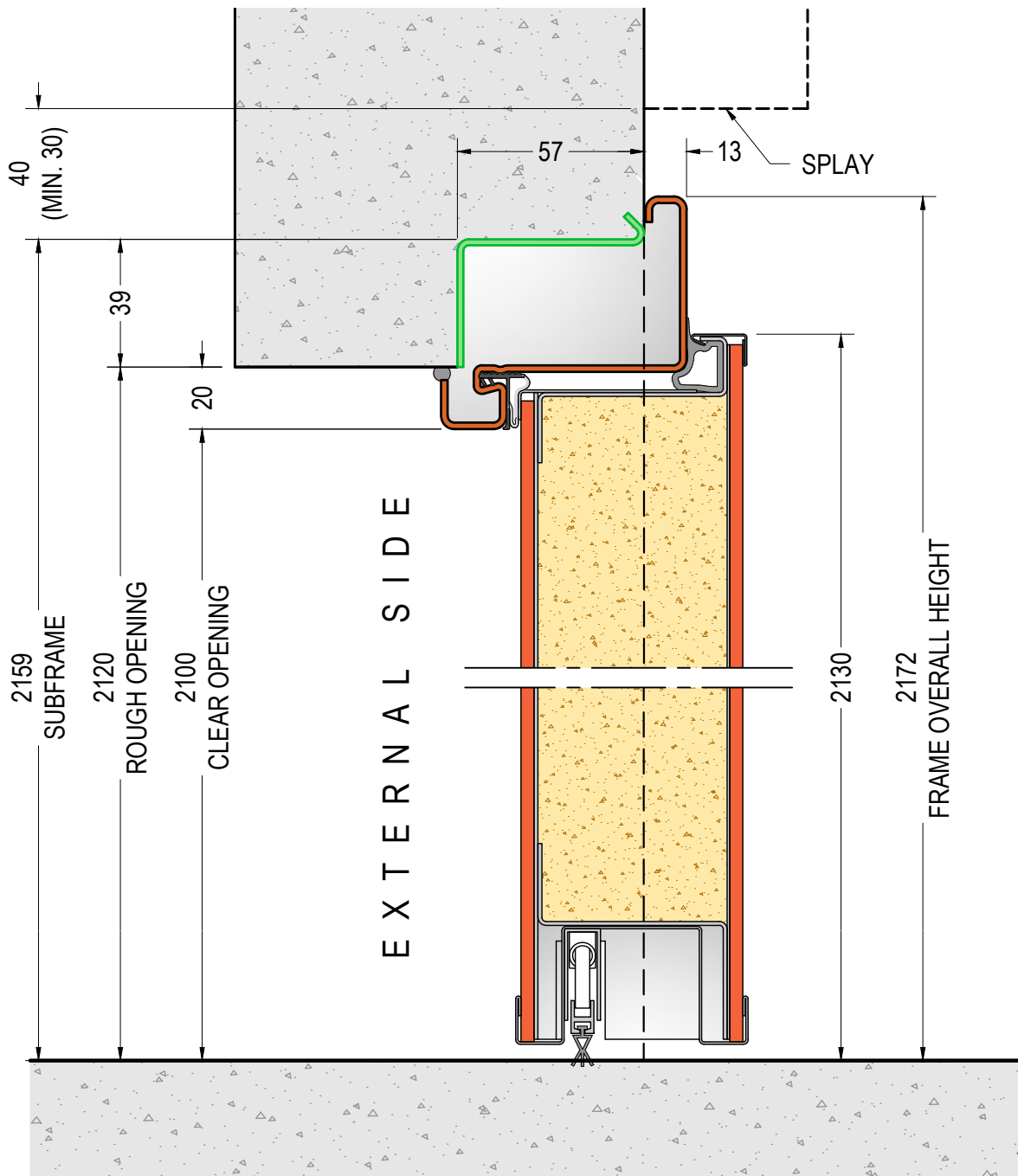

**DOOR VERTICAL SECTION
MODEL "A"**
ref. DOOR H=2100

DOOR DIMENSIONS:
W=min.700 - max.2000
H=min.2000 - max.2700



external side view



**STANDARD SUBFRAME "CT1" WITH
STANDARD FRAME – Solution 1**

3.2

VERTICAL SECTION
scale 1:2

v 4.3

DI.BI. PORTE BLINDATE Srl - Fano (PU) ITALY - www.dibigroup.com

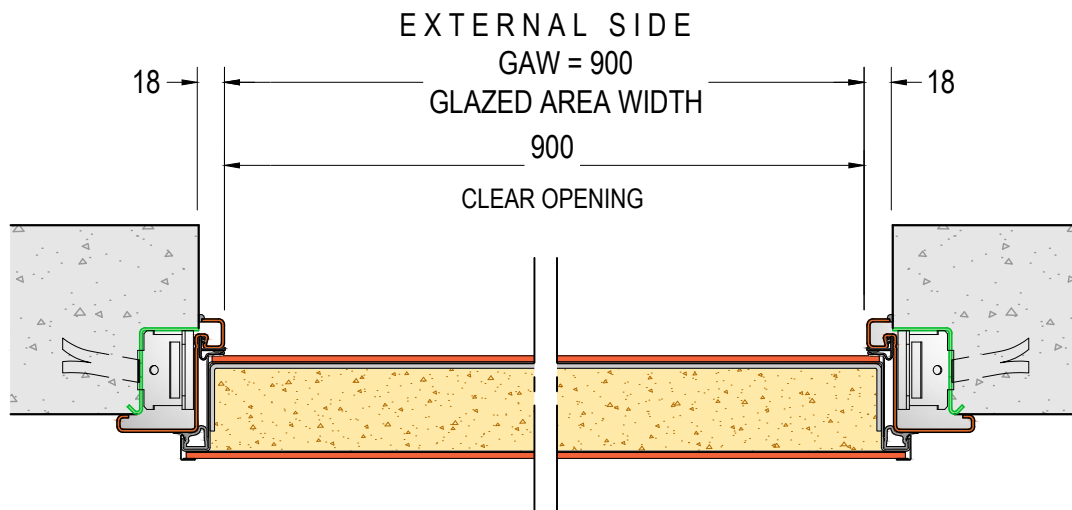

**DOOR HORIZONTAL SECTION
MODEL "B"**

ref. DOOR W=900 - GLAZED AREA WIDTH GAW=900

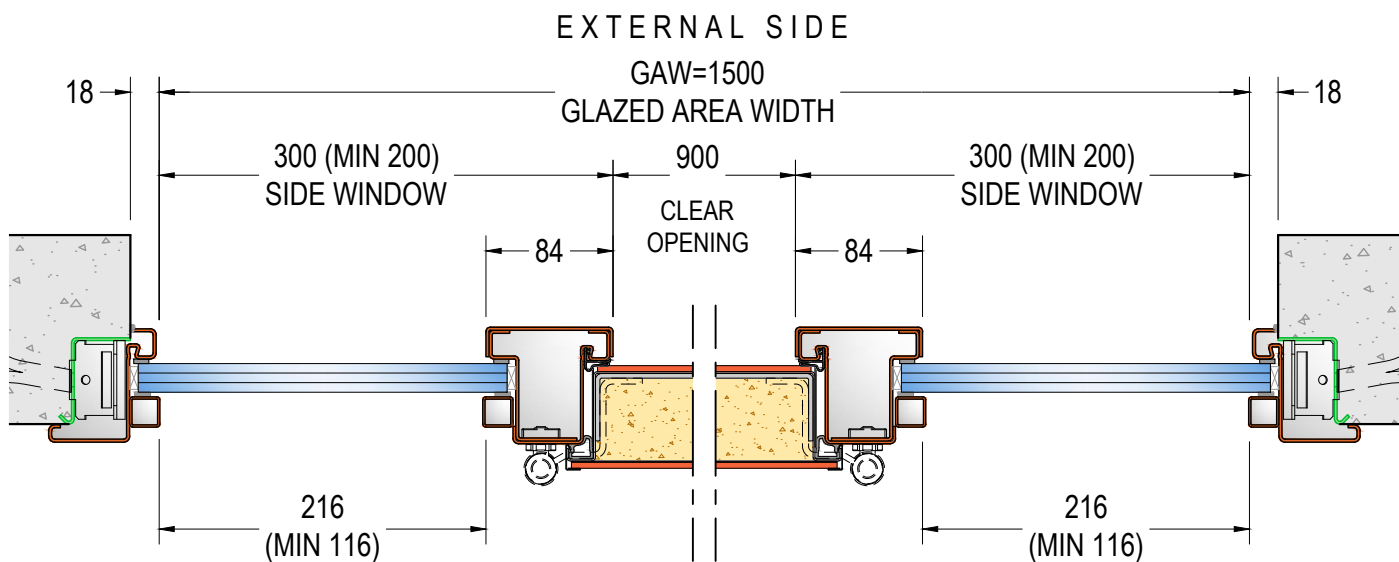

**DOOR HORIZONTAL SECTION
MODELS "E-F"**

ref. DOOR W=900 - SIDE WINDOW 300
GLAZED AREA WIDTH GAW=1500

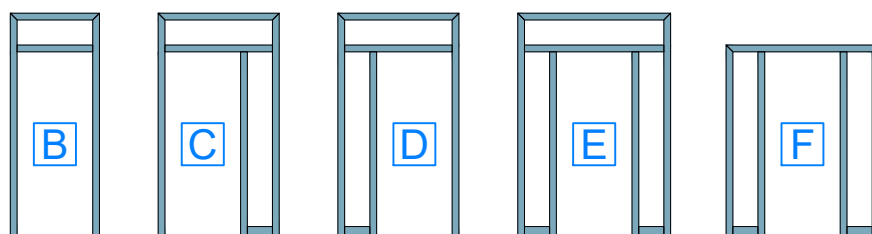

external side view



**STANDARD SUBFRAME "CT1" WITH
STANDARD FRAME – Solution 1**

3.3

HORIZONTAL SECTIONS

scale 1:5

v 4.1

DI.BI. PORTE BLINDATE Srl - Fano (PU) ITALY - www.dibigroup.com

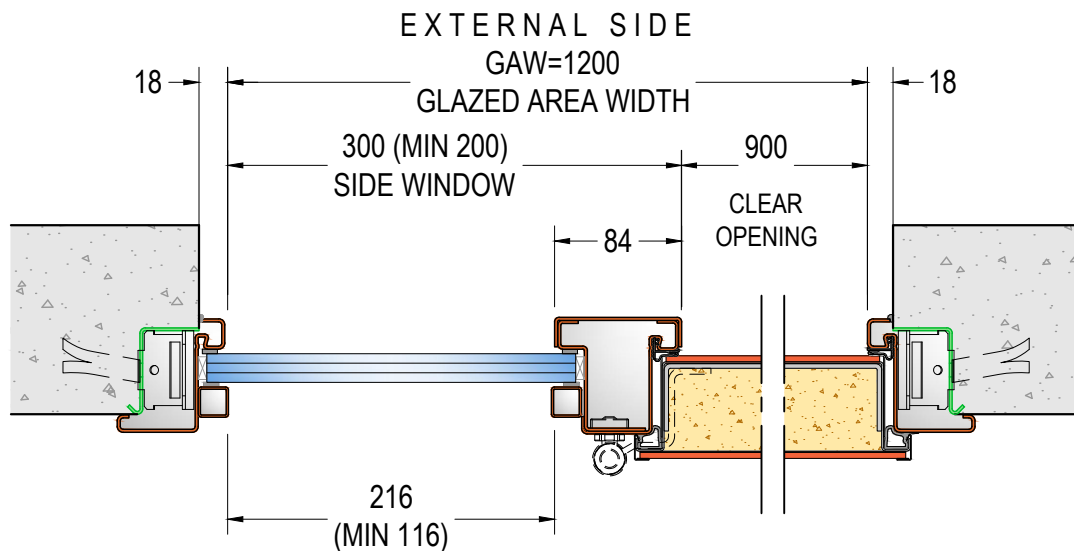

**DOOR HORIZONTAL SECTION
MODELS "C-G"**

ref. DOOR W=900 - SIDE WINDOW 300
GLAZED AREA WIDTH GAW=1200

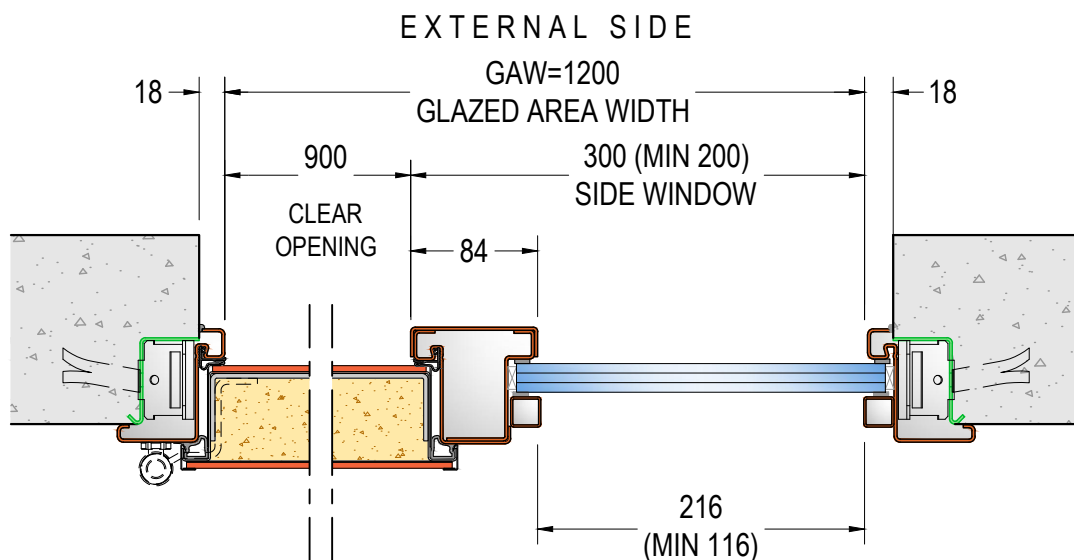

**DOOR HORIZONTAL SECTION
MODELS "D-H"**

ref. DOOR W=900 - SIDE WINDOW 300
GLAZED AREA WIDTH GAW=1200

GLAZED AREA:
MAXIMUM OVERALL DIMENSIONS
(GAWxGAH)
2000x2850 model B
1800x2850 models C-D-E
2850x2700 models F-G-H

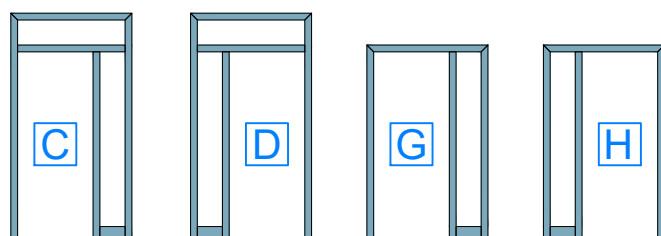

external side view



**STANDARD SUBFRAME "CT1" WITH
STANDARD FRAME – Solution 1**

3.4

HORIZONTAL SECTIONS

scale 1:5

v 4.1

EXTERNAL SIDE

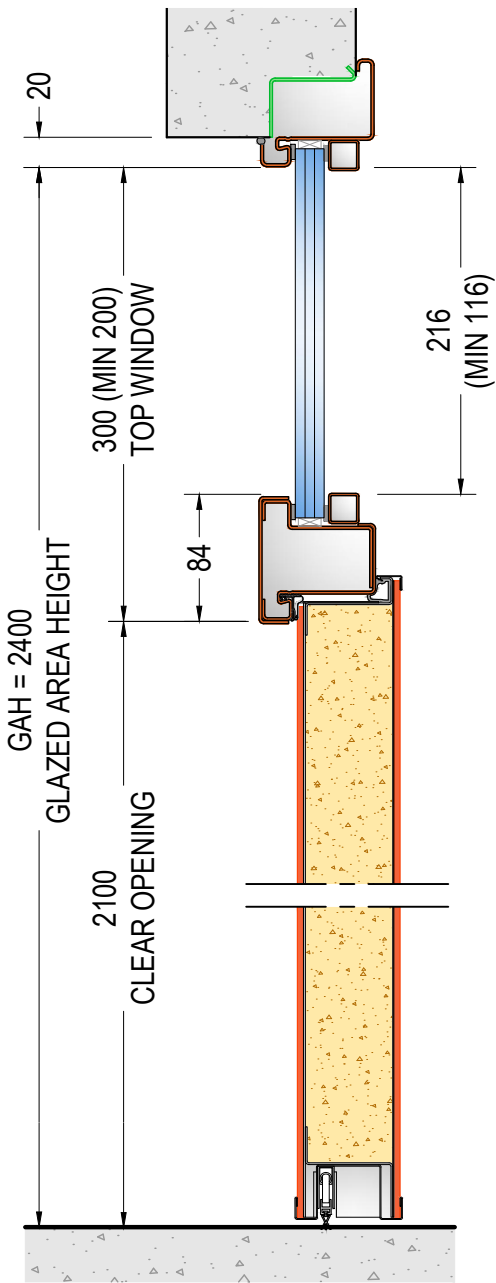

**DOOR VERTICAL SECTION
MODELS "B-C-D-E"**

ref. DOOR H=2100 - TOP WINDOW 300
GLAZED AREA HEIGHT GAH=2400

EXTERNAL SIDE

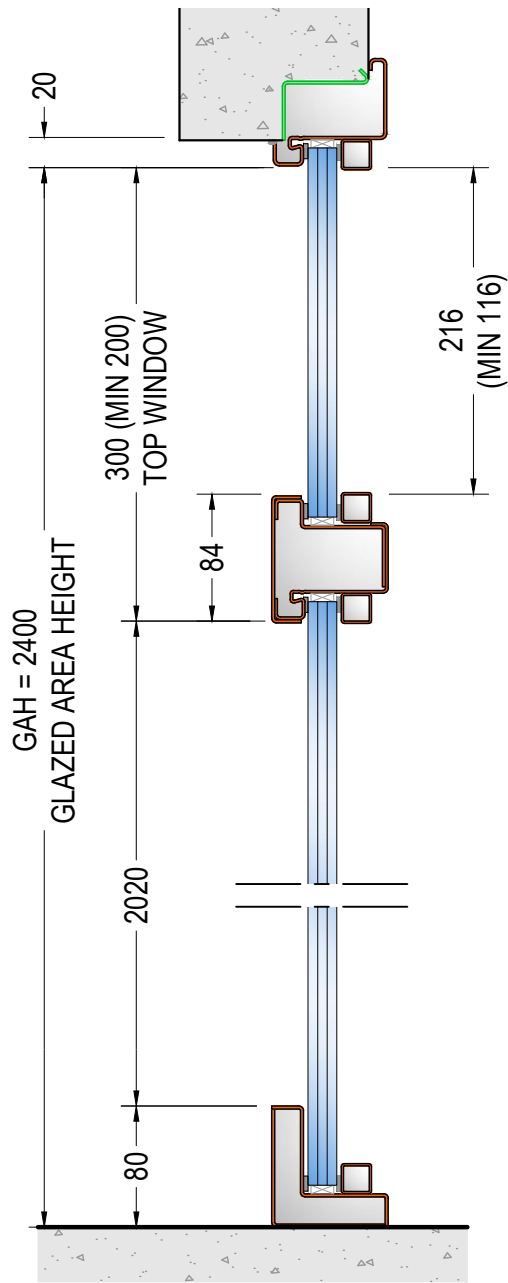

**SIDE WINDOW VERTICAL SECTION
MODELS "C-D-E"**

ref. DOOR H=2100 - TOP WINDOW 300
GLAZED AREA HEIGHT GAH=2400

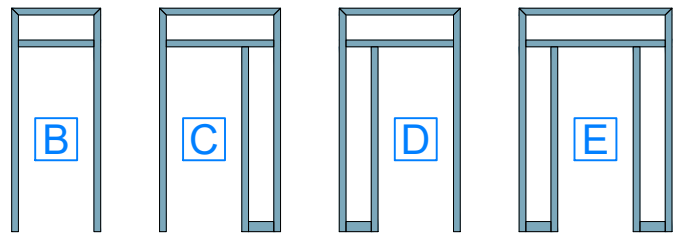

external side view



**STANDARD SUBFRAME "CT1" WITH
STANDARD FRAME – Solution 1**

3.5

VERTICAL SECTIONS
scale 1:2

v 4.1

DI.BI. PORTE BLINDATE Srl - Fano (PU) ITALY - www.dibigroup.com

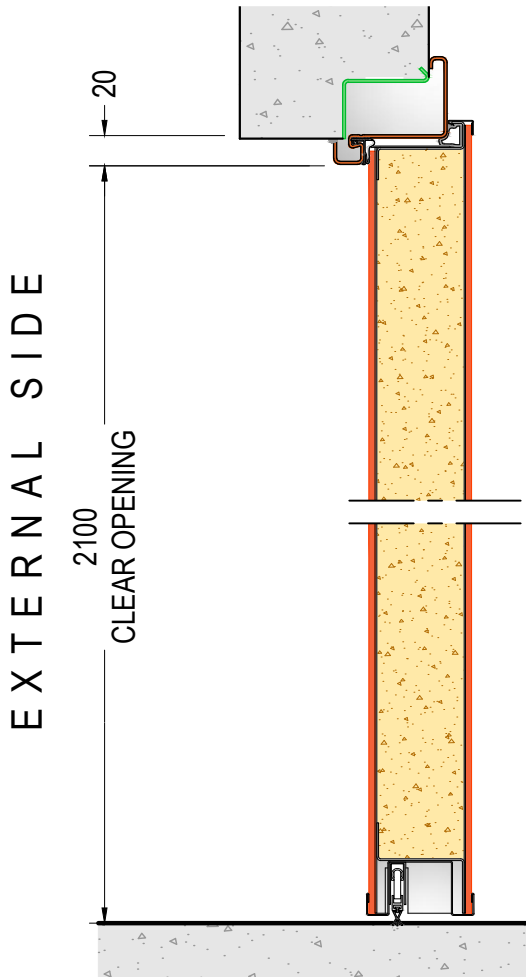

DOOR VERTICAL SECTION
MODELS "F-G-H"
 ref. DOOR H=2100
 GLAZED AREA HEIGHT GAH=2100

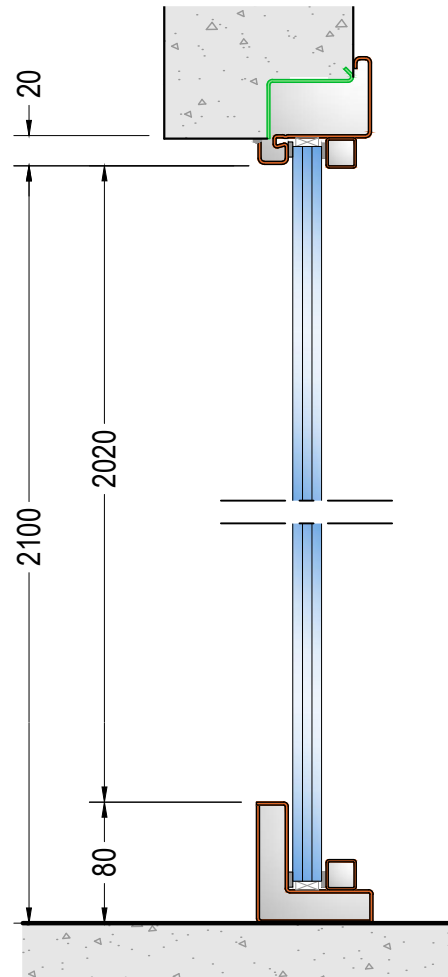

SIDE WINDOW VERTICAL SECTION
MODELS "F-G-H"
 ref. DOOR H=2100
 GLAZED AREA HEIGHT GAH=2100

GLAZED AREA:
 MAXIMUM OVERALL DIMENSIONS
 (GAWxGAH)
 2000x2850 model B
 1800x2850 models C-D-E
 2850x2700 models F-G-H

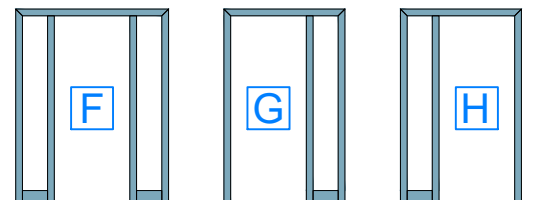

external side view



**STANDARD SUBFRAME "CT1" WITH
 STANDARD FRAME – Solution 1**

3.6

VERTICAL SECTIONS
 scale 1:2

v 4.1

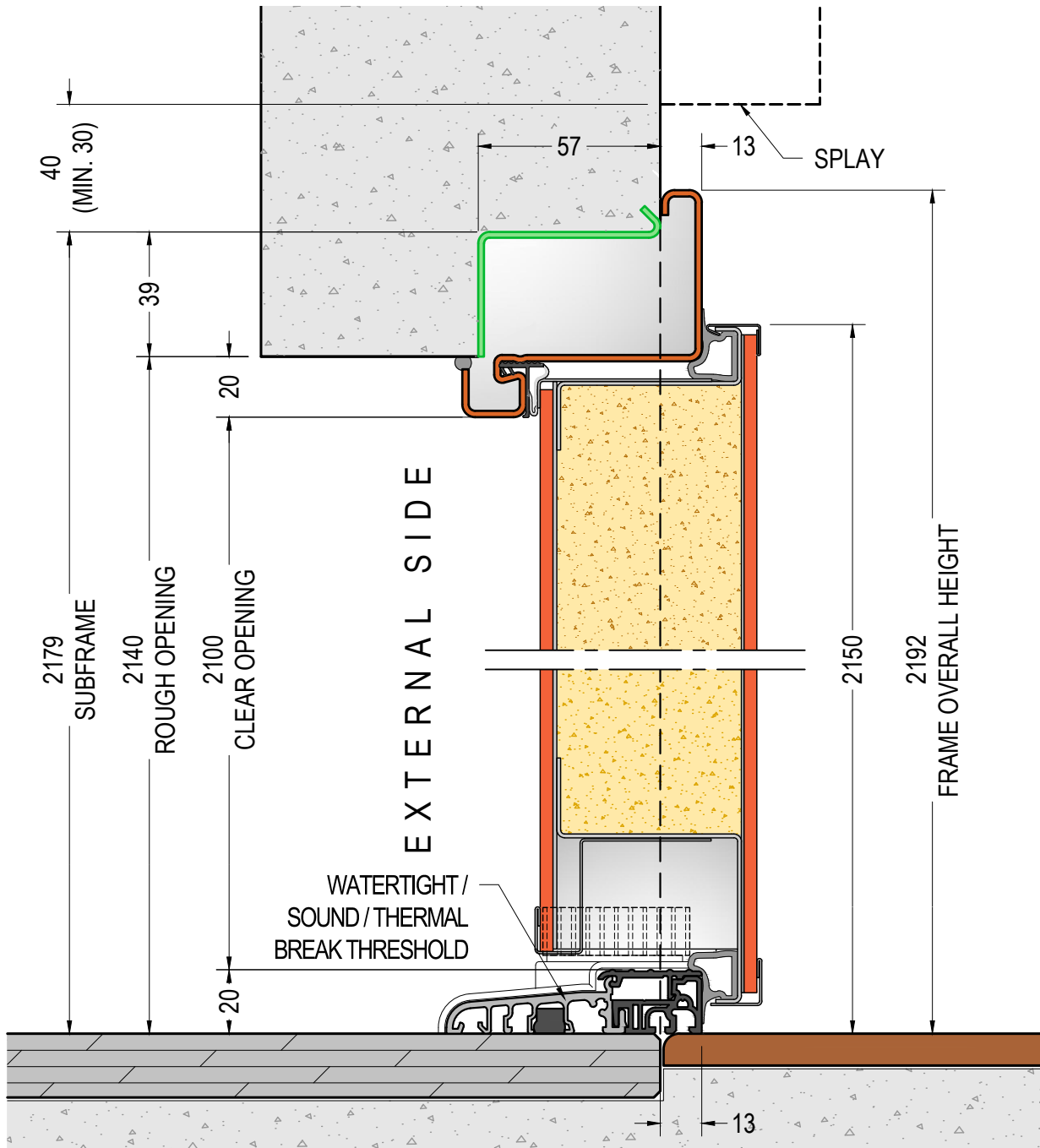

DOOR VERTICAL SECTION
MODELS "A-F-G-H"
 ref. DOOR H=2100

DOOR DIMENSIONS:
 W=min.700 - max.2000
 H=min.2000 - max.2700

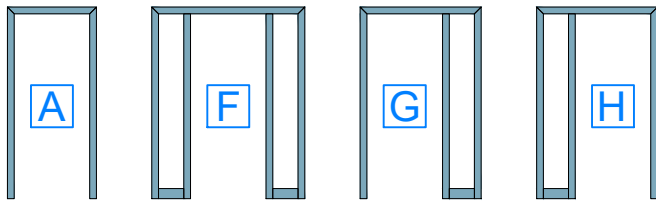

external side view



**STANDARD SUBFRAME "CT1" AND
 STANDARD FRAME WITH WATERTIGHT /
 SOUND / THERMAL BREAK THRESHOLD - Sol. 6, 6a, 6b**

3.7

VERTICAL SECTION - scale 1:2

v 4.3

DI.BI. PORTE BLINDATE Srl - Fano (PU) ITALY - www.dibigroup.com

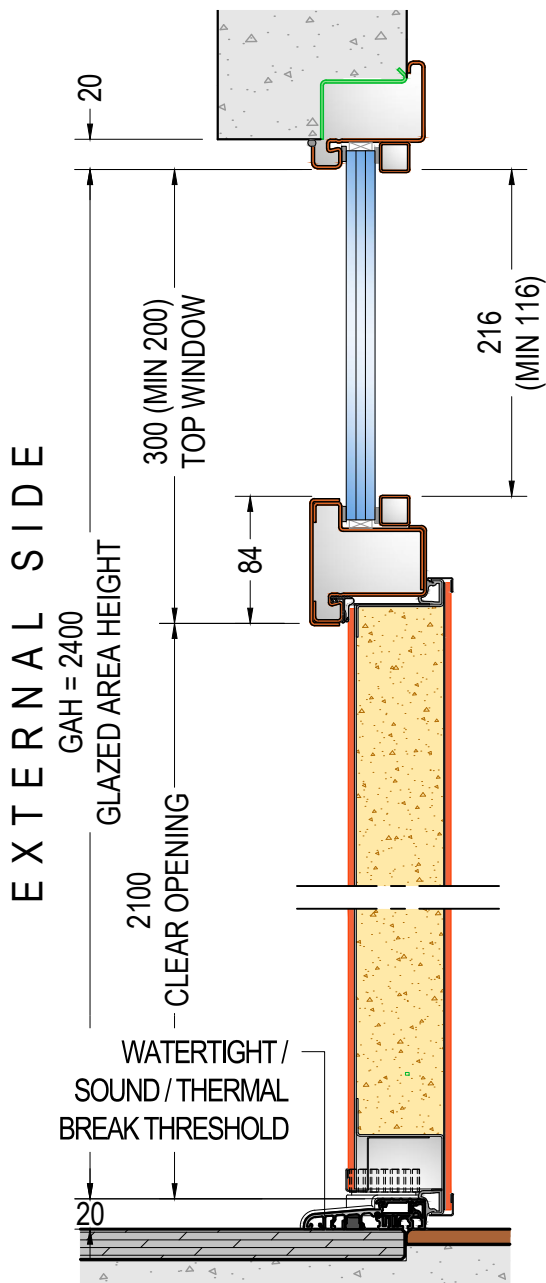

EXTERNAL SIDE

**DOOR VERTICAL SECTION
MODELS "B-C-D-E"**
ref. DOOR H=2100 - TOP WINDOW 300
GLAZED AREA HEIGHT GAH=2400

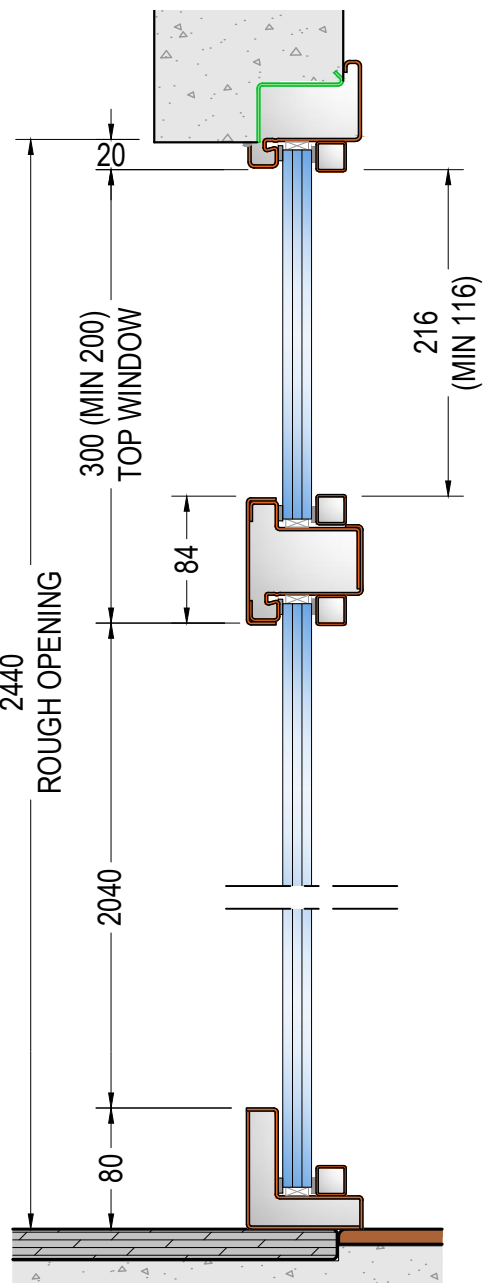

EXTERNAL SIDE

**SIDE WINDOW VERTICAL SECTION
MODELS "C-D-E"**
ref. DOOR H=2100 - TOP WINDOW 300

GLAZED AREA:
MAXIMUM OVERALL DIMENSIONS
(GAWxGAH)
2000x2850 model B
1800x2850 models C-D-E
2850x2700 models F-G-H

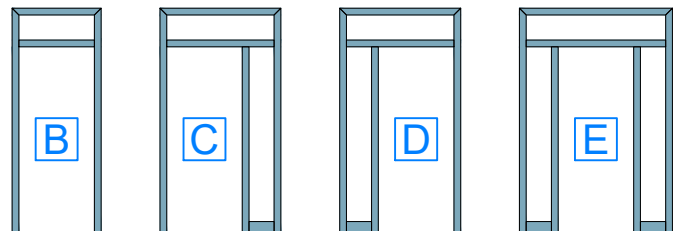

external side view



**STANDARD SUBFRAME "CT1" AND
STANDARD FRAME WITH WATERTIGHT /
SOUND / THERMAL BREAK THRESHOLD - Sol. 6 ,6a, 6b**

3.8

VERTICAL SECTIONS - scale 1:5

v 4.3

DI.BI. PORTE BLINDATE Srl - Fano (PU) ITALY - www.dibigroup.com

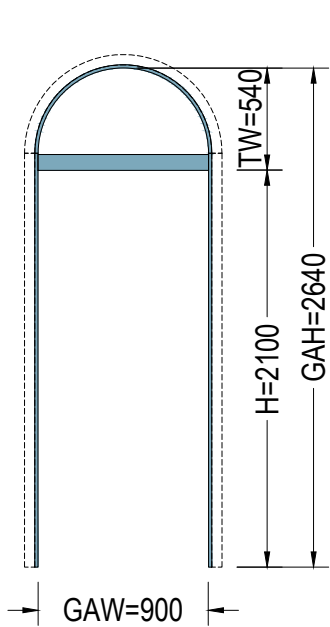

external side view
mod. "B"

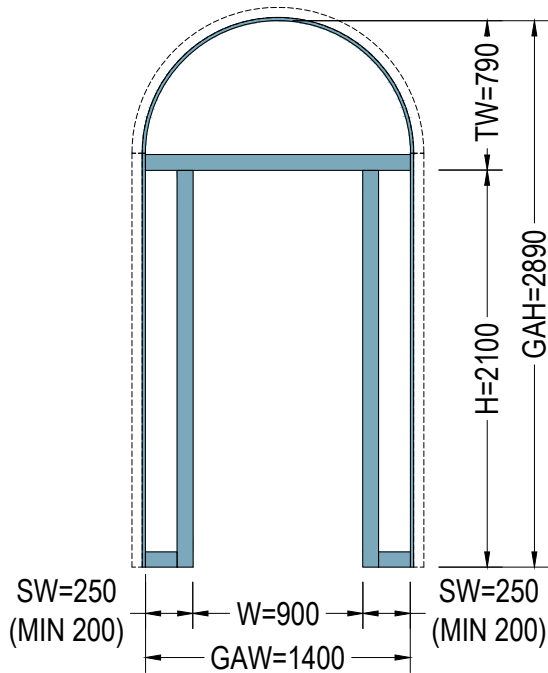

external side view
mod. "E"

mod. "B"

ref. DOOR 900x2100 (WxH)
TOP WINDOW 540 (TW)
GLAZED AREA 900x2640
(GAWxGAH)

mod. "E"

ref. DOOR W= 900x2100 (WxH)
TOP WINDOW 790 (TW)
SIDE WINDOW 250 (SW)
GLAZED AREA 1400x2890
(GAWxGAH)

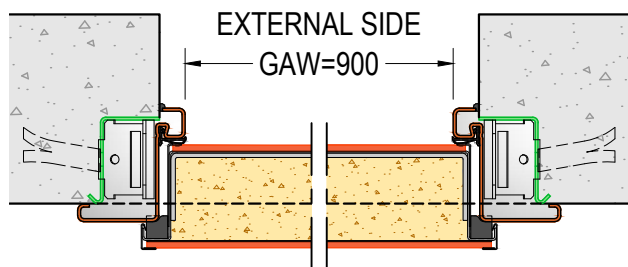

horizontal section
mod. "B"

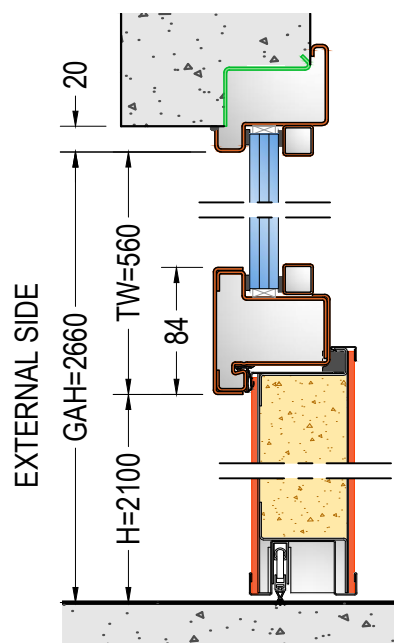

vertical section
mod. "B"

GLAZED AREA:
MAXIMUM OVERALL DIMENSIONS
1800x2850 (GAWxGAH)

TOP WINDOW
FIXED DIMENSIONS:
TW=GAW/2+90

note: Top window dimensions in frame models
with round arched top window are set by glazed
area width.

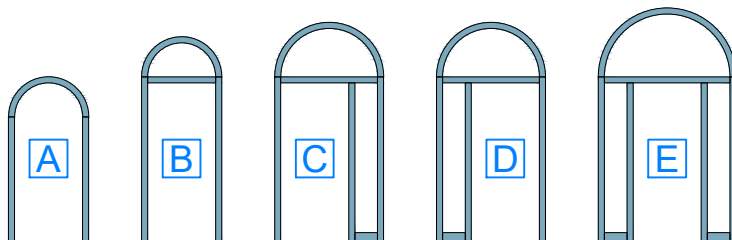

external side view

**STANDARD SUBFRAME "CT1"
WITH STANDARD FRAME**

3.9

ROUND ARCHED TOP WINDOW SCHEMES

scale 1:5 1:40 1:100

v 3.2

DI.BI. PORTE BLINDATE Srl - Fano (PU) ITALY - www.dibigroup.com



SICUREZZA & DESIGN

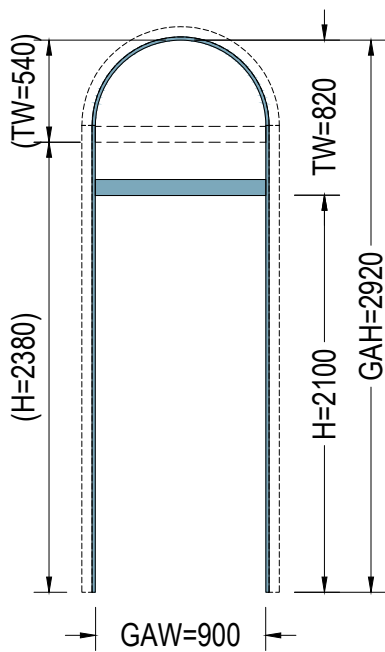

external side view
mod. "B"

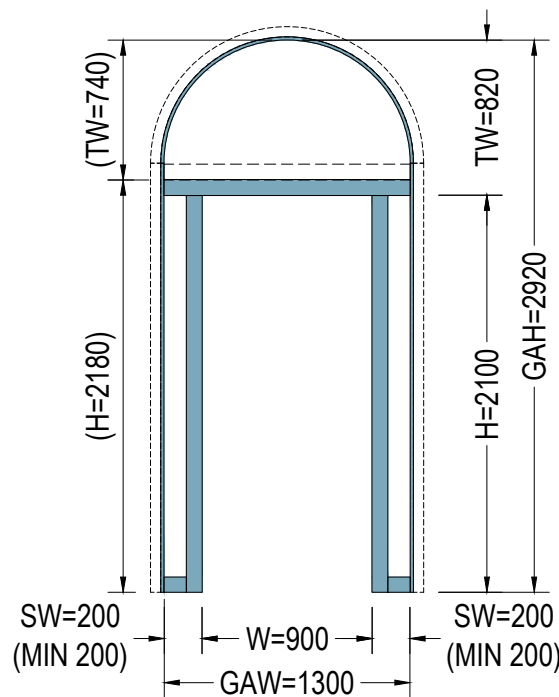

external side view
mod. "E"

mod. "B"

ref. DOOR 900x2100/2380 (WxH)
TOP WINDOW 820/540 (TW)
GLAZED AREA 900x2920
(GAWxGAH)

mod. "E"

ref. DOOR W= 900x2100/2180 (WxH)
TOP WINDOW 820/740 (TW)
SIDE WINDOW 200 (SW)
GLAZED AREA 1300x2920
(GAWxGAH)

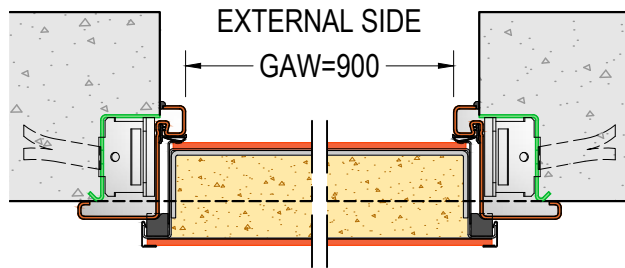

horizontal section
mod. "B"

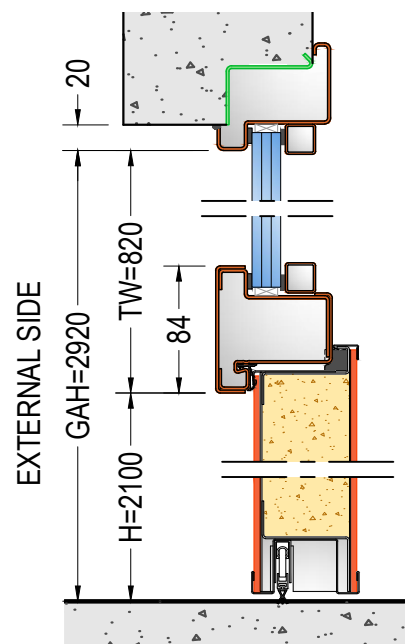

vertical section
mod. "B"

GLAZED AREA:
MAXIMUM OVERALL DIMENSIONS
1800x2850 (GAWxGAH)

TOP WINDOW
MINIMUM DIMENSIONS:
 $TW = GAW/2 + 90$

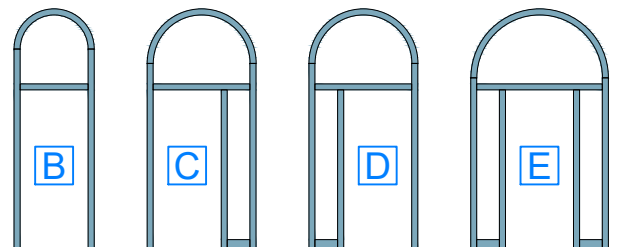

external side view



STANDARD SUBFRAME "CT1" 3.10
WITH STANDARD FRAME

STILTED ROUND ARCHED TOP WINDOW
SCHEMES - scale 1:5 1:40 1:100

v 3.2

DI.BI. PORTE BLINDATE Srl - Fano (PU) ITALY - www.dibigroup.com

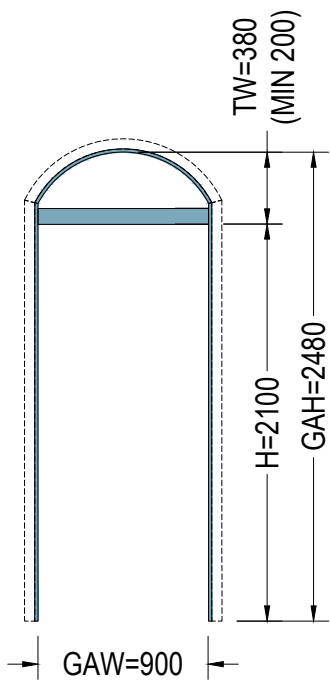

external side view
mod. "B"

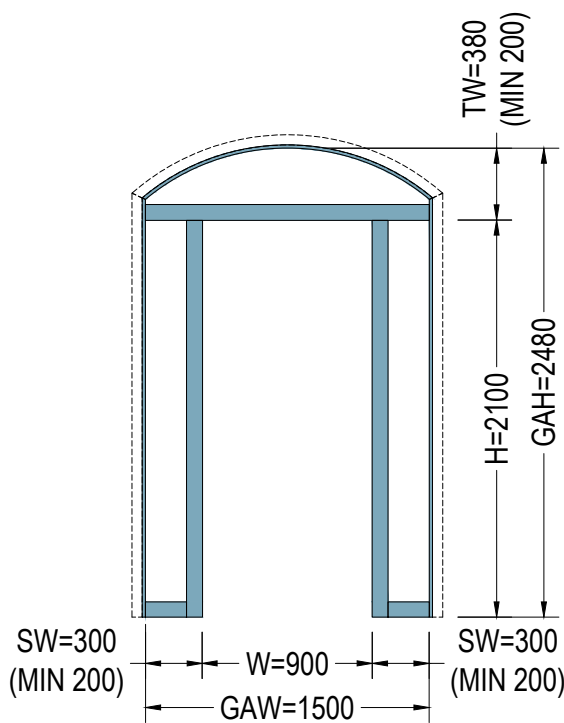

external side view
mod. "E"

mod. "B"

ref. DOOR 900x2100 (WxH)
TOP WINDOW 380 (TW)
GLAZED AREA 900x2480
(GAWxGAH)

mod. "E"

ref. DOOR W= 900x2100 (WxH)
TOP WINDOW 380 (TW)
SIDE WINDOW 250 (SW)
GLAZED AREA 1500x2480
(GAWxGAH)

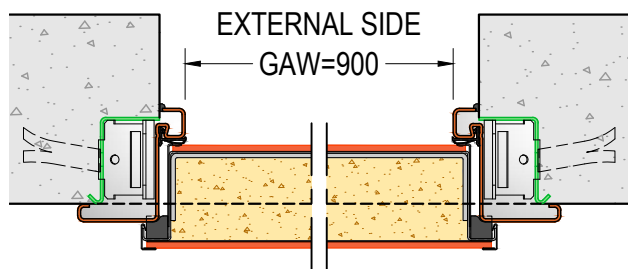

horizontal section
mod. "B"

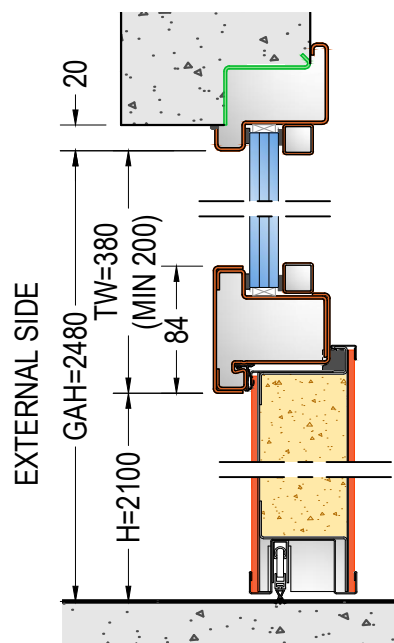

vertical section
mod. "B"

GLAZED AREA:
MAXIMUM OVERALL DIMENSIONS
1800x2850 (GAWxGAH)

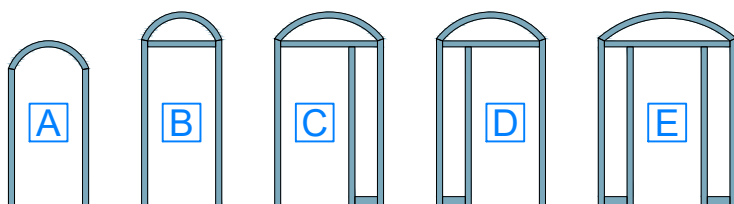

external side view



STANDARD SUBFRAME "CT1" WITH STANDARD FRAME 3.11

SEGMENTAL ARCHED TOP WINDOW SCHEMES
scale 1:5 1:40 1:100

v 3.2

DI.BI. PORTE BLINDATE Srl - Fano (PU) ITALY - www.dibigroup.com

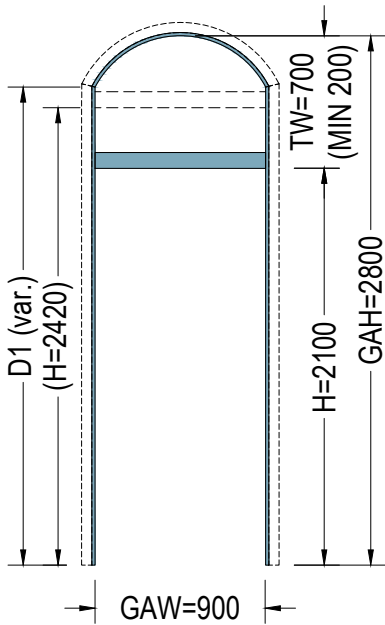

external side view
mod. "B"

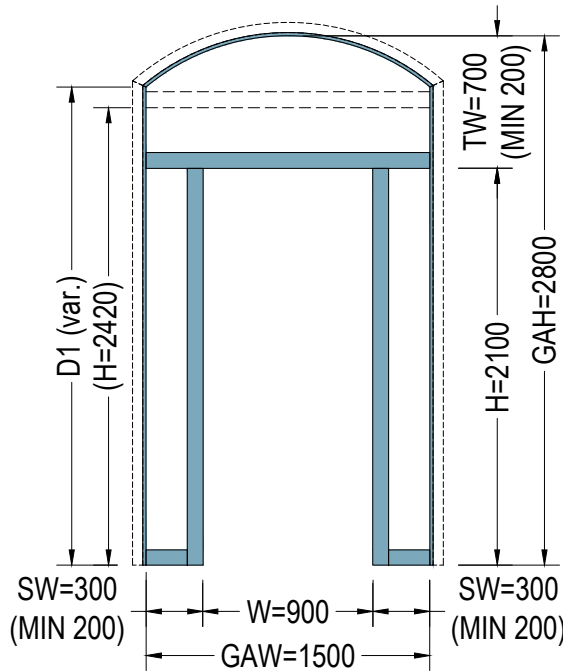

external side view
mod. "E"

mod. "B"

ref. DOOR 900x2100/2420 (WxH)
TOP WINDOW 700/380 (TW)
GLAZED AREA 900x2800
(GAWxGAH)

mod. "E"

ref. DOOR 900x2100/2420 (WxH)
TOP WINDOW 700/380 (TW)
SIDE WINDOW 300 (SW)
GLAZED AREA 1500x2800
(GAWxGAH)

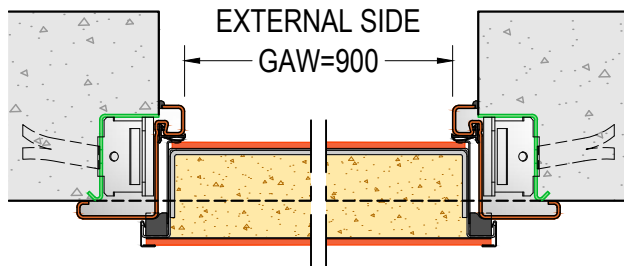

horizontal section
mod. "B"

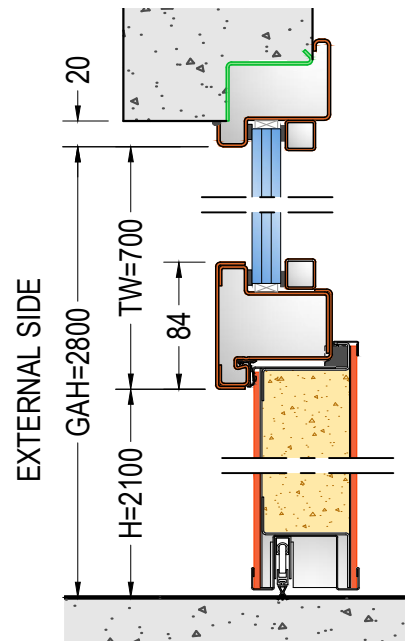

vertical section
mod. "B"

GLAZED AREA:

MAXIMUM OVERALL DIMENSIONS
1800x2850 (GAWxGAH)

VARIABLE DIMENSION:

D1=

stilt below the segmental arch

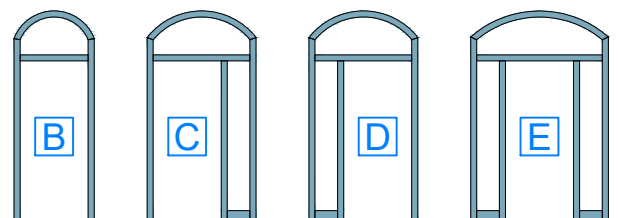

external side view



STANDARD SUBFRAME "CT1" WITH STANDARD FRAME 3.12

STILTED SEGMENTAL ARCHED TOP WINDOW
SCHEMES - scale 1:5 1:40 1:100

v 3.2

DI.BI. PORTE BLINDATE Srl - Fano (PU) ITALY - www.dibigroup.com

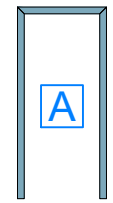
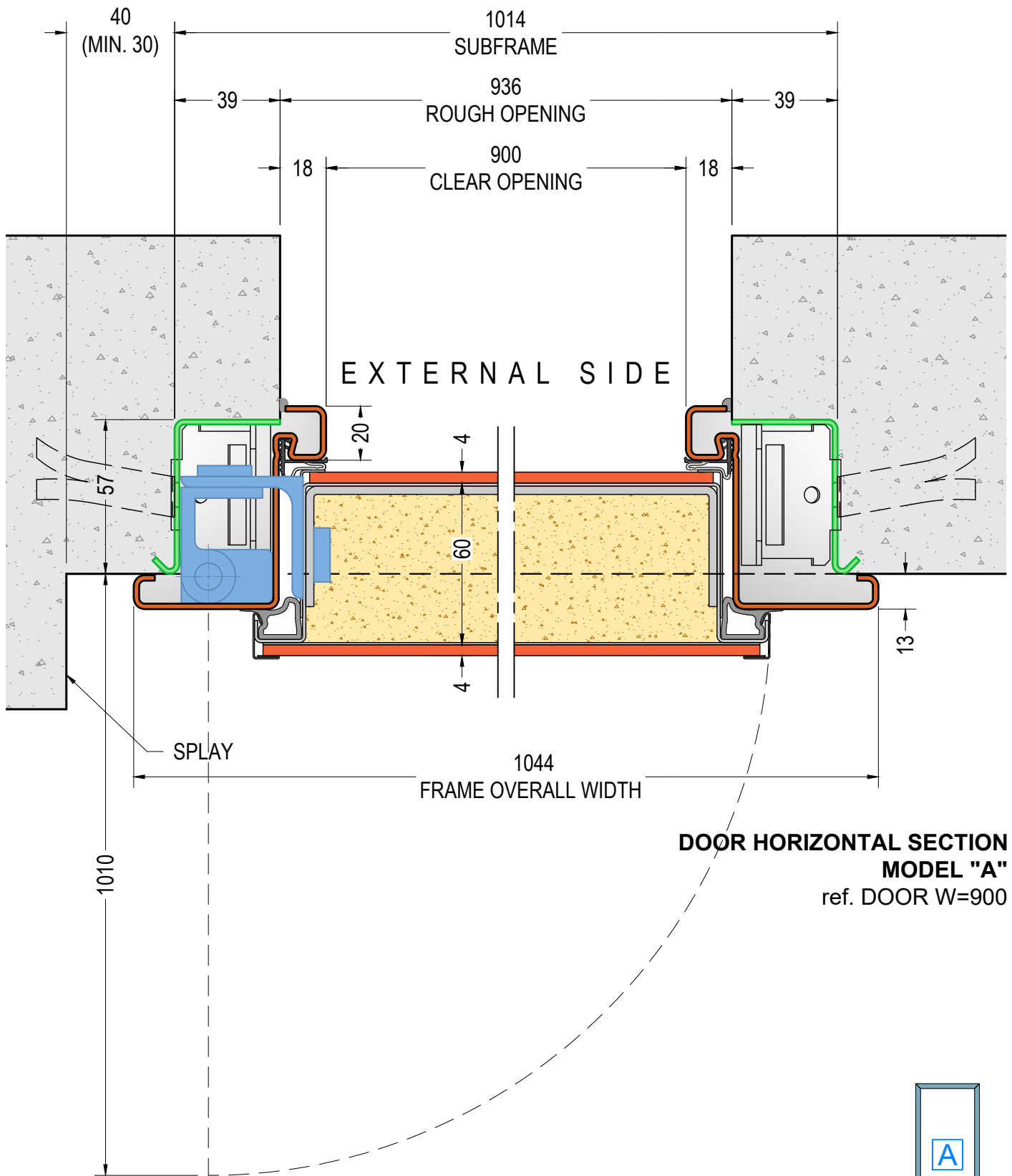

external side view



STANDARD SUBFRAME "CT1"
WITH STANDARD FRAME, WITH
CONCEALED HINGES – Solution 1a
 HORIZONTAL SECTION - scale 1:2

3.13

v 4.3

DI.BI. PORTE BLINDATE Srl - Fano (PU) ITALY - www.dibigroup.com

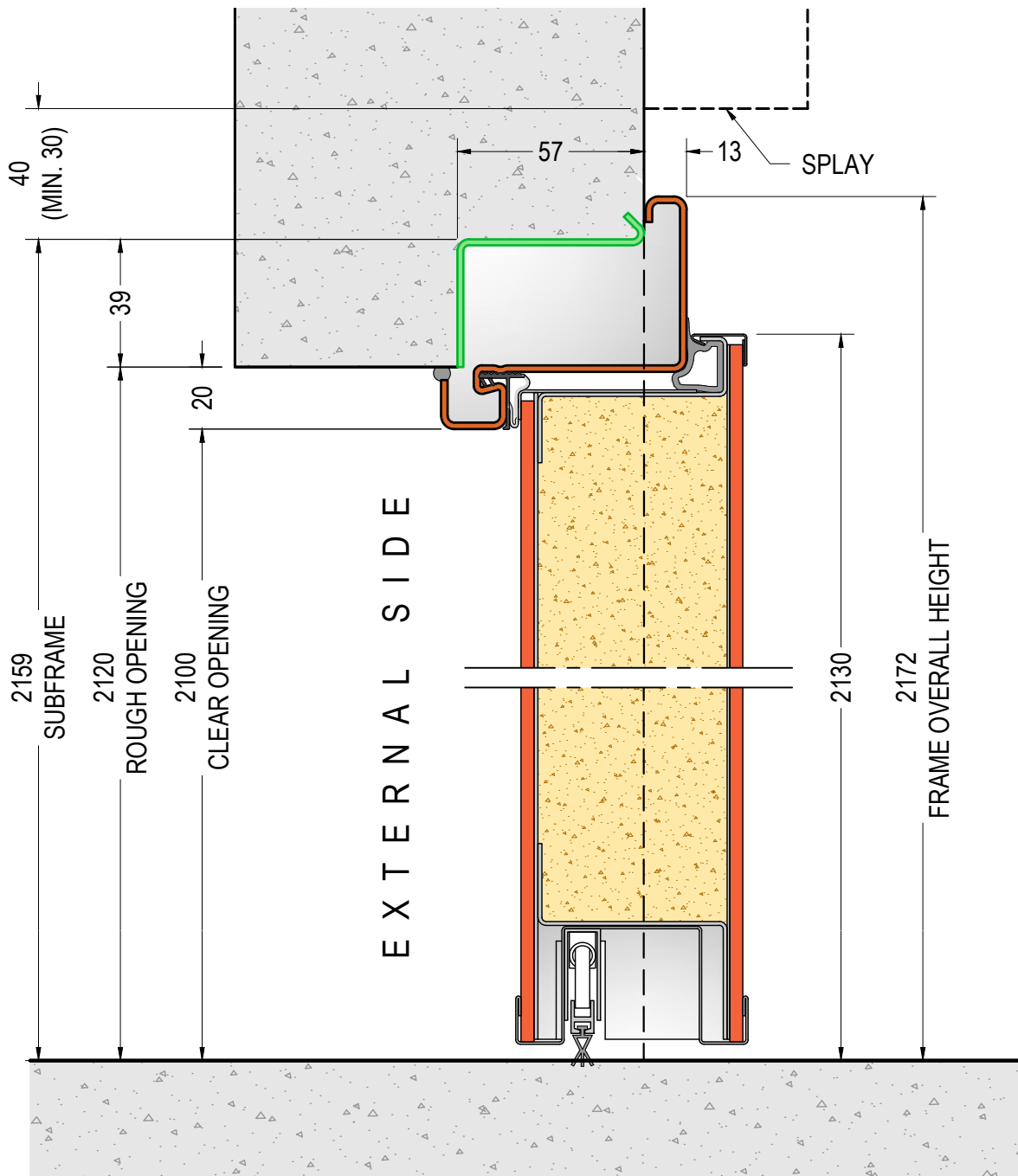

**DOOR VERTICAL SECTION
MODEL "A"**
ref. DOOR H=2100

DOOR DIMENSIONS:
W=min.700 - max.2000
H=min.2000 - max.2450

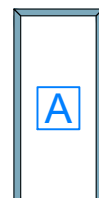

external side view



**STANDARD SUBFRAME "CT1"
WITH STANDARD FRAME, WITH
CONCEALED HINGES – Solution 1a**

3.14

VERTICAL SECTION - scale 1:2

v 4.3

DI.BI. PORTE BLINDATE Srl - Fano (PU) ITALY - www.dibigroup.com

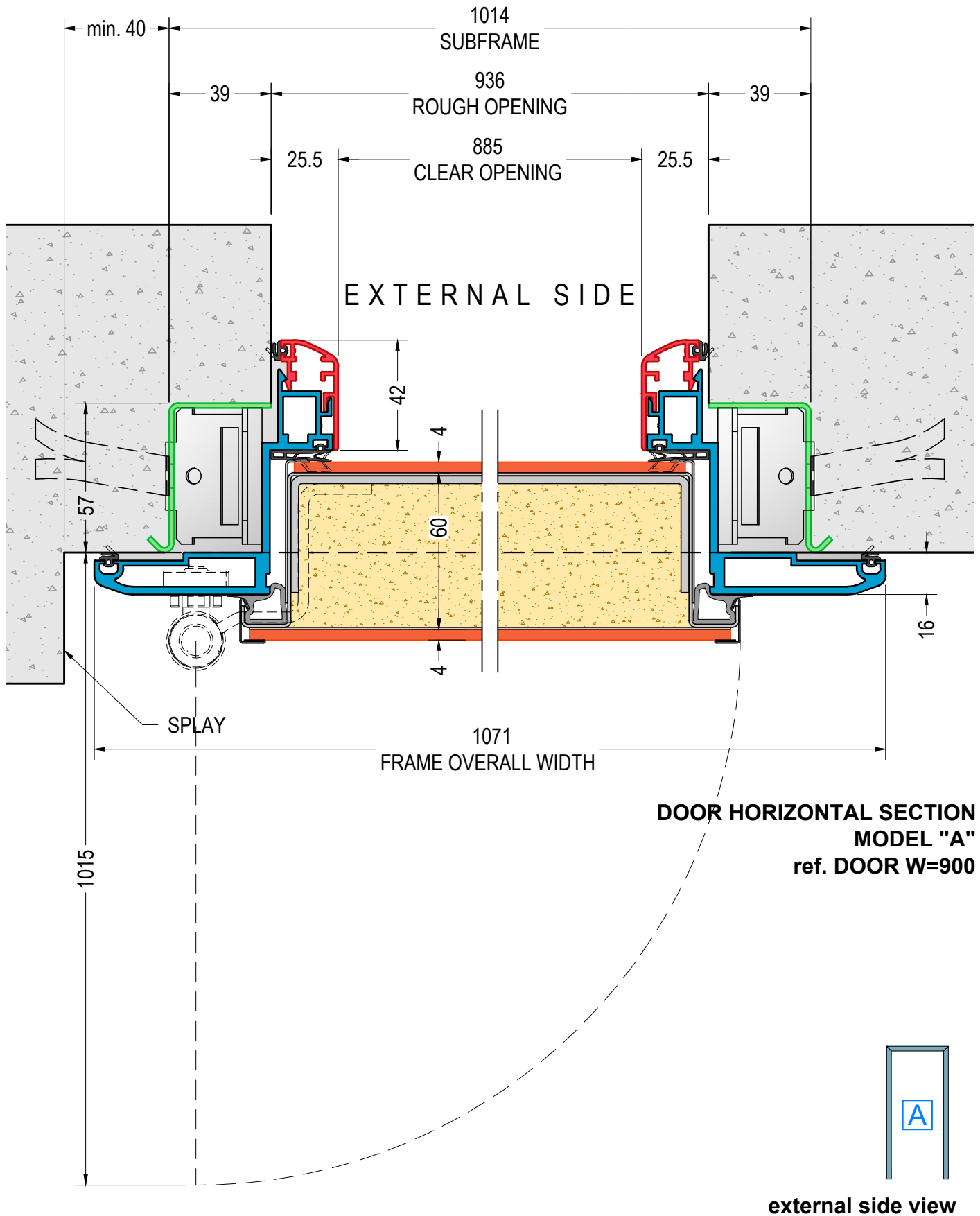

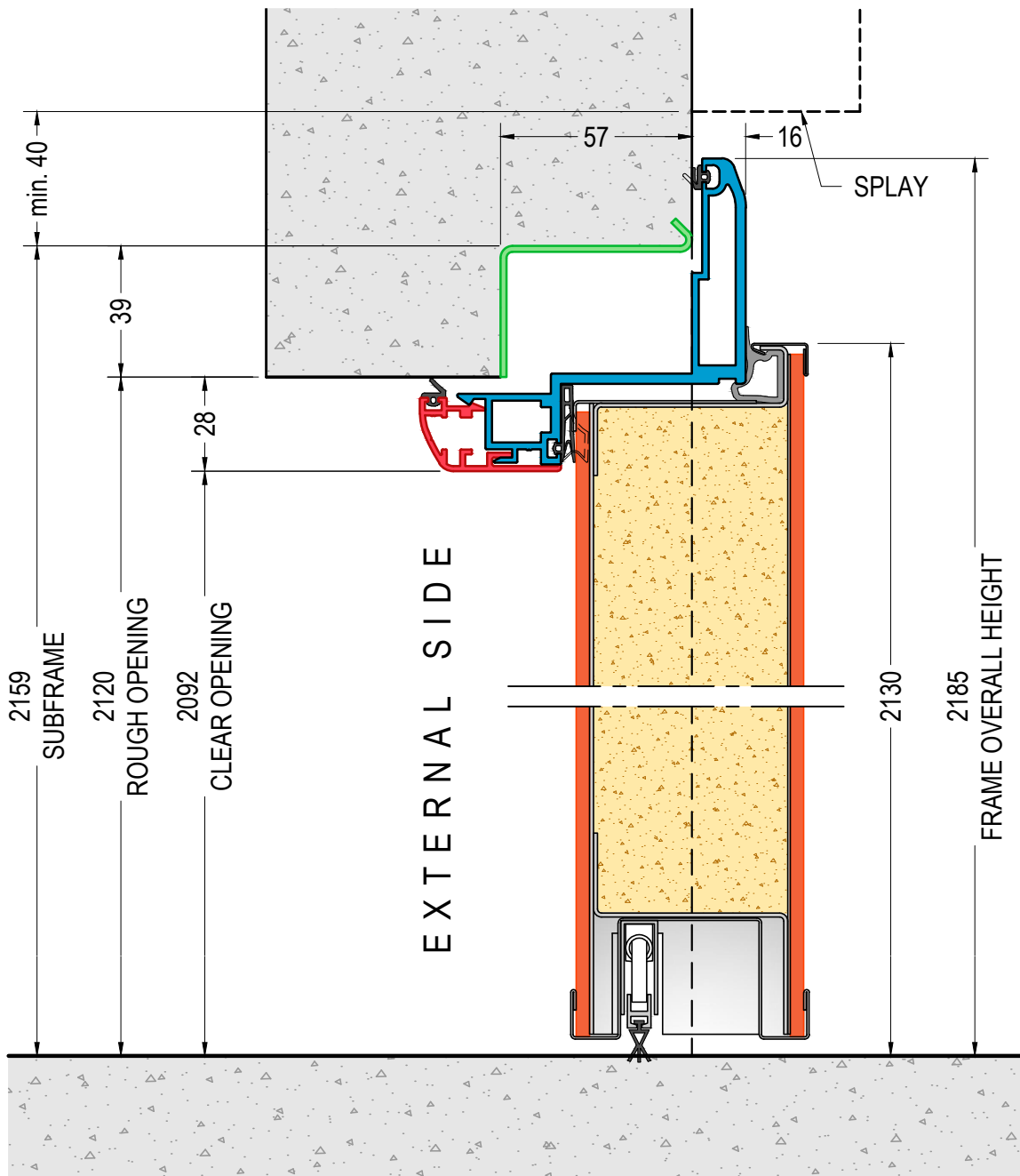

**DOOR VERTICAL SECTION
MODEL "A"
ref. DOOR H=2100**

DOOR DIMENSIONS:
W=min.700 - max.2000
H=min.2000 - max.2700

**OPTIONAL
WATERTIGHT
THRESHOLD**
H THRESHOLD=20
ref. DOOR H=2100
H SUBFRAME=2179
H ROUGH OPENING =2140

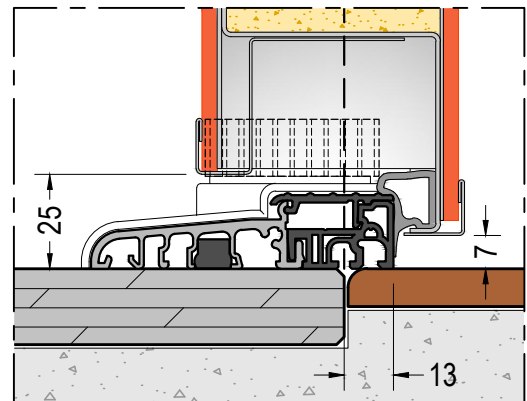

**STANDARD SUBFRAME "CT1" WITH
BICOLOUR ALUMINIUM FRAME – Sol. 8**

4.2

VERTICAL SECTION
scale 1:2

v 3.4

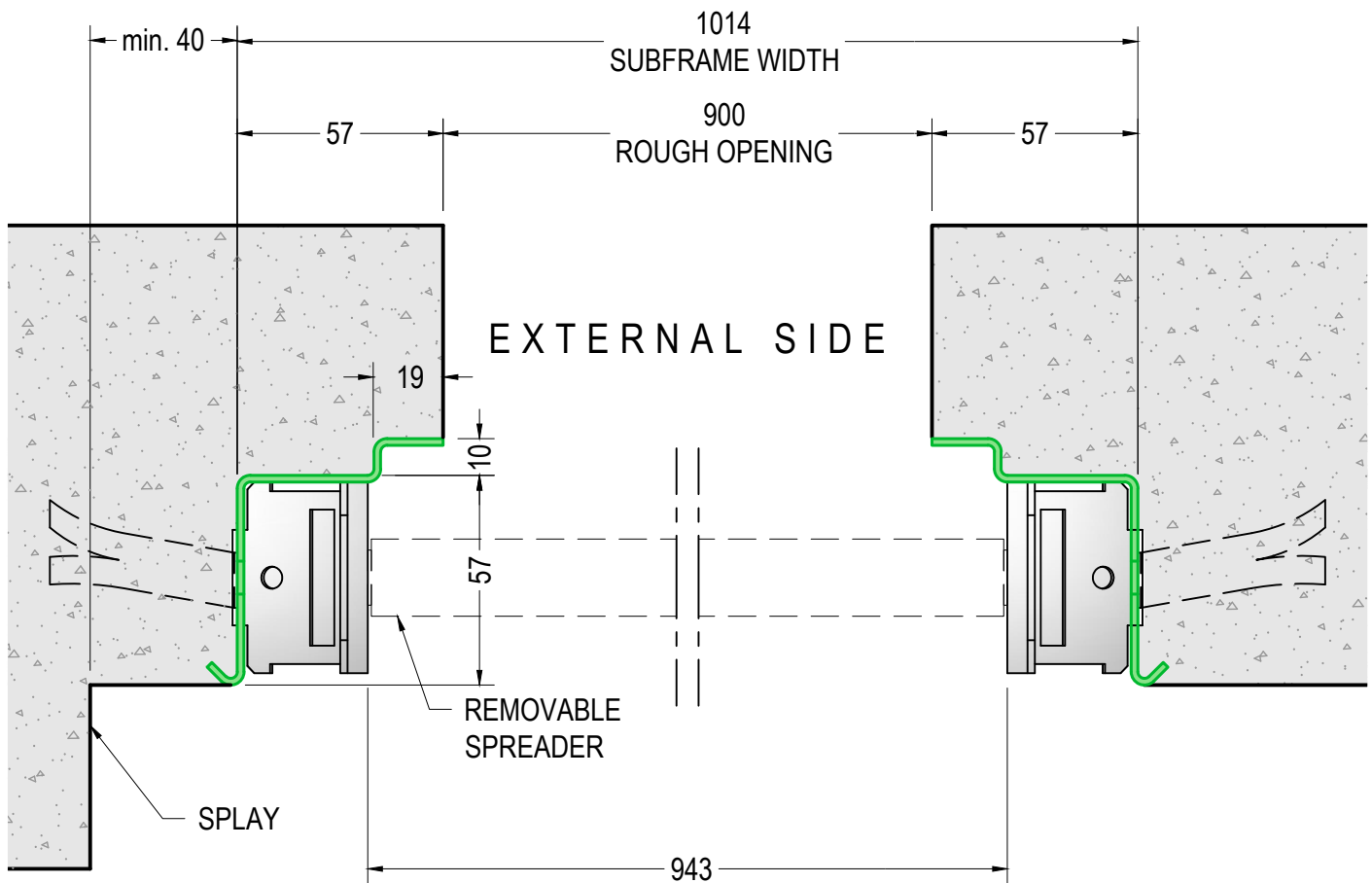

HORIZONTAL SECTION
ref. DOOR W=900

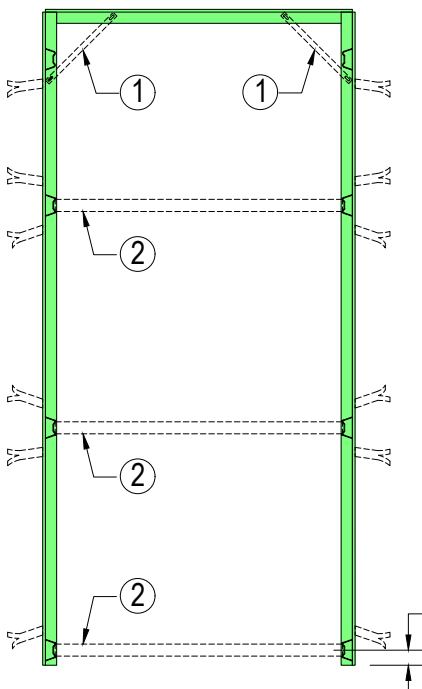

- ① Removable corner gussets
- ② Removable spreaders

INTERNAL SIDE VIEW



**SUBFRAME WITH EXTENSION
"CT2"**

5.1

HORIZONTAL SECTION - scale 1:2
INTERNAL SIDE VIEW - scale 1:25

v 4.4

DI.BI. PORTE BLINDATE Srl - Fano (PU) ITALY - www.dibigroup.com

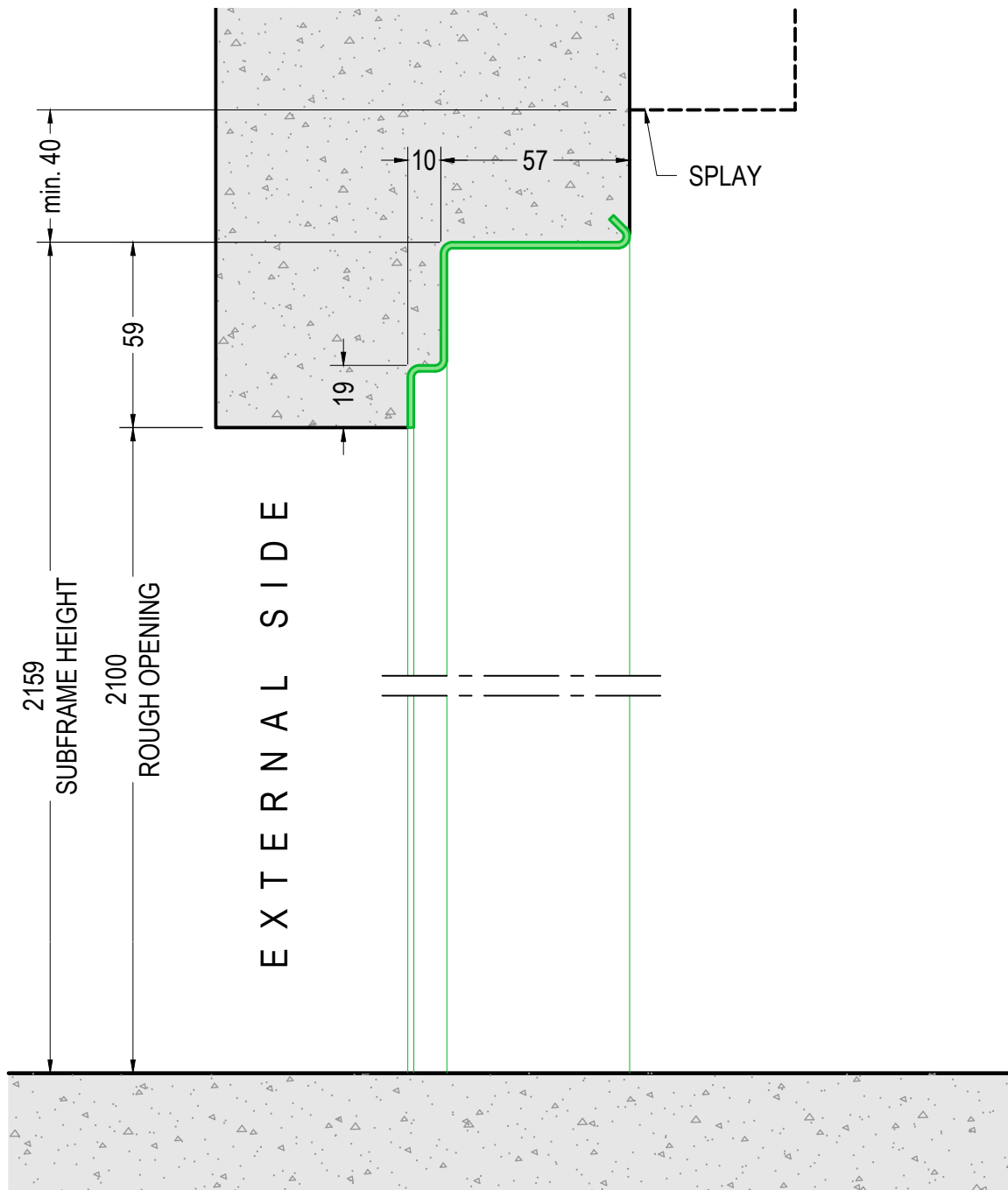

VERTICAL SECTION
ref. DOOR H=2100



**SUBFRAME WITH EXTENSION
"CT2"**

5.2

VERTICAL SECTION
scale 1:2

v 4.4

DI.BI. PORTE BLINDATE Srl - Fano (PU) ITALY - www.dibigroup.com

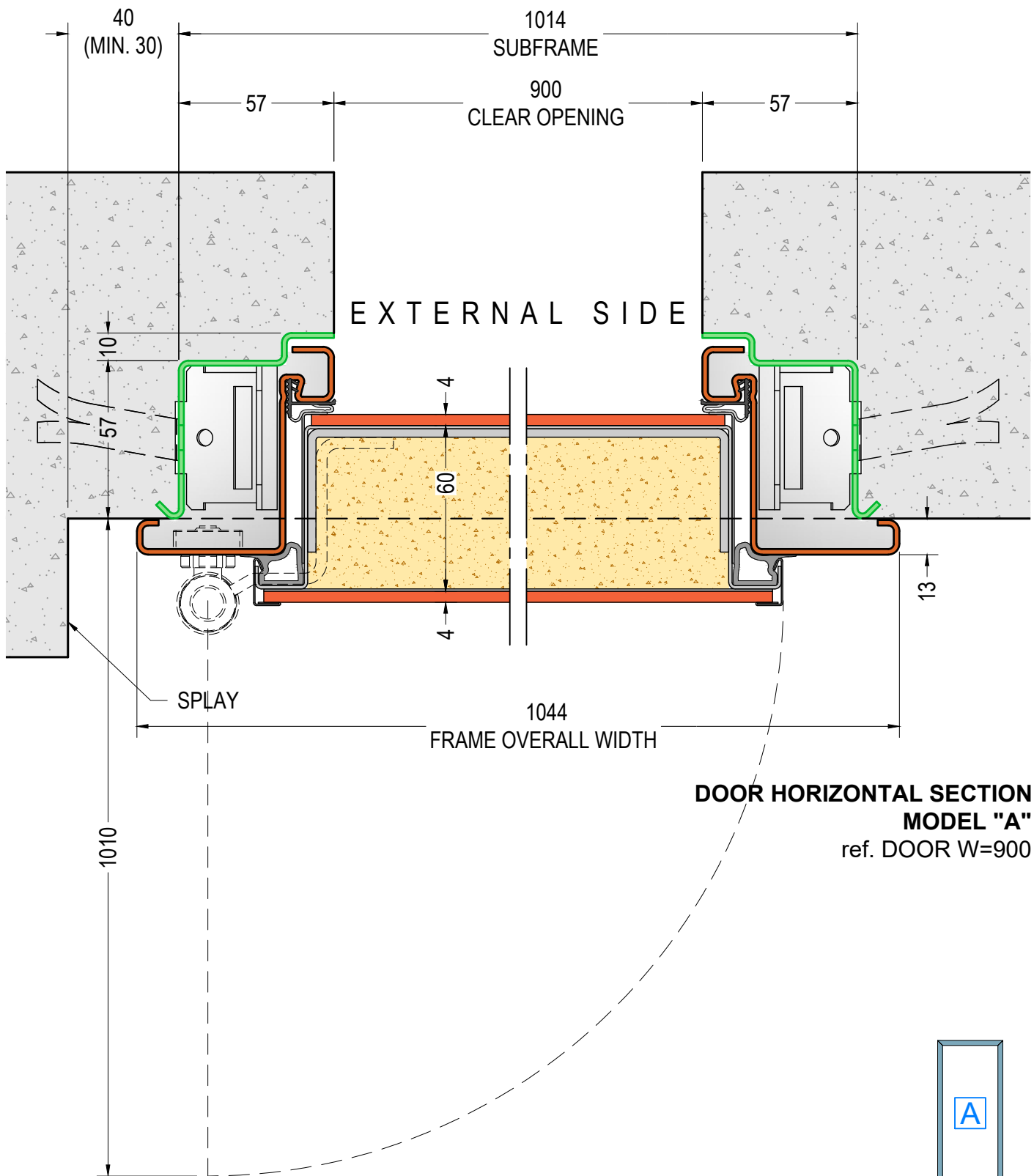

external side view

**SUBFRAME WITH EXTENSION "CT2"
AND STANDARD FRAME - Solution 3**

6.1

HORIZONTAL SECTION
scale 1:2

v 4.4

DI.BI. PORTE BLINDATE Srl - Fano (PU) ITALY - www.dibigroup.com



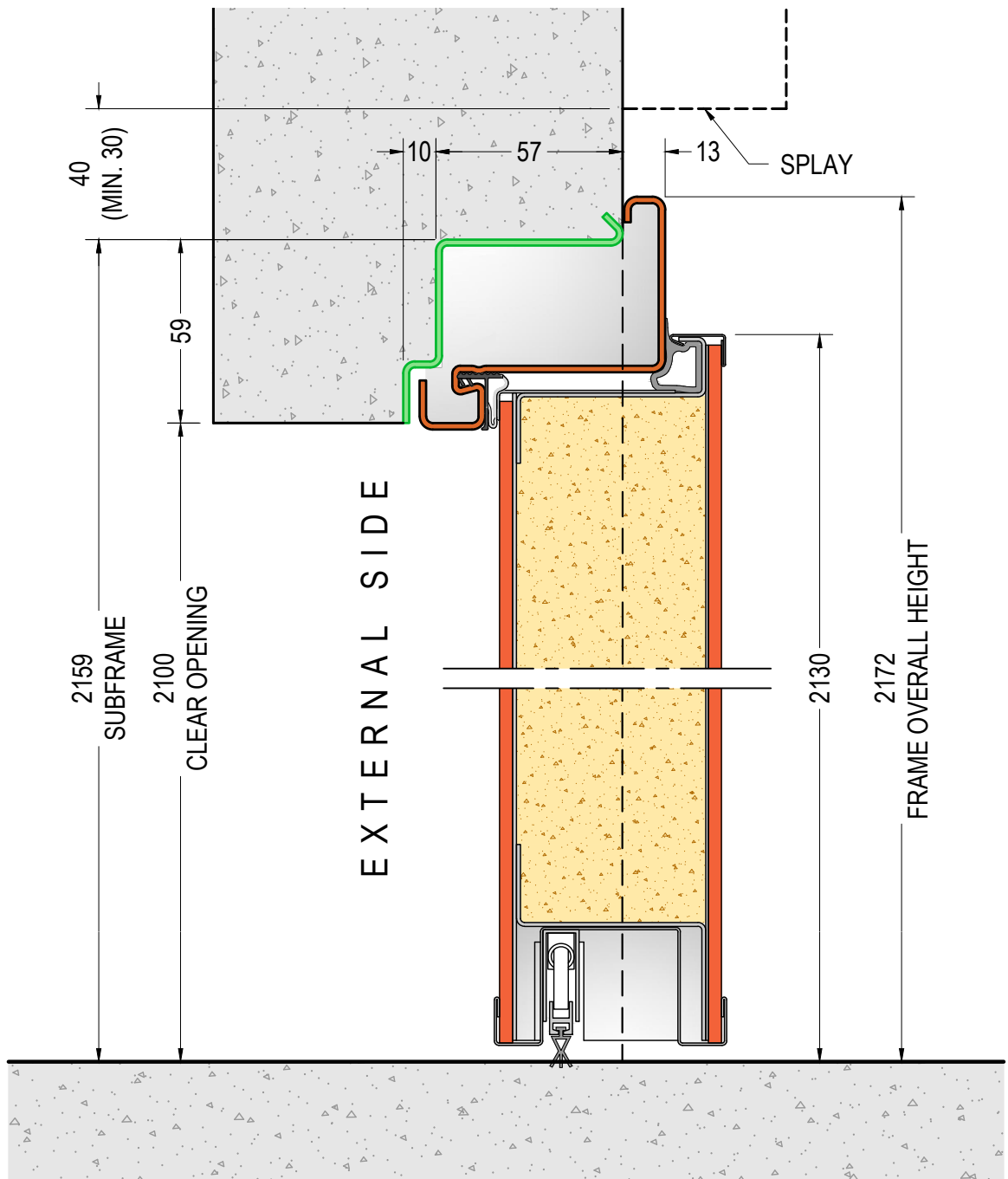

**DOOR VERTICAL SECTION
MODEL "A"**
ref. DOOR H=2100

DOOR DIMENSIONS:
W=min.700 - max.2000
H=min.2000 - max.2700



external side view



**SUBFRAME WITH EXTENSION "CT2"
AND STANDARD FRAME - Solution 3**

6.2

VERTICAL SECTION
scale 1:2

v 4.4

DI.BI. PORTE BLINDATE Srl - Fano (PU) ITALY - www.dibigroup.com

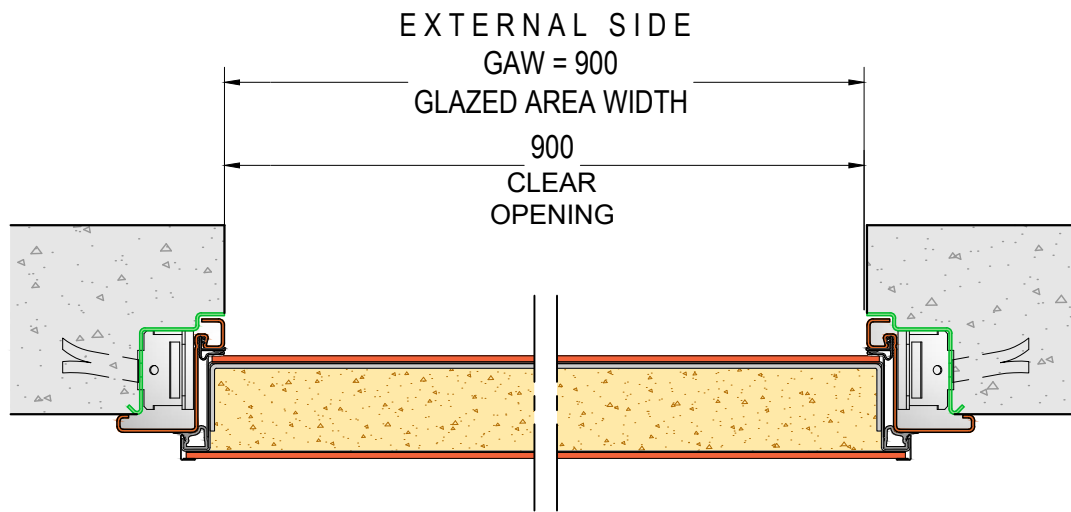

**DOOR HORIZONTAL SECTION
MODEL "B"**

ref. DOOR W=900 - GLAZED AREA WIDTH GAW=900

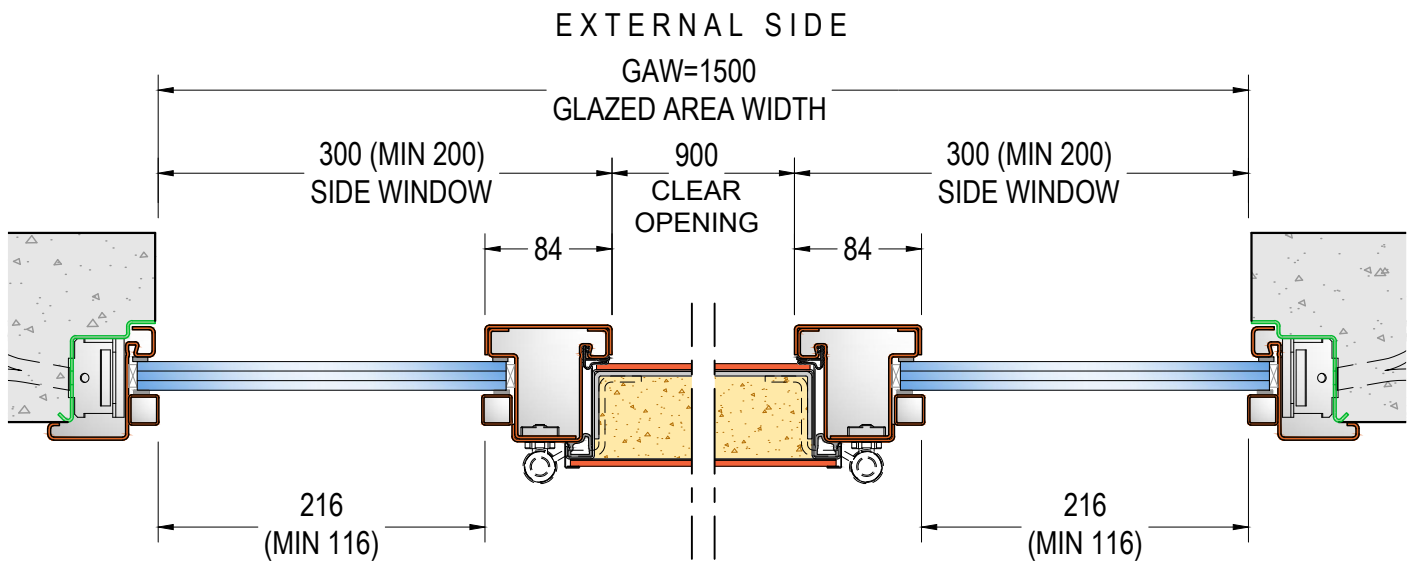

**DOOR HORIZONTAL SECTION
MODELS "E-F"**

ref. DOOR W=900 -SIDE WINDOW 300
GLAZED AREA WIDTH GAW=1500

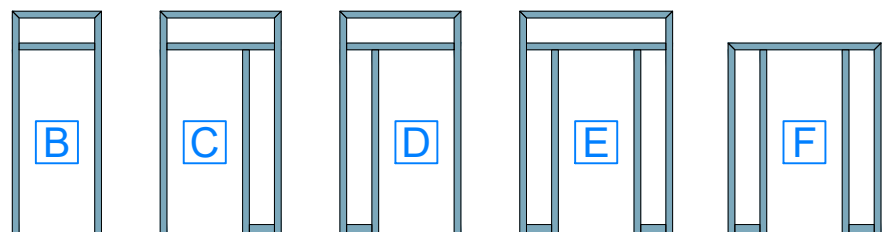

external side view



**SUBFRAME WITH EXTENSION
"CT2" AND STANDARD FRAME**

6.3

HORIZONTAL SECTIONS

scale 1:5

v 4.1

DI.BI. PORTE BLINDATE Srl - Fano (PU) ITALY - www.dibigroup.com

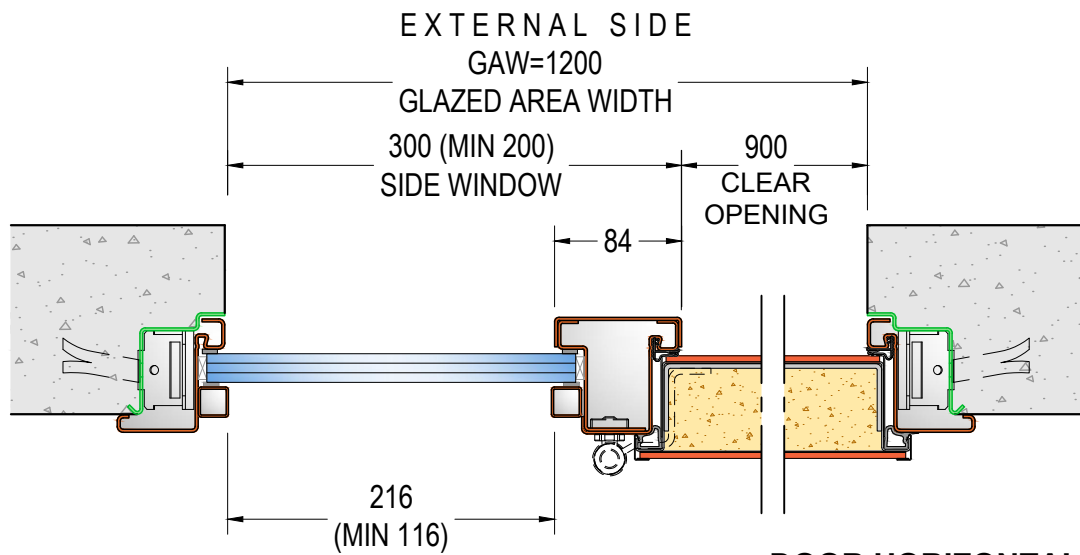

**DOOR HORIZONTAL SECTION
MODELS "C-G"**

ref. DOOR W=900 - SIDE WINDOW 300
GLAZED AREA WIDTH GAW=1200

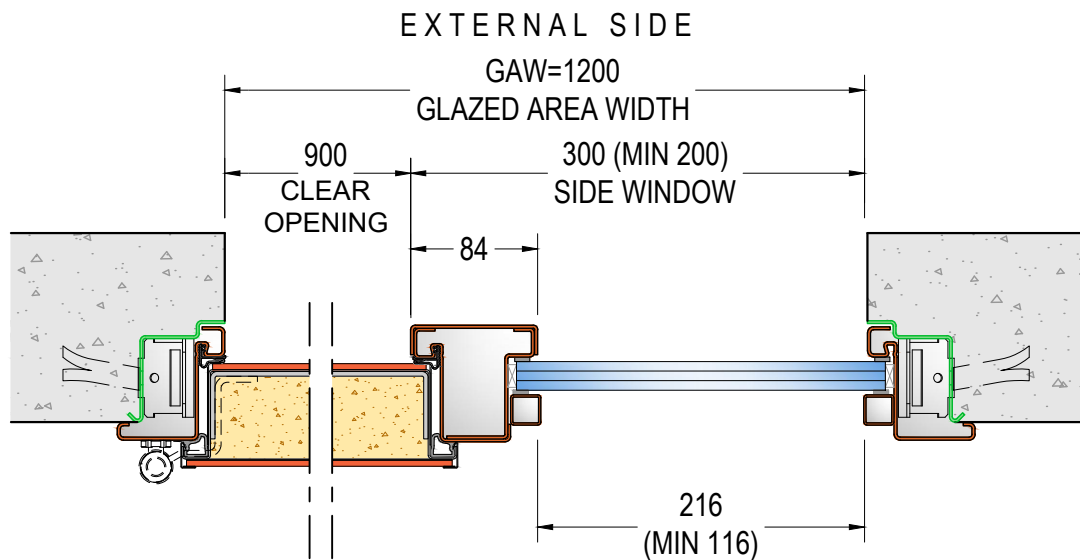

**DOOR HORIZONTAL SECTION
MODELS "D-H"**

ref. DOOR W=900 - SIDE WINDOW 300
GLAZED AREA WIDTH GAW=1200

GLAZED AREA:
MAXIMUM OVERALL DIMENSIONS
(GAWxGAH)
2000x2850 model B
1800x2850 models C-D-E
2850x2700 models F-G-H

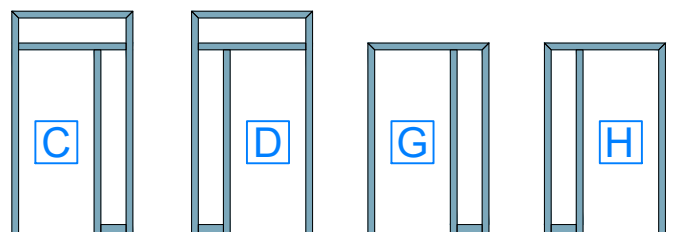

external side view



**SUBFRAME WITH EXTENSION
"CT2" AND STANDARD FRAME 6.4**

HORIZONTAL SECTIONS

scale 1:5

v 4.1

DI.BI. PORTE BLINDATE Srl - Fano (PU) ITALY - www.dibigroup.com

EXTERNAL SIDE

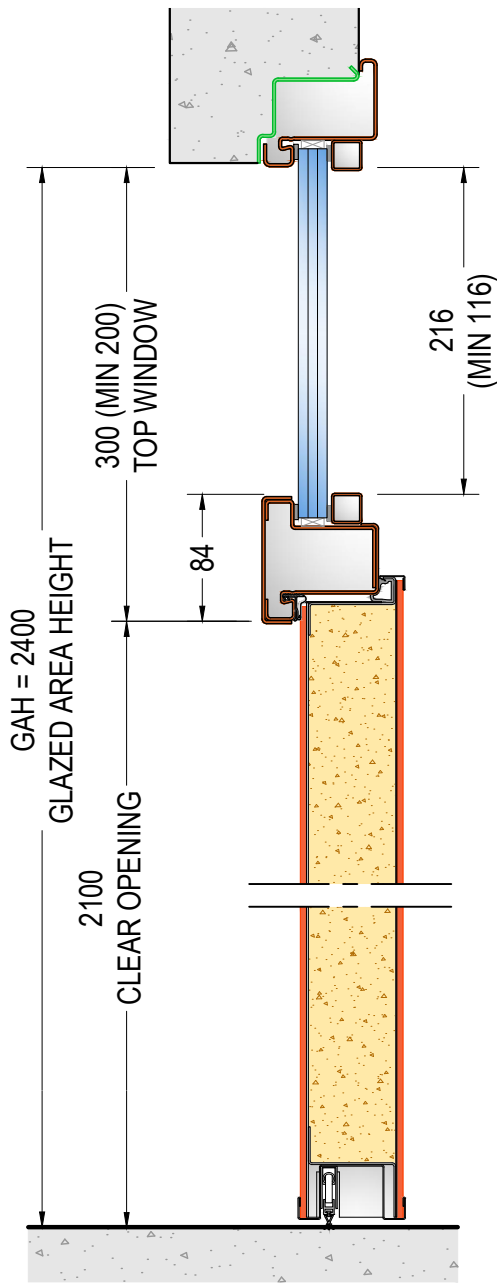

**DOOR VERTICAL SECTION
MODELS "B-C-D-E"**

ref. DOOR H=2100 - TOP WINDOW 300
GLAZED AREA HEIGHT GAH=2400

EXTERNAL SIDE

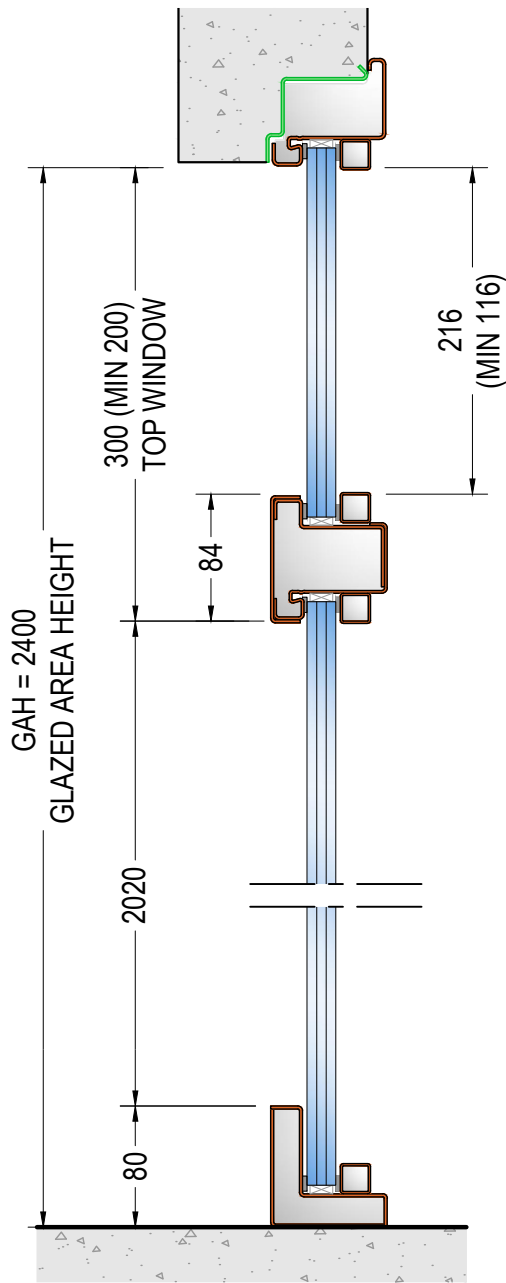

**SIDE WINDOW VERTICAL SECTION
MODELS "C-D-E"**

ref. DOOR H=2100 - TOP WINDOW 300
GLAZED AREA HEIGHT GAH=2400

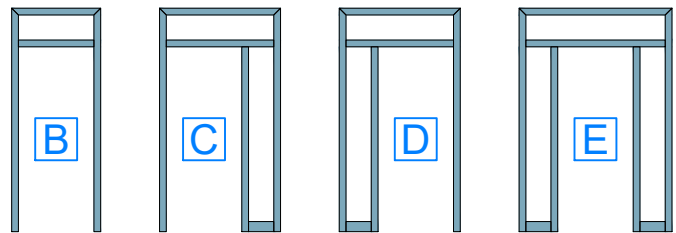

external side view



**SUBFRAME WITH EXTENSION
"CT2" AND STANDARD FRAME**

6.5

VERTICAL SECTIONS
scale 1:2

v 4.1

DI.BI. PORTE BLINDATE Srl - Fano (PU) ITALY - www.dibigroup.com

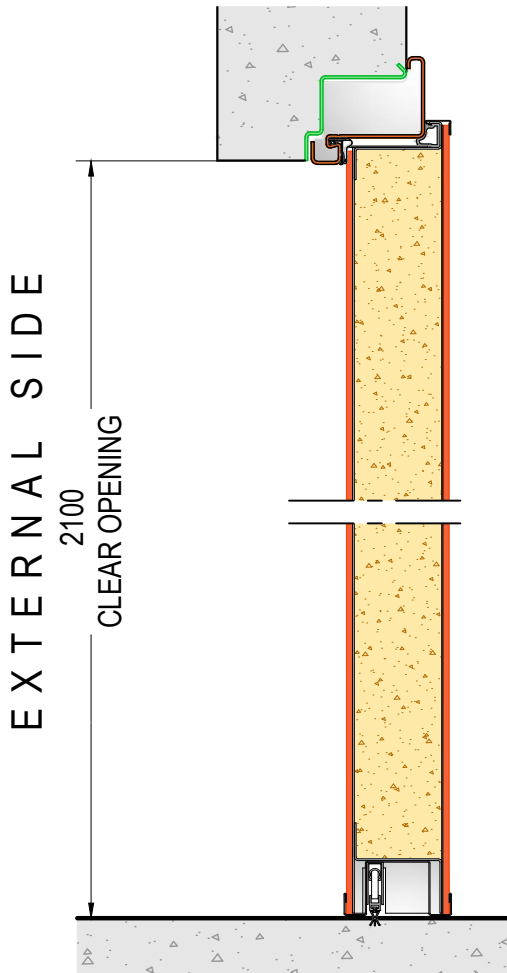

DOOR VERTICAL SECTION
MODELS "F-G-H"
 ref. DOOR H=2100
 GLAZED AREA HEIGHT GAH=2100

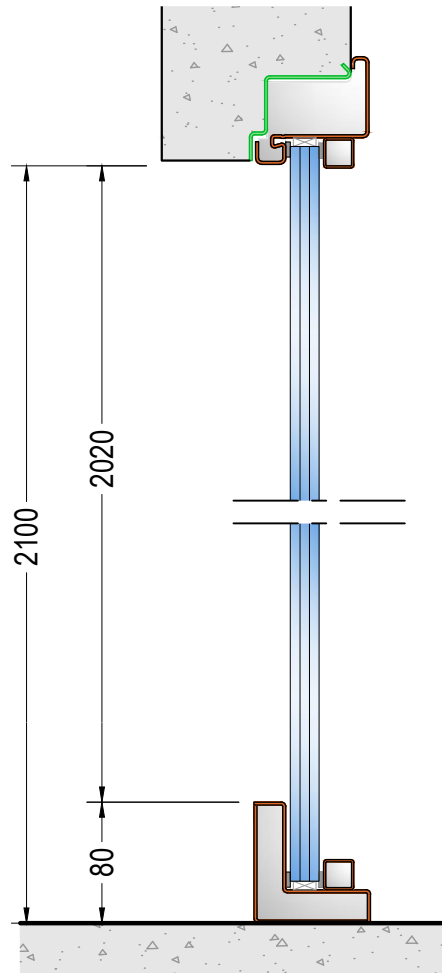

SIDE WINDOW VERTICAL SECTION
MODELS "F-G-H"
 ref. DOOR H=2100
 GLAZED AREA HEIGHT GAH=2100

GLAZED AREA:
 MAXIMUM OVERALL DIMENSIONS
 (GAWxGAH)
2000x2850 model B
1800x2850 models C-D-E
2850x2700 models F-G-H

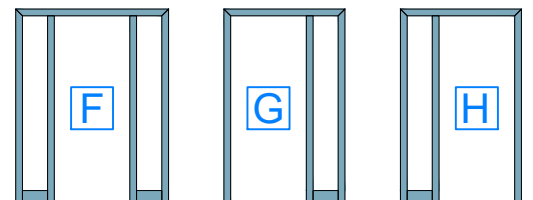

external side view



SUBFRAME WITH EXTENSION "CT2" AND STANDARD FRAME **6.6**

VERTICAL SECTIONS
 scale 1:2

v 4.1

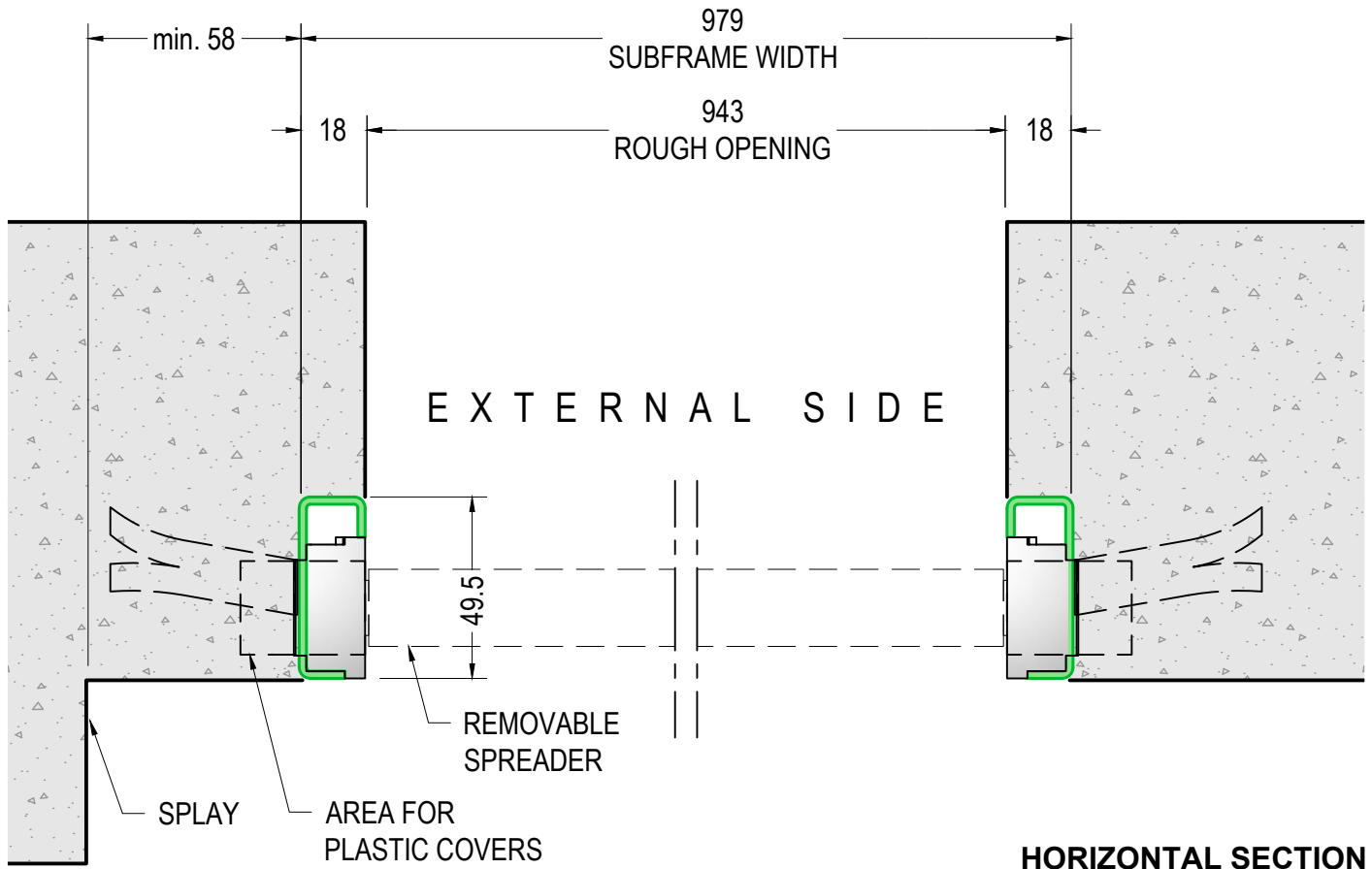

HORIZONTAL SECTION
ref. DOOR W=900

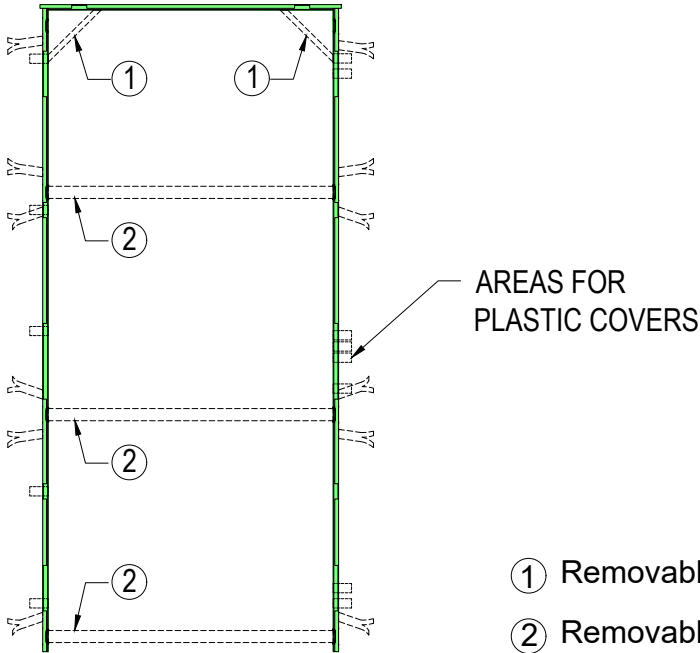

INTERNAL SIDE VIEW

**SMALLER SUBFRAME
"CT3"**

7.1

HORIZONTAL SECTION - scale 1:2
INTERNAL SIDE VIEW - scale 1:25

v 3.1

DI.BI. PORTE BLINDATE Srl - Fano (PU) ITALY - www.dibigroup.com

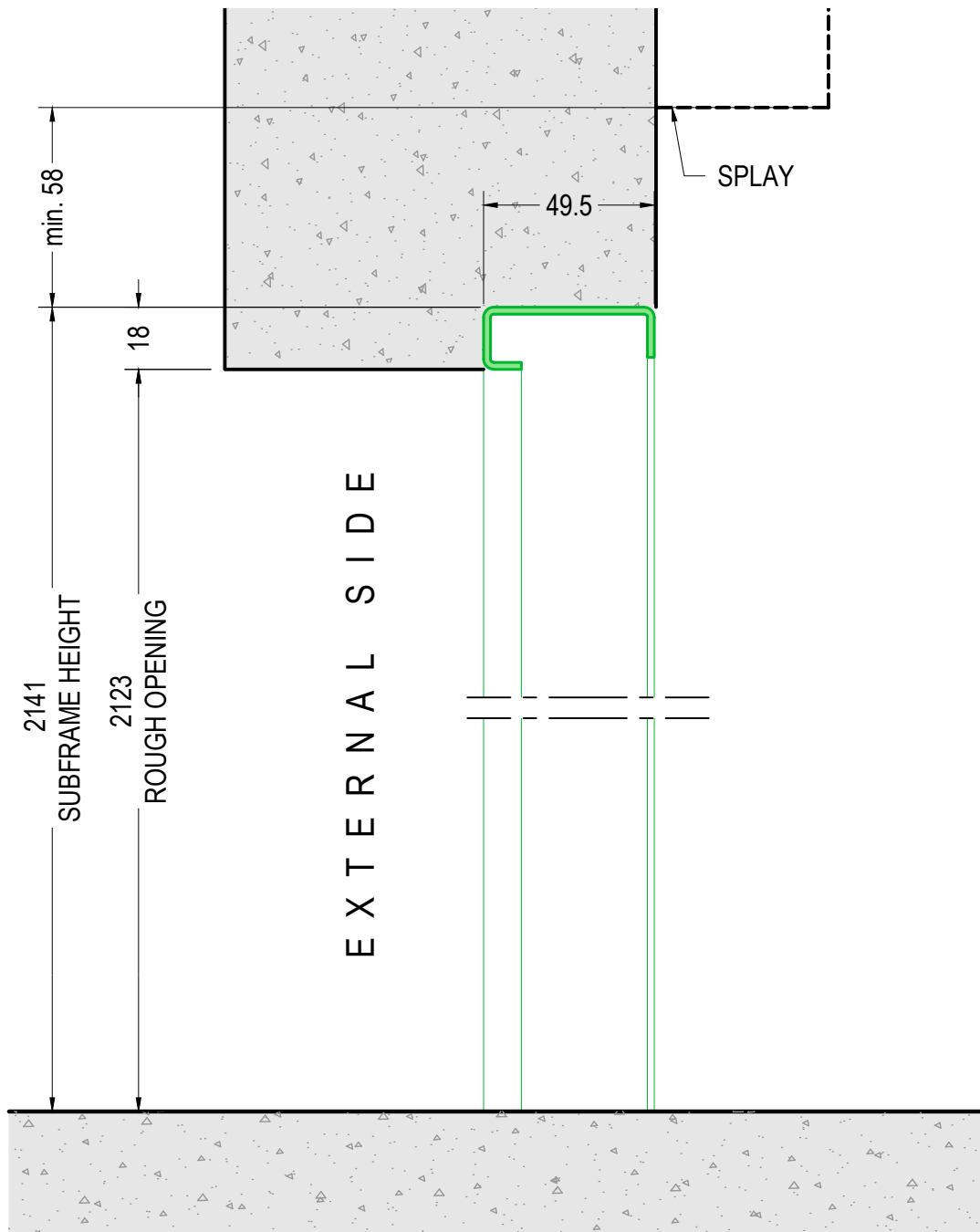

VERTICAL SECTION
ref. DOOR H=2100



**SMALLER SUBFRAME
"CT3"**

VERTICAL SECTION
scale 1:2

7.2

v 4.2

DI.BI. PORTE BLINDATE Srl - Fano (PU) ITALY - www.dibigroup.com

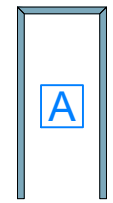
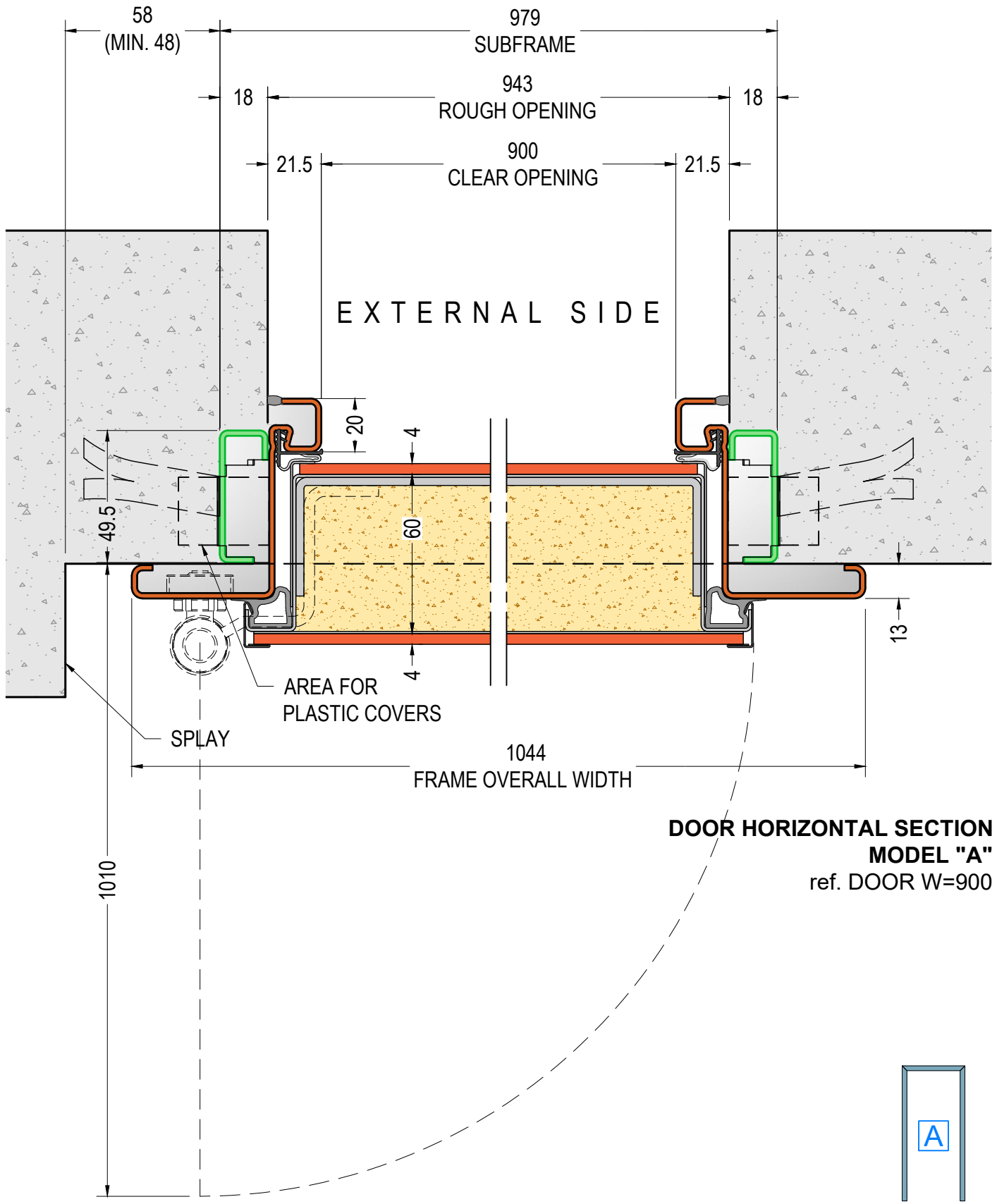

external side view



SMALLER SUBFRAME "CT3" WITH STANDARD FRAME – Solution 4

8.1

HORIZONTAL SECTION
scale 1:2

v 4.2

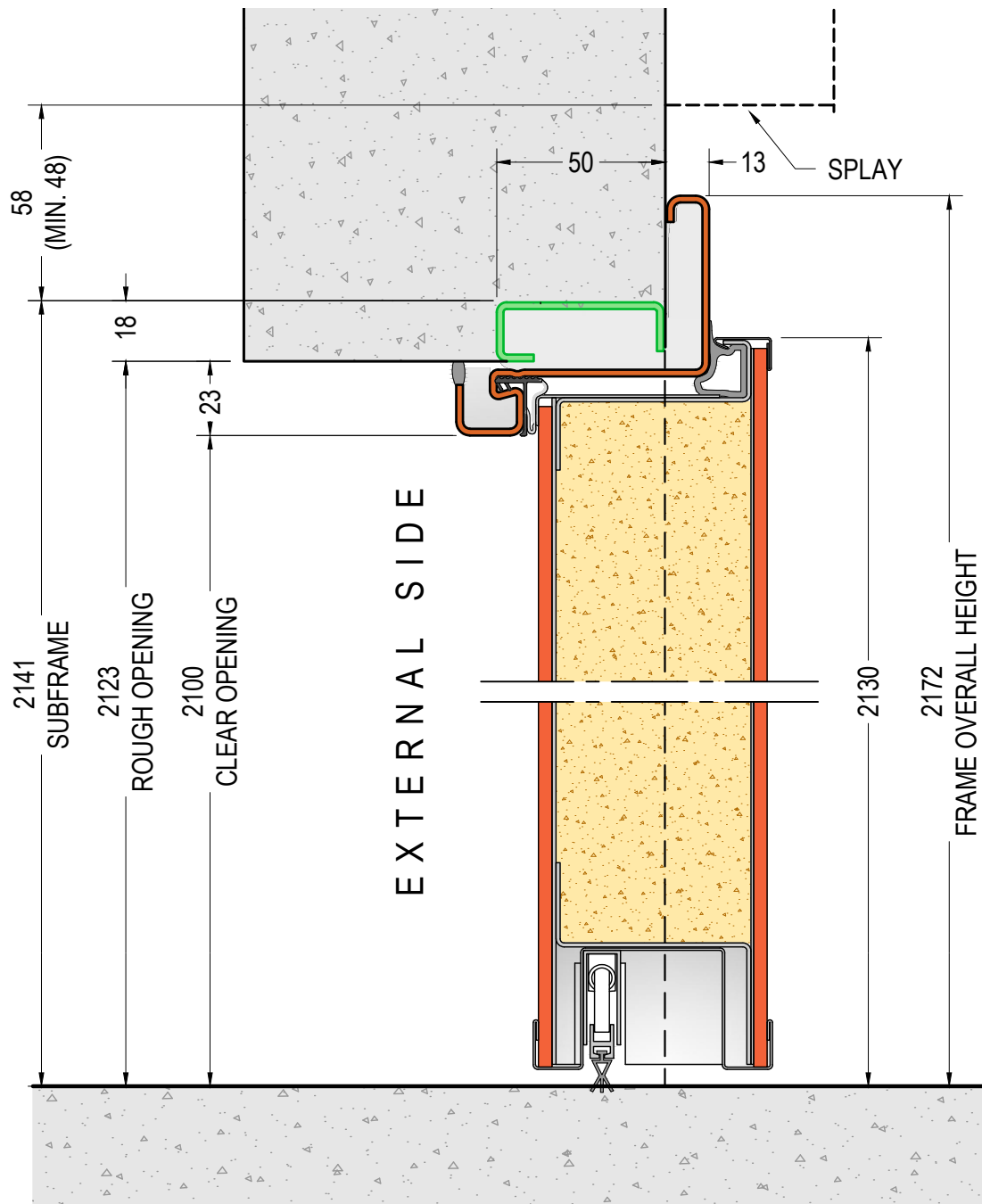

**DOOR VERTICAL SECTION
MODEL "A"**
ref. DOOR H=2100

DOOR DIMENSIONS:
W=min.700 - max.2000
H=min.2000 - max.2450

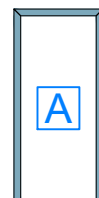

external side view



**SMALLER SUBFRAME "CT3" WITH
STANDARD FRAME – Solution 4**

8.2

VERTICAL SECTION
scale 1:2

v 3.2

DI.BI. PORTE BLINDATE Srl - Fano (PU) ITALY - www.dibigroup.com

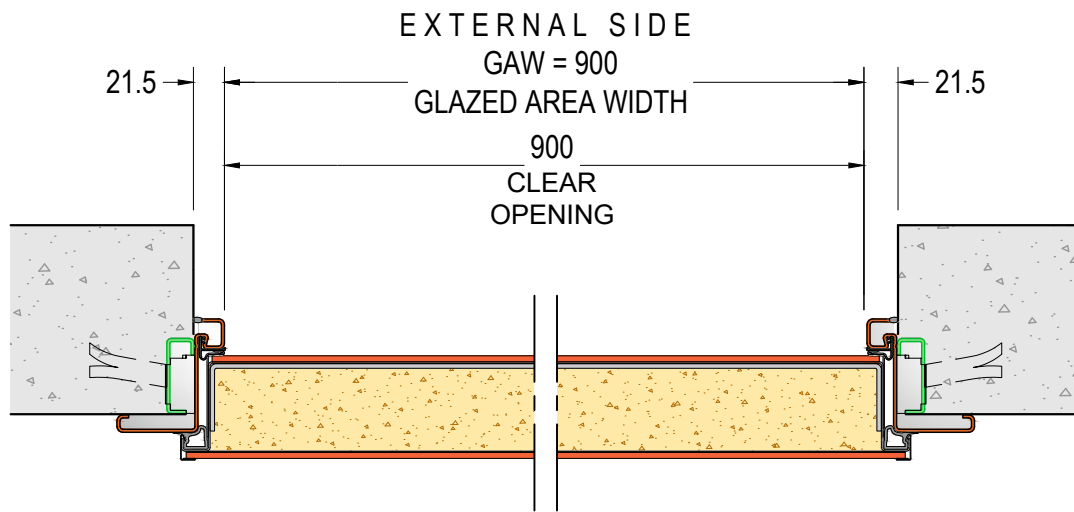

**DOOR HORIZONTAL SECTION
MODEL "B"**

ref. DOOR W=900 - GLAZED AREA WIDTH GAW=900

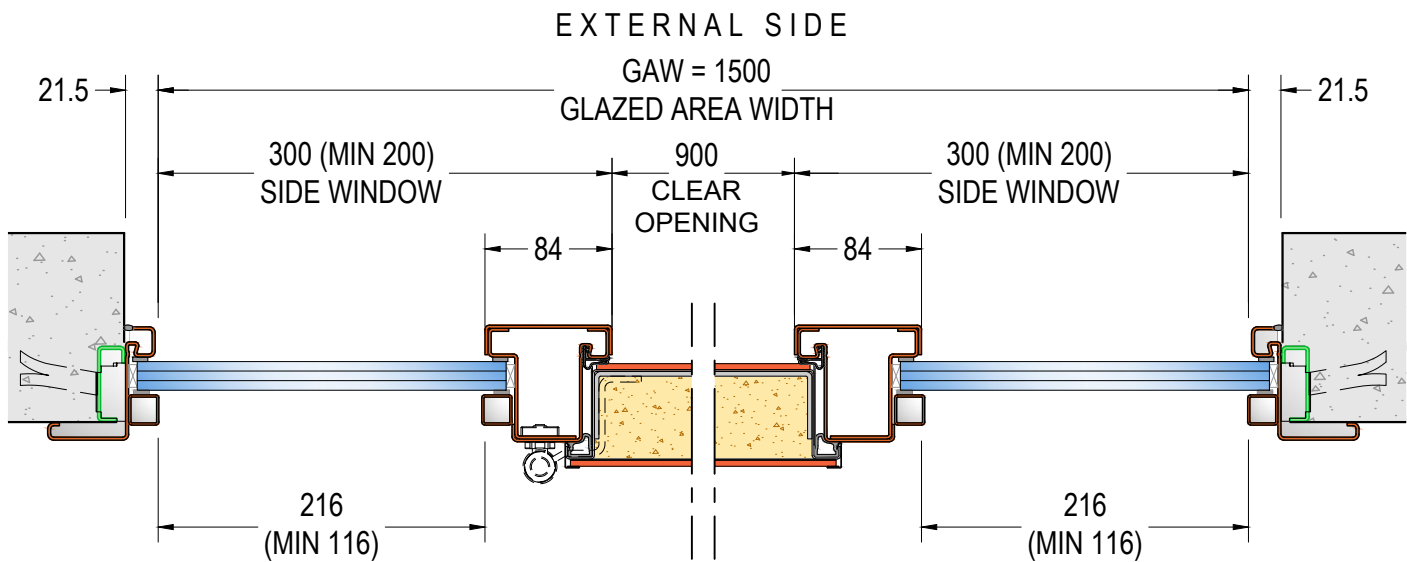

**DOOR HORIZONTAL SECTION
MODELS "E-F"**

ref. DOOR W=900 -SIDE WINDOW 300
GLAZED AREA WIDTH GAW=1500

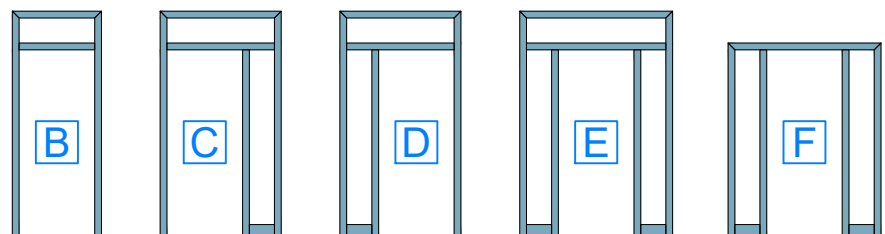

external side view



**SMALLER SUBFRAME "CT3" WITH
STANDARD FRAME – Solution 4**

8.3

HORIZONTAL SECTIONS

scale 1:5

v 4.1

DI.BI. PORTE BLINDATE Srl - Fano (PU) ITALY - www.dibigroup.com

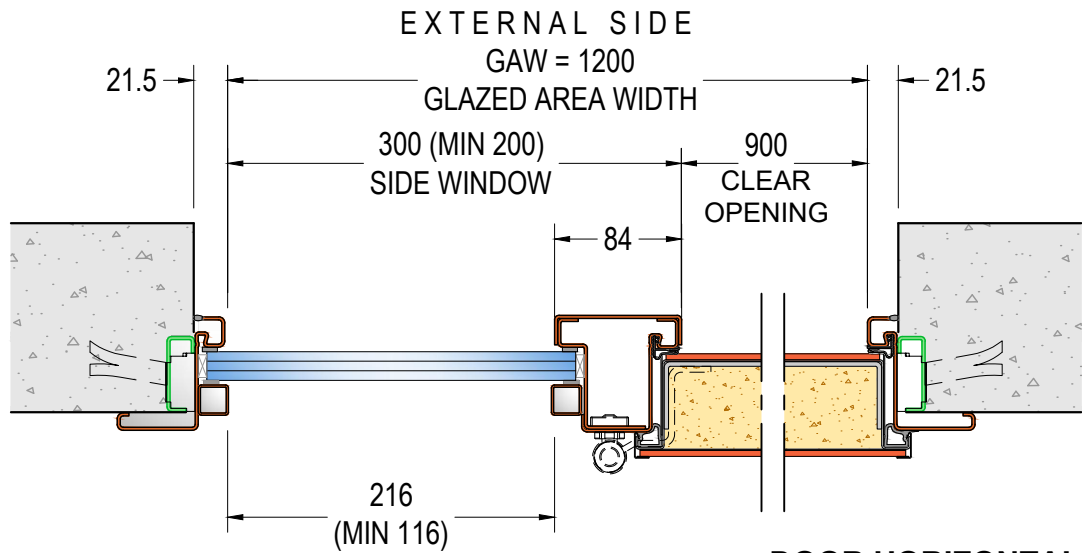

**DOOR HORIZONTAL SECTION
MODELS "C-G"**

ref. DOOR W=900 - SIDE WINDOW 300
GLAZED AREA WIDTH GAW=1200

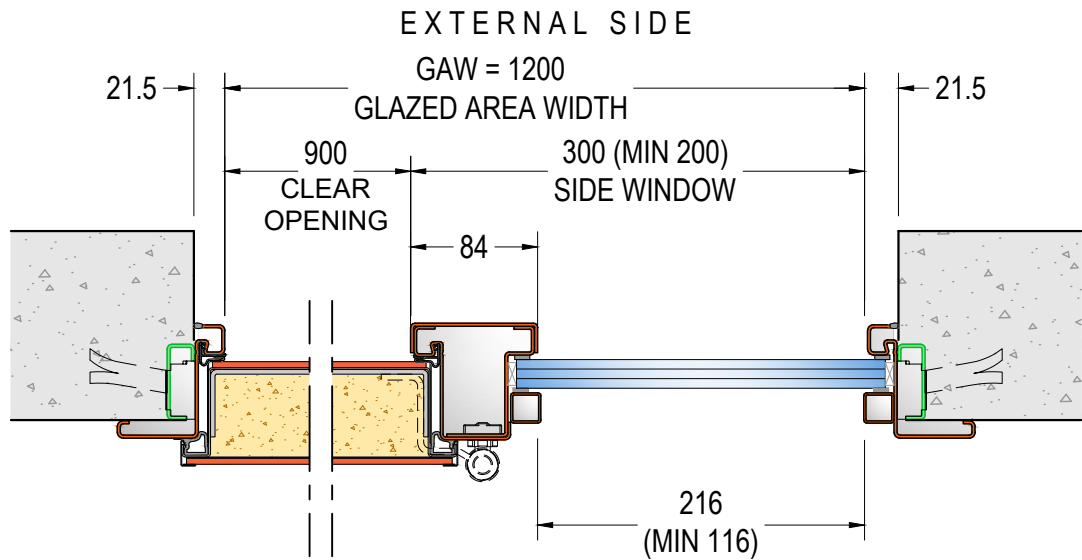

**DOOR HORIZONTAL SECTION
MODELS "D-H"**

ref. DOOR W=900 - SIDE WINDOW 300
GLAZED AREA WIDTH GAW=1200

GLAZED AREA:
MAXIMUM OVERALL DIMENSIONS
(GAWxGAH)
2000x2850 model B
1800x2850 models C-D-E
2850x2700 models F-G-H

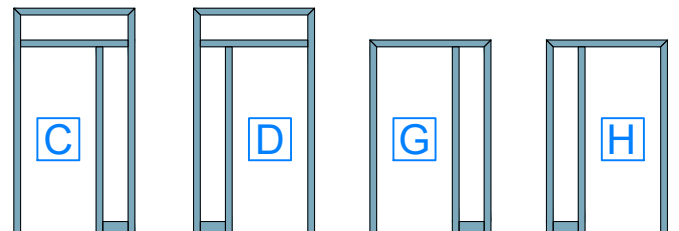

external side view



**SMALLER SUBFRAME "CT3" WITH
STANDARD FRAME – Solution 4**

8.4

HORIZONTAL SECTIONS
scale 1:5

v 4.1

EXTERNAL SIDE

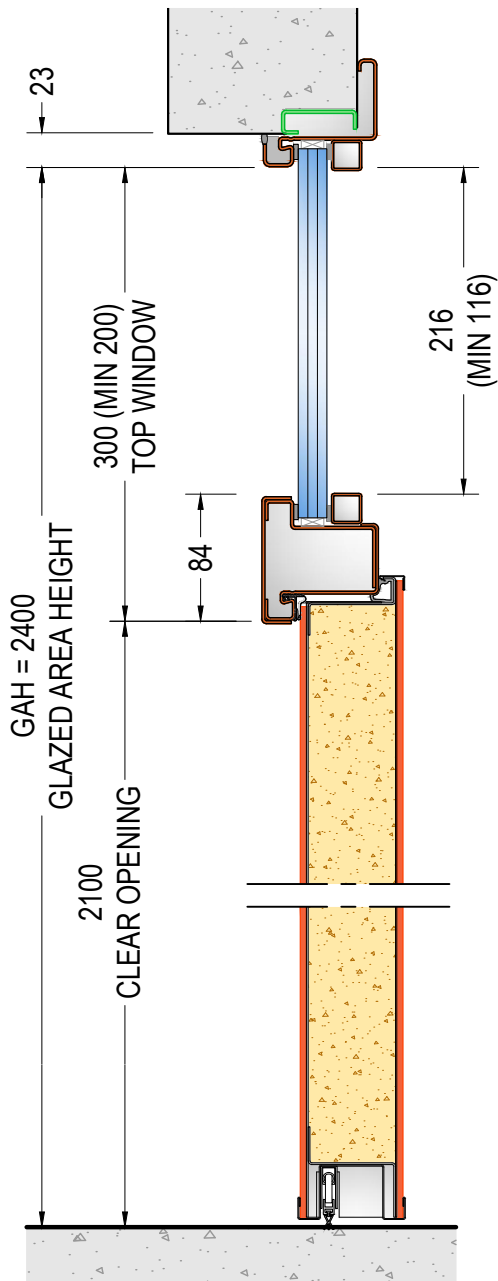

**DOOR VERTICAL SECTION
MODELS "B-C-D-E"**

ref. DOOR H=2100 - TOP WINDOW 300
GLAZED AREA HEIGHT GAH=2400

EXTERNAL SIDE

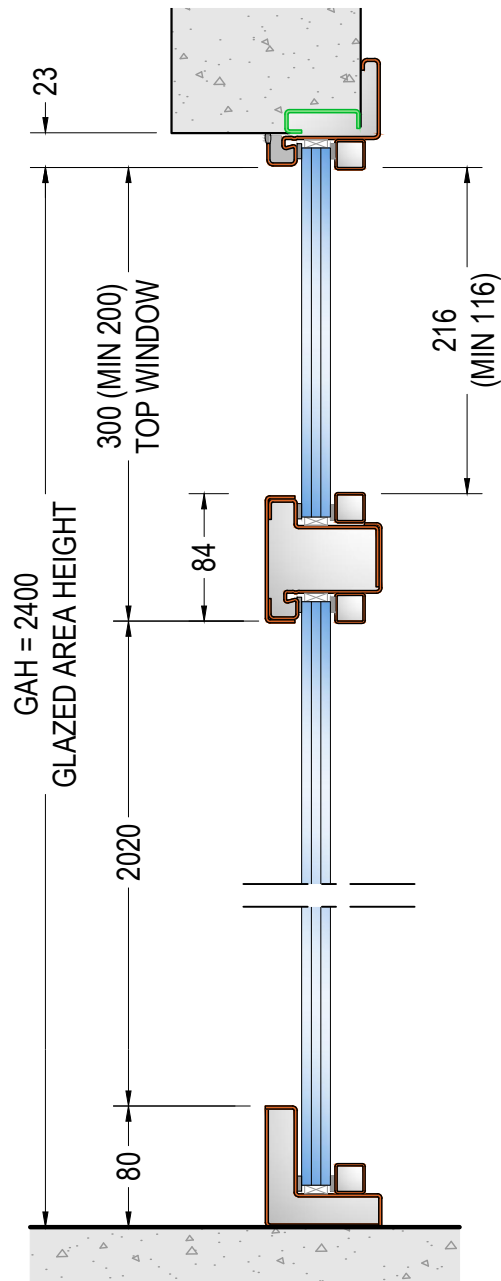

**SIDE WINDOW VERTICAL SECTION
MODELS "C-D-E"**

ref. DOOR H=2100 - TOP WINDOW 300
GLAZED AREA HEIGHT GAH=2400

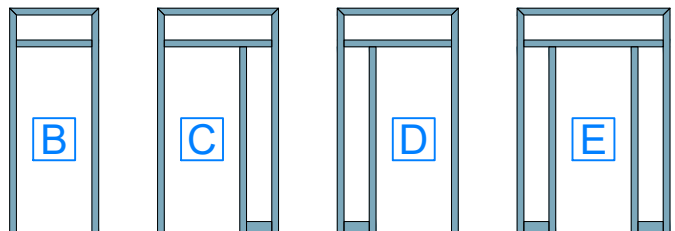

external side view



**SMALLER SUBFRAME "CT3" WITH
STANDARD FRAME – Solution 4**

8.5

VERTICAL SECTIONS
scale 1:2

v 4.1

DI.BI. PORTE BLINDATE Srl - Fano (PU) ITALY - www.dibigroup.com

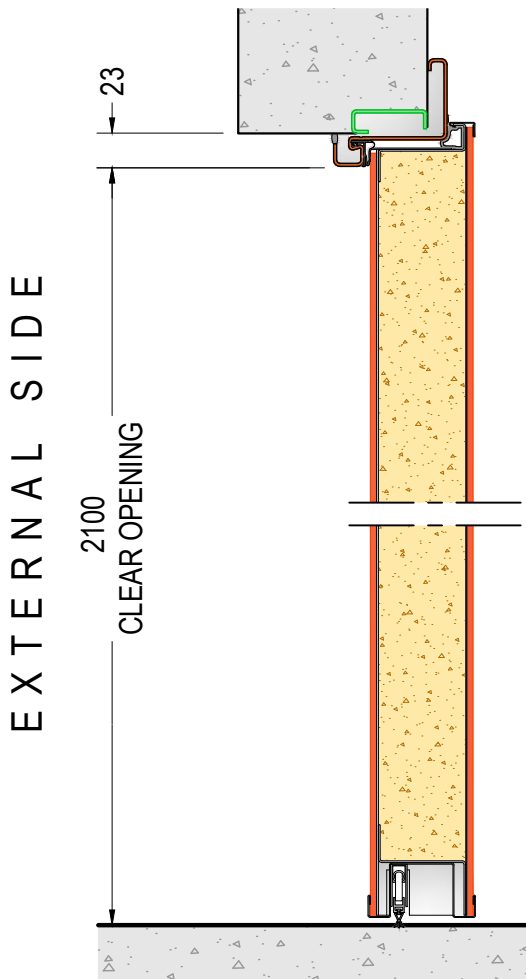

DOOR VERTICAL SECTION
MODELS "F-G-H"
 ref. DOOR H=2100
 GLAZED AREA HEIGHT GAH=2100

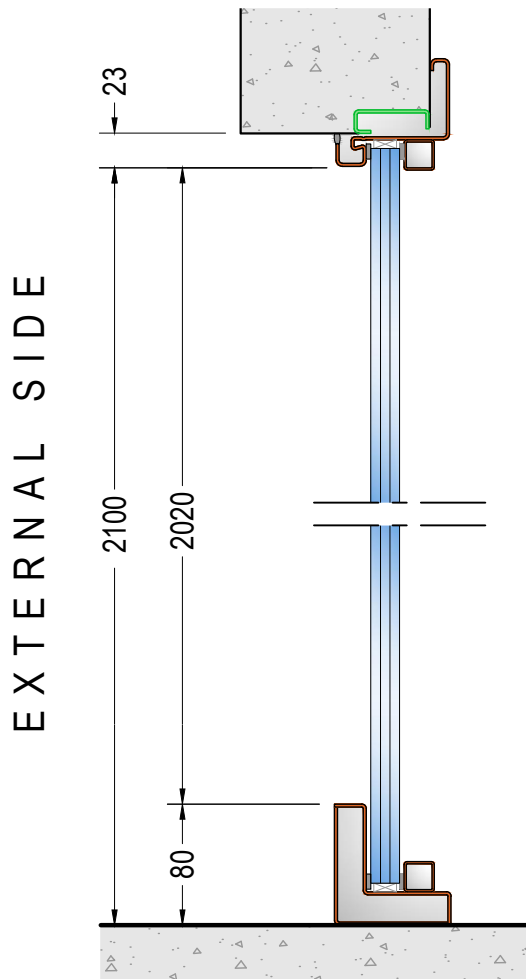

SIDE WINDOW VERTICAL SECTION
MODELS "F-G-H"
 ref. DOOR H=2100
 GLAZED AREA HEIGHT GAH=2100

GLAZED AREA:
 MAXIMUM OVERALL DIMENSIONS
 (GAWxGAH)
2000x2850 model B
1800x2850 models C-D-E
2850x2700 models F-G-H

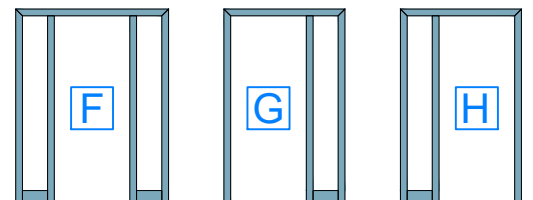

external side view



**SMALLER SUBFRAME "CT3" WITH
 STANDARD FRAME – Solution 4**

8.6

VERTICAL SECTIONS
 scale 1:2

v 4.1

DI.BI. PORTE BLINDATE Srl - Fano (PU) ITALY - www.dibigroup.com

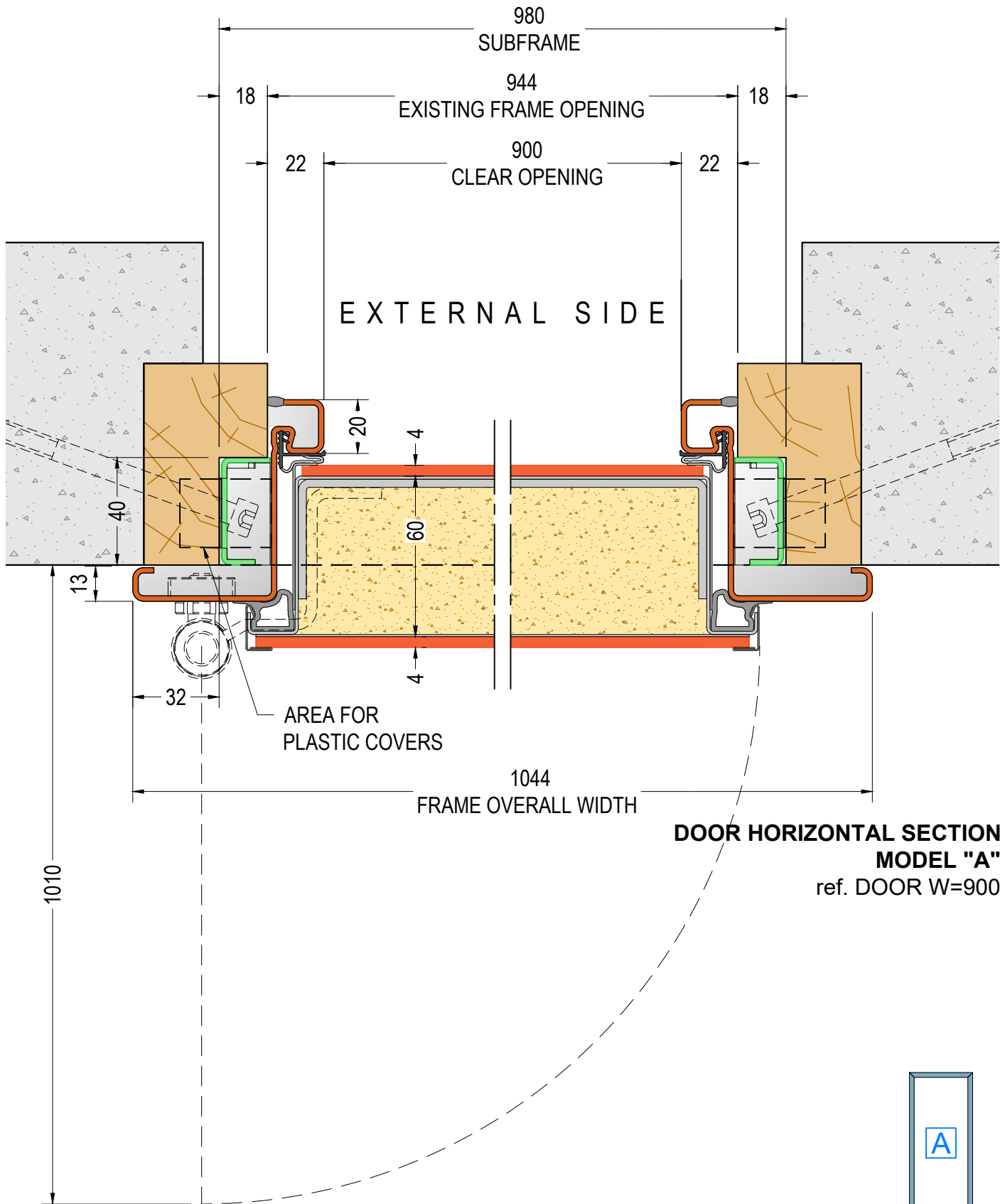

external side view

**SMALLER SUBFRAME "CT3.1"
WITH STANDARD FRAME**

8.7

HORIZONTAL SECTION
scale 1:2

v 1.0

DI.BI. PORTE BLINDATE Srl - Fano (PU) ITALY - www.dibigroup.com

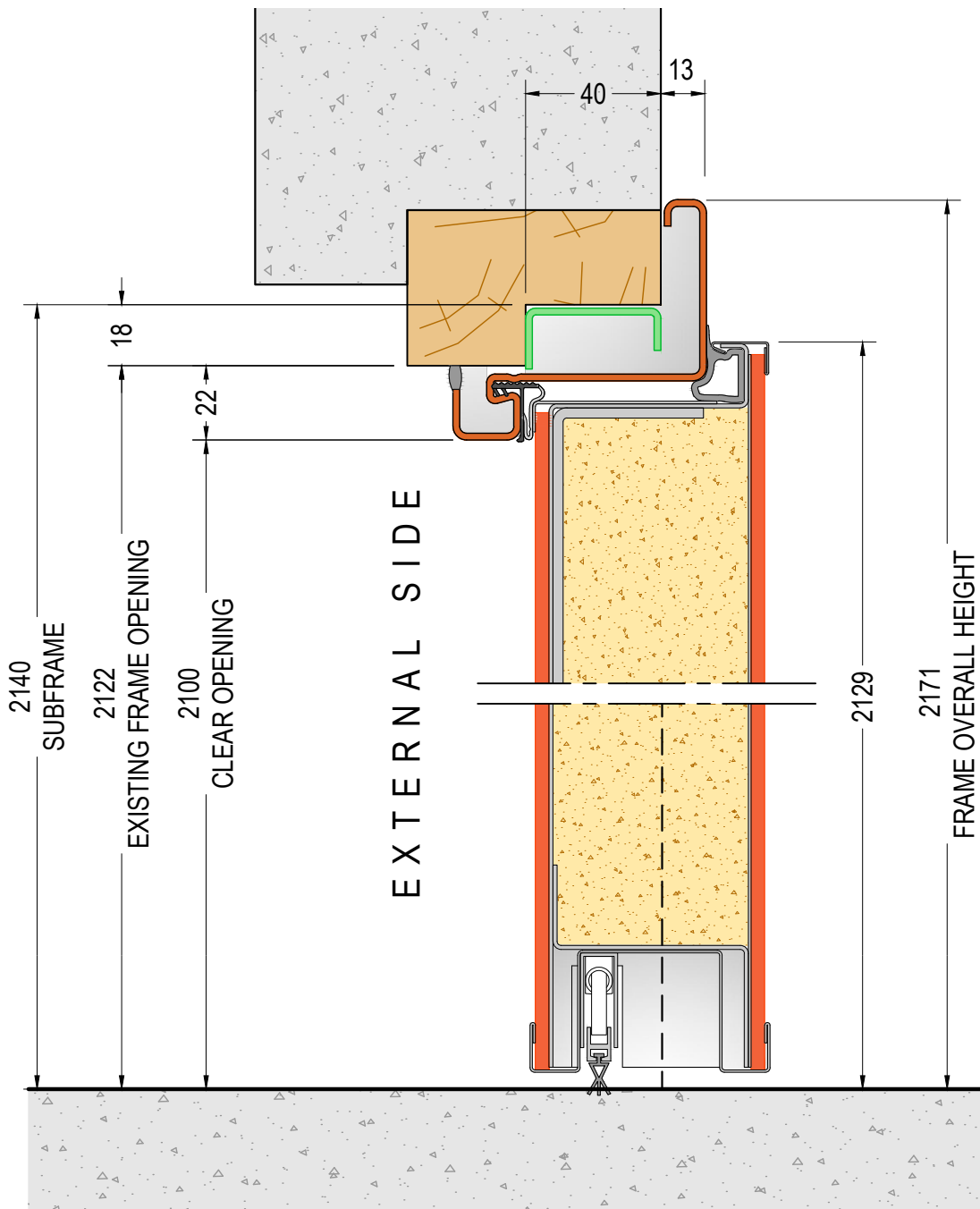

**DOOR VERTICAL SECTION
MODEL "A"**
ref. DOOR H=2100

DOOR DIMENSIONS:
W=min.700 - max.2000
H=min.2000 - max.2450



external side view



**SMALLER SUBFRAME "CT3.1"
WITH STANDARD FRAME**

8.8

VERTICAL SECTION
scale 1:2

v 1.0

DI.BI. PORTE BLINDATE Srl - Fano (PU) ITALY - www.dibigroup.com

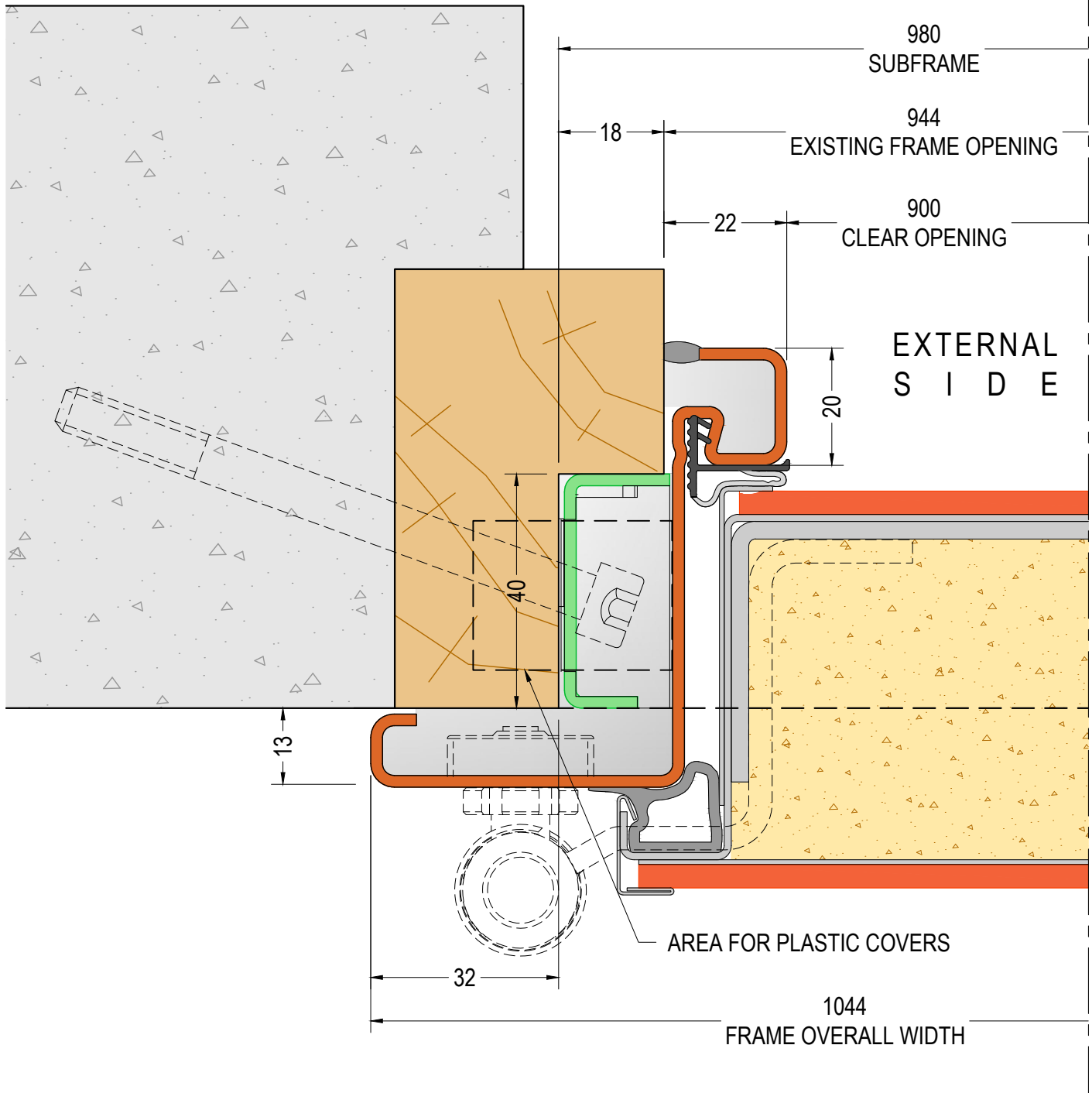

**DOOR HORIZONTAL SECTION
MODEL "A"**
ref. DOOR W=900

external side view

**SMALLER SUBFRAME "CT3.1"
WITH STANDARD FRAME**

8.9

HORIZONTAL SECTION
scale 1:1

v 1.0

DI.BI. PORTE BLINDATE Srl - Fano (PU) ITALY - www.dibigroup.com

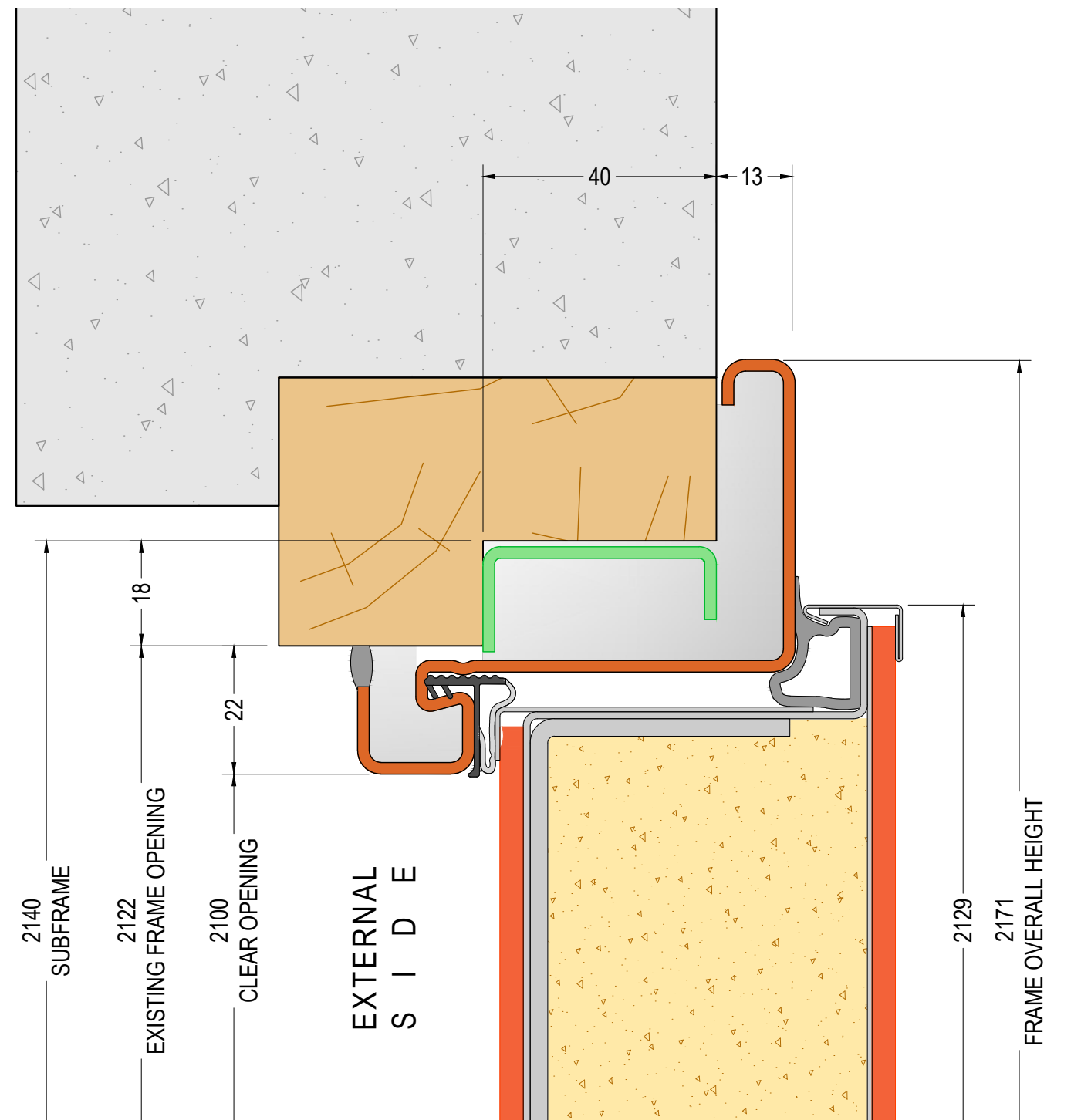

**DOOR VERTICAL SECTION
MODEL "A"**
ref. DOOR H=2100

DOOR DIMENSIONS:
W=min.700 - max.2000
H=min.2000 - max.2450

external side view



SMALLER SUBFRAME "CT3.1" WITH STANDARD FRAME **8.10**

VERTICAL SECTION
scale 1:1

v 1.0

DI.BI. PORTE BLINDATE Srl - Fano (PU) ITALY - www.dibigroup.com

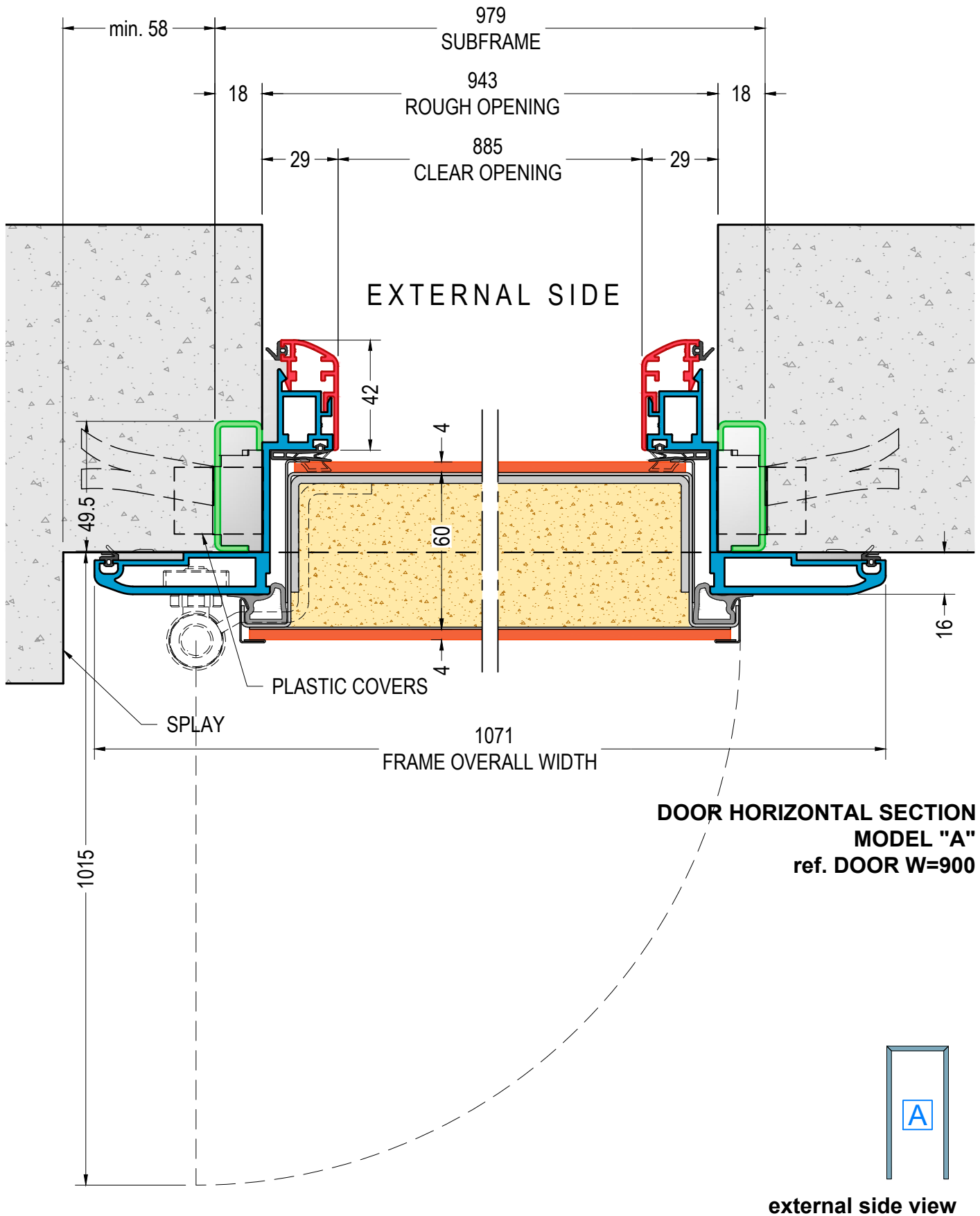

**SMALLER SUBFRAME "CT3"
WITH BICOLOUR ALUMINIUM
FRAME**

9.1

HORIZONTAL SECTION - scale 1:2

v 3.2

DI.BI. PORTE BLINDATE Srl - Fano (PU) ITALY - www.dibigroup.com

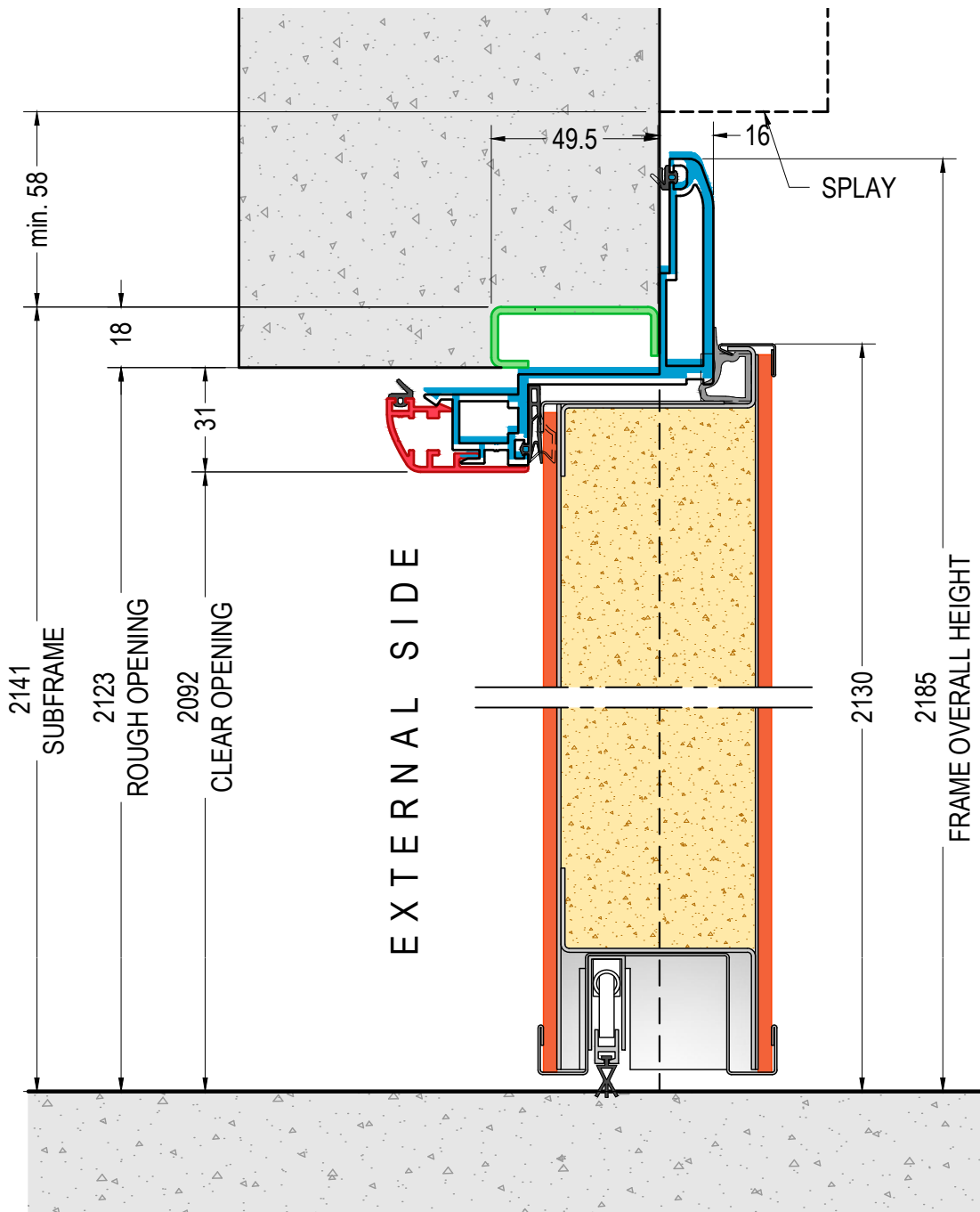

**DOOR VERTICAL SECTION
MODEL "A"**
ref. DOOR H=2100

DOOR DIMENSIONS:
W=min.700 - max.2000
H=min.2000 - max.2450



external side view



**SMALLER SUBFRAME "CT3"
WITH BICOLOUR ALUMINIUM
FRAME**

9.2

VERTICAL SECTION - scale 1:2

v 3.2

DI.BI. PORTE BLINDATE Srl - Fano (PU) ITALY - www.dibigroup.com

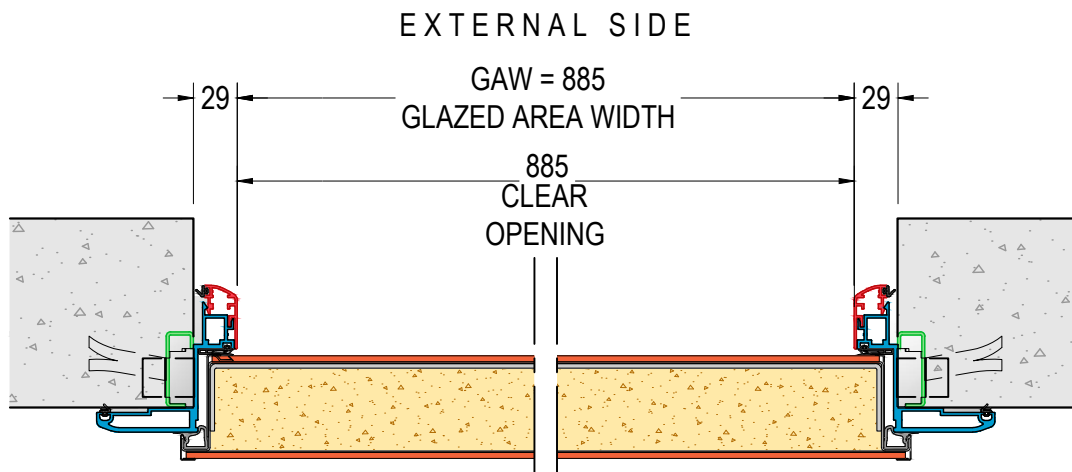

**DOOR HORIZONTAL SECTION
MODEL "B"**

ref. DOOR W=900 - GLAZED AREA WIDTH GAW=885

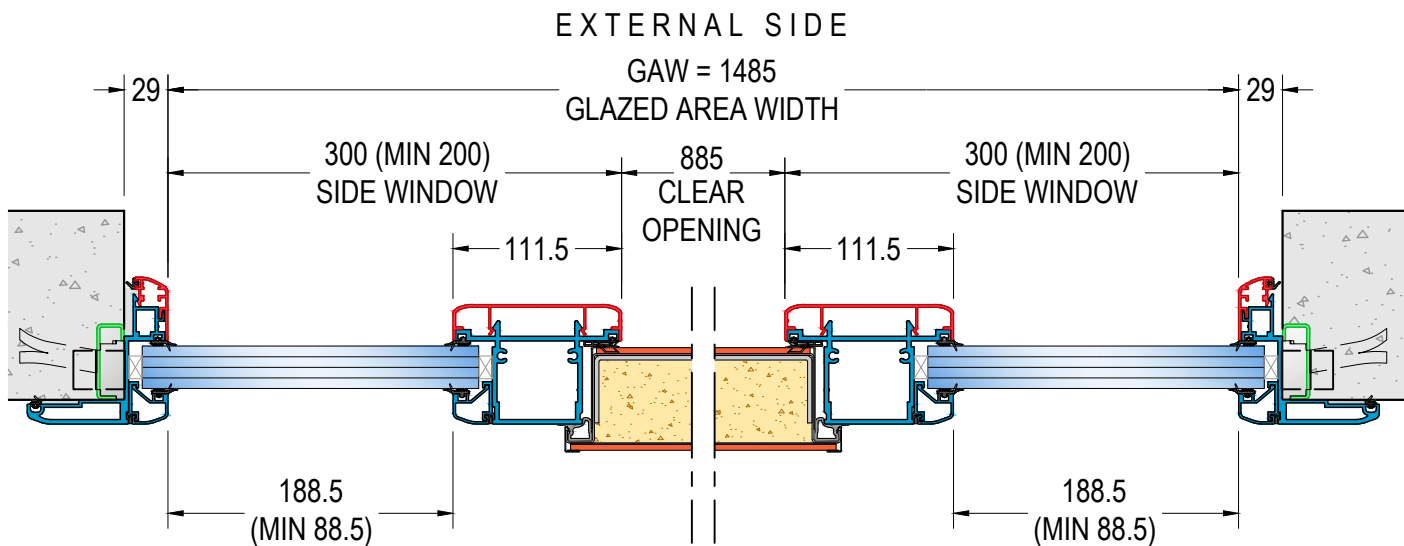

**DOOR HORIZONTAL SECTION
MODELS "E-F"**

ref. DOOR W=900 - SIDE WINDOW 300
GLAZED AREA WIDTH GAW=1485

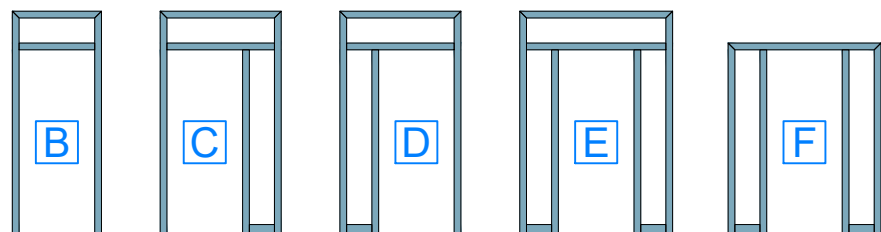

external side view



**SMALLER SUBFRAME "CT3"
WITH BICOLOUR ALUMINIUM
FRAME**

9.3

HORIZONTAL SECTIONS - scale 1:5

v 3.1

DI.BI. PORTE BLINDATE Srl - Fano (PU) ITALY - www.dibigroup.com

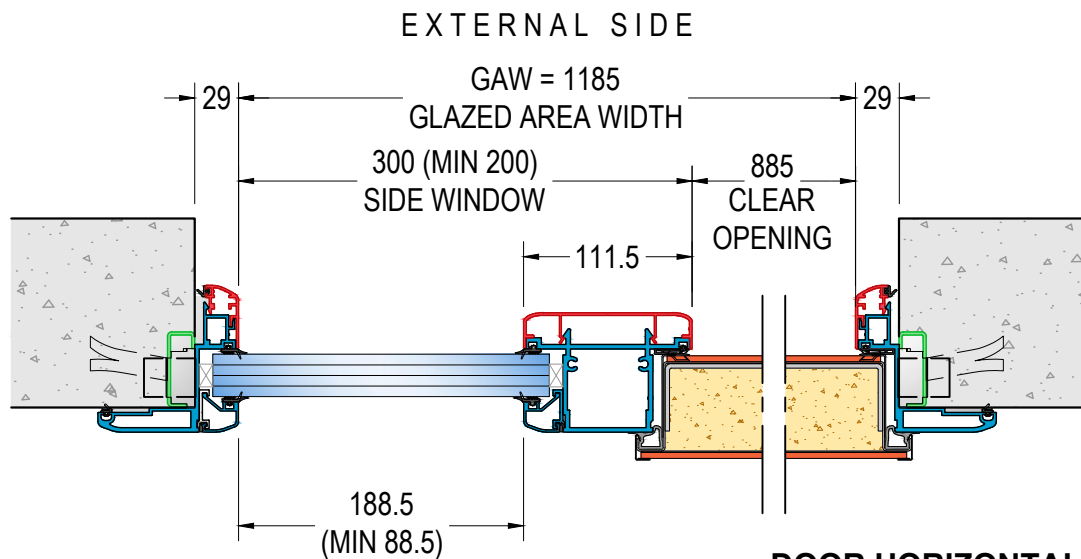

**DOOR HORIZONTAL SECTION
MODELS "C-G"**

ref. DOOR W=900 - SIDE WINDOW 300
GLAZED AREA WIDTH GAW=1185

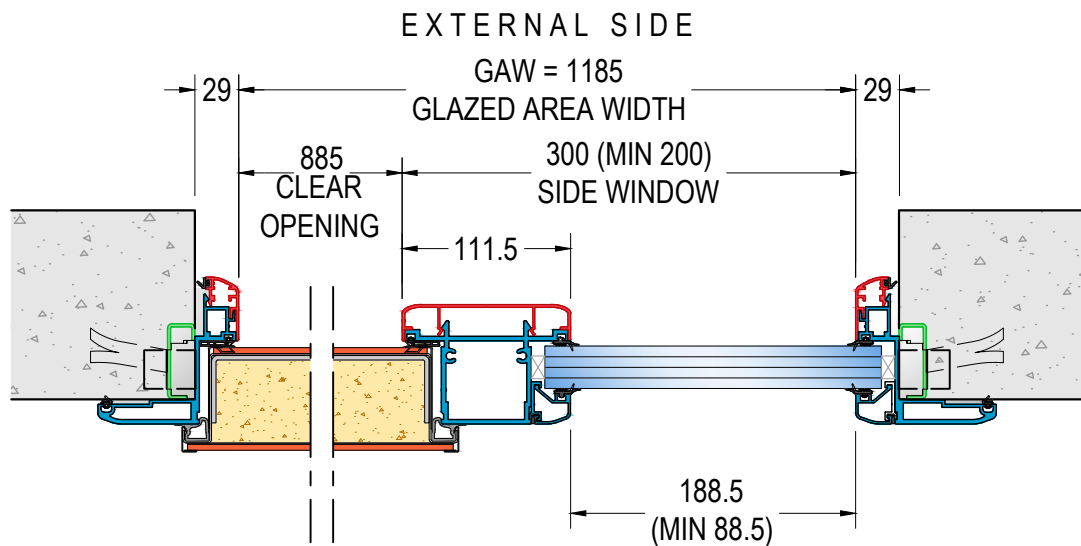

**DOOR HORIZONTAL SECTION
MODELS "D-H"**

ref. DOOR W=900 - SIDE WINDOW 300
GLAZED AREA WIDTH GAW=1185

GLAZED AREA:
MAXIMUM OVERALL DIMENSIONS
4800x4900 (GAWxGAH / GAHxGAW)

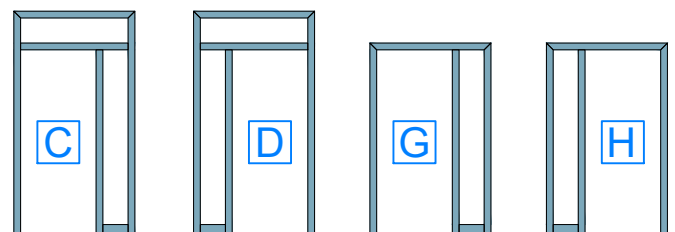

external side view



**SMALLER SUBFRAME "CT3"
WITH BICOLOUR ALUMINIUM
FRAME**

9.4

HORIZONTAL SECTIONS - scale 1:5

v 3.1

DI.BI. PORTE BLINDATE Srl - Fano (PU) ITALY - www.dibigroup.com

EXTERNAL SIDE

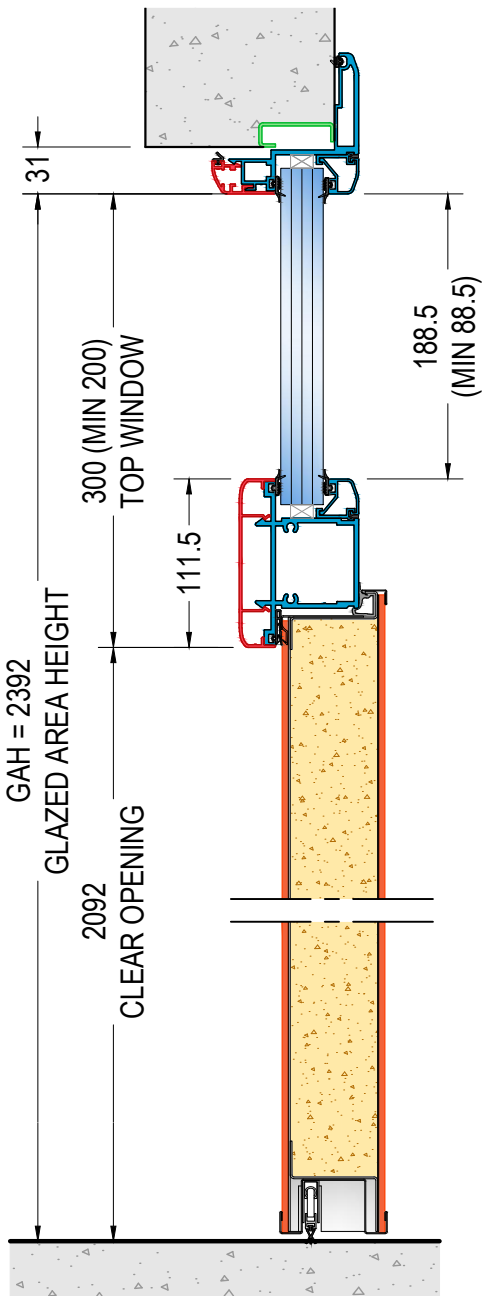

**DOOR VERTICAL SECTION
MODELS "B-C-D-E"**

ref. DOOR H=2100 - TOP WINDOW 300
GLAZED AREA HEIGHT GAH=2392

EXTERNAL SIDE

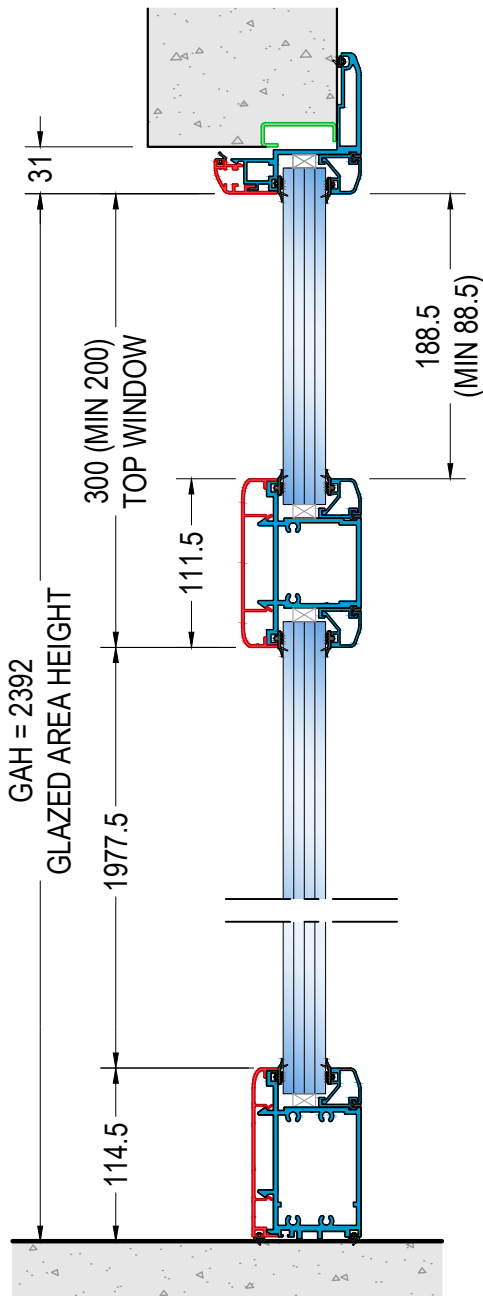

**SIDE WINDOW VERTICAL SECTION
MODELS "C-D-E"**

ref. DOOR H=2100 - TOP WINDOW 300
GLAZED AREA HEIGHT GAH=2392

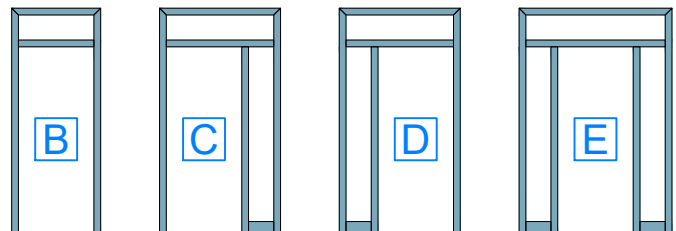

external side view



**SMALLER SUBFRAME "CT3"
WITH BICOLOUR ALUMINIUM
FRAME**

9.5

VERTICAL SECTIONS - scale 1:2

v 3.1

DI.BI. PORTE BLINDATE Srl - Fano (PU) ITALY - www.dibigroup.com

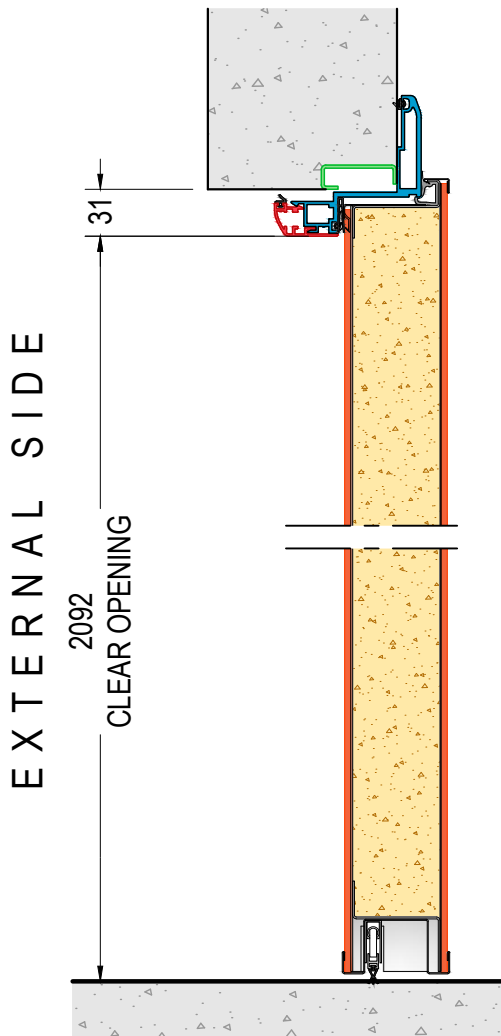

DOOR VERTICAL SECTION
MODELS "F-G-H"
 ref. DOOR H=2100
 GLAZED AREA HEIGHT GAH=2092

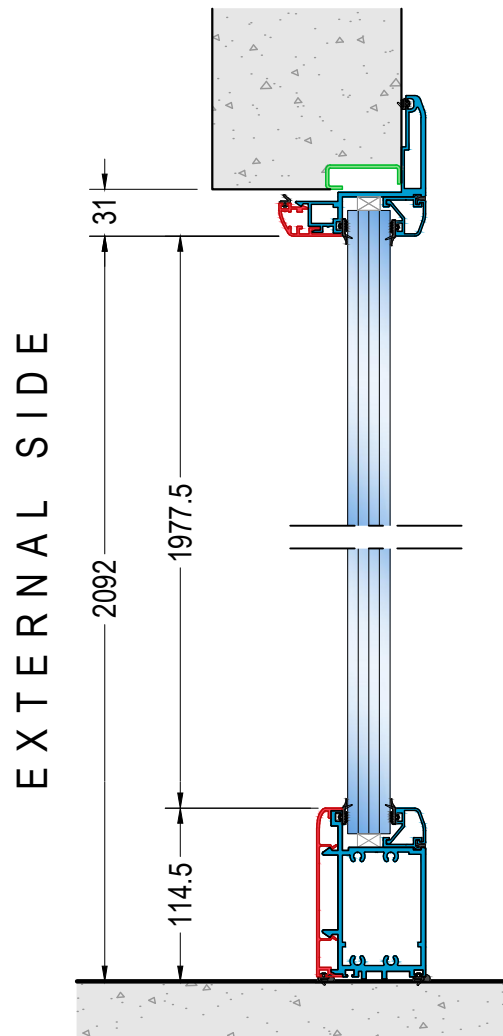

SIDE WINDOW VERTICAL SECTION
MODELS "F-G-H"
 ref. DOOR H=2100
 GLAZED AREA HEIGHT GAH=2092

GLAZED AREA:
 MAXIMUM OVERALL DIMENSIONS
4800x4900 (GAWxGAH / GAHxGAW)

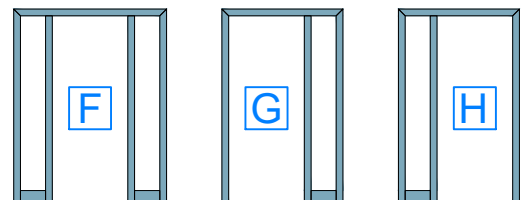

external side view



SMALLER SUBFRAME "CT3"
WITH BICOLOUR ALUMINIUM
FRAME

9.6

VERTICAL SECTIONS - scale 1:2

v 3.1

DI.BI. PORTE BLINDATE Srl - Fano (PU) ITALY - www.dibigroup.com

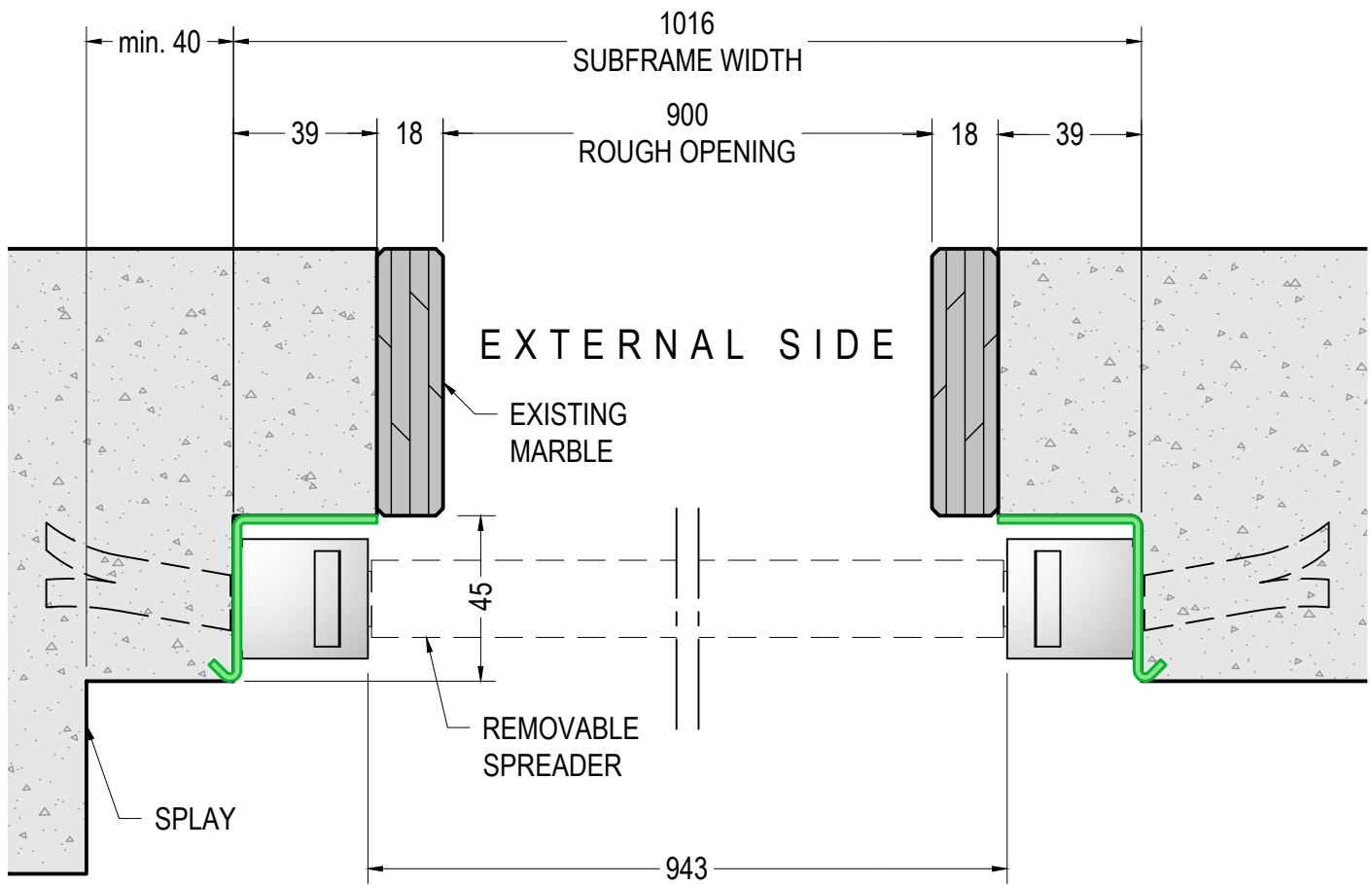

HORIZONTAL SECTION
ref. DOOR W=900

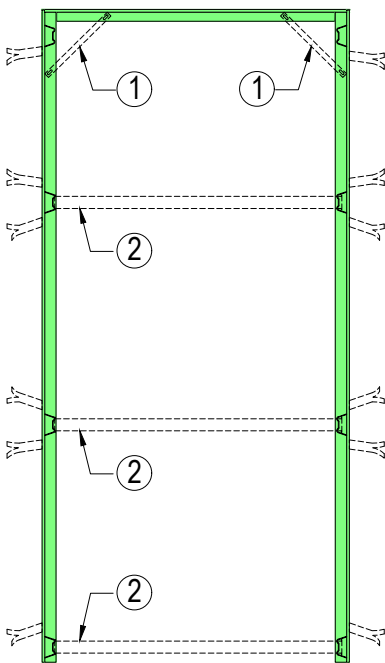

- ① Removable corner gussets
- ② Removable spreaders

INTERNAL SIDE VIEW



**SUBFRAME "CT4" WITH
REDUCED EXTENSION**

10.1

HORIZONTAL SECTION - scale 1:2
INTERNAL SIDE VIEW - scale 1:25

v 4.2

DI.BI. PORTE BLINDATE Srl - Fano (PU) ITALY - www.dibigroup.com

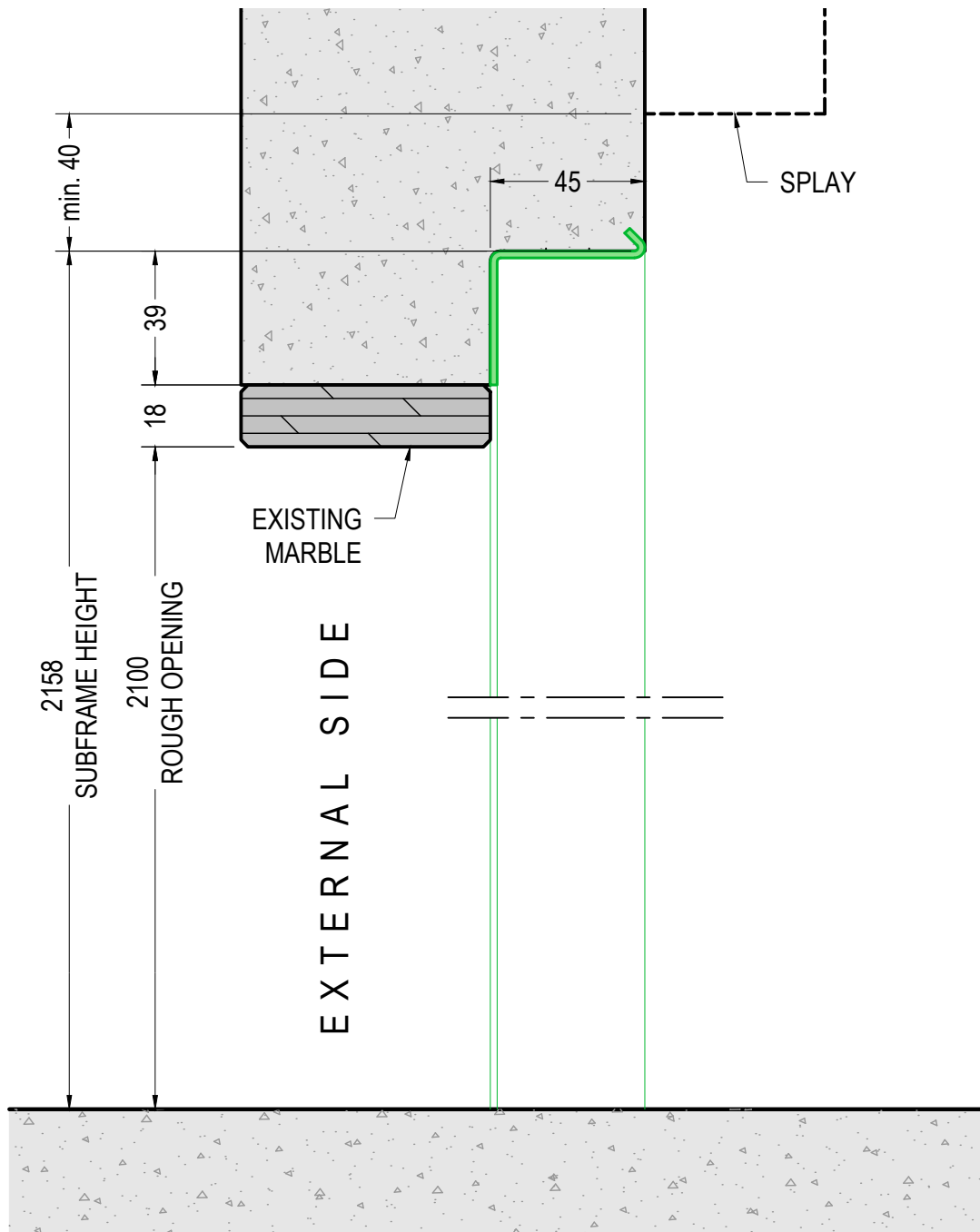

VERTICAL SECTION
ref. DOOR H=2100

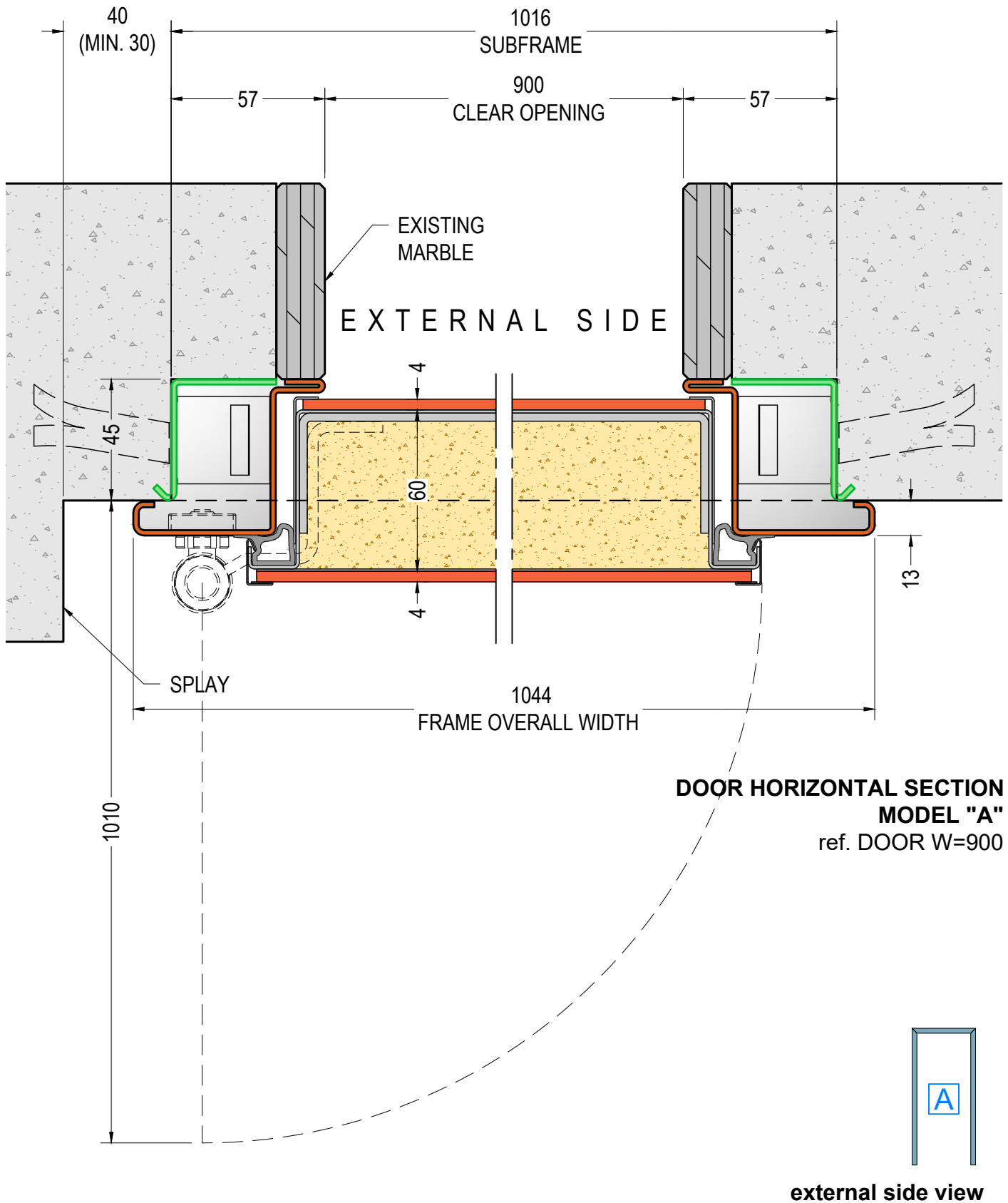

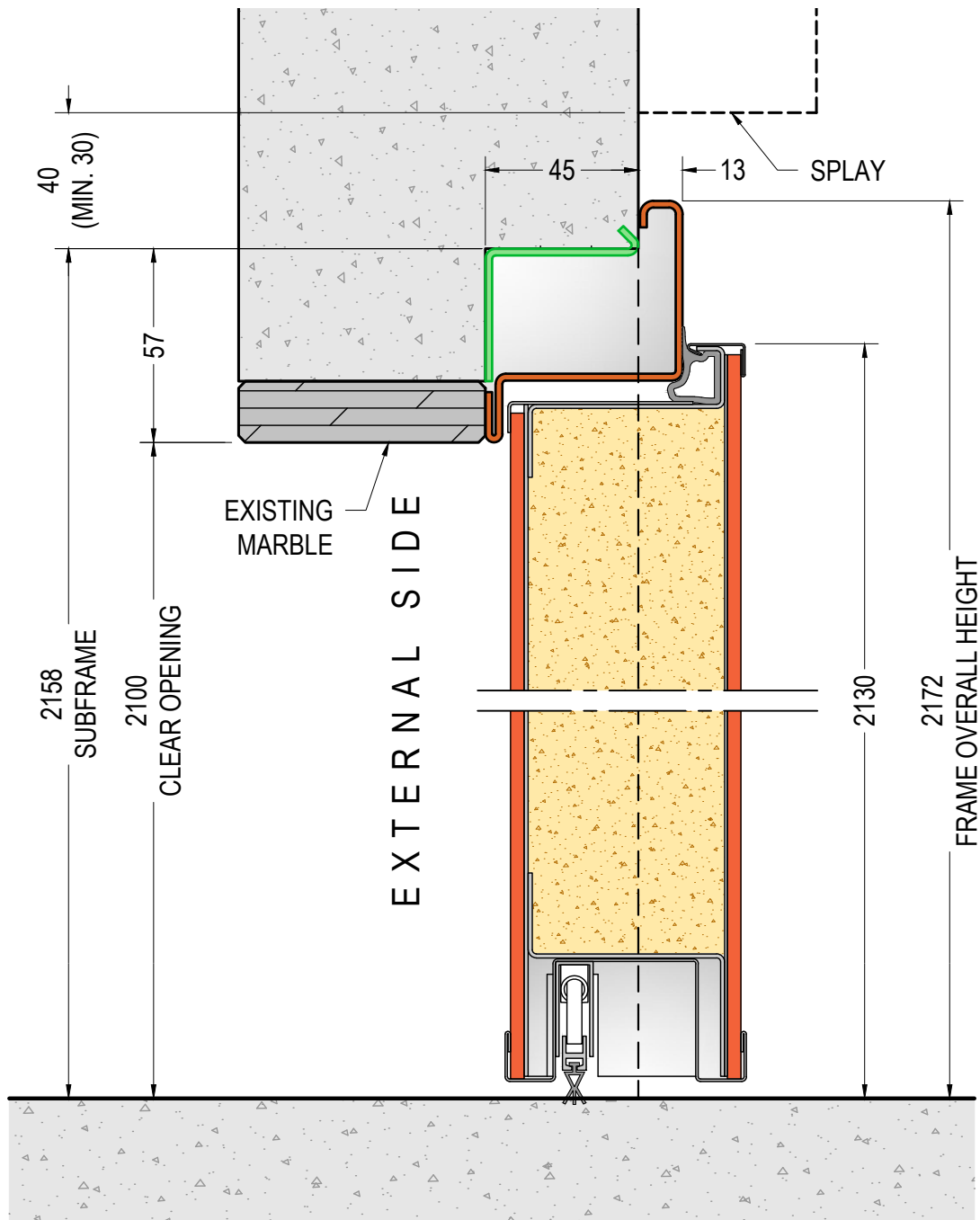

**DOOR VERTICAL SECTION
MODEL "A"**
ref. DOOR H=2100

DOOR DIMENSIONS:
W=min.700 - max.2000
H=min.2000 - max.2700



external side view



**SUBFRAME AND FRAME
WITH REDUCED EXTENSION
"CT4" – Solution 5**

10.4

VERTICAL SECTION - scale 1:2

v 4.3

DI.BI. PORTE BLINDATE Srl - Fano (PU) ITALY - www.dibigroup.com

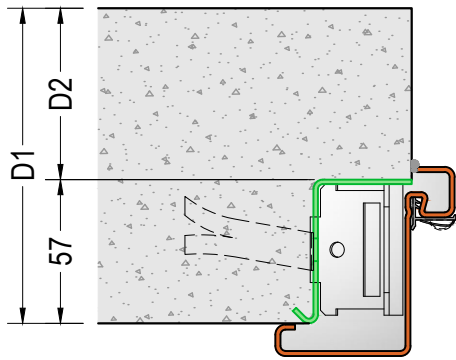

Standard solution 1 (6, 6a, 6b)

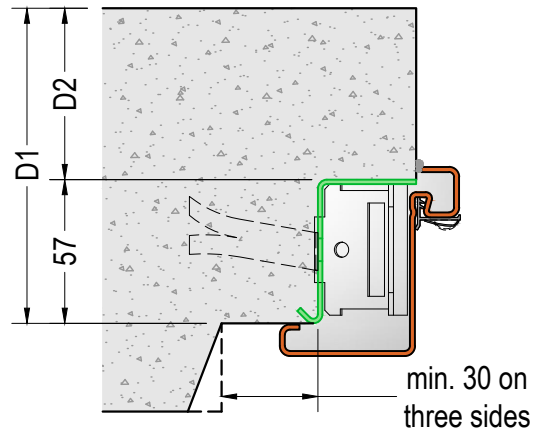

Standard solution with internal splay

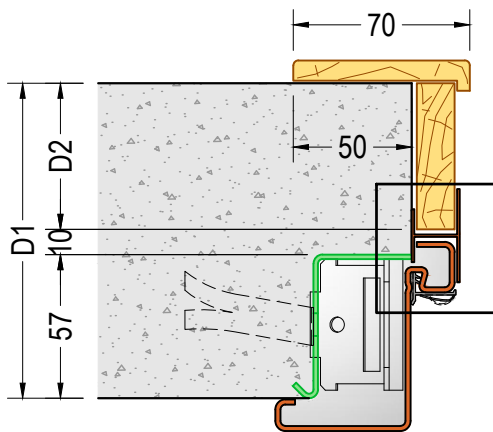

Solution 2 with exposed wooden extension lining

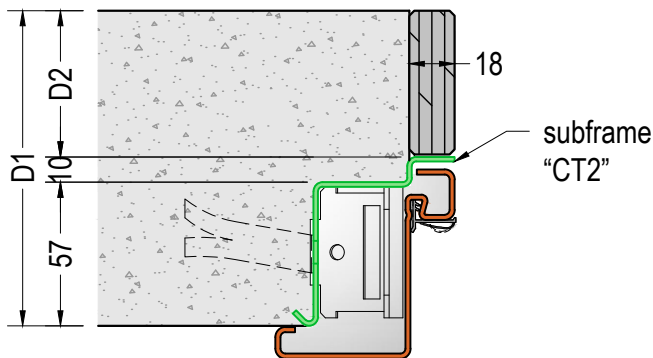
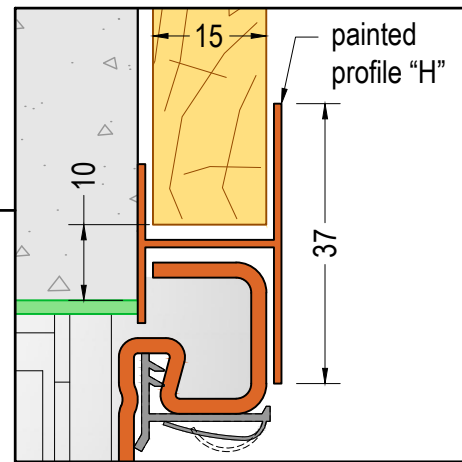

Solution 3 with exposed marble extension lining

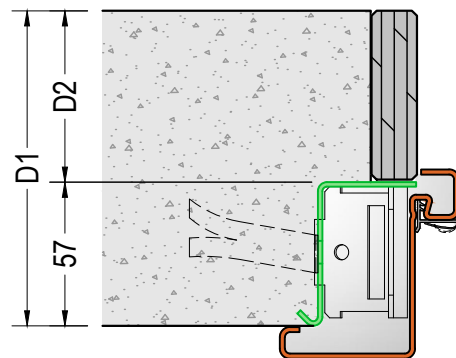

Solution 5 with marble extension lining flush with the subframe

VARIABLE DIMENSIONS	
Wall thickness	D1 =
Extension lining dimensions	D2 =

STEEL FRAME INSTALLATION SOLUTIONS

12.1

HORIZONTAL SECTIONS
scale 1:3

v 2.3

DI.BI. PORTE BLINDATE Srl - Fano (PU) ITALY - www.dibigroup.com

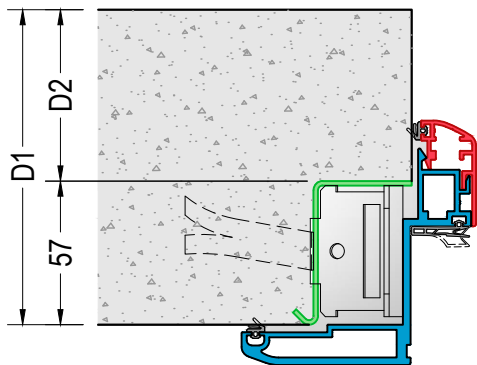

Standard solution 8

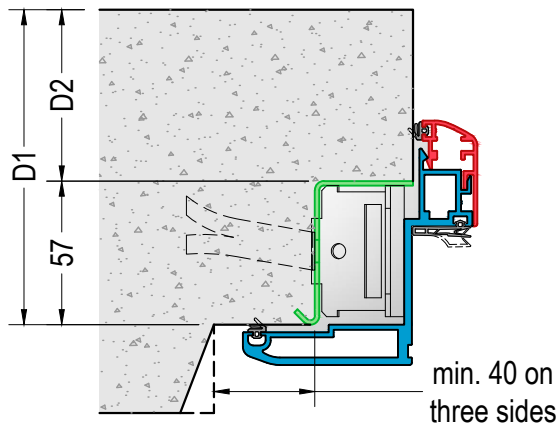

Standard solution with internal splay

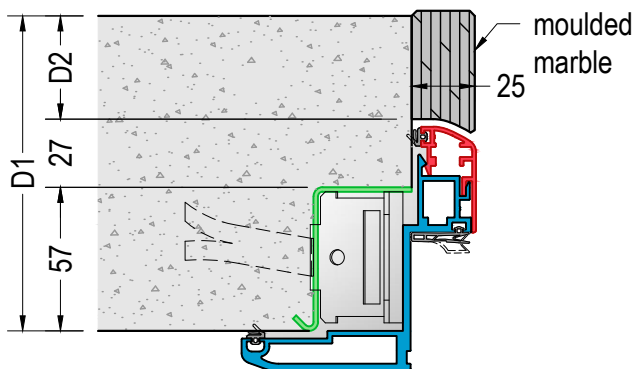

Solution with exposed aluminium extension lining

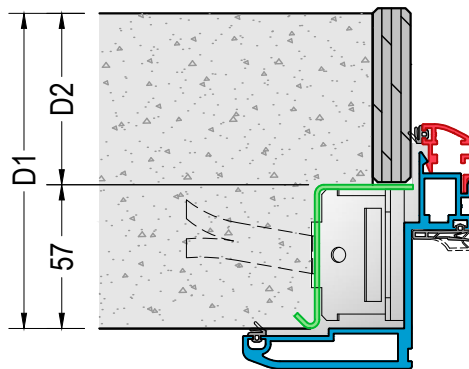

Solution 9 with exposed aluminium extension lining and subframe

VARIABLE DIMENSIONS	
Wall thickness	D1 =
Extension lining dimensions	D2 =



ALUMINIUM FRAME INSTALLATION SOLUTIONS

12.2

VERTICAL SECTIONS

scale 1:3

v 2.3

DI.BI. PORTE BLINDATE Srl - Fano (PU) ITALY - www.dibigroup.com

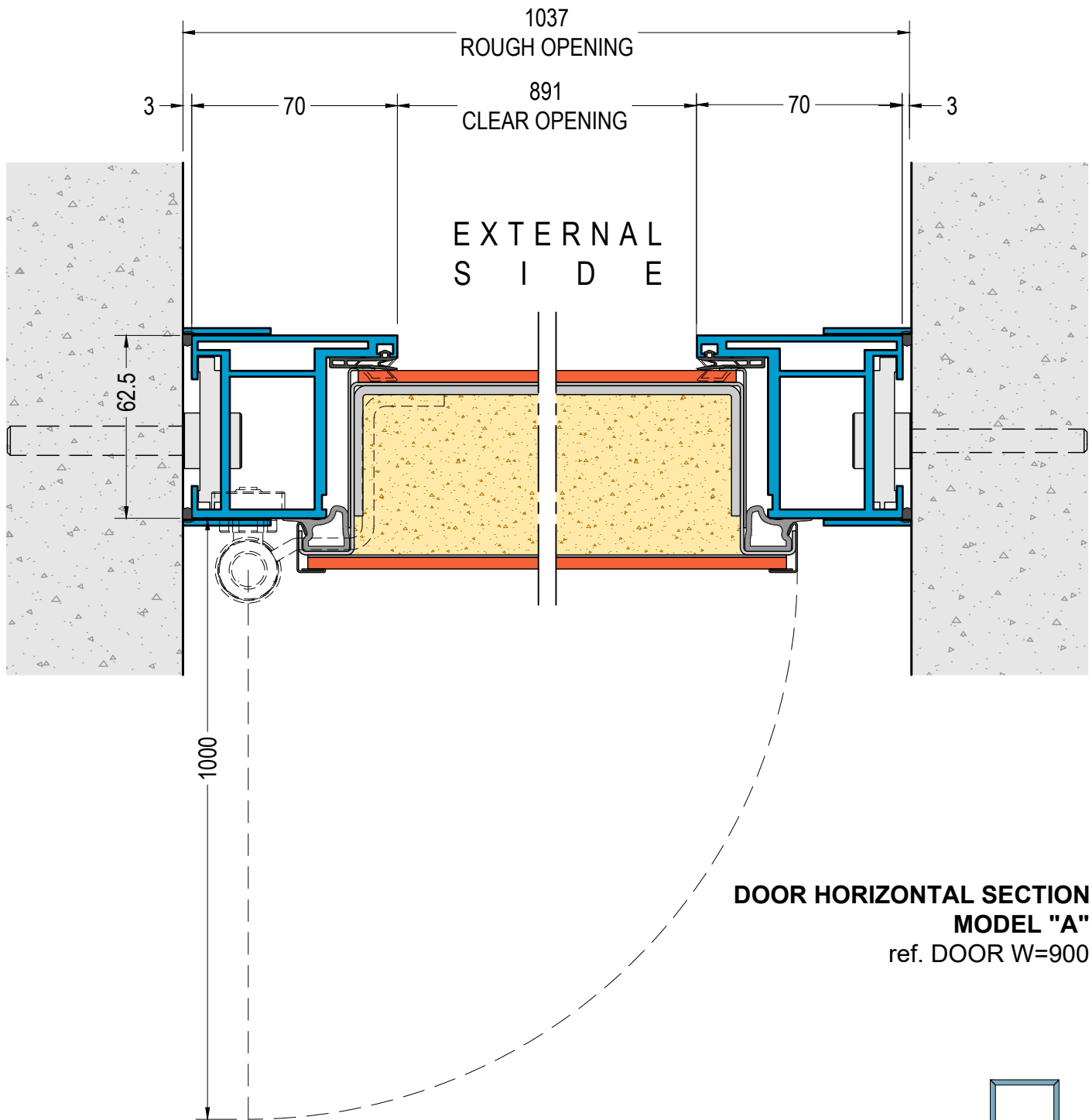

**DOOR HORIZONTAL SECTION
MODEL "A"**
ref. DOOR W=900

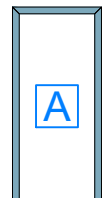

external side view



**ONE COLOUR ALUMINIUM
FRAME FLUSH WITH THE
WALL - Solution 11**

HORIZONTAL SECTION - scale 1:2

14.1

v 3.3

DI.BI. PORTE BLINDATE Srl - Fano (PU) ITALY - www.dibigroup.com

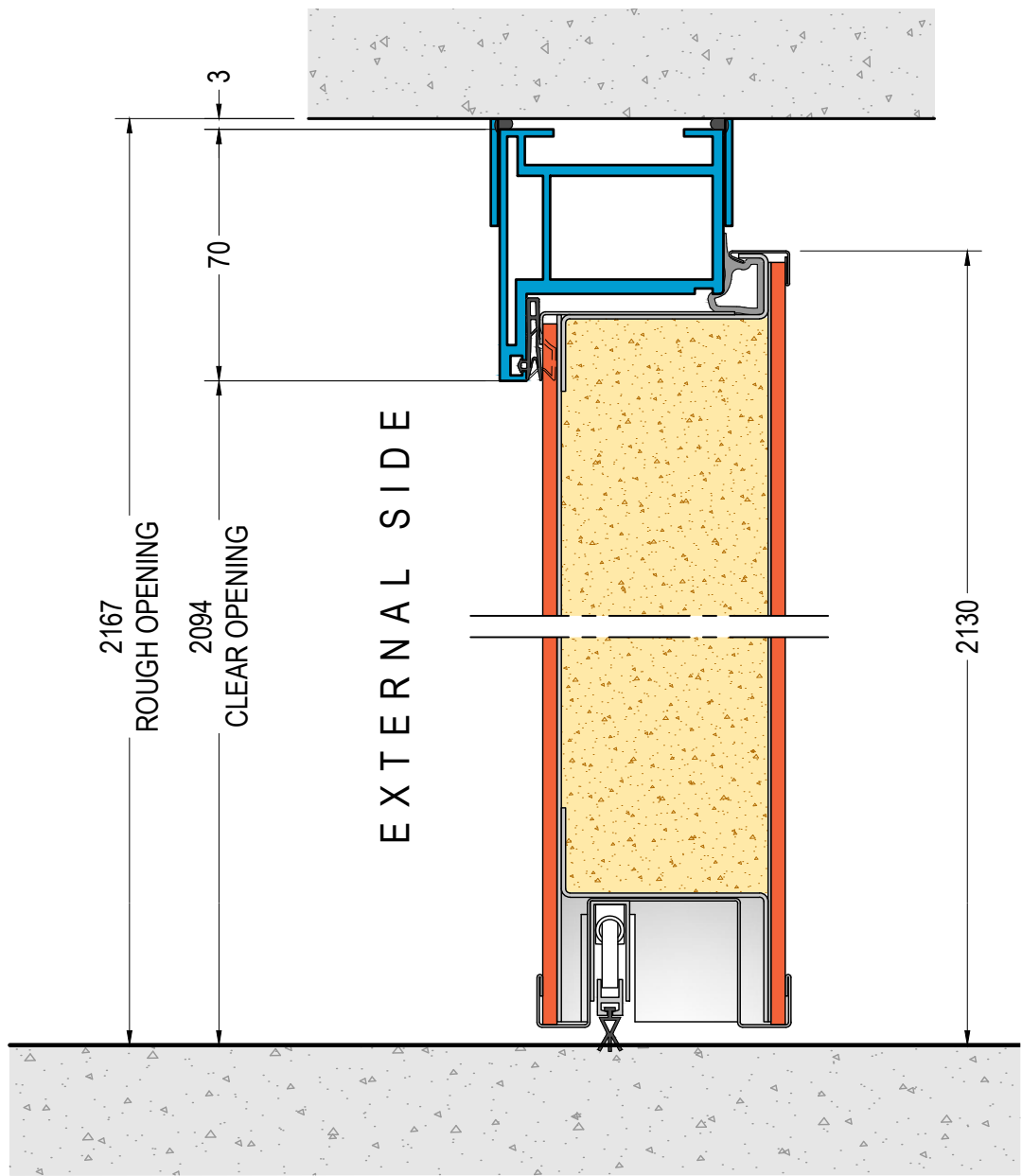

**DOOR VERTICAL SECTION
MODEL "A"**
ref. DOOR H=2100

DOOR DIMENSIONS:
W=min.700 - max.2000
H=min.2000 - max.2700

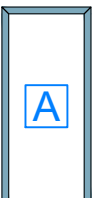

external side view



**ONE COLOUR ALUMINIUM
FRAME FLUSH WITH THE
WALL - Solution 11**

14.2

VERTICAL SECTION - scale 1:2

v 3.3

DI.BI. PORTE BLINDATE Srl - Fano (PU) ITALY - www.dibigroup.com

EXTERNAL SIDE

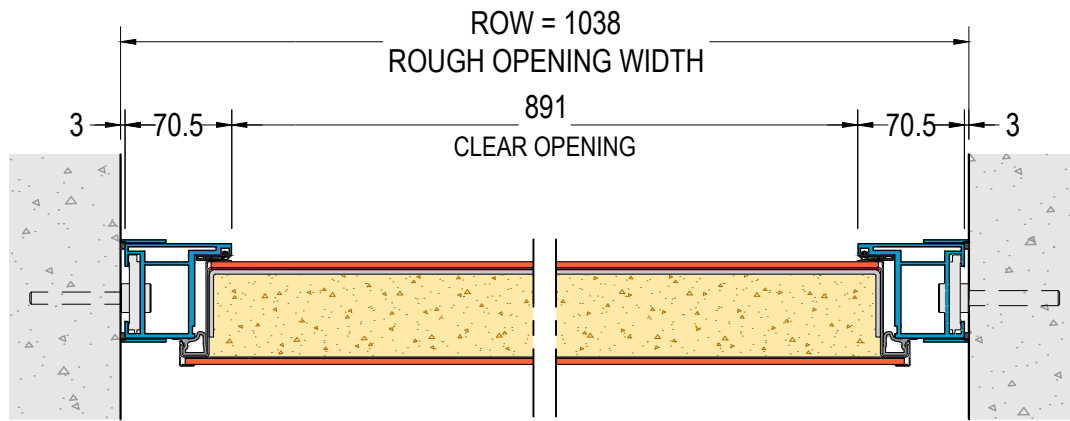

**DOOR HORIZONTAL SECTION
MODEL "B"**

ref. DOOR W=900 - ROUGH OPENING WIDTH ROW=1038

EXTERNAL SIDE

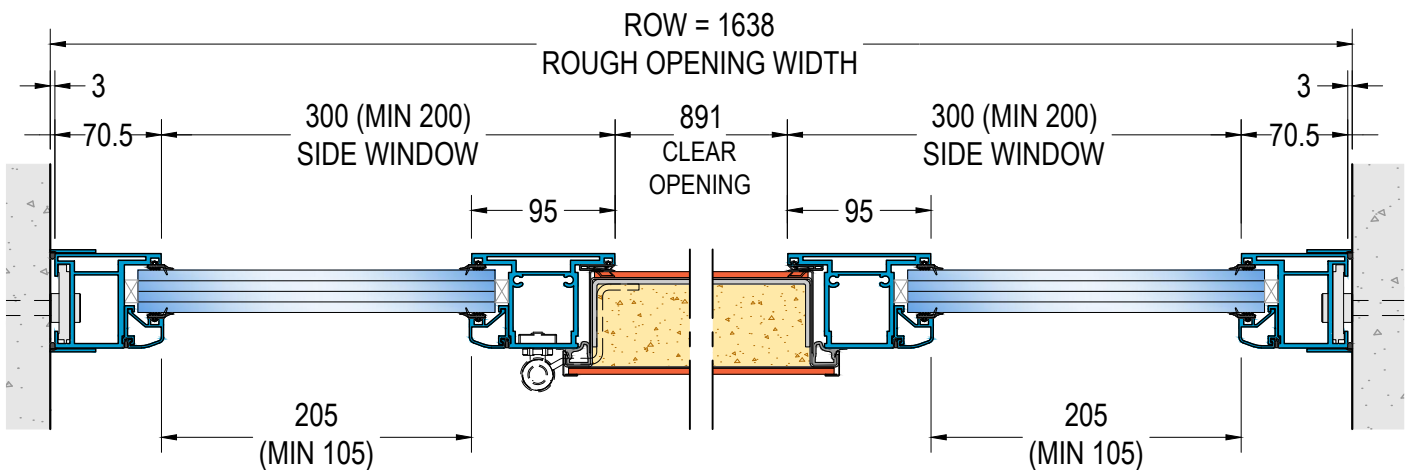

**DOOR HORIZONTAL SECTION
MODELS "E-F"**

ref. DOOR W=900 - SIDE WINDOW 300
ROUGH OPENING WIDTH ROW=1638

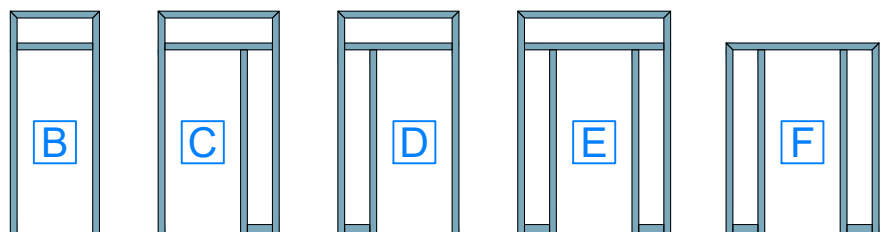

external side view



**ONE COLOUR ALUMINIUM
FRAME FLUSH WITH THE
WALL**

14.3

HORIZONTAL SECTIONS - scale 1:5

v 3.1

DI.BI. PORTE BLINDATE Srl - Fano (PU) ITALY - www.dibigroup.com

EXTERNAL SIDE

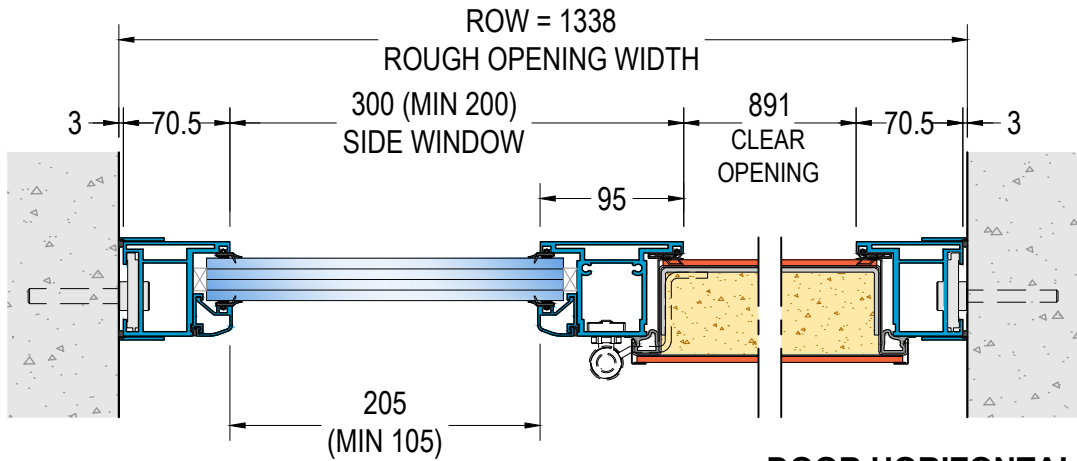

**DOOR HORIZONTAL SECTION
MODELS "C-G"**

ref. DOOR W=900 - SIDE WINDOW 300
ROUGH OPENING WIDTH ROW=1338

EXTERNAL SIDE

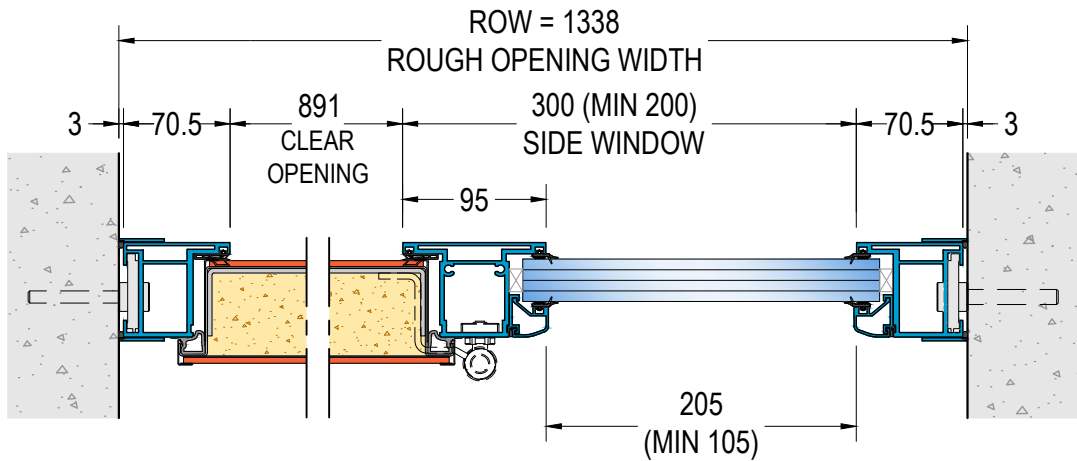

**DOOR HORIZONTAL SECTION
MODELS "D-H"**

ref. DOOR W=900 - SIDE WINDOW 300
ROUGH OPENING WIDTH ROW=1338

ROUGH OPENING:
MAXIMUM OVERALL DIMENSIONS
5000x5000 (ROWxROH)

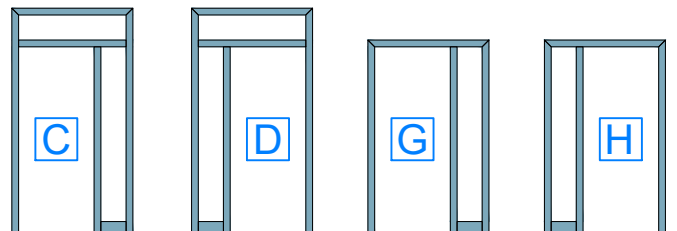

external side view



**ONE COLOUR ALUMINIUM
FRAME FLUSH WITH THE
WALL**

14.4

HORIZONTAL SECTIONS - scale 1:5

v 3.1

DI.BI. PORTE BLINDATE Srl - Fano (PU) ITALY - www.dibigroup.com

EXTERNAL SIDE

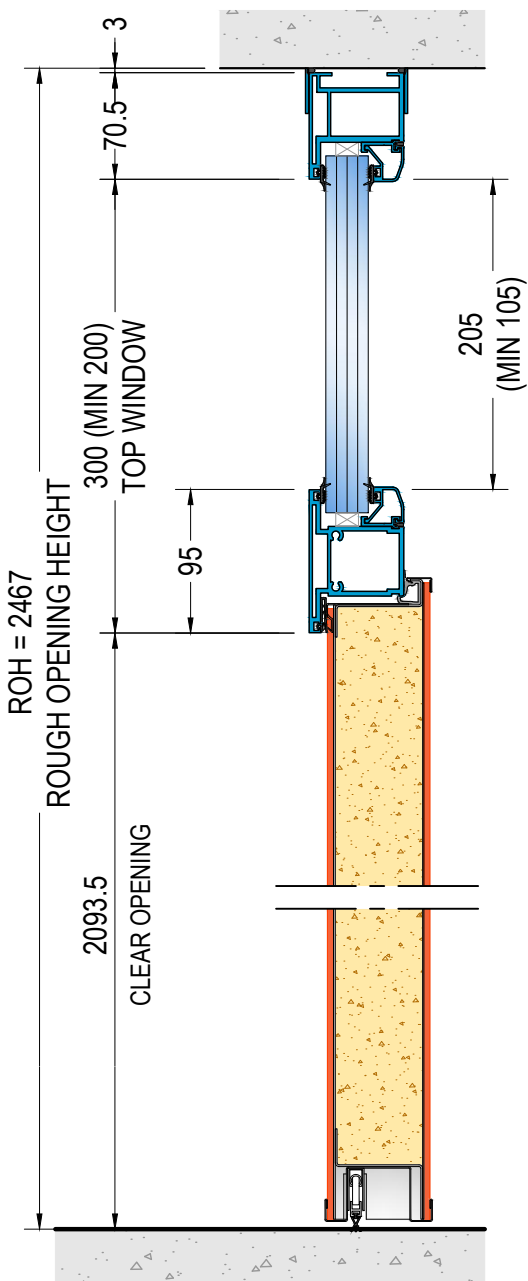

**DOOR VERTICAL SECTION
MODELS "B-C-D-E"**

ref. DOOR H=2100 - TOP WINDOW 300
ROUGH OPENING HEIGHT ROH=2467

EXTERNAL SIDE

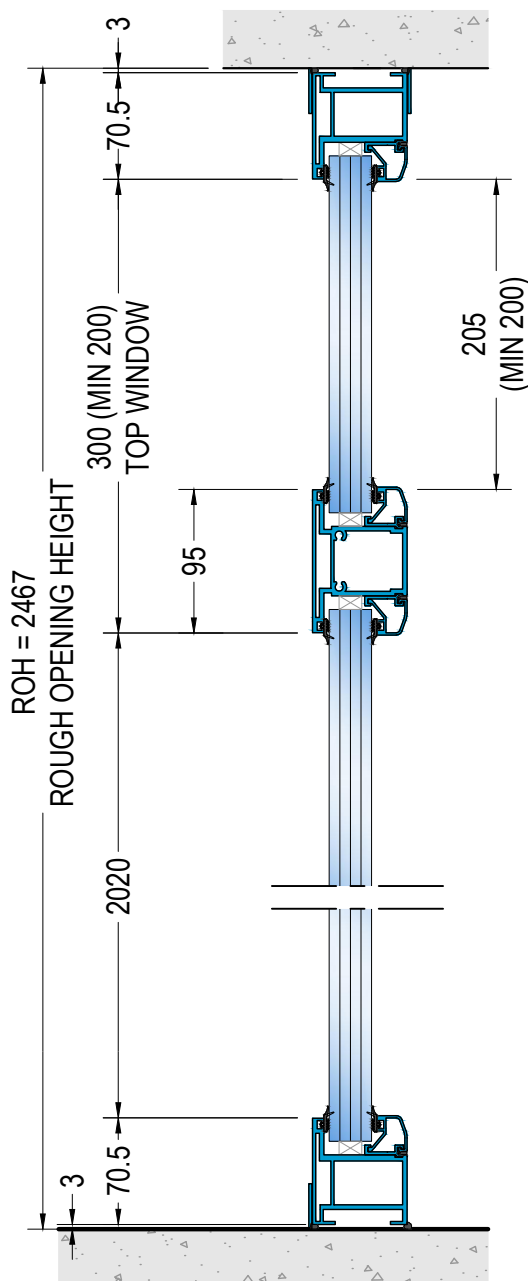

**SIDE WINDOW VERTICAL SECTION
MODELS "C-D-E"**

ref. DOOR H=2100 - TOP WINDOW 300
ROUGH OPENING HEIGHT ROH=2467

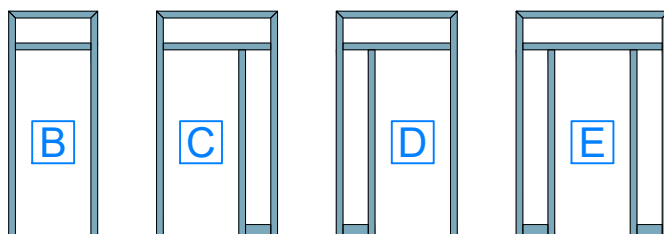

external side view



**ONE COLOUR ALUMINIUM
FRAME FLUSH WITH THE
WALL**

14.5

VERTICAL SECTIONS - scale 1:2

v 3.1

DI.BI. PORTE BLINDATE Srl - Fano (PU) ITALY - www.dibigroup.com

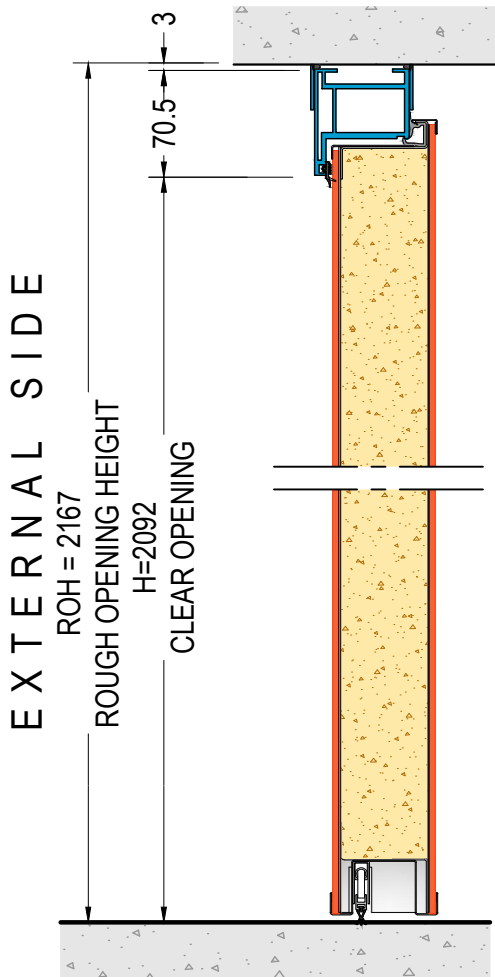

EXTERNAL SIDE

DOOR VERTICAL SECTION
MODELS "F-G-H"
 ref. DOOR H=2100
 ROUGH OPENING HEIGHT ROH=2167

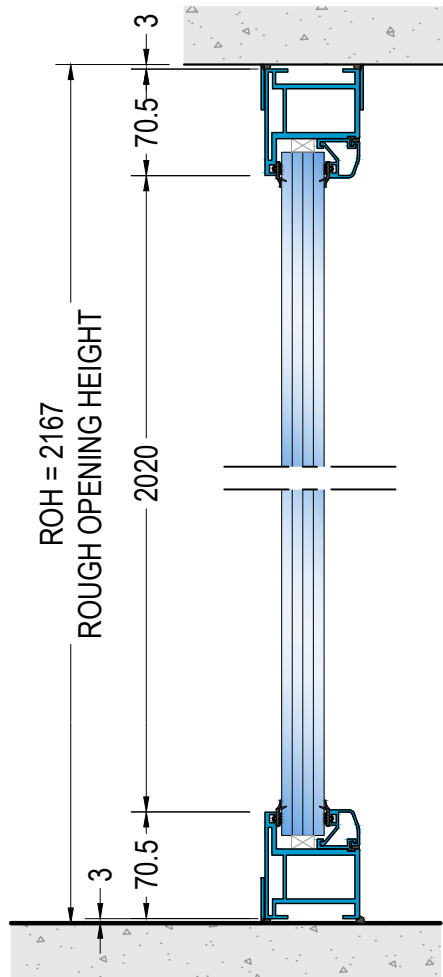

EXTERNAL SIDE

SIDE WINDOW VERTICAL SECTION
MODELS "F-G-H"
 ref. DOOR H=2100
 ROUGH OPENING HEIGHT ROH=2167

ROUGH OPENING:
 MAXIMUM OVERALL DIMENSIONS
 5000x5000 (ROWxROH)

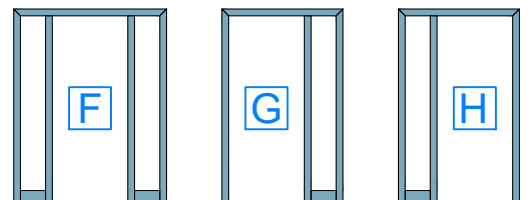

external side view



ONE COLOUR ALUMINIUM
FRAME FLUSH WITH THE
WALL

VERTICAL SECTIONS - scale 1:2

DI.BI. PORTE BLINDATE Srl - Fano (PU) ITALY - www.dibigroup.com

14.6

v 3.1

EXTERNAL SIDE

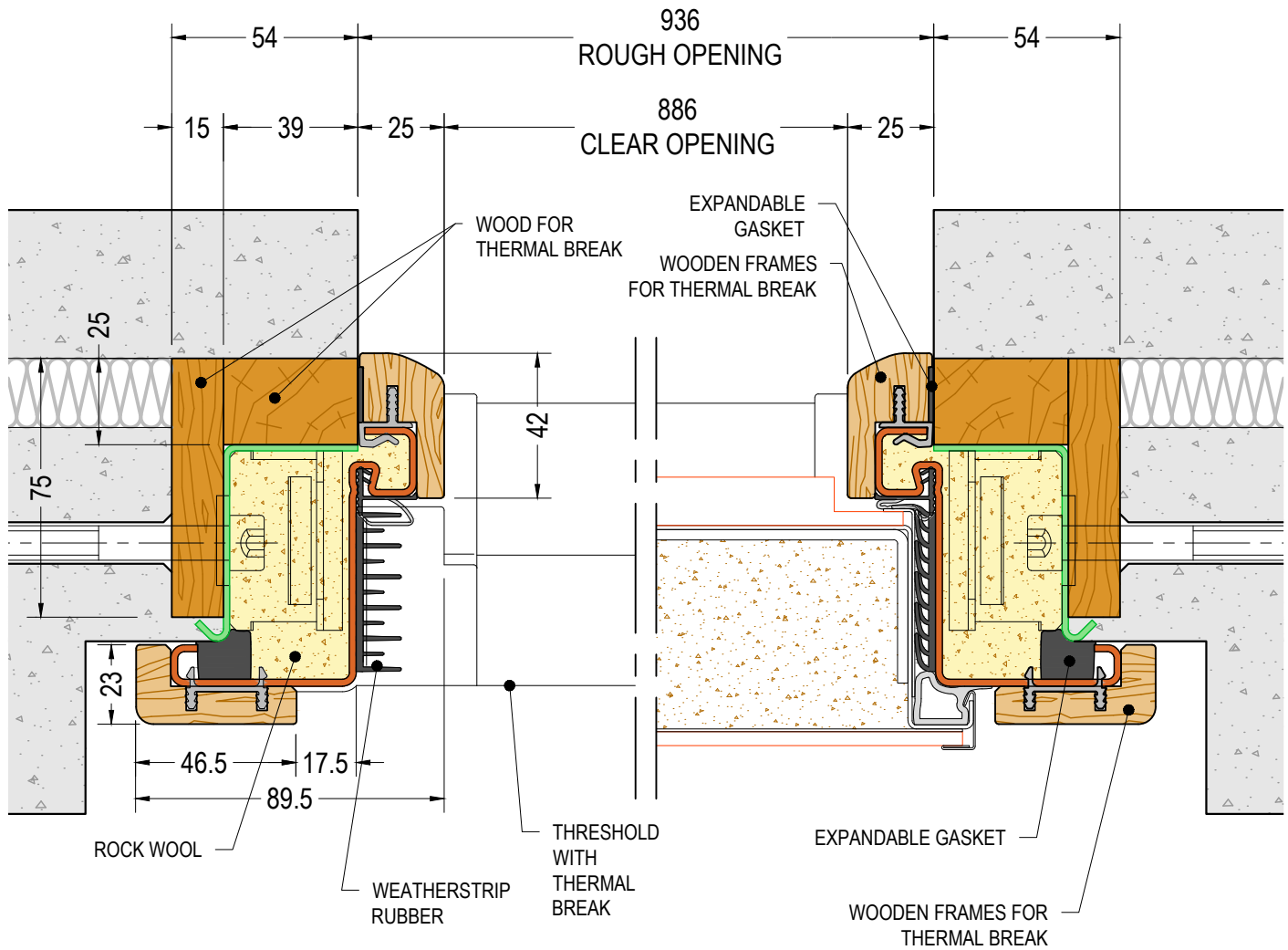

**DOOR HORIZONTAL SECTION
MODEL "A"**
ref. DOOR W=900

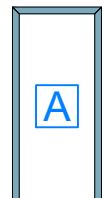

external side view

FRAME AND SUBFRAME WITH THERMAL BREAK - Solution 6 **15.1**

HORIZONTAL SECTION
scale 1:2

v 2.2

DI.BI. PORTE BLINDATE Srl - Fano (PU) ITALY - www.dibigroup.com

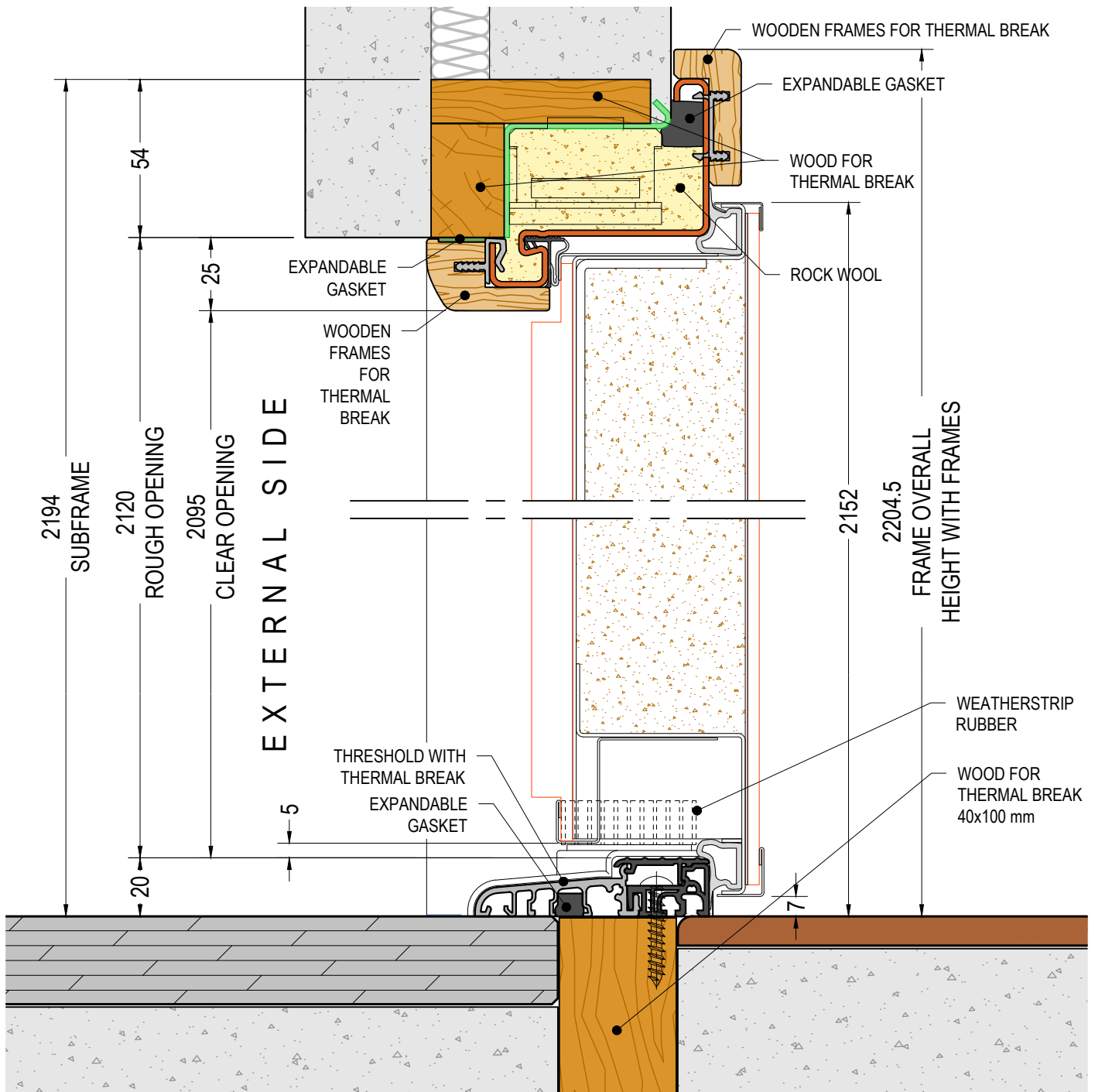

**DOOR VERTICAL SECTION
MODEL "A"**
ref. DOOR H=2100

DOOR DIMENSIONS:
W=min.700 - max.2000
H=min.2000 - max.2450



external side view



FRAME AND SUBFRAME WITH THERMAL BREAK - Solution 6 15.2

VERTICAL SECTION
scale 1:2

v 2.2

DI.BI. PORTE BLINDATE Srl - Fano (PU) ITALY - www.dibigroup.com

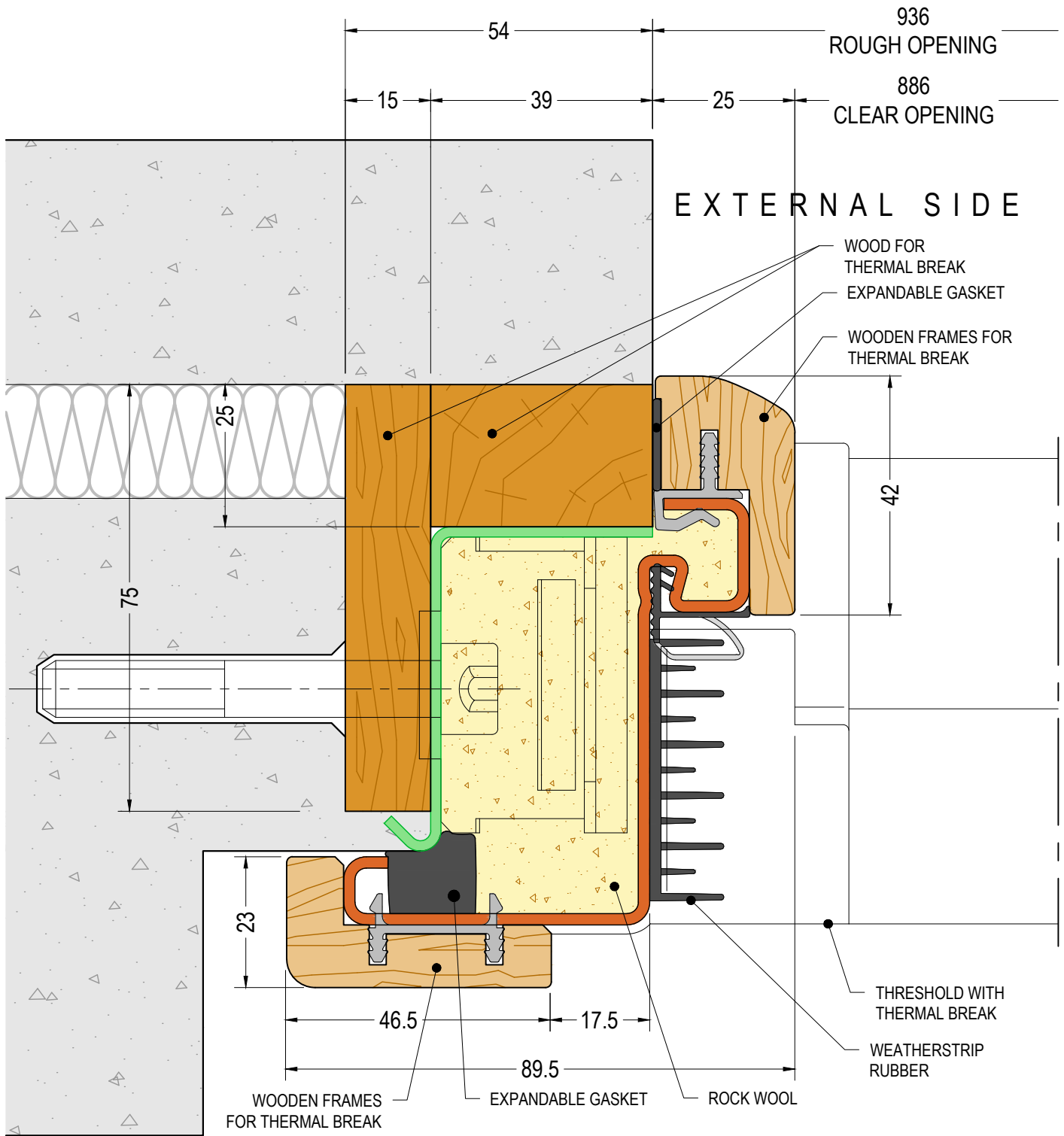

DOOR HORIZONTAL SECTION
MODEL "A"
 ref. DOOR W=900

FRAME AND SUBFRAME WITH THERMAL BREAK - Solution 6 **15.3**

LH HORIZONTAL SECTION
 scale 1:1

v 2.2

DI.BI. PORTE BLINDATE Srl - Fano (PU) ITALY - www.dibigroup.com



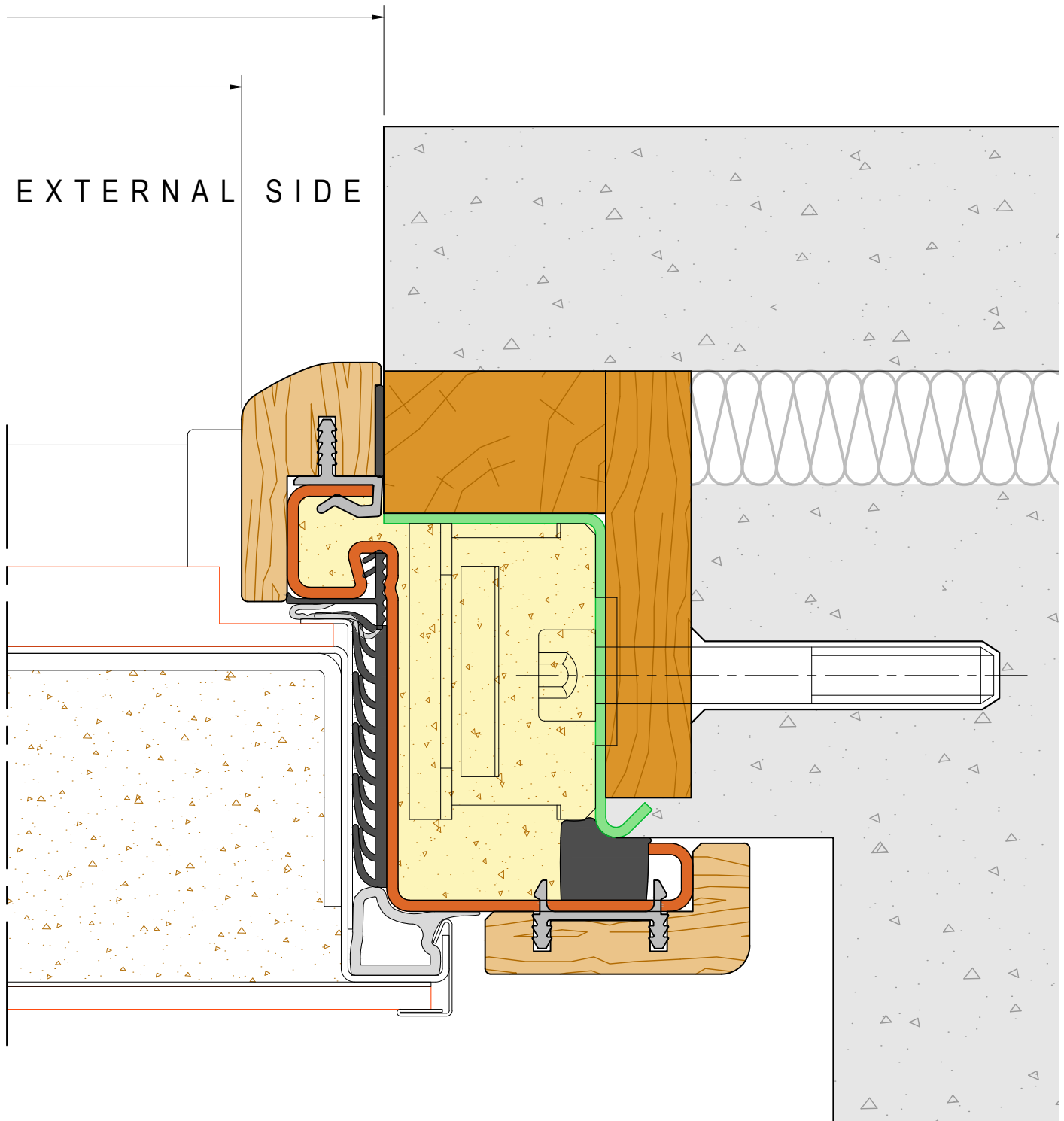

**DOOR HORIZONTAL SECTION
MODEL "A"**
ref. DOOR W=900

DOOR DIMENSIONS:
W=min.700 - max.2000
H=min.2000 - max.2450



FRAME AND SUBFRAME WITH THERMAL BREAK - Solution 6 **15.4**

RH HORIZONTAL SECTION
scale 1:1

v 2.2

DI.BI. PORTE BLINDATE Srl - Fano (PU) ITALY - www.dibigroup.com

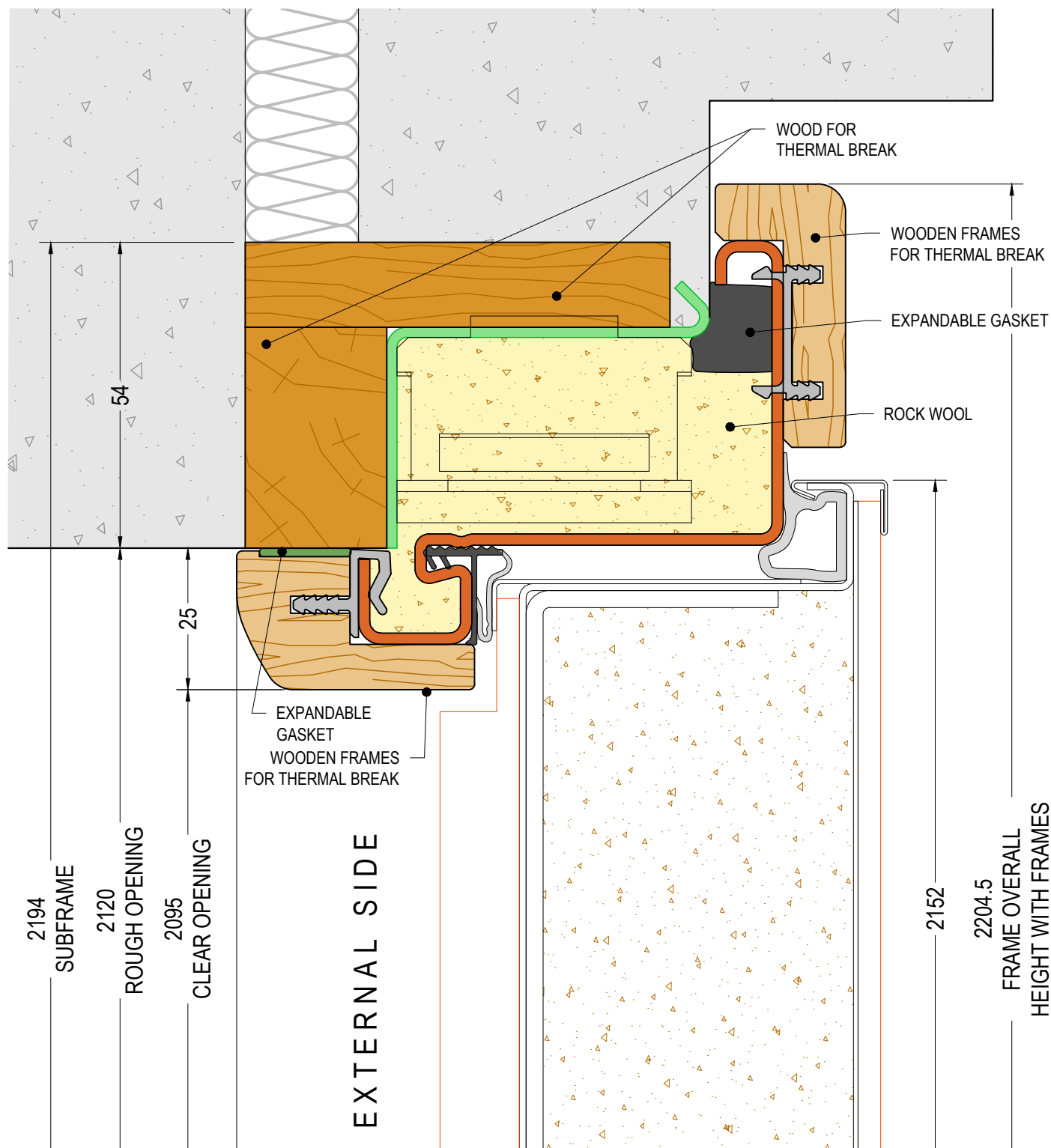

LINTEL VERTICAL SECTION
MODEL "A"
 ref. DOOR H=2100

FRAME AND SUBFRAME WITH THERMAL BREAK - Solution 6 **15.5**

LINTEL VERTICAL SECTION
 scale 1:2

v 2.2

DI.BI. PORTE BLINDATE Srl - Fano (PU) ITALY - www.dibigroup.com



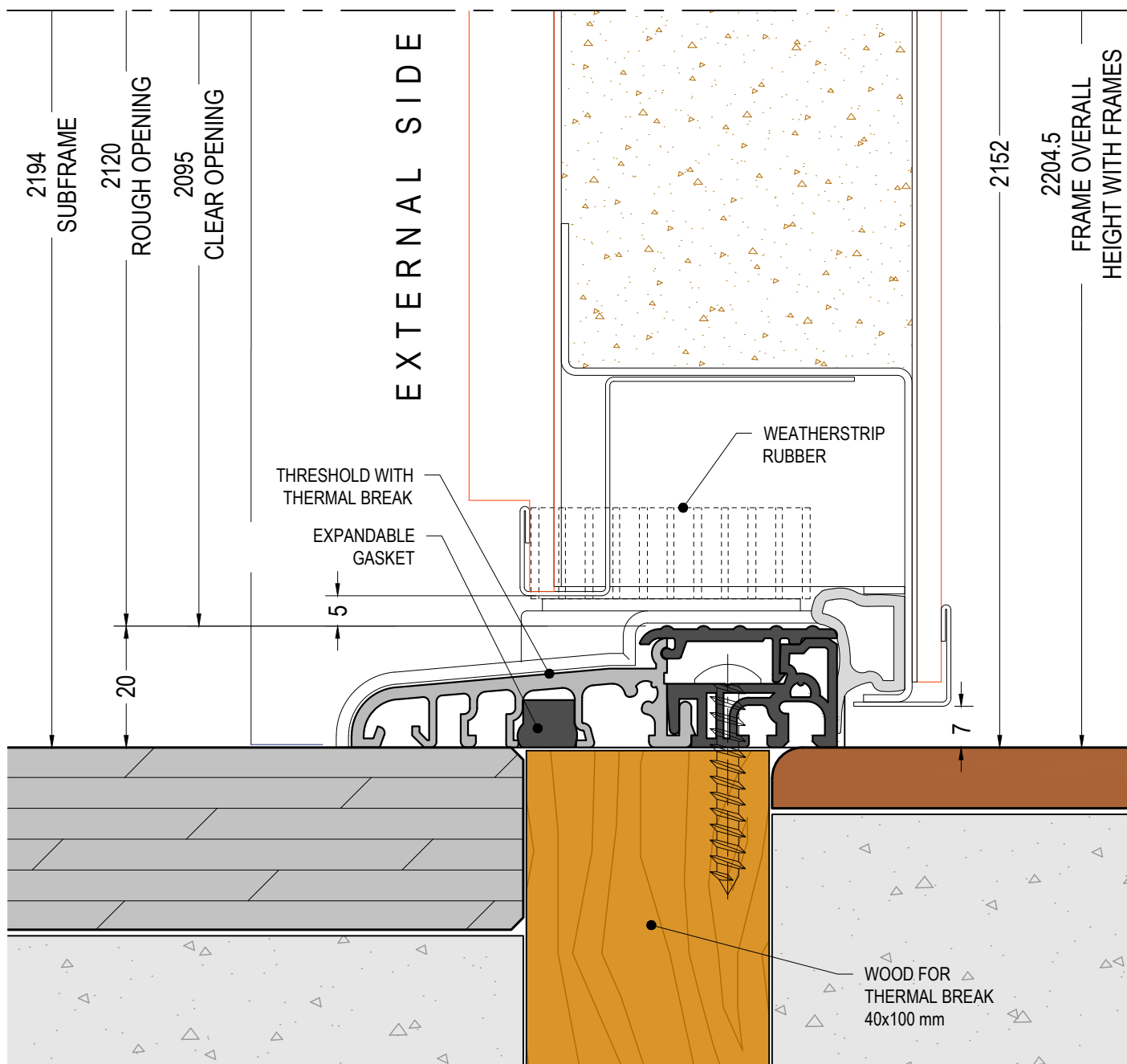

**THRESHOLD VERTICAL SECTION
MODEL "A"**
ref. DOOR H=2100

DOOR DIMENSIONS:
W=min.700 - max.2000
H=min.2000 - max.2450



FRAME AND SUBFRAME WITH THERMAL BREAK - Solution 6 **15.6**

THRESHOLD VERTICAL SECTION
scale 1:2

v 2.2

DI.BI. PORTE BLINDATE Srl - Fano (PU) ITALY - www.dibigroup.com

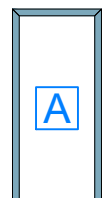
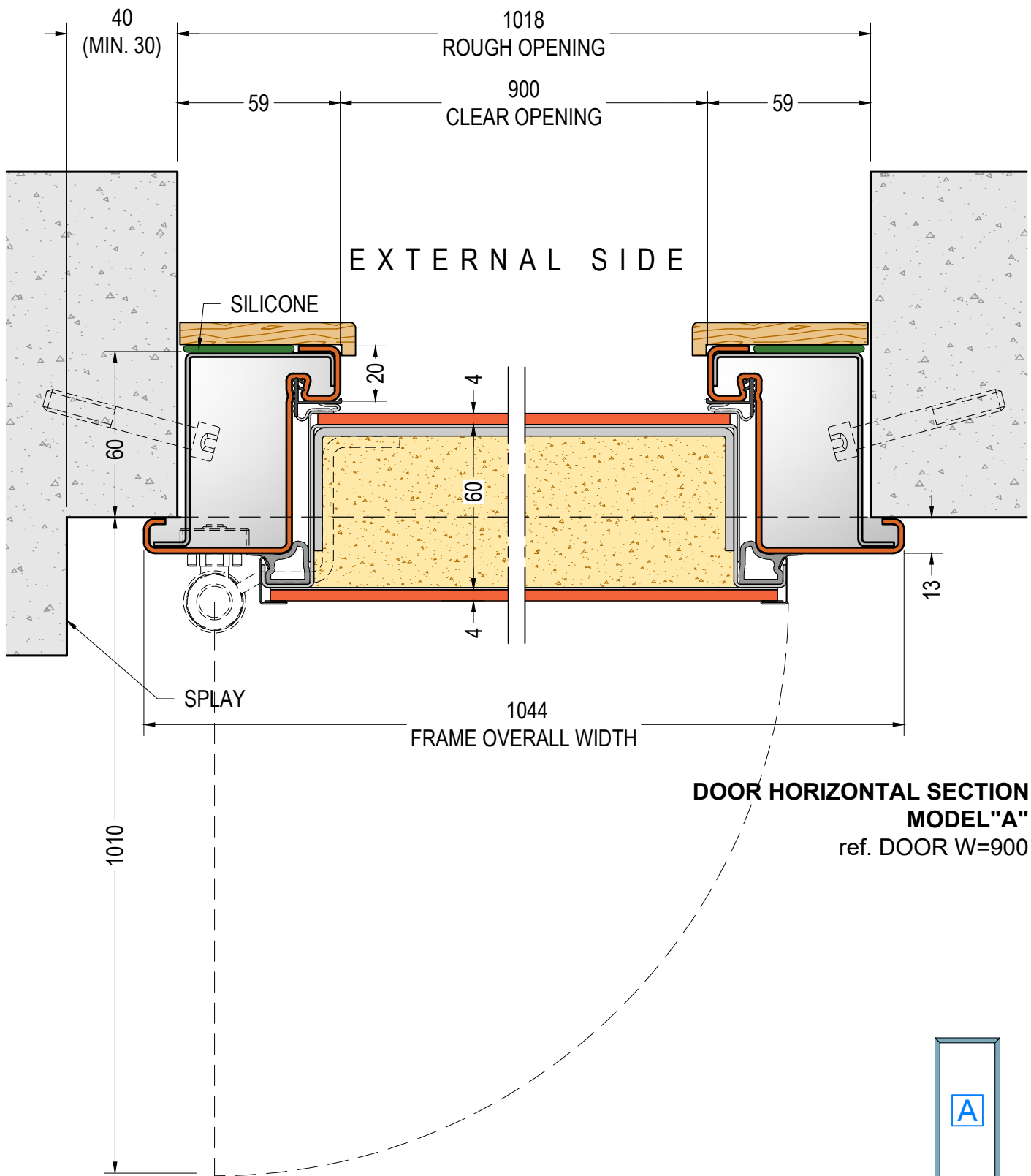

external side view



**BOX-SHAPED FRAME WITH
EXTERNAL COVERING-FRAME
PROFILE – Sol. 13**

16.1

HORIZONTAL SECTION - scale 1:2

v 1.2

DI.BI. PORTE BLINDATE Srl - Fano (PU) ITALY - www.dibigroup.com

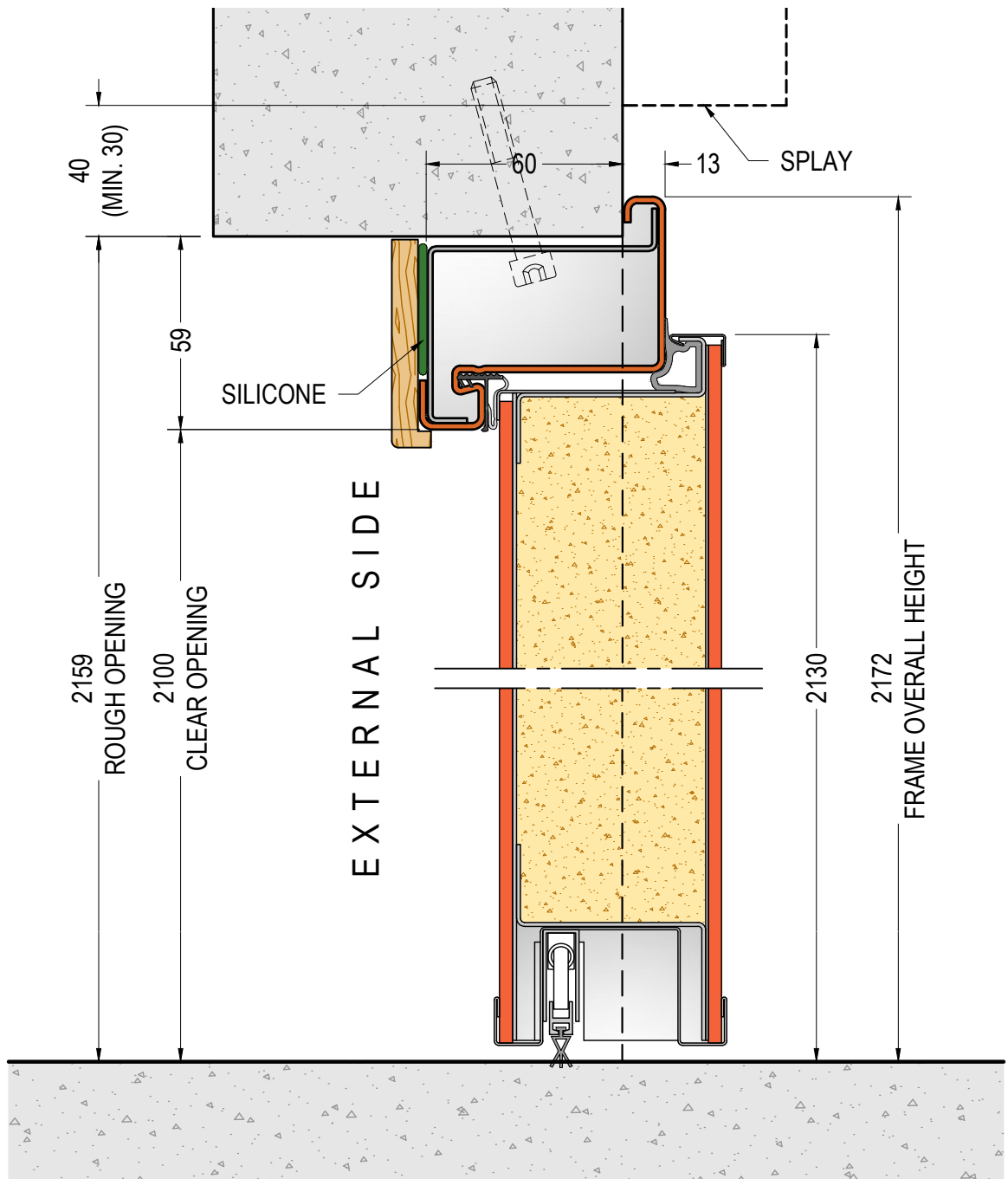

**DOOR VERTICAL SECTION
MODEL "A"**
ref. DOOR H=2100

DOOR DIMENSIONS:
W=min.700 - max.2000
H=min.2000 - max.2300



external side view



**BOX-SHAPED FRAME WITH
EXTERNAL COVERING-FRAME PROFILE – Sol. 13**

16.2

VERTICAL SECTION - scale 1:2

v 1.2

DI.BI. PORTE BLINDATE Srl - Fano (PU) ITALY - www.dibigroup.com

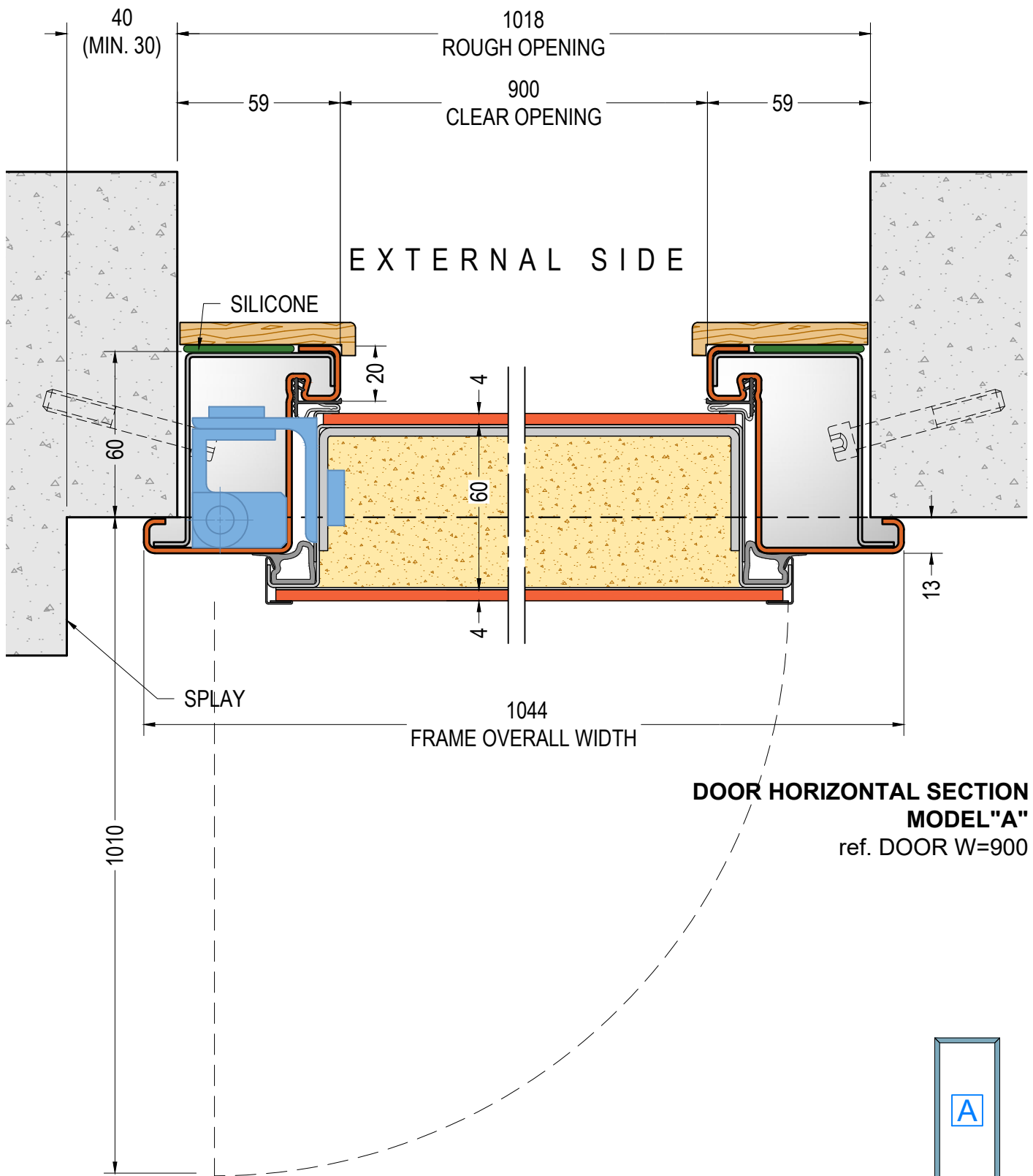

external side view



**BOX-SHAPED FRAME WITH
EXTERNAL COVERING-FRAME
PROFILE WITH CONCEALED HINGES – Sol. 13a**

16.3

HORIZONTAL SECTION - scale 1:2

v 1.6

DI.BI. PORTE BLINDATE Srl - Fano (PU) ITALY - www.dibigroup.com

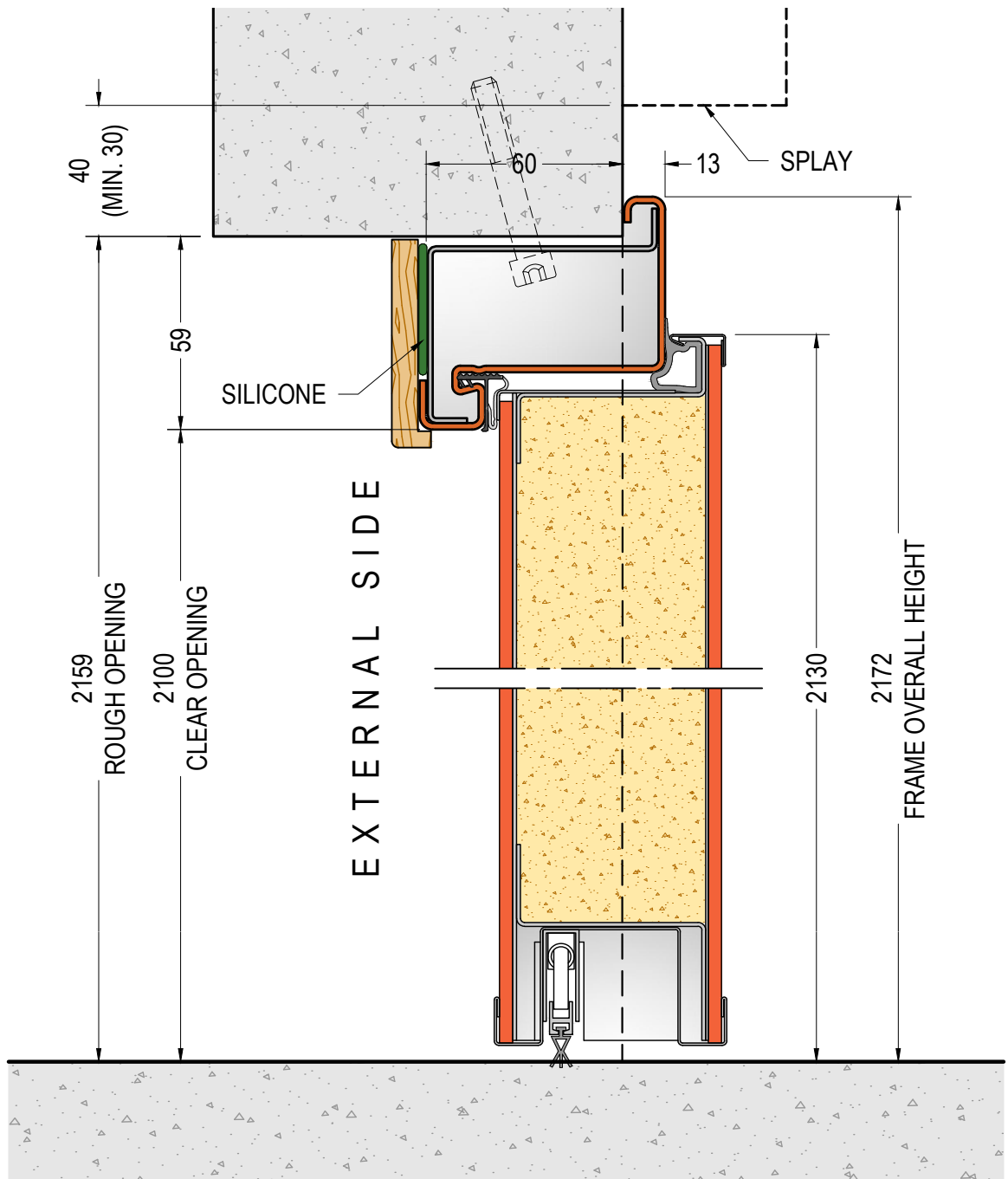

**DOOR VERTICAL SECTION
MODEL "A"**
ref. DOOR H=2100

DOOR DIMENSIONS:
W=min.700 - max.2000
H=min.2000 - max.2300



external side view



**BOX-SHAPED FRAME WITH
EXTERNAL COVERING-FRAME
PROFILE WITH CONCEALED HINGES – Sol. 13a**

16.4

VERTICAL SECTION - scale 1:2

v 1.6

DI.BI. PORTE BLINDATE Srl - Fano (PU) ITALY - www.dibigroup.com

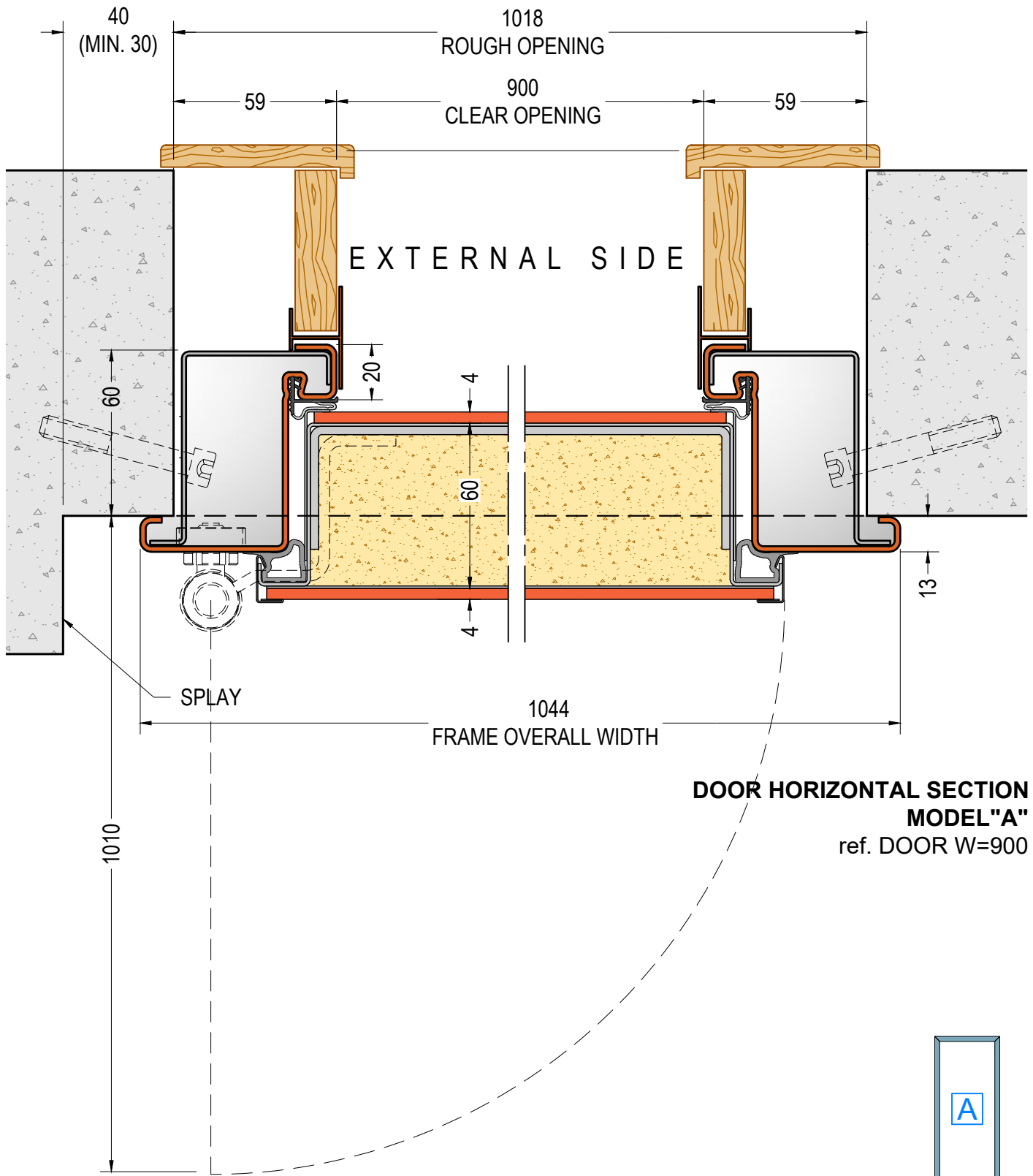

external side view

**BOX-SHAPED FRAME WITH
EXTENSION LINING**
Solution 14

17.1

HORIZONTAL SECTION - scale 1:2

v 1.2

DI.BI. PORTE BLINDATE Srl - Fano (PU) ITALY - www.dibigroup.com

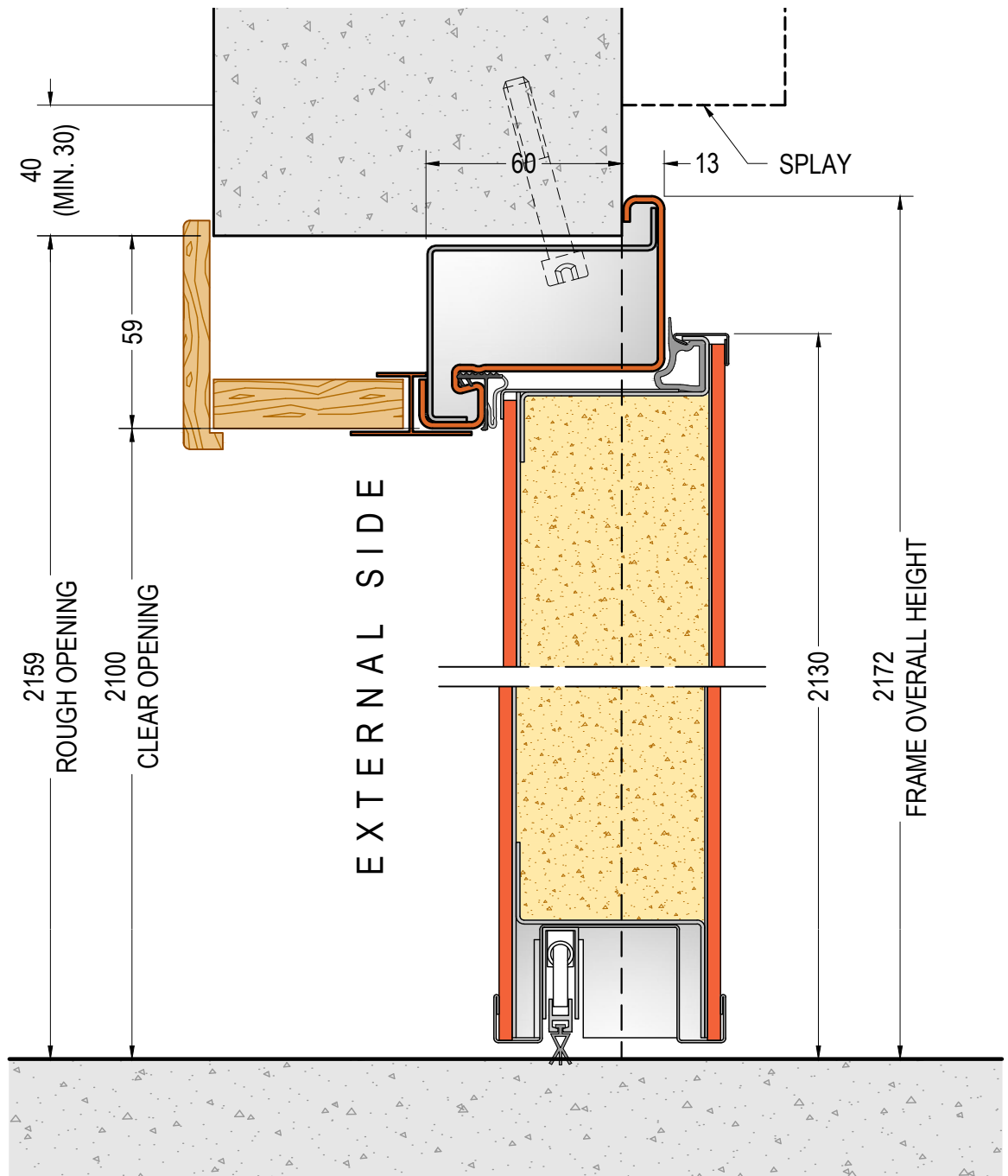

**DOOR VERTICAL SECTION
MODEL "A"**
ref. DOOR H=2100

DOOR DIMENSIONS:
W=min.700 - max.2000
H=min.2000 - max.2300



external side view



**BOX-SHAPED FRAME WITH
EXTENSION LINING**
Solution 14

17.2

VERTICAL SECTION - scale 1:2

v 1.2

DI.BI. PORTE BLINDATE Srl - Fano (PU) ITALY - www.dibigroup.com

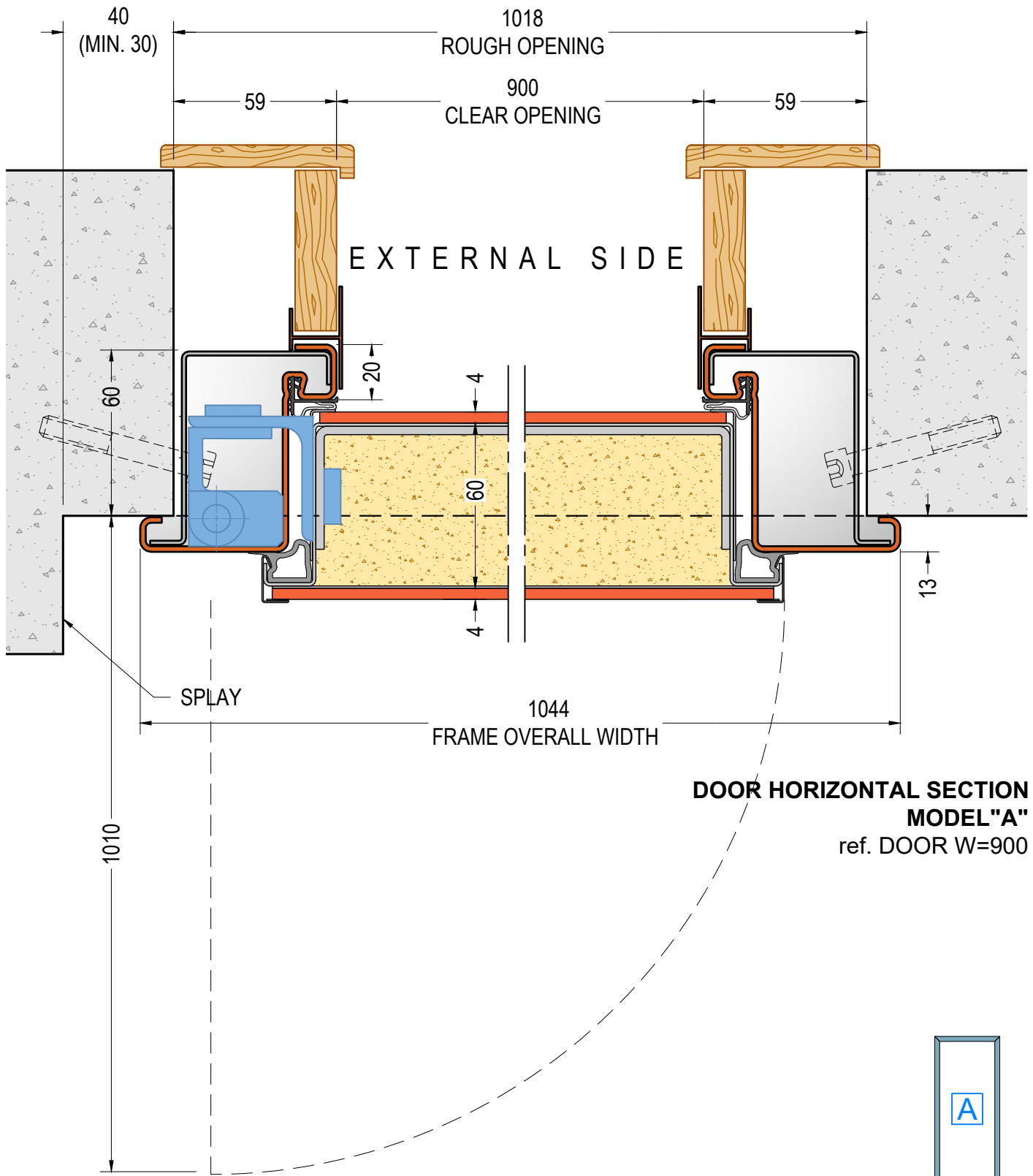

external side view



**BOX-SHAPED FRAME WITH
EXTENSION LINING, WITH
CONCEALED HINGES - Solution 14a**

17.3

HORIZONTAL SECTION - scale 1:2

v 1.6

DI.BI. PORTE BLINDATE Srl - Fano (PU) ITALY - www.dibigroup.com

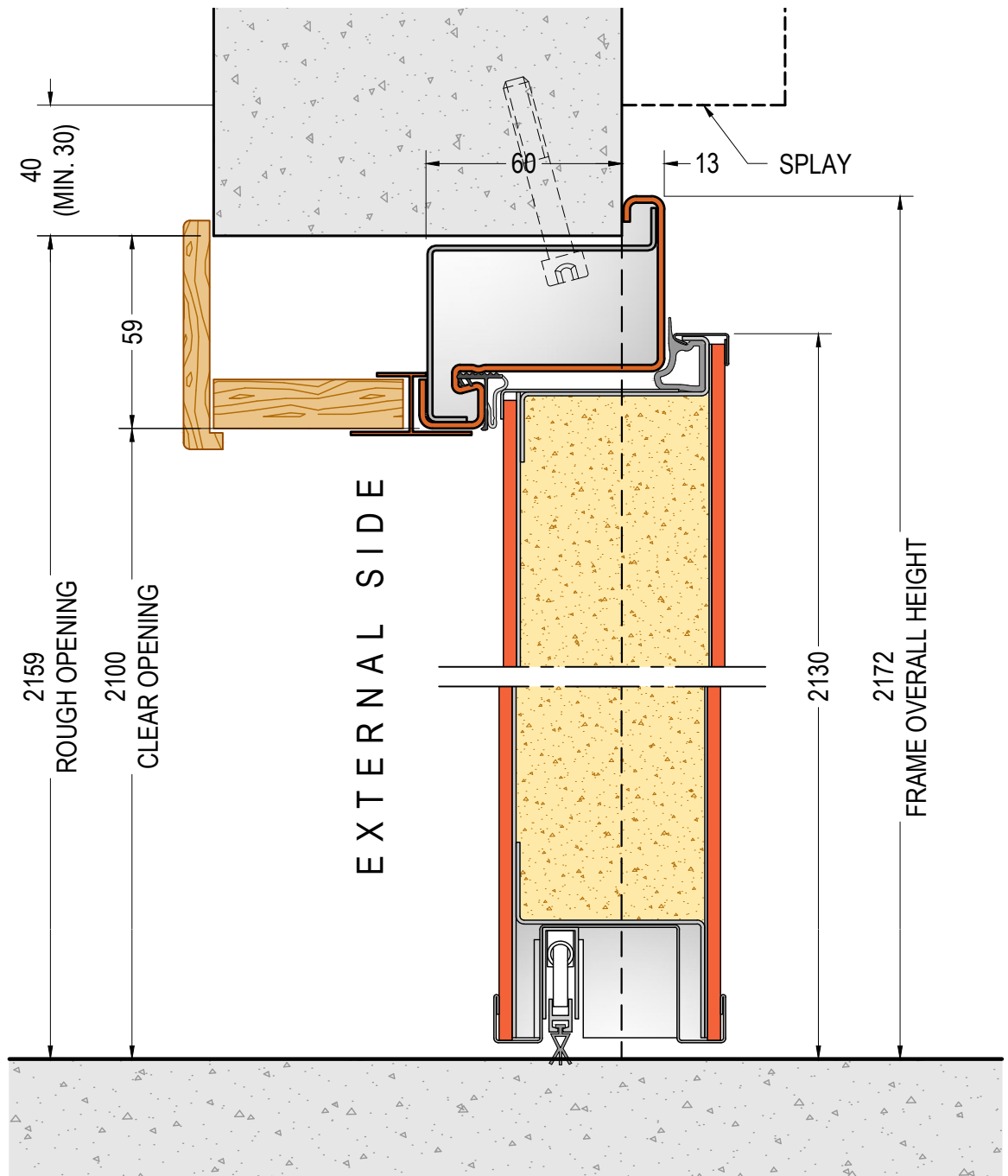

**DOOR VERTICAL SECTION
MODEL "A"**
ref. DOOR H=2100

DOOR DIMENSIONS:
W=min.700 - max.2000
H=min.2000 - max.2300



external side view



**BOX-SHAPED FRAME WITH
EXTENSION LINING, WITH
CONCEALED HINGES - Solution 14a**

17.4

VERTICAL SECTION - scale 1:2

v 1.6

DI.BI. PORTE BLINDATE Srl - Fano (PU) ITALY - www.dibigroup.com

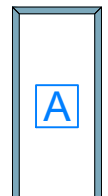
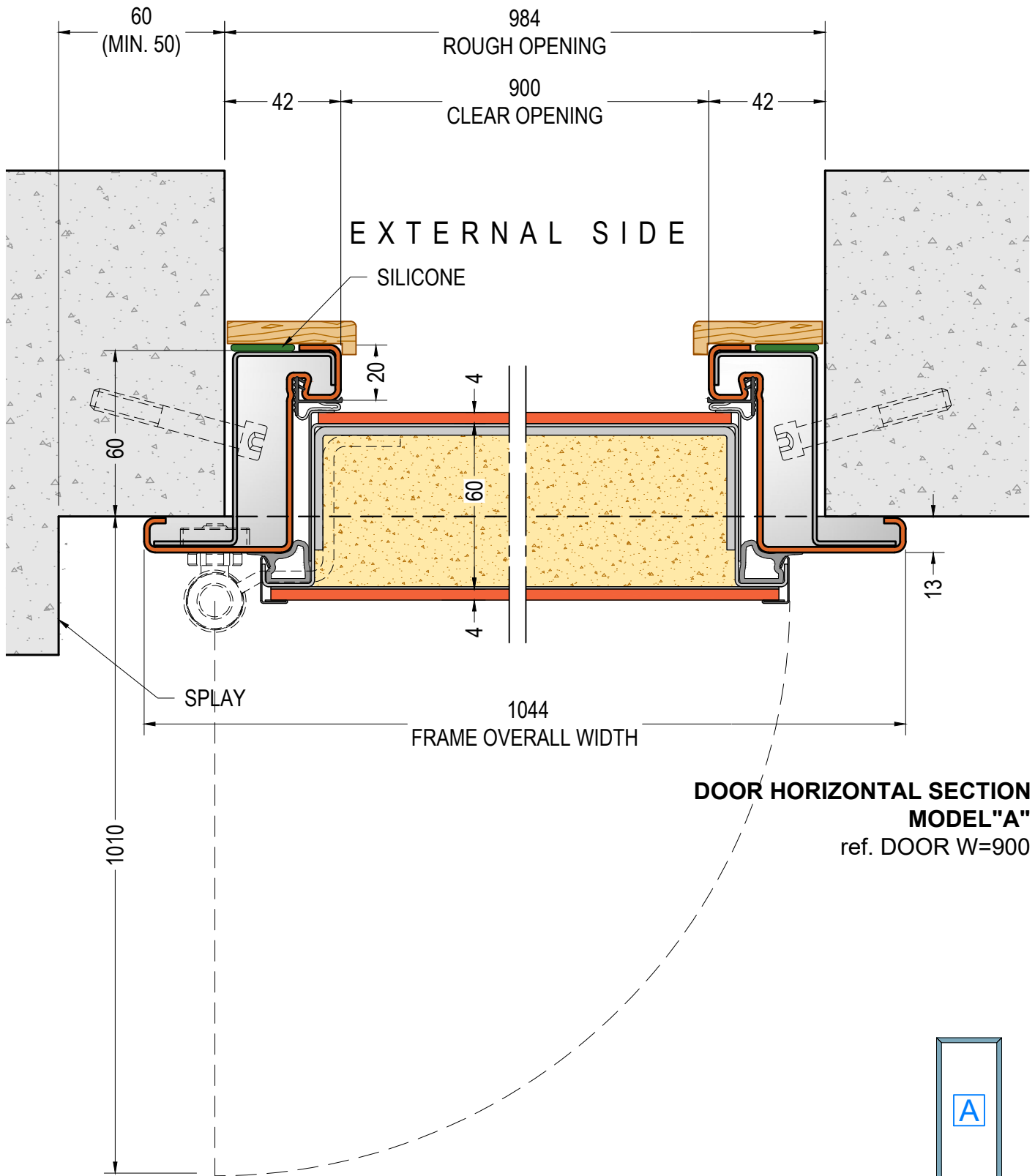

external side view



**SMALLER BOX-SHAPED FRAME
WITH EXTERNAL COVERING-FRAME
PROFILE – Solution 15**

18.1

HORIZONTAL SECTION - scale 1:2

v 1.2

DI.BI. PORTE BLINDATE Srl - Fano (PU) ITALY - www.dibigroup.com

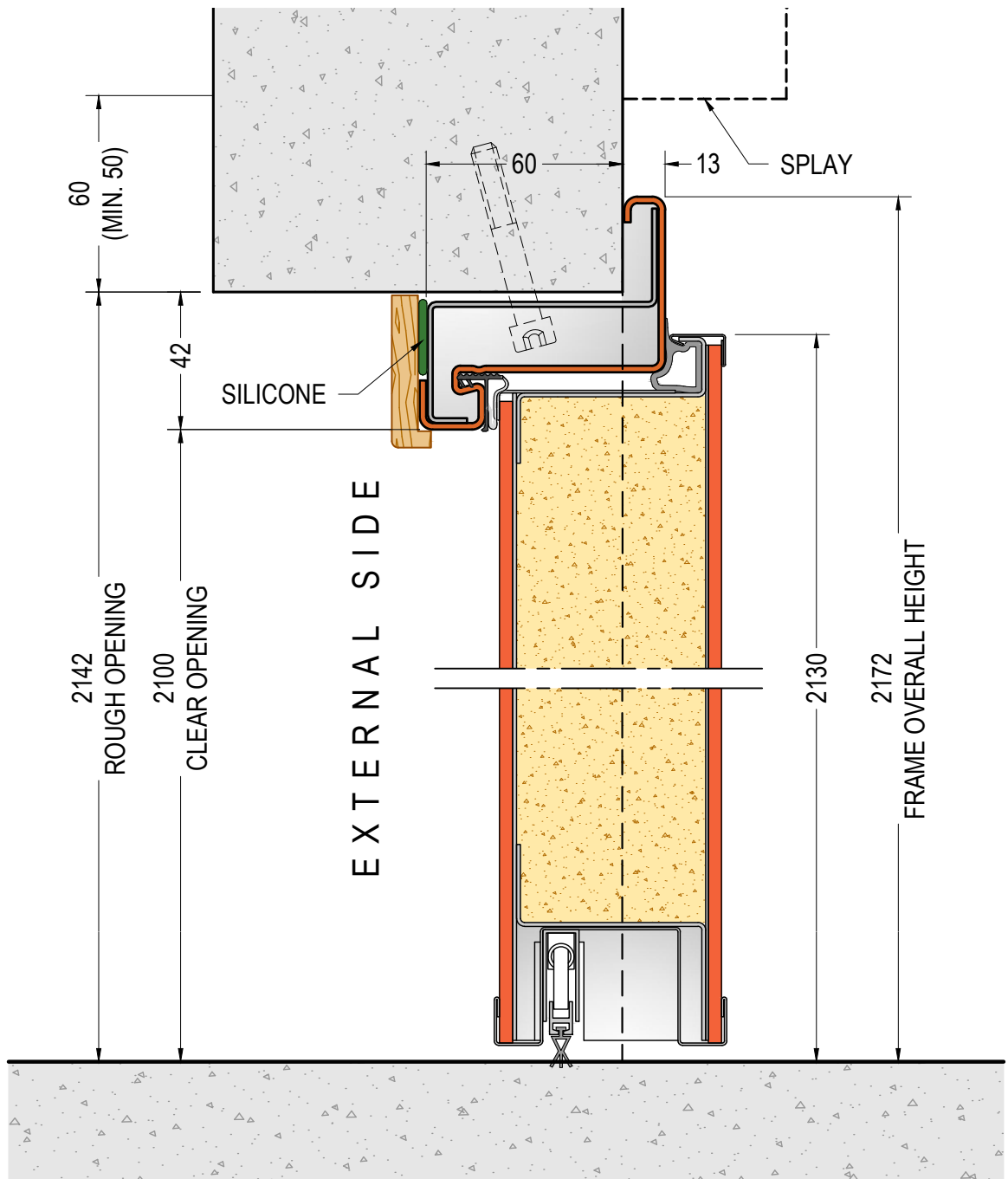

**DOOR VERTICAL SECTION
MODEL "A"**
ref. DOOR H=2100

DOOR DIMENSIONS:
W=min.700 - max.2000
H=min.2000 - max.2300



external side view



**SMALLER BOX-SHAPED FRAME
WITH EXTERNAL COVERING-FRAME** **18.2**
PROFILE – Solution 15

VERTICAL SECTION - scale 1:2

v 1.2

DI.BI. PORTE BLINDATE Srl - Fano (PU) ITALY - www.dibigroup.com

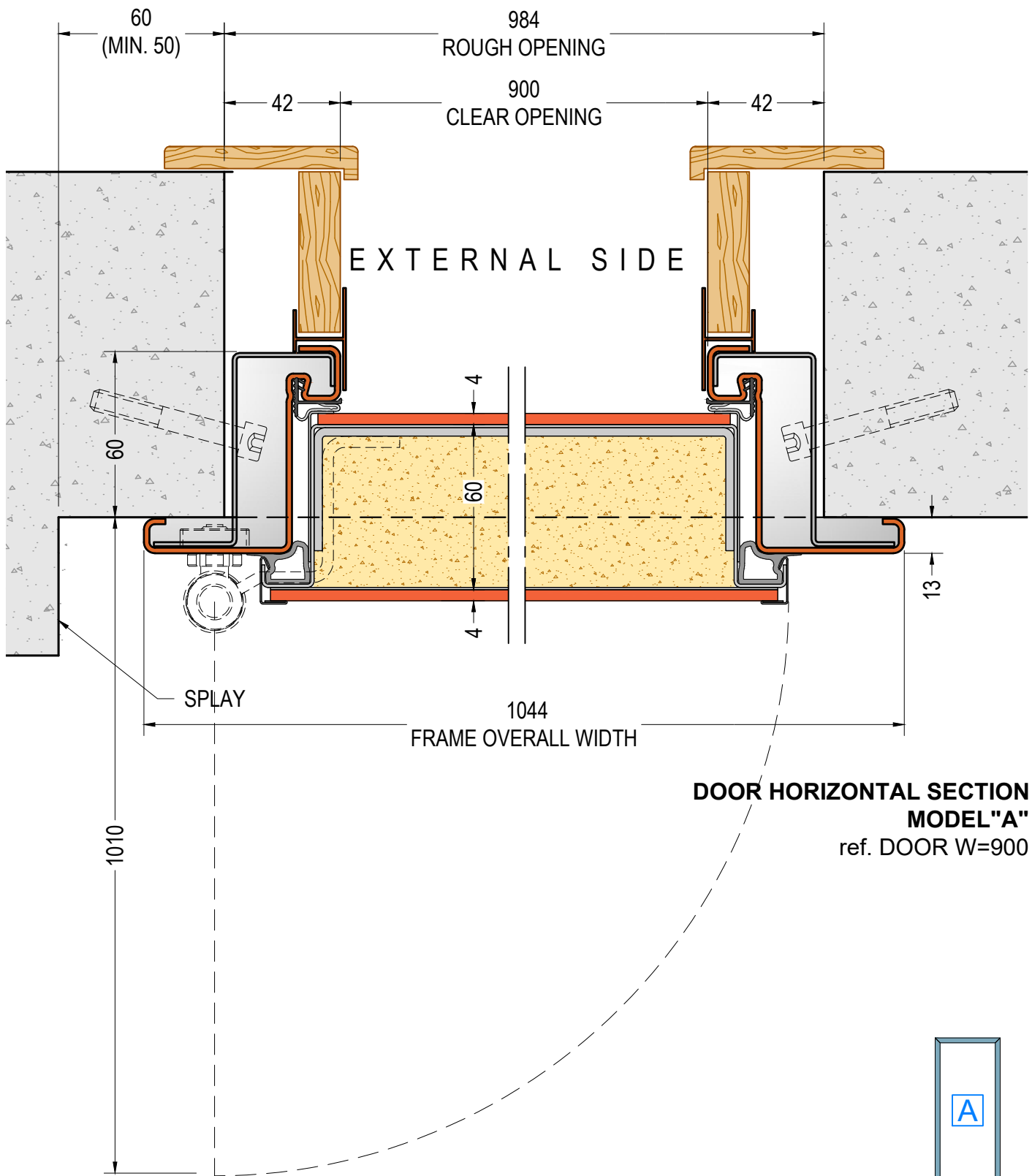

external side view

**SMALLER BOX-SHAPED
FRAME WITH EXTENSION
LINING - Solution 15 bis**

19.1

HORIZONTAL SECTION - scale 1:2

v 1.2

DI.BI. PORTE BLINDATE Srl - Fano (PU) ITALY - www.dibigroup.com

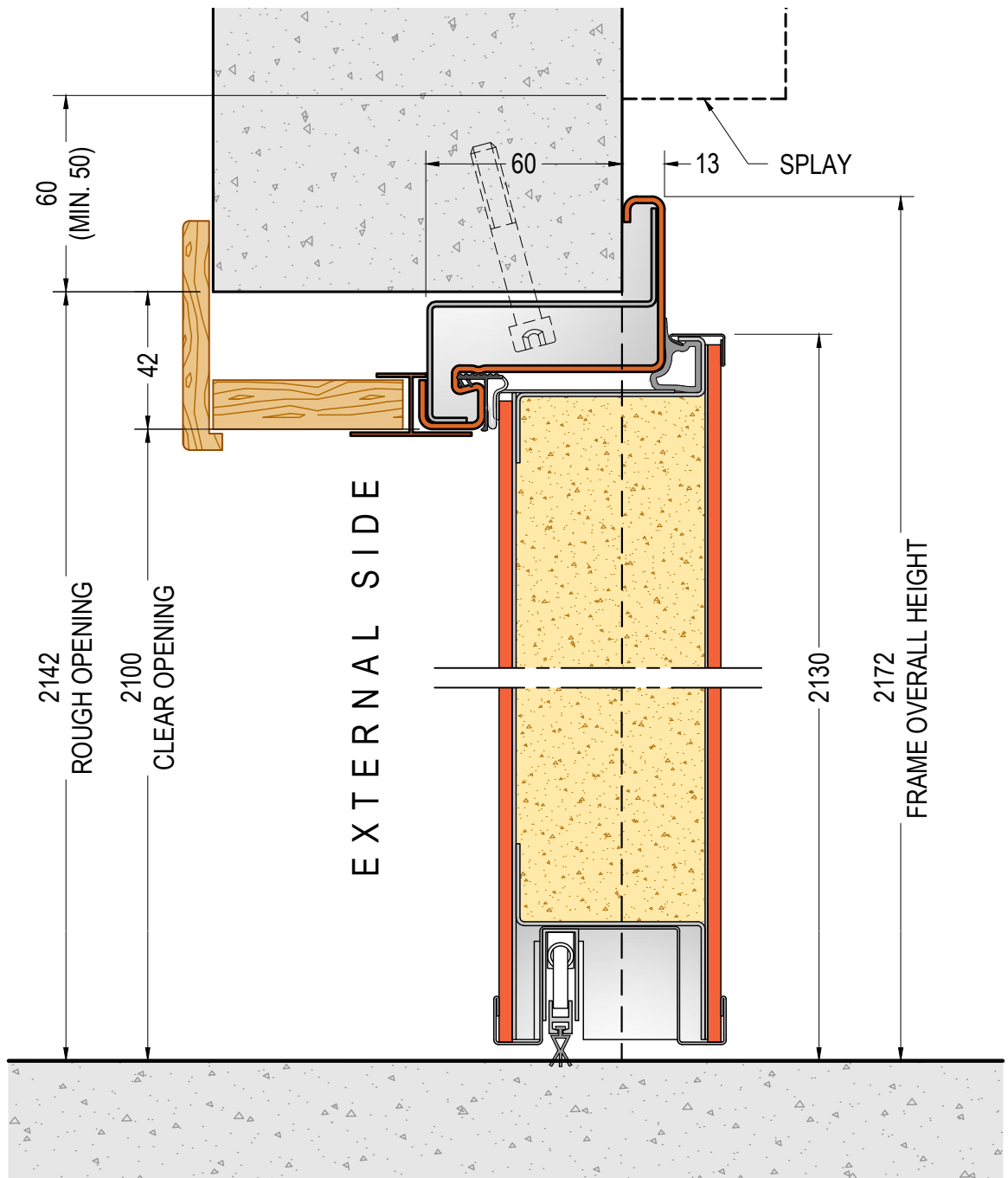

**DOOR VERTICAL SECTION
MODEL "A"**
ref. DOOR H=2100

DOOR DIMENSIONS:
W=min.700 - max.2000
H=min.2000 - max.2300



external side view



**SMALLER BOX-SHAPED
FRAME WITH EXTENSION
LINING - Solution 15 bis**

19.2

VERTICAL SECTION - scale 1:2

v 1.2

DI.BI. PORTE BLINDATE Srl - Fano (PU) ITALY - www.dibigroup.com

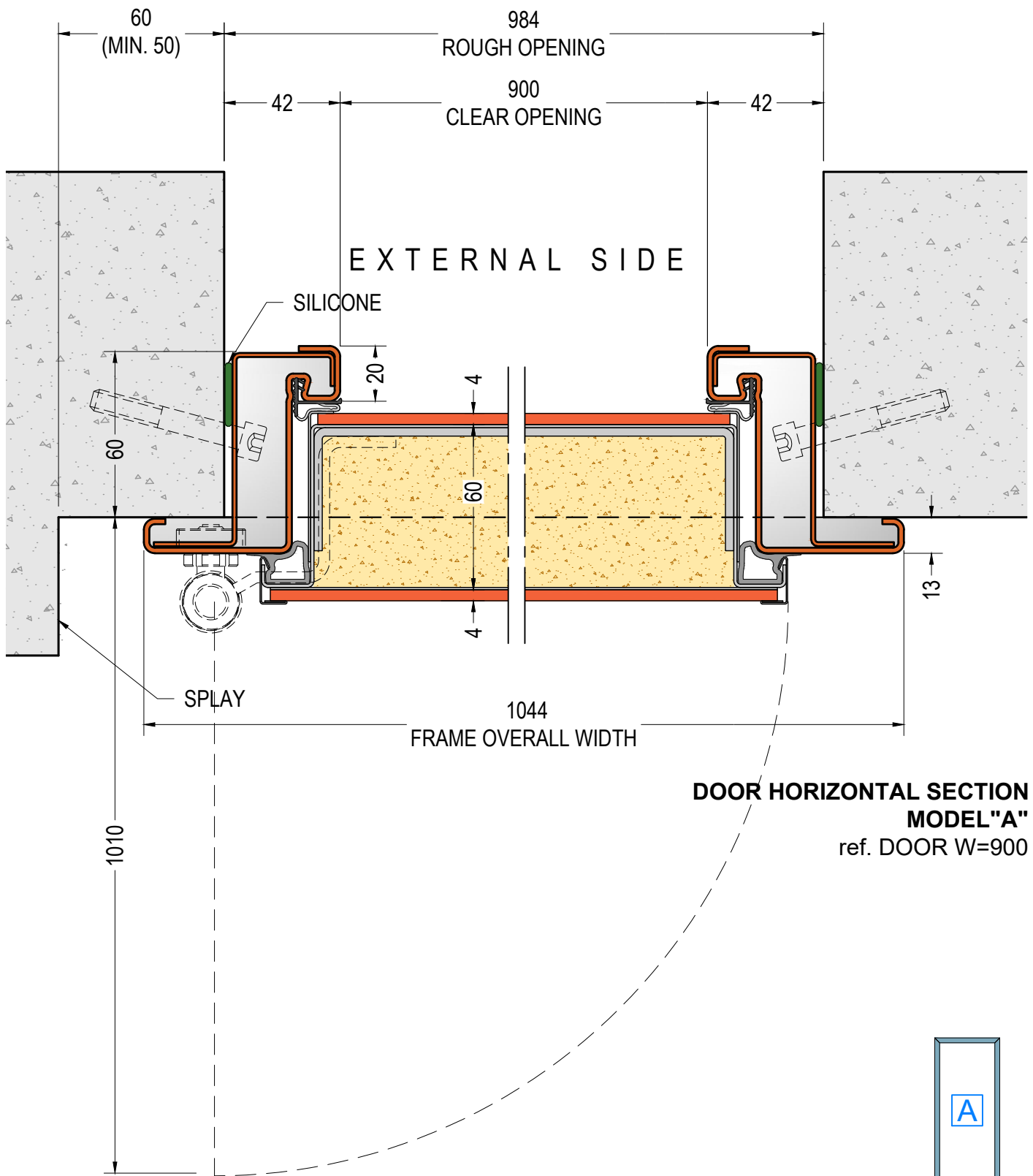

external side view

**SMALLER WELDED
BOX-SHAPED FRAME
Solution 15 tris**

19.3

HORIZONTAL SECTION - scale 1:2

v 1.1

DI.BI. PORTE BLINDATE Srl - Fano (PU) ITALY - www.dibigroup.com

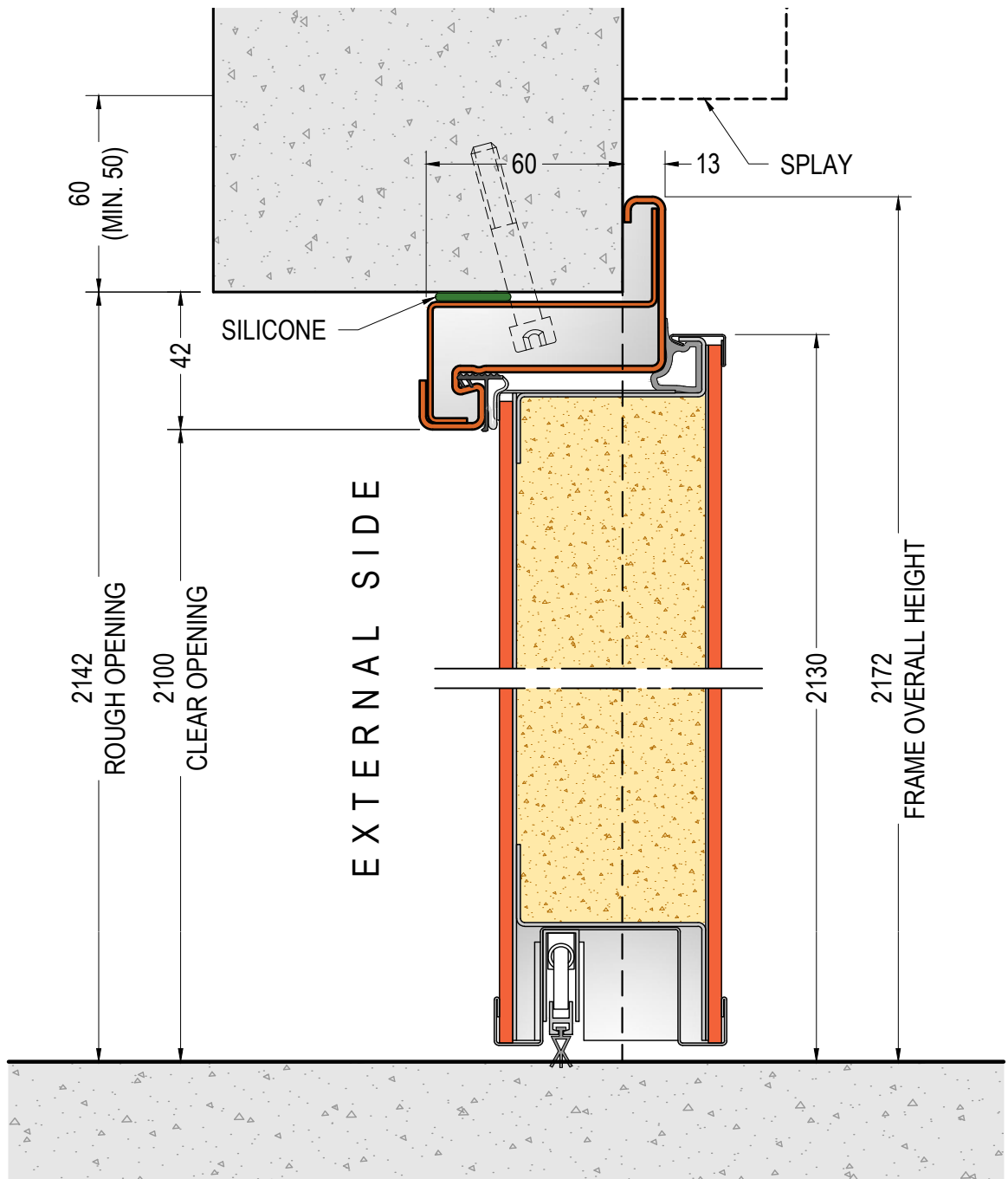

**DOOR VERTICAL SECTION
MODEL "A"**
ref. DOOR H=2100

DOOR DIMENSIONS:
W=min.700 - max.2000
H=min.2000 - max.2300



external side view



**SMALLER WELDED
BOX-SHAPED FRAME
Solution 15 tris**

19.4

VERTICAL SECTION - scale 1:2

v 1.1

DI.BI. PORTE BLINDATE Srl - Fano (PU) ITALY - www.dibigroup.com

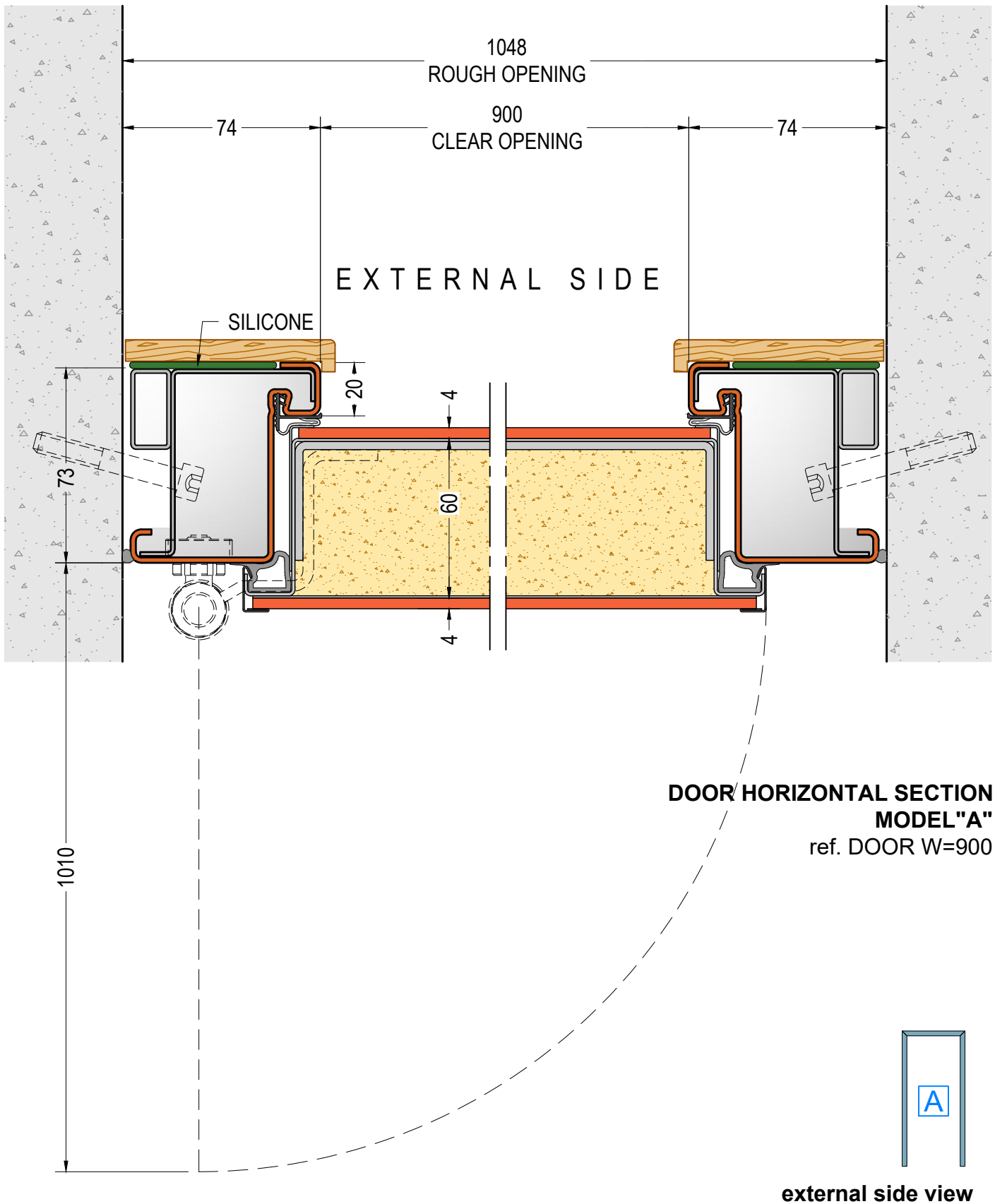

**BOX-SHAPED FRAME FLUSH
WITH THE WALL
Solution 16**

20.1

HORIZONTAL SECTION - scale 1:2

v 1.2

DI.BI. PORTE BLINDATE Srl - Fano (PU) ITALY - www.dibigroup.com

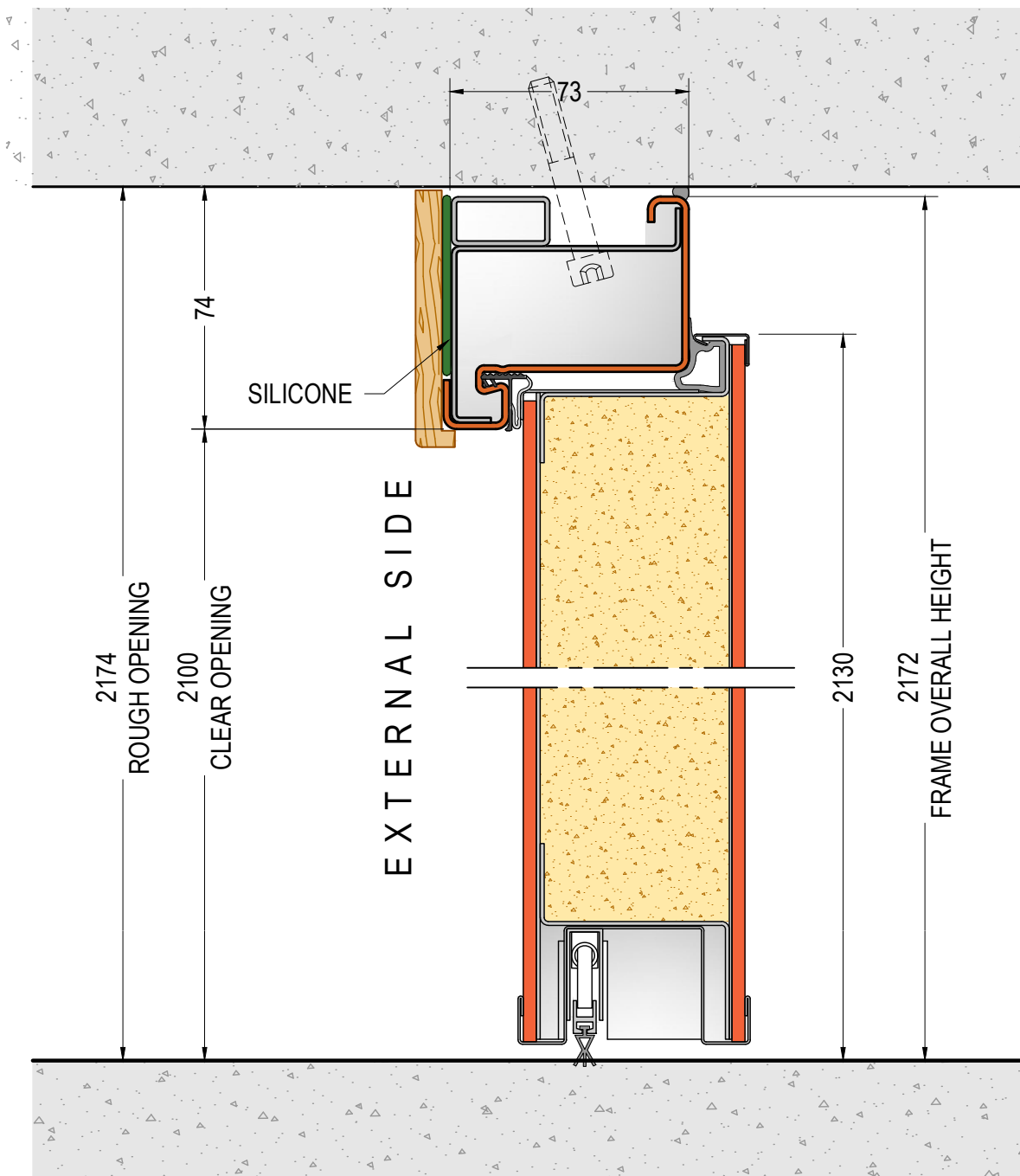

**DOOR VERTICAL SECTION
MODEL "A"**
ref. DOOR H=2100

DOOR DIMENSIONS:
W=min.700 - max.2000
H=min.2000 - max.2300



external side view



BOX-SHAPED FRAME FLUSH WITH THE WALL **20.2**

Solution 16

VERTICAL SECTION - scale 1:2

v 1.2

DI.BI. PORTE BLINDATE Srl - Fano (PU) ITALY - www.dibigroup.com

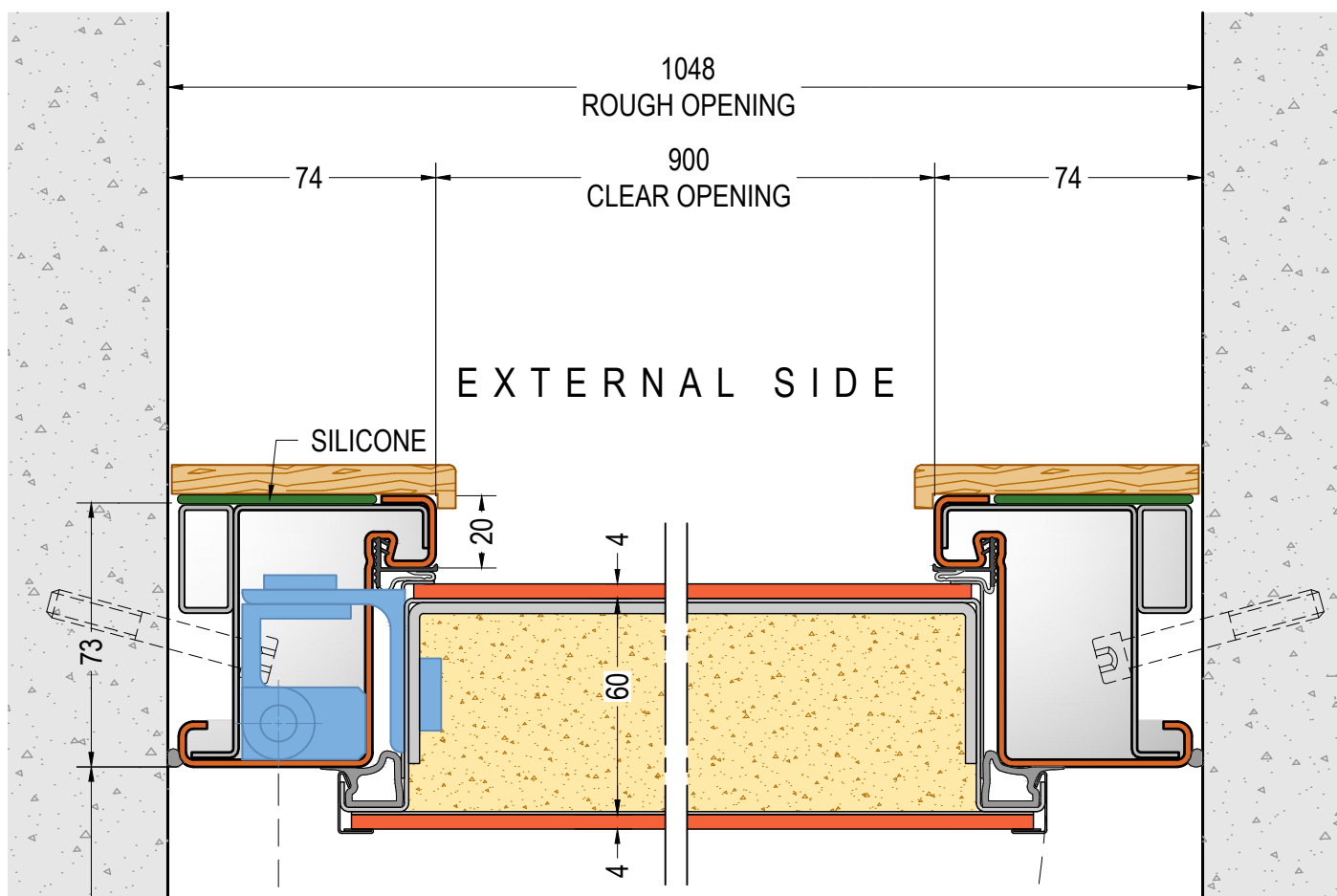

DOOR HORIZONTAL SECTION
MODEL "A"
ref. DOOR W=900



external side view



BOX-SHAPED FRAME FLUSH WITH THE WALL, WITH CONCEALED HINGES Solution 16a

20.3

HORIZONTAL SECTION - scale 1:2

v 1.6

DI.BI. PORTE BLINDATE Srl - Fano (PU) ITALY - www.dibigroup.com

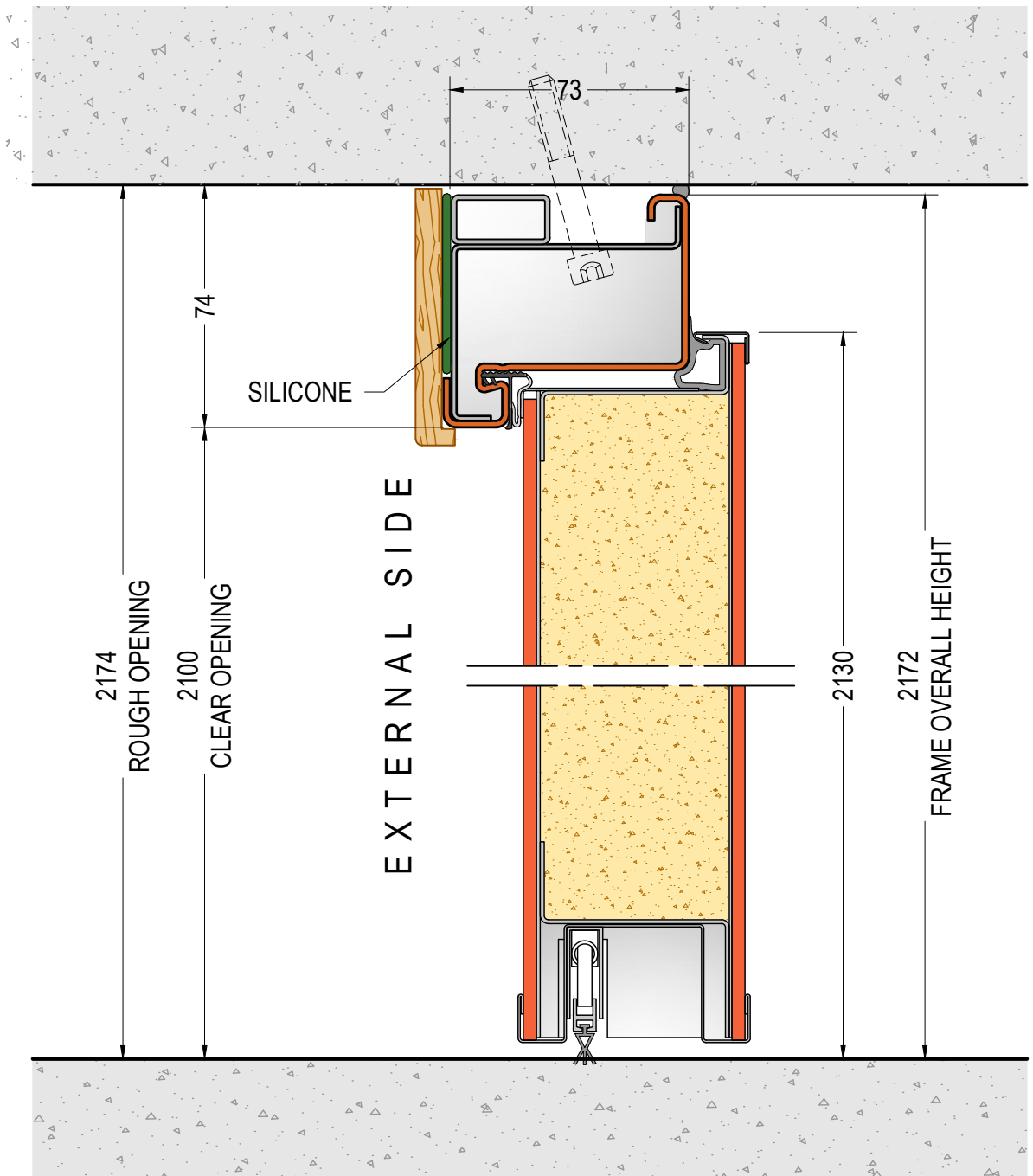

**DOOR VERTICAL SECTION
MODEL "A"**
ref. DOOR H=2100

DOOR DIMENSIONS:
W=min.700 - max.2000
H=min.2000 - max.2300



external side view



**BOX-SHAPED FRAME FLUSH WITH THE WALL, WITH
CONCEALED HINGES Solution 16a**

20.4

VERTICAL SECTION - scale 1:2

v 1.6

DI.BI. PORTE BLINDATE Srl - Fano (PU) ITALY - www.dibigroup.com

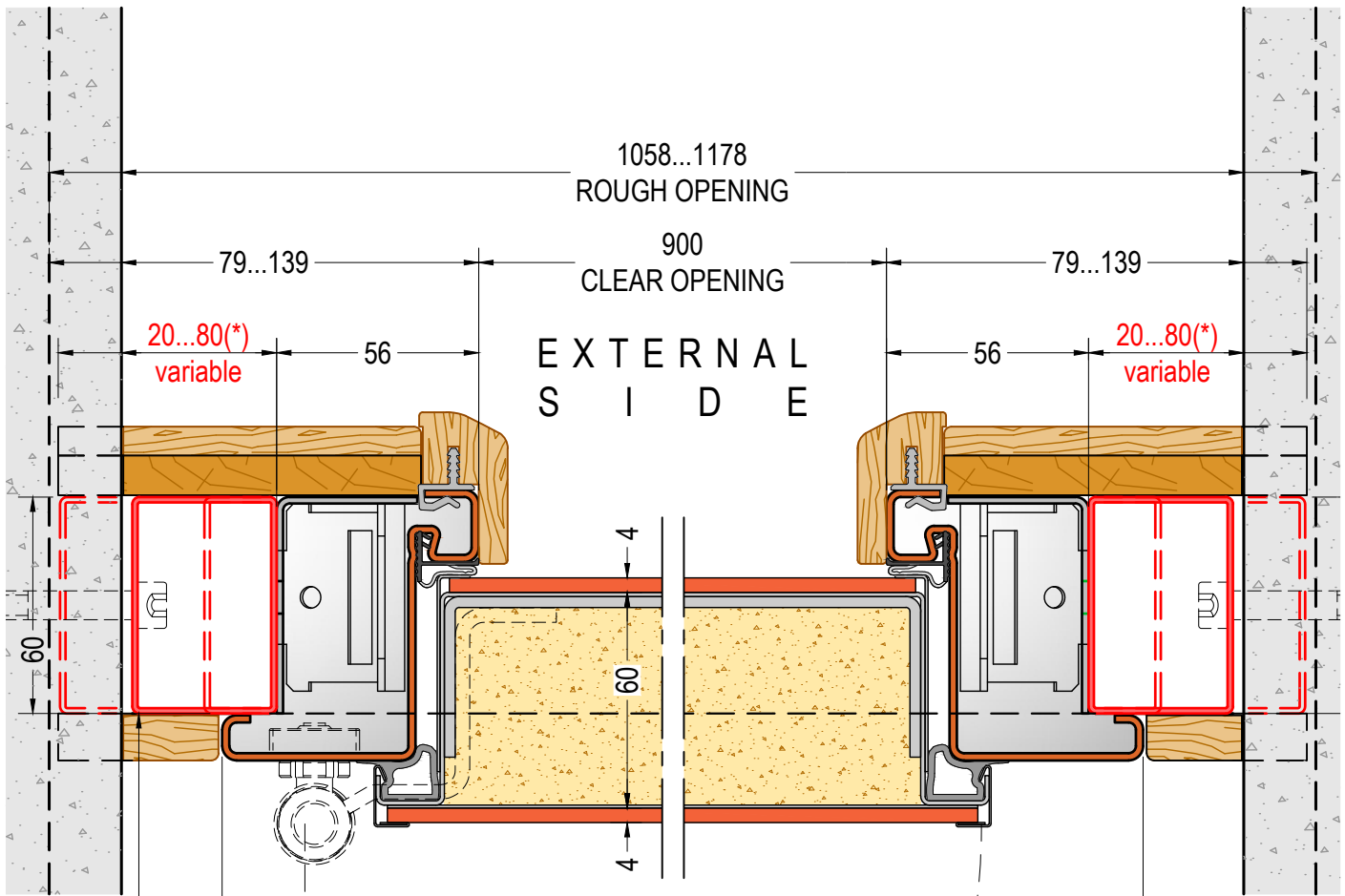

**DOOR HORIZONTAL SECTION
MODEL "A"**
ref. DOOR W=900

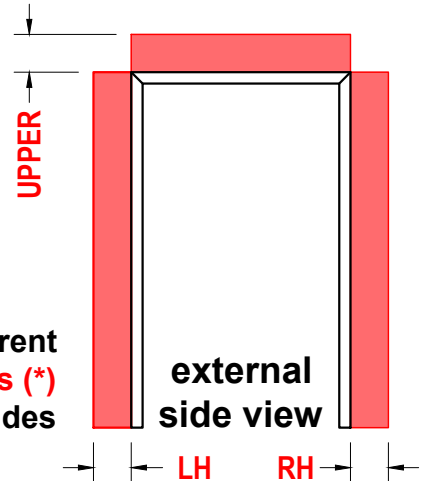

Possibility to have different
compensating measurements (*)
on three sides



**BOX-SHAPED FRAME WITH
EXTRA THICKNESS ON
STANDARD SUBFRAME – Sol. 17/A**

21.1

HORIZONTAL SECTION - scale 1:2

v 1.2

DI.BI. PORTE BLINDATE Srl - Fano (PU) ITALY - www.dibigroup.com

SICUREZZA & DESIGN

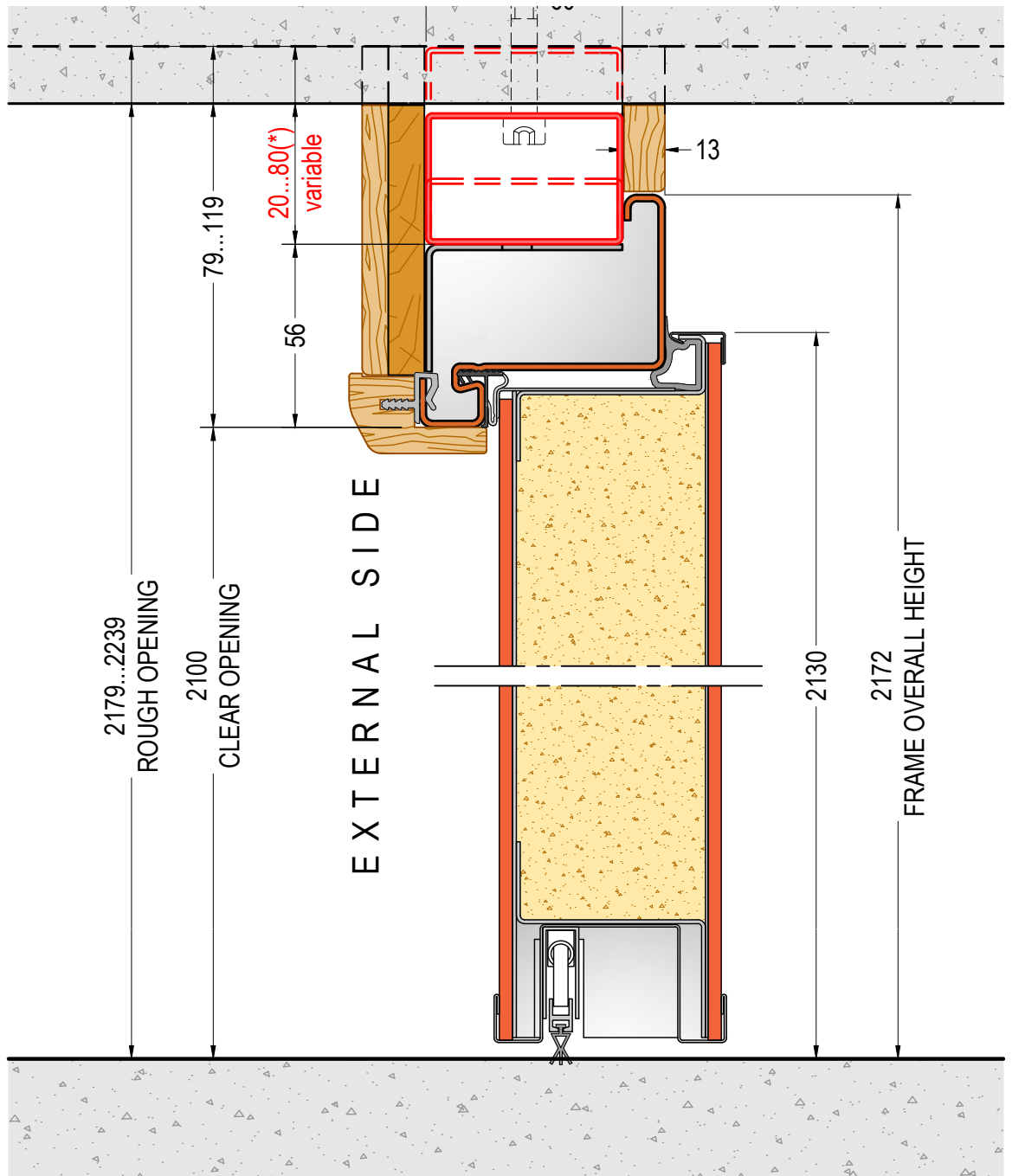

**DOOR VERTICAL SECTION
MODEL "A"**
ref. DOOR H=2100

DOOR DIMENSIONS:
W=min.700 - max.2000
H=min.2000 - max.2300



external side view



**BOX-SHAPED FRAME WITH
EXTRA THICKNESS ON
STANDARD SUBFRAME – Sol. 17/A**

21.2

VERTICAL SECTION - scale 1:2

v 1.2

DI.BI. PORTE BLINDATE Srl - Fano (PU) ITALY - www.dibigroup.com

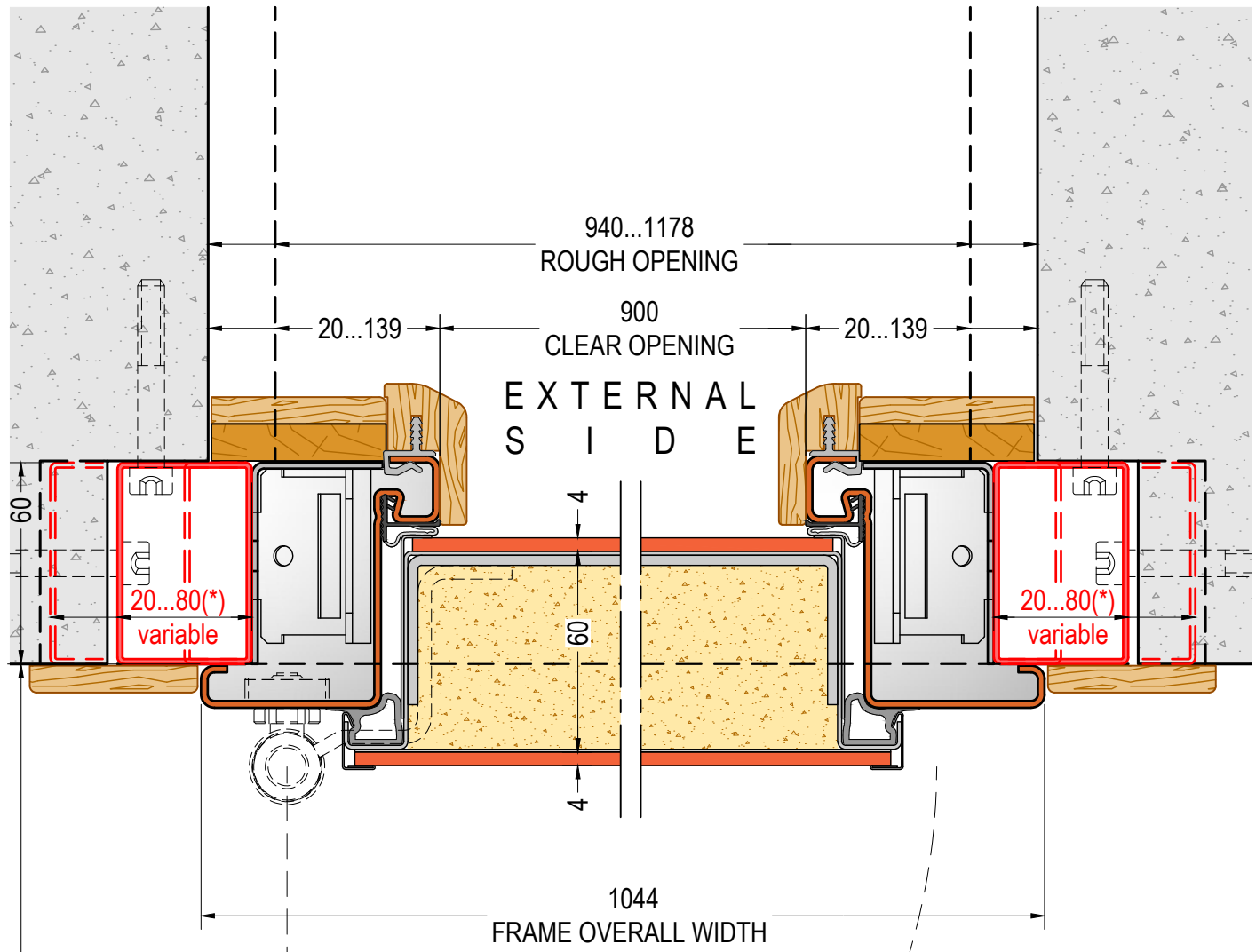

**DOOR HORIZONTAL SECTION
MODEL "A"**
ref. DOOR W=900

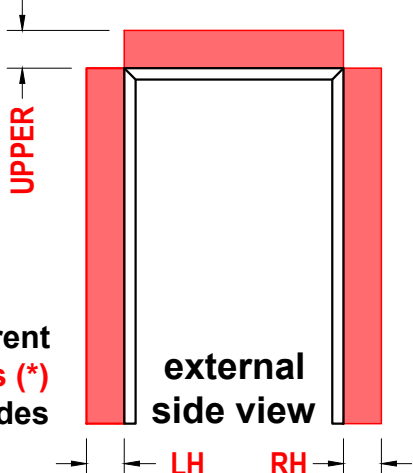

Possibility to have different
compensating measurements (*)
on three sides



**BOX-SHAPED FRAME WITH
EXTRA THICKNESS
Solution 17/B**

22.1

HORIZONTAL SECTION - scale 1:2

v 1.2

DI.BI. PORTE BLINDATE Srl - Fano (PU) ITALY - www.dibigroup.com

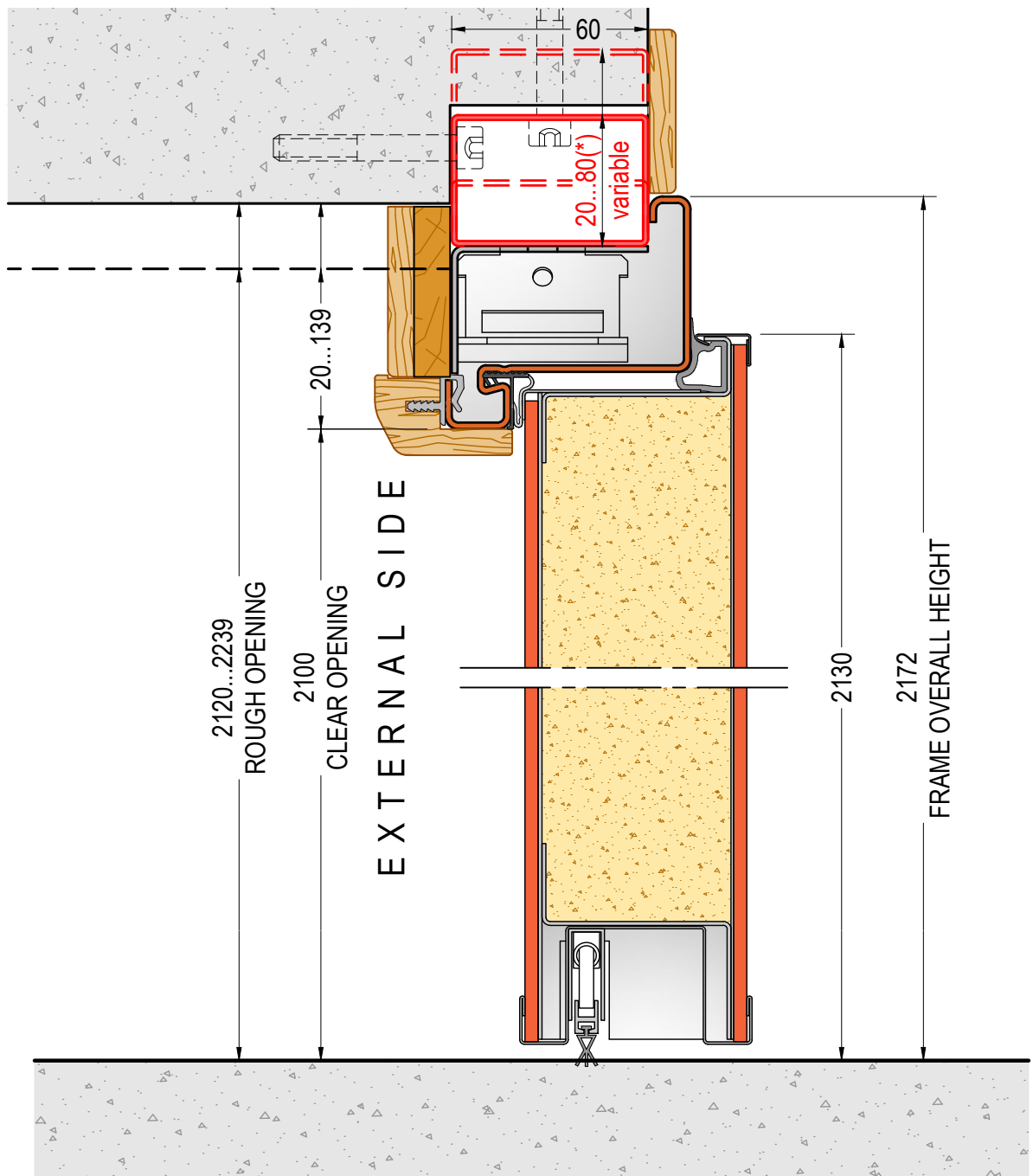

**DOOR VERTICAL SECTION
MODEL "A"**
ref. DOOR H=2100

DOOR DIMENSIONS:
W=min.700 - max.2000
H=min.2000 - max.2300



external side view



**BOX-SHAPED FRAME WITH
EXTRA THICKNESS**
Solution 17/B

22.2

VERTICAL SECTION - scale 1:2

v 1.2

DI.BI. PORTE BLINDATE Srl - Fano (PU) ITALY - www.dibigroup.com

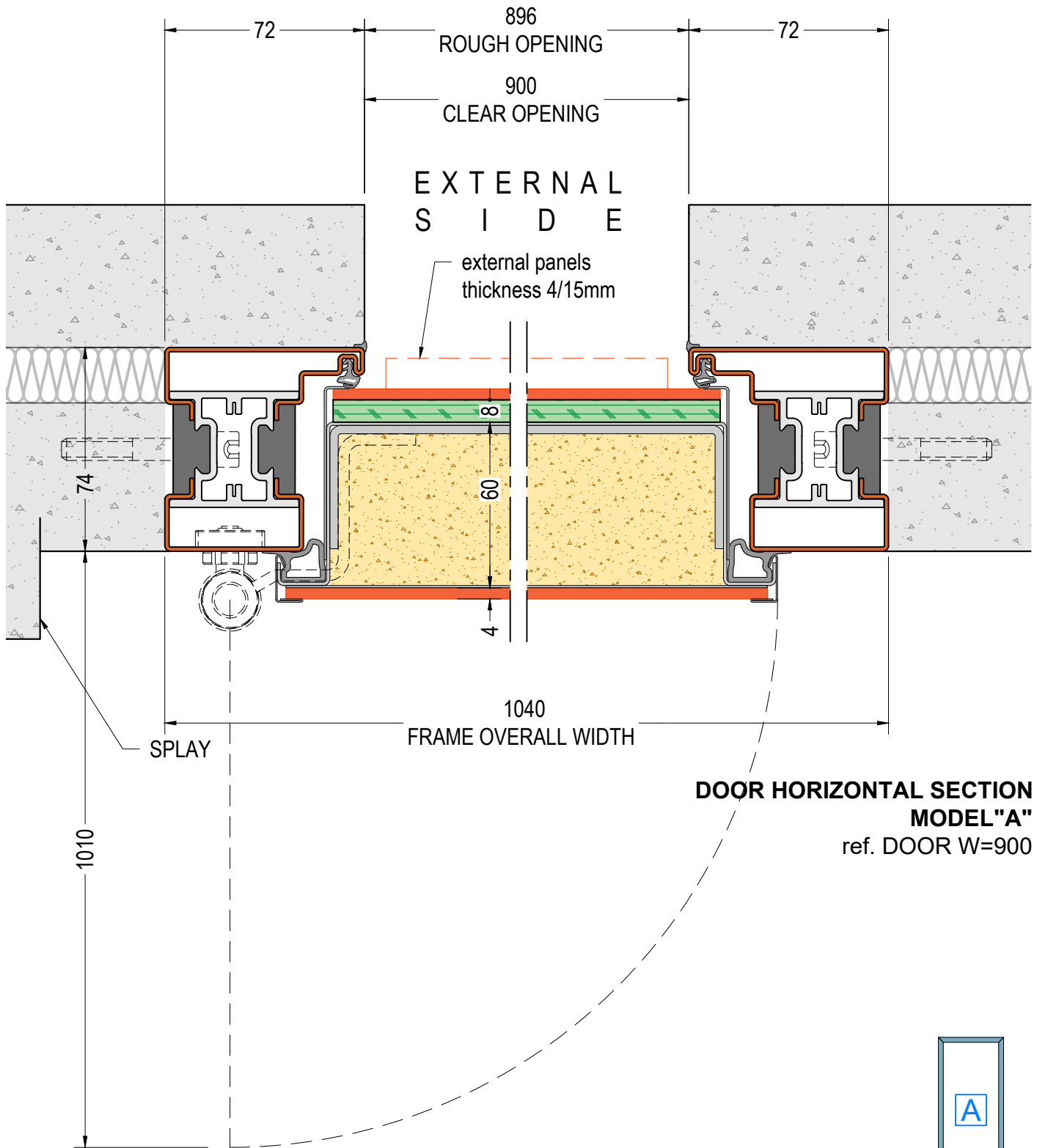

**DOOR HORIZONTAL SECTION
MODEL "A"**
ref. DOOR W=900

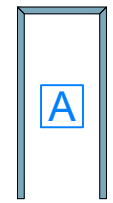

external side view



**PAINTED STEEL FRAME
WITH THERMAL BREAK
Solution 19**

23.1

HORIZONTAL SECTION - scale 1:2

v 1.4

DI.BI. PORTE BLINDATE Srl - Fano (PU) ITALY - www.dibigroup.com

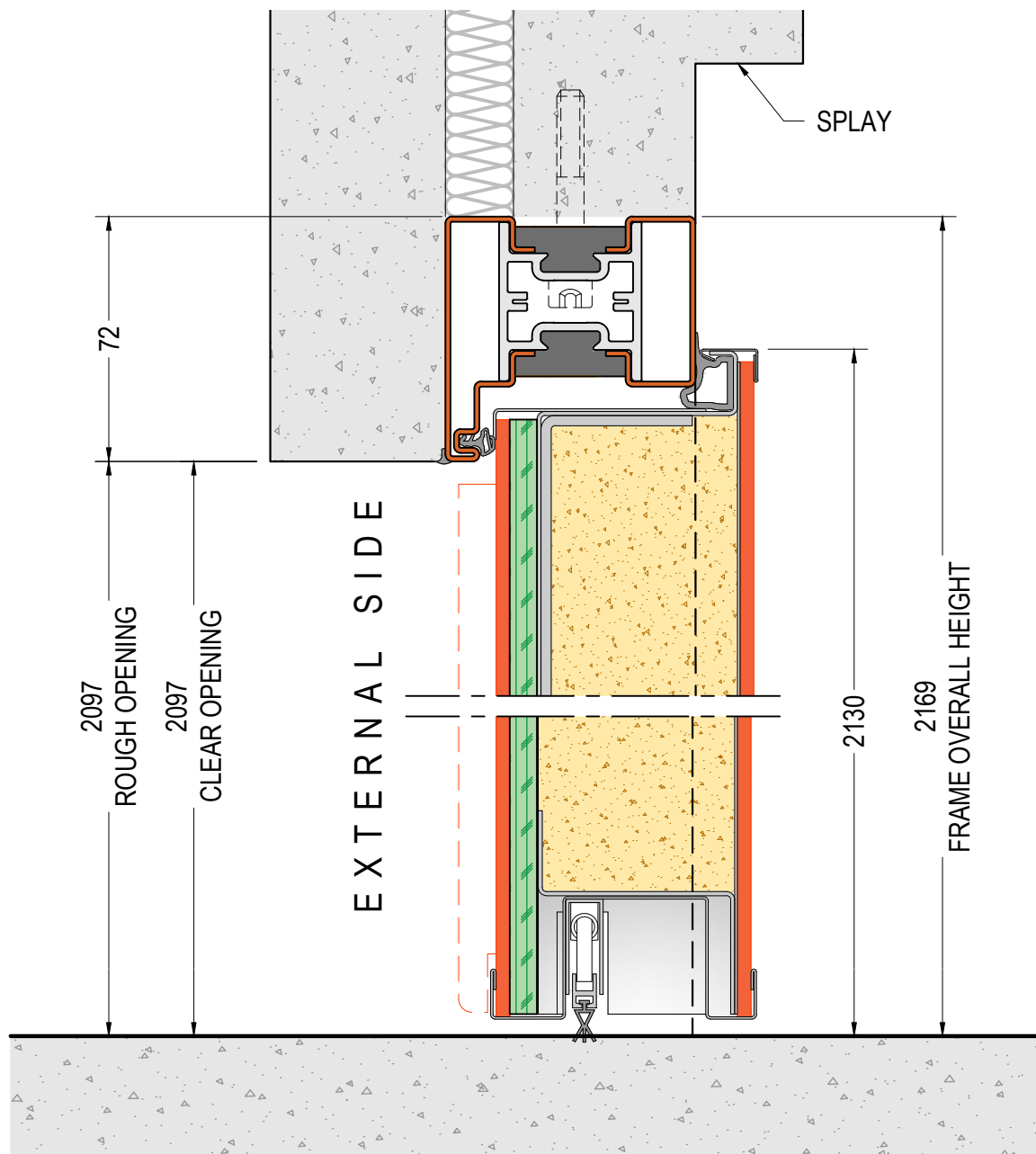

**DOOR VERTICAL SECTION
MODEL "A"**
ref. DOOR H=2100

DOOR DIMENSIONS:
W=min.700 - max.2000
H=min.2000 - max.2450



external side view



**PAINTED STEEL FRAME
WITH THERMAL BREAK
Solution 19**

23.2

VERTICAL SECTION - scale 1:2

v 1.4

DI.BI. PORTE BLINDATE Srl - Fano (PU) ITALY - www.dibigroup.com

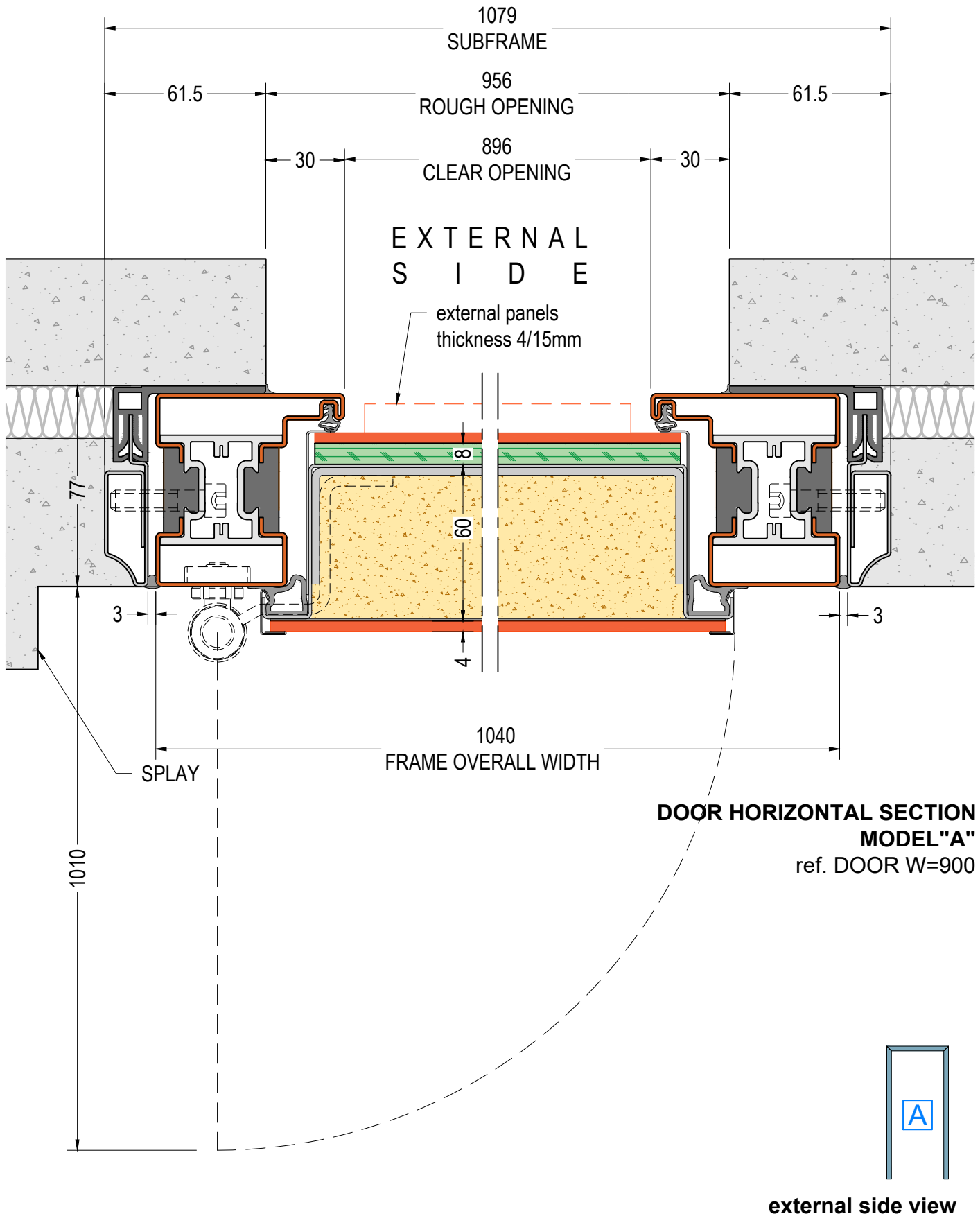

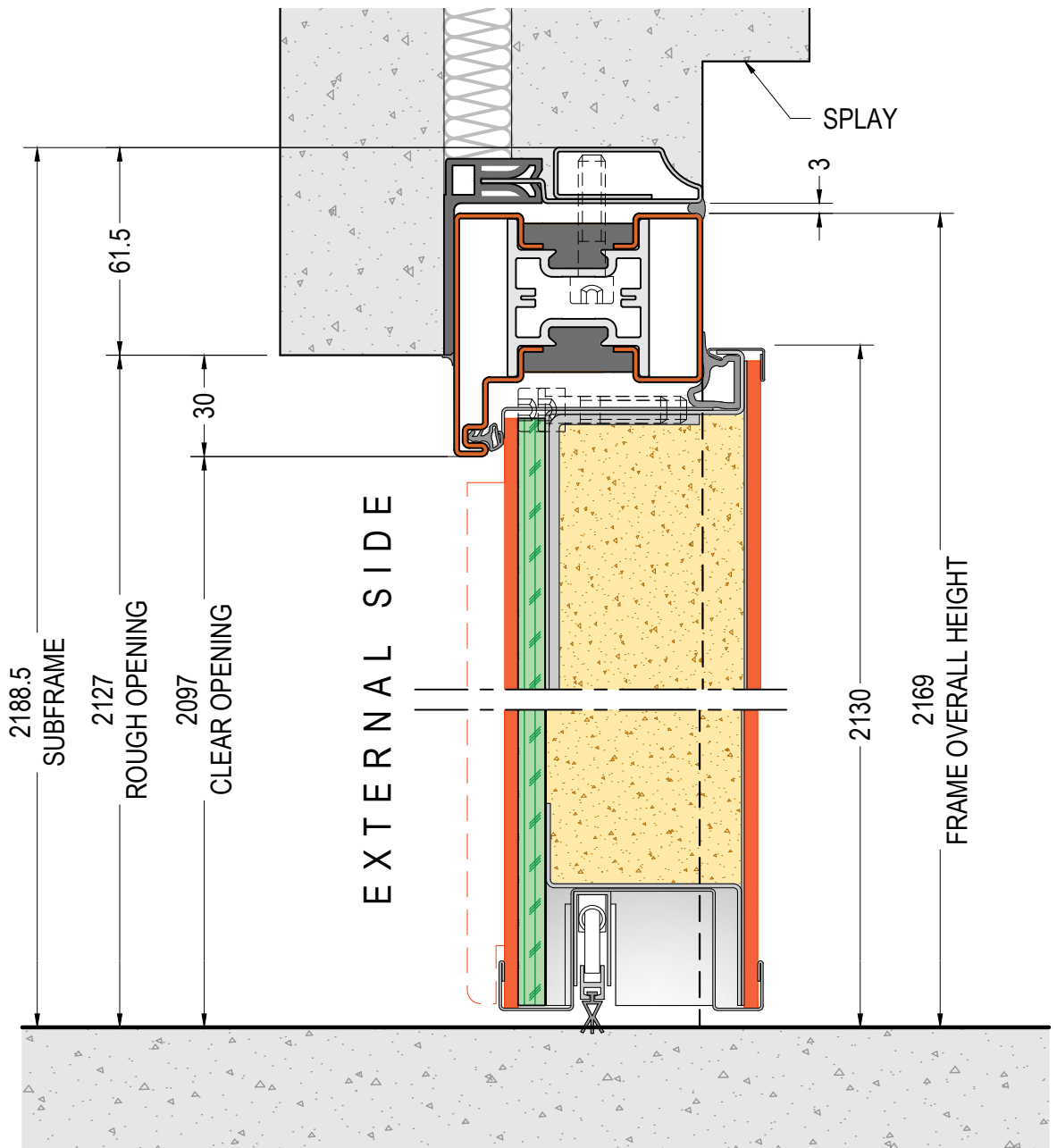

**DOOR VERTICAL SECTION
MODEL "A"**
ref. DOOR H=2100

DOOR DIMENSIONS:
W=min.700 - max.2000
H=min.2000 - max.2450



external side view



**PAINTED STEEL FRAME AND
SUBFRAME WITH THERMAL
BREAK – Soution 19 bis**

23.4

VERTICAL SECTION - scale 1:2

v 1.4

DI.BI. PORTE BLINDATE Srl - Fano (PU) ITALY - www.dibigroup.com

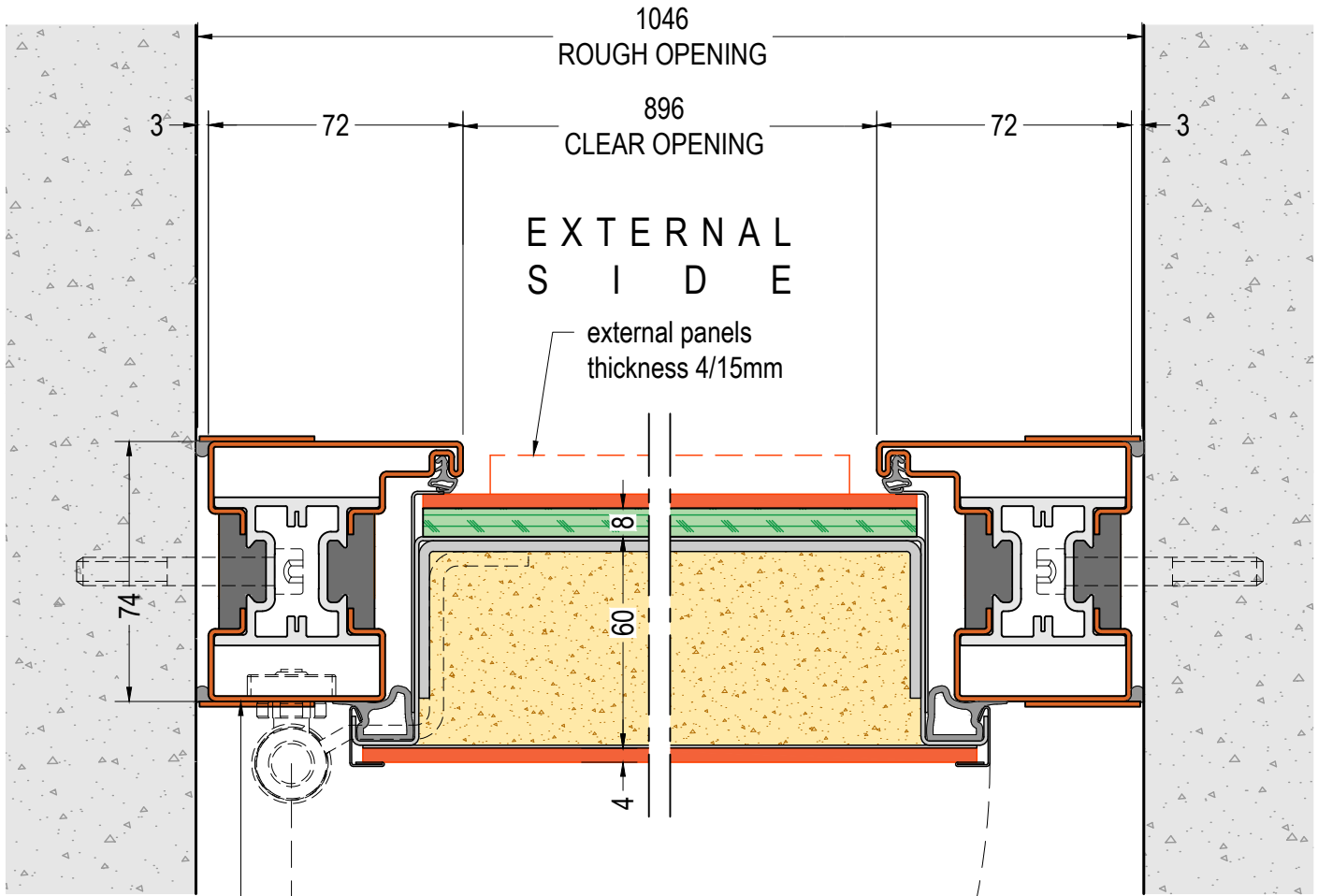

**DOOR HORIZONTAL SECTION
MODEL "A"**
ref. DOOR W=900

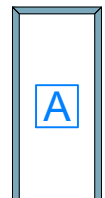

external side view



**PAINTED STEEL FRAME WITH
THERMAL BREAK FLUSH
WITH THE WALL – Sol. 18**

24.1

HORIZONTAL SECTION - scale 1:2

v 1.4

DI.BI. PORTE BLINDATE Srl - Fano (PU) ITALY - www.dibigroup.com

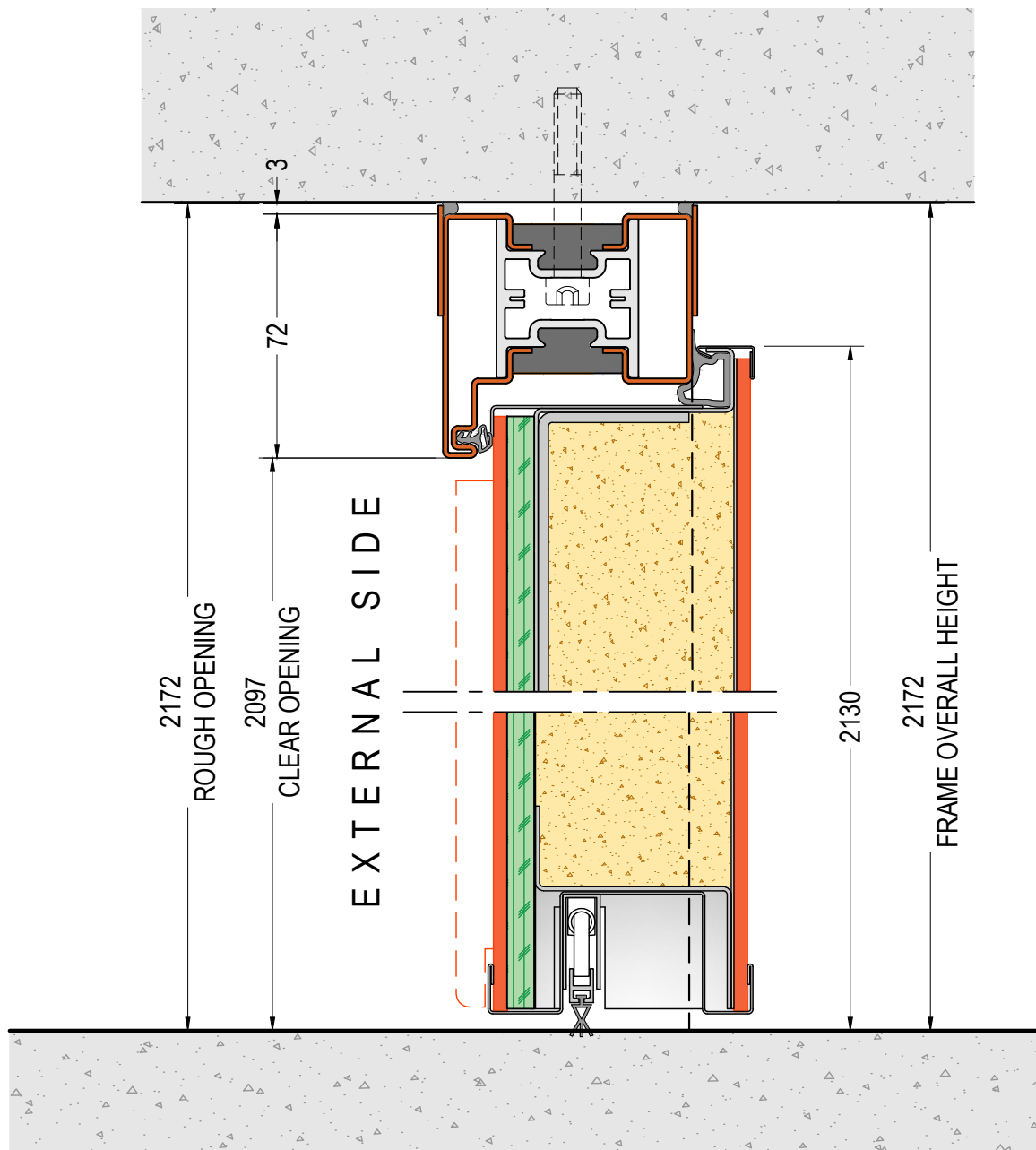

**DOOR VERTICAL SECTION
MODEL "A"**
ref. DOOR H=2100

DOOR DIMENSIONS:
W=min.700 - max.2000
H=min.2000 - max.2300

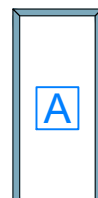

external side view



**PAINTED STEEL FRAME WITH
THERMAL BREAK FLUSH
WITH THE WALL – Sol. 18**

24.2

VERTICAL SECTION - scale 1:2

v 1.4

DI.BI. PORTE BLINDATE Srl - Fano (PU) ITALY - www.dibigroup.com

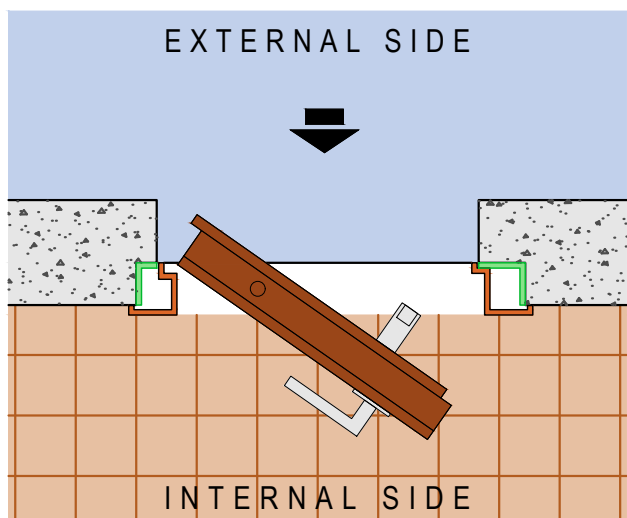

RH Push door

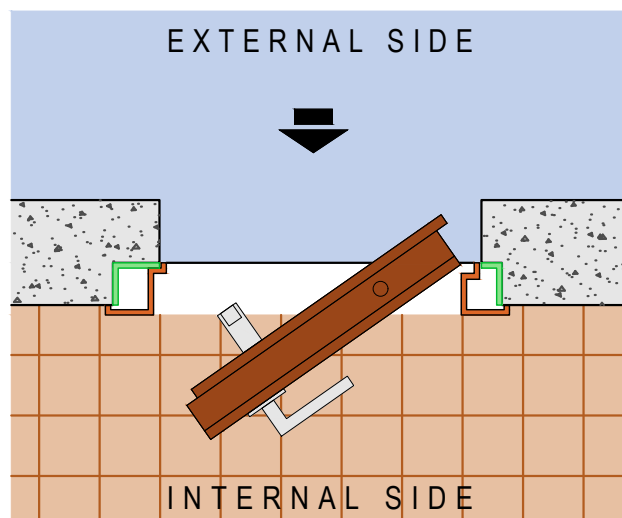

LH Push door

PUSH DOOR ASSEMBLY

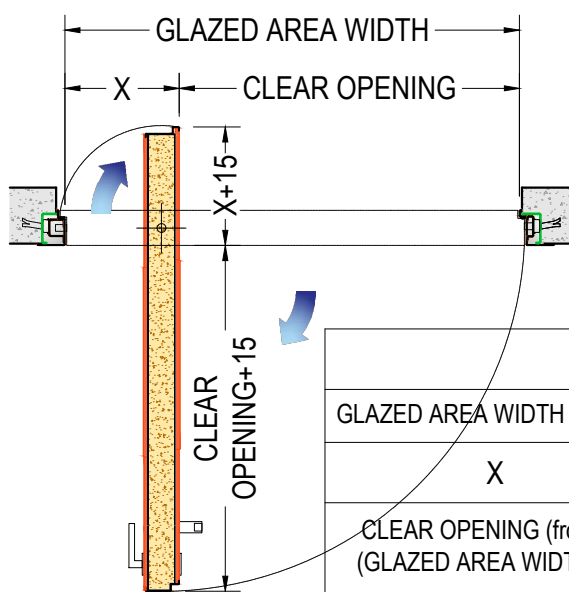

CLEAR OPENING CALCULATION					
GLAZED AREA WIDTH (from-to)	1100-1300	1301-1400	1401-1550	1551-1700	1701-1800
X	300	350	400	450	500
CLEAR OPENING (from-to) (GLAZED AREA WIDTH - X)	800-1000	951-1050	1001-1150	1001-1250	1201-1300

CLEAR OPENING SCHEMA – CLEAR OPENING X

EXTERNAL SIDE

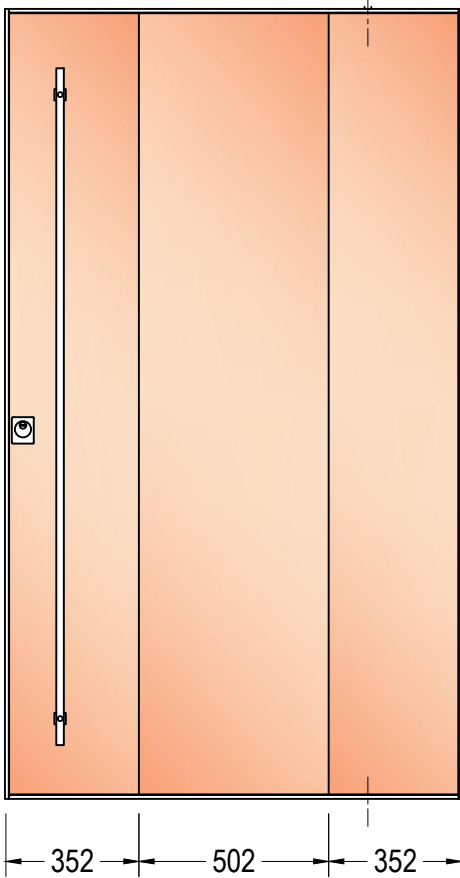
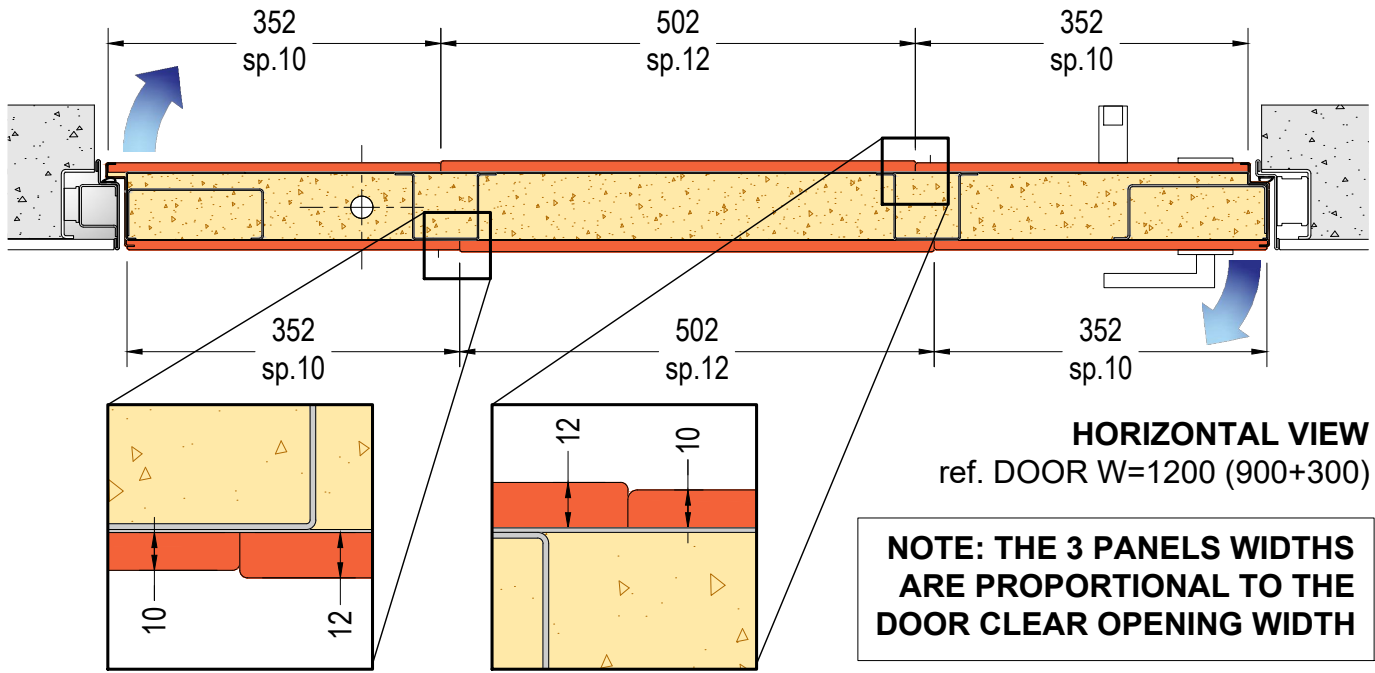

EXTERNAL SIDE VIEW
ref. DOOR W=1200

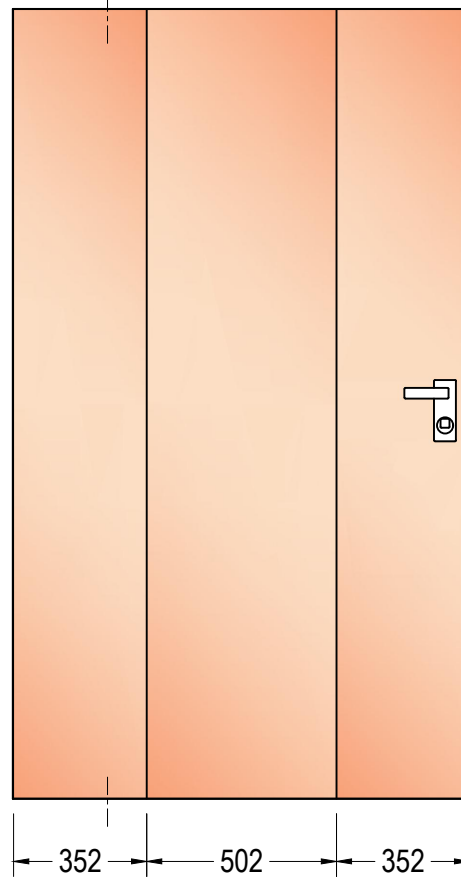

INTERNAL SIDE VIEW
ref. DOOR W=1200



STANDARD PANELS DI.BIG DOOR SCHEMES

25.2

HORIZONTAL VIEW - scale 1:8 - VIEWS scale 1:20 v 1.0

DI.BI. PORTE BLINDATE Srl - Fano (PU) ITALY - www.dibigroup.com

EXTERNAL SIDE

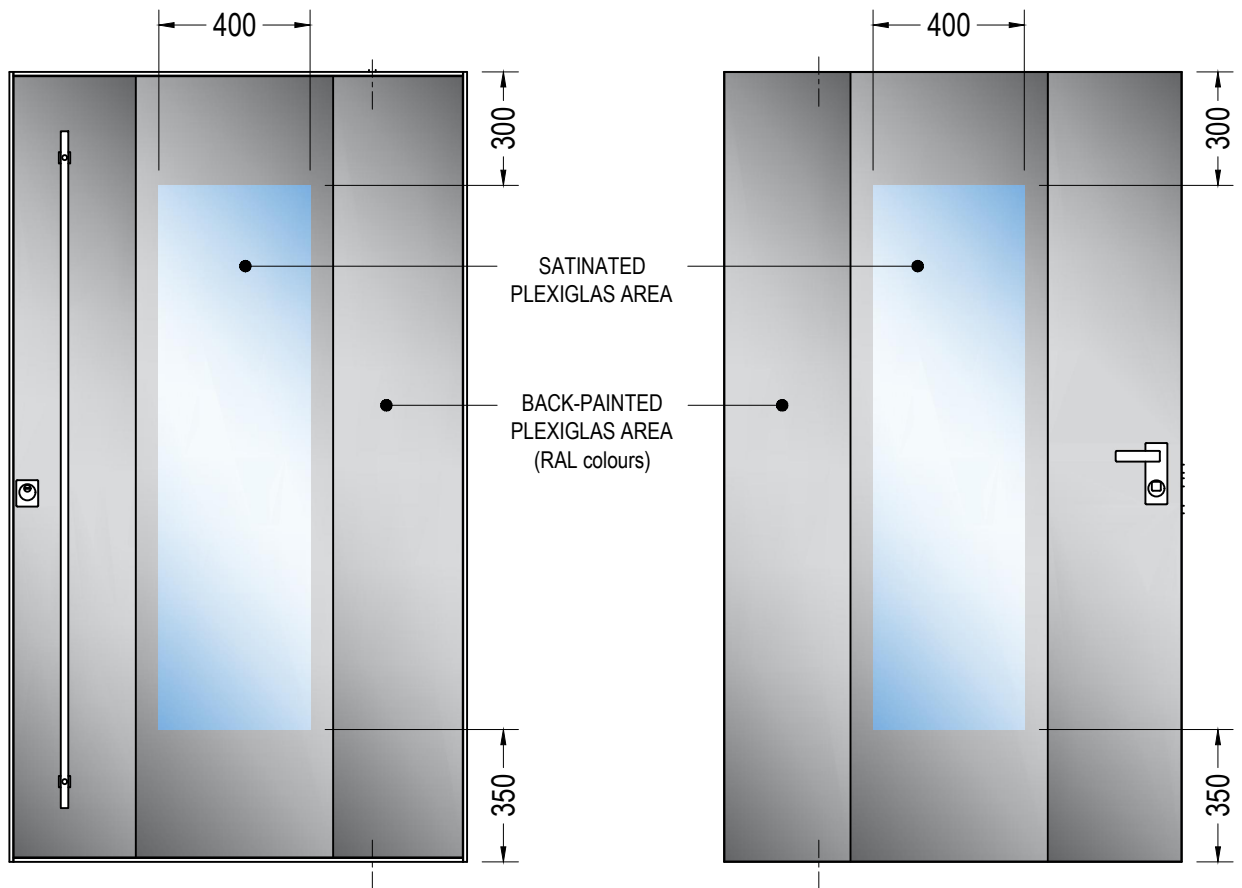
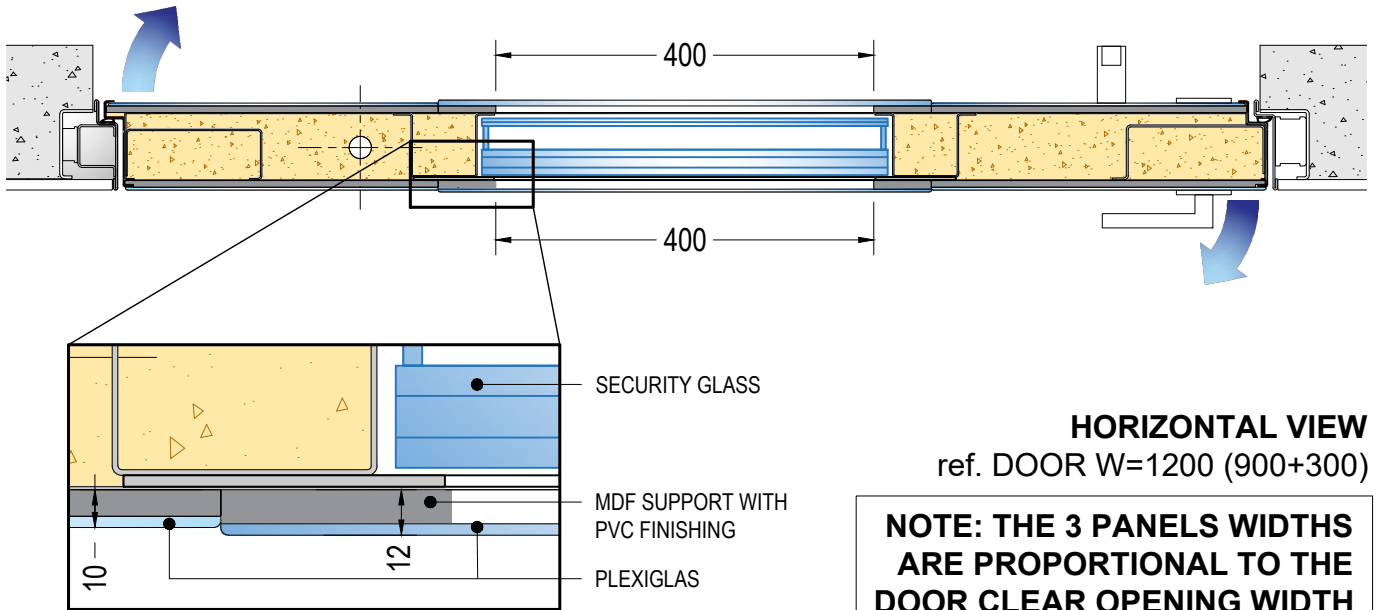

EXTERNAL SIDE VIEW
ref. DOOR W=1200

INTERNAL SIDE VIEW
ref. DOOR W=1200



PANELS FOR DI.BIG DOOR WITH GLASS INSERT. DOOR SCHEMES

25.3

HORIZONTAL VIEW - scale 1:8 - VIEWS scale 1:20 v 2.0

DI.BI. PORTE BLINDATE Srl - Fano (PU) ITALY - www.dibigroup.com

EXTERNAL SIDE

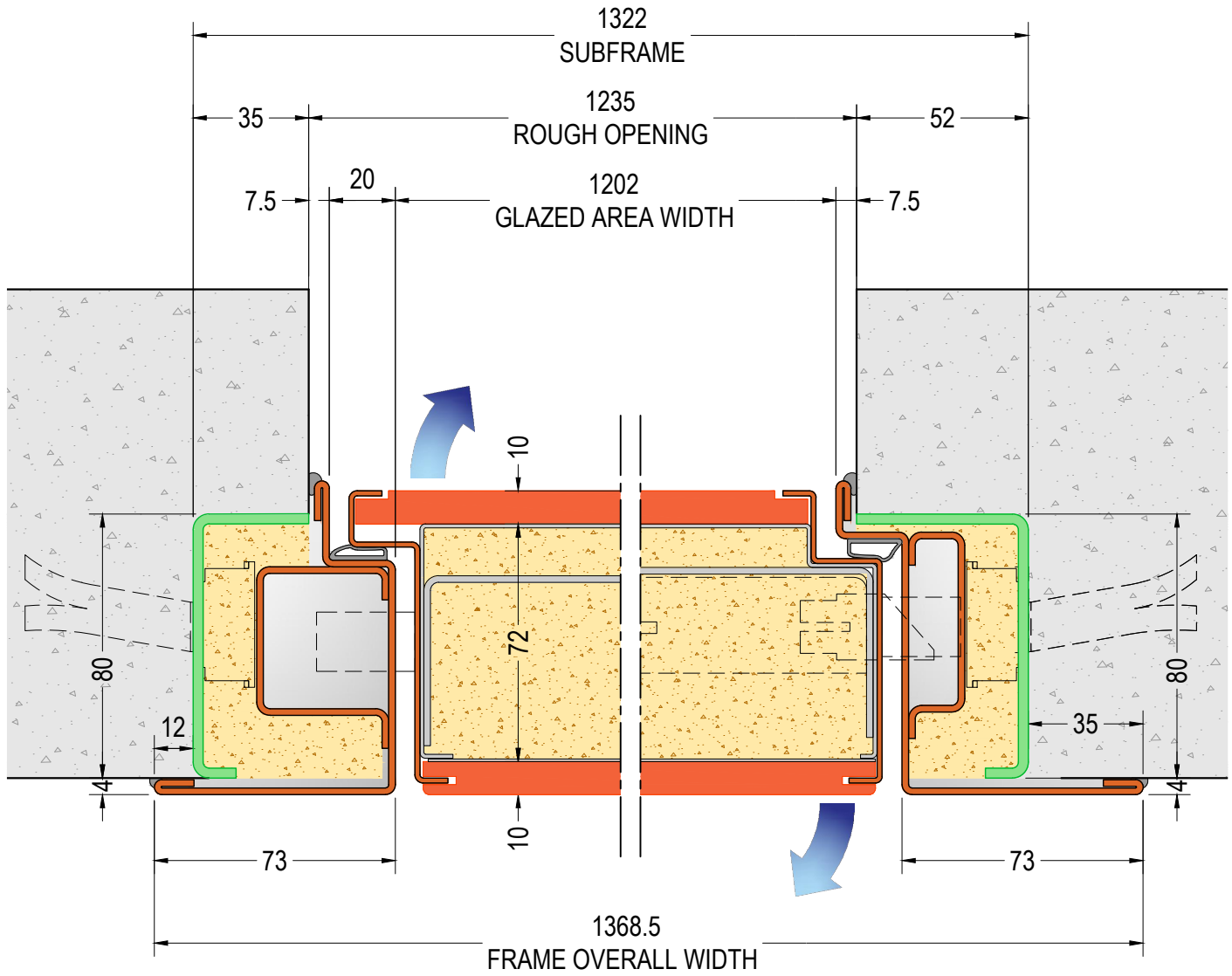

**DOOR HORIZONTAL SECTION
MODEL "A"**
ref. DOOR W=1200(900+300)

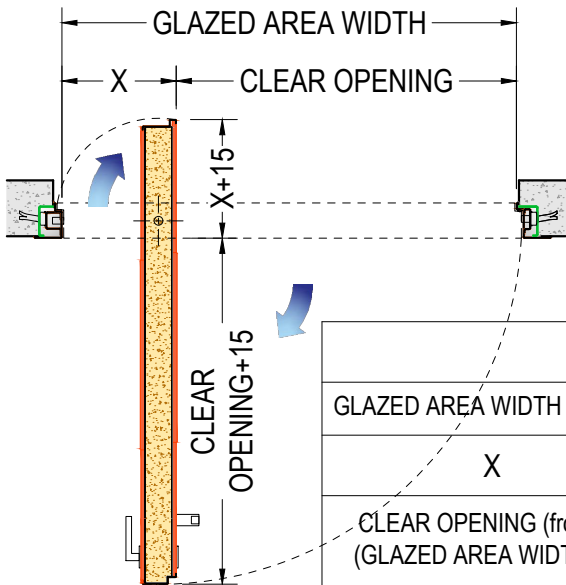

CLEAR OPENING CALCULATION

GLAZED AREA WIDTH (from-to)	1100-1300	1301-1400	1401-1550	1551-1700	1701-1800
X	300	350	400	450	500
CLEAR OPENING (from-to) (GLAZED AREA WIDTH - X)	800-1000	951-1050	1001-1150	1001-1250	1201-1300



SUBFRAME AND FRAME FOR DI.BIG PIVOT SECURITY DOOR - Solution 20

26.1

HORIZONTAL SECTION - scale 1:2

v 1.6

DI.BI. PORTE BLINDATE Srl - Fano (PU) ITALY - www.dibigroup.com

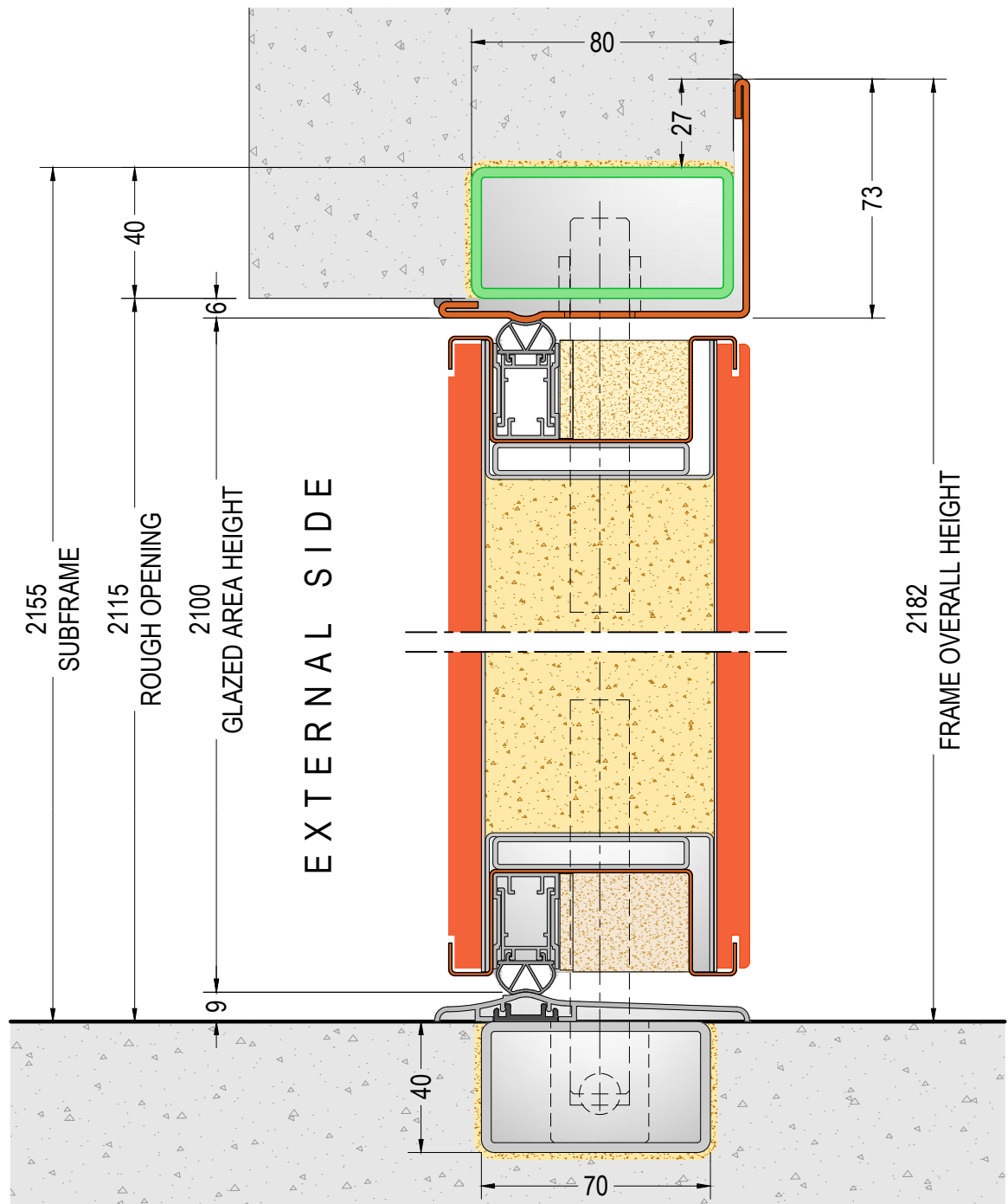

**DOOR VERTICAL SECTION
MODEL "A"**
ref. DOOR H=2100

DOOR DIMENSIONS:
W=min.1100 - max.1800
H=min.2100 - max.2800



external side view



**SUBFRAME AND FRAME FOR
DI.BIG PIVOT SECURITY
DOOR - Solution 20**

26.2

VERTICAL SECTION - scale 1:2

v 1.6

DI.BI. PORTE BLINDATE Srl - Fano (PU) ITALY - www.dibigroup.com

EXTERNAL SIDE

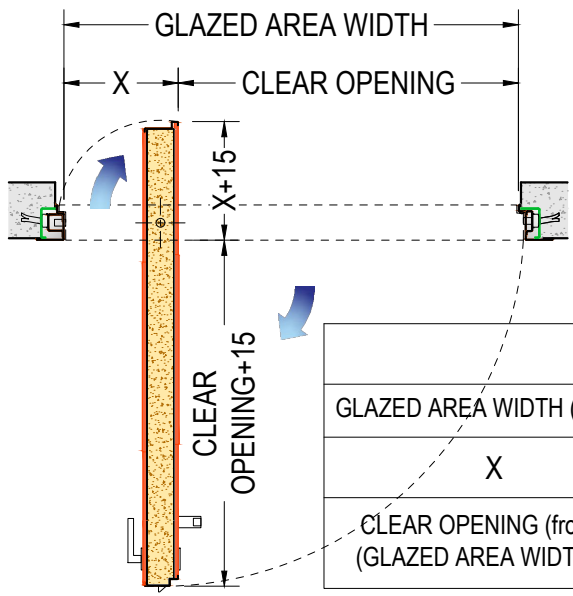
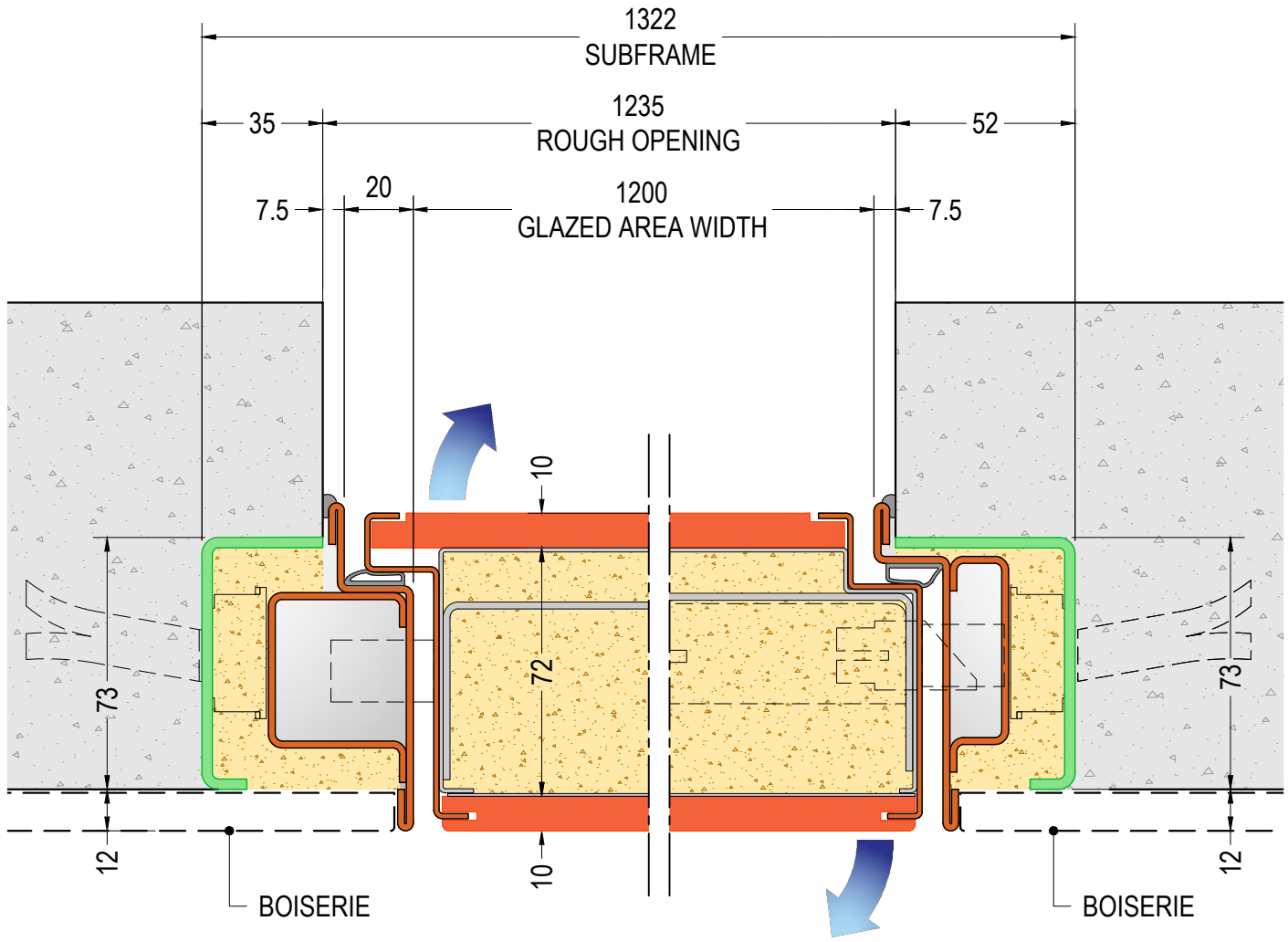

**DOOR HORIZONTAL SECTION
MODEL "A"**
ref. DOOR W=1200(900+300)

CLEAR OPENING CALCULATION					
GLAZED AREA WIDTH (from-to)	1100-1300	1301-1400	1401-1550	1551-1700	1701-1800
X	300	350	400	450	500
CLEAR OPENING (from-to) (GLAZED AREA WIDTH - X)	800-1000	951-1050	1001-1150	1001-1250	1201-1300



SUBFRAME AND FRAME FOR DI.BIG PIVOT DOOR with **26.3**
interior wall finish - Solution 21

HORIZONTAL SECTION - scale 1:2 v 1.6

DI.BI. PORTE BLINDATE Srl - Fano (PU) ITALY - www.dibigroup.com

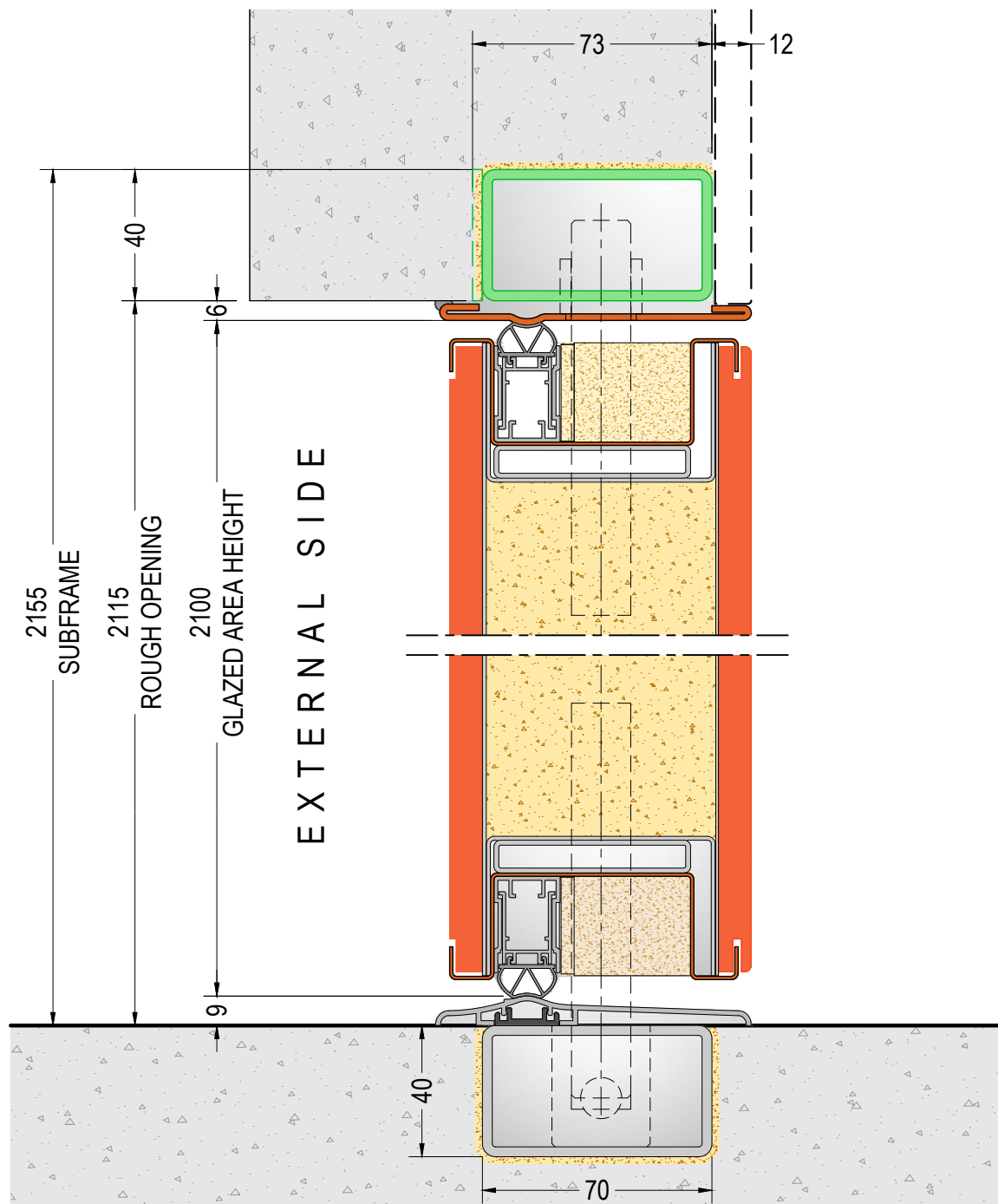

**DOOR VERTICAL SECTION
MODEL "A"**
ref. DOOR H=2100

DOOR DIMENSIONS:
W=min.1100 - max.1800
H=min.2100 - max.2800

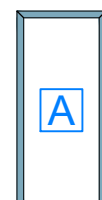

external side view



SUBFRAME AND FRAME FOR **26.4**
DI.BIG PIVOT DOOR with
interior wall finish - Solution 21

HORIZONTAL SECTION - scale 1:2

v 1.6

DI.BI. PORTE BLINDATE Srl - Fano (PU) ITALY - www.dibigroup.com

EXTERNAL SIDE

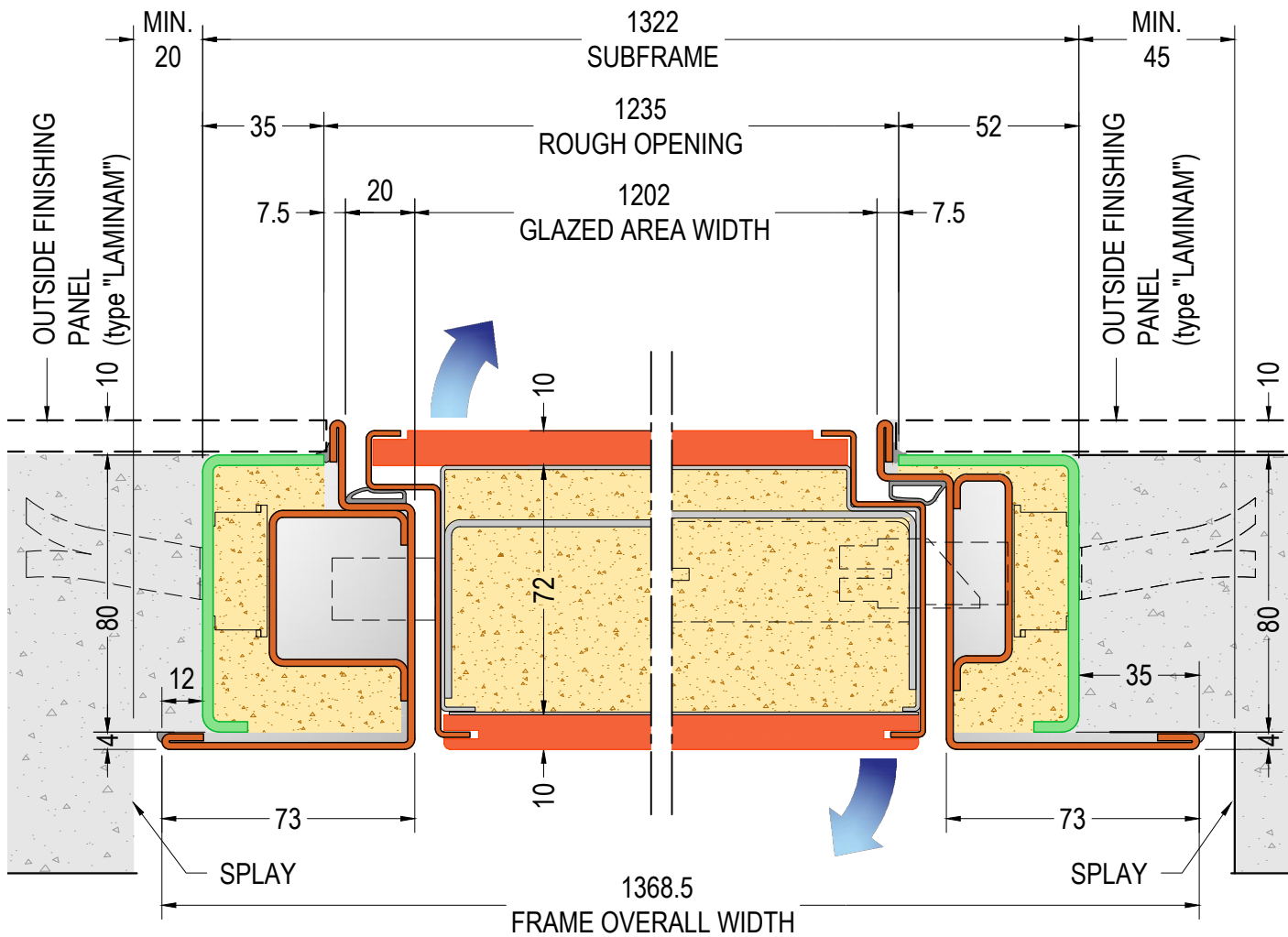

**DOOR HORIZONTAL SECTION
MODEL "A"**
ref. DOOR W=1200(900+300)

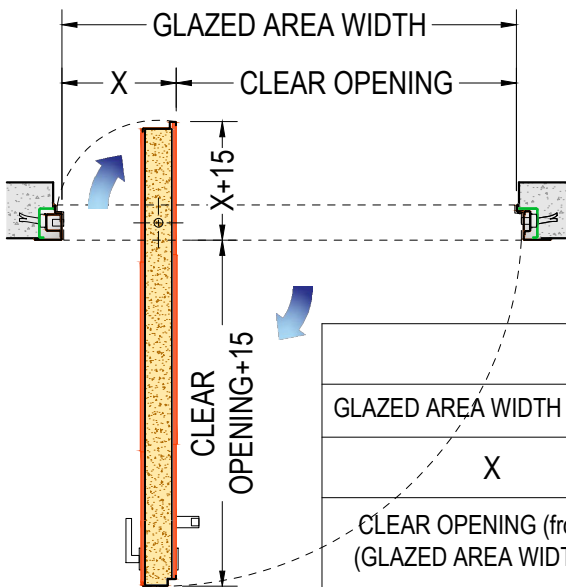

CLEAR OPENING CALCULATION

GLAZED AREA WIDTH (from-to)	1100-1300	1301-1400	1401-1550	1551-1700	1701-1800
X	300	350	400	450	500
CLEAR OPENING (from-to) (GLAZED AREA WIDTH - X)	800-1000	951-1050	1001-1150	1001-1250	1201-1300

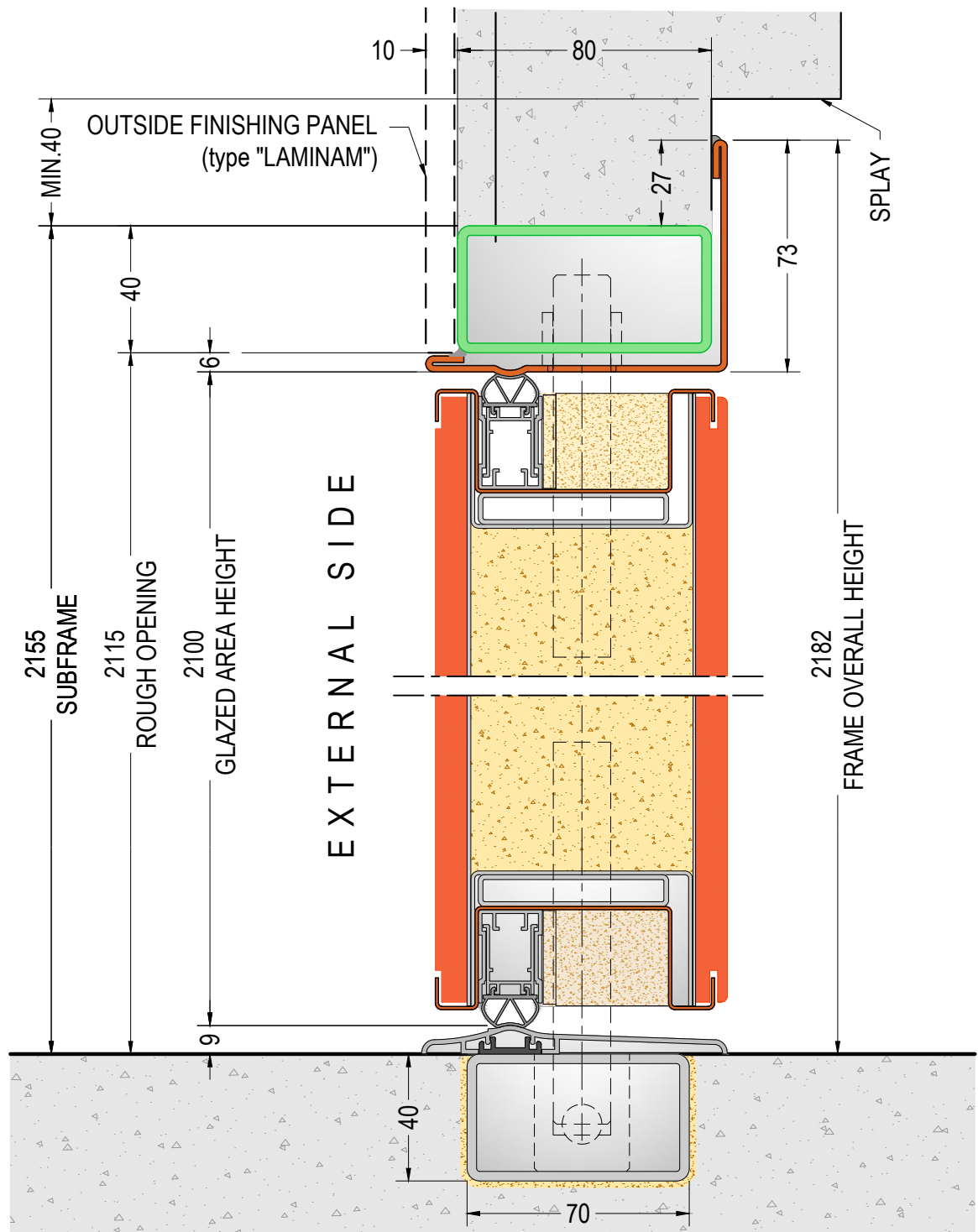

**DOOR VERTICAL SECTION
MODEL "A"**
ref. DOOR H=2100

DOOR DIMENSIONS:
W=min.1100 - max.1800
H=min.2100 - max.2800



external side view



SUBFRAME AND FRAME FOR **26.6**
DI.BIG PIVOT DOOR with
exterior wall finish - Solution 22

HORIZONTAL SECTION - scale 1:2

v 1.6

DI.BI. PORTE BLINDATE Srl - Fano (PU) ITALY - www.dibigroup.com

EXTERNAL SIDE

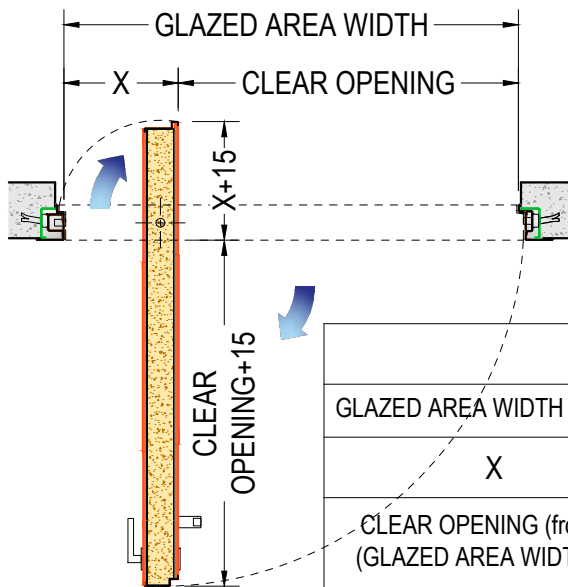
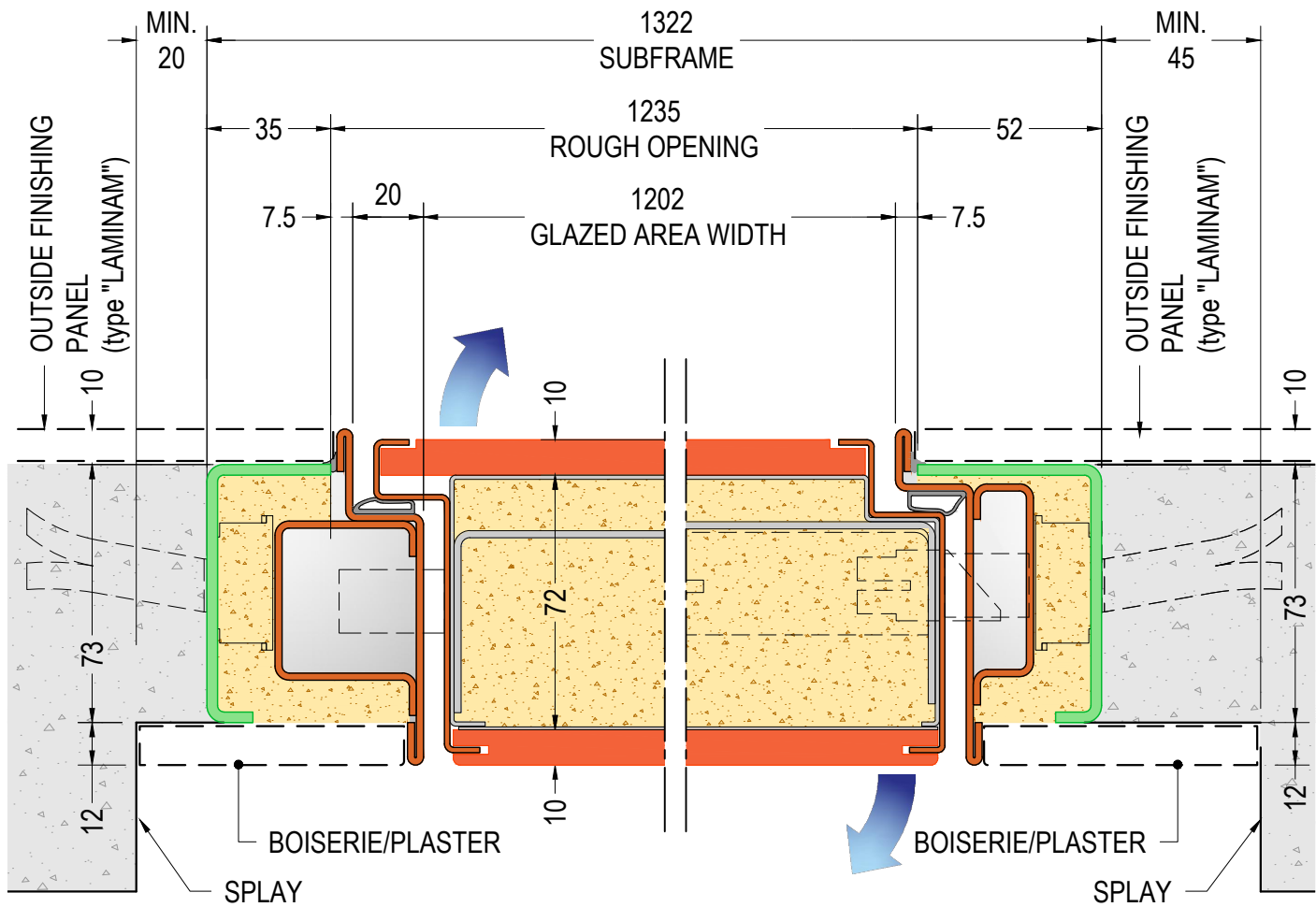

**DOOR HORIZONTAL SECTION
MODEL "A"**
ref. DOOR W=1200(900+300)

CLEAR OPENING CALCULATION

GLAZED AREA WIDTH (from-to)	1100-1300	1301-1400	1401-1550	1551-1700	1701-1800
X	300	350	400	450	500
CLEAR OPENING (from-to) (GLAZED AREA WIDTH - X)	800-1000	951-1050	1001-1150	1001-1250	1201-1300



**SUBFRAME AND FRAME FOR DI.BIG
PIVOT DOOR with exterior and
interior wall finish - Solution 23**

26.7

HORIZONTAL SECTION - scale 1:2

v 1.6

DI.BI. PORTE BLINDATE Srl - Fano (PU) ITALY - www.dibigroup.com

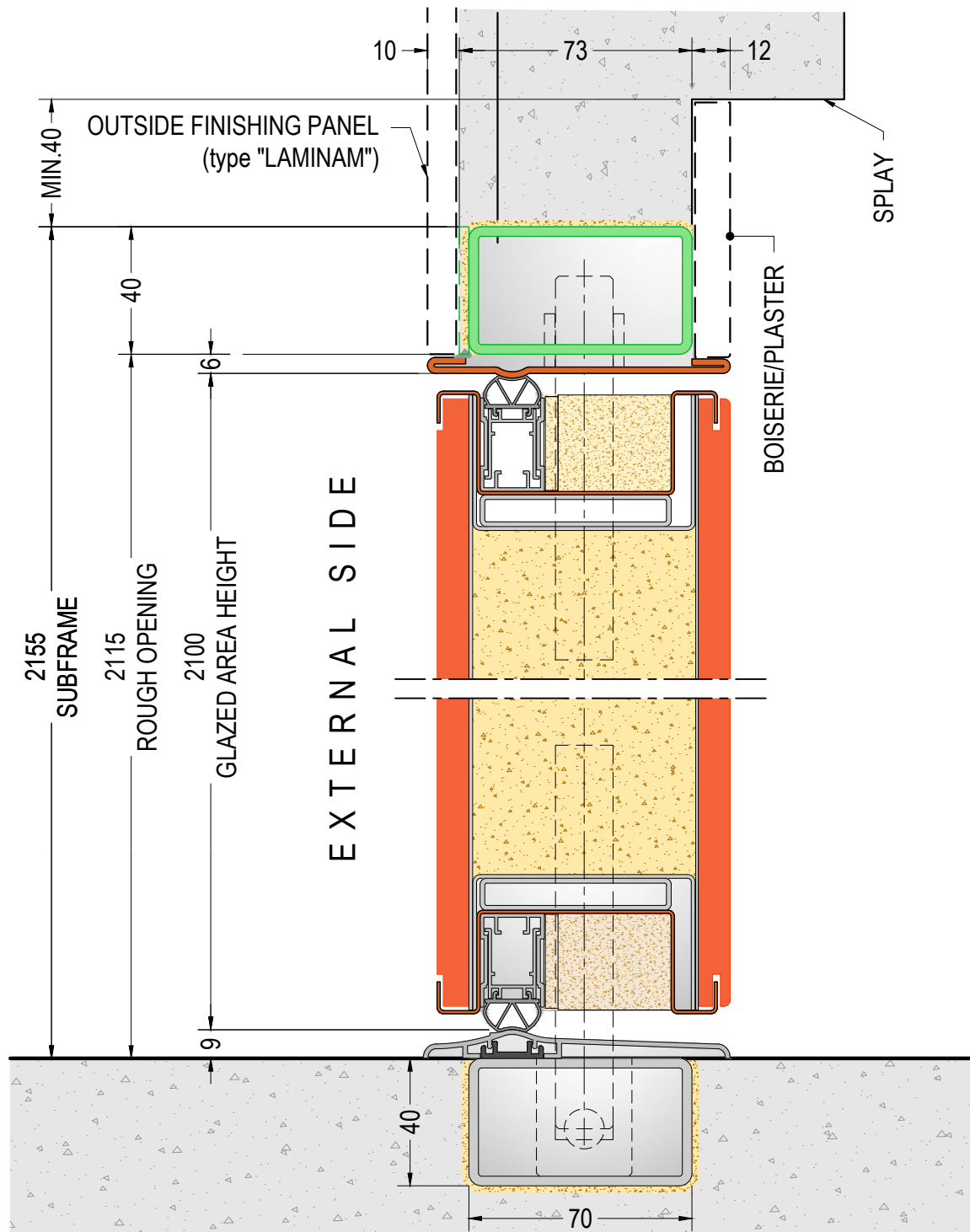

**DOOR VERTICAL SECTION
MODEL "A"**
ref. DOOR H=2100

DOOR DIMENSIONS:
W=min.1100 - max.1800
H=min.2100 - max.2800

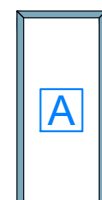

external side view



**SUBFRAME AND FRAME FOR DI.BIG
PIVOT DOOR with exterior and
interior wall finish - Solution 23**

26.8

HORIZONTAL SECTION - scale 1:2

v 1.6

DI.BI. PORTE BLINDATE Srl - Fano (PU) ITALY - www.dibigroup.com

EXTERNAL SIDE

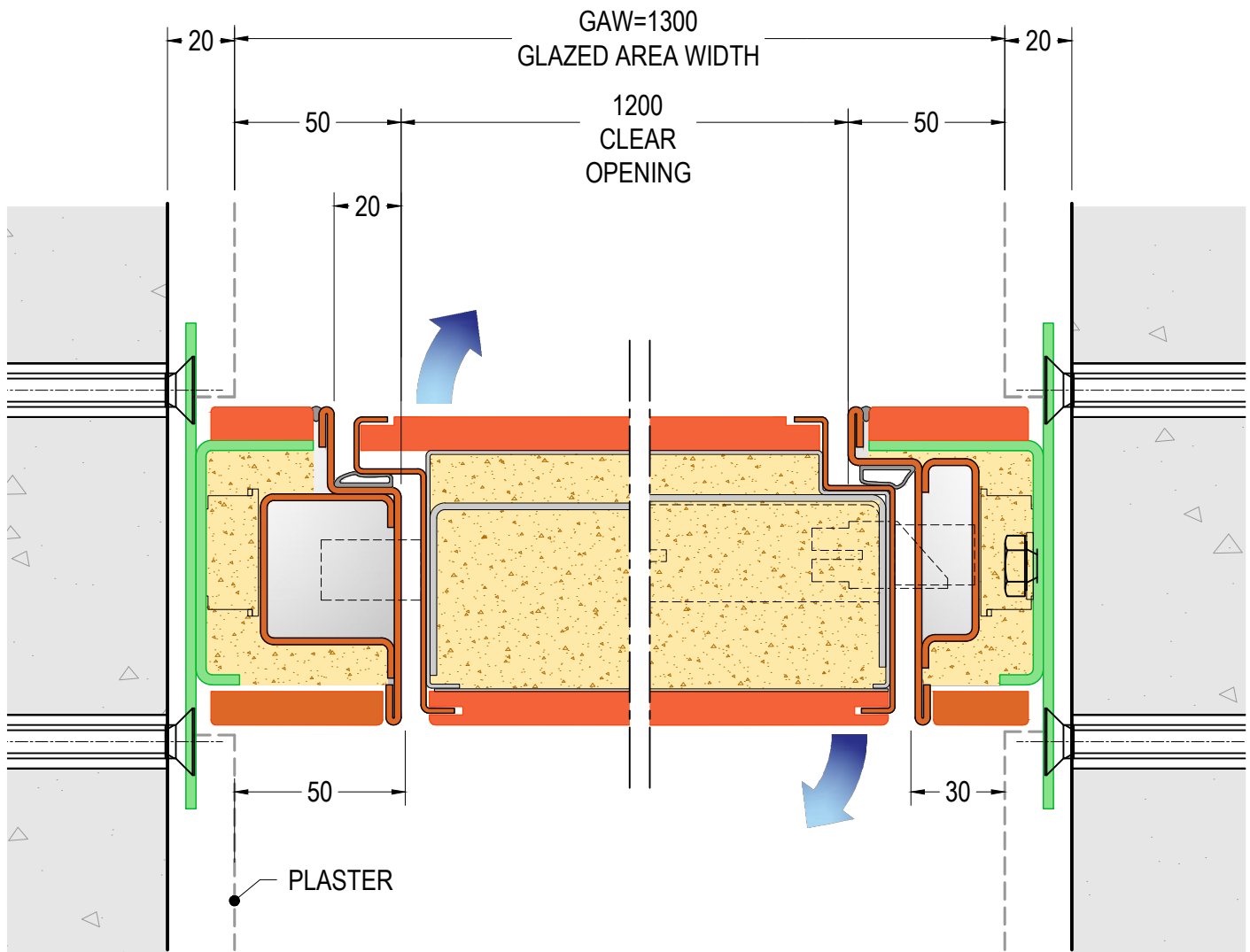

**DOOR HORIZONTAL SECTION
MODEL "A"**
ref. DOOR W=1200(900+300)

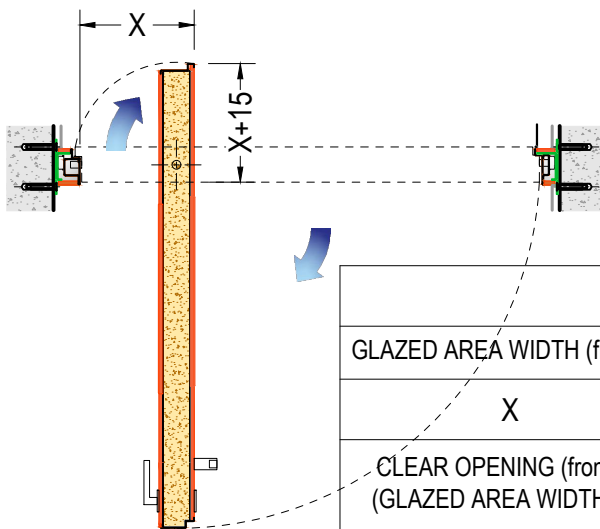

CLEAR OPENING CALCULATION

GLAZED AREA WIDTH (from-to)	1100-1300	1301-1400	1401-1550	1551-1700	1701-1800
X	300	350	400	450	500
CLEAR OPENING (from-to) (GLAZED AREA WIDTH - X)	800-1000	951-1050	1001-1150	1001-1250	1201-1300



**SUBFRAME AND FRAME FOR
DI.BIG PIVOT DOOR TUNNEL
Solution 24**

26.9

HORIZONTAL SECTION - scale 1:2

v 1.9

DI.BI. PORTE BLINDATE Srl - Fano (PU) ITALY - www.dibigroup.com

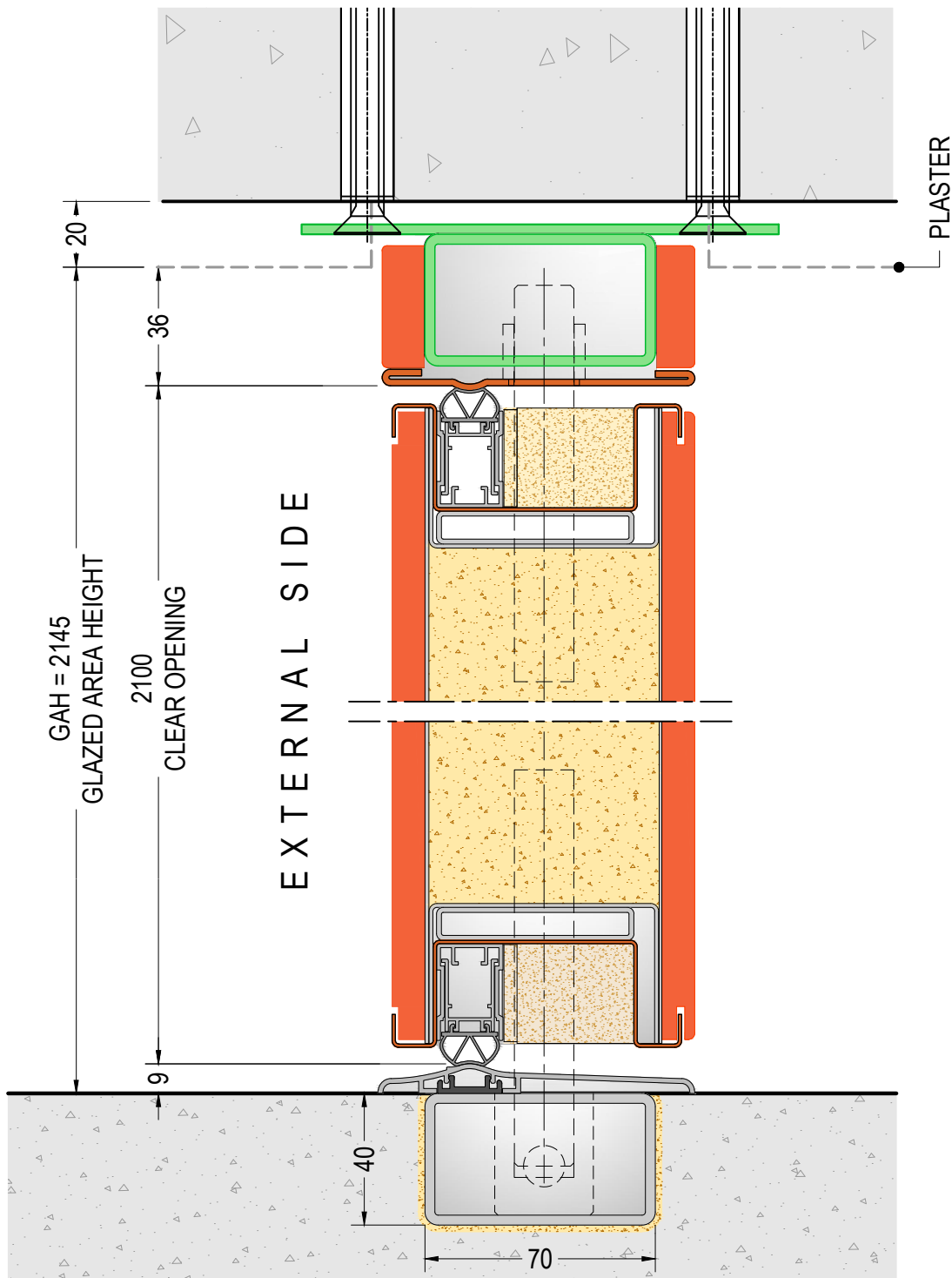

**DOOR VERTICAL SECTION
MODEL "A"**
ref. DOOR H=2100

DOOR DIMENSIONS:
W=min.1100 - max.1800
H=min.2100 - max.2800

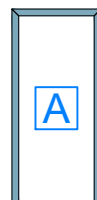

external side view



**SUBFRAME AND FRAME FOR
DI.BIG PIVOT DOOR TUNNEL
Solution 24**

26.10

HORIZONTAL SECTION - scale 1:2

v 1.9

DI.BI. PORTE BLINDATE Srl - Fano (PU) ITALY - www.dibigroup.com

EXTERNAL SIDE

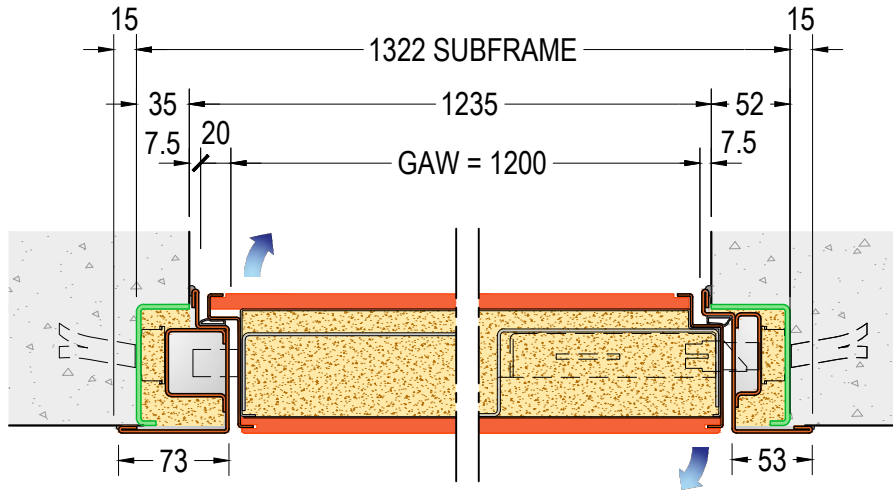

DOOR HORIZONTAL SECTION - MODEL "B"

ref. DOOR W=1200 - GLAZED AREA WIDTH GAW=1200

EXTERNAL SIDE

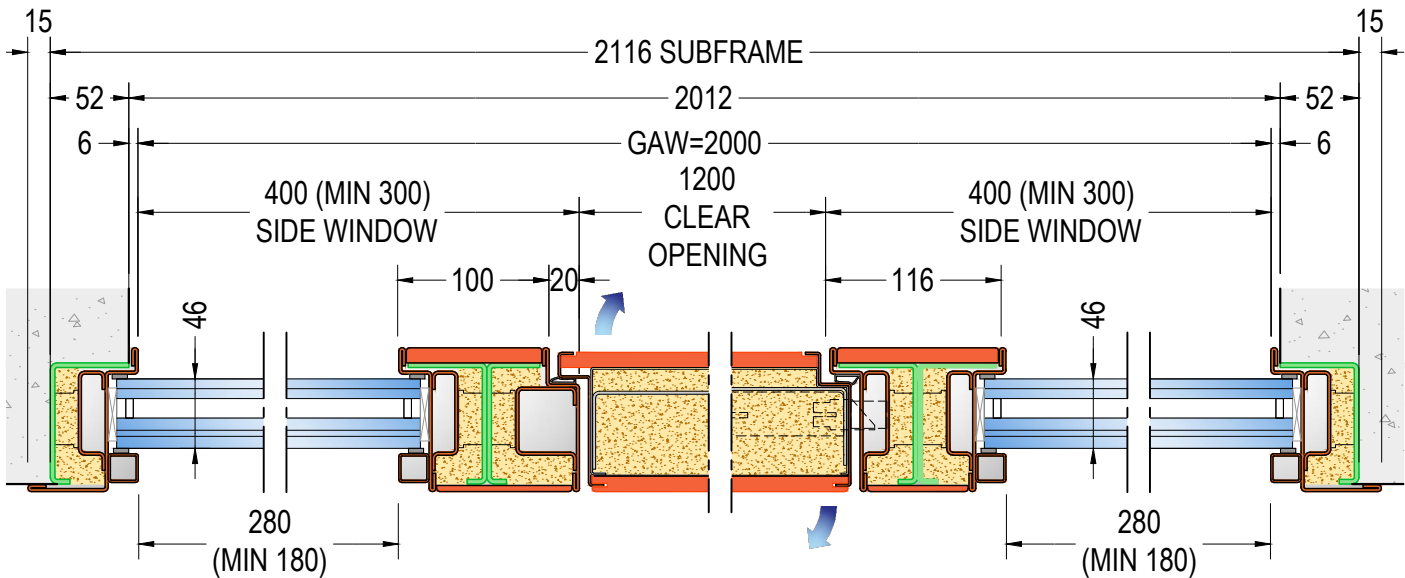

DOOR HORIZONTAL SECTION - MODELS "E-F"

ref. DOOR W=1200 - SIDE WINDOW 400
GLAZED AREA WIDTH GAW=2000

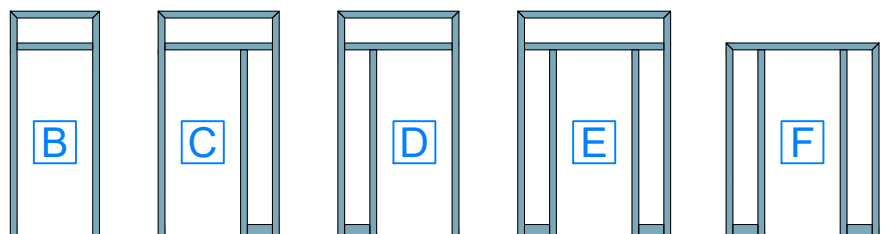

external side view



SUBFRAME AND FRAME FOR DI.BIG PIVOT SECURITY DOOR 27.1 WITH SIDE AND TOP WINDOWS

HORIZONTAL SECTIONS - scale 1:5

v1.7

DI.BI. PORTE BLINDATE Srl - Fano (PU) ITALY - www.dibigroup.com

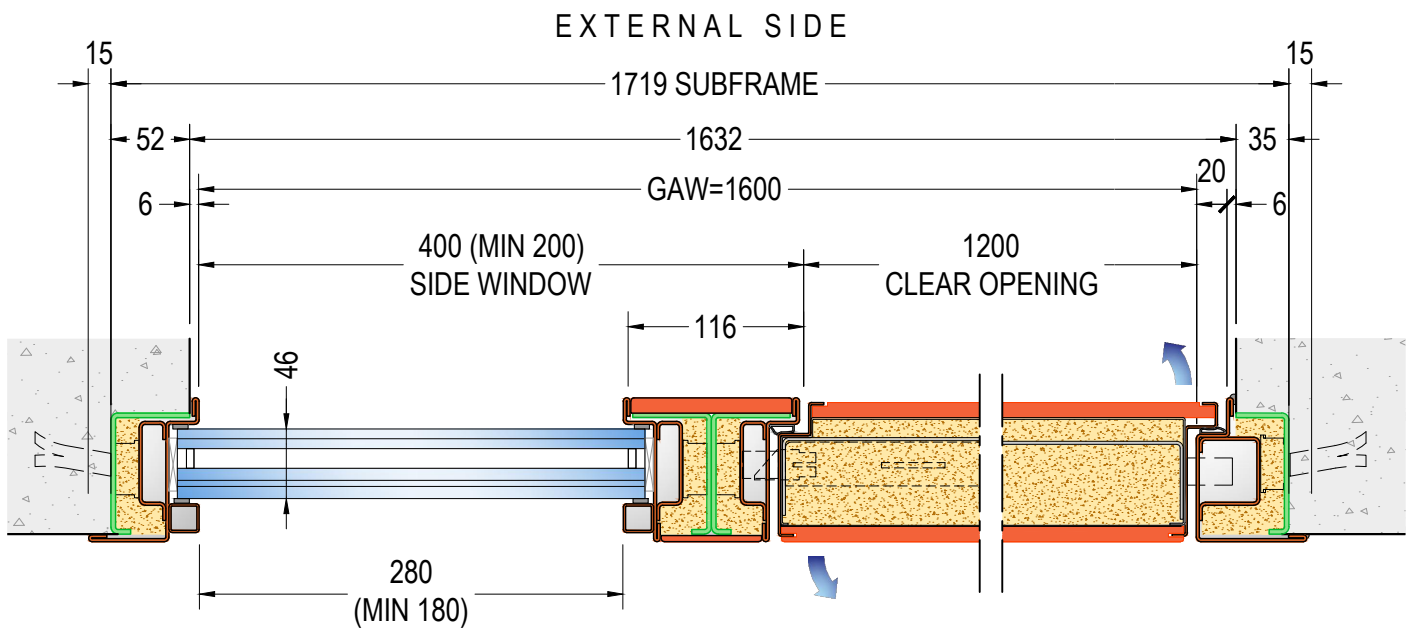

DOOR HORIZONTAL SECTION - MODELS "C-G"

ref. DOOR W=1200 - SIDE WINDOW 400

GLAZED AREA WIDTH GAW=1600

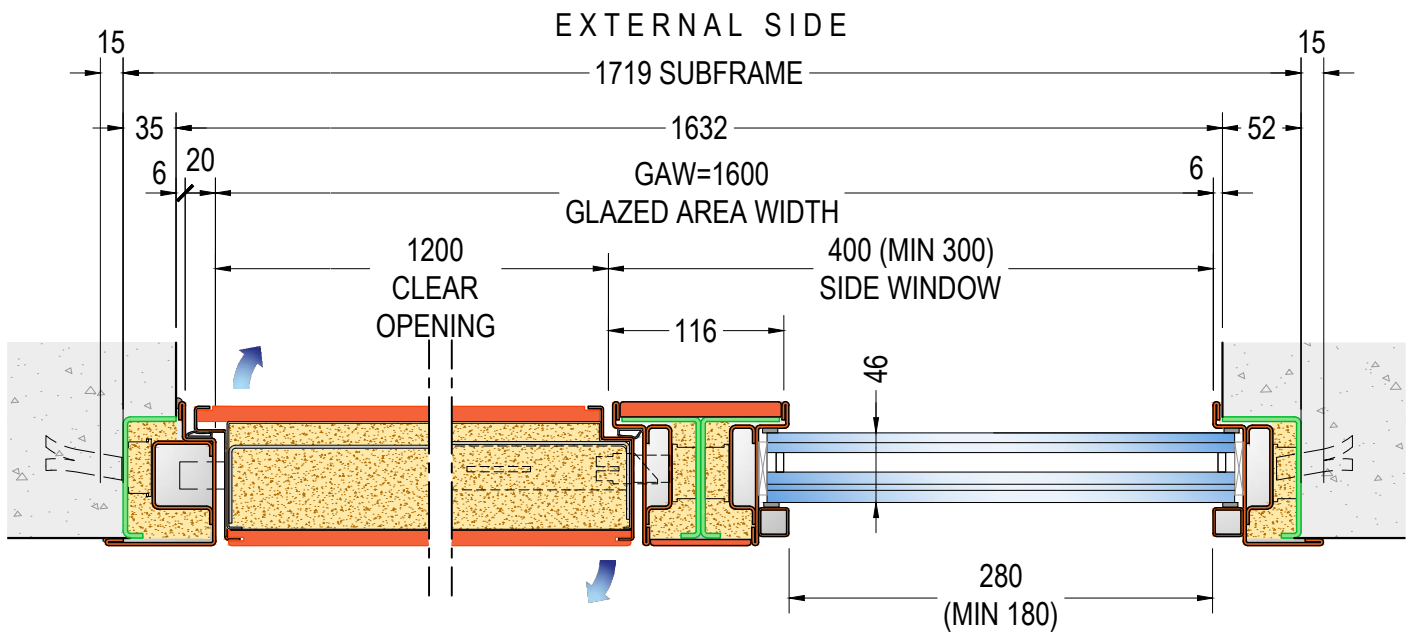

DOOR HORIZONTAL SECTION - MODELS "D-H"

ref. DOOR W=1200 - SIDE WINDOW 400

GLAZED AREA WIDTH GAW=1600

GLAZED AREA:
 MAXIMUM OVERALL DIMENSIONS
 (GAWxGAH / GAHxGAW)
 2900x3700 (CDE) 3700x2700 (FGH)

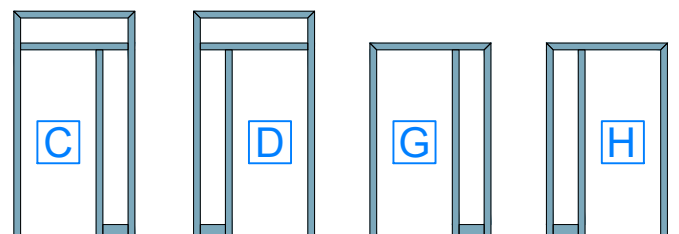

external side view



SUBFRAME AND FRAME FOR DI.BIG PIVOT SECURITY DOOR 27.2 WITH SIDE AND TOP WINDOWS

HORIZONTAL SECTIONS - scale 1:5

v1.7

DI.BI. PORTE BLINDATE Srl - Fano (PU) ITALY - www.dibigroup.com

EXTERNAL SIDE

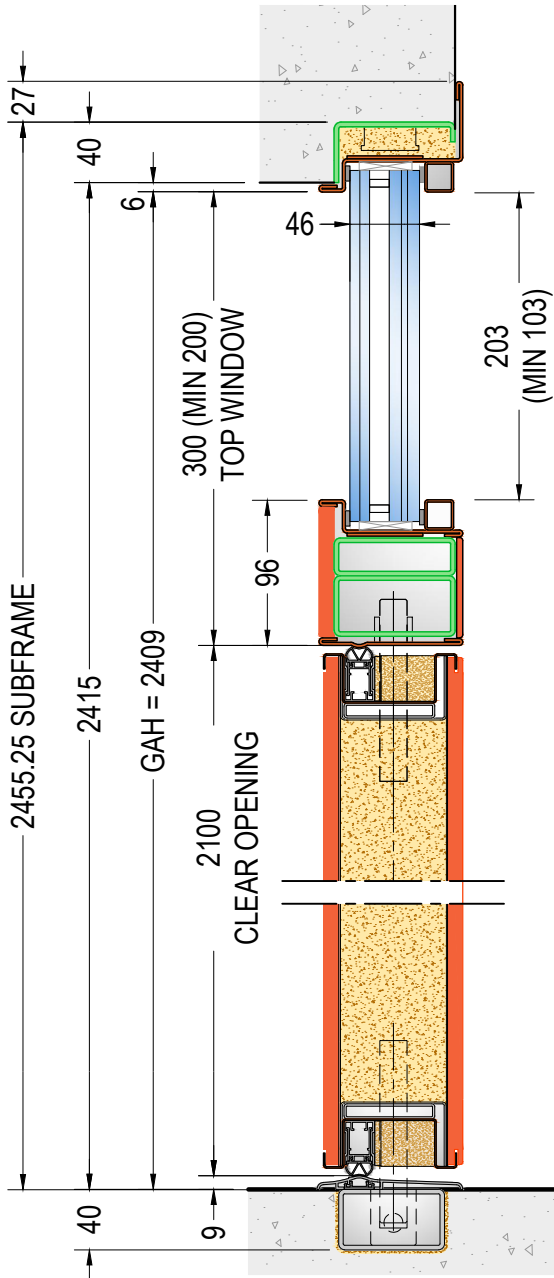

**DOOR VERTICAL SECTION
MODELS "B-C-D-E"**

ref. DOOR H=2100 - TOP WINDOW 300
GLAZED AREA HEIGHT GAH=2409

EXTERNAL SIDE

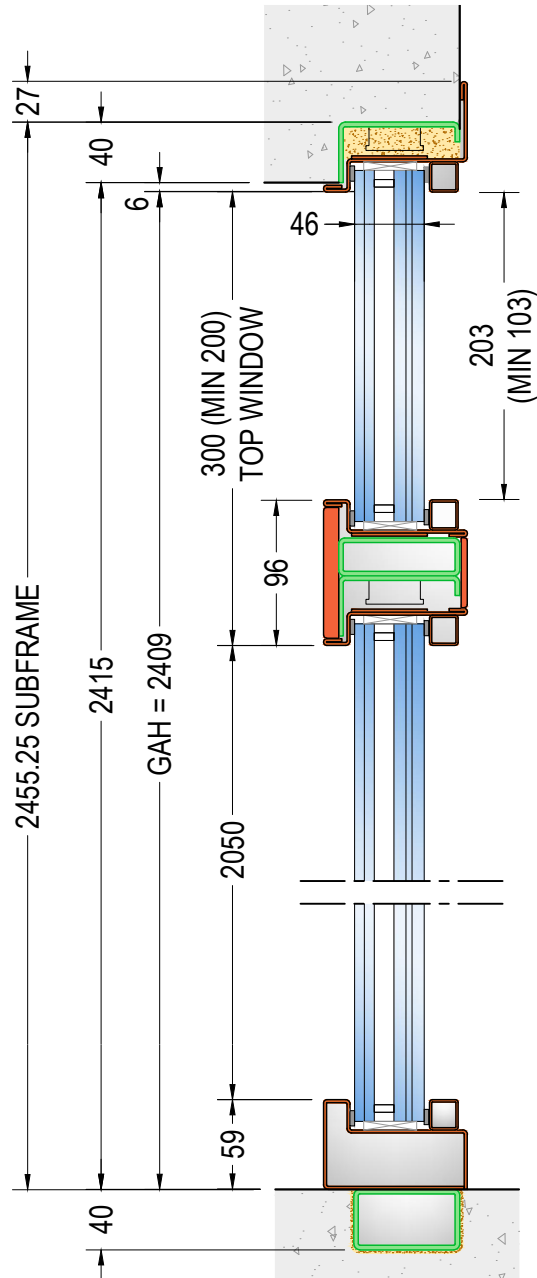

**SIDE WINDOW VERTICAL SECTION
MODELS "C-D-E"**

ref. DOOR H=2100 - TOP WINDOW 300
GLAZED AREA HEIGHT GAH=2409

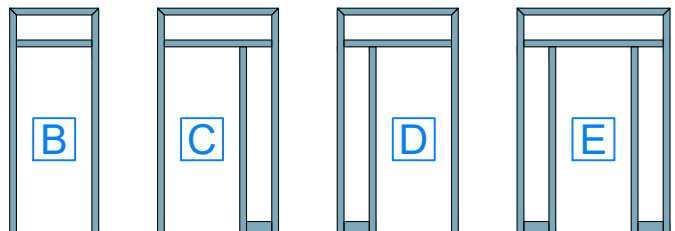

external side view



**SUBFRAME AND FRAME FOR DI.BIG PIVOT SECURITY DOOR 27.3
WITH SIDE AND TOP WINDOWS**

VERTICAL SECTIONS - scale 1:2

v1.7

DI.BI. PORTE BLINDATE Srl - Fano (PU) ITALY - www.dibigroup.com

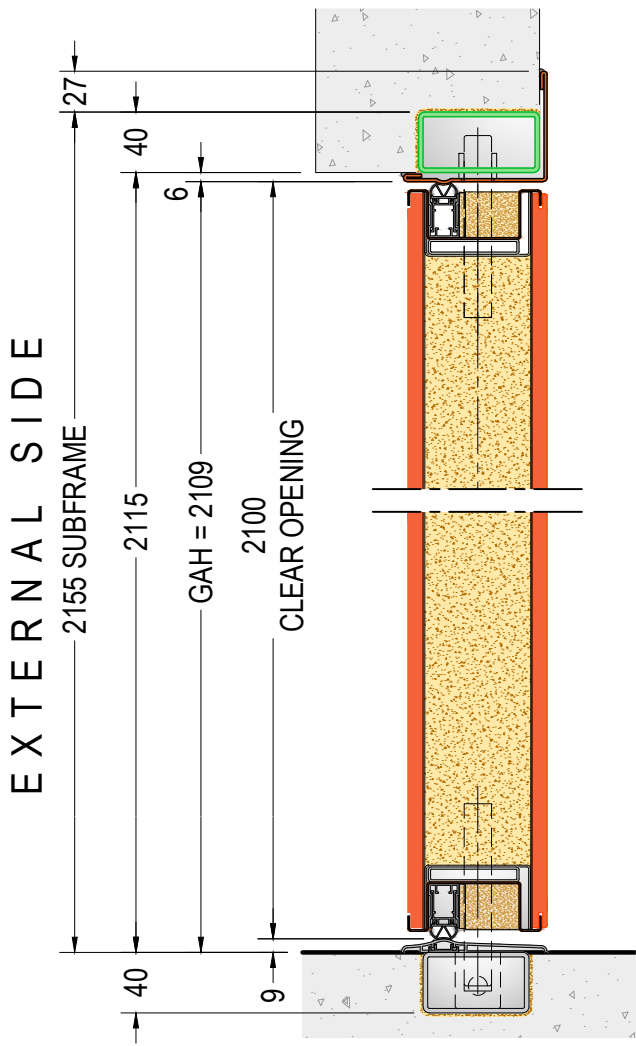

DOOR VERTICAL SECTION
MODELS "F-G-H"
 ref. DOOR H=2100
 GLAZED AREA HEIGHT GAH=2109

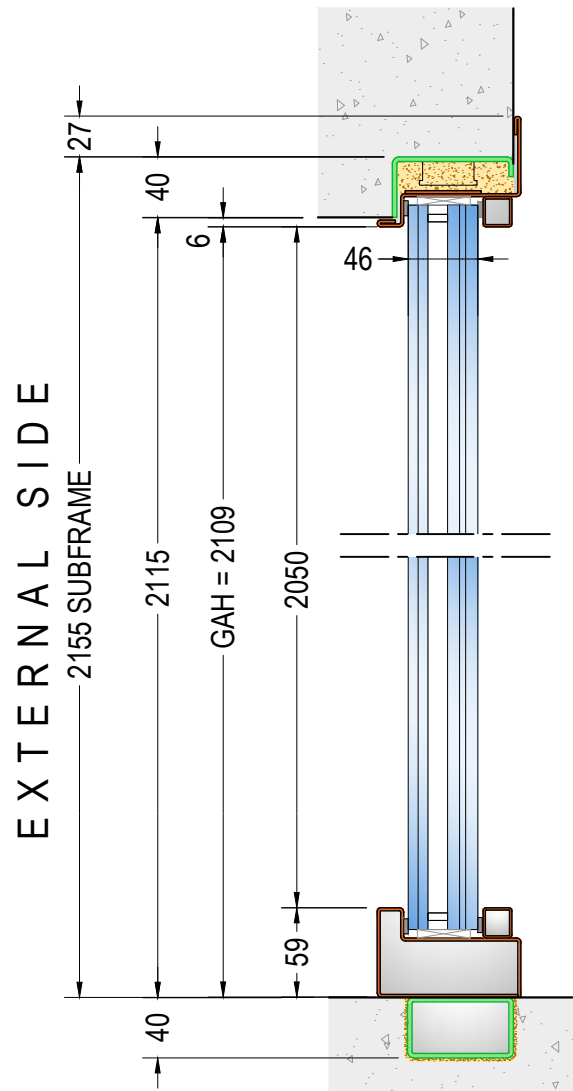

SIDE WINDOW VERTICAL SECTION
MODELS "F-G-H"
 ref. DOOR H=2100
 GLAZED AREA HEIGHT GAH=2109

GLAZED AREA:
 MAXIMUM OVERALL DIMENSIONS
 (GAWxGAH / GAHxGAW)
 2900x3700 (CDE) 3700x2700 (FGH)

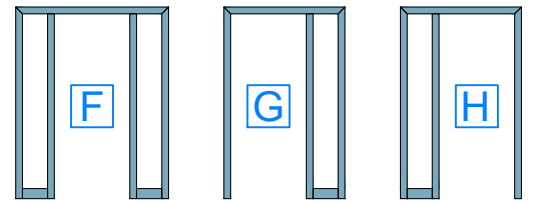

external side view



SUBFRAME AND FRAME FOR DI.BIG PIVOT SECURITY DOOR 27.4 WITH SIDE AND TOP WINDOWS

VERTICAL SECTIONS - scale 1:2

v1.7

DI.BI. PORTE BLINDATE Srl - Fano (PU) ITALY - www.dibigroup.com

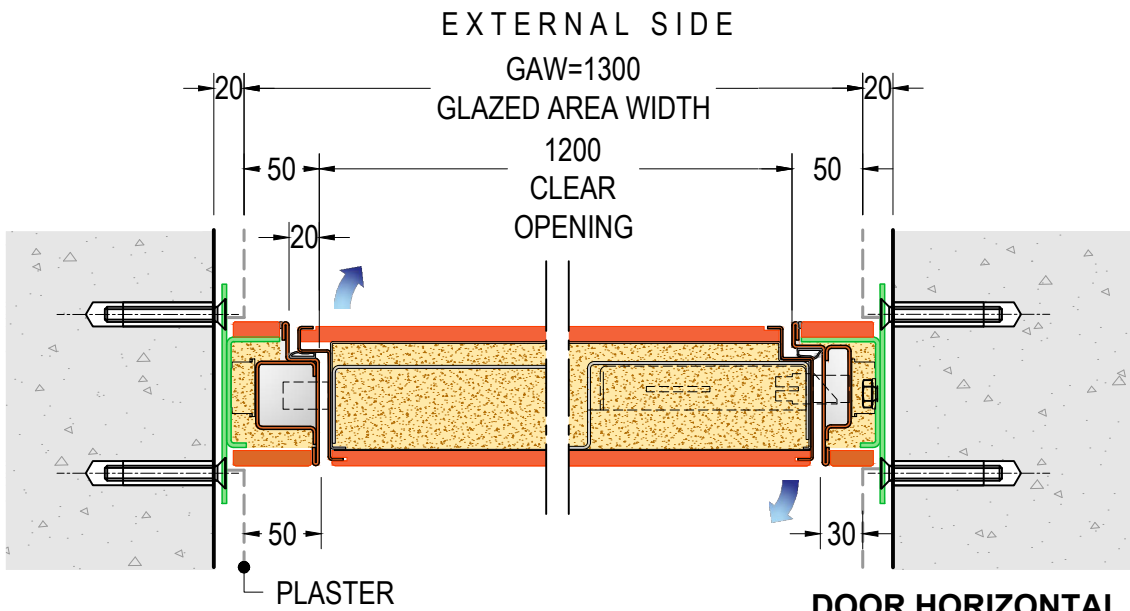

**DOOR HORIZONTAL SECTION
MODEL "B"**

ref. DOOR W=1200 - GLAZED AREA WIDTH GAW=1300

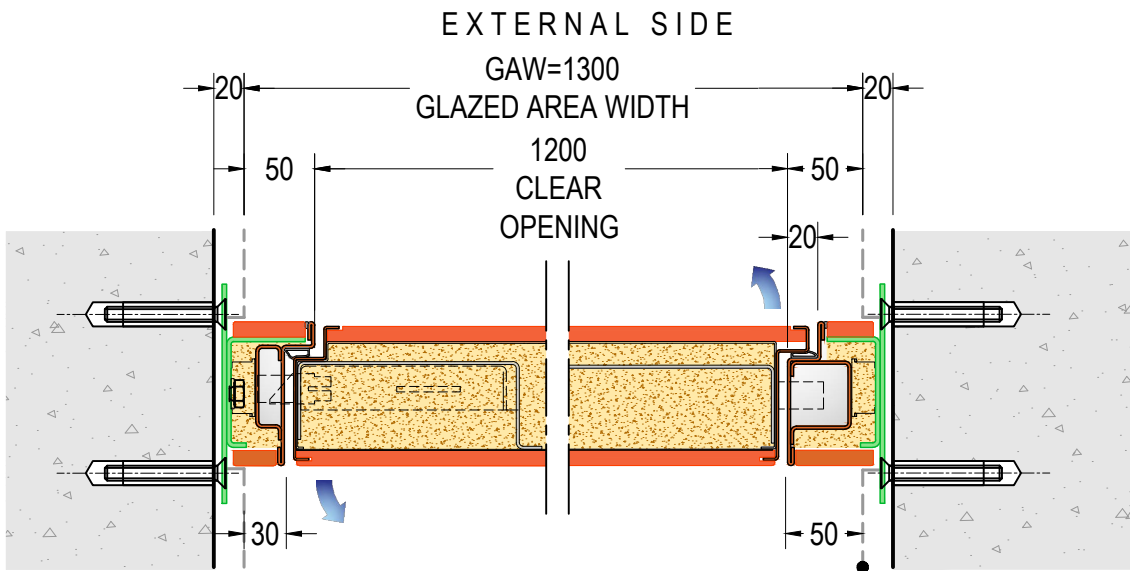

**DOOR HORIZONTAL SECTION
MODEL "B"**

ref. DOOR W=1200 - GLAZED AREA WIDTH GAW=1300



external side view



**SUBFRAME AND FRAME FOR DI.BIG PIVOT SECURITY DOOR 28.1
WITH BLIND SIDE AND TOP WINDOWS**

HORIZONTAL SECTIONS - scale 1:5

v1.9

DI.BI. PORTE BLINDATE Srl - Fano (PU) ITALY - www.dibigroup.com

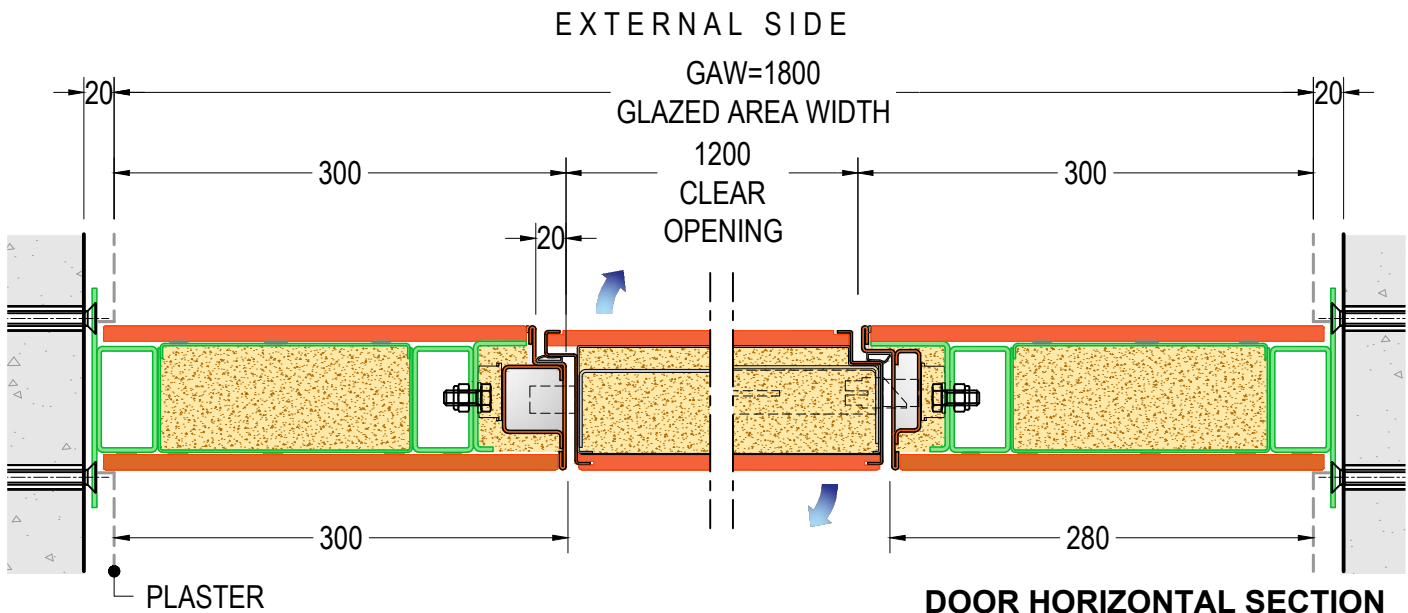

ref. DOOR W=1200 - BLIND SIDE WINDOW 300
GLAZED AREA WIDTH GAW=1800

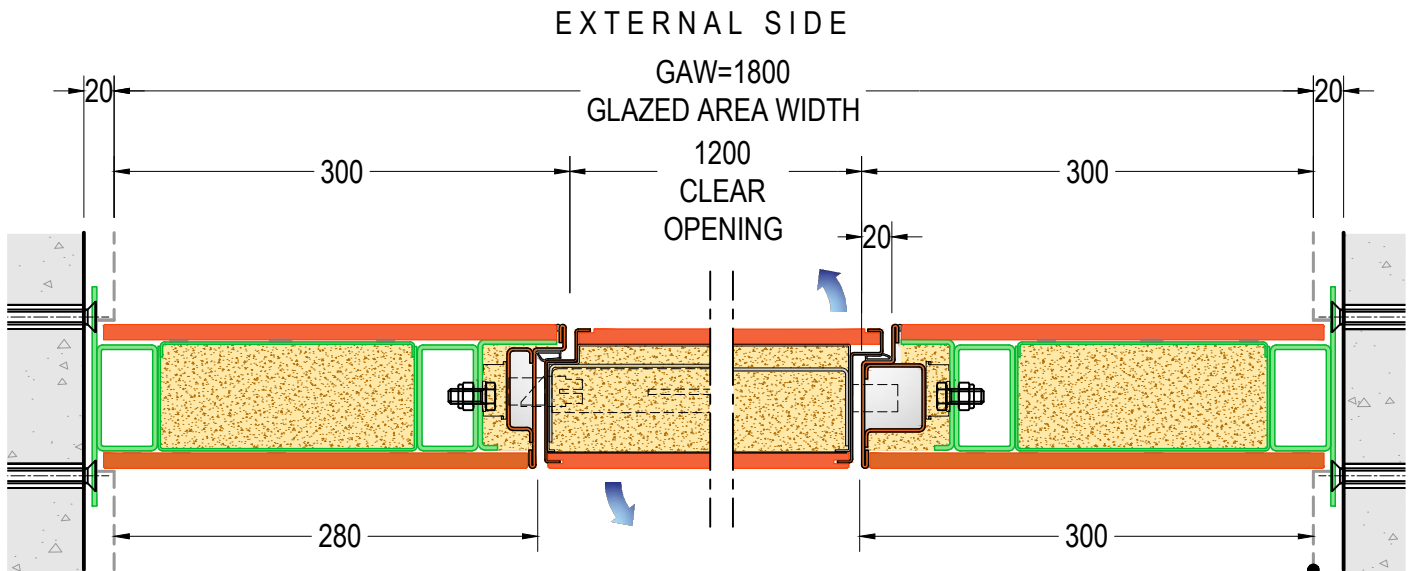

**DOOR HORIZONTAL SECTION
MODELS "E-F"**

ref. DOOR W=1200 - BLIND SIDE WINDOW 300
GLAZED AREA WIDTH GAW=1800

GLAZED AREA:
MAXIMUM OVERALL DIMENSIONS
(GAWxGAH / GAHxGAW)
2900x3700 (CDE) 3700x2700 (FGH)

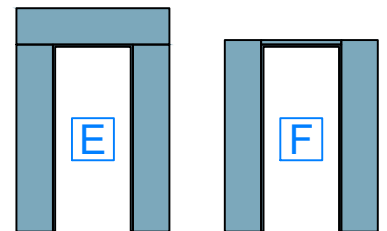

external side view



**SUBFRAME AND FRAME FOR DI.BIG PIVOT SECURITY DOOR 28.2
WITH BLIND SIDE AND TOP WINDOWS**

HORIZONTAL SECTIONS - scale 1:5

v1.9

DI.BI. PORTE BLINDATE Srl - Fano (PU) ITALY - www.dibigroup.com

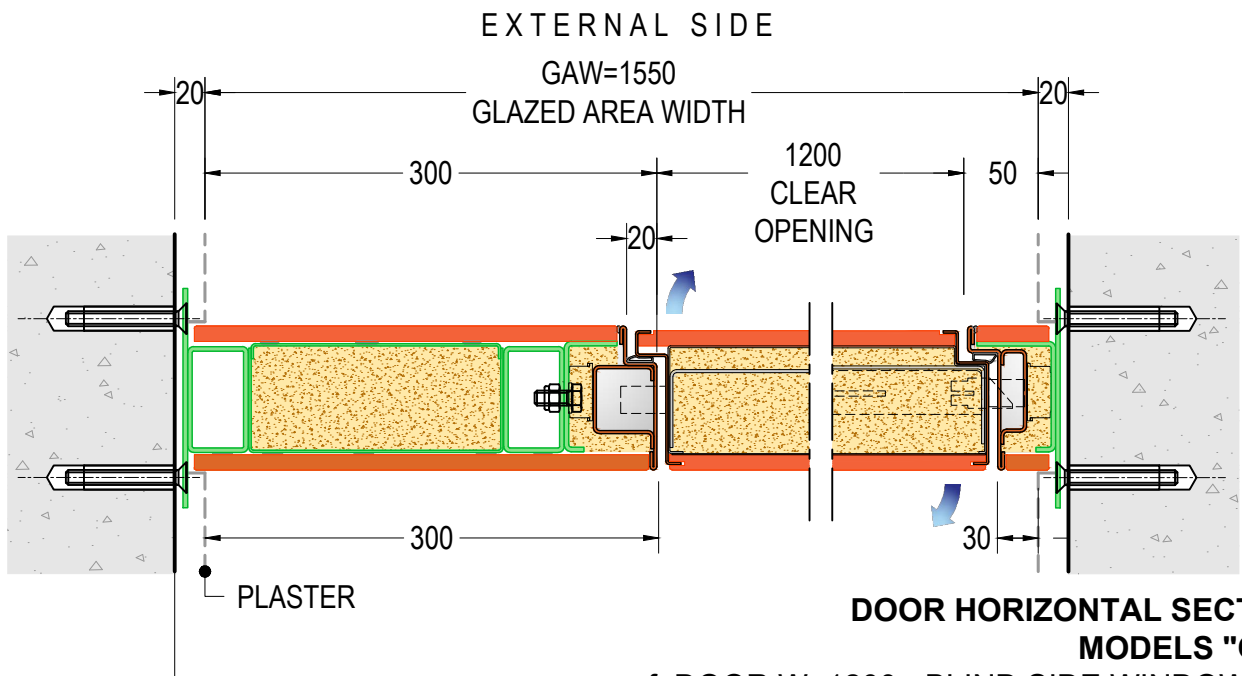

**DOOR HORIZONTAL SECTION
MODELS "C-G"**

ref. DOOR W=1200 - BLIND SIDE WINDOW 300
GLAZED AREA WIDTH GAW=1550

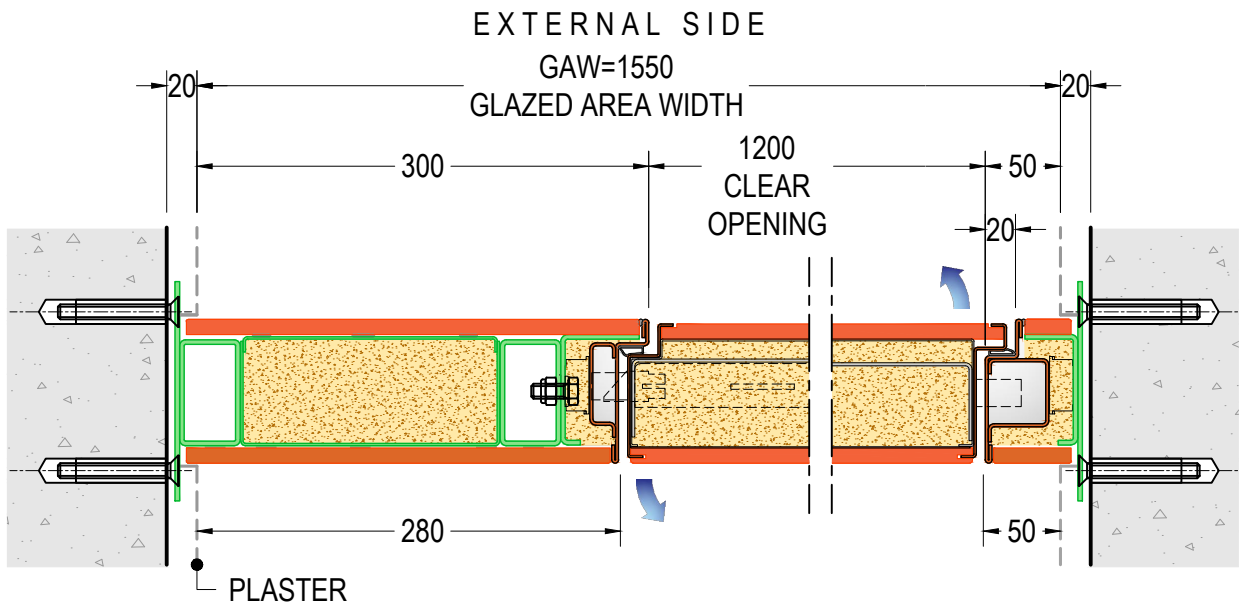

**DOOR HORIZONTAL SECTION
MODELS "D-H"**

ref. DOOR W=900 - BLIND SIDE WINDOW 300
GLAZED AREA WIDTH GAW=1550

RH PUSH DOOR

GLAZED AREA:
MAXIMUM OVERALL DIMENSIONS
(GAWxGAH / GAHxGAW)
2900x3700 (CDE) 3700x2700 (FGH)

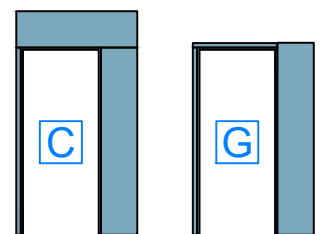

external side view



**SUBFRAME AND FRAME FOR DI.BIG PIVOT SECURITY DOOR 28.3
WITH BLIND SIDE AND TOP WINDOWS**

HORIZONTAL SECTIONS - scale 1:5

v2.0

DI.BI. PORTE BLINDATE Srl - Fano (PU) ITALY - www.dibigroup.com

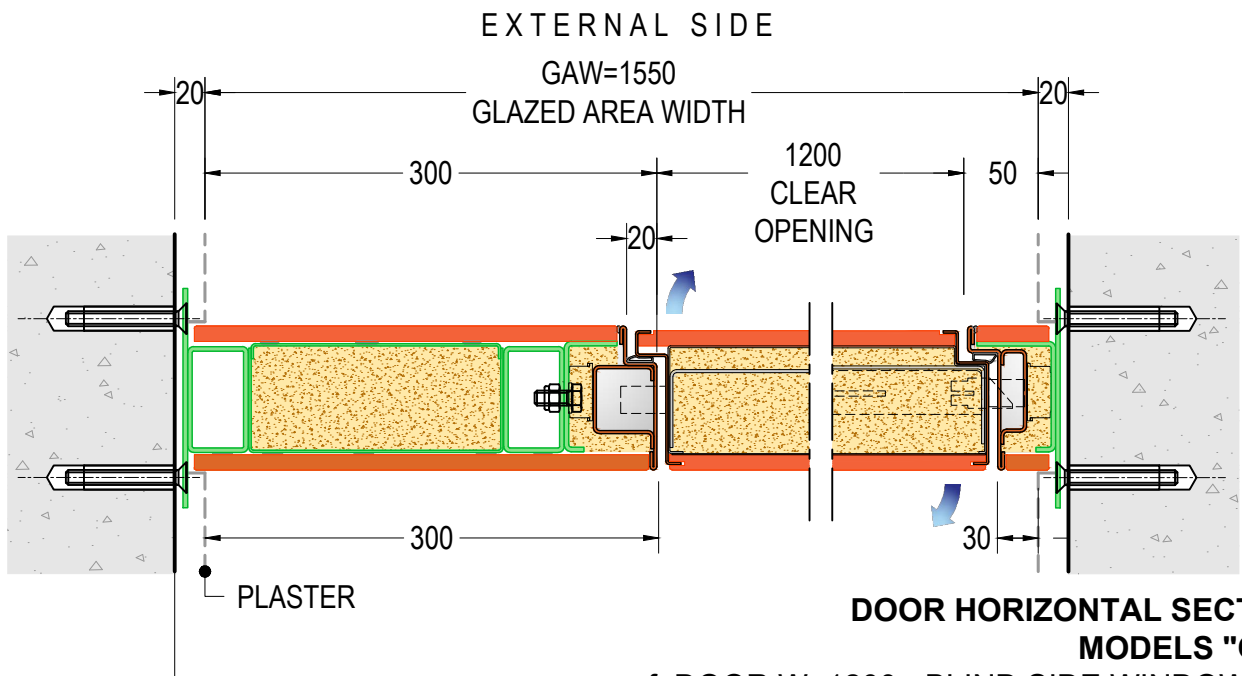

**DOOR HORIZONTAL SECTION
MODELS "C-G"**

ref. DOOR W=1200 - BLIND SIDE WINDOW 300
GLAZED AREA WIDTH GAW=1550

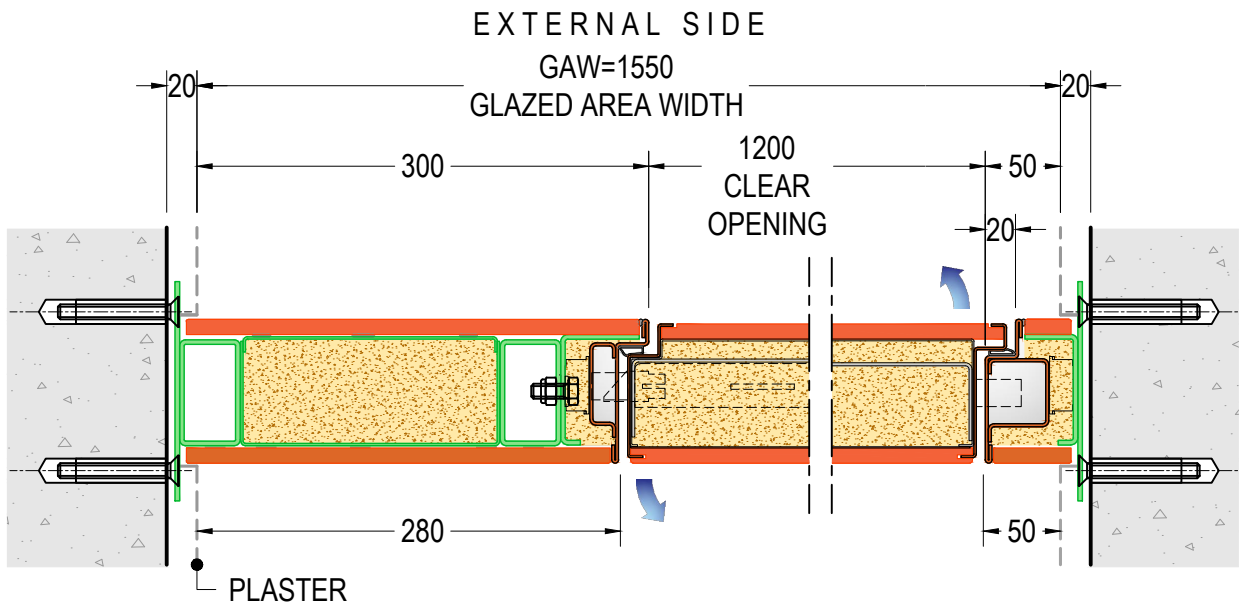

**DOOR HORIZONTAL SECTION
MODELS "D-H"**

ref. DOOR W=900 - BLIND SIDE WINDOW 300
GLAZED AREA WIDTH GAW=1550

RH PUSH DOOR

GLAZED AREA:
MAXIMUM OVERALL DIMENSIONS
(GAWxGAH / GAHxGAW)
2900x3700 (CDE) 3700x2700 (FGH)

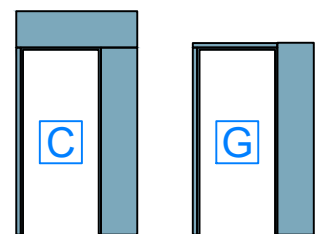

external side view



**SUBFRAME AND FRAME FOR DI.BIG PIVOT SECURITY DOOR 28.3
WITH BLIND SIDE AND TOP WINDOWS**

HORIZONTAL SECTIONS - scale 1:5

v2.0

DI.BI. PORTE BLINDATE Srl - Fano (PU) ITALY - www.dibigroup.com

EXTERNAL SIDE

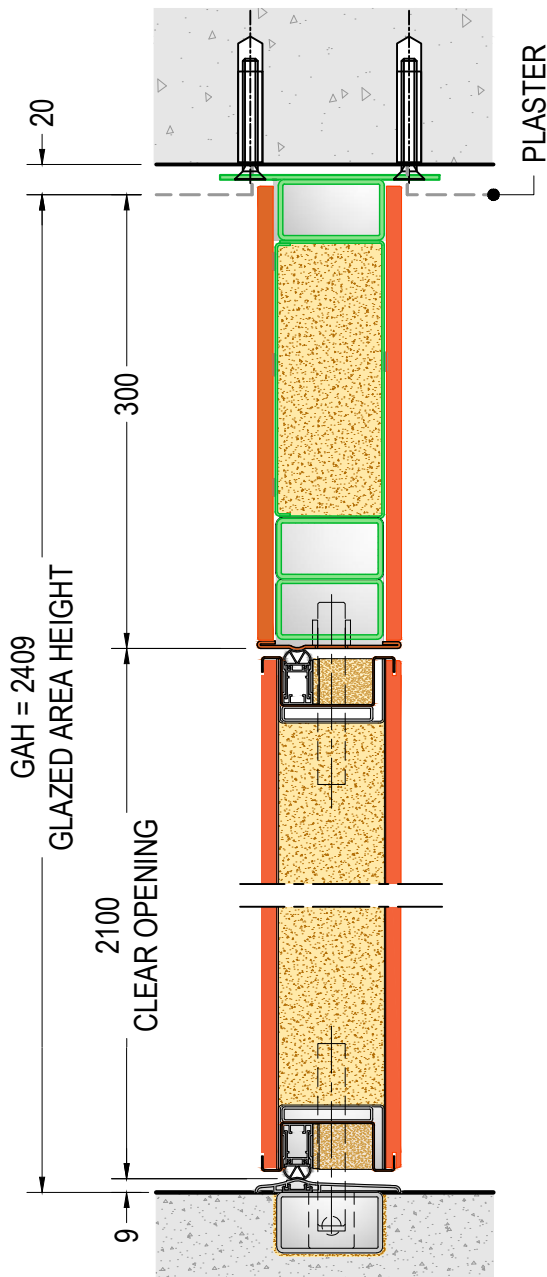

DOOR VERTICAL SECTION
MODELS "B-C-D-E"
 ref. DOOR H=2100
 BLIND TOP WINDOW 300
 GLAZED AREA HEIGHT GAH=2409

EXTERNAL SIDE

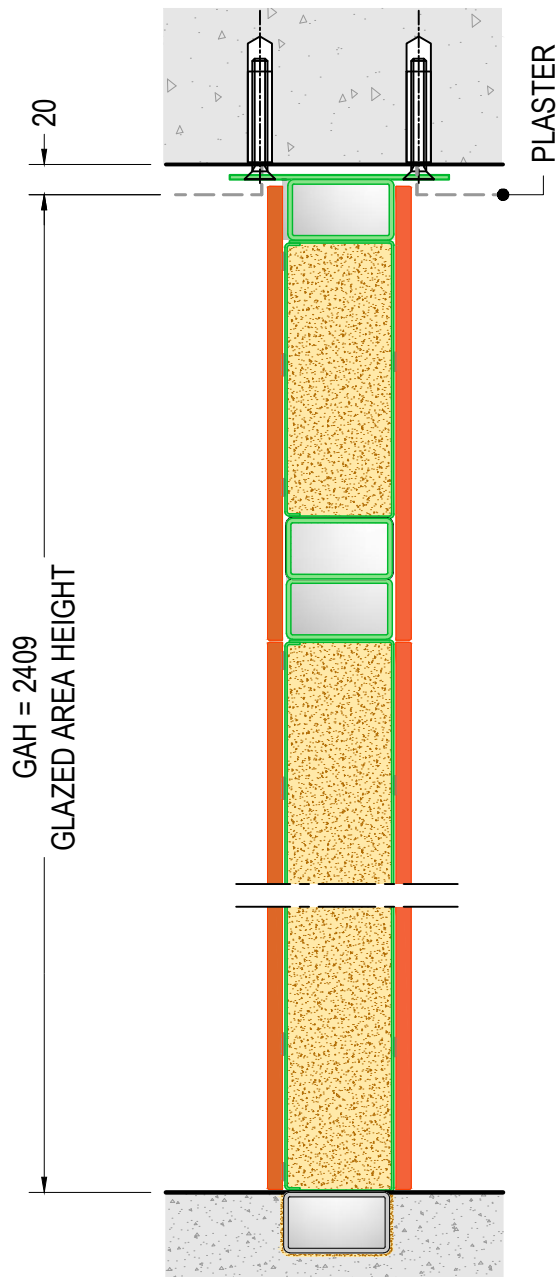

SIDE WINDOW VERTICAL SECTION
MODELS "C-D-E"
 ref. DOOR H=2100
 BLIND TOP WINDOW 300
 GLAZED AREA HEIGHT GAH=2409

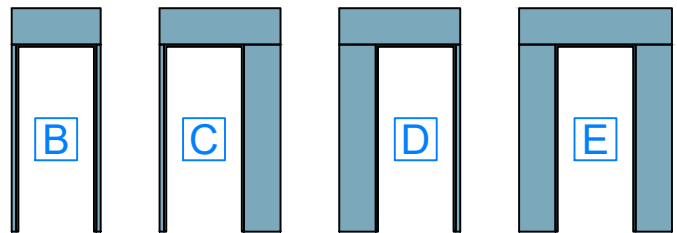

external side view



SUBFRAME AND FRAME FOR DI.BIG PIVOT SECURITY DOOR 28.5
WITH BLIND SIDE AND TOP WINDOWS

VERTICAL SECTIONS - scale 1:2

v1.7

DI.BI. PORTE BLINDATE Srl - Fano (PU) ITALY - www.dibigroup.com

EXTERNAL SIDE

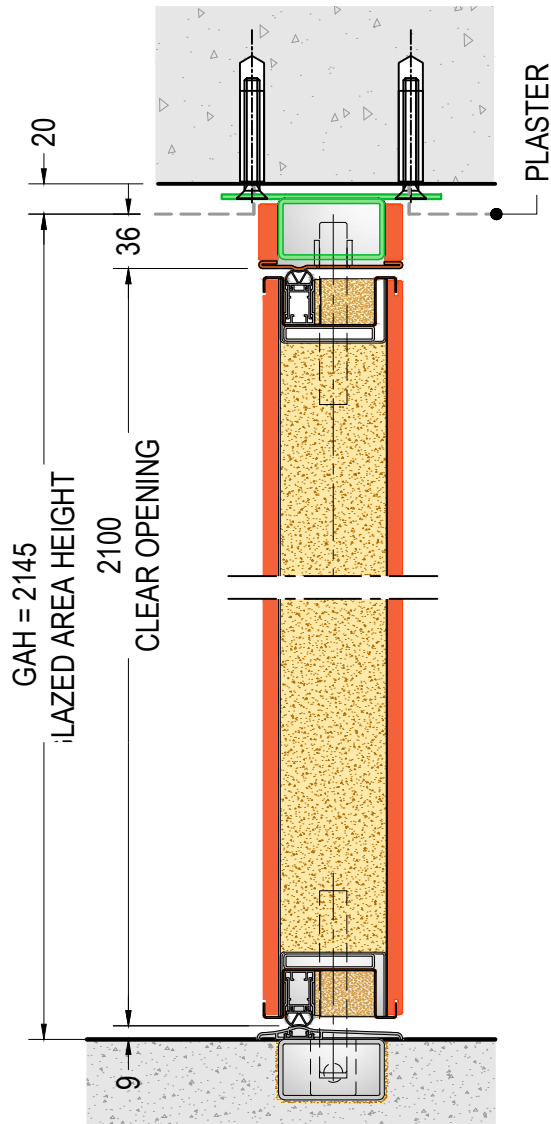

**DOOR VERTICAL SECTION
MODELS "F-G-H"**
ref. DOOR H=2100
GLAZED AREA HEIGHT GAH=2145

EXTERNAL SIDE

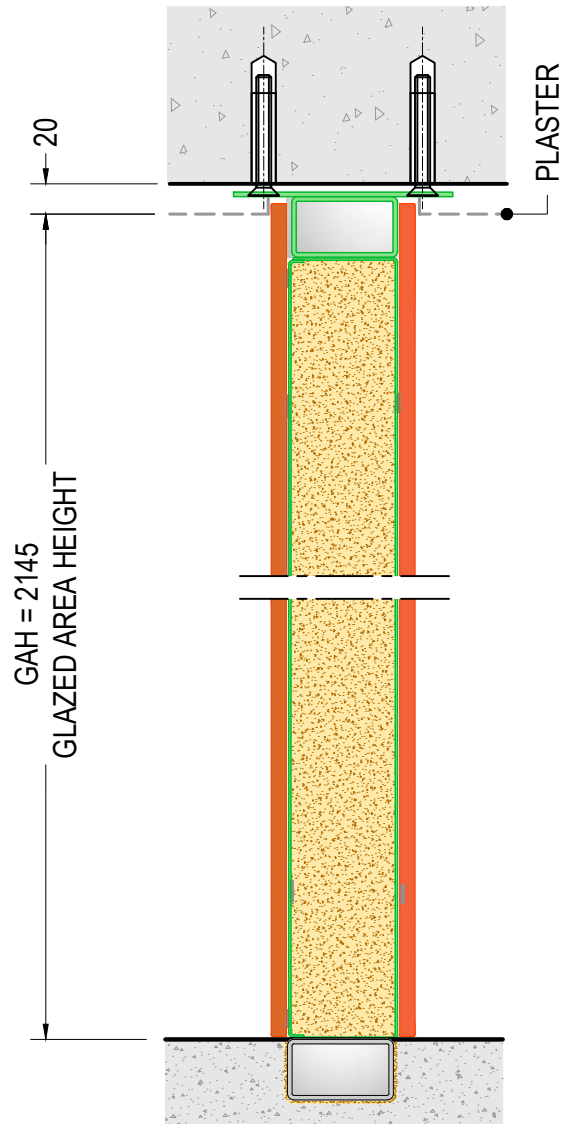

**SIDE WINDOW VERTICAL SECTION
MODELS "F-G-H"**
ref. DOOR H=2100
GLAZED AREA HEIGHT GAH=2145

GLAZED AREA:
MAXIMUM OVERALL DIMENSIONS
(GAWxGAH / GAHxGAW)
2900x3700 (CDE) 3700x2700 (FGH)

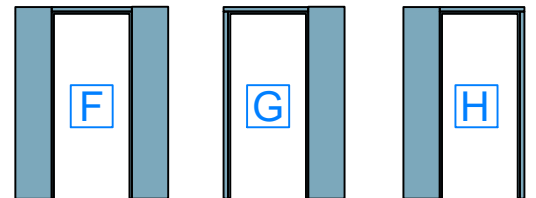

external side view



**SUBFRAME AND FRAME FOR DI.BIG PIVOT SECURITY DOOR 28.6
WITH BLIND SIDE AND TOP WINDOWS**

VERTICAL SECTIONS

v1.7

scale 1:2

DI.BIG PIVOT BLINDATE Srl - Fano (PU) ITALY - www.dibigroup.com

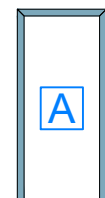
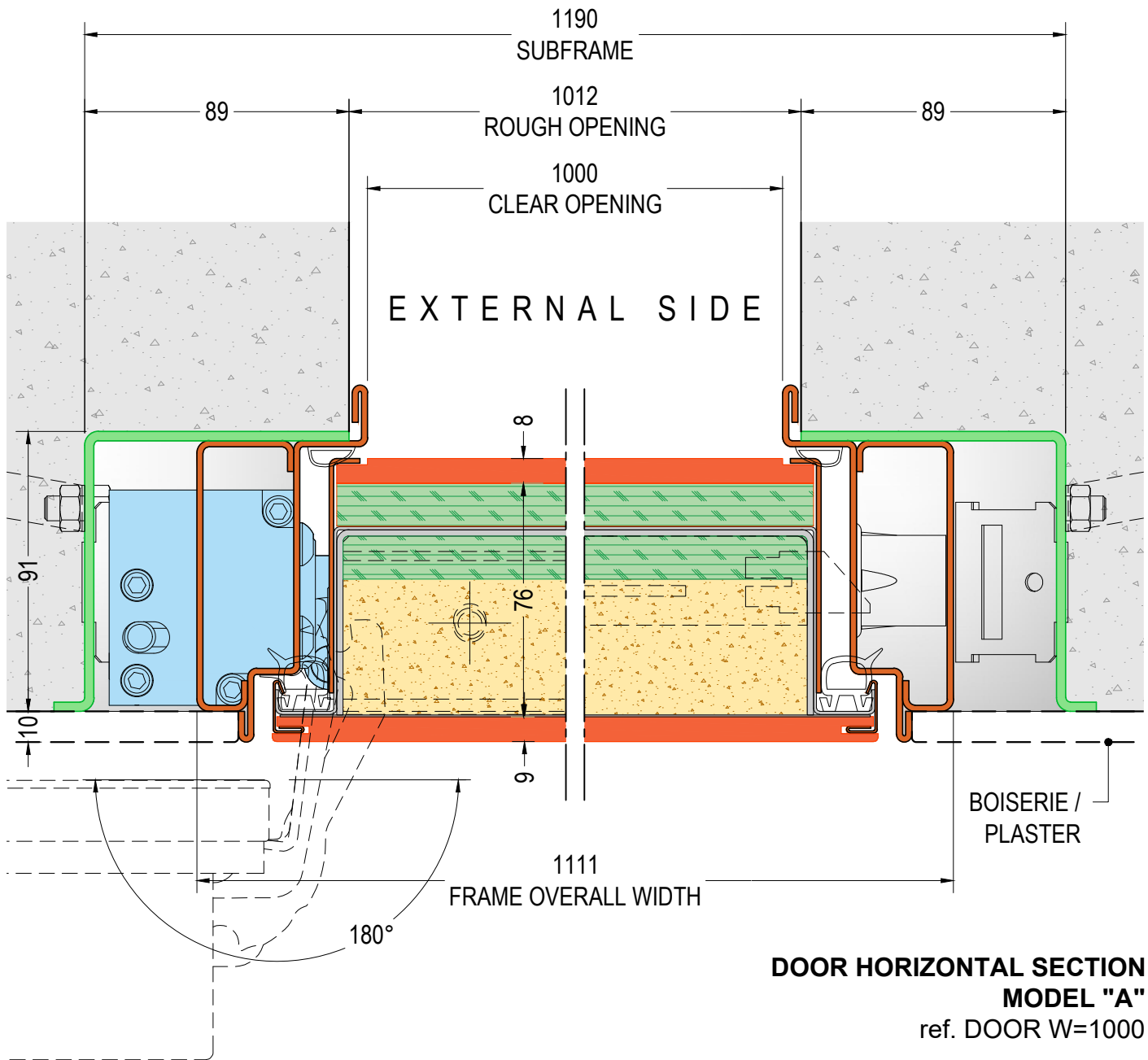

external side view



**SUBFRAME AND FRAME FOR RASOMURO SECURITY DOOR 29.1
WITH INTERIOR WALL FINISH – Sol. 25**

HORIZONTAL SECTION - scale 1:2

v 1.1

DI.BI. PORTE BLINDATE Srl - Fano (PU) ITALY - www.dibigroup.com

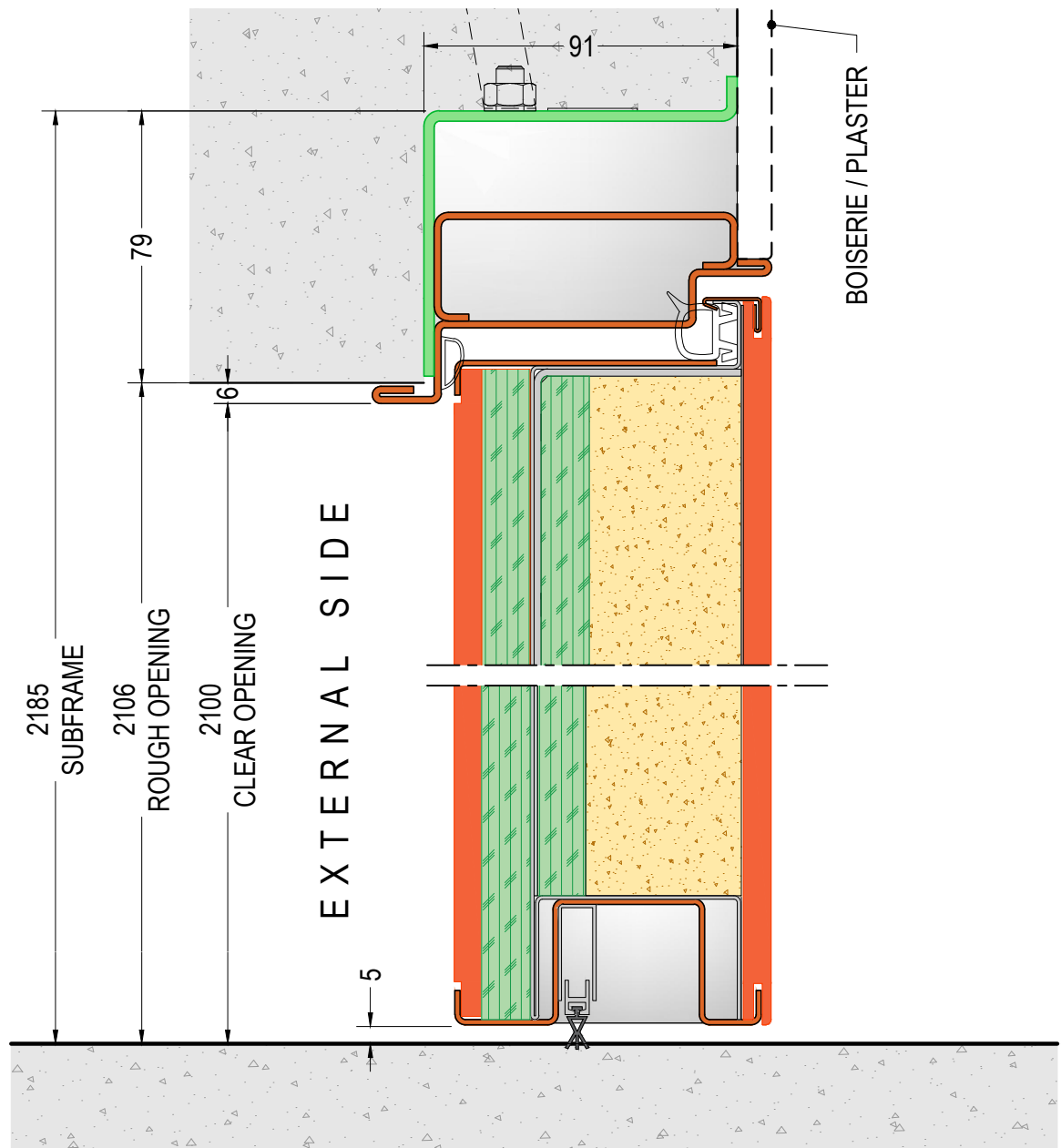

**DOOR VERTICAL SECTION - WEATHERSTRIP BAR
MODEL "A"**
ref. DOOR H=2100

DOOR DIMENSIONS:
W=min.800 - max.1200
H=min.2000 - max.2400

**OPTIONAL
WATERTIGHT
THRESHOLD**
H THRESHOLD=20
ref. DOOR H=2100
H SUBFRAME=2205
H ROUGH OPENING =2126

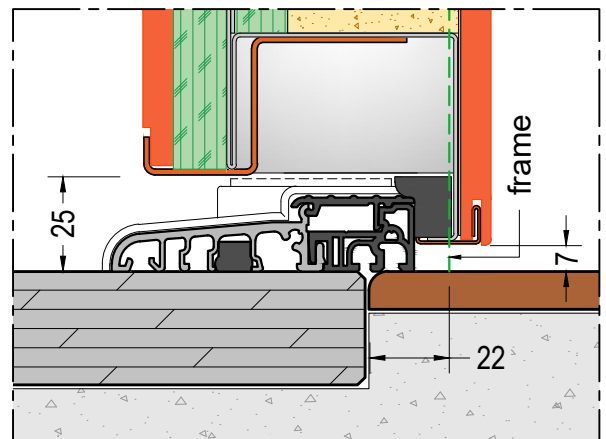

**SUBFRAME AND FRAME FOR RASOMURO SECURITY DOOR 29.2
WITH INTERIOR WALL FINISH – Sol. 25**

VERTICAL SECTION - scale 1:2

v 1.1

DI.BI. PORTE BLINDATE Srl - Fano (PU) ITALY - www.dibigroup.com



NOTES

DI.BI. PORTE BLINDATE Srl - Fano (PU) ITALY - www.dibigroup.com



DI.BI. PORTE BLINDATE Srl - Fano (PU) ITALY - www.dibigroup.com