

EUROVENT

C L A S S I C

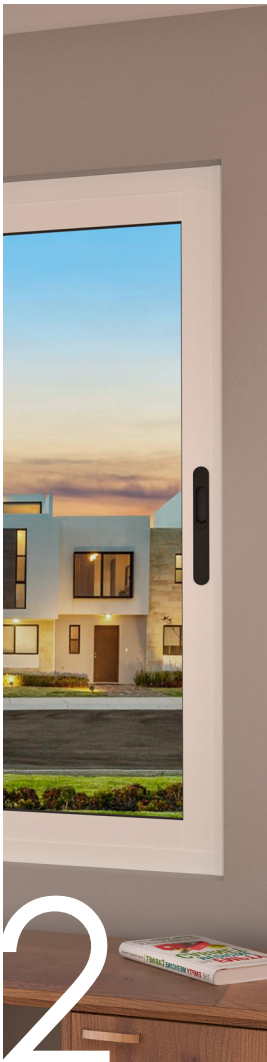

 CUPRUM

SOLUCIONES
ARQUITECTÓNICAS

EUROVENT[□]



Eurovent Classic, es una de las líneas de perfiles de **Cuprum**, en ella podrá encontrar todas las soluciones para su cancelaría de aluminio, desde un simple Fijo hasta un Muro Cortina.

La línea Eurovent destaca por su alto desempeño, elegancia, funcionalidad y hermeticidad, brindando al usuario el confort necesario en lugares cálidos, fríos o ruidosos, esto se logra a través de su diseño innovador y superior, uso de vidrio doble y herrajes versátiles de alto desempeño.



EUROVENT[®]
CUPRUM

C L A S S I C

Fijos

Fijo Serie 35	06
Fijo Serie 50	15
Fijo Serie 60	26
Fijo Serie 70	37
Fijo Serie 140	49

Corredizas

Ventana corrediza S50	64
Ventana corrediza S60	88
Ventana y puerta corrediza S70	121

Cortinas

Cortina Anticiclónica HV	166
--------------------------	-----

Ventanas Batientes

 Ventana Batiente y Proyección Serie 35 "Americana"	183
--	-----

Puertas

Puerta Comercial Serie 50	204
Puerta Residencial Serie 50	223

Muro Cortina

Muro Cortina Serie MC-500	240
---------------------------	-----

Índice general de herrajes	249
Índice general por claves	254

EUROVENT[®]
CUPRUM

EUROVENT

C L A S S I C



FIJO SERIE 35
FIJO SERIE 50
FIJO SERIE 60
FIJO SERIE 70
FIJO SERIE 140

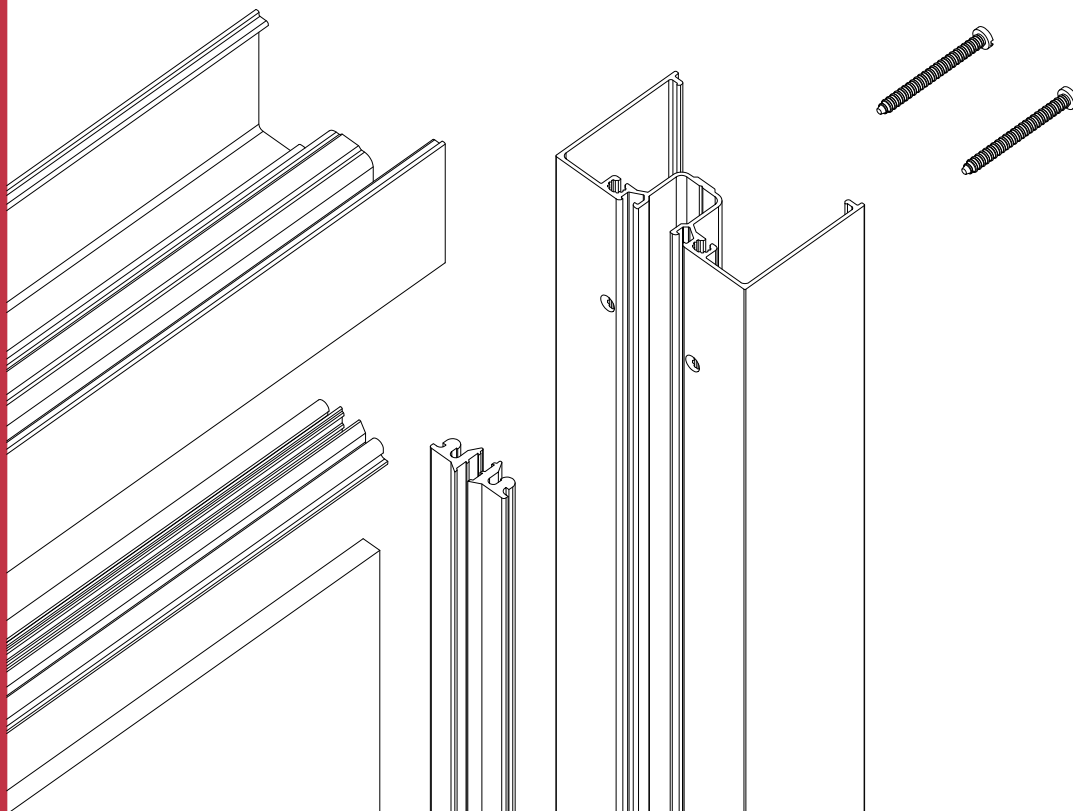

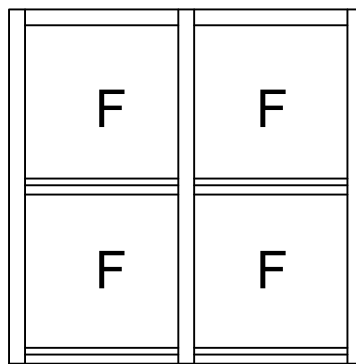
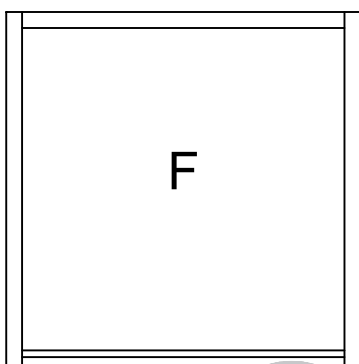

EUROVENT

C L A S S I C

CLASSIC
SERIE

S35



FIJO

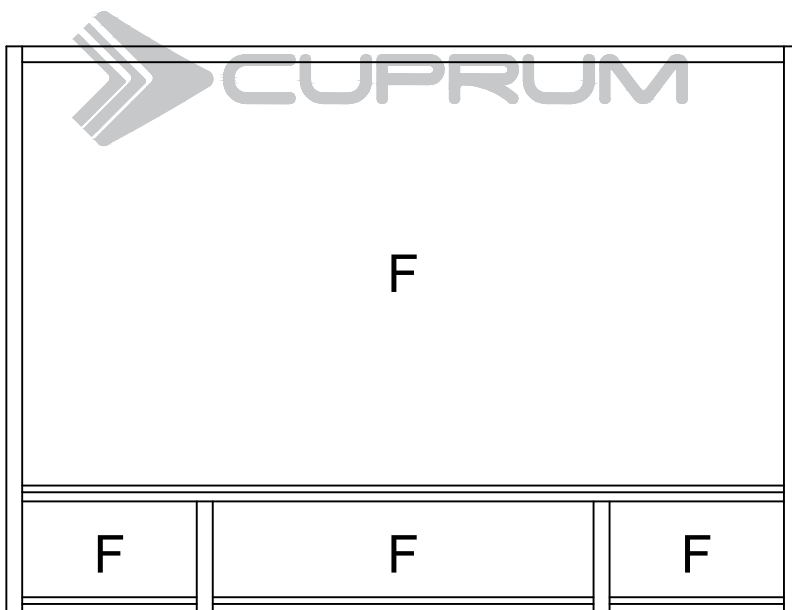

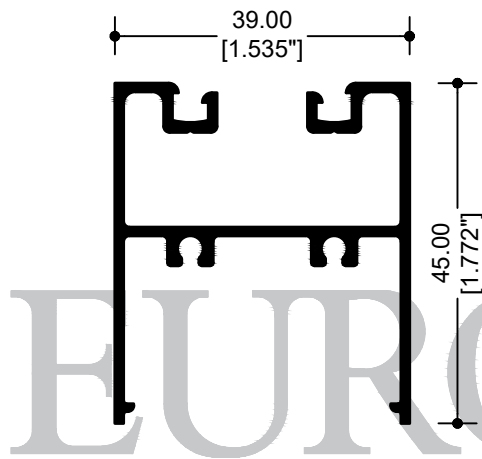

12606
BOLSA

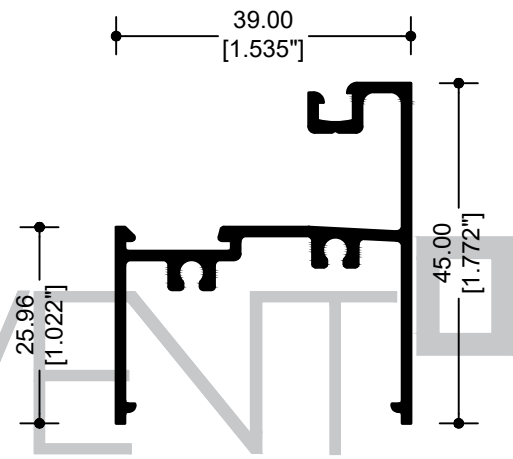

12608
ESCALONADO

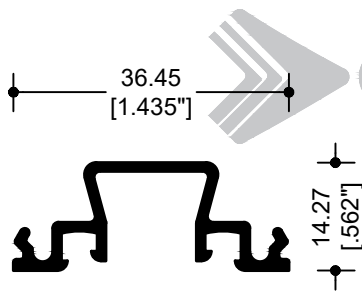

12607
TAPA BOLSA

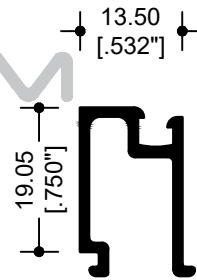

12609
JUNQUILLO

EUROVENT
CLASSIC

FIJO

CLASSIC
SERIE

S35

CUPRUM

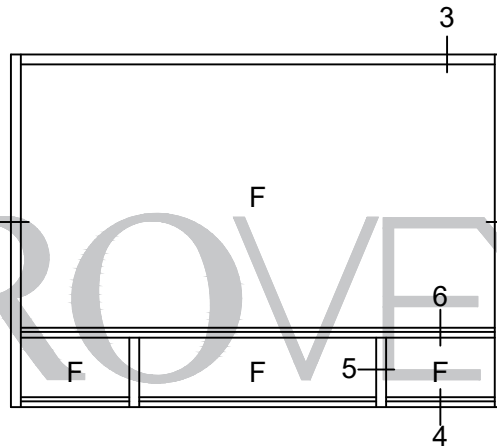
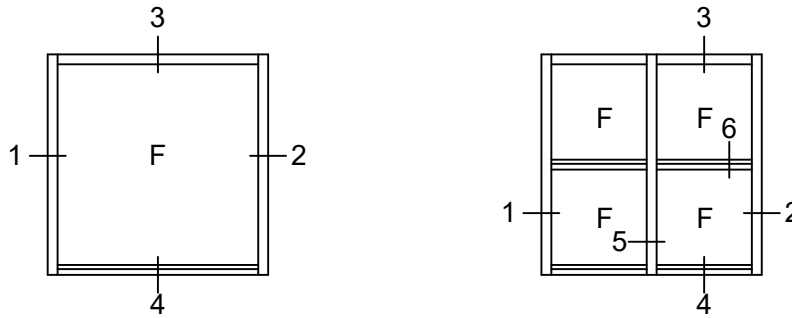

CLASSIC
SERIE

S35



FIJO

EUROVENT[®]
CLASSIC

ELEVACIONES TIPO

SIN ESCALA

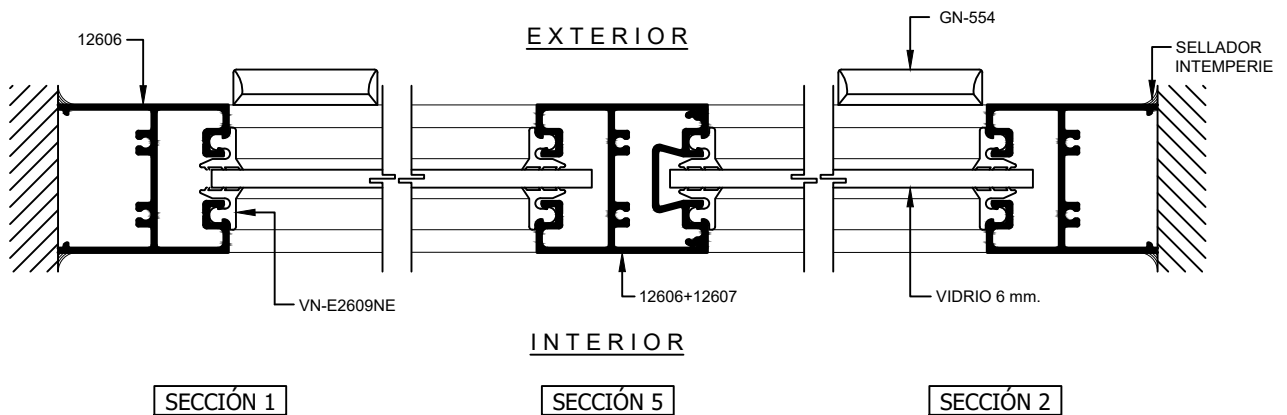

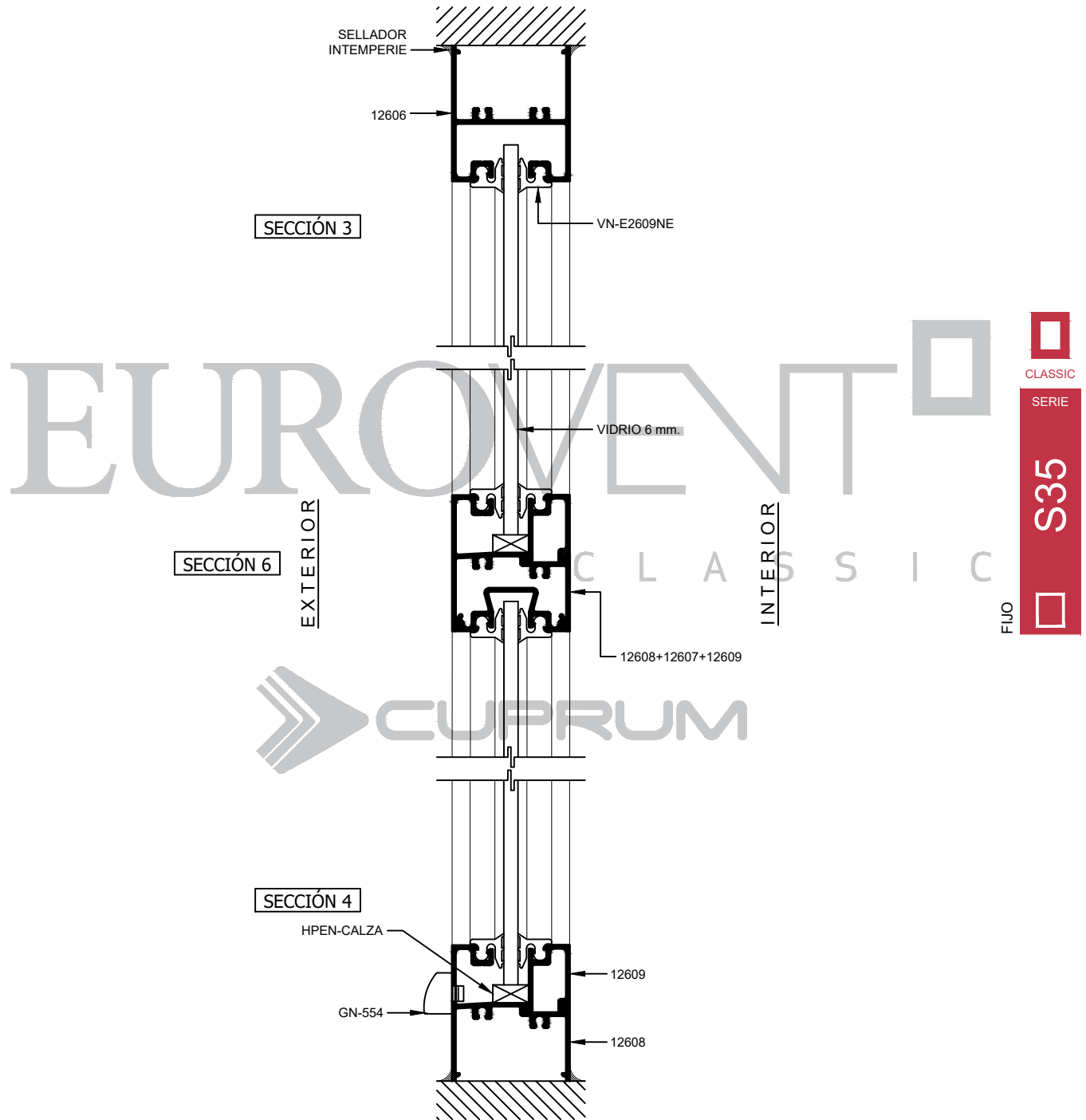

OPERACIÓN MANUAL
DREN PARA DESAGÜE

CLASSIC
SERIE
S35
FIJO

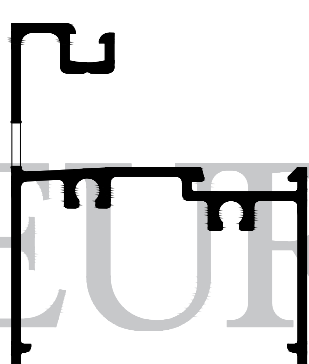

12608
ESCALONADO

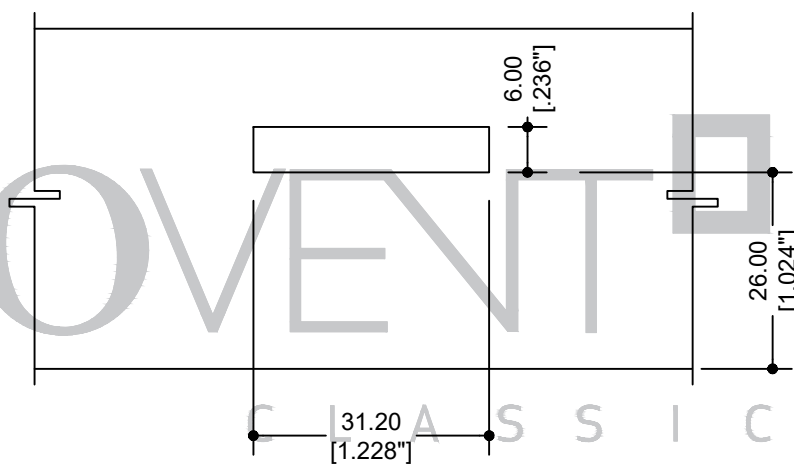

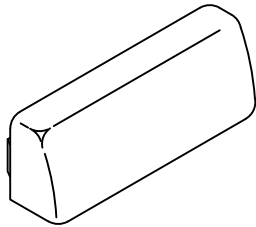

GN-554
TAPA DREN

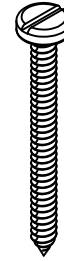

PFNG-0817
PIJA #8x1½"

EUROVENT
CLASSIC



CLASSIC
SERIE

S35



FIJO

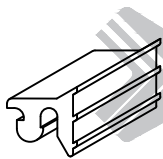

VN-E2609NE
EMPAQUE

CUPRUM

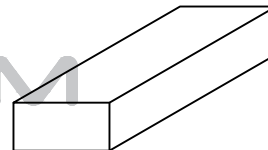

HPEN-CALZA
CALZA DE 1/4" x 3/8" x 4"

CLASSIC
SERIE
S35

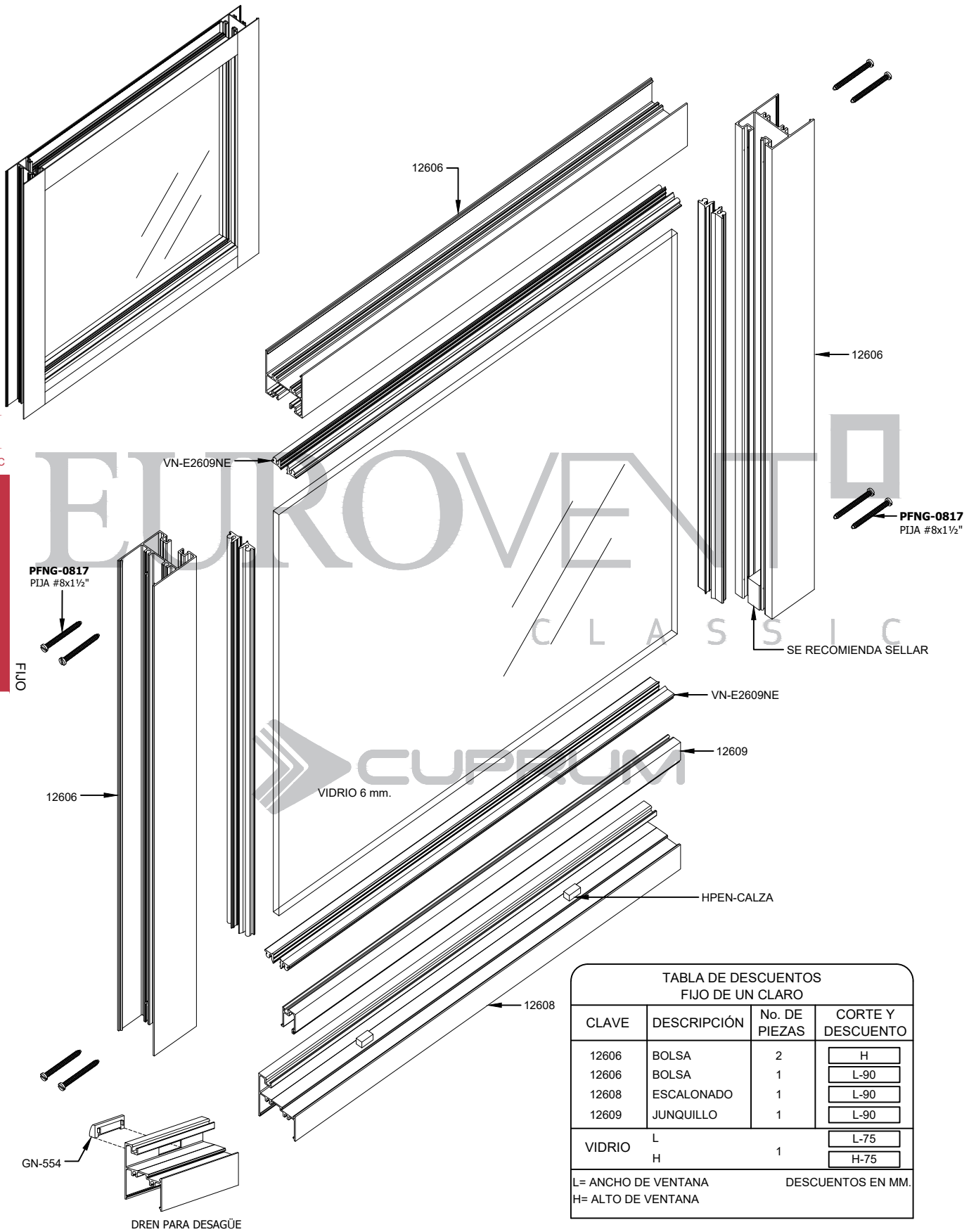

FIJO SERIE 35
A UNA ALTURA DE 15 METROS
DEFLEXIÓN MAX. L/175

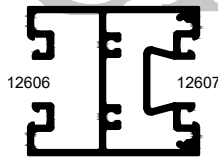
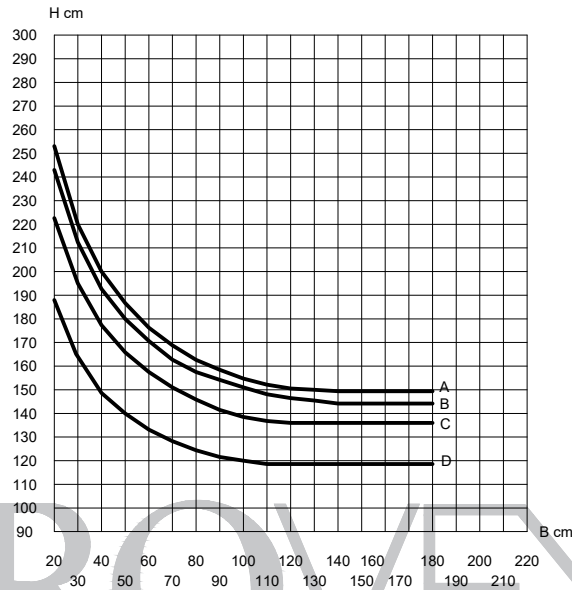

I x-x= 5.29 cm⁴

LOS LÍMITES DE FABRICACIÓN
PARA LOS PERFILES, SERÁN
LOS QUE SE ENCUENTREN DEBAJO
DE LAS CURVAS GRAFICADAS.

ALEACIÓN: 6063
TEMPLE: 5



Curvas	Presión del diseño	Velocidad de viento	Zona
A	45 Kg/m ²	80 Km/h	Centro de grandes ciudades
B	50 Kg/m ²	90 Km/h	Barrios Residenciales
C	65 Kg/m ²	120 Km/h	Campo Abierto
D	145 Kg/m ²	160 Km/h	Zona Costera

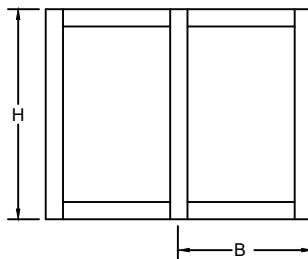

LOS LÍMITES DE UN CANCEL VAN EN FUNCIÓN DE LA
COMBINACIÓN DE RESISTENCIA DEL PERFIL DE ALUMINIO,
EL VIDRIO Y LOS ACCESORIOS QUE LO INTEGRAN.

VERIFICAR QUE LA DEFLEXIÓN DEL PERFIL SEA
COMPATIBLE CON EL VIDRIO UTILIZADO.

PARÁMETROS MÍNIMOS Y MÁXIMOS DE FABRICACIÓN.

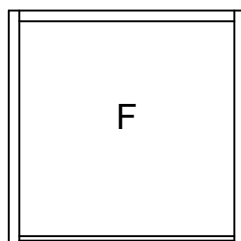

F-35
MÍNIMO 0.30 x 0.30

MÁXIMO 4m² CON VIDRIO RECOCIDO DE 6 mm. SIN INTERMEDIOS,
PARA OTROS ESPESORES VER CON EL FABRICANTE,
CON INTERMEDIOS VER GRÁFICA.

CLASSIC
SERIE

S35



FIJO

ALUMINIO

CLAVE	DESCRIPCIÓN	PIEZAS X ATADO	LARGO STD. MTS.	PERÍMETRO ANOD. CM.	PERÍMETRO PUL. CM.
12606	BOLSA	8	6.10	37.33	10.82
12607	TAPA BOLSA	16	6.10	16.72	1.91
12608	ESCALONADO	8	6.10	30.23	8.61
12609	JUNQUILLO	20	6.10	12.91	2.81



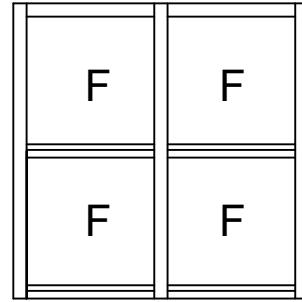
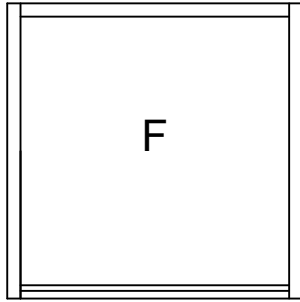

EUROVENT

C L A S S I C



CLASSIC
SERIE

S50

FIJO

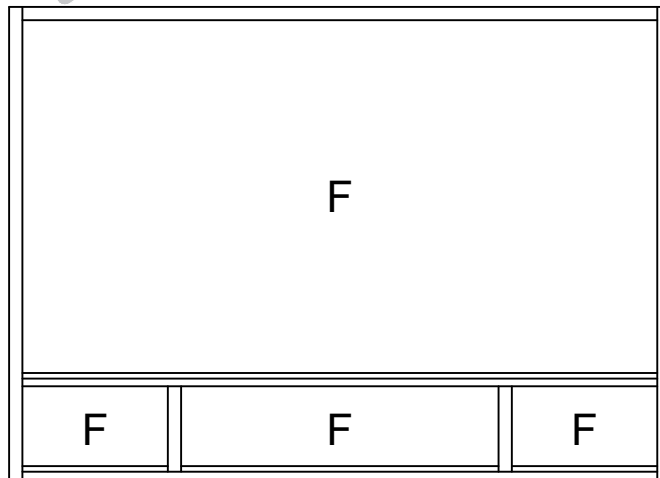

56.54
[2.226"]

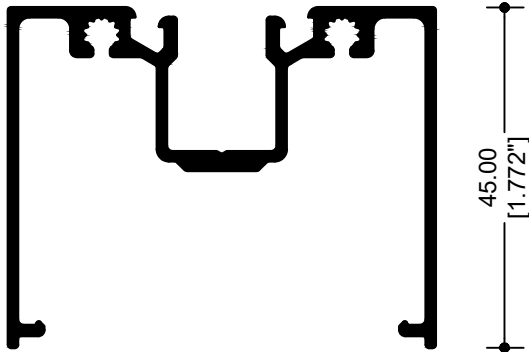

12504
BOLSА

56.54
[2.226"]

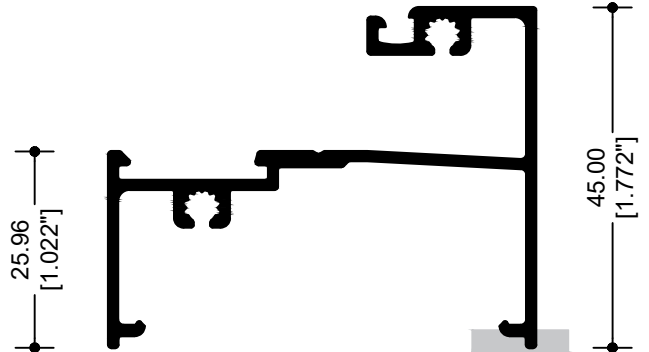

12513
ESCALONADO INTERIOR

25.96
[1.022"]

45.00
[1.772"]

22.28
[.877"]

52.73
[2.076"]

18.92
[.745"]

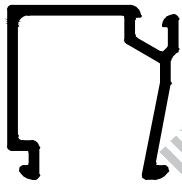

12507
JUNQUILLO

C L A S S I C

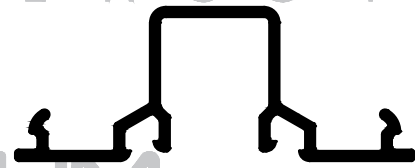

12505
TAPA BOLSА

20.27
[.798"]

56.52
[2.225"]

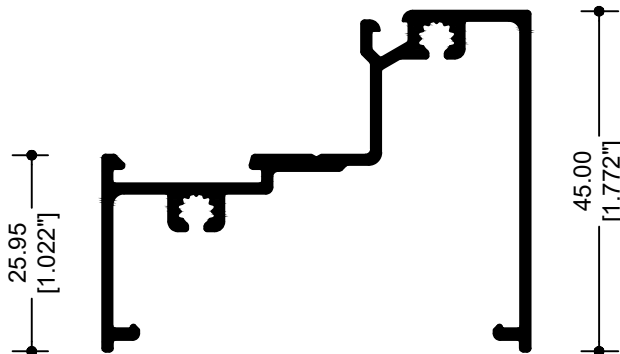

12506
ESCALONADO EXTERIOR

25.95
[1.022"]

45.00
[1.772"]



FIJO

56.54
[2.226"]

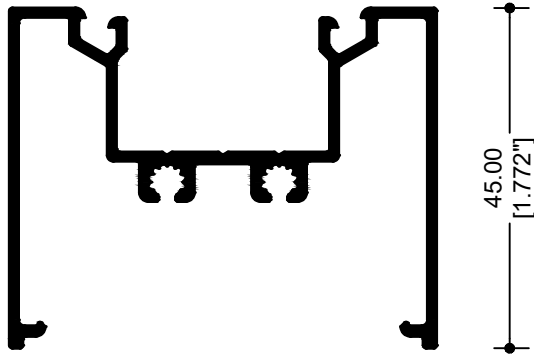

12592
BOLSА

56.54
[2.226"]

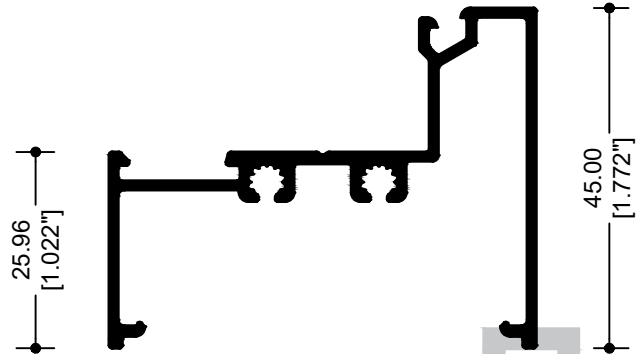

12593
ESCALONADO EXTERIOR

52.73
[2.076"]



12594
TAPA BOLSА

12.70
[.500"]

15.47
[.609"]

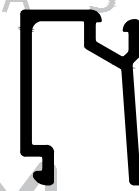

12543
JUNQUILLO

19.05
[.750"]

CLASSIC
SERIE

S50

FIJO

52.73
[2.076"]



12563
TAPA LISA

6.63
[.261"]

59.61
[2.347"]



12581
MOLDURA DE UNIÓN

24.51
[.965"]

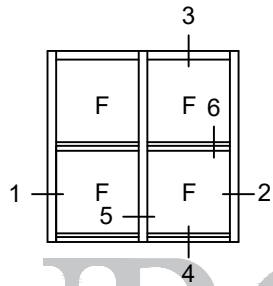
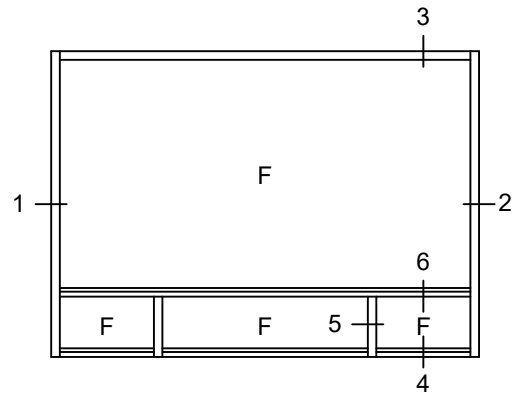
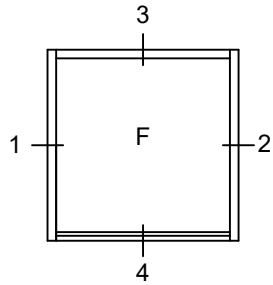

ELEVACIONES TIPO

SIN ESCALA

EUROVENT
CLASSIC

CLASSIC
SERIE

S50

FIJO

C L A S S I C

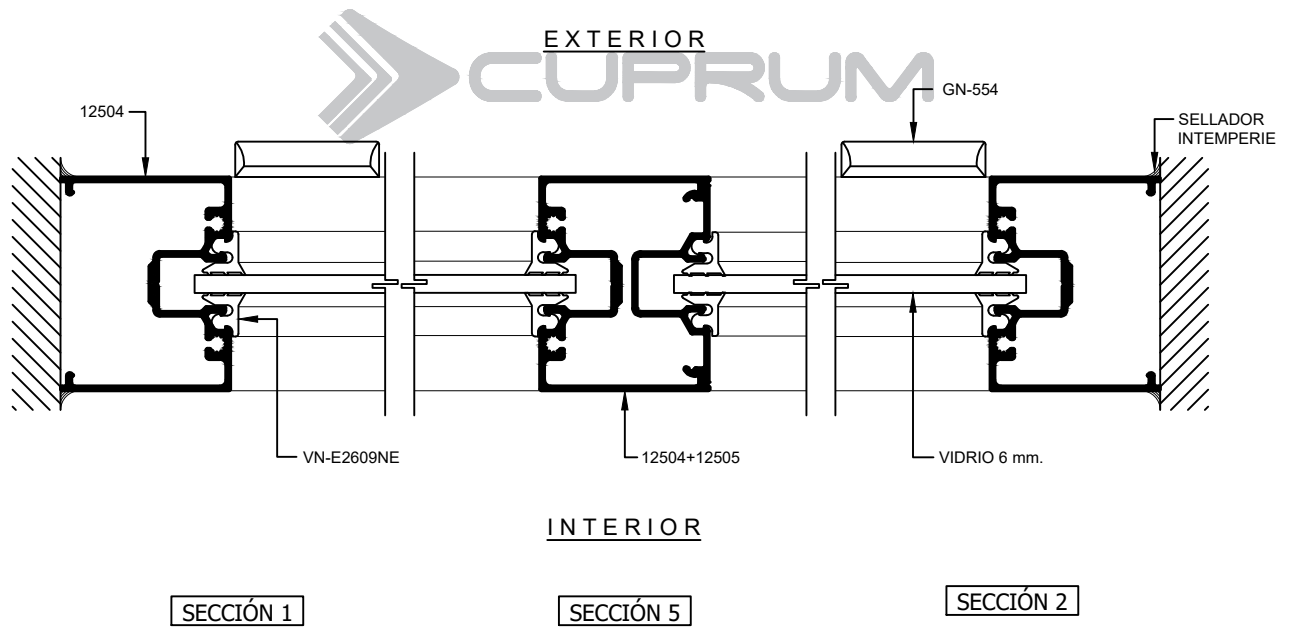

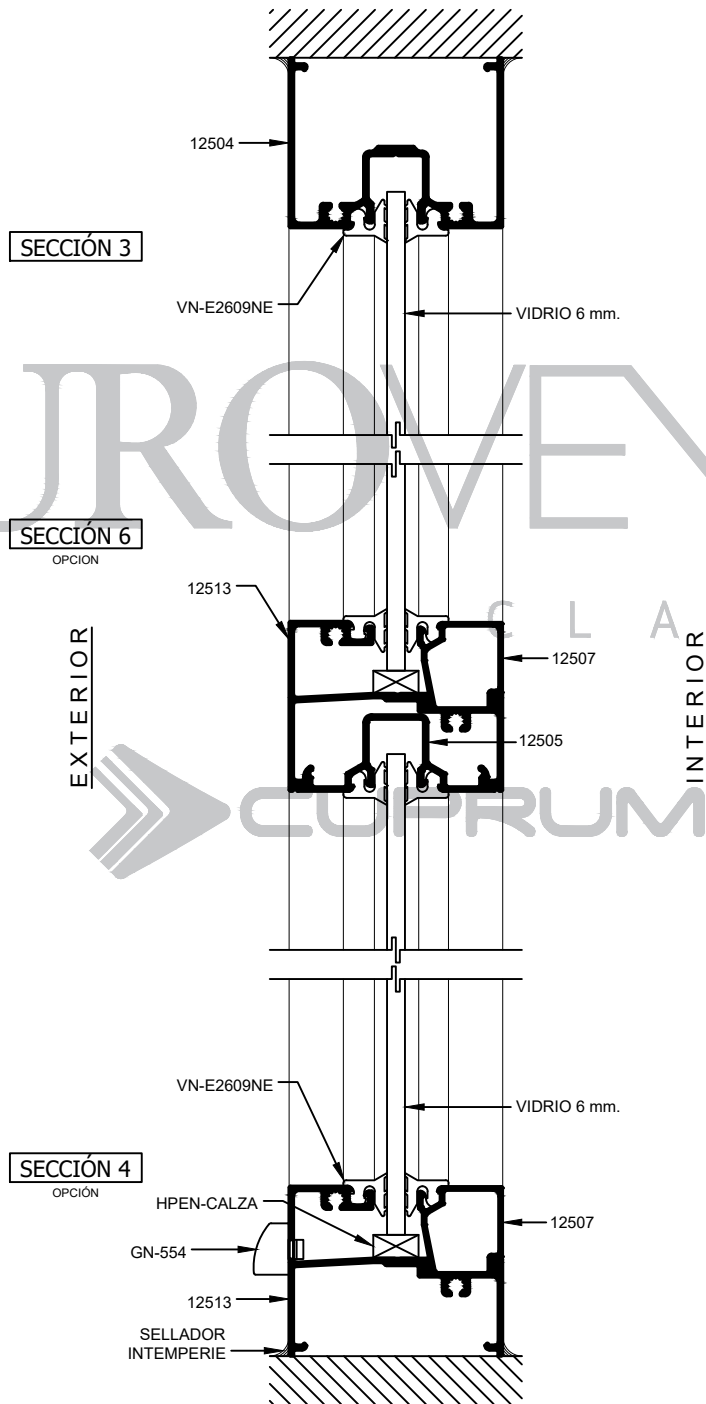

EUROVENT[®]

CLASSIC

EXTERIOR

INTERIOR

CUPRUM



CLASSIC

SERIE

S50



FIJO

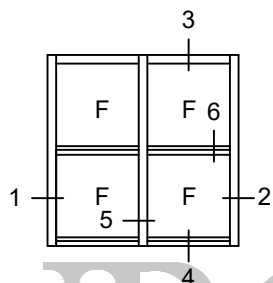
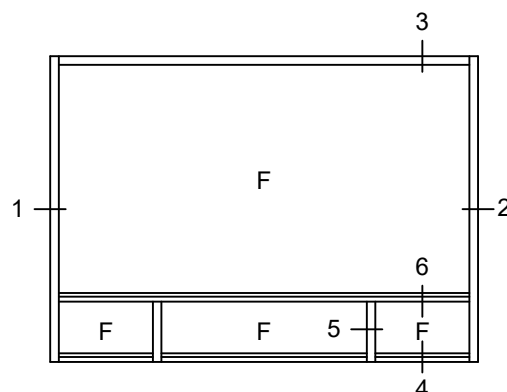
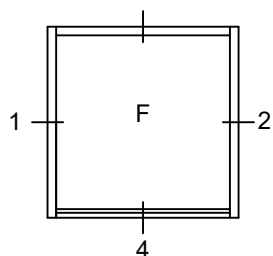

ELEVACIONES TIPO

SIN ESCALA

CLASSIC
SERIE

S50

FIJO

EUROVENT

C L A S S I C

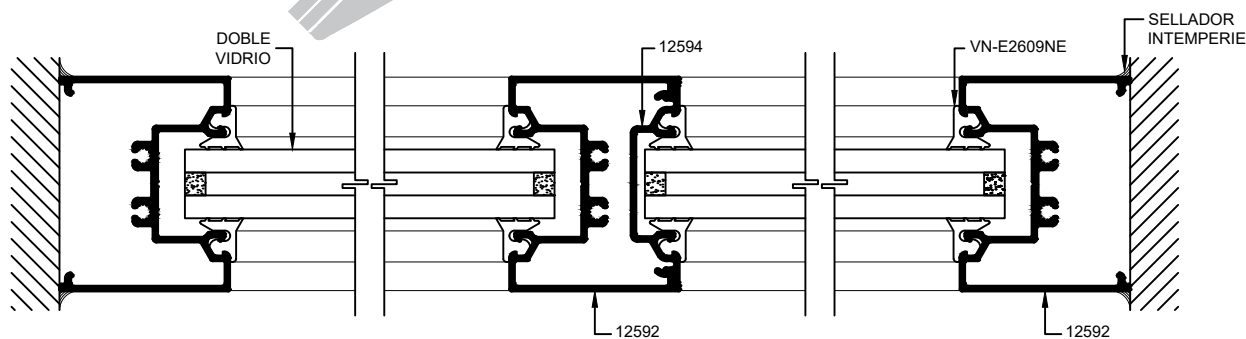

SECCIÓN 1

SECCIÓN 5

SECCIÓN 2

PERFILES PARA DOBLE VIDRIO DE 18mm.

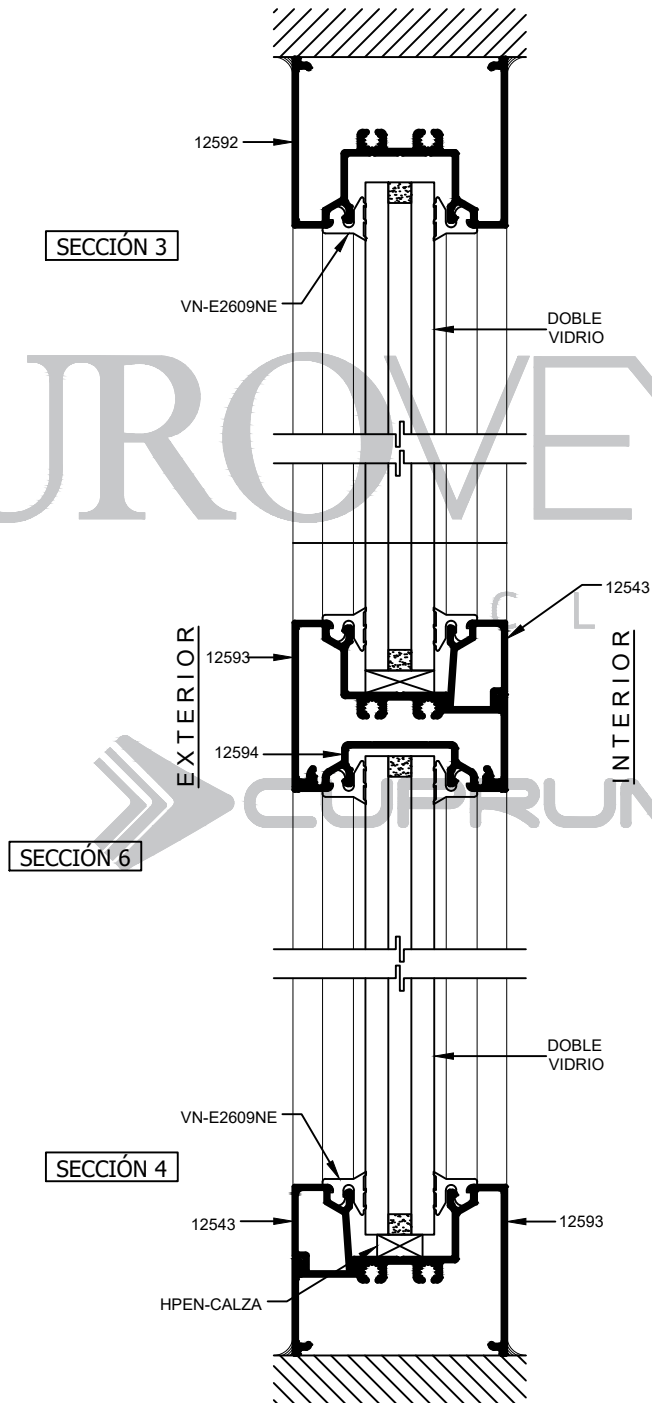

EUROVENT[®]

CLASSIC

CUPRUM

FIJO

CLASSIC

SERIE

S50

PERFILES PARA DOBLE VIDRIO DE 18mm.

OPERACIÓN MANUAL
DREN PARA DESAGÜE

CLASSIC
SERIE
S50
FIJO

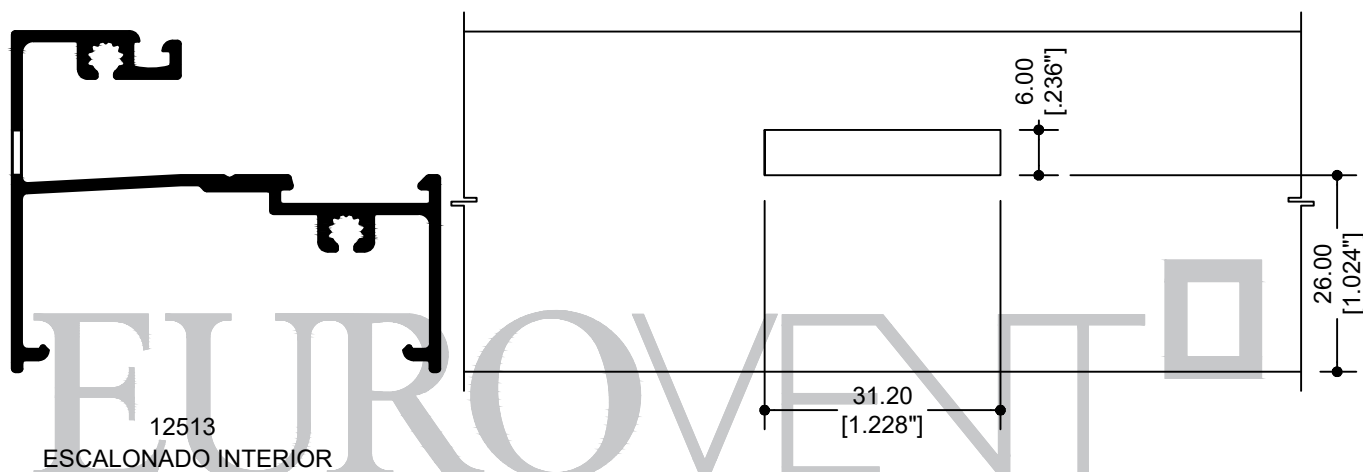

C L A S S I C

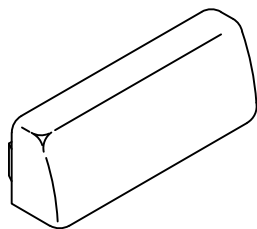

GN-554
TAPA DREN

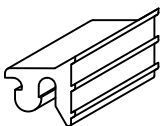

VN-E2609NE
EMPAQUE EZ

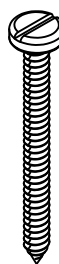

PFNG-1017
#10x1 1/2"

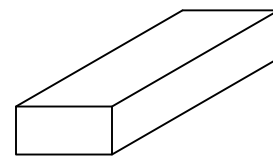

HPEN-CALZA
CALZA DE 1/4" x 3/8" x 4"

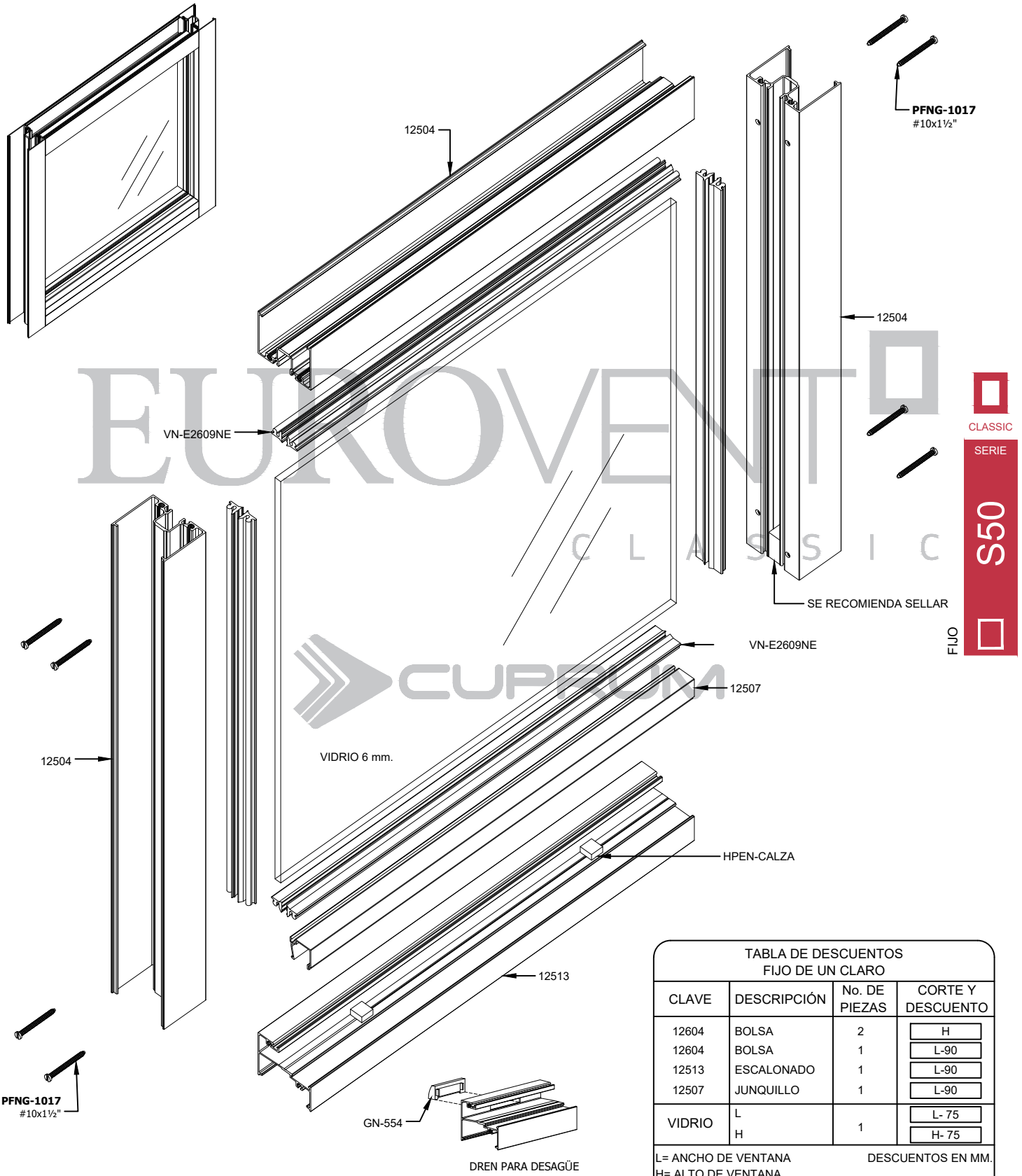

CLASSIC
SERIE
S50

Tabla de descuentos para el modelo FIJO DE UN CLARO.

CLAVE	DESCRIPCIÓN	No. DE PIEZAS	CORTE Y DESCUENTO
12604	BOLSA	2	H
12604	BOLSA	1	L-90
12513	ESCALONADO	1	L-90
12507	JUNQUILLO	1	L-90
VIDRIO	L	1	L- 75
	H		H- 75

L= ANCHO DE VENTANA
H= ALTO DE VENTANA

DESCUENTOS EN MM.

FIJO SERIE 50

A UNA ALTURA DE 15 METROS

DEFLEXIÓN MAX. L/175

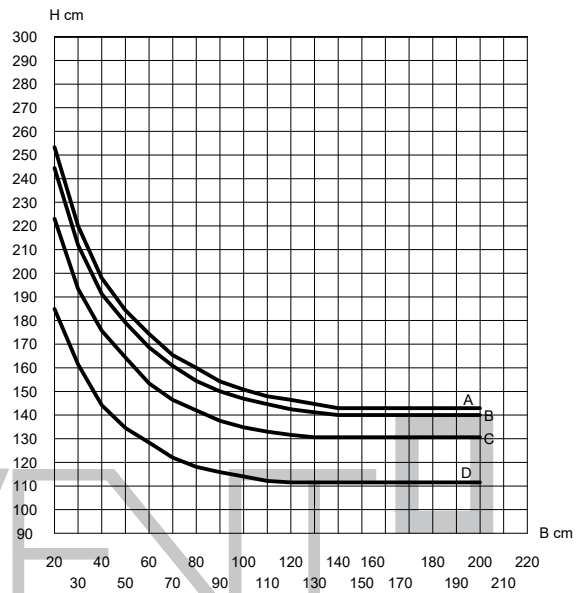
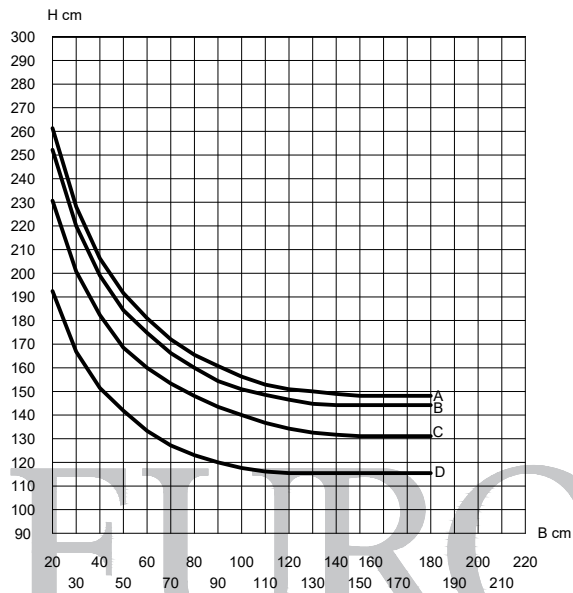

CLASSIC
SERIE

50

FIJO

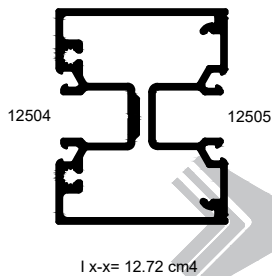

ALEACIÓN: 6063
TEMPLE: 5

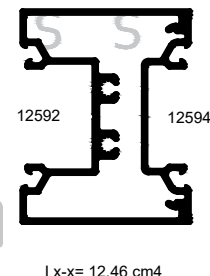

LOS LÍMITES DE FABRICACIÓN
PARA LOS PERFILES, SERÁN
LOS QUE SE ENCUENTREN DEBAJO
DE LAS CURVAS GRÁFICAS.

Valores de presión por velocidad de viento

Curvas	Presión del diseño	Velocidad de viento	Zona
A	45 Kg/m ²	80 Km/h	Centro de grandes ciudades
B	50 Kg/m ²	90 Km/h	Barrios Residenciales
C	65 Kg/m ²	120 Km/h	Campo Abierto
D	145 Kg/m ²	160 Km/h	Zona Costera

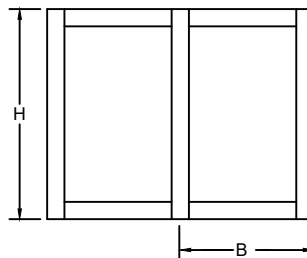

LOS LÍMITES DE UN CANCEL VAN EN FUNCIÓN DE LA
COMBINACIÓN DE RESISTENCIA DEL PERFIL DE ALUMINIO,
EL VIDRIO Y LOS ACCESORIOS QUE LO INTEGRAN.

VERIFICAR QUE LA DEFLEXIÓN DEL PERFIL SEA
COMPATIBLE CON EL VIDRIO UTILIZADO.

PARÁMETROS MÍNIMOS Y MÁXIMOS DE FABRICACIÓN.

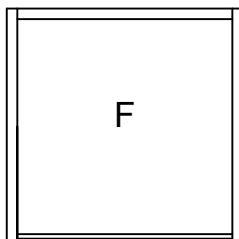

F-50
MÍNIMO 0.30 x 0.30

MÁXIMO 4m² CON VIDRIO RECOCIDO DE 6 mm. SIN INTERMEDIOS,
PARA OTROS ESPESORES VER CON EL FABRICANTE,
CON INTERMEDIOS VER GRÁFICA.

EUROVENT[®]



CLASSIC

SERIE

S50

FIJO



ALUMINIO					
CLAVE	DESCRIPCIÓN	PIEZAS X ATADO	LARGO STD. MTS.	PERÍMETRO ANOD. CM.	PERÍMETRO PUL. CM.
12504	BOLSA	4	6.10	42.56	12.76
12505	TAPA BOLSA	8	6.10	23.17	3.43
12506	ESCALONADO	6	6.10	35.43	9.50
12507	JUNQUILLO	20	6.10	15.08	3.48
12513	ESCALONADO INTERIOR	4	6.10	36.48	9.56
12543	JUNQUILLO	20	6.10	13.57	2.95
12563	TAPA LISA	20	6.10	13.06	5.55
12581	MOLDURA DE UNIÓN	8	6.10	21.45	4.90
12592	BOLSA	4	6.10	44.08	11.50
12593	ESCALONADO	4	6.10	35.60	8.93
12594	TAPA BOLSA	8	6.10	18.35	2.04

CLASSIC
SERIE
S60
FIJO

EUROVENT[®]
CLASSIC

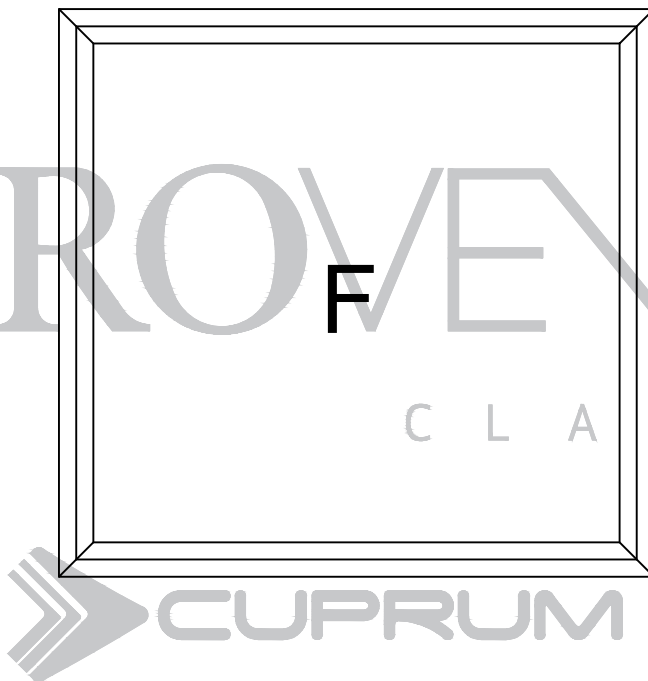

62022
JUNQUILLO

42.97
[1.692"]

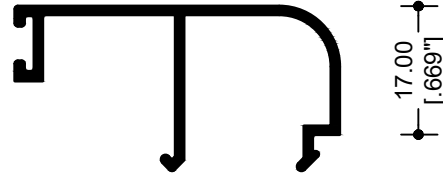

17.00
[.669"]

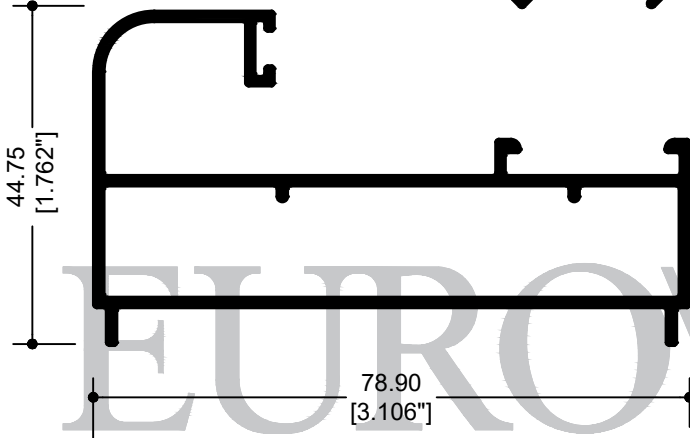

44.75
[1.762"]

62093
COMPATIBLE CON ESCALONADO
DE TRES VIAS SERIE 60

78.90
[3.106"]

27.48
[1.082"]

62072
JUNQUILLO

19.75
[.777"]

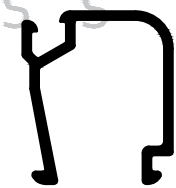

18.92
[.745"]

CLASSIC
SERIE
S60
FIJO

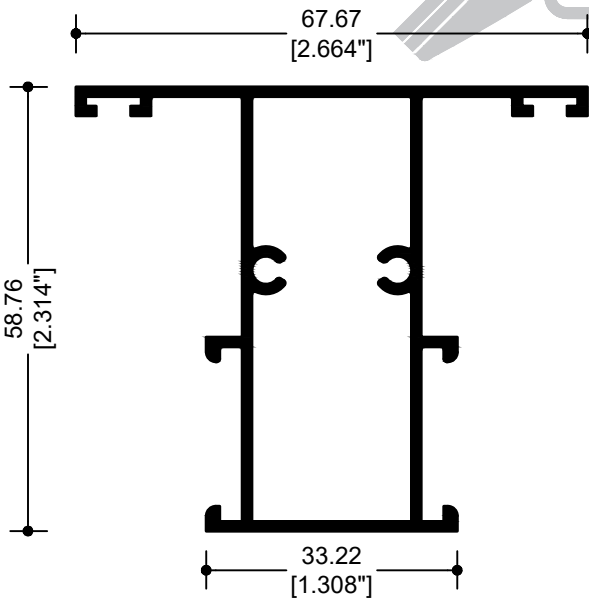

58.76
[2.314"]

67.67
[2.664"]

33.22
[1.308"]

62047
INTERMEDIO CUADRÍCULA

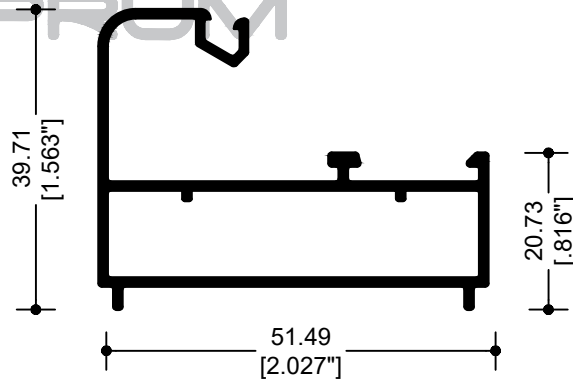

39.71
[1.563"]

51.49
[2.027"]

20.73
[.816"]

62079
ESCALONADO

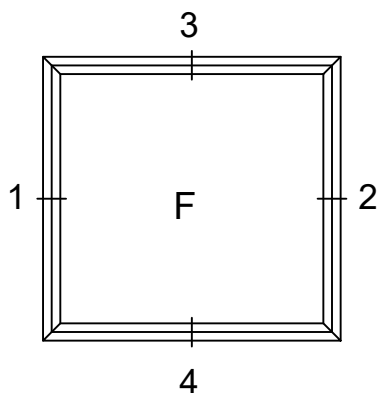

CLASSIC
SERIE
S60
FIJO

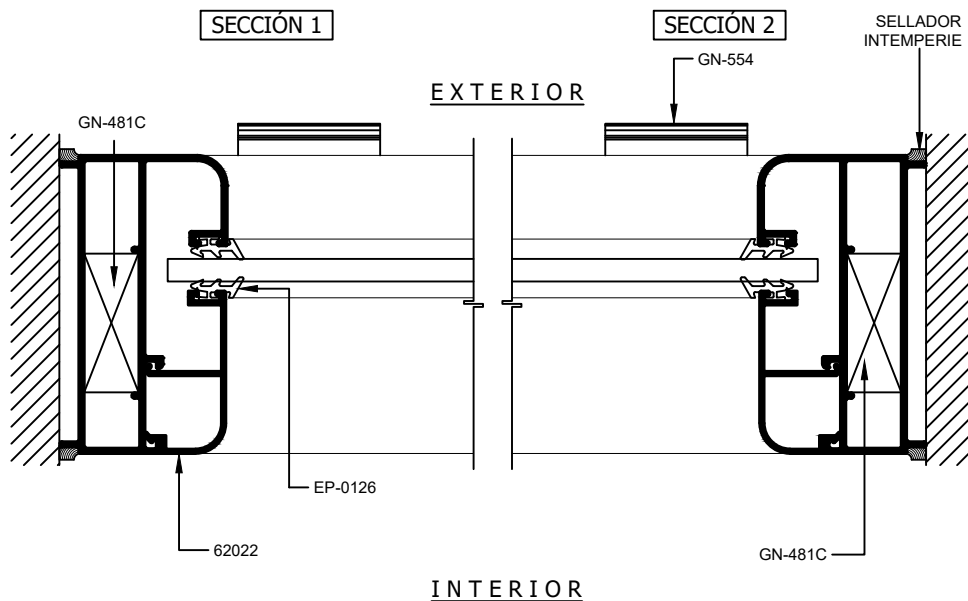
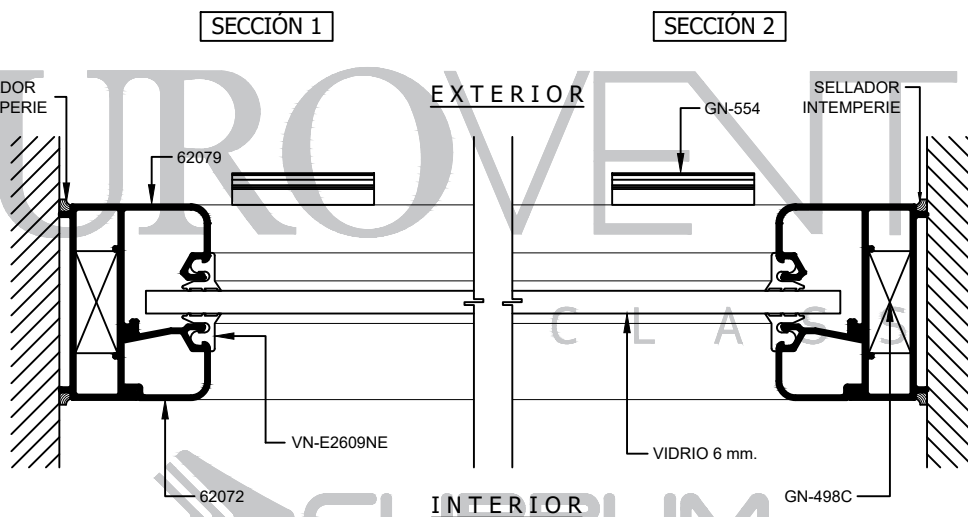

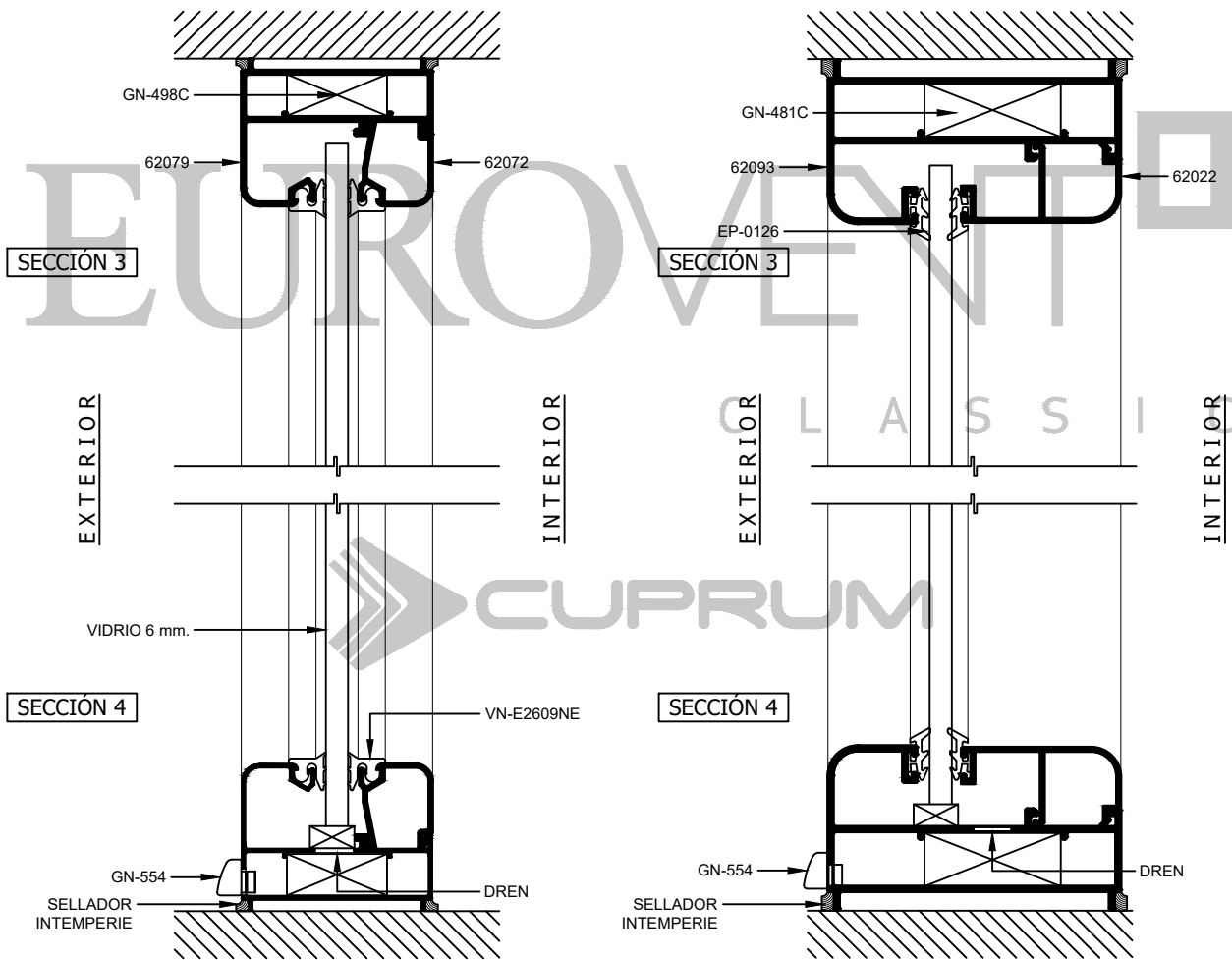



 CLASSIC
 SERIE
S60

 FIJO

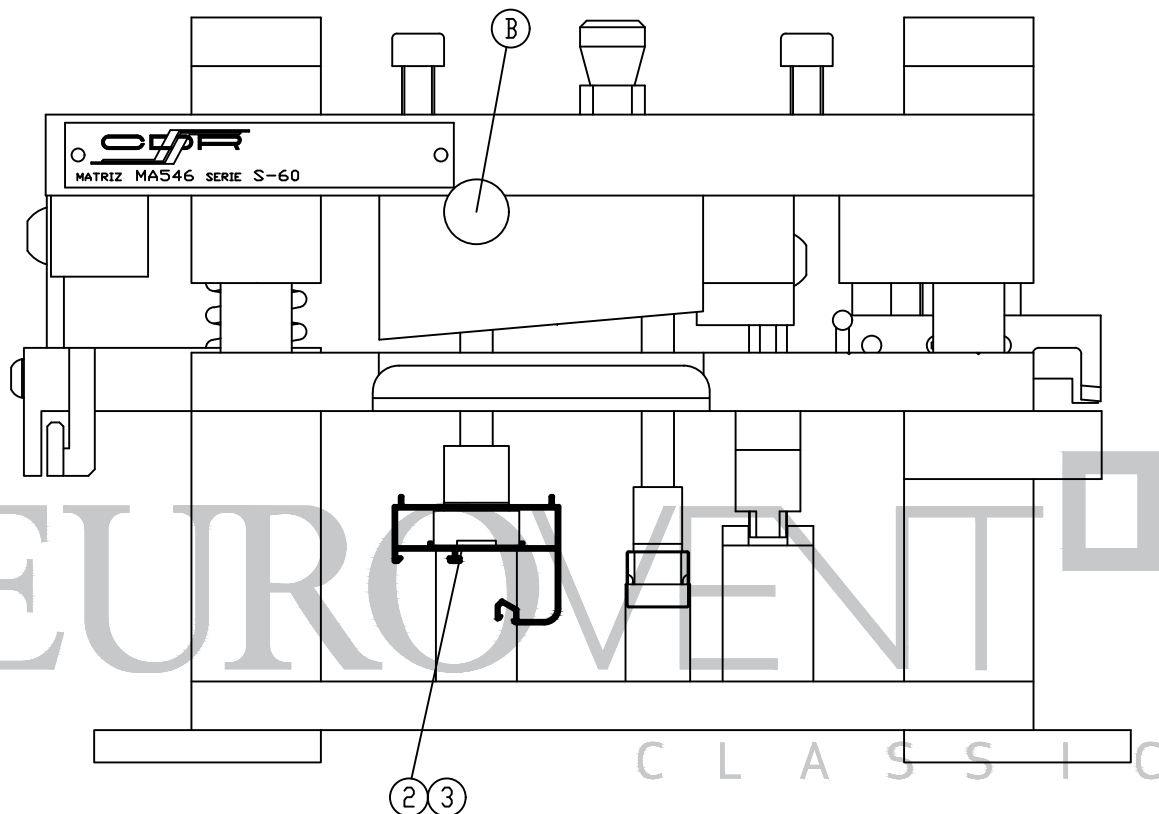
TROQUEL GN-533CDR
VISTA FRONTAL



CLASSIC
SERIE
S60
FIJO

TROQUEL GN-533CDR
VISTA LATERAL

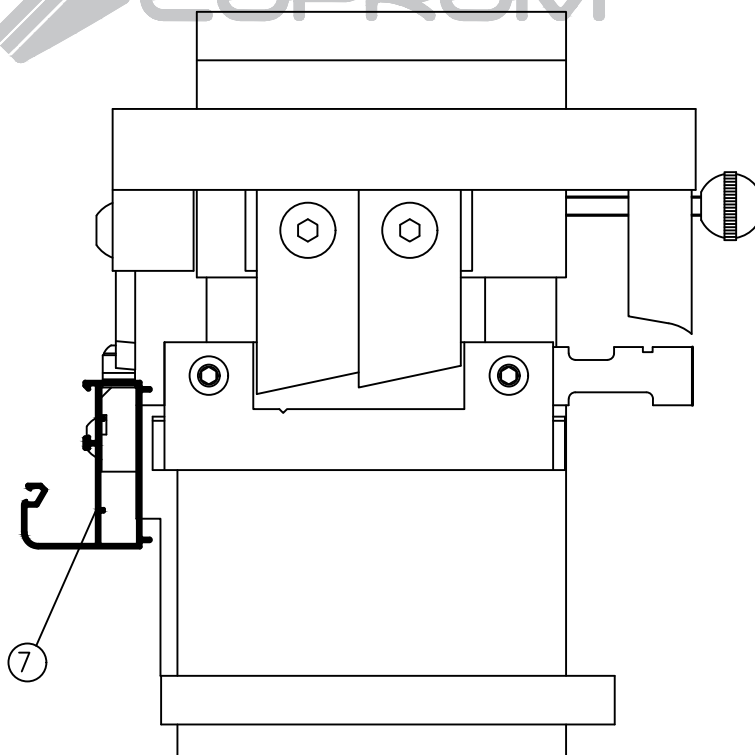

OPERACIÓN 2

62079
BOLA "B" FUERA

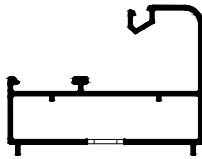

62079

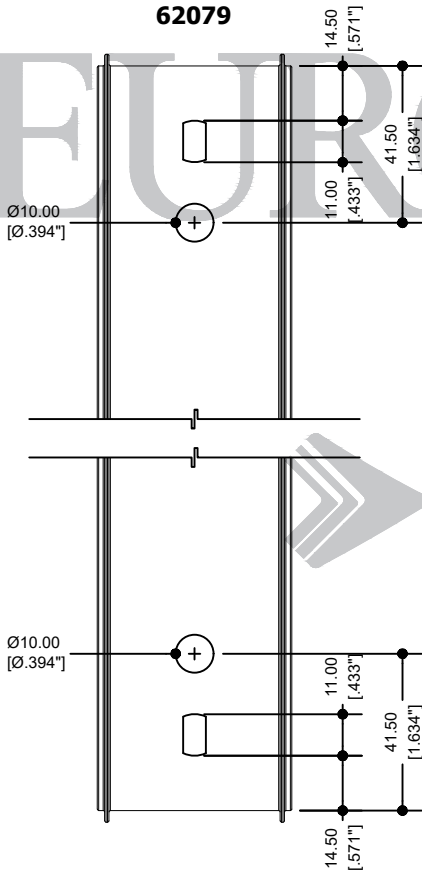

OPERACIÓN 3

62079
BOLA "B" DENTRO

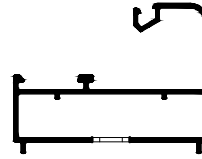

62079

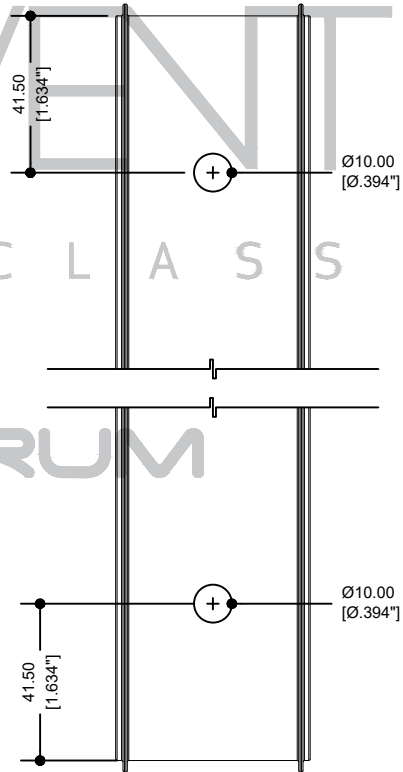

EUROVENT[®]
CLASSIC

CLASSIC
SERIE
S60
FIJO

CUPRUM

OPERACIÓN 7

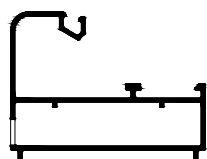

62079

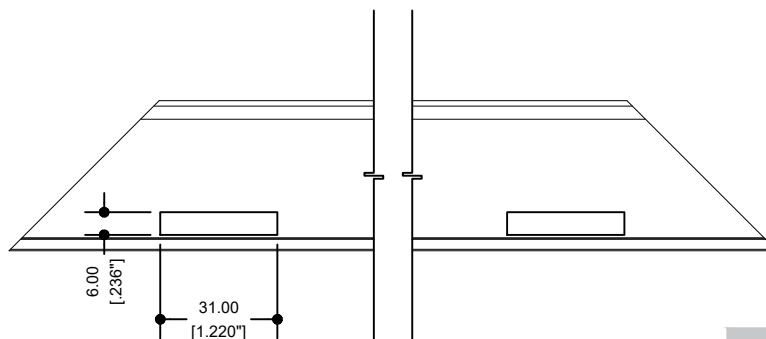

CLASSIC
SERIE

S60

FIJO

EUROVENT[®]

C L A S S I C

62079
OPERACIÓN MANUAL
BARRENO PARA DESAGÜE

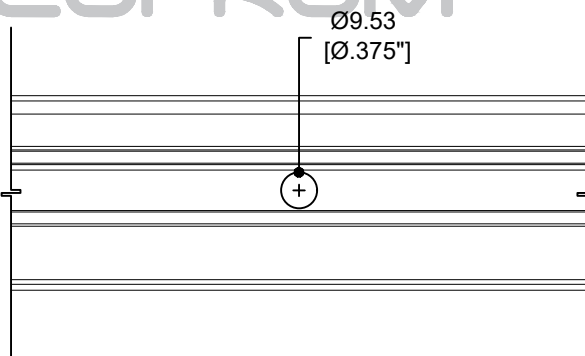
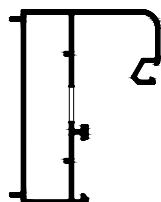

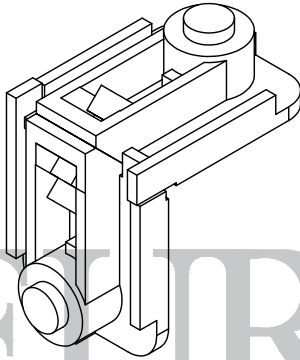

GN-481C
ESCUADRA DE BOTÓN

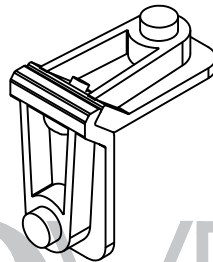

GN-498C
ESCUADRA DE BOTÓN
CONTRAMARCO

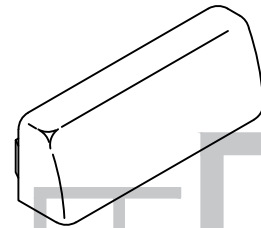

GN-554
TAPA DREN

EUROVENT CLASSIC

CLASSIC
SERIE
S60
FIJO

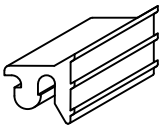

VN-E2609NE
EMPAQUE EZ

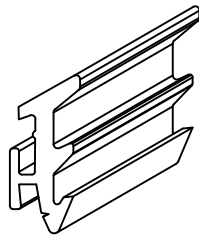

EP-0126
EMPAQUE VIDRIO DE HOJA

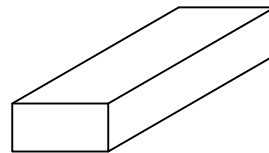

HPEN-CALZA
CALZA DE 1/4" x 3/8" x 4"

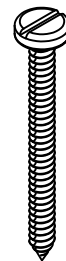

PFNG-1017
#10x1 1/2"

SIN ESCALA.

CLASSIC
SERIE
S60
FIJO

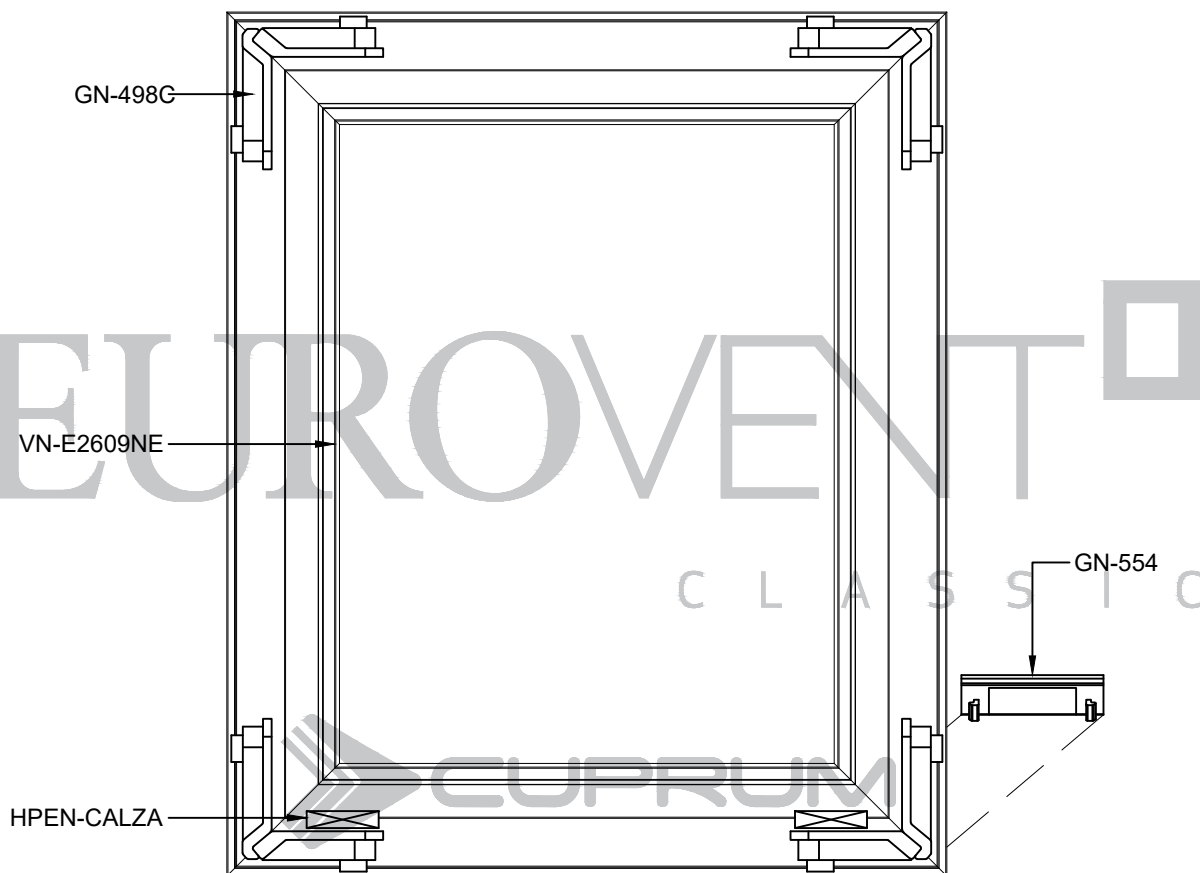

VENTANA FIJO		
CLAVE	DESCRIPCIÓN	PIEZAS
GN-498C	ESCUADRA DE BOTÓN CONTRAMARCO	4
GN-554	TAPA DREN	2
HPEN-CALZA	CALZA	1
GN-554	VN-E2609NE	4L + 4H

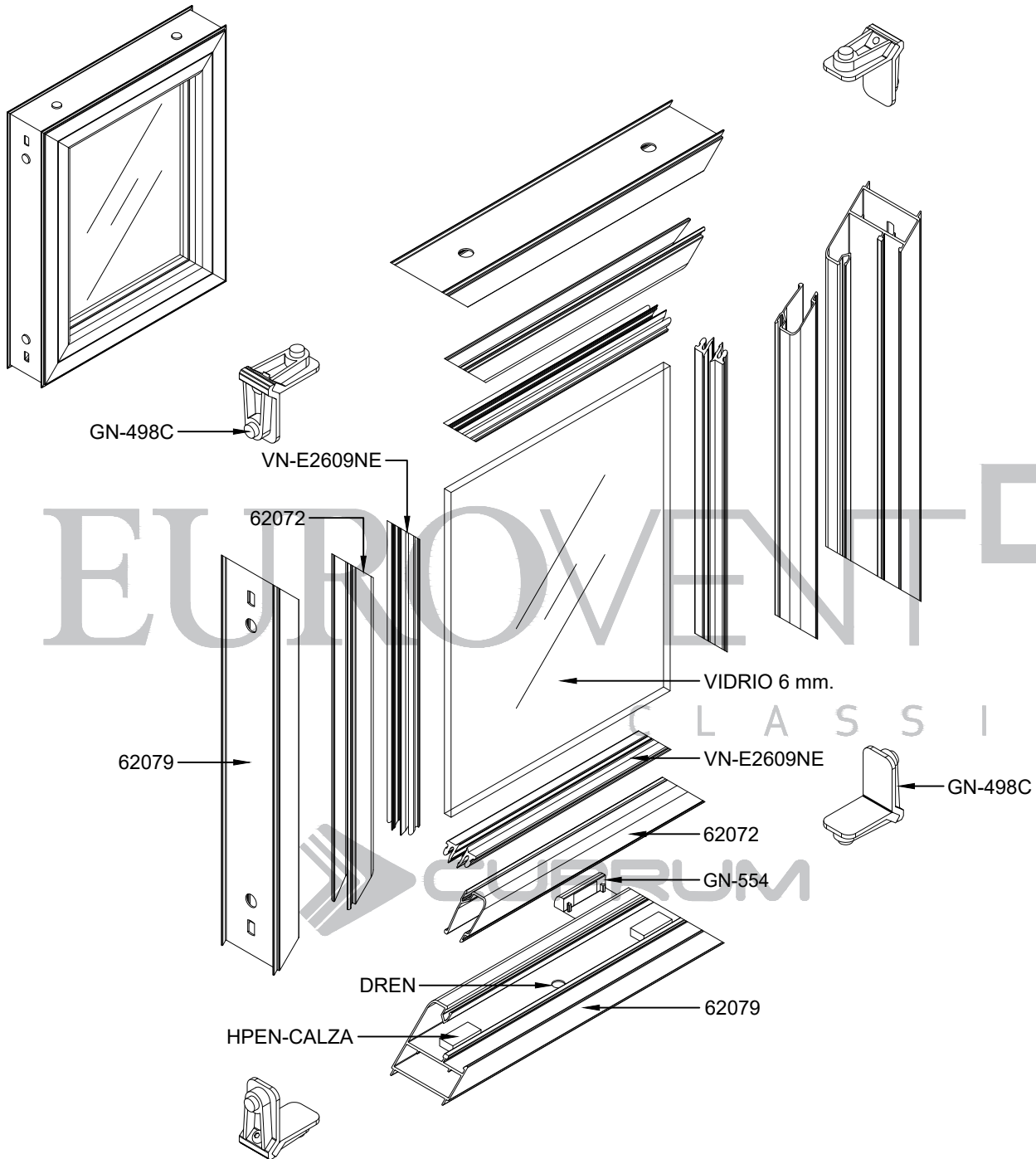

CLASSIC
SERIE
S60
FIJO

TABLA DE DESCUENTOS FIJO			
CLAVE	DESCRIPCIÓN	# DE PIEZAS	CORTES Y DESCUENTOS
62093	ESCALONADO	2	L
62093	ESCALONADO	2	H
62022	JUNQUILLO	2	L-45
62022	JUNQUILLO	2	H-45
VIDRIO	L H	1	L-62 H-62
L = ANCHO H = ALTO			
DESCUENTOS EN MILIMETROS			

TABLA DE DESCUENTOS FIJO			
CLAVE	DESCRIPCIÓN	# DE PIEZAS	CORTES Y DESCUENTOS
62079	CONTRAMARCO	2	L
62079	CONTRAMARCO	2	H
62072	JUNQUILLO	2	L-34
62072	JUNQUILLO	2	H-34
VIDRIO	L H	1	L-49 H-49
L = ANCHO H = ALTO			
DESCUENTOS EN MILIMETROS			

PARÁMETROS MÍNIMOS Y MÁXIMOS DE FABRICACIÓN.

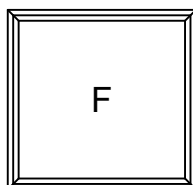

F-60
MÍNIMO 0.30 x 0.30

MÁXIMO 4m² CON VIDRIO RECOCIDO DE 6 mm. SIN INTERMEDIOS,
PARA OTROS ESPESORES VER CON EL FABRICANTE,
CON INTERMEDIOS VER GRÁFICA.

CLASSIC
SERIE

S60

FIJO

C L A S S I C

ALUMINIO

CLAVE	DESCRIPCIÓN	PIEZAS X ATADO	LARGO STD. MTS.	PERÍMETRO ANOD. CM.	PERÍMETRO PUL. CM.
62072	JUNQUILLO	20	6.10	14.03	3.23
62079	ESCALONADO	8	6.10	26.05	6.94
62022	JUNQUILLO	20	6.10	20.17	5.65
62093	ESCALONADO 2 VIAS CON MOSQ.	4	6.10	34.34	8.29
62047	INTERMEDIO CUADRÍCULA	4	6.10	33.47	10.72

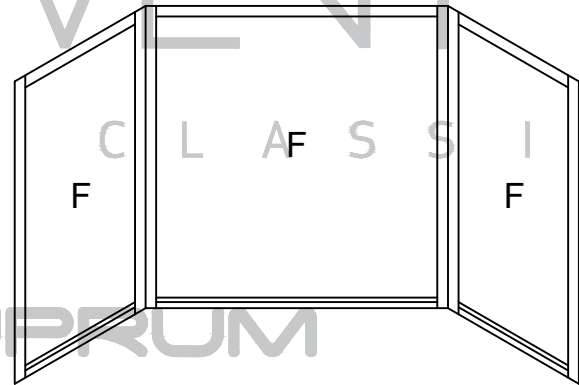
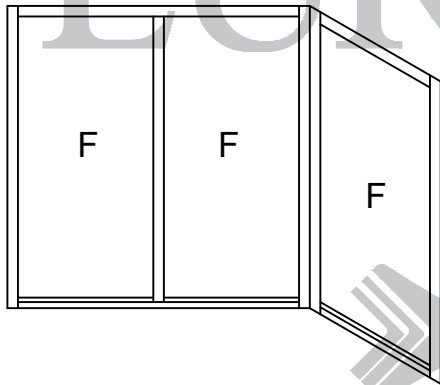
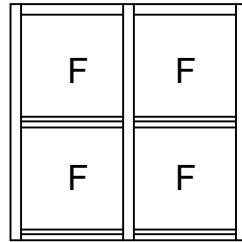
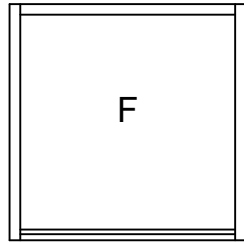

CLASSIC
SERIE
S70
FIJO

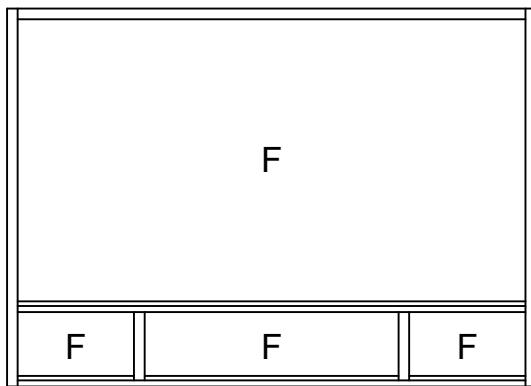

CLASSIC
SERIE
S70

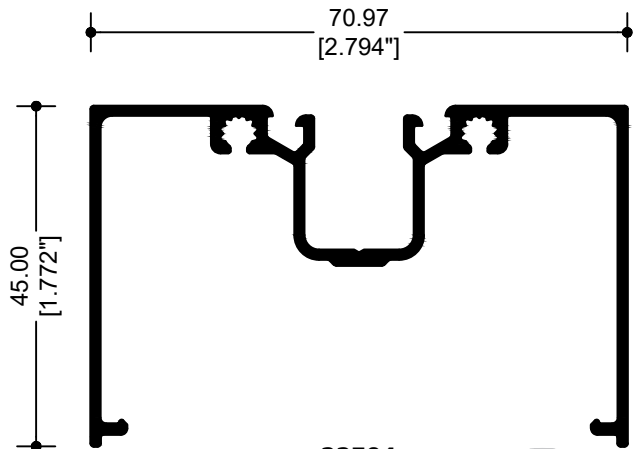

22504
BOLSA

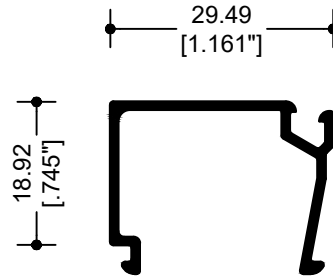

42507
JUNQUILLO

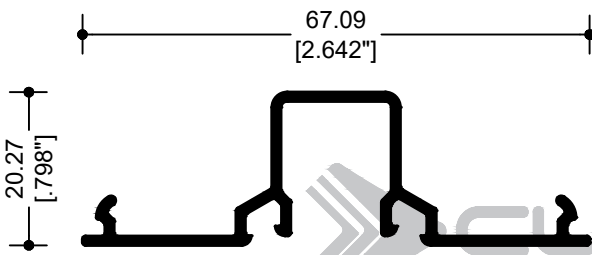

42505
TAPA BOLSA

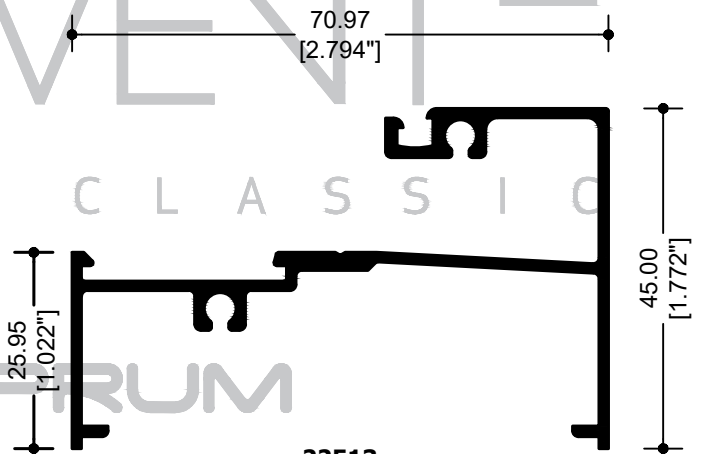

22513
ESCALONADO INTERIOR

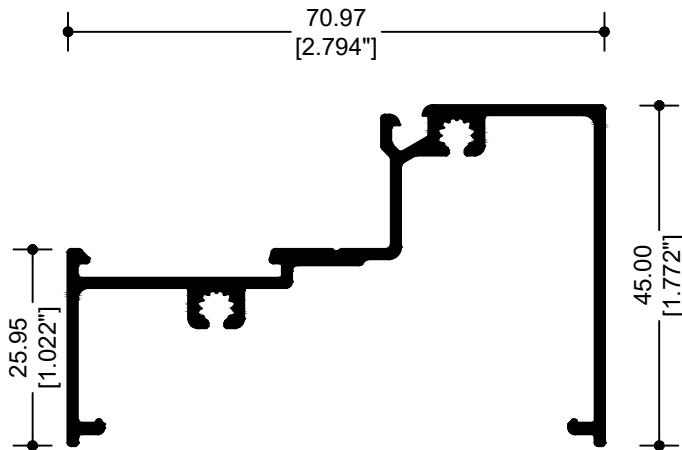

32506
ESCALONADO EXTERIOR

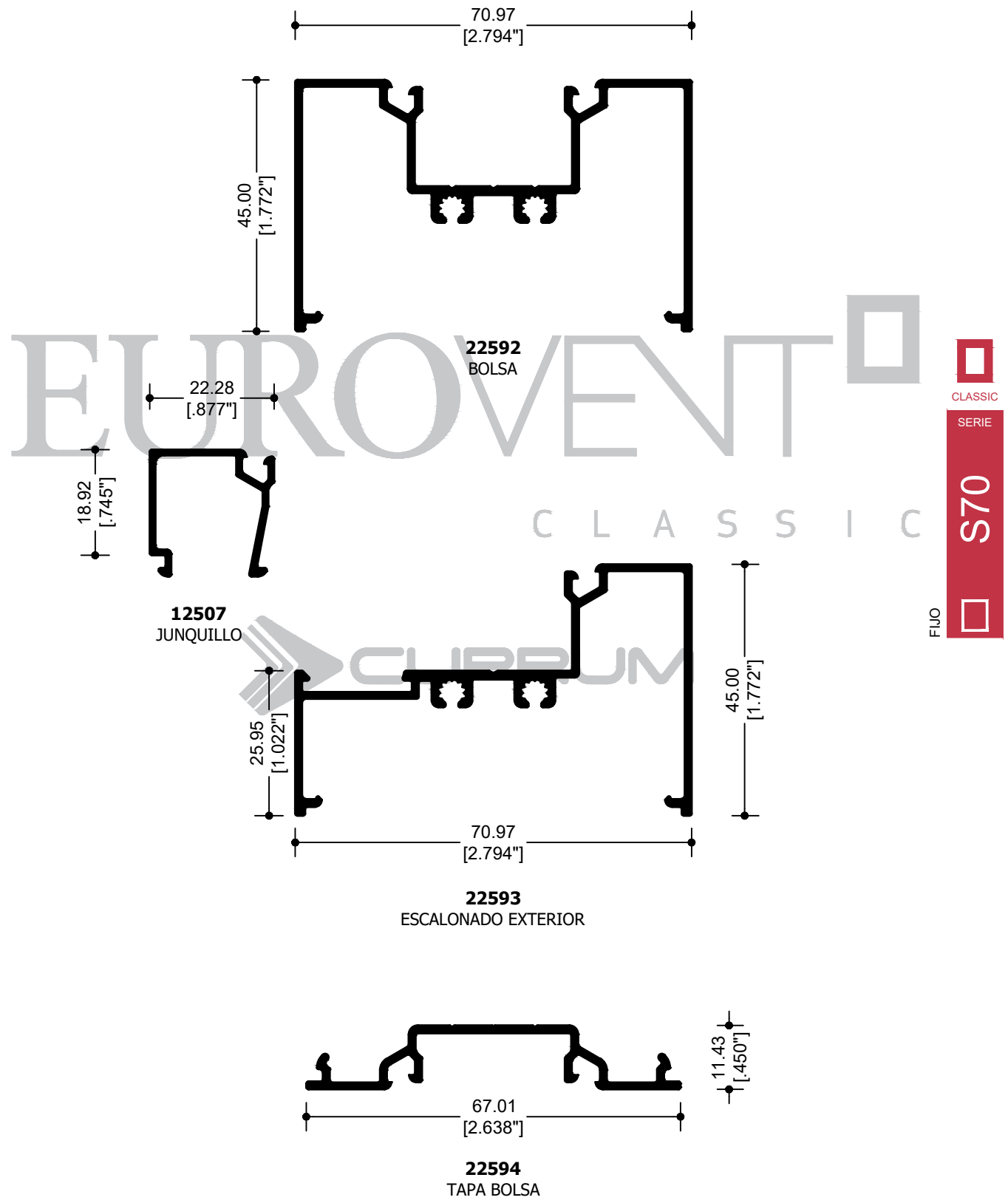

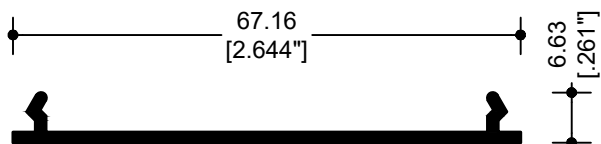

32563
TAPA LISA

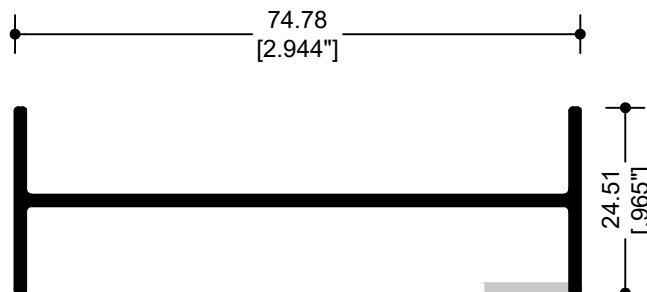

22581
MOLDURA DE UNIÓN



CLASSIC
SERIE

S70

 F.I.O.

EUROVENT

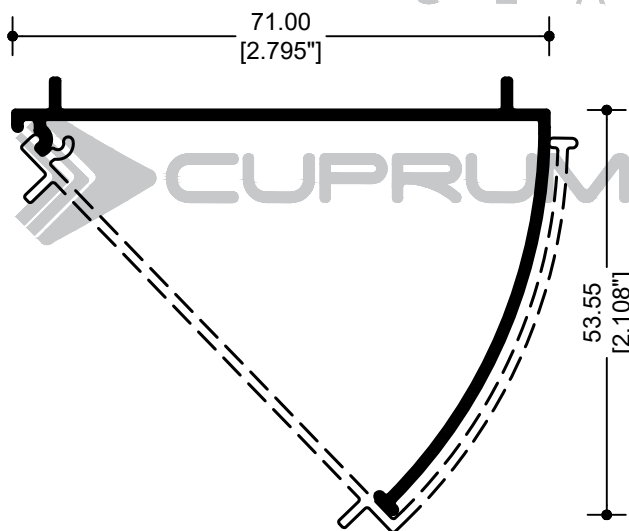
C L A S S I C



62170
ESQ. REGULABLE
AUTO-ENSAMBLE

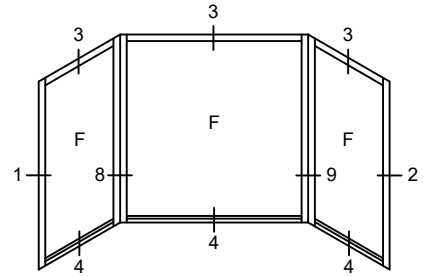
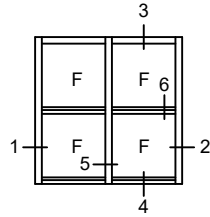
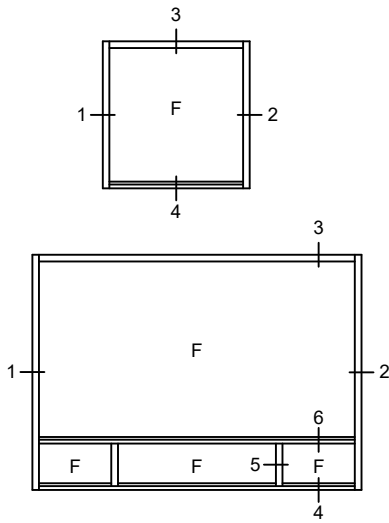

SIN ESCALA

ELEVACIONES TIPO

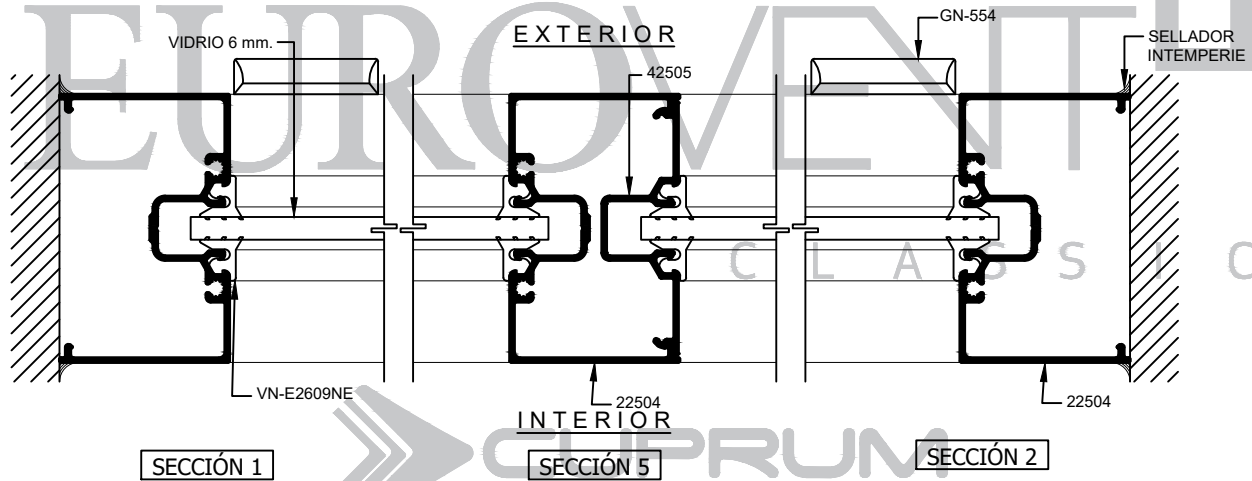

FIJO

CLASSIC
SERIE

S70

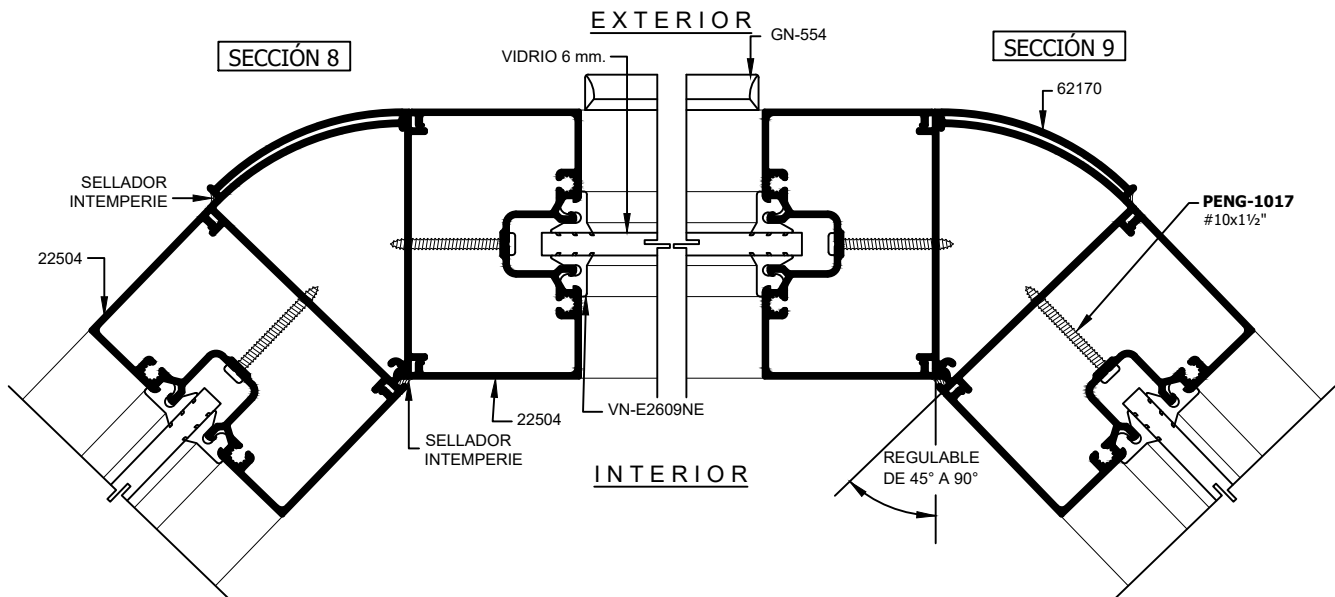

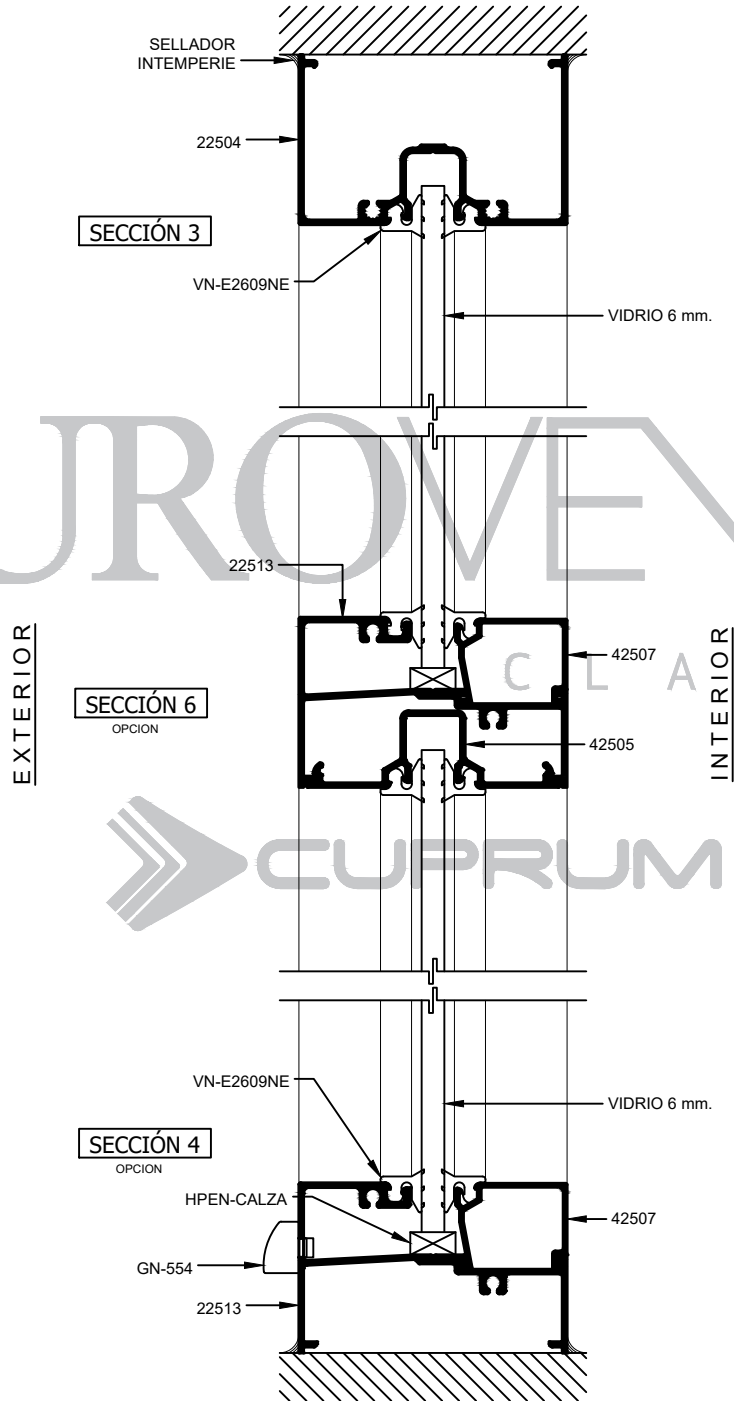

 CLASSIC
 SERIE
S70
 FIJO

EUROVENT CLASSIC

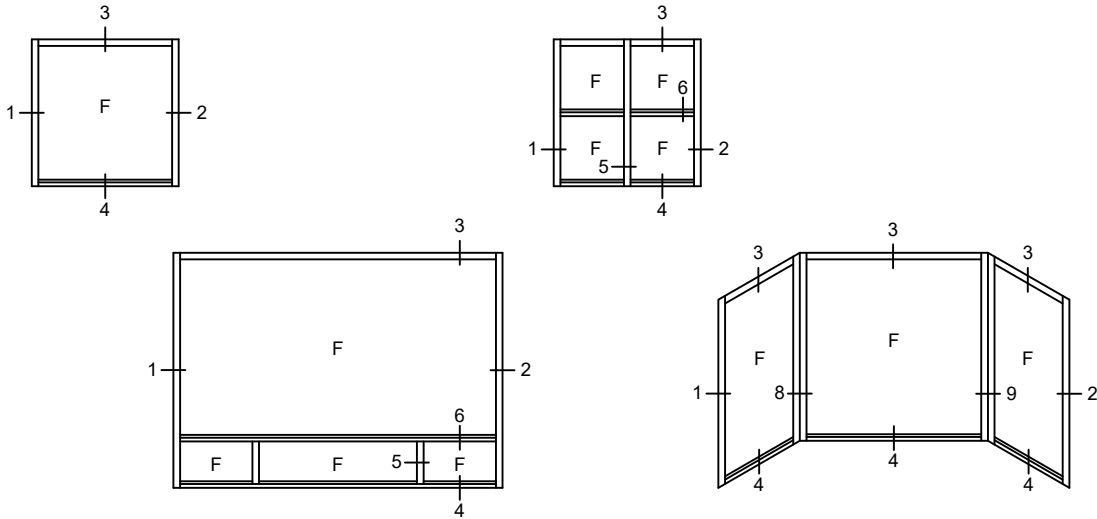

CUPRUM



ELEVACIONES TIPO

SIN ESCALA

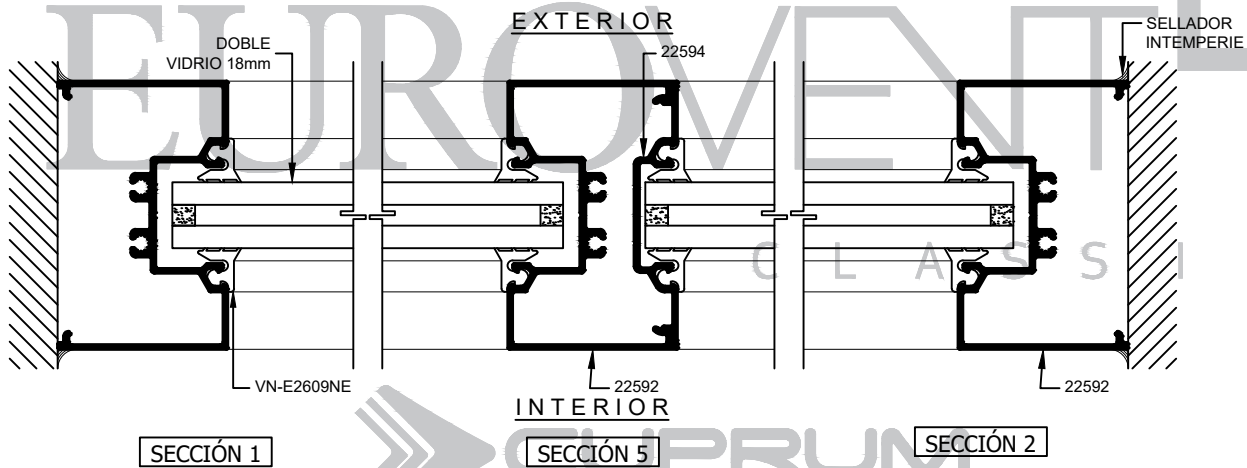

 CLASSIC
 SERIE
 S70
 FIJO

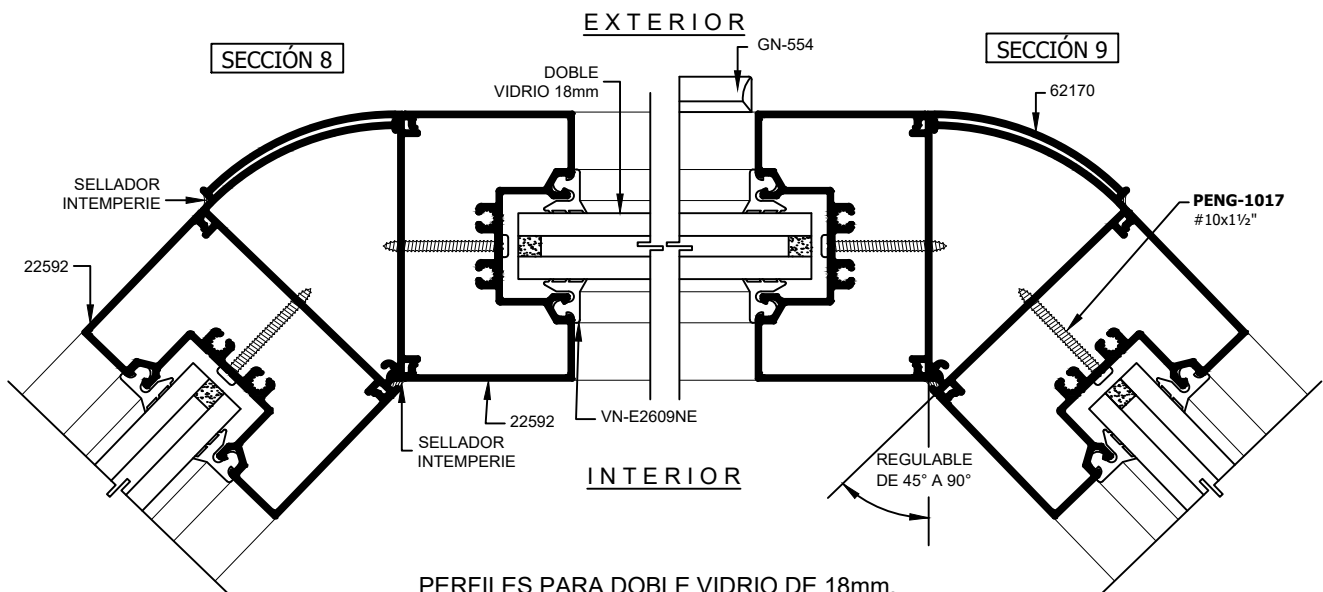

PERFILES PARA DOBLE VIDRIO DE 18mm.

CLASSIC
SERIE
S70
FIJO

EUROVENT

CLASSIC

CUPRUM

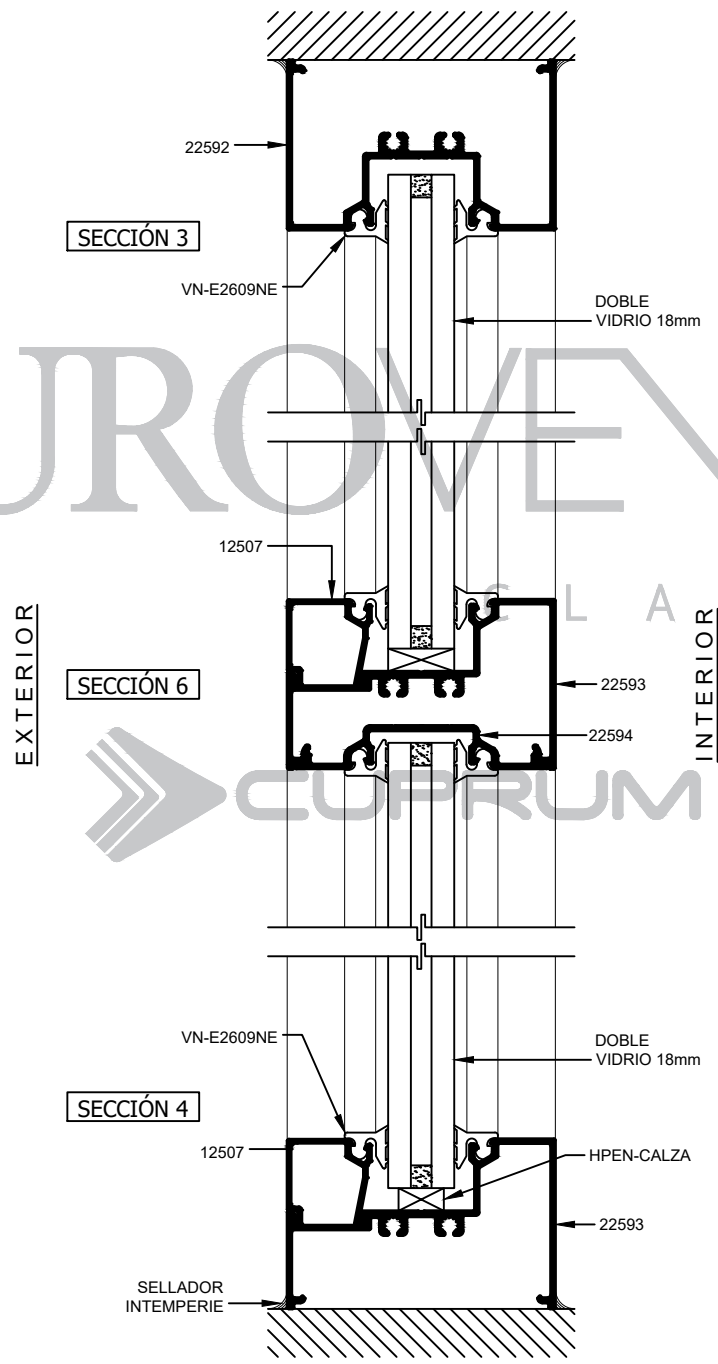

PERFILES PARA DOBLE VIDRIO DE 18mm.

OPERACIÓN MANUAL
DREN PARA DESAGÜE

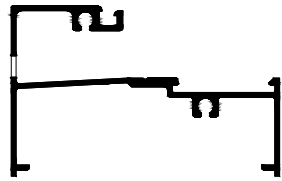

22513
ESCALONADO INTERIOR

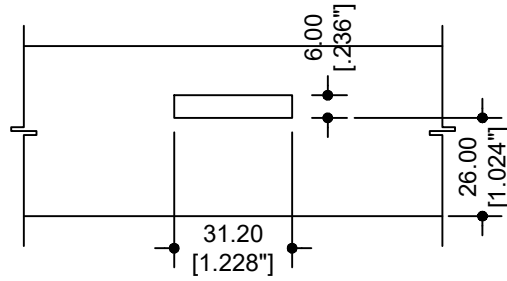

EUROVENT

C L A S S I C

CLASSIC
SERIE

S70

FIJO

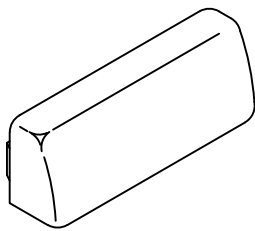

GN-554
TAPA DREN

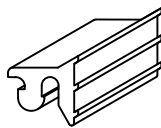

VN-E2609NE
EMPAQUE EZ

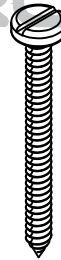

PENG-1017
#10x1 1/2"

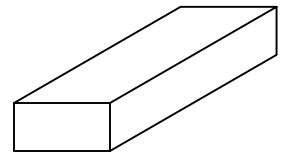

HPEN-CALZA
CALZA DE 1/4" x 3/8" x 4"

CLASSIC
SERIE
S70



Tabla de descuentos para el modelo FIJO DE UN CLARO.

CLAVE	DESCRIPCION	No. DE PIEZAS	CORTE Y DESCUENTO
22504	BOLSA	2	H
22504	BOLSA	1	L-90
22513	ESCALONADO	1	L-90
42507	JUNQUILLO	1	L-90
VIDRIO	L	1	L-75
	H		H-75

L= ANCHO
H= ALTO

DESCUENTOS EN MM.

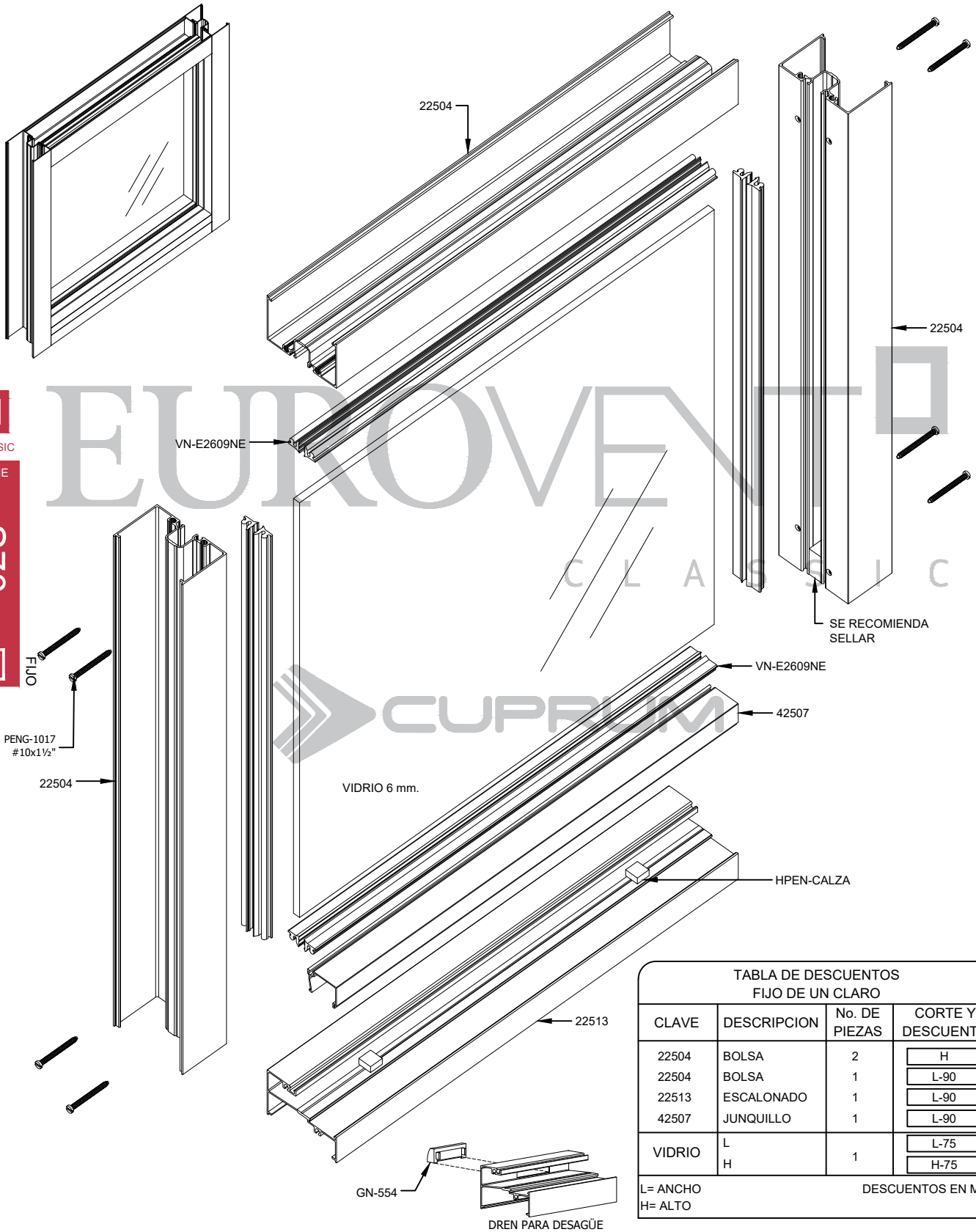
FIJO SERIE 70
A UNA ALTURA DE 15 METROS
DEFLEXIÓN MAX. L/175

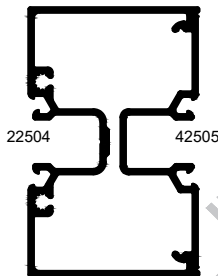
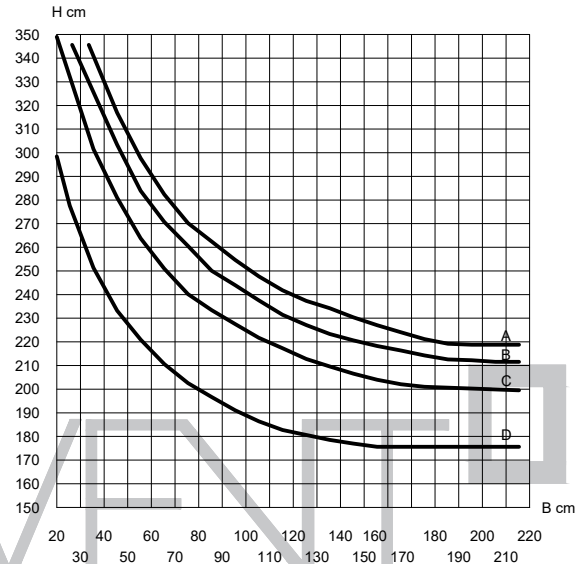
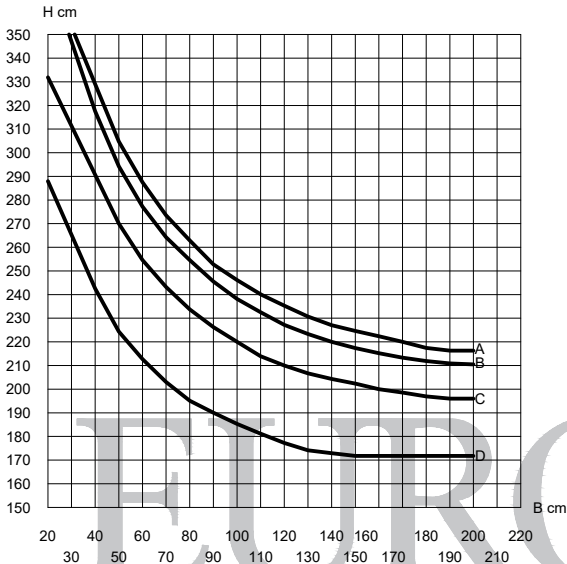

I x-x= 19.08 cm⁴

ALEACIÓN: 6063
TEMPLE: 5

LOS LIMITES DE FABRICACIÓN
PARA LOS PERFILES, SERÁN
LOS QUE SE ENCUENTREN DEBAJO
DE LAS CURVAS GRAFICADAS.

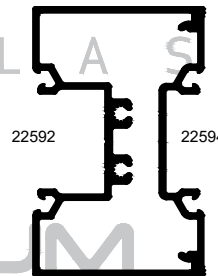

I x-x= 19.58 cm⁴

Valores de presión por velocidad de viento

Curvas	Presión del diseño	Velocidad de viento	Zona
A	45 Kg/m ²	80 Km/h	Centro de grandes ciudades
B	50 Kg/m ²	90 Km/h	Barrios Residenciales
C	65 Kg/m ²	120 Km/h	Campo Abierto
D	145 Kg/m ²	160 Km/h	Zona Costera

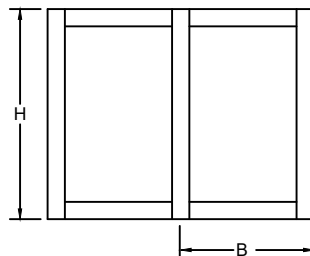

LOS LIMITES DE UN CANCEL VAN EN FUNCIÓN DE LA
COMBINACIÓN DE RESISTENCIA DEL PERFIL DE ALUMINIO,
EL VIDRIO Y LOS ACCESORIOS QUE LO INTEGRAN.

VERIFICAR QUE LA DEFLEXIÓN DEL PERFIL SEA
COMPATIBLE CON EL VIDRIO UTILIZADO.



PARÁMETROS MÍNIMOS Y MÁXIMOS DE FABRICACIÓN.

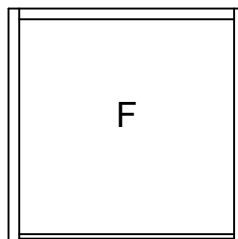

F-70
MÍNIMO 0.50 x 0.50

MÁXIMO 4m² CON VIDRIO RECOCIDO DE 6 mm. SIN INTERMEDIOS,
PARA OTROS ESPESORES VER CON EL FABRICANTE,
CON INTERMEDIOS VER GRÁFICA.

CLASSIC
SERIE

S70

FIJO

C L A S S I C

ALUMINIO

CLAVE	DESCRIPCIÓN	PIEZAS X ATADO	LARGO STD. MTS.	PERÍMETRO ANOD. CM.	PERÍMETRO PUL. CM.
12507	JUNQUILLO	20	6.10	15.08	3.48
22504	BOLSA	4	6.10	44.92	13.96
22513	ESCALONADO INTERIOR	4	6.10	40.90	9.57
22581	MOLDURA DE UNION	8	6.10	24.22	4.87
22592	BOLSA	4	6.10	47.13	16.02
22593	ESCALONADO	4	6.10	38.88	9.22
22594	TAPA BOLSA	8	6.10	21.08	3.11
32506	ESCALONADO	6	6.10	38.54	9.57
32563	TAPA LISA	20	6.10	15.95	6.72
42507	JUNQUILLO	8	6.10	16.51	4.42
42505	TAPA BOLSA	8	6.10	26.07	4.63
62170	ESQ. REGULABLE	10	6.10	28.90	6.66

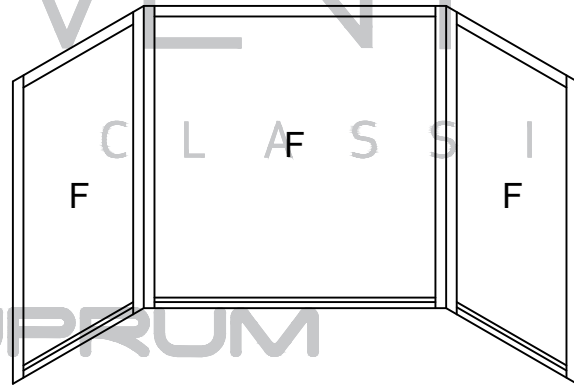
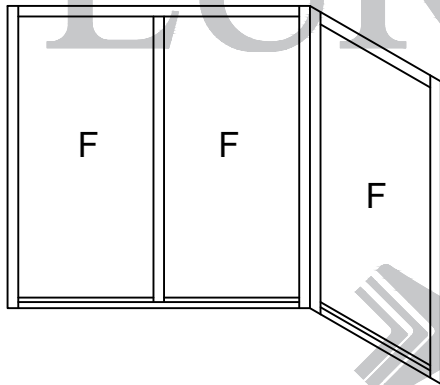
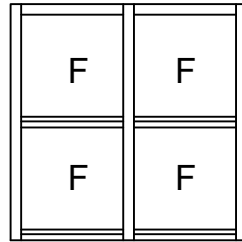
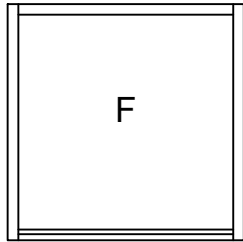

EUROVENT

CLASSIC

CUPRUM

FIJO CLASSIC SERIE S140

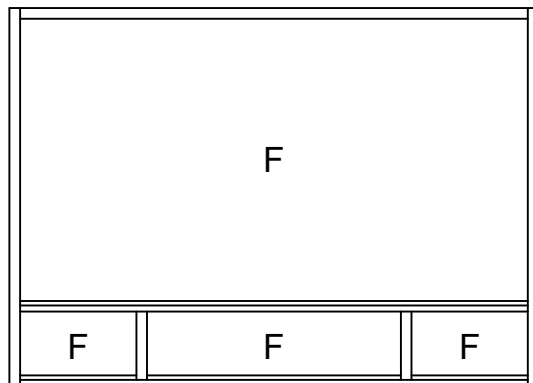

CLASSIC
SERIE
S140
FIJO

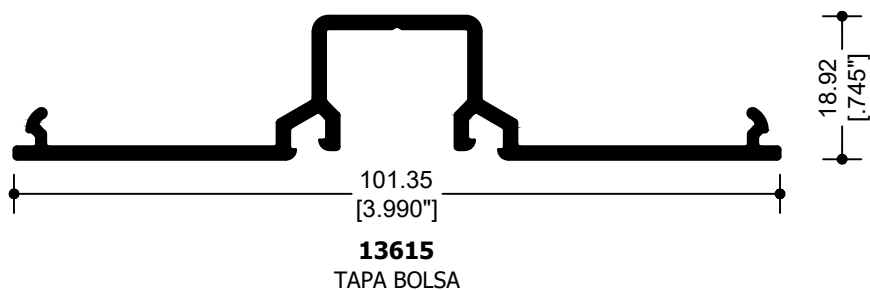
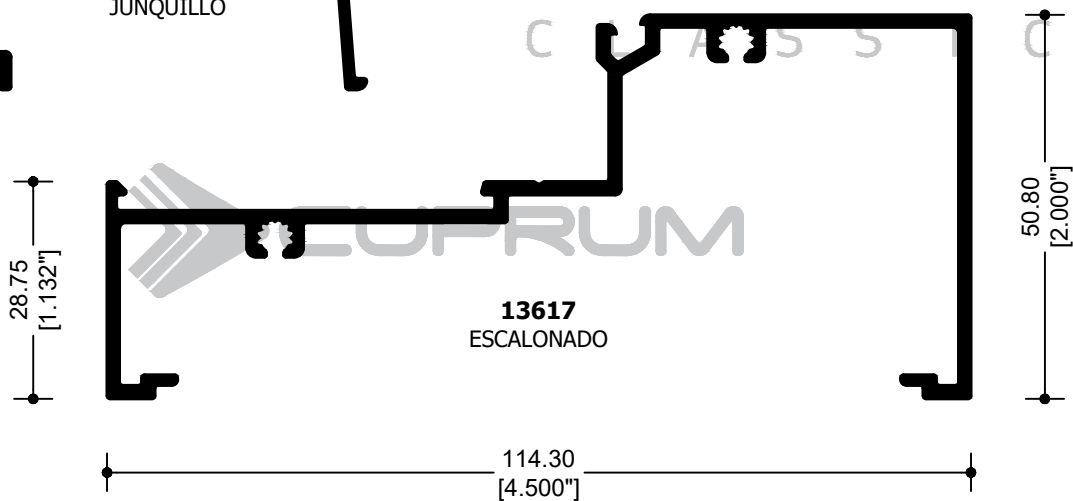
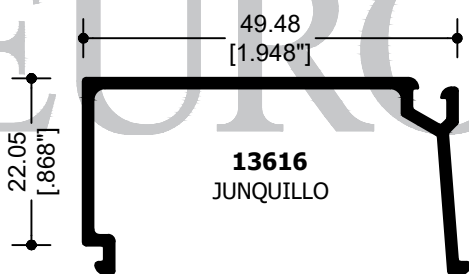
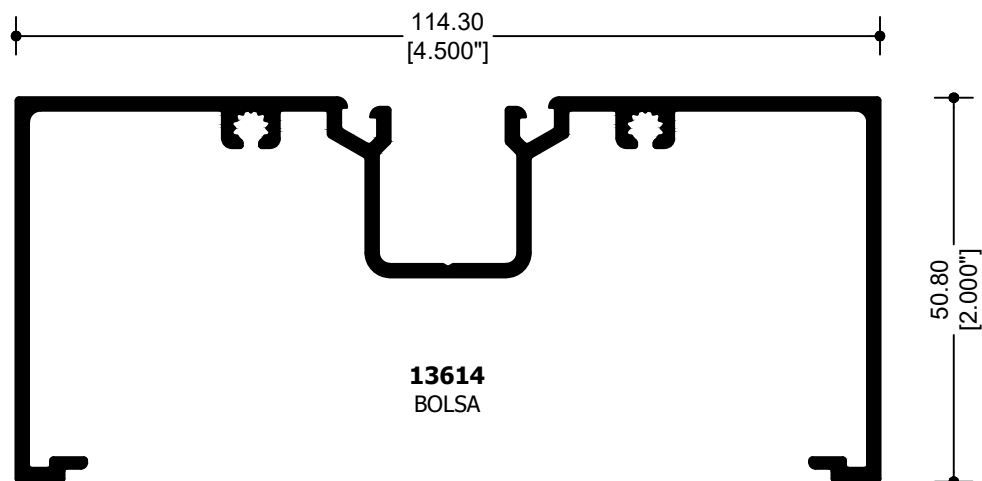

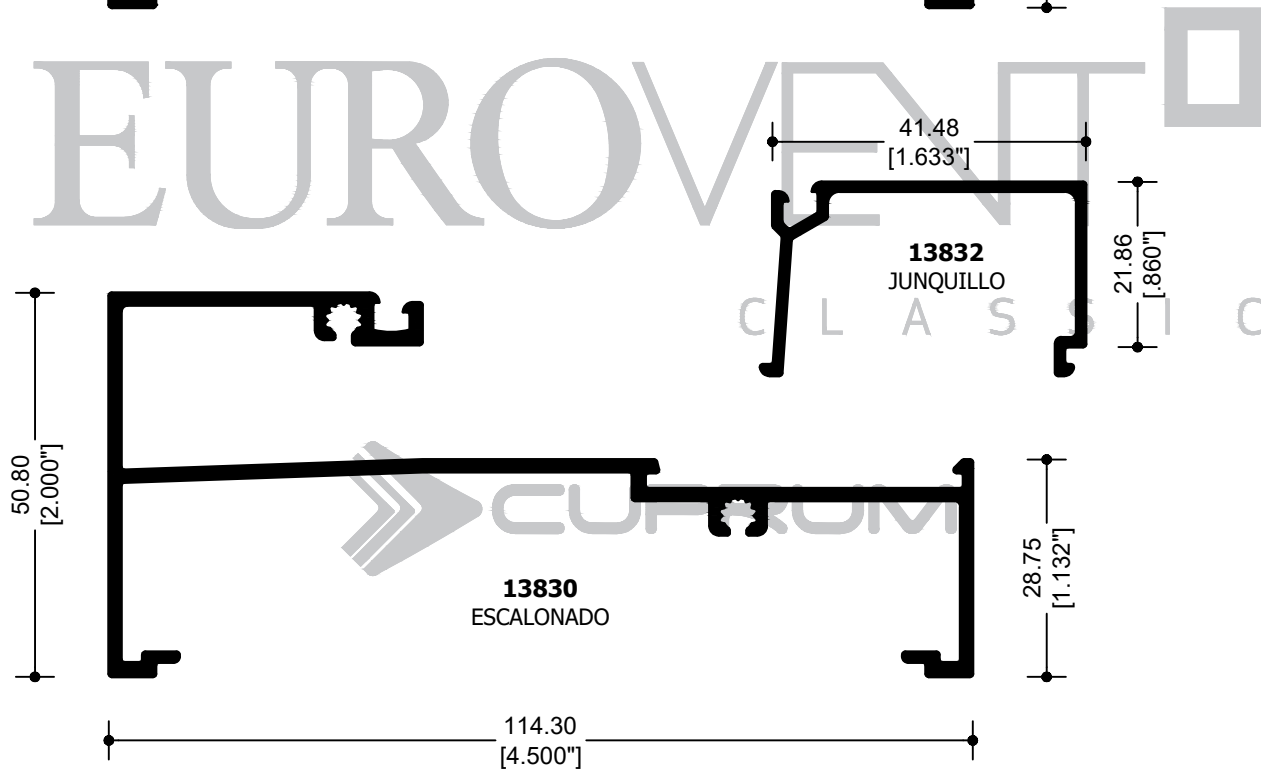
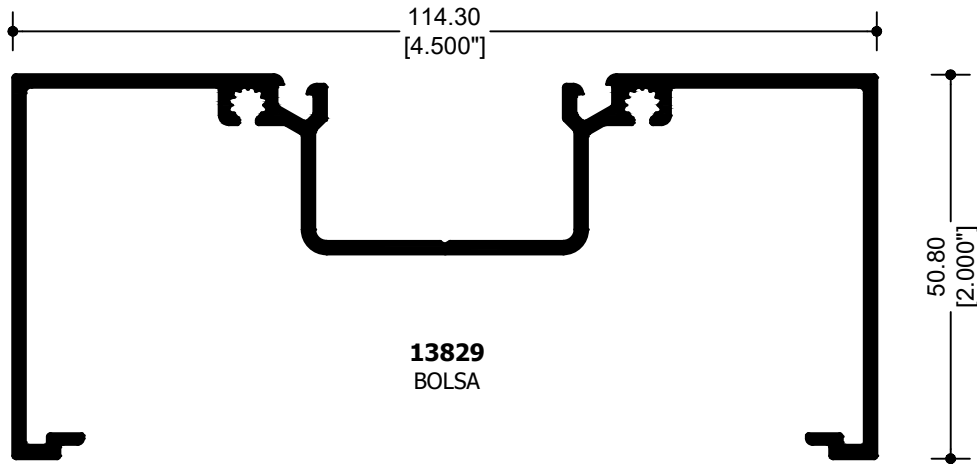

EUROVENT[®]
CLASSIC
SERIE
S140
FIJO

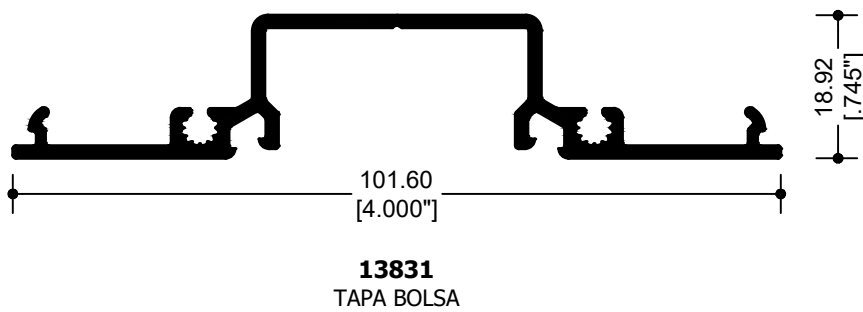

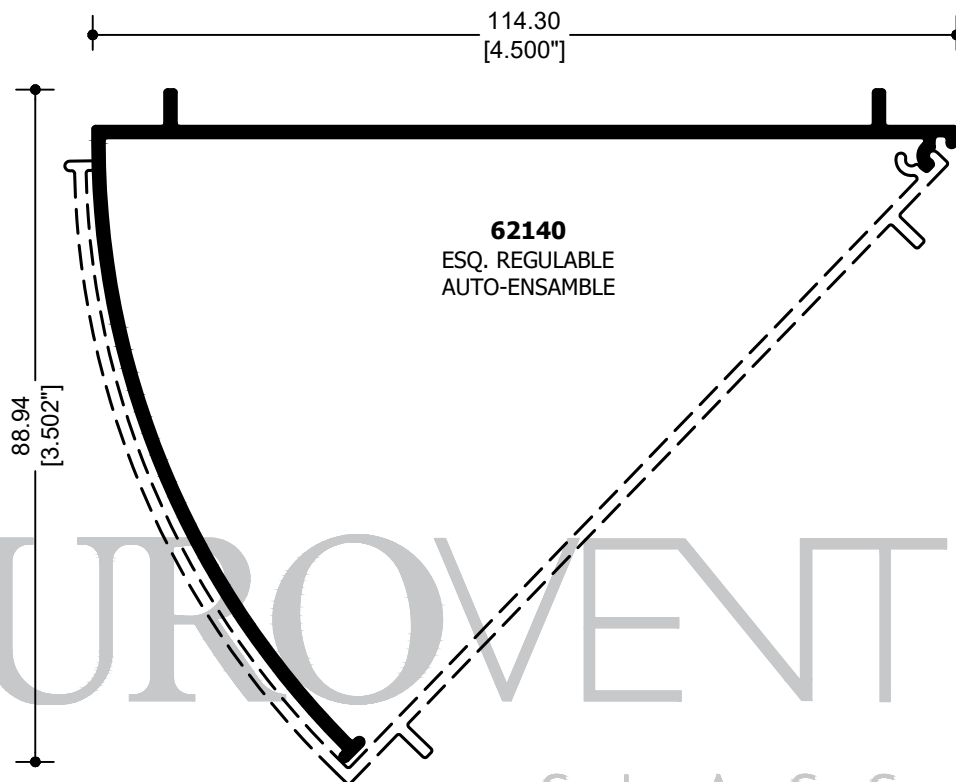

CLASSIC
SERIE
S140
FIJO

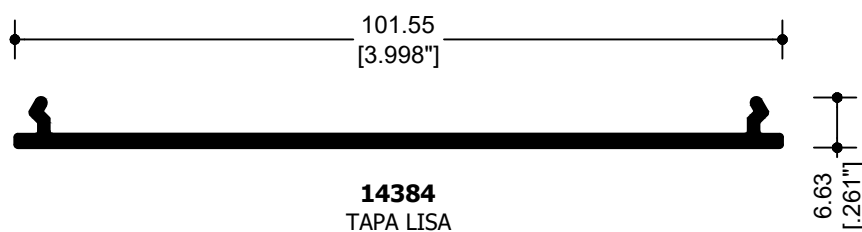
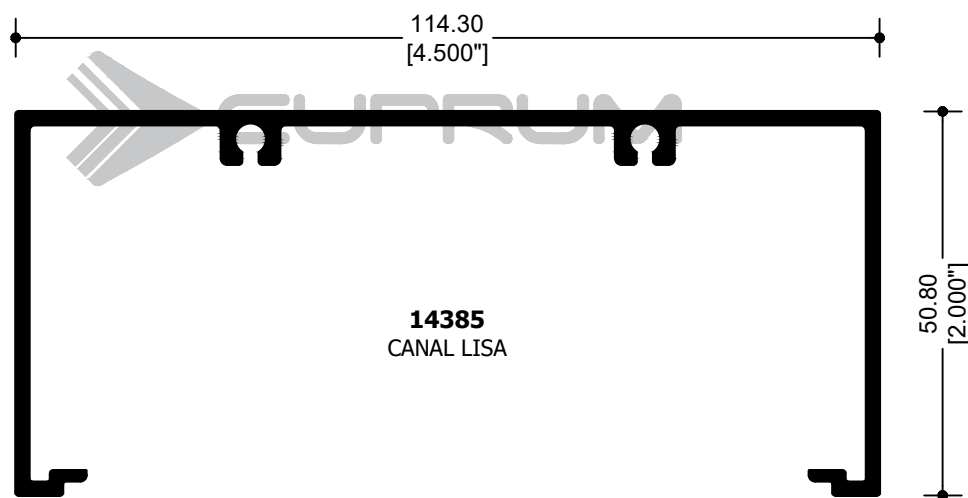

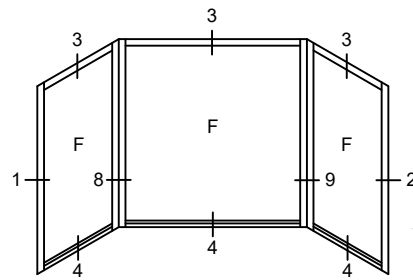
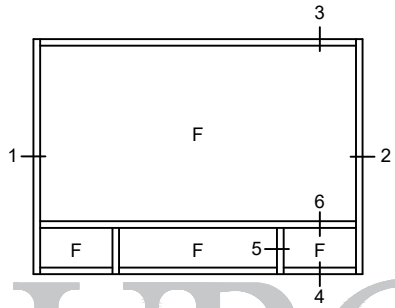
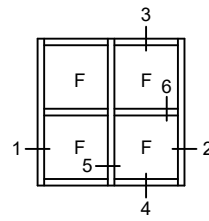
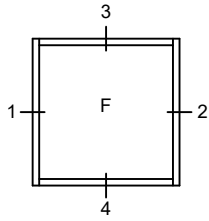

ELEVACIONES TIPO

SIN ESCALA

EUROVENT

C L A S S I C

EXTERIOR

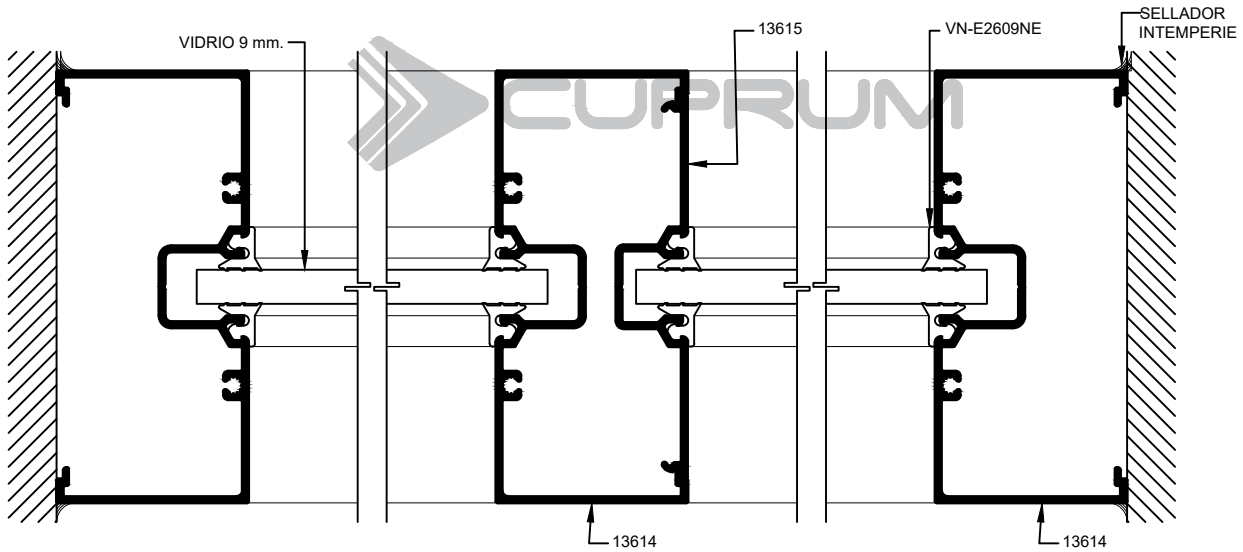

INTERIOR

SECCIÓN 1

SECCIÓN 5

SECCIÓN 2

 CLASSIC
 SERIE
S140

 FIJO



 CLASSIC
 SERIE
S140

 FIJO

SECCIÓN 3

SECCIÓN 6

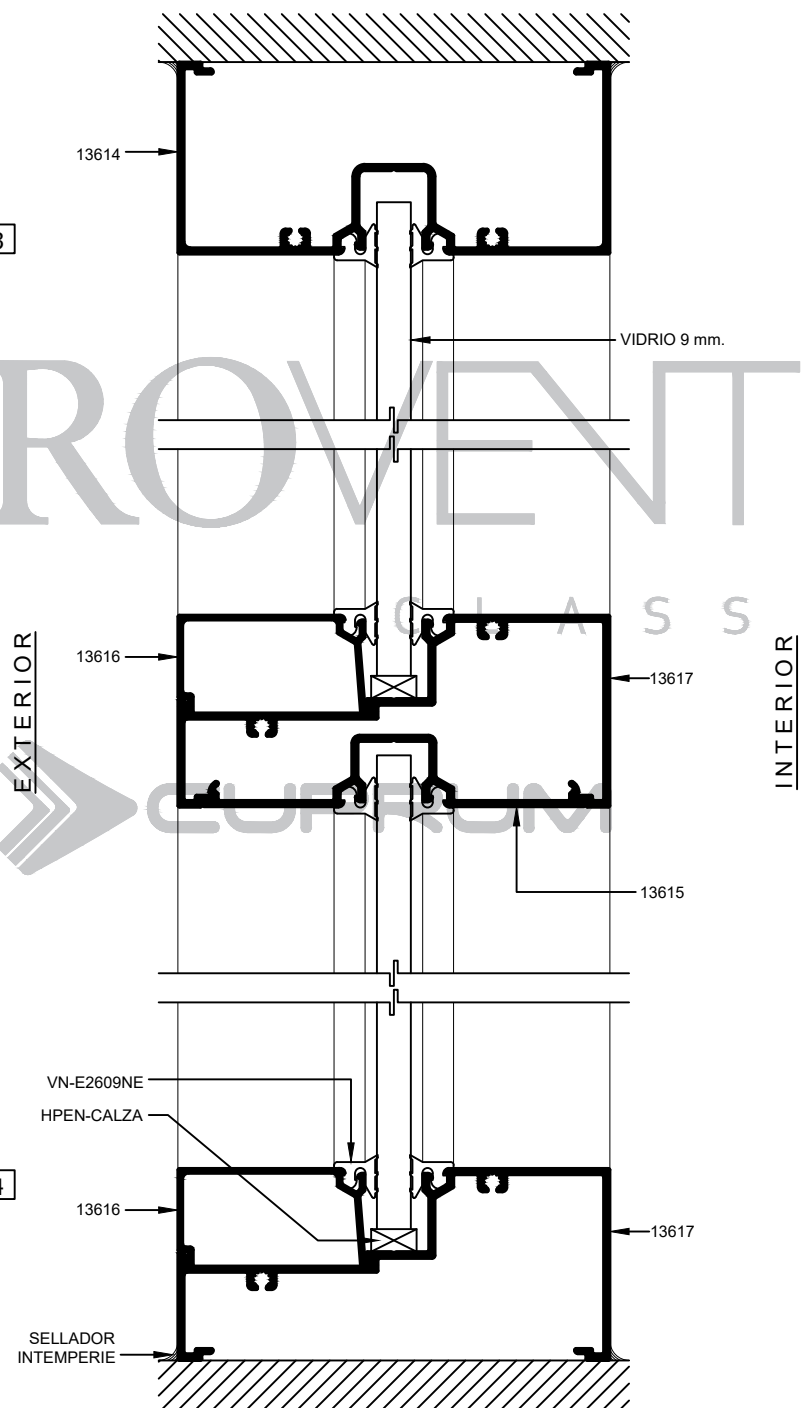
SECCIÓN 4



EXTERIOR

SECCIÓN 9

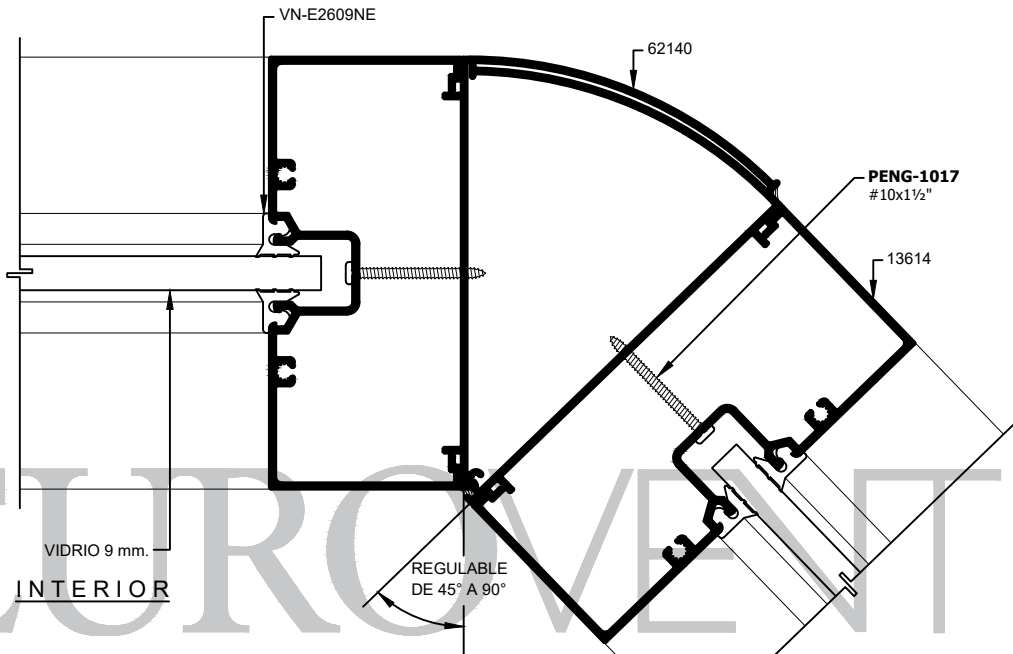

INTERIOR

EXTERIOR

SECCIÓN 8

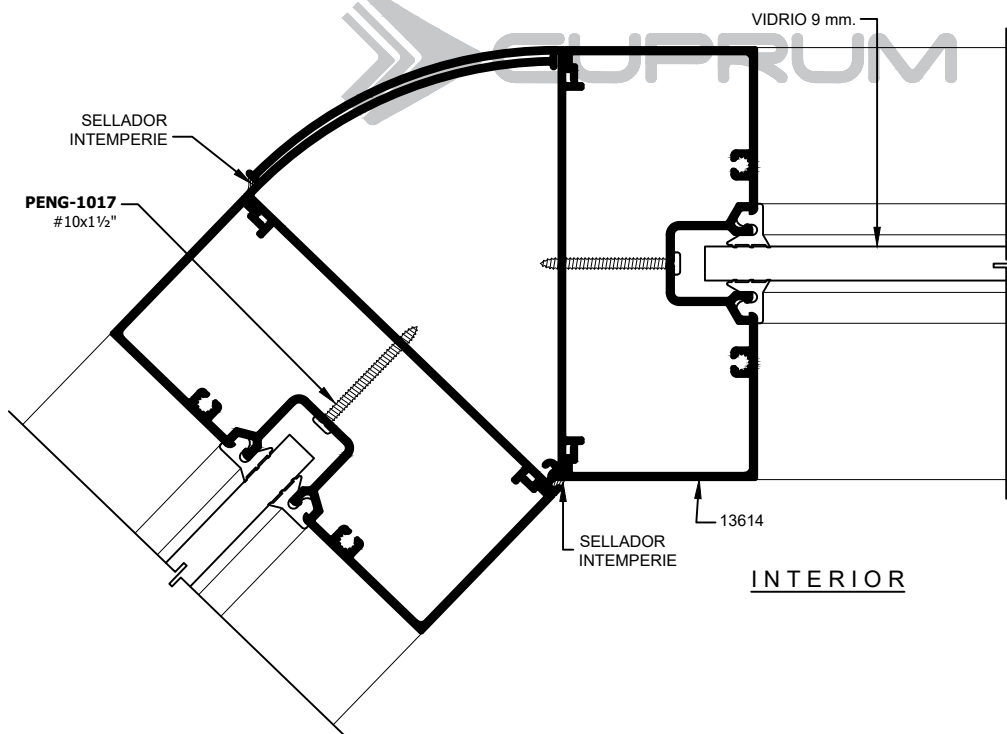

INTERIOR



CLASSIC

SERIE

S140



FIJO

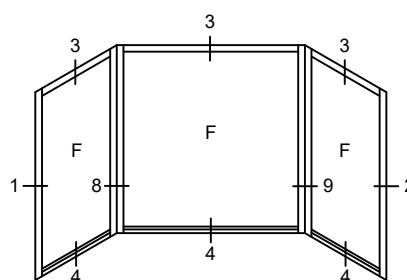
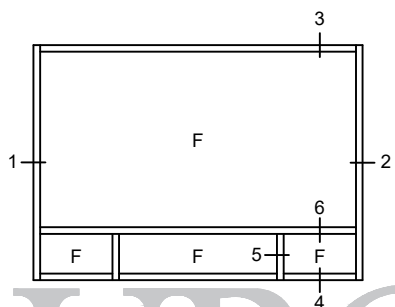
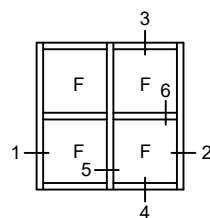
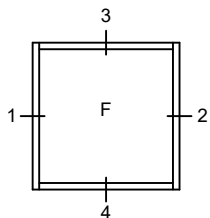

ELEVACIONES TIPO

SIN ESCALA

CLASSIC
SERIE

S140

FIJO

EXTERIOR

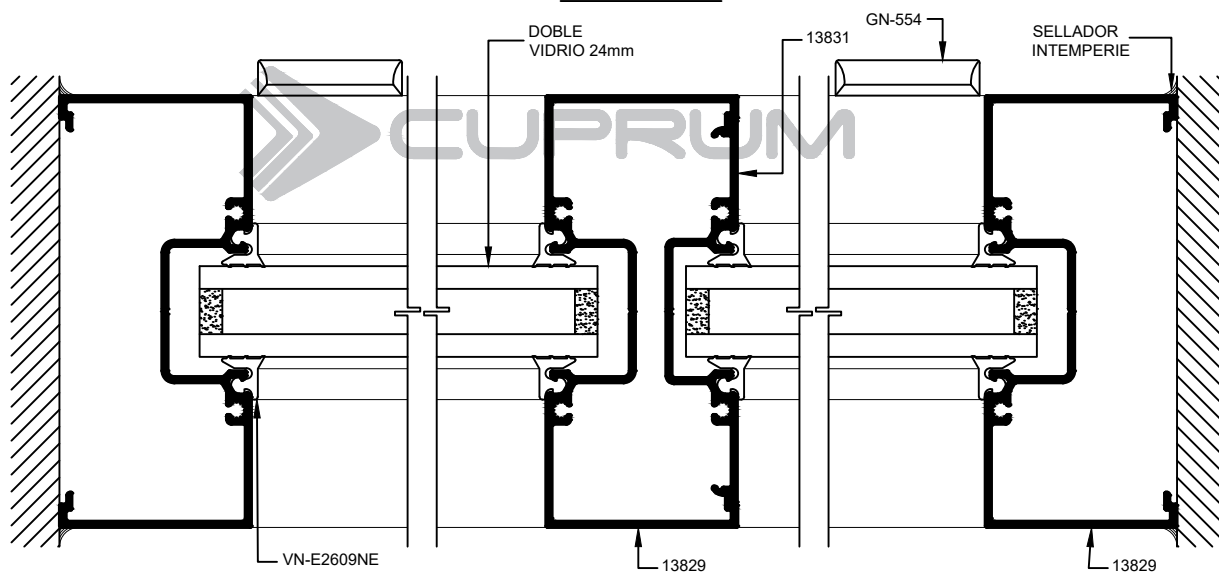

INTERIOR

SECCIÓN 1

SECCIÓN 5

SECCIÓN 2

PERFILES PARA DOBLE VIDRIO DE 24mm.

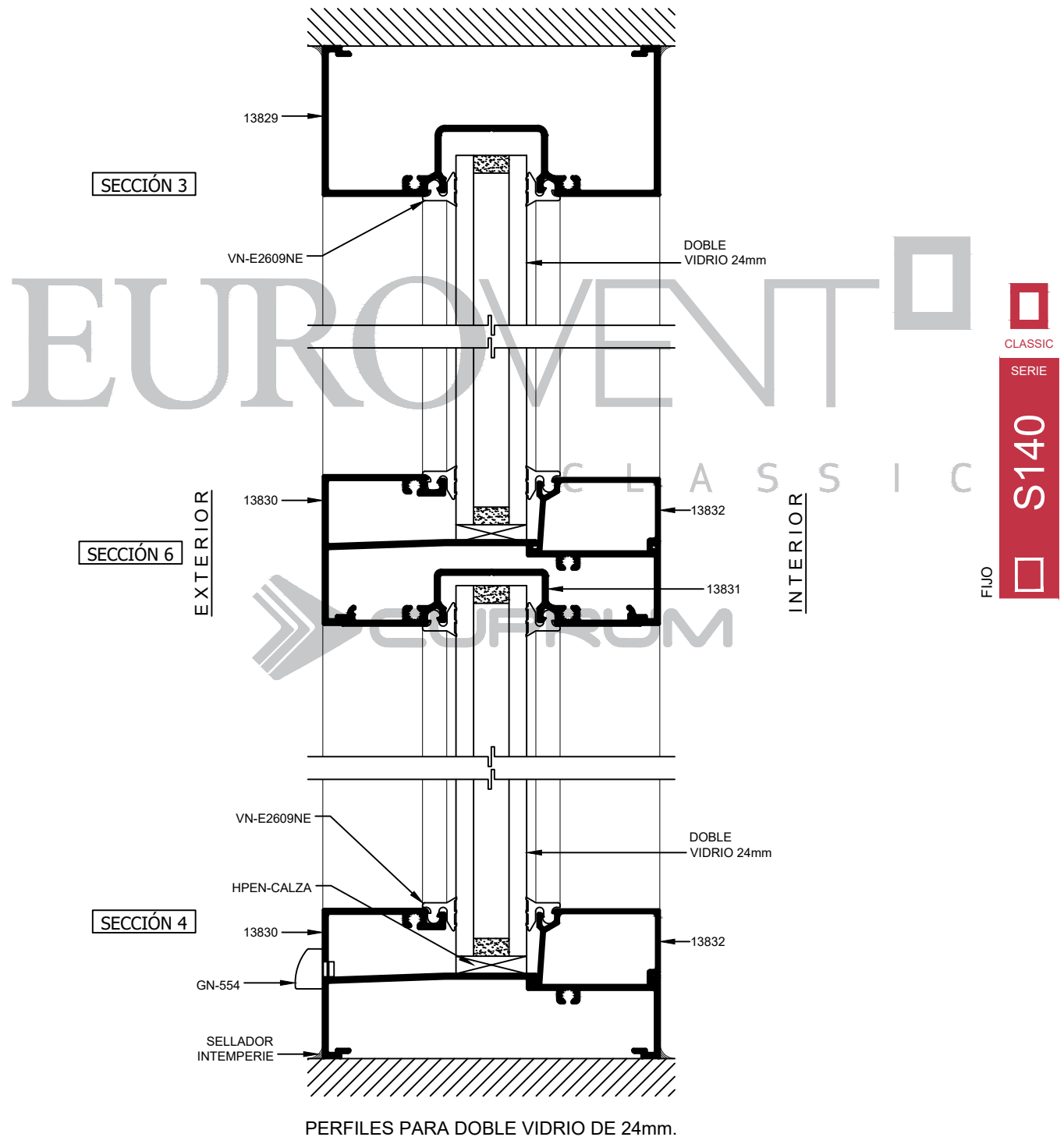

CLASSIC
SERIE
S140
FIJO

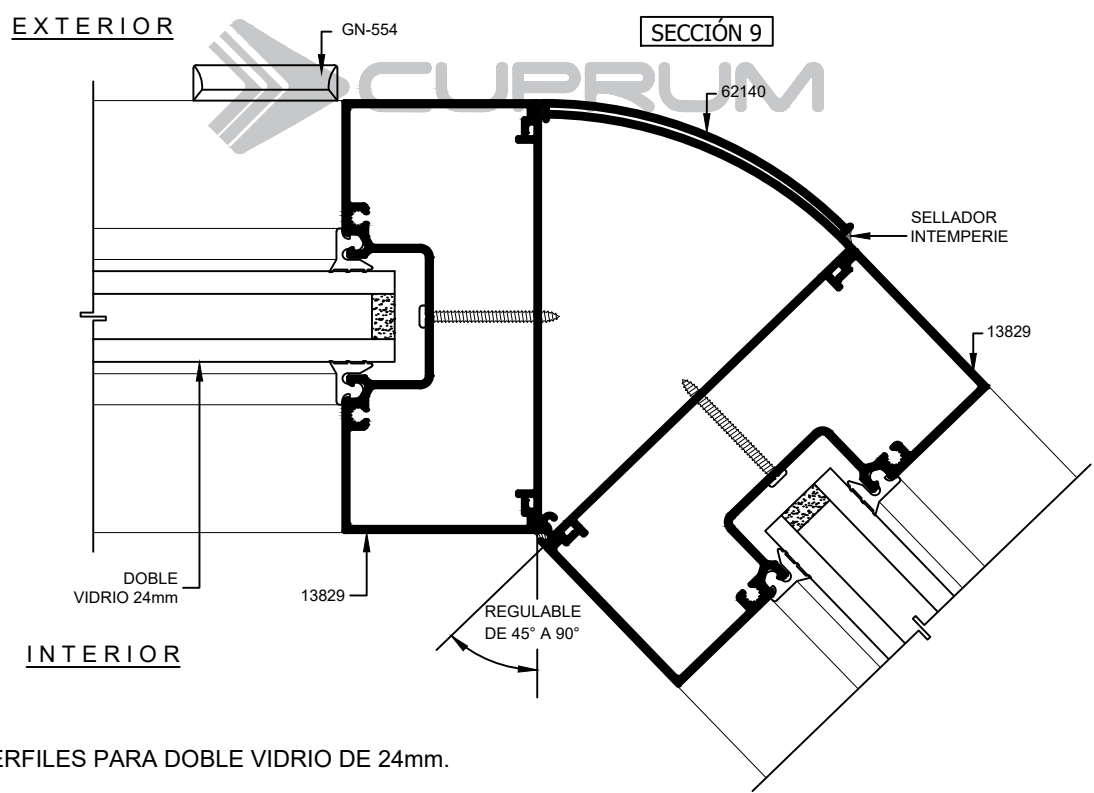
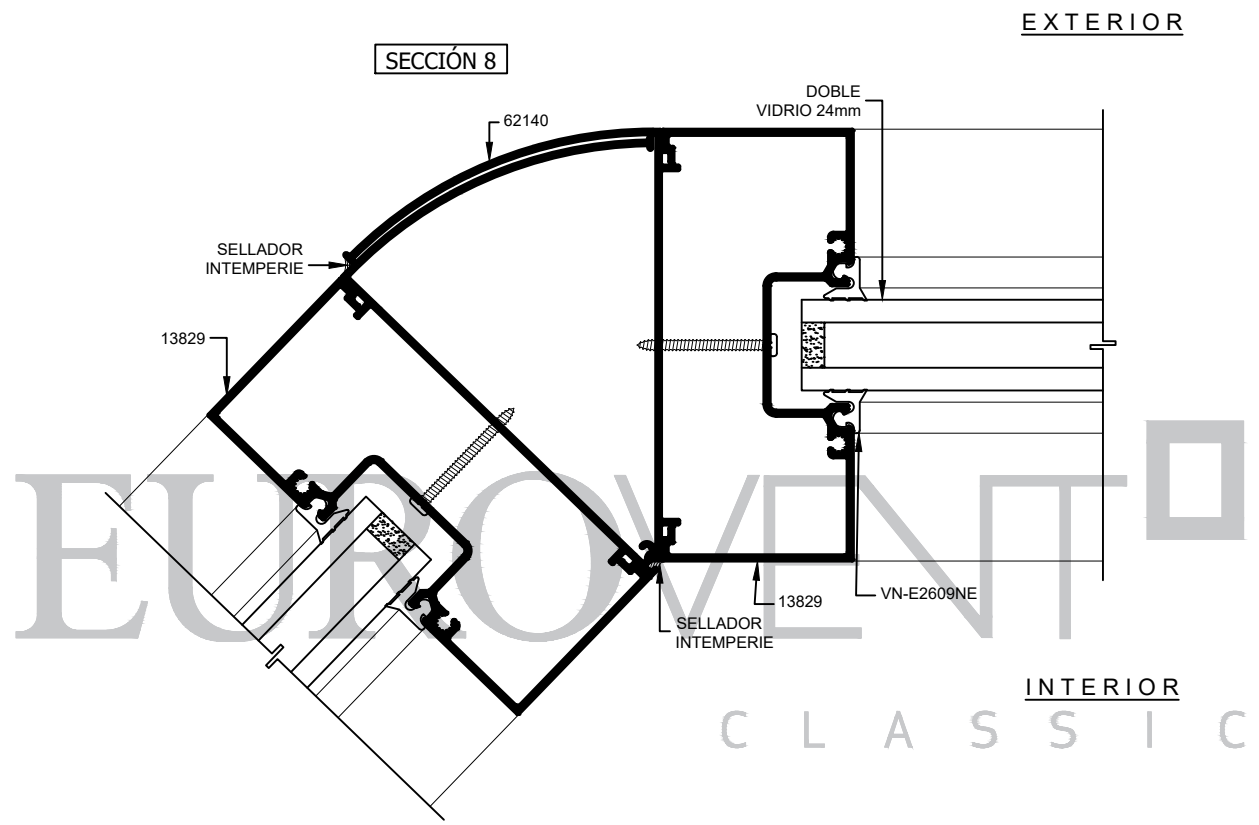

PERFILES PARA DOBLE VIDRIO DE 24mm.

OPERACIÓN MANUAL
DREN PARA DESAGÜE

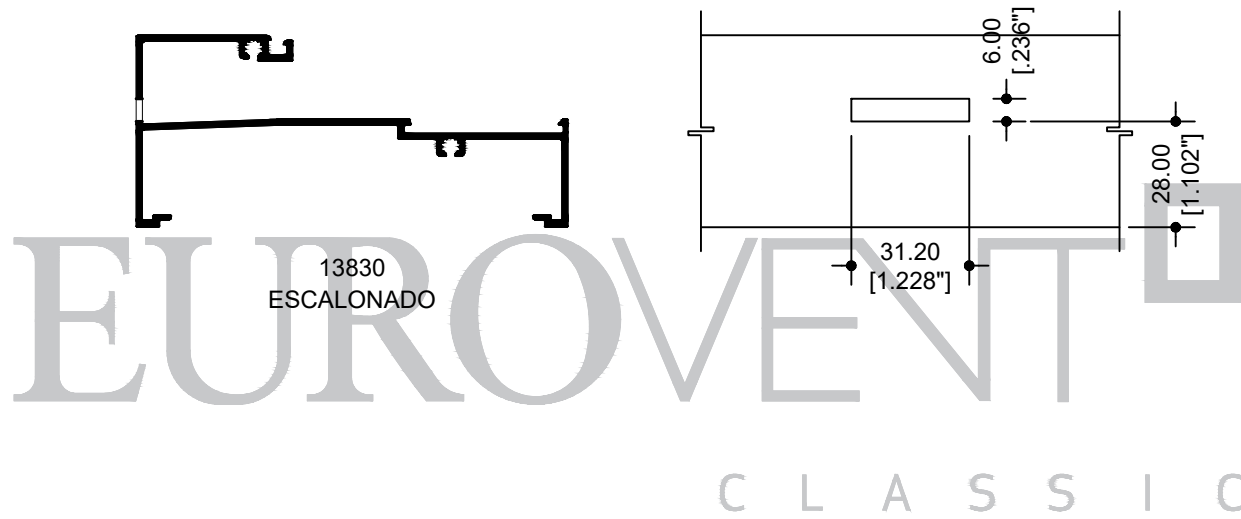

CLASSIC
SERIE
S140
FIJO

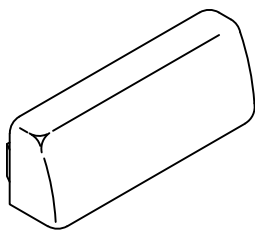

GN-554
TAPA DREN

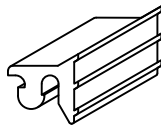

VN-E2609NE
EMPAQUE EZ

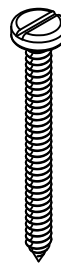

PENG-1017
#10x1½"

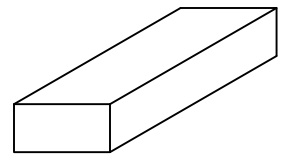

HPEN-CALZA
CALZA DE 1/4" x 3/8" x 4"

CLASSIC
SERIE
S140

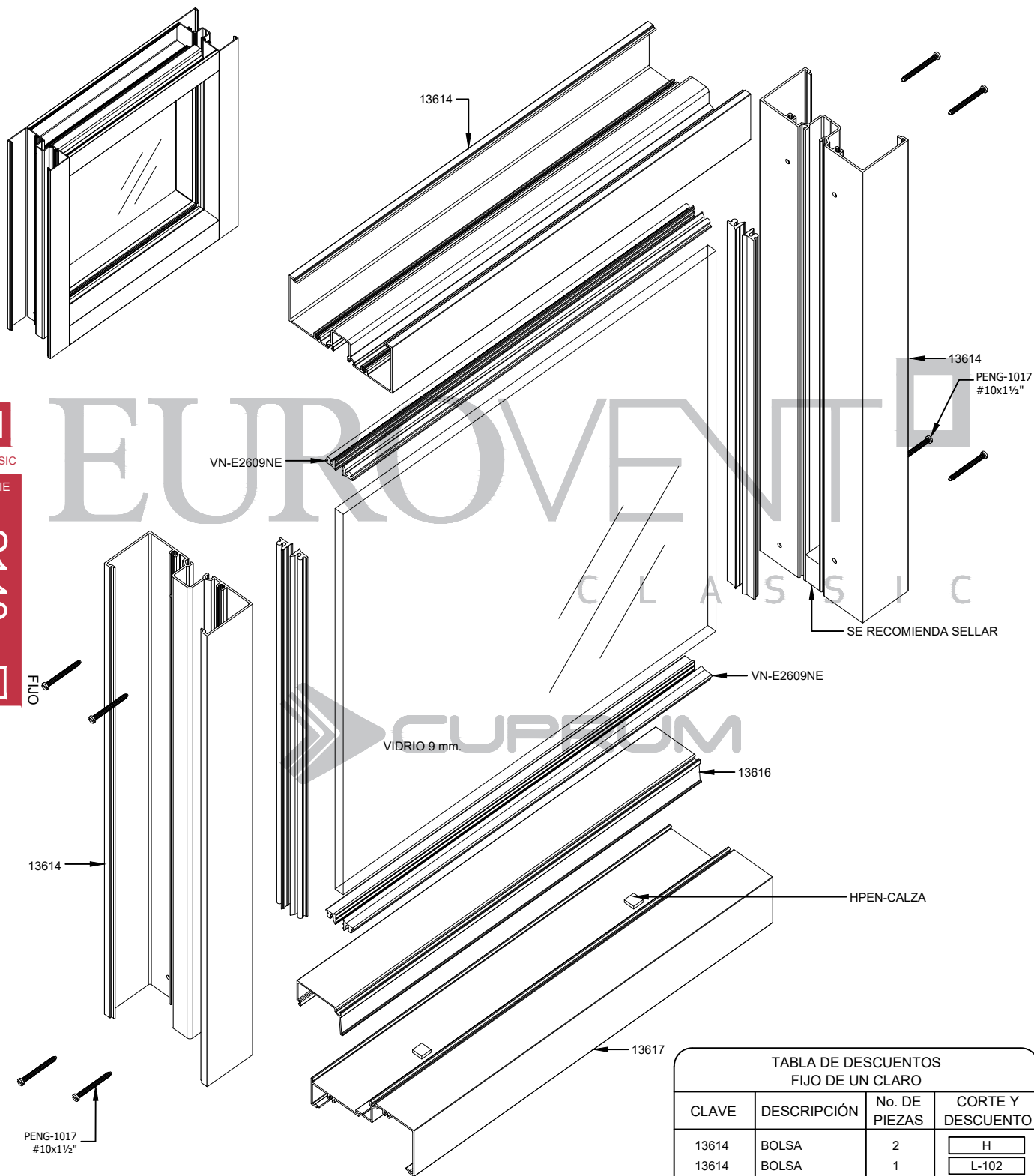

CLAVE
SERIE
S140
CLAVE

TABLA DE DESCUENTOS FIJO DE UN CLARO			
CLAVE	DESCRIPCIÓN	No. DE PIEZAS	CORTE Y DESCUENTO
13614	BOLSA	2	H
13614	BOLSA	1	L-102
13617	ESCALONADO	1	L-102
13616	JUNQUILLO	1	L-102
VIDRIO	L	1	L-83
	H		H-83

L= ANCHO DE VENTANA DESCUENTOS EN MM.
 H= ALTO DE VENTANA

FIJO SERIE 140
A UNA ALTURA DE 15 METROS

DEFLECCIÓN MAX. L/175

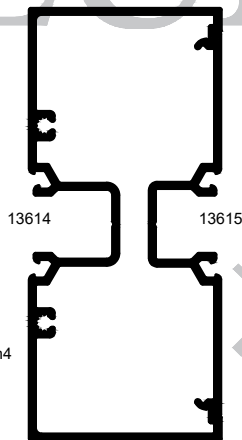
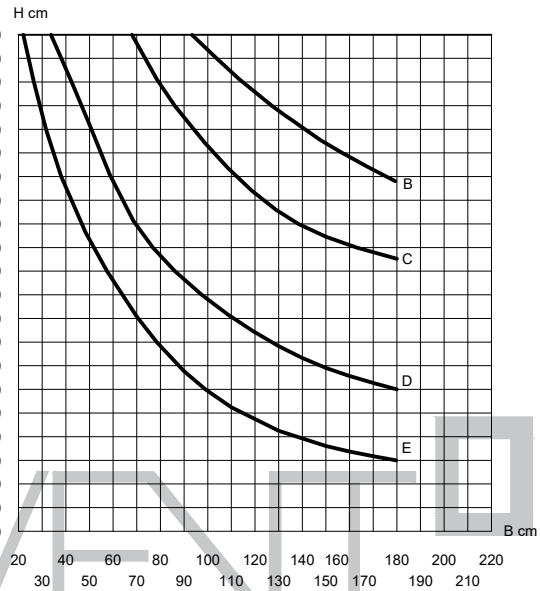
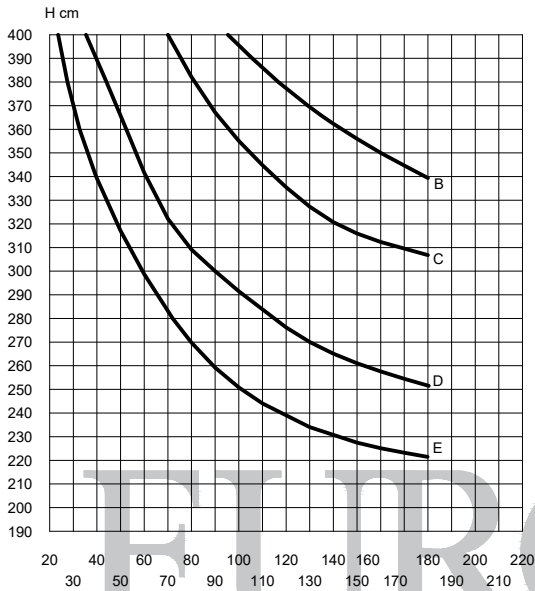

ALEACIÓN: 6063
TEMPLE: 5

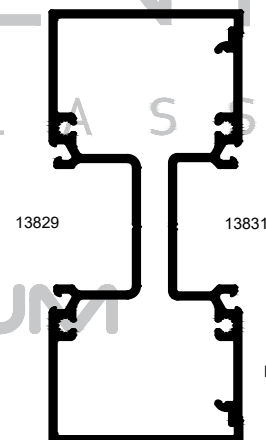

LOS LÍMITES DE FABRICACIÓN
PARA LOS PERFILES, SERÁN
LOS QUE SE ENCUENTREN DEBAJO
DE LAS CURVAS GRAFICADAS.



Valores de presión por velocidad de viento

Curvas	Presión del diseño	Velocidad de viento	Zona
A	45 Kg/m ²	80 Km/h	Centro de grandes ciudades
B	50Kg/m ²	90 Km/h	Barrios Residenciales
C	65 Kg/m ²	120 Km/h	Campo Abierto
D	145 Kg/m ²	160 Km/h	Zona Costera
E	195 Kg/m ²	180 Km/h	Zona de Huracanes

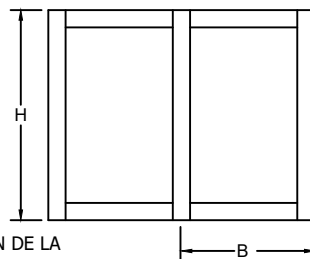

LOS LÍMITES DE UN CANCEL VAN EN FUNCIÓN DE LA
COMBINACIÓN DE RESISTENCIA DEL PERFIL DE ALUMINIO,
EL VIDRIO Y LOS ACCESORIOS QUE LO INTEGRAN.

VERIFICAR QUE LA DEFLECCIÓN DEL PERFIL SEA
COMPATIBLE CON EL VIDRIO UTILIZADO.

PARÁMETROS MÍNIMOS Y MÁXIMOS DE FABRICACIÓN

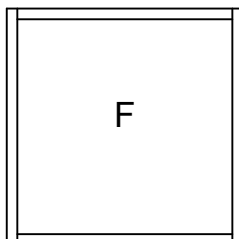

F-140
MÍNIMO 0.60 x 0.60

MÁXIMO 6m² CON VIDRIO RECOCIDO DE 9 mm. SIN INTERMEDIOS,
PARA OTROS ESPESORES VER CON EL FABRICANTE,
CON INTERMEDIOS VER GRÁFICA.

CLASSIC
SERIE

S140

FIJO

ALUMINIO					
CLAVE	DESCRIPCIÓN	PIEZAS X ATADO	LARGO STD. MTS.	PERÍMETRO ANOD. CM.	PERÍMETRO PUL. CM.
13614	BOLSA	3	6.10	61.60	25.20
13615	TAPA BOLSA	6	6.10	32.22	7.14
13616	JUNQUILLO	12	6.10	21.40	6.44
13617	ESCALONADO	3	6.10	52.72	12.20
13829	BOLSA	3	6.10	60.00	17.50
13830	ESCALONADO	4	6.10	55.58	12.65
13831	TAPA BOLSA	6	6.10	34.44	9.53
13832	JUNQUILLO	16	6.10	19.80	5.57
14384	TAPA LISA	8	6.10	22.66	10.16
14385	CANAL LISA	4	6.10	50.20	22.81
62140	ESQ. REGULABLE	5	6.10	44.51	10.07

EUROVENT

C L A S S I C



CORREDIZA SERIE 50
CORREDIZA SERIE 60
CORREDIZA SERIE 70

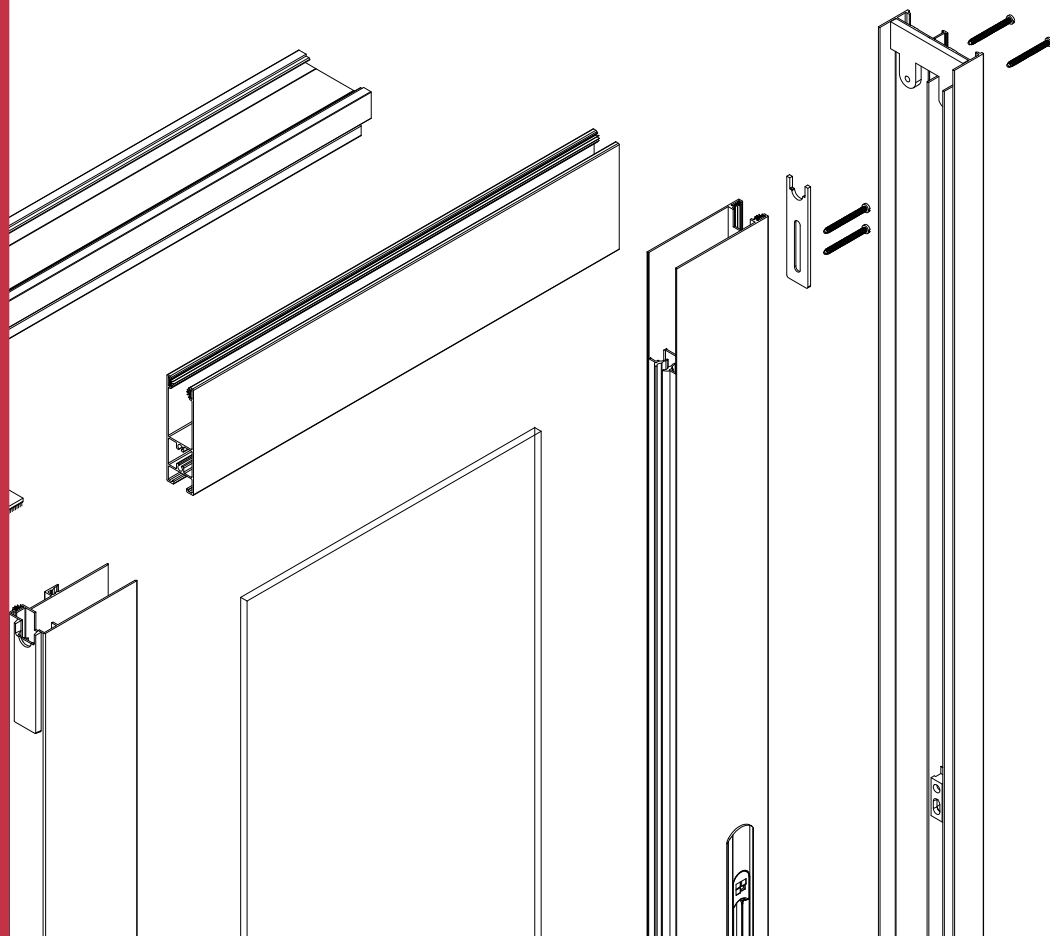

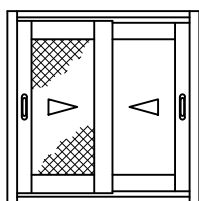

X X

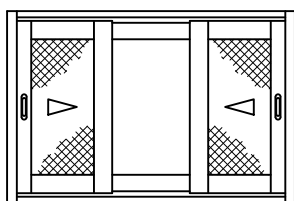

X O X

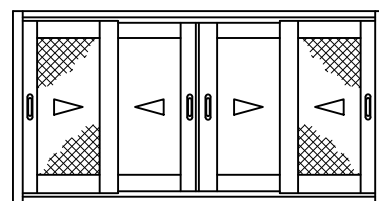

X X X X



CLASSIC

SERIE

S50



CORREDIZA

EUROVENT

CLASSIC

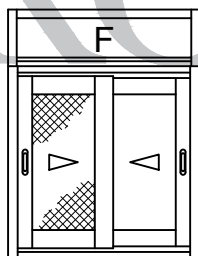

X X

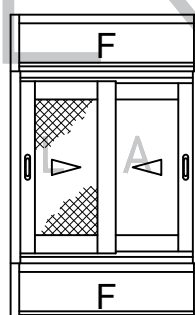

X X



CUPRUM

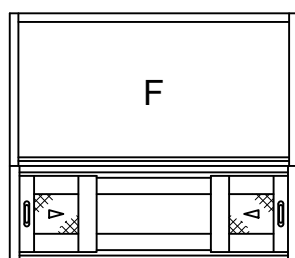
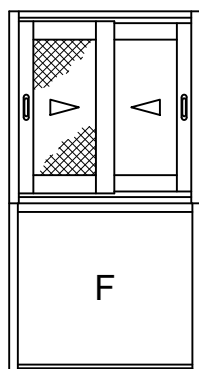

X O X

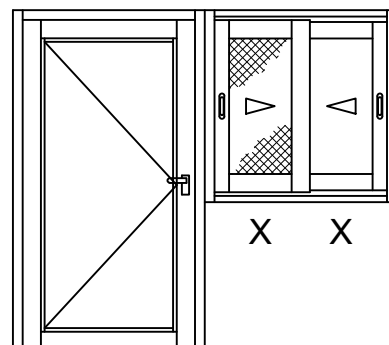

X X

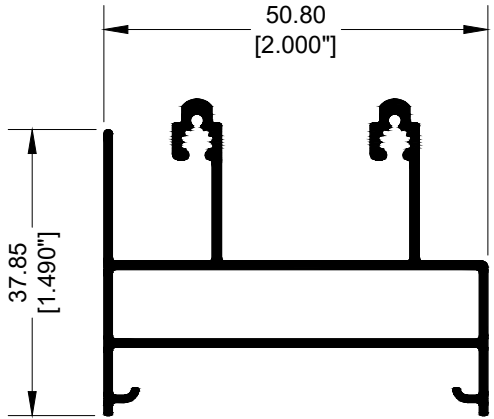

68842
RIEL CABEZAL

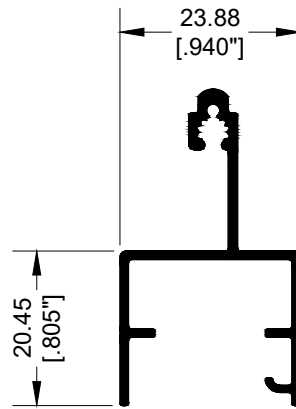

68846
EXTENSION
RIEL

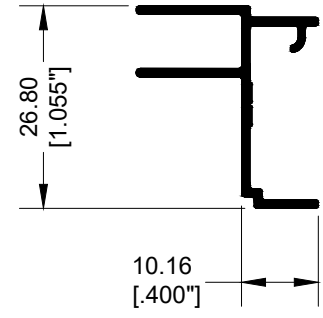

68847
EXTENSION
JAMBA

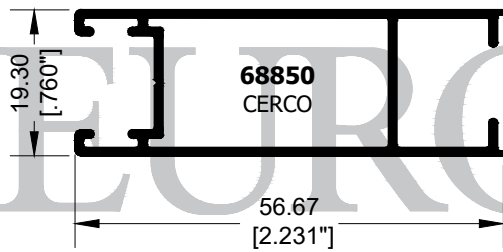

68850
CERCO

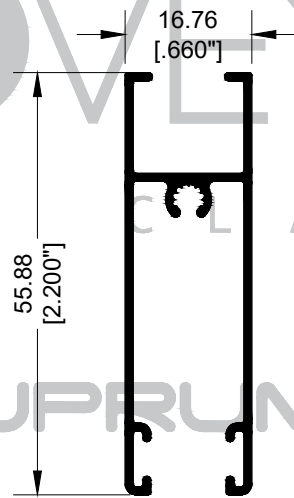

68843
ZOCLO

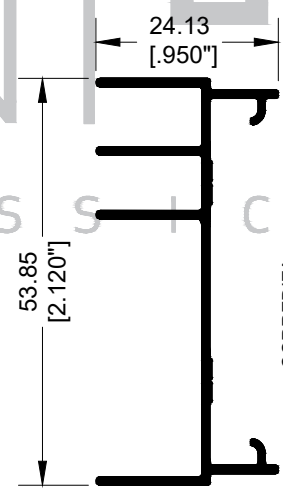

68844
JAMBA

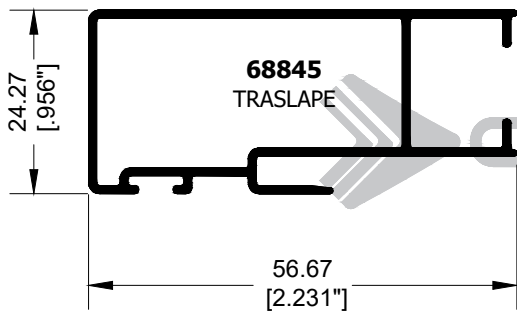

68845
TRASLAPE

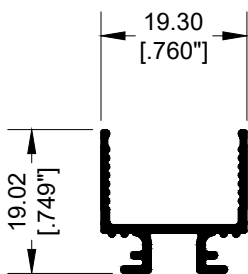

69356
ADAPTADOR
DOBLE VIDRIO

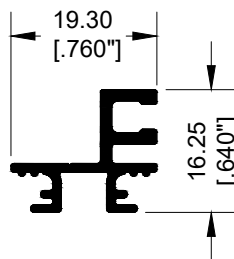

69368
ADAPTADOR
MOSQUITERO

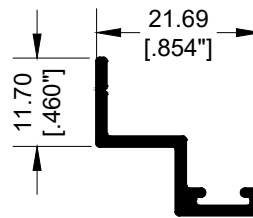

50701
ADAPTADOR
OXXO

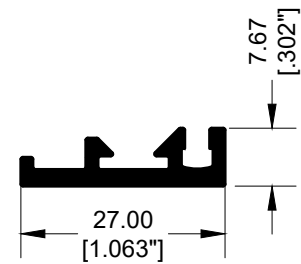

5173
MOSQUITERO



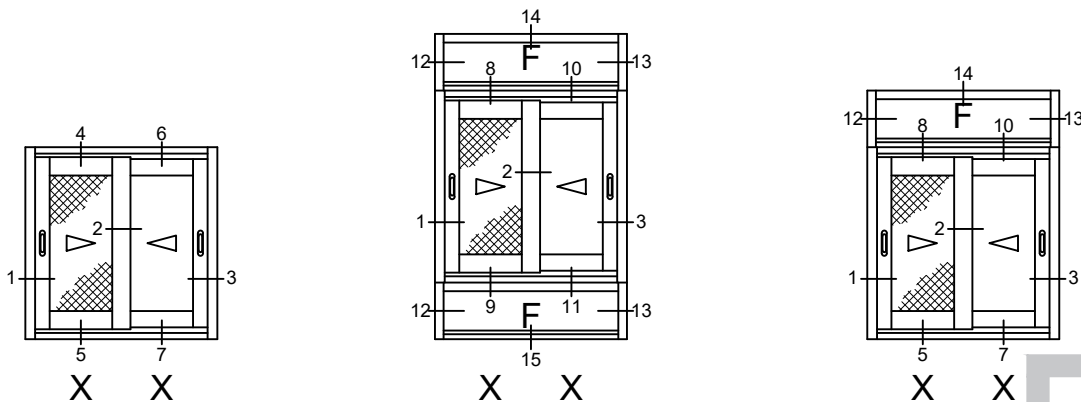

CLASSIC
SERIE

S50



CORREDIZA

EUROVENT[®]

C L A S S I C

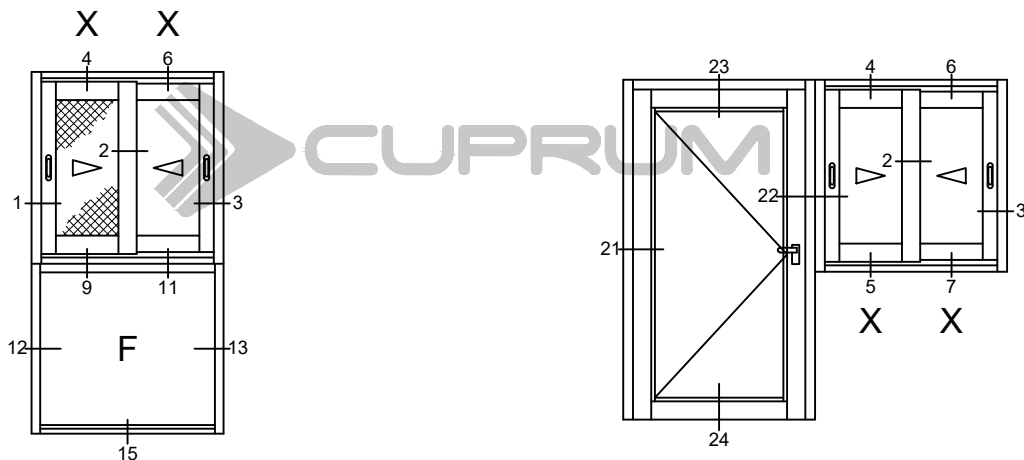

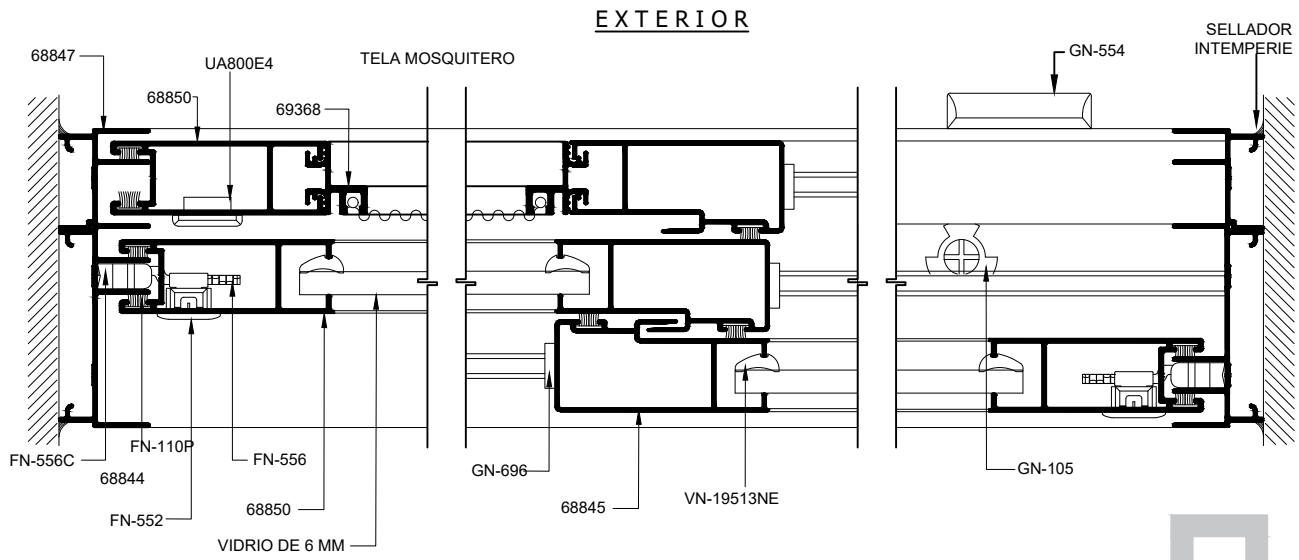

EUROVENT

SECCIÓN 1

SECCIÓN 2

SECCIÓN 3

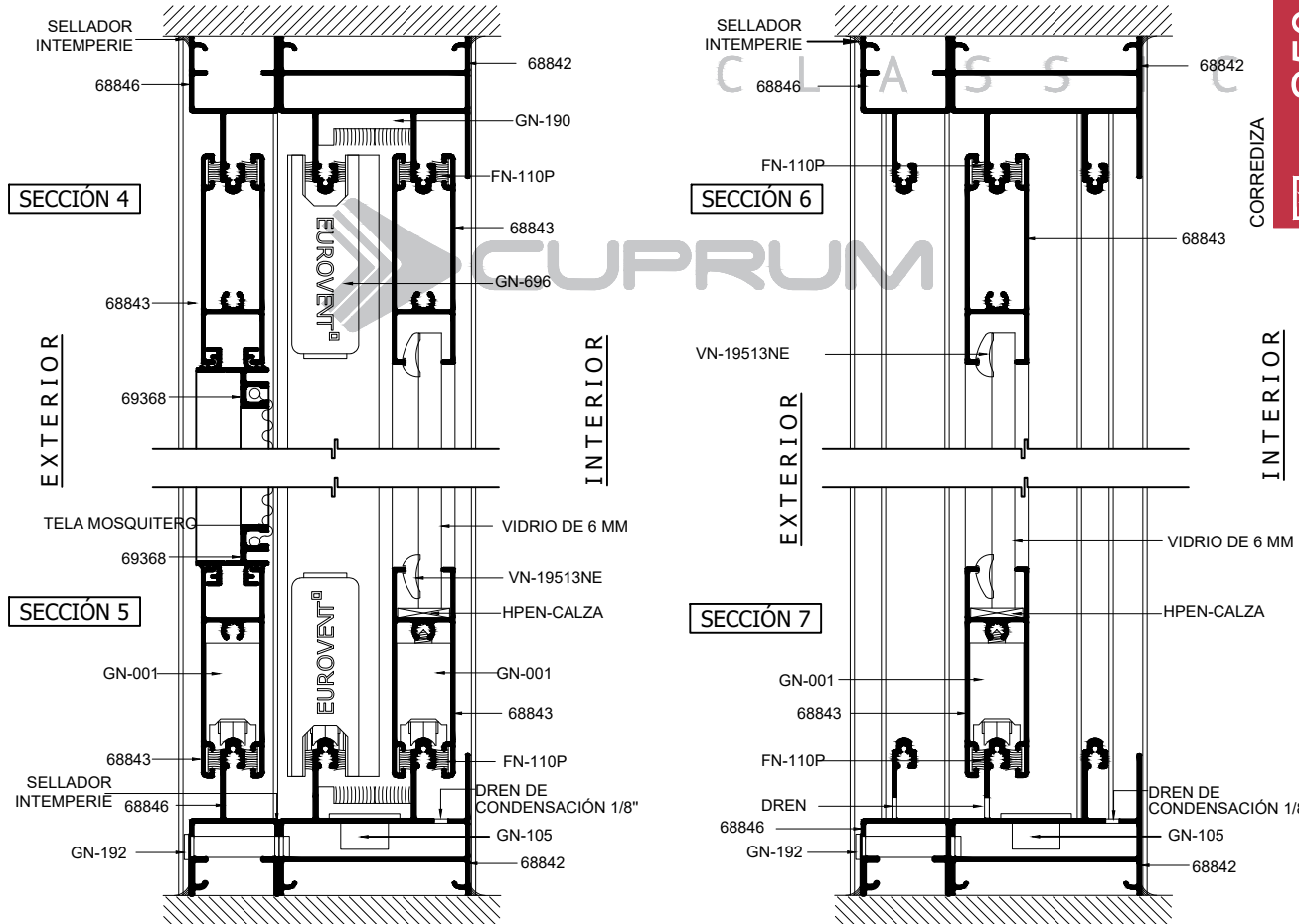

CLASSIC
SERIE
S50
CORREDIZA

CLASSIC
SERIE
S50

CORREDIZA

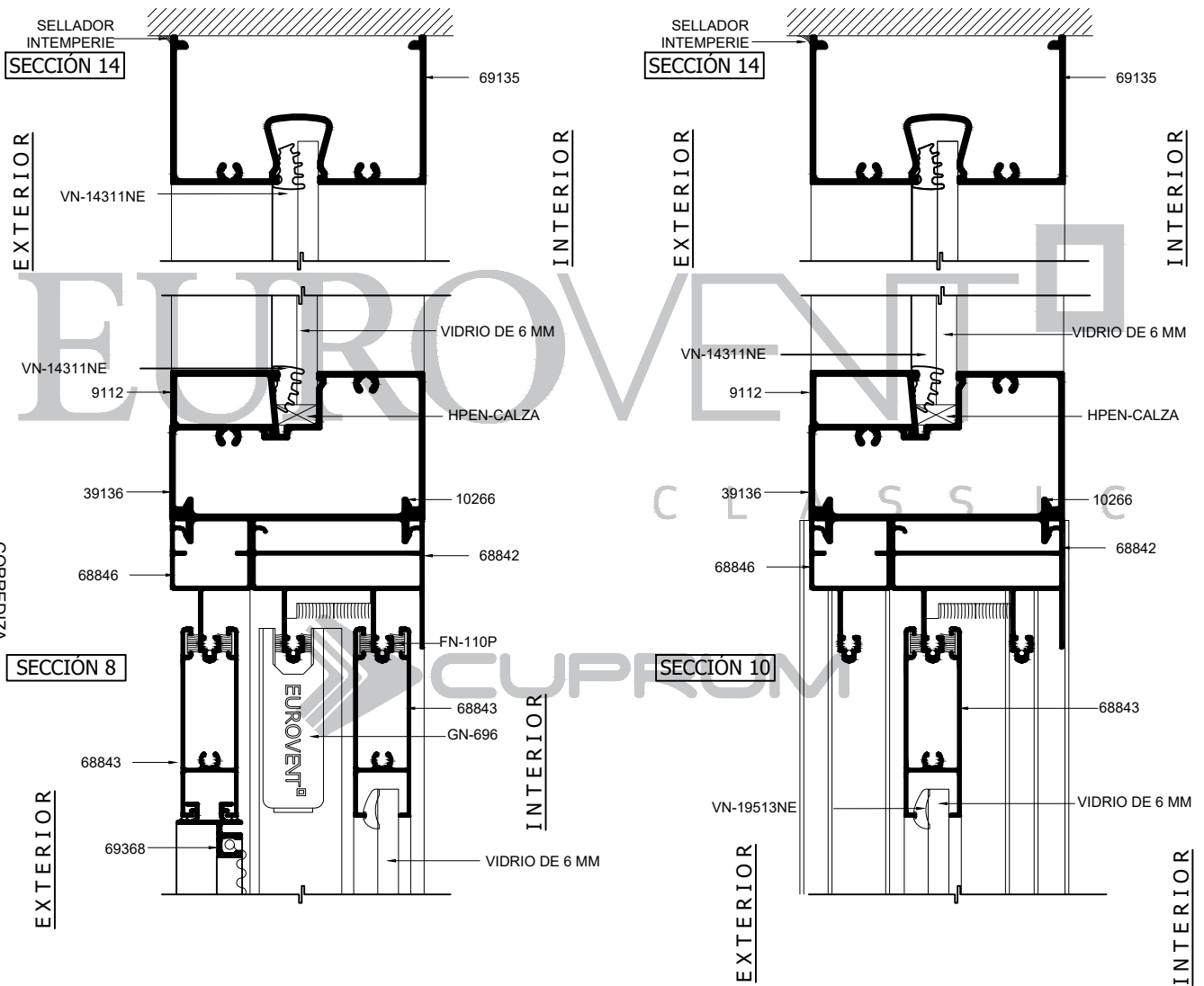

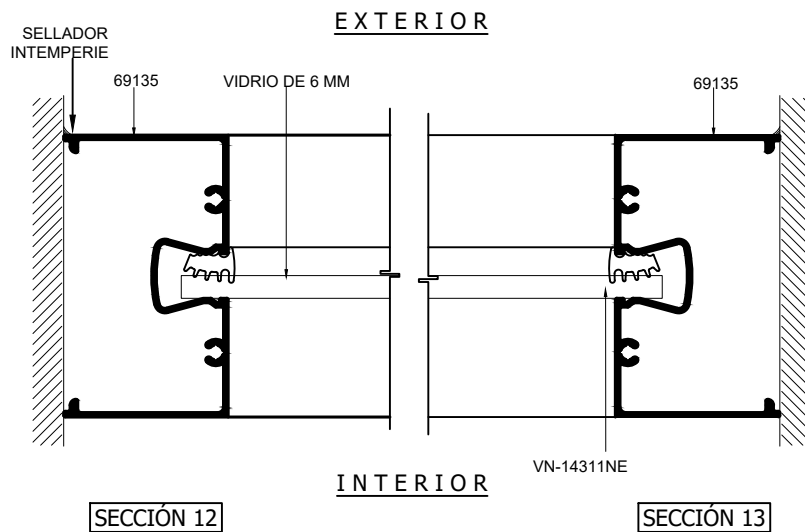
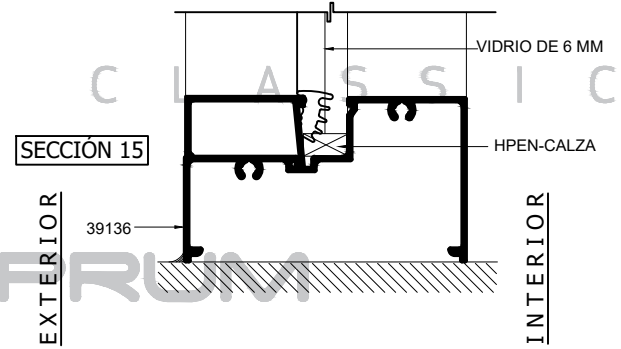
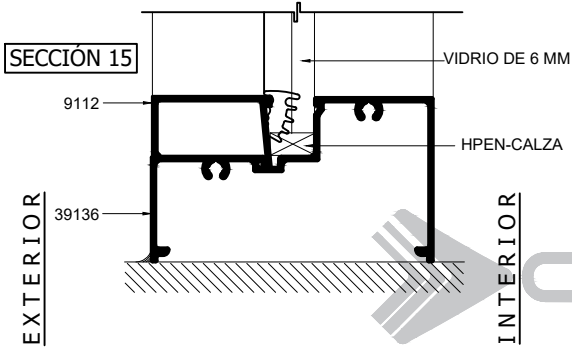
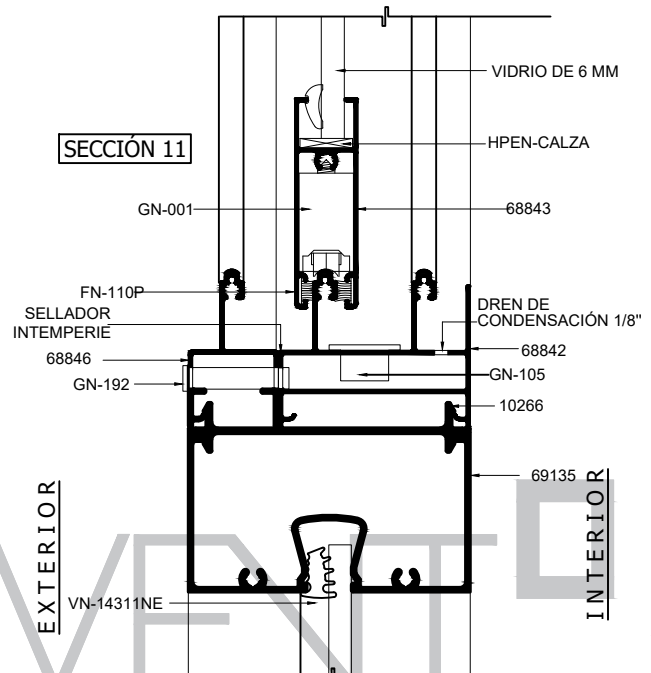
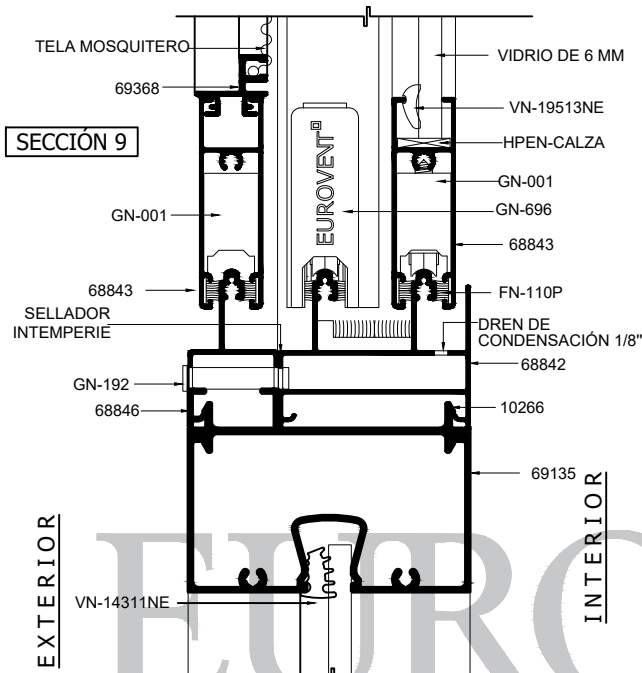

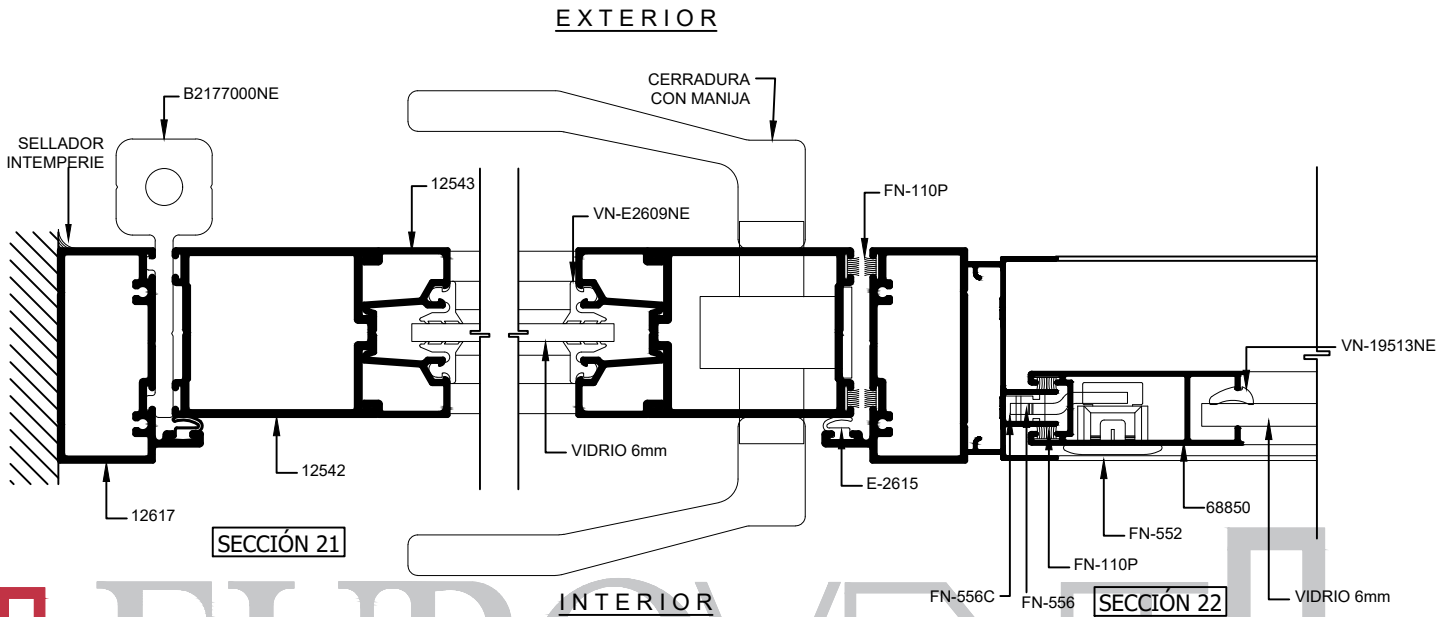

 CLASSIC
 SERIE
S50
 CORREDIZA

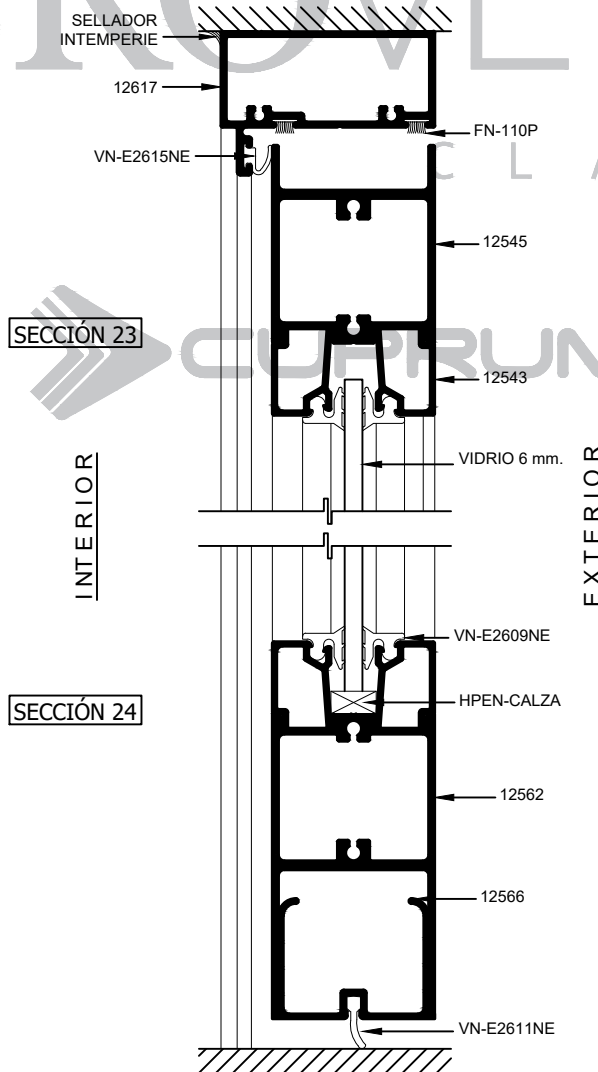

CLASSIC
SERIE
S50
CORREDIZA

EUROVENT
CLASSIC

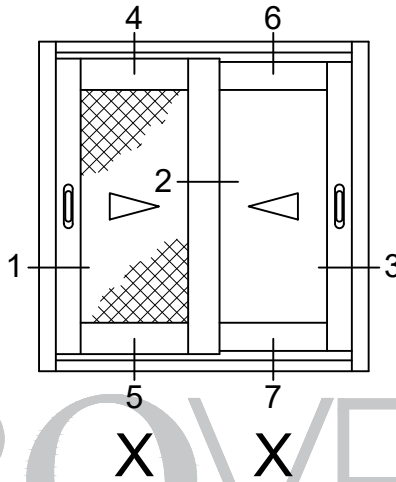



EUROVENT[®]
CLASSIC
SERIE
S50
C L A S S I C

CORREDIZA
CLASSIC
SERIE
S50

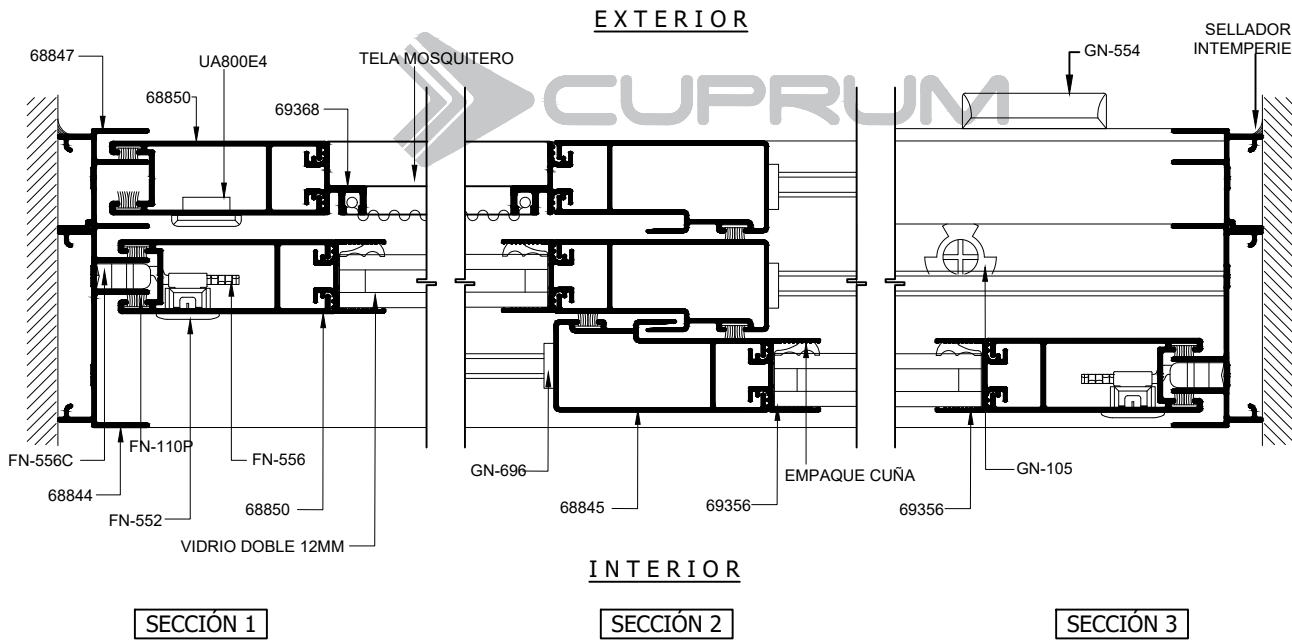

CLASSIC
SERIE
S50
CORREDIZA

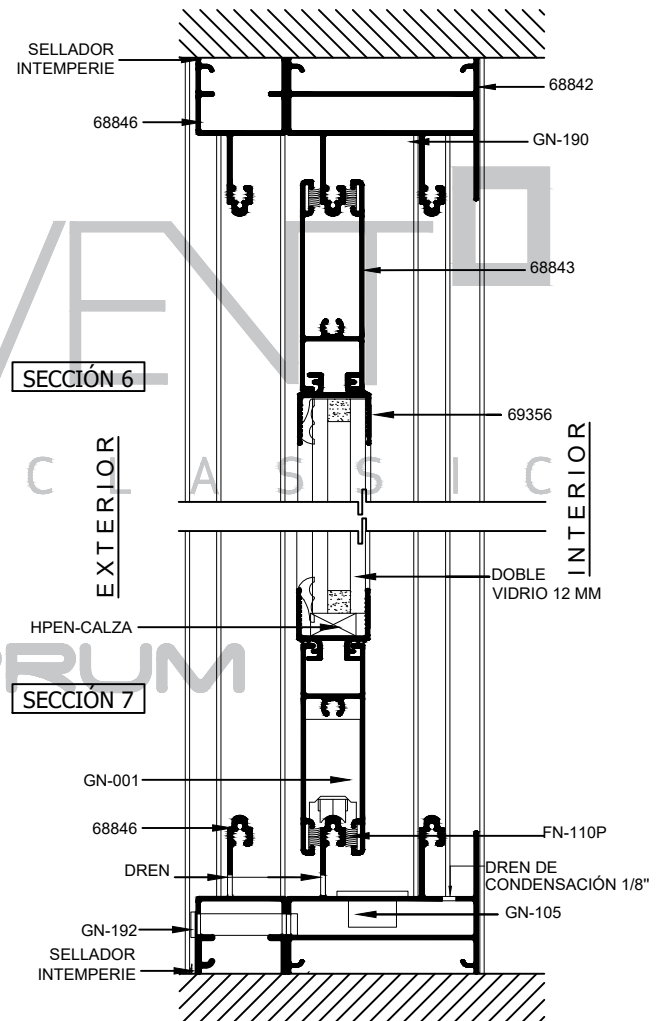
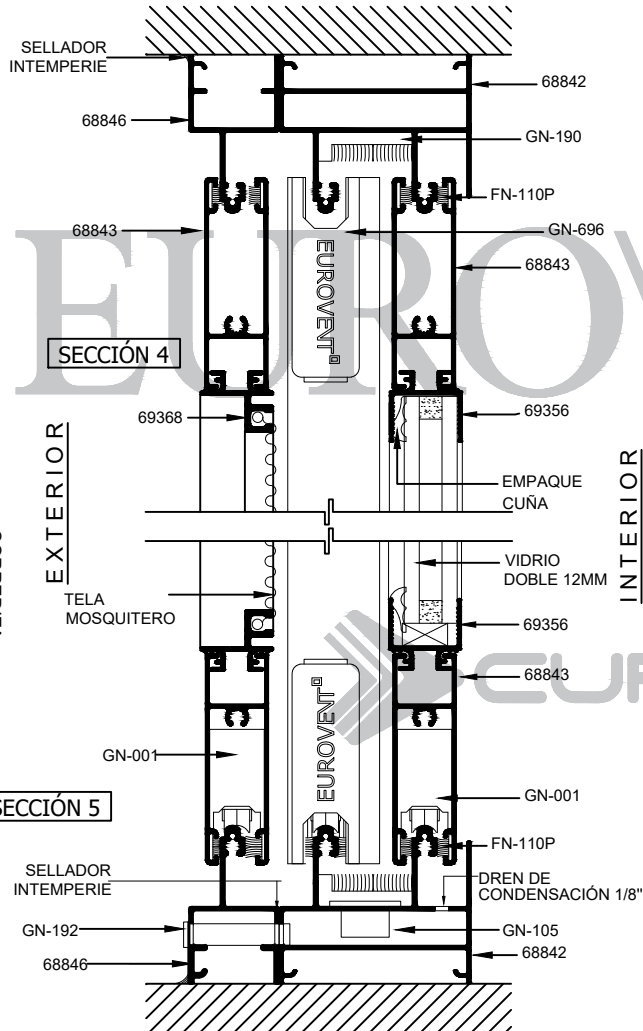

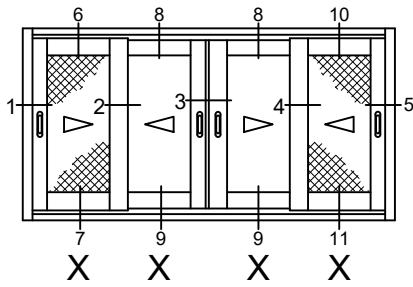

ELEVACIONES TIPO

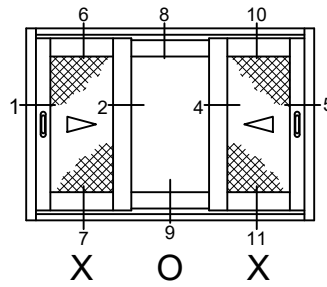

SIN ESCALA

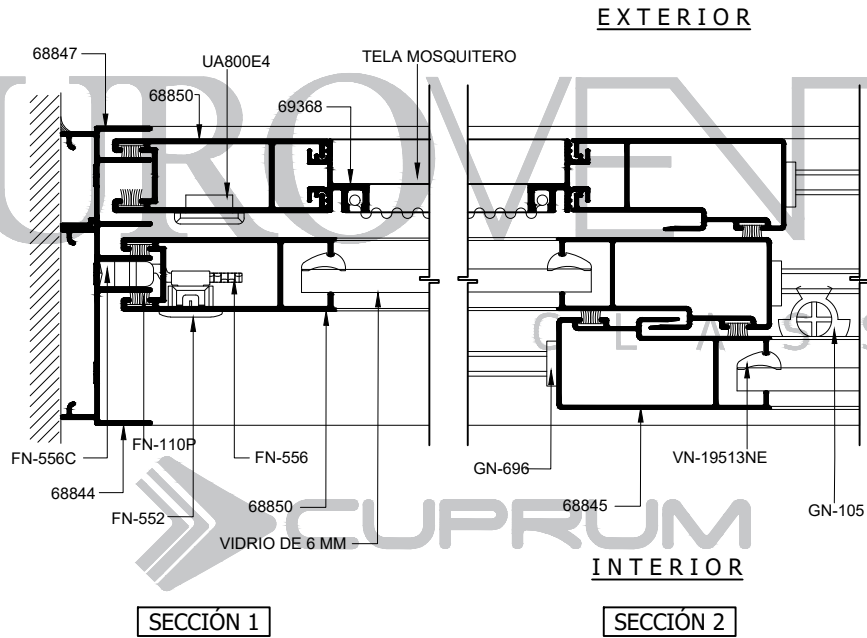
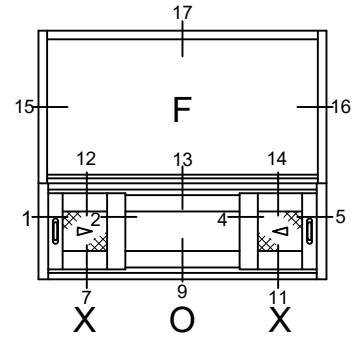

SECCIÓN 1

SECCIÓN 2

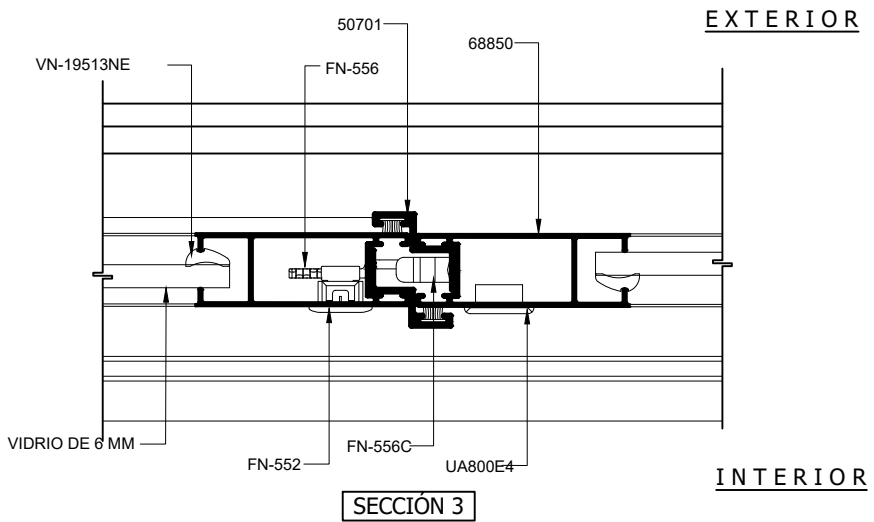

SECCIÓN 3

CLASSIC
SERIE
S50
CORREDIZA

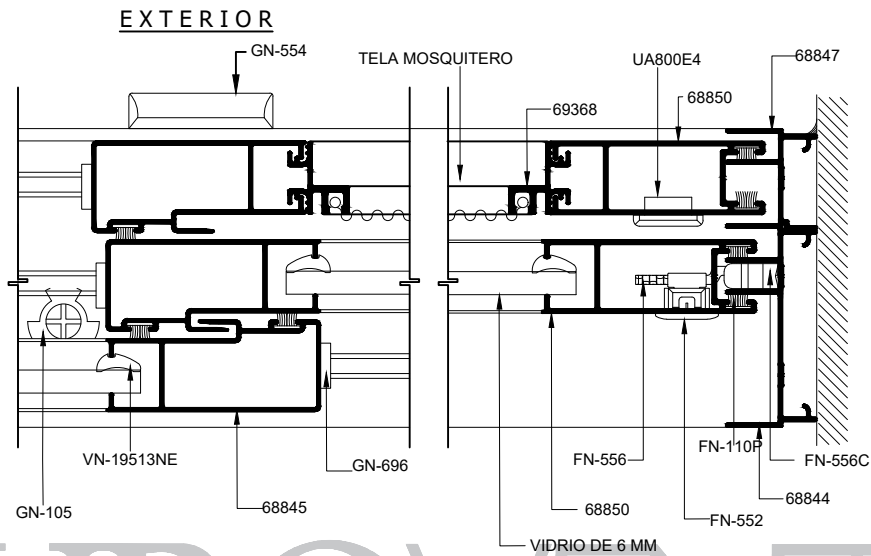

INTERIOR

SECCIÓN 4

SECCIÓN 5

CLASSIC
SERIE
S50
CORREDIZA

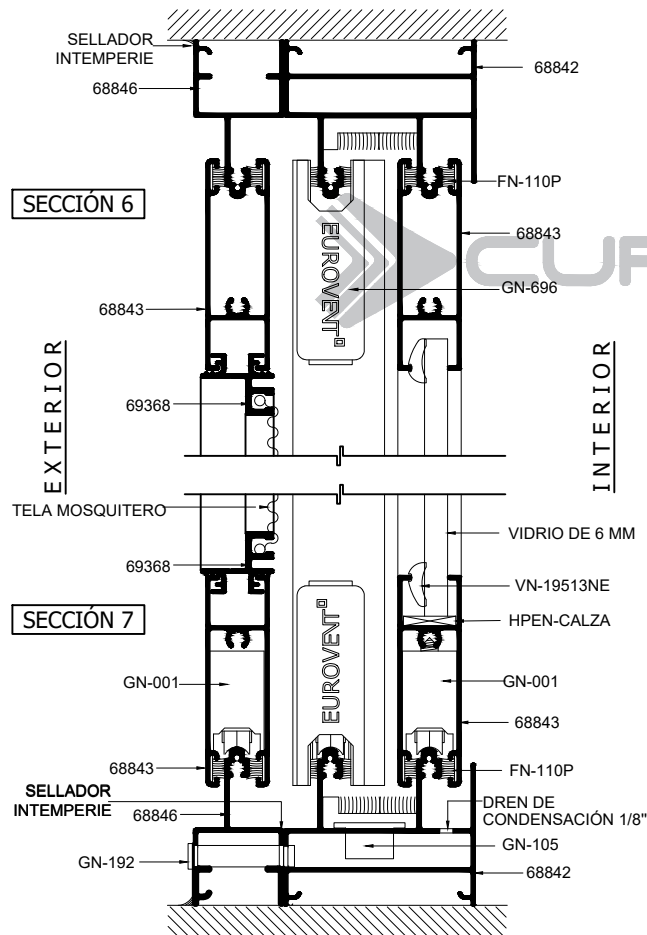

SECCIÓN 6

SECCIÓN 8

SECCIÓN 7

SECCIÓN 9

EXTERIOR

INTERIOR

EXTERIOR

INTERIOR

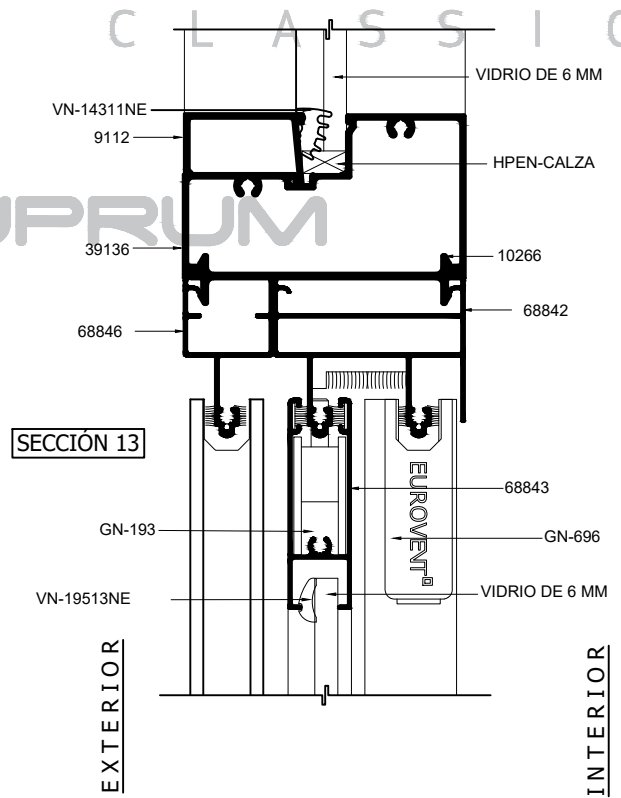
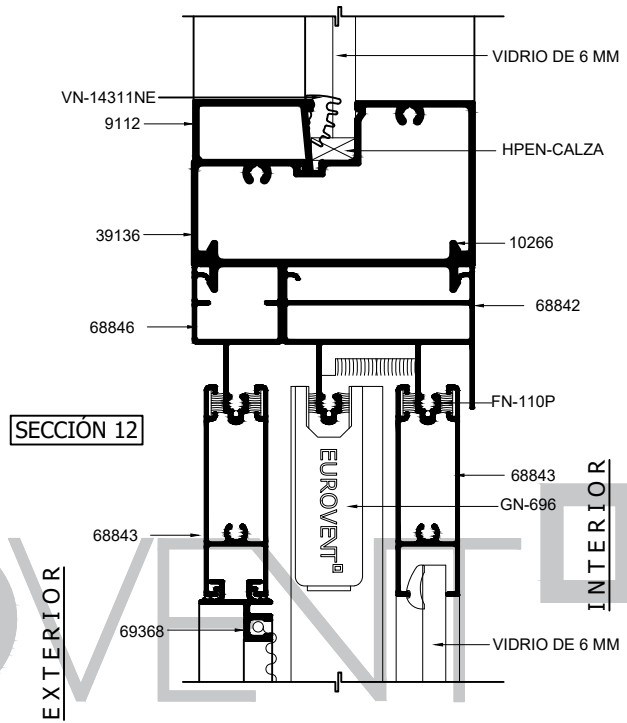
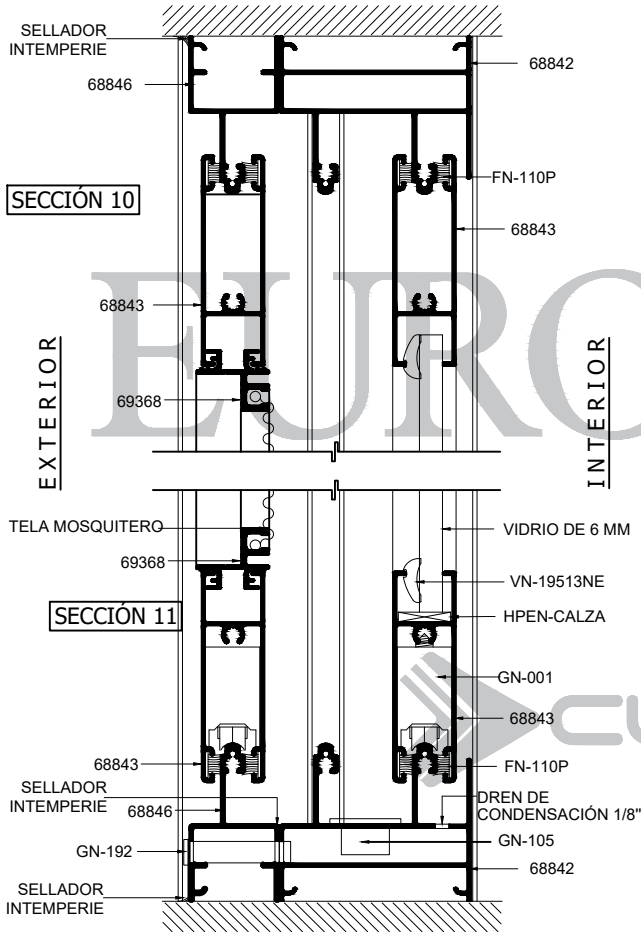

CLASSIC
SERIE

S50



CORREDIZA

 CLASSIC
 SERIE
S50
 CORREDIZA

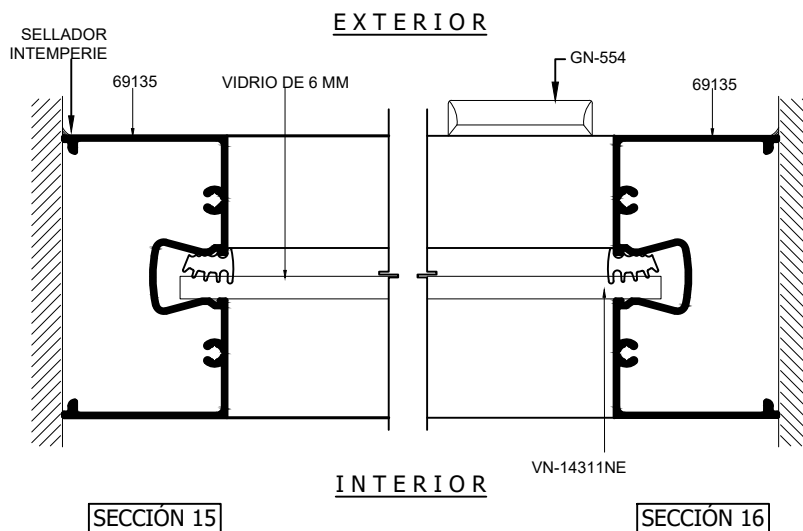
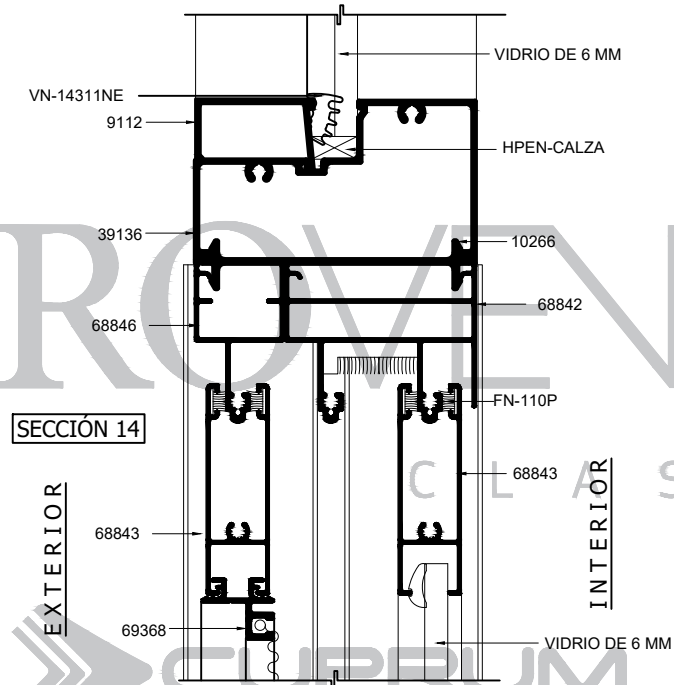
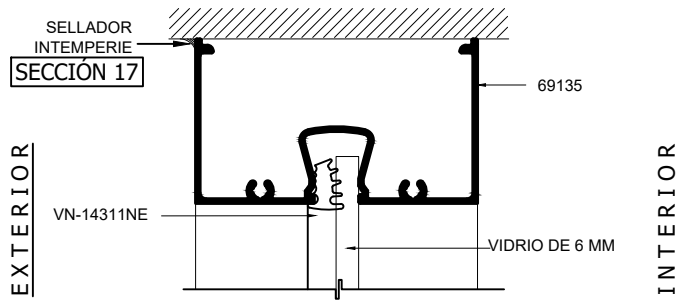

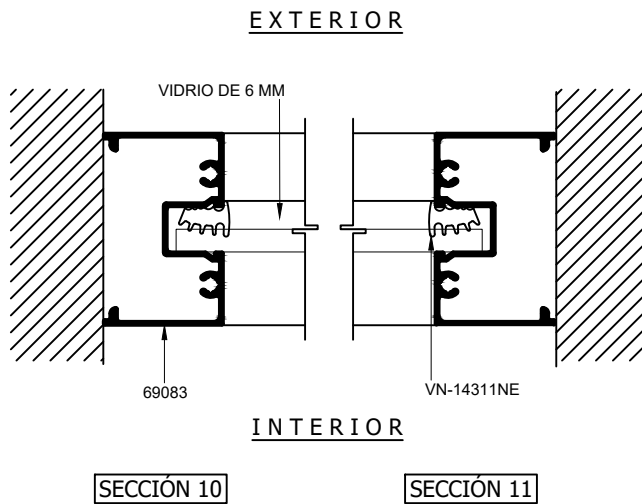
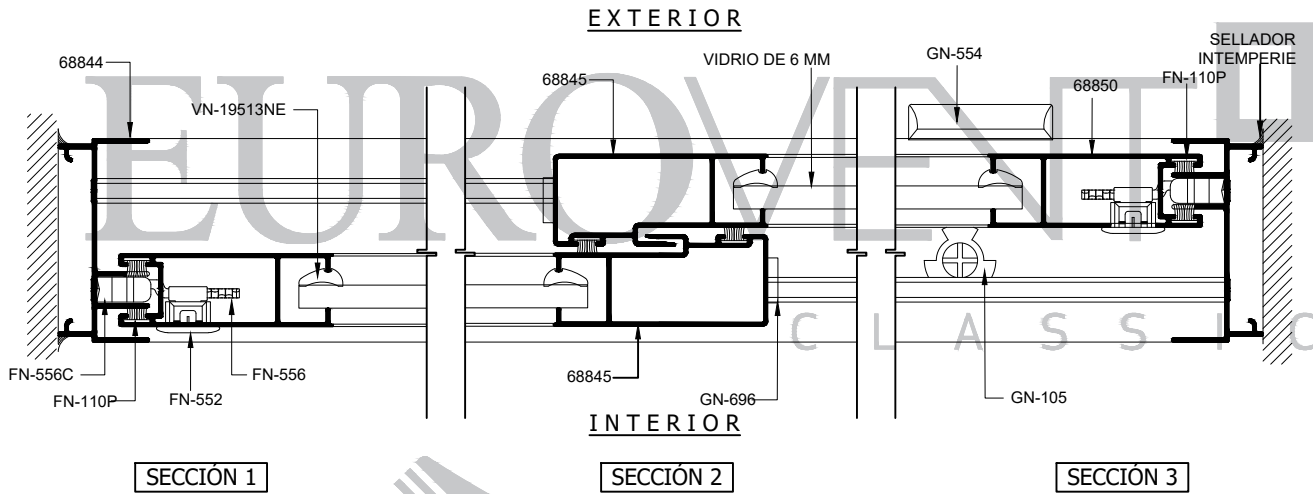
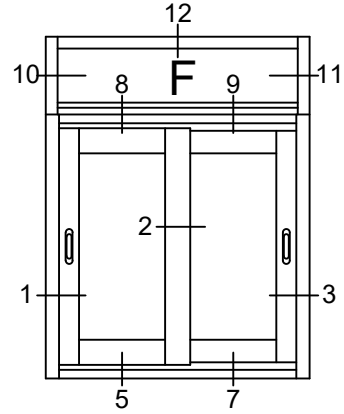
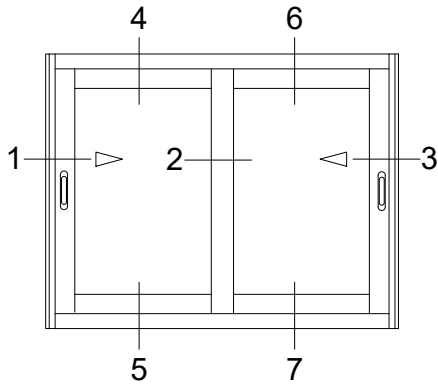

CLASSIC
SERIE
S50
CORREDIZA

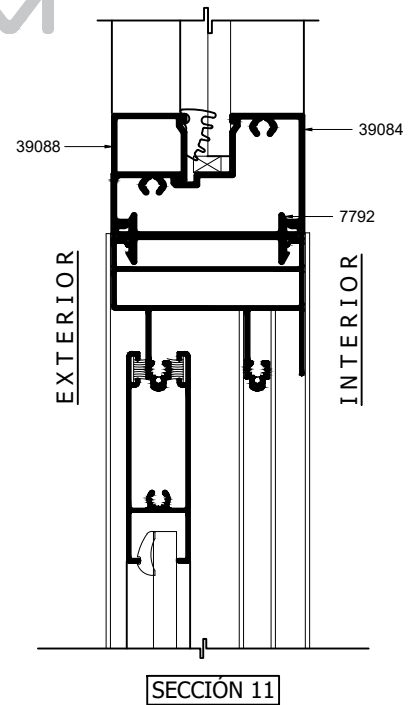
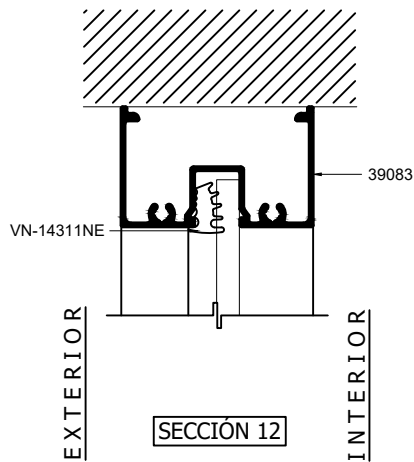
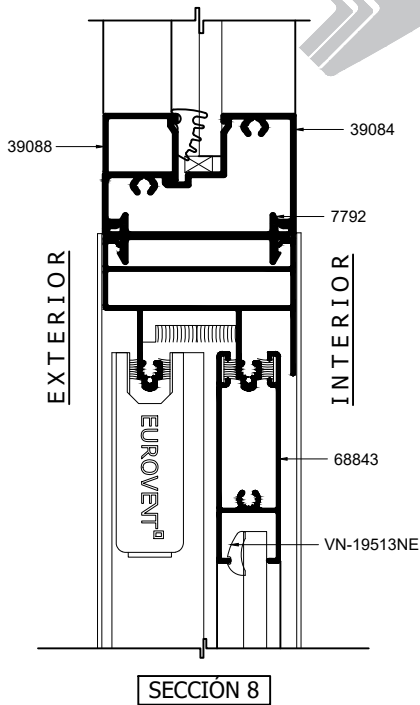
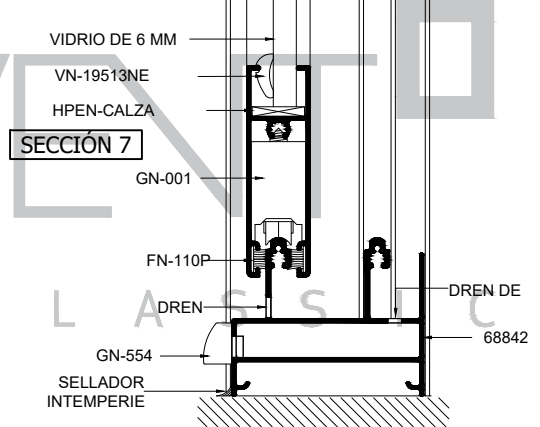
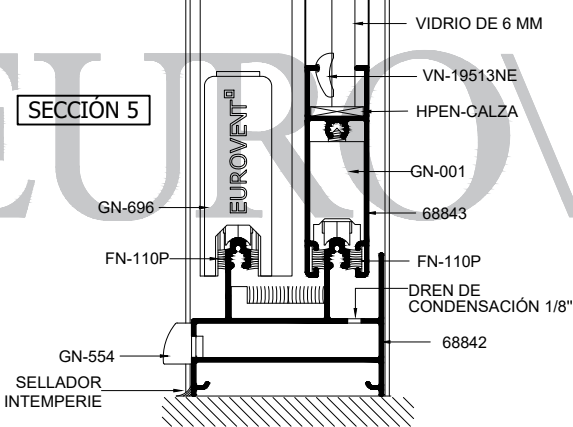
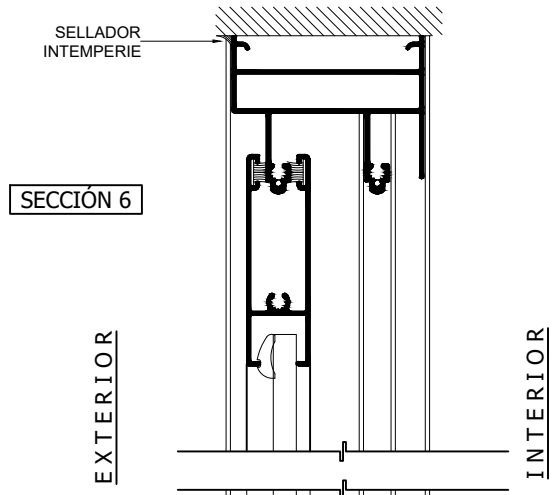
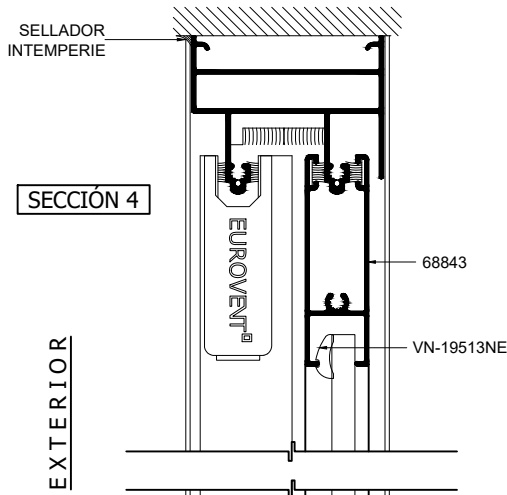

TROQUEL S-50
GN-508A

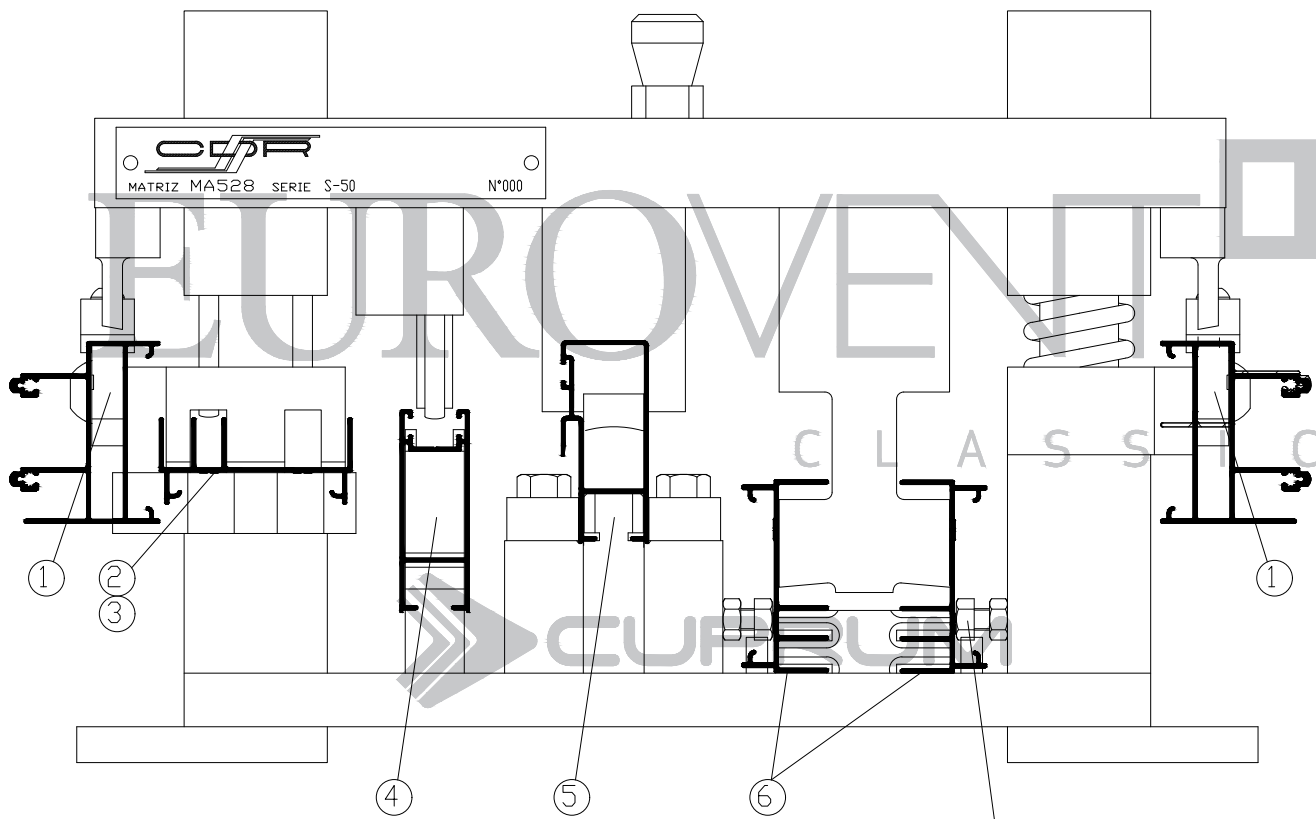

VISTA FRONTAL

Nota: Guías ajustables

DATOS DEL TROQUEL

MATRIZ ABIERTA: 180 mm.
MATRIZ CERRADA: 160 mm.
RECORRIDO: 20 mm.
MUELLES DE RECUPERACION
MATRIZ 4 COLUMNAS

CLASSIC
SERIE
S50
CORREDIZA

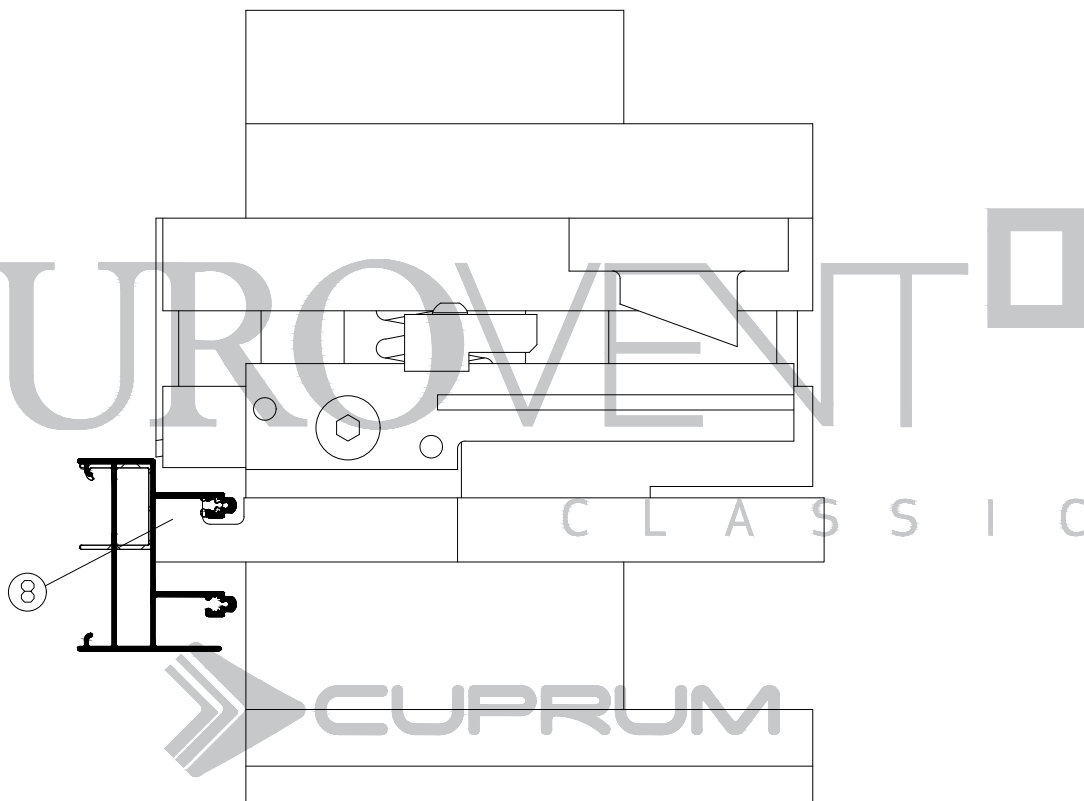

VISTA LATERAL

OPERACIÓN 1

DREN CAJA RIEL Y RIEL MOSQUITERO

68842
RIEL

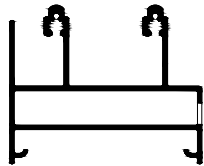

68846
EXTENSION
RIEL

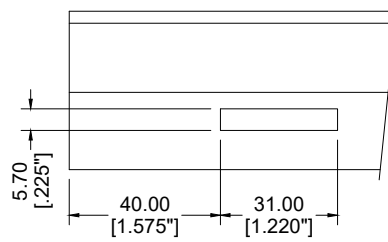
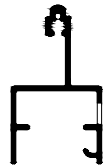

OPERACIÓN 2

PUNZONADO JAMBA

68844
JAMBA

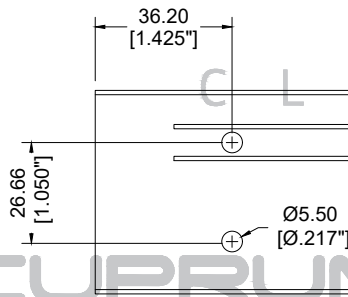
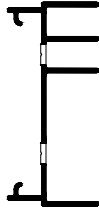

EUROVENT

CLASSIC

CUPRUM



CLASSIC

SERIE

S50

CORREDIZA



OPERACIÓN 3

PUNZONADO JAMBA MOSQUITERA

68847
EXTENSIÓN
JAMBA

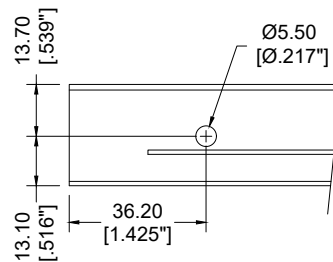
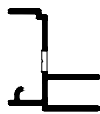

OPERACIÓN 4

PUNZONADO CERCO, TRASLAPE, CERCO DV
Y TRASLAPE DV (REALIZAR ANTES OPERACIÓN N°5)

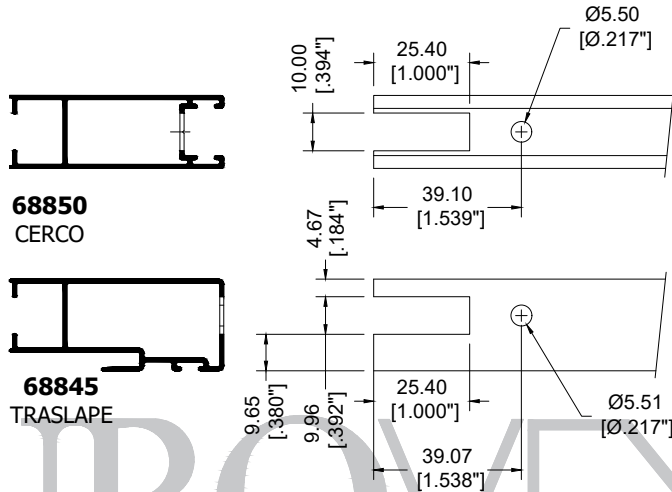

OPERACIÓN 5

CAJEADO CERCO, TRASLAPE, CERCO DV
Y TRASLAPE DV

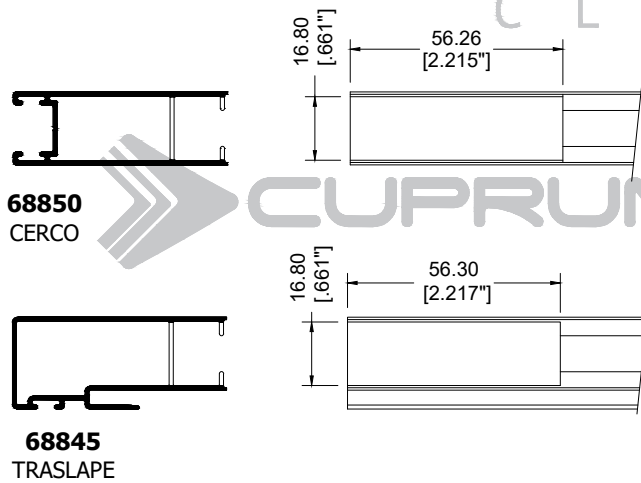

OPERACIÓN 8

DREN DE PISTA RIEL Y RIEL MOSQUITERA

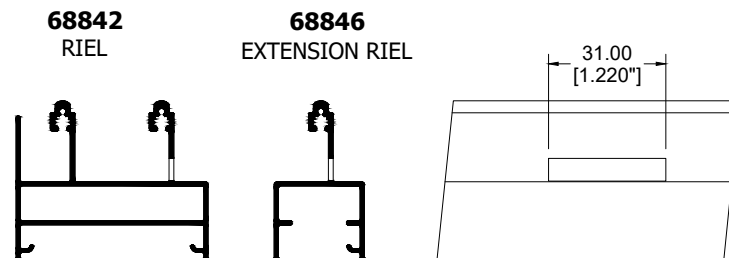

CLASSIC
SERIE
S50
CORREDIZA

EUROVENT[®]
CLASSIC
CUPRUM

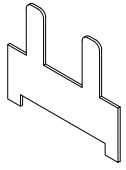

EH-01
EMPAQUE DE
HERMETICIDAD

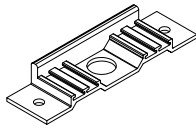

GN-190
CORTAVIENTOS S-50

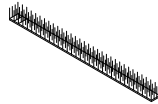

FN-110P
FELPA CON PLÁSTICO

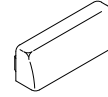

GN-554
TAPA DREN



GN-105
TAPÓN DESAGÜE



GN-696
TAPA TRASLAPE

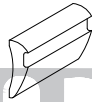

VN-19513NE
EMPAQUE

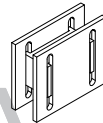

GN-193
CALZA CANDADO S-50

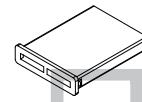

GN-192
CONECTOR DREN S-50

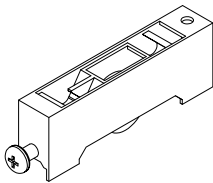

GN-001
CARRETLILLA AJUSTABLE A BASE
DE BALEROS 20 KG X PZA

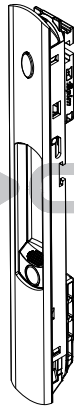

FN-552
BROCHE MINI 160MM
(EMBUTIDO)

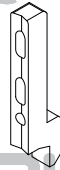

FN-556C
CONTRA



UA800E4
UÑERO EMBUTIDO

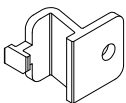

GN-191
GRAPA MOSQUITERO

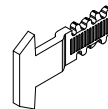

FN-556
GANCHO/FLECHA

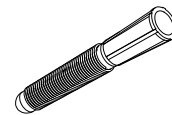

TAQ1147
TAQUETE 1/4 D/PLASTICO

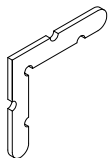

ESC2039
ESCUADRA PLANA
PARA MOSQUITERO

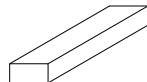

HPEN-CALZA
CALZA DE 1/4" x 3/8" x 4"

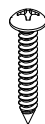

PFNG-0811
TORNILLO PIJA #8 X 1"



PFNG-0805
TORNILLO PIJA #8 X 1/2"

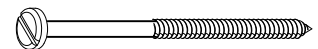

TMNG-1026
TORN P/MADERA 10X76 GAL

CLASSIC
SERIE
S50
CORREDIZA

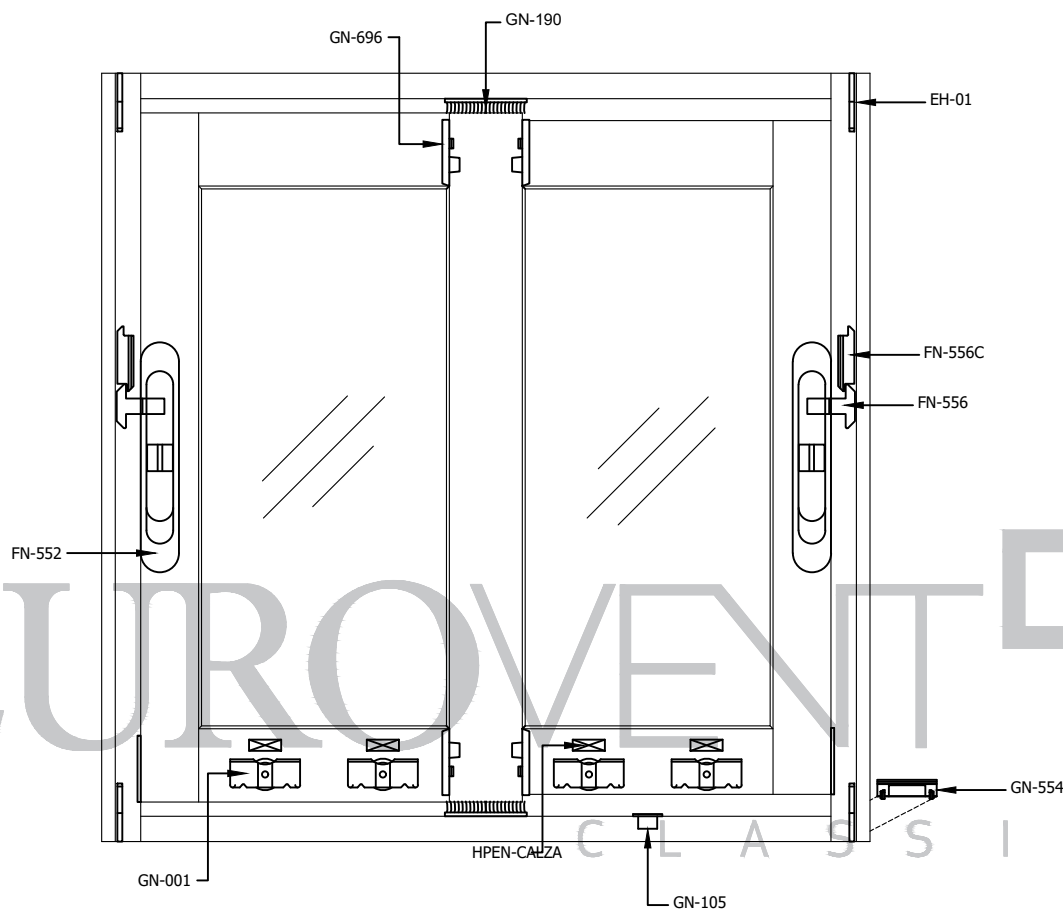

CLASSIC
SERIE

S50



CORREDIZA



VENTANA CORREDIZA S50 XX

CLAVE	DESCRIPCIÓN	PIEZAS
EH-01	EMPAQUE DE HERMETICIDAD	4
GN-001	CARRETILLA AJUSTABLE DE BALEROS	4
FN-552	BROCHE MINI 160MM (EMBUTIDO)	2
FN-556B	FLECHA	2
FN-556C	CONTRA	2
GN-190	CORTAVIENTO	2
GN-554	TAPA DREN CON VÁLVULA	2
GN-105	TAPÓN DESAGÜE	1
GN-696	TAPA TRASLAPE	4
VN-19513NE	VINIL CUÑA PARA CRISTAL	2L + 4H
FN-110P	FELPA CON PÁSTICO	4L + 6H
HPEN-CALZA	HPEN-CALZA DE SILICON	4
PFNG-0811	PIJA #8 X 1" CABEZA FIJADORA	17
PFNG-0805	PIJA #8 X 1/2" CABEZA PLANA	4

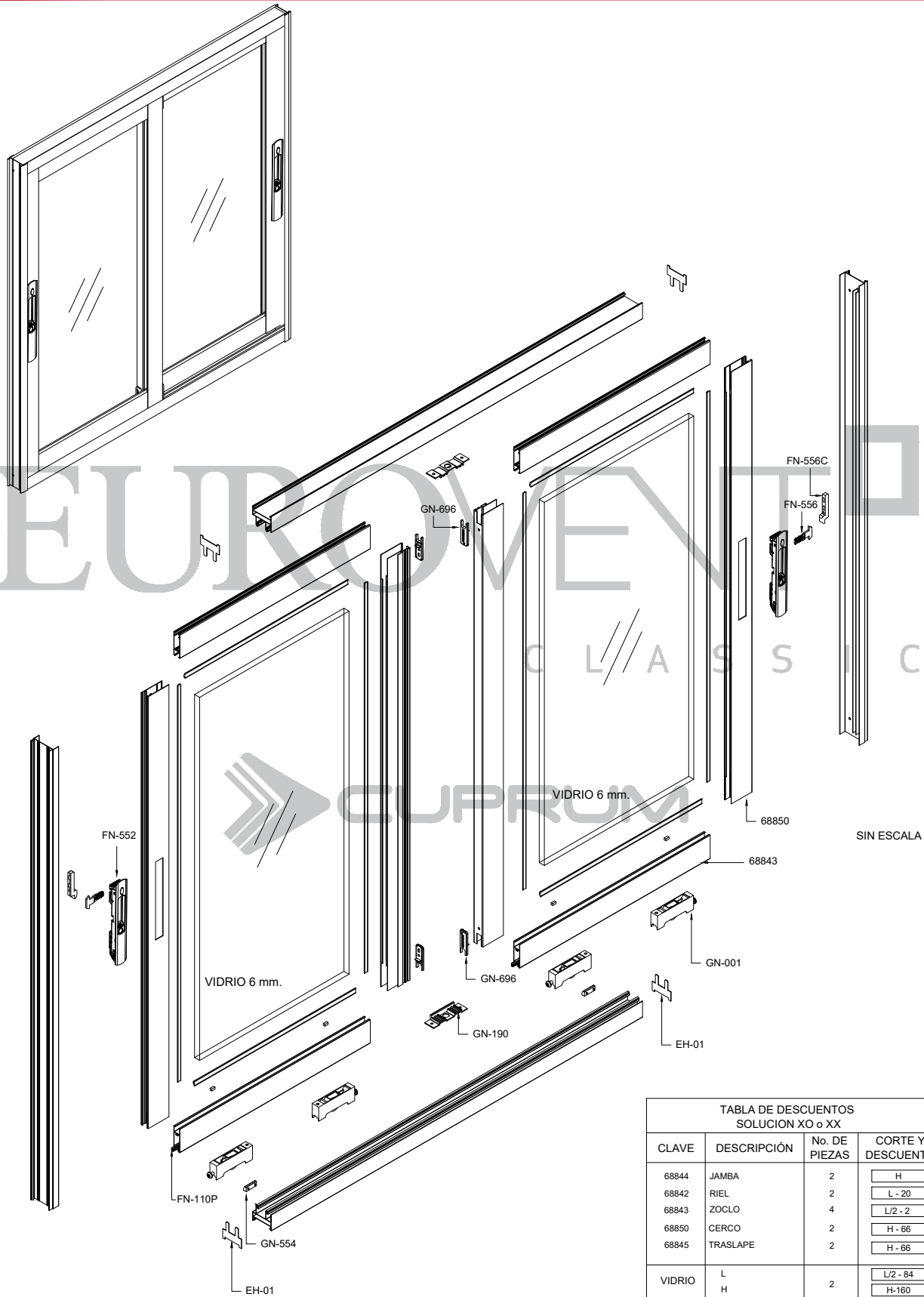

CLASSIC
SERIE
S50

CORREDIZA

TABLA DE DESCUENTOS
SOLUCION XO o XX

CLAVE	DESCRIPCIÓN	No. DE PIEZAS	CORTE Y DESCUENTO
68844	JAMBA	2	H
68842	RIEL	2	L - 20
68843	ZOCLO	4	L/2 - 2
68850	CERCO	2	H - 66
68845	TRASLAPE	2	H - 66
VIDRIO	L	2	L/2 - 84
	H		H - 160

L= ANCHO
H= ALTO

DESCUENTOS EN MM.

CORREDIZA SERIE 50
A UNA ALTURA DE 15 METROS

H cm DEFLEXIÓN MAX. L/175

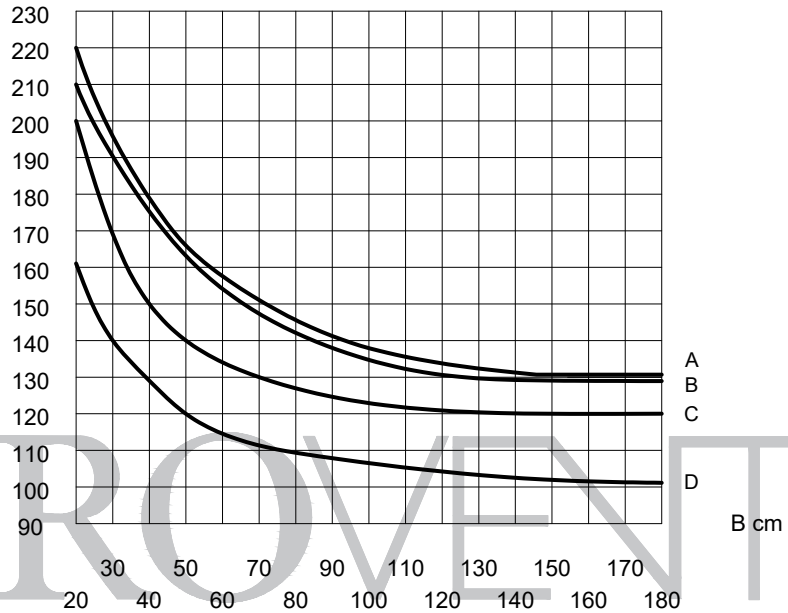

CLASSIC
SERIE
S50
CORREDIZA

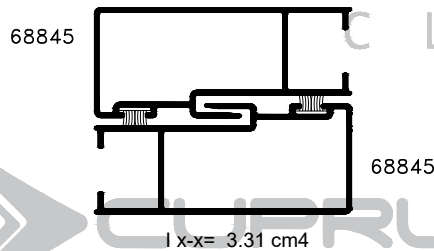

LOS LÍMITES DE FABRICACIÓN PARA LOS PERFILES, SERÁN LOS QUE SE ENCUENTREN DEBAJO DE LAS CURVAS GRAFICADAS.

ALEACIÓN: 6063
TEMPLE: 5

Curvas	Presión del diseño	Velocidad de viento	Zona
A	45 Kg/m ²	80 Km/h	Centro de grandes ciudades
B	50 Kg/m ²	90 Km/h	Barrios Residenciales
C	65 Kg/m ²	120 Km/h	Campo Abierto
D	110 Kg/m ²	160 Km/h	Zona Costera

LOS LÍMITES DE UN CANCEL VAN EN FUNCIÓN DE LA COMBINACIÓN DE RESISTENCIA DEL PERFIL DE ALUMINIO, EL VIDRIO Y LOS ACCESORIOS QUE LO INTEGRAN.

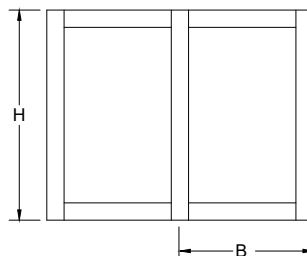

VERIFICAR QUE LA DEFLEXIÓN DEL PERFIL SEA COMPATIBLE CON EL VIDRIO UTILIZADO.

PARÁMETROS MÍNIMOS Y MÁXIMOS DE FABRICACIÓN.

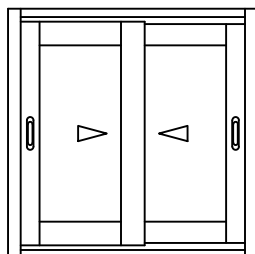

VC-50
MÍNIMO 0.40 x 0.40 HOJA
MÁXIMO 0.80 x 1.80 HOJA

EUROVENT[®]

CLASSIC
SERIE

S50

CORREDIZA



ALUMINIO					
CLAVE	DESCRIPCIÓN	PIEZAS X ATADO	LARGO STD. MTS.	PERÍMETRO ANOD. CM.	PERÍMETRO PUL. CM.
68844	JAMBA	8	6.10	26.80	18.56
68847	EXTENSIÓN JAMBA	20	6.10	15.17	9.32
69356	ADAPTADOR DOBLE VIDRIO	20	6.10	12.97	4.23
68842	RIEL	6	6.10	33.87	17.27
68846	EXTENSIÓN RIEL	8	6.10	21.10	10.64
69368	ADAPTADOR MOSQUITERO	20	6.10	12.01	4.10
68845	TRASLAPE	8	6.10	35.58	16.10
68850	CERCO	8	6.10	33.18	17.01
68843	ZOCLO	10	6.10	30.60	12.60
50701	ADAPTADOR OXXO	30	6.10	9.17	4.20

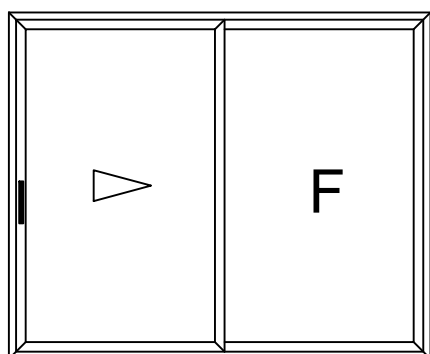

X O

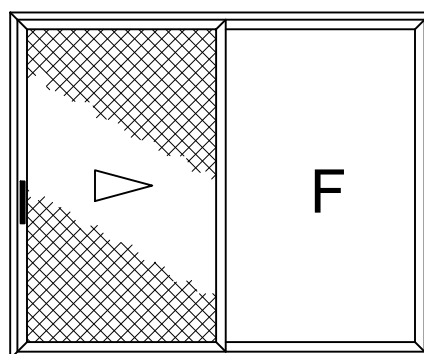

X O

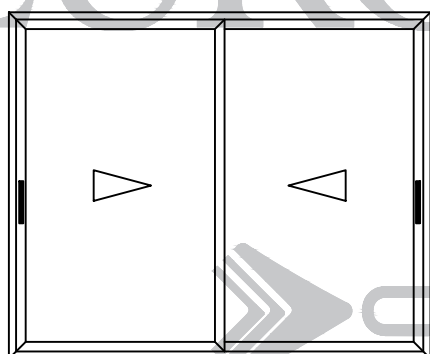

X X

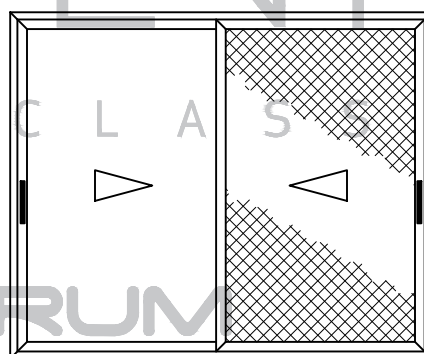

X X

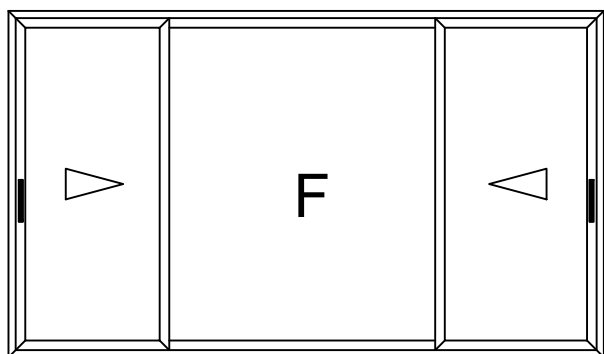

X O X

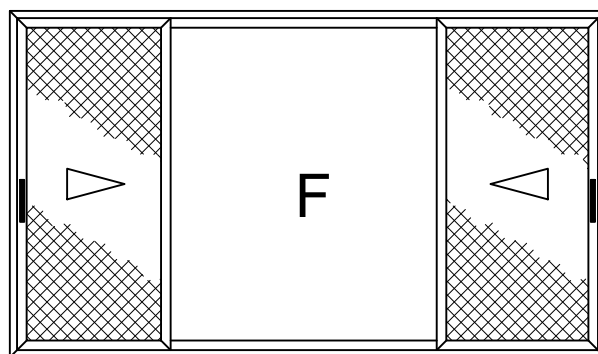

X O X

CLASSIC
SERIE
S60
CORREDIZA

EUROVENT

CLASSIC

CUPRUM

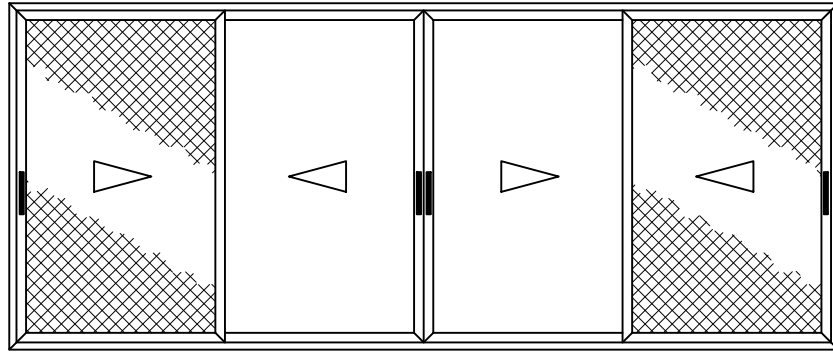

X X X X

EUROVENT

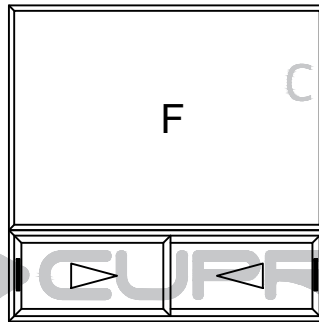

X X

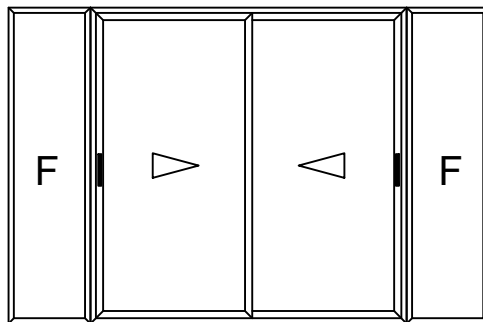

O X X O

CLASSIC
SERIE
S60
CORREDIZA

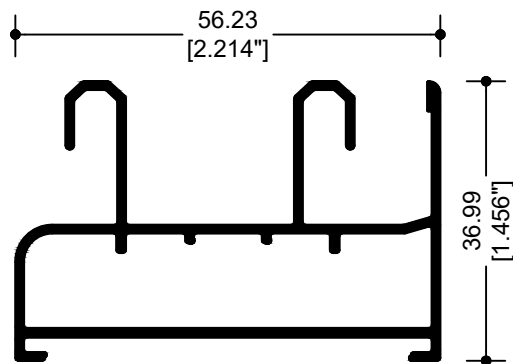

67896
RIEL BASICO

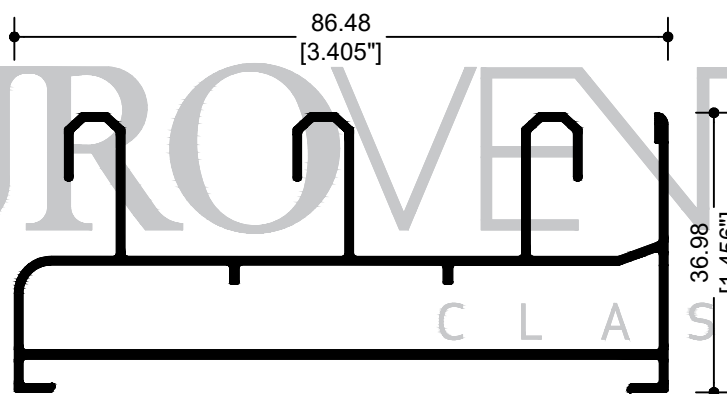

68300
RIEL TRIPLE

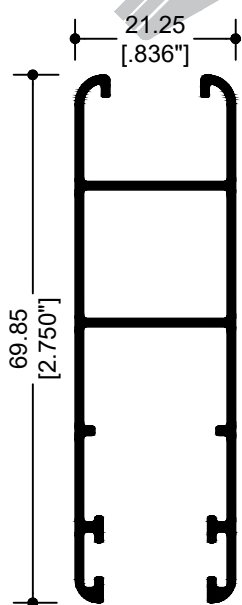

67894
CERCO PUERTA

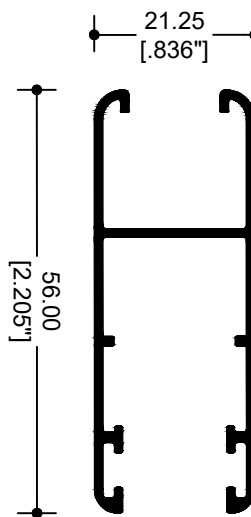

62066
CERCO VENTANA



 CLASSIC
 SERIE
S60
 CORREDIZA

EUROVENT CLASSIC

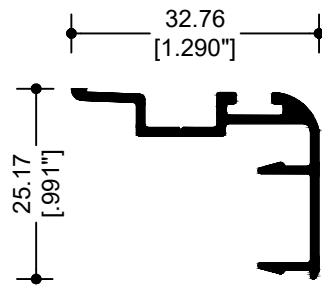
CUPRUM

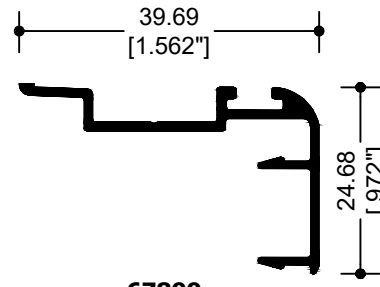

62070
TRASLAPE
VENTANA



67899
TRASLAPE
PUERTA

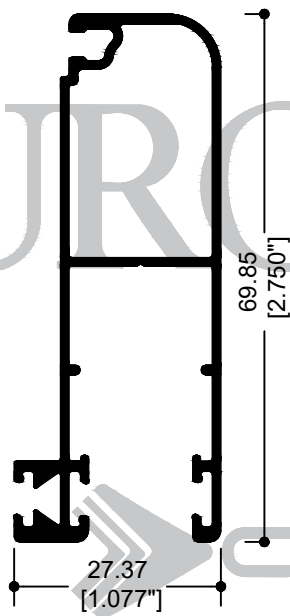

68299
MOSQUITERO
PUERTA
EXT.

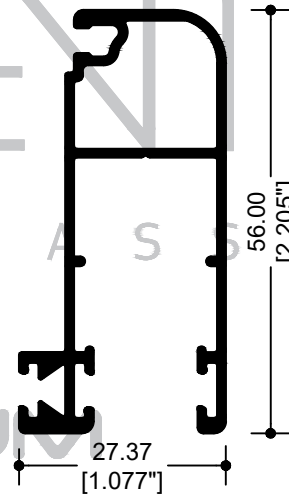

68337
MOSQUITERO
VENTANA

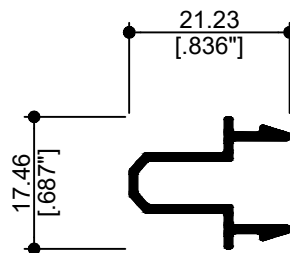

62078
ADAPTADOR OXXO

EUROVENT
CLASSIC
SERIE

CORREDIZA
S60

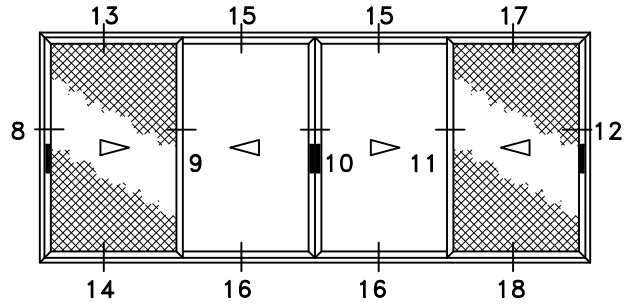
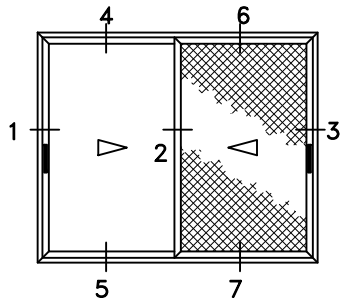

CLASSIC

SERIE

S60



CORREDIZA

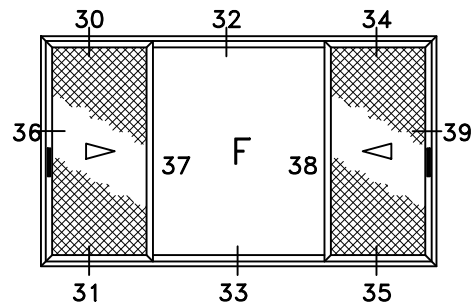
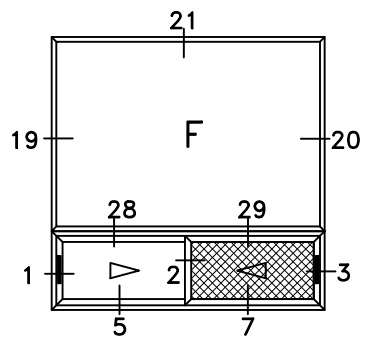
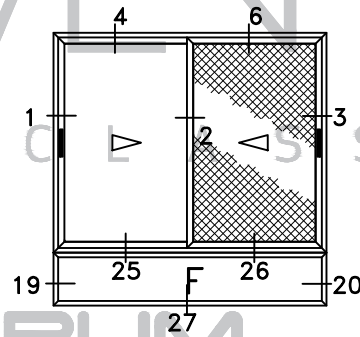
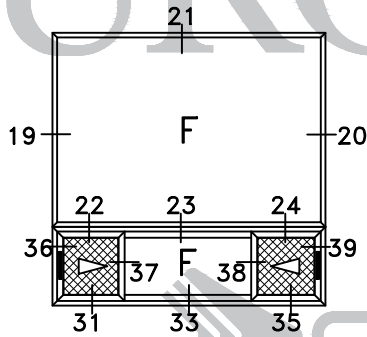

EXTERIOR

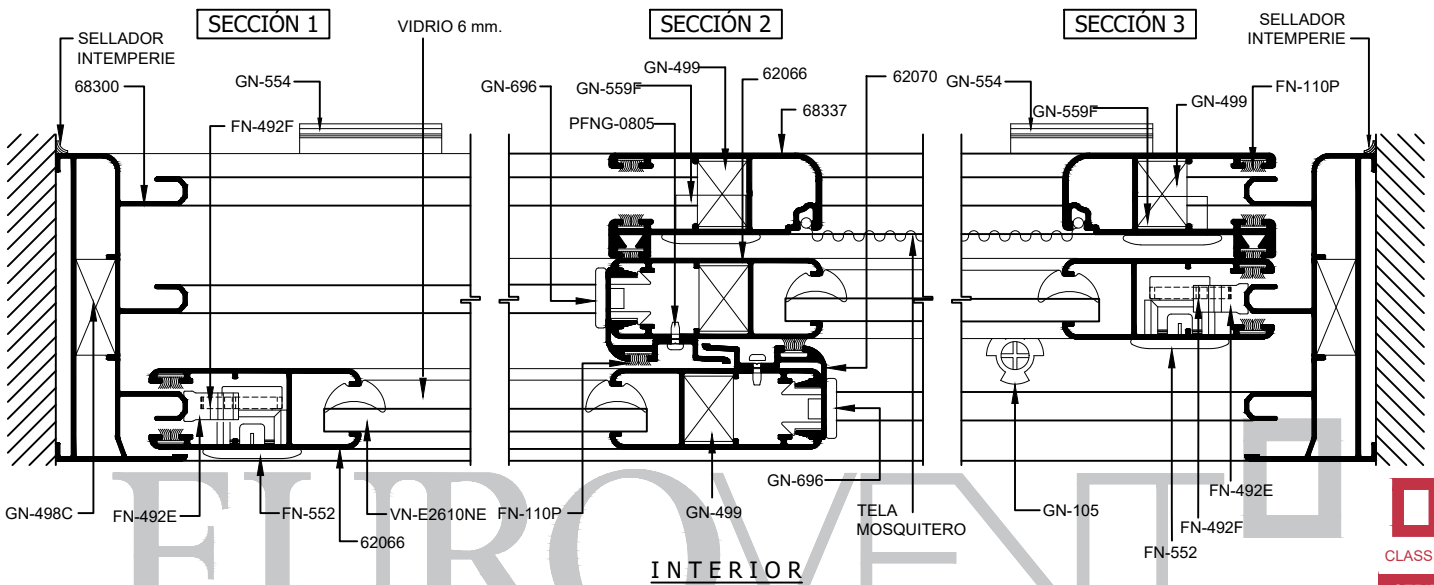

CLASSIC
SERIE

S60
CORREDIZA

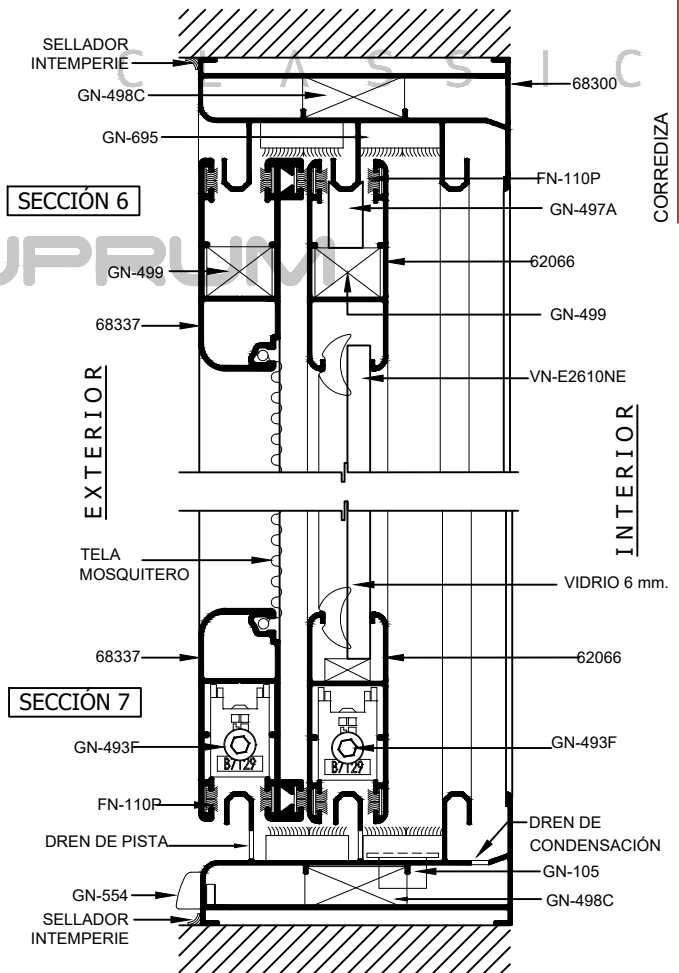
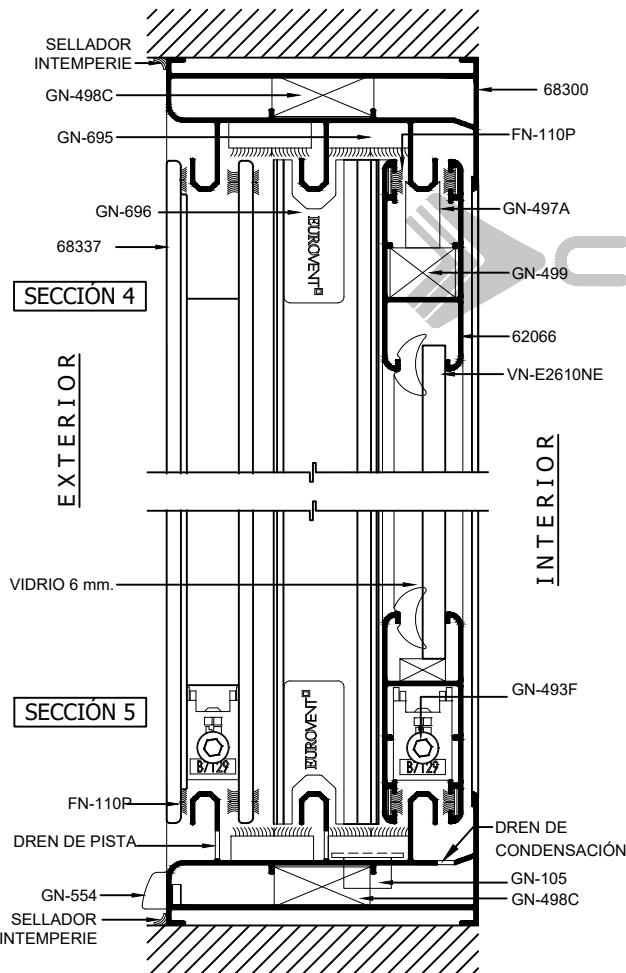

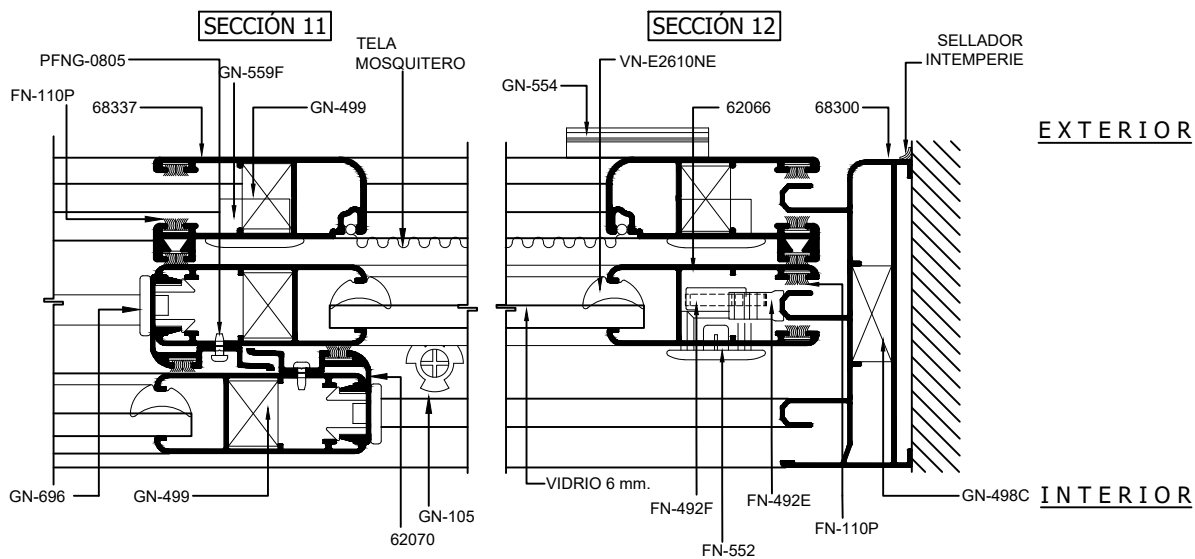
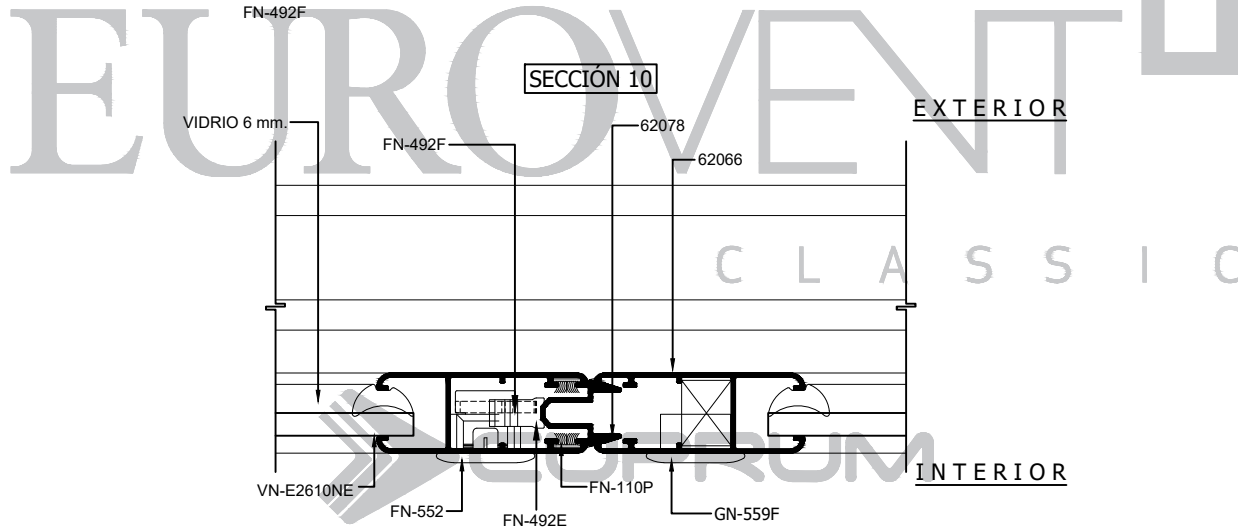
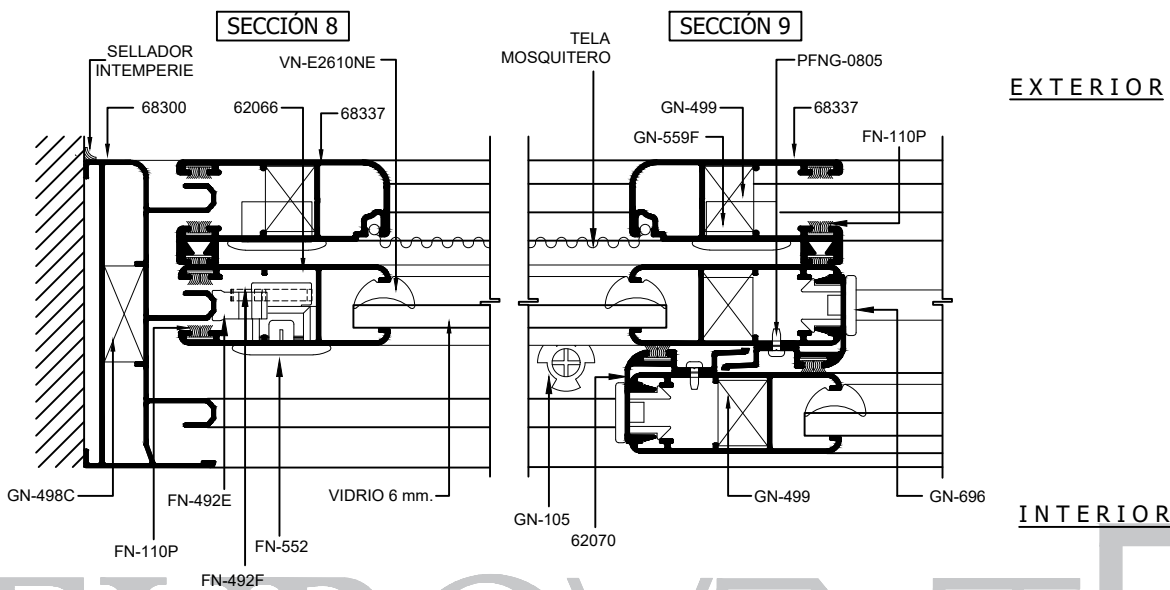

CLASSIC
SERIE
S60
CORREDIZA

EUROVENT[®]
CLASSIC

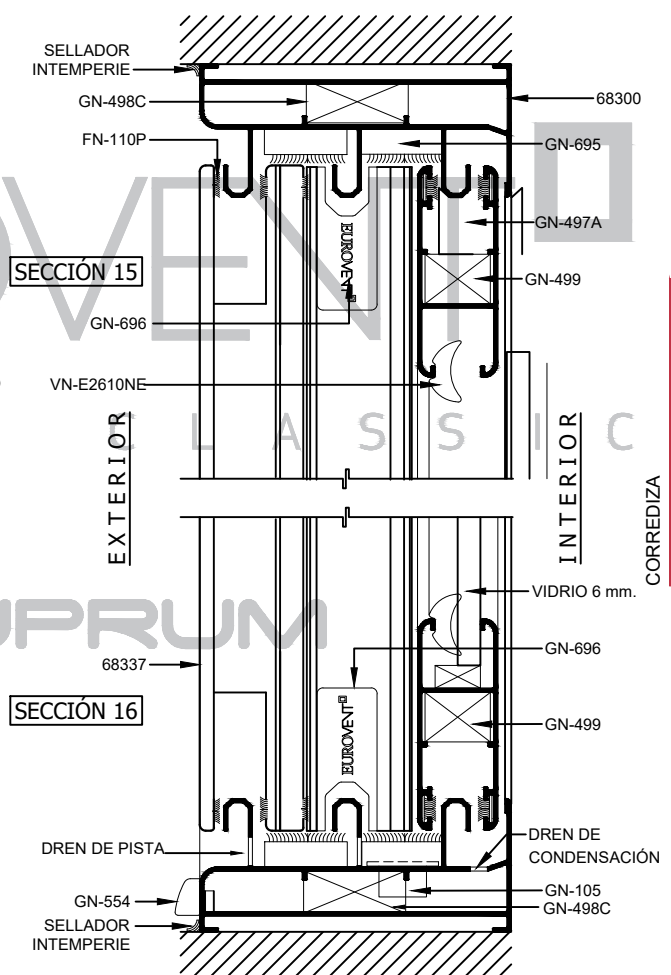
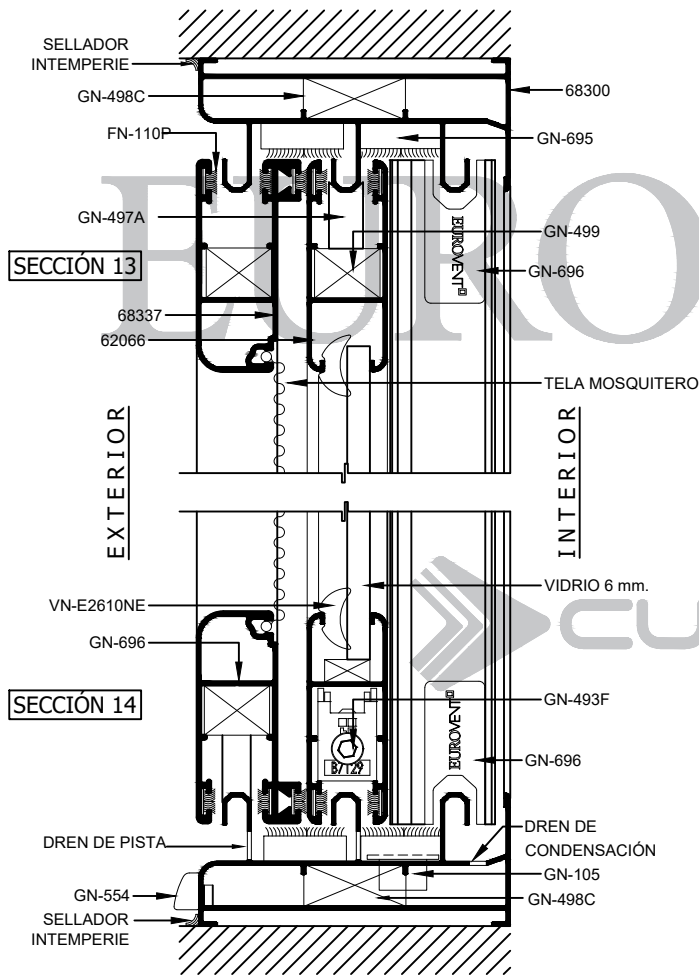

CLASSIC
SERIE
S60
CORREDIZA

CLASSIC
SERIE
S60
CORREDIZA

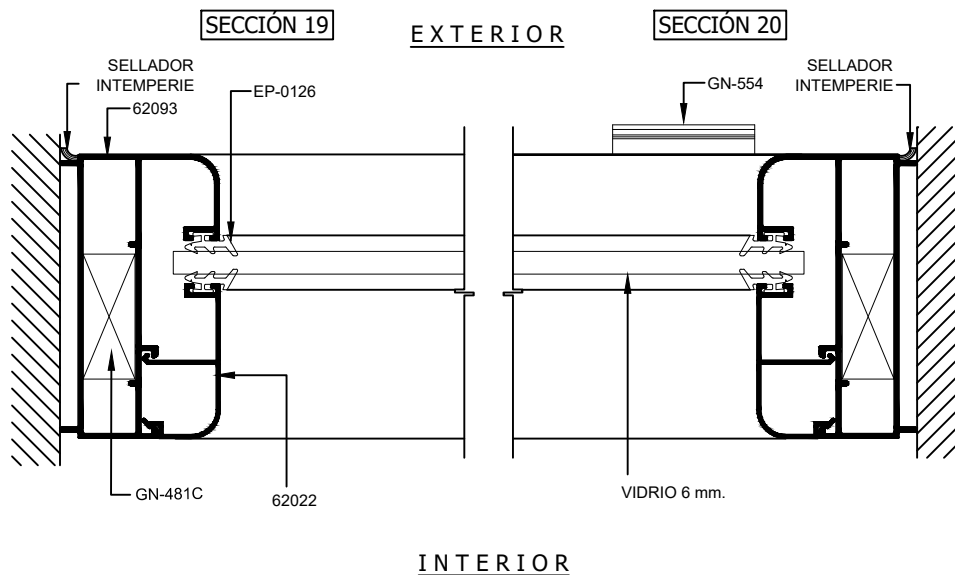
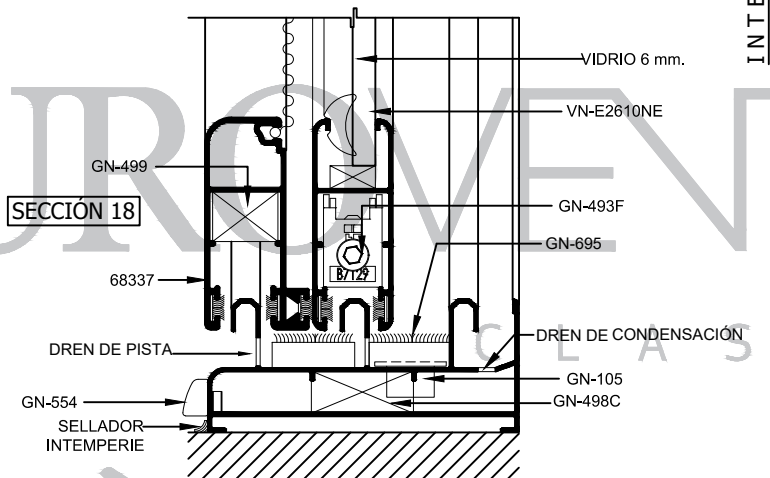
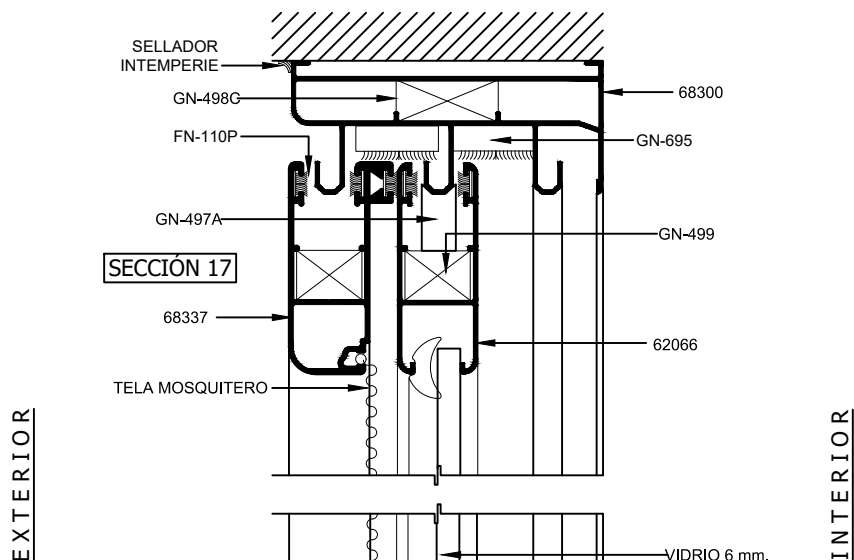

EUROVENT[®] VENTANA CORREDIZA SERIE 60 - CORTES SECCIONALES

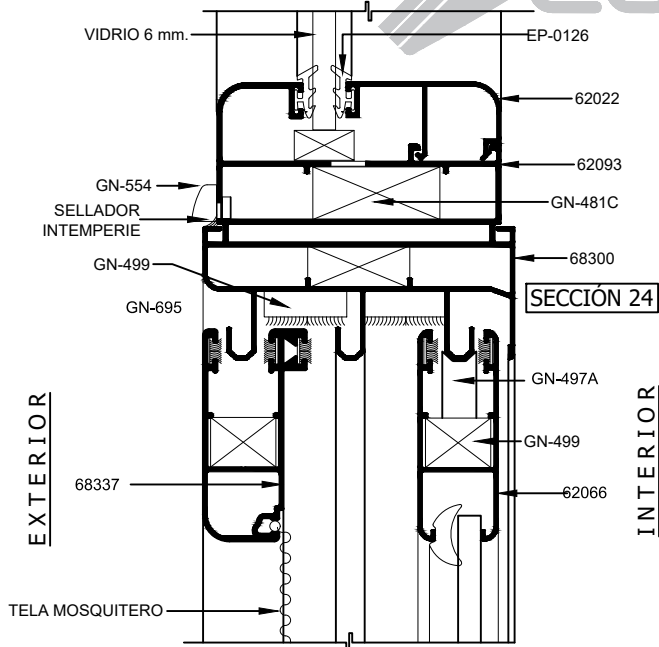
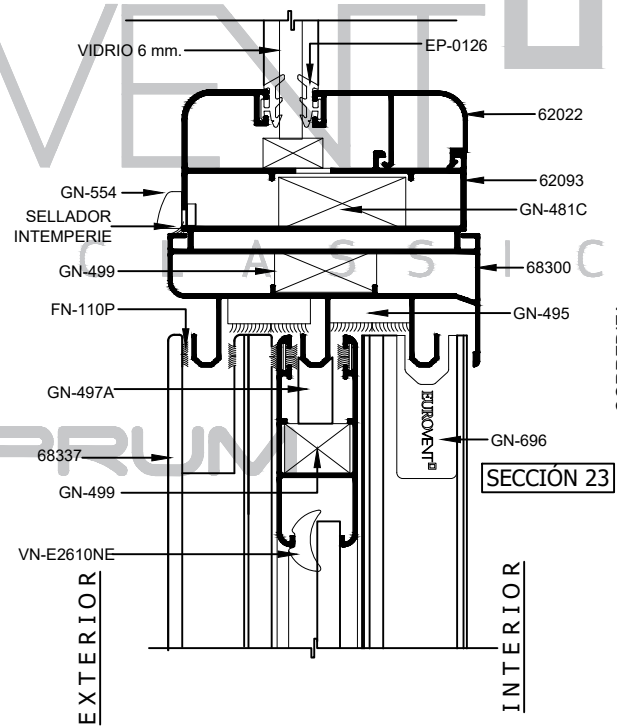
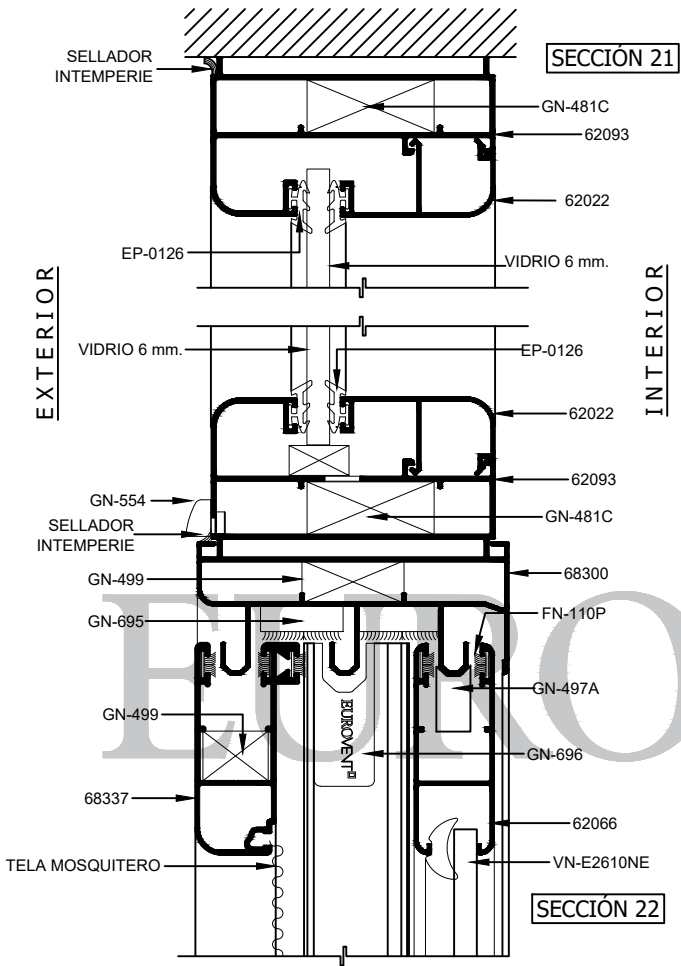

CLASSIC
SERIE

S60

CORREDIZA

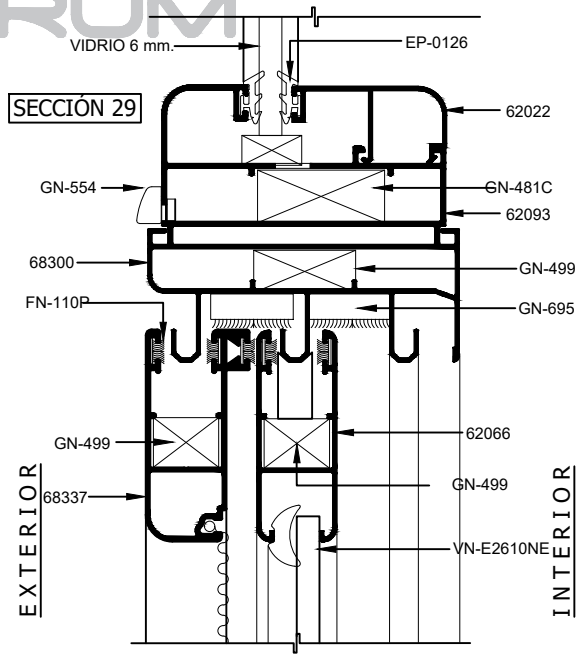
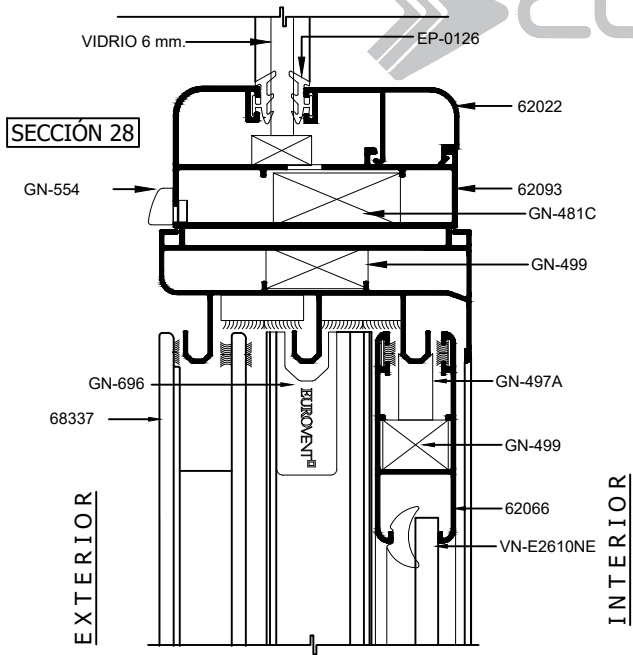
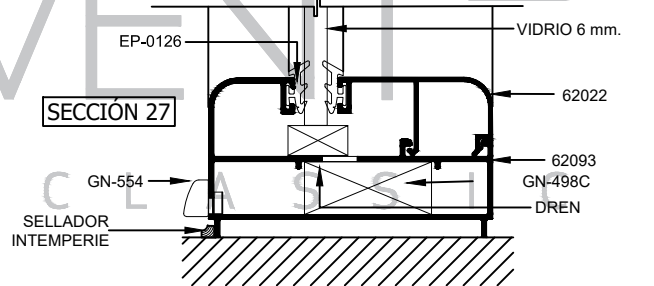
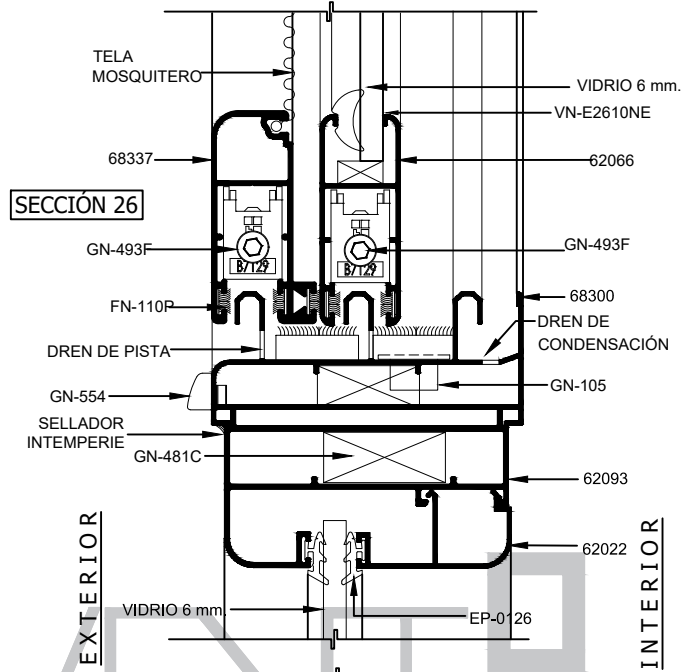
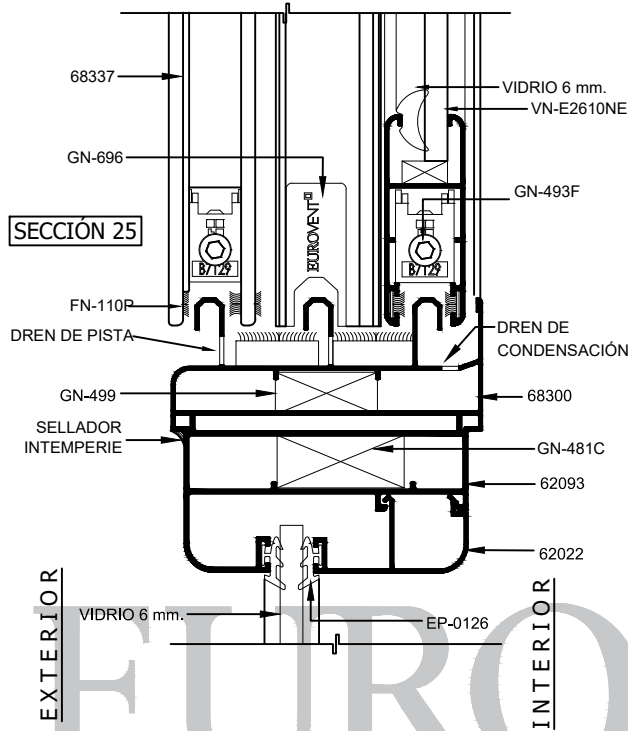

CLASSIC
SERIE
S60
CORREDIZA

EUROVENT[®] VENTANA CORREDIZA SERIE 60 - CORTES SECCIONALES

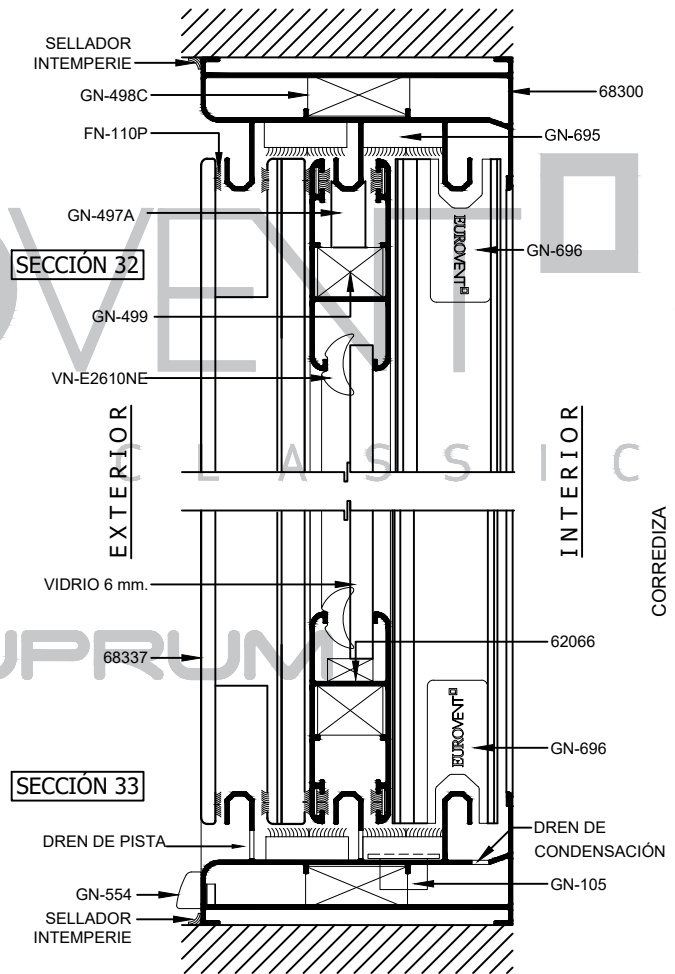
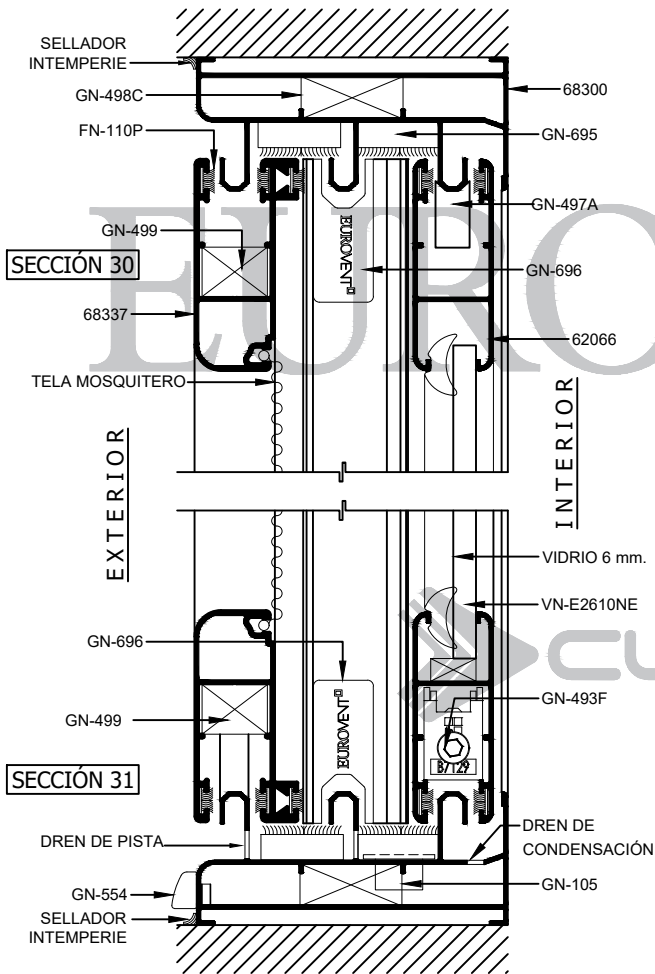

CLASSIC
SERIE
S60
CORREDIZA

CLASSIC
SERIE
S60
CORREDIZA

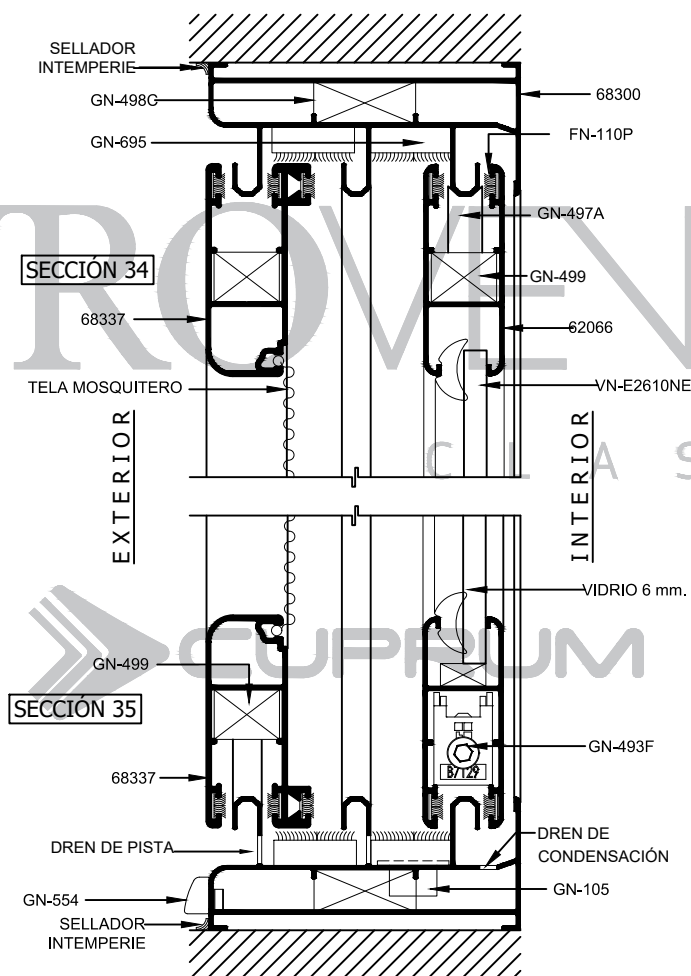

EUROVENT[®] VENTANA CORREDIZA SERIE 60 - CORTES SECCIONALES

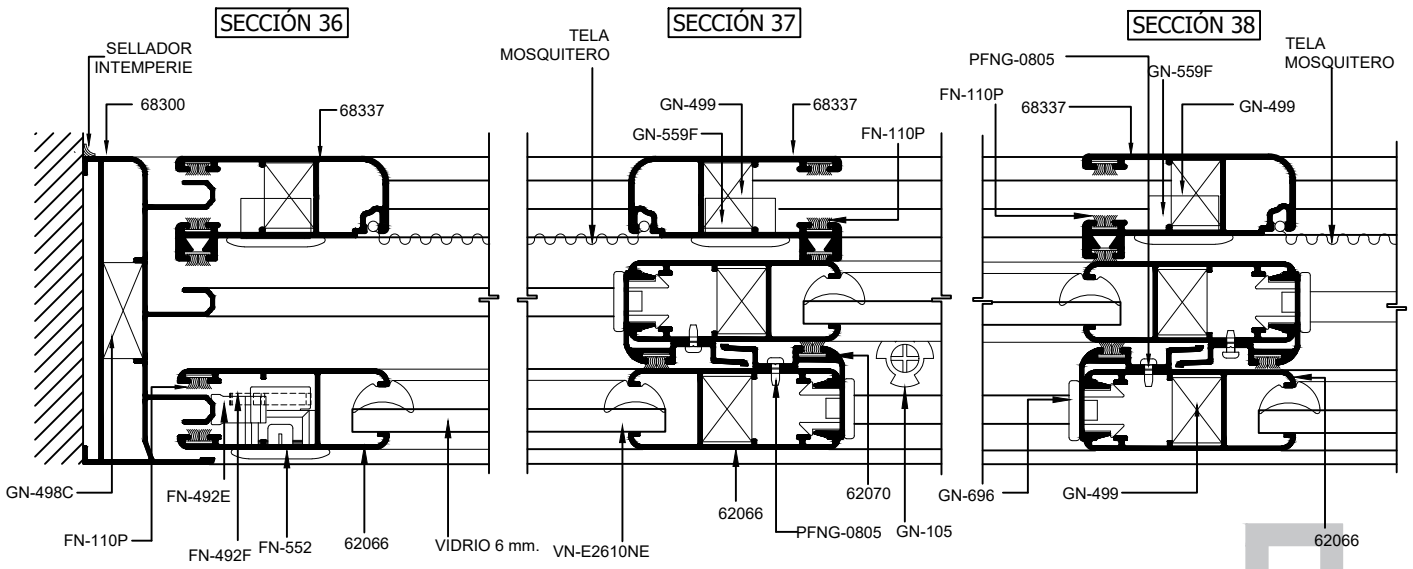

EUROVENT[®]

C L A S S I C



CLASSIC

SERIE

S60

CORREDIZA

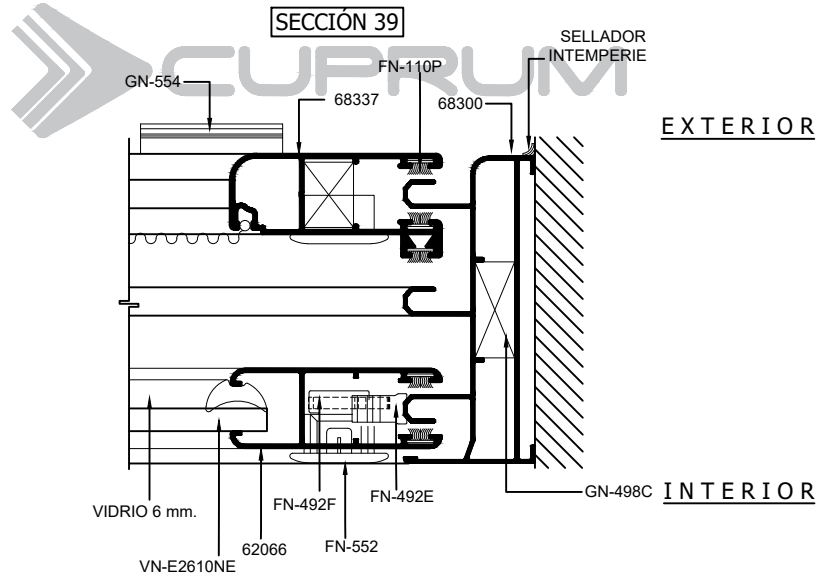

EXTERIOR

INTERIOR

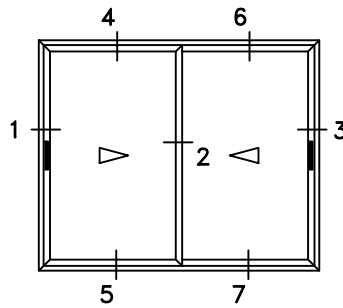

CLASSIC
SERIE

S60

CORREDIZA

EUROVENT[®]

C L A S S I C

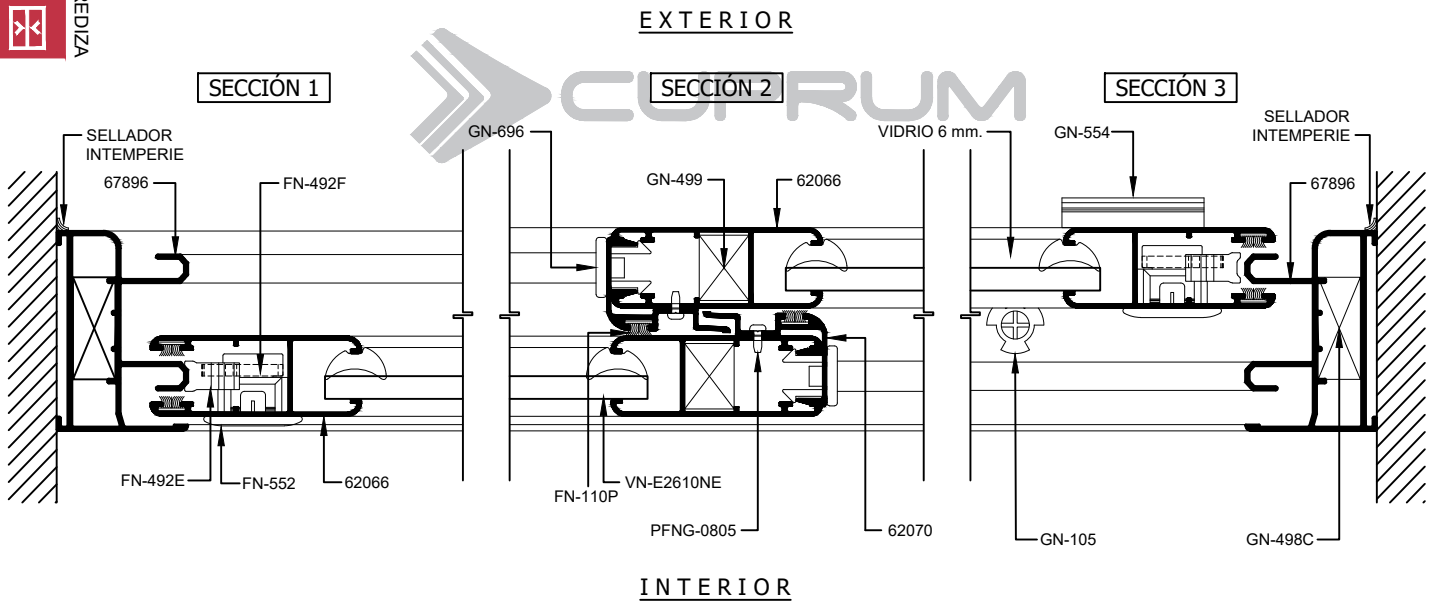

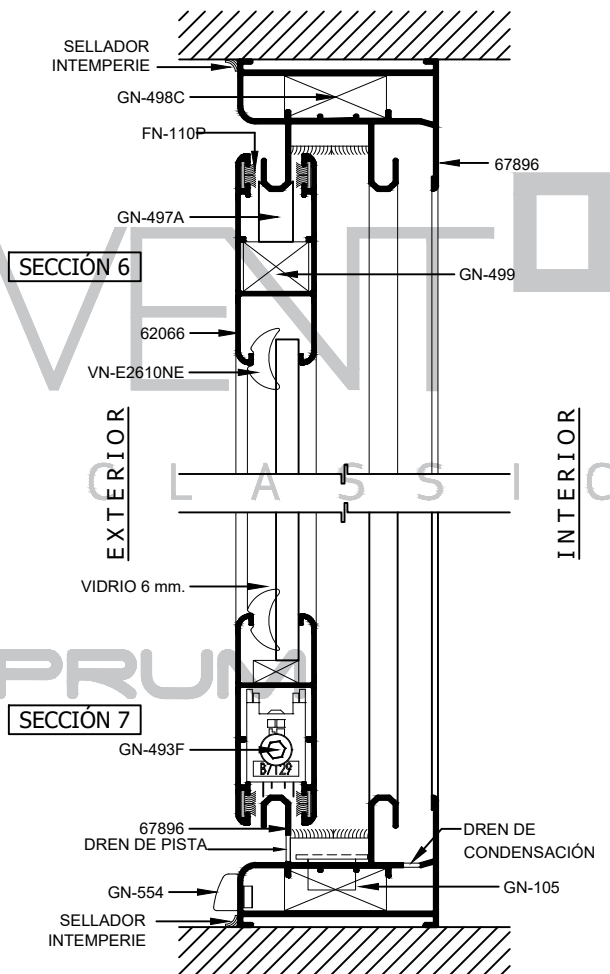
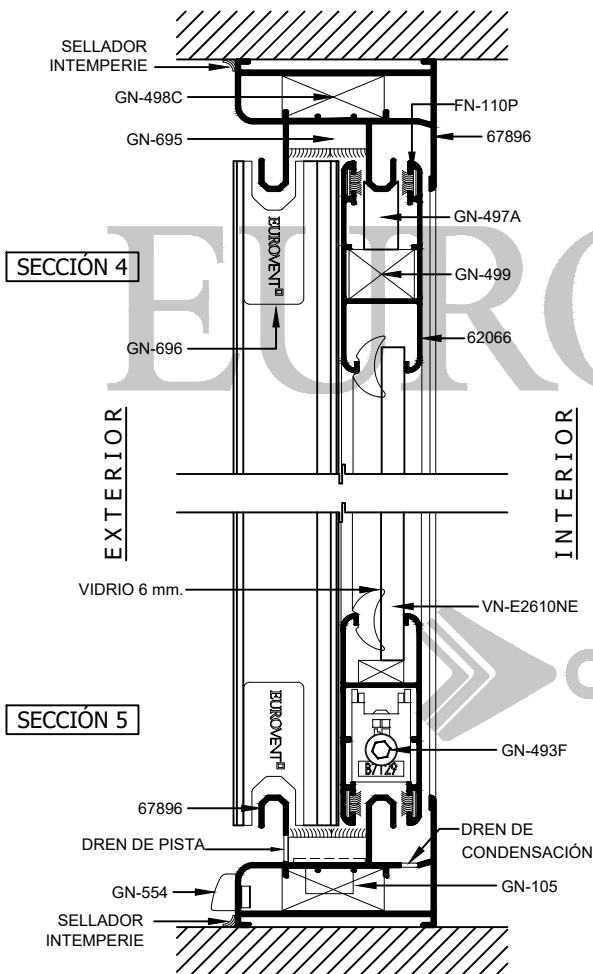

CLASSIC
SERIE
S60
CORREDIZA

CLASSIC
SERIE
S60
CORREDIZA

EUROVENT[®]
CLASSIC

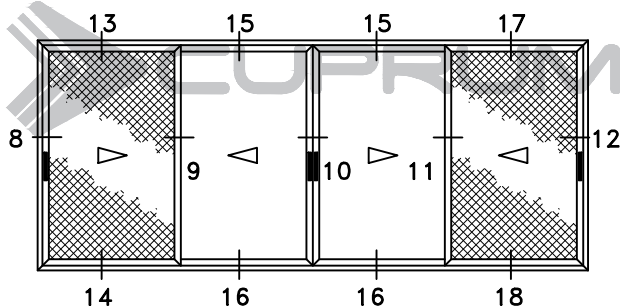
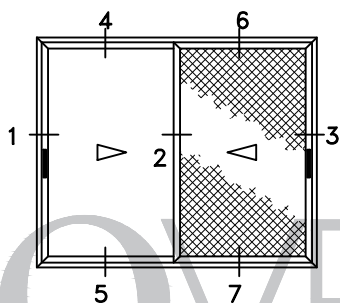

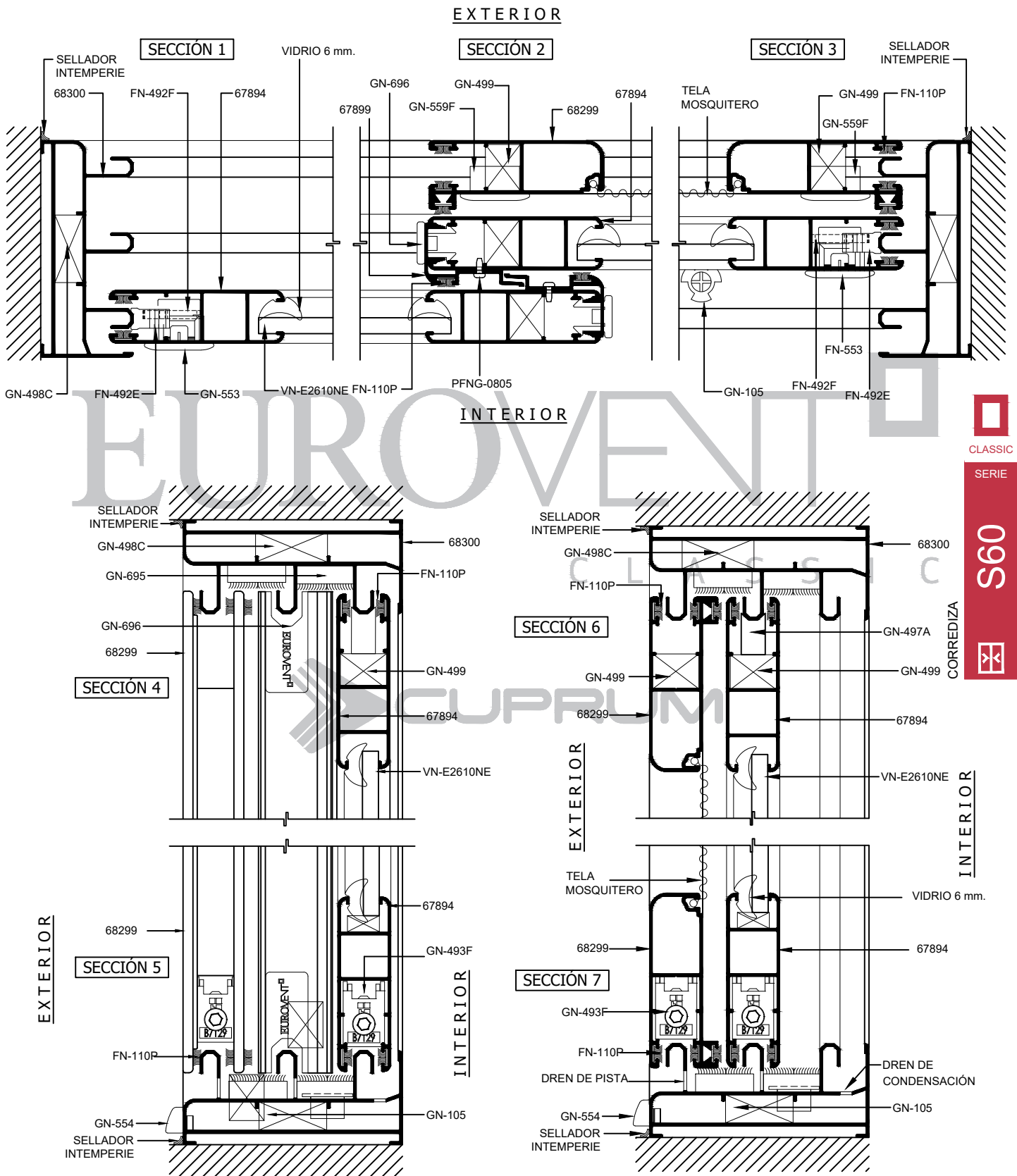

CLASSIC

SERIE

S60



CORREDIZA

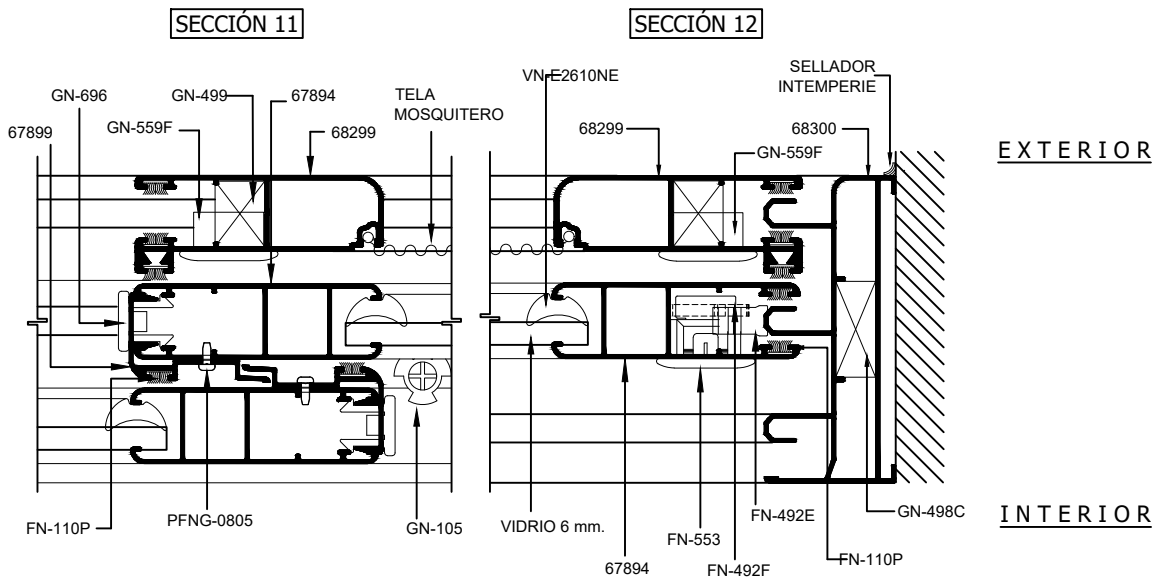
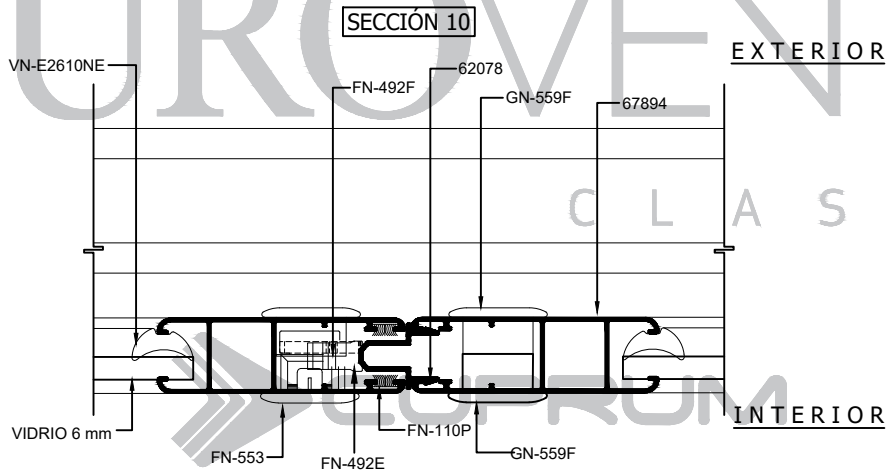
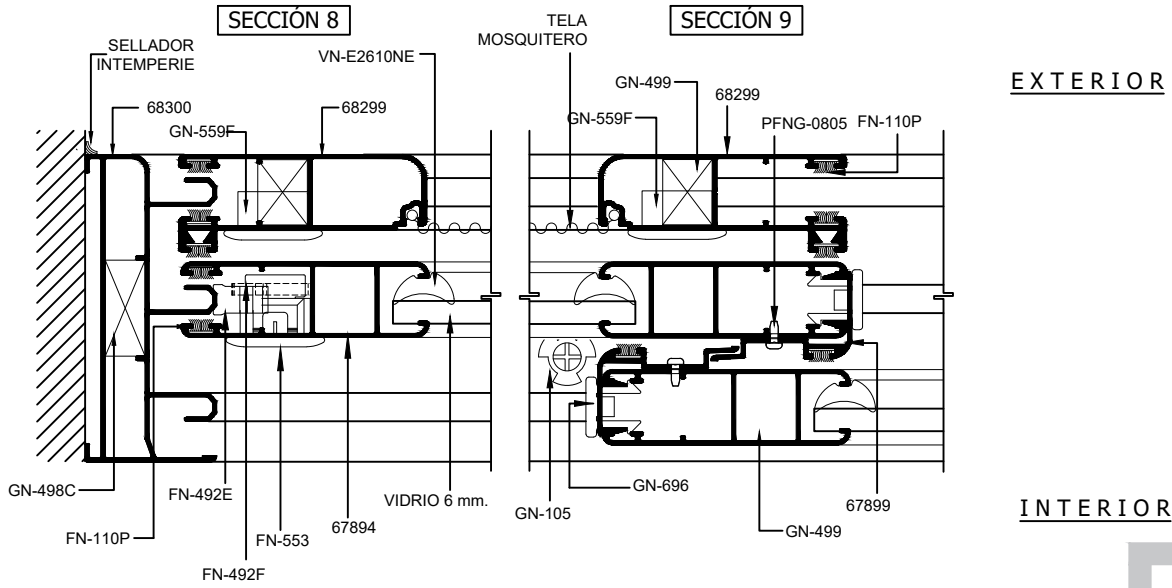

 CLASSIC
 SERIE
S60
 COREDIZA

EUROVENT
CLASSIC

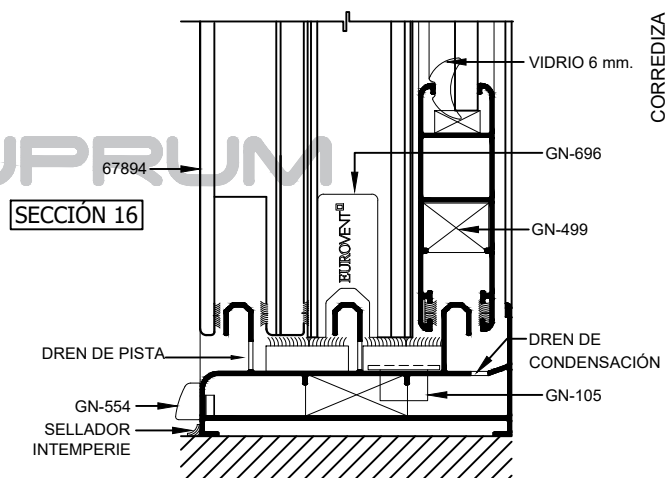
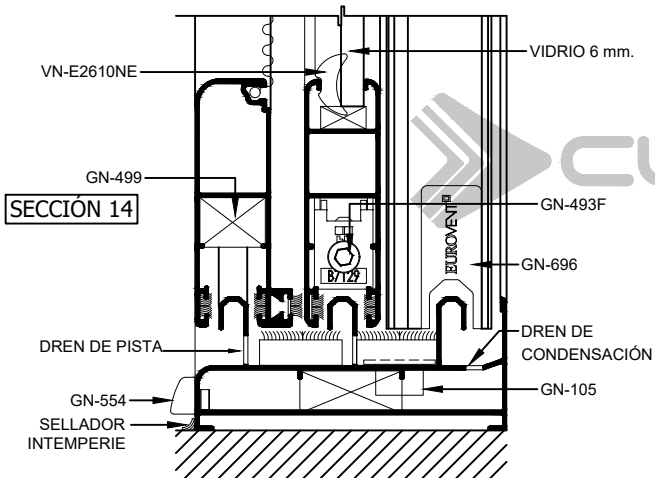
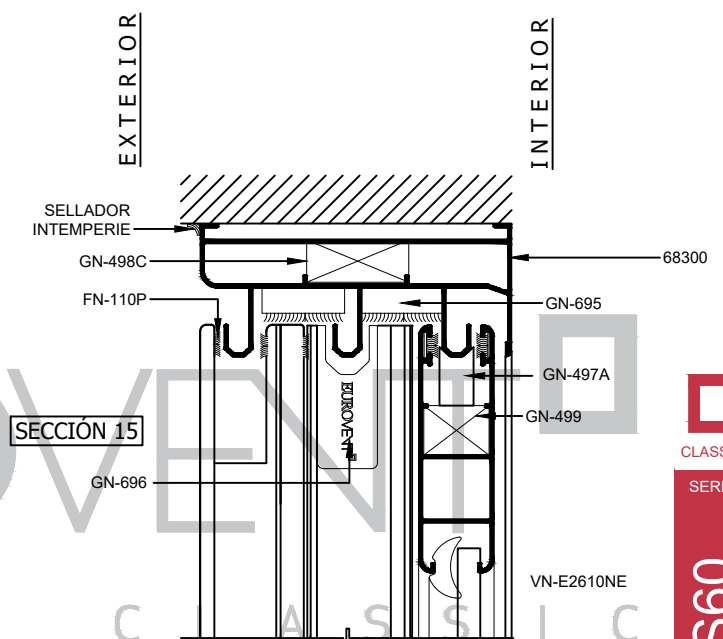
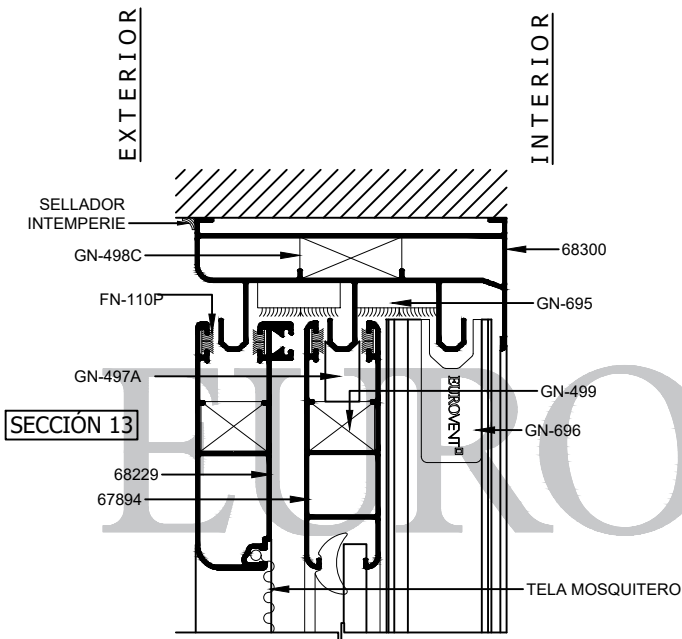



 CLASSIC
 SERIE
S60
 CORREDIZA

EUROVENT CLASSIC

EXTERIOR

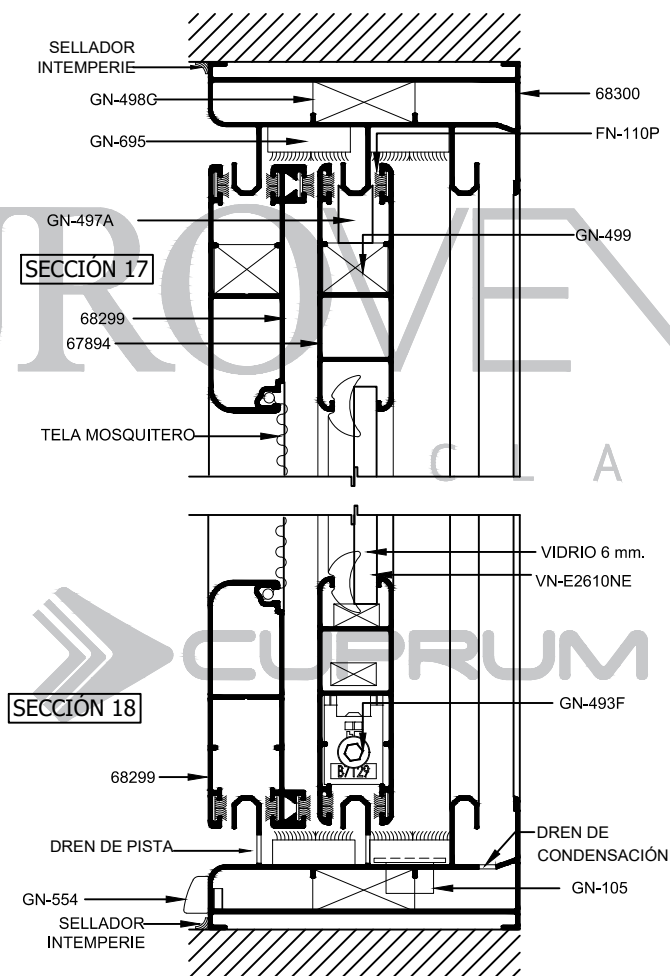
INTERIOR



TROQUEL GN-533CDR
VISTA FRONTAL

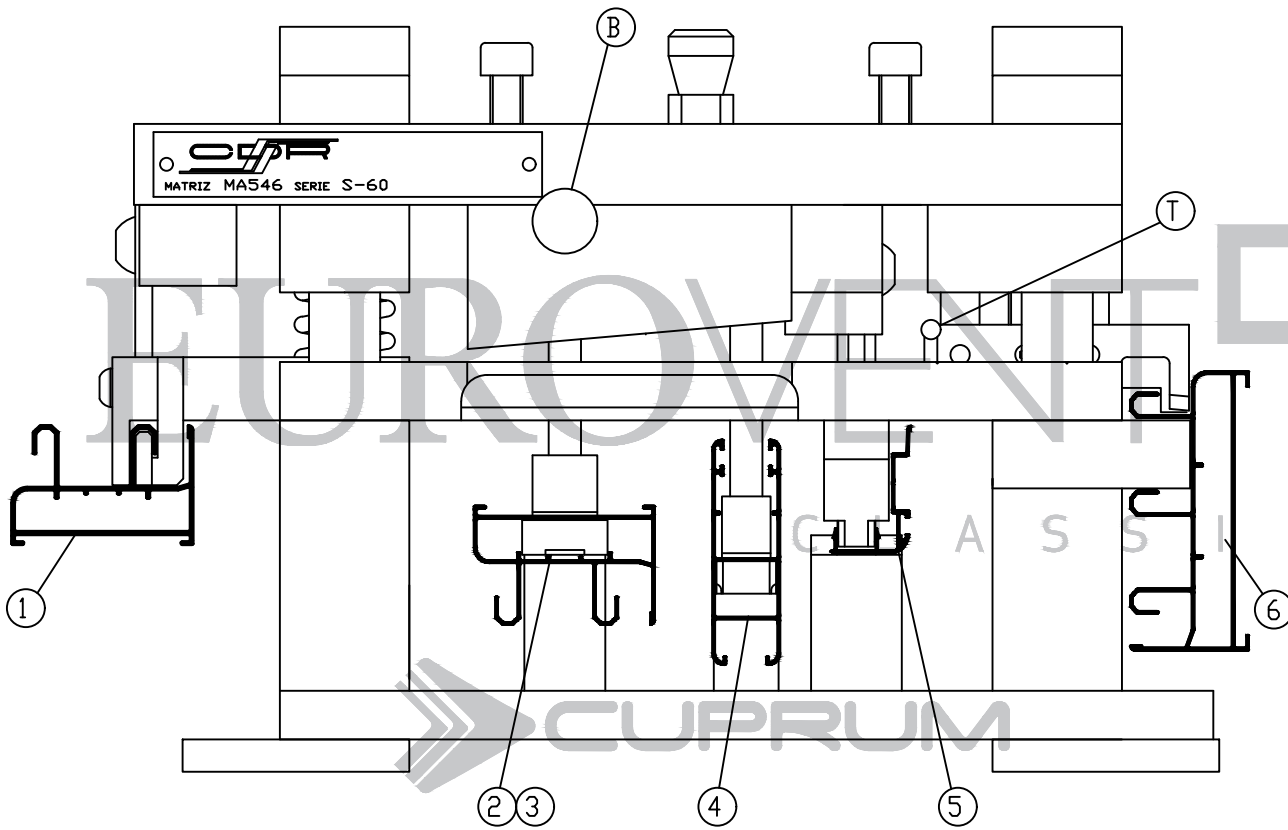

CLASSIC
SERIE
S60
CORREDIZA

TROQUEL GN-533CDR
VISTA LATERAL

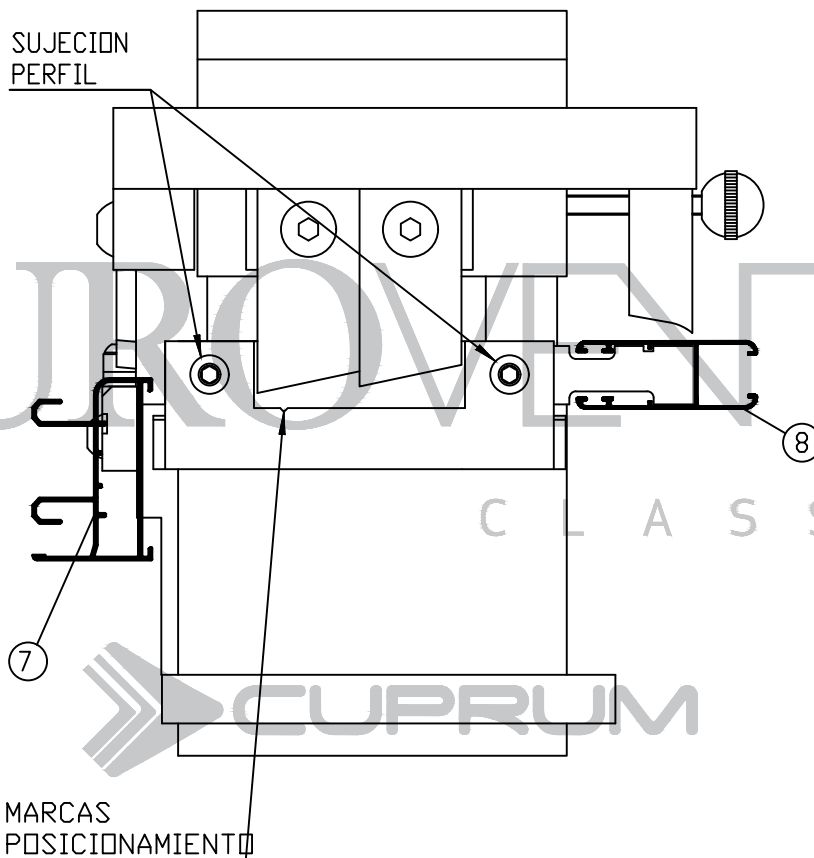

CLASSIC
SERIE
S60
CORREDIZA

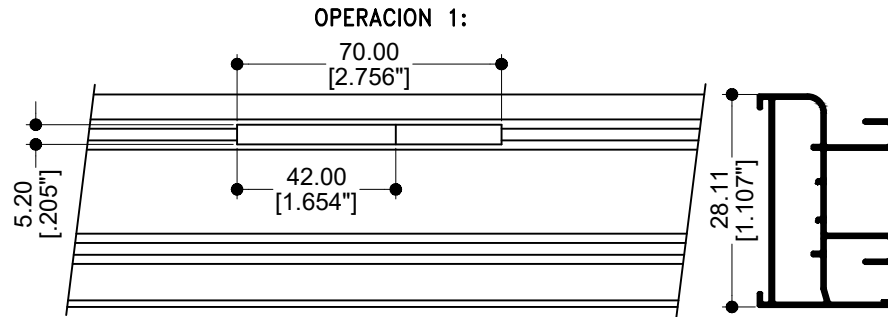

CAJEADO PARA CONTRA (2 CORTES)
PERFILES: 67896 Y 68300

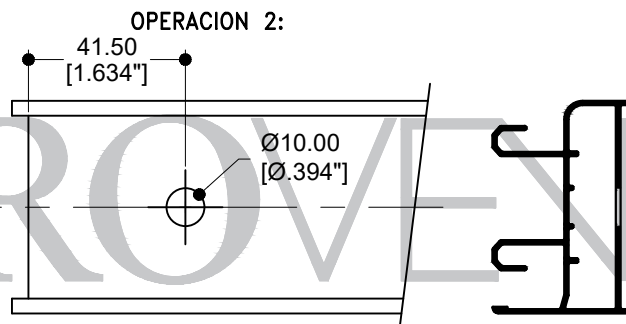

ESCUADRA MARCO
(BOLA B FUERA)
PERFILES: 67896, 68300 Y 62079

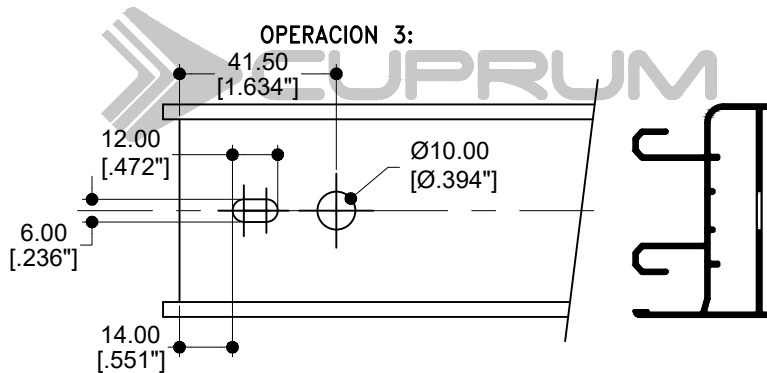

ESCUADRA MARCO
(BOLA B DENTRO)
PERFILES: 67896, 68300 Y 62079

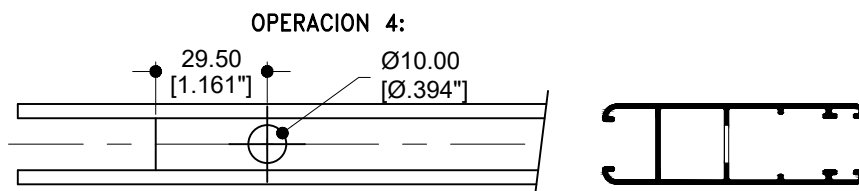

ESCUADRA HOJA
PERFILES: 68337, 62066, 67894 Y 68299

EUROVENT[®] CLASSIC

CLASSIC
SERIE
S60
CORREDIZA

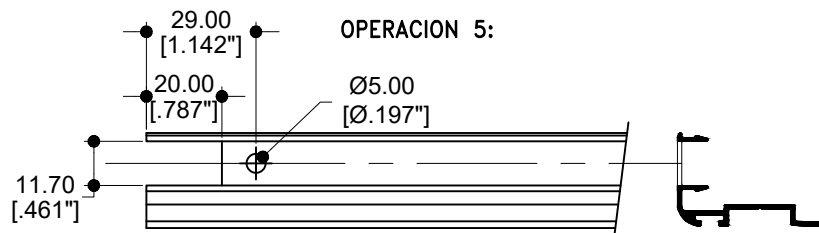

CAJEADO TRASLAPE
PERFILES: 67899 Y 62070

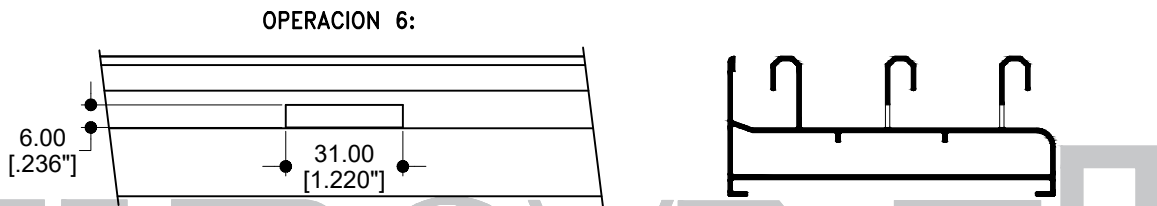

DREN DE PISTA
PERFILES: 67896, 68300

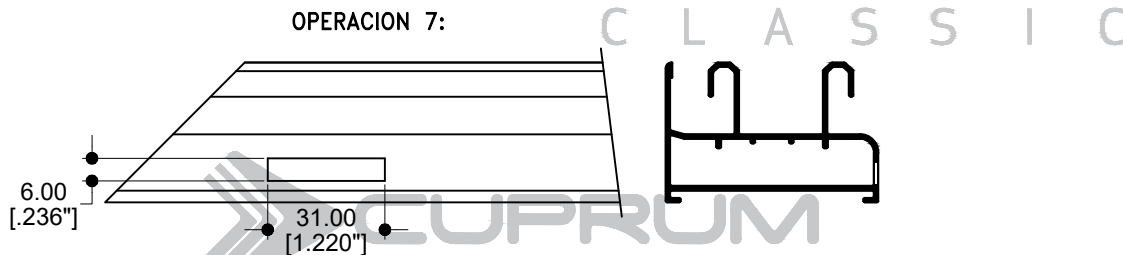

DREN DE CAMARA
PERFILES: 67896, 68300 Y 62079

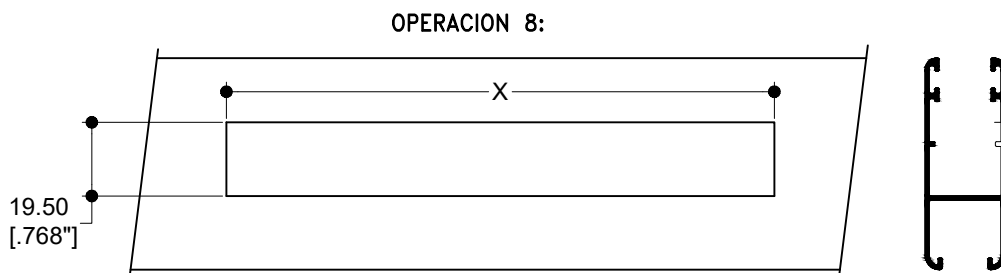

CAJEADO CIERRE (2 CORTES)
CIERRE GRANE x =182
CIERRE CHICO x =142
PERFILES: 62066, 68337, 67894 Y 68299

CLASSIC
SERIE
S60
CORREDIZA

EUROVENT[®]
CLASSIC
CUPRUM

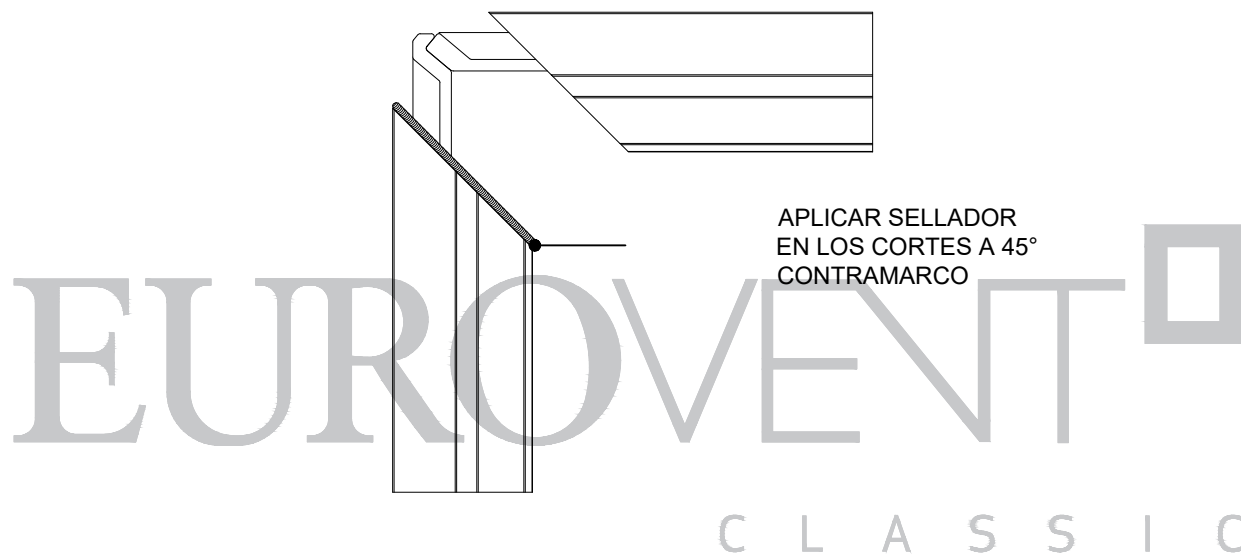

CLASSIC

SERIE

S60

CORREDIZA

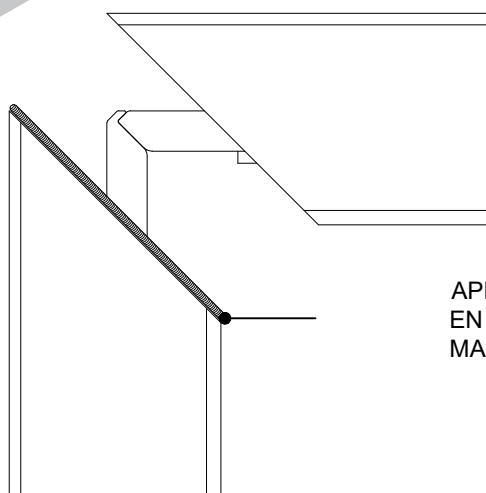

APLICAR SELLADOR
EN LOS CORTES A 45°
MARCO

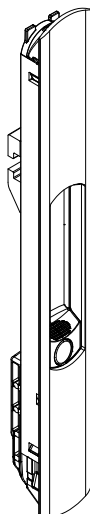

FN-553
BROCHE OLÉ TOP 200MM

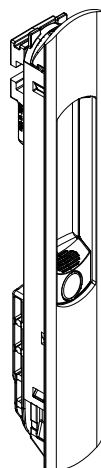

FN-552
CIERRE EMBUTIDO

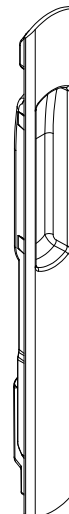

GN-559F
UÑERO EMBUTIDO

CLASSIC
SERIE

S60

CORREDIZA

EUROVENT

CLASSIC



FN-492E
CONTRA

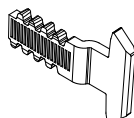

FN-492F
GANCHO

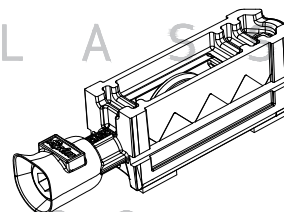

GN-493F
CARRETILLA
CAPACIDAD: 15 KG. X PZA.

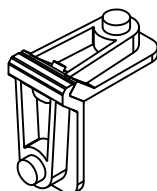

GN-498C
ESCUADRA DE BOTÓN
CONTRAMARCO

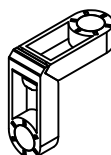

GN-499
ESCUADRA DE BOTÓN
DE HOJA

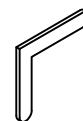

GN-618A
ESCUADRA DE
ALINEACIÓN

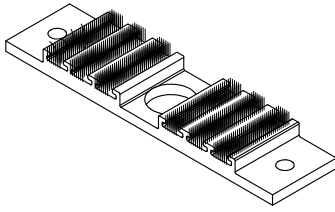

GN-695
CORTAVIENTO

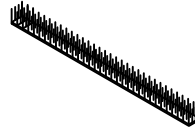

FN-110P
FELPA CON PLÁSTICO



GN-105
TAPÓN DESAGÜE

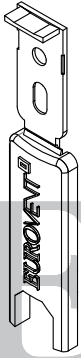

GN-696
TAPA TRASLAPE



GN-497A
CANDADO
ANTIELEVACIÓN

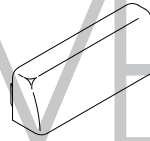

GN-554
TAPA DREN



VN-E2002NE
EMPAQUE COLA DE RATA

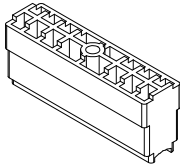

GN-235
CALZO HOJA FIJA

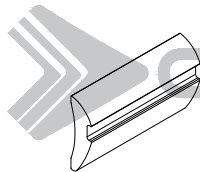

VN-E2610NE
EMPAQUE

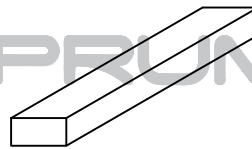

HPEN-CALZA
CALZA DE 1/4" x 3/8" x 4"



EURO-GN102D
TAPÓN CUBRE PIJA

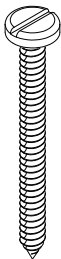

TMNG-1026
TORN P/MADERA 10X76 GAL

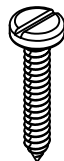

PFNG-0805
#8 X 1/2"

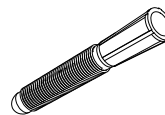

TAQ1147
TAQUETE 1/4 D/PLASTICO

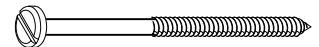

TMNG-1026
TORN P/MADERA 10X76 GAL

CLASSIC
SERIE
S60
CORREDIZA

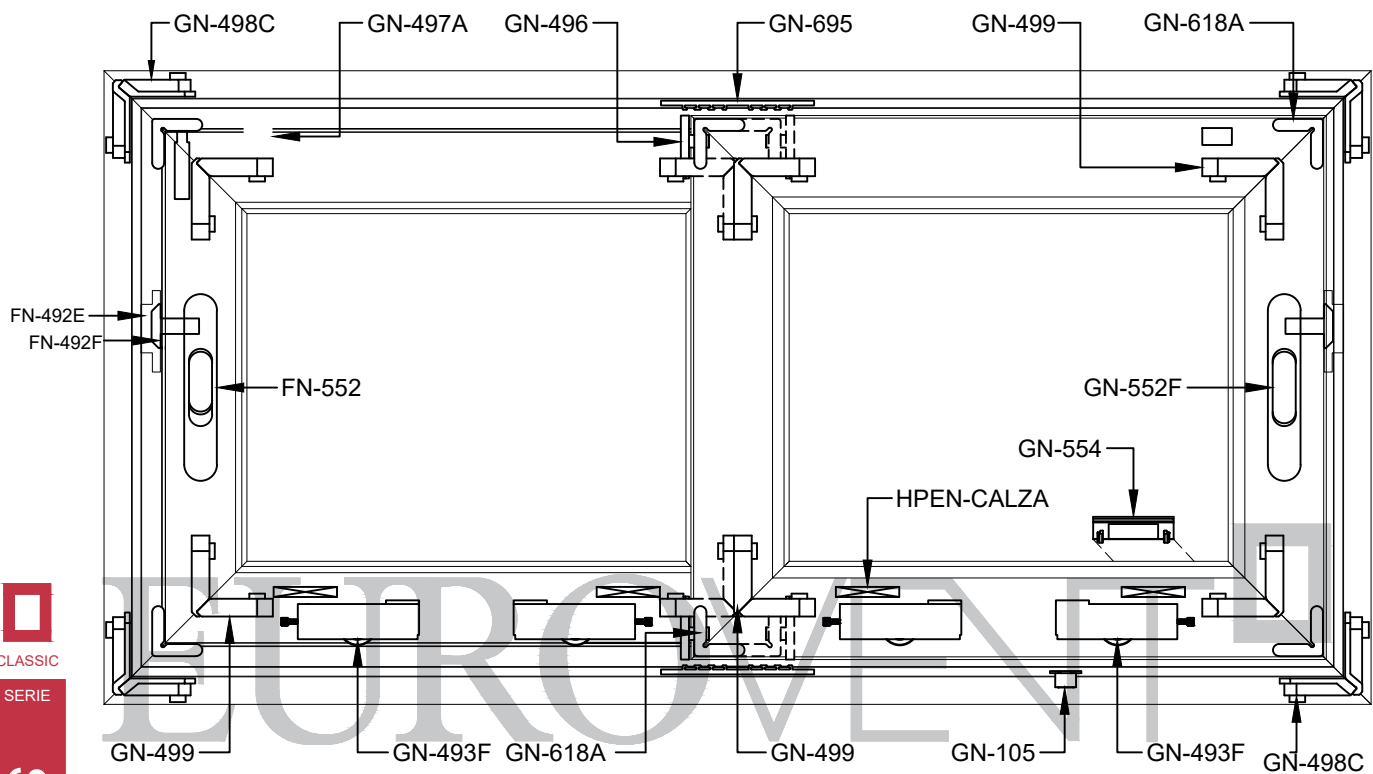

CLASSIC
SERIE

S60



CORREDIZA

VENTANA CORREDIZA S60 XX

CLAVE	DESCRIPCIÓN	PIEZAS
FN-492E	ENGANCHE	2
FN-492F	FLECHA	2
FN-552	CIERRE CHICO	2
GN-105	TAPÓN DESAGÜE	1
GN-493F	CARRETILLA (25 KG X PZA)	4
GN-497A	CANDADO ANTI-ELEVACIÓN	4
GN-498C	ESCUADRA DE BOTÓN CONTRAMARCO	4
GN-499	ESCUADRA DE BOTÓN DE HOJA	8
GN-554	TAPA DREN CON VALVULA	2
GN-618A	ESCUADRA DE ALINEACIÓN	16
GN-696	TAPA TRASLAPE	4
GN-695	CORTAVIENTOS	2
VN-E2610NE	EMPAQUE CUÑA	2L + 4H
FN-110P	FELPA CON PLÁSTICO	4L + 6H
HPEN-CALZA	CALZA	1
GENERICA	TELA MOSQUITERO	
VN-E2002NE	EMPAQUE COLA DE RATA	1L + 2H
GN-559F	UÑERO EMBUTIDO	1
GN-499	ESCUADRA MOSQUITERO	4
GN-493F	CARRETILLA MOSQUITERO	2

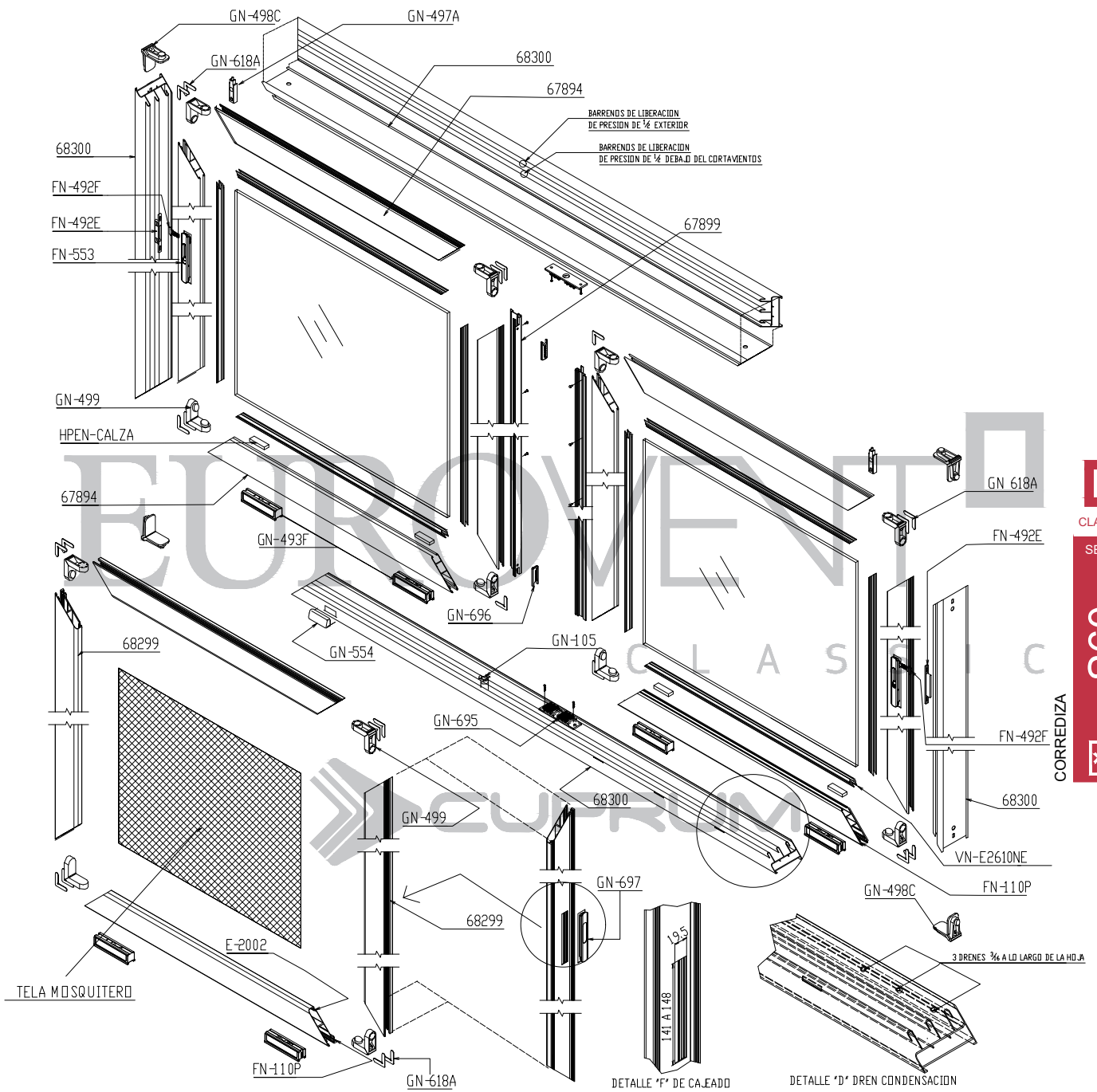

CLASSIC
SERIE
S60
CORREDIZA

TABLA DE DESCUENTOS VENTANA XX CON MOSQUITERO

CLAVE	DESCRIPCIÓN	No. DE PIEZAS.	CORTE Y DESCUENTO
68300	JAMBA	2	H
68300	RIEL CABEZAL TRIPLE	2	L
62066	CERCO	4	H - 57
62066	CABEZAL-ZOCLO	4	L/2
62070	TRASLAPE	2	H - 57
68337	ZOCLO-CABEZAL MOSQ.	2	L/2
68337	CERCO MOSQ.	2	H - 57
VIDRIO	L		L/2 - 82
	H	2	H - 138

L = ANCHO
H = ALTO
DESCUENTOS EN MILIMETROS

TABLA DE DESCUENTOS PUERTA XX CON MOSQUITERO

CLAVE	DESCRIPCIÓN	No. DE PIEZAS.	CORTE Y DESCUENTO
68300	JAMBA	2	H
68300	RIEL CABEZAL TRIPLE	2	L
67894	CERCO PUERTA	4	H - 57
67894	CABEZAL-ZOCLO	4	L/2+7
67899	TRASLAPE	2	H - 57
68299	ZOCLO-CABEZAL MOSQ.	2	L/2+7
68299	CERCO MOSQ.	2	H - 57
VIDRIO	L		L/2 - 110
	H	2	H - 175

L = ANCHO
H = ALTO
DESCUENTOS EN MILIMETROS

VENTANA CORREDIZA SERIE 60
A UNA ALTURA DE 15 METROS
DEFLEXIÓN MAX. L/175

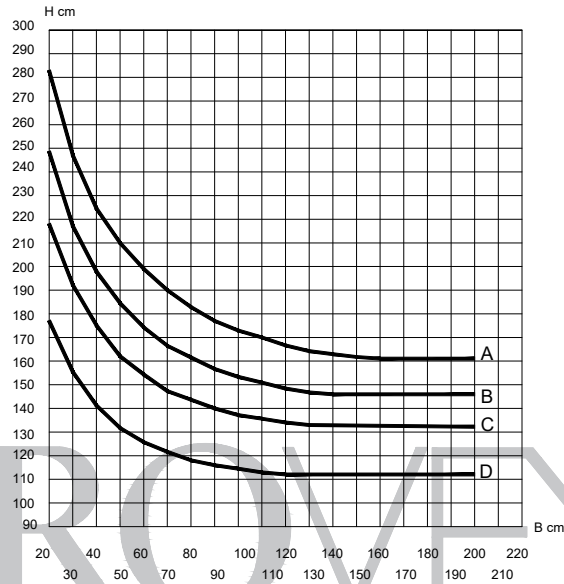

SERIE

S60



CORREDIZA

LOS LÍMITES DE FABRICACIÓN PARA LOS PERFILES, SERÁN LOS QUE SE ENCUENTREN DEBAJO DE LAS CURVAS GRAFICADAS

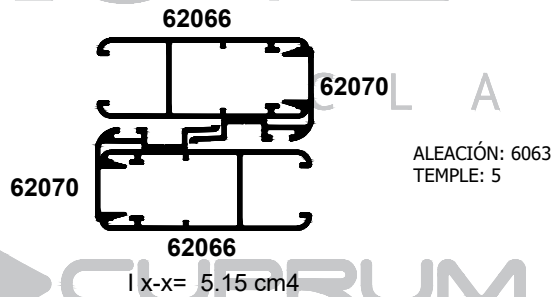

ALEACIÓN: 6063
TEMPLE: 5

Valores de presión por velocidad de viento

Curvas	Presión del diseño	Velocidad de viento	Zona
A	30 Kg/m ²	80 Km/h	Centro de grandes ciudades
B	45 Kg/m ²	100 Km/h	Barrios Residenciales
C	65 Kg/m ²	120 Km/h	Campo Abierto
D	145 Kg/m ²	160 Km/h	Zona Costera

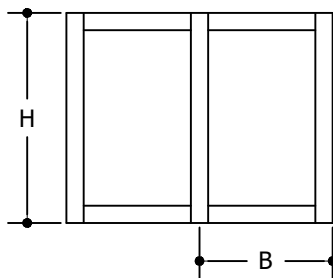

LOS LÍMITES DE UN CANCEL, VAN EN FUNCIÓN DE LA COMBINACIÓN DE LA RESISTENCIA DEL PERFIL DE ALUMINIO, VIDRIO Y ACCESORIOS QUE LO INTEGRAN.

VERIFICAR QUE LA DEFLEXIÓN DEL PERFIL SEA COMPATIBLE CON EL VIDRIO UTILIZADO.

PUERTA CORREDIZA SERIE 60
A UNA ALTURA DE 15 METROS
DEFLEXIÓN MAX. L/175

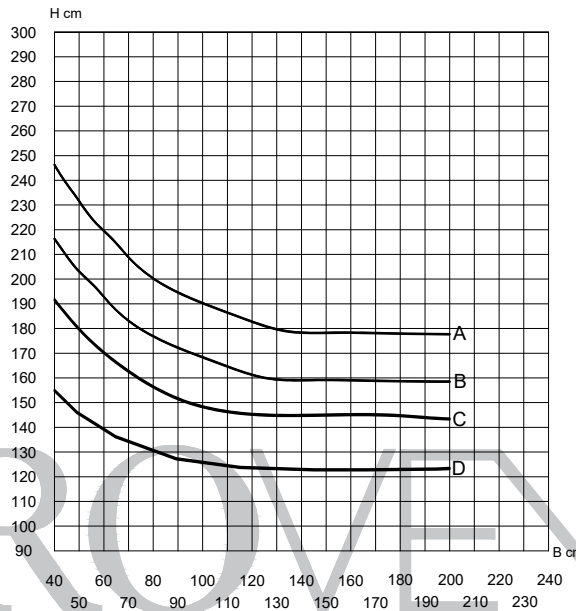

LOS LÍMITES DE FABRICACIÓN PARA LOS PERFILES, SERÁN LOS QUE SE ENCUENTREN DEBAJO DE LAS CURVAS GRAFICADAS

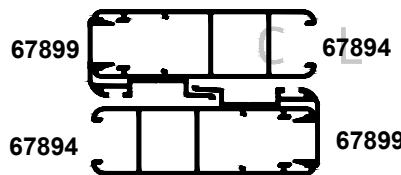

ALEACIÓN: 6063
TEMPLE: 5

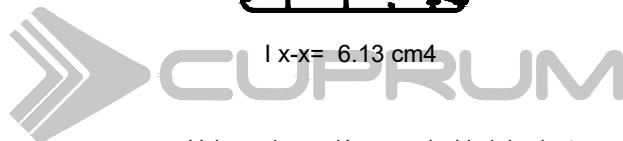

Valores de presión por velocidad de viento

Curvas	Presión del diseño	Velocidad de viento	Zona
A	30 Kg/m ²	80 Km/h	Centro de grandes ciudades
B	45 Kg/m ²	100 Km/h	Barrios Residenciales
C	65 Kg/m ²	120 Km/h	Campo Abierto
D	124 Kg/m ²	160 Km/h	Zona Costera

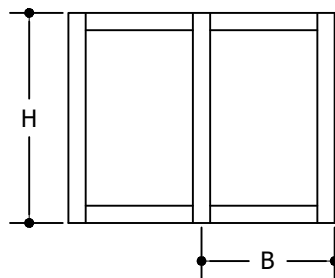

LOS LÍMITES DE UN CANCEL, VAN EN FUNCIÓN DE LA COMBINACIÓN DE LA RESISTENCIA DEL PERFIL DE ALUMINIO, VIDRIO Y ACCESORIOS QUE LO INTEGRAN.

VERIFICAR QUE LA DEFLEXIÓN DEL PERFIL SEA COMPATIBLE CON EL VIDRIO UTILIZADO.

PARAMETROS MÍNIMOS Y MÁXIMOS DE FABRICACIÓN

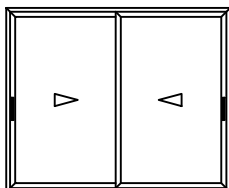

VC-60
MÍNIMO 0.40 x 0.40 HOJA
MÁXIMO 0.80 x 1.80 HOJA

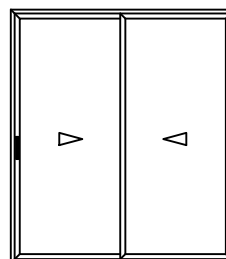

VC-60
MÍNIMO 0.40 x 0.40 HOJA
MÁXIMO 0.80 x 2.10 HOJA

CLASSIC
SERIE

S60



CORREDIZA

EUROVENT[®]
CLASSIC



ALUMINIO

CLAVE	DESCRIPCIÓN	PIEZAS X ATADO	LARGO STD. MTS.	PERÍMETRO ANOD. CM.	PERÍMETRO PUL. CM.
62066	CERCO VENTANA	8	6.10	31.18	12.42
67896	RIEL BASICO	4	6.10	32.40	16.52
68300	RIEL TRIPLE	4	6.10	45.34	22.12
67894	CERCO PUERTA	4	6.10	32.93	15.18
62070	TRASLAPE VENTANA	16	6.10	15.92	7.40
67899	TRASLAPE PUERTA	12	6.10	17.29	6.55
68299	MOSQUITERO EXT. PUERTA	4	6.10	32.95	17.23
68337	MOSQUITERO VENTANA	4	6.10	30.18	14.42
62078	ADAPTADOR OXXO	24	6.10	11.19	6.20

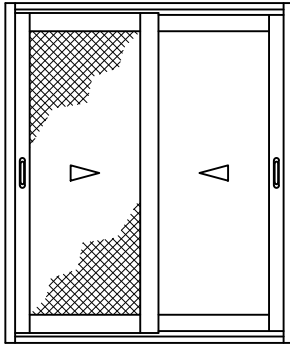

X X

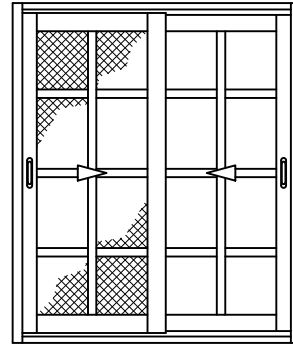

X X

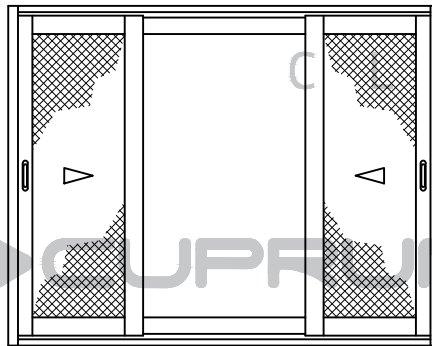

X O X

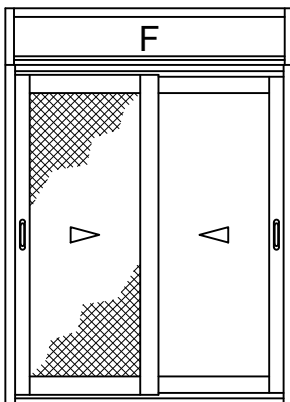

X X

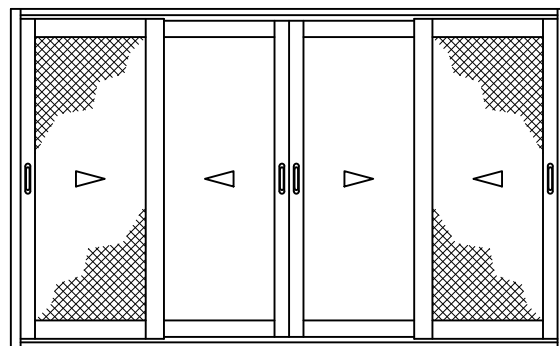

X X X X

EUROVENT

CUPRUM

CLASSIC

CLASSIC
SERIE
S70
CORREDIZA

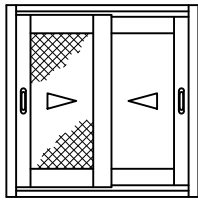

X X

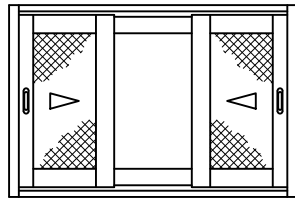

X O X

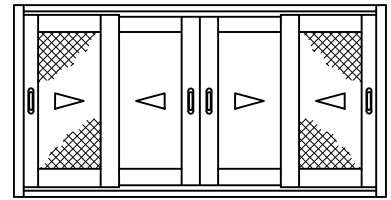

X X X X

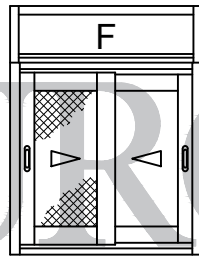

X X

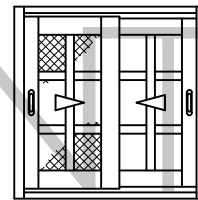

X X

CLASSIC
SERIE

S70



CORREDIZA

EUROVENT CLASSIC

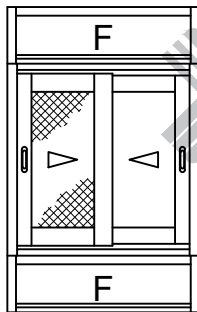

X X

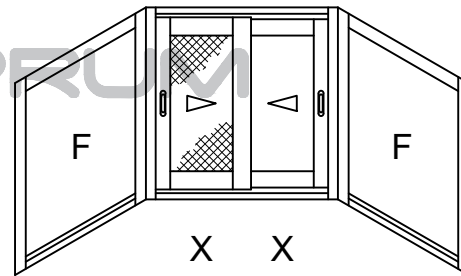

X X

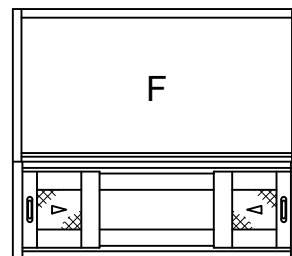
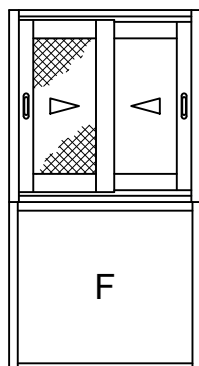

X O X

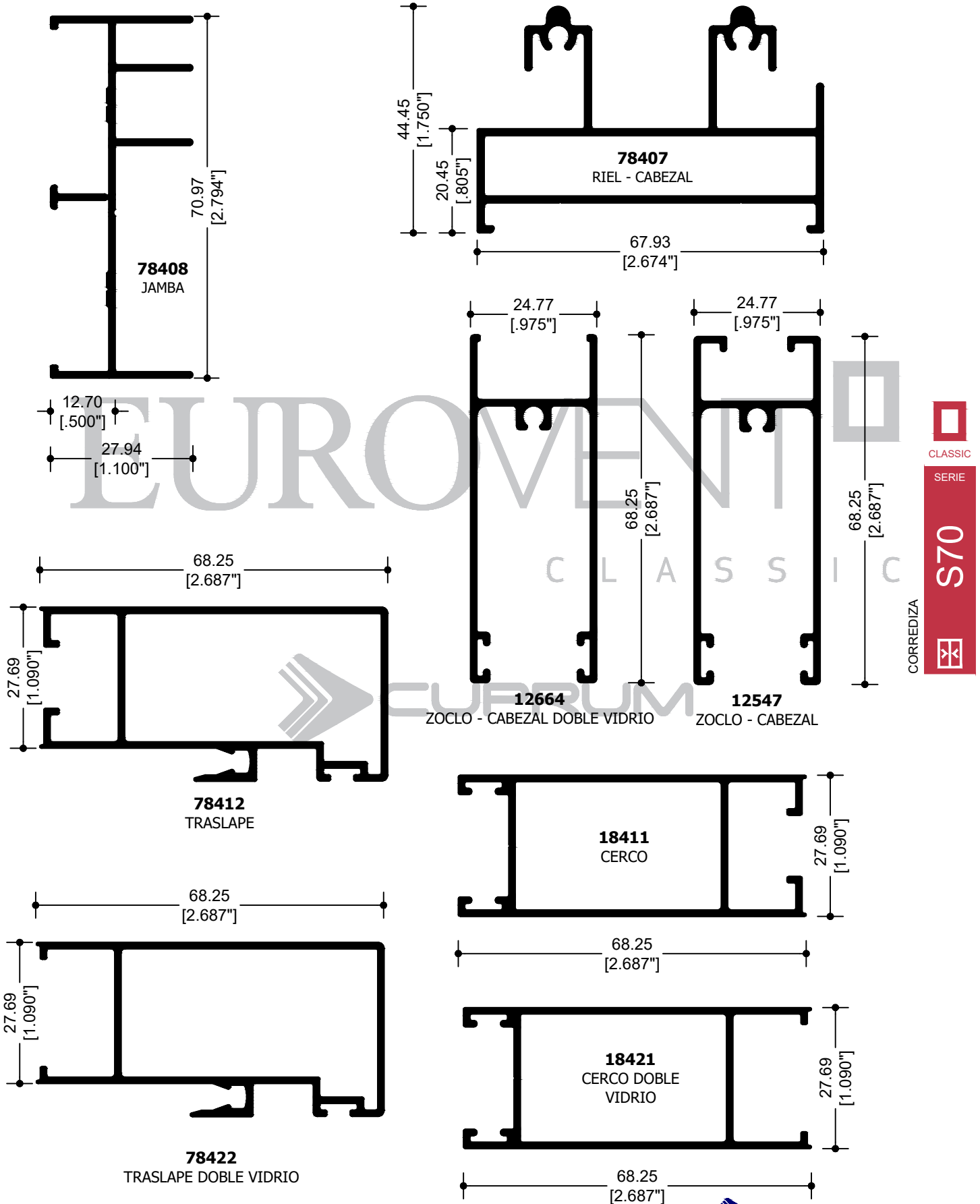

CLASSIC
SERIE
S70
CORREDIZA

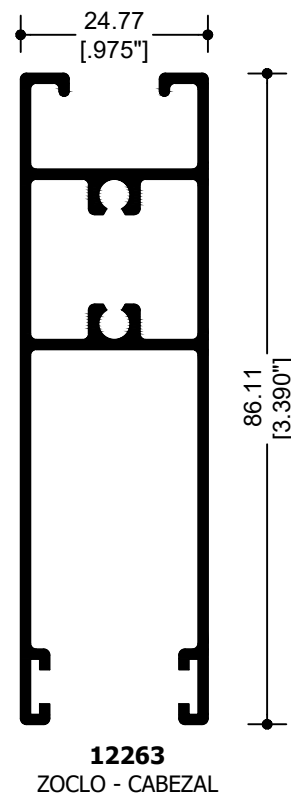
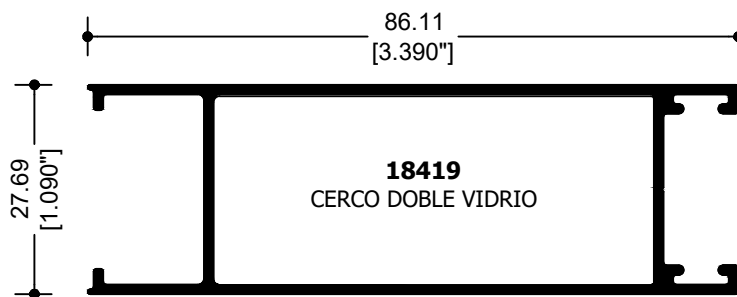
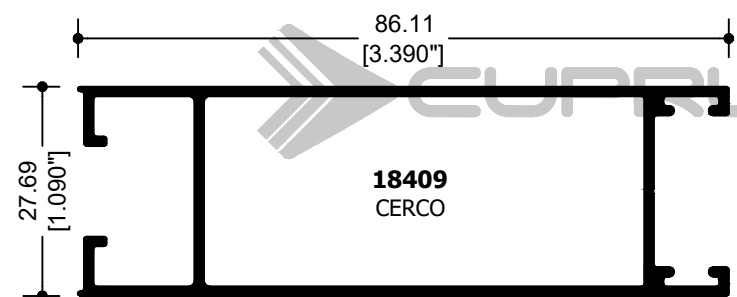
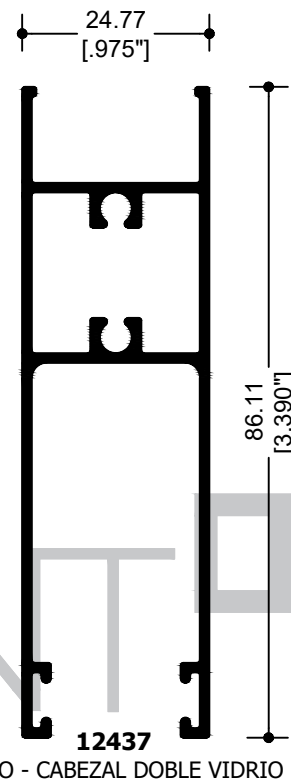
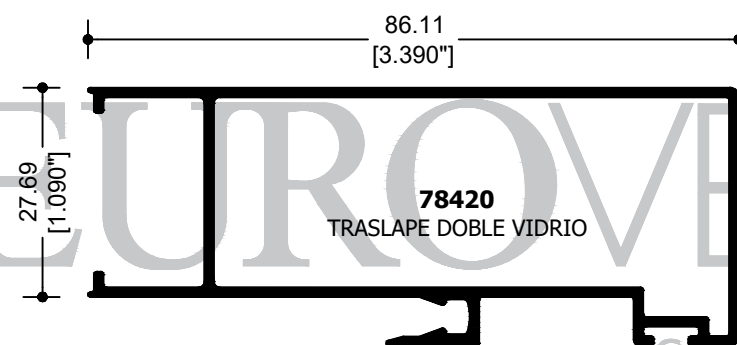
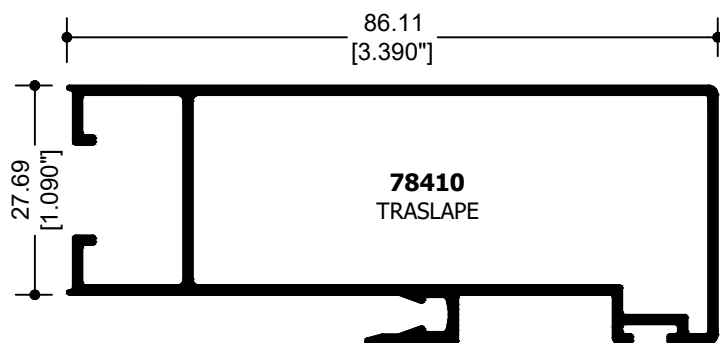

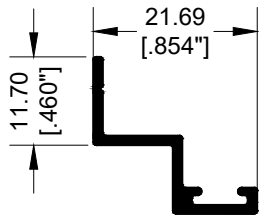

50701
ADAPTADOR
OXO

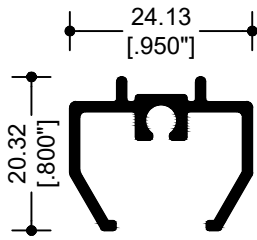

14702
PERFIL P/CUADRÍCULA

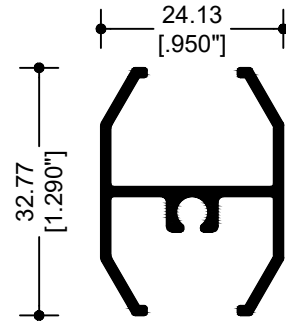

14918
PERFIL P/CUADRÍCULA

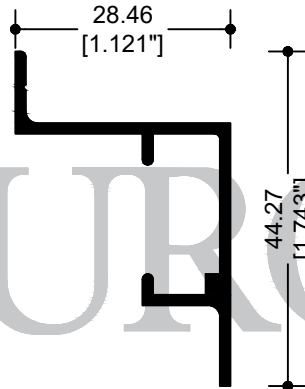

11409
CABEZAL MOSQUITERO

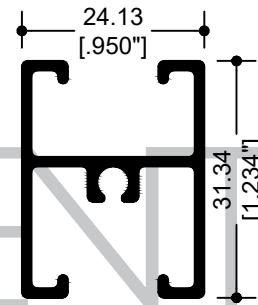

12456
INTERMEDIO

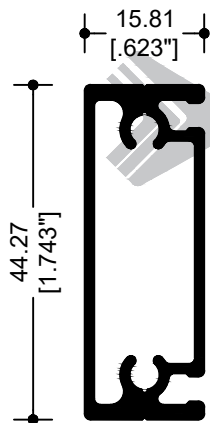

11411
MOSQUITERO

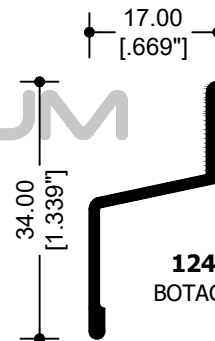

12428
BOTAGUAS

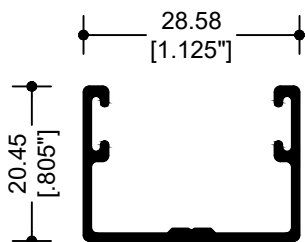

18413
GUÍA INFERIOR

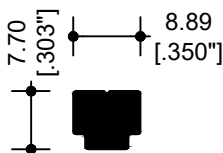

14412
CONECTOR P/REFUERZO

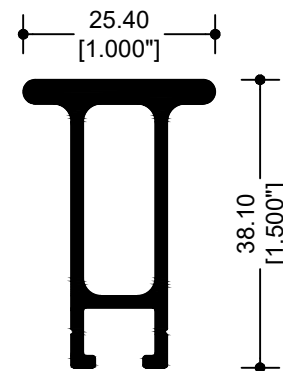

14411
REFUERZO 1 1/2"

EUROVENT CLASSIC

C L A S S I C

CLASSIC
SERIE
S70
CORREDIZA

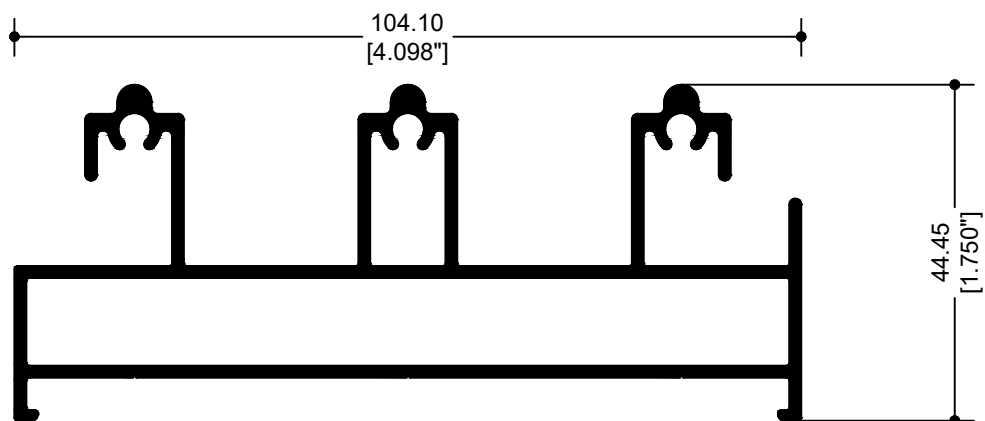

72373
RIEL TRIPLE

CLASSIC
SERIE
S70
CORREDIZA

EUROVENT[®]
CLASSIC

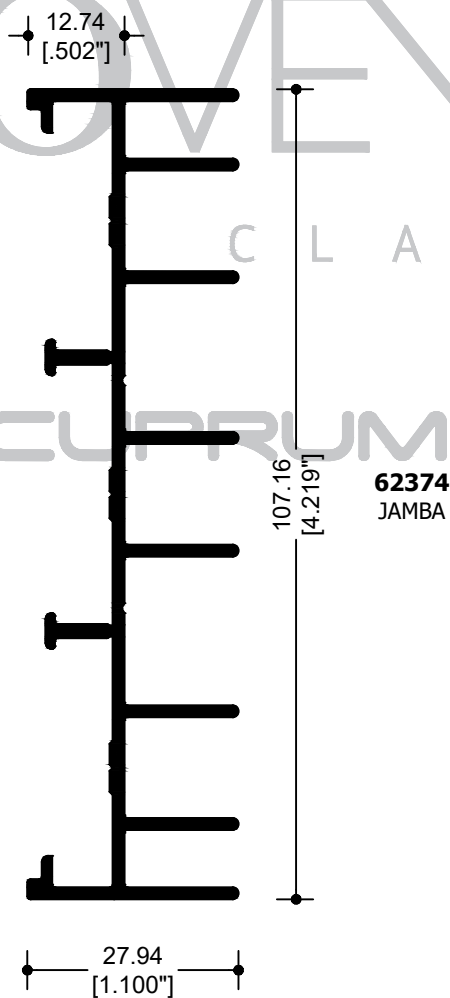

62374
JAMBA

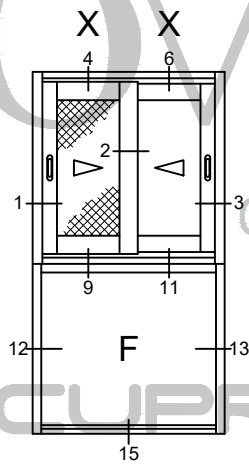
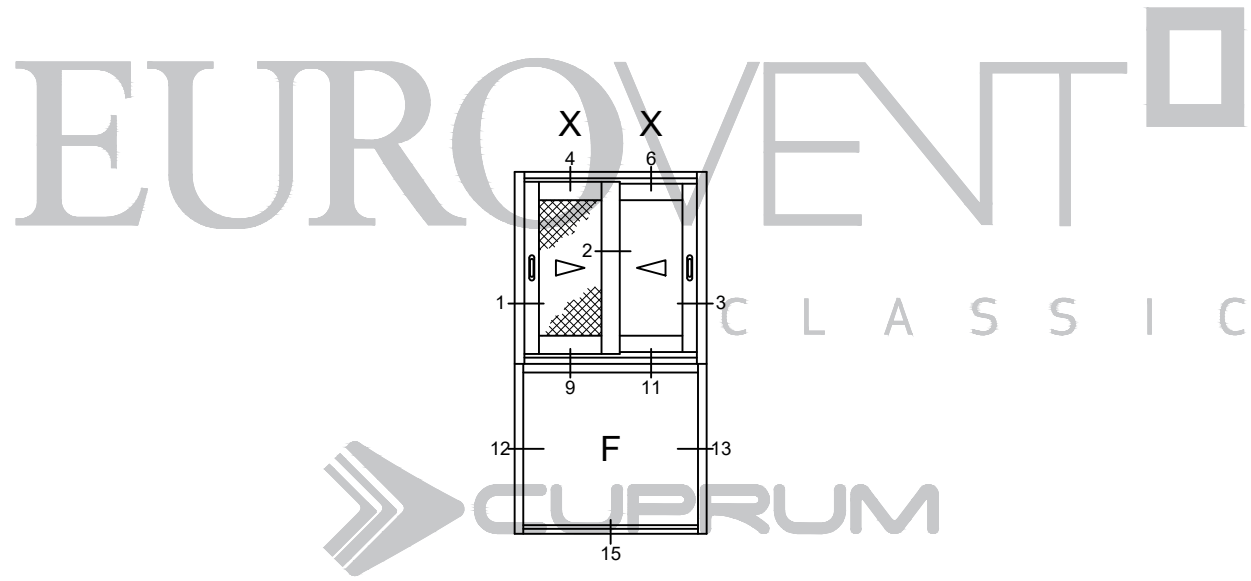
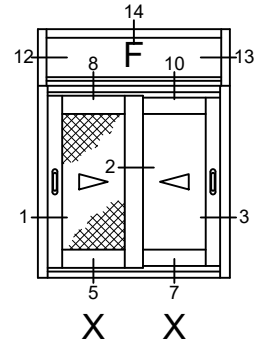
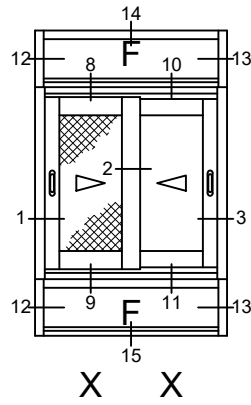
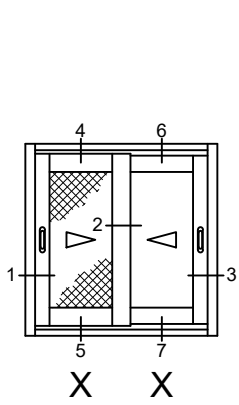

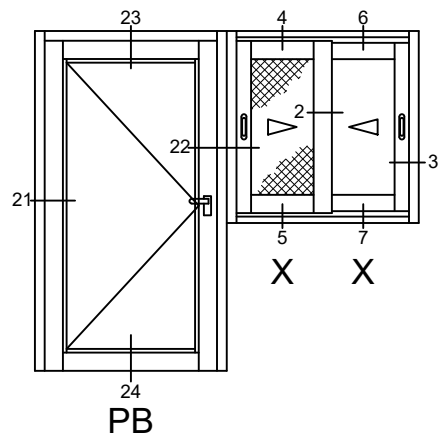
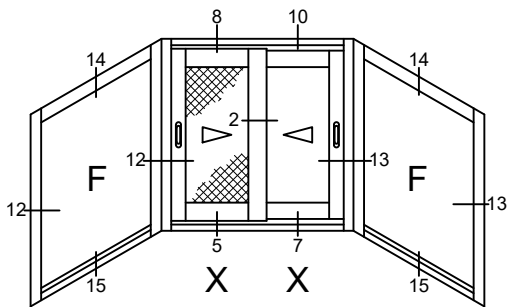

 CLASSIC
 SERIE
S70

 CORREDIZA

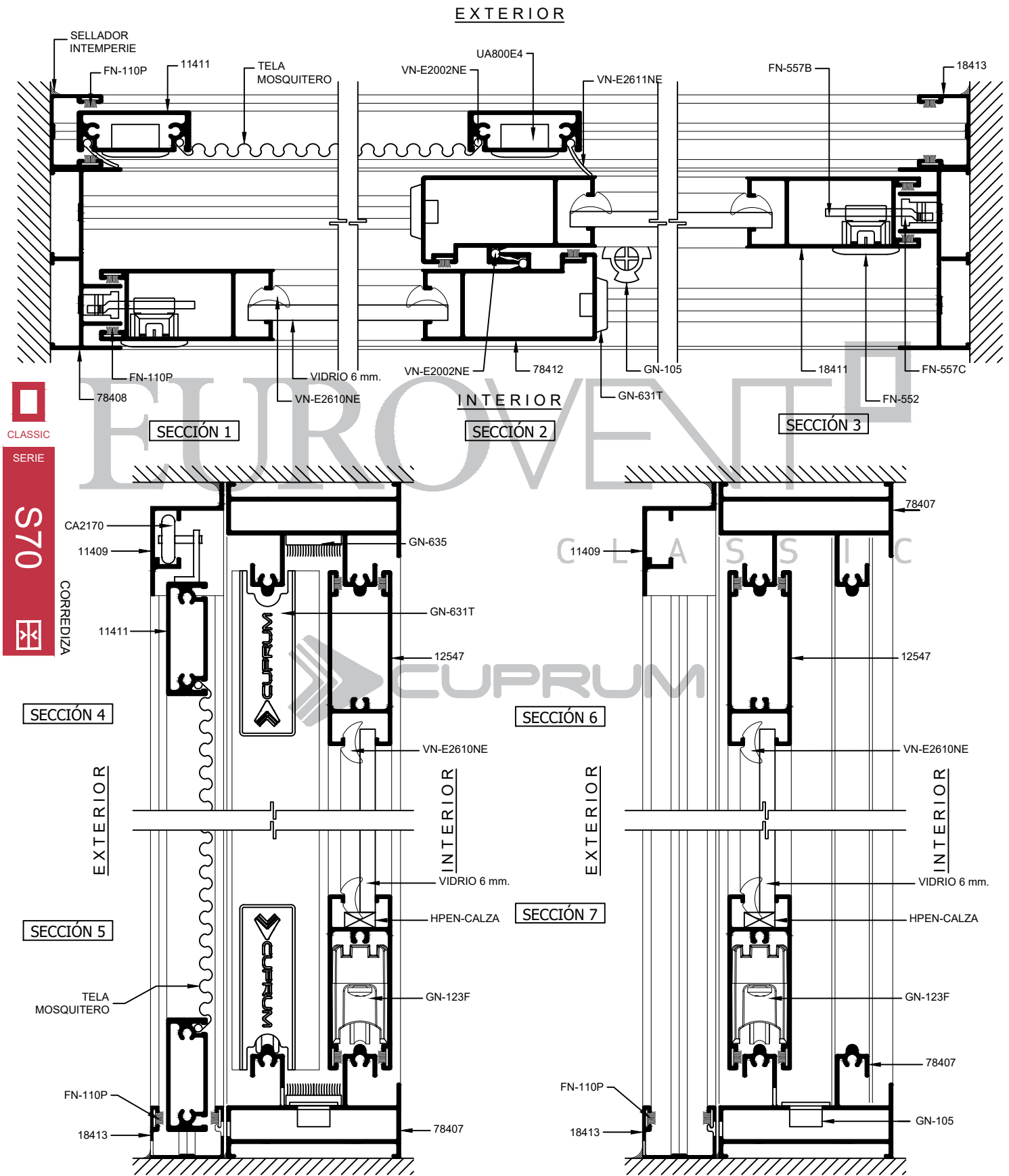

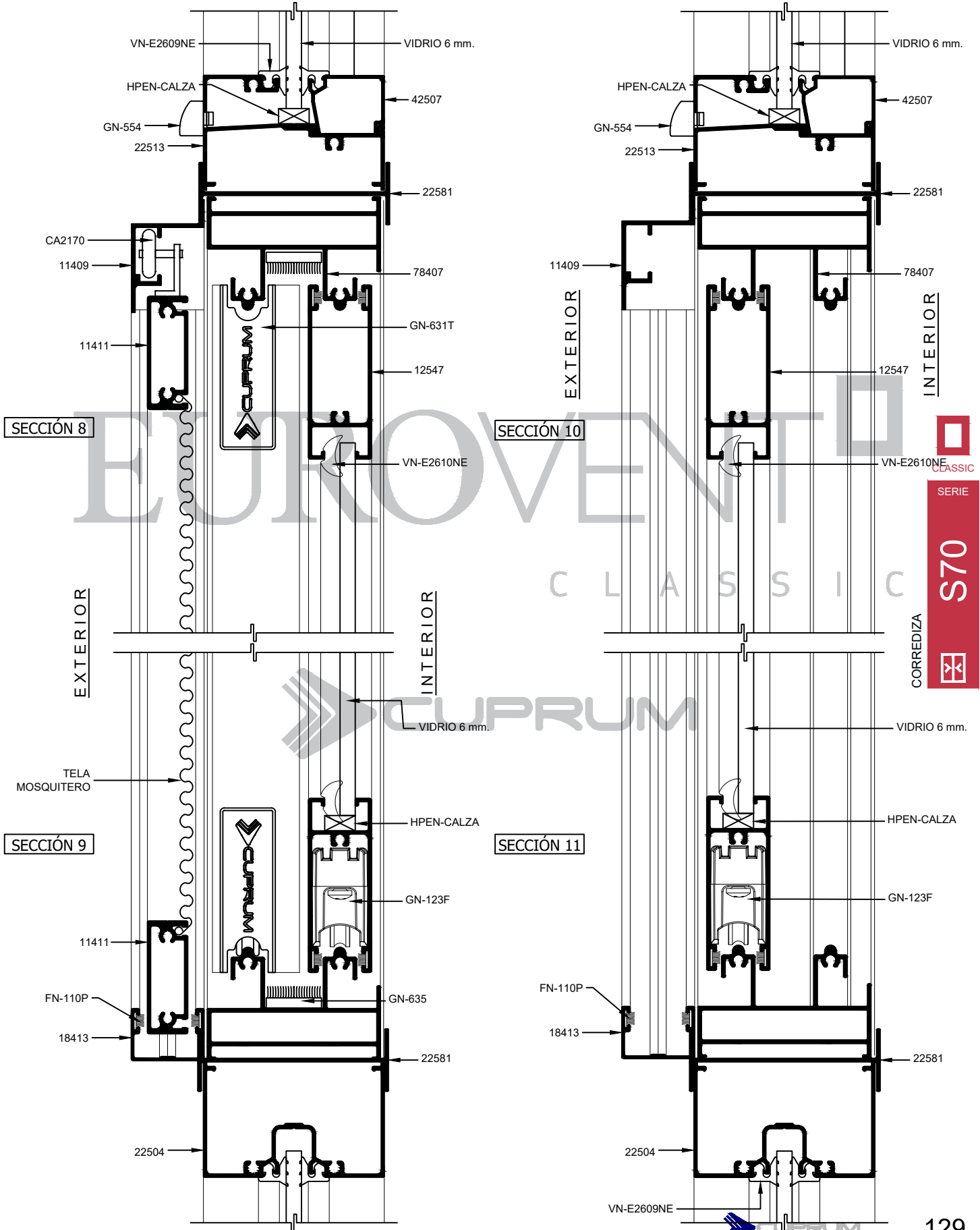

CLASSIC
SERIE
S70
CORREDIZA



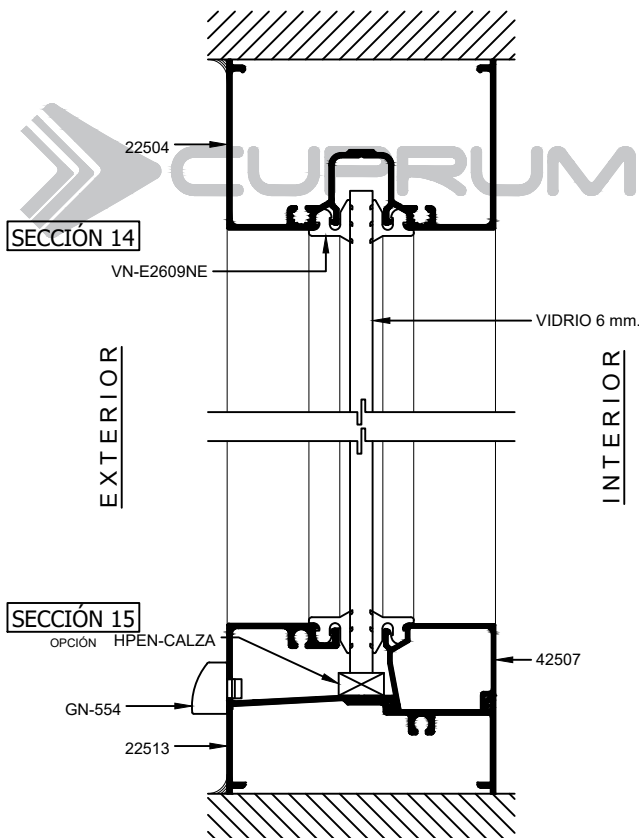
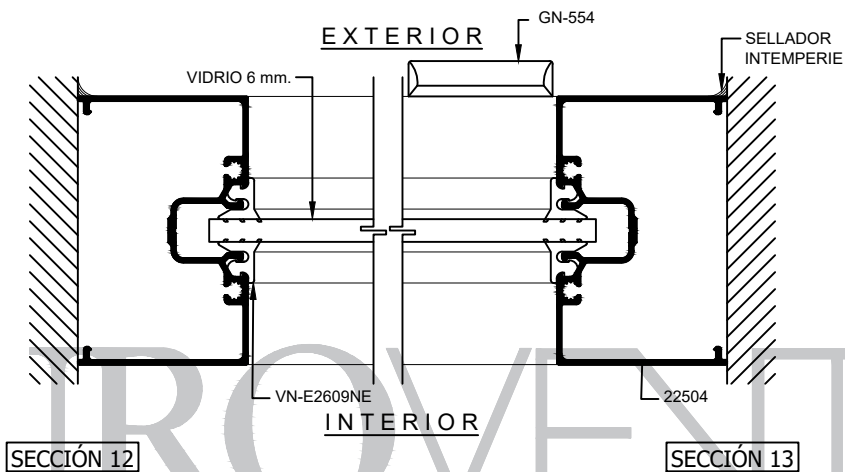

 CLASSIC
 SERIE
S70
 CORREDIZA

CLASSIC
SERIE
S70
CORREDIZA

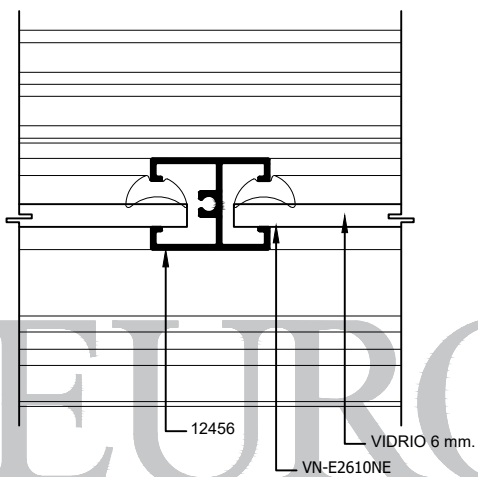

EXTERIOR



INTERIOR

SECCIÓN 17

EXTERIOR

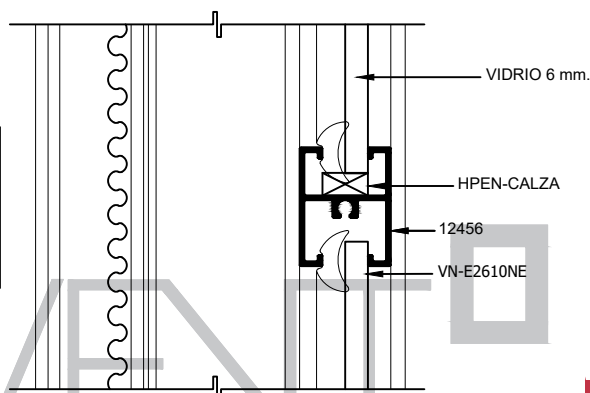

INTERIOR

SECCIÓN 18

CLASSIC

SERIE

S70

CORREDIZA



C L A S S I C

EXTERIOR

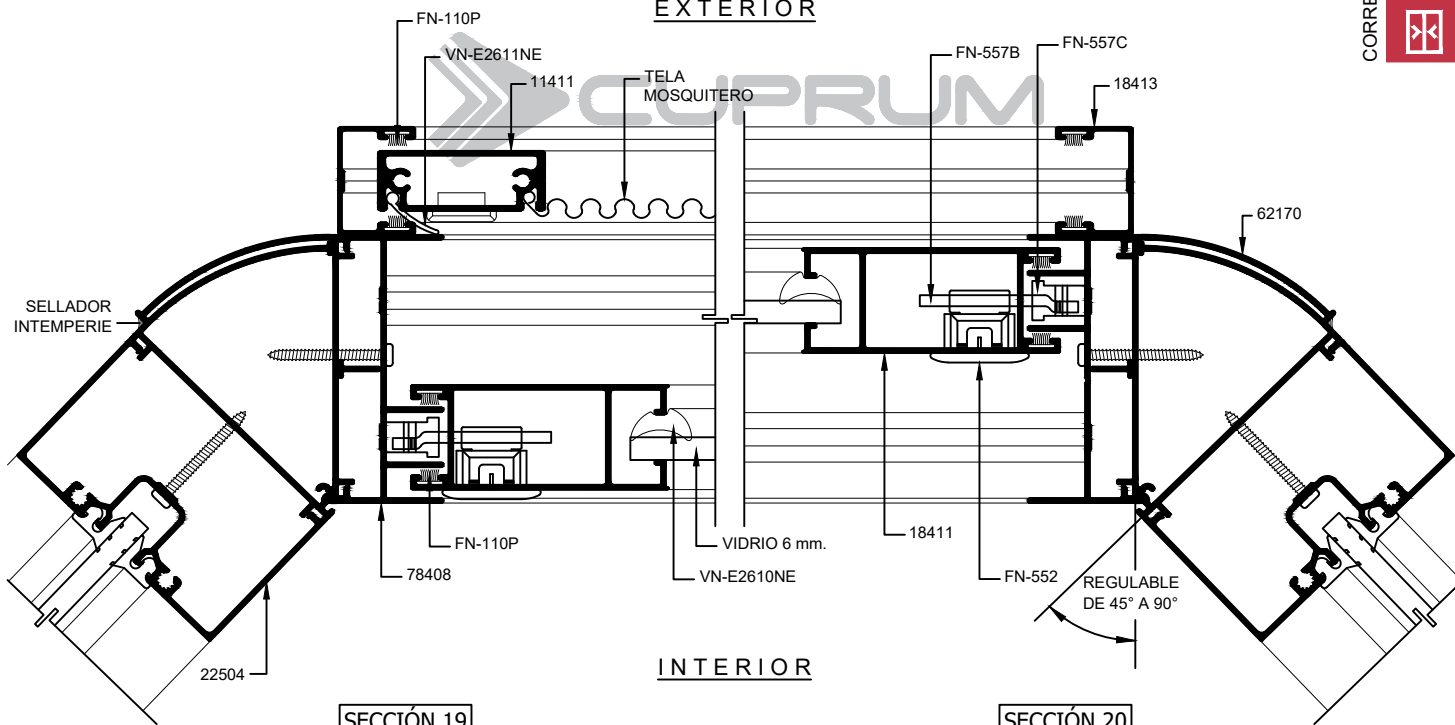

SECCIÓN 19

SECCIÓN 20

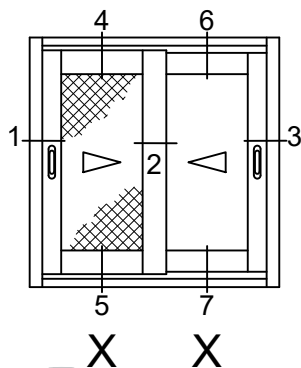

CLASSIC
SERIE
S70
CORREDIZA

EUROVENT

SIN ESCALA

C L A S S I C

CUPRUM
EXTERIOR

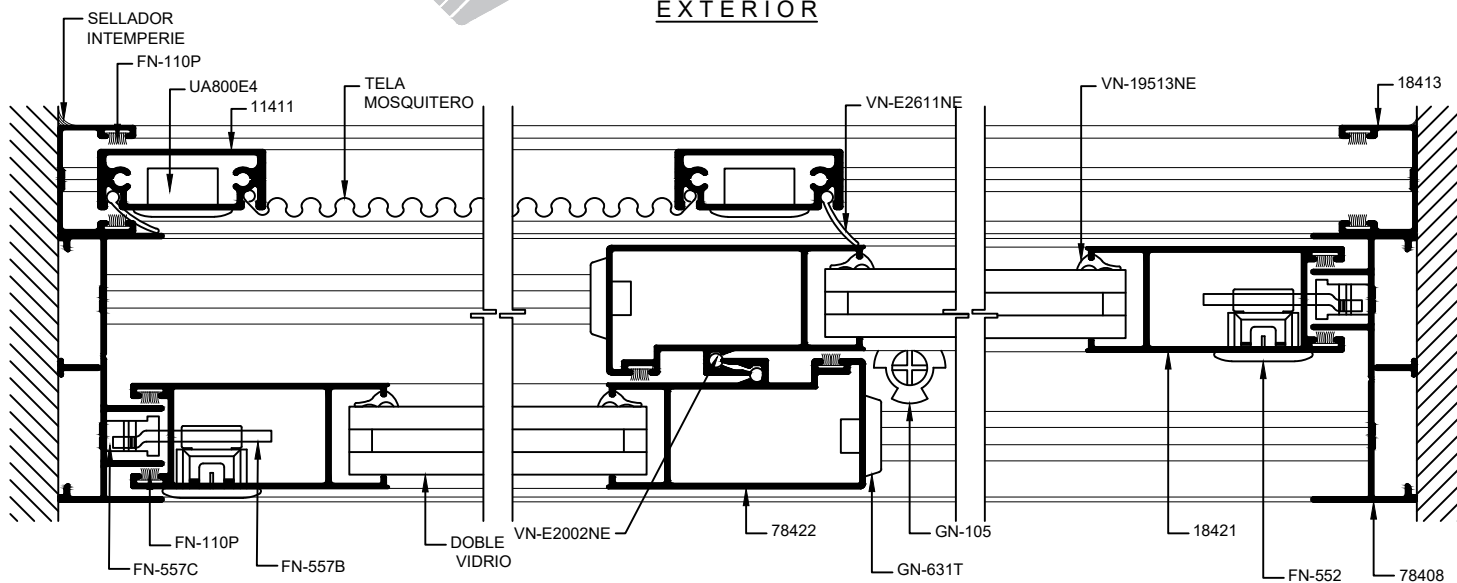

INTERIOR

SECCIÓN 1

SECCIÓN 2

SECCIÓN 3

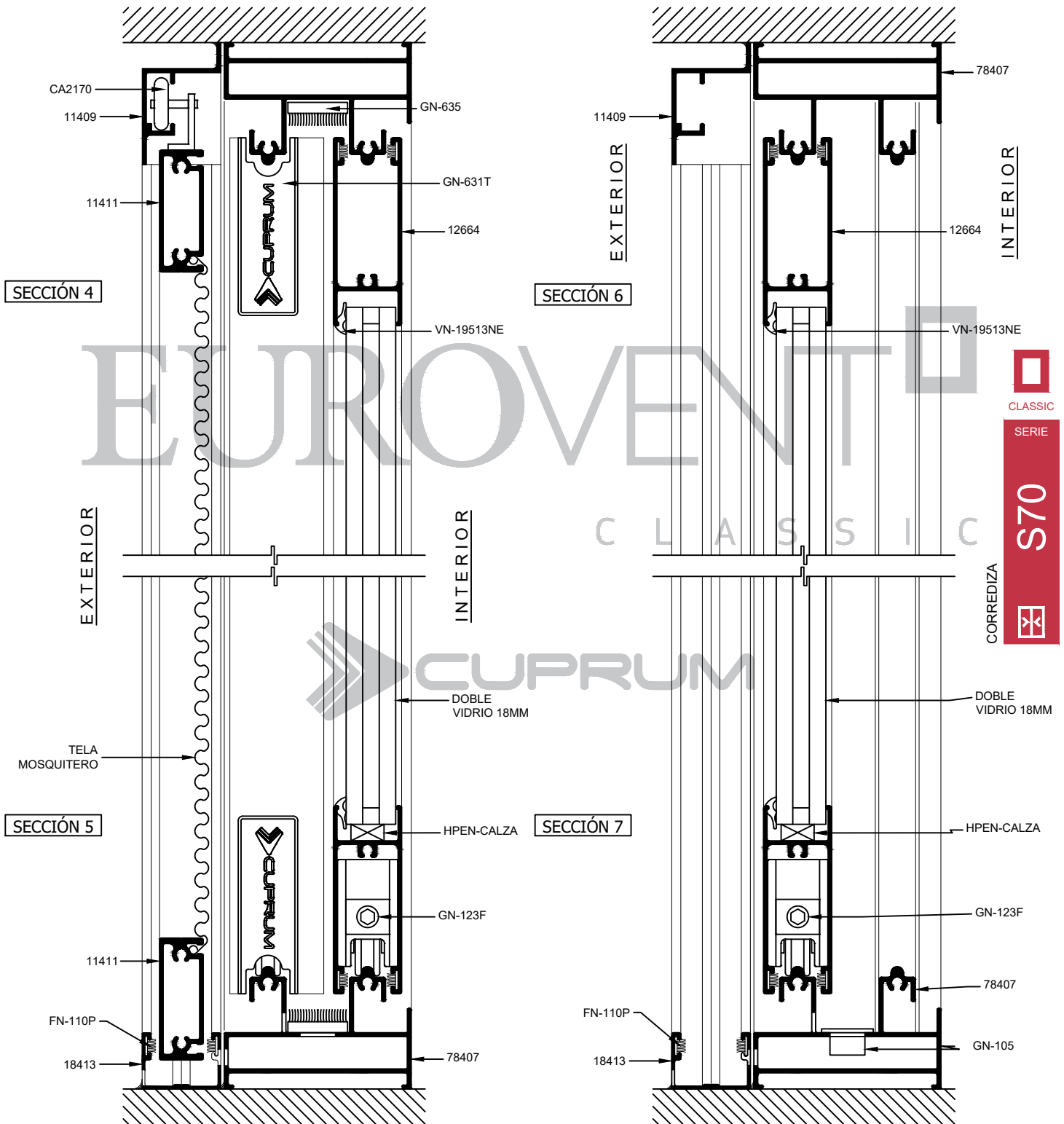

EUROVENTO

CLASSIC

CUPRUM



CLASSIC
SERIE

S70



CORREDIZA

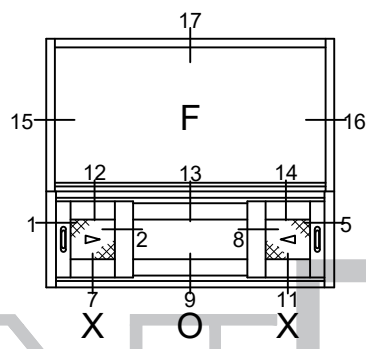
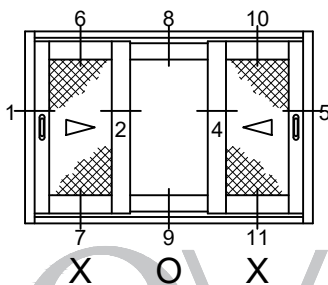
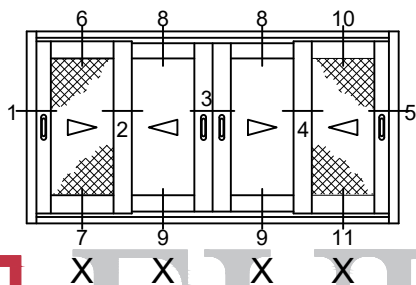

CLASSIC
SERIE

S70

CORREDIZA

EUROVENT

CLASSIC

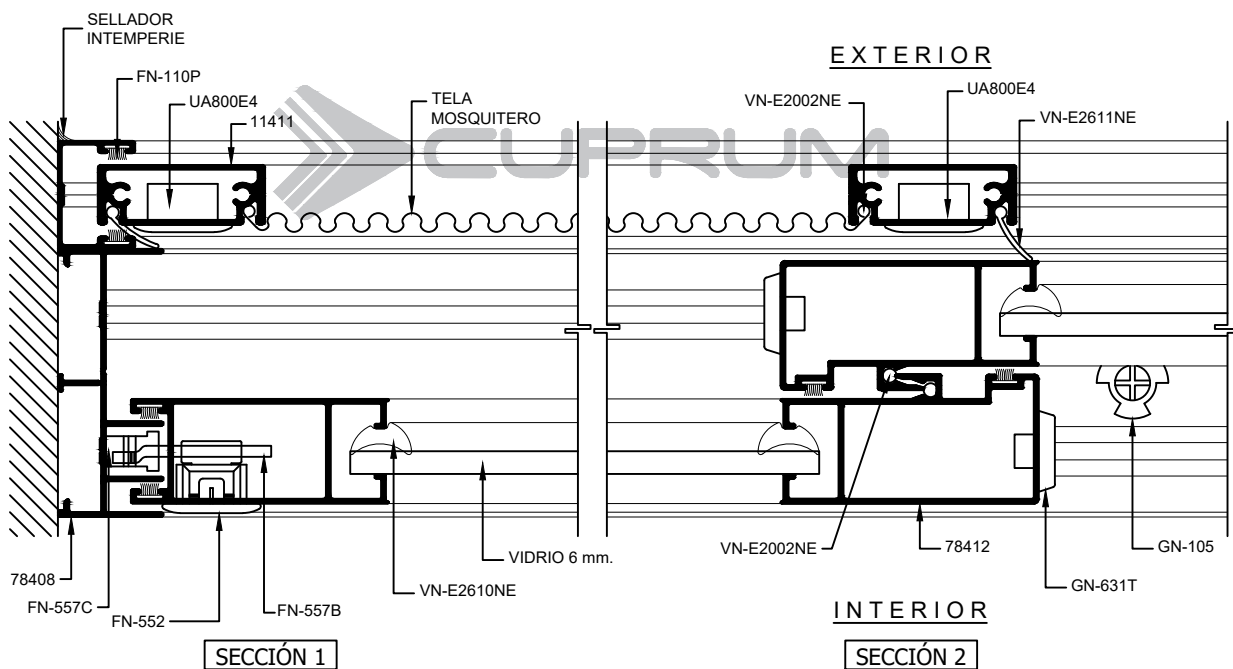

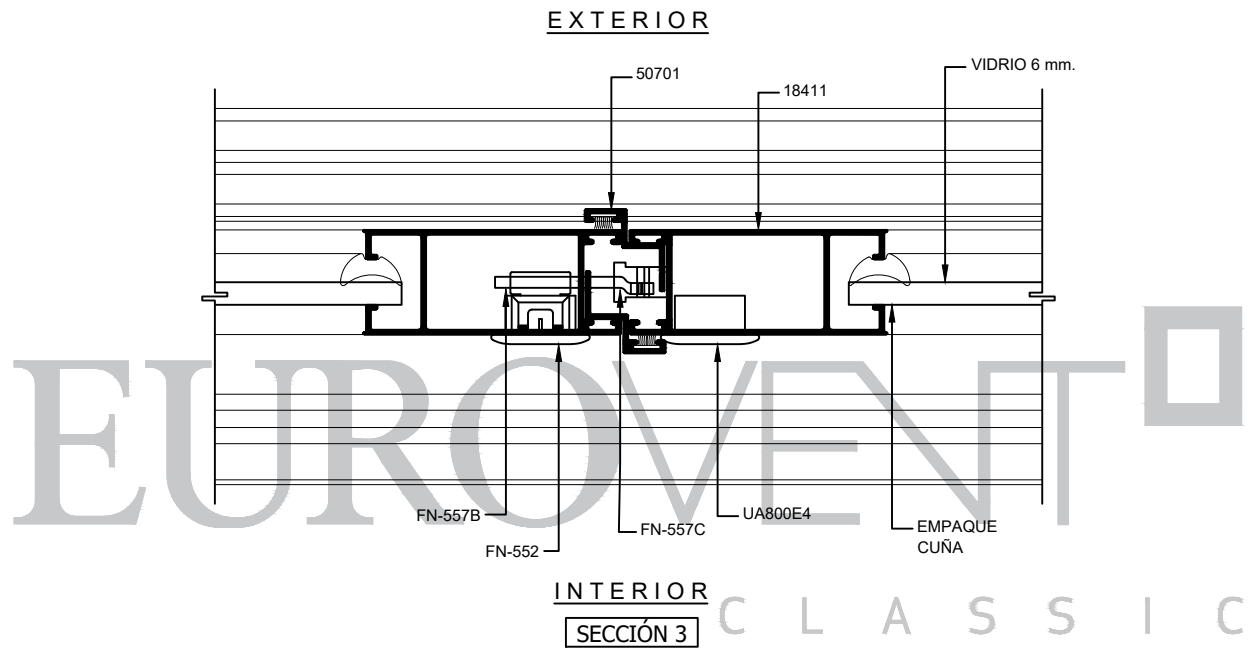

CLASSIC
SERIE
S70
CORREDIZA

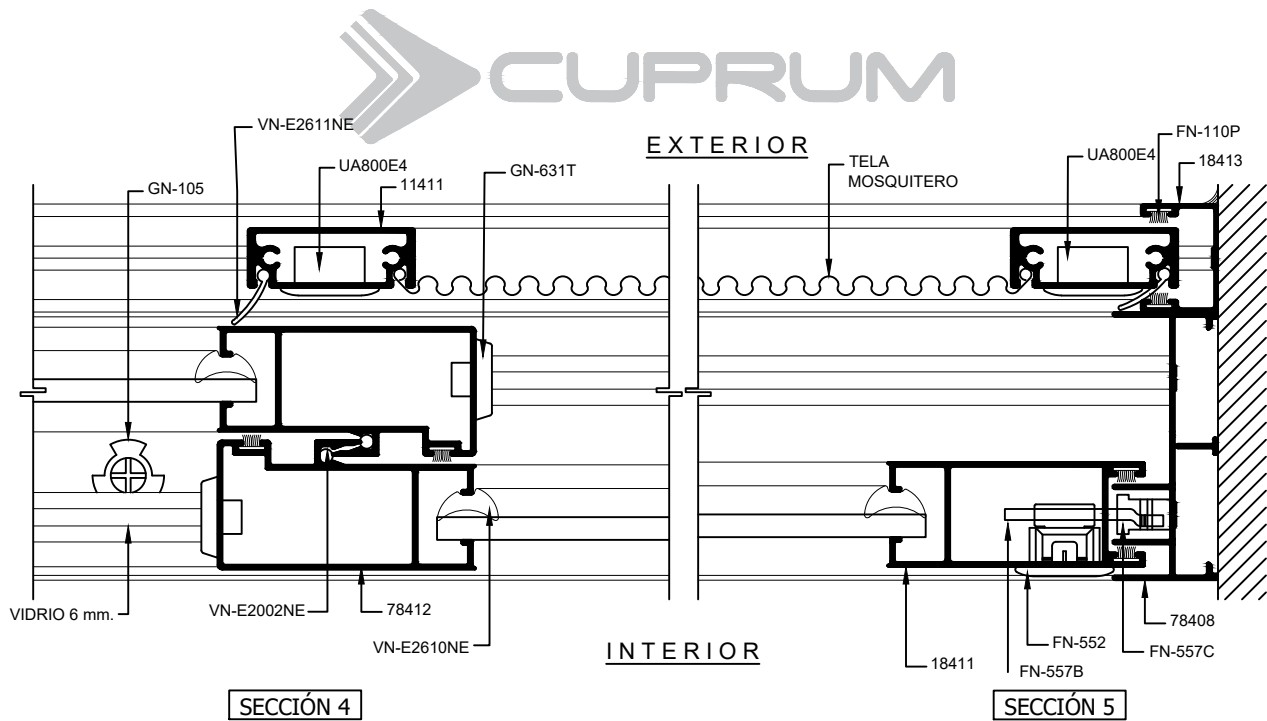

CLASSIC
SERIE
S70
CORREDIZA

SECCIÓN 6

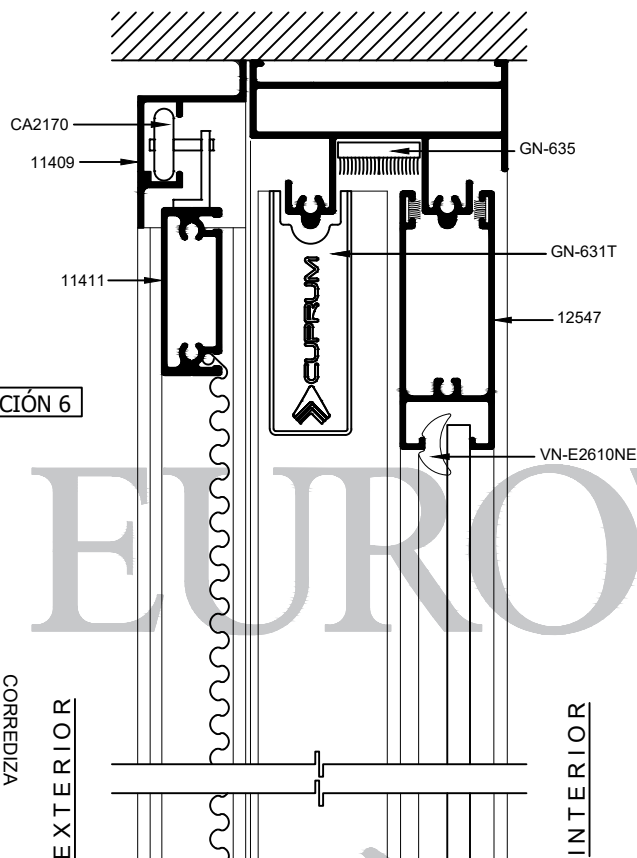

SECCIÓN 8

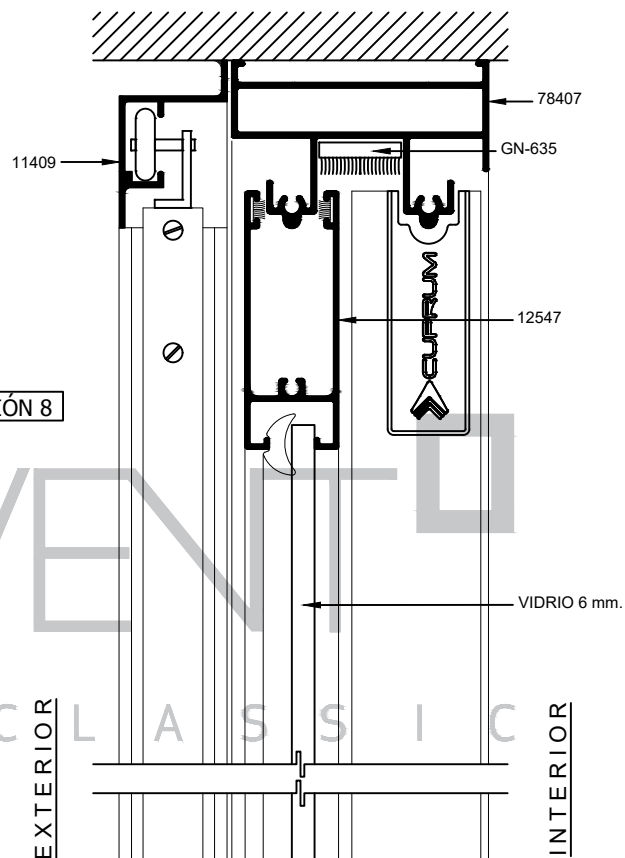

SECCIÓN 7

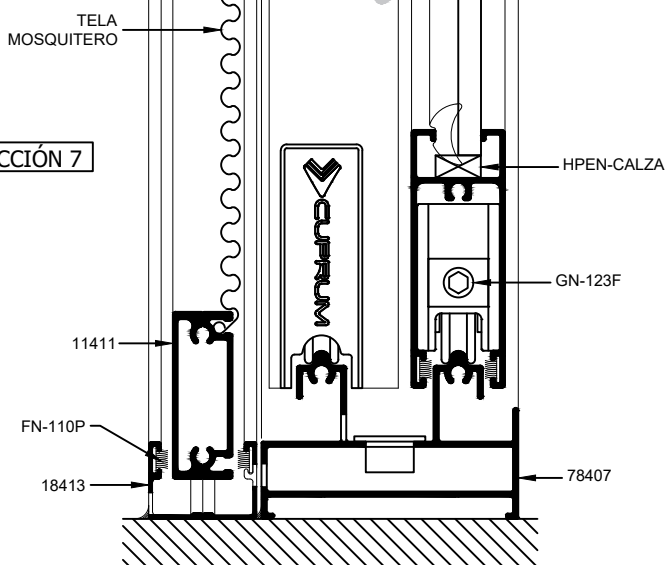

SECCIÓN 9

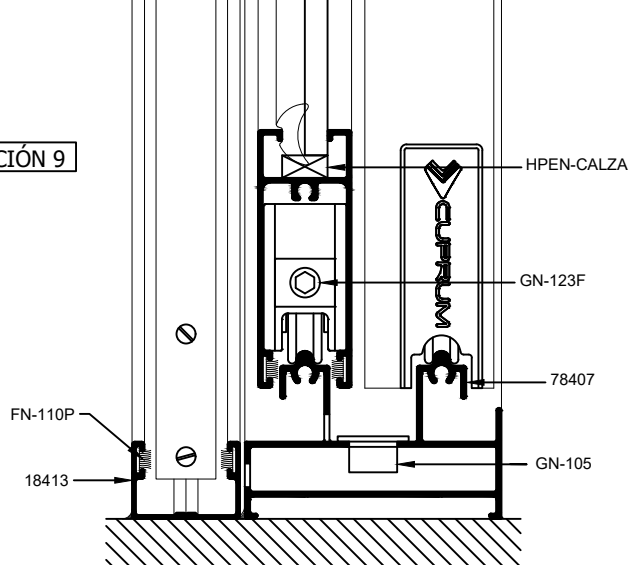

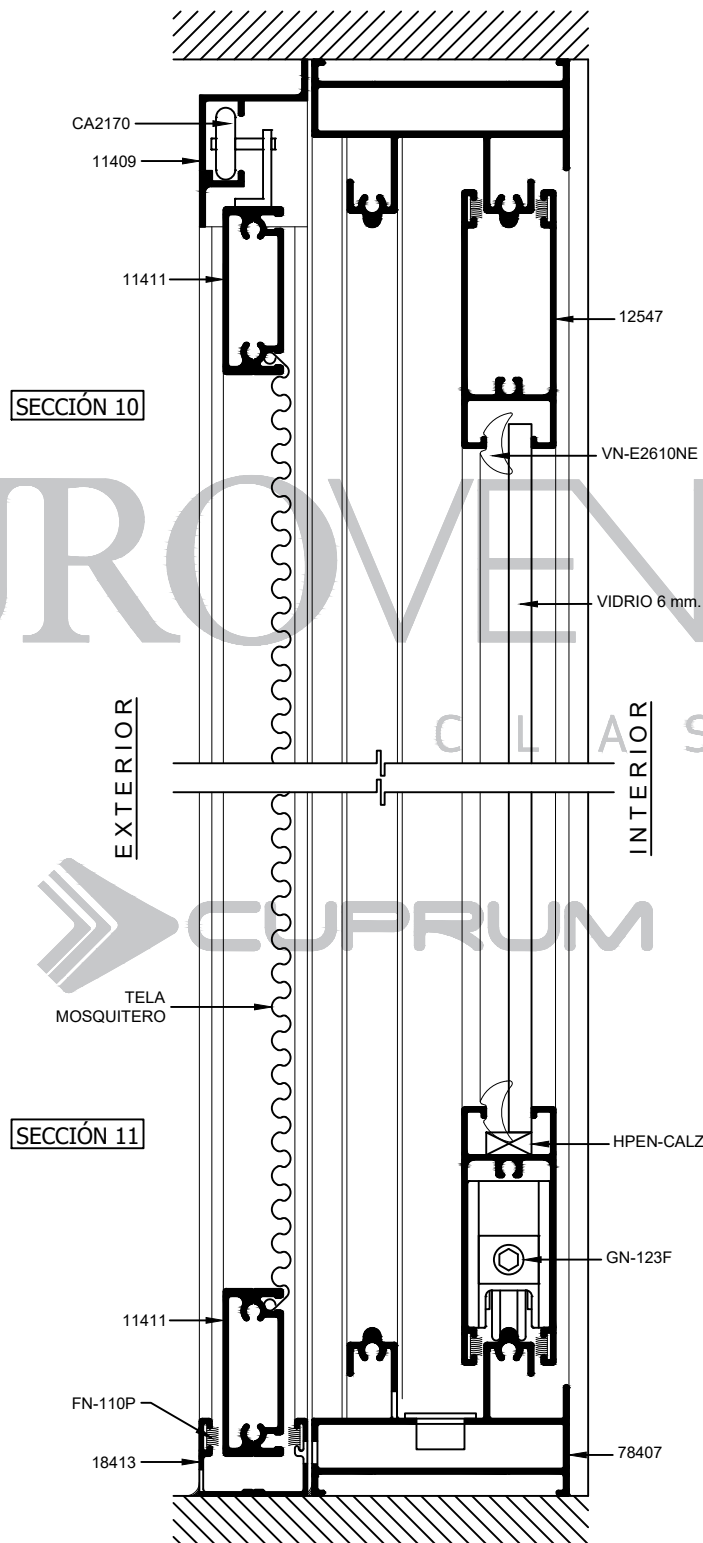

EUROVENT[®] CLASSIC

CUPRUM

CLASSIC
SERIE
S70
CORREDIZA

CLASSIC
SERIE
S70
CORREDIZA

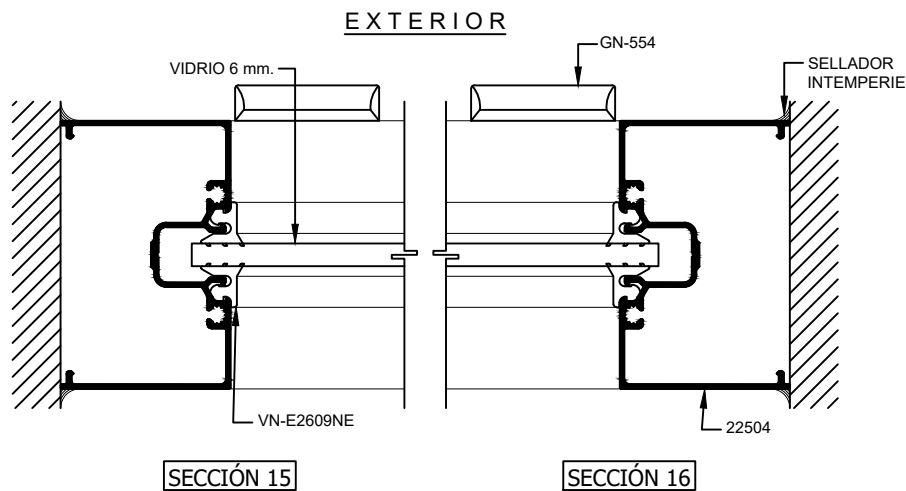
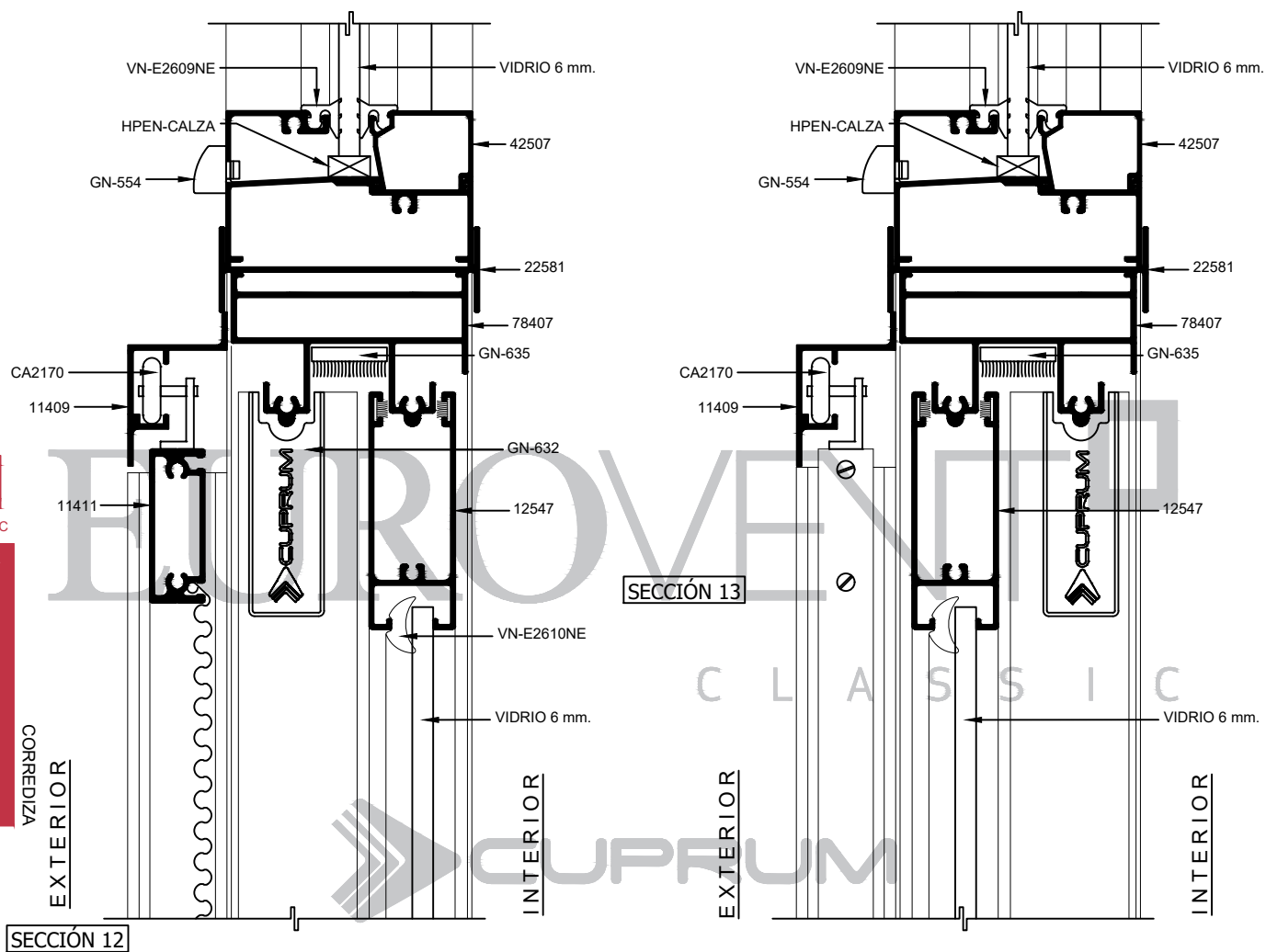

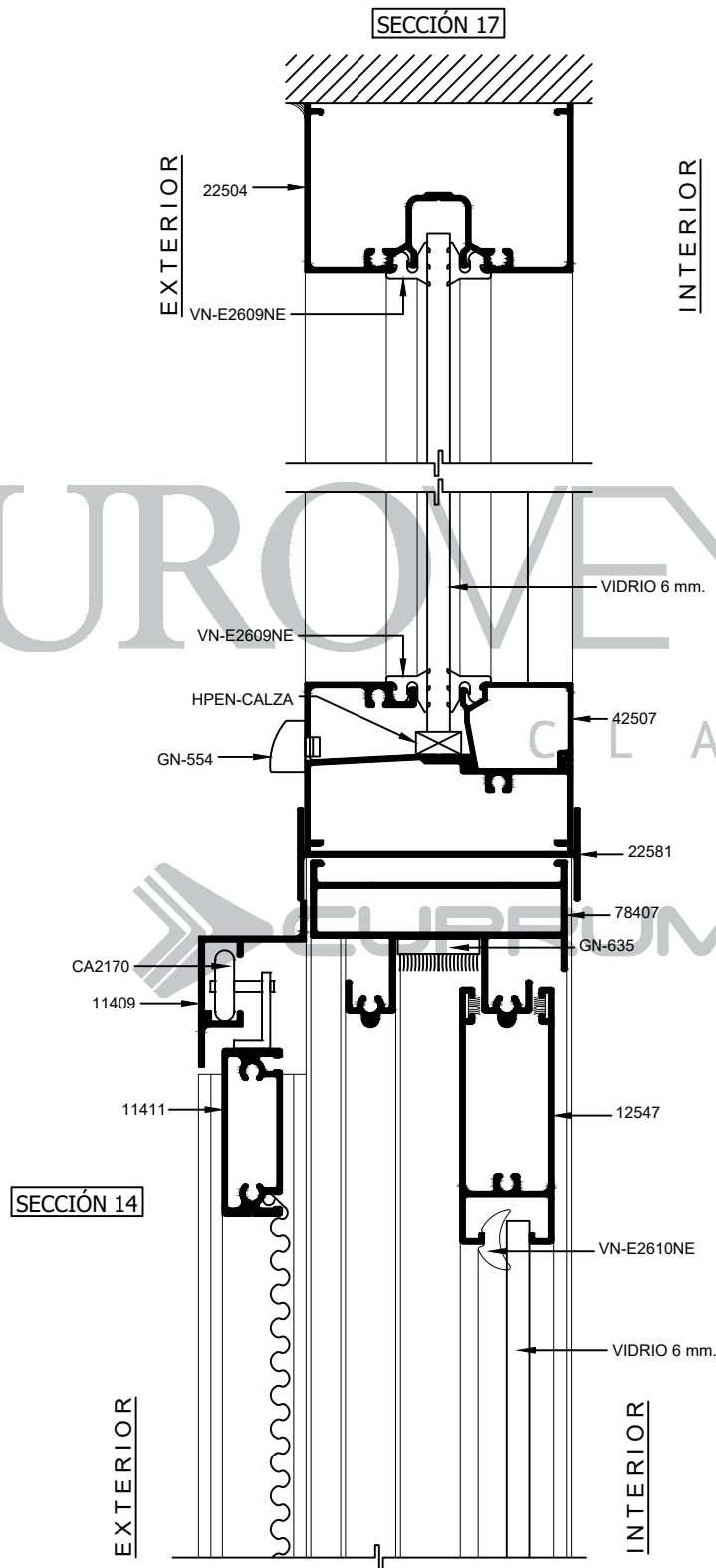

EUROVENT[®] CLASSIC S70

CLASSIC
SERIE
CORREDIZA

CLASSIC
SERIE
S70
CORREDIZA

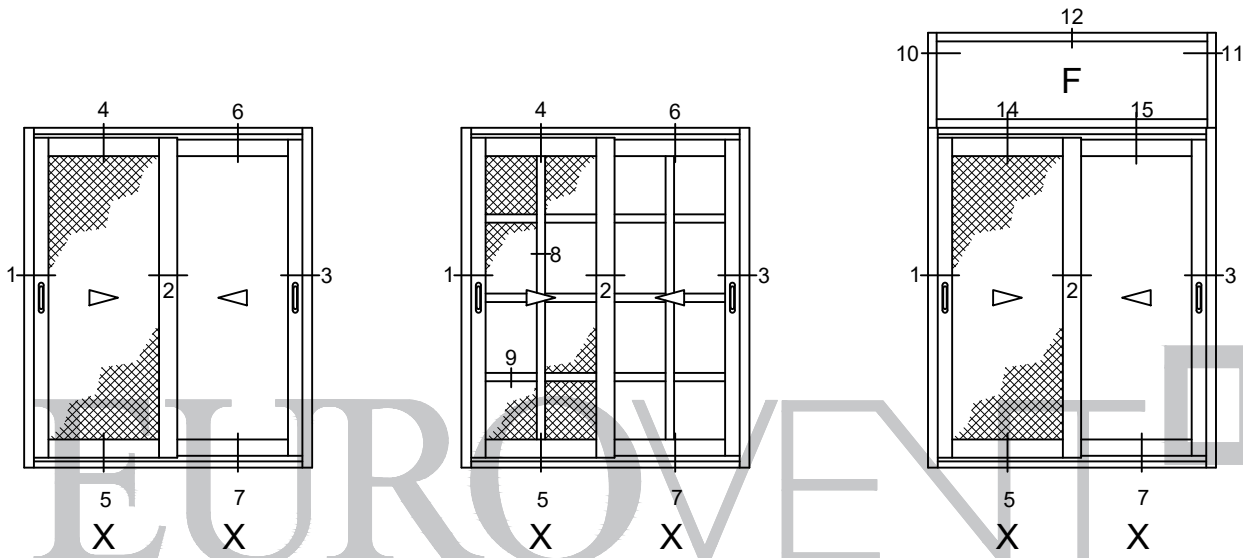

C L A S S I C SIN ESCALA



EXTERIOR

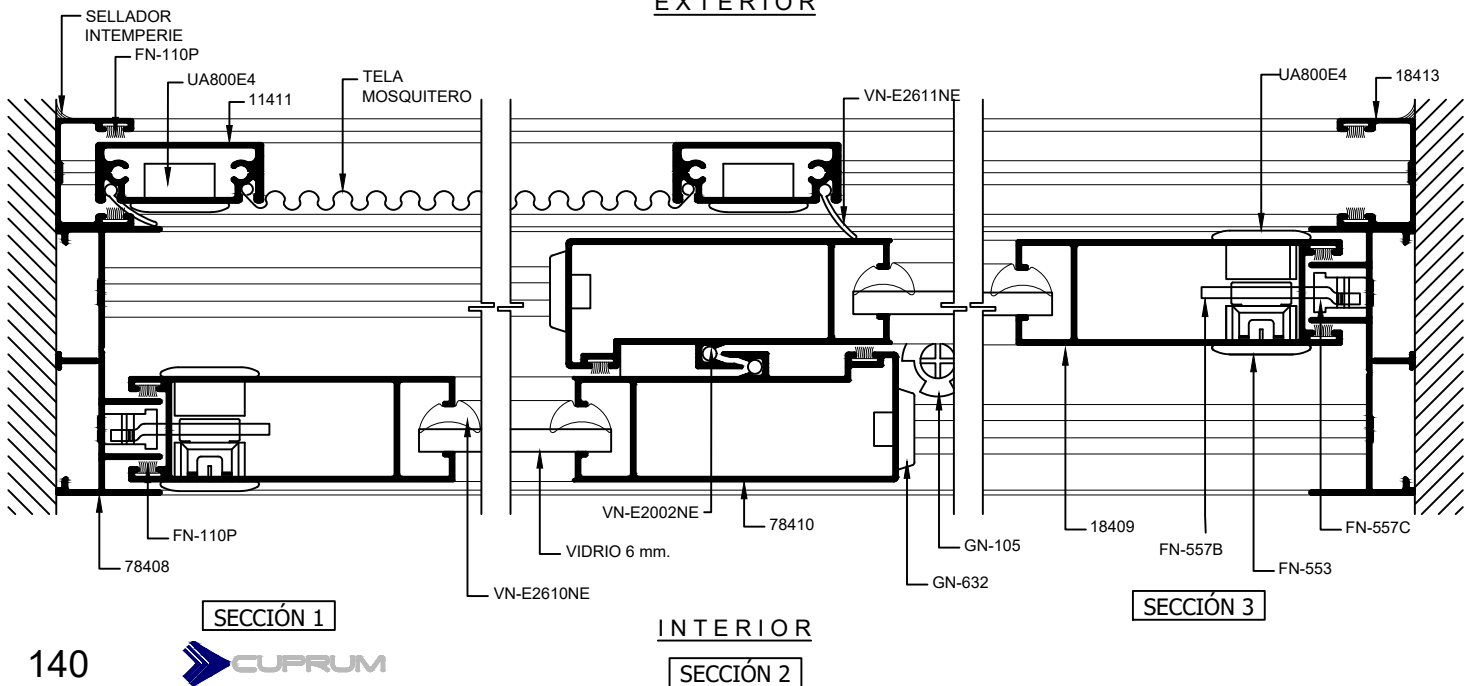

INTERIOR

SECCIÓN 2

SECCIÓN 1

SECCIÓN 3

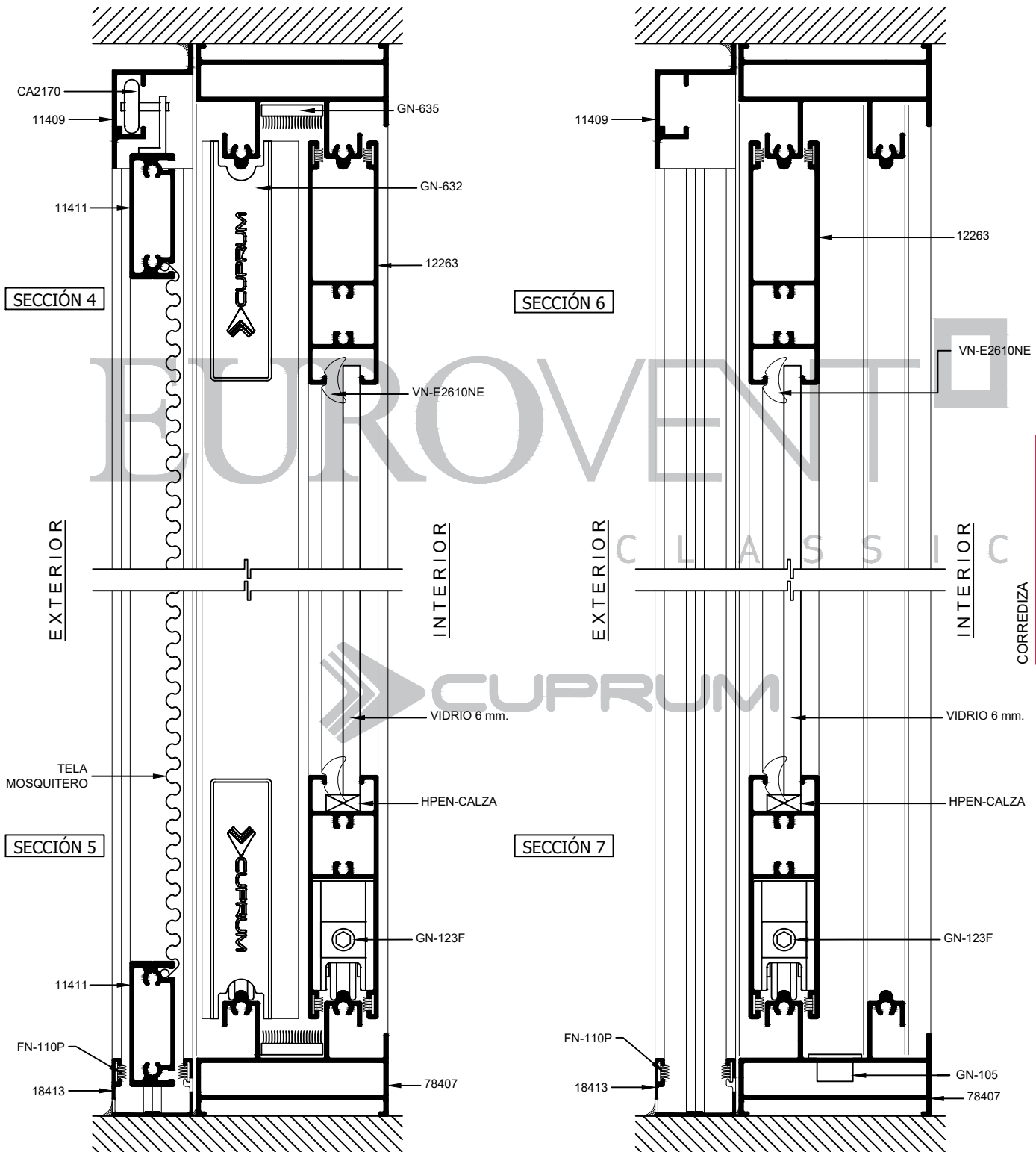

CLASSIC
SERIE
S70
CORREDIZA

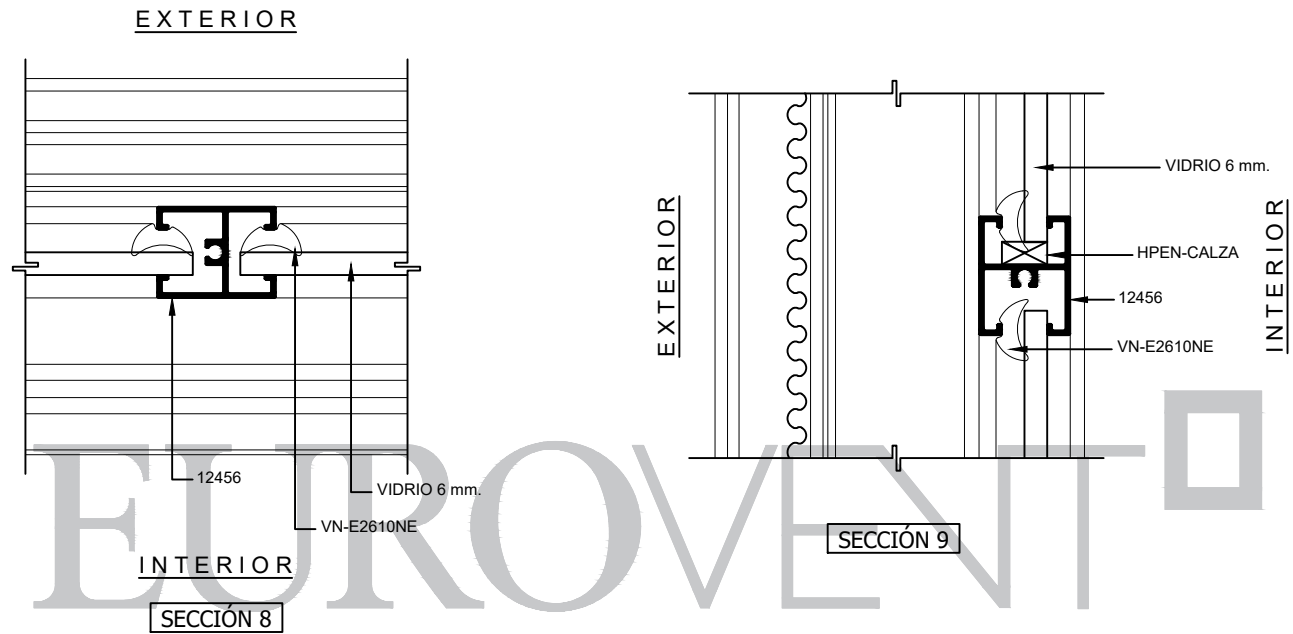

CLASSIC

SERIE

S70

CORREDIZA

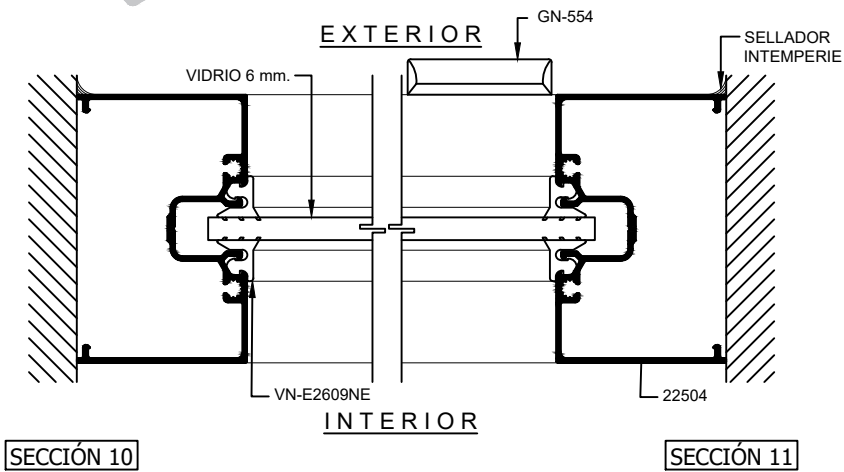

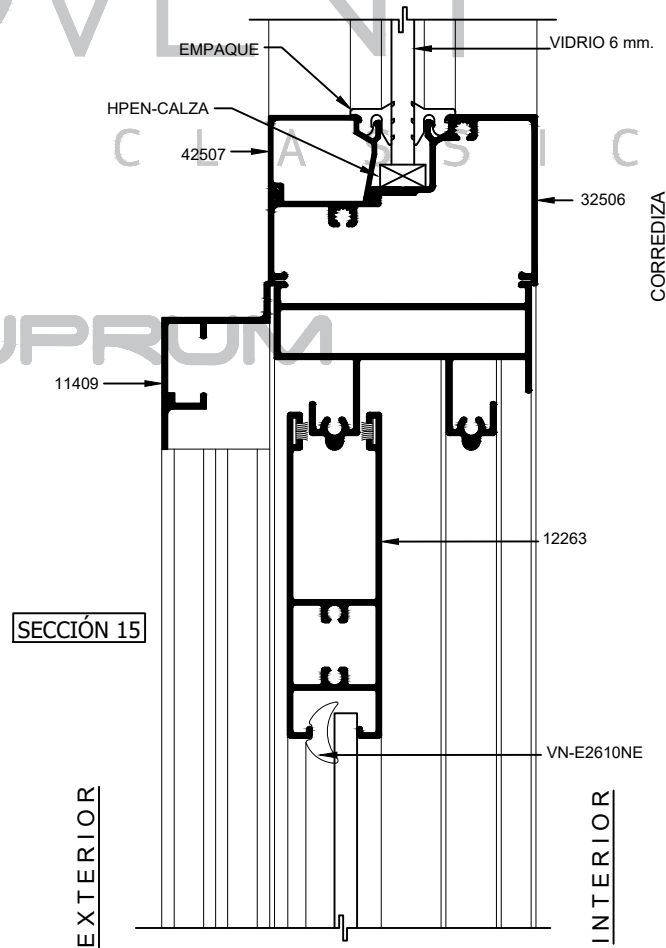
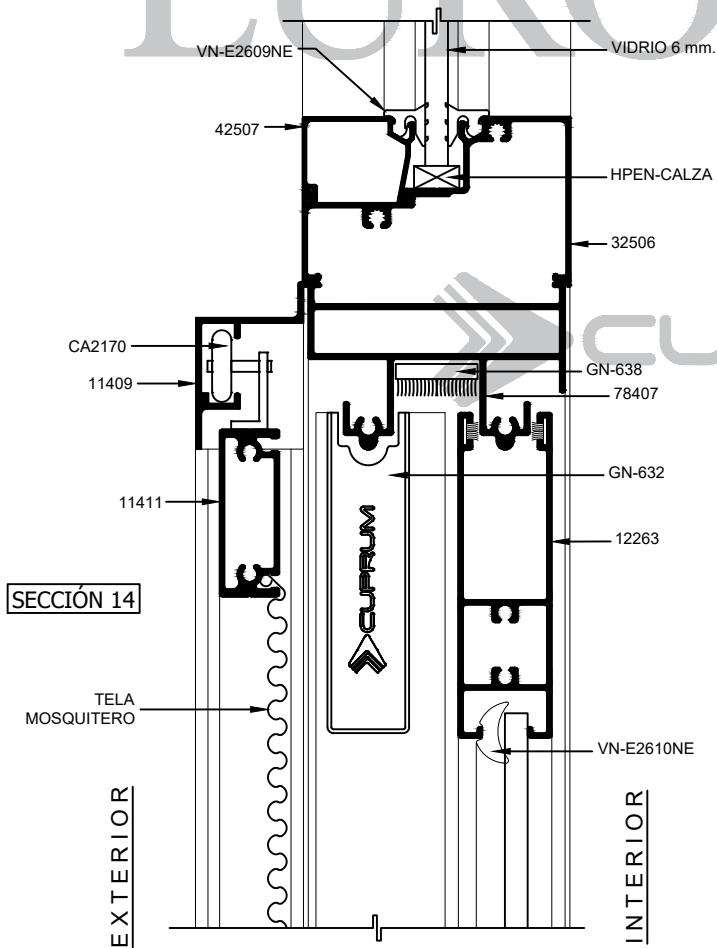
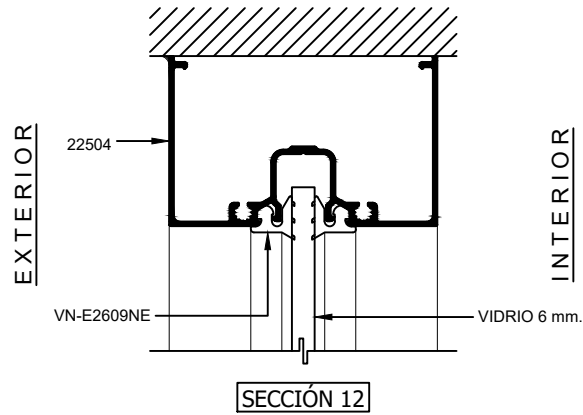

EUROVENT



CLASSIC

SERIE

S70

CORREDIZA



CLASSIC
SERIE

S70



CORREDIZA

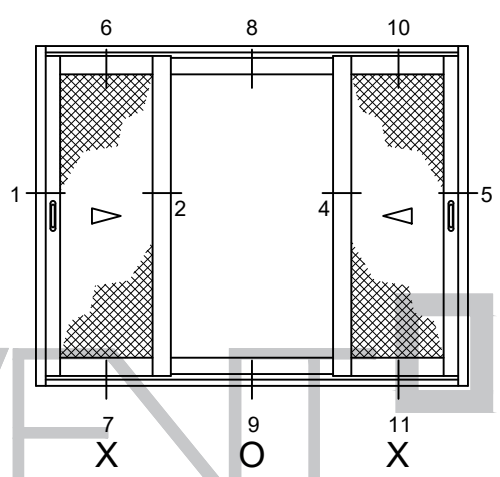
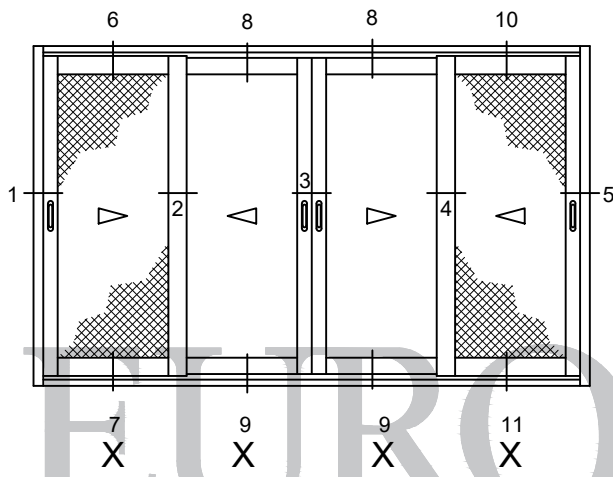

C L A S S I C

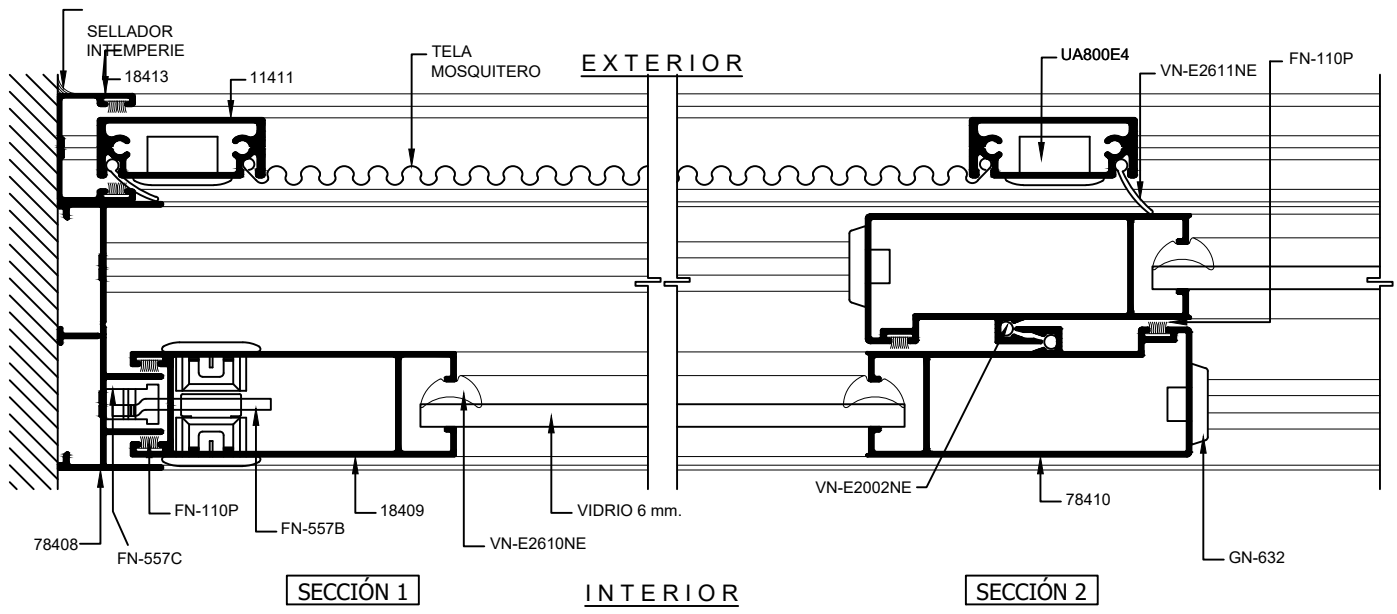

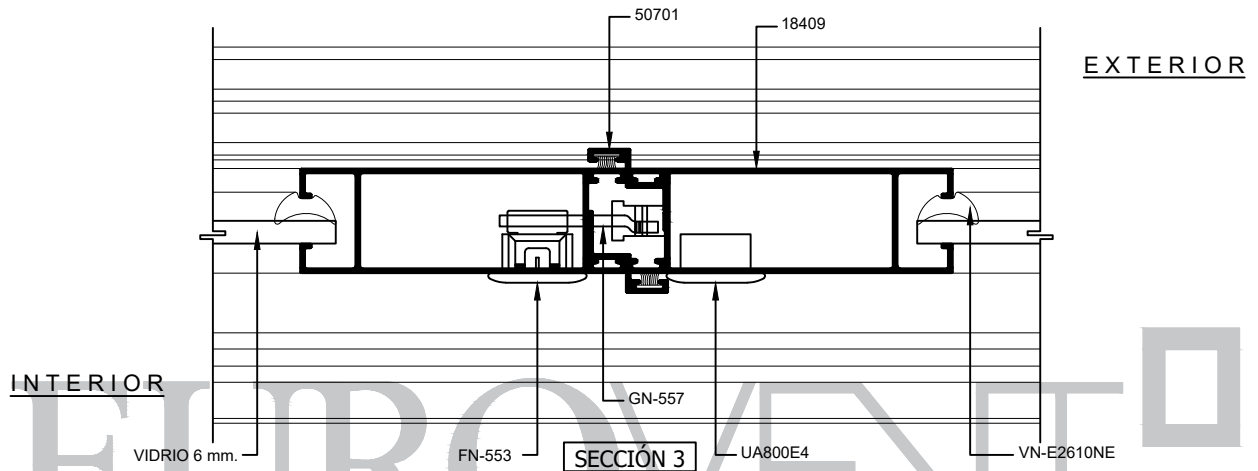

INTERIOR

EXTERIOR

EUROVENT[®]
CLASSIC

CLASSIC
SERIE

S70

CORREDIZA

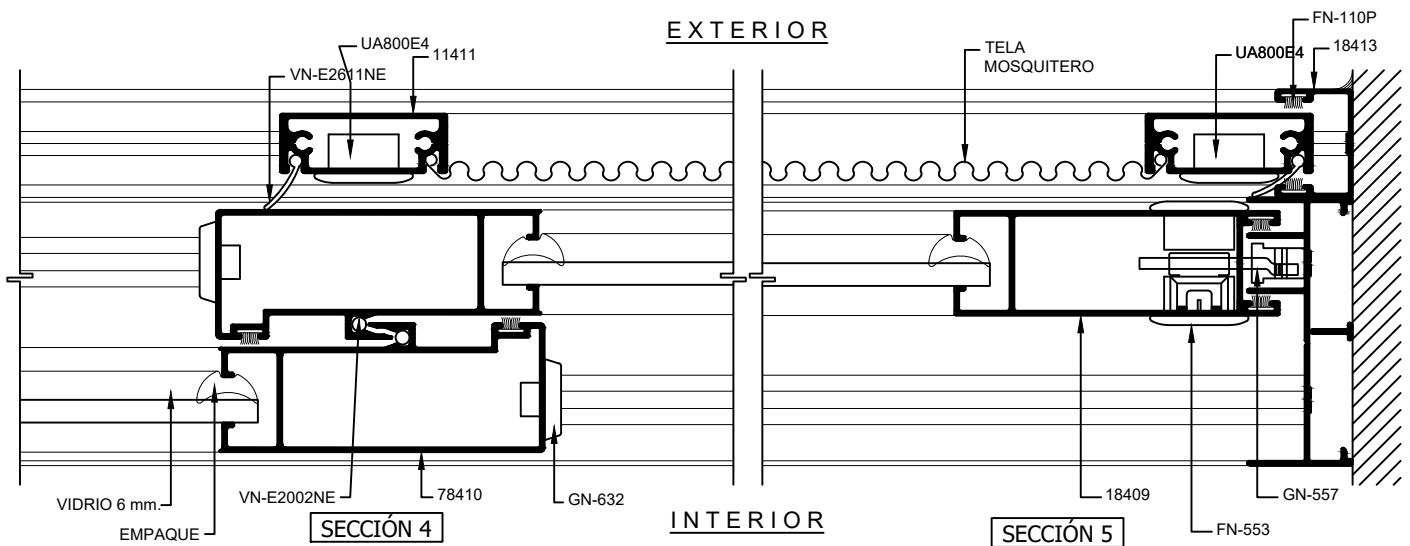

EXTERIOR

INTERIOR

SECCIÓN 4

SECCIÓN 5

CLASSIC
SERIE
S70
CORREDIZA

EUROVENT

CLASSIC

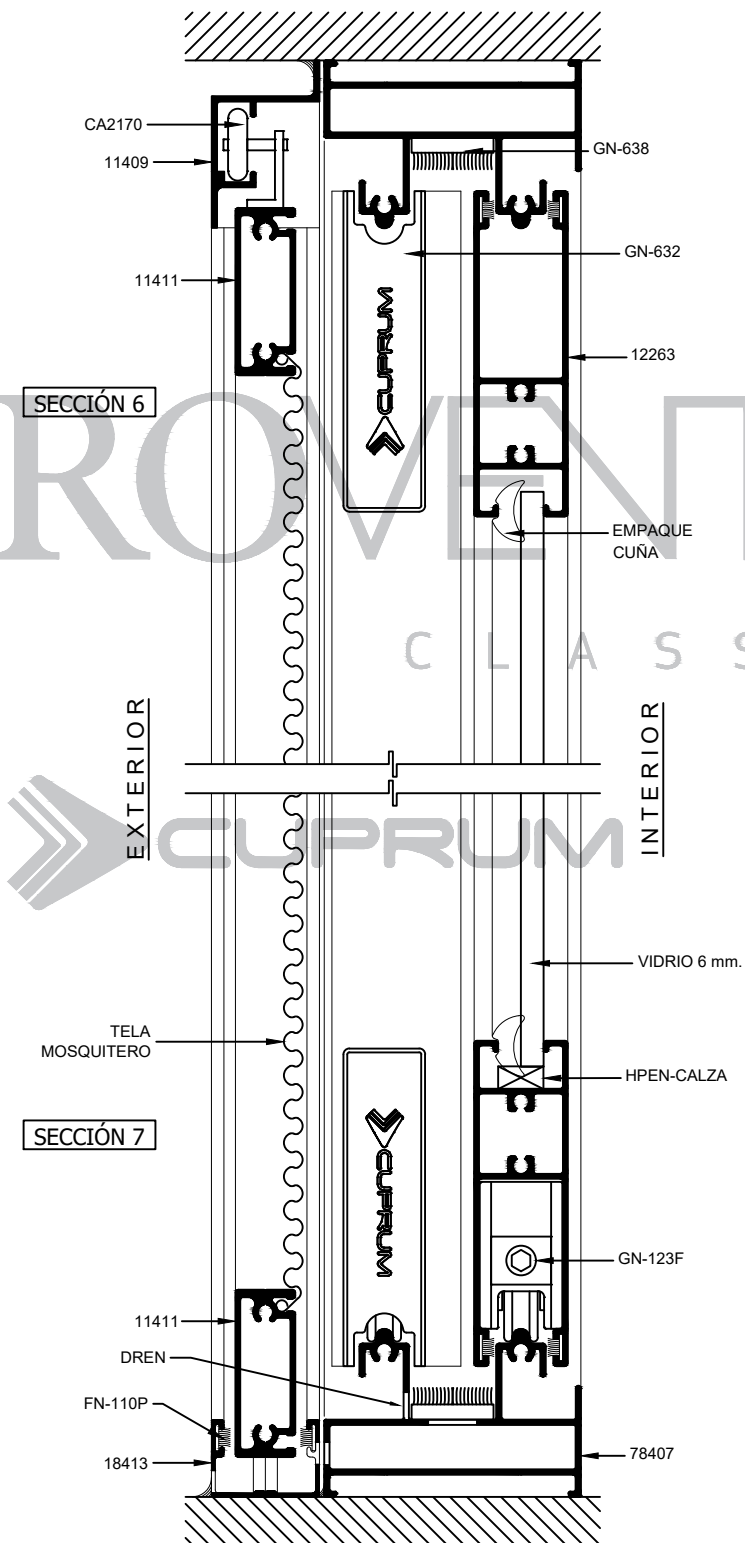

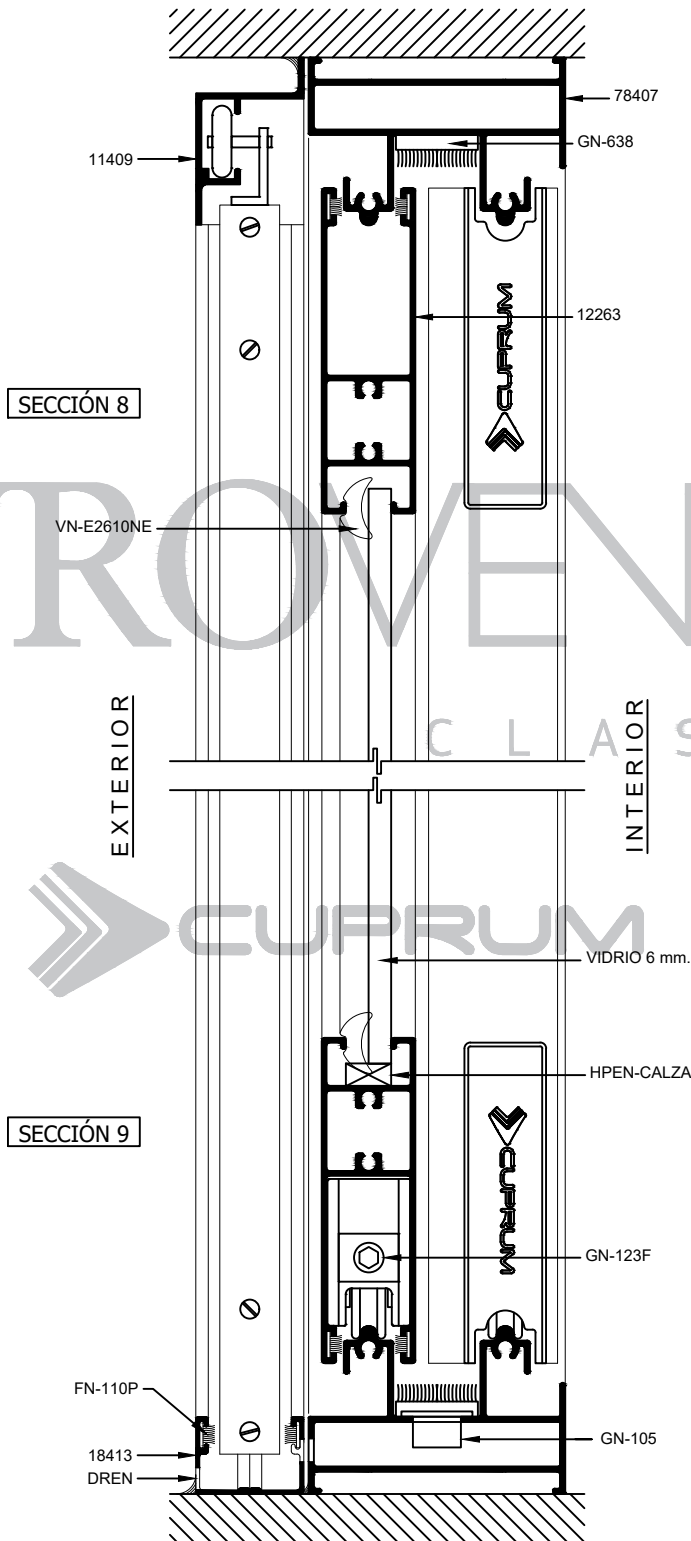

EUROVENT CLASSIC

CLASSIC
SERIE
S70
CORREDIZA

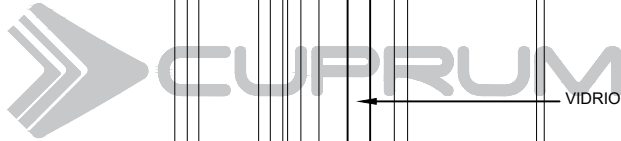

CLASSIC
SERIE
S70
CORREDIZA

EUROVENT

CLASSIC

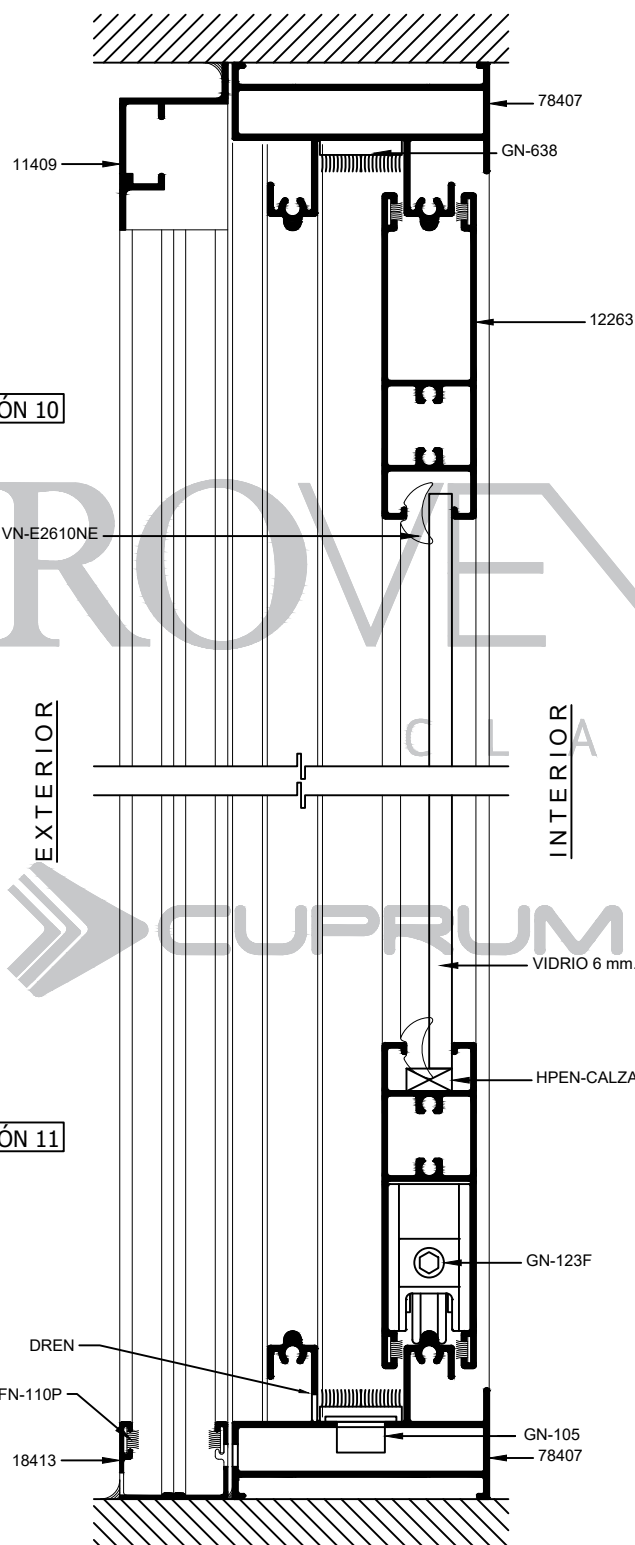

EUROVENT

CLASSIC

SIN ESCALA

CLASSIC
SERIE
S70
CORREDIZA

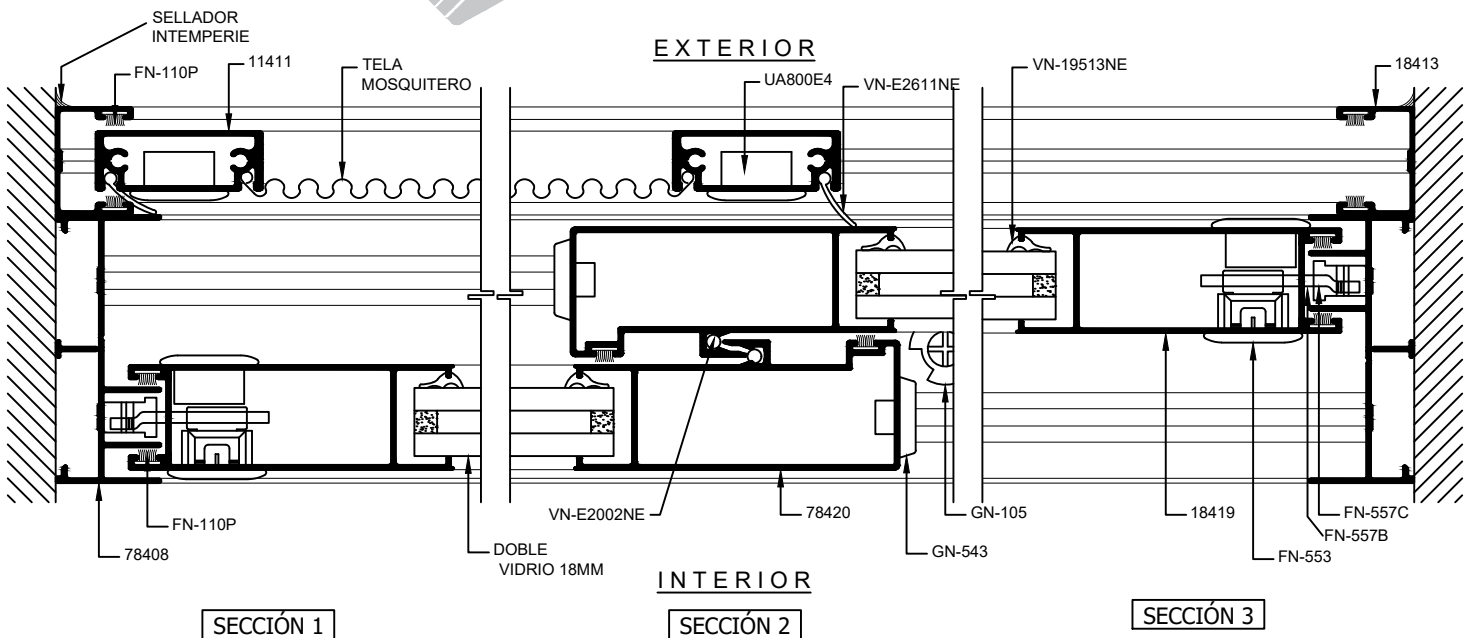
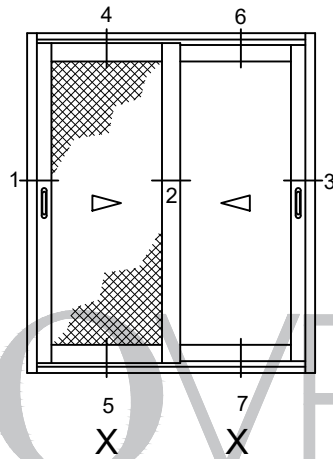

CLASSIC
SERIE
S70
CORREDIZA

SECCIÓN 4

SECCIÓN 6

SECCIÓN 5

SECCIÓN 7

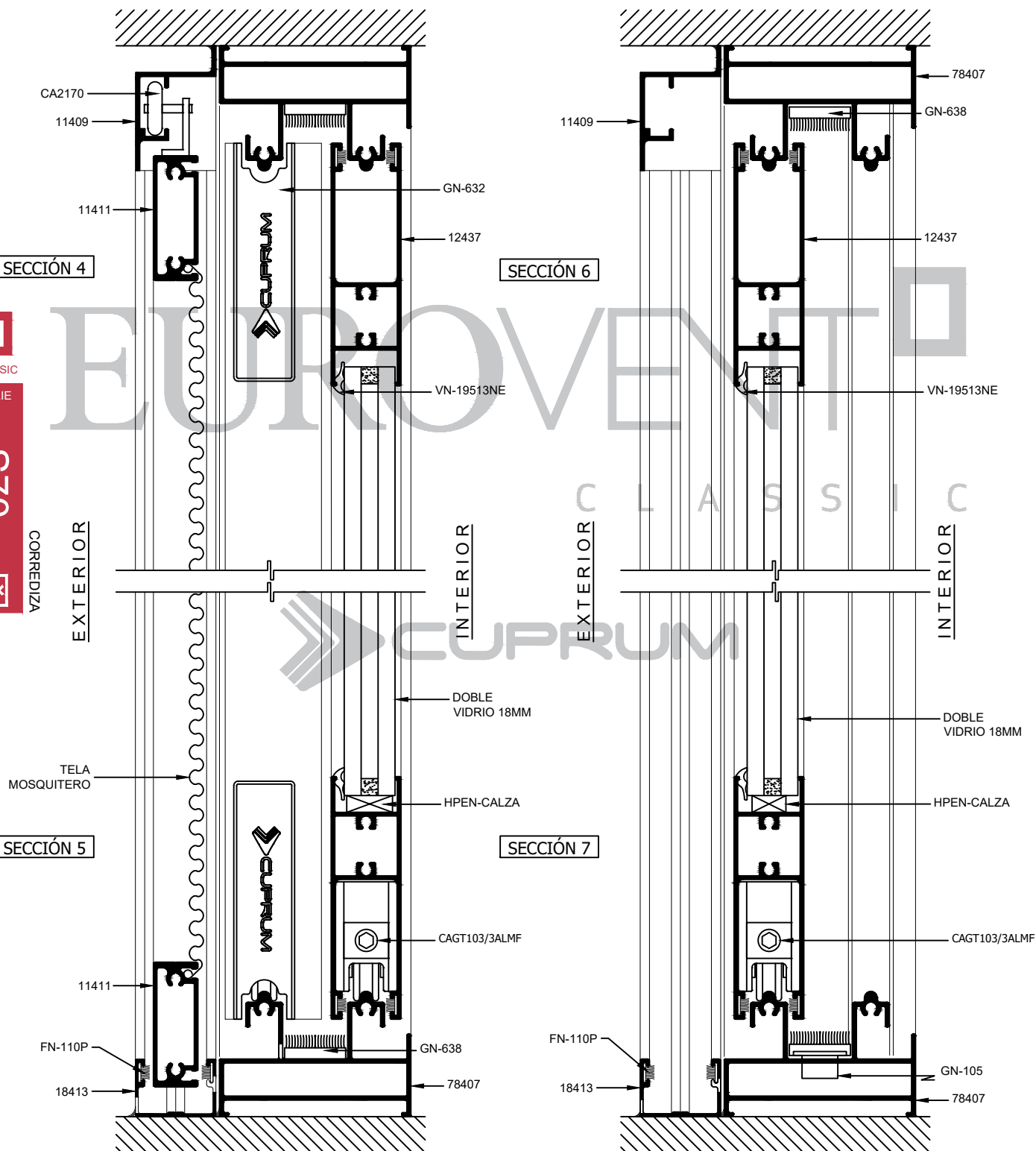

GN-506A
TROQUEL VENTANA Y PUERTA SERIE 70

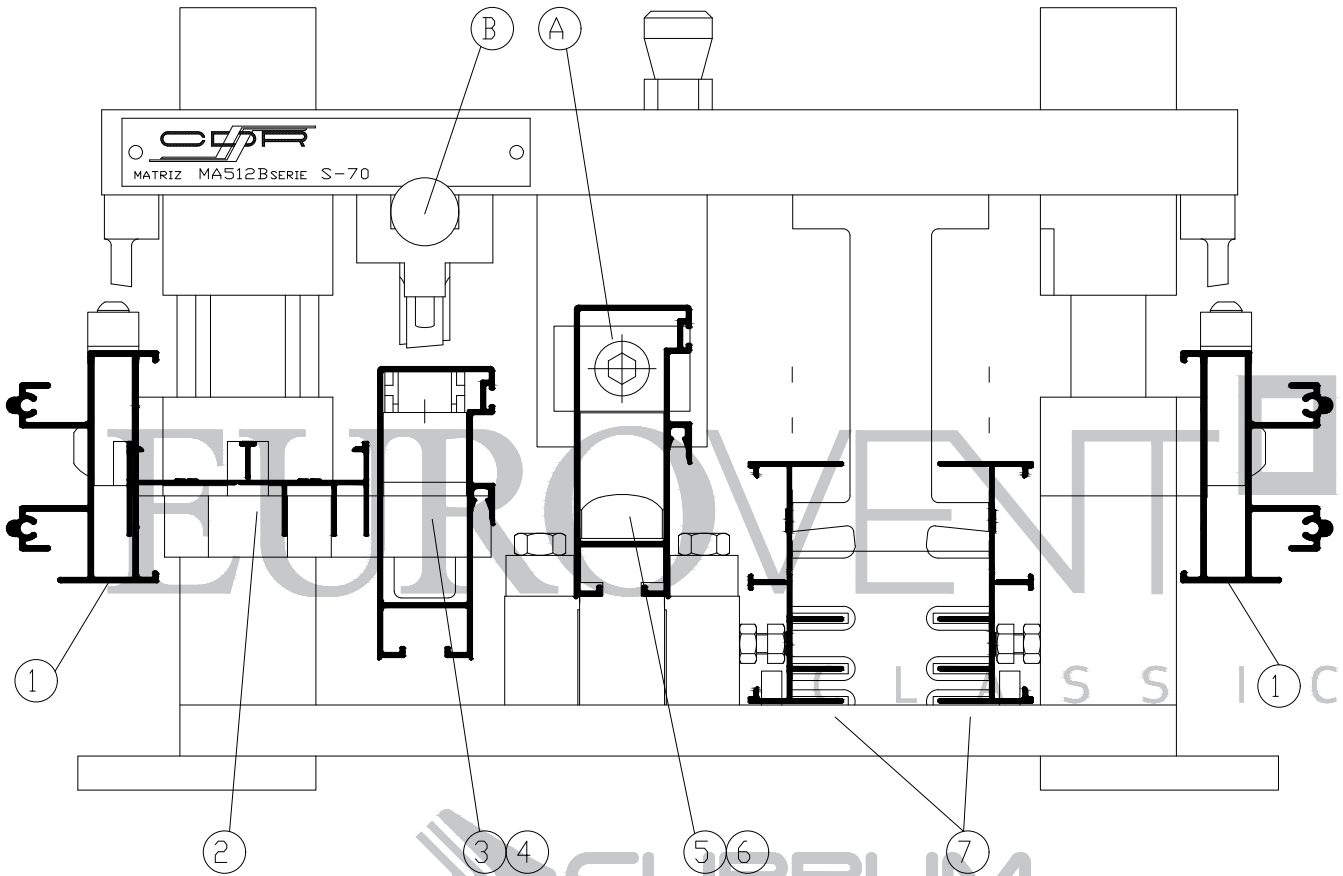

CLASSIC
SERIE
S70
CORREDIZA

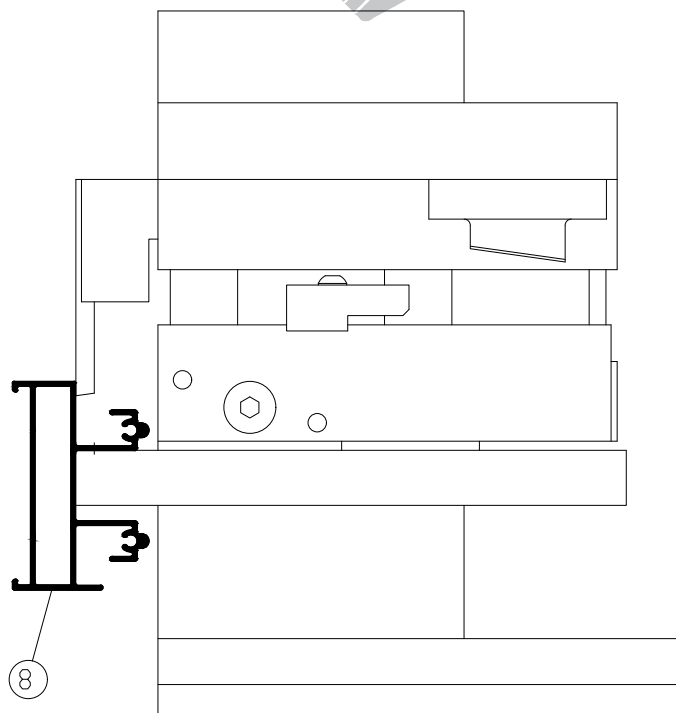

INDICACIONES

PARA REALIZAR TODAS LAS OPERACIONES DE TROQUELADO, EL MATERIAL DEBE DE ESTAR CORTADO A MEDIDA DE FABRICACIÓN.

OPERACIÓN 1

78407 RIEL-CABEZAL
DREN TUBULAR

OPERACIÓN 2

78408 JAMBA
BARRENOS PARA ENSAMBLE
REALIZAR PRIMERO OPERACIÓN 7

CLASSIC
SERIE
S70
CORREDIZA

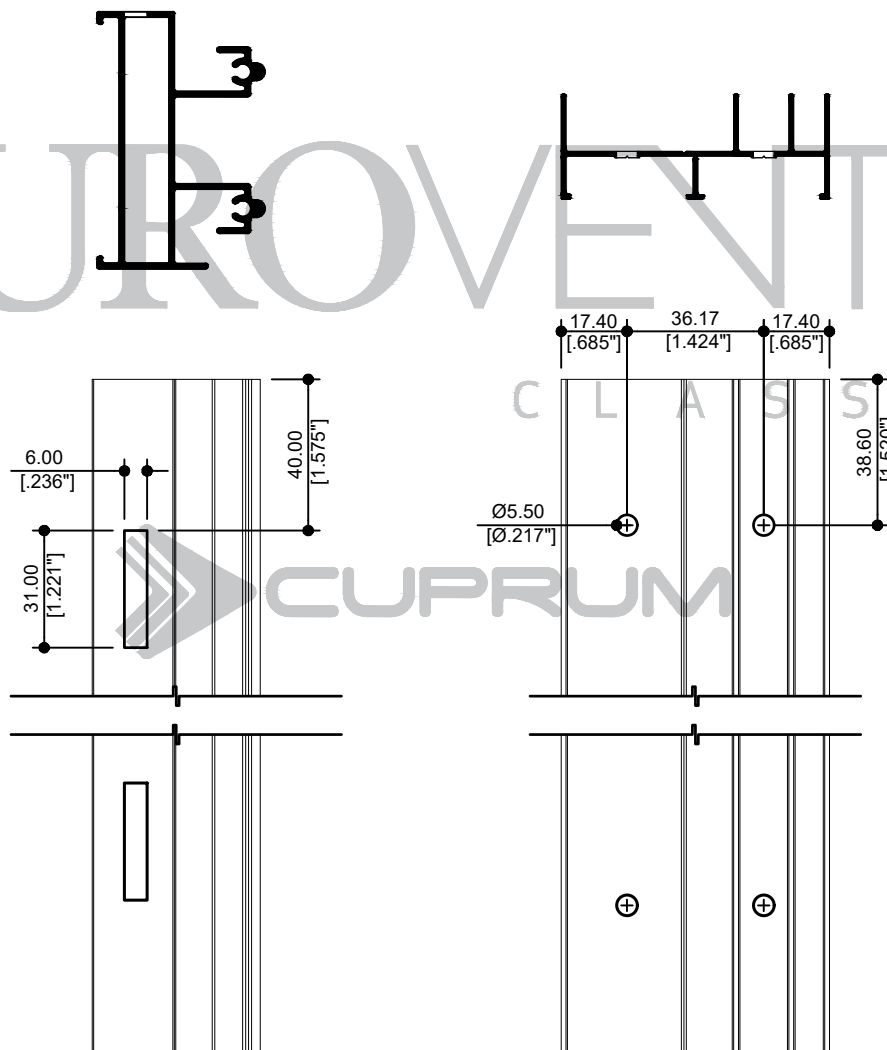

78412 TRASLAPE
SAQUE PARA PISTA Y BARRENO
REALIZAR ANTES OPERACIÓN 5
PERILLA "B" AFUERA

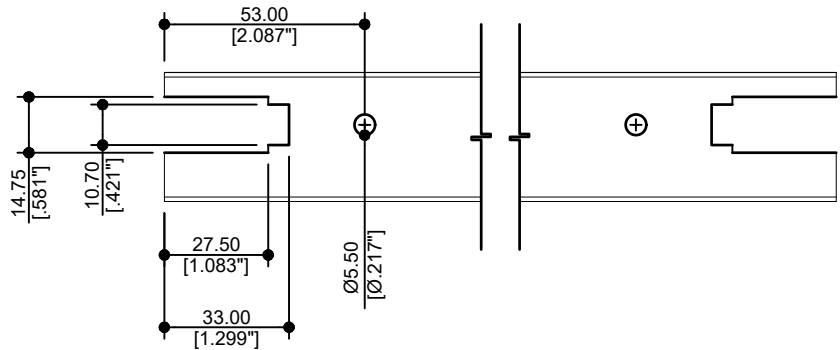
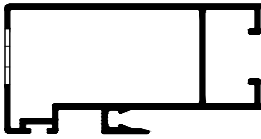

OPERACIÓN 3

18411 CERCO
SAQUE PARA PISTA Y BARRENO
REALIZAR ANTES OPERACIÓN 5
PERILLA "B" AFUERA

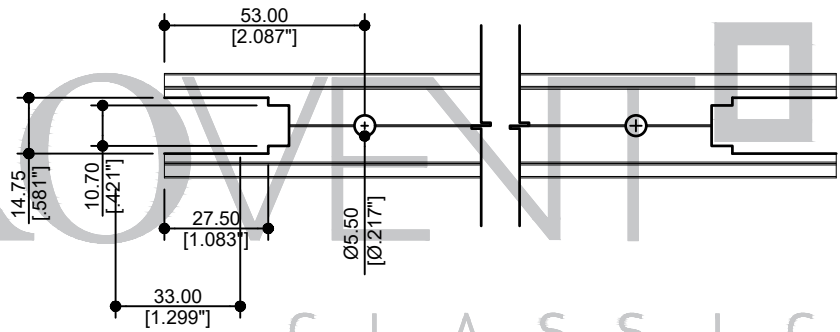

78412 TRASLAPE
SAQUE PARA PISTA Y BARRENO
REALIZAR ANTES OPERACIÓN 6
PERILLA DENTRO

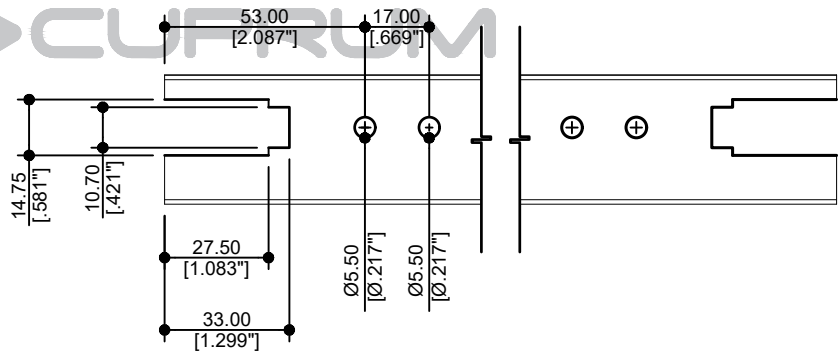
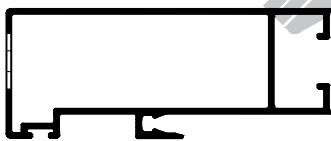

OPERACIÓN 4

18411 CERCO
SAQUE PARA PISTA Y BARRENO
REALIZAR ANTES OPERACIÓN 6
PERILLA "B" DENTRO

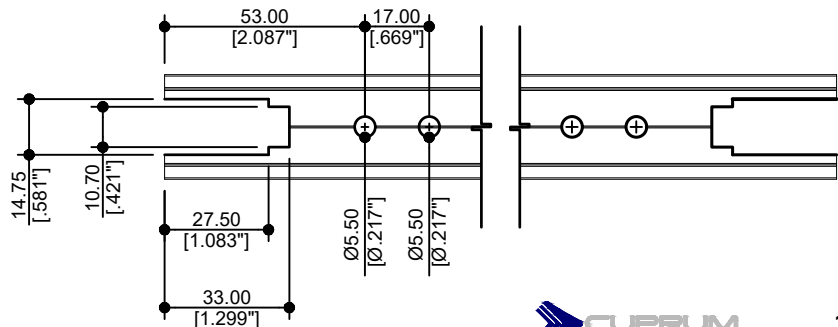

CLASSIC
SERIE

S70

CORREDIZA



78412
TRASLAPE ENCASTRADO
CON TOPE "A"

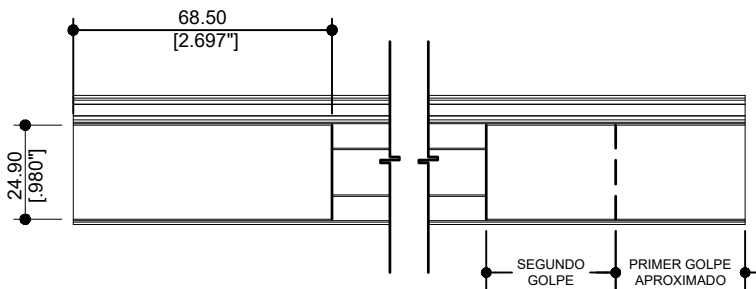
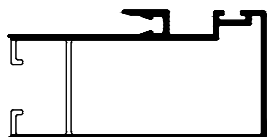

OPERACIÓN 5

18411
CERCO ENCASTRADO
CON TOPE "A"

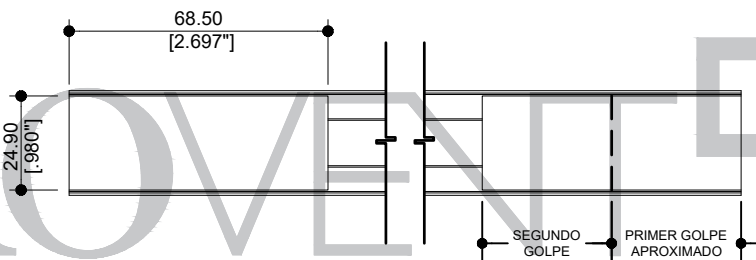

CLASSIC
SERIE
S70
CORREDIZA



PARA EVITAR UNA POSIBLE RUPTURA DEL CORTADOR, AL REALIZAR LA OPERACIÓN, SE RECOMIENDA HACERLO EN DOS PASOS.

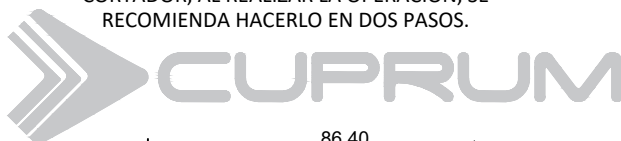

78410
TRASLAPE ENCASTRADO
SIN TOPE "A"

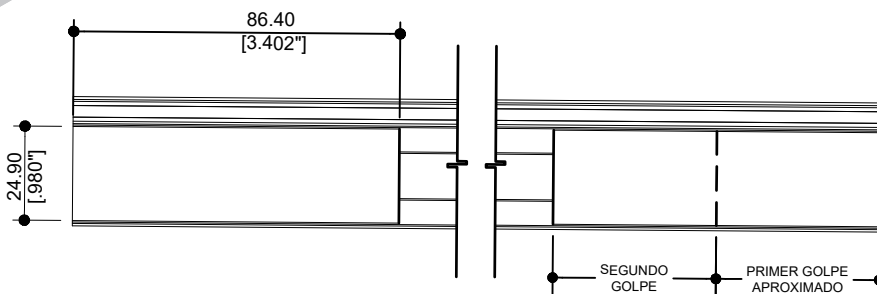
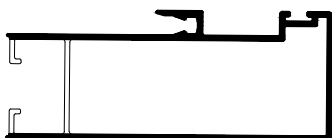

OPERACIÓN 6

18409
CERCO ENCASTRADO
SIN TOPE "A"

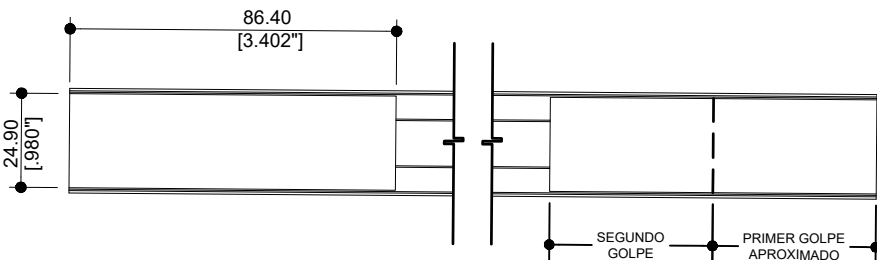

OPERACIÓN 7

78408 JAMBA
SAQUE PARA ENSAMBLE

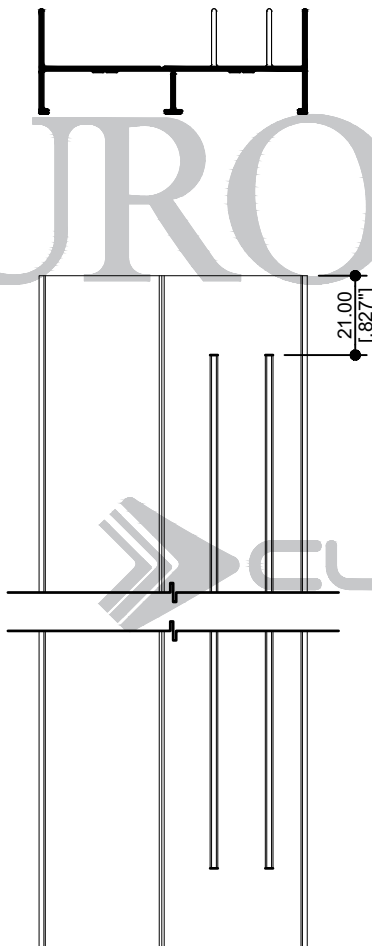

OPERACIÓN 8

78407 ZOCLO-CABEZAL
DRENES DE PISTA

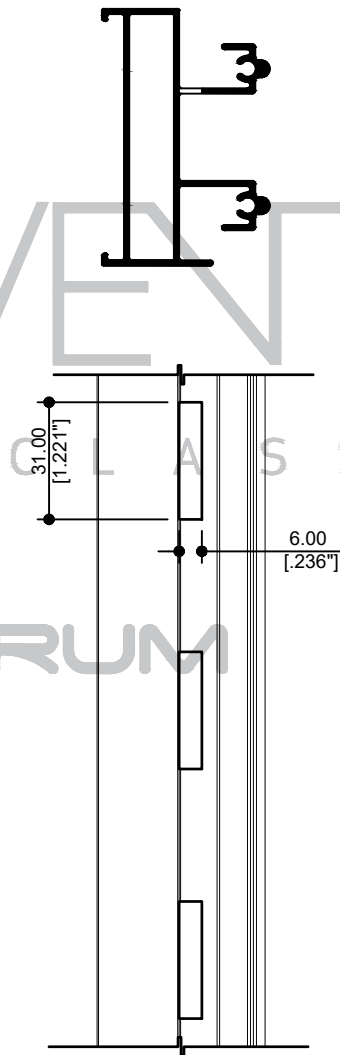

EUROVENT CLASSIC

CLASSIC
SERIE
S70
CORREDIZA

SE RECOMIENDA HACER 4 DRENES DE PISTA EQUIDISTANTES POR METRO LINEAL.

NO HACER DRENES EN LA PISTA DE BAJO DE LA HOJA CORREDIZA EN POSICIÓN CERRADA.

NO HACER DRENES EN LA PISTA INTERIOR.

18411 CERCO
CIERRE EMBUTIDO

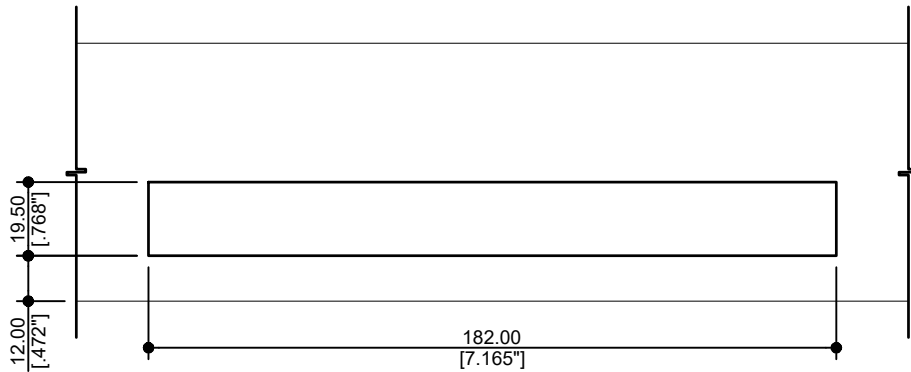
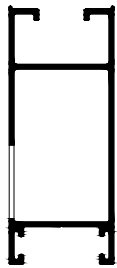

MEDIDA DEL CIERRE

CONTRA Y GANCHO

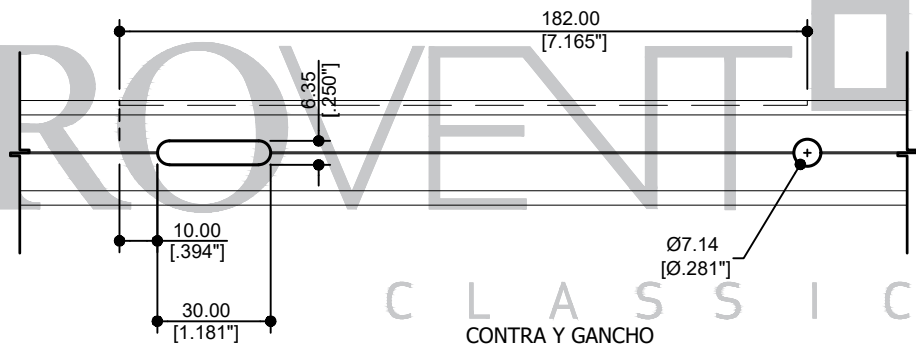

18411 CERCO
CIERRE EMBUTIDO

CLASSIC
SERIE

S70



CORREDIZA

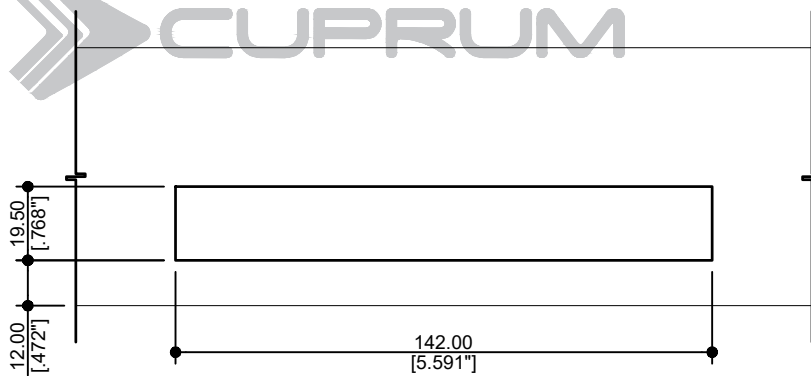
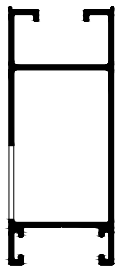

MEDIDA DEL CIERRE

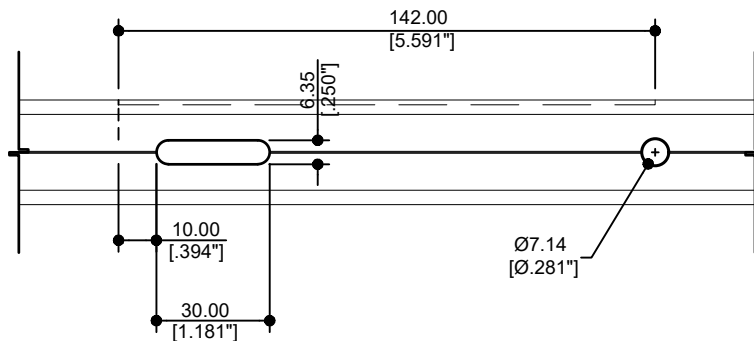

OPERACIÓN MANUAL

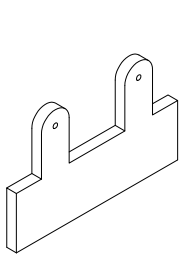

EH-70I
JUNTA DE HERMETICIDAD

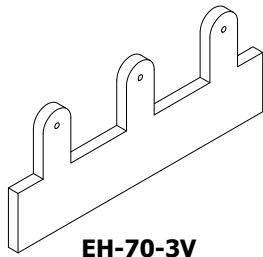

EH-70-3V
JUNTA DE HERMETICIDAD
RIEL 3 VIAS

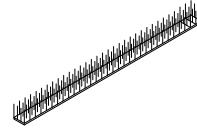

FN-110P
FELPA CON PÁSTICO

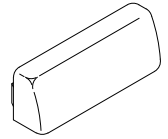

GN-554
TAPA DREN



GN-105
TAPÓN DESAGÜE



HPEN-CALZA
CALZA DE 1/4" x 3/8" x 4"

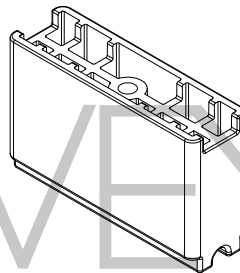

PN-0301
CALZO HOJA FIJA

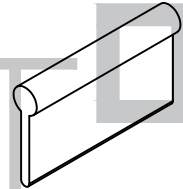

VN-E2611NE
VINIL ALETA



CLASSIC

SERIE

S70

CORREDIZA

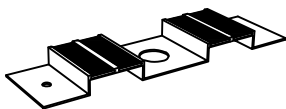

GN-635
CORTAVIENTO
VENTANA

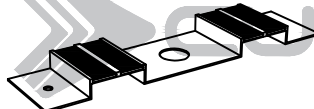

GN-638
CORTAVIENTO
PUERTA



VN-E2002NE
EMPAQUE COLA DE RATA

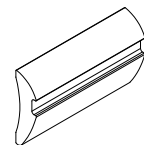

VN-E2610NE
VN-E2611NE

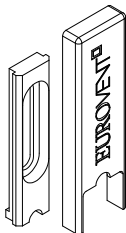

GN-631T
TAPA TRASLAPE VENTANA



GN-633T
TAPA CERCO VENTANA

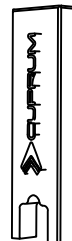

GN-632
TAPA TRASLAPE

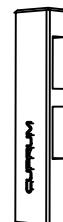

GN-634
TAPA CERCO

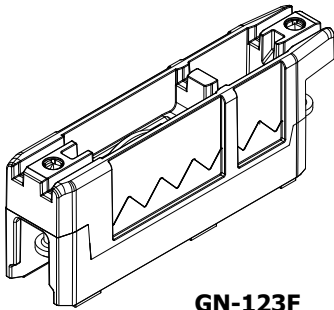

GN-123F
CARRETILLA AJUSTABLE
(45 KG POR CARRETILLA - 90 POR HOJA)

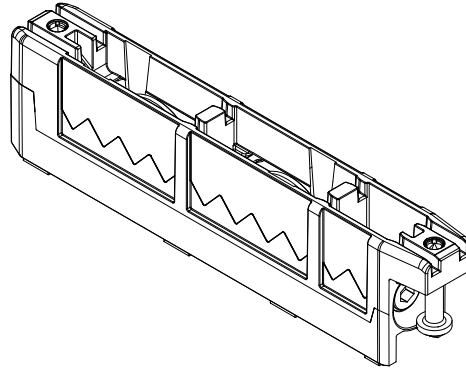

CAGT103/3ALMF
PARA DOBLE VIDRIO PUERTA
(100 KG POR CARRETILLA - 200 POR HOJA)

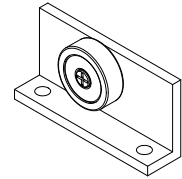

CA2170
CARRETILLA MOSQUITERO



CLASSIC

SERIE

S70



CORREDIZA

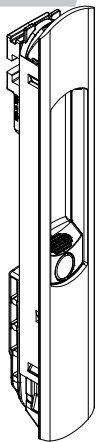

FN-552
BROCHE MINI 160MM
(EMBUTIDO)

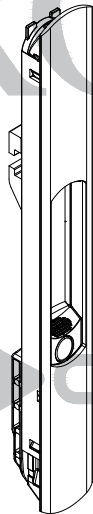

FN-553
BROCHE OLÉ TOP 200MM
(EMBUTIDO)

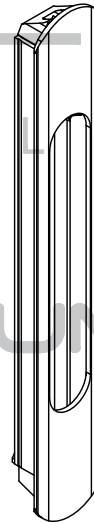

UA800E4
UÑERO EMBUTIDO

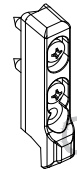

FN-557C
CONTRA

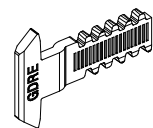

FN-557B
GANCHO

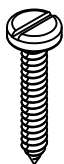

PFNG-0805
#8 X 1/2"

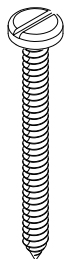

PFNG-1017
10 x 1 1/2"

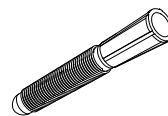

TAQ1147
TAQUETE 1/4 D/PLASTICO

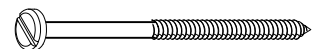

TMNG-1026
TORN P/MADERA 10X76 GAL

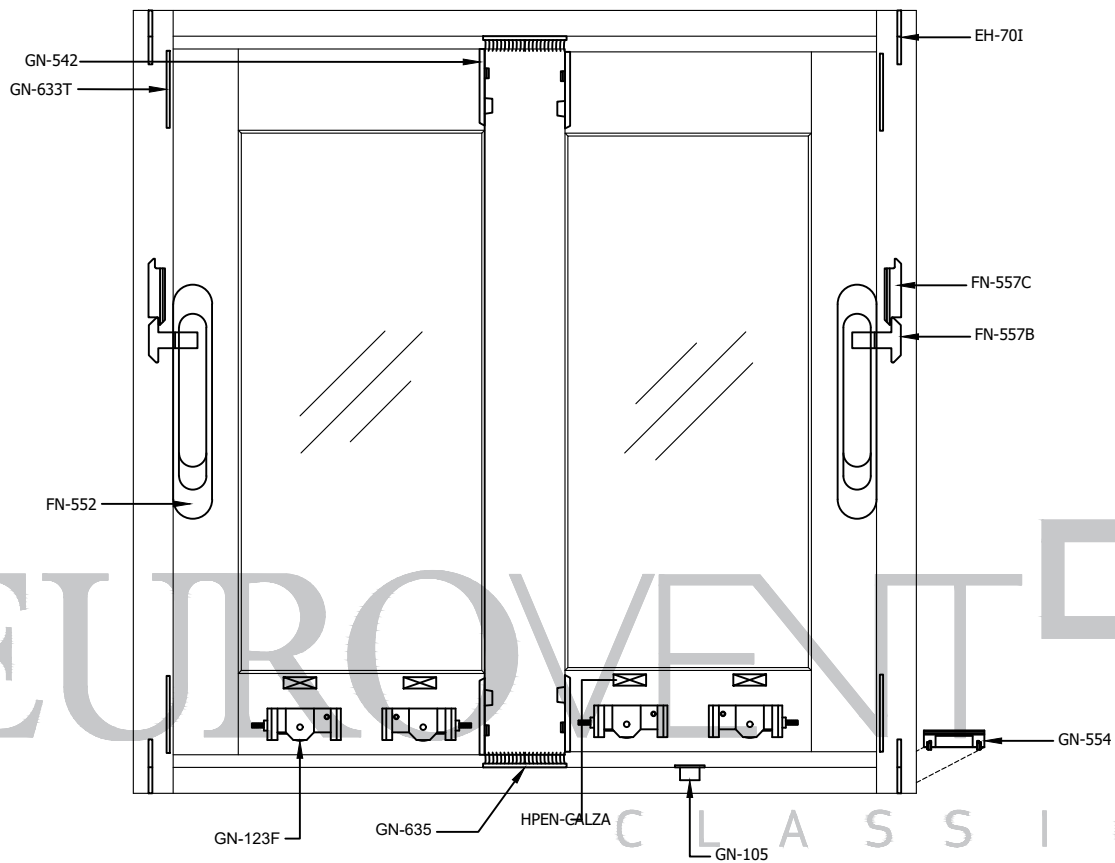

CORREDIZA

VENTANA CORREDIZA S70 XX		
CLAVE	DESCRIPCIÓN	PIEZAS
EH-70I	JUNTA DE HERMETICIDAD	4
FN-552	CIERRE CHICO 165 MM	2
FN-557B	FLECHA	2
FN-557C	CONTRA	2
GN-554	TAPA DREN CON VÁLVULA	2
GN-105	TAPÓN DESAGÜE	1
GN-123F	CARRETILLA	4
GN-631T	TAPA TRASLAPE VENTANA	4
GN-633T	TAPA CERCO VENTANA	4
GN-635	CORTAVIENTO	2
PFNG-1017	PIJA #10 X 1 1/2"	24
PFNG-0805	PIJA #8 X 1/2"	8
VN-E2002NE	EMPAQUE COLA DE RATA	1L + 2H
VN-2610NE	VN-E2610NE PARA CRISTAL	2L + 4H
FN-110P	FELPA CON PÁSTICO	4L + 6H
HPEN-CALZA	CALZA DE NEOPRENO	1

MOSQUITERO		
UA800E4	UÑERO PARA MOSQUITERO	2
CA2170	CARRETILLA PARA MOSQUITERO COLGANTE	2
PFNG-1017	PIJA #10 X 1 1/2"	4
PPNG-1020	PIJA #10 X 2"	4
PFNG-0805	PIJA #8 X 1/2" (SUJETAR RIEL MOSQUITERO A RIEL)	3
VN-E2611NE	EMPAQUE ALETA PARA MOSQUITERO	2H
-	TELA MOSQUITERO	-

CLASSIC
SERIE
S70
CORREDIZA

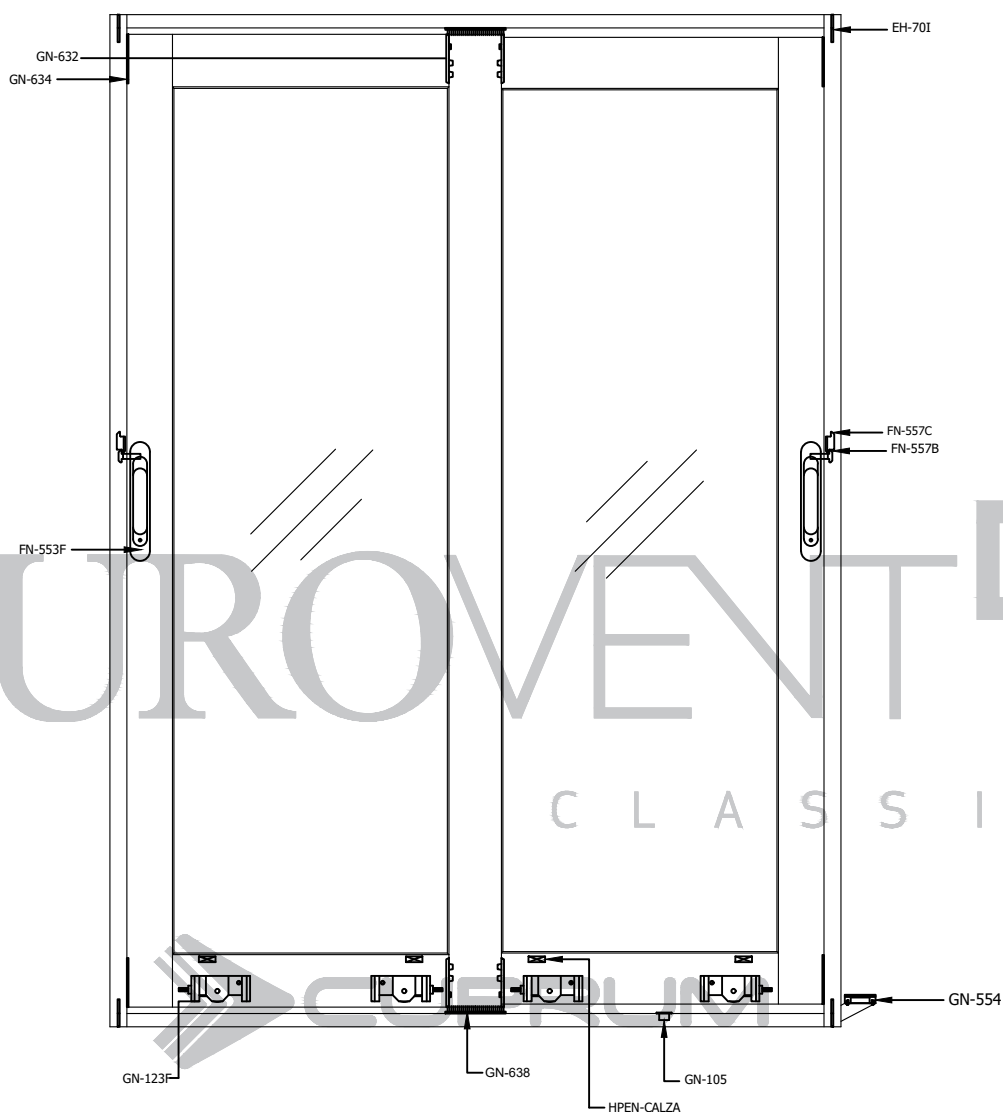

PUERTA CORREDIZA S70 XX

CLAVE	DESCRIPCIÓN	PIEZAS
EH-701	JUNTA DE HERMETICIDAD	4
FN-553	CIERRE GRANDE 185 MM	2
FN-557B	FLECHA	2
FN-557C	CONTRA	2
GN-554	TAPA DREN CON VÁLVULA	2
GN-105	TAPÓN DESAGÜE	1
GN-123F	CARRETILLA	4
GN-632	TAPA TRASLAPE PUERTA	4
GN-634	TAPA CERCO PUERTA	4
GN-638	CORTAVIENTO	2
PFNG-1017	PIJA #10 X 1 ½"	24
PFNG-0805	PIJA #8 X ½"	8
VN-E2002NE	EMPAQUE COLA DE RATA	1L + 2H
VN-2610NE	VINIL CUÑA PARA CRISTAL	2L + 4H
FN-110P	FELPA CON PÁSTICO	4L + 6H
HPEN-CALZA	CALZA DE NEOPRENO	1

MOSQUITERO

CLAVE	DESCRIPCIÓN	PIEZAS
UA800E4	UÑERO PARA MOSQUITERO	4
CA2170	CARRETILLA PARA MOSQUITERO COLGANTE	2
PFNG-1017	PIJA #10 X 1 ½"	4
PPNG-1020	PIJA #10 X 2"	4
PFNG-0805	PIJA #8 X ½" (SUJETAR RIEL MOSQUITERO A RIEL)	3
VN-E2611NE	EMPAQUE ALETA PARA MOSQUITERO	2H
-	TELA MOSQUITERO	-

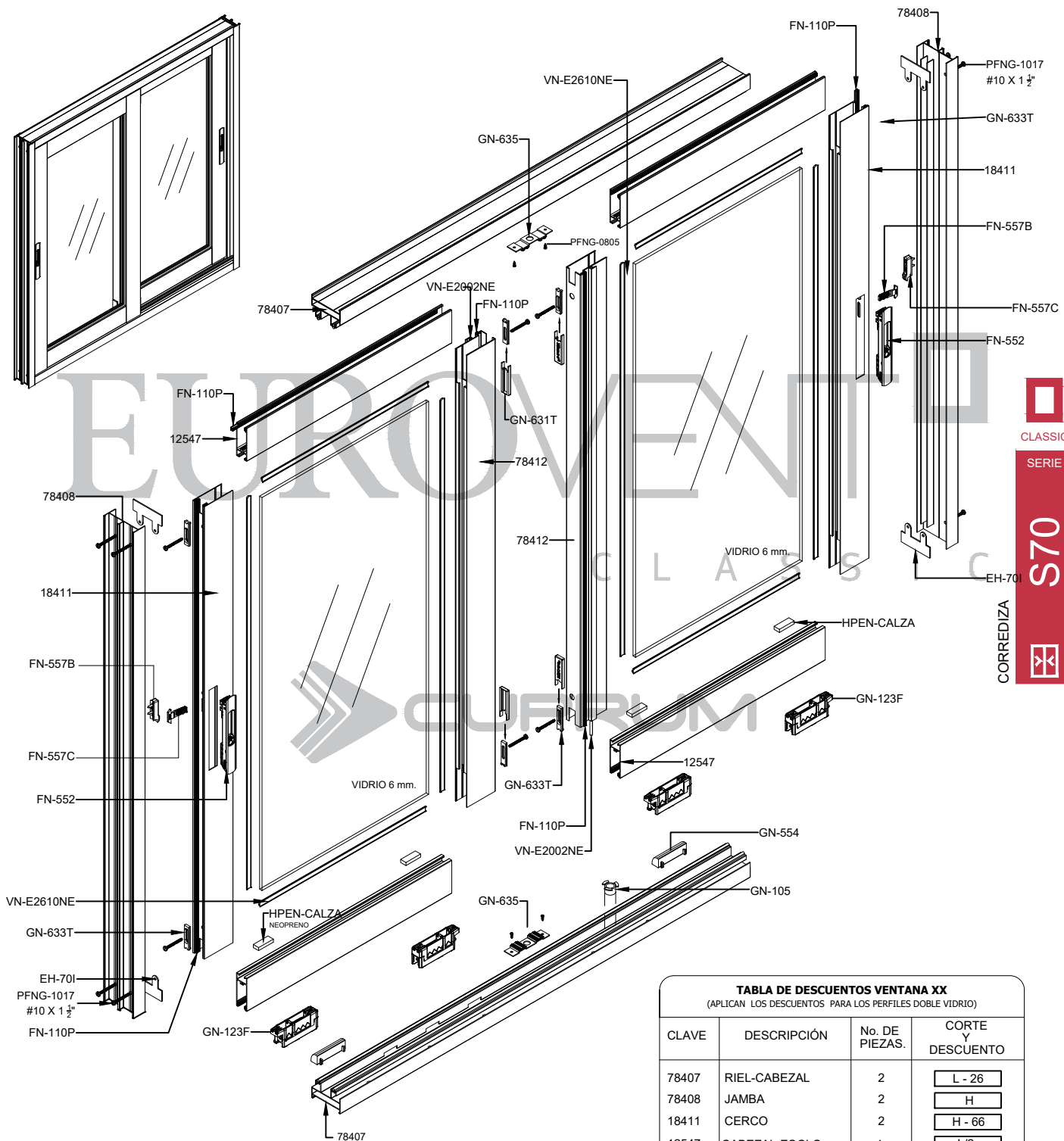

CLASSIC
SERIE
S70
CORREDIZA

HERRAMIENTAS ADICIONALES REQUERIDAS

LLAVE ALLEN 4 MM. CARRETILLA AJUSTABLE (GN-123F)

LLAVE ALLEN 3 MM. BROCHE MINI 160MM (FN-552)

SIN ESCALA.

TABLA DE DESCUENTOS VENTANA XX (APLICAN LOS DESCUENTOS PARA LOS PERFILES DOBLE VIDRIO)			
CLAVE	DESCRIPCIÓN	No. DE PIEZAS.	CORTE Y DESCUENTO
78407	RIEL-CABEZAL	2	L - 26
78408	JAMBA	2	H
18411	CERCO	2	H - 66
12547	CABEZAL-ZOCLO	4	L/2
78412	TRASLAPE	2	H - 66
VIDRIO	L	2	L/2 - 100
	H		H - 189

L = ANCHO DE CANCEL
H = ALTO DE CANCEL

DESCUENTOS EN MILÍMETROS

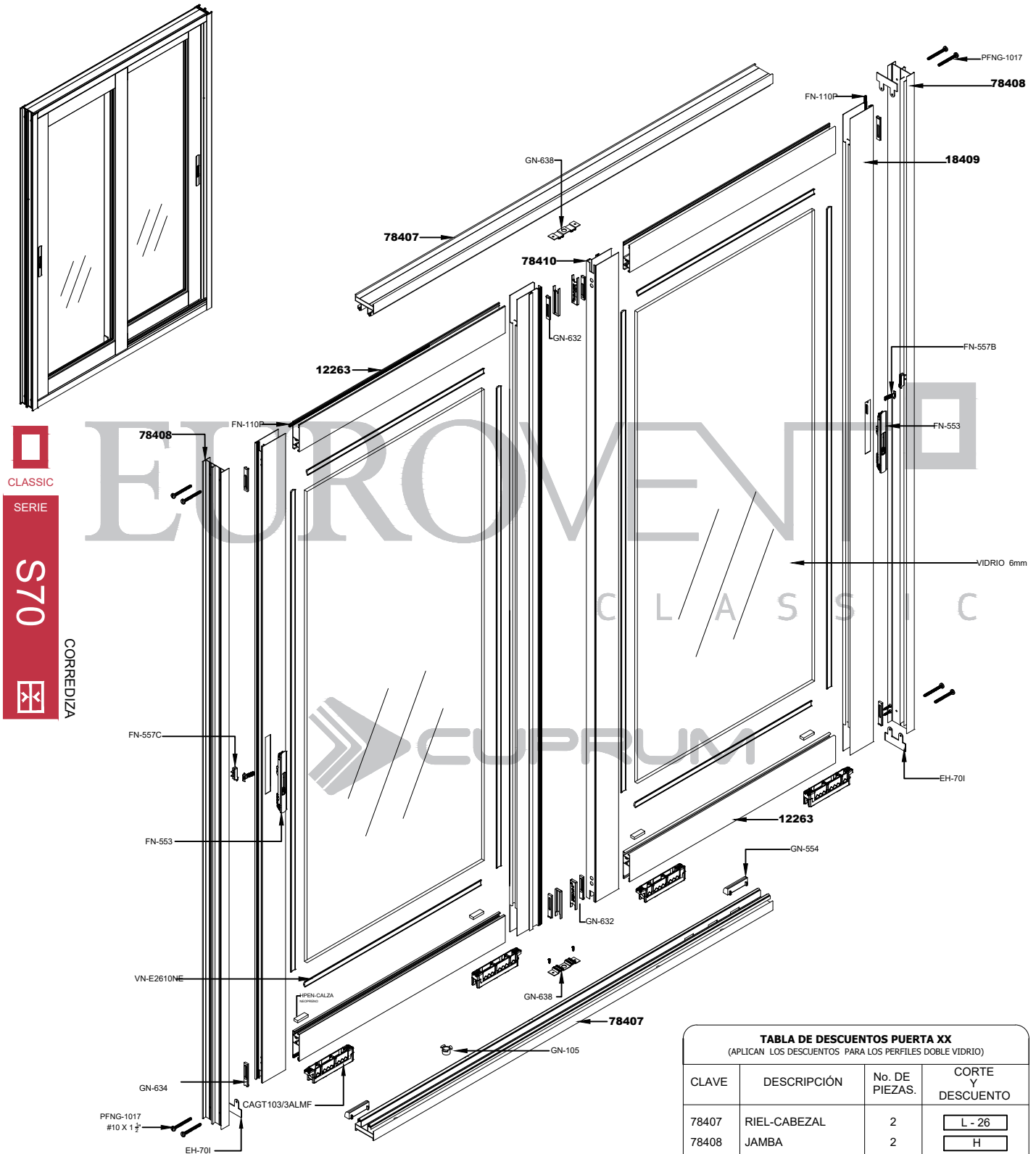

CLASSIC
 SERIE
S70
 CORREDIZA

HERRAMIENTAS ADICIONALES REQUERIDAS

- LLAVE ALLEN 4 MM. CARRETILLA AJUSTABLE (CAGT103/3ALMF)
- LLAVE ALLEN 3 MM. BROCHE OLÉ TOP 200MM (FN-553)

TABLA DE DESCUENTOS PUERTA XX <small>(APLICAN LOS DESCUENTOS PARA LOS PERFILES DOBLE VIDRIO)</small>			
CLAVE	DESCRIPCIÓN	No. DE PIEZAS.	CORTE Y DESCUENTO
78407	RIEL-CABEZAL	2	L - 26
78408	JAMBA	2	H
18409	CERCO	2	H - 66
12263	CABEZAL-ZOCLO	4	L/2 + 9
78410	TRASLAPE	2	H - 66
	L		L/2 - 126
VIDRIO	H	2	H - 223
L = ANCHO DE CANCEL H = ALTO DE CANCEL			DESCUENTOS EN MILÍMETROS

CORREDIZA SERIE 70

A UNA ALTURA DE 15 METROS

DEFLEXIÓN MAX. L/175

VENTANA CORREDIZA SERIE 70

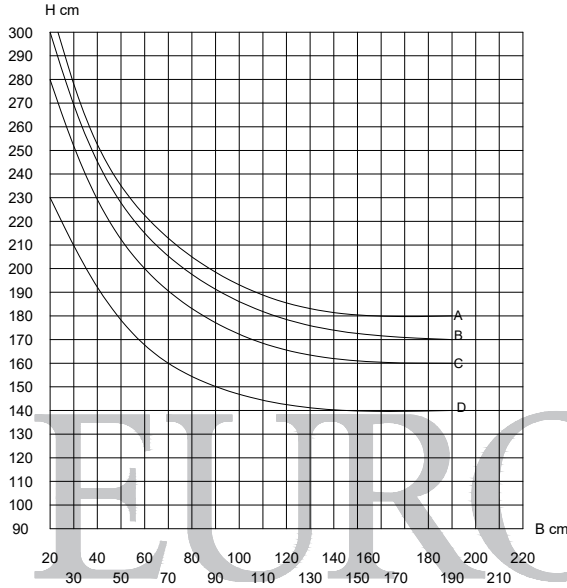

PUERTA CORREDIZA SERIE 70

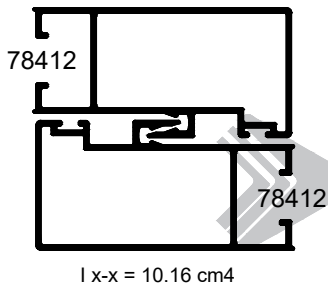
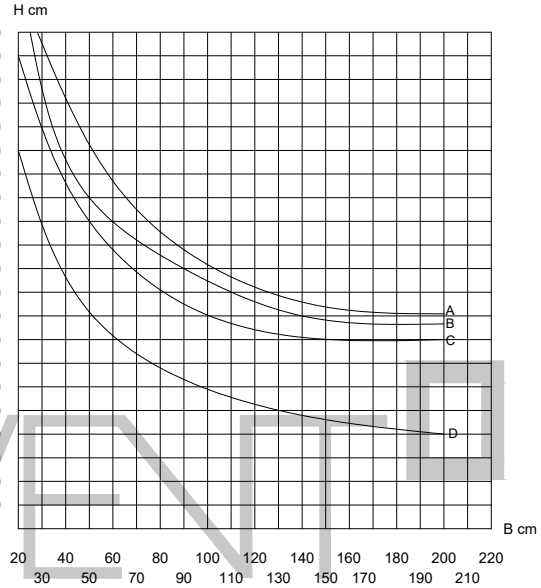

LOS LÍMITES DE FABRICACIÓN PARA LOS PERFILES, SERÁN LOS QUE SE ENCUENTREN DEBAJO DE LAS CURVAS GRAFICADAS.

ALEACIÓN: 6063
TEMPLE: 5

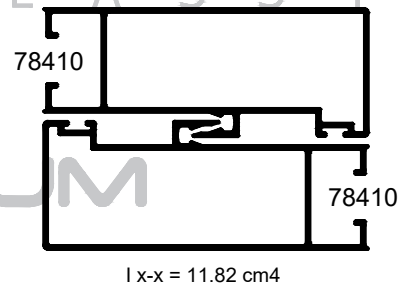

Valores de presión por velocidad de viento

Curvas	Presión del diseño	Velocidad de viento	Zona
A	45 Kg/m ²	80 Km/h	Centro de grandes ciudades
B	50 Kg/m ²	90 Km/h	Barrios Residenciales
C	65 Kg/m ²	120 Km/h	Campo Abierto
D	145 Kg/m ²	160 Km/h	Zona Costera

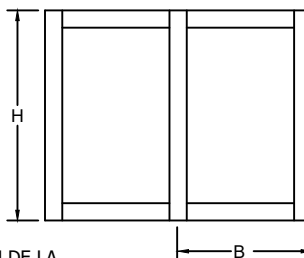

LOS LÍMITES DE UN CANCEL VAN EN FUNCIÓN DE LA COMBINACIÓN DE RESISTENCIA DEL PERFIL DE ALUMINIO, EL VIDRIO Y LOS ACCESORIOS QUE LO INTEGRAN.

VERIFICAR QUE LA DEFLEXIÓN DEL PERFIL SEA COMPATIBLE CON EL VIDRIO UTILIZADO.

PARÁMETROS MÍNIMOS Y MÁXIMOS DE FABRICACIÓN.

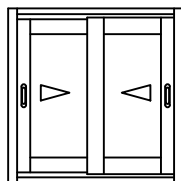

VC-70
MÍNIMO 0.50 x 0.60 HOJA
MÁXIMO 1.20 x 1.80 HOJA

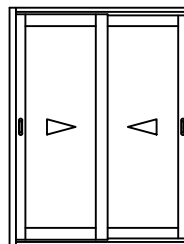

PC-70
MÍNIMO 0.80 x 1.80 HOJA
MÁXIMO 1.20 x 2.40 HOJA

CLASSIC
SERIE
S70
COREDIZA

ALUMINIO					
CLAVE	DESCRIPCIÓN	PIEZAS X ATADO	LARGO STD. MTS.	PERÍMETRO ANOD. CM.	PERÍMETRO PUL. CM.
11409	CABEZAL	12	6.10	18.30	7.30
11411	MOSQUITERO	8	6.10	14.17	11.36
12263	ZOCLO-CABEZAL	4	6.10	39.29	19.26
12428	BOTAGUAS	28	6.10	9.99	8.18
12437	ZOCLO-CABEZAL DOBLE VIDRIO	4	6.10	37.22	19.00
12456	INTERMEDIO	8	6.10	23.33	9.53
12547	ZOCLO-CABEZAL	8	6.10	38.54	16.74
12664	ZOCLO-CABEZAL DOBLE VIDRIO	6	6.10	36.46	15.39
14411	REFUERZO 1/2"	16	6.10	14.35	11.06
14412	CONECTOR	29	6.10	3.22	0.62
14702	PERFIL P/CUADRICULA	20	6.10	14.83	4.11
14918	PERFIL P/CUADRICULA	16	6.10	20.84	7.82
18408	JAMBA	6	6.10	35.58	22.86
18409	CERCO	6	5.00	32.53	25.30
18411	CERCO	4	5.00	28.96	21.73
18413	GUÍA INFERIOR	12	6.10	15.91	13.08
18419	CERCO DOBLE VIDRIO	4	6.10	30.10	24.53
18421	CERCO DOBLE VIDRIO	4	6.10	26.53	20.96
50701	ADAPTADOR OXXO	30	6.10	9.17	4.20
62374	JAMBA	4	6.10	55.82	36.74
72373	RIEL TRIPLE	2	6.10	50.53	26.83
78407	RIEL-CABEZAL	4	6.10	40.04	19.52
78408	JAMBA	8	6.10	34.95	5.64
78410	TRASLAPE	4	5.00	34.29	21.38
78412	TRASLAPE	4	6.10	30.71	17.81
78420	TRASLAPE DOBLE VIDRIO	4	5.00	31.86	21.38
78422	TRASLAPE DOBLE VIDRIO	4	6.10	28.29	17.81

EUROVENT

CLASSIC



CORTINA ANTICICLÓNICA HV

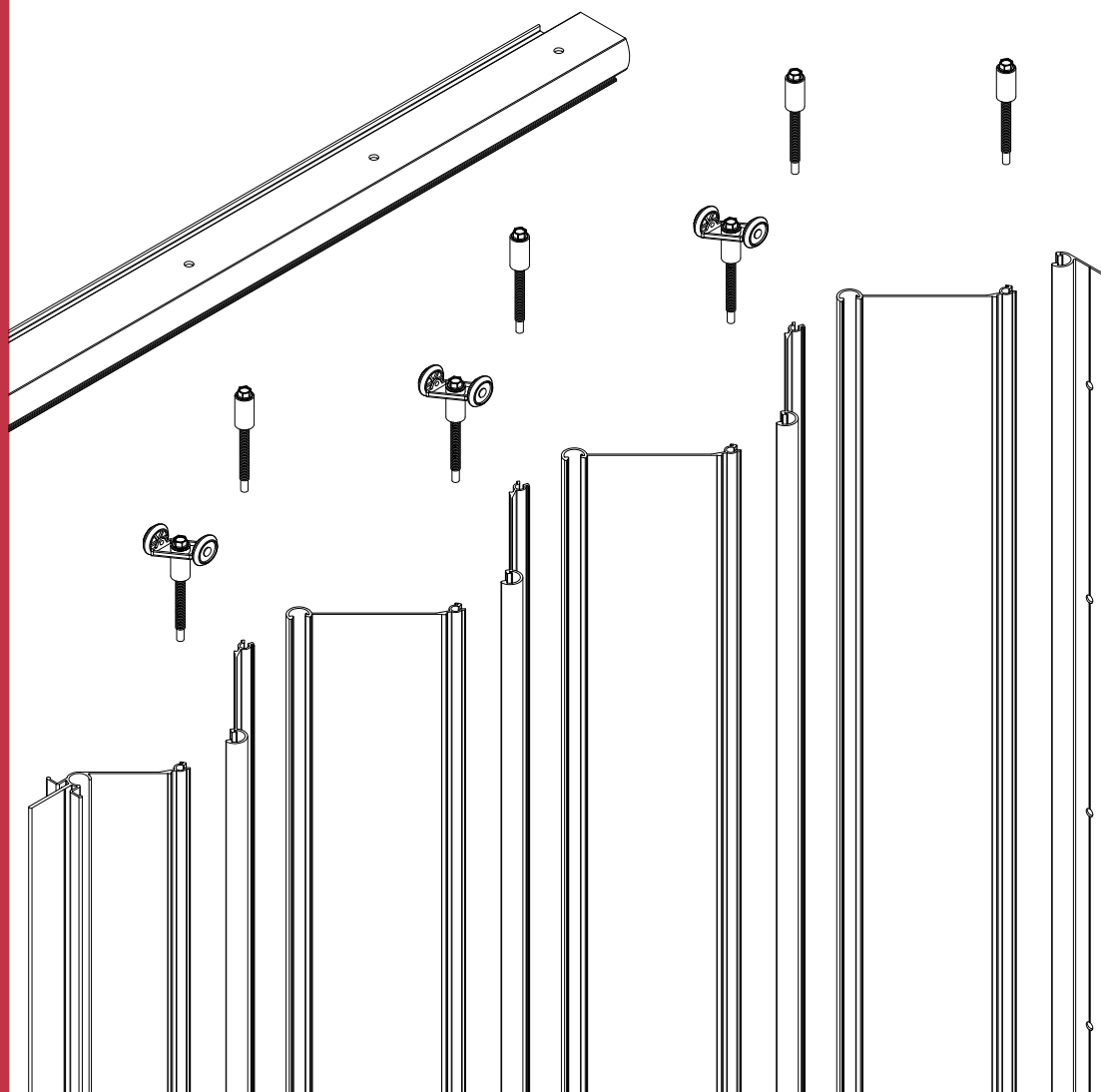

CLASSIC
SERIE
CA HV
CORTINA ANTICICLÓNICA

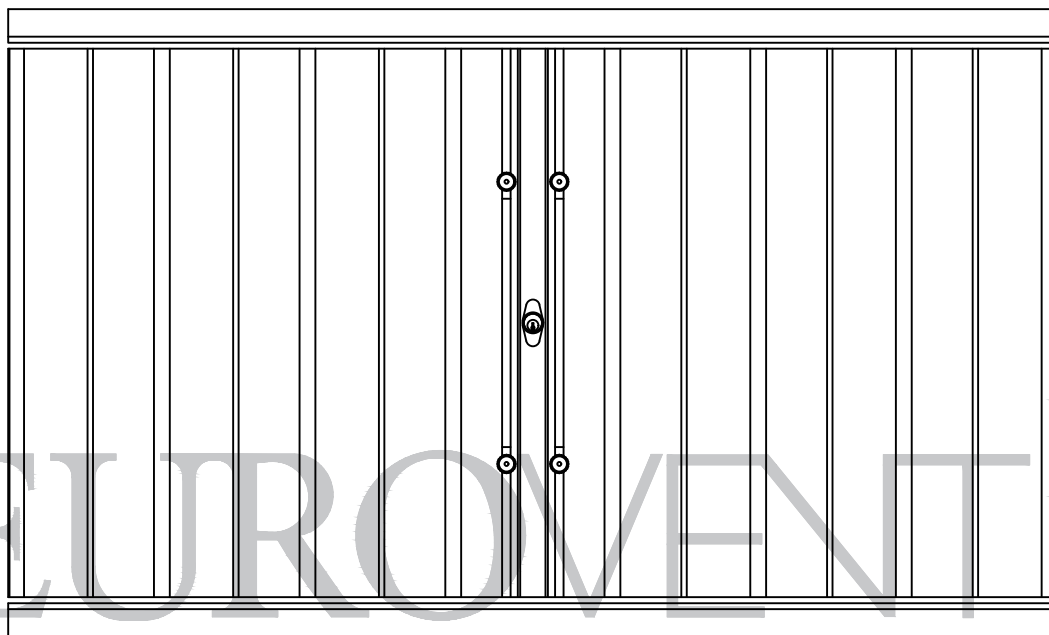

CIERRES AL CENTRO

C L A S S I C

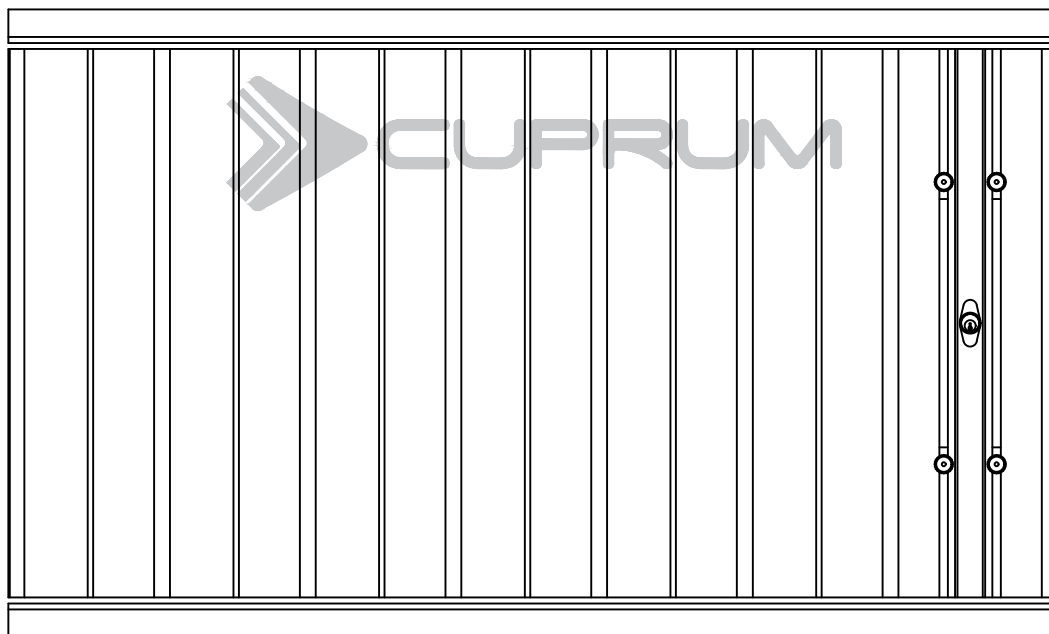

CIERRES LATERALES

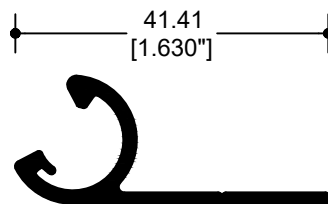
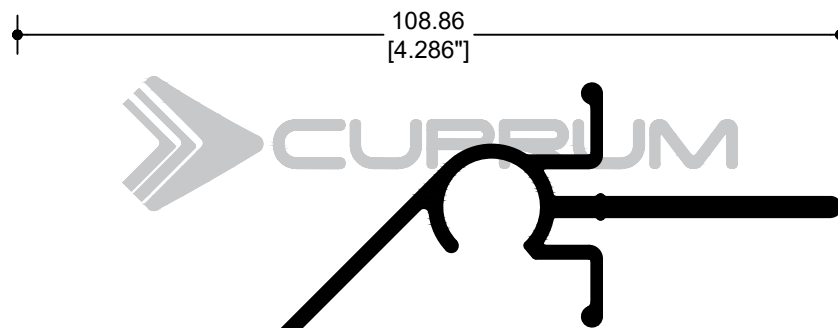
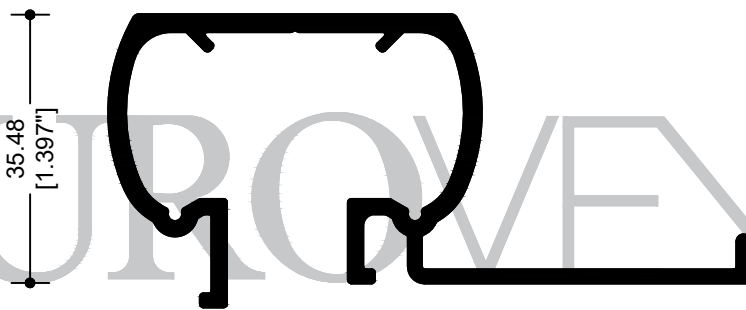
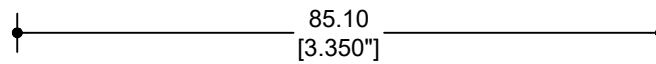
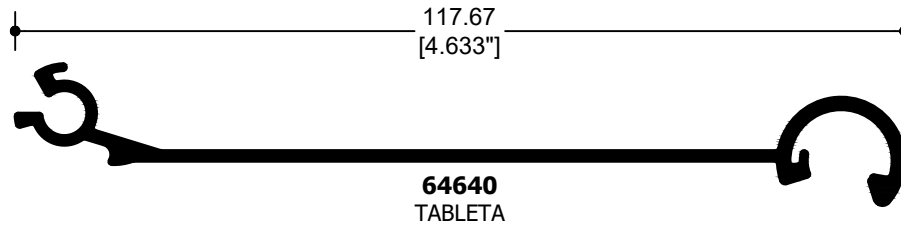

EUROVENT[®] CLASSIC

CLASSIC
SERIE
CA HV
CORTINA ANTICICLÓNICA



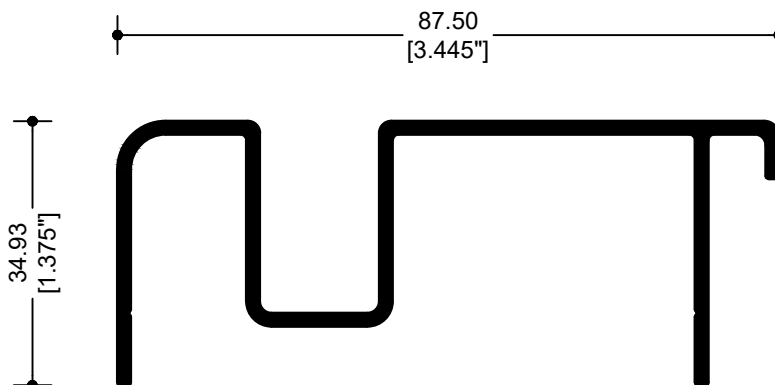

64644
ADAPTADOR AJUSTABLE MACHO

CLASSIC
SERIE
CA HV
CORTINA ANTICICLÓNICA

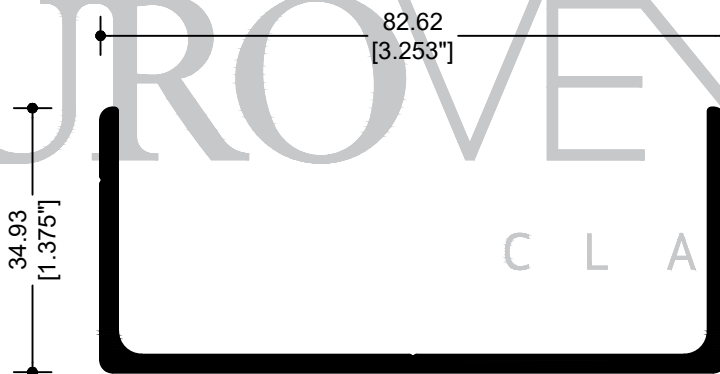
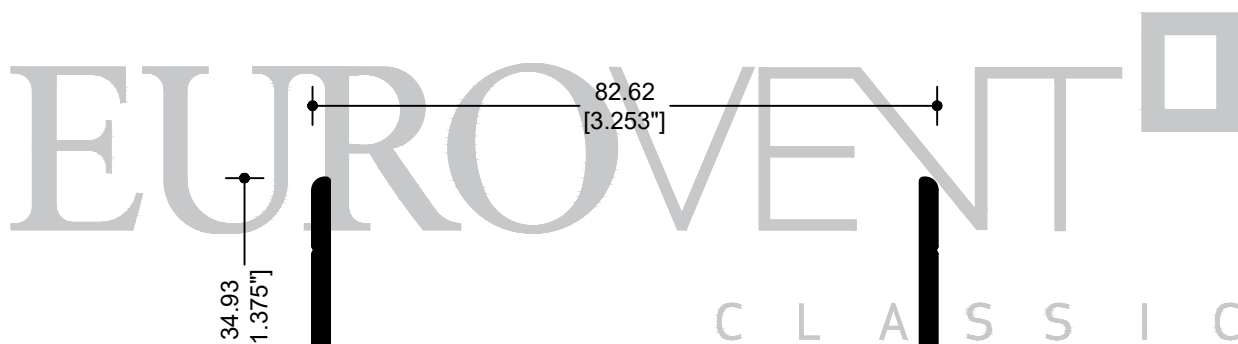

64645
ADAPTADOR AJUSTABLE HEMBRA

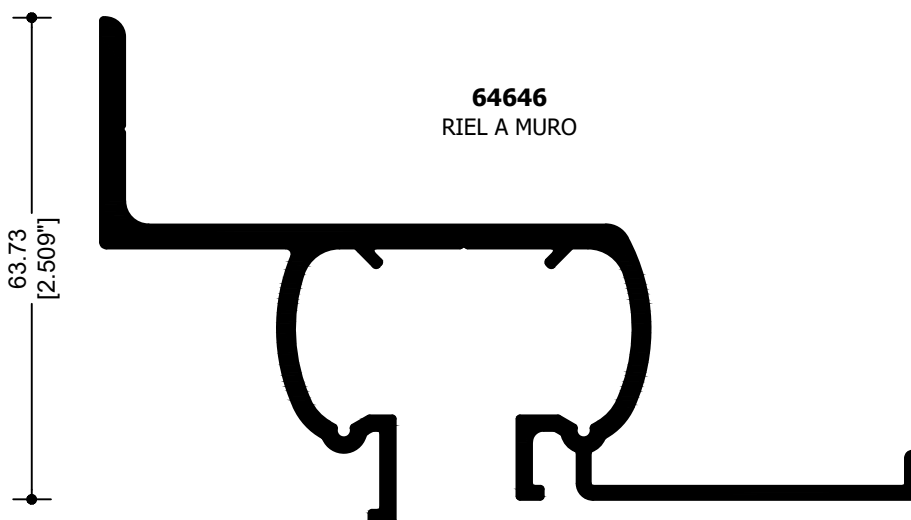
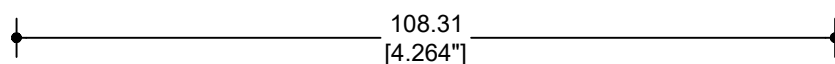

64646
RIEL A MURO



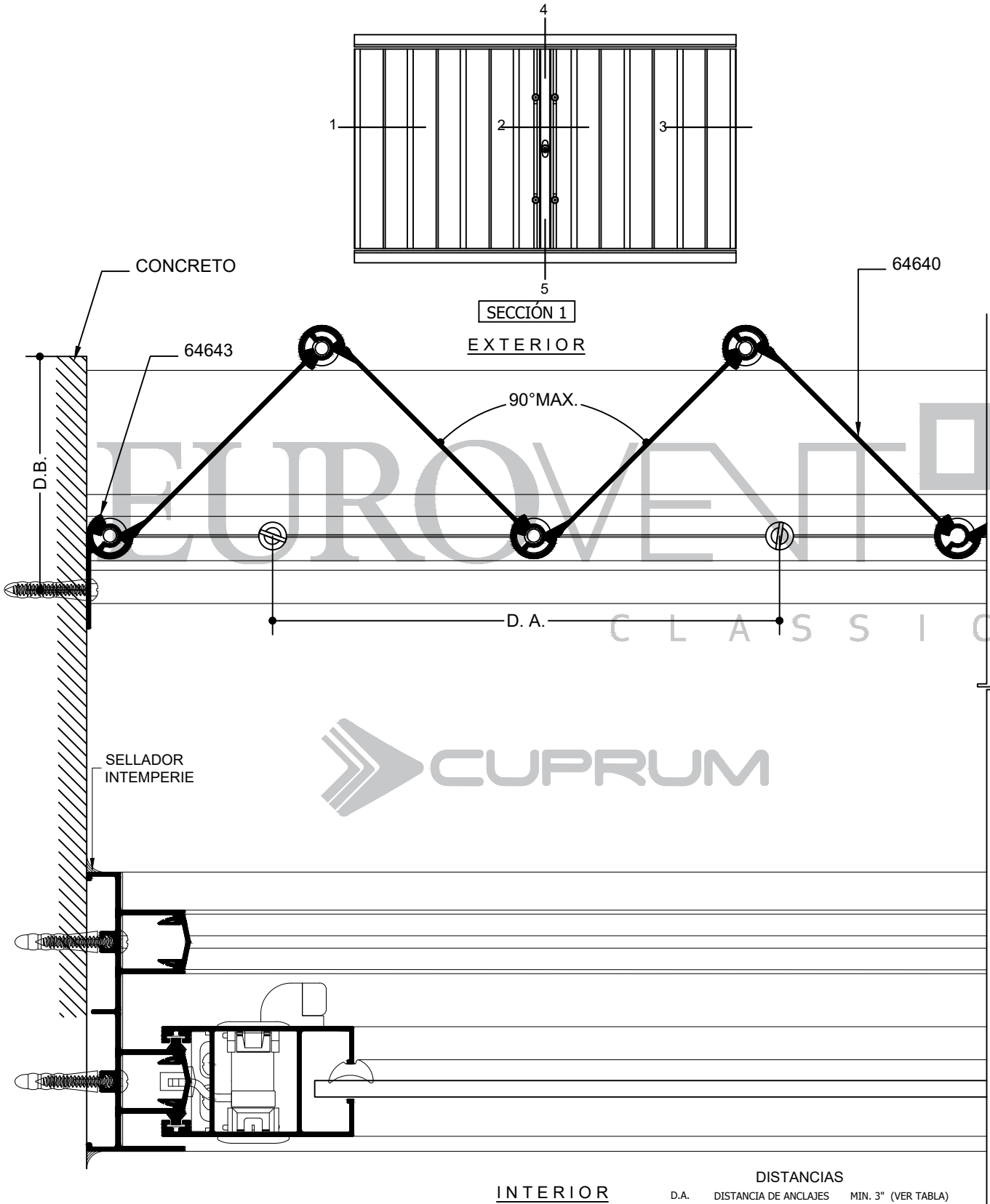

CLASSIC
SERIE
CA HV
CORTINA ANTICICLÓNICA

DISTANCIAS

D.A.	DISTANCIA DE ANCLAJES	MIN. 3" (VER TABLA)
D.B.	DISTANCIA DE BORDE	MIN. 3 1/2"
D.V.	DISTANCIA DE VIDRIO	MIN. 4"
EQ	EQUIDISTANTE	



Cert. No: 13-0306 01
 CUMPLE EL PROTOCOLO (High Velocity Hurricane Zone) Velocidades Extremas en Zona de Huracanes
 Certificación realizada en el Condado de Miami Dade por el laboratorio FENESTRATION TESTING LABORATORY, INC.

SECCIÓN 2

EXTERIOR

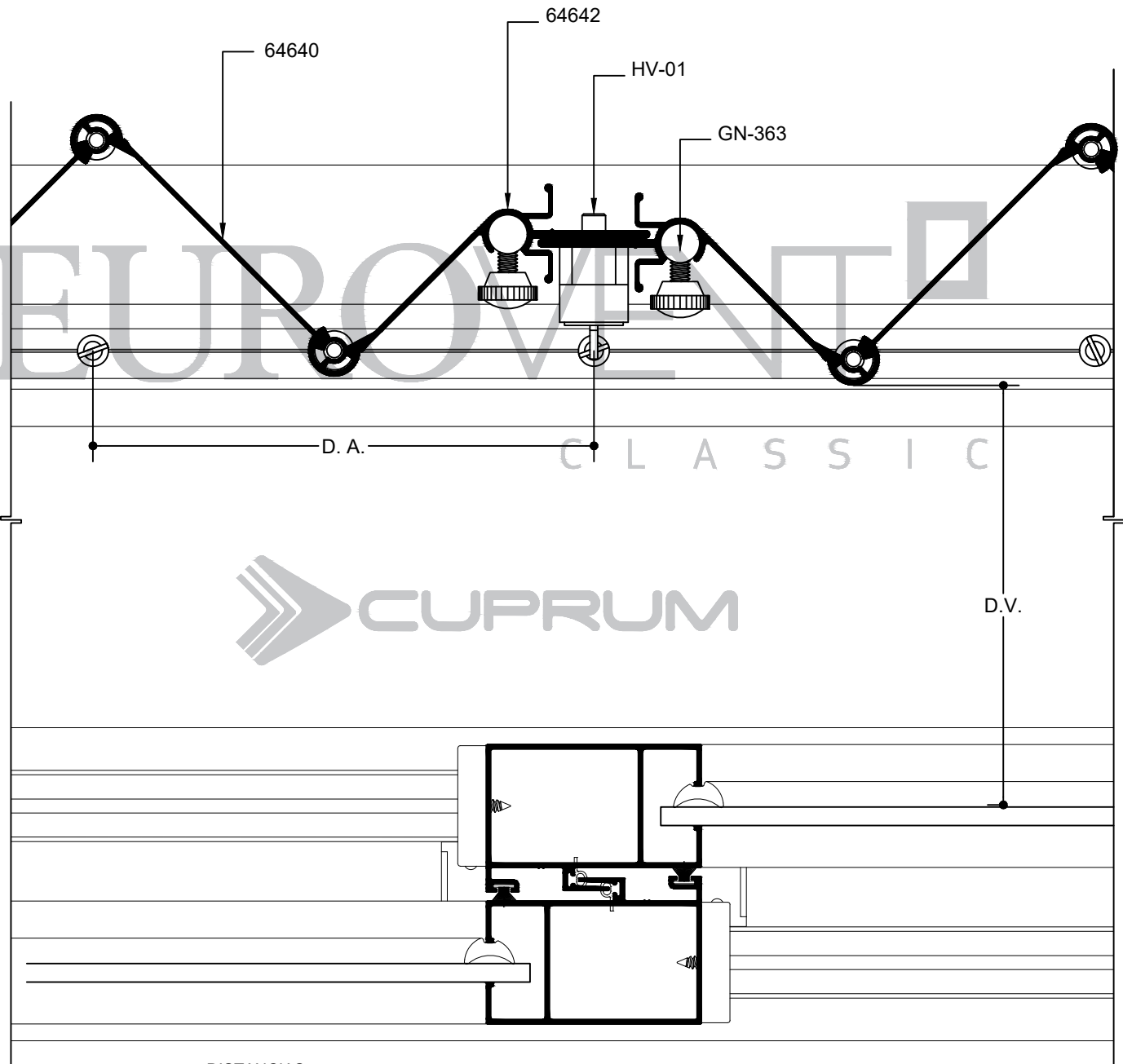

CLASSIC
SERIE
CA HV
CORTINA ANTICICLÓNICA



DISTANCIAS

D.A.	DISTANCIA DE ANCLAJES	MIN. 3" (VER TABLA)
D.B.	DISTANCIA DE BORDE	MIN. 3 1/2"
D.V.	DISTANCIA DE VIDRIO	MIN. 4"
EQ	EQUIDISTANTE	

INTERIOR



SECCIÓN 3

EXTERIOR

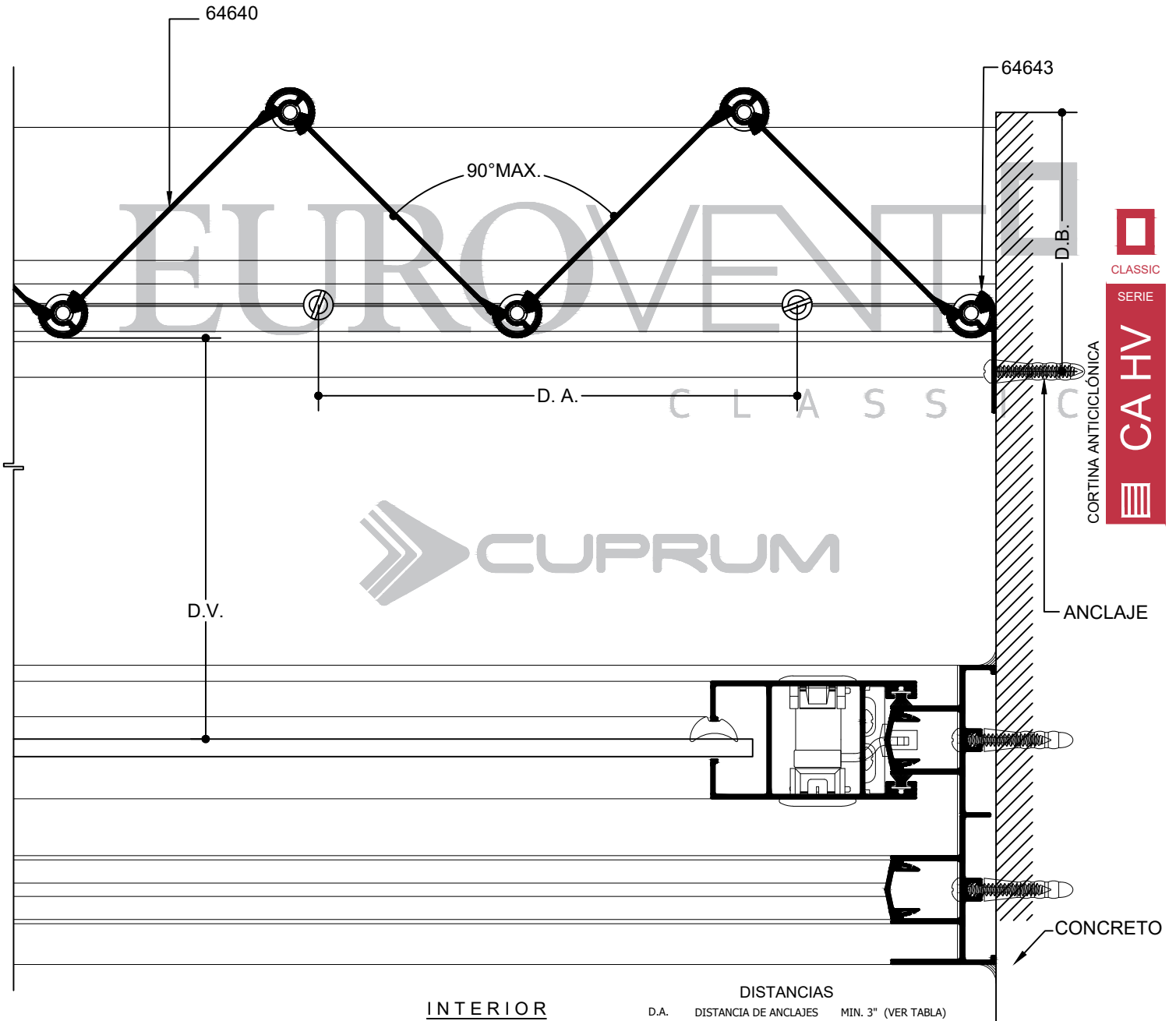

INTERIOR

DISTANCIAS

D.A.	DISTANCIA DE ANCLAJES	MIN. 3" (VER TABLA)
D.B.	DISTANCIA DE BORDE	MIN. 3 1/2"
D.V.	DISTANCIA DE VIDRIO	MIN. 4"
EQ	EQUIDISTANTE	



Cert. No: 13-0306 01
 CUMPLE EL PROTOCOLO (High Velocity Hurricane Zone) Velocidades Extremas en Zona de Huracanes
 Certificación realizada en el Condado de Miami Dade por el laboratorio FENESTRATION TESTING LABORATORY, INC.

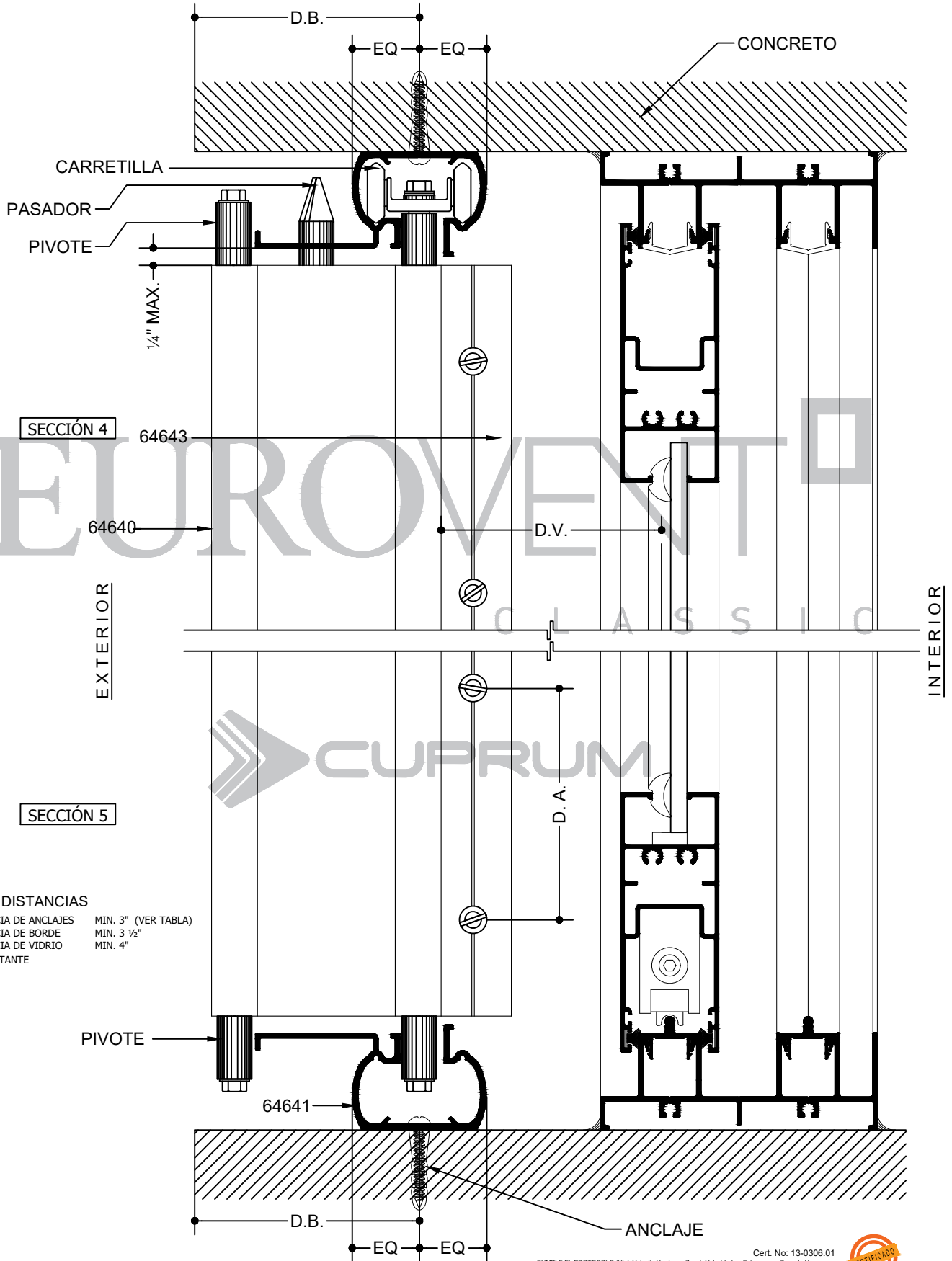

CLASSIC
SERIE
CA HV
CORTINA ANTICICLÓNICA

SECCIÓN 4

SECCIÓN 5

DISTANCIAS

D.A.	DISTANCIA DE ANCLAJES	MIN. 3" (VER TABLA)
D.B.	DISTANCIA DE BORDE	MIN. 3 1/2"
D.V.	DISTANCIA DE VIDRIO	MIN. 4"
EQ	EQUIDISTANTE	

SECCIÓN 4

OPCIÓN SUPERIOR

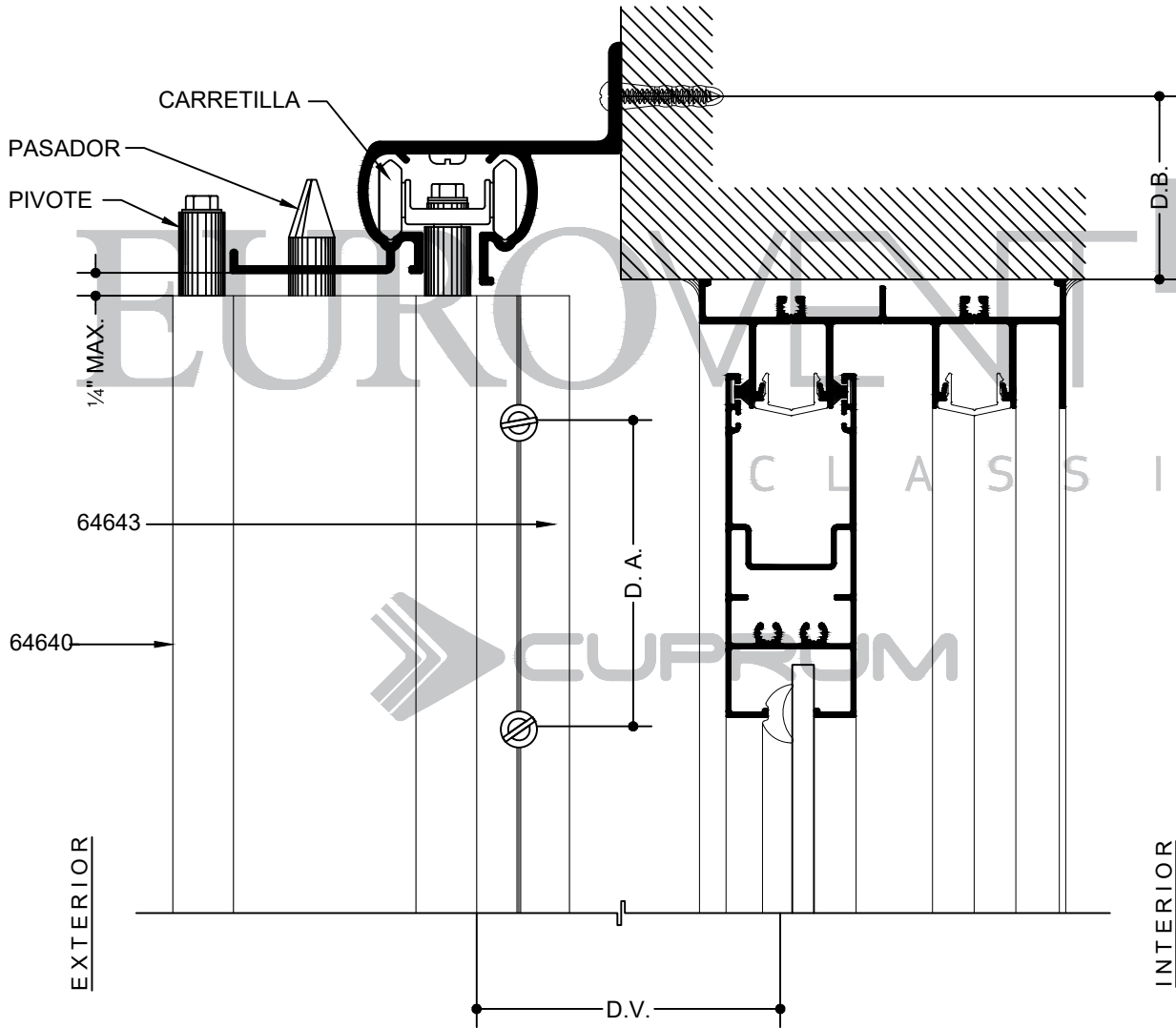

CLASSIC
SERIE
CA HV
CORTINA ANTICICLÓNICA

DISTANCIAS

D.A.	DISTANCIA DE ANLAJES	MIN. 3" (VER TABLA)
D.B.	DISTANCIA DE BORDE	MIN. 3 1/2"
D.V.	DISTANCIA DE VIDRIO	MIN. 4"
EQ	EQUIDISTANTE	



Cert. No: 13-0306 01
CUMPLE EL PROTOCOLO (High Velocity Hurricane Zone) Velocidades Extremas en Zona de Huracanes
Certificación realizada en el Condado de Miami Dade por el laboratorio FENESTRATION TESTING LABORATORY, INC.

SECCIÓN 5

OPCIÓN INFERIOR

CLASSIC
SERIE
CA HV
CORTINA ANTICICLÓNICA

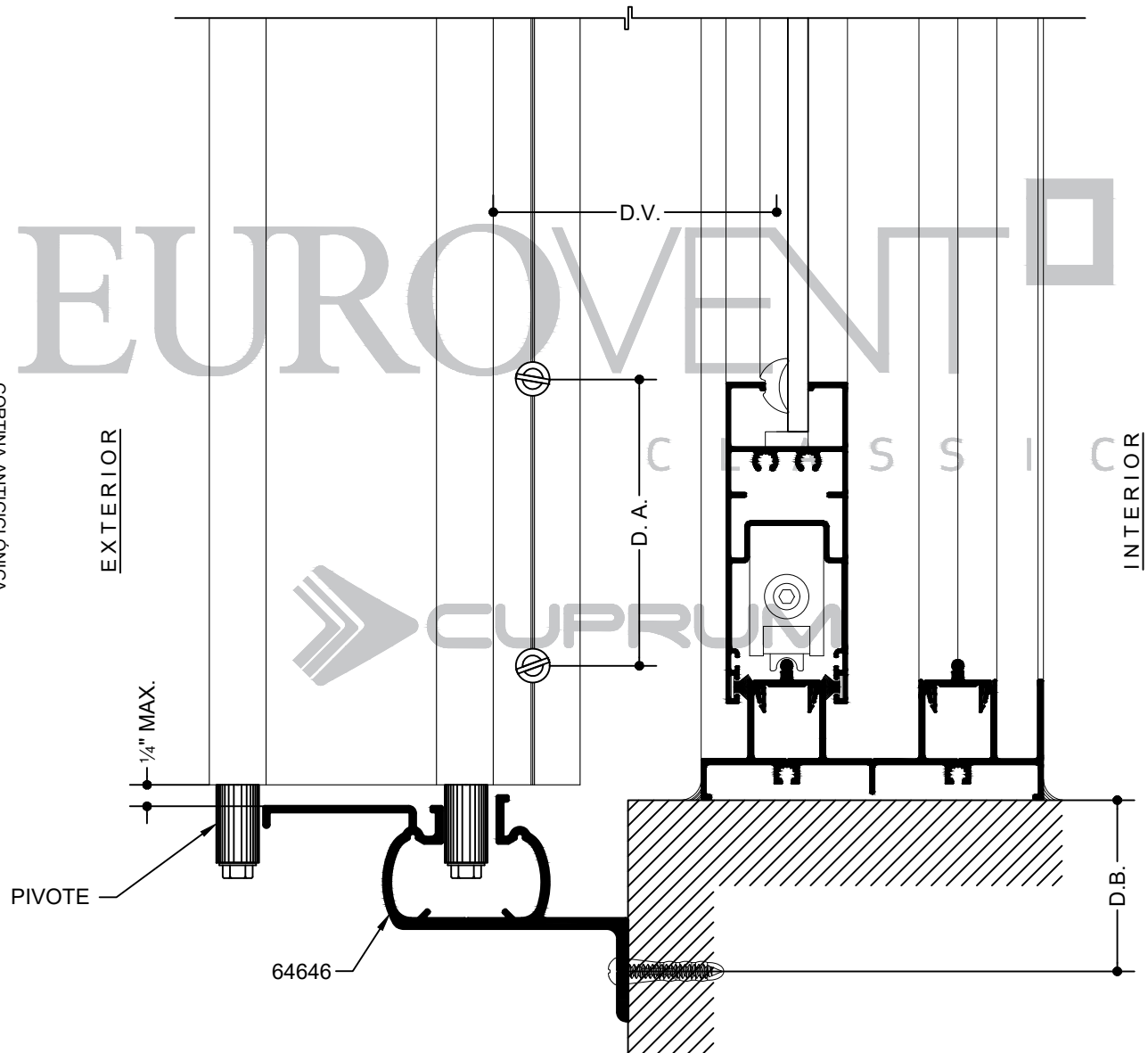

DISTANCIAS

D.A.	DISTANCIA DE ANCLAJES	MIN. 3" (VER TABLA)
D.B.	DISTANCIA DE BORDE	MIN. 3 1/2"
D.V.	DISTANCIA DE VIDRIO	MIN. 4"
EQ	EQUIDISTANTE	

SECCIÓN 5

OPCIÓN INFERIOR

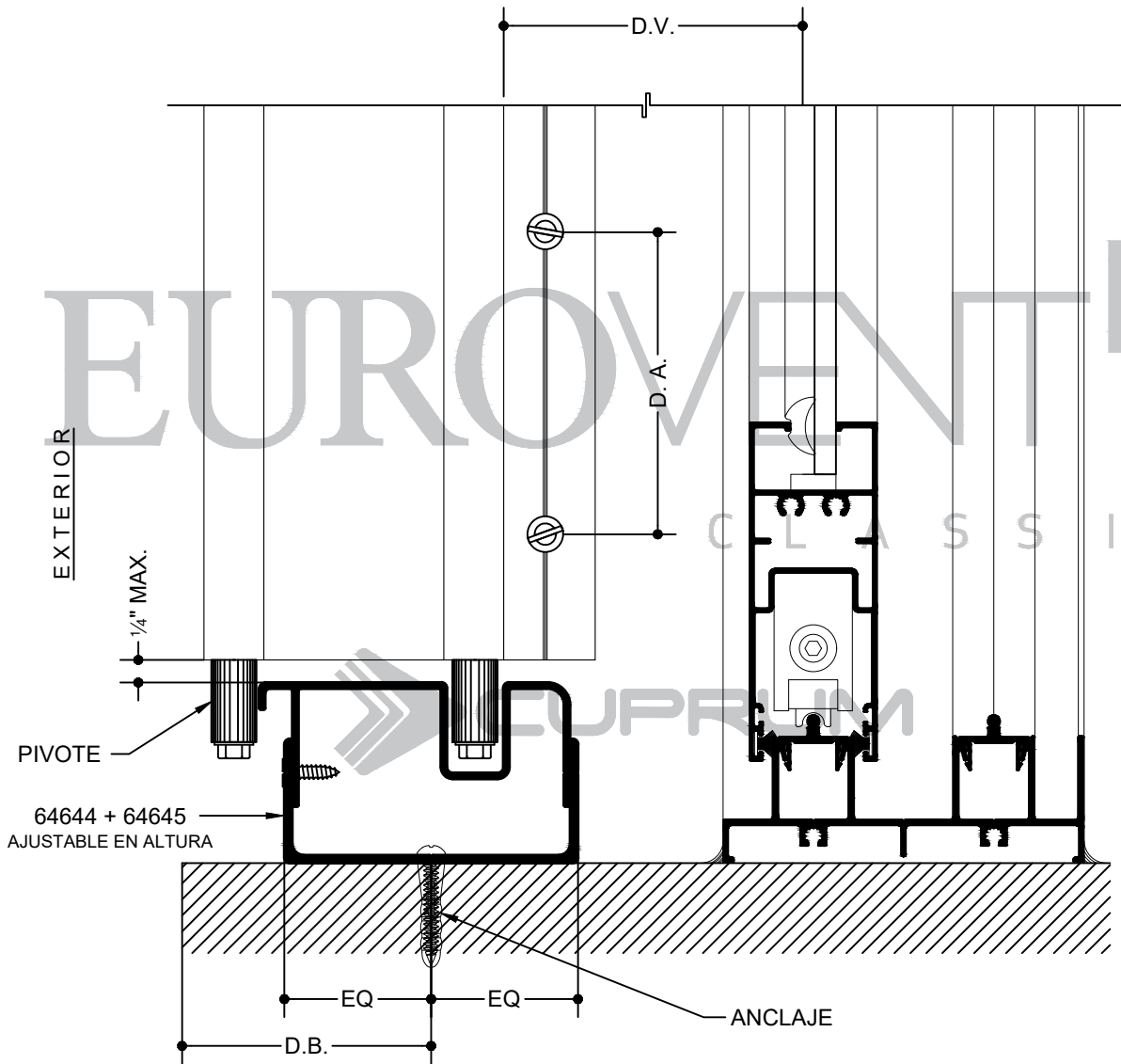

CLASSIC
SERIE
CORTINA ANTICICLÓNICA R
CA HV

DISTANCIAS

D.A.	DISTANCIA DE ANCLAJES	MIN. 3" (VER TABLA)
D.B.	DISTANCIA DE BORDE	MIN. 3 1/2"
D.V.	DISTANCIA DE VIDRIO	MIN. 4"
EQ	EQUIDISTANTE	



Cert. No: 13-0306 01
CUMPLE EL PROTOCOLO (High Velocity Hurricane Zone) Velocidades Extremas en Zona de Huracanes
Certificación realizada en el Condado de Miami Dade por el laboratorio FENESTRATION TESTING LABORATORY, INC.

NUMERO APROXIMADO DE TABLETAS POR METRO LINEAL, 12 PZA.
MÍNIMA ALTURA 0.40 m, UNA CERRADURA HV SIN PASADOR

UTILIZAR TORNILLO DE FIJACIÓN PARA CONCRETO DE ¼" (TAPCON)
MÍNIMA PENETRACIÓN DEL TORNILLO EN EL CONCRETO 1 ¾"

ALTURA MÁXIMA

ALTURA (m)	MÁXIMA CARGA DE DISEÑO (kg/m ²)	VELOCIDAD DE VIENTO (km/h)
3.70	146	160
3.58	170	172
3.45	195	184
3.38	219	195
3.28	244	206
3.20	268	216
3.12	292	225
3.05	317	235
2.95	341	243
2.84	366	252
2.74	390	260
2.67	415	268
2.59	439	276
2.51	463	284
2.46	488	291
2.41	512	298
2.34 O MENOS	537	305



DISTANCIA ENTRE ANCLAJES (cm)

CARGA \ ALTURA (m)	CARGA DE DISEÑO (kg/m ²)							
	146	195	292	366	439	585	781	1000
	VELOCIDAD DE VIENTO (km/h)							
	160	184	225	252	276	319	368	417
0.91 O MENOS	35	30	25	22	20	20	15	15
1.22	35	30	25	22	20	20	15	15
1.52	35	30	25	22	20	20	15	12
1.83	35	30	25	22	20	17	12	10
2.13	35	30	25	22	20	15	10	-
2.44	35	30	25	22	17	12	10	-
2.74	35	30	25	20	15	12	-	-
3.05	35	30	22	17	15	10	-	-
3.35	35	30	20	15	12	10	-	-
3.66	35	28	17	15	12	-	-	-
3.70	33	25	15	12	10	-	-	-



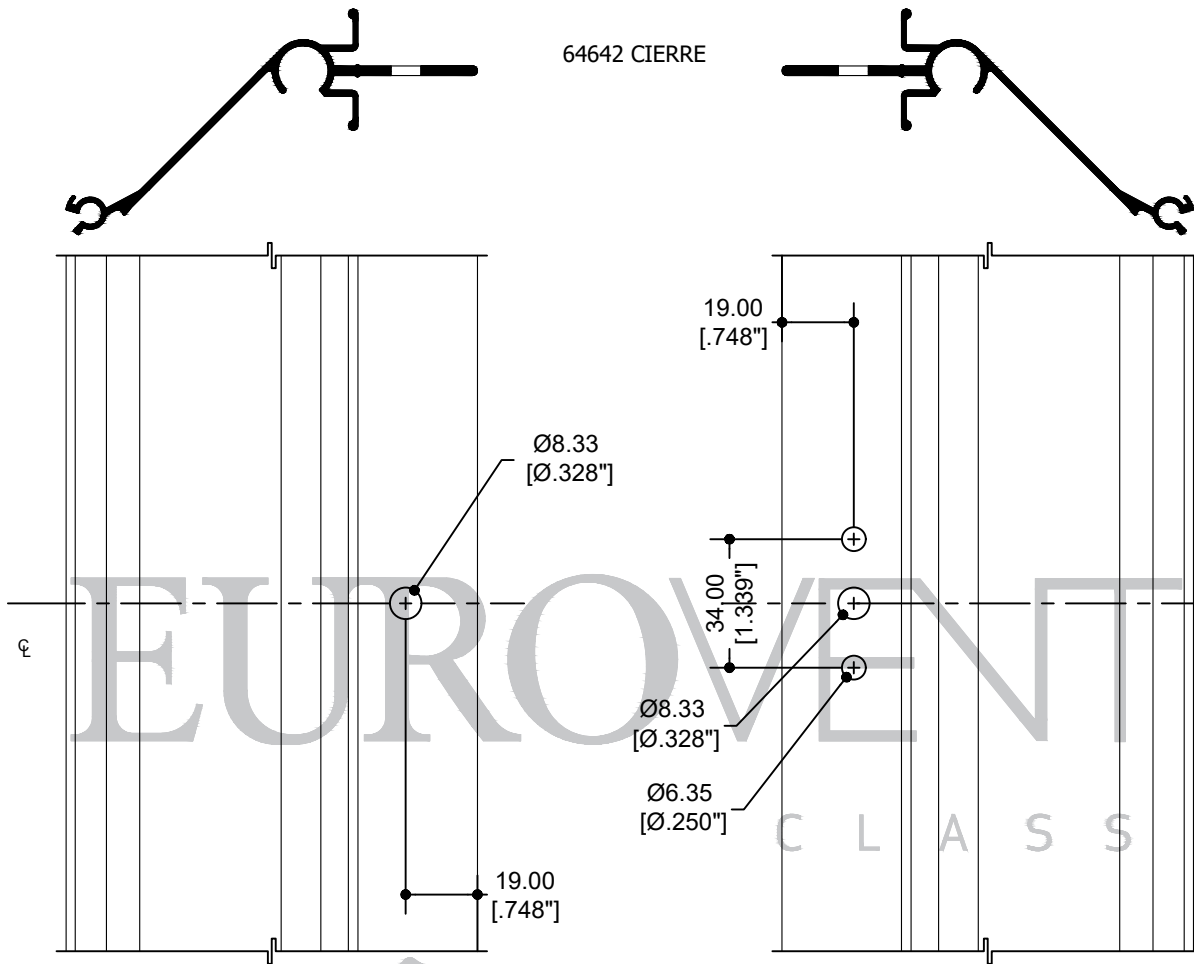

CLASSIC
SERIE
CA HV
CORTINA ANTICICLÓNICA

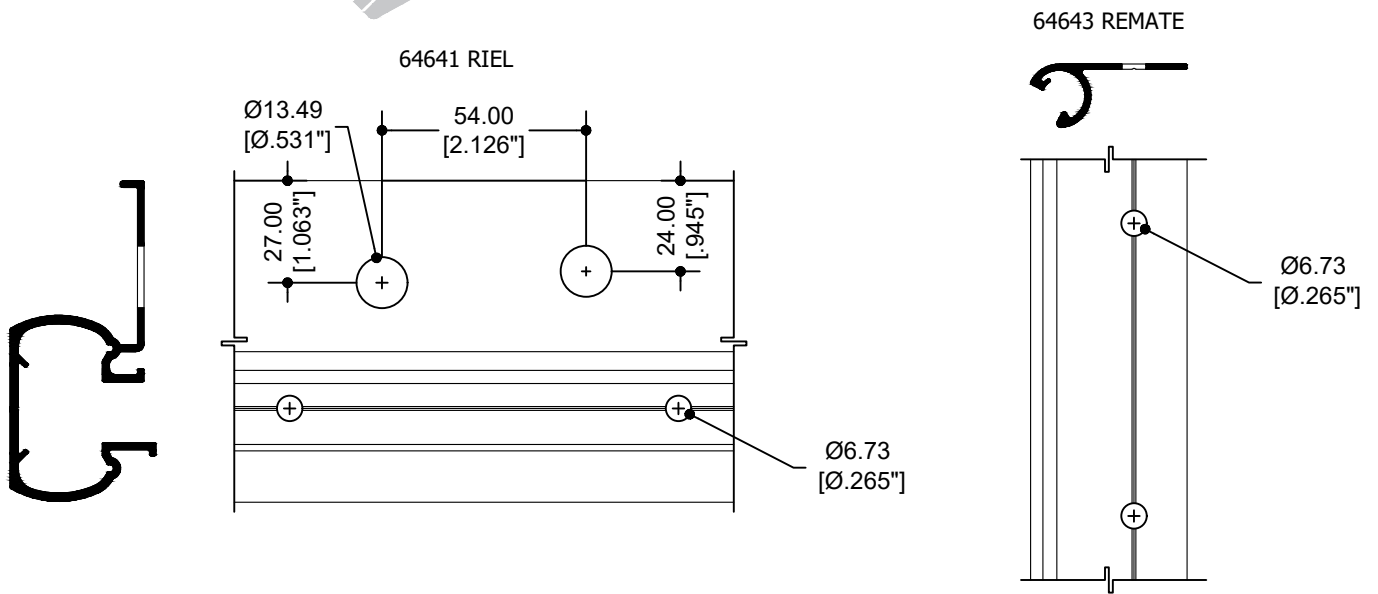

Cert. No: 13-0306.01
CUMPLE EL PROTOCOLO (High Velocity Hurricane Zone) Velocidades Extremas en Zona de Huracanes
Certificación realizada en el Condado de Miami Dade por el laboratorio FENESTRATION TESTING LABORATORY, INC.

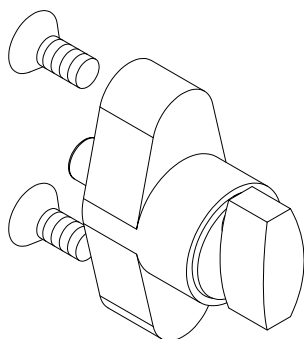

HV-01
CERRADURA HV (BOTON)

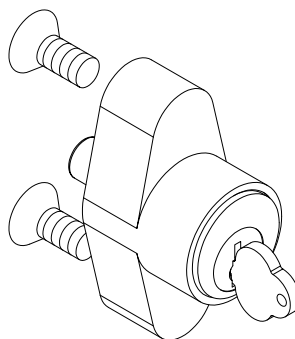

HV-02
CERRADURA HV (C/LLAVE)

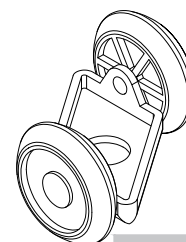

HV-100
CARRETILLA HV



SERIE

CA HV

CORTINA ANTICICLÓNICA

EUROVENT

CLASSIC

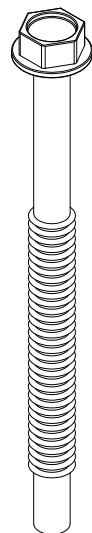

HV-101
TORNILLO HV 3"

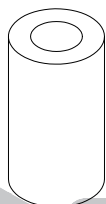

HV-102
BUSHING 0.900"

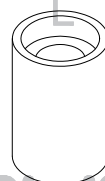

HV-103
BUSHING 0.750"

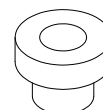

HV-104
BUSHING HAT



HV-105
ARANDELA

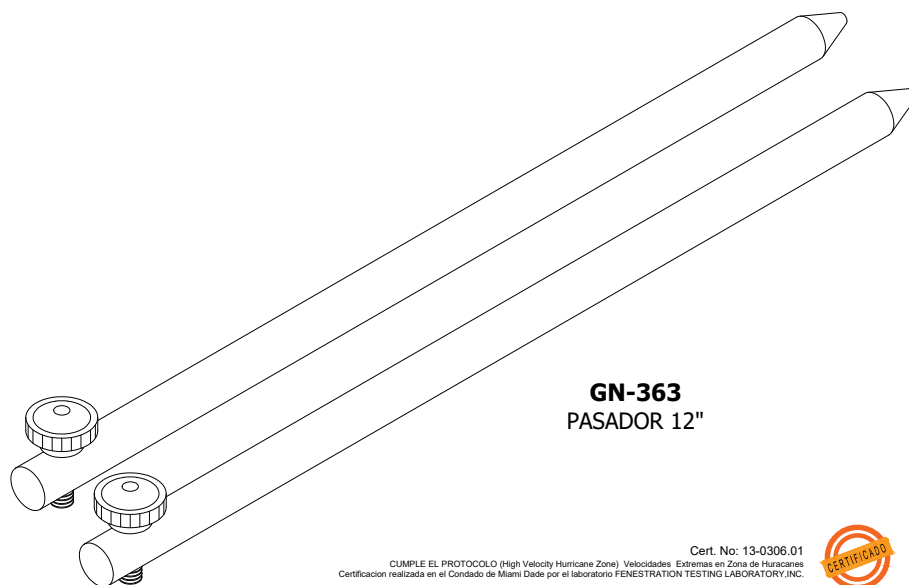

GN-363
PASADOR 12"



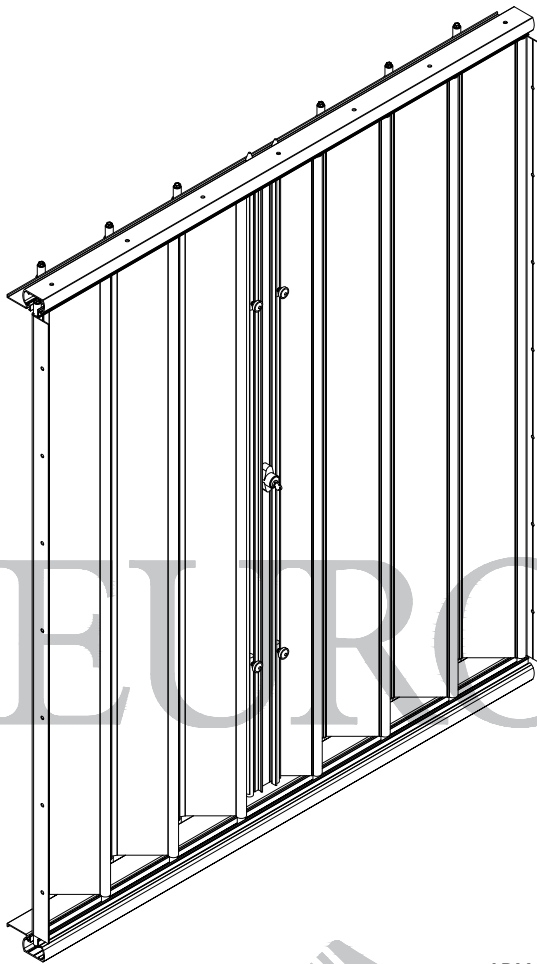

ACCESORIOS		
CLAVE	DESCRIPCIÓN	PIEZAS
HV-01	CERRADURA HV (C/LLAVE) OPCIÓN	1
HV-02	CERRADURA HV (BOTON) OPCIÓN	1
HV-100	CARRETILLA HV	6
HV-101	TORNILLO HV 3"	28
HV-102	BUSHING 0.900"	22
HV-103	BUSHING 0.750"	6
HV-104	BUSHING HAT	6
HV-105	ARANDELA	6
GN-363	PASADOR 12"	4

CALCULO DE ACCESORIOS PARA UNA CORTINA CON 12 TABLETAS



SERIE



CORTINA ANTICICLÓNICA

C L A S S I C

ARMADO DE CARRETILLA

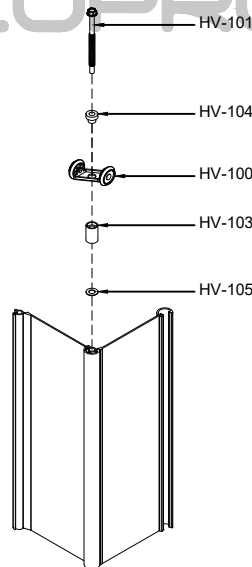

ARMADO DE PIVOTE

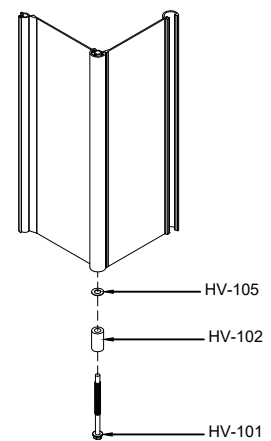

LAS TABLETAS, CIERRES Y REMATES SE DESLIZAN PARA EL ARMADO

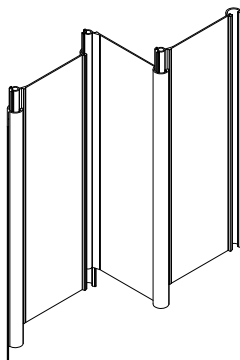

Cert. No: 13-0306 01
 CUMPLE EL PROTOCOLO (High Velocity Hurricane Zone) Velocidades Extremas en Zona de Huracanes
 Certificación realizada en el Condado de Miami Dade por el laboratorio FENESTRATION TESTING LABORATORY, INC.

CLASSIC
SERIE
CA HV
CORTINA ANTICICLÓNICA



TABLA DE DESCUENTOS			
CLAVE	DESCRIPCIÓN	No. DE PIEZAS.	CORTE Y DESCUENTO.
64641	RIEL-CABEZAL	2	L
64640	TABLETA	12	H-83
64642	CIERRE	2	H-83
64643	REMATE	2	H-83

L=ANCHO DE VENTANA DESCUENTOS EN MM.
H=ALTO DE VENTANA

ALUMINIO					
CLAVE	DESCRIPCIÓN	PIEZAS X ATADO	LARGO STD. MTS.	PERÍMETRO ANOD. CM.	PERÍMETRO PUL. CM.
64640	TABLETA	6	6.10	31.49	23.66
64641	RIEL PARA TECHO	4	6.10	39.90	18.75
64642	CIERRE	4	6.10	39.04	31.99
64643	REMATE	16	6.10	13.50	4.86
64644	ADAPTADOR AJUSTABLE MACHO	4	6.10	41.08	13.72
64645	ADAPTADOR AJUSTABLE HEMBRA	4	6.10	29.52	7.24
64646	RIEL A MURO	2	6.10	50.22	30.37

EUROVENT[®]

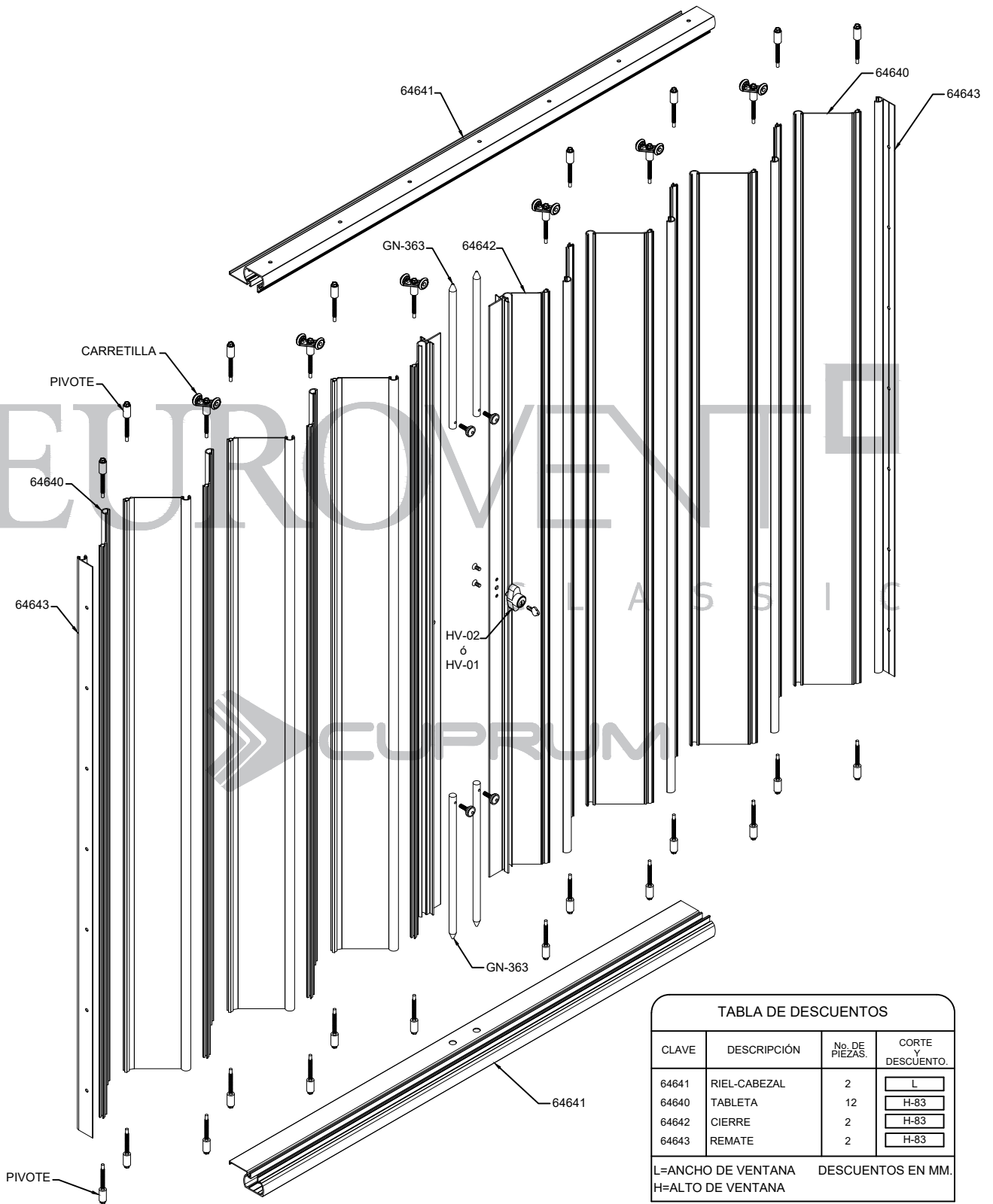
C L A S S I C

 CUPRUM

CLASSIC
SERIE
CORTINA ANTICICLÓNICA
CA HV



EUROVENT

CLASSIC



PROYECCIÓN SERIE 35

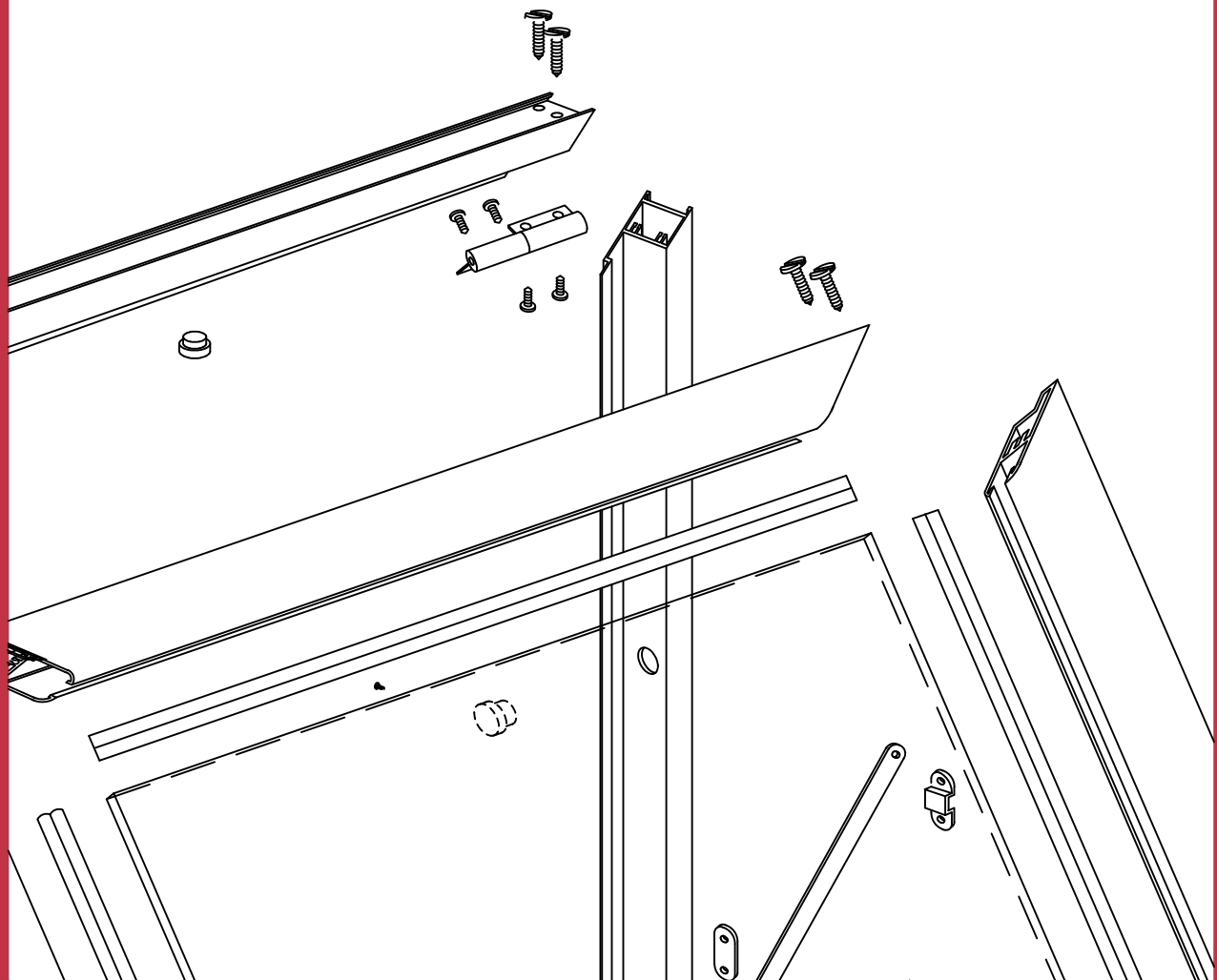

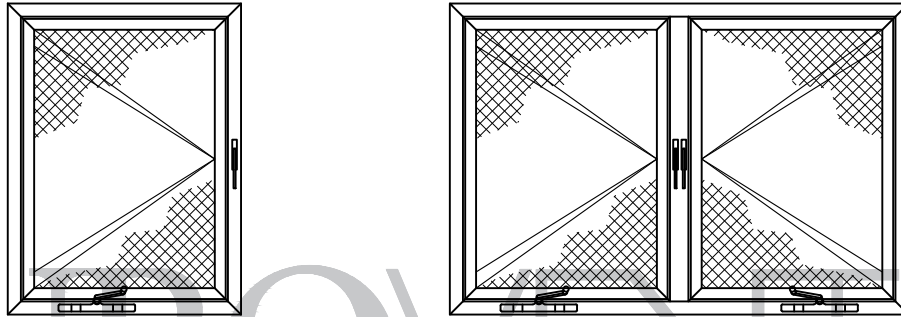

EUROVENT CLASSIC

CLASSIC
SERIE
S35
BATIENTE Y PROYECCIÓN

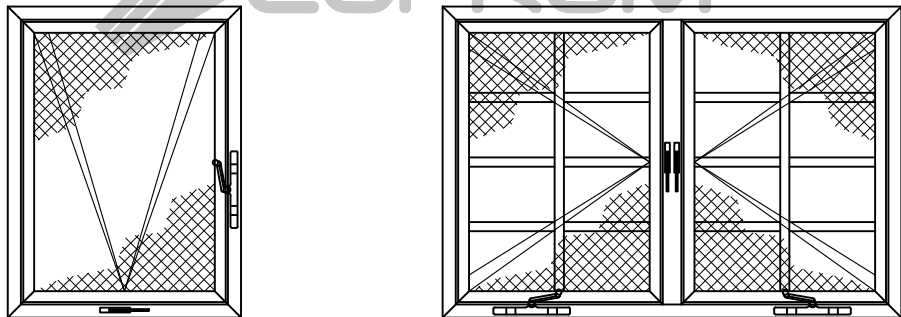

CUPRUM

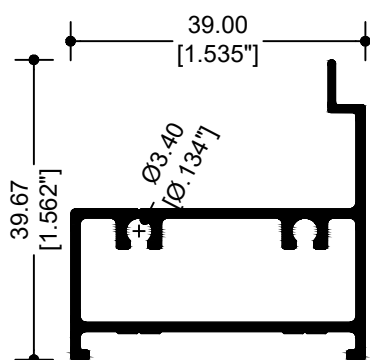

12273
CONTRAMARCO

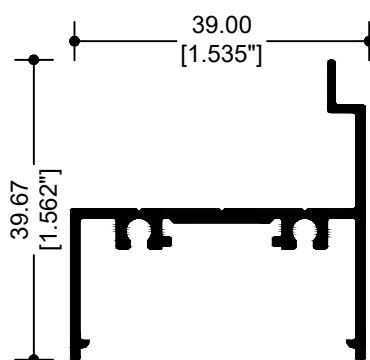

13363
CONTRAMARCO

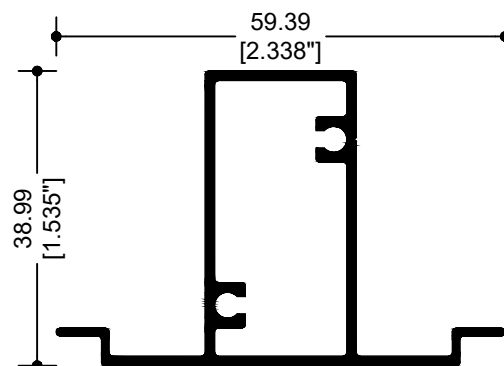

12275
INTERMEDIO

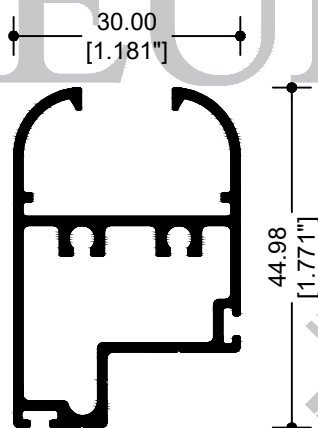

12274
MARCO COLONIAL

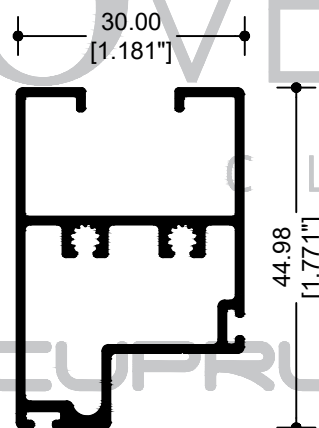

12276
MARCO

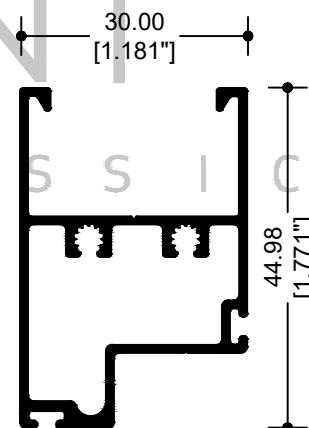

12277
MARCO DOBLE VIDRIO

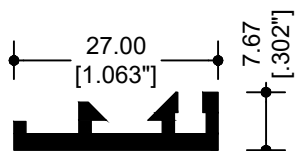

5173
MOSQUITERO

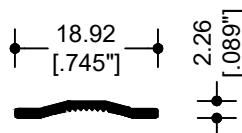

81642
CUADRÍCULA
INGLESA EXPUESTA

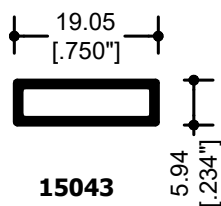

15043
CUADRÍCULA AMERICANA

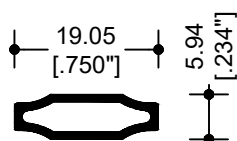

12393
CUADRÍCULA INGLESA DOBLE VIDRIO

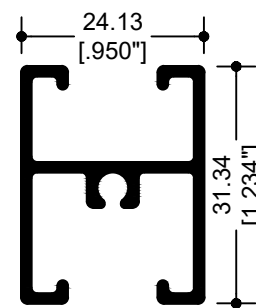

12456
INTERMEDIO

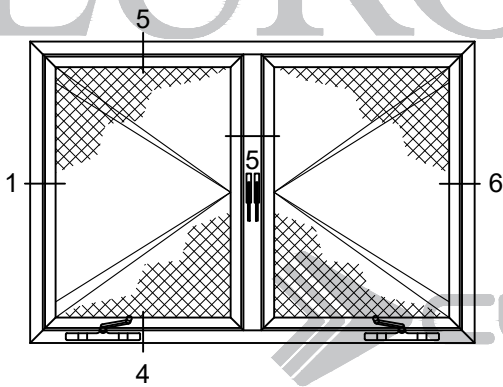
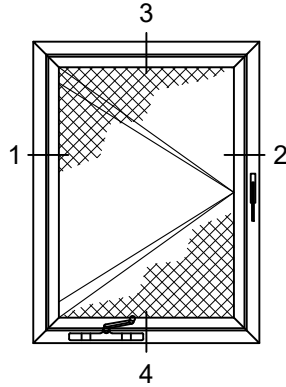

ELEVACIONES TIPO

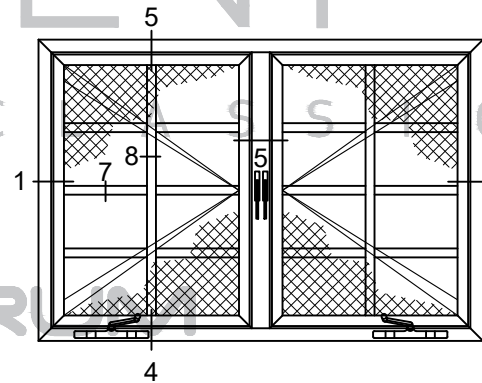

SIN ESCALA

EUROVENT[®]



CLASSIC

SERIE



S35



BATIENTE Y PROYECCIÓN

CLASSIC
SERIE
S35
BATIENTE Y PROYECCIÓN

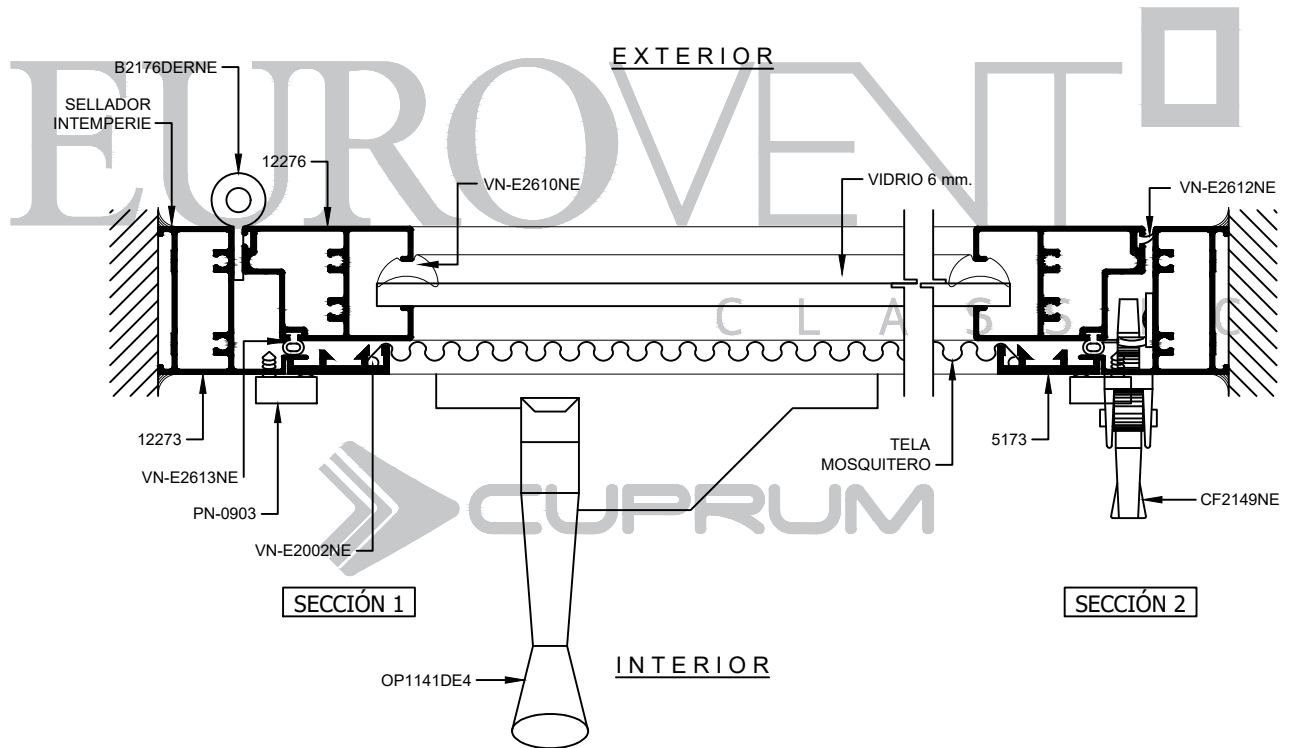

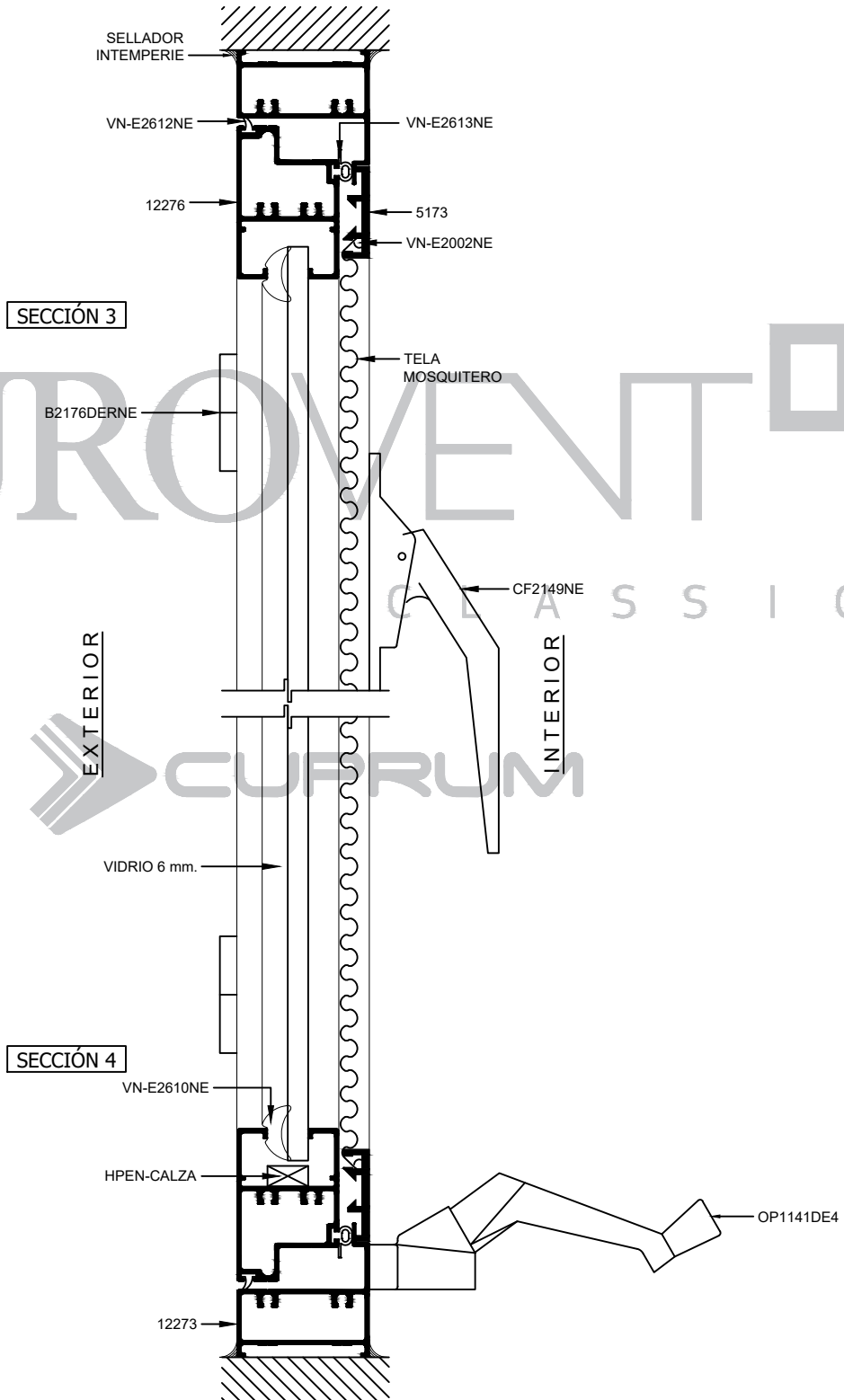

EUROVENT CLASSIC S35

CLASSIC

SERIE

BATIENTE Y PROYECCIÓN

S35

EXTERIOR

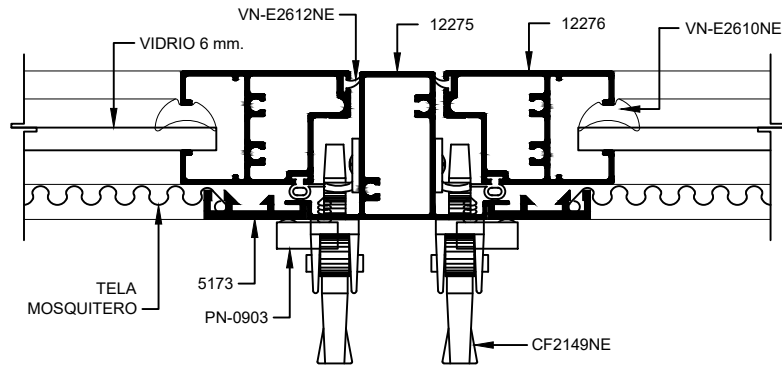

INTERIOR

SECCIÓN 5

CLASSIC

SERIE



S35



BATIENTE Y PROYECCIÓN

EUROVENT[®]
CLASSIC

EXTERIOR

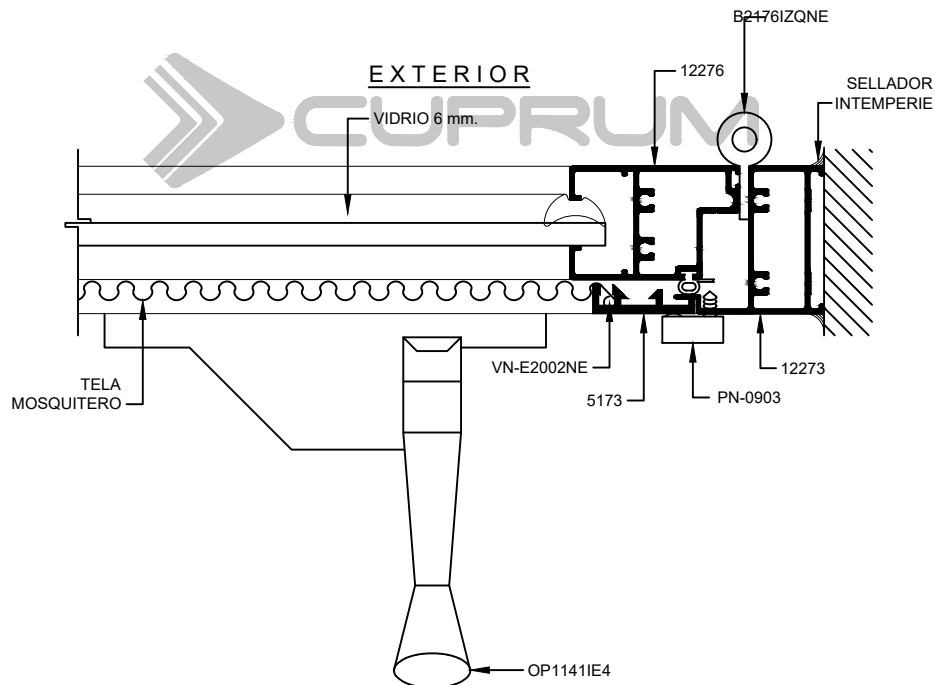

INTERIOR

SECCIÓN 6

SECCIÓN 7

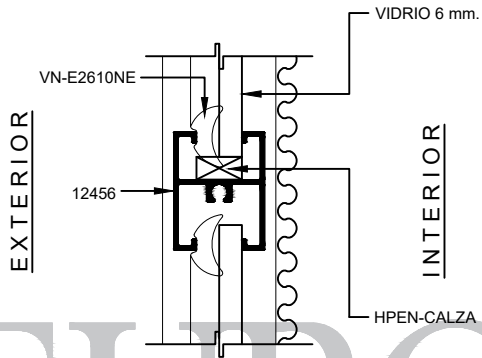

SECCIÓN 8

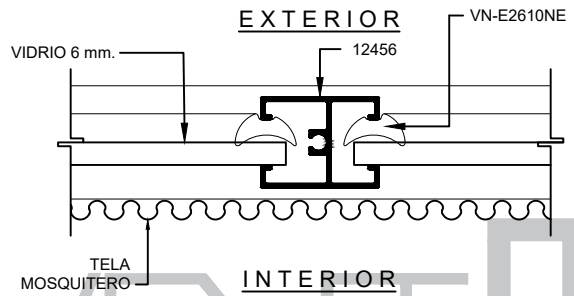

EUROVENT CLASSIC

CLASSIC
SERIE
S35
BATIENTE Y PROYECCIÓN

CUPRUM

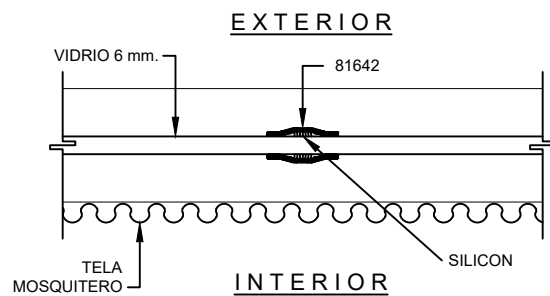
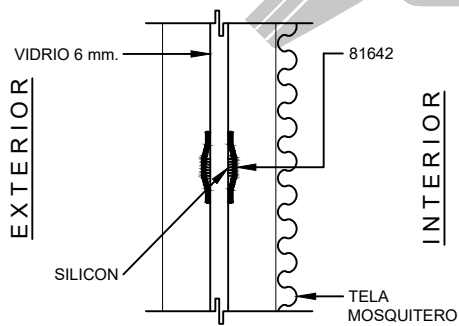

CLASSIC
SERIE
S35
BATIENTE Y PROYECCIÓN

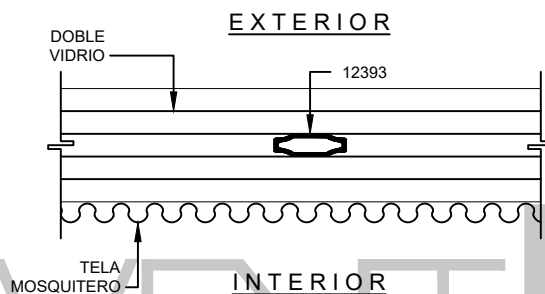
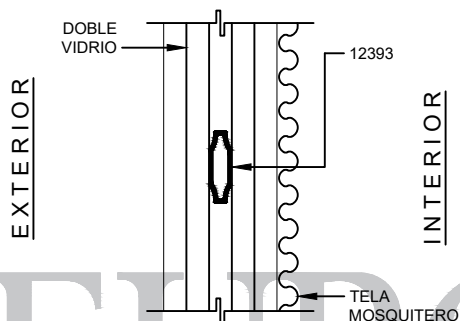

EUROVENT[®]
CLASSIC

CUPRUM

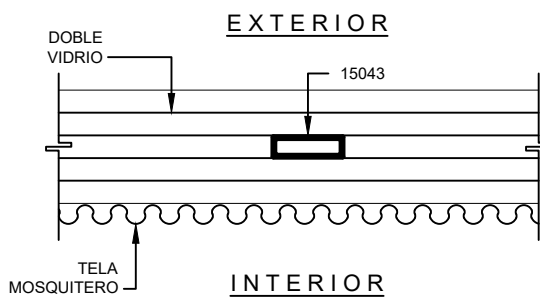
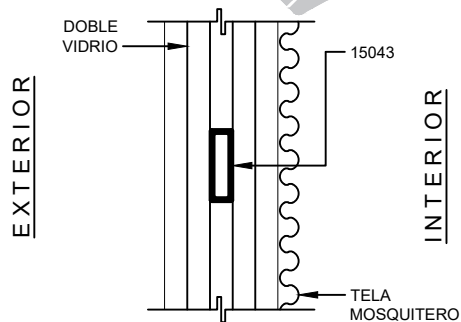

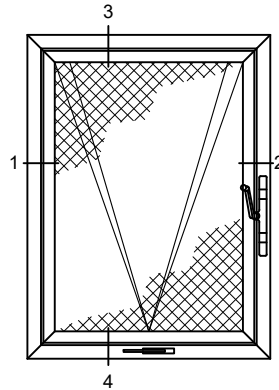

ELEVACIONES TIPO

SIN ESCALA

EUROVENT

EXTERIOR



CLASSIC

SERIE



S35



BATIENTE Y PROYECCIÓN

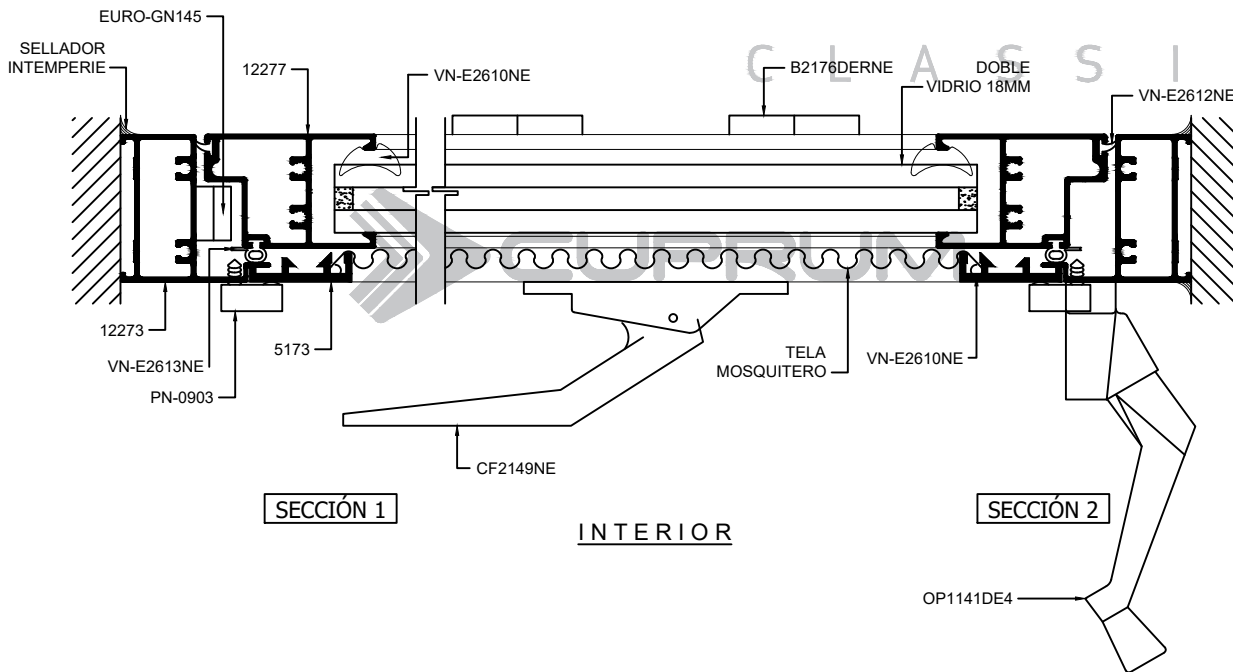

CLASSIC
SERIE
S35
BATIENTE Y PROYECCIÓN

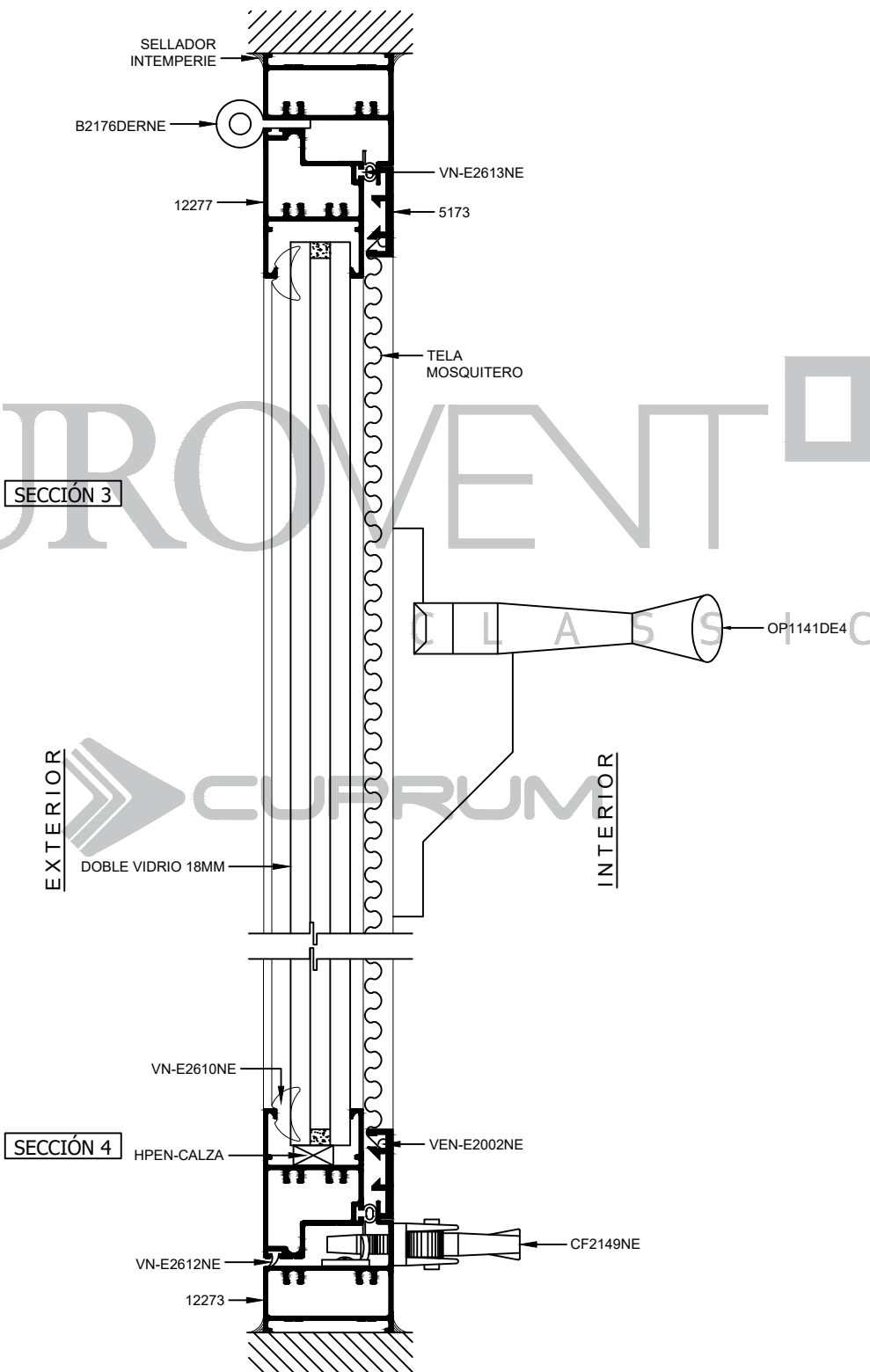

TROQUEL S-35
MN-1203

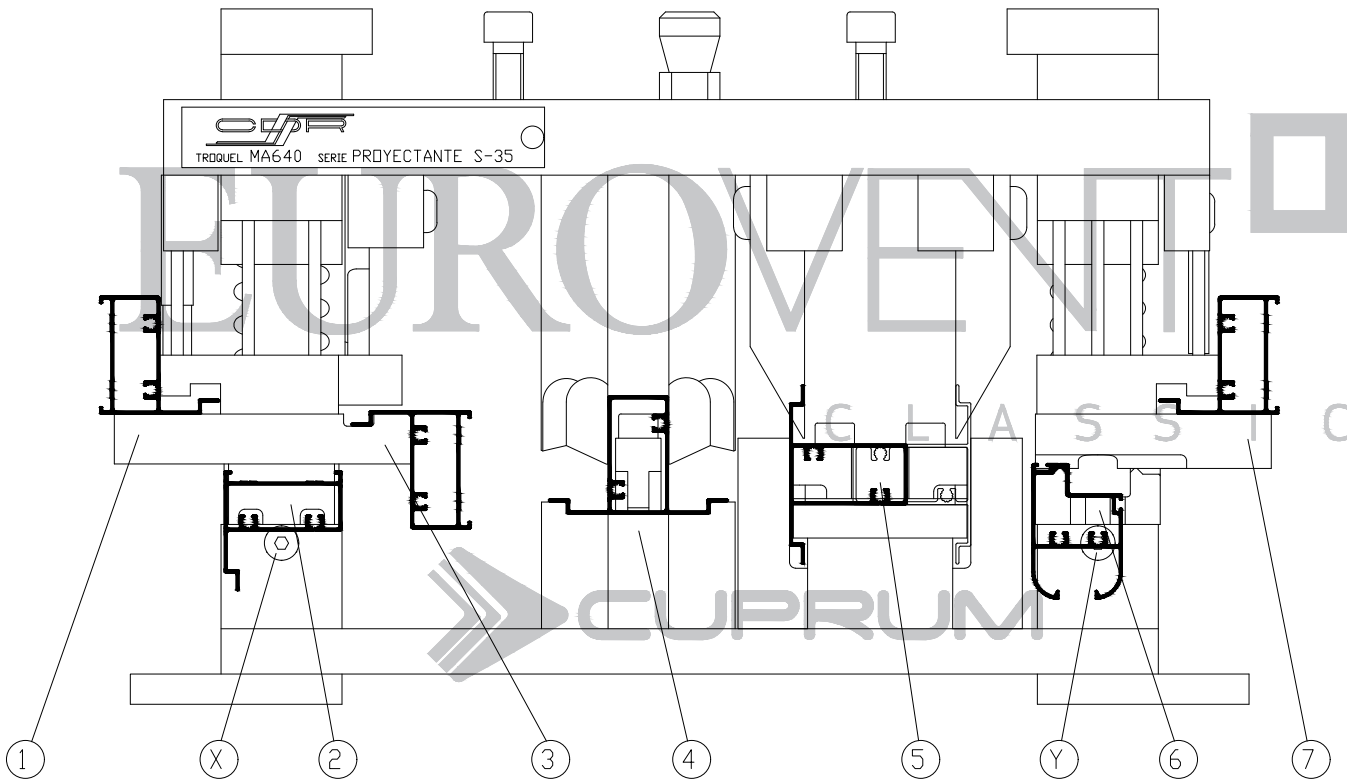

CLASSIC
SERIE
S35
BATIENTE Y PROYECCIÓN

OPERACIÓN 1

12273 CONTRAMARCO
12275 INTERMEDIO

OPERACIÓN 2

12273 CONTRAMARCO

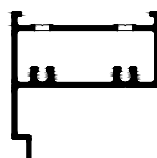
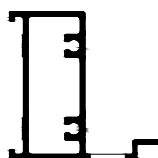

EUROVENT

C L A S S I C

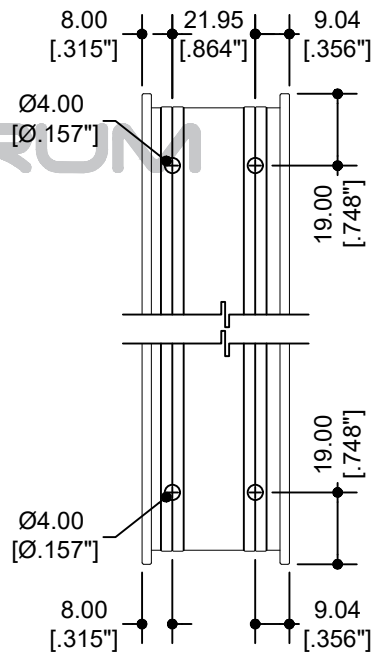
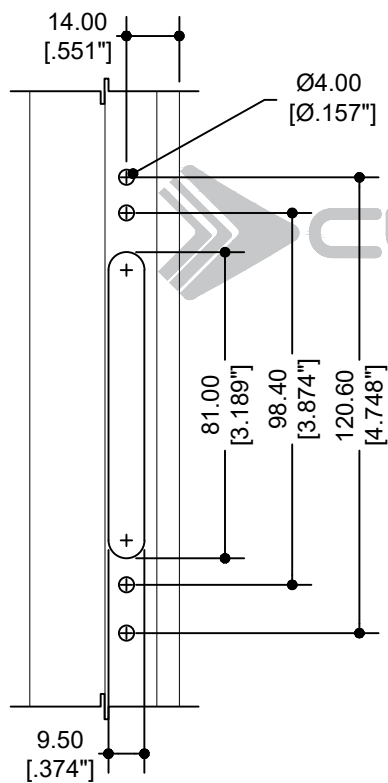

NOTA: PARA REALIZAR LA OPERACIÓN "2" y "6" DE LOS PERFILES DEBERÁN MECANIZARSE CORTADOS A INGLETE.

OPERACIÓN 3

12273 CONTRAMARCO

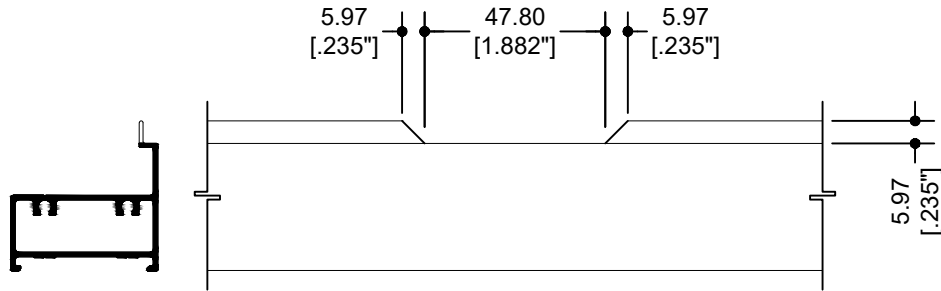

OPERACIÓN 4

12275 INTERMEDIO

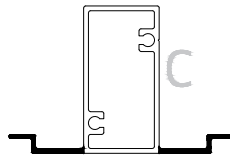

EUROVENT CLASSIC

CLASSIC
SERIE
S35
BATIENTE Y PROYECCIÓN

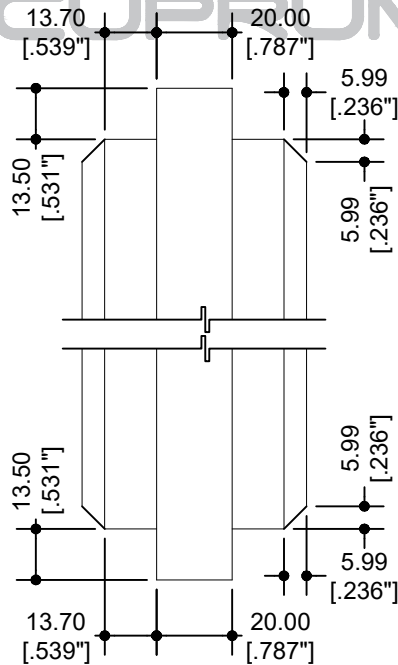

OPERACIÓN 5

12275 INTERMEDIO
REALIZAR ANTERIORMENTE LA OP. 4

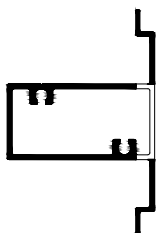

OPERACIÓN 6

12274 MARCO COLONIAL
12276 MARCO
12277 MARCO DOBLE VIDRIO

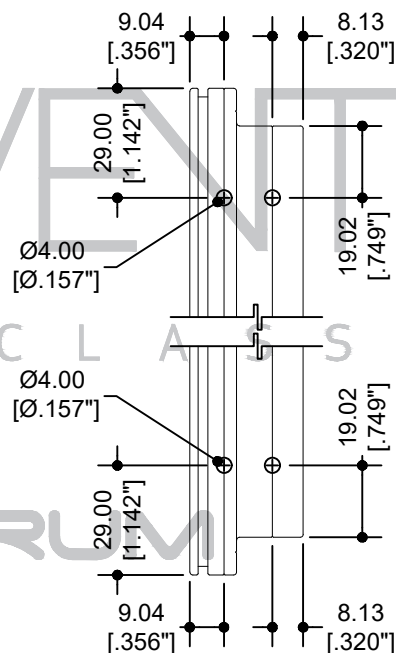
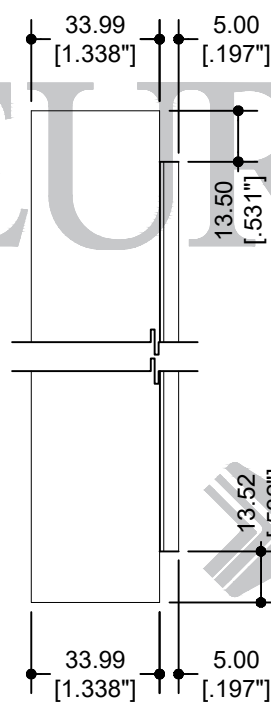
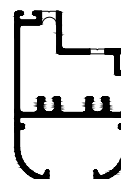

NOTA: PARA REALIZAR LA OPERACIÓN "2" y "6" DE LOS PERFILES DEBERÁN MECANIZARSE CORTADOS A INGLETE.

OPERACIÓN D

12273 CONTRAMARCO
12275 INTERMEDIO

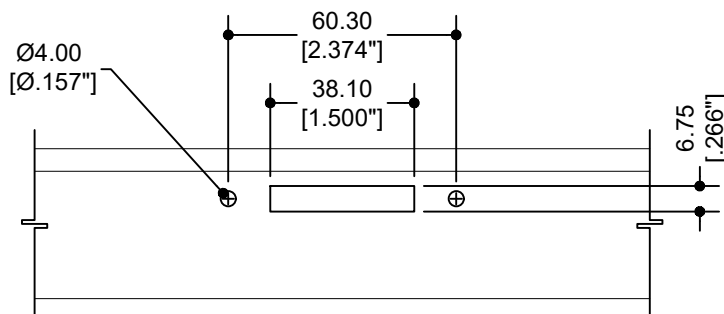
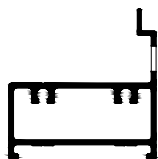

NOTA: PARA REALIZAR LA OPERACIÓN "2" y "6" DE LOS PERFILES DEBERÁN MECANIZARSE CORTADOS A INGLETE.

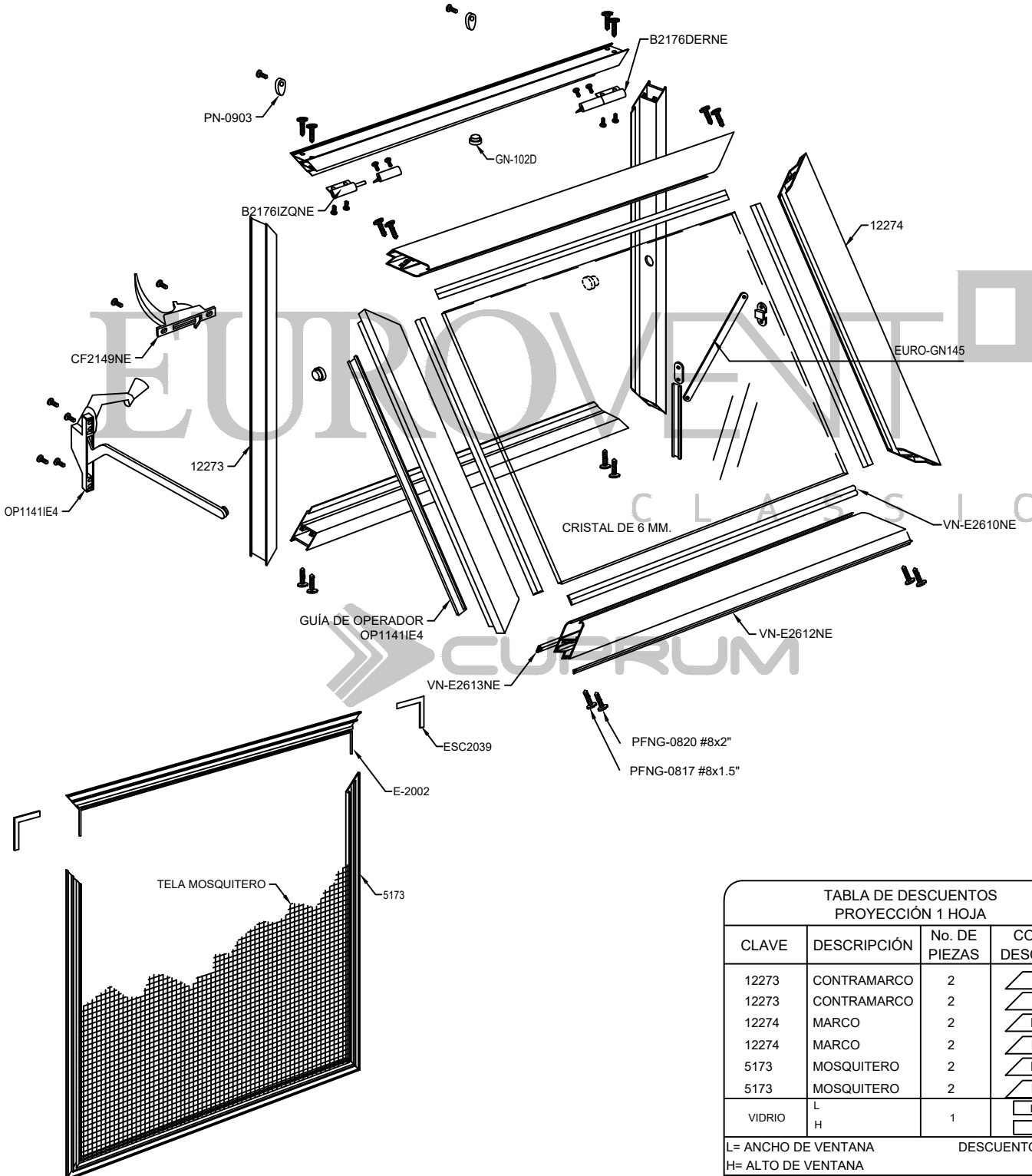

CLASSIC
SERIE
S35
BATIENTE Y PROYECCIÓN

TABLA DE DESCUENTOS PROYECCIÓN 1 HOJA			
CLAVE	DESCRIPCIÓN	No. DE PIEZAS	CORTE Y DESCUENTO
12273	CONTRAMARCO	2	L
12273	CONTRAMARCO	2	H
12274	MARCO	2	H-48
12274	MARCO	2	L-48
5173	MOSQUITERO	2	H-69
5173	MOSQUITERO	2	L-69
VIDRIO	L	1	L-115
	H		H-115

L= ANCHO DE VENTANA
H= ALTO DE VENTANA

DESCUENTOS EN MM.

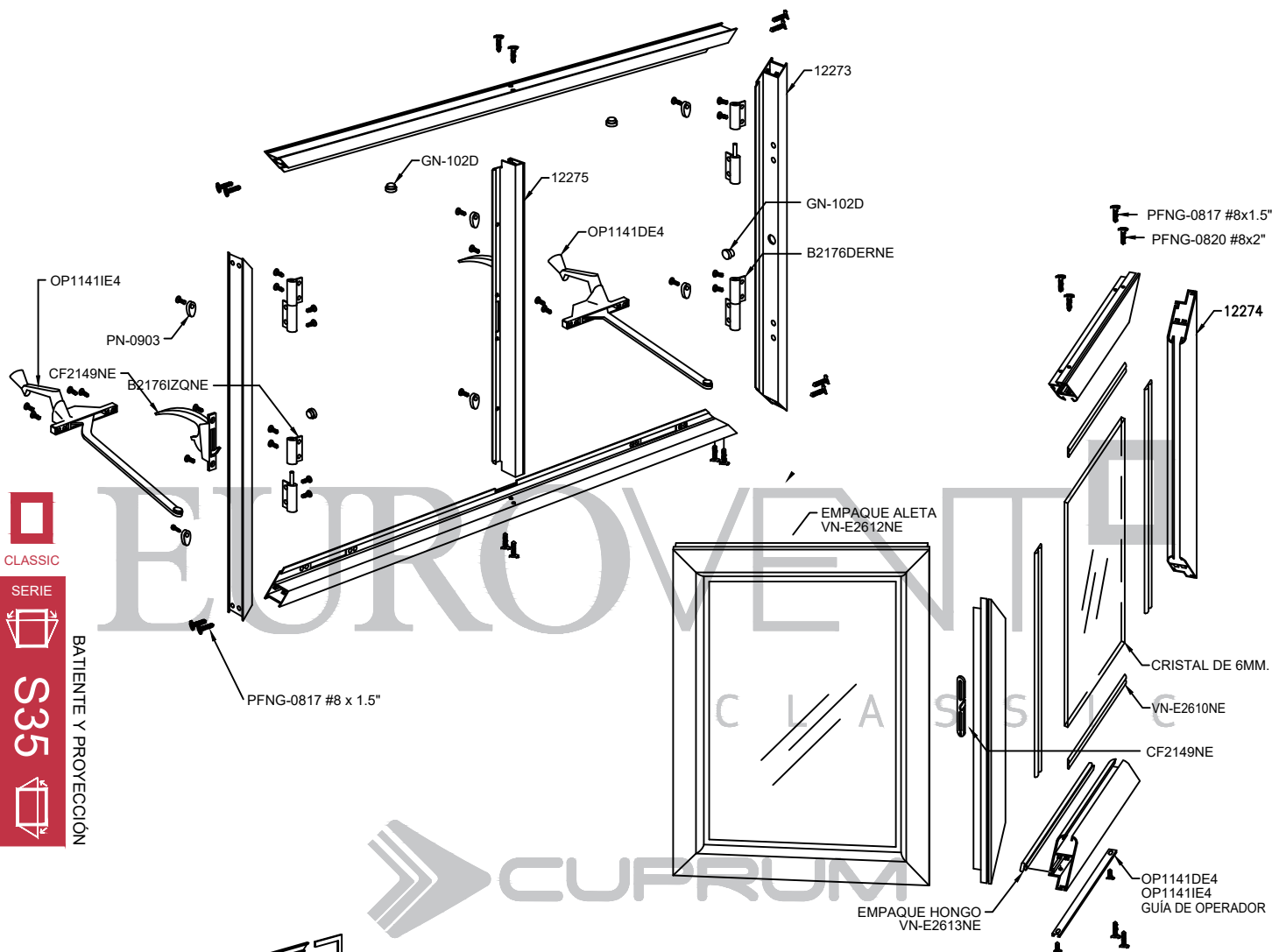

CLASSIC
SERIE
S35
BATIENTE Y PROYECCIÓN



TABLA DE DESCUENTOS BATIENTE 2 HOJA			
CLAVE	DESCRIPCIÓN	No. DE PIEZAS	CORTE Y DESCUENTO
12273	CONTRAMARCO	2	L
12273	CONTRAMARCO	2	H
12275	INTERMEDIO	1	H-40
12274	MARCO	4	H-48
12274	MARCO	4	L/2-38
5173	MOSQUITERO	4	H-68
5173	MOSQUITERO	4	L/2-59
VIDRIO	L	2	L/2-103
	H		H-114

L= ANCHO DE VENTANA
H= ALTO DE VENTANA

DESCUENTOS EN MM.

VENTANA BATIENTE SERIE 35
A UNA ALTURA DE 15 METROS

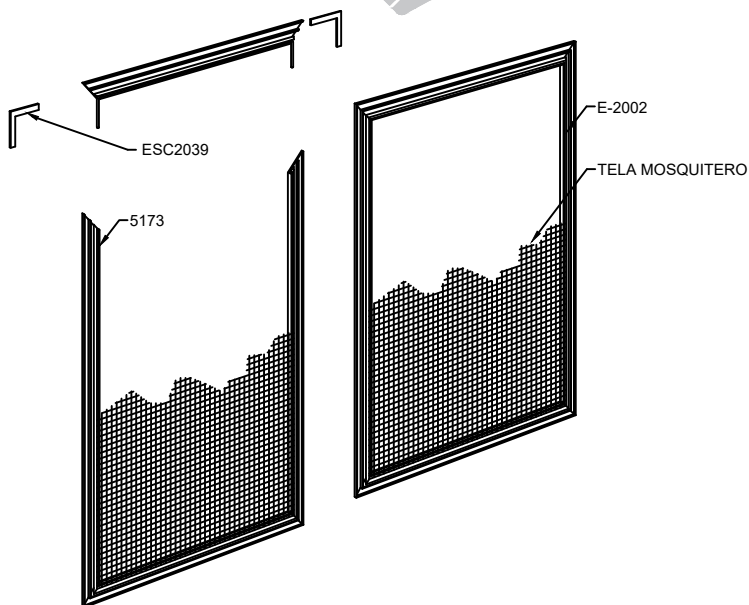
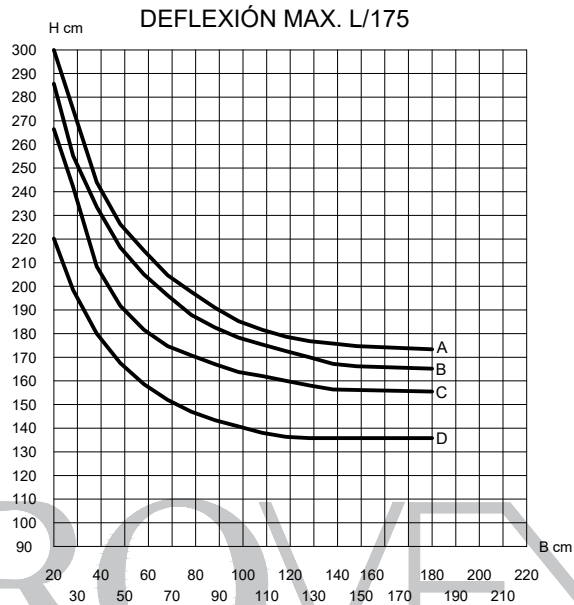

ALEACIÓN: 6063
TEMPLE: 5

12275

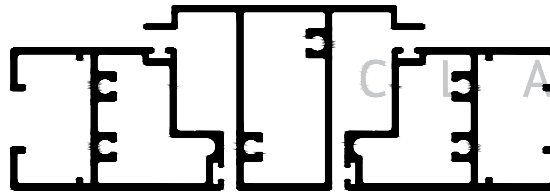

12276

12276

$I_{x-x} = 9.49 \text{ cm}^4$

LOS LÍMITES DE FABRICACIÓN
PARA LOS PERFILES, SERÁN
LOS QUE SE ENCUENTREN DEBAJO
DE LAS CURVAS GRAFICADAS.

Valores de presión por velocidad de viento

Curvas	Presión del diseño	Velocidad de viento	Zona
A	45 Kg/m ²	80 Km/h	Centro de grandes ciudades
B	50 Kg/m ²	90 Km/h	Barrios Residenciales
C	65 Kg/m ²	120 Km/h	Campo Abierto
D	110 Kg/m ²	160 Km/h	Zona Costera

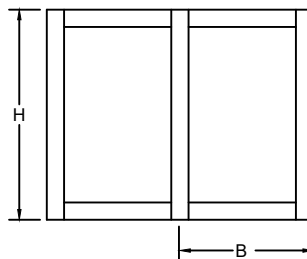

LOS LÍMITES DE UN CANCEL VAN EN FUNCIÓN DE LA
COMBINACIÓN DE RESISTENCIA DEL PERFIL DE ALUMINIO,
EL VIDRIO Y LOS ACCESORIOS QUE LO INTEGRAN.

VERIFICAR QUE LA DEFLEXIÓN DEL PERFIL SEA
COMPATIBLE CON EL VIDRIO UTILIZADO.



VENTANA BATIENTE SERIE 35
A UNA ALTURA DE 15 METROS

DEFLEXIÓN MAX. L/175

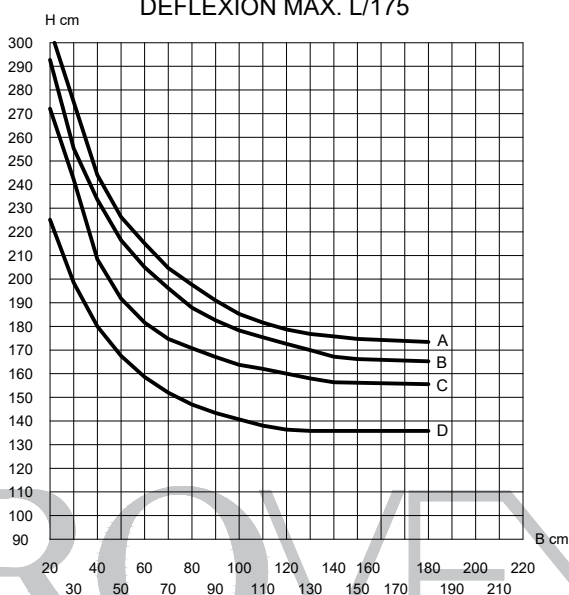

ALEACIÓN: 6063
TEMPLE: 5

12275

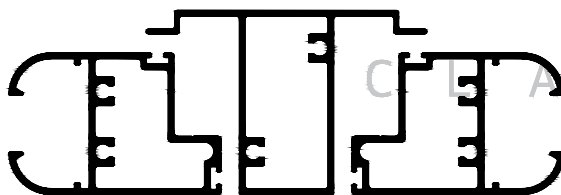

12274

12274

I X-X = 10.07 cm⁴

LOS LÍMITES DE FABRICACIÓN
PARA LOS PERFILES, SERÁN
LOS QUE SE ENCUENTREN DEBAJO
DE LAS CURVAS GRAFICADAS.

Valores de presión por velocidad de viento

Curvas	Presión del diseño	Velocidad de viento	Zona
A	45 Kg/m ²	80 Km/h	Centro de grandes ciudades
B	50 Kg/m ²	90 Km/h	Barrios Residenciales
C	65 Kg/m ²	120 Km/h	Campo Abierto
D	110 Kg/m ²	160 Km/h	Zona Costera

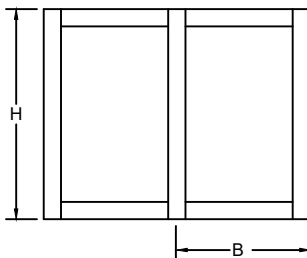

LOS LÍMITES DE UN CANCEL VAN EN FUNCIÓN DE LA
COMBINACIÓN DE RESISTENCIA DEL PERFIL DE ALUMINIO,
EL VIDRIO Y LOS ACCESORIOS QUE LO INTEGRAN.

VERIFICAR QUE LA DEFLEXIÓN DEL PERFIL SEA
COMPATIBLE CON EL VIDRIO UTILIZADO.

VENTANA BATIENTE SERIE 35
 A UNA ALTURA DE 15 METROS
 DEFLEXIÓN MAX. L/175

LOS LÍMITES DE FABRICACIÓN
 PARA LOS PERFILES, SERÁN
 LOS QUE SE ENCUENTREN DEBAJO
 DE LAS CURVAS GRAFICADAS.

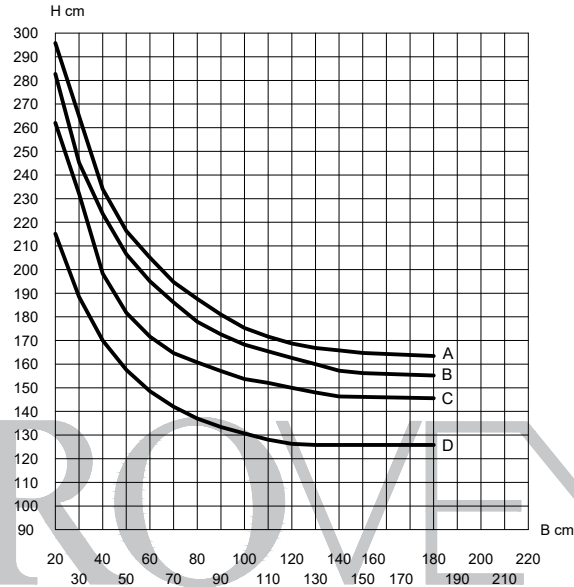

ALEACIÓN: 6063
 TEMPLE: 5

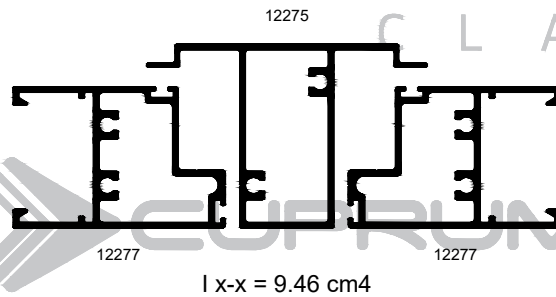

Valores de presión por velocidad de viento

Curvas	Presión del diseño	Velocidad de viento	Zona
A	45 Kg/m ²	80 Km/h	Centro de grandes ciudades
B	50 Kg/m ²	90 Km/h	Barrios Residenciales
C	65 Kg/m ²	120 Km/h	Campo Abierto
D	110 Kg/m ²	160 Km/h	Zona Costera

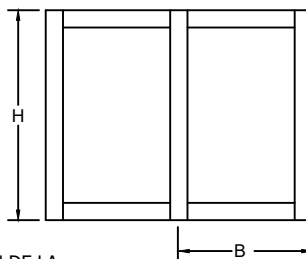

LOS LÍMITES DE UN CANCEL VAN EN FUNCIÓN DE LA
 COMBINACIÓN DE RESISTENCIA DEL PERFIL DE ALUMINIO,
 EL VIDRIO Y LOS ACCESORIOS QUE LO INTEGRAN.

VERIFICAR QUE LA DEFLEXIÓN DEL PERFIL SEA
 COMPATIBLE CON EL VIDRIO UTILIZADO.

CLASSIC

SERIE

S35

BATIENTE Y PROYECCIÓN

PARÁMETROS MÍNIMOS Y MÁXIMOS DE FABRICACIÓN.

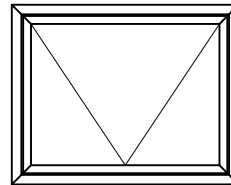
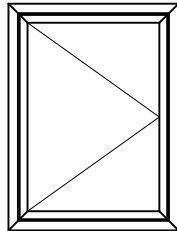

VB-35
MÍNIMO 0.45 x 0.45 HOJA
MÁXIMO 0.90 x 1.80 HOJA

VP-35
MÍNIMO 0.45 x 0.60 HOJA
MÁXIMO 1.00 x 1.00 HOJA

CLASSIC
SERIE
S35
BATIENTE Y PROYECCIÓN

ALUMINIO					
CLAVE	DESCRIPCIÓN	PIEZAS X ATADO	LARGO STD. MTS.	PERÍMETRO ANOD. CM.	PERÍMETRO PUL. CM.
5173	MOSQUITERO	20	6.10	9.50	3.85
12273	CONTRAMARCO	8	6.10	17.42	12.45
12274	MARCO COLONIAL	4	6.10	22.31	11.71
12275	INTERMEDIO	8	6.10	21.14	21.14
12276	MARCO	4	6.10	23.71	8.09
12277	MARCO DOBLE VIDRIO	4	6.10	21.69	10.39
12363	CONTRAMARCO	10	6.10	39.29	19.26
12393	CUADRÍCULA INGLESA DV	40	6.10	4.56	4.56
12456	INTERMEDIO	8	6.10	23.33	9.53
13609	ADAPTADOR	18	6.10	14.62	8.75
81642	CUADRÍCULA INGLESA EXPUESTA	108	3.66	4.30	2.20

EUROVENT

CLASSIC



PUERTA COMERCIAL SERIE 50 PUERTA RESIDENCIAL SERIE 50

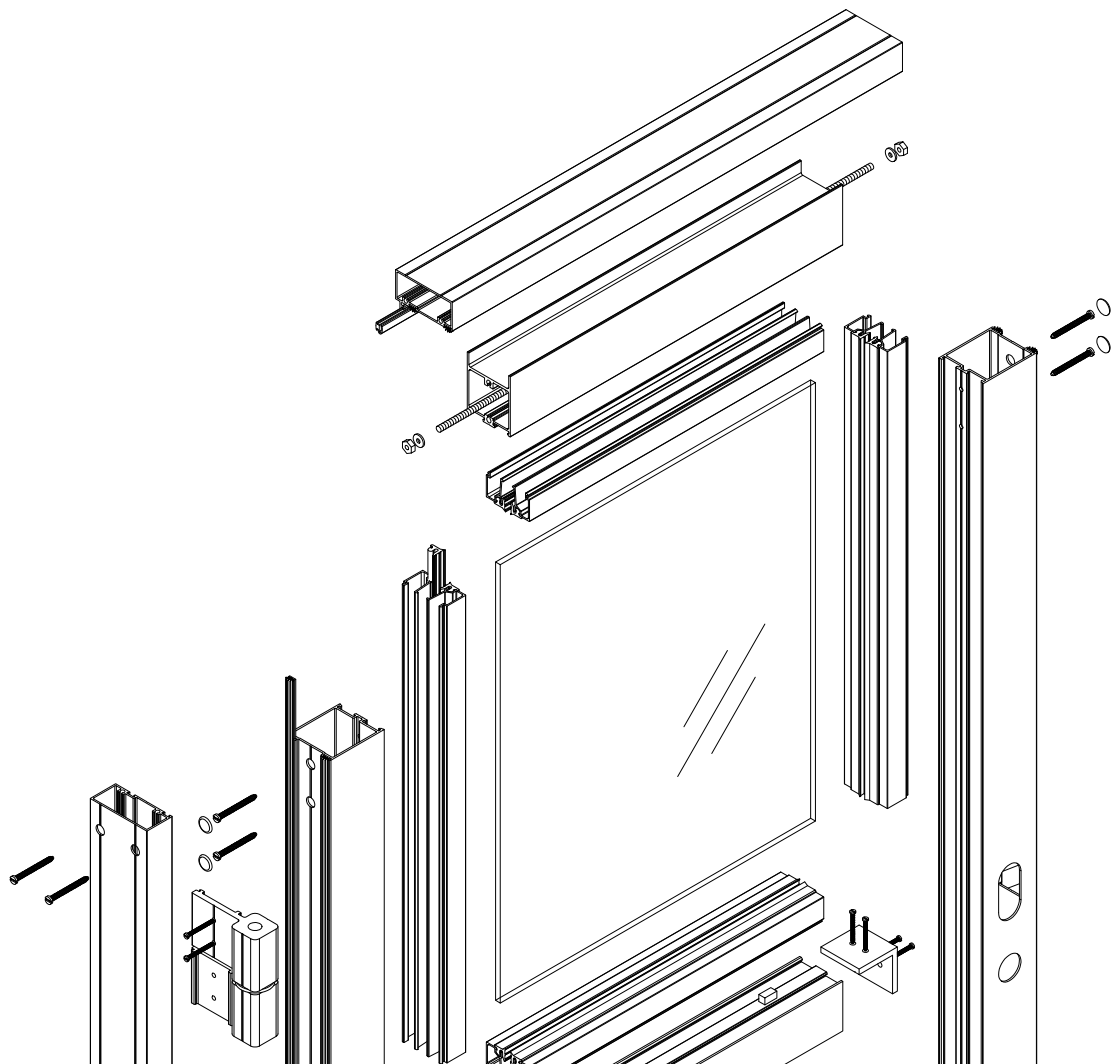

UNA ACCIÓN

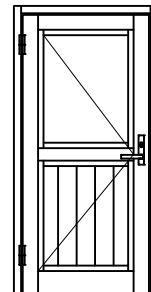
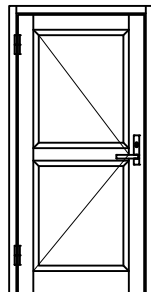
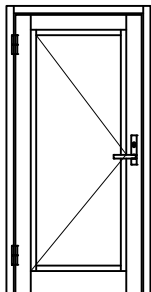

CLASSIC
SERIE
S50
BATIENTE PUERTA

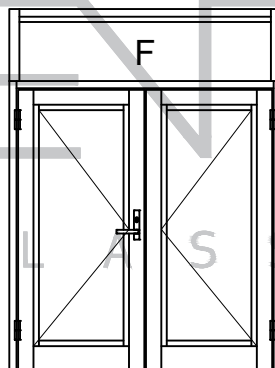
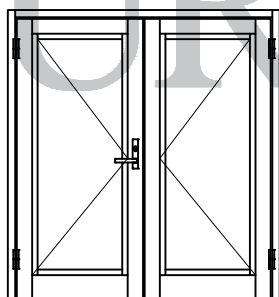

DOBLE ACCIÓN

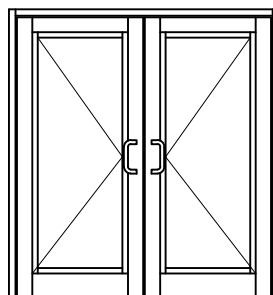
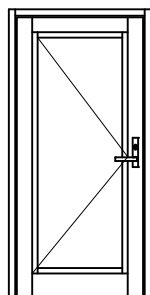

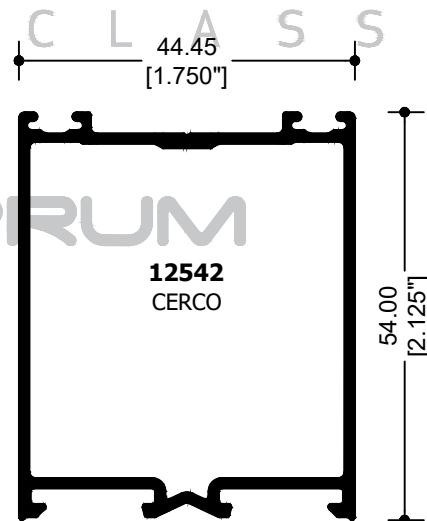
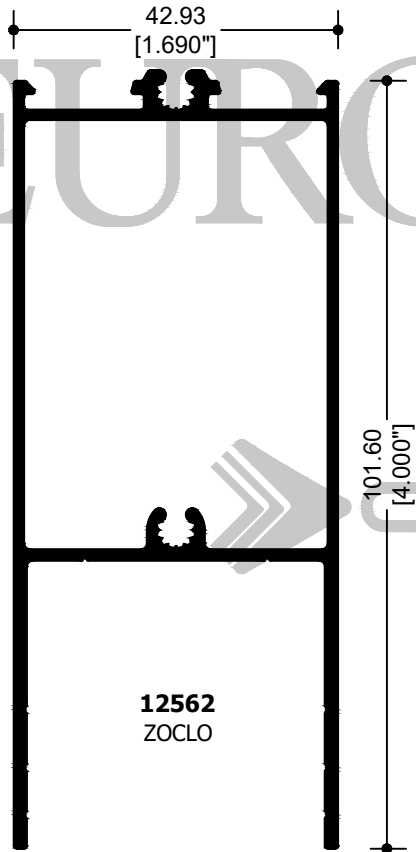
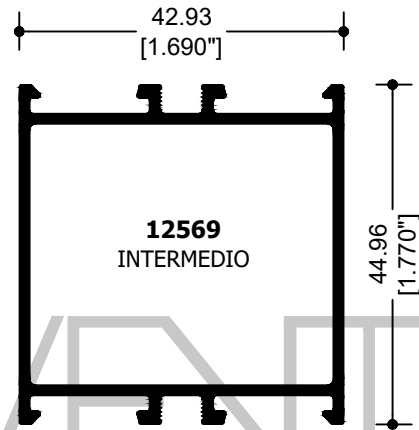
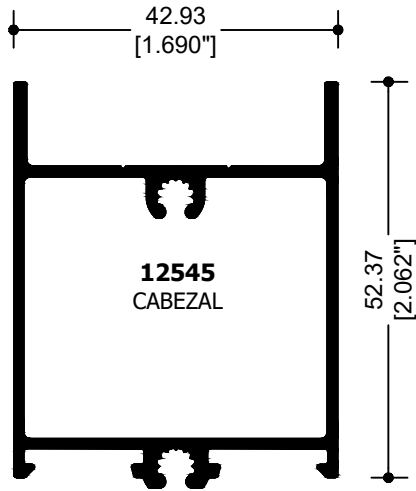

CLASSIC

SERIE

S50



BATIENTE PUERTA

CLASSIC
SERIE
S50
BATIENTE PUERTA

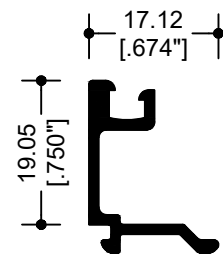
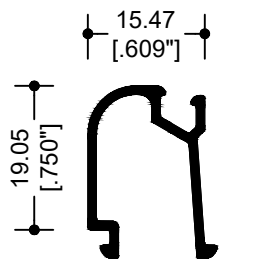
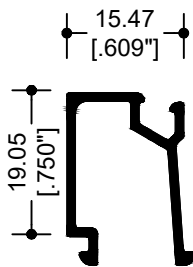
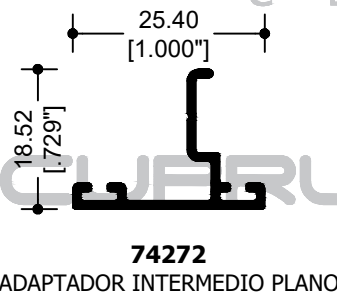
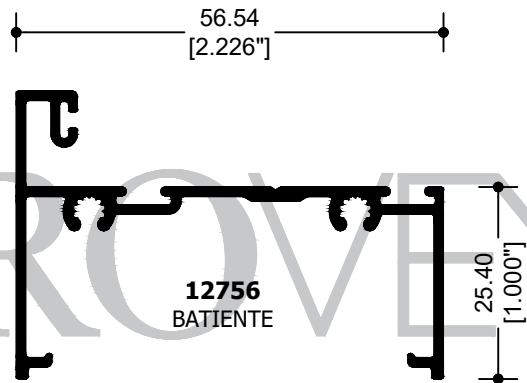
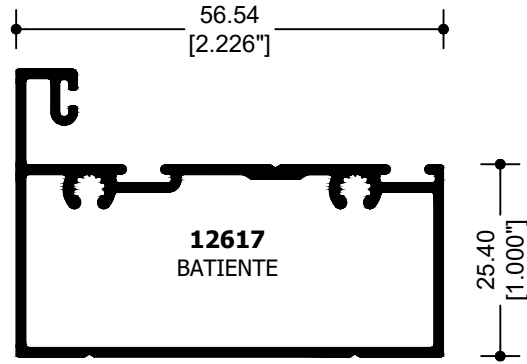

PUERTA UNA ACCIÓN,
DOBLE VIDRIO

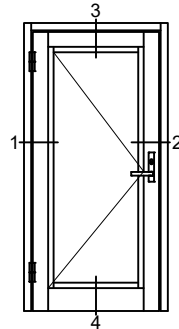

ELEVACION TIPO

SIN ESCALA

EUROVENT[®]

CLASSIC
SERIE

S50

EXTERIOR

C L A S S I C

BATIENTE PUERTA

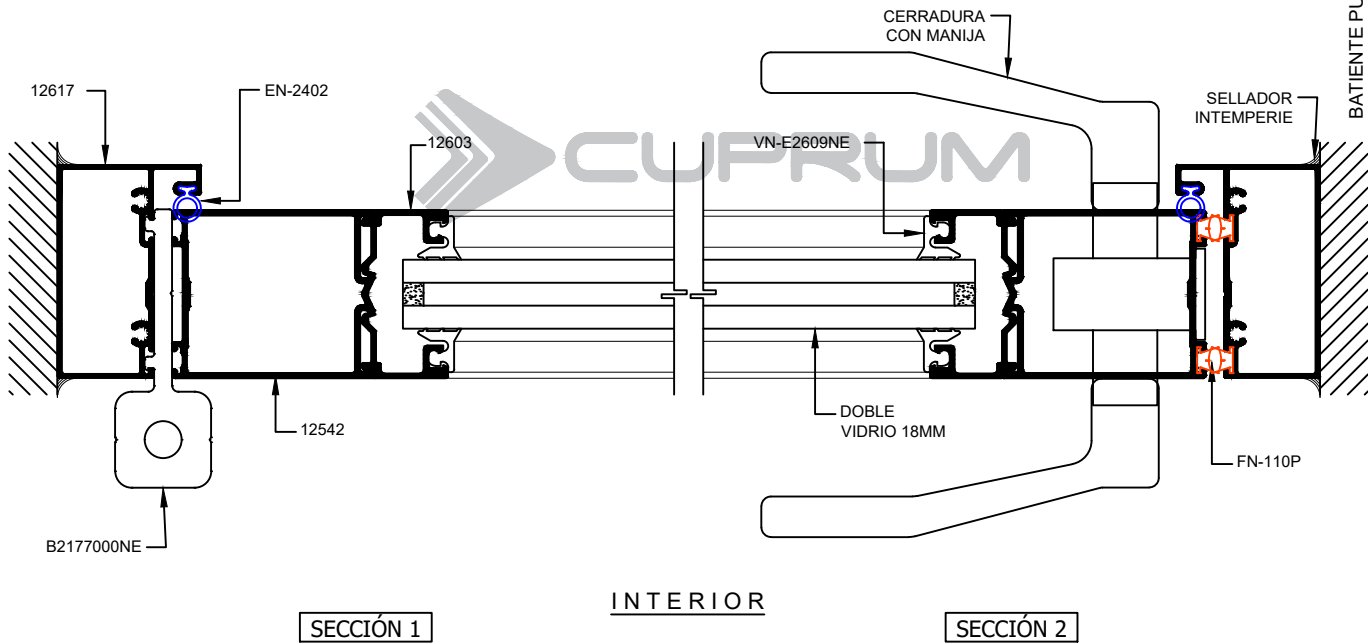

JUNQUILLO PARA DOBLE VIDRIO DE 18mm.

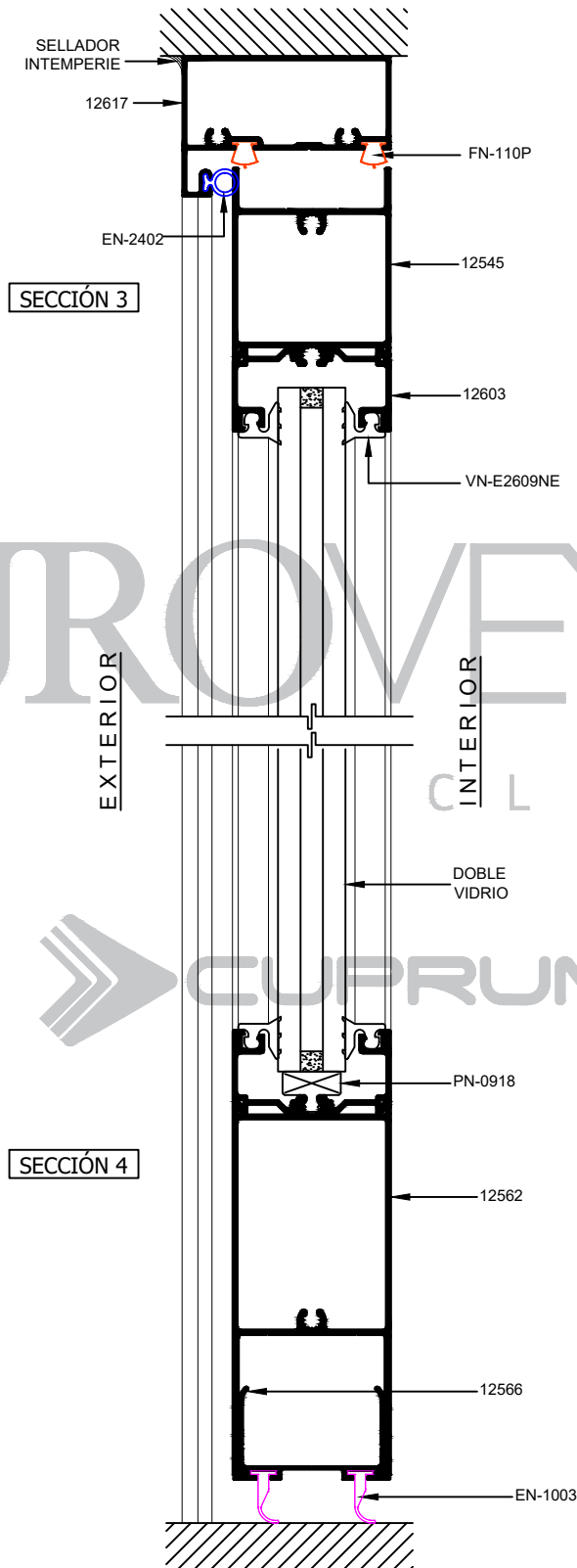

CLASSIC
SERIE
S50
BATIENTE PUERTA

EUROVENT[®]
CL A S S I C

CUPRUM

PUERTA UNA ACCIÓN, VIDRIO
SENCILLO

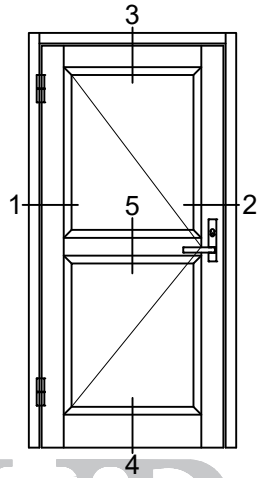

ELEVACIONES TIPO

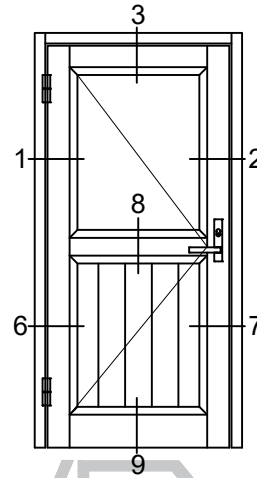

SIN ESCALA

EUROVENT

C L A S S I C



CLASSIC

SERIE

S50



BATIENTE PUERTA

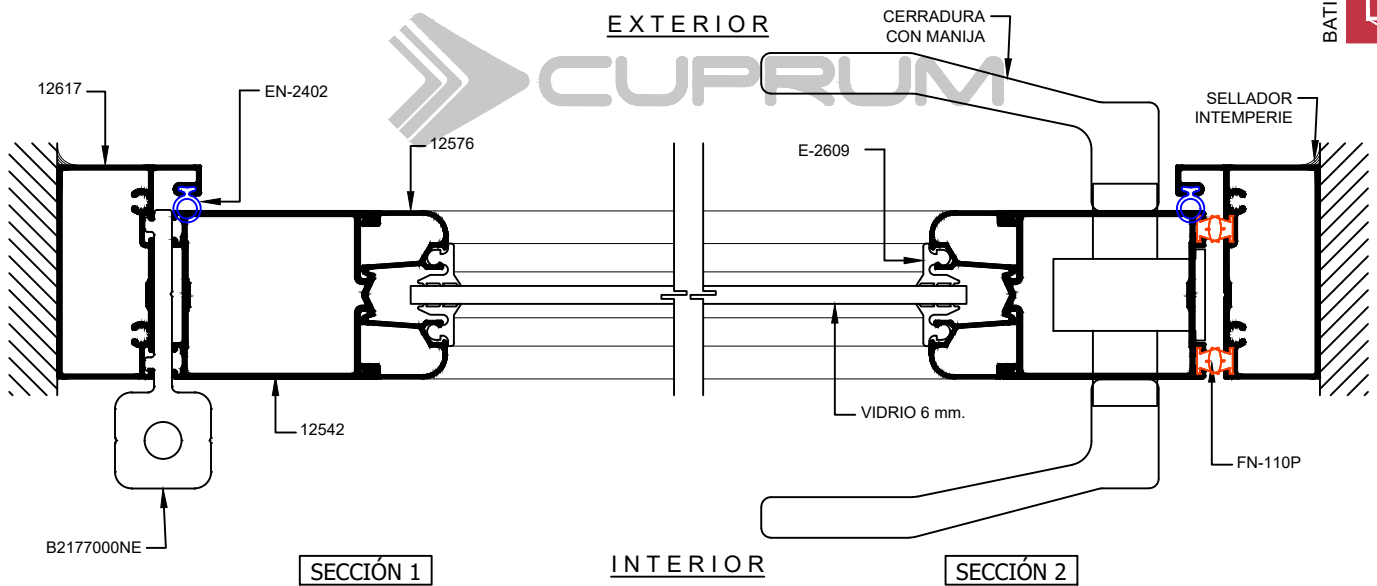

CLASSIC
SERIE
S50
BATIENTE PUERTA

EUROVENT
CLASSIC

EXTERIOR

INTERIOR

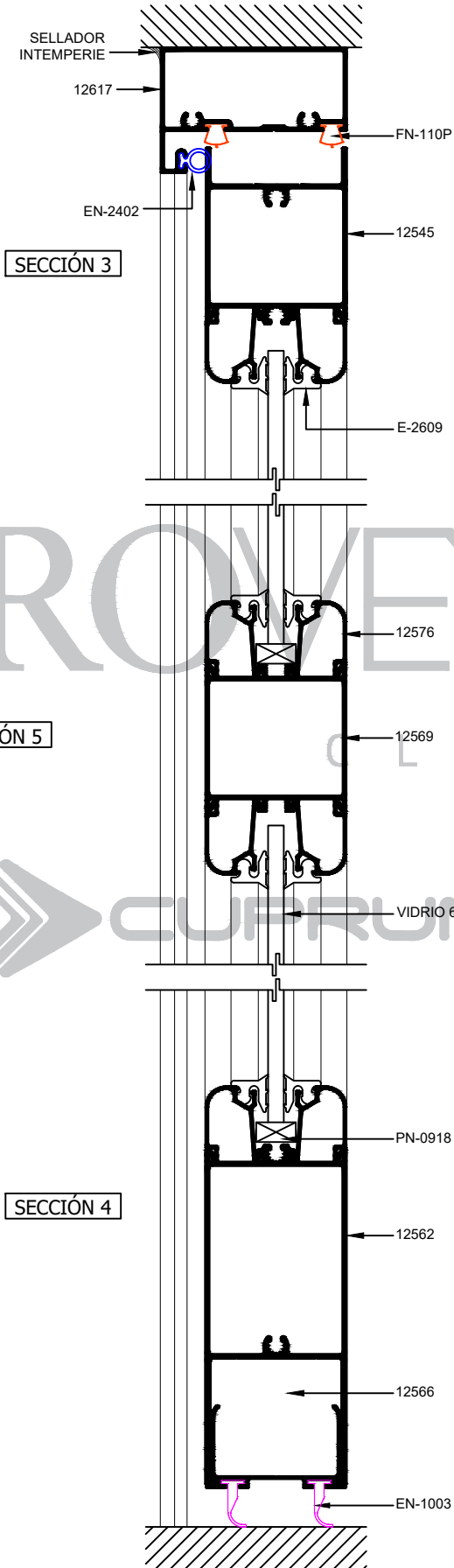

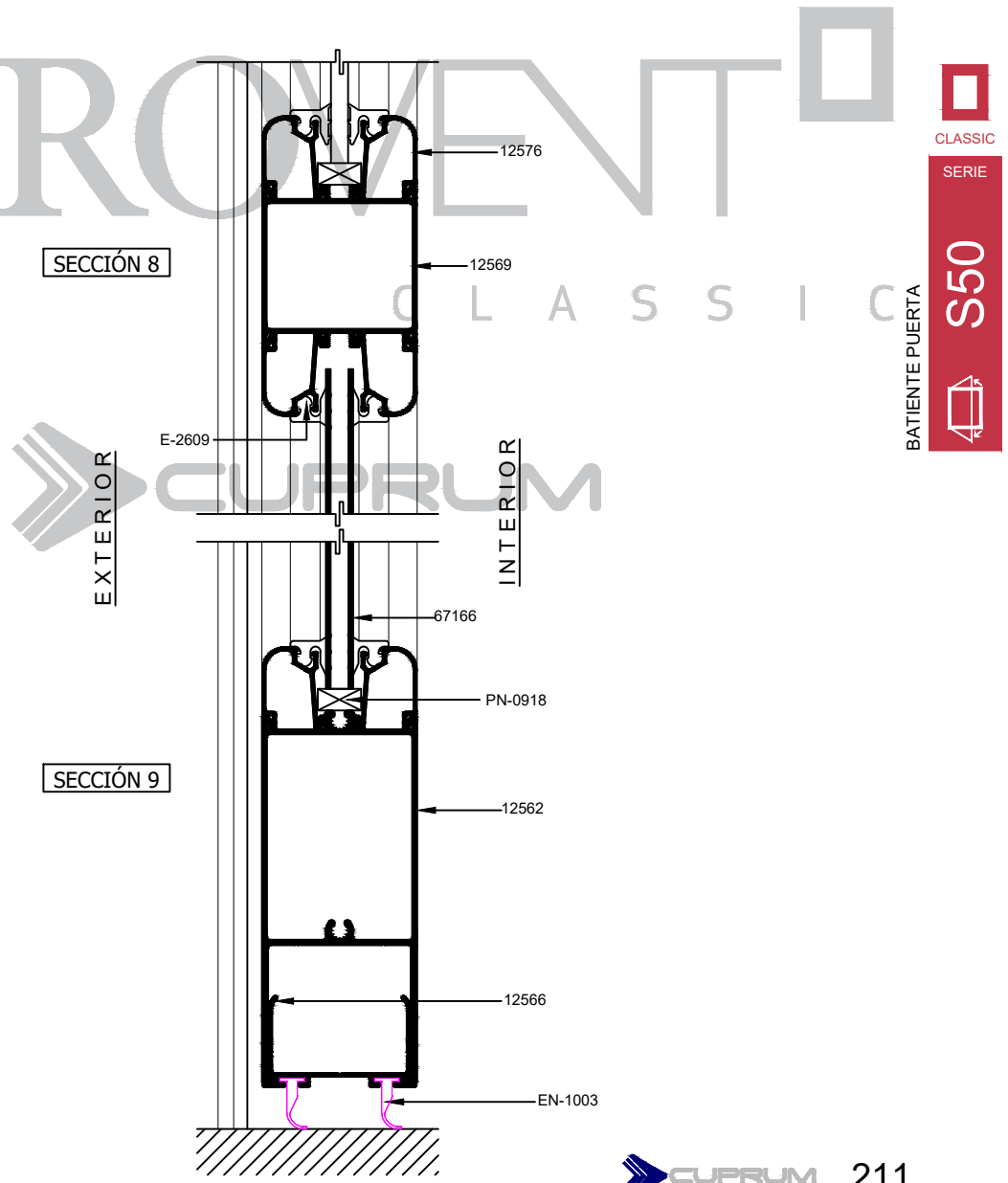
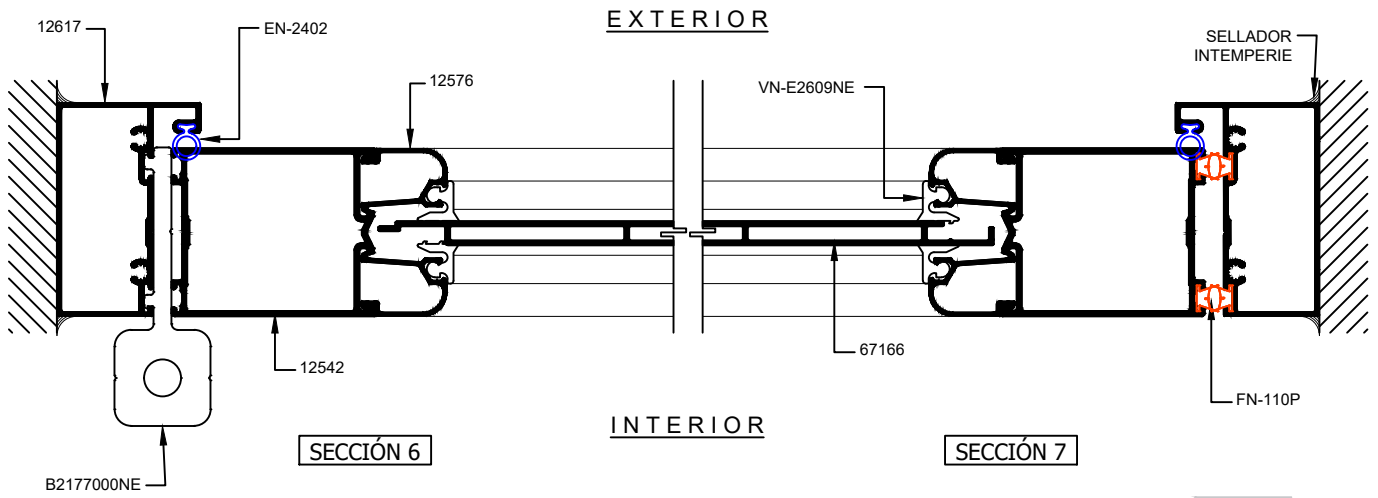



 CLASSIC
 SERIE
S50

 BATIENTE PUERTA

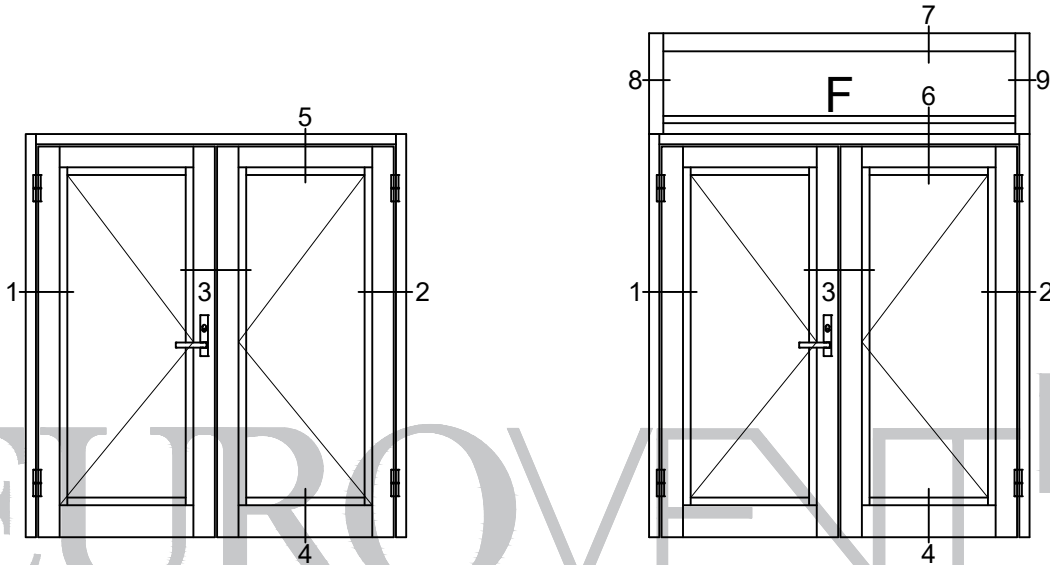
PUERTA UNA ACCIÓN,
VIDRIO SENCILLO



CLASSIC

SERIE

S50



SIN ESCALA

BATIENTE PUERTA

C L A S S I C

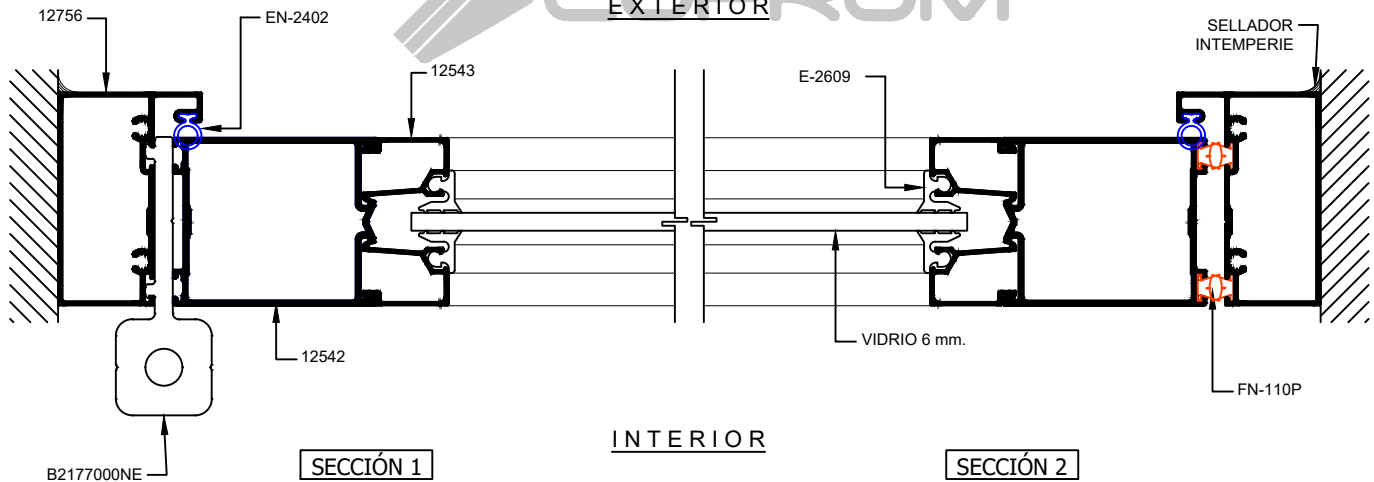

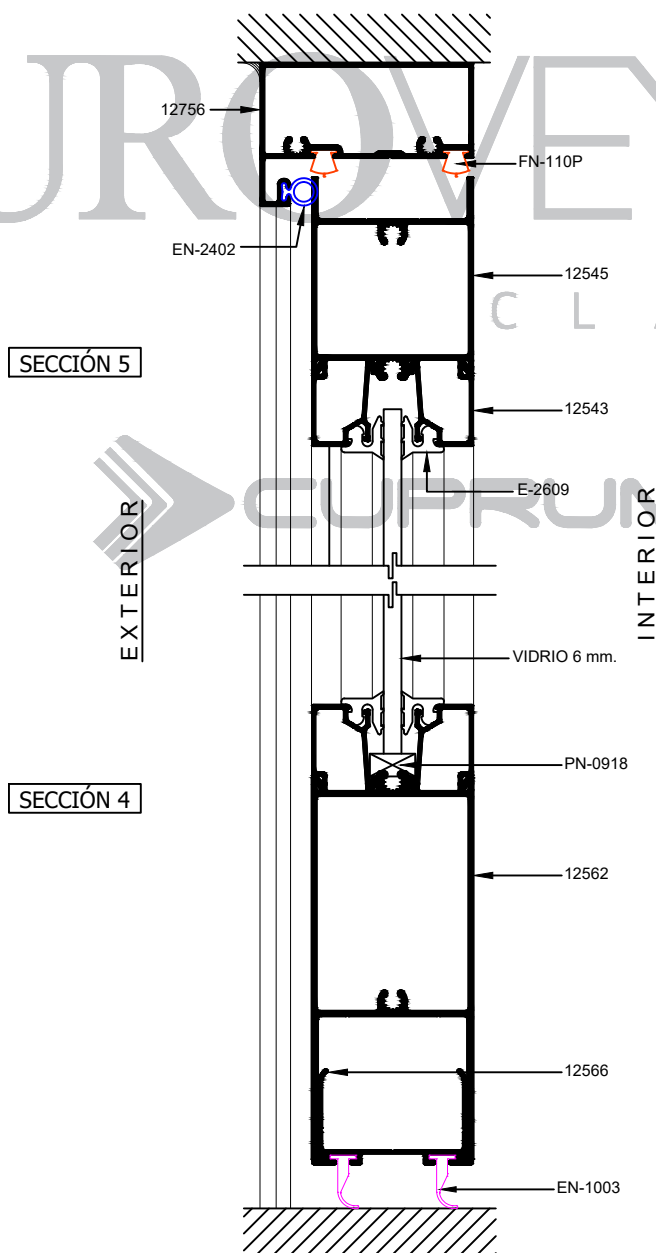
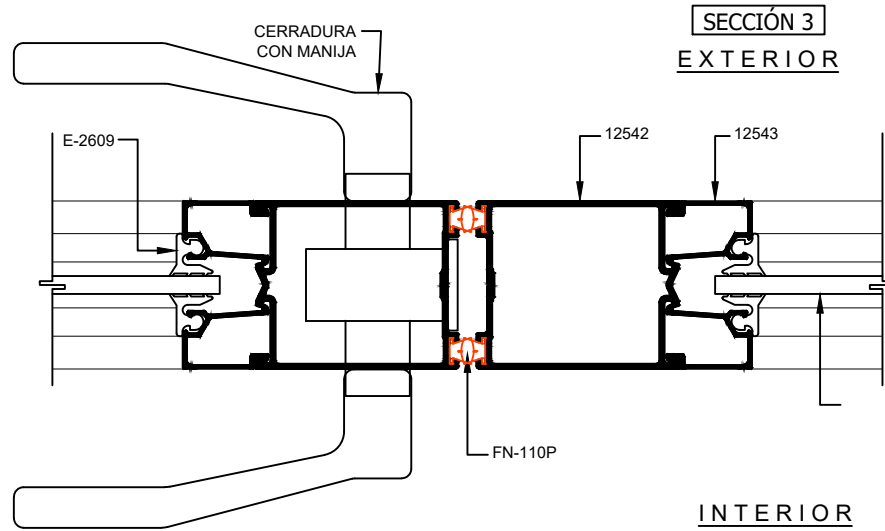

EUROVENT

CLASSIC

SERIE

S50

BATIENTE PUERTA

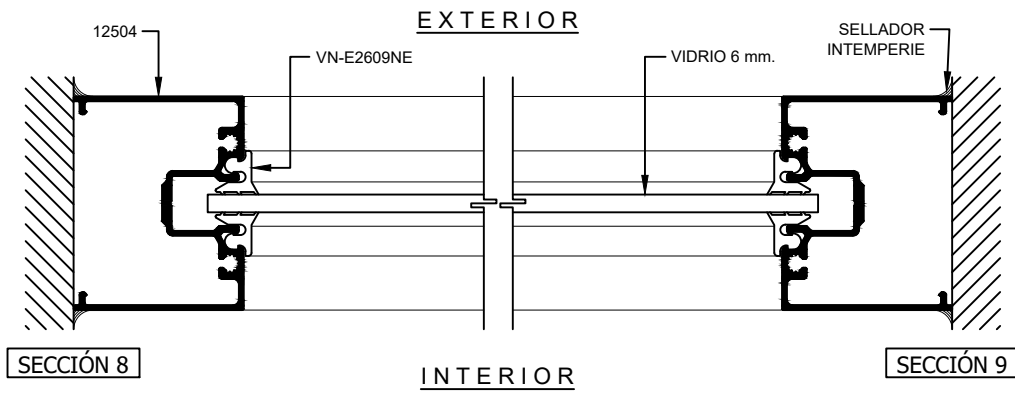

CLASSIC
SERIE
S50
BATIENTE PUERTA

SIN ESCALA

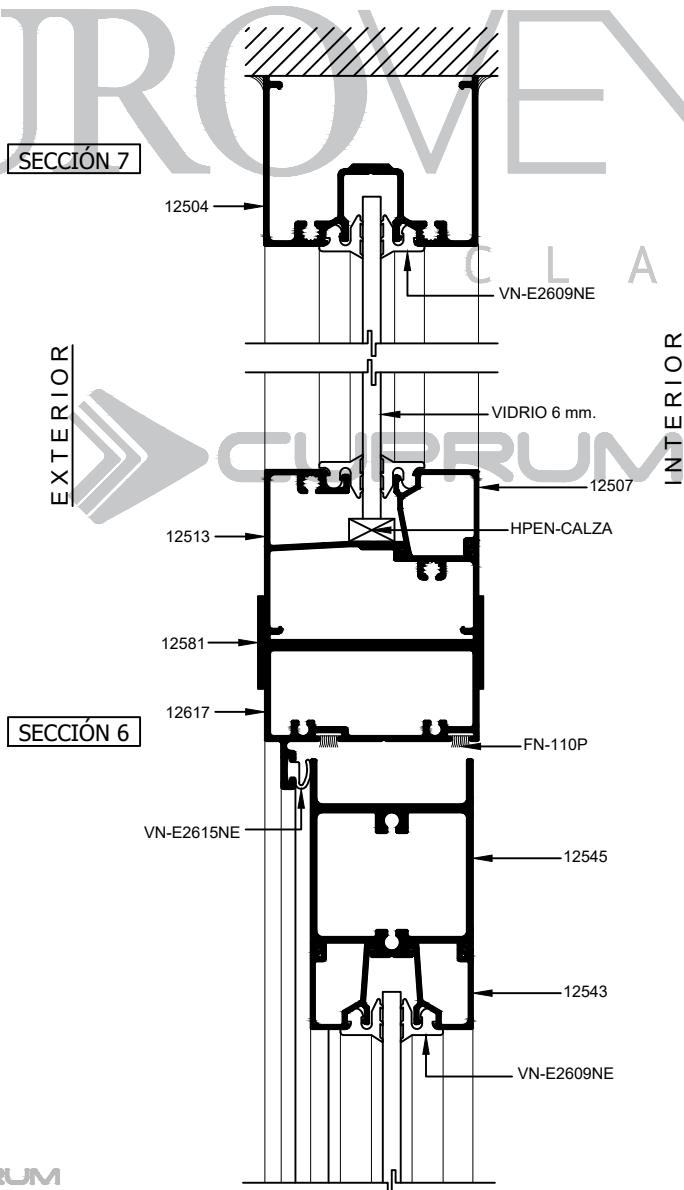

PUERTA DOBLE ACCIÓN,
VIDRIO SENCILLO

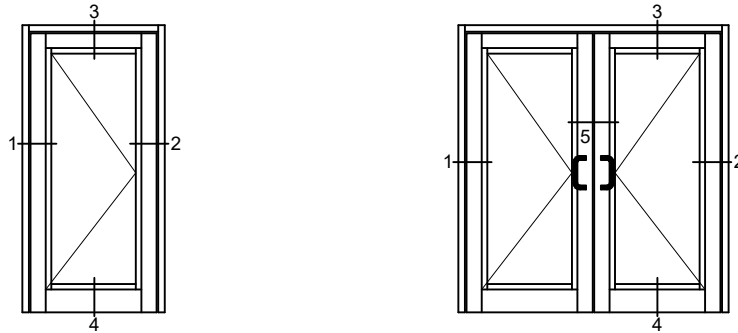

EXTERIOR

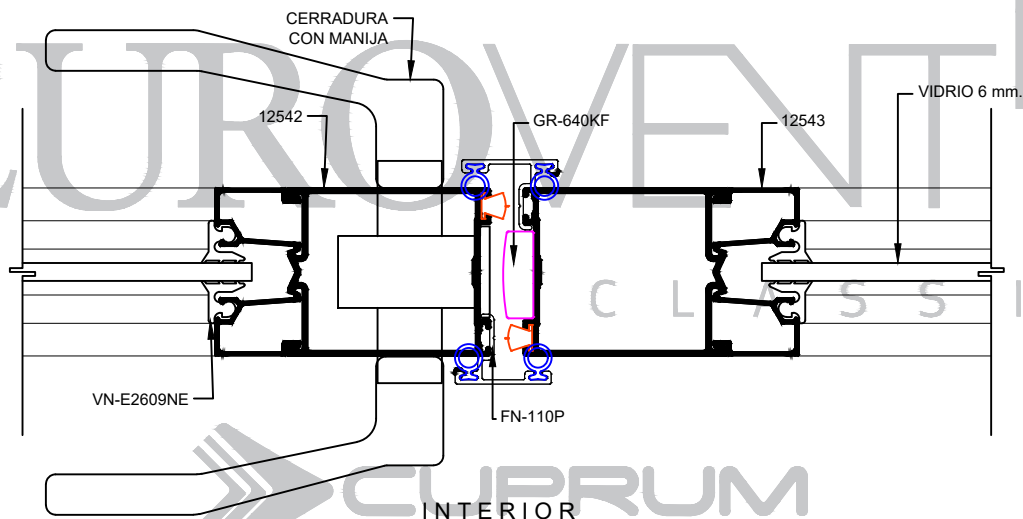

INTERIOR

SECCIÓN 5

EXTERIOR

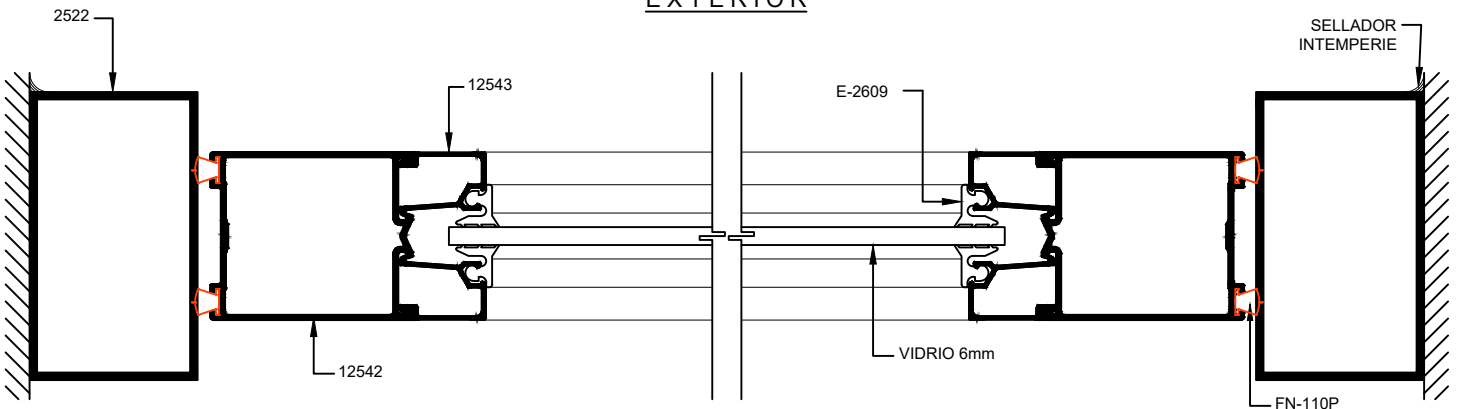

INTERIOR

SECCIÓN 1

SECCIÓN 2

CLASSIC
SERIE
S50
BATIENTE PUERTA

CLASSIC
SERIE
S50
BATIENTE PUERTA

EUROVENT
CLASSIC

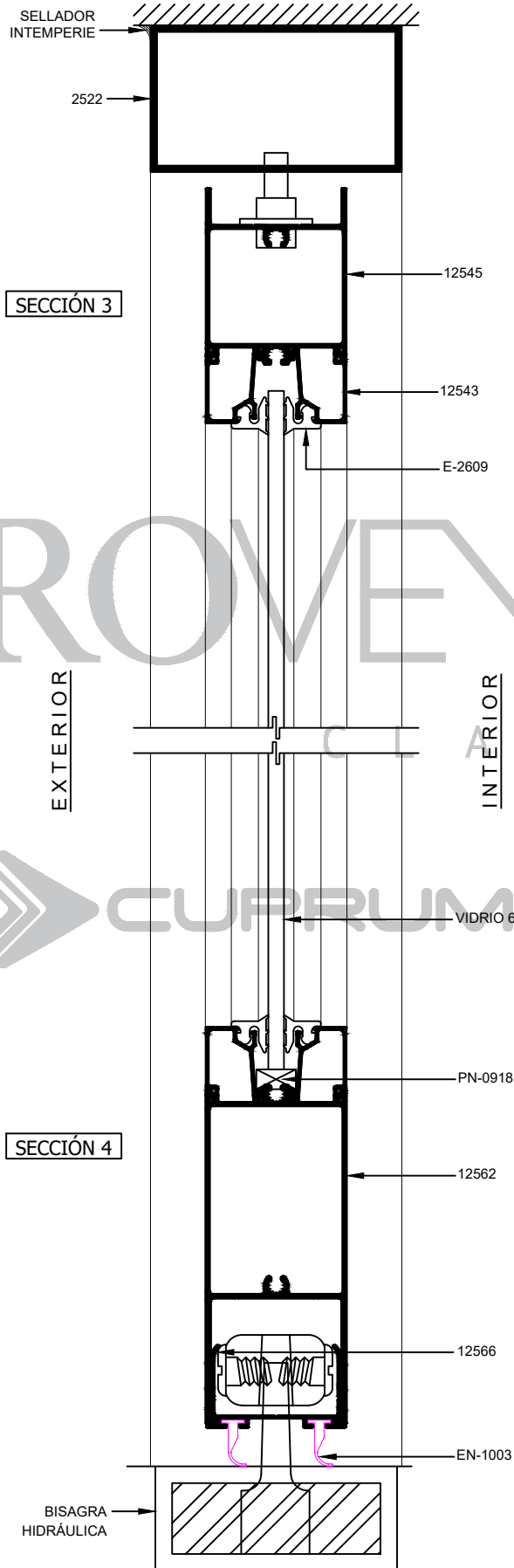

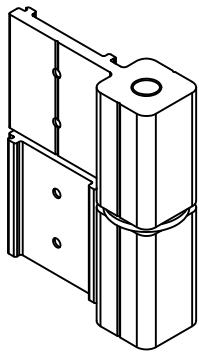

B2177000NE
 BISAGRA LIBRO
 CAPACIDAD DE CARGA:
 CON 2 BISAGRAS 80 KG.
 CON 3 BISAGRAS 100 KG.
 (CONSIDERANDO LAS
 DIMENSIONES DE 1000 MM. x
 2000 MM.)

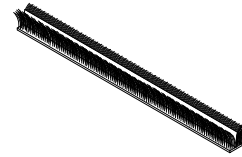

FN-110P
 FELPA CON PLÁSTICO

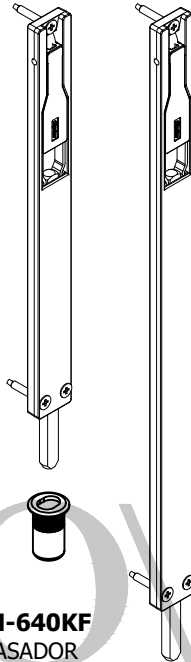

GN-640KF
 PASADOR

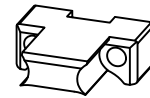

PN-0919
 SOPORTE ZOCLO
 S-50PB

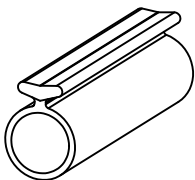

EN-2402
 EMPAQUE HONGO
 S-50PB

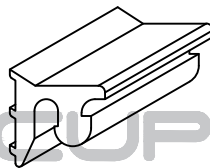

VN-E2609NE
 EMPAQUE BATIENTE

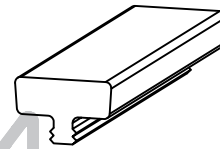

PN-0918
 CALZA DE VIDRIO
 S-50PB

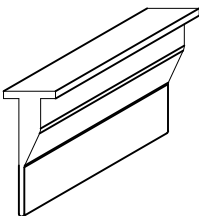

EN-1003
 VINIL ALETA



GN-102D
 TAPÓN CUBRE PIJA

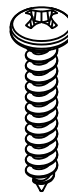

PFNG-0820
 #8x1 1/2"

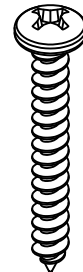

PENG-1017
 #10x1 1/2"



T21371000
T21371200
 TENSOR 3/8"

CLASSIC
 SERIE
S50
 BATIENTE PUERTA

Clave: MN-1210

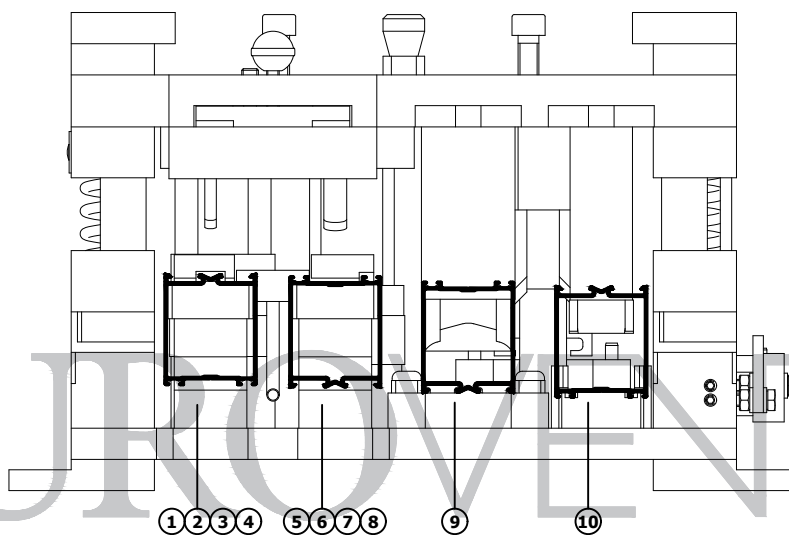

CLASSIC
SERIE

S50



BATIENTE PUERTA

C L A S S I C

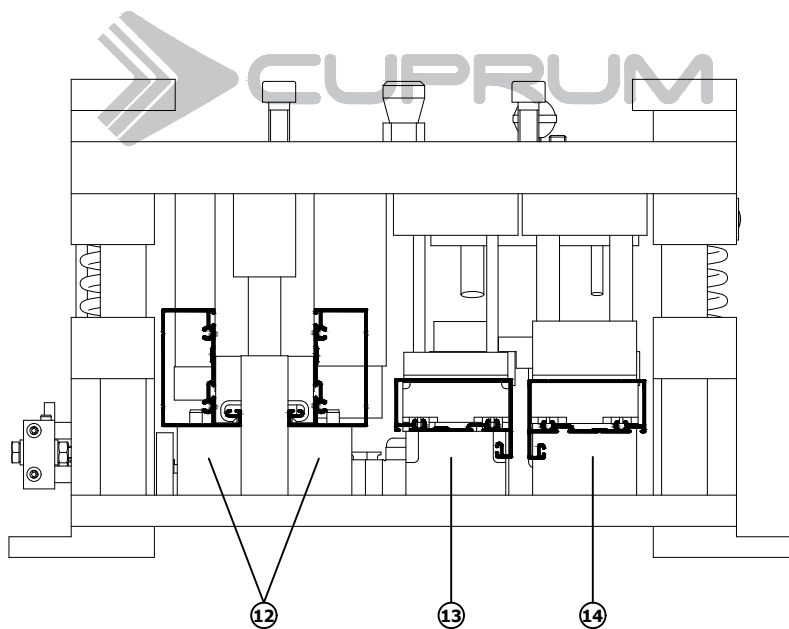

12542

OPERACIÓN 1
CON TOPE "Z"
TAJADERA POSICION 1

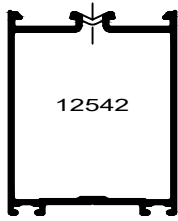

12542

OPERACIÓN 2
CON TOPE "Z"
TAJADERA POSICION 1

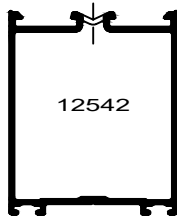

12542

OPERACIÓN 3
CON TOPE "Z"
TAJADERA POSICION 3

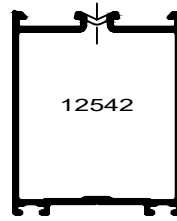

12542

OPERACIÓN 4
CON TOPE "Z"
TAJADERA POSICION 2

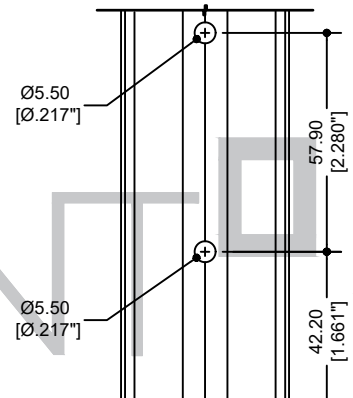
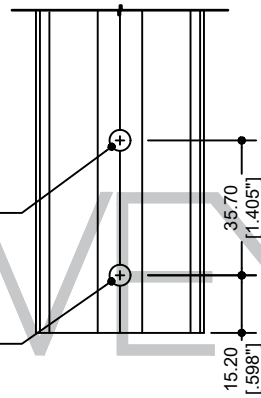
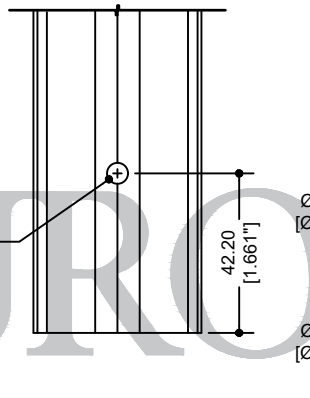
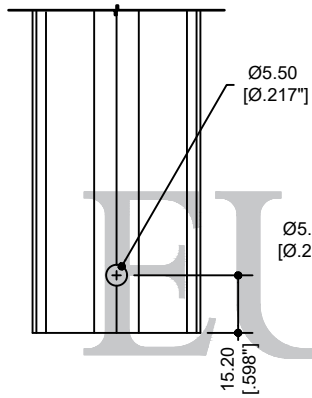
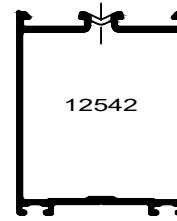

12542

OPERACIÓN 5
CON TOPE "Z"
TAJADERA POSICION 1

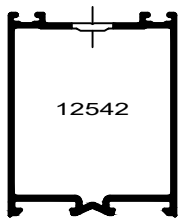

12542

OPERACIÓN 6
CON TOPE "Z"
TAJADERA POSICION 1

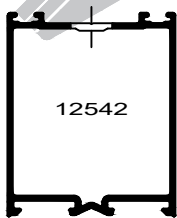

12542

OPERACIÓN 7
CON TOPE "Z"
TAJADERA POSICION 3

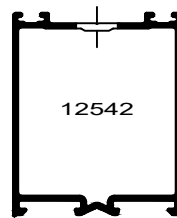

12542

OPERACIÓN 8
CON TOPE "Z"
TAJADERA POSICION 2

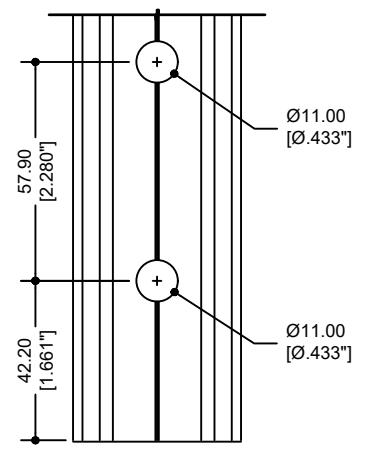
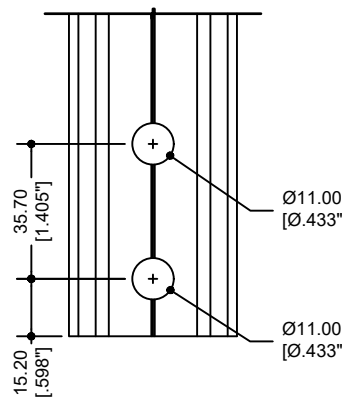
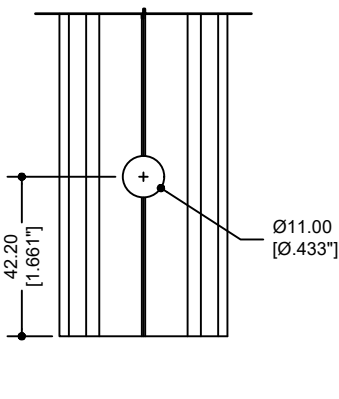
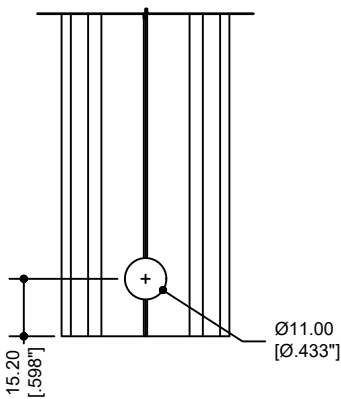
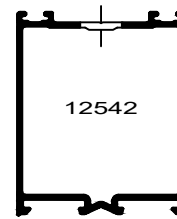

CLASSIC

SERIE

S50



BATIENTE PUERTA

CLASSIC
SERIE
S50
BATIENTE PUERTA

12542
OPERACIÓN 9

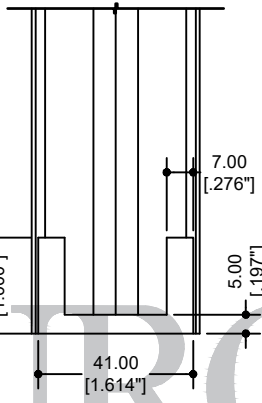
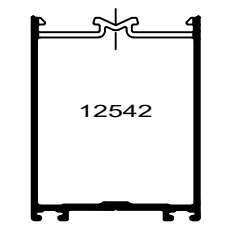

12617
OPERACIÓN 13

12617
OPERACIÓN 12

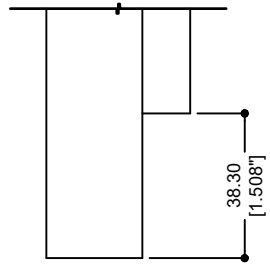
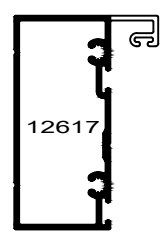

12617
OPERACIÓN 14

REALIZAR PREVIAMENTE LA OPERACIÓN 12

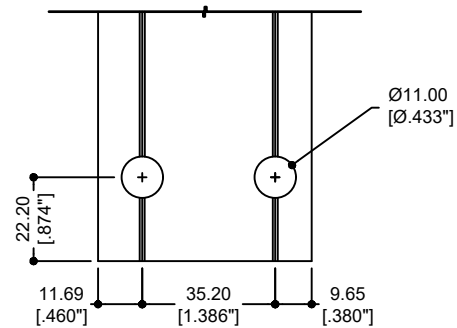
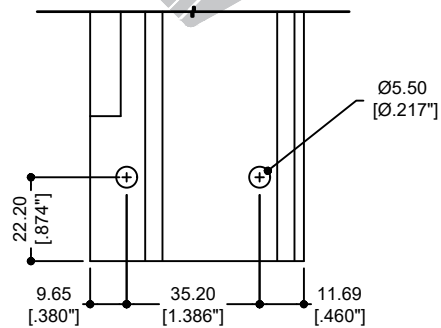
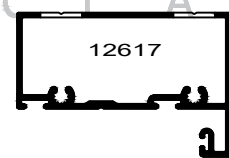
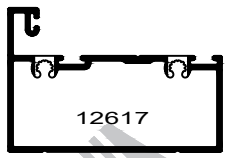

OPERACION MANUAL

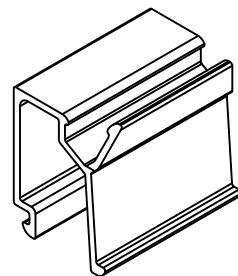
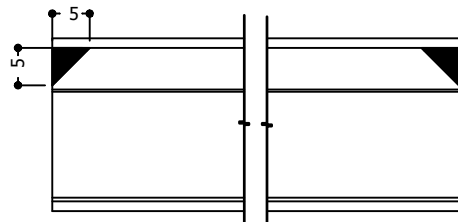
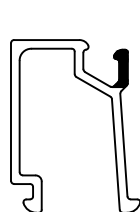

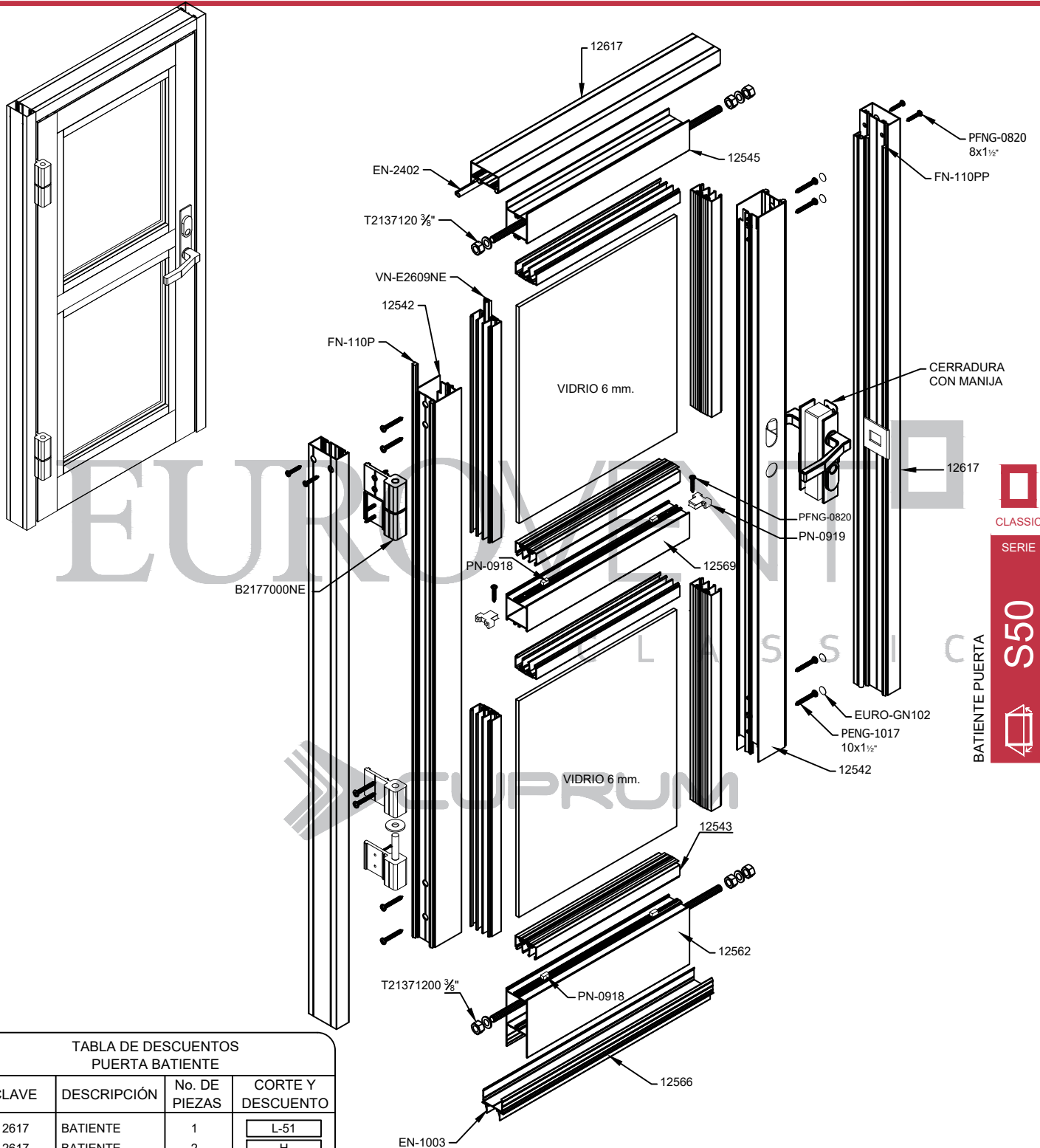

CLASSIC
SERIE
S50
BATIENTE PUERTA

TABLA DE DESCUENTOS PUERTA BATIENTE			
CLAVE	DESCRIPCIÓN	No. DE PIEZAS	CORTE Y DESCUENTO
12617	BATIENTE	1	L-51
12617	BATIENTE	2	H
12542	CERCO	2	H-44
12562	ZOCLO	1	L-171
12545	CABEZAL	1	L-171
12569	INTERMEDIO	1	L-171
12543	JUNQUILLO	8	L-209
12543	JUNQUILLO	8	H/2 - 110
12566	S HERMETICIDAD	1	L-73
T21371000 T21371200	TENSOR 3#8"	2	L-121
VIDRIO	L	2	L-180
	H		H/2-120

L= ANCHO DE VENTANA DESCUENTOS EN MM.
H= ALTO DE VENTANA

PARÁMETROS MÍNIMOS Y MÁXIMOS DE FABRICACIÓN.

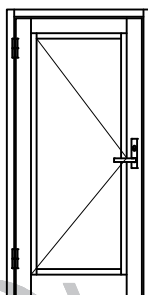

PBC-50
MÍNIMO 0.60 x 1.80
MÁXIMO 1.00 x 2.40

CLASSIC
SERIE

S50

BATIENTE PUERTA

C L A S S I C

ALUMINIO					
CLAVE	DESCRIPCIÓN	PIEZAS X ATADO	LARGO STD. MTS.	PERÍMETRO ANOD. CM.	PERÍMETRO PUL. CM.
12542	CERCO	6	4.60	24.41	9.612
12543	JUNQUILLO	20	6.10	13.43	5.289
12545	CABEZAL	4	6.10	25.01	9.85
12562	ZOCLO	4	6.10	40.35	15.89
12566	SELLO DE HERMETICIDAD	10	6.10	24.35	9.59
12569	INTERMEDIO	4	6.10	21.94	8.63
12576	JUNQUILLO COLONIAL	20	6.10	12.95	5.10
12603	JUNQUILLO DOBLE VIDRIO	20	6.10	10.47	2.30
12617	BATIENTE	6	6.10	23.91	9.41
12756	BATIENTE ABIERTO	8	6.10	33.31	13.11

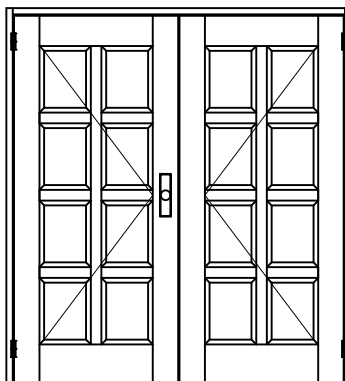
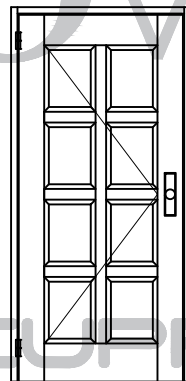
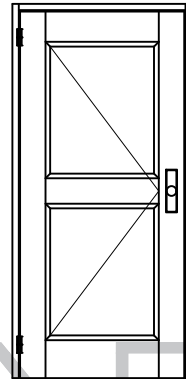
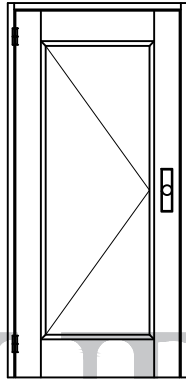

EUROVENT

CLASSIC

CUPRUM



CLASSIC

SERIE

S50



BATIENTE PUERTA

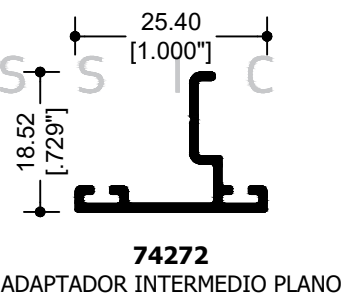
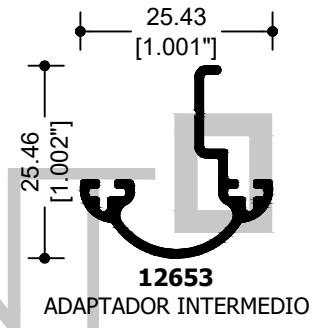
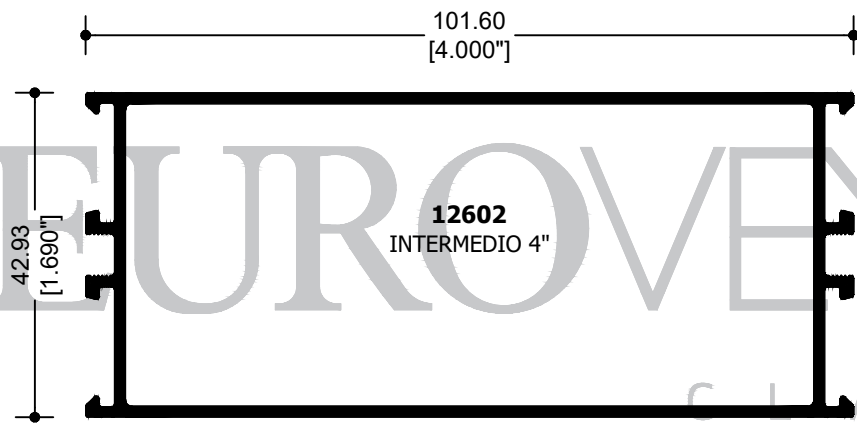
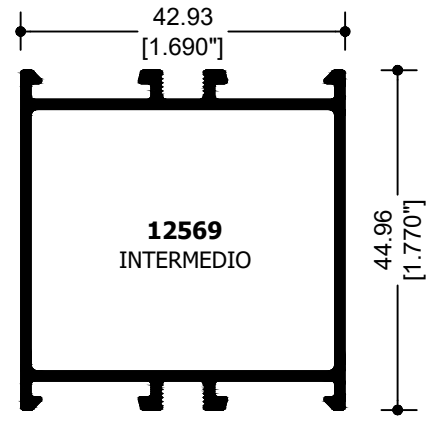
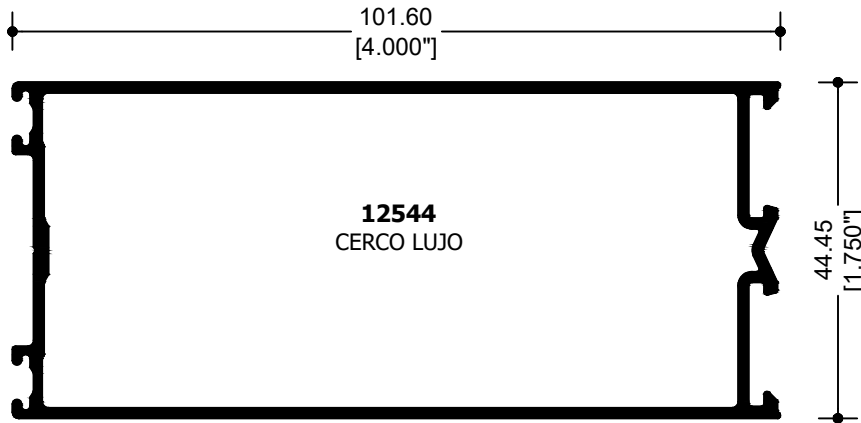

CLASSIC
SERIE
S50
BATIENTE PUERTA

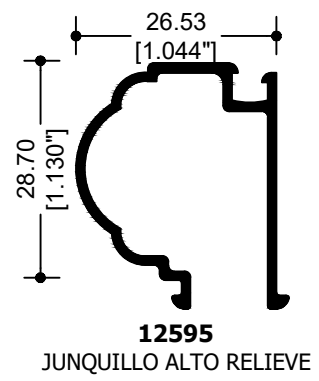
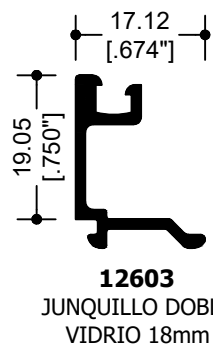
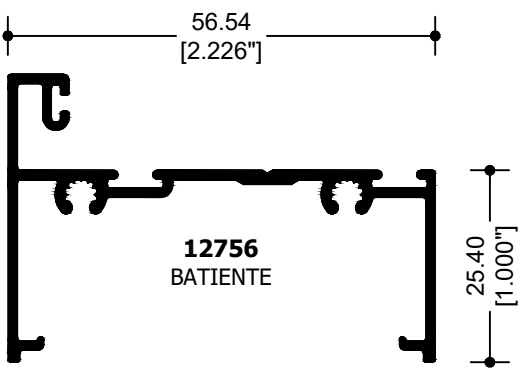
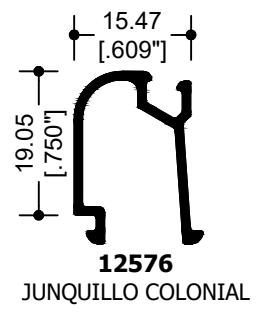
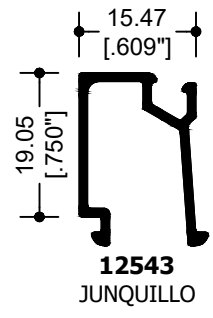
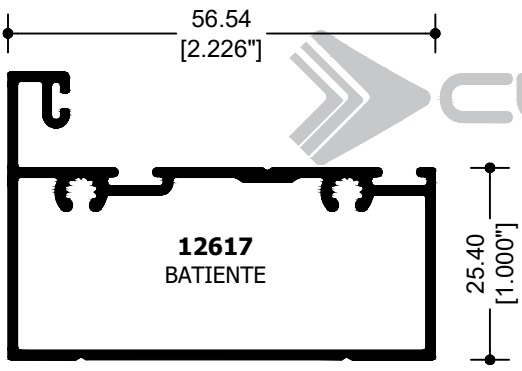

PUERTA BATIENTE RESIDENCIAL S50 - PERFILES

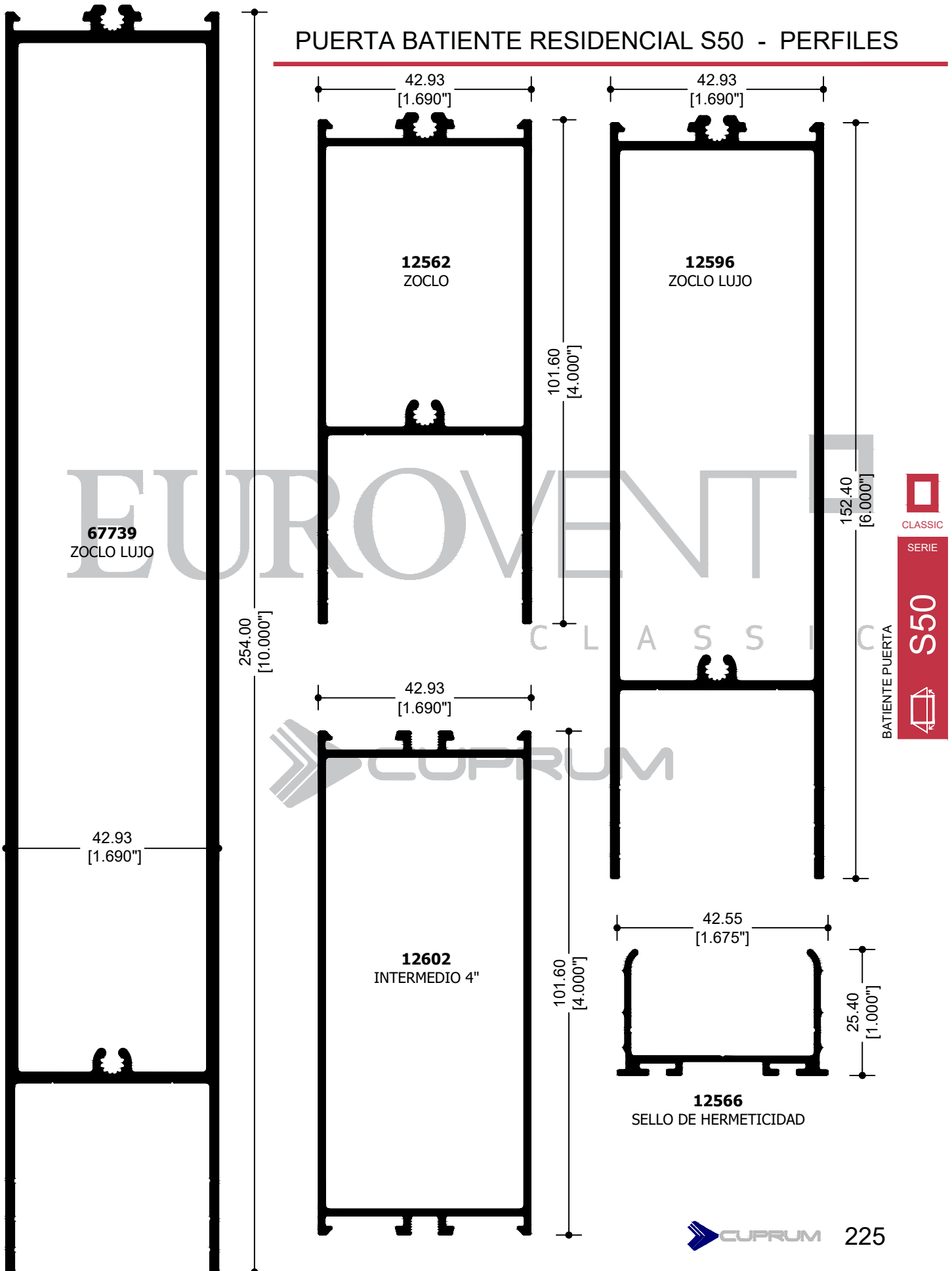

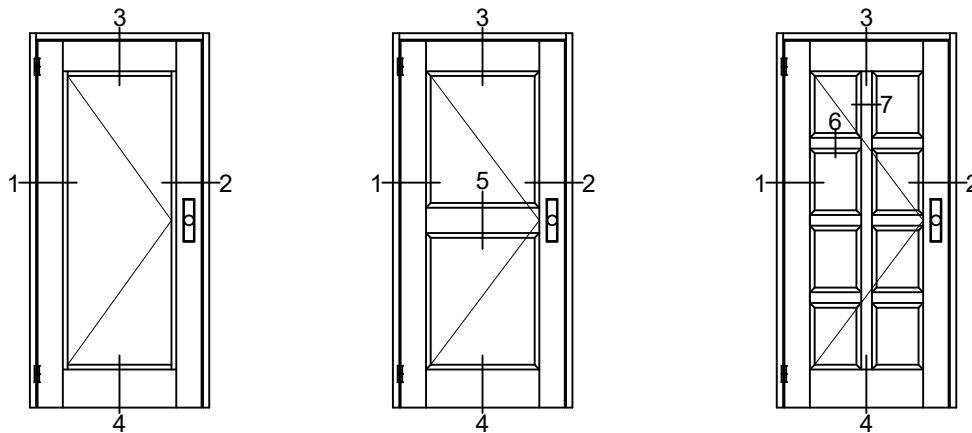

SIN ESCALA

CLASSIC
SERIE
S50
BATIENTE PUERTA

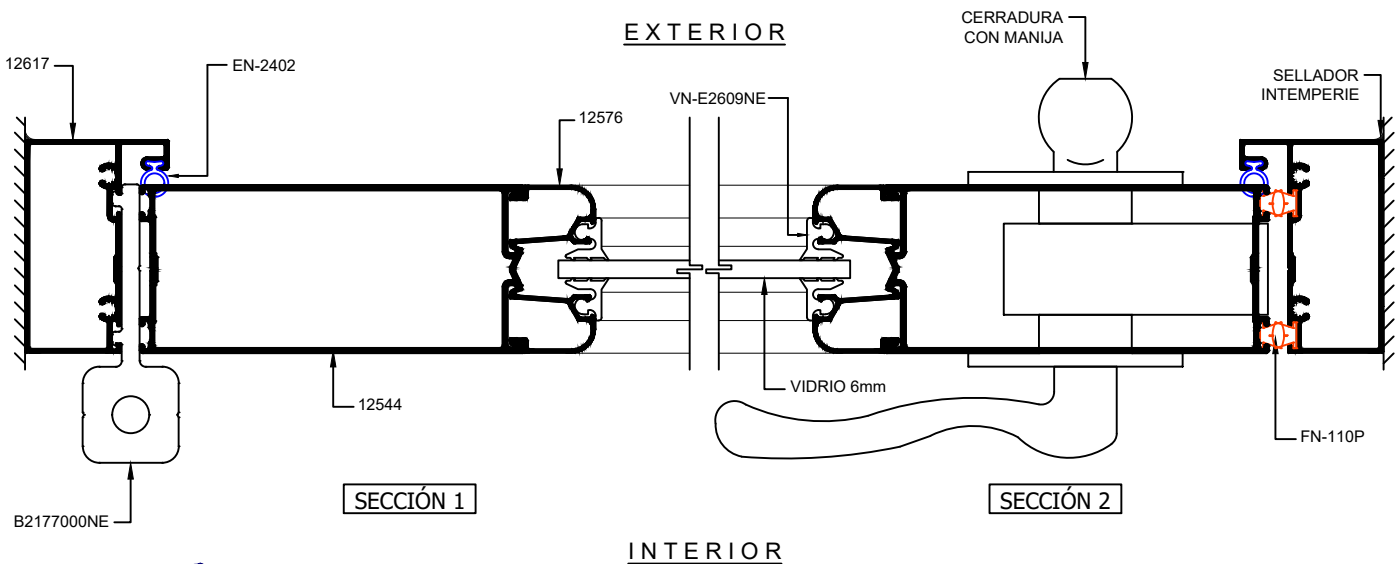
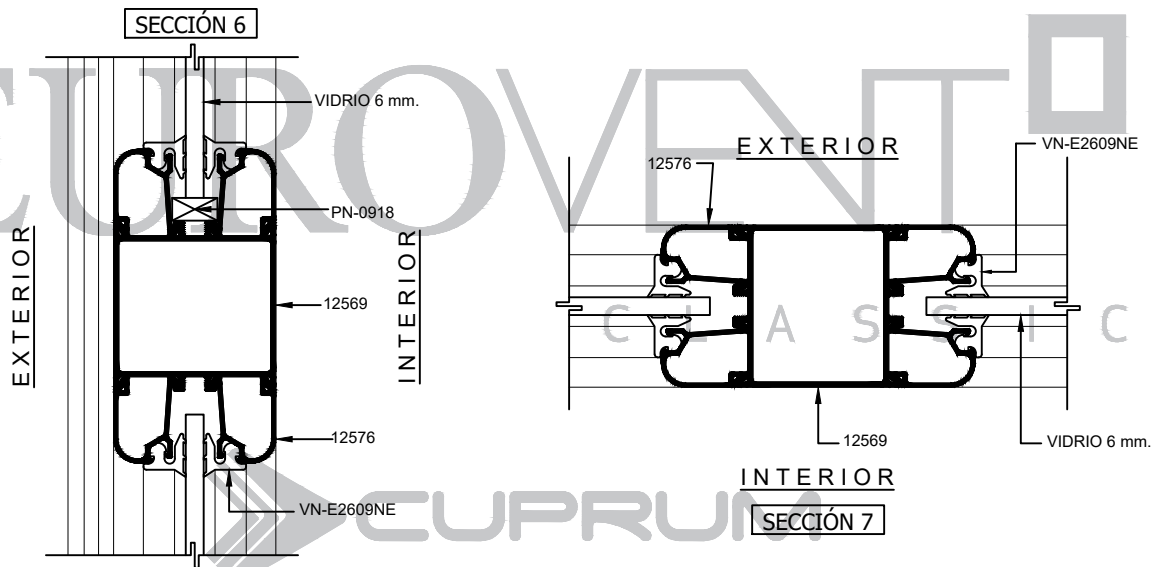

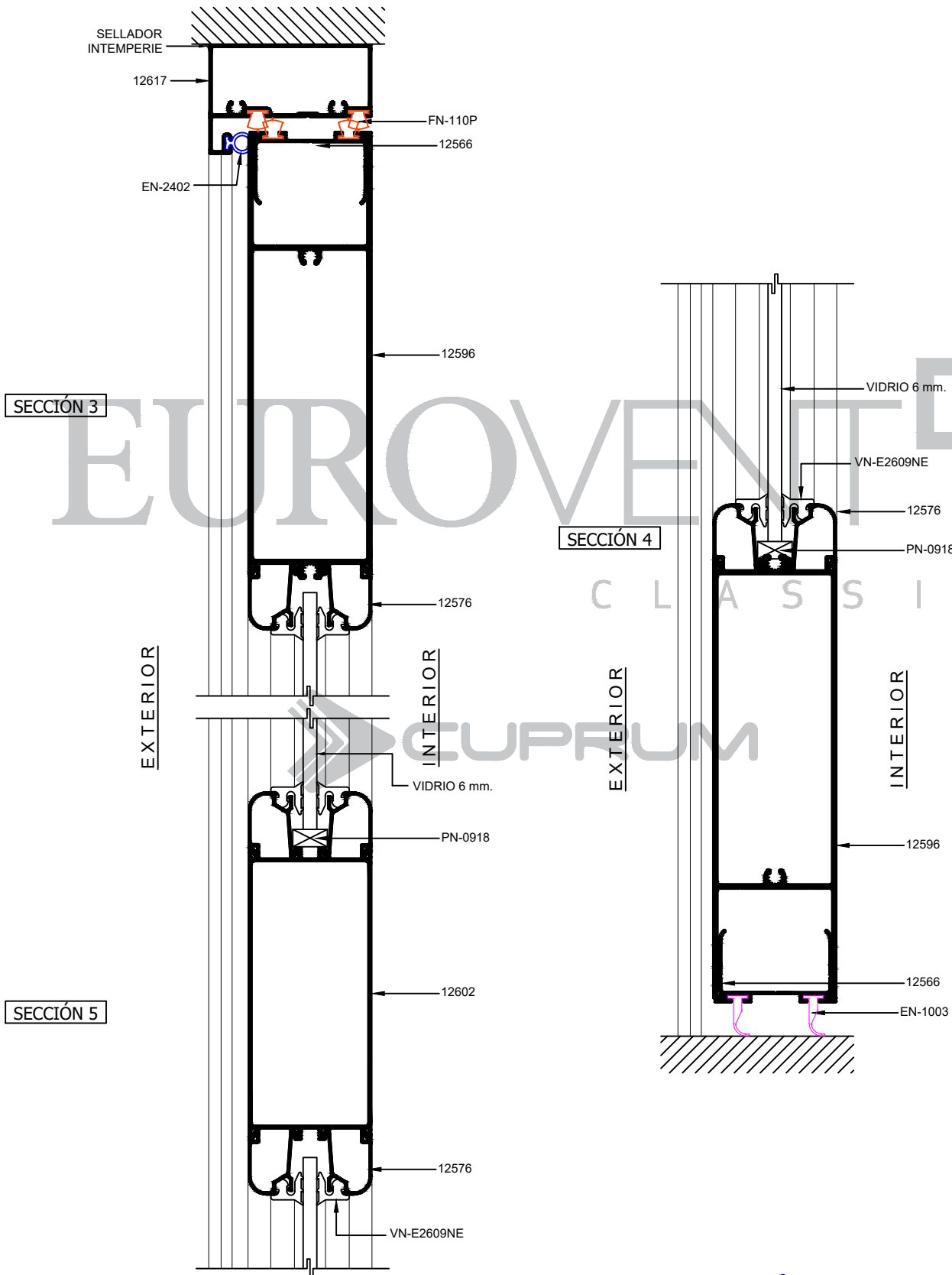

CLASSIC
SERIE

BATIENTE PUERTA

S50

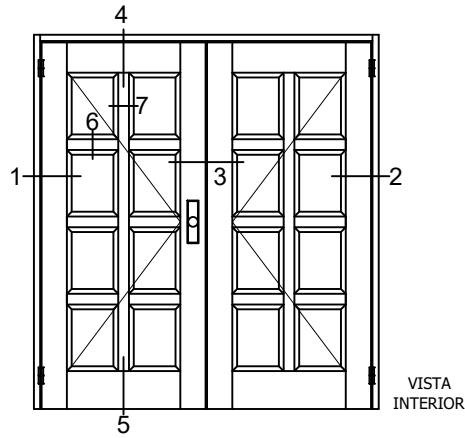

SIN ESCALA

CLASSIC
SERIE
S50
BATIENTE PUERTA

EUROVENT CLASSIC

SECCIÓN 1

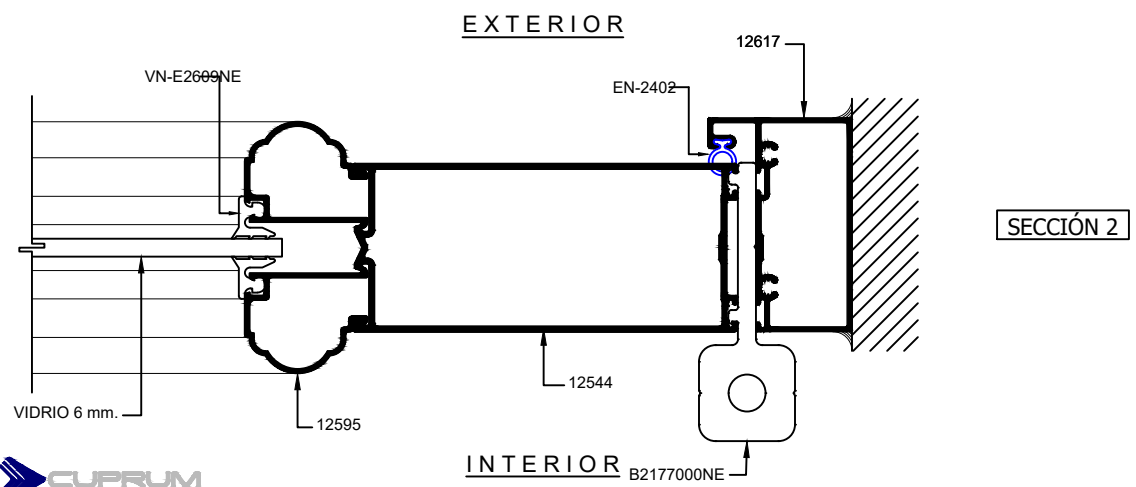
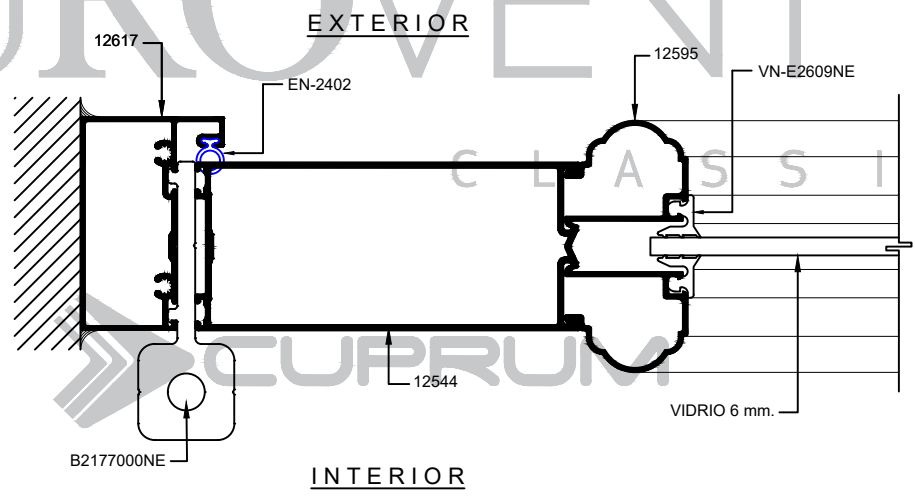

SECCIÓN 2

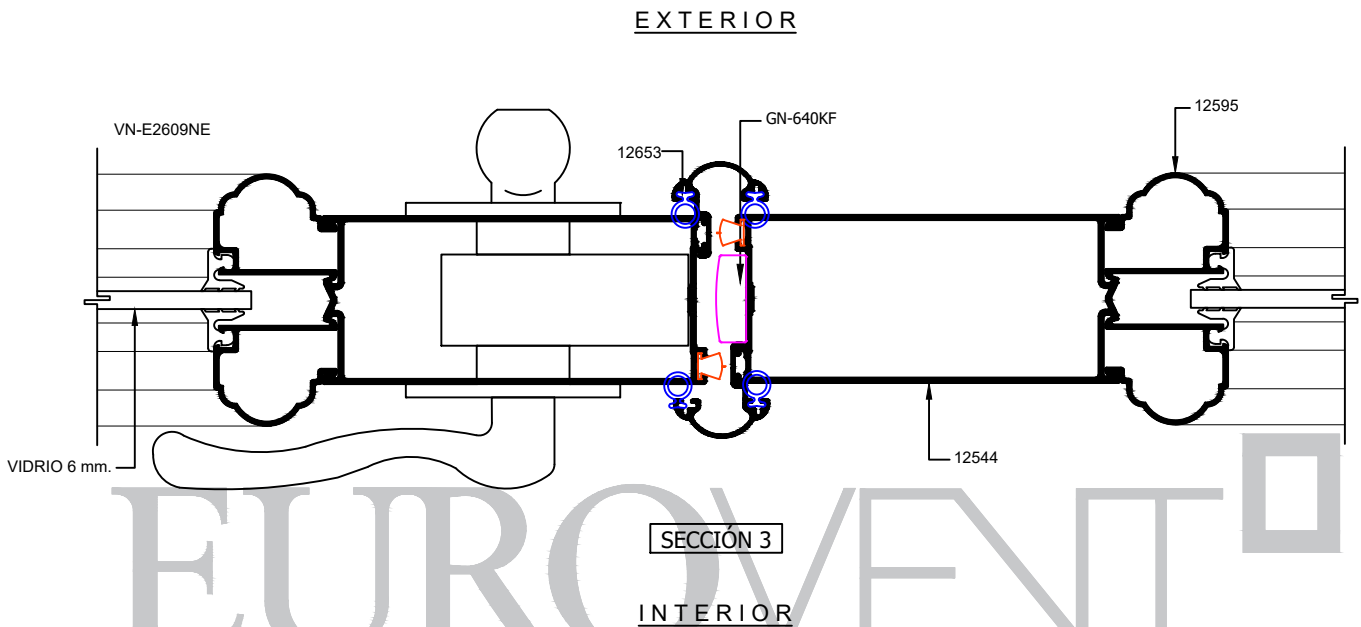

CLASSIC
SERIE
S50
BATIENTE PUERTA

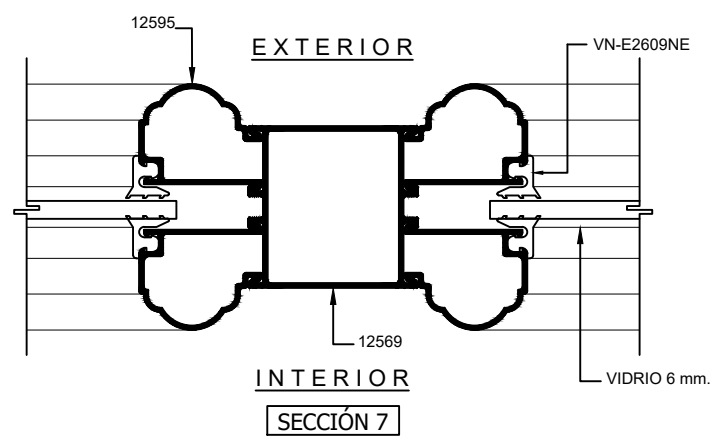
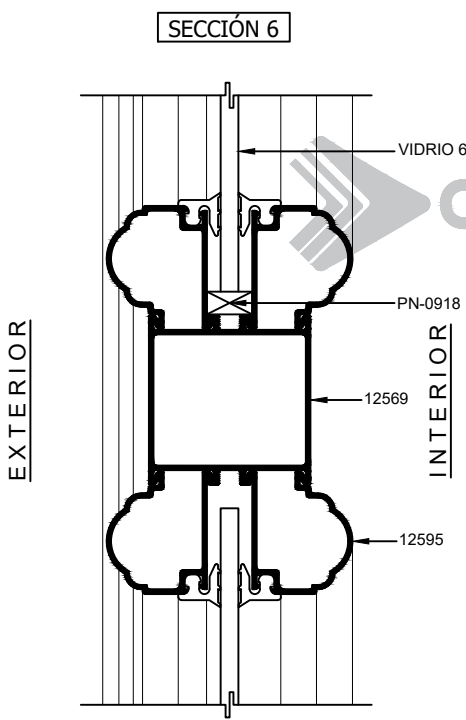

CLASSIC
SERIE
S50
BATIENTE PUERTA

SECCIÓN 4

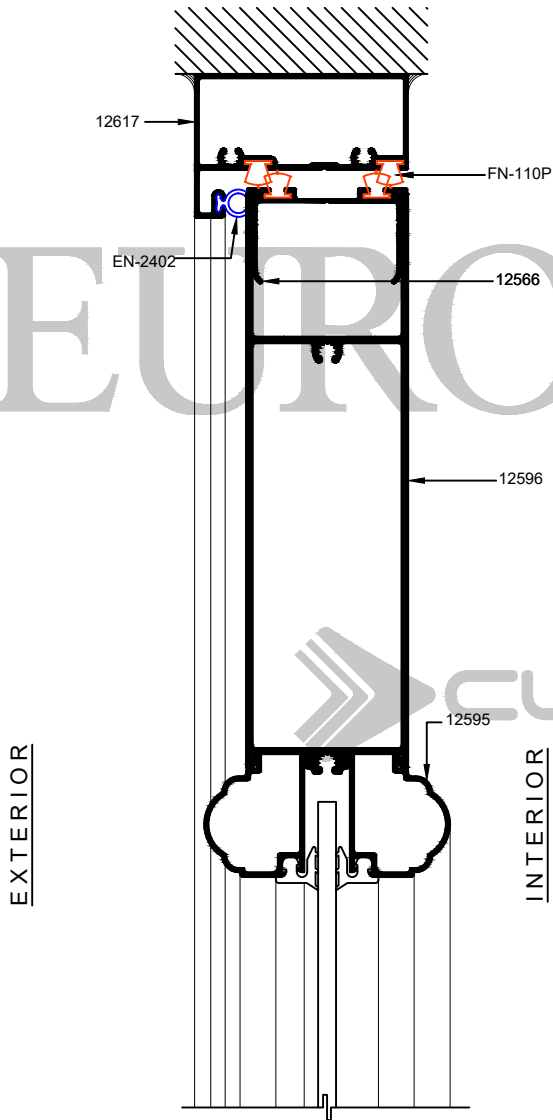

SECCIÓN 5

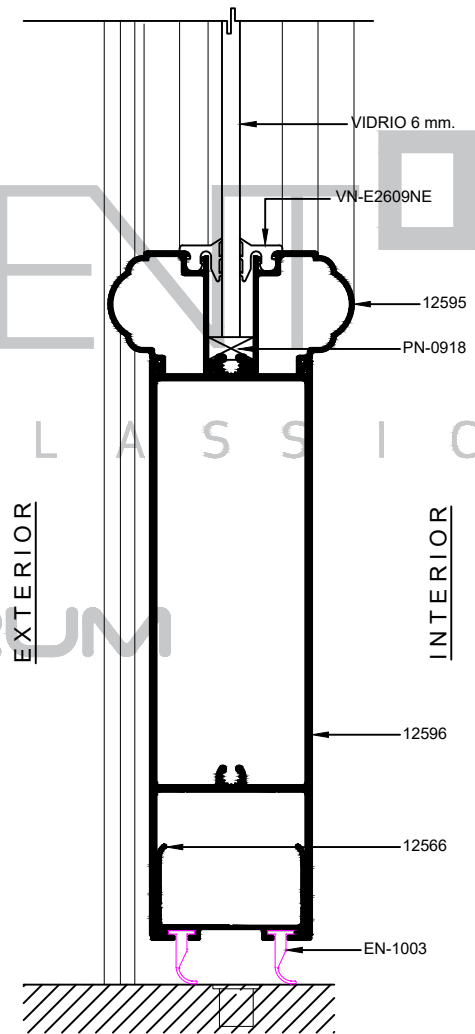

Clave: MN-1210

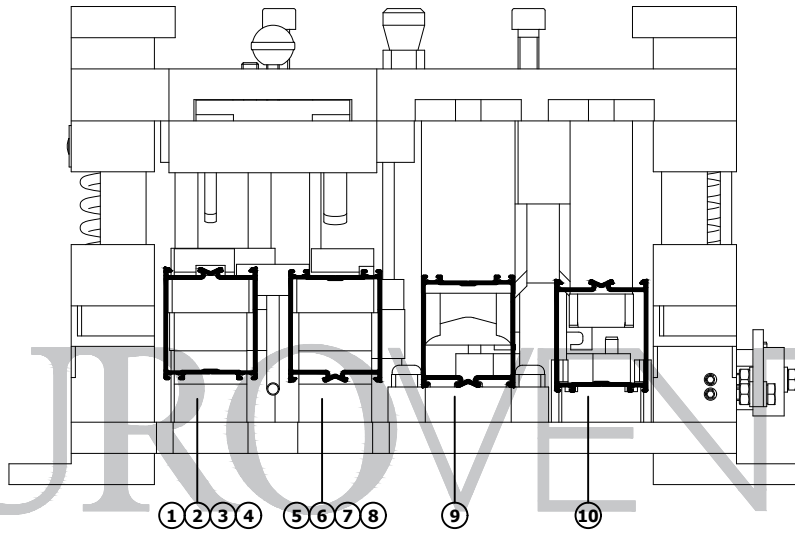

C L A S S I C



CLASSIC

SERIE

S50



BATIENTE PUERTA

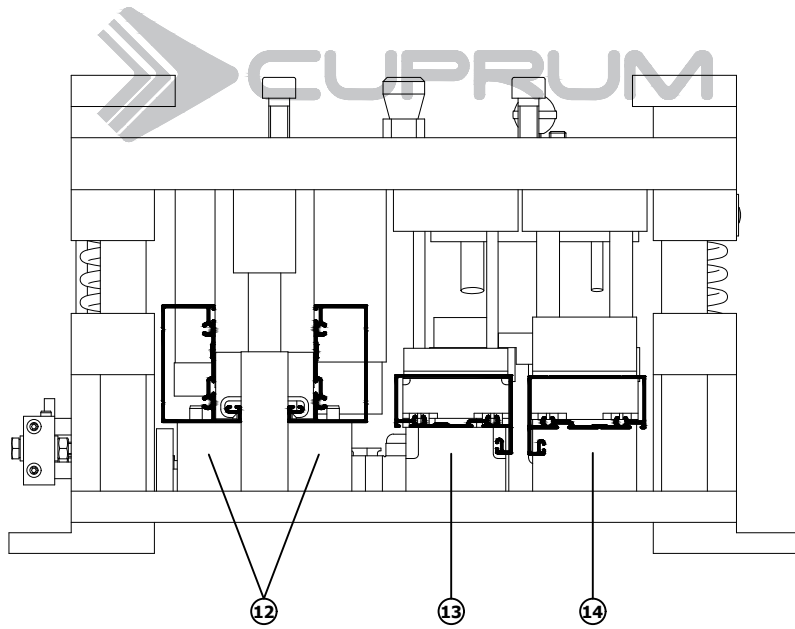

12544
OPERACIÓN 1
CON TOPE "Z"
TAJADERA POSICION 1

12544
OPERACIÓN 2
CON TOPE "Z"
TAJADERA POSICION 1

12544
OPERACIÓN 3
CON TOPE "Z"
TAJADERA POSICION 3

12544
OPERACIÓN 4
CON TOPE "Z"
TAJADERA POSICION 2

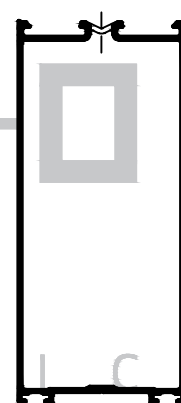

CLASSIC

SERIE

S50

BATIENTE PUERTA

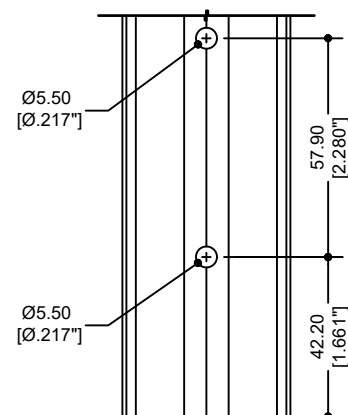
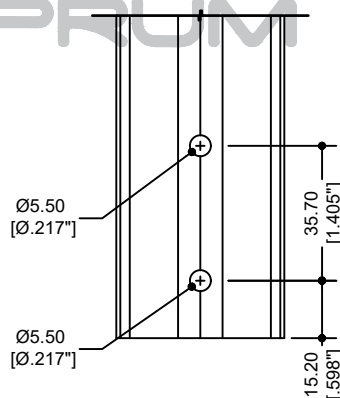
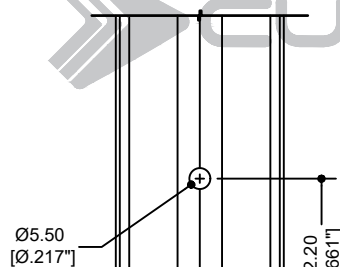
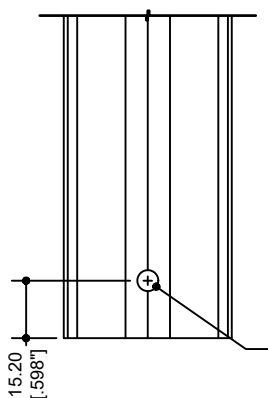

12544
OPERACIÓN 5
CON TOPE "Z"
TAJADERA POSICION 1

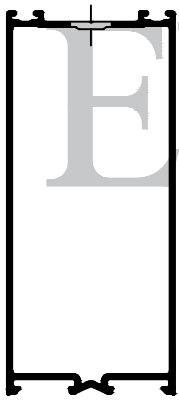

12544
OPERACIÓN 6
CON TOPE "Z"
TAJADERA POSICION 1



12544
OPERACIÓN 7
CON TOPE "Z"
TAJADERA POSICION 3



12544
OPERACIÓN 8
CON TOPE "Z"
TAJADERA POSICION 2

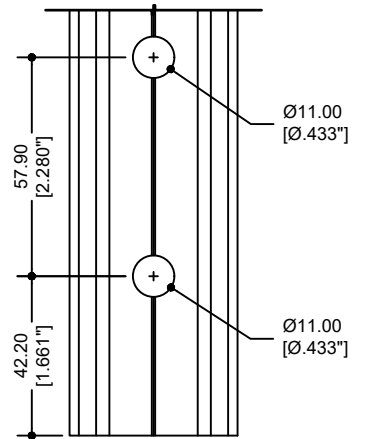
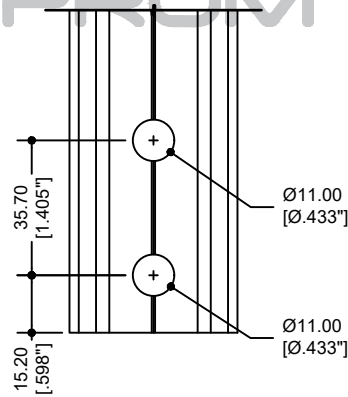
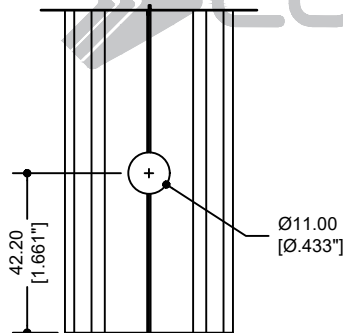
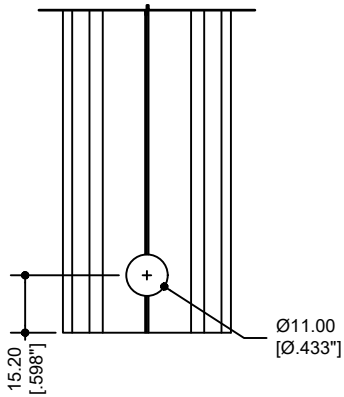
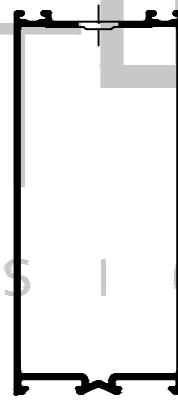

CLASSIC
SERIE
S50
BATIENTE PUERTA

12542
OPERACIÓN 9

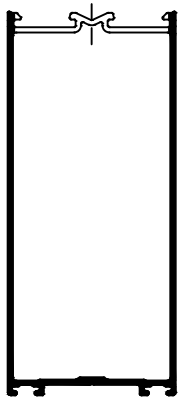

OPERACION MANUAL

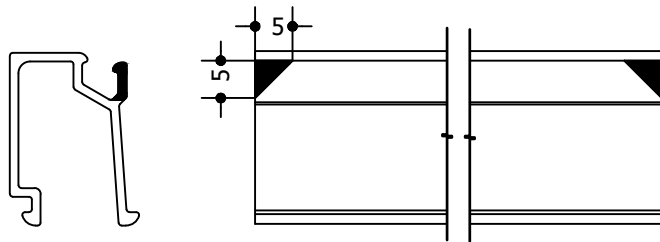

CLASSIC
SERIE
S50
BATIENTE PUERTA

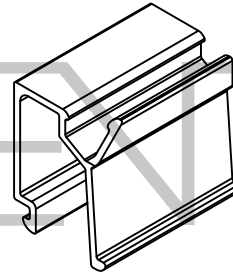
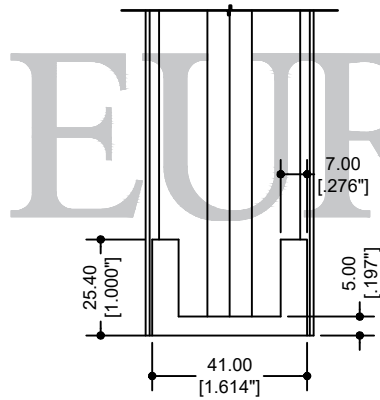

12617
OPERACIÓN 12

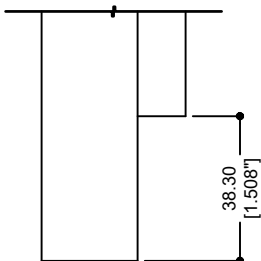
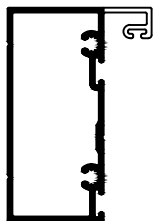

12617
OPERACIÓN 13

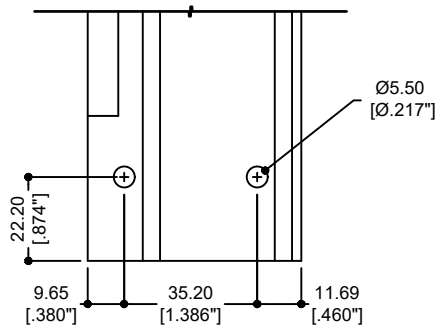
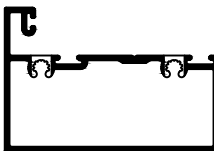

12617
OPERACIÓN 14

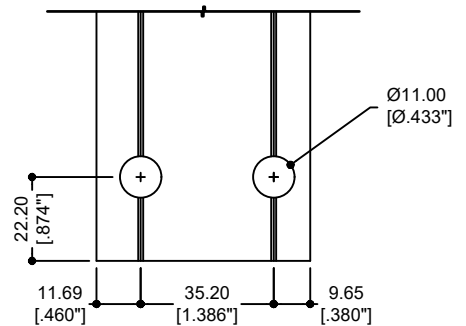
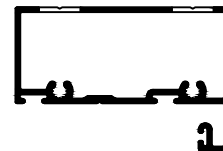

REALIZAR PREVIAMENTE LA OPERACIÓN 12

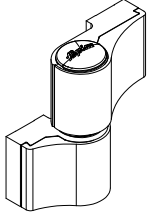

GN-616F
 BISAGRA LOIRA DOS ALAS
 CAPACIDAD DE CARGA:
 CON 2 BISAGRAS 120 KG.
 (CONSIDERANDO LAS DIMENSIONES
 DE 1000 MM. x 2200 MM.)

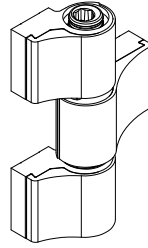

GN-617F
 BISAGRA LOIRA TRES ALAS
 CAPACIDAD DE CARGA:
 CON 2 BISAGRAS 150 Kg.
 (CONSIDERANDO LAS DIMENSIONES
 DE 1000 MM. x 2000 MM.)

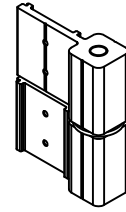

B2177000NE
 BISAGRA LIBRO
 CAPACIDAD DE CARGA:
 CON 2 BISAGRAS 80 KG.
 CON 3 BISAGRAS 100 KG.
 (CONSIDERANDO LAS DIMENSIONES
 DE 1000 MM. x 2000 MM.)

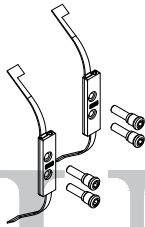

GN-616K
 KIT DE FIJACIÓN 2 PALAS

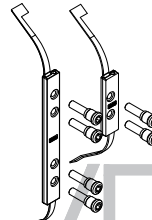

GN-617K
 KIT DE FIJACIÓN 3 PALAS

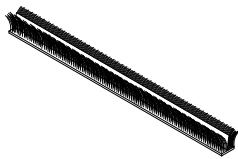

FN-110P
 FELPA CON PLÁSTICO

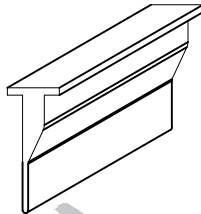

EN-1003
 VINIL ALETA

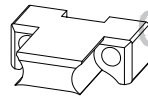

PN-0919
 SOPORTE ZOCLO
 S-50PB



PFNG-0820
 #8x1 1/2"



GN-640KF
 PASADOR

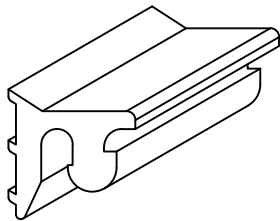

VN-E2609NE
 EMPAQUE BATIENTE

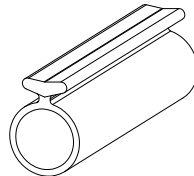

EN-2402
 EMPAQUE HONGO
 S-50PB

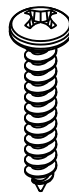

PFNG-0811
 #8x1"

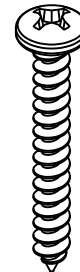

PENG-1017
 #10x1 1/2"

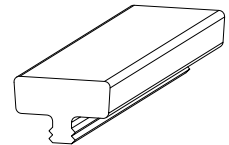

PN-0918
 CALZA VIDRIO S-50PB



GN-102D
 TAPÓN CUBRE PIJA



T21371000
T21371200
 TENSOR 3/8"

EUROVENT



CLASSIC

SERIE

S50



BATIENTE PUERTA

CLASSIC
SERIE
S50
BATIENTE PUERTA



TABLA DE DESCUENTOS PUERTA BATIENTE 1 HOJA			
CLAVE	DESCRIPCIÓN	No. DE PIEZAS	CORTE Y DESCUENTO
12617	BATIENTE	1	L-51
12617	BATIENTE	2	H
12544	CERCO DE LUJO	2	H-44
12596	ZOCLO DE LUJO	2	L-266
12569	INTERMEDIO	6	L/2-154
12569	INTERMEDIO	1	H-349
12595	J/ALTO RELIEVE	32	L/2-146
12595	J/ALTO RELIEVE	32	H/4-111
12566	S HERMETICIDAD	2	L-73
T21371000 T21371200	TENSOR 3#8"	2	L-121
VIDRIO	L	8	L/2-165
	H		H/4-130

L= ANCHO DE VENTANA
H= ALTO DE VENTANA

DESCUENTOS EN MM.

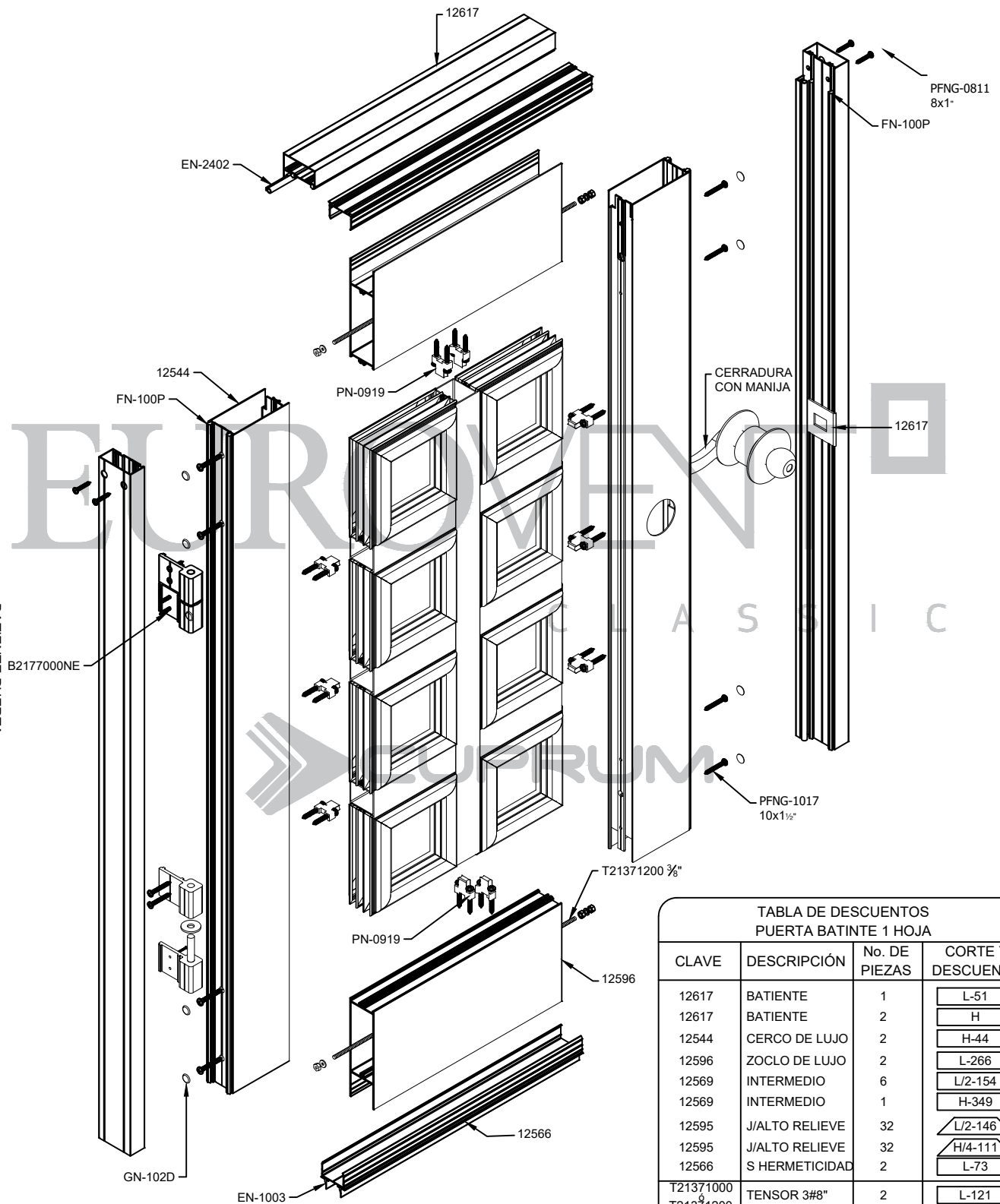
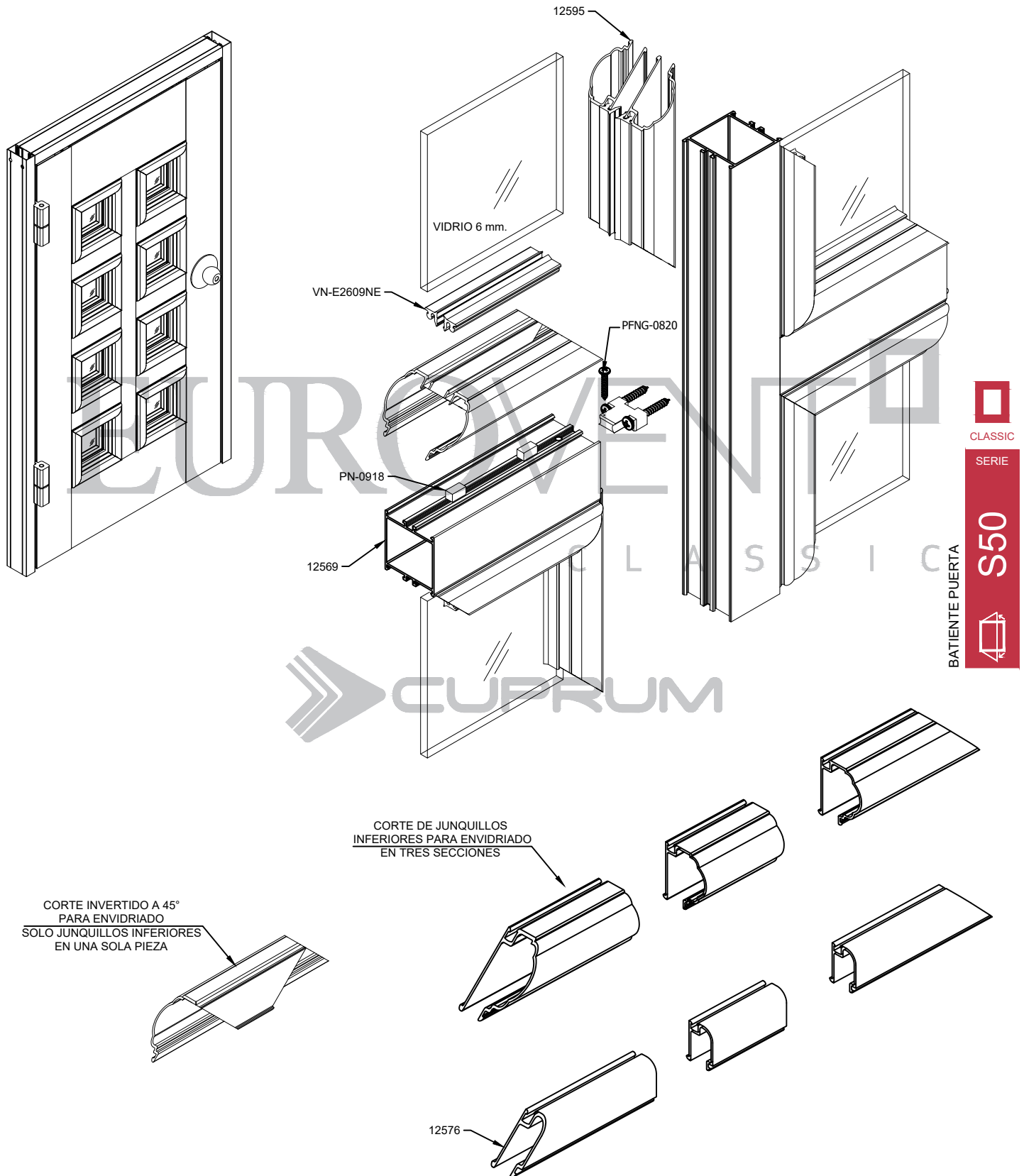

PARÁMETROS MÍNIMOS Y MÁXIMOS DE FABRICACIÓN.

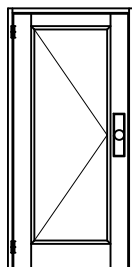

PBR-50
MÍNIMO 0.80 x 1.80
MÁXIMO 1.30 x 2.80



CLASSIC

SERIE

S50



BATIENTE PUERTA

ALUMINIO

CLAVE	DESCRIPCIÓN	PIEZAS X ATADO	LARGO STD. MTS.	PERÍMETRO ANOD. CM.	PERÍMETRO PUL. CM.
12543	JUNQUILLO	20	6.10	13.43	5.289
12544	CERCO LUJO	4	4.60	34.13	13.44
12544	CERCO LUJO	4	6.10	34.13	13.44
12562	ZOCLO	4	5.00	40.35	15.89
12566	SELLO DE HERMETICIDAD	10	6.10	24.35	9.59
12569	INTERMEDIO	4	6.10	21.94	8.63
12576	JUNQUILLO COLONIAL	20	6.10	13.14	2.74
12595	JUNQUILLO ALTO RELIEVE	12	6.10	20.15	5.17
12596	ZOCLO LUJO	2	6.10	50.51	19.89
12602	INTERMEDIO LUJO	3	6.10	33.31	13.90
12603	JUNQUILLO	20	6.10	10.47	2.30
12617	BATIENTE	6	6.10	23.91	9.41
12653	ADAPTADOR INTERMEDIO	20	6.10	14.21	5.60
12756	BATIENTE ABIERTO	8	6.10	33.31	13.11

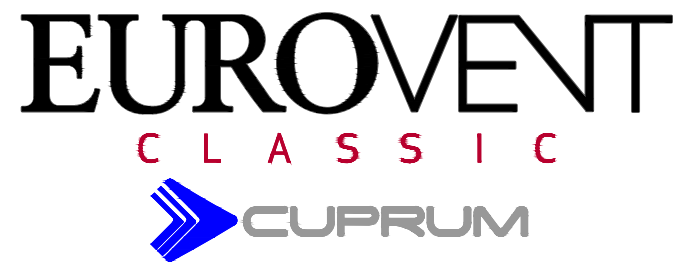

FACHADA MC-500

CLASSIC
SERIE
MC500
MURO CORTINA

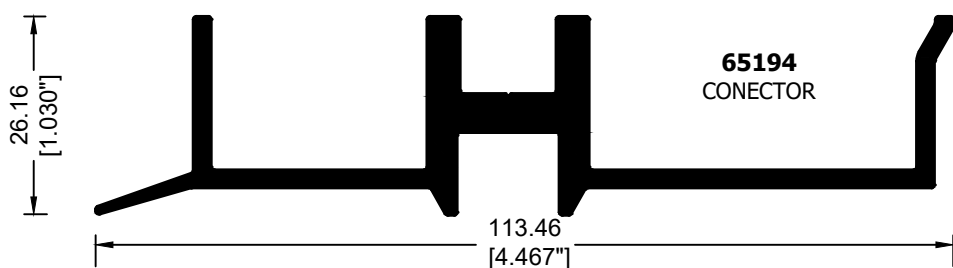
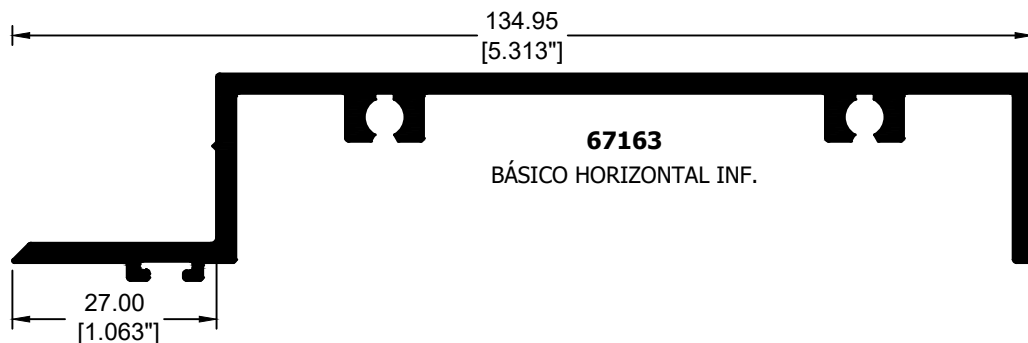
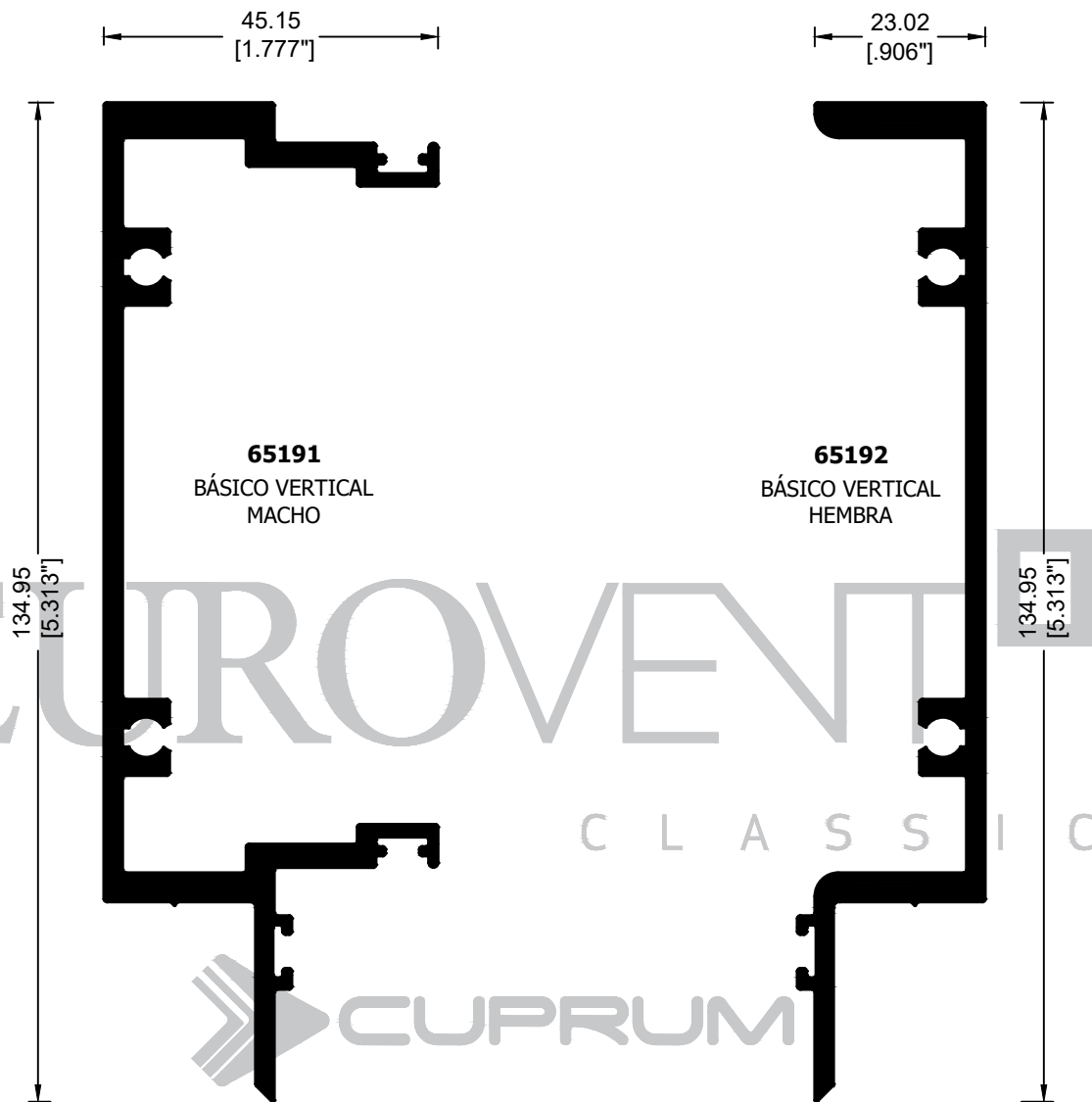

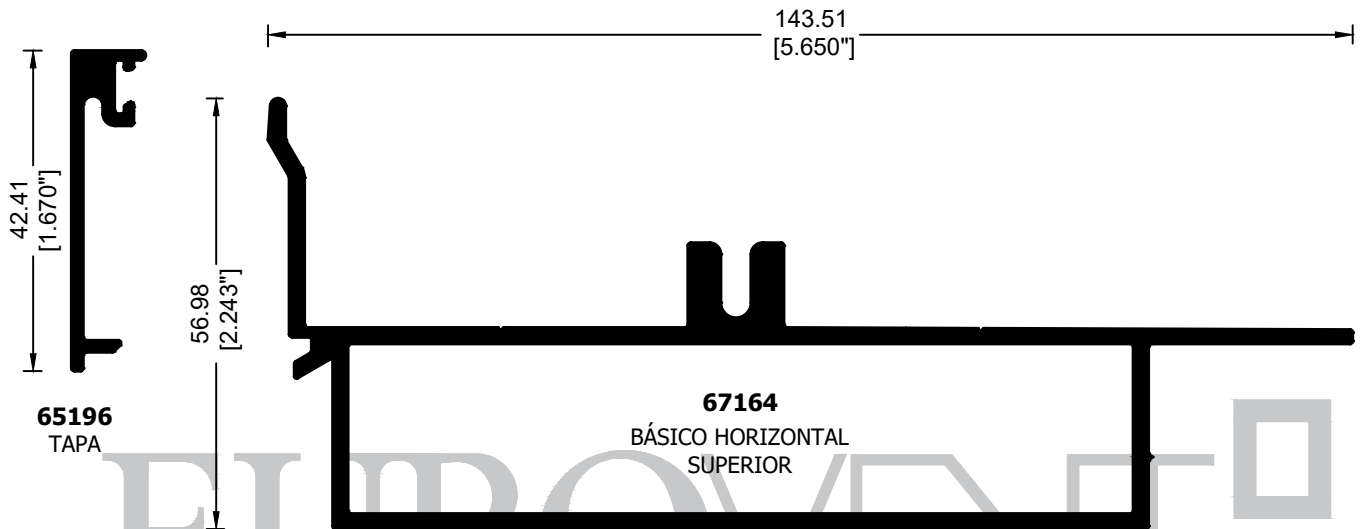

EUROVENT[®]
CLASSIC

MURO CORTINA
SERIE
MC500

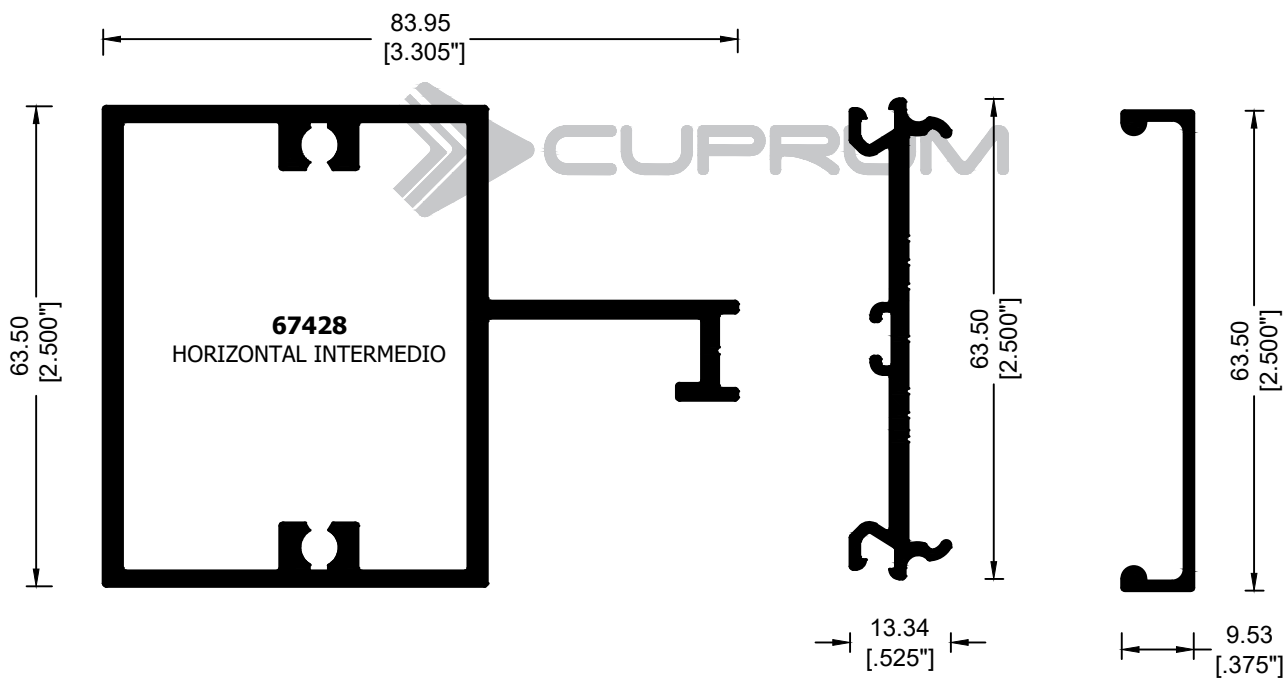

14350
MOLDURA DE UNIÓN

14349
TAPA PARA BÁSICO

109.20
[4.299"]

67430
VERTICAL ESQUINERO 90° DER.

CLASSIC
SERIE
MC500

MURO CORTINA

109.88
[4.326"]

67429
VERTICAL ESQUINERO 90° IZQ.

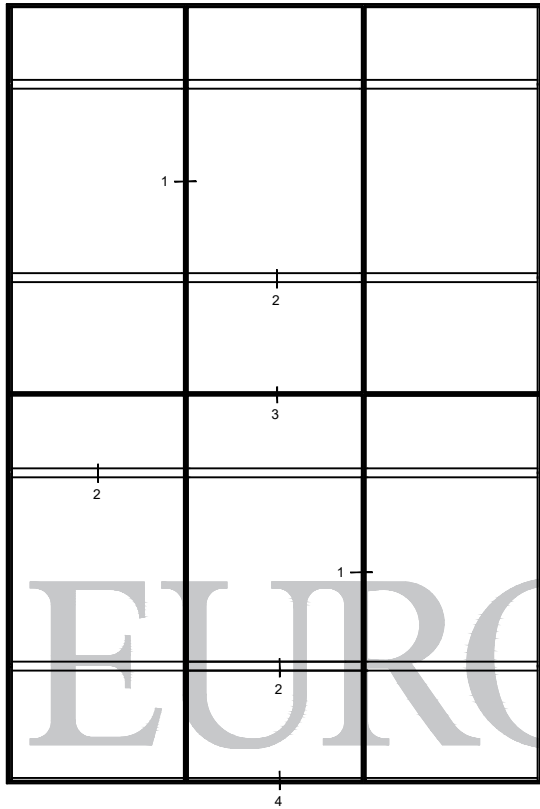

EUROVENT CLASSIC



CLASSIC

SERIE

MC500

MURO CORTINA

SECCIÓN 1

SECCIÓN 1

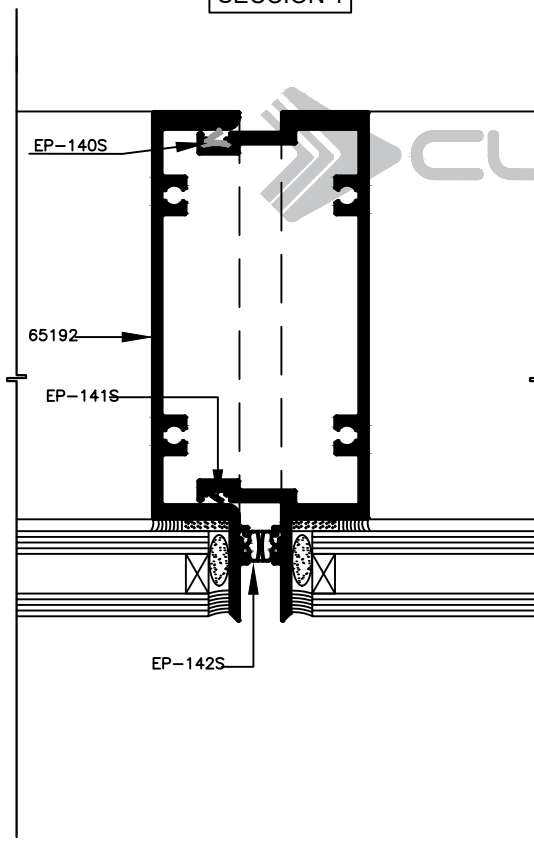

EXTERIOR

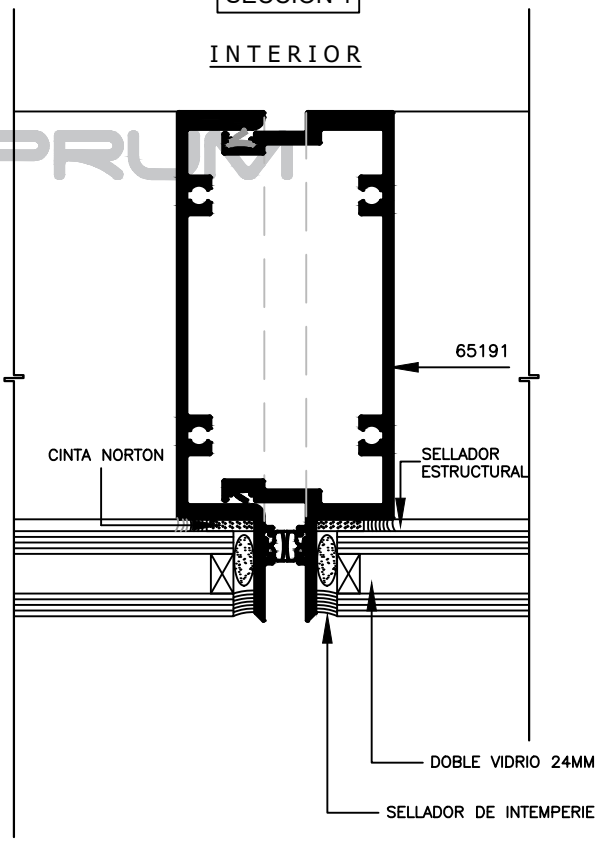

EXTERIOR

CLASSIC
SERIE
MC500
MURO CORTINA

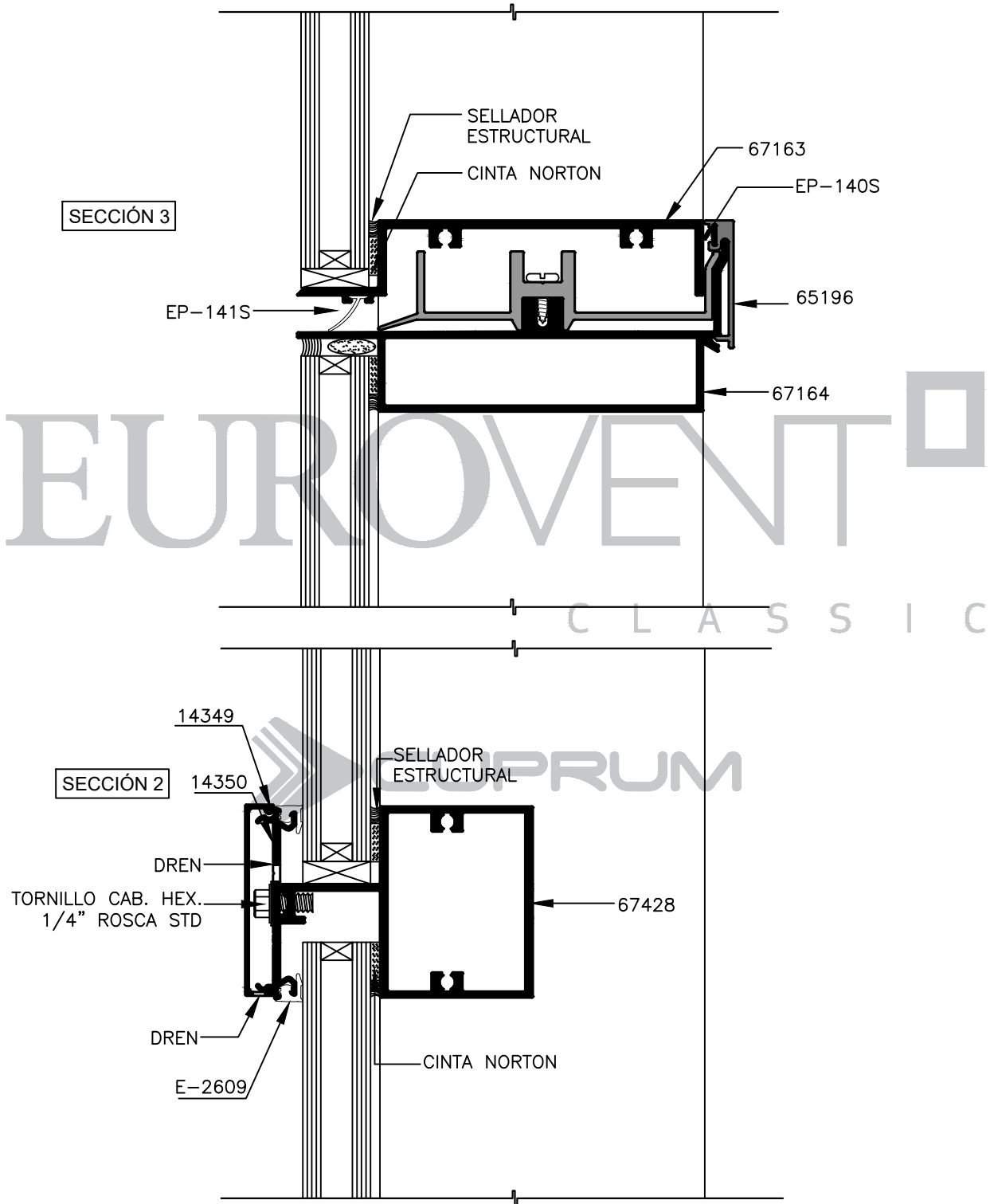

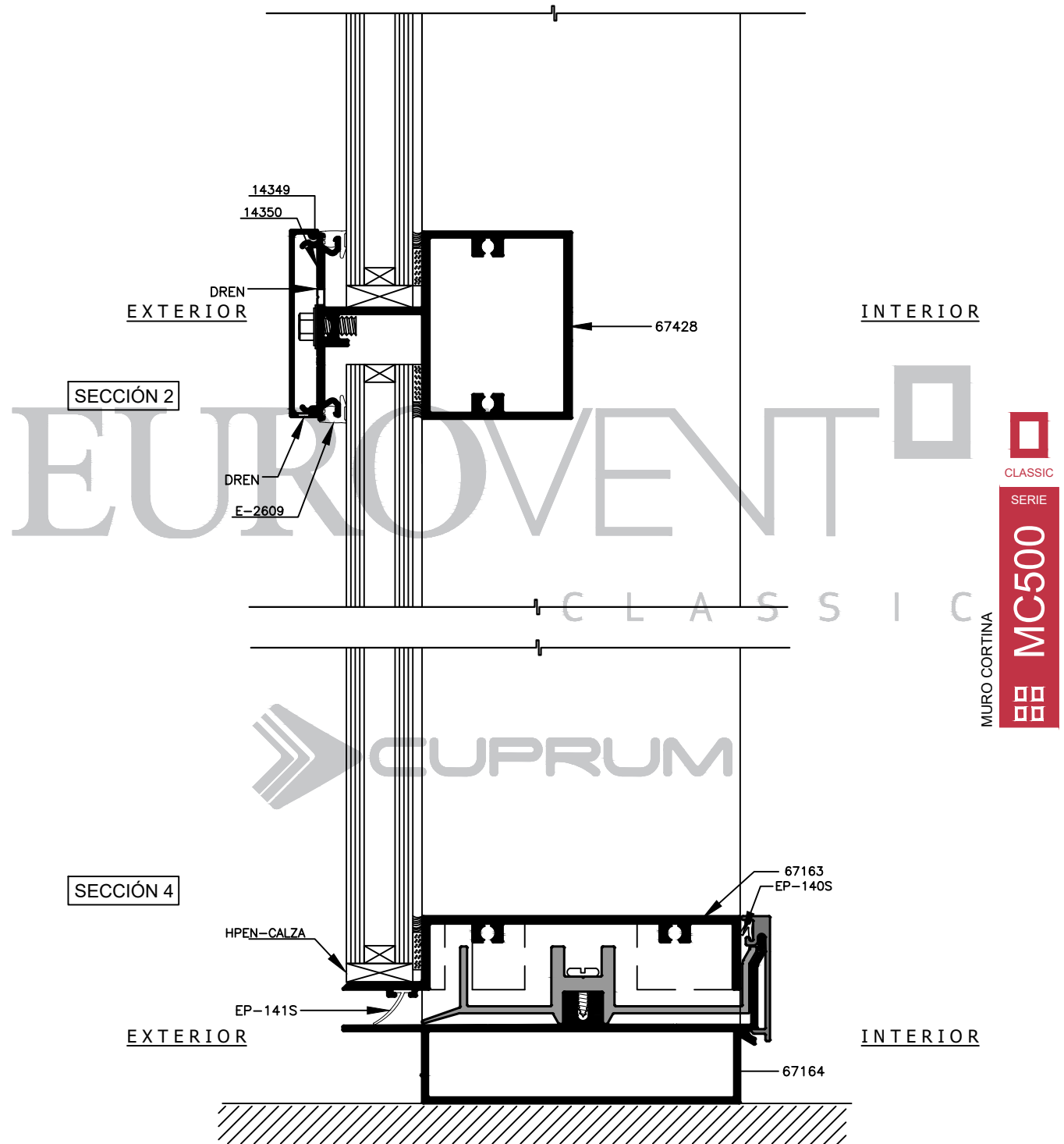

CLASSIC
SERIE
MC500
MURO CORTINA

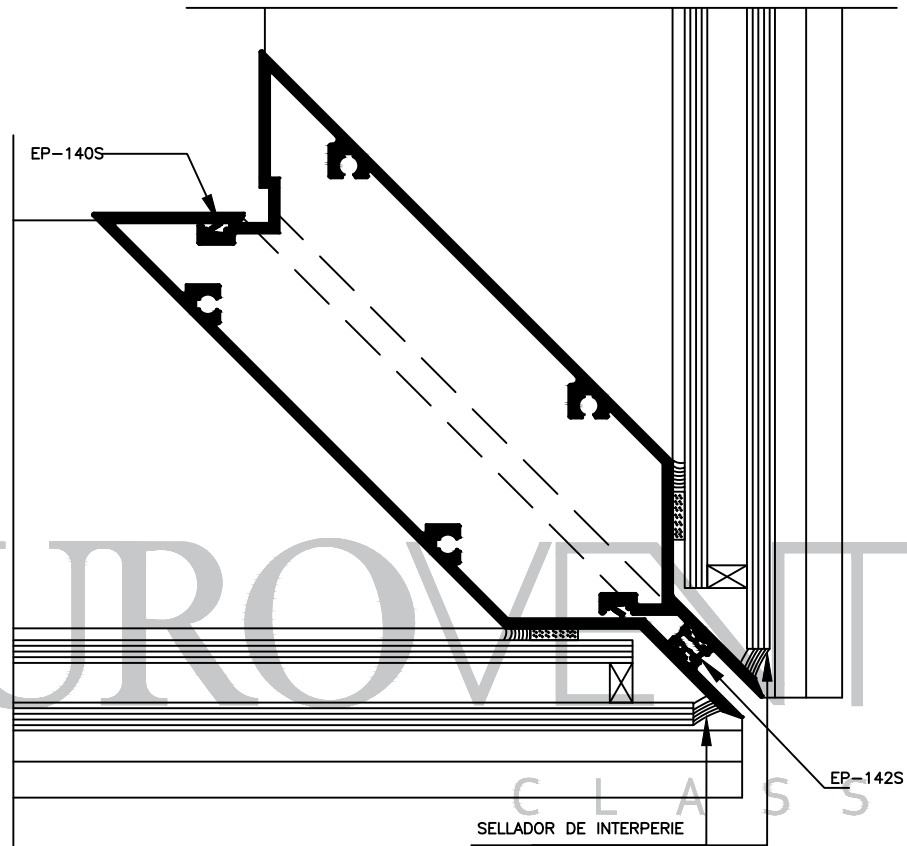

CUPRUM
ACCESORIOS

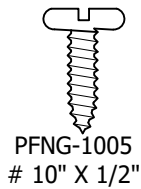

SIN ESCALA.

DEFLEXIÓN MAX. L/175

MURO CORTINA
A UNA ALTURA DE 15 METROS

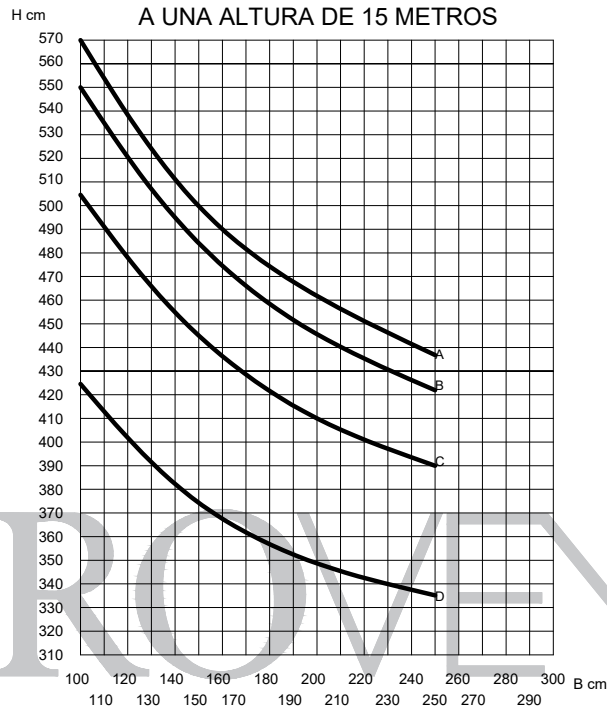

LOS LÍMITES DE FABRICACIÓN
PARA LOS PERFILES, SERÁN
LOS QUE SE ENCUENTREN DEBAJO
DE LAS CURVAS GRAFICADAS.

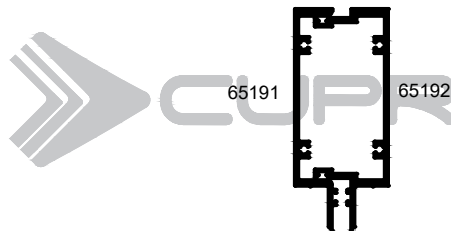

$I_{x-x} = 264.09 \text{ cm}^4$

ALEACIÓN: 6063
TEMPLE: 5

Valores de presión por velocidad de viento, a una altura de 15m

Curvas	Presión del diseño	Velocidad de viento	Zona
A	45 Kg/m ²	80 Km/h	Centro de grandes ciudades
B	50 Kg/m ²	90 Km/h	Barrios Residenciales
C	65 Kg/m ²	120 Km/h	Campo Abierto
D	124 Kg/m ²	160 Km/h	Zona Costera

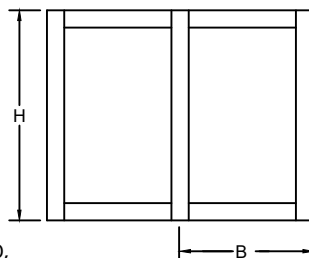

LOS LÍMITES DE UN CANCEL VAN EN FUNCIÓN DE LA
COMBINACIÓN DE RESISTENCIA DEL PERFIL DE ALUMINIO,
EL VIDRIO Y LOS ACCESORIOS QUE LO INTEGRAN.











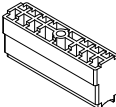
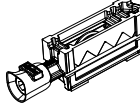

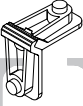
VERIFICAR QUE LA DEFLEXIÓN DEL PERFIL SEA
COMPATIBLE CON EL VIDRIO UTILIZADO.









CLASSIC
SERIE
MC500
MURO CORTINA

CLASSIC
SERIE
MC500
MURO CORTINA

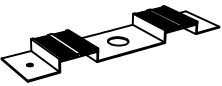
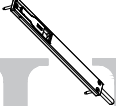
ALUMINIO					
CLAVE	DESCRIPCIÓN	PIEZAS X ATADO	LARGO STD. MTS.	PERÍMETRO ANOD. CM.	PERÍMETRO PUL. CM.
14349	TAPA PARA BASICO	12	6.10	16.54	8.25
14350	MOLDURA DE UNION	8	6.10	-	-
65191	BÁSICO VERTICAL MACHO	2	6.10	56.10	18.29
65192	BÁSICO VERTICAL HEMBRA	2	6.10	42.31	18.29
65194	CONECTOR	2	6.10	39.32	0.00
65196	TAPA	12	6.10	12.71	6.16
67163	BÁSICO HORIZONTAL INF.	2	6.10	42.69	18.31
67164	BÁSICO HORIZONTAL SUP.	2	6.10	44.06	23.32
67428	HORIZONTAL INTERMEDIO	2	6.10	32.60	16.52
67429	VERTICAL EZQUINERO IZQ.	1	6.10	58.75	27.00
67430	VERTICAL EZQUINERO DER.	1	6.10	71.53	30.86

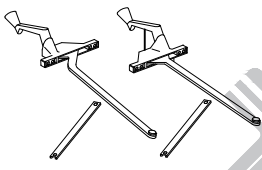
CLAVE	FIGURA	DESCRIPCION	APLICACION																	
			VC-50	VC-60	VYPC-70	VBYF-35 A	PBC-50	PBR-50	F-35	F-50	F-60	F-70	F-140							
FN-556C		CONTRA	●																	
FN-557B		FLECHA			●															
FN-557C		CONTRA			●															
GN-001		CARRETILLA 20 KG. X PZA.	●																	
GN-102D		TAPÓN CUBRE PIJA		●	●	●	●													
GN-105		TAPÓN DESAGÜE	●	●	●															
GN-123F		CARRETILLA 45 KG POR CARRETILLA - 90 POR HOJA			●															
CA-2170		CARRETILLA PARA MOSQUITERO			●															
PN-0903		GRAPA PARA MOSQUITERO				●														
B2177000NE		BISAGRA PUERTA (PAR)					●	●												
GN-190		CORTAVIENTOS S50	●																	
GN-191		GRAPA MOSQUITERO			●															
GN-192		CONECTOR DREN	●																	
GN-193		CALZA CANDADO	●																	

CLAVE	FIGURA	DESCRIPCION	APLICACION																	
			VC-50	VC-60	VYPC-70	VBYP-35 A	PBC-50	PBR-50	F-35	F-50	F-60	F-70	F-140							
GN-235		CALZA HOJA FIJA	●																	
GN-493F		CARRETILLA CAPACIDAD: 15 KG. X PZA.		●																
GN-481C		ESCUADRA DE BOTÓN																		●
GN-497A		CANDADO ANTELEVACIÓN		●																
GN-498C		ESCUADRA DE BOTÓN CONTRAMARCO		●																
GN-499		ESCUADRA DE BOTÓN HOJA		●																
GN-554		TAPA DREN	●	●	●						●	●	●	●	●	●				
GN-559F		UÑERO EMBUTIDO		●	●															
GN-616F		BISAGRA LOIRA DOS ALAS									●	●								
GN-617F		BISAGRA LOIRA TRES ALAS									●	●								
GN-616FC		CALZO PARA BISAGRA									●	●								
GN-617K		CALZO PARA BISAGRA									●	●								
GN-631T		TAPA TRASLAPE VENTANA		●																
GN-632		TAPA TRASLAPE PUERTA		●																

CLAVE	FIGURA	DESCRIPCION	APLICACION																	
			VC-50	VC-60	VYPC-70	VBYF-35 A	PBC-50	PBR-50	F-35	F-50	F-60	F-70	F-140							
GN-633T		TAPA CERCO VENTANA			●															
GN-634		TAPA CERCO PUERTA			●															
GN-635		CORTAVIENTOS VENTANA			●															
GN-638		CORTAVIENTOS PUERTA			●															
GN-640KF		PASADOR						●	●											
GN-695		CORTAVIENTOS			●															
GN-696		TAPA TRASLAPE			●															
OP1141DE4		OPERADOR DE CREMALLERA DER. E IZQ.							●											
OP1141IE4																				
PN-0301		CALZO HOJA FIJA			●															
T2137120		JALADERA MOSQUITERO									●	●								
UA800E4		UÑERO EMBUTIDO			●	●														

CLAVE	FIGURA	DESCRIPCION	APLICACION	CLAVE	FIGURA	DESCRIPCION	APLICACION															
							VC-50	VC-60	VYPC-70	VB-35 E	PBC-50	PBR-50	F-35	F-50	F-90	F-140						
HV-01		CERRADURA HV (BOTON)	CORTINA ANTICICLONICA HV	VN-E2608NE		VINIL EZ 6mm	•	•	•	•	•	•	•	•	•	•	•	•	•	•	•	•
HV-02		CERRADURA HV (C/LLAVE)	CORTINA ANTICICLONICA HV	VN-E2609NE		VINIL EZ 6mm VINIL EZ 9mm	•	•	•	•	•	•	•	•	•	•	•	•	•	•	•	•
HV-100		CARRETILLA HV	CORTINA ANTICICLONICA HV	VN-E2610NE		VINIL CUÑA PARA CRISTAL 6mm	•	•	•													
HV-101		TORNILLO HV 3"	CORTINA ANTICICLONICA HV	VN-E2611NE		VINIL ALETA	•	•	•													
HV-102		BUSHING 0.900"	CORTINA ANTICICLONICA HV	VN-E2612NE		VINIL ALETA	•															
HV-103		BUSHING 0.750"	CORTINA ANTICICLONICA HV	VN-E2613NE		VINIL HONGO	•															
HV-104		BUSHING HAT	CORTINA ANTICICLONICA HV	VN-E2615NE		VINIL BATIENTE	•	•														
HV-105		ARANDELA	CORTINA ANTICICLONICA HV	VN-E2002NE		VINIL COLA DE RATA PARA MOSQUITERO	•	•	•	•												
GN-363		PASADOR 12" (2 BARRAS Y 2 PERILLAS)	CORTINA ANTICICLONICA HV	EP-140S		VINIL MACHO																MC-500
PFNG-0805		#8 X 1/2"		EP-141S		VINIL LENGUETA																MC-500
PFNG-0817		#8 X 1"		EP-142S		VINIL HONGO																MC-500
PFNG-0820		#8x1/2"		HPEN-CALZA		CALZA DE 1/4" x 3/8" x 4"																TODAS
PFNG-1017		#10x1/2"																				
TMNG-1026		TORN P/MADERA 10X76 GAL																				
TAQ1147		TAQUETE 1/4 D/PLASTICO																				

CLAVE	FIGURA	SUP. ANOD.	SUP. EXPUESTA	LARGO STD.	PIEZAS x ATADO	PAGINA	CLAVE	FIGURA	SUP. ANOD.	SUP. EXPUESTA	LARGO STD.	PIEZAS x ATADO	PAGINA
5173		9.5	3.85	6.1	20	65 184	12507		15.08	3.48	6.1	20	16
11409		18.3	7.30	6.1	12	125	12513		36.48	9.56	6.1	4	16
11411		14.17	11.36	6.1	8	125	12542		24.41	17.38	4.6	6	205
12263		39.29	19.26	6.1	4	124	12543		13.42	2.98	6.1	20	17 206 224
12273		17.42	12.45	6.1	8	184	12544		33.94	26.91	4.6	4	224
12274		22.31	11.71	6.1	4	184	12545		23.54	10.47	6.1	4	205
12275		21.14	21.14	6.1	8	184	12547		38.54	16.74	6.1	6	123
12276		23.71	8.09	6.1	4	184	12562		40.35	21.34	6.1	4	205 225
12277		21.69	10.39	6.1	4	184	12563		13.06	5.55	6.1	20	17
12393		4.56	4.56	6.1	40	184	12566		20.79	0.0	6.1	10	205 225
12428		10.00	8.19	6.1	22	125	12569		23.98	9.08	6.1	4	205 224
12437		37.26	19.00	6.1	4	124	12576		12.95	2.72	6.1	20	206 224
12456		23.33	9.53	6.1	8	125 184	12581		21.45	4.90	6.1	8	17
12504		42.00	12.76	6.1	4	16	12592		44.08	11.50	6.1	4	17
12505		23.17	3.43	6.1	8	16	12593		35.6	8.93	6.1	4	17
12506		35.43	9.50	6.1	6	16	12594		18.35	2.04	6.1	8	17

CLAVE	FIGURA	SUP. ANOD.	SUP. EXPUESTA	LARGO STD.	PIEZAS x ATADO	PAGINA	CLAVE	FIGURA	SUP. ANOD.	SUP. EXPUESTA	LARGO STD.	PIEZAS x ATADO	PAGINA
12595		20.15	5.17	6.1	12	224	13617		52.72	12.20	6.1	3	50
12596		48.79	30.57	6.1	2	225	13829		60.01	17.50	6.1	2	51
12602		35.31	20.41	4.6	3	225	13830		55.58	12.65	6.1	4	51
12603		10.21	2.30	6.1	20	206 224	13831		34.44	9.53	6.1	6	51
12606		37.33	10.82	6.1	8	7	13832		19.8	5.57	6.1	16	51
12607		16.72	1.91	6.1	16	7	14384		22.60	10.16	6.1	8	52
12608		30.23	8.61	6.1	8	7	14385		50.20	22.81	6.1	4	52
12609		12.91	2.81	6.1	20	7	14411		14.35	11.06	6.1	5	125
12617		23.91	15.64	6.1	6	206 224	14412		3.22	0.0	6.1	24	125
12653		14.21	11.45	6.1	20	224	14702		21.65	11.23	6.1	20	125
12664		36.46	15.39	6.1	6	123	14918		20.84	7.82	6.1	12	125
12756		33.31	15.64	6.1	8	206 224	15043		4.39	4.39	6.1	32	184
13363		23.98	12.63	6.1	8	184	18409		32.53	25.3	5.0	6	124
13614		61.6	25.20	6.1	3	50	18411		28.96	21.73	6.1	4	123
13615		32.27	7.14	6.1	6	50	18413		15.91	13.08	6.1	12	125
13616		21.40	6.44	6.1	12	50	18419		30.10	24.53	5.0	4	124

CLAVE	FIGURA	SUP. ANOD.	SUP. EXPUESTA	LARGO STD.	PIEZAS x ATADO	PAGINA
18421		26.53	20.96	6.1	4	123
22504		44.92	13.96	6.1	4	38
22513		40.98	9.57	6.1	4	38
22581		24.22	5.25	6.1	8	40
22592		47.13	16.02	6.1	4	39
22593		38.88	9.22	6.1	4	39
22594		21.08	3.11	6.1	8	39
32506		38.54	9.57	6.1	6	38
32563		15.95	6.72	6.1	12	40
42505		26.07	4.63	6.1	8	38
42507		16.51	4.42	6.1	8	38
50701		9.27	4.75	6.1	30	65 125
62042		16.42	3.30	6.1	12	37
62066		31.18	12.42	6.1	8	90
62070		15.92	7.40	6.1	16	91
62072		14.03	3.23	6.1	20	27

CLAVE	FIGURA	SUP. ANOD.	SUP. EXPUESTA	LARGO STD.	PIEZAS x ATADO	PAGINA
62078		11.19	6.20	6.1	24	91
62079		26.05	6.94	6.1	8	27
62140		44.51	10.07	6.1	4	52
62170		28.90	6.66	6.1	8	40
62374		55.82	36.74	6.1	4	126
64640		31.49	23.66	6.1	6	167
64641		39.90	18.75	6.1	4	167
64642		39.04	31.99	6.1	4	167
64643		13.50	4.86	6.1	6	167
64644		41.08	13.72	6.1	4	168
64645		29.52	7.24	6.1	4	168
64646		50.22	30.37	6.1	2	168
65191		56.10	18.29	6.1	2	240
65192		42.31	18.29	6.1	2	240
65194		39.32	NA	6.1	2	240
65196		12.71	6.16	6.1	12	241

CLAVE	FIGURA	SUP. ANOD.	SUP. EXPUESTA	LARGO STD.	PIEZAS x ATADO	PAGINA
67163		42.69	18.31	6.1	2	240
67164		44.06	23.32	6.1	2	241
67428		32.60	16.52	6.1	2	241
67429		58.75	27.00	6.1	2	242
67430		71.53	30.86	6.1	2	242
67739		70.83	51.21	6.1	2	225
67894		32.94	15.19	6.1	4	90
67896		32.40	16.52	6.1	4	90
67899		17.29	6.55	6.1	12	91
68299		32.95	17.23	6.1	4	91
68300		45.35	22.12	6.1	4	90
68337		30.18	14.42	6.1	4	91
68842		45.34	17.27	6.1	6	65
68843		30.61	12.70	6.1	10	65
68844		26.81	18.57	6.1	8	65
68845		35.59	16.10	6.1	8	65

CLAVE	FIGURA	SUP. ANOD.	SUP. EXPUESTA	LARGO STD.	PIEZAS x ATADO	PAGINA
68846		21.10	10.54	6.1	8	65
68847		15.17	9.32	6.1	20	65
68850		33.19	17.02	6.1	8	65
69356		12.91	4.24	6.1	20	65
69368		12.01	4.11	6.1	20	65
72373		50.53	26.83	6.1	2	126
74272		11.17	9.59	6.1	18	206 224
78407		40.04	19.52	6.1	4	123
78408		34.95	5.64	6.1	8	123
78410		34.29	21.38	6.1	4	124
78412		30.71	17.81	6.1	4	123
78420		31.86	21.38	6.1	4	124
78422		28.29	17.81	6.1	4	123
81642		4.30	2.20	6.1	108	184

EUROVENT[□]

EUROVENT

C L A S S I C

PLANTA Y VENTAS EN MÉXICO

Av. La Presa # 290, Col. San Juan Ixhuatepec
Tlanepantla, Edo. de México, C.P. 54180
Tels.: (55) 5 746 7900 / (55) 5746 7800
(55) 5746 7975

PLANTA Y VENTAS EN MONTERREY

Av. Diego Días de Berlanga # 132 Nte.
Col. El Nogalar, San Nicolás de los Garza, N.L.
C.P. 66480
Tels.: (81) 8305 8500
(81) 8305 8600

PLANTA Y VENTAS EN GUADALAJARA

Antigua Carretera a Chapala # 3345
Alamo Industrial
Guadalajara, Jalisco
C.P. 44470
Tel.: (33) 3666 9000

SALA DE EXHIBICION CIUDAD DE MÉXICO

Altavista #79 entre Av. Revolución y
Camino a Desierto de los Leones,
Col. San Angel Inn, Del. Álvaro Obregón, Cd. México.
Tel: (55) 5550 3690, (55) 5616 6674, (55) 5616 7308

SALA DE EXHIBICION MONTERREY

Plaza Tanarah/ Av Vasconcelos 345 Ote.,
Segundo piso Local 17 y 18,
San Pedro Garza García, Nuevo León.
Tel: (81) 8356 6529, 8356 6611, 8356 6263

