

S-INTERLOCKING roof tiles

Versatility, innovation
and aesthetics



TEJAS BORJA

Since 1899



CONTENTS

- pp. 03-07** RANGE OF FINISHES
- pp. 08-15** S-INTERLOCKING ROOF TILES
- pp. 16-22** ACCESSORIES
- pp. 23-25** S-INTERLOCKING ROOF TILES INSTALLATION
- pp. 26-31** SYSTEMS & ROOF COMPONENTS
- pp. 32-35** PROJECTS



TBS+

NEW S-interlocking roof tile model, whose similarity to curved tiles when installed on roofs is far more faithful to Arabic-style tiles.

P.16



TB-10 Tech

Technological evolution in the large size S-interlocking roof tile format. Its perfect definition and finish simulate curved roof tile aesthetics.

P.18



TB-12

Classic S-interlocking roof tiles small format. Thanks to its versatility and aesthetic, the S-Interlocking roof tile is usually the first choice of architects and roofers.

P.20



TB-4

Exclusive one-piece high-profile S-interlocking roof tile design with curved roof tile effect (appearance of 50 units per sq.m., with the installation of just over 12 tiles). Adapts to small deviations such as false angle sections and rounded gables.

P.21

NB: The representation of tile colour is approximate and subject to change due to the natural colours of the clays. Check our range of finishes for different accessories by calling + 34 96 279 80 16 or by email at: info@tejasborja.com.

Versatility, innovation and aesthetics

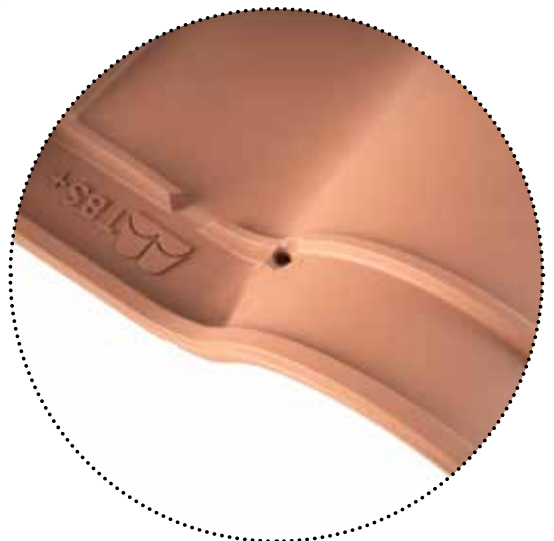

- **Secure support on batten**
- **Double overlapping, guaranteed watertightness** ..
- **Easy installation, pre-marked hole**
- **High strength, reinforced ribs**

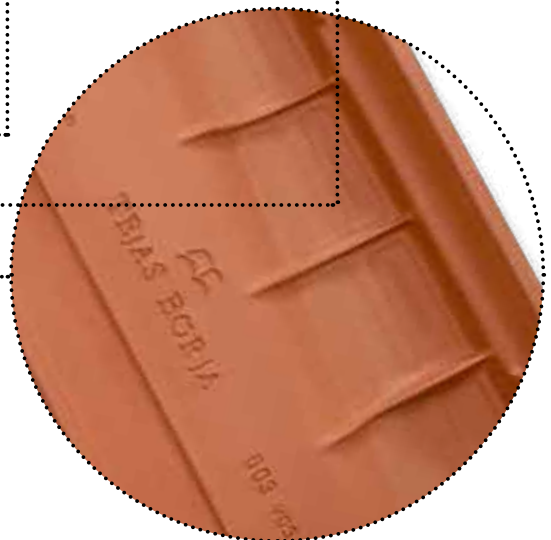

S-interlocking roof tiles designed with a discontinuous lateral and longitudinal multiple interlocking system, which ensures the watertightness of the roof from a 30% slope upwards.

Easy to install, with flat support on a batten and pre-marked hole for mechanical fixing.



Minimum
Slope 30%



Easy to
install



Borja JET

Ceramic inkjet technology in ceramic roof tiles

The perfect fusion of nature and Inkjet technology to bring the charm of historic roofs to our tiles.

The perfect union of nature and technology, our Ceramic Cotto series recreates the colours and tones that develop naturally over time in ceramic tiles.

Unique and exclusive finishes on S-interlocking roof tiles, obtained using the latest technology in ceramic tile decoration: ceramic digital printing.

Borja LINE

Analogue technology based on the application of engobes and ceramic deposits. Unique aged and monochrome colours.





Nature



Centenaria



Plain Colour

Borja DECOR

High gloss glazed roof tiles
which prevent premature ageing,
delaying moss formation.



Glazed



Matt



Metallic



Crystal



Irisados

TBS+

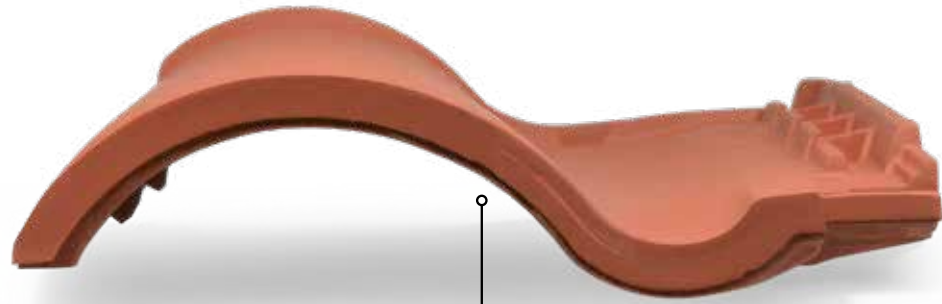

- Similar to curved roof tiles, "S" shape
- Batten distance variable
- Side overlap



Easy to install



Longitudinal Overlap
15 mm



Side overlap
10 mm

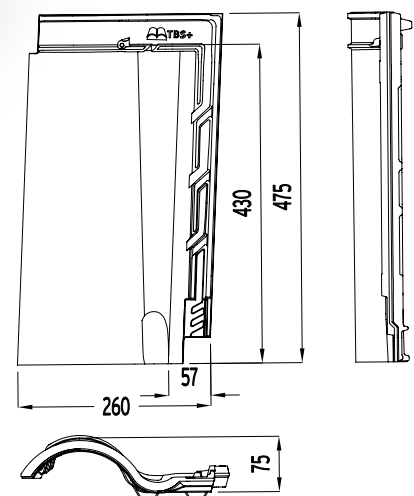

| | |
|--|---------------------------|
| Dimensions | 475 mm x 260 mm |
| Minimum pitch recommended | 30% - 17° (*) |
| Weight | 3.50 Kg./unit |
| Units / sq. m. | 11 units |
| Units per LM eave line | 4.52-4.74 units |
| Useful width | 221-211 mm |
| Useful length (Batten distance) VARIABLE | 395-410 mm |
| Pallet data | (X5) 280 units / 1027 Kg. |
| Minimum order** | 7 units |



Approximate values: If the roof tiles are installed on battens, the useful length must be calculated on site. A tolerance of +2% on the dimensions of the roof tiles is allowed according to UNE-EN 1024.

Type: Double lateral overlapping and double longitudinal overlapping. Installation must comply with the Code of Practice regarding the design and fixing of roofs with clay roofing tiles in application in the region and Tejas Borja specifications.

(*) Check table of minimum roof pitch values depending on roof length and geographical area.

** All tiles are subject to a minimum order quantity and must be multiples thereof..

NATURE



Red



Moss Red



Fosca



Manoir®



Lamalou®



Castilla

CENTENARIA®



Ground

NB: TBS+ Centenaria finishes are untextured. Finishes on TBS+ tiles are applied to one side only.





- Adapts to various batten spacings
- Curved tile aesthetic
- Clearly-defined finish
- BORJAJET finishes

> Klinker



Mountain climate



Longitudinal Overlap 10 mm

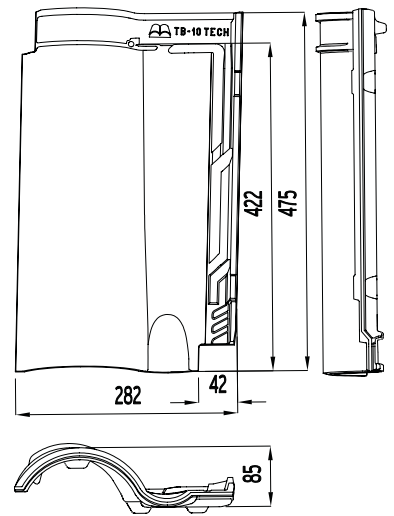

| | |
|--|---------------------------|
| Dimensions | 475 mm x 282 mm |
| Minimum pitch recommended | 30% - 17° (*) |
| Weight | 3.45 Kg./unit |
| Units / sq. m. | 10.3 units |
| Units per LM eave line | 4.25-4.54 units |
| Useful width | 232 mm |
| Useful length (Batten distance) VARIABLE | 395-405 mm |
| Pallet data T7 - Standard | (T7) 210 units. / 747 Kg. |
| Minimum order** | 6 units |



Approximate values: If the roof tiles are installed on battens, the useful length must be calculated on site. A tolerance of +2% on the dimensions of the roof tiles is allowed according to UNE-EN 1024.

The certified characteristics for the **NF** Terracotta tiles are compliant with the requirements of the NF EN 1304 standard: Structural faults, the geometric characteristics, resistance to flexural strength, impermeability (class 1), frost resistance according to the NF EN 539-2 standard for all products made with red mixture. AFNOR Certification: 11 rue Francis de Pressensé // 93571 LA PLAINE SAINT-DENIS CEDEX // www.marque-nf.com.

Type: Double lateral overlapping and double longitudinal overlapping. Installation must comply with the Code of Practice regarding the design and fixing of roofs with clay roofing tiles in application in the region and Tejas Borja specifications.

(*) Check table of minimum roof pitch values depending on roof length and geographical area.

** All tiles are subject to a minimum order quantity and must be multiples thereof.

PLAIN COLOUR



Chocolate



Graphite

BorjaJET - Inkjet Technology



Entrepins



Irati

CENTENARIA



Ground



Sand

NATURE



Red



Edetania®

NATURE

Check availability



Moss Red



Fosca



Manoir®



Lamalou®

TB-12

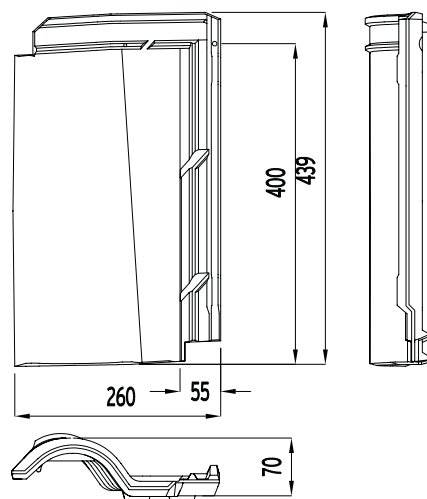

| | |
|---------------------------------|--------------------------------|
| Dimensions | 439 mm x 260 mm |
| Minimum pitch recommended | 30% - 17° (*) |
| Weight | 3.05 Kg./unit |
| Units / sq. m. | 12.8 units |
| Units per LM eave line | 5 units |
| Useful width | 205 mm |
| Useful length (Batten distance) | 370mm / 380mm (white clay) |
| Pallet data | (X3/X5) 280 units. / 865 Kg. |
| X3 / X5 - Standard | (X1) 240 units. / 735 Kg. |
| X1 - Exclusive truck | (X6) 210 units. / 646 Kg. |
| X6 / X7 - Exclusive container | (X7) 140 units. / 430 Kg. |
| Minimum order** | 7 units / 6 units (white clay) |



Approximate values: If the roof tiles are installed on battens, the useful length must be calculated on site. A tolerance of +2% on the dimensions of the roof tiles is allowed according to UNE-EN 1024.

The certified characteristics for the **NF** Terracotta tiles are compliant with the requirements of the NF EN 1304 standard: Structural faults, the geometric characteristics, resistance to flexural strength, impermeability (class 1), frost resistance according to the NF EN 539-2 standard for all products made with red mixture. AFNOR Certification: 11 rue Francis de Pressensé // 93571 LA PLAINE SAINT-DENIS CEDEX // www.marque-nf.com.

Type: Double lateral overlapping and double longitudinal overlapping. Installation must comply with the Code of Practice regarding the design and fixing of roofs with clay roofing tiles in application in the region and Tejas Borja specifications.

(*) Check table of minimum roof pitch values depending on roof length and geographical area.

** All tiles are subject to a minimum order quantity and must be multiples thereof.

TB-12 / FINISHES

NATURE



Red



Aged Red



Fosca



Manoir®



Lamalou®



Bidasoa®



Castilla



Shaded White



Aged White



Vilavella®



R. Rosarena®



Brown

CENTENARIA®



Ground



Mediterrània®

PLAIN COLOUR



Graphite

NB:
 Finishes on TB-12 tiles are applied to one side only, except Graphite.
 The Brown finish is the colour of the clay.
 Vilavella finish is available in BorjaBLANC (white clay) and also red clay.

- roof tiles with texture - white clay

BorjaDECOR
 Check availability

- Adaptable to rounded areas
- Imitation curved tile, gives effect of 50 tiles / sq. m.
- Free lateral fitting

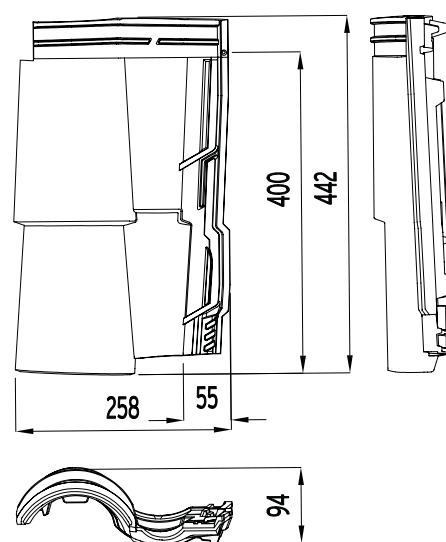

| | |
|---------------------------------|--------------------------|
| Dimensions | 442 mm x 258 mm |
| Minimum pitch recommended | 30% - 17° (*) |
| Weight | 3.40 Kg./unit |
| Units / sq. m. | 12.8 units |
| Units per LM eave line | 5 units |
| Useful width | 205 mm |
| Useful length (Batten distance) | 370 mm |
| Pallet data | (X1) 240 units / 799 Kg. |
| X1 - Standard | (X4) 180 units / 600 Kg. |
| X4 - Exclusive container | |
| Minimum order** | 6 units |



Approximate values: If the roof tiles are installed on battens, the useful length must be calculated on site. A tolerance of $\pm 2\%$ on the dimensions of the roof tiles is allowed according to UNE-EN 1024.

Type: Double lateral overlapping and double longitudinal overlapping. Installation must comply with the Code of Practice regarding the design and fixing of roofs with clay roofing tiles in application in the region and Tejas Borja specifications.

(*) Check table of minimum roof pitch values depending on roof length and geographical area.

** All tiles are subject to a minimum order quantity and must be multiples thereof.

NATURE



Red























Vilaterra®

NB: Finishes on TB-4 tiles are applied to one side only.

BorjaDECOR
Check availability



ACCESSORIES - S-INTERLOCKING ROOF TILES

| | | | |
|---|--|---|--|
|  <p>1</p> <p>Circular Ridge 43 x 23 x 9 cm. 2.5 Units/ml / 2.90 Kg. Max. Slope 47%-25.10°</p> |  <p>2</p> <p>Circular Hip Starter 43 x 20 x 8.5 cm. 2.95 Kg.</p> |  <p>3</p> <p>Circular 3 Ways 37.5 x 23 x 9.5 cm. 4.20 Kg.</p> |  <p>4</p> <p>Circular 4 Ways 40 x 40 x 15 cm. 4.80 Kg.</p> |
|  <p>5</p> <p>Circular Straight End Cap 7.5 x 24.5 x 27.9 cm. 2.40 Kg.</p> |  <p>6</p> <p>Circular Curved End Cap 17.5 x 26.7 x 27 cm. 2.80 Kg.</p> |  <p>7</p> <p>Cover+ Ridge 44 x 28.5 x 10.5 cm. 2.5 Units/ml / 3.40 Kg. Max. Slope 47%-25.10°</p> |  <p>8</p> <p>Cover+ Hip Starter 43.5 x 23 x 8.5 cm. 3.20 Kg.</p> |
|  <p>9</p> <p>Cover+ 3 Ways 32.5 x 42.5 x 14.5 cm. 3.10 Kg.</p> |  <p>10</p> <p>Cover+ 4 Ways 42 x 42 x 14 cm. 4.00 Kg.</p> |  <p>11</p> <p>Cover+ Straight End Cap 6.5 x 27 x 31 cm. 2.00 Kg.</p> |  <p>12</p> <p>Cover+ Curved End Cap 14.7 x 27.5 x 29.5 cm. 2.25 Kg.</p> |
|  <p>13</p> <p>Under Ridge 24 x 12.2 x 5.6 cm. 5 Units/ml (on monopitch) 0.80 Kg.</p> |  <p>14</p> <p>Straight Edge Left 47 x 9 x 17 cm. 2.5 Units/ml 3.00 Kg.</p> |  <p>15</p> <p>Straight Edge Right 47 x 9 x 17 cm. 2.5 Units/ml 3.00 Kg.</p> |  <p>16</p> <p>Curved Edge Left 47 x 24.5 x 16 cm. 2.5 Units/ml / 3.30 Kg.</p> |
|  <p>17</p> <p>Curved Edge Right 47 x 24.5 x 16 cm. 2.5 Units/ml / 3.30 Kg.</p> |  <p>18</p> <p>Universal Angular Edge (on monopitch) 43 x 14.5 x 14.5 cm. 2.5 Units/ml / 2.85 Kg.</p> |  <p>19</p> <p>Chimney d.140 22.5 Øext-20 Øint x 23.5 cm. 2.35 Kg.</p> |  <p>20</p> <p>Chimney d.130 20.4 Øext-18 Øint x 20 cm. 2.15 Kg.</p> |
|  <p>21</p> <p>Ventilation Cap 24.5 Øext-22 Øint x 6 cm. 1.70 Kg.</p> | | | |

TBS+



22

Chimney Carrier
TBS+ d.130
47.5 x 26 x 11.5 cm.
3.5 Kg.



23

Half TBS+
48 x 16.5 x 5.5 cm.
1.9 Kg.



24

Tile and a Half TBS+
47.5 x 38 x 8.5 cm.
4.9 Kg.



25

Ventilation TBS+
47.5 x 26.5 x 7.2 cm.
3.6 Kg.

TB - 10 Tech



26

Chimney Carrier
TB-10 Tech d.140
47.5 x 28.2 x 18 cm.
20 Øext-14 Øint / 4.6 Kg.



27

Half
TB-10 Tech
47.5 x 18 x 7.5 cm.
2.10 Kg.



28

Tile and a Half
TB-10 Tech
47.5 x 40 x 7.5 cm.
5.40 Kg.



29

Ventilation
TB-10 Tech
47.4 x 28.2 x 7.5 cm.
3.6 Kg.

TB - 12



30

Chimney Carrier TB-12 d.130
43.9 x 26 x 12 / 16 cm. Øext-12
Øint 4.15 Kg.



31

Half TB-12
43.9 x 15.5 x 5.5 cm.
2.50 Units/ml
1.80 Kg.



32

Tile and a Half TB-12
43.9 x 36 x 7 cm.
2.50 Units/ml
4.50 Kg.



33

Ventilation TB-12
43.9 x 26 x 7 cm.
3.20 Kg.



34

Pan Decocurva TB-12
47 x 16 x 7 cm.
5.00 Units/ml
2.50 Kg.

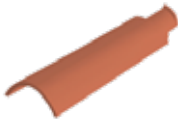

35

Cover Decocurva TB-12
47 x 17 x 7 cm.
5.00 Units/ml
2.00 Kg.

TB - 4

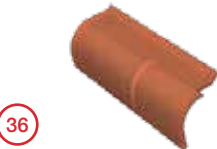

36

Curved Edge TB-4 Left
43 x 13.5 x 14 cm.
2.50 Units/ml
2.55 Kg.



37

Curved Edge TB-4 Right
43 x 13.5 x 14 cm.
2.50 Units/ml
2.55 Kg.



38

Chimney Carrier TB-4 d.130
44.2 x 26 x 18 cm.
16 Øext-13 Øint
4 Kg.



39

Ventilation TB-4
44.2 x 26 x 10 cm.
3.50 Kg.



40

Half TB-4 / Cover Decocurva TB-4
A: Right lateral finish
B: Eaves
44 x 15.5 x 6 cm. 5 Units/ml / 1.83 Kg.



41

Pan Decocurva TB-4
46 x 16 x 6 cm.
5.00 Units/ml
2.60 Kg.

A tolerance of +2% on the dimensions of the roof tiles and clay accessories is allowed according to UNE-EN 1024. Dimensions in centimeters. Check finishing colours for accessories. Accessories for ridge line and edges in Irati finish are available in compatible colours, not digital. Accessories for ridge line and edges in Entrepins finish are available in digital version as well as in compatible colours, not digital.

ACCESSORIES

1 Circular Ridge

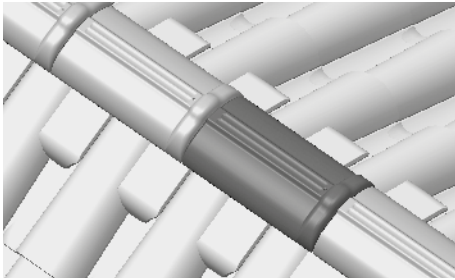
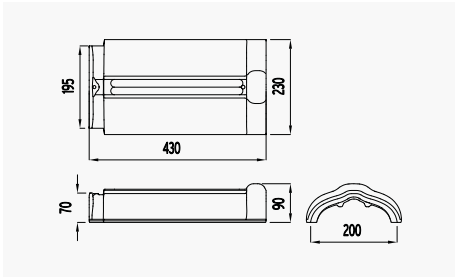

2 Circular Hip Starter

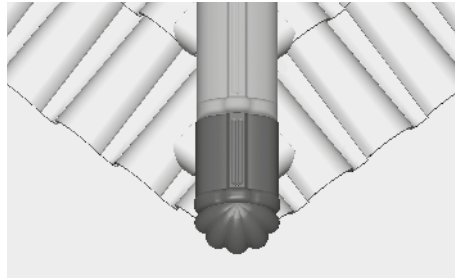
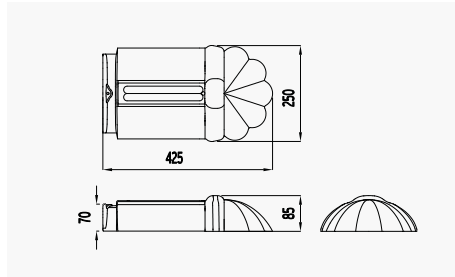

3 Circular 3 Ways

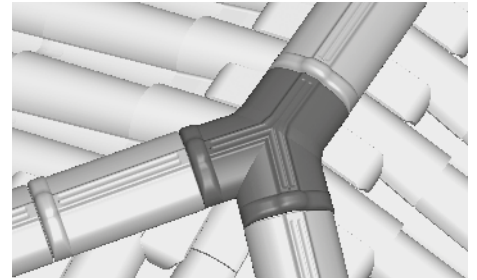
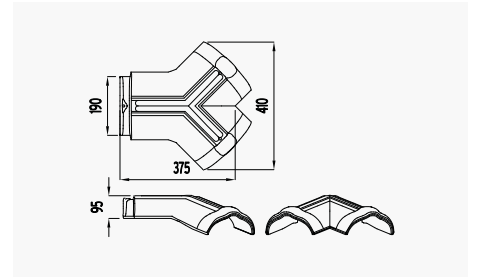

4 Circular 4 Ways

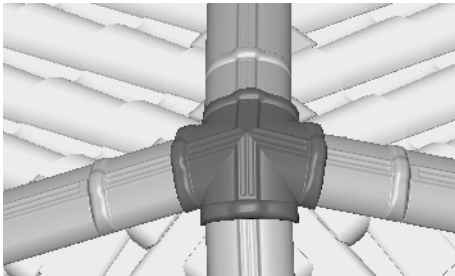
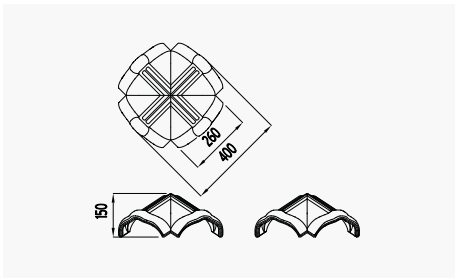

5 Circular Straight End Cap

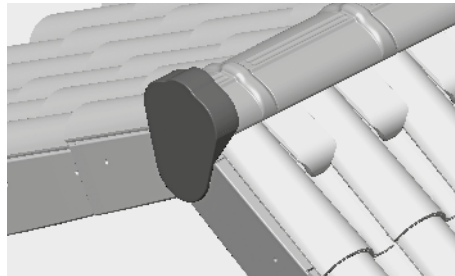
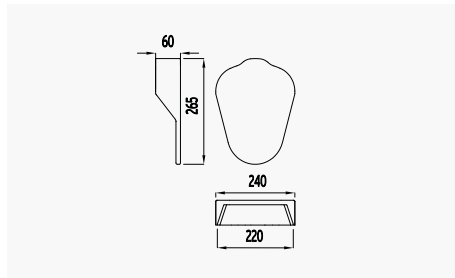

6 Circular Curved End Cap

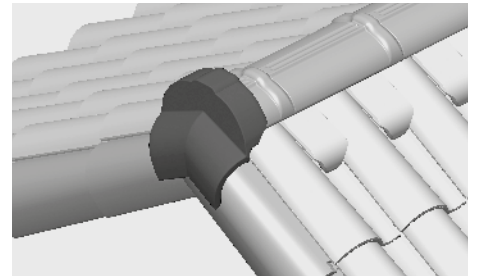
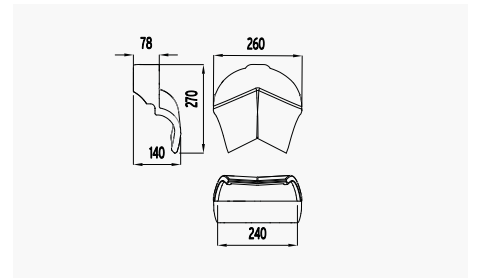

7 Cover+ Ridge

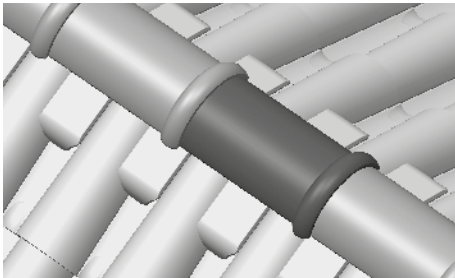
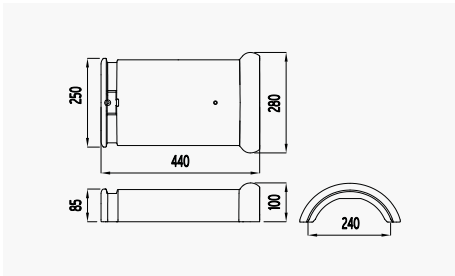

8 Cover+ Hip Starter

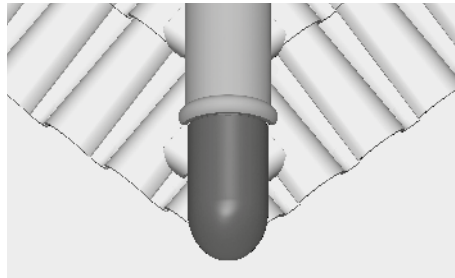
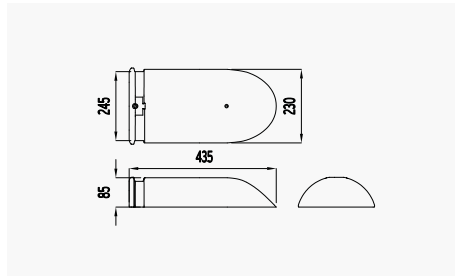

9 Cover+ 3 Ways

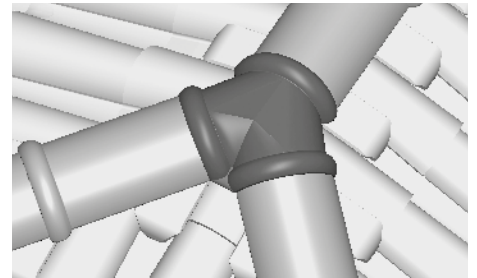
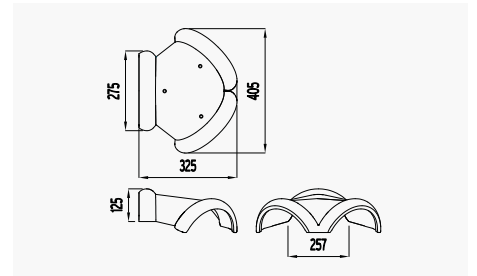

ACCESSORIES

10 Cover+ 4 Ways

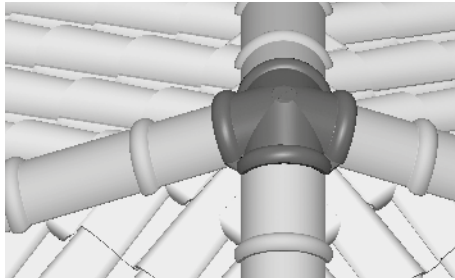
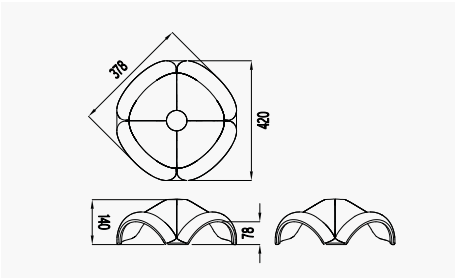

11 Cover+ Straight End Cap

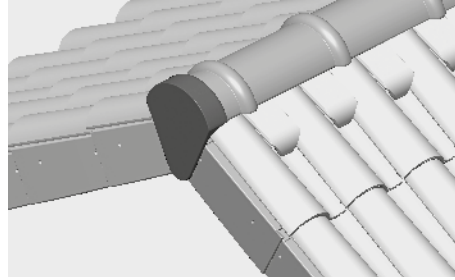
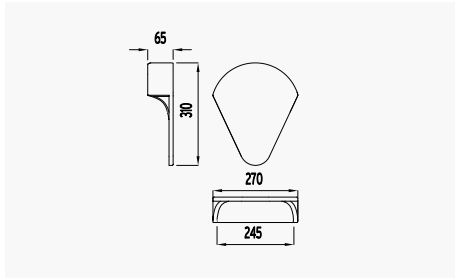

12 Cover+ Curved End Cap

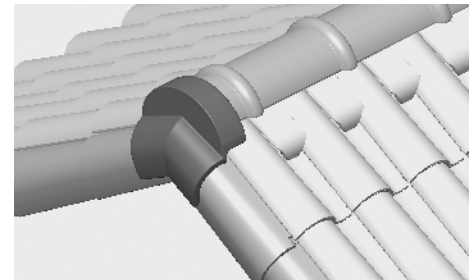
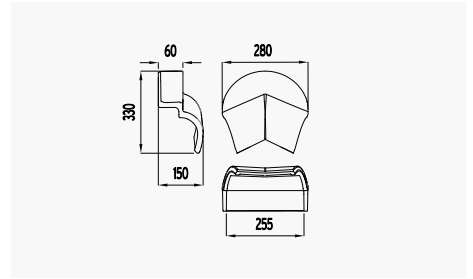

13 Under Ridge

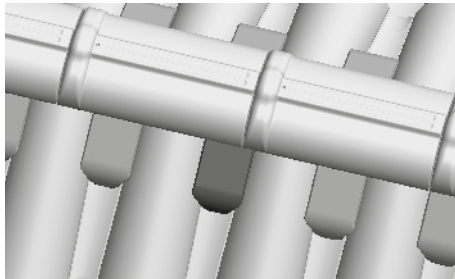
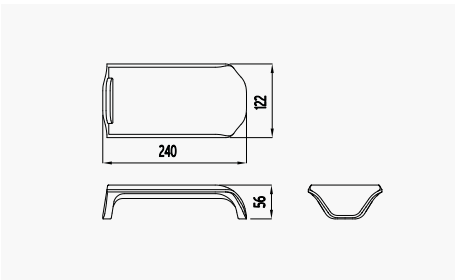

14 Straight Edge Left

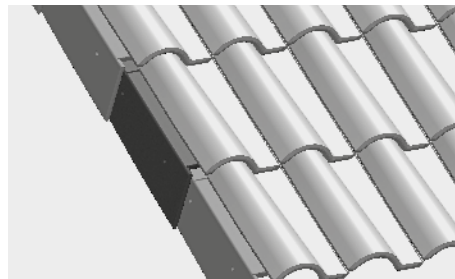
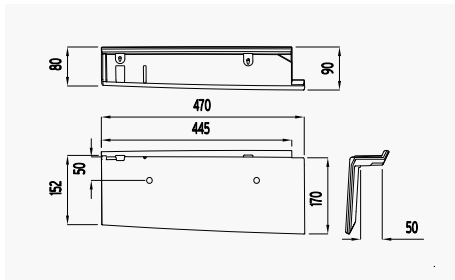

15 Straight Edge Right

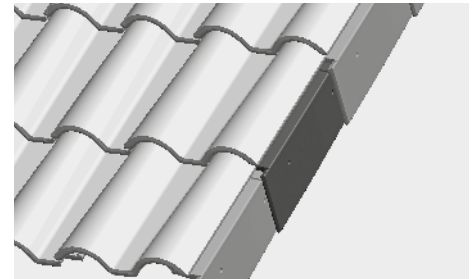
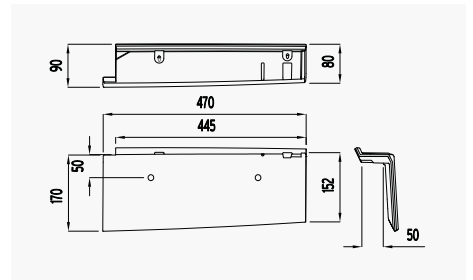

16 Curved Edge Left

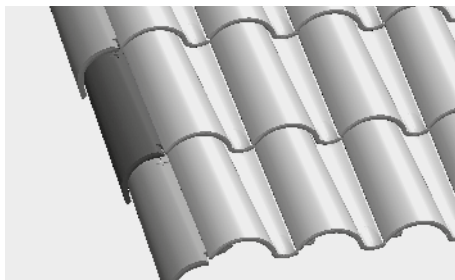
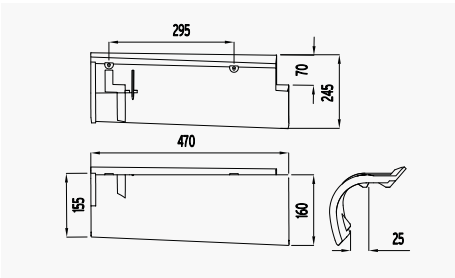

17 Curved Edge Right

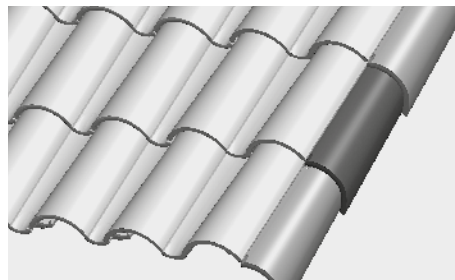
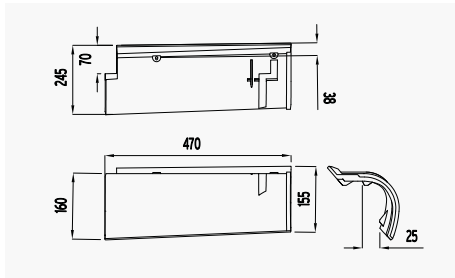

18 Universal Angular Edge (on monopitch)

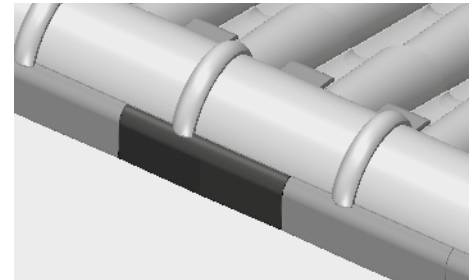
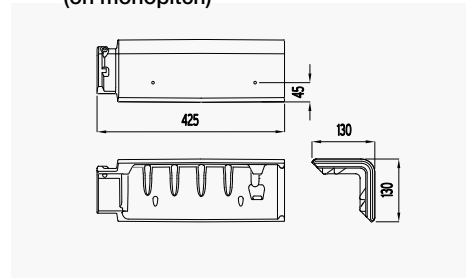

ACCESSORIES

19 Chimney d.140

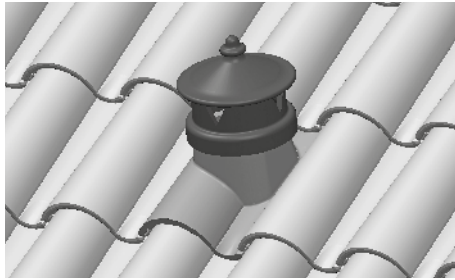
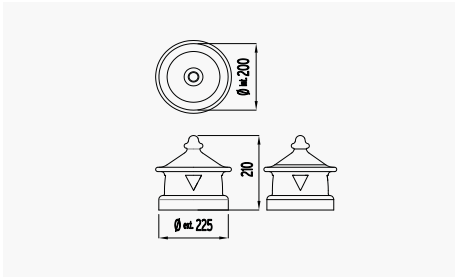

20 Chimney d.130

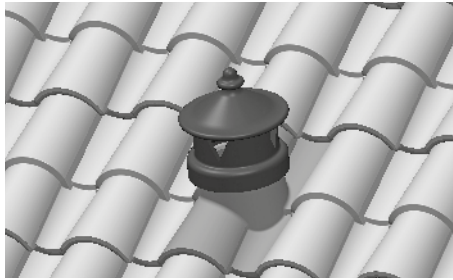
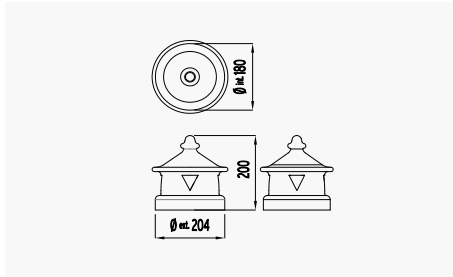

21 Ventilation Cap

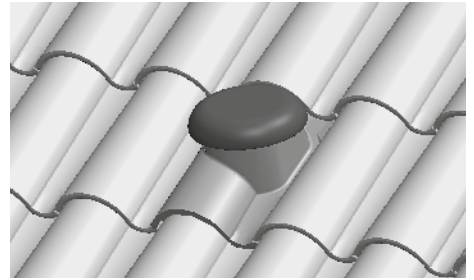
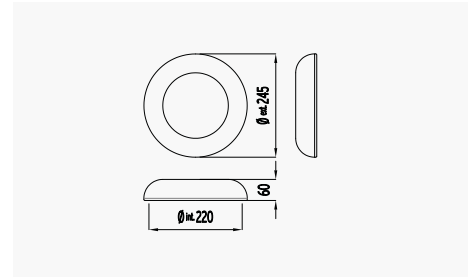

22 Chimney Carrier TBS+

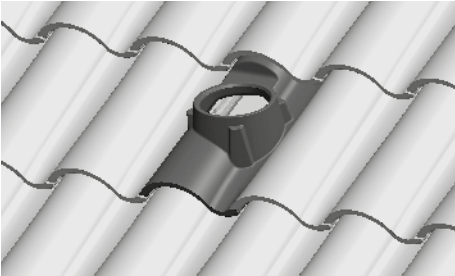
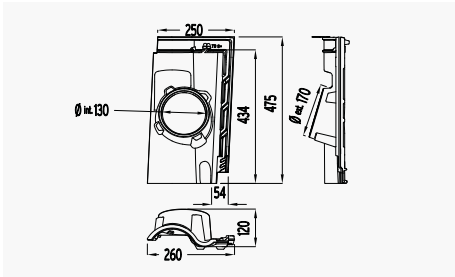

23 Half TBS+

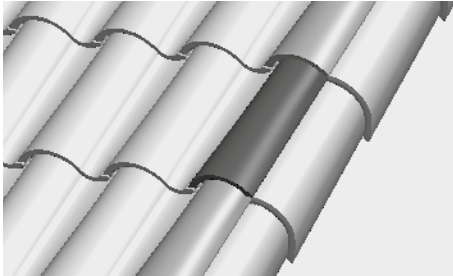
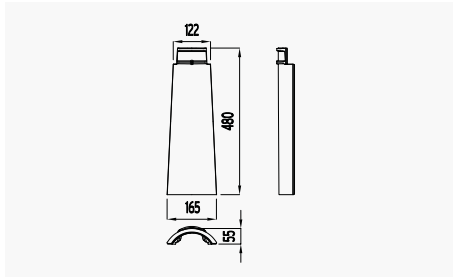

24 Tile and a Half TBS+

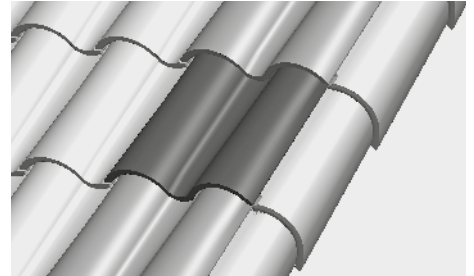
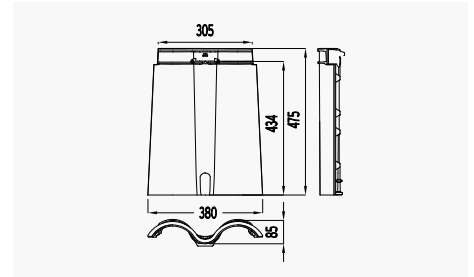

25 Ventilation TBS+

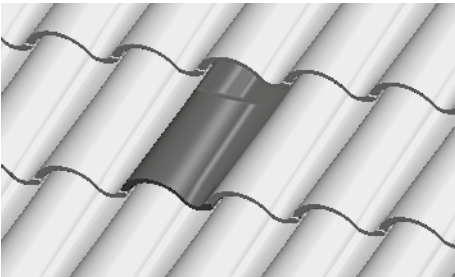
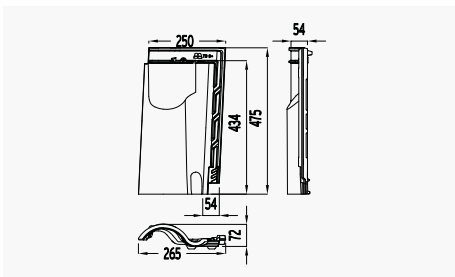

26 Chimney Carrier TB-10 Tech d.140

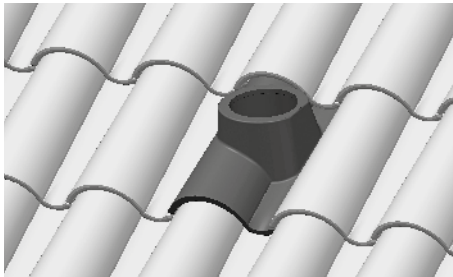
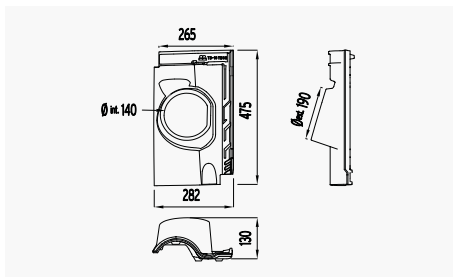

27 Half TB-10 Tech

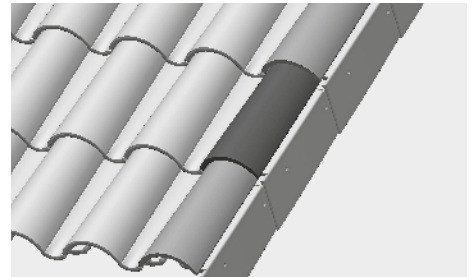
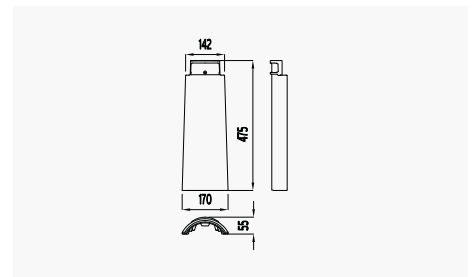

ACCESSORIES

28 Tile and a Half TB-10 Tech

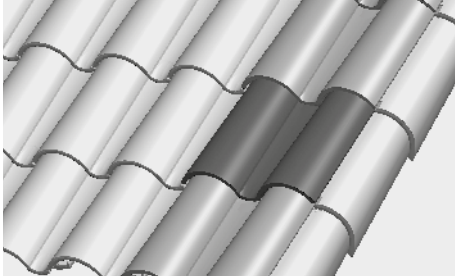
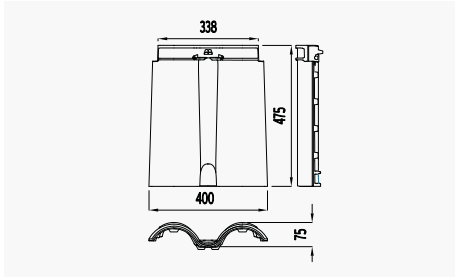

29 Ventilation TB-10 Tech

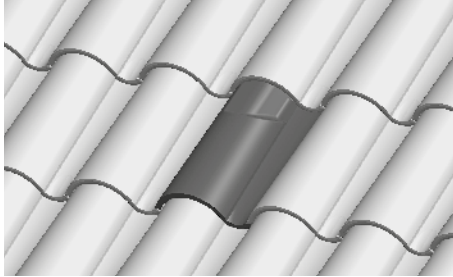
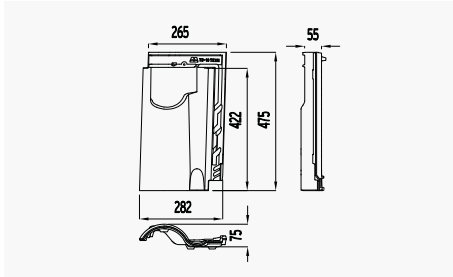

30 Chimney Carrier TB-12 d.140

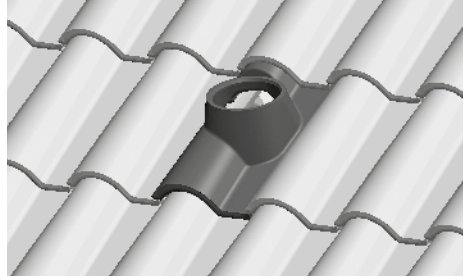
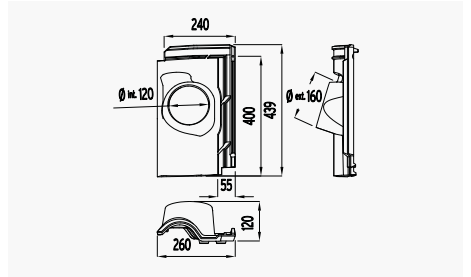

31 Half TB-12

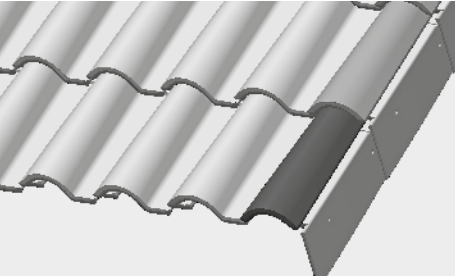
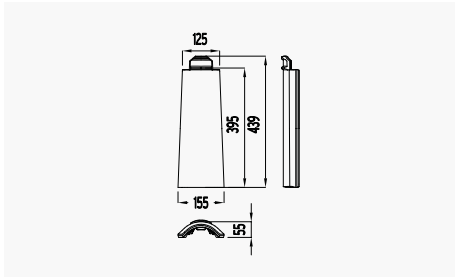

32 Tile and a Half TB-12

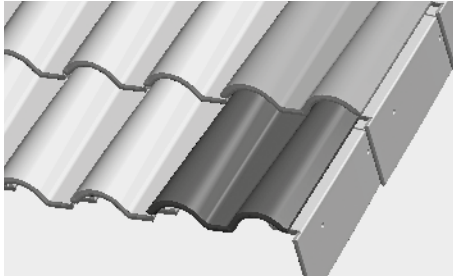
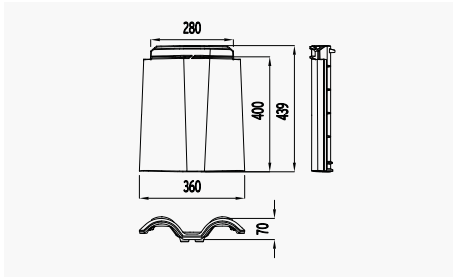

33 Ventilation TB-12

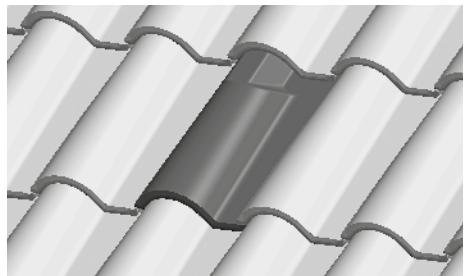
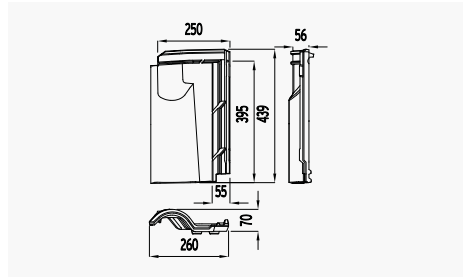

34 Pan Decocurva TB-12

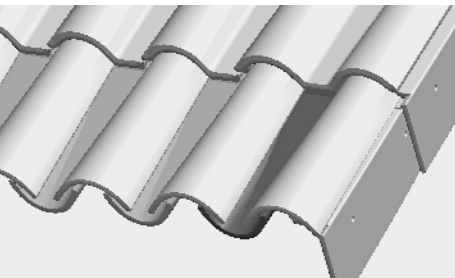
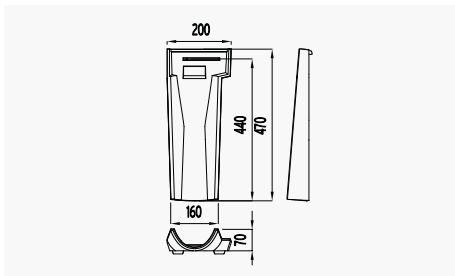

35 Cover Decocurva TB-12

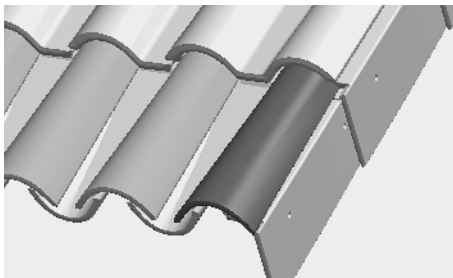
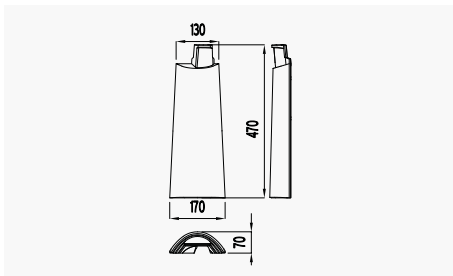

36 Curved Edge TB-4 Left

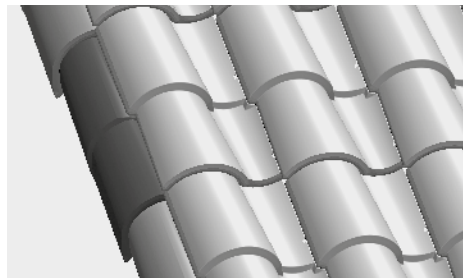
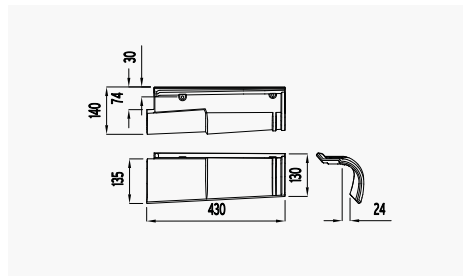

ACCESSORIES

37 Curved Edge TB-4 Right

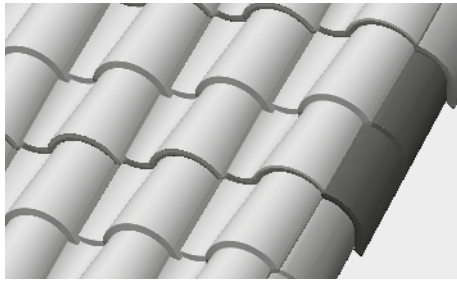
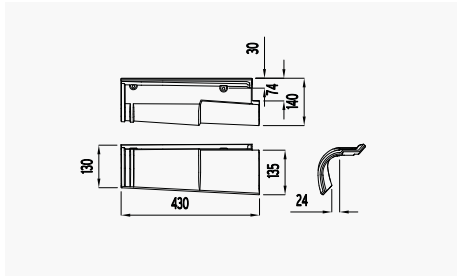

38 Chimney Carrier TB-4

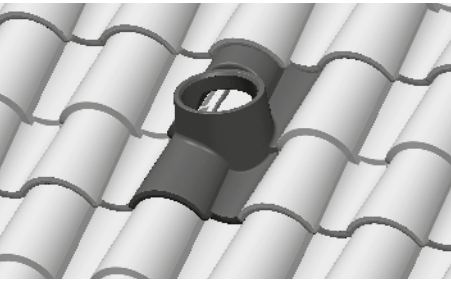
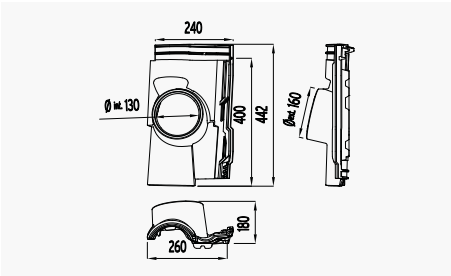

39 Ventilation TB-4

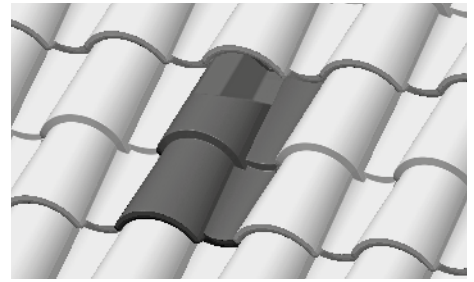
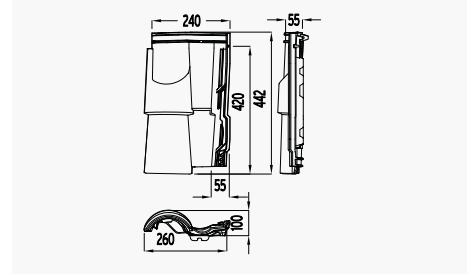

40 Half TB-4 Cover / Decocurva TB-4
A: Right lateral finish (Half TB-4)

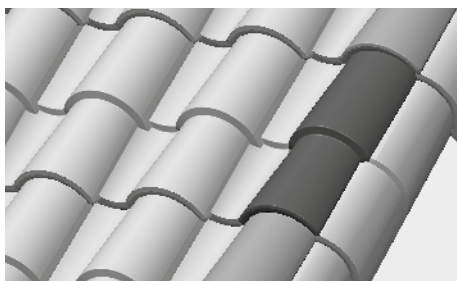
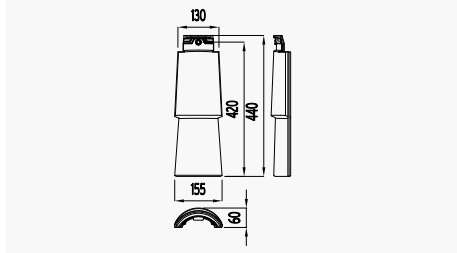

40 Half TB-4 Cover / Decocurva TB-4
B: Eaves (Cover Decocurva TB-4)

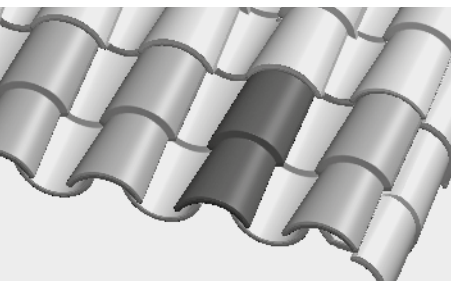
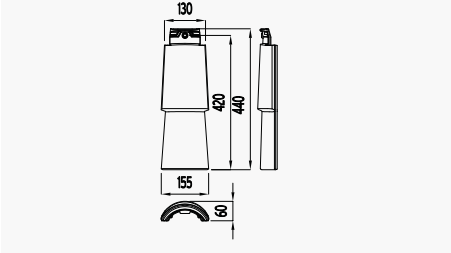

41 Pan Decocurva TB-4

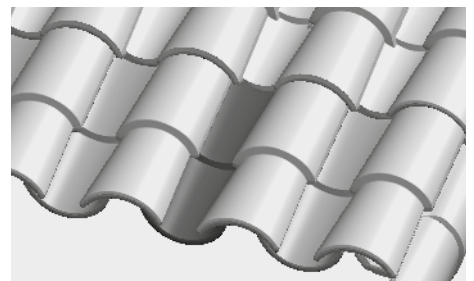
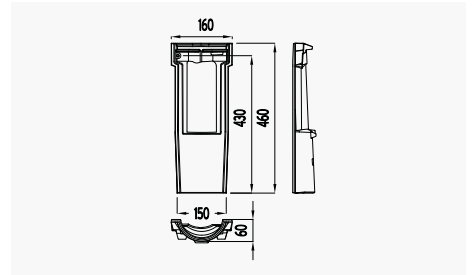

S-INTERLOCKING ROOF TILES INSTALLATION

EAVE LINE

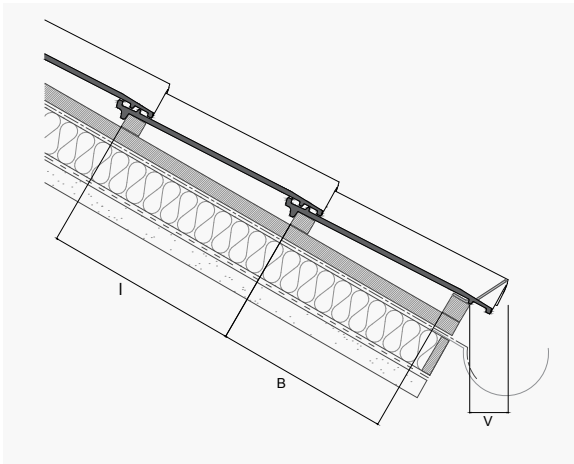

RIDGE LINE

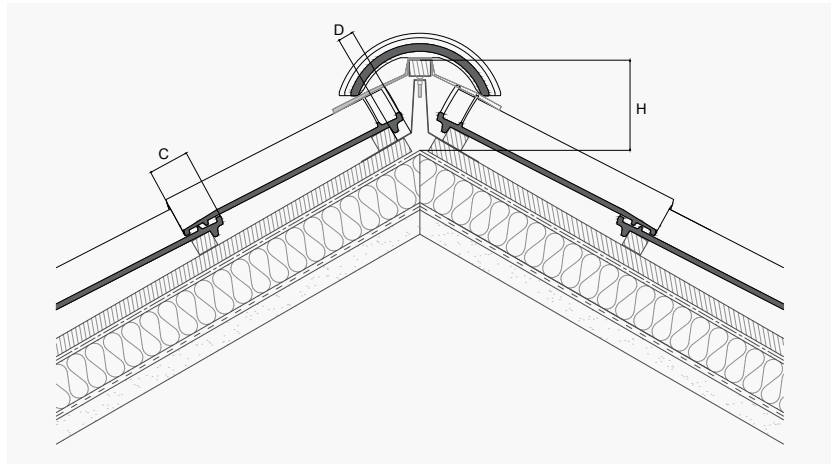

HORIZONTAL FLASHING

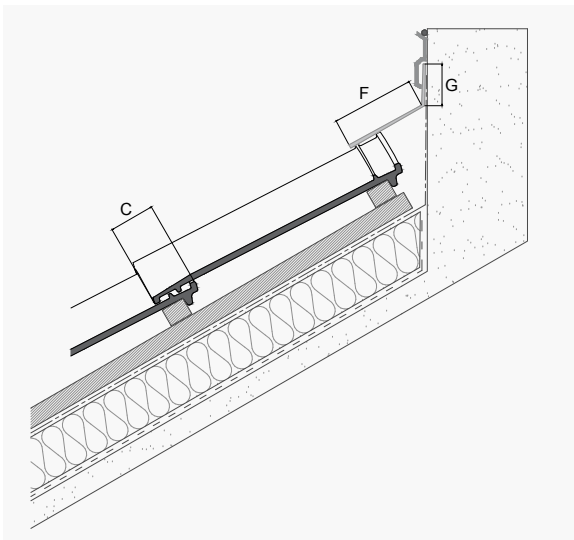

MONOPITCH

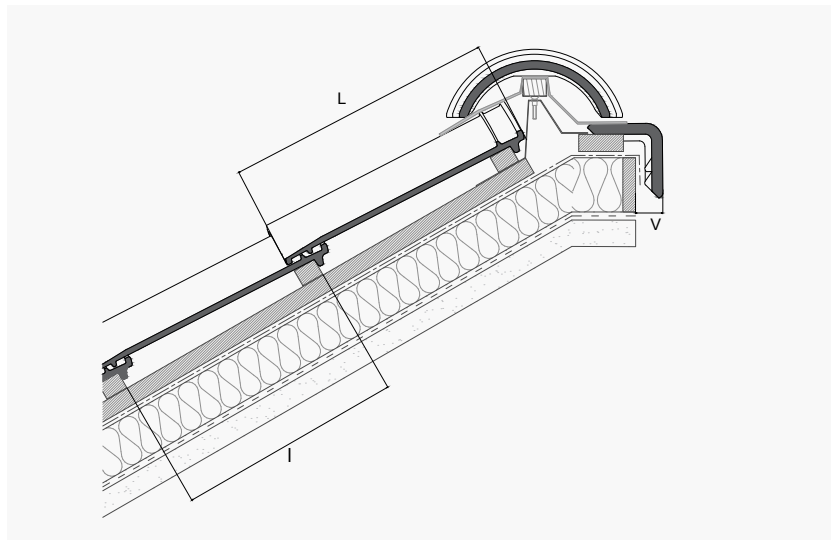

UPPER FLASHING

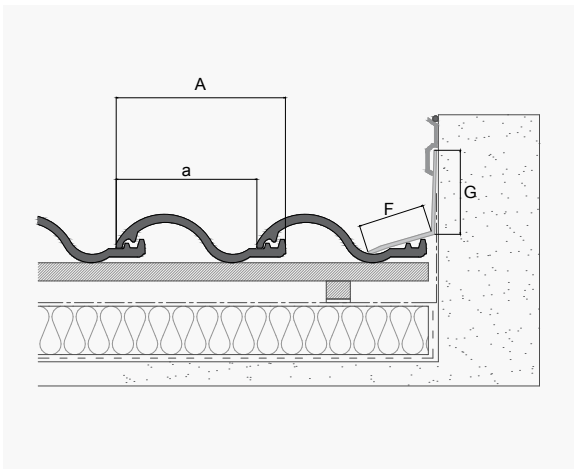

GABLES

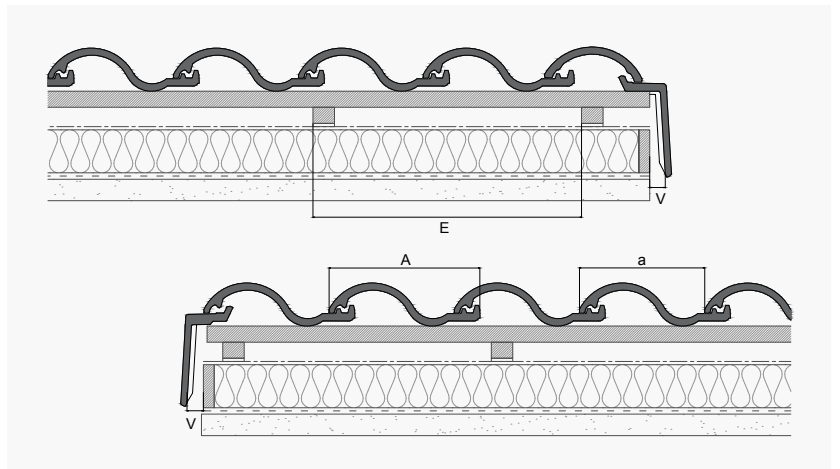

| ROOF TILE | A | a | L | I | B | C | D | E | F | G | H | V |
|--------------------|-----|---------|-----|---------|----------|-------|-------|------|-------|-------|--------|------|
| TBS+ | 260 | 221-211 | 475 | 395-410 | <345-410 | 65-80 | 25-55 | ≤500 | ≥ 100 | ≥ 150 | 70-100 | ≥ 50 |
| TB-10 Tech | 282 | 232 | 475 | 390-410 | <340-360 | 65-85 | 25-55 | ≤500 | ≥ 100 | ≥ 150 | 70-100 | ≥ 50 |
| TB-4 | 258 | 205 | 442 | 370 | 320 | 72 | 25-55 | ≤500 | ≥ 100 | ≥ 150 | 70-100 | ≥ 50 |
| TB-12 | 360 | 205 | 439 | 370 | 320 | 69 | 25-55 | ≤500 | ≥ 100 | ≥ 150 | 70-100 | ≥ 50 |
| TB-12 (BORJABLANC) | 360 | 205 | 439 | 370 | 320 | 69 | 25-55 | ≤500 | ≥ 100 | ≥ 150 | 70-100 | ≥ 50 |

Dimensions in millimetres

S-INTERLOCKING ROOF TILES INSTALLATION

ROOF SLOPES

Minimum pitch values required, depending on roof location and length (according to UNE - 136020)

| | Location | Roof length up to 6.5 m | Roof length from 6.5 to 9 m | Roof length from 9 to 12 m |
|--------|-----------|-------------------------|-----------------------------|----------------------------|
| Zone 1 | Protected | 25% - 14° | 26% - 15° | 27% - 15.5° |
| | Normal | 25% - 14° | 28% - 16° | 32% - 18° |
| | Exposed | 33% - 18.5° | 35% - 19.5° | 42% - 23° |
| Zone 2 | Protected | 25% - 14° | 28% - 16° | 30% - 17° |
| | Normal | 27% - 15.5° | 32% - 18° | 35% - 19.5° |
| | Exposed | 37% - 20.5° | 39% - 21.5° | 45% - 24.5° |
| Zone 3 | Protected | 27% - 15.5° | 30% - 17° | 35% - 19.5° |
| | Normal | 30% - 17° | 36% - 20° | 40% - 22° |
| | Exposed | 40% - 22° | 43% - 23.5° | 50% - 26.5° |

Each roof must be designed taking into account the geography and climate where it is being built, in accordance with the technical standards applicable in each territory and the length of the deck.

The roof pitch must always comply with the standards applicable to the region, location and length of the deck, and a breathable/waterproof membrane must be used on the support.

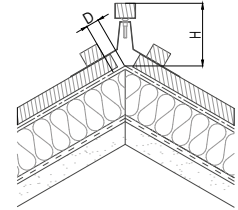

| ° | TB-10 TECH COVER+ RIDGE | | TB-10 TECH CIRCULAR RIDGE | | TBS+ COVER+ RIDGE | | TBS+ CIRCULAR RIDGE | | TB-12 COVER+ RIDGE | | TB-12 CIRCULAR RIDGE | | TB-4 COVER+ RIDGE | | TB-4 CIRCULAR RIDGE | |
|--------|-------------------------|-----|---------------------------|-----|-------------------|-----|---------------------|-----|--------------------|-----|----------------------|-----|-------------------|-----|---------------------|-----|
| | 20° | 30° | 20° | 30° | 20° | 30° | 20° | 30° | 20° | 30° | 20° | 30° | 20° | 30° | 20° | 30° |
| D (mm) | 58 | 40 | 42 | 23 | 58 | 40 | 40 | 20 | 58 | 40 | 40 | 23 | 58 | 40 | 40 | 23 |
| H (mm) | 100 | 95 | 85 | 70 | 100 | 95 | 85 | 70 | 95 | 90 | 80 | 65 | 95 | 90 | 80 | 65 |

D - Distance between the last batten and ridge line; H - Height of ridge batten; ° - Pitch

The technical drawing is an example of construction. The roof tiles must be overlapped approx. 7-9 cm with the ridge.

FITTING

Roof tiles on the roof surface must be fixed to the support to a greater or lesser extent, depending on the pitch. In the case of singular points such as eave lines, edges, hip lines, valleys, joints and the ridge line, all roof tiles and accessories at these joints must be fixed to the battens.

We recommend that all roof tiles that form the perimeter of each deck be fixed mechanically.

| | |
|-------------------|--|
| Batten type: | Metallic |
| | Treated wood |
| Dry installation: | Self-drilling stainless screws or nails (depending on the support) |
| | Roof tiles adhesives |

- A** 25% - 100% The roof tiles will rest on battens, since they are provided with nib support.
- B** 100%-173% All tiles which make up the perimeter of each deck must be fixed mechanically and at least one in every 5 of the other tiles in a regular manner.
- C** > 173% In areas with strong winds, exposed areas or areas with basic seismic acceleration of > 0.12g, all roof tiles should be fixed mechanically to the battens.

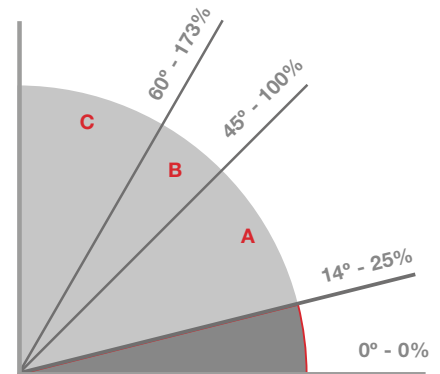

Less than 25% - The entire roof surface must be waterproofed.

Installation must comply with the technical standards applicable in each territory, the Code of Practice regarding the design and fixing of roofs with clay roofing tiles and Tejas Borja specifications.

VENTILATION

Under-tile ventilation is necessary at all times. This will guarantee the durability of the material used to build the roof and their optimum characteristics, improving the hygrothermal performance of the roof tiles against the moisture resulting from condensation.

All the roof tiles around the perimeter of each roof surface must be fixed and at least one in every five should be fixed in a regular manner.

Ventilation roof tiles will also be installed in a uniform manner across the surface of the roof. In the case of dry installation, it is recommendable to use at least 1 ventilation roof tile every 10 sq. m. and 4 ventilation tiles per roof surface.

S-INTERLOCKING ROOF TILES INSTALLATION

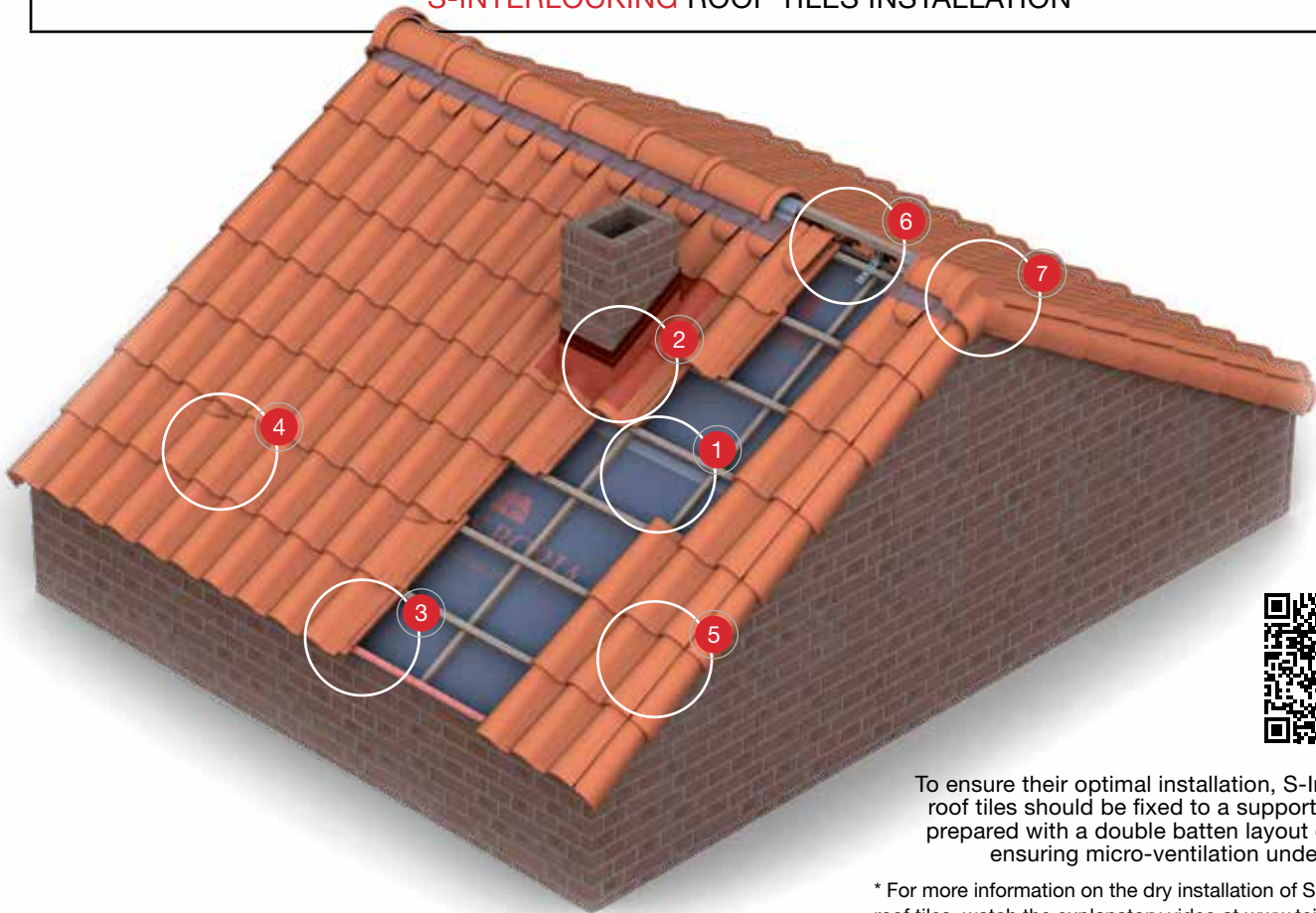

To ensure their optimal installation, S-Interlocking roof tiles should be fixed to a support previously prepared with a double batten layout or systems ensuring micro-ventilation under roof tiles.

* For more information on the dry installation of S-Interlocking roof tiles, watch the explanatory video at www.tejasborja.com



A breathable waterproof membrane should be laid on the support of the roof and the main battens (L1) should be installed every 50/70 cm, parallel to the steepest slope. The horizontal support battens (L2) for the roof tiles should be fixed to the main battens depending on the useful length of each roof tile (the useful length must be calculated on site).



Ventilation roof tiles are installed in the same manner as other roof tiles, interlocking into each other laterally and from the top. These roof tiles should be distributed along the roof surface.



To adequately seal roof joints and chimneys, multi-use (Premium or Aluminium) waterproofing bands should be used. Once attached to the clean dry surface, they must then be finished with the Counter flashing profile, sealing the upper line with a continuous line of putty.



Clay edge accessories (left and right) should be installed under the roof tiles and following the direction of the tile. To complete the slope on the right side, a half tile or tile and a half should be used, depending on the width of the roof surface.



To prevent birds from entering the roof and allow ventilation, an Eave Ventilation Comb or Eave Closure (clay accessory) should be installed.



The batten installed on the ridge line should be attached to the Cantilevel supports. To install the battens, they must be installed to the Cantilevel support at the required pitch and height so that the ridges are directly supported on the roof tiles in the last row and the Universal Under Ridge (clay accessory).



The first batten to be installed on the eaves must be 2 cm taller than the others. To achieve this effect, a taller batten, an Eave Ventilation Comb Profile or Eave Closure can be installed in this area.

S-Interlocking roof tiles are installed from left to right, and from the eave to the ridge line. The first row of roof tiles have variable overhanging, depending on the model and installation.



The Under Ridge roll tape (mixed, aluminium or roof ridge PVC vent brush) should be placed on the ridge batten and fixed with clips or nails. The rolls have adhesive strips of butyl to attach to the profile of the roof tiles and waterproof joints. Finally, the Ridges and End Caps clay accessories should be installed with screws/nails and ridge clips.

Always follow the Code of Practice for installation of roofs with clay roofing tiles in accordance with latest regulations and those applicable in each zone of application.



BORJASAT

Advanced Roofing System



Install **horizontally** for a batten spacing of **370 mm**.



Install **vertically** for a batten spacing of **395 mm**.

JUST ONE PANEL FOR ALL TILE MODELS

- ✔ **MULTIPURPOSE PANEL WHICH CAN BE USED WITH ANY ROOF TILE WITH A BATTEN SPACING OF 37 CM OR 39.5 CM.**
- ✔ **LIGHT AND EASY TO INSTALL WITHOUT PRIOR ADJUSTMENT.**
- ✔ **VENTILATED ROOF WHICH PREVENTS CONDENSATION AND IMPROVES HEAT INSULATION.**
- ✔ **LATERAL AND LONGITUDINAL INTERLOCKING TO MAXIMIZE WATERTIGHTNESS.**
- ✔ **HIGH LEVELS OF INSULATION USING A THINNER PRODUCT. NO THERMAL BRIDGES.**

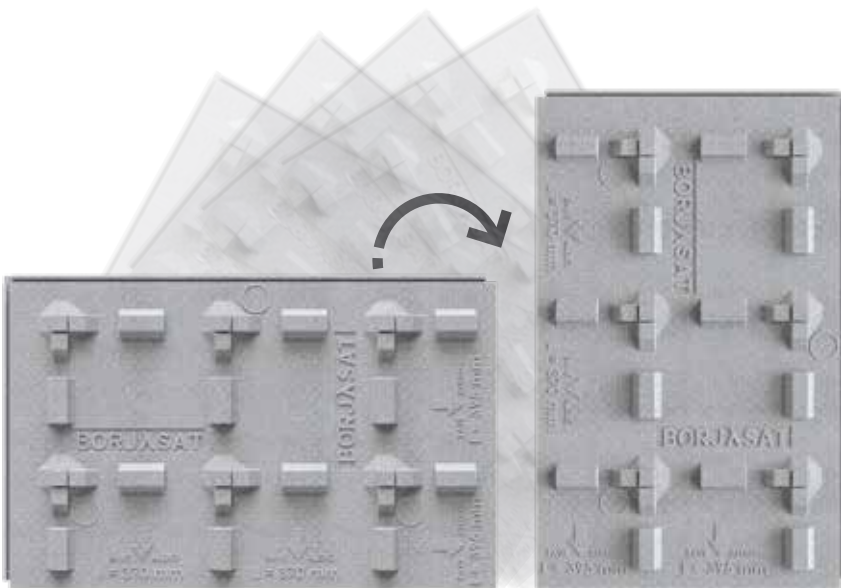

BORJASAT ACCESSORIES



Metallic Batten U 40x15
BorjaSAT



100% Neopor®

$\lambda = 0.031 \text{ W/mk}$

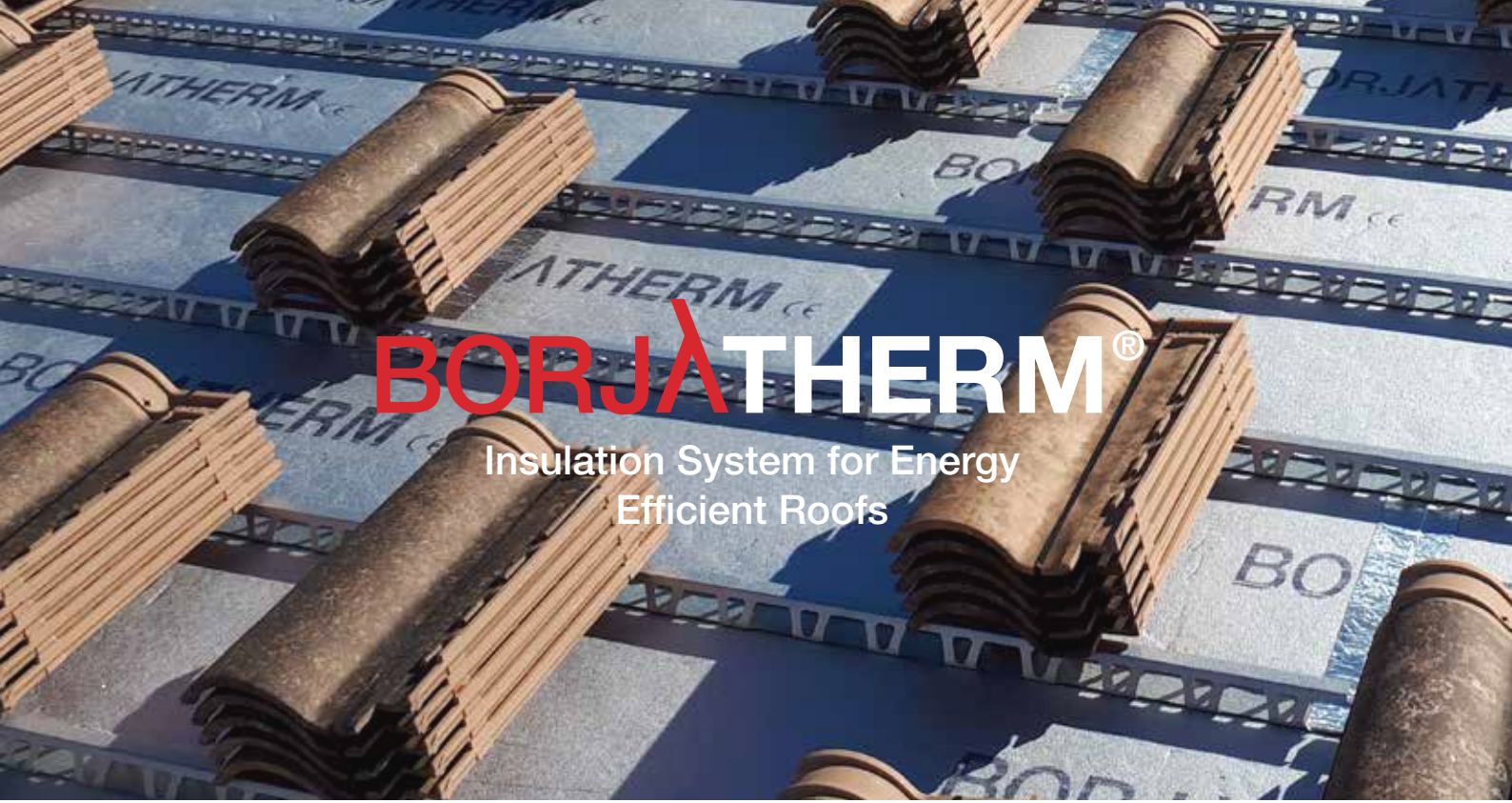

BORJATHERM®

Insulation System for Energy Efficient Roofs

- ✓ INTUITIVE, SIMPLE AND FAST TO INSTALL.
- ✓ COMPLETE TECHNICAL SYSTEM FOR LIGHTWEIGHT ROOFS.
- ✓ SIGNIFICANT SAVINGS IN STRUCTURAL AND LABOUR COSTS.
- ✓ MAXIMUM INSULATION WITH NO THERMAL BRIDGES.
- ✓ EXCELLENT UNDER-TILE VENTILATION.
- ✓ ROOF INSULATION WITHOUT INTERNAL SPACE LOSS.

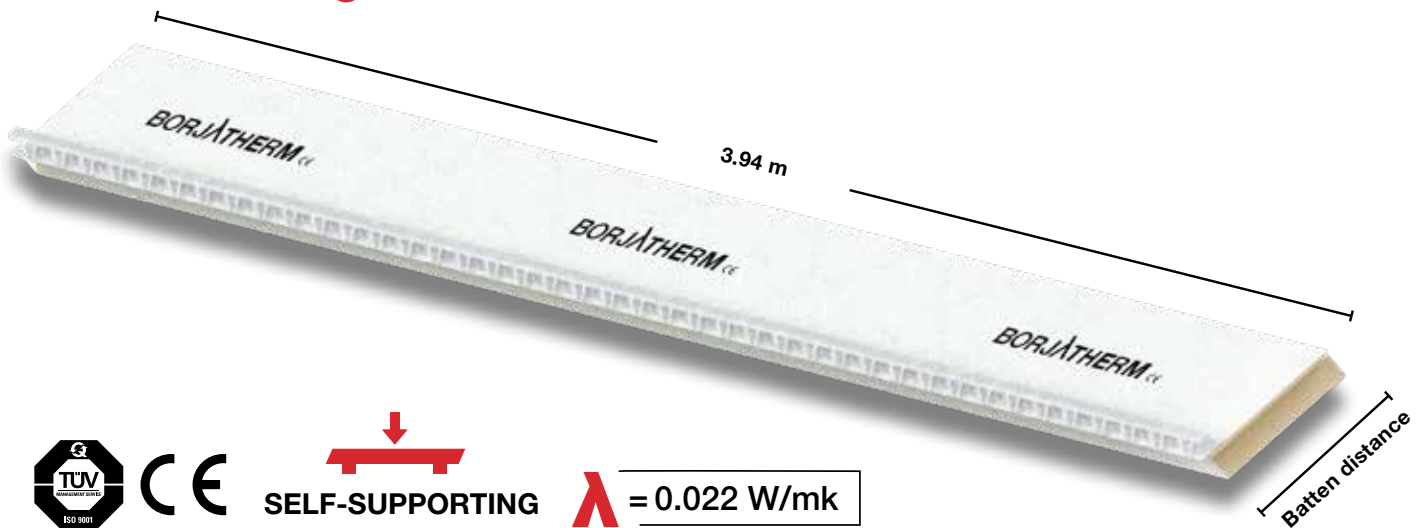

SELF-SUPPORTING

$\lambda = 0.022 \text{ W/mk}$

BORJATHERM ACCESSORIES



BORJATHERM Extra Batten



Butyl Adhesive Band BORJATHERM 100 mm.



Treated Wooden Batten 60x50 mm.



Treated Wooden Batten 80x50 mm.

ROOF COMPONENTS

WATERPROOFING OF JOINTS



Multi-Use Premium 300/450
(waterproofing flashing)



Multi-Use Alu 300
(waterproofing flashing)



Counter Flashing
Profile



Valley Adjustable
Alu Flashing



Auto-adhesive
Butyl Band 300



BATTENS



Metallic Batten
30x30



Ventilated Batten
30x20



Treated Wooden
Batten 40x30



Metallic Batten U
40x40 (Ridge Line)

ROOF SHEETS



Corrugated Bitumen Sheet for Tiles
with Battens (Interlocking Roof Tiles)

ROOF COMPONENTS

WATERPROOF AND BREATHABLE MEMBRANES



Waterproof Breathable Membrane TB 180 Premium



Waterproof Breathable Membrane TB 160



Waterproof Breathable Membrane TB 130



Vapour Barrier 100 (installation under insulation)



Waterproof Breathable Membrane Eco-135



Nail Sealing Tape



Roofing Adhesive Tape 50 mm

RIDGE LINE VENTILATION



Under Ridge Mixed Roll Tape



Under Ridge ALU Roll Tape



TB-Roll Ridge Tape (waterproof)



ROOF COMPONENTS

FIXING



Adhesive foam for roof tiles



Ridge batten supports



Fixing clips for roof tiles



Ridge clips



Straight snow stopper



Fixing screws

EAVE LINE VENTILATION

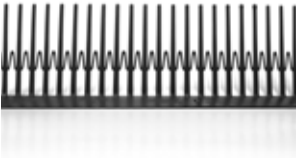

Ventilation Comb 100 mm



Ventilation Comb 60 mm



Bird Stop Grate 80 mm



Batten + Ventilation Comb
(Batten 30 mm; comb 60 mm)



PAINT



Touch-up paints

NB: Roof components are subject to a minimum order quantity and orders must be in multiples thereof.

Installation system



Projects

BorjaJET



TB-10 Tech Entrepins



TB-10 Tech Entrepins



TB-10 Tech Irati



TB-10 Tech Irati

Projects

BorjaLINE



TB-12 Bidasoa



Manoir



Graphite



Red



Lamalou

Projects

Borja**LINE**



Centenaria Ground



TB-4 Vilaterra



Fosca



TB-12 Brown

Projects

BorjaDECOR



TB-4 Irisado Cognac



Glazed Green



Glazed Cognac



Glazed Blue



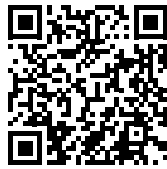

View more projects in our Flickr gallery

flickr

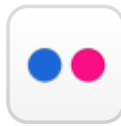

THE [®]EVOLUTION of the ceramic tile sector

Tejas Borja S.A.U. reserves the right to change the characteristics and availability of the products and colours displayed in this catalogue without prior notice. The colours of the pieces shown may vary slightly from the originals. The settings shown in this catalogue are decorative suggestions for publicity purposes only and in real installations the fitting instructions published by Tejas Borja must be followed.



TEJAS BORJA, S.A.U.

Ctra. Llíria a Pedralba, Km. 3
46160 Llíria, Valencia, SPAIN
T. +34 96 279 80 16
F. +34 96 278 25 63
info@tejasborja.com

tejasborja.com