



**TEJAS BORJA**  
Since 1899

CURVED roof tiles

Mediterranean tradition



# Index of CONTENTS

04

Finishing techniques

06

Raw materials

08

Curved roof tiles formats

15

Accessories

20

Installation guide

24

Curved roof tiles projects

**Note:** The colour reproduction is approximate, subject to change due to the natural colours of the clays.  
Check finishing colours for different accessories by telephone at: **+34 96 279 80 16.**



## STEP CELLER 50/45

A special roof tile installed over battens to create channels. Ideal for dry installation. Compatible with curved tiles 50 and 45.

P.8-9



## C-50.21 Celler® C-45.20

The largest and widest curved roof tiles. They have a conical profile and are made using an extrusion process.

P.10-11



## C-40.19 C-40.15

The range of curved roof tiles which are the smallest in size. Traditional formats based on tiles customarily used in specific geographical areas. Narrower with a conical profile.

P.12-13



## C-25.12

Curved pressed tile ideal for decorating and covering small areas.

P.14



- **Mediterranean tradition** .....
- **Ideal for renovation projects** .....
- **Perfect overlapping without cuts** .....
- **Rounded edges** .....



Minimum  
Slope 26%

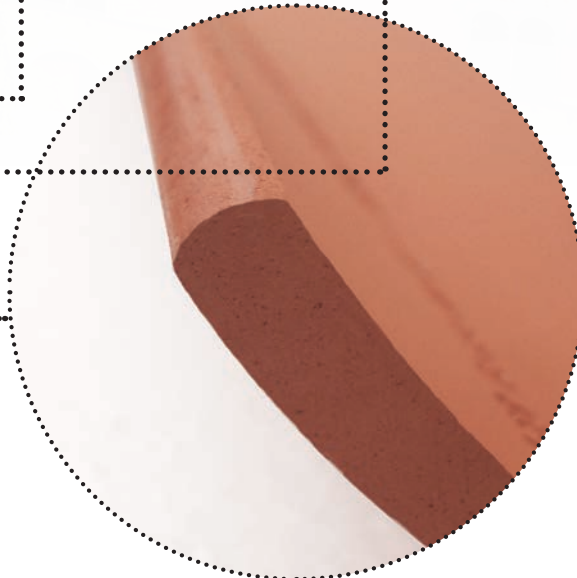
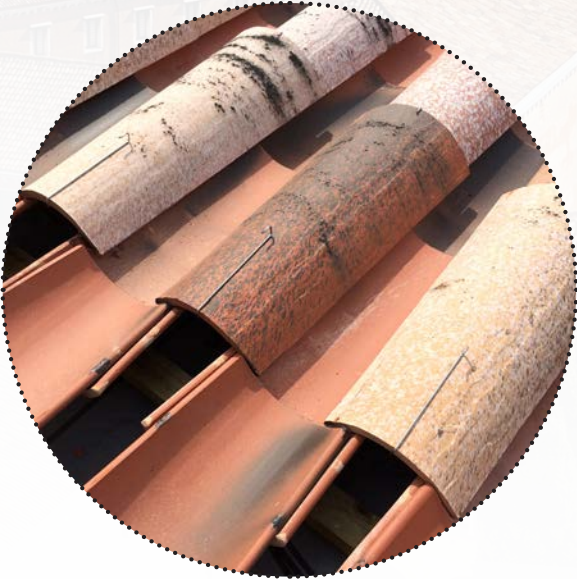

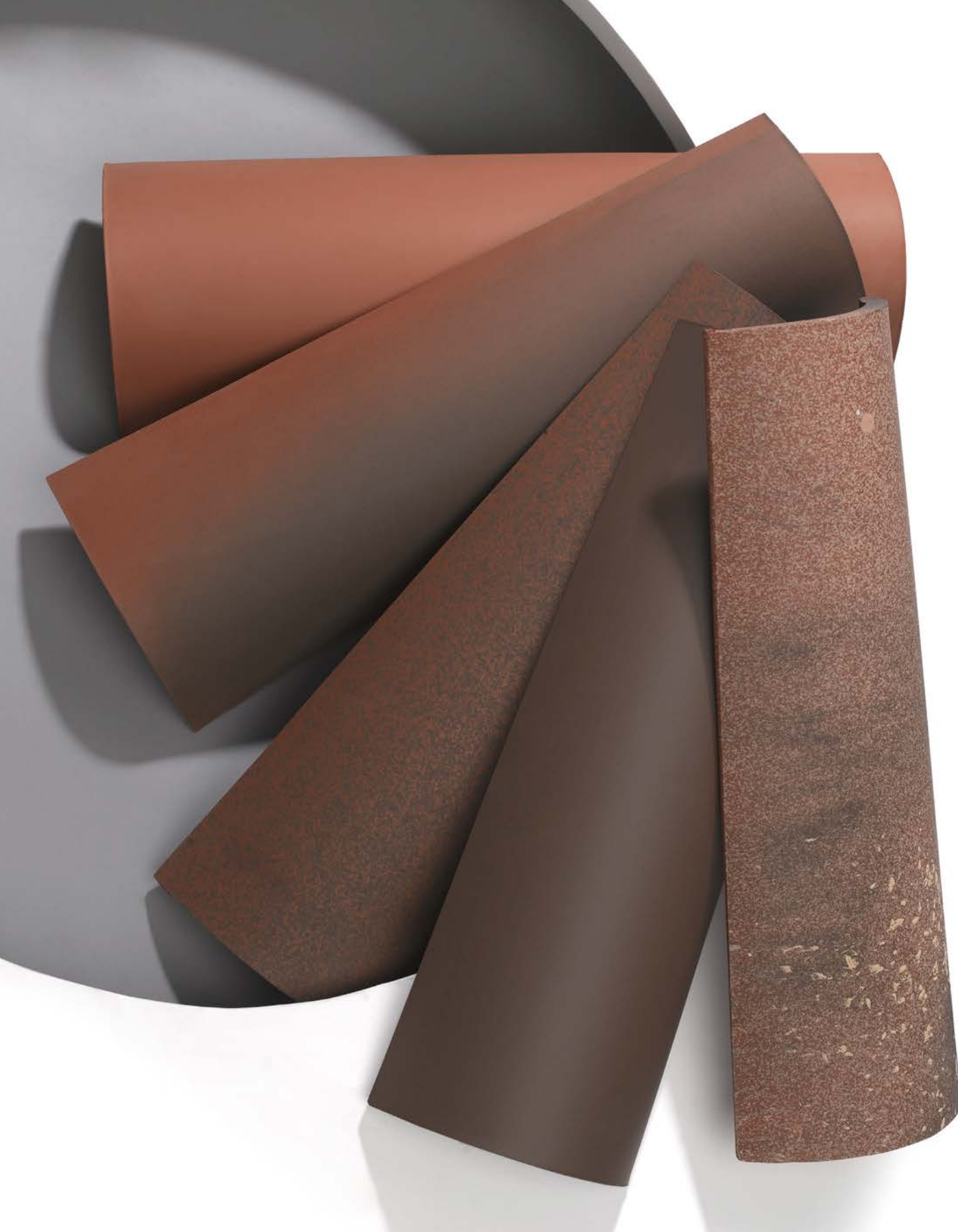

## Borja **LINE**

Technology based on the application of engobes and ceramic decoration.  
Unique weathered and single-colour finishes.

# Borja DECOR

Glazed tiles with a high shine. Glossy and metalized finishes which prevent premature ageing, slowing the growth of mould and moss.







The choice of raw material is as important as the quality of the final product. Tejas Borja's tiles are distinguished by the use of very fine, high quality clays. The careful selection of the clays results in tiles which are both strong and stable. Through the manufacturing process we produce high-quality curved ceramic tiles in a variety of formats, colours and textures.

## RED CLAY TILES

Manufactured using sintered red clays resulting in highly resistant tiles with a low absorption capacity.

## BROWN CLAY TILES

Manufactured using red clays to add colour during the production process, resulting in a uniform brown finish. The colour is integral to the tile, even when they are cut.

## WHITE CLAY TILES

Manufactured using special white clays which offer beautiful natural shades. Ideal for the Mediterranean climate.

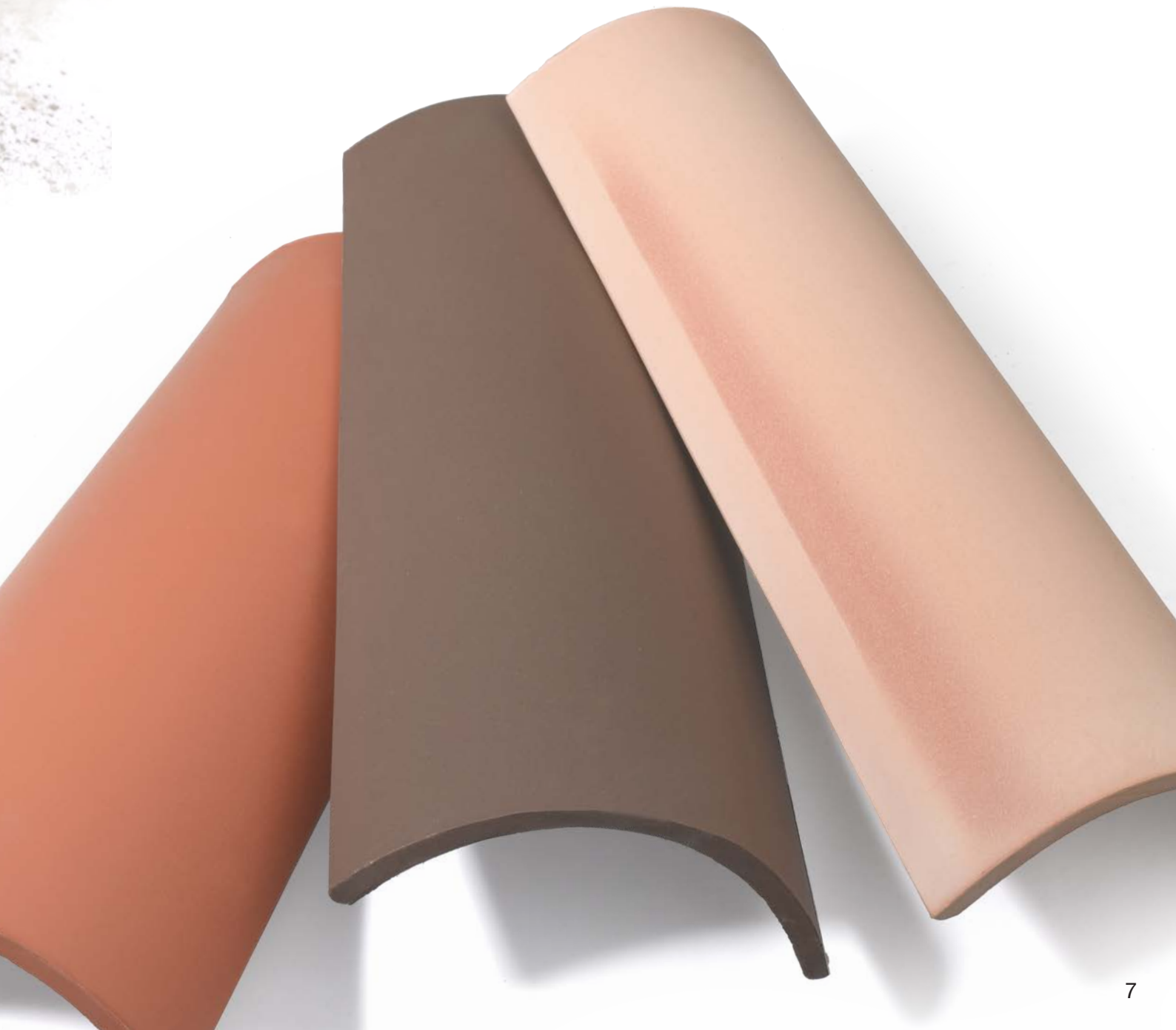

## STEP CELLER 50/45

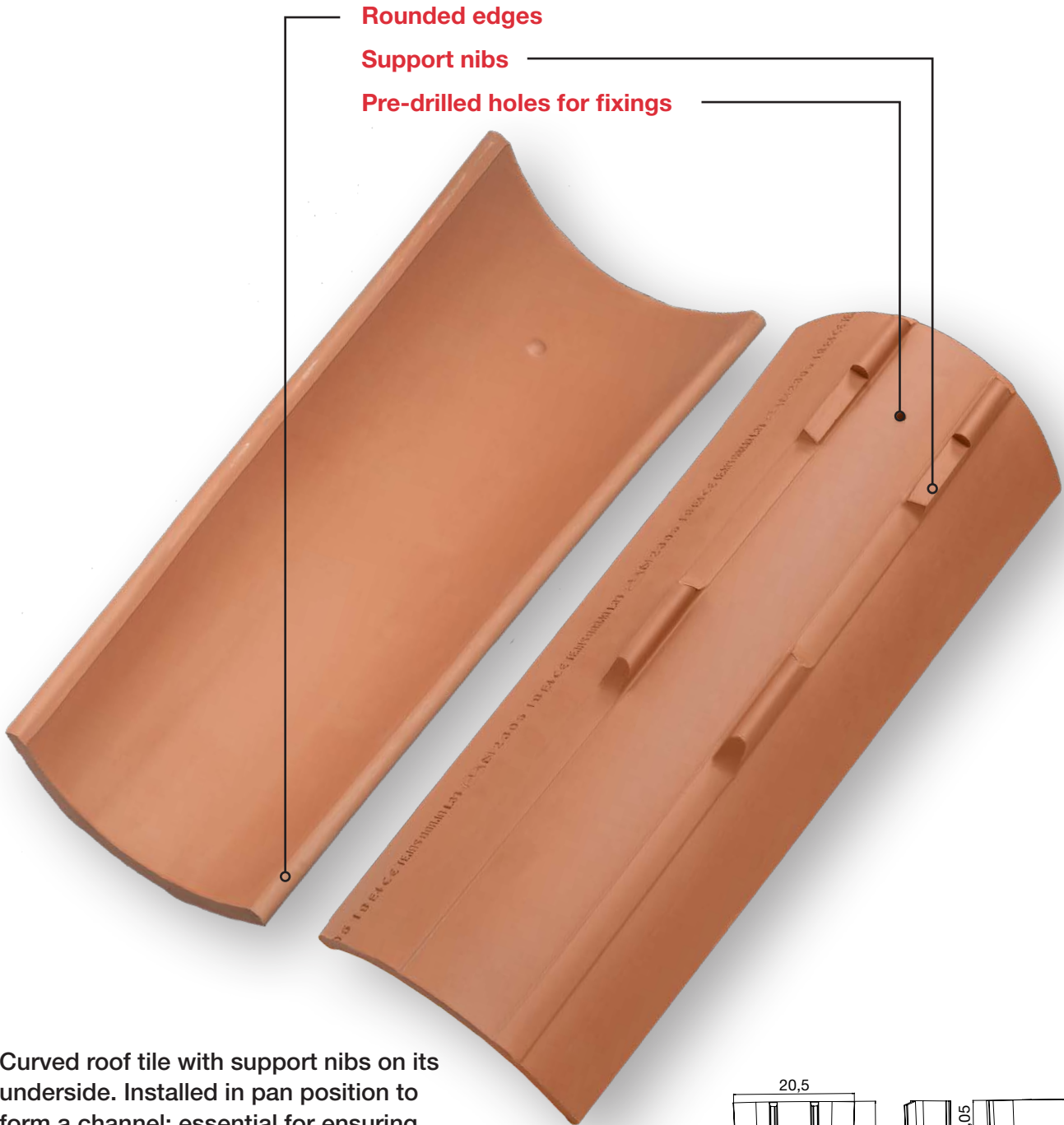

Curved roof tile with support nibs on its underside. Installed in pan position to form a channel: essential for ensuring the proper drainage of water from the roof. Compatible with curved tiles C-50.21 Celler® and C-45.20. Dry installation over roof battens.

Dimensions	500 mm x 205 mm / 165 mm
Minimum pitch recommended	30% - 17°
Weight	2,50 Kg./Unit
Units / sq. m.	10 Units
Units per LM eave line	4 Units
Units per LM ridge / LM eave	2,5 Units C-50.21 Celler®
Minimum / maximum overlap <sup>1</sup>	80 - 170 mm
Useful length (Batten distance)	350 - 400 mm
Pallet data	(C1) 160 Units / 420 Kg.
Minimum order	8 Units

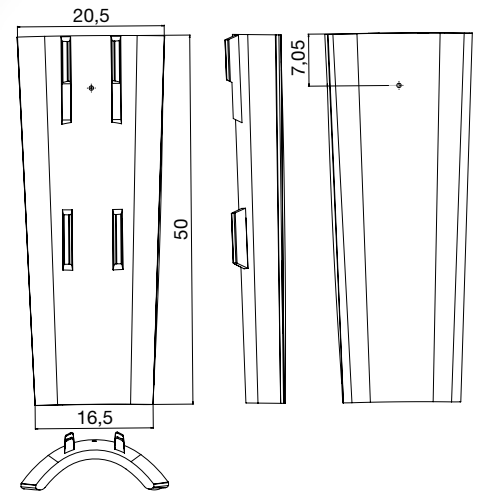

**Approximate values:** If the roof tiles are installed on battens, the useful length must be calculated on site. A tolerance of  $\pm 2\%$  is allowed on the dimensions of the roof tiles according to EN 1024.

<sup>1</sup> To guarantee the roof's watertightness, both the slope and minimum overlaps must always be determined in accordance with the geographical area and location of the roof, exactly as specified in Standard UNE-136020 regarding the design and installation of ceramic tile roofs.

## STEP CELLER 50/45 - FINISHES

### NATURE



Red

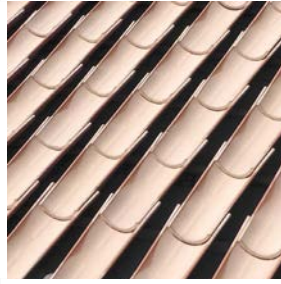

R. Shaded White



Manoir® \*

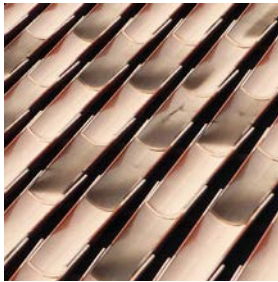

Serrania \*\*

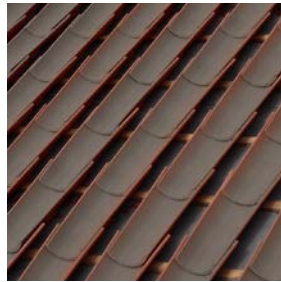

Fosca Brown \*\*\*

\* Compatible with Centenaria® Ground & Manoir®.  
\*\* Compatible with Centenaria® Mediterrania®,  
Vilavella®, Edetania®, Lamalou® & Montseny.  
\*\*\* Compatible with Fosca & Brown.





Minimum  
Slope 26%

### C-50.21 Celler®

Dimensions	500 mm x 210 mm / 170 mm
Weight	2,40 Kg./Unit
Units por m <sup>2</sup>	18 Units
Units per LM eave line	8 Units
Units per LM ridge / LM eave	2,5 Units
Minimum / maximum overlap <sup>1</sup>	80 - 210 mm
Pallet data	(C1) 250 Units / 620 Kg.
C1 - Nature	(C1*) 225 Units / 570 Kg.
C1* - Centenaria®	(C9) 225 Units / 576 Kg.
C9 - Shaded White	
Minimum order	10 Units (Nature) 9 Units (Centenaria®)

### C-45.20

Dimensions	450 mm x 200 mm / 160 mm
Weight	1,95 Kg./Unit
Units por m <sup>2</sup>	25 Units
Units per LM eave line	10 Units
Units per LM ridge / LM eave	3 Units
Minimum / maximum overlap <sup>1</sup>	80 - 190 mm
Pallet data	(C3) 275 Units / 531 Kg.
(C5) 550 Units / 1.063 Kg.	
Minimum order	11 Units

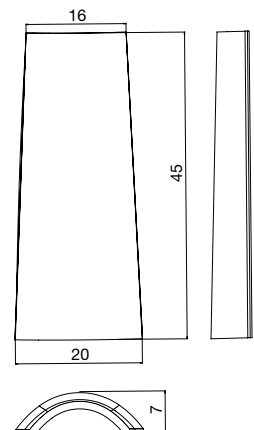
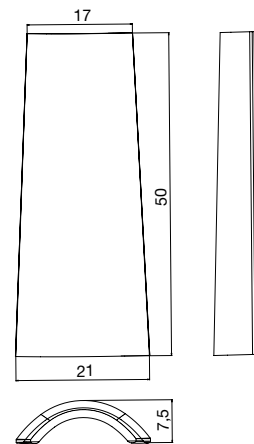

**Approximate values:** If the roof tiles are installed on battens, the useful length must be calculated on site. A tolerance of  $\pm 2\%$  is allowed on the dimensions of the roof tiles according to EN 1024.

<sup>1</sup> To guarantee the roof's watertightness, both the slope and minimum overlaps must always be determined in accordance with the geographical area and location of the roof, exactly as specified in Standard UNE-136020 regarding the design and installation of ceramic tile roofs.

The type of pallet will be confirmed upon order.

## C-50.21 Celler® - FINISHES

### NATURE



Red



Shaded White



Fosca



Manoir®

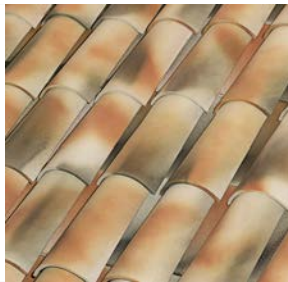

Vilavella®



Edetania®



Lamalou®



Montseny



Brown

### CENTENARIA®



Ground



Mediterrània®

NOTE:

 - roof tiles with texture.

 - white clay

## C-45.20 - FINISHES

### NATURE



Red



Moss Red

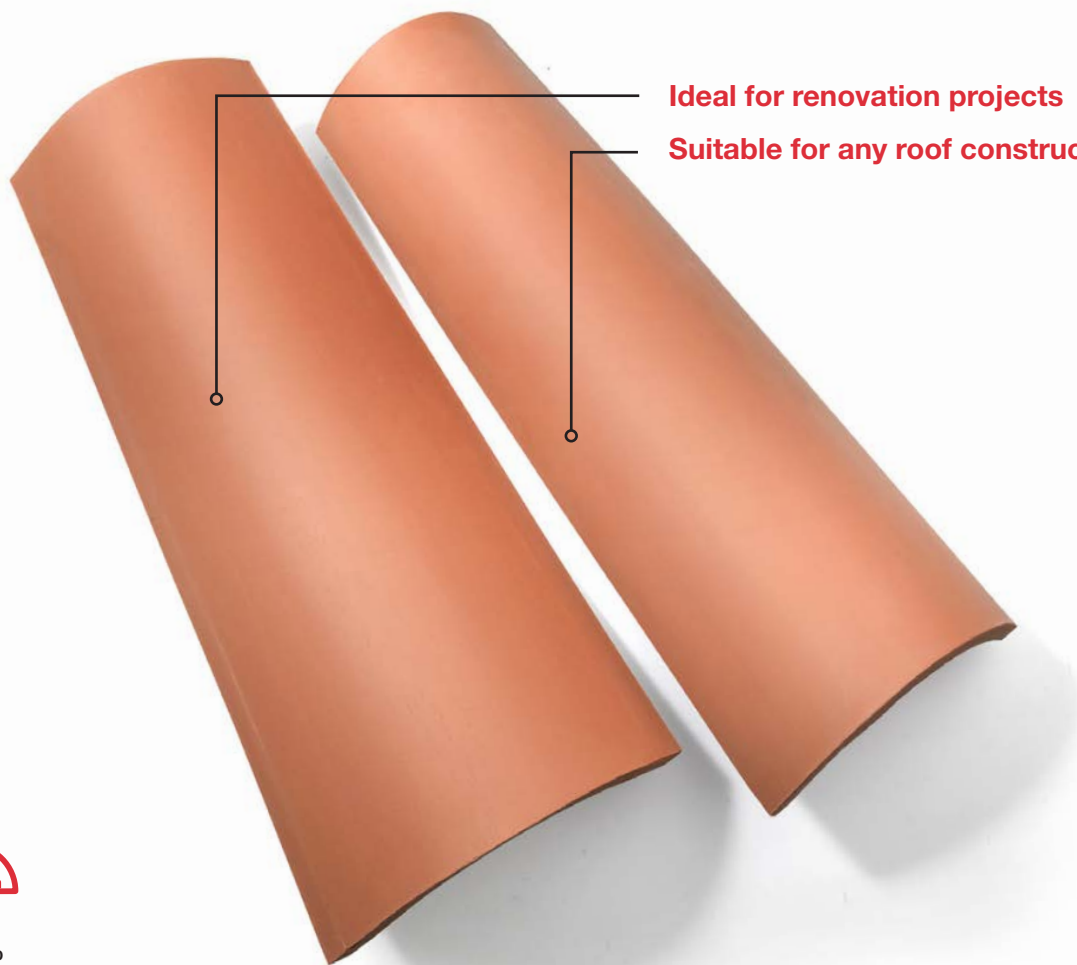

Ideal for renovation projects

Suitable for any roof construction solution



Minimum Slope 26%

C-40.19

Dimensions	408 mm x 180 mm / 140 mm
Weight	1,60 Kg./Unit
Units por m <sup>2</sup>	30 Units
Units per LM eave line	12 Units
Units per LM ridge / LM eave	3 Units
Minimum / maximum overlap <sup>1</sup>	80 - 170 mm
Pallet data C9 / C2 (C-40.19) - white clay	(C8) 720 Units / 1.164 Kg. (C4) 360 Units / 587 Kg. (C9) 624 Units / 1.010 Kg. (C2) 312 Units / 515 Kg.
Minimum order	12 / 13 Units

C-40.15

Dimensions	408 mm x 150 mm / 116 mm
Weight	1,35 Kg./Unit
Units por m <sup>2</sup>	33 Units
Units per LM eave line	12 Units
Units per LM ridge / LM eave	3 Units
Minimum / maximum overlap <sup>1</sup>	80 - 150 mm
Pallet data C9 / C2 (C-40.19) - white clay	(C8) 728 Units / 950 Kg. (C2) 364 Units / 506 Kg.
Minimum order	13 Units

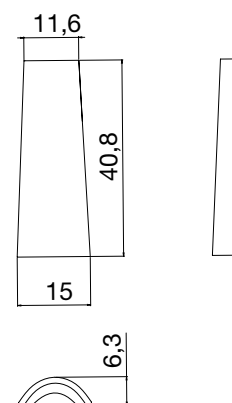
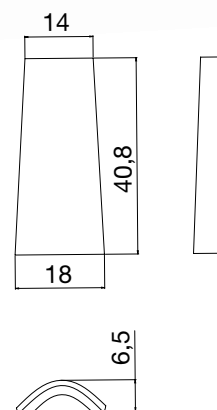

**Approximate values:** If the roof tiles are installed on battens, the useful length must be calculated on site. A tolerance of ± 2% is allowed on the dimensions of the roof tiles according to EN 1024.

<sup>1</sup> To guarantee the roof's watertightness, both the slope and minimum overlaps must always be determined in accordance with the geographical area and location of the roof, exactly as specified in Standard UNE-136020 regarding the design and installation of ceramic tile roofs.

The type of pallet will be confirmed upon order.

## C-40.19 - FINISHES

### NATURE



Red



Aged Red



Shaded White



Aged White



Vilavella®

### CENTENARIA®



Sand

NOTE:

 - white clay

## C-40.15 - FINISHES

### NATURE



Red



Fosca



Brown

### CENTENARIA®



Ground

# C-25.12



## NATURE



Red

## C-25.12

Dimensions	250 mm x 120 mm / 95 mm
Weight	0,65 Kg./Unit
Units / sq. m.	70 Units
Units per LM eave line	14 Units
Units per LM ridge	5 Units
Pallet data	495 Units / 336 Kg. (bulk cage)
Minimum order*	32 Units (1 box)

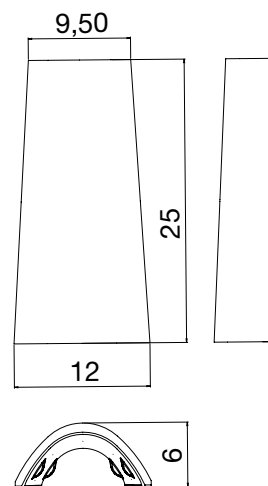

**Approximate values:** If the roof tiles are installed on battens, the useful length must be calculated on site. A tolerance of  $\pm 2\%$  is allowed on the dimensions of the roof tiles according to EN 1024.



## ACCESSORIES

- |  |  |  |  |  |
|--|--|--|--|--|
| <br><b>1</b>          | <br><b>2</b>    | <br><b>3</b>    | <br><b>4</b>     | <br><b>5</b>      |
| Step Celler 50/45<br>50 x 20,5 x 16,5 cm.<br>2,5 Units/lm<br>2,50 Kg.                                  | Circular Ridge<br>43 x 23 x 9 cm.<br>2,5 Units/lm / 2,90 Kg.<br>Max. Slope 47%-25.10°            | Circular Hip Starter<br>43 x 20 x 8,5 cm.<br>2,95 Kg.  | Circular 3 Ways<br>37,5 x 23 x 9,5 cm.<br>4,20 Kg.   | Circular 4 Ways<br>38,5 x 44,5 x 13,5 cm.<br>4,50 Kg.  |
| <br><b>6</b>          | <br><b>7</b>    | <br><b>8</b>    | <br><b>9</b>    | <br><b>10</b>     |
| Circular Straight End Cap<br>7,5 x 24,5 x 27,9 cm.<br>2,40 Kg.   | Circular Curved End Cap<br>17,5 x 26,7 x 27 cm.<br>2,80 Kg.                                      | Cover + Ridge<br>44 x 28,5 x 10,5 cm.<br>2,5 Units/lm / 3,40 Kg.<br>Max. Slope 47%-25.10°        | Cover + Hip Starter<br>43,5 x 23 x 8,5 cm.<br>3,20 Kg.   | Cover + 3 Ways<br>32,5 x 42,5 x 14,5 cm.<br>3,10 Kg.   |
| <br><b>11</b>         | <br><b>12</b>   | <br><b>13</b>   | <br><b>14</b>   | <br><b>15</b>     |
| Cover + 4 Ways<br>40,5 x 40,5 x 14 cm.<br>4,00 Kg.   | Cover + Straight End Cap<br>6,5 x 27 x 31 cm.<br>2,00 Kg.  | Cover + Curved End Cap<br>14,7 x 27,5 x 29,5 cm.<br>2,25 Kg.                                     | Under Ridge<br>24 x 12,2 x 5,6 cm.<br>5 Units/lm (on monopitch)<br>0,80 Kg.                        | Edge for curved roof tiles left<br>(only in Red)<br>47,5 x 19,5 x 8,5 cm.<br>2,5 Units/lm / 3,00 Kg. |
| <br><b>16</b>        | <br><b>17</b>  | <br><b>18</b>  | <br><b>19</b>  | <br><b>20</b>    |
| Edge for curved roof tiles right.<br>(only in Red)<br>47,5 x 19,5 x 8,5 cm.<br>2,5 Units/lm / 3,30 Kg. | Straight Edge Left<br>47 x 9 x 17 cm.<br>2,5 Units/lm / 3,00 Kg.                                 | Straight Edge Right<br>47 x 9 x 17 cm.<br>2,5 Units/lm / 3,00 Kg.                                | Curved Edge Left<br>47 x 24,5 x 16 cm.<br>2,5 Units/lm / 3,30 Kg.                                  | Curved Edge Right<br>47 x 24,5 x 16 cm.<br>2,5 Units/lm / 3,30 Kg.                                   |
| <br><b>21</b>       | <br><b>22</b> | <br><b>23</b> | <br><b>24</b> | <br><b>25</b>   |
| Universal Angular Edge<br>(on monopitch)<br>43 x 14,5 x 14,5 cm.<br>2,5 Units/lm / 2,85 Kg.            | C-50.21 Hip Starter<br>50 x 17,5 x 7,5 cm.<br>2,80 Kg.   | C-50.21 3 Ways<br>32,5 x 30,5 x 15 cm.<br>2,70 Kg.   | C-50.21 4 Ways<br>40,5 x 37,5 x 15,5 cm.<br>5,50 Kg.   | Chimney Carrier<br>C-50.21 d.130<br>50 x 21,5-17,5 x 18 cm.<br>16 Øext-12 Øint / 3,20 Kg.            |
| <br><b>26</b>       | <br><b>27</b> | <br><b>28</b> | <br><b>29</b> | <br><b>30</b>   |
| Chimney d.130<br>20,4 Øext-18 Øint x 23,5 cm.<br>2,15 Kg.  | Ventilation Cap<br>24,5 Øext-22 Øint x 6 cm.<br>1,70 Kg.   | Ventilation C-50.21<br>50 x 21 x 17,4 cm.<br>2,60 Kg.  | Eave Closure<br>C-50.21<br>26,5 x 9,7 x 11 cm.<br>0,90 Kg.   | Ventilation C-45.20<br>49 x 20-15,5 x 17,4 cm.<br>2,10 Kg.   |
| <br><b>31</b>       | <br><b>32</b> | <br><b>33</b> | <br><b>34</b> | <br><b>35</b>   |
| Ventilation C-40.19<br>40 x 18-14 x 6,5 cm.<br>1,70 Kg.  | Ventilation C-40.15<br>40,8 x 15-11,6 x 6,3 cm.<br>1,70 Kg.                                      | Eave Closure<br>13,8 x 7,1 x 6,8 cm.<br>5 Units/lm / 0,60 Kg.                                    | Under Ridge C-40.15<br>20,6 x 10,5 x 6,25 cm.<br>5,5 Units/lm (on monopitch) /<br>0,5 Kg.          | Booster C-40.15<br>440,5 x 15 / 5,5-6 cm. L precorte<br>1,35 Kg.                                     |
| <br><b>36</b>       |  |  |  |  |

Decorative pieces  
 Various models and sizes  
 (more info available at: [tejasborja.com](http://tejasborja.com))

A tolerance of ± 2% is allowed on the dimensions according to EN 1024. Dimensions in centimeters. Check finishing colours for different accessories. Accessories are subject to minimum order and must be multiples thereof.

# ACCESSORIES

1 Step Celler 50/45

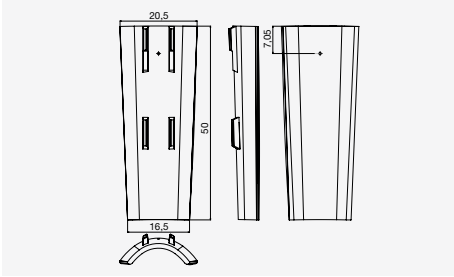

2 Circular Ridge

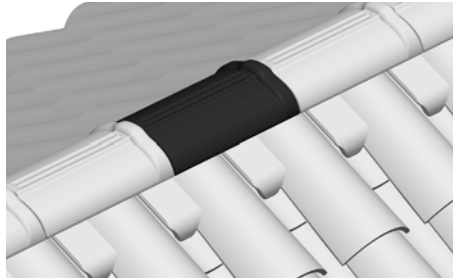
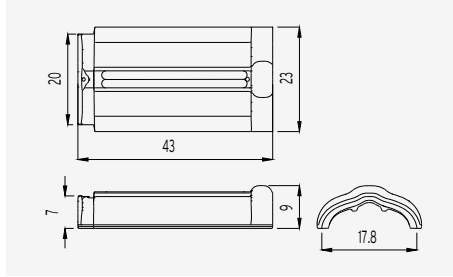

3 Circular Hip Starter

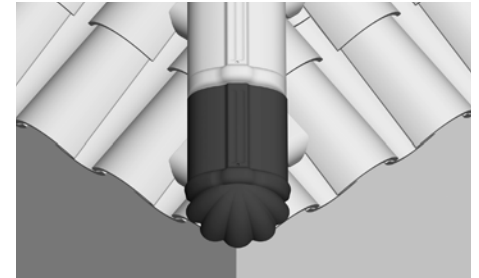
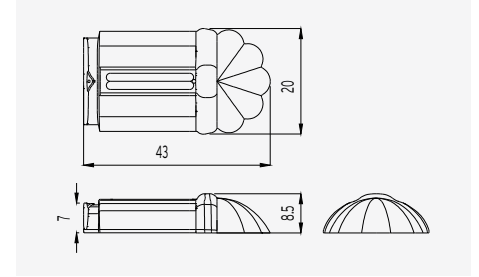

4 Circular 3 Ways

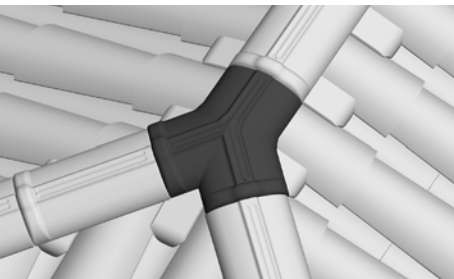
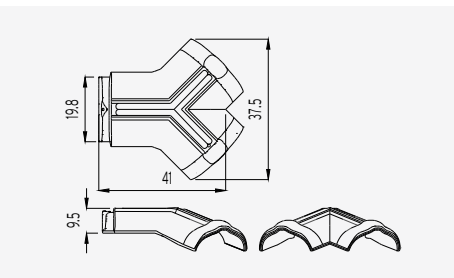

5 Circular 4 Ways

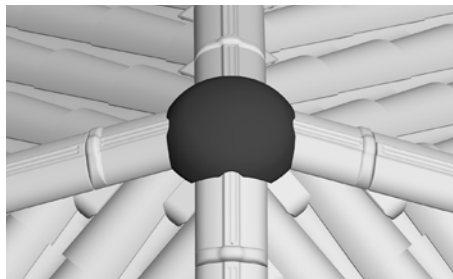
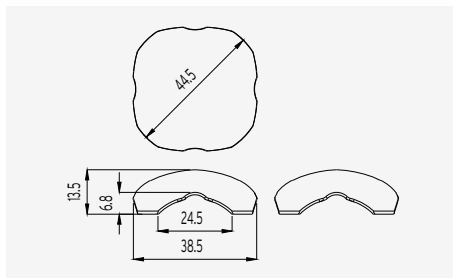

6 Circular Straight End Cap

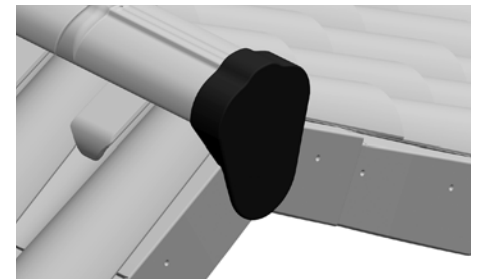
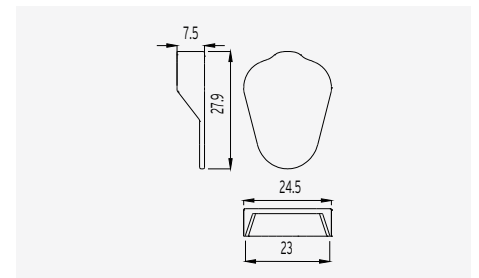

7 Circular Curved End Cap

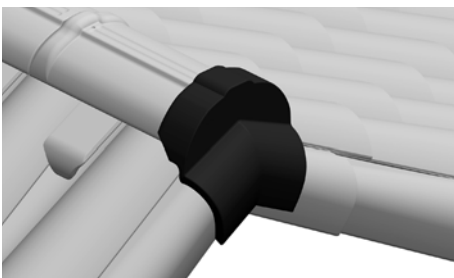
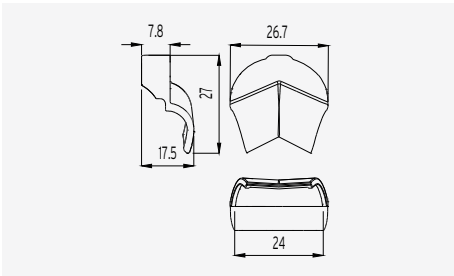

8 Cover + Ridge

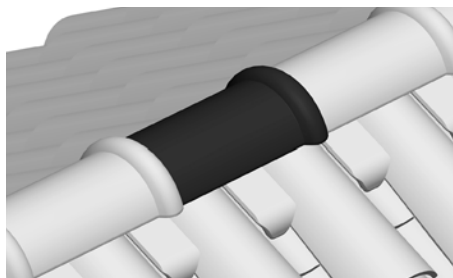
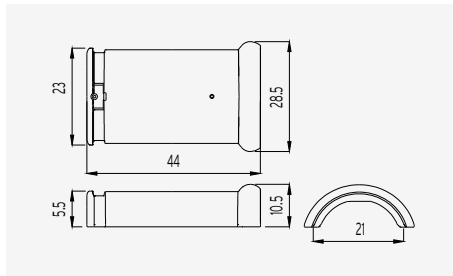

9 Cover + Hip Starter

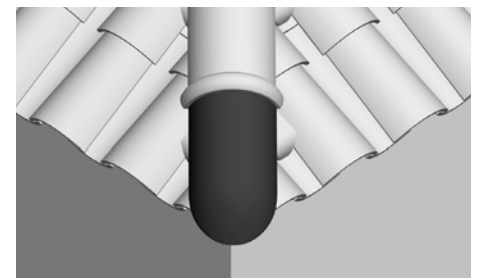
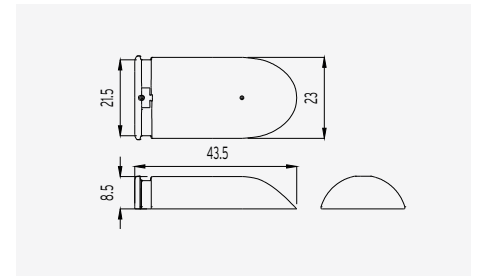

# ACCESSORIES

10 Cover + 3 Ways

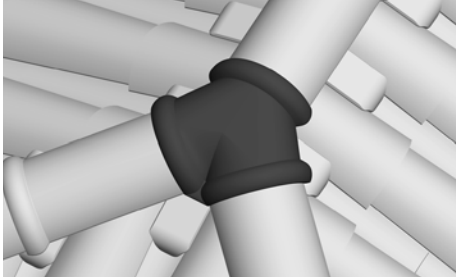
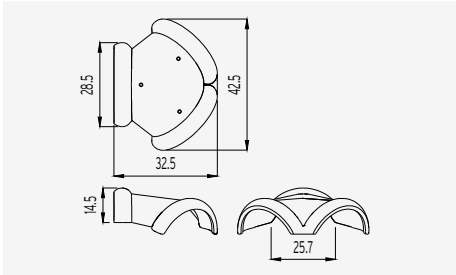

11 Cover + 4 Ways

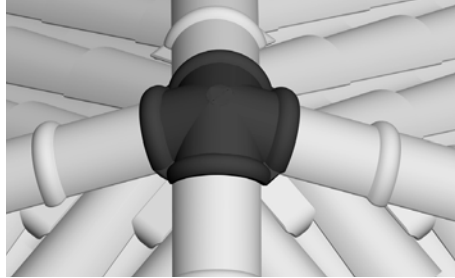
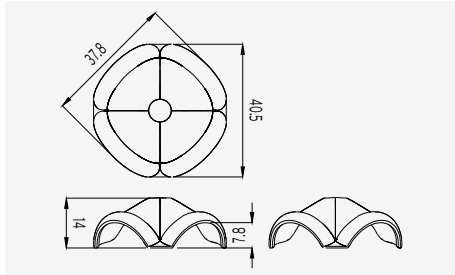

12 Cover + Straight End Cap

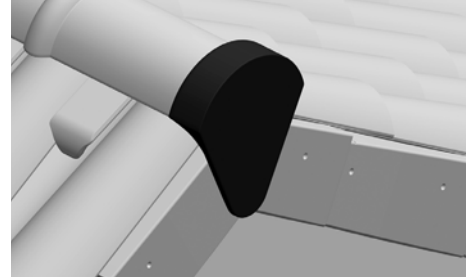
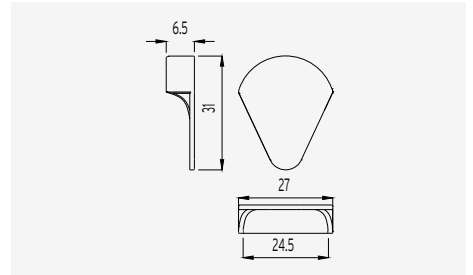

13 Cover + Curved End Cap

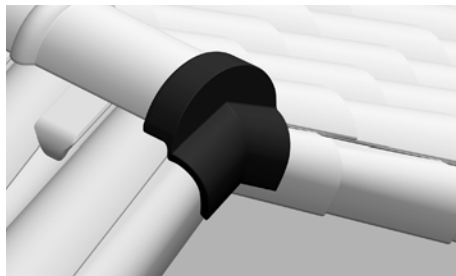
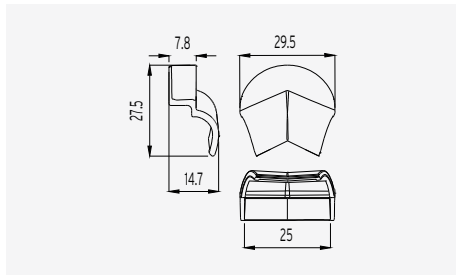

14 Under Ridge

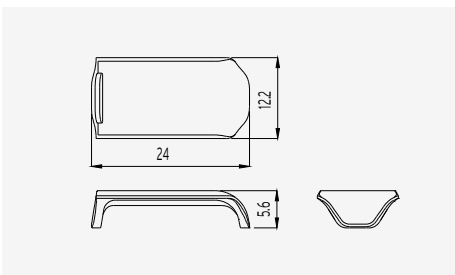

15 Edge for curved roof tiles left

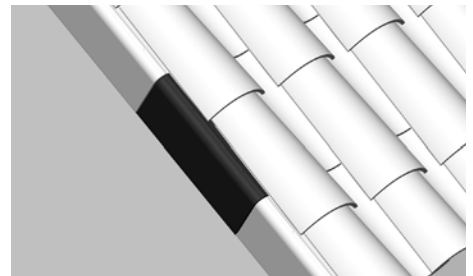
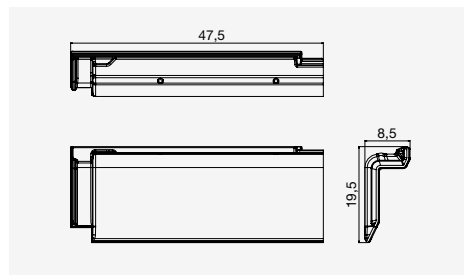

16 Edge for curved roof tiles right

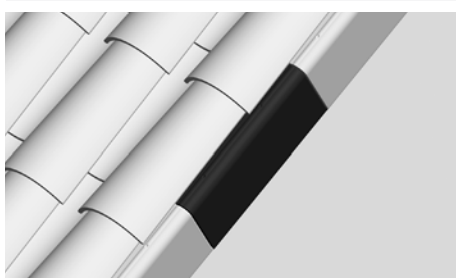
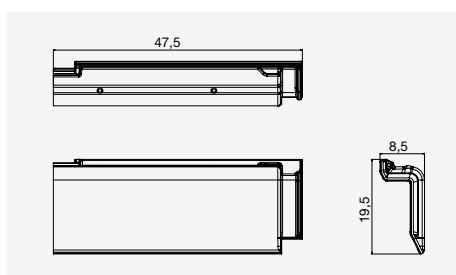

17 Straight Edge Left

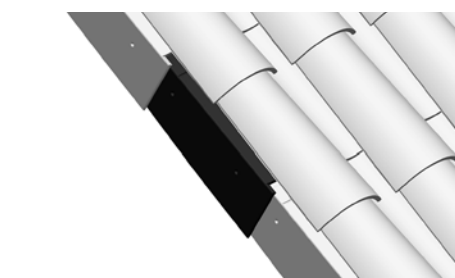
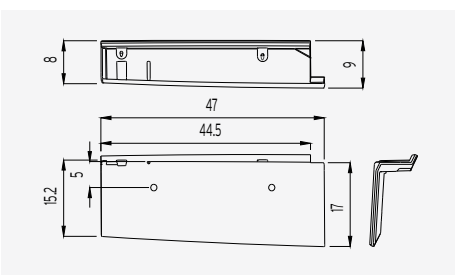

18 Straight Edge Right

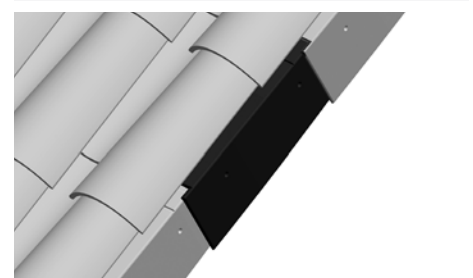
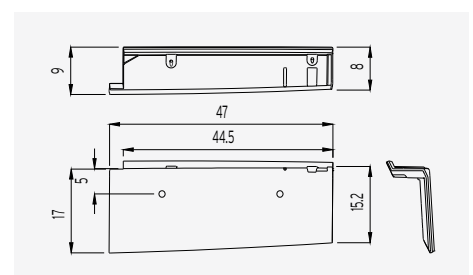

# ACCESSORIES

19 Curved Edge Left

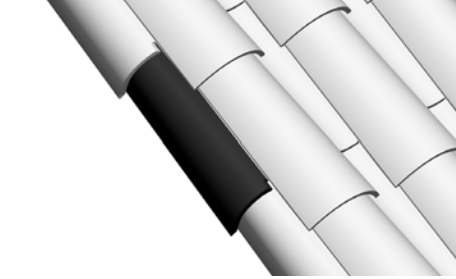
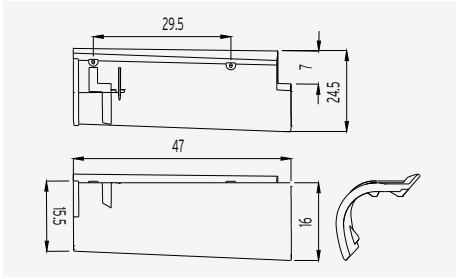

20 Curved Edge Right

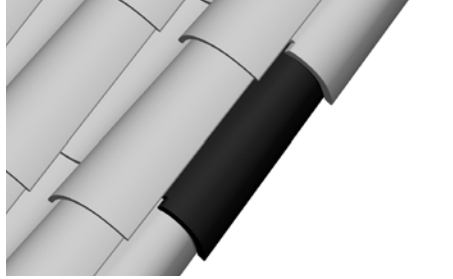
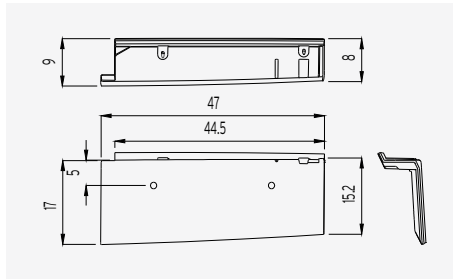

21 Universal Angular Edge (on monopitch)

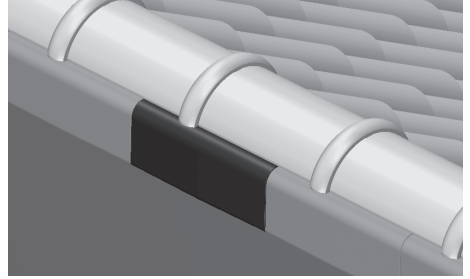
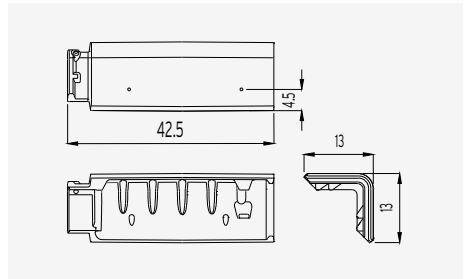

22 C-50.21 Hip Starter

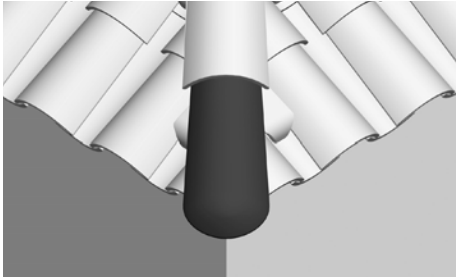
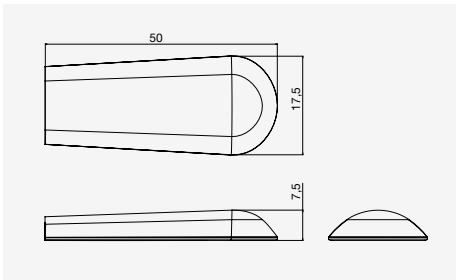

23 C-50.21 3 Ways

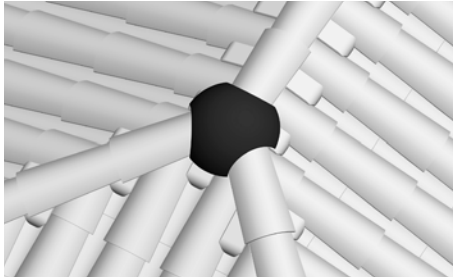
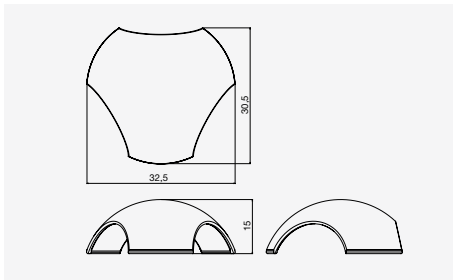

24 C-50.21 4 Ways

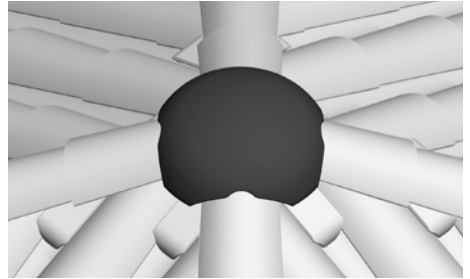
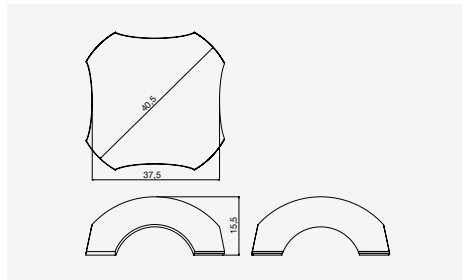

25 Chimney Carrier C-50.21 d.130

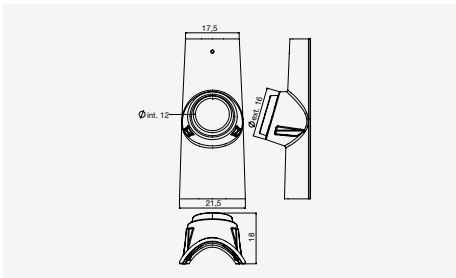

26 Chimney d.130

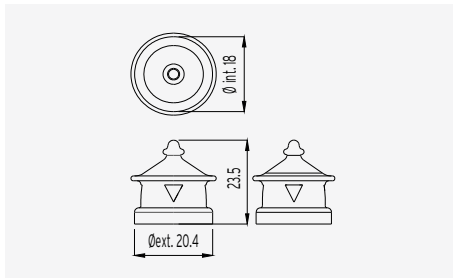

27 Ventilation Cap

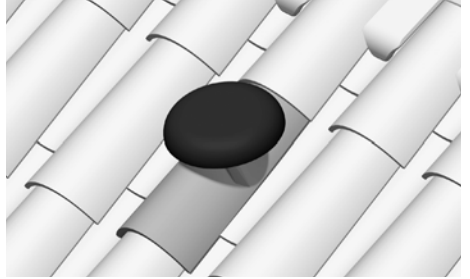
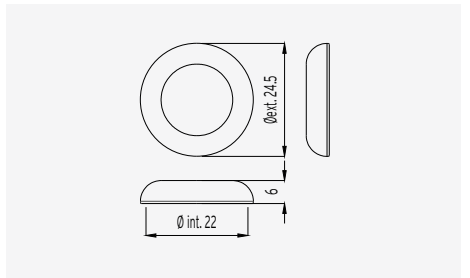

# ACCESSORIES

28 Ventilation C-50.21

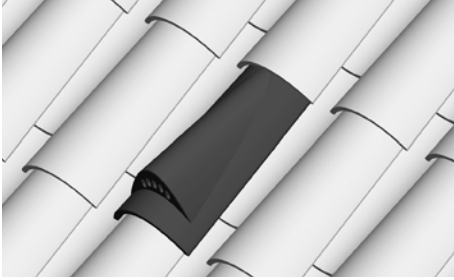
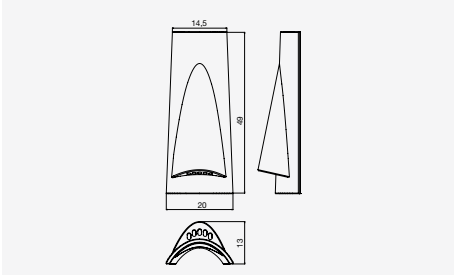

29 Eave Closure C-50.21

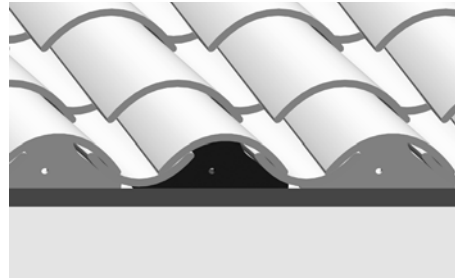
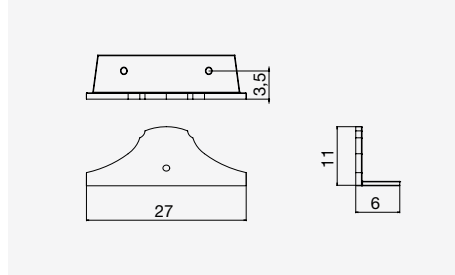

30 Ventilation C-45.20

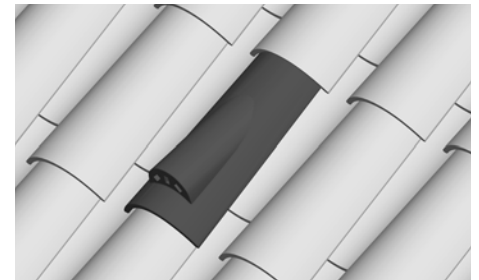
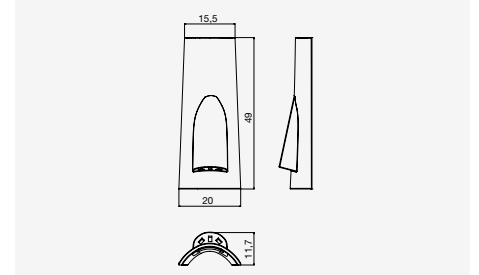

31 Ventilation C-40.19

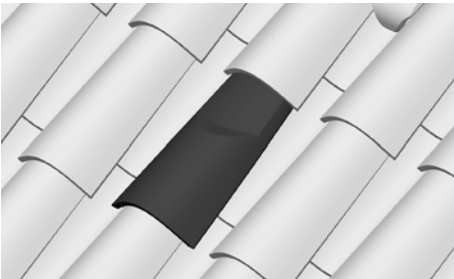
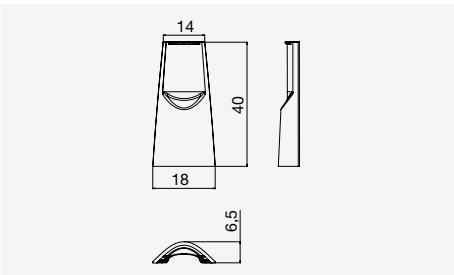

32 Eave Closure Universal

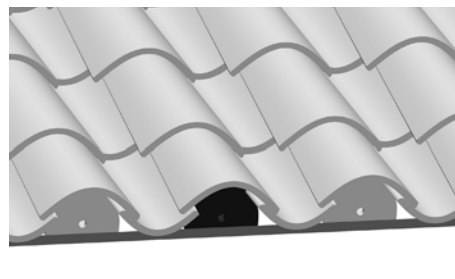
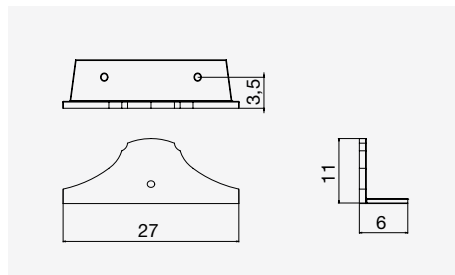

33 Under Ridge C-40.15

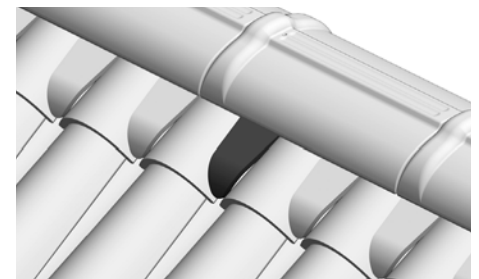
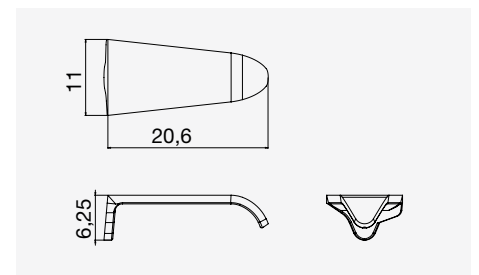

34 Ventilation C-40.15

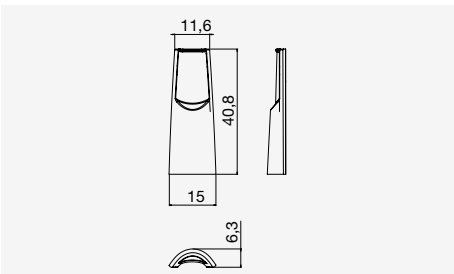

35 Booster C-40.15

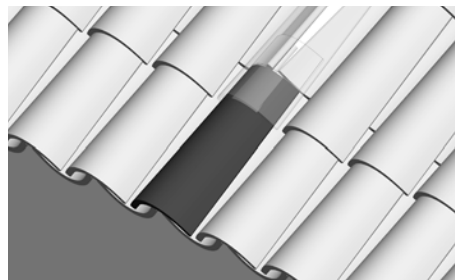
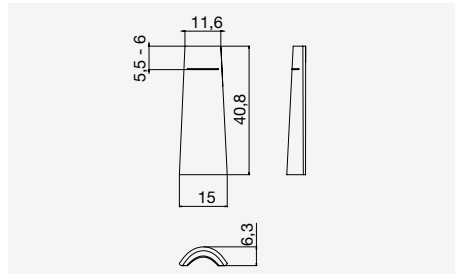

36 Decorative pieces

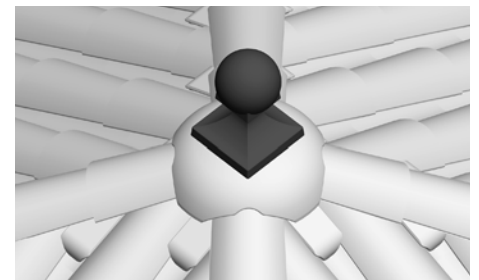
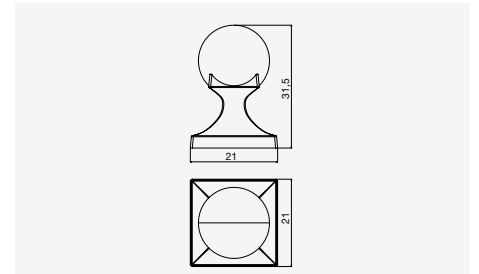

# CURVED ROOF TILES INSTALLATION

## ROOF SLOPES

Each roof must be planned taking into account where it should be built and the length of the deck, in accordance with the technical standards applicable in each territory.

**Pitch panel according to the roof length and the location. (according to UNE - 136020)**

Zone 1	Pitch	26%-15°	28%-16°	30%-17°	32%-18°	34%-19°	36%-20°	38%-21°	40%-22°	42%-23°	44%-24°	> 46%-25°
	Overlap	15	14	13,5	13	12,5	12	11,5	11	10	10	7
Zone 2	Pitch	26%-15°	28%-16°	30%-17°	32%-18°	34% 19°	36%-20°	38%-21°	40%-22°	42%-23°	44%-24°	> 46%-25°
	Overlap	X	15	14,5	14	13,5	13	12,5	12	11	10	7
Zone 3	Pitch	26%-15°	28%-16°	30%-17°	32%-18°	34% 19°	36%-20°	38%-21°	40%-22°	42%-23°	44%-24°	> 46%-25°
	Overlap	X	X	X	15	14,5	14	13,5	13	12	11	7

Use the breathable/waterproof membrane on the support.

A special study should be carried out for roof length more than 12m in length (ask us).

Pitch 17°								
Roof Tile	C-40.15	C-40.15	C-40.19	C-40.19	C-45.20	C-45.20	C-50.21 Celler®	C-50.21 Celler®
Ridge	Circular	Cover +	Circular	Cover +	Circular	Cover +	Circular	Cover +
D (mm)	60 mm	70 mm	60 mm	70 mm	60 mm	70 mm	60 mm	70 mm
H (mm)	130 mm	130 mm	130 mm	135 mm	125 mm	135 mm	135 mm	140 mm

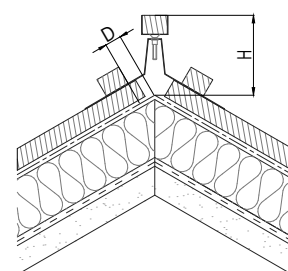

D - Distance between the last batten and ridge line; H - Height of ridge batten; ° - Pitch

## FITTING

Roof tiles on the roof surface must be fixed to the support to a greater or lesser extent, depending on the pitch. In the case of singular points such as eave lines, edges, hip lines, valleys, joints and the ridge line, all roof tiles and accessories of these joints must be fixed to the battens.

**We recommend that all roof tiles that form the perimeter of each skirt be fixed mechanically.**

Batten type:	Metallic
	Treated wood
Dry installation:	Screws, nails and clips (depending on the support)
	Roof tiles adhesives

**A** 26%-70% All roof tiles (pan and cover) must be fixed every 5 rows.

**B** > 70% All pans and covers should be fixed mechanically.

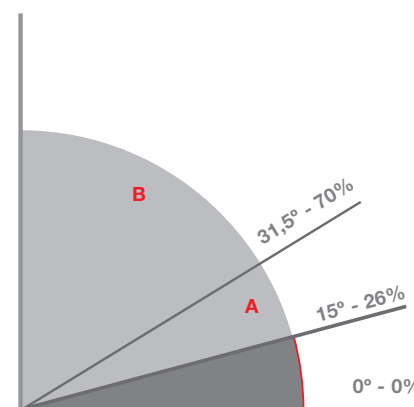

Less than 26% -  
Not recommended

Installation must comply with the technical standards applicable in each territory Code of practice for design and fixing of roofs with clay roofing tiles and Tejas Borja specifications.

## VENTILATION

Under-tile ventilation is necessary at all times. This will guarantee the durability of the material used to build the roof with their optimal characteristics, improving the hygrothermal performance of the roof tiles against the moisture resulting from condensation.

There must be a continuous air flow between eave lines and ridge line. Therefore, a space must be left between the roof tiles and the support. As a result, eave lines, ridge lines and singular points must never be filled in with mortar, as this will impede micro-ventilation.

Ventilation roof tiles will also be installed in a uniform manner across the surface of the roof. In case of dry installation, it is recommended that at least 1 ventilation roof tile be used every 10 sq.m. and 4 ventilation roof tiles per each roof skirt.

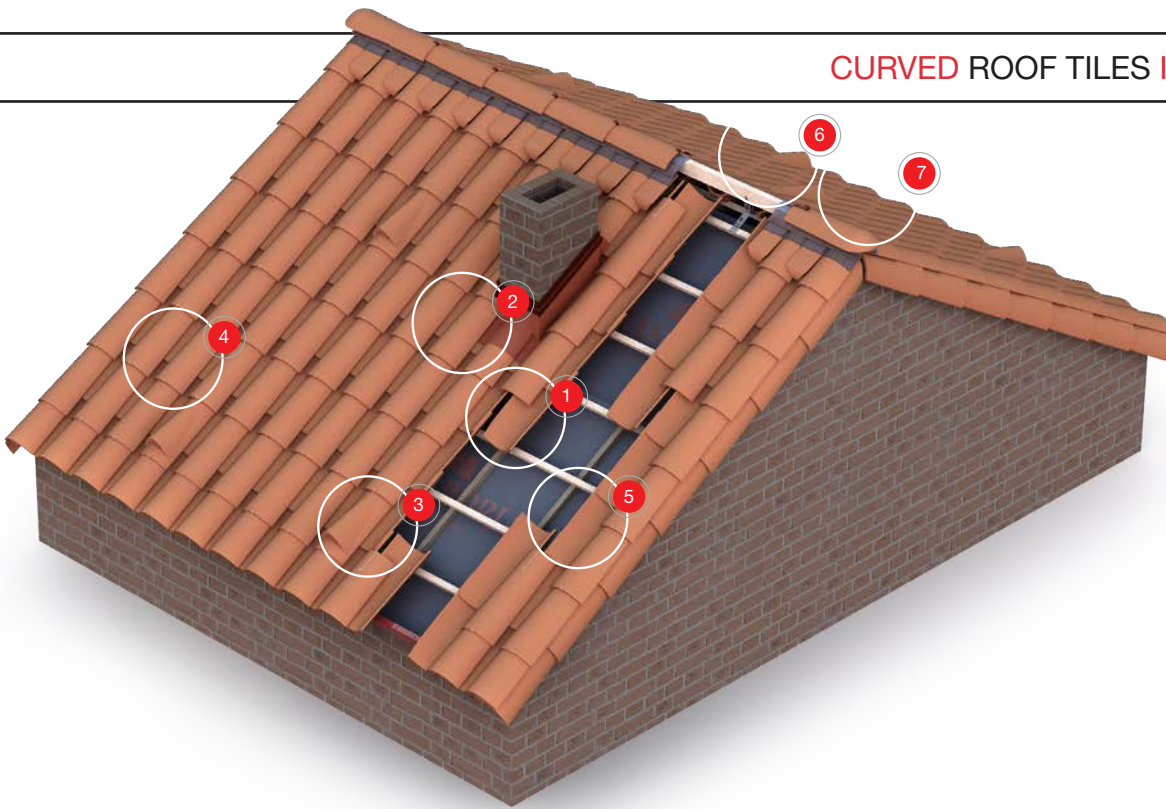

An optimal installation of C-50.21 Celler® tiles uses TALÓN 50/45 tiles in pan position to form a channel, fixing them to a batten system. The curved tiles can also be dry installed over under-tile panels (fibre cement or bitumen).  
 \*Watch our dry installation videos at [www.tejasborja.com](http://www.tejasborja.com)



Double batten structure. Batten height 3 cm minimum. Install primary battens (L1) perpendicular to the maximum roof pitch with 50-70 cm space between them. The same spacing must be used across the roof slope. Install secondary battens (L2) to distribute the tiles taking into account geography, climate and tile overlap, in accordance with standard UNE - 136020. The position of the second L2 depends on the overhang at the eaves and the overlap of each tile.



Structure with under-tile panels. Follow the current installation regulations for under-tile panels.

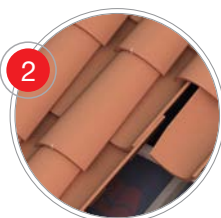

To dry fix the tiles in cover position, use curved tile hooks to maintain a consistent overlap across all the rows on the roof.  
 On roofs with a steep pitch we also recommend securing the joins using special foam adhesive for tiles.



Installation begins with the first row of tiles, ensuring a consistent distance between the centre of each tile and leaving a 3-7 cm gap for drainage. The tile overhang at the eaves must be greater than 5 cm. The tile overlap will be determined by local climate and the slope of the roof.



Use ventilation tiles to increase the circulation of air underneath the tiles. Ventilation tiles must be installed in accordance with standard UNE - 136020.

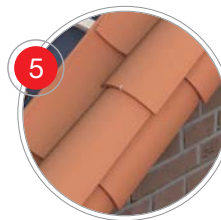

Edge piece must always be installed underneath the cover tiles which make up each side of the roof, and following the direction of the channel of tiles in pan position.



The batten which is installed on the ridge is fixed to the batten supports. The batten supports must be fixed to the supporting structure at the appropriate pitch and height so that the ridge pieces rest directly on the final row of tiles and the ridge wedges.



Ridge tape is installed over the ridge batten, fixed using staples or nails. To waterproof the join, the ridge tapes have butyl adhesive strips which fix to the profile of the tiles.

Finally, install the ridges and End Caps accessory, fixing them using screws, nails or ridge clips.

Always follow installation rules in accordance with applicable regulations (UNE - 136020) and those in force in the relevant local jurisdiction.

# LARGE CURVED ROOF TILES INSTALLATION - WITH STEP CELLER 50/45

EAVE LINE

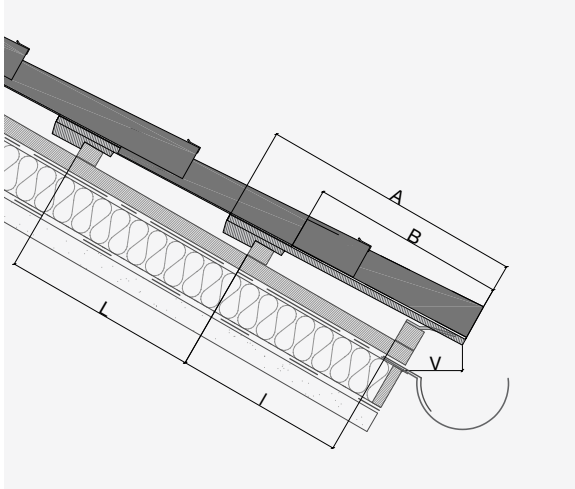

RIDGE LINE

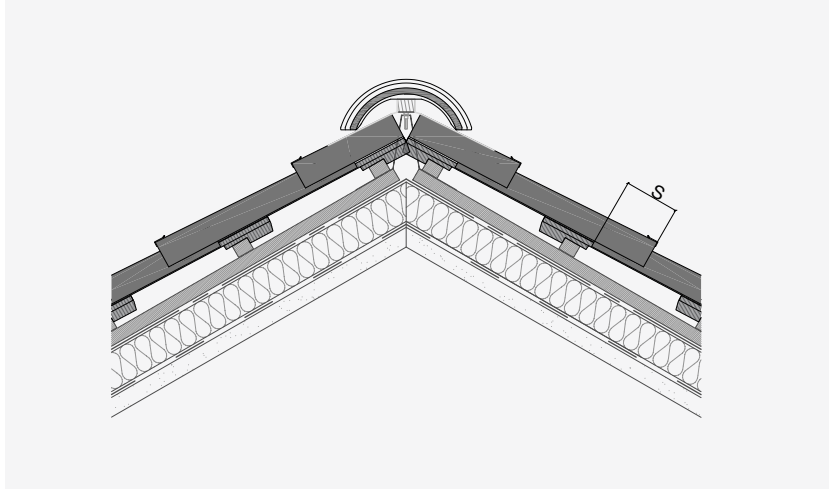

HORIZONTAL FLASHING

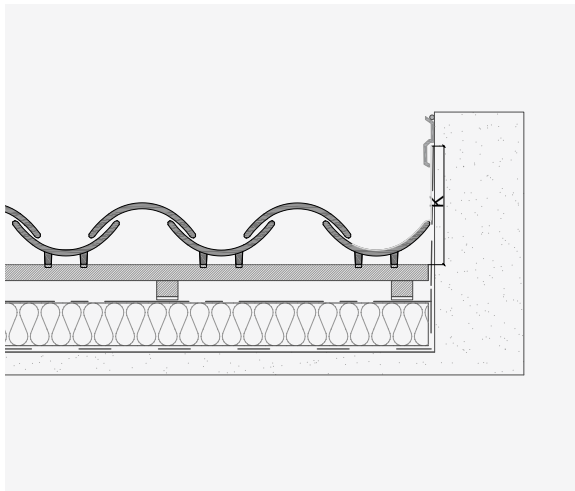

MONOPITCH

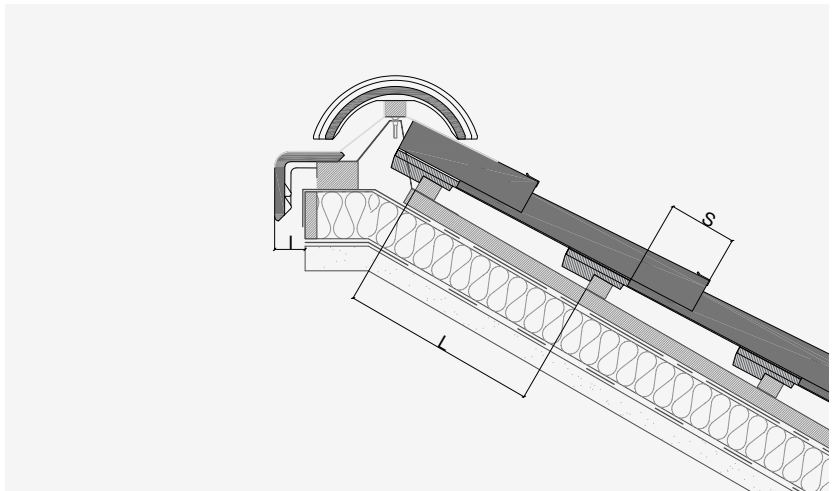

UPPER FLASHING

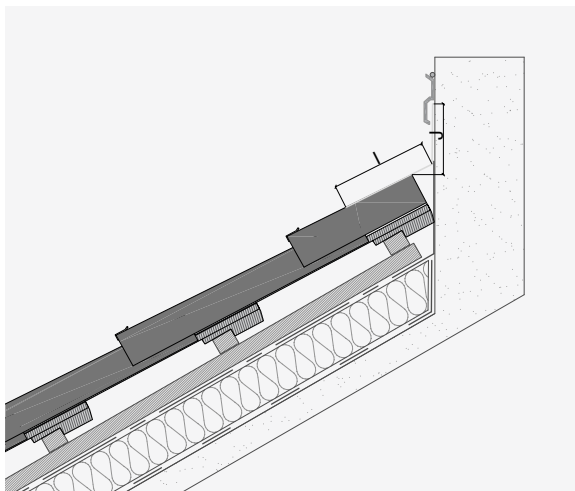

GABLES

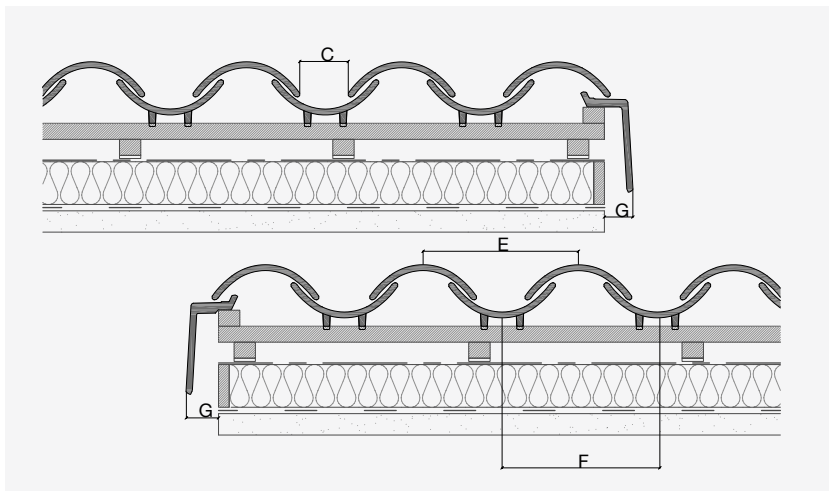

ROOF TILE	A	B	C	E	F	G	I	J	k	L	I	S'	V
STEP CELLER 50/45 WITH C-50.21 CELLER	500	330-420	≥ 30	240-200	235-195	≥ 50	≥ 100	≥ 150	≥ 250	300-350	300-350	80-170	≥ 50
STEP CELLER 50/45 WITH C-45.20	500	330-420	≥ 30		235-195	≥ 50	≥ 100	≥ 150	≥ 250	350-400	300-350	80-170	≥ 50
C-50.21 CELLER	500	310-420	≥ 30			≥ 50	≥ 100	≥ 150	≥ 250	-	-	80-210	≥ 50
C-45.20	450	240-370	≥ 30			≥ 50	≥ 100	≥ 150	≥ 250	-	-	80-190	≥ 50



# CURVED ROOF TILES INSTALLATION

EAVE LINE

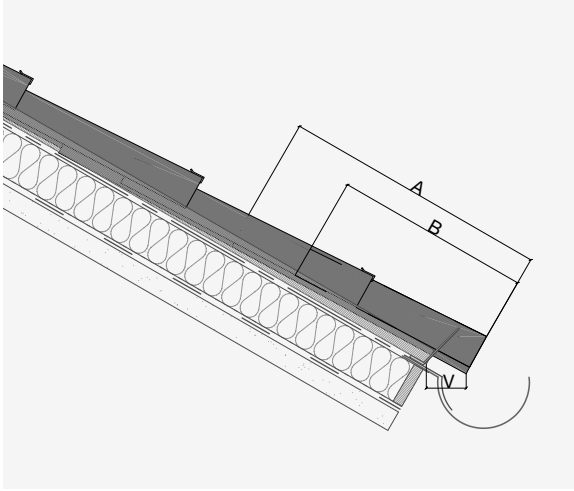

RIDGE LINE

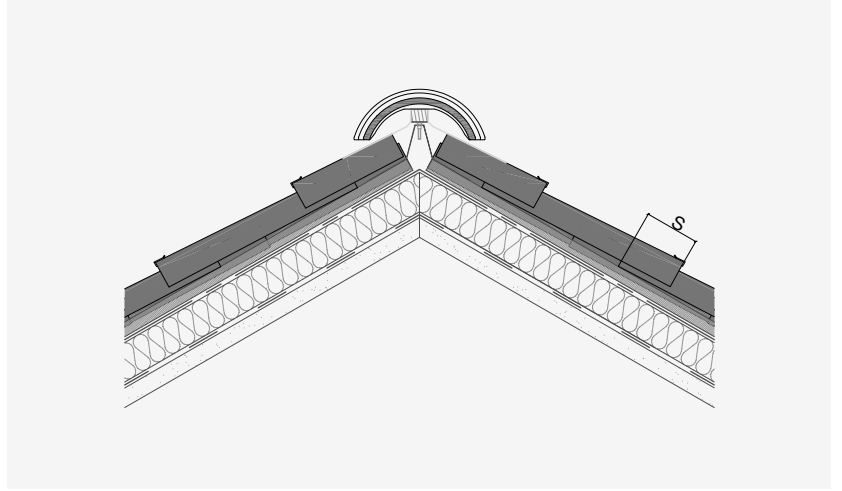

HORIZONTAL FLASHING

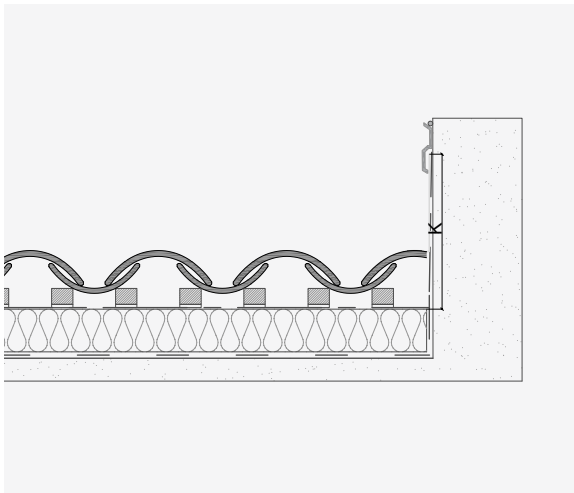

MONOPITCH

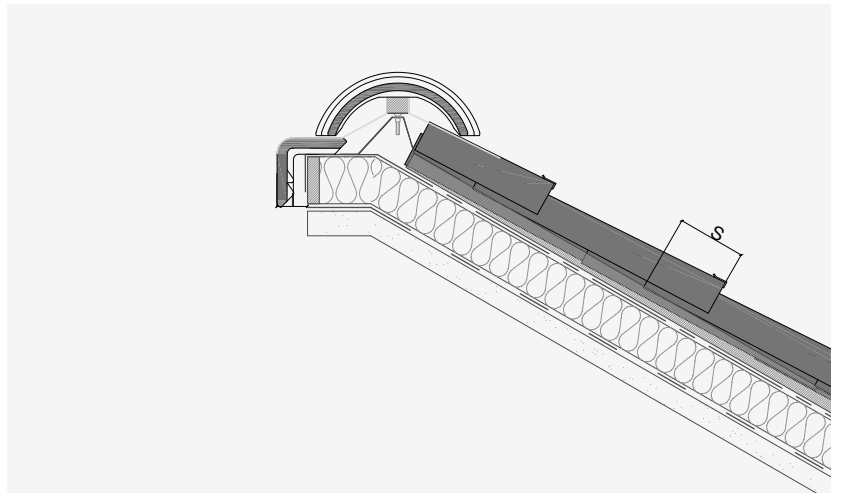

UPPER FLASHING

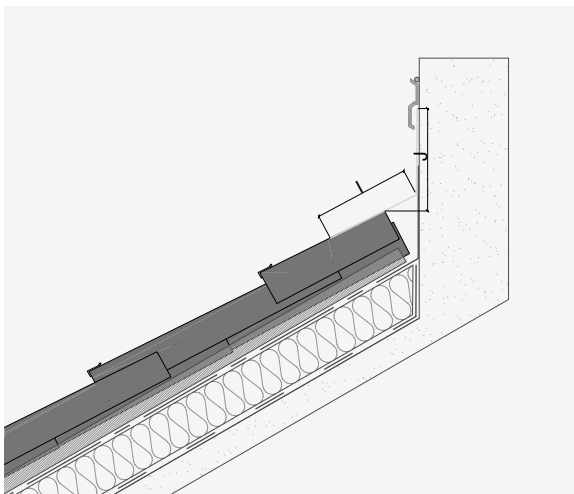

GABLES

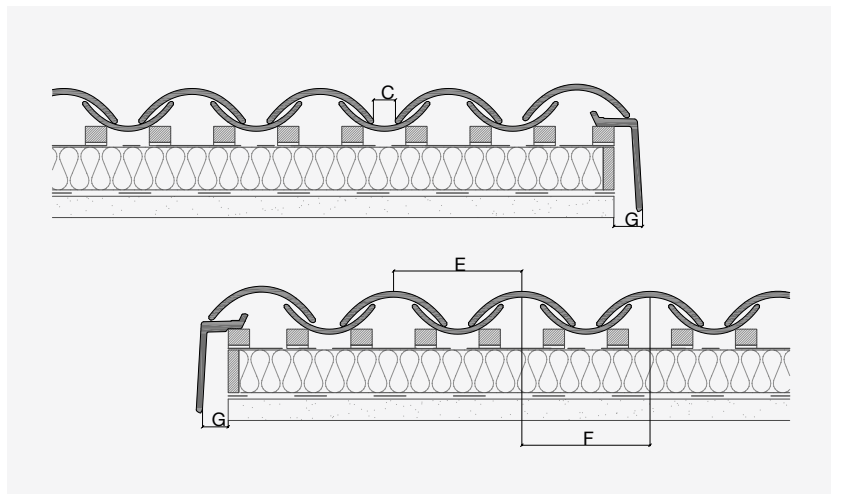

ROOF TILE	A	B	C	E	F	G	I	J	k	L	I	S <sup>1</sup>	V
C-40.19	408	238-328	≥ 30			≥ 50	≥ 100	≥ 150	≥ 250	-	-	80-170	≥ 50
C-40.15	408	258-328	≥ 30			≥ 50	≥ 100	≥ 150	≥ 250	-	-	80-150	≥ 50

<sup>1</sup> To guarantee the roof's watertightness, both the slope and minimum overlaps must always be determined in accordance with the geographical area and location of the roof, exactly as specified in Standard UNE-136020 regarding the design and installation of ceramic tile roofs.

Measurements in millimetres



# Projects





---

## NATURE

---

Red

Available in:

C-50.21 Celler®  
STEP CELLER 50/45  
C-45.20  
C-40.19  
C-40.15  
C-25.12





---

**NATURE**

---

Shaded White

Available in:

C-50.21 Celler®

TALÓN 50/45

C-40.19





---

**CENTENARIA®**

---

Ground



Available in:

C-50.21 Celler®  
C-40.15

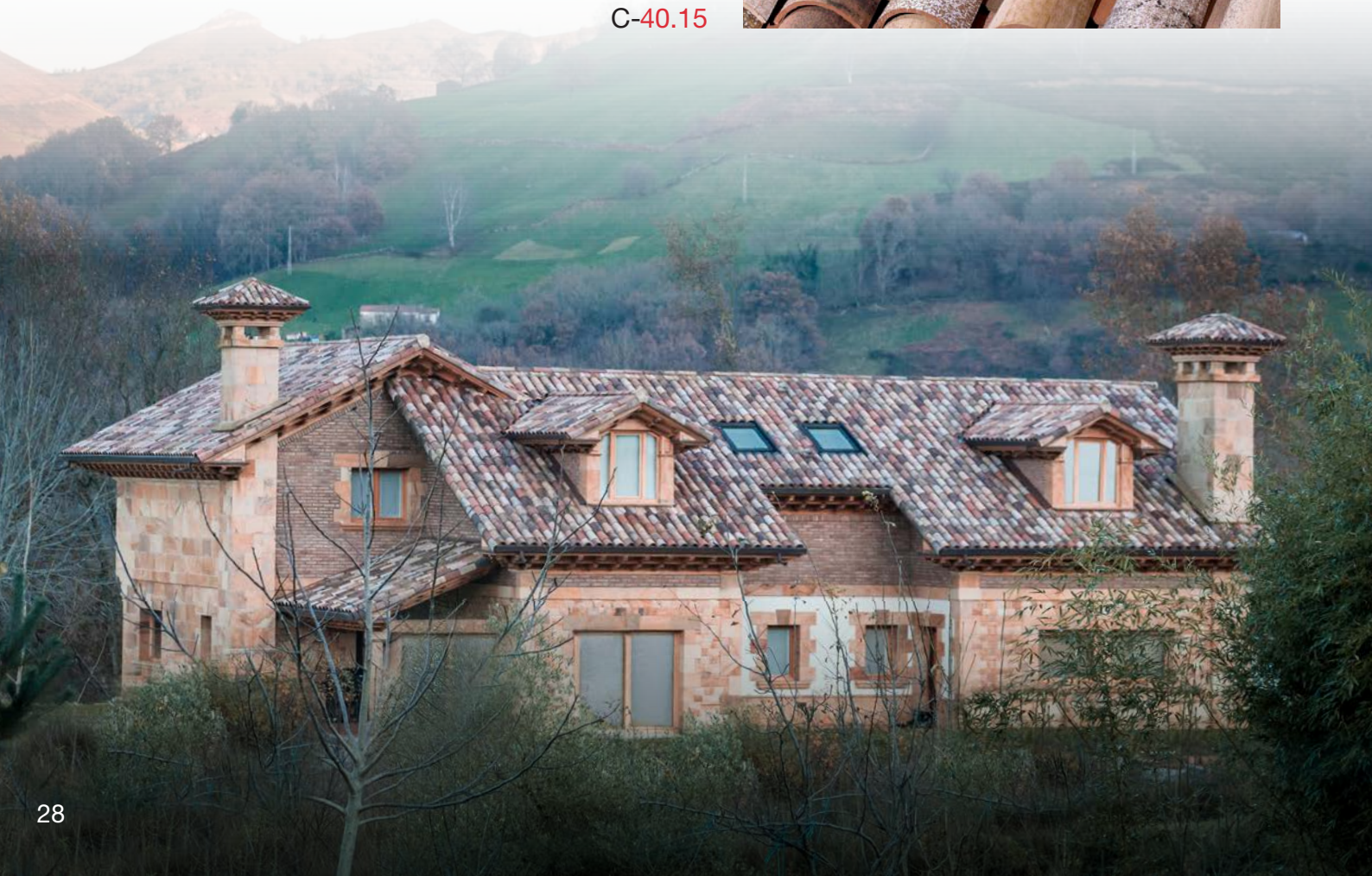



---

**CENTENARIA®**

---

Mediterrània®

Available in:

C-50.21 Celler®





---

**NATURE**

---

Edetania®



Available in:  
C-50.21 Celler®







STEP CELLER 50/45





Matt Slate



Lamalou®



Montseny



32

Fosca



Vilavella®

T H E ® E V O L U T I O N  
of the ceramic tile sector

Tejas Borja S.A.U. reserves the right to change the characteristics and availability of the products and colours displayed in this catalogue without prior notice. The colours of the pieces shown may vary slightly from the originals. The settings shown in this catalogue are decorative suggestions for publicity purposes only and in real installations the fitting instructions published by Tejas Borja must be followed.



TEJAS BORJA, S.A.U.

Ctra. Lliria a Pedralba, Km. 3  
46160 Lliria, Valencia, SPAIN  
T.+34 96 279 80 16  
F. +34 96 278 25 63  
info@tejasborja.com

[tejasborja.com](http://tejasborja.com)