



Roof & Plug

**PHOTOVOLTAIC SOLAR
ENERGY SOLUTIONS**

*Perfect integration
into the roof*



TEJAS BORJA

Since 1899

Produce your own clean energy

**Solar energy solutions for your home.
An inexhaustible source, ecological
and efficient.**

Tejas Borja's solar photovoltaic energy solutions can be adapted to meet the specific energy generation requirements of each project.

The choice of material for the roof tiles is crucial to guarantee the durability, protection and energy efficiency of the property, and nor should the importance of the roof's aesthetic appearance be overlooked.

In order to combine efficiency with design, Tejas Borja solar solutions are integrated into the ceramic roof in such a way that they affect the design of the original project as little as possible.

The products in our SOLAR range and our ceramic tiles must always be installed using dry installation systems. Using standard international connections, it guarantees an optimal level of security, being hidden from the naked eye. In this way, the maximum tightness and durability of the roof is achieved.

THE IMPORTANCE OF SELF-CONSUMPTION: Save while protecting the environment.

Photovoltaic energy is a clean and environmentally-friendly form of energy, ideal for self-consumption and to reduce monthly electricity bills, both for homes and company premises.

A technology which is widely used around the world, photovoltaic panels convert solar energy into electricity. Make your home more sustainable, independent and committed to the environment, while increasing the value of the property and providing the possibility of making a profit from the sale of excess energy generated into the grid.

TILES OR SOLAR PANELS?

Although both solutions serve the same purpose, there are clear differences between installing non-integrated solar panels versus solar tiles, such as the tiles in the Tejas Borja SOLAR range. The main advantage of solar tiles over panels is their perfect integration into the roof. The solar tiles barely affect the building design as they are installed together with ceramic tiles with a similar appearance. They also have a matt, full-black finish which makes them as unobtrusive as possible.

When non-integrated solar panels are installed, they are fixed above the roof's surface which makes them much more visible from any angle. Moreover, the installation of brackets to support solar panels tends to put the watertightness of the roof at risk as the fixings have to pass through the tiles and the roof support. By contrast, solar tiles are screwed directly to the roof battens, in the same way as any flat ceramic roof tiles would be attached.

HIGH EFFICIENCY AND DURABILITY

With an output of more than 143 Wp/sq. m. (power / sq. m.), the benefits of the installation can be maximized without altering the appearance and harmony of the home.

The long term durability and performance of the solar cells is guaranteed thanks to the use of glass-glass panels which ensure the seal of the cells is watertight and long-lasting.

"Tejas Borja's solar solutions achieve electricity bill savings, helping to reduce the carbon footprint on the planet by not using other natural resources for energy".

The SOLAR roof tile range of Tejas Borja

Products that are perfectly integrated into flat tile roofs from Tejas Borja's "Flat" range.



SOLAR FLAT-5XL
Ceramic Roof Tile
MONOCRYSTALLINE

SOLAR FLAT-5XL
Ceramic Roof Tile
CIGS



SOLAR FLAT-10
Roof Tile
CIGS



SOLAR FLAT-5XL

Ceramic Roof Tile

DESIGN AND SUSTAINABILITY

Quality guaranteed



Tejas Borja's solar solutions achieve electricity bill savings, and cut electricity bills while helping to reduce our carbon footprint by providing an alternative, environmentally-friendly way to generate electricity.

The photovoltaic panel is perfectly integrated into the tile, this being the best way to achieve a roof which captures clean energy without affecting its aesthetic appearance, preserving the line and usual thickness of the covering. This perfect integration is completed with the installation of the roof or facade using FLAT-5XL tiles and other ceramic accessories.



Perfect integration

SOLAR Flat-5XL ceramic roof tiles are the only large ceramic tiles with an integrated solar energy system. They are ideal for providing a reliable supply of solar energy. Thanks to the integration of the solar panel into the tile, the tiles provide all the benefits of a roof made from ceramic tiles in terms of watertightness, without any risk of deterioration or oxidation.

FULL - BLACK aesthetics

The SOLAR Flat-5XL ceramic roof tiles has an entirely black (FULL-BLACK), anti-reflective finish, with none of the typically visible connections.



SOLAR FLAT-5XL

Ceramic Roof Tile

Technical Characteristics

The SOLAR FLAT-5XL ceramic roof tile comes in two versions to adapt to each project's energy generation needs and available space.



SOLAR FLAT-5XL Roof Tile CIGS ⁽¹⁾

SOLAR FLAT-5XL Roof Tile MONO-CRYSTALLINE ⁽¹⁾ (v3.M1G)

Dimensions	457 x 510 (mm)	457 x 510 (mm)
Weight	7,50 Kg.	7,50 Kg.
Colour	LEON MATTE / CRISTAL FULL-BLACK	LEON MATTE / CRISTAL FULL-BLACK
Cell type	CIGS (Cadmium and Lead free products) ⁽¹⁾	Monocrystalline
Base	Flat-5XL Ceramic Roof Tile	Flat-5XL Ceramic Roof Tile
Solar module size	410 x 360 mm (380 x 300 mm active zone)	410 x 360 mm (385 x 315 mm active zone)
Flat-5XL tiles equivalence	1 roof tile	1 roof tile
Installation	As per Flat-5XL *	As per Flat-5XL *
Connection	mixed connection (series and parallel)	mixed connection (series and parallel)
Nominal Power (Pmax)	17 Wp	23 Wp
Current at Nominal Power (Impp)	0,54 A	1,79 A
Voltage at Nominal Power (Vmpp)	31,7 V	14,30 V
Short Circuit Current (Isc)	0,61 A	2,05 A
Open Circuit Voltage (Voc)	40,2 V	15,16 V
Standard	IEC 61646 - IEC 61730 ⁽²⁾	IEC 61646 - IEC 61730
Front glass	3,2 mm. Tempered Glass	3,2 mm. Tempered Glass
Back layer / Back glass	1,8 mm. Tempered Glass	Polymers combination
Junction Box	IP 67	IP 67
Connection Plug	MC4 Compatible	MC4 Compatible
Cable DC	4.0 mm ² , (12 AWG)	4.0 mm ² , (12 AWG)
Cable DC Length	2 x 600 mm	2 x 470 mm
Recommended batten distance (max. efficiency)	355 mm	355 mm
Units /sq. m.	5,85- 5,50 Units	5,85- 5,50 Units
Maximum power / sq. m. **	102 Wp/m²	143.26 Wp/m²
sq.m. - 1 KWp	9,8 m²	6,98 m²
Units/kWp	58,82 Units	41,32 Units
Units/Pallet	36 roof tiles	36 roof tiles

* The SOLAR roof tiles must be installed always on ventilated roofs, being able to use double batten system or equivalent system.

** According to the batten distance.

(1) CIGS - acronym that defines the latest technology in high efficiency solar cells with high performance (copper, indium, gallium and selenium), free of Cadmium and Lead.

(2) SOLAR FLAT-5XL: Ref. SMG-20W;

STC standard conditions: Irradiance 1,000 W / m², Cell temperature: 25°C, AM =1.5 * The SOLAR roof tiles must be installed always on ventilated roofs, being able to use double batten system or equivalent system.

INSTALLATION design

The solar roof tiles are connected in various strings and in parallel to increase the efficiency of the panels.

SOLAR FLAT-5XL

Ceramic Roof Tile

MONOCRYSTALLINE

For a 3 kW installation with a 3.000 W inverter, 124 SOLAR Flat-5XL MONOCRYSTALLINE tiles will be required. The optimum configuration features 4 strings in parallel with 31 tiles in each string. The power output of this configuration is 3,001 Wp, producing an annual energy output of 4.685 kWh.

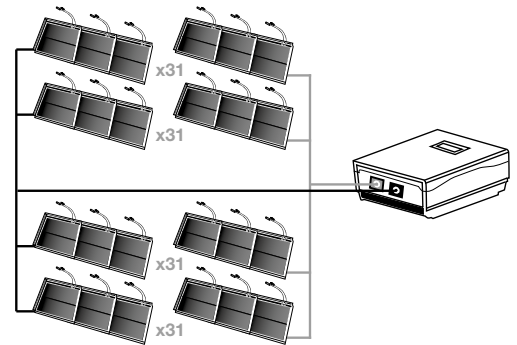

STRING CONFIGURATION

31 // 31
+
31 // 31

We can advise you on the design and specification of a SOLAR FLAT-5XL ceramic roof tile installation to meet your needs.

Contact us! solar@tejasborja.com

SOLAR FLAT-5XL

Ceramic Roof Tile

CIGS ⁽¹⁾

For a 3 kW installation with a 3.000 W inverter, 180 SOLAR Flat-5XL CIGS tiles will be required. The optimum configuration features 18 strings in parallel with 10 tiles in each string. This power output of this configuration is 3.060 Wp, producing an annual energy output of 4.792 kWh.

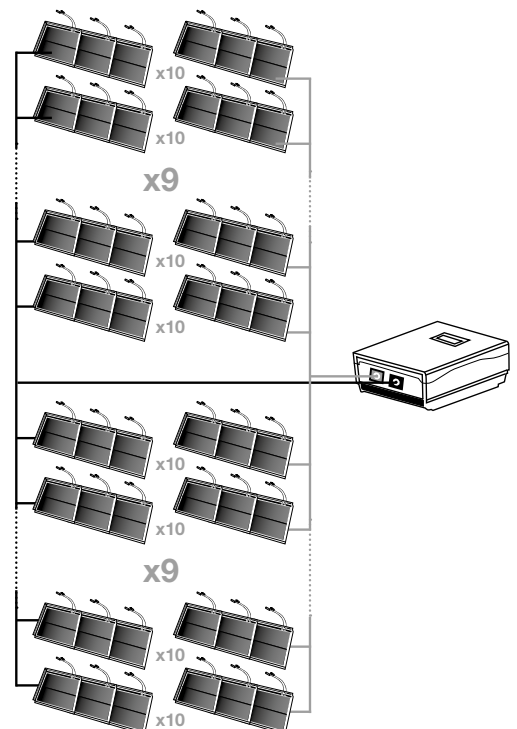

STRING CONFIGURATION

10 // 10 // 10 // 10 // 10 // 10 // 10 // 10 // 10 // 10
+
10 // 10 // 10 // 10 // 10 // 10 // 10 // 10 // 10 // 10

SOLAR FLAT-10

Roof Tile

HIGH TECHNOLOGY
Perfect aesthetics



The SOLAR FLAT-10 tile integrates perfectly into the roof, maintaining the same aesthetic appearance as a ceramic tile, preserving the line and usual thickness of the covering layer as thin as the tile itself.

The SOLAR Flat-10 roof tile is designed to blend seamlessly into your roof. Thanks to its integration, it confers all the benefits of capturing renewable photovoltaic solar energy as well as presenting excellent reliability in terms of watertightness throughout the roof.



Efficiency and durability

The sealed photovoltaic panel with tempered glass on both sides (GLASS-GLASS), the large surface of the tile and new CIGS (thin film) technology, which is free of cadmium and lead, mean that the Solar Flat-10 tile complies with all the requirements for it to be installed in any sustainable, self-consumption project.

FULL-BLACK aesthetics

Solar FLAT-10 roof tiles have a uniform, anti-reflective black finish, without any of the typically visible connections. They are manufactured on an aluminium frame with a FULL-BLACK finish being the equivalent of five Flat-10 ceramic roof tiles.

SOLAR FLAT-10

Roof Tile

CIGS

Technical Characteristics



Dimensions	457 x 1 268 mm
Weight	9,30 Kg.
Colour	Black / Cristal FULL-BLACK
Cell type	CIGS (Cadmium and Lead free products) ⁽¹⁾
Base	Aluminium base
Solar module size	345 x 1215 mm (300 x 1200 mm active zone)
FLAT-10 tiles equivalence	5 roof tiles
Installation	According to FLAT-10 roof tile
Connection	Mixed connection (series and parallel)
Nominal Power (Pmax)	56 Wp
Current at Nominal Power (Impp)	1,7 A
Voltage at Nominal Power (Vmpp)	33 V
Short Circuit Current (Isc)	1.89 A
Open Circuit Voltage (Voc)	41.3 V
Standard	IEC 61646 - IEC 61730
Front glass	3.2 mm. Tempered Glass
Back glass	1.8 mm. Tempered Glass
Junction Box	IP 67
Connection Plug	MC4 Compatible
Cable DC	4.0 mm ² , (12 AWG)
Cable DC Length	2 x 900 mm
Recommended batten distance (max. efficiency)	370 mm
Units /sq. m.	2,22 - 2,02 Units
Maximum power / sq. m. **	123 Wp/m²
sq.m. - 1 kWp	8,12 m²
Units/kWp	17.86 Units
Units/Pallet	32 roof tiles



STC standard conditions:
Irradiance 1.000 W / sq. m.,
Cell temperature: 25°C, AM =1,5

* The SOLAR roof tiles must be installed always on ventilated roofs, being able to use double batten system or equivalent system.

** According to the batten distance.

⁽¹⁾ CIGS - acronym that defines the latest technology in high efficiency solar cells with high performance (copper, indium, gallium and selenium), free of Cadmium and Lead.

⁽²⁾ SOLAR FLAT-10: Ref. TUV CIGS-05xxT1

STC standard conditions: Irradiance 1,000 W / m², Cell temperature: 25°C, AM =1.5

INSTALLATION design

The solar roof tiles are connected in various strings and in parallel to increase the efficiency of the panels.

SOLAR FLAT-10 Roof Tile CIGS

For a 3 kW installation with a 3.000 W inverter, 54 SOLAR Flat-10 tiles will be required. The optimum configuration features 6 strings in parallel with 9 panels in each string. The power output of this configuration is 3.024 Wp, producing an annual energy output of 4.736 kWh.

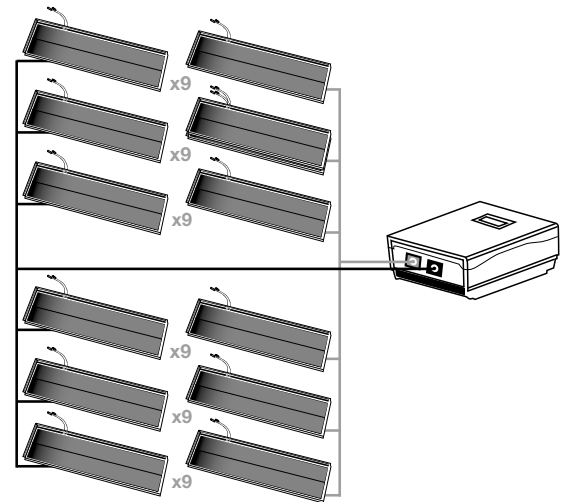

STRING CONFIGURATION

9 // 9 // 9
+
9 // 9 // 9

We can advise you on the design and specification of a SOLAR FLAT-10 roof tile installation to meet your needs.

Contact us!

solar@tejasborja.com

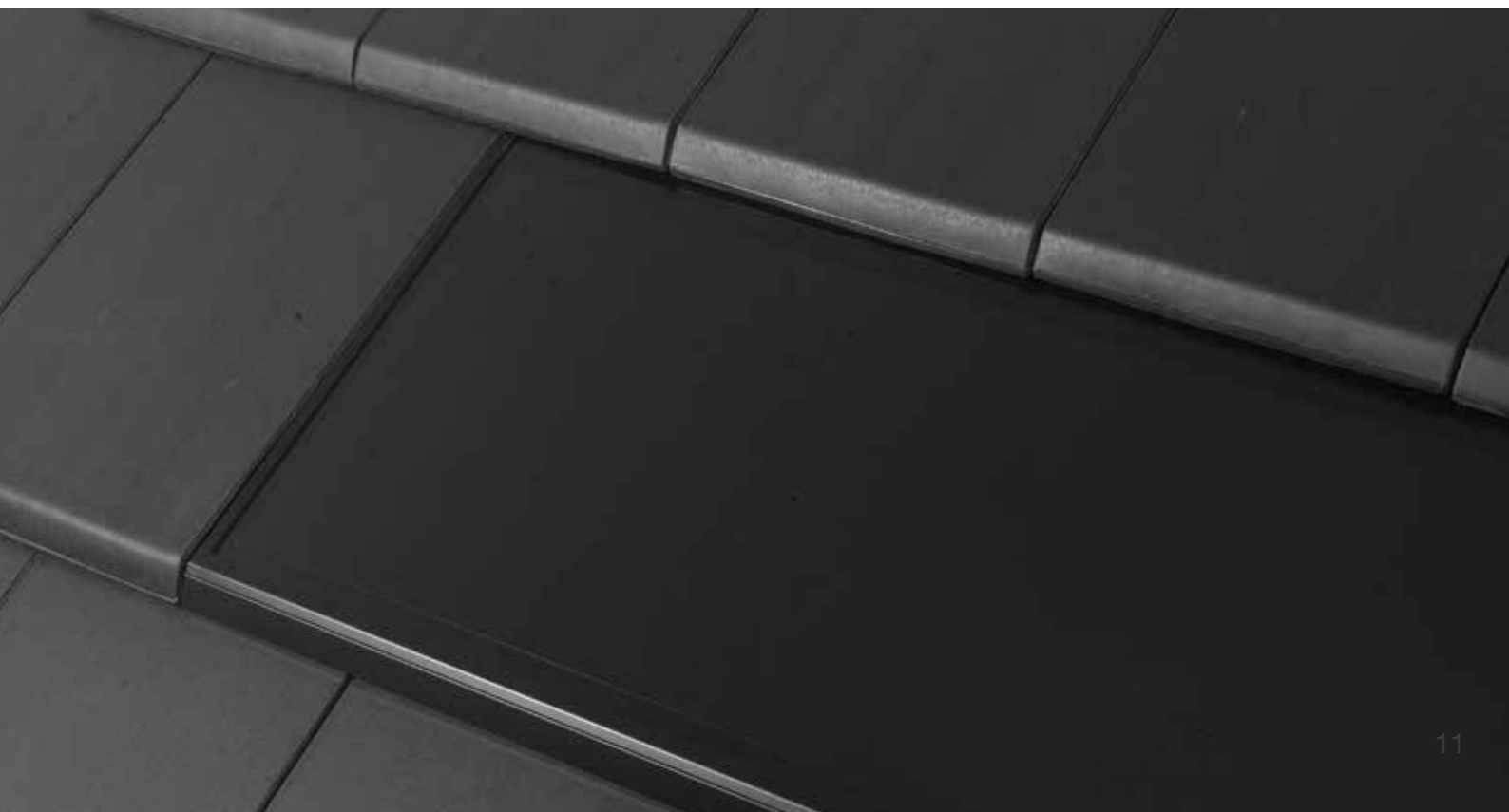

INSTALLATION

types

Possible configurations to generate your own photovoltaic solar energy.

I. Limited Self-consumption:

Photovoltaic roof tiles capture solar energy and transform it into domestic electricity for immediate use. In this case, it is necessary to connect to the public electricity grid to complete energy use at times when power is not generated through the facility itself, such as at night.

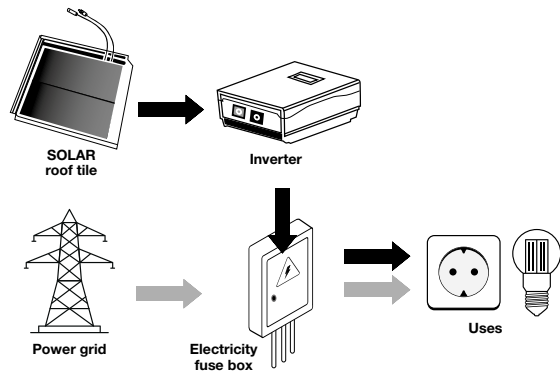

II. Self-consumption with Surpluses:

In this type of photovoltaic energy production installation, in addition to supplying energy for self-consumption, you can sell energy, the surplus that is not consumed into the transportation and distribution grid*.

* According to specific regulations of each country.

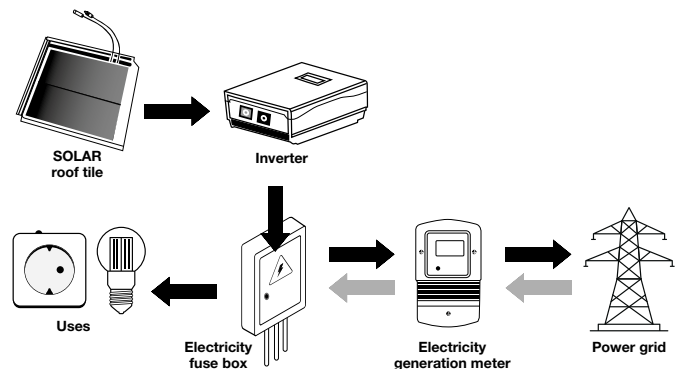

III. Self-consumption with Storage:

To maximize the self-consumption of energy produced by a photovoltaic installation made with solar tiles, there is the possibility of storing the surplus produced in batteries. In this way, your home or business will be self-sufficient only from the energy generated without depending on energy distribution companies.

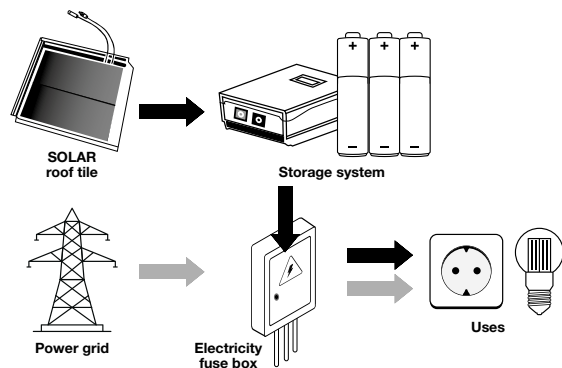

Check Installation and safety manual available on the website: tejasborja.com.

SAVINGS AND SUSTAINABILITY

The best way to reduce your energy costs and help improve the environment.

Official public bodies are continually updating laws and regulations to promote the use of renewable energy to supply homes and companies with electricity. Consequently, the administrative, technical and economic conditions with regard to the self-consumption of electrical energy are periodically regulated, thereby eliminating any doubt as to the importance of encouraging the generation of electricity in the very place it is to be consumed.



*Estimated savings compared to annual electricity costs you would otherwise have.

Example type of installation

For a 3 kWp-type installation

Average annual consumption per household in Spain: 2.900 kWh

Estimated annual photovoltaic energy: 4.600 – 4.800 kWh

Total annual savings: 960 € / year and 19.200 € / 20 years.

FINIS

FLAT ceram

 **FLAT-5XL**



Dimensions	457 mm x 510 mm
Minimum pitch recommended	30% - 17° (*)
Weight	6,55 Kg./Unit
Batten distance VARIABLE	340-385 mm
Units/sq. m.:	5,5 Units

PLAIN COLOUR

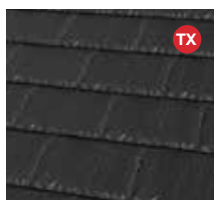

Leon Matte



Ceramic SLATE



Nepal Orange



Paris Ocre

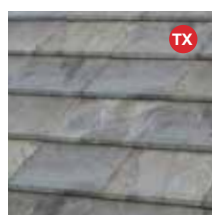

Irish Green

Ceramic COTTO



Ibiza Pink

Ceramic CEMENT

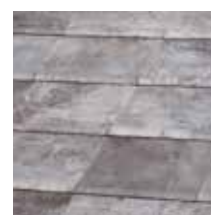

Sidney Graphite

Ceramic STONE

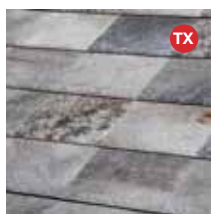

Austin Grey



Denver Gold



Denver Iris

Ceramic OXIDE



Tokyo Copper

Ceramic MARBLE



Roma Dark

SHES

ic roof tiles

H FLAT-10



Dimensions	475 mm x 285 mm
Minimum pitch recommended	30% - 17° (*)
Weight	3,5 Kg./Unit
Batten distance VARIABLE	365-400 mm
Units/sq. m.:	9,9 Units



PLAIN COLOUR



Artica

Graphite

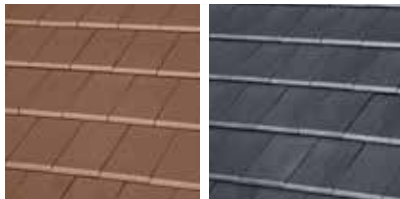

Chocolate

Natural Black

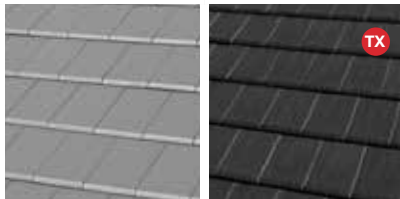

Mid Grey

Leon Matte

NATURE

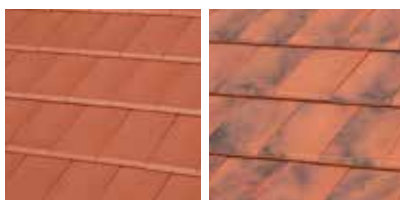

Red

Moss Red

Ceramic SLATE

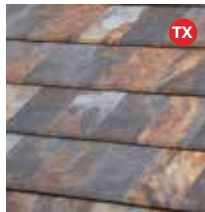

Nepal Orange



Paris Ocre

Ceramic CEMENT



Sidney Graphite

Ceramic WOOD



Toronto Oak



Weathered Cedar

Ceramic COTTO



Ibiza Pink

Ceramic OXIDE



Tokyo Copper

WARRANTY



Terms and Conditions

All the photovoltaic panels that make up the final products included in the SOLAR range of Tejas Borja guarantee power generation for more than 25 years (with 80% efficiency of performance) and a 10-year guarantee of integrity of the photovoltaic cells*.

Tile SOLAR FLAT-5XL: The support base SOLAR FLAT-5XL is manufactured as ceramic tile equivalent FLAT-5XL, with the same performance and quality. Therefore, this ceramic base has a 50-year warranty.



*Check the terms and conditions of the warranty for the SOLAR range of products on Tejas Borja website.



Roof & Plug

Continuous improvement is one of Tejas Borja's objectives and we reserve the right to make changes to these data at any time. The data added to the latest versions of our product data sheets may not be in this document. If any information provided in this document conflicts with the information in a data sheet for a product described herein, the latest version of the data sheet takes precedence and prevails over this document.



TEJAS BORJA, S.A.U.

Ctra. Llíria a Pedralba, Km. 3
46160 Llíria, Valencia, SPAIN
T.+34 96 279 80 16
F. +34 96 278 25 63
info@tejasborja.com

tejasborja.com