

REMER

ABSOLUTE
COLLECTION

ABSOLUTE

ESSENZA DI PRECISIONE
ESSENCE OF PRECISION



ABSOLUTE è una collezione di rubinetteria monocomando dalle linee prevalentemente squadrate. Il miscelatore, fuso in un unico blocco, elimina qualsiasi intersezione creando un'elegante continuità nel design. Disponibile in diverse colorazioni di finitura, la rubinetteria ABSOLUTE si inserisce con gusto ed originalità in ogni progetto di arredo bagno moderno. La serie è dotata di cartuccia a dischi ceramici Ø 35 mm.

ABSOLUTE is a single-lever faucet collection with a predominance of squared lines. The mixer, cast in a single block, eliminates any intersection, creating an elegant continuity of design. Available in different finishing colours, ABSOLUTE faucets fit with taste and originality in any modern bathroom furnishing project. The series is equipped with a Ø 35 mm ceramic disc cartridge





AU10L

ABSOLUTE



AU08

A large, illuminated 'A' logo is mounted on a dark, textured wall. The word 'ABSOLUTE' is written vertically in a glowing, yellow font within the right vertical bar of the 'A'. To the right of the 'A', a dynamic splash of red liquid is captured in mid-air, with a dark red sphere resting on the floor below it. The scene is lit from the left, creating a strong shadow of the 'A' on the wall.

ABSOLUTE



AU12ANO - AU11BO

//////////////////// OPZIONI DI FINITURA - FINISHING OPTIONS //////////////////////

CR		FIN 1		FIN 2	
	cromo chrome		nero opaco matt black		cromo nero spazzolato brushed black chrome
	CR		bianco opaco matt white		oro spazzolato brushed gold
			visual inox visual steel		oro lucido shiny gold
			NO		CFP
			BO		BG
			XV		DO

MISCELATORI LAVABO - WASHBASIN MIXERS

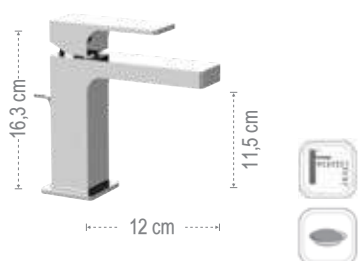

AU10

Monocomando lavabo, con scarico.
Single-lever basin mixer, with pop-up waste.



AU10ACC

Miscelatore monocomando per lavabo, modello "A" altezza media, scarico click-clack con troppo-pieno incluso.
Single-lever basin mixer, model "A" medium height, click-clack waste with overflow included.

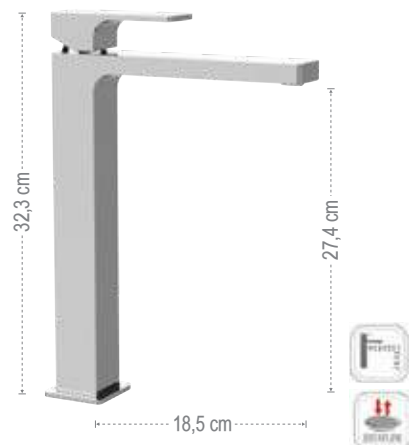

AU10L

Monocomando lavabo alto senza foro sul corpo, con scarico click-clack con troppo-pieno.
High basin mixer without body hole, with click-clack waste and overflow.



AU11

Monocomando lavabo, senza scarico.
Single-lever basin mixer, without waste.



AU12A

Miscelatore monocomando per lavabo, modello "A" altezza media, senza scarico e senza foro sul corpo.
Single-lever basin mixer, model "A" medium height, without pop-up waste and with no rear hole.



AU11L

Monocomando lavabo alto senza foro sul corpo, senza scarico.
High basin mixer without body hole, without waste.



AU12

Monocomando lavabo, senza scarico e senza foro sul corpo.
Single-lever basin mixer, without waste and without body hole.



AU57

Miscelatore monocomando lavabo due fori.
Two holes single-lever washbasin mixer.



AU10G

Miscelatore monocomando lavabo, con canna corta a "U" e scarico click-clack quadrato con troppo pieno.
Single-lever one-hole sink mixer, with short "U" spout, with squared click-clack waste with overflow.

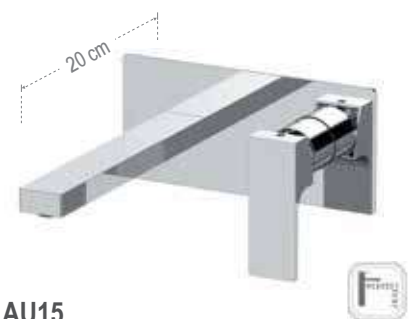

AU15

Miscelatore monocomando a incasso per lavabo, in ottone, lunghezza bocca 20 cm.
Single-lever built-in basin mixer, in brass, spout length 20 cm.



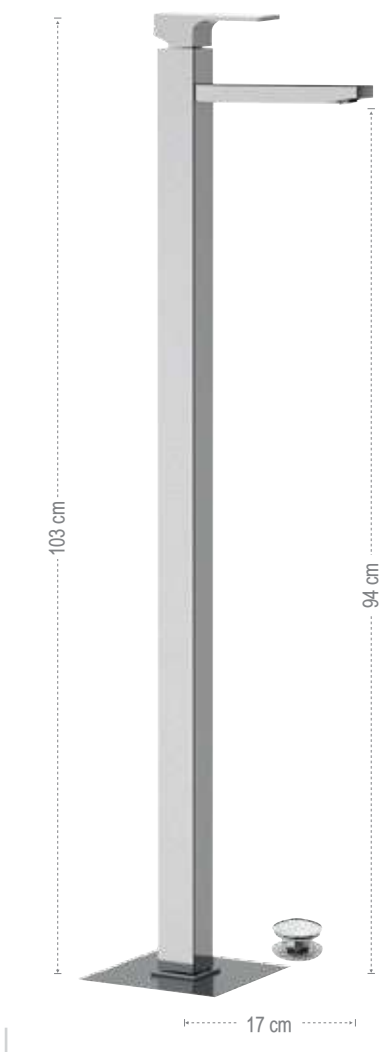

AU18

Miscelatore monocomando lavabo da terra con scarico click-clack con troppo-pieno. Prodotto completo.

Single-lever mixer for floor mounting with click-clack waste with overflow. Complete product.



Q08FIS2

Solo parte interna.
Built-in components only.

AU18E

Solo parti esterne.
Exposed components only.

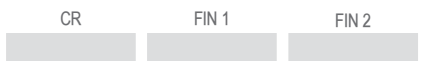

BOCCE - SPOUTS

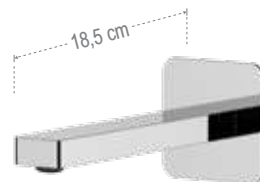

91SL

Bocca a incasso. Lunghezza bocca: 18,5 cm.
Built-in spout. Spout length: 18,5 cm

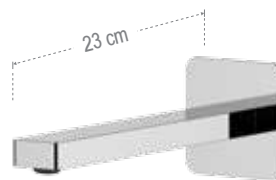

91SLL

Bocca a incasso. Lunghezza bocca: 23 cm.
Built-in spout. Spout length: 23 cm

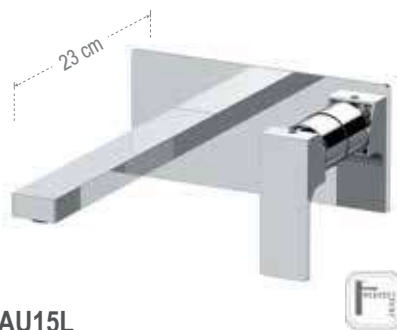
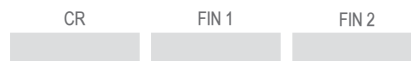

AU15L

Miscelatore monocomando a incasso per lavabo, in ottone, lunghezza bocca 23 cm.
Single-lever built-it basin mixer, in brass, spout length 23 cm.

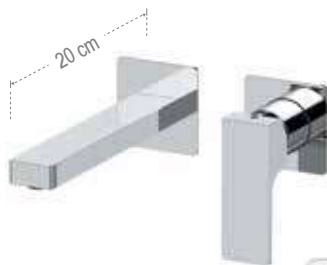

AU15P

Miscelatore monocomando a incasso per lavabo, su due piastre quadre separate, lunghezza bocca 20 cm.
Built-in single-lever basin mixer on two separate square plates, spout length 20 cm.

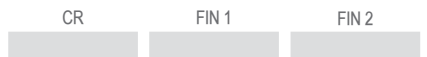

AU15PL

Miscelatore monocomando a incasso per lavabo, su due piastre quadre separate. Lunghezza bocca 23 cm.
Built-in single-lever basin mixer on two separate square plates. Spout length 23 cm.



MISCELATORI A INCASSO PER VASCA - BUILT-IN MIXERS FOR BATH



2 VIE
WAYS



SOLO PARTE ESTERNA - EXPOSED COMPONENTS ONLY:

AU53D2WB

Set a incasso a 2 vie per vasca su piastra unica rettangolare.
2-way built-in set for bathtub on a single rectangular plate.

CR FIN 1 FIN 2

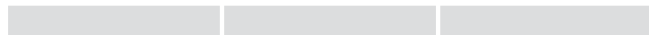

SOLO PARTE INTERNA - BUILT-IN COMPONENTS ONLY:

WBOX97D2

pag 304



SOLO PARTE ESTERNA - EXPOSED COMPONENTS ONLY:

AU53D2PWB

Set a incasso a 2 vie per vasca su piastre quadrate separate.
2-way built-in set for bathtub on separate square plates.

CR FIN 1 FIN 2

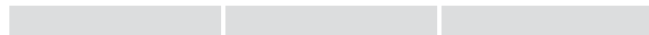

SOLO PARTE INTERNA - BUILT-IN COMPONENTS ONLY:

WBOX97D2

pag 304



2 VIE
WAYS



SOLO PARTE ESTERNA - EXPOSED COMPONENTS ONLY:

AU54D2WB

Set miscelatore a incasso a 2 vie per vasca/doccia su piastra unica rettangolare. Da completare con la seconda uscita.
2-way built-in mixer set for bathtub / shower on single rectangular plate. To be completed with the second water outlet.

CR FIN 1 FIN 2

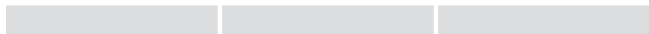

SOLO PARTE INTERNA - BUILT-IN COMPONENTS ONLY:

WBOX97D2

pag 304



SOLO PARTE ESTERNA - EXPOSED COMPONENTS ONLY:

AU54D2PWB

Set miscelatore a incasso a 2 vie per vasca/doccia su piastre quadrate separate. Da completare con la seconda uscita.
2-way built-in mixer set for bathtub / shower on separate square plates. To be completed with the second water outlet.

CR FIN 1 FIN 2

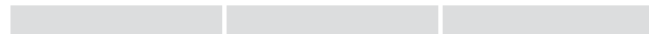

SOLO PARTE INTERNA - BUILT-IN COMPONENTS ONLY:

WBOX97D2

pag 304



3 VIE
WAYS



SOLO PARTE ESTERNA - EXPOSED COMPONENTS ONLY:

AU54D3WB

Set miscelatore a incasso a 3 vie per vasca/doccia su piastra unica rettangolare. Da completare con la seconda e la terza uscita acqua.
3-way built-in mixer set for bathtub / shower on single rectangular plate. To be completed with the second and the third water outlet.

CR FIN 1 FIN 2



SOLO PARTE INTERNA - BUILT-IN COMPONENTS ONLY:

WBOX97D3

pag 308



SOLO PARTE ESTERNA - EXPOSED COMPONENTS ONLY:

AU54D3PWB

Set miscelatore a incasso a 3 vie per vasca/doccia su piastre quadrate separate. Da completare con la seconda e la terza uscita acqua.
3-way built-in mixer set for bathtub / shower on separate square plates. To be completed with the second and the third water outlet.

CR FIN 1 FIN 2



SOLO PARTE INTERNA - BUILT-IN COMPONENTS ONLY:

WBOX97D3

pag 308

MISCELATORI A INCASSO PER DOCCIA - BUILT-IN MIXERS FOR SHOWER

1 VIA WAY



AU30

Miscelatore monocomando a incasso per doccia completo, su piastra rettangolare.

Complete single lever built-in shower mixer, on rectangular plate.



2 VIE WAYS



AU09

Miscelatore monocomando incasso con deviatore per vasca/doccia completo, su piastra rettangolare.

Complete single lever built-in bath/shower mixer with diverter, on rectangular plate.



2 VIE WAYS

N09B

Solo parte interna.
Built-in components only.



AU09E

Solo parte esterna.
Exposed components only.



2 VIE WAYS

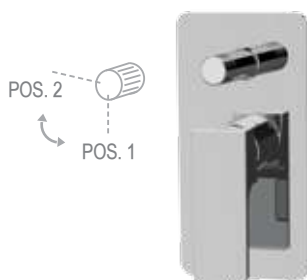

AU09HL

Miscelatore a incasso per vasca/doccia con deviatore a 2 vie a vitone ceramico. Per selezionare l'uscita desiderata, la manopola del deviatore deve essere ruotata da una posizione all'altra.

Built-in bath/shower mixer with 2-way diverter with ceramic head valve. To select the desired output, the diverter knob must be turned from one position to the other.



2 VIE WAYS

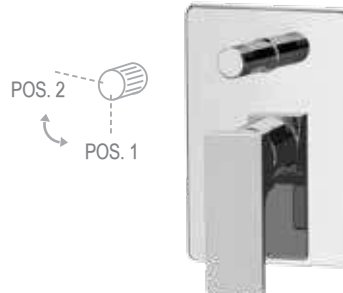

AU09HG

Miscelatore a incasso per vasca/doccia con deviatore a 2 vie a vitone ceramico, su piastra rettangolare. Per selezionare l'uscita desiderata, la manopola del deviatore deve essere ruotata da una posizione all'altra.

Built-in bath/shower mixer with 2-way diverter with ceramic head valve, on rectangular wall plate. To select the desired output, the diverter knob must be turned from one position to the other.



2 VIE WAYS

N09HB

Solo parte interna.
Built-in components only.



AU09E

Solo parte esterna.
Exposed components only.



N09HB

Solo parte interna.
Built-in components only.



AU09GE

Solo parte esterna.
Exposed components only.





AU09HRG

Miscelatore a incasso per vasca/doccia con deviatore a 2 vie con vitone ceramico, su piastra rettangolare, montaggio orizzontale. Per selezionare l'uscita desiderata, la manopola del deviatore deve essere ruotata da una posizione all'altra.

Built-in bath/shower mixer with 2-way diverter with ceramic head valve, on rectangular plate, horizontal mounting. To select the desired output, the diverter knob must be turned from one position to the other.

CR FIN 1 FIN 2



AU92

Miscelatore monocomando a incasso per doccia, con deviatore a due posizioni (due uscite ed una entrata) su piastra unica rettangolare.

Single-lever built-in shower mixer with 2 positions diverter (2 outlets and 1 inlet) on single on rectangular plate.

CR FIN 1 FIN 2

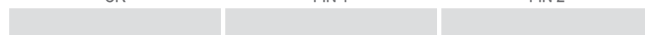

N09HRB

Solo parte interna.
Built-in components only.



CR FIN 1 FIN 2



AU09GE

Solo parte esterna.
Exposed components only.

CR FIN 1 FIN 2

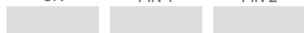

SOLO PARTE ESTERNA - EXPOSED COMPONENTS ONLY:

AU92ZPW

Miscelatore a incasso per vasca/doccia con deviatore a 2 vie di tipo meccanico, su due piastre quadrate.

Built-in bath/shower mixer with 2-way mechanical diverter, on two square plates.

CR FIN 1 FIN 2



SOLO PARTE ESTERNA - EXPOSED COMPONENTS ONLY:

AU92ZWB

Miscelatore a incasso per vasca/doccia con deviatore a 2 vie di tipo meccanico, su piastra rettangolare.

Built-in bath/shower mixer with 2-way mechanical diverter, on rectangular plate.

CR FIN 1 FIN 2



SOLO PARTE INTERNA - BUILT-IN COMPONENTS ONLY:

WBOX92Z

pag 300

SOLO PARTE INTERNA - BUILT-IN COMPONENTS ONLY:

WBOX92Z

pag 300

2 VIE
WAYS



SOLO PARTE ESTERNA - EXPOSED COMPONENTS ONLY:

AU97D2WB

Set miscelatore a incasso a 2 vie per vasca/doccia su piastra rettangolare. Da completare con la seconda uscita.
2-way built-in shower mixer set on rectangular plate. To be completed with the second water outlet.

CR FIN 1 FIN 2



SOLO PARTE ESTERNA - EXPOSED COMPONENTS ONLY:

AU97D2PWB

Set miscelatore a incasso a 2 vie per vasca/doccia su 3 piastre quadrate. Da completare con la seconda uscita.
2-way built-in shower mixer set on 3 square plates. To be completed with the second water outlet.

CR FIN 1 FIN 2

SOLO PARTE INTERNA - BUILT-IN COMPONENTS ONLY:

WBOX97D2

pag 304

SOLO PARTE INTERNA - BUILT-IN COMPONENTS ONLY:

WBOX97D2

pag 304

3 VIE
WAYS



SOLO PARTE ESTERNA - EXPOSED COMPONENTS ONLY:

AU93ZPWB

Miscelatore a incasso per vasca/doccia con deviatore a 3 vie di tipo meccanico, su due piastre quadrate.
Built-in bath/shower mixer with 3-way mechanical diverter, on two square plates.

CR FIN 1 FIN 2

SOLO PARTE INTERNA - BUILT-IN COMPONENTS ONLY:

WBOX93Z

pag 302



SOLO PARTE ESTERNA - EXPOSED COMPONENTS ONLY:

AU93ZWB

Miscelatore a incasso per vasca/doccia con deviatore a 3 vie di tipo meccanico, su piastra rettangolare.
Built-in bath/shower mixer with 3-way mechanical diverter, on rectangular plate.

CR FIN 1 FIN 2

SOLO PARTE INTERNA - BUILT-IN COMPONENTS ONLY:

WBOX93Z

pag 302

3 VIE
WAYS



SOLO PARTE ESTERNA - EXPOSED COMPONENTS ONLY:

AU97D3WB

Set miscelatore a incasso a 3 vie per vasca/doccia su piastra rettangolare. Da completare con la seconda e la terza uscita acqua.
3-way built-in shower mixer set on rectangular plate. To be completed with the second and the third water outlet.

CR FIN 1 FIN 2

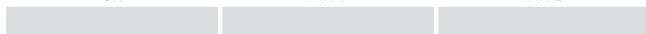

SOLO PARTE INTERNA - BUILT-IN COMPONENTS ONLY:

WBOX97D3

pag 308



SOLO PARTE ESTERNA - EXPOSED COMPONENTS ONLY:

AU97D3PWB

Set miscelatore a incasso a 3 vie per vasca/doccia su 3 piastre quadrate. Da completare con la seconda e la terza uscita acqua.
3-way built-in bath/shower mixer set on 3 square plates. To be completed with the second and the third water outlet.

CR FIN 1 FIN 2

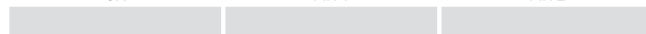

SOLO PARTE INTERNA - BUILT-IN COMPONENTS ONLY:

WBOX97D3

pag 308

4/5 VIE
WAYS



AU93

Miscelatore monocomando per doccia con deviatore a tre vie (una entrata e tre uscite) su unica piastra rettangolare.
Single lever built-in shower mixer with three ways diverter (1 inlet and 3 outlets) on single rectangular plate.

CR FIN 1 FIN 2



AU94

Miscelatore monocomando per doccia, con deviatore a 4 posizioni (4 uscite ed 1 entrata) su piastra unica rettangolare.
Single-lever shower mixer with 4 positions diverter (4 outlets and 1 inlet,) on single rectangular plate.

CR FIN 1 FIN 2



AU95

Miscelatore monocomando per doccia, con deviatore a 5 posizioni (5 uscite ed una entrata) su piastra unica rettangolare.
Single-lever shower mixer with 5 positions diverter (5 outlets and 1 inlet,) on single rectangular plate.

CR FIN 1 FIN 2

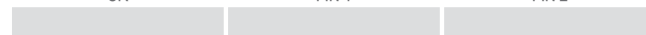

COLONNE DOCCIA - SHOWER COLUMNS

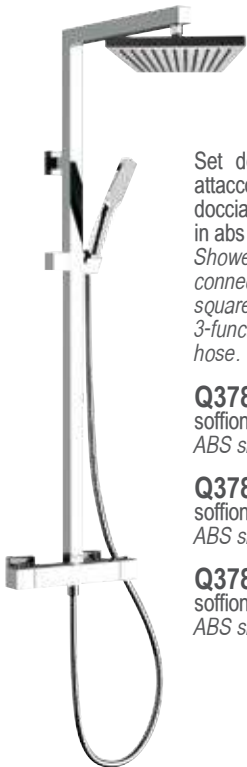

Set doccia composto da: miscelatore esterno con attacco superiore, soffione in ABS 356SD20X, colonna doccia quadrata in ottone con deviatore 330S, doccetta in abs con 3 funzioni 318CP, flessibile 150 cm.

Shower set including: exposed mixer with upper connection, ABS antilimescale showerhead 356SD20X, square brass shower column with diverter 330S, 3-function abs hand shower 318CP, 150 cm flexible hose.

Q378CPSD20

soffione in ABS 20x20 cm.
ABS showerhead 20x20 cm.

CR

Q378CPSD25

soffione in ABS 25x25 cm.
ABS showerhead 25x25 cm.

CR

Q378CPSD30

soffione in ABS 30x30 cm.
ABS showerhead 30x30 cm.

CR

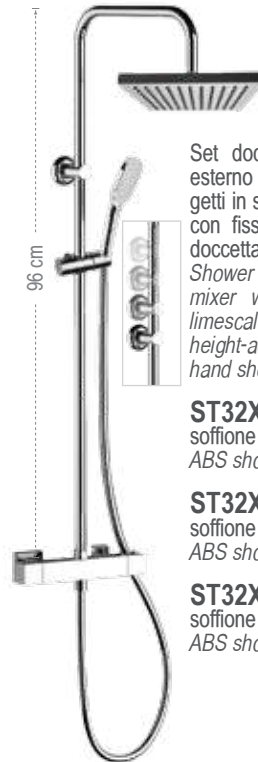

Set doccia composto da: miscelatore termostatico esterno quadrato con deviatore, soffione in ABS con getti in silicone anticalcare 356SD20X, colonna doccia con fissaggio superiore regolabile in altezza 329X, doccetta in abs con 3 funzioni 318CP, flessibile 150 cm.

Shower set including: square exposed thermostatic mixer with diverter, abs shower head with anti-limescale silicone jets 356SD20X, shower column with height-adjustable upper fixing 329X, 3-function abs hand shower 318CP, 150 cm flexible hose.

ST32X8CPSD20

soffione in ABS 20x20 cm.
ABS showerhead 20x20 cm.

CR

ST32X8CPSD25

soffione in ABS 25x25 cm.
ABS showerhead 25x25 cm.

CR

ST32X8CPSD30

soffione in ABS 30x30 cm.
ABS showerhead 30x30 cm.

CR

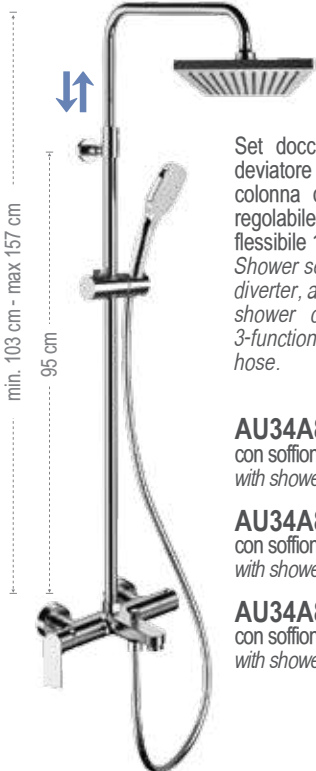

Set doccia composto da: miscelatore esterno con deviatore vasca/doccia, soffione in abs 356SD20X, colonna doccia in ottone telescopica, altezza asta regolabile 329A, doccetta in abs con 3 funzioni 318CP, flessibile 150 cm.

Shower set including: exposed mixer with bath/shower diverter, abs shower head 356SD20X, telescopic brass shower column, with height-adjustable rod 329A, 3-function abs hand shower 318CP, 150 cm flexible hose.

AU34A8CPSD20

con soffione da 25x25 cm.
with shower head 25x25 cm.

CR

AU34A8CPSD25

con soffione da 25x25 cm.
with shower head 25x25 cm.

CR

AU34A8CPSD30

con soffione da 25x25 cm.
with shower head 25x25 cm.

CR



MISCELATORI LAVABO CASCATA - WATERFALL WASHBASIN MIXERS



QC10

Miscelatore monocomando lavabo bocca a cascata, con scarico quadrato. *Single-lever basin mixer with waterfall spout, with squared pop-up waste.*

CR



QC11

Miscelatore monocomando lavabo bocca a cascata, senza scarico. *Single-lever basin mixer with waterfall spout, without waste.*

CR



QC10L

Miscelatore monocomando lavabo alto L con bocca a cascata, con scarico quadrato click-clack con troppo-pieno. *Single-lever basin mixer L high neck with waterfall spout, with squared click-clack waste with overflow.*

CR



QC10LB

Miscelatore monocomando lavabo alto L con bocca a cascata, con scarico quadrato click-clack senza troppo-pieno. *Single-lever basin mixer L high neck with waterfall spout, with squared click-clack waste without overflow.*

CR



QC11L

Miscelatore monocomando lavabo alto L con bocca a cascata, senza scarico, senza foro sul corpo. *Single-lever basin mixer L high neck with waterfall spout, without waste and body hole.*

CR



QC15

Miscelatore monocomando a incasso per lavabo, con piastra verticale rettangolare in ottone e bocca a cascata squadrata. *Single lever built-it basin mixer, with rectangular wall plate in chrome plated brass.*

CR

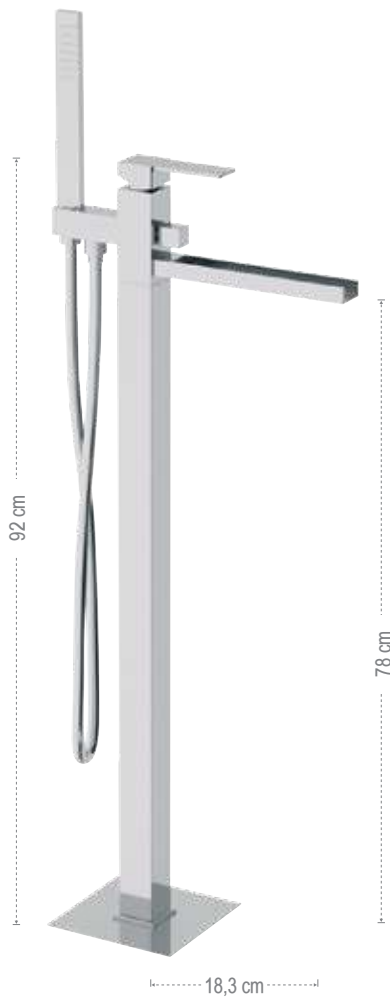

QC08

Miscelatore vasca da pavimento, con doccetta ad 1 funzione in ottone, bocca a cascata, deviatore e flessibile 150 cm. Prodotto completo.
Single-lever bath mixer floor mounting, with 1 function handshower in brass, with waterfall spout and diverter, flexible hose 150 cm. Complete product.



CR

Q08FIS2

Solo parte interna.
Built-in components only.



CR

QC08E

Solo parti esterne.
Exposed components only.

CR

BOCCE - SPOUTS

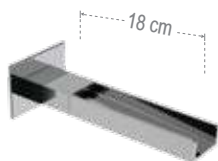

91QC

Bocca incasso a cascata.
Built-in spout with waterfall jet.

CR



91ZC

Bocca incasso a cascata.
Built-in spout with waterfall jet.

CR



91ZCA

Bocca bordo vasca getto cascata.
Spout for deck bath/shower with waterfall jet.

CR



91ZCF

Bocca bordo vasca multigetto.
Spout for deck bath/shower with multijet.

CR



LEGENDA ICONE - *ICONS LEGEND*



Acciaio INOX
Stainless Steel



Perfect Tune: Prodotto diponibile in più varianti.
Perfect Tune: Product available in different variants.

RUBINETTERIA - FAUCETS



Con scarico
With pop-up waste



Con scarico in plastica
With plastic waste



Con Click-Clack
With Click-Clak



Con Click-Clack con Troppo Pieno
With Click-Clak with Overflow



Senza Scarico
Without Waste



Eco
Eco



Cartuccia Energy Saving
Energy Saving Cartridge



Limitatore di Temperatura
Antiscalding



Risparmio Idrico Dinamico
Water Saving Dynamic



Risparmio Idrico
Water Saving



Risparmio Energetico
Energy Saving



Risparmio Idrico e Energetico
Water and Energy Saving

CUCINA - KITCHEN



Bocca Girevole
Swivel Spout



Corpo girevole
Swivel body



Doccetta Orientabile
Adjustable handshower



Doccetta Estraibile
Pull-Out Handshower



Bocca Abbattibile
Folding Spout



Doccetta a due funzioni
Two functions hand shower.



Acqua Frizzante
Sparkling Water



Acqua Potabile
Drinking Water

TECNOLOGIA - TECHNOLOGY



Touch-Me
Touch-Me



Tempor Touch
Tempor Touch



Con Luce Led
Whit Led Light



Con Batterie Alcaline Include
With Alkaline Batteries included



Alimentazione Elettrica
Power Supply



Azionamento a Sensore
Sensor Control



Con Temporizzazione per Lavatrice/Lavastoviglie
With Timing for washing/machine and Dish/Washer



Con filtro incluso
With filter included



Con Batterie al Litio Include
With Lithium Batteries included



Termostatico
Thermostatic

SOFFIONI - SHOWER HEADS



Getto effetto pioggia ad ampia copertura
Wide coverage rain effect



Getto effetto pioggia a risparmio idrico
Water-saving rain effect jet



Con Multigetto
With Multi Jet



Con Getto a Cascata
With Waterfall Jet



Getto Nebulizzato
Nebulized Jet



Cromoterapia
Colortherapy



Autopulente
Self-Cleaning



Con Getti Anticalcare
With Antilimestone Jets

DOCLETTE - HANDSHOWERS



Posizione d'interruzione getto
Stop flow position



Getto intenso esterno con getto effetto pioggia interno
Intense external jet with internal rain effect jet



Getto intenso a risparmio idrico
Intense water-saving jet



Massaggio vigoroso ampia copertura effetto pioggia
Vigorous massage wide coverage rain jet



Getto vigoroso concentrato e getto esterno
Concentrated vigorous jet and external jet



Getto vigoroso concentrato
Vigorous concentrated jet



Getto Aerato Intenso
Intense Aerated Jet



Getto vigoroso effetto pioggia
Vigorous rain effect jet



Getto Vigoroso ed Ampio
Vigorous and Wide Jet



Getto spray ampia copertura e getto intenso esterno a risparmio idrico
Wide coverage spray jet and intense water saving external jet



Getto soft aerato mischiato ad un getto vigoroso a risparmio idrico
Soft aerated jet mixed with a vigorous water-saving jet



Pioggia soft a risparmio idrico
Soft rain water saving



Getto Esterno
External Jet



Con Getti Anticalcare
With Antilimestone Jets

KIT DOCCIA - SHOWER KIT



2 Vie
2 Ways



3 Vie
3 Ways



4 Vie
4 Ways



5 Vie
5 Ways



Flessibile Lungo 120 cm
Flexible Length 120 cm



Flessibile Lungo 150 cm
Flexible Length 150 cm



Flessibile Lungo 200 cm
Flexible Length 200 cm

COLONNE DOCCIA - SHOWER COLUMNS



Colonna Doccia Girevole
Swivable shower column



Colonna Doccia Telescopica
Telescopic shower column

REMER
RUBINETTERIE

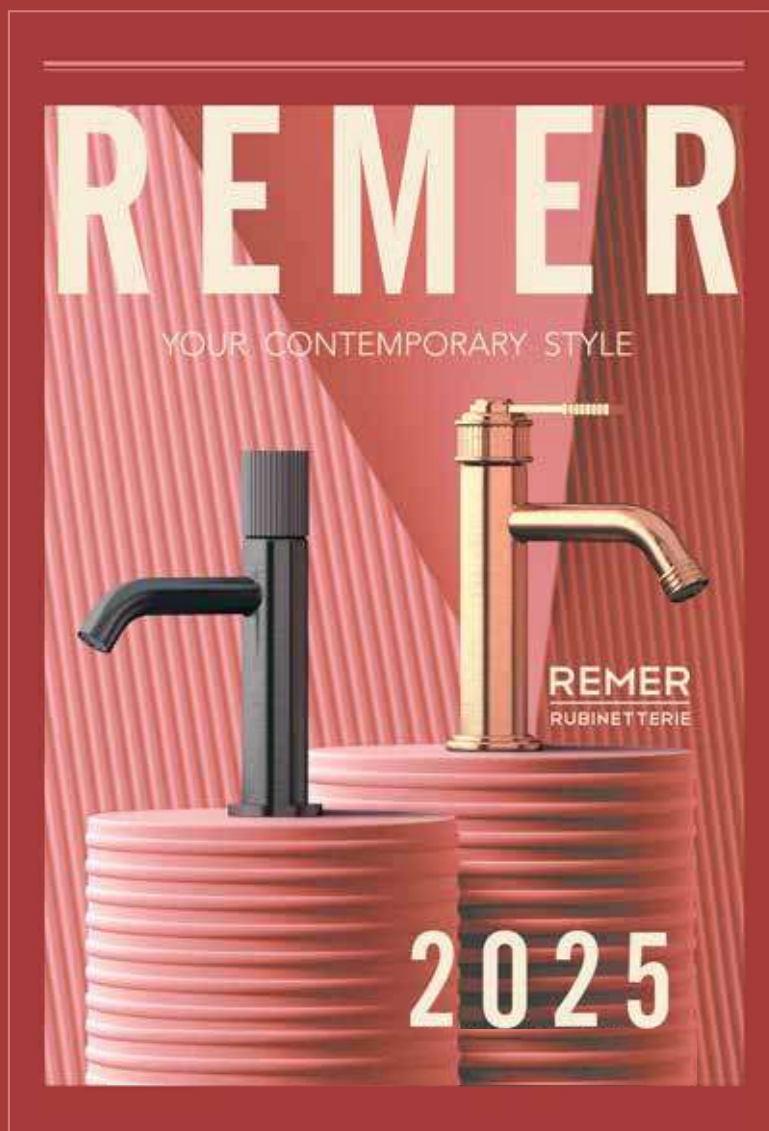

REMER RUBINETTERIE S.P.A.

Via Leonardo da Vinci, 83
20062 Cassano d'Adda
(MI) Italy
Tel. +39 0363 364 330

info@remer.eu
www.remer.eu

UFFICIO COMMERCIALE ITALIA:

Tel. 0363 364 333
Fax 0363 63 575

EXPORT COMMERCIAL DEPARTMENT:

Tel. +39 0363 364 364
Fax +39 0363 364 300