

NHB-H Series

 **navien**

NEW NHB-H Condensing Boilers

Premium efficiency,
performance and innovation
packed into one lightweight,
compact wall-hung boiler



Introducing NHB-H condensing boilers

DUAL STAINLESS
STEEL
HEAT EXCHANGERS

ADVANCED
USER INTERFACE

TDR **UP TO**
15:1

3 ZONES
VALVES or PUMPS

2" VENT & **3" VENT**
UP TO 65 FEET & UP TO 150 FEET

 **AFUE**
95.0%

1/2" GAS CAPABILITY
UP TO 40 FT



Save installation time and costs
with so much integrated technology

Built-in control for a boiler pump, 3 zone pumps or 3 zone valves

The NHB-H boiler's PCB provides the ability to connect a boiler pump, 3 zone pumps or 3 zone valves, and to set temperatures independently in each zone (see NHB-H Installation Manual for details).

NHB-H outdoor reset control

Available with 6 preset curves, an optional custom curve and the ability to run off supply or return water temperatures with a wide range of temperature options.

Advanced user-friendly interface control panel with built-in Setup Wizard software

Navien's new backlit control panel is simple and intuitive to use with its plain text display and an innovative click wheel that improves usability.



An inside look at the NHB-H

Featuring added durability, functionality and safety

2" PVC venting up to 65', 3" up to 150'. Including economical schedule 40 PVC.

Stainless steel burner. Navien designed and built, fully modulating metal fiber premix burner system.

Dual stainless steel heat exchangers for heating. Stainless steel heat exchangers offer durability and added condensing performance.

Built-in Air Pressure Sensor (APS). Monitors vent system for blockage, compensates for vent lengths and maintains proper air/gas ratio.

Vent Installation Detector (VID).

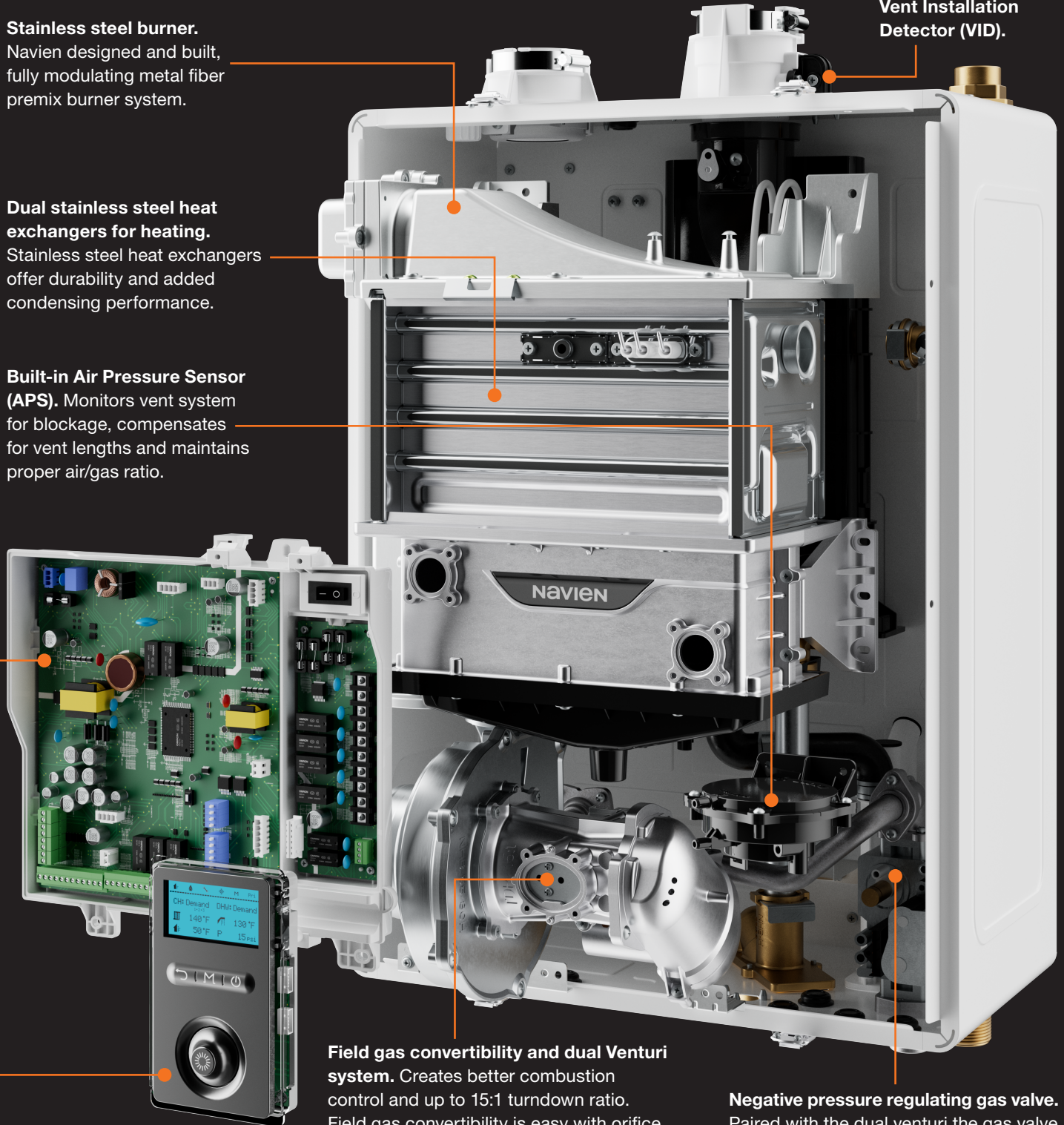

Field gas convertibility and dual Venturi system. Creates better combustion control and up to 15:1 turndown ratio. Field gas convertibility is easy with orifice conversion kits for natural gas high altitude (5,400–10,100 ft.) and liquid propane (up to 10,100 ft.) included with NHB-H series boilers.

Negative pressure regulating gas valve. Paired with the dual venturi the gas valve provides consistent control of the air/gas ratio. Negative regulation reduces issues on low gas pressure systems.

Navien adds more innovation to its compact, high-efficiency wall-hung boiler

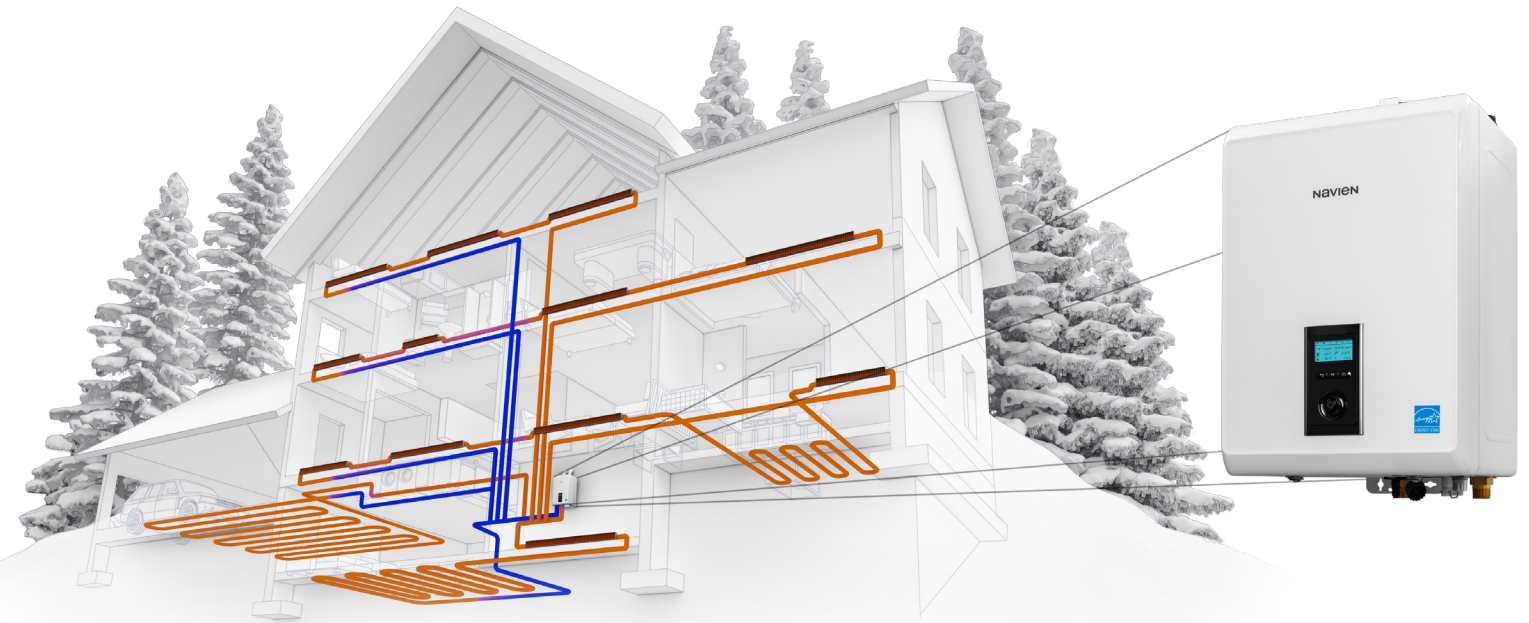

As a leader in condensing wall-hung boilers, Navien continues its tradition of innovation with the new NHB-H Series high-efficiency condensing boilers. All NHB-H boilers have Navien's advanced burner system, an AFUE of 95.0% and industry-leading turndown ratios up to 15:1.

The NHB-H boiler is available in four sizes: 55,000 BTU/h, 80,000 BTU/h, 110,000 BTU/h and 150,000 BTU/h.

Optional NaviClean® magnetic boiler filtration

NaviClean® is designed to work with Navien boilers and combi-boilers with flow rates up to 21 GPM. It features a permanent magnet mounted inside the nylon housing.

- Powerful permanent magnet for removing higher levels of iron oxide, and large canister design for capturing sludge and debris
- 360° rotation allows flexibility of installation
- Inlet and outlet ports for rapid in-line installation
- Tool-free valve connection prevents cross threading
- Large canister and full flow valves result in minimal pressure drop and unrestricted flow
- Low profile drain valve makes installation and service easier
- High performance seals provide higher protection against leaks



In minutes,
the NaviClean® filter
traps the debris,
and water is clear





Commercial and residential



Up to 80%
smaller than
a traditional
boiler

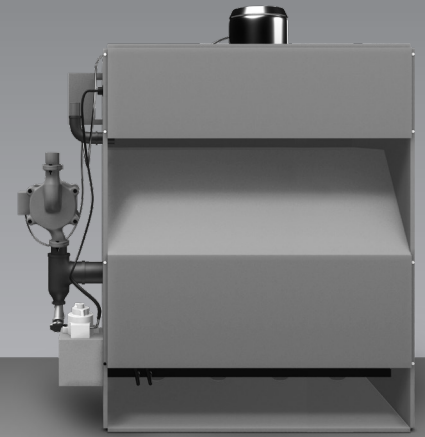

Space saving, lightweight design



NaviLink® optional WiFi remote control



Works with radiators, hydronic baseboard, fan coil
and in-floor heating systems



Common vent up to 8 units and cascade up to 16 units (NHB-110H and NHB-150H models only)

Accessories



For all optional accessories

Plumb Easy Valve Set, 1"
30010950A



SmartZone+™ Pump Controller

- 2 Zones: PFMZ-02P-001
- 3 Zones: PFMZ-03P-001
- 4 Zones: PFMZ-04P-001
- 6 Zones: PFMZ-06P-001

NaviLink® Wi-Fi Control
PBCM-AS-001



**NaviLink® Lite
Wi-Fi Control (1 Unit)**
PBCM-AS-002



Common Vent Collar Kit
30014367B
(Includes Cascade Cable)



**Universal
Temperature
Sensor**
GXXX001769

**Ready-Link®
Communications
Cable**
GXXX000546



Commercial Neutralizer
GXXX001325

Commercial Replacement Media
GXXX001329



Light Commercial Neutralizer
GXXX001324

**Light Commercial
Replacement Media**
GXXX001328



**Residential
Neutralizer (V2)**
GXXX002212

**Residential
Replacement Media**
GXXX001323

ReadyLink® Rack

Base (V3)
GFFMKDIZUS-005

Add-on (V3)
GFFMKDIZUS-006



Base

Add-On

Dimensions

NHB-H Series

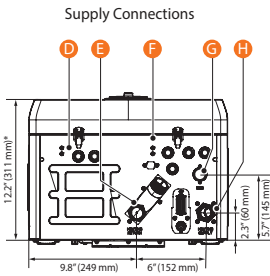
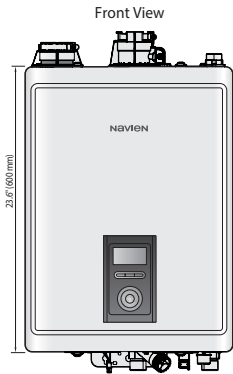
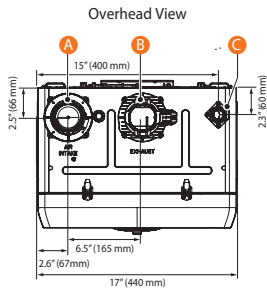

	Connection Size
A Air Intake	Ø 2"
B Exhaust Gas Vent	Ø 2"
C Air Vent Connection	Ø 3/4"
D Rubber Grommet	Ø 1"
E Space Heating Return	Ø 1"
F Condensate Outlet	Ø 1/2"
G Gas Connection	Ø 3/4"
H Space Heating Supply	Ø 1"



New NHB-H stainless steel manifold kit

NHB-H Primary Manifold Kit GXXX002396

This system-matched stainless steel manifold kit is another high-quality accessory to help make your installation faster and easier. The kit includes the space heating supply and return isolation valves, PRV/LWCO adapter tree, threaded connection adapter with clip, and LWCO plug.



Customer support and advanced training makes Navien your best choice for condensing boilers

Besides supplying innovative and energy efficient systems for residential and commercial applications, Navien provides extensive field support, webinars and training events for builders, architects and contractors. Our full-time customer support network provides quick answers to installation and operational questions.

Ratings & Specifications

Navien Condensing Boiler Space Heating Ratings					
Model Number ¹	Heating Input, BTU/h		Heating Capacity ² BTU/h	Net AHRI Rating, Water ³ BTU/h	AFUE ² Percentage
	Min	Max			
NHB-55H	8,000	55,000	51,000	44,000	95.0
NHB-80H	8,000	80,000	74,000	64,000	95.0
NHB-110H	10,000	110,000	102,000	89,000	95.0
NHB-150H	10,000	150,000	138,000	120,000	95.0

¹Ratings are the same for Natural Gas models converted to Propane use.

²Based on U.S. Department of Energy (DOE) test procedures.

³The NET AHRI Water Ratings shown are based on a piping and pickup allowance of 1.15.

Consult Navien before selecting a boiler for installations having unusual piping and pickup requirements, such as intermittent system operation, extensive piping systems, etc.

Specifications					
Item	NHB-55H		NHB-80H	NHB-110H	NHB-150H
Dimensions	17.3" (W) x 12.8" (D) x 23.8" (H)				
Weight	73 lbs (33 kg)			80 lbs (36 kg)	
Installation type	Indoor wall-hung				
Venting type	Forced draft direct vent				
Ignition	Electronic ignition				
Natural gas supply pressure (from source)	3.5" – 10.5" WC				
Propane gas supply pressure (from source)	8.0" – 13.5" WC				
Natural gas manifold pressure	-0.11" WC	-0.17" WC		-0.26" WC	-0.40" WC
Propane gas manifold pressure	-0.11" WC	-0.17" WC		-0.25" WC	-0.41" WC
Gas connection size	3/4" NPT (male)				
Power supply	Main supply	120V AC, 60Hz			
	Maximum power consumption	Less than 10A			
Materials	Casing	Cold rolled carbon steel			
	Heat exchangers	Primary and secondary heat exchangers: stainless steel			
Venting	Exhaust	2" or 3" PVC, CPVC, PP, SS (see installation manual for more details) 2" or 3" special gas vent type BH (Class III, A/B/C)			
	Intake	2" or 3" PVC, CPVC, PP, SS 2" or 3" special gas vent type BH (Class III, A/B/C)			
	Vent clearances	0" to combustibles			
Safety devices	Flame rod, APS, gas valve operation detector, ignition operation detector, water temperature high limit switch, exhaust temperature high limit sensor, Vent Installation Detector (VID)				

Navien reserves the right to change specifications at any time without prior notice.

Please refer to www.Navieninc.com to verify you have the most current information.

Gas Input Ranges

Model	Range	TDR
NHB-55H	8,000–55,000 BTU/h	7:1
NHB-80H	8,000–80,000 BTU/h	10:1
NHB-110H	10,000–110,000 BTU/h	11:1
NHB-150H	10,000–150,000 BTU/h	15:1

Warranty

Type	Residential*	Commercial
Heat Exchanger	15 year limited warranty	10 year limited warranty
Parts	5 years	3 years
Labor	1 year	1 year

*Applies to single family residential locations.

Navien's warranty (which may be changed without prior notice) is subject to the terms and conditions found at www.Navieninc.com.

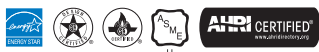

We are @Navieninc everywhere



Navien Inc. Navieninc.com 800-519-8794
20 Goodyear, Irvine, CA 92618

Navien Canada, Inc. Navieninc.ca 800-519-8794
555 Hanlan Rd., Unit 7, Vaughan, ON L4L 4R8

