

TRADE CATALOGUE

GEWISS

2023
2024

INSTALLATION

ENERGY

BUILDING

MOBILITY

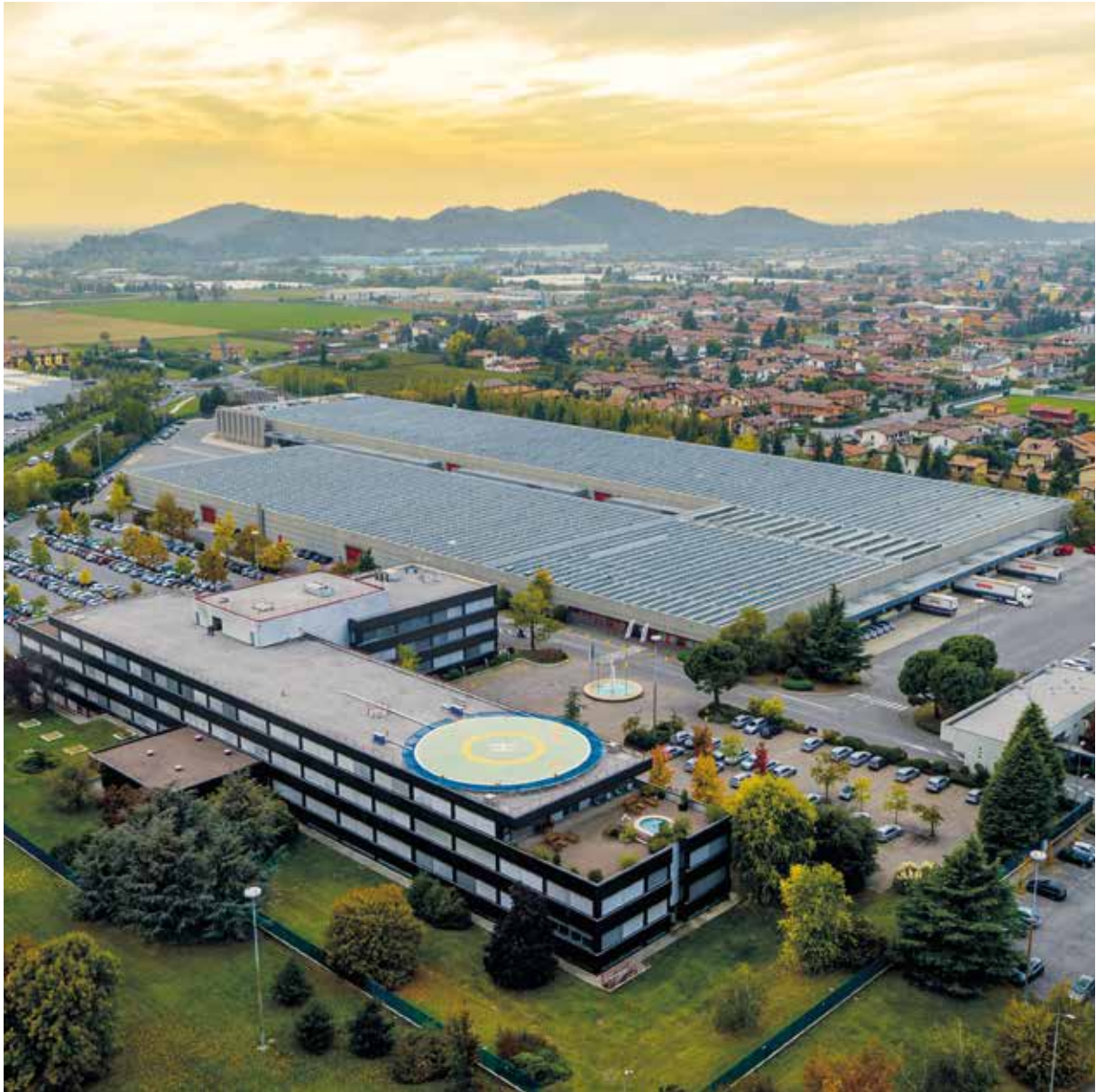

GEWISS HEADQUARTERS - ITALY



We have a great passion: **innovation**. A calling that turns into a steady force for change, a **predisposition for excellence** that demands imagination, knowledge, entrepreneurship and enthusiasm: qualities that form part of our history and that have enabled us to grow, demonstrating our capacity to **“look beyond”**.

We aim to **create value for our customers** and our team by offering solutions innovative and scalable for buildings, industries and infrastructures, able to connect people and things and improve safety and life, guided by values **integrity**, a culture of **excellence** and **sustainability**.

VISION

To be a leading company in our industry providing **meaningful innovation for the community.**

VALUES



INTEGRITY

For us integrity is the base on which coworkers, customers and stakeholders build relationships and trust. It means to be accountable, reliable and driven by strong ethical principles.

- HONESTY
- FAIRNESS
- CONSISTENCY
- TRANSPARENCY
- RELIABILITY
- RESPECT
- ACCOUNTABILITY
- ETHICAL LEADERSHIP
- LOYALTY



EXCELLENCE

Our culture of excellence is driven by a relentless tension to improve and reach challenging goals, creating every day something better than the day before, exploring innovative solutions and enhancing our potential.

- PASSION FOR RESULTS
- AGILITY
- TEAMWORKING
- SELF MOTIVATION
- INNOVATION
- PERSONAL DEVELOPMENT
- ENTREPRENEURSHIP
- FOCUS ON GROWTH
- EVOLUTION



SUSTAINABILITY

We act to reduce waste and manage efficiently human, natural and financial resources. We aim to create value for our people, customers, communities and future generations.

- DIVERSITY
- INCLUSION
- EFFICIENCY
- HEALTH & SAFETY
- ENVIRONMENT
- PROFITABILITY
- WELL-BEING
- COMMUNITY
- FUTURE



MISSION

Creating values for our **customers** and our **staff** providing innovative and scalable solutions for buildings, industries and infrastructures, connecting people and things, while improving the safety and the quality of life, driven by **integrity**, culture of **excellence** and **sustainability**.

BEHAVIORS

- BE** CREATIVE
DEVELOPING **INNOVATIVE IDEA**
- BE** COOPERATIVE
PROMOTE **TEAMWORKING**
- BE** RESILIENT
ACCOUNTABLE TO REACH **AMBITIOUS TARGETS**
- BE** PRAGMATIC
EFFICIENT, **SIMPLIFYING** AND ACTING **QUICKLY**
- BE** EFFECTIVE COMMUNICATOR
USE YOUR **EMOTIONAL INTELLIGENCE**
- BE** INCLUSIVE
EMBRACE **DIVERSITY** IN A MULTICULTURAL ENVIRONMENT
- BE** RELENTLESS
IN THE PURSUIT OF **CUSTOMER SATISFACTION**
- BE** TALENT ENHANCER
LEARN AND **TEACH** BY DOING





INSTALLATION



ENERGY



BUILDING



LIGHTING



MOBILITY



GEWISS EXPERIENCE CENTER

GEWISS EXPERIENCE CENTER is a **technological & innovative** «concept», an **interactive meeting space** where all the stakeholders can live the GEWISS world and its Solutions through an **immersive digital experience** that will **growth based on the market needs**.

An annual Calendar of **digital & events in presence**, training courses and customized events will develop business opportunities, from wholesaler to installer, from specifier, architect to consumer included media and academic audience.

We create connections between people and things

Our ability to understand the needs of society, of our customers and all professionals who rely on our work, led us to redefine our value proposition. Each product is conceived and created to be a solution for every different application: from **residential** to **industry**, from **sport** to **city landscape**, from **hospitality** to **office**, up to retail, **healthcare** and **transportation**.

A flexible and scalable offer that consists of **connected devices** that communicate with each other to create tailor-made solutions. Connectivity and smart solutions direct us to a more **open, sustainable, shared way of living**, built on new skills and platforms.



GSS, the new business model: GEWISS Solutions & Services

GSS is a customer centric platform that **combines products and services** in complete proposals **keys in hand**. GSS offers peace of mind and **360° integrated assistance** on all aspects of the customer project.

The GSS is an innovative business model in which GEWISS takes care of all aspects of a project, leveraging its **50 years of experience** and acting as general contractor on behalf of the client, from initial design to procurement, al coordination of contractors and suppliers up to final delivery.

Products overview

IEC 309 HP



pag. 16

IEC 309 BTS



pag. 52

IEC 309 MA



pag. 58

IB



pag. 68

68 Q-DIN



pag. 104

40 CDε



pag. 196

42 RV



pag. 210

44 CE



pag. 218

GW CONNECT



pag. 232

42 TV



pag. 236

FK



pag. 326

DF



pag. 340

PZ



pag. 348

GW FIT



pag. 354

90 RESTART



pag. 398

97 MSS



pag. 548

47 CVX 160 I



pag. 556

47 CVX 160 E



pag. 566

QDX 630 L



pag. 578

QDX 630 H



pag. 598

SYSTEM
PLATES



pag. 948

SYSTEM
MODULAR DEVICES



pag. 962

27 COMBI



pag. 1018

PLAYBUS
PLATES



pag. 1032

PLAYBUS
MODULAR DEVICES



pag. 1042

28 SPIC



pag. 1150

DOMO CENTER



pag. 1158

JOINON
WALLBOX I-CON



pag. 1178

JOINON
STATION I-ON



pag. 1186

JOINON
SOCKET



pag. 1192

68 ACS



pag. 118

70 RT HP



pag. 138

74 PS



pag. 148

46



pag. 158

40 CD



pag. 180

GREEN WALL



pag. 242

40 CDi



pag. 264

48



pag. 286

24 SC



pag. 302

RK



pag. 312

90 MCB



pag. 416

90 RCD



pag. 438

90 AM



pag. 470

90 PV



pag. 508

MSX



pag. 522

QDX 1600 H



pag. 620

BUSBAR



pag. 640

CHORUSMART PLATES



pag. 662

CHORUSMART MODULAR DEVICES



pag. 740

CHORUSMART ANTIBACTERIAL RANGE



pag. 932

DAHLIA PLATES



pag. 1062

DAHLIA MODULAR DEVICES

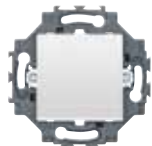

pag. 1070

CONNECTED SMART HOME



pag. 1086

HOME & BUILDING PRO



pag. 1106

DATA CENTER



pag. 1140

68 Q-MC 63X



pag. 1200

68 Q-MC



pag. 1206

- INSTALLATION
- ENERGY
- BUILDING
- MOBILITY

Index

INSTALLATION

IEC 309 PLUGS AND SOCKET-OUTLETS	IEC 309 HP	Plugs and socket-outlets IEC 309 standard	16
	IEC 309 BTS	Extra-low voltage plugs and socket-outlets IEC 309 standard	52
	IEC 309 MA	Multiple sockets and adaptor for industrial and domestic uses, protected and watertight	58
INTERLOCKED SOCKET-OUTLETS IEC 309 STANDARD	IB	Interlocked socket-outlets IEC 309 standard	68
IEC 309 COMBINED BOARDS	68 Q-DIN	Distribution boards	104
	68 ACS	ACS distribution board system for construction sites	118
CONTROL AND SIGNALLING	70 RT HP	Rotary isolator	138
	74 PS	Push-buttons, selectors and indicators Ø 22 mm	148
WALL-MOUNTING ENCLOSURES	46	Watertight surface-mounting distribution and automation boards	158
	40 CD	Surface-mounting distribution boards and enclosures	180
	40 CDE	Enclosures and distribution boards for specific standards	196
	42 RV	Surface and flush-mounting watertight emergency enclosures	210
	44 CE	Technopolymer surface mounting watertight junction boxes	218
	GW Connect	Metal surface-mounting watertight junction boxes	232
	42 TV	Multifunctional supporting bases	236
FLUSH-MOUNTING ENCLOSURES	GREEN WALL	Flush-mounting system for plasterboard walls	242
	40 CDi	Flush-mounting distribution boards and enclosures	264
	48	Flush-mounting junction and modular boxes system	286
CONDUITS AND ACCESSORIES FOR INSTALLATION	24 SC	Flush mounting; surface or underfloor boxes	302
	RK	Rigid protective conduit systems	312
	FK	Pliable protective conduit system	326
	DF	Flexible protective conduit systems	340
	PZ	Access chambers systems	348
	GW FIT	Accessories for electrical installation	354

ENERGY

AUTOMATIC RECLOSING DEVICES	90 ReStart	Automatic reclosing devices	398
CIRCUIT BREAKERS FOR CIRCUIT PROTECTION	90 MCB	Modular circuit breakers for circuit protection	416
CIRCUIT BREAKERS FOR RESIDUAL CURRENT PROTECTION	90 RCD	Modular circuit breakers for residual current protection	438
MODULAR ACCESSORIES	90 AM	Modular accessories	470
	90 PV	Products for photovoltaic systems	508
MOULDED CASE CIRCUIT BRAKERS	MSX	Moulded case circuit breakers for power distribution	522
	97 MSS	Rotary switch disconnectors	548
ELECTRICAL DISTRIBUTION BOARDS	47 CVX 160 I	Flush-mounting distribution boards up to 160 A	556
	47 CVX 160 E	Wall-mounting distribution boards up to 160 A with extractable frame	566
	QDX 630 L	Modular distribution boards up to 630A - IP43	578
	QDX 630 H	Monobloc and modular distribution boards up to 630A - IP55	598
	QDX 1600 H	Modular enclosures up to 1600A - IP55	620
	BUSBAR	Distribution systems for distribution boards	640

CHORUSMART	DOMESTIC RANGE	ONE International plates	662
		GEO International plates	668
		EGO INTERNATIONAL plates	674
		EGO SMART INTERNATIONAL plates	680
		LUX International plates	686
		ONE plates	694
		GEO plates	700
		EGO plates	706
		EGO SMART plates	712
		LUX plates	718
		ICE plates	728
		Installation accessories	734
		White modular devices	740
		Satin white modular devices	788
		Satin Natural Beige modular devices	820
		Black modular devices	854
		Glossy titanium modular devices	888
Ivory modular devices	922		
Antibacterial range	932		
SYSTEM	DOMESTIC RANGE	Plates	948
		White modular devices	962
		Black modular devices	990
27 COMBI	27 COMBI	Wall-mounting enclosures and modular components	1018
PLAYBUS	DOMESTIC RANGE	Plates	1032
		Modular devices	1042
DAHLIA	DOMESTIC RANGE	Plates	1062
		White monobloc devices	1070
		Ivory monobloc devices	1076
SMART HOME & BUILDING	CONNECTED SMART HOME	Connected SMART HOME	1086
	HOME & BUILDING PRO	Home & Building Pro	1106
DATA AND ENERGY DISTRIBUTION	DATA CENTER	Network cabling	1140
	28 SPIC	Plugs, sockets and adapters for domestic and similar uses	1150
FLUSH-MOUNTING ENCLOSURES	DOMO CENTER	Flush-mounting system columns for distribution, Home & Building automation and data	1158

ELECTRIC VEHICLE CHARGING	JOINON	Electric vehicle charging wallbox I-CON	1178
		Electric vehicle charging station I-ON	1186
		Electric vehicle charging socket - Type2	1192
ENERGY AND SERVICES DISTRIBUTION PEDESTALS	68 Q-MC 63X	Stainless steel distribution and service terminals	1200
	68 Q-MC	Terminal system for energy distribution and service in insulating material	1206



INSTALLATION

IEC 309 PLUGS AND SOCKET-OUTLETS

The IEC 309 system of sockets and plugs consists of the IEC 309 HP range (16 to 125A low-voltage sockets and plugs in mobile straight, 10° flush-mounted and wall-mounted versions), IEC 309 BTS (very low-voltage industrial sockets and plugs for requirements below 50V) and IEC 309 MA (a range of protected and watertight multipliers, adaptors and shunts for industrial and domestic uses).



INTERLOCKED SOCKET-OUTLETS IEC 309 STANDARD

The IEC 309 compliant interlocked socket system consists of the 67 IB (vertical interlocked sockets), 66 IB (heavy-duty vertical interlocked sockets), 44 IB (protected horizontal interlocked sockets) and COMBIBLOC (protected and watertight compact interlocked sockets) series.



IEC 309 COMBINED BOARDS

A system of empty or wired boards, compliant with the EN 61439 standard, able to satisfy any system necessity for wall, flush, mast and floor-mounting in service and industrial sectors, small and large construction sites and in ports/campsites.



CONTROL AND SIGNALLING

A complete system for the control and automation in industrial and robotic application, on-board machines and in electrical/electronic industry. The offer consists of wall-mounted or board rotary switch-disconnectors, push-buttons, selectors and indicators.



WALL-MOUNTING ENCLOSURES

A range of containers for surface-mounting systems and applications in the industrial, commercial and residential contexts. The range consists of watertight boards (in technopolymer, polyester reinforced with fibreglass, metal and stainless steel), boxes (in technopolymer and metal) and multifunctional supporting bases.



FLUSH-MOUNTING ENCLOSURES

Container system for commercial and residential applications. The system columns (for energy distribution, domotics and multimedia) are also part of the range, along with enclosures, distribution boards, boxes for domestic ranges and junction boxes with integrated DIN rail.



CONDUITS AND ACCESSORIES FOR INSTALLATION

A range of protective conduits for surface-mounting and flush-mounting applications in the industrial, commercial and residential contexts. The range includes medium to heavy rigid conduits (including Halogen Free versions), medium folding protective conduits, coextruded folding protective conduits and self-recovering protective conduits (ICTA Halogen Free).





IEC 309 PLUGS AND SOCKET-OUTLETS



IEC 309 HP

PLUGS AND SOCKET-OUTLETS
IEC 309 STANDARD

pag. 16



IEC 309 BTS

EXTRA-LOW VOLTAGE PLUGS AND SOCKET-OUTLETS
IEC 309 STANDARD

pag. 52



IEC 309 MA

MULTIPLE SOCKETS AND ADAPTORS FOR INDUSTRIAL
AND DOMESTIC USE, PROTECTED AND WATERTIGHT

pag. 58

IEC 309 HP

16A AND 32A LOW VOLTAGE INDUSTRIAL PLUGS AND SOCKET-OUTLETS IEC 309 STANDARD - IEC 309 HP

Rated current (In)	Rated Voltage (Un)	Frequency	Poles	Reference h	Straight plugs IP44/IP54		Straight plugs IP66/IP67/IP68/IP69	
								
					Fast wiring	Screw wiring	Fast wiring	Screw wiring
16 A	100 ÷ 130 V	50/60 Hz	2P+E	4	GW 60 001 FH	GW 60 001 H	GW 60 023 FH	GW 60 023 H
			3P+E	4	GW 60 002 FH	GW 60 002 H	GW 60 024 FH	GW 60 024 H
			3P+N+E	4	GW 60 003 FH	GW 60 003 H	GW 60 025 FH	GW 60 025 H
	200 ÷ 250 V	50/60 Hz	2P+E	6	GW 60 004 FH	GW 60 004 H	GW 60 026 FH	GW 60 026 H
			3P+E	9	GW 60 005 FH	GW 60 005 H GW 60 005 WH (*)	GW 60 027 FH	GW 60 027 H GW 60 027 WH (*)
			3P+N+E	9	GW 60 006 FH	GW 60 006 H GW 60 006 WH (*)	GW 60 028 FH	GW 60 028 H GW 60 028 WH (*)
	380 ÷ 415 V	50/60 Hz	2P+E	9	GW 60 007 FH	GW 60 007 H	GW 60 029 FH	GW 60 029 H
			3P+E	6	GW 60 008 FH	GW 60 008 H GW 60 008 WH (*)	GW 60 030 FH	GW 60 030 H GW 60 030 WH (*)
			3P+N+E	6	GW 60 009 FH	GW 60 009 H GW 60 009 WH (*)	GW 60 031 FH	GW 60 031 H GW 60 031 WH (*)
	480 ÷ 500 V	50/60 Hz	2P+E	7		GW 60 701 H		GW 60 735 H
			3P+E	7		GW 60 010 H		GW 60 032 H
			3P+N+E	7		GW 60 011 H		GW 60 033 H
	600 ÷ 690 V	50/60 Hz	3P+E	5		GW 60 702 H		GW 60 736 H
			3P+N+E	5		GW 60 703 H		GW 60 737 H
						GW 60 704 H		GW 60 738 H
	> 50 V	100 ÷ 300 Hz	2P+E	10		GW 60 705 H		GW 60 739 H
			3P+E	10		GW 60 706 H		GW 60 740 H
			3P+N+E	10		GW 60 707 H		GW 60 741 H
	> 50 V	> 300 ÷ 500 Hz	2P+E	2		GW 60 708 H		GW 60 742 H
			3P+E	2		GW 60 709 H		GW 60 743 H
3P+N+E			2		GW 60 710 H		GW 60 744 H	
440 ÷ 460 V	60 Hz	3P+E	11		GW 60 711 H		GW 60 745 H	
		3P+N+E	11		GW 60 712 H		GW 60 746 H	
380 V / 440 V	50 Hz / 60 Hz	3P+E	3		GW 60 713 H		GW 60 747 H	
		3P+N+E	3		GW 60 714 H		GW 60 748 H	
transf.	50/60 Hz	2P+E	12		GW 60 715 H		GW 60 749 H	
> 50 ÷ 250V	dc	2P+E	3		GW 60 716 H		GW 60 750 H	
> 250V	dc	2P+E	8		GW 60 717 H		GW 60 751 H	
32 A	100 ÷ 130 V	50/60 Hz	2P+E	4	GW 60 012 FH	GW 60 012 H	GW 60 034 FH	GW 60 034 H
			3P+E	4	GW 60 013 FH	GW 60 013 H	GW 60 035 FH	GW 60 035 H
			3P+N+E	4	GW 60 014 FH	GW 60 014 H	GW 60 036 FH	GW 60 036 H
	200 ÷ 250 V	50/60 Hz	2P+E	6	GW 60 015 FH	GW 60 015 H	GW 60 037 FH	GW 60 037 H
			3P+E	9	GW 60 016 FH	GW 60 016 H GW 60 016 WH (*)	GW 60 038 FH	GW 60 038 H GW 60 038 WH (*)
			3P+N+E	9	GW 60 017 FH	GW 60 017 H GW 60 017 WH (*)	GW 60 039 FH	GW 60 039 H GW 60 039 WH (*)
	380 ÷ 415 V	50/60 Hz	2P+E	9	GW 60 018 FH	GW 60 018 H	GW 60 040 FH	GW 60 040 H
			3P+E	6	GW 60 019 FH	GW 60 019 H GW 60 019 WH (*)	GW 60 041 FH	GW 60 041 H GW 60 041 WH (*)
			3P+N+E	6	GW 60 020 FH	GW 60 020 H GW 60 020 WH (*)	GW 60 042 FH	GW 60 042 H GW 60 042 WH (*)
	480 ÷ 500 V	50/60 Hz	2P+E	7		GW 60 718 H		GW 60 752 H
			3P+E	7		GW 60 021 H		GW 60 043 H
			3P+N+E	7		GW 60 022 H		GW 60 044 H
	600 ÷ 690 V	50/60 Hz	3P+E	5		GW 60 719 H		GW 60 753 H
			3P+N+E	5		GW 60 720 H		GW 60 754 H
						GW 60 721 H		GW 60 755 H
	> 50 V	100 ÷ 300 Hz	2P+E	10		GW 60 722 H		GW 60 756 H
			3P+E	10		GW 60 723 H		GW 60 757 H
			3P+N+E	10		GW 60 724 H		GW 60 758 H
	> 50 V	> 300 ÷ 500 Hz	2P+E	2		GW 60 725 H		GW 60 759 H
			3P+E	2		GW 60 726 H		GW 60 760 H
3P+N+E			2		GW 60 727 H		GW 60 761 H	
440 ÷ 460 V	60 Hz	3P+E	11		GW 60 728 H		GW 60 762 H	
		3P+N+E	11		GW 60 729 H		GW 60 145 H	
380 V / 440 V	50 Hz / 60 Hz	3P+E	3		GW 60 730 H		GW 60 763 H	
		3P+N+E	3		GW 60 731 H		GW 60 764 H	
transf.	50/60 Hz	2P+E	12		GW 60 732 H		GW 60 765 H	
> 50 ÷ 250V	dc	2P+E	3		GW 60 733 H		GW 60 766 H	
> 250V	dc	2P+E	8		GW 60 734 H		GW 60 767 H	

(*) Straight plugs with phase inverter

16A AND 32A LOW VOLTAGE INDUSTRIAL PLUGS AND SOCKET-OUTLETS IEC 309 STANDARD - IEC 309 HP

Straight connectors IP44/IP54		Straight connectors IP66/IP67/IP68/IP69		10° flush-mounting socket-outlets IP44/IP45		10° flush-mounting socket-outlets IP66/IP67		APPLICATIONS
Fast wiring	Screw wiring	Fast wiring	Screw wiring	Fast wiring	Screw wiring	Fast wiring	Screw wiring	
GW 62 001 FH	GW 62 001 H	GW 62 023 FH	GW 62 023 H	GW 62 201 FH	GW 62 201 H	GW 62 224 FH	GW 62 224 H	Standard use
GW 62 002 FH	GW 62 002 H	GW 62 024 FH	GW 62 024 H	GW 62 202 FH	GW 62 202 H	GW 62 225 FH	GW 62 225 H	
GW 62 003 FH	GW 62 003 H	GW 62 025 FH	GW 62 025 H	GW 62 203 FH	GW 62 203 H	GW 62 226 FH	GW 62 226 H	
GW 62 004 FH	GW 62 004 H	GW 62 026 FH	GW 62 026 H	GW 62 205 FH	GW 62 205 H (**)	GW 62 227 FH	GW 62 227 H	
GW 62 005 FH	GW 62 005 H	GW 62 027 FH	GW 62 027 H	GW 62 206 FH	GW 62 206 H	GW 62 228 FH	GW 62 228 H	
GW 62 006 FH	GW 62 006 H	GW 62 028 FH	GW 62 028 H	GW 62 207 FH	GW 62 207 H	GW 62 229 FH	GW 62 229 H	
GW 62 007 FH	GW 62 007 H	GW 62 029 FH	GW 62 029 H	GW 62 208 FH	GW 62 208 H	GW 62 230 FH	GW 62 230 H	
GW 62 008 FH	GW 62 008 H	GW 62 030 FH	GW 62 030 H	GW 62 209 FH	GW 62 209 H	GW 62 231 FH	GW 62 231 H	
GW 62 009 FH	GW 62 009 H	GW 62 031 FH	GW 62 031 H	GW 62 210 FH	GW 62 210 H	GW 62 232 FH	GW 62 232 H	
	GW 62 701 H		GW 62 735 H		GW 62 801 H		GW 62 835 H	Use with particular voltage
	GW 62 010 H		GW 62 032 H		GW 62 211 H		GW 62 233 H	
	GW 62 011 H		GW 62 033 H		GW 62 212 H		GW 62 234 H	
	GW 62 702 H		GW 62 736 H		GW 62 802 H		GW 62 836 H	
	GW 62 703 H		GW 62 737 H		GW 62 803 H		GW 62 837 H	Use with high frequencies
	GW 62 704 H		GW 62 738 H		GW 62 804 H		GW 62 838 H	
	GW 62 705 H		GW 62 739 H		GW 62 805 H		GW 62 839 H	
	GW 62 706 H		GW 62 740 H		GW 62 806 H		GW 62 840 H	
	GW 62 707 H		GW 62 741 H		GW 62 807 H		GW 62 841 H	
	GW 62 708 H		GW 62 742 H		GW 62 808 H		GW 62 842 H	
	GW 62 709 H		GW 62 743 H		GW 62 809 H		GW 62 843 H	
	GW 62 710 H		GW 62 744 H		GW 62 810 H		GW 62 844 H	Marine, port and naval, installations
	GW 62 711 H		GW 62 745 H		GW 62 811 H		GW 62 845 H	
	GW 62 712 H		GW 62 746 H		GW 62 812 H		GW 62 846 H	Refrigeration containers
	GW 62 713 H		GW 62 747 H		GW 62 813 H		GW 62 847 H	
	GW 62 714 H		GW 62 748 H		GW 62 814 H		GW 62 848 H	Isolation transformers
	GW 62 715 H		GW 62 749 H		GW 62 815 H		GW 62 849 H	Use in direct current
	GW 62 716 H		GW 62 750 H		GW 62 816 H		GW 62 850 H	
	GW 62 717 H		GW 62 751 H		GW 62 817 H		GW 62 851 H	
GW 62 012 FH	GW 62 012 H	GW 62 034 FH	GW 62 034 H	GW 62 213 FH	GW 62 213 H	GW 62 235 FH	GW 62 235 H	Standard use
GW 62 013 FH	GW 62 013 H	GW 62 035 FH	GW 62 035 H	GW 62 214 FH	GW 62 214 H	GW 62 236 FH	GW 62 236 H	
GW 62 014 FH	GW 62 014 H	GW 62 036 FH	GW 62 036 H	GW 62 215 FH	GW 62 215 H	GW 62 237 FH	GW 62 237 H	
GW 62 015 FH	GW 62 015 H	GW 62 037 FH	GW 62 037 H	GW 62 216 FH	GW 62 216 H	GW 62 238 FH	GW 62 238 H	
GW 62 016 FH	GW 62 016 H	GW 62 038 FH	GW 62 038 H	GW 62 217 FH	GW 62 217 H	GW 62 239 FH	GW 62 239 H	
GW 62 017 FH	GW 62 017 H	GW 62 039 FH	GW 62 039 H	GW 62 218 FH	GW 62 218 H	GW 62 240 FH	GW 62 240 H	Standard use
GW 62 018 FH	GW 62 018 H	GW 62 040 FH	GW 62 040 H	GW 62 219 FH	GW 62 219 H	GW 62 241 FH	GW 62 241 H	
GW 62 019 FH	GW 62 019 H	GW 62 041 FH	GW 62 041 H	GW 62 220 FH	GW 62 220 H	GW 62 242 FH	GW 62 242 H	
GW 62 020 FH	GW 62 020 H	GW 62 042 FH	GW 62 042 H	GW 62 221 FH	GW 62 221 H	GW 62 243 FH	GW 62 243 H	
	GW 62 718 H		GW 62 752 H		GW 62 818 H		GW 62 852 H	Use with particular voltage
	GW 62 021 H		GW 62 043 H		GW 62 222 H		GW 62 244 H	
	GW 62 022 H		GW 62 044 H		GW 62 223 H		GW 62 245 H	
	GW 62 719 H		GW 62 753 H		GW 62 819 H		GW 62 853 H	
	GW 62 720 H		GW 62 754 H		GW 62 820 H		GW 62 854 H	Use with high frequencies
	GW 62 721 H		GW 62 755 H		GW 62 821 H		GW 62 855 H	
	GW 62 722 H		GW 62 756 H		GW 62 822 H		GW 62 856 H	
	GW 62 723 H		GW 62 757 H		GW 62 823 H		GW 62 857 H	
	GW 62 724 H		GW 62 758 H		GW 62 824 H		GW 62 858 H	
	GW 62 725 H		GW 62 759 H		GW 62 825 H		GW 62 859 H	
	GW 62 726 H		GW 62 760 H		GW 62 826 H		GW 62 860 H	
	GW 62 727 H		GW 62 761 H		GW 62 827 H		GW 62 861 H	Marine, port and naval, installations
	GW 62 728 H		GW 62 762 H		GW 62 828 H		GW 62 862 H	
	GW 62 729 H		GW 62 128 H		GW 62 829 H		GW 62 283 H	Refrigeration containers
	GW 62 730 H		GW 62 763 H		GW 62 830 H		GW 62 863 H	
	GW 62 731 H		GW 62 764 H		GW 62 831 H		GW 62 864 H	Isolation transformers
	GW 62 732 H		GW 62 765 H		GW 62 832 H		GW 62 865 H	
	GW 62 733 H		GW 62 766 H		GW 62 833 H		GW 62 866 H	Use in direct current
	GW 62 734 H		GW 62 767 H		GW 62 834 H		GW 62 867 H	





(**) APPLICATION: GW62204, cap of reduced dimensions (62 x 62mm) for use in restricted spaces..

IEC 309 HP

63A AND 125A LOW VOLTAGE INDUSTRIAL PLUGS AND SOCKET-OUTLETS IEC 309 STANDARD - IEC 309 HP





Rated current (In)	Rated voltage (Un)	Frequency	Poles	Reference h	Straight mobile plugs IP44/IP54	Straight mobile plugs IP66/IP67/IP68/IP69
						
					Mantle connection	Mantle connection
63 A	100 ÷ 130 V	50/60 Hz	2P+E	4	GW 61 013 H	GW 61 045 H
			3P+E	4	GW 61 014 H	GW 61 046 H
			3P+N+E	4	GW 61 015 H	GW 61 047 H
	200 ÷ 250 V	50/60 Hz	2P+E	6	GW 61 016 H	GW 61 048 H
			3P+E	9	GW 61 017 H	GW 61 049 H
			3P+N+E	9	GW 61 018 H	GW 61 050 H
	380 ÷ 415 V	50/60 Hz	2P+E	9	GW 61 019 H	GW 61 051 H
			3P+E	6	GW 61 020 H	GW 61 052 H
			3P+N+E	6	GW 61 021 H	GW 61 053 H
	480 ÷ 500 V	50/60 Hz	2P+E	7		GW 61 056 H
			3P+E	7		GW 61 054 H
			3P+N+E	7		GW 61 055 H
	600 ÷ 690 V	50/60 Hz	3P+E	5		GW 61 057 H
			3P+N+E	5		GW 61 058 H
	> 50 V	100 ÷ 300 Hz	2P+E	10		GW 61 059 H
			3P+E	10		GW 61 060 H
			3P+N+E	10		GW 61 061 H
	> 50 V	> 300 ÷ 500 Hz	2P+E	2		GW 61 062 H
3P+E			2		GW 61 063 H	
3P+N+E			2		GW 61 064 H	
440 ÷ 460 V	60 Hz	3P+E	11		GW 61 065 H	
		3P+N+E	11		GW 61 066 H	
> 50 ÷ 250V	dc	2P+E	3		GW 61 067 H	
> 250V	dc	2P+E	8		GW 61 068 H	
125 A	100 ÷ 130 V	50/60 Hz	2P+E	4		GW 60 664 H
			3P+E	4		GW 60 056 H
			3P+N+E	4		GW 60 057 H
	200 ÷ 250 V	50/60 Hz	2P+E	6		GW 60 665 H
			3P+E	9		GW 60 058 H
			3P+N+E	9		GW 60 059 H
	380 ÷ 415 V	50/60 Hz	2P+E	9		GW 60 666 H
			3P+E	6		GW 60 060 H
			3P+N+E	6		GW 60 061 H
	480 ÷ 500 V	50/60 Hz	2P+E	7		GW 60 667 H
			3P+E	7		GW 60 062 H
			3P+N+E	7		GW 60 063 H
	600 ÷ 690 V	50/60 Hz	3P+E	5		GW 60 668 H
			3P+N+E	5		GW 60 669 H
	> 50 V	100 ÷ 300 Hz	2P+E	10		GW 60 670 H
			3P+E	10		GW 60 671 H
			3P+N+E	10		GW 60 672 H
	> 50 V	> 300 ÷ 500 Hz	2P+E	2		GW 60 673 H
3P+E			2		GW 60 674 H	
3P+N+E			2		GW 60 675 H	
440 ÷ 460 V	60 Hz	3P+E	11		GW 60 676 H	
		3P+N+E	11		GW 60 677 H	

Notes: all plugs are equipped with pilot contact.
 (*) Connectors equipped with pilot contact (screw wiring);
 (**) Connectors equipped with clean contact.

Straight mobile connectors IP44/IP54 	Straight connectors IP66/IP67/IP68/IP69 	10° fixed flush-mounting socket- outlets IP44/IP54 	10° fixed flush-mounting socket- outlets IP66/IP67 	APPLICATIONS
Mantle connection	Mantle connection	Mantle connection	Mantle connection	Standard use
GW 63 013 H	GW 63 045 H	GW 63 213 H	GW 63 246 H	
GW 63 014 H	GW 63 046 H	GW 63 214 H	GW 63 247 H	
GW 63 015 H	GW 63 047 H	GW 63 215 H	GW 63 248 H	
GW 63 016 H	GW 63 048 H	GW 63 216 H	GW 63 249 H	
	GW 63 048 PH*		GW 63 249 PH*	
GW 63 017 H	GW 63 049 H	GW 63 217 H	GW 63 250 H	
GW 63 018 H	GW 63 050 H	GW 63 218 H	GW 63 251 H	
GW 63 019 H	GW 63 051 H	GW 63 219 H	GW 63 252 H	
GW 63 020 H	GW 63 052 H	GW 63 220 H	GW 63 253 H	
	GW 63 052 PH*		GW 63 253 PH*	
GW 63 021 H	GW 63 053 H	GW 63 221 H	GW 63 254 H	
	GW 63 053 PH*		GW 63 254 PH*	
	GW 63 056 H		GW 63 257 H	
	GW 63 054 H		GW 63 255 H	
	GW 63 055 H		GW 63 256 H	
	GW 63 057 H		GW 63 258 H	
	GW 63 058 H		GW 63 259 H	
	GW 63 059 H		GW 63 260 H	
	GW 63 060 H		GW 63 261 H	
	GW 63 061 H		GW 63 262 H	
	GW 63 062 H		GW 63 263 H	
	GW 63 063 H		GW 63 264 H	
	GW 63 064 H		GW 63 265 H	
	GW 63 065 H		GW 63 266 H	
	GW 63 066 H		GW 63 267 H	
	GW 63 067 H		GW 63 268 H	
	GW 63 068 H		GW 63 269 H	
	GW 62 664 H		GW 62 965 H	
	GW 62 056 H		GW 62 257 H	
	GW 62 057 H		GW 62 258 H	
	GW 62 665 H		GW 62 966 H	
	GW 62 058 H		GW 62 259 H	
	GW 62 059 H		GW 62 260 H	
	GW 62 666 H		GW 62 967 H	
	GW 62 060 H		GW 62 261 H	
	GW 62 060 PH*		GW 62 261 PH*	
			GW 68 785**	
	GW 62 061 H		GW 62 262 H	
			GW 62 262 PH*	
	GW 62 061 PH*		GW 68 786**	
	GW 62 667 H		GW 62 968 H	
	GW 62 062 H		GW 62 263 H	
	GW 62 063 H		GW 62 264 H	
	GW 62 668 H		GW 62 969 H	
	GW 62 669 H		GW 62 970 H	
	GW 62 670 H		GW 62 971 H	
	GW 62 671 H		GW 62 972 H	
	GW 62 672 H		GW 62 973 H	
	GW 62 673 H		GW 62 974 H	
	GW 62 674 H		GW 62 975 H	
	GW 62 675 H		GW 62 976 H	
	GW 62 676 H		GW 62 977 H	
	GW 62 677 H		GW 62 978 H	
				Marine, port and naval, installations

IEC 309 HP







16-32-63-125A LOW VOLTAGE INDUSTRIAL PLUGS AND SOCKET-OUTLETS COMPLYING WITH IEC 309 STANDARD

Rated current (In)	Rated voltage (Un)	Frequency	Poles	Reference h	90° plugs IP44	90° plugs IP67	Straight flush-mounting inlets IP44	Straight flush-mounting inlets IP67
								
					Screw wiring	Screw wiring	Screw wiring	Screw wiring
16 A	100 ÷ 130 V	50/60 Hz	2P+E	4	GW 60 082	GW 60 105	GW 60 201	GW 60 223
			3P+E	4	GW 60 083	GW 60 106	GW 60 202	GW 60 224
			3P+N+E	4	GW 60 084	GW 60 107	GW 60 203	GW 60 225
	200 ÷ 250 V	50/60 Hz	2P+E	6	GW 60 085	GW 60 108	GW 60 204	GW 60 226
			3P+E	9	GW 60 086	GW 60 109	GW 60 205	GW 60 227
			3P+N+E	9	GW 60 087	GW 60 110	GW 60 206	GW 60 228
	380 ÷ 415 V	50/60 Hz	2P+E	9	GW 60 088	GW 60 111	GW 60 207	GW 60 229
			3P+E	6	GW 60 089	GW 60 112	GW 60 208	GW 60 230
			3P+N+E	6	GW 60 090	GW 60 113	GW 60 209	GW 60 231
	480 ÷ 500 V	50/60 Hz	3P+E	7	GW 60 091	GW 60 114	GW 60 210	GW 60 232
			3P+N+E	7	GW 60 092	GW 60 115	GW 60 211	GW 60 233
32 A	100 ÷ 130 V	50/60 Hz	2P+E	4	GW 60 093	GW 60 116	GW 60 212	GW 60 234
			3P+E	4	GW 60 094	GW 60 117	GW 60 213	GW 60 235
			3P+N+E	4	GW 60 095	GW 60 118	GW 60 214	GW 60 236
	200 ÷ 250 V	50/60 Hz	2P+E	6	GW 60 096	GW 60 119	GW 60 215	GW 60 237
			3P+E	9	GW 60 097	GW 60 120	GW 60 216	GW 60 238
			3P+N+E	9	GW 60 098	GW 60 121	GW 60 217	GW 60 239
	380 ÷ 415 V	50/60 Hz	2P+E	9	GW 60 099	GW 60 122	GW 60 218	GW 60 240
			3P+E	6	GW 60 101	GW 60 123	GW 60 219	GW 60 241
			3P+N+E	6	GW 60 102	GW 60 124	GW 60 220	GW 60 242
	480 ÷ 500 V	50/60 Hz	3P+E	7	GW 60 103	GW 60 125	GW 60 221	GW 60 243
			3P+N+E	7	GW 60 104	GW 60 126	GW 60 222	GW 60 244
	380 V / 440 V	50 Hz / 60 Hz	3P+E	3		GW 60 146		GW 60 268
63 A	100 ÷ 130 V	50/60 Hz	2P+E	4				
			3P+E	4				
			3P+N+E	4				
	200 ÷ 250 V	50/60 Hz	2P+E	6				
			3P+E	9				
			3P+N+E	9				
	380 ÷ 415 V	50/60 Hz	2P+E	9				
			3P+E	6				
			3P+N+E	6				
	480 ÷ 500 V	50/60 Hz	3P+E	7				
			3P+N+E	7				
	125 A	100 ÷ 130 V	50/60 Hz	2P+E	4			
3P+E				4				
3P+N+E				4				
200 ÷ 250 V		50/60 Hz	2P+E	6				
			3P+E	9				
			3P+N+E	9				
380 ÷ 415 V		50/60 Hz	2P+E	9				
			3P+E	6				
			3P+N+E	6				
480 ÷ 500 V		50/60 Hz	3P+E	7				
			3P+N+E	7				

DOMESTIC SOCKET OUTLETS - IP54

	Description	Rated current (In)	Rated voltage (Un)	Poles	Dimensions (mm)	Code
	Domestic socket-outlets, German standard - IP54	16 A	230V	2P+E	85x75	GW 62 392
	Domestic socket-outlets, German standard - IP54	16 A	230V	2P+E	50x50	GW 62 393
	Domestic socket-outlets, French standard - IP54	16 A	230V	2P+E	50x50	GW 62 394

16-32-63-125A LOW VOLTAGE INDUSTRIAL PLUGS AND SOCKET-OUTLETS COMPLYING WITH IEC 309 STANDARD

90° surface-mounting inlets IP44	90° surface-mounting inlets IP67	10° surface-mounting socket-outlets IP44	10° surface-mounting socket-outlets IP67	90° surface-mounting socket-outlets IP44	90° surface-mounting socket-outlets IP67	APPLICATIONS
						
Screw wiring	Screw wiring	Screw wiring	Screw wiring	Screw wiring	Screw wiring	
GW 60 401	GW 60 423	GW 62 401	GW 62 423	GW 62 474	GW 62 496	Standard use
GW 60 402	GW 60 424	GW 62 402	GW 62 424	GW 62 475	GW 62 497	
GW 60 403	GW 60 425	GW 62 403	GW 62 425	GW 62 476	GW 62 498	
GW 60 404	GW 60 426	GW 62 404	GW 62 426	GW 62 477	GW 62 499	
GW 60 405	GW 60 427	GW 62 405	GW 62 427	GW 62 478	GW 62 501	
GW 60 406	GW 60 428	GW 62 406	GW 62 428	GW 62 479	GW 62 502	
GW 60 407	GW 60 429	GW 62 407	GW 62 429	GW 62 480	GW 62 503	
GW 60 408	GW 60 430	GW 62 408	GW 62 430	GW 62 481	GW 62 504	
GW 60 409	GW 60 431	GW 62 409	GW 62 431	GW 62 482	GW 62 505	
GW 60 410	GW 60 432	GW 62 410	GW 62 432	GW 62 483	GW 62 506	
GW 60 411	GW 60 433	GW 62 411	GW 62 433	GW 62 484	GW 62 507	Standard use
GW 60 412	GW 60 434	GW 62 412	GW 62 434	GW 62 485	GW 62 508	
GW 60 413	GW 60 435	GW 62 413	GW 62 435	GW 62 486	GW 62 509	
GW 60 414	GW 60 436	GW 62 414	GW 62 436	GW 62 487	GW 62 510	
GW 60 415	GW 60 437	GW 62 415	GW 62 437	GW 62 488	GW 62 511	
GW 60 416	GW 60 438	GW 62 416	GW 62 438	GW 62 489	GW 62 512	
GW 60 417	GW 60 439	GW 62 417	GW 62 439	GW 62 490	GW 62 513	
GW 60 418	GW 60 440	GW 62 418	GW 62 440	GW 62 491	GW 62 514	
GW 60 419	GW 60 441	GW 62 419	GW 62 441	GW 62 492	GW 62 515	
GW 60 420	GW 60 442	GW 62 420	GW 62 442	GW 62 493	GW 62 516	
GW 60 421	GW 60 443	GW 62 421	GW 62 443	GW 62 494	GW 62 517	Refrigeration containers
GW 60 422	GW 60 444	GW 62 422	GW 62 444	GW 62 495	GW 62 518	
	GW 60 482		GW 62 556		GW 62 557	Standard use
	GW 61 445		GW 63 445		GW 63 519	
	GW 61 446		GW 63 446		GW 63 520	
	GW 61 447		GW 63 447		GW 63 521	
	GW 61 448		GW 63 448		GW 63 522	
	GW 61 449		GW 63 449		GW 63 523	
	GW 61 450		GW 63 450		GW 63 524	
	GW 61 451		GW 63 451		GW 63 525	
	GW 61 452		GW 63 452		GW 63 526	
	GW 61 453		GW 63 453		GW 63 527	
	GW 61 454		GW 63 454		GW 63 528	Use with particular voltage
	GW 61 455		GW 63 455		GW 63 529	Standard use
	GW 60 456				GW 62 530	
	GW 60 457				GW 62 531	
	GW 60 458				GW 62 532	
	GW 60 459				GW 62 533	
	GW 60 460				GW 62 534	
	GW 60 461				GW 62 535	
	GW 60 462				GW 62 536	
	GW 60 463				GW 62 537	

IEC 309 HP

Plugs and socket-outlets IEC 309 standard

The IEC 309 HP system comprises plugs and socket-outlets from 16 to 125 A in two different versions - straight mobile and 10° flush-mounting - which have IP44/IP54 and IP66/IP67/IP68/IP69 degrees of protection (IP68/IP69 only available for straight versions). The introduction of all the hours references for the earthing contact completes the range for specific applications and installations. The 16-32 A versions are available with screw wiring or fast wiring with spring terminals, while the 63-125A versions propose indirect wiring with mantle terminals.



IEC 309 HP - LOW VOLTAGE FAST WIRING STRAIGHT PLUGS

IP44/IP54



GW 60 004 FH

LOW VOLTAGE FAST WIRING STRAIGHT PLUGS - HIGH PERFORMANCE



Code	No. of poles	Rated voltage	Colour	Frequency	Reference h	Pack Carton
Rated current (A): 16						
GW 60 001 FH	2P+E	100 - 130 V	Yellow	50/60 Hz	4	25
GW 60 002 FH	3P+E	100 - 130 V	Yellow	50/60 Hz	4	15
GW 60 003 FH	3P+N+E	100 - 130 V	Yellow	50/60 Hz	4	50
GW 60 004 FH	2P+E	200 - 250 V	Blue	50/60 Hz	6	50
GW 60 005 FH	3P+E	200 - 250 V	Blue	50/60 Hz	9	15
GW 60 006 FH	3P+N+E	200 - 250 V	Blue	50/60 Hz	9	15
GW 60 007 FH	2P+E	380 - 415 V	Red	50/60 Hz	9	15
GW 60 008 FH	3P+E	380 - 415 V	Red	50/60 Hz	6	25
GW 60 009 FH	3P+N+E	380 - 415 V	Red	50/60 Hz	6	50
Rated current (A): 32						
GW 60 012 FH	2P+E	100 - 130 V	Yellow	50/60 Hz	4	15
GW 60 013 FH	3P+E	100 - 130 V	Yellow	50/60 Hz	4	15
GW 60 014 FH	3P+N+E	100 - 130 V	Yellow	50/60 Hz	4	15
GW 60 015 FH	2P+E	200 - 250 V	Blue	50/60 Hz	6	15
GW 60 016 FH	3P+E	200 - 250 V	Blue	50/60 Hz	9	15
GW 60 017 FH	3P+N+E	200 - 250 V	Blue	50/60 Hz	9	15
GW 60 018 FH	2P+E	380 - 415 V	Red	50/60 Hz	9	15
GW 60 019 FH	3P+E	380 - 415 V	Red	50/60 Hz	6	15
GW 60 020 FH	3P+N+E	380 - 415 V	Red	50/60 Hz	6	15

NOTES: all products are packaged individually.

Halogen free according to EN 60754-2.

CHARACTERISTICS: connection technology with spring terminals. Nickel-plated pins.

IEC 309 HP - LOW VOLTAGE SCREW WIRING STRAIGHT PLUGS

IP66/IP67/IP68/IP69



GW 60 030 FH

LOW VOLTAGE FAST WIRING STRAIGHT PLUGS - HIGH PERFORMANCE



Code	No. of poles	Rated voltage	Colour	Frequency	Reference h	Pack Carton
Rated current (A): 16						
GW 60 023 FH	2P+E	100 - 130 V	■	50/60 Hz	4	15
GW 60 024 FH	3P+E	100 - 130 V	■	50/60 Hz	4	15
GW 60 025 FH	3P+N+E	100 - 130 V	■	50/60 Hz	4	15
GW 60 026 FH	2P+E	200 - 250 V	■	50/60 Hz	6	50
GW 60 027 FH	3P+E	200 - 250 V	■	50/60 Hz	9	15
GW 60 028 FH	3P+N+E	200 - 250 V	■	50/60 Hz	9	15
GW 60 029 FH	2P+E	380 - 415 V	■	50/60 Hz	9	15
GW 60 030 FH	3P+E	380 - 415 V	■	50/60 Hz	6	15
GW 60 031 FH	3P+N+E	380 - 415 V	■	50/60 Hz	6	25
Rated current (A): 32						
GW 60 034 FH	2P+E	100 - 130 V	■	50/60 Hz	4	15
GW 60 035 FH	3P+E	100 - 130 V	■	50/60 Hz	4	15
GW 60 036 FH	3P+N+E	100 - 130 V	■	50/60 Hz	4	15
GW 60 037 FH	2P+E	200 - 250 V	■	50/60 Hz	6	15
GW 60 038 FH	3P+E	200 - 250 V	■	50/60 Hz	9	15
GW 60 039 FH	3P+N+E	200 - 250 V	■	50/60 Hz	9	15
GW 60 040 FH	2P+E	380 - 415 V	■	50/60 Hz	9	15
GW 60 041 FH	3P+E	380 - 415 V	■	50/60 Hz	6	15
GW 60 042 FH	3P+N+E	380 - 415 V	■	50/60 Hz	6	15

NOTES: all products are packaged individually.
 IP68: 2 bar/6 h in accordance with EN 60529 after ageing according to standard EN 60309.
 IP69: in accordance with EN 60529 after ageing according to standard EN 60309.
 Halogen-free in compliance with EN 60754-2.
CHARACTERISTICS: connection technology with spring terminals. Nickel-plated plugs.

IP44/IP54



GW 60 004 H

LOW VOLTAGE SCREW WIRING STRAIGHT PLUGS - HIGH PERFORMANCE



Code	No. of poles	Rated voltage	Colour	Frequency	Reference h	Pack Carton
Rated current (A): 16						
GW 60 001 H	2P+E	100 - 130 V	■	50/60 Hz	4	50
GW 60 002 H	3P+E	100 - 130 V	■	50/60 Hz	4	50
GW 60 003 H	3P+N+E	100 - 130 V	■	50/60 Hz	4	15
GW 60 004 H	2P+E	200 - 250 V	■	50/60 Hz	6	50
GW 60 005 H	3P+E	200 - 250 V	■	50/60 Hz	9	25
GW 60 006 H	3P+N+E	200 - 250 V	■	50/60 Hz	9	15
GW 60 007 H	2P+E	380 - 415 V	■	50/60 Hz	9	15
GW 60 008 H	3P+E	380 - 415 V	■	50/60 Hz	6	50
GW 60 009 H	3P+N+E	380 - 415 V	■	50/60 Hz	6	50
GW 60 701 H	2P+E	480 - 500 V	■	50/60 Hz	7	15
GW 60 010 H	3P+E	480 - 500 V	■	50/60 Hz	7	15
GW 60 011 H	3P+N+E	480 - 500 V	■	50/60 Hz	7	15
GW 60 702 H	3P+E	600 - 690 V	■	50/60 Hz	5	15
GW 60 703 H	3P+N+E	600 - 690 V	■	50/60 Hz	5	15
GW 60 704 H	2P+E	>50 V	■	100 - 300 Hz	10	15
GW 60 705 H	3P+E	>50 V	■	100 - 300 Hz	10	15
GW 60 706 H	3P+N+E	>50 V	■	100 - 300 Hz	10	15
GW 60 707 H	2P+E	>50 V	■	>300 - 500 Hz	2	15
GW 60 708 H	3P+E	>50 V	■	>300 - 500 Hz	2	15
GW 60 709 H	3P+N+E	>50 V	■	>300 - 500 Hz	2	15
GW 60 710 H	3P+E	440 - 460 V	■	60 Hz	11	15
GW 60 711 H	3P+N+E	440 - 460 V	■	60 Hz	11	15
GW 60 712 H	3P+E	380 - 440 V	■	50/60 Hz	3	15
GW 60 713 H	3P+N+E	380 - 440 V	■	50/60 Hz	3	15
GW 60 714 H	2P+E	transf.	■	50/60 Hz	12	15
GW 60 715 H	3P+E	transf.	■	50/60 Hz	12	15
GW 60 716 H	2P+E	>50 - 250 V	■	d.c.	3	15
GW 60 717 H	2P+E	>250 V	■	d.c.	8	15
Rated current (A): 32						
GW 60 012 H	2P+E	100 - 130 V	■	50/60 Hz	4	15
GW 60 013 H	3P+E	100 - 130 V	■	50/60 Hz	4	15
GW 60 014 H	3P+N+E	100 - 130 V	■	50/60 Hz	4	15
GW 60 015 H	2P+E	200 - 250 V	■	50/60 Hz	6	25
GW 60 016 H	3P+E	200 - 250 V	■	50/60 Hz	9	50
GW 60 017 H	3P+N+E	200 - 250 V	■	50/60 Hz	9	15
GW 60 018 H	2P+E	380 - 415 V	■	50/60 Hz	9	15
GW 60 019 H	3P+E	380 - 415 V	■	50/60 Hz	6	50
GW 60 020 H	3P+N+E	380 - 415 V	■	50/60 Hz	6	50
GW 60 718 H	2P+E	480 - 500 V	■	50/60 Hz	7	15
GW 60 021 H	3P+E	480 - 500 V	■	50/60 Hz	7	15
GW 60 022 H	3P+N+E	480 - 500 V	■	50/60 Hz	7	15
GW 60 719 H	3P+E	600 - 690 V	■	50/60 Hz	5	15
GW 60 720 H	3P+N+E	600 - 690 V	■	50/60 Hz	5	15
GW 60 721 H	2P+E	>50 V	■	100 - 300 Hz	10	15
GW 60 722 H	3P+E	>50 V	■	100 - 300 Hz	10	15
GW 60 723 H	3P+N+E	>50 V	■	100 - 300 Hz	10	15
GW 60 724 H	2P+E	>50 V	■	>300 - 500 Hz	2	15
GW 60 725 H	3P+E	>50 V	■	>300 - 500 Hz	2	15
GW 60 726 H	3P+N+E	>50 V	■	>300 - 500 Hz	2	15
GW 60 727 H	3P+E	440 - 460 V	■	60 Hz	11	15
GW 60 728 H	3P+N+E	440 - 460 V	■	60 Hz	11	15
GW 60 729 H	3P+E	380 - 440 V	■	50/60 Hz	3	15
GW 60 730 H	3P+N+E	380 - 440 V	■	50/60 Hz	3	15
GW 60 731 H	2P+E	transf.	■	50/60 Hz	12	15
GW 60 732 H	3P+E	transf.	■	50/60 Hz	12	15
GW 60 733 H	2P+E	>50 - 250 V	■	d.c.	3	15
GW 60 734 H	2P+E	>250 V	■	d.c.	8	15

NOTES: all products are packaged individually. Halogen free according to EN 60754-2.

CHARACTERISTICS: nickel-plated pins.

IP66/IP67/IP68/IP69



GW 60 030 H

LOW VOLTAGE SCREW WIRING STRAIGHT PLUGS - HIGH PERFORMANCE



Code	No. of poles	Rated voltage	Colour	Frequency	Reference h	Pack Carton
Rated current (A): 16						
GW 60 023 H	2P+E	100 - 130 V	■	50/60 Hz	4	25
GW 60 024 H	3P+E	100 - 130 V	■	50/60 Hz	4	15
GW 60 025 H	3P+N+E	100 - 130 V	■	50/60 Hz	4	15
GW 60 026 H	2P+E	200 - 250 V	■	50/60 Hz	6	50
GW 60 027 H	3P+E	200 - 250 V	■	50/60 Hz	9	15
GW 60 028 H	3P+N+E	200 - 250 V	■	50/60 Hz	9	15
GW 60 029 H	2P+E	380 - 415 V	■	50/60 Hz	9	15
GW 60 030 H	3P+E	380 - 415 V	■	50/60 Hz	6	25
GW 60 031 H	3P+N+E	380 - 415 V	■	50/60 Hz	6	25
GW 60 735 H	2P+E	480 - 500 V	■	50/60 Hz	7	15
GW 60 032 H	3P+E	480 - 500 V	■	50/60 Hz	7	15
GW 60 033 H	3P+N+E	480 - 500 V	■	50/60 Hz	7	15
GW 60 736 H	3P+E	600 - 690 V	■	50/60 Hz	5	15
GW 60 737 H	3P+N+E	600 - 690 V	■	50/60 Hz	5	15
GW 60 738 H	2P+E	>50 V	■	100 - 300 Hz	10	15
GW 60 739 H	3P+E	>50 V	■	100 - 300 Hz	10	15
GW 60 740 H	3P+N+E	>50 V	■	100 - 300 Hz	10	15
GW 60 741 H	2P+E	>50 V	■	>300 - 500 Hz	2	15
GW 60 742 H	3P+E	>50 V	■	>300 - 500 Hz	2	15
GW 60 743 H	3P+N+E	>50 V	■	>300 - 500 Hz	2	15
GW 60 744 H	3P+E	440 - 460 V	■	60 Hz	11	15
GW 60 745 H	3P+N+E	440 - 460 V	■	60 Hz	11	15
GW 60 746 H	3P+E	380 - 440 V	■	50/60 Hz	3	15
GW 60 747 H	3P+N+E	380 - 440 V	■	50/60 Hz	3	15
GW 60 748 H	2P+E	transf.	■	50/60 Hz	12	15
GW 60 749 H	3P+E	transf.	■	50/60 Hz	12	15
GW 60 750 H	2P+E	>50 - 250 V	■	d.c.	3	15
GW 60 751 H	2P+E	>250 V	■	d.c.	8	15
Rated current (A): 32						
GW 60 034 H	2P+E	100 - 130 V	■	50/60 Hz	4	15
GW 60 035 H	3P+E	100 - 130 V	■	50/60 Hz	4	15
GW 60 036 H	3P+N+E	100 - 130 V	■	50/60 Hz	4	15
GW 60 037 H	2P+E	200 - 250 V	■	50/60 Hz	6	15
GW 60 038 H	3P+E	200 - 250 V	■	50/60 Hz	9	15
GW 60 039 H	3P+N+E	200 - 250 V	■	50/60 Hz	9	15
GW 60 040 H	2P+E	380 - 415 V	■	50/60 Hz	9	15
GW 60 041 H	3P+E	380 - 415 V	■	50/60 Hz	6	15
GW 60 042 H	3P+N+E	380 - 415 V	■	50/60 Hz	6	25
GW 60 752 H	2P+E	480 - 500 V	■	50/60 Hz	7	15
GW 60 043 H	3P+E	480 - 500 V	■	50/60 Hz	7	15
GW 60 044 H	3P+N+E	480 - 500 V	■	50/60 Hz	7	15
GW 60 753 H	3P+E	600 - 690 V	■	50/60 Hz	5	15
GW 60 754 H	3P+N+E	600 - 690 V	■	50/60 Hz	5	15
GW 60 755 H	2P+E	>50 V	■	100 - 300 Hz	10	15
GW 60 756 H	3P+E	>50 V	■	100 - 300 Hz	10	15
GW 60 757 H	3P+N+E	>50 V	■	100 - 300 Hz	10	15
GW 60 758 H	2P+E	>50 V	■	>300 - 500 Hz	2	15
GW 60 759 H	3P+E	>50 V	■	>300 - 500 Hz	2	15
GW 60 760 H	3P+N+E	>50 V	■	>300 - 500 Hz	2	15
GW 60 761 H	3P+E	440 - 460 V	■	60 Hz	11	15
GW 60 762 H	3P+N+E	440 - 460 V	■	60 Hz	11	15
GW 60 145 H	3P+E	380 - 440 V	■	50/60 Hz	3	25
GW 60 763 H	3P+N+E	380 - 440 V	■	50/60 Hz	3	15
GW 60 764 H	2P+E	transf.	■	50/60 Hz	12	15
GW 60 765 H	3P+E	transf.	■	50/60 Hz	12	15
GW 60 766 H	2P+E	>50 - 250 V	■	d.c.	3	15
GW 60 767 H	2P+E	>250 V	■	d.c.	8	15

NOTES: all products are packaged individually. Halogen-free in compliance with EN 60754-2.

IP68: 2 bar/6 h according EN 60529 after ageing according to standard EN 60309.

IP69: in accordance with EN 60529 after ageing according to standard EN 60309.

CHARACTERISTICS: nickel-plated plugs.

IEC 309 HP

IEC 309 HP - LOW VOLTAGE SCREW WIRING STRAIGHT PLUGS WITH PHASE INVERTERS

IP44/IP54



GW 60 009 WH

LOW VOLTAGE SCREW WIRING STRAIGHT PLUGS WITH PHASE INVERTER - HIGH PERFORMANCE INVERTER



Code	No. of poles	Rated voltage	Colour	Frequency	Reference h	Pack Carton
Rated current (A): 16						
GW 60 005 WH	3P+E	200 - 250 V	■	50/60 Hz	9	15
GW 60 006 WH	3P+N+E	200 - 250 V	■	50/60 Hz	9	15
GW 60 008 WH	3P+E	380 - 415 V	■	50/60 Hz	6	15
GW 60 009 WH	3P+N+E	380 - 415 V	■	50/60 Hz	6	15
Rated current (A): 32						
GW 60 016 WH	3P+E	200 - 250 V	■	50/60 Hz	9	15
GW 60 017 WH	3P+N+E	200 - 250 V	■	50/60 Hz	9	15
GW 60 019 WH	3P+E	380 - 415 V	■	50/60 Hz	6	15
GW 60 020 WH	3P+N+E	380 - 415 V	■	50/60 Hz	6	15

NOTES: all products are packaged individually.

Halogen free according to EN 60754-2.

CHARACTERISTICS: nickel-plated pins.

allow the fast exchange of two phases by using a screwdriver to reverse the direction of rotation of three-phase motors.

IP66/IP67/IP68/IP69

LOW VOLTAGE SCREW WIRING STRAIGHT PLUGS WITH PHASE INVERTER - HIGH PERFORMANCE INVERTER



GW 60 030 WH



Code	No. of poles	Rated voltage	Colour	Frequency	Reference h	Pack Carton
Rated current (A): 16						
GW 60 027 WH	3P+E	200 - 250 V	■	50/60 Hz	9	15
GW 60 028 WH	3P+N+E	200 - 250 V	■	50/60 Hz	9	15
GW 60 030 WH	3P+E	380 - 415 V	■	50/60 Hz	6	15
GW 60 031 WH	3P+N+E	380 - 415 V	■	50/60 Hz	6	15
Rated current (A): 32						
GW 60 038 WH	3P+E	200 - 250 V	■	50/60 Hz	9	15
GW 60 039 WH	3P+N+E	200 - 250 V	■	50/60 Hz	9	15
GW 60 041 WH	3P+E	380 - 415 V	■	50/60 Hz	6	15
GW 60 042 WH	3P+N+E	380 - 415 V	■	50/60 Hz	6	15

NOTES: all products are packaged individually.

Halogen-free in compliance with EN 60754-2.

IP68: 2 bar/6 h according to EN 60529 after ageing according to standard EN 60309.

IP69: in accordance with EN 60529 after ageing according to standard EN 60309.

CHARACTERISTICS: nickel-plated plugs.

Allow the fast exchange of two phases by using a screwdriver to reverse the direction of rotation of three-phase motors.

IEC 309 HP

IEC 309 HP - LOW VOLTAGE HIGH CURRENT STRAIGHT PLUGS WITH MANTLE CONNECTION

IP44/IP54



GW 61 016 H

LOW VOLTAGE HIGH CURRENT PROTECTED STRAIGHT PLUGS WITH MANTLE TERMINAL - HIGH PERFORMANCE



Code	No. of poles	Rated voltage	Colour	Frequency	Reference h	Pack Carton
Rated current (A): 63						
GW 61 013 H	2P+E	100 - 130 V	■	50/60 Hz	4	1/4
GW 61 014 H	3P+E	100 - 130 V	■	50/60 Hz	4	1/4
GW 61 015 H	3P+N+E	100 - 130 V	■	50/60 Hz	4	1/4
GW 61 016 H	2P+E	200 - 250 V	■	50/60 Hz	6	1/4
GW 61 017 H	3P+E	200 - 250 V	■	50/60 Hz	9	1/4
GW 61 018 H	3P+N+E	200 - 250 V	■	50/60 Hz	9	1/4
GW 61 019 H	2P+E	380 - 415 V	■	50/60 Hz	9	1/4
GW 61 020 H	3P+E	380 - 415 V	■	50/60 Hz	6	1/4
GW 61 021 H	3P+N+E	346 - 415 V	■	50/60 Hz	6	1/4

NOTES: all products are packaged individually.

Halogen free in accordance with Standard EN 60754-2.

CHARACTERISTICS: connection technology with mantle terminals. Nickel-plated plugs.

Versions with pilot contact.

IP66/IP67/IP68/IP69



GW 61 053 H

LOW VOLTAGE HIGH CURRENT WATERTIGHT STRAIGHT PLUGS WITH MANTLE TERMINAL - HIGH PERFORMANCE



Code	No. of poles	Rated voltage	Colour	Frequency	Reference h	Pack Carton
Rated current (A): 63						
GW 61 045 H	2P+E	100 - 130 V	■	50/60 Hz	4	1/4
GW 61 046 H	3P+E	100 - 130 V	■	50/60 Hz	4	1/4
GW 61 047 H	3P+N+E	100 - 130 V	■	50/60 Hz	4	1/4
GW 61 048 H	2P+E	200 - 250 V	■	50/60 Hz	6	1/4
GW 61 049 H	3P+E	200 - 250 V	■	50/60 Hz	9	1/4
GW 61 050 H	3P+N+E	200 - 250 V	■	50/60 Hz	9	1/4
GW 61 051 H	2P+E	380 - 415 V	■	50/60 Hz	9	1/4
GW 61 052 H	3P+E	380 - 415 V	■	50/60 Hz	6	1/4
GW 61 053 H	3P+N+E	346 - 415 V	■	50/60 Hz	6	1/4
GW 61 056 H	2P+E	480 - 500 V	■	50/60 Hz	7	1/4
GW 61 054 H	3P+E	480 - 500 V	■	50/60 Hz	7	1/4
GW 61 055 H	3P+N+E	480 - 500 V	■	50/60 Hz	7	1/4
GW 61 057 H	3P+E	600 - 690 V	■	50/60 Hz	5	1/4
GW 61 058 H	3P+N+E	600 - 690 V	■	50/60 Hz	5	1/4
GW 61 059 H	2P+E	>50 V	■	100 - 300 Hz	10	1/4
GW 61 060 H	3P+E	>50 V	■	100 - 300 Hz	10	1/4
GW 61 061 H	3P+N+E	>50 V	■	100 - 300 Hz	10	1/4
GW 61 062 H	2P+E	>50 V	■	>300 - 500 Hz	2	1/4
GW 61 063 H	3P+E	>50 V	■	>300 - 500 Hz	2	1/4
GW 61 064 H	3P+N+E	>50 V	■	>300 - 500 Hz	2	1/4
GW 61 065 H	3P+E	440 - 460 V	■	60 Hz	11	1/4
GW 61 066 H	3P+N+E	440 - 460 V	■	60 Hz	11	1/4
GW 61 067 H	2P+E	>50 - 250 V	■	d.c.	3	1/4
GW 61 068 H	2P+E	>250 V	■	d.c.	8	1/4
Rated current (A): 125						
GW 60 664 H	2P+E	100 - 130 V	■	50/60 Hz	4	1/2
GW 60 056 H	3P+E	100 - 130 V	■	50/60 Hz	4	1/2
GW 60 057 H	3P+N+E	100 - 130 V	■	50/60 Hz	4	1/2
GW 60 665 H	2P+E	200 - 250 V	■	50/60 Hz	6	1/2
GW 60 058 H	3P+E	200 - 250 V	■	50/60 Hz	9	1/2
GW 60 059 H	3P+N+E	200 - 250 V	■	50/60 Hz	9	1/2
GW 60 666 H	2P+E	380 - 415 V	■	50/60 Hz	9	1/2
GW 60 060 H	3P+E	380 - 415 V	■	50/60 Hz	6	1/2
GW 60 061 H	3P+N+E	346 - 415 V	■	50/60 Hz	6	1/2
GW 60 667 H	2P+E	480 - 500 V	■	50/60 Hz	7	1/2
GW 60 062 H	3P+E	480 - 500 V	■	50/60 Hz	7	1/2
GW 60 063 H	3P+N+E	480 - 500 V	■	50/60 Hz	7	1/2
GW 60 668 H	3P+E	600 - 690 V	■	50/60 Hz	5	1/2
GW 60 669 H	3P+N+E	600 - 690 V	■	50/60 Hz	5	1/2
GW 60 670 H	2P+E	>50 V	■	100 - 300 Hz	10	1/2
GW 60 671 H	3P+E	>50 V	■	100 - 300 Hz	10	1/2
GW 60 672 H	3P+N+E	>50 V	■	100 - 300 Hz	10	1/2
GW 60 673 H	2P+E	>50 V	■	>300 - 500 Hz	2	1/2
GW 60 674 H	3P+E	>50 V	■	>300 - 500 Hz	2	1/2
GW 60 675 H	3P+N+E	>50 V	■	>300 - 500 Hz	2	1/2
GW 60 676 H	3P+E	440 - 460 V	■	60 Hz	11	1/2
GW 60 677 H	3P+N+E	440 - 460 V	■	60 Hz	11	1/2

NOTES: all products are packaged individually.
 Halogen-free according to EN 60754-2.
 IP68: 2 bar / 6 h in accordance with EN 60529 after ageing according to Standard EN 60309.
 IP69: in accordance with EN 60529 after ageing according to Standard EN 60309.
CHARACTERISTICS: connection technology with mantle terminals. Nickel-plated plugs.
 Versions with pilot contact.

60 - LOW VOLTAGE SCREW WIRING 90° PLUGS

IP44



GW 60 085

LOW VOLTAGE SCREW WIRING 90° PLUGS



Code	No. of poles	Rated voltage	Colour	Frequency	Reference h	Pack Carton
Rated current (A): 16						
GW 60 082	2P+E	100 - 130 V	■	50/60 Hz	4	10/40
GW 60 083	3P+E	100 - 130 V	■	50/60 Hz	4	10/20
GW 60 084	3P+N+E	100 - 130 V	■	50/60 Hz	4	10/20
GW 60 085	2P+E	200 - 250 V	■	50/60 Hz	6	10/40
GW 60 086	3P+E	200 - 250 V	■	50/60 Hz	9	10/20
GW 60 087	3P+N+E	200 - 250 V	■	50/60 Hz	9	10/20
GW 60 088	2P+E	380 - 415 V	■	50/60 Hz	9	10/20
GW 60 089	3P+E	380 - 415 V	■	50/60 Hz	6	10/40
GW 60 090	3P+N+E	380 - 415 V	■	50/60 Hz	6	10/40
GW 60 091	3P+E	480 - 500 V	■	50/60 Hz	7	10/20
GW 60 092	3P+N+E	480 - 500 V	■	50/60 Hz	7	10/20
Rated current (A): 32						
GW 60 093	2P+E	100 - 130 V	■	50/60 Hz	4	8/16
GW 60 094	3P+E	100 - 130 V	■	50/60 Hz	4	8/16
GW 60 095	3P+N+E	100 - 130 V	■	50/60 Hz	4	8/16
GW 60 096	2P+E	200 - 250 V	■	50/60 Hz	6	8/16
GW 60 097	3P+E	200 - 250 V	■	50/60 Hz	9	8/16
GW 60 098	3P+N+E	200 - 250 V	■	50/60 Hz	9	8/16
GW 60 099	2P+E	380 - 415 V	■	50/60 Hz	9	8/16
GW 60 101	3P+E	380 - 415 V	■	50/60 Hz	6	8/16
GW 60 102	3P+N+E	380 - 415 V	■	50/60 Hz	6	8/16
GW 60 103	3P+E	480 - 500 V	■	50/60 Hz	7	8/16
GW 60 104	3P+N+E	480 - 500 V	■	50/60 Hz	7	8/16

CHARACTERISTICS: PG16 cable gland for 16A versions; PG21 cable gland for 32A versions.

IP67



GW 60 112

LOW VOLTAGE SCREW WIRING 90° PLUGS



Code	No. of poles	Rated voltage	Colour	Frequency	Reference h	Pack Carton
Rated current (A): 16						
GW 60 105	2P+E	100 - 130 V	■	50/60 Hz	4	10/20
GW 60 106	3P+E	100 - 130 V	■	50/60 Hz	4	10/20
GW 60 107	3P+N+E	100 - 130 V	■	50/60 Hz	4	10/20
GW 60 108	2P+E	200 - 250 V	■	50/60 Hz	6	10/40
GW 60 109	3P+E	200 - 250 V	■	50/60 Hz	9	10/20
GW 60 110	3P+N+E	200 - 250 V	■	50/60 Hz	9	10/20
GW 60 111	2P+E	380 - 415 V	■	50/60 Hz	9	10/20
GW 60 112	3P+E	380 - 415 V	■	50/60 Hz	6	10/40
GW 60 113	3P+N+E	380 - 415 V	■	50/60 Hz	6	10/40
GW 60 114	3P+E	480 - 500 V	■	50/60 Hz	7	10/20
GW 60 115	3P+N+E	480 - 500 V	■	50/60 Hz	7	10/20
Rated current (A): 32						
GW 60 116	2P+E	100 - 130 V	■	50/60 Hz	4	8/16
GW 60 117	3P+E	100 - 130 V	■	50/60 Hz	4	8/16
GW 60 118	3P+N+E	100 - 130 V	■	50/60 Hz	4	8/16
GW 60 119	2P+E	200 - 250 V	■	50/60 Hz	6	8/16
GW 60 120	3P+E	200 - 250 V	■	50/60 Hz	9	8/16
GW 60 121	3P+N+E	200 - 250 V	■	50/60 Hz	9	8/16
GW 60 122	2P+E	380 - 415 V	■	50/60 Hz	9	8/16
GW 60 123	3P+E	380 - 415 V	■	50/60 Hz	6	8/16
GW 60 124	3P+N+E	380 - 415 V	■	50/60 Hz	6	8/16
GW 60 125	3P+E	480 - 500 V	■	50/60 Hz	7	8/16
GW 60 126	3P+N+E	480 - 500 V	■	50/60 Hz	7	8/16
GW 60 146	3P+E	380 - 440 V	■	50/60 Hz	3	8/16

CHARACTERISTICS: PG16 cable gland for 16A versions; PG21 cable gland for 32A versions.

60 - LOW VOLTAGE SCREW WIRING STRAIGHT FLUSH MOUNTING INLETS

IP44



GW 60 204

LOW VOLTAGE SCREW WIRING STRAIGHT FLUSH MOUNTING INLETS



Code	No. of poles	Rated voltage	Colour	Frequency	Reference h	Flange dimensions (mm)	Pack Carton
Rated current (A): 16							
GW 60 201	2P+E	100 - 130 V	■	50/60 Hz	4	85x75	10/20
GW 60 202	3P+E	100 - 130 V	■	50/60 Hz	4	85x75	10/20
GW 60 203	3P+N+E	100 - 130 V	■	50/60 Hz	4	85x75	10/20
GW 60 204	2P+E	200 - 250 V	■	50/60 Hz	6	85x75	10/20
GW 60 205	3P+E	200 - 250 V	■	50/60 Hz	9	85x75	10/20
GW 60 206	3P+N+E	200 - 250 V	■	50/60 Hz	9	85x75	10/20
GW 60 207	2P+E	380 - 415 V	■	50/60 Hz	9	85x75	10/20
GW 60 208	3P+E	380 - 415 V	■	50/60 Hz	6	85x75	10/20
GW 60 209	3P+N+E	380 - 415 V	■	50/60 Hz	6	85x75	10/20
GW 60 210	3P+E	480 - 500 V	■	50/60 Hz	7	85x75	10/20
GW 60 211	3P+N+E	480 - 500 V	■	50/60 Hz	7	85x75	10/20
Rated current (A): 32							
GW 60 212	2P+E	100 - 130 V	■	50/60 Hz	4	95x80	8/16
GW 60 213	3P+E	100 - 130 V	■	50/60 Hz	4	95x80	8/16
GW 60 214	3P+N+E	100 - 130 V	■	50/60 Hz	4	95x80	8/16
GW 60 215	2P+E	200 - 250 V	■	50/60 Hz	6	95x80	8/16
GW 60 216	3P+E	200 - 250 V	■	50/60 Hz	9	95x80	8/16
GW 60 217	3P+N+E	200 - 250 V	■	50/60 Hz	9	95x80	8/16
GW 60 218	2P+E	380 - 415 V	■	50/60 Hz	9	95x80	8/16
GW 60 219	3P+E	380 - 415 V	■	50/60 Hz	6	95x80	8/16
GW 60 220	3P+N+E	380 - 415 V	■	50/60 Hz	6	95x80	8/16
GW 60 221	3P+E	480 - 500 V	■	50/60 Hz	7	95x80	8/16
GW 60 222	3P+N+E	480 - 500 V	■	50/60 Hz	7	95x80	8/16

IP67



GW 60 231

LOW VOLTAGE SCREW WIRING STRAIGHT FLUSH MOUNTING INLETS



Code	No. of poles	Rated voltage	Colour	Frequency	Reference h	Flange dimensions (mm)	Pack Carton
Rated current (A): 16							
GW 60 223	2P+E	100 - 130 V	■	50/60 Hz	4	85x75	10/20
GW 60 224	3P+E	100 - 130 V	■	50/60 Hz	4	85x75	10/20
GW 60 225	3P+N+E	100 - 130 V	■	50/60 Hz	4	85x75	10/20
GW 60 226	2P+E	200 - 250 V	■	50/60 Hz	6	85x75	10/20
GW 60 227	3P+E	200 - 250 V	■	50/60 Hz	9	85x75	10/20
GW 60 228	3P+N+E	200 - 250 V	■	50/60 Hz	9	85x75	10/20
GW 60 229	2P+E	380 - 415 V	■	50/60 Hz	9	85x75	10/20
GW 60 230	3P+E	380 - 415 V	■	50/60 Hz	6	85x75	10/20
GW 60 231	3P+N+E	380 - 415 V	■	50/60 Hz	6	85x75	10/20
GW 60 232	3P+E	480 - 500 V	■	50/60 Hz	7	85x75	10/20
GW 60 233	3P+N+E	480 - 500 V	■	50/60 Hz	7	85x75	10/20
Rated current (A): 32							
GW 60 234	2P+E	100 - 130 V	■	50/60 Hz	4	95x80	8/16
GW 60 235	3P+E	100 - 130 V	■	50/60 Hz	4	95x80	8/16
GW 60 236	3P+N+E	100 - 130 V	■	50/60 Hz	4	95x80	8/16
GW 60 237	2P+E	200 - 250 V	■	50/60 Hz	6	95x80	8/16
GW 60 238	3P+E	200 - 250 V	■	50/60 Hz	9	95x80	8/16
GW 60 239	3P+N+E	200 - 250 V	■	50/60 Hz	9	95x80	8/16
GW 60 240	2P+E	380 - 415 V	■	50/60 Hz	9	95x80	8/16
GW 60 241	3P+E	380 - 415 V	■	50/60 Hz	6	95x80	8/16
GW 60 242	3P+N+E	380 - 415 V	■	50/60 Hz	6	95x80	8/16
GW 60 243	3P+E	480 - 500 V	■	50/60 Hz	7	95x80	8/16
GW 60 244	3P+N+E	480 - 500 V	■	50/60 Hz	7	95x80	8/16
GW 60 268	3P+E	380 - 440 V	■	50/60 Hz	3	95x80	8/16

IEC 309 HP

60 - LOW VOLTAGE SCREW WIRING 90° ANGLED SURFACE MOUNTING INLETS

IP44



GW 60 404

LOW VOLTAGE SCREW WIRING 90° ANGLED SURFACE MOUNTING INLETS



Code	No. of poles	Rated voltage	Colour	Frequency	Reference h	Pack Carton
Rated current (A): 16						
GW 60 401	2P+E	100 - 130 V	■	50/60 Hz	4	10/40
GW 60 402	3P+E	100 - 130 V	■	50/60 Hz	4	10/20
GW 60 403	3P+N+E	100 - 130 V	■	50/60 Hz	4	10/20
GW 60 404	2P+E	200 - 250 V	■	50/60 Hz	6	10/40
GW 60 405	3P+E	200 - 250 V	■	50/60 Hz	9	10/20
GW 60 406	3P+N+E	200 - 250 V	■	50/60 Hz	9	10/20
GW 60 407	2P+E	380 - 415 V	■	50/60 Hz	9	10/20
GW 60 408	3P+E	380 - 415 V	■	50/60 Hz	6	10/40
GW 60 409	3P+N+E	380 - 415 V	■	50/60 Hz	6	10/40
GW 60 410	3P+E	480 - 500 V	■	50/60 Hz	7	10/20
GW 60 411	3P+N+E	480 - 500 V	■	50/60 Hz	7	10/20
Rated current (A): 32						
GW 60 412	2P+E	100 - 130 V	■	50/60 Hz	4	8/16
GW 60 413	3P+E	100 - 130 V	■	50/60 Hz	4	8/16
GW 60 414	3P+N+E	100 - 130 V	■	50/60 Hz	4	8/16
GW 60 415	2P+E	200 - 250 V	■	50/60 Hz	6	8/16
GW 60 416	3P+E	200 - 250 V	■	50/60 Hz	9	8/16
GW 60 417	3P+N+E	200 - 250 V	■	50/60 Hz	9	8/16
GW 60 418	2P+E	380 - 415 V	■	50/60 Hz	9	8/16
GW 60 419	3P+E	380 - 415 V	■	50/60 Hz	6	8/16
GW 60 420	3P+N+E	380 - 415 V	■	50/60 Hz	6	8/16
GW 60 421	3P+E	480 - 500 V	■	50/60 Hz	7	8/16
GW 60 422	3P+N+E	480 - 500 V	■	50/60 Hz	7	8/16

CHARACTERISTICS: Ø 20 mm cable gland for 16 A versions; Ø 23 mm cable gland for 32 A versions.

IP67

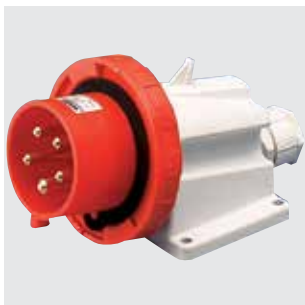

GW 60 431

LOW VOLTAGE SCREW WIRING 90° ANGLED SURFACE MOUNTING INLETS



Code	No. of poles	Rated voltage	Colour	Frequency	Reference h	Pack Carton
Rated current (A): 16						
GW 60 423	2P+E	100 - 130 V	■	50/60 Hz	4	10/20
GW 60 424	3P+E	100 - 130 V	■	50/60 Hz	4	10/20
GW 60 425	3P+N+E	100 - 130 V	■	50/60 Hz	4	10/20
GW 60 426	2P+E	200 - 250 V	■	50/60 Hz	6	10/40
GW 60 427	3P+E	200 - 250 V	■	50/60 Hz	9	10/20
GW 60 428	3P+N+E	200 - 250 V	■	50/60 Hz	9	10/20
GW 60 429	2P+E	380 - 415 V	■	50/60 Hz	9	10/20
GW 60 430	3P+E	380 - 415 V	■	50/60 Hz	6	10/40
GW 60 431	3P+N+E	380 - 415 V	■	50/60 Hz	6	10/20
GW 60 432	3P+E	480 - 500 V	■	50/60 Hz	7	10/20
GW 60 433	3P+N+E	480 - 500 V	■	50/60 Hz	7	10/20
Rated current (A): 32						
GW 60 434	2P+E	100 - 130 V	■	50/60 Hz	4	8/16
GW 60 435	3P+E	100 - 130 V	■	50/60 Hz	4	8/16
GW 60 436	3P+N+E	100 - 130 V	■	50/60 Hz	4	8/16
GW 60 437	2P+E	200 - 250 V	■	50/60 Hz	6	8/16
GW 60 438	3P+E	200 - 250 V	■	50/60 Hz	9	8/16
GW 60 439	3P+N+E	200 - 250 V	■	50/60 Hz	9	8/16
GW 60 440	2P+E	380 - 415 V	■	50/60 Hz	9	8/16
GW 60 441	3P+E	380 - 415 V	■	50/60 Hz	6	8/16
GW 60 442	3P+N+E	380 - 415 V	■	50/60 Hz	6	8/16
GW 60 443	3P+E	480 - 500 V	■	50/60 Hz	7	8/16
GW 60 444	3P+N+E	480 - 500 V	■	50/60 Hz	7	8/16
GW 60 482	3P+E	380 - 440 V	■	50/60 Hz	3	8/16

CHARACTERISTICS: PG21 cable gland for 16-32A versions;

60/61 - 90° SURFACE-MOUNTING FIXED PLUGS WITH LOW VOLTAGE HIGH CURRENT MANTLE CONNECTION

IP67



GW 61 453

LOW VOLTAGE HIGH CURRENT FIXED WATERTIGHT 90° SURFACE-MOUNTING PLUGS WITH MANTLE CONNECTION



Code	No. of poles	Rated voltage	Colour	Frequency	Reference h	Pack Carton
Rated current (A): 63						
GW 61 445	2P+E	100 - 130 V	■	50/60 Hz	4	1/4
GW 61 446	3P+E	100 - 130 V	■	50/60 Hz	4	1/4
GW 61 447	3P+N+E	100 - 130 V	■	50/60 Hz	4	1/4
GW 61 448	2P+E	200 - 250 V	■	50/60 Hz	6	1/4
GW 61 449	3P+E	200 - 250 V	■	50/60 Hz	9	1/4
GW 61 450	3P+N+E	200 - 250 V	■	50/60 Hz	9	1/4
GW 61 451	2P+E	380 - 415 V	■	50/60 Hz	9	1/4
GW 61 452	3P+E	380 - 415 V	■	50/60 Hz	6	1/4
GW 61 453	3P+N+E	380 - 415 V	■	50/60 Hz	6	1/4
GW 61 454	3P+E	480 - 500 V	■	50/60 Hz	7	1/4
GW 61 455	3P+N+E	480 - 500 V	■	50/60 Hz	7	1/4
Rated current (A): 125						
GW 60 456	3P+E	100 - 130 V	■	50/60 Hz	4	1/2
GW 60 457	3P+N+E	100 - 130 V	■	50/60 Hz	4	1/2
GW 60 458	3P+E	200 - 250 V	■	50/60 Hz	9	1/2
GW 60 459	3P+N+E	200 - 250 V	■	50/60 Hz	9	1/2
GW 60 460	3P+E	380 - 415 V	■	50/60 Hz	6	1/2
GW 60 461	3P+N+E	380 - 415 V	■	50/60 Hz	6	1/2
GW 60 462	3P+E	480 - 500 V	■	50/60 Hz	7	1/2
GW 60 463	3P+N+E	480 - 500 V	■	50/60 Hz	7	1/2

CHARACTERISTICS: PG36 cable gland for 63A versions; PG48 cable gland for 125A versions. Equipped with pilot contact.

ACCESSORIES FOR PLUGS

WATERTIGHT



GW 60 263

WATERTIGHT COVERS FOR PLUGS

Code	For inlets	Pack Carton
Rated current (A): 16		
GW 60 263	2P+E	10/120
GW 60 264	3P+E	10/120
GW 60 265	3P+N+E	10/80
Rated current (A): 32		
GW 60 266	2P+E and 3P+E	8/64
GW 60 267	3P+N+E	8/64
Rated current (A): 63		
GW 60 269	2P+E; 3P+E; 3P+N+E	5/40
Rated current (A): 125		
GW 60 270	2P+E; 3P+E; 3P+N+E	5/20

APPLICATIONS: used to maintain the original IP degree on IEC 309 HP mobile or fixed (up to IP66/IP67/IP68/IP69).

IEC 309 HP

IEC 309 HP - LOW VOLTAGE FAST WIRING STRAIGHT CONNECTORS

IP44/IP54



GW 62 004 FH

LOW VOLTAGE FAST WIRING STRAIGHT CONNECTORS - HIGH PERFORMANCE



Code	No. of poles	Rated voltage	Colour	Frequency	Reference h	Pack Carton
Rated current (A): 16						
GW 62 001 FH	2P+E	100 - 130 V	■	50/60 Hz	4	15
GW 62 002 FH	3P+E	100 - 130 V	■	50/60 Hz	4	15
GW 62 003 FH	3P+N+E	100 - 130 V	■	50/60 Hz	4	15
GW 62 004 FH	2P+E	200 - 250 V	■	50/60 Hz	6	50
GW 62 005 FH	3P+E	200 - 250 V	■	50/60 Hz	9	15
GW 62 006 FH	3P+N+E	200 - 250 V	■	50/60 Hz	9	15
GW 62 007 FH	2P+E	380 - 415 V	■	50/60 Hz	9	15
GW 62 008 FH	3P+E	380 - 415 V	■	50/60 Hz	6	15
GW 62 009 FH	3P+N+E	380 - 415 V	■	50/60 Hz	6	15
Rated current (A): 32						
GW 62 012 FH	2P+E	100 - 130 V	■	50/60 Hz	4	15
GW 62 013 FH	3P+E	100 - 130 V	■	50/60 Hz	4	15
GW 62 014 FH	3P+N+E	100 - 130 V	■	50/60 Hz	4	15
GW 62 015 FH	2P+E	200 - 250 V	■	50/60 Hz	6	15
GW 62 016 FH	3P+E	200 - 250 V	■	50/60 Hz	9	15
GW 62 017 FH	3P+N+E	200 - 250 V	■	50/60 Hz	9	15
GW 62 018 FH	2P+E	380 - 415 V	■	50/60 Hz	9	15
GW 62 019 FH	3P+E	380 - 415 V	■	50/60 Hz	6	15
GW 62 020 FH	3P+N+E	380 - 415 V	■	50/60 Hz	6	15

NOTES: all products are packaged individually.

Halogen free according to EN 60754-2.

CHARACTERISTICS: connection technology with spring terminals. Nickel-plated contacts.

IP66/IP67/IP68/IP69



GW 62 030 FH

LOW VOLTAGE FAST WIRING STRAIGHT CONNECTORS - HIGH PERFORMANCE



Code	No. of poles	Rated voltage	Colour	Frequency	Reference h	Pack Carton
Rated current (A): 16						
GW 62 023 FH	2P+E	100 - 130 V	■	50/60 Hz	4	15
GW 62 024 FH	3P+E	100 - 130 V	■	50/60 Hz	4	25
GW 62 025 FH	3P+N+E	100 - 130 V	■	50/60 Hz	4	15
GW 62 026 FH	2P+E	200 - 250 V	■	50/60 Hz	6	50
GW 62 027 FH	3P+E	200 - 250 V	■	50/60 Hz	9	15
GW 62 028 FH	3P+N+E	200 - 250 V	■	50/60 Hz	9	15
GW 62 029 FH	2P+E	380 - 415 V	■	50/60 Hz	9	15
GW 62 030 FH	3P+E	380 - 415 V	■	50/60 Hz	6	15
GW 62 031 FH	3P+N+E	380 - 415 V	■	50/60 Hz	6	25
Rated current (A): 32						
GW 62 034 FH	2P+E	100 - 130 V	■	50/60 Hz	4	15
GW 62 035 FH	3P+E	100 - 130 V	■	50/60 Hz	4	15
GW 62 036 FH	3P+N+E	100 - 130 V	■	50/60 Hz	4	15
GW 62 037 FH	2P+E	200 - 250 V	■	50/60 Hz	6	15
GW 62 038 FH	3P+E	200 - 250 V	■	50/60 Hz	9	15
GW 62 039 FH	3P+N+E	200 - 250 V	■	50/60 Hz	9	15
GW 62 040 FH	2P+E	380 - 415 V	■	50/60 Hz	9	15
GW 62 041 FH	3P+E	380 - 415 V	■	50/60 Hz	6	15
GW 62 042 FH	3P+N+E	380 - 415 V	■	50/60 Hz	6	15

NOTES: all products are packaged individually.
 IP68: 2 bar/6 h according EN 60529 after ageing according to standard EN 60309.
 IP69: in accordance with EN 60529 after ageing according to standard EN 60309.
 Halogen-free in compliance with EN 60754-2.
CHARACTERISTICS: connection technology with spring terminals. Nickel-plated contacts.

IEC 309 HP

IEC 309 HP - LOW VOLTAGE SCREW WIRING STRAIGHT CONNECTORS

IP44/IP54



GW 62 004 H

LOW VOLTAGE SCREW WIRING STRAIGHT CONNECTORS - HIGH PERFORMANCE



Code	No. of poles	Rated voltage	Colour	Frequency	Reference h	Pack Carton
Rated current (A): 16						
GW 62 001 H	2P+E	100 - 130 V	■	50/60 Hz	4	50
GW 62 002 H	3P+E	100 - 130 V	■	50/60 Hz	4	50
GW 62 003 H	3P+N+E	100 - 130 V	■	50/60 Hz	4	25
GW 62 004 H	2P+E	200 - 250 V	■	50/60 Hz	6	50
GW 62 005 H	3P+E	200 - 250 V	■	50/60 Hz	9	15
GW 62 006 H	3P+N+E	200 - 250 V	■	50/60 Hz	9	15
GW 62 007 H	2P+E	380 - 415 V	■	50/60 Hz	9	15
GW 62 008 H	3P+E	380 - 415 V	■	50/60 Hz	6	50
GW 62 009 H	3P+N+E	380 - 415 V	■	50/60 Hz	6	25
GW 62 701 H	2P+E	480 - 500 V	■	50/60 Hz	7	15
GW 62 010 H	3P+E	480 - 500 V	■	50/60 Hz	7	15
GW 62 011 H	3P+N+E	480 - 500 V	■	50/60 Hz	7	15
GW 62 702 H	3P+E	600 - 690 V	■	50/60 Hz	5	15
GW 62 703 H	3P+N+E	600 - 690 V	■	50/60 Hz	5	15
GW 62 704 H	2P+E	>50 V	■	100 - 300 Hz	10	15
GW 62 705 H	3P+E	>50 V	■	100 - 300 Hz	10	15
GW 62 706 H	3P+N+E	>50 V	■	100 - 300 Hz	10	15
GW 62 707 H	2P+E	>50 V	■	>300 - 500 Hz	2	15
GW 62 708 H	3P+E	>50 V	■	>300 - 500 Hz	2	15
GW 62 709 H	3P+N+E	>50 V	■	>300 - 500 Hz	2	15
GW 62 710 H	3P+E	440 - 460 V	■	60 Hz	11	15
GW 62 711 H	3P+N+E	440 - 460 V	■	60 Hz	11	15
GW 62 712 H	3P+E	380 - 440 V	■	50/60 Hz	3	15
GW 62 713 H	3P+N+E	380 - 440 V	■	50/60 Hz	3	15
GW 62 714 H	2P+E	transf.	■	50/60 Hz	12	15
GW 62 715 H	3P+E	transf.	■	50/60 Hz	12	15
GW 62 716 H	2P+E	>50 - 250 V	■	d.c.	3	15
GW 62 717 H	2P+E	>250 V	■	d.c.	8	15
Rated current (A): 32						
GW 62 012 H	2P+E	100 - 130 V	■	50/60 Hz	4	15
GW 62 013 H	3P+E	100 - 130 V	■	50/60 Hz	4	15
GW 62 014 H	3P+N+E	100 - 130 V	■	50/60 Hz	4	15
GW 62 015 H	2P+E	200 - 250 V	■	50/60 Hz	6	25
GW 62 016 H	3P+E	200 - 250 V	■	50/60 Hz	9	15
GW 62 017 H	3P+N+E	200 - 250 V	■	50/60 Hz	9	15
GW 62 018 H	2P+E	380 - 415 V	■	50/60 Hz	9	15
GW 62 019 H	3P+E	380 - 415 V	■	50/60 Hz	6	25
GW 62 020 H	3P+N+E	380 - 415 V	■	50/60 Hz	6	25
GW 62 718 H	2P+E	480 - 500 V	■	50/60 Hz	7	15
GW 62 021 H	3P+E	480 - 500 V	■	50/60 Hz	7	15
GW 62 022 H	3P+N+E	480 - 500 V	■	50/60 Hz	7	15
GW 62 719 H	3P+E	600 - 690 V	■	50/60 Hz	5	15
GW 62 720 H	3P+N+E	600 - 690 V	■	50/60 Hz	5	15
GW 62 721 H	2P+E	>50 V	■	100 - 300 Hz	10	15
GW 62 722 H	3P+E	>50 V	■	100 - 300 Hz	10	15
GW 62 723 H	3P+N+E	>50 V	■	100 - 300 Hz	10	15
GW 62 724 H	2P+E	>50 V	■	>300 - 500 Hz	2	15
GW 62 725 H	3P+E	>50 V	■	>300 - 500 Hz	2	15
GW 62 726 H	3P+N+E	>50 V	■	>300 - 500 Hz	2	15
GW 62 727 H	3P+E	440 - 460 V	■	60 Hz	11	15
GW 62 728 H	3P+N+E	440 - 460 V	■	60 Hz	11	15
GW 62 729 H	3P+E	380 - 440 V	■	50/60 Hz	3	15
GW 62 730 H	3P+N+E	380 - 440 V	■	50/60 Hz	3	15
GW 62 731 H	2P+E	transf.	■	50/60 Hz	12	15
GW 62 732 H	3P+E	transf.	■	50/60 Hz	12	15
GW 62 733 H	2P+E	>50 - 250 V	■	d.c.	3	15
GW 62 734 H	2P+E	>250 V	■	d.c.	8	15

NOTES: all products are packaged individually. Halogen free according to EN 60754-2
CHARACTERISTICS: nickel-plated contacts.

IP66/IP67/IP68/IP69



GW 62 030 H

LOW VOLTAGE SCREW WIRING STRAIGHT CONNECTORS - HIGH PERFORMANCE



Code	No. of poles	Rated voltage	Colour	Frequency	Reference h	Pack Carton
Rated current (A): 16						
GW 62 023 H	2P+E	100 - 130 V	■	50/60 Hz	4	50
GW 62 024 H	3P+E	100 - 130 V	■	50/60 Hz	4	15
GW 62 025 H	3P+N+E	100 - 130 V	■	50/60 Hz	4	15
GW 62 026 H	2P+E	200 - 250 V	■	50/60 Hz	6	50
GW 62 027 H	3P+E	200 - 250 V	■	50/60 Hz	9	15
GW 62 028 H	3P+N+E	200 - 250 V	■	50/60 Hz	9	15
GW 62 029 H	2P+E	380 - 415 V	■	50/60 Hz	9	15
GW 62 030 H	3P+E	380 - 415 V	■	50/60 Hz	6	25
GW 62 031 H	3P+N+E	380 - 415 V	■	50/60 Hz	6	25
GW 62 735 H	2P+E	480 - 500 V	■	50/60 Hz	7	15
GW 62 032 H	3P+E	480 - 500 V	■	50/60 Hz	7	15
GW 62 033 H	3P+N+E	480 - 500 V	■	50/60 Hz	7	25
GW 62 736 H	3P+E	600 - 690 V	■	50/60 Hz	5	15
GW 62 737 H	3P+N+E	600 - 690 V	■	50/60 Hz	5	15
GW 62 738 H	2P+E	>50 V	■	100 - 300 Hz	10	15
GW 62 739 H	3P+E	>50 V	■	100 - 300 Hz	10	15
GW 62 740 H	3P+N+E	>50 V	■	100 - 300 Hz	10	15
GW 62 741 H	2P+E	>50 V	■	>300 - 500 Hz	2	15
GW 62 742 H	3P+E	>50 V	■	>300 - 500 Hz	2	15
GW 62 743 H	3P+N+E	>50 V	■	>300 - 500 Hz	2	15
GW 62 744 H	3P+E	440 - 460 V	■	60 Hz	11	15
GW 62 745 H	3P+N+E	440 - 460 V	■	60 Hz	11	15
GW 62 746 H	3P+E	380 - 440 V	■	50/60 Hz	3	15
GW 62 747 H	3P+N+E	380 - 440 V	■	50/60 Hz	3	15
GW 62 748 H	2P+E	transf.	■	50/60 Hz	12	15
GW 62 749 H	3P+E	transf.	■	50/60 Hz	12	15
GW 62 750 H	2P+E	>50 - 250 V	■	d.c.	3	15
GW 62 751 H	2P+E	>250 V	■	d.c.	8	15
Rated current (A): 32						
GW 62 034 H	2P+E	100 - 130 V	■	50/60 Hz	4	15
GW 62 035 H	3P+E	100 - 130 V	■	50/60 Hz	4	15
GW 62 036 H	3P+N+E	100 - 130 V	■	50/60 Hz	4	15
GW 62 037 H	2P+E	200 - 250 V	■	50/60 Hz	6	15
GW 62 038 H	3P+E	200 - 250 V	■	50/60 Hz	9	15
GW 62 039 H	3P+N+E	200 - 250 V	■	50/60 Hz	9	15
GW 62 040 H	2P+E	380 - 415 V	■	50/60 Hz	9	15
GW 62 041 H	3P+E	380 - 415 V	■	50/60 Hz	6	15
GW 62 042 H	3P+N+E	380 - 415 V	■	50/60 Hz	6	15
GW 62 752 H	2P+E	480 - 500 V	■	50/60 Hz	7	15
GW 62 043 H	3P+E	480 - 500 V	■	50/60 Hz	7	15
GW 62 044 H	3P+N+E	480 - 500 V	■	50/60 Hz	7	15
GW 62 753 H	3P+E	600 - 690 V	■	50/60 Hz	5	15
GW 62 754 H	3P+N+E	600 - 690 V	■	50/60 Hz	5	15
GW 62 755 H	2P+E	>50 V	■	100 - 300 Hz	10	15
GW 62 756 H	3P+E	>50 V	■	100 - 300 Hz	10	15
GW 62 757 H	3P+N+E	>50 V	■	100 - 300 Hz	10	15
GW 62 758 H	2P+E	>50 V	■	>300 - 500 Hz	2	15
GW 62 759 H	3P+E	>50 V	■	>300 - 500 Hz	2	15
GW 62 760 H	3P+N+E	>50 V	■	>300 - 500 Hz	2	15
GW 62 761 H	3P+E	440 - 460 V	■	60 Hz	11	15
GW 62 762 H	3P+N+E	440 - 460 V	■	60 Hz	11	15
GW 62 128 H	3P+E	380 - 440 V	■	50/60 Hz	3	25
GW 62 763 H	3P+N+E	380 - 440 V	■	50/60 Hz	3	15
GW 62 764 H	2P+E	transf.	■	50/60 Hz	12	15
GW 62 765 H	3P+E	transf.	■	50/60 Hz	12	15
GW 62 766 H	2P+E	>50 - 250 V	■	d.c.	3	15
GW 62 767 H	2P+E	>250 V	■	d.c.	8	15

NOTES: all products are packaged individually. Halogen-free in compliance with EN 60754-2.

IP68: 2 bar/6 h according EN 60529 after ageing according to standard EN 60309.

IP69: in accordance with EN 60529 after ageing according to standard EN 60309.

CHARACTERISTICS: nickel-plated contacts.

IEC 309 HP

IEC 309 HP - LOW VOLTAGE HIGH CURRENT STRAIGHT CONNECTORS WITH MANTLE CONNECTION

IP44/IP54



GW 63 016 H

PRESE MOBILI DIRITTE PROTETTE CABLAGGIO A MANTELLO ALTE CORRENTI BASSA TENSIONE - HIGH PERFORMANCE



Code	No. of poles	Rated voltage	Colour	Frequency	Reference h	Pack Carton
Rated current (A): 63						
GW 63 013 H	2P+E	100 - 130 V	■	50/60 Hz	4	1/4
GW 63 014 H	3P+E	100 - 130 V	■	50/60 Hz	4	1/4
GW 63 015 H	3P+N+E	100 - 130 V	■	50/60 Hz	4	1/4
GW 63 016 H	2P+E	200 - 250 V	■	50/60 Hz	6	1/4
GW 63 017 H	3P+E	200 - 250 V	■	50/60 Hz	9	1/4
GW 63 018 H	3P+N+E	200 - 250 V	■	50/60 Hz	9	1/4
GW 63 019 H	2P+E	380 - 415 V	■	50/60 Hz	9	1/4
GW 63 020 H	3P+E	380 - 415 V	■	50/60 Hz	6	1/4
GW 63 021 H	3P+N+E	346 - 415 V	■	50/60 Hz	6	1/4

NOTES: all products are packaged individually.

Halogen free in accordance with Standard EN 60754-2.

CHARACTERISTICS: connection technology with mantle terminals. nickel-plated contacts.

All the versions are available with a pilot contact upon request.

IP66/IP67/IP68/IP69



GW 63 053 H

LOW VOLTAGE HIGH CURRENT WATERTIGHT STRAIGHT CONNECTORS WITH MANTLE TERMINAL - HIGH PERFORMANCE



Code	No. of poles	Rated voltage	Colour	Frequency	Reference h	Characteristics	Pack Carton
Rated current (A): 63							
GW 63 045 H	2P+E	100 - 130 V	■	50/60 Hz	4	-	1/4
GW 63 046 H	3P+E	100 - 130 V	■	50/60 Hz	4	-	1/4
GW 63 047 H	3P+N+E	100 - 130 V	■	50/60 Hz	4	-	1/4
GW 63 048 H	2P+E	200 - 250 V	■	50/60 Hz	6	-	1/4
GW 63 048 PH	2P+E	200 - 250 V	■	50/60 Hz	6	Pilot contact	1/4
GW 63 049 H	3P+E	200 - 250 V	■	50/60 Hz	9	-	1/4
GW 63 050 H	3P+N+E	200 - 250 V	■	50/60 Hz	9	-	1/4
GW 63 051 H	2P+E	380 - 415 V	■	50/60 Hz	9	-	1/4
GW 63 052 H	3P+E	380 - 415 V	■	50/60 Hz	6	-	1/4
GW 63 052 PH	3P+E	380 - 415 V	■	50/60 Hz	6	Pilot contact	1/4
GW 63 053 H	3P+N+E	346 - 415 V	■	50/60 Hz	6	-	1/4
GW 63 053 PH	3P+N+E	346 - 415 V	■	50/60 Hz	6	Pilot contact	1/4
GW 63 056 H	2P+E	480 - 500 V	■	50/60 Hz	7	-	1/4
GW 63 054 H	3P+E	480 - 500 V	■	50/60 Hz	7	-	1/4
GW 63 055 H	3P+N+E	480 - 500 V	■	50/60 Hz	7	-	1/4
GW 63 057 H	3P+E	600 - 690 V	■	50/60 Hz	5	-	1/4
GW 63 058 H	3P+N+E	600 - 690 V	■	50/60 Hz	5	-	1/4
GW 63 059 H	2P+E	>50 V	■	100 - 300 Hz	10	-	1/4
GW 63 060 H	3P+E	>50 V	■	100 - 300 Hz	10	-	1/4
GW 63 061 H	3P+N+E	>50 V	■	100 - 300 Hz	10	-	1/4
GW 63 062 H	2P+E	>50 V	■	>300 - 500 Hz	2	-	1/4
GW 63 063 H	3P+E	>50 V	■	>300 - 500 Hz	2	-	1/4
GW 63 064 H	3P+N+E	>50 V	■	>300 - 500 Hz	2	-	1/4
GW 63 065 H	3P+E	440 - 460 V	■	60 Hz	11	-	1/4
GW 63 066 H	3P+N+E	440 - 460 V	■	60 Hz	11	-	1/4
GW 63 067 H	2P+E	>50 - 250 V	■	d.c.	3	-	1/4
GW 63 068 H	2P+E	>250 V	■	d.c.	8	-	1/4
Rated current (A): 125							
GW 62 664 H	2P+E	100 - 130 V	■	50/60 Hz	4	-	1/2
GW 62 056 H	3P+E	100 - 130 V	■	50/60 Hz	4	-	1/2
GW 62 057 H	3P+N+E	100 - 130 V	■	50/60 Hz	4	-	1/2
GW 62 665 H	2P+E	200 - 250 V	■	50/60 Hz	6	-	1/2
GW 62 058 H	3P+E	200 - 250 V	■	50/60 Hz	9	-	1/2
GW 62 059 H	3P+N+E	200 - 250 V	■	50/60 Hz	9	-	1/2
GW 62 666 H	2P+E	380 - 415 V	■	50/60 Hz	9	-	1/2
GW 62 060 H	3P+E	380 - 415 V	■	50/60 Hz	6	-	1/2
GW 62 060 PH	3P+E	380 - 415 V	■	50/60 Hz	6	Pilot contact	1/2
GW 62 061 H	3P+N+E	346 - 415 V	■	50/60 Hz	6	-	1/2
GW 62 061 PH	3P+N+E	346 - 415 V	■	50/60 Hz	6	Pilot contact	1/2
GW 62 667 H	2P+E	480 - 500 V	■	50/60 Hz	7	-	1/2
GW 62 062 H	3P+E	480 - 500 V	■	50/60 Hz	7	-	1/2
GW 62 063 H	3P+N+E	480 - 500 V	■	50/60 Hz	7	-	1/2
GW 62 668 H	3P+E	600 - 690 V	■	50/60 Hz	5	-	1/2
GW 62 669 H	3P+N+E	600 - 690 V	■	50/60 Hz	5	-	1/2
GW 62 670 H	2P+E	>50 V	■	100 - 300 Hz	10	-	1/2
GW 62 671 H	3P+E	>50 V	■	100 - 300 Hz	10	-	1/2
GW 62 672 H	3P+N+E	>50 V	■	100 - 300 Hz	10	-	1/2
GW 62 673 H	2P+E	>50 V	■	>300 - 500 Hz	2	-	1/2
GW 62 674 H	3P+E	>50 V	■	>300 - 500 Hz	2	-	1/2
GW 62 675 H	3P+N+E	>50 V	■	>300 - 500 Hz	2	-	1/2
GW 62 676 H	3P+E	440 - 460 V	■	60 Hz	11	-	1/2
GW 62 677 H	3P+N+E	440 - 460 V	■	60 Hz	11	-	1/2

NOTES: all products are packaged individually. Halogen-free according to EN 60754-2.

IP68: 2 bar/ 6 h in accordance with EN60529 after ageing according to Standard EN60309.

IP69: in accordance with EN60529 after ageing according to Standard EN60309.

GW63048PH, GW63052PH, GW63053PH, GW62060PH, GW62061PH: connectors with pilot contact and direct screw wiring.

CHARACTERISTICS: connection technology with mantle terminals. nickel-plated contacts.

All the versions are available with a pilot contact upon request.

IEC 309 HP - LOW VOLTAGE FAST WIRING 10° ANGLED FLUSH-MOUNTING SOCKET-OUTLETS

IP44/IP54



GW 62 205 FH

LOW VOLTAGE FAST WIRING 10° ANGLED FLUSH-MOUNTING SOCKET-OUTLETS - HIGH PERFORMANCE



Code	No. of poles	Rated voltage	Colour	Frequency	Reference h	Flange dimensions (mm)	Pack Carton
Rated current (A): 16							
GW 62 201 FH	2P+E	100 - 130 V	■	50/60 Hz	4	85x75	15
GW 62 202 FH	3P+E	100 - 130 V	■	50/60 Hz	4	85x75	15
GW 62 203 FH	3P+N+E	100 - 130 V	■	50/60 Hz	4	85x75	15
GW 62 205 FH	2P+E	200 - 250 V	■	50/60 Hz	6	85x75	25
GW 62 206 FH	3P+E	200 - 250 V	■	50/60 Hz	9	85x75	15
GW 62 207 FH	3P+N+E	200 - 250 V	■	50/60 Hz	9	85x75	15
GW 62 208 FH	2P+E	380 - 415 V	■	50/60 Hz	9	85x75	15
GW 62 209 FH	3P+E	380 - 415 V	■	50/60 Hz	6	85x75	15
GW 62 210 FH	3P+N+E	380 - 415 V	■	50/60 Hz	6	85x75	15
Rated current (A): 32							
GW 62 213 FH	2P+E	100 - 130 V	■	50/60 Hz	4	95x80	15
GW 62 214 FH	3P+E	100 - 130 V	■	50/60 Hz	4	95x80	15
GW 62 215 FH	3P+N+E	100 - 130 V	■	50/60 Hz	4	95x80	15
GW 62 216 FH	2P+E	200 - 250 V	■	50/60 Hz	6	95x80	15
GW 62 217 FH	3P+E	200 - 250 V	■	50/60 Hz	9	95x80	15
GW 62 218 FH	3P+N+E	200 - 250 V	■	50/60 Hz	9	95x80	15
GW 62 219 FH	2P+E	380 - 415 V	■	50/60 Hz	9	95x80	15
GW 62 220 FH	3P+E	380 - 415 V	■	50/60 Hz	6	95x80	15
GW 62 221 FH	3P+N+E	380 - 415 V	■	50/60 Hz	6	95x80	15

NOTES: all products are packaged individually.

Halogen free according to EN 60754-2.

CHARACTERISTICS. connection technology with spring terminals. Nickel-plated contacts.

IP66/IP67



GW 62 231 FH

LOW VOLTAGE FAST WIRING 10° ANGLED FLUSH-MOUNTING SOCKET-OUTLETS - HIGH PERFORMANCE



Code	No. of poles	Rated voltage	Colour	Frequency	Reference h	Flange dimensions (mm)	Pack Carton
Rated current (A): 16							
GW 62 224 FH	2P+E	100 - 130 V	■	50/60 Hz	4	85x75	15
GW 62 225 FH	3P+E	100 - 130 V	■	50/60 Hz	4	85x75	15
GW 62 226 FH	3P+N+E	100 - 130 V	■	50/60 Hz	4	85x75	15
GW 62 227 FH	2P+E	200 - 250 V	■	50/60 Hz	6	85x75	25
GW 62 228 FH	3P+E	200 - 250 V	■	50/60 Hz	9	85x75	15
GW 62 229 FH	3P+N+E	200 - 250 V	■	50/60 Hz	9	85x75	15
GW 62 230 FH	2P+E	380 - 415 V	■	50/60 Hz	9	85x75	15
GW 62 231 FH	3P+E	380 - 415 V	■	50/60 Hz	6	85x75	15
GW 62 232 FH	3P+N+E	380 - 415 V	■	50/60 Hz	6	85x75	15
Rated current (A): 32							
GW 62 235 FH	2P+E	100 - 130 V	■	50/60 Hz	4	95x80	15
GW 62 236 FH	3P+E	100 - 130 V	■	50/60 Hz	4	95x80	15
GW 62 237 FH	3P+N+E	100 - 130 V	■	50/60 Hz	4	95x80	15
GW 62 238 FH	2P+E	200 - 250 V	■	50/60 Hz	6	95x80	15
GW 62 239 FH	3P+E	200 - 250 V	■	50/60 Hz	9	95x80	15
GW 62 240 FH	3P+N+E	200 - 250 V	■	50/60 Hz	9	95x80	15
GW 62 241 FH	2P+E	380 - 415 V	■	50/60 Hz	9	95x80	15
GW 62 242 FH	3P+E	380 - 415 V	■	50/60 Hz	6	95x80	15
GW 62 243 FH	3P+N+E	380 - 415 V	■	50/60 Hz	6	95x80	15

NOTES: all products are packaged individually.

Halogen free according to EN 60754-2.

CHARACTERISTICS: connection technology with spring terminals. Nickel-plated contacts.

IEC 309 HP

IEC 309 HP - LOW VOLTAGE SCREW WIRING 10° ANGLED FLUSH-MOUNTING SOCKET-OUTLETS

IP44/IP54



GW 62 205 H

LOW VOLTAGE SCREW WIRING 10° ANGLED FLUSH-MOUNTING SOCKET-OUTLETS - HIGH PERFORMANCE



Code	No. of poles	Rated voltage	Colour	Frequency	Reference h	Flange dimensions (mm)	Pack Carton
Rated current (A): 16							
GW 62 201 H	2P+E	100 - 130 V	■	50/60 Hz	4	85x75	50
GW 62 202 H	3P+E	100 - 130 V	■	50/60 Hz	4	85x75	15
GW 62 203 H	3P+N+E	100 - 130 V	■	50/60 Hz	4	85x75	15
GW 62 205 H	2P+E	200 - 250 V	■	50/60 Hz	6	85x75	50
GW 62 206 H	3P+E	200 - 250 V	■	50/60 Hz	9	85x75	25
GW 62 207 H	3P+N+E	200 - 250 V	■	50/60 Hz	9	85x75	15
GW 62 208 H	2P+E	380 - 415 V	■	50/60 Hz	9	85x75	15
GW 62 209 H	3P+E	380 - 415 V	■	50/60 Hz	6	85x75	50
GW 62 210 H	3P+N+E	380 - 415 V	■	50/60 Hz	6	85x75	50
GW 62 801 H	2P+E	480 - 500 V	■	50/60 Hz	7	85x75	15
GW 62 211 H	3P+E	480 - 500 V	■	50/60 Hz	7	85x75	15
GW 62 212 H	3P+N+E	480 - 500 V	■	50/60 Hz	7	85x75	15
GW 62 802 H	3P+E	600 - 690 V	■	50/60 Hz	5	85x75	15
GW 62 803 H	3P+N+E	600 - 690 V	■	50/60 Hz	5	85x75	15
GW 62 804 H	2P+E	>50 V	■	100 - 300 Hz	10	85x75	15
GW 62 805 H	3P+E	>50 V	■	100 - 300 Hz	10	85x75	15
GW 62 806 H	3P+N+E	>50 V	■	100 - 300 Hz	10	85x75	15
GW 62 807 H	2P+E	>50 V	■	>300 - 500 Hz	2	85x75	15
GW 62 808 H	3P+E	>50 V	■	>300 - 500 Hz	2	85x75	15
GW 62 809 H	3P+N+E	>50 V	■	>300 - 500 Hz	2	85x75	15
GW 62 810 H	3P+E	440 - 460 V	■	60 Hz	11	85x75	15
GW 62 811 H	3P+N+E	440 - 460 V	■	60 Hz	11	85x75	15
GW 62 812 H	3P+E	380 - 440 V	■	50/60 Hz	3	85x75	15
GW 62 813 H	3P+N+E	380 - 440 V	■	50/60 Hz	3	85x75	15
GW 62 814 H	2P+E	transf.	■	50/60 Hz	12	85x75	15
GW 62 815 H	3P+E	transf.	■	50/60 Hz	12	85x75	15
GW 62 816 H	2P+E	>50 - 250 V	■	d.c.	3	85x75	15
GW 62 817 H	2P+E	>250 V	■	d.c.	8	85x75	15
Rated current (A): 32							
GW 62 213 H	2P+E	100 - 130 V	■	50/60 Hz	4	95x80	15
GW 62 214 H	3P+E	100 - 130 V	■	50/60 Hz	4	95x80	15
GW 62 215 H	3P+N+E	100 - 130 V	■	50/60 Hz	4	95x80	15
GW 62 216 H	2P+E	200 - 250 V	■	50/60 Hz	6	95x80	25
GW 62 217 H	3P+E	200 - 250 V	■	50/60 Hz	9	95x80	15
GW 62 218 H	3P+N+E	200 - 250 V	■	50/60 Hz	9	95x80	15
GW 62 219 H	2P+E	380 - 415 V	■	50/60 Hz	9	95x80	15
GW 62 220 H	3P+E	380 - 415 V	■	50/60 Hz	6	95x80	15
GW 62 221 H	3P+N+E	380 - 415 V	■	50/60 Hz	6	95x80	25
GW 62 818 H	2P+E	480 - 500 V	■	50/60 Hz	7	95x80	15
GW 62 222 H	3P+E	480 - 500 V	■	50/60 Hz	7	95x80	15
GW 62 223 H	3P+N+E	480 - 500 V	■	50/60 Hz	7	95x80	15
GW 62 819 H	3P+E	600 - 690 V	■	50/60 Hz	5	95x80	15
GW 62 820 H	3P+N+E	600 - 690 V	■	50/60 Hz	5	95x80	15
GW 62 821 H	2P+E	>50 V	■	100 - 300 Hz	10	95x80	15
GW 62 822 H	3P+E	>50 V	■	100 - 300 Hz	10	95x80	15
GW 62 823 H	3P+N+E	>50 V	■	100 - 300 Hz	10	95x80	15
GW 62 824 H	2P+E	>50 V	■	>300 - 500 Hz	2	95x80	15
GW 62 825 H	3P+E	>50 V	■	>300 - 500 Hz	2	95x80	15
GW 62 826 H	3P+N+E	>50 V	■	>300 - 500 Hz	2	95x80	15
GW 62 827 H	3P+E	440 - 460 V	■	60 Hz	11	95x80	15
GW 62 828 H	3P+N+E	440 - 460 V	■	60 Hz	11	95x80	15
GW 62 829 H	3P+E	380 - 440 V	■	50/60 Hz	3	95x80	15
GW 62 830 H	3P+N+E	380 - 440 V	■	50/60 Hz	3	95x80	15
GW 62 831 H	2P+E	transf.	■	50/60 Hz	12	95x80	15
GW 62 832 H	3P+E	transf.	■	50/60 Hz	12	95x80	15
GW 62 833 H	2P+E	>50 - 250 V	■	d.c.	3	95x80	15
GW 62 834 H	2P+E	>250 V	■	d.c.	8	95x80	15

NOTES: all products are packaged individually. Halogen free according to EN 60754-2
CHARACTERISTICS: nickel-plated contacts.

IP66/IP67



GW 62 231 H

LOW VOLTAGE SCREW WIRING 10° ANGLED FLUSH-MOUNTING SOCKET-OUTLETS - HIGH PERFORMANCE



Code	No. of poles	Rated voltage	Colour	Frequency	Reference h	Flange dimensions (mm)	Pack Carton
Rated current (A): 16							
GW 62 224 H	2P+E	100 - 130 V	■	50/60 Hz	4	85x75	25
GW 62 225 H	3P+E	100 - 130 V	■	50/60 Hz	4	85x75	15
GW 62 226 H	3P+N+E	100 - 130 V	■	50/60 Hz	4	85x75	15
GW 62 227 H	2P+E	200 - 250 V	■	50/60 Hz	6	85x75	50
GW 62 228 H	3P+E	200 - 250 V	■	50/60 Hz	9	85x75	15
GW 62 229 H	3P+N+E	200 - 250 V	■	50/60 Hz	9	85x75	15
GW 62 230 H	2P+E	380 - 415 V	■	50/60 Hz	9	85x75	15
GW 62 231 H	3P+E	380 - 415 V	■	50/60 Hz	6	85x75	25
GW 62 232 H	3P+N+E	380 - 415 V	■	50/60 Hz	6	85x75	25
GW 62 835 H	2P+E	480 - 500 V	■	50/60 Hz	7	85x75	15
GW 62 233 H	3P+E	480 - 500 V	■	50/60 Hz	7	85x75	15
GW 62 234 H	3P+N+E	480 - 500 V	■	50/60 Hz	7	85x75	15
GW 62 836 H	3P+E	600 - 690 V	■	50/60 Hz	5	85x75	15
GW 62 837 H	3P+N+E	600 - 690 V	■	50/60 Hz	5	85x75	15
GW 62 838 H	2P+E	>50 V	■	100 - 300 Hz	10	85x75	15
GW 62 839 H	3P+E	>50 V	■	100 - 300 Hz	10	85x75	15
GW 62 840 H	3P+N+E	>50 V	■	100 - 300 Hz	10	85x75	15
GW 62 841 H	2P+E	>50 V	■	>300 - 500 Hz	2	85x75	15
GW 62 842 H	3P+E	>50 V	■	>300 - 500 Hz	2	85x75	15
GW 62 843 H	3P+N+E	>50 V	■	>300 - 500 Hz	2	85x75	15
GW 62 844 H	3P+E	440 - 460 V	■	60 Hz	11	85x75	15
GW 62 845 H	3P+N+E	440 - 460 V	■	60 Hz	11	85x75	15
GW 62 846 H	3P+E	380 - 440 V	■	50/60 Hz	3	85x75	15
GW 62 847 H	3P+N+E	380 - 440 V	■	50/60 Hz	3	85x75	15
GW 62 848 H	2P+E	transf.	■	50/60 Hz	12	85x75	15
GW 62 849 H	3P+E	transf.	■	50/60 Hz	12	85x75	15
GW 62 850 H	2P+E	>50 - 250 V	■	d.c.	3	85x75	15
GW 62 851 H	2P+E	>250 V	■	d.c.	8	85x75	15
Rated current (A): 32							
GW 62 235 H	2P+E	100 - 130 V	■	50/60 Hz	4	95x80	25
GW 62 236 H	3P+E	100 - 130 V	■	50/60 Hz	4	95x80	15
GW 62 237 H	3P+N+E	100 - 130 V	■	50/60 Hz	4	95x80	15
GW 62 238 H	2P+E	200 - 250 V	■	50/60 Hz	6	95x80	15
GW 62 239 H	3P+E	200 - 250 V	■	50/60 Hz	9	95x80	15
GW 62 240 H	3P+N+E	200 - 250 V	■	50/60 Hz	9	95x80	15
GW 62 241 H	2P+E	380 - 415 V	■	50/60 Hz	9	95x80	15
GW 62 242 H	3P+E	380 - 415 V	■	50/60 Hz	6	95x80	15
GW 62 243 H	3P+N+E	380 - 415 V	■	50/60 Hz	6	95x80	15
GW 62 852 H	2P+E	480 - 500 V	■	50/60 Hz	7	95x80	15
GW 62 244 H	3P+E	480 - 500 V	■	50/60 Hz	7	95x80	15
GW 62 245 H	3P+N+E	480 - 500 V	■	50/60 Hz	7	95x80	15
GW 62 853 H	3P+E	600 - 690 V	■	50/60 Hz	5	95x80	15
GW 62 854 H	3P+N+E	600 - 690 V	■	50/60 Hz	5	95x80	15
GW 62 855 H	2P+E	>50 V	■	100 - 300 Hz	10	95x80	15
GW 62 856 H	3P+E	>50 V	■	100 - 300 Hz	10	95x80	15
GW 62 857 H	3P+N+E	>50 V	■	100 - 300 Hz	10	95x80	15
GW 62 858 H	2P+E	>50 V	■	>300 - 500 Hz	2	95x80	15
GW 62 859 H	3P+E	>50 V	■	>300 - 500 Hz	2	95x80	15
GW 62 860 H	3P+N+E	>50 V	■	>300 - 500 Hz	2	95x80	15
GW 62 861 H	3P+E	440 - 460 V	■	60 Hz	11	95x80	15
GW 62 862 H	3P+N+E	440 - 460 V	■	60 Hz	11	95x80	15
GW 62 283 H	3P+E	380 - 440 V	■	50/60 Hz	3	95x80	25
GW 62 863 H	3P+N+E	380 - 440 V	■	50/60 Hz	3	95x80	15
GW 62 864 H	2P+E	transf.	■	50/60 Hz	12	95x80	15
GW 62 865 H	3P+E	transf.	■	50/60 Hz	12	95x80	15
GW 62 866 H	2P+E	>50 - 250 V	■	d.c.	3	95x80	15
GW 62 867 H	2P+E	>250 V	■	d.c.	8	95x80	15

NOTES: all products are packaged individually. Halogen free according to EN 60754-2

CHARACTERISTICS: nickel-plated contacts

IEC 309 HP

IEC 309 HP - LOW VOLTAGE HIGH CURRENT 10° STRAIGHT FLUSH-MOUNTING FIXED SOCKET-OUTLETS WITH MANTLE CONNECTION

IP44/IP54



GW 63 216 H

LOW VOLTAGE HIGH CURRENT PROTECTED FLUSH-MOUNTING 10° SOCKET-OUTLETS WITH MANTLE TERMINAL - HIGH PERFORMANCE



Code	No. of poles	Rated voltage	Colour	Frequency	Reference h	Flange dimensions (mm)	Pack Carton
Rated current (A): 63							
GW 63 213 H	2P+E	100 - 130 V	■	50/60 Hz	4	110x100	1/4
GW 63 214 H	3P+E	100 - 130 V	■	50/60 Hz	4	110x100	1/4
GW 63 215 H	3P+N+E	100 - 130 V	■	50/60 Hz	4	110x100	1/4
GW 63 216 H	2P+E	200 - 250 V	■	50/60 Hz	6	110x100	1/4
GW 63 217 H	3P+E	200 - 250 V	■	50/60 Hz	9	110x100	1/4
GW 63 218 H	3P+N+E	200 - 250 V	■	50/60 Hz	9	110x100	1/4
GW 63 219 H	2P+E	380 - 415 V	■	50/60 Hz	9	110x100	1/4
GW 63 220 H	3P+E	380 - 415 V	■	50/60 Hz	6	110x100	1/4
GW 63 221 H	3P+N+E	346 - 415 V	■	50/60 Hz	6	110x100	1/4

NOTES: all products are packaged individually.

Halogen free in accordance with Standard EN 60754-2.

CHARACTERISTICS: connection technology with mantle terminals, nickel-plated contacts.

All the versions are available with a pilot contact upon request.

IP66/IP67



GW 63 254 H

LOW VOLTAGE HIGH CURRENT WATERTIGHT 10° FIXED FLUSH-MOUNTING SOCKET-OUTLETS WITH MANTLE TERMINAL - HIGH PERFORMANCE



Code	No. of poles	Rated voltage	Colour	Frequency	Reference h	Characteristics	Flange dimensions (mm)	Pack Carton
Rated current (A): 63								
GW 63 246 H	2P+E	100 - 130 V	■	50/60 Hz	4	-	110x100	1/4
GW 63 247 H	3P+E	100 - 130 V	■	50/60 Hz	4	-	110x100	1/4
GW 63 248 H	3P+N+E	100 - 130 V	■	50/60 Hz	4	-	110x100	1/4
GW 63 249 H	2P+E	200 - 250 V	■	50/60 Hz	6	-	110x100	1/4
GW 63 249 PH	2P+E	200 - 250 V	■	50/60 Hz	6	Pilot contact	110x100	1/4
GW 63 250 H	3P+E	200 - 250 V	■	50/60 Hz	9	-	110x100	1/4
GW 63 251 H	3P+N+E	200 - 250 V	■	50/60 Hz	9	-	110x100	1/4
GW 63 252 H	2P+E	380 - 415 V	■	50/60 Hz	9	-	110x100	1/4
GW 63 253 H	3P+E	380 - 415 V	■	50/60 Hz	6	-	110x100	1/4
GW 63 253 PH	3P+E	380 - 415 V	■	50/60 Hz	6	Pilot contact	110x100	1/4
GW 63 254 H	3P+N+E	346 - 415 V	■	50/60 Hz	6	-	110x100	1/4
GW 63 254 PH	3P+N+E	346 - 415 V	■	50/60 Hz	6	Pilot contact	110x100	1/4
GW 63 257 H	2P+E	480 - 500 V	■	50/60 Hz	7	-	110x100	1/4
GW 63 255 H	3P+E	480 - 500 V	■	50/60 Hz	7	-	110x100	1/4
GW 63 256 H	3P+N+E	480 - 500 V	■	50/60 Hz	7	-	110x100	1/4
GW 63 258 H	3P+E	600 - 690 V	■	50/60 Hz	5	-	110x100	1/4
GW 63 259 H	3P+N+E	600 - 690 V	■	50/60 Hz	5	-	110x100	1/4
GW 63 260 H	2P+E	>50 V	■	100 - 300 Hz	10	-	110x100	1/4
GW 63 261 H	3P+E	>50 V	■	100 - 300 Hz	10	-	110x100	1/4
GW 63 262 H	3P+N+E	>50 V	■	100 - 300 Hz	10	-	110x100	1/4
GW 63 263 H	2P+E	>50 V	■	>300 - 500 Hz	2	-	110x100	1/4
GW 63 264 H	3P+E	>50 V	■	>300 - 500 Hz	2	-	110x100	1/4
GW 63 265 H	3P+N+E	>50 V	■	>300 - 500 Hz	2	-	110x100	1/4
GW 63 266 H	3P+E	440 - 460 V	■	60 Hz	11	-	110x100	1/4
GW 63 267 H	3P+N+E	440 - 460 V	■	60 Hz	11	-	110x100	1/4
GW 63 268 H	2P+E	>50 - 250 V	■	d.c.	3	-	110x100	1/4
GW 63 269 H	2P+E	>250 V	■	d.c.	8	-	110x100	1/4
Rated current (A): 125								
GW 62 965 H	2P+E	100 - 130 V	■	50/60 Hz	4	-	114x114	1/2
GW 62 257 H	3P+E	100 - 130 V	■	50/60 Hz	4	-	114x114	1/2
GW 62 258 H	3P+N+E	100 - 130 V	■	50/60 Hz	4	-	114x114	1/2
GW 62 966 H	2P+E	200 - 250 V	■	50/60 Hz	6	-	114x114	1/2
GW 62 259 H	3P+E	200 - 250 V	■	50/60 Hz	9	-	114x114	1/2
GW 62 260 H	3P+N+E	200 - 250 V	■	50/60 Hz	9	-	114x114	1/2
GW 62 967 H	2P+E	380 - 415 V	■	50/60 Hz	9	-	114x114	1/2
GW 62 261 H	3P+E	380 - 415 V	■	50/60 Hz	6	-	114x114	1/2
GW 62 261 PH	3P+E	380 - 415 V	■	50/60 Hz	6	Pilot contact	114x114	1/2
GW 62 262 H	3P+N+E	346 - 415 V	■	50/60 Hz	6	-	114x114	1/2
GW 62 262 PH	3P+N+E	346 - 415 V	■	50/60 Hz	6	Pilot contact	114x114	1/2
GW 62 968 H	2P+E	480 - 500 V	■	50/60 Hz	7	-	114x114	1/2
GW 62 263 H	3P+E	480 - 500 V	■	50/60 Hz	7	-	114x114	1/2
GW 62 264 H	3P+N+E	480 - 500 V	■	50/60 Hz	7	-	114x114	1/2
GW 62 969 H	3P+E	600 - 690 V	■	50/60 Hz	5	-	114x114	1/2
GW 62 970 H	3P+N+E	600 - 690 V	■	50/60 Hz	5	-	114x114	1/2
GW 62 971 H	2P+E	>50 V	■	100 - 300 Hz	10	-	114x114	1/2
GW 62 972 H	3P+E	>50 V	■	100 - 300 Hz	10	-	114x114	1/2
GW 62 973 H	3P+N+E	>50 V	■	100 - 300 Hz	10	-	114x114	1/2
GW 62 974 H	2P+E	>50 V	■	>300 - 500 Hz	2	-	114x114	1/2
GW 62 975 H	3P+E	>50 V	■	>300 - 500 Hz	2	-	114x114	1/2
GW 62 976 H	3P+N+E	>50 V	■	>300 - 500 Hz	2	-	114x114	1/2
GW 62 977 H	3P+E	440 - 460 V	■	60 Hz	11	-	114x114	1/2
GW 62 978 H	3P+N+E	440 - 460 V	■	60 Hz	11	-	114x114	1/2

NOTES: all products are packaged individually. Halogen-free according to EN 60754-2.

GW63249PH, GW63253PH, GW63254PH, GW62261PH, GW62262PH: socket-outlets with pilot contact and direct screw wiring.

CHARACTERISTICS: connection technology with mantle terminals. nickel-plated contacts. All the versions are available with a pilot contact upon request.

IEC 309 HP

FLUSH-MOUNTING SOCKET-OUTLETS WITH CLEAN CONTACT - 125 A - IP67



GW 68 785

LOW VOLTAGE SCREW WIRING 10° ANGLED FLUSH-MOUNTING INTERLOCKED SOCKET-OUTLETS 125A



Code	No. of poles	Rated voltage	Colour	Frequency	Reference h	Flange dimensions (mm)	Pack Carton
GW 68 785	3P+E	380 - 415 V	■	50/60 Hz	6	114x114	1
GW 68 786	3P+N+E	380 - 415 V	■	50/60 Hz	6	114x114	1

CHARACTERISTICS: the socket-outlets are equipped with a NO contact (mechanically activated by the plug pilot) to allow the creation of the electric interlock circuit. nickel-plated contacts.

62 - LOW VOLTAGE SCREW WIRING 10° ANGLED SURFACE-MOUNTING SOCKET-OUTLETS

IP44



GW 62 404

LOW VOLTAGE SCREW WIRING 10° ANGLED SURFACE-MOUNTING SOCKET-OUTLETS



Code	No. of poles	Rated voltage	Colour	Frequency	Reference h	Pack Carton
Rated current (A): 16						
GW 62 401	2P+E	100 - 130 V	■	50/60 Hz	4	40
GW 62 402	3P+E	100 - 130 V	■	50/60 Hz	4	20
GW 62 403	3P+N+E	100 - 130 V	■	50/60 Hz	4	20
GW 62 404	2P+E	200 - 250 V	■	50/60 Hz	6	40
GW 62 405	3P+E	200 - 250 V	■	50/60 Hz	9	20
GW 62 406	3P+N+E	200 - 250 V	■	50/60 Hz	9	20
GW 62 407	2P+E	380 - 415 V	■	50/60 Hz	9	20
GW 62 408	3P+E	380 - 415 V	■	50/60 Hz	6	40
GW 62 409	3P+N+E	380 - 415 V	■	50/60 Hz	6	40
GW 62 410	3P+E	480 - 500 V	■	50/60 Hz	7	20
GW 62 411	3P+N+E	480 - 500 V	■	50/60 Hz	7	20

Rated current (A): 32

GW 62 412	2P+E	100 - 130 V	■	50/60 Hz	4	16
GW 62 413	3P+E	100 - 130 V	■	50/60 Hz	4	16
GW 62 414	3P+N+E	100 - 130 V	■	50/60 Hz	4	16
GW 62 415	2P+E	200 - 250 V	■	50/60 Hz	6	16
GW 62 416	3P+E	200 - 250 V	■	50/60 Hz	9	16
GW 62 417	3P+N+E	200 - 250 V	■	50/60 Hz	9	16
GW 62 418	2P+E	380 - 415 V	■	50/60 Hz	9	16
GW 62 419	3P+E	380 - 415 V	■	50/60 Hz	6	16
GW 62 420	3P+N+E	380 - 415 V	■	50/60 Hz	6	16
GW 62 421	3P+E	480 - 500 V	■	50/60 Hz	7	14
GW 62 422	3P+N+E	480 - 500 V	■	50/60 Hz	7	14

CHARACTERISTICS: nickel-plated contacts. Ø 29 mm cable gland.

NOTE: all products are packaged individually.

IP67



GW 62 430

LOW VOLTAGE SCREW WIRING 10° ANGLED SURFACE-MOUNTING SOCKET-OUTLETS



Code	No. of poles	Rated voltage	Colour	Frequency	Reference h	Pack Carton
Rated current (A): 16						
GW 62 423	2P+E	100 - 130 V	■	50/60 Hz	4	20
GW 62 424	3P+E	100 - 130 V	■	50/60 Hz	4	20
GW 62 425	3P+N+E	100 - 130 V	■	50/60 Hz	4	20
GW 62 426	2P+E	200 - 250 V	■	50/60 Hz	6	40
GW 62 427	3P+E	200 - 250 V	■	50/60 Hz	9	20
GW 62 428	3P+N+E	200 - 250 V	■	50/60 Hz	9	20
GW 62 429	2P+E	380 - 415 V	■	50/60 Hz	9	20
GW 62 430	3P+E	380 - 415 V	■	50/60 Hz	6	40
GW 62 431	3P+N+E	380 - 415 V	■	50/60 Hz	6	40
GW 62 432	3P+E	480 - 500 V	■	50/60 Hz	7	20
GW 62 433	3P+N+E	480 - 500 V	■	50/60 Hz	7	20
Rated current (A): 32						
GW 62 434	2P+E	100 - 130 V	■	50/60 Hz	4	16
GW 62 435	3P+E	100 - 130 V	■	50/60 Hz	4	16
GW 62 436	3P+N+E	100 - 130 V	■	50/60 Hz	4	16
GW 62 437	2P+E	200 - 250 V	■	50/60 Hz	6	16
GW 62 438	3P+E	200 - 250 V	■	50/60 Hz	9	16
GW 62 439	3P+N+E	200 - 250 V	■	50/60 Hz	9	16
GW 62 440	2P+E	380 - 415 V	■	50/60 Hz	9	16
GW 62 441	3P+E	380 - 415 V	■	50/60 Hz	6	16
GW 62 442	3P+N+E	380 - 415 V	■	50/60 Hz	6	16
GW 62 443	3P+E	480 - 500 V	■	50/60 Hz	7	14
GW 62 444	3P+N+E	480 - 500 V	■	50/60 Hz	7	14
GW 62 556	3P+E	380 - 440 V	■	50/60 Hz	3	16

CHARACTERISTICS: PG21 cable gland. Nickel-plated contacts.
NOTE: all products are packaged individually.

63 - LOW VOLTAGE SCREW WIRING 10° ANGLED SURFACE-MOUNTING SOCKET-OUTLETS

IP67



GW 63 453

LOW VOLTAGE SCREW WIRING 10° ANGLED SURFACE-MOUNTING SOCKET-OUTLETS FOR HIGH CURRENTS



Code	No. of poles	Rated voltage	Colour	Frequency	Reference h	Pack Carton
Rated current (A): 63						
GW 63 445	2P+E	100 - 130 V	■	50/60 Hz	4	2/4
GW 63 446	3P+E	100 - 130 V	■	50/60 Hz	4	2/4
GW 63 447	3P+N+E	100 - 130 V	■	50/60 Hz	4	2/4
GW 63 448	2P+E	200 - 250 V	■	50/60 Hz	6	2/4
GW 63 449	3P+E	200 - 250 V	■	50/60 Hz	9	2/4
GW 63 450	3P+N+E	200 - 250 V	■	50/60 Hz	9	2/4
GW 63 451	2P+E	380 - 415 V	■	50/60 Hz	9	2/4
GW 63 452	3P+E	380 - 415 V	■	50/60 Hz	6	2/4
GW 63 453	3P+N+E	380 - 415 V	■	50/60 Hz	6	2/4
GW 63 454	3P+E	480 - 500 V	■	50/60 Hz	7	2/4
GW 63 455	3P+N+E	480 - 500 V	■	50/60 Hz	7	2/4

CHARACTERISTICS: cable gland PG36. Equipped with pilot contact. nickel-plated contacts.
NOTE: all products are packaged individually.

62 - LOW VOLTAGE SCREW WIRING 90° ANGLED SURFACE-MOUNTING SOCKET-OUTLETS

IP44



GW 62 481

LOW VOLTAGE SCREW WIRING 90° ANGLED SURFACE-MOUNTING SOCKET-OUTLETS



Code	No. of poles	Rated voltage	Colour	Frequency	Reference h	Pack Carton
Rated current (A): 16						
GW 62 474	2P+E	100 - 130 V	■	50/60 Hz	4	20
GW 62 475	3P+E	100 - 130 V	■	50/60 Hz	4	20
GW 62 476	3P+N+E	100 - 130 V	■	50/60 Hz	4	20
GW 62 477	2P+E	200 - 250 V	■	50/60 Hz	6	20
GW 62 478	3P+E	200 - 250 V	■	50/60 Hz	9	20
GW 62 479	3P+N+E	200 - 250 V	■	50/60 Hz	9	20
GW 62 480	2P+E	380 - 415 V	■	50/60 Hz	9	20
GW 62 481	3P+E	380 - 415 V	■	50/60 Hz	6	20
GW 62 482	3P+N+E	380 - 415 V	■	50/60 Hz	6	20
GW 62 483	3P+E	480 - 500 V	■	50/60 Hz	7	20
GW 62 484	3P+N+E	480 - 500 V	■	50/60 Hz	7	20
Rated current (A): 32						
GW 62 485	2P+E	100 - 130 V	■	50/60 Hz	4	16
GW 62 486	3P+E	100 - 130 V	■	50/60 Hz	4	16
GW 62 487	3P+N+E	100 - 130 V	■	50/60 Hz	4	16
GW 62 488	2P+E	200 - 250 V	■	50/60 Hz	6	16
GW 62 489	3P+E	200 - 250 V	■	50/60 Hz	9	16
GW 62 490	3P+N+E	200 - 250 V	■	50/60 Hz	9	16
GW 62 491	2P+E	380 - 415 V	■	50/60 Hz	9	16
GW 62 492	3P+E	380 - 415 V	■	50/60 Hz	6	16
GW 62 493	3P+N+E	380 - 415 V	■	50/60 Hz	6	16
GW 62 494	3P+E	480 - 500 V	■	50/60 Hz	7	16
GW 62 495	3P+N+E	480 - 500 V	■	50/60 Hz	7	16

CHARACTERISTICS: Ø 20 mm cable gland for 16 A versions; Ø 23 mm cable gland for 32 A versions. nickel-plated contacts.

NOTE: all products are packaged individually.

IP67



GW 62 499

LOW VOLTAGE SCREW WIRING 90° ANGLED SURFACE-MOUNTING SOCKET-OUTLETS



Code	No. of poles	Rated voltage	Colour	Frequency	Reference h	Pack Carton
Rated current (A): 16						
GW 62 496	2P+E	100 - 130 V	■	50/60 Hz	4	20
GW 62 497	3P+E	100 - 130 V	■	50/60 Hz	4	20
GW 62 498	3P+N+E	100 - 130 V	■	50/60 Hz	4	20
GW 62 499	2P+E	200 - 250 V	■	50/60 Hz	6	20
GW 62 501	3P+E	200 - 250 V	■	50/60 Hz	9	20
GW 62 502	3P+N+E	200 - 250 V	■	50/60 Hz	9	20
GW 62 503	2P+E	380 - 415 V	■	50/60 Hz	9	20
GW 62 504	3P+E	380 - 415 V	■	50/60 Hz	6	20
GW 62 505	3P+N+E	380 - 415 V	■	50/60 Hz	6	20
GW 62 506	3P+E	480 - 500 V	■	50/60 Hz	7	20
GW 62 507	3P+N+E	480 - 500 V	■	50/60 Hz	7	20
Rated current (A): 32						
GW 62 508	2P+E	100 - 130 V	■	50/60 Hz	4	16
GW 62 509	3P+E	100 - 130 V	■	50/60 Hz	4	16
GW 62 510	3P+N+E	100 - 130 V	■	50/60 Hz	4	16
GW 62 511	2P+E	200 - 250 V	■	50/60 Hz	6	16
GW 62 512	3P+E	200 - 250 V	■	50/60 Hz	9	16
GW 62 513	3P+N+E	200 - 250 V	■	50/60 Hz	9	16
GW 62 514	2P+E	380 - 415 V	■	50/60 Hz	9	16
GW 62 515	3P+E	380 - 415 V	■	50/60 Hz	6	16
GW 62 516	3P+N+E	380 - 415 V	■	50/60 Hz	6	16
GW 62 517	3P+E	480 - 500 V	■	50/60 Hz	7	16
GW 62 518	3P+N+E	480 - 500 V	■	50/60 Hz	7	16
GW 62 557	3P+E	380 - 440 V	■	50/60 Hz	3	16

CHARACTERISTICS: PG21 cable gland.

NOTE: all products are packaged individually.

62/63 - LOW VOLTAGE SCREW WIRING 90° ANGLED SURFACE-MOUNTING SOCKET-OUTLETS

IP67



GW 63 527

LOW VOLTAGE SCREW WIRING 90° ANGLED SURFACE-MOUNTING SOCKET-OUTLETS FOR HIGH CURRENTS



Code	No. of poles	Rated voltage	Colour	Frequency	Reference h	Pack Carton
Rated current (A): 63						
GW 63 519	2P+E	100 - 130 V	■	50/60 Hz	4	2/4
GW 63 520	3P+E	100 - 130 V	■	50/60 Hz	4	2/4
GW 63 521	3P+N+E	100 - 130 V	■	50/60 Hz	4	2/4
GW 63 522	2P+E	200 - 250 V	■	50/60 Hz	6	2/4
GW 63 523	3P+E	200 - 250 V	■	50/60 Hz	9	2/4
GW 63 524	3P+N+E	200 - 250 V	■	50/60 Hz	9	2/4
GW 63 525	2P+E	380 - 415 V	■	50/60 Hz	9	2/4
GW 63 526	3P+E	380 - 415 V	■	50/60 Hz	6	2/4
GW 63 527	3P+N+E	380 - 415 V	■	50/60 Hz	6	2/4
GW 63 528	3P+E	480 - 500 V	■	50/60 Hz	7	2/4
GW 63 529	3P+N+E	480 - 500 V	■	50/60 Hz	7	2/4
Rated current (A): 125						
GW 62 530	3P+E	100 - 130 V	■	50/60 Hz	4	1/2
GW 62 531	3P+N+E	100 - 130 V	■	50/60 Hz	4	1/2
GW 62 532	3P+E	200 - 250 V	■	50/60 Hz	9	1/2
GW 62 533	3P+N+E	200 - 250 V	■	50/60 Hz	9	1/2
GW 62 534	3P+E	380 - 415 V	■	50/60 Hz	6	1/2
GW 62 535	3P+N+E	380 - 415 V	■	50/60 Hz	6	1/2
GW 62 536	3P+E	480 - 500 V	■	50/60 Hz	7	1/2
GW 62 537	3P+N+E	480 - 500 V	■	50/60 Hz	7	1/2

CHARACTERISTICS: PG36 cable gland for 63A versions; PG48 cable gland for 125A versions. Versions with pilot contact. nickel-plated contacts.

NOTE: all products are packaged individually.

FLUSH-MOUNTING SOCKTES FOR SPECIFIC USES



GW 62 204

LOW VOLTAGE SCREW WIRING 10° ANGLED FLUSH-MOUNTING SOCKET-OUTLETS WITH REDUCED DIMENSION FLANGE



Code	No. of poles	Rated voltage	Colour	Frequency	Reference h	Flange dimensions (mm)	Pack Carton
Rated current (A): 16							
GW 62 204	2P+E	200 - 250 V	■	50/60 Hz	6	62x62	10/100

CHARACTERISTICS: nickel-plated contacts. For use in restricted spaces.



GW 62 393

DOMESTIC SOCKET OUTLET - IP54



Code	No. of poles	Rated current (A)	Rated voltage	Colour	Frequency	Flange dimensions (mm)	Pack Carton
Standard: German							
GW 62 393	2P+E	16	230 V	■	50/60 Hz	50x50	1/20
GW 62 392	2P+E	16	200 - 250 V	■	50/60 Hz	85x75	1/12
Standard: French							
GW 62 394	2P+E	16	230 V	■	50/60 Hz	50x50	1/20

CHARACTERISTICS: domestic socket-outlets equipped with child protection (shutter) and with rear connection.

NOTES: domestic socket-outlets 50x50 mm can be installed also on flanges 85x75 mm using the adapter code GW68281.



IEC 309 HP



Scan the QR Code and find out all the technical informations.

4 IP DEGREES FOR TOTAL PROTECTION



The HP straight plugs and socket-outlets are the first and only on the electrotechnical field with IP68 and IP69 degrees of protection. Nickel-plated pins and sleeves also offers the best protection against corrosion, oxidation and abrasion, even in critical environmental conditions.

EXCELLENT RESISTANCE TO STRESS











The use of high-performance technopolymers and the inness of rubberised surfaces to protect those most exposed to impact (in all 63-125A versions) offer excellent resistance to mechanical stress (IK09), also at low temperatures (down to -25 °C).

SAFE AND INTUITIVE ASSEMBLY



The 16-32A versions are distinguished by the patented SAFE-LOCK ¼ turn body-grip closure, while the 63-125A versions feature a closure system with captive screws attached to brass inserts made with an increased contrast-flange.

IEC 309 BTS

16A AND 32A EXTRA LOW VOLTAGE INDUSTRIAL PLUGS AND SOCKET-OUTLETS TO IEC 309 STANDARD													
Rated current (In)	Rated Voltage (Un)	Frequency	Poles	Reference h									
					Screw wiring	Screw wiring	Screw wiring	Screw wiring	Screw wiring	Screw wiring	Screw wiring	Screw wiring	
16 A	20 ÷ 25 V	50/60 Hz	2P	-	GW 60 064	GW 60 127	GW 60 464	GW 62 064	GW 62 265	GW 62 365	GW 62 456	GW 62 538	
		50/60 Hz	3P	-	GW 60 065	GW 60 128	GW 60 465	GW 62 065	GW 62 266	GW 62 366	GW 62 457	GW 62 539	
	40 ÷ 50 V	50/60 Hz	2P	12	GW 60 066	GW 60 129	GW 60 466	GW 62 066	GW 62 267		GW 62 458	GW 62 540	
		50/60 Hz	3P	12	GW 60 067	GW 60 130	GW 60 467	GW 62 067	GW 62 268		GW 62 459	GW 62 541	
	20 ÷ 25 V and 40 ÷ 50 V	100÷200 Hz	2P	4	GW 60 068	GW 60 131	GW 60 468	GW 62 068	GW 62 269		GW 62 460	GW 62 542	
		100÷200 Hz	3P	4	GW 60 069	GW 60 132	GW 60 469	GW 62 069	GW 62 270		GW 62 461	GW 62 543	
		> 400÷500 Hz	2P	11	GW 60 070	GW 60 133	GW 60 470	GW 62 070	GW 62 271		GW 62 462	GW 62 544	
		> 400÷500 Hz	3P	11	GW 60 071	GW 60 134	GW 60 471	GW 62 071	GW 62 272		GW 62 463	GW 62 545	
	20 ÷ 25 V and 40 ÷ 50 V	dc	2P	10	GW 60 072	GW 60 135	GW 60 472	GW 62 072	GW 62 273		GW 62 464	GW 62 546	
	32 A	20 ÷ 25 V	50/60 Hz	2P	-	GW 60 073	GW 60 136	GW 60 473	GW 62 073	GW 62 274		GW 62 465	GW 62 547
			50/60 Hz	3P	-	GW 60 074	GW 60 137	GW 60 474	GW 62 074	GW 62 275		GW 62 466	GW 62 548
		40 ÷ 50 V	50/60 Hz	2P	12	GW 60 075	GW 60 138	GW 60 475	GW 62 075	GW 62 276		GW 62 467	GW 62 549
50/60 Hz			3P	12	GW 60 076	GW 60 139	GW 60 476	GW 62 076	GW 62 277		GW 62 468	GW 62 550	
20 ÷ 25 V and 40 ÷ 50 V		100÷200 Hz	2P	4	GW 60 077	GW 60 140	GW 60 477	GW 62 077	GW 62 278		GW 62 469	GW 62 551	
		100÷200 Hz	3P	4	GW 60 078	GW 60 141	GW 60 478	GW 62 078	GW 62 279		GW 62 470	GW 62 552	
		> 400÷500 Hz	2P	11	GW 60 079	GW 60 142	GW 60 479	GW 62 079	GW 62 280		GW 62 471	GW 62 553	
		> 400÷500 Hz	3P	11	GW 60 080	GW 60 143	GW 60 480	GW 62 080	GW 62 281		GW 62 472	GW 62 554	
20 ÷ 25 V and 40 ÷ 50 V		dc	2P	10	GW 60 081	GW 60 144	GW 60 481	GW 62 081	GW 62 282		GW 62 473	GW 62 555	

IEC 309 BTS

Extra-low voltage plugs and socket-outlets IEC 309 standard

The IEC 309 BTS range of extra-low voltage plugs and sockets for industrial applications enable machinery and devices that operate on voltages of less than 50 V to be connected. The range includes different versions - straight mobile, 90° connectors, surface-mounting and flush mounting, protected and watertight. Available for currents from 16 to 32 A.



60/62 - EXTRA LOW VOLTAGE SCREW WIRING INDUSTRIAL PLUGS AND SOCKET-OUTLETS

STRAIGHT PLUGS - IP44



GW 60 064

EXTRA-LOW VOLTAGE SCREW WIRING STRAIGHT PLUGS



Code	No. of poles	Rated voltage	Colour	Frequency	Reference h	Pack Carton
Rated current (A): 16						
GW 60 064	2P	20-25 V	Violet	50 - 60 Hz	-	10/40
GW 60 065	3P	20-25 V	Violet	50 - 60 Hz	-	10/20
GW 60 066	2P	40-50 V	White	50 - 60 Hz	12	10/20
GW 60 067	3P	40-50 V	White	50 - 60 Hz	12	10/20
GW 60 068	2P	20-25V and 40-50 V	Green	100 - 200 Hz	4	10/20
GW 60 069	3P	20-25V and 40-50 V	Green	100 - 200 Hz	4	10/20
GW 60 070	2P	20-25V and 40-50 V	Green	401 - 500 Hz	11	10/20
GW 60 071	3P	20-25V and 40-50 V	Green	401 - 500 Hz	11	10/20
GW 60 072	2P	20-25V and 40-50 V	White	d.c.	10	10/20
Rated current (A): 32						
GW 60 073	2P	20-25 V	Violet	50 - 60 Hz	-	10/20
GW 60 074	3P	20-25 V	Violet	50 - 60 Hz	-	10/20
GW 60 075	2P	40-50 V	White	50 - 60 Hz	12	10/20
GW 60 076	3P	40-50 V	White	50 - 60 Hz	12	10/20
GW 60 077	2P	20-25V and 40-50 V	Green	100 - 200 Hz	4	10/20
GW 60 078	3P	20-25V and 40-50 V	Green	100 - 200 Hz	4	10/20
GW 60 079	2P	20-25V and 40-50 V	Green	401 - 500 Hz	11	10/20
GW 60 080	3P	20-25V and 40-50 V	Green	401 - 500 Hz	11	10/20
GW 60 081	2P	20-25V and 40-50 V	White	d.c.	10	10/20

CHARACTERISTICS: Ø 23mm cable gland.

90° PLUGS - IP44



GW 60 127

EXTRA-LOW VOLTAGE SCREW WIRING 90° PLUGS



Code	No. of poles	Rated voltage	Colour	Frequency	Reference h	Pack Carton
Rated current (A): 16						
GW 60 127	2P	20-25 V	Violet	50 - 60 Hz	-	10/40
GW 60 128	3P	20-25 V	Violet	50 - 60 Hz	-	10/20
GW 60 129	2P	40-50 V	White	50 - 60 Hz	12	10/20
GW 60 130	3P	40-50 V	White	50 - 60 Hz	12	10/20
GW 60 131	2P	20-25V and 40-50 V	Green	100 - 200 Hz	4	10/20
GW 60 132	3P	20-25V and 40-50 V	Green	100 - 200 Hz	4	10/20
GW 60 133	2P	20-25V and 40-50 V	Green	401 - 500 Hz	11	10/20
GW 60 134	3P	20-25V and 40-50 V	Green	401 - 500 Hz	11	10/20
GW 60 135	2P	20-25V and 40-50 V	White	d.c.	10	10/20
Rated current (A): 32						
GW 60 136	2P	20-25 V	Violet	50 - 60 Hz	-	10/20
GW 60 137	3P	20-25 V	Violet	50 - 60 Hz	-	10/20
GW 60 138	2P	40-50 V	White	50 - 60 Hz	12	10/20
GW 60 139	3P	40-50 V	White	50 - 60 Hz	12	10/20
GW 60 140	2P	20-25V and 40-50 V	Green	100 - 200 Hz	4	10/20
GW 60 141	3P	20-25V and 40-50 V	Green	100 - 200 Hz	4	10/20
GW 60 142	2P	20-25V and 40-50 V	Green	401 - 500 Hz	11	10/20
GW 60 143	3P	20-25V and 40-50 V	Green	401 - 500 Hz	11	10/20
GW 60 144	2P	20-25V and 40-50 V	White	d.c.	10	10/20

CHARACTERISTICS: PG21 cable gland.

IEC 309 BTS

90° SURFACE-MOUNTING INLETS - IP44



GW 60 464

EXTRA-LOW VOLTAGE SCREW WIRING 90° ANGLED SURFACE-MOUNTING INLETS



Code	No. of poles	Rated voltage	Colour	Frequency	Reference h	Pack Carton
Rated current (A): 16						
GW 60 464	2P	20-25 V	Violet	50 - 60 Hz	-	10/40
GW 60 465	3P	20-25 V	Violet	50 - 60 Hz	-	10/20
GW 60 466	2P	40-50 V	White	50 - 60 Hz	12	10/20
GW 60 467	3P	40-50 V	White	50 - 60 Hz	12	10/20
GW 60 468	2P	20-25V and 40-50 V	Green	100 - 200 Hz	4	10/20
GW 60 469	3P	20-25V and 40-50 V	Green	100 - 200 Hz	4	10/20
GW 60 470	2P	20-25V and 40-50 V	Green	401 - 500 Hz	11	10/20
GW 60 471	3P	20-25V and 40-50 V	Green	401 - 500 Hz	11	10/20
GW 60 472	2P	20-25V and 40-50 V	White	d.c.	10	10/20
Rated current (A): 32						
GW 60 473	2P	20-25 V	Violet	50 - 60 Hz	-	10/20
GW 60 474	3P	20-25 V	Violet	50 - 60 Hz	-	10/20
GW 60 475	2P	40-50 V	White	50 - 60 Hz	12	10/20
GW 60 476	3P	40-50 V	White	50 - 60 Hz	12	10/20
GW 60 477	2P	20-25V and 40-50 V	Green	100 - 200 Hz	4	10/20
GW 60 478	3P	20-25V and 40-50 V	Green	100 - 200 Hz	4	10/20
GW 60 479	2P	20-25V and 40-50 V	Green	401 - 500 Hz	11	10/20
GW 60 480	3P	20-25V and 40-50 V	Green	401 - 500 Hz	11	10/20
GW 60 481	2P	20-25V and 40-50 V	White	d.c.	10	10/20

ACCESSORIES SUPPLIED: Ø 23mm cable gland.

CONNECTORS - IP44



GW 62 064

EXTRA-LOW VOLTAGE SCREW WIRING STRAIGHT CONNECTORS



Code	No. of poles	Rated voltage	Colour	Frequency	Reference h	Pack Carton
Rated current (A): 16						
GW 62 064	2P	20-25 V	Violet	50 - 60 Hz	-	10/40
GW 62 065	3P	20-25 V	Violet	50 - 60 Hz	-	10/20
GW 62 066	2P	40-50 V	White	50 - 60 Hz	12	10/20
GW 62 067	3P	40-50 V	White	50 - 60 Hz	12	10/20
GW 62 068	2P	20-25V and 40-50 V	Green	100 - 200 Hz	4	10/20
GW 62 069	3P	20-25V and 40-50 V	Green	100 - 200 Hz	4	10/20
GW 62 070	2P	20-25V and 40-50 V	Green	401 - 500 Hz	11	10/20
GW 62 071	3P	20-25V and 40-50 V	Green	401 - 500 Hz	11	10/20
GW 62 072	2P	20-25V and 40-50 V	White	d.c.	10	10/20
Rated current (A): 32						
GW 62 073	2P	20-25 V	Violet	50 - 60 Hz	-	10/20
GW 62 074	3P	20-25 V	Violet	50 - 60 Hz	-	10/20
GW 62 075	2P	40-50 V	White	50 - 60 Hz	12	10/20
GW 62 076	3P	40-50 V	White	50 - 60 Hz	12	10/20
GW 62 077	2P	20-25V and 40-50 V	Green	100 - 200 Hz	4	10/20
GW 62 078	3P	20-25V and 40-50 V	Green	100 - 200 Hz	4	10/20
GW 62 079	2P	20-25V and 40-50 V	Green	401 - 500 Hz	11	10/20
GW 62 080	3P	20-25V and 40-50 V	Green	401 - 500 Hz	11	10/20
GW 62 081	2P	20-25V and 40-50 V	White	d.c.	10	10/20

CHARACTERISTICS: nickel-plated contacts. Ø 23mm cable gland.

10° FLUSH-MOUNTING SOCKET-OUTLETS - IP44



GW 62 265

EXTRA-LOW VOLTAGE SCREW WIRING 10° ANGLED FLUSH-MOUNTING SOCKET-OUTLETS



Code	No. of poles	Rated voltage	Colour	Frequency	Reference h	Flange dimensions (mm)	Pack Carton
Rated current (A): 16							
GW 62 265	2P	20-25 V	Violet	50 - 60 Hz	-	85x75	10/40
GW 62 266	3P	20-25 V	Violet	50 - 60 Hz	-	85x75	10/20
GW 62 267	2P	40-50 V	White	50 - 60 Hz	12	85x75	10/20
GW 62 268	3P	40-50 V	White	50 - 60 Hz	12	85x75	10/20
GW 62 269	2P	20-25V and 40-50 V	Green	100 - 200 Hz	4	85x75	10/20
GW 62 270	3P	20-25V and 40-50 V	Green	100 - 200 Hz	4	85x75	10/20
GW 62 271	2P	20-25V and 40-50 V	Green	401 - 500 Hz	11	85x75	10/20
GW 62 272	3P	20-25V and 40-50 V	Green	401 - 500 Hz	11	85x75	10/20
GW 62 273	2P	20-25V and 40-50 V	White	d.c.	10	85x75	10/20
Rated current (A): 32							
GW 62 274	2P	20-25 V	Violet	50 - 60 Hz	-	85x75	10/20
GW 62 275	3P	20-25 V	Violet	50 - 60 Hz	-	85x75	10/20
GW 62 276	2P	40-50 V	White	50 - 60 Hz	12	85x75	10/20
GW 62 277	3P	40-50 V	White	50 - 60 Hz	12	85x75	10/20
GW 62 278	2P	20-25V and 40-50 V	Green	100 - 200 Hz	4	85x75	10/20
GW 62 279	3P	20-25V and 40-50 V	Green	100 - 200 Hz	4	85x75	10/20
GW 62 280	2P	20-25V and 40-50 V	Green	401 - 500 Hz	11	85x75	10/20
GW 62 281	3P	20-25V and 40-50 V	Green	401 - 500 Hz	11	85x75	10/20
GW 62 282	2P	20-25V and 40-50 V	White	d.c.	10	85x75	10/20

CHARACTERISTICS: nickel-plated contacts.

10° FLUSH-MOUNTING SOCKET-OUTLETS - IP67

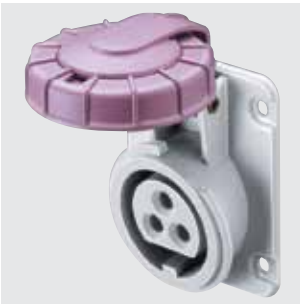

GW 62 366

EXTRA-LOW VOLTAGE SCREW WIRING 10° ANGLED FLUSH-MOUNTING SOCKET-OUTLETS



Code	No. of poles	Rated voltage	Colour	Frequency	Reference h	Flange dimensions (mm)	Pack Carton
Rated current (A): 16							
GW 62 365	2P	20-25 V	Violet	50 - 60 Hz	-	85x75	10/40
GW 62 366	3P	20-25 V	Violet	50 - 60 Hz	-	85x75	10/20

CHARACTERISTICS: nickel-plated contacts.

10° SURFACE-MOUNTING SOCKET-OUTLETS - IP44



GW 62 456

EXTRA-LOW VOLTAGE SCREW WIRING 10° ANGLED SURFACE-MOUNTING SOCKET-OUTLETS



Code	No. of poles	Rated voltage	Colour	Frequency	Reference h	Pack Carton
Rated current (A): 16						
GW 62 456	2P	20-25 V	Violet	50 - 60 Hz	-	10/40
GW 62 457	3P	20-25 V	Violet	50 - 60 Hz	-	10/20
GW 62 458	2P	40-50 V	White	50 - 60 Hz	12	10/20
GW 62 459	3P	40-50 V	White	50 - 60 Hz	12	10/20
GW 62 460	2P	20-25V and 40-50 V	Green	100 - 200 Hz	4	10/20
GW 62 461	3P	20-25V and 40-50 V	Green	100 - 200 Hz	4	10/20
GW 62 462	2P	20-25V and 40-50 V	Green	401 - 500 Hz	11	10/20
GW 62 463	3P	20-25V and 40-50 V	Green	401 - 500 Hz	11	10/20
GW 62 464	2P	20-25V and 40-50 V	White	d.c.	10	10/20
Rated current (A): 32						
GW 62 465	2P	20-25 V	Violet	50 - 60 Hz	-	10/20
GW 62 466	3P	20-25 V	Violet	50 - 60 Hz	-	10/20
GW 62 467	2P	40-50 V	White	50 - 60 Hz	12	10/20
GW 62 468	3P	40-50 V	White	50 - 60 Hz	12	10/20
GW 62 469	2P	20-25V and 40-50 V	Green	100 - 200 Hz	4	10/20
GW 62 470	3P	20-25V and 40-50 V	Green	100 - 200 Hz	4	10/20
GW 62 471	2P	20-25V and 40-50 V	Green	401 - 500 Hz	11	10/20
GW 62 472	3P	20-25V and 40-50 V	Green	401 - 500 Hz	11	10/20
GW 62 473	2P	20-25V and 40-50 V	White	d.c.	10	10/20

CHARACTERISTICS: nickel-plated contacts. Ø 29mm cable gland.

90° SURFACE-MOUNTING SOCKET-OUTLETS - IP44



GW 62 538

EXTRA-LOW VOLTAGE SCREW WIRING 90° ANGLED SURFACE-MOUNTING SOCKET-OUTLETS



Code	No. of poles	Rated voltage	Colour	Frequency	Reference h	Pack Carton
Rated current (A): 16						
GW 62 538	2P	20-25 V	Violet	50 - 60 Hz	-	10/20
GW 62 539	3P	20-25 V	Violet	50 - 60 Hz	-	10/20
GW 62 540	2P	40-50 V	White	50 - 60 Hz	12	10/20
GW 62 541	3P	40-50 V	White	50 - 60 Hz	12	10/20
GW 62 542	2P	20-25V and 40-50 V	Green	100 - 200 Hz	4	10/20
GW 62 543	3P	20-25V and 40-50 V	Green	100 - 200 Hz	4	10/20
GW 62 544	2P	20-25V and 40-50 V	Green	401 - 500 Hz	11	10/20
GW 62 545	3P	20-25V and 40-50 V	Green	401 - 500 Hz	11	10/20
GW 62 546	2P	20-25V and 40-50 V	White	d.c.	10	10/20
Rated current (A): 32						
GW 62 547	2P	20-25 V	Violet	50 - 60 Hz	-	10/20
GW 62 548	3P	20-25 V	Violet	50 - 60 Hz	-	10/20
GW 62 549	2P	40-50 V	White	50 - 60 Hz	12	10/20
GW 62 550	3P	40-50 V	White	50 - 60 Hz	12	10/20
GW 62 551	2P	20-25V and 40-50 V	Green	100 - 200 Hz	4	10/20
GW 62 552	3P	20-25V and 40-50 V	Green	100 - 200 Hz	4	10/20
GW 62 553	2P	20-25V and 40-50 V	Green	401 - 500 Hz	11	10/20
GW 62 554	3P	20-25V and 40-50 V	Green	401 - 500 Hz	11	10/20
GW 62 555	2P	20-25V and 40-50 V	White	d.c.	10	10/20

CHARACTERISTICS: nickel-plated contacts. Ø 29mm cable gland.



IEC 309 BTS



Scan the QR Code and find out all the technical informations.

WIDE RANGE



The range consists of 16-32A straight and 90°, surface-mounting and flushmounting plugs and socket-outlets, in protected versions (10° flushmounting socket-outlet versions also available in a waterproof version IP67).

FOR ULTRA-LOW VOLTAGE APPLICATIONS





The range consists of 16-32A straight and 90°, surface-mounting and flushmounting plugs and socket-outlets, in protected versions (10° flushmounting socket-outlet versions also available in a waterproof version IP67).

SYNERGY WITH DISTRIBUTION BOARDS





The 10° flush-mounted socket-outlets of the extra-low voltage range have the same dimensions and the same fixing centre distance as the normal IEC 309 socket-outlets, therefore they can also be installed on the Q-DIN, Q-BOX and QMC boards.



MULTIPLE SOCKET COUPLERS								
Type	Rated current (In)	INPUT			COUPLER OUTPUTS			
		Rated Voltage (Un)	Poles	Reference h	No. 2 socket-outlets 16A	No. 3 socket-outlets 16A	No. 3 socket-outlets 32A	
	16 A	100 ÷ 130 V	2P+E	4	GW 64 008	GW 64 022		
			3P+E	4		GW 64 023		
		200 ÷ 250 V	2P+E	6	GW 64 010	GW 64 024		
			3P+E	9	GW 64 011	GW 64 025		
			3P+N+E	9	GW 64 012	GW 64 026		
		380 ÷ 415 V	3P+E	9	GW 64 013	GW 64 027		
			3P+N+E	6	GW 64 014	GW 64 028		
		32 A	380 ÷ 415 V	3P+E	6			GW 64 068
	16 A	100 ÷ 130 V	2P+E	4		GW 64 050		
		200 ÷ 250 V	2P+E	6		GW 64 052		
		380 ÷ 415 V	3P+E	6		GW 64 055		
			3P+N+E	6		GW 64 056		

MULTIPLE SOCKET ADAPTORS								
Rated current (In)	Rated Voltage (Un)	Poles	Reference h	OUTLETS			Code	
				No. 3 socket-outlets				
				2P+E 230 V-	3P+E 400 V-	3P+N+E 400 V-		
16 A	380 ÷ 415 V	3P+N+E	6	2x16A		1x16A	GW 64 059	
				1x16A	1x16A	1x16A	GW 64 060	
32 A	200 ÷ 250 V	2P+E	6	3x16A			GW 64 062	
	380 ÷ 415 V	3P+N+E	6	1x16A	1x16A	1x16A	GW 64 063	
				2x16A		1x32A	GW 64 064	
				1x32A	1x32A	1x32A	GW 64 061	
63 A	380 ÷ 415 V	3P+N+E	6	2x32A		1x63A	GW 64 065	

PHASE INVERTER						
INPUT				OUTLETS		
Rated current (In)	Rated Voltage (Un)	Poles	Reference h	No. 1 socket outlets		Code
				3P+E 400 V-	3P+N+E 400 V-	
 16 A	380 ÷ 415 V	3P+E	6	1x16A		GW 64 066
		3P+N+E	6		1x16A	GW 64 067

Important notice: the range of multiple socket adaptors, adaptors and shunts should be considered an integral part of the electrical system, since they are products suitable only for temporary, trailing installations and connections, and not for permanent applications. Furthermore, the range cannot be used in areas with a fire hazard.

SYSTEM ADAPTORS										
INPUT					DOMESTIC SOCKET-OUTLET					INDUSTRIAL SOCKET-OUTLET
Type	Rated current (In)	Rated Voltage (Un)	Poles	Reference h	N. 2 outputs 2P+E 16A dual amp. (P17/P11)	No. 1 output 2P+E 16A dual amp. (P30/P17)	No. 1 output 2P+E 10/16A German Std.	No. 1 output 2P+E 16A French Std.	No. 1 output 2P+E 13A British Std.	
 IEC 309 industrial plug	16 A	200 ÷ 250 V	2P+E	6	GW 64 211					
						GW 64 212				
							GW 64 210			
								GW 64 203		
								GW 64 204		
					GW 64 206 fitted for other combinations					
 Domestic sockets	16 A	380 ÷ 415 V	3P+N+E	6	GW 64 216					
						GW 64 217				
					GW 64 207 fitted for other combinations					
	2P+E 16A 250V S17									GW 64 208
	2P+E 16A 250V German/French Std.									GW 64 209

SYSTEM BRANCHED ADAPTORS									
INPUT					OUTPUT				Code
Type	Rated current (In)	Rated Voltage (Un)	Poles	Reference h	INDUSTRIAL IEC 309	DOMESTIC No. 2 socket-outlets 2P+E 16A dual amp. (P17/P11)	DOMESTIC No. 1 socket outlets 2P+E 16A dual amp. (P30/P17)	DOMESTIC No. 2 socket-outlets 2P+E 16A dual amp. (P17/P11) No. 1 socket-outlet 2P+E 16A dual amp. (P30/P17)	
 IEC 309 industrial plug	16 A	200 ÷ 250 V	2P+E	6	•	•			GW 64 221
					•		•		GW 64 222
					•	Fitted for No. 2 SYSTEM modules			GW 64 223
					•			•	GW 64 231
					•	Fitted for No. 2+2 SYSTEM modules			GW 64 232
 Cable with IEC309 plug	16 A	380 ÷ 415 V	3P+N+E	6	•			•	GW 64 236
					•	Fitted for No. 2+2 SYSTEM modules			GW 64 237
					•			•	GW 64 256
 Cable with domestic plug	16 A	200 ÷ 250 V	2P+E S17		2P+E 16A - 230V			•	GW 64 263
					Fitted for cable and plug	2P+E 16A - 230V	Fitted for No. 2+2 SYSTEM modules		GW 64 265

Important notice: the range of multiple socket adaptors, adaptors and shunts should be considered an integral part of the electrical system, since they are products suitable only for temporary, trailing installations and connections, and not for permanent applications. Furthermore, the range cannot be used in areas with a fire hazard.

IEC 309 MA

Multiple sockets and adaptors for industrial and domestic use, protected and watertight

The IEC 309 MA range is a range of multipliers, adapters and branched. They are available in currents of 16, 32 or 63 A and have a varying number of outlets and poles in numerous different combinations. These products should be considered supplementary to the system as they are only suitable for use in temporary installations and mobile connections, and they have not been designed for permanent applications.



64 - MULTIPLE SOCKET-COUPLERS

2-OUTPUTS



GW 64 013

MULTIPLE SOCKET-COUPLERS 2 OUTPUTS WITH 16A PLUG - 50/60HZ - IP67



Code	No. of poles	Rated voltage	Colour	Reference h	Pack Carton
Plug IEC 309: 16A					
GW 64 008	2P+E	110 V	Yellow	4	5/20
GW 64 010	2P+E	230 V	Blue	6	5/20
GW 64 011	3P+E	230 V	Blue	9	5/10
GW 64 012	3P+N+E	230 V	Blue	9	5/10
GW 64 013	3P+E	400 V	Red	6	5/10
GW 64 014	3P+N+E	400 V	Red	6	5/10

3-OUTPUTS



GW 64 027

MULTIPLE SOCKET-COUPLERS 3 OUTPUTS WITH 16-32A PLUG - 50/60HZ - IP67



Code	No. of poles	Rated voltage	Colour	Reference h	Pack Carton
Plug IEC 309: 16A					
GW 64 022	2P+E	110 V	Yellow	4	5/10
GW 64 023	3P+E	110 V	Yellow	4	5/10
GW 64 024	2P+E	230 V	Blue	6	5/10
GW 64 025	3P+E	230 V	Blue	9	5/10
GW 64 026	3P+N+E	230 V	Blue	9	5/10
GW 64 027	3P+E	400 V	Red	6	5/10
GW 64 028	3P+N+E	400 V	Red	6	5/10
Plug IEC 309: 32A					
GW 64 068	3P+E	400 V	Red	6	1/4

3-OUTPUTS WITH CABLE AND PLUG



GW 64 052

WATERTIGHT MULTIPLE SOCKET-COUPLERS 3 OUTPUTS WITH 2M FLEXIBLE CABLE AND 16A PLUG - 50/60HZ - IP67



Code	No. of poles	Rated voltage	Colour	Reference h	Pack Carton
Plug IEC 309: 16A					
GW 64 050	2P+E	110 V	Yellow	4	1/6
GW 64 052	2P+E	230 V	Blue	6	1/6
GW 64 055	3P+E	400 V	Red	6	1/3
GW 64 056	3P+N+E	400 V	Red	6	1/3

64 - MULTIPLE SOCKET-ADAPTORS

CONFIGURATION ADAPTORS



GW 64 059

WATERTIGHT MULTIPLE SOCKET-ADAPTORS WITH 16A PLUG - 50/60 HZ - IP67



Code	Socket-outlet IEC 309	Socket-outlet IEC 309	Socket-outlet IEC 309	Pack Carton
Plug IEC 309: 3P+N+E - 16A - 400V ac				
GW 64 059	2P+T - 16 A - 230 V ac	2P+T - 16 A - 230 V ac	3P+N+T - 16 A - 400 V ac	5/10
GW 64 060	2P+T - 16 A - 230 V ac	3P+T - 16 A - 400 V ac	3P+N+T - 16 A - 400 V ac	5/10



GW 64 061

WATERTIGHT MULTIPLE SOCKET-ADAPTORS WITH 32A PLUG - 50/60HZ - IP67



Code	Socket-outlet IEC 309	Socket-outlet IEC 309	Socket-outlet IEC 309	Pack Carton
Plug IEC 309: 3P+N+E - 32A - 400V ac				
GW 64 061	2P+T - 32 A - 230 V ac	3P+T - 32 A - 400 V ac	3P+N+T - 32 A - 400 V ac	1/5

CURRENT ADAPTORS



GW 64 062

WATERTIGHT MULTIPLE-SOCKET ADAPTOR WITH 32 A PLUG - 50/60 HZ - IP67



Code	Socket-outlet IEC 309	Socket-outlet IEC 309	Socket-outlet IEC 309	Pack Carton
Plug IEC 309: 2P+E - 32A - 230V ac				
GW 64 062	2P+E - 16 A - 230 V ac	2P+E - 16 A - 230 V ac	2P+E - 16 A - 230 V ac	5/10
Plug IEC 309: 3P+N+E - 32A - 400V ac				
GW 64 063	2P+E - 16 A - 230 V ac	3P+E - 16 A - 400 V ac	3P+N+E - 16 A - 400 V ac	5/10
GW 64 064	2P+T - 16 A - 230 V ac	2P+T - 16 A - 230 V ac	3P+N+T - 32 A - 400 V ac	1/5



GW 64 065

WATERTIGHT MULTIPLE SOCKET-ADAPTORS PLUG 63A - 50/60 HZ - IP67



Code	Socket-outlet IEC 309	Socket-outlet IEC 309	Socket-outlet IEC 309	Pack Carton
Plug IEC 309: 3P+N+E - 63A - 400V ac				
GW 64 065	2P+T - 32 A - 230 V ac	2P+T - 32 A - 230 V ac	3P+N+T - 63 A - 400 V ac	1/2

IEC 309 MA

PHASE INVERTER



GW 64 066

PROTECTED PHASE INVERTER - 16 A - 50/60 HZ - IP44



Code	Socket-outlet IEC 309	Pack Carton
Plug IEC 309: 3P+E - 16A - 400V ac		
GW 64 066		10/20
Plug IEC 309: 3P+N+E - 16A - 400V ac		
GW 64 067		10/20

64 IC/CI - SYSTEM ADAPTORS

FROM INDUSTRIAL TO DOMESTIC: WIRED



GW 64 203

SYSTEM ADAPTORS: IEC 309 IP44 PLUG / SOCKET-OUTLET FOR RESIDENTIAL USE - 50/60HZ



Code	Resid. socket-outlets 250V~	Pack Carton
Plug IEC 309: 2P+E - 16A - 230V ac		
GW 64 203	N. 1 - 2P+E - 16A French	10/40
GW 64 204	N. 1 - 2P+E - 13A British	10/40
GW 64 210	N. 1 - 2P+E - 10/16A German	10/40
GW 64 211	N. 2 - 2P+E - 16A Dual amp (P17/T1)	10/40
GW 64 212	N. 1 - 2P+E - 16A Dual amp (P30 - P17)	10/40
Plug IEC 309: 3P+N+E - 16A - 400V ac		
GW 64 216	N. 2 - 2P+E - 16A Dual amp (P17/T1)	10/40
GW 64 217	N. 1 - 2P+E - 16A Dual amp (P30 - P17)	10/40

CHARACTERISTICS: GW64211 - GW64216, domestic socket-outlets with Ø 4 / 5 mm plug pins.

GW64212 - GW64217, domestic socket-outlets with Ø 4 / 4.8 / 5 mm plug pins, with side and central earth contact.

NOTES: only for temporary uses.

FROM INDUSTRIAL TO DOMESTIC: FITTED



GW 64 206

SYSTEM ADAPTORS: IEC 309 IP44 PLUG FOR FITTING FOR 2 MODULE SYSTEM RANGE - 50/60HZ



Code	Housing for	Pack Carton
Plug IEC 309: 2P+E - 16A - 230V ac		
GW 64 206	2	10/40
Plug IEC 309: 3P+N+E - 16A - 400V ac		
GW 64 207	2	10/40

ACCESSORIES SUPPLIED: wiring cables.

NOTES: only for temporary uses.

FROM DOMESTIC TO INDUSTRIAL: WIRED



GW 64 209

SYSTEM ADAPTORS DOMESTIC USE PLUG / IEC 309 IP44 SOCKET-OUTLET - 50/60HZ



Code	Socket-outlet IEC 309	Pack Carton
Domestic socket-outlet: 2P+E - 16A - 250V ac S17		
GW 64 208	2P+E - 16A - 230V ac	10/40
Domestic socket-outlet: 2P+E - 16A - 250V ac German/French		
GW 64 209	2P+E - 16A - 230V ac	10/40

CHARACTERISTICS: GW64209, with double earth contact (German standard side contact and French standard middle contact).
NOTES: only for temporary uses.

64 IC/CI - SYSTEM BRANCHED ADAPTORS

1 BRANCHED OUTLET: WIRED



GW 64 221

CONVERSION ADAPTORS: PLUG FOR DOMESTIC USE / IEC 309 SOCKET-COUPLER IP44 - 50/60HZ



Code	Resid. socket-outlets 250V~	Socket-outlet IEC 309	Pack Carton
Plug IEC 309: 2P+E - 16A - 230V ac			
GW 64 221	N. 2 - 2P+T - 16 A Bivalente (P17/11)	2P+T - 16 A - 230 V ac	5/20
GW 64 222	N. 1 - 2P+T - 16 A Bivalente (P30 - P17)	2P+T - 16 A - 230 V ac	5/20

CHARACTERISTICS: GW64221 domestic socket-outlets with plug pins Ø 4/5mm.
GW64222 domestic socket-outlets with plug pins Ø 4/4.8/5mm, with side and central earthing.
NOTES: only for temporary uses.

1 BRANCHED OUTLET: FITTED



GW 64 223

CONVERSION ADAPTORS: IEC 309 PLUG FITTING FOR 2 SYSTEM MODULES/IEC 309 SOCKET-COUPLER IP44 - 50/60HZ



Code	Housing for	Socket-outlet IEC 309	Pack Carton
Plug IEC 309: 2P+E - 16A - 230V ac			
GW 64 223	2	2P+T - 16 A - 230 V ac	5/20

ACCESSORIES SUPPLIED: wiring cables.
NOTES: only for temporary uses.

2 BRANCHED OUTLETS: WIRED



GW 64 231

CONVERSION ADAPTORS: PLUG IEC 309 IP44. SOCKET-OUTLET FOR DOMESTIC USE / IEC 309 SOCKET-COUPLER IP44 - 50/60HZ



Code	Resid. socket-outlets 250V~	Socket-outlet IEC 309	Pack Carton
Plug IEC 309: 2P+E - 16A - 230V ac			
GW 64 231	N. 2 (P17/11) - N. 1 (P30-P17)	2P+T - 16 A - 230 V ac	5/20
Plug IEC 309: 3P+N+E - 16A - 400V ac			
GW 64 236	N. 2 (P17/11) - N. 1 (P30-P17)	3P+N+T - 16 A - 400 V ac	5/10

NOTES: only for temporary uses.

IEC 309 MA

2 BRANCHED OUTLETS: FITTED



GW 64 232

CONVERSION ADAPTORS: IEC 309 PLUG. FITTING FOR 2+2 SYSTEM MODULES/IEC 309 SOCKET-COUPLER IP44 - 50/60HZ



Code	Housing for	Socket-outlet IEC 309	Pack Carton
Plug IEC 309: 2P+E - 16A - 230V ac			
GW 64 232	2+2	2P+T - 16 A - 230 V ac	5/20
Plug IEC 309: 3P+N+E - 16A - 400V ac			
GW 64 237	2+2	3P+N+T - 16 A - 400 V ac	5/10

ACCESSORIES SUPPLIED: wiring cables.

NOTES: only for temporary uses.

2 BRANCHED OUTLETS WITH CABLE AND PLUG: WIRED



GW 64 256

CONVERSION ADAPTOR SHUNT WITH 2 M OF FLEXIBLE CABLE: IEC 309 PLUG IP44 DOMESTIC SOCKETS / IEC 309 SOCKET-COUPLER IP44 - 50/60HZ



Code	Resid. socket-outlets 250V~	Socket-outlet IEC 309	Pack Carton
Plug IEC 309: 3P+N+E - 16A - 400V ac			
GW 64 256	N. 2 (P17/11) - N. 1 (P30-P17)	3P+N+T - 16 A - 400 V ac	1/3

CHARACTERISTICS: 2 domestic socket-outlets with Ø 4 / 5 mm plug pins (P17/11) and 1 domestic socket-outlet with Ø 4 / 4.8 / 5 mm plug pins (P30 - P17) with side and central earth control.

NOTES: only for temporary uses.



GW 64 263

CONVERSION ADAPTOR SHUNT WITH 2 M OF FLEXIBLE CABLE: PLUG FOR DOMESTIC USE / SOCKETS-OUTLETS FOR DOMESTIC USE / IEC 309 SOCKET-COUPLER IP44 - 50/60HZ



Code	Resid. socket-outlets 250V~	Socket-outlet IEC 309	Pack Carton
Domestic socket-outlet: 2P+E - 16A - 250V ac S17			
GW 64 263	N. 2 (P17/11) -N. 1 (P30-P17)	2P+E - 16A - 230V ac	1/6

CHARACTERISTICS: 2 domestic socket-outlets with Ø 4 / 5 mm plug pins (P17/11) and 1 domestic socket-outlet with Ø 4 / 4.8 / 5 mm plug pins (P30 - P17) with side and central earth control.

NOTES: only for temporary uses.

2 BRANCHED OUTLETS FITTED FOR CABLE AND PLUG



GW 64 265

CONVERSION ADAPTOR SHUNT: FITTING FOR 2+2 SYSTEM MODULES / IEC 309 SOCKET-COUPLER IP44 - 50/60HZ



Code	Housing for	Socket-outlet IEC 309	Pack Carton
GW 64 265	2+2	2P+E - 16A - 230V ac	5/20

ACCESSORIES SUPPLIED: wiring cables.

NOTES: only for temporary uses.



IEC 309 MA



Scan the QR Code and find out all the technical informations.

MOBILE MULTIPLIERS

MULTIPLE-SOCKET ADAPTORS

ADAPTORS AND BRACHED-ADAPTORS



The IEC 309 MA range has a number of different watertight mobile multiplier models available equipped with 2 or 3 outputs with or without cable. Available with screw wiring and with currents up to 32A.



3 versions that allow to meet even the most varied connection and power take-off requirements: configuration adaptors, current adaptors and phase inverters.



They can transform an industrial connection into a domestic connection and vice versa. Available with currents from 16A, pre-wired or just "prearranged" to allow the user to complete the configuration of the product depending on the specific needs.



INTERLOCKED SOCKET- OUTLETS IEC 309 STANDARD



67 IB

VERTICAL INTERLOCKED SOCKET-OUTLETS
IEC 309 STANDARD - IP66 / IP67

pag. 68



66 IB

VERTICAL INTERLOCKED SOCKET-OUTLETS
IEC 309 STANDARD FOR HEAVY DUTY - IP66

pag. 82



44 IB

HORIZONTAL PROTECTED INTERLOCKED
SOCKET-OUTLETS IEC 309 STANDARD











pag. 90















COMBIBLOC

COMPACT PROTECTED AND WATERTIGHT INTERLOCKED
SOCKET-OUTLETS IEC 309 STANDARD

pag. 96

				VERTICAL SOCKET-OUTLETS - 67 IB						VERTICAL SOCKET-OUTLETS FOR HEAVY DUTY USE - 66 IB		
												
Rated current In	Rated voltage Un	No. poles	Reference h.	Vertical socket-outlets with MCB, without bottom (AUTOMATIKA) IP66 / IP67	Vertical socket-outlets with MCB, with bottom (AUTOMATIKA) IP66 / IP67	Vertical socket-outlets with rotary switch, without bottom IP66 / IP67	Vertical socket-outlets with rotary switch, with bottom IP66 / IP67	Vertical socket-outlets with fuse-holder base, without bottom IP66 / IP67	Vertical socket-outlets with fuse-holder base, with bottom IP66 / IP67	Vertical socket-outlets with rotary switch, without bottom IP66	Vertical socket-outlets with rotary switch, with bottom IP66	Vertical socket-outlets with fuse-holder base, without bottom IP66
16 A	20 ÷ 25 V	2P	w.r.			GW 66 359 N	GW 66 259 N					GW 66 886
	100 ÷ 130 V	2P+E	4	GW 66 151 N	GW 66 051 N	GW 66 301 N	GW 66 201 N	GW 66 323 N	GW 66 223 N	GW 66 535	GW 66 501	GW 66 801
		3P+E	4	GW 66 152 N	GW 66 052 N	GW 66 302 N	GW 66 202 N	GW 66 324 N	GW 66 224 N	GW 66 536	GW 66 502	GW 66 802
		3P+N+E	4	GW 66 153 N	GW 66 053 N	GW 66 303 N	GW 66 203 N	GW 66 325 N	GW 66 225 N	GW 66 537	GW 66 503	GW 66 803
	200 ÷ 250 V	2P+E	6	GW 66 154 N	GW 66 054 N	GW 66 304 N	GW 66 204 N	GW 66 326 N	GW 66 226 N	GW 66 538	GW 66 504	GW 66 804
		3P+E	9	GW 66 155 N	GW 66 055 N	GW 66 305 N	GW 66 205 N	GW 66 327 N	GW 66 227 N	GW 66 539	GW 66 505	GW 66 805
		3P+N+E	9	GW 66 156 N	GW 66 056 N	GW 66 306 N	GW 66 206 N	GW 66 328 N	GW 66 228 N	GW 66 540	GW 66 506	GW 66 806
	380 ÷ 415 V	2P+E	9	GW 66 157 N	GW 66 057 N	GW 66 307 N	GW 66 207 N	GW 66 329 N	GW 66 229 N	GW 66 541	GW 66 507	GW 66 807
		3P+E	6	GW 66 158 N	GW 66 058 N	GW 66 308 N	GW 66 208 N	GW 66 330 N	GW 66 230 N	GW 66 542	GW 66 508	GW 66 808
		3P+N+E	6	GW 66 159 N	GW 66 059 N	GW 66 309 N	GW 66 209 N	GW 66 331 N	GW 66 231 N	GW 66 543	GW 66 509	GW 66 809
	480 ÷ 500 V	3P+E	7			GW 66 310 N	GW 66 210 N	GW 66 332 N	GW 66 232 N	GW 66 544	GW 66 510	GW 66 810
		3P+N+E	7			GW 66 311 N	GW 66 211 N	GW 66 333 N	GW 66 233 N	GW 66 545	GW 66 511	GW 66 811
32 A	100 ÷ 130 V	2P+E	4	GW 66 162 N	GW 66 062 N	GW 66 312 N	GW 66 212 N	GW 66 334 N	GW 66 234 N	GW 66 546	GW 66 512	GW 66 812
		3P+E	4	GW 66 163 N	GW 66 063 N	GW 66 313 N	GW 66 213 N	GW 66 335 N	GW 66 235 N	GW 66 547	GW 66 513	GW 66 813
		3P+N+E	4	GW 66 164 N	GW 66 064 N	GW 66 314 N	GW 66 214 N	GW 66 336 N	GW 66 236 N	GW 66 548	GW 66 514	GW 66 814
	200 ÷ 250 V	2P+E	6	GW 66 165 N	GW 66 065 N	GW 66 315 N	GW 66 215 N	GW 66 337 N	GW 66 237 N	GW 66 549	GW 66 515	GW 66 815
		3P+E	9	GW 66 166 N	GW 66 066 N	GW 66 316 N	GW 66 216 N	GW 66 338 N	GW 66 238 N	GW 66 550	GW 66 516	GW 66 816
		3P+N+E	9	GW 66 167 N	GW 66 067 N	GW 66 317 N	GW 66 217 N	GW 66 339 N	GW 66 239 N	GW 66 551	GW 66 517	GW 66 817
	380 ÷ 415 V	2P+E	9	GW 66 168 N	GW 66 068 N	GW 66 318 N	GW 66 218 N	GW 66 340 N	GW 66 240 N	GW 66 552	GW 66 518	GW 66 818
		3P+E	6	GW 66 169 N	GW 66 069 N	GW 66 319 N	GW 66 219 N	GW 66 341 N	GW 66 241 N	GW 66 553	GW 66 519	GW 66 819
		3P+N+E	6	GW 66 170 N	GW 66 070 N	GW 66 320 N	GW 66 220 N	GW 66 342 N	GW 66 242 N	GW 66 554	GW 66 520	GW 66 820
	480 ÷ 500 V	3P+E	7			GW 66 321 N	GW 66 221 N	GW 66 343 N	GW 66 243 N	GW 66 555	GW 66 521	GW 66 821
		3P+N+E	7			GW 66 322 N	GW 66 222 N	GW 66 344 N	GW 66 244 N	GW 66 556	GW 66 522	GW 66 822
	380/440 V	3P+E	3			GW 66 357 N	GW 66 257 N	GW 66 358 N	GW 66 258 N	GW 66 557	GW 66 523	GW 66 823
63 A	100 ÷ 130 V	2P+E	4			GW 67 356 N	GW 67 256 N	GW 66 345 N	GW 67 245 N		GW 66 524	
		3P+E	4			GW 67 357 N	GW 67 257 N	GW 66 346 N	GW 67 246 N		GW 66 525	
		3P+N+E	4			GW 67 358 N	GW 67 258 N	GW 66 347 N	GW 67 247 N		GW 66 526	
	200 ÷ 250 V	2P+E	6			GW 67 359 N	GW 67 259 N	GW 66 348 N	GW 67 248 N		GW 66 527	
		3P+E	9			GW 67 360 N	GW 67 260 N	GW 66 349 N	GW 67 249 N		GW 66 528	
		3P+N+E	9			GW 67 361 N	GW 67 261 N	GW 66 350 N	GW 67 250 N		GW 66 529	
	380 ÷ 415 V	2P+E	9			GW 67 362 N	GW 67 262 N	GW 66 351 N	GW 67 251 N		GW 66 530	
		3P+E	6			GW 67 363 N	GW 67 263 N	GW 66 352 N	GW 67 252 N		GW 66 531	
		3P+N+E	6			GW 67 364 N	GW 67 264 N	GW 66 353 N	GW 67 253 N		GW 66 532	
	480 ÷ 500 V	3P+E	7			GW 67 365 N	GW 67 265 N	GW 66 354 N	GW 67 254 N		GW 66 533	
		3P+N+E	7			GW 67 366 N	GW 67 266 N	GW 66 355 N	GW 67 255 N		GW 66 534	
											Vertical surface-mounting socket-outlets with electric interlock, with circuit breaker protection	
125 A	100 ÷ 130 V	3P+E	4								GW 66 581	
		3P+N+E	4								GW 66 582	
	200 ÷ 250 V	3P+E	9								GW 66 583	
		3P+N+E	9								GW 66 584	
	380 ÷ 415 V	3P+E	6								GW 66 585	
		3P+N+E	6								GW 66 586	

NOTE: interlocked sockets 63A equipped with pilot contact, interlocked sockets 125A equipped with 1NO clean contact.

VERTICAL SOCKET-OUTLETS FOR HEAVY DUTY USE - 66 IB			HORIZONTAL SOCKET-OUTLETS - 44 IB				COMPACT SOCKET-OUTLETS - COMBIBLOC				
											
Vertical socket-outlets with fuse-holder base, with bottom IP66	Vertical socket-outlets for modular devices, without bottom IP66	Vertical socket-outlets for modular devices, with bottom IP66	Horizontal socket-outlets with rotary switch, without bottom IP44	Horizontal socket-outlets with rotary switch, with bottom IP44	Horizontal socket-outlets with fuse-holder base, without bottom IP44	Horizontal socket-outlets with fuse-holder base, with bottom IP44	Compact socket-outlets with rotary switch, without bottom IP44	Compact socket-outlets with rotary switch, with bottom IP44	Compact socket-outlets with rotary switch, without bottom IP55	Compact socket-outlets with rotary switch, with bottom IP55	
GW 66 998											
GW 66 951	GW 66 824	GW 66 974	GW 66 101	GW 66 001	GW 66 123	GW 66 023	GW 66 423	GW 66 401	GW 66 467	GW 66 445	
GW 66 952	GW 66 825	GW 66 975	GW 66 102	GW 66 002	GW 66 124	GW 66 024	GW 66 424	GW 66 402	GW 66 468	GW 66 446	
GW 66 953	GW 66 826	GW 66 976	GW 66 103	GW 66 003	GW 66 125	GW 66 025	GW 66 425	GW 66 403	GW 66 469	GW 66 447	
GW 66 954	GW 66 827	GW 66 977	GW 66 104	GW 66 004	GW 66 126	GW 66 026	GW 66 426	GW 66 404	GW 66 470	GW 66 448	
GW 66 955	GW 66 828	GW 66 978	GW 66 105	GW 66 005	GW 66 127	GW 66 027	GW 66 427	GW 66 405	GW 66 471	GW 66 449	
GW 66 956	GW 66 829	GW 66 979	GW 66 106	GW 66 006	GW 66 128	GW 66 028	GW 66 428	GW 66 406	GW 66 472	GW 66 450	
GW 66 957	GW 66 830	GW 66 980	GW 66 107	GW 66 007	GW 66 129	GW 66 029	GW 66 429	GW 66 407	GW 66 473	GW 66 451	
GW 66 958	GW 66 831	GW 66 981	GW 66 108	GW 66 008	GW 66 130	GW 66 030	GW 66 430	GW 66 408	GW 66 474	GW 66 452	
GW 66 959	GW 66 832	GW 66 982	GW 66 109	GW 66 009	GW 66 131	GW 66 031	GW 66 431	GW 66 409	GW 66 475	GW 66 453	
GW 66 960	GW 66 833	GW 66 983	GW 66 110	GW 66 010	GW 66 132	GW 66 032					
GW 66 961	GW 66 834	GW 66 984	GW 66 111	GW 66 011	GW 66 133	GW 66 033					
GW 66 962	GW 66 835	GW 66 985	GW 66 112	GW 66 012	GW 66 134	GW 66 034	GW 66 434	GW 66 412	GW 66 478	GW 66 456	
GW 66 963	GW 66 836	GW 66 986	GW 66 113	GW 66 013	GW 66 135	GW 66 035	GW 66 435	GW 66 413	GW 66 479	GW 66 457	
GW 66 964	GW 66 837	GW 66 987	GW 66 114	GW 66 014	GW 66 136	GW 66 036	GW 66 436	GW 66 414	GW 66 480	GW 66 458	
GW 66 965	GW 66 838	GW 66 988	GW 66 115	GW 66 015	GW 66 137	GW 66 037	GW 66 437	GW 66 415	GW 66 481	GW 66 459	
GW 66 966	GW 66 839	GW 66 989	GW 66 116	GW 66 016	GW 66 138	GW 66 038	GW 66 438	GW 66 416	GW 66 482	GW 66 460	
GW 66 967	GW 66 840	GW 66 990	GW 66 117	GW 66 017	GW 66 139	GW 66 039	GW 66 439	GW 66 417	GW 66 483	GW 66 461	
GW 66 968	GW 66 841	GW 66 991	GW 66 118	GW 66 018	GW 66 140	GW 66 040	GW 66 440	GW 66 418	GW 66 484	GW 66 462	
GW 66 969	GW 66 842	GW 66 992	GW 66 119	GW 66 019	GW 66 141	GW 66 041	GW 66 441	GW 66 419	GW 66 485	GW 66 463	
GW 66 970	GW 66 843	GW 66 993	GW 66 120	GW 66 020	GW 66 142	GW 66 042	GW 66 442	GW 66 420	GW 66 486	GW 66 464	
GW 66 971	GW 66 844	GW 66 994	GW 66 121	GW 66 021	GW 66 143	GW 66 043					
GW 66 972	GW 66 845	GW 66 995	GW 66 122	GW 66 022	GW 66 144	GW 66 044					
GW 66 973	GW 66 846	GW 66 996									
GW 66 847		GW 66 866									
GW 66 848		GW 66 867									
GW 66 849		GW 66 868									
GW 66 850		GW 66 869									
GW 66 851		GW 66 870									
GW 66 852		GW 66 871									
GW 66 853		GW 66 872									
GW 66 854		GW 66 873									
GW 66 855		GW 66 874									
GW 66 856		GW 66 875									
GW 66 857		GW 66 876									
	Vertical surface-mounting socket-outlets with electric interlock with residual current circuit breaker protection										
GW 66 591											
GW 66 592											
GW 66 593											
GW 66 594											
GW 66 595											
GW 66 596											

		COMPLEMENTARY ITEMS								
		MODULAR BASES			DISTRIBUTION BOARDS					
										
		1 Socket-outlet	2 Socket-outlets	3 Socket-outlets	1 Socket-outlet	2 Socket-outlets	3 Socket-outlets		4 Socket-outlets	
67 IB VERTICAL RANGE		IP67 vertical socket-outlets with rotary switch, with fuse-holder base and AUTOMATIKA 16/32A and 24V (SELV)	GW 66 690	GW 66 691	GW 66 694		GW 68 025 N (10 modules)	GW 68 010 N (14 modules)	GW 68 022 N (20 modules) 1 socket-outlet 63A 2 socket-outlets 16/32A	GW 68 015 N (20 modules)
		IP67 vertical socket-outlets with rotary switch (SBF) or with fuse-holder base 63A (CBF)	GW 66 693							
66 IB RANGE FOR HEAVY-DUTY USE		IP66 vertical socket-outlets for heavy duty use 16/32A	GW 66 696	GW 66 697	GW 66 698					
		IP66 vertical socket-outlets for heavy duty 63A	GW 66 700							
COMBIBLOC RANGE		IP44/55 compact protected watertight socket-outlets - 16/32A				GW 66 491	GW 66 492	GW 66 493		
44 IB HORIZONTAL RANGE		IP44 horizontal socket-outlets, without fuse-holder base (SBF) 16/32A					GW 68 006 N (14 modules)			GW 68 009 N (14 modules)
		IP44 horizontal socket-outlets with fuse-holder base (CBF) 16/32A					GW 68 019 N (10 modules)			GW 68 014 N (20 modules)

COMPLEMENTARY ITEMS

MODULAR BASES WITH WINDOW PANEL			LID/BOXES			
 1 Socket-outlet	 2 Socket-outlets	 3 Socket-outlets	 Flanged lid	 Flush-mounting boxes (brick and plasterboard walls)	 Surface-mounting bottom	
			GW 66 709 N	GW 66 683 N* (for brick wall) GW 66 683 PM* (for plasterboard wall)	GW 66 678 N	 GW 27 401
					GW 66 686 (for SBF) GW 66 680 N (for CBF)	 GW 27 403
GW 66 781 (6 modules)	GW 66 782 (12 modules)	GW 66 783 (18 modules)	GW 66 707		GW 66 685	 IEC 309 HP Range
GW 66 784 (6 modules)						
				GW 66 498	GW 66 496	 Range IEC 309 BTS
				GW 66 681 (for brick wall) GW 66 681 PM (for plasterboard wall)	GW 66 676	 74 PS Range
				GW 66 682 (for brick wall) GW 66 682 PM (for plasterboard wall)	GW 66 677	

* Cannot be used for SELV 24V

IB

Interlocked socket-outlets IEC 309 standard

System of industrial socket-outlets for power distribution in the industrial and commercial sector, equipped with locking device, enabling the most varied professional requirements of installers and panel builder to be met. The IB range is composed of 4 product lines: IP67 standard vertical socket-outlets, IP66 vertical socket-outlets for heavy duty applications, IP44 horizontal socket-outlets and IP44 and IP55 compact socket-outlets.



67 IB - VERTICAL INTERLOCKED SOCKET-OUTLETS - IP66 / IP67

AUTOMATIKA - WITH CIRCUIT BREAKER PROTECTION (MCB), WITHOUT BOTTOM - IP66 / IP67



GW 66 170 N

AUTOMATIKA VERTICAL INTERLOCKED SOCKET-OUTLETS WITH MINIATURE CIRCUIT BREAKER MT 6KA C CHARACTERISTIC - 50/60HZ - IP66 / IP67

Code	No. of poles	Rated voltage	Colour	Reference h	Pack Carton
Rated current (A): 16					
GW 66 151 N	2P+E	100 - 130 V	Yellow	4	1/12
GW 66 152 N	3P+E	100 - 130 V	Yellow	4	1/12
GW 66 153 N	3P+N+E	100 - 130 V	Yellow	4	1/12
GW 66 154 N	2P+E	200 - 250 V	Blue	6	1/12
GW 66 155 N	3P+E	200 - 250 V	Blue	9	1/12
GW 66 156 N	3P+N+E	200 - 250 V	Blue	9	1/12
GW 66 157 N	2P+E	380 - 415 V	Red	9	1/12
GW 66 158 N	3P+E	380 - 415 V	Red	6	1/12
GW 66 159 N	3P+N+E	380 - 415 V	Red	6	1/12
Rated current (A): 32					
GW 66 162 N	2P+E	100 - 130 V	Yellow	4	1/12
GW 66 163 N	3P+E	100 - 130 V	Yellow	4	1/12
GW 66 164 N	3P+N+E	100 - 130 V	Yellow	4	1/12
GW 66 165 N	2P+E	200 - 250 V	Blue	6	1/12
GW 66 166 N	3P+E	200 - 250 V	Blue	9	1/12
GW 66 167 N	3P+N+E	200 - 250 V	Blue	9	1/12
GW 66 168 N	2P+E	380 - 415 V	Red	9	1/12
GW 66 169 N	3P+E	380 - 415 V	Red	6	1/12
GW 66 170 N	3P+N+E	380 - 415 V	Red	6	1/12

CHARACTERISTICS: the socket-outlets use the miniature circuit breaker for control and protection.

ACCESSORIES SUPPLIED: the interlocked sockets are supplied with LED on the front that indicate the operating status of the switch and the presence of voltage.

AUTOMATIKA - WITH CIRCUIT BREAKER PROTECTION (MCB), WITH BOTTOM - IP66 / IP67

GW 66 070 N

**AUTOMATIKA VERTICAL INTERLOCKED SOCKET-OUTLETS
WITH MINIATURE CIRCUIT BREAKER MT 6KA C CHARACTERISTIC - 50/60HZ - IP66 / IP67**

Code	No. of poles	Rated voltage	Colour	Reference h	Pack Carton
Rated current (A): 16					
GW 66 051 N	2P+E	100 - 130 V	Yellow	4	1/12
GW 66 052 N	3P+E	100 - 130 V	Yellow	4	1/12
GW 66 053 N	3P+N+E	100 - 130 V	Yellow	4	1/12
GW 66 054 N	2P+E	200 - 250 V	Blue	6	1/12
GW 66 055 N	3P+E	200 - 250 V	Blue	9	1/12
GW 66 056 N	3P+N+E	200 - 250 V	Blue	9	1/12
GW 66 057 N	2P+E	380 - 415 V	Red	9	1/12
GW 66 058 N	3P+E	380 - 415 V	Red	6	1/12
GW 66 059 N	3P+N+E	380 - 415 V	Red	6	1/12
Rated current (A): 32					
GW 66 062 N	2P+E	100 - 130 V	Yellow	4	1/12
GW 66 063 N	3P+E	100 - 130 V	Yellow	4	1/12
GW 66 064 N	3P+N+E	100 - 130 V	Yellow	4	1/12
GW 66 065 N	2P+E	200 - 250 V	Blue	6	1/12
GW 66 066 N	3P+E	200 - 250 V	Blue	9	1/12
GW 66 067 N	3P+N+E	200 - 250 V	Blue	9	1/12
GW 66 068 N	2P+E	380 - 415 V	Red	9	1/12
GW 66 069 N	3P+E	380 - 415 V	Red	6	1/12
GW 66 070 N	3P+N+E	380 - 415 V	Red	6	1/12

CHARACTERISTICS: the socket-outlets use the miniature circuit breaker for command and protection.

ACCESSORIES SUPPLIED: 4 screwcaps in insulating material, diam. 14/16mm. The interlocked sockets are supplied with LED on the front that indicate the operating status of the switch and the presence of voltage.

WITH ROTARY SWITCH, WITHOUT FUSE-HOLDER BASE (SBF), WITHOUT BOTTOM - IP66 / IP67



GW 66 357 N

INTERLOCKED VERTICAL SOCKET-OUTLETS WITH ROTARY SWITCH WITHOUT FUSE-HOLDER BASE WITHOUT BOTTOM - 50/60HZ - IP66 / IP67

Code	No. of poles	Rated voltage	Colour	Reference h	Pack Carton
Rated current (A): 16					
GW 66 301 N	2P+E	100 - 130 V	Yellow	4	1/12
GW 66 302 N	3P+E	100 - 130 V	Yellow	4	1/12
GW 66 303 N	3P+N+E	100 - 130 V	Yellow	4	1/12
GW 66 304 N	2P+E	200 - 250 V	Blue	6	1/12
GW 66 305 N	3P+E	200 - 250 V	Blue	9	1/12
GW 66 306 N	3P+N+E	200 - 250 V	Blue	9	1/12
GW 66 307 N	2P+E	380 - 415 V	Red	9	1/12
GW 66 308 N	3P+E	380 - 415 V	Red	6	1/12
GW 66 309 N	3P+N+E	380 - 415 V	Red	6	1/12
GW 66 310 N	3P+E	480 - 500 V	Black	7	1/12
GW 66 311 N	3P+N+E	480 - 500 V	Black	7	1/12
Rated current (A): 32					
GW 66 312 N	2P+E	100 - 130 V	Yellow	4	1/12
GW 66 313 N	3P+E	100 - 130 V	Yellow	4	1/12
GW 66 314 N	3P+N+E	100 - 130 V	Yellow	4	1/12
GW 66 315 N	2P+E	200 - 250 V	Blue	6	1/12
GW 66 316 N	3P+E	200 - 250 V	Blue	9	1/12
GW 66 317 N	3P+N+E	200 - 250 V	Blue	9	1/12
GW 66 318 N	2P+E	380 - 415 V	Red	9	1/12
GW 66 319 N	3P+E	380 - 415 V	Red	6	1/12
GW 66 320 N	3P+N+E	380 - 415 V	Red	6	1/12
GW 66 321 N	3P+E	480 - 500 V	Black	7	1/12
GW 66 322 N	3P+N+E	480 - 500 V	Black	7	1/12
GW 66 357 N	3P+E	380 - 440 V	Red	3	1/12



GW 67 364 N

INTERLOCKED SWITCHED VERTICAL SOCKET-OUTLETS WITHOUT BOTTOM - WITH ROTARY SWITCH WITHOUT FUSE-HOLDER BASE - 63A - 50/60HZ - IP66 / IP67

Code	No. of poles	Rated voltage	Colour	Reference h	Pack Carton
Rated current (A): 63					
GW 67 356 N	2P+E	100 - 130 V	Yellow	4	1/4
GW 67 357 N	3P+E	100 - 130 V	Yellow	4	1/4
GW 67 358 N	3P+N+E	100 - 130 V	Yellow	4	1/4
GW 67 359 N	2P+E	200 - 250 V	Blue	6	1/4
GW 67 360 N	3P+E	200 - 250 V	Blue	9	1/4
GW 67 361 N	3P+N+E	200 - 250 V	Blue	9	1/4
GW 67 362 N	2P+E	380 - 415 V	Red	9	1/4
GW 67 363 N	3P+E	380 - 415 V	Red	6	1/4
GW 67 364 N	3P+N+E	380 - 415 V	Red	6	1/4
GW 67 365 N	3P+E	480 - 500 V	Black	7	1/4
GW 67 366 N	3P+N+E	480 - 500 V	Black	7	1/4

CHARACTERISTICS: 63A versions equipped with a pilot contact.



GW 66 359 N

VERTICAL SOCKET-OUTLETS WITHOUT BOTTOM WITH SAFETY TRANSFORMER (SELV) 230/24V 50/60HZ - IP66 / IP67

Code	No. of poles	Output voltage	Colour	Rated power	Pack Carton
Rated current (A): 16					
GW 66 359 N	2P	20-25 V	Violet	160 VA	1/4

CHARACTERISTICS: the socket-outlet is equipped with a thermal protection device. If the device trips, extract the plug from the socket-outlet and check the applied load.

WITH ROTARY SWITCH, WITHOUT FUSE-HOLDER BASE (SBF), WITH BOTTOM - IP66 / IP67



GW 66 257 N

**INTERLOCKED VERTICAL SOCKET-OUTLETS WITH BOTTOM WITH ROTARY SWITCH
WITHOUT FUSE-HOLDER BASE - 50/60HZ - IP66 / IP67**

Code	No. of poles	Rated voltage	Colour	Reference h	Pack Carton
Rated current (A): 16					
GW 66 201 N	2P+E	100 - 130 V	Yellow	4	1/12
GW 66 202 N	3P+E	100 - 130 V	Yellow	4	1/12
GW 66 203 N	3P+N+E	100 - 130 V	Yellow	4	1/12
GW 66 204 N	2P+E	200 - 250 V	Blue	6	1/12
GW 66 205 N	3P+E	200 - 250 V	Blue	9	1/12
GW 66 206 N	3P+N+E	200 - 250 V	Blue	9	1/12
GW 66 207 N	2P+E	380 - 415 V	Red	9	1/12
GW 66 208 N	3P+E	380 - 415 V	Red	6	1/12
GW 66 209 N	3P+N+E	380 - 415 V	Red	6	1/12
GW 66 210 N	3P+E	480 - 500 V	Black	7	1/12
GW 66 211 N	3P+N+E	480 - 500 V	Black	7	1/12
Rated current (A): 32					
GW 66 212 N	2P+E	100 - 130 V	Yellow	4	1/12
GW 66 213 N	3P+E	100 - 130 V	Yellow	4	1/12
GW 66 214 N	3P+N+E	100 - 130 V	Yellow	4	1/12
GW 66 215 N	2P+E	200 - 250 V	Blue	6	1/12
GW 66 216 N	3P+E	200 - 250 V	Blue	9	1/12
GW 66 217 N	3P+N+E	200 - 250 V	Blue	9	1/12
GW 66 218 N	2P+E	380 - 415 V	Red	9	1/12
GW 66 219 N	3P+E	380 - 415 V	Red	6	1/12
GW 66 220 N	3P+N+E	380 - 415 V	Red	6	1/12
GW 66 221 N	3P+E	480 - 500 V	Black	7	1/12
GW 66 222 N	3P+N+E	480 - 500 V	Black	7	1/12
GW 66 257 N	3P+E	380 - 440 V	Red	3	1/12

ACCESSORIES SUPPLIED: 4 screwcaps in insulating material, diam. 14/16mm.



GW 67 264 N

**INTERLOCKED SWITCHED VERTICAL SOCKET-OUTLETS WITH BOTTOM AND ROTARY SWITCH
WITHOUT FUSE-HOLDER BASE - 63A - 50/60HZ - IP66 / IP67**

Code	No. of poles	Rated voltage	Colour	Reference h	Pack Carton
Rated current (A): 63					
GW 67 256 N	2P+E	100 - 130 V	Yellow	4	1/4
GW 67 257 N	3P+E	100 - 130 V	Yellow	4	1/4
GW 67 258 N	3P+N+E	100 - 130 V	Yellow	4	1/4
GW 67 259 N	2P+E	200 - 250 V	Blue	6	1/4
GW 67 260 N	3P+E	200 - 250 V	Blue	9	1/4
GW 67 261 N	3P+N+E	200 - 250 V	Blue	9	1/4
GW 67 262 N	2P+E	380 - 415 V	Red	9	1/4
GW 67 263 N	3P+E	380 - 415 V	Red	6	1/4
GW 67 264 N	3P+N+E	380 - 415 V	Red	6	1/4
GW 67 265 N	3P+E	480 - 500 V	Black	7	1/4
GW 67 266 N	3P+N+E	480 - 500 V	Black	7	1/4

ACCESSORIES SUPPLIED: 4 screwcaps in insulating material, diam. 25mm.

CHARACTERISTICS: 63A versions equipped with a pilot contact.



GW 66 259 N

**VERTICAL SOCKET-OUTLETS WITH BOTTOM
WITH SAFETY TRANSFORMER (SELV) 230/24V 50/60HZ - IP66 / IP67**

Code	No. of poles	Output voltage	Colour	Rated power	Pack Carton
Rated current (A): 16					
GW 66 259 N	2P	20-25 V	Violet	160 VA	1/4

CHARACTERISTICS: the socket-outlet is equipped with a thermal protection device. If the device trips, extract the plug from the socket-outlet and check the applied load.

ACCESSORIES SUPPLIED: 4 screwcaps in insulating material, diam. 14/16mm.

WITH ROTARY SWITCH AND FUSE-HOLDER BASE (CBF) WITHOUT BOTTOM - IP66 / IP67



GW 66 358 N

INTERLOCKED VERTICAL SOCKET-OUTLETS WITHOUT BOTTOM WITH ROTARY SWITCH AND FUSE-HOLDER BASE - 50/60HZ - IP66 / IP67

Code	No. of poles	Rated voltage	Colour	Type of fuse	Reference h	Pack Carton
Rated current (A): 16						
GW 66 323 N	2P+E	100 - 130 V	Yellow	Ø 10.3x38 mm	4	1/12
GW 66 324 N	3P+E	100 - 130 V	Yellow	Ø 10.3x38 mm	4	1/12
GW 66 325 N	3P+N+E	100 - 130 V	Yellow	Ø 10.3x38 mm	4	1/12
GW 66 326 N	2P+E	200 - 250 V	Blue	Ø 10.3x38 mm	6	1/12
GW 66 327 N	3P+E	200 - 250 V	Blue	Ø 10.3x38 mm	9	1/12
GW 66 328 N	3P+N+E	200 - 250 V	Blue	Ø 10.3x38 mm	9	1/12
GW 66 329 N	2P+E	380 - 415 V	Red	Ø 10.3x38 mm	9	1/12
GW 66 330 N	3P+E	380 - 415 V	Red	Ø 10.3x38 mm	6	1/12
GW 66 331 N	3P+N+E	380 - 415 V	Red	Ø 10.3x38 mm	6	1/12
GW 66 332 N	3P+E	480 - 500 V	Black	Ø 10.3x38 mm	7	1/12
GW 66 333 N	3P+N+E	480 - 500 V	Black	Ø 10.3x38 mm	7	1/12
Rated current (A): 32						
GW 66 334 N	2P+E	100 - 130 V	Yellow	Ø 10.3x38 mm	4	1/12
GW 66 335 N	3P+E	100 - 130 V	Yellow	Ø 10.3x38 mm	4	1/12
GW 66 336 N	3P+N+E	100 - 130 V	Yellow	Ø 10.3x38 mm	4	1/12
GW 66 337 N	2P+E	200 - 250 V	Blue	Ø 10.3x38 mm	6	1/12
GW 66 338 N	3P+E	200 - 250 V	Blue	Ø 10.3x38 mm	9	1/12
GW 66 339 N	3P+N+E	200 - 250 V	Blue	Ø 10.3x38 mm	9	1/12
GW 66 340 N	2P+E	380 - 415 V	Red	Ø 10.3x38 mm	9	1/12
GW 66 341 N	3P+E	380 - 415 V	Red	Ø 10.3x38 mm	6	1/12
GW 66 342 N	3P+N+E	380 - 415 V	Red	Ø 10.3x38 mm	6	1/12
GW 66 343 N	3P+E	480 - 500 V	Black	Ø 10.3x38 mm	7	1/12
GW 66 344 N	3P+N+E	480 - 500 V	Black	Ø 10.3x38 mm	7	1/12
GW 66 358 N	3P+E	380 - 440 V	Red	Ø 10.3x38 mm	3	1/12

NOTES:

fuses to be purchased separately. Measures for protection of person against electric shock by enclosures.



GW 66 353 N

INTERLOCKED SWITCHED VERTICAL SOCKET-OUTLETS WITHOUT BOTTOM - WITH ROTARY SWITCH AND FUSE-HOLDER BASE - 63A - 50/60HZ - IP66 / IP67

Code	No. of poles	Rated voltage	Colour	Type of fuse	Reference h	Pack Carton
Rated current (A): 63						
GW 66 345 N	2P+E	100 - 130 V	Yellow	Ø 22x58 mm	4	1/4
GW 66 346 N	3P+E	100 - 130 V	Yellow	Ø 22x58 mm	4	1/4
GW 66 347 N	3P+N+E	100 - 130 V	Yellow	Ø 22x58 mm	4	1/4
GW 66 348 N	2P+E	200 - 250 V	Blue	Ø 22x58 mm	6	1/4
GW 66 349 N	3P+E	200 - 250 V	Blue	Ø 22x58 mm	9	1/4
GW 66 350 N	3P+N+E	200 - 250 V	Blue	Ø 22x58 mm	9	1/4
GW 66 351 N	2P+E	380 - 415 V	Red	Ø 22x58 mm	9	1/4
GW 66 352 N	3P+E	380 - 415 V	Red	Ø 22x58 mm	6	1/4
GW 66 353 N	3P+N+E	380 - 415 V	Red	Ø 22x58 mm	6	1/4
GW 66 354 N	3P+E	480 - 500 V	Black	Ø 22x58 mm	7	1/4
GW 66 355 N	3P+N+E	480 - 500 V	Black	Ø 22x58 mm	7	1/4

NOTES: fuses to be purchased separately. Measures for protection of person against electric shock by enclosures.

CHARACTERISTICS: 63A versions equipped with a pilot contact.

WITH ROTARY SWITCH AND FUSE-HOLDER BASE (CBF) WITH BOTTOM - IP66 / IP67



GW 66 258 N

INTERLOCKED VERTICAL SOCKET-OUTLETS WITH BOTTOM WITH ROTARY SWITCH AND FUSE-HOLDER BASE - 50/60HZ - IP66 / IP67

Code	No. of poles	Rated voltage	Colour	Type of fuse	Reference h	Pack Carton
Rated current (A): 16						
GW 66 223 N	2P+E	100 - 130 V	Yellow	Ø 10.3x38 mm	4	1/12
GW 66 224 N	3P+E	100 - 130 V	Yellow	Ø 10.3x38 mm	4	1/12
GW 66 225 N	3P+N+E	100 - 130 V	Yellow	Ø 10.3x38 mm	4	1/12
GW 66 226 N	2P+E	200 - 250 V	Blue	Ø 10.3x38 mm	6	1/12
GW 66 227 N	3P+E	200 - 250 V	Blue	Ø 10.3x38 mm	9	1/12
GW 66 228 N	3P+N+E	200 - 250 V	Blue	Ø 10.3x38 mm	9	1/12
GW 66 229 N	2P+E	380 - 415 V	Red	Ø 10.3x38 mm	9	1/12
GW 66 230 N	3P+E	380 - 415 V	Red	Ø 10.3x38 mm	6	1/12
GW 66 231 N	3P+N+E	380 - 415 V	Red	Ø 10.3x38 mm	6	1/12
GW 66 232 N	3P+E	480 - 500 V	Black	Ø 10.3x38 mm	7	1/12
GW 66 233 N	3P+N+E	480 - 500 V	Black	Ø 10.3x38 mm	7	1/12
Rated current (A): 32						
GW 66 234 N	2P+E	100 - 130 V	Yellow	Ø 10.3x38 mm	4	1/12
GW 66 235 N	3P+E	100 - 130 V	Yellow	Ø 10.3x38 mm	4	1/12
GW 66 236 N	3P+N+E	100 - 130 V	Yellow	Ø 10.3x38 mm	4	1/12
GW 66 237 N	2P+E	200 - 250 V	Blue	Ø 10.3x38 mm	6	1/12
GW 66 238 N	3P+E	200 - 250 V	Blue	Ø 10.3x38 mm	9	1/12
GW 66 239 N	3P+N+E	200 - 250 V	Blue	Ø 10.3x38 mm	9	1/12
GW 66 240 N	2P+E	380 - 415 V	Red	Ø 10.3x38 mm	9	1/12
GW 66 241 N	3P+E	380 - 415 V	Red	Ø 10.3x38 mm	6	1/12
GW 66 242 N	3P+N+E	380 - 415 V	Red	Ø 10.3x38 mm	6	1/12
GW 66 243 N	3P+E	480 - 500 V	Black	Ø 10.3x38 mm	7	1/12
GW 66 244 N	3P+N+E	480 - 500 V	Black	Ø 10.3x38 mm	7	1/12
GW 66 258 N	3P+E	380 - 440 V	Red	Ø 10.3x38 mm	3	1/12

ACCESSORIES SUPPLIED: 4 screwcaps in insulating material, diam. 14/16mm.

NOTES: Fuses to be purchased separately. Measures for protection of person against electric shock by enclosures.



GW 67 253 N

INTERLOCKED SWITCHED VERTICAL SOCKET-OUTLETS WITH BOTTOM - WITH ROTARY SWITCH AND FUSE-HOLDER BASE - 63A - 50/60HZ - IP66 / IP67

Code	No. of poles	Rated voltage	Colour	Type of fuse	Reference h	Pack Carton
Rated current (A): 63						
GW 67 245 N	2P+E	100 - 130 V	Yellow	Ø 22x58 mm	4	1/4
GW 67 246 N	3P+E	100 - 130 V	Yellow	Ø 22x58 mm	4	1/4
GW 67 247 N	3P+N+E	100 - 130 V	Yellow	Ø 22x58 mm	4	1/4
GW 67 248 N	2P+E	200 - 250 V	Blue	Ø 22x58 mm	6	1/4
GW 67 249 N	3P+E	200 - 250 V	Blue	Ø 22x58 mm	9	1/4
GW 67 250 N	3P+N+E	200 - 250 V	Blue	Ø 22x58 mm	9	1/4
GW 67 251 N	2P+E	380 - 415 V	Red	Ø 22x58 mm	9	1/4
GW 67 252 N	3P+E	380 - 415 V	Red	Ø 22x58 mm	6	1/4
GW 67 253 N	3P+N+E	380 - 415 V	Red	Ø 22x58 mm	6	1/4
GW 67 254 N	3P+E	480 - 500 V	Black	Ø 22x58 mm	7	1/4
GW 67 255 N	3P+N+E	480 - 500 V	Black	Ø 22x58 mm	7	1/4

ACCESSORIES SUPPLIED: 4 screwcaps in insulating material, diam. 25mm.

NOTES: fuses to be purchased separately. Measures for protection of person against electric shock by enclosures.

CHARACTERISTICS: 63A versions equipped with a pilot contact.

COMPONENTS FOR VERTICAL SOCKET-OUTLETS IP66 / IP67



GW 66 678 N

SURFACE-MOUNTING BOXES FOR VERTICAL SOCKET-OUTLETS - 16/32A - IP66 / IP67

Code	Houseable interloc. socket	Houseable IB socket-outlets	Top entries	Bottom entries	Pack Carton
GW 66 678 N	1	16/32 A	2xØ 23	1xØ 29/37	1/12

NOTES: GW66678N for socket-outlets with rotary (SBF), with fuse-holder base (CBF) and Automatika 16-32A. Kit of screwcaps GW44622 and wall fixing brackets GW46621 (for double insulation) to be purchased separately.



GW 66 686

SURFACE-MOUNTING BOXES FOR VERTICAL SOCKET-OUTLETS - 63A - SBF - IP66 / IP67

Code	Houseable interloc. socket	Houseable IB socket-outlets	Top entries	Bottom entries	Pack Carton
GW 66 686	1	63 A	2xØ 29/37	1xØ 37/47	1/10

NOTES: Kit of screwcaps GW44623 and wall fixing brackets GW46621 (for double insulation) to be purchased separately.



GW 66 680 N

SURFACE-MOUNTING BOX FOR VERTICAL SOCKET-OUTLETS - 63A - CBF - IP66 / IP67

Code	Houseable interloc. socket	Houseable IB socket-outlets	Top entries	Bottom entries	Pack Carton
GW 66 680 N	1	63A	2xØ 29/37	1xØ 37/47	1/10

NOTES: Kit of screwcaps GW44623 and wall fixing brackets GW46621 (for double insulation) to be purchased separately.

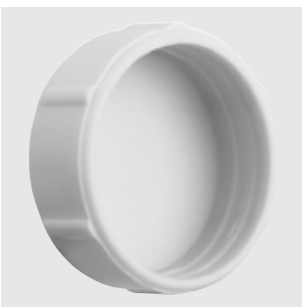

GW 44 622

INSULATING SCREW CAPS

Code	Description	Characteristics	Pack Carton
GW 44 622	Screwcap Ø16mm	Halogen free	10/100
GW 44 623	Screwcap Ø25mm	Halogen free	10/100

APPLICATIONS: used to maintain the double insulation and the original IP degree of protection of the boxes, containers and other GEWISS products.



GW 44 621

WALL FIXING BRACKET, COMPLETE WITH SELF-TAPPING SCREWS

Code	Characteristics	Pack Carton
GW 44 621	Halogen free	40/480

APPLICATIONS: used to maintain the double insulation and the original IP degree of protection of the boxes, containers and other GEWISS products.
ACCESSORIES SUPPLIED: 2 fixing screws.



GW 66 741 N

SURFACE-MOUNTING BOX WITH FLANGED LID PREARRANGED FOR 2 CAPS - IP66 / IP67

Code	Houseable IB socket-outlets	Top entries	Bottom entries	Pack Carton
GW 66 741 N	N. 1 IEC 309 16-32A IP44/67 + N.1 16A MAX 3P+E or GW27401/GW27403	2xØ 23	1xØ 29/37	1/10

APPLICATIONS: The flange of 85x75 mm dimension is suited for mounting IEC 309 16 A socket-outlets and COMBI-IN GW27401 and GW27403 watertight covers; The flange of 95x80 mm dimension is suited for IEC 309 16 -32 A socket-outlets.
ACCESSORIES SUPPLIED: 1 blank flange - blue - 16 A, 1 blank flange - blue 16 -32 A, 3 gaskets and fixing screws.



GW 66 742

SURFACE-MOUNTING BOX WITH FLANGED COVER FITTED FOR 2 LIDS - IP55

Code	Flange dimensions (mm)	Top entries	Bottom entries	Pack Carton
GW 66 742	85x75 - 95x80	2xØ 23	1xØ 29/37	1/10

APPLICATIONS: 75x85 mm dimension is suited for mounting IEC309 16A devices or GW27401 COMBI-IN weatherproof cover.
 80x95 mm dimension is suited for mounting IEC309 32A devices.

ACCESSORIES SUPPLIED: blank cap 32A, 2 gaskets and mounting screws.



GW 66 690

MODULAR BASES FOR MOUNTING COMBINATIONS OF FIXED VERTICAL SOCKET-OUTLETS - IP55

Code	Houseable interloc. socket	Houseable IB socket-outlets	Side entries	Top entries	Bottom entries	Pack Carton
GW 66 690	1	16/32 A	2xØ 23	2xØ 23	-	1/6
GW 66 691	2	16/32 A	4xØ 23	4xØ 23	1xØ 29	1/6
GW 66 694	3	16/32 A	2xØ 23	5xØ 23	-	1/6
GW 66 693	1	63 A	6xØ 23	2xØ 37/48	-	1/6

NOTES: the bases for 16-32A can house interlocked switched socket-outlets with rotary (SBF), fuse-holder base (CBF) or Automatika.

ACCESSORIES SUPPLIED: 1 coupling device for combined assembly and 4 screwcaps for restoring double insulation.

GW66694: 1 blank lid for closing the socket-outlet compartment.

GW66693: already supplied with adapter for new 67IB 63A socket-outlets SBF/CBF.



GW 66 683 N

BOX WITH FRAME FOR THE FLUSH-MOUNTING ASSEMBLY OF FIXED VERTICAL SOCKET-OUTLETS - IP55

Code	Houseable interloc. socket	Houseable IB socket-outlets	Characteristics	Pack Carton
GW 66 683 N	1	16/32 A SBF / CBF / Automatika	For brick wall	1/10

NOTES: the box cannot house the version with a 24 V transformer.



GW 66 683 PM

BOX WITH FRAME FOR LIGHTWEIGHT AND PLASTERBOARD WALLS, FOR THE FLUSH-MOUNTING ASSEMBLY OF VERTICAL SOCKET-OUTLETS - IP55

Code	Houseable interloc. socket	Houseable IB socket-outlets	Characteristics	Pack Carton
GW 66 683 PM	1	16/32 A SBF / CBF / Automatika	For plasterboard	1/10

NOTES: the box cannot house the version with a 24V transformer.

Halogen-free casing, in accordance with EN 60754-2.

Casing type H in accordance with EN 60670-1, and type Ha in accordance with IEC 60670-1.

GWT 850°C according to EN 60695-2-11.

CHARACTERISTICS: locators for tracing the wall along the edges of the box; box equipped with tabs for direct fixing on panels or a metal structure, for lightweight and plasterboard walls.

ACCESSORIES SUPPLIED: self-tapping screw kit ø 4x45mm.



GW 66 743 N

BOXES WITH FRAME FOR FLUSH-MOUNTING WITH FLANGED COVER FITTED FOR 2 LIDS - IP55

Code	Houseable IB socket-outlets	Pack Carton
GW 66 743 N	N. 1 IEC 309 16-32A IP44/67 + N.1 16A MAX 3P+E or GW27401/GW27403	1/10

APPLICATIONS: the flange of 85x75 mm dimension is suited for mounting IEC 309 16 A socket-outlets and COMBI-IN GW27401 and GW27403 flange; the flange of 95x80 mm dimension is suited for IEC 309 16 -32 A socket-outlets.

ACCESSORIES SUPPLIED: 1 blank flange - blue - 16 A; 1 blank flange - blue 16 -32 A; 3 gaskets and fixing screws.



GW 66 703 N

BLANK LID FOR CLOSING INTERLOCKED SOCKET-OUTLET COMPARTMENT 16- 32A - IP65

Code	Description	Pack Carton
GW 66 703 N	Lid for vertical interlocked socket-outlet 16-32A	1/10
GW 66 705 N	Lid for vertical interlocked socket-outlet 63A	1/10

APPLICATIONS: also compatible with flush-mounting boxes for brick walls (code GW66683N) and lightweight and plasterboard walls (code GW66683PM).



GW 66 709 N

FLANGED LID PREARRANGED FOR 2 CAPS - IP67

Code	Houseable IB socket-outlets	Pack Carton
GW 66 709 N	N. 1 IEC 309 16-32A IP44/67 + N.1 16A MAX 3P+E or GW27401/GW27403	1/10

APPLICATIONS: the flange of 85x75 mm dimension is suited for mounting IEC 309 16 A socket-outlets and COMBI-IN GW27401 and GW27403 flange; the flange of 95x80 mm dimension is suited for IEC 309 16 -32 A socket-outlets.

ACCESSORIES SUPPLIED: 1 blank flange - blue - 16 A; 1 blank flange - blue 16 -32 A; 3 gaskets and fixing screws.



GW 66 715 N

ADAPTER FLANGE IP65

Code	Suitable for	Pack Carton
GW 66 715 N	IP67 16/32A vertical socket-outlets	1/10
GW 66 716 N	IP67 63A Vertical socket-outlets	1/10

APPLICATIONS: GW66715N to assemble all the vertical socket-outlets 16-32A IP67 of the 67 IB range on the Q-DIN boards, or on the modular bases of the previous versions for socket-outlets 16-32A CBF IP55.

GW66716N to assemble the vertical socket-outlets 63A IP67 of the 67 IB range on the modular bases of the previous versions for socket-outlets 63A CBF IP55.

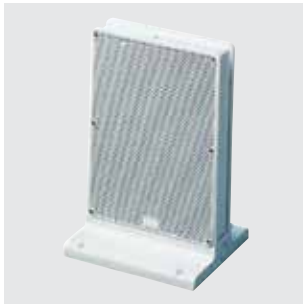

GW 68 441

DISTRIBUTION PILLAR FOR FLOOR-MOUNTING AND WORK SURFACES - IP55

Code	Outer dim. LxHxD (mm)	Houseable IB socket-outlets	Installable Q-DIN boards	Characteristics	Pack Carton
GW 68 441	200x295x180	16/32 A	Q-DIN 5	Halogen free	1/6

CHARACTERISTICS: double-sided panels double-sided panels with smooth or honeycomb surface for fixing interlocked switched socket-outlets 16/32A of the IB range: Combibloc, horizontal IP44 with bottom and vertical IP67 with bottom.

DISTRIBUTION BOARDS FOR VERTICAL SOCKET-OUTLETS - IP65



GW 68 025N



GW 68 010N



GW 68 015N



GW 68 022N



GW 68 025 N

Q-DIN 10/14/20 WATERTIGHT BOARDS - UNWIRED - RAL 7035 - IP65

Code	No. IB socket-outlets houseable	No. of provided blank lids	Dispersible power A (W)	Dispersible power B (W)	Pack Carton
No. of modules EN 50022: 10					
GW 68 025 N	2 IB Vert. 16-32A IP67	1 IB 16/32A	16	42	6
No. of modules EN 50022: 14					
GW 68 010 N	3 IB Vert. 16/32A IP67	1 IB 16/32A	24	64	3
No. of modules EN 50022: 20					
GW 68 015 N	4IB 16/32A IP67 + 4 IEC MAX 3P+E 16A	2 IB 16/32A + 4 IEC 16A	30	92	2
GW 68 022 N	1 IB Vert. 63A IP67 + 2 IB Vert. 16/32A IP67	1 IB 16/32A	30	92	2

ACCESSORIES SUPPLIED: cable clamp and 4/6 screwcaps.

NOTES: dispersible power (B) is calculated according to IEC 60890 standard. It refers to the 40K overtemperature, between the temperature inside and outside the board.

GW68015N: the 4 flanges - measuring 85x75 - can be equipped with the COMBI-IN GW27401 and GW27403 watertight covers.

The IP65 degree of protection is obtained with blank flange lid installed correctly on all the seats of the unwired board.

External dimensions GW68025N (LxHxD): 220x435x96.

External dimensions GW68010N (LxHxD): 320x360x120.

External dimensions GW68015N and GW68022N (LxHxD): 450x560x120.

66 IB - HEAVY DUTY, VERTICAL WATERTIGHT INTERLOCKED SOCKET-OUTLETS

WITHOUT BOTTOM AND WITHOUT FUSE-HOLDER BASE - IP66



GW 66 542

VERTICAL INTERLOCKED SOCKET-OUTLETS - 50/60HZ

Code	No. of poles	Rated voltage	Colour	Reference h	Pack Carton
Rated current (A): 16					
GW 66 535	2P+E	100 - 130 V	Yellow	4	1/6
GW 66 536	3P+E	100 - 130 V	Yellow	4	1/6
GW 66 537	3P+N+E	100 - 130 V	Yellow	4	1/6
GW 66 538	2P+E	200 - 250 V	Blue	6	1/6
GW 66 539	3P+E	200 - 250 V	Blue	9	1/6
GW 66 540	3P+N+E	200 - 250 V	Blue	9	1/6
GW 66 541	2P+E	380 - 415 V	Red	9	1/6
GW 66 542	3P+E	380 - 415 V	Red	6	1/6
GW 66 543	3P+N+E	380 - 415 V	Red	6	1/6
GW 66 544	3P+E	480 - 500 V	Black	7	1/6
GW 66 545	3P+N+E	480 - 500 V	Black	7	1/6
Rated current (A): 32					
GW 66 546	2P+E	100 - 130 V	Yellow	4	1/6
GW 66 547	3P+E	100 - 130 V	Yellow	4	1/6
GW 66 548	3P+N+E	100 - 130 V	Yellow	4	1/6
GW 66 549	2P+E	200 - 250 V	Blue	6	1/6
GW 66 550	3P+E	200 - 250 V	Blue	9	1/6
GW 66 551	3P+N+E	200 - 250 V	Blue	9	1/6
GW 66 552	2P+E	380 - 415 V	Red	9	1/6
GW 66 553	3P+E	380 - 415 V	Red	6	1/6
GW 66 554	3P+N+E	380 - 415 V	Red	6	1/6
GW 66 555	3P+E	480 - 500 V	Black	7	1/6
GW 66 556	3P+N+E	480 - 500 V	Black	7	1/6
GW 66 557	3P+E	380 - 440 V	Red	3	1/6

CHARACTERISTICS: IK10, in compliance with EN 62262.

WITH BOTTOM AND WITHOUT FUSE-HOLDER BASE - IP66

GW 66 508

VERTICAL INTERLOCKED SOCKET-OUTLETS - 50/60HZ

Code	No. of poles	Rated voltage	Colour	Reference h	Pack Carton
Rated current (A): 16					
GW 66 501	2P+E	100 - 130 V	Yellow	4	1/6
GW 66 502	3P+E	100 - 130 V	Yellow	4	1/6
GW 66 503	3P+N+E	100 - 130 V	Yellow	4	1/6
GW 66 504	2P+E	200 - 250 V	Blue	6	1/6
GW 66 505	3P+E	200 - 250 V	Blue	9	1/6
GW 66 506	3P+N+E	200 - 250 V	Blue	9	1/6
GW 66 507	2P+E	380 - 415 V	Red	9	1/6
GW 66 508	3P+E	380 - 415 V	Red	6	1/6
GW 66 509	3P+N+E	380 - 415 V	Red	6	1/6
GW 66 510	3P+E	480 - 500 V	Black	7	1/6
GW 66 511	3P+N+E	480 - 500 V	Black	7	1/6
Rated current (A): 32					
GW 66 512	2P+E	100 - 130 V	Yellow	4	1/6
GW 66 513	3P+E	100 - 130 V	Yellow	4	1/6
GW 66 514	3P+N+E	100 - 130 V	Yellow	4	1/6
GW 66 515	2P+E	200 - 250 V	Blue	6	1/6
GW 66 516	3P+E	200 - 250 V	Blue	9	1/6
GW 66 517	3P+N+E	200 - 250 V	Blue	9	1/6
GW 66 518	2P+E	380 - 415 V	Red	9	1/6
GW 66 519	3P+E	380 - 415 V	Red	6	1/6
GW 66 520	3P+N+E	380 - 415 V	Red	6	1/6
GW 66 521	3P+E	480 - 500 V	Black	7	1/6
GW 66 522	3P+N+E	480 - 500 V	Black	7	1/6
GW 66 523	3P+E	380 - 440 V	Red	3	1/6
Rated current (A): 63					
GW 66 524	2P+E	100 - 130 V	Yellow	4	1/3
GW 66 525	3P+E	100 - 130 V	Yellow	4	1/3
GW 66 526	3P+N+E	100 - 130 V	Yellow	4	1/3
GW 66 527	2P+E	200 - 250 V	Blue	6	1/3
GW 66 528	3P+E	200 - 250 V	Blue	9	1/3
GW 66 529	3P+N+E	200 - 250 V	Blue	9	1/3
GW 66 530	2P+E	380 - 415 V	Red	9	1/3
GW 66 531	3P+E	380 - 415 V	Red	6	1/3
GW 66 532	3P+N+E	380 - 415 V	Red	6	1/3
GW 66 533	3P+E	480 - 500 V	Black	7	1/3
GW 66 534	3P+N+E	480 - 500 V	Black	7	1/3

CHARACTERISTICS: IK10, in compliance with EN 62262. 63A versions equipped with a pilot contact.

WITHOUT BOTTOM FOR MOUNTING MODULAR DEVICES - IP66



GW 66 831

VERTICAL INTERLOCKED SOCKET-OUTLETS FOR MOUNTING MODULAR DEVICES - 50/60HZ

Code	No. of poles	Rated voltage	Colour	Reference h	Pack Carton
Rated current (A): 16					
GW 66 824	2P+E	100 - 130 V	Yellow	4	1/6
GW 66 825	3P+E	100 - 130 V	Yellow	4	1/6
GW 66 826	3P+N+E	100 - 130 V	Yellow	4	1/6
GW 66 827	2P+E	200 - 250 V	Blue	6	1/6
GW 66 828	3P+E	200 - 250 V	Blue	9	1/6
GW 66 829	3P+N+E	200 - 250 V	Blue	9	1/6
GW 66 830	2P+E	380 - 415 V	Red	9	1/6
GW 66 831	3P+E	380 - 415 V	Red	6	1/6
GW 66 832	3P+N+E	380 - 415 V	Red	6	1/6
GW 66 833	3P+E	480 - 500 V	Black	7	1/6
GW 66 834	3P+N+E	480 - 500 V	Black	7	1/6
Rated current (A): 32					
GW 66 835	2P+E	100 - 130 V	Yellow	4	1/6
GW 66 836	3P+E	100 - 130 V	Yellow	4	1/6
GW 66 837	3P+N+E	100 - 130 V	Yellow	4	1/6
GW 66 838	2P+E	200 - 250 V	Blue	6	1/6
GW 66 839	3P+E	200 - 250 V	Blue	9	1/6
GW 66 840	3P+N+E	200 - 250 V	Blue	9	1/6
GW 66 841	2P+E	380 - 415 V	Red	9	1/6
GW 66 842	3P+E	380 - 415 V	Red	6	1/6
GW 66 843	3P+N+E	380 - 415 V	Red	6	1/6
GW 66 844	3P+E	480 - 500 V	Black	7	1/6
GW 66 845	3P+N+E	480 - 500 V	Black	7	1/6
GW 66 846	3P+E	380 - 440 V	Red	3	1/6

CHARACTERISTICS: pre-arrangement for 6 DIN EN 50022 modules. IK10, in compliance with EN 62262.

WITH BOTTOM FOR MOUNTING MODULAR DEVICES - IP66

GW 66 981

VERTICAL INTERLOCKED SOCKET-OUTLETS FOR MOUNTING MODULAR DEVICES - 50/60HZ

Code	No. of poles	Rated voltage	Colour	Reference h	Pack Carton
Rated current (A): 16					
GW 66 974	2P+E	100 - 130 V	Yellow	4	1/6
GW 66 975	3P+E	100 - 130 V	Yellow	4	1/6
GW 66 976	3P+N+E	100 - 130 V	Yellow	4	1/6
GW 66 977	2P+E	200 - 250 V	Blue	6	1/6
GW 66 978	3P+E	200 - 250 V	Blue	9	1/6
GW 66 979	3P+N+E	200 - 250 V	Blue	9	1/6
GW 66 980	2P+E	380 - 415 V	Red	9	1/6
GW 66 981	3P+E	380 - 415 V	Red	6	1/6
GW 66 982	3P+N+E	380 - 415 V	Red	6	1/6
GW 66 983	3P+E	480 - 500 V	Black	7	1/6
GW 66 984	3P+N+E	480 - 500 V	Black	7	1/6
Rated current (A): 32					
GW 66 985	2P+E	100 - 130 V	Yellow	4	1/6
GW 66 986	3P+E	100 - 130 V	Yellow	4	1/6
GW 66 987	3P+N+E	100 - 130 V	Yellow	4	1/6
GW 66 988	2P+E	200 - 250 V	Blue	6	1/6
GW 66 989	3P+E	200 - 250 V	Blue	9	1/6
GW 66 990	3P+N+E	200 - 250 V	Blue	9	1/6
GW 66 991	2P+E	380 - 415 V	Red	9	1/6
GW 66 992	3P+E	380 - 415 V	Red	6	1/6
GW 66 993	3P+N+E	380 - 415 V	Red	6	1/6
GW 66 994	3P+E	480 - 500 V	Black	7	1/6
GW 66 995	3P+N+E	480 - 500 V	Black	7	1/6
GW 66 996	3P+E	380 - 440 V	Red	3	1/6
Rated current (A): 63					
GW 66 866	2P+E	100 - 130 V	Yellow	4	1/3
GW 66 867	3P+E	100 - 130 V	Yellow	4	1/3
GW 66 868	3P+N+E	100 - 130 V	Yellow	4	1/3
GW 66 869	2P+E	200 - 250 V	Blue	6	1/3
GW 66 870	3P+E	200 - 250 V	Blue	9	1/3
GW 66 871	3P+N+E	200 - 250 V	Blue	9	1/3
GW 66 872	2P+E	380 - 415 V	Red	9	1/3
GW 66 873	3P+E	380 - 415 V	Red	6	1/3
GW 66 874	3P+N+E	380 - 415 V	Red	6	1/3
GW 66 875	3P+E	480 - 500 V	Black	7	1/3
GW 66 876	3P+N+E	480 - 500 V	Black	7	1/3

CHARACTERISTICS: pre-arrangement for 6 DIN EN 50022 modules. IK10, in compliance with EN 62262. 63A versions equipped with a pilot contact.

WITHOUT BOTTOM WITH FUSE HOLDER BASE - IP66



GW 66 808

VERTICAL INTERLOCKED SOCKET-OUTLETS AND FUSE HOLDER BASE - 50/60HZ

Code	No. of poles	Rated voltage	Colour	Type of fuse	Reference h	Pack Carton
Rated current (A): 16						
GW 66 801	2P+E	100 - 130 V	Yellow	Ø 10.3x38 mm	4	1/6
GW 66 802	3P+E	100 - 130 V	Yellow	Ø 10.3x38 mm	4	1/6
GW 66 803	3P+N+E	100 - 130 V	Yellow	Ø 10.3x38 mm	4	1/6
GW 66 804	2P+E	200 - 250 V	Blue	Ø 10.3x38 mm	6	1/6
GW 66 805	3P+E	200 - 250 V	Blue	Ø 10.3x38 mm	9	1/6
GW 66 806	3P+N+E	200 - 250 V	Blue	Ø 10.3x38 mm	9	1/6
GW 66 807	2P+E	380 - 415 V	Red	Ø 10.3x38 mm	9	1/6
GW 66 808	3P+E	380 - 415 V	Red	Ø 10.3x38 mm	6	1/6
GW 66 809	3P+N+E	380 - 415 V	Red	Ø 10.3x38 mm	6	1/6
GW 66 810	3P+E	480 - 500 V	Black	Ø 10.3x38 mm	7	1/6
GW 66 811	3P+N+E	480 - 500 V	Black	Ø 10.3x38 mm	7	1/6
Rated current (A): 32						
GW 66 812	2P+E	100 - 130 V	Yellow	Ø 10.3x38 mm	4	1/6
GW 66 813	3P+E	100 - 130 V	Yellow	Ø 10.3x38 mm	4	1/6
GW 66 814	3P+N+E	100 - 130 V	Yellow	Ø 10.3x38 mm	4	1/6
GW 66 815	2P+E	200 - 250 V	Blue	Ø 10.3x38 mm	6	1/6
GW 66 816	3P+E	200 - 250 V	Blue	Ø 10.3x38 mm	9	1/6
GW 66 817	3P+N+E	200 - 250 V	Blue	Ø 10.3x38 mm	9	1/6
GW 66 818	2P+E	380 - 415 V	Red	Ø 10.3x38 mm	9	1/6
GW 66 819	3P+E	380 - 415 V	Red	Ø 10.3x38 mm	6	1/6
GW 66 820	3P+N+E	380 - 415 V	Red	Ø 10.3x38 mm	6	1/6
GW 66 821	3P+E	480 - 500 V	Black	Ø 10.3x38 mm	7	1/6
GW 66 822	3P+N+E	480 - 500 V	Black	Ø 10.3x38 mm	7	1/6
GW 66 823	3P+E	380 - 440 V	Red	Ø 10.3x38 mm	3	1/6

CHARACTERISTICS: IK10, in compliance with EN 62262.



GW 66 886

VERTICAL SOCKET-OUTLET WITH SAFETY TRANSFORMER (SELV) 230V / 24V - 50/60HZ - IP66

Code	No. of poles	Output voltage	Colour	Rated power	Type of fuse	Pack Carton
Rated current (A): 16						
GW 66 886	2P	20-25 V	Violet	160 VA	Ø 10.3x38 mm	1/4

CHARACTERISTICS: the socket-outlet is equipped with a thermal protection device. If the device trips, extract the plug from the socket-outlet and check the applied load. IK10, in compliance with EN 62262.

ACCESSORIES SUPPLIED: fuses (2A for primary and 6A for secondary).

WITH BOTTOM WITH FUSE HOLDER BASE - IP66



GW 66 958

VERTICAL INTERLOCKED SOCKET-OUTLETS AND FUSE HOLDER BASE - 50/60HZ

Code	No. of poles	Rated voltage	Colour	Type of fuse	Reference h	Pack Carton
Rated current (A): 16						
GW 66 951	2P+E	100 - 130 V	Yellow	Ø 10.3x38 mm	4	1/6
GW 66 952	3P+E	100 - 130 V	Yellow	Ø 10.3x38 mm	4	1/6
GW 66 953	3P+N+E	100 - 130 V	Yellow	Ø 10.3x38 mm	4	1/6
GW 66 954	2P+E	200 - 250 V	Blue	Ø 10.3x38 mm	6	1/6
GW 66 955	3P+E	200 - 250 V	Blue	Ø 10.3x38 mm	9	1/6
GW 66 956	3P+N+E	200 - 250 V	Blue	Ø 10.3x38 mm	9	1/6
GW 66 957	2P+E	380 - 415 V	Red	Ø 10.3x38 mm	9	1/6
GW 66 958	3P+E	380 - 415 V	Red	Ø 10.3x38 mm	6	1/6
GW 66 959	3P+N+E	380 - 415 V	Red	Ø 10.3x38 mm	6	1/6
GW 66 960	3P+E	480 - 500 V	Black	Ø 10.3x38 mm	7	1/6
GW 66 961	3P+N+E	480 - 500 V	Black	Ø 10.3x38 mm	7	1/6
Rated current (A): 32						
GW 66 962	2P+E	100 - 130 V	Yellow	Ø 10.3x38 mm	4	1/6
GW 66 963	3P+E	100 - 130 V	Yellow	Ø 10.3x38 mm	4	1/6
GW 66 964	3P+N+E	100 - 130 V	Yellow	Ø 10.3x38 mm	4	1/6
GW 66 965	2P+E	200 - 250 V	Blue	Ø 10.3x38 mm	6	1/6
GW 66 966	3P+E	200 - 250 V	Blue	Ø 10.3x38 mm	9	1/6
GW 66 967	3P+N+E	200 - 250 V	Blue	Ø 10.3x38 mm	9	1/6
GW 66 968	2P+E	380 - 415 V	Red	Ø 10.3x38 mm	9	1/6
GW 66 969	3P+E	380 - 415 V	Red	Ø 10.3x38 mm	6	1/6
GW 66 970	3P+N+E	380 - 415 V	Red	Ø 10.3x38 mm	6	1/6
GW 66 971	3P+E	480 - 500 V	Black	Ø 10.3x38 mm	7	1/6
GW 66 972	3P+N+E	480 - 500 V	Black	Ø 10.3x38 mm	7	1/6
GW 66 973	3P+E	380 - 440 V	Red	Ø 10.3x38 mm	3	1/6
Rated current (A): 63						
GW 66 847	2P+E	100 - 130 V	Yellow	Ø 22x58 mm	4	1/3
GW 66 848	3P+E	100 - 130 V	Yellow	Ø 22x58 mm	4	1/3
GW 66 849	3P+N+E	100 - 130 V	Yellow	Ø 22x58 mm	4	1/3
GW 66 850	2P+E	200 - 250 V	Blue	Ø 22x58 mm	6	1/3
GW 66 851	3P+E	200 - 250 V	Blue	Ø 22x58 mm	9	1/3
GW 66 852	3P+N+E	200 - 250 V	Blue	Ø 22x58 mm	9	1/3
GW 66 853	2P+E	380 - 415 V	Red	Ø 22x58 mm	9	1/3
GW 66 854	3P+E	380 - 415 V	Red	Ø 22x58 mm	6	1/3
GW 66 855	3P+N+E	380 - 415 V	Red	Ø 22x58 mm	6	1/3
GW 66 856	3P+E	480 - 500 V	Black	Ø 22x58 mm	7	1/3
GW 66 857	3P+N+E	480 - 500 V	Black	Ø 22x58 mm	7	1/3

CHARACTERISTICS: IK10, in compliance with EN 62262. 63A versions equipped with a pilot contact.



GW 66 998

VERTICAL SOCKET-OUTLET WITH SAFETY TRANSFORMER (SELV) - 230V / 24V - 50HZ - IP66

Code	No. of poles	Output voltage	Colour	Rated power	Type of fuse	Pack Carton
Rated current (A): 16						
GW 66 998	2P	20-25 V	Violet	160 VA	Ø 10.3x38 mm	1/4

CHARACTERISTICS: the socket-outlet is equipped with a thermal protection device. If the device trips, extract the plug from the socket-outlet and check the applied load. IK10, in compliance with EN 62262.

ACCESSORIES SUPPLIED: fuses (2A for primary and 6A for secondary).

COMPLEMENTARY ITEMS FOR INTERLOCKED SOCKET-OUTLETS - IP66



GW 66 685

SURFACE-MOUNTING BOTTOM FOR VERTICAL FIXED SOCKET-OUTLETS FOR HEAVY-DUTY USE IP66

Code	Houseable interloc. socket	Houseable IB socket-outlets	Pack Carton
GW 66 685	1	16/32 A SELV	1/10

CHARACTERISTICS: Equipped with top and bottom centres to make the holes for mounting the cable glands PG 21 / 29.



GW 66 700

MODULAR BASES FOR COMBINATION MOUNTING OF VERTICAL SOCKET-OUTLETS FOR HEAVY-DUTY USE - IP66

Code	Houseable interloc. socket	Houseable IB socket-outlets	Side entries	Top entries	Bottom entries	Pack Carton
GW 66 696	1	16/32 A SELV	2xØ 23	2xØ 23/29	-	1/6
GW 66 697	2	16/32 A SELV	4xØ 23	4xØ 23/29	1xØ 29/37	1/2
GW 66 698	3	16/32 A SELV	2xØ 23	5xØ 23/29	1xØ 29/37	1/2
GW 66 700	1	63 A	6xØ 23	2xØ 37/48	-	1/6

NOTES: Installation of the 63 A version is possible after removal of the socket-outlet base.

ACCESSORIES SUPPLIED: GW66698: 1 blank lid for closing the socket-outlet compartment.



GW 66 781

MODULAR BASES WITH PANEL AND WITH WINDOW WITH EN 50022 DIN RAIL - IP66

Code	Houseable interloc. socket	Houseable IB socket-outlets	Side entries	Top entries	Bottom entries	No. of modules EN 50022	Dispersible power (W)	Pack Carton
GW 66 781	1	16/32 A SELV	2xØ 23	2xØ 23/29	-	6	18	1/6
GW 66 782	2	16/32 A SELV	4xØ 23	4xØ 23/29	1xØ 29/37	12	27	1/2
GW 66 783	3	16/32 A SELV	2xØ 23	5xØ 23/29	1xØ 29/37	18	34	1/2
GW 66 784	1	63 A	6xØ 23	2xØ 37/48	-	6	18	1/6

CHARACTERISTICS: Possibility of installing security cylinder lock GW40422 (supplied with 2 keys).

Installation of the 63 A version is possible after removal of the socket-outlet base.

ACCESSORIES SUPPLIED: GW66783: 1 blank lid for closing the socket-outlet compartment.



GW 66 706

BLANK LID VERTICAL FIXED SOCKET-OUTLET COMPARTMENT FOR HEAVY-DUTY USE - IP66

Code	For Modular bases	For back boxes	Pack Carton
GW 66 706	GW66696 - GW66697 - GW66698 - GW66781 - GW66782 - GW66783	GW66685	1/10



GW 66 707

FLANGED LID FITTED FOR 2 COVERS - IP66

Code	Houseable IB socket-outlets	Pack Carton
GW 66 707	Nr 2 IEC 309 16-32A IP44/67	1/10

APPLICATIONS: possibility of assembly on modular bases GW66696 - GW66697 - GW66698 - GW66781 - GW66782 - GW66783 and back-mounting box GW66685.
The flange of 85x75 mm dimension is suited for mounting IEC 309 16 A socket-outlets and COMBI-IN GW27401 and GW27403 watertight covers.
The flange of 95x80 mm dimension is suited for mounting IEC 309 32 A socket-outlets.
ACCESSORIES SUPPLIED: 1 blank flange 16-32A, 1 gasket and fixing screws.

66 IB - VERTICAL SOCKET-OUTLETS ELECTRICAL INTERLOCKED FOR HEAVY-DUTY

WITH MINIATURE CIRCUIT BREAKER - IP66



GW 66 585

WATERTIGHT VERTICAL SURFACE-MOUNTING SOCKET-OUTLETS WITH ELECTRIC INTERLOCK CIRCUIT BREAKER PROTECTION - IN 125A - 50/60HZ

Code	No. of poles	Rated voltage	Colour	Reference h	Pack Carton
Rated current (A): 125					
GW 66 581	3P+E	100 - 130 V	Yellow	4	1
GW 66 582	3P+N+E	100 - 130 V	Yellow	4	1
GW 66 583	3P+E	200 - 250 V	Blue	9	1
GW 66 584	3P+N+E	200 - 250 V	Blue	9	1
GW 66 585	3P+E	380 - 415 V	Red	6	1
GW 66 586	3P+N+E	380 - 415 V	Red	6	1

CHARACTERISTICS: miniature circuit breaker: In= 125A, C curve, Icu (380/415V)= 25kA, electrical life= 8,000 cycles; mechanical life= 25,000 cycles; Insulating voltage Ui= 690V;
Terminal capacity: flexible cables: 2.5-50 mm², rigid cables: 2.5-70 mm².
125A versions equipped with 1 NO clean contact.

WITH RESIDUAL CURRENT MINIATURE CIRCUIT BREAKER - IP66



GW 66 595

WATERTIGHT VERTICAL SURFACE-MOUNTING SOCKET-OUTLETS WITH ELECTRIC INTERLOCK RESIDUAL CURRENT CIRCUIT BREAKER PROTECTION - IN 125A - 50/60HZ

Code	No. of poles	Rated voltage	Colour	Reference h	Pack Carton
Rated current (A): 125					
GW 66 591	3P+E	100 - 130 V	Yellow	4	1
GW 66 592	3P+N+E	100 - 130 V	Yellow	4	1
GW 66 593	3P+E	200 - 250 V	Blue	9	1
GW 66 594	3P+N+E	200 - 250 V	Blue	9	1
GW 66 595	3P+E	380 - 415 V	Red	6	1
GW 66 596	3P+N+E	380 - 415 V	Red	6	1

CHARACTERISTICS: residual current circuit breaker In= 125A, class A, Sensitivity= adjustable 30-3,000mA instantaneous and selective, Insulating voltage Ui= 690V.
Terminal capacity: flexible cables: 2.5-50 mm², rigid cables: 2.5-70 mm².
125A versions equipped with 1 NO clean contact.

44 IB - HORIZONTAL PROTECTED INTERLOCKED SOCKET-OUTLETS

WITHOUT BOTTOM, WITHOUT FUSE-HOLDER BASE - IP44



GW 66 108

HORIZONTAL INTERLOCKED SOCKET OUTLETS - 50/60HZ

Code	No. of poles	Rated voltage	Colour	Reference h	Pack Carton
Rated current (A): 16					
GW 66 101	2P+E	100 - 130 V	Yellow	4	1/12
GW 66 102	3P+E	100 - 130 V	Yellow	4	1/12
GW 66 103	3P+N+E	100 - 130 V	Yellow	4	1/12
GW 66 104	2P+E	200 - 250 V	Blue	6	1/12
GW 66 105	3P+E	200 - 250 V	Blue	9	1/12
GW 66 106	3P+N+E	200 - 250 V	Blue	9	1/12
GW 66 107	2P+E	380 - 415 V	Red	9	1/12
GW 66 108	3P+E	380 - 415 V	Red	6	1/12
GW 66 109	3P+N+E	380 - 415 V	Red	6	1/12
GW 66 110	3P+E	480 - 500 V	Black	7	1/12
GW 66 111	3P+N+E	480 - 500 V	Black	7	1/12
Rated current (A): 32					
GW 66 112	2P+E	100 - 130 V	Yellow	4	1/12
GW 66 113	3P+E	100 - 130 V	Yellow	4	1/12
GW 66 114	3P+N+E	100 - 130 V	Yellow	4	1/12
GW 66 115	2P+E	200 - 250 V	Blue	6	1/12
GW 66 116	3P+E	200 - 250 V	Blue	9	1/12
GW 66 117	3P+N+E	200 - 250 V	Blue	9	1/12
GW 66 118	2P+E	380 - 415 V	Red	9	1/12
GW 66 119	3P+E	380 - 415 V	Red	6	1/12
GW 66 120	3P+N+E	380 - 415 V	Red	6	1/12
GW 66 121	3P+E	480 - 500 V	Black	7	1/12
GW 66 122	3P+N+E	480 - 500 V	Black	7	1/12

WITH BOTTOM, WITHOUT FUSE-HOLDER BASE - IP44



GW 66 004

HORIZONTAL INTERLOCKED SOCKET OUTLETS - 50/60HZ

Code	No. of poles	Rated voltage	Colour	Reference h	Pack Carton
Rated current (A): 16					
GW 66 001	2P+E	100 - 130 V	Yellow	4	1/12
GW 66 002	3P+E	100 - 130 V	Yellow	4	1/12
GW 66 003	3P+N+E	100 - 130 V	Yellow	4	1/12
GW 66 004	2P+E	200 - 250 V	Blue	6	1/12
GW 66 005	3P+E	200 - 250 V	Blue	9	1/12
GW 66 006	3P+N+E	200 - 250 V	Blue	9	1/12
GW 66 007	2P+E	380 - 415 V	Red	9	1/12
GW 66 008	3P+E	380 - 415 V	Red	6	1/12
GW 66 009	3P+N+E	380 - 415 V	Red	6	1/12
GW 66 010	3P+E	480 - 500 V	Black	7	1/12
GW 66 011	3P+N+E	480 - 500 V	Black	7	1/12
Rated current (A): 32					
GW 66 012	2P+E	100 - 130 V	Yellow	4	1/12
GW 66 013	3P+E	100 - 130 V	Yellow	4	1/12
GW 66 014	3P+N+E	100 - 130 V	Yellow	4	1/12
GW 66 015	2P+E	200 - 250 V	Blue	6	1/12
GW 66 016	3P+E	200 - 250 V	Blue	9	1/12
GW 66 017	3P+N+E	200 - 250 V	Blue	9	1/12
GW 66 018	2P+E	380 - 415 V	Red	9	1/12
GW 66 019	3P+E	380 - 415 V	Red	6	1/12
GW 66 020	3P+N+E	380 - 415 V	Red	6	1/12
GW 66 021	3P+E	480 - 500 V	Black	7	1/12
GW 66 022	3P+N+E	480 - 500 V	Black	7	1/12

ACCESSORIES SUPPLIED: coupling for Ø 20 mm conduits and Ø 23 mm cable gland.

WITHOUT BOTTOM, WITH FUSE-HOLDER BASE - IP44



GW 66 130

HORIZONTAL INTERLOCKED SOCKET OUTLETS WITH FUSE HOLDER BASE - 50/60HZ

Code	No. of poles	Rated voltage	Colour	Fuses holder	Reference h	Pack Carton
Rated current (A): 16						
GW 66 123	2P+E	100 - 130 V	Yellow	E14	4	1/12
GW 66 124	3P+E	100 - 130 V	Yellow	E14	4	1/12
GW 66 125	3P+N+E	100 - 130 V	Yellow	E14	4	1/12
GW 66 126	2P+E	200 - 250 V	Blue	E14	6	1/12
GW 66 127	3P+E	200 - 250 V	Blue	E14	9	1/12
GW 66 128	3P+N+E	200 - 250 V	Blue	E14	9	1/12
GW 66 129	2P+E	380 - 415 V	Red	E14	9	1/12
GW 66 130	3P+E	380 - 415 V	Red	E14	6	1/12
GW 66 131	3P+N+E	380 - 415 V	Red	E14	6	1/12
GW 66 132	3P+E	480 - 500 V	Black	gG	7	1/12
GW 66 133	3P+N+E	480 - 500 V	Black	gG	7	1/12
Rated current (A): 32						
GW 66 134	2P+E	100 - 130 V	Yellow	E18	4	1/12
GW 66 135	3P+E	100 - 130 V	Yellow	E18	4	1/12
GW 66 136	3P+N+E	100 - 130 V	Yellow	E18	4	1/12
GW 66 137	2P+E	200 - 250 V	Blue	E18	6	1/12
GW 66 138	3P+E	200 - 250 V	Blue	E18	9	1/12
GW 66 139	3P+N+E	200 - 250 V	Blue	E18	9	1/12
GW 66 140	2P+E	380 - 415 V	Red	E18	9	1/12
GW 66 141	3P+E	380 - 415 V	Red	E18	6	1/12
GW 66 142	3P+N+E	380 - 415 V	Red	E18	6	1/12
GW 66 143	3P+E	480 - 500 V	Black	gG	7	1/12
GW 66 144	3P+N+E	480 - 500 V	Black	gG	7	1/12

CHARACTERISTIC: compatible with ND fuses, except for versions 16A - 500V that have to accommodate GG cylindrical fuses ø 10,3x38 mm and version 32A - 500V that have to accommodate GG cylindrical fuses ø 14x51 mm.

WITH BOTTOM, WITH FUSE-HOLDER BASE - IP44



GW 66 026

HORIZONTAL INTERLOCKED SOCKET OUTLETS WITH FUSE HOLDER BASE - 50/60HZ

Code	No. of poles	Rated voltage	Colour	Fuses holder	Reference h	Pack Carton
Rated current (A): 16						
GW 66 023	2P+E	100 - 130 V	Yellow	E14	4	1/12
GW 66 024	3P+E	100 - 130 V	Yellow	E14	4	1/12
GW 66 025	3P+N+E	100 - 130 V	Yellow	E14	4	1/12
GW 66 026	2P+E	200 - 250 V	Blue	E14	6	1/12
GW 66 027	3P+E	200 - 250 V	Blue	E14	9	1/12
GW 66 028	3P+N+E	200 - 250 V	Blue	E14	9	1/12
GW 66 029	2P+E	380 - 415 V	Red	E14	9	1/12
GW 66 030	3P+E	380 - 415 V	Red	E14	6	1/12
GW 66 031	3P+N+E	380 - 415 V	Red	E14	6	1/12
GW 66 032	3P+E	480 - 500 V	Black	gG	7	1/12
GW 66 033	3P+N+E	480 - 500 V	Black	gG	7	1/12
Rated current (A): 32						
GW 66 034	2P+E	100 - 130 V	Yellow	E18	4	1/12
GW 66 035	3P+E	100 - 130 V	Yellow	E18	4	1/12
GW 66 036	3P+N+E	100 - 130 V	Yellow	E18	4	1/12
GW 66 037	2P+E	200 - 250 V	Blue	E18	6	1/12
GW 66 038	3P+E	200 - 250 V	Blue	E18	9	1/12
GW 66 039	3P+N+E	200 - 250 V	Blue	E18	9	1/12
GW 66 040	2P+E	380 - 415 V	Red	E18	9	1/12
GW 66 041	3P+E	380 - 415 V	Red	E18	6	1/12
GW 66 042	3P+N+E	380 - 415 V	Red	E18	6	1/12
GW 66 043	3P+E	480 - 500 V	Black	gG	7	1/12
GW 66 044	3P+N+E	480 - 500 V	Black	gG	7	1/12

ACCESSORIES SUPPLIED: coupling for Ø 20 mm and Ø 25 mm conduits and Ø 29 mm cable gland.

CHARACTERISTIC: compatible with ND fuses, except for versions 16A - 500V that have to accommodate GG cylindrical fuses ø 10,3x38 mm and version 32A - 500V that have to accommodate GG cylindrical fuses ø 14x51 mm.

COMPLEMENTARY ITEMS FOR SOCKET-OUTLETS WITHOUT FUSE-HOLDER BASE - SBF - IP44



GW 66 676

SURFACE-MOUNTING BOX FOR FIXED HORIZONTAL SOCKET-OUTLETS - SBF - IP44

Code	Houseable interloc. socket	Houseable IB socket-outlets	Side entries	Top entries	Bottom entries	Pack Carton
GW 66 676	1	16/32 A	4xØ 23	3xØ 23	3xØ 23	1/10



GW 66 681

BOX WITH FRAME FOR THE FLUSH-MOUNTING ASSEMBLY OF FIXED HORIZONTAL SOCKET-OUTLETS SBF - IP44

Code	Houseable interloc. socket	Houseable IB socket-outlets	Characteristics	Pack Carton
GW 66 681	1	16/32 A	For brick wall	1/10

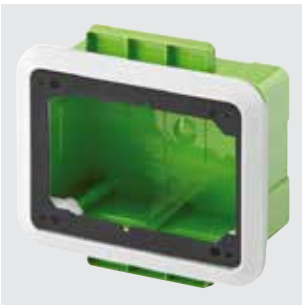

GW 66 681 PM

BOX WITH FRAME FOR LIGHTWEIGHT AND PLASTERBOARD WALLS FOR THE FLUSH-MOUNTING ASSEMBLY OF HORIZONTAL SOCKET-OUTLETS SBF - IP44

Code	Houseable interloc. socket	Houseable IB socket-outlets	Characteristics	Pack Carton
GW 66 681 PM	1	16/32 A	For plasterboard	1/10

NOTES: Halogen-free casing, in accordance with EN 60754-2.

Casing type H in accordance with EN 60670-1, and type Ha in accordance with IEC 60670-1.

GWT 850°C according to EN 60695-2-11.

CHARACTERISTICS: locators for tracing the wall along the edges of the box; box equipped with tabs for direct fixing on panels or a metal structure, for lightweight and plasterboard walls.

ACCESSORIES SUPPLIED: self-tapping screw kit ø 4x45mm.



GW 66 701

BLANK LID FOR THE COMPARTMENT CONTAINING FIXED HORIZONTAL SOCKET-OUTLETS - SBF - IP44

Code	For distribution boards	For back boxes	For flush-mounting boxes	Pack Carton
GW 66 701	GW68006N/09N/19N	GW66676	GW66681 - GW66681PM	1/10

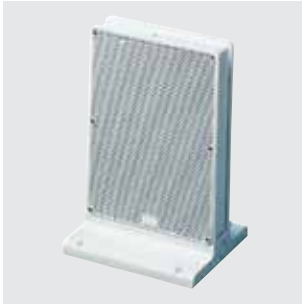

GW 68 441

FLOOR MOUNTING AND WORKBENCH TOWER - IP55

Code	Outer dim. LxHxD (mm)	Houseable IB socket-outlets	Installable Q-DIN boards	Characteristics	Pack Carton
GW 68 441	200x295x180	16/32 A	Q-DIN 5	Halogen free	1/6

CHARACTERISTICS: contrasting flanges with smooth and honeycomb surface, for fixing interlocked switched socket-outlets 16-32A of the IB range: Combibloc, horizontal socket-outlets IP44 with bottom and vertical socket-outlets IP67 with bottom.

APPLICATIONS: installed combined using the coupler GW26406.

DISTRIBUTION BOARDS FOR SOCKET-OUTLETS WITHOUT FUSE-HOLDER BASE - SBF - IP65



GW 68 019N



GW 68 006N



GW 68 009N



GW 68 006 N

Q-DIN 10/14 WATERTIGHT BOARDS - UNWIRED - RAL 7035 - IP65

Code	No. IB socket-outlets houseable	No. of provided blank lids	Dispersible power A (W)	Dispersible power B (W)	Pack Carton
No. of modules EN 50022: 10					
GW 68 019 N	2 IB Horiz. 16/32A SBF IP44 overlapping	1 IB 16/32A	16	42	6
No. of modules EN 50022: 14					
GW 68 006 N	2 IB Horiz. 16/32A SBF IP44 side by side	1 IB 16/32A	24	64	4
GW 68 009 N	4 IB Horiz. 16/32A SBF IP44	2 IB 16/32A	24	64	3

ACCESSORIES SUPPLIED: cable clamp and 4 screw caps.

NOTES: Dispersible power (B) is calculated according to IEC 60890 standard. It refers to the 40K overtemperature, between the temperature inside and outside the board.

The IP65 degree of protection is obtained with blank flange lid installed correctly on all the seats of the unwired board.

External dimensions GW68019N (LxHxD): 220x435x96.

External dimensions GW68006N (LxHxD): 320x360x120.

External dimensions GW68009N (LxHxD): 320x510x120.

COMPLEMENTARY ITEMS FOR SOCKET-OUTLETS WITH FUSE-HOLDER BASE - CBF - IP44



GW 66 677

SURFACE-MOUNTING BOTTOM - IP44

Code	Houseable interloc. socket	Houseable IB socket-outlets	Side entries	Top entries	Bottom entries	Pack Carton
GW 66 677	1	16/32 A	4xØ 23	2xØ 23 - 1xØ 29	2xØ 23 - 1xØ 29	1/10



GW 66 682

BOX WITH FRAME FOR FLUSH-MOUNTING FIXED HORIZONTAL SOCKET-OUTLETS - CBF - IP44

Code	Houseable interloc. socket	Houseable IB socket-outlets	Characteristics	Pack Carton
GW 66 682	1	16/32 A	For brick wall	1/10



GW 66 682 PM

BOX WITH FRAME FOR LIGHTWEIGHT AND PLASTERBOARD WALLS FOR THE FLUSH-MOUNTING ASSEMBLY OF HORIZONTAL SOCKET-OUTLETS CBF - IP44

Code	Houseable interloc. socket	Houseable IB socket-outlets	Characteristics	Pack Carton
GW 66 682 PM	1	16/32 A	For plasterboard	1/10

NOTES: Halogen-free casing, in accordance with EN 60754-2.

Casing type H in accordance with EN 60670-1, and type Ha in accordance with IEC 60670-1.

GWT 850°C in accordance with EN 60695-2-11.

CHARACTERISTICS: locators for tracing the wall along the edges of the box; box equipped with tabs for direct fixing on panels or a metal structure, for lightweight and plasterboard walls.

ACCESSORIES SUPPLIED: self-tapping screw kit Ø 4x45mm.



GW 66 702

BLANK LID FOR THE COMPARTMENT CONTAINING FIXED HORIZONTAL SOCKET-OUTLETS - CBF - IP44

Code	For distribution boards	For back boxes	For flush-mounting boxes	Pack Carton
GW 66 702	GW68014N	GW66677	GW66682 - GW66682PM	1/10

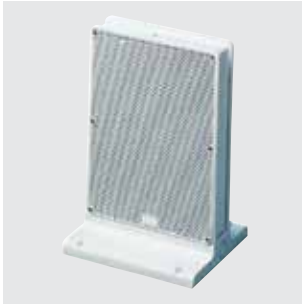

GW 68 441

FLOOR MOUNTING AND WORKBENCH TOWER - IP55

Code	Outer dim. LxHxD (mm)	Houseable IB socket-outlets	Installable Q-DIN boards	Characteristics	Pack Carton
GW 68 441	200x295x180	16/32 A	Q-DIN 5	Halogen free	1/6

CHARACTERISTICS: contrasting flanges with smooth and honeycomb surface, for fixing interlocked switched socket-outlets 16-32A of the IB range: Combibloc, horizontal socket-outlets IP44 with bottom and vertical socket-outlets IP67 with bottom.

APPLICATIONS: installed combined using the coupler GW26406.

DISTRIBUTION BOARDS FOR SOCKET-OUTLETS WITH FUSE-HOLDER BASE - CBF - IP65



GW 68 014N



GW 68 014 N

Q-DIN 20 WATERTIGHT BOARD - UNWIRED - RAL 7035 - IP65

Code	No. IB socket-outlets houseable	No. of provided blank lids	Dispersible power A (W)	Dispersible power B (W)	Pack Carton
No. of modules EN 50022: 20					
GW 68 014 N	4 IB Horiz. 16/32A CBF IP44	2 IB 16/32A	30	92	2

ACCESSORIES SUPPLIED: cable clamp and 6 screw caps.

NOTES: dispersible power (B) is calculated according to IEC 60890 standard. It refers to the 40K overtemperature, between the temperature inside and outside the board.

The IP65 degree of protection is obtained with blank flange lid installed correctly on all the seats of the unwired board.

External dimensions (LxHxD): 450x560x120.

COMBIBLOC - COMPACT, PROTECTED AND WATERTIGHT INTERLOCKED SOCKET-OUTLETS

WITHOUT BOTTOM AND WITHOUT FUSE-HOLDER BASE - IP44



GW 66 441

COMPACT INTERLOCKED SOCKET-OUTLETS - 50/60 HZ

Code	No. of poles	Rated voltage	Colour	Reference h	Pack Carton
Rated current (A): 16					
GW 66 423	2P+E	100 - 130 V	Yellow	4	1/12
GW 66 424	3P+E	100 - 130 V	Yellow	4	1/12
GW 66 425	3P+N+E	100 - 130 V	Yellow	4	1/12
GW 66 426	2P+E	200 - 250 V	Blue	6	1/12
GW 66 427	3P+E	200 - 250 V	Blue	9	1/12
GW 66 428	3P+N+E	200 - 250 V	Blue	9	1/12
GW 66 429	2P+E	380 - 415 V	Red	9	1/12
GW 66 430	3P+E	380 - 415 V	Red	6	1/12
GW 66 431	3P+N+E	380 - 415 V	Red	6	1/12
Rated current (A): 32					
GW 66 434	2P+E	100 - 130 V	Yellow	4	1/12
GW 66 435	3P+E	100 - 130 V	Yellow	4	1/12
GW 66 436	3P+N+E	100 - 130 V	Yellow	4	1/12
GW 66 437	2P+E	200 - 250 V	Blue	6	1/12
GW 66 438	3P+E	200 - 250 V	Blue	9	1/12
GW 66 439	3P+N+E	200 - 250 V	Blue	9	1/12
GW 66 440	2P+E	380 - 415 V	Red	9	1/12
GW 66 441	3P+E	380 - 415 V	Red	6	1/12
GW 66 442	3P+N+E	380 - 415 V	Red	6	1/12

CHARACTERISTICS: the interlock lever can be padlocked in the ON/OFF position using the security lock GW40422.

WITH BOTTOM AND WITHOUT FUSE-HOLDER BASE - IP44



GW 66 404

COMPACT INTERLOCKED SOCKET-OUTLETS - 50/60 HZ

Code	No. of poles	Rated voltage	Colour	Reference h	Pack Carton
Rated current (A): 16					
GW 66 401	2P+E	100 - 130 V	Yellow	4	1/12
GW 66 402	3P+E	100 - 130 V	Yellow	4	1/12
GW 66 403	3P+N+E	100 - 130 V	Yellow	4	1/12
GW 66 404	2P+E	200 - 250 V	Blue	6	1/12
GW 66 405	3P+E	200 - 250 V	Blue	9	1/12
GW 66 406	3P+N+E	200 - 250 V	Blue	9	1/12
GW 66 407	2P+E	380 - 415 V	Red	9	1/12
GW 66 408	3P+E	380 - 415 V	Red	6	1/12
GW 66 409	3P+N+E	380 - 415 V	Red	6	1/12
Rated current (A): 32					
GW 66 412	2P+E	100 - 130 V	Yellow	4	1/12
GW 66 413	3P+E	100 - 130 V	Yellow	4	1/12
GW 66 414	3P+N+E	100 - 130 V	Yellow	4	1/12
GW 66 415	2P+E	200 - 250 V	Blue	6	1/12
GW 66 416	3P+E	200 - 250 V	Blue	9	1/12
GW 66 417	3P+N+E	200 - 250 V	Blue	9	1/12
GW 66 418	2P+E	380 - 415 V	Red	9	1/12
GW 66 419	3P+E	380 - 415 V	Red	6	1/12
GW 66 420	3P+N+E	380 - 415 V	Red	6	1/12

CHARACTERISTICS: the interlock lever can be padlocked in the ON/OFF position using the security lock GW40422.

WITHOUT BOTTOM AND WITHOUT FUSE-HOLDER BASE - IP55



GW 66 471

COMPACT INTERLOCKED SOCKET-OUTLETS - 50/60 HZ

Code	No. of poles	Rated voltage	Colour	Reference h	Pack Carton
Rated current (A): 16					
GW 66 467	2P+E	100 - 130 V	Yellow	4	1/12
GW 66 468	3P+E	100 - 130 V	Yellow	4	1/12
GW 66 469	3P+N+E	100 - 130 V	Yellow	4	1/12
GW 66 470	2P+E	200 - 250 V	Blue	6	1/12
GW 66 471	3P+E	200 - 250 V	Blue	9	1/12
GW 66 472	3P+N+E	200 - 250 V	Blue	9	1/12
GW 66 473	2P+E	380 - 415 V	Red	9	1/12
GW 66 474	3P+E	380 - 415 V	Red	6	1/12
GW 66 475	3P+N+E	380 - 415 V	Red	6	1/12
Rated current (A): 32					
GW 66 478	2P+E	100 - 130 V	Yellow	4	1/12
GW 66 479	3P+E	100 - 130 V	Yellow	4	1/12
GW 66 480	3P+N+E	100 - 130 V	Yellow	4	1/12
GW 66 481	2P+E	200 - 250 V	Blue	6	1/12
GW 66 482	3P+E	200 - 250 V	Blue	9	1/12
GW 66 483	3P+N+E	200 - 250 V	Blue	9	1/12
GW 66 484	2P+E	380 - 415 V	Red	9	1/12
GW 66 485	3P+E	380 - 415 V	Red	6	1/12
GW 66 486	3P+N+E	380 - 415 V	Red	6	1/12

NOTES: the gasket is inserted in the complementary items, bottom box and distribution boards.

CHARACTERISTICS: the interlock lever can be padlocked in the ON/OFF position using the security lock GW40422.

WITH BOTTOM AND WITHOUT FUSE-HOLDER BASE - IP55



GW 66 453

COMPACT INTERLOCKED SOCKET-OUTLETS - 50/60 HZ

Code	No. of poles	Rated voltage	Colour	Reference h	Pack Carton
Rated current (A): 16					
GW 66 445	2P+E	100 - 130 V	Yellow	4	1/12
GW 66 446	3P+E	100 - 130 V	Yellow	4	1/12
GW 66 447	3P+N+E	100 - 130 V	Yellow	4	1/12
GW 66 448	2P+E	200 - 250 V	Blue	6	1/12
GW 66 449	3P+E	200 - 250 V	Blue	9	1/12
GW 66 450	3P+N+E	200 - 250 V	Blue	9	1/12
GW 66 451	2P+E	380 - 415 V	Red	9	1/12
GW 66 452	3P+E	380 - 415 V	Red	6	1/12
GW 66 453	3P+N+E	380 - 415 V	Red	6	1/12
Rated current (A): 32					
GW 66 456	2P+E	100 - 130 V	Yellow	4	1/12
GW 66 457	3P+E	100 - 130 V	Yellow	4	1/12
GW 66 458	3P+N+E	100 - 130 V	Yellow	4	1/12
GW 66 459	2P+E	200 - 250 V	Blue	6	1/12
GW 66 460	3P+E	200 - 250 V	Blue	9	1/12
GW 66 461	3P+N+E	200 - 250 V	Blue	9	1/12
GW 66 462	2P+E	380 - 415 V	Red	9	1/12
GW 66 463	3P+E	380 - 415 V	Red	6	1/12
GW 66 464	3P+N+E	380 - 415 V	Red	6	1/12

CHARACTERISTICS: the interlock lever can be padlocked in the ON/OFF position using the security lock GW40422.

COMPLEMENTARY ITEMS



GW 66 496

BOTTOM FOR COMPACT SOCKET-OUTLETS - IP55

Code	Houseable interloc. socket	Houseable IB socket-outlets	Side entries	Top entries	Bottom entries	Pack Carton
GW 66 496	1	Compact 16A/32A	2xØ 23	1xØ 23/29	1xØ 29/23	1/12

ACCESSORIES SUPPLIED: gasket for COMBIBLOC socket.



GW 66 498

FLUSH-MOUNTING BOX WITH FRAME - IP55

Code	Houseable interloc. socket	Houseable IB socket-outlets	Pack Carton
GW 66 498	1	Compact 16A/32A	1/12

APPLICATIONS: possibility of mounting on rectangular flush-mounting box for modular ranges (GW24403) with 83.5mm distance between centres and on 48 PT range junction box (GW48002).

ACCESSORIES SUPPLIED: gasket for COMBIBLOC socket.



GW 68 295

BLANK LID FOR IP55 COMBIBLOC CAP

Code	Suitable for	Pack Carton
GW 68 295	Boards GW66491/2/3, flush-mounting boxes GW66498 e enclosures base boxes GW44696	1/10



GW 40 422

CYLINDRICAL SECURITY LOCK

Code	Material	Pack Carton
GW 40 422	Pressure die-cast metal	1/10

ACCESSORIES SUPPLIED: 2 keys.

NOTES: all the keys and relative locks with the same product code are identical.



GW 68 441

FLOOR MOUNTING AND WORKBENCH TOWER - IP55

Code	Outer dim. LxHxD (mm)	Houseable IB socket-outlets	Installable Q-DIN boards	Characteristics	Pack Carton
GW 68 441	200x295x180	16/32 A	Q-DIN 5	Halogen free	1/6

CHARACTERISTICS: double-sided panels with smooth or honeycomb surface, for fixing interlocked switched socket-outlets 16-32A of the IB range: Combibloc, horizontal IP44 with bottom and vertical IP67 with bottom.

APPLICATIONS: installed combined using the coupler GW26406.

DISTRIBUTION BOARDS FOR COMBIBLOC SOCKET-OUTLET - IP55



GW 66 491



GW 66 492

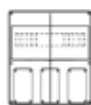

GW 66 493



GW 66 493

EMPTY BOARDS FOR FIXED COMPACT SOCKET-OUTLETS

Code	No. IB socket-outlets houseable	No. of modules EN 50022	No. of blank lids supplied	Dispersible power (W)	Pack Carton
GW 66 491	1 COMBIBLOC 16/32A	4	None	10	1/12
GW 66 492	2 COMBIBLOC 16/32A	8	1	13	1/6
GW 66 493	3 COMBIBLOC 16/32A	12	1	24	1/4

CHARACTERISTICS: the transparent door is pre-arranged for the GW40422 security lock.

ACCESSORIES SUPPLIED: sealing gaskets for COMBIBLOC socket-outlets.



GW 68 295

BLANK LID FOR INTERLOCKED SWITCHED SOCKET-OUTLETS COMBIBLOC IP55

Code	Suitable for	Pack Carton
GW 68 295	Boards GW66491/2/3, flush-mounting boxes GW66498 e enclosures base boxes GW44696	1/10

INSULATED SCREW TERMINAL BLOCK BIPOLAR AND UNIPOLAR FOR ENCLOSURES AND BOARDS

Code	Pole 1 (mm ²)	Pole 2 (mm ²)	Suitable for	Fastener to supports	Pack Carton
Type: Bipolar - Rated current 125 A					
GW 40 401	N (1x35) + (7x10)	E (1x35) + (7x10)	GW66492 and GW66493	With screws	10
GW 40 402	N (3x35) + (10x10)	E (3x35) + (10x10)	GW66493	With screws and/or clip	10
Type: Bipolar - Rated current 80 A - IP20					
GW 40 408 B	N/E (2x16) + (7x10)	N/E (2x16) + (7x10)	GW66492 and GW66493	With screws	1/10
GW 40 412 B	N/E (3x16) + (11x10)	N/E (3x16) + (11x10)	GW66493	With screws and/or clip	1/10
Type: Unipolar - Rated current 80 A - IP20					
GW 40 408 U	N/E (2x16) + (7x10)	-	GW66492 and GW66493	With screws	1/10
GW 40 412 U	N/E (3x16) + (11x10)	-	GW66493	With screws and/or clip	1/10
GW 40 422 U	N/E (3x16) + (29x10)	-	GW66493	With screws and/or clip	1/10

ACCESSORIES SUPPLIED: fixing screws. The 80 A terminal blocks are equipped with N and E labels to be placed on the respective spaces to identify the poles.

CHARACTERISTICS: GWT 960°C according to EN60695-2-11.

INSTALLATION: the installation of the GW40401, GW40408B and GW40408U terminal blocks on the GW66493 board is permitted by using the GW40413 adapter.



GW 40 412 B

ADAPTERS FOR SCREW TERMINAL BLOCKS

Code	Suitable for	Fastener to supports	Pack Carton
GW 40 413	GW66493	With screws	20

ACCESSORIES SUPPLIED: fixing screws.

CHARACTERISTICS: the adapter is pre-drilled for the correct assembly of the terminal block.

INSTALLATION: it permits installation of the GW40401, GW40408B and GW40408U terminal blocks on the GW66493 board.



GW 40 413

72 - FUSE FOR INTERLOCKED SOCKET-OUTLETS

FUSES



GW 72 003

ND FUSES 380V~

Code	Rated current (A)	Rated voltage	Type	Breaking capacity	Pack Carton
Dimensions (mm): Ø 11 x 36					
GW 72 001	2	380 V	D01 E14	50 kA	10/100
GW 72 003	6	380 V	D01 E14	50 kA	10/100
GW 72 005	16	380 V	D01 E14	50 kA	10/100
Dimensions (mm): Ø 15 x 36					
GW 72 013	35	380 V	D02 E18	50 kA	10/100
GW 72 015	63	380 V	D02 E18	50 kA	10/100

NOTES: Compatible with interlocked socket-outlets horizontal type - 44IB Range.



GW 72 023

DD FUSES 500V~

Code	Rated current (A)	Rated voltage	Type	Breaking capacity	Pack Carton
Dimensions (mm): Ø 13 x 50					
GW 72 021	2	500 V	DI E16 Delayed	50 kA	10/50
GW 72 023	6	500 V	DI E16 Delayed	50 kA	10/50
Dimensions (mm): Ø 22 x 50					
GW 72 065	16	500 V	DII E27 quick	50 kA	5/20
Dimensions (mm): Ø 28 x 50					
GW 72 092	35	500 V	DIII E33 Rapid	50 kA	5/20
GW 72 095	63	500 V	DIII E33 Rapid	50 kA	5/20

GG CYLINDRICAL FUSES - 500V~

Code	Rated current	Rated voltage	Type	Breaking capacity	Pack Carton
Dimensions (mm): Ø 10.3 x 38					
GW 72 104	2 A	500 V	gG	120 kA	10/100
GW 72 105	6 A	500 V	gG	120 kA	10/100
GW 72 101	16 A	500 V	gG	120 kA	10/100
GW 72 110	32 A	400 V	gG	120 kA	10/100
Dimensions (mm): Ø 14 x 51					
GW 72 122	32 A	500 V	gG	80 kA	10/100
Dimensions (mm): Ø 22 x 58					
GW 72 103	63 A	690 V	gG	80 kA	10/30

NOTES: Compatible with interlocked socket-outlets vertical type - 67IB and 66IB Range.



GW 72 122



IB

INTERLOCKED SOCKET-OUTLETS
IEC 309 STANDARD



67 IB



66 IB



Scan the QR Code and find out all the technical informations.



44 IB



COMBIBLOC

FULL RANGE
FOR ALL APPLICATIONS



In addition to the 67 IB series, the offer is completed with 3 additional product lines. The 66 IB vertical socket-outlets are appreciated by operators for their robustness and electrical performance. The 44 IB horizontal socket-outlets are perfect for flush-mounted installations, even in drywall. The compact COMBIBLOC socket-outlets are the ideal solution for minimising space.

67 IB (AUTOMATIKA)
WITH INTEGRATED MCB



The integration of the MCB switch in the socket-outlet individually protects the load reducing the spaces on boards. The LEDs integrated on the front indicate the operating status of the switch and the presence of voltage. Available with currents 16-32A.

67 IB (CBF)
WITH FUSE BASE HOLDER



The knob has been designed to avoid the accumulations of dust and to ensure an ergonomic grip. The knob can also be padlocked to the ON/OFF position for added safety. Available with currents 16-32-63A.



IEC 309 COMBINED BOARDS



68 Q-DIN

DISTRIBUTION
BOARDS

pag. 104





















































68 ACS

ACS DISTRIBUTION BOARD SYSTEM
FOR CONSTRUCTION SITES

pag. 118

68 Q-DIN

Unwired versions				
Type	No. EN 50022 modules	Code	Layout	Pre-arrangement
	5	GW 68 017 N		1 IEC 309 socket-outlet 16A IP44/67 or GW 27 401 or GW 27 403 watertight cap
		GW 68 018 N		2 IEC 309 socket-outlets 16A IP44/67 or GW 27 401 or GW 27 403 watertight caps
		GW 68 001 N		3 IEC 309 socket-outlets 16A IP44/67 or GW 27 401 or GW 27 403 watertight caps
		GW 68 031 N		3 IEC 309 socket-outlets 16A IP44/67 or GW 27 401 or GW 27 403 watertight caps and shockproof case
		GW 68 020 N		2 IEC 309 socket-outlets 16-32A IP44/67 or GW 27 401 or GW 27 403 watertight caps
		GW68026N GW68032N		4 domestic socket std 50x50mm IP54 4 domestic socket std 50x50mm IP54 and shockproof case
	10	GW 68 002 N		Blank
		GW 68 003 N		2 IEC 309 socket-outlets 16A 2P+E or 16A 3P+E IP44/67 or GW 27 401 or GW 27 403 watertight caps 2 IEC 309 socket-outlets 16-32A IP44/67 or GW 27 401 or GW 27 403 watertight caps
		GW 68 019 N		2 horizontal interlocked switched socket-outlets 16-32A IP44 with rotary switch
		GW 68 025 N		2 vertical interlocked switched socket-outlets 16-32A IP67
		GW68027N		3 domestic socket std 50x50mm IP54 2 IEC 309 socket-outlets 16-32A IP44/67
	14	GW 68 004 N		Blank
		GW 68 005 N		3 IEC 309 socket-outlets 16-32A IP44/67 or GW 27 401 watertight caps
		GW 68 006 N		2 horizontal interlocked switched socket-outlets 16-32A IP44 with rotary switch
		GW 68 007 N		Blank
		GW 68 008 N		6 IEC 309 socket-outlets 16-32A IP44/67 or GW 27 401 or GW 27 403 watertight caps
		GW 68 009 N		4 horizontal interlocked switched socket-outlets 16-32A IP44 with rotary switch
		GW 68 010 N		3 vertical interlocked switched socket-outlets 16-32A IP67
	20	GW 68 012 N		Blank
		GW 68 013 N		8 IEC 309 socket-outlets 16-32A IP44/67 or GW 27 401 or GW 27 403 watertight caps
		GW 68 021 N		4 IEC 309 socket-outlets 16-32A IP44/67 or GW 27 401 or GW 27 403 watertight caps 2 IEC 309 socket-outlets 63A
		GW 68 014 N		4 horizontal interlocked switched socket-outlets 16-32A IP44 with fuse-holder base
		GW 68 015 N		4 vertical interlocked switched socket-outlets 16-32A IP67 4 IEC 309 socket-outlets 16A 2P+E or 16A 3P+E IP44/67 or GW 27 401 or GW 27 403 watertight caps
		GW 68 022 N		2 vertical interlocked switched socket-outlets 16-32A IP67 1 vertical interlocked switched socket-outlet 63A IP67
	14	GW 68 023 N		14 gang additional module
	20	GW 68 024 N		20 gang additional module

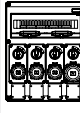
Wired versions							
Type	No. EN 50022 modules	Code	Layout	Equipment	Code	Layout	Equipment
	5	GW 68 212 N	 DBO	1 domestic socket-outlet 13A UK	GW 68 227 N	 DBO	1 IEC 309 - socket-outlet 2P+E 16A IP44 230V
		GW 68 225 N	 DBO	1 IEC 309 socket-outlet 2P+E 16A IP44 230V 1 Schuko domestic socket-outlet 10/16A	GW 68 226 N	 DBO	1 IEC 309 socket-outlet 2P+E 16A IP44 230V 1 IEC 309 socket-outlet 3P+E 16A IP44 400V
		GW 68 224 N	 DBO	1 IEC 309 socket-outlet 2P+E 16A IP44 230V 1 IEC 309 socket-outlet 3P+E 16A IP44 400V 1 Schuko domestic socket-outlet 10/16A			
	10	GW 68 202 N	 DBO	2 GW IEC 309 2P+T 16A IP44 230V 1 IEC 309 socket outlet 3P+E 16A IP44 400V 1 domestic socket-outlet 10/16A Schuko	GW 68 228 N	 DBO	1 IEC 309 socket-outlet 2P+E 16A IP44 230V 1 IEC 309 socket-outlet 3P+E 16A IP44 400V 1 IEC 309 socket-outlet 3P+N+E 16A IP44 400V 1 Schuko domestic socket-outlet 10/16A
		GW 68 232 N	 DBO	2 vert.interl.socket-outlets 2P+E 16A IP67 230V with rotary switch	GW 68 233 N	 DBO	1 vert.interl.socket-outlet 2P+E 16A IP67 230V 1 vert.interl.socket-outlet 3P+E 16A IP67 400V with rotary switch
	14	GW 68 205 N	 DBO	2 IEC 309 socket-outlets 2P+E 16A IP67 230V 1 IEC 309 socket-outlet 3P+E 16A IP67 400V			
		GW 68 229 N	 DBO	2 IEC 309 socket-outlets 2P+E 16A IP44 230V 1 IEC 309 socket-outlet 3P+E 16A IP44 400V 1 IEC 309 socket-outlet 3P+N+E 16A IP44 400V 1 Schuko domestic socket-outlet 10/16A	GW 68 206 N	 DBO	2 horiz. interlocked switched socket-outlets 2P+E 16A IP44 230V 1 horiz. interlocked switched socket-outlet 3P+E 16A IP44 400V 1 horiz. interlocked switched socket-outlet 3P+E 32A IP44 400V with rotary isolator
		GW 68 207 N	 DBO	2 vert. interlocked switched socket-outlets 2P+E 16A IP67 230V 2 vert. interlocked switched socket-outlets 3P+E 16A IP67 400V with rotary switch	GW 68 230 N	 DBO	2 AUTOMATIKA vert. interlocked switched socket-outlets 2P+E 16A IP67 230V 1 AUTOMATIKA vert. interlocked switched socket-outlet 3P+N+E 16A IP67 400V
		GW 68 231 N	 DBO	1 AUTOMATIKA vert. interlocked switched socket-outlet 2P+E 16A IP67 230V 2 AUTOMATIKA vert. interlocked switched socket-outlets 3P+N+E 16A IP67 400V			
	20	GW 68 208 N	 DBO	2 vert. interlocked switched socket-outlets 2P+E 16A IP67 230V 1 vert. interlocked switched socket-outlet 3P+E 16A IP67 400V 1 vert. interlocked switched socket-outlet 3P+E 32A IP67 400V with rotary switch			

68 Q-DIN

Distribution boards

A complete system of IP65 boards for distributing energy in tertiary, commercial sector and building applications, available both empty and pre-wired, in accordance with the international standard IEC 61439. The Q-DIN range comprises boards from 5 to 20 DIN modules, plus supplementary modules of 14 or 20 M to add even more DIN spaces. They can accommodate flush-mounting socket-outlets and interlocked socket-outlets of up to 63 A, and they can be combined with numerous accessories.



EMPTY BOARDS FOR MOBILE AND FIXED INSTALLATIONS

Q-DIN 5 - SURFACE-MOUNTING - IP65



GW 68 017N



GW 68 018N



GW 68 001N
GW 68 031N



GW 68 020N



GW68026N
GW68032N



GW 68 001 N

Q-DIN 5 WATERTIGHT BOARDS - UNWIRED - RAL 7035 - IP65

Code	Houseable socket	No. of provided blank lids	Dispersible power A (W)	Dispersible power B (W)	Pack Carton
No. of modules EN 50022: 5					
GW 68 017 N	1 IEC 309 16A IP44/67	-	10	37	16
GW 68 018 N	2 IEC 309 16A IP44/67	-	10	37	12
GW 68 001 N	3 IEC 309 16A IP44/67	1 IEC 16A	10	37	8
GW 68 031 N	3 IEC 309 16A IP44/67	1 IEC 16A	10	37	4
GW 68 020 N	2 IEC 309 16/32A IP44/67	1 IEC 16/32A	10	37	8
GW 68 026 N	4 domestic socket std.50x50 mm	1 domestic socket std.50x50 mm	10	37	8

ACCESSORIES SUPPLIED: cable clamp and 2 screw caps. GW68031N complete with rubber shockproof case. Adapter flange for every IEC 309 socket-outlet housing seat - 16/32 A.

NOTES: key not installable. Dispersible power (B) is calculated according to IEC 60890 standard. It refers to the 40 K overtemperature, between the temperature inside and outside the board. The IP65 degree of protection is obtained with blank flange lid installed correctly on all the seats of the unwired board.

External dimensions GW68017N (LxHxD): 105x258x96 mm.

External dimensions GW68018N (LxHxD): 105x337x96 mm.

External dimensions GW68001N and GW68020N (LxHxD): 105x430x96 mm.

External dimensions GW68031N (LxHxD): 140x560x105 mm.

Halogen-Free in accordance with Standard EN 60754-2.

Q-DIN 10 - SURFACE-MOUNTING - IP65



GW 68 002N



GW 68 025N



GW 68 003N



GW 68 019N



GW68027N



GW 68 025 N

Q-DIN 10 WATERTIGHT BOARDS - UNWIRED - RAL 7035 - IP65

Code	Houseable socket	No. of provided blank lids	Dispersible power A (W)	Dispersible power B (W)	Pack Carton
No. of modules EN 50022: 10					
GW 68 002 N	Blank lid	-	16	42	6
GW 68 025 N	2 IB Vert. 16-32A IP67	1 IB 16/32A	16	42	6
GW 68 003 N	2 IEC 16A + 2 IEC 16/32A	1 IEC 309 16A+1 16/32A	16	42	6
GW 68 019 N	2 IB Horiz. 16/32A SBF IP44 overlapping	1 IB 16/32A	16	42	6
GW 68 027 N	3 dom.socket 50x50 mm + 2 IEC 16/32 A	1 domestic + 1 IEC 16 A	16	42	6

ACCESSORIES SUPPLIED: cable clamp and 4 screw caps. Adapter flange for every IEC 309 socket-outlet housing seat - 16/32 A.

NOTES: Dispersible power (B) is calculated according to IEC 60890 standard. It refers to the 40K overtemperature, between the temperature inside and outside the board.

GW68003N: pre-arranged for two 16-32 A socket-outlets in the lower flanges and two 16A socket-outlets in the upper flanges. The IP65 degree of protection is obtained with blank flange lid installed correctly on all the seats of the unwired board.

External dimensions (LxHxD): 220x435x96.

Halogen-Free in accordance with Standard EN 60754-2.

Q-DIN 14 - SURFACE-MOUNTING - IP65



GW 68 004N



GW 68 005N



GW 68 006N



GW 68 005 N

Q-DIN 14 WATERTIGHT BOARDS - UNWIRED - RAL 7035 - IP65

Code	Houseable socket	No. of provided blank lids	Dispersible power A (W)	Dispersible power B (W)	Pack Carton
No. of modules EN 50022: 14					
GW 68 004 N	Blank lid	-	24	64	4
GW 68 005 N	3 IEC 309 16/32A IP44/67	1 IEC 16/32A	24	64	4
GW 68 006 N	2 IB Horiz. 16/32A SBF IP44 side by side	1 IB 16/32A	24	64	4

ACCESSORIES SUPPLIED: cable clamp and 4 screw caps. Adapter flange for every IEC 309 socket-outlet housing seat - 16/32 A.

NOTES: Dispersible power (B) is calculated according to IEC 60890 standard. It refers to the 40K overtemperature, between the temperature inside and outside the board. The IP65 degree of protection is obtained with blank flange lid installed correctly on all the seats of the unwired board.

External dimensions (LxHxD): 320x360x120.

Halogen-Free in accordance with Standard EN 60754-2.

Q-DIN 14 - SURFACE-MOUNTING - IP65



GW 68 007N



GW 68 008N



GW 68 009N



GW 68 010N



GW 68 008 N

Q-DIN 14 WATERTIGHT BOARDS - UNWIRED - RAL 7035 - IP65

Code	Houseable socket	No. of provided blank lids	Dispersible power A (W)	Dispersible power B (W)	Pack Carton
No. of modules EN 50022: 14					
GW 68 007 N	Blank lid	-	24	64	3
GW 68 008 N	6 IEC 309 16/32A IP44/67	2 IEC 16/32A	24	64	3
GW 68 009 N	4 IB Horiz. 16/32A SBF IP44	2 IB 16/32A	24	64	3
GW 68 010 N	3 IB Vert. 16/32A IP67	1 IB 16/32A	24	64	3

ACCESSORIES SUPPLIED: cable clamp and 4 screw caps. Adapter flange for every IEC 309 socket-outlet housing seat - 16/32 A.

NOTES: Dispersible power (B) is calculated according to IEC 60890 standard. It refers to the 40K overtemperature, between the temperature inside and outside the board. The IP65 degree of protection is obtained with blank flange lid installed correctly on all the seats of the unwired board.

External dimensions (LxHxD): 320x510x120.

Halogen-Free in accordance with Standard EN 60754-2.

Q-DIN 20 - SURFACE-MOUNTING - IP65



GW 68 012N



GW 68 013N



GW 68 014N



GW 68 021N



GW 68 014 N

Q-DIN 20 WATERTIGHT BOARDS - UNWIRED - RAL 7035 - IP65

Code	Houseable socket	No. of provided blank lids	Dispersible power A (W)	Dispersible power B (W)	Pack Carton
No. of modules EN 50022: 20					
GW 68 012 N	Blank lid	-	30	92	2
GW 68 013 N	8 IEC 309 16/32A IP44/67	2 IEC 16/32A	30	92	2
GW 68 014 N	4 IB Horiz. 16/32A CBF IP44	2 IB 16/32A	30	92	2
GW 68 021 N	2 IEC 309 63A - 4 IEC 309 16/32A	2 IEC 309 16/32A+1 63A	30	92	2

ACCESSORIES SUPPLIED: cable clamp and 6 screw caps. Adapter flange for every IEC 309 socket-outlet housing seat - 16/32 A.

NOTES: Dispersible power (B) is calculated according to IEC 60890 standard. It refers to the 40K overtemperature, between the temperature inside and outside the board. The IP65 degree of protection is obtained with blank flange lid installed correctly on all the seats of the unwired board.

External dimensions (LxHxD): 450x560x120.

Halogen-Free in accordance with Standard EN 60754-2.

68 Q-DIN

Q-DIN 20 - SURFACE-MOUNTING - IP65

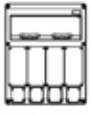

GW 68 015N



GW 68 022N



GW 68 015 N

Q-DIN 20 WATERTIGHT BOARDS - UNWIRED - RAL 7035 - IP65

Code	Houseable socket	No. of provided blank lids	Dispersible power A (W)	Dispersible power B (W)	Pack Carton
No. of modules EN 50022: 20					
GW 68 015 N	4IB 16/32A IP67 + 4 IEC MAX 3P+E 16A	2 IB 16/32A + 4 IEC 16A	30	92	2
GW 68 022 N	1IB Vert. 63A IP67 + 2 IB Vert. 16/32A IP67	1 IB 16/32A	30	92	2

ACCESSORIES SUPPLIED: cable clamp and 6 screw caps.

NOTES: Dispersible power (B) is calculated according to IEC 60890 standard. It refers to the 40K overtemperature, between the temperature inside and outside the board.

GW68015N: the 4 flanges - measuring 85x75 - can be equipped with the COMBI-IN GW27401 and GW27403 watertight covers. The IP65 degree of protection is obtained with blank flange lid installed correctly on all the seats of the unwired board.

External dimensions (LxHxD): 450x560x120.

Halogen-Free in accordance with Standard EN 60754-2.

ADDITIONAL Q-DIN MODULES - IP65



GW 68 023N



GW 68 024N



GW 68 023 N

ADDITIONAL Q-DIN MODULES - RAL 7035 - IP65

Code	No. of modules EN 50022	Dispersible power (W)	Pack Carton
GW 68 023 N	14	40	1/3
GW 68 024 N	20	52	1/3

NOTES: to be used with Q-DIN 14 and 20 M to double the DIN modules available, the dispersible power is calculated according to the document IEC 60890 (CEI 17-43) and refers to an overtemperature of 40K between the air temperature inside the board and in the room.

External dimensions GW68023N (LxHxD): 320x241x120.

External dimensions GW68024N (LxHxD): 450x241x120.

Halogen-Free in accordance with Standard EN 60754-2.

COMPLEMENTARY ITEMS



GW 68 431

YELLOW-PAINTED METAL CONDUIT SUPPORT WITH SUPPORT FOR CABLES OF UP TO 20 M

Code	Outer dim. LxHxD (mm)	For distribution board type	Pack Carton
GW 68 431	350x715x435	Q-DIN 10	1
GW 68 433	350x770x520	Q-DIN 14/20	1

NOTES: the type of cable considered is H 07 RN - F 5 x 4 mm²; the length varies according to the type of cable.

GW68433: Q-DIN protection system against the front drops.

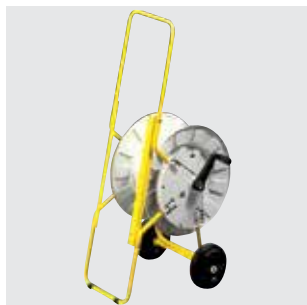

GW 68 432

METAL CARRIER PAINTED IN YELLOW EQUIPPED WITH TWO WHEELS AND ROTATING DRUM TO WIND UP TO 50 M OF CABLE

Code	Outer dim. LxHxD (mm)	For distribution board type	Pack Carton
GW 68 432	495x1000x605	Q-DIN 14/20	1

NOTES: the type of cable considered is H 07 RN - F 5 x 4 mm²; the length varies according to the type of cable. 1+1 flanges for socket-outlets IEC 309 16A and 32A.

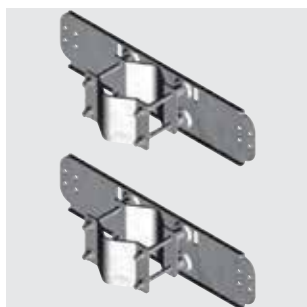

GW 46 552

POLE SUPPORT KIT FOR 68 Q-DIN BOARDS

Code	For Q-DIN	Max sustainable load (kg)	Pack Carton
GW 46 552	14	12	1
GW 46 553	20	125	1

CHARACTERISTICS: fixed on the back of the boards. The maximum sustainable load values refer to Q-DIN boards.

APPLICATIONS: for application of boards on poles from 60 to 80mm.

ACCESSORIES SUPPLIED: 2 pieces. For the correct use of the kit, see the instructions sheet.



GW 46 446

BRACKETS FOR FIXING BOARDS TO THE WALL

Code	Material	For Q-DIN	Accessories supplied	Pack Carton
GW 44 621	Insulation	5	Self-tapping fixing screws	40/480
GW 46 446	Galvanised steel	10/14/20	Self-tapping fixing screws	20
GW 46 451	Stainless steel	10/14/20	Self-tapping fixing screws	20

NOTES: GW44621: used to maintain the double insulation and the original IP degree of protection of the boxes, containers and other GEWISS products. GW46446 and GW46451: set composed of 4 brackets. Maximum sustainable load 8 kg for Q-DIN10, 12 kg for Q-DIN14 and 15 kg for Q-DIN20.



GW 62 393

DOMESTIC SOCKET OUTLET - IP54



Code	No. of poles	Rated current (A)	Rated voltage	Colour	Frequency	Flange dimensions (mm)	Pack Carton
Standard: German							
GW 62 393	2P+E	16	230 V	Blue	50/60 Hz	50x50	1/20
GW 62 392	2P+E	16	200 - 250 V	Blue	50/60 Hz	85x75	1/12
Standard: French							
GW 62 394	2P+E	16	230 V	Blue	50/60 Hz	50x50	1/20

CHARACTERISTICS: domestic socket-outlets equipped with child protection (shutter) and with rear connection.

NOTES: domestic socket-outlets 50x50 mm can be installed also on flanges 85x75 mm using the adapter code GW68281.



GW 74 361

ROUND MUSHROOM-HEAD EMERGENCY PUSH-BUTTON - MUSHROOM Ø 40MM

Code	Functions	Characteristics	Pack Carton
GW 74 361	With holding	Not illuminated	10/60

APPLICATION: suitable for emergency use, in accordance with Standard IEC 60947-5-5.

SUPPLIED: 3-seat flange (2 of which are contact-holders).

68 Q-DIN



ZC6

CONTACTS - ITH=10A - 250V AC

Code	Type	Colour	Pack Carton
GW 74 501	1 NO	Green	1/30
GW 74 502	1 NC	Red	1/30
GW 74 503	2 NO	Green	1/30
GW 74 504	1 NO + 1 NC	White	1/30
GW 74 505	2 NC	Red	1/30

CHARACTERISTICS: GW74502 suitable for contact opening also in the event of slight sticking, in compliance with Standard EN 60947-5-1. Clip assembly on the contact-holder flanges.

NOTES: the dual contacts type: GW74503, GW74504 and GW74505 are not compatible with the watertight emergency enclosures GW42204 and GW42207.



GW 40 422

CYLINDRICAL SECURITY LOCK

Code	Material	For distribution board type	Pack Carton
GW 40 422	Pressure die-cast metal	Q-DIN 10/14/20 and additional modules	1/10

ACCESSORIES SUPPLIED: 2 keys.

NOTES: All the keys and relative locks with the same product code are identical.



GW 68 436 N

Q-DIN TRANSPORTATION HANDLE

Code	Description	For distribution board type	Pack Carton
GW 68 436 N	Handle	Q-DIN 10/14/20 and additional modules	1/10



GW 68 292

BLANK LIDS FOR CLOSING COMPARTMENT CONTAINING IEC AND IB VERTICAL SOCKET-OUTLETS

Code	Description	Dimensions LxH (mm)	Pack Carton
GW 68 292	Lid for IEC 309 16A	85x75	1/10
GW 68 293	Lid for IEC 309 32A	95x80	1/10
GW 68 294	Lid for IEC 309 63A	110x100	1/10
GW 66 703 N	Lid for vertical interlocked socket-outlet 16-32A	220x103	1/10
GW 66 705 N	Lid for vertical interlocked socket-outlet 63A	270x145	1/10
GW 68 296	Lid for domestic socket outlet 50x50 mm	50x50	1/10



GW 66 702

BLANK LIDS FOR CLOSING COMPARTMENT CONTAINING IB HORIZONTAL SOCKET-OUTLETS

Code	For distribution boards	For back boxes	For flush-mounting boxes	Pack Carton
GW 66 701	GW68006N/09N/19N	GW66676	GW66681 - GW66681PM	1/10
GW 66 702	GW68014N	GW66677	GW66682 - GW66682PM	1/10



GW 66 709 N

FLANGED LID PREARRANGED FOR 2 CAPS - IP67

Code	Houseable IB socket-outlets	Pack Carton
GW 66 709 N	N. 1 IEC 309 16-32A IP44/67 + N.1 16A MAX 3P+E or GW27401/GW27403	1/10

APPLICATIONS: the flange of 85x75 mm dimension is suited for mounting IEC 309 16 A socket-outlets and COMBI-IN GW27401 and GW27403 flange; the flange of 95x80 mm dimension is suited for IEC 309 16 -32 A socket-outlets.

ACCESSORIES SUPPLIED: 1 blank flange - blue - 16 A; 1 blank flange - blue 16 -32 A; 3 gaskets and fixing screws.



GW 66 715 N

ADAPTER

Code	Suitable for	Pack Carton
GW 66 715 N	IP67 16/32A vertical socket-outlets	1/10
GW 66 716 N	IP67 63A Vertical socket-outlets	1/10
GW 68 281	Domestic socket outlet std.50x50 mm	1/10

APPLICATIONS: GW66715N to assemble all the vertical socket-outlets 16-32 A IP67 of the 67 IB range on the Q-DIN boards, or on the modular bases of the previous versions for socket-outlets 16-32 A CBF IP55.

GW66716N to assemble the vertical socket-outlets 63A IP67 of the 67 IB range on the modular bases of the previous versions for socket-outlets 63A CBF IP55.



GW 27 403

COMBI-IN WATERTIGHT COVERS FOR 2 SYSTEM RANGE MODULES

Code	Dimensions LxH (mm)	Door type	IP degree	Colour	Pack Carton
GW 27 401	75x85	With membrane	IP55	Grey RAL 7035	3/60
GW 27 403	75x85	Rigid IK09	IP65	Grey RAL 7035	3/60

NOTES: they are installed in the same seat of IEC 309 socket-outlets - 16 A IP44/67

ACCESSORIES SUPPLIED: gasket and mounting screws.



GW 66 745

WATERTIGHT LIDS

Code	Dimensions LxH (mm)	Suitable for	Colour	Pack Carton
GW 66 708	75x85	1 Button Ø22 mm Range 74 PS	Grey	1/20
GW 66 745	75x85	1 Button Ø22 mm Range 74 PS	Yellow	1/20

APPLICATIONS: GW66745 specific for emergency push-buttons.

ACCESSORIES SUPPLIED: gasket and mounting screws.



GW 44 626

BACK-MOUNTING PLATE IN INSULATED MATERIAL WITH SELF-TAPPING FIXING SCREWS

Code	For Q-DIN	Pack Carton
GW 44 626	10	20
GW 44 627	14	20
GW 44 628	20	4

NOTE: to be installed on the base of the Q-DIN, for inserting DIN rails/terminal blocks/components.



GW 40 412 B

INSULATED SCREW TERMINAL BLOCK BIPOLAR AND UNIPOLAR FOR ENCLOSURES AND BOARDS

Code	Pole 1 (mm ²)	Pole 2 (mm ²)	Suitable for	Fastener to supports	Pack Carton
Type: Bipolar - Rated current 125 A					
GW 40 401	N (1x35) + (7x10)	E (1x35) + (7x10)	Q-DIN 10/14/20	With screws	10
GW 40 402	N (3x35) + (10x10)	E (3x35) + (10x10)	Q-DIN 14/20	With screws and/or clip	10
Type: Bipolar - Rated current 80 A - IP20					
GW 40 408 B	N/E (2x16) + (7x10)	N/E (2x16) + (7x10)	Q-DIN 10/14/20	With screws	1/10
GW 40 412 B	N/E (3x16) + (11x10)	N/E (3x16) + (11x10)	Q-DIN 14/20	With screws and/or clip	1/10
Type: Unipolar - Rated current 80 A - IP20					
GW 40 408 U	N/E (2x16) + (7x10)	-	Q-DIN 10/14/20	With screws	1/10
GW 40 412 U	N/E (3x16) + (11x10)	-	Q-DIN 14/20	With screws and/or clip	1/10
GW 40 422 U	N/E (3x16) + (29x10)	-	Q-DIN 14/20	With screws and/or clip	1/10

ACCESSORIES SUPPLIED: fixing screws. The 80 A terminal blocks are equipped with N and E labels to be placed on the respective spaces to identify the poles.

CHARACTERISTICS: CWT 960°C according to EN60695-2-11.

INSTALLATION: the installation of the GW40401, GW40408B and GW40408U terminal blocks on Q-DIN 14/20 boards is permitted by using the GW40413 adapter.



GW 40 413

ADAPTERS FOR SCREW TERMINAL BLOCKS

Code	Suitable for	Fastener to supports	Pack Carton
GW 40 413	Q-DIN 14/20	With screws	20

ACCESSORIES SUPPLIED: fixing screws.

CHARACTERISTICS: the adapter is pre-drilled for the correct assembly of the terminal block.

INSTALLATION: permits installation of the GW40401, GW40408B and GW40408U terminal blocks on Q-DIN 14/20 boards.



GW 66 673

COUPLING FOR 68Q-DIN BOARDS - IP65

Code	Description	Pack Carton
GW 66 673	Coupler PG29	10/120

SURFACE-MOUNTING FOR COMBIBLOC COMPACT SOCKET-OUTLETS IP44 - IP55



GW 66 493

EMPTY BOARDS FOR FIXED COMPACT SOCKET-OUTLETS

Code	No. IB socket-outlets houseable	No. of modules EN 50022	No. of blank lids supplied	Dispersible power (W)	Pack Carton
GW 66 491	1 COMBIBLOC 16/32A	4	None	10	1/12
GW 66 492	2 COMBIBLOC 16/32A	8	1	13	1/6
GW 66 493	3 COMBIBLOC 16/32A	12	1	24	1/4

CHARACTERISTICS: the transparent door is pre-arranged for the GW40422 security lock.

ACCESSORIES SUPPLIED: sealing gaskets for COMBIBLOC socket-outlets.



GW 68 295

BLANK COVERS FOR COMBIBLOC INTERLOCKED SWITCHED SOCKET-OUTLETS

Code	Dimensions LxH (mm)	Pack Carton
GW 68 295	132x71	1/10

ACCESSORIES SUPPLIED: sealing gasket and 4 fixing screws.



GW 40 412 B

INSULATED SCREW TERMINAL BLOCK BIPOLAR AND UNIPOLAR FOR ENCLOSURES AND BOARDS

Code	Pole 1 (mm ²)	Pole 2 (mm ²)	Suitable for	Fastener to supports	Pack Carton
Type: Bipolar - Rated current 125 A					
GW 40 401	N (1x35) + (7x10)	E (1x35) + (7x10)	GW66492 and GW66493	With screws	10
GW 40 402	N (3x35) + (10x10)	E (3x35) + (10x10)	GW66493	With screws and/or clip	10
Type: Bipolar - Rated current 80 A - IP20					
GW 40 408 B	N/E (2x16) + (7x10)	N/E (2x16) + (7x10)	GW66492 and GW66493	With screws	1/10
GW 40 412 B	N/E (3x16) + (11x10)	N/E (3x16) + (11x10)	GW66493	With screws and/or clip	1/10
Type: Unipolar - Rated current 80 A - IP20					
GW 40 408 U	N/E (2x16) + (7x10)	-	GW66492 and GW66493	With screws	1/10
GW 40 412 U	N/E (3x16) + (11x10)	-	GW66493	With screws and/or clip	1/10
GW 40 422 U	N/E (3x16) + (29x10)	-	GW66493	With screws and/or clip	1/10

ACCESSORIES SUPPLIED: fixing screws. The 80 A terminal blocks are equipped with N and E labels to be placed on the respective spaces to identify the poles.

CHARACTERISTICS: GWT 960°C according to EN60695-2-11.

INSTALLATION: the installation of the GW40401, GW40408B and GW40408U terminal blocks on the GW66493 board is permitted by using the GW40413 adapter.

ADAPTERS FOR SCREW TERMINAL BLOCKS

Code	Suitable for	Fastener to supports	Pack Carton
GW 40 413	GW66493	With screws	20

ACCESSORIES SUPPLIED: fixing screws.

CHARACTERISTICS: the adapter is pre-drilled for the correct assembly of the terminal block.

INSTALLATION: it permits installation of the GW40401, GW40408B and GW40408U terminal blocks on the GW66493 board.



GW 40 413

WIRED BOARDS FOR FIXED APPLICATIONS

SURFACE-MOUNTING



GW 68 226 N

WIRED Q-DIN 5 DBU BOARDS WITH IEC 309 SOCKET-OUTLETS - IP44

Code	Socket-outlet 2P+E 16A - IEC 309		Socket-outlet 3P+E 16A - IEC 309		Schuko socket-outlet 10/16A	UK socket-outlet 13A	Pack Carton
	16A	16A	16A	16A			
GW 68 212 N	-	-	-	-	-	1	1/8
GW 68 224 N	1	-	1	-	1	-	1/2
GW 68 225 N	1	-	-	-	1	-	1/6
GW 68 226 N	1	-	1	-	-	-	1/6
GW 68 227 N	1	-	-	-	-	-	1/8

PROTECTIONS:

GW68212N: Board In: 10A
1 RCCB - SD Range 2P 230 V 25 A 0,03 A - AC Type

GW68224N: Board In: 13A
1 RCBO - MDC Range 4P 400 V 16 A C 6 kA 0,03 A - AC Type

GW68225N: Board In: 13A
1 RCBO - MDC Range 2P 230 V 16 A C 6 kA 0,03 A - AC Type

GW68226N: Board In: 25A
1 MCB - MTC Range 2P 230 V 16 A C 6 kA
1 MCB - MTC Range 3P 400 V 16 A C 6 kA

GW68227N: Board In: 13A
1 RCBO - MDC Range 2P 230 V 16 A C 6 kA 0,03 A - AC Type

ACCESSORIES SUPPLIED: cable clamp and 2 screw caps.



GW 68 202 N

WIRED Q-DIN 10 DBU BOARDS WITH IEC 309 SOCKET-OUTLETS - IP44

Code	Socket-outlet 2P+E 16A - IEC 309		Socket-outlet 3P+E 16A - IEC 309		Socket-outlet 3P+N+E 16A - IEC 309		Schuko socket-outlet 10/16A	Pack Carton
	16A	16A	16A	16A	16A	16A		
GW 68 202 N	2	-	1	-	-	1	1/3	
GW 68 228 N	1	-	1	-	1	1	1/3	

PROTECTIONS:

GW68202N: Board In: 25A
1 MCB - MTC Range 2P 230 V 16 A C 6 kA
1 MCB - MTC Range 3P 400 V 16 A C 6 kA

GW68228N: Board In: 25A
2 MCB - MTC Range 2P 230 V 16 A C 6 kA
1 MCB - MTC Range 4P 400 V 16 A C 6 kA

ACCESSORIES SUPPLIED: cable clamp and 4 screw caps.



GW 68 233 N

WATERTIGHT Q-DIN 10 DBO BOARDS WIRED WITH VERTICAL INTERLOCKED SWITCHED SOCKET-OUTLETS - IP65

Code	Socket-outlet 2P+E 16A - IB		Socket-outlet 3P+E 16A - IB		Pack Carton
	16A	16A	16A	16A	
GW 68 232 N	2	-	-	-	1/2
GW 68 233 N	1	-	1	-	1/2

PROTECTIONS:

GW68232N: Board In: 25 A.
2 MCB - MT Range 2P 230 V 16 A C 6 kA.

GW68233N: Board In: 25 A.
1 MCB - MT Range 2P 230 V 16 A C 6 kA.
1 MCB - MT Range 3P 400 V 16 A C characteristic 6 kA.

ACCESSORIES SUPPLIED: cable clamp and 4 screw caps.



GW 68 205 N

WIRED Q-DIN 14 DBO DISTRIBUTION BOARD WITH NON-INTERLOCKED SOCKET-OUTLETS - IP65

Code	Socket-outlet 2P+E 16A - IEC 309		Socket-outlet 3P+E 16A - IEC 309		Pack Carton
	16A	16A	16A	16A	
GW 68 205 N	2	-	1	-	1/3

Board In: 25A

PROTECTIONS:







2 MCB - MTC Range 2P 230 V 16 A C 6 kA
1 MCB - MTC Range 3P 400 V 16 A C 6 kA

ACCESSORIES SUPPLIED: cable clamp and 4 screw caps.



GW 68 229 N

WIRED Q-DIN 14 DBU BOARD WITH IEC 309 SOCKET-OUTLETS - IP44

	 DBO EUROPEAN STANDARD	 EN 62208	 16A	 16A	 16A	 32A	 16A		
Code	Socket-outlet 2P+E 16A - IEC 309		Socket-outlet 3P+E 16A - IEC 309		Socket-outlet 3P+N+E 16A - IEC 309		Socket-out 3P+E 32A - IEC309	Schuko socket-outlet 16A	Pack Carton
GW 68 229 N	2		1		1		1	1	1

Board In: 50A

PROTECTIONS: 1 MCB - MTC Range 2P 230 V 16 A C 6 kA for the 2P+E 16 A 230 V and the 10/16 A IT/DE 230 V domestic socket-outlets

1 MCB - MTC Range 4P 400 V 16 A C 6 kA for the 3P+E 16 A 400 V and 3P+N+E 16 A 400 V socket-outlets





1 MCB - MTC Range 3P 400 V 32 A C 6 kA for the 3P+E 32 A 400 V socket-outlet

ACCESSORIES SUPPLIED: cable clamp and 4 screw caps.



GW 68 206 N

WIRED, Q-DIN 14 DBU BOARD WITH HORIZONTAL INTERLOCKED SOCKET-OUTLETS - IP44

	 DBO EUROPEAN STANDARD	 EN 62208	 16A	 16A	 32A		
Code	Socket-outlet 2P+E 16A - IB		Socket-outlet 3P+E 16A - IB		Socket-out 3P+E 32A - IB		Pack Carton
GW 68 206 N	2		1		1		1

Board In: 50A

PROTECTIONS: Board with horizontal interlocked switched socket-outlets 44 IB

1 MCB - MTC Range 2P 230 V 16 A C 6 kA

1 MCB - MTC Range 3P 400 V 16 A C 6 kA





1 MCB - MTC Range 3P 400 V 32 A C 6 kA

ACCESSORIES SUPPLIED: cable clamp and 4 screw caps.



GW 68 207 N

WIRED Q-DIN 14 DBU BOARDS WITH VERTICAL INTERLOCKED SOCKET-OUTLETS - IP65

	 DBO EUROPEAN STANDARD	 EN 62208	 16A	 16A	 16A		
Code	Socket-outlet 2P+E 16A - IB		Socket-outlet 3P+E 16A - IB		Socket-outlet 3P+N+E 16A - IB		Pack Carton
GW 68 207 N	2		1		-		1
GW 68 230 N	2		-		1		1
GW 68 231 N	1		-		2		1

PROTECTIONS:

GW68207N: Board In: 25A

2 MCB - MTC Range 2P 230 V 16 A C 6 kA

1 MCB - MTC Range 3P 400 V 16 A C 6 kA

GW68230N: Board In: 25A

1 RCCB - SD Range 4P 400 V 40 A 0,03 A - AC Type

2 MCB - MT Range 2P 230 V 16 A C 6 kA

1 MCB - MT Range 4P 400 V 16 A C 6 kA

GW68231N: Board In: 32A

1 RCCB - SD Range 4P 400 V 40 A 0,03 A - AC Type

1 MCB - MT Range 2P 230 V 16 A C 6 kA

2 MCB - MT Range 4P 400 V 16 A C 6 kA





CHARACTERISTICS: GW68230N and GW68231N board equipped with AUTOMATIKA sockets.

ACCESSORIES SUPPLIED: cable clamp and 4 screw caps.



GW 68 208 N

WIRED Q-DIN 20 DBU BOARD WITH VERTICAL INTERLOCKED SOCKET-OUTLETS AND 4 FLANGES FOR NON-INTERLOCKED SOCKET-OUTLETS 16A - IP65

	 DBO EUROPEAN STANDARD	 EN 62208	 16A	 16A	 32A		
Code	Socket-outlet 2P+E 16A - IB		Socket-outlet 3P+E 16A - IB		Socket-out 3P+E 32A - IB		Pack Carton
GW 68 208 N	2		1		1		1

Board In: 50A

PROTECTIONS: 2 MCB - MTC Range 2P 230 V 16 A C 6 kA

1 MCB - MTC Range 3P 400 V 16 A C 6 kA

1 MCB - MTC Range 3P 400 V 32 A C 6 kA

ACCESSORIES SUPPLIED: cable clamp and 6 screw caps.

SURFACE-MOUNTING WITH COMBIBLOC COMPACT SOCKET-OUTLETS



GW 66 391

WIRED COMBIBLOC BOARD WITH COMPACT INTERLOCKED SOCKET-OUTLETS - IP44



Code	Socket-outlet 2P+E 16A - IB	IP degree	Pack Carton
GW 66 391	1	IP44	1/2

Board In: 14A

PROTECTIONS: 1 RCBO - MDC Range 2P 230 V 16 A C 6 kA 0,03 A - AC Type



GW 66 392

WIRED COMBIBLOC BOARDS WITH COMPACT INTERLOCKED SOCKET-OUTLETS - IP44 / IP55



Code	Socket-outlet 2P+E 16A - IB	Socket-outlet 3P+E 16A - IB	Socket-outlet 3P+N+E 16A - IB	IP degree	Pack Carton
GW 66 392	1	1	-	IP44	1/2
GW 66 393	1	-	1	IP55	1/2

PROTECTIONS:

GW66392: Board In: 25A

1 MCB - MTC Range 2P 230 V 16 A C 6 kA

1 MCB - MTC Range 3P 400 V 16 A C 6 kA

GW66393: Board In: 25A

1 MCB - MTC Range 2P 230 V 16 A C 6 kA

1 MCB - MTC Range 4P 400 V 16 A C 6 kA.



GW 66 394

WIRED COMBIBLOC BOARDS WITH COMPACT INTERLOCKED SOCKET-OUTLETS - IP44 / IP55



Code	Socket-outlet 2P+E 16A - IB	Socket-outlet 3P+E 16A - IB	Socket-outlet 3P+N+E 16A - IB	Socket-out 3P+E 32A - IB	IP degree	Pack Carton
GW 66 394	1	1	1	-	IP44	1
GW 66 395	2	1	-	-	IP55	1
GW 66 396	1	1	-	1	IP44	1
GW 66 397	1	1	1	-	IP55	1

PROTECTIONS:

GW66394: Board In: 20A

1 RCCB - SD Range 4P 400 V 25 A 0,03 A - AC Type

1 MCB - MTC Range 2P 230 V 16 A C 6 kA

1 MCB - MTC Range 4P 400 V 16 A C 6 kA

GW66395: Board In: 20A

1 RCCB - SD Range 4P 400 V 25 A 0,03 A - AC Type

1 MCB - MTC Range 2P 230 V 16 A C 6 kA

1 MCB - MTC Range 3P 400 V 16 A C 6 kA

GW66396: Board In: 50A

1 MCB - MTC Range 2P 230 V 16 A C 6 kA

1 MCB - MTC Range 3P 400 V 16 A C 6 kA

1 MCB - MTC Range 3P 400 V 32 A C 6 kA

GW66397: Board In: 38A

1 MCB - MTC Range 2P 230 V 16 A C 6 kA

1 MCB - MTC Range 3P 400 V 16 A C 6 kA

1 MCB - MTC Range 4P 400 V 16 A C 6 kA.



68 Q-DIN



Scan the QR Code and find out all the technical informations.

QUADRI COMBINATI IEC 309

WIDE AND CONFIGURABLE RANGE



The power distribution board range is made up of 23 empty casings with IP65 degree of protection, for flushmounted and interlocked socketoutlets up to 63A, and with numerous complementary items that increase the fields of application.

INNOVATIVE TECHNICAL SOLUTIONS



The boards have many innovative technical features, such as the ergonomic handle, which simplifies the opening of the door, and the screws to "hinge" the front facilitating wiring. Additional enclosures 14 and 20M modules are also available, ideal for increasing the modular space.

TOP-LEVEL ACCESSORY OPTIONS



The boards can be equipped with a key lock with a metal cylinder and mushroom emergency button. They can be fixed to a pole, surfacemounted, flush-mounted or on accident prevention mobile supports.

68 ACS

68 QP ACS - WIRED MAIN BOARDS FOR CONSTRUCTION SITES

TYPE	DOOR	MAIN SWITCH			EMERGENCY KIT	POWER MAX (KW)	CODE
		N° OF POLES	In (A)	PROTECTION DEVICE			
 QP	Blind	4	125	MCB 125A 4P C 10kA + RCD adjustable - A Type	YES	65	GW 68 521
		4	160	MSXD 160A - 3P+N 25kA + integrated adjustable RCD	YES	85	GW 68 526
		4	250	MSXD 250A - 3P+N 36kA + integrated adjustable RCD	YES	130	GW 68 531





68 Q-BOX ACS - WIRED DISTRIBUTION BOARDS FOR CONSTRUCTION SITES

TYPE	TOTAL N. SOCKET OUTLETS	SOCKET-OUTLETS CONFIGURATION									MAIN RCBO		EMERGENCY KIT	POWER MAX (KW)
		16A std. DE	16A 2P+E 230 V	16A 3P+E 400 V	16A 3P+N+E 400 V	32A 2P+E 230 V	32A 3P+E 400 V	32A 3P+N+E 400 V	63A 3P+E 400 V	63A 3P+N+E 400 V	N° OF POLES	In (A)		
 Q-BOX	4		4								2	32	YES	6
			3	1							4	32	YES	17
			2	2							4	32	YES	17
			2	1	1						4	32	YES	17
			3			1					2	63	YES	12
			3				1				4	32	YES	17
			3					1			4	32	YES	17
			2	1				1			4	32	YES	17
			2		1				1		4	32	YES	17
			2	1						1	4	32	YES	17
		1	2					1		4	32	YES	17	
		5		2	3						4	63	YES	33
				3	1				1		4	63	YES	33
				3	1					1	4	63	YES	33
				2	2				1		4	63	YES	33
				2	2					1	4	63	YES	33
				2	1	1				1	4	63	YES	33
				2	1				1		4	63	YES	33
				2	1				1		4	80	YES	42
		6		2		1				1	4	80	YES	42
				6							2	32	YES	6
				4	2						4	32	YES	17
				3	3						4	32	YES	17
				3	2	1					4	32	YES	17
				3	2				1		4	63	YES	33
				3	2					1	4	63	YES	33
				3		2				1	4	63	YES	33
				3	1	1			1		4	63	YES	33
			3	1	1				1	4	63	YES	33	
			2	3				1		4	63	YES	33	
			2	2				1	1	4	63	YES	33	
			2	1	1			1	1	4	63	YES	33	
			2	2				2		4	63	YES	33	
		2		2				2	4	63	YES	33		
		2	1					3	4	63	YES	33		
		3						2	4	100	YES	53		
		2						2	4	100	YES	53		
	8		4	3				1	4	63	YES	33		
	9	4	2	2				1	4	63	YES	33		
	11	4	3	2				1	4	100	YES	53		
	12		6	3	1			2	4	63	YES	33		
			12							2	63	YES	12	
			6	6					4	63	YES	33		

(*) Versions where n.2 sockets-outlets 16A 2P+E are type IEC 309 (not interlocked)

68 CDK ACS - WIRED MAIN BOARDS FOR CONSTRUCTION SITES

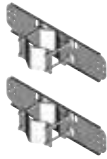
TYPE	DOOR	MAIN SWITCH			EMERGENCY KIT	POWER MAX (KW)	CODE
		N° OF POLES	In (A)	PROTECTION DEVICE			
	Transparent	4	32	RCBO 32A 4P C 6kA 0,03A - AC Type	YES	17	GW 68 536
		4	63	RCBO 63A 4P C 6kA 0,03A - AC Type	YES	33	GW 68 537
		4	100	MCB 100A 4P C 10kA + RCD 0,03A - AC Type	YES	53	GW 68 538
		4	125	MCB 125A 4P C 10kA + RCD 0,03A - AC Type	YES	65	GW 68 539





SOCKETS TYPE					COMPLIMENTARY ITEMS
INTERLOCKED WITHOUT FUSE HOLDER (SBF)		INTERLOCKED WITH FUSE HOLDER (CBF)		FIXED IEC 309	
SUPPLY TERMINAL BLOCK	SUPPLY FIXED PLUG	SUPPLY TERMINAL BLOCK	SUPPLY FIXED PLUG	SUPPLY TERMINAL BLOCK	
GW 68 561	GW 68 584	GW 68 561 F	GW 68 584 F		 <p>Security lock GW 46 445</p>
GW 68 562	GW 68 481	GW 68 562 F	GW 68 481 F		
GW 68 563	GW 68 482	GW 68 563 F	GW 68 482 F		
GW 68 564	GW 68 585	GW 68 564 F			
GW 68 511		GW 68 511 F			
GW 68 565		GW 68 565 F			
GW 68 566		GW 68 566 F			
GW 68 567	GW 68 586	GW 68 567 F	GW 68 586 F		
GW 68 568		GW 68 568 F			
GW 68 569	GW 68 587	GW 68 569 F	GW 68 587 F		
GW 68 570	GW 68 588	GW 68 570 F	GW 68 588 F		
GW 68 512*		GW 68 512 F		 <p>floor mounting support GW 68 463</p>	
GW 68 571*	GW 68 589*	GW 68 571 F	GW 68 589 F		
GW 68 572	GW 68 590*	GW 68 572 F	GW 68 590 F		
GW 68 513*	GW 68 483*	GW 68 513 F	GW 68 483 F		
GW 68 573	GW 68 592*	GW 68 573 F	GW 68 592 F		
GW 68 514*	GW 68 484*	GW 68 514 F	GW 68 484 F		
GW 68 574*	GW 68 593*				
		GW 68 574 F			
		GW 68 498 F			
GW 68 575	GW 68 594	GW 68 575 F	GW 68 594 F		 <p>Pole support kit (only for Q-BOX4) GW 46 554</p>
GW 68 576	GW 68 595	GW 68 576 F	GW 68 595 F		
GW 68 577	GW 68 473	GW 68 577 F	GW 68 473 F		
GW 68 578	GW 68 596	GW 68 578 F	GW 68 596 F		
GW 68 493	GW 68 471	GW 68 493 F	GW 68 471 F		
GW 68 579	GW 68 597	GW 68 579 F	GW 68 597 F		
	GW 68 598		GW 68 598 F		
GW 68 580		GW 68 580 F			
GW 68 581					
GW 68 582	GW 68 472	GW 68 582 F	GW 68 472 F	 <p>Plug-socket outlets block GW 68 505</p>	
GW 68 583	GW 68 599	GW 68 583 F	GW 68 599 F		
GW 68 492					
GW 68 494	GW 68 600	GW 68 494 F	GW 68 600 F		
GW 68 491	GW 68 474	GW 68 491 F			
GW 68 495					
GW 68 496					
GW 68 497					
GW 68 542					
GW 68 541					
GW 68 543				 <p>Document holder wallet GW 46 447</p>	
GW 68 544					
				GW 68 468	
				GW 68 469	

68 ACS

68 Q-DIN ACS - WIRED MOBILE BOARDS FOR CONSTRUCTION SITES

TYPE	TOTAL N. SOCKET OUTLETS	IP DEGREE	SOCKET-OUTLETS CONFIGURATION							
			16A std. DE	16A 2P 24 V	16A 2P+E 230 V	16A 3P+E 400 V	16A 3P+N+E 400 V	32A 3P+E 400 V		32A 3P+N+E 400 V
	2	IP65		2						
	3	IP44	1		2					
		IP65			3					
		IP65			3					
		IP65			2	1				
		IP65			1	2				
		IP65					3			
	4	IP44	2			2				
		IP44	1			2	1			
		IP65				4				
		IP65				3	1			
		IP65				3		1		
		IP65				2	2			
		IP65					4			
		IP65				2	1		1	
	6	IP65			2	2				
		IP65				6				
		IP65				4	2			
		IP65				3	3			
		IP65				3	2		1	
8	IP44	2			2	2		2		
COMBIBLOC	3	IP55			2			1		
		IP55			1			1		1
QMC	6	IP56			2	1	2			1
	7	IP56			7					
		IP56			4	1	1			1

(*) NOTE Version GW68223N with yellow shockproof case versions GW68401N, GW66388 ad GW68389 with metal conduit support versions GW68411N, GW68421N and GW68424N equipped with metal conduit carriage with two wheels

	MAIN RCBO		EMERGENCY KIT	POWER MAX (KW)	SOCKET TYPE		COMPLIMENTARY ITEMS
	N° OF POLES	In (A)			INTERLOCKED WITHOUT FUSE HOLDER (SBF)	FIXED IEC 309	
	2	16	-	3	GW 68 235 N		
	2	16	-	3		GW 68 241N	 <p>Security lock GW 40 422 (Q-DIN 10/14/20)</p>
	2	16	-	3		GW 68 217 N	
	2	16	-	3		GW 68 223 N*	
	4	16	-	8		GW 68 242 N	
	4	16	-	8		GW 68 243 N	 <p>floor mounting support GW 68 431 (Q-DIN 10)</p> <p>GW 68 433 (Q-DIN 14/20)</p>
	4	16	-	8		GW 68 244 N	
	2	16	-	3		GW 68 203 N	
	4	16	-	8		GW 68 401 N*	
	2	16	-	3		GW 68 216 N	
	4	16	-	8		GW 68 245 N	 <p>Metal Carrier with two wheels GW 68 432 (Q-DIN 14/20)</p>
	4	16	-	8		GW 68 246 N	
	4	16	-	8		GW 68 204 N	
	4	16	-	8		GW 68 247 N	
	4	63	-	33	GW 68 424 N*		
	2	16	-	3	GW 68 236 N		
	4	16	-	8		GW 68 248 N	 <p>Metallic transportation handle GW 68 436 N (Q-DIN 10/14/20)</p>
	4	32	-	17		GW 68 249 N	
	4	32	-	17		GW 68 250 N	
	4	32	-	17		GW 68 251 N	
	4	32	-	17		GW 68 411 N*	
	4	32	-	17		GW 68 421 N*	
	4	40	-	21	GW 66 388*		
	4	40	-	21	GW 66 389*		
	4	50	YES	26		GW 68 884 A	
	4	40	YES	21		GW 68 881 A	
	4	50	YES	26		GW 68 883 A	

68 ACS

ACS distribution board system for construction sites

The 68 ACS range is composed of an extensive selection of wired boards which are certified in accordance with the Standard EN 61439-4, and are capable of meeting all electrification requirements, from the smallest to the biggest construction sites. The boards are available in numerous configurations that differ in terms of number and type of socket-outlet, protected by MCB or fuse holder base. A selection of ready to use pre-wired or empty versions is available, and these can be personalised to suit all site needs and certified using GWENERGYpro software. The range is completed by a range of portable floodlights and luminous indicator devices.



WIRED MAIN BOARDS FOR CONSTRUCTION SITES

68 CDK ACS - WATERTIGHT THERMOPLASTIC BOARDS



GW 68 537

WIRED BOARDS IN THERMOPLASTIC WITH TRANSPARENT DOOR EQUIPPED WITH LOCK - GREY RAL 7035



Code	Outer dim. LxHxD (mm)	In/out power supply	MCB'S MT main RCCB	Power suppliable (kW)	Pack Carton
No. of poles: 4					
GW 68 536	298x260x140	PG29x2	RCBO 32 A	17	1
GW 68 537	298x260x140	PG36x2	RCBO 63 A	33	1
GW 68 538	410x285x140	PG36x2	RCBO 100 A	53	1
GW 68 539	410x285x140	PG42x2	RCBO 125 A	65	1

APPLICATIONS: Typical application: main boars for construction sites. It is installed downstream of the energy meter and protects the lenght of the cable from the main energy board to the secondary distribution boards.

ACCESSORIES SUPPLIED: Emergency push-botton; PG-type cable glands for cable inlet and outlet; kit of 4 wall fixing brackets.

68 QP ACS - WATERTIGHT POLYESTER BOARDS



GW 68 526

WIRED POLYESTER BOARDS WITH BLANK DOOR EQUIPPED WITH LOCK - GREY RAL 7035



Code	Outer dim. LxHxD (mm)	In/out power supply	Mains switch	RCCB protection	Power suppliable (kW)	Pack Carton
No. of poles: 4						
GW 68 521	405x500x200	2xPG42	MTHP125	Side-by-side -adjustable	60	1
GW 68 526	405x500x200	2xPG42	MSXD 160	Integrated adjustable	75	1
GW 68 531	515x650x250	8xPG29	MSXD 250	Integrated adjustable	140	1

CHARACTERISTICS: The last modular row of the board should be reserved for the cable input / output terminals. the cable glands for cable input / output are positioned on the back of the boards.

APPLICATIONS: Typical application: main boars for construction sites. It is installed downstream of the energy meter and protects the lenght of the cable from the main energy board to the secondary distribution boards.

ACCESSORIES SUPPLIED: Transportation handle; mushroom-head emergency push-button connected to the minimum voltage release of the mains switch; PG-type cable glands for cable inlet and outlet; set of 4 surface-mounting fixing brackets in stainless steel; key-operated security locks with handle.

WIRED DISTRIBUTION BOARDS FOR CONSTRUCTION SITES

Q-BOX BOARD WITH SOCKETS IEC 309



GW 68 469

Q-BOX 4 - WIRED BOARDS WITH SOCKETS IEC 309 EQUIPPED WITH TERMINAL BLOCK - IP55



Code	Socket-outlet 2P+E 16A - IEC 309	Socket-outlet 3P+E 16A - IEC 309	Power suppliable (kW)	Pack Carton
No. socket outlets: 12				
GW 68 468	12	-	12	1
GW 68 469	6	6	33	1

CHARACTERISTICS: Thermoplastic boards with high resistance impact (IK10). Typical application: main or secondary distribution boards for construction sites, exhibition areas, and temporary uses.

ACCESSORIES SUPPLIED: Emergency push-button, terminal block, stainless steel tear-proof cablefastening hooks, N. 2 triangular lock, set of steel brackets for surface-mounting.

NOTES: external dimensions (BxHxP) 636x821x400 mm.

Please refer to Gewiss web site to download the wiring diagrams of the boards..

Q-BOX BOARD WITH INTERLOCKED SOCKET-OUTLETS (SBF TYPE)



GW 68 511

Q-BOX 4 - WIRED BOARDS WITH INTERLOCKED SOCKETS EQUIPPED WITH TERMINAL BLOCK - IP55



Code	2P+E 16 A	3P+E 16 A	3P+N+E 16 A	2P+E 32 A	3P+E 32 A	3P+N+E 32 A	Power suppliable (kW)	Pack Carton
No. socket outlets: 4								
GW 68 561	4	-	-	-	-	-	6	1
GW 68 562	3	1	-	-	-	-	17	1
GW 68 563	2	2	-	-	-	-	17	1
GW 68 564	2	1	1	-	-	-	17	1
GW 68 511	3	-	-	1	-	-	12	1
GW 68 565	3	-	-	-	1	-	17	1
GW 68 566	3	-	-	-	-	1	17	1
GW 68 567	2	1	-	-	1	-	17	1
GW 68 568	2	-	1	-	-	1	17	1
GW 68 569	2	1	-	-	-	1	17	1
GW 68 570	1	2	-	-	1	-	17	1

CHARACTERISTICS: Thermoplastic boards with high resistance impact (IK10). Typical application: main or secondary distribution boards for construction sites, exhibition areas, and temporary uses.

ACCESSORIES SUPPLIED: Emergency push-button, terminal block, stainless steel tear-proof cablefastening hooks, N. 2 triangular lock, set of steel brackets for surface-mounting.

NOTES: external dimensions (BxHxP) 636x821x400 mm.

Please refer to Gewiss web site to download the wiring diagrams of the boards..



GW 68 513

Q-BOX 4 - WIRED BOARDS WITH INTERLOCKED SOCKETS AND NOT INTERLOCKED SOCKETS (IEC 309) EQUIPPED WITH TERMINAL BLOCK - IP55



Code	2P+ E 16 A - IEC 309	2P+E 16 A	3P+E 16 A	3P+N+E 16 A	3P+E 32 A	3P+N+E 32 A	3P+E 63 A	Power suppliable (kW)	Pack Carton
No. socket outlets: 5									
GW 68 512	2	-	3	-	-	-	-	33	1
GW 68 571	2	1	1	-	1	-	-	33	1
GW 68 572	2	1	1	-	-	1	-	33	1
GW 68 513	2	-	2	-	1	-	-	33	1
GW 68 573	2	-	2	-	-	1	-	33	1
GW 68 514	2	-	1	1	-	1	-	33	1
GW 68 574	2	-	1	-	1	-	1	33	1
No. socket outlets: 8									
GW 68 542	-	4	3	-	-	1	-	53	1

CHARACTERISTICS: Thermoplastic boards with high resistance impact (IK10). Typical application: main or secondary distribution boards for construction sites, exhibition areas, and temporary uses.

GW68542 equipped with interlocked sockets type COMBIBLOC IP55.

ACCESSORIES SUPPLIED: Emergency push-button, terminal block, stainless steel tear-proof cablefastening hooks, N. 2 triangular lock, set of steel brackets for surface-mounting.

NOTES: external dimensions (BxHxP) 636x821x400 mm.

Please refer to Gewiss web site to download the wiring diagrams of the boards..



GW 68 541

Q-BOX 4 - WIRED BOARDS WITH INTERLOCKED SOCKETS AND DOMESTIC SOCKETS EQUIPPED WITH TERMINAL BLOCK - IP55



Code	German Std socket-outlet 16 A	2P+E 16 A	3P+E 16 A	3P+N+E 32 A	Power supplyable (kW)	Pack Carton
No. socket outlets: 9						
GW 68 541	4	2	2	1	33	1

CHARACTERISTICS: Thermoplastic boards with high resistance impact (IK10). Typical application: main or secondary distribution boards for construction sites, exhibition areas, and temporary uses.

ACCESSORIES SUPPLIED: Emergency push-button, terminal block, stainless steel tear-proof cablefastening hooks, N. 2 triangular lock, set of steel brackets for surface-mounting.

NOTES: external dimensions (BxHxP) 636x821x400 mm.

Please refer to Gewiss web site to download the wiring diagrams of the boards..



GW 68 491

Q-BOX 6 - WIRED BOARDS WITH INTERLOCKED SOCKETS EQUIPPED WITH TERMINAL BLOCK - IP55



Code	2P+E 16 A	3P+E 16 A	3P+N+E 16 A	3P+E 32 A	3P+N+E 32 A	3P+N+E 63 A	Power supplyable (kW)	Pack Carton
No. socket outlets: 6								
GW 68 575	6	-	-	-	-	-	6	1
GW 68 576	4	2	-	-	-	-	17	1
GW 68 577	3	3	-	-	-	-	17	1
GW 68 578	3	2	1	-	-	-	17	1
GW 68 493	3	2	-	1	-	-	33	1
GW 68 579	3	2	-	-	1	-	33	1
GW 68 580	3	1	1	1	-	-	33	1
GW 68 581	3	1	1	-	1	-	33	1
GW 68 582	2	3	-	1	-	-	33	1
GW 68 583	2	2	-	1	1	-	33	1
GW 68 492	2	1	1	1	1	-	33	1
GW 68 494	2	2	-	2	-	-	33	1
GW 68 491	2	-	2	-	2	-	33	1
GW 68 495	2	1	-	-	3	-	33	1
GW 68 496	3	-	-	-	2	1	53	1
GW 68 497	2	-	-	-	2	2	53	1
No. socket outlets: 12								
GW 68 544	6	3	1	-	2	-	33	1

CHARACTERISTICS: Thermoplastic boards with high resistance impact (IK10). Typical application: main or secondary distribution boards for construction sites, exhibition areas, and temporary uses.

GW68544 equipped with interlocked sockets type COMBIBLOC IP55.

ACCESSORIES SUPPLIED: Emergency push-button, terminal block, stainless steel tear-proof cablefastening hooks, N. 2 triangular lock, set of steel brackets for surface-mounting.

NOTES: external dimensions (BxHxP) 914x821x400 mm.

Please refer to Gewiss web site to download the wiring diagrams of the boards..



GW 68 543

Q-BOX 6 - WIRED BOARDS WITH INTERLOCKED SOCKETS AND DOMESTIC SOCKETS EQUIPPED WITH TERMINAL BLOCK - IP55



Code	German Std socket-outlet 16 A	2P+E 16 A	3P+E 16 A	3P+N+E 32 A	3P+N+E 63 A	Power supplyable (kW)	Pack Carton
No. socket outlets: 11							
GW 68 543	4	3	2	1	1	53	1

CHARACTERISTICS: Thermoplastic boards with high resistance impact (IK10). Typical application: main or secondary distribution boards for construction sites, exhibition areas, and temporary uses.

ACCESSORIES SUPPLIED: Emergency push-button, terminal block, stainless steel tear-proof cablefastening hooks, N. 2 triangular lock, set of steel brackets for surface-mounting.

NOTES: external dimensions (BxHxP) 914x821x400 mm.

Please refer to Gewiss web site to download the wiring diagrams of the boards..



GW 68 481

Q-BOX 4 - WIRED BOARDS WITH INTERLOCKED SOCKETS EQUIPPED WITH FIXED PLUG - IP55



Code	2P+E 16 A	3P+E 16 A	3P+N+E 16 A	3P+E 32 A	3P+N+E 32 A	Power supplyable (kW)	Pack Carton
No. socket outlets: 4							
GW 68 584	4	-	-	-	-	6	1
GW 68 481	3	1	-	-	-	17	1
GW 68 482	2	2	-	-	-	17	1
GW 68 585	2	1	1	-	-	17	1
GW 68 586	2	1	-	1	-	17	1
GW 68 587	2	1	-	-	1	17	1
GW 68 588	1	2	-	1	-	17	1

CHARACTERISTICS: Thermoplastic boards with high resistance impact (IK10). Typical application: main or secondary distribution boards for construction sites, exhibition areas, and temporary uses.

ACCESSORIES SUPPLIED: Emergency push-button, fixed plug, stainless steel tear-proof cablefastening hooks, N. 2 triangular lock, set of steel brackets for surface-mounting.

NOTES: external dimensions (BxHxP) 636x821x400 mm.

Please refer to Gewiss web site to download the wiring diagrams of the boards..



GW 68 483

Q-BOX 4 - WIRED BOARDS WITH INTERLOCKED SOCKETS AND SOCKETS IEC 309 EQUIPPED WITH FIXED PLUG - IP55



Code	2P+ E 16 A - IEC 309	2P+E 16 A	3P+E 16 A	3P+N+E 16 A	3P+E 32 A	3P+N+E 32 A	3P+E 63 A	Power supplyable (kW)	Pack Carton
No. socket outlets: 5									
GW 68 589	2	1	1	-	1	-	-	33	1
GW 68 590	2	1	1	-	-	1	-	33	1
GW 68 483	2	-	2	-	1	-	-	33	1
GW 68 592	2	-	2	-	-	1	-	33	1
GW 68 484	2	-	1	1	-	1	-	33	1
GW 68 593	2	-	1	-	1	-	1	33	1

CHARACTERISTICS: Thermoplastic boards with high resistance impact (IK10). Typical application: main or secondary distribution boards for construction sites, exhibition areas, and temporary uses.

ACCESSORIES SUPPLIED: Emergency push-button, fixed plug, stainless steel tear-proof cablefastening hooks, N. 2 triangular lock, set of steel brackets for surface-mounting.

NOTES: external dimensions (BxHxP) 636x821x400 mm.

Please refer to Gewiss web site to download the wiring diagrams of the boards..



GW 68 473

Q-BOX 6 - WIRED BOARDS WITH INTERLOCKED SOCKETS EQUIPPED WITH FIXED PLUG - IP55



Code	2P+E 16 A	3P+E 16 A	3P+N+E 16 A	3P+E 32 A	3P+N+E 32 A	Power supplyable (kW)	Pack Carton
No. socket outlets: 6							
GW 68 594	6	-	-	-	-	6	1
GW 68 595	4	2	-	-	-	17	1
GW 68 473	3	3	-	-	-	17	1
GW 68 596	3	2	1	-	-	17	1
GW 68 471	3	2	-	1	-	33	1
GW 68 597	3	2	-	-	1	33	1
GW 68 598	3	-	2	-	1	33	1
GW 68 472	2	3	-	1	-	33	1
GW 68 599	2	2	-	1	1	33	1
GW 68 600	2	2	-	2	-	33	1
GW 68 474	2	-	2	-	2	33	1

CHARACTERISTICS: Thermoplastic boards with high resistance impact (IK10). Typical application: main or secondary distribution boards for construction sites, exhibition areas, and temporary uses.

ACCESSORIES SUPPLIED: Emergency push-button, fixed plug, stainless steel tear-proof cablefastening hooks, N. 2 triangular lock, set of steel brackets for surface-mounting.

NOTES: external dimensions (BxHxP) 914x821x400 mm.

Please refer to Gewiss web site to download the wiring diagrams of the boards..

Q-BOX BOARD WITH INTERLOCKED SOCKET-OUTLETS WITH FUSE-HOLDER (CBF TYPE)



GW 68 562 F

Q-BOX 4 - WIRED BOARDS WITH INTERLOCKED SOCKETS AND FUSE-HOLDER EQUIPPED WITH TERMINAL BLOC - IP55



Code	2P+E 16 A	3P+E 16 A	3P+N+E 16 A	2P+E 32 A	3P+E 32 A	3P+N+E 32 A	Power suppliable (kW)	Pack Carton
No. socket outlets: 4								
GW 68 561 F	4	-	-	-	-	-	6	1
GW 68 562 F	3	1	-	-	-	-	17	1
GW 68 563 F	2	2	-	-	-	-	17	1
GW 68 564 F	2	1	1	-	-	-	17	1
GW 68 511 F	3	-	-	1	-	-	12	1
GW 68 565 F	3	-	-	-	1	-	17	1
GW 68 566 F	3	-	-	-	-	1	17	1
GW 68 567 F	2	1	-	-	1	-	17	1
GW 68 568 F	2	-	1	-	-	1	17	1
GW 68 569 F	2	1	-	-	-	1	17	1
GW 68 570 F	1	2	-	-	1	-	17	1
No. socket outlets: 5								
GW 68 512 F	2	3	-	-	-	-	33	1
GW 68 571 F	3	1	-	-	1	-	33	1
GW 68 572 F	3	1	-	-	-	1	33	1
GW 68 513 F	2	2	-	-	1	-	33	1
GW 68 573 F	2	2	-	-	-	1	33	1
GW 68 514 F	2	1	1	-	-	1	33	1

CHARACTERISTICS: Thermoplastic boards with high resistance impact (IK10). Typical application: main or secondary distribution boards for construction sites, exhibition areas, and temporary uses. Each sockets is protected by fuses (supplied as accessory in the boards).

ACCESSORIES SUPPLIED: Emergency push-botton, terminal block, stainless steel tear-proof cablefastening hooks, N. 2 triangular lock, set of steel brackets for surface-mounting.

NOTES: external dimensions (BxHxP) 636x821x400 mm.

Please refer to Gewiss web site to download the wiring diagrams of the boards..



GW 68 577 F

Q-BOX 6 - WIRED BOARDS WITH INTERLOCKED SOCKETS AND FUSE-HOLDER EQUIPPED WITH TERMINAL BLOCK - IP55



Code	2P+E 16 A	3P+E 16 A	3P+N+E 16 A	3P+E 32 A	3P+N+E 32 A	3P+E 63 A	3P+N+E 63 A	Power suppliable (kW)	Pack Carton
No. socket outlets: 5									
GW 68 574 F	2	1	-	1	-	1	-	42	1
GW 68 498 F	2	-	1	-	1	-	1	42	1
No. socket outlets: 6									
GW 68 575 F	6	-	-	-	-	-	-	6	1
GW 68 576 F	4	2	-	-	-	-	-	17	1
GW 68 577 F	3	3	-	-	-	-	-	17	1
GW 68 578 F	3	2	1	-	-	-	-	17	1
GW 68 493 F	3	2	-	1	-	-	-	33	1
GW 68 579 F	3	2	-	-	1	-	-	33	1
GW 68 580 F	3	1	1	1	-	-	-	33	1
GW 68 582 F	2	3	-	1	-	-	-	33	1
GW 68 583 F	2	2	-	1	1	-	-	33	1
GW 68 494 F	2	2	-	2	-	-	-	33	1
GW 68 491 F	2	-	2	-	2	-	-	33	1

CHARACTERISTICS: Thermoplastic boards with high resistance impact (IK10). Typical application: main or secondary distribution boards for construction sites, exhibition areas, and temporary uses. Each sockets is protected by fuses (supplied as accessory in the boards).

ACCESSORIES SUPPLIED: Emergency push-botton, terminal block, stainless steel tear-proof cablefastening hooks, N. 2 triangular lock, set of steel brackets for surface-mounting.

NOTES: external dimensions (BxHxP) 914x821x400 mm.

Please refer to Gewiss web site to download the wiring diagrams of the boards..



GW 68 481 F

Q-BOX 4 - WIRED BOARDS WITH INTERLOCKED SOCKETS AND FUSE-HOLDER EQUIPPED WITH FIXED PLUG - IP55



Code	2P+E 16 A	3P+E 16 A	3P+N+E 16 A	3P+E 32 A	3P+N+E 32 A	Power supplyable (kW)	Pack Carton
No. socket outlets: 4							
GW 68 584 F	4	-	-	-	-	6	1
GW 68 481 F	3	1	-	-	-	17	1
GW 68 482 F	2	2	-	-	-	17	1
GW 68 586 F	2	1	-	1	-	17	1
GW 68 587 F	2	1	-	-	1	17	1
GW 68 588 F	1	2	-	1	-	17	1
No. socket outlets: 5							
GW 68 589 F	3	1	-	1	-	33	1
GW 68 590 F	3	1	-	-	1	33	1
GW 68 483 F	2	2	-	1	-	33	1
GW 68 592 F	2	2	-	-	1	33	1
GW 68 484 F	2	1	1	-	1	33	1

CHARACTERISTICS: Thermoplastic boards with high resistance impact (IK10). Typical application: main or secondary distribution boards for construction sites, exhibition areas, and temporary uses. Each sockets is protected by fuses (supplied as accessory in the boards).

ACCESSORIES SUPPLIED: Emergency push-button, fixed plug, stainless steel tear-proof cablefastening hooks, N. 2 triangular lock, set of steel brackets for surface-mounting.

NOTES: external dimensions (BxHxP) 636x821x400 mm.

Please refer to Gewiss web site to download the wiring diagrams of the boards..



GW 68 473 F

Q-BOX 6 - WIRED BOARDS WITH INTERLOCKED SOCKETS AND FUSE-HOLDER EQUIPPED WITH FIXED PLUG - IP55



Code	2P+E 16 A	3P+E 16 A	3P+N+E 16 A	3P+E 32 A	3P+N+E 32 A	Power supplyable (kW)	Pack Carton
No. socket outlets: 6							
GW 68 594 F	6	2	-	-	-	6	1
GW 68 595 F	4	2	-	-	-	17	1
GW 68 473 F	3	3	-	-	-	17	1
GW 68 596 F	3	2	1	-	-	17	1
GW 68 471 F	3	2	-	1	-	33	1
GW 68 597 F	3	2	-	-	1	33	1
GW 68 598 F	3	-	2	-	1	33	1
GW 68 472 F	2	3	-	1	-	33	1
GW 68 599 F	2	2	-	1	1	33	1
GW 68 600 F	2	2	-	2	-	33	1

CHARACTERISTICS: Thermoplastic boards with high resistance impact (IK10). Typical application: main or secondary distribution boards for construction sites, exhibition areas, and temporary uses. Each sockets is protected by fuses (supplied as accessory in the boards).

ACCESSORIES SUPPLIED: Emergency push-button, fixed plug, stainless steel tear-proof cablefastening hooks, N. 2 triangular lock, set of steel brackets for surface-mounting.

NOTES: external dimensions (BxHxP) 914x821x400 mm.

Please refer to Gewiss web site to download the wiring diagrams of the boards..

WIRED MOBILE BOARDS FOR CONSTRUCTION SITES

Q-DIN 5 - MOBILE, PORTABLE BOARDS WITH SOCKETS IEC 309



GW 68 241 N

PROTECTED BOARD EQUIPPED WITH CABLE AND MOBILE PLUG - IP44



Code	Socket-outlet 2P+E 16A - IEC 309	German Std socket-outlet 16 A	Power supplyable (kW)	Pack Carton
No. socket outlets: 3				
GW 68 241 N	2	1	3	1

ACCESSORIES SUPPLIED: 4 m of cable H 07 RN - F and mobile plug, insulating screw caps to maintain double insulation and original IP degree of boards.

NOTES: external dimensions (BxHxP) 105x430x96 mm.

Please refer to Gewiss web site to download the wiring diagrams of the boards..



GW 68 217 N

WATERTIGHT BOARD EQUIPPED WITH CABLE AND MOBILE PLUG - IP65



Code	Socket-outlet 2P+E 16A - IEC 309	Socket-outlet 3P+E 16A - IEC 309	Power suppliable (kW)	Pack Carton
No. socket outlets: 3				
GW 68 217 N	3	-	3	1
GW 68 242 N	2	1	8	1
GW 68 243 N	1	2	8	1
GW 68 244 N	-	3	8	1

ACCESSORIES SUPPLIED: 4 m of cable H 07 RN - F and mobile plug, insulating screw caps to maintain double insulation and original IP degree of boards.

NOTES: external dimensions (BxHxP) 105x430x96 mm.

Please refer to Gewiss web site to download the wiring diagrams of the boards..



GW 68 223 N

WATERTIGHT BOARD IN YELLOW SCHOCKPROOF EQUIPPED WITH CABLE AND MOBILE PLUG - IP65



Code	Socket-outlet 2P+E 16A - IEC 309	Power suppliable (kW)	Pack Carton
No. socket outlets: 3			
GW 68 223 N	3	3	1

ACCESSORIES SUPPLIED: 4 m of cable H 07 RN - F and mobile plug, insulating screw caps to maintain double insulation and original IP degree of boards.

NOTES: external dimensions (BxHxP) 140x560x105 mm.

Please refer to Gewiss web site to download the wiring diagrams of the boards..

Q-DIN 10 - MOBILE, PORTABLE BOARDS WITH SOCKETS IEC 309



GW 68 203 N

PROTECTED BOARD EQUIPPED WITH CABLE AND MOBILE PLUG - IP44



Code	Socket-outlet 2P+E 16A - IEC 309	German Std socket-outlet 16 A	Power suppliable (kW)	Pack Carton
No. socket outlets: 4				
GW 68 203 N	2	2	3	1

NOTES: 4 m of cable H 07 RN - F and mobile plug, insulating screw caps to maintain double insulation and original IP degree of boards.

NOTES: external dimensions (BxHxP) 140x560x105 mm.

Please refer to Gewiss web site to download the wiring diagrams of the boards..



GW 68 216 N

WATERTIGHT BOARD EQUIPPED WITH CABLE AND MOBILE PLUG - IP65



Code	Socket-outlet 2P+E 16A - IEC 309	Socket-outlet 3P+E 16A - IEC 309	Socket-outlet 3P+N+E 16A - IEC 309	Power suppliable (kW)	Pack Carton
No. socket outlets: 4					
GW 68 216 N	4	-	-	3	1
GW 68 245 N	3	1	-	8	1
GW 68 246 N	3	-	1	8	1
GW 68 204 N	2	2	-	8	1
GW 68 247 N	-	4	-	8	1

ACCESSORIES SUPPLIED: 4 m of cable H 07 RN - F and mobile plug, insulating screw caps to maintain double insulation and original IP degree of boards.

NOTES: external dimensions (BxHxP) 220x435x96 mm.

Please refer to Gewiss web site to download the wiring diagrams of the boards..



GW 68 401 N

PROTECTED BOARD EQUIPPED WITH CABLE AND MOBILE PLUG, WITH YELLOW PAINTED ACCIDENT PREVENTION METAL CONDUIT SUPPORT - IP44



Code	Socket-outlet 2P+E 16A - IEC 309	Socket-outlet 3P+E 16A - IEC 309	German Std socket-outlet 16 A	Power suppliable (kW)	Pack Carton
No. socket outlets: 4					
GW 68 401 N	2	1	1	8	1

ACCESSORIES SUPPLIED: 15 m of cable H 07 RN - F and mobile plug, yellow metal support.

NOTES: external dimensions (BxHxP) 220x435x96 mm.

Please refer to Gewiss web site to download the wiring diagrams of the boards..

Q-DIN 14 - MOBILE, PORTABLE BOARDS WITH SOCKETS IEC 309



GW 68 250 N

WATERTIGHT BOARD EQUIPPED WITH CABLE AND MOBILE PLUG - IP65



Code	Socket-outlet 2P+E 16A - IEC 309	Socket-outlet 3P+E 16A - IEC 309	Socket-outlet 3P+E 32A - IEC 309	Power suppliable (kW)	Pack Carton
No. socket outlets: 6					
GW 68 248 N	6	-	-	8	1
GW 68 249 N	4	2	-	17	1
GW 68 250 N	3	3	-	17	1
GW 68 251 N	3	2	1	17	1

ACCESSORIES SUPPLIED: 4 m of cable H 07 RN - F and mobile plug, insulating screw caps to maintain double insulation and original IP degree of boards.

NOTES: external dimensions (BxHxP) 320x510x120 mm.

Please refer to Gewiss web site to download the wiring diagrams of the boards..

PROTECTED BOARD EQUIPPED WITH CABLE AND MOBILE PLUG, WITH YELLOW PAINTED ACCIDENT PREVENTION METAL CONDUIT CARRIAGE WITH TWO WHEELS AND ROTARY DRUM FOR REWINDING AND STORING THE CABLE - IP44



GW 68 411 N



Code	Socket-outlet 2P+E 16A - IEC 309	Socket-outlet 3P+E 16A - IEC 309	German Std socket-outlet 16 A	Power suppliable (kW)	Pack Carton
No. socket outlets: 6					
GW 68 411 N	2	2	2	17	1

ACCESSORIES SUPPLIED: 25 m of cable H 07 RN - F and mobile plug, yellow metal carriage.

NOTES: external dimensions (BxHxP) 320x510x120 mm.

Please refer to Gewiss web site to download the wiring diagrams of the boards..

Q-DIN 20 - MOBILE, PORTABLE BOARDS WITH SOCKETS IEC 309 AND INTERLOCKED SOCKET-OUTLETS



GW 68 421 N

PROTECTED BOARD EQUIPPED WITH CABLE AND MOBILE PLUG, WITH YELLOW PAINTED ACCIDENT PREVENTION METAL CONDUIT CARRIAGE WITH TWO WHEELS AND ROTARY DRUM FOR REWINDING AND STORING THE CABLE - IP44



Code	Socket-outlet 2P+E 16A - IEC 309	Socket-outlet 3P+E 16A - IEC 309	Socket-out 3P+E 32A - IEC309	German Std socket-outlet 16 A	Power suppliable (kW)	Pack Carton
No. socket outlets: 8						
GW 68 421 N	2	2	2	2	17	1

ACCESSORIES SUPPLIED: 35 m of cable H 07 RN - F and mobile plug, yellow metal carriage.

NOTES: external dimensions (BxHxP) 450x560x120 mm.

Please refer to Gewiss web site to download the wiring diagrams of the boards..



GW 68 424 N

WATERTIGHT BOARD EQUIPPED WITH CABLE AND MOBILE PLUG, WITH YELLOW PAINTED ACCIDENT PREVENTION METAL CONDUIT CARRIAGE WITH TWO WHEELS AND ROTARY DRUM FOR REWINDING AND STORING THE CABLE - IP65



Code	Socket-outlet 2P+E 16A - IB	Socket-outlet 3P+E 16A - IB	Socket-out 3P+E 32A - IB	Power suppliable (kW)	Pack Carton
No. socket outlets: 4					
GW 68 424 N	2	1	1	33	1

ACCESSORIES SUPPLIED: 35 m of cable H 07 RN - F and mobile plug, yellow metal carriage.

NOTES: external dimensions (BxHxP) 450x560x120 mm.

Please refer to Gewiss web site to download the wiring diagrams of the boards..

Q-DIN - MOBILE, PORTABLE BOARDS WITH SAFETY TRANSFORMER



GW 68 235 N

WATERTIGHT BOARD WITH EQUIPPED SAFETY TRANSFORMER WITH CABLE AND MOBILE PLUG - IP65



Code	with transformer 2P - 16A - 24V	Socket-outlet 2P+E 16A - IB	Power suppliable (kW)	Pack Carton
No. socket outlets: 2				
GW 68 235 N	2	-	3	1
No. socket outlets: 4				
GW 68 236 N	2	2	3	1

ACCESSORIES SUPPLIED: 4 m of cable H 07 RN - F and mobile plug, insulating screw caps to maintain double insulation and original IP degree of boards.

NOTES: external dimensions (BxHxP) GW68235N 220x435x96 mm; GW68236N 450x560x120 mm.

Please refer to Gewiss web site to download the wiring diagrams of the boards..

66 COMBIBLOC - WIRED BOARDS FOR CONSTRUCTION SITES

COMBIBLOC - PORTABLE DISTRIBUTION BOARDS



GW 66 388

COMBIBLOC ACS BOARDS EQUIPPED WITH CABLE AND PLUG IEC309 METAL CONDUIT SUPPORT YELLOW-PAINTED SUPPORT - IP55



Code	Socket-outlet 2P+E 16A - IB	Socket-outlet 3P+N+E 16A - IB	Socket-outlet 3P+N+E 32A - IB	Pack Carton
GW 66 388	2	1	-	1
GW 66 389	1	1	1	1

ACCESSORIES SUPPLIED: 5 m of cable H 07 RN - F and mobile plug, metal conduit support.

NOTES: external dimensions (BxHxP) 320x360x95 mm.

Please refer to Gewiss web site to download the wiring diagrams of the boards..

68 QMC - WIRED PEDESTAL FOR CONSTRUCTION SITES

Q-MC 16T - TRANSPORTABLE PEDESTAL



GW 68 881 A

QMC 16 T ACS TRANSPORTABLE WIRED TERMINAL WITH DOUBLE-FACE TAKE-OFF EQUIPPED WITH NON-INTERLOCKED SWITCHED SOCKET-OUTLETS - IP56



Code	Socket-outlet 2P+E 16A - IEC 309	Socket-outlet 3P+E 16A - IEC 309	Socket-outlet 3P+N+E 16A - IEC 309	Socket-outlet 3P+N+E 32A - IEC 309	Pack Carton
GW 68 881 A	7	-	-	-	1
GW 68 883 A	4	1	1	1	1
GW 68 884 A	2	1	2	1	1

CHARACTERISTICS: Stainless steel cable fastener devices, enclosure with hinged opening that can be fitted with security lock for access to modular devices.
ACCESSORIES SUPPLIED: 5 m of cable H 07 RN - F and mobile plug, metal conduit support.
 Please refer to Gewiss web site to download the wiring diagrams of the boards..

ACS PREDETERMINED CONSTRUCTION SYSTEM COMPONENTS

46 QP - WATERTIGHT POLYESTER BOARDS - IP66



GW 46 004 F

WATERTIGHT BOARDS IN POLYESTER WITH BLANK DOOR FITTED WITH LOCK - GREY RAL 7035



Code	Nominal dim. LxHxD (mm)	No. of modules EN 50022	No. locks	Pack Carton
GW 46 003 F	405x500x200	54 (18x3)	2	1
GW 46 004 F	405x650x200	72 (18x4)	2	1
GW 46 005 F	515x650x250	96 (24x4)	2	1
GW 46 006 F	585x800x300	140 (28x5)	2	1

NOTES: It is necessary use GWenergy software to realize certification in accordance with ACS standard and the GEWISS construction standard.
 Refer to section in the catalogue "46 QP Range - Watertight Surface mounting distribution and automation boards" for any further information related to the boards and their acceries.



GW 46 203 F

POLYESTER WATERTIGHT BOARDS WITH TRANSPARENT DOOR AND LOCK - GREY RAL 7035



Code	Nominal dim. LxHxD (mm)	No. of modules EN 50022	No. locks	Pack Carton
GW 46 203 F	405x500x200	54 (18x3)	2	1
GW 46 204 F	405x650x200	72 (18x4)	2	1
GW 46 205 F	515x650x250	96 (24x4)	2	1
GW 46 206 F	585x800x300	140 (28x5)	2	1

NOTES: It is necessary use GWenergy software to realize certification in accordance with ACS standard and the GEWISS construction standard.
 Refer to section in the catalogue "46 QP Range - Watertight Surface mounting distribution and automation boards" or any further information related to the boards and their acceries.

40 CDK - UNWIRED ENCLOSURES FOR INGOING AND MEASUREMENT ASSEMBLIES



GW 40 103

ENCLOSURES PREARRANGED FOR HOUSING TERMINAL BLOCKS TRANSPARENT SMOKED DOOR - SMOOTH WALLS - IP65

Code	No. of modules EN 50022	Outer dim. LxHxD (mm)	Pack Carton
GW 40 103	12	298x260x140	6
GW 40 106	18	410x285x140	3
GW 40 104	24	298x420x140	3

NOTES: It is necessary use GWenergy software to realize certification in accordance with ACS standard and the GEWISS construction standard.
 Refer to section in the catalogue "40 CDK Range - Surface mounting distribution boards and enclosures" for any further information related to the boards and their acceries.

68 Q-BOX - UNWIRED FINAL DISTRIBUTION BOARD



GW 68 465

Q-BOX 4 UNWIRED DISTRIBUTION BOARD - IP55

Code	Supplied Earth Terminal block	No. of modules EN 50022	Pack Carton
GW 68 465	(7x10 mm ²)	12	1

ACCESSORIES SUPPLIED: modular enclosure 12+1M and blank enclosure for terminal block. Set of brackets for surface-mounting.

NOTES: It is necessary use GWEnergy software to realize certification in accordance with ACS standard and the GEWISS construction standard



GW 68 466

Q-BOX 6 UNWIRED DISTRIBUTION BOARDS - IP55

Code	Supplied Earth Terminal block	No. of modules EN 50022	Pack Carton
GW 68 466	(2x25mm ²)+(10x10mm ²)	24 (12+12)	1

ACCESSORIES SUPPLIED: 2 modular enclosures 12+1M each, and blank enclosure for terminal block. Set of brackets for surface-mounting.

NOTES: It is necessary use GWEnergy software to realize certification in accordance with ACS standard and the GEWISS construction standard.

COMPLEMENTARY ITEMS FOR 68 Q-BOX

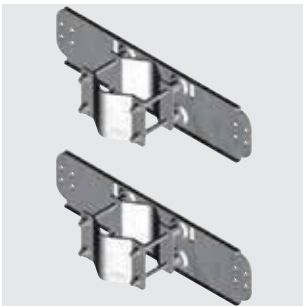

GW 46 554

POLE SUPPORT KIT

Code	For distribution boards	Pack Carton
GW 46 554	Q-BOX 4	1

APPLICATIONS: for applying boards 68 Q-BOX 4 on poles from 60mm to 80mm.

CHARACTERISTICS: fixed on the back of the boards.

ACCESSORIES SUPPLIED: 2 pieces. For the correct use of the kit, see the instructions sheet.



GW 68 552

PANELS FOR Q-BOX 4/6 - IP55

Code	Description	Dimensions (mm)	Pack Carton
GW 68 551	Panel - blank	270x368	1
GW 68 552	12 modules board	270x368	1
GW 68 554	4 COMBIBLOC 16-32A IP44/55	270x368	1
GW 68 556	2 IB Vert. 16-32A IP67 + 2 IEC 309 16A IP44/67 or GW27401	270x368	1
GW 68 559	5 IB Vert. 16-32A IP67 + 4 IEC 309 16A IP44/67 or GW27401	540x368	1

ACCESSORIES SUPPLIED: panels with base, fixing screws and closure.

CHARACTERISTICS:

Internal space of Q-BOX 4: 540x415mm

Internal space of Q-BOX 6: 810x415mm.



GW 68 591

FIXING KIT FOR 160A ONE-WAY SWITCHES FOR GW68552 PANEL

Code	Description	Pack Carton
GW 68 591	For inserting from 160A	1/20



GW 68 504

EMERGENCY PUSH BUTTON KIT

Code	Description	Pack Carton
GW 68 504	Kit equipped with red emergency push button and green light to show the integrity of the circuit	1/4



GW 68 503

12-MODULE WATERTIGHT ENCLOSURE FRONT FOR Q-BOX - IP55

Code	No. of modules EN 50022	Pack Carton
GW 68 503	12+1	1/8



GW 68 505

WATERTIGHT PLUG - SOCKET-OUTLET BLOCK

Code	Description	Pack Carton
GW 68 505	Plug/socket-outlet block	1/10

NOTE: the block is suitable for 32A (only 3P+T and 3P+N+T) and 63 A socket-outlet - plug connections.



GW 68 463

YELLOW METAL SUPPORT FOR Q-BOX 4/6

Code	Outer dim. LxHxD (mm)	Pack Carton
GW 68 463	1100x1650x630	1

CHARACTERISTICS: 2 side handles for manual handling; 2 slots on the top for lifting with a crane.

68 ACS



GW 46 445

SECURITY LOCK WITH HANDLE

Code	Description	Pack Carton
GW 46 445	Security lock key and handle	10

ACCESSORIES SUPPLIED: 2 keys.

NOTES: all the keys and relative locks with the same product code are identical.



GW 46 447

DOCUMENT HOLDER POCKET IN SELF-ADHESIVE INSULATING MATERIAL WITH KIT OF BLANK LABELS

Code	Dimensions LxH (mm)	Pack Carton
GW 46 447	230x310	1/10

CHARACTERISTICS: the document wallet can be inserted in all Gewiss distribution boards starting with the 405x500x200 mm dimension.

LUMINOUS INDICATOR DEVICES

RETTA - RECTANGULAR LUMINAIRES



GW 80 401

VERSIONS FOR INCANDESCENT LAMPS - IP44 - CLASS II

Code	Max lamp power	Lamp	Lamp holder	Diffuser colour	Weight (kg)	Pack Carton
GW 80 401	75 W	IA/IB	E27	Transparent	0.3	12
GW 80 403	75 W	IA/IB	E27	Red	0.3	12
GW 80 404	75 W	IA/IB	E27	Green	0.3	12

TARTA - OVAL LUMINAIRES



GW 80 411

VERSIONS FOR INCANDESCENT LAMPS - IP44 - CLASS II

Code	Max lamp power	Lamp	Lamp holder	Diffuser colour	Weight (kg)	Pack Carton
GW 80 409	60 W	IA/IB	E27	Transparent	0.2	36
GW 80 411	60 W	IA/IB	E27	Red	0.2	36
GW 80 412	60 W	IA/IB	E27	Green	0.2	36

CHARACTERISTICS: suitable for installation directly on to walls via screws or on to pipes using cable ties.



68 ACS



Scan the QR Code and find out all the technical informations.

IEC 309
COMBINED BOARDS

OUT-OF-THE-BOX WIRED SOLUTIONS



Pre-wired versions are available, equipped with interlocked sockets (with or without fuse holder base) up to 63A or IEC type fixed sockets. They are also equipped with an emergency push button, key locked doors, SST strain-resistant cable hooks and carrying handles located at the top of the enclosure.

CUSTOMISABLE CONFIGURATIONS



Empty versions are available that can be customised for all site needs. With GWENERGY software, you can quickly and easily create and certify your ASC configuration.

CONFIGURATION PANELS



Specific additional panels permit to create different distribution board configurations, according to the specific needs of each construction site. Thanks to switchboard panels, for example, it is possible to obtain panels of switches only (up to 60 modules), while with the socket-outlets panels it is possible to have boards with 12 interlocked socket-outlets.



CONTROL AND SIGNALLING



70 RT HP

ROTARY ISOLATORS

pag. 138









74 PS

PUSH-BUTTONS, SELECTORS
AND INDICATORS Ø 22 MM

pag. 148

70 RT HP

		ISOLATORS - 70 RT HP RANGE			
In	POLES	VERSION: SURFACE-MOUNTING IN PLASTIC BOX		VERSION: SURFACE-MOUNTING IN METAL BOX	
		CONTROL	EMERGENCY	CONTROL	EMERGENCY
					
		Dim: 125 x 150 x 75,5 mm	Dim: 125 x 150 x 75,5 mm	Dim: 140 x 165 x 64 mm	Dim: 140 x 165 x 64 mm
16 A	2P	GW 70 401 P	GW 70 431 P	GW 70 401 M	GW 70 431 M
	3P	GW 70 402 P	GW 70 432 P	GW 70 402 M	GW 70 432 M
	3P+N	GW 70 402 NP	GW 70 432 NP	GW 70 402 NM	GW 70 432 NM
	4P	GW 70 403 P	GW 70 433 P	GW 70 403 M	GW 70 433 M
25 A	2P	GW 70 416 P	GW 70 486 P	GW 70 416 M	GW 70 486 M
	3P	GW 70 417 P	GW 70 487 P	GW 70 417 M	GW 70 487 M
	3P+N	GW 70 417 NP	GW 70 487 NP	GW 70 417 NM	GW 70 487 NM
	4P	GW 70 418 P	GW 70 488 P	GW 70 418 M	GW 70 488 M
32 A	2P	GW 70 404 P	GW 70 434 P	GW 70 404 M	GW 70 434 M
	3P	GW 70 405 P	GW 70 435 P	GW 70 405 M	GW 70 435 M
	3P+N	GW 70 405 NP	GW 70 435 NP	GW 70 405 NM	GW 70 435 NM
	4P	GW 70 406 P	GW 70 436 P	GW 70 406 M	GW 70 436 M
40 A	2P	GW 70 413 P	GW 70 441 P	GW 70 413 M	GW 70 441 M
	3P	GW 70 414 P	GW 70 442 P	GW 70 414 M	GW 70 442 M
	3P+N	GW 70 414 NP	GW 70 442 NP	GW 70 414 NM	GW 70 442 NM
	4P	GW 70 415 P	GW 70 443 P	GW 70 415 M	GW 70 443 M
					
		Dim: 156 x 200 x 95 mm	Dim: 156 x 200 x 95 mm	Dim: 215 x 252 x 91 mm	Dim: 215 x 252 x 91 mm
63 A	3P	GW 70 407 P	GW 70 437 P	GW 70 407 M	GW 70 437 M
	3P+N	GW 70 407 NP	GW 70 437 NP	GW 70 407 NM	GW 70 437 NM
	4P	GW 70 408 P	GW 70 438 P	GW 70 408 M	GW 70 438 M
80 A	3P	GW 70 419 P	GW 70 489 P	GW 70 419 M	GW 70 489 M
	3P+N	GW 70 419 NP	GW 70 489 NP	GW 70 419 NM	GW 70 489 NM
	4P	GW 70 420 P	GW 70 490 P	GW 70 420 M	GW 70 490 M
					
		Dim: 236,5 x 316 x 178 mm	Dim: 236,5 x 316 x 178 mm	Dim: 257 x 307 x 121 mm	Dim: 257 x 307 x 121 mm
100 A	3P	GW 70 421 P	GW 70 491 P	GW 70 421 M	GW 70 491 M
	3P+N	GW 70 421 NP	GW 70 491 NP	GW 70 421 NM	GW 70 491 NM
	4P	GW70422P	GW 70 492 P	GW 70 422 M	GW 70 492 M
125 A	3P	GW 70 423 P	GW 70 493 P	GW 70 423 M	GW 70 493 M
	3P+N	GW 70 423 NP	GW 70 493 NP	GW 70 423 NM	GW 70 493 NM
	4P	GW 70 424 P	GW 70 494 P	GW 70 424 M	GW 70 494 M
160 A	3P	GW 70 425 P	GW 70 495 P	GW 70 425 M	GW 70 495 M
	3P+N	GW 70 425 NP	GW 70 495 NP	GW 70 425 NM	GW 70 495 NM
	4P	GW 70 426 P	GW 70 496 P	GW 70 426 M	GW 70 496 M

(*) Versions for panel/door mounting can be accessorized with galvanized steel extending brackets GW 70 009.

NOTE: the dimensions showed above refer to the external dimensions of the boxes without considering the knob.

Panel/door mounting*	ISOLATORS - 70 RT HP RANGE				ISOLATORS - 70 RT HP ATEX RANGE	
	VERSION: FOR BOARD	AUXILIARY CONTACTS			VERSION: SURFACE-MOUNTING IN METAL BOX	
	DIN rail mounting	1NO + 1NC	2NO	2NC	CONTROL	EMERGENCY
						
					Dim: 140 x 165 x 63 mm	Dim: 140 x 165 x 63 mm
GW 70 001	GW 70 201	GW 70 026	GW 70 027	GW 70 028	GW 70 451	GW 70 471
GW 70 002	GW 70 202				GW 70 452	GW 70 472
GW 70 003	GW 70 203				GW 70 453	GW 70 473
		GW 70 026	GW 70 027	GW 70 028		
GW 70 004	GW 70 204	GW 70 026	GW 70 027	GW 70 028	GW 70 454	GW 70 474
GW 70 005	GW 70 205				GW 70 455	GW 70 475
GW 70 006	GW 70 206				GW 70 456	GW 70 476
		GW 70 026	GW 70 027	GW 70 028		
						
					Dim: 215 x 252 x 91 mm	Dim: 215 x 252 x 91 mm
GW 70 007	GW 70 207	GW 70 026	GW 70 027	GW 70 028	GW 70 457	GW 70 477
GW 70 008	GW 70 208				GW 70 458	GW 70 478
		GW 70 026	GW 70 027	GW 70 028		
						
					Dim: 307 x 257 x 120 mm	Dim: 307 x 257 x 120 mm
		GW 70 029			GW 70 459	GW 70 479
		GW 70 029			GW 70 460	GW 70 480
		GW 70 029				

70 RT HP

Rotary isolators

70 RT HP is a new range of surface mounted rotary isolators available with plastic or metal boxes, in versions from 16A to 160A, for control (black knob) or emergency (red knob) applications. The range includes distribution board options for front-panel or DIN rail assembly, in 16 to 63A options, all of which can be equipped with auxiliary contacts. The isolators guarantee an innovative IP degree up to IP66/IP67/IP69 and they have been designed to reduce wiring time, simplifying installation, and offer maximum safety and durability.



70 RT HP - SURFACE MOUNTING ROTARY ISOLATOR IN ISOLATING BOX - IP66/IP67/69

CONTROL VERSIONS



GW 70 406 P

SURFACE-MOUNTING ISOLATOR - CONTROL VERSION WITH LOCKABLE BLACK KNOB - IP66/IP67/IP69

Code	No. of poles	Outer dim. LxHxD (mm)	Holes entry	Lid screws (no. and type)	Pack Carton
Rated current (A): 16					
GW 70 401 P	2P	125x150x75,5	2 x M20/25 + 2 x M20/25	4 insul. a 1/4 turn	1/16
GW 70 402 P	3P	125x150x75,5	2 x M20/25 + 2 x M20/25	4 insul. a 1/4 turn	1/16
GW 70 402 NP	3P+N	125x150x75,5	2 x M20/25 + 2 x M20/25	4 insul. a 1/4 turn	1/16
GW 70 403 P	4P	125x150x75,5	2 x M20/25 + 2 x M20/25	4 insul. a 1/4 turn	1/16
Rated current (A): 25					
GW 70 416 P	2P	125x150x75,5	2 x M20/25 + 2 x M20/25	4 insul. a 1/4 turn	1/16
GW 70 417 P	3P	125x150x75,5	2 x M20/25 + 2 x M20/25	4 insul. a 1/4 turn	1/16
GW 70 417 NP	3P+N	125x150x75,5	2 x M20/25 + 2 x M20/25	4 insul. a 1/4 turn	1/16
GW 70 418 P	4P	125x150x75,5	2 x M20/25 + 2 x M20/25	4 insul. a 1/4 turn	1/16
Rated current (A): 32					
GW 70 404 P	2P	125x150x75,5	2 x M20/25 + 2 x M20/25	4 insul. a 1/4 turn	1/16
GW 70 405 P	3P	125x150x75,5	2 x M20/25 + 2 x M20/25	4 insul. a 1/4 turn	1/16
GW 70 405 NP	3P+N	125x150x75,5	2 x M20/25 + 2 x M20/25	4 insul. a 1/4 turn	1/16
GW 70 406 P	4P	125x150x75,5	2 x M20/25 + 2 x M20/25	4 insul. a 1/4 turn	1/16
Rated current (A): 40					
GW 70 413 P	2P	125x150x75,5	2 x M20/25 + 2 x M20/25	4 insul. a 1/4 turn	1/16
GW 70 414 P	3P	125x150x75,5	2 x M20/25 + 2 x M20/25	4 insul. a 1/4 turn	1/16
GW 70 414 NP	3P+N	125x150x75,5	2 x M20/25 + 2 x M20/25	4 insul. a 1/4 turn	1/16
GW 70 415 P	4P	125x150x75,5	2 x M20/25 + 2 x M20/25	4 insul. a 1/4 turn	1/16
Rated current (A): 63					
GW 70 407 P	3P	156x200x95	2 x M25/32 + 2 x M25/32	4 insul. a 1/4 turn	1/6
GW 70 407 NP	3P+N	156x200x95	2 x M25/32 + 2 x M25/32	4 insul. a 1/4 turn	1/6
GW 70 408 P	4P	156x200x95	2 x M25/32 + 2 x M25/32	4 insul. a 1/4 turn	1/6
Rated current (A): 80					
GW 70 419 P	3P	156x200x95	2 x M25/32 + 2 x M25/32	4 insul. a 1/4 turn	1/6
GW 70 419 NP	3P+N	156x200x95	2 x M25/32 + 2 x M25/32	4 insul. a 1/4 turn	1/6
GW 70 420 P	4P	156x200x95	2 x M25/32 + 2 x M25/32	4 insul. a 1/4 turn	1/6
Rated current (A): 100					
GW 70 421 P	3P	236,5x316x178	-	4 insulation	1
GW 70 421 NP	3P+N	236,5x316x178	-	4 insulation	1
GW 70 422 P	4P	236,5x316x178	-	4 insulation	1
Rated current (A): 125					
GW 70 423 P	3P	236,5x316x178	-	4 insulation	1
GW 70 423 NP	3P+N	236,5x316x178	-	4 insulation	1
GW 70 424 P	4P	236,5x316x178	-	4 insulation	1
Rated current (A): 160					
GW 70 425 P	3P	236,5x316x178	-	4 insulation	1
GW 70 425 NP	3P+N	236,5x316x178	-	4 insulation	1
GW 70 426 P	4P	236,5x316x178	-	4 insulation	1

NOTE: can be padlocked in ON and OFF position with max. 3 locks with diameter max. 8 mm.

Versions 100-160A allow to install max. 2 x M63 cable glands.

All Lid screws are sealable.

EMERGENCY VERSIONS



GW 70 436 P

SURFACE-MOUNTING ISOLATOR - EMERGENCY VERSION WITH LOCKABLE RED KNOB - IP66/IP67/IP69

Code	No. of poles	Outer dim. LxHxD (mm)	Holes entry	Lid screws (no. and type)	Pack Carton
Rated current (A): 16					
GW 70 431 P	2P	125x150x75,5	2 x M20/25 + 2 x M20/25	4 insul. a 1/4 turn	1/16
GW 70 432 P	3P	125x150x75,5	2 x M20/25 + 2 x M20/25	4 insul. a 1/4 turn	1/16
GW 70 432 NP	3P+N	125x150x75,5	2 x M20/25 + 2 x M20/25	4 insul. a 1/4 turn	1/16
GW 70 433 P	4P	125x150x75,5	2 x M20/25 + 2 x M20/25	4 insul. a 1/4 turn	1/16
Rated current (A): 25					
GW 70 486 P	2P	125x150x75,5	2 x M20/25 + 2 x M20/25	4 insul. a 1/4 turn	1/16
GW 70 487 P	3P	125x150x75,5	2 x M20/25 + 2 x M20/25	4 insul. a 1/4 turn	1/16
GW 70 487 NP	3P+N	125x150x75,5	2 x M20/25 + 2 x M20/25	4 insul. a 1/4 turn	1/16
GW 70 488 P	4P	125x150x75,5	2 x M20/25 + 2 x M20/25	4 insul. a 1/4 turn	1/16
Rated current (A): 32					
GW 70 434 P	2P	125x150x75,5	2 x M20/25 + 2 x M20/25	4 insul. a 1/4 turn	1/16
GW 70 435 P	3P	125x150x75,5	2 x M20/25 + 2 x M20/25	4 insul. a 1/4 turn	1/16
GW 70 435 NP	3P+N	125x150x75,5	2 x M20/25 + 2 x M20/25	4 insul. a 1/4 turn	1/16
GW 70 436 P	4P	125x150x75,5	2 x M20/25 + 2 x M20/25	4 insul. a 1/4 turn	1/16
Rated current (A): 40					
GW 70 441 P	2P	125x150x75,5	2 x M20/25 + 2 x M20/25	4 insul. a 1/4 turn	1/16
GW 70 442 P	3P	125x150x75,5	2 x M20/25 + 2 x M20/25	4 insul. a 1/4 turn	1/16
GW 70 442 NP	3P+N	125x150x75,5	2 x M20/25 + 2 x M20/25	4 insul. a 1/4 turn	1/16
GW 70 443 P	4P	125x150x75,5	2 x M20/25 + 2 x M20/25	4 insul. a 1/4 turn	1/16
Rated current (A): 63					
GW 70 437 P	3P	156x200x95	2 x M25/32 + 2 x M25/32	4 insul. a 1/4 turn	1/6
GW 70 437 NP	3P+N	156x200x95	2 x M25/32 + 2 x M25/32	4 insul. a 1/4 turn	1/6
GW 70 438 P	4P	156x200x95	2 x M25/32 + 2 x M25/32	4 insul. a 1/4 turn	1/6
Rated current (A): 80					
GW 70 489 P	3P	156x200x95	2 x M25/32 + 2 x M25/32	4 insul. a 1/4 turn	1/6
GW 70 489 NP	3P+N	156x200x95	2 x M25/32 + 2 x M25/32	4 insul. a 1/4 turn	1/6
GW 70 490 P	4P	156x200x95	2 x M25/32 + 2 x M25/32	4 insulation	1/6
Rated current (A): 100					
GW 70 491 P	3P	236,5x316x178	-	4 insulation	1
GW 70 491 NP	3P+N	236,5x316x178	-	4 insulation	1
GW 70 492 P	4P	236,5x316x178	-	4 insulation	1
Rated current (A): 125					
GW 70 493 P	3P	236,5x316x178	-	4 insulation	1
GW 70 493 NP	3P+N	236,5x316x178	-	4 insulation	1
GW 70 494 P	4P	236,5x316x178	-	4 insulation	1
Rated current (A): 160					
GW 70 495 P	3P	236,5x316x178	-	4 insulation	1
GW 70 495 NP	3P+N	236,5x316x178	-	4 insulation	1
GW 70 496 P	4P	236,5x316x178	-	4 insulation	1

NOTE: can be padlocked in OFF position with max. 3 locks with diameter max. 8 mm.

Versions 100-160A allow to install max. 2 x M63 cable glands.

All Lid screws are sealable.

70 RT HP

70 RT HP - SURFACE-MOUNTING ROTARY ISOLATOR IN METAL BOX - IP66

CONTROL VERSIONS



GW 70 406 M

SURFACE-MOUNTING ISOLATOR - CONTROL VERSION WITH LOCKABLE BLACK/GREY KNOB - IP66

Code	No. of poles	Outer dim. LxHxD (mm)	Holes entry	Pack Carton
Rated current (A): 16				
GW 70 401 M	2P	140x165x64	4xM20	1
GW 70 402 M	3P	140x165x64	4xM20	1
GW 70 402 NM	3P+N	140x165x64	4xM20	1
GW 70 403 M	4P	140x165x64	4xM20	1
Rated current (A): 25				
GW 70 416 M	2P	140x165x64	2 x M20 + 2 x M25	1
GW 70 417 M	3P	140x165x64	2 x M20 + 2 x M25	1
GW 70 417 NM	3P+N	140x165x64	2 x M20 + 2 x M25	1
GW 70 418 M	4P	140x165x64	2 x M20 + 2 x M25	1
Rated current (A): 32				
GW 70 404 M	2P	140x165x64	2 x M20 + 2 x M25	1
GW 70 405 M	3P	140x165x64	2 x M20 + 2 x M25	1
GW 70 405 NM	3P+N	140x165x64	2 x M20 + 2 x M25	1
GW 70 406 M	4P	140x165x64	2 x M20 + 2 x M25	1
Rated current (A): 40				
GW 70 413 M	2P	140x165x64	2 x M20 + 2 x M25	1
GW 70 414 M	3P	140x165x64	2 x M20 + 2 x M25	1
GW 70 414 NM	3P+N	140x165x64	2 x M20 + 2 x M25	1
GW 70 415 M	4P	140x165x64	2 x M20 + 2 x M25	1
Rated current (A): 63				
GW 70 407 M	3P	215x252x91	4xM32	1
GW 70 407 NM	3P+N	215x252x91	4xM32	1
GW 70 408 M	4P	215x252x91	4xM32	1
Rated current (A): 80				
GW 70 419 M	3P	215x252x91	4xM32	1
GW 70 419 NM	3P+N	215x252x91	4xM32	1
GW 70 420 M	4P	215x252x91	4xM32	1
Rated current (A): 100				
GW 70 421 M	3P	257x307x121	-	1
GW 70 421 NM	3P+N	257x307x121	-	1
GW 70 422 M	4P	257x307x121	-	1
Rated current (A): 125				
GW 70 423 M	3P	257x307x121	-	1
GW 70 423 NM	3P+N	257x307x121	-	1
GW 70 424 M	4P	257x307x121	-	1
Rated current (A): 160				
GW 70 425 M	3P	257x307x121	-	1
GW 70 425 NM	3P+N	257x307x121	-	1
GW 70 426 M	4P	257x307x121	-	1

NOTE: can be padlocked in ON and OFF position with max. 3 locks with diameter max. 8 mm.
Versions 100-160A allow to install max. 2 x M63 cable glands.

EMERGENCY VERSIONS



GW 70 436 M

SURFACE-MOUNTING ISOLATOR - EMERGENCY VERSION WITH LOCKABLE RED/YELLOW - IP66

Code	No. of poles	Outer dim. LxHxD (mm)	Holes entry	Pack Carton
Rated current (A): 16				
GW 70 431 M	2P	140x165x64	4xM20	1
GW 70 432 M	3P	140x165x64	4xM20	1
GW 70 432 NM	3P+N	140x165x64	4xM20	1
GW 70 433 M	4P	140x165x64	4xM20	1
Rated current (A): 25				
GW 70 486 M	2P	140x165x64	2 x M20 + 2 x M25	1
GW 70 487 M	3P	140x165x64	2 x M20 + 2 x M25	1
GW 70 487 NM	3P+N	140x165x64	2 x M20 + 2 x M25	1
GW 70 488 M	4P	140x165x64	2 x M20 + 2 x M25	1
Rated current (A): 32				
GW 70 434 M	2P	140x165x64	2 x M20 + 2 x M25	1
GW 70 435 M	3P	140x165x64	2 x M20 + 2 x M25	1
GW 70 435 NM	3P+N	140x165x64	2 x M20 + 2 x M25	1
GW 70 436 M	4P	140x165x64	2 x M20 + 2 x M25	1
Rated current (A): 40				
GW 70 441 M	2P	140x165x64	2 x M20 + 2 x M25	1
GW 70 442 M	3P	140x165x64	2 x M20 + 2 x M25	1
GW 70 442 NM	3P+N	140x165x64	2 x M20 + 2 x M25	1
GW 70 443 M	4P	140x165x64	2 x M20 + 2 x M25	1
Rated current (A): 63				
GW 70 437 M	3P	215x252x91	4xM32	1
GW 70 437 NM	3P+N	215x252x91	4xM32	1
GW 70 438 M	4P	215x252x91	4xM32	1
Rated current (A): 80				
GW 70 489 M	3P	215x252x91	4xM32	1
GW 70 489 NM	3P+N	215x252x91	4xM32	1
GW 70 490 M	4P	215x252x91	4xM32	1
Rated current (A): 100				
GW 70 491 M	3P	257x307x121	-	1
GW 70 491 NM	3P+N	257x307x121	-	1
GW 70 492 M	4P	257x307x121	-	1
Rated current (A): 125				
GW 70 493 M	3P	257x307x121	-	1
GW 70 493 NM	3P+N	257x307x121	-	1
GW 70 494 M	4P	257x307x121	-	1
Rated current (A): 160				
GW 70 495 M	3P	257x307x121	-	1
GW 70 495 NM	3P+N	257x307x121	-	1
GW 70 496 M	4P	257x307x121	-	1

NOTE: can be padlocked in OFF position with max. 3 locks with diameter max. 8 mm.
Versions 100-160A allow to install max. 2 x M63 cable glands.

ISOLATORS FOR AUTOMATION AND DISTRIBUTION BOARDS

VERSIONS FOR BOARDS



GW 70 001

ISOLATOR SWITCHES FOR DISTRIBUTION BOARD WITH PADLOCKABLE RED/YELLOW KNOB AND CONTROL TRANSMISSION SHAFT

Code	No. of poles	No. of modules EN 50022	Regulation field	Pack Carton
Rated current (A): 16				
GW 70 001	2	4	87 - 145 mm	1/10
GW 70 002	3	4	87 - 145 mm	1/10
GW 70 003	4	4	87 - 145 mm	1/10
Rated current (A): 32				
GW 70 004	2	4	87 - 145 mm	1/10
GW 70 005	3	4	87 - 145 mm	1/10
GW 70 006	4	4	87 - 145 mm	1/10
Rated current (A): 63				
GW 70 007	3	5	114 - 177 mm	1/5
GW 70 008	4	5	114 - 177 mm	1/5

CHARACTERISTICS: the regulation field can be obtained by cutting the shaft supplied.



GW 70 009

GALVANIZED STEEL EXTENDING BRACKETS FOR REAR FIXING

Code	For isolator	Regulation field	Pack Carton
Rated current (A): 16			
GW 70 009	16A - 32A - 63A	117-305mm (16-32A) - 144-337mm (63A)	1/10

CHARACTERISTICS: the regulation field can be obtained by cutting both the shaft supplied and the extension brackets at the references shown.

ACCESSORIES SUPPLIED: self-tapping screw kit.

VERION FOR FIXING ON DIN RAIL

GW 70 203

ISOLATOR SWITCHES FOR DIN RAIL WITH BLACK KNOB

Code	No. of poles	No. of modules EN 50022	Pack Carton
Rated current (A): 16			
GW 70 201	2	4	1/24
GW 70 202	3	4	1/24
GW 70 203	4	4	1/24
Rated current (A): 32			
GW 70 204	2	4	1/24
GW 70 205	3	4	1/24
GW 70 206	4	4	1/24
Rated current (A): 63			
GW 70 207	3	5	1/12
GW 70 208	4	5	1/12

COMPLEMENTARY ITEMS

GW 70 026

AUXILIARY CONTACTS

Code	Type of contact	For isolator	Pack Carton
GW 70 026	1 NO + 1 NC	16 A - 25 A - 32 A - 40 A - 63 A - 80 A	1/12
GW 70 027	2 NO	16 A - 25 A - 32 A - 40 A - 63 A - 80 A	1/12
GW 70 028	2 NC	16 A - 25 A - 32 A - 40 A - 63 A - 80 A	1/12
GW 70 029	1 NO + 1 NC	100 A - 125 A - 160 A	1/12

NOTE: it's possible to install:

- max. 2 (1 x side) aux contacts GW70026/GW70027/GW70028 on isolator up to 80A;
- max. 4 (2 x side) aux contacts GW70029 on isolator 100-125-160A (max 1. contatto ausiliario installabile su sezionatori 160A 4P);

70 ATEX - DISCONNECTING SWITCHES IN PAINTED ALUMINIUM BOX - ZONE 22 (D)

CONTROL VERSIONS IN ALUMINIUM ALLOY BOX



GW 70 451

ATEX ROTARY WALL-MOUNTING SWITCHES FOR CONTROL, WITH BLACK KNOB - IP65

Code	No. of poles	Power AC3 400V (kW)	Outer dim. LxHxD (mm)	Pack Carton
Rated current (A): 16				
GW 70 451	2	6 (230V)	140x165x135	1
GW 70 452	3	10	140x165x135	1
GW 70 453	4	10	140x165x135	1
Rated current (A): 32				
GW 70 454	2	9 (230V)	140x165x135	1
GW 70 455	3	15	140x165x135	1
GW 70 456	4	15	140x165x135	1
Rated current (A): 63				
GW 70 457	3	18.5	140x165x135	1
GW 70 458	4	18.5	140x165x135	1
Rated current (A): 100				
GW 70 459	3	30	215x252x94	1
GW 70 460	4	30	215x252x94	1

ACCESSORIES SUPPLIED: cable gland M25 for 16A versions, M32 for 32-63A versions, and M40 for 100A.

CHARACTERISTICS: box in aluminium alloy painted in Grey RAL 7037.

ATEX Classification: Equipment-group II Category 3D.

Dust protection mode: tc.

Room temperature: -20°C ≤ Ta ≤ +40 °C.

NOTES: Can be padlocked with 3 locks in the OFF position and one in the ON position.

EMERGENCY VERSIONS IN ALUMINIUM ALLOY BOX



GW 70 471

ATEX ROTARY WALL-MOUNTING SWITCHES FOR EMERGENCY, WITH RED KNOB - IP65

Code	No. of poles	Power AC3 400V (kW)	Outer dim. LxHxD (mm)	Pack Carton
Rated current (A): 16				
GW 70 471	2	6 (230V)	140x165x135	1
GW 70 472	3	10	140x165x135	1
GW 70 473	4	10	140x165x135	1
Rated current (A): 32				
GW 70 474	2	9 (230V)	140x165x135	1
GW 70 475	3	15	140x165x135	1
GW 70 476	4	15	140x165x135	1
Rated current (A): 63				
GW 70 477	3	18.5	140x165x135	1
GW 70 478	4	18.5	140x165x135	1
Rated current (A): 100				
GW 70 479	3	30	215x252x94	1
GW 70 480	4	30	215x252x94	1

ACCESSORIES SUPPLIED: cable gland M25 for 16A versions, M32 for 32-63A versions, and M40 for 100A.

CHARACTERISTICS: box in aluminium alloy painted in Grey RAL 7037.

ATEX Classification: Equipment-group II Category 3D.

Dust protection mode: tc.

Room temperature: -20°C ≤ Ta ≤ +40 °C.

NOTES: Can be padlocked with 3 locks in the OFF position.



70 RT HP



Scan the QR Code and find out all the technical informations.

CONTROL AND
SIGNALLING

TOTAL PROTECTION



The versions in plastic box have a degree of protection up to IP66/IP67/IP69, which guarantee a total protection against the entry of dust and liquids. Thanks to their high impact resistance, this range is suitable for all the most demanding application contexts.

QUICK MOUNTING



The frontal part of the versions in plastic box is fixed with only 4 captive and sealable screws with ¼ turn: a simple and innovative system, which allows to fix or remove the cover in less time than any other system currently available on the market.

VERSATILE AND INNOVATIVE



Double metric inputs, external points for wall fixing, large internal space for cable routing and accessorisability with different auxiliary contacts, are just some of the features that make this range suitable for various applications.

74 PS

Push-buttons, selectors and indicators Ø 22 mm

The 74 PS range is a system of push-buttons, selectors and indicators (diameter 22 mm) with a degree of protection of IP66 for creating a real interface between man and machine, whilst at the same time controlling the operating status of the drives and equipment to ensure the highest safety standards. The range includes six types of empty enclosure with between 1 and 12 gangs, and enclosures that come fitted with push-buttons and contacts.



OPERATORS Ø 22 MM - IP66

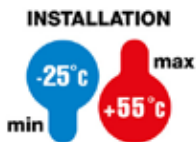

**IP
66**

MOMENTARY PUSH-BUTTONS



GW 74 301

MOMENTARY PUSH-BUTTONS WITH ROUND GUARD

Code	Colour	Pack Carton
GW 74 301	Green	10/60
GW 74 302	Black	10/60
GW 74 303	White	10/60
GW 74 304	Red	10/60
GW 74 305	Blue	10/60
GW 74 306	Yellow	10/60

APPLICATION: suitable for avoiding accidental activation, e.g.: gates, tool machines, etc..

SUPPLIED: 3-seat flange (2 of which are contact-holders).

CHARACTERISTICS: Also compatible with the watertight emergency enclosure GW42204 and GW42207.



GW 74 311

MOMENTARY PUSH-BUTTONS WITHOUT ROUND GUARD

Code	Colour	Pack Carton
GW 74 311	Red	10/60
GW 74 312	Black	10/60
GW 74 313	Green	10/60
GW 74 314	White	10/60
GW 74 315	Blue	10/60
GW 74 316	Yellow	10/60

SUPPLIED: 3-seat flange (2 of which are contact-holders).

CHARACTERISTICS: Also compatible with the watertight emergency enclosure GW42204 and GW42207.



GW 74 345

MOMENTARY PUSH-BUTTONS WITH BACKLIT ROUND GUARD

Code	Colour	Pack Carton
GW 74 341	Green	10/60
GW 74 342	White	10/60
GW 74 343	Red	10/60
GW 74 344	Blue	10/60
GW 74 345	Yellow	10/60

APPLICATION: ideal for viewing the user operating status without the need for additional indicator lamps.

SUPPLIED: 3-seat flange (2 of which are contact-holders).

CHARACTERISTICS: can be combined with the lamp-holder GW74511 + LED lamp.
Also compatible with the watertight emergency enclosure GW42204 and GW42207.

MUSHROOM-HEAD PUSH-BUTTONS



GW 74 367

ROUND MUSHROOM-HEAD PUSH-BUTTONS - MUSHROOM Ø 40MM

Code	Functions	Characteristics	Pack Carton
GW 74 363	Without holding	Not illuminated	10/60
GW 74 364	With holding	Not illuminated	10/60
GW 74 366	Without holding	Backlit	10/60
GW 74 367	With holding	Backlit	10/60

SUPPLIED: 3-seat flange (2 of which are contact-holders).

NOTE: compatible with the emergency enclosure GW42204.

CHARACTERISTICS: GW74366 and GW74367 can be combined with the lamp-holder GW74511 + LED lamp.

Also compatible with the watertight emergency enclosure GW42204 and GW42207.

EMERGENCY PUSH-BUTTONS



GW 74 361

ROUND MUSHROOM-HEAD EMERGENCY BUTTONS - MUSHROOM Ø 40MM

Code	Functions	Characteristics	Pack Carton
GW 74 361	With holding	Not illuminated	10/60
GW 74 362	With holding and key	Not illuminated	10/60
GW 74 365	With holding	Backlit	10/60

APPLICATION: suitable for emergency use, in accordance with Standard IEC 60947-5-5.

SUPPLIED: 3-seat flange (2 of which are contact-holders).

NOTE: all the keys are supplied with a standardised code.

CHARACTERISTICS: GW74365 can be combined with the lamp-holder GW74511 + LED lamp.

SELECTORS



GW 74 401

ROUND LEVER SELECTORS WITH FIXED POSITION

Code	No. gangs	Type	Pack Carton
GW 74 401	2	0 - 1	10/60
GW 74 402	3	1 - 0 - 2	10/60

CHARACTERISTICS: operator in thermoplastic material.

Also compatible with the watertight emergency enclosure GW42204 and GW42207.

SUPPLIED: 3-seat flange (2 of which are contact-holders).



GW 74 411

ROUND KEY SELECTORS WITH FIXED POSITION AND REMOVABLE KEY

Code	No. gangs	Type	Pack Carton
GW 74 411	2	0 - 1	10/60
GW 74 412	3	1 - 0 - 2	10/60

CHARACTERISTIC: operator in thermoplastic material.

SUPPLIED: 3-seat flange (2 of which are contact-holders).

NOTE: all the keys are supplied with a standardised code.



GW 74 421

ROUND LEVER SELECTORS WITH - 0 - RETURN POSITION

Code	No. gangs	Type	Pack Carton
GW 74 421	2	0 - 1	10/60
GW 74 422	3	1 - 0 - 2	10/60

CHARACTERISTIC: operator in thermoplastic material. Also compatible with the watertight emergency enclosure GW42204 and GW42207.

SUPPLIED: 3-seat flange (2 of which are contact-holders).

INDICATORS - IP66

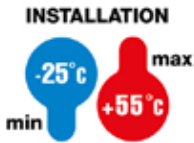

**IP
66**

INDICATORS



GW 74 452

ROUND BACKLIT INDICATORS WITH DIRECT SUPPLY NOMINAL VOLTAGE 230 V - BA9S LAMP FIXING

Code	Colour	Pack Carton
GW 74 451	Green	10/60
GW 74 452	Red	10/60
GW 74 453	Yellow	10/60
GW 74 454	Blue	10/60
GW 74 455	White	10/60

CHARACTERISTICS: lamp not included. Max lamp power 1 W.

Also compatible with the watertight emergency enclosure GW42204 and GW42207.

NOTE: the colour of the diffuser should be chosen in accordance with the colour code recommended by Standard CEI 16-3. If using 110 V LEDs code GW74517 and 230 V LEDs code GW74518, it is recommended to remove the opal cover on the indicator to improve the light flow.

COMPLEMENTARY ITEMS

ACCESSORIES



ZC6

CONTACTS - ITH=10A - 250V AC

Code	Type	Colour	Pack Carton
GW 74 501	1 NO	Green	1/30
GW 74 502	1 NC	Red	1/30
GW 74 503	2 NO	Green	1/30
GW 74 504	1 NO + 1 NC	White	1/30
GW 74 505	2 NC	Red	1/30

CHARACTERISTICS: GW74502 suitable for contact opening also in the event of slight sticking, in compliance with Standard EN 60947-5-1.

Clip assembly on the contact-holder flanges.

NOTES: the dual contacts type: GW74503, GW74504 and GW74505 are not compatible with the watertight emergency enclosures GW42204 and GW42207.



GW 74 511

LAMP-HOLDER - LAMP COUPLING BA9S

Code	Power supply	Lamp power	Pack Carton
GW 74 511	Direct	1 W	1/30

CHARACTERISTICS: Clip assembly on the contact-holder flanges. To be positioned in the central seat of the flange.

APPLICATIONS: to be used with the backlit momentary push-buttons with guard and backlit mushroom-head push-buttons, to produce operating signals.



GW 74 515

BULBS - BA9S LAMP FIXING

Code	Type	Rated voltage	Pack Carton
GW 74 515	LED	12 V	10/100
GW 74 516	LED	24 V	10/100
GW 74 517	LED	110 V	10/100
GW 74 518	LED	230 V	10/100

APPLICATIONS: To be used with the backlit indicators or the lamp-holder GW74511.

NOTE: If using 110 V LEDs code GW74517 and 230 V LEDs code GW74518, it is recommended to remove the opal cover on the indicator to improve the light flow.



GW 74 521

BLACK SCREWCAP FOR UNWIRED ENCLOSURES FOR PUSH-BUTTONS WITH A ROUND SHAPE - Ø 22 MM

Code	Colour	Pack Carton
GW 74 521	Black	10/100

CHARACTERISTIC: thermoplastic screw cap.



GW 74 523

PLATES

Code	Suitable for	Shape	Colour	Text	Pack Carton
GW 74 522	Push-buttons, indicators and selectors Ø 22mm	Rectangular	Black	-	5/100
GW 74 523	Mushroom-head emergency button	Round	Yellow	Emergency-Stop	10/100

CHARACTERISTIC: the plates allow you to assign the push-button, selector and indicator functions.

NOTE: GW74523 to be used when the emergency push-buttons are installed on the panel.



GW 74 525

TOOLS

Code	Description	Material	Pack Carton
GW 74 524	Tool for mounting ring nuts	Metal	10/100
GW 74 525	extraction tool Lamp	Thermoplastic	10/100

COMBI 22 - INSULATING ENCLOSURES FOR OPERATORS AND INDICATORS - IP66

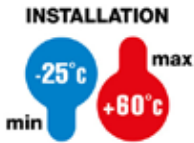

**IK
08**



**IP
66**

**GWT
650°C**



ENCLOSURES



GW 27 101

UNWIRED ENCLOSURES FOR PUSH-BUTTONS, CONTROLS AND INDICATORS Ø 22 MM - GREY RAL 7035

Code	No. gangs	Side entries	Top entries	Bottom entries	Outer dim. LxHxD (mm)	Pack Carton
Colour: Grey RAL 7035						
GW 27 101	1	2xØ 23	1xØ 23	1xØ 23	66x82x65	5/60
GW 27 102	2	6xØ 23	1xØ 23	1xØ 23	132x82x65	2/30
GW 27 103	3	4xØ 23	1xØ 23	1xØ 23	66x171x65	1/20
GW 27 104	6	4xØ 23	3xØ 23	3xØ 23	132x171x65	1/10
GW 27 105	12	4xØ 23	3xØ 23	3xØ 23	264x171x65	1/10
Colour: Yellow cover						
GW 27 111	1	2xØ 23	1xØ 23	1xØ 23	66x82x65	5/60

CHARACTERISTICS: degree of protection guaranteed with IP66 operators correctly installed.
 The hole seat has knockouts for installing operators with any reference.
 GW27111 with specific yellow lid for assembling emergency push-buttons GW74361, GW74362 and GW74365.
NOTES: the empty containers can be supplied with push-buttons, commands and indicators Ø 22 mm and single contacts, type GW74501 and GW74502.

COMPLETE ENCLOSURES



GW 27 202

COMPLETE ENCLOSURES - GREY RAL 7035

Code	No. gangs	Contacts	Operators Ø 22	Outer dim. LxHxD (mm)	Pack Carton
GW 27 201	1	1 NO	General (black)	66x82x65	1/30
GW 27 202	1	1 NO - 1 NC	Emergency (red)	66x82x65	1/30
GW 27 203	2	1 NO - 1 NC	Start (green) Stop (red)	132x82x65	1/10
GW 27 204	3	1 NO - 1 NC	Start, stop, indicator	66x171x65	1/10

CHARACTERISTICS: 3-seat flange. Maximum protrusion of the operator from the container: GW27201, GW20203, GW27204 - 20mm; GW27202 - 25mm.
 GW27202: yellow lid, mushroom-head push-button with retainer.
 GW27204: direct supply, BA95 coupling included, max 380V-2 W, lamp not included, operators Ø 22 for run (green), stop (red), signalling (white).
 Complete insulation, in accordance with Standard IEC 536.

WATERTIGHT LIDS

Code	Dimensions LxH (mm)	Suitable for	Colour	Pack Carton
GW 66 708	75x85	1 Button Ø22 mm Range 74 PS	Grey	1/20
GW 66 745	75x85	1 Button Ø22 mm Range 74 PS	Yellow	1/20

APPLICATIONS: GW66745 specific for emergency push-buttons.
ACCESSORIES SUPPLIED: gasket and mounting screws.



GW 66 745

COMPLEMENTARY ITEMS



GW 27 402

JUNCTION BOX FOR COMBINED ASSEMBLY OF MODULAR CONTAINERS GREY RAL 7035 - IP55

Code	No. knockout holes Ø23	Lid screws	Outer dim. LxHxD (mm)	Pack Carton
GW 27 402	8 on sides / 1 on the bottom	Stainless steel	132x82x55	2/60

CHARACTERISTICS: knockout holes removable with tool. Enclosures are fit for fixing the earth terminal GW26407. Complete insulation can be obtained by using the screwcaps GW44622.



GW 26 406

WATERTIGHT COUPLING DEVICE FOR CONTAINERS, DEVICES AND BOXES - IP55

Code	Mounting hole Ø (mm)	Type of pitch	Pack Carton
GW 26 406	23	PG16	25/250

APPLICATIONS: for the combined assembly of enclosures, junction boxes, etc..

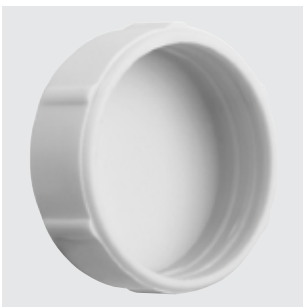

GW 44 622

INSULATING SCREW CAP

Code	Description	Pack Carton
GW 44 622	Screwcap Ø16mm	10/100

APPLICATIONS: used to maintain the double insulation and the original IP degree of protection of the boxes, containers and other GEWISS products.



ZC6

CONTACTS - ITH=10A - 250V AC

Code	Type	Colour	Pack Carton
GW 74 501	1 NO	Green	1/30
GW 74 502	1 NC	Red	1/30

CHARACTERISTICS: GW74502 suitable for contact opening also in the event of slight sticking, in compliance with Standard EN 60947-5-1. Clip assembly on the contact-holder flanges. Compatible with the emergency enclosure GW42204.



74 PS



Scan the QR Code and find out all the technical informations.

QUICK, RELIABLE AND SAFE INSTALLATION



Thanks to the practical clip coupling mechanism of the contacts, panel assembly times are drastically reduced. The dual contact versions increase installation flexibility and extend the maximum number of contacts for each device.

SYNERGY WITH GEWISS RANGES



The high degree of protection - IP66 - means the 74 PS operators can be housed inside or outside GEWISS containers such as the 46 range boards, the 42RV emergency enclosures, the 27 COMBI boxes or the 42TV support bases.

THE BENEFITS OF LED TECHNOLOGY



The products of the 74 PS range can be illuminated and combined with LED lamps with a BA9S coupling for optimum performance, full reliability, a longer lifespan and less maintenance.



SURFACE-MOUNTING ENCLOSURES



46

WATERTIGHT SURFACE-MOUNTING
DISTRIBUTION AND AUTOMATION
BOARDS

pag. 158



40 CD

SURFACE-MOUNTING DISTRIBUTION
BOARDS AND ENCLOSURES

pag. 180



40 CDe

ENCLOSURES AND DISTRIBUTION
BOARDS FOR SPECIFIC STANDARDS

pag. 196



42 RV

SURFACE AND FLUSH-MOUNTING
WATERTIGHT EMERGENCY
ENCLOSURES

pag. 210



44 CE

TECHNOPOLYMER
SURFACE MOUNTING
WATERTIGHT JUNCTION BOXES

pag. 218



GW Connect

METAL SURFACE-MOUNTING
WATERTIGHT JUNCTION BOXES



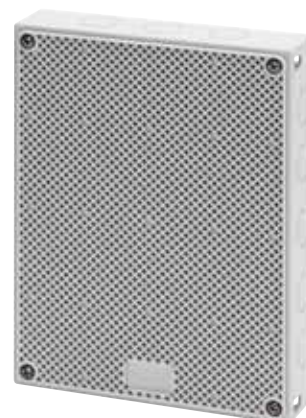









pag. 232

















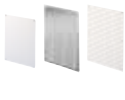

























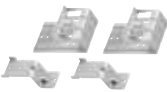

42 TV

MULTIFUNCTIONAL
SUPPORTING BASES

pag. 236

	BOARD					COMPLEMENTARY ITEMS		
						FRONT CONFIGURATION		
						Single panels  with window and DIN rail	PANELS  with window and DIN rail	
DIMENSIONS (LxHxD) mm	Material	Code		No. modules EN 50022				
		BLANK door	Transparent door					
44 CEP GWPLAST 120 IP55 	200x254x135	GWPLAST 120	GW 44 808	GW 44 818				
	236x316x135	GWPLAST 120	GW 44 809	GW 44 819	8	GW 44 852 8 modules		
	316x396x160	GWPLAST 120	GW 44 810	GW 44 820	24 (12x2)	GW 44 853 14 modules GW 44 854 24 modules (12x2)		
	396x474x160	GWPLAST 120	GW 44 811	GW 44 821	32 (16x2)	GW 44 855 32 modules (16x2)		
46 QP POLYESTER BOARD IP66 	250x300x160	Polyester	GW 46 001 F	GW 46 201 F				
		Metal	GW 46 031					
	310x425x160	Polyester	GW 46 002 F	GW 46 202 F	36 (12x3)		3 single panels width 12 modules 	
		Metal	GW 46 032	GW 46 232				
		Stainless steel	GW 46 052					GW 46 420 F
	405x500x200	Polyester	GW 46 003 F	GW 46 203 F	54 (18x3)		3 single panels width 18 modules 	
Metal		GW 46 033	GW 46 233	GW 46 421 F				GW 46 426 F
405x650x200	Polyester	GW 46 004 F	GW 46 204 F	72 (18x4)		4 single panels width 18 modules 		
	Metal	GW 46 034	GW 46 234					
	Stainless steel	GW 46 054					GW 46 421 F	GW 46 426 F
515x650x250	Polyester	GW 46 005 F	GW 46 205 F	96 (24x4)		4 single panels width 24 modules 		
	Metal	GW 46 035	GW 46 235				GW 46 422 F	GW 46 427 F
585x800x300	Polyester	GW 46 006 F	GW 46 206 F	140 (28x5)		5 single panels width 28 modules 		
	Metal	GW 46 036	GW 46 236					
	Stainless steel	GW 46 056					GW 46 423 F	GW 46 428 F
800x1060x350	Polyester	GW 46 007 F	GW 46 207 F	180 (36x5)		5 single panels width 36 modules 		
	Metal	GW 46 037	GW 46 237				GW 46 424 F	GW 46 429 F
46 QM METAL BOARD IP55 	405x650x200	Polyester	GW 46 004 F	GW 46 204 F	72 (18x4)		4 single panels width 18 modules 	
		Metal	GW 46 034	GW 46 234				GW 46 421 F
46 QX STAINLESS STEEL BOARD IP55 	515x650x250	Polyester	GW 46 005 F	GW 46 205 F	96 (24x4)		4 single panels width 24 modules 	
		Metal	GW 46 035	GW 46 235				GW 46 422 F

COMPLEMENTARY ITEMS

FRONT CONFIGURATION				INTERNAL CONFIGURATION			SERVICE ACCESSORIES		
DOUBLE PANELS	INNER DOORS	UPRIGHTS	DIN RAILS	BACK-MOUNTING PLATES	PLATES		MISCELLANEOUS		
 Blank	 Material: insulating/ metal	 Pair	 simple/ double	 Material: metal/ steel (perforated)/ insulating	 H 1 module: full	 H 2 modules: full			
				GW 44 636 GW 44 646				 Resin bracket GW 44 621	 Safety lock with handle GW 46 445
				GW 44 637 GW 44 647				 4 stainless steel brackets GW 46 451	 Set 4 galvanised brackets GW 46 446
				GW 44 638 GW 44 648					
				GW 44 639 GW 44 649					
				GW 46 401 GW 46 461 GW 46 408			GW 46 551	 Clip nut GW 46 450	 4 stainless steel brackets GW 46 451
1 double panel  GW 46 475 F	GW 46 414 GW 46 564	GW 46 435 F	GW 46 430 F GW 46 530 F	GW 46 402 GW 46 462 GW 46 409	3 single plates  GW 46 540	1 double plate  GW 46 580	GW 46 552	 Set 4 galvanised brackets GW 46 446	 Gasket for board coupling GW 46 449
1 double panel  GW 46 476 F	GW 46 415 GW 46 565	GW 46 436 F	GW 46 431 F GW 46 531 F	GW 46 403 GW 46 463 GW 46 410	3 single plates  GW 46 541	1 double plate  GW 46 581	GW 46 553	 Set of 4 reversible squares for back-mounting plate fixing or uprights for mod- ular equipment fixing For back plate fixing GW 46 521 F	 Safety lock with handle GW 46 445
2 double panels  GW 46 476 F	GW 46 416 GW 46 566	GW 46 437 F	GW 46 431 F GW 46 531 F	GW 46 404 GW 46 464 GW 46 411	4 single plates  GW 46 541	2 double plates  GW 46 581	GW 46 553	 Document holder wallet GW 46 447	 Ventilation kit IP 44 GW 46 448 and GW 46 471
2 double panels  GW 46 477 F	GW 46 417 GW 46 567	GW 46 437 F	GW 46 432 F GW 46 532 F	GW 46 405 GW 46 465 GW 46 412	4 single plates  GW 46 542	2 double plates  GW 46 582	GW 46 554	 KIT for wiring trunking GW 46 557 F	 Double insulation KIT GW 46 526
2 double panels  GW 46 478 F	GW 46 418 GW 46 568	GW 46 438 F	GW 46 433 F GW 46 533 F	GW 46 406 GW 46 466 GW 46 413	5 single plates  GW 46 543	2 double plates  GW 46 583	GW 46 555	 Pair of handles for transport GW 46 591	 Kit inserts GW 46 592 F
2 double panels  GW 46 479 F	GW 46 419 GW 46 569	GW 46 439 F	GW 46 434 F GW 46 534 F	GW 46 407 GW 46 467	5 single plates  GW 46 544	2 double plates  GW 46 584			

	COMPATIBILITY BETWEEN 46 RANGE BOARDS AND KIT FOR MCCBS MSX RANGE AND KIT SWITCH DISCONNECTORS MSS RANGE				
	BOARD				
	DIMENSIONS (LxHxD) mm	Material	Code		No. modules EN 50022
BLANK door			Transparent door		
44 CEP GWPLAST 120 IP55 	200x254x135	GWPLAST 120	GW 44 808	GW 44 818	-
	236x316x135	GWPLAST 120	GW 44 809	GW 44 819	8
	316x396x160	GWPLAST 120	GW 44 810	GW 44 820	24 (12x2)
	396x474x160	GWPLAST 120	GW 44 811	GW 44 821	32 (16x2)
46 QP POLYESTER BOARD IP66  46 QM METAL BOARD IP55  46 QX STAINLESS STEEL BOARD IP55 	250x300x160	Polyester	GW 46 001 F	GW 46 201 F	-
		Metal	GW 46 031	-	
	310x425x160	Polyester	GW 46 002 F	GW 46 202 F	36 (12x3)
		Metal	GW 46 032	GW 46 232	
		Stainless steel	GW 46 052	-	
	405x500x200	Polyester	GW 46 003 F	GW 46 203 F	54 (18x3)
		Metal	GW 46 033	GW 46 233	
	405x650x200	Polyester	GW 46 004 F	GW 46 204 F	72 (18x4)
		Metal	GW 46 034	GW 46 234	
		Stainless steel	GW 46 054	-	
	515x650x250	Polyester	GW 46 005 F	GW 46 205 F	96 (24x4)
		Metal	GW 46 035	GW 46 235	
585x800x300	Polyester	GW 46 006 F	GW 46 206 F	140 (28x5)	
	Metal	GW 46 036	GW 46 236		
	Stainless steel	GW 46 056	-		
800x1060x350	Polyester	GW 46 007 F	GW 46 207 F	180 (36x5)	
	Metal	GW 46 037	GW 46 237		

NOTES: The configurations reported in the table are ONLY valid if the peak current of the indicated switch (in correspondence of the assumed short-circuit current in the installation point) is NOT higher than 17kA, or if the assumed short-circuit current in the delivery point, in line with the main board switch, is NOT greater than 10kA.

Check the thermal power according to the method indicated in the pages of the technical catalogue.

The kits are fixed by means of uprights. The kit panels are 2-modules high.

MSX/M 160c (both 3P and 4P) must be fixed to the DIN rail through the specific brackets contained in the kit GWD8875.

MSX/M 250c, MSX/D 125, MSX/D 160 e MSX/D 250 (both 3P and 4P) require the kit GWD8876.

In the case of cable entry from below, it is recommended to insert a blank panel above the moulded-case/switch disconnector kit, so the wires can be pulled more easily.

MSX moulded case circuit breakers can be mounted on the same DIN rail close to modular devices and MSS switch disconnectors using GWD3317 depth adapter in order to compensate difference in depth.

COMPATIBILITY BETWEEN 46 RANGE BOARDS AND KIT FOR MCCBS MSX RANGE AND KIT SWITCH DISCONNECTORS MSS RANGE

MCCBs	SWITCH DISCONNECTOR	
MSX/M 160c - MSX/M 250c - MSX/D 125 - MSX/D 160 - MSX/D 250	MSS 160	MSS 250
		
-	-	-
-	-	-
GW 44 853 (for MSX/M 160c and MSX/D 160 only)	-	-
GW 44 855 (for MSX/M 160c and MSX/D 160 only)	-	-
-	-	-
-	-	-
-	-	-
-	-	-
GW 46 570 F	GW 46 570 F	-
GW 46 570 F	GW 46 570 F	-
GW 46 571 F	GW 46 571 F	GW 46 577 F
GW 46 572 F	GW 46 572 F	GW 46 578 F
GW 46 573 F	GW 46 573 F	GW 46 579 F

46

Watertight surface-mounting distribution and automation boards

The offer includes: 46 QP boards - monobloc, Halogen Free glass fiber loaded polyester, degree of protection IP66; 46 QM boards - IP55 in metal; 46 QX boards - IP55 in stainless steel; 44 CEP boards - monobloc, Halogen Free technopolymer. The 46 QP, QM and 44 CEP boards are available in transparent and blank door versions. In addition, 46 QP, QM and QX boards features Fast & Easy accessories with metal snap fastening.



46 QP - POLYESTER WATERTIGHT BOARDS - IP66



IP
66

GWT
960°C



DISTRIBUTION BOARDS



GW 46 004 F

POLYESTER WATERTIGHT BOARDS WITH BLANK DOOR FITTED WITH LOCK - GREY RAL 7035



Code	Nominal dim. LxHxD (mm)	No. of modules EN 50022	No. locks	Dispersible power A (W)	Dispersible power B (W)	Pack Carton
GW 46 001 F	250x300x160	-	1	34	-	1
GW 46 002 F	310x425x160	36 (12x3)	2	48	39	1
GW 46 003 F	405x500x200	54 (18x3)	2	95	53	1
GW 46 004 F	405x650x200	72 (18x4)	2	118	81	1
GW 46 005 F	515x650x250	96 (24x4)	2	126	106	1
GW 46 006 F	585x800x300	140 (28x5)	2	205	146	1
GW 46 007 F	800x1060x350	180 (36x5)	2	324	226	1

CHARACTERISTICS: boxes equipped with inserts pre-assembled in the slots, to speed up the configuration of the board. Doors equipped with functional grid of reference for fixing the devices. From board GW46002F to board GW46006F it is possible to fix the panels with windows or blank (1 or 2 modules) directly in the seats housed in the vertical walls of the boards; for the board GW46007F use uprights GW46439F. Impact resistance: IK10 according to EN 62262.

ACCESSORIES SUPPLIED: 4 reversible brackets with relative screws for fixing back-mounting plates or uprights for modular devices.

NOTES: Dispersible power calculated according to CEI 23-49.

Dispersible power A (W): board configuration with back-mounting plate (as far back as possible).

Dispersible power B (W): board configuration with DIN rails + panels with windows.

The nominal dimensions in the table above refer to the external size of the boards; for the real outer dimensions refer to the technical data sheet downloadable from professionals website GEWISS or to the technical section of this catalogue.

For applications in the photovoltaic environment, use the surface-mounting brackets - code GW44621.



GW 46 203 F

POLYESTER WATERTIGHT BOARDS WITH TRANSPARENT DOOR AND LOCK - GREY RAL 7035

FAST EASY

HF
HERMETIC FRAME

U_i
1000V
EN 62208

EN 62206

Code	Nominal dim. LxHxD (mm)	No. of modules EN 50022	No. locks	Dispersible power A (W)	Dispersible power B (W)	Pack Carton
GW 46 201 F	250x300x160	-	1	34	-	1
GW 46 202 F	310x425x160	36 (12x3)	2	48	39	1
GW 46 203 F	405x500x200	54 (18x3)	2	95	53	1
GW 46 204 F	405x650x200	72 (18x4)	2	118	81	1
GW 46 205 F	515x650x250	96 (24x4)	2	126	106	1
GW 46 206 F	585x800x300	140 (28x5)	2	205	146	1
GW 46 207 F	800x1060x350	180 (36x5)	2	324	226	1

ACCESSORIES SUPPLIED: boxes equipped with inserts pre-assembled in the slots, to speed up the configuration of the board. For the transparent door version: GWT 650°C. From board GW46202F to board GW46206F it is possible to fix the panels with windows or blank (1 or 2 modules) directly in the seats housed in the vertical walls of the boards; for the board GW46207F use uprights GW46439F. Impact resistance of the bottom: IK10 according to EN 62262.

ACCESSORIES SUPPLIED: 4 reversible brackets with relative screws for fixing back-mounting plates or uprights for modular devices.

NOTES: Dispersible power calculated according to CEI 23-49.

Dispersible power A (W): board configuration with back-mounting plate (as far back as possible).

Dispersible power B (W): board configuration with DIN rails + panels with windows.

The nominal dimensions in the table above refer to the external size of the boards; for the real outer dimensions refer to the technical data sheet downloadable from professionals website GEWISS or to the technical section of this catalogue.

For applications in the photovoltaic environment, use the surface-mounting brackets - code GW44621.

SPARE PARTS



GW 46 504 F

BLANK DOOR WITH LOCK

HF
HERMETIC FRAME

Code	For boards LxH (mm)	No. locks	Pack Carton
GW 46 501 F	250x300	1	1/6
GW 46 502 F	310x425	2	1/6
GW 46 503 F	405x500	2	1/8
GW 46 504 F	405x650	2	1/8
GW 46 505 F	515x650	2	1
GW 46 506 F	585x800	2	1
GW 46 507 F	800x1060	2	1

NOTE: spare blank doors as compatible with the respective back plates of the previous boards of the 46QP range.



GW 46 513 F

TRANSPARENT DOOR AND LOCK

HF
HERMETIC FRAME

Code	For boards LxH (mm)	No. locks	Pack Carton
GW 46 511 F	250x300	1	1/6
GW 46 512 F	310x425	2	1/6
GW 46 513 F	405x500	2	1/8
GW 46 514 F	405x650	2	1/8
GW 46 515 F	515x650	2	1
GW 46 516 F	585x800	2	1
GW 46 517 F	800x1060	2	1

NOTE: spare transparent doors as compatible with the respective back plates of the previous boards of the 46QP range.

46 QM - WATERTIGHT METAL BOARDS - IP55



**IP
55**

DISTRIBUTION BOARDS



GW 46 034

WATERTIGHT BOARDS IN METAL WITH BLANK DOOR FITTED WITH LOCK GREY RAL 7035

**FAST
EASY** **IK
10**

Code	Nominal dim. LxHxD (mm)	No. of modules EN 50022	No. locks	Dispersible power A (W)	Dispersible power B (W)	Pack Carton
GW 46 031	250x300x160	-	1	49	-	1
GW 46 032	310x425x160	36 (12x3)	2	70	58	1
GW 46 033	405x500x200	54 (18x3)	2	106	80	1
GW 46 034	405x650x200	72 (18x4)	2	135	97	1
GW 46 035	515x650x250	96 (24x4)	2	180	115	1
GW 46 036	585x800x300	140 (28x5)	2	240	159	1
GW 46 037	800x1060x350	180 (36x5)	2	400	284	1

ACCESSORIES SUPPLIED: screwcaps, threaded pins or reversible squares with the relative bolts and screws for fixing the back-mounting plates or uprights for modular devices.

GW46034, GW46035, GW46036, GW46037 with perforated bottom equipped with flange for cables to pass through.

NOTES: Dispersible power calculated according to CEI 23-49.

For the front configuration (via panels and DIN rails), it is necessary to use the uprights.

Dispersible power A (W): board configuration with back-mounting plate (as far back as possible).

Dispersible power B (W): board configuration with DIN rails + panels with windows.

The technical and functional characteristics, and the nominal values, refer to vertical installation only.

APPLICATIONS: for indoor use (e.g. in industrial systems, on machines, etc.).

The nominal dimensions LxHxD in the table above refer to the external size of the boards.

For the real outer dimensions LxHxD refer to the technical data sheet downloadable from professionals website GEWISS or to the technical section of this catalogue.



GW 46 232

WATERTIGHT BOARDS IN METAL WITH BLANK DOOR FITTED WITH TEMPERED GLASS WINDOW AND LOCK GREY RAL 7035

**FAST
EASY** **IK
08**

Code	Nominal dim. LxHxD (mm)	No. of modules EN 50022	No. locks	Dispersible power A (W)	Dispersible power B (W)	Pack Carton
GW 46 232	310x425x160	36 (12x3)	2	70	58	1
GW 46 233	405x500x200	54 (18x3)	2	106	80	1
GW 46 234	405x650x200	72 (18x4)	2	135	97	1
GW 46 235	515x650x250	96 (24x4)	2	180	115	1
GW 46 236	585x800x300	140 (28x5)	2	240	159	1
GW 46 237	800x1060x350	180 (36x5)	2	400	284	1

ACCESSORIES SUPPLIED: screwcaps, threaded pins or reversible squares with the relative bolts and screws for fixing the back-mounting plates or uprights for modular devices.

GW46234, GW46235, GW46236, GW46237 with perforated bottom equipped with flange for cables to pass through.

NOTES: Dispersible power calculated according to CEI 23-49.

For the front configuration (via panels and DIN rails), it is necessary to use the uprights.

Dispersible power A (W): board configuration with back-mounting plate (as far back as possible).

Dispersible power B (W): board configuration with DIN rails + panels with windows.

The technical and functional characteristics, and the nominal values, refer to vertical installation only.

APPLICATIONS: for indoor use (e.g. in industrial systems, on machines, etc.).

The nominal dimensions LxHxD in the table above refer to the external size of the boards.

For the real outer dimensions LxHxD refer to the technical data sheet downloadable from professionals website GEWISS or to the technical section of this catalogue.

46 QX - WATERTIGHT BOARDS IN STAINLESS STEEL - IP55



**IK
10**

**IP
55**

DISTRIBUTION BOARDS

WATERTIGHT BOARDS IN SATIN STAINLESS STEEL WITH BLANK DOOR FITTED WITH LOCK

**FAST
EASY**



GW 46 054

Code	Nominal dim. LxHxD (mm)	No. of modules EN 50022	No. locks	Dispersible power A (W)	Dispersible power B (W)	Pack Carton
GW 46 052	310x425x160	36 (12x3)	2	70	58	1
GW 46 054	405x650x200	72 (18x4)	2	135	97	1
GW 46 056	585x800x300	140 (28x5)	2	240	159	1

ACCESSORIES SUPPLIED: screwcaps, threaded pins or reversible squares with the relative bolts and screws for fixing the back-mounting plates or uprights for modular equipment.
GW46054, GW46056 with perforated bottom equipped with flange for cables to pass through.

NOTES: Dispersible power calculated according to CEI 23-49.

For the front configuration (via panels and DIN rails), it is necessary to use the uprights.

Dispersible power A (W): board configuration with back-mounting plate (as far back as possible).

Dispersible power B (W): board configuration with DIN rails + panels with windows.

The technical and functional characteristics, and the nominal values, refer to vertical installation only.

The nominal dimensions LxHxD in the table above refer to the external size of the boards.

For the real outer dimensions LxHxD refer to the technical data sheet downloadable from professionals website GEWISS or to the technical section of this catalogue.

APPLICATIONS: for indoor use, in areas that are frequently cleaned with water jets for reasons of hygiene (e.g. industrial kitchens, butchers' shops, etc.).

COMPLEMENTARY ITEMS FOR 46 QP, QM AND QX BOARDS

FRONT CONFIGURATION



GW 46 414

HINGED ENCLOSURE DOORS IN POLYESTER FOR ASSEMBLY OF COMMAND, SIGNALLING AND MEASURING DEVICES - GREY RAL 7035



Code	For boards LxH (mm)	Pack Carton
GW 46 414	310x425	1/5
GW 46 415	405x500	1/4
GW 46 416	405x650	1/5
GW 46 417	515x650	1/2
GW 46 418	585x800	1/2
GW 46 419	800x1060	1

NOTES: for further information about the distances between board door, inner door and back-mounting plate, refer to the dimensional data in the technical catalogue.

CHARACTERISTICS: these are reversible (for the technical details refer to the dedicated section in the technical catalogue).



GW 46 566

HINGED ENCLOSURE DOORS IN METAL FOR ASSEMBLY OF COMMAND, SIGNALLING AND MEASURING DEVICES - GREY RAL 7035

Code	For boards LxH (mm)	Pack Carton
GW 46 564	310x425	1/5
GW 46 565	405x500	1/4
GW 46 566	405x650	1/5
GW 46 567	515x650	1/2
GW 46 568	585x800	1/2
GW 46 569	800x1060	1

NOTES: for further information about the distances between board door, inner door and back-mounting plate, refer to the dimensional data in the technical catalogue. The use of the metal inner door in the boards of the 46QP range requires the earth pin to be connected to the relative PE protection conductor only if non-class 2 devices are assembled on it.

CHARACTERISTICS: these are reversible (for the technical details refer to the dedicated section in the technical catalogue).



GW 46 421 F

COVERING PANELS WITH WINDOW, HEIGHT 1 MODULE, FAST & EASY QUICK ASSEMBLY - GREY RAL 7035



Code	No. of modules EN 50022	For standard boards (mm)	Pack Carton
Height: 1 Module			
GW 46 420 F	12	310	1/10
GW 46 421 F	18	405	1/10
GW 46 422 F	24	515	1/10
GW 46 423 F	28	585	1/5
GW 46 424 F	36	800	1/5

CHARACTERISTICS: captive panel 1/4 turn sealing screws.

GW46420F, GW46421F, GW46422F, GW46423F, possibility to fix directly on the inner walls of the polyester boards.

ACCESSORIES SUPPLIED: fixing accessories. Complete with DIN rail.

NOTES: in all boards, the panel GW46424F can be fixed only with uprights GW46439F.



GW 46 425 F

FAST & EASY QUICK ASSEMBLY BLANK COVERING PANELS - GREY RAL 7035



Code	For standard boards (mm)	Pack Carton
Height: 1 Module		
GW 46 425 F	310	1/10
GW 46 426 F	405	1/10
GW 46 427 F	515	1/13
GW 46 428 F	585	1/5
GW 46 429 F	800	1/5
Height: 2 Modules		
GW 46 475 F	310	1/5
GW 46 476 F	405	1/5
GW 46 477 F	515	1/5
GW 46 478 F	585	1/5
GW 46 479 F	800	1

CHARACTERISTICS:

GW46425F, GW46426F, GW46427F, GW46428F, GW46475F, GW46476F, GW46477F, GW46478F possibility to fix directly on the inner walls of the polyester boards. captive panel 1/4 turn sealing screws.

in all boards, the panel GW46429F and GW46479F can be fixed only with uprights GW46439F.

ACCESSORIES SUPPLIED: fixing accessories.



GW 46 437 F

PAIR OF UPRIGHTS FOR INSTALLATION OF FAST & EASY QUICK ASSEMBLY TECHNICAL COMPONENTS, FOR MODULAR DEVICES, MOULDED-CASE DEVICES, SWITCH- DISCONNECTORS AND BLANK/PERFORATED PLATES H = 1 AND 2 MODULES

Code	For boards LxH (mm)	Pack Carton
GW 46 435 F	310x425	1/10
GW 46 436 F	405x500	1/10
GW 46 437 F	405x650/515x650	1/10
GW 46 438 F	585x800	1/10
GW 46 439 F	800x1060	1/10

ACCESSORIES SUPPLIED: the uprights are provided with a kit with 4 inserts to be inserted in the seats located on the lower and upper horizontal surfaces. The position of the seats where the inserts have to be housed is shown on the instruction sheet inside the 46QP boards. The insert is fixed in the seat through the expansion of the plate located inside the insert, using a pin with diameter 4 mm. The uprights are installed using the 4 brackets provided with the 46QP boards.

APPLICATIONS: the uprights make it possible to implement extractable frames by using: panels without and with windows, perforated or non-perforated plate with height of 1 or 2 modules, MCCB or switch disconnector kits.



GW 46 431 F

FAST & EASY QUICK ASSEMBLY DIN RAILS

Code	No. of modules EN 50022	For standard boards (mm)	Pack Carton
GW 46 430 F	12	310	1/10
GW 46 431 F	18	405	1/10
GW 46 432 F	24	515	1/10
GW 46 433 F	28	585	1/10
GW 46 434 F	36	800	1/10

ACCESSORIES SUPPLIED: accessories for fixing to panel brackets.

NOTES: To use the DIN rails without the relative blank panel, use the GW46524F kit.

To restore the minimum degree of protection of the open door board, use the relative inner door.



GW 46 531 F

FAST & EASY QUICK ASSEMBLY DOUBLE DIN RAILS

Code	No. of modules EN 50022	For standard boards (mm)	Pack Carton
GW 46 530 F	12	310	1/10
GW 46 531 F	18	405	1/10
GW 46 532 F	24	515	1/10
GW 46 533 F	28	585	1/10
GW 46 534 F	36	800	1/10

APPLICATIONS: suitable for use with the GWFIX100 system.

ACCESSORIES SUPPLIED: accessories for fixing to panel brackets.

NOTES: the use of the double DIN rails GW46531F, GW46532F, GW46533F, GW46534F prevents the positioning of the vertical trunking.

To use the DIN rails without the relative blank panel, use the GW46524F kit.

To restore the minimum degree of protection of the open door board, use the relative inner door.



GW 46 570 F

KIT OF MOULDED-CASE DEVICES AND SWITCH-DISCONNECTORS - FIXING BY MEANS OF UPRIGHTS 2-MODULE PANEL HEIGHT - GREY RAL 7035

Code	MSX Type	Disconnecter Type	For standard boards (mm)	Pack Carton
Equipment fixing: Plate, DIN rail EN 50022				
GW 46 570 F	MSX/M 160c - MSX/M 250c - MSX/D 125 - MSX/D 160 - MSX/D 250	MSS 160	405	1
GW 46 571 F	MSX/M 160c - MSX/M 250c - MSX/D 125 - MSX/D 160 - MSX/D 250	MSS 160	515	1
GW 46 572 F	MSX/M 160c - MSX/M 250c - MSX/D 125 - MSX/D 160 - MSX/D 250	MSS 160	585	1
GW 46 573 F	MSX/M 160c - MSX/M 250c - MSX/D 125 - MSX/D 160 - MSX/D 250	MSS 160	800	1
Equipment fixing: on plate				
GW 46 577 F	-	MSS 250	515	1
GW 46 578 F	-	MSS 250	585	1
GW 46 579 F	-	MSS 250	800	1

CHARACTERISTICS: panels with windows H=45mm; captive and sealing 1/4 turn screws; Fixed with uprights.

Pre-arrangement for vertically positioned devices. Halogen-free plastic material in accordance with EN 60754-2 (CEI EN 50267-2-2).

ACCESSORIES SUPPLIED: fixing accessories.

NOTES: the MSX/M 160c (both 3P and 4P) must be fixed to the DIN rail through the brackets of the kit GWD8875.

The MSX/M 250c, MSX/D 125, MSX/D 160 and MSX/D 250 (both 3P and 4P) require the kit GWD8876.

You are advised to always insert a blank panel above the moulded-case/switch-disconnector kit, to facilitate the cord positioning in the case of cord entry from the bottom. The MSX can be installed together with MSS on the same DIN rail through the depth adapter GWD3317 to compensate the different heights

The peak current of the one-way switch indicated (in line with the presumed short-circuit current in the installation point) must NOT be greater than 17kA.

The presumed short-circuit current in the power supply line of the main switch of the board must NOT be greater than 10kA.

INTERNAL CONFIGURATION



GW 46 401

STEEL BACK-MOUNTING PLATES WITH ANTI-CORROSION TREATMENT FOR THE ASSEMBLY OF NON-MODULAR EQUIPMENT

Code	For boards LxH (mm)	Pack Carton
GW 46 401	250x300	1/5
GW 46 402	310x425	1/5
GW 46 403	405x500	1/5
GW 46 404	405x650	1/4
GW 46 405	515x650	1/2
GW 46 406	585x800	1/2
GW 46 407	800x1060	1

NOTES: for further information relating to the maximum applicable loads, see the table on the corresponding pages of the technical catalogue.



GW 46 464

PERFORATED BACK-MOUNTING PLATES IN GALVANISED STEEL FOR THE ASSEMBLY OF NON-MODULAR EQUIPMENT

Code	For boards LxH (mm)	Pack Carton
GW 46 461	250x300	1/5
GW 46 462	310x425	1/5
GW 46 463	405x500	1/5
GW 46 464	405x650	1/5
GW 46 465	515x650	1/4
GW 46 466	585x800	1/3
GW 46 467	800x1060	1/2

NOTES: to install devices, use nut and clips GW46450.

for further information relating to the maximum applicable loads, see the table on the corresponding pages of the technical catalogue.



GW 46 408

BACK-MOUNTING PLATES IN INSULATING MATERIAL FOR THE ASSEMBLY OF NON-MODULAR EQUIPMENT

Code	For boards LxH (mm)	Pack Carton
GW 46 408	250x300	1/5
GW 46 409	310x425	1/5
GW 46 410	405x500	1/5
GW 46 411	405x650	1/4
GW 46 412	515x650	1/3
GW 46 413	585x800	1/2

NOTES: for further information relating to the maximum applicable loads, see the table on the corresponding pages of the technical catalogue.



GW 46 540

BLANK PLATES IN STEEL - FIXING BY MEANS OF UPRIGHTS

Code	For boards LxH (mm)	No. of modules EN 50022	Pack Carton
Height: 1 Module			
GW 46 540	310x425	12	1/5
GW 46 541	405x500/405x650	18	1/5
GW 46 542	515x650	24	1/5
GW 46 543	585x800	28	1/5
GW 46 544	800x1060	36	1/4
Height: 2 Modules			
GW 46 580	310x425	12	1/5
GW 46 581	405x500/405x650	18	1/5
GW 46 582	515x650	24	1/5
GW 46 583	585x800	28	1/5
GW 46 584	800x1060	36	1/2

NOTES: to install non-standard devices and/or moulded-case devices.



GW 46 450

NUT AND CLIPS IN GALVANISED STEEL FOR THE FIXING OF DEVICES ON TO PERFORATED BACK-MOUNTING PLATES

Code	Description	Pack Carton
GW 46 450	Clip nut for screw M5	10/100

SERVICE COMPLEMENTARY ITEMS



GW 46 526

DOUBLE INSULATION AND DRAINAGE KIT

Code	Description	Pack Carton
GW 46 526	4 caps for resetting double insulation and 1 cap for closing the drain hole	1/20

CHARACTERISTICS: isolating technopolymer.

APPLICATIONS: correctly installed, makes it possible to restore original IP degree and double insulation of 46QP range boards in case of direct fixing of the board to the wall by drilling the back plate and without using the set of 4 steel brackets.



GW 46 451

SET OF 4 STEEL BRACKETS FOR FIXING SURFACE-MOUNTING BOARDS

Code	Material	Accessories supplied	Pack Carton
GW 46 446	Galvanised steel	Self-tapping fixing screws	20
GW 46 451	Stainless steel	Self-tapping fixing screws	20

CHARACTERISTICS: To restore the double insulation and original IP degree of the boards in case of indirect fixing to the wall. Suitable also for 46QP photovoltaic application.



GW 46 551

POLE SUPPORT KIT FOR BOARDS 46 QP

Code	For boards LxH (mm)	Max sustainable load (kg)	Pack Carton
GW 46 551	250x300	125	1
GW 46 552	310x425	125	1
GW 46 553	405x500/405x650	125	1
GW 46 554	515x650	125	1
GW 46 555	585x800	125	1

CHARACTERISTICS: fixed on the back of the boards.

APPLICATIONS: for applications of the 46QP boards on poles from 60 to 80mm and, by means of a banding (not included with the accessories supplied), from 80 to 200mm. To restore the double insulation and original IP degree of the boards in case of indirect fixing to the wall. Suitable also for 46QP photovoltaic application.

ACCESSORIES SUPPLIED: 2 pieces. For the correct use of the kit, see the instructions sheet.



GW 46 557 F

KIT FOR WIRING TRUNKING ASSEMBLY

Code	Trunking use	Pack Carton
GW 46 557 F	Horizontal and/or vertical	1/10

CHARACTERISTICS: fixing on the board uprights. In the boards of size 3, 4, 5 and 6, vertical trunking support up to (LxH) 60x60 mm and horizontal trunking up to (LxH) 60x40 mm, while for boards of size 7, vertical and horizontal trunking support up to (LxH) 40x60 mm.

APPLICATIONS: for boards of at least 405x500 mm.

NOTES: the kit for wiring trunking assembly is used to create flat horizontal and vertical routes.

ACCESSORIES SUPPLIED: 2 trunking fixing brackets, 2 DIN rail assembly brackets and 6 - 4x6 mm screws. For the use of the kit, see the instructions sheet.



GW 46 524 F

FAST & EASY QUICK ASSEMBLY BRACKETS KIT WITH SUPPORT SLIDE, ADJUSTABLE FOR DIN RAILS

Code	Used for DIN rails	Pack Carton
GW 46 524 F	Simple and double	1/4

NOTES: use the GW46524F kit to assembly the 18; 24; 28; 36 F&E DIN rails without the specific blank panel.

To restore the minimum degree of protection of the open door board, use the relative inner door.



GW 46 591

HANDLES FOR TRANSPORTATION

Code	Description	Pack Carton
GW 46 591	Pair of handles	1/10

APPLICATIONS: allows the 46QP boards to be transported.

NOTES: the handle kit can be used simultaneously with the pole support kit or the set of brackets, for wall mounting.

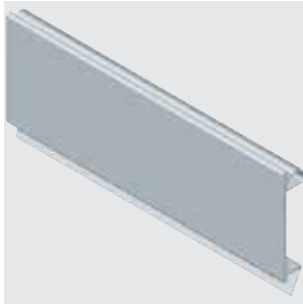

GW 47 291

BLANKING MODULE PROFILE IN PLASTIC MATERIAL - GREY RAL 7035



Code	No. of modules EN 50022	Colour	Pack Carton
GW 40 423	4.5	Grey RAL 7035	50
GW 47 291	24	Grey RAL 7035	10

CHARACTERISTICS: clip fixing on DIN perforated front panels.

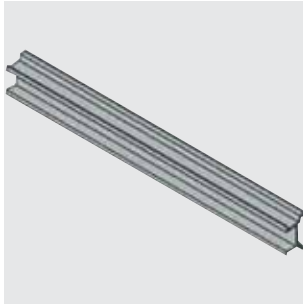

GW D3 317

DEPTH ADAPTER

Code	Length (mm)	Pack Carton
GW D3 317	600	1

CHARACTERISTICS: plastic adapter for compensation of the different installation depths on DIN rail EN 50022 of the modular devices (90 range) and moulded case circuit breakers (MSX range).



GW 46 449

SEAL FOR COUPLING BOARDS EQUIPPED WITH DRILLING TEMPLATE - IP55

Code	Dimensions (mm)	Pack Carton
GW 46 449	300x171	1/10

APPLICATIONS: can be used on enclosures starting with the 515x650x250 mm dimension.



GW 46 521 F

SET OF 4 REVERSIBLE SQUARES FOR FIXING BACK-MOUNTING PLATES OR UPRIGHTS FOR MODULAR EQUIPMENT

Code	Description	Pack Carton
GW 46 521 F	Reversible squares	1/20

APPLICATIONS: allows the combined installation of the back-mounting plate and the frame.

ACCESSORIES SUPPLIED: fixing screws; 4 inserts.



GW 46 592 F

INSERTS KIT

Code	Description	Pack Carton
GW 46 592 F	M6 inserts kit	1/100

APPLICATIONS: allows you to extend the possibility of adding functional accessories to all the slots of the 46QP boards.

NOTES: the inserts are inserted in the free slots of the 46QP boards and are expanded in the housing, using a small dowel with a diameter of 4mm. One insert kit package contains 10 inserts.

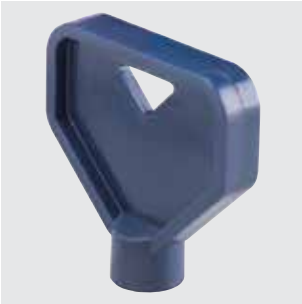

GW 46 522

TRIANGULAR KEY

Code	Description	Pack Carton
GW 46 522	Triangular key	10

APPLICATIONS: for boards 46QP, QX, QM e CEP.



GW 46 523

TRIANGULAR LOCK

Code	Description	Pack Carton
GW 46 523	Triangular lock	10

APPLICATIONS: for boards 46QP, QX, QM e CEP.



GW 46 445

SECURITY LOCK WITH HANDLE

Code	Description	Pack Carton
GW 46 445	Security lock key and handle	10

APPLICATIONS: for boards 46QP, QX, QM e CEP.

ACCESSORIES SUPPLIED: 2 keys.

NOTES: All the keys and relative locks with the same product code are identical.



GW 46 448

VENTILATION KIT

Code	IP degree	Rated voltage	Fixing hole (mm)	Screws centre distance (mm)	Pack Carton
GW 46 448	IP44	230 V - 50 / 60 Hz	125x117	123x115	1/2

CHARACTERISTICS: the fan takes in air from the outside and introduces it into the distribution board, creating a slight overpressure that prevents foreign particles from entering. Max fan capacity 60 m³/h. Absorbed power equal to 20 W.

APPLICATIONS: forced ventilation in critical thermal conditions.

ACCESSORIES SUPPLIED: drilling template.



GW 46 471

AERATION KIT

Code	IP degree	Fixing hole (mm)	Screws centre distance (mm)	Pack Carton
GW 46 471	IP44	125x117	123x115	1/10

ACCESSORIES SUPPLIED: drilling template.



GW 46 447

DOCUMENT HOLDER POCKET IN SELF-ADHESIVE INSULATING MATERIAL WITH KIT OF BLANK LABELS

Code	Dimensions LxH (mm)	Pack Carton
GW 46 447	230x310	1/10

CHARACTERISTICS: can be inserted in all GEWISS enclosures from dimension 405x500x200 mm upwards.



GW 44 651

SINGLE-POLE MODULAR DISTRIBUTION TERMINAL BLOCK - FIXING ON PLATE OR DIN RAIL - IP20

Code	Outer dim. LxHxD (mm)	No. of modules EN 50022	Input connecting capacity	Output connecting capacity	Pack Carton
Rated current (A): 160					
GW 44 651	35x92x49	2	1x(10-70) mm ²	6x(2.5-16) mm ²	1/5

APPLICATIONS: possibility to create 1, 2, 3 and 4-pole distributing frames.

CHARACTERISTICS: terminal tightening torque: input cable 4 Nm, output cables 1.5 Nm.



GW 44 652

RIGID JUMPER KIT AND CAP FOR ONE-POLE TERMINAL BLOCK GW44651

Code	Description	Pack Carton
GW 44 652	Jumper kit	1/25



GW 44 693

TWO-POLE DISTRIBUTION TERMINAL BLOCKS WITH TRANSPARENT PROTECTION COVER FIXING ON PLATE OR DIN RAIL EN 50022 - 750V - T 85°C

Code	Outer dim. LxHxD (mm)	No. of modules EN 50022	Input connecting capacity	Output connecting capacity	Icw (1s)	Pack Carton
Rated current (A): 100						
GW 44 691	70x49x50	4	1x(6-35) mm ²	[1x(4-25) + 5x(1.5-10)] mm ²	6 kA	2/40
Rated current (A): 125						
GW 44 693	141x49x50	8	1x(6-35) mm ²	[2x(4-25) + 2x(4-16) + 10x(1.5-10)] mm ²	6 kA	1/12

CHARACTERISTICS: the indicated connection capacity is "per pole" and refers to the fitting of cables with "test prods".

NOTES: products bearing the IMQ quality mark.



GW 44 696

FOUR-POLE DISTRIBUTION TERMINAL BLOCKS WITH TRANSPARENT PROTECTION COVER. FIXING ON PLATE OR DIN RAIL EN 50022 - 750V - T 85°C

Code	Outer dim. LxHxD (mm)	No. of modules EN 50022	Input connecting capacity	Output connecting capacity	Icw (1s)	Pack Carton
Rated current (A): 100						
GW 44 696	70x88.5x50	4	1x(6-35) mm ²	[1x(4-25) + 5x(1.5-10)] mm ²	6 kA	2/20
Rated current (A): 125						
GW 44 698	141x88.5x50	8	1x(6-35) mm ²	[2x(4-25) + 2x(4-16) + 10x(1.5-10)] mm ²	6 kA	1/10
Rated current (A): 160						
GW 44 699	185x135x75	10	1x(16-50) mm ²	[2x(10-35) + 2x(6-25) + 8x(4-16)] mm ²	10 kA	1/12

CHARACTERISTICS: terminal tightening torque: input cables 4 Nm, output cables 1.5 Nm.

the indicated connection capacity is "per pole" and refers to the fitting of cables with "test prods".

NOTES: products bearing the IMQ quality mark.



GW 44 700

HORIZONTAL FOUR-POLE DIVIDER 250 A WITH PRE-DRILLED THREADED M6 BARS - 20X5 MM

Code	Dimensions (mm)	No. of modules EN 50022	Installation	Input connecting capacity	Output connecting capacity	Icw (1s)	Pack Carton
GW 44 700	285x190x70	16	On profile EN 50022	1xM12	10xM6	17 kA	1/2

ACCESSORIES SUPPLIED: installation clip on DIN rail.

44 CEP - WATERTIGHT BOARDS IN GWPLAST 120 - GWT 650 °C - IP55

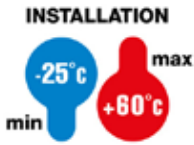

**IK
08**

**IP
55**

**GWT
650°C**



DISTRIBUTION BOARDS

WATERTIGHT BOARDS WITH BLANK DOOR FITTED WITH LOCK - GREY RAL 7035



GW 44 810



Code	Outer dim. LxHxD (mm)	No. of modules EN 50022	No. locks	Dispersible power A (W)	Dispersible power B (W)	Pack Carton
GW 44 808	200x254x135	-	1	16	17	4
GW 44 809	236x316x135	8	1	26	31	4
GW 44 810	316x396x160	24 (12X2)	2	42	34	2
GW 44 811	396x474x160	32 (16X2)	2	52	46	2

CHARACTERISTICS: Doors equipped with functional grid of reference for fixing the devices. Impact resistance: 5 J.

ACCESSORIES SUPPLIED: frame for semi-flush-mounting installations, screwcap for double insulation, triangle key.

NOTES: The technical and functional characteristics, and the nominal values, refer to vertical installation only.

Dispersible power calculated according to CEI 23-49:

Dispersible power A (W): configuration of the board with relative back-mounting plate.

Dispersible power B (W): configuration of the board with relative panel with windows.

WATERTIGHT BOARDS WITH TRANSPARENT DOOR FITTED WITH LOCK - GREY RAL 7035



GW 44 820



Code	Outer dim. LxHxD (mm)	No. of modules EN 50022	No. locks	Dispersible power A (W)	Dispersible power B (W)	Pack Carton
GW 44 818	200x254x135	-	1	16	17	4
GW 44 819	236x316x135	8	1	26	31	4
GW 44 820	316x396x160	24 (12X2)	2	42	34	2
GW 44 821	396x474x160	32 (16X2)	2	52	46	2

CHARACTERISTICS: Doors equipped with functional grid of reference for fixing the devices. Impact resistance: 5 J.

ACCESSORIES SUPPLIED: frame for semi-flush-mounting installations, screwcap for double insulation, triangle key.

NOTES: The technical and functional characteristics, and the nominal values, refer to vertical installation only.

Dispersible power calculated according to CEI 23-49:

Dispersible power A (W): configuration of the board with relative back-mounting plate.

Dispersible power B (W): configuration of the board with relative panel with windows.

INTERNAL CONFIGURATION



GW 44 639

BACK-MOUNTING PLATE IN GALVANISED STEEL WITH SELF-TAPPING FIXING SCREWS

Code	For boards LxH (mm)	Pack Carton
GW 44 636	200x254	20
GW 44 637	236x316	20
GW 44 638	316x396	5
GW 44 639	396x474	5

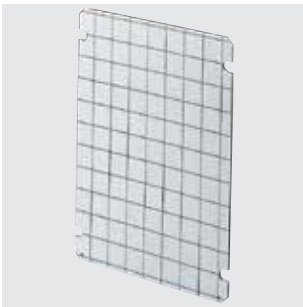

GW 44 649

BACK-MOUNTING PLATE IN INSULATED MATERIAL WITH SELF-TAPPING FIXING SCREWS

Code	For boards LxH (mm)	Pack Carton
GW 44 646	200x254	20
GW 44 647	236x316	20
GW 44 648	316x396	4
GW 44 649	396x474	5

CHARACTERISTICS: equipped with functional grid for fixing devices.



GW 44 854

PANELS WITH WINDOW FOR MODULAR DEVICES AND MOULDED-CASE CIRCUIT BREAKERS IN FIXED POSITION EXECUTION, UP TO 160 A COUPLING - GREY RAL 7035

Code	No. of modules EN 50022	For boards LxH (mm)	Suitable for	Pack Carton
GW 44 852	8	236x316	Moulded case max 125 A	8
GW 44 853	14	316x396	Moulded case max 160 A	8
GW 44 854	24 (12X2)	316x396	Moulded case max 125 A	8
GW 44 855	32 (16X2)	396x474	Moulded case max 160 A	8

ACCESSORIES SUPPLIED: fixing uprights and DIN rails, module masks, user labels.

SERVICE COMPLEMENTARY ITEMS



GW 46 451

SET OF 4 STEEL BRACKETS FOR FIXING SURFACE-MOUNTING BOARDS

Code	Material	Accessories supplied	Pack Carton
GW 46 446	Galvanised steel	Self-tapping fixing screws	20
GW 46 451	Stainless steel	Self-tapping fixing screws	20



GW 44 621

WALL FIXING BRACKET



Code	Material	Accessories supplied	For enclosures For dist. boards	Pack Carton
GW 44 621	Insulation	Self-tapping fixing screws	All wall types	40/480

APPLICATIONS: used to maintain the double insulation and the original IP degree of protection of the boxes, containers and other GEWISS products.
ACCESSORIES SUPPLIED: 2 fixing screws.



GW 40 423

PLASTIC MODULE COVER PROFILE



Code	No. of modules EN 50022	Colour	Pack Carton
GW 40 423	4.5	Grey RAL 7035	50

CHARACTERISTICS: clip fixing on DIN perforated front panels.

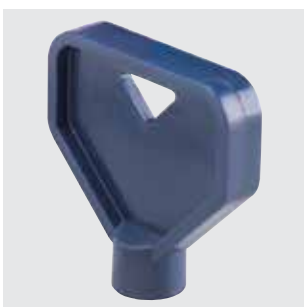

GW 46 522

TRIANGULAR KEY

Code	Description	Pack Carton
GW 46 522	Triangular key	10

APPLICATIONS: for boards 46QP, QX, QM e CEP.



GW 46 523

TRIANGULAR LOCK

Code	Description	Pack Carton
GW 46 523	Triangular lock	10

APPLICATIONS: for boards 46QP, QX, QM e CEP.



GW 46 445

SECURITY LOCK WITH HANDLE

Code	Description	Pack Carton
GW 46 445	Security lock key and handle	10

ACCESSORIES SUPPLIED: 2 keys.

NOTES: All the keys and relative locks with the same product code are identical.



46



Scan the QR Code and find out all the technical informations.

46 QP - NEW STYLE AND PERFORMANCE



The 46 QP polyester boards feature an IP66 protection rating, and the modern-design transparent door versions offer more than 20% extra internal visibility than previous versions.

46 QP - SOLUTIONS FOR EVERY APPLICATION









GEWISS has subjected the 46 QP boards to rigorous testing in order to obtain valid certifications for their use in various applications. 46 QP boards are, for example, ASC approved and certified for site applications and are ideal for photovoltaic installations.

FAST & EASY - ROBUSTNESS, SPEED AND MULTIPLE ACCESSORY OPTIONS































The FAST & EASY system, common to the 46 QP/QM/QX boards, reduces assembly time by up to 40% compared to traditional systems. Robustness and reliability are achieved through the use of metal components and via a rapid and intuitive usage.

		SURFACE-MOUNTING ENCLOSURES				
		40 CDK SURFACE-MOUNTING MODULAR WATERTIGHT ENCLOSURES AND BOARDS IP65			40 CD SURFACE-MOUNTING WATERTIGHT ENCLOSURES IP55	
		Colour: RAL 7035 Grey Walls: smooth				Colour: RAL 7035 Grey Walls: with perforations centres
			Door: smoked transparent			
Without terminal block	With 80A - IP20 bipolar terminal block					
		1st level	2nd level	Door: smoked transparent		
Modules	2	-	-	-	-	
	4	GW 40 101	-	-	GW 40 001	
	6	-	-	-	-	
	8	GW 40 102	GW 40 102 BS	-	GW 40 003	
	12	GW 40 103	GW 40 103 BS	-	GW 40 005	
	18	GW 40 106	GW 40 106 BS	-	-	
	24 (12x2)	GW 40 104	GW 40 104 BS	GW 40 104 BD	GW 40 007	
	36 (12x3)	GW 40 105	GW 40 105 BD	GW 40 105 UD	-	
	36 (18x2)	GW 40 107	GW 40 107 BS	GW 40 107 BD	GW 40 009	
	54 (18x3)	GW 40 108	GW 40 108 BD	GW 40 108 BT	-	
	72 (18x4)	GW 40 109	GW 40 109 BD	GW 40 109 BQ	-	
COMPLEMENTARY ITEMS	INSTALLATION	Surface-mounting fixing brackets for enclosures and boards 	4 x GW 44 621		4 x GW 44 621	
		Stylish coupling covers for conduit and trunking entry 	Modules	Code		
		12-24-36(12x3)	GW 40 473	-		
		18-36(18x2)-54-72	GW 40 474	-		
	WIRING	Internal horizontal dividers 	Modules	Code		
			24-36(12x3)	GW 40 487	-	
			36(18x2)-54-72	GW 40 488	-	
		Blind cover panels 1 module height 	Modules	Code		
	24-36(12x3)		GW 40 492	-		
		36(18x2)-54-72	GW 40 493	-		
MISCELLANEOUS	Cylindrical safety lock 	Modules	Code			
		4-8-12-24-36(18x2)	1 x GW 40 422			
		36(12x3)-54-72	2 x GW 40 422			
	Triangular key 	-		1 x GW 40 421		

SURFACE-MOUNTING ENCLOSURES

40 CD PROTECTED SURFACE-MOUNTING DECORATIVE ENCLOSURES IP40						40 CD PROTECTED SURFACE-MOUNTING ENCLOSURES IP40
Colour: RAL 9016 White Walls: smooth					Colour: RAL 7035 Grey Walls: with perforation centres	
Door: smoked transparent			Door: blank			Door: no
Without terminal block	With 80A - IP20 bipolar terminal block		Without terminal block	With 80A - IP20 bipolar terminal block		Without terminal block
	1st level	2nd level		1st level	2nd level	
-	-	-	-	-	-	GW 40 022
-	-	-	-	-	-	GW 40 023
-	-	-	-	-	-	GW 40 024
GW 40 043	GW 40 043 BS	-	GW 40 063	GW 40 063 BS	-	GW 40 026
GW 40 045	GW 40 045 BS	-	GW 40 065	GW 40 065 BS	-	GW 40 028
-	-	-	-	-	-	-
GW 40 047	GW 40 047 BS	GW 40 047 BD	GW 40 067	GW 40 067 BS	GW 40 067 BD	GW 40 030
-	-	-	-	-	-	GW 40 032
GW 40 049	GW 40 049 BS	GW 40 049 BD	GW 40 069	GW 40 069 BS	GW 40 069 BD	-
GW 40 051	GW 40 051 BD	-	GW 40 071	GW 40 071 BD	-	-
GW 40 053	GW 40 053 BD	GW 40 053 BQ	GW 40 073	GW 40 073 BD	GW 40 073 BQ	-
4 x GW 44 621						4 x GW 44 621
-						-
-						-
-						-
Modules			Code			
8-12-18-24-36-54			1 x GW 40 422			-
72			2 x GW 40 422			-
-						-

COMPATIBILITY OF SURFACE MOUNTING ENCLOSURES WITH BIPOLAR AND UNIPOLAR TERMINAL BLOCKS

Surface-mounting enclosure range	Modules	Door	Code	Terminal blocks position	Screw terminal blocks		
							
					Terminal block size 1		
					Bipolar 125 A 2 x [(1x35)+(7x10)]	Bipolar 80 A 2 x [(2x16)+(7x10)]	Unipolar 80 A 1 x [(2x16)+(7x10)]
GW 40 401	GW 40 408 B	GW 40 408 U					
40 CDK SURFACE-MOUNTING MODULAR WATERTIGHT ENCLOSURES AND BOARDS IP65 	8	Door: smoked transparent	GW 40 102		No. 1	No. 1	No. 1
	12	Door: smoked transparent	GW 40 103		No. 1 (*)	No. 1 (*)	No. 1 (*)
	18	Door: smoked transparent	GW 40 106		No. 1 (*)	No. 1 (*)	No. 1 (*)
	24 (12x2)	Door: smoked transparent	GW 40 104		No. 2 (*)	No. 2 (*)	No. 2 (*)
	36 (12x3)	Door: smoked transparent	GW 40 105		No. 2 (*)	No. 2 (*)	No. 2 (*)
	36 (18x2)	Door: smoked transparent	GW 40 107		No. 2 (*)	No. 2 (*)	No. 2 (*)
	54 (18x3)	Door: smoked transparent	GW 40 108		No. 3 (*)	No. 3 (*)	No. 3 (*)
	72 (18x4)	Door: smoked transparent	GW 40 109		No. 4 (*)	No. 4 (*)	No. 4 (*)
40 CD SURFACE-MOUNTING WATERTIGHT ENCLOSURES IP55 	8	Door: smoked transparent	GW 40 003		No. 1	No. 1	No. 1
	12	Door: smoked transparent	GW 40 005		No. 1 (*)	No. 1 (*)	No. 1 (*)
	24 (12x2)	Door: smoked transparent	GW 40 007		No. 2	No. 2	No. 2
	36 (18x2)	Door: smoked transparent	GW 40 009		No. 2 (*)	No. 2 (*)	No. 2 (*)
40 CD PROTECTED SURFACE-MOUNTING DECORATIVE ENCLOSURES IP40  	8	Door: smoked transparent	GW 40 043		No. 1	No. 1	No. 1
		Door: blank	GW 40 063				
	12	Door: smoked transparent	GW 40 045		No. 1 (*)	No. 1 (*)	No. 1 (*)
		Door: blank	GW 40 065				
	24 (12x2)	Door: smoked transparent	GW 40 047		No. 2 (*)	No. 2 (*)	No. 2 (*)
		Door: blank	GW 40 067				
	36 (18x2)	Door: smoked transparent	GW 40 049		No. 2 (*)	No. 2 (*)	No. 2 (*)
		Door: blank	GW 40 069				
	54 (18x3)	Door: smoked transparent	GW 40 051		No. 2 (*)	No. 2 (*)	No. 2 (*)
		Door: blank	GW 40 071				
72 (18x4)	Door: smoked transparent	GW 40 053		No. 4 (*)	No. 4 (*)	No. 4 (*)	
	Door: blank	GW 40 073					
40 CD PROTECTED SURFACE-MOUNTING ENCLOSURES IP40 	8	Door: no	GW 40 026		No. 1	No. 1	No. 1
	12	Door: no	GW 40 028		No. 1 (*)	No. 1 (*)	No. 1 (*)
	24 (12x2)	Door: no	GW 40 030		No. 2	No. 2	No. 2
	36 (12x3)	Door: no	GW 40 032		No. 2 (*)	No. 2 (*)	No. 2 (*)

(*) The installation is allowed using No.1 adapter GW40413 for each terminal block installed.

COMPATIBILITY OF SURFACE MOUNTING ENCLOSURES WITH BIPOLAR AND UNIPOLAR TERMINAL BLOCKS

Screw terminal blocks



Terminal block size 2				Terminal block size 3		
Bipolar 125 A 2 x [(3x35)+(10x10)]	Bipolar 80 A 2 x [(3x16)+(11x10)]	Unipolar 80 A 1 x [(3x16)+(11x10)]	Unipolar 80 A 1 x [(3x16)+(29x10)]	Bipolar 125 A 2 x [(5x35)+(14x10)]	Bipolar 80 A 2 x [(3x16)+(17x10)]	Unipolar 80 A 1 x [(3x16)+(17x10)]
GW 40 402	GW 40 412 B	GW 40 412 U	GW 40 422 U	GW 40 404	GW 40 418 B	GW 40 418 U
-	-	-	-	-	-	-
No. 1	No. 1	No. 1	No. 1	-	-	-
No. 1 (*)	No. 1 (*)	No. 1 (*)	No. 1 (*)	No. 1	No. 1	No. 1
No. 2	No. 2	No. 2	No. 2	-	-	-
No. 2	No. 2	No. 2	No. 2	-	-	-
No. 2 (*)	No. 2 (*)	No. 2 (*)	No. 2 (*)	No. 2	No. 2	No. 2
No. 3 (*)	No. 3 (*)	No. 3 (*)	No. 3 (*)	No. 3	No. 3	No. 3
No. 4 (*)	No. 4 (*)	No. 4 (*)	No. 4 (*)	No. 4	No. 4	No. 4
-	-	-	-	-	-	-
No. 1	No. 1	No. 1	No. 1	-	-	-
-	-	-	-	-	-	-
No. 2	No. 2	No. 2	No. 2	-	-	-
-	-	-	-	-	-	-
No. 1	No. 1	No. 1	No. 1	-	-	-
No. 2	No. 2	No. 2	No. 2	-	-	-
No. 2 (*)	No. 2 (*)	No. 2 (*)	No. 2 (*)	No. 2	No. 2	No. 2
No. 2 (*)	No. 2 (*)	No. 2 (*)	No. 2 (*)	No. 2	No. 2	No. 2
No. 4 (*)	No. 4 (*)	No. 4 (*)	No. 4 (*)	No. 4	No. 4	No. 4
-	-	-	-	-	-	-
No. 1	No. 1	No. 1	No. 1	-	-	-
-	-	-	-	-	-	-
No. 2	No. 2	No. 2	No. 2	-	-	-

40 CD

Surface-mounting distribution boards and enclosures

The 40CD Series of control units, available in transparent or blind door versions and in sizes from 8 to 72 modules, guarantees aesthetic integration with all types of furniture. The offer includes: 40CDK - IP65 watertight panels with removable frame (from 24M) and lead-in panels; accessories with wiring ducts, locks, aesthetic covers and blind panels; 40CD - IP55 watertight control units with drilling doilies on the walls, door with lock for each modular row; 40CD control units protected by Furniture - IP40 up to 72M in the smoke and blind door versions; 40CD control units without door - IP40. All materials are Halogen Free.



40 CDK - MODULAR WATERTIGHT ENCLOSURES AND DISTRIBUTION BOARDS - IP65



IK
09

IP
65

GWT
650°C



SMOKED TRANSPARENT DOOR - SMOOTH WALLS



GW 40 101

ENCLOSURES - PREDISPOSED FOR TERMINAL BLOCK - GREY RAL 7035



Code	No. of modules EN 50022	Outer dim. LxHxD (mm)	Dispersible power (W)	Pack Carton
GW 40 101	4	143x210x100	13	19
GW 40 102	8	215x210x100	16	12
GW 40 103	12	298x260x140	26	6
GW 40 106	18	410x285x140	38	3

ACCESSORIES SUPPLIED: screwcaps and module masks, circuit labels. GW40102, GW40103 and GW40106, self-adhesive label to be filled out for certification according to standard CEI 23-51.

NOTES: Dispersible power calculated according to CEI 23-49. For the perforations, use the GW52401 milling cutter.

To restore the double insulation, use the relative accessories supplied (module masks and screwcaps) or the brackets for surface-mounting (GW44621).

For applications in the photovoltaic environment, use the surface-mounting brackets - code GW44621.

CHARACTERISTICS: Thermo-pressure with ball equal to 70°C.

INSTALLATION: for the possible enclosure-terminal block combinations, refer to the summary "COMPATIBILITY OF SURFACE-MOUNTING ENCLOSURES WITH BIPOLAR AND UNIPOLAR TERMINAL BLOCKS" in the selection guides of 40CD range.

ENCLOSURES - EQUIPPED WITH 80 A IP20 BIPOLAR SCREW TERMINAL BLOCK - GREY RAL 7035



Code	No. of modules EN 50022	Outer dim. LxHxD (mm)	Dispersible power (W)	Pole 1 (mm ²)	Pole 2 (mm ²)	Pack Carton
GW 40 102 BS	8	215x210x100	16	N/E (2x16) + (7x10)	N/E (2x16) + (7x10)	12
GW 40 103 BS	12	298x260x140	26	N/E (3x16) + (11x10)	N/E (3x16) + (11x10)	6
GW 40 106 BS	18	410x285x140	38	N/E (3x16) + (17x10)	N/E (3x16) + (17x10)	3

ACCESSORIES SUPPLIED: screwcaps and module masks, circuit labels. Self-adhesive label to be filled out for certification according to standard CEI 23-51. Insulated bipolar screw 80A - IP20 terminal blocks to be installed on the frame before wiring.

NOTES: dispersible power calculated according to CEI 23-49. For the perforations, use the GW52401 milling cutter. To restore the double insulation, use the relative accessories supplied (module masks and screwcaps) or the brackets for surface-mounting (GW44621). For applications in the photovoltaic environment, use the surface-mounting brackets - code GW44621.

CHARACTERISTICS: thermo-pressure with ball equal to 70°C.



GW 40 102 BS



GW 40 105

DISTRIBUTION BOARDS WITH PANELS WITH WINDOW AND EXTRACTABLE FRAME PREDISPOSED FOR TERMINAL BLOCK - GREY RAL 7035



Code	No. of modules EN 50022	Outer dim. LxHxD (mm)	Dispersible power (W)	Pack Carton
GW 40 104	24 (12x2)	298x420x140	32	3
GW 40 105	36 (12x3)	298x570x140	42	2
GW 40 107	36 (18x2)	410x463x140	43	2
GW 40 108	54 (18x3)	410x655x140	66	1
GW 40 109	72 (18x4)	410x878x160	89	1

ACCESSORIES SUPPLIED: screwcaps and module masks, circuit labels. Self-adhesive label to be filled out for certification according to standard CEI 23-51.

NOTES: Dispersible power calculated according to CEI 23-49. For the perforations, use the GW52401 milling cutter.

To restore the double insulation, use the relative accessories supplied (module masks and screwcaps) or the brackets for surface-mounting (GW44621).

For applications in the photovoltaic environment, use the surface-mounting brackets - code GW44621.

CHARACTERISTICS: removable and plumbable panels with windows. Thermo-pressure with ball equal to 70°C.

INSTALLATION: for the possible enclosure-terminal block combinations, refer to the summary "COMPATIBILITY OF SURFACE-MOUNTING ENCLOSURES WITH BIPOLAR AND UNIPOLAR TERMINAL BLOCKS" in the selection guides of 40CD range.



GW 40 105 BD

DISTRIBUTION BOARDS WITH WINDOWED REMOVABLE PANELS, EXTRACTABLE FRAME EQUIPPED WITH 80 A IP20 BIPOLAR SCREW TERMINAL BLOCKS - GREY RAL 7035



Code	No. of modules EN 50022	Outer dim. LxHxD (mm)	Dispersible power (W)	Pole 1 (mm ²)	Pole 2 (mm ²)	Pack Carton
GW 40 104 BS	24 (12x2)	298x420x140	32	N/E (3x16) + (11x10)	N/E (3x16) + (11x10)	3
GW 40 104 BD	24 (12x2)	298x420x140	32	N/E 2x[(3x16) + (11x10)]	N/E 2x[(3x16) + (11x10)]	3
GW 40 105 BS	36 (12x3)	298x570x140	42	N/E 2x[(3x16) + (11x10)]	N/E 2x[(3x16) + (11x10)]	2
GW 40 105 UD	36 (12x3)	298x570x140	42	N/E (3x16) + (29x10)	N/E (3x16) + (29x10)	2
GW 40 107 BS	36 (18x2)	410x463x140	43	N/E (3x16) + (17x10)	N/E (3x16) + (17x10)	2
GW 40 107 BD	36 (18x2)	410x463x140	43	N/E 2x[(3x16) + (17x10)]	N/E 2x[(3x16) + (17x10)]	2
GW 40 108 BD	54 (18x3)	410x655x140	66	N/E 2x[(3x16) + (17x10)]	N/E 2x[(3x16) + (17x10)]	1
GW 40 108 BT	54 (18x3)	410x655x140	66	N/E 3x[(3x16) + (17x10)]	N/E 3x[(3x16) + (17x10)]	1
GW 40 109 BD	72 (18x4)	410x878x160	89	N/E 2x[(3x16) + (17x10)]	N/E 2x[(3x16) + (17x10)]	1
GW 40 109 BQ	72 (18x4)	410x878x160	89	N/E 4x[(3x16) + (17x10)]	N/E 4x[(3x16) + (17x10)]	1

ACCESSORIES SUPPLIED: screwcaps and module masks, circuit labels. Self-adhesive label to be filled out for certification according to standard CEI 23-51. Insulated bipolar screw 80A - IP20 terminal blocks to be installed on the frame before wiring.

NOTES: dispersible power calculated according to CEI 23-49. For the perforations, use the GW52401 milling cutter. To restore the double insulation, use the relative accessories supplied (module masks and screwcaps) or the brackets for surface-mounting (GW44621). For applications in the photovoltaic environment, use the surface-mounting brackets - code GW44621.

CHARACTERISTICS: thermo-pressure with ball equal to 70°C.

40 CD

40 CD - WATERTIGHT ENCLOSURES - IP55

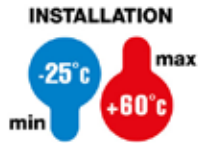

IK
09

IP
55

GWT
650°C



SMOKED TRANSPARENT DOOR - WALLS WITH PERFORATION CENTRES



GW 40 001

ENCLOSURES PREDISPOSED FOR TERMINAL BLOCK - GREY RAL 7035



Code	No. of modules EN 50022	Outer dim. LxHxD (mm)	Dispersible power (W)	Pack Carton
GW 40 001	4	105x170x98	12	24
GW 40 003	8	180x180x98	13	24
GW 40 005	12	250x250x135	25	8
GW 40 007	24 (12X2)	250x375x135	27	6
GW 40 009	36 (18x2)	376x400x135	41	4

ACCESSORIES SUPPLIED: screwcaps and module masks, circuit labels, spare screws in insulating material.

Self-adhesive label to be filled out for certification according to standard CEI 23-51.

GW40005, GW40007, GW40009: doors equipped with lock, with 2 triangular keys.

NOTES: Dispersible power calculated according to CEI 23-49. For the perforations, use the GW52401 milling cutter.

To restore the double insulation, use the relative accessories supplied (module masks and screwcaps) or the brackets for surface-mounting (GW44621).

For applications in the photovoltaic environment, use the surface-mounting brackets - code GW44621.

CHARACTERISTICS: Thermo-pressure with ball equal to 70°C.

INSTALLATION: for the possible enclosure-terminal block combinations, refer to the summary "COMPATIBILITY OF SURFACE-MOUNTING ENCLOSURES WITH BIPOLAR AND UNIPOLAR TERMINAL BLOCKS" in the selection guides of 40CD range.

40 CD - PROTECTED DECORATIVE ENCLOSURES - IP40



**IK
08**

**IP
40**

**GWT
650°C**



SMOKED TRANSPARENT DOOR - SMOOTH WALLS

ENCLOSURES PREDISPOSED FOR TERMINAL BLOCK - WHITE RAL 9016



Code	No. of modules EN 50022	Outer dim. LxHxD (mm)	Dispersible power (W)	Pack Carton
GW 40 043	8	200x180x100	15	14
GW 40 045	12	280x225x100	22	9
GW 40 047	24 (12X2)	280x350x100	25	6
GW 40 049	36 (18x2)	400x400x130	45	2
GW 40 051	54 (18x3)	400x550x130	63	2
GW 40 053	72 (18x4)	400x850x150	75	1



GW 40 043

ACCESSORIES SUPPLIED: module masks, circuit labels. Self-adhesive label to be filled out for certification according to standard CEI 23-51.

GW40049, GW40051, GW40053, fitted with removable frame, to carry out the wiring operations outside the enclosure.

NOTES: Dispersible power calculated according to CEI 23-49. For the perforations, use the GW52401 milling cutter.

To restore the double insulation, use the relative accessories supplied (module masks and screwcaps or brackets for surface-mounting).

CHARACTERISTICS: Thermo-pressure with ball equal to 70°C.

INSTALLATION: for the possible enclosure-terminal block combinations, refer to the summary "COMPATIBILITY OF SURFACE-MOUNTING ENCLOSURES WITH BIPOLAR AND UNIPOLAR TERMINAL BLOCKS" in the selection guides of 40CD range.

ENCLOSURES EQUIPPED WITH 80 A IP20 BIPOLAR SCREW TERMINAL BLOCKS - WHITE RAL 9016

Code	No. of modules EN 50022	Outer dim. LxHxD (mm)	Dispersible power (W)	Pole 1 (mm ²)	Pole 2 (mm ²)	Pack Carton
GW 40 043 BS	8	200x180x100	15	N/E (2x16) + (7x10)	N/E (2x16) + (7x10)	14
GW 40 045 BS	12	280x225x100	22	N/E (3x16) + (11x10)	N/E (3x16) + (11x10)	9
GW 40 047 BS	24 (12X2)	280x350x100	25	N/E (3x16) + (11x10)	N/E (3x16) + (11x10)	6
GW 40 047 BD	24 (12X2)	280x350x100	25	N/E 2x[(3x16) + (11x10)]	N/E 2x[(3x16) + (11x10)]	6
GW 40 049 BS	36 (18x2)	400x400x130	45	N/E (3x16) + (17x10)	N/E (3x16) + (17x10)	2
GW 40 049 BD	36 (18x2)	400x400x130	45	N/E 2x[(3x16) + (17x10)]	N/E 2x[(3x16) + (17x10)]	2
GW 40 051 BD	54 (18x3)	400x550x130	63	N/E 2x[(3x16) + (17x10)]	N/E 2x[(3x16) + (17x10)]	2
GW 40 053 BD	72 (18x4)	400x850x150	75	N/E 2x[(3x16) + (17x10)]	N/E 2x[(3x16) + (17x10)]	1
GW 40 053 BQ	72 (18x4)	400x850x150	75	N/E 4x[(3x16) + (17x10)]	N/E 4x[(3x16) + (17x10)]	1



GW 40 043 BS

ACCESSORIES SUPPLIED: module masks, circuit labels. Self-adhesive label to be filled out for certification according to standard CEI 23-51. GW40049BS, GW40049BD, GW40051BD, GW40053BD, GW40053BQ, fitted with removable frame, to carry out the wiring operations outside the enclosure. Insulated bipolar screw 80A - IP20 terminal blocks to be installed on the frame before wiring.

NOTES: dispersible power calculated according to CEI 23-49. For the perforations, use the GW52401 milling cutter. To restore the double insulation, use the relative accessories supplied (module masks and screwcaps or brackets for surface-mounting).

CHARACTERISTICS: thermo-pressure with ball equal to 70°C.

BLANK DOOR - SMOOTH WALLS



GW 40 067

ENCLOSURES PREDISPOSED FOR TERMINAL BLOCK - WHITE RAL 9016



Code	No. of modules EN 50022	Outer dim. LxHxD (mm)	Dispersible power (W)	Pack Carton
GW 40 063	8	200x180x100	15	14
GW 40 065	12	280x225x100	22	9
GW 40 067	24 (12X2)	280x350x100	25	6
GW 40 069	36 (18x2)	400x400x130	45	2
GW 40 071	54 (18x3)	400x550x130	63	2
GW 40 073	72 (18x4)	400x850x150	75	1

ACCESSORIES SUPPLIED: module masks, circuit labels. Self-adhesive label to be filled out for certification according to standard CEI 23-51. GW40069, GW40071, GW40073, fitted with removable frame, to carry out the wiring operations outside the enclosure.

NOTES: Dispersible power calculated according to CEI 23-49. For the perforations, use the GW52401 milling cutter. To restore the double insulation, use the relative accessories supplied (module masks and screwcaps or brackets for surface-mounting).

CHARACTERISTICS: thermo-pressure with ball equal to 70°C.

INSTALLATION: for the possible enclosure-terminal block combinations, refer to the summary "COMPATIBILITY OF SURFACE-MOUNTING ENCLOSURES WITH BIPOLAR AND UNIPOLAR TERMINAL BLOCKS" in the selection guides of 40CD range.



GW 40 067 BD

ENCLOSURES EQUIPPED WITH 80A IP20 BIPOLAR SCREW TERMINAL BLOCKS - WHITE RAL 9016

Code	No. of modules EN 50022	Outer dim. LxHxD (mm)	Dispersible power (W)	Pole 1 (mm ²)	Pole 2 (mm ²)	Pack Carton
GW 40 063 BS	8	200x180x100	15	N/E (2x16) + (7x10)	N/E (2x16) + (7x10)	14
GW 40 065 BS	12	280x225x100	22	N/E (3x16) + (11x10)	N/E (3x16) + (11x10)	9
GW 40 067 BS	24 (12X2)	280x350x100	25	N/E (3x16) + (11x10)	N/E (3x16) + (11x10)	6
GW 40 067 BD	24 (12X2)	280x350x100	25	N/E 2x[(3x16) + (11x10)]	N/E 2x[(3x16) + (11x10)]	6
GW 40 069 BS	36 (18x2)	400x400x130	45	N/E (3x16) + (17x10)	N/E (3x16) + (17x10)	2
GW 40 069 BD	36 (18x2)	400x400x130	45	N/E 2x[(3x16) + (17x10)]	N/E 2x[(3x16) + (17x10)]	2
GW 40 071 BD	54 (18x3)	400x550x130	63	N/E 2x[(3x16) + (17x10)]	N/E 2x[(3x16) + (17x10)]	2
GW 40 073 BD	72 (18x4)	400x850x150	75	N/E 2x[(3x16) + (17x10)]	N/E 2x[(3x16) + (17x10)]	1
GW 40 073 BQ	72 (18x4)	400x850x150	75	N/E 4x[(3x16) + (17x10)]	N/E 4x[(3x16) + (17x10)]	1

ACCESSORIES SUPPLIED: module masks, circuit labels. Self-adhesive label to be filled out for certification according to standard CEI 23-51. GW40069BS, GW40069BD, GW40071BD, GW40073BD, GW40073BQ fitted with removable frame, to carry out the wiring operations outside the enclosure. Insulated bipolar screw 80A - IP20 terminal blocks to be installed on the frame) before wiring.

NOTES: dispersible power calculated according to CEI 23-49. For the perforations, use the GW52401 milling cutter. To restore the double insulation, use the relative accessories supplied (module masks and screwcaps or brackets for surface-mounting).

CHARACTERISTICS: thermo-pressure with ball equal to 70°C.

40 CD - PROTECTED ENCLOSURES - IP40

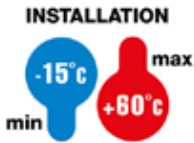

**IK
08**

**IP
40**

**GWT
650°C**



WITHOUT DOOR - WALLS WITH PERFORATION CENTRES

ENCLOSURES PRE-ARRANGED FOR TERMINAL BLOCK - GREY RAL 7035



GW 40 022

Code	No. of modules EN 50022	Outer dim. LxHxD (mm)	Dispersible power (W)	Pack Carton
GW 40 022	2	45x130x85	7	84
GW 40 023	4	90x130x85	9	36
GW 40 024	6	140x155x85	14	34
GW 40 026	8	180x180x95	18	24
GW 40 028	12+1	250x215x95	27	12
GW 40 030	24+2 (12x2)	250x340x95	40	12
GW 40 032	36+3 (12x3)	250x465x95	54	9

CHARACTERISTICS: Thermo-pressure with ball equal to 70°C. GW40022 plumbable front.

ACCESSORIES SUPPLIED: module masks, circuit labels.

GW40026, GW40028, GW40030, GW40032 supplied with self-adhesive label to be filled out for certification according to standard CEI 23-51.

NOTES: Dispersible power calculated according to CEI 23-49. For the perforations, use the GW52401 milling cutter.

To restore the double insulation, use the relative accessories supplied (module masks and screwcaps or brackets for surface-mounting). To maintain the IP degree declared, install devices with a degree of protection of at least IP40 and use the relative accessories (module masks, screwcaps or wall mounting brackets).

INSTALLATION: for the possible enclosure-terminal block combinations, refer to the summary "COMPATIBILITY OF SURFACE-MOUNTING ENCLOSURES WITH BIPOLAR AND UNIPOLAR TERMINAL BLOCKS" in the selection guides of 40CD range.

COMPLEMENTARY ITEMS

INSTALLATION AND COUPLING



GW 44 621

WALL FIXING BRACKET



Code	Material	Accessories supplied	For enclosures	For dist. boards	Pack Carton
GW 44 621	Insulation	Self-tapping fixing screws	All wall types		40/480

APPLICATIONS: used to maintain the double insulation and the original IP degree of protection of the boxes, containers and other GEWISS products.

ACCESSORIES SUPPLIED: 2 fixing screws.



GW 40 474

AESTHETIC COUPLING COVERS FOR CONDUIT AND TRUNKING ENTRY FOR CDK DISTRIBUTION BOARDS AND ENCLOSURES



Code	For encl. /boards with rail	Fixing	Pack Carton
GW 40 473	12 Modules	Clip	20
GW 40 474	18 Modules	Clip	20

CHARACTERISTICS: covers with internal knockouts for trunking from 60x30mm to 200x60mm.

WIRING



GW 40 412 B

INSULATED SCREW TERMINAL BLOCK BIPOLAR AND UNIPOLAR FOR ENCLOSURES AND BOARDS

Code	Pole 1 (mm ²)	Pole 2 (mm ²)	Fastener to supports	Pack Carton
Type: Bipolar - Rated current 125 A				
GW 40 401	N (1x35) + (7x10)	E (1x35) + (7x10)	With screws	10
GW 40 402	N (3x35) + (10x10)	E (3x35) + (10x10)	With screws and/or clip	10
GW 40 404	N (5x35) + (14x10)	E (5x35) + (14x10)	With screws and/or clip	10
Type: Bipolar - Rated current 80 A - IP20				
GW 40 408 B	N/E (2x16) + (7x10)	N/E (2x16) + (7x10)	With screws	1/10
GW 40 412 B	N/E (3x16) + (11x10)	N/E (3x16) + (11x10)	With screws and/or clip	1/10
GW 40 418 B	N/E (3x16) + (17x10)	N/E (3x16) + (17x10)	With screws and/or clip	1/10
Type: Unipolar - Rated current 80 A - IP20				
GW 40 408 U	N/E (2x16) + (7x10)	-	With screws	1/10
GW 40 412 U	N/E (3x16) + (11x10)	-	With screws and/or clip	1/10
GW 40 422 U	N/E (3x16) + (29x10)	-	With screws and/or clip	1/10
GW 40 418 U	N/E (3x16) + (17x10)	-	With screws and/or clip	1/10

ACCESSORIES SUPPLIED: fixing screws. The 80 A terminal blocks are equipped with N and E labels to be placed on the respective spaces to identify the poles.

USES: Ideal also for earth connection of SPD.

CHARACTERISTICS: GWT 960°C according to EN60695-2-11.

INSTALLATION: for the possible enclosure-terminal block combinations, refer to the summary "COMPATIBILITY OF SURFACE-MOUNTING ENCLOSURES WITH BIPOLAR AND UNIPOLAR TERMINAL BLOCKS" in the selection guides of 40CD range.



GW 40 413

ADAPTERS FOR SCREW TERMINAL BLOCKS

Code	For enclosures	Fastener to supports	Pack Carton
GW 40 413	12 M (and multiples) and 18 M (and multiples)	With screws	20

ACCESSORIES SUPPLIED: fixing screws.

CHARACTERISTICS: the adapter is pre-drilled for the correct assembly of the terminal block and pre-cut to allow installation also in enclosures with a 12 M modular step.

INSTALLATION: used to expand the number of possible enclosure-terminal block combinations, refer to the summary "COMPATIBILITY OF SURFACE-MOUNTING ENCLOSURES WITH BIPOLAR AND UNIPOLAR TERMINAL BLOCKS" in the selection guides of 40CD range.



GW 40 488

INTERNAL HORIZONTAL DIVIDERS FOR CDK DISTRIBUTION BOARDS



Code	For boards EN 50022 rail	Fixing	Pack Carton
GW 40 487	12 Modules	Clip	10/100
GW 40 488	18 Modules	Clip	10/100

NOTES: they permit making internal separation between the circuits having different voltages located on more than one row inside the same shell.



GW 40 493

BLANK COVER PANELS 1 MODULE HIGH FOR CDK DISTRIBUTION BOARDS



Code	Suitable for	For boards EN 50022 rail	Colour	Pack Carton
GW 40 492	CDK enclosures and boards decorative (Surface-mounting)	12 Modules	Grey RAL 7035	20
GW 40 493	CDK enclosures and boards decorative (Surface-mounting)	18 Modules	Grey RAL 7035	20

CHARACTERISTICS: sealing.

MISCELLANEOUS



GW 40 421

SECURITY TRIANGULAR KEY



Code	For enclosures	Material	Pack Carton
GW 40 421	40 CD Watertight IP55	Insulation	10/100



GW 40 422

CYLINDRICAL SECURITY LOCK - FOR 40 CDK AND 40 CD DECORATIVE ENCLOSURES

Code	Material	Pack Carton
GW 40 422	Pressure die-cast metal	1/10

ACCESSORIES SUPPLIED: 2 keys.

NOTES: All the keys and relative locks with the same product code are identical.



GW 40 467

PLASTIC MODULE COVER PROFILE



Code	No. of modules EN 50022	Colour	Pack Carton
GW 40 467	4.5	White RAL 9016	50
GW 40 423	4.5	Grey RAL 7035	50

CHARACTERISTICS: clip fixing.

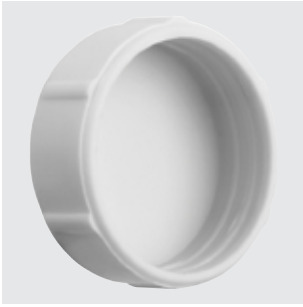

GW 44 623

INSULATING SCREW CAPS



Code	Description	Pack Carton
GW 44 623	Screwcap Ø25mm	10/100

APPLICATIONS: used to maintain the double insulation and the original IP degree of protection of the boxes, containers and other GEWISS products.



40 CD



Scan the QR Code and find out all the technical informations.

40 CDK - WATERTIGHT ENCLOSURES AND DISTRIBUTION BOARDS



IP65 40 CDK 4 to 72M watertight enclosure range in smoked transparent door version. The main technical features are: reversible bottoms and fronts, removable windowed frames and panels, and doors that open up to 180°, are removable and can be fitted with a lock.

40 CD - DECORATIVE PROTECTED ENCLOSURES



The IP40-rated 40 CD protected decorative enclosures are available in sizes from 8 to 72M and ensure seamless aesthetic integration with any interior design scheme. Available with smoked transparent or white blank doors, feature the PUSH opening and closing system.

ONE-POLE AND TWO-POLE TERMINAL BLOCKS - 80 A - IP20



Available with screw wiring, the two-pole and single-pole terminal blocks enable quick wiring as the cable screws are supplied unscrewed. The terminal blocks can be fixed directly on the back plate of the enclosures or with specific adapter.

40 CDE

Enclosures and distribution boards for country-specific standards

The range of enclosures and distribution boards for specific country standards: 40 CD French standard enclosures (IP30), also including VDI multimedia enclosures (Grade 1, Grade 2 and Grade 3); 40 CDKE German standard enclosures - IP65 watertight with flanges for quick cable insertion, and 40 CDE German standard enclosures - IP40 for home use, either surface-mounted or flush-mounted in masonry or plasterboard. The range is completed by the 40 CDE Spanish standard enclosures - IP40 with smoked transparent doors.



40 CDE - SPANISH STANDARD SURFACE-MOUNTING AND FLUSH-MOUNTING ENCLOSURES

FLUSH-MOUNTING ENCLOSURES WITH DOOR - IP40



GW 40 336

DISTRIBUTION BOARDS TO HOUSE ICP POWER LIMITING CIRCUIT BREAKER SEALABLE - IN=40A - SMOKED TRANSPARENT DOOR

Code	No. EN 50022 mod. ICP sect.	N. EN 50022 mod. CB section	Outer dim. LxHxD (mm)	R.U. 1407-D Classifications	Pack Carton
Door colour: Smoked Transparent					
GW 40 336	4	8	329x225x75	CCE-ICP32	10
GW 40 337	4	12	400x225x75	CCE-ICP32	6

ACCESSORIES SUPPLIED: service labels.

40 CDKE - GERMAN STANDARD SURFACE-MOUNTING ENCLOSURES AND DISTRIBUTION BOARDS

ENCLOSURES WITH SMOKED TRANSPARENT DOOR - IP65



GW 40 101

ENCLOSURES AND DISTRIBUTION BOARDS FITTED WITH BIPOLAR 125 A TERMINAL BLOCKS

Code	No. of modules EN 50022	Outer dim. LxHxD (mm)	Pole 1 (mm ²)	Pole 2 (mm ²)	Pack Carton
GW 40 101	4	143x210x100	-	-	19
GW 40 112	8	215x210x100	N (1x25) + (7x10)	E (1x25) + (7x10)	1/12
GW 40 116	18	410x285x140	N (5x25) + (14x10)	E (5x25) + (14x10)	1/3



GW 40 119

ENCLOSURES AND DISTRIBUTION BOARDS FITTED WITH BIPOLAR 125 A TERMINAL BLOCKS

Code	No. of modules EN 50022	Outer dim. LxHxD (mm)	Pole 1 (mm ²)	Pole 2 (mm ²)	Pack Carton
GW 40 117	36 (18x2)	410x463x140	N (10x25)+(28x10)	E (10x25)+(28x10)	1/2
GW 40 118	54 (18x3)	410x655x140	N (10x25)+(28x10)	E (10x25)+(28x10)	1
GW 40 119	72 (18x4)	410x878x160	N (10x25)+(28x10)	E (10x25)+(28x10)	1



GW 40 113

DISTRIBUTION BOARDS AND ENCLOSURES EQUIPPED WITH BIPOLAR 125 A TERMINAL BLOCKS AND TWO INTERCHANGEABLE FLANGES (2 FLANGES WITH KNOCKOUTS HOLE) - GREY RAL 7035

Code	No. of modules EN 50022	Outer dim. LxHxD (mm)	Pole 1 (mm ²)	Pole 2 (mm ²)	Pack Carton
GW 40 113	12	298x260x140	N (3x35) + (10x10)	E (3x35) + (10x10)	6
GW 40 114	24 (12X2)	298x420x140	N (3x35) + (10x10)	E (3x35) + (10x10)	3
GW 40 115	36 (12x3)	298x570x140	N (6x35)+(20x10)	E (6x35)+(20x10)	2

CHARACTERISTICS: the flanges with knockout holes have the following inputs: 4xM16; 4xM20; 3xM25; 1xM32; Glow Wire Test: 750°C

ACCESSORIES SUPPLIED: terminal block, screwcaps and module masks for double insulation, circuit labels.

To restore the double insulation, use the relative accessories (module masks, screwcaps or wall mounting brackets).



GW 40 124

DISTRIBUTION BOARDS AND ENCLOSURES EQUIPPED WITH BIPOLAR 125 A TERMINAL BLOCKS AND TWO INTERCHANGEABLE FLANGES (1 FLANGE WITH KNOCKOUTS HOLE + 1 FLANGE WITH QUICK ENTRY CABLE GLANDS) - GREY RAL 7035

Code	No. of modules EN 50022	Outer dim. LxHxD (mm)	Pole 1 (mm ²)	Pole 2 (mm ²)	Pack Carton
GW 40 123	12	298x260x140	N (3x35) + (10x10)	E (3x35) + (10x10)	6
GW 40 124	24 (12X2)	298x420x140	N (3x35) + (10x10)	E (3x35) + (10x10)	3
GW 40 125	36 (12x3)	298x570x140	N (6x35)+(20x10)	E (6x35)+(20x10)	2

CHARACTERISTICS: the flanges with knockout holes have the following inputs: 4xM16; 4xM20; 3xM25; 1xM32; Glow Wire Test: 750°C

ACCESSORIES SUPPLIED: terminal block, screwcaps and module masks for double insulation, circuit labels.

To restore the double insulation, use the relative accessories (module masks, screwcaps or wall mounting brackets).

COMPLEMENTARY ITEMS



GW 44 621

WALL FIXING BRACKET



Code	Material	Accessories supplied	For enclosures For dist. boards	Pack Carton
GW 44 621	Insulation	Self-tapping fixing screws	All wall types	40/480

APPLICATIONS: used to maintain the double insulation and the original IP degree of protection of the boxes, containers and other GEWISS products.

ACCESSORIES SUPPLIED: 2 fixing screws.



GW 40 423

4.5 MODULES COVER



Code	No. of modules EN 50022	Colour	Pack Carton
GW 40 467	4.5	White RAL 9016	50
GW 40 423	4.5	Grey RAL 7035	50

CHARACTERISTICS: clip fixing.

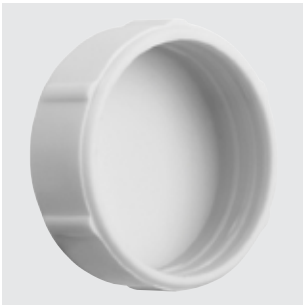

GW 44 623

INSULATING SCREW CAPS



Code	Description	Pack Carton
GW 44 623	Screwcap Ø25mm	10/100

APPLICATIONS: used to restore the double insulation and the original IP degree of protection of the boxes, containers and other GEWISS products.



GW 40 473

DESIGN COUPLING COVER FOR CONDUIT AND TRUNKING ENTRY FOR CDK ENCLOSURES AND BOARDS



Code	For encl. /boards with rail	Fixing	Pack Carton
GW 40 473	12 Modules	Clip	20
GW 40 474	18 Modules	Clip	20

CHARACTERISTICS: covers with internal knockouts for trunking from 60x30mm to 200x60mm.



GW 40 412 B

INSULATED SCREW TERMINAL BLOCK BIPOLAR AND UNIPOLAR FOR ENCLOSURES AND BOARDS

Code	Pole 1 (mm ²)	Pole 2 (mm ²)	Suitable for	Fastener to supports	Pack Carton
Type: Bipolar - Rated current 125 A					
GW 40 401	N (1x35) + (7x10)	E (1x35) + (7x10)	40 CDKe std. Germany	With screws	10
GW 40 402	N (3x35) + (10x10)	E (3x35) + (10x10)	40 CDKe std. Germany	With screws and/or clip	10
GW 40 404	N (5x35) + (14x10)	E (5x35) + (14x10)	-	With screws and/or clip	10
Type: Bipolar - Rated current 80 A - IP20					
GW 40 408 B	N/E (2x16) + (7x10)	N/E (2x16) + (7x10)	40 CDKe std. Germany	With screws	1/10
GW 40 412 B	N/E (3x16) + (11x10)	N/E (3x16) + (11x10)	40 CDKe std. Germany	With screws and/or clip	1/10
Type: Unipolar - Rated current 80 A - IP20					
GW 40 408 U	N/E (2x16) + (7x10)	-	40 CDKe std. Germany	With screws	1/10
GW 40 412 U	N/E (3x16) + (11x10)	-	40 CDKe std. Germany	With screws and/or clip	1/10
GW 40 422 U	N/E (3x16) + (29x10)	-	40 CDKe std. Germany	With screws and/or clip	1/10

ACCESSORIES SUPPLIED: fixing screws. The 80 A terminal blocks are equipped with N and E labels to be placed on the respective spaces to identify the poles.

CHARACTERISTICS: GWT 960°C according to EN60695-2-11.

INSTALLATION: The GW40401, GW40408B and GW40408U terminal blocks can be installed on the Germany standard 40CDKe enclosures using the GW40413 adapter.



GW 40 413

ADAPTER FOR SCREW TERMINAL BLOCKS

Code	Suitable for	Fastener to supports	Pack Carton
GW 40 413	40 CDKe std. Germany	With screws	20

ACCESSORIES SUPPLIED: fixing screws.

CHARACTERISTICS: the adapter is pre-drilled for the correct assembly of the terminal block and pre-cut to allow installation also on enclosures with a 12 M modular step.

INSTALLATION: permits the installation of GW40401, GW40408B and GW40408U terminal blocks on Germany standard 40CDKe enclosures.



GW 40 487

INTERNAL HORIZONTAL DIVIDER FOR CDK BOARDS



Code	For boards EN 50022 rail	Fixing	Pack Carton
GW 40 487	12 Modules	Clip	10/100
GW 40 488	18 Modules	Clip	10/100

CHARACTERISTICS: sealing.



GW 40 492

BLANK LID PANELS - 1 MODULE HEIGHT FOR CDKE BOARDS



Code	Suitable for	For boards EN 50022 rail	Colour	Pack Carton
GW 40 492	CDK enclosures and boards decorative (Surface-mounting)	12 Modules	Grey RAL 7035	20
GW 40 493	CDK enclosures and boards decorative (Surface-mounting)	18 Modules	Grey RAL 7035	20

NOTES: for creating internal separation between circuits of differing voltages on several rows within a single casing.



GW 40 422

CYLINDRICAL SECURITY LOCK - FOR 40 CDKE ENCLOSURES

Code	Material	Pack Carton
GW 40 421	Insulation	10/100
GW 40 422	Pressure die-cast metal	1/10

ACCESSORIES SUPPLIED: 2 keys.

NOTES: All the keys and relative locks with the same product code are identical.



GW 40 428

INTERCHANGEABLE FLANGE WITH QUICK-ENTRY CABLE GLANDS

Code	Entries for flanged	Pack Carton
GW 40 428	1 for cables Ø 16-29 mm 4 for cables Ø 11-20 m 8 f	1/20

40 CDE - GERMAN STANDARD SURFACE-MOUNTING ENCLOSURES AND DISTRIBUTION BOARDS

40 CDE IP30 WITH TERMINAL BLOCK



GW 43 022 S

SURFACE-MOUNTING SMALL DISTRIBUTION BOARDS - WHITE RAL 9016

Code	No. of modules EN 50022	Outer dim. LxHxD (mm)	Pack Carton
GW 43 021 S	12	300x245x95	1
GW 43 022 S	24 (12x2)	300x370x95	1
GW 43 023 S	36 (12x3)	300x515x95	1
GW 43 024 S	48 (12x4)	300x640x95	1

COMPLEMENTARY ITEMS



GW 43 071 S

BLANK DOORS FOR SURFACE-MOUNTING SMALL DISTRIBUTION BOARDS - WHITE RAL 9016

Code	No. of modules EN 50022	Colour	Pack Carton
GW 43 071 S	12	White RAL 9016	1/4
GW 43 072 S	24 (12x2)	White RAL 9016	1/6
GW 43 073 S	36 (12x3)	White RAL 9016	1/2
GW 43 074 S	48 (12x4)	White RAL 9016	1/2



GW 43 112 S

PLASTIC FRONTAL FOR SURFACE-MOUNTING SMALL DISTRIBUTION BOARDS

Code	No. of modules EN 50022	Pack Carton
GW 43 111 S	12	1
GW 43 112 S	24 (12x2)	1
GW 43 113 S	36 (12x3)	1
GW 43 114 S	48 (12x4)	1



GW 40 451

BIPOLAR TERMINAL BLOCKS WITH SUPPORT FOR GERMAN STANDARD SURFACE-MOUNTING SMALL DISTRIBUTION BOARDS

Code	Pole 1 (mm ²)	Pole 2 (mm ²)	For enclosures	Pack Carton
GW 40 451	N (1x25)+(3x16)+(14x10)	E (1x25)+(3x16)+(14x10)	12 modules	20
GW 40 452	N (2x25)+(6x16)+(16x10)	E (1x25)+(3x16)+(14x10)	24 modules	20
GW 40 453	N (2x25)+(6x16)+(22x10)	E (1x25)+(5x16)+(22x10)	36-48 modules	20

CHARACTERISTICS: clip fixing.



GW 43 042 S

SEALABLE CLOSURE

Code	Suitable for	Pack Carton
GW 43 042 S	Wall mounting	2/20



GW 40 463

SECURITY LOCK

Code	For enclosures	Pack Carton
GW 40 463	40 CDE German standard surface-mounting	1/10

ACCESSORIES SUPPLIED: 2 keys.

NOTES: All the keys and relative locks with the same product code are identical.



GW 40 467

4.5 MODULES COVER - COLOUR WHITE



Code	No. of modules EN 50022	Colour	Pack Carton
GW 40 467	4.5	White RAL 9016	50

CHARACTERISTICS: clip fixing.



GW 43 122 S

CIRCUIT LETTERING STRIPS

Code	Dimensions (mm)	Pack Carton
GW 43 122 S	265x120	1/10



GW 43 044 S

CIRCUIT LETTERING STRIPS

Code	Dimensions (mm)	Pack Carton
GW 43 044 S	350x165	10/100



GW 43 052 S

ENCLOSURE DOOR LOCK CLOSING SHUTTER

Code	Description	Pack Carton
GW 43 052 S	Lock seat shutter	1/10



GW 43 040 S

SCREW FOR ENCLOSURE FRONT

Code	Description	Pack Carton
GW 43 040 S	Screws for enclosure front	100

40 CDE - GERMAN STANDARD FLUSH-MOUNTING DISTRIBUTION BOARDS

METAL DOOR DISTRIBUTION BOARDS - IP40



GW 40 151 N

DISTRIBUTION BOARDS FOR BRICK WALLS EQUIPPED WITH BIPOLAR TERMINAL BLOCKS - RAL 9016

Code	No. of modules EN 50022	Pole 1 (mm ²)	Pole 2 (mm ²)	Dispersible power (W)	Pack Carton
GW 40 151 N	12+2	N (2x16)+(8x10)	PE (2x16)+(8x10)	60	1
GW 40 152 N	24+4 (12x2)	N (2x16)+(14x10)	PE (2x16)+(14x10)	80	1
GW 40 153 N	36+6 (12x3)	N 2x[(2x16)+(14x10)]	PE 2x[(2x16)+(14x10)]	90	1
GW 40 154 N	48+8 (12x4)	N 2x[(2x16)+(14x10)]	PE 2x[(2x16)+(14x10)]	100	1
GW 40 155 N	60+10 (12x5)	N 2x[(2x16)+(14x10)]	PE 2x[(2x16)+(14x10)]	120	1

Accessories supplied: positioning brackets, mortar guard, certification label, modules cover, terminal blocks.

Notes: extractable frame already installed.



GW 40 161 N

DISTRIBUTION BOARDS FOR PLASTERBOARD (GWT 850 °C) WALLS EQUIPPED WITH BIPOLAR TERMINAL BLOCKS - RAL 9016

Code	No. of modules EN 50022	Pole 1 (mm ²)	Pole 2 (mm ²)	Dispersible power (W)	Pack Carton
GW 40 161 N	12+2	N (2x16)+(8x10)	PE (2x16)+(8x10)	60	1
GW 40 162 N	24+4 (12x2)	N (2x16)+(14x10)	PE (2x16)+(14x10)	80	1
GW 40 163 N	36+6 (12x3)	N 2x[(2x16)+(14x10)]	PE 2x[(2x16)+(14x10)]	90	1
GW 40 164 N	48+8 (12x4)	N 2x[(2x16)+(14x10)]	PE 2x[(2x16)+(14x10)]	100	1
GW 40 165 N	60+10 (12x5)	N 2x[(2x16)+(14x10)]	PE 2x[(2x16)+(14x10)]	120	1

Accessories supplied: installation brackets, plaster guard, certification label, modules cover, terminal blocks.

Notes: extractable frame already installed.

METAL DOOR MULTIMEDIA ENCLOSURE - IP40



GW 40 173 N

MULTIMEDIA ENCLOSURES FOR BRICK WALLS - RAL 9016

Code	No. line	Pack Carton
GW 40 173 N	3	1
GW 40 174 N	4	1

Accessories supplied: positioning brackets, mortar guard, 1x multimedia device bracket, 2x Schuko socket, 2x supports, 1x Dahlia plate

Notes: perforated mounting plates and patch panel already installed.



GW 40 178 N

MULTIMEDIA ENCLOSURES FOR PLASTERBOARD (GWT 850 °C) WALLS - RAL 9016

Code	No. line	Pack Carton
GW 40 178 N	3	1
GW 40 179 N	4	1

Accessories supplied: installation brackets, plaster guard, 1x multimedia device bracket, 2x Schuko socket, 2x supports, 1x Dahlia plate

Notes: perforated mounting plates and patch panel already installed.

COMPLEMENTARY ITEMS



GW 40 454 N

TERMINAL BLOCKS

Code	Description	Pack Carton
GW 40 454 N	N+PE terminal block (2x16 mm ² + 14x10 mm ²)	1
GW 40 455 N	Terminal block N (7x16mm ²)	1



GW 40 467

ACCESSORIES

Code	Description	Pack Carton
GW 40 461 N	Pair of brackets for horizontal coupling	1
GW 40 463 N	Safety lock for German standard flush-mounting enclosures	1
GW 40 467	Plastic module cover profile	50

40 CDE - FRENCH STANDARD MODULAR SURFACE-MOUNTING ENCLOSURES

ENCLOSURES WITHOUT DOOR - IP30



GW 40 501

ENCLOSURES EQUIPPED WITH MULTIPOLAR TERMINAL BLOCKS - WALLS WITH KNOCKOUT ELEMENTS - WHITE RAL 9016

Code	No. of modules EN 50022	Outer dim. LxHxD (mm)	Phase terminal block (mm ²)	Neutral terminal block (mm ²)	Earth terminal block (mm ²)	Pack Carton
GW 40 501	13	250x225x93.5	-	-	E(3x25)+(12x4)	8
GW 40 502	26 (13x2)	250x350x93.5	L(1x35)+(5x25)	N(1x35)+(5x25)	E(4x25)+(24x4)	4
GW 40 503	39 (13x3)	250x475x93.5	L(1x35)+(5x25)	N(1x35)+(5x25)	E(7x25)+(36x4)	4
GW 40 504	52 (13x4)	250x600x93.5	L(1x35)+(5x25)	N(1x35)+(5x25)	E(8x25)+(48x4)	2

ACCESSORIES SUPPLIED: terminal blocks, module masks, circuit labels with self-adhesive pictograms, instruction sheet.

NOTES: earth terminal blocks with Push-Wire technology.

To restore the double insulation, use the relative accessories (module masks and screwcaps)

SUPPORT BASES FOR TARIF BLEU CONNECTING SWITCH



GW 40 512

SUPPORT BASES WITHOUT DOOR FOR EDF CONNECTION SWITCH - PLUMBABLE WHITE RAL 9016

Code	Depth	Outer dim. LxHxD (mm)	Pack Carton
GW 40 511	40 mm	250x225x43.5	4
GW 40 512	55 mm	250x225x58.5	3

ACCESSORIES SUPPLIED: fixing screws for the circuit breaker, screwcaps for sealing.

HOME VDI ENCLOSURE - GRADE 1



GW 40 506

HOME VDI ENCLOSURE GRADE 1 WITH 4 CONNECTORS RJ 45 AND 4 TV-SAT OUTPUTS - WHITE RAL 9016

Code	Outer dim. LxHxD (mm)	Pack Carton
GW 40 506	250x225x112	4

APPLICATIONS: allows to distribute Voice (telephone), Data (Internet) and Image (television) signals in every room of the house.

Complete and pre-equipped enclosure fitted with:

- 1 DTI RJ45 connection box with RC module integrated.
- 1 xDSL filter 4 outputs for phone et 1 output for modem.
- 1 TV-SAT splitter 5-2500 MHz 4 outputs.
- 1 Patch panel with 8 seats RJ45 "Keystone".
- 4 Connectors RJ45 Cat.5e UTP wiring without tool.
- 1 Kit of cords RJ45 for connection.
- 1 Earth terminal block.
- 1 Free space 100mm on DIN rail for the optical fiber DTI.

NOTES: complies with the minimum equipment required by the French standard NF C 15-100 and guide UTE C 90-483.

ACCESSORIES FOR EXPANSION AND WIRING

Code	Description	Pack Carton
GW 40 596	Expansion kit with 2 RJ45 connectors cat. 5e	1/10
GW 40 597	Quadruple RJ45 cord	1/10

GW40596 is composed with:

- 2 Connectors RJ45 Cat.5e UTP wiring without tool:
- 1 Patch cord RJ45 - L = 30 cm.

NOTE:

GW40597 cord RJ45 1 input/ 4 outputs RJ45 for delivering the phone on 4 connectors from only one input.



ZC6

COMPLEMENTARY ITEMS



GW 40 516

KIT OF MODULAR SPACERS FOR SUBSCRIBER ENCLOSURES, BASES, CONTAINERS AND BOARDS 50MM THICK - CLIP ASSEMBLY - WHITE RAL 9016

Code	Outer dim. LxHxD (mm)	Pack Carton
GW 40 516	250x225x50	8
GW 40 517	250x350x50	4
GW 40 518	250x475x50	4
GW 40 519	250x600x50	2

NOTE: code GW40516 is also suitable for the support bases and containers for services via cable (T.R.I.)



GW 40 546

2 PIPE FITTINGS FOR VERTICAL AND HORIZONTAL COUPLING OF ENCLOSURES, BASES AND SPACERS

Code	Fixing type	Pack Carton
GW 40 546	Clip	20

APPLICATIONS: for creating combined compositions and subscriber boards.



GW 40 526

BACK-MOUNTING PLATES IN INSULATING MATERIAL FOR SURFACE-MOUNTING ENCLOSURES AND SPACER KIT SLIDE FIXING ON RAIL

Code	Outer dim. LxHxD (mm)	For enclosures	Pack Carton
GW 40 526	156x216x2	13 mod.- 1 row	8
GW 40 527	156x341x2	26 mod.- 2 rows	4
GW 40 528	156x466x2	39 mod.- 3 rows	4
GW 40 529	156x591x2	52 mod.- 4 rows	2



GW 40 591

ISOLATED UNIPOLAR TERMINAL BLOCKS IP20 FOR FRENCH STANDARD MODULAR ENCLOSURES

Code	Type	Cap colour	Connections no. x section (mm ²)	Type of connection	For enclosures	Pack Carton
GW 40 591	Earth	Green	(3x25)+(12x4)	Push-Wire	13M-39M	20
GW 40 592	Earth	Green	(4x25)+(24x4)	Push-Wire	26M-39M-52M	20
GW 40 593	Phase	Black	(1x35)+(5x25)	With screw	26M-39M-52M	20
GW 40 594	Neutral	Blue	(1x35)+(5x25)	With screw	26M-39M-52M	20

CHARACTERISTICS: Terminal blocks for phase and neutral with In=100 A and Vn=450V.



GW 40 531

BLANK DOOR WITH FRAME FOR FINISHING FRENCH STANDARD MODULAR ENCLOSURES WITHOUT DOOR WHITE RAL 9016 - IP40

Code	For enclosures	Pack Carton
GW 40 531	13 mod.- 1 row	8
GW 40 532	26 mod.- 2 rows	4
GW 40 533	39 mod.- 3 rows	4
GW 40 534	52 mod.- 4 rows	2

CHARACTERISTICS: pre-arranged for housing the GW40422 cylinder security locks



GW 40 536

TRANSPARENT SMOKED DOOR WITH FRAME FOR FINISHING FRENCH STANDARD MODULAR ENCLOSURES WITHOUT DOOR - WHITE RAL 9016 - IP40

Code	For enclosures	Pack Carton
GW 40 536	13 mod.- 1 row	8
GW 40 537	26 mod.- 2 rows	4
GW 40 538	39 mod.- 3 rows	4
GW 40 539	52 mod.- 4 rows	2

CHARACTERISTICS: pre-arranged for housing the GW40422 cylinder security locks



GW 40 542

DOOR WITH FRAME FOR FINISHING SUPPORT BASES - CLIP FIXING WHITE RAL 9016 - IP40

Code	Outer dim. LxHxD (mm)	Door colour	Pack Carton
GW 40 541	250x225	White RAL 9016	4
GW 40 542	250x225	Smoked Transparent	4

CHARACTERISTICS: pre-arranged for housing the GW40422 cylinder security locks.



GW 40 422

CYLINDRICAL SECURITY LOCK - FOR 40 CDE (FRENCH STANDARD) ENCLOSURES

Code	Material	Pack Carton
GW 40 422	Pressure die-cast metal	1/10

ACCESSORIES SUPPLIED: 2 keys.

NOTES: All the keys and relative locks with the same product code are identical.

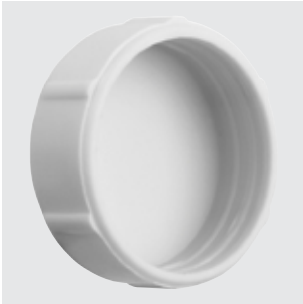

GW 44 622

SCREWCAPS IN INSULATING MATERIAL



Code	Description	For enclosures	Pack Carton
GW 44 622	Screwcap Ø16mm	GW42201	10/100

APPLICATIONS: used to maintain the double insulation and the original IP degree of protection of the boxes, containers and other GEWISS products.



GW 40 467

PLASTIC MODULE COVER PROFILE



Code	No. of modules EN 50022	Colour	Pack Carton
GW 40 467	4.5	White RAL 9016	50

CHARACTERISTICS: clip fixing.



40 CDE



Scan the QR Code and find out all the technical informations.

FRENCH STANDARD ENCLOSURES



Surface-mounting enclosures equipped with phase, neutral and earth terminal blocks, with an IP20 rating in accordance with French regulations. Earth terminal blocks with Push-Wire clamping. VDI enclosures complete the offer for the distribution of TV, internet and telephony signals.

GERMAN STANDARD ENCLOSURES









IP65-rated surface-mounting enclosures with top or bottom cable-entry flanges. IP30 surface- and IP40 flush-mounting versions with metal frame and door for masonry and plasterboard. Also available flush-mounting multimedia enclosures.





SPANISH STANDARD ENCLOSURES



Flush-mounted versions with smoked door and IP40 rating. The enclosures are designed to accommodate the ICP power limiter.

42 RV

		EQUIPPED WITH ILLUMINABLE PUSH-BUTTON						
								
	Code	GW 42 201						
	Colour	Red RAL 3000						
	Hammer	GW 42 216						
	Replacement glass	GW 42 211						
	Watertight cylinder security lock	-						
	NO	GW 74 201						
	NC	GW 74 202						
	Code	GW 30 951	GW 30 952	GW 30 943	GW 30 945	GW 30 958	GW 30 959	GW 30 960
	Voltage (V AC/DC)	12	24	230	110	12-24	110-230	48
	Power (W)	0.4	0.8	0.4	0.8			
	Light emission	White	White	Red	White	Green	Green	Green

PRE-ARRANGED WITH Ø 22 mm HOLE	WITH DIN RAIL				WITH BACKMOUNTING PLATE	FLUSH-MOUNTING ENCLOSURE WITH DIN RAIL	
							
GW 42 204	GW 42 206 (4 modules)	GW 42 202 (8 modules)	GW 42 207 (4 modules)	GW 42 208 (8 modules)	GW 42 203	GW 42 231 (4 modules)	GW 42 232 (4 modules)
Red RAL 3000	Red RAL 3000	Red RAL 3000	Grey RAL 7035	Grey RAL 7035	Red RAL 3000	Red RAL 3000	Grey RAL 7035
GW 42 216	GW 42 216	GW 42 216	GW 42 216	GW 42 216	GW 42 216	GW 42 216	GW 42 216
GW 42 213	GW 42 213	GW 42 212	GW 42 213	GW 42 212	GW 42 212	GW 42 214	GW 42 214
GW 48 644	GW 48 644	GW 48 644	GW 48 644	GW 48 644	GW 48 644	GW 48 644	GW 48 644
-	-				-	-	-
-	-				-	-	-

42 RV

Surface and flush-mounting watertight emergency enclosures

IP55 watertight enclosures, Red RAL 3000, available in 5 versions: with backlit push button; can be equipped with 22 mm dia. stop button or with rail coupling, the latter being available in Grey RAL 7035. The best seller is the GW42201, equipped with 1 NO contact and 1 NC contact and expandable up to 4 contacts, supplied with 1 long automatically operated push-button when glass is broken or short button for manual operation.



42 RV - WATERTIGHT ENCLOSURES FOR EMERGENCY MANOEUVRES - IP55



**IP
55**

**GWT
650°C**



EQUIPMENT WITH ILLUMINABLE PUSH-BUTTON



GW 42 201

WATERTIGHT ENCLOSURE FOR EMERGENCY SYSTEMS, EQUIPPED WITH ILLUMINATED PUSH-BUTTON AND 2 CONTACTS 1NO+1NC THAT CAN BE EXPANDED UP TO 4 CONTACTS PRE-ARRANGEMENT FOR USE OF GREEN LED TO INDICATE THE GOOD CONDITION OF THE EMERGENCY CIRCUIT



Code	Outer dim. LxHxD (mm)	Colour	No. of contacts that can be installed	Pack Carton
GW 42 201	120x120x50	Red RAL 3000	4	1/10

CHARACTERISTICS: can be mounted on flush-mounting box GW24403. Contact-holder flange with 4 seats.

ACCESSORIES SUPPLIED: substitute button key for the possible configuration of manual or automatic activation when the glass is broken, self-adhesive pictograms "Break the glass" and "Press the button key", screwcaps for double insulation, screws and accessories for plumbing the front, 1NO contact and 1NC contact.

Sicur Push breakable glass.

NOTES: substitute NO contacts: GW74201, NC: GW74202; lamps for push-button backlighting: GW30951 12 V-/-, GW30952 24 V-/-, GW30943 230 V-/-; green LEDs for signalling the integrity of the emergency circuit: GW30958 for 12 to 24 V-/-, GW30959 for 110 to 230 V-/-, GW30960 for 48 V-/-;

To restore the double insulation use the relative screwcaps supplied.

Pre-arranged for installation of 4 contacts type NO or NC.

FITTED WITH HOLE Ø 22 MM



GW 42 204

WATERTIGHT ENCLOSURE FOR EMERGENCY SYSTEMS FITTED WITH HOLE Ø 22MM



Code	Outer dim. LxHxD (mm)	Colour	Pack Carton
GW 42 204	108x180x100	Red RAL 3000	1/10

ACCESSORIES SUPPLIED: Door fitted with lock with 2 keys, self adhesive pictogram "Break glass" and screwcaps for double insulation.

Sicur Push breakable glass.

To restore the double insulation, use the relative accessories supplied (module masks and screwcaps) or the brackets for surface-mounting (GW44621).

NOTES: compatible with momentary push-buttons, selectors and indicators Ø 22 mm of the 74 PS series.

WITH DIN RAIL



GW 42 202

WATERTIGHT ENCLOSURES FOR EMERGENCY USE AND SPECIAL APPLICATIONS WITH RAIL DIN



Code	No. of modules EN 50022	Outer dim. LxHxD (mm)	Dispersible power (W)	Pack Carton
Colour: Red RAL 3000				
GW 42 206	4	108x180x100	12	1/10
GW 42 202	8	180x180x100	18	1/10
Colour: Grey RAL 7035				
GW 42 207	4	108x180x100	12	1/10
GW 42 208	8	180x180x100	18	1/10

ACCESSORIES SUPPLIED: door fitted with lock with 2 keys, self adhesive pictogram "Break glass", circuit label and screwcaps for double insulation. Sicur Push breakable glass. GW44207 pre-arranged also for the installation of momentary push-buttons, mushroom-head push-buttons, selectors and indicators ø 22 mm of the 74PS series.

NOTES: Dispersible power calculated according to CEI 23-49.

To restore the double insulation use the relative accessories supplied (module mask and screwcaps) or brackets for surface mounting GW44621.

WITH BACK-MOUNTING PLATE



GW 42 203

WATERTIGHT ENCLOSURE FOR EMERGENCY USE AND SPECIAL APPLICATIONS WITH GALVANISED METAL BACK MOUNTING PLATE



Code	Outer dim. LxHxD (mm)	Colour	Pack Carton
GW 42 203	180x180x100	Red RAL 3000	1/10

ACCESSORIES SUPPLIED: Door fitted with lock with 2 keys, self adhesive pictogram "Break glass" and screwcaps for double insulation. "Sicur Push" breakable glass.

To restore the double insulation use the relative accessories supplied (module mask and screwcaps) or brackets for surface mounting GW44621

FLUSH-MOUNTING ENCLOSURE WITH DIN RAIL



GW 42 232

WATERTIGHT FLUSH-MOUNTING ENCLOSURES FOR EMERGENCIES AND SPECIAL APPLICATIONS WITH RAIL DIN



Code	No. of modules EN 50022	Outer dim. LxHxD (mm)	Dispersible power (W)	Colour	Pack Carton
GW 42 231	4	145x200x70	12	Red RAL 3000	1/10
GW 42 232	4	145x200x70	12	Grey RAL 7035	1/10

ACCESSORIES SUPPLIED: door equipped with security lock with 1 key, self-adhesive pictogram "Break the glass", user label. "Sicur Push" breakable glass.

NOTES: if the flush-mounting box is not embedded in line with the wall, use the screw kit plus the spacers GW48645. dispersible power calculated according to IEC 60670-24.

To restore the double insulation use the relative accessories supplied (module masks and screwcaps)

PLATES FOR LIFTS / EMERGENCY

WIRED PLATES FOR LIFT AND EMERGENCY



GW 32 450

SELF-SUPPORTING WIRED PLATES FOR LIFT/EMERGENCY WITH ILLUMINABLE BUTTON SWITCH TRIANGLE KEY AND BREAKABLE GLASS - IP40

Code	Output contacts	Colour	Suitable for	Pack Carton
GW 32 450	1 NO + 1 NC 10A (AC1) / 6A (AC15) 380 V ac	White	Lift	1/10
GW 32 451	1 NO + 1 NC	Red	Emergency	1/10

The articles are supplied with an 11mm button key already assembled, without a lamp. They use the GW30941 12V-/-, GW30942 24V-/- and GW30943 230V-/- signalling units.

CHARACTERISTICS: the plates are suitable for the GW40422 security lock, available as an accessory.

For flush-mounting box GW24403; for surface-mounting box GW32431, GW32432;

ACCESSORIES SUPPLIED: accessory button key, 17mm high, to operate the contacts when glass is broken.

COMPLEMENTARY ITEMS

GLASS BREAKER



GW 42 216

GLASS BREAKER WITH UNIVERSAL FIXING SUPPORT

Code	Colour	Support dimension (mm)	Pack Carton
GW 42 216	Toner black	70x60	1/10

CHARACTERISTICS: the hammer is joined to the base with a fine chain, so it can not be lost.

SPARE GLASS

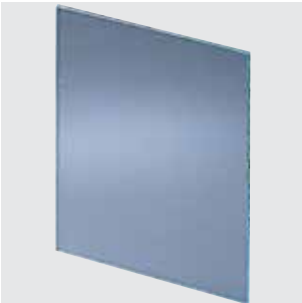

GW 42 212

SPARE SICUR PUSH GLASS FOR WATERTIGHT ENCLOSURES FOR EMERGENCIES

Code	For enclosures	Pack Carton
GW 42 211	GW42201	1/10
GW 42 213	GW42204, GW42206, GW42207	1/10
GW 42 212	GW42202, GW42203, GW42208	1/10
GW 42 214	GW42231, GW42232	1/10



GW 32 457

SPARE BREAKABLE GLASS FOR PLATES FOR LIFTS/EMERGENCIES

Code	Suitable for	Pack Carton
GW 32 457	GW32450, GW32451, GW32452, GW32453	1/10

ACCESSORIES AND SPARE PARTS



ZC6

MINIATURE LAMPS WITH WIRED LEAD

Code	Lamp voltage	Lamp power	Lamp	Light emitted	Pack Carton
GW 30 951	12V ac/dc	0.4 W	Incandescence	White	50
GW 30 952	24V ac/dc	0.8 W	Incandescence	White	50
GW 30 943	230 V ac	0.4 W	Fluorescent	Red	50
GW 30 945	110V ac/dc	0.8 W	Fluorescent	White	50



GW 30 958

SIGNALLING UNIT FOR INTEGRITY OF EMERGENCY CIRCUIT - WITH LEDS

Code	Lamp voltage	Lamp	Light emitted	Pack Carton
GW 30 958	12-24V ac/dc	LED	Green	10
GW 30 959	110-230V ac/dc	LED	Green	10
GW 30 960	48V ac/dc	LED	Green	10



ZC6

CONTACTS - ITH 10A - 240V AC

Code	Type	Category of use 240V ac15	Category of use 240V dc13	Colour	For enclosure	Pack Carton
GW 74 201	1 NO	3 A	0.27 A	Green	GW42201	10/60
GW 74 202	1 NC	3 A	0.27 A	Red	GW42201	10/60

CHARACTERISTICS: GW74202, suitable for opening the contact also in the event of it slightly sticking, in conformity with the EN 60947-5-1 standard. Clip assembly on the contact-holder flanges. Contacts compatible with emergency control unit GW42201.



GW 40 422

CYLINDRICAL SECURITY LOCK - SUITABLE FOR PLATES USED IN LIFTS/EMERGENCIES

Code	Material	Pack Carton
GW 40 422	Pressure die-cast metal	1/10

ACCESSORIES SUPPLIED: 2 keys.

NOTES: All the keys and relative locks with the same product code are identical.



GW 48 644

WATERTIGHT CYLINDRICAL SECURITY LOCK

Code	For enclosures	Material	Pack Carton
GW 48 644	48 PTC and 42 RV range	Pressure die-cast metal	1/10

ACCESSORIES SUPPLIED: 2 keys.

NOTES: All the keys and relative locks with the same product code are identical.



GW 48 645

KIT CONTAINING 4 LONG SELF-THREADING SCREWS WITH SPACERS FOR FIXING LIDS AND FRONTS

Code	Screw dimension (mm)	Spacer thickness (mm)	Pack Carton
GW 48 645	Ø 4x45	Max 10 mm reducible	1/100

CHARACTERISTICS: the kit can also be used for the following flush-mounting ranges: CD/CDK (starting from 6 modules), 48 CM and 42 RV.



GW 44 621

WALL FIXING BRACKET, COMPLETE WITH SELF-TAPPING SCREWS



Code	Suitable for	Pack Carton
GW 44 621	Enclosures 42 RV wall range	40/480

APPLICATIONS: used to maintain the double insulation and the original IP degree of protection of the boxes, containers and other GEWISS products.

ACCESSORIES SUPPLIED: 2 fixing screws.

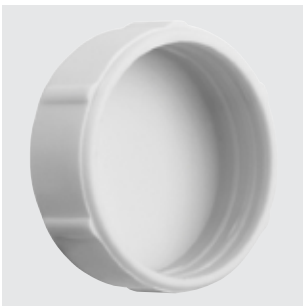

GW 44 622

SCREWCAPS IN INSULATING MATERIAL



Code	Description	For enclosures	Pack Carton
GW 44 622	Screwcap Ø16mm	GW42201	10/100
GW 44 623	Screwcap Ø25mm	from GW42202 to GW42208	10/100

APPLICATIONS: used to maintain the double insulation and the original IP degree of protection of the boxes, containers and other GEWISS products.



GW 40 423

4.5 MODULES COVER - COLOUR WHITE



Code	No. of modules EN 50022	Colour	Pack Carton
GW 40 423	4,5	Grey RAL 7035	50



42 RV



Scan the QR Code and find out all the technical informations.

ENCLOSURES FOR EMERGENCY SYSTEMS



The GW42201 emergency-system enclosure is the ideal product for handling emergency systems. It can be fitted with up to four NO and NC contacts, and it also offers the possibility of signalling emergency circuit integrity, thanks to the green LED.

FUNCTIONALITY AND FLEXIBILITY IN A SINGLE ITEM









The GW42201 enclosure can be fitted with a short or long push button for voluntary movement or intrinsically safe operation, and has a back panel flange that expands the number of contacts installable up to four, thus increasing the configurable solutions.

MAXIMUM SECURITY

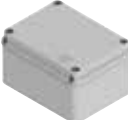
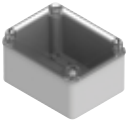

All the enclosures have a high IP55 protection rating and thanks to the emergency hammer (available as accessory), breakable panel and halogen-free materials, they are suitable for use even in areas open to the public.

44 CE RANGE - SURFACE-MOUNTING JUNCTION BOXES									
Material	Technopolymer GW PLAST 75								
Heat resistance	Thermo-pressure with ball: 85°C								
Fire resistance	Glow Wire Test: 650°C - UL94: HB								
Applications	For ordinary junctions								
Degree of protection	IP44	IP55			IP56				
Walls	with quick entry cable glands	with quick entry cable glands		smooth	smooth				
Depth of back-mounting box	standard	standard		standard	standard		high capacity		
Cover	blank plain	1/4 turn screws blank plain	blank plain	1/4 turn screws blank plain	blank plain	deep blank	blank plain	transparent plain	
INTERNAL DIMENSIONS OF BOX BASE LxH (mm)									
	Ø 65	GW 44 001							
	Ø 80	GW 44 002							
	80x80	GW 44 003							
	100x100		GW 44 024	GW 44 004	GW 44 234	GW 44 204	GW 44 214	GW 44 114	
	120x80			GW 44 005		GW 44 205	GW 44 215		
	150x110		GW 44 026	GW 44 006	GW 44 236	GW 44 206	GW 44 216		
	190x140			GW 44 007		GW 44 207	GW 44 217	GW 44 117	GW 44 137
	240x190			GW 44 008		GW 44 208	GW 44 218	GW 44 118	GW 44 138
	300x220			GW 44 009		GW 44 209	GW 44 219	GW 44 119	GW 44 139
	380x300			GW 44 010		GW 44 210	GW 44 220	GW 44 120	GW 44 140
	460x380			GW 44 011		GW 44 211	GW 44 221		

(*) Versions with red back-mounting box and grey cover

(**) Versions CSA approved (in accordance to the UL50 Standard)

(***) UL94: V0 only back-mounting box and cover









In green: insulation voltage $U_i=1000V$ according to EN 60670-1 and EN 60670-22. For photovoltaic applications use the wall fixing brackets , code GW 44 621.

In red: insulation voltage $U_i=750V$ according to EN 60670-1 and EN 60670-22. For photovoltaic applications use the wall fixing brackets , code GW 44 621.

Halogen-Free versions.

44 CE RANGE - SURFACE-MOUNTING JUNCTION BOXES

Technopolymer GW PLAST 75					Technopolymer GW PLAST 120			
Thermo-pressure with ball: 85°C					Thermo-pressure with ball: 110°C			
Glow Wire Test: 960 °C - UL94: V0 (***)					Glow Wire Test: 650°C - UL94: HB			
For special uses (e.g. raised floors, suspended ceilings...)					For industrial uses			
IP44	IP55		IP56		IP56			
with quick entry cable glands	with quick entry cable glands		smooth		smooth			
standard	standard		standard		standard			
blank plain	1/4 turn screws blank plain	blank plain	blank plain	deep blank	blank plain	deep blank	transparent plain	transparent deep
								
GW 44 051 GW 44 051 R (*)								
GW 44 052								
GW 44 053 GW 44 053 R (*)								
	GW 44 054 GW 44 054 R (*)		GW 44 274	GW 44 254	GW 44 404	GW 44 414		
		GW 44 055	GW 44 275	GW 44 255	GW 44 405	GW 44 415		
	GW 44 056 GW 44 056 R (*)		GW 44 276 GW 44 276 C (**)	GW 44 256	GW 44 406	GW 44 416	GW 44 426	GW 44 436
		GW 44 057	GW 44 277 GW 44 277 C (**)	GW 44 257	GW 44 407	GW 44 417	GW 44 427	GW 44 437
		GW 44 058	GW 44 278	GW 44 258	GW 44 408	GW 44 418	GW 44 428	GW 44 438
		GW 44 059	GW 44 279	GW 44 259	GW 44 409	GW 44 419	GW 44 429	GW 44 439
		GW 44 060	GW 44 280	GW 44 260	GW 44 410	GW 44 420	GW 44 430	GW 44 440
		GW 44 061	GW 44 281	GW 44 261	GW 44 411	GW 44 421	GW 44 431	GW 44 441

		ACCESSORIES APPLICATION TABLE													
		INTERNAL DIMENSIONS OF BOX BASE (mm)													
		Code	Ø 65	Ø 80	80x80	100x100	120x80	150x110	190x140	240x190	300x220	380x300	460x380		
ACCESSORIES FOR COUPLING AND JUNCTION SURFACE-MOUNTING BOXES	EQUIPOTENTIAL SINGLE-POLE TERMINAL BLOCKS	 GW 44 704	•	•	•	•	•	•	•	•	•	•	•		
		GW 44 706	•	•	•	•	•	•	•	•	•	•	•		
		GW 44 708		•	•	•	•	•	•	•	•	•	•	•	
		 GW 44 671	•	•	•	•	•	•	•	•	•	•	•	•	
		GW 44 672		•	•	•	•	•	•	•	•	•	•	•	
		GW 44 673					•								
		GW 44 674					•								
		GW 44 675							•	•	•	•	•	•	
	GW 44 676								•	•	•	•	•		
	MULTIPLE TERMINAL BLOCKS	 GW 44 606	•	•	•	•	•								
		GW 44 607	•	•	•	•	•								
		GW 44 608	•	•	•	•	•								
	MULTIPLE FEEDTHROUGH TERMINAL BLOCKS	 GW 44 609		•	•	•	•			•	•	•	•	•	
		GW 44 610													
		GW 44 611													
		GW 44 610 (**)					•	•	•	•	•	•	•	•	
		GW 44 612													
		GW 44 613													
	GW 44 614								•	•	•	•	•		
	BACK-MOUNTING PLATES	Galvanised sheet metal	GW 44 615							•	• (*)				
			GW 44 616								•	• (*)			
			GW 44 617									•	• (*)		
			GW 44 618										•		
			GW 44 619											•	
		Insulating material	GW 44 625								•	• (*)			
			GW 44 626									•	• (*)		
			GW 44 627										•	• (*)	
			GW 44 628											•	
GW 44 629														•	
COUPL.	 GW 44 620				•				•	•	•	•			
SCREW CAPS	 GW 44 622	2	2	2	4	4	4	4	4	4					
	GW 44 623											6	supplied		
BRACKET	 GW 44 621								6	8	12	16	8		
Cable glands		GW 50 428													
		GW 50 429	4	4	6										
		GW 50 430				6	6	10							
		GW 50 431							10	12					
		GW 50 432										12	12	14	

(*) GW 44 615 and GW 44 625 are also suitable for GW 44 118 and GW 44 138.

(**) CSA certified version (in accordance with UL50 standards).

GW 44 616 and GW 44 626 are also suitable for GW 44 119 and GW 44 139.

GW 44 617 and GW 44 627 are also suitable for GW 44 120 and GW 44 140.

Note: quick entry cable glands with exception GW 50 428.

44 CE

Technopolymer surface mounting watertight junction boxes

The 44 CE junction boxes range consists of 3 families made of different technopolymers (two of which are Halogen Free) and available in 11 sizes with an ordinary or high-capacity base, high or low lids, blank or transparent lids, smooth walls or with quick-entry cable glands.



SURFACE-MOUNTING BOXES IN GWPLAST 75 - GWT 650°C - FOR ORDINARY JUNCTIONS



IK
08

GWT
650°C



WALLS WITH QUICK ENTRY CABLE GLANDS - IP44 AND IP55

JUNCTION BOXES WITH PLAIN PRESS-ON LID - IP44 - GREY RAL 7035



GW 44 001



Code	Internal dim. LxHxD (mm)	Entries No. holes / Ø	Pack Carton
GW 44 001	Ø 65x35	4 / 23	5/280
GW 44 002	Ø 80x40	4 / 23	5/135
GW 44 003	80x80x40	6 / 23	5/90

NOTES: to restore the double insulation and original IP degree of protection of the boxes, use the isolating screwcaps.

CHARACTERISTICS: IP 44 boxes with IK07 impact resistance.

The external part of the junction box bottom is provided of central threaded seat. Quick entry cable glands for cables with Ø from 4 to 14 mm and tubes with Ø 16, 20 mm. pressure closing lid.

JUNCTION BOXES WITH PLAIN QUICK FIXING LID - IP55 - GREY RAL 7035



GW 44 024



Code	Internal dim. LxHxD (mm)	Entries No. holes / Ø	Lid screws (no. and type)	Pack Carton
GW 44 024	100x100x50	6 / 29	4 insul. a 1/4 turn, sealable	66
GW 44 026	150x110x70	10 / 29	4 insul. a 1/4 turn, sealable	40

NOTES: to restore the double insulation and original IP degree of protection of the boxes, use the isolating screwcaps.

CHARACTERISTICS: Quick entry cable glands for cables with Ø from 4 to 14 mm and tubes with Ø 16, 20 and 25 mm. the box bottom has 2 windows of dimensions 6 x 4 mm that allows the box mounting of the box, using the cables ties, to mesh wire cables trays, perforated cables trays, pole supports, etc...

JUNCTION BOXES WITH PLAIN SCREWED LID - IP55 - GREY RAL 7035



GW 44 007



Code	Internal dim. LxHxD (mm)	Entries No. holes / Ø	Lid screws (no. and type)	Pack Carton
GW 44 004	100x100x50	6 / 29	4 - Stainless steel	66
GW 44 005	120x80x50	6 / 29	4 - Stainless steel	66
GW 44 006	150x110x70	10 / 29	4 - Stainless steel	40
GW 44 007	190x140x70	10 / 37	4 insul. sealable hinged	24
GW 44 008	240x190x90	12 / 37	4 insul. sealable hinged	12
GW 44 009	300x220x120	12 / 48	4 insul. sealable hinged	6
GW 44 010	380x300x120	12 / 48	4 insul. sealable hinged	4
GW 44 011	460x380x120	14 / 48	6 insul. sealable hinged	3

ACCESSORIES SUPPLIED: GW44011 screwcaps for double insulation.

NOTES: to restore the double insulation and original IP degree of protection of the boxes, use the isolating screwcaps or the surface-mounting fixing brackets for boxes measuring at least 190x140mm.

CHARACTERISTICS:

quick entry cable glands, suitable for cables with Ø from 4 to 14mm.

For GW44007 and GW44008 quick entry cable glands suitable for conduits ø 16, 20, 25 and 32mm.

For GW44007, GW44008 quick entry cable glands suitable for conduits ø 16, 20, 25 and 32 mm.

For GW44009, GW44010, GW44011 quick entry cable glands suitable for conduits ø 16, 20, 25, 32 and 40mm.

SMOOTH WALLS - IP55 AND IP56



GW 44 234

JUNCTION BOXES WITH PLAIN QUICK FIXING LID - IP55 - GREY RAL 7035



Code	Internal dim. LxHxD (mm)	Max Ø holes possible	Lid screws (no. and type)	Pack Carton
GW 44 234	100x100x50	29 mm	4 insul. a 1/4 turn, sealable	105
GW 44 236	150x110x70	29 mm	4 insul. a 1/4 turn, sealable	50

NOTES: to restore the double insulation and original IP degree of protection of the boxes, use the isolating screwcaps.



GW 44 207

JUNCTION BOXES WITH PLAIN SCREWED LID - IP56 - GREY RAL 7035



Code	Internal dim. LxHxD (mm)	Max Ø holes possible	Lid screws (no. and type)	Pack Carton
GW 44 204	100x100x50	29 mm	4 - Stainless steel	105
GW 44 205	120x80x50	29 mm	4 - Stainless steel	91
GW 44 206	150x110x70	29 mm	4 - Stainless steel	50
GW 44 207	190x140x70	37 mm	4 insul. sealable hinged	30
GW 44 208	240x190x90	37 mm	4 insul. sealable hinged	14
GW 44 209	300x220x120	48 mm	4 insul. sealable hinged	6
GW 44 210	380x300x120	48 mm	4 insul. sealable hinged	4
GW 44 211	460x380x120	48 mm	6 insul. sealable hinged	3

ACCESSORIES SUPPLIED: GW44211 screwcaps for double insulation.

NOTES: to restore the double insulation and original IP degree of protection of the boxes, use the isolating screwcaps or the surface-mounting fixing brackets for boxes measuring at least 190x140mm.



GW 44 217

JUNCTION BOXES WITH DEEP SCREWED LID - IP56 - GREY RAL 7035



Code	Internal dim. LxHxD (mm)	Max Ø holes possible	Lid screws (no. and type)	Pack Carton
GW 44 214	100x100x120	29 mm	4 - Stainless steel	45
GW 44 215	120x80x120	29 mm	4 - Stainless steel	55
GW 44 216	150x110x140	29 mm	4 - Stainless steel	24
GW 44 217	190x140x140	37 mm	4 insul. sealable hinged	12
GW 44 218	240x190x160	37 mm	4 insul. sealable hinged	12
GW 44 219	300x220x180	48 mm	4 insul. sealable hinged	7
GW 44 220	380x300x180	48 mm	4 insul. sealable hinged	3
GW 44 221	460x380x180	48 mm	6 insul. sealable hinged	2

ACCESSORIES SUPPLIED: GW44221 screwcaps for double insulation.

NOTES: to restore the double insulation and original IP degree of protection of the boxes, use the isolating screwcaps or the surface-mounting fixing brackets for boxes measuring at least 190x140mm.

HIGH CAPACITY BOTTOM WITH SMOOTH WALLS - IP56

JUNCTION BOXES WITH HIGH CAPACITY BOTTOM AND PLAIN SCREWED LID - GREY RAL 7035



GW 44 117



Code	Internal dim. LxHxD (mm)	Max Ø holes possible	Effective height of bottom	Lid screws (no. and type)	Pack Carton
GW 44 114	100x100x80	48 mm	63 mm	4 - Stainless steel	1/45
GW 44 117	190x140x110	54 mm	83 mm	4 insul. sealable hinged	1/16
GW 44 118	240x190x130	54 mm	100 mm	4 insul. sealable hinged	1/12
GW 44 119	300x220x170	54 mm	119 mm	4 insul. sealable hinged	1/7
GW 44 120	380x300x170	54 mm	119 mm	4 insul. sealable hinged	1/3

NOTES: to restore the double insulation and original IP degree of protection of the boxes, use the isolating screwcaps or the surface-mounting fixing brackets for boxes measuring at least 190x140mm.

For all box/back-mounting plate combinations, refer to the summary.

APPLICATIONS: used to connect conduits up to Ø 40mm (for the 100x100x80mm version) and up to Ø 50mm (for the other sizes).

CHARACTERISTICS: for codes GW44117; GW44118; GW44119; GW44120, Ui=750V in accordance with EN 60670-1 and EN 60670-22. For applications in the photovoltaic environment, use the wall fixing brackets - code GW44621.

JUNCTION BOXES WITH HIGH CAPACITY BOTTOM AND TRANSPARENT PLAIN SCREWED LID GREY RAL 7035



GW 44 137



Code	Internal dim. LxHxD (mm)	Max Ø holes possible	Effective height of bottom	Lid screws (no. and type)	Pack Carton
GW 44 137	190x140x110	54 mm	83 mm	4 insul. sealable hinged	1/16
GW 44 138	240x190x130	54 mm	100 mm	4 insul. sealable hinged	1/12
GW 44 139	300x220x170	54 mm	119 mm	4 insul. sealable hinged	1/7
GW 44 140	380x300x170	54 mm	119 mm	4 insul. sealable hinged	1/3

NOTES: to restore the double insulation and original IP degree of protection of the boxes, use the isolating screwcaps or the surface-mounting fixing brackets for boxes measuring at least 190x140mm.

For all box/back-mounting plate combinations, refer to the summary.

APPLICATIONS: used to connect conduits up to Ø 50mm.

CHARACTERISTICS: for codes GW44137; GW44138; GW44139; GW44140, Ui=750V in accordance with EN 60670-1 and EN 60670-22.

For applications in the photovoltaic environment, use the wall fixing brackets - code GW44621.

SURFACE-MOUNTING BOXES IN GWPLAST 75 - GWT 960°C - FOR SPECIAL USES



IK
08

GWT
960°C



WALLS WITH QUICK ENTRY CABLE GLANDS - IP44 AND IP55



GW 44 051

JUNCTION BOXES WITH PLAIN PRESS-ON LID - IP44 - GREY RAL 7035

GWT
960°C

Code	Internal dim. LxHxD (mm)	Entries No. holes / Ø	Pack Carton
GW 44 051	Ø 65x35	4 / 23	5/280
GW 44 052	Ø 80x40	4 / 23	5/135
GW 44 053	80x80x40	6 / 23	5/90

CHARACTERISTIC: Casing type H in accordance with EN60670-1, and type Ha in accordance with IEC60670-1. IK07 impact resistance.

The external part of the junction box bottom is provided of central threaded seat.

Quick entry cable glands for cables with Ø from 4 to 14 mm and tubes with Ø 16, 20 mm. pressure closing lid.

APPLICATIONS: ideal for applications requiring a minimum GWT of 850°C in compliance with standards EN 60670 and IEC 60670, such as floating floors and suspended ceilings.

NOTES: to restore the double insulation and original IP degree of protection of the boxes, use the isolating screwcaps.

Quick entry cable glands for cables with Ø from 4 to 14 mm and tubes with Ø 16, 20 mm.



GW 44 054

JUNCTION BOXES WITH PLAIN QUICK FIXING LID - IP55 - GREY RAL 7035

GWT
960°C

Code	Internal dim. LxHxD (mm)	Entries No. holes / Ø	Lid screws (no. and type)	Pack Carton
GW 44 054	100x100x50	6 / 29	4 insul. a 1/4 turn, sealable	66
GW 44 056	150x110x70	10 / 29	4 insul. a 1/4 turn, sealable	40

CHARACTERISTICS: Casing type H in accordance with EN60670-1, and type Ha in accordance with IEC60670-1. Quick entry cable glands for cables with Ø from 4 to 14 mm and tubes with Ø 16, 20 and 25 mm. the box bottom has 2 windows of dimensions 6 x 4 mm that allows the box mounting of the box, using the cables ties, to mesh wire cables trays, perforated cables trays, pole supports, etc...

APPLICATIONS: ideal for applications requiring a minimum GWT of 850°C in compliance with standards EN 60670 and IEC 60670, such as floating floors and suspended ceilings.

NOTES: to restore the double insulation and original IP degree of protection of the boxes, use the isolating screwcaps.

JUNCTION BOXES WITH PLAIN PRESS-ON LID - IP44 BOX BASE RED RAL 3000, LID AND CABLE GLAND GREY RAL 7035

**GWT
960°C**

Code	Internal dim. LxHxD (mm)	Entries No. holes / Ø	Pack Carton
GW 44 051 R	Ø 65x35	4 / 23	5/280
GW 44 053 R	80x80x40	6 / 23	5/90

CHARACTERISTICS: Casing type H in accordance with EN60670-1, and type Ha in accordance with IEC60670-1. thermo-pressure with ball = 75° C.

The external part of the junction box bottom is provided of central threaded seat.

Quick entry cable glands for cables with Ø from 4 to 14 mm and tubes with Ø 16, 20 mm.

pressure closing lid.

APPLICATION: Ideal for safety circuits (door release, illumination, signal) and for ideal for applications requiring a minimum GWT of 850°C in compliance with standards EN 60670 and IEC 60670, such as floating floors and suspended ceilings.

NOTES: to restore the double insulation and original IP degree of protection of the boxes, use the isolating screwcaps.

Quick entry cable glands for cables with Ø from 4 to 14 mm and tubes with Ø 16, 20 mm.



GW 44 051 R

JUNCTION BOXES WITH PLAIN QUICK FIXING LID - IP55 BOX BASE RED RAL 3000, LID AND CABLE GLAND GREY RAL 7035

**GWT
960°C**

Code	Internal dim. LxHxD (mm)	Entries No. holes / Ø	Lid screws (no. and type)	Pack Carton
GW 44 054 R	100x100x50	6 / 29	4 insul. a 1/4 turn, sealable	66
GW 44 056 R	150x110x70	10 / 29	4 insul. a 1/4 turn, sealable	40

CHARACTERISTICS: Casing type H in accordance with EN60670-1, and type Ha in accordance with IEC60670-1. thermo-pressure with ball = 75° C. Quick entry cable glands for cables with Ø from 4 to 14 mm and tubes with Ø 16, 20 and 25 mm. the box bottom has 2 windows of dimensions 6 x 4 mm that allows the box mounting of the box, using the cables ties, to mesh wire cables trays, perforated cables trays, pole supports, etc...

APPLICATIONS: ideal for applications requiring a minimum GWT of 850°C in compliance with standards EN 60670 and IEC 60670, such as floating floors and suspended ceilings.

NOTES: to restore the double insulation and original IP degree of protection of the boxes, use the isolating screwcaps.

Quick entry cable glands for cables with Ø from 4 to 14 mm and tubes with Ø 16, 20 and 25 mm.



GW 44 054 R



GW 44 057

JUNCTION BOXES WITH PLAIN SCREWED LID - IP55 - GREY RAL 7035

**GWT
960°C**

Code	Internal dim. LxHxD (mm)	Entries No. holes / Ø	Lid screws (no. and type)	Pack Carton
GW 44 055	120x80x50	6 / 29	4 - Stainless steel	66
GW 44 057	190x140x70	10 / 37	4 insul. sealable hinged	24
GW 44 058	240x190x90	12 / 37	4 insul. sealable hinged	12
GW 44 059	300x220x120	12 / 48	4 insul. sealable hinged	6
GW 44 060	380x300x120	12 / 48	4 insul. sealable hinged	4
GW 44 061	460x380x120	14 / 48	4 insul. sealable hinged	3

ACCESSORIES SUPPLIED: GW44061 screwcaps for double insulation.

CHARACTERISTICS: Casing type H in accordance with EN60670-1, and type Ha in accordance with IEC60670-1.

APPLICATIONS: ideal for applications requiring a minimum GWT of 850°C in compliance with standards EN 60670 and IEC 60670, such as floating floors and suspended ceilings.

NOTES: to restore the double insulation and original IP degree of protection of the boxes, use the isolating screwcaps or the surface-mounting fixing brackets for boxes measuring at least 190x140mm.

For GW44055 quick entry cable glands, suitable for cables with Ø from 4 to 14mm and conduits Ø 16, 20 and 25mm.

For GW44057 and GW44058 quick entry cable glands, suitable for cables with Ø from 4 to 14mm and conduits Ø 16, 20, 25 and 32mm.

For GW44059, GW44060 and GW44061 quick entry cable glands, suitable for cables with Ø from 4 to 14mm and conduits Ø 16, 20, 25, 32 and 40mm.

SMOOTH WALLS - IP56



GW 44 277

JUNCTION BOXES WITH PLAIN SCREWED LID - IP56 - GREY RAL 7035

**GWT
960°C**

Code	Internal dim. LxHxD (mm)	Max Ø holes possible	Lid screws (no. and type)	Pack Carton
GW 44 274	100x100x50	29 mm	4 - Stainless steel	105
GW 44 275	120x80x50	29 mm	4 - Stainless steel	91
GW 44 276	150x110x70	29 mm	4 - Stainless steel	50
GW 44 276 C	150x110x70	29 mm	4 - Stainless steel	50
GW 44 277	190x140x70	37 mm	4 insul. sealable hinged	30
GW 44 277 C	190x140x70	37 mm	4 insul. sealable hinged	30
GW 44 278	240x190x90	37 mm	4 insul. sealable hinged	14
GW 44 279	300x220x120	48 mm	4 insul. sealable hinged	6
GW 44 280	380x300x120	48 mm	4 insul. sealable hinged	4
GW 44 281	460x380x120	48 mm	6 insul. sealable hinged	3

ACCESSORIES SUPPLIED: GW44281 screwcaps for double insulation.

CHARACTERISTICS: for codes GW44277; GW44277C; GW44278; GW44279; GW44280; GW44281 Ui=750V in accordance with EN 60670-1 and EN 60670-22.

For applications in a photovoltaic environment, use the surface-mounting brackets - code GW44621. Type H casing in accordance with EN60670-1, and type Ha in accordance with IEC60670-1. For junction boxes GW44276C and GW44277C, thermo-pressure with ball TP = 75°C according to EN 60670-1 and IEC 60670-1. Maximum installation temperature +50°C.

APPLICATIONS: ideal for applications requiring a minimum GWT of 850°C in compliance with standards EN 60670 and IEC 60670, such as floating floors and suspended ceilings.

NOTES: to restore the double insulation and original IP degree of protection of the boxes, use the isolating screwcaps or the surface-mounting fixing brackets for boxes measuring at least 190 x 140mm.

Junction boxes GW44276C and GW44277C certified CSA (in accordance with UL50). To be used with multipolar terminal blocks 5 x 6mm2 GW44610C.



GW 44 260

JUNCTION BOXES WITH DEEP SCREWED LID - IP56 - GREY RAL 7035

**GWT
960°C**

Code	Internal dim. LxHxD (mm)	Max Ø holes possible	Lid screws (no. and type)	Pack Carton
GW 44 254	100x100x120	29 mm	4 - Stainless steel	45
GW 44 255	120x80x120	29 mm	4 - Stainless steel	55
GW 44 256	150x110x140	29 mm	4 - Stainless steel	24
GW 44 257	190x140x140	37 mm	4 insul. sealable hinged	16
GW 44 258	240x190x160	37 mm	4 insul. sealable hinged	12
GW 44 259	300x220x180	48 mm	4 insul. sealable hinged	7
GW 44 260	380x300x180	48 mm	4 insul. sealable hinged	3
GW 44 261	460x380x180	48 mm	6 insul. sealable hinged	2

ACCESSORIES SUPPLIED: GW44261 screwcaps for double insulation.

CHARACTERISTICS: for codes GW44257; GW44258; GW44259; GW44260; GW44261 Ui=750V in accordance with EN 60670-1 and EN 60670-22.

For applications in the photovoltaic environment, use the wall fixing brackets - code GW44621. Casing type H in accordance with EN60670-1, and type Ha in accordance with IEC60670-1.

APPLICATIONS: ideal for applications requiring a minimum GWT of 850°C in compliance with standards EN 60670 and IEC 60670, such as floating floors and suspended ceilings.

NOTES: to restore the double insulation and original IP degree of protection of the boxes, use the isolating screwcaps or the surface-mounting fixing brackets for boxes measuring at least 190x140mm.

SURFACE-MOUNTING BOXES IN GWPLAST 120 - GWT 650°C - FOR INDUSTRIAL USES



**IK
08**

**GWT
650°C**



BLANK LID - IP56



GW 44 407

BOXES WITH SMOOTH WALLS FOR JUNCTIONS AND FOR ELECTRIC AND ELECTRONIC EQUIPMENT PLAIN SCREWED LID - GREY RAL 7035



Code	Internal dim. LxHxD (mm)	Max Ø holes possible	Lid screws (no. and type)	Pack Carton
GW 44 404	100x100x50	29 mm	4 - Stainless steel	108
GW 44 405	120x80x50	29 mm	4 - Stainless steel	108
GW 44 406	150x110x70	29 mm	4 - Stainless steel	50
GW 44 407	190x140x70	37 mm	4 insul. sealable hinged	32
GW 44 408	240x190x90	37 mm	4 insul. sealable hinged	14
GW 44 409	300x220x120	48 mm	4 insul. sealable hinged	6
GW 44 410	380x300x120	48 mm	4 insul. sealable hinged	4
GW 44 411	460x380x120	48 mm	6 insul. sealable hinged	3

ACCESSORIES SUPPLIED: GW44411 screwcaps for double insulation.

NOTES: to restore the double insulation and original IP degree of protection of the boxes, use the isolating screwcaps or the surface-mounting fixing brackets for boxes measuring at least 190x140mm.

CHARACTERISTICS: for codes GW44407; GW44408; GW44409; GW44410; GW44411 Ui=1000V in accordance with EN 60670-1 and EN 60670-22.

For applications in the photovoltaic environment, use the wall fixing brackets - code GW44621.



GW 44 417

BOXES WITH SMOOTH WALLS FOR JUNCTIONS AND FOR ELECTRIC AND ELECTRONIC EQUIPMENT DEEP SCREWED LID - GREY RAL 7035



Code	Internal dim. LxHxD (mm)	Max Ø holes possible	Lid screws (no. and type)	Pack Carton
GW 44 414	100x100x120	29 mm	4 - Stainless steel	45
GW 44 415	120x80x120	29 mm	4 - Stainless steel	55
GW 44 416	150x110x140	29 mm	4 - Stainless steel	24
GW 44 417	190x140x140	37 mm	4 insul. sealable hinged	16
GW 44 418	240x190x160	37 mm	4 insul. sealable hinged	12
GW 44 419	300x220x180	48 mm	4 insul. sealable hinged	7
GW 44 420	380x300x180	48 mm	4 insul. sealable hinged	3
GW 44 421	460x380x180	48 mm	6 insul. sealable hinged	2

ACCESSORIES SUPPLIED: GW44421 screwcaps for double insulation.

NOTES: to restore the double insulation and original IP degree of protection of the boxes, use the isolating screwcaps or the surface-mounting fixing brackets for boxes measuring at least 190x140mm.

CHARACTERISTICS: for codes GW44417; GW44418; GW44419; GW44420; GW44421 Ui=1000V in accordance with EN 60670-1 and EN 60670-22.

For applications in the photovoltaic environment, use the wall fixing brackets - code GW44621.

TRANSPARENT LID - IP56



GW 44 427

BOXES WITH SMOOTH WALLS FOR JUNCTIONS AND FOR ELECTRIC AND ELECTRONIC EQUIPMENT PLAIN SCREWED LID - GREY RAL 7035



Code	Internal dim. LxHxD (mm)	Max Ø holes possible	Lid screws (no. and type)	Pack Carton
GW 44 426	150x110x70	29 mm	4 - Stainless steel	50
GW 44 427	190x140x70	37 mm	4 insul. sealable hinged	32
GW 44 428	240x190x90	37 mm	4 insul. sealable hinged	14
GW 44 429	300x220x120	48 mm	4 insul. sealable hinged	6
GW 44 430	380x300x120	48 mm	4 insul. sealable hinged	4
GW 44 431	460x380x120	48 mm	6 insul. sealable hinged	3

ACCESSORIES SUPPLIED: GW44431 screwcaps for double insulation.

NOTES: to restore the double insulation and original IP degree of protection of the boxes, use the isolating screwcaps or the surface-mounting fixing brackets for boxes measuring at least 190x140mm.

CHARACTERISTICS: for codes GW44427; GW44428; GW44429; GW44430; GW44431 Ui=1000V in accordance with EN 60670-1 and EN 60670-22. For applications in the photovoltaic environment, use the wall fixing brackets - code GW44621.



GW 44 437

BOXES WITH SMOOTH WALLS FOR JUNCTIONS AND FOR ELECTRIC AND ELECTRONIC EQUIPMENT DEEP SCREWED LID - GREY RAL 7035



Code	Internal dim. LxHxD (mm)	Max Ø holes possible	Lid screws (no. and type)	Pack Carton
GW 44 436	150x110x140	29 mm	4 - Stainless steel	24
GW 44 437	190x140x140	37 mm	4 insul. sealable hinged	16
GW 44 438	240x190x160	37 mm	4 insul. sealable hinged	12
GW 44 439	300x220x180	48 mm	4 insul. sealable hinged	7
GW 44 440	380x300x180	48 mm	4 insul. sealable hinged	3
GW 44 441	460x380x180	48 mm	6 insul. sealable hinged	2

ACCESSORIES SUPPLIED: GW44441 screwcaps for double insulation.

NOTES: to restore the double insulation and original IP degree of protection of the boxes, use the isolating screwcaps or the surface-mounting fixing brackets for boxes measuring at least 190x140mm.

CHARACTERISTICS: for codes GW44437; GW44438; GW44439; GW44440; GW44441 Ui=1000V in accordance with EN 60670-1 and EN 60670-22. For applications in the photovoltaic environment, use the wall fixing brackets - code GW44621.

COMPLEMENTARY ITEMS

BACK-MOUNTING PLATES

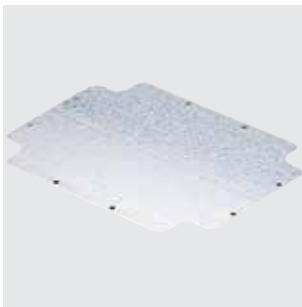

GW 44 615

BACK-MOUNTING PLATE IN GALVANISED STEEL WITH SELF-TAPPING FIXING SCREWS

Code	For boxes centre distance BxH (mm)	Pack Carton
GW 44 615	190x140	20
GW 44 616	240x190	20
GW 44 617	300x220	20
GW 44 618	380x300	5
GW 44 619	460x380	5

NOTES: GW44615 also fitted for high capacity boxes GW44118 and GW44138.

GW44616 also fitted for high capacity boxes GW44119 and GW44139.

GW44617 also fitted for high capacity boxes GW44120 and GW44140.



GW 44 625

BACK-MOUNTING PLATE IN INSULATED MATERIAL WITH SELF-TAPPING FIXING SCREWS

Code	For boxes centre distance BxH (mm)	Pack Carton
GW 44 625	190x140	20
GW 44 626	240x190	20
GW 44 627	300x220	20
GW 44 628	380x300	4
GW 44 629	460x380	5

NOTES: GW44625 also fitted for high capacity boxes GW44118 and GW44138.

GW44626 also fitted for high capacity boxes GW44119 and GW44139.

GW44627 also fitted for high capacity boxes GW44120 and GW44140.

INSTALLATION AND COUPLING ELEMENTS

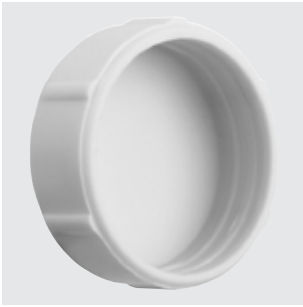

GW 44 622

INSULATING SCREW CAPS



Code	Description	Pack Carton
GW 44 622	Screwcap Ø16mm	10/100
GW 44 623	Screwcap Ø25mm	10/100

APPLICATIONS: used to maintain the double insulation and the original IP degree of protection of the boxes, containers and other GEWISS products.



GW 44 621

WALL FIXING BRACKET, COMPLETE WITH SELF-TAPPING SCREWS



Code	For boxes centre distance BxH (mm)	Pack Carton
GW 44 621	300x220 380x300 460x380 190x140 240x190	40/480

APPLICATIONS: used to maintain the double insulation and the original IP degree of protection of the boxes, containers and other GEWISS products.

ACCESSORIES SUPPLIED: 2 fixing screws.

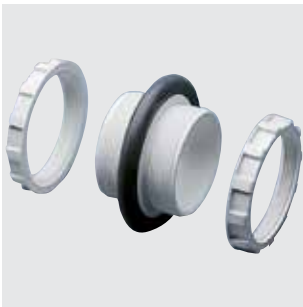

GW 44 620

WATERTIGHT COUPLER - IP56

Code	For boxes centre distance BxH (mm)	For holes Ø (mm)	Ø ring nut (mm)	Internal Ø (mm)	Length (mm)	Pack Carton
GW 44 620	300x220 380x300 460x380	48	58.5	39	37.5	10/160



GW 50 430

CABLE GLANDS IN FLEXIBLE POLYMER - GREY RAL 7035 - IP55

Code	For ext. conduits max (mm)	Mounting hole Ø (mm)	Glow Wire Test	Pack Carton
GW 50 428	16	19	960 °C	100/1000
GW 50 429	20	23	960 °C	100/1000
GW 50 430	25	29	960 °C	100/1000
GW 50 431	32	37	960 °C	50/500
GW 50 432	40	48	960 °C	35/350

NOTES: quick entry cable glands, except GW50428.

CHARACTERISTICS: quick entry cable glands, suitable for cables with Ø from 4 to 14mm.

Cable gland GW50429, suitable for conduits ø 16, 20mm.

Cable gland GW50430, suitable for conduits ø 16, 20, 25mm.

Cable gland GW50431, suitable for conduits ø 16, 20, 25, 32mm.

Cable gland GW50432, suitable for conduits ø 16, 20, 25, 32, 40mm.



GW 52 401

MULTI-DIAMETER DRILL MILLING CUTTER IN HSS STEEL TO DRILL BOXES, BOARDS AND TRUNKING IN INSULATING MATERIAL

Code	Description	Ø of perforation	Pack Carton
GW 52 401	Drill milling cutter	From 3.5 to 40	1/4



44 CE



Scan the QR Code and find out all the technical informations.

VERSIONS WITH QUICK-ENTRY CABLE GLANDS

LARGE CAPACITY BOXES

HINGED LID VERSIONS



The boxes with cable glands enable quick insertion of rigid and flexible cables. The innovative geometric shape guarantees high-levels of mechanical performance and ensures that IP rating of the box is maintained even with cables or conduits inserted, thanks to the special suction effect.







The boxes with high-capacity bottoms have been studied in every detail for practicality and robustness, even for the connection of larger diameter conduits (up to 50 mm). This attention to detail has produced a range of boxes that are ideal in systems with a high-density of connections,



All GEWISS junction boxes 190x140 mm and larger in size have plastic screws with a spherical head allowing the lid to open like a small distribution board (GEWISS patent). This innovative system also allows the covers to be sealed.

GW CONNECT - WATERTIGHT METAL JUNCTION BOXES, SURFACE-MOUNTING

Table of Choices

DIE-CAST ALUMINIUM JUNCTION BOXES - IP66				
DIMENSIONS B x H x P (mm)	VARNISHED	NOT VARNISHED	ATEX	BOTTOM PLATES
				
91 x 91 x 54	GW 76 261	GW 76 281	GW 76 291	-
128 x 103 x 57	GW 76 262	GW 76 282	GW 76 292	GW 76 272
155 x 130 x 58	GW 76 263	GW 76 283	GW 76 293	GW 76 273
178 x 156 x 75	GW 76 264	GW 76 284	GW 76 294	GW 76 274
239 x 202 x 85	GW 76 265	GW 76 285	GW 76 295	GW 76 275
294 x 244 x 114	GW 76 266	GW 76 286	GW 76 296	GW 76 276
392 x 298 x 149	GW 76 267	GW 76 287	GW 76 297	GW 76 277

GW Connect

Metal surface-mounting watertight junction boxes

Made of die-cast aluminium. In addition to junction and connection, they are also used in automation applications. The offer includes painted and unpainted versions and ATEX versions for Zone 2 (G) and Zone 22 (D). The cover is equipped with stainless steel captive screws. The back plate of the box has a ground insert and is ready for the assembly of the DIN rail. Accessories include back-mounting plates in galvanised steel (available from the second dimension).



WALL-MOUNTING BOXES IN DIE-CAST ALUMINIUM - IP66

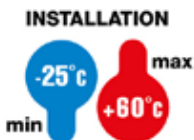

**IP
66**

**IK
08**

PAINTED BOXES



GW 76 261

METALLISED GREY BOXES

Code	Internal dim. LxHxD (mm)	IP degree	Pack Carton
GW 76 261	91x91x54	IP66	1/40
GW 76 262	128x103x57	IP66	1/32
GW 76 263	155x130x58	IP66	1/24
GW 76 264	178x156x75	IP66	1/16
GW 76 265	239x202x85	IP66	1/8
GW 76 266	294x244x114	IP66	1/4
GW 76 267	392x298x149	IP66	1

CHARACTERISTICS: Temperature range: -60° C to +100° C.

UNPAINTED BOXES



GW 76 281

BOXES

Code	Internal dim. LxHxD (mm)	IP degree	Pack Carton
GW 76 281	91x91x54	IP66	1/40
GW 76 282	128x103x57	IP66	1/32
GW 76 283	155x130x58	IP66	1/24
GW 76 284	178x156x75	IP66	1/16
GW 76 285	239x202x85	IP66	1/8
GW 76 286	294x244x114	IP66	1/4
GW 76 287	392x298x149	IP66	1

CHARACTERISTICS: Temperature range: -60° C to +100° C.

76 ATEX - PAINTED BOXES - ZONE 2 (G) ZONE 22 (D)



GW 76 291

GREY RAL 7037 BOXES

Code	Internal dim. LxHxD (mm)	IP degree	Pack Carton
GW 76 291	91x91x54	IP66	1/40
GW 76 292	128x103x57	IP66	1/32
GW 76 293	155x130x58	IP66	1/24
GW 76 294	178x156x75	IP66	1/16
GW 76 295	239x202x85	IP66	1/8
GW 76 296	294x244x114	IP66	1/4
GW 76 297	392x298x149	IP66	1

ACCESSORIES SUPPLIED: kit for external earthing.

ATEX Classification: Equipment-group II Category 3GD.

Type of protection for use in explosive gas atmospheres: nA.

Type of protection for use in explosive dust atmospheres: tc.

Ambient temperature range: -20°C ≤ Ta ≤ +85°C.

COMPLEMENTARY ITEMS



GW 76 272

BACK-MOUNTING PLATE IN GALVANISED STEEL

Code	For boxes LxH (mm)	Pack Carton
GW 76 272	128x103	1/10
GW 76 273	155x130	1/10
GW 76 274	178x156	1/10
GW 76 275	239x202	1/5
GW 76 276	294x244	1/5
GW 76 277	392x298	1/5



GW Connect



Scan the QR Code and find out all the technical informations.

CONVENIENCE AND ROBUSTNESS



The 7 sizes are designed for surface mounting, with both internal and external fixing. The cover has stainless steel captive screws, with thicknesses optimised for maximum mechanical strength and resistance to climate and environmental stresses.

PROFESSIONAL RANGE



The IP66 rated boxes can be used as junction boxes, with options to mount bottom plates or DIN rails. The cover is equipped with stainless steel captive fixing screws and the bottom contains a earthing insert.

ATEX VERSIONS





The GW Connect Series boxes are available in coated and uncoated versions and also in an ATEX version, to integrate perfectly with other GEWISS solutions for potentially explosive environments, classified as 2(G) and 22(D) areas.

SURFACE-MOUNTING BOARDS

Code	External dimensions LxHxD (mm)	Input number	Input diameter (mm)
	GW 42 001	200x150x40	Ø 20,5
	GW 42 002	200x150x60	
	GW 42 003	200x150x80	
	GW 42 004	300x200x40	Ø 23/29
	GW 42 005	300x200x60	
	GW 42 006	300x200x80	
	GW 42 007	300x200x120	
	GW 42 008	400x300x60	
	GW 42 009	400x300x80	
	GW 42 010	400x300x120	





BACK-MOUNTING PLATES

METAL	INSULATING	Dimensions LxH (mm)
		190x140
GW 44 615	GW 44 625	
GW 44 615	GW 44 625	
GW 44 615	GW 44 625	240x190
GW 44 616	GW 44 626	
GW 44 616	GW 44 626	
GW 44 616	GW 44 626	
GW 44 616	GW 44 626	300x220
GW 44 617	GW 44 627	
GW 44 617	GW 44 627	
GW 44 617	GW 44 627	

FLOOR-MOUNTING DISTRIBUTION BOARD

Code	External dimensions LxHxD (mm)	Input number	Input diameter (mm)
	GW 68 441	200x295x180	-

SOCKET-OUTLETS IB 16/32 A

Vertical 67 IB with back-mounting box IP67	Combibloc IP44/55		Horizontal 44 IB with back-mounting box IP44	
- SBF - CBF - AUTOMATIKA (MT)	Without back-mounting box	With back-mounting box	Without fuse-holder base	With fuse-holder base
				
They can only be installed in the high part of the support base				

Q-DIN 5

27 COMBI IP55

	GW 68 227 N	
	GW 68 212 N	
	GW 68 017 N	
Up to the 12-gang version		

42 TV

Multifunctional supporting bases

A range of boards for universal applications, as for example the support of electronic devices, power supply units or for the creation of small control boards with indicators and push-buttons. The cover with honeycomb finish offers the possibility of direct screw mounting of exposed equipment. Completing the offer is the watertight floor version outlet box ideal for example for the fixing of surface or recessed sockets-outlets.

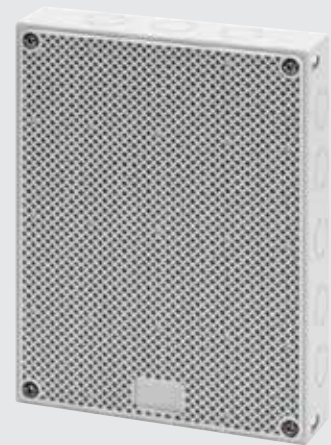

DISTRIBUTION TOWER AND BOARDS



**IK
08**

**GWT
650°C**



SURFACE-MOUNTING DISTRIBUTION BOARDS - IP41



GW 42 001

BOARDS WITH REVERSIBLE DOOR - SMOOTH AND HONEYCOMB SURFACE - GREY RAL 7035



Code	Outer dim. LxHxD (mm)	No. input	Pack Carton
GW 42 001	200x150x40	Ø 20.5 = 16	32
GW 42 002	200x150x60	Ø 20.5 = 12 Ø 20.5/23 = 4	44
GW 42 003	200x150x80	Ø 20.5 = 12 Ø 20.5/23 = 4	32
GW 42 004	300x200x40	Ø 20.5 = 16	16
GW 42 005	300x200x60	Ø 23/29 = 16	21
GW 42 006	300x200x80	Ø 23/29 = 16	16
GW 42 007	300x200x120	Ø 23/29 = 16	10
GW 42 008	400x300x60	Ø 23/29 = 22	10
GW 42 009	400x300x80	Ø 23/29 = 22	8
GW 42 010	400x300x120	Ø 23/29 = 22	5

CHARACTERISTICS: TV board (BxH) 200x150 mm with impact resistance IK07.

NOTES: to restore the double insulation, use the screwcaps provided.

FLOOR MOUNTING AND WORKBENCH TOWER - IP55



GW 68 441

PILLAR WITH REVERSIBLE DOOR WITH SMOOTH AND HONEYCOMBED SURFACE GREY RAL 7035



Code	Outer dim. LxHxD (mm)	Houseable IB socket-outlets	Installable Q-DIN boards	Pack Carton
GW 68 441	200x295x180	16/32 A	Q-DIN 5	1/6

CHARACTERISTICS: double-sided panels with smooth or honeycomb surface, for fixing interlocked switched socket-outlets 16/32A of the IB range: Combibloc, horizontal IP44 with bottom and vertical IP67 with bottom.

COMPLEMENTARY ITEMS



GW 26 406

WATERPROOF COUPLER

Code	Mounting hole Ø (mm)	Type of pitch	Pack Carton
GW 26 406	23	PG16	25/250

APPLICATIONS: for the combined assembly of enclosures, junction boxes, etc..

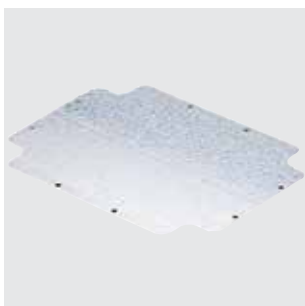

GW 44 615

BACK-MOUNTING PLATE WITH SELF-TAPPING FIXING SCREWS

Code	For boxes dimensions	For distribution boards	Pack Carton
Material: Galvanized metal			
GW 44 615	190x140	GW42001 - GW42002 - GW42003	20
GW 44 616	240x190	GW42004 - GW42005 - GW42006 - GW42007	20
GW 44 617	300x220	GW42008 - GW42009 - GW42010	20
Material: Insulation			
GW 44 625	190x140	GW42001 - GW42002 - GW42003	20
GW 44 626	240x190	GW42004 - GW42005 - GW42006 - GW42007	20
GW 44 627	300x220	GW42008 - GW42009 - GW42010	20



GW 52 402

CUP DRILL MILLING CUTTER TO DRILL PANELS

Code	Description	Pack Carton
GW 52 402	Cup drill milling Ø56	10

APPLICATIONS: suitable for low voltage flush-mounting socket-outlets IEC 309 2P+E 16A and for all the extra-low voltage flush-mounting socket-outlets IEC 309.



42 TV

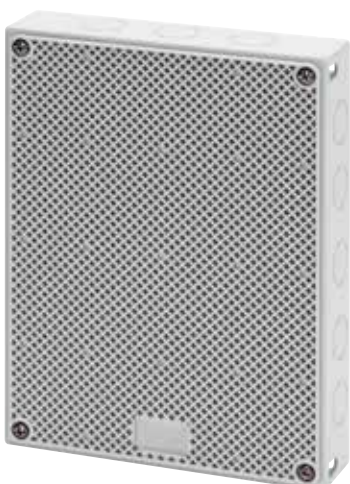

Scan the QR Code and find out all the technical informations.

A COMPLETE OFFER



The range consists of three sizes with different depths, and the practical floor-mounted tower. The accessories line includes back-mounting plates in sheet metal or insulating material, screwcaps to restore the IP protection rating and double insulation.

APPLICATION MULTIFUNCTIONALITY



The front panel of the support bases is reversible: one face is smooth, to facilitate the fitting of recessed components and the other has a hollow structure to facilitate visible fitting of the products. Ideal for control and signalling boards.

FLOOR-STANDING TOWER VERSION



The practical and functional floor-standing tower, with an IP55 rating, enables configurations with IB interlocked sockets, Q-DIN distribution boards and enclosures of the 27 COMBI range.



FLUSH-MOUNTING ENCLOSURES



Domo Center

FLUSH-MOUNTING SYSTEM COLUMNS
FOR DISTRIBUTION, HOME & BUILDING
AUTOMATION AND DATA

pag. 1158

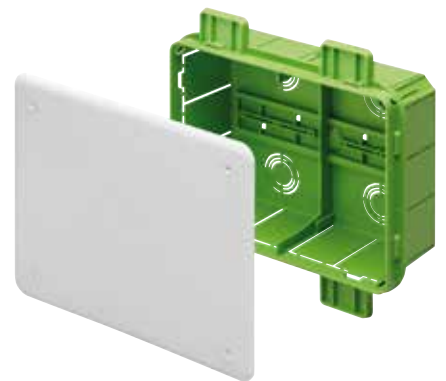

Green Wall

FLUSH-MOUNTING SYSTEM FOR
PLASTERBOARD WALLS

pag. 242



40 CDi

FLUSH-MOUNTING DISTRIBUTION
BOARDS AND ENCLOSURES

pag. 264



48

FLUSH-MOUNTING JUNCTION AND
MODULAR BOXES SYSTEM

pag. 286



24 SC

FLUSH MOUNTING; SURFACE OR
UNDERFLOOR BOXES

pag. 302

Green Wall

40 CDKI RANGE GREEN WALL MODULAR AND PROTECTED ENCLOSURE AND DISTRIBUTION BOARDS - IP40



Color: RAL 9016 white
Door: smoked transparent

Code	Modules
GW 40 605 PM	12
GW 40 606 PM	24 (12X2)
GW 40 609 PM	36 (18X2)
GW 40 610 PM	54 (18X3)
GW 40 611 PM	72 (18X4)

COMPLEMENTARY ITEMS

1-module cover profile	kit long self-threading screws	Element for combined coupling	Internal horizontal dividers	Blank covering panels	Cylindrical security lock
Code	Code	Code	Code	Code	Code
GW 40 467	GW 48 645	2 x GW 40 425	-	-	1 x GW 40 422
			GW 40 487	GW 40 495	
			GW 40 488	GW 40 496	2 x GW 40 422

48 PT DIN GREEN WALL BOXES FOR JUNCTION AND DOMOTICS - IP40



(equipped with DIN rail on the bottom)

Code	Dimensions	Lid colour
GW 48 006 PM	196x152x75	RAL9016 white
GW 48 126 PM	196x152x75	Transparent
GW 48 007 PM	294x152x75	RAL9016 white
GW 48 008 PM	392x152x75	RAL9016 white
GW 48 009 PM	480x160x75	RAL9016 white

COMPLEMENTARY ITEMS

Protective shield	No. of internal divider	Joining element	Spare lid plain IP40	Spare lid deep IP40
Code	Code	Code	Code	Code
GW 48 006 P	1 x GW 48 012	2 x GW 48 051	GW 48 017	GW 48 086
GW 48 007 P	2 x GW 48 012		GW 48 018	GW 48 087
GW 48 008 P	3 x GW 48 012		GW 48 019	GW 48 088
GW 48 009 P	2 x GW 48 012		GW 48 020	-

48 CM GREEN WALL LARGE CAPACITY CONNECTION AND JUNCTION BOXES - IP40

			COMPLEMENTARY ITEMS			
			No. of internal divider	Joining element	Spare lid plain IP44	Spare lid deep IP44
						
Code	Dimensions	Lid colour	Code	Code	Code	Code
GW 48 207 PM	260x260x121	RAL9016 white	1 supplied	2 supplied	GW 48 247	GW 48 267
GW 48 211 PM	520x260x121	RAL9016 white	4 supplied	2 supplied	GW 48 251	GW 48 271

40 CDKI GREEN WALL PROTECTED ENCLOSURES AND DISTRIBUTION BOARDS - IP40 WITH ANTIBACTERIAL FRONT

Modules	Antibacterial Front	Green Wall Back box
12	GW 41 885 AB	GW 40 685 PM
24 (12X2)	GW 41 886 AB	GW 40 687 PM
36 (18X2)	GW 41 889 AB	GW 40 688 PM
54 (18X3)	GW 41 890 AB	GW 40 689 PM
72 (18X4)	GW 41 891 AB	GW 40 690 PM

48 PT DIN GREEN WALL BOXES FOR JUNCTION AND DOMOTICS - IP40 WITH ANTIBACTERIAL LID IK10

Dimensions	Lid colour	Antibacterial Lid	Green Wall Back box
196x152x75	White RAL 9016	GW 48 017 AB	GW 48 116 PM
294x152x75	White RAL 9016	GW 48 018 AB	GW 48 117 PM
392x152x75	White RAL 9016	GW 48 019 AB	GW 48 118 PM
480x160x75	White RAL 9016	GW 48 020 AB	GW 48 119 PM

Green Wall

GREEN WALL BOXES FOR INTERLOCKED SOCKETS

**Flush-mounting boxes
for 67 IB sockets**



Code

GW 66 683 PM

Houseable sockets

16/32A version SBF-CBF-AUTOMATIKA

**Flush-mounting boxes
for 44 IB horizontal sockets**



Code

GW 66 681 PM















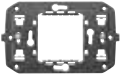



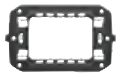













GW 66 682 PM

Houseable sockets

16/32A version SBF

16/32A version CBF







24 SC GREEN WALL - FLUSH-MOUNTING BOXES FOR MODULAR RANGE

24 SC RANGE GREEN WALL		No. place	CHORUSMART RANGE		SYSTEM RANGE		COMPLEMENTARY ITEMS	
Boxes	Code		Support	Plates	Support	Support	Internal divider	Lid
 <p>RECTANGULAR</p>	GW 24 403 PM	1	 GW 16 802	 ONE - GEO - EGO	 GW 24 201	 TOP SYSTEM - VIRNA	GW 24 321	-
		2	 GW 16 802	 ONE - GEO - EGO - LUX - ICE	 GW 24 262	 TOP SYSTEM - VIRNA		
		3	 GW 16 803 - GW 16 803 N*	 ONE - GEO - EGO - LUX - ICE - ICE TOUCH - ICE TOUCH KNX	 GW 24 201	 TOP SYSTEM - VIRNA		
	GW 24 404 PM	4	 GW 16 804 - GW 16 804 N* GW 16 824	 ONE - GEO - EGO - LUX - ICE	 GW 24 202	 TOP SYSTEM - VIRNA		
	GW 24 406 PM	6	 GW 16 806	 ONE - GEO - LUX - ICE	 GW 24 230	 TOP SYSTEM - VIRNA		
		7	 GW 16 807 N	 EGO	-	-		
	GW 24 237 PM	(4+4)	 GW 16 808	 ONE	 GW 24 240	 TOP SYSTEM - VIRNA		
 <p>ROUND</p>	GW 24 234 PM	1	 GW 16 802	 ONE - GEO - EGO	-	-	GW 24 218	
		2	 GW 16 802	 ONE - GEO - EGO - ICE	-			
			 GW 16 822 - GW 16 822 N*	 ONE - GEO - EGO - LUX (International)	-			

* For EGO SMART

Green Wall

COMPATIBILITY OF FLUSH-MOUNTING ENCLOSURES WITH BIPOLAR AND UNIPOLAR TERMINAL BLOCKS

Enclosures	Code	Terminal block position	Screw terminal type		
					
			TERMINAL BLOCK SIZE 1		
			Bipolar 125 A 2 x [(1x35)+(7x10)]	Bipolar 80 A 2 x [(2x16)+(7x10)]	Unipolar 80 A 1 x [(2x16)+(7x10)]
			GW 40 401	GW 40 408 B	GW 40 408 U
40 CDK GREEN WALL ENCLOSURES AND DISTRIBUTION BOARDS FOR PLASTERBOARD WALLS IP40 	GW 40 605 PM		No. 1 (*)	No. 1 (*)	No. 1 (*)
	GW 40 606 PM		No. 2 (*)	No. 2 (*)	No. 2 (*)
	GW 40 609 PM		No. 2 (*)	No. 2 (*)	No. 2 (*)
	GW 40 610 PM		No. 3 (*)	No. 3 (*)	No. 3 (*)
	GW 40 611 PM		No. 4 (*)	No. 4 (*)	No. 4 (*)

(*) The installation is allowed using No.1 adapter GW40413 for each terminal block installed.

COMPATIBILITY BETWEEN GEWISS DOMOTIC DEVICE AND 48 PT DIN GREEN WAL

GEWISS DOMOTIC DEVICES		48 PT DIN GREEN WALL BOXES				
		Code	GW 48 006 PM GW 48 126 PM	GW 48 007 PM	GW 48 008 PM	GW 48 009 PM
Compartments			2	3	4	3
No. of EN 50022 modules per compartment			4,5	5	5	8
No. mod. EN 50022 MAX pde (W)*			11	13	17	25
KNX DEVICES FROM DIN RAIL	KNX line/field couplers	2	●	●	●	●
	KNX power supplies	4	●	●	●	●
	KNX motor control actuators	4	●	●	●	●
		8				●
	KNX dimmer	4	●	●	●	●
	KNX general actuators	4	●	●	●	●
		8				●
	DALI/KNX, Gateway	4	●	●	●	●
	KNX input modules	4	●	●	●	●
KNX BUS interfaces	1	●	●	●	●	
DOMOTIC DEVICES FOR DOMESTIC RANGES	KNX domestic range actuators	3	●	●	●	●
	Relay	1,5 and 3	●	●	●	●

* Dispersible power calculated according to IEC 60674-24.

COMPATIBILITY OF FLUSH-MOUNTING ENCLOSURES WITH BIPOLAR AND UNIPOLAR TERMINAL BLOCKS

Screw terminal type



TERMINAL BLOCK SIZE 2				TERMINAL BLOCK SIZE 3		
Bipolar 125 A 2 x [(3x35)+(10x10)]	Bipolar 80 A 2 x [(3x16)+(11x10)]	Unipolar 80 A 1 x [(3x16)+(11x10)]	Unipolar 80 A 1 x [(3x16)+(29x10)]	Bipolar 125 A 2 x [(5x35)+(14x10)]	Bipolar 80 A 2 x [(3x16)+(17x10)]	Unipolar 80 A 1 x [(3x16)+(17x10)]
GW 40 402	GW 40 412 B	GW 40 412 U	GW 40 422 U	GW 40 404	GW 40 418 B	GW 40 418 U
No. 1	No. 1	No. 1	No. 1	-	-	-
No. 2	No. 2	No. 2	No. 2	-	-	-
No. 2 (*)	No. 2 (*)	No. 2 (*)	No. 2 (*)	No. 2	No. 2	No. 2
No. 3 (*)	No. 3 (*)	No. 3 (*)	No. 3 (*)	No. 3	No. 3	No. 3
No. 4 (*)	No. 4 (*)	No. 4 (*)	No. 4 (*)	No. 4	No. 4	No. 4

COMPATIBILITY BETWEEN 48 GREEN WALL BOXES AND AND TERMINAL BLOCKS 44 RANGE

Range	Code	MULTI-POLE			SINGLE-POLE EQUIPOTENTIAL							
		GW 44 609	GW 44 611	GW 44 613	GW 44 704	GW 44 706	GW 44 708	GW 44 671	GW 44 672	GW 44 673	GW 44 675	GW 44 676
		GW 44 610	GW 44 612	GW 44 614						GW 44 674		
48 PT DIN GREEN WALL	GW 48 006 PM	●	●	●	●	●	●	●	●	●	-	-
	GW 48 126 PM	●	●	●	●	●	●	●	●	●	-	-
	GW 48 007 PM	●	●	●	●	●	●	●	●	●	-	-
	GW 48 008 PM	●	●	●	●	●	●	●	●	●	-	-
	GW 48 009 PM	●	●	●	●	●	●	●	●	●	-	-
48 CM GREEN WALL	GW 48 207 PM	●	●	-	●	●	●	●	●	●	-	-
	GW 48 211 PM	●	●	-	●	●	●	●	●	●	-	-

Green Wall

Flush-mounting system for plasterboard walls

The most complete system of containers for lightweight and plasterboard walls; GEWISS patented solutions. Made with halogen-free technopolymer and GWT 850°C. The range include enclosures and distribution boards up to 72 M; 48 PT DIN GREENWALL range junction boxes with integrated DIN rail on the back plate, compliant with CEI 23-49, ideal for the pre-arrangement and installation of domotic devices; boxes for wiring devices and boxes for interlocked switched socket-outlets.



40 CDKI GREEN WALL - ENCLOSURES AND DISTRIBUTION BOARDS FOR LIGHTWEIGHT AND PLASTERBOARD WALLS - IP40

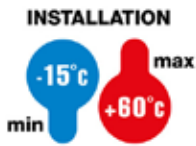

IK
08

IP
40

GWT
850°C



SMOKED TRANSPARENT DOOR



GW 40 606 PM

MODULAR ENCLOSURES AND DISTRIBUTION BOARDS WITH WINDOWED PANEL AND EXTRACTABLE FRAME PREDISPOSED FOR HOUSING TERMINAL BLOCKS - WHITE RAL 9016 - SMOKED DOOR



Code	No. of modules EN 50022	Outer dim. LxHxD (mm)	Dispersible power (W)	Pack Carton
GW 40 605 PM	12	330x270x85	36	8
GW 40 606 PM	24 (12X2)	330x420x85	37	6
GW 40 609 PM	36 (18x2)	465x505x85	52	3
GW 40 610 PM	54 (18x3)	465x680x95	62	3
GW 40 611 PM	72 (18x4)	465x880x95	95	1

CHARACTERISTICS: Lead sealable and removable panels with windows, except for code GW40605PM. Back plates equipped with tabs for fixing on a metal structure for lightweight and plasterboard walls. Locators to mark the wall along the edges of the back plate. Horizontal modularity using the joining element GW40425 for enclosure GW40605PM. Vertical modularity using the joining element GW40425 for boards GW40606PM-GW40609PM-GW40610PM-GW40611PM.

NOTES: Dissipated power calculated according to CEI 23-49. Casing type H according to EN 60670-1, and type Ha according to IEC 60670-1.

GWT 850°C, according to EN 60695-2-11, related to the green flush-mounting box.

Upon request, flush-mounting boxes and cabinets (including frame and DIN rails) can be supplied separately.

ACCESSORIES SUPPLIED: Self-tapping screws kit ø 4x45 mm with spacers for fixing frontal panels.

INSTALLATION: For the possible enclosure-terminal block combinations, refer to the summary "COMPATIBILITY OF FLUSH-MOUNTING ENCLOSURES WITH BIPOLAR AND UNIPOLAR TERMINAL BLOCKS" in the selection guides of 40CDI range.

ANTIBACTERIAL FRONT KIT



GW 41 890 AB

DISTRIBUTION FRONT KIT WINDOWED PANELS AND EXTRACTABLE FRAME PREDISPOSED FOR HOUSING THE TERMINAL BLOCKS - WHITE RAL 9016 - ANTIBACTERIAL



Code	No. of modules EN 50022	Outer dim. LxHxD (mm)	Dispersible power (W)	Pack Carton
GW 41 885 AB	12	330x270x16	36	12
GW 41 886 AB	24 (12X2)	330x420x16	37	5
GW 41 889 AB	36 (18x2)	465x505x16	52	3
GW 41 890 AB	54 (18x3)	465x680x25	62	2
GW 41 891 AB	72 (18x4)	465x880x25	95	1

ACCESSORIES SUPPLIED: module masks, circuit labels. Self-adhesive label to be filled out for certification according to standard CEI 23-51.

NOTES: dissipated power calculated according to CEI 23-49. The antibacterial front kit is composed of frame, door, lock covers, opening handles. The kit includes also functional frame and DIN rails.

CHARACTERISTICS: lead sealable and removable panels with windows. Thermo-pressure with ball equal to 70 °C. Flush-mounting boxes can be assembled side-by-side through the coupling tool code GW40425.

INSTALLATION: the matching back box for brick walls or plasterboard walls must be ordered separately. For the possible enclosure-terminal block combinations, refer to the summary "COMPATIBILITY OF FLUSH-MOUNTING ENCLOSURES WITH BIPOLAR AND UNIPOLAR TERMINAL BLOCKS" in the selection guides of 40CDI range.



GW 40 689 PM

FLUSH-MOUNTING GREEN WALL BACK BOX FOR ANTIBACTERIAL FRONT KIT - FOR PLASTERBOARD WALL

Code	No. of modules EN 50022	Suitable for ANTIBACTERIAL front kit	Pack Carton
GW 40 685 PM	12	GW41885AB	1/12
GW 40 687 PM	24 (12x2)	GW41886AB	1/5
GW 40 688 PM	36 (18x2)	GW41889AB	1/5
GW 40 689 PM	54 (18x3)	GW41890AB	1/3
GW 40 690 PM	72 (18x4)	GW41891AB	1/2

CHARACTERISTICS: equipped with tabs for fixing on a metal structure for lightweight and plasterboard walls. Locators to mark the wall along the edges of the back box. Back boxes can be coupled with the accessory GW40425.

NOTE: GWT 850°C, according to EN 60695-2-11.

INSTALLATION: the matching antibacterial front kit must be ordered separately.

COMPLEMENTARY ITEMS FOR ENCLOSURES AND BOARDS 40 CDKI GREEN WALL



GW 40 422

CYLINDER SECURITY LOCK FOR 40 CDKI ENCLOSURES

Code	Material	Pack Carton
GW 40 422	Pressure die-cast metal	1/10

ACCESSORIES SUPPLIED: 2 keys.

NOTES: All the keys and relative locks with the same product code are identical.



GW 40 467

PLASTIC MODULE COVER PROFILE



Code	No. of modules EN 50022	Colour	Pack Carton
GW 40 467	4.5	White RAL 9016	50

CHARACTERISTICS: clip fixing.



GW 40 425

ELEMENT FOR COMBINED COUPLING OF CDKI AND CDI FLUSH-MOUNTING DECORATIVE ENCLOSURES AND DISTRIBUTION BOARDS



Code	Fixing	Pack Carton
GW 40 425	Clip	10

APPLICATIONS: for CDKI enclosures and boards from 12 modules upwards. Also suitable for 40 CDi decorative enclosures with 8 and 12 modules and for the QDSA enclosures. For CDKI GREEN WALL enclosures and boards, the GW40425 element permits horizontal paths for the 12M enclosure and vertical paths for 24M to 72M boards.

NOTES: GWT 850 °C according to EN 60695-2-11.



GW 40 487

INTERNAL HORIZONTAL DIVIDERS FOR CDKI DISTRIBUTION BOARDS



Code	For boards EN 50022 rail	Fixing	Pack Carton
GW 40 487	12 Modules	Clip	10/100
GW 40 488	18 Modules	Clip	10/100

NOTES: they permit making internal separation between the circuits having different voltages located on more than one row inside the same shell.



GW 40 495

BLANK COVERING PANELS - 1-MODULE HEIGHT - FOR CDKI BOARDS



Code	Suitable for	For boards EN 50022 rail	Colour	Pack Carton
GW 40 495	Flush mounting distr. boards	12 Modules	White RAL 9016	20
GW 40 496	Flush mounting distr. boards	18 Modules	White RAL 9016	20

CHARACTERISTICS: sealing.



GW 40 412 B

INSULATED SCREW TERMINAL BLOCK BIPOLAR AND UNIPOLAR FOR ENCLOSURES AND BOARDS

Code	Pole 1 (mm ²)	Pole 2 (mm ²)	Fastener to supports	Pack Carton
Type: Bipolar - Rated current 125 A				
GW 40 401	N (1x35) + (7x10)	E (1x35) + (7x10)	With screws	10
GW 40 402	N (3x35) + (10x10)	E (3x35) + (10x10)	With screws and/or clip	10
GW 40 404	N (5x35) + (14x10)	E (5x35) + (14x10)	With screws and/or clip	10
Type: Bipolar - Rated current 80 A - IP20				
GW 40 408 B	N/E (2x16) + (7x10)	N/E (2x16) + (7x10)	With screws	1/10
GW 40 412 B	N/E (3x16) + (11x10)	N/E (3x16) + (11x10)	With screws and/or clip	1/10
GW 40 418 B	N/E (3x16) + (17x10)	N/E (3x16) + (17x10)	With screws and/or clip	1/10
Type: Unipolar - Rated current 80 A - IP20				
GW 40 408 U	N/E (2x16) + (7x10)	-	With screws	1/10
GW 40 412 U	N/E (3x16) + (11x10)	-	With screws and/or clip	1/10
GW 40 422 U	N/E (3x16) + (29x10)	-	With screws and/or clip	1/10
GW 40 418 U	N/E (3x16) + (17x10)	-	With screws and/or clip	1/10

ACCESSORIES SUPPLIED: fixing screws. The 80 A terminal blocks are equipped with N and E labels to be placed on the respective spaces to identify the poles.

CHARACTERISTICS: GWT 960°C according to EN60695-2-11.

INSTALLATION: for the possible enclosure-terminal block combinations, refer to the summary "EQUIPPABILITY OF GREEN WALL FLUSH-MOUNTING ENCLOSURES WITH TWO-POLE OR ONE-POLE TERMINAL" within the selection guides for the GREEN WALL range.



GW 40 413

ADAPTER FOR SCREW TERMINAL BLOCKS

Code	For enclosures	Fastener to supports	Pack Carton
GW 40 413	12 M (and multiples) and 18 M (and multiples)	With screws	20

ACCESSORIES SUPPLIED: fixing screws.

CHARACTERISTICS: the adapter is pre-drilled for the correct assembly of the terminal block and pre-cut to allow installation also in enclosures with a 12 M modular step.

INSTALLATION: used to expand the number of possible enclosure-terminal block combinations, refer to the summary "COMPATIBILITY OF FLUSH-MOUNTING ENCLOSURES WITH BIPOLAR AND UNIPOLAR TERMINAL BLOCKS" in the selection guides of GREEN WALL range.



GW 48 645

KIT OF 4 LONG SELF-TAPPING SCREWS WITH SPACERS FOR FIXING LIDS AND FRONTS

Code	Screw dimension (mm)	Spacer thickness (mm)	Pack Carton
GW 48 645	∅ 4x45	Max 10 mm reducible	1/100

CHARACTERISTICS: the kit can be used for the following flush-mounting ranges: CD Chorus, CDi/CDKi (from 6 modules upwards), 48 CM and 42 RV.

40 CDKI GREEN WALL - MULTI-SERVICE SYSTEM ENCLOSURES

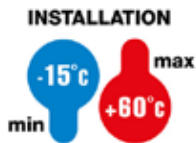

**IK
08**

**IP
40**

**GWT
850°C**



MULTIMEDIA ENCLOSURES



GW 40 390 C

MULTIMEDIA ENCLOSURE COMPACT VERSION 36 DIN MODULES - WHITE RAL 9016 - BLANK DOOR



Code	Description	Outer dim. LxHxD (mm)	Pack Carton
GW 40 390 C	Front cover, inner frame and accessories 36 DIN modules	465x505x85	1
GW 40 688 PM	Empty Green Wall back box 36 DIN modules	-	1/5

APPLICATIONS: the compact multimedia enclosure is the central element of multi-service wiring within the home, allowing the distribution of signals to the various rooms. The compact version is ideal for settings where the available space is limited and a small number of services need to be managed.

CHARACTERISTICS: the product is compliant with the CEI 306-2 Guide. The back of the box has plastic tabs for an easier installation on metal frames and drywall panels. The product can be joined vertically with other enclosures of the CDKi range (minimum size 36 DIN modules) using GW40425 coupling elements.

ACCESSORIES SUPPLIED: the GW40390C is composed of 1 pc front cover with blank door, 1 pc detachable frame with 2 pcs perforated mounting plates (1 pc with 18 Keystone Jack slots), 2 m velcro roll w=16 mm, 4 pcs brackets with screws, 4 pcs self-adhesive cable clips with cable ties, 5 pcs RJ45 Cat.6 keystone jacks.

INSTALLATION: the product can be installed on both lightweight and plasterboard partition walls.



GW 40 390 F

MULTIMEDIA ENCLOSURE COMPACT VERSION 54 DIN MODULES - WHITE RAL 9016 - BLANK DOOR



Code	Description	Outer dim. LxHxD (mm)	Pack Carton
GW 40 390 F	Front cover, inner frame and accessories 54 DIN modules	465x680x95	1
GW 40 689 PM	Empty Green Wall back box 54 DIN modules	-	1/3

APPLICATIONS: the complete multimedia enclosure is the central element of multi-service wiring within the home, allowing the distribution of signals to the various rooms. The full version is ideal for residential settings where a large number of services and reception/transmission devices need to be managed.

FEATURES: the product is compliant with the CEI 306-2 Guide. The back box has plastic tabs for easier installation on metal frames and drywall panels. The product can be joined vertically with other enclosures of the CDKi range (minimum size 36 DIN modules) using GW40425 coupling elements.

ACCESSORIES SUPPLIED: the GW40390F includes of 1 pc front cover with blank door, 1 pc detachable frame with 3 pcs perforated mounting plates (1 pc with 18 Keystone Jack slots), 3 m velcro roll w=16 mm, 6 pcs brackets with screws, 6 pcs self-adhesive cable clips with cable ties, 6 pcs RJ45 Cat.6 data sockets, 6 pcs RJ45-RJ45 Cat.6 Ethernet cable 0.6 m, 1 pc telephone splitter with 5 pcs RJ11 socket and 5 pcs RJ11-RJ45 telephone cables, 1 pc multiple socket.

INSTALLATION: the product can be installed on both lightweight and plasterboard partition walls.

TECHNICAL ACCESSORIES FOR HOME NETWORKING ENCLOSURES



GW 40 422

CYLINDRICAL SECURITY LOCK

Code	Material	Pack Carton
GW 40 422	Pressure die-cast metal	1/10

ACCESSORIES SUPPLIED: 2 keys.

NOTES: all the keys and relative locks with the same product code are identical.



GW 40 425

ELEMENT FOR COMBINED COUPLING OF CDKI AND CDI FLUSH-MOUNTING DECORATIVE ENCLOSURES AND DISTRIBUTION BOARDS



Code	Fixing	Pack Carton
GW 40 425	Clip	10

APPLICATIONS: for CDKI enclosures and boards from 12 modules upwards. Also suitable for 40 CDI decorative enclosures with 8 and 12 modules and for the QDSA enclosures. For CDKI GREEN WALL enclosures and boards, the GW40425 element permits horizontal paths for the 12M enclosure and vertical paths for 24M to 72M boards.

NOTES: GWT 850 °C according to EN 60695-2-11.



GW 38 098

TELEPHONE JACK EXPANSION KIT

Code	Description	Pack Carton
GW 38 098	RJ11 telephone socket and telephone cable	1

ACCESSORIES SUPPLIED: 1 multiple telephone socket-outlet with 5 RJ11 socket-outlets.

48 PT DIN GREEN WALL - JUNCTION BOXES FOR LIGHTWEIGHT AND PLASTERBOARD WALLS - IP40

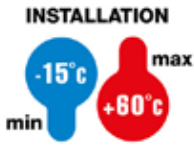

**IK
07**

**IP
40**

**GWT
850°C**



FOR LIGHTWEIGHT AND PLASTERBOARD WALLS



GW 48 006 PM

JUNCTION AND CONNECTION BOXES FOR SIDE-BY-SIDE ASSEMBLY WITH DIN RAIL INTEGRATED ON THE BACK-MOUNTING BOX - COLOUR: WHITE LID RAL 9016



Code	Outer dim. LxHxD (mm)	Compartment pre-arrangement	No. EN 50022 mod. per comp.	Domotic equipment coupling	Dispersible max power (W)	No. supports GW44720	Pack Carton
GW 48 006 PM	196x152x75	2	4,5	DIN rail	11	2	1/30
GW 48 007 PM	294x152x75	3	5	DIN rail	13	3	1/21
GW 48 008 PM	392x152x75	4	5	DIN rail	17	4	1/14
GW 48 009 PM	480x160x75	3	8	DIN rail	25	5	1/12

APPLICATIONS: boxes with a built-in DIN rail on the back-mounting box, in accordance with regulations that require to fix by DIN rail the devices that disperse a certain amount of power inside the junction boxes (calculated in compliance with CEI 23-49). Ideal for relocation of domotic equipment as actuators, power supplies, etc...

CHARACTERISTICS: surface embossing of the covers to facilitate painting. Pre-arrangement combined horizontal coupling using joining element, code GW48051. Lid protected with heat-shrinking film that also contains the bag of fixing screws. Locators to aid tracing the wall along the edges of the box. Boxes equipped with tabs for direct fixing on panels or a metal structure for lightweight and plasterboard walls. Possibility of fixing directly on the back-mounting box of the box.

ACCESSORIES SUPPLIED: ø3x38 mm screw kit for lid fixing.

NOTES: for the inputs, remove the knockouts after cutting the relative tangs with scissors. Dispersible power calculated according to CEI 23-49. Casing type H in accordance with EN60670-1, and type Ha in accordance with IEC60670-1.

GWT 850°C, according to EN 60695-2-11, relative to the green flush-mounting back-mounting box. Also for KNX devices from DIN rail, domotic devices for domestic ranges, and devices for video entryphones.



GW 48 126 PM

JUNCTION AND CONNECTION BOX FOR SIDE-BY-SIDE ASSEMBLY WITH DIN RAIL INTEGRATED ON THE BACK-MOUNTING BOX - TRANSPARENT LID



Code	Outer dim. LxHxD (mm)	Compartment pre-arrangement	No. EN 50022 mod. per comp.	Domotic equipment coupling	Dispersible max power (W)	No. supports GW44720	Pack Carton
GW 48 126 PM	196x152x75	2	4,5	DIN rail	11	2	1/30

APPLICATION: boxes with a built-in DIN rail on the back-mounting box, in accordance with regulations that require to fix by DIN rail the devices that disperse a certain amount of power inside the junction boxes (calculated in compliance with CEI 23-49).

CHARACTERISTICS: Pre-arrangement combined horizontal coupling using joining element, code GW48051. Lid protected with heat-shrinking film that also contains the bag of fixing screws. Locators to aid tracing the wall along the edges of the box. Boxes equipped with tabs for direct fixing on panels or a metal structure for lightweight and plasterboard walls. Possibility of fixing directly on the back-mounting box of the box.

ACCESSORIES SUPPLIED: ø3x38 mm screw kit for lid fixing.

NOTES: for the inputs, remove the knockouts after cutting the relative tangs with scissors. Dispersible power calculated according to CEI 23-49. Casing type H in accordance with EN60670-1, and type Ha in accordance with IEC60670-1.

GWT 850°C, according to EN 60695-2-11, relative to the green flush-mounting back-mounting box. Ideal for medical room applications where the earthing point must be inspectable.

ANTIBACTERIAL SHOCKPROOF LIDS



GW 48 017 AB

ANTIBACTERIAL SHOCKPROOF LIDS FOR PT / PT DIN AND PT DIN GREEN WALL BOXES WHITE RAL 9016 - IP40



Code	Suitable for	Mechanical resistance	Pack Carton
GW 48 017 AB	GW48116 and GW48116PM	IK10	1/50
GW 48 018 AB	GW48117 and GW48117PM	IK10	80/40
GW 48 019 AB	GW48118 and GW48118PM	IK10	1/20
GW 48 020 AB	GW48119 and GW48119PM	IK10	1/20

CHARACTERISTICS: the packaging includes screws for installation in brick walls or plasterboard walls. GWT 850 °C according to EN 60695-2-11.



GW 48 116 PM

FLUSH-MOUNTING GREEN WALL BACK BOXES FOR ANTIBACTERIAL SHOCKPROOF LIDS - FOR BRICK WALL



Code	Suitable for	Pack Carton
GW 48 116 PM	GW48017AB	30
GW 48 117 PM	GW48018AB	20
GW 48 118 PM	GW48019AB	10
GW 48 119 PM	GW48020AB	10

NOTE: the Antibacterial shockproof lid must be ordered separately.

COMPLEMENTARY ITEMS FOR BOXES FOR LIGHTWEIGHT AND PLASTERBOARD WALLS



GW 48 006 P

PROTECTIVE SHIELD FOR JUNCTION, CONNECTION AND DOMOTICS BOXES PT DIN AND PT DIN GREEN WALL



Code	For boxes PT DIN	For PT DIN GREEN WALL boxes	Pack Carton
GW 48 006 P	GW48006	GW48006PM and GW48126PM	70
GW 48 007 P	GW48007	GW48007PM	60
GW 48 008 P	GW48008	GW48008PM	50
GW 48 009 P	GW48009	GW48009PM	40

CHARACTERISTICS: in technopolymer. applying the protective shield beneath the lid, the dispersible power of the box is reduced by 2W for GW48006PM, GW48007PM, GW48008PM boxes and by 3W for GW48009.

NOTES: clip fixing to speed up assembly and removal operations. Reusable.



GW 48 051

JOINING ELEMENT FOR PT / PT DIN AND PT DIN GREEN WALL BOXES



Code	For PT / PT DIN boxes	For PT DIN GREEN WALL boxes	Pack Carton
GW 48 051	GW48003 - GW48011	GW48006PM - GW48009PM	10

NOTES: the use of the joining element makes it possible to create horizontal and/or vertical sets of boxes PT/PT DIN. For PT DIN GREEN WALL boxes, GW40425 element permits horizontal paths. GW48051 also for the box with transparent lid GW48126PM. GWT 850 °C according to EN 60695-2-11.



GW 48 012

INTERNAL DIVIDER FOR PT DIN AND PT DIN GREEN WALL BOXES



Code	For boxes PT DIN	For PT DIN GREEN WALL boxes	Pack Carton
GW 48 012	GW48006 - GW48011	GW48006PM - GW48009PM	50/300



GW 48 018

HIGH-RESISTANCE SHOCKPROOF PLAIN COVERS FOR PT DIN AND PT DIN GREEN WALL BOXES WHITE RAL 9016 - IP40



Code	Suitable for	Mechanical resistance	Pack Carton
GW 48 017	GW48006 and GW48006PM	IK10	10/100
GW 48 018	GW48007 and GW48007PM	IK10	10/80
GW 48 019	GW48008 and GW48008PM	IK10	10/40
GW 48 020	GW48009 and GW48009PM	IK10	10/40

CHARACTERISTICS: surface embossing of the covers to facilitate painting.



GW 48 086

DEEP LIDS FOR PT DIN AND PT DIN GREEN WALL BOXES



Code	Suitable for	Pack Carton
GW 48 086	GW48006 and GW48006PM	1/10
GW 48 087	GW48007 and GW48007PM	1/5
GW 48 088	GW48008 and GW48008PM	1/5

CHARACTERISTICS: the deep lids are ideal for passing from an exposed system to a chased one. They have a removable front plate and a frame for connecting with trunking. Max lid H = 49mm for boxes up to 196x152; max lid H = 66mm for boxes up to 392x152 and conduits with max Ø = 32mm.



GW 48 023

LONG SELF-TAPPING SCREWS FOR SECURING COVER

Code	Dimensions (mm)	Suitable for	Pack Carton
GW 48 023	Ø3x38	Junction boxes range 48 PT / PT DIN and PT DIN GREEN WALL	300/4200

44 ME - UNIPOLAR EQUIPOTENTIAL TERMINAL BLOCKS

GWT
850°C



TERMINAL BLOCKS FOR SIDE-BY-SIDE ASSEMBLY



GW 44 706

TERMINAL BLOCKS WITH INDIRECT PLATE TIGHTENING - 450V - T 85°C - TRANSPARENT

Code	Connecting capacity	Pack Carton
GW 44 704	4 ways x 6 mm ²	10/100
GW 44 706	6 ways x 6 mm ²	10/100
GW 44 708	8 ways x 6 mm ²	10/100

APPLICATIONS: embedded fixing on the GW44720 support, for coupling with the DIN rail.

NOTES: for the connection capacity, refer to the technical catalogue

ACCESSORIES FOR TERMINAL BLOCKS FOR SIDE-BY-SIDE ASSEMBLY



GW 44 720

SUPPORT FOR FIXING SIDE-BY-SIDE TERMINAL BLOCKS ON DIN RAIL

Code	For equipotential terminal blocks	Terminal block fixing	Fixing on DIN rail	Pack Carton
GW 44 720	GW44704, GW44706, GW44708	Clip	Lock-joint	1/50

NOTES: ideal for applications on boxes of the 48 PT DIN range.

CHARACTERISTICS: supports a combination of terminal blocks with maximum 12-way capacity.

Possible combinations: 3xGW44704; 2xGW44706; 1xGW44704 + 1xGW44706; 1xGW44704 + 1xGW44708; Modular overall dimensions (width): 4.5 modules EN 50022.

MODULAR TERMINAL BLOCKS



GW 44 671

TERMINAL BLOCKS WITH INDIRECT SCREW TIGHTENING - 450V - T 85°C - TRANSPARENT

Code	Connecting capacity	Pack Carton
GW 44 671	3 ways x 6 mm ²	10/100
GW 44 672	5 ways x 6 mm ²	10/100
GW 44 673	4 ways x 16 mm ²	10/50
GW 44 674	2 ways x 16mm ² + 3 ways x 6 mm ²	10/50
GW 44 675	2 ways x 16mm ² + 9 ways x 6 mm ²	5/25
GW 44 676	2 ways x 35 mm ² + 4 ways x 16 mm ²	1/10

APPLICATIONS: especially suitable for creating equipotential nodes.

ACCESSORIES SUPPLIED: self-adhesive label for identification of electrical lines.

NOTES: GW44676 equipped with feedthrough terminals. These allow the creation of cut-outs from the main cables which, unsheathed in the part concerned, are not interrupted.

ACCESSORIES FOR MODULAR TERMINAL BLOCKS



GW 44 681

SUPPORT FOR FIXING MODULAR TERMINAL BLOCKS ON DIN RAIL

Code	For equipotential terminal blocks	Terminal block fixing	Pack Carton
GW 44 681	From GW44671 to GW44676	Clip	100



GW 44 682

ADAPTER FOR FIXING MODULAR TERMINAL BLOCKS

Code	For equipotential terminal blocks	Terminal block fixing	Pack Carton
GW 44 682	From GW44671 to GW44676	Lock-joint	200

APPLICATIONS: for fixing the equipotential terminal blocks on the plates or directly on the base inside the junction boxes and watertight boxes.
ACCESSORIES SUPPLIED: screws for fixing the adapter.

Green Wall

48 CM GREEN WALL - HIGH-CAPACITY BOXES FOR LIGHTWEIGHT AND PLASTERBOARD WALLS - IP40

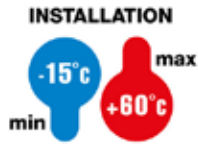

IK
07

IP
40

GWT
850°C



PLAIN LID



GW 48 207 PM

JUNCTION AND CONNECTION BOXES FOR SIDE-BY-SIDE ASSEMBLY, FOR UPRIGHTS FOR LIGHTWEIGHT AND PLASTERBOARD WALLS PLAIN PLUMBABLE LID - WHITE RAL 9016



Code	Outer dim. LxHxD (mm)	Compartment pre-arrangement	Dispersible max power (W)	Pack Carton
GW 48 207 PM	260x260x121	2	13	8
GW 48 211 PM	520x260x121	5	30	6

ACCESSORIES SUPPLIED: internal dividers, joint elements for combined assembly, self-adhesive symbol labels for circuit identification, and plumbable screws.

NOTES: dispersible power calculated according to IEC 60670-24. Casing type H in accordance with EN60670-1, and type Ha in accordance with IEC60670-1.

GWT 850°C, according to EN 60695-2-11, relative to the green flush-mounting back-mounting box.

CHARACTERISTICS: Locators to aid tracing the wall along the edges of the box. Boxes equipped with tabs for direct fixing on panels or a metal structure for lightweight and plasterboard walls. Possibility of fixing directly on the back-mounting box of the box. Horizontal modularity.

COMPLEMENTARY ITEMS



GW 48 251

SHOCKPROOF PLUMBABLE PLAIN LIDS FOR BOXES FOR UPRIGHTS - WHITE RAL 9016- IP44



Code	Front dim. LxH (mm)	Mechanical resistance	Pack Carton
GW 48 247	260x260	IK10	1/15
GW 48 251	520x260	IK10	1/10

ACCESSORIES SUPPLIED: self-adhesive symbol labels for circuit identification, and plumbable screws.



GW 48 271

SHOCKPROOF SEALABLE DEEP LIDS FOR BOXES FOR UPRIGHTS - GREY RAL 7035 - IP44



Code	For boxes dimensions	Mechanical resistance	Pack Carton
GW 48 267	260x260	IK10	1/10
GW 48 271	520x260	IK10	1/5

CHARACTERISTICS: the lid has a removable front plate and a frame for connection with trunking (max h = 65mm) and conduits (max Ø = 40mm).

The frame is fitted for fixing the DIN rails (not supplied).

Pre-arrangement EN 50022: GW48267 horizontal 24 modules (2x12), vertical 24 modules (2x12); GW48271 horizontal 78 modules (26x3), vertical 36 modules (12x3)

ACCESSORIES SUPPLIED: self-adhesive symbol labels for circuit identification, and plumbable screws.

24 SC GREEN WALL - BOXES FOR MODULAR RANGES AND KNX DEVICES

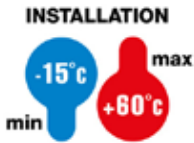

**GWT
850°C**



RECTANGULAR BOXES FOR LIGHTWEIGHT AND PLASTERBOARD WALLS

HIGH CAPACITY RECTANGULAR BOXES FOR MODULAR DOMESTIC RANGES



GW 24 403 PM



Code	Description	Fixing supports axles distance	Compartment pre-arrangement	Outer dim. LxHxD (mm)	Pack Carton
GW 24 403 PM	3 modules	83.5 mm	2	110x73x50	9/180
GW 24 404 PM	4 modules	108.5 mm	2	133x73x50	2/120
GW 24 406 PM	6-7 modules	100 mm	3	182x73x50	2/60
GW 24 237 PM	8 modules (4+4)	108.5 mm	2	131x129x53	2/24

CHARACTERISTICS: high resistance to mechanical stress and crushing. Removal of the knockouts without the use of tools. GW24403PM, GW24404PM, GW24406PM with unlosable metal grids and inserts with adjustable depth for fixing. GW24237PM with tabs for direct fixing on panels or a metal structure.

It is recommended to use a Ø 68 mm hollow mill for the correct installation of the rectangular boxes.

NOTES: Casing type H in accordance with EN60670-1, and type Ha in accordance with IEC60670-1.

ROUND BOXES FOR LIGHTWEIGHT AND PLASTERBOARD WALLS

FLUSH-MOUNTING ROUND BOXES Ø65 WITH ADJUSTABLE DEPTH INSERTS



GW 24 234 PM



Code	Description	Fixing supports axles distance	Dimensions (mm)	Pack Carton
GW 24 234 PM	Round	60 mm	Ø 65x45	5/200
GW 24 282 PM	Double	-	125x72x45	2/108

CHARACTERISTICS: high resistance to mechanical stress and crushing. GW24282PM vertical assembly to be used in combination with 2 pcs vertically coupled GW16821 or GW16822 or GW16823 supports, (removing the knockouts located on their contact side) and the ChoruSmart International plates, 2 vertical gangs, 57 mm centre distance; Supplied with 4 pcs fixing screws. GW24234PM to be used in combination with GW16821 or GW16822 or GW16823 supports and the ChoruSmart International plates. Supplied with 4 pcs fixing screws. Removal of the knockouts without the use of tools. It is recommended to use a Ø 65 mm router bit for the correct installation of the round boxes.

NOTES: Casing type H in accordance with EN60670-1, and type Ha in accordance with IEC60670-1.

GWT 850°C, according to EN 60695-2-11 relative to the green flush-mounting box. for the inputs, remove the knockouts after cutting the relative tangs using scissors.

COMPLEMENTARY ITEMS FOR BOXES FOR LIGHTWEIGHT AND PLASTERBOARD WALLS - 24 SC GREEN WALL



GW 24 321

FUNCTIONAL DIVIDER FOR RECTANGULAR BOXES



Code	For BIG BOX boxes	For GREEN WALL boxes	Pack Carton
GW 24 321	GW24403, GW24404, GW24406	GW24403PM, GW24404PM, GW24406PM	200

APPLICATIONS: to separate circuits of different voltages in accordance with Systems Standard IEC 60364 (international) and HD 384 (european).



GW 24 218

LID FOR ROUND FLUSH-MOUNTING BOXES - WHITE

Code	Description	Fixing	Pack Carton
GW 24 218	Ø 65mm	With fixing clutches	50/400

GREEN WALL BOXES FOR INTERLOCKED SOCKET-OUTLETS 67IB AND 44IB

**GWT
850°C**



FLUSH-MOUNTING BOX FOR VERTICAL INTERLOCKED SWITCHED SOCKET-OUTLETS 67IB FOR LIGHTWEIGHT AND PLASTERBOARD WALLS



GW 66 683 PM

BOX WITH FRAME FOR FLUSH-MOUNTING OF VERTICAL INTERLOCKED SOCKET-OUTLETS - IP55



Code	Houseable interloc. socket	For 67IB socket-outlets	Pack Carton
GW 66 683 PM	1	-	1/10

NOTES: the box cannot house the version with a 24V transformer. Halogen-free casing, in accordance with EN 60754-2. Casing type H in accordance with EN 60670-1, and type Ha in accordance with IEC 60670-1

GWT 850°C, according to EN 60695-2-11, relative to the green flush-mounting back-mounting box.

CHARACTERISTICS: locators for tracing the wall along the edges of the box; box equipped with tabs for direct fixing on panels or a metal structure, for lightweight and plasterboard walls.

ACCESSORIES SUPPLIED: self-tapping screw kit ø 4x45mm.

FLUSH-MOUNTING BOXES FOR HORIZONTAL INTERLOCKED SWITCHED SOCKET-OUTLETS 44IB FOR LIGHTWEIGHT AND PLASTERBOARD WALLS

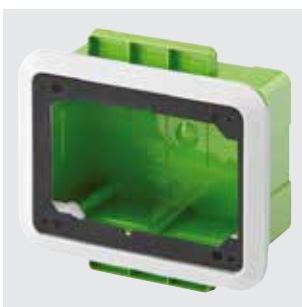

GW 66 681 PM

BOXES WITH FRAME FOR FLUSH-MOUNTING OF FIXED HORIZONTAL SOCKET-OUTLETS SBF AND CBF IP44



Code	Houseable interloc. socket	For 44 IB socket-outlets	Houseable IB socket-outlets	Pack Carton
GW 66 681 PM	1	16/32 A SBF	16/32 A	1/10
GW 66 682 PM	1	16/32 A CBF	16/32 A	1/10

NOTES: Halogen-free casings, in accordance with EN 60754-2.

Casing type H in accordance with EN 60670-1, and type Ha in accordance with IEC 60670-1.

GWT 850°C, according to EN 60695-2-11, relative to the green flush-mounting back-mounting box.

CHARACTERISTICS: locators for tracing the wall along the edges of the boxes; Boxes equipped with tabs for direct fixing on panels or a metal structure for lightweight and plasterboard walls.

ACCESSORIES SUPPLIED: self-tapping screw kit ø 4x45mm.

Green Wall

PLIABLE CONDUITS FOR THE GREEN WALL SYSTEM

CLASSIFICATION
34223
EN 50086
EN 61386



GWT
850°C

ICTA - "LOW SMOKE ZERO HALOGEN" MEDIUM PLIABLE CONDUIT



DX 22 016 R

MEDIUM PLIABLE CONDUIT, GREEN , SELF-EXTINGUISHING AND SELF- RECOVERING - PP



Code	Conduits Ø (mm)	Pack Carton
Type: without cable puller		
DX 22 016 R	16	100/2800
DX 22 020 R	20	100/2400
DX 22 025 R	25	75/1500
DX 22 032 R	32	50/800
DX 22 040 R	40	25/500
DX 22 050 R	50	25/400
DX 22 063 R	63	20/240
Type: with cable puller		
DX 22 116 R	16	100/2800
DX 22 120 R	20	100/2400
DX 22 125 R	25	75/1500
DX 22 132 R	32	50/800
DX 22 140 R	40	25/500
DX 22 150 R	50	25/400
DX 22 163 R	63	20/240

USE: the cable puller-feeder allows the wires to be pulled easily. Conformity to standards refers to the protective conduit and not to the cable puller-feeder.
Do not expose the conduits to direct solar irradiation for long periods.
Do not remove the protective white film during the storage.



Green Wall

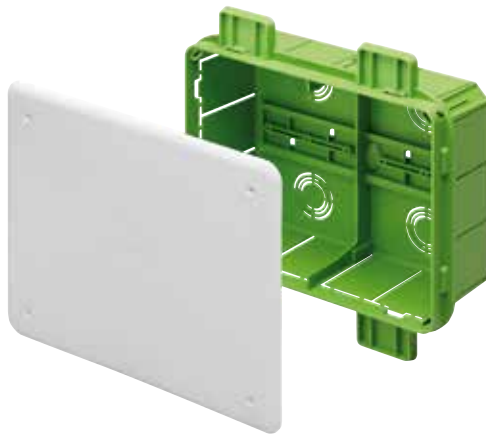

Scan the QR Code and find out all the technical informations.

VERSATILE AND SAFE FIXING

SIMPLE AND INNOVATIVE

HIGH QUALITY MATERIALS





The fixing tabs on the enclosures allow fixing on plasterboard metal struts or panels. The clamps on the wiring devices boxes allow installation on plasterboard panels. The fixing holes allow surface mounting in the case of renovation.



The 24 SC Green Wall range has been completely renewed: the special geometry of the knock-out holes enables convenient insertion of the conduit, which is held firmly in place. The "L" profile allows the conduit to be rotated vertically within its fitting.







Constant research in the field of plastic materials has enabled the use of materials with high mechanical strength, that are halogen-free, and that pass the GWT 850°C Glow Wire Test, in accordance with the specific product standard and the CEI [Comitato Elettrotecnico Italiano] 64/8 system standard.

		FLUSH-MOUNTING ENCLOSURES												
		40 CDi RANGE PROTECTED DECORATIVE ENCLOSURES IP40					40 CDKI RANGE - MODULAR PROTECTED ENCLOSURES AND DISTRIBUTION BOARDS - IP40					40 CDKI RANGE - MODULAR PROTECTED ENCLOSURES AND DISTRIBUTION BOARDS - ANTIBACTERIAL - IP40		
														
		White		Black	Varnished titanium	Varnished slate	White RAL 9016				White RAL 9016 Antibacterial	Back box for brickwall	Back box for plasterboard	
Enclosure	Door	Smoked transparent	Blank	Smoked transparent	Smoked transparent	Smoked transparent	Smoked transparent	Blank	Blank	Blank	Blank			
MODULES	2	with back-mounting box	-	-	-	-	-	-	-	-	-	-	-	-
	4	with back-mounting box	GW 40 237 TB	GW 40 287 TB	GW 40 237 TN	GW 40 237 VT	GW 40 237 VA	GW 40 602	-	GW 40 882	-	-	-	-
		front cover	GW 41 237 TB	-	GW 41 237 TN	GW 41 237 VT	GW 41 237 VA	-	-	-	-	-	-	-
	6	with back-mounting box	-	-	-	-	-	GW 40 603	-	GW 40 883	-	-	-	-
	8	with back-mounting box	GW 40 225 TB	GW 40 285 TB	GW 40 225 TN	GW 40 225 VT	GW 40 225 VA	GW 40 604	-	GW 40 884	-	-	-	-
		including back-mounting box and terminal block	-	-	-	-	-	GW 40 604 BS	-	GW 40 884 BS	-	-	-	-
		front cover	GW 41 225 TB	-	GW 41 225 TN	GW 41 225 VT	GW 41 225 VA	-	-	-	-	-	-	-
	12	with back-mounting box	GW 40 229 TB	GW 40 289 TB	GW 40 229 TN	GW 40 229 VT	GW 40 229 VA	GW 40 605	-	GW 40 885	-	-	-	-
		including back-mounting box and terminal block	-	-	-	-	-	GW 40 605 BS	-	GW 40 885 BS	-	GW 41 885 AB	GW 40 685	GW 40 685 PM
		front cover	GW 41 229 TB	-	GW 41 229 TN	GW 41 229 VT	GW 41 229 VA	-	-	-	-	-	-	-
	18	with back-mounting box	-	-	-	-	-	GW 40 608	-	GW 40 888	-	-	-	-
		including back-mounting box and terminal block	-	-	-	-	-	GW 40 608 BS	-	GW 40 888 BS	-	-	-	-
	24 (12x2)	with back-mounting box	GW 40 233 TB	GW 40 293 TB	GW 40 233 TN	GW 40 233 VT	GW 40 233 VA	GW 40 606	-	GW 40 886	-	-	-	-
		including back-mounting box and terminal block	-	-	-	-	-	GW 40 606 BS	GW 40 606 BD	GW 40 886 BS	GW 40 886 BD	GW 41 886 AB	GW 40 687	GW 40 687 PM
		front cover	GW 41 233 TB	-	GW 41 233 TN	GW 41 233 VT	GW 41 233 VA	-	-	-	-	-	-	-
	36 (12x3)	with back-mounting box	GW 40 239 TB	GW 40 299 TB	GW 40 239 TN	GW 40 239 VT	GW 40 239 VA	-	-	-	-	-	-	-
		including back-mounting box and terminal block	-	-	-	-	-	-	-	-	-	-	-	-
		front cover	GW 41 239 TB	-	GW 41 239 TN	GW 41 239 VT	GW 41 239 VA	-	-	-	-	-	-	-
	36 (18x2)	with back-mounting box	-	-	-	-	-	GW 40 609	-	GW 40 889	-	-	-	-
		including back-mounting box and terminal block	-	-	-	-	-	GW 40 609 BS	GW 40 609 BD	GW 40 889 BS	GW 40 889 BD	GW 41 889 AB	GW 40 688	GW 40 688 PM
48 (12x4)	including back-mounting box and terminal block	-	-	-	-	-	-	-	-	-	-	-	-	
54 (18x3)	with back-mounting box	-	-	-	-	-	GW 40 610	-	GW 40 890	-	-	-	-	
	including back-mounting box and terminal block	-	-	-	-	-	GW 40 610 BD	GW 40 610 BT	GW 40 890 BD	GW 40 890 BT	GW 41 890 AB	GW 40 689	GW 40 689 PM	
72 (18x4)	with back-mounting box	-	-	-	-	-	GW 40 611	-	GW 40 891	-	-	-	-	
	including back-mounting box and terminal block	-	-	-	-	-	GW 40 611 BD	GW 40 611 BQ	GW 40 891 BD	GW 40 891 BQ	GW 41 891 AB	GW 40 690	GW 40 690 PM	
COMPLEMENTARY ITEMS	Anti-deformation brackets for walling back-mounting boxes						GW 40 479 from 36M							
	Combined coupling component	2 x GW 40 425 for 8M and 12M					2 x GW 40 425 from 12M							
	Kit of 4 long screws with spacers	GW 48 645 from 8M					GW 48 645 from 6M							
	Internal dividers (horizontal and vertical)						horizontal	Modules				Code		
								24 (12x2)				GW 40 487		
						36-54-72				GW 40 488				
	1-module high blank cover panels						Modules				Code			
							24				GW 40 495			
						36-54-72				GW 40 496				
	Security lock						Modules				Code			
							24				1 x GW 40 422			
						36				2 x GW 40 422				
Back-mounting boxes						Modules				Code				
						4				GW 40 671				
						8				GW 40 673				
						12				GW 40 674				
						24				GW 40 677				
					36				GW 40 679					
Blanking module profile	6,5M					4,5M								
	GW 40 467 TB (White)	GW 40 467 TB (White)	GW 40 467 TN (Black)	GW 40 467 VT (Titanium)	GW 40 467 VA (Slate)	RAL 9016 White GW 40 467								
Expansion kit for home network enclosure														

(*) Without door.

FLUSH-MOUNTING ENCLOSURES

40 CDi RANGE PROTECTED ENCLOSURES IP40	48 PTC RANGE MODULAR WATERTIGHT ENCLOSURES AND BOARDS - IP55	40 CDKI RANGE GREEN WALL MODULAR AND PROTECTED ENCLOSURE AND DISTRIBUTION BOARDS FOR PLASTERBOARD - IP40	40 CDE RANGE PROTECTED DISTRIBUTION BOARDS METAL DOOR - IP40		HOME NETWORKING KIT
					
White RAL 9016	Grey RAL 7035	White RAL 9016	White RAL 9016		White RAL 9016
Blank	Smoked transparent	Smoked transparent	Brickwall	Plasterboard	Blank
-	-	-	-	-	-
-	GW 48 686 (prepared to housing N°2 IEC309 socket-outlets)	-	-	-	-
-	-	-	-	-	-
-	GW 48 681	-	-	-	-
GW 40 655	-	-	-	-	-
-	-	-	-	-	-
-	-	-	-	-	-
GW 40 657	GW 48 682	GW 40 605 PM	-	-	-
-	-	-	GW 40 151 N	GW 40 161 N	-
-	-	-	-	-	-
-	-	-	-	-	-
-	-	-	-	-	-
GW 40 659	-	GW 40 606 PM	-	-	-
-	-	-	GW 40 152 N	GW 40 162 N	-
-	-	-	-	-	-
-	-	-	GW 40 153 N	GW 40 163 N	-
-	-	-	GW 40 173 N (*)	GW 40 178 N (*)	-
-	-	-	-	-	-
GW 40 661	-	GW 40 609 PM	-	-	Front kit 36M GW 40 390 C Plasterboard box GW 40 688 PM Brickwall box GW 40 688
-	-	-	-	-	-
-	-	-	GW 40 154 N	GW 40 164 N	-
-	-	-	GW 40 174 N (*)	GW 40 179 N (*)	-
-	-	GW 40 610 PM	-	-	Front kit 54M GW 40 390 F Plasterboard box GW 40 689 PM Brickwall box GW 40 689
-	-	-	-	-	-
-	-	GW 40 611 PM	-	-	-
-	-	-	-	-	-
-	-	-	-	-	-
-	GW 48 026 (also more than one)	2 x GW 40 425 PM for 12 M	1 x GW 40 461 N		2 x GW 40 425
GW 48 645	GW 48 645	GW 48 645 for 12 M	-		-
-	-	Modules	Code		-
-	-	24	GW 40 487 (horizontal)		-
-	-	36-54-72	GW 40 488 (horizontal)		-
-	-	Modules	Code		-
-	-	24	GW 40 495		-
-	-	36-54-72	GW 40 496		-
1 x GW 40 421 (triangular) from 12M	1 x GW 48 644 (watertight metal cylinder)	Modules	Code		1 x GW 40 422 (36M) 2x GW 40 422 (54M)
-	-	12-24-36	1 x GW 40 422		-
-	-	54-72	2 x GW 40 422		-
-	-	-	1 x GW 40 463 (metal cylinder)		GW 40 688 PM (36M) GW 40 689 PM (54M)
4,5M	4,5M	4,5M	4,5M		-
RAL 9016 White - GW 40 467	RAL 7035 Grey - GW 40 423	RAL 9016 White - GW 40 467	RAL 9016 White - GW 40 467		-
-	-	-	-		GW 38 098

(*) Multimedia enclosure - IP30

COMPATIBILITY OF FLUSH-MOUNTING ENCLOSURES WITH BIPOLAR AND UNIPOLAR TERMINAL BLOCKS

Flush-mounting enclosure range	MODULES	Door	Code	Terminal blocks position	Screw terminal blocks type			
								
					TERMINAL BLOCK SIZE 1			
					Bipolar 125 A 2 x [(1x35)+(7x10)]	Bipolar 80 A 2 x [(2x16)+(7x10)]	Unipolar 80 A 1 x [(2x16)+(7x10)]	
GW 40 401	GW 40 408 B	GW 40 408 U						
40CDI DECORATIVE ENCLOSURES IP40  	8	Smoked transparent	GW 40 225 TB		No. 1	No. 1	No. 1	
		Smoked transparent	GW 40 225 TN					
		Smoked transparent	GW 40 225 VT					
		Smoked transparent	GW 40 225 VA					
	12	Blank	GW 40 285 TB		No. 1 (*)	No. 1 (*)	No. 1 (*)	
		Smoked transparent	GW 40 229 TB					
		Smoked transparent	GW 40 229 TN					
		Smoked transparent	GW 40 229 VT					
	24 (12x2)	Smoked transparent	GW 40 229 VA		No. 2 (*)	No. 2 (*)	No. 2 (*)	
		Smoked transparent	GW 40 233 TB					
		Smoked transparent	GW 40 233 TN					
		Smoked transparent	GW 40 233 VT					
	36 (12x3)	Smoked transparent	GW 40 233 VA		No. 2 (*)	No. 2 (*)	No. 2 (*)	
		Smoked transparent	GW 40 239 TB					
		Smoked transparent	GW 40 239 TN					
		Smoked transparent	GW 40 239 VT					
40 CDi PROTECTED MODULAR ENCLOSURES AND DISTRIBUTION BOARDS IP40  	8	Smoked transparent	GW 40 604		No. 1	No. 1	No. 1	
		Blank	GW 40 884					
	12	Smoked transparent	GW 40 605		No. 1 (*)	No. 1 (*)	No. 1 (*)	
		Blank	GW 40 885					
	18	Smoked transparent	GW 40 608		No. 1 (*)	No. 1 (*)	No. 1 (*)	
		Blank	GW 40 888					
	24 (12x2)	Smoked transparent	GW 40 606		No. 2 (*)	No. 2 (*)	No. 2 (*)	
		Blank	GW 40 886					
	36 (18x2)	Smoked transparent	GW 40 609		No. 2 (*)	No. 2 (*)	No. 2 (*)	
		Blank	GW 40 889					
	54 (18x3)	Smoked transparent	GW 40 610		No. 3 (*)	No. 3 (*)	No. 3 (*)	
		Blank	GW 40 890					
	72 (18x4)	Smoked transparent	GW 40 611		No. 4 (*)	No. 4 (*)	No. 4 (*)	
		Blank	GW 40 891					
	40 CDi PROTECTED ENCLOSURES IP40 	8	Blank	GW 40 655		No. 1	No. 1	No. 1
		12	Blank	GW 40 657		No. 1 (*)	No. 1 (*)	No. 1 (*)
24 (12x2)		Blank	GW 40 659		No. 2	No. 2	No. 2	
36 (18x2)		Blank	GW 40 661		No. 2 (*)	No. 2 (*)	No. 2 (*)	
40 CDK GREEN WALL ENCLOSURES AND DISTRIBUTION BOARDS FOR PLASTERBOARD WALLS - IP40 	12	Smoked transparent	GW 40 605 PM		No. 1 (*)	No. 1 (*)	No. 1 (*)	
	24 (12x2)	Smoked transparent	GW 40 606 PM		No. 2 (*)	No. 2 (*)	No. 2 (*)	
	36 (18x2)	Smoked transparent	GW 40 609 PM		No. 2 (*)	No. 2 (*)	No. 2 (*)	
	54 (18x3)	Smoked transparent	GW 40 610 PM		No. 3 (*)	No. 3 (*)	No. 3 (*)	
	72 (18x4)	Smoked transparent	GW 40 611 PM		No. 4 (*)	No. 4 (*)	No. 4 (*)	

(*) The installation is allowed using No.1 adapter GW40413 for each terminal block installed.

COMPATIBILITY OF FLUSH-MOUNTING ENCLOSURES WITH BIPOLAR AND UNIPOLAR TERMINAL BLOCKS

Screw terminal blocks type



TERMINAL BLOCK SIZE 2				TERMINAL BLOCK SIZE 3		
Bipolar 125 A 2 x [(3x35)+(10x10)]	Bipolar 80 A 2 x [(3x16)+(11x10)]	Unipolar 80 A 1 x [(3x16)+(11x10)]	Unipolar 80 A 1 x [(3x16)+(29x10)]	Bipolar 125 A 2 x [(5x35)+(14x10)]	Bipolar 80 A 2 x [(3x16)+(17x10)]	Unipolar 80 A 1 x [(3x16)+(17x10)]
GW 40 402	GW 40 412 B	GW 40 412 U	GW 40 422 U	GW 40 404	GW 40 418 B	GW 40 418 U
-	-	-	-	-	-	-
No. 1	No. 1	No. 1	No. 1	-	-	-
No. 2	No. 2	No. 2	No. 2	-	-	-
No. 2	No. 2	No. 2	No. 2	-	-	-
-	-	-	-	-	-	-
No. 1	No. 1	No. 1	No. 1	-	-	-
No. 1 (*)	No. 1 (*)	No. 1 (*)	No. 1 (*)	No. 1	No. 1	No. 1
No. 2	No. 2	No. 2	No. 2	-	-	-
No. 2 (*)	No. 2 (*)	No. 2 (*)	No. 2 (*)	No. 2	No. 2	No. 2
No. 3 (*)	No. 3 (*)	No. 3 (*)	No. 3 (*)	No. 3	No. 3	No. 3
No. 4 (*)	No. 4 (*)	No. 4 (*)	No. 4 (*)	No. 4	No. 4	No. 4
-	-	-	-	-	-	-
No. 1	No. 1	No. 1	No. 1	-	-	-
-	-	-	-	-	-	-
No. 2	No. 2	No. 2	No. 2	-	-	-
No. 1	No. 1	No. 1	No. 1	-	-	-
No. 2	No. 2	No. 2	No. 2	-	-	-
No. 2 (*)	No. 2 (*)	No. 2 (*)	No. 2 (*)	No. 2	No. 2	No. 2
No. 3 (*)	No. 3 (*)	No. 3 (*)	No. 3 (*)	No. 3	No. 3	No. 3
No. 4 (*)	No. 4 (*)	No. 4 (*)	No. 4 (*)	No. 4	No. 4	No. 4

40 CDi

Flush-mounting distribution boards and enclosures

The widest offer of flush-mounting distribution boards and enclosures currently available on the market. Seven families designed to offer advanced solutions in the residential and commercial sector, also available in halogen-free material. Versions from 2 to 72 modules, degree of protection from IP40 to IP55 and special versions for plasterboard. The range includes also two Multimedia Enclosures: Full Version (54 modules) and Compact Version (36 modules).



40 CDi - DECORATIVE ENCLOSURES - IP40



IK
08

IP
40

GWT
650°C



SMOKED TRANSPARENT DOOR



GW 40 229 TB

DECORATIVE ENCLOSURES PRE-ARRANGED FOR HOUSING TERMINAL BLOCKS



Code	Colour	Front dim. LxHxD (mm)	Spare base	Dispersible power (W)	Pack Carton
No. of modules EN 50022: 4+1/2					
GW 40 237 TB	White	148x165x23	GW40671	13	12
GW 40 237 TN	Black	148x165x23	GW40671	13	12
GW 40 237 VT	Varnished titanium	148x165x23	GW40671	13	12
GW 40 237 VA	Varnished slate	148x165x23	GW40671	13	12
No. of modules EN 50022: 8+1/2					
GW 40 225 TB	White	250x195x26	GW40673	19	16
GW 40 225 TN	Black	250x195x26	GW40673	19	16
GW 40 225 VT	Varnished titanium	250x195x26	GW40673	19	16
GW 40 225 VA	Varnished slate	250x195x26	GW40673	19	16
No. of modules EN 50022: 12+1					
GW 40 229 TB	White	330x218x25	GW40674	24	12
GW 40 229 TN	Black	330x218x25	GW40674	24	12
GW 40 229 VT	Varnished titanium	330x218x25	GW40674	24	12
GW 40 229 VA	Varnished slate	330x218x25	GW40674	24	12
No. of modules EN 50022: 24+2 (12x2)					
GW 40 233 TB	White	330x338x28	GW40677	25	5
GW 40 233 TN	Black	330x338x28	GW40677	25	5
GW 40 233 VT	Varnished titanium	330x338x28	GW40677	25	5
GW 40 233 VA	Varnished slate	330x338x28	GW40677	25	5
No. of modules EN 50022: 36+3 (12x3)					
GW 40 239 TB	White	330x493x28	GW40679	42	5
GW 40 239 TN	Black	330x493x28	GW40679	42	5
GW 40 239 VT	Varnished titanium	330x493x28	GW40679	42	5
GW 40 239 VA	Varnished slate	330x493x28	GW40679	42	5

ACCESSORIES SUPPLIED: 6.5 M module-covering profiles co-ordinated with the colour of the enclosure front (for 4, 8 and 12-module enclosures - 1 profile; for 24-module enclosures - 2 profiles; for 36-module enclosures - 3 profiles), circuit labels, mortar guard element in cardboard supplied as standard in the packs and packed with paper banding.

NOTES: Dispersible power calculated according to CEI 23-49.

CHARACTERISTICS: Module-covering profiles can be divided into 1/2 module elements, using scissors.

Mortar guard element assembled by pressing on the base opening. Thermo-pressure with ball equal to 70°C.

IP40 guaranteed even with open door, in the case of wall-embedded installation using devices of at least IP40 and the module-covering profiles supplied.

Bottoms of 8 and 12 module enclosures can be assembled side-by-side using combined coupling element GW40425.

Enclosures composed by front cover; Front of the enclosure and DIN rail frame fully compatible with the bottom of the previous decorative flush mounting enclosures 40CDi Range DIN frame, terminal blocks and back plastic bottom.

INSTALLATION: for the possible enclosure-terminal block combinations, refer to the summary "COMPATIBILITY OF FLUSH-MOUNTING ENCLOSURES WITH BIPOLAR AND UNIPOLAR TERMINAL BLOCKS" in the selection guides of 40CDi range.

BLANK DOOR



GW 40 293 TB

DECORATIVE ENCLOSURES PREDISPOSED FOR HOUSING TERMINAL BLOCKS -WHITE



Code	No. of modules EN 50022	Colour	Outer dim. LxHxD (mm)	Dispersible power (W)	Spare base	Pack Carton
GW 40 287 TB	4	White	148x165x23	13	GW40671	12
GW 40 285 TB	8	White	250x195x26	19	GW40673	16
GW 40 289 TB	12	White	330x218x25	24	GW40674	12
GW 40 293 TB	24 (12x2)	White	330x338x28	25	GW40677	5
GW 40 299 TB	36 (12x3)	White	330x493x28	42	GW40679	5

ACCESSORIES SUPPLIED: 6.5 M module-covering profiles co-ordinated with the colour of the enclosure front (for 4, 8 and 12-module enclosures - 1 profile; for 24-module enclosures - 2 profiles; for 36-module enclosures- 3 profiles), circuit labels, mortar guard element in cardboard supplied as standard in the packs and packed with paper banding.

NOTES: Dispersible power calculated according to CEI 23-49.

CHARACTERISTICS: Module-covering profiles can be divided into 1/2 module elements, using scissors.

Mortar guard element assembled by pressing on the base opening. Thermo-pressure with ball equal to 70°C.

IP40 guaranteed even with open door, in the case of wall-embedded installation using devices of at least IP40 and the module-covering profiles supplied.

Bottoms of 8 and 12 module enclosures can be assembled side-by-side using combined coupling element GW40425.

Enclosures composed by front cover;Front of the enclosure and DIN rail frame fully compatible with the bottom of the previous decorative flush mounting enclosures 40CDI Range DIN frame, terminal blocks and back plastic bottom.

INSTALLATION: for the possible enclosure-terminal block combinations, refer to the summary "COMPATIBILITY OF FLUSH-MOUNTING ENCLOSURES WITH BIPOLAR AND UNIPOLAR TERMINAL BLOCKS" in the selection guides of 40CDI range.

COMPLEMENTARY ITEMS FOR DECORATIVE ENCLOSURES



GW 41 229 VT

FRONT COVERS AND RELATIVE FUNCTIONAL FRAMES WITH DIN RAIL FOR DECORATIVE ENCLOSURES



Code	Colour	Front dim. LxHxD (mm)	Corresponding back plate	Dispersible power (W)	Pack Carton
No. of modules EN 50022: 4+1/2					
GW 41 237 TB	White	148x165x23	GW40671	13	12
GW 41 237 TN	Black	148x165x23	GW40671	13	12
GW 41 237 VT	Varnished titanium	148x165x23	GW40671	13	12
GW 41 237 VA	Varnished slate	148x165x23	GW40671	13	12
No. of modules EN 50022: 8+1/2					
GW 41 225 TB	White	250x195x26	GW40673	19	16
GW 41 225 TN	Black	250x195x26	GW40673	19	16
GW 41 225 VT	Varnished titanium	250x195x26	GW40673	19	16
GW 41 225 VA	Varnished slate	250x195x26	GW40673	19	16
No. of modules EN 50022: 12+1					
GW 41 229 TB	White	330x218x25	GW40674	24	12
GW 41 229 TN	Black	330x218x25	GW40674	24	12
GW 41 229 VT	Varnished titanium	330x218x25	GW40674	24	12
GW 41 229 VA	Varnished slate	330x218x25	GW40674	24	12
No. of modules EN 50022: 24+2 (12x2)					
GW 41 233 TB	White	330x338x28	GW40677	25	5
GW 41 233 TN	Black	330x338x28	GW40677	25	5
GW 41 233 VT	Varnished titanium	330x338x28	GW40677	25	5
GW 41 233 VA	Varnished slate	330x338x28	GW40677	25	5
No. of modules EN 50022: 36+3 (12x3)					
GW 41 239 TB	White	330x493x28	GW40679	42	5
GW 41 239 TN	Black	330x493x28	GW40679	42	5
GW 41 239 VT	Varnished titanium	330x493x28	GW40679	42	5
GW 41 239 VA	Varnished slate	330x493x28	GW40679	42	5

ACCESSORIES SUPPLIED: 6.5M module-covering profiles co-ordinated with the colour of the enclosure front (for 4, 8 and 12-module enclosures - 1 profile; for 24-module enclosures - 2 profiles; for 36-module enclosures- 3 profiles), service labels.

NOTES: dispersible power calculated according to IEC 60670-24.

CHARACTERISTICS: Module-covering profiles can be divided into 1/2 module elements, using scissors. Thermo-pressure with ball equal to 70°C.

IP40 guaranteed even with open door, in the case of wall-embedded installation using devices of at least IP40 and the module-covering profiles supplied.

Front of the enclosure and DIN rail frame fully compatible with the bottom of the previous decorative flush mounting enclosures 40CDI Range.



GW 40 674

BACK-MOUNTING BOXES FOR DECORATIVE ENCLOSURES DESIGNED TO HOUSE A TERMINAL BLOCK



Code	No. of modules EN 50022	Back plate dim. LxHxD (mm)	Pack Carton
GW 40 671	4	115x142x85	12
GW 40 673	8	209x174x81	16
GW 40 674	12	293x189x81	12
GW 40 677	24	294x310x80	5
GW 40 679	36	294x461x90	5

ACCESSORIES SUPPLIED: Mortar guard element in cardboard with clip-fixing on the opening of the back-mounting box - supplied as standard and packed with paper banding.

CHARACTERISTICS: there is an identification code on the back-mounting box, along with the word "up" to aid installation.

40 CDKI - PROTECTED MODULAR ENCLOSURES AND DISTRIBUTION BOARDS - IP40

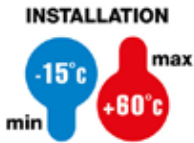

**IK
08**

**IP
40**

**GWT
650°C**



SMOKED TRANSPARENT DOOR



GW 40 602

ENCLOSURES PREDISPOSED FOR TERMINAL BLOCK HOUSING WITH EXTRACTABLE FRAME - WHITE RAL 9016



Code	No. of modules EN 50022	Outer dim. LxHxD (mm)	Dispersible power (W)	Pack Carton
GW 40 601	2	83x160x74	12	60
GW 40 602	4	120x160x85	18	36
GW 40 603	6	200x170x85	19	21
GW 40 604	8	240x195x85	20	12
GW 40 605	12	330x270x85	36	8
GW 40 608	18	465x310x85	50	4

CHARACTERISTICS: GW40601, provided without the door and with the DIN rail fixed directly on the back plate.

Thermo-pressure with ball equal to 70 °C.

Flush-mounting boxes in 12 and 18 modules can be assembled side-by-side through the coupling tool code GW40425.

ACCESSORIES SUPPLIED: Module masks, circuit labels.

For GW40604, GW40605 and GW40608, self-adhesive labels to be filled out for certification according to standard CEI 23-51.

NOTES: Dissipated power calculated according to CEI 23-49.

Upon request, starting from the 8 modules version, flush-mounting boxes and cabinets (including frame and DIN rails) can be supplied separately.

INSTALLATION: For the possible enclosure-terminal block combinations, refer to the summary "COMPATIBILITY OF FLUSH-MOUNTING ENCLOSURES WITH BIPOLAR AND UNIPOLAR TERMINAL BLOCKS" in the selection guides of 40CDI range.



GW 40 604 BS

ENCLOSURES EQUIPPED WITH 80 A IP20 BIPOLAR SCREW TERMINAL BLOCK AND EXTRACTABLE FRAME - WHITE RAL 9016

Code	No. of modules EN 50022	Outer dim. LxHxD (mm)	Dispersible power (W)	Pole 1 (mm ²)	Pole 2 (mm ²)	Pack Carton
GW 40 604 BS	8	240x195x85	20	N/E (2x16) + (7x10)	N/E (2x16) + (7x10)	12
GW 40 605 BS	12	330x270x85	36	N/E (3x16) + (11x10)	N/E (3x16) + (11x10)	8
GW 40 608 BS	18	465x310x85	50	N/E (3x16) + (17x10)	N/E (3x16) + (17x10)	4

CHARACTERISTICS: Thermo-pressure with ball equal to 70°C. Bottoms of 12 and 18 module enclosures can be assembled side-by-side using combined coupling element GW40425.

ACCESSORIES SUPPLIED: module masks, circuit labels. Self-adhesive labels to be filled out for certification according to standard CEI 23-51. Insulated bipolar screw 80A - IP20 terminal blocks to be installed on the frame before wiring.

NOTES: dispersible power calculated according to CEI 23-49. Upon request, flush-mounting boxes and cabinets (including frame and DIN rails) can be supplied separately.



GW 40 606

DISTRIBUTION BOARDS WITH WINDOWED PANEL AND EXTRACTABLE FRAME PREDISPOSED FOR TERMINAL BLOCK HOUSING - WHITE RAL 9016



Code	No. of modules EN 50022	Outer dim. LxHxD (mm)	Dispersible power (W)	Pack Carton
GW 40 606	24 (12x2)	330x420x85	37	6
GW 40 609	36 (18x2)	465x505x85	52	3
GW 40 610	54 (18x3)	465x680x95	62	2
GW 40 611	72 (18x4)	465x880x95	95	1

ACCESSORIES SUPPLIED: Module masks, circuit labels. Self-adhesive label to be filled out for certification according to standard CEI 23-51.

NOTES: Dissipated power calculated according to CEI 23-49.

Upon request, flush-mounting boxes and cabinets (including frame and DIN rails) can be supplied separately.

CHARACTERISTICS: Lead sealable and removable panels with windows. Thermo-pressure with ball equal to 70 °C.

Flush-mounting boxes can be assembled side-by-side through the coupling tool code GW40425.

INSTALLATION: For the possible enclosure-terminal block combinations, refer to the summary "COMPATIBILITY OF FLUSH-MOUNTING ENCLOSURES WITH BIPOLAR AND UNIPOLAR TERMINAL BLOCKS" in the selection guides of 40CDI range.



GW 40 606 BD

DISTRIBUTION BOARDS WITH WINDOWED AND 80 A IP20 BIPOLAR SCREW TERMINAL BLOCK AND EXTRACTABLE FRAME WHITE RAL 9016

Code	No. of modules EN 50022	Outer dim. LxHxD (mm)	Dispersible power (W)	Pole 1 (mm ²)	Pole 2 (mm ²)	Pack Carton
GW 40 606 BS	24 (12x2)	330x420x85	37	N/E (3x16) + (11x10)	N/E (3x16) + (11x10)	6
GW 40 606 BD	24 (12x2)	330x420x85	37	N/E 2x[(3x16) + (11x10)]	N/E 2x[(3x16) + (11x10)]	6
GW 40 609 BS	36 (18x2)	465x505x85	52	N/E (3x16) + (17x10)	N/E (3x16) + (17x10)	3
GW 40 609 BD	36 (18x2)	465x505x85	52	N/E 2x[(3x16) + (17x10)]	N/E 2x[(3x16) + (17x10)]	3
GW 40 610 BD	54 (18x3)	465x680x95	62	N/E 2x[(3x16) + (17x10)]	N/E 2x[(3x16) + (17x10)]	2
GW 40 610 BT	54 (18x3)	465x680x95	62	N/E 3x[(3x16) + (17x10)]	N/E 3x[(3x16) + (17x10)]	2
GW 40 611 BD	72 (18x4)	465x855x95	95	N/E 2x[(3x16) + (17x10)]	N/E 2x[(3x16) + (17x10)]	1
GW 40 611 BQ	72 (18x4)	465x880x95	95	N/E 4x[(3x16) + (17x10)]	N/E 4x[(3x16) + (17x10)]	1

ACCESSORIES SUPPLIED: module masks, circuit labels. Self-adhesive label to be filled out for certification according to standard CEI 23-51. Insulated bipolar screw 80A - IP20 terminal blocks to be installed on the frame before wiring.

NOTES: dispersible power calculated according to CEI 23-49. Upon request, flush-mounting boxes and cabinets (including frame and DIN rails) can be supplied separately.

CHARACTERISTICS: removable and plumbable panels with windows. Thermo-pressure with ball equal to 70°C. Bottoms of enclosures can be assembled side-by-side using combined coupling element GW40425.

BLANK DOOR



GW 40 885

ENCLOSURES PREDISPOSED FOR TERMINAL BLOCK HOUSING AND EXTRACTABLE FRAME - WHITE RAL 9016



Code	No. of modules EN 50022	Outer dim. LxHxD (mm)	Dispersible power (W)	Pack Carton
GW 40 882	4	120x160x85	18	36
GW 40 883	6	200x170x85	19	21
GW 40 884	8	240x195x85	20	12
GW 40 885	12	330x270x85	36	8
GW 40 888	18	465x310x85	50	4

ACCESSORIES SUPPLIED: Module masks, circuit labels.

For GW40884, GW40885 and GW40888, self-adhesive labels to be filled out for certification according to standard CEI 23-51.

NOTES: Dissipated power calculated according to CEI 23-49. Upon request, starting from the 8 modules version, flush-mounting boxes and cabinets (including frame and DIN rails) can be supplied separately.

CHARACTERISTICS: Thermo-pressure with ball equal to 70 °C.

Flush-mounting boxes in 12 and 18 modules can be assembled side-by-side through the coupling tool code GW40425.

INSTALLATION: For the possible enclosure-terminal block combinations, refer to the summary "COMPATIBILITY OF FLUSH-MOUNTING ENCLOSURES WITH BIPOLAR AND UNIPOLAR TERMINAL BLOCKS" in the selection guides of 40CDI range.

ENCLOSURES EQUIPPED WITH 80 A IP20 BIPOLAR SCREW TERMINAL BLOCK AND EXTRACTABLE FRAME - WHITE RAL 9016

Code	No. of modules EN 50022	Outer dim. LxHxD (mm)	Dispersible power (W)	Pole 1 (mm ²)	Pole 2 (mm ²)	Pack Carton
GW 40 884 BS	8	240x195x85	20	N/E (2x16) + (7x10)	N/E (2x16) + (7x10)	12
GW 40 885 BS	12	330x270x85	36	N/E (3x16) + (11x10)	N/E (3x16) + (11x10)	8
GW 40 888 BS	18	465x310x85	50	N/E (3x16) + (17x10)	N/E (3x16) + (17x10)	4

ACCESSORIES SUPPLIED: module masks, circuit labels. Self-adhesive labels to be filled out for certification according to standard CEI 23-51. Insulated bipolar screw 80A - IP20 terminal blocks to be installed on the frame before wiring.

NOTES: dispersible power calculated according to CEI 23-49. Upon request, flush-mounting boxes and cabinets (including frame and DIN rails) can be supplied separately.

CHARACTERISTICS: thermo-pressure with ball equal to 70°C. Bottoms of 12 and 18 module enclosures can be assembled side-by-side using combined coupling element GW40425.



GW 40 885 BS



GW 40 890

DISTRIBUTION BOARDS WINDOWED PANELS AND EXTRACTABLE FRAME PREDISPOSED FOR HOUSING THE TERMINAL BLOCKS- WHITE RAL 9016



Code	No. of modules EN 50022	Outer dim. LxHxD (mm)	Dispersible power (W)	Pack Carton
GW 40 886	24 (12X2)	330x420x85	37	6
GW 40 889	36 (18x2)	465x505x85	52	3
GW 40 890	54 (18x3)	465x680x95	62	2
GW 40 891	72 (18x4)	465x880x95	95	1

ACCESSORIES SUPPLIED: Module masks, circuit labels. Self-adhesive label to be filled out for certification according to standard CEI 23-51.

NOTES: Dissipated power calculated according to CEI 23-49.

Upon request, flush-mounting boxes and cabinets (including frame and DIN rails) can be supplied separately.

CHARACTERISTICS: Lead sealable and removable panels with windows. Thermo-pressure with ball equal to 70 °C.

Flush-mounting boxes can be assembled side-by-side through the coupling tool code GW40425.

INSTALLATION: For the possible enclosure-terminal block combinations, refer to the summary "COMPATIBILITY OF FLUSH-MOUNTING ENCLOSURES WITH BIPOLAR AND UNIPOLAR TERMINAL BLOCKS" in the selection guides of 40CDi range.



GW 40 890 BT

DISTRIBUTION BOARDS WITH WINDOWED PANELS AND 80 A IP20 BIPOLAR SCREW TERMINAL BLOCK AND EXTRACTABLE FRAME WHITE RAL 9016

Code	No. of modules EN 50022	Outer dim. LxHxD (mm)	Dispersible power (W)	Pole 1 (mm ²)	Pole 2 (mm ²)	Pack Carton
GW 40 886 BS	24 (12X2)	330x420x85	37	N/E (3x16) + (11x10)	N/E (3x16) + (11x10)	6
GW 40 886 BD	24 (12X2)	330x420x85	37	N/E 2x[(3x16) + (11x10)]	N/E 2x[(3x16) + (11x10)]	6
GW 40 889 BS	36 (18x2)	465x505x85	52	N/E (3x16) + (17x10)	N/E (3x16) + (17x10)	3
GW 40 889 BD	36 (18x2)	465x505x85	52	N/E 2x[(3x16) + (17x10)]	N/E 2x[(3x16) + (17x10)]	3
GW 40 890 BD	54 (18x3)	465x680x95	62	N/E 2x[(3x16) + (17x10)]	N/E 2x[(3x16) + (17x10)]	2
GW 40 890 BT	54 (18x3)	465x680x95	62	N/E 3x[(3x16) + (17x10)]	N/E 3x[(3x16) + (17x10)]	2
GW 40 891 BD	72 (18x4)	465x855x95	95	N/E 2x[(3x16) + (17x10)]	N/E 2x[(3x16) + (17x10)]	1
GW 40 891 BQ	72 (18x4)	465x880x95	95	N/E 4x[(3x16) + (17x10)]	N/E 4x[(3x16) + (17x10)]	1

ACCESSORIES SUPPLIED: module masks, circuit labels. Self-adhesive label to be filled out for certification according to standard CEI 23-51. Insulated bipolar screw 80A - IP20 terminal blocks to be installed on the frame before wiring.

NOTES: dispersible power calculated according to CEI 23-49. Upon request, flush-mounting boxes and cabinets (including frame and DIN rails) can be supplied separately.

CHARACTERISTICS: removable and plumbable panels with windows. Thermo-pressure with ball equal to 70°C. Bottoms of enclosures can be assembled side-by-side using combined coupling element GW40425.

ANTIBACTERIAL FRONT KIT



GW 41 890 AB

DISTRIBUTION FRONT KIT WINDOWED PANELS AND EXTRACTABLE FRAME PREDISPOSED FOR HOUSING THE TERMINAL BLOCKS - WHITE RAL 9016 - ANTIBACTERIAL



Code	No. of modules EN 50022	Outer dim. LxHxD (mm)	Dispersible power (W)	Pack Carton
GW 41 885 AB	12	330x270x16	36	12
GW 41 886 AB	24 (12X2)	330x420x16	37	5
GW 41 889 AB	36 (18x2)	465x505x16	52	3
GW 41 890 AB	54 (18x3)	465x680x25	62	2
GW 41 891 AB	72 (18x4)	465x880x25	95	1

ACCESSORIES SUPPLIED: module masks, circuit labels. Self-adhesive label to be filled out for certification according to standard CEI 23-51.

NOTES: dissipated power calculated according to CEI 23-49. The antibacterial front kit is composed of frame, door, lock covers, opening handles. The kit includes also functional frame and DIN rails.

CHARACTERISTICS: lead sealable and removable panels with windows. Thermo-pressure with ball equal to 70 °C. Flush-mounting boxes can be assembled side-by-side through the coupling tool code GW40425.

INSTALLATION: the matching back box for brick walls or plasterboard walls must be ordered separately. For the possible enclosure-terminal block combinations, refer to the summary ""COMPATIBILITY OF FLUSH-MOUNTING ENCLOSURES WITH BIPOLAR AND UNIPOLAR TERMINAL BLOCKS"" in the selection guides of 40CDi range.

FLUSH-MOUNTING BACK BOX FOR ANTIBACTERIAL FRONT KIT - FOR BRICK WALL



GW 40 689

Code	No. of modules EN 50022	Suitable for ANTIBACTERIAL front kit	Pack Carton
GW 40 685	12	GW41885AB	1/12
GW 40 687	24 (12X2)	GW41886AB	1/5
GW 40 688	36 (18x2)	GW41889AB	1/5
GW 40 689	54 (18x3)	GW41890AB	1/3
GW 40 690	72 (18x4)	GW41891AB	1/2

CHARACTERISTICS: back boxes can be coupled with the accessory GW40425.

INSTALLATION: the matching antibacterial front kit must be ordered separately.

40 CDKI GREEN WALL - MULTI-SERVICE SYSTEM ENCLOSURES

MULTIMEDIA ENCLOSURES



**IK
08**

**IP
40**

**GWT
650°C**



GW 40 390 C

MULTIMEDIA ENCLOSURE COMPACT VERSION 36 DIN MODULES - WHITE RAL 9016 - BLANK DOOR



Code	Description	Outer dim. LxHxD (mm)	Pack Carton
GW 40 390 C	Front cover, inner frame and accessories 36 DIN modules	465x505x85	1
GW 40 688	Empty masonry bottom for compact multimedia enclosure	-	1/5

APPLICATIONS: the compact multimedia enclosure is the central element of multi-service wiring within the home, allowing the distribution of signals to the various rooms. The compact version is ideal for settings where the available space is limited and a small number of services need to be managed.

FEATURES: the product is compliant with the CEI 306-2 Guide. The back of the box has plastic tabs for an easier installation on metal frames and drywall panels. The product can be joined vertically with other enclosures of the CDKI range (minimum size 36 DIN modules) using GW40425 coupling elements.

ACCESSORIES SUPPLIED: the GW40390C is composed of 1 pc front cover with blank door, 1 pc detachable frame with 2 pcs perforated mounting plates (1 pc with 18 Keystone Jack slots), 2 m velcro roll w=16 mm, 4 pcs brackets with screws, 4 pcs self-adhesive cable clips with cable ties, 5 pcs RJ45 Cat.6 keystone jacks.

INSTALLATION: suitable for recessed installation on masonry walls.



GW 40 390 F

MULTIMEDIA ENCLOSURE COMPACT VERSION 54 DIN MODULES - WHITE RAL 9016 - BLANK DOOR



Code	Description	Outer dim. LxHxD (mm)	Pack Carton
GW 40 390 F	Front cover, inner frame and accessories 54 DIN modules	465x680x95	1
GW 40 689	Empty masonry bottom for full multimedia enclosure	-	1/3

APPLICATIONS: the complete multimedia enclosure is the central element of multi-service wiring within the home, allowing the distribution of signals to the various rooms. The full version is ideal for residential settings where a large number of services and reception/transmission devices need to be managed.

FEATURES: the product is compliant with the CEI 306-2 Guide. The back box has plastic tabs for easier installation on metal frames and drywall panels. The product can be joined vertically with other enclosures of the CDKI range (minimum size 36 DIN modules) using GW40425 coupling elements.

ACCESSORIES SUPPLIED: the GW40390F includes of 1 pc front cover with blank door, 1 pc detachable frame with 3 pcs perforated mounting plates (1 pc with 18 Keystone Jack slots), 3 m velcro roll w=16 mm, 6 pcs brackets with screws, 6 pcs self-adhesive cable clips with cable ties, 6 pcs RJ45 Cat.6 data sockets, 6 pcs RJ45-RJ45 Cat.6 Ethernet cable 0.6 m, 1 pc telephone splitter with 5 pcs RJ11 socket and 5 pcs RJ11-RJ45 telephone cables, 1 pc multiple socket.

INSTALLATION: suitable for recessed installation on masonry walls.

40 CDE - GERMAN STANDARD FLUSH-MOUNTING DISTRIBUTION BOARDS

METAL DOOR DISTRIBUTION BOARDS - IP40



GW 40 151 N

DISTRIBUTION BOARDS FOR BRICK WALLS EQUIPPED WITH BIPOLAR TERMINAL BLOCKS - RAL 9016

Code	No. of modules EN 50022	Pole 1 (mm ²)	Pole 2 (mm ²)	Dispersible power (W)	Pack Carton
GW 40 151 N	12+2	N (2x16)+(8x10)	PE (2x16)+(8x10)	60	1
GW 40 152 N	24+4 (12x2)	N (2x16)+(14x10)	PE (2x16)+(14x10)	80	1
GW 40 153 N	36+6 (12x3)	N 2x[(2x16)+(14x10)]	PE 2x[(2x16)+(14x10)]	90	1
GW 40 154 N	48+8 (12x4)	N 2x[(2x16)+(14x10)]	PE 2x[(2x16)+(14x10)]	100	1
GW 40 155 N	60+10 (12x5)	N 2x[(2x16)+(14x10)]	PE 2x[(2x16)+(14x10)]	120	1

Accessories supplied: positioning brackets, mortar guard, certification label, modules cover, terminal blocks.

Notes: extractable frame already installed.

DISTRIBUTION BOARDS FOR PLASTERBOARD (GWT 850 °C) WALLS EQUIPPED WITH BIPOLAR TERMINAL BLOCKS - RAL 9016

Code	No. of modules EN 50022	Pole 1 (mm ²)	Pole 2 (mm ²)	Dispersible power (W)	Pack Carton
GW 40 161 N	12+2	N (2x16)+(8x10)	PE (2x16)+(8x10)	60	1
GW 40 162 N	24+4 (12x2)	N (2x16)+(14x10)	PE (2x16)+(14x10)	80	1
GW 40 163 N	36+6 (12x3)	N 2x[(2x16)+(14x10)]	PE 2x[(2x16)+(14x10)]	90	1
GW 40 164 N	48+8 (12x4)	N 2x[(2x16)+(14x10)]	PE 2x[(2x16)+(14x10)]	100	1
GW 40 165 N	60+10 (12x5)	N 2x[(2x16)+(14x10)]	PE 2x[(2x16)+(14x10)]	120	1

Accessories supplied: installation brackets, plaster guard, certification label, modules cover, terminal blocks.

Notes: extractable frame already installed.



GW 40 161 N

METAL DOOR MULTIMEDIA ENCLOSURE - IP40



GW 40 173 N

MULTIMEDIA ENCLOSURES FOR BRICK WALLS - RAL 9016

Code	No. line	Pack Carton
GW 40 173 N	3	1
GW 40 174 N	4	1

Accessories supplied: positioning brackets, mortar guard, 1x multimedia device bracket, 2x Schuko socket, 2x supports, 1x Dahlia plate

Notes: perforated mounting plates and patch panel already installed.

MULTIMEDIA ENCLOSURES FOR PLASTERBOARD (GWT 850 °C) WALLS - RAL 9016

Code	No. line	Pack Carton
GW 40 178 N	3	1
GW 40 179 N	4	1

Accessories supplied: installation brackets, plaster guard, 1x multimedia device bracket, 2x Schuko socket, 2x supports, 1x Dahlia plate

Notes: perforated mounting plates and patch panel already installed.



GW 40 178 N

COMPLEMENTARY ITEMS



GW 40 454 N

TERMINAL BLOCKS

Code	Description	Pack Carton
GW 40 454 N	N+PE terminal block (2x16 mm ² + 14x10 mm ²)	1
GW 40 455 N	Terminal block N (7x16mm ²)	1



GW 40 467

ACCESSORIES

Code	Description	Pack Carton
GW 40 461 N	Pair of brackets for horizontal coupling	1
GW 40 463 N	Safety lock for German standard flush-mounting enclosures	1
GW 40 467	Plastic module cover profile	50

40 CDi

40 CDi - PROTECTED ENCLOSURES - IP40



IK
08

IP
40

GWT
650°C



BLANK DOOR



GW 40 655

ENCLOSURES PREDISPOSED FOR TERMINAL BLOCK - WHITE RAL 9016



Code	No. of modules EN 50022	Outer dim. LxHxD (mm)	Dispersible power (W)	Pack Carton
GW 40 655	8	236x195x89	19	18
GW 40 657	12+1	326x217x89	26	8
GW 40 659	24+2 (12x2)	326x346x89	36	6
GW 40 661	36+2 (18x2)	453x396x95	47	3

ACCESSORIES SUPPLIED: module masks, circuit labels, spare hinges. Self-adhesive label to be filled out for certification according to standard CEI 23-51.

GW40657, GW40659, GW40661 door equipped with lock, with 2 triangular keys.

NOTES: Dispersible power calculated according to CEI 23-49.

CHARACTERISTICS: Thermo-pressure with ball equal to 70°C.

INSTALLATION: for the possible enclosure-terminal block combinations, refer to the summary "COMPATIBILITY OF FLUSH-MOUNTING ENCLOSURES WITH BIPOLAR AND UNIPOLAR TERMINAL BLOCKS" in the selection guides of 40CDi range.

48 PTC - COMBINATION WATERTIGHT ENCLOSURES AND BOARDS - IP55

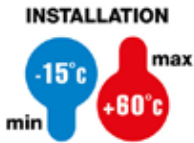

**IK
08**

**IP
55**

**GWT
650°C**



MODULAR ENCLOSURES WITH SMOKED TRANSPARENT DOOR



GW 48 681

WATERTIGHT FLUSH-MOUNTING MODULAR ENCLOSURES WITH SHOCKPROOF FRONTS - GREY RAL 7035



Code	No. of modules EN 50022	Outer dim. LxHxD (mm)	Front dim. LxH (mm)	Dispersible power (W)	Pack Carton
GW 48 681	6	138x169x70	175x210	15	1/6
GW 48 682	12	308x169x70	345x210	25	1/4

ACCESSORIES SUPPLIED: module masks, user labels, kit of self-tapping stainless steel screws Ø 4x32mm. mortar guard element in cardboard supplied as standard in the packs and packed with paper banding.

NOTES: dispersible power calculated according to IEC 60670-24.

CHARACTERISTICS: Thermo-pressure with ball equal to 70°C. pre-arrangement for combined coupling (both horizontal and vertical) via the feedthrough coupling device GW48026. Mortar guard element assembled by pressing on the base opening.

COMBINATION BOARD WITH SMOKED TRANSPARENT DOOR



GW 48 686

WATERTIGHT FLUSH-MOUNTING COMBINED BOARD FITTED FOR MODULAR DEVICES AND FOR 2 FLANGES 85X75 MM FOR MOUNTING IEC 309 STANDARD SOCKET-OUTLETS - SHOCKPROOF FRONT - GREY RAL 7035



Code	No. of modules EN 50022	Outer dim. LxHxD (mm)	Front dim. LxH (mm)	Dispersible power (W)	Pack Carton
GW 48 686	4	308x169x70	345x210	19	1/4

ACCESSORIES SUPPLIED: user labels, kit of self-tapping screws of Ø 4 x 32mm in stainless steel. mortar guard element in cardboard supplied as standard in the packs and packed with paper banding.

NOTES: dispersible power calculated according to IEC 60670-24. Compatible with IEC 309 16A 10° angled receptacle.

CHARACTERISTICS: Thermo-pressure with ball equal to 70°C. pre-arrangement for combined coupling (both horizontal and vertical) via the feedthrough coupling device GW48026. Mortar guard element assembled by pressing on the base opening.

COMPLEMENTARY ITEMS

INSTALLATION AND COUPLING



GW 40 467 VT

MODULE COVER PROFILE IN PLASTIC COLOURS CO-ORDINATED WITH 40CDI FLUSH-MOUNTING DECORATIVE ENCLOSURES



Code	Colour	No. of modules EN 50022	Pack Carton
GW 40 467 TB	White	6.5	50
GW 40 467 TN	Black	6.5	50
GW 40 467 VT	Titanium	6.5	50
GW 40 467 VA	Slate	6.5	50

CHARACTERISTICS: clip fixing on the windows of the front. Can be divided into 1/2 module elements, using scissors.



GW 48 645

KIT CONTAINING 4 LONG SELF-THREADING SCREWS WITH SPACERS FOR FIXING LIDS AND FRONTS

Code	Screw dimension (mm)	Spacer thickness (mm)	Pack Carton
GW 48 645	Ø 4x45	Max 10 mm reducible	1/100

CHARACTERISTICS: the kit can be used for the following flush-mounting ranges: CD Chorus, CDi/CDKi (from 6 modules upwards), 48 CM and 42 RV.



GW 40 425

ELEMENT FOR COMBINED COUPLING OF CDKi AND CDi FLUSH-MOUNTING DECORATIVE ENCLOSURES AND DISTRIBUTION BOARDS



Code	Fixing	Pack Carton
GW 40 425	Clip	10

APPLICATIONS: for CDKi enclosures and boards from 12 modules upwards. Also suitable for 40 CDi decorative enclosures with 8 and 12 modules and for the Home Networking enclosure.

NOTE: GWT 850° C according to EN 60695-2-11.



GW 40 479

ANTI-DEFORMATION BRACKET FOR WALLING BASE BOXES OF CDKi BOARDS



Code	For boards EN 50022 rail	Pack Carton
GW 40 479	18 Modules	5

APPLICATIONS: avoid back-mounting box deformations during masonry work.



GW 48 026

PTC BOX COUPLING ADAPTOR



Code	Description	Pack Carton
GW 48 026	Base box coupling	5/25

APPLICATIONS: allows the creation of vertical/horizontal combined compositions and easier cable passage.



GW 70 009

GALVANIZED STEEL EXTENDING BRACKETS FOR REAR FIXING COMPLETE WITH SELF-TAPPING SCREWS - SET OF 4 BRACKETS - 70 RT RANGE

Code	Adjustment range	Pack Carton
GW 70 009	90 - 160 mm	1/10

APPLICATIONS: when creating upright columns, it allows the creation of an air gap for the passage of conduits between the PTC box and the wall.

WIRING



GW 40 412 B

INSULATED SCREW TERMINAL BLOCK BIPOLAR AND UNIPOLAR FOR ENCLOSURES AND BOARDS

Code	Pole 1 (mm ²)	Pole 2 (mm ²)	Fastener to supports	Pack Carton
Type: Bipolar - Rated current 125 A				
GW 40 401	N (1x35) + (7x10)	E (1x35) + (7x10)	With screws	10
GW 40 402	N (3x35) + (10x10)	E (3x35) + (10x10)	With screws and/or clip	10
GW 40 404	N (5x35) + (14x10)	E (5x35) + (14x10)	With screws and/or clip	10
Type: Bipolar - Rated current 80 A - IP20				
GW 40 408 B	N/E (2x16) + (7x10)	N/E (2x16) + (7x10)	With screws	1/10
GW 40 412 B	N/E (3x16) + (11x10)	N/E (3x16) + (11x10)	With screws and/or clip	1/10
GW 40 418 B	N/E (3x16) + (17x10)	N/E (3x16) + (17x10)	With screws and/or clip	1/10
Type: Unipolar - Rated current 80 A - IP20				
GW 40 408 U	N/E (2x16) + (7x10)	-	With screws	1/10
GW 40 412 U	N/E (3x16) + (11x10)	-	With screws and/or clip	1/10
GW 40 422 U	N/E (3x16) + (29x10)	-	With screws and/or clip	1/10
GW 40 418 U	N/E (3x16) + (17x10)	-	With screws and/or clip	1/10

ACCESSORIES SUPPLIED: fixing screws. The 80 A terminal blocks are equipped with N and E labels to be placed on the respective spaces to identify the poles.

CHARACTERISTICS: GWT 960°C according to EN60695-2-11.

INSTALLATION: for the possible enclosure-terminal block combinations, refer to the summary "COMPATIBILITY OF FLUSH-MOUNTING ENCLOSURES WITH BIPOLAR AND UNIPOLAR TERMINAL BLOCKS" in the selection guides of 40CDi range.

ADAPTERS FOR SCREW TERMINAL BLOCKS

Code	Material	For enclosures	Fastener to supports	Pack Carton
GW 40 413	Metal	12 M (and multiples) and 18 M (and multiples)	With screws	20

ACCESSORIES SUPPLIED: fixing screws.

CHARACTERISTICS: the adapter is pre-drilled for the correct assembly of the terminal block and pre-cut to allow installation also in enclosures with a 12 M modular step.

INSTALLATION: used to expand the number of the possible enclosure-terminal block combinations, refer to the summary "COMPATIBILITY OF FLUSH-MOUNTING ENCLOSURES WITH BIPOLAR AND UNIPOLAR TERMINAL BLOCKS" in the selection guides of 40CDi range.



GW 40 413



GW 40 488

INTERNAL HORIZONTAL DIVIDERS FOR CDKI DISTRIBUTION BOARDS



Code	For boards EN 50022 rail	Fixing	Pack Carton
GW 40 487	12 Modules	Clip	10/100
GW 40 488	18 Modules	Clip	10/100

NOTES: they permit making internal separation between the circuits having different voltages located on more than one row inside the same shell.

BLANK COVERING PANELS - 1-MODULE HEIGHT - FOR CDKI BOARDS



Code	Suitable for	For boards EN 50022 rail	Colour	Pack Carton
GW 40 495	Flush mounting distr. boards	12 Modules	White RAL 9016	20
GW 40 496	Flush mounting distr. boards	18 Modules	White RAL 9016	20

CHARACTERISTICS: sealing.



GW 40 495



GW 66 745

WATERTIGHT LIDS FOR COMBINED ENCLOSURE 48 PTC RANGE, OF THE GW48686 TYPE

Code	Dimensions LxH (mm)	Suitable for	Colour	Pack Carton
GW 66 708	75x85	1 Button Ø22 mm Range 74 PS	Grey	1/20
GW 66 745	75x85	1 Button Ø22 mm Range 74 PS	Yellow	1/20
GW 27 403	75x85	2 SYSTEM modules	Grey RAL 7035	3/60
GW 27 401	75x85	2 SYSTEM modules	Grey RAL 7035	3/60

APPLICATIONS: GW66745 specific for emergency push-buttons. Possibility of assembly on Q-DIN boards, PTC junction boxes, flanged lids and panels.

ACCESSORIES SUPPLIED: gasket and mounting screws.

OTHERS



GW 40 421

TRIANGULAR SECURITY KEY - FOR 40CDI ENCLOSURES PROTECTED WITH A BLANK DOOR



Code	Material	Pack Carton
GW 40 421	Insulation	10/100



GW 40 422

CYLINDER SECURITY LOCK - FOR 40 CDKI AND 40 CDI DECORATIVE ENCLOSURES

Code	Material	Pack Carton
GW 40 422	Pressure die-cast metal	1/10

APPLICATIONS: for all the 40 CDKi with door, for the decorative 40 CDi with 24 and 36 modules and for QDSA.
ACCESSORIES SUPPLIED: 2 keys.

NOTES: All the keys and relative locks with the same product code are identical.



GW 48 644

WATERTIGHT CYLINDRICAL SECURITY LOCK

Code	For enclosures	Material	Pack Carton
GW 48 644	48 PTC and 42 RV range	Pressure die-cast metal	1/10

ACCESSORIES SUPPLIED: 2 keys.

NOTES: All the keys and relative locks with the same product code are identical.



GW 40 467

PLASTIC MODULE COVER PROFILE



Code	No. of modules EN 50022	Colour	Pack Carton
GW 40 467	4.5	White RAL 9016	50
GW 40 423	4.5	Grey RAL 7035	50
GW 40 468	4.5	Toner black	50

CHARACTERISTICS: clip fixing.

TECHNICAL ACCESSORIES FOR HOME NETWORKING ENCLOSURES



GW 38 098

TELEPHONE JACK EXPANSION KIT

Code	Description	Pack Carton
GW 38 098	RJ11 telephone socket and telephone cable	1

ACCESSORIES SUPPLIED: 1 multiple telephone socket-outlet with 5 RJ11 socket-outlets.



40 CDi



Scan the QR Code and find out all the technical informations.

40 CDi - DECORATIVE ENCLOSURES



The enclosures feature a modern, elegant and linear design that matches the shapes and colours of the Chorusmart wiring devices. Available in four colours, the white version is available with smoked transparent or blank doors.

40 CDKi - PROTECTED ENCLOSURES AND DISTRIBUTION BOARDS







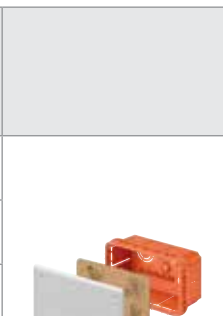
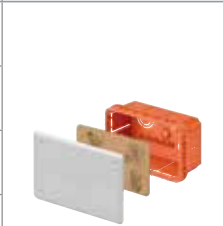
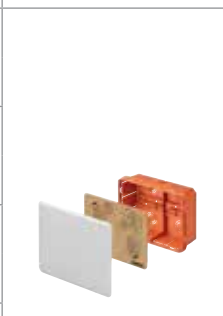

The 40 CDKi enclosures and distribution boards come in 10 sizes (from 2 to 72 modules) and various models, available in smoked transparent door versions (particularly suitable for the tertiary and industrial sectors) and with blank doors ideal for home automation applications.

MULTIMEDIA ENCLOSURES FOR MULTISERVICE SYSTEMS



The offer is completed by the multimedia enclosures, which contain and sort the services and optical signals intended for the apartment, hosting the passive components (apartment termination box, mixers, filters) and active devices (modems, switches, signal amplifiers) of the home system.

48 PT / PT DIN and 48 PTC: cardboard mortar guard element supplied 48 CM: protective technopolymer shield supplied			ACCESSORIES APPLICATION TABLE							
			Dimensions (mm)	Protective shield	No. of internal dividers	Coupling element	Boxes	Spare lids		
Antibacterial	Plain	Deep								
RANGE	Code									
48 PT / PT DIN	GW 48 001		92x92x45	-	-	-	-	-	IP40 GW 48 013	-
	GW 48 002		118x96x50	-	-	-	-	-	IP40 GW 48 014	-
	GW 48 003		118x96x70	-	-	2 x GW 48 051	-	-	IP40 GW 48 014	-
	GW 48 004		152x98x70	-	-	2 x GW 48 051	-	-	IP40 GW 48 015	IP40 GW 48 084
	GW 48 005		160x130x70	-	-	2 x GW 48 051	-	-	IP40 GW 48 016	IP40 GW 48 085
	GW 48 006	 (Integrated DIN rail on the bottom)	196x152x70	1 X GW 48 006 P	1 x GW 48 012	2 x GW 48 051	Brickwall GW 48 116 Plasterboard GW 48 116 PM	IP40 - IK10 GW 48 017 AB	IP40 - IK10 GW 48 017	IP40 GW 48 086
	GW 48 007		294x152x70	1 X GW 48 007 P	2 x GW 48 012	2 x GW 48 051	Brickwall GW 48 117 Plasterboard GW 48 117 PM	IP40 - IK10 GW 48 018 AB	IP40 - IK10 GW 48 018	IP40 GW 48 087
	GW 48 008		392x152x70	1 X GW 48 008 P	3 x GW 48 012	2 x GW 48 051	Brickwall GW 48 118 Plasterboard GW 48 118 PM	IP40 - IK10 GW 48 019 AB	IP40 - IK10 GW 48 019	IP40 GW 48 088
	GW 48 009		480x160x70	1 X GW 48 009 P	2 x GW 48 012	2 x GW 48 051	Brickwall GW 48 119 Plasterboard GW 48 119 PM	IP40 - IK10 GW 48 020 AB	IP40 - IK10 GW 48 020	-
	GW 48 010		516x202x80	1 x GW 48 010 P	2 x GW 48 012	2 x GW 48 051	-	-	IP40 - IK10 GW 48 021	-
	GW 48 011		516x294x80	1 x GW 48 011 P	5 supplied	2 x GW 48 051	-	-	IP40 - IK10 GW 48 022	-
48 CM	GW 48 207		260x260x121	-	1 supplied	2 supplied	-	-	IP44 GW 48 247	IP44 GW 48 267
	GW 48 211		520x260x121	-	4 supplied	2 supplied	-	-	IP44 GW 48 251	IP44 GW 48 271
	GW 48 227		260x260x121	-	2 supplied	2 supplied	-	-	IP44 GW 48 247	IP44 GW 48 267
	GW 48 231		520x260x121	-	5 supplied	2 supplied	-	-	IP44 GW 48 251	IP44 GW 48 271
48 PTC - IP 40	GW 48 661		138x169x70	-	-	In-line coupling connector GW 48 026 	-	-	GW 48 611	-
	GW 48 662		308x169x70	-	1 x GW 48 024		-	-	GW 48 612	-
	GW 48 663		398x169x70	-	2 x GW 48 024		-	-	GW 48 613	-
48 PTC - IP 55	GW 48 671		138x169x70	-	-		-	-	GW 48 621	-
	GW 48 691		308x169x70	-	1 x GW 48 024		-	-	GW 48 651	-
	GW 48 672		308x169x70	-	1 x GW 48 024		-	-	GW 48 622	-
	GW 48 673		398x169x70	-	2 x GW 48 024		-	-	GW 48 623	-

Compatibility between GEWISS domotic devices and 48 PT DIN range boxes

The PT DIN boxes for domotics establish a new market standard in the world of domotic Home & Building Automation systems, as they allow you to distribute the domotic devices in the key points of the building; this widens the advantages of domotics, producing innovative solutions while optimising resources and reducing wiring.

The following table shows all the possible combinations - in terms of dimensions and dispersible power - of individual Gewiss domotic devices and individual PT DIN compartment.

To identify the best technical solution that takes into account dimensions and the dissipated power of the domotic modules and, consequently, to identify the best PT DIN for the chosen application devices the GW BUS software has been developed, to simplify the professional's work, quickly guiding him to design a domotic system with Gewiss material; at the end of the study, the relative certification is also issued.

GEWISS DOMOTIC DEVICES		48 PT DIN BOXES							
		Code	GW 48 006	GW 48 007	GW 48 008	GW 48 009	GW 48 010	GW 48 011	
		Compartments	2	3	4	3	3	6	
		No. of EN 50022 modules per compartment	4,5	5	5	8	9	4	
		No. mod. EN 50022	MAX pde (W)*	11	13	17	25	29	30
KNX DEVICES FROM DIN RAIL	KNX line/field couplers	2	●	●	●	●	●	●	
	KNX power supplies	4	●	●	●	●	●	●	
	KNX motor control actuators	4	●	●	●	●	●	●	
		8					●		
	KNX dimmer	4	●	●	●	●	●	●	
	KNX general actuators	4	●	●	●	●	●	●	
		8				●	●		
	DALI/KNX Gateway	4	●	●	●	●	●	●	
	KNX input modules	4	●	●	●	●	●	●	
	Combined devices	4	●	●	●	●	●	●	
KNX BUS interfaces	1	●	●	●	●	●	●		
DOMOTIC DEVICES FOR DOMESTIC RANGES	KNX domestic range actuators	3	●	●	●	●	●	●	
	Relay	1,5 and 3	●	●	●	●	●	●	



GW BUS software for domotic projects

- Identification of the most suitable PT DIN
- Dispersible power check
- Issuing of relative certification

For further information, go to www.gewiss.com
or contact GEWISS Customer Service +39 035 94 61 11

48

Flush-mounting junction and modular boxes range

The system is composed of three ranges:

48 PT / 48 PT DIN Range with moulded DIN rail, compliant to CEI 23-48, suitable to install also H&B devices; 48 CM Range composed of high-capacity junction boxes, suitable to create distribution columns; 48 PTC Range composed of modular junction, control and distribution boxes. All boxes are made with Halogen Free technopolymer.



48 PT / PT DIN - JUNCTION, CONNECTION AND DOMOTIC BOXES - IP40



IK
07

IP
40

GWT
650°C



FOR BRICK WALLS



GW 48 004

48 PT - JUNCTION AND CONNECTION BOXES FOR SIDE-BY-SIDE ASSEMBLY - WHITE LID RAL 9016



Code	Outer dim. LxHxD (mm)	Compartment pre-arrangement	Pack Carton
GW 48 001	92x92x45	1	162
GW 48 002	118x96x50	1	114
GW 48 003	118x96x70	1	84
GW 48 004	152x98x70	1	64
GW 48 005	160x130x70	1	49

CHARACTERISTICS: surface embossing of the lids to facilitate painting.

External knurling of the base to improve mortar adherence.

Pre-arrangement for combined coupling (both horizontal and vertical) via the joining element GW48051.

Lid protected with heat-shrinking film that also contains the bag of fixing screws.

Mortar guard element assembled by pressing on the base opening.

ACCESSORIES SUPPLIED: ø3x25 mm screw kit for lid fixing, mortar guard element in cardboard supplied as standard in the packs and packed with paper banding.

NOTES: for the inputs, remove the knockouts after cutting the relative tangs with scissors.



GW 48 006

48 PT DIN - JUNCTION AND CONNECTION BOXES FOR SIDE-BY-SIDE ASSEMBLY WITH DIN RAIL INTEGRATED ON THE BACK-MOUNTING BOX COLOUR: WHITE LID RAL 9016



Code	Outer dim. LxHxD (mm)	Compartment pre-arrangement	No. EN 50022 mod. per comp.	Domotic equipment coupling	Dispersible max power (W)	No. supports GW44720	Pack Carton
GW 48 006	196x152x75	2	4.5	DIN rail	11	2	34
GW 48 007	294x152x75	3	5	DIN rail	13	3	22
GW 48 008	392x152x75	4	5	DIN rail	17	4	17
GW 48 009	480x160x75	3	8	DIN rail	25	5	17
GW 48 010	516x202x90	3	9	DIN rail	29	5	9
GW 48 011	516x294x90	6	4	DIN rail	30	5	5

APPLICATIONS: boxes with a built-in DIN rail on the back-mounting box, in accordance with regulations that require to fix by DIN rail the devices that disperse a certain amount of power inside the junction boxes (calculated in compliance with CEI 23-49). Ideal for installation of home and building automation equipment as actuators, power supplies, etc...

CHARACTERISTICS: surface embossing of the covers to facilitate painting. External knurling of the base to improve mortar adherence. Pre-arrangement for combined coupling (both horizontal and vertical) via the joining element GW48051. Lid protected with heat-shrinking film that also contains the bag of fixing screws. Mortar guard element assembled by pressing on the base opening.

ACCESSORIES SUPPLIED: Junction box GW48011 supplied with 5 internal separators. ø 3x25mm screw kit for lid fixing. Mortar guard element in cardboard supplied as standard in the packs and packed with paper banding.

NOTES: for the inputs, remove the knockouts after cutting the relative tangs with scissors.

ANTIBACTERIAL SHOCKPROOF LIDS



GW 48 017 AB

ANTIBACTERIAL SHOCKPROOF LIDS FOR PT / PT DIN AND PT DIN GREEN WALL BOXES WHITE RAL 9016 - IP40



Code	Suitable for	Mechanical resistance	Pack Carton
GW 48 017 AB	GW48116 and GW48116PM	IK10	1/50
GW 48 018 AB	GW48117 and GW48117PM	IK10	80/40
GW 48 019 AB	GW48118 and GW48118PM	IK10	1/20
GW 48 020 AB	GW48119 and GW48119PM	IK10	1/20

CHARACTERISTICS: the packaging includes screws for installation in brick walls or plasterboard walls. GWT 850 °C according to EN 60695-2-11.



GW 48 116

FLUSH-MOUNTING BACK BOXES FOR ANTIBACTERIAL SHOCKPROOF LIDS - FOR BRICK WALL



Code	Suitable for	Pack Carton
GW 48 116	GW48017AB	30
GW 48 117	GW48018AB	20
GW 48 118	GW48019AB	10
GW 48 119	GW48020AB	10

NOTE: the Antibacterial shockproof lid must be ordered separately.

COMPLEMENTARY ITEMS FOR 48 PT / PT DIN E 48 PT DIN GREEN WALL

COMPLEMENTARY ITEMS



GW 48 007 P

PROTECTIVE SHIELD FOR JUNCTION, CONNECTION AND DOMOTICS BOXES



Code	For boxes PT DIN	For PT DIN GREEN WALL boxes	Pack Carton
GW 48 006 P	GW48006	GW48006PM and GW48126PM	70
GW 48 007 P	GW48007	GW48007PM	60
GW 48 008 P	GW48008	GW48008PM	50
GW 48 009 P	GW48009	GW48009PM	40
GW 48 010 P	GW48010	-	30
GW 48 011 P	GW48011	-	25

CHARACTERISTICS: in technopolymer. Total protection during brick wall work, painting and finishing operations. Applying the protective shield beneath the lid, the dispersible power of the box is reduced by 2 W for GW48006, GW48007, GW48008, GW48010, GW48011, GW48006PM, GW48007PM, GW48008PM boxes and by 3W GW48009 and GW48009PM boxes.

NOTES: clip fixing to speed up assembly and removal operations. Reusable.



GW 48 051

JOINING ELEMENT FOR PT / PT DIN AND PT DIN GREEN WALL BOXES



Code	For PT / PT DIN boxes	For PT DIN GREEN WALL boxes	Pack Carton
GW 48 051	GW48003 - GW48011	GW48006PM - GW48009PM	10

NOTES: the use of the joining element makes it possible to create horizontal and/or vertical sets of boxes PT/PT DIN. For PT DIN GREEN WALL boxes, GW40425 element permits horizontal paths. GW48051 also for the box with transparent lid GW48126PM. GWT 850 °C according to EN 60695-2-11.



GW 48 012

INTERNAL SEPARATOR FOR PT DIN AND PT DIN GREEN WALL BOXES



Code	For boxes PT DIN	For PT DIN GREEN WALL boxes	Pack Carton
GW 48 012	GW48006 - GW48011	GW48006PM - GW48009PM	50/300



GW 48 018

HIGH RESISTANCE SHOCKPROOF PLAIN LIDS FOR PT / PT DIN AND PT DIN GREEN WALL BOXES WHITE RAL 9016 - IP40



Code	Suitable for	Mechanical resistance	Pack Carton
GW 48 013	GW48001	IK10	10/120
GW 48 014	GW48002 - GW48003	IK10	10/100
GW 48 015	GW48004	IK10	10/100
GW 48 016	GW48005	IK10	10/100
GW 48 017	GW48006 and GW48006PM	IK10	10/100
GW 48 018	GW48007 and GW48007PM	IK10	10/80
GW 48 019	GW48008 and GW48008PM	IK10	10/40
GW 48 020	GW48009 and GW48009PM	IK10	10/40
GW 48 021	GW48010	IK10	10/30
GW 48 022	GW48011	IK10	10/20

CHARACTERISTICS: surface embossing of the covers to facilitate painting. GWT 850 °C according to EN 60695-2-11.



GW 48 084

DEEP LIDS FOR PT / PT DIN AND PT DIN GREEN WALL BOXES - WHITE RAL 9016 - IP40



Code	Suitable for	Pack Carton
GW 48 084	GW48004	1/10
GW 48 085	GW48005	1/8
GW 48 086	GW48006 and GW48006PM	1/10
GW 48 087	GW48007 and GW48007PM	1/5
GW 48 088	GW48008 and GW48008PM	1/5

CHARACTERISTICS: the deep lids are ideal for passing from an exposed system to a chased one. They have a removable front plate and a frame for connecting with trunking. GWT 850 °C secondo EN 60695-2-11; max lid H = 66mm for boxes up to 392x152 and conduits with max Ø = 32mm.



GW 48 023

LONG SELF-TAPPING SCREWS FOR SECURING COVER

Code	Dimensions (mm)	Suitable for	Pack Carton
GW 48 023	Ø3x38	junction boxes range 48 PT / PT DIN and PT DIN GREEN WALL	300/4200

44 ME - UNIPOLAR EQUIPOTENTIAL TERMINAL BLOCKS

GWT
850°C

TERMINAL BLOCKS FOR SIDE-BY-SIDE ASSEMBLY



GW 44 706

TERMINAL BLOCKS WITH INDIRECT PLATE TIGHTENING - 450V - T 85°C - TRANSPARENT

Code	Connecting capacity	Pack Carton
GW 44 704	4 ways x 6 mm ²	10/100
GW 44 706	6 ways x 6 mm ²	10/100
GW 44 708	8 ways x 6 mm ²	10/100

APPLICATIONS: embedded fixing on the GW44720 support, for coupling with the DIN rail.

NOTES: for the connection capacity, refer to the technical catalogue

ACCESSORIES FOR TERMINAL BLOCKS FOR SIDE-BY-SIDE ASSEMBLY



GW 44 720

SUPPORT FOR FIXING SIDE-BY-SIDE TERMINAL BLOCKS ON DIN RAIL

Code	For equipotential terminal blocks	Terminal block fixing	Fixing on DIN rail	Pack Carton
GW 44 720	GW44704, GW44706, GW44708	Clip	Lock-joint	1/50

NOTES: ideal for applications on boxes of the 48 PT DIN range.

CHARACTERISTICS: supports a combination of terminal blocks with maximum 12-way capacity.

Possible combinations: 3xGW44704; 2xGW44706; 1xGW44704 + 1xGW44706; 1xGW44704 + 1xGW44708; Modular overall dimensions (width): 4.5 modules EN 50022.

MODULAR TERMINAL BLOCKS



GW 44 671

TERMINAL BLOCKS WITH INDIRECT SCREW TIGHTENING - 450V - T 85°C - TRANSPARENT

Code	Connecting capacity	Pack Carton
GW 44 671	3 ways x 6 mm ²	10/100
GW 44 672	5 ways x 6 mm ²	10/100
GW 44 673	4 ways x 16 mm ²	10/50
GW 44 674	2 ways x 16mm ² + 3 ways x 6 mm ²	10/50
GW 44 675	2 ways x 16mm ² + 9 ways x 6 mm ²	5/25
GW 44 676	2 ways x 35 mm ² + 4 ways x 16 mm ²	1/10

APPLICATIONS: especially suitable for creating equipotential nodes.

ACCESSORIES SUPPLIED: self-adhesive label for identification of electrical lines.

NOTES: GW44676 equipped with feedthrough terminals. These allow the creation of cut-outs from the main cables which, unsheathed in the part concerned, are not interrupted.

ACCESSORIES FOR MODULAR TERMINAL BLOCKS



GW 44 681

SUPPORT FOR FIXING MODULAR TERMINAL BLOCKS ON DIN RAIL

Code	For equipotential terminal blocks	Terminal block fixing	Pack Carton
GW 44 681	From GW44671 to GW44676	Clip	100



GW 44 682

ADAPTER FOR FIXING MODULAR TERMINAL BLOCKS

Code	For equipotential terminal blocks	Terminal block fixing	Pack Carton
GW 44 682	From GW44671 to GW44676	Lock-joint	200

APPLICATIONS: for fixing the equipotential terminal blocks on the plates or directly on the base inside the junction boxes and watertight boxes.
ACCESSORIES SUPPLIED: screws for fixing the adapter.

48 CM - LARGE CAPACITY CONNECTION AND JUNCTION BOXES - IP40

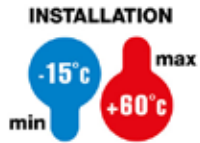
IK
07IP
40GWT
650°C

PLAIN LID



GW 48 207

JUNCTION AND CONNECTION BOXES FOR SIDE-BY-SIDE ASSEMBLY, FOR UPRIGHTS - PLAIN PLUMBABLE LID WHITE RAL 9016

Code	Outer dim. LxHxD (mm)	Compartment pre-arrangement	Dispersible max power (W)	Pack Carton
GW 48 207	260x260x121	2	13	8
GW 48 211	520x260x121	5	30	6

ACCESSORIES SUPPLIED: internal dividers, joint elements for combined assembly, self-adhesive symbol labels for circuit identification, and sealing screws. Mortar-proof paint protection shield in technopolymer with additional electro-acoustic insulation function, with central handles making it easier to pull it out.

NOTES: applying the protective shield beneath the lid, the dispersible power of the box is reduced by 2W for GW48207 and by 3W for the GW48211 box. dispersible power calculated according to IEC 60670-24.

DEEP LID

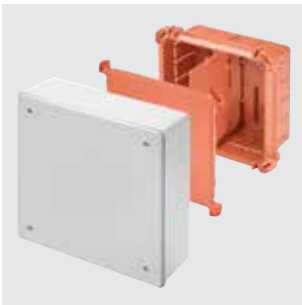

GW 48 227

JUNCTION AND CONNECTION BOXES FOR SIDE-BY-SIDE ASSEMBLY, FOR UPRIGHTS - DEEP PLUMBABLE LID GREY RAL 7035

Code	Outer dim. LxHxD (mm)	Compartment pre-arrangement	Dispersible max power (W)	Pack Carton
GW 48 227	260x260x121	2	13	4
GW 48 231	520x260x121	5	30	4

CHARACTERISTICS: the lid has a removable front plate and a frame for the connection with the trunking (max height = 66mm) and conduits (max Ø = 40mm). The frame is fitted for fixing the DIN rails (not supplied).
Pre-arrangement EN 50022: GW48227 horizontal - 24 modules (2x12), vertical - 24 modules (2x12); GW48231: horizontal - 78 modules (26x3), vertical - 36 modules (12x3).

ACCESSORIES SUPPLIED: internal dividers, joint elements for combined assembly, self-adhesive symbol labels for circuit identification, and sealing screws. Mortar-proof paint protection shield in technopolymer with additional electro-acoustic insulation function, with central handles making it easier to pull it out.

NOTES: applying the protective shield beneath the lid, the dispersible power of the box is reduced by 2W for GW48227 and by 3W for the GW48231 box. dispersible power calculated according to IEC 60670-24.

COMPLEMENTARY ITEMS FOR 48 CM AND 48 CM GREEN WALL

COMPLEMENTARY ITEMS



GW 48 251

SHOCKPROOF SEALABLE PLAIN LIDS FOR BOXES FOR UPRIGHTS - WHITE RAL 9016 - IP44



Code	Front dim. LxH (mm)	Mechanical resistance	Pack Carton
GW 48 247	260x260	IK10	1/15
GW 48 251	520x260	IK10	1/10

ACCESSORIES SUPPLIED: self-adhesive symbol labels for circuit identification, and plumbable screws.



GW 48 271

SHOCKPROOF SEALABLE DEEP LIDS FOR BOXES FOR UPRIGHTS - GREY RAL 7035 - IP44



Code	For boxes dimensions	Mechanical resistance	Pack Carton
GW 48 267	260x260	IK10	1/10
GW 48 271	520x260	IK10	1/5

CHARACTERISTICS: the lid has a removable front plate and a frame for connection with trunking (max h = 65mm) and conduits (max Ø = 40mm).

The frame is fitted for fixing the DIN rails (not supplied).

Pre-arrangement EN 50022: GW48267 horizontal 24 modules (2x12), vertical 24 modules (2x12); GW48271 horizontal 78 modules (26x3), vertical 36 modules (12x3)

ACCESSORIES SUPPLIED: self-adhesive symbol labels for circuit identification, and plumbable screws.

48 PTC - MODULAR JUNCTIONS, CONTROL AND DISTRIBUTION BOXES

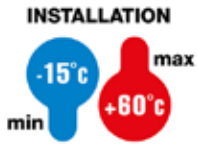

**IK
07**

**GWT
650°C**



BOXES WITH LID - IP55



GW 48 671

MODULAR, WATERTIGHT, FLUSH-MOUNTING JUNCTION AND CONNECTION BOXES SHOCKPROOF LID - GREY RAL 7035



Code	Outer dim. LxHxD (mm)	Compartment pre-arrangement	Pack Carton
GW 48 671	138x169x70	1	1/28
GW 48 672	308x169x70	2	1/14
GW 48 673	398x169x70	3	1/9

ACCESSORIES SUPPLIED: self-adhesive symbol discs for the identification of circuits, kit of Ø 4x32mm stainless steel self-tapping screws, hinge for constrained lid opening.

GW48672 pre-arranged to house a DIN rail. Space available: 14 modules.

Mortar guard element in cardboard supplied as standard in the packs and packed with paper banding.

CHARACTERISTICS: pre-arrangement for combined coupling (both horizontal and vertical) via the feedthrough coupling device GW48026.

Mortar guard element assembled by pressing on the base opening.

NOTES: for the inputs, remove the knockouts after cutting the relative tangs with scissors.

The IP55 degree of protection is guaranteed with the lid closed and with installations on waterproof walls made of tiles or similar materials, without joints.

BOXES WITH TRANSPARENT SHOCKPROOF LID - IP55

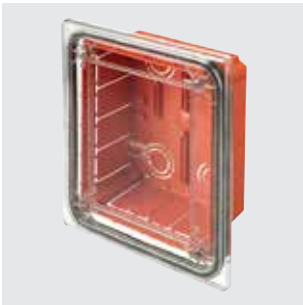

GW 48 691

MODULAR, WATERTIGHT, FLUSH-MOUNTING JUNCTION AND CONNECTION BOX TRANSPARENT SHOCKPROOF LID



Code	Outer dim. LxHxD (mm)	Compartment pre-arrangement	Pack Carton
GW 48 691	138x169x70	1	1/28

ACCESSORIES SUPPLIED: self-adhesive symbol discs for the identification of circuits, kit of Ø 4x32mm stainless steel self-tapping screws, hinge for constrained lid opening.

Mortar guard element in cardboard supplied as standard in the packs and packed with paper banding.

CHARACTERISTICS: pre-arrangement for combined coupling (both horizontal and vertical) via the feedthrough coupling device GW48026.

Mortar guard element assembled by pressing on the base opening.

NOTES: for the inputs, remove the knockouts after cutting the relative tangs with scissors.

The IP55 degree of protection is guaranteed with the lid closed and with installations on waterproof walls made of tiles or similar materials, without joints.

APPLICATIONS: ideal for medical room applications where the earthing point must be inspectable.

MODULAR ENCLOSURES WITH SMOKED TRANSPARENT DOOR - IP55

WATERTIGHT FLUSH-MOUNTING MODULAR ENCLOSURES WITH SHOCKPROOF FRONTS - GREY RAL 7035



GW 48 681



Code	No. of modules EN 50022	Outer dim. LxHxD (mm)	Front dim. LxH (mm)	Dispersible power (W)	Pack Carton
GW 48 681	6	138x169x70	175x210	15	1/6
GW 48 682	12	308x169x70	345x210	25	1/4

ACCESSORIES SUPPLIED: module masks, user labels, kit of self-tapping stainless steel screws Ø 4x32mm.
 Mortar guard element in cardboard supplied as standard in the packs and packed with paper banding. Enclosures with back plastic bottom.
CHARACTERISTICS: pre-arrangement for combined coupling (both horizontal and vertical) via the feedthrough coupling device GW48026.
 Mortar guard element assembled by pressing on the base opening.
NOTES: dispersible power calculated according to IEC 60670-24.



GW 48 686

WATERTIGHT FLUSH-MOUNTING COMBINED BOARD FITTED FOR MODULAR DEVICES AND FOR 2 FLANGES 85X75 MM FOR MOUNTING IEC 309 STANDARD SOCKET-OUTLETS - SHOCKPROOF FRONT - GREY RAL 7035



Code	No. of modules EN 50022	Outer dim. LxHxD (mm)	Front dim. LxH (mm)	Dispersible power (W)	Pack Carton
GW 48 686	4	308x169x70	345x210	19	1/4

ACCESSORIES SUPPLIED: user labels, kit of self-tapping screws of Ø 4 x 32mm in stainless steel.
 Mortar guard element in cardboard supplied as standard in the packs and packed with paper banding.
 Enclosures with back plastic bottom.
CHARACTERISTICS: pre-arrangement for combined coupling (both horizontal and vertical) via the feedthrough coupling device GW48026.
 Mortar guard element assembled by pressing on the base opening.
NOTES: dispersible power calculated according to IEC 60670-24. Compatible with IEC 309 16A 10° angled receptacle.

COMPLEMENTARY ITEMS



GW 48 024

INTERNAL DIVIDER FOR PTC BOXES



Code	For boxes dimensions	Pack Carton
GW 48 024	398x169x70 and 308x169x70 mm	10/200

APPLICATIONS: guarantees that circuits of a different nature are separated according to Standard CEI 64-8.



GW 48 026

PTC BOX COUPLING ADAPTOR



Code	Description	Pack Carton
GW 48 026	Base box coupling	5/25

APPLICATIONS: allows the creation of vertical/horizontal combined compositions and easier cable passage.



GW 70 009

GALVANIZED STEEL EXTENDING BRACKETS FOR REAR FIXING, COMPLETE WITH SELF-TAPPING SCREWS - SET OF 4 BRACKETS - 70 RT RANGE

Code	Adjustment range	Pack Carton
GW 70 009	90 - 160 mm	1/10

APPLICATIONS: when creating upright columns, it allows the creation of an air gap for the passage of conduits between the PTC box and the wall.



GW 44 683

RAIL FOR FIXING EQUIPOTENTIAL TERMINAL BLOCKS IN THE PTC MODULAR FLUSH- MOUNTING BOXES



Code	Installable terminal blocks	Pack Carton
GW 44 683	4xGW44671; 3xGW44672; 2xGW44673; 2xGW44674; 1xGW44675	1/50

CHARACTERISTICS: width: 1 compartment. For applications with PTC boxes with 2 and 3 compartments, the rail is fixed on the dividers GW48024.



GW 48 643

KIT FOR SEALING LIDS / FRONTS OF PTC BOXES 2 SCREWS WITH HEAD WITH THROUGH HOLE

Code	Description	Screw dimension (mm)	Pack Carton
GW 48 643	Screws nichel-plated brass	Ø 4x32	1/100

APPLICATIONS: in areas that can be accessed by unauthorised personnel, it prevents anyone tampering with the system.



GW 48 645

KIT CONTAINING 4 LONG SELF-THREADING SCREWS WITH SPACERS FOR FIXING LIDS AND FRONTS

Code	Screw dimension (mm)	Spacer thickness (mm)	Pack Carton
GW 48 645	Ø 4x45	Max 10 mm reducible	1/100

CHARACTERISTICS: the kit can be used for the following flush-mounting ranges: CD/CDK (from 6 modules upwards), 48 CM and 42 RV.



GW 48 644

WATERTIGHT CYLINDRICAL SECURITY LOCK

Code	For enclosures	Material	Pack Carton
GW 48 644	48 PTC and 42 RV range	Pressure die-cast metal	1/10

ACCESSORIES SUPPLIED: 2 keys.

NOTES: All the keys and relative locks with the same product code are identical.



GW 66 745

WATERTIGHT LIDS FOR COMBINED ENCLOSURE 48 PTC RANGE, OF THE GW48686 TYPE

Code	Dimensions LxH (mm)	Suitable for	Colour	Pack Carton
GW 66 708	75x85	1 Button Ø22 mm Range 74 PS	Grey	1/20
GW 66 745	75x85	1 Button Ø22 mm Range 74 PS	Yellow	1/20
GW 27 401	75x85	2 SYSTEM modules	Grey RAL 7035	3/60
GW 27 403	75x85	2 SYSTEM modules	Grey RAL 7035	3/60

APPLICATIONS: GW66745 specific for emergency push-buttons. Possibility of assembly on Q-DIN boards, PTC junction boxes, flanged lids and panels.

ACCESSORIES SUPPLIED: gasket and mounting screws.

SPARE PARTS



GW 48 621

WATERTIGHT SHOCKPROOF LIDS FOR PTC JUNCTION BOXES - RAL 7035 - IP55



Code	For boxes dimensions	Pack Carton
GW 48 621	138x169x70	1/30
GW 48 622	308x169x70	1/20
GW 48 623	398x169x70	1/15

ACCESSORIES SUPPLIED: stainless steel self-tapping screw kit 4x32 mm.



GW 48 651

PROTECTED WATERTIGHT TRANSPARENT SHOCKPROOF LIDS FOR PTC JUNCTION BOXES - I55



Code	For boxes dimensions	Pack Carton
GW 48 651	138x169x70	1/30

ACCESSORIES SUPPLIED: stainless steel self-tapping screw kit 4x32 mm.



GW 40 423

PLASTIC MODULE COVER PROFILE



Code	No. of modules EN 50022	Colour	Pack Carton
GW 40 423	4.5	Grey RAL 7035	50



48



Scan the QR Code and find out all the technical informations.

48 PT / PT DIN BOXES

48 CM BOXES

48 PTC BOXES



The range comes in 11 sizes, complete with mortar guard elements, which enable the creation of junctions for all needs. The 6-11 size boxes have a built-in DIN rail on the bottom, a feature that makes the range unique. Dispersible max power can be used to match the value with domotic and video entryphone devices, a feature that makes the range unique in the market.



Thanks to the great depth of the box, all the models in the range are able to accommodate a greater number of conduits, even of large diameter, vertically and horizontally along the walls. The range has ideal features for junctions along the system uprights.



A system of boxes, enclosures and modular distribution boards for junctions, control and distribution. The IP55 version is the ideal solution in technical rooms, kitchens or spaces where the devices can be accidentally subjected to water jets.

24 SC

Flush-mounting, surface-mounting and underfloor boxes

Wide range of surface-mounting and flush-mounting boxes for domestic ranges with high mechanical robustness and accessories supplied: dividers, junction elements, mortarguard shield etc.. Completing the range, the distribution outlet boxes for floor-mounting installations can be personalised in terms of capacity, external design finish, and internal fittings (they take both System range components and DIN rail devices).



UNDERFLOOR OUTLET BOXES

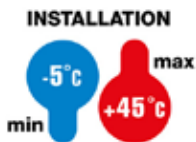

GWT
850°C

UNDERFLOOR OUTLET BOXES - WITH SUPPORTS POSITIONED VERTICALLY



GW 24 601

UNDERFLOOR OUTLET BOXES WITH HOLLOW LID - GLOW WIRE TEST 850° C



Code	Internal modularity	No. of supports	Outer dim. LxHxD (mm)	Pack Carton
GW 24 601	10 SYSTEM modules	2 supports with 5 System mod.	212x98x320	1
GW 24 602	20 SYSTEM modules	4 supports with 5 System mod.	364x98x320	1

CHARACTERISTICS: the supports are suitable for the insertion of plastic mobile dividers (energy/data) included.
The lid can be removed with the aid of a tool, and can be assembled on either side of the box.
The lid can be completed by inserting the same finish as used for the floor of the installation area.

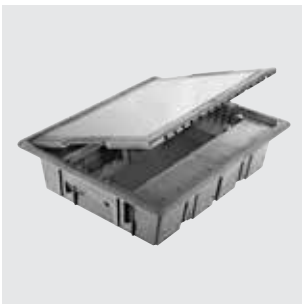

GW 24 612

UNDERFLOOR OUTLET BOXES WITH STAINLESS STEEL LID - GLOW WIRE TEST 850° C



Code	Internal modularity	No. of supports	Outer dim. LxHxD (mm)	Pack Carton
GW 24 611	10 SYSTEM modules	2 supports with 5 System mod.	212x98x320	1
GW 24 612	20 SYSTEM modules	4 supports with 5 System mod.	364x98x320	1

CHARACTERISTICS: the supports are suitable for the insertion of plastic mobile dividers (energy/data) included.
The lid can be removed with the aid of a tool, and can be assembled on either side of the box.
The lid has a stainless steel design surface finish.

UNDERFLOOR OUTLET BOXES - WITH SUPPORTS POSITIONED HORIZONTALLY



GW 24 606

UNDERFLOOR OUTLET BOXES WITH HOLLOW LID - GLOW WIRE TEST 850° C



Code	Internal modularity	No. of bases	No. of supports	Outer dim. LxHxD (mm)	Pack Carton
GW 24 606	16 SYSTEM modules	1 base	8 supports with 2 System mod.	212x98x320	1
GW 24 607	32 SYSTEM modules	2 bases	16 supports with 2 System mod.	364x98x320	1

CHARACTERISTICS: each base includes 8 snap-fit System supports.
The base is fixed with screws to the underfloor outlet box.
Plastic dividers (energy/data) are already included in the base.
The lid can be removed with the aid of a tool, and can be assembled on either side of the box.
The lid can be completed by inserting the same finish as used for the floor of the installation area.

UNDERFLOOR OUTLET BOXES WITH STAINLESS STEEL LID - GLOW WIRE TEST 850° C



GW 24 616

Code	Internal modularity	No. of bases	No. of supports	Outer dim. LxHxD (mm)	Pack Carton
GW 24 616	16 SYSTEM modules	1 base	8 supports with 2 System mod.	212x98x320	1
GW 24 617	32 SYSTEM modules	2 bases	16 supports with 2 System mod.	364x98x320	1

CHARACTERISTICS: each base includes 8 snap-fit System supports.
 The base is fixed with screws to the underfloor outlet box.
 Plastic dividers (energy/data) are already included in the base.
 The lid can be removed with the aid of a tool, and can be assembled on either side of the box.
 The lid has a stainless steel design surface finish.

ACCESSORIES

METAL CASING



GW 24 622

Code	Suitable for outlet boxes	Pack Carton
GW 24 621	GW24601, GW24611, GW24606, GW24616	1
GW 24 622	GW24602, GW24612, GW24607, GW24617	1

NOTES: suitable for the laying of the underfloor outlet boxes in cast flooring. Supplied with coupling flanges for conduits and channels. With lid.

KIT FOR INSTALLATION OF DEVICES ON DIN RAIL

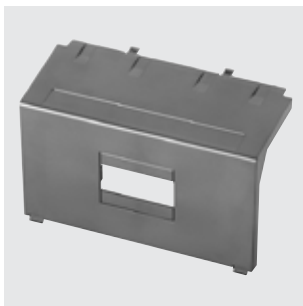

GW 24 633

Code	Suitable for outlet boxes	Pack Carton
GW 24 633	GW24601, GW24611, GW24602, GW24612	1/30

CHARACTERISTICS: suitable for the installation of DIN rail devices - max. 2 modules, only for underfloor outlet boxes with supports positioned vertically.
NOTES: the kit includes a DIN rail to be fixed on the back-mounting box of the underfloor outlet box, along with a plastic covering support.

FLUSH-MOUNTING BOXES FOR MASONRY WALLS



GWT
650°C



RECTANGULAR BOXES - BIG BOX



GW 24 403

BIG BOX HIGH CAPACITY RECTANGULAR BOXES FOR DOMESTIC, MODULAR AND DOMOTICS RANGES



Code	Description	Fixing supports axles distance	Compartment pre-arrangement	Outer dim. LxHxD (mm)	Pack Carton
GW 24 403	3 modules	83.5 mm	3	119x80x50	15/345
GW 24 404	4 modules	108.5 mm	4	144x85x50	5/135
GW 24 406	6-7 modules	100 mm	6	194x90x50	3/36
GW 24 206	6 modules (3+3)	83.5 mm	1	108x124x50	5/150
GW 24 237	8 modules (4+4)	108.5 mm	2	131x129x53	2/24
GW 24 238	12 modules (6+6)	163.5 mm	2	186x132x53	2/24
GW 24 239	18 modules (6+6+6)	163.5 mm	3	186x190x65	2/16

CHARACTERISTICS: GW24403, GW24404 and GW24406 can be combined with a reusable, mortar-proof, protective shield; functional dividers and joint elements.

GW24206: suitable for assembly of GW24005 self-supporting "Compact" plates and GW24215 - GW24216 blank "Compact" plates.

ACCESSORIES SUPPLIED: GW24237, GW24238 and GW24239 include functional dividers.

APPLICATIONS: ideal for use in the Home and Building Automation.

NOTES: GW24239 for PLAYBUS range only.



GW 24 403 P

MORTAR-PROOF PROTECTIVE SHIELDS FOR BIG BOX RECTANGULAR BOXES



Code	For BIG BOX boxes	Pack Carton
GW 24 403 P	GW24403	200
GW 24 404 P	GW24404	50
GW 24 406 P	GW24406	50

CHARACTERISTICS: in technopolymer. Total protection during brick wall work, painting and finishing operations.

Equipped with soft technopolymer antennas for identification purposes, and a central handle making it easier to pull it out.

NOTES: clip fixing to speed up assembly and removal operations.



GW 24 321

FUNCTIONAL DIVIDER FOR RECTANGULAR BOXES

Code	For BIG BOX boxes	For GREEN WALL boxes	Pack Carton
GW 24 321	GW24403, GW24404, GW24406	GW24403PM, GW24404PM, GW24406PM	200

APPLICATIONS: to separate circuits of different voltages in accordance with Systems Standard IEC 60364 (international) and HD 384 (european).



GW 24 330

CONNECTION ELEMENT FOR THE COMBINED ASSEMBLY OF BIG BOX RECTANGULAR BOXES



Code	For BIG BOX boxes	Pack Carton
GW 24 330	GW24403, GW24404, GW24406	150

APPLICATIONS: for horizontal/vertical composition of BIG BOX boxes from 3/4/6 gang.

NOTES: GW24330 allows for the mounting of System, Playbus and ChoruSmart series plates.

SQUARE BOX



GW 24 231

MODULAR SQUARE BOX



Code	Description	Fixing supports axles distance	Outer dim. LxHxD (mm)	Pack Carton
GW 24 231	2 modules sectional	60 mm	70x70x50	5/200

CHARACTERISTICS: fitted for multiple horizontal/vertical configurations, with centre distance 71 mm between the boxes. Supplied with 2 fixing screws.

ROUND BOXES



GW 24 232

ROUND MODULAR BOXES Ø 60MM WITH COLUMNS FOR THE FIXING SCREWS



Code	Description	Fixing supports axles distance	Dimensions (mm)	Pack Carton
GW 24 232	Modular round	60 mm	Ø 60 x 42	5/200
GW 24 233	Base/unit spacer for coupling at 91 mm	-	-	20/200

CHARACTERISTICS: GW24232, fitted for single or double installation, with centre distance composition of 71mm (or 91mm with the special spacer available as an accessory). Supplied with 2 fixing screws.



GW 24 208

ROUND BOXES



Code	Description	Dimensions (mm)	Pack Carton
GW 24 208	Conical	Ø 60 x 46	270
GW 24 209	Cylindrical	Ø 65x38	312
GW 24 210	Cylindrical	Ø 85x42	152

TELEPHONE SYSTEMS BOX

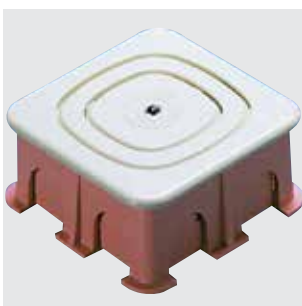

GW 24 221

TELEPHONE SYSTEMS BOX - IVORY COLOUR LID

Code	Type of installation	Outer dim. LxHxD (mm)	Pack Carton
GW 24 221	Conventional	68x68x30	280

CHARACTERISTICS: entries for conduits Ø 20 mm.

WALL-MOUNTING BOXES

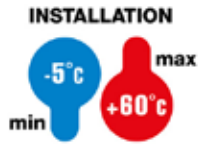

GWT
650°C



BOXES FOR CHORUSMART RANGE



GW 16 743

WALL-MOUNTING BOXES FOR MINI-TRUNKING AND TRUNKING USED AS SKIRTING FOR ONE PLATES



Code	Description	Support	Outer dim. LxHxD (mm)	Pack Carton
Colour: Satin White				
GW 16 743	3 modules	GW16803	118x90x46	3/60
GW 16 744	4 modules	GW16804	140x90x46	1/30
Colour: Satin black				
GW 16 773	3 modules	GW16803	118x90x46	3/30
GW 16 774	4 modules	GW16804	140x90x46	1/30

CHARACTERISTICS: support and plate not included. Use ONE plates (interchangeability with the entire colour range of plates). Pre-arranged for mini-trunking with dimensions BxH (mm): 15x8, 15x10, 22x10, 30x15.

NOTES: fitted for fixing the earth terminal GW26407.



GW 16 752

WALL-MOUNTING BOXES FOR MINI-TRUNKING AND TRUNKING USED AS SKIRTING FOR ONE INTERNATIONAL PLATES



Code	Description	Type	Support	Outer dim. LxHxD (mm)	Pack Carton
Colour: Satin White					
GW 16 752	2 modules	-	GW16822	90x90x46	1/30
GW 16 753	2+2 modules	Horizontal	GW16822	161x90x46	1/15
GW 16 754	2+2 modules	Vertical	GW16822	90x161x46	1/15
Colour: Satin black					
GW 16 782	2 modules	-	GW16822	90x90x46	1/30
GW 16 783	2+2 modules	Horizontal	GW16822	161x90x46	1/15
GW 16 784	2+2 modules	Vertical	GW16822	90x161x46	1/15

CHARACTERISTICS: support and plate not included. Use ONE International plates (interchangeability with the entire colour range of the plates).

Pre-arranged for mini-trunking with dimensions BxH (mm): 15x15, 20x20, 22x10, 30x10, 30x15, 35x15, 45x15.

GW16754 and GW16784 to be used together with plates with a centre distance of 71mm.

GW16752 - GW16782 supplied with 2 fixing screws. GW16753 - GW16754 - GW16783 - GW16784 supplied with 6 fixing screws.

NOTES: fitted for fixing the earth terminal GW26407.

BOXES FOR SYSTEM RANGE



GW 22 471

WALL-MOUNTING BOXES FOR TOP SYSTEM PLATES



Code	Suitable for	Colour	For trunking dim. (mm)	For conduits max Ø (mm)	Pack Carton
GW 22 471	1/2/3 modules TOP SYSTEM	Cloud white	14x8.5 30x13 20x10	16 - 20	3/60
GW 22 472	4 modules TOP SYSTEM	Cloud white	14x8.5 30x13 20x10	16 - 20	3/30

CHARACTERISTICS: fitted for fixing the earth terminal GW26407.



GW 24 006

WALL-MOUNTING BOXES FOR COMPACT SELF-SUPPORTING PLATES



Code	Suitable for	Colour	For trunking dim. (mm)	For conduits max Ø (mm)	Pack Carton
GW 24 006	1/2/3 modules COMPACT	Cloud white	14x8.5 30x13 20x10	16 - 20 - 25	3/60
GW 24 007	3+3 modules COMPACT	Cloud white	14x8.5 30x13 20x10	16 - 20 - 25	3/30

CHARACTERISTICS: fitted for fixing the earth terminal GW26407.



GW 32 431

WALL-MOUNTING BOXES FOR VIRNA PLATES



Code	Suitable for plates	Colour	For trunking dim. (mm)	For conduits max Ø (mm)	Pack Carton
GW 32 431	1/2/3 modules	Cloud white	15x17 / 22x10 / 25x17	16 - 20	3/60
GW 32 432	1/2/3 modules	Toner black	15x17 / 22x10 / 25x17	16 - 20	3/60

CHARACTERISTICS: fitted for fixing the earth terminal GW26407.

BOXES FOR PLAYBUS RANGE



GW 32 431

WALL-MOUNTING BOXES



Code	Suitable for	Colour	Pack Carton
GW 32 431	1/2/3 modules PLAYBUS	Cloud white	3/60
GW 32 432	1/2/3 modules PLAYBUS	Toner black	3/60

CHARACTERISTICS: fitted for fixing the earth terminal GW26407. Suitable for conduit Ø 16 - 20 mm.

COMPLEMENTARY ITEMS



GW 24 322

FUNCTIONAL DIVIDERS IN METAL FOR MODULAR, FLUSH-MOUNTING CONTAINERS

Code	Suitable for	Pack Carton
GW 24 322	GW24237	10/100
GW 24 323	GW24238	10/100
GW 24 324	GW24239	10/100

APPLICATIONS: energy separation - signal / separation special circuits.



GW 24 227

DEEP LIDS FOR 3-GANG FLUSH-MOUNTING RECTANGULAR BOXES TO INTERFACE BETWEEN WALL AND FLUSH INSTALLATIONS - IP40

Code	Description	Colour	Pack Carton
GW 24 227	Blank lid	Cloud white	5/50
GW 24 228	Device frame	Cloud white	5/50

APPLICATIONS: the deep lids allow the system to be extended, deriving additional points for drawing and controlling power from a 3 gang flush-mounting rectangular box.

The version with a window, GW24228, permits installing frames and plates with up to 3 gang.

CHARACTERISTICS: for trunking, 15x17 - 22x10 - 25x17mm.



GW 24 211

BLANK PLATES FOR RECTANGULAR FLUSH-MOUNTING BOXES



Code	Description	Configuration	Fixing	Colour	Pack Carton
GW 24 211	3 modules	-	With screw	Cloud white	1/120
GW 24 212	3 modules	-	With screw	Toner black	1/120
GW 24 213	4 modules	-	With screw	Cloud white	1/60
GW 24 214	4 modules	-	With screw	Toner black	1/60
GW 24 215	3+3 modules	Overlapping	With screw	Cloud white	1/60
GW 24 216	3+3 modules	Overlapping	With screw	Toner black	1/60



GW 24 218

LIDS FOR ROUND FLUSH-MOUNTING BOXES

Code	Description	Colour	Fixing	Pack Carton
GW 24 218	Ø 65mm	White RAL 9016	With fixing clutches	50/400
GW 24 220	Ø 85mm	White	With fixing clutches	50/600



GW 24 224

SPECIAL SELF-TAPPING SCREWS FOR FIXING THE SUPPORTS AND COMPACT SELF-SUPPORTING PLATES

Code	Dimensions (mm)	Suitable for	Pack Carton
GW 24 224	TC 3.5x17	Wood, plastic, aluminium	500/7000
GW 24 225	TC 3.5x30	Deep-mounted boxes	300/4200
GW 24 229	TC 3.5x50	Deep-mounted boxes	300/4200



24 SC



Scan the QR Code and find out all the technical informations.

BOXES FOR BRICK WALLS



The BIG BOX robust, high-capacity boxes are ideal for traditional and smart home applications. They differ to conventional products due to their greater internal space and the large number of accessories available (mortar guards, separators, joining elements, etc.).

BOXES FOR UNDERFLOOR APPLICATIONS



The range of underfloor boxes meets the demands for safety, connectivity and energy usage. 10-20 or 16-32 System module versions, with walkable cover (empty or stainless finish). Also available metal casing for installation in poured cement floors.

BOXES FOR SURFACE-MOUNTING DOMESTIC RANGE PLATES



Developed with an aesthetic line that adapts to the GEWISS domestic series plate design, the wall boxes for the Chorusmart, System and Playbus ranges make quality installations possible even in environments where concealed installation is not possible.



CONDUITS AND ACCESSORIES FOR INSTALLATION



RK

RIGID PROTECTIVE CONDUIT
SYSTEMS

pag. 312



FK

PLIABLE PROTECTIVE CONDUIT
SYSTEMS

pag. 326



DF

FLEXIBLE PROTECTIVE CONDUIT
SYSTEMS

pag. 340



PZ

ACCESS CHAMBERS SYSTEMS













pag. 348









GW FIT

ACCESSORIES FOR ELECTRICAL
INSTALLATION

pag. 354

Ø Conduit (mm)	RIGID CONDUITS											
	RK9 range				RK9 HF range	IRL/B range		RK 15 range		RKB range	RKHF range	
												
16	DX 24 816	DX 24 916	DX 25 116	DX 25 116 W	DX 26 716 W	DX 27 616	DX 27 716	DX 25 216	DX 25 316	DX 25 716	DX 26 216	DX 26 316
20	DX 24 820	DX 24 920	DX 25 120	DX 25 120 W	DX 26 720 W	DX 27 620	DX 27 720	DX 25 220	DX 25 320	DX 25 720	DX 26 220	DX 26 320
25	DX 24 825	DX 24 925	DX 25 125	DX 25 125 W	DX 26 725 W	DX 27 625	DX 27 725	DX 25 225	DX 25 325	DX 25 725	DX 26 225	DX 26 325
32	DX 24 832	DX 24 932	DX 25 132	DX 25 132 W	DX 26 732 W	DX 27 632	DX 27 732	DX 25 232	DX 25 332	DX 25 732	DX 26 232	DX 26 332
40	DX 24 840	DX 24 940	DX 25 140	DX 25 140 W		DX 27 640	DX 27 740		DX 25 340	DX 25 740	DX 26 240	
50		DX 24 950	DX 25 150			DX 27 650	DX 27 750		DX 25 350	DX 25 750	DX 26 250	
63						DX 27 663	DX 27 763		DX 25 363	DX 25 763	DX 26 263	

Description	BOXES	COUPLING DEVICES FOR TRIX AND QUADRIX BOXES - IP54		
		Cap	Box-box coupling device	Coupling device for smooth conduits
				
				Conduit Ø 16 mm
TRIX BOX 3-inlet	DX 45 003	DX 47 000	DX 47 001	DX 47 616
QUADRIX BOX 4-inlet	DX 45 004	DX 47 000	DX 47 001	DX 47 616
QUADRIX BOX 7-inlet	DX 45 007	DX 47 000	DX 47 001	DX 47 616
QUADRIX BOX 10-inlet	DX 45 010	DX 47 000	DX 47 001	DX 47 616

Ø Conduit (mm)	IP 44 - IP 66 ROUTING COMPONENTS		ACCESSORIES		
	Flexible couplings SPEEDY-FLEX range		Conduit-bending springs RK 15	Conduit-bending springs RKB	Conduit cutting shears
					
16	GW 50 201	GW 50 207	DX 51 416	DX 51 316	DX 51 600
20	GW 50 202	GW 50 208	DX 51 420	DX 51 320	
25	GW 50 203	GW 50 209	DX 51 425	DX 51 325	
32	GW 50 204	GW 50 210	DX 51 432		
40	GW 50 205	GW 50 211	DX 51 440		
50	GW 50 206	GW 50 212	DX 51 450		

In bold: Halogen Free material versions

RK RANGE - IP40 COUPLINGS				MORBIDX RANGE - WATERTIGHT COUPLINGS								
Coupling IP40	Narrow radius curves IP40	Inspectionable T-joint IP40	Inspectionable bend IP40	Coupling IP67	Narrow radius curves IP67	Conduit-box coupling IP67		Conduit-sheath coupling device IP65		Conduit-sheath coupling device equal diameter - IP65		La Svolta conduit-conduit IP65
						Metric pitch		Sheath Ø		Sheath Ø		
DX 40 016	DX 40 116	DX 40 216	DX 40 316	DX 43 016	DX 43 116	M16x1,5	DX 43 216	12	DX 43 316	16	DX 43 416	DX 43 516
DX 40 020	DX 40 120	DX 40 220	DX 40 320	DX 43 020	DX 43 120	M20x1,5	DX 43 220	16	DX 43 320	20	DX 43 420	DX 43 520
DX 40 025	DX 40 125	DX 40 225	DX 40 325	DX 43 025	DX 43 125	M25x1,5	DX 43 225	20	DX 43 325	25	DX 43 425	DX 43 525
DX 40 032	DX 40 132	DX 40 232	DX 40 332	DX 43 032	DX 43 132	M32x1,5	DX 43 232	25	DX 43 332	28	DX 43 432	DX 43 532
DX 40 040	DX 40 140			DX 43 040	DX 43 140	M40x1,5	DX 43 240	32	DX 43 340	40	DX 43 440	DX 43 540
DX 40 050	DX 40 150			DX 43 050	DX 43 150	M50x1,5	DX 43 250	40	DX 43 350			DX 43 550
DX 40 063	DX 40 163											

COUPLING DEVICES FOR TRIX AND QUADRIX BOXES - IP54							
Coupling device for smooth conduits		Coupling device for spiral sheaths			Cable gland coupling device		
Conduit Ø 20 mm	Conduit Ø 25 mm	Sheath Ø 12 mm	Sheath Ø 16 mm	Sheath Ø 20 mm	Cables Ø 3-6 mm	Cables Ø 6-9 mm	Cables Ø 9-12 mm
DX 47 620	DX 47 625	DX 47 212	DX 47 216	DX 47 220	DX 47 503	DX 47 506	DX 47 509
DX 47 620	DX 47 625	DX 47 212	DX 47 216	DX 47 220	DX 47 503	DX 47 506	DX 47 509
DX 47 620	DX 47 625	DX 47 212	DX 47 216	DX 47 220	DX 47 503	DX 47 506	DX 47 509
DX 47 620	DX 47 625	DX 47 212	DX 47 216	DX 47 220	DX 47 503	DX 47 506	DX 47 509

RK

Rigid protective conduit systems

The system of rigid protective conduits, made of extremely high quality material, guarantees excellent quality such as to offer greater performance. Available with diameters from 16 to 63 mm, in versions RK9 (light), RK15 (medium) and RKB (heavy), made of PVC. Also available Halogne Free versions RK9 HF (light) and RKHF (heavy), made of PP. They may be fully integrated into flexible conduit systems and junction boxes. Completing the offer, a wide range of couplings and routing components with IP40 and IP67 protection ratings.



RIGID CONDUITS

RK9 LIGHT RIGID CONDUIT - GREY RAL 7035

CLASSIFICATION
22211
EN 50086
EN 61386

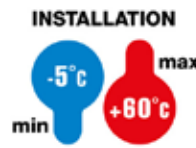

GWT
960°C



DX 25 116

LIGHT RIGID CONDUIT - STRAIGHT END - LENGHT: 3 METERS - PVC

Code	Conduits Ø (mm)	Pack Carton
DX 25 116	16	111/3330
DX 25 120	20	57/2223
DX 25 125	25	57/1311
DX 25 132	32	30/780
DX 25 140	40	30/540
DX 25 150	50	15/360



DX 24 816

LIGHT RIGID CONDUIT - SLEEVED - LENGHT: 2 METERS - PVC

Code	Conduits Ø (mm)	Pack Carton
DX 24 816	16	74/2220
DX 24 820	20	48/1344
DX 24 825	25	48/864
DX 24 832	32	38/532
DX 24 840	40	14/350

RK9 LIGHT RIGID CONDUIT - WHITE RAL 9010



DX 25 116 W

LIGHT RIGID CONDUIT - STRAIGHT END - LENGHT: 3 METERS - PVC

Code	Conduits Ø (mm)	Pack Carton
DX 25 116 W	16	111/3330
DX 25 120 W	20	57/2223
DX 25 125 W	25	57/1311
DX 25 132 W	32	30/780
DX 25 140 W	40	30/540

RK9 HF LIGHT RIGID CONDUIT HALOGEN FREE (EN50642) - WHITE RAL 9010

CLASSIFICATION
23431
EN 50086
EN 61386

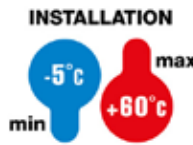

GWT
960°C



DX 26 716 W

LIGHT RIGID CONDUIT - STRAIGHT END - LENGHT: 3 METERS - PP HF

Code	Conduits Ø (mm)	Pack Carton
DX 26 716 W	16	87/1827
DX 26 720 W	20	69/1449
DX 26 725 W	25	60/840
DX 26 732 W	32	36/504

IRL/B MEDIUM RIGID CONDUIT - GREY RAL 7035

CLASSIFICATION
33211
 EN 50086
 EN 61386

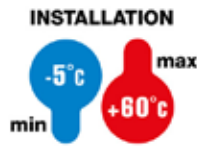

GWT
960°C



DX 27 616

MEDIUM RIGID CONDUIT - SLEEVED - LENGTH: 2 METRES - PVC

Code	Conduits Ø (mm)	Pack Carton
DX 27 616	16	74/2220
DX 27 620	20	48/1344
DX 27 625	25	48/864
DX 27 632	32	38/532
DX 27 640	40	14/350
DX 27 650	50	10/240
DX 27 663	63	6/120



DX 27 716

MEDIUM RIGID CONDUIT - SLEEVED - LENGTH: 3 METRES - PVC

Code	Conduits Ø (mm)	Pack Carton
DX 27 716	16	75/3150
DX 27 720	20	51/2142
DX 27 725	25	51/1224
DX 27 732	32	30/780
DX 27 740	40	21/525
DX 27 750	50	15/360
DX 27 763	63	9/180

RK 15 MEDIUM RIGID CONDUIT - GREY RAL 7035

CLASSIFICATION
33211
EN 50086
EN 61386

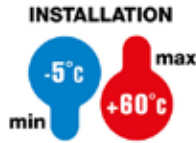

GWT
960°C



DX 25 216

MEDIUM RIGID CONDUIT - LENGTH: 2 METRES - PVC

Code	Conduits Ø (mm)	Pack Carton
DX 25 216	16	74/2220
DX 25 220	20	48/1344
DX 25 225	25	48/864
DX 25 232	32	38/532



DX 25 316

MEDIUM RIGID CONDUIT - LENGTH: 3 METRES - PVC

Code	Conduits Ø (mm)	Pack Carton
DX 25 316	16	111/3330
DX 25 320	20	57/2223
DX 25 325	25	57/1311
DX 25 332	32	30/780
DX 25 340	40	30/540
DX 25 350	50	15/360
DX 25 363	63	9/180

RKB HEAVY RIGID CONDUIT - GREY RAL 7035

CLASSIFICATION
43211
EN 50086
EN 61386



GWT
960°C



DX 25 716

HEAVY RIGID CONDUIT - LENGTH: 3 METRES - PVC

Code	Conduits Ø (mm)	Pack Carton
DX 25 716	16	57/3192
DX 25 720	20	57/2223
DX 25 725	25	57/1311
DX 25 732	32	30/780
DX 25 740	40	30/540
DX 25 750	50	15/360
DX 25 763	63	9/180

RKHF HEAVY RIGID CONDUIT, HALOGEN-FREE - GREY RAL 7035

CLASSIFICATION
44221
 EN 50086
 EN 61386

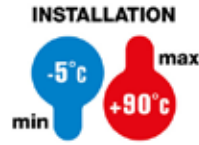

DX 26 216

HEAVY RIGID CONDUIT - LENGTH: 2 METERS - HALOGEN FREE



Code	External Ø conduits (mm)	Internal Ø conduits (mm)	Pack Carton
DX 26 216	16	10.8	60/4620
DX 26 220	20	14.5	46/3542
DX 26 225	25	19.3	48/2640
DX 26 232	32	25.8	36/1980
DX 26 240	40	32.8	30/1080
DX 26 250	50	42.4	18/648
DX 26 263	63	54.6	12/420

NOTE: to fix the RKHF conduit, you are advised to use collar clip with a distance between clip to clip equal 50 + 60cm.



DX 26 316

HEAVY RIGID CONDUIT - LENGTH: 3 METERS - HALOGEN FREE



Code	External Ø conduits (mm)	Internal Ø conduits (mm)	Pack Carton
DX 26 316	16	10.8	87/1827
DX 26 320	20	14.5	69/1449
DX 26 325	25	19.3	60/840
DX 26 332	32	25.8	36/504

NOTE: to fix the RKHF conduit, you are advised to use collar clip with a distance between clip to clip equal 50 + 60cm.

ROUTING COMPONENTS

RK CONNECTIONS - GREY RAL 7035



DX 40 016

COUPLING - IP40



Code	Conduits Ø (mm)	Pack Carton
DX 40 016	16	30/300
DX 40 020	20	30/450
DX 40 025	25	20/240
DX 40 032	32	10/100
DX 40 040	40	5/25
DX 40 050	50	15
DX 40 063	63	8

NOTE: DX40063 not Halogen Free



DX 40 116

TIGHT RADIUS BEND - IP40



Code	Conduits Ø (mm)	Pack Carton
DX 40 116	16	30/300
DX 40 120	20	30/300
DX 40 125	25	20/100
DX 40 132	32	10/50
DX 40 140	40	5/25
DX 40 150	50	10
DX 40 163	63	1

NOTE: DX40063 not Halogen Free



DX 40 216

INSPECTABLE T - IP40

Code	Conduits Ø (mm)	Pack Carton
DX 40 216	16	30/120
DX 40 220	20	30/120
DX 40 225	25	20/60
DX 40 232	32	10/30



DX 40 316

INSPECTABLE BEND - IP40

Code	Conduits Ø (mm)	Pack Carton
DX 40 316	16	30/180
DX 40 320	20	30/120
DX 40 325	25	20/60
DX 40 332	32	10/40

MORBIDIX CONNECTIONS - GREY RAL 7035



DX 43 016

RELEASE COUPLING - IP67



Code	Conduits Ø (mm)	Pack Carton
DX 43 016	16	10/300
DX 43 020	20	10/240
DX 43 025	25	5/150
DX 43 032	32	5/120
DX 43 040	40	5/90
DX 43 050	50	3/54



DX 43 116

RELEASE TIGHT BEND - IP67



Code	Conduits Ø (mm)	Pack Carton
DX 43 116	16	10/100
DX 43 120	20	10/80
DX 43 125	25	5/50
DX 43 132	32	5/30
DX 43 140	40	5/15
DX 43 150	50	8



DX 43 216

RELEASE CONDUIT-BOX COUPLING - IP67



Code	Conduits Ø (mm)	ISO pitch	For holes Ø (mm)	Pack Carton
DX 43 216	16	M 16x1.5	16	10/360
DX 43 220	20	M 20x1.5	20	10/300
DX 43 225	25	M 25x1.5	25	5/180
DX 43 232	32	M 32x1.5	32	5/150
DX 43 240	40	M 40x1.5	40	5/30
DX 43 250	50	M 50x1.5	50	5/15



DX 43 316

RELEASE CONDUIT-SHEATH COUPLING - IP65



Code	Conduits Ø (mm)	Sheath Ø (mm)	Pack Carton
DX 43 316	16	12	10/450
DX 43 320	20	16	10/300
DX 43 325	25	20	5/210
DX 43 332	32	25	5/120
DX 43 340	40	32	5/25
DX 43 350	50	40	5/20



DX 43 416

RELEASE CONDUIT-SHEATH COUPLING EQUAL DIAMETER - IP65

Code	Conduits Ø (mm)	Sheath Ø (mm)	Pack Carton
DX 43 416	16	16	10/360
DX 43 420	20	20	10/240
DX 43 425	25	25	5/150
DX 43 432	32	28	5/40
DX 43 440	40	40	5/20

USE: coupling of a rigid protective conduit with a spiral sheath of the DIFLEX range these connections allow rigid conduits and sheaths to have the same internal diameter, making the wiring easy.



DX 43 516

LA SVOLTA CONDUIT-CONDUIT COUPLING - IP65

Code	Conduits Ø (mm)	Working length (mm)	Pack Carton
DX 43 516	16	110	60
DX 43 520	20	132	40
DX 43 525	25	209	20
DX 43 532	32	301	20
DX 43 540	40	302	12
DX 43 550	50	311	9

SPEEDY-FLEX COUPLINGS - GREY RAL 7035

GW 50 201

WATERTIGHT FLEXIBLE COUPLINGS - IP66

Code	For external conduits (mm)	External Ø (mm)	Internal Ø (mm)	Length (mm)	Pack Carton
GW 50 201	16	27	13	140	20/60
GW 50 202	20	31.5	17	160	20/120
GW 50 203	25	41	21.5	205	10/40
GW 50 204	32	55	28	290	10/60
GW 50 205	40	65	35.5	400	6/30
GW 50 206	50	72	44.5	515	6/36

CHARACTERISTICS: multifunctional couplings allowing the realisation of 0-90° variable angle curves and misaligned conduit-conduit couplings.

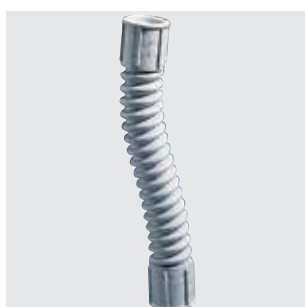

GW 50 210

PROTECTED FLEXIBLE COUPLINGS - IP44

Code	For external conduits (mm)	External Ø (mm)	Internal Ø (mm)	Length (mm)	Pack Carton
GW 50 207	16	24	13	135	20/60
GW 50 208	20	30	17	160	20/120
GW 50 209	25	35	21.5	205	20/120
GW 50 210	32	45	28	280	10/20
GW 50 211	40	55	35.5	400	6/30
GW 50 212	50	65	44.5	515	6/36

CHARACTERISTICS: multifunctional couplings allowing the realisation of 0-90° variable angle curves and misaligned conduit-conduit couplings.

ACCESSORIES



DX 51 416

CONDUIT-BENDING SPRING FOR RK15

Code	Conduits Ø (mm)	Pack Carton
DX 51 416	16	1/10
DX 51 420	20	1/10
DX 51 425	25	1/5
DX 51 432	32	1/5
DX 51 440	40	1
DX 51 450	50	1

USE: for cold bending rigid conduits.

MATERIAL: special galvanised steel square wire mesh.



DX 51 316

CONDUIT-BENDING SPRING FOR RKB

Code	Conduits Ø (mm)	Pack Carton
DX 51 316	16	1/10
DX 51 320	20	1/10
DX 51 325	25	1/5

USE: for cold bending rigid conduits.

MATERIAL: special galvanised steel square wire mesh.



DX 51 600

CONDUIT CUTTER

Code	Description	Pack Carton
DX 51 600	Conduit cutter	1/5

JUNCTION BOXES

TRIX - GREY RAL 7035



DX 45 003

TRIX BOX - IP54



Code	Description	Outer dim. LxHxD (mm)	Pack Carton
DX 45 003	TX3-3 inputs	87x64x53	3/15

NOTES: Without coupling devices and without caps.

QUADRIX - GREY RAL 7035



DX 45 004

QUADRIX BOX - IP54



Code	Description	Accessories supplied	Outer dim. LxHxD (mm)	Pack Carton
DX 45 004	QX4-4 inputs	1 cap	100x106x53	5/60
DX 45 007	QX7-7 inputs	3 caps	106x106x53	5/60
DX 45 010	QX10-10 inputs	4 caps	140x140x53	1/16

NOTE: Without coupling devices.

COUPLINGS AND ACCESSORIES - GREY RAL 7035



DX 47 616

TRIX/QUADRIX-CONDUIT MORBIDX COUPLING



Code	Conduits Ø (mm)	Pack Carton
DX 47 616	16	10/390
DX 47 620	20	10/360
DX 47 625	25	10/300



DX 47 212

SHEATH -TRIX/QUADRIX COUPLING



Code	Sheath Ø (mm)	Pack Carton
DX 47 212	12	10/450
DX 47 216	16	10/450
DX 47 220	20	10/390



DX 47 503

CABLE - TRIX/QUADRIX CABLE GLAND COUPLING



Code	For cables Ø (mm)	Pack Carton
DX 47 503	6	10/300
DX 47 506	9	10/300
DX 47 509	12	10/300



DX 47 000

CLOSURE CAP



Code	Description	Pack Carton
DX 47 000	Closing Cap	50/450



DX 47 001

BOX-BOX COUPLING



Code	Description	Pack Carton
DX 47 001	Box-box pipe-fitting	20/60



RK



Scan the QR Code and find out all the technical informations.

FOR EVERY INSTALLATION NEED

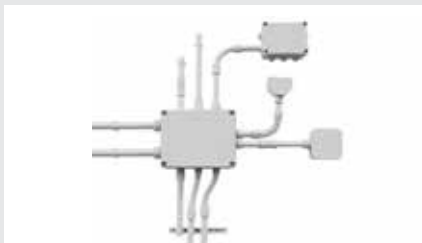

The GEWISS rigid conduit range includes the RK9 (classification 22211), RK9 HF (classification 23431), RK15 (classification 3321), RKB (classification 4321) and RKHF (classification 4422), available in 7 sizes from 16 to 63 mm, and specific routing components for the creation of watertight or protected surface-mounted systems.

SIMPLE AND RELIABLE SYSTEM











The MORBIDX quick connect system allows the creation of surface mounted systems with IP65 and IP67 ratings, and a significant reduction in installation time. The perfect fit of the O-ring seal material ensures a firm conduit seal even in vertical position or if the conduit is not cut perfectly to size.

HALOGEN-FREE RANGE



RK9 HF, RKHF and a wide range of HF routing components enable the installation of Halogen Free surface-mounting systems, ideal for installations in public environments with high concentrations of people, thanks to lower toxic emissions and less smoke opacity in the event of fire.



Ø CONDUITS (mm)	FK 15 RANGE PLIABLE CONDUIT					
	Natural white		Black		Green	
						
		with probe		with probe		with probe
16	DX 16 216 R	DX 16 316 R	DX 15 016 R	DX 15 116 R	DX 15 216 R	DX 15 316 R
20	DX 16 220 R	DX 16 320 R	DX 15 020 R	DX 15 120 R	DX 15 220 R	DX 15 320 R
25	DX 16 225 R	DX 16 325 R	DX 15 025 R	DX 15 125 R	DX 15 225 R	DX 15 325 R
32	DX 16 232 R	DX 16 332 R	DX 15 032 R	DX 15 132 R	DX 15 232 R	DX 15 332 R
40	DX 16 240 R		DX 15 040 R	DX 15 140 R	DX 15 240 R	
50	DX 16 250 R		DX 15 050 R	DX 15 150 R	DX 15 250 R	
63			DX 15 063 R	DX 15 163 R		

Ø CONDUITS (mm)	COEXTRUDED PLIABLE CONDUIT - FK-XTREME		
	Natural white	Black	Green
			
20	DX 16 220 X	DX 15 020 X	DX 15 220 X
25	DX 16 225 X	DX 15 025 X	DX 15 225 X
32	DX 16 232 X	DX 15 032 X	DX 15 232 X
40	DX 16 240 X	DX 15 040 X	DX 15 240 X







Ø CONDUITS (mm)	HALOGEN-FREE SELF-RECOVERING PLIABLE CONDUITS - ICTA RANGE					
	Grey		Dark grey		Green	
						
		with probe		with probe		with probe
16	DX 20 016 R	DX 20 116 R	DX 20 416 R	DX 20 516 R	DX 22 016 R	DX 22 116 R
20	DX 20 020 R	DX 20 120 R	DX 20 420 R	DX 20 520 R	DX 22 020 R	DX 22 120 R
25	DX 20 025 R	DX 20 125 R	DX 20 425 R	DX 20 525 R	DX 22 025 R	DX 22 125 R
32	DX 20 032 R	DX 20 132 R	DX 20 432 R	DX 20 532 R	DX 22 032 R	DX 22 132 R
40	DX 20 040 R	DX 20 140 R	DX 20 440 R	DX 20 540 R	DX 22 040 R	DX 22 140 R
50	DX 20 050 R	DX 20 150 R	DX 20 450 R	DX 20 550 R	DX 22 050 R	DX 22 150 R
63	DX 20 063 R	DX 20 163 R	DX 20 463 R	DX 20 563 R	DX 22 063 R	DX 22 163 R

CABLE PULLER PROBES				
				
	Probe Ø 3 mm	Probe Ø 4 mm		
Length (m)			Flexible head	Tail ring
5	DX 52 205	DX 52 305	DX 52 299	DX 52 399
10	DX 52 210	DX 52 310	DX 52 299	DX 52 399
15	DX 52 215	DX 52 315	DX 52 299	DX 52 399
20	DX 52 220	DX 52 320	DX 52 299	DX 52 399
25	DX 52 225	DX 52 325	DX 52 299	DX 52 399



In bold: halogen-free material versions

COMPONENTS		
		
Coupling	Cap	Conduit-box coupling device
DX 52 016	DX 52 116	GW 50 415
DX 52 020	DX 52 120	GW 50 416
DX 52 025	DX 52 125	GW 50 417
DX 52 032	DX 52 132	GW 50 418
DX 52 040	DX 52 140	GW 50 419
DX 52 050	DX 52 150	GW 50 420
DX 52 063	DX 52 163	





FK 15 RANGE PLIABLE CONDUIT

Light blue		Brown		Lilac	
	 with probe		 with probe		 with probe
DX 15 416 R	DX 15 516 R	DX 15 616 R	DX 15 716 R	DX 15 816 R	DX 15 916 R
DX 15 420 R	DX 15 520 R	DX 15 620 R	DX 15 720 R	DX 15 820 R	DX 15 920 R
DX 15 425 R	DX 15 525 R	DX 15 625 R	DX 15 725 R	DX 15 825 R	DX 15 925 R
DX 15 432 R	DX 15 532 R	DX 15 632 R	DX 15 732 R	DX 15 832 R	DX 15 932 R
DX 15 440 R		DX 15 640 R		DX 15 840 R	
DX 15 450 R		DX 15 650 R		DX 15 850 R	

COEXTRUDED PLIABLE CONDUIT - FK-XTREME RANGE

Light blue	Brown	Lilac
		
DX 15 420 X	DX 15 620 X	DX 15 820 X
DX 15 425 X	DX 15 625 X	DX 15 825 X
DX 15 432 X	DX 15 632 X	DX 15 832 X
DX 15 440 X	DX 15 640 X	DX 15 840 X

**FKHF RANGE HALOGEN-FREE
SELF-RECOVERING PLIABLE CONDUITS**

Blue		Ø CONDUITS (mm)	Grey	
	 with probe			 with probe
DX 23 016 R	DX 23 116 R	16	DX 23 216 R	DX 23 316 R
DX 23 020 R	DX 23 120 R	20	DX 23 220 R	DX 23 320 R
DX 23 025 R	DX 23 125 R	25	DX 23 225 R	DX 23 325 R
DX 23 032 R	DX 23 132 R	32	DX 23 232 R	DX 23 332 R
DX 23 040 R	DX 23 140 R	40	DX 23 240 R	DX 23 340 R
DX 23 050 R	DX 23 150 R	50	DX 23 250 R	DX 23 350 R
DX 23 063 R	DX 23 163 R	63	DX 23 263 R	DX 23 363 R

FK

Pliable protective conduit system

System of protective corrugated conduits for concealed installation, available in two materials: PVC and Polypropylene (PP) and in different colours for easy identification of the lines according to normative recommendations. The pallets are protected with white stretch film to prevent exposure of the coils to UV rays and ensure at the same time a greater resistance to weathering and improved preservation during external storage.



SELF-EXTINGUISHING PLIABLE CONDUITS

CLASSIFICATION
22212
EN 50086
EN 61386



GWT
960°C

FK9 LIGHT PLIABLE CONDUIT



DX 10 016 R

LIGHT GREY RAL 7035 PLIABLE CONDUIT - PVC

Code	Conduits Ø (mm)	Pack Carton
Type: without cable puller		
DX 10 016 R	16	100/6400
DX 10 020 R	20	100/5200
DX 10 025 R	25	75/3300
DX 10 032 R	32	50/1800
DX 10 040 R	40	25/1100
DX 10 050 R	50	25/400
Type: with cable puller		
DX 10 116 R	16	100/6400
DX 10 120 R	20	100/5200
DX 10 125 R	25	75/3300
DX 10 132 R	32	50/1800
DX 10 140 R	40	25/500
DX 10 150 R	50	25/400

APPLICATION: Recommended for chased wall and ceiling installation. Cable puller-feeder allows the wires to be pulled easily. Conformity to standards refers to the protective conduit and not to the cable puller-feeder. Do not expose the conduits to direct solar irradiation for long periods. Do not remove the protective white film during the storage.

ARCOBALENO SELF-EXTINGUISHING PLIABLE CONDUITS

CLASSIFICATION
33212
EN 50086
EN 61386



GWT
960°C

FK15 MEDIUM PLIABLE CONDUIT

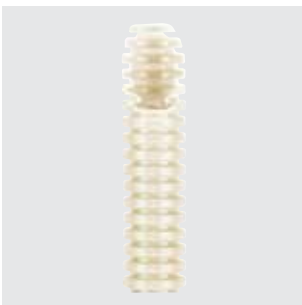

DX 16 216 R

MEDIUM NATURAL WHITE PLIABLE CONDUIT - PVC

Code	Conduits Ø (mm)	Pack Carton
Type: without cable puller		
DX 16 216 R	16	100/2800
DX 16 220 R	20	100/2400
DX 16 225 R	25	75/1500
DX 16 232 R	32	50/800
DX 16 240 R	40	25/500
DX 16 250 R	50	25/400
Type: with cable puller		
DX 16 316 R	16	100/2800
DX 16 320 R	20	100/2400
DX 16 325 R	25	75/1500
DX 16 332 R	32	50/800

USE: natural white is recommended for the identification of the co-axial computer cables. The cable puller-feeder allows the wires to be pulled easily. Conformity to standards refers to the protective conduit and not to the cable puller-feeder. Do not expose the conduits to direct solar irradiation for long periods. Do not remove the protective white film during the storage.



DX 15 116 R

MEDIUM BLACK PLIABLE CONDUIT - PVC

Code	Conduits Ø (mm)	Pack Carton
Type: without cable puller		
DX 15 016 R	16	100/6400
DX 15 020 R	20	100/5200
DX 15 025 R	25	75/3300
DX 15 032 R	32	50/1800
DX 15 040 R	40	25/1100
DX 15 050 R	50	25/400
DX 15 063 R	63	20/240
Type: with cable puller		
DX 15 116 R	16	100/6400
DX 15 120 R	20	100/5200
DX 15 125 R	25	75/3300
DX 15 132 R	32	50/1800
DX 15 140 R	40	25/500
DX 15 150 R	50	25/400
DX 15 163 R	63	20/240

USE: black is recommended for the identification of the distribution and force lines.
 The cable puller-feeder allows the wires to be pulled easily.
 Conformity to standards refers to the protective conduit and not to the cable puller-feeder. Do not expose the conduits to direct solar irradiation for long periods.
 Do not remove the protective white film during the storage.

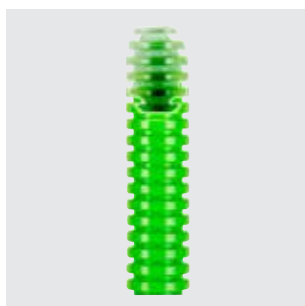

DX 15 216 R

MEDIUM GREEN PLIABLE CONDUIT - PVC

Code	Conduits Ø (mm)	Pack Carton
Type: without cable puller		
DX 15 216 R	16	100/2800
DX 15 220 R	20	100/5200
DX 15 225 R	25	75/3300
DX 15 232 R	32	50/800
DX 15 240 R	40	25/500
DX 15 250 R	50	25/400
Type: with cable puller		
DX 15 316 R	16	100/2800
DX 15 320 R	20	100/2400
DX 15 325 R	25	75/1500
DX 15 332 R	32	50/800

USE: the green colour is recommended for identifying the telephone lines, BUS lines and domestic automation lines.
 The cable puller-feeder allows the wires to be pulled easily.
 Conformity to standards refers to the protective conduit and not to the cable puller-feeder. Do not expose the conduits to direct solar irradiation for long periods.
 Do not remove the protective white film during the storage.

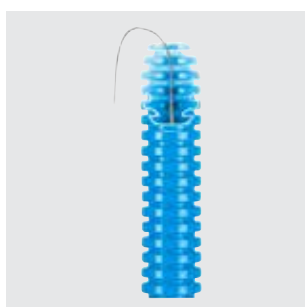

DX 15 516 R

MEDIUM LIGHT BLUE PLIABLE CONDUIT - PVC

Code	Conduits Ø (mm)	Pack Carton
Type: without cable puller		
DX 15 416 R	16	100/2800
DX 15 420 R	20	100/5200
DX 15 425 R	25	75/3300
DX 15 432 R	32	50/800
DX 15 440 R	40	25/500
DX 15 450 R	50	25/400
Type: with cable puller		
DX 15 516 R	16	100/2800
DX 15 520 R	20	100/2400
DX 15 525 R	25	75/1500
DX 15 532 R	32	50/800

USE: light blue is recommended for the identification of the entryphone lines.
 The cable puller-feeder allows the wires to be pulled easily.
 Conformity to standards refers to the protective conduit and not to the cable puller-feeder. Do not expose the conduits to direct solar irradiation for long periods.
 Do not remove the protective white film during the storage.

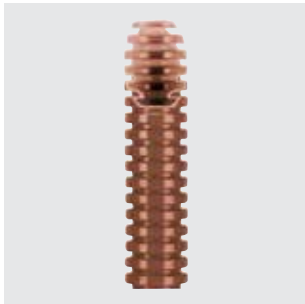

DX 15 616 R

MEDIUM BROWN PLIABLE CONDUIT - PVC

Code	Conduits Ø (mm)	Pack Carton
Type: without cable puller		
DX 15 616 R	16	100/2800
DX 15 620 R	20	100/2400
DX 15 625 R	25	75/1500
DX 15 632 R	32	50/800
DX 15 640 R	40	25/500
DX 15 650 R	50	25/400
Type: with cable puller		
DX 15 716 R	16	100/2800
DX 15 720 R	20	100/2400
DX 15 725 R	25	75/1500
DX 15 732 R	32	50/800

USE: brown is recommended for the identification of the emergency light and alarm lines.

The cable puller-feeder allows the wires to be pulled easily.

Conformity to standards refers to the protective conduit and not to the cable puller-feeder. Do not expose the conduits to direct solar irradiation for long periods.

Do not remove the protective white film during the storage.



DX 15 916 R

MEDIUM LILAC PLIABLE CONDUIT - PVC

Code	Conduits Ø (mm)	Pack Carton
Type: without cable puller		
DX 15 816 R	16	100/2800
DX 15 820 R	20	100/2400
DX 15 825 R	25	75/1500
DX 15 832 R	32	50/800
DX 15 840 R	40	25/500
DX 15 850 R	50	25/400
Type: with cable puller		
DX 15 916 R	16	100/2800
DX 15 920 R	20	100/2400
DX 15 925 R	25	75/1500
DX 15 932 R	32	50/800

USE: lilac is recommended for the identification of the cable radio and hi-fi lines.

The cable puller-feeder allows the wires to be pulled easily.

Conformity to standards refers to the protective conduit and not to the cable puller-feeder. Do not expose the conduits to direct solar irradiation for long periods.

Do not remove the protective white film during the storage.

SELF-EXTINGUISHING PLIABLE CONDUITS FOR LIQUID CONCRETE

CLASSIFICATION
33412
EN 50086
EN 61386

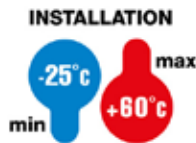

GWT
960°C

FK-XTREME MEDIUM PLIABLE CONDUIT COEXTRUDED

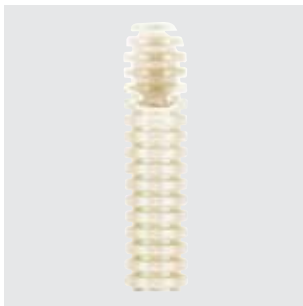

DX 16 220 X

MEDIUM NATURAL WHITE PLIABLE CONDUIT, COEXTRUDED - PVC

Code	Conduits Ø (mm)	Pack Carton
Type: without cable puller		
DX 16 220 X	20	100/2400
DX 16 225 X	25	75/1500
DX 16 232 X	32	50/800
DX 16 240 X	40	25/500

NOTE: conduits with diameter 20, 25 and 32 mm feature internal lubrication.
APPLICATIONS: ideal for use in self-levelling liquid cement. Natural white colour is recommended for identifying the computer coaxial cables.
Do not expose the conduits to direct solar irradiation for long periods.
Do not remove the protective white film during the storage.

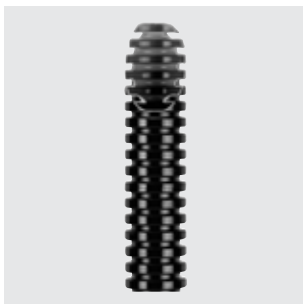

DX 15 020 X

MEDIUM BLACK PLIABLE CONDUIT, COEXTRUDED - PVC

Code	Conduits Ø (mm)	Pack Carton
Type: without cable puller		
DX 15 020 X	20	100/5200
DX 15 025 X	25	75/3300
DX 15 032 X	32	50/1800
DX 15 040 X	40	25/500

NOTE: conduits with diameter 20, 25 and 32 mm with internal lubrication.
APPLICATIONS: ideal for use in self-levelling liquid cement. Black colour is recommended for identifying the force distribution lines.
Do not expose the conduits to direct solar irradiation for long periods.
Do not remove the protective white film during the storage.

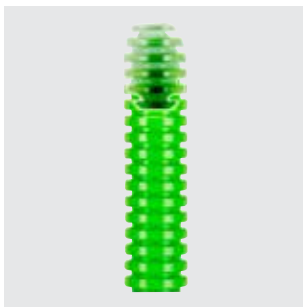

DX 15 220 X

MEDIUM GREEN PLIABLE CONDUIT, COEXTRUDED - PVC

Code	Conduits Ø (mm)	Pack Carton
Type: without cable puller		
DX 15 220 X	20	100/2400
DX 15 225 X	25	75/1500
DX 15 232 X	32	50/800
DX 15 240 X	40	25/500

NOTE: conduits with diameter 20; 25 and 32 mm with internal lubrication.
APPLICATIONS: ideal for use in self-levelling liquid cement. Green colour is recommended for identifying the telephone lines, BUS lines and domestic automation lines.
Do not expose the conduits to direct solar irradiation for long periods.
Do not remove the protective white film during the storage.



DX 15 420 X

MEDIUM LIGHT BLUE PLIABLE CONDUIT, COEXTRUDED - PVC

Code	Conduits Ø (mm)	Pack Carton
Type: without cable puller		
DX 15 420 X	20	100/2400
DX 15 425 X	25	75/1500
DX 15 432 X	32	50/800
DX 15 440 X	40	25/500

NOTE: conduits with diameter 20; 25 and 32 mm with internal lubrication.
APPLICATIONS: ideal for use in self-levelling liquid cement. Light blue is recommended for the identification of the entrophyne lines.
Do not expose the conduits to direct solar irradiation for long periods.
Do not remove the protective white film during the storage.

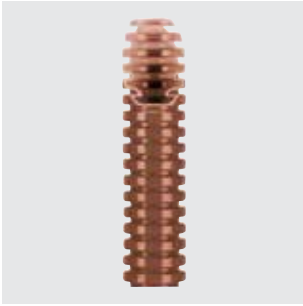

DX 15 620 X

MEDIUM BROWN PLIABLE CONDUIT, COEXTRUDED - PVC

Code	Conduits Ø (mm)	Pack Carton
Type: without cable puller		
DX 15 620 X	20	100/2400
DX 15 625 X	25	75/1500
DX 15 632 X	32	50/800
DX 15 640 X	40	25/500

NOTE: conduits with diameter 20; 25 and 32 mm with internal lubrication.

APPLICATIONS: ideal for use in self-levelling liquid cement. Brown is recommended for the identification of the emergency light and alarm lines.

Do not expose the conduits to direct solar irradiation for long periods.

Do not remove the protective white film during the storage.

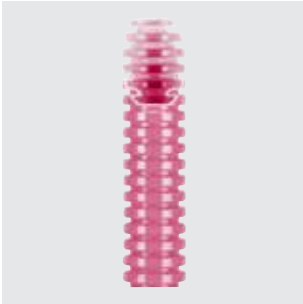

DX 15 820 X

MEDIUM LILAC PLIABLE CONDUIT, COEXTRUDED - PVC

Code	Conduits Ø (mm)	Pack Carton
Type: without cable puller		
DX 15 820 X	20	100/5200
DX 15 825 X	25	75/3300
DX 15 832 X	32	50/1800
DX 15 840 X	40	25/500

NOTE: conduits with diameter 20; 25 and 32 mm with internal lubrication.

APPLICATIONS: ideal for use in self-levelling liquid cement. Lilac blue is recommended for the identification of the cable radio and hi-fi lines.

Do not expose the conduits to direct solar irradiation for long periods.

Do not remove the protective white film during the storage.

SELF-EXTINGUISHING PLIABLE CONDUITS FKMF -SUPERSPEED

CLASSIFICATION
33232
 EN 50086
 EN 61386

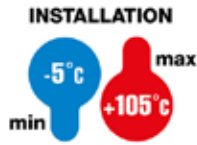

MEDIUM PLIABLE CONDUIT FKMF - SUPERSPEED



DX 24 220 R

MEDIUM PLIABLE CONDUIT, GREY

Code	Conduits Ø (mm)	Pack Carton
Type: without cable puller		
DX 24 216 R	16	100/5600
DX 24 220 R	20	100/4400
DX 24 225 R	25	75/2700
DX 24 232 R	32	50/1600
DX 24 240 R	40	25/500
DX 24 250 R	50	25/400
DX 24 263 R	63	20/240

NOTE: SUPERSPEED versions, with specific internal layer for high speed cables sliding, related to 20,25,32 mm diameters.

PLIABLE CONDUITS ICTA

CLASSIFICATION
34223
EN 50086
EN 61386

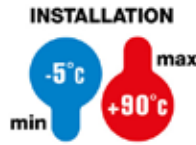

GWT
850°C

ICTA - "LOW SMOKE ZERO HALOGEN" MEDIUM PLIABLE CONDUIT



DX 20 016 R

MEDIUM PLIABLE CONDUIT, GREY RAL 7035, SELF-EXTINGUISHING AND SELF-RECOVERING - PP



Code	Conduits Ø (mm)	Pack Carton
Type: without cable puller		
DX 20 016 R	16	100/6400
DX 20 020 R	20	100/5200
DX 20 025 R	25	75/3300
DX 20 032 R	32	50/1800
DX 20 040 R	40	25/500
DX 20 050 R	50	25/400
DX 20 063 R	63	20/240
Type: with cable puller		
DX 20 116 R	16	100/6400
DX 20 120 R	20	100/5200
DX 20 125 R	25	75/3300
DX 20 132 R	32	50/1800
DX 20 140 R	40	25/500
DX 20 150 R	50	25/400
DX 20 163 R	63	20/240

USE: the cable puller-feeder allows the wires to be pulled easily. Conformity to standards refers to the protective conduit and not to the cable puller-feeder.
Do not expose the conduits to direct solar irradiation for long periods.
Do not remove the protective white film during the storage.



DX 20 516 R

MEDIUM PLIABLE CONDUIT, DARK GREY, SELF-EXTINGUISHING AND SELF-RECOVERING - PP



Code	Conduits Ø (mm)	Pack Carton
Type: without cable puller		
DX 20 416 R	16	100/6400
DX 20 420 R	20	100/5200
DX 20 425 R	25	75/3300
DX 20 432 R	32	50/1800
DX 20 440 R	40	25/500
DX 20 450 R	50	25/400
DX 20 463 R	63	20/240
Type: with cable puller		
DX 20 516 R	16	100/6400
DX 20 520 R	20	100/5200
DX 20 525 R	25	75/3300
DX 20 532 R	32	50/1800
DX 20 540 R	40	25/500
DX 20 550 R	50	25/400
DX 20 563 R	63	20/240

USE: the cable puller-feeder allows the wires to be pulled easily. Conformity to standards refers to the protective conduit and not to the cable puller-feeder.
Do not expose the conduits to direct solar irradiation for long periods.
Do not remove the protective white film during the storage.



DX 22 016 R

MEDIUM PLIABLE CONDUIT, GREEN , SELF-EXTINGUISHING AND SELF- RECOVERING - PP



Code	Conduits Ø (mm)	Pack Carton
Type: without cable puller		
DX 22 016 R	16	100/2800
DX 22 020 R	20	100/2400
DX 22 025 R	25	75/1500
DX 22 032 R	32	50/800
DX 22 040 R	40	25/500
DX 22 050 R	50	25/400
DX 22 063 R	63	20/240
Type: with cable puller		
DX 22 116 R	16	100/2800
DX 22 120 R	20	100/2400
DX 22 125 R	25	75/1500
DX 22 132 R	32	50/800
DX 22 140 R	40	25/500
DX 22 150 R	50	25/400
DX 22 163 R	63	20/240

USE: the cable puller-feeder allows the wires to be pulled easily. Conformity to standards refers to the protective conduit and not to the cable puller-feeder.
Do not expose the conduits to direct solar irradiation for long periods.
Do not remove the protective white film during the storage.



DX 23 116 R

MEDIUM PLIABLE CONDUIT, LIGHT BLUE , SELF-EXTINGUISHING AND SELF- RECOVERING - PP



Code	Conduits Ø (mm)	Pack Carton
Type: without cable puller		
DX 23 016 R	16	100/2800
DX 23 020 R	20	100/2400
DX 23 025 R	25	75/1500
DX 23 032 R	32	50/800
DX 23 040 R	40	25/500
DX 23 050 R	50	25/400
DX 23 063 R	63	20/240
Type: with cable puller		
DX 23 116 R	16	100/2800
DX 23 120 R	20	100/2400
DX 23 125 R	25	75/1500
DX 23 132 R	32	50/800
DX 23 140 R	40	25/500
DX 23 150 R	50	25/400
DX 23 163 R	63	20/240

USE: the cable puller-feeder allows the wires to be pulled easily. Conformity to standards refers to the protective conduit and not to the cable puller-feeder.
Do not expose the conduits to direct solar irradiation for long periods.
Do not remove the protective white film during the storage.

PLIABLE CONDUIT FKHF HALOGEN-FREE

CLASSIFICATION
23223
EN 50086
EN 61386

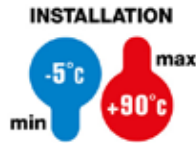

FKHF LIGHT PLIABLE CONDUIT



DX 23 216 R

LIGHT PLIABLE CONDUIT, GREY, HALOGEN-FREE, SELF-EXTINGUISHING AND SELF-RECOVERING - PP



Code	Conduits Ø (mm)	Pack Carton
Type: without cable puller		
DX 23 216 R	16	100/2800
DX 23 220 R	20	100/5200
DX 23 225 R	25	75/3300
DX 23 232 R	32	50/800
DX 23 240 R	40	25/500
DX 23 250 R	50	25/400
DX 23 263 R	63	20/240
Type: with cable puller		
DX 23 316 R	16	100/2800
DX 23 320 R	20	100/5200
DX 23 325 R	25	75/3300
DX 23 332 R	32	50/800
DX 23 340 R	40	25/500
DX 23 350 R	50	25/400
DX 23 363 R	63	20/240

USE: the cable puller-feeder allows the wires to be pulled easily. Conformity to standards refers to the protective conduit and not to the cable puller-feeder.

COMPONENTS FOR PLIABLE CONDUITS

COUPLING



DX 52 016

GF COUPLING FOR PLIABLE CONDUIT

Code	Conduits Ø (mm)	Pack Carton
DX 52 016	16	50/200
DX 52 020	20	50/300
DX 52 025	25	50/200
DX 52 032	32	25/150
DX 52 040	40	10/40
DX 52 050	50	10/40
DX 52 063	63	25

USE: for the jointing of corrugated conduits of the same diameter. the corrugation creates a vacuum effect between the crest and its underside, making the connection highly effective.

This accessory allows you to recover and use pieces of corrugated conduit, thereby minimising waste.

MATERIAL: Soft transparent PVC.

CAPS



DX 52 116

PLIABLE CONDUIT CAP

Code	Conduits Ø (mm)	Pack Carton
DX 52 116	16	100/500
DX 52 120	20	100/400
DX 52 125	25	50/250
DX 52 132	32	25/125
DX 52 140	40	25/100
DX 52 150	50	25/75
DX 52 163	63	50

USE: protects tubing from undesired entry of liquids or solid bodies during the installation phase or when left empty. Ready for the subsequent passage of the cables. Accidental obstructions are avoided, and the caps can be removed/re-used when the work is finished.

MATERIAL: PP - Grey RAL 7035.

COUPLINGS AND CABLE-GLANDS



GWT
750°C



GW 50 415

SHOCKPROOF POLYMER CONDUIT/BOX COUPLINGS GREY RAL 7035

Code	For external conduits (mm)	Mounting hole Ø (mm)	IP with rigid conduit	IP with corrugated conduit	Pack Carton
GW 50 415	16	20	IP66	IP54	25/200
GW 50 416	20	23	IP66	IP54	25/200
GW 50 417	25	29	IP66	IP54	25/150
GW 50 418	32	37	IP66	IP54	10/100
GW 50 419	40	48	IP66	IP44	6/60
GW 50 420	50	54	IP66	IP44	5/50

CHARACTERISTICS: the box conduit coupling device allows corrugated conduits to be connected to the junction boxes, guaranteeing the minimum IP4X degree of protection in areas at greater risk in the event of a fire whenever required.

ACCESSORIES SUPPLIED: fixing nut.

CABLE PULLER-FEEDER



DX 52 205

Ø 3 MM NYLON CABLE PULLER-FEEDER

Code	Length (m)	Pack Carton
DX 52 205	5	1/10
DX 52 210	10	1/10
DX 52 215	15	1/10
DX 52 220	20	1/10
DX 52 225	25	1/10

USE: for the insertion of electrical cables into protective conduits. It consists of a solid nylon rod 3 mm in diameter giving the probe extreme lightness and flexibility, ideal for systems with short and simple sections. It is also equipped at one end with a probe with extreme resistance to wear and therefore very durable.



DX 52 305

Ø 4 MM NYLON CABLE PULLER-FEEDER AND ACCESSORIES

Code	Description	Length (m)	Pack Carton
DX 52 305	-	5	1/40
DX 52 310	-	10	1/25
DX 52 315	-	15	1/15
DX 52 320	-	20	1/15
DX 52 325	-	25	1/15
DX 52 299	Flexible head	-	10/200
DX 52 399	Tail ring	-	10/200

USE: this probe is powerful and flexible, allowing it to cope with even sharp bends in conduit, thanks to a 4mm nylon rod and soft flexible head. The interchangeability of the head with the tail ring also helps to reduce the times for inserting the cables in short sections.



FK



Scan the QR Code and find out all the technical informations.

FK-XTREME COEXTRUDED MEDIUM CONDUIT



The FK-Xtreme conduits, thanks to their special double-walled design, ensure total protection from the penetration of liquid cement components. The outer coating offers additional resistance during construction work against trampling, crushing and impact, even at low temperatures (down to -25°C).

FK15 ARCOBALENO MEDIUM CONDUIT

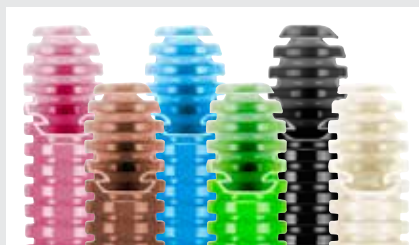









Available in versions with or without cable puller feeder and in six different colourways for all ordinary construction installations. A ringed profile gives the conduits better flexibility, higher load resistance and reduced thermal memory.

ICTA SELF-RECOVERING MEDIUM CONDUIT



Those with classification 34223 have high resistance to impact and a wide range of operating temperatures. Made of LSZH (Low Smoke Zero Halogen) material, they are ideal in public environments (e.g. theatres, schools, etc.). Also available in version with cable pullers.

SHEATH Ø (mm)	SPIRALLED SHEATHS		
	DIFLEX range		LIGHT range
	Grey	Black	Grey
8	 DX 30 008	 DX 30 108	 DX 30 812
10	DX 30 010	DX 30 110	
12	DX 30 012	DX 30 112	
14	DX 30 014	DX 30 114	
16	DX 30 016	DX 30 116	DX 30 816
20	DX 30 020	DX 30 120	DX 30 820
22	DX 30 022	DX 30 122	
25	DX 30 025	DX 30 125	DX 30 825
28	DX 30 028	DX 30 128	
32	DX 30 032	DX 30 132	
35	DX 30 035	DX 30 135	
40	DX 30 040	DX 30 140	
50	DX 30 050	DX 30 150	
60	DX 30 060	DX 30 160	

SHEATH Ø (mm)	FIXED STRAIGHT PIPE FITTINGS - RUN IP54 RANGE						PIPE FITTINGS IP65			
	Metric pitch	Grey	GAS pitch	Grey	PG pitch	Grey	Conduit-sheath pipe fitting		Conduit-sheath pipe fitting (equal diameter)	
							Ø Conduit		Ø Conduit	
8	M12x1	DX 56 008	1/4"	DX 56 208	7	DX 56 408				
10	M16x1,5	DX 56 010	1/4"	DX 56 210	7	DX 56 410				
12	M16x1,5	DX 56 012	3/8"	DX 56 212	9	DX 56 411	16	DX 43 316		
					11	DX 56 412				
					13,5	DX 56 413				
14	M16x1,5	DX 56 014	1/2"	DX 56 214	13,5	DX 56 414				
16	M20x1,5	DX 56 016	1/2"	DX 56 216	11	DX 56 415	20	DX 43 320	16	DX 43 416
					13,5	DX 56 416				
					16	DX 56 417				
20	M25x1,5	DX 56 022	3/4"	DX 56 222	16	DX 56 422	25	DX 43 325	20	DX 43 420
					21	DX 56 423				
					16	DX 56 422				
22	M25x1,5	DX 56 022	3/4"	DX 56 222	21	DX 56 423				
					21	DX 56 423				
25	M25x1,5	DX 56 025	3/4"	DX 56 225	21	DX 56 425	32	DX 43 332	25	DX 43 425
28	M32x1,5	DX 56 028	1"	DX 56 228	29	DX 56 428			32	DX 43 432
32			1 1/4"	DX 56 232	36	DX 56 432	40	DX 43 340		
35			1 1/4"	DX 56 235	36	DX 56 435				
40	M40x1,5	DX 56 040	1 1/4"	DX 56 240	42	DX 56 440	50	DX 43 350	40	DX 43 440
50	M50x1,5	DX 56 050	2"	DX 56 250	48	DX 56 450				

ROTATING STRAIGHT PIPE FITTINGS - IP54 RANGE

	Grey	Black		Grey	Black		Grey	Black
Metric pitch			GAS pitch			PG pitch		
M12x1,5	DX 54 008	DX 54 108	1/4"	DX 54 208	DX 54 308	7	DX 54 408	DX 54 508
M16x1,5	DX 54 010	DX 54 110	1/4"	DX 54 210	DX 54 310	7 9	DX 54 410 DX 54 411	DX 54 510 DX 54 511
M16x1,5	DX 54 012	DX 54 112	3/8"	DX 54 212	DX 54 312	11 13,5	DX 54 412 DX 54 413	DX 54 512 DX 54 513
			1/2"	DX 54 214	DX 54 314	13,5	DX 54 414	DX 54 514
M20x1,5	DX 54 016	DX 54 116	1/2"	DX 54 216	DX 54 316	13,5 16	DX 54 416 DX 54 417	DX 54 516 DX 54 517
M25x1,5	DX 54 020	DX 54 120	3/4"	DX 54 220	DX 54 320	21	DX 54 420	DX 54 520
M25x1,5	DX 54 022	DX 54 122	3/4"	DX 54 222	DX 54 322	21	DX 54 422	DX 54 522
M32x1,5	DX 54 025	DX 54 125	1"	DX 54 225	DX 54 325	29	DX 54 425	DX 54 525
M32x1,5	DX 54 028	DX 54 128	1"	DX 54 228	DX 54 328	29	DX 54 428	DX 54 528
M40x1,5	DX 54 032	DX 54 132	1 1/4"	DX 54 232	DX 54 332	36	DX 54 432	DX 54 532
			1 1/4"	DX 54 235	DX 54 335	36	DX 54 435	DX 54 535
M50x1,5	DX 54 040	DX 54 140	1 1/2"	DX 54 240	DX 54 340			
M63x1,5	DX 54 050	DX 54 150	2"	DX 54 250	DX 54 350			

DF

Flexible protective conduit systems

The DF range of flexible protective conduits and accessories provide protection for the wiring of moving mechanical parts, as well as the interface between rigid conduits, junction boxes and distribution boards for the completion of exposed systems in tertiary and industrial sectors. Available in two mechanical strength levels, two colours and 14 diameters from 8 to 60 mm.



SELF-EXTINGUISHING INSULATING SHEATHS

CLASSIFICATION
2311
EN 50086
EN 61386



INSTALLATION
+5°C min
+60°C max

GWT
960°C

DIFLEX SPIRALLED SHEATH



DX 30 008

DIFLEX SPIRALLED SHEATH - GREY RAL 7035 - PVC

Code	Sheath Ø (mm)	Pack Carton
DX 30 008	8	30/2070
DX 30 010	10	30/1800
DX 30 012	12	30/1800
DX 30 014	14	30/1440
DX 30 016	16	30/1080
DX 30 020	20	30/1080
DX 30 022	22	30/720
DX 30 025	25	30/600
DX 30 028	28	30/480
DX 30 032	32	30/480
DX 30 035	35	30/480
DX 30 040	40	30/360
DX 30 050	50	30/180
DX 30 060	60	30/120

NOTE: the specified measurements must be considered internal diameters. Do not expose the sheaths to direct sunlight.



DX 30 108

DIFLEX SPIRALLED SHEATH - BLACK RAL 9005 - PVC

Code	Sheath Ø (mm)	Pack Carton
DX 30 108	8	30/2070
DX 30 110	10	30/1800
DX 30 112	12	30/1800
DX 30 114	14	30/1440
DX 30 116	16	30/1080
DX 30 120	20	30/1080
DX 30 122	22	30/720
DX 30 125	25	30/600
DX 30 128	28	30/480
DX 30 132	32	30/480
DX 30 135	35	30/480
DX 30 140	40	30/360
DX 30 150	50	30/180
DX 30 160	60	30/120

NOTE: the specified measurements must be considered internal diameters. Do not expose the conduits to direct sunlight.

COUPLINGS

ROTATING UNIONS



DX 54 020

STRAIGHT, REVOLVING COUPLING DEVICE - METRIC PITCH - IP54

Code	Sheath Ø (mm)	ISO pitch	Pack Carton
Colour: Grey RAL 7035			
DX 54 008	8	M 12x1.5	20/180
DX 54 010	10	M 16x1.5	20/160
DX 54 012	12	M 16x1.5	10/100
DX 54 016	16	M 20x1.5	10/150
DX 54 020	20	M 25x1.5	10/100
DX 54 022	22	M 25x1.5	10/100
DX 54 025	25	M 32x1.5	5/60
DX 54 028	28	M 32x1.5	5/40
DX 54 032	32	M 40x1.5	5/30
DX 54 040	40	M 50x1.5	25
DX 54 050	50	M 63x1.5	15
Colour: Black RAL 9005			
DX 54 108	8	M 12x1.5	20/180
DX 54 110	10	M 16x1.5	20/160
DX 54 112	12	M 16x1.5	10/100
DX 54 116	16	M 20x1.5	10/150
DX 54 120	20	M 25x1.5	10/100
DX 54 122	22	M 25x1.5	10/100
DX 54 125	25	M 32x1.5	5/60
DX 54 128	28	M 32x1.5	5/40
DX 54 132	32	M 40x1.5	5/30
DX 54 140	40	M 50x1.5	25
DX 54 150	50	M 63x1.5	15

USE: for the coupling of spiral sheaths to junction boxes in threaded holes with metric pitch or in non-threaded holes via the nut and gasket supplied.



DX 54 220

STRAIGHT, REVOLVING COUPLING DEVICE - GAS PITCH - IP54

Code	Sheath Ø (mm)	GAS pitch	Pack Carton
Colour: Grey RAL 7035			
DX 54 208	8	1/4"	20/180
DX 54 210	10	1/4"	20/160
DX 54 212	12	3/8"	10/100
DX 54 214	14	1/2"	10/150
DX 54 216	16	1/2"	10/150
DX 54 220	20	3/4"	10/100
DX 54 222	22	3/4"	10/100
DX 54 225	25	1"	5/60
DX 54 228	28	1"	5/40
DX 54 232	32	1 1/4"	5/30
DX 54 235	35	1 1/4"	5/30
DX 54 240	40	1 1/2"	25
DX 54 250	50	2"	15
Colour: Black RAL 9005			
DX 54 308	8	1/4"	20/180
DX 54 310	10	1/4"	20/160
DX 54 312	12	3/8"	10/100
DX 54 314	14	1/2"	10/150
DX 54 316	16	1/2"	10/150
DX 54 320	20	3/4"	10/100
DX 54 322	22	3/4"	10/100
DX 54 325	25	1"	5/60
DX 54 328	28	1"	5/40
DX 54 332	32	1 1/4"	5/30
DX 54 335	35	1 1/4"	5/30
DX 54 340	40	1 1/2"	25
DX 54 350	50	2"	15

USE: for the coupling of spiral sheaths to junction boxes in threaded holes with GAS pitches or in non-threaded holes via the nut and gasket supplied.



DX 54 420

STRAIGHT, REVOLVING COUPLING DEVICE - PG PITCH - IP54

Code	Sheath Ø (mm)	PG pitch	Pack Carton
Colour: Grey RAL 7035			
DX 54 408	8	7	20/180
DX 54 410	10	7	20/160
DX 54 411	10	9	20/160
DX 54 412	12	11	10/100
DX 54 413	12	13.5	10/100
DX 54 414	14	13.5	10/150
DX 54 416	16	13.5	10/150
DX 54 417	16	16	10/150
DX 54 420	20	21	10/100
DX 54 422	22	21	10/100
DX 54 425	25	29	5/60
DX 54 428	28	29	5/40
DX 54 432	32	36	5/30
DX 54 435	35	36	5/30
Colour: Black RAL 9005			
DX 54 508	8	7	20/180
DX 54 510	10	7	20/160
DX 54 511	10	9	20/160
DX 54 512	12	11	10/100
DX 54 513	12	13.5	10/100
DX 54 514	14	13.5	10/150
DX 54 516	16	13.5	10/150
DX 54 517	16	16	10/150
DX 54 520	20	21	10/100
DX 54 522	22	21	10/100
DX 54 525	25	29	5/60
DX 54 528	28	29	5/40
DX 54 532	32	36	5/30
DX 54 535	35	36	5/30

USE: for the coupling of spiral sheaths to junction boxes in threaded holes with Pg pitches or in non-threaded holes via the nut and gasket supplied.

FIXED UNIONS



DX 56 008

STRAIGHT, FIXED COUPLING DEVICE - METRIC PITCH - IP54

Code	Sheath Ø (mm)	ISO pitch	Pack Carton
Colour: Grey RAL 7035			
DX 56 008	8	M12x1,5	20/160
DX 56 010	10	M16x1.5	10/170
DX 56 012	12	M16x1.5	10/150
DX 56 014	14	M16x1.5	10/130
DX 56 016	16	M20x1.5	10/110
DX 56 022	22	M25x1.5	10/50
DX 56 025	25	M25x1.5	10/50
DX 56 028	28	M32x1.5	10/40
DX 56 040	40	M40x1.5	15
DX 56 050	50	M50x1.5	12

USE: for the coupling of spiral sheaths to junction boxes in threaded holes with metric pitch or in non-threaded holes via the nut and gasket supplied.



DX 56 208

STRAIGHT, FIXED COUPLING DEVICE - GAS PITCH - IP54

Code	Sheath Ø (mm)	GAS pitch	Pack Carton
Colour: Grey RAL 7035			
DX 56 208	8	1/4"	20/160
DX 56 210	10	1/4"	10/170
DX 56 212	12	3/8"	10/150
DX 56 214	14	1/2"	10/130
DX 56 216	16	1/2"	10/110
DX 56 222	22	3/4"	10/50
DX 56 225	25	3/4"	10/50
DX 56 228	28	1"	10/40
DX 56 232	32	1 1/4"	3/18
DX 56 235	35	1 1/4"	3/18
DX 56 240	40	1 1/2"	15
DX 56 250	50	2"	12

USE: for the coupling of spiral sheaths to junction boxes in threaded holes with GAS pitches or in non-threaded holes via the nut and gasket supplied.



DX 56 408

STRAIGHT, FIXED COUPLING DEVICE - PG PITCH - IP54

Code	Sheath Ø (mm)	PG pitch	Pack Carton
Colour: Grey RAL 7035			
DX 56 408	8	7	20/160
DX 56 410	10	7	10/170
DX 56 411	12	9	10/150
DX 56 412	12	11	10/150
DX 56 413	12	13.5	10/150
DX 56 414	14	13.5	10/130
DX 56 415	16	11	10/110
DX 56 416	16	13.5	10/110
DX 56 417	16	16	10/110
DX 56 422	22	16	10/50
DX 56 423	22	21	10/50
DX 56 425	25	21	10/50
DX 56 428	28	29	10/40
DX 56 432	32	36	3/18
DX 56 435	35	36	3/18
DX 56 440	40	42	15
DX 56 450	50	48	12

USE: for the coupling of spiral sheaths to junction boxes in threaded holes with Pg pitches or in non-threaded holes via the nut and gasket supplied.

CONDUIT-SHEATH UNIONS



DX 43 316

MORBIDX RELEASE CONDUIT-SHEATH UNION - IP65

Code	Conduits Ø (mm)	Sheath Ø (mm)	Pack Carton
DX 43 316	16	12	10/450
DX 43 320	20	16	10/300
DX 43 325	25	20	5/210
DX 43 332	32	25	5/120
DX 43 340	40	32	5/25
DX 43 350	50	40	5/20



DX 43 416

RELEASE CONDUIT-SHEATH UNION EQUAL DIAMETER - IP65

Code	Conduits Ø (mm)	Sheath Ø (mm)	Pack Carton
DX 43 416	16	16	10/360
DX 43 420	20	20	10/240
DX 43 425	25	25	5/150
DX 43 432	32	28	5/40
DX 43 440	40	40	5/20

USE: coupling of a solid protective conduit with a spiral sheath of the DIFLEX range; allows the maintenance of the same internal diameter in line with the joint; the internal section for cable passage remains constant, increasing the space available for the system wires.

SHEATH FOR NON-HEAVY DUTY USES

CLASSIFICATION
1311
 EN 50086
 EN 61386

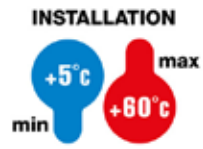

LIGHT SPIRALLED SHEATH



LIGHT SPIRALLED SHEATH - GREY RAL 7035 - PVC

Code	Sheath Ø (mm)	Pack Carton
DX 30 812	12	30/1800
DX 30 816	16	30/1080
DX 30 820	20	30/1080
DX 30 825	25	30/600

NOTE: all measurements are internal diameters. Do not expose the sheaths to direct solar irradiation.

DX 30 812



DF



Scan the QR Code and find out all the technical informations.

PROFESSIONAL SPIRALLED SHEATHS

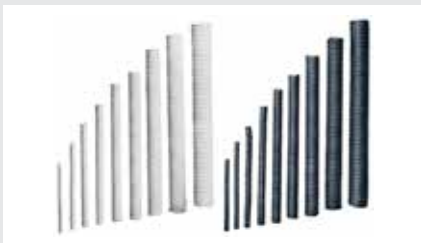

The range of spiralled sheaths with classification 2311 is available in 14 different diameters in grey and black. They are also available in the Light version, with classification 1311 (in 12, 16, 20 and 25 mm diameters), ideal for use in air conditioning equipment.

FLEXIBILITY AND DURABILITY









The particular shape of the sheath, which has a rigid PVC inner coil and plasticised PVC outer coating, provides high resistance to crushing and ensures the flexibility necessary for every type of application and routing.

COUPLING DEVICES FOR EASY INSTALLATION



Once in place, the sheath can rotate freely, while maintaining IP54 rated protection, thanks to the straight swivel couplings. This facilitates the movement of sheaths already connected to boxes and distribution boards.

THERMOPLASTIC ACCESS CHAMBERS

Type	Dimensions (mm)	Complete access chambers	Access chambers without covers	Covers						Separator Plate	Sealing gaskets	Kit of 4 screws	Central bolt for lifting kit
				Closed			Gridded						
				Grey	Green	Blue	Grey	Green	Blue				
													
Square base access chambers 	200x200x200	DX 59 401	DX 59 402	DX 59 410	DX 59 430		DX 59 411	DX 59 431		DX 59 440	DX 59 451	DX 59 450	
	300x300x300	DX 59 701	DX 59 702	DX 59 710	DX 59 730		DX 59 711	DX 59 731		DX 59 740	DX 59 751	DX 59 450	
	400x400x400	DX 59 801	DX 59 802	DX 59 810	DX 59 830		DX 59 811	DX 59 831		DX 59 840	DX 59 851	DX 59 452	DX 59 453
	550x550x520	DX 59 901	DX 59 902	DX 59 910	DX 59 930		DX 59 911	DX 59 931		DX 59 940	DX 59 951	DX 59 452	DX 59 453
Rectangular base access chambers 	360x260x326	DX 59 501	DX 59 502	DX 59 511	DX 59 230	DX 59 220	DX 59 520	DX 59 231	DX 59 221	Transversal DX 59 240	DX 59 551	DX 59 650	
										Longitudinal DX 59 241			
										Diagonal DX 59 242			

PZ

Access chambers systems

The range of PZ access chambers, available in 5 sizes, is ideal for junctions and manholes in electrical and telecommunication systems. These are provided with knockouts for cable ducts and knockouts base for stacking installation. Thanks to the thermoplastic material, knockouts for cable ducts and knockouts base for stacking installation, the PZ range is an efficient alternative to the access chambers made of concrete.

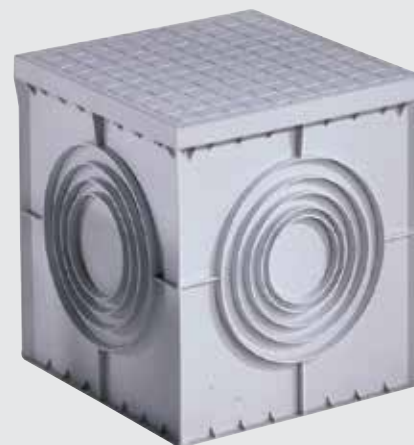

THERMOPLASTIC ACCES CHAMBERS

SQUARE ACCES CHAMBERS



DX 59 401

SQUARE ACCES CHAMBER 200X200X200

Code	Characteristics	Colour	Pack Carton
DX 59 401	Flat knockout base and high resistance lid	Grey	1/60
DX 59 402	Flat semi-pierced base for boosting	Grey	1/60

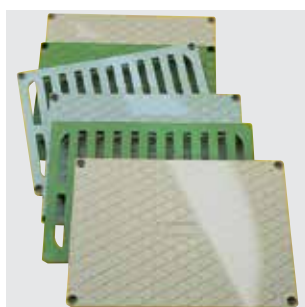

ZC6

COVERS AND COMPONENTS

Code	Description	Characteristics	Colour	Pack Carton
DX 59 410	Closed cover	High resistance	Grey	1/5
DX 59 430	Closed cover	High resistance	Green	1/5
DX 59 411	Gridded cover	High resistance	Grey	1/5
DX 59 431	Gridded cover	High resistance	Green	1/5
DX 59 440	Separator plate	-	-	1/10
DX 59 451	Seal	-	-	1/10
DX 59 450	4 screws kit	Self-threading steel screws	-	1/50



DX 59 701

SQUARE ACCES CHAMBER 300X300X300

Code	Characteristics	Colour	Pack Carton
DX 59 701	Flat knockout base and high resistance lid	Grey	1/36
DX 59 702	Flat semi-pierced base for boosting	Grey	1/36

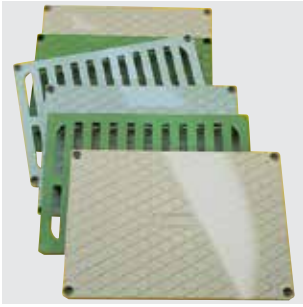

ZC6

COVERS AND COMPONENTS

Code	Description	Characteristics	Colour	Pack Carton
DX 59 710	Closed cover	High resistance	Grey	1/5
DX 59 730	Closed cover	High resistance	Green	1/5
DX 59 711	Gridded cover	High resistance	Grey	1/5
DX 59 731	Gridded cover	High resistance	Green	1/5
DX 59 740	Separator plate	-	-	1/10
DX 59 751	Seal	-	-	1/10
DX 59 450	4 screws kit	Self-threading steel screws	-	1/50



DX 59 801

SQUARE ACCES CHAMBERS 400X400X400

Code	Characteristics	Colour	Pack Carton
DX 59 801	Flat knockout base and high resistance lid	Grey	1/18
DX 59 802	Flat semi-pierced base for boosting	Grey	1/18

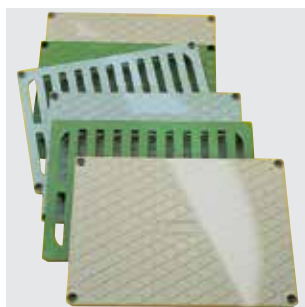

ZC6

COVERS AND COMPONENTS

Code	Description	Characteristics	Colour	Pack Carton
DX 59 810	Closed cover	High resistance	Grey	1/5
DX 59 830	Closed cover	High resistance	Green	1/5
DX 59 811	Gridded cover	High resistance	Grey	1/5
DX 59 831	Gridded cover	High resistance	Green	1/5
DX 59 840	Separator plate	-	-	1/10
DX 59 851	Seal	-	-	1/10
DX 59 452	4 screws kit	Self-threading steel screws	-	1/50
DX 59 453	Kit - central bolt for lifting	-	-	1/20

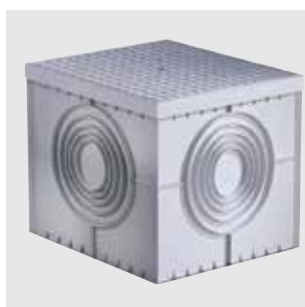

DX 59 901

SQUARE ACCES CHAMBERS 550X550X520

Code	Characteristics	Colour	Pack Carton
DX 59 901	Flat knockout base and high resistance lid	Grey	1/8
DX 59 902	Flat semi-pierced base for boosting	Grey	1/8

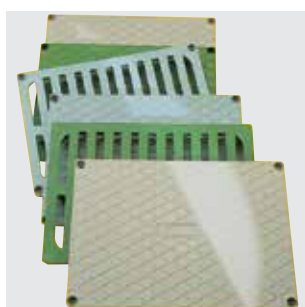

ZC6

COVERS AND COMPONENTS

Code	Description	Characteristics	Colour	Pack Carton
DX 59 910	Closed cover	High resistance	Grey	1/5
DX 59 930	Closed cover	High resistance	Green	1/5
DX 59 911	Gridded cover	High resistance	Grey	1/5
DX 59 931	Gridded cover	High resistance	Green	1/5
DX 59 940	Separator plate	-	-	1/10
DX 59 951	Seal	-	-	1/10
DX 59 452	4 screws kit	Self-threading steel screws	-	1/50
DX 59 453	Kit - central bolt for lifting	-	-	1/20

RECTANGULAR ACCES CHAMBER



DX 59 501

RECTANGULAR ACCES CHAMBER 360X260X320

Code	Characteristics	Accessories supplied	Colour	Pack Carton
DX 59 501	Flat semi-pierced base	Cover high resistance and 4 S/Steel screws	Grey	1
DX 59 502	Flat semi-pierced base for boosting	4 stainless steel screws	Grey	1

NOTE: the lids supplied are without the gasket, available as an accessory DX59551.

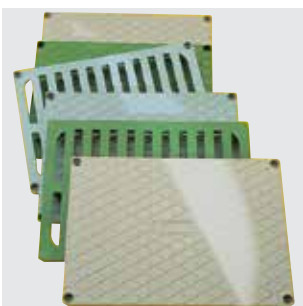

ZC6

COVERS AND COMPONENTS

Code	Description	Characteristics	Colour	Pack Carton
DX 59 511	Closed cover	High resistance	Grey	1/6
DX 59 520	Gridded cover	-	Grey	1/6
DX 59 230	Closed cover	-	Green	1/6
DX 59 231	Gridded cover	-	Green	1/6
DX 59 240	Separator plate	Cross	-	1/6
DX 59 241	Separator plate	Longitudinal	-	1/4
DX 59 242	Separator plate	Diagonal	-	1/4
DX 59 551	Seal	-	-	1/10
DX 59 650	4 screws kit	Self-threading steel screws	-	1/50



Scan the QR Code and find out all the technical informations.

WIDE AND FUNCTIONAL RANGE



A broad offering that includes square and rectangular access chambers and related technical components. The rectangular access chamber offers the option of a double junction on the long side, and of installing seven separators longitudinally, transversely or diagonally.

KNOCKOUTS AND STAKING OPTIONS



The sides of the access chamber have knock-outs of different diameters for cable ducts entry. The removable base allows the PZ access chambers be layered, creating a modular system to increase access chamber depth and capacity.

HIGH-STRENGTH LIDS



The high-resistance PZ access chamber covers can be secured with 4 stainless steel self-threading screws for added safety and stability during installation. Only one tool is required to open the access chamber.

	PLASTIC CABLE GLANDS								METAL CABLE GLANDS				
	IP68		IP66		IP66 with housing		IP54		IP68		IP 65		
Thread	Code	For cables Ø (mm)	Code	For cables Ø (mm)	Code	For conduits Ø (mm)	For cables Ø (mm)	Code	For cables Ø (mm)	Code	For cables Ø (mm)	Code	For cables Ø (mm)
PG7	GW 52 071	3 ÷ 6,5	GW 52 001	3 ÷ 6				GW 52 081	4 ÷ 6				
PG9	GW 52 072	4 ÷ 8	GW 52 002	5 ÷ 8				GW 52 082	4,5 ÷ 7				
PG11	GW 52 073	5 ÷ 10	GW 52 003	7 ÷ 10,5				GW 52 083	6 ÷ 9	GW 76 825	4 ÷ 9	GW 76 841	7,5/10/12,5
PG13,5	GW 52 074	6 ÷ 12	GW 52 004	9 ÷ 12,5	GW 52 024	16	9 ÷ 12,5	GW 52 084	9 ÷ 12	GW 76 826	7 ÷ 11	GW 76 842	7,5/10/12,5
PG16	GW 52 075	10 ÷ 14	GW 52 005	13 ÷ 16	GW 52 025	20	13 ÷ 16	GW 52 085	11 ÷ 14	GW 76 827	10 ÷ 13	GW 76 843	7,5/10/12,5
PG21	GW 52 076	13 ÷ 18	GW 52 006	9 ÷ 10 17 ÷ 20	GW 52 026	25	9 ÷ 10 17 ÷ 20	GW 52 086	14 ÷ 18	GW 76 828	12 ÷ 17	GW 76 844	10/13/16/19
PG29	GW 52 077	18 ÷ 25	GW 52 007	13,5 ÷ 15 21 ÷ 26	GW 52 027	32	13,5 ÷ 15 21 ÷ 26	GW 52 087	18 ÷ 25	GW 76 829	17 ÷ 24	GW 76 845	18/21/24/27
PG36	GW 52 078	22 ÷ 32	GW 52 008	17 ÷ 20 30 ÷ 34	GW 52 028	40	17 ÷ 20 30 ÷ 34	GW 52 088	26 ÷ 32	GW 76 830	20 ÷ 26 27 ÷ 24	GW 76 846	24/27/30/33
PG42	GW 52 079	30 ÷ 38	GW 52 009	36 ÷ 39 40 ÷ 43	GW 52 029	50	36 ÷ 39 40 ÷ 43			GW 76 897	32 ÷ 36	GW 76 847	30/33/36/39
PG48	GW 52 080	34 ÷ 44	GW 52 010	38 ÷ 40 46 ÷ 50									
M12	GW 52 042	3 ÷ 6,5								GW 76 894	3 ÷ 6,5		
M16	GW 52 043	5 ÷ 10								GW 76 896	4 ÷ 9		
M20	GW 52 044	10 ÷ 14								GW 76 831	10 ÷ 13	GW 76 848	4/7/10/13
M25	GW 52 045	13 ÷ 18								GW 76 832	12 ÷ 17	GW 76 849	8,5/11,5/14,5/17,5
M32	GW 52 046	18 ÷ 25								GW 76 833	14 ÷ 21	GW 76 850	16/19/22/25
M40	GW 52 047	22 ÷ 32								GW 76 834	19 ÷ 27	GW 76 851	23/26/29/32
M50	GW 52 048	30 ÷ 38								GW 76 835	25 ÷ 34	GW 76 852	30/33/36/39
M63	GW 52 049	35 ÷ 44								GW 76 895	34 ÷ 48		

	PLASTIC ACCESSORIES			METAL ACCESSORIES					GASKETS	
	Caps	Nuts		Caps	Nuts		Extensions			O-ring for caps
Thread	Code	Code	Spanner (mm)	Code	Code	Spanner (mm)	Code	Male thread	Female thread	Code
PG7	GW 52 361	GW 52 341	19							GW 52 441
PG9	GW 52 362	GW 52 342	22							GW 52 442
PG11	GW 52 363	GW 52 343	24	GW 76 980	GW 76 957	21	GW 76 865	PG11	PG13,5	GW 52 443
PG13,5	GW 52 364	GW 52 344	27	GW 76 981	GW 76 958	23	GW 76 866	PG13,5	PG16	GW 52 444
PG16	GW 52 365	GW 52 345	30	GW 76 982	GW 76 959	26	GW 76 867	PG16	PG21	GW 52 445
PG21	GW 52 366	GW 52 346	36	GW 76 983	GW 76 960	32	GW 76 868	PG21	PG29	GW 52 446
PG29	GW 52 367	GW 52 347	46	GW 76 984	GW 76 961	41	GW 76 869	PG29	PG36	GW 52 447
PG36	GW 52 368	GW 52 348	60	GW 76 985	GW 76 962	51				GW 52 448
PG42	GW 52 369	GW 52 349	65	GW 76 986	GW 76 963	60				GW 52 449
PG48	GW 52 370	GW 52 350	70							GW 52 450
M12	GW 52 372	GW 52 352	18	GW 76 972	GW 76 966	15				GW 52 452
M16	GW 52 373	GW 52 353	22	GW 76 973	GW 76 951	19				GW 52 453
M20	GW 52 374	GW 52 354	26	GW 76 975	GW 76 952	23	GW 76 870	M20	M25	GW 52 454
M25	GW 52 375	GW 52 355	32	GW 76 976	GW 76 953	29	GW 76 871	M25	M32	GW 52 455
M32	GW 52 376	GW 52 356	41	GW 76 977	GW 76 954	36	GW 76 872	M32	M40	GW 52 456
M40	GW 52 377	GW 52 357	50	GW 76 978	GW 76 955	45	GW 76 873	M40	M50	GW 52 457
M50	GW 52 378	GW 52 358	60	GW 76 979	GW 76 956	55				GW 52 458
M63	GW 52 379	GW 52 359	75	GW 76 974	GW 76 967	70				GW 52 459

METAL CABLE GLANDS WITH FIXING NUTS - IP68 - ATEX VERSION

Cable glands				Fixing nuts			
Thread		Thread		Thread		Thread	
PG7	GW 76 901	M12	GW 76 921	PG7	GW 76 941	M12	GW 76 949
PG9	GW 76 902	M16	GW 76 922	PG9	GW 76 942	M16	GW 76 951
PG11	GW 76 903	M20	GW 76 923	PG11	GW 76 957	M20	GW 76 952
PG13,5	GW 76 904	M25	GW 76 924	PG13,5	GW 76 958	M25	GW 76 953
PG16	GW 76 905	M32	GW 76 925	PG16	GW 76 959	M32	GW 76 954
PG21	GW 76 906	M40	GW 76 926	PG21	GW 76 960	M40	GW 76 955
PG29	GW 76 907	M50	GW 76 927	PG29	GW 76 961	M50	GW 76 956
PG36	GW 76 908	M63	GW 76 928	PG36	GW 76 962	M63	GW 76 950
PG42	GW 76 909			PG42	GW 76 963		
PG48	GW 76 910			PG48	GW 76 943		





NOTE: the ATEX products are only available in the following countries: Austria, France, Germany, Italy, Liechtenstein, Luxembourg, the Principality of Monaco, the United Kingdom and Spain. For all other countries, contact GEWISS Technical service assistance.

COUPLINGS FOR CONDUITS AND CABLES



For conduits/cables (mm)	Conduit-box couplings				Conduit-box couplings in flexible polymer IP44		Cable glands in flexible polymer IP55	
	Code	Assembly hole (mm)	IP with rigid conduits	IP with corrugated conduits	Code	Assembly hole (mm)	Code	Assembly hole (mm)
16	GW 50 415	20	IP66	IP54	GW 50 421	23	GW 50 428	19
20	GW 50 416	23	IP66	IP54	GW 50 422	23	GW 50 429	23
					GW 50 423	29		
25	GW 50 417	29	IP66	IP54	GW 50 424	29	GW 50 430	29
32	GW 50 418	37	IP66	IP54	GW 50 425	37	GW 50 431	37
40	GW 50 419	48	IP66	IP44	GW 50 426	37	GW 50 432	48
50	GW 50 420	54	IP66	IP44	GW 50 427	42		

GW FIT



PLASTIC FIXING DEVICES

Ø conduits (mm)	Clip-on supports	Collar supports	Rail for clip-on and collar supports	Supports with multi-diameter clamp
				
16	GW 50 601	GW 50 605	GW 50 609	GW 50 651
20	GW 50 602	GW 50 606	GW 50 609	GW 50 651
25	GW 50 603	GW 50 607	GW 50 609	GW 50 652
32	GW 50 604	GW 50 608	GW 50 609	GW 50 652
40	GW 50 628	GW 50 630	GW 50 609	GW 50 653
50	GW 50 629	GW 50 631	GW 50 609	GW 50 653

PLASTIC FIXING DEVICES

Ø conduits (mm)	Re-openable fixing collars	Non re-openable fixing collars		Wall plugs	
				Wall plug Ø 6mm	Wall plug Ø 8mm
16	DX 51 120	DX 51 232		DX 51 306	DX 51 308
20	DX 51 120	DX 51 232		DX 51 306	DX 51 308
25		DX 51 232	DX 51 263	DX 51 306	DX 51 308
32		DX 51 232	DX 51 263	DX 51 306	DX 51 308
40			DX 51 263	DX 51 306	DX 51 308
60			DX 51 263	DX 51 306	DX 51 308
63			DX 51 263	DX 51 306	DX 51 308

FIXING SUPPORTS AND ACCESSORIES FOR CABLES

Ø cables (mm)	Staples with nail	Width of flat cables (mm)	Staples with nail for flat cables
			
3-4	GW 50 610		
5-6	GW 50 611	5-6	GW 50 623
	GW 50 621*		
7-8	GW 50 612	7-8	GW 50 624
	GW 50 622*		
9-10	GW 50 613	10-11	GW 50 625
11-12	GW 50 614		
13-14	GW 50 615		
15-16	GW 50 616		
19-20	GW 50 617		
21-22	GW 50 618		
25-26	GW 50 619		
31-32	GW 50 620		

* Colour: White





METAL FIXING DEVICES





Ø cables/conduits (mm)	Galvanized steel collars with 2 screws	Galvanized steel staples with a single hole	Galvanized steel staples with a double hole
			
10-11	GW 50 801	GW 50 811	GW 50 821
12-13	GW 50 802	GW 50 812	GW 50 822
14-15	GW 50 803	GW 50 813	GW 50 823
16-17	GW 50 804	GW 50 814	GW 50 824
19-20	GW 50 805	GW 50 815	GW 50 825
21-22	GW 50 806	GW 50 816	GW 50 826
25-26	GW 50 807	GW 50 817	GW 50 827
31-32	GW 50 808	GW 50 818	GW 50 828
38-40	GW 50 809	GW 50 819	GW 50 829
48-50	GW 50 810	GW 50 820	GW 50 830



FIXING STRAPS

Galvanized steel fixing strap - 10m	Fabric fixing strap - 10m	Firing pin for manual nailing	Steel nail, 18mm long
			
GW 50 791	GW 50 792	GW 50 798	GW 50 799

GW FIT



CONDUITS Ø (mm)	RK RANGE - IP40 COUPLINGS			
	Coupling IP40 	Tight radius elbow IP40 	Controllable "T" joint IP40 	Controllable elbow IP40 
16	DX 40 016	DX 40 116	DX 40 216	DX 40 316
20	DX 40 020	DX 40 120	DX 40 220	DX 40 320
25	DX 40 025	DX 40 125	DX 40 225	DX 40 325
32	DX 40 032	DX 40 132	DX 40 232	DX 40 332
40	DX 40 040	DX 40 140		
50	DX 40 050	DX 40 150		
63	DX 40 063	DX 40 163		

CONDUITS Ø (mm)	MORBIDX RANGE - WATERTIGHT COUPLINGS							
	Coupling IP67 	Tight radius elbow IP67 	Conduit-box coupling IP67 		Conduit-sheath coupling IP65 		Conduit-sheath coupling (equal diameter) IP65 	
	Code	Code	Metric pitch	Code	Sheath Ø	Code	Sheath Ø	Code
16	DX 43 016	DX 43 116	M16x1,5	DX 43 216	12	DX 43 316	16	DX 43 416
20	DX 43 020	DX 43 120	M20x1,5	DX 43 220	16	DX 43 320	20	DX 43 420
25	DX 43 025	DX 43 125	M25x1,5	DX 43 225	20	DX 43 325	25	DX 43 425
32	DX 43 032	DX 43 132	M32x1,5	DX 43 232	25	DX 43 332	28	DX 43 432
40	DX 43 040	DX 43 140	M40x1,5	DX 43 240	32	DX 43 340	40	DX 43 440
50	DX 43 050	DX 43 150	M50x1,5	DX 43 250	40	DX 43 350		

CONDUITS Ø (mm)	FLEXIBLE COUPLINGS		
	Flexible couplings SPEEDY-FLEX range		La Svolta conduit-conduit
			
	IP66	IP44	IP 65
16	GW 50 201	GW 50 207	DX 43 516
20	GW 50 202	GW 50 208	DX 43 520
25	GW 50 203	GW 50 209	DX 43 525
32	GW 50 204	GW 50 210	DX 43 532
40	GW 50 205	GW 50 211	DX 43 540
50	GW 50 206	GW 50 212	DX 43 550

In bold: versions with halogen-free material.



Ø sheaths (mm)	STRAIGHT ROTATING COUPLING DEVICES - IP54 RANGE								
	M pitch	Grey	Black	GAS pitch	Grey	Black	PG pitch	Grey	Black
8	M12			1/4"			7		
10	M16	DX 54 010	DX 54 110	1/4"	DX 54 210	DX 54 310	7	DX 54 410	DX 54 510
12	M16	DX 54 012	DX 54 112	3/8"	DX 54 212	DX 54 312	9	DX 54 411	DX 54 511
14				1/2"	DX 54 214	DX 54 314	11	DX 54 412	DX 54 512
16	M20	DX 54 016	DX 54 116	1/2"	DX 54 216	DX 54 316	13,5	DX 54 413	DX 54 513
20	M25	DX 54 020	DX 54 120	3/4"	DX 54 220	DX 54 320	16	DX 54 414	DX 54 514
22	M25	DX 54 022	DX 54 122	3/4"	DX 54 222	DX 54 322	13,5	DX 54 416	DX 54 516
25	M32	DX 54 025	DX 54 125	1"	DX 54 225	DX 54 325	16	DX 54 417	DX 54 517
28	M32	DX 54 028	DX 54 128	1"	DX 54 228	DX 54 328	21	DX 54 420	DX 54 520
32	M40	DX 54 032	DX 54 132	1 1/4"	DX 54 232	DX 54 332	21	DX 54 422	DX 54 522
35				1 1/4"	DX 54 235	DX 54 335	29	DX 54 425	DX 54 525
40	M50	DX 54 040	DX 54 140	1 1/2"	DX 54 240	DX 54 340	29	DX 54 428	DX 54 528
50	M63	DX 54 050	DX 54 150	2"	DX 54 250	DX 54 350	36	DX 54 432	DX 54 532
							36	DX 54 435	DX 54 535

Ø sheaths (mm)	STRAIGHT FIXED COUPLING DEVICES - IP54 RANGE						COUPLING DEVICES IP65			
	M pitch	Grey	GAS pitch	Grey	PG pitch	Grey	Conduit-sheath pipe coupling	Conduit-sheath coupling (equal diameter)		
8	M12		1/4"		7					
10	M16	DX 56 010	1/4"	DX 56 210	7	DX 56 410				
12	M16	DX 56 012	3/8"	DX 56 212	9	DX 56 411	16	DX 43 316		
					11	DX 56 412				
					13,5	DX 56 413				
14	M16	DX 56 014	1/2"	DX 56 214	13,5	DX 56 414				
16	M20	DX 56 016	1/2"	DX 56 216	11	DX 56 415	20	DX 43 320	16	
					13,5	DX 56 416				
					16	DX 56 417				
20	M25	DX 56 022	3/4"	DX 56 222	16	DX 56 422	25	DX 43 325	20	
					21	DX 56 423				
22	M25	DX 56 022	3/4"	DX 56 222	16	DX 56 422				
					21	DX 56 423				
25	M25	DX 56 025	3/4"	DX 56 225	21	DX 56 425	32	DX 43 332	25	
28	M32	DX 56 028	1"	DX 56 228	29	DX 56 428			32	
32			1 1/4"	DX 56 232	36	DX 56 432	40	DX 43 340		
35			1 1/4"	DX 56 235	36	DX 56 435				
40	M40	DX 56 040	1 1/4"	DX 56 240	42	DX 56 440	50	DX 43 350	40	
50	M50	DX 56 050	2"	DX 56 250	48	DX 56 450				

CABLE TIES

Dimensions LxH (mm)	Tightening capacity Ø (mm)	STANDARD TYPE	FOR HEAVY DUTY	RE-OPENABLE	WITH EYELET	WITH PLATE
2,4x75	1.5 - 18	GW 52 231	GW 52 251	-	-	-
2,5x96	1.5 - 23	GW 52 232	GW 52 252	-	-	-
2,5x100	1.5 - 25	-	-	-	GW 52 281	-
2,5x100	5 - 25	-	-	-	-	GW 52 291
2,5x110	1.5 - 25	-	-	-	-	GW 52 292
2,5x140	1.5 - 35	GW 52 233	GW 52 253	-	-	-
2,5x200	10 - 50	-	-	-	-	GW 52 293
2,5x203	1.5 - 55	GW 52 234	GW 52 254	-	-	-
3,6x150	2.5 - 39	GW 52 235	GW 52 255	-	-	-
3,6x203	2.5 - 55	GW 52 236	GW 52 256	-	-	-
3,6x292	2.5 - 85	GW 52 237	GW 52 257	-	-	-
4,2x205	2.5 - 60	-	-	-	GW 52 282	-
4,6x200	10 - 50	-	-	-	-	GW 52 294
4,8x190	3 - 52	GW 52 238	GW 52 258	-	-	-
4,8x280	3 - 81	GW 52 239	GW 52 259	-	-	-
4,8x368	3 - 182	GW 52 240	GW 52 260	-	-	-
7,6x150	4 - 35	-	-	GW 52 271	-	-
7,6x200	4 - 50	-	-	GW 52 272	-	-
7,6x300	4 - 80	-	-	GW 52 273	-	-
7,6x380	4 - 110	GW 52 241	GW 52 261	-	-	-
9,0x610	5 - 185	GW 52 242	GW 52 262	-	-	-
9,0x914	5 - 270	GW 52 243	GW 52 263	-	-	-



TECHNICAL COMPONENTS AND ACCESSORIES FOR CABLE TIES

Self-adhesive fixing clips for ties		GW 52 226	For tie widths up to 4.5mm
		GW 52 227	For tie widths up to 5mm
Fixing supports for ties		GW 52 228	For tie widths up to 5mm
		GW 52 229	For tie widths up to 9mm
Tie-puller clamp		GW 52 410	Tie-puller clamp for standard ties



OUTDOOR TIES





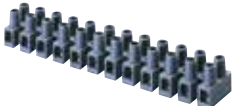

Dimensions LxH (mm)	Tightening capacity Ø (mm)	LTR TIES	
			
6x115	5 - 25		GW 52 201
6x180	9 - 45		GW 52 202
6x290	20 - 78		GW 52 203
9x180	10 - 40		GW 52 204
9x265	26 - 60		GW 52 205
9x360	26 - 93		GW 52 206
9x510	70 - 140		GW 52 207
9x760	70 - 220		GW 52 208



TECHNICAL COMPONENTS AND ACCESSORIES FOR OUTDOOR TIES

Supports for outdoor ties		GW 52 209	Screw support
Fixing supports for ties		GW 52 210	Wall plug support
Tie-puller clamp		GW 52 411	Tie-puller clamp for outdoor ties

CONNECTION CAPACITY	44 MS - MOBILE AND MODULAR TERMINAL BLOCKS				
	MODULAR BARS TRAILING TERMINAL BLOCKS TRANSPARENT - IP20		12-POLE MODULAR TERMINAL BLOCKS WITH BRASS TERMINALS - BLACK		
		SCREW TYPE: SLOTTED			
2,5 mm ²			GW 44 661		GW 44 601
4 mm ²			GW 44 665		GW 44 602
6 mm ²			GW 44 662		
10 mm ²			GW 44 663		GW 44 603
16 mm ²			GW 44 664		GW 44 604
		SCREW TYPE: HEXAGONAL			
25 mm ²		GW 44 666	GW 44 605		
35 mm ²		GW 44 667			

CONNECTION CAPACITY	44 MM - MULTI-POLE TERMINAL BLOCKS				
	PRESS-ON FIXING MULTI-POLE TERMINAL BLOCKS - GREY RAL 7035		SCREW-ON FIXING MULTI-POLE FEEDTHROUGH TERMINAL BLOCKS - GREY RAL 7035		
		GW 44 606			
3 poles x 4 mm ²					GW 44 609
3 poles x 6 mm ²					GW 44 611
3 poles x 16 mm ²					GW 44 613
4 poles x 4 mm ²			GW 44 607		
5 poles x 4 mm ²			GW 44 608		
5 poles x 6 mm ²					GW 44 610
5 poles x 16 mm ²					GW 44 612
5 poles x 35 mm ²			GW 44 614		



CONNECTION CAPACITY	44 ME - SINGLE-POLE EQUIPOTENTIAL TERMINAL BLOCKS			
	SINGLE-POLE EQUIPOTENTIAL TERMINAL BLOCKS WITH INDIRECT PLATE-TIGHTENING - TRANSPARENT			
	4 way x 6 mm ²		GW 44 704	
6 way x 6 mm ²	GW 44 706			
8 way x 6 mm ²	GW 44 708			
Support for fixing on DIN rail		GW 44 720		
CONNECTION CAPACITY	SINGLE-POLE EQUIPOTENTIAL TERMINAL BLOCKS WITH INDIRECT SCREW-TIGHTENING - TRANSPARENT			
	3 way x 6 mm ²		GW 44 671	
	5 way x 6 mm ²		GW 44 672	
4 way x 16 mm ²	GW 44 673			
2 way x 6 mm ² + 3 way x 6 mm ²	GW 44 674			
2 way x 16 mm ² + 9 way x 6 mm ²	GW 44 675			
2 way x 35 mm ² + 4 way x 16 mm ²	GW 44 676			
Support for fixing on DIN rail		GW 44 681		
Adapter		GW 44 682		
Rail for fixing in PTC boxes		GW 44 683		

RATED CURRENT	44 MP - MODULAR DISTRIBUTION TERMINAL BLOCKS				
		CODE	MAX. INPUT CONNEC- TION	MAX. OUTPUT CONNECTION	ICW (15)
	SINGLE-POLE MODULAR DIVIDER TERMINAL BLOCK				
In: 160 A		GW 44 651 (1)	1x(10-70) mm ²	6x(2,5-16) mm ²	10 kA
In: 100 A		TWO-POLE MODULAR DIVIDER TERMINAL BLOCKS WITH TRANSPARENT PROTECTION COVER			
		GW 44 691	1x(6-35) mm ²	[1x(4-25) + 5x(1,5-10)] mm ²	6 kA
In: 125 A		GW 44 693	1x(6-35) mm ²	[2x(4-25) + 2x(4-16) + 10x(1,5-10)] mm ²	6 kA
In: 100 A		FOUR-POLE MODULAR DIVIDER TERMINAL BLOCKS WITH TRANSPARENT PROTECTION COVER			
		GW 44 696	1x(6-35) mm ²	[1x(4-25) + 5x(1,5-10)] mm ²	6 kA
		GW 44 698	1x(6-35) mm ²	[2x(4-25) + 2x(4-16) + 10x(1,5-10)] mm ²	6 kA
In: 160 A		GW 44 699	1x(16-50) mm ²	[2x(10-35) + 2x(6-25) + 8x(4-16)] mm ²	10 kA

(1) When assembling several terminal blocks side by side to extend the number of outputs, use the jumper kit GW 44 652.

			COMPATIBILITY BETWEEN TERMINAL BLOCKS AND JUNCTION BOXES							
			44 MM RANGE - MULTI-POLE TERMINAL BLOCKS							
			Press-on fixing			Screw-on fixing with feedthrough terminals				
										
Type	Range	Dimensions (mm)	GW 44 606 3x4 mm ²	GW 44 607 4x4 mm ²	GW 44 608 5x4 mm ²	GW 44 609 3x6 mm ² GW 44 610 5x6 mm ²	GW 44 611 3x16 mm ² GW 44 612 5x16 mm ²	GW 44 613 3x35 mm ² GW 44 614 5x35 mm ²		
44 CE RANGE: SURFACE-MOUNTING JUNCTION BOXES	IP 44 	Ø 65	•	•	•					
		Ø 80	•	•	•	•				
		80x80	•	•	•	•				
		IP 55 - IP 56 	100x100	•	•	•	•	•		
			120x80	•	•	•	•	•		
			150x110				•	•	•	
			190x140				•	•	•	
			240x190				•	•	•	
			300x220				•	•	•	
			380x300				•	•	•	
	460x380				•	•	•			
	48 RANGE: FLUSH-MOUNTING JUNCTION BOXES		48 PT/PT DIN 	92x92				•	•	
				118x96				•	•	
152x98							•	•		
160x130							•	•	•	
196x152							•	•	•	
294x152							•	•	•	
392x152							•	•	•	
480x160							•	•	•	
516x202							•	•	•	
516x294					•	•	•			
		48 CM	260x260				•	•		
			520x260				•	•		
			48 PTC 	138x169	•	•	•	•	•	•
			308x169				•	•	•	
			398x169				•	•	•	

• = Suitable

			COMPATIBILITY BETWEEN TERMINAL BLOCKS AND JUNCTION BOXES								
			44 ME RANGE - SINGLE-POLE EQUIPOTENTIAL TERMINAL BLOCKS								
			With indirect plate-tightening				With indirect screw-tightening				
Type	Range	Dimensions (mm)	GW 44 704	GW 44 706	GW 44 708	GW 44 671	GW 44 672	GW 44 673	GW 44 675	GW 44 676	
			4-way x 6 mm ²	6-way x 6 mm ²	8-way x 6 mm ²	3-way x 6 mm ²	5-way x 6 mm ²	4-way x 16 mm ² GW 44 674 (2x16)+(3x6) mm ²	(2x16)+(9x6) mm ²	(2x35)+(4x16) mm ²	
44 CE RANGE: SURFACE-MOUNTING JUNCTION BOXES	IP 44 	Ø 65	•	•		•					
		Ø 80	•	•	•	•	•				
		80x80	•	•	•	•	•				
	IP 55 - IP 56 	100x100	•	•	•	•	•	•			
		120x80	•	•	•	•	•	•			
		150x110	•	•	•	•	•	•		•	•
		190x140	•	•	•	•	•	•		•	•
		240x190	•	•	•	•	•	•		•	•
		300x220	•	•	•	•	•	•		•	•
		380x300	•	•	•	•	•	•		•	•
460x380	•	•	•	•	•	•		•	•		
48 RANGE: FLUSH-MOUNTING JUNCTION BOXES	48 PT/PT DIN 	92x92	•	•	•	•	•	•			
		118x96	•	•	•	•	•	•			
		152x98	•	•	•	•	•	•			
		160x130	•	•	•	•	•	•		•	
		196x152	•	•	•	•	•	•			
		294x152	•	•	•	•	•	•			
		392x152	•	•	•	•	•	•			
	(with GW 44 682 adapter)	480x160	•	•	•	•	•	•			
		516x202	•	•	•	•	•	•		•	
	48 CM (with GW 44 682 adapter)	516x294	•	•	•	•	•	•		•	
		260x260	•	•	•	•	•	•			
	48 PTC (with adapter)	520x260	•	•	•	•	•	•			
		138x169	•	•	•	•	•	•		•	•
		308x169	•	•	•	•	•	•		•	
	48 PTC (with GW 44 683 rail)	398x169	•	•	•	•	•	•		•	
138x169		•	•	•	•	•	•		•		
308x169		•	•	•	•	•	•		•		
		398x169	•	•	•	•	•		•		

• = Suitable

Note: The 44 ME range terminal blocks with indirect screw-tightening are mounted on plates, or on the bottom of the boxes, using the suitable GW 44 682 adapter. For 48 PTC range boxes on the other hand, use code GW 44 683.

The 44 ME range terminal blocks with indirect plate-tightening are mounted on the DIN rail of the 48 PT DIN boxes, using the suitable GW 44 720 support.

GW FIT

Accessories for electrical installation

Complete system comprising cable glands, plastic and metal fixings, couplings for rigid conduits and sheaths, cable ties for external and junction and connection terminal blocks. The depth of the range and breadth of the offers of each family makes GEWISS the specialist and ideal partner when implementing any type of system, from residential to commercial and industrial sector.



PLASTIC CABLE GLANDS AND ACCESSORIES

CABLE GLANDS

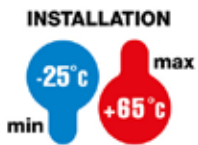

GWT
650°C



GW 52 001

NYLON CABLE GLANDS - PG PITCH - GREY RAL 7035 - IP66

Code	PG pitch	Mounting hole Ø (mm)	For cables Ø (mm)	Pack Carton
GW 52 001	7	12.5	from 3 to 6	50/900
GW 52 002	9	16	from 6 to 8	50/600
GW 52 003	11	19	from 8 to 10.5	25/500
GW 52 004	13.5	20	from 9 to 12.5	25/500
GW 52 005	16	23	from 13 to 16	25/375
GW 52 006	21	29	from 9 to 10/from 17 to 20	25/400
GW 52 007	29	37	from 13.5 to 15/from 21 to 26	25/250
GW 52 008	36	48	from 17 to 20/from 30 to 34	10/130
GW 52 009	42	54	from 36 to 39/from 40 to 43	6/120
GW 52 010	48	60	from 38 to 40/from 46 to 50	5/100

ACCESSORIES SUPPLIED: fixing nut.

APPLICATIONS: for making watertight installations with direct grip on cable.



GW 52 075

NYLON CABLE GLANDS - PG PITCH - GREY RAL 7035 - IP68

Code	PG pitch	Mounting hole Ø (mm)	For cables Ø (mm)	Pack Carton
GW 52 071	7	12.5	from 3.5 to 6.5	50/600
GW 52 072	9	16	from 4 to 8	50/400
GW 52 073	11	19	from 5 to 10	50/600
GW 52 074	13.5	20	from 6 to 12	25/300
GW 52 075	16	23	from 10 to 14	25/300
GW 52 076	21	29	from 13 to 18	25/200
GW 52 077	29	37	from 18 to 25	25/150
GW 52 078	36	48	from 22 to 32	10/120
GW 52 079	42	54	from 30 to 38	6/84
GW 52 080	48	60	from 34 to 44	5/60

ACCESSORIES SUPPLIED: fixing nut.



GW 52 042

NYLON CABLE GLANDS - METRIC PITCH - GREY RAL 7035 - IP68

Code	ISO pitch	Mounting hole Ø (mm)	For cables Ø (mm)	Pack Carton
GW 52 042	12x1.25	12	from 3 to 6.5	50/600
GW 52 043	16x1.5	16	from 5 to 10	50/400
GW 52 044	20x1.5	20	from 10 to 14	25/300
GW 52 045	25x1.5	25	from 13 to 18	25/200
GW 52 046	32x1.5	32	from 18 to 25	25/150
GW 52 047	40x1.5	40	from 22 to 32	10/120
GW 52 048	50x1.5	50	from 30 to 38	6/84
GW 52 049	63x1.5	63	from 35 to 44	5/60

ACCESSORIES SUPPLIED: fixing nut.

APPLICATIONS: direct installation on fixing enclosures or components in feedthrough holes.

Coupling in installations where a high protection rating is required in the presence of chemical substances, shocks and vibrations.



GW 52 025

NYLON CABLE GLANDS - PG PITCH WITH HOUSING FOR RIGID CONDUIT - GREY RAL 7035 - IP66

Code	PG pitch	Mounting hole Ø (mm)	For external conduits (mm)	For cables Ø (mm)	Pack Carton
GW 52 024	13.5	20	16	from 9 to 12.5	15/300
GW 52 025	16	23	20	from 13 to 16	15/240
GW 52 026	21	29	25	from 9 to 10/from 17 to 20	15/240
GW 52 027	29	37	32	from 13.5 to 15/from 21 to 26	15/135
GW 52 028	36	48	40	from 17 to 20/from 30 to 34	6/54
GW 52 029	42	54	50	from 36 to 39/from 40 to 43	4/80

ACCESSORIES SUPPLIED: fixing nut.

APPLICATIONS: for making watertight installations with direct clamping on the cable and attractive conduit-box coupling.

CLOSURE CAPS

GW 52 366

NYLON CLOSURE CAPS - GREY RAL 7035 - IP65

Code	Pitch	Pack Carton
GW 52 361	PG7	100/500
GW 52 362	PG9	100/500
GW 52 363	PG11	100/400
GW 52 364	PG13.5	100/400
GW 52 365	PG16	100/300
GW 52 366	PG21	100/300
GW 52 367	PG29	50/250
GW 52 368	PG36	25/150
GW 52 369	PG42	25/125
GW 52 370	PG48	10/100
GW 52 372	M12	100/500
GW 52 373	M16	100/500
GW 52 374	M20	100/400
GW 52 375	M25	100/400
GW 52 376	M32	50/250
GW 52 377	M40	50/200
GW 52 378	M50	25/150
GW 52 379	M63	10/100

NOTE: IP65 - only obtained with the aid of an O-ring.

O-RING FOR CLOSURE CAPS

GW 52 452

Code	For caps with pitch	Pack Carton
GW 52 441	PG7	500/2500
GW 52 442	PG9	500/2500
GW 52 443	PG11	500/2000
GW 52 444	PG13.5	500/2000
GW 52 445	PG16	500/2000
GW 52 446	PG21	500/1500
GW 52 447	PG29	250/1250
GW 52 448	PG36	100/1000
GW 52 449	PG42	50/500
GW 52 450	PG48	50/400
GW 52 452	M12	500/2500
GW 52 453	M16	500/2500
GW 52 454	M20	500/2000
GW 52 455	M25	500/2000
GW 52 456	M32	250/1250
GW 52 457	M40	50/1250
GW 52 458	M50	500/1000
GW 52 459	M63	50/500

FIXING NUTS



GW 52 341

NYLON FIXING NUTS - GREY RAL 7035

Code	Pitch	Pack Carton
GW 52 341	PG7	100/1000
GW 52 342	PG9	100/1000
GW 52 343	PG11	100/800
GW 52 344	PG13.5	100/800
GW 52 345	PG16	100/600
GW 52 346	PG21	100/500
GW 52 347	PG29	50/250
GW 52 348	PG36	25/200
GW 52 349	PG42	25/150
GW 52 350	PG48	25/100
GW 52 352	M12	100/1000
GW 52 353	M16	100/1000
GW 52 354	M20	100/800
GW 52 355	M25	100/800
GW 52 356	M32	100/600
GW 52 357	M40	100/500
GW 52 358	M50	50/250
GW 52 359	M63	25/125

COUPLINGS AND CABLE-GLANDS

INSTALLATION



GW 50 415

SHOCKPROOF POLYMER CONDUIT/BOX COUPLINGS GREY RAL 7035

**GWT
650°C**

Code	For external conduits (mm)	Mounting hole Ø (mm)	IP with rigid conduit	IP with corrugated conduit	Pack Carton
GW 50 415	16	20	IP66	IP54	25/200
GW 50 416	20	23	IP66	IP54	25/200
GW 50 417	25	29	IP66	IP54	25/150
GW 50 418	32	37	IP66	IP54	10/100
GW 50 419	40	48	IP66	IP44	6/60
GW 50 420	50	54	IP66	IP44	5/50

CHARACTERISTICS: the box conduit coupling device allows corrugated conduits to be connected to the junction boxes, guaranteeing the minimum IP4X degree of protection in areas at greater risk in the event of a fire whenever required.

ACCESSORIES SUPPLIED: fixing nut.



GW 50 421

FLEXIBLE POLYMER CONDUIT/BOX COUPLINGS GREY RAL 7035 - IP44

**GWT
650°C**

Code	For external conduits (mm)	Mounting hole Ø (mm)	Pack Carton
GW 50 421	16	23	50/700
GW 50 422	20	23	50/700
GW 50 423	20	29	25/350
GW 50 424	25	29	25/350
GW 50 425	32	37	15/210
GW 50 426	40	37	10/160
GW 50 427	50	48	10/90



GW 50 430

FLEXIBLE POLYMER CABLE GLAND - GREY RAL 7035 - IP55

**GWT
960°C**

Code	For ext. conduits max (mm)	Mounting hole Ø (mm)	Pack Carton
GW 50 428	16	19	100/1000
GW 50 429	20	23	100/1000
GW 50 430	25	29	100/1000
GW 50 431	32	37	50/500
GW 50 432	40	48	35/350

NOTE: quick entry cable glands, except GW50428.

CHARACTERISTICS: quick entry cable glands, suitable for cables with Ø from 4 to 14mm.

Cable gland GW50429, suitable for conduits ø 16, 20mm.

Cable gland GW50430, suitable for conduits ø 16, 20, 25mm.

Cable gland GW50431, suitable for conduits ø 16, 20, 25, 32mm.

Cable gland GW50432, suitable for conduits ø 16, 20, 25, 32, 40mm.

METAL CABLE GLANDS AND ACCESSORIES

INSTALLATION



CABLE GLANDS



GW 76 837

INSULATED CABLE GLAND - IP65

Code	Type of pitch	Seals Ø (mm)	Pack Carton
GW 76 837	PG11	7.5 / 10 / 12.5	1/50
GW 76 839	M20	4 / 7 / 10 / 13	1/50



GW 76 845

NICKEL-PLATED BRASS CABLE GLANDS - IP65

Code	Type of pitch	Seals Ø (mm)	Pack Carton
GW 76 841	PG11	7.5 / 10 / 12.5	1/50
GW 76 842	PG13.5	7.5 / 10 / 12.5	1/50
GW 76 843	PG16	7.5 / 10 / 12.5	1/50
GW 76 844	PG21	10 / 13 / 16 / 19	1/50
GW 76 845	PG29	18 / 21 / 24 / 27	1/10
GW 76 846	PG36	24 / 27 / 30 / 33	1/10
GW 76 847	PG42	30 / 33 / 36 / 39	1/10
GW 76 848	M20	4 / 7 / 10 / 13	1/50
GW 76 849	M25	8.5 / 11.5 / 14.5 / 17.5	1/50
GW 76 850	M32	16 / 19 / 22 / 25	1/10
GW 76 851	M40	23 / 26 / 29 / 32	1/10
GW 76 852	M50	30 / 33 / 36 / 39	1/10

CHARACTERISTICS: nickel-plated brass cable gland with complete sealing gaskets for a wide range of cable diameters.



GW 76 829

NICKEL-PLATED BRASS CABLE GLANDS - IP68

Code	Type of pitch	For cables Ø (mm)	Pack Carton
GW 76 825	PG11	from 4 to 9	10/100
GW 76 826	PG13.5	from 7 to 11	10/100
GW 76 827	PG16	from 10 to 13	10/100
GW 76 828	PG21	from 12 to 17	5/50
GW 76 829	PG29	from 17 to 24	5/50
GW 76 830	PG36	from 20 to 26 / from 27 to 34	5/50
GW 76 897	PG42	from 32 to 36	2/10
GW 76 894	M12	from 3 to 6.5	50/250
GW 76 896	M16	from 4 to 9	10/100
GW 76 831	M20	from 10 to 13	10/100
GW 76 832	M25	from 12 to 17	10/100
GW 76 833	M32	from 14 to 21	5/50
GW 76 834	M40	from 19 to 27	5/50
GW 76 835	M50	from 25 to 34	2/10
GW 76 895	M63	from 34 to 48	5/40

CHARACTERISTICS: nickel-plated brass cable gland with mechanic cable-snap device.

NOTE: fixing nuts not supplied.

EXTENSIONS

GW 76 867

NICKEL-PLATED BRASS EXTENSIONS - IP65

Code	Male thread	Female thread	Pack Carton
GW 76 865	PG11	PG13.5	10/100
GW 76 866	PG13.5	PG16	10/100
GW 76 867	PG16	PG21	10/100
GW 76 868	PG21	PG29	5/50
GW 76 869	PG29	PG36	5/50
GW 76 870	M20	M25	10/100
GW 76 871	M25	M32	10/100
GW 76 872	M32	M40	5/50
GW 76 873	M40	M50	5/50

NOTE: IP degree of protection: depends on the other components with which they are coupled.

CLOSURE CAPS



GW 76 979

NICKEL-PLATED BRASS CLOSURE CAPS - IP65

Code	Type of pitch	Pack Carton
GW 76 980	PG11	10/100
GW 76 981	PG13.5	10/100
GW 76 982	PG16	10/100
GW 76 983	PG21	10/100
GW 76 984	PG29	5/50
GW 76 985	PG36	5/50
GW 76 986	PG42	5/50
GW 76 972	M12	100/400
GW 76 973	M16	100/300
GW 76 975	M20	10/100
GW 76 976	M25	10/100
GW 76 977	M32	10/100
GW 76 978	M40	5/50
GW 76 979	M50	5/50
GW 76 974	M63	10/100

ACCESSORIES SUPPLIED: sealing gasket.

FIXING NUTS



GW 76 959

NICKEL-PLATED BRASS FIXING NUTS

Code	Type of pitch	Pack Carton
GW 76 957	PG11	25/100
GW 76 958	PG13.5	25/100
GW 76 959	PG16	25/100
GW 76 960	PG21	25/100
GW 76 961	PG29	25/100
GW 76 962	PG36	10/50
GW 76 963	PG42	10/50
GW 76 966	M12	100/500
GW 76 951	M16	25/100
GW 76 952	M20	25/100
GW 76 953	M25	25/100
GW 76 954	M32	25/100
GW 76 955	M40	10/50
GW 76 956	M50	10/50
GW 76 967	M63	25/125

METAL CABLE GLANDS AND ACCESSORIES FOR ATEX ENVIRONMENTS - ZONE 1(G) - ZONE 20(D)

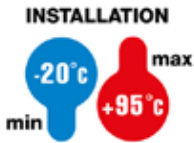

METAL CABLE GLANDS



GW 76 901

ATEX CABLE GLANDS IN NICKEL-PLATED BRASS WITH PG-PITCH AND LONG THREAD - IP68

Code	Type of pitch	Mounting hole Ø (mm)	For cables Ø (mm)	Pack Carton
GW 76 901	PG7	12.5	from 3 to 6.5	10/100
GW 76 902	PG9	16	from 4 to 8	10/100
GW 76 903	PG11	19	from 5 to 10	10/100
GW 76 904	PG13.5	20	from 6.5 to 12	10/100
GW 76 905	PG16	23	from 7 to 12	10/100
GW 76 906	PG21	29	from 13 to 18	5/50
GW 76 907	PG29	37	from 18 to 25	5/50
GW 76 908	PG36	48	from 22 to 32	5/50
GW 76 909	PG42	54	from 32 to 38	2/10
GW 76 910	PG48	60	from 37 to 44	2/10

NOTE: fixing nuts not supplied.

ATEX Classification. Equipment-group II Category 2G 1D.

Type of protection for use in explosive gas atmospheres: e.

Type of protection for use in explosive dust atmospheres: ta.

Ambient temperature range: -60°C <= Ta <= +95°C.



GW 76 921

ATEX CABLE GLANDS IN NICKEL-PLATED BRASS WITH METRIC PITCH AND LONG THREAD - IP68

Code	Type of pitch	Mounting hole Ø (mm)	For cables Ø (mm)	Pack Carton
GW 76 921	M12	12	from 3 to 6.5	10/100
GW 76 922	M16	16	from 6 to 10	10/100
GW 76 923	M20	20	from 10 to 14	10/100
GW 76 924	M25	25	from 14 to 18	10/100
GW 76 925	M32	32	from 20 to 25	5/50
GW 76 926	M40	40	from 22 to 32	5/50
GW 76 927	M50	50	from 32 to 38	2/10
GW 76 928	M63	63	from 37 to 44	2/10

NOTE: fixing nuts not supplied.

ATEX Classification. Equipment-group II Category 2G 1D.

Type of protection for use in explosive gas atmospheres: e.

Type of protection for use in explosive dust atmospheres: ta.

Ambient temperature range: -60°C <= Ta <= +95°C.

FIXING NUTS



GW 76 941

NICKEL-PLATED BRASS FIXING NUTS

Code	Type of pitch	Pack Carton
GW 76 941	PG7	25/100
GW 76 942	PG9	25/100
GW 76 957	PG11	25/100
GW 76 958	PG13.5	25/100
GW 76 959	PG16	25/100
GW 76 960	PG21	25/100
GW 76 961	PG29	25/100
GW 76 962	PG36	10/50
GW 76 963	PG42	10/50
GW 76 943	PG48	10/50
GW 76 949	M12	25/100
GW 76 951	M16	25/100
GW 76 952	M20	25/100
GW 76 953	M25	25/100
GW 76 954	M32	25/100
GW 76 955	M40	10/50
GW 76 956	M50	10/50
GW 76 950	M63	10/50

PLASTIC FIXINGS FOR CONDUITS AND CABLES

FIXINGS FOR CONDUITS

INSTALLATION

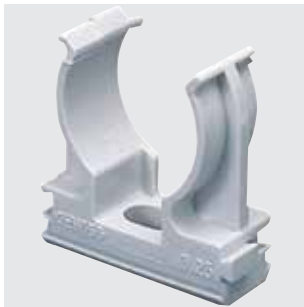

GW 50 603

SHOCKPROOF POLYMER SADDLE SNAP CLIP - GREY RAL 7035



Code	For external conduits (mm)	Wall-conduit axis distance (mm)	Pack Carton
GW 50 601	16	20	100/1800
GW 50 602	20	22	100/1600
GW 50 603	25	24.5	100/900
GW 50 604	32	28	100/900
GW 50 628	40	32	50/450
GW 50 629	50	37	50/450

NOTES: suitable for riveting machines. GW50628 and GW50629 are not Halogen Free.

APPLICATIONS: recommended for surface mounting



GW 50 605

SHOCKPROOF POLYMER SADDLE COLLAR CLIP - GREY RAL 7035



Code	For external conduits (mm)	Wall-conduit axis distance (mm)	Pack Carton
GW 50 605	16	20	100/900
GW 50 606	20	22	100/900
GW 50 607	25	24.5	100/600
GW 50 608	32	28	50/450
GW 50 630	40	32	35/350
GW 50 631	50	37	25/200

APPLICATIONS: Recommended for ceiling applications.



GW 50 609

MODULAR LOCK-JOINT RAIL TO FIX SHOCKPROOF POLYMER SUPPORTS - GREY RAL 7035

Code	Length (mm)	Pack Carton
GW 50 609	200	50/350



GW 50 651

MULTI-DIAMETER CLAMP SUPPORTS - GREY RAL 7035

Code	For external conduits (mm)	Wall-conduit axis distance (mm)	Pack Carton
GW 50 651	16-20	14-16	75/900
GW 50 652	25-32	21.5-25	25/250
GW 50 653	40-50	30-35	15/150



DX 51 120

FIXING COLLAR - GREY RAL 7035



Code	For external conduits (mm)	Description	Pack Carton
DX 51 120	16-20	Reopened collar	100/1500
DX 51 232	16-32	Collar cannot be reopened	100/800
DX 51 263	25-63	Collar cannot be reopened	100/400

USE: rigid conduits can be fixed to the wall with the aid of the wall plugs. Assembly hole Ø7mm.

MATERIAL: self-extinguishing polyamide.

NOTE: for an optimal collar closing use the tie tool.



DX 51 306

FIXING DOWELS FOR COLLAR - GREY RAL 7035

Code	For mounting holes Ø (mm)	Characteristics	Pack Carton
DX 51 306	6	1 Impact insert included	200/600
DX 51 308	8	1 Impact insert included	200/600

USE: allow fixing of rigid conduits fixing collars to walls.

FIXINGS FOR CABLES



GW 50 610

SHOCKPROOF POLYMER CLIPS WITH HARDENED STEEL PIN - GREY RAL 7035



Code	For external conduits (mm)	Pack Carton
Colour: Grey RAL 7035		
GW 50 610	3-4	100/8000
GW 50 611	5-6	100/8000
GW 50 612	7-8	100/8000
GW 50 613	9-10	100/6000
GW 50 614	11-12	100/6000
GW 50 615	13-14	100/6000
GW 50 616	15-16	100/3000
GW 50 617	19-20	100/1800
GW 50 618	21-22	100/2000
GW 50 619	25-26	50/900
GW 50 620	31-32	50/1000
Colour: White		
GW 50 621	5-6	100/8000
GW 50 622	7-8	100/8000



GW 50 623

FLAT SHOCKPROOF POLYMER CLIPS WITH PIN OF HARDENED STEEL - WHITE

Code	Colour	For flat cables width	Pack Carton
GW 50 623	White	5 - 6 mm	100/4000
GW 50 624	White	7 - 8 mm	100/15000
GW 50 625	White	10 - 11 mm	100/4800



GW 50 626

HARDENED STEEL PINS

Code	Description	Pack Carton
GW 50 626	Totally insulated	100/1000
GW 50 627	With insulating collar	100/1000

NOTE: Each package contains 100 small nails.

METAL COLLARS FOR CONDUITS AND CABLES

COLLARS IN GALVANIZED STEEL



GW 50 801

GALVANISED STEEL COLLARS M6 THREAD WITH 2 SCREWS

Code	For external conduits (mm)	Pack Carton
GW 50 801	10-11	100/1600
GW 50 802	12-13	100/800
GW 50 803	14-15	100/800
GW 50 804	16-17	100/800
GW 50 805	19-20	100/800
GW 50 806	21-22	100/600
GW 50 807	25-26	100/600
GW 50 808	31-32	100/600
GW 50 809	38-40	100/300
GW 50 810	48-50	50/300

CLIPS IN GALVANIZED STEEL



GW 50 811

GALVANISED STEEL CLIPS HOLE 12X6 MM

Code	For external conduits (mm)	Pack Carton
GW 50 811	10-11	100/2400
GW 50 812	12-13	100/2000
GW 50 813	14-15	100/2000
GW 50 814	16-17	100/1600
GW 50 815	19-20	100/1000
GW 50 816	21-22	50/1000
GW 50 817	25-26	50/1000
GW 50 818	31-32	50/600
GW 50 819	38-40	50/600
GW 50 820	48-50	50/300



GW 50 821

GALVANISED STEEL U-BOLTS WITH TWO HOLES

Code	For external conduits (mm)	Pack Carton
Hole dimension (mm): 7x4		
GW 50 821	10-11	100/2400
GW 50 822	12-13	100/3500
GW 50 823	14-15	100/2000
GW 50 824	16-17	100/1600
GW 50 825	19-20	100/2000
GW 50 826	21-22	50/1000
GW 50 827	25-26	50/800
Hole dimension (mm): 10x6		
GW 50 828	31-32	50/600
GW 50 829	38-40	50/600
GW 50 830	48-50	50/300

STRAPS FOR CORRUGATED CONDUITS

FIXING STRAPS



GW 50 791

STRAPS FOR POSITIONING THE CONDUITS ON THE FLOOR

Code	Description	Roll length (m)	Ribbon height (mm)	Pack Carton
GW 50 791	Strap in perforated, galvanized steel	10	12	1/10
GW 50 792	Strap in fabric	10	15	10/100



GW 50 798

KIT FOR MANUAL RIVETING

Code	Description	Pack Carton
GW 50 798	Firing pin	1/10
GW 50 799	Steel pin - 18mm	200/4000

DISPENSER FOR ACCESSORIES

DISPENSER CASE FOR ELECTRICAL INSTALLATION ACCESSORIES



GW 52 420

MULTI-COMPARTMENT DISPENSER CASE WITH SNAP-ON SECURITY CLOSURE

Code	Accessories supplied	Dimensions LxHxD (mm)	Pack Carton
GW 52 420	Upper compartment and 4 extractable compartments	420x400x320 mm	1

TOOLS FOR PERFORATING ENCLOSURES

DRILL MILLING CUTTER



GW 52 401

MULTI-DIAMETER DRILL MILLING CUTTER IN HSS STEEL TO DRILL BOXES, BOARDS AND TRUNKING IN INSULATING MATERIAL

Code	Description	Ø of perforation	Pack Carton
GW 52 401	Drill milling cutter	From 3.5 to 40	1/4



GW 52 402

CUP DRILL MILLING CUTTER TO DRILL PANELS

Code	Description	Pack Carton
GW 52 402	Cup drill milling Ø56	10

APPLICATIONS: suitable for low voltage flush-mounting socket-outlets IEC 309 2P+E 16A and for all the extra-low voltage flush-mounting socket-outlets IEC 309.



GW 52 403

CUP DRILL MILLING CUTTER TO DRILL HOLLOW CAVITY WALL

Code	Description	Pack Carton
GW 52 403	Cup drill milling Ø62	10



GW 52 412

TAPERED DRILL MILLING CUTTER IN HSS STEEL TO FINISH AND COUNTERSINK HOLES FOR METAL BOARDS AND TRUNKING

Code	Description	For holes Ø (mm)	Pack Carton
GW 52 412	Tapered drill milling cutter	40	1/4

COUPLING DEVICES FOR RIGID CONDUITS

RK CONNECTIONS - GREY RAL 7035



DX 40 016

COUPLING - IP40



Code	Conduits Ø (mm)	Pack Carton
DX 40 016	16	30/300
DX 40 020	20	30/450
DX 40 025	25	20/240
DX 40 032	32	10/100
DX 40 040	40	5/25
DX 40 050	50	15
DX 40 063	63	8

NOTE: DX40063 not Halogen Free



DX 40 116

TIGHT RADIUS BEND - IP40



Code	Conduits Ø (mm)	Pack Carton
DX 40 116	16	30/300
DX 40 120	20	30/300
DX 40 125	25	20/100
DX 40 132	32	10/50
DX 40 140	40	5/25
DX 40 150	50	10
DX 40 163	63	1

NOTE: DX40063 not Halogen Free



DX 40 216

INSPECTABLE T - IP40

Code	Conduits Ø (mm)	Pack Carton
DX 40 216	16	30/120
DX 40 220	20	30/120
DX 40 225	25	20/60
DX 40 232	32	10/30



DX 40 316

INSPECTABLE BEND - IP40

Code	Conduits Ø (mm)	Pack Carton
DX 40 316	16	30/180
DX 40 320	20	30/120
DX 40 325	25	20/60
DX 40 332	32	10/40

MORBIDX CONNECTIONS - GREY RAL 7035



DX 43 016

RELEASE COUPLING - IP67



Code	Conduits Ø (mm)	Pack Carton
DX 43 016	16	10/300
DX 43 020	20	10/240
DX 43 025	25	5/150
DX 43 032	32	5/120
DX 43 040	40	5/90
DX 43 050	50	3/54



DX 43 116

RELEASE TIGHT BEND - IP67



Code	Conduits Ø (mm)	Pack Carton
DX 43 116	16	10/100
DX 43 120	20	10/80
DX 43 125	25	5/50
DX 43 132	32	5/30
DX 43 140	40	5/15
DX 43 150	50	8



DX 43 216

RELEASE CONDUIT-BOX COUPLING - IP67



Code	Conduits Ø (mm)	ISO pitch	For holes Ø (mm)	Pack Carton
DX 43 216	16	M 16x1.5	16	10/360
DX 43 220	20	M 20x1.5	20	10/300
DX 43 225	25	M 25x1.5	25	5/180
DX 43 232	32	M 32x1.5	32	5/150
DX 43 240	40	M 40x1.5	40	5/30
DX 43 250	50	M 50x1.5	50	5/15



DX 43 316

RELEASE CONDUIT-SHEATH COUPLING - IP65



Code	Conduits Ø (mm)	Sheath Ø (mm)	Pack Carton
DX 43 316	16	12	10/450
DX 43 320	20	16	10/300
DX 43 325	25	20	5/210
DX 43 332	32	25	5/120
DX 43 340	40	32	5/25
DX 43 350	50	40	5/20



DX 43 416

RELEASE CONDUIT-SHEATH COUPLING EQUAL DIAMETER - IP65



Code	Conduits Ø (mm)	Sheath Ø (mm)	Pack Carton
DX 43 416	16	16	10/360
DX 43 420	20	20	10/240
DX 43 425	25	25	5/150
DX 43 432	32	28	5/40
DX 43 440	40	40	5/20

USE: coupling of a rigid protective conduit with a spiral sheath of the DIFLEX range these connections allow rigid conduits and sheaths to have the same internal diameter, making the wiring easy.



DX 43 516

LA SVOLTA CONDUIT-CONDUIT COUPLING - IP65

Code	Conduits Ø (mm)	Working length (mm)	Pack Carton
DX 43 516	16	110	60
DX 43 520	20	132	40
DX 43 525	25	209	20
DX 43 532	32	301	20
DX 43 540	40	302	12
DX 43 550	50	311	9

SPEEDY-FLEX COUPLINGS - GREY RAL 7035



GW 50 201

WATERTIGHT FLEXIBLE COUPLINGS - IP66

Code	For external conduits (mm)	External Ø (mm)	Internal Ø (mm)	Length (mm)	Pack Carton
GW 50 201	16	27	13	140	20/60
GW 50 202	20	31.5	17	160	20/120
GW 50 203	25	41	21.5	205	10/40
GW 50 204	32	55	28	290	10/60
GW 50 205	40	65	35.5	400	6/30
GW 50 206	50	72	44.5	515	6/36

CHARACTERISTICS: multifunctional couplings allowing the realisation of 0-90° variable angle curves and misaligned conduit-conduit couplings.



GW 50 210

PROTECTED FLEXIBLE COUPLINGS - IP44

Code	For external conduits (mm)	External Ø (mm)	Internal Ø (mm)	Length (mm)	Pack Carton
GW 50 207	16	24	13	135	20/60
GW 50 208	20	30	17	160	20/120
GW 50 209	25	35	21.5	205	20/120
GW 50 210	32	45	28	280	10/20
GW 50 211	40	55	35.5	400	6/30
GW 50 212	50	65	44.5	515	6/36

CHARACTERISTICS: multifunctional couplings allowing the realisation of 0-90° variable angle curves and misaligned conduit-conduit couplings.



DX 51 416

CONDUIT-BENDING SPRING FOR RK15

Code	Conduits Ø (mm)	Pack Carton
DX 51 416	16	1/10
DX 51 420	20	1/10
DX 51 425	25	1/5
DX 51 432	32	1/5
DX 51 440	40	1
DX 51 450	50	1

USE: for cold bending rigid conduits.
 MATERIAL: special galvanised steel square wire mesh.



DX 51 316

CONDUIT-BENDING SPRING FOR RKB

Code	Conduits Ø (mm)	Pack Carton
DX 51 316	16	1/10
DX 51 320	20	1/10
DX 51 325	25	1/5

USE: for cold bending rigid conduits.
 MATERIAL: special galvanised steel square wire mesh.



DX 51 600

CONDUIT CUTTER

Code	Description	Pack Carton
DX 51 600	Conduit cutter	1/5

COUPLING DEVICES FOR SPIRAL SHEATH

ROTATING UNIONS



DX 54 020

STRAIGHT, REVOLVING COUPLING DEVICE - METRIC PITCH - IP54

Code	Sheath Ø (mm)	ISO pitch	Pack Carton
Colour: Grey RAL 7035			
DX 54 008	8	M 12x1.5	20/180
DX 54 010	10	M 16x1.5	20/160
DX 54 012	12	M 16x1.5	10/100
DX 54 016	16	M 20x1.5	10/150
DX 54 020	20	M 25x1.5	10/100
DX 54 022	22	M 25x1.5	10/100
DX 54 025	25	M 32x1.5	5/60
DX 54 028	28	M 32x1.5	5/40
DX 54 032	32	M 40x1.5	5/30
DX 54 040	40	M 50x1.5	25
DX 54 050	50	M 63x1.5	15
Colour: Black RAL 9005			
DX 54 108	8	M 12x1.5	20/180
DX 54 110	10	M 16x1.5	20/160
DX 54 112	12	M 16x1.5	10/100
DX 54 116	16	M 20x1.5	10/150
DX 54 120	20	M 25x1.5	10/100
DX 54 122	22	M 25x1.5	10/100
DX 54 125	25	M 32x1.5	5/60
DX 54 128	28	M 32x1.5	5/40
DX 54 132	32	M 40x1.5	5/30
DX 54 140	40	M 50x1.5	25
DX 54 150	50	M 63x1.5	15

USE: for the coupling of spiral sheaths to junction boxes in threaded holes with metric pitch or in non-threaded holes via the nut and gasket supplied.



DX 54 220

STRAIGHT, REVOLVING COUPLING DEVICE - GAS PITCH - IP54

Code	Sheath Ø (mm)	GAS pitch	Pack Carton
Colour: Grey RAL 7035			
DX 54 208	8	1/4"	20/180
DX 54 210	10	1/4"	20/160
DX 54 212	12	3/8"	10/100
DX 54 214	14	1/2"	10/150
DX 54 216	16	1/2"	10/150
DX 54 220	20	3/4"	10/100
DX 54 222	22	3/4"	10/100
DX 54 225	25	1"	5/60
DX 54 228	28	1"	5/40
DX 54 232	32	1 1/4"	5/30
DX 54 235	35	1 1/4"	5/30
DX 54 240	40	1 1/2"	25
DX 54 250	50	2"	15
Colour: Black RAL 9005			
DX 54 308	8	1/4"	20/180
DX 54 310	10	1/4"	20/160
DX 54 312	12	3/8"	10/100
DX 54 314	14	1/2"	10/150
DX 54 316	16	1/2"	10/150
DX 54 320	20	3/4"	10/100
DX 54 322	22	3/4"	10/100
DX 54 325	25	1"	5/60
DX 54 328	28	1"	5/40
DX 54 332	32	1 1/4"	5/30
DX 54 335	35	1 1/4"	5/30
DX 54 340	40	1 1/2"	25
DX 54 350	50	2"	15

USE: for the coupling of spiral sheaths to junction boxes in threaded holes with GAS pitches or in non-threaded holes via the nut and gasket supplied.



DX 54 420

STRAIGHT, REVOLVING COUPLING DEVICE - PG PITCH - IP54

Code	Sheath Ø (mm)	PG pitch	Pack Carton
Colour: Grey RAL 7035			
DX 54 408	8	7	20/180
DX 54 410	10	7	20/160
DX 54 411	10	9	20/160
DX 54 412	12	11	10/100
DX 54 413	12	13.5	10/100
DX 54 414	14	13.5	10/150
DX 54 416	16	13.5	10/150
DX 54 417	16	16	10/150
DX 54 420	20	21	10/100
DX 54 422	22	21	10/100
DX 54 425	25	29	5/60
DX 54 428	28	29	5/40
DX 54 432	32	36	5/30
DX 54 435	35	36	5/30
Colour: Black RAL 9005			
DX 54 508	8	7	20/180
DX 54 510	10	7	20/160
DX 54 511	10	9	20/160
DX 54 512	12	11	10/100
DX 54 513	12	13.5	10/100
DX 54 514	14	13.5	10/150
DX 54 516	16	13.5	10/150
DX 54 517	16	16	10/150
DX 54 520	20	21	10/100
DX 54 522	22	21	10/100
DX 54 525	25	29	5/60
DX 54 528	28	29	5/40
DX 54 532	32	36	5/30
DX 54 535	35	36	5/30

USE: for the coupling of spiral sheaths to junction boxes in threaded holes with Pg pitches or in non-threaded holes via the nut and gasket supplied.

FIXED UNIONS

DX 56 008

STRAIGHT, FIXED COUPLING DEVICE - METRIC PITCH - IP54

Code	Sheath Ø (mm)	ISO pitch	Pack Carton
Colour: Grey RAL 7035			
DX 56 008	8	M12x1,5	20/160
DX 56 010	10	M16x1.5	10/170
DX 56 012	12	M16x1.5	10/150
DX 56 014	14	M16x1.5	10/130
DX 56 016	16	M20x1.5	10/110
DX 56 022	22	M25x1.5	10/50
DX 56 025	25	M25x1.5	10/50
DX 56 028	28	M32x1.5	10/40
DX 56 040	40	M40x1.5	15
DX 56 050	50	M50x1.5	12

USE: for the coupling of spiral sheaths to junction boxes in threaded holes with metric pitch or in non-threaded holes via the nut and gasket supplied.



DX 56 208

STRAIGHT, FIXED COUPLING DEVICE - GAS PITCH - IP54

Code	Sheath Ø (mm)	GAS pitch	Pack Carton
Colour: Grey RAL 7035			
DX 56 208	8	1/4"	20/160
DX 56 210	10	1/4"	10/170
DX 56 212	12	3/8"	10/150
DX 56 214	14	1/2"	10/130
DX 56 216	16	1/2"	10/110
DX 56 222	22	3/4"	10/50
DX 56 225	25	3/4"	10/50
DX 56 228	28	1"	10/40
DX 56 232	32	1 1/4"	3/18
DX 56 235	35	1 1/4"	3/18
DX 56 240	40	1 1/2"	15
DX 56 250	50	2"	12

USE: for the coupling of spiral sheaths to junction boxes in threaded holes with GAS pitches or in non-threaded holes via the nut and gasket supplied.



DX 56 408

STRAIGHT, FIXED COUPLING DEVICE - PG PITCH - IP54

Code	Sheath Ø (mm)	PG pitch	Pack Carton
Colour: Grey RAL 7035			
DX 56 408	8	7	20/160
DX 56 410	10	7	10/170
DX 56 411	12	9	10/150
DX 56 412	12	11	10/150
DX 56 413	12	13.5	10/150
DX 56 414	14	13.5	10/130
DX 56 415	16	11	10/110
DX 56 416	16	13.5	10/110
DX 56 417	16	16	10/110
DX 56 422	22	16	10/50
DX 56 423	22	21	10/50
DX 56 425	25	21	10/50
DX 56 428	28	29	10/40
DX 56 432	32	36	3/18
DX 56 435	35	36	3/18
DX 56 440	40	42	15
DX 56 450	50	48	12

USE: for the coupling of spiral sheaths to junction boxes in threaded holes with Pg pitches or in non-threaded holes via the nut and gasket supplied.

CONDUIT-SHEATH UNIONS



DX 43 316

MORBIDX RELEASE CONDUIT-SHEATH UNION - IP65

Code	Conduits Ø (mm)	Sheath Ø (mm)	Pack Carton
DX 43 316	16	12	10/450
DX 43 320	20	16	10/300
DX 43 325	25	20	5/210
DX 43 332	32	25	5/120
DX 43 340	40	32	5/25
DX 43 350	50	40	5/20



DX 43 416

RELEASE CONDUIT-SHEATH UNION EQUAL DIAMETER - IP65

Code	Conduits Ø (mm)	Sheath Ø (mm)	Pack Carton
DX 43 416	16	16	10/360
DX 43 420	20	20	10/240
DX 43 425	25	25	5/150
DX 43 432	32	28	5/40
DX 43 440	40	40	5/20

USE: coupling of a solid protective conduit with a spiral sheath of the DIFLEX range; allows the maintenance of the same internal diameter in line with the joint; the internal section for cable passage remains constant, increasing the space available for the system wires.

52 FS - CABLE TIES

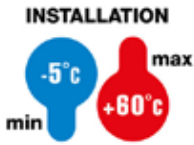

**GWT
650°C**

STANDARD TYPE



GW 52 231

STANDARD CABLE TIES IN COLOURLESS POLYMER

Code	Dimensions LxH (mm)	Tensile stress (daN)	Terminal grip capacity Ø	Pack Carton
GW 52 231	2.4x75	8	2 - 13 mm	1000/20000
GW 52 232	2.5x96	8	2 - 19 mm	1000/20000
GW 52 233	2.5x142	8	3 - 32 mm	100/10000
GW 52 234	2.5x203	8	4 - 50 mm	100/10000
GW 52 235	3.6x150	18	3 - 33 mm	100/10000
GW 52 236	3.6x203	18	5 - 47 mm	100/10000
GW 52 237	3.6x292	18	7 - 75 mm	100/5000
GW 52 238	4.8x190	18	4 - 45 mm	100/5000
GW 52 239	4.8x280	22	7 - 70 mm	100/5000
GW 52 240	4.8x368	22	7 - 96 mm	100/5000
GW 52 241	7.6x380	55	8 - 96 mm	100/1000
GW 52 242	9.0x610	80	11 - 162 mm	50/500
GW 52 243	9.0x914	80	12 - 253 mm	50/500

daN = Decanewton (approx. 1kg).

CHARACTERISTICS: sloping tail and rounded edges. Values for resistance to tensile stress refer to T=20°C, in compliance with Standard EN 62275.

HEAVY-DUTY



GW 52 251

HEAVY DUTY WIRING TIES - BLACK POLYMER

Code	Dimensions LxH (mm)	Tensile stress (daN)	Terminal grip capacity Ø	Pack Carton
GW 52 251	2.4x75	8	2 - 13 mm	1000/20000
GW 52 252	2.5x96	8	2 - 19 mm	1000/20000
GW 52 253	2.5x142	8	3 - 32 mm	100/10000
GW 52 254	2.5x203	8	4 - 50 mm	100/10000
GW 52 255	3.6x150	18	3 - 33 mm	100/10000
GW 52 256	3.6x203	18	5 - 47 mm	100/10000
GW 52 257	3.6x292	18	7 - 75 mm	100/5000
GW 52 258	4.8x190	18	4 - 45 mm	100/5000
GW 52 259	4.8x280	22	7 - 70 mm	100/5000
GW 52 260	4.8x368	22	7 - 96 mm	100/5000
GW 52 261	7.6x380	55	8 - 96 mm	100/1000
GW 52 262	9.0x610	80	11 - 162 mm	50/500
GW 52 263	9.0x914	80	12 - 253 mm	50/500

daN = Decanewton (approx. 1kg).

CHARACTERISTICS: sloping tail and rounded edges. Values for resistance to tensile stress refer to T=20°C, in compliance with Standard EN 62275.

RE-OPENABLE



GW 52 271

RE-OPENABLE CABLE TIES IN BLACK POLYMER

Code	Dimensions LxH (mm)	Tensile stress (daN)	Terminal grip capacity Ø	Pack Carton
GW 52 271	7.6x150	22	6 - 32 mm	100/1000
GW 52 272	7.6x203	22	6 - 46 mm	100/1000
GW 52 273	7.6x300	22	6 - 73 mm	100/1000

daN = Decanewton (approx. 1kg).

CHARACTERISTICS: Values for resistance to tensile stress refer to T=20°C, in compliance with Standard EN 62275.

WITH EYELET



GW 52 281

CABLE TIES WITH EYELET IN COLOURLESS POLYMER

Code	Dimensions LxH (mm)	Hole dimensions (mm)	Tensile stress (daN)	Terminal grip capacity Ø	Pack Carton
GW 52 281	2.5x110	4.8	8	3 - 23 mm	100/5000
GW 52 282	4.2x219	4.8	22	4 - 47 mm	100/2000

daN = Decanewton (approx. 1kg).

CHARACTERISTICS: sloping tail and rounded edges. Values for resistance to tensile stress refer to T=20°C, in compliance with Standard EN 62275.

WITH PLATE



GW 52 291

CABLE TIES WITH IDENTIFICATION TAG IN COLOURLESS POLYMER

Code	Dimensions LxH (mm)	Tensile stress (daN)	Terminal grip capacity Ø	Label	Pack Carton
GW 52 291	2.5x100	8	6 - 21 mm	25 x 8 crossways	100/5000
GW 52 292	2.5x110	8	4 - 18 mm	25 x 8 double-sided	100/5000
GW 52 293	2.5x200	8	6 - 46 mm	30 x 15 crossways	100/2000
GW 52 294	4.6x200	22	12 - 46 mm	28 x 13 lengthways	100/2000

daN = Decanewton (approx. 1kg).

CHARACTERISTICS: sloping tail and rounded edges. Values for resistance to tensile stress refer to T=20°C, in compliance with Standard EN 62275.

COMPLEMENTARY ITEMS

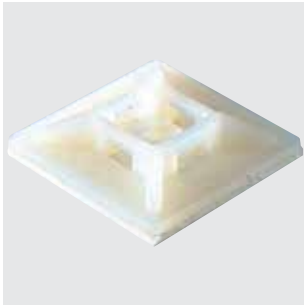

GW 52 227

TWO-WAY SELF-ADHESIVE BASES IN COLOURLESS POLYMER TO SECURE CABLE TIES

Code	Description	Outer dim. LxHxD (mm)	Pack Carton
GW 52 226	For ties up to 4.5mm	19x3.9x19	100/3000
GW 52 227	For ties up to 5mm	28x4.0x28	100/3000

USE: use the self-adhesive clips for non heavy-duty applications only. In all other cases where it is necessary to guarantee the hold, use the special supports.

NOTES: to install the product correctly, fix the clip on a smooth, clean, dry surface, with a maximum distance of 10cm between the clips, and place on a horizontal surface with the self-adhesive part facing downwards.



GW 52 229

COLOURLESS POLYMER SADDLES TO SECURE CABLE TIES

Code	Description	Outer dim. LxHxD (mm)	Pack Carton
GW 52 228	For ties up to 5mm	15x7x10	100/3000
GW 52 229	For ties up to 9mm	23x9x16	100/3000

CHARACTERISTICS: screw fixing.



GW 52 410

TIE TOOL

Code	Suitable for	Pack Carton
GW 52 410	Cable ties	1/10

GW FIT

52 FS - OUTDOOR TIES



GWT
650°C

L.T.R. TIES



GW 52 201

OUTDOOR BLACK TIES IN L.T.R. POLYAMIDE 12

Code	Dimensions LxH (mm)	Number of heads	Tensile stress (daN)	Terminal grip capacity Ø	Pack Carton
GW 52 201	6x115	1	24.5	5 - 25 mm	100/4000
GW 52 202	6x180	1	24.5	9 - 45 mm	100/3000
GW 52 203	6x290	1	24.5	20 - 78 mm	100/1000
GW 52 204	9x180	1	36	10 - 40 mm	100/3000
GW 52 205	9x265	2	50	26 - 60 mm	100/1200
GW 52 206	9x360	2	50	26 - 93 mm	100/1000
GW 52 207	9x510	2	53	70 - 140 mm	100/500
GW 52 208	9x760	2	53	70 - 220 mm	100/500

daN = Decanewton (approx. 1kg).

L.T.R. (Low Temperature Resistance): high resistance to tensile stress at low temperatures.

CHARACTERISTICS: Values for resistance to tensile stress refer to T=20°C, in compliance with Standard EN 62275.

COMPLEMENTARY ITEMS



ZC6

SHOCKPROOF POLYMER SADDLES TO SECURE OUTDOOR CABLE TIES

Code	Description	Pack Carton
GW 52 209	Screw support	100/3000
GW 52 210	Wall plug base	100/3000

CHARACTERISTICS: GW52209 can be installed with Ø 4.8 mm self-tapping screws.

GW52210 can be installed with Ø 8 mm holes in hard materials (e.g. concrete) and Ø 7 mm in soft materials (e.g. hollow brick).



GW 52 411

TIE TOOL

Code	Suitable for	Pack Carton
GW 52 411	Outdoor ties	1/10

44 MS - TRAILING AND MODULAR TERMINAL BLOCKS



TRAILING TERMINALS BLOCKS



GW 44 665

MOBILE TERMINAL BLOCKS WITH MODULAR BUSBARS - 450V - T 85°C - TRANSPARENT - IP20

Code	Max. section flex. cables	Min. section flex. cables	No. poles per bar	Pack Carton
Type of screw: Slotted				
GW 44 661	2.5 mm ²	1 mm ²	10	10/450
GW 44 665	4 mm ²	1.5 mm ²	10	10/450
GW 44 662	6 mm ²	2.5 mm ²	10	10/450
GW 44 663	10 mm ²	4 mm ²	10	10/300
GW 44 664	16 mm ²	6 mm ²	5	10/240
Type of screw: Socket head 5mm				
GW 44 666	25 mm ²	10 mm ²	1	5/150
GW 44 667	35 mm ²	16 mm ²	1	5/150

CHARACTERISTICS: GW44666 and GW44667 supplied in single terminals.

MODULAR TERMINAL BLOCKS



GW 44 601

POLYMER 12 POLE MODULAR TERMINAL BLOCKS WITH BRASS TERMINALS - 450V - T 85°C - BLACK

Code	Max. section flex. cables	Min. section flex. cables	hole Ø	Max load	Outer dim. LxHxD (mm)	Fixing	Pack Carton
GW 44 601	2.5 mm ²	0.75 mm ²	2.9 mm	24 A	95x15x16	With screw	10/480
GW 44 602	4 mm ²	1.5 mm ²	3.4 mm	32 A	117x17x20	With screw	10/240
GW 44 603	10 mm ²	4 mm ²	4.4 mm	57 A	141x20x23	With screw	10/160
GW 44 604	16 mm ²	6 mm ²	5.8 mm	76 A	172x25x32	With screw	10/120
GW 44 605	25 mm ²	10 mm ²	7.4 mm	101 A	210x34x38	With screw	3/36

44 MM - MULTI-POLE TERMINAL BLOCKS



PRESS-ON FIXING

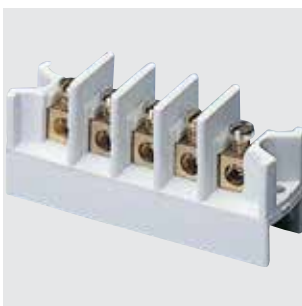

GW 44 608

PRESS-ON MULTI-POLE TERMINAL BLOCKS - 450 V - GREY RAL 7035

Code	Connecting capacity	Pack Carton
GW 44 606	3 holes x 4 mm ²	10/100
GW 44 607	4 holes x 4 mm ²	10/100
GW 44 608	5 holes x 4 mm ²	10/100

NOTES: press-on fixing on 44 CE range boxes. (see "Selection Guide" synoptic table).

SCREW-ON FIXING



GW 44 610

SCREW-ON FEEDTHROUGH MULTI-POLE TERMINAL BLOCKS - 750V- T 85°C - GREY RAL 7035

Code	Connecting capacity	Pack Carton
GW 44 609	3 holes x 6 mm ²	10/100
GW 44 610	5 holes x 6 mm ²	10/100
GW 44 610 C	5 holes x 6 mm ²	10/100
GW 44 611	3 holes x 16 mm ²	10/100
GW 44 612	5 holes x 16 mm ²	10/100
GW 44 613	3 holes x 35 mm ²	1/10
GW 44 614	5 holes x 35 mm ²	1/10

APPLICATIONS: These allow the creation of cut-outs from the main cables which, unsheathed in the part concerned, are not interrupted.

ACCESSORIES SUPPLIED: fixing screws.

NOTE: Multi-pole terminal block GW44610C is certified CSA (according to UL1059). For use also with junction boxes GW44276C and GW44277C.

44 ME - UNIPOLAR EQUIPOTENTIAL TERMINAL BLOCKS



TERMINAL BLOCKS FOR SIDE-BY-SIDE ASSEMBLY



GW 44 706

TERMINAL BLOCKS WITH INDIRECT PLATE TIGHTENING - 450V - T 85°C - TRANSPARENT

Code	Connecting capacity	Pack Carton
GW 44 704	4 ways x 6 mm ²	10/100
GW 44 706	6 ways x 6 mm ²	10/100
GW 44 708	8 ways x 6 mm ²	10/100

APPLICATIONS: embedded fixing on the GW44720 support, for coupling with the DIN rail.

NOTES: for the connection capacity, refer to the technical catalogue

ACCESSORIES FOR TERMINAL BLOCKS FOR SIDE-BY-SIDE ASSEMBLY



GW 44 720

SUPPORT FOR FIXING SIDE-BY-SIDE TERMINAL BLOCKS ON DIN RAIL

Code	For equipotential terminal blocks	Terminal block fixing	Fixing on DIN rail	Pack Carton
GW 44 720	GW44704, GW44706, GW44708	Clip	Lock-joint	1/50

NOTES: ideal for applications on boxes of the 48 PT DIN range.

CHARACTERISTICS: supports a combination of terminal blocks with maximum 12-way capacity.

Possible combinations: 3xGW44704; 2xGW44706; 1xGW44704 + 1xGW44706; 1xGW44704 + 1xGW44708. Modular overall dimensions (width): 4.5 modules EN 50022.

MODULAR TERMINAL BLOCKS



GW 44 671

SINGLE-POLE EQUIPOTENTIAL TERMINAL BLOCKS WITH BLANKET GRIP - 450V - T 85°C - TRANSPARENT

Code	Connecting capacity	Pack Carton
GW 44 671	3 ways x 6 mm ²	10/100
GW 44 672	5 ways x 6 mm ²	10/100
GW 44 673	4 ways x 16 mm ²	10/50
GW 44 674	2 ways x 16mm ² + 3 ways x 6 mm ²	10/50
GW 44 675	2 ways x 16mm ² + 9 ways x 6 mm ²	5/25
GW 44 676	2 ways x 35 mm ² + 4 ways x 16 mm ²	1/10

APPLICATIONS: especially suitable for creating equipotential nodes.

ACCESSORIES SUPPLIED: self-adhesive label for identification of electrical lines.

NOTES: GW44676 equipped with feedthrough terminals. These allow the creation of cut-outs from the main cables which, unsheathed in the part concerned, are not interrupted.

ACCESSORIES FOR MODULAR TERMINAL BLOCKS



GW 44 681

SUPPORT FOR FIXING EQUIPOTENTIAL TERMINAL BLOCKS ON RAIL DIN

Code	For equipotential terminal blocks	Terminal block fixing	Pack Carton
GW 44 681	From GW44671 to GW44676	Clip	100

NOTE: not compatible with PT DIN and PT DIN GREEN WALL.



GW 44 682

ADAPTOR FOR FIXING EQUIPOTENTIAL TERMINAL BLOCKS

Code	For equipotential terminal blocks	Terminal block fixing	Pack Carton
GW 44 682	From GW44671 to GW44676	Lock-joint	200

APPLICATIONS: for fixing the equipotential terminal blocks on the plates or directly on the base inside the junction boxes and watertight boxes.

ACCESSORIES SUPPLIED: screws for fixing the adaptor.



GW 44 683

RAIL FOR FIXING EQUIPOTENTIAL TERMINAL BLOCKS IN PTC FLUSH-MOUNTING MODULAR BOXES

Code	Installable terminal blocks	Pack Carton
GW 44 683	4xGW44671; 3xGW44672; 2xGW44673; 2xGW44674; 1xGW44675	1/50

CHARACTERISTICS: width: 1 compartment. For applications with PTC boxes with 2 and 3 compartments, the rail is fixed on the dividers GW48024.

44 MP - MODULAR DISTRIBUTING FRAME TERMINAL BLOCKS

GWT
850°C



SINGLE-POLE



GW 44 651

SINGLE-POLE MODULAR DISTRIBUTION TERMINAL BLOCK - FIXING ON PLATE OR DIN RAIL - IP20

Code	Outer dim. LxHxD (mm)	No. of modules EN 50022	Input connecting capacity	Output connecting capacity	Icw (1s)	Pack Carton
Rated current (A): 160						
GW 44 651	35x92x49	2	1x(10-70) mm ²	6x(2.5-16) mm ²	10 kA	1/5

CHARACTERISTICS: terminal tightening torque: input cables 4 Nm, output cables 1.5 Nm.

APPLICATIONS: possibility to create 1, 2, 3 and 4-pole distributing frames.



GW 44 652

RIGID JUMPER KIT AND CAP FOR ONE-POLE TERMINAL BLOCK GW44651

Code	Description	Pack Carton
GW 44 652	Jumper kit	1/25

TWO-POLE



GW 44 691

TWO-POLE DISTRIBUTION TERMINAL BLOCKS WITH TRANSPARENT PROTECTION COVER FIXING ON PLATE OR DIN RAIL EN 50022 - 750V - T 85°C

Code	Outer dim. LxHxD (mm)	No. of modules EN 50022	Input connecting capacity	Output connecting capacity	Icw (1s)	Pack Carton
Rated current (A): 100						
GW 44 691	70x49x50	4	1x(6-35) mm ²	[1x(4-25) + 5x(1.5-10)] mm ²	6 kA	2/40
Rated current (A): 125						
GW 44 693	141x49x50	8	1x(6-35) mm ²	[2x(4-25) + 2x(4-16) + 10x(1.5-10)] mm ²	6 kA	1/12

CHARACTERISTICS: the indicated connection capacity is "per pole" and refers to the fitting of cables with "test prods".

NOTES: products bearing the IMQ quality mark.

FOUR-POLE



GW 44 696

FOUR-POLE DISTRIBUTION TERMINAL BLOCKS WITH TRANSPARENT PROTECTION COVER FIXING ON PLATE OR DIN RAIL EN 50022 - 750V - T 85°C

Code	Outer dim. LxHxD (mm)	No. of modules EN 50022	Input connecting capacity	Output connecting capacity	Icw (1s)	Pack Carton
Rated current (A): 100						
GW 44 696	70x88.5x50	4	1x(6-35) mm ²	[1x(4-25) + 5x(1.5-10)] mm ²	6 kA	2/20
Rated current (A): 125						
GW 44 698	141x88.5x50	8	1x(6-35) mm ²	[2x(4-25) + 2x(4-16) + 10x(1.5-10)] mm ²	6 kA	1/10
Rated current (A): 160						
GW 44 699	185x135x75	10	1x(16-50) mm ²	[2x(10-35) + 2x(6-25) + 8x(4-16)] mm ²	10 kA	1/12

CHARACTERISTICS: terminal tightening torque: input cables 4 Nm, output cables 1.5 Nm.

the indicated connection capacity is "per pole" and refers to the fitting of cables with "test prods".

NOTES: products bearing the IMQ quality mark.



GW FIT



Scan the QR Code and find out all the technical informations.

HIGH PERFORMANCE CABLE GLANDS



The GEWISS cable gland range includes plastic and metal versions with IP54, IP66 and IP68 protection ratings, developed to adapt to all installation requirements, including industrial and machine applications. Metal glands for ATEX environments complete the offer.

AN EXTENSIVE CONDUIT AND CABLE FIXING SYSTEM



Available in plastic and metal and designed to meet every need: the range consists of snap-fit or collar conduit fixings accessories, also in multidiameter version and with a built-in wall plug version for faster installation.

CABLE TIES AND TERMINAL BLOCKS FOR EFFECTIVE WIRING



The cable-tie range includes 6 different product lines, from versions for wiring in PA66 to external L.T.R. versions in PA12. The range of terminal blocks covers various types: single-screw, multi-pole, modular distribution and single-pole equipotential terminal blocks for DIN rails.



ENERGY

AUTOMATIC RECLOSING DEVICES

In the event that the automatic circuit breaker trips, the ReStart devices restore the power supply after checking the system status, thereby ensuring continuity of service in complete safety. Available both for residual current circuit breakers and miniature circuit breakers, the Restart range also includes Autotest and PRO versions.



CIRCUIT BREAKERS FOR CIRCUIT PROTECTION

The 90 MCB range meets any requirement for protection against overcurrent and short-circuit, for all domestic, commercial and industrial applications. The range consists of MTC (compact miniature circuit breakers), MT (traditional miniature circuit breakers) and MTHP (high performance miniature circuit breakers).



CIRCUIT BREAKERS FOR RES. CURR. PROTECTION

The RCD 90 range is ideal for ground fault protection. The range consists of MDC compact miniature circuit breakers, BD and BDHP add-on residual current devices for MT and MTHP circuit breakers and IDP residual current circuit breaker.



MODULAR ACCESSORIES

The 90 AM range, in addition to auxiliaries common for the all circuit breakers, comprises many modular accessories for the protection, command, programming, measurement and signalling in electrical systems.



MOULDED CASE DEVICES

The Gewiss range of moulded-case protection circuit breakers and control switch disconnectors ensures maximum reliability and safety in every environment. The range includes a wide range of accessories, releases and connection terminals.



DISTRIBUTION BOARDS

The GEWISS metal distribution boards are the best solution for the installation of all modular and moulded-case products. With a design that seamlessly integrates into any environment, these floor and surface-mounting boards provide increased robustness with reduced overall dimensions.





AUTOMATIC RECLOSING DEVICES

90 ReStart

AUTOMATIC RECLOSING DEVICES

pag. 398









RESTART AUTOTEST

Selection tables

Automatic reclosing devices with preventive check of the insulation and automatic test of the residual current circuit breaker.



COUPLED VERSIONS WITH RCCB'S								
ATR2 - 2 poles				ATR4 - 4 poles				
5 mod.		7 mod.		7 mod.				
								
Tipo A[IR] - PRO		Tipo B - PRO		A[IR] - PRO type		B - PRO type		Tipo A[S] - PRO
In (A)	I Δ n = 30 mA	I Δ n = 300 mA	I Δ n = 30 mA	I Δ n = 30 mA	I Δ n = 300 mA	I Δ n = 30 mA	I Δ n = 300 mA	I Δ n = 300 mA
25	GW 90 901 N	GW 90 917	GW 90 911 B	GW 90 921	GW 90 927	GW 90 921 B	GW 90 927 B	-
40	GW 90 902 N	GW 90 918	GW 90 912 B	GW 90 922	GW 90 928	GW 90 922 B	GW 90 928 B	-
63	GW 90 913	GW 90 919	GW 90 913 B	GW 90 923	GW 90 929	GW 90 923 B	GW 90 929 B	GW 90 930







NOTE: ARD must be supplied with 230 V AC phase-neutral for working.

RESTART RD

Selection tables

Automatic reclosing devices with preventive check of the insulation

	COUPLED VERSIONS WITH RCCB'S IDP	
	RD2 - 2 poles	RD2 - 2 poles, PRO version
	3 mod.	
		
	$I\Delta n = 30 \text{ mA}$	
In (A)	A type	
25	GW D4 817 R	GW D4 817 P
40	GW D4 827 R	GW D4 827 P

	VERSIONS TO BE COUPLED WITH RCCB'S IDP								
	RD2 - 2 poles	RD2 - 2 poles, PRO version				RD4 - 4 poles, PRO version			
									
	GW D0 971	GW D0 976	GW D0 978		GW 90 967	GW 90 969			
	1 mod.	1 mod.				3 mod.			
	+	+	+		+	+			
RCCB'S IDP 2P					RCCB'S IDP 4P				
2 mod.					4 mod.				
									
In (A)	Type	$I\Delta n = 30 \text{ mA}$	$I\Delta n = 100 \text{ mA}$	$I\Delta n = 300 \text{ mA}$	$I\Delta n = 500 \text{ mA}$	$I\Delta n = 30 \text{ mA}$	$I\Delta n = 100 \text{ mA}$	$I\Delta n = 300 \text{ mA}$	$I\Delta n = 500 \text{ mA}$
25	AC	GW D4 002 GW D4 617*	GW D4 003	GW D4 004	-	GW D4 102 GW D4 302***	GW D4 103	GW D4 104 GW D4 304***	-
	A	GW D4 012 GW D4 817*	GW D4 013	GW D4 014	-	GW D4 112 GW D4 312***	GW D4 113	GW D4 114 GW D4 314***	-
	A[IR]	GW D4 202	-	GW D4 203	-	GW D4 217 GW D4 317***	-	GW D4 218	-
	F	GW D4 261	-	-	-	GW D4 281	-	-	-
	B	-	-	-	-	GW D4 502** GW D4 527	-	GW D4 504** GW D4 529	-
40	AC	GW D4 022 GW D4 627*	GW D4 023	GW D4 024	GW D4 025	GW D4 122 GW D4 322***	GW D4 123	GW D4 124 GW D4 324***	GW D4 125
	A	GW D4 032 GW D4 827*	GW D4 033	GW D4 034	GW D4 035	GW D4 132 GW D4 332***	GW D4 133	GW D4 134 GW D4 334***	GW D4 135
	A[IR]	GW D4 205	-	GW D4 206	-	GW D4 220 GW D4 337***	-	GW D4 221	-
	A[S]	-	-	GW D4 234	GW D4 235	-	-	GW D4 249	GW D4 250
	F	GW D4 265	-	-	-	GW D4 285	-	-	-
	B	-	-	-	-	GW D4 507** GW D4 532	-	GW D4 509** GW D4 534	-
63	AC	GW D4 042	GW D4 043	GW D4 044	GW D4 045	GW D4 142 GW D4 342***	GW D4 143	GW D4 144 GW D4 344***	GW D4 145
	A	GW D4 052	GW D4 053	GW D4 054	GW D4 055	GW D4 152 GW D4 352***	GW D4 153	GW D4 154 GW D4 354***	GW D4 155
	A[IR]	GW D4 208	-	GW D4 209	-	GW D4 223 GW D4 357***	-	GW D4 224	-
	A[S]	-	-	GW D4 237	GW D4 238	-	-	GW D4 252	GW D4 253
	F	GW D4 269	-	-	-	GW D4 289	-	-	-
	B	-	-	-	-	GW D4 512** GW D4 537	-	GW D4 514** GW D4 539	-
80	AC	GW D4 062	-	-	-	-	-	-	-
	A	GW D4 072	-	-	-	-	-	-	-



NOTE: ARD must be supplied with 230 V AC phase-neutral for working.
 GW90967 and GW90969 ARD's can be coupled with RCCB's IDP 2 poles.
 *Additional accessories not available, **2P 4 Modules, ***RCCB with Neutral on the left.





90 ReStart

RESTART RM

Selection tables

Automatic reclosing devices with preventive check of the insulation and of the short circuit

			COUPLED VERSIONS WITH RCBO'S MDC	
			RM2 - 2 poles	RM2 - 2 poles, PRO version
			3 mod.	
				
			IΔn = 30 mA	
Icn (A)	Curve	In (A)	A type	
4500	C	16	GW D4 227 R	GW D4 227 P
		25	GW D4 229 R	GW D4 229 P

			VERSIONS TO BE COUPLED WITH RCBO'S MDC 2 POLES										
			RM2 - 2 poles		RM2 - 2 poles, PRO version								
													
			GW D0 991	GW D0 996				GW D0 998					
			1 mod.	1 mod.				1 mod.					
			+	+				+					
			RCBO'S MDC 1P+N, 2P										
			2 mod.										
													
			IΔn = 30 mA					IΔn = 300 mA					
			AC type		A type		A[IR] type	F type	AC type		A type		A[S] type
Icn (A)	Curve	In (A)	1P+N	2P	1P+N	2P	2P	2P	1P+N	2P	1P+N	2P	2P
4500	C	6	GW 94 005	GW 94 025	GW 94 205	GW 94 225	-	-	GW 94 015	GW 94 035	GW 94 215	GW 94 235	-
		10	GW 94 006	GW 94 026	GW 94 206	GW 94 226	-	-	GW 94 016	GW 94 036	GW 94 216	GW 94 236	-
		13	GW 94 011	GW 94 031	GW 94 211	GW 94 231	-	-	-	-	-	-	-
		16	GW 94 007	GW 94 027	GW 94 207	GW 94 227	-	-	GW 94 017	GW 94 037	GW 94 217	GW 94 237	-
		20	GW 94 008	GW 94 028	GW 94 208	GW 94 228	-	-	GW 94 018	GW 94 038	GW 94 218	GW 94 238	-
		25	GW 94 009	GW 94 029	GW 94 209	GW 94 229	-	-	GW 94 019	GW 94 039	GW 94 219	GW 94 239	-
		32	GW 94 010	GW 94 030	GW 94 210	GW 94 230	-	-	GW 94 020	GW 94 040	GW 94 220	GW 94 240	-
6000	C	6	GW 94 105	GW 94 125	GW 94 305	GW 94 325	GW 95 805	GW 95 935	GW 94 115	GW 94 135	GW 94 315	GW 94 335	-
		10	GW 94 106	GW 94 126	GW 94 306	GW 94 326	GW 95 806	GW 95 936	GW 94 116	GW 94 136	GW 94 316	GW 94 336	-
		13	GW 94 111	GW 94 131	GW 94 311	GW 94 331	GW 95 811	GW 95 941	-	-	-	-	-
		16	GW 94 107	GW 94 127	GW 94 307	GW 94 327	GW 95 807	GW 95 937	GW 94 117	GW 94 137	GW 94 317	GW 94 337	GW 95 847
		20	GW 94 108	GW 94 128	GW 94 308	GW 94 328	GW 95 808	GW 95 938	GW 94 118	GW 94 138	GW 94 318	GW 94 338	GW 95 848
		25	GW 94 109	GW 94 129	GW 94 309	GW 94 329	GW 95 809	GW 95 939	GW 94 119	GW 94 139	GW 94 319	GW 94 339	GW 95 849
		32	GW 94 110	GW 94 130	GW 94 310	GW 94 330	GW 95 810	GW 95 940	GW 94 120	GW 94 140	GW 94 320	GW 94 340	GW 95 850
	B	6	-	-	GW 95 105	GW 95 125	-	GW 95 975	-	-	GW 95 115	GW 95 135	-
		10	-	-	GW 95 106	GW 95 126	-	GW 95 976	-	-	GW 95 116	GW 95 136	-
		13	-	-	GW 95 111	GW 95 131	-	GW 95 981	-	-	-	-	-
		16	-	-	GW 95 107	GW 95 127	-	GW 95 977	-	-	GW 95 117	GW 95 137	-
		20	-	-	GW 95 108	GW 95 128	-	GW 95 978	-	-	GW 95 118	GW 95 138	-
		25	-	-	GW 95 109	GW 95 129	-	GW 95 979	-	-	GW 95 119	GW 95 139	-
		32	-	-	GW 95 110	GW 95 130	-	GW 95 980	-	-	GW 95 120	GW 95 140	-

NOTE: ARD must be supplied with 230 V AC phase-neutral for working.

Selection tables

Automatic Reset devices with preventive check of the insulation and of the short circuit



VERSIONS TO BE COUPLED WITH RCBO'S MDC 4 POLES								
RM4 - 4 poles, PRO version								
								
			GW 90 986			GW 90 988		
			3 mod.			3 mod.		
			+			+		
RCBO'S MDC 4P								
			4 mod.			4 mod.		
								
			IΔn = 30 mA			IΔn = 300 mA		
Icn (A)	Curve	In (A)	AC type	A type	A[IR] type	AC type	A type	A[S] type
4500	C	6	GW 94 065	GW 94 265	-	GW 94 075	GW 94 275	-
		10	GW 94 066	GW 94 266	-	GW 94 076	GW 94 276	-
		13	GW 94 071	GW 94 271	-	-	-	-
		16	GW 94 067	GW 94 267	-	GW 94 077	GW 94 277	-
		20	GW 94 068	GW 94 268	-	GW 94 078	GW 94 278	-
		25	GW 94 069	GW 94 269	-	GW 94 079	GW 94 279	-
		32	GW 94 070	GW 94 270	-	GW 94 080	GW 94 280	-
6000	C	6	GW 94 165	GW 94 365	GW 95 815	GW 94 175	GW 94 375	-
		10	GW 94 166	GW 94 366	GW 95 816	GW 94 176	GW 94 376	-
		13	GW 94 171	GW 94 371	GW 95 821	-	-	-
		16	GW 94 167	GW 94 367	GW 95 817	GW 94 177	GW 94 377	GW 95 857
		20	GW 94 168	GW 94 368	GW 95 818	GW 94 178	GW 94 378	GW 95 858
		25	GW 94 169	GW 94 369	GW 95 819	GW 94 179	GW 94 379	GW 95 859
	32	GW 94 170	GW 94 370	GW 95 820	GW 94 180	GW 94 380	GW 95 860	
	B	6	-	GW 95 165	-	-	GW 95 175	-
		10	-	GW 95 166	-	-	GW 95 176	-
		13	-	GW 95 171	-	-	-	-
		16	-	GW 95 167	-	-	GW 95 177	-
		20	-	GW 95 168	-	-	GW 95 178	-
		25	-	GW 95 169	-	-	GW 95 179	-
		32	-	GW 95 170	-	-	GW 95 180	-

NOTE: they are also compatible with RCBO's 1P+N and 2 poles (MDC 1P+N e 2P).
ARD must be supplied with 230 V AC phase-neutral for working.

RESTART RM TOP

Selection tables



Adjustable reclosing device with/without preventive check of the insulation and/or short-circuits.

VERSION TO BE COUPLED WITH MCB'S AND ADD-ON RCD'S 4 POLES						
						
GW 90 893						
4 mod.						
+						
MCB'S MT 4 POLES						
4 mod.						
						
Curve	In (A)	Icn = 6000 A	Icn = 10000 A	Icn = 25000 A		
C	1	GW 92 081	-	-	-	
	2	GW 92 082	-	-	-	
	3	GW 92 083	-	-	-	
	4	GW 92 084	-	-	-	
	6	GW 92 085	GW 92 685	GW 92 885	GW 92 885	
	10	GW 92 086	GW 92 686	GW 92 886	GW 92 886	
	13	GW 92 094	GW 92 694	-	-	
	16	GW 92 087	GW 92 687	GW 92 887	GW 92 887	
	20	GW 92 088	GW 92 688	GW 92 888	GW 92 888	
	25	GW 92 089	GW 92 689	GW 92 889	GW 92 889	
	32	GW 92 090	GW 92 690	GW 92 890	GW 92 890	
	40	GW 92 091	GW 92 691	GW 92 891	GW 92 891	
	50	GW 92 092	GW 92 692	GW 92 892	GW 92 892	
	63	GW 92 093	GW 92 693	GW 92 893	GW 92 893	
B	6	GW 92 285	GW 92 585	-	-	
	10	GW 92 286	GW 92 586	-	-	
	13	GW 92 294	GW 92 587	-	-	
	16	GW 92 287	GW 92 588	-	-	
	20	GW 92 288	GW 92 589	-	-	
	25	GW 92 289	GW 92 590	-	-	
	32	GW 92 290	GW 92 591	-	-	
	40	GW 92 291	GW 92 592	-	-	
	50	GW 92 292	GW 92 593	-	-	
	63	GW 92 293	GW 92 594	-	-	
D	1	-	GW 92 781	-	-	
	2	-	GW 92 782	-	-	
	3	-	GW 92 783	-	-	
	4	-	GW 92 784	-	-	
	6	GW 92 485	GW 92 785	-	-	
	10	GW 92 486	GW 92 786	-	-	
	13	GW 92 494	GW 92 794	-	-	
	16	GW 92 487	GW 92 787	-	-	
	20	GW 92 488	GW 92 788	-	-	
	25	GW 92 489	GW 92 789	-	-	
	32	GW 92 490	GW 92 790	-	-	
	40	GW 92 491	GW 92 791	-	-	
	+					
	ADD-ON RESIDUAL CURRENT DEVICES BD 4 POLES					
3.5 mod.						
						
In (A)	IΔn (mA)	AC type	A type	A[IR] type	A[S] type	
≤25	30	GW 94 422	GW 94 522	-	-	
	300	GW 94 423	GW 94 523	-	-	
	500	GW 94 424	GW 94 524	-	-	
≤63	30	GW 94 432	GW 94 532	GW 94 586	-	
	300	GW 94 433	GW 94 533	-	GW 94 583	
	500	GW 94 434	GW 94 534	-	-	
	1000	-	-	-	GW 94 585	

NOTE: they are also compatible with MCB's MTC, RCBO's MDC, MCB's MT and with Add-on RCD's BD 1P+N, 2 e 3 poles.
ARD must be supplied with 230 V AC phase-neutral for working.

RESTART AUTOTEST

Technical data

TYPE	ReStart with Autotest PRO 2P	ReStart with Autotest PRO 4P
		
Electrical characteristics		
Standards: IEC EN 63024, IEC EN 61008-1		
Distribution system: TT - TN-S		
Rated operational voltage (Ue):	(V) 230 AC ⁽¹⁾	400 AC
Minimum operating voltage (min Ue)	(V)	85% Ue
Maximum operating voltage (max Ue):	(V)	110% Ue
Rated insulation voltage (Ui):	(V)	500
Dielectric strength test voltage between pole and earth:	(V)	2500 AC for 1 minute
Rated impulse withstand voltage (Uimp):	(kV)	4
Overvoltage category:		III
Rated frequency:	(Hz)	50
Residual making and breaking capacity (IΔm):	(A)	630
Rated conditional residual short-circuit current with fuse (IΔc):	(A)	Type A[IR] and A[S] 10000 (gL 63A) for In=25-40A 10000 (gL 80A) for In=63A Type B 10000 (gL 63A) for In=25-40-63A
Number of poles:	2	4
Type of associated residual current circuit breaker:		A[IR], A[S], B
Rated current (In):	(A)	25 - 40 - 63
Rated residual operating current (IΔn):	(mA)	30 - 300
Rated non-operating resistance between live parts and earth (Rdo):	(kΩ)	8 (30mA) - 2.5 (300mA)
Rated operating resistance between live parts and earth (Rd):	(kΩ)	16 (30mA) - 5 (300mA)
Power loss at In:	(W)	2.2 (25A) - 5.4 (40A) - 6.2 (63A) 3.5 (25A) - 6 (40A) - 12 (63A)
Off-load absorbed power:	(VA)	4 (cosφ=0.2)
Power absorbed during automatic reclosing:	(VA)	41 (cosφ=0.5)
Power supply:		from above
Mechanical characteristics		
Width in DIN modules:	Type A[IR]: 5 Type B: 7	7
Reclosing time:	(s)	10
Autotest cycle time:	(s)	7
Maximum operational frequency:	(oper./h)	30
Max mechanical endurance (total no. operations):		4000
Maximum no. of consecutive automatic reclosure operations ⁽²⁾:		3
Counter reset time no. of consecutive automatic reclosure operations:	(s)	60
Section of circuit breaker terminals:	(mm ²)	flexible cable: ≤ 1x35 - ≤ 2x16 - ≤ 1x16+2x10 rigid cable: ≤ 1x35 - ≤ 2x16 - ≤ 1x16+2x10
Rated tightening torque:	(Nm)	2
Mounting position:		any
Degree of protection:		IP20 (terminals) - IP40 (front)
Pollution degree:		2
Operating temperature:	(°C)	-25 +60 ⁽³⁾
Stocking temperature:	(°C)	-40 +70
Tropicalization:		55°C - RH 95%
Auxiliary contact characteristics		
Type of contact:		Photomos (potential free contact)
Operating voltage:	(V)	5÷230 AC/DC
Operating current:	(mA)	0.6 (min) - 100 cosφ=1 (max)
Operating frequency:	(Hz)	50
Category of use:		AC12
Operating mode:		NO / NC / NC + impulse ⁽⁴⁾
Terminal section:	(mm ²)	≤ 2.5
Rated tightening torque:	(Nm)	0.4
Autotest FUNCTION		
Regular and automatic RCCB test:		•
Light signalling for autotest cycle in progress:		•
Light signalling for any device anomaly:		•
ReStart FUNCTION		
Automatic reclosure for untimely tripping:		•
Earth leakage check:		•
Continuous system check:		•
Interruption of reclosure operation in the event of a fault:		•
Signalling of reclosure operation in progress:		•
Light signalling of failure:		•
Activation / exclusion of ReSTART function:		•
Auxiliary contact for remote operating status access:		•
Compatible with WiFi/ModBus interface module:		•
Internal electrical protection:		PTC



⁽¹⁾ 230V phase-neutral power supply ⁽²⁾ In the absence of failure in the system ⁽³⁾ Average daily temperature ≤ +35°C

⁽⁴⁾ By setting NC+pulse mode, the auxiliary contact switches for 100ms at the end of each Autotest cycle performed successfully.

90 ReStart

RESTART RD

Technical data

TYPE	RESTART Rd 2P	RESTART Rd PRO 2P	RESTART Rd PRO 4P
			
Electrical characteristics			
Standards:	IEC EN 63024		
Distribution system:	TT - TN-S		
Rated operational voltage (Ue):	(V) 230 AC ⁽¹⁾		
Minimum operating voltage (min Ue):	(V) 85% Ue		
Maximum operating voltage (max Ue):	(V) 110% Ue		
Rated insulation voltage (Ui):	(V) 500		
Dielectric strength test voltage between pole and earth:	(V) 2500 AC for 1 minute		
Rated impulse withstand voltage (Uimp):	(kV) 4		
Overvoltage category:	III		
Rated frequency:	(Hz) 50/60		50
Residual making and breaking capacity (IΔm):	(A) IΔm of the associated circuit breaker		
Rated conditional residual short-circuit current with fuse (IΔc):	(A) IΔc of the associated circuit breaker		
Number of poles:	2		4
Type of IDP RCCB:	AC - A - A [IR] - A[S] - F - B		
Rated current (In):	(A) 25 - 40 - 63 - 80		
Rated residual operating current (IΔn):	(mA) 30 - 100 - 300 - 500		
Rated non-operating resistance between live parts and earth (Rdo):	(kΩ) 8 (30mA) - 2,5 (100/300/500mA)		
Rated operating resistance between live parts and earth (Rd):	(kΩ) 16 (30mA) - 5 (100/300/500mA)		
Power loss at In:	(W) Power loss of the associated circuit breaker		
Off-load absorbed power:	(VA) 3 (cosφ=0.4)		4 (cosφ=0.2)
Power absorbed during automatic reclosing:	(VA) 18 (cosφ=0.5)		45 (cosφ=0.5)
Mechanical characteristics			
Width in DIN modules:	1		3
Reclosing time:	(s) 10		
Maximum operational frequency:	(oper./h) 30		
Max mechanical endurance (total no. operations):	4000		
Maximum no. of consecutive automatic reclosure operations ⁽²⁾ :	3		
Counter reset time no. of consecutive automatic reclosure operations:	(s) 60		
Section of circuit breaker terminals:	(mm ²) flexible cable: ≤ 1x35 - ≤ 2x16 - ≤ 1x16+2x10 rigid cable: ≤ 1x35 - ≤ 2x16 - ≤ 1x16+2x10		
Circuit breaker rated tightening torque:	(Nm) 3 (IDP) - 2 (IDP NA)		
Mounting position:	any		
Circuit breaker degree of protection:	IP20 (terminals) - IP40 (front)		
Pollution degree:	2		
Operating temperature:	(°C) -5 +40		-5 +60 ⁽³⁾
Stocking temperature:	(°C) -40 +70		
Tropicalization:	55°C - RH 95%		
Auxiliary contact characteristics			
Can be fitted with auxiliary:	no	yes (with GWD0951)	already integrated in the ReStart
Type of contact:	-	Photomos (potential free contact)	
Operating voltage:	(V) -	5+230 AC/DC	
Operating current:	(mA) -	0.6 (min) - 100 cosφ=1 (max)	
Operating frequency:	(Hz) -	50	
Category of use:	-	AC12	
Operating mode:	-	NO\NC\NO as signal of handle position	
Terminal section:	(mm ²) -	≤ 2.5	
Rated tightening torque:	(Nm) -	0.4	
ReStart FUNCTION			
Automatic reclosure for untimely tripping:	•	•	•
Earth leakage check:	•	•	•
Continuous system check:	•	•	•
Interruption of reclosure operation in the event of a fault:	•	•	•
Signalling of reclosure operation in progress:	•	•	•
Light signalling of failure:	•	•	•
Activation / exclusion of RESTART function:	•	•	•
Auxiliary contact for remote operating status access:	•	•	•
Compatible with WiFi/ModBus interface module:	•	•	•
Internal electrical protection:	PTC	PTC	PTC

⁽¹⁾ Power supply 230V phase-neutral ⁽²⁾ In the absence of a system fault ⁽³⁾ Average daily temperature ≤ +35°C

RESTART RM

Technical data

TYPE	ReStart Rm 2P	ReStart Rm PRO 2P	ReStart Rm PRO 4P	Rm TOP	CM	
Electrical characteristics						
Standards:	IEC EN 63024			-	-	
Distribution system:	TT - TN-S			TT - TN - IT ⁽¹⁾	TT-TN-IT	
Rated operational voltage (Ue):	(V)	230 AC ⁽²⁾				
Minimum operating voltage (min Ue)	(V)	85% Ue				
Maximum operating voltage (max Ue):	(V)	110% Ue				
Rated insulation voltage (Ui):	(V)	500				
Dielectric strength test voltage between pole and earth:	(V)	2500 AC for 1 minute				
Rated impulse withstand voltage (Uimp):	(kV)	4				
Overvoltage category:		III				
Rated frequency:	(Hz)	50/60		50		
Residual making and breaking capacity (IΔm):	(A)	IΔm of the associated circuit breaker				
Number of poles:		2		4		
Type of MDC RCBO:		AC - A - A[IR] - A[S] - F				
Type of MT+BD RCBO:		AC - A - A[IR] - A[S]				
Rated current (In):	(A)	from 6 to 32		from 1 to 63		
Rated residual operating current (IΔn):	(mA)	30 - 300		30 - 300 - 500 - 1000		
Rated non-operating resistance between live parts and earth (Rdo):	(kΩ)	8 (30mA) - 2.5 (300mA)		8 (30mA) - 2.5 (300/500/1000mA)		
Rated operating resistance between live parts and earth (Rd):	(kΩ)	16 (30mA) - 5 (300mA)		16 (30mA) - 5 (300/500/1000mA)		
Rated non-operating resistance between live parts (Rcco):	(Ω)	0.4		0.3		
Rated operating resistance between live parts (Rcc):	(Ω)	2.3		1.8		
Power loss at In:	(W)	Power loss of the associated circuit breaker				
Off-load absorbed power:	(VA)	3 (cosφ=0.4)	16 (cosφ=0.2)	15 (cosφ=0.1)	0 (cosφ=0.2)	
Power absorbed during automatic reclosing:	(VA)	18 (cosφ=0.5)	34 (cosφ=0.7)	30 (cosφ=0.6)	30 (cosφ=0.6)	
Reclosing control:		automatic		automatic / remote ⁽³⁾	remote ⁽³⁾	
Mechanical characteristics						
Width in DIN modules:		1	3	4	2	
Reclosing time:	(s)	10		3 (without system test) 10 (with system test)	3	
Remote control opening time:	(s)	-		2		
Maximum operational frequency:	(oper./h)	30				
Max mechanical endurance (total no. operations):		4000		10000		
Maximum no. of consecutive automatic reclosure operations ⁽⁴⁾ :		3				
Counter reset time	(s)	60				
No. of consecutive automatic reclosure operations:		-				
Section of circuit breaker terminals:	(mm ²)	flexible cable: ≤ 1x35 - ≤ 2x16 - ≤ 1x16+2x10 rigid cable: ≤ 1x35 - ≤ 2x16 - ≤ 1x16+2x10				
Circuit breaker rated tightening torque:	(Nm)	2				
Mounting position:		any				
Circuit breaker degree of protection:		IP20 (terminals) - IP40 (front)				
Pollution degree:		2				
Operating temperature:	(°C)	-5 +40	-5 +60 ⁽⁵⁾	-25 +60 ⁽⁵⁾		
Stocking temperature:	(°C)	-40 +70				
Tropicalization:		55°C - RH 95%				
Auxiliary contact characteristics						
Can be fitted with auxiliary:		no	yes (with GWD0951)	already integrated in the ReStart	already integrated in the ReStart	already integrated in the ReStart
Type of contact:		-	Photomos (potential free contact)	Changeover	Photomos (potential free contact)	Changeover
Operating voltage:	(V)	-	5÷230 AC/DC	230 AC/ 30 DC	5÷230 AC/DC	230 AC/ 30 DC
Operating current:	(mA)	-	0.6 (min) - 100 cosφ=1 (max)	1.5 a.c. / 0.8 d.c.	0.6 (min) - 100 cosφ=1 (max)	1.5 a.c. / 0.8 d.c.
Operating frequency:	(Hz)	-	-	50	-	-
Category of use:		-	-	AC12	-	-
Operating mode:		-	NO\NC\NO as signal of handle position	CO	NO/NC/ INTERMITTENT	CO
Terminal section:	(mm ²)	-	-	≤ 2.5	-	-
Rated tightening torque:	(Nm)	-	-	0.4	-	-
ReStart FUNCTION						
Automatic reclosure for untimely tripping:		•	•	•	•	
Earth leakage check:		•	•	•	•	
Short-circuit check:		•	•	•	•	
Adjustable insulation threshold:					•	
Continuous system check:			•	•	•	
Adjustable reset standby time ⁽⁶⁾ :					•	
Adjustable reclosing mode:					•	
Interruption of reclosure operation in the event of a fault:		•	•	•	•	
Signalling of reclosure operation in progress:		•	•	•	•	
Light signalling of failure:		•	•	•	•	
Activation / exclusion of RESTART function:		•	•	•	•	•
Auxiliary contact for remote operating status access:			•	•	•	•
Compatible with WiFi/ModBus interface module:			•	•	•	•
Internal electrical protection:		PTC	PTC	PTC	PTC	PTC

⁽¹⁾ For IT system reclosing without fault check

⁽⁴⁾ In the absence of a system fault

⁽²⁾ Power supply 230V phase-neutral

⁽⁵⁾ Average daily temperature ≤ +35°C

⁽³⁾ Impulse duration ≥ 200ms

⁽⁶⁾ Automatic reclosure delay time: 0-1h

90 ReStart

Automatic reclosing devices

In the event the switch trips, the ReStart devices, after checking the system status, restore the power supply thereby ensuring maximum continuity of service in complete safety. Available for both residual current circuit breakers and residual current circuit breakers with overcurrent protection, the range is characterized by the Autotest functions, with periodic and automatic control of the residual current protection without interrupting the power supply and PRO with extended control of the system.



RESTART AUTOTEST

RESTART AUTOTEST 2 POLES - VERSIONS COUPLED WITH RCCB'S



GW 90 901 N

AUTOMATIC RECLOSING DEVICES WITH PREVENTIVE CHECK OF THE INSULATION AND AUTOMATIC TEST OF THE RESIDUAL CURRENT CIRCUIT BREAKER - PRO VERSION



Code	Rated current	Idn	Type of RCCB	Rated voltage	Compatibility with WiFi interface	No. of modules EN 50022	Pack Carton
GW 90 901 N	25 A	30 mA	A[IR]	230 V	Yes	5	1/4
GW 90 911 B	25 A	30 mA	B	230 V	Yes	7	1/2
GW 90 902 N	40 A	30 mA	A[IR]	230 V	Yes	5	1/4
GW 90 912 B	40 A	30 mA	B	230 V	Yes	7	1/2
GW 90 913	63 A	30 mA	A[IR]	230 V	Yes	5	1/4
GW 90 913 B	63 A	30 mA	B	230 V	Yes	7	1/2
GW 90 917	25 A	300 mA	A[IR]	230 V	Yes	5	1/4
GW 90 918	40 A	300 mA	A[IR]	230 V	Yes	5	1/4
GW 90 919	63 A	300 mA	A[IR]	230 V	Yes	5	1/4

CHARACTERISTICS: after RCCB has tripped, ReStart checks the insulation prior to the automatic reclosure. In the event of a fault (earth leakage), ReStart will not reset the circuit breaker but will continue to monitor the circuit every 2 minutes reclosing the circuit breaker when safe to do so. In the meantime the integrated configurable auxiliary contact will change state to indicate that the automatic reset did not take place.

Compatible with:

- GW90953 WiFi Interface Module
- GW90992 ModBus RS485 interface module.

NOTE: the Autotest function automatically and periodically (every 28 days) tests the RCCB, without interrupting the electric power supply, thus maintaining the performance of the residual current protection over time.

230 V ac power supply, phase-neutral.

RCCB's type B and A[IR] Impulse Resistant presents greater resistance to untimely tripping in comparison to standard residual current circuit breakers. Immunity level 8/20µs: 3000A for IR type, 250A for standard type.

RESTART AUTOTEST 4 POLES - VERSIONS COUPLED WITH RCCB'S



GW 90 921

AUTOMATIC RECLOSING DEVICES WITH PREVENTIVE CHECK OF THE INSULATION AND AUTOMATIC TEST OF THE RESIDUAL CURRENT CIRCUIT BREAKER - PRO VERSION



Code	Rated current	Idn	Type of RCCB	Rated voltage	Compatibility with WiFi interface	No. of modules EN 50022	Pack Carton
GW 90 921	25 A	30 mA	A[IR]	400 V	Yes	7	1/2
GW 90 921 B	25 A	30 mA	B	400 V	Yes	7	1/2
GW 90 922	40 A	30 mA	A[IR]	400 V	Yes	7	1/2
GW 90 922 B	40 A	30 mA	B	400 V	Yes	7	1/2
GW 90 923	63 A	30 mA	A[IR]	400 V	Yes	7	1/2
GW 90 923 B	63 A	30 mA	B	400 V	Yes	7	1/2
GW 90 927	25 A	300 mA	A[IR]	400 V	Yes	7	1/2
GW 90 927 B	25 A	300 mA	B	400 V	Yes	7	1/2
GW 90 928	40 A	300 mA	A[IR]	400 V	Yes	7	1/2
GW 90 928 B	40 A	300 mA	B	400 V	Yes	7	1/2
GW 90 929	63 A	300 mA	A[IR]	400 V	Yes	7	1/2
GW 90 929 B	63 A	300 mA	B	400 V	Yes	7	1/2
GW 90 930	63 A	300 mA	A[S]	400 V	Yes	7	1/2

CHARACTERISTICS: when the 'RCCB switch trips, ReStart performs' the isolation check before the automatic reset. In the event of a ground fault, ReStart does not reset' the switch but continues to check the system every 2 minutes until, once the safety conditions are restored, it resets the switch. The auxiliary contact that can be configured and integrated in the meantime switches on to signal the failure of automatic resetting.

Coupled with: -WiFi interface
module GW90954 -ModBus RS485 GW90992 interface module.

NOTE: the SELF-TEST function automatically and periodically (every 28 days) tests the RCCB without cutting off power to the system to maintain the efficiency of the RCCB protection over time. Reinforced Immunity Type A[S], B and A[IR] circuit breakers are equipped with greater resistance to unexpected trips than standard RCCBs. Immunity level 8/20µs: 3000A for IR versions and 5, 250A for standard versions.

RESTART RD

RESTART RD 2 POLES - VERSIONS COUPLED WITH RCCB'S IDP



GW D4 817 R

AUTOMATIC RECLOSING DEVICES WITH PREVENTIVE CHECK OF THE INSULATION



Code	Rated current	Idn	Type of RCCB	Rated voltage	Compatibility with WiFi interface	No. of modules EN 50022	Pack Carton
GW D4 817 R	25 A	30 mA	A	230 V	No	3	1/4
GW D4 827 R	40 A	30 mA	A	230 V	No	3	1/4

CHARACTERISTICS: after RCCB has tripped, ReStart checks the insulation prior to the automatic reclosure. In the event of a fault (earth leakage), ReStart will not reset the circuit breaker.

NOTE: the ARD must be supplied at 230 Vac phase-neutral.



GW D4 817 P

AUTOMATIC RECLOSING DEVICES WITH PREVENTIVE CHECK OF THE INSULATION - PRO VERSION



Code	Rated current	Idn	Type of RCCB	Rated voltage	Compatibility with WiFi interface	No. of modules EN 50022	Pack Carton
GW D4 817 P	25 A	30 mA	A	230 V	Yes	3	1/4
GW D4 827 P	40 A	30 mA	A	230 V	Yes	3	1/4

CHARACTERISTICS: after RCCB has tripped, ReStart checks the insulation prior to the automatic reclosure.

In the event of a fault (earth leakage), ReStart will not reset the circuit breaker but will continue to monitor the circuit every 2 minutes reclosing the circuit breaker when safe to do so.

Compatible with:

- GWD0951 auxiliary contact
- GWD0953 WiFi Interface Module
- GW90992 ModBus RS485 interface module (only if already coupled with GWD0951 auxiliary contact).

NOTE: the ARD must be supplied at 230 Vac phase-neutral.

90 ReStart

RESTART RD 2 POLES - VERSIONS TO BE COUPLED WITH RCCB'S IDP



GW D0 971

AUTOMATIC RECLOSING DEVICES WITH PREVENTIVE CHECK OF THE INSULATION



Code	Suitable for	Rated voltage	Compatibility with WiFi interface	No. of modules EN 50022	Pack Carton
GW D0 971	IDP RCCBs - 2P up to 80 A - 30 mA	230 V	No	1	1/4

CHARACTERISTICS: after RCCB has tripped, ReStart checks the insulation prior to the automatic reclosure. In the event of a fault (earth leakage), ReStart will not reset the circuit breaker.
NOTES: cannot be used with 4P RCCBs in 3 modules and type B RCCBs. the ARD must be supplied at 230 Vac phase-neutral.



GW D0 976

AUTOMATIC RECLOSING DEVICES WITH PREVENTIVE CONTROL OF THE INSULATION - PRO VERSION



Code	Suitable for	Rated voltage	Compatibility with WiFi interface	No. of modules EN 50022	Pack Carton
GW D0 976	IDP RCCBs - 2P up to 80 A - 30 mA	230 V	Yes	1	1/4
GW D0 978	IDP RCCBs - 2P up to 63 A - 100/300/500 mA	230 V	Yes	1	1/4

CHARACTERISTICS: after RCCB has tripped, ReStart checks the insulation prior to the automatic reclosure. In the event of a fault (earth leakage), ReStart will not reset the circuit breaker but will continue to monitor the circuit every 2 minutes reclosing the circuit breaker when safe to do so.

Compatible with:

- GWD0951 auxiliary contact
- GWD0953 WiFi Interface Module
- GW90992 ModBus RS485 interface module (only if already coupled with GWD0951 auxiliary contact)

NOTES: cannot be used with 4P RCCBs in 3 modules and type B RCCBs. The ARD must be supplied at 230 Vac phase-neutral.

RESTART RD 4 POLES - VERSIONS TO BE COUPLED WITH RCCB'S IDP



GW 90 967

AUTOMATIC RECLOSING DEVICES WITH PREVENTIVE CONTROL OF THE INSULATION - PRO VERSION



Code	Suitable for	Rated voltage	Compatibility with WiFi interface	No. of modules EN 50022	Pack Carton
GW 90 967	IDP RCCBs - 2P up to 80 A and 4P up to 63 A - 30 mA	230 V	Yes	3	1/4
GW 90 969	IDP RCCBs - 2P/4P up to 63 A - 100/300/500 mA	230 V	Yes	3	1/4

CHARACTERISTICS: after RCCB has tripped, ReStart checks the insulation prior to the automatic reclosure. In the event of a fault (earth leakage), ReStart will not reset the circuit breaker but will continue to monitor the circuit every 2 minutes reclosing the circuit breaker when safe to do so. In the meantime the integrated configurable auxiliary contact will change state to indicate that the automatic reset did not take place.

Compatible with:

- GW90945 WiFi Interface Module
- GW90992 ModBus RS485 interface module.

NOTES: they cannot be used with 4P RCCBs in 3 modules. 230 V ac power supply, phase-neutral.

RESTART RM

RESTART RM 2 POLES - VERSIONS COUPLED WITH COMPACT RCBO'S MDC



GW D4 229 R

AUTOMATIC RECLOSING DEVICES WITH PREVENTIVE CHECK OF THE INSULATION AND OF THE SHORT CIRCUIT



Code	Rated current	I _{dn}	Type of RCBO	Curve	Rated voltage	Compatibility with WiFi interface	No. of modules EN 50022	Pack Carton
Breaking capacity (EN 61009-1): 4500 A								
GW D4 227 R	16 A	30 mA	A	C	230 V	No	3	1/4
GW D4 229 R	25 A	30 mA	A	C	230 V	No	3	1/4

CHARACTERISTICS: after RCBO has tripped, ReStart checks the insulation and the short circuit prior to the automatic reclosure.. In the event of a fault (earth leakage or short circuit), ReStart will not reset the circuit breaker.

NOTE: the ARD must be supplied at 230 Vac phase-neutral.



GW D4 229 P

AUTOMATIC RECLOSING DEVICES WITH PREVENTIVE CHECK OF THE INSULATION AND OF THE SHORT CIRCUIT - PRO VERSION



Code	Rated current	I _{dn}	Type of RCBO	Curve	Rated voltage	Compatibility with WiFi interface	No. of modules EN 50022	Pack Carton
Breaking capacity (EN 61009-1): 4500 A								
GW D4 227 P	16 A	30 mA	A	C	230 V	Yes	3	1/4
GW D4 229 P	25 A	30 mA	A	C	230 V	Yes	3	1/4

CHARACTERISTICS: after RCBO has tripped, ReStart checks the insulation and the short circuit prior to the automatic reclosure.

In the event of a fault (earth leakage), ReStart will not reset the circuit breaker but will continue to monitor the circuit every 2 minutes reclosing the circuit breaker when safe to do so.

Compatible with:

- GWD0951 auxiliary contact
- GWD0953 WiFi Interface Module
- GW90992 ModBus RS485 interface module (only if already coupled with GWD0951 auxiliary contact).

NOTE: the ARD must be supplied at 230 Vac phase-neutral.

90 ReStart

RESTART RM 2 POLES - VERSIONS TO BE COUPLED WITH COMPACT RCBO'S MDC



GW DO 991

AUTOMATIC RECLOSING DEVICES WITH PREVENTIVE CHECK OF THE INSULATION AND OF THE SHORT CIRCUIT



Code	Suitable for	Rated voltage	Compatibility with WiFi interface	No. of modules EN 50022	Pack Carton
GW DO 991	RCBO's MDC - 1P+N/2P - 30 mA	230 V	No	1	1/4

CHARACTERISTICS: after RCBO has tripped, ReStart checks the insulation and the short circuit prior to the automatic reclosure. In the event of a fault (earth leakage or short circuit), ReStart will not reset the circuit breaker.

NOTE: the ARD must be supplied at 230 Vac phase-neutral.



GW DO 996

AUTOMATIC RECLOSING DEVICES WITH PREVENTIVE CHECK OF THE INSULATION AND OF THE SHORT CIRCUIT - PRO VERSION



Code	Suitable for	Rated voltage	Compatibility with WiFi interface	No. of modules EN 50022	Pack Carton
GW DO 996	RCBO's MDC - 1P+N/2P - 30 mA	230 V	Yes	1	1/4
GW DO 998	RCBO's MDC - 1P+N/2P - 100-300 mA	230 V	Yes	1	1/4

CHARACTERISTICS: after RCBO has tripped, ReStart checks the insulation and the short circuit prior to the automatic reclosure. In the event of a fault (earth leakage), ReStart will not reset the circuit breaker but will continue to monitor the circuit every 2 minutes reclosing the circuit breaker when safe to do so.

Compatible with:

- GWD0951 auxiliary contact
- GWD0953 WiFi Interface Module
- GW90992 ModBus RS485 interface module (only if already coupled with GWD0951 auxiliary contact).

NOTE: the ARD must be supplied at 230 Vac phase-neutral.

RESTART RM 4 POLES - VERSIONS TO BE COUPLED WITH COMPACT RCBO'S MDC



GW 90 986

AUTOMATIC RECLOSING DEVICES WITH PREVENTIVE CHECK OF THE INSULATION AND OF THE SHORT CIRCUIT PRO VERSION



Code	Suitable for	Rated voltage	Compatibility with WiFi interface	No. of modules EN 50022	Pack Carton
GW 90 986	RCBO's MDC - 1P+N/2P/4P - 30 mA	230 V	Yes	3	1/4
GW 90 988	RCBO's MDC - 1P+N/2P/4P - 100 and 300 mA	230 V	Yes	3	1/4

CHARACTERISTICS: after RCBO has tripped, ReStart checks the insulation and the short circuit prior to the automatic reclosure. In the event of a fault (earth leakage), ReStart will not reset the circuit breaker but will continue to monitor the circuit every 2 minutes reclosing the circuit breaker when safe to do so. In the meantime the integrated configurable auxiliary contact will change state to indicate that the automatic reset did not take place.

Compatible with:

- GW90945 WiFi interface module
- GW90992 ModBus RS485 interface module

NOTE: the ARD must be supplied at 230 Vac phase-neutral.

RESTART RM TOP - VERSION TO BE COUPLED WITH RCBO'S MDC/MT+BD OR MCB'S MTC/MT



GW 90 893

ADJUSTABLE AUTOMATIC RECLOSING DEVICE WITH/WITHOUT PREVENTIVE CHECK OF THE INSULATION AND/OR OF THE SHORT CIRCUIT



Code	Suitable for	Rated voltage	Compatibility with WiFi interface	No. of modules EN 50022	Pack Carton
GW 90 893	RCBO's MDC/MT+BD and MCB's MTC/MT	230 V	No	4	1/4

CHARACTERISTICS: the Rm TOP ReStart allows to:

- set the reclosing mode (reclosing with system check, reclosing by attempts, remote reclosing and excluded reclosing)
- adapt the insulation threshold in according to the associated circuit breaker
- regulate the reclosing time delay.

The device is equipped with 2 integrated auxiliary contacts of position and/or tripped relay.

NOTE: the ARD must be supplied at 230 V ac phase-neutral.

RESTART CM - MOTOR OPERATING DEVICE TO BE COUPLED WITH RCBO'S MDC/MT+BD OR MCB'S MTC/MT



GW 90 896

MOTOR OPERATING DEVICE WITHOUT PREVENTIVE CONTROL OF THE INSULATION AND OF THE SHORT CIRCUIT



Code	Suitable for	Rated coil voltage	Rated voltage	Compatibility with WiFi interface	No. of modules EN 50022	Pack Carton
GW 90 896	RCBO's MDC/MT+BD or MCB's MTC/MT	230 V ac	230 V	No	2	1/4
GW 90 898	RCBO's MDC/MT+BD or MCB's MTC/MT	12 V dc	230 V	No	2	1/4

CHARACTERISTICS: the device is equipped with 1 integrated auxiliary position contact or tripped relay.

NOTE: the reclosing device must be supplied at 230 V ac phase-neutral.

ELECTRIC AUXILIARY FOR RESTART DEVICES



GW 96 014

SHUNT TRIP RELEASE WITH SIMULTANEOUS RECLOSING

Code	Suitable for	Rated voltage	No. of modules EN 50022	Pack Carton
GW 96 014	ReStart RM TOP/Restart CM	230 V ac	1	1/6

CHARACTERISTICS: when the circuit breaker trips, thanks to GW96014, it can be reclosed remotely by means the ReStart RM TOP or the motor operating ReStart CM, even before the shunt trip release has been reclosed. ReStart RM TOP and ReStart CM activate a remote reclosing of both the circuit breaker lever and the shunt trip release lever simultaneously.

APPLICATIONS: it is used to cause the remote opening of the circuit breaker coupled with the ReStart RM TOP or the motor operating ReStart CM. When using a release associated with ReStart RM TOP, pay attention to the system control and reclose logic set on the ReStart RM TOP.

NOTE: when using a ReStart RM TOP, the shunt trip release must be placed between the ReStart RM TOP device and the circuit breaker.

When using a ReStart CM, the shunt trip release must be placed to the left of the ReStart CM device. A position auxiliary contact or a fault indication switch can also be added to the left of the release GW96014.

RESTART ACCESSORIES

ACCESSORIES FOR RESTART DEVICES



GW D0 951

AUXILIARY CONTACT

Code	Suitable for	Voltage operating	Current operating	No. of modules EN 50022	Pack Carton
GW D0 951	ReStart Rd PRO 2P (GWD0976 and GWD0978)/ ReStart Rm PRO 2P (GWD0996 and GWD0998)	5-230 V ac/dc	0,6-100 mA ac/dc	1	1/4

CHARACTERISTICS: the auxiliary contact, coupled on the right side of ReStart device, will change state to indicate that the automatic reset did not take place because there is a fault in the electrical system.

The auxiliary contact can be set in three operating modes:

- NO (default condition)
- NC
- NO as signal of handle position

NOTE: the auxiliary contacts is free potential type.



GW D0 953

WI-FI COMMUNICATION INTERFACE MODULE

Code	Suitable for	Measure of electrical parameters	No. of modules EN 50022	Pack Carton
GW D0 953	ReStart Rd PRO 2P / ReStart Rm PRO 2P	Yes	1	1/4
GW 90 953	ReStart Autotest PRO 2P	Yes	1	1/4
GW 90 945	ReStart Rd PRO 4P /ReStart Rm PRO 4P	No	1	1/4
GW 90 954	ReStart Autotest PRO 4P	No	1	1/4

CHARACTERISTICS: the Wi-Fi modules (to be coupled on the right side of the ReStart PRO device) if connected to a router, allow the following information to be remoted on devices connected to the internet network:

- status of the ' switch (ON/off)
- lack of power supply in the ' system due to the presence of a fault
- restoration of the power ' supply following the successful automatic reset
- if combined with ReStart Rd/Rm PRO 2P and ReStart Autotest PRO 2P, the consumption related to electricity produced and consumed, active and reactive power, current and voltage of the system
- if combined with ReStart Autotest PRO 2P and 4P, the details of the ' last Autotest operation (outcome, date and time)



GW 90 992

BUS RS485 COMMUNICATION INTERFACE MODULE

Code	Suitable for	No. of modules EN 50022	Pack Carton
GW 90 992	ReStart Autotest 2P-4P/ReStart Rd PRO 2P-4P/ReStart Rm PRO 2P-4P	1	1

CHARACTERISTICS: the BUS module, by means software available on www.GEWISS.com website, allows to:

- monitor the status of circuit breaker coupled with ReStart
- control Autotest fuunction remotely
- manage automatic reclosing function remotely.

APPLICATION: it allows the installation of ReStart device in monitoring systems with BUS RS485 communication protocol.



90 ReStart



Scan the QR Code and find out all the technical informations.

AN ALWAYS-PROTECTED SYSTEM



Thanks to the GEWISS patented automatic self-test system with no power interruption, the ReStart Autotest ensures maximum protection efficiency and removes the need for the user to manually perform periodic RCCB relay trip tests.

ALL UNDER CONTROL



The LEDs on the faceplate of the device provide information on the operating status of the system. At a glance, you can tell if the system is working properly, if the auto-test is in progress, or if there is a fault.

CONTINUOUS MONITORING GUARANTEED

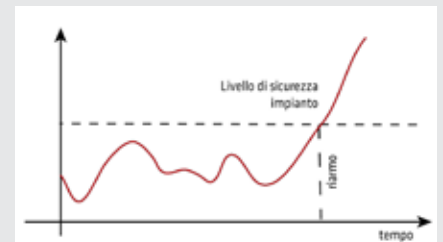

After a failure, the ReStart PRO performs a continuous system check until safety is re-established and then resets the protection switch. The auxiliary contact also allows remote monitoring of the system status information.



CIRCUIT BREAKERS FOR CIRCUIT PROTECTION

90 MCB

MODULAR CIRCUIT BREAKERS FOR
CIRCUIT PROTECTION











pag. 416













90 MCB

Selection tables

			MINIATURE CIRCUIT BREAKERS										
			MTC					MT					
Icn [A] (EN60898)	Curve	In [A]											
			1P 1 mod.	1P+N* 1 mod.	1P+N** 1 mod.	2P 1 mod.	3P 2 mod.	4P 2 mod.	1P 1 mod.	1P+N 2 mod.	2P 2 mod.	3P 3 mod.	4P 4 mod.
			MTC 45					MT 45					
4500	C	2	-	GW 90 022	GW 90 602	-	-	-	-	-	-	-	-
		6	GW 90 005	GW 90 025	GW 90 605	GW 90 045	GW 90 065	GW 90 085	GW 92 105	GW 92 125	GW 92 145	GW 92 165	GW 92 185
		10	GW 90 006	GW 90 026	GW 90 606	GW 90 046	GW 90 066	GW 90 086	GW 92 106	GW 92 126	GW 92 146	GW 92 166	GW 92 186
		13	GW 90 011	GW 90 031	-	GW 90 051	GW 90 071	GW 90 091	GW 92 107	GW 92 127	GW 92 147	GW 92 167	GW 92 187
		16	GW 90 007	GW 90 027	GW 90 607	GW 90 047	GW 90 067	GW 90 087	GW 92 108	GW 92 128	GW 92 148	GW 92 168	GW 92 188
		20	GW 90 008	GW 90 028	GW 90 608	GW 90 048	GW 90 068	GW 90 088	GW 92 109	GW 92 129	GW 92 149	GW 92 169	GW 92 189
		25	GW 90 009	GW 90 029	GW 90 609	GW 90 049	GW 90 069	GW 90 089	GW 92 110	GW 92 130	GW 92 150	GW 92 170	GW 92 190
	B	32	GW 90 010	GW 90 030	GW 90 610	GW 90 050	GW 90 070	GW 90 090	GW 92 111	GW 92 131	GW 92 151	GW 92 171	GW 92 191
		40	-	-	-	-	-	-	GW 92 112	GW 92 132	GW 92 152	GW 92 172	GW 92 192
		6	-	-	-	-	-	-	GW 92 305	GW 92 325	GW 92 345	GW 92 365	GW 92 385
		10	-	-	-	-	-	-	GW 92 306	GW 92 326	GW 92 346	GW 92 366	GW 92 386
		13	-	-	-	-	-	-	GW 92 307	GW 92 327	GW 92 347	GW 92 367	GW 92 387
		16	-	-	-	-	-	-	GW 92 308	GW 92 328	GW 92 348	GW 92 368	GW 92 388
		20	-	-	-	-	-	-	GW 92 309	GW 92 329	GW 92 349	GW 92 369	GW 92 389
6000	C	25	-	-	-	-	-	-	GW 92 310	GW 92 330	GW 92 350	GW 92 370	GW 92 390
		32	-	-	-	-	-	-	GW 92 311	GW 92 331	GW 92 351	GW 92 371	GW 92 391
		40	-	-	-	-	-	-	GW 92 312	GW 92 332	GW 92 352	GW 92 372	GW 92 392
		1	-	-	-	-	-	-	GW 92 001	GW 92 021	GW 92 041	GW 92 061	GW 92 081
		2	-	-	-	-	-	-	GW 92 002	GW 92 022	GW 92 042	GW 92 062	GW 92 082
		3	-	-	-	-	-	-	GW 92 003	GW 92 023	GW 92 043	GW 92 063	GW 92 083
		4	-	-	-	-	-	-	GW 92 004	GW 92 024	GW 92 044	GW 92 064	GW 92 084
		6	-	GW 90 225	-	GW 90 245	GW 90 265	GW 90 285	GW 92 005	GW 92 025	GW 92 045	GW 92 065	GW 92 085
		10	-	GW 90 226	-	GW 90 246	GW 90 266	GW 90 286	GW 92 006	GW 92 026	GW 92 046	GW 92 066	GW 92 086
		13	-	GW 90 231	-	GW 90 251	GW 90 271	GW 90 291	GW 92 014	GW 92 034	GW 92 054	GW 92 074	GW 92 094
		16	-	GW 90 227	-	GW 90 247	GW 90 267	GW 90 287	GW 92 007	GW 92 027	GW 92 047	GW 92 067	GW 92 087
	20	-	GW 90 228	-	GW 90 248	GW 90 268	GW 90 288	GW 92 008	GW 92 028	GW 92 048	GW 92 068	GW 92 088	
	25	-	GW 90 229	-	GW 90 249	GW 90 269	GW 90 289	GW 92 009	GW 92 029	GW 92 049	GW 92 069	GW 92 089	
	32	-	GW 90 230	-	GW 90 250	GW 90 270	GW 90 290	GW 92 010	GW 92 030	GW 92 050	GW 92 070	GW 92 090	
40	-	-	-	-	-	-	GW 92 011	GW 92 031	GW 92 051	GW 92 071	GW 92 091		
50	-	-	-	-	-	-	GW 92 012	GW 92 032	GW 92 052	GW 92 072	GW 92 092		
63	-	-	-	-	-	-	GW 92 013	GW 92 033	GW 92 053	GW 92 073	GW 92 093		
B	6	-	GW 90 325	-	GW 90 345	-	-	GW 92 205	-	GW 92 245	GW 92 265	GW 92 285	
	10	-	GW 90 326	-	GW 90 346	-	-	GW 92 206	-	GW 92 246	GW 92 266	GW 92 286	
	13	-	GW 90 327	-	GW 90 347	-	-	GW 92 214	-	GW 92 254	GW 92 274	GW 92 294	
	16	-	GW 90 328	-	GW 90 348	-	-	GW 92 207	-	GW 92 247	GW 92 267	GW 92 287	
	20	-	GW 90 329	-	GW 90 349	-	-	GW 92 208	-	GW 92 248	GW 92 268	GW 92 288	
	25	-	GW 90 330	-	GW 90 350	-	-	GW 92 209	-	GW 92 249	GW 92 269	GW 92 289	
	32	-	GW 90 331	-	GW 90 351	-	-	GW 92 210	-	GW 92 250	GW 92 270	GW 92 290	
	40	-	-	-	-	-	-	GW 92 211	-	GW 92 251	GW 92 271	GW 92 291	
	50	-	-	-	-	-	-	GW 92 212	-	GW 92 252	GW 92 272	GW 92 292	
	63	-	-	-	-	-	-	GW 92 213	-	GW 92 253	GW 92 273	GW 92 293	
	D	6	-	-	-	-	-	-	GW 92 405	-	GW 92 445	GW 92 465	GW 92 485
		10	-	-	-	-	-	-	GW 92 406	-	GW 92 446	GW 92 466	GW 92 486
		13	-	-	-	-	-	-	GW 92 414	-	GW 92 454	GW 92 474	GW 92 494
16		-	-	-	-	-	-	GW 92 407	-	GW 92 447	GW 92 467	GW 92 487	
20		-	-	-	-	-	-	GW 92 408	-	GW 92 448	GW 92 468	GW 92 488	
25		-	-	-	-	-	-	GW 92 409	-	GW 92 449	GW 92 469	GW 92 489	
32		-	-	-	-	-	-	GW 92 410	-	GW 92 450	GW 92 470	GW 92 490	
40	-	-	-	-	-	-	GW 92 411	-	GW 92 451	GW 92 471	GW 92 491		

* 1P+N versions cannot be equipped with extra accessories





** Miniature circuit breakers with neutral on the left

			MINIATURE CIRCUIT BREAKERS									
			MTC	MT				MTHP				
												
lcn [A] (EN60898)	Curve	In [A]	2P 1 mod.	1P 1 mod.	2P 2 mod.	3P 3 mod.	4P 4 mod.	1P 1.5 mod.	2P 3 mod.	3P 4.5 mod.	4P 6 mod.	
			MTC 100		MT 100							
10000	C	6	GW 90 445	GW 92 605	GW 92 645	GW 92 665	GW 92 685	-	-	-	-	
		10	GW 90 446	GW 92 606	GW 92 646	GW 92 666	GW 92 686	-	-	-	-	
		13	GW 90 451	GW 92 614	GW 92 654	GW 92 674	GW 92 694	-	-	-	-	
		16	GW 90 447	GW 92 607	GW 92 647	GW 92 667	GW 92 687	-	-	-	-	
		20	GW 90 448	GW 92 608	GW 92 648	GW 92 668	GW 92 688	-	-	-	-	
		25	GW 90 449	GW 92 609	GW 92 649	GW 92 669	GW 92 689	-	-	-	-	
		32	GW 90 450	GW 92 610	GW 92 650	GW 92 670	GW 92 690	-	-	-	-	
		40	-	GW 92 611	GW 92 651	GW 92 671	GW 92 691	-	-	-	-	
	50	-	GW 92 612	GW 92 652	GW 92 672	GW 92 692	-	-	-	-		
	63	-	GW 92 613	GW 92 653	GW 92 673	GW 92 693	-	-	-	-		
	B	6	-	GW 92 505	GW 92 545	GW 92 565	GW 92 585	-	-	-	-	
		10	-	GW 92 506	GW 92 546	GW 92 566	GW 92 586	-	-	-	-	
		13	-	GW 92 507	GW 92 547	GW 92 567	GW 92 587	-	-	-	-	
		16	-	GW 92 508	GW 92 548	GW 92 568	GW 92 588	-	-	-	-	
		20	-	GW 92 509	GW 92 549	GW 92 569	GW 92 589	-	-	-	-	
		25	-	GW 92 510	GW 92 550	GW 92 570	GW 92 590	-	-	-	-	
		32	-	GW 92 511	GW 92 551	GW 92 571	GW 92 591	-	-	-	-	
		40	-	GW 92 512	GW 92 552	GW 92 572	GW 92 592	-	-	-	-	
	50	-	GW 92 513	GW 92 553	GW 92 573	GW 92 593	-	-	-	-		
	63	-	GW 92 514	GW 92 554	GW 92 574	GW 92 594	-	-	-	-		
	D	1	-	GW 92 701	GW 92 741	GW 92 761	GW 92 781	-	-	-	-	
		2	-	GW 92 702	GW 92 742	GW 92 762	GW 92 782	-	-	-	-	
		3	-	GW 92 703	GW 92 743	GW 92 763	GW 92 783	-	-	-	-	
		4	-	GW 92 704	GW 92 744	GW 92 764	GW 92 784	-	-	-	-	
		6	-	GW 92 705	GW 92 745	GW 92 765	GW 92 785	-	-	-	-	
		10	-	GW 92 706	GW 92 746	GW 92 766	GW 92 786	-	-	-	-	
		13	-	GW 92 714	GW 92 754	GW 92 774	GW 92 794	-	-	-	-	
		16	-	GW 92 707	GW 92 747	GW 92 767	GW 92 787	-	-	-	-	
		20	-	GW 92 708	GW 92 748	GW 92 768	GW 92 788	-	-	-	-	
		25	-	GW 92 709	GW 92 749	GW 92 769	GW 92 789	-	-	-	-	
		32	-	GW 92 710	GW 92 750	GW 92 770	GW 92 790	-	-	-	-	
		40	-	GW 92 711	GW 92 751	GW 92 771	GW 92 791	-	-	-	-	
10000 (16kA EN60947-2)	C	80	-	-	-	-	-	GW 93 307	GW 93 327	GW 93 337	GW 93 347	
		100	-	-	-	-	-	GW 93 308	GW 93 328	GW 93 338	GW 93 348	
		125	-	-	-	-	-	GW 93 309	GW 93 329	GW 93 339	GW 93 349	
	D	50	-	-	-	-	-	GW 93 355	GW 94 375	GW 93 385	GW 93 395	
		63	-	-	-	-	-	GW 93 356	GW 93 376	GW 93 386	GW 93 396	
		80	-	-	-	-	-	GW 93 357	GW 93 377	GW 93 387	GW 93 397	
100	-	-	-	-	-	GW 93 358	GW 93 378	GW 93 388	GW 93 398			
12500	C	50	-	GW 92 812	GW 92 852	GW 92 872	GW 92 892	-	-	-	-	
		63	-	GW 92 813	GW 92 853	GW 92 873	GW 92 893	-	-	-	-	
15000	C	32	-	GW 92 810	GW 92 850	GW 92 870	GW 92 890	-	-	-	-	
		40	-	GW 92 811	GW 92 851	GW 92 871	GW 92 891	-	-	-	-	
20000	C	25	-	GW 92 809	GW 92 849	GW 92 869	GW 92 889	-	-	-	-	
25000	C	6	-	GW 92 805	GW 92 845	GW 92 865	GW 92 885	-	-	-	-	
		10	-	GW 92 806	GW 92 846	GW 92 866	GW 92 886	-	-	-	-	
		16	-	GW 92 807	GW 92 847	GW 92 867	GW 92 887	-	-	-	-	
		20	-	GW 92 808	GW 92 848	GW 92 868	GW 92 888	GW 93 201	GW 93 221	GW 93 231	GW 93 241	
		25	-	-	-	-	-	GW 93 202	GW 93 222	GW 93 232	GW 93 242	
		32	-	-	-	-	-	GW 93 203	GW 93 223	GW 93 233	GW 93 243	
		40	-	-	-	-	-	GW 93 204	GW 93 224	GW 93 234	GW 93 244	
		50	-	-	-	-	-	GW 93 205	GW 93 225	GW 93 235	GW 93 245	
63	-	-	-	-	-	GW 93 206	GW 93 226	GW 93 236	GW 93 246			

90 MCB

MCB - MTC - MT - MTHP

Technical data

TYPE		MTC						MT							
		MTC 45		MTC 60		MTC 100		MT 45		MT 60					
															
Standards		IEC EN 60898-1 IEC EN 60947-2													
Rated current (In)	(A)	2-32		6-32		6-32		6-40		1-63					
Utilization category		A		A		A		A		A					
Rated operational voltage (Ue)	(V)	230/400 - 240/415		230/400 - 240/415		230 - 240		230/400 - 240/415		230/400 - 240/415					
Minimum operating voltage (Ue min)	(V)	12 AC/DC		12 AC/DC		12 AC/DC		12 AC/DC		12 AC/DC					
Maximum operating voltage (Ue max)	(V)	440 AC/ 250 DC		440 AC/ 250 DC		253 AC/ 125 DC		440 AC/ 220 DC		440 AC/ 250 DC					
Insulation voltage (Ui)	(V)	500		500		500		500		500					
Rated frequency	(Hz)	50/60		50/60		50/60		50 / 60		50/60					
Rated impulse withstand voltage (Uimp)	(kV)	4		4		4		4		4					
Overvoltage category:		III		III		III		III		III					
Number of poles		1P+N	2	3,4	1+N	2	3,4	2	1,1+N	2,3,4	1,1+N	2,3,4			
Energy limiting class (B and C curve):		3	3	3	3	3	3 (≤16A) 1 (>16A)	3	3	3	3	3			
Breaking capacity															
Alternating current	IEC/EN 60898-1	Icn	(A)	4500		6000 ⁽¹⁾		6000		10000 ⁽¹⁾		4500		6000	
		Ics	(A)	1 Icn		1 Icn		1 Icn		0.75 Icn		1 Icn		1 Icn	
		Icu	230/240 V (kA)	4.5	6	6	6	10	10	15	4.5	6	10	20	
	IEC/EN 60947-2	Icu	400/415 V (kA)	-	-	4.5	-	-	6	-	-	6	-	10	
Direct current	IEC/EN 60947-2	Ics	(kA)	100% Icu		100% Icu		75% Icu		100% Icu		50% Icu		100% Icu	
		Icu (1 pole)	72 V (kA)	6		10		10		-		6		10	
		Ics (2 poles in series) ⁽²⁾	125 V (kA)	6		10		10		10 (15 at 72V)		6		10	
		Icu (4 poles in series)	250 V (kA)	4.5		6		6		10 (15 at 72V)		6		6	
		Ics	(kA)	4.5		6		6		-		4.5		10	
		Ics	(kA)	4.5		6		6		-		4.5		10	
Wiring		cable section (mm ²) ⁽³⁾	rigid	≤ 1x16 - ≤ 1x10+1x6		≤ 1x16 - ≤ 1x10+1x6		≤ 1x16 - ≤ 1x10+1x6		≤ 1x16 - ≤ 1x10+1x6		≤ 1x35 - ≤ 2x16 - ≤ 1x16+2x10		≤ 1x35 - ≤ 2x16 - ≤ 1x16+2x10	
		flexible	≤ 1x10 - ≤ 2x6		≤ 1x10 - ≤ 2x6		≤ 1x10 - ≤ 2x6		≤ 1x10 - ≤ 2x6		≤ 1x35 - ≤ 2x16 - ≤ 1x16+2x10		≤ 1x35 - ≤ 2x16 - ≤ 1x16+2x10		
Screwdriver suggested:			PZ2		PZ2		PZ2		PZ2		PZ2		PZ2		
Electrical endurance:			10000		10000		10000		10000		10000		10000		
Mechanical endurance:			20000		20000		20000		20000		20000		20000		
Max. no. of usable modular accessories			2 ⁽⁵⁾		2 ⁽⁵⁾		2		2		2		2		
Upline/downline power supply:			YES		YES		YES		YES		yes		YES		
ON/OFF status displayed:			YES		YES		YES		YES		yes		YES		
Mounting position:			any		any		any		any		any		any		
Type of residual current device:			-		-		-		-		Add-on RCD BD		Add-on RCD BD		
Rated tightening torque:	(Nm)		1.2		1.2		1.2		2		2		2		
Degree of protection:		terminals	IP20		IP20		IP20		IP20		IP20		IP20		
		front	IP40		IP40		IP40		IP40		IP40		IP40		
Pollution degree:			2		2		2		2		2		2		
Tropicalization:			55°C - RH 95%		55°C - RH 95%		55°C - RH 95%		55°C - RH 95%		55°C - RH 95%		55°C - RH 95%		
Reference temperature:	(°C)		30		30		30		30		30		30		
Operating temperature:	(°C)		-25 +70 ⁽⁶⁾		-25 +70 ⁽⁶⁾		-25 +70 ⁽⁶⁾		-25 +70 ⁽⁶⁾		-25 +70 ⁽⁶⁾		-25 +70 ⁽⁶⁾		
Stocking temperature:	(°C)		-40 +70		-40 +70		-40 +70		-40 +70		-40 +70		-40 +70		
Double connection (cable+fork busbar)			no		no		no		no		yes (only downstream)		yes (only downstream terminals)		
Weight:	(g)		135 (per module)		135 (per module)		135 (per module)		145 (per pole)		145 (per pole)		145 (per pole)		
Curve			C	C	B	C	C	B	C	B	C	B	D		
Rated currents available In:	(A)		-	-	-	-	-	-	-	-	1	-	-		
			2	-	-	-	-	-	-	-	2	-	-		
			-	-	-	-	-	-	-	-	3	-	-		
			-	-	-	-	-	-	-	-	4	-	-		
			6	6	6	6	6	6	6	6	6	6	6		
			10	10	10	10	10	10	10	10	10	10	10		
			13	13	13	13	13	13	13	13	13	13	13		
			16	16	16	16	16	16	16	16	16	16	16		
			20	20	20	20	20	20	20	20	20	20	20		
			25	25	25	25	25	25	25	25	25	25	25		
			32	32	32	32	32	32	32	32	32	32	32		
			-	-	-	-	-	-	40	40	40	40	40		
			-	-	-	-	-	-	-	-	50	50	-		
			-	-	-	-	-	-	-	-	63	63	-		
			-	-	-	-	-	-	-	-	-	-	-		
			-	-	-	-	-	-	-	-	-	-	-		
			-	-	-	-	-	-	-	-	-	-	-		

(1) Breaking capacity of the single pole Icn1=4500A





(2) 1P+N version not allowed

(3) Minimum cable section is 1mm² for MTC and MT, 1,5mm² for MTHP

(4) ≤95mm² with reduced connection terminal (width flap connection < 17mm)

(5) 1P+N versions cannot be accessorised

(6) With temperatures greater than 30°C, derating of In rated current is expected

MT												MTHP											
MT 100						MT 250						MTHP 160			MTHP 250								
																							
IEC EN 60898-1 IEC EN 60947-2																							
1-25			32-63			6-20			25			32-40			50-63			50-125			20-63		
A			A			A			A			A			A			A			A		
230/400 - 240/415			230/400 - 240/415			230/400 - 240/415			230/400 - 240/415			230/400 - 240/415			230/400 - 240/415			230/400 - 240/415			230/400 - 240/415		
12 AC/DC			12 AC/DC			12 AC/DC			12 AC/DC			12 AC/DC			12 AC/DC			12 AC/DC			12 AC/DC		
440 AC/ 250 DC			440 AC/ 250 DC			440 AC/ 250 DC			440 AC/ 250 DC			440 AC/ 250 DC			440 AC/ 250 DC			440 AC/ 250 DC			440 AC/ 250 DC		
500			500			500			500			500			500			500			500		
50/60			50/60			50/60			50/60			50/60			50/60			50/60			50/60		
4			4			4			4			4			4			4			4		
III			III			III			III			III			III			IV			IV		
1	2	3.4	1	2	3.4	1	2	3.4	1	2	3.4	1	2	3.4	1	2	3.4	1	2,3,4	1	2	3.4	
3	3	3	3	3	3	-	-	-	-	-	-	-	-	-	-	-	-	-	-	-	-	-	
10000			10000			25000			20000			15000			12500			10000			25000		
0.75 Icn			0.75 Icn			0.5 Icn			0.5 Icn			0.5 Icn			0.5 Icn			0.75 Icn			0.75 Icn		
15	30	25	12.5	25	20	25	50	40	20	40	30	15	30	25	15	25	20	15	25	20	16	20	25
-	20	15	-	15	12.5	-	30	25	-	25	20	-	20	15	-	15	15	4.5	16	6	6	25	25
50% Icu			50% Icu			50% Icu			50% Icu			50% Icu			50% Icu			75% Icu					
10			10			20			20			20			20			10					
10			10			15			15			15			15			10					
15			15			25			25			25			25			15					
15			15			20			20			20			20			12					
15			15			25			25			25			25			15					
12			12			20			20			20			20			12					
≤1x35 - ≤2x16 - ≤1x16+2x10			≤1x35 - ≤2x16 - ≤1x16+2x10			≤1x35 - ≤2x16 - ≤1x16+2x10			≤1x35 - ≤2x16 - ≤1x16+2x10			≤1x35 - ≤2x16 - ≤1x16+2x10			≤1x35 - ≤2x16 - ≤1x16+2x10			≤1x70 - ≤2x25 - ≤2x25+1x10			≤1x70 - ≤2x25 - ≤2x25+1x10		
≤1x35 - ≤2x16 - ≤1x16+2x10			≤1x35 - ≤2x16 - ≤1x16+2x10			≤1x35 - ≤2x16 - ≤1x16+2x10			≤1x35 - ≤2x16 - ≤1x16+2x10			≤1x35 - ≤2x16 - ≤1x16+2x10			≤1x35 - ≤2x16 - ≤1x16+2x10			≤1x50 ⁽⁴⁾ - ≤2x25 - ≤3x16			≤1x50 ⁽⁴⁾ - ≤2x25 - ≤3x16		
PZ2			PZ2			PZ2			PZ2			PZ2			PZ2			PZ2					
10000			10000			10000			10000			10000			10000			10000					
20000			20000			20000			20000			20000			20000			20000					
2			2			2			2			2			2			2					
YES			YES			YES			YES			YES			YES			YES					
YES			YES			YES			YES			YES			YES			YES					
any			any			any			any			any			any			any					
Add-on RCD BD			Add-on RCD BD			Add-on RCD BD			Add-on RCD BD			Add-on RCD BD			Add-on RCD BD			Add-on RCD BDHP			Add-on RCD BDHP		
2			2			2			2			2			2			3.5 / 3 (terminal)			3.5 / 3 (terminal)		
IP20			IP20			IP20			IP20			IP20			IP20			IP20					
IP40			IP40			IP40			IP40			IP40			IP40			IP40					
2			2			2			2			2			2			2					
55°C - RH 95%			55°C - RH 95%			55°C - RH 95%			55°C - RH 95%			55°C - RH 95%			55°C - RH 95%			55°C - RH 95%					
30			30			30			30			30			30			30					
-25 +70 ⁽⁶⁾			-25 +70 ⁽⁶⁾			-25 +70 ⁽⁶⁾			-25 +70 ⁽⁶⁾			-25 +70 ⁽⁶⁾			-25 +70 ⁽⁶⁾			-25 +70 ⁽⁶⁾					
-40 +70			-40 +70			-40 +70			-40 +70			-40 +70			-40 +70			-40 +70					
yes (only downstream terminals)			yes (only downstream terminals)			yes (only downstream terminals)			yes (only downstream terminals)			yes (only downstream terminals)			yes (only downstream terminals)			no			no		
145 (per pole)			145 (per pole)			145 (per pole)			145 (per pole)			145 (per pole)			145 (per pole)			250 (per pole)			250 (per pole)		
C	B	D										C	D	C									
-	-	1										-	-	-									
-	-	2										-	-	-									
-	-	3										-	-	-									
-	-	4										-	-	-									
6	6	6										6	-	-									
10	10	10										10	-	-									
13	13	13										-	-	-									
16	16	16										16	-	-									
20	20	20										20	-	-	20								
25	25	25										25	-	-	25								
32	32	32										32	-	-	32								
40	40	40										40	-	-	40								
50	50	-										50	-	50	50								
63	63	-										63	-	63	63								
-	-	-										-	80	80	-								
-	-	-										-	100	100	-								
-	-	-										-	125	-	-								

90 MCD

Modular circuit breakers for circuit protection

The 90 MCB range meets any requirement for protection against overcurrent and shortcircuit, for all domestic, commercial and industrial applications. The range comprises MTC, compact miniature circuit breakers (from 2 to 32 A, curves B and C up to 10 kA) MT traditional miniature circuit breakers (from 1 to 63 A, curves B, C and D up to 25 kA) MTHP High-Power Miniature circuit breakers (from 20 to 125 A, curves C and D up to 25 kA).



MTC - COMPACT MINIATURE CIRCUIT BREAKERS

MTC 45 - C CURVE - 4500 A (EN 60898) - 4.5 KA (EN 60947-2)

BREAKING CAPACITY 1P-1P+N				BREAKING CAPACITY 2-3-4P				BREAKING CAPACITY 3-4P			
230V	EN60898	EN60947-2		230V	EN60898	EN60947-2		400V	EN60898	EN60947-2	
In	Icn	Ics	Icu	In	Icn	Ics	Icu	In	Icn	Ics	Icu
6-32 A	4500 A	4.5 kA		6-32 A	4500 A	4.5 kA		6-32 A	4500 A	4.5 kA	



GW 90 046

COMPACT MINIATURE CIRCUIT BREAKERS

Code	Rated current	Rated voltage	Auxiliaries compatibility	No. of modules EN 50022	Pack Carton
No. of poles: 1P					
GW 90 005	6 A	230 - 400 V	Yes	1	6/24
GW 90 006	10 A	230 - 400 V	Yes	1	6/24
GW 90 011	13 A	230 - 400 V	Yes	1	6/24
GW 90 007	16 A	230 - 400 V	Yes	1	6/24
GW 90 008	20 A	230 - 400 V	Yes	1	6/24
GW 90 009	25 A	230 - 400 V	Yes	1	6/24
GW 90 010	32 A	230 - 400 V	Yes	1	6/24
No. of poles: 1P+N					
GW 90 022	2 A	230 V	No	1	6/24
GW 90 025	6 A	230 V	No	1	6/24
GW 90 026	10 A	230 V	No	1	6/24
GW 90 031	13 A	230 V	No	1	6/24
GW 90 027	16 A	230 V	No	1	6/24
GW 90 028	20 A	230 V	No	1	6/24
GW 90 029	25 A	230 V	No	1	6/24
GW 90 030	32 A	230 V	No	1	6/24
No. of poles: 1P+N (N-conductor left)					
GW 90 602	2 A	230 V	No	1	6/24
GW 90 605	6 A	230 V	No	1	6/24
GW 90 606	10 A	230 V	No	1	6/24
GW 90 607	16 A	230 V	No	1	6/24
GW 90 608	20 A	230 V	No	1	6/24
GW 90 609	25 A	230 V	No	1	6/24
GW 90 610	32 A	230 V	No	1	6/24
No. of poles: 2P					
GW 90 045	6 A	230 V	Yes	1	6/24
GW 90 046	10 A	230 V	Yes	1	6/24
GW 90 051	13 A	230 V	Yes	1	6/24
GW 90 047	16 A	230 V	Yes	1	6/24
GW 90 048	20 A	230 V	Yes	1	6/24
GW 90 049	25 A	230 V	Yes	1	6/24
GW 90 050	32 A	230 V	Yes	1	6/24
No. of poles: 3P					
GW 90 065	6 A	230 - 400 V	Yes	2	3/12
GW 90 066	10 A	230 - 400 V	Yes	2	3/12
GW 90 071	13 A	230 - 400 V	Yes	2	3/12
GW 90 067	16 A	230 - 400 V	Yes	2	3/12
GW 90 068	20 A	230 - 400 V	Yes	2	3/12
GW 90 069	25 A	230 - 400 V	Yes	2	3/12
GW 90 070	32 A	230 - 400 V	Yes	2	3/12
No. of poles: 4P					
GW 90 085	6 A	230 - 400 V	Yes	2	3/12
GW 90 086	10 A	230 - 400 V	Yes	2	3/12
GW 90 091	13 A	230 - 400 V	Yes	2	3/12
GW 90 087	16 A	230 - 400 V	Yes	2	3/12
GW 90 088	20 A	230 - 400 V	Yes	2	3/12
GW 90 089	25 A	230 - 400 V	Yes	2	3/12
GW 90 090	32 A	230 - 400 V	Yes	2	3/12

MTC 60 - C CURVE - 6000 A (EN 60898) - 6 KA (EN 60947-2)

BREAKING CAPACITY 1P+N	BREAKING CAPACITY 2-3-4P	BREAKING CAPACITY 3-4P
230V EN60898 EN60947-2 Icu Ics In=6x32 A 6000A 6kA	230V EN60898 EN60947-2 Icu Ics In=6x32 A 6000A 10kA	400V EN60898 EN60947-2 Icu Ics In=6x32 A 6000A 6kA



GW 90 290

COMPACT MINIATURE CIRCUIT BREAKERS

Code	Rated current	Rated voltage	Auxiliaries compatibility	No. of modules EN 50022	Pack Carton
No. of poles: 1P+N					
GW 90 225	6 A	230 V	No	1	6/24
GW 90 226	10 A	230 V	No	1	6/24
GW 90 231	13 A	230 V	No	1	6/24
GW 90 227	16 A	230 V	No	1	6/24
GW 90 228	20 A	230 V	No	1	6/24
GW 90 229	25 A	230 V	No	1	6/24
GW 90 230	32 A	230 V	No	1	6/24
No. of poles: 2P					
GW 90 245	6 A	230 V	Yes	1	6/24
GW 90 246	10 A	230 V	Yes	1	6/24
GW 90 251	13 A	230 V	Yes	1	6/24
GW 90 247	16 A	230 V	Yes	1	6/24
GW 90 248	20 A	230 V	Yes	1	6/24
GW 90 249	25 A	230 V	Yes	1	6/24
GW 90 250	32 A	230 V	Yes	1	6/24
No. of poles: 3P					
GW 90 265	6 A	230 - 400 V	Yes	2	3/12
GW 90 266	10 A	230 - 400 V	Yes	2	3/12
GW 90 271	13 A	230 - 400 V	Yes	2	3/12
GW 90 267	16 A	230 - 400 V	Yes	2	3/12
GW 90 268	20 A	230 - 400 V	Yes	2	3/12
GW 90 269	25 A	230 - 400 V	Yes	2	3/12
GW 90 270	32 A	230 - 400 V	Yes	2	3/12
No. of poles: 4P					
GW 90 285	6 A	230 - 400 V	Yes	2	3/12
GW 90 286	10 A	230 - 400 V	Yes	2	3/12
GW 90 291	13 A	230 - 400 V	Yes	2	3/12
GW 90 287	16 A	230 - 400 V	Yes	2	3/12
GW 90 288	20 A	230 - 400 V	Yes	2	3/12
GW 90 289	25 A	230 - 400 V	Yes	2	3/12
GW 90 290	32 A	230 - 400 V	Yes	2	3/12

90 MCB

MTC 60 - B CURVE - 6000 A (EN 60898) - 10 KA (EN 60947-2)

BREAKING CAPACITY 1P+N			
230V	EN60898	EN60947-2	
	Icn	Icu	
In=6+32 A	6000 A	6 kA	

BREAKING CAPACITY 2P			
230V	EN60898	EN60947-2	
	Icn	Icu	
In=6+32 A	6000 A	10 kA	



GW 90 326

COMPACT MINIATURE CIRCUIT BREAKERS

Code	Rated current	Rated voltage	Auxiliaries compatibility	No. of modules EN 50022	Pack Carton
No. of poles: 1P+N					
GW 90 325	6 A	230 V	No	1	6/24
GW 90 326	10 A	230 V	No	1	6/24
GW 90 327	13 A	230 V	No	1	6/24
GW 90 328	16 A	230 V	No	1	6/24
GW 90 329	20 A	230 V	No	1	6/24
GW 90 330	25 A	230 V	No	1	6/24
GW 90 331	32 A	230 V	No	1	6/24
No. of poles: 2P					
GW 90 345	6 A	230 V	Yes	1	6/24
GW 90 346	10 A	230 V	Yes	1	6/24
GW 90 347	13 A	230 V	Yes	1	6/24
GW 90 348	16 A	230 V	Yes	1	6/24
GW 90 349	20 A	230 V	Yes	1	6/24
GW 90 350	25 A	230 V	Yes	1	6/24
GW 90 351	32 A	230 V	Yes	1	6/24

MTC 100 - C CURVE - 10000 A (EN 60898) - 15 KA (EN 60947-2)

BREAKING CAPACITY 2P			
230V	EN60898	EN60947-2	
	Icn	Icu	
In=6+32 A	10000 A	15 kA	



GW 90 446

COMPACT MINIATURE CIRCUIT BREAKERS

Code	Rated current	Rated voltage	Auxiliaries compatibility	No. of modules EN 50022	Pack Carton
No. of poles: 2P					
GW 90 445	6 A	230 V	Yes	1	6/24
GW 90 446	10 A	230 V	Yes	1	6/24
GW 90 451	13 A	230 V	Yes	1	6/24
GW 90 447	16 A	230 V	Yes	1	6/24
GW 90 448	20 A	230 V	Yes	1	6/24
GW 90 449	25 A	230 V	Yes	1	6/24
GW 90 450	32 A	230 V	Yes	1	6/24

MT - MINIATURE CIRCUIT BREAKERS

MT 45 - C CURVE - 4500 A (EN 60898) - 6 KA (EN 60947-2)

BREAKING CAPACITY 1P, 1P+N			
230V	EN60898	EN60947-2	
I _{ns} 6-81A	I _{cs}	I _{cs}	I _{cs}
4500 A	6 kA	6 kA	

BREAKING CAPACITY 2-3-4P			
230V	EN60898	EN60947-2	
400V	I _{cs}	I _{cs}	I _{cs}
I _{ns} 6-81A	4500 A	6 kA	6 kA



GW 92 149

MINIATURE CIRCUIT BREAKERS

Code	Rated current	Rated voltage	No. of modules EN 50022	Pack Carton
No. of poles: 1P				
GW 92 105	6 A	230 - 400 V	1	6/24
GW 92 106	10 A	230 - 400 V	1	6/24
GW 92 107	13 A	230 - 400 V	1	6/24
GW 92 108	16 A	230 - 400 V	1	6/24
GW 92 109	20 A	230 - 400 V	1	6/24
GW 92 110	25 A	230 - 400 V	1	6/24
GW 92 111	32 A	230 - 400 V	1	6/24
GW 92 112	40 A	230 - 400 V	1	6/24
No. of poles: 1P+N				
GW 92 125	6 A	230 V	2	3/12
GW 92 126	10 A	230 V	2	3/12
GW 92 127	13 A	230 V	2	3/12
GW 92 128	16 A	230 V	2	3/12
GW 92 129	20 A	230 V	2	3/12
GW 92 130	25 A	230 V	2	3/12
GW 92 131	32 A	230 V	2	3/12
GW 92 132	40 A	230 V	2	3/12
No. of poles: 2P				
GW 92 145	6 A	230 - 400 V	2	3/12
GW 92 146	10 A	230 - 400 V	2	3/12
GW 92 147	13 A	230 - 400 V	2	3/12
GW 92 148	16 A	230 - 400 V	2	3/12
GW 92 149	20 A	230 - 400 V	2	3/12
GW 92 150	25 A	230 - 400 V	2	3/12
GW 92 151	32 A	230 - 400 V	2	3/12
GW 92 152	40 A	230 - 400 V	2	3/12
No. of poles: 3P				
GW 92 165	6 A	230 - 400 V	3	2/8
GW 92 166	10 A	230 - 400 V	3	2/8
GW 92 167	13 A	230 - 400 V	3	2/8
GW 92 168	16 A	230 - 400 V	3	2/8
GW 92 169	20 A	230 - 400 V	3	2/8
GW 92 170	25 A	230 - 400 V	3	2/8
GW 92 171	32 A	230 - 400 V	3	2/8
GW 92 172	40 A	230 - 400 V	3	2/8
No. of poles: 4P				
GW 92 185	6 A	230 - 400 V	4	1/3
GW 92 186	10 A	230 - 400 V	4	1/3
GW 92 187	13 A	230 - 400 V	4	1/3
GW 92 188	16 A	230 - 400 V	4	1/3
GW 92 189	20 A	230 - 400 V	4	1/3
GW 92 190	25 A	230 - 400 V	4	1/3
GW 92 191	32 A	230 - 400 V	4	1/3
GW 92 192	40 A	230 - 400 V	4	1/3

90 MCB

MT 45 - B CURVE - 4500 A (EN 60898) - 6 KA (EN 60947-2)

BREAKING CAPACITY 1P, 1P+N			
230V	EN60898	EN60947-2	
10kA	10kA	10kA	
10kA-60A	4500 A	6 kA	

BREAKING CAPACITY 2-3-4P			
230V	EN60898	EN60947-2	
10kA	10kA	10kA	
10kA-60A	4500 A	6 kA	



GW 92 371

MINIATURE CIRCUIT BREAKERS

Code	Rated current	Rated voltage	No. of modules EN 50022	Pack Carton
No. of poles: 1P				
GW 92 305	6 A	230 - 400 V	1	6/24
GW 92 306	10 A	230 - 400 V	1	6/24
GW 92 307	13 A	230 - 400 V	1	6/24
GW 92 308	16 A	230 - 400 V	1	6/24
GW 92 309	20 A	230 - 400 V	1	6/24
GW 92 310	25 A	230 - 400 V	1	6/24
GW 92 311	32 A	230 - 400 V	1	6/24
GW 92 312	40 A	230 - 400 V	1	6/24
No. of poles: 1P+N				
GW 92 325	6 A	230 V	2	3/12
GW 92 326	10 A	230 V	2	3/12
GW 92 327	13 A	230 V	2	3/12
GW 92 328	16 A	230 V	2	3/12
GW 92 329	20 A	230 V	2	3/12
GW 92 330	25 A	230 V	2	3/12
GW 92 331	32 A	230 V	2	3/12
GW 92 332	40 A	230 V	2	3/12
No. of poles: 2P				
GW 92 345	6 A	230 - 400 V	2	3/12
GW 92 346	10 A	230 - 400 V	2	3/12
GW 92 347	13 A	230 - 400 V	2	3/12
GW 92 348	16 A	230 - 400 V	2	3/12
GW 92 349	20 A	230 - 400 V	2	3/12
GW 92 350	25 A	230 - 400 V	2	3/12
GW 92 351	32 A	230 - 400 V	2	3/12
GW 92 352	40 A	230 - 400 V	2	3/12
No. of poles: 3P				
GW 92 365	6 A	230 - 400 V	3	2/8
GW 92 366	10 A	230 - 400 V	3	2/8
GW 92 367	13 A	230 - 400 V	3	2/8
GW 92 368	16 A	230 - 400 V	3	2/8
GW 92 369	20 A	230 - 400 V	3	2/8
GW 92 370	25 A	230 - 400 V	3	2/8
GW 92 371	32 A	230 - 400 V	3	2/8
GW 92 372	40 A	230 - 400 V	3	2/8
No. of poles: 4P				
GW 92 385	6 A	230 - 400 V	4	1/3
GW 92 386	10 A	230 - 400 V	4	1/3
GW 92 387	13 A	230 - 400 V	4	1/3
GW 92 388	16 A	230 - 400 V	4	1/3
GW 92 389	20 A	230 - 400 V	4	1/3
GW 92 390	25 A	230 - 400 V	4	1/3
GW 92 391	32 A	230 - 400 V	4	1/3
GW 92 392	40 A	230 - 400 V	4	1/3

MT 60 - C CURVE - 6000 A (EN 60898) - 10 KA (EN 60947-2)

BREAKING CAPACITY 1P, 1P+N
230V EN60898 EN60947-2 Icu Ics
In=1-63 A 4000 A 10 kA

BREAKING CAPACITY 2-3-4P
230V EN60898 EN60947-2 Icu Ics
In=1-63 A 4000 A 20 kA

BREAKING CAPACITY 2-3-4P
400V EN60898 EN60947-2 Icu Ics
In=1-63 A 4000 A 10 kA



GW 92 048

MINIATURE CIRCUIT BREAKERS

Code	Rated current	Rated voltage	No. of modules EN 50022	Pack Carton
No. of poles: 1P				
GW 92 001	1 A	230 - 400 V	1	6/24
GW 92 002	2 A	230 - 400 V	1	6/24
GW 92 003	3 A	230 - 400 V	1	6/24
GW 92 004	4 A	230 - 400 V	1	6/24
GW 92 005	6 A	230 - 400 V	1	6/24
GW 92 006	10 A	230 - 400 V	1	6/24
GW 92 014	13 A	230 - 400 V	1	6/24
GW 92 007	16 A	230 - 400 V	1	6/24
GW 92 008	20 A	230 - 400 V	1	6/24
GW 92 009	25 A	230 - 400 V	1	6/24
GW 92 010	32 A	230 - 400 V	1	6/24
GW 92 011	40 A	230 - 400 V	1	6/24
GW 92 012	50 A	230 - 400 V	1	6/24
GW 92 013	63 A	230 - 400 V	1	6/24
No. of poles: 1P+N				
GW 92 021	1 A	230 V	2	3/12
GW 92 022	2 A	230 V	2	3/12
GW 92 023	3 A	230 V	2	3/12
GW 92 024	4 A	230 V	2	3/12
GW 92 025	6 A	230 V	2	3/12
GW 92 026	10 A	230 V	2	3/12
GW 92 034	13 A	230 V	2	3/12
GW 92 027	16 A	230 V	2	3/12
GW 92 028	20 A	230 V	2	3/12
GW 92 029	25 A	230 V	2	3/12
GW 92 030	32 A	230 V	2	3/12
GW 92 031	40 A	230 V	2	3/12
GW 92 032	50 A	230 V	2	3/12
GW 92 033	63 A	230 V	2	3/12
No. of poles: 2P				
GW 92 041	1 A	230 - 400 V	2	3/12
GW 92 042	2 A	230 - 400 V	2	3/12
GW 92 043	3 A	230 - 400 V	2	3/12
GW 92 044	4 A	230 - 400 V	2	3/12
GW 92 045	6 A	230 - 400 V	2	3/12
GW 92 046	10 A	230 - 400 V	2	3/12
GW 92 054	13 A	230 - 400 V	2	3/12
GW 92 047	16 A	230 - 400 V	2	3/12
GW 92 048	20 A	230 - 400 V	2	3/12
GW 92 049	25 A	230 - 400 V	2	3/12
GW 92 050	32 A	230 - 400 V	2	3/12
GW 92 051	40 A	230 - 400 V	2	3/12
GW 92 052	50 A	230 - 400 V	2	3/12
GW 92 053	63 A	230 - 400 V	2	3/12
No. of poles: 3P				
GW 92 061	1 A	230 - 400 V	3	2/8
GW 92 062	2 A	230 - 400 V	3	2/8
GW 92 063	3 A	230 - 400 V	3	2/8
GW 92 064	4 A	230 - 400 V	3	2/8
GW 92 065	6 A	230 - 400 V	3	2/8
GW 92 066	10 A	230 - 400 V	3	2/8
GW 92 074	13 A	230 - 400 V	3	2/8
GW 92 067	16 A	230 - 400 V	3	2/8
GW 92 068	20 A	230 - 400 V	3	2/8
GW 92 069	25 A	230 - 400 V	3	2/8
GW 92 070	32 A	230 - 400 V	3	2/8
GW 92 071	40 A	230 - 400 V	3	2/8
GW 92 072	50 A	230 - 400 V	3	2/8
GW 92 073	63 A	230 - 400 V	3	2/8
No. of poles: 4P				
GW 92 081	1 A	230 - 400 V	4	1/3
GW 92 082	2 A	230 - 400 V	4	1/3
GW 92 083	3 A	230 - 400 V	4	1/3
GW 92 084	4 A	230 - 400 V	4	1/3
GW 92 085	6 A	230 - 400 V	4	1/3
GW 92 086	10 A	230 - 400 V	4	1/3
GW 92 094	13 A	230 - 400 V	4	1/3
GW 92 087	16 A	230 - 400 V	4	1/3
GW 92 088	20 A	230 - 400 V	4	1/3
GW 92 089	25 A	230 - 400 V	4	1/3
GW 92 090	32 A	230 - 400 V	4	1/3
GW 92 091	40 A	230 - 400 V	4	1/3
GW 92 092	50 A	230 - 400 V	4	1/3
GW 92 093	63 A	230 - 400 V	4	1/3

MT 60 - B CURVE - 6000 A (EN 60898) - 10 KA (EN 60947-2)

BREAKING CAPACITY 1P			
230V	EN60898	EN60947-2	
	I _{cs}	I _{cu}	
I _{cs} 6 A	6000 A	10 kA	

BREAKING CAPACITY 2-3-4P			
230V	EN60898	EN60947-2	
	I _{cs}	I _{cu}	
I _{cs} 6 A	6000 A	20 kA	

BREAKING CAPACITY 2-3-4P			
400V	EN60898	EN60947-2	
	I _{cs}	I _{cu}	
I _{cs} 6 A	6000 A	10 kA	



GW 92 292

MINIATURE CIRCUIT BREAKERS

Code	Rated current	Rated voltage	No. of modules EN 50022	Pack Carton
No. of poles: 1P				
GW 92 205	6 A	230 - 400 V	1	6/24
GW 92 206	10 A	230 - 400 V	1	6/24
GW 92 214	13 A	230 - 400 V	1	6/24
GW 92 207	16 A	230 - 400 V	1	6/24
GW 92 208	20 A	230 - 400 V	1	6/24
GW 92 209	25 A	230 - 400 V	1	6/24
GW 92 210	32 A	230 - 400 V	1	6/24
GW 92 211	40 A	230 - 400 V	1	6/24
GW 92 212	50 A	230 - 400 V	1	6/24
GW 92 213	63 A	230 - 400 V	1	6/24
No. of poles: 2P				
GW 92 245	6 A	230 - 400 V	2	3/12
GW 92 246	10 A	230 - 400 V	2	3/12
GW 92 254	13 A	230 - 400 V	2	3/12
GW 92 247	16 A	230 - 400 V	2	3/12
GW 92 248	20 A	230 - 400 V	2	3/12
GW 92 249	25 A	230 - 400 V	2	3/12
GW 92 250	32 A	230 - 400 V	2	3/12
GW 92 251	40 A	230 - 400 V	2	3/12
GW 92 252	50 A	230 - 400 V	2	3/12
GW 92 253	63 A	230 - 400 V	2	3/12
No. of poles: 3P				
GW 92 265	6 A	230 - 400 V	3	2/8
GW 92 266	10 A	230 - 400 V	3	2/8
GW 92 274	13 A	230 - 400 V	3	2/8
GW 92 267	16 A	230 - 400 V	3	2/8
GW 92 268	20 A	230 - 400 V	3	2/8
GW 92 269	25 A	230 - 400 V	3	2/8
GW 92 270	32 A	230 - 400 V	3	2/8
GW 92 271	40 A	230 - 400 V	3	2/8
GW 92 272	50 A	230 - 400 V	3	2/8
GW 92 273	63 A	230 - 400 V	3	2/8
No. of poles: 4P				
GW 92 285	6 A	230 - 400 V	4	1/3
GW 92 286	10 A	230 - 400 V	4	1/3
GW 92 294	13 A	230 - 400 V	4	1/3
GW 92 287	16 A	230 - 400 V	4	1/3
GW 92 288	20 A	230 - 400 V	4	1/3
GW 92 289	25 A	230 - 400 V	4	1/3
GW 92 290	32 A	230 - 400 V	4	1/3
GW 92 291	40 A	230 - 400 V	4	1/3
GW 92 292	50 A	230 - 400 V	4	1/3
GW 92 293	63 A	230 - 400 V	4	1/3

MT 60 - D CURVE - 6000 A (EN 60898) - 10 KA (EN 60947-2)

BREAKING CAPACITY 1P		
230V	EN60898 EN60947-2	I _{cn} I _{cu}
In(I)-40 A	4000 A	10 kA

BREAKING CAPACITY 2-3-4P		
230V	EN60898 EN60947-2	I _{cn} I _{cu}
In(I)-40 A	4000 A	20 kA

BREAKING CAPACITY 2-3-4P		
400V	EN60898 EN60947-2	I _{cn} I _{cu}
In(I)-40 A	4000 A	10 kA



GW 92 470

MINIATURE CIRCUIT BREAKERS

Code	Rated current	Rated voltage	No. of modules EN 50022	Pack Carton
No. of poles: 1P				
GW 92 405	6 A	230 - 400 V	1	6/24
GW 92 406	10 A	230 - 400 V	1	6/24
GW 92 414	13 A	230 - 400 V	1	6/24
GW 92 407	16 A	230 - 400 V	1	6/24
GW 92 408	20 A	230 - 400 V	1	6/24
GW 92 409	25 A	230 - 400 V	1	6/24
GW 92 410	32 A	230 - 400 V	1	6/24
GW 92 411	40 A	230 - 400 V	1	6/24
No. of poles: 2P				
GW 92 445	6 A	230 - 400 V	2	3/12
GW 92 446	10 A	230 - 400 V	2	3/12
GW 92 454	13 A	230 - 400 V	2	3/12
GW 92 447	16 A	230 - 400 V	2	3/12
GW 92 448	20 A	230 - 400 V	2	3/12
GW 92 449	25 A	230 - 400 V	2	3/12
GW 92 450	32 A	230 - 400 V	2	3/12
GW 92 451	40 A	230 - 400 V	2	3/12
No. of poles: 3P				
GW 92 465	6 A	230 - 400 V	3	2/8
GW 92 466	10 A	230 - 400 V	3	2/8
GW 92 474	13 A	230 - 400 V	3	2/8
GW 92 467	16 A	230 - 400 V	3	2/8
GW 92 468	20 A	230 - 400 V	3	2/8
GW 92 469	25 A	230 - 400 V	3	2/8
GW 92 470	32 A	230 - 400 V	3	2/8
GW 92 471	40 A	230 - 400 V	3	2/8
No. of poles: 4P				
GW 92 485	6 A	230 - 400 V	4	1/3
GW 92 486	10 A	230 - 400 V	4	1/3
GW 92 494	13 A	230 - 400 V	4	1/3
GW 92 487	16 A	230 - 400 V	4	1/3
GW 92 488	20 A	230 - 400 V	4	1/3
GW 92 489	25 A	230 - 400 V	4	1/3
GW 92 490	32 A	230 - 400 V	4	1/3
GW 92 491	40 A	230 - 400 V	4	1/3

MT 100 - C CURVE - 10000 A (EN 60898) - UP TO 15 KA (EN 60947-2)

BREAKING CAPACITY 1P			
230V	EN60898	EN60947-2	
	I _{cn}	I _{cu}	
I _{cn} =25 A	10000 A	15 kA	
I _{cn} =32-63 A	10000 A	12.5 kA	

BREAKING CAPACITY 2P			
230V	EN60898	EN60947-2	
	I _{cn}	I _{cu}	
I _{cn} =25 A	10000 A	30 kA	
I _{cn} =32-63 A	10000 A	25 kA	

BREAKING CAPACITY 2P			
400V	EN60898	EN60947-2	
	I _{cn}	I _{cu}	
I _{cn} =25 A	10000 A	20 kA	
I _{cn} =32-63 A	10000 A	15 kA	

BREAKING CAPACITY 3-4P			
230V	EN60898	EN60947-2	
	I _{cn}	I _{cu}	
I _{cn} =25 A	10000 A	25 kA	
I _{cn} =32-63 A	10000 A	20 kA	

BREAKING CAPACITY 3-4P			
400V	EN60898	EN60947-2	
	I _{cn}	I _{cu}	
I _{cn} =25 A	10000 A	15 kA	
I _{cn} =32-63 A	10000 A	12.5 kA	



GW 92 692

MINIATURE CIRCUIT BREAKERS

Code	Rated current	Rated voltage	No. of modules EN 50022	Pack Carton
No. of poles: 1P				
GW 92 605	6 A	230 - 400 V	1	6/24
GW 92 606	10 A	230 - 400 V	1	6/24
GW 92 614	13 A	230 - 400 V	1	6/24
GW 92 607	16 A	230 - 400 V	1	6/24
GW 92 608	20 A	230 - 400 V	1	6/24
GW 92 609	25 A	230 - 400 V	1	6/24
GW 92 610	32 A	230 - 400 V	1	6/24
GW 92 611	40 A	230 - 400 V	1	6/24
GW 92 612	50 A	230 - 400 V	1	6/24
GW 92 613	63 A	230 - 400 V	1	6/24
No. of poles: 2P				
GW 92 645	6 A	230 - 400 V	2	3/12
GW 92 646	10 A	230 - 400 V	2	3/12
GW 92 654	13 A	230 - 400 V	2	3/12
GW 92 647	16 A	230 - 400 V	2	3/12
GW 92 648	20 A	230 - 400 V	2	3/12
GW 92 649	25 A	230 - 400 V	2	3/12
GW 92 650	32 A	230 - 400 V	2	3/12
GW 92 651	40 A	230 - 400 V	2	3/12
GW 92 652	50 A	230 - 400 V	2	3/12
GW 92 653	63 A	230 - 400 V	2	3/12
No. of poles: 3P				
GW 92 665	6 A	230 - 400 V	3	2/8
GW 92 666	10 A	230 - 400 V	3	2/8
GW 92 674	13 A	230 - 400 V	3	2/8
GW 92 667	16 A	230 - 400 V	3	2/8
GW 92 668	20 A	230 - 400 V	3	2/8
GW 92 669	25 A	230 - 400 V	3	2/8
GW 92 670	32 A	230 - 400 V	3	2/8
GW 92 671	40 A	230 - 400 V	3	2/8
GW 92 672	50 A	230 - 400 V	3	2/8
GW 92 673	63 A	230 - 400 V	3	2/8
No. of poles: 4P				
GW 92 685	6 A	230 - 400 V	4	1/3
GW 92 686	10 A	230 - 400 V	4	1/3
GW 92 694	13 A	230 - 400 V	4	1/3
GW 92 687	16 A	230 - 400 V	4	1/3
GW 92 688	20 A	230 - 400 V	4	1/3
GW 92 689	25 A	230 - 400 V	4	1/3
GW 92 690	32 A	230 - 400 V	4	1/3
GW 92 691	40 A	230 - 400 V	4	1/3
GW 92 692	50 A	230 - 400 V	4	1/3
GW 92 693	63 A	230 - 400 V	4	1/3

MT 100 - B CURVE - 10000 A (EN 60898) - UP TO 15 KA (EN 60947-2)

BREAKING CAPACITY 1P			
230V	EN60898	EN60947-2	
I _{cn}	I _{cu}	I _{cu}	
I _{cn} =6-25 A	10000 A	15 kA	
I _{cn} =32-63 A	10000 A	12.5 kA	

BREAKING CAPACITY 2P			
230V	EN60898	EN60947-2	
I _{cn}	I _{cu}	I _{cu}	
I _{cn} =6-25 A	10000 A	20 kA	
I _{cn} =32-63 A	10000 A	25 kA	

BREAKING CAPACITY 2P			
400V	EN60898	EN60947-2	
I _{cn}	I _{cu}	I _{cu}	
I _{cn} =6-25 A	10000 A	20 kA	
I _{cn} =32-63 A	10000 A	15 kA	

BREAKING CAPACITY 3-4P			
230V	EN60898	EN60947-2	
I _{cn}	I _{cu}	I _{cu}	
I _{cn} =6-25 A	10000 A	25 kA	
I _{cn} =32-63 A	10000 A	20 kA	

BREAKING CAPACITY 3-4P			
400V	EN60898	EN60947-2	
I _{cn}	I _{cu}	I _{cu}	
I _{cn} =6-25 A	10000 A	15 kA	
I _{cn} =32-63 A	10000 A	12.5 kA	



GW 92 549

MINIATURE CIRCUIT BREAKERS

Code	Rated current	Rated voltage	No. of modules EN 50022	Pack Carton
No. of poles: 1P				
GW 92 505	6 A	230 - 400 V	1	6/24
GW 92 506	10 A	230 - 400 V	1	6/24
GW 92 507	13 A	230 - 400 V	1	6/24
GW 92 508	16 A	230 - 400 V	1	6/24
GW 92 509	20 A	230 - 400 V	1	6/24
GW 92 510	25 A	230 - 400 V	1	6/24
GW 92 511	32 A	230 - 400 V	1	6/24
GW 92 512	40 A	230 - 400 V	1	6/24
GW 92 513	50 A	230 - 400 V	1	6/24
GW 92 514	63 A	230 - 400 V	1	6/24
No. of poles: 2P				
GW 92 545	6 A	230 - 400 V	2	3/12
GW 92 546	10 A	230 - 400 V	2	3/12
GW 92 547	13 A	230 - 400 V	2	3/12
GW 92 548	16 A	230 - 400 V	2	3/12
GW 92 549	20 A	230 - 400 V	2	3/12
GW 92 550	25 A	230 - 400 V	2	3/12
GW 92 551	32 A	230 - 400 V	2	3/12
GW 92 552	40 A	230 - 400 V	2	3/12
GW 92 553	50 A	230 - 400 V	2	3/12
GW 92 554	63 A	230 - 400 V	2	3/12
No. of poles: 3P				
GW 92 565	6 A	230 - 400 V	3	2/8
GW 92 566	10 A	230 - 400 V	3	2/8
GW 92 567	13 A	230 - 400 V	3	2/8
GW 92 568	16 A	230 - 400 V	3	2/8
GW 92 569	20 A	230 - 400 V	3	2/8
GW 92 570	25 A	230 - 400 V	3	2/8
GW 92 571	32 A	230 - 400 V	3	2/8
GW 92 572	40 A	230 - 400 V	3	2/8
GW 92 573	50 A	230 - 400 V	3	2/8
GW 92 574	63 A	230 - 400 V	3	2/8
No. of poles: 4P				
GW 92 585	6 A	230 - 400 V	4	1/3
GW 92 586	10 A	230 - 400 V	4	1/3
GW 92 587	13 A	230 - 400 V	4	1/3
GW 92 588	16 A	230 - 400 V	4	1/3
GW 92 589	20 A	230 - 400 V	4	1/3
GW 92 590	25 A	230 - 400 V	4	1/3
GW 92 591	32 A	230 - 400 V	4	1/3
GW 92 592	40 A	230 - 400 V	4	1/3
GW 92 593	50 A	230 - 400 V	4	1/3
GW 92 594	63 A	230 - 400 V	4	1/3

90 MCB

MT 100 - D CURVE - 10000 A (EN 60898) - UP TO 15 KA (EN 60947-2)

BREAKING CAPACITY 1P			
230V	EN60898	EN60947-2	
	Icn	Icu	
I _{ne} 1-25 A	10000 A	15 kA	
I _{ne} 32-40 A	10000 A	12.5 kA	

BREAKING CAPACITY 2P			
230V	EN60898	EN60947-2	
	Icn	Icu	
I _{ne} 1-25 A	10000 A	30 kA	
I _{ne} 32-40 A	10000 A	25 kA	

BREAKING CAPACITY 2P			
400V	EN60898	EN60947-2	
	Icn	Icu	
I _{ne} 1-25 A	10000 A	20 kA	
I _{ne} 32-40 A	10000 A	15 kA	

BREAKING CAPACITY 3-4P			
230V	EN60898	EN60947-2	
	Icn	Icu	
I _{ne} 1-25 A	10000 A	25 kA	
I _{ne} 32-40 A	10000 A	20 kA	

BREAKING CAPACITY 3-4P			
400V	EN60898	EN60947-2	
	Icn	Icu	
I _{ne} 1-25 A	10000 A	15 kA	
I _{ne} 32-40 A	10000 A	12.5 kA	



GW 92 770

MINIATURE CIRCUIT BREAKERS

Code	Rated current	Rated voltage	No. of modules EN 50022	Pack Carton
No. of poles: 1P				
GW 92 701	1 A	230 - 400 V	1	6/24
GW 92 702	2 A	230 - 400 V	1	6/24
GW 92 703	3 A	230 - 400 V	1	6/24
GW 92 704	4 A	230 - 400 V	1	6/24
GW 92 705	6 A	230 - 400 V	1	6/24
GW 92 706	10 A	230 - 400 V	1	6/24
GW 92 714	13 A	230 - 400 V	1	6/24
GW 92 707	16 A	230 - 400 V	1	6/24
GW 92 708	20 A	230 - 400 V	1	6/24
GW 92 709	25 A	230 - 400 V	1	6/24
GW 92 710	32 A	230 - 400 V	1	6/24
GW 92 711	40 A	230 - 400 V	1	6/24
No. of poles: 2P				
GW 92 741	1 A	230 - 400 V	2	3/12
GW 92 742	2 A	230 - 400 V	2	3/12
GW 92 743	3 A	230 - 400 V	2	3/12
GW 92 744	4 A	230 - 400 V	2	3/12
GW 92 745	6 A	230 - 400 V	2	3/12
GW 92 746	10 A	230 - 400 V	2	3/12
GW 92 754	13 A	230 - 400 V	2	3/12
GW 92 747	16 A	230 - 400 V	2	3/12
GW 92 748	20 A	230 - 400 V	2	3/12
GW 92 749	25 A	230 - 400 V	2	3/12
GW 92 750	32 A	230 - 400 V	2	3/12
GW 92 751	40 A	230 - 400 V	2	3/12
No. of poles: 3P				
GW 92 761	1 A	230 - 400 V	3	2/8
GW 92 762	2 A	230 - 400 V	3	2/8
GW 92 763	3 A	230 - 400 V	3	2/8
GW 92 764	4 A	230 - 400 V	3	2/8
GW 92 765	6 A	230 - 400 V	3	2/8
GW 92 766	10 A	230 - 400 V	3	2/8
GW 92 774	13 A	230 - 400 V	3	2/8
GW 92 767	16 A	230 - 400 V	3	2/8
GW 92 768	20 A	230 - 400 V	3	2/8
GW 92 769	25 A	230 - 400 V	3	2/8
GW 92 770	32 A	230 - 400 V	3	2/8
GW 92 771	40 A	230 - 400 V	3	2/8
No. of poles: 4P				
GW 92 781	1 A	230 - 400 V	4	1/3
GW 92 782	2 A	230 - 400 V	4	1/3
GW 92 783	3 A	230 - 400 V	4	1/3
GW 92 784	4 A	230 - 400 V	4	1/3
GW 92 785	6 A	230 - 400 V	4	1/3
GW 92 786	10 A	230 - 400 V	4	1/3
GW 92 794	13 A	230 - 400 V	4	1/3
GW 92 787	16 A	230 - 400 V	4	1/3
GW 92 788	20 A	230 - 400 V	4	1/3
GW 92 789	25 A	230 - 400 V	4	1/3
GW 92 790	32 A	230 - 400 V	4	1/3
GW 92 791	40 A	230 - 400 V	4	1/3

MT 250 - C CURVE - 25000 A (EN 60898) - UP TO 25 KA (EN 60947-2)

BREAKING CAPACITY 1P			
230V	EN60898	EN60947-2	
I _{cn}	I _{cn}	I _{cn}	I _{cn}
I _{cn} =6-20 A	25000 A	25 kA	
I _{cn} =25 A	20000 A	20 kA	
I _{cn} =32-40 A	15000 A	15 kA	
I _{cn} =50-63 A	12500 A	15 kA	

BREAKING CAPACITY 2P			
230V	EN60898	EN60947-2	
I _{cn}	I _{cn}	I _{cn}	I _{cn}
I _{cn} =6-20 A	25000 A	50 kA	
I _{cn} =25 A	25000 A	40 kA	
I _{cn} =32-40 A	25000 A	30 kA	
I _{cn} =50-63 A	25000 A	25 kA	

SCHALTVERMÖGEN 2P			
400V	EN60898	EN60947-2	
I _{cn}	I _{cn}	I _{cn}	I _{cn}
I _{cn} =6-20 A	25000 A	30 kA	
I _{cn} =25 A	25000 A	25 kA	
I _{cn} =32-40 A	20000 A	20 kA	
I _{cn} =50-63 A	15000 A	15 kA	

BREAKING CAPACITY 3-4P			
230V	EN60898	EN60947-2	
I _{cn}	I _{cn}	I _{cn}	I _{cn}
I _{cn} =6-20 A	25000 A	40 kA	
I _{cn} =25 A	25000 A	30 kA	
I _{cn} =32-40 A	25000 A	25 kA	
I _{cn} =50-63 A	20000 A	20 kA	

BREAKING CAPACITY 3-4P			
400V	EN60898	EN60947-2	
I _{cn}	I _{cn}	I _{cn}	I _{cn}
I _{cn} =6-20 A	25000 A	25 kA	
I _{cn} =25 A	20000 A	20 kA	
I _{cn} =32-40 A	15000 A	15 kA	
I _{cn} =50-63 A	12500 A	15 kA	



GW 92 890

MINIATURE CIRCUIT BREAKERS

Code	Rated current	Rated voltage	No. of modules EN 50022	Pack Carton
No. of poles: 1P				
GW 92 805	6 A	230 - 400 V	1	6/24
GW 92 806	10 A	230 - 400 V	1	6/24
GW 92 807	16 A	230 - 400 V	1	6/24
GW 92 808	20 A	230 - 400 V	1	6/24
GW 92 809	25 A	230 - 400 V	1	6/24
GW 92 810	32 A	230 - 400 V	1	6/24
GW 92 811	40 A	230 - 400 V	1	6/24
GW 92 812	50 A	230 - 400 V	1	6/24
GW 92 813	63 A	230 - 400 V	1	6/24
No. of poles: 2P				
GW 92 845	6 A	230 - 400 V	2	3/12
GW 92 846	10 A	230 - 400 V	2	3/12
GW 92 847	16 A	230 - 400 V	2	3/12
GW 92 848	20 A	230 - 400 V	2	3/12
GW 92 849	25 A	230 - 400 V	2	3/12
GW 92 850	32 A	230 - 400 V	2	3/12
GW 92 851	40 A	230 - 400 V	2	3/12
GW 92 852	50 A	230 - 400 V	2	3/12
GW 92 853	63 A	230 - 400 V	2	3/12
No. of poles: 3P				
GW 92 865	6 A	230 - 400 V	3	2/8
GW 92 866	10 A	230 - 400 V	3	2/8
GW 92 867	16 A	230 - 400 V	3	2/8
GW 92 868	20 A	230 - 400 V	3	2/8
GW 92 869	25 A	230 - 400 V	3	2/8
GW 92 870	32 A	230 - 400 V	3	2/8
GW 92 871	40 A	230 - 400 V	3	2/8
GW 92 872	50 A	230 - 400 V	3	2/8
GW 92 873	63 A	230 - 400 V	3	2/8
No. of poles: 4P				
GW 92 885	6 A	230 - 400 V	4	1/3
GW 92 886	10 A	230 - 400 V	4	1/3
GW 92 887	16 A	230 - 400 V	4	1/3
GW 92 888	20 A	230 - 400 V	4	1/3
GW 92 889	25 A	230 - 400 V	4	1/3
GW 92 890	32 A	230 - 400 V	4	1/3
GW 92 891	40 A	230 - 400 V	4	1/3
GW 92 892	50 A	230 - 400 V	4	1/3
GW 92 893	63 A	230 - 400 V	4	1/3

MTHP - HIGH PERFORMANCE MINIATURE CIRCUIT BREAKERS

MTHP 160 - C CURVE - 10000 A (EN 60898) - 16 KA (EN 60947-2)

BREAKING CAPACITY 1P		
230V	EN60898	EN60947-2
Icn	Icn	Icn
In=80-125A	10000A	16 kA

BREAKING CAPACITY 1P		
400V	EN60898	EN60947-2
Icn	Icn	Icn
In=80-125A		4,5 kA

BREAKING CAPACITY 2-3-4P		
230V	EN60898	EN60947-2
Icn	Icn	Icn
In=80-125A	10000A	20 kA

BREAKING CAPACITY 2-3-4P		
400V	EN60898	EN60947-2
Icn	Icn	Icn
In=80-125A	10000A	16 kA



GW 93 349

HIGH PERFORMANCE MINIATURE CIRCUIT BREAKERS

Code	Rated current	Rated voltage	No. of modules EN 50022	Pack Carton
No. of poles: 1P				
GW 93 307	80 A	230 - 400 V	1,5	1/12
GW 93 308	100 A	230 - 400 V	1,5	1/12
GW 93 309	125 A	230 - 400 V	1,5	1/12
No. of poles: 2P				
GW 93 327	80 A	230 - 400 V	3	1/4
GW 93 328	100 A	230 - 400 V	3	1/4
GW 93 329	125 A	230 - 400 V	3	1/4
No. of poles: 3P				
GW 93 337	80 A	230 - 400 V	4,5	1/4
GW 93 338	100 A	230 - 400 V	4,5	1/4
GW 93 339	125 A	230 - 400 V	4,5	1/4
No. of poles: 4P				
GW 93 347	80 A	230 - 400 V	6	1/4
GW 93 348	100 A	230 - 400 V	6	1/4
GW 93 349	125 A	230 - 400 V	6	1/4

ACCESSORIES SUPPLIED: kit for cable terminals wiring and poles separators.

MTHP 160 - D CURVE - 10000 A (EN 60898) - 16 KA (EN 60947-2)

BREAKING CAPACITY 1P	BREAKING CAPACITY 1P	SCHALTVERMÖGEN 2-3-4P	BREAKING CAPACITY 2-3-4P
230V EN60898 EN60947-2 Icu Icm	400V EN60898 EN60947-2 Icu Icm	230V EN60898 EN60947-2 Icu Icm	400V EN60898 EN60947-2 Icu Icm
In=50-100 A 10000 A 16 kA	In=50-100 A 4.5 kA	In=50-100 A 10000 A 20 kA	In=50-100 A 10000 A 16 kA



GW 93 388

HIGH PERFORMANCE MINIATURE CIRCUIT BREAKERS

Code	Rated current	Rated voltage	No. of modules EN 50022	Pack Carton
No. of poles: 1P				
GW 93 355	50 A	230 - 400 V	1.5	1/12
GW 93 356	63 A	230 - 400 V	1.5	1/12
GW 93 357	80 A	230 - 400 V	1.5	1/12
GW 93 358	100 A	230 - 400 V	1.5	1/12
No. of poles: 2P				
GW 93 375	50 A	230 - 400 V	3	1/4
GW 93 376	63 A	230 - 400 V	3	1/4
GW 93 377	80 A	230 - 400 V	3	1/4
GW 93 378	100 A	230 - 400 V	3	1/4
No. of poles: 3P				
GW 93 385	50 A	230 - 400 V	4.5	1/4
GW 93 386	63 A	230 - 400 V	4.5	1/4
GW 93 387	80 A	230 - 400 V	4.5	1/4
GW 93 388	100 A	230 - 400 V	4.5	1/4
No. of poles: 4P				
GW 93 395	50 A	230 - 400 V	6	1/4
GW 93 396	63 A	230 - 400 V	6	1/4
GW 93 397	80 A	230 - 400 V	6	1/4
GW 93 398	100 A	230 - 400 V	6	1/4

ACCESSORIES SUPPLIED: kit for cable terminals wiring and poles separators.

MTHP 250 - C CURVE - 25000 A (EN 60898) - 25 KA (EN 60947-2)

BREAKING CAPACITY 1P			
230V	EN60898	EN60947-2	
In=20-63A	25000 A	25 kA	

BREAKING CAPACITY 1P			
400V	EN60898	EN60947-2	
In=20-63A	6 kA		

BREAKING CAPACITY 2P			
230V	EN60898	EN60947-2	
In=20-63A	25000 A	25 kA	

BREAKING CAPACITY 3-4P			
230V	EN60898	EN60947-2	
In=20-63A	25000 A	25 kA	

BREAKING CAPACITY 2-3-4P			
400V	EN60898	EN60947-2	
In=20-63A	25000 A	25 kA	



GW 93 222

HIGH PERFORMANCE MINIATURE CIRCUIT BREAKERS

Code	Rated current	Rated voltage	No. of modules EN 50022	Pack Carton
No. of poles: 1P				
GW 93 201	20 A	230 - 400 V	1.5	1/12
GW 93 202	25 A	230 - 400 V	1.5	1/12
GW 93 203	32 A	230 - 400 V	1.5	1/12
GW 93 204	40 A	230 - 400 V	1.5	1/12
GW 93 205	50 A	230 - 400 V	1.5	1/12
GW 93 206	63 A	230 - 400 V	1.5	1/12
No. of poles: 2P				
GW 93 221	20 A	230 - 400 V	3	1/4
GW 93 222	25 A	230 - 400 V	3	1/4
GW 93 223	32 A	230 - 400 V	3	1/4
GW 93 224	40 A	230 - 400 V	3	1/4
GW 93 225	50 A	230 - 400 V	3	1/4
GW 93 226	63 A	230 - 400 V	3	1/4
No. of poles: 3P				
GW 93 231	20 A	230 - 400 V	4.5	1/4
GW 93 232	25 A	230 - 400 V	4.5	1/4
GW 93 233	32 A	230 - 400 V	4.5	1/4
GW 93 234	40 A	230 - 400 V	4.5	1/4
GW 93 235	50 A	230 - 400 V	4.5	1/4
GW 93 236	63 A	230 - 400 V	4.5	1/4
No. of poles: 4P				
GW 93 241	20 A	230 - 400 V	6	1/4
GW 93 242	25 A	230 - 400 V	6	1/4
GW 93 243	32 A	230 - 400 V	6	1/4
GW 93 244	40 A	230 - 400 V	6	1/4
GW 93 245	50 A	230 - 400 V	6	1/4
GW 93 246	63 A	230 - 400 V	6	1/4

ACCESSORIES SUPPLIED: kit for cable terminals wiring and poles separators.



90 MCB

CIRCUIT BREAKERS
FOR CIRCUIT PROTECTION



Scan the QR Code and find out all the technical informations.

REDUCED FOOTPRINT

MAXIMUM SECURITY

SIMPLIFIED ACCESSORY MANAGEMENT

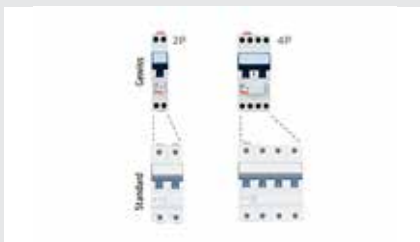

The compact MCCB protect 2 poles per module, reducing space by up to 50%. This also allows installation of smaller enclosures, for savings on costs.



To ensure the most secure fastening and protection from possible contact with live parts, the terminals are equipped with a protective, sliding insulating insert. In addition, the double DIN hook provides a more stable fastening and facilitates maintenance operations.



The 90 MCB range of circuit breakers integrate seamlessly with the 90 range of electrical auxiliaries, providing simplified and streamlined accessory management.



CIRCUIT BREAKERS FOR RESIDUAL CURRENT PROTECTION

90 RCD









MODULAR CIRCUIT BREAKERS FOR
RESIDUAL CURRENT PROTECTION





pag. 438











Selection tables

				COMPACT RESIDUAL CURRENT CIRCUIT BREAKERS WITH OVERCURRENT PROTECTION								
				IΔn = 30mA				IΔn = 300mA				
												
Icn [A] (EN 61009-1)	Curve	Type	In [A]	2 mod.	2 mod.	3 mod.	4 mod.	2 mod.	2 mod.	3 mod.	4 mod.	
MDC 45												
4500	C	AC	6	GW 94 005	GW 94 025	GW 94 045	GW 94 065	GW 94 015	GW 94 035	GW 94 055	GW 94 075	
			10	GW 94 006	GW 94 026	GW 94 046	GW 94 066	GW 94 016	GW 94 036	GW 94 056	GW 94 076	
			13	GW 94 011	GW 94 031	GW 94 051	GW 94 071	-	-	-	-	
			16	GW 94 007	GW 94 027	GW 94 047	GW 94 067	GW 94 017	GW 94 037	GW 94 057	GW 94 077	
			20	GW 94 008	GW 94 028	GW 94 048	GW 94 068	GW 94 018	GW 94 038	GW 94 058	GW 94 078	
			25	GW 94 009	GW 94 029	GW 94 049	GW 94 069	GW 94 019	GW 94 039	GW 94 059	GW 94 079	
		A	6	GW 94 205	GW 94 225	GW 94 245	GW 94 265	GW 94 215	GW 94 235	GW 94 255	GW 94 275	
			10	GW 94 206	GW 94 226	GW 94 246	GW 94 266	GW 94 216	GW 94 236	GW 94 256	GW 94 276	
			13	GW 94 211	GW 94 231	GW 94 251	GW 94 271	-	-	-	-	
			16	GW 94 207	GW 94 227	GW 94 247	GW 94 267	GW 94 217	GW 94 237	GW 94 257	GW 94 277	
			20	GW 94 208	GW 94 228	GW 94 248	GW 94 268	GW 94 218	GW 94 238	GW 94 258	GW 94 278	
			25	GW 94 209	GW 94 229	GW 94 249	GW 94 269	GW 94 219	GW 94 239	GW 94 259	GW 94 279	
			32	GW 94 210	GW 94 230	GW 94 250	GW 94 270	GW 94 220	GW 94 240	GW 94 260	GW 94 280	
			MDC 60									
6000	C	AC	6	GW 94 105	GW 94 125	GW 94 145	GW 94 165	GW 94 115	GW 94 135	GW 94 155	GW 94 175	
			10	GW 94 106	GW 94 126	GW 94 146	GW 94 166	GW 94 116	GW 94 136	GW 94 156	GW 94 176	
			13	GW 94 111	GW 94 131	GW 94 151	GW 94 171	-	-	-	-	
			16	GW 94 107	GW 94 127	GW 94 147	GW 94 167	GW 94 117	GW 94 137	GW 94 157	GW 94 177	
			20	GW 94 108	GW 94 128	GW 94 148	GW 94 168	GW 94 118	GW 94 138	GW 94 158	GW 94 178	
			25	GW 94 109	GW 94 129	GW 94 149	GW 94 169	GW 94 119	GW 94 139	GW 94 159	GW 94 179	
			32	GW 94 110	GW 94 130	GW 94 150	GW 94 170	GW 94 120	GW 94 140	GW 94 160	GW 94 180	
			A	6	GW 94 305	GW 94 325	GW 94 345	GW 94 365	GW 94 315	GW 94 335	GW 94 355	GW 94 375
				10	GW 94 306	GW 94 326	GW 94 346	GW 94 366	GW 94 316	GW 94 336	GW 94 356	GW 94 376
				13	GW 94 311	GW 94 331	GW 94 351	GW 94 371	-	-	-	-
				16	GW 94 307	GW 94 327	GW 94 347	GW 94 367	GW 94 317	GW 94 337	GW 94 357	GW 94 377
				20	GW 94 308	GW 94 328	GW 94 348	GW 94 368	GW 94 318	GW 94 338	GW 94 358	GW 94 378
		25		GW 94 309	GW 94 329	GW 94 349	GW 94 369	GW 94 319	GW 94 339	GW 94 359	GW 94 379	
		A(IR)	6	-	GW 95 805	-	GW 95 815	-	-	-	-	
			10	-	GW 95 806	-	GW 95 816	-	-	-	-	
			13	-	GW 95 811	-	GW 95 821	-	-	-	-	
			16	-	GW 95 807	-	GW 95 817	-	-	-	-	
			20	-	GW 95 808	-	GW 95 818	-	-	-	-	
			25	-	GW 95 809	-	GW 95 819	-	-	-	-	
		A(S)	6	-	-	-	-	-	GW 95 847	-	GW 95 857	
			10	-	-	-	-	-	GW 95 848	-	GW 95 858	
			13	-	-	-	-	-	-	-	-	
			25	-	-	-	-	-	GW 95 849	-	GW 95 859	
		F	6	-	GW 95 935	-	-	-	-	-	-	
			10	-	GW 95 936	-	-	-	-	-	-	
			13	-	GW 95 941	-	-	-	-	-	-	
			16	-	GW 95 937	-	-	-	-	-	-	
			20	-	GW 95 938	-	-	-	-	-	-	
			25	-	GW 95 939	-	-	-	-	-	-	
		B	A	6	GW 95 105	GW 95 125	GW 95 145	GW 95 165	GW 95 115	GW 95 135	GW 95 155	GW 95 175
10	GW 95 106			GW 95 126	GW 95 146	GW 95 166	GW 95 116	GW 95 136	GW 95 156	GW 95 176		
13	GW 95 111			GW 95 131	GW 95 151	GW 95 171	-	-	-	-		
16	GW 95 107			GW 95 127	GW 95 147	GW 95 167	GW 95 117	GW 95 137	GW 95 157	GW 95 177		
20	GW 95 108			GW 95 128	GW 95 148	GW 95 168	GW 95 118	GW 95 138	GW 95 158	GW 95 178		
25	GW 95 109			GW 95 129	GW 95 149	GW 95 169	GW 95 119	GW 95 139	GW 95 159	GW 95 179		
F	6		-	GW 95 975	-	-	-	-	-	-		
	10		-	GW 95 976	-	-	-	-	-	-		
	13		-	GW 95 981	-	-	-	-	-	-		
	16		-	GW 95 977	-	-	-	-	-	-		
	20		-	GW 95 978	-	-	-	-	-	-		
	25		-	GW 95 979	-	-	-	-	-	-		
A	6		GW 95 110	GW 95 130	GW 95 150	GW 95 170	GW 95 120	GW 95 140	GW 95 160	GW 95 180		
	10		GW 95 105	GW 95 125	GW 95 145	GW 95 165	GW 95 115	GW 95 135	GW 95 155	GW 95 175		
	13		GW 95 111	GW 95 131	GW 95 151	GW 95 171	-	-	-	-		
	16		GW 95 107	GW 95 127	GW 95 147	GW 95 167	GW 95 117	GW 95 137	GW 95 157	GW 95 177		
	20		GW 95 108	GW 95 128	GW 95 148	GW 95 168	GW 95 118	GW 95 138	GW 95 158	GW 95 178		
	25		GW 95 109	GW 95 129	GW 95 149	GW 95 169	GW 95 119	GW 95 139	GW 95 159	GW 95 179		

				COMPACT RESIDUAL CURRENT CIRCUIT BREAKERS WITH OVERCURRENT PROTECTION					
				IΔn = 30mA		IΔn = 100mA		IΔn = 300mA	
									
Icn [A] (EN 61009-1)	Curve	Type	In [A]	2P 2 mod.	3P 3 mod.	2P 2 mod.	2P 2 mod.	MDC 100	
10000	C	AC	6	GW 95 025	GW 95 025 MA*	-	-	GW 95 035	
			10	GW 95 026	GW 95 026 MA*	-	-	GW 95 036	
			13	GW 95 031	GW 95 031 MA*	-	-	-	
			16	GW 95 027	GW 95 027 MA*	-	-	GW 95 037	
			20	GW 95 028	GW 95 028 MA*	-	-	GW 95 038	
			25	GW 95 029	GW 95 029 MA*	-	-	GW 95 039	
			32	GW 95 030	GW 95 030 MA*	-	-	GW 95 040	
			6	GW 95 225	GW 95 225 MA*	GW 95 245**	GW 95 785	GW 95 235	
			10	GW 95 226	GW 95 226 MA*	GW 95 246**	GW 95 786	GW 95 236	
			13	GW 95 231	GW 95 231 MA*	-	GW 95 791	-	
			16	GW 95 227	GW 95 227 MA*	GW 95 247**	GW 95 787	GW 95 237	
			20	GW 95 228	GW 95 228 MA*	GW 95 248**	GW 95 788	GW 95 238	
		25	GW 95 229	GW 95 229 MA*	GW 95 249**	GW 95 789	GW 95 239		
		32	GW 95 230	GW 95 230 MA*	GW 95 250**	GW 95 790	GW 95 240		
		6		GW 95 825	-	-	-		
		10		GW 95 826	-	-	-		
		13		GW 95 831	-	-	-		
		16		GW 95 827	-	-	-		
		20		GW 95 828	-	-	-		
		25		GW 95 829	-	-	-		
		32		GW 95 830	-	-	-		
		6		GW 95 955	-	-	-		
		10		GW 95 956	-	-	-		
		13		GW 95 961	-	-	-		
		16		GW 95 957	-	-	-		
		20		GW 95 958	-	-	-		
		25		GW 95 959	-	-	-		
		32		GW 95 960	-	-	-		
		6		GW 95 325	-	-	GW 95 795	GW 95 335	
		10		GW 95 326	-	-	GW 95 796	GW 95 336	
		13		GW 95 331	-	-	GW 95 801	-	
		16		GW 95 327	-	-	GW 95 797	GW 95 337	
		20		GW 95 328	-	-	GW 95 798	GW 95 338	
		25		GW 95 329	-	-	GW 95 799	GW 95 339	
		32		GW 95 330	-	-	GW 95 800	GW 95 340	
		6		GW 95 835	-	-	-	-	
10		GW 95 836	-	-	-	-			
13		GW 95 841	-	-	-	-			
16		GW 95 837	-	-	-	-			
20		GW 95 838	-	-	-	-			
25		GW 95 839	-	-	-	-			
32		GW 95 840	-	-	-	-			
6		GW 95 965	-	-	-	-			
10		GW 95 966	-	-	-	-			
13		GW 95 971	-	-	-	-			
16		GW 95 967	-	-	-	-			
20		GW 95 968	-	-	-	-			
25		GW 95 969	-	-	-	-			
32		GW 95 970	-	-	-	-			







* Rated operating voltage equal to 110V ac ** Rated operating voltage equal to 230V ac

		ADD-ON RESIDUAL CURRENT DEVICES								
		BD			BDHP					
										
Type	IΔn [mA]	2P 2 mod.	3P 3.5 mod.	4P 3.5 mod.	2P 4 mod.	3P 6 mod.	4P 6 mod.			
		Ins25 A	Ins63 A	Ins25 A	Ins63 A	Ins25 A	Ins63 A	Ins125 A	Ins125 A	Ins125 A
AC	10	GW 94 401	-	-	-	-	-	-	-	-
	30	GW 94 402	GW 94 412	GW 94 442	GW 94 448	GW 94 422	GW 94 432	GW 95 406	GW 95 416	GW 95 426
	300	GW 94 403	GW 94 413	GW 94 443	GW 94 449	GW 94 423	GW 94 433	GW 95 408	GW 95 418	GW 95 428
	500	GW 94 404	GW 94 414	GW 94 444	GW 94 450	GW 94 424	GW 94 434	-	-	-
A	30	GW 94 502	GW 94 512	GW 94 542	GW 94 547	GW 94 522	GW 94 532	GW 95 436	GW 95 446	GW 95 456
	300	GW 94 503	GW 94 513	GW 94 543	GW 94 548	GW 94 523	GW 94 533	GW 95 438	GW 95 448	GW 95 458
	500	GW 94 504	GW 94 514	GW 94 544	GW 94 549	GW 94 524	GW 94 534	-	-	-
A[IR]	30	GW 94 566	-	GW 94 595	-	GW 94 586	-	-	-	-
	300	GW 94 563	-	GW 94 598	-	GW 94 583	-	GW 95 468	GW 95 478	GW 95 488
A[S]	1000	GW 94 565	-	GW 94 600	-	GW 94 585	-	GW 95 470	GW 95 480	GW 95 490
A reg.	300-3000	-	-	-	-	-	-	-	-	GW 95 512

				RCD SAFETY SOCKET		RCD SAFETY UNIT		WALL-MOUNTING BOX	
In [A]	Ue [V]	Type	IΔn [mA]	IP21	IP44	IP41			
16	230	A	10	GW 95 521	GW 95 523	GW 95 525		GW 95 527	
			30	GW 95 522	GW 95 524	GW 95 526			

90 RCD

Selection tables

			RCCB						
			2P		4P				
									
In [A]	Type	IΔn [mA]	2 mod. (NA)*	2 mod.		3 mod.	4 mod. (NA)*	4 mod.	4 mod.****
25	AC	10	-	GW D4 001		-	-	-	-
		30	GW D4 617	GW D4 002		GW 94 662	GW D4 427	GW D4 102	GW D4 302
		100	-	GW D4 003		-	-	GW D4 103	-
		300	-	GW D4 004		GW 94 664	GW D4 429	GW D4 104	GW D4 304
	A	10	-	GW D4 011		-	-	GW D4 111	-
		30	GW D4 817	GW D4 012	GW D4 012 MA**	GW 94 867	GW D4 439	GW D4 112	GW D4 312
		100	-	GW D4 013		-	-	GW D4 113	-
		300	-	GW D4 014		GW 94 869	GW D4 441	GW D4 114	GW D4 314
	A(IR)	30	-	GW D4 202		-	-	GW D4 217	GW D4 317
		300	-	GW D4 203		-	-	GW D4 218	-
	F	30	-	GW D4 261		-	-	GW D4 281	-
	B	30	-	GW D4 502 ***		-	-	GW D4 527	-
		300	-	GW D4 504 ***		-	-	GW D4 529	-
	40	AC	30	GW D4 627	GW D4 022		GW 94 667	GW D4 431	GW D4 122
100			-	GW D4 023		GW 94 668	-	GW D4 123	-
300			-	GW D4 024		GW 94 669	GW D4 433	GW D4 124	GW D4 324
500			-	GW D4 025		GW 94 670	-	GW D4 125	-
A		30	GW D4 827	GW D4 032	GW D4 032 MA**	GW 94 897	GW D4 443	GW D4 132	GW D4 332
		100	-	GW D4 033		GW 94 898	-	GW D4 133	-
		300	-	GW D4 034		GW 94 899	GW D4 445	GW D4 134	GW D4 334
		500	-	GW D4 035		GW 94 900	-	GW D4 135	-
A(IR)		30	-	GW D4 205		-	-	GW D4 220	GW D4 337
		300	-	GW D4 206		-	-	GW D4 221	-
A(S)		300	-	GW D4 234		-	-	GW D4 249	-
		500	-	GW D4 235		-	-	GW D4 250	-
F		30	-	GW D4 265		-	-	GW D4 285	-
		30	-	GW D4 507 ***		-	-	GW D4 532	-
B	300	-	GW D4 509 ***		-	-	GW D4 534	-	
	30	-	GW D4 042		-	-	GW D4 142	GW D4 342	
63	AC	100	-	GW D4 043		-	-	GW D4 143	-
		300	-	GW D4 044		-	-	GW D4 144	GW D4 344
		500	-	GW D4 045		-	-	GW D4 145	-
		30	-	GW D4 052	GW D4 052 MA**	-	-	GW D4 152	GW D4 352
	A	100	-	GW D4 053		-	-	GW D4 153	-
		300	-	GW D4 054		-	-	GW D4 154	GW D4 354
		500	-	GW D4 055		-	-	GW D4 155	-
		30	-	GW D4 208		-	-	GW D4 223	GW D4 357
	A(IR)	300	-	GW D4 209		-	-	GW D4 224	-
		300	-	GW D4 237		-	-	GW D4 252	-
	A(S)	500	-	GW D4 238		-	-	GW D4 253	-
		30	-	GW D4 269		-	-	GW D4 289	-
	B	30	-	GW D4 512 ***		-	-	GW D4 537	-
		300	-	GW D4 514 ***		-	-	GW D4 539	-
80	AC	30	-	GW D4 062		-	-	GW 94 761 K	-
		300	-	-		-	-	GW 94 766 K	-
100	A	30	-	GW D4 072		-	-	-	-
		300	-	-		-	-	GW 94 777 K	-
	AC	300	-	-		-	-	GW 94 779 K	-
		30	-	-		-	-	GW 94 957 K	-
		300	-	-		-	-	GW 94 959 K	-
		30	-	-		-	-	GW 95 696 K	-
A(IR)	300	-	-		-	-	GW 95 696 K	-	
	300	-	-		-	-	GW 94 996 K	-	
125	AC	30	-	-		-	-	GW 95 601	-
		300	-	-		-	-	GW 95 603	-
		500	-	-		-	-	GW 95 604	-
	A	30	-	-		-	-	GW 95 606	-
		300	-	-		-	-	GW 95 608	-
		500	-	-		-	-	GW 95 609	-

* Accessories not available

** Rated operational voltage is 110V AC

*** 4 Modules

**** RCCBs with left neutral

RCBO - MDC

Technical data

TYPE			MDC 45		MDC 60		MDC 100		MDC 100 MA	
Standards			IEC EN 61009-1 IEC EN 61009-2-1		IEC EN 61009-1 IEC EN 61009-2-1		IEC EN 61009-1 IEC EN 61009-2-1		IEC EN 61009-1 IEC EN 61009-2-1	
Rated current (In) (A)			6-32		6-32		6-32		6-32	
Utilization category			A		A		A		A	
Rated operational voltage (Ue) (V AC)			230/400 - 240/415		230/400 - 240/415		230 - 240		110	
Insulation voltage (Ui) (V)			500		500		500		500	
Rated frequency (Hz)			50/60		50/60		50/60		50/60	
Rated impulse withstand voltage (Uimp) (kV)			4		4		4		4	
Overvoltage category:			III		III		III		III	
Number of poles			1+N,2 3, 4		1+N,2 3, 4		2, 3		2	
Energy limiting class (B and C)			3 1		3 1		3		3	
Breaking capacity										
Alternating current	IEC/EN 61009-1	Icn (A)	4500		6000		10000		10000	
		Ics (A)	1 Icn		1 Icn		0.75 Icn		0.75 Icn	
	IEC/EN 60947-2	Icu 230/240 V (kA)	6	-	10	-	15	-	15	-
		Icu 400/415 V (kA)	-	4,5	-	6	-	-	-	-
			Ics (kA)		100% Icu	75% Icu	100% Icu	50% Icu	50% Icu	
Rated residual operating current (IΔn) (mA)										
Type	AC		30		30		30		30	
			300		300		300		-	
			30		30		30		30	
	A		-		-		100		-	
			300		300		300		-	
			-		30		30		-	
	A[I _R]	-		30		30		-		
	A[S]	-		300		-		-		
	F	-		30		30		-		
Level of immunity (8/20 μs) (A)			250		250 (for AC and A types) 3000 (for A[I _R], A[S], F types)		250 (for AC and A types) 3000 (for type A[I _R], F)		250	
Residual making and breaking capacity (IΔm) (A)			4500		4500		4500		4500	
Voltage independent working:			YES		YES		YES		YES	
Wiring	cable section (mm²)⁽¹⁾	rigid	≤ 1x35 - ≤ 2x16 - ≤ 1x16+2x10		≤ 1x35 - ≤ 2x16 - ≤ 1x16+2x10		≤ 1x35 - ≤ 2x16 - ≤ 1x16+2x10		≤ 1x35 - ≤ 2x16 - ≤ 1x16+2x10	
		flexible	≤ 1x35 - ≤ 2x16 - ≤ 1x16+2x10		≤ 1x35 - ≤ 2x16 - ≤ 1x16+2x10		≤ 1x35 - ≤ 2x16 - ≤ 1x16+2x10		≤ 1x35 - ≤ 2x16 - ≤ 1x16+2x10	
Electrical endurance			10000		10000		10000		10000	
Mechanical endurance			20000		20000		20000		20000	
Max. no. of usable modular accessories			2		2		2		2	
Upline/Downline power supply			YES		YES		YES		YES	
Status displayed			YES		YES		YES		YES	
Mounting position:			any		any		any		any	
Rated tightening torque: (Nm)			2		2		2		2	
Screwdriver suggested			P22		P22		P22		P22	
Degree of protection	terminals front		IP20		IP20		IP20		IP20	
			IP40		IP40		IP40		IP40	
Pollution degree:			2		2		2		2	
Tropicalization			55°C - RH 95%		55°C - RH 95%		55°C - RH 95%		55°C - RH 95%	
Reference temperature (°C)			30		30		30		30	
Operating temperature (°C)			-25 +60 ⁽²⁾		-25 +60 ⁽²⁾		-25 +60 ⁽²⁾		-25 +60 ⁽²⁾	
Stocking temperature (°C)			-40 +70		-40 +70		-40 +70		-40 +70	
Double connection (cable+fork busbar)			yes (only downstream terminals)		yes (only downstream terminals)		yes (only downstream terminals)		yes (only downstream terminals)	
Weight per pole (g)			120		120		120		120	
Curve			C		C B		C B		C	
Rated currents available (In) (A)			6		6 6		6 6		6	
			10		10 10		10 10		10	
			13		13 13		13 13		13	
			16		16 16		16 16		16	
			20		20 20		20 20		20	
			25		25 25		25 25		25	
			32		32 32		32 32		32	



⁽¹⁾ Minimum cable section is 1mm²

⁽²⁾ With temperatures greater than 30°C, derating of In rated current is expected

90 RCD

ADD-ON RCD - BD - BDHP

Technical data

TYPE			BD		BDHP	BDHP ADJUSTABLE
						
Standards			IEC EN 61009-1 Annex G IEC EN 61009-2-1		IEC EN 61009-1 Annex G IEC EN 61009-2-1	EN 60947-2 app. B
Rated current (I _n)	(A)		≤ 25	≤ 63	≤ 125	≤ 125
Rated operational voltage (U _e)	(V AC)		230/400		230/400	400
Insulation voltage (U _i)	(V)		500		500	500
Rated frequency	(Hz)		50/60		50/60	50
Rated impulse withstand voltage (U _{imp})	(kV)		4		4	4
Overvoltage category:			III		III	III
Number of poles			2,3,4		2,3,4	4
Rated residual operating current (I _{Δn})	(mA)					
Type	AC		10 ⁽¹⁾	-	-	-
			30	30	30	-
			300	300	300	-
			500	500	-	-
	A		30	30	30	-
			300	300	300	-
			500	500	-	-
	A[IR]		-	30	-	-
	A[S]		-	300	300	-
			-	1000	1000	-
A[Adj.]		-	-	-	300 - 500 - 1000 - 3000	
Adjustable tripping time (t)	(ms)		-		-	0 - 60 - 150
Level of immunity (8/20 μs)	(A)		250 (for AC and A types) 3000 (for A[IR] and A[S] types)		250 (for AC and A types) 3000 (for A[S] type)	3000
Residual making and breaking capacity (I _{Δm})	(A)		Icn circuit breaker		Icn circuit breaker	Icn circuit breaker
Voltage independent working:			YES		YES	YES
Wiring	cable section (mm ²)	rigid	≤ 1x35 - ≤ 2x16 - ≤ 1x16+2x10		≤ 1x70 - ≤ 2x25 - ≤ 2x25+1x10	≤ 1x70 - ≤ 2x25 - ≤ 2x25+1x10
		flexible	≤ 1x35 - ≤ 2x16 - ≤ 1x16+2x10		≤ 1x50 - ≤ 2x25 - ≤ 3x16	≤ 1x50 - ≤ 2x25 - ≤ 3x16
Upline/Downline power supply			YES		YES	YES
Mounting position:			any		any	any
Rated tightening torque:	(Nm)		2		3.5 / 3 (terminal)	3.5 / 3 (terminal)
Screwdriver suggested			P22		P22	P22
Degree of protection	terminals		IP20		IP20	IP20
	front		IP40		IP40	IP40
Pollution degree:			2		2	2
Tropicalization			55°C - RH 95%		55°C - RH 95%	55°C - RH 95%
Reference temperature	(°C)		30		30	30
Operating temperature	(°C)		-25 +40		-25 +40	-25 +40
Stocking temperature	(°C)		-40 +70		-40 +70	-40 +70
Weight per pole	(g)		100		200	200

⁽¹⁾ Only for 2P versions

RCCB - IDP

Technical data

TYPE	IDP NA	IDP	IDP 4P (3M)	SD K	IDP 125A	
Standard	IEC EN 61008-1 IEC EN 61008-2-1	IEC EN 61008-1 IEC EN 61008-2-1 IEC EN 62423 (type F and B)	IEC EN 61008-1 IEC EN 61008-2-1	IEC EN 61008-1 IEC EN 61008-2-1	IEC EN 61008-1 IEC EN 61008-2-1	
Rated current (I _n) (A)	25-40-63	25-80	25-40	80-100	125	
Rated operational voltage (U _e) (V a.c.)	230/400 - 240/415	230/400 - 240/415 110 (for MA versions)	400	400 - 415	400	
Insulation voltage (U _i) (V)	500	500	500	400	500	
Rated impulse withstand voltage (U _{imp}) (kV)	4	4	4	4	4	
Overtoltage category	III	III	III	III	III	
Rated frequency (Hz)	50	50/60	50/60	50	50	
Poles	2 (Up to 40A) 4 (Up to 63A)	2, 4	4	4	4	
Number of modules	2 (2P) 4 (4P)	2 (2P) 4 (4P) 4 (2P/4P type B)	3	4	4	
Rated residual operating current (I _{Δn}) (mA)						
Type	AC	-	10 ⁽¹⁾	-	-	-
		30	30	30	30	30
		-	100	100	-	-
		300	300	300	300	300
		-	500	500	-	500
		-	10 ⁽¹⁾	-	-	-
	A	30	30	30	30	30
		-	100	100	-	-
		300	300	300	300	300
		-	500	500	-	500
		-	30	-	30	-
		-	300	-	300	-
IR - Impulse resistant	-	30	-	-	-	
S - Selective	-	300	-	300	-	
F	-	500	-	-	-	
B	-	30	-	-	-	
-	-	300	-	-	-	
Level of immunity (8/20μs) (A)	250	250 (Type AC - A) 3000 (Type A[IR] - A[S] - F - B)	250	250 (Type AC - A) 3000 (Type A[IR] - A[S])	250	
Residual making and breaking capacity (I _{dm}) (A)	10 x I _n (630A min)	10 x I _n (630A min)	630	800 (80A) - 1000 (100A)	1250	
Making and breaking capacity (I _m) (A)	10 x I _n (630A min)	10 x I _n (630A min)	630	800 (80A) - 1000 (100A)	1250	
Voltage independent working	yes	yes	yes	yes	yes	
Wiring Cable section (mm ²) ⁽²⁾	rigid flexible	≤ 1x35 - ≤ 2x16 - ≤ 1x16+2x10 ≤ 1x35 - ≤ 2x16 - ≤ 1x16+2x10	≤ 1x35 - ≤ 2x16 - ≤ 1x16+2x10 ≤ 1x35 - ≤ 2x16 - ≤ 1x16+2x10	≤ 1x35 - ≤ 2x16 - ≤ 1x16+2x10 ≤ 1x25 - ≤ 1x16+1x10 - ≤ 3x6	≤ 35 ≤ 35	≤ 50 ≤ 50
Electrical endurance	5000	10000	5000	4000	10000	
Mechanical endurance	10000	20000	10000	10000	10000	
Upstream / Downstream supply	yes	yes	yes	yes	yes	
Mounting position	any	any	any	any	any	
Rated tightening torque (Nm)	2	3	2	2	3	
Screw type	PZ2	PZ2	PZ2	PZ2	PZ2	
Pollution degree	2	2	2	2	2	
Fire resistance	Glow wire Test IEC 60695-2-11 according with IEC 61008-1					
IP degree (inside the distribution board)	IP40	IP40	IP40	IP40	IP40	
Tropicalization	55°C - UR 95%	55°C - UR 95%	55°C - UR 95%	55°C - UR 95%	55°C - UR 95%	
Installation altitude (m)	≤ 2000	≤ 2000	≤ 2000	≤ 2000	≤ 2000	
Operating temperature (average daily temperature ≤ 35°C) (°C)	-5 ÷ +40	-25 ÷ +60 ⁽³⁾	-25 ÷ +40	-25 ÷ +40	-25 ÷ +60 ⁽³⁾	
Storage temperature (°C)	-40 ÷ +70	-40 ÷ +70	-40 ÷ +70	-35 ÷ +60	-40 ÷ +70	
Double connection (cable + fork busbar)	no (for 2P) yes (only downstream for 4P)	yes (Upstream and downstream)	yes (Upstream and downstream)	yes (Upstream and downstream)	no	
Signalization of the relay tripping	no	yes 175 (2P), 320 (4P)	no	no	no	
Weight of device (g)	160 (2P), 300 (4P)	275 (2P TYPE B) 340 (4P TYPE B)	280	350	555	

⁽¹⁾ Up to 25A

⁽²⁾ Minimum cable section is 1.5mm²

⁽³⁾ With temperatures greater than 40°C, derating of I_n rated current is expected

RATED CONDITIONAL RESIDUAL SHORT-CIRCUIT CURRENT I _{Δc} (kA)												
Rated current I _n	Poles	25A / 40A (NA)		25A / 40A			63A(NA)	63A	80A		100A	125A
		2P	4P	2P	4P	4P (3M)	2P/4P	2P/4P	2P	4P	4P	4P
Fuse	gG 63A	6	6	10	10	6	6	10*	-	-	-	-
	gG 80A	-	-	-	-	-	-	10	6	10	-	-
	gG 100	-	-	-	-	-	-	-	-	-	10	-
	gG 125	-	-	-	-	-	-	-	-	-	-	10
MCB	MTC 45	-	-	4.5	-	-	-	-	-	-	-	-
	MTC 60	-	-	6	-	-	-	-	-	-	-	-
	MTC 100	-	-	10	-	-	-	-	-	-	-	-
	MT 45	-	-	4.5	-	-	-	-	-	-	-	-
	MT 60	-	-	6	-	-	6	-	-	-	-	-
	MT 100	-	-	10	-	-	10	-	-	-	-	-
	MT 250	-	-	10	-	-	10	-	-	-	-	-
	MTHP 160	-	-	-	-	-	10	-	10	-	10	10
MTHP 250	-	-	10	-	-	10	-	-	-	-	-	

* Only F and B type RCCBs

90 RCD

Modular circuit breakers for residual current protection

The 90 RCD range meets any ground fault protection requirement for any area of application. The range comprises MDC compact residual current c.b. with overcurrent protection. (from 6 to 32 A, curves B and C, up to 10 kA and $I_{\Delta n}$ from 30 and 300 mA type AC, A, A[IR] and A[S] and F) BD and BDHP, add-on residual current devices for circuit breakers MT and MTHP ($I_{\Delta n}$ from 10 mA to 3 A type AC, A, A[IR], A[S] and A adjustable) IDP residual current circuit breakers (up to 125 A, $I_{\Delta n}$ from 10 to 500 mA type AC, A, A[IR], A[S], F, B).



MDC - MONOBLOC COMPACT RCBO'S

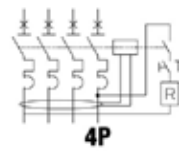
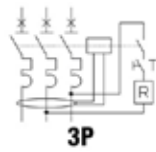
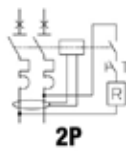
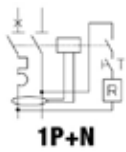

MDC 45 - AC TYPE - C CURVE - 4500 A (EN 61009-1) - 4.5 KA (EN 60947-2)

BREAKING CAPACITY 1P+N-2P			
230V	EN61009-1	EN60947-2	
$I_{n0.1}$	I_{cn}	I_{cu}	I_{cs}
4500 A	4500 A	6 KA	

BREAKING CAPACITY 3-4P			
400V	EN61009-1	EN60947-2	
$I_{n0.1}$	I_{cn}	I_{cu}	I_{cs}
4500 A	4500 A	4.5 KA	



GW 94 027

COMPACT RESIDUAL CURRENT CIRCUIT BREAKERS WITH OVERCURRENT PROTECTION



Code	$I_{\Delta n}$	Rated current	Rated voltage	No. of modules EN 50022	Pack Carton
No. of poles: 1P+N					
GW 94 005	30 mA	6 A	230 V	2	1/6
GW 94 006	30 mA	10 A	230 V	2	1/6
GW 94 011	30 mA	13 A	230 V	2	1/6
GW 94 007	30 mA	16 A	230 V	2	1/6
GW 94 008	30 mA	20 A	230 V	2	1/6
GW 94 009	30 mA	25 A	230 V	2	1/6
GW 94 010	30 mA	32 A	230 V	2	1/6
GW 94 015	300 mA	6 A	230 V	2	1/6
GW 94 016	300 mA	10 A	230 V	2	1/6
GW 94 017	300 mA	16 A	230 V	2	1/6
GW 94 018	300 mA	20 A	230 V	2	1/6
GW 94 019	300 mA	25 A	230 V	2	1/6
GW 94 020	300 mA	32 A	230 V	2	1/6
No. of poles: 2P					
GW 94 025	30 mA	6 A	230 V	2	1/6
GW 94 026	30 mA	10 A	230 V	2	1/6
GW 94 031	30 mA	13 A	230 V	2	1/6
GW 94 027	30 mA	16 A	230 V	2	1/6
GW 94 028	30 mA	20 A	230 V	2	1/6
GW 94 029	30 mA	25 A	230 V	2	1/6
GW 94 030	30 mA	32 A	230 V	2	1/6
GW 94 035	300 mA	6 A	230 V	2	1/6
GW 94 036	300 mA	10 A	230 V	2	1/6
GW 94 037	300 mA	16 A	230 V	2	1/6
GW 94 038	300 mA	20 A	230 V	2	1/6
GW 94 039	300 mA	25 A	230 V	2	1/6
GW 94 040	300 mA	32 A	230 V	2	1/6

CONTINUED

Code	Idn	Rated current	Rated voltage	No. of modules EN 50022	Pack Carton
No. of poles: 3P					
GW 94 045	30 mA	6 A	400 V	3	1/4
GW 94 046	30 mA	10 A	400 V	3	1/4
GW 94 051	30 mA	13 A	400 V	3	1/4
GW 94 047	30 mA	16 A	400 V	3	1/4
GW 94 048	30 mA	20 A	400 V	3	1/4
GW 94 049	30 mA	25 A	400 V	3	1/4
GW 94 050	30 mA	32 A	400 V	3	1/4
GW 94 055	300 mA	6 A	400 V	3	1/4
GW 94 056	300 mA	10 A	400 V	3	1/4
GW 94 057	300 mA	16 A	400 V	3	1/4
GW 94 058	300 mA	20 A	400 V	3	1/4
GW 94 059	300 mA	25 A	400 V	3	1/4
GW 94 060	300 mA	32 A	400 V	3	1/4
No. of poles: 4P					
GW 94 065	30 mA	6 A	400 V	4	1/3
GW 94 066	30 mA	10 A	400 V	4	1/3
GW 94 071	30 mA	13 A	400 V	4	1/3
GW 94 067	30 mA	16 A	400 V	4	1/3
GW 94 068	30 mA	20 A	400 V	4	1/3
GW 94 069	30 mA	25 A	400 V	4	1/3
GW 94 070	30 mA	32 A	400 V	4	1/3
GW 94 075	300 mA	6 A	400 V	4	1/3
GW 94 076	300 mA	10 A	400 V	4	1/3
GW 94 077	300 mA	16 A	400 V	4	1/3
GW 94 078	300 mA	20 A	400 V	4	1/3
GW 94 079	300 mA	25 A	400 V	4	1/3
GW 94 080	300 mA	32 A	400 V	4	1/3

MDC 45 - A TYPE - C CURVE - 4500 A (EN 61009-1) - 4.5 KA (EN 60947-2)

BREAKING CAPACITY 1P+N-2P		
230V	EN61009-1	EN60947-2
I _{cs}		I _{cu}
30A-32 A	4500 A	6 kA

BREAKING CAPACITY 3-4P		
400V	EN61009-1	EN60947-2
I _{cs}		I _{cu}
30A-32 A	4500 A	4.5 kA



GW 94 227

COMPACT RESIDUAL CURRENT CIRCUIT BREAKERS WITH OVERCURRENT PROTECTION



Code	I _{dn}	Rated current	Rated voltage	No. of modules EN 50022	Pack Carton
No. of poles: 1P+N					
GW 94 205	30 mA	6 A	230 V	2	1/6
GW 94 206	30 mA	10 A	230 V	2	1/6
GW 94 211	30 mA	13 A	230 V	2	1/6
GW 94 207	30 mA	16 A	230 V	2	1/6
GW 94 208	30 mA	20 A	230 V	2	1/6
GW 94 209	30 mA	25 A	230 V	2	1/6
GW 94 210	30 mA	32 A	230 V	2	1/6
GW 94 215	300 mA	6 A	230 V	2	1/6
GW 94 216	300 mA	10 A	230 V	2	1/6
GW 94 217	300 mA	16 A	230 V	2	1/6
GW 94 218	300 mA	20 A	230 V	2	1/6
GW 94 219	300 mA	25 A	230 V	2	1/6
GW 94 220	300 mA	32 A	230 V	2	1/6
No. of poles: 2P					
GW 94 225	30 mA	6 A	230 V	2	1/6
GW 94 226	30 mA	10 A	230 V	2	1/6
GW 94 231	30 mA	13 A	230 V	2	1/6
GW 94 227	30 mA	16 A	230 V	2	1/6
GW 94 228	30 mA	20 A	230 V	2	1/6
GW 94 229	30 mA	25 A	230 V	2	1/6
GW 94 230	30 mA	32 A	230 V	2	1/6
GW 94 235	300 mA	6 A	230 V	2	1/6
GW 94 236	300 mA	10 A	230 V	2	1/6
GW 94 237	300 mA	16 A	230 V	2	1/6
GW 94 238	300 mA	20 A	230 V	2	1/6
GW 94 239	300 mA	25 A	230 V	2	1/6
GW 94 240	300 mA	32 A	230 V	2	1/6
No. of poles: 3P					
GW 94 245	30 mA	6 A	400 V	3	1/4
GW 94 246	30 mA	10 A	400 V	3	1/4
GW 94 251	30 mA	13 A	400 V	3	1/4
GW 94 247	30 mA	16 A	400 V	3	1/4
GW 94 248	30 mA	20 A	400 V	3	1/4
GW 94 249	30 mA	25 A	400 V	3	1/4
GW 94 250	30 mA	32 A	400 V	3	1/4
GW 94 255	300 mA	6 A	400 V	3	1/4
GW 94 256	300 mA	10 A	400 V	3	1/4
GW 94 257	300 mA	16 A	400 V	3	1/4
GW 94 258	300 mA	20 A	400 V	3	1/4
GW 94 259	300 mA	25 A	400 V	3	1/4
GW 94 260	300 mA	32 A	400 V	3	1/4
No. of poles: 4P					
GW 94 265	30 mA	6 A	400 V	4	1/3
GW 94 266	30 mA	10 A	400 V	4	1/3
GW 94 271	30 mA	13 A	400 V	4	1/3
GW 94 267	30 mA	16 A	400 V	4	1/3
GW 94 268	30 mA	20 A	400 V	4	1/3
GW 94 269	30 mA	25 A	400 V	4	1/3
GW 94 270	30 mA	32 A	400 V	4	1/3
GW 94 275	300 mA	6 A	400 V	4	1/3
GW 94 276	300 mA	10 A	400 V	4	1/3
GW 94 277	300 mA	16 A	400 V	4	1/3
GW 94 278	300 mA	20 A	400 V	4	1/3
GW 94 279	300 mA	25 A	400 V	4	1/3
GW 94 280	300 mA	32 A	400 V	4	1/3

MDC 60 - AC TYPE - C CURVE - 6000 A (EN 61009-1) - 6 KA (EN 60947-2)

BREAKING CAPACITY 1P+N-2P			
230V	ENS1009-1	ENS60947-2	
<i>I_{cn}</i>	<i>I_{cn}</i>	<i>I_{cn}</i>	
<i>I_n</i> =6-32 A	6000 A	10 kA	

BREAKING CAPACITY 3-4P			
400V	ENS1009-1	ENS60947-2	
<i>I_{cn}</i>	<i>I_{cn}</i>	<i>I_{cn}</i>	
<i>I_n</i> =6-32 A	6000 A	6 kA	



GW 94 168

COMPACT RESIDUAL CURRENT CIRCUIT BREAKERS WITH OVERCURRENT PROTECTION



Code	<i>I_{dn}</i>	Rated current	Rated voltage	No. of modules EN 50022	Pack Carton
No. of poles: 1P+N					
GW 94 105	30 mA	6 A	230 V	2	1/6
GW 94 106	30 mA	10 A	230 V	2	1/6
GW 94 111	30 mA	13 A	230 V	2	1/6
GW 94 107	30 mA	16 A	230 V	2	1/6
GW 94 108	30 mA	20 A	230 V	2	1/6
GW 94 109	30 mA	25 A	230 V	2	1/6
GW 94 110	30 mA	32 A	230 V	2	1/6
GW 94 115	300 mA	6 A	230 V	2	1/6
GW 94 116	300 mA	10 A	230 V	2	1/6
GW 94 117	300 mA	16 A	230 V	2	1/6
GW 94 118	300 mA	20 A	230 V	2	1/6
GW 94 119	300 mA	25 A	230 V	2	1/6
GW 94 120	300 mA	32 A	230 V	2	1/6
No. of poles: 2P					
GW 94 125	30 mA	6 A	230 V	2	1/6
GW 94 126	30 mA	10 A	230 V	2	1/6
GW 94 131	30 mA	13 A	230 V	2	1/6
GW 94 127	30 mA	16 A	230 V	2	1/6
GW 94 128	30 mA	20 A	230 V	2	1/6
GW 94 129	30 mA	25 A	230 V	2	1/6
GW 94 130	30 mA	32 A	230 V	2	1/6
GW 94 135	300 mA	6 A	230 V	2	1/6
GW 94 136	300 mA	10 A	230 V	2	1/6
GW 94 137	300 mA	16 A	230 V	2	1/6
GW 94 138	300 mA	20 A	230 V	2	1/6
GW 94 139	300 mA	25 A	230 V	2	1/6
GW 94 140	300 mA	32 A	230 V	2	1/6
No. of poles: 3P					
GW 94 145	30 mA	6 A	400 V	3	1/4
GW 94 146	30 mA	10 A	400 V	3	1/4
GW 94 151	30 mA	13 A	400 V	3	1/4
GW 94 147	30 mA	16 A	400 V	3	1/4
GW 94 148	30 mA	20 A	400 V	3	1/4
GW 94 149	30 mA	25 A	400 V	3	1/4
GW 94 150	30 mA	32 A	400 V	3	1/4
GW 94 155	300 mA	6 A	400 V	3	1/4
GW 94 156	300 mA	10 A	400 V	3	1/4
GW 94 157	300 mA	16 A	400 V	3	1/4
GW 94 158	300 mA	20 A	400 V	3	1/4
GW 94 159	300 mA	25 A	400 V	3	1/4
GW 94 160	300 mA	32 A	400 V	3	1/4
No. of poles: 4P					
GW 94 165	30 mA	6 A	400 V	4	1/3
GW 94 166	30 mA	10 A	400 V	4	1/3
GW 94 171	30 mA	13 A	400 V	4	1/3
GW 94 167	30 mA	16 A	400 V	4	1/3
GW 94 168	30 mA	20 A	400 V	4	1/3
GW 94 169	30 mA	25 A	400 V	4	1/3
GW 94 170	30 mA	32 A	400 V	4	1/3
GW 94 175	300 mA	6 A	400 V	4	1/3
GW 94 176	300 mA	10 A	400 V	4	1/3
GW 94 177	300 mA	16 A	400 V	4	1/3
GW 94 178	300 mA	20 A	400 V	4	1/3
GW 94 179	300 mA	25 A	400 V	4	1/3
GW 94 180	300 mA	32 A	400 V	4	1/3

MDC 60 - A TYPE - C CURVE - 6000 A (EN 61009-1) - 6 KA (EN 60947-2)

BREAKING CAPACITY 1P+N-2P		
230V	EN61009-1	EN60947-2
I _{cn}	I _{cs}	I _{cu}
In=2;32 A	6000 A	19 kA

BREAKING CAPACITY 3-4P		
400V	EN61009-1	EN60947-2
I _{cn}	I _{cs}	I _{cu}
In=6;32 A	6000 A	6 kA



GW 94 347

COMPACT RESIDUAL CURRENT CIRCUIT BREAKERS WITH OVERCURRENT PROTECTION



Code	I _{dn}	Rated current	Rated voltage	No. of modules EN 50022	Pack Carton
No. of poles: 1P+N					
GW 94 305	30 mA	6 A	230 V	2	1/6
GW 94 306	30 mA	10 A	230 V	2	1/6
GW 94 311	30 mA	13 A	230 V	2	1/6
GW 94 307	30 mA	16 A	230 V	2	1/6
GW 94 308	30 mA	20 A	230 V	2	1/6
GW 94 309	30 mA	25 A	230 V	2	1/6
GW 94 310	30 mA	32 A	230 V	2	1/6
GW 94 315	300 mA	6 A	230 V	2	1/6
GW 94 316	300 mA	10 A	230 V	2	1/6
GW 94 317	300 mA	16 A	230 V	2	1/6
GW 94 318	300 mA	20 A	230 V	2	1/6
GW 94 319	300 mA	25 A	230 V	2	1/6
GW 94 320	300 mA	32 A	230 V	2	1/6
No. of poles: 2P					
GW 94 325	30 mA	6 A	230 V	2	1/6
GW 94 326	30 mA	10 A	230 V	2	1/6
GW 94 331	30 mA	13 A	230 V	2	1/6
GW 94 327	30 mA	16 A	230 V	2	1/6
GW 94 328	30 mA	20 A	230 V	2	1/6
GW 94 329	30 mA	25 A	230 V	2	1/6
GW 94 330	30 mA	32 A	230 V	2	1/6
GW 94 335	300 mA	6 A	230 V	2	1/6
GW 94 336	300 mA	10 A	230 V	2	1/6
GW 94 337	300 mA	16 A	230 V	2	1/6
GW 94 338	300 mA	20 A	230 V	2	1/6
GW 94 339	300 mA	25 A	230 V	2	1/6
GW 94 340	300 mA	32 A	230 V	2	1/6
No. of poles: 3P					
GW 94 345	30 mA	6 A	400 V	3	1/4
GW 94 346	30 mA	10 A	400 V	3	1/4
GW 94 351	30 mA	13 A	400 V	3	1/4
GW 94 347	30 mA	16 A	400 V	3	1/4
GW 94 348	30 mA	20 A	400 V	3	1/4
GW 94 349	30 mA	25 A	400 V	3	1/4
GW 94 350	30 mA	32 A	400 V	3	1/4
GW 94 355	300 mA	6 A	400 V	3	1/4
GW 94 356	300 mA	10 A	400 V	3	1/4
GW 94 357	300 mA	16 A	400 V	3	1/4
GW 94 358	300 mA	20 A	400 V	3	1/4
GW 94 359	300 mA	25 A	400 V	3	1/4
GW 94 360	300 mA	32 A	400 V	3	1/4
No. of poles: 4P					
GW 94 365	30 mA	6 A	400 V	4	1/3
GW 94 366	30 mA	10 A	400 V	4	1/3
GW 94 371	30 mA	13 A	400 V	4	1/3
GW 94 367	30 mA	16 A	400 V	4	1/3
GW 94 368	30 mA	20 A	400 V	4	1/3
GW 94 369	30 mA	25 A	400 V	4	1/3
GW 94 370	30 mA	32 A	400 V	4	1/3
GW 94 375	300 mA	6 A	400 V	4	1/3
GW 94 376	300 mA	10 A	400 V	4	1/3
GW 94 377	300 mA	16 A	400 V	4	1/3
GW 94 378	300 mA	20 A	400 V	4	1/3
GW 94 379	300 mA	25 A	400 V	4	1/3
GW 94 380	300 mA	32 A	400 V	4	1/3

MDC 60 - A[IR] TYPE IMPULSE RESISTANT - C CURVE - 6000 A (EN 61009-1) - 6 KA (EN 60947-2)

BREAKING CAPACITY 2P			
230V	EN61009-1	EN60947-2	
I _{cs}	I _{cu}	I _{cs}	I _{cu}
I _n = 6-32 A	6000 A	10 kA	

BREAKING CAPACITY 4P			
400V	EN61009-1	EN60947-2	
I _{cs}	I _{cu}	I _{cs}	I _{cu}
I _n = 6-32 A	4000 A	6 kA	



GW 95 817

COMPACT RESIDUAL CURRENT CIRCUIT BREAKERS WITH OVERCURRENT PROTECTION



Code	I _{dn}	Rated current	Rated voltage	No. of modules EN 50022	Pack Carton
No. of poles: 2P					
GW 95 805	30 mA	6 A	230 V	2	1/6
GW 95 806	30 mA	10 A	230 V	2	1/6
GW 95 811	30 mA	13 A	230 V	2	1/6
GW 95 807	30 mA	16 A	230 V	2	1/6
GW 95 808	30 mA	20 A	230 V	2	1/6
GW 95 809	30 mA	25 A	230 V	2	1/6
GW 95 810	30 mA	32 A	230 V	2	1/6
No. of poles: 4P					
GW 95 815	30 mA	6 A	400 V	4	1/3
GW 95 816	30 mA	10 A	400 V	4	1/3
GW 95 821	30 mA	13 A	400 V	4	1/3
GW 95 817	30 mA	16 A	400 V	4	1/3
GW 95 818	30 mA	20 A	400 V	4	1/3
GW 95 819	30 mA	25 A	400 V	4	1/3
GW 95 820	30 mA	32 A	400 V	4	1/3

CHARACTERISTICS: type A[IR] presents greater resistance to mains disturbances and atmospheric discharges in comparison to standard residual current circuit breakers with overcurrent protection. Immunity level 8/20 μs is 3000 A.

90 RCD

MDC 60 - A[S] TYPE SELECTIVE - C CURVE - 6000 A (EN 61009-1) - 6 KA (EN 60947-2)

BREAKING CAPACITY 2P			
230V	EN61009-1	EN60947-2	
$I_{n16-32A}$	6000 A	10 kA	

BREAKING CAPACITY 4P			
400V	EN61009-1	EN60947-2	
$I_{n16-32A}$	6000 A	6 kA	



GW 95 850

COMPACT RESIDUAL CURRENT CIRCUIT BREAKERS WITH OVERCURRENT PROTECTION



Code	I_{dn}	Rated current	Rated voltage	No. of modules EN 50022	Pack Carton
No. of poles: 2P					
GW 95 847	300 mA	16 A	230 V	2	1/6
GW 95 848	300 mA	20 A	230 V	2	1/6
GW 95 849	300 mA	25 A	230 V	2	1/6
GW 95 850	300 mA	32 A	230 V	2	1/6
No. of poles: 4P					
GW 95 857	300 mA	16 A	400 V	4	1/3
GW 95 858	300 mA	20 A	400 V	4	1/3
GW 95 859	300 mA	25 A	400 V	4	1/3
GW 95 860	300 mA	32 A	400 V	4	1/3

MDC 60 - F TYPE - C CURVE - 6000 A (EN 61009-1) - 10 KA (EN 60947-2)

BREAKING CAPACITY 2P			
230V	EN61009-1	EN60947-2	
$I_{n16-32A}$	6000 A	10 kA	



GW 95 937

COMPACT RESIDUAL CURRENT CIRCUIT BREAKERS WITH OVERCURRENT PROTECTION



Code	I_{dn}	Rated current	Rated voltage	No. of modules EN 50022	Pack Carton
No. of poles: 2P					
GW 95 935	30 mA	6 A	230 V	2	1/6
GW 95 936	30 mA	10 A	230 V	2	1/6
GW 95 941	30 mA	13 A	230 V	2	1/6
GW 95 937	30 mA	16 A	230 V	2	1/6
GW 95 938	30 mA	20 A	230 V	2	1/6
GW 95 939	30 mA	25 A	230 V	2	1/6
GW 95 940	30 mA	32 A	230 V	2	1/6

CHARACTERISTICS: F type presents greater resistance to mains disturbances and atmospheric discharges in comparison to standard residual current circuit breakers with overcurrent protection. Immunity level 8/20 μ s is 3000 A.

MDC 60 - A TYPE - B CURVE - 6000 A (EN 61009-1) - 6 KA (EN 60947-2)



GW 95 168

COMPACT RESIDUAL CURRENT CIRCUIT BREAKERS WITH OVERCURRENT PROTECTION



Code	Idn	Rated current	Rated voltage	No. of modules EN 50022	Pack Carton
No. of poles: 1P+N					
GW 95 105	30 mA	6 A	230 V	2	1/6
GW 95 106	30 mA	10 A	230 V	2	1/6
GW 95 111	30 mA	13 A	230 V	2	1/6
GW 95 107	30 mA	16 A	230 V	2	1/6
GW 95 108	30 mA	20 A	230 V	2	1/6
GW 95 109	30 mA	25 A	230 V	2	1/6
GW 95 110	30 mA	32 A	230 V	2	1/6
GW 95 115	300 mA	6 A	230 V	2	1/6
GW 95 116	300 mA	10 A	230 V	2	1/6
GW 95 117	300 mA	16 A	230 V	2	1/6
GW 95 118	300 mA	20 A	230 V	2	1/6
GW 95 119	300 mA	25 A	230 V	2	1/6
GW 95 120	300 mA	32 A	230 V	2	1/6
No. of poles: 2P					
GW 95 125	30 mA	6 A	230 V	2	1/6
GW 95 126	30 mA	10 A	230 V	2	1/6
GW 95 131	30 mA	13 A	230 V	2	1/6
GW 95 127	30 mA	16 A	230 V	2	1/6
GW 95 128	30 mA	20 A	230 V	2	1/6
GW 95 129	30 mA	25 A	230 V	2	1/6
GW 95 130	30 mA	32 A	230 V	2	1/6
GW 95 135	300 mA	6 A	230 V	2	1/6
GW 95 136	300 mA	10 A	230 V	2	1/6
GW 95 137	300 mA	16 A	230 V	2	1/6
GW 95 138	300 mA	20 A	230 V	2	1/6
GW 95 139	300 mA	25 A	230 V	2	1/6
GW 95 140	300 mA	32 A	230 V	2	1/6
No. of poles: 3P					
GW 95 145	30 mA	6 A	400 V	3	1/4
GW 95 146	30 mA	10 A	400 V	3	1/4
GW 95 151	30 mA	13 A	400 V	3	1/4
GW 95 147	30 mA	16 A	400 V	3	1/4
GW 95 148	30 mA	20 A	400 V	3	1/4
GW 95 149	30 mA	25 A	400 V	3	1/4
GW 95 150	30 mA	32 A	400 V	3	1/4
GW 95 155	300 mA	6 A	400 V	3	1/4
GW 95 156	300 mA	10 A	400 V	3	1/4
GW 95 157	300 mA	16 A	400 V	3	1/4
GW 95 158	300 mA	20 A	400 V	3	1/4
GW 95 159	300 mA	25 A	400 V	3	1/4
GW 95 160	300 mA	32 A	400 V	3	1/4
No. of poles: 4P					
GW 95 165	30 mA	6 A	400 V	4	1/3
GW 95 166	30 mA	10 A	400 V	4	1/3
GW 95 171	30 mA	13 A	400 V	4	1/3
GW 95 167	30 mA	16 A	400 V	4	1/3
GW 95 168	30 mA	20 A	400 V	4	1/3
GW 95 169	30 mA	25 A	400 V	4	1/3
GW 95 170	30 mA	32 A	400 V	4	1/3
GW 95 175	300 mA	6 A	400 V	4	1/3
GW 95 176	300 mA	10 A	400 V	4	1/3
GW 95 177	300 mA	16 A	400 V	4	1/3
GW 95 178	300 mA	20 A	400 V	4	1/3
GW 95 179	300 mA	25 A	400 V	4	1/3
GW 95 180	300 mA	32 A	400 V	4	1/3

90 RCD

MDC 60 - F TYPE - B CURVE - 6000 A (EN 61009-1) - 10 KA (EN 60947-2)

BREAKING CAPACITY 2P		
230V	EN61009-1	EN60947-2
I_{nB}	I_{nB}	I_{nB}
16-32 A	6000 A	10 kA



GW 95 977

COMPACT RESIDUAL CURRENT CIRCUIT BREAKERS WITH OVERCURRENT PROTECTION



Code	I_{dn}	Rated current	Rated voltage	No. of modules EN 50022	Pack Carton
No. of poles: 2P					
GW 95 975	30 mA	6 A	230 V	2	1/6
GW 95 976	30 mA	10 A	230 V	2	1/6
GW 95 981	30 mA	13 A	230 V	2	1/6
GW 95 977	30 mA	16 A	230 V	2	1/6
GW 95 978	30 mA	20 A	230 V	2	1/6
GW 95 979	30 mA	25 A	230 V	2	1/6
GW 95 980	30 mA	32 A	230 V	2	1/6

CHARACTERISTICS: F type presents greater resistance to mains disturbances and atmospheric discharges in comparison to standard residual current circuit breakers with overcurrent protection. Immunity level 8/20 μ s is 3000 A.

MDC 100 - AC TYPE - C CURVE - 10000 A (EN 61009-1) - 15 KA (EN 60947-2)

BREAKING CAPACITY 2P		
230V	EN61009-1	EN60947-2
I_{nB}	I_{nB}	I_{nB}
16-32 A	10000 A	15 kA



GW 95 027

COMPACT RESIDUAL CURRENT CIRCUIT BREAKERS WITH OVERCURRENT PROTECTION



Code	I_{dn}	Rated current	Rated voltage	No. of modules EN 50022	Pack Carton
No. of poles: 2P					
GW 95 025	30 mA	6 A	230 V	2	1/6
GW 95 026	30 mA	10 A	230 V	2	1/6
GW 95 031	30 mA	13 A	230 V	2	1/6
GW 95 027	30 mA	16 A	230 V	2	1/6
GW 95 028	30 mA	20 A	230 V	2	1/6
GW 95 029	30 mA	25 A	230 V	2	1/6
GW 95 030	30 mA	32 A	230 V	2	1/6
GW 95 035	300 mA	6 A	230 V	2	1/6
GW 95 036	300 mA	10 A	230 V	2	1/6
GW 95 037	300 mA	16 A	230 V	2	1/6
GW 95 038	300 mA	20 A	230 V	2	1/6
GW 95 039	300 mA	25 A	230 V	2	1/6
GW 95 040	300 mA	32 A	230 V	2	1/6

MDC 100 MA - AC TYPE - C CURVE - 10000 A (EN 61009-1) - 15 KA (EN 60947-2)

BREAKING CAPACITY 2P		
110V	EN61009-1	EN60947-2
I_{cn}	I_{cn}	I_{cn}
$I_{n=6-32A}$	10000 A	15 kA



GW 95 025 MA

COMPACT RESIDUAL CURRENT CIRCUIT BREAKERS WITH OVERCURRENT PROTECTION



Code	I_{dn}	Rated current	Rated voltage	No. of modules EN 50022	Pack Carton
No. of poles: 2P					
GW 95 025 MA	30 mA	6 A	110 V	2	1/6
GW 95 026 MA	30 mA	10 A	110 V	2	1/6
GW 95 031 MA	30 mA	13 A	110 V	2	1/6
GW 95 027 MA	30 mA	16 A	110 V	2	1/6
GW 95 028 MA	30 mA	20 A	110 V	2	1/6
GW 95 029 MA	30 mA	25 A	110 V	2	1/6
GW 95 030 MA	30 mA	32 A	110 V	2	1/6

MDC 100 - A TYPE - C CURVE - 10000 A (EN 61009-1) - 15 KA (EN 60947-2)

BREAKING CAPACITY 1P+N-2P-3P		
230V	EN61009-1	EN60947-2
I_{cn}	I_{cn}	I_{cn}
$I_{n=6-32A}$	10000 A	15 kA

BREAKING CAPACITY 2P		
230V	EN61009-1	EN60947-2
I_{cn}	I_{cn}	I_{cn}
$I_{n=6-32A}$	10000 A	15 kA



GW 95 227

COMPACT RESIDUAL CURRENT CIRCUIT BREAKERS WITH OVERCURRENT PROTECTION



Code	I_{dn}	Rated current	Rated voltage	No. of modules EN 50022	Pack Carton
No. of poles: 2P					
GW 95 225	30 mA	6 A	230 V	2	1/6
GW 95 226	30 mA	10 A	230 V	2	1/6
GW 95 231	30 mA	13 A	230 V	2	1/6
GW 95 227	30 mA	16 A	230 V	2	1/6
GW 95 228	30 mA	20 A	230 V	2	1/6
GW 95 229	30 mA	25 A	230 V	2	1/6
GW 95 230	30 mA	32 A	230 V	2	1/6
GW 95 785	100 mA	6 A	230 V	2	1/6
GW 95 786	100 mA	10 A	230 V	2	1/6
GW 95 791	100 mA	13 A	230 V	2	1/6
GW 95 787	100 mA	16 A	230 V	2	1/6
GW 95 788	100 mA	20 A	230 V	2	1/6
GW 95 789	100 mA	25 A	230 V	2	1/6
GW 95 790	100 mA	32 A	230 V	2	1/6
GW 95 235	300 mA	6 A	230 V	2	1/6
GW 95 236	300 mA	10 A	230 V	2	1/6
GW 95 237	300 mA	16 A	230 V	2	1/6
GW 95 238	300 mA	20 A	230 V	2	1/6
GW 95 239	300 mA	25 A	230 V	2	1/6
GW 95 240	300 mA	32 A	230 V	2	1/6
No. of poles: 3P					
GW 95 245	30 mA	6 A	230 V	3	1/4
GW 95 246	30 mA	10 A	230 V	3	1/4
GW 95 247	30 mA	16 A	230 V	3	1/4
GW 95 248	30 mA	20 A	230 V	3	1/4
GW 95 249	30 mA	25 A	230 V	3	1/4
GW 95 250	30 mA	32 A	230 V	3	1/4

90 RCD

MDC 100 MA - A TYPE - C CURVE - 10000 A (EN 61009-1) - 15 KA (EN 60947-2)

BREAKING CAPACITY 2P		
110V	EN61009-1	EN60947-2
$I_{n=32A}$	10000A	15KA



GW 95 225 MA

COMPACT RESIDUAL CURRENT CIRCUIT BREAKERS WITH OVERCURRENT PROTECTION



Code	I_{dn}	Rated current	Rated voltage	No. of modules EN 50022	Pack Carton
No. of poles: 2P					
GW 95 225 MA	30 mA	6 A	110 V	2	1/6
GW 95 226 MA	30 mA	10 A	110 V	2	1/6
GW 95 231 MA	30 mA	13 A	110 V	2	1/6
GW 95 227 MA	30 mA	16 A	110 V	2	1/6
GW 95 228 MA	30 mA	20 A	110 V	2	1/6
GW 95 229 MA	30 mA	25 A	110 V	2	1/6
GW 95 230 MA	30 mA	32 A	110 V	2	1/6

MDC 100 - A[IR] TYPE IMPULSE RESISTANT - C CURVE - 10000 A (EN 61009-1) - 15 KA (EN 60947-2)

BREAKING CAPACITY 2P		
230V	EN61009-1	EN60947-2
$I_{n=32A}$	10000A	15KA



GW 95 827

COMPACT RESIDUAL CURRENT CIRCUIT BREAKERS WITH OVERCURRENT PROTECTION



Code	I_{dn}	Rated current	Rated voltage	No. of modules EN 50022	Pack Carton
No. of poles: 2P					
GW 95 825	30 mA	6 A	230 V	2	1/6
GW 95 826	30 mA	10 A	230 V	2	1/6
GW 95 831	30 mA	13 A	230 V	2	1/6
GW 95 827	30 mA	16 A	230 V	2	1/6
GW 95 828	30 mA	20 A	230 V	2	1/6
GW 95 829	30 mA	25 A	230 V	2	1/6
GW 95 830	30 mA	32 A	230 V	2	1/6

CHARACTERISTICS: type A[IR] presents greater resistance to mains disturbances and atmospheric discharges in comparison to standard residual current circuit breakers with overcurrent protection. Immunity level 8/20 μ s is 3000 A.

MDC 100 - F TYPE - C CURVE - 10000 A (EN 61009-1) - 15 KA (EN 60947-2)

BREAKING CAPACITY 2P			
230V	ENS1009-1	EN60947-2	
I_{cn}	I_{cu}	I_{cu}	
6-32 A	10000 A	15 kA	



GW 95 957

COMPACT RESIDUAL CURRENT CIRCUIT BREAKERS WITH OVERCURRENT PROTECTION



Code	I_{dn}	Rated current	Rated voltage	No. of modules EN 50022	Pack Carton
No. of poles: 2P					
GW 95 955	30 mA	6 A	230 V	2	1/6
GW 95 956	30 mA	10 A	230 V	2	1/6
GW 95 961	30 mA	13 A	230 V	2	1/6
GW 95 957	30 mA	16 A	230 V	2	1/6
GW 95 958	30 mA	20 A	230 V	2	1/6
GW 95 959	30 mA	25 A	230 V	2	1/6
GW 95 960	30 mA	32 A	230 V	2	1/6

CARATTERISTICHE: F type presents greater resistance to mains disturbances and atmospheric discharges in comparison to standard residual current circuit breakers with overcurrent protection. Immunity level 8/20 μ s is 3000 A.

MDC 100 - A TYPE - B CURVE - 10000 A (EN 61009-1) - 15 KA (EN 60947-2)

BREAKING CAPACITY 2P			
230V	ENS1009-1	EN60947-2	
I_{cn}	I_{cu}	I_{cu}	
6-32 A	10000 A	15 kA	



GW 95 327

COMPACT RESIDUAL CURRENT CIRCUIT BREAKERS WITH OVERCURRENT PROTECTION



Code	I_{dn}	Rated current	Rated voltage	No. of modules EN 50022	Pack Carton
No. of poles: 2P					
GW 95 325	30 mA	6 A	230 V	2	1/6
GW 95 326	30 mA	10 A	230 V	2	1/6
GW 95 331	30 mA	13 A	230 V	2	1/6
GW 95 327	30 mA	16 A	230 V	2	1/6
GW 95 328	30 mA	20 A	230 V	2	1/6
GW 95 329	30 mA	25 A	230 V	2	1/6
GW 95 330	30 mA	32 A	230 V	2	1/6
GW 95 795	100 mA	6 A	230 V	2	1/6
GW 95 796	100 mA	10 A	230 V	2	1/6
GW 95 801	100 mA	13 A	230 V	2	1/6
GW 95 797	100 mA	16 A	230 V	2	1/6
GW 95 798	100 mA	20 A	230 V	2	1/6
GW 95 799	100 mA	25 A	230 V	2	1/6
GW 95 800	100 mA	32 A	230 V	2	1/6
GW 95 335	300 mA	6 A	230 V	2	1/6
GW 95 336	300 mA	10 A	230 V	2	1/6
GW 95 337	300 mA	16 A	230 V	2	1/6
GW 95 338	300 mA	20 A	230 V	2	1/6
GW 95 339	300 mA	25 A	230 V	2	1/6
GW 95 340	300 mA	32 A	230 V	2	1/6

90 RCD

MDC 100 - A[IR] TYPE IMPULSE RESISTANT - B CURVE - 10000 A (EN 61009-1) - 15 KA (EN 60947-2)

BREAKING CAPACITY 2P		
230V	EN61009-1	EN60947-2
	I _{cn}	I _{cs}
I _{cn} = 6-32 A	10000 A	15 kA



GW 95 837

COMPACT RESIDUAL CURRENT CIRCUIT BREAKERS WITH OVERCURRENT PROTECTION



Code	I _{dn}	Rated current	Rated voltage	No. of modules EN 50022	Pack Carton
No. of poles: 2P					
GW 95 835	30 mA	6 A	230 V	2	1/6
GW 95 836	30 mA	10 A	230 V	2	1/6
GW 95 841	30 mA	13 A	230 V	2	1/6
GW 95 837	30 mA	16 A	230 V	2	1/6
GW 95 838	30 mA	20 A	230 V	2	1/6
GW 95 839	30 mA	25 A	230 V	2	1/6
GW 95 840	30 mA	32 A	230 V	2	1/6

CHARACTERISTICS: type A[IR] presents greater resistance to mains disturbances and atmospheric discharges in comparison to standard residual current circuit breakers with overcurrent protection. Immunity level 8/20 μs is 3000 A.

MDC 100 - F TYPE - B CURVE - 10000 A (EN 61009-1) - 15 KA (EN 60947-2)

BREAKING CAPACITY 2P		
230V	EN61009-1	EN60947-2
	I _{cn}	I _{cs}
I _{cn} = 6-32 A	10000 A	15 kA



GW 95 967

COMPACT RESIDUAL CURRENT CIRCUIT BREAKERS WITH OVERCURRENT PROTECTION



Code	I _{dn}	Rated current	Rated voltage	No. of modules EN 50022	Pack Carton
No. of poles: 2P					
GW 95 965	30 mA	6 A	230 V	2	1/6
GW 95 966	30 mA	10 A	230 V	2	1/6
GW 95 971	30 mA	13 A	230 V	2	1/6
GW 95 967	30 mA	16 A	230 V	2	1/6
GW 95 968	30 mA	20 A	230 V	2	1/6
GW 95 969	30 mA	25 A	230 V	2	1/6
GW 95 970	30 mA	32 A	230 V	2	1/6

CHARACTERISTIC: F type presents greater resistance to mains disturbances and atmospheric discharges in comparison to standard residual current circuit breakers with overcurrent protection. Immunity level 8/20 μs is 3000 A.

BD - ADD-ON RESIDUAL CURRENT DEVICES FOR MT CIRCUIT BREAKERS

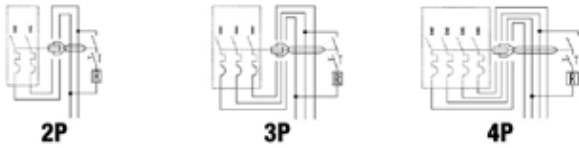

BD - AC TYPE (INSTANTANEOUS)



GW 94 402

ADD-ON RESIDUAL CURRENT DEVICES



Code	Idn	Rated current	Rated voltage	No. of modules EN 50022	Pack Carton
No. of poles: 2P					
GW 94 401	10 mA	25 A	230 V	2	1/2
GW 94 402	30 mA	25 A	230 V	2	1/2
GW 94 403	300 mA	25 A	230 V	2	1/2
GW 94 404	500 mA	25 A	230 V	2	1/2
GW 94 412	30 mA	63 A	230 V	2	1/2
GW 94 413	300 mA	63 A	230 V	2	1/2
GW 94 414	500 mA	63 A	230 V	2	1/2
No. of poles: 3P					
GW 94 442	30 mA	25 A	400 V	3.5	1/2
GW 94 443	300 mA	25 A	400 V	3.5	1/2
GW 94 444	500 mA	25 A	400 V	3.5	1/2
GW 94 448	30 mA	63 A	400 V	3.5	1/2
GW 94 449	300 mA	63 A	400 V	3.5	1/2
GW 94 450	500 mA	63 A	400 V	3.5	1/2
No. of poles: 4P					
GW 94 422	30 mA	25 A	400 V	3.5	1/2
GW 94 423	300 mA	25 A	400 V	3.5	1/2
GW 94 424	500 mA	25 A	400 V	3.5	1/2
GW 94 432	30 mA	63 A	400 V	3.5	1/2
GW 94 433	300 mA	63 A	400 V	3.5	1/2
GW 94 434	500 mA	63 A	400 V	3.5	1/2

BD - A TYPE (INSTANTANEOUS)



GW 94 502

ADD-ON RESIDUAL CURRENT DEVICES



Code	Idn	Rated current	Rated voltage	No. of modules EN 50022	Pack Carton
No. of poles: 2P					
GW 94 502	30 mA	25 A	230 V	2	1/2
GW 94 503	300 mA	25 A	230 V	2	1/2
GW 94 504	500 mA	25 A	230 V	2	1/2
GW 94 512	30 mA	63 A	230 V	2	1/2
GW 94 513	300 mA	63 A	230 V	2	1/2
GW 94 514	500 mA	63 A	230 V	2	1/2
No. of poles: 3P					
GW 94 542	30 mA	25 A	400 V	3.5	1/2
GW 94 543	300 mA	25 A	400 V	3.5	1/2
GW 94 544	500 mA	25 A	400 V	3.5	1/2
GW 94 547	30 mA	63 A	400 V	3.5	1/2
GW 94 548	300 mA	63 A	400 V	3.5	1/2
GW 94 549	500 mA	63 A	400 V	3.5	1/2
No. of poles: 4P					
GW 94 522	30 mA	25 A	400 V	3.5	1/2
GW 94 523	300 mA	25 A	400 V	3.5	1/2
GW 94 524	500 mA	25 A	400 V	3.5	1/2
GW 94 532	30 mA	63 A	400 V	3.5	1/2
GW 94 533	300 mA	63 A	400 V	3.5	1/2
GW 94 534	500 mA	63 A	400 V	3.5	1/2

90 RCD

BD - A[IR] TYPE (IMPULSE RESISTANT)



GW 94 566

ADD-ON RESIDUAL CURRENT DEVICES



Code	Idn	Rated current	Rated voltage	No. of modules EN 50022	Pack Carton
No. of poles: 2P					
GW 94 566	30 mA	63 A	230 V	2	1/2
No. of poles: 3P					
GW 94 595	30 mA	63 A	400 V	3.5	1/2
No. of poles: 4P					
GW 94 586	30 mA	63 A	400 V	3.5	1/2

CHARACTERISTICS: type A[IR] presents greater resistance to mains disturbances and atmospheric discharges in comparison to add-on residual current devices. Immunity level 8/20 μ s is 3000 A.

BD - A[S] TYPE (SELECTIVE)



GW 94 563

ADD-ON RESIDUAL CURRENT DEVICES



Code	Idn	Rated current	Rated voltage	No. of modules EN 50022	Pack Carton
No. of poles: 2P					
GW 94 563	300 mA	63 A	230 V	2	1/2
GW 94 565	1000 mA	63 A	230 V	2	1/2
No. of poles: 3P					
GW 94 598	300 mA	63 A	400 V	3.5	1/2
GW 94 600	1000 mA	63 A	400 V	3.5	1/2
No. of poles: 4P					
GW 94 583	300 mA	63 A	400 V	3.5	1/2
GW 94 585	1000 mA	63 A	400 V	3.5	1/2

BDHP - ADD-ON RESIDUAL CURRENT DEVICES FOR MTHP CIRCUIT BREAKERS

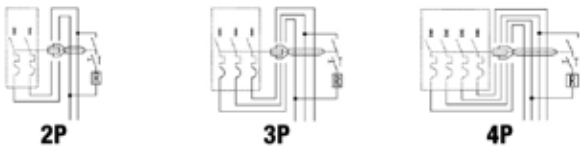

BDHP - AC TYPE (INSTANTANEOUS)



GW 95 416

ADD-ON RESIDUAL CURRENT DEVICES



Code	Idn	Rated current	Rated voltage	No. of modules EN 50022	Pack Carton
No. of poles: 2P					
GW 95 406	30 mA	125 A	230 V	4	1/2
GW 95 408	300 mA	125 A	230 V	4	1/2
No. of poles: 3P					
GW 95 416	30 mA	125 A	400 V	6	1/2
GW 95 418	300 mA	125 A	400 V	6	1/2
No. of poles: 4P					
GW 95 426	30 mA	125 A	400 V	6	1/2
GW 95 428	300 mA	125 A	400 V	6	1/2

BDHP - A TYPE (INSTANTANEOUS)



GW 95 446

ADD-ON RESIDUAL CURRENT DEVICES



Code	Idn	Rated current	Rated voltage	No. of modules EN 50022	Pack Carton
No. of poles: 2P					
GW 95 436	30 mA	125 A	230 V	4	1/2
GW 95 438	300 mA	125 A	230 V	4	1/2
No. of poles: 3P					
GW 95 446	30 mA	125 A	400 V	6	1/2
GW 95 448	300 mA	125 A	400 V	6	1/2
No. of poles: 4P					
GW 95 456	30 mA	125 A	400 V	6	1/2
GW 95 458	300 mA	125 A	400 V	6	1/2

BDHP - A[S] TYPE (SELECTIVE)



GW 95 478

ADD-ON RESIDUAL CURRENT DEVICES



Code	Idn	Rated current	Rated voltage	No. of modules EN 50022	Pack Carton
No. of poles: 2P					
GW 95 468	300 mA	125 A	230 V	4	1/2
GW 95 470	1000 mA	125 A	230 V	4	1/2
No. of poles: 3P					
GW 95 478	300 mA	125 A	400 V	6	1/2
GW 95 480	1000 mA	125 A	400 V	6	1/2
No. of poles: 4P					
GW 95 488	300 mA	125 A	400 V	6	1/2
GW 95 490	1000 mA	125 A	400 V	6	1/2

BDHP - TYPE A[IR] ADJUSTABLE BOOSTED IMMUNITY



GW 95 512

ADD-ON RESIDUAL CURRENT DEVICE



Code	Idn	Adjustable tripping time	Rated current	Rated voltage	No. of modules EN 50022	Pack Carton
No. of poles: 4P						
GW 95 512	300 - 3000 mA	0 - 60 - 150 ms	125 A	400 V	6	1/2

CHARACTERISTICS: I_{da}: adjustable 300-500-1000-3000 mA; adjustable tripping time 0-60-150 ms.

Type A[IR] presents greater resistance to mains disturbances and atmospheric discharges in comparison to standard add-on residual current devices. Immunity level 8/20 μs is 3000 A.

90 RCD

IDP NA - RESIDUAL CURRENT CIRCUIT BREAKERS (ACCESSORIES NOT AVAILABLE)

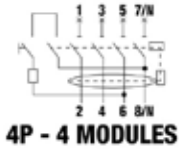
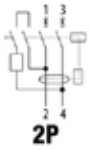

IDP NA - AC TYPE INSTANTANEOUS



GW D4 617

RESIDUAL CURRENT CIRCUIT BREAKERS



Code	Rated current	I_{dn}	Rated voltage	Auxiliaries compatibility	ReStart compatibility	No. of modules EN 50022	Pack Carton
No. of poles: 2P							
GW D4 617	25 A	30 mA	230 V	No	Yes	2	1/6
GW D4 627	40 A	30 mA	230 V	No	Yes	2	1/6
No. of poles: 4P							
GW D4 427	25 A	30 mA	400 V	No	No	4	1/3
GW D4 429	25 A	300 mA	400 V	No	No	4	1/3
GW D4 431	40 A	30 mA	400 V	No	No	4	1/3
GW D4 433	40 A	300 mA	400 V	No	No	4	1/3
GW D4 435	63 A	30 mA	400 V	No	No	4	1/3
GW D4 437	63 A	300 mA	400 V	No	No	4	1/3

IDP NA - A TYPE INSTANTANEOUS



GW D4 817

RESIDUAL CURRENT CIRCUIT BREAKERS



Code	Rated current	I_{dn}	Rated voltage	Auxiliaries compatibility	ReStart compatibility	No. of modules EN 50022	Pack Carton
No. of poles: 2P							
GW D4 817	25 A	30 mA	230 V	No	Yes	2	1/6
GW D4 827	40 A	30 mA	230 V	No	Yes	2	1/6
No. of poles: 4P							
GW D4 439	25 A	30 mA	400 V	No	No	4	1/3
GW D4 441	25 A	300 mA	400 V	No	No	4	1/3
GW D4 443	40 A	30 mA	400 V	No	No	4	1/3
GW D4 445	40 A	300 mA	400 V	No	No	4	1/3
GW D4 447	63 A	30 mA	400 V	No	No	4	1/3
GW D4 449	63 A	300 mA	400 V	No	No	4	1/3

IDP - RESIDUAL CURRENT CIRCUIT BREAKERS

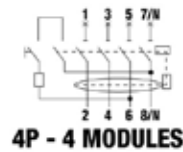
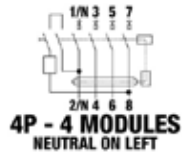
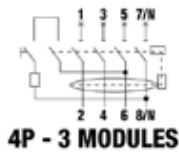
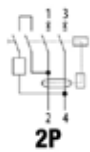

IDP - AC TYPE INSTANTANEOUS



GW D4 001

RESIDUAL CURRENT CIRCUIT BREAKERS



Code	Rated current	Idn	Rated voltage	Auxiliaries compatibility	ReStart compatibility	No. of modules EN 50022	Pack Carton
No. of poles: 2P							
GW D4 001	25 A	10 mA	230 V	Yes	Yes	2	1/6
GW D4 002	25 A	30 mA	230 V	Yes	Yes	2	1/6
GW D4 003	25 A	100 mA	230 V	Yes	Yes	2	1/6
GW D4 004	25 A	300 mA	230 V	Yes	Yes	2	1/6
GW D4 022	40 A	30 mA	230 V	Yes	Yes	2	1/6
GW D4 023	40 A	100 mA	230 V	Yes	Yes	2	1/6
GW D4 024	40 A	300 mA	230 V	Yes	Yes	2	1/6
GW D4 025	40 A	500 mA	230 V	Yes	Yes	2	1/6
GW D4 042	63 A	30 mA	230 V	Yes	Yes	2	1/6
GW D4 043	63 A	100 mA	230 V	Yes	Yes	2	1/6
GW D4 044	63 A	300 mA	230 V	Yes	Yes	2	1/6
GW D4 045	63 A	500 mA	230 V	Yes	Yes	2	1/6
GW D4 062	80 A	30 mA	230 V	Yes	Yes	2	1/6
No. of poles: 4P							
GW 94 662	25 A	30 mA	400 V	Yes	No	3	1/4
GW 94 664	25 A	300 mA	400 V	Yes	No	3	1/4
GW 94 667	40 A	30 mA	400 V	Yes	No	3	1/4
GW 94 668	40 A	100 mA	400 V	Yes	No	3	1/4
GW 94 669	40 A	300 mA	400 V	Yes	No	3	1/4
GW 94 670	40 A	500 mA	400 V	Yes	No	3	1/4
GW D4 102	25 A	30 mA	400 V	Yes	Yes	4	1/3
GW D4 103	25 A	100 mA	400 V	Yes	Yes	4	1/3
GW D4 104	25 A	300 mA	400 V	Yes	Yes	4	1/3
GW D4 122	40 A	30 mA	400 V	Yes	Yes	4	1/3
GW D4 123	40 A	100 mA	400 V	Yes	Yes	4	1/3
GW D4 124	40 A	300 mA	400 V	Yes	Yes	4	1/3
GW D4 125	40 A	500 mA	400 V	Yes	Yes	4	1/3
GW D4 142	63 A	30 mA	400 V	Yes	Yes	4	1/3
GW D4 143	63 A	100 mA	400 V	Yes	Yes	4	1/3
GW D4 144	63 A	300 mA	400 V	Yes	Yes	4	1/3
GW D4 145	63 A	500 mA	400 V	Yes	Yes	4	1/3
GW 94 761 K	80 A	30 mA	400 V	No	No	4	1/3
GW 94 766 K	80 A	300 mA	400 V	No	No	4	1/3
GW 94 777 K	100 A	30 mA	400 V	No	No	4	1/3
GW 94 779 K	100 A	300 mA	400 V	No	No	4	1/3
GW 95 601	125 A	30 mA	400 V	Yes	No	4	1
GW 95 603	125 A	300 mA	400 V	Yes	No	4	1
GW 95 604	125 A	500 mA	400 V	Yes	No	4	1
No. of poles: 4P (N-conductor left)							
GW D4 302	25 A	30 mA	400 V	Yes	Yes	4	1/3
GW D4 304	25 A	300 mA	400 V	Yes	Yes	4	1/3
GW D4 322	40 A	30 mA	400 V	Yes	Yes	4	1/3
GW D4 324	40 A	300 mA	400 V	Yes	Yes	4	1/3
GW D4 342	63 A	30 mA	400 V	Yes	Yes	4	1/3
GW D4 344	63 A	300 mA	400 V	Yes	Yes	4	1/3

IDP - A TYPE INSTANTANEOUS



GW D4 011

RESIDUAL CURRENT CIRCUIT BREAKERS



Code	Rated current	I _{dn}	Rated voltage	Auxiliaries compatibility	ReStart compatibility	No. of modules EN 50022	Pack Carton
No. of poles: 2P							
GW D4 011	25 A	10 mA	230 V	Yes	Yes	2	1/6
GW D4 012	25 A	30 mA	230 V	Yes	Yes	2	1/6
GW D4 012 MA	25 A	30 mA	110 V	Yes	No	2	1/6
GW D4 013	25 A	100 mA	230 V	Yes	Yes	2	1/6
GW D4 014	25 A	300 mA	230 V	Yes	Yes	2	1/6
GW D4 032	40 A	30 mA	230 V	Yes	Yes	2	1/6
GW D4 032 MA	40 A	30 mA	110 V	Yes	No	2	1/6
GW D4 033	40 A	100 mA	230 V	Yes	Yes	2	1/6
GW D4 034	40 A	300 mA	230 V	Yes	Yes	2	1/6
GW D4 035	40 A	500 mA	230 V	Yes	Yes	2	1/6
GW D4 052	63 A	30 mA	230 V	Yes	Yes	2	1/6
GW D4 052 MA	63 A	30 mA	110 V	Yes	No	2	1/6
GW D4 053	63 A	100 mA	230 V	Yes	Yes	2	1/6
GW D4 054	63 A	300 mA	230 V	Yes	Yes	2	1/6
GW D4 055	63 A	500 mA	230 V	Yes	Yes	2	1/6
GW D4 072	80 A	30 mA	230 V	Yes	Yes	2	1/6
No. of poles: 4P							
GW 94 867	25 A	30 mA	400 V	Yes	No	3	1/4
GW 94 869	25 A	300 mA	400 V	Yes	No	3	1/4
GW 94 885	40 A	30 mA	230 V	Yes	No	3	1/4
GW 94 897	40 A	30 mA	400 V	Yes	No	3	1/4
GW 94 898	40 A	100 mA	400 V	Yes	No	3	1/4
GW 94 899	40 A	300 mA	400 V	Yes	No	3	1/4
GW 94 900	40 A	500 mA	400 V	Yes	No	3	1/4
GW D4 111	25 A	10 mA	400 V	Yes	Yes	4	1/3
GW D4 112	25 A	30 mA	400 V	Yes	Yes	4	1/3
GW D4 113	25 A	100 mA	400 V	Yes	Yes	4	1/3
GW D4 114	25 A	300 mA	400 V	Yes	Yes	4	1/3
GW D4 132	40 A	30 mA	400 V	Yes	Yes	4	1/3
GW D4 133	40 A	100 mA	400 V	Yes	Yes	4	1/3
GW D4 134	40 A	300 mA	400 V	Yes	Yes	4	1/3
GW D4 135	40 A	500 mA	400 V	Yes	Yes	4	1/3
GW D4 152	63 A	30 mA	400 V	Yes	Yes	4	1/3
GW D4 153	63 A	100 mA	400 V	Yes	Yes	4	1/3
GW D4 154	63 A	300 mA	400 V	Yes	Yes	4	1/3
GW D4 155	63 A	500 mA	400 V	Yes	Yes	4	1/3
GW 94 957 K	100 A	30 mA	400 V	No	No	4	1/3
GW 94 959 K	100 A	300 mA	400 V	No	No	4	1/3
GW 95 606	125 A	30 mA	400 V	Yes	No	4	1
GW 95 608	125 A	300 mA	400 V	Yes	No	4	1
GW 95 609	125 A	500 mA	400 V	Yes	No	4	1
No. of poles: 4P (N-conductor left)							
GW D4 312	25 A	30 mA	400 V	Yes	Yes	4	1/3
GW D4 314	25 A	300 mA	400 V	Yes	Yes	4	1/3
GW D4 332	40 A	30 mA	400 V	Yes	Yes	4	1/3
GW D4 334	40 A	300 mA	400 V	Yes	Yes	4	1/3
GW D4 352	63 A	30 mA	400 V	Yes	Yes	4	1/3
GW D4 354	63 A	300 mA	400 V	Yes	Yes	4	1/3

IDP - A[IR] TYPE (IMPULSE RESISTANT)



GW D4 217

RESIDUAL CURRENT CIRCUIT BREAKERS



Code	Rated current	I _{dn}	Rated voltage	Auxiliaries compatibility	ReStart compatibility	No. of modules EN 50022	Pack Carton
No. of poles: 2P							
GW D4 202	25 A	30 mA	230 V	Yes	Yes	2	1/6
GW D4 203	25 A	300 mA	230 V	Yes	Yes	2	1/6
GW D4 205	40 A	30 mA	230 V	Yes	Yes	2	1/6
GW D4 206	40 A	300 mA	230 V	Yes	Yes	2	1/6
GW D4 208	63 A	30 mA	230 V	Yes	Yes	2	1/6
GW D4 209	63 A	300 mA	230 V	Yes	Yes	2	1/6
No. of poles: 4P							
GW D4 217	25 A	30 mA	400 V	Yes	Yes	4	1/3
GW D4 218	25 A	300 mA	400 V	Yes	Yes	4	1/3
GW D4 220	40 A	30 mA	400 V	Yes	Yes	4	1/3
GW D4 221	40 A	300 mA	400 V	Yes	Yes	4	1/3
GW D4 223	63 A	30 mA	400 V	Yes	Yes	4	1/3
GW D4 224	63 A	300 mA	400 V	Yes	Yes	4	1/3
GW 95 696 K	100 A	30 mA	400 V	No	No	4	1/3
No. of poles: 4P (N-conductor left)							
GW D4 317	25 A	30 mA	400 V	Yes	Yes	4	1/3
GW D4 337	40 A	30 mA	400 V	Yes	Yes	4	1/3
GW D4 357	63 A	30 mA	400 V	Yes	Yes	4	1/3

CHARACTERISTICS: type A[IR] presents greater resistance to mains disturbances and atmospheric discharges in comparison to standard residual current circuit breakers. Immunity level 8/20 µs is 3000 A.

IDP - A[S] TYPE (SELECTIVE)



GW D4 249

RESIDUAL CURRENT CIRCUIT BREAKERS



Code	Rated current	I _{dn}	Rated voltage	Auxiliaries compatibility	ReStart compatibility	No. of modules EN 50022	Pack Carton
No. of poles: 2P							
GW D4 234	40 A	300 mA	230 V	Yes	Yes	2	1/6
GW D4 235	40 A	500 mA	230 V	Yes	Yes	2	1/6
GW D4 237	63 A	300 mA	230 V	Yes	Yes	2	1/6
GW D4 238	63 A	500 mA	230 V	Yes	Yes	2	1/6
No. of poles: 4P							
GW D4 249	40 A	300 mA	400 V	Yes	Yes	4	1/3
GW D4 250	40 A	500 mA	400 V	Yes	Yes	4	1/3
GW D4 252	63 A	300 mA	400 V	Yes	Yes	4	1/3
GW D4 253	63 A	500 mA	400 V	Yes	Yes	4	1/3
GW 94 996 K	100 A	300 mA	400 V	No	No	4	1/3

90 RCD

IDP - F TYPE INSTANTANEOUS



GW D4 261

RESIDUAL CURRENT CIRCUIT BREAKERS



Code	Rated current	I_{dn}	Rated voltage	Auxiliaries compatibility	ReStart compatibility	No. of modules EN 50022	Pack Carton
No. of poles: 2P							
GW D4 261	25 A	30 mA	230 V	Yes	Yes	2	1/6
GW D4 265	40 A	30 mA	230 V	Yes	Yes	2	1/6
GW D4 269	63 A	30 mA	230 V	Yes	Yes	2	1/6
No. of poles: 4P							
GW D4 281	25 A	30 mA	400 V	Yes	Yes	4	1/3
GW D4 285	40 A	30 mA	400 V	Yes	Yes	4	1/3
GW D4 289	63 A	30 mA	400 V	Yes	Yes	4	1/3
No. of poles: 4P (N-conductor left)							
GW D4 307	25 A	30 mA	400 V	Yes	Yes	4	1/3
GW D4 327	40 A	30 mA	400 V	Yes	Yes	4	1/3
GW D4 347	63 A	30 mA	400 V	Yes	Yes	4	1/3

CHARACTERISTIC: F type presents greater resistance to mains disturbances and atmospheric discharges in comparison to standard residual current circuit breakers with overcurrent protection. Immunity level 8/20 μ s is 3000 A.

IDP - B TYPE INSTANTANEOUS



GW D4 512

RESIDUAL CURRENT CIRCUIT BREAKERS



Code	Rated current	I_{dn}	Rated voltage	Auxiliaries compatibility	ReStart compatibility	No. of modules EN 50022	Pack Carton
No. of poles: 2P							
GW D4 502	25 A	30 mA	230 V	Yes	Yes	4	1/3
GW D4 504	25 A	300 mA	230 V	Yes	Yes	4	1/3
GW D4 507	40 A	30 mA	230 V	Yes	Yes	4	1/3
GW D4 509	40 A	300 mA	230 V	Yes	Yes	4	1/3
GW D4 512	63 A	30 mA	230 V	Yes	Yes	4	1/3
GW D4 514	63 A	300 mA	230 V	Yes	Yes	4	1/3
No. of poles: 4P							
GW D4 527	25 A	30 mA	400 V	Yes	Yes	4	1/3
GW D4 529	25 A	300 mA	400 V	Yes	Yes	4	1/3
GW D4 532	40 A	30 mA	400 V	Yes	Yes	4	1/3
GW D4 534	40 A	300 mA	400 V	Yes	Yes	4	1/3
GW D4 537	63 A	30 mA	400 V	Yes	Yes	4	1/3
GW D4 539	63 A	300 mA	400 V	Yes	Yes	4	1/3

CHARACTERISTICS: type B presents greater resistance to mains disturbances and atmospheric discharges in comparison to standard residual current circuit breakers. Immunity level 8/20 μ s is 3000 A.

LOCAL RESIDUAL CURRENT PROTECTION DEVICES

SOCKET OUTLETS WITH RESIDUAL CURRENT PROTECTION



GW 95 521

IP21 RCD SAFETY SOCKET OUTLETS - WHITE COLOUR

Code	I _{dn}	Rated current	Type	Rated voltage	Pack Carton
GW 95 521	10 mA	16 A	A	230 V	1/2
GW 95 522	30 mA	16 A	A	230 V	1/2

NOTE: RCD socket-outlets can be used for flush-mounting or wall-mounting application. Only for wall-mounting application, GW95527 is necessary.



GW 95 524

IP44 RCD SAFETY SOCKET OUTLETS - WHITE COLOUR

Code	I _{dn}	Rated current	Type	Rated voltage	Pack Carton
GW 95 523	10 mA	16 A	A	230 V	1/2
GW 95 524	30 mA	16 A	A	230 V	1/2

NOTE: RCD socket-outlets can be used for flush-mounting or wall-mounting application. Only for wall-mounting application, GW95527 is necessary.

90 RCD



GW 95 525

IP41 RCD SAFETY UNIT - WHITE COLOUR

Code	Idn	Rated current	Type	Rated voltage	Pack Carton
GW 95 525	10 mA	16 A	A	230 V	1/2
GW 95 526	30 mA	16 A	A	230 V	1/2

NOTE: RCD safety units can be used for flush-mounting or wall-mounting application. Only for wall-mounting application, GW95527 is necessary.



GW 95 527

WALL-MOUNTING BOX - WHITE COLOUR

Code	Outer dim. LxHxD (mm)	Entries No. holes / Ø	Pack Carton
GW 95 527	80x80x50	6 / 19	100

CHARACTERISTICS: box suitable for all RCD socket-outlets and RCD safety unit types.

NOTE: only for wall-mounting application. The IP protection rating depends on IP of RCD socket-outlet or RCD safety unit chosen.



90 RCD



Scan the QR Code and find out all the technical informations.

A CIRCUIT BREAKER FOR EVERY NEED

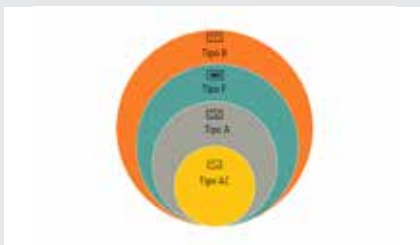

The Series 90 RCD meets all the protection requirements against earth leakage in electrical systems with different types of current, from sinusoidal (AC type) and one-way push button (A type), to variable frequency (F type) and continuous component (B type).

SERVING CONTINUITY

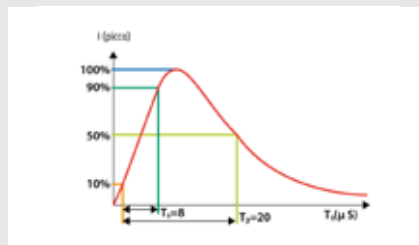

The 90 RCD range also includes IR Reinforced Immunity versions, which are characterised by high resistance to untimely tripping caused by power surges. These versions are particularly suitable in systems where continuity of service is essential.

MAXIMUM PROTECTION IN MINIMUM SPACE



The use of MDC compact residual current circuit breakers reduces the number of modules installed, allowing the installation of smaller, and therefore less costly, enclosures.



MODULAR ACCESSORIES



90 AM

MODULAR ACCESSORIES

pag. 470



90 PV

PRODUCTS FOR PHOTOVOLTAIC SYSTEMS

pag. 508

90 AM

Modular accessories

The 90 AM range, in addition to auxiliaries common for the all circuit breakers, comprises many modular accessories for the protection, command, programming, measurement and signalling in electrical systems.



AUXILIARIES AND ACCESSORIES FOR MODULAR CIRCUIT BREAKERS

ELECTRICAL AUXILIARIES FOR CIRCUIT BREAKERS MTC / MT / MTHP / MDC



GW 96 001

AUXILIARY CONTACT OF OPEN/CLOSED POSITION

Code	Contact rating in AC	Contact rating in DC	Type of contacts	No. of modules EN 50022	Pack Carton
GW 96 001	6 A (230 V) 3 A (400 V)	6 A (24 V) 2 A (60 V) 1.5 A (110 V) 1 A (250 V)	1 Changeover	0.5	1/16

APPLICATIONS: signals the position of circuit breaker contacts, when manually open or tripped.
NOTE: up to max. 2 auxiliary contacts can be fitted to each circuit breaker.



GW 96 006

AUXILIARY CONTACT OF FAULT INDICATOR SWITCH

Code	Contact rating in AC	Contact rating in DC	Type of contacts	No. of modules EN 50022	Pack Carton
GW 96 006	6 A (230 V) 3 A (400 V)	6 A (24 V) 2 A (60 V) 1.5 A (110 V) 1 A (250 V)	1 Changeover	0.5	1/16

APPLICATIONS: signals the automatic trip of the circuit breaker caused by overloading, short-circuiting or earth leakage. In the event of manual manoeuvring, it does not indicate the change of position of the contacts.
NOTE: up to max. 2 auxiliary contacts can be fitted to each circuit breaker.



GW 96 009

ADJUSTABLE AUXILIARY CONTACT OF FAULT INDICATOR SWITCH OR OPEN/CLOSED POSITION

Code	Contact rating in AC	Contact rating in DC	Type of contacts	No. of modules EN 50022	Pack Carton
GW 96 009	6 A (230 V) 3 A (400 V)	6 A (24 V) 2 A (60 V) 1.5 A (110 V) 1 A (250 V)	1 Changeover	0.5	1/16

APPLICATIONS: using the specific button key, 2 separate functions can be obtained: signalling of automatic trip of the circuit breaker (auxiliary contact of fault indicator switch) or signalling of the circuit breaker contact position (auxiliary contact of position).
NOTE: up to max. 2 auxiliary contacts can be fitted to each circuit breaker.



GW 96 012

SHUNT TRIP RELEASES

Code	Rated voltage (V)	No. of modules EN 50022	Pack Carton
GW 96 011	12-48 ac/dc	1	1/8
GW 96 012	110-125 dc 110-415 ac	1	1/8

APPLICATIONS: used for the remote trip of the coupled circuit breaker.

CHARACTERISTICS: minimum operating voltage: 0.7 Vn min. Maximum operating voltage: 1.1 Vn max.

NOTE: up to max. one release (shunt trip or under voltage) can be fitted to each circuit breaker with an auxiliary contact.



GW 96 016

UNDER VOLTAGE RELEASES (DELAYED)

Code	Rated voltage (V)	No. of modules EN 50022	Pack Carton
GW 96 016	230 ac	1	1/8
GW 96 017	24 ac/dc	1	1/8
GW 96 018	48 ac/dc	1	1/8

APPLICATIONS: constantly controls the effective value of the voltage, and trips the coupled circuit breaker when the voltage falls below its minimum value.

The 300 ms delay allows any tiny blackouts to be avoided, preventing the untimely tripping of circuit breaker.

NOTE: up to max. one release (shunt trip or under voltage) can be fitted to each circuit breaker with an auxiliary contact.

ACCESSORIES FOR CIRCUIT BREAKERS MTC / MT / MTHP / MDC



GW 96 022

SEALABLE SCREW CAPS

Code	Suitable for	Nr. pieces per module	Pack Carton
GW 96 022	MTC/MT/MDC	2	10/100
GW 96 026	MTHP/BDHP	1	10/100

APPLICATIONS: allows for sealing of terminal screws, preventing access to cable connections.



GW 96 042

POLE SEPARATOR

Code	Suitable for	Pack Carton
GW 96 042	MT/MDC	10/100

ELECTRICAL AUXILIARIES FOR RCCBS IDP



GW D6 002

AUXILIARY CONTACTS FOR OPEN/CLOSED POSITION

Code	Suitable for	Contact rating in AC	Contact rating in DC	Type of contacts	No. of modules EN 50022	Pack Carton
GW D6 002	IDP 25-80A 2P / IDP 25-63A 4P	6 A (230 V) 3 A (400 V)	6 A (24 V) 2 A (60 V) 1.5 A (110 V) 1 A (250 V)	1 Changeover	0.5	1/16
GW 96 003	IDP 4P - 3 modules	6 A (230 V) 2 A (400 V)	4 A (24 V) 1 A (110 V)	1 NO - 1 NC	0.5	1/12
GW 96 005	IDP 125 A	5 A (230 V) 0.5 A (400 V) -	-	1 NO - 1 NC	0.5	1

APPLICATIONS: signals the position of circuit breaker contacts, when manually open or tripped.



GW D6 007

FAULT INDICATOR SWITCH

Code	Suitable for	Contact rating in AC	Contact rating in DC	Type of contacts	No. of modules EN 50022	Pack Carton
GW D6 007	IDP 25-80A 2P / IDP 25-63A 4P	6 A (230 V) 3 A (400 V)	6 A (24 V) 2 A (60 V) 1.5 A (110 V) 1 A (250 V)	1 Changeover	0.5	1/16
GW 96 004	IDP 4P - 3 modules	6 A (230 V) 2 A (400 V)	4 A (24 V) 1 A (110 V)	1 NO - 1 NC	0.5	1/12

APPLICATIONS: indicates the automatic trip of the circuit breaker due to an earth leakage. In the event of manual manoeuvring, it does not indicate the change of position of the contacts.



GW D6 010

ADJUSTABLE AUXILIARY CONTACT OR FAULT INDICATOR SWITCH

Code	Suitable for	Contact rating in AC	Contact rating in DC	Type of contacts	No. of modules EN 50022	Pack Carton
GW D6 010	IDP 25-80A 2P / IDP 25-63A 4P	6 A (230 V) 3 A (400 V)	6 A (24 V) 2 A (60 V) 1.5 A (110 V) 1 A (250 V)	1 Changeover	0.5	1/16

APPLICATIONS: using the specific button key, 2 separate functions can be obtained: signalling of automatic trip of the circuit breaker (auxiliary contact of fault indicator switch) or signalling of the circuit breaker contact position (auxiliary contact of position).

NOTE: they cannot be used with 4P RCCBs in 3 modules.



GW D6 013

SHUNT TRIP RELEASES

Code	Suitable for	Rated voltage (V)	No. of modules EN 50022	Pack Carton
GW D6 013	IDP 25-80A 2P / IDP 25-63A 4P	12-48 ac/dc	1	1/8
GW D6 015	IDP 25-80A 2P / IDP 25-63A 4P	110-125 dc 110-415 ac	1	1/8
GW 96 015	IDP 4P - 3 modules	230 AC	0.5	1/12

APPLICATIONS: used for the remote trip of the coupled circuit breaker.

CHARACTERISTICS: minimum operating voltage: 0.7 Vn min. maximum operating voltage: 1.1 Vn max.

ACCESSORIES FOR RCCB'S - IDP



GW D6 026

COUPLE OF SEALABLE SCREW CAPS

Code	Suitable for	Pack Carton
GW D6 026	IDP 25-80A 2P	1/50
GW D6 027	IDP 25-63A 4P	1/10
GW 96 038	IDP 4P - 3 modules	1/10

ELECTRICAL AUXILIARIES FOR SWITCH DISCONNECTORS WITH ACCESSORY OPTIONS



GW D6 002

AUXILIARY CONTACT OF OPEN/CLOSED POSITION

Code	Contact rating in AC	Contact rating in DC	Type of contacts	No. of modules EN 50022	Pack Carton
GW D6 002	6 A (230 V) 3 A (400 V)	6 A (24 V) 2 A (60 V) 1.5 A (110 V) 1 A (250 V)	1 Changeover	0.5	1/16

APPLICATIONS: signals the position of switch disconnecter contacts, when manually open.



GW D6 015

SHUNT TRIP RELEASES

Code	Rated voltage (V)	No. of modules EN 50022	Pack Carton
GW D6 013	12-48 ac/dc	1	1/8
GW D6 015	110-125 dc 110-415 ac	1	1/8

APPLICATIONS: used for the remote trip of the coupled switch disconnecter.

CHARACTERISTICS: minimum operating voltage: 0.7 Vn min. maximum operating voltage: 1.1 Vn max.

NOTES: up to max. one release (shunt trip or undervoltage) can be fitted to each switch disconnecter with one auxiliary contact.



GW D6 019

UNDER VOLTAGE RELEASES (DELAYED)

Code	Rated voltage (V)	No. of modules EN 50022	Pack Carton
GW D6 019	230 ac	1	1/8
GW D6 020	24 ac/dc	1	1/8
GW D6 021	48 ac/dc	1	1/8

APPLICATIONS: constantly controls the effective value of the voltage, and trips the coupled switch disconnecter when the voltage falls below its minimum value. The 300 ms delay allows any momentary voltage drops to be avoided, preventing the untimely tripping of switch disconnecter.

NOTE: up to max. one release (shunt trip or undervoltage) can be fitted to each switch disconnecter with an auxiliary contact.

ACCESSORIES FOR SWITCH DISCONNECTORS WITH ACCESSORY OPTIONS



GW D6 026

COUPLE OF SEALABLE SCREW CAPS

Code	Suitable for	Pack Carton
GW D6 026	2P isolators	1/50
GW D6 027	4P isolators	1/10

ACCESSORIES FOR MODULAR CIRCUIT BREAKERS



GW 96 041

PADLOCKING LEVER BLOCK

Code	Suitable for	Pack Carton
GW 96 041	MTC/MT/MTHP/MDC/IDP/Switch disconnectors	10/100

APPLICATIONS: to lock the control lever in "ON" or "OFF" positions. For padlocks max Ø 5 mm.



GW D6 766

SPACER INSERT

Code	No. of modules EN 50022	Pack Carton
GW D6 766	0.5	12

CHARACTERISTICS: it reduces heating when modular devices are installed side-by-side and it allows crossing of wiring cables.

APPLICATIONS: it's suggested the use of spacer insert to separate the elettromechanical devices (e.g. circuit breakers, contactors, latching relays etc...) from electronic devices (e.g. time switches etc...) for optimum operation.

BUSBARS

MONOBLOC BUSBARS



GW 96 507 F

MONOBLOC BUSBARS 2P

Code	Type of main	Type of outgoing	Rated current	Pack Carton
Length: 13 modules				
GW 96 507 F	IDP/MDC/MT 2P	11 MTC 1P+N/2P	63 A	1/10

ACCESSORY SUPPLIED: closing plug (to be used only if the busbar is cut); plumbable screw caps with an adhesive indicating voltage presence.
APPLICATIONS: busbars indicated for domestic enclosures.

BUSBARS FOR CIRCUIT BREAKERS MTC



GW 96 500

PIN BUSBARS

Code	Type	Colour	Rated current	Pack Carton
Length: 13 modules				
GW 96 500	1P	Grey	80 A	25
GW 96 501	1P	Blue	80 A	25
Length: 1 meter (56 modules)				
GW 96 988	1P	White	80 A	50

NOTE: not compatible with GW96963 end caps.

BUSBARS FOR CIRCUIT BREAKERS MT / MDC / IDP



GW 96 984

PIN BUSBARS

Code	Type	Rated current	Pack Carton
Length: 12 modules			
GW 96 984	1P	63 A	50
GW 96 985	2P	63 A	25
GW 96 986	3P	63 A	25
GW 96 987	4P	80 A	20
Length: 1 meter (56 modules)			
GW 96 988	1P	80 A	50
GW 96 989	2P	63 A	20
GW 96 990	3P	63 A	20
GW 96 991	4P	80 A	15

NOTES: 12 module versions complete with end caps.
 The 1P versions are not compatible with GW96963 end caps.
 Busbars are suitable also for modular switch-disconnectors with red lever.



GW 96 992

FORK BUSBARS

Code	Type	Rated current	Pack Carton
Length: 12 modules			
GW 96 992	1P	63 A	50
GW 96 993	2P	63 A	25
GW 96 994	3P	63 A	25
GW 96 995	4P	80 A	20
Length: 1 meter (56 modules)			
GW 96 996	1P	63 A	50
GW 96 997	2P	63 A	20
GW 96 998	3P	63 A	20
GW 96 999	4P	80 A	15

NOTES: 12 module versions complete with end caps.
 Busbars are suitable also for modular switch-disconnectors with red lever.

WIRING COMPONENTS



GW 96 962

CONNECTION TERMINALS FOR PIN BUSBARS

Code	Suitable for	Type	Length (mm)	Conductors section (mm ²)	Pack Carton
GW 96 503	1P busbar for MTC	-	-	25	50
GW 96 961	1P, 2P, 3P busbar for MT/MDC/IDP	Short	14	25	50
GW 96 962	4P busbar for MT/MDC/IDP	Long	27	25	50



GW 96 963

CLOSING CAPS FOR BUSBARS

Code	Type	Pack Carton
GW 96 963	1P	10
GW 96 964	2P	10
GW 96 965	3P	10
GW 96 966	4P	10

APPLICATIONS: to isolate the ends of the connection busbars.

NOTE: code GW96963 is not compatible with push rod 1P busbars.



GW 96 967

TEETH-COVER ROW FOR BUSBARS

Code	No. teeth-cover	Pack Carton
GW 96 967	5	10

APPLICATIONS: to insulate the unused busbar teeth.

PROTECTION

DISCONNECTABLE FUSE-HOLDERS



GW 96 312

DISCONNECTABLE FUSE-HOLDERS



Code	Rated current	Fuse dimension (mm)	No. of modules EN 50022	Rated voltage	Pack Carton
No. of poles: 1P					
GW 96 206	20 A	8.5x31.5	1	400 V ac	12
GW 96 226	20 A	10.3x38	1	1000 V dc	12
GW 96 205	32 A	10.3x38	1	690 V ac	12
GW 96 207	50 A	14x51	1.5	690 V ac	12
No. of poles: 1P+N					
GW 96 216	20 A	8.5x31.5	2	400 V ac	6
GW 96 220	32 A	10.3x38	1	690 V ac	12
GW 96 215	32 A	10.3x38	2	690 V ac	6
GW 96 217	50 A	14x51	3	690 V ac	6
GW 96 218	100 A	22x58	4	690 V ac	2
No. of poles: 2P					
GW 96 301	20 A	8.5x31.5	2	400 V ac	6
GW 96 227	20 A	10.3x38	2	1000 V dc	6
GW 96 302	32 A	10.3x38	2	690 V ac	6
GW 96 303	50 A	14x51	3	690 V ac	6
No. of poles: 3P					
GW 96 306	20 A	8.5x31.5	3	400 V ac	4
GW 96 307	32 A	10.3x38	3	690 V ac	4
GW 96 308	50 A	14x51	4.5	690 V ac	4
No. of poles: 3P+N					
GW 96 311	20 A	8.5x31.5	4	400 V ac	3
GW 96 312	32 A	10.3x38	4	690 V ac	3
GW 96 313	50 A	14x51	6	690 V ac	3
GW 96 314	100 A	22x58	8	690 V ac	1

APPLICATIONS: protection against low voltage overcurrents in industrial and advanced tertiary application in case of high short-circuit currents.

NOTES: the products GW96226 and GW96227 are suitable for the protection and isolation of the photovoltaic strings too (Utilization category DC20B)

FUSES



GW 72 105

CYLINDRICAL FUSES - TYPE GG

Code	Rated current	Rated voltage AC	Breaking capacity AC	Pack Carton
Dimensions (mm): Ø 8.5 x 31.5				
GW 72 111	2 A	400 V	50 kA	10/100
GW 72 112	4 A	400 V	50 kA	10/100
GW 72 113	6 A	400 V	50 kA	10/100
GW 72 114	10 A	400 V	50 kA	10/100
GW 72 115	16 A	400 V	50 kA	10/100
GW 72 116	20 A	400 V	50 kA	10/100
GW 72 117	25 A	400 V	50 kA	10/100
Dimensions (mm): Ø 10.3 x 38				
GW 72 104	2 A	500 V	120 kA	10/100
GW 72 105	6 A	500 V	120 kA	10/100
GW 72 107	10 A	500 V	120 kA	10/100
GW 72 101	16 A	500 V	120 kA	10/100
GW 72 108	20 A	500 V	120 kA	10/100
GW 72 109	25 A	500 V	120 kA	10/100
GW 72 110	32 A	400 V	120 kA	10/100
Dimensions (mm): Ø 14 x 51				
GW 72 121	25 A	690 V	80 kA	10/100
GW 72 122	32 A	500 V	80 kA	10/100
GW 72 123	40 A	500 V	80 kA	10/100
GW 72 124	50 A	400 V	80 kA	10/100
Dimensions (mm): Ø 22 x 58				
GW 72 103	63 A	690 V	80 kA	10/30

NOTE: fast fuse type.



GW 72 131

CYLINDRICAL FUSES - TYPE GPV

Code	Rated current	Rated voltage DC	Breaking capacity DC	Pack Carton
Dimensions (mm): Ø 10.3 x 38				
GW 72 131	6 A	1000 V	30 kA	10
GW 72 132	8 A	1000 V	30 kA	10
GW 72 133	10 A	1000 V	30 kA	10
GW 72 134	12 A	1000 V	30 kA	10
GW 72 135	16 A	1000 V	30 kA	10
GW 72 136	20 A	1000 V	30 kA	10

APPLICATIONS: photovoltaic systems.

MOTOR PROTECTION SWITCHES



GW 96 758

MOTOR PROTECTION SWITCHES

Code	Operating current	Rated voltage (V)	No. of modules EN 50022	Pack Carton
No. of poles: 3P				
GW 96 751	0.1 - 0.16 A	230/400 ac	3	1/4
GW 96 752	0.16 - 0.25 A	230/400 ac	3	1/4
GW 96 753	0.25 - 0.4 A	230/400 ac	3	1/4
GW 96 754	0.4 - 0.63 A	230/400 ac	3	1/4
GW 96 755	0.63 - 1 A	230/400 ac	3	1/4
GW 96 756	1 - 1.6 A	230/400 ac	3	1/4
GW 96 757	1.6 - 2.5 A	230/400 ac	3	1/4
GW 96 758	2.5 - 4 A	230/400 ac	3	1/4
GW 96 759	4 - 6.3 A	230/400 ac	3	1/4
GW 96 760	6.3 - 10 A	230/400 ac	3	1/4
GW 96 761	10 - 16 A	230/400 ac	3	1/4
GW 96 762	16 - 25 A	230/400 ac	3	1/4
GW 96 763	25 - 40 A	230/400 ac	3	1/4

APPLICATIONS: protection of electric motors both in single-phase and 3-phase distribution. Using an adjustment screw, it is possible to set the thermal tripping threshold within an adjustable value range with a ratio of 1:1.6.

ACCESSORIES FOR MOTOR PROTECTION SWITCHES

GW 96 765

AUXILIARY CONTACTS FOR MOTOR PROTECTION SWITCHES

Code	Contacts Description	No. of contacts	Type of contacts	No. of modules EN 50022	Pack Carton
GW 96 764	Position	2	1 NO + 1 NC	0.5	1/12
GW 96 765	Fault/position indicator	2	CHANGE-OVER	0.5	1/12



GW 96 767

SHUNT TRIP RELEASE FOR MOTOR PROTECTION SWITCHES

Code	Rated voltage (V)	No. of modules EN 50022	Pack Carton
GW 96 767	110-415 ac	1	1/6



GW 96 769

UNDER VOLTAGE RELEASE FOR MOTOR PROTECTION SWITCHES

Code	Rated voltage (V)	No. of modules EN 50022	Pack Carton
GW 96 769	230 ac	1	1/6
GW 96 770	400 ac	1	1/6



GW 96 771

SURFACE-MOUNTING BOX IP54 FOR MOTOR PROTECTION SWITCHES

Code	Description	Pack Carton
GW 96 771	Box with rotary manoeuvre	1

SURGE PROTECTIVE DEVICES LST



GW D6 405

SURGE PROTECTIVE DEVICES TYPE 1+2

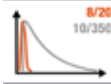

Code	Impulse current	Maximum discharge current	Rated voltage AC	No. of modules EN 50022	Aux end-of-life contact	Pack Carton
No. of poles: 1P+N						
GW D6 401	12.5 kA	65 kA	230 V	2	No	1
GW D6 404	25 kA	100 kA	230 V	4	Yes	1
No. of poles: 3P+N						
GW D6 402	12.5 kA	65 kA	400 V	4	No	1
GW D6 405	25 kA	100 kA	400 V	8	Yes	1

CHARACTERISTICS: SPDs are equipped with extractable cartridges with optic end-of-life signal.



GW D6 420

SURGE PROTECTIVE DEVICES TYPE 2



Code	Maximum discharge current	Rated voltage AC	No. of modules EN 50022	Aux end-of-life contact	Pack Carton
No. of poles: 1P					
GW D6 411	40 kA	230 V	1	No	1
GW D6 412	40 kA	230 V	1	Yes	1
GW D6 413	40 kA	400 V	1	No	1
No. of poles: 1P+N					
GW D6 407	20 kA	230 V	2	No	1
GW D6 417	40 kA	230 V	2	No	1
GW D6 418	40 kA	230 V	2	Yes	1
No. of poles: 3P+N					
GW D6 409	20 kA	400 V	4	No	1
GW D6 419	40 kA	400 V	4	No	1
GW D6 420	40 kA	400 V	4	Yes	1

CHARACTERISTICS: SPDs are equipped with extractable cartridges with optic end-of-life signal.



GW D6 426

SURGE PROTECTIVE DEVICES TYPE 2 FOR PHOTOVOLTAIC APPLICATIONS



Code	Maximum discharge current	Rated voltage DC	No. of modules EN 50022	Aux end-of-life contact	Pack Carton
GW D6 426	40 kA	600 V	3	No	1
GW D6 428	40 kA	1000 V	3	No	1

CHARACTERISTICS: SPDs are equipped with extractable cartridges with optic end-of-life signal.



GW D6 430

SURGE PROTECTIVE DEVICES FOR TELECOM AND DATALINE



Code	Maximum discharge current	Rated voltage AC	No. of modules EN 50022	Aux end-of-life contact	Pack Carton
GW D6 430	10 kA	50 V	1	No	1



GW D6 433

EXTRACTABLE SPARE CARTRIDGES FOR LST TYPE 1+2

Code	Type	Impulse current	Pack Carton
Suitable for: GWD6401 and GWD6402			
GW D6 451	Phase	12.5 kA	1
GW D6 452	Neutral	25 kA	1
GW D6 453	Neutral	50 kA	1
Suitable for: GWD6404 and GWD6405			
GW D6 433	Phase	25 kA	1
GW D6 434	Neutral	50 kA	1
GW D6 435	Neutral	100 kA	1

CHARACTERISTICS: a fissure on the base of the surge protection devices will help you to insert the cartridges, and prevents the insertion of the phase cartridge in place of the neutral one, or viceversa.



GW D6 436

EXTRACTABLE SPARE CARTRIDGES FOR LST TYPE 2

Code	Type	Maximum discharge current	Rated voltage	Pack Carton
Suitable for: from GWD6407 to GWD6420				
GW D6 436	Phase	20 kA	230 V ac	1
GW D6 438	Neutral	20 kA	-	1
GW D6 441	Phase	40 kA	230 V ac	1
GW D6 442	Phase	40 kA	400 V ac	1
GW D6 443	Neutral	40 kA	-	1

CHARACTERISTICS: a fissure on the base of the surge protection devices will help you to insert the cartridges, and prevents the insertion of the phase cartridge in place of the neutral one, or viceversa.



GW D6 446

EXTRACTABLE SPARE CARTRIDGES FOR LST TYPE 2 FOR PHOTOVOLTAIC APPLICATIONS

Code	Maximum discharge current	Rated voltage	Pack Carton
Suitable for: GWD6426 and GWD6428			
GW D6 446	40 kA	600 V dc	1
GW D6 448	40 kA	1000 V dc	1

PERMANENT AND TRANSIENT SURGE PROTECTIVE DEVICE POP



GW D6 461

COMBINED SPD+POP

Code	Type of SPD	SPD Maximum discharge current	Rated voltage	No. of modules EN 50022	Pack Carton
No. of poles: 1P+N					
GW D6 461	Type 2	15 kA	230 V	2	1/6

NOTES: it is necessary to use a MCB and a shunt trip release for correct working of the device

APPLICATIONS: protection of single-phase electrical system both from voltage transients indirect (produced by discharges from lightning or switching operations on the network) to permanent overvoltages (produced by instable networks or neutral loss). When permanent overvoltages occurs, SPD+POP devices use release coil to open circuit breaker. Instead, when transient overvoltages occurs, SPD+POP device works as a common surge protective device without opening the circuit breaker.

RESIDUAL CURRENT RELAY WITH SEPARATE TOROID



GW 96 331

RESIDUAL CURRENT RELAY WITH SEPARATE TOROID

Code	Rated voltage (V)	Type	No. of modules EN 50022	Pack Carton
GW 96 331	230 ac	A	3	1/4

CHARACTERISTICS: the tripping (I_{dn}) and delay (dt) thresholds are adjustable:

I_{dn} (A): 0.03 - 0.05 - 0.1 - 0.25 - 0.3 - 0.35 - 0.5 - 1 - 1.5 - 2 - 3.

dt (s): 0 - 0.25 - 0.5 - 1 - 2 - 3 - 4 - 5 - 6 - 7 - 8 - 10.

NOTE: mounting on DIN rail EN 50022. For the operation of the residual current protection, it is necessary to use: the residual current relay, a suitable toroid, and a release for the associated circuit breaker.



GW 96 332

SEPARATE TOROID FOR RESIDUAL CURRENT RELAY GW96331

Code	Description	Internal diameter	Operating current I_{max}	Maximum wire section (3F+N)	Minimum I_{dn} threshold	Pack Carton
GW 96 332	Solid-core toroid	35 mm	160 A	16 mm ²	30 mA	1
GW 96 333	Solid-core toroid	80 mm	400 A	70 mm ²	30 mA	1
GW 96 334	Solid-core toroid	110 mm	630 A	100 mm ²	100 mA	1
GW 96 335	Solid-core toroid	210 mm	1600 A	2x185 mm ²	300 mA	1

NOTE: The I_{max} operating current is the maximum current value that can circulate through the toroid when the set of cables is positioned in the centre, perpendicularly, and occupies less than 60% of the toroid's diameter.

COMMAND

SWITCH DISCONNECTORS (EN 60947-3)



GW 96 193

AC SWITCH DISCONNECTORS, WITH ACCESSORY OPTION



Code	Rated current	Rated voltage AC	Accessorisable with auxiliary contacts	Accessorisable with opening releases	No. of modules EN 50022	Pack Carton
No. of poles: 2P						
GW 96 182	40 A	415 V	Yes	Yes	2	1/6
GW 96 183	63 A	415 V	Yes	Yes	2	1/6
No. of poles: 4P						
GW 96 192	40 A	415 V	Yes	Yes	4	1/3
GW 96 193	63 A	415 V	Yes	Yes	4	1/3
GW 96 195	100 A	415 V	Yes	Yes	4	1/3

NOTES: can be combined with GWD6002 open/closed position auxiliary contact, with shunt trip release (GWD6013, GWD6015) and undervoltage release (GWD6019, GWD6020, GWD6021). Up to a maximum of 2 accessories consisting of 1 auxiliary contact and 1 opening release (shunt trip or undervoltage) can be assembled on each switch disconnector. Lockable with accessory GW96041 to block the operating lever in either the "ON" or "OFF" position. For padlocks Ø5 mm max.



GW 96 134

AC SWITCH DISCONNECTORS, WITHOUT ACCESSORY OPTION



Code	Rated current	Rated voltage AC	Accessorisable with auxiliary contacts	Accessorisable with opening releases	No. of modules EN 50022	Pack Carton
No. of poles: 1P						
GW 96 104	32 A	240 V	Yes	No	1	6/24
GW 96 105	40 A	240 V	Yes	No	1	6/24
GW 96 146*	63 A	240 V	Yes	No	1	6/24
GW 96 147	80 A	240 V	Yes	No	1	6/24
GW 96 148	100 A	240 V	Yes	No	1	6/24
GW 96 149	125 A	240 V	Yes	No	1	6/24
No. of poles: 2P						
GW 96 114	32 A	415 V	Yes	No	2	3/12
GW 96 115	40 A	415 V	Yes	No	2	3/12
GW 96 156*	63 A	415 V	Yes	No	2	3/12
GW 96 157	80 A	415 V	Yes	No	2	3/12
GW 96 158	100 A	415 V	Yes	No	2	3/12
GW 96 159	125 A	415 V	Yes	No	2	3/12
No. of poles: 3P						
GW 96 124	32 A	415 V	Yes	No	3	2/8
GW 96 125	40 A	415 V	Yes	No	3	2/8
GW 96 166*	63 A	415 V	Yes	No	3	2/8
GW 96 167	80 A	415 V	Yes	No	3	2/8
GW 96 168	100 A	415 V	Yes	No	3	2/8
GW 96 169	125 A	415 V	Yes	No	3	2/8
No. of poles: 4P						
GW 96 134	32 A	415 V	Yes	No	4	1/3
GW 96 135	40 A	415 V	Yes	No	4	1/3
GW 96 176*	63 A	415 V	Yes	No	4	1/3
GW 96 177	80 A	415 V	Yes	No	4	1/3
GW 96 178	100 A	415 V	Yes	No	4	1/3
GW 96 179	125 A	415 V	Yes	No	4	1/3

NOTES: Can ONLY be accessorised with an auxiliary open/closed position contact GW96001.

* The codes GW96146, GW96156, GW96166, GW96176 will be replaced by following codes GW96106, GW96116, GW96126, GW96136 from April 2023.



GW 96 187

DC ROTARY SWITCH DISCONNECTORS

Code	No. of poles	Rated current	Rated voltage DC	No. of modules EN 50022	Pack Carton
GW 96 186	2P	25 A	600 V	3.5	1
GW 96 187	4P	32 A	1000 V	3.5	1

NOTE: utilisation category DC21B. These switch disconnectors cannot be combined.

ISOLATING SWITCHES (EN 60669-2-4)



GW 96 538

COMPACT ISOLATING SWITCHES



Code	Rated current	No. of modules EN 50022	Rated voltage	Pack Carton
No. of poles: 1P				
GW 96 531	16 A	1	250 V	3/12
GW 96 532	32 A	1	250 V	3/12
No. of poles: 2P				
GW 96 533	16 A	1	250 - 415 V	3/12
GW 96 534	32 A	1	250 - 415 V	3/12
No. of poles: 3P				
GW 96 535	16 A	1	250 - 415 V	1/12
GW 96 536	32 A	1	250 - 415 V	1/12
No. of poles: 4P				
GW 96 537	16 A	1	250 - 415 V	1/12
GW 96 538	32 A	1	250 - 415 V	1/12

NOTES: switch disconnectors cannot be combined.

They can be padlocked with the accessory GW96041, to lock the operating lever in either the "ON" or "OFF" position. For padlocks max Ø 5 mm.

ON-OFF SWITCHES



GW 96 542

ON-OFF SWITCHES WITH INDICATOR LAMP



Code	Rated current	Characteristics	No. of modules EN 50022	Rated voltage	Pack Carton
No. of poles: 1P					
GW 96 539	16 A	With red indicator lamp	1	230 V	3/12
GW 96 540	32 A	With red indicator lamp	1	230 V	1/12
No. of poles: 2P					
GW 96 541	16 A	With red indicator lamp	1	230 V	1/12
GW 96 542	32 A	With red indicator lamp	1	230 V	1/12

ACCESSORIES SUPPLIED: indicator light with LED.

NOTE: they can be padlocked with the accessory GW96041, to lock the operating lever in either the "ON" or "OFF" position. For padlocks with max Ø 5 mm.

LEVER SWITCHES



GW 96 554

LEVER SWITCHES



Code	Rated current	No. of poles	No. of modules EN 50022	Rated voltage	Pack Carton
Type: Change-over switch (1-2)					
GW 96 551	16 A	1P	1	250 V	3/12
GW 96 552	16 A	2P	1	250 V	1/12
Type: Three-way switch (1-0-2)					
GW 96 553	16 A	1P	1	250 V	3/12
GW 96 554	16 A	2P	1	250 V	1/12
Type: Two-ways switch (1-2)					
GW 96 555	16 A	2P (1NO+1NC)	1	250 V	3/12
GW 96 556	32 A	2P (1NO+1NC)	1	250 V	1/12

NOTE: they can be padlocked with the accessory GW96041, to lock the operating lever in either the "ON" or "OFF" position. For padlocks with max Ø 5 mm.

ROTARY SWITCHES



GW 96 851

VOLTMETER SWITCHES

Code	Description	Characteristics	Rated current	Rated voltage	No. of modules EN 50022	Pack Carton
GW 96 851	4 positions	Phase - Neutral	16 A	690 V	3	1/4
GW 96 852	4 positions	Phase - Phase	16 A	690 V	3	1/4
GW 96 853	7 positions	Phase - Phase and Phase - Neutral	16 A	690 V	3	1/4



GW 96 856

AMMETER SWITCH

Code	Description	Rated current	Rated voltage	No. of modules EN 50022	Pack Carton
GW 96 856	4 positions	16 A	690 V	3	1/4

NOTES: the GW96856 can also be used as a single-pole command three-way switch with 4 positions.



GW 96 951

LINE SWITCHES



Code	Description	Characteristics	Rated current	Rated voltage	No. of modules EN 50022	Pack Carton
No. of poles: 2P						
GW 96 951	2 positions	-	16 A	690 V	3	1/4
GW 96 952	3 positions	0 central	16 A	690 V	3	1/4
GW 96 953	3 positions	With 0 return position	16 A	690 V	3	1/4

APPLICATIONS: DIN rail three-way switches usable for motor, pump and fan command.

CONTACTORS CTR



GW D6 703

CONTACTORS



Code	Contacts	Control coil voltage (V)	No. of modules EN 50022	Pack Carton
Rated current (AC-1/AC-7a): 20 A - CTR20				
GW D6 701	1NO	230 ac	1	6/24
GW D6 702	2NO	24 ac	1	6/24
GW D6 703	2NO	230 ac	1	6/24
GW D6 705	2NC	230 ac	1	6/24
GW D6 706	1NO+1NC	24 ac	1	6/24
GW D6 707	1NO+1NC	230 ac	1	6/24
GW D6 708	3NO	230 ac	2	3/12
GW D6 709	4NO	230 ac	2	3/12
Rated current (AC-1/AC-7a): 25 A - CTR25				
GW D6 711	2NO	24 ac/dc	2	3/12
GW D6 712	2NO	230 ac - 220 dc	2	3/12
GW D6 713	3NO	230 ac - 220 dc	2	3/12
GW D6 714	4NO	24 ac/dc	2	3/12
GW D6 715	4NO	230 ac - 220 dc	2	3/12
GW D6 716	4NC	24 ac/dc	2	3/12
GW D6 717	4NC	230 ac - 220 dc	2	3/12
GW D6 718	3NO+1NC	230 ac - 220 dc	2	3/12
Rated current (AC-1/AC-7a): 40 A - CTR40				
GW D6 721	2NO	230 ac - 220 dc	3	2/8
GW D6 722	3NO	230 ac - 220 dc	3	2/8
GW D6 723	4NO	24 ac/dc	3	2/8
GW D6 724	4NO	230 ac - 220 dc	3	2/8
GW D6 725	2NO+2NC	230 ac - 220 dc	3	2/8
GW D6 726	4NC	230 ac - 220 dc	3	2/8
Rated current (AC-1/AC-7a): 63 A - CTR63				
GW D6 731	2NO	230 ac - 220 dc	3	2/8
GW D6 732	3NO	230 ac - 220 dc	3	2/8
GW D6 733	4NO	24 ac/dc	3	2/8
GW D6 734	4NO	230 ac - 220 dc	3	2/8
GW D6 735	3NO+1NC	230 ac - 220 dc	3	2/8
GW D6 736	4NC	230 ac - 220 dc	3	2/8

APPLICATIONS: they are used for automatic control of electrical devices with high number of operations. The switching of contacts happens when the coil is both energized and de-energized. For other applications than AC-1/AC-7a utilization category, please consult the technical pages.

CHARACTERISTICS: they can be combined with auxiliary contacts and sealing terminal covers.

NOTE: it's suggested the use of a spacer insert between adjacent contactors to ensure optimum operation.



GW D6 742

MANUAL CONTROL CONTACTORS

Code	Contacts	Control coil voltage (V)	No. of modules EN 50022	Pack Carton
Rated current (AC-1/AC-7a): 20 A - CTRM20				
GW D6 741	2NO	24 ac	1	6/24
GW D6 742	2NO	230 ac	1	6/24
GW D6 743	2NC	230 ac	1	6/24
GW D6 744	1NO+1NC	230 ac	1	6/24
Rated current (AC-1/AC-7a): 25 A - CTRM25				
GW D6 751	2NO	230 ac - 220 dc	2	3/12
GW D6 752	3NO	230 ac - 220 dc	2	3/12
GW D6 753	4NO	24 ac/dc	2	3/12
GW D6 754	4NO	230 ac - 220 dc	2	3/12
Rated current (AC-1/AC-7a): 32 A - CTRM32				
GW D6 755	2NO+2NC	12 ac/dc	2	3/12

APPLICATIONS: they have a three positions built-in toggle handle switch (A - 0 - I) to enable permanent opening or closing manually leaving out normal contactor function

Position A: working as normal contactor

Position O: working as manual control contactor (contacts locked mechanically)

Position I: working as manual control contactor (contacts are switched without control coil voltage). When coil is energized the toggle handle switch is automatically set to position A maintaining the previous contacts status.

CHARACTERISTICS: they can be combined with auxiliary contacts and sealing terminal covers

NOTE: it's suggested the use of a spacer insert between adjacent contactors to ensure optimum operation.

INSTALLATION RELAYS RLM

INSTALLATION RELAY 16 A



GW D6 604



Code	Contacts	Control coil voltage (V)	No. of modules EN 50022	Pack Carton
GW D6 601	1NO	8 ac	1	6/24
GW D6 602	1NO	12 ac	1	6/24
GW D6 603	1NO	24 ac	1	6/24
GW D6 604	1NO	230 ac	1	6/24
GW D6 606	1 Changeover	8 ac	1	6/24
GW D6 608	1 Changeover	12 ac/dc	1	6/24
GW D6 610	1 Changeover	24 ac/dc	1	6/24
GW D6 611	1 Changeover	230 ac	1	6/24
GW D6 617	1NO+1NC	12 ac	1	6/24
GW D6 618	1NO+1NC	24 ac	1	6/24
GW D6 619	1NO+1NC	230 ac	1	6/24
GW D6 624	2NO	230 ac	1	6/24
GW D6 626	2 Changeover	8 ac	2	3/12
GW D6 627	2 Changeover	12 ac	2	3/12
GW D6 629	2 Changeover	24 ac/dc	2	3/12
GW D6 630	2 Changeover	230 ac	2	3/12
GW D6 632	4NO	12 ac	2	3/12
GW D6 633	4NO	24 ac	2	3/12
GW D6 634	4NO	230 ac	2	3/12

CHARACTERISTICS: relay with single stable state; the contacts are maintained in switched position only while the control coil is supplied. they can be combined with auxiliary contacts (except for GWD6608 e GWD6610) and sealing terminal covers.

APPLICATION: command of low voltage circuits with high number of switchovers (lighting, heating and ventilation systems), they have a three positions built-in toggle handle switch (A - 0 - I) to enable permanent opening or closing manually independently of the external commands:

Position A: automatic operation as a momentary relay.

Position 0: operation as a manually commanded momentary relay (contacts locked mechanically in the rest state).

Position I: operation as a manually commanded momentary relay (contacts switched without the need for a remote control with return to automatic on A as soon as the lever is released).

ACCESSORIES FOR CTR CONTACTORS AND RLM INSTALLATION RELAYS



GW D6 761

AUXILIARY CONTACTS

Code	Contacts	Contact rating in AC-15	No. of modules EN 50022	Pack Carton
GW D6 761	2NO	6 A (230 V) 4 A (400 V)	0.5	1/12
GW D6 762	1NO+1NC	6 A (230 V) 4 A (400 V)	0.5	1/12

APPLICATION: used in order to signal the contacts position (open or closed).

NOTE: each device can be associated with 1 auxiliary contact. Auxiliary contacts cannot be coupled with GWD6608 and GWD6610 installation relays.



GW D6 766

SPACER INSERT

Code	No. of modules EN 50022	Pack Carton
GW D6 766	0.5	12

APPLICATIONS: used in order to have a better heat dissipation when more contactors/relay are installed in adjacent position.

SUGGESTIONS FOR AN OPTIMAL HEAT DISSIPATION:

- Room temperature up to 40°C: 1 spacer every 3 side-by-side devices.
- Room temperature between 40°C and 55°C: 1 spacer every 2 side-by-side devices.



GW D6 764

SEALING TERMINAL COVERS

Code	Suitable for contactor	No. of pieces	Pack Carton
GW D6 763	1 mod. width	2	1/10
GW D6 764	2 mod. width	2	1/10
GW D6 765	3 mod. width	2	1/10

APPLICATIONS: they enable to seal terminal screws, preventing access to cable connections.

LATCHING RELAY RLB



GW D6 644

LATCHING RELAY 16 A



Code	Contacts	Control coil voltage (V)	No. of modules EN 50022	Pack Carton
GW D6 641	1NO	8 ac	1	6/24
GW D6 642	1NO	12 ac	1	6/24
GW D6 643	1NO	24 ac	1	6/24
GW D6 644	1NO	230 ac	1	6/24
GW D6 646	1 Changeover	8 ac	1	6/24
GW D6 647	1 Changeover	12 ac	1	6/24
GW D6 648	1 Changeover	24 ac	1	6/24
GW D6 649	1 Changeover	24 dc	1	6/24
GW D6 650	1 Changeover	230 ac	1	6/24
GW D6 652	1NO+1NC	12 ac	1	6/24
GW D6 653	1NO+1NC	24 ac	1	6/24
GW D6 654	1NO+1NC	230 ac	1	6/24
GW D6 657	2NO	12 ac	1	6/24
GW D6 658	2NO	24 ac	1	6/24
GW D6 659	2NO	230 ac	1	6/24
GW D6 663	2 Changeover	24 ac	2	3/12
GW D6 664	2 Changeover	230 ac	2	3/12
GW D6 667	4NO	12 ac	2	3/12
GW D6 668	4NO	24 ac	2	3/12
GW D6 669	4NO	230 ac	2	3/12

CHARACTERISTICS: relay with two stable states; every impulse to the coil switches over the contacts position that is maintained until the next signal. Auxiliary contacts, central command or group command (except for GWD6649) can be used up to max 1 accessory for each relay.

APPLICATION: control of lighting circuits in domestic and commercial environments.

It is possible to inhibit the remote command thanks to the ON/OFF frontal selector.

The lever indicates the contacts status and it could be used in order to manual command the relay.

ACCESSORIES FOR LATCHING RELAY RLB



GW D6 676

AUXILIARY CONTACTS

Code	Contacts	Contact rating in AC-15	No. of modules EN 50022	Pack Carton
GW D6 676	1 Changeover	4A (230V)	0.5	1/20
GW D6 677	1NO+1NC	4A (230V)	0.5	1/20
GW D6 678	2NO	4A (230V)	0.5	1/20

APPLICATION: used in order to signal the contacts position (open or closed).

NOTE: it is possible to use 1 auxiliary contact for each contactor. It is not possible to use auxiliary contacts with CWD6649 latching relay.



GW D6 671

CENTRALIZED COMMAND

Code	Functions	No. of modules EN 50022	Pack Carton
GW D6 671	Central command	0.5	1/20
GW D6 672	Group command	0.5	1/20

NOTE: It is not possible to use them with CWD6649 latching relay.

APPLICATION:

- GW D6 671: used to centralize the command in only one point allowing to simultaneously turning ON and OFF 2 or more relays independently by their position. In order to use this function every relay has to mount this accessory.
- GW D6 672: used to realize the simultaneously command of 2 or more groups of centralized relays from one point. In order to obtain this function it is necessary to install this accessory for each group of centralized relay.

EXAMPLE: It is possible to centralize the command of a group of latching relay installed on a building floor (every relay has a GW D6 671 coupled). With the GW D6 672 it is possible to command from one point all groups of centralized relays installed on the different buildings floors.



GW D6 766

SPACER INSERT

Code	No. of modules EN 50022	Pack Carton
GW D6 766	0.5	12

APPLICATIONS: used in order to have a better heat dissipation when more contactors/relay are installed in adjacent position.

SUGGESTIONS FOR AN OPTIMAL HEAT DISSIPATION:

- Operating temperature up to 40°C: no limitations.
- Operating temperature between 40°C and 55°C: No limitation for AC coils, 1 spacer every 3 adjacent relays with DC coils:
- Operating temperature between 55°C and 70°C: 1 spacer every 3 adjacent relays with AC coils. It is not possible the adjacent installation of relay with DC coil.

MONITORING RELAYS



GW 96 906

CURRENT MONITORING RELAY - 1 PHASE AC ELECTRICAL SYSTEM

Code	Rated voltage (V)	Controlled current (A)	Output contacts	Contact capacity (A)	No. of modules EN 50022	Pack Carton
GW 96 906	230 ac	10	1 Changeover	5	1	1/8

APPLICATIONS: overcurrent control: the output contact changes status when the measured current exceeds the "MAX" set value.

Undercurrent control: the output contact changes status when the measured current falls below the "MIN" set value.

Window function: the output contact changes status when the measured current is not within the "MIN"- "MAX" set range.

Adjustment of contact switchover delay, from minimum 0.1s to maximum 10s.

For the three operating modes, there is a memory function for exceeding the set threshold.

NOTE: if you need to monitor currents greater than 10A, use a current transformer (CT).

If necessary, connect the output contact with a device (usually a contactor) suitable for the needs of the line to be commanded.



GW 96 907

PHASE MONITORING RELAY - 3 PHASE ELECTRICAL SYSTEM

Code	Rated voltage (V)	Controlled voltage (V)	Adjustable asymmetry	Output contacts	Contact capacity (A)	No. of modules EN 50022	Pack Carton
GW 96 907	230/400 ac	230/400 ac	5% ... 25%	1 Changeover	5	1	1/8

APPLICATIONS: phase sequence check: if the check shows that the phases are not in the correct sequence, the output contact will change its status.

Phase and neutral failure: if one of the three phases or the neutral fails, the output contact will change its status.

Asymmetry check: if the measured asymmetry value exceeds the set threshold, the output contact will change its status.

NOTE: if necessary, connect the output contact with a device (usually a contactor) suitable for the needs of the line to be commanded.



GW 96 908

UNDERVOLTAGE MONITORING RELAY - 1 PHASE AC/DC ELECTRICAL SYSTEM

Code	Rated voltage (V)	Controlled voltage (V)	Output contacts	Contact capacity (A)	No. of modules EN 50022	Pack Carton
GW 96 908	24 ac/dc - 230 ac	24 ac/dc - 230 ac	1 Changeover	5	1	1/8

APPLICATIONS: undervoltage check: when the measured voltage falls below the set value, the output contact will change its status.

The contact switches back again when the measured voltage exceeds the set value plus the hysteresis.

NOTE: if necessary, connect the output contact with a device (usually a contactor) suitable for the needs of the line to be commanded.



GW 96 909

UNDERVOLTAGE MONITORING RELAY - 3 PHASE AC ELECTRICAL SYSTEM

Code	Rated voltage (V)	Controlled voltage (V)	Output contacts	Contact capacity (A)	No. of modules EN 50022	Pack Carton
GW 96 909	230/400 ac	230/400 ac	1 Changeover	5	1	1/8

APPLICATIONS: undervoltage check with variable threshold: when the measured voltage of one of the phases falls below the set value, the output contact will change its status.

The undervoltage threshold can be adjusted from 160 V to 240 V (Phase - Neutral).

NOTE: if necessary, connect the output contact with a device (usually a contactor) suitable for the needs of the line to be commanded.

LOAD MANAGEMENT RELAY P-COMFORT

LOAD MANAGEMENT RELAY P-COMFORT (WIRE VERSION)

Code	Rated voltage (V)	Rated current	Type relay contact	Capacity relay contact	No. of modules EN 50022	Pack Carton
GW D6 916	230 ac	32 A	Changeover (potential free contact)	16 A AC1 250 V ac	2	1/6

APPLICATION: The P-Comfort relay can be installed in electrical systems up to 6 kW. In the event of overload due to the simultaneous switching of several electric loads, P-Comfort prevents power supply interruption disconnecting the non-preferential loads wired to the relay inside the device. After a time period, P-Comfort automatically power supplies non-preferential loads again, avoiding service interruptions. P-Comfort allows the measurement and visualisation on the display of the active energy values (supplied and absorbed), and instantaneous active power (supplied and absorbed).



GW D6 916

LOAD MANAGEMENT RELAY P-COMFORT RF ZIGBEE (RADIO FREQUENCY VERSION)

Code	Rated voltage (V)	Rated current	Type relay contact	Capacity relay contact	No. of modules EN 50022	Pack Carton
GW A1 916	230V ac	32 A	Changeover (potential free contact)	16 A AC1 250 V ac	2	1/6

APPLICATION: The P-Comfort relay can be installed in electrical systems up to 6 kW. In the event of overload due to the simultaneous switching of several electric loads, P-Comfort prevents power supply interruption disconnecting the non-preferential loads connected by radio frequency to smart plug RF ZigBee (GWA1526), to flush-mounting actuator RF ZigBee (GWA1523) or wired to the relay inside the device (max 10 devices). The disconnection and connection of preferential loads can be set by Priority (regardless of power consumption) or by Power (depending on the power consumption).



GW A1 916

KNX LOAD MANAGEMENT RELAY P-COMFORT - IP20 - DIN RAIL MOUNTING

Code	Supply voltage	Rated current	Type relay contact	Capacity relay contact	No. DIN modules	Pack Carton
GW A9 916	230V ac - 50Hz	32 A	Changeover (potential free contact)	16 A AC1 250 V ac	2	1/6

CHARACTERISTICS: load management to control the activation/deactivation of electrical appliances wired to the relay inside the device or connected to KNX actuators, preventing the main line power supply disconnection and avoiding service interruptions. The device supports KNX Secure. To be configured with ETS software.

APPLICATIONS: allows the measurement, the visualisation on the display and the sending on the KNX bus of the active energy (exported and imported), instantaneous active and reactive power (exported and imported), voltage, current, power factor and frequency.

NOTES: equipped with coupling terminal for connection to bus.



GW A9 916

ACCESSORIES FOR P-COMFORT RF ZIGBEE (RADIO FREQUENCY VERSION)



GW A1 526

SMART PLUG RF ZIGBEE - GERMAN STANDARD - 230V AC

Code	Type of plug	Socket-outlet type	Dimensions ØxH (mm)	Colour	Pack Carton
GW A1 526	2P+E - 10A	2P+E - 10A	41x45	White	1/4

CHARACTERISTICS: adapter with side earthing and safety shields. Measures the power consumed of the load connected and sends the data to the P-Comfort RF ZigBee which disconnects the load according to the current setting.



GW A1 523

ZIGBEE 1-CHANNEL ACTUATOR WITH POWER METER

Code	Supply voltage	No. output channels	Output contacts	Dimensions LxHxD (mm)	Pack Carton
GW A1 523	230V ac - 50 Hz	1	1 NO 10A (AC1) 230 V ac	42x40x20	1/4

CHARACTERISTICS: 1-channel actuator for activating loads via a 230V output contact (NO) with the measure of the instantaneous power. Suitable for commanding incandescent lamps (230Vac): 2300W, loads controlled from toroidal transformers: 450W, loads controlled from electronic transformers: 600W, compact fluorescent lamps: 150W, LED lamps (230Vac): 150W, motors: 500W. Equipped with 1 input for the local command of the output.

APPLICATIONS: execution of ON-OFF commands, timed commands, priority commands, scene management commands and instantaneous consumption metering (instantaneous power). Measures the power consumed by the connected load and, when combined with a RF ZigBee P-comfort load management relay, can disconnect the load according to the chosen setting of the P-Comfort.

NOTES: installation in flush-mounting boxes, junction boxes or in Chorus blanking modules GW1x750.



GW 14 750

BLANKING MODULES FOR HOUSING ZIGBEE CONTACTS INTERFACES AND ACTUATORS

Code	Colour	No. modules	Pack Carton
GW 10 750	Glossy white	1	1/12
GW 15 750	Satin White	1	1/12
GW 13 750	Natural satin beige	1	1/12
GW 12 750	Satin black	1	1/12
GW 14 750	Glossy Titanium	1	1/12

CHARACTERISTICS: 1-module blanking module with pad printing. Allows the housing and the fast identification of the ZigBee contacts interfaces and actuators.

NOTES: snap-fit design.

KIT P-COMFORT RF ZIGBEE (RADIO FREQUENCY VERSION)



GW A1 912

PRE-INSTALLED KIT P-COMFORT RF ZIGBEE AND SMART PLUG

Code	Number of smart plugs included	Pack Carton
GW A1 911	1	1
GW A1 912	2	1

CHARACTERISTICS: P-Comfort RF ZigBee provided with the kit is pre-installed to operate in Priority mode: when the power threshold is exceeded, loads connected to the Smart plug 1 are disconnected, then the loads connected to the Smart plug 2 and after all the loads wired to the relay inside the device. The reconnection of non-preferential loads is done following reverse sequence.

BIOCOMFORT MAIN DISCONNECTION SWITCH



GW 96 339

MAIN DISCONNECTION SWITCH WITH SELF LEARNING FUNCTION

Code	Rated voltage (V)	Rated current	Monitoring voltage (V)	No. of modules EN 50022	Pack Carton
GW 96 339	230 ac	16 A	5 - 230 dc	1	1/2

APPLICATIONS: the BIOCOMFORT disconnection switch reduces the voltage of the electrical system when the loads connected to it in the sleeping area are switched off. It is not necessary to manually adjust the relay tripping threshold because the main disconnection switch, thanks to the self-learning function, automatically learns the value of the current absorbed by the loads and applies it as the tripping threshold. During operation of the disconnection switch, the line downstream of BIOCOMFORT is powered by a continuous monitoring voltage (5-230 V dc). This voltage prevents the formation of electromagnetic fields in the sleeping area and is necessary for restoring the mains voltage (230 V ac) at any moment when a load is switched on.



GW 96 340

BASE LOAD

Code	Rated voltage (V)	Pack Carton
GW 96 340	230 ac	1/5

NOTE: base load necessary for fluorescent lamps, low consumption lamps, LED lamps, halogen lamps with transformer, dimmers, electronic transformers or loads with absorption lower than 30 mA (e.g. loads with stand-by).

PROGRAMMING

TIMERS



GW 96 814

MULTIFUNCTION TIMER

Code	Rated coil voltage (V)	Regulation field	Type of contacts	Contact rating - In	No. of modules EN 50022	Pack Carton
GW 96 814	24...240 ac/dc	0.05 s - 100 h	1 Changeover	8 A	1	1/8

APPLICATIONS: allows to activate and deactivate the power supply to a load for a time set.
NOTE: cannot be used with illuminated push-buttons.



GW 96 815

ASYMMETRICAL CYCLE TIMER

Code	Rated coil voltage (V)	Regulation field	Type of contacts	Contact rating - In	No. of modules EN 50022	Pack Carton
GW 96 815	12...240 ac/dc	0.05 s - 100 h	1 Changeover	8 A	1	1/8

APPLICATIONS: allows to activate and deactivate the power supply to a load, for a time set with different ON and OFF times.
NOTE: cannot be used with illuminated push-buttons.



GW 96 809

STAIRCASE LIGHTING TIME DELAY SWITCHES

Code	Rated voltage (V)	Regulation field	Type of contacts	Contact rating - In	No. of modules EN 50022	Pack Carton
GW 96 809	230 ac	30 s - 12 min	1 NO	16 A	1	1/8

APPLICATION: timed management of the lights in passageway environments (stairs, corridors, entrances, etc.).
CHARACTERISTICS: the electronic staircase time switch, without switch-off warning, also allow to:
 -turn off the lights completely by prolonged pressing of push-button (energy saving function).
 -to extend lighting time by rapid and multiple pressing of the push-button (pumping function).

ANALOGUE/ELECTROMECHANICAL TIME SWITCHES TMR

GW D6 771

COMPACT DAILY TIME SWITCHES

Code	Charge reserve	Type of contacts	Contact rating	Rated voltage (V)	No. of modules EN 50022	Pack Carton
GW D6 771	No	1 NO	16 A	230V ac	1	1/12
GW D6 772	150 h	1 NO	16 A	230V ac	1	1/12

APPLICATIONS: command and management of electrical loads according to daily programming; particularly useful for timing control of functions (for example: ventilation, lighting, heating, irrigation), comfort optimization and energy saving.

NOTE: 24 hours quadrant with 96 trippers (minimum adjustment of the time switch: 15 minutes).

CHARACTERISTICS: equipped with the switch for the choice of operating mode:

- OFF permanent mode
- automatic (according to the set programming with the trippers)
- ON permanent mode



GW D6 773

DAILY TIME SWITCH

Code	Charge reserve	Type of contacts	Contact rating	Rated voltage (V)	No. of modules EN 50022	Pack Carton
GW D6 773	150 h	1 Changeover	16 A	230V ac	2	1/6

APPLICATIONS: command and management of electrical loads according to daily programming; particularly useful for timing control of functions (for example: ventilation, lighting, heating, irrigation), comfort optimization and energy saving.

NOTE: 24 hours quadrant with 48 trippers (minimum adjustment of the time switch: 30 minutes).

CHARACTERISTICS: equipped with the switch for the choice of operating mode:

- OFF permanent mode
- automatic (according to the set programming with the trippers)
- ON permanent mode



GW D6 776

WEEKLY TIME SWITCH

Code	Charge reserve	Type of contacts	Contact rating	Rated voltage (V)	No. of modules EN 50022	Pack Carton
GW D6 776	150 h	1 Changeover	16 A	230V ac	2.5	1/4

APPLICATIONS: command and management of electrical loads according to daily programming; particularly useful for timing control of functions (for example: ventilation, lighting, heating, irrigation), comfort optimization and energy saving.

NOTE: 7 days quadrant with 84 trippers (minimum adjustment of the time switch: 2 hours).

CHARACTERISTICS: equipped with the switch for the choice of operating mode:

- OFF permanent mode
- automatic (according to the set programming with the trippers)
- ON permanent mode

DIGITAL TIME SWITCHES TMR



GW D6 781

COMPACT WEEKLY TIME SWITCH

Code	Type of contacts	Contact rating	Rated voltage (V)	Charge reserve	No. of modules EN 50022	Pack Carton
GW D6 781	1 NO	16 A	230V ac	4 years	1	1/6

APPLICATIONS: command and management of electrical loads according to weekly programming; particularly useful for timing control of functions (for example: ventilation, lighting, heating, irrigation), comfort optimization and energy saving.

NOTE: quadrant with 48 virtual trippers (minimum adjustment of the time switch: 30 minutes).



GW D6 782

WEEKLY TIME SWITCHES



Code	Type of contacts	Contact rating	Rated voltage (V)	Charge reserve	No. of modules EN 50022	Pack Carton
GW D6 782	1 Changeover	16 A	230V ac	5 years	2	1/3
GW D6 783	2 Changeover	16 A	230V ac	5 years	2	1/3

APPLICATIONS: command and management of electrical loads according to weekly programming; particularly useful for timing control of functions (for example: ventilation, lighting, heating, irrigation), comfort optimization and energy saving.

NOTE: maximum number of programs that can be stored: 120.

CHARACTERISTICS: The NFC interface allows the connection with smartphone and tablet to transfer the programs set on the time switch by means of the specific APP. Particularly with free of charge Gewiss TimerOn APP you can:

- create programs directly on your smartphone and tablet
- transfer programs created on several time switches
- copy and paste programs among several time switches
- switch channels manually
- obtain settings (date, time, coordinates) automatically and transfer them to the time switch

TWILIGHT SWITCH TMR



GW D6 779

TWILIGHT SWITCH (WITH OUTDOOR PROBE)

Code	Type of contacts	Contact rating	Rated voltage (V)	Brightness control	No. of modules EN 50022	Pack Carton
GW D6 779	1 NO	16 A	230V ac	1...100 lux	1	1/3

APPLICATIONS: command the ON/OFF switching of lighting devices according to outdoor lighting measured by outdoor probe.

NOTE: maximum distance between the probe and the twilight switch: 50 m (we recommend using twisted or double insulated cable).



GW D6 780

OUTDOOR PROBE FOR TWILIGHT SWITCH

Code	Suitable for	Pack Carton
GW D6 780	Twilight switch GWD6779	1/4

NOTE: maximum distance between the probe and the twilight switch: 50 m (we recommend using twisted or double insulated cable).

ASTRONOMICAL SWITCH TMR



GW D6 785

ASTRONOMICAL SWITCH WITH SIMPLIFIED PROGRAMMING

Code	Type of contacts	Contact rating	Rated voltage (V)	Charge reserve	No. of modules EN 50022	Pack Carton
GW D6 785	1 Changeover	16 A	230V ac	5 years	2	1/4

APPLICATIONS: command ON/OFF switching of lighting devices (without the outdoor probe) according to sunrise and sunset of geographical area.

NOTE: equipped with display with virtual trippers to set one or more OFF switching periods during the night (minimum adjustment of the time switch: 30 minutes). The programming is daily type.



GW D6 786

ASTRONOMICAL SWITCH



Code	Type of contacts	Contact rating	Rated voltage (V)	Charge reserve	No. of modules EN 50022	Pack Carton
GW D6 786	2 Changeover	16 A	230V ac	3 years	2	1/3

APPLICATIONS: command ON/OFF switching of lighting devices (without the outdoor probe) according to sunrise and sunset of geographical area.

NOTE: commands the ON/OFF night weekly switching, divided between 2 contacts (maximum number of 120 programs can be stored divided between 2 channels).

CHARACTERISTICS: The NFC interface allows the connection with smartphone and tablet to transfer the programs set on the astronomical switch by means of the specific APP.

Particularly with free of charge Gewiss TimerOn APP you can:

- create programs directly on your smartphone and tablet
- transfer programs created on several astronomical switches
- copy and paste programs among several astronomical switches
- switch channels manually
- obtain settings (date, time, coordinates) automatically and transfer them to the astronomical switch

TIME/ASTRONOMICAL SWITCHES TMR



GW D6 788

TIME/ASTRONOMICAL SWITCHES



Code	Type of contacts	Contact rating	Rated voltage (V)	Charge reserve	No. of modules EN 50022	Pack Carton
GW D6 788	1 Changeover	16 A	230V ac	5 years	2	1/3
GW D6 789	2 Changeover	16 A	230V ac	5 years	2	1/3

APPLICATIONS: command and management of electrical loads according to weekly or astronomical programming; for GWD6789 code it is possible to set a different program for each channel (time or astronomical).

NOTE: maximum number of programs that can be stored: 120.

CHARACTERISTICS: The Bluetooth interface allows the connection with smartphone and tablet to transfer the programs set on the time/astronomical switch by means of the specific APP.

Particularly with free of charge Gewiss TimerOn APP you can:

- create programs directly on your smartphone and tablet
- transfer programs created on several time/astronomical switches
- copy and paste programs among several time/astronomical switches
- switch channels manually
- obtain settings (date, time, coordinates) automatically and transfer them to the time switch

MEASUREMENT

VOLTMETERS



GW 96 861

SINGLE-PHASE ANALOGUE VOLTMETERS WITH DIRECT CONNECTION - 40/60 HZ

Code	Scale	Accuracy	No. of modules EN 50022	Pack Carton
GW 96 861	0 - 300 V	1.5	3	1/4
GW 96 862	0 - 500 V	1.5	3	1/4



GW 96 867

SINGLE-PHASE DIGITAL VOLTMETER WITH DIRECT CONNECTION

Code	Scale	Supply voltage	Accuracy	No. of modules EN 50022	Pack Carton
GW 96 867	0 - 500 V	230 V ac	0.5	2	1/4

AMMETERS



GW 96 871

ANALOGUE AMMETERS - 40/60 HZ

Code	Capacity	Connection	Accuracy	No. of modules EN 50022	Pack Carton
GW 96 871	10 A	Direct	1.5	3	1/4
GW 96 872	20 A	Direct	1.5	3	1/4
GW 96 873	30 A	Direct	1.5	3	1/4
GW 96 878	5 A	Using C.T./5 A	1.5	3	1/4

NOTE: GW96878 does not have a scale. Select the most suitable interchangeable scale based on the primary current of the C.T..



ZC6

INTERCHANGEABLE SCALES FOR GW96878 ANALOGUE AMMETER

Code	Scale (A)	Pack Carton
GW 96 971	40	1/10
GW 96 972	50	1/10
GW 96 973	60	1/10
GW 96 974	100	1/10
GW 96 975	150	1/10
GW 96 976	250	1/10
GW 96 977	400	1/10
GW 96 978	600	1/10
GW 96 979	1000	1/10
GW 96 980	1200	1/10
GW 96 981	1500	1/10



GW 96 879

DIGITAL AMMETER FOR CONNECTION USING CURRENT TRANSFORMER

Code	Capacity	Supply voltage	Accuracy	No. of modules EN 50022	Pack Carton
GW 96 879	5 - 999 A	230 V ac	0.5	2	1/4

NOTE: connection using a current transformer (up to 1000 A) with secondary of 5 A.

ENERGY METERS



GW D6 801

SINGLE-PHASE DIGITAL ENERGY METERS FOR DIRECT CONNECTION

Code	Type MID	Integrated Modbus	Accuracy	I max (A)	Rated voltage (V)	No. of modules EN 50022	Pack Carton
GW D6 801	No	No	1	40 A	230 ac	1	1/5
GW D6 802	Yes	No	1	40 A	230 ac	1	1/5
GW D6 803	Yes	Yes	1	40 A	230 ac	1	1/5

APPLICATION: they allow the measurement and visualisation on the display (No. digits: 5 units + 2 decimals) of the active energy values (exported and imported), instantaneous active power (exported and imported), voltage, current, power factor and frequency.

If the GWD6801 and GWD6802 energy meters are used with the KNX GW90876 interface, the measured values can be sent by KNX BUS network.

If the GWD6801 and GWD6802 energy meters are used with the MODBUS GWD6820 interface, the measured values can be sent by Modbus RS485 network.

If the GWD6801 and GWD6802 energy meters are used with the LAN-TCP/IP GWD6821 interface, the measured values can be sent by TCP/IP network.

CHARACTERISTICS: the energy meters have an impulse output for remote energy consumption control.



GW D6 809

THREE-PHASE DIGITAL ENERGY METERS

Code	Type MID	Integrated Modbus	Accuracy	Connection	Rated voltage (V)	No. of modules EN 50022	Pack Carton
GW D6 804	Yes	Yes	1 (active energy) 2 (reactive energy)	Direct (I _{max} =80 A)	400 ac	4	1/2
GW D6 805	Yes	Yes	1 (active energy) 2 (reactive energy)	Using C.T./5 A	400 ac	4	1/2
GW D6 807	Yes	No	1 (active energy) 2 (reactive energy)	Direct (I _{max} =80 A)	400 ac	4	1/2
GW D6 809	Yes	No	1 (active energy) 2 (reactive energy)	Using C.T./5 A	400 ac	4	1/2

APPLICATION: they allow the measurement and visualisation on the display (No. digits: 7 units + 2 decimals) of the active and reactive energy values (exported and imported), instantaneous active and reactive power values (exported and imported), apparent power, voltage, current, power factor, frequency, THD voltage and THD current.

If the GWD6807 and GWD6809 energy meters are used with the KNX GW90876 interface, the measured values can be sent by KNX BUS network.

If the GWD6807 and GWD6809 energy meters are used with the MODBUS GWD6820 interface, the measured values can be sent by Modbus RS485 network.

If the GWD6801 and GWD6802 energy meters are used with the LAN-TCP/IP GWD6821 interface, the measured values can be sent by TCP/IP network.

CHARACTERISTICS: the meters have two impulse outputs for remote energy consumption control.



GW 90 876

COMMUNICATION INTERFACES FOR SINGLE-PHASE AND THREE-PHASE ENERGY METERS

Code	Technology	No. of modules EN 50022	Pack Carton
GW 90 876	KNX	1	1/5
GW D6 820	RS485 MODBUS	1	1/5
GW D6 821	LAN-TCP/IP	1	1/5

CHARACTERISTICS: GW90876 to be configured with ETS software.

APPLICATIONS: KNX BUS, MODBUS RS485 or TCP/IP interface send values measured by the energy meters GWD6801, GWD6802, GWD6807 and GWD6809. The interfaces are optically coupled with the energy meters if installed side-by-side.

HOUR COUNTER



GW D6 911

HOUR COUNTER

Code	N. digit	Accuracy	No. of modules EN 50022	Pack Carton
GW D6 911	5 unit + 2 decimals	1/100 h (36 s.)	2	1/6

APPLICATIONS: computing the operating hours of electrical devices (motors, machines, tools, adjustment devices etc.).

MULTIMETER



GW 96 897

VOLTAGE/CURRENT MULTIMETER

Code	Type of display	Rated voltage (V)	Measured sizes	Accuracy	No. of modules EN 50022	Pack Carton
GW 96 897	LED 3 units on 3 lines	230 ac	V, I	0.5	2	1/4

NOTE: connection using current transformers (up to 1000 A) with secondary of 5 A.

NETWORK ANALYSER



GW 96 899

NETWORK ANALYSER

Code	Type of display	Measured sizes	Accuracy	No. of modules EN 50022	Pack Carton
GW 96 899	LCD	V, I, F, W, VAR, VA, kWh, kvarh, power factor	2	4	1/2

NOTE: connection using current transformers with secondary of 5 A. It allows remote communication of all measured sizes via RS485 (MODBUS RTU).

CURRENT TRANSFORMERS



GW 96 452

CURRENT TRANSFORMERS WITH 5 A SECONDARY

Code	Primary current	Primary circuit with bar	Primary circuit with cable	Performance	Accuracy	Pack Carton
GW 96 441	15 A	Wound	-	3 VA	1	1
GW 96 442	25 A	Wound	-	3 VA	1	1
GW 96 443	40 A	Busbar 30x10 mm max	Cable Ø 25 mm max	1.5 VA	3	1
GW 96 444	50 A	Busbar 30x10 mm max	Cable Ø 25 mm max	2 VA	3	1
GW 96 445	60 A	Busbar 30x10 mm max	Cable Ø 25 mm max	2 VA	3	1
GW 96 446	100 A	Busbar 30x10 mm max	Cable Ø 25 mm max	2.5 VA	1	1
GW 96 447	150 A	Busbar 30x10 mm max	Cable Ø 25 mm max	3 VA	0.5	1
GW 96 448	250 A	Busbar 30x10 mm max	Cable Ø 25 mm max	5 VA	0.5	1
GW 96 449	400 A	Busbar 30x10 mm max	Cable Ø 25 mm max	6 VA	0.5	1
GW 96 450	600 A	Busbar 40x10 mm max	Cable Ø 32 mm max	10 VA	0.5	1
GW 96 451	1000 A	Busbar 64x20 mm max	Cable Ø 50 mm max	20 VA	0.5	1
GW 96 452	1200 A	Busbar 64x20 mm max	Cable Ø 50 mm max	15 VA	0.5	1
GW 96 453	1500 A	Busbar 64x20 mm max	Cable Ø 50 mm max	20 VA	0.5	1

CHARACTERISTICS: two types of primary circuit: wound type (supplied with busbar or primary terminal already available) and through type (with a hole through which the busbar, or the cable constituting the primary, is passed). Transformers up to 600 A can be installed on DIN rail.

APPLICATIONS: allow the measurement of high currents by analogue and digital ammeters; provide a current to the secondary which is proportional to the primary current.

NOTE: current transformers can be used up to 20% more than the primary current without derating (permanent rated thermal current I_{ct}h = 120% I_{pr}).

SIGNALLING

INDICATOR LIGHTS



GW 96 592

INDICATOR LIGHTS

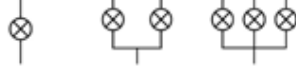

Code	Type	Colour	No. of modules EN 50022	Pack Carton
Rated voltage: 12-24-48 V ac/dc				
GW 96 586	Single	Red	1	1/12
GW 96 587	Single	Green	1	1/12
GW 96 588	Single	Yellow	1	1/12
GW 96 589	Single	Blue	1	1/12
GW 96 590	Single	White	1	1/12
Rated voltage: 230 V ac				
GW 96 581	Single	Red	1	3/12
GW 96 582	Single	Green	1	3/12
GW 96 583	Single	Yellow	1	3/12
GW 96 584	Single	Blue	1	3/12
GW 96 585	Single	White	1	3/12
GW 96 591	Double	Green/Red	1	1/12
GW 96 592	Triple	Red	1	1/12
GW 96 598	Triple	Red/Green/Yellow	1	1/12

CHARACTERISTICS: indicator light with LED.

ILLUMINATED PUSH-BUTTONS



GW 96 568

ILLUMINATED PUSH-BUTTONS

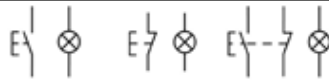

Code	Contacts	Indicator light colour	Characteristics	Rated current	No. of modules EN 50022	Pack Carton
Rated lamp voltage: 12-24-48 V ac/dc						
GW 96 570	1 NO	Green	Single push-button	16 A	1	1/12
GW 96 571	1 NC	Red	Single push-button	16 A	1	1/12
Rated lamp voltage: 230 V ac						
GW 96 566	1 NO	Green	Single push-button	16 A	1	1/12
GW 96 567	1 NC	Red	Single push-button	16 A	1	1/12
GW 96 568	1 NO + 1 NC	Green	Single push-button	16 A	1	1/12
GW 96 569	1 NO + 1 NC	Red	Single push-button	16 A	1	1/12

CHARACTERISTICS: indicator light with LED.

PUSH-BUTTONS WITHOUT LIGHTING



GW 96 565

PUSH-BUTTONS

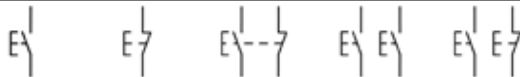

Code	Contacts	Characteristics	Rated current	No. of modules EN 50022	Pack Carton
Rated voltage: 230 V ac					
GW 96 561	1 NO	Single push-button	16 A	1	3/12
GW 96 562	1 NC	Single push-button	16 A	1	3/12
GW 96 563	1 NO + 1 NC	Single push-button	16 A	1	1/12
GW 96 564	1 NO / 1 NO	Double push-button (grey / grey)	16 A	1	1/12
GW 96 565	1 NO / 1 NC	Double push-button (green / red)	16 A	1	1/12

BELLS AND BUZZERS



GW 96 402

BELLS

Code	Rated voltage	Power loss	No. of modules EN 50022	Pack Carton
GW 96 401	12 V	5 VA	1	12
GW 96 402	230 V	10 VA	1	12
GW 96 403	230 V	6.1 VA	2	6

CHARACTERISTICS: GW96403 incorporates a transformer with a very low safety voltage of 24 V-.

APPLICATIONS: acoustic signal of an operation in the domestic and commercial sectors.



GW 96 408

BUZZERS

Code	Rated voltage	Power loss	No. of modules EN 50022	Pack Carton
GW 96 406	12 V	5 VA	1	12
GW 96 407	230 V	10 VA	1	12
GW 96 408	230 V	6.1 VA	2	6

CHARACTERISTICS: GW96408 incorporates a transformer with a very low safety voltage of 24 V-.

APPLICATIONS: acoustic signal of an operation in the domestic and commercial sectors.



GW 96 411

COMBINED TRANSFORMER-BELL-BUZZER

Code	Rated voltage	Power loss	No. of modules EN 50022	Pack Carton
GW 96 411	230 V	3.8 VA	2	4

CHARACTERISTICS: GW96411 incorporates a transformer with a very low safety voltage of 24 V.

TRANSFORMERS



GW 96 421

BELLS TRANSFORMERS (FOR DISCONTINUOUS USE)

Code	Rated power	Primary voltage	Secondary voltage	No. of modules EN 50022	Pack Carton
GW 96 421	6 VA (12 V) 4 VA (8 V) 2 VA (4 V)	230 V	4+8=12 V	2	6
GW 96 422	6 VA (24 V) 3 VA (12 V)	230 V	12+12=24 V	2	6
GW 96 423	10 VA (12 V)/6.6 VA (8 V)/3.3 VA (4 V)	230 V	4+8=12 V	2	6
GW 96 424	10 VA (24 V)/5 VA (12 V)	230 V	12+12=24 V	2	6
GW 96 425	15 VA (12 V)/10 VA (8 V)/5 VA (4 V)	230 V	4+8=12 V	2	6
GW 96 426	15 VA (24 V)/7.5 VA (12 V)	230 V	12+12=24 V	2	6
GW 96 431	30 VA (12 V)/20 VA (8 V)/10 VA (4 V)	230 V	4+8=12 V	3	4
GW 96 432	30 VA (24 V)/15 VA (12 V)	230 V	12+12=24 V	3	4
GW 96 433	40 VA (12 V)/27 VA (8 V)/13 VA (4 V)	230 V	4+8=12 V	3	4
GW 96 434	40 VA (24 V)/20 VA (12 V)	230 V	12+12=24 V	3	4

APPLICATIONS: distribution and realisation of SELV very low voltage safety circuits, with a value lower or equal to 24 V.

They allow electrical separation between the primary and secondary circuits, thus allowing the supply of bells and similar discontinuous operation signalling devices. They can also be used to supply the shunt trip release GW96011 with a rated voltage up to 24 V ac. To know the maximum number of releases that can be supplied with the transformers, refer to the technical characteristics.



GW 96 781

TRANSFORMERS FOR BELLS AND BUZZERS (SWITCH OFF TYPE)

Code	Rated power	Primary voltage	Secondary voltage	No. of modules EN 50022	Pack Carton
GW 96 781	8 VA	230 V	8 V	2	1/6



GW 96 323

SAFETY TRANSFORMERS

Code	Rated power	Primary voltage	Secondary voltage	No. of modules EN 50022	Pack Carton
GW 96 321	15 VA (12/24 V)	230 V	12+12=24 V	3	4
GW 96 322	25 VA (12/24 V)	230 V	12+12=24 V	3	4
GW 96 323	40 VA (12/24 V)	230 V	12+12=24 V	4	1
GW 96 324	63 VA (12/24 V)	230 V	12+12=24 V	6	1
GW 96 325	100 VA (24 V)	230 V	24 V	8	1

OTHER ACCESSORIES

ACCESSORIES FOR MOUNTING ON DIN RAIL EN 50022



GW 96 523

SOCKET-OUTLETS FOR MOUNTING ON DIN RAIL EN 50022

Code	No. of poles	Standard	Rated voltage (V)	Rated current	No. of modules EN 50022	Pack Carton
GW 96 522	2P+E	German	250 V ac	16 A	2.5	2/8
GW 96 523	2P+E	German, with lid	250 V ac	16 A	2.5	2/8
GW 96 524	2P+E	French	250 V ac	16 A	2.5	2/8
GW 96 525	2P+E	Italian / German	250 V ac	10/16 A*	2.5	2/8
GW 96 526	2P+E	Danish	250 V ac	16 A	2.5	2/8

* 10 A Italian standard / 16 A German standard

CHORUSMART RANGE COMPONENTS AND SUPPORTS FOR MOUNTING ON DIN RAIL EN 50022



GW 10 204

ITALIAN/GERMAN STANDARD SOCKET-OUTLETS - 250 V AC

Code	Description	Earth pit	Socket-out type	For plug pins	No. modules	Pack Carton
GW 10 204	2P+E - 16 A Dual amperage	Side and central	P40	Ø 4 / 4.8 / 5 mm	2	6/48

CHARACTERISTICS: with safety shields.



GW 10 661

EXTRACTABLE ANTI BLACK-OUT LAMP

Code	Supply voltage	Power supply batteries	Minimum autonomy	Lamp	Pack Carton
GW 10 661	230 V ac - 50/60 Hz	Ni - Mh	2 h	White LED	1/6

CHARACTERISTICS: equipped with a 3-position selector on the front panel, for anti black-out inhibition and night functioning. To be inserted in any socket-outlet of the Italian, German or French type. Highly efficient, white LED lamp.



GW 16 841

SUPPORTS FOR ASSEMBLING CHORUSMART DEVICES ON DIN EN 50022 RAIL

Code	Description	No. DIN modules	Pack Carton
GW 16 841	1 module	1.5	5/300
GW 16 842	2 modules	3	5/150
GW 16 843	3 modules	4	5/50

CHARACTERISTICS: tool-free manual release system for flush-mounting devices.

NOTES: pay attention when using particularly deep devices (two-pole, three-way switches, movement detectors and IR receivers, relays, German standard socket-outlets with front tightening, quick wiring terminals, British standard socket-outlets, interlocked switched sockets-outlets, shaver sockets-outlets, USB power supplies, MCCB and RCCB, anti-black-out and emergency lamps, ringers and buzzers, thermostats and timed thermostats, programmers, water and gas detectors, timers, dimmers, touch commands, electronic soft-click push buttons with interlock, KNX flush-mounting timed thermostats, etc.) as they may interfere with the DIN rail, preventing the correct passage of the wires.

SYSTEM RANGE COMPONENTS AND SUPPORTS FOR MOUNTING ON DIN RAIL EN 50022



GW 20 246

ITALIAN/GERMAN STANDARD SOCKET-OUTLETS - 250 V AC

Code	Description	Earth pit	Type	For plug pins	No. SYSTEM modules	Pack Carton
GW 20 246	2P+E - 16 A Dual amperage	Side and central	P40	Ø 4 / 4.8 / 5 mm	2	30/120

CHARACTERISTICS: with safety shields.



GW 20 833

EXTRACTABLE ANTI BLACK-OUT LAMP

Code	Supply voltage	Power supply batteries	Autonomy	Type of lamp	No. SYSTEM modules	Pack Carton
GW 20 833	230 V ac - 50/60 Hz	Ni-Mh	2 h	White LED	2	1/4

CHARACTERISTICS: equipped with inhibition selector on the front. Replaceable batteries (battery pack 4.8 V 40 mAh).

APPLICATION: according to CEI 64-8 (chapter 37).



GW 26 409

SUPPORTS FOR ASSEMBLING SYSTEM DEVICES ON DIN RAIL EN 50022

Code	Description	No. of modules EN 50022	Pack Carton
GW 26 409	1 module	1.5	5/300
GW 26 410	2 modules	3	5/150



90 AM



Scan the QR Code and find out all the technical informations.

INTELLIGENT LOAD MANAGEMENT

SIMPLIFIED ACCESSORY MANAGEMENT

OVERVOLTAGE UNDER CONTROL



P-COMFORT prevents the interruption of electrical power: in the event of an overload, it only disconnects non-preferred loads, and then automatically reactivates them after a predefined time, thus eliminating any inconvenience due to blackout.





Auxiliary contacts and trip coils, common to all circuit breakers, guarantee simplicity, interchangeability, multiple uses and rationalisation of the items.



The LST surge protection device range offers maximum protection against intense atmospheric discharges caused by direct and indirect lightning. The easy-to-extract cartridges makes it quicker and more convenient to replace used cartridges.

PREWIRED STRING BOARDS AND MODULAR DEVICES IN DIRECT CURRENT

Selection tables

PREWIRED STRING BOARDS						
	2 STRINGS		3 STRINGS		STRINGS	
						
String voltage (V)	600 DC	800 DC	600 DC	1000 DC	600 DC	1000 DC
In (A)	25	20	25	32	50	32
No. of board modules	1x12	1x12	2x12	2x12	2x12	2x12
No. two-pole rotary switch disconnectors	1	1	1	1	1	1
No. surge protective device	1	1	1	1	1	1
No. Disconnectable fuse-holders	-	-	3	3	4	4
	GW D9 901	GW D9 906	GW D9 902	GW D9 907	GW D9 903	GW D9 908

SWITCH DISCONNECTORS



In (A)	Rated operational voltage(V)	2P	4P
25	600 DC	GW 96 186	-
		3,5 mod.	
32	1000 DC	-	GW 96 187
			3,5 mod.

SURGE PROTECTIVE DEVICES LST



TYPE 2 - For photovoltaic applications		
Imax (kA)	600 Vdc	1000 Vdc
40	GW D6 426	GW D6 428
	3 mod.	3 mod.

DISCONNECTABLE FUSE-HOLDER



In (A)	Rated operational voltage(V)	Dimensions (mm)	1P	2P
20	1000 DC	10,3x38	GW 96 226	GW 96 227
			1 mod.	2 mod.

FUSES



Breaking Capacity DC (kA)	Rated operational voltage(V)	Dimensions (mm)	In (A)	Tipo GPV
30	1000 DC	10,3x38	6	GW 72 131
			8	GW 72 132
			10	GW 72 133
			12	GW 72 134
			16	GW 72 135
			20	GW 72 136

90 PV

Products for photovoltaic systems

The 90 PV range comprises 6 versions of string boards able to meet the most varying photovoltaic plant engineering requirements, from the residential context to the commercial/industrial one. The different versions are distinguished by the number of strings that can be managed, and by the voltage level of the photovoltaic generator. In addition to string boards, the range also includes modular products specifically for the DC side of the photovoltaic system.



PREWIRED STRING BOARDS

PREWIRED STRING BOARDS



GW D9 903

PREWIRED STRING BOARDS

Code	No. of strings	Rated current	No. of board modules	Pack Carton
String voltage: 600 V dc				
GW D9 901	2	25 A	1x12	1
GW D9 902	3	25 A	2x12	1
GW D9 903	4	50 A	2x12	1
String voltage: 800 V dc				
GW D9 906	2	20 A	1x12	1
String voltage: 1000 V dc				
GW D9 907	3	32 A	2x12	1
GW D9 908	4	32 A	2x12	1

ACCESSORIES SUPPLIED: cable glands as spare parts and equipotential terminal blocks.
DC fuses not included. Refer to the fuse code list.

DC MODULAR DEVICES

SWITCH DISCONNECTORS



GW 96 187

DC ROTARY SWITCH DISCONNECTORS

Code	No. of poles	Rated current	Rated voltage DC	No. of modules EN 50022	Pack Carton
GW 96 186	2P	25 A	600 V	3.5	1
GW 96 187	4P	32 A	1000 V	3.5	1

NOTE: utilisation category DC21B. These switch disconnectors cannot be combined.

SURGE PROTECTIVE DEVICES LST



GW D6 426

SURGE PROTECTIVE DEVICES TYPE 2 FOR PHOTOVOLTAIC APPLICATIONS



Code	Maximum discharge current	Rated voltage DC	No. of modules EN 50022	Aux end-of-life contact	Pack Carton
GW D6 426	40 kA	600 V	3	No	1
GW D6 428	40 kA	1000 V	3	No	1

CHARACTERISTICS: SPDs are equipped with extractable cartridges with optic end-of-life signal.

DISCONNECTABLE FUSE-HOLDERS



GW 96 227

DISCONNECTABLE FUSE-HOLDERS

Code	No. of poles	Rated current	Rated voltage	Fuse dimension (mm)	No. of modules EN 50022	Pack Carton
GW 96 226	1P	20 A	1000 V dc	10.3x38	1	12
GW 96 227	2P	20 A	1000 V dc	10.3x38	2	6

NOTE: utilization category DC20B.

FUSES



GW 72 131

CYLINDRICAL FUSES - TYPE GPV

Code	Rated current	Rated voltage DC	Breaking capacity DC	Pack Carton
Dimensions (mm): Ø 10.3 x 38				
GW 72 131	6 A	1000 V	30 kA	10
GW 72 132	8 A	1000 V	30 kA	10
GW 72 133	10 A	1000 V	30 kA	10
GW 72 134	12 A	1000 V	30 kA	10
GW 72 135	16 A	1000 V	30 kA	10
GW 72 136	20 A	1000 V	30 kA	10

APPLICATIONS: photovoltaic systems.



90 PV



Scan the QR Code and find out all the technical informations.

READY TO CONNECT RIGHT AWAY

ALREADY TESTED AND CERTIFIED

COMPLETENESS OF RANGE



To allow for easy, fast and secure connection, the string boards include cable glands and equipotential terminal blocks. The cable glands are supplied loose, to allow entry of the cables according to your needs (from the top, the bottom or the sides).



The string distribution boards are tested in GEWISS laboratories, passing and exceeding all tests required by EN 61439-1 and EN 61439-2 for the issue of product certification.



The GEWISS AC protection offer meets all system needs, from residential to tertiary/industrial, with a wide range of products, including modular devices, moulded case circuit breakers, modular accessories and distribution boards



MOULDED CASE CIRCUIT BREAKERS



MSX

MOULDED CASE CIRCUIT BREAKERS FOR POWER
DISTRIBUTION

pag. 522



97 MSS

ROTARY SWITCH DISCONNECTORS

pag. 548

MSXc - MOULDED CASE CIRCUIT BREAKERS

Selection tables

		MSX 160c				
		16kA		25kA		
Release	In [A]	3P	3P+N	3P	3P+N	
THERMAL MAGNETIC	Adjustable thermal Fixed magnetic	25	GW D9 001	GW D9 011	GW D9 041	GW D9 051
		40	GW D9 002	GW D9 012	GW D9 042	GW D9 052
		63	GW D9 003	GW D9 013	GW D9 043	GW D9 053
		80	GW D9 004	GW D9 014	GW D9 044	GW D9 054
		100	GW D9 005	GW D9 015	GW D9 045	GW D9 055
		125	GW D9 026	GW D9 036	GW D9 066	GW D9 076
		160	GW D9 027	GW D9 037	GW D9 067	GW D9 077





		MSX 250c				
		16kA		25kA		
Release	In [A]	3P	3P+N	3P	3P+N	
THERMAL MAGNETIC	Adjustable thermal Adjustable magnetic	160	GW D9 087	GW D9 097	GW D9 107	GW D9 117
		250	GW D9 088	GW D9 098	GW D9 108	GW D9 118



MSX - MOULDED CASE CIRCUIT BREAKERS

Selection tables

		MSX 125					
							
Release		In [A]	36kA		65kA		
			3P	4P	3P	4P	
THERMAL MAGNETIC	Adjustable thermal Adjustable magnetic	20	GW D9 121	GW D9 141	GW D9 151	GW D9 171	
		32	GW D9 122	GW D9 142	GW D9 152	GW D9 172	
		50	GW D9 123	GW D9 143	GW D9 153	GW D9 173	
		63	GW D9 124	GW D9 144	GW D9 154	GW D9 174	
		100	GW D9 125	GW D9 145	GW D9 155	GW D9 175	
		125	GW D9 126	GW D9 146	GW D9 156	GW D9 176	
	Adjustable magnetic	20	GW D9 201	GW D9 211	-	-	
		32	GW D9 202	GW D9 212	-	-	
		63	GW D9 204	GW D9 214	-	-	
		100	GW D9 205	GW D9 215	-	-	
	125	GW D9 206	GW D9 216	-	-		

		MSX 160 - MSX 250					
							
Release		In [A]	36kA		65kA		
			3P	4P	3P	4P	
THERMAL MAGNETIC	Adjustable thermal Adjustable magnetic	160	GW D9 127	GW D9 147	GW D9 157	GW D9 177	
		250	GW D9 128	GW D9 138	GW D9 158	GW D9 168	
	Adjustable magnetic	160	GW D9 207	GW D9 217	-	-	
		250	GW D9 208	GW D9 218	-	-	

		MSX 400						
								
Release		In [A]	36kA			65kA		
			3P	3P+N	4P	3P	3P + N	4P
THERMAL MA- GNETIC	Adjustable thermal Adjustable magnetic	400	GW D9 361	GW D9 362	GW D9 363	GW D9 365	GW D9 366	GW D9 367

MSXE - ELECTRONIC MOULDED CASE CIRCUIT BREAKERS

Selection tables

		MSXE 160 - MSXE 250						
								
Release	In [A]	36kA			65kA			
		3P	3P+N	4P	3P	3P+N	4P	
ELECTRONIC	LSI	40	GW D9 302	GW D9 312	GW D9 322	GW D9 332	GW D9 342	GW D9 352
		125	GW D9 306	GW D9 316	GW D9 326	GW D9 336	GW D9 346	GW D9 356
		160	GW D9 307	GW D9 317	GW D9 327	GW D9 337	GW D9 347	GW D9 357
		250	GW D9 308	GW D9 318	GW D9 328	GW D9 338	GW D9 348	GW D9 358

		MSXE 400 - MSXE 630						
								
Release	In [A]	36kA			50kA			
		3P	3P+N	4P	3P	3P+N	4P	
ELECTRONIC	LSI	400	GW D9 371	GW D9 372	GW D9 373	GW D9 375	GW D9 376	GW D9 377
		630	GW D9 381	GW D9 382	GW D9 383	GW D9 385	GW D9 386	GW D9 387
	DISC	400	-	-	GW D9 374	-	-	GW D9 378
		630	-	-	GW D9 384	-	-	GW D9 388

		MSXE 1000						
								
Release	In [A]	50kA						
		3P			4P			
ELECTRONIC	LSI	800	GW D9 401			GW D9 403		
		1000	GW D9 406			GW D9 408		
	DISC	800	-			GW D9 404		
		1000	-			GW D9 409		

		MSXE 1250 - MSXE 1600							
									
Release	In [A]	Terminals	50kA						
			3P			4P			
ELECTRONIC	LSI	1250	front	GW D9 411			GW D9 415		
			rear	GW D9 412			GW D9 416		
		1600	front	GW D9 421			GW D9 425		
			rear	GW D9 422			GW D9 426		
	DISC	1250	front	-			GW D9 417		
			rear	-			GW D9 418		
		1600	front	-			GW D9 427		
			rear	-			GW D9 428		

NOTE: adding the final letter B at the end of the GW codes in table MSXE 1250 - MSXE 1600 gives the corresponding versions with cable mechanical interlock

MSXD - THERMAL MAGNETIC MCCB + RCD





Selection tables

		MSXD 125	
			
Release	In [A]	3P+N	
		25kA	36kA
MCCB RCD Adjustable thermal Fixed Magnetic Adjustable residual current	20	GW D9 551	GW D9 571
	32	GW D9 552	GW D9 572
	50	GW D9 553	GW D9 573
	63	GW D9 554	GW D9 574
	100	GW D9 555	GW D9 575
	125	GW D9 556	GW D9 576

		MSXD 160 - MSXD 250	
			
Release	In [A]	3P+N	
		25kA	36kA
MCCB RCD Adjustable thermal Fixed Magnetic Adjustable residual current	160	GW D9 557	GW D9 277
	250	GW D9 558	GW D9 278

MSXM - SWITCH DISCONNECTOR





Selection tables

		MSXM									
		MSXM 160c		MSXM 250c		MSXM 400 - MSXM 630		MSXM 1000		MSXM 1250 - MSXM 1600	
											
In [A]	Terminals	3P	4P	3P	4P	3P	4P	3P	4P	3P	4P
160	front	GW D9 441	GW D9 442								
250	front			GW D9 443	GW D9 444						
400	front					GW D9 445	GW D9 446				
630	front					GW D9 447	GW D9 448				
800	front							GW D9 449	GW D9 450		
1000	front							GW D9 451	GW D9 452		
1600	front									GW D9 453*	GW D9 454*
	rear									GW D9 455*	GW D9 456*
										GW D9 457*	GW D9 458*





*adding the final letter B at the end of the GW codes gives the corresponding versions with cable mechanical interlock

MSX moulded case circuit breaker

Technical data



TYPE	MSX 160c	MSX 250c	MSX 125	MSX 160 - MSX 250	MSXE 160 - MSXE 250	
						
Standard	IEC EN 60947-2	IEC EN 60947-2	IEC EN 60947-2	IEC EN 60947-2	IEC EN 60947-2	
Rated current (In)	(A) 25, 40, 63, 80, 100, 125, 160	160, 250	20, 32, 50, 63, 100, 125	125, 160, 250	40, 125, 160, 250	
Utilization category	A	A	A	A	A	
Brief allowable rated current for 0.3s (Icw)	(kA) -	-	-	-	-	
Number of poles	3.3+N	3.3+N	3.4	3.3+N,4	3.3+N,4	
Rated frequency	(Hz) 50/60	50/60	50/60	50/60	50/60	
Rated operating voltage (Ui)	(V) 525 AC - 250 DC	525 AC - 250 DC	690 AC - 250 DC	690 AC - 250 DC	690 AC	
Rated impulse withstand voltage (Uimp)	(kV) 8	8	8	8	8	
Overvoltage category	IV	IV	IV	IV	IV	
Rated insulation voltage (Ui)	(V) 690	800	800	800	800	
Rated breaking capacity (Icu)						
Alternating current	220/240V	(kA) 25 35	25 35	50 85	65 85	65 85
	400/415V	(kA) 16 25	16 25	36 65	36 65	36 65
	440V	(kA) 10 15	10 15	25 50	25 50	25 50
	525V	(kA) 6 7.5	6 7.5	22 25	25 25	25 25
	690V	(kA) - -	- -	6 6	7.5 7.5	7.5 7.5
Direct current	250V	(kA) 13 20	13 15	25 40	40 40	- -
Service breaking capacity (Ics)						
Alternating current	220/240V	(kA) 13 18	13 27	50 85	65 85	65 85
	400/415V	(kA) 8 13	8 19	36/30 36/33	36 36	36 36
	440V	(kA) 5 7.5	5 12	25 25	25 25	25 25
	525V	(kA) 3 4	3 6	22 22	25 25	25 25
	690V	(kA) - -	- -	6 6	7.5 7.5	7.5 7.5
Direct current	250V	(kA) 7 10	7 12	19 40	40 40	- -
Type of protection		Adjustable thermal Fixed magnetic	Adjustable thermal Fixed magnetic	Adjustable thermal Adjustable magnetic	Adjustable thermal Adjustable magnetic	Electronic LSI
Versions		Fixed	Fixed	Fixed Plug-in	Fixed Plug-in	Fixed Plug-in ¹
Mounting on DIN rail by means of the accessory		yes	yes	yes	yes	no
Mounting position		any	any	any	any	any
Upline/downline power supply		yes	yes	yes	yes	yes
Terminals	Front for cables (FW)	■ (20A+100A)	-	□	-	-
	Front (FC)	■ (125-160A)	■	■	■	■
	Front extended (FB)	□ (63+160A)	□	□	□	□
	Front extended spread terminals (FB)	□ (63+160A)	□	-	-	-
	Rear (RC)	□ (63+160A)	□	□	□	□
Electrical life (415 V AC)	(No. cycles)	14,000 (≤125A) 10,000 (160 A)	6,000	30,000	20,000 (MSX 160) 10,000 (MSX 250)	10,000
Mechanical life	(No. cycles)	20,000	18,000	30,000	30,000	30,000
Can be equipped with motor operator		no	yes	yes	yes	yes
Interlock type		-	Lever / Cable	Lever / Cable	Lever / Cable	Lever / Cable
Operating temperature	(°C)	-5 +65	-5 +65	-5 +65	-5 +65	-5 +65
Reference temperature	(°C)	50	50	50	50	40
Storage temperature	(°C)	-20 +65	-20 +65	-20 +65	-20 +65	-20 +65
Tropicalization		65°C - RH 95%	65°C - RH 95%	65°C - RH 95%	65°C - RH 95%	65°C - RH 95%
Dimensions	Width (3P / 4P)	(mm) 75 / 100	105 / 140	90 / 120	105 / 140	105 / 140
	Height	(mm) 130	165	155	165	165
	Depth	(mm) 68	68	68	68	103
Weight (3P / 4P)	(kg)	0.8 / 1	1.5 / 1.9	1.1 / 1.4	1.5 / 1.9	2.3 / 3.1

Key:
 ■ supplied as standard ¹ max 225A
 □ optional ² max 536A
 - not available



MSX 400		MSXE 400 - MSXE 630		MSXE 1000		MSXE 1250		MSXE 1600	
									
IEC EN 60947-2		IEC EN 60947-2		IEC EN 60947-2		IEC EN 60947-2		IEC EN 60947-2	
400		400, 630		800	1000	1250		1600	
A		B (MSXE 400) A (MSXE 630)		B	A	B		B	
-		(for MSXE 400)		10	-	15		20	
3.3+N,4		3.3+N,4		3.4		3.4		3.4	
50/60		50/60		50/60		50/60		50/60	
690 AC - 250 DC		690 AC		690 AC		690 AC		690 AC	
8		8		8		8		8	
IV		IV		IV		IV		IV	
800		800		800		800		800	
50	85	50	85	85	85	85	85	85	85
36	50	36	50	50	50	50	50	50	50
30	45	25	45	50	45	45	45	45	45
22	30	15	30	30	30	30	30	30	30
15	20	10	20	20	20	20	20	20	20
40	40	-	-	-	-	-	-	-	-
50	85	50	85	85	65	65	65	65	65
36	50	36	50	50	38	38	38	38	38
30	45	25	45	50	34	34	34	34	34
22	30	15	30	30	23	23	23	23	23
15	15	10	15	20	15	15	15	15	15
40	40	-	-	-	-	-	-	-	-
Adjustable thermal Adjustable magnetic		Electronic LSI Electronic LSIG		Electronic LSI Electronic LSIG		Electronic LSI Electronic LSIG		Electronic LSI Electronic LSIG	
Fixed Plug-in		Fixed Plug-in ²		Fixed, Plug-in	Fixed	Fixed		Fixed	
no		no		no		no		no	
any		any		any		any		any	
yes		yes		yes		yes		yes	
-		-		-	-	-	-	-	-
■		■		■	-	-	-	-	-
□		□		□	■	■	■	■	■
□		□		-	-	-	-	-	-
□		□		□	□	■	■	■	■
4,500		4,500		4,000		4,000		2,000	
15,000		15,000		10,000		5,000		5,000	
yes		yes		yes		yes		yes	
Lever / Cable		Lever / Cable		Lever / Cable		Cable		Cable	
-5 +65		-5 +65		-5 +65		-5 +65		-5 +65	
50		40		40		40		40	
-20 +65		-20 +65		-20 +65		-20 +65		-20 +65	
65°C - RH 95%		65°C - RH 95%		65°C - RH 95%		65°C - RH 95%		65°C - RH 95%	
140 / 185		140 / 185		210 / 280		210 / 280		210 / 280	
260		260		273		370		370	
103		103		103		120		140	
4.3 / 5.6		4.3 / 5.7 (MSXE 400) 5 / 6.5 (MSXE 630)		9.1 / 12.3	11 / 14.8	19.8 / 25		27 / 35	

Switch disconnecter MSXM

Technical data

TYPE		MSXM 160c	MSXM 250c	MSXM 400 - MSXM 630
				
Standard		IEC EN 60947-3	IEC EN 60947-3	IEC EN 60947-3
Rated uninterrupted current (Iu)	(A)	160	250	400, 630
Utilization category		AC-23A DC-22A	AC-23A DC-22A	AC-23A DC-22A
Number of poles		3.4	3.4	3.4
Rated frequency	(Hz)	50/60	50/60	50/60
Rated operating voltage (Ui)	(V)	690 AC - 250 DC	690 AC - 250 DC	690 AC - 250 DC
Rated impulse withstand voltage (Uimp)	(kV)	8	8	8
Overtoltage category		IV	IV	IV
Rated insulation voltage (Ui)	(V)	690	800	800
Rated short-circuit making capacity (Icm)	(kA)	2.8	6	9
Brief allowable rated current for 0.3s (Icw)	(kA)	2	3	5
Versions	(kA)	Fixed	Fixed	Fixed Plug-in ¹
Mounting on DIN rail by means of the accessory		yes	yes	no
Mounting position		any	any	any
Upline/downline power supply		yes	yes	yes
Terminals	Front for cables (FW)	-	-	-
	Front (FC)	■	■	■
	Front extended (FB)	□	□	□
	Front extended spread terminals (FB)	□	□	□
	Rear (RC)	□	□	□
Electrical life (415 V AC)	(No. cycles)	10,000	6,000	4,500
Mechanical life	(No. cycles)	20,000	18,000	15,000
Can be equipped with motor operator		no	yes	yes
Interlock type		-	Lever / Cable	Lever / Cable
Operating temperature	(°C)	-5 +65	-5 +65	-5 +65
Reference temperature	(°C)	50	50	50
Storage temperature	(°C)	-20 +65	-20 +65	-20 +65
Tropicalization		65°C - RH 95%	65°C - RH 95%	65°C - RH 95%
Dimensions	Width (3P / 4P)	(mm) 75 / 100	105 / 140	140 / 185
	Height	(mm) 130	165	260
	Depth	(mm) 68	68	103
	Weight (3P / 4P)	(kg) 0.7 / 0.9	1.5 / 1.9	4.2 / 5.6 (MSXM 400) 4.4 / 5.8 (MSXM 630)

Key:
 ■ supplied as standard ¹ max 536A
 □ optional
 - not available



MSXM 1000		MSXM 1250	MSXM 1600
			
IEC EN 60947-3		IEC EN 60947-3	IEC EN 60947-3
800	1000	1250	1600
AC-23A DC-22A		AC-23A DC-22A	AC-23A DC-22A
3.4		3.4	3.4
50/60		50/60	50/60
690 AC - 250 DC		690 AC - 250 DC	690 AC - 250 DC
8		8	8
IV		IV	IV
800		800	800
17		32	45
10		15	20
Fixed, Plug-in	Fixed	Fixed	Fixed
no		no	no
any		any	any
yes		yes	yes
-	-	-	-
■	-	-	-
□	■	■	■
-	-	-	-
□	□	-	■
4,000		4,000	2,000
10,000		5,000	5,000
yes		yes	yes
Lever / Cable		Cable	Cable
-5 +65		-5 +65	-5 +65
50		50	50
-20 +65		-20 +65	-20 +65
65°C - RH 95%		65°C - RH 95%	65°C - RH 95%
210 / 280		210 / 280	210 / 280
273		370	370
103		120	140
8.5 / 11.5	10.4 / 14	18.2 / 23.4	24.9 / 32.9

Coordination between switch disconnectors and MCCB's - 400/415V AC

		SWITCH DISCONNECTORS									
CIRCUIT BREAKERS	RANGE	Icu (kA)	MSXM 160c	MSXM 250c	MSXM 400	MSXM 630	MSXM 1000 (800 A)	MSXM 1000 (1000 A)	MSXM 1250	MSXM 1600	
	MSX 160c	16	16								
		25	25								
	MSX 250c	16		16							
		25		25							
	MSX/E/D 160	25		25							
		36		36							
		65		36							
	MSX/E/D 250	25		25							
		36		36							
		65		36							
	MSX/E 400	36				36					
		50				50					
	MSXE 630	36					36				
50						50					
MSXE 1000 (800A)	50						50				
MSXE 1000 (1000A)	50							50			
MSXE 1250	50								50		
MSXE 1600	50									50	

Thermal magnetic MCCB + RCD MSXD

Technical data

TYPE	MSXD 125	MSXD 160 - MSXD 250	
			
Standard	IEC 60947-1 IEC 60947-2 IEC 60755	IEC 60947-1 IEC 60947-2 IEC 60755	
Rated current (In)	(A)	20, 32, 50, 63, 100, 125	160, 250
Utilization category		A	A
Number of poles		3P+N	3P+N
Rated frequency	(Hz)	50/60	50/60
Rated operating voltage (Ui)	(V)	525 AC	525 AC
Rated impulse withstand voltage (Uimp)	(kV)	8	8
Overvoltage category		IV	IV
Rated insulation voltage (Ui)	(V)	525	525
Rated breaking capacity (Icu)			
	220/240V (kA)	35	50
Alternating current	400/415V (kA)	25	36
	440V (kA)	15	25
	525V (kA)	8	22
Service breaking capacity (Ics)			
	220/240V (kA)	27	50
Alternating current	400/415V (kA)	19	36/30
	440V (kA)	12	25
	525V (kA)	6	22
Type of protection		Adjustable thermal Fixed magnetic	Adjustable thermal Fixed magnetic
Versions		Fixed	Fixed
Mounting on DIN rail by means of the accessory		yes	yes
Mounting position		any	any
Upline/downline power supply		yes	yes
Terminals	Front for cables (FW)	<input type="checkbox"/>	-
	Front (FC)	<input checked="" type="checkbox"/>	<input checked="" type="checkbox"/>
	Front extended (FB)	<input type="checkbox"/>	<input type="checkbox"/>
	Front extended spread terminals (FB)	-	-
	Rear (RC)	<input type="checkbox"/>	<input type="checkbox"/>
Electrical life (415 V AC)	(No. cycles)	30,000	10,000
Mechanical life	(No. cycles)	30,000	10,000
Can be equipped with motor operator		yes	yes
Interlock type		-	-
Operating temperature	(°C)	-5 +65	-5 +65
Reference temperature	(°C)	50	50
Storage temperature	(°C)	-20 +65	-20 +65
Tropicalization		65°C - RH 95%	65°C - RH 95%
Dimensions	Width (3P / 4P) (mm)	120	140
	Height (mm)	155	165
	Depth (mm)	68	68
Weight (3P / 4P) (kg)		1.4	1.9

Key: optional
 supplied as standard
 -not available

MSX

Moulded case circuit breakers for power distribution

The moulded case circuit breakers MSX range is made up of circuit breakers with thermo-magnetic release, circuit breakers with thermo-magnetic release and Overcurrent Protection, circuit breakers with electronic release and switch disconnectors.



MSXC - COMPACT MOULDED CASE CIRCUIT BREAKERS

MSX 160C - COMPACT MOULDED CASE CIRCUIT BREAKERS UP TO 160 A - 16 KA



GW D9 037

ADJUSTABLE THERMAL AND FIXED MAGNETIC RELEASE

Code	Rated current	Rated voltage	Pack Carton
No. of poles: 3P			
GW D9 001	25 A	525 V	1
GW D9 002	40 A	525 V	1
GW D9 003	63 A	525 V	1
GW D9 004	80 A	525 V	1
GW D9 005	100 A	525 V	1
GW D9 026	125 A	525 V	1
GW D9 027	160 A	525 V	1
No. of poles: 3P+N			
GW D9 011	25 A	525 V	1
GW D9 012	40 A	525 V	1
GW D9 013	63 A	525 V	1
GW D9 014	80 A	525 V	1
GW D9 015	100 A	525 V	1
GW D9 036	125 A	525 V	1
GW D9 037	160 A	525 V	1

NOTES: or mounting on EN 50022 DIN rail, choose the fixing bracket GWD8875. The space taken up on the EN 50022 DIN rail is approximately 4 modules for 3P versions and 6 modules for 3P+N versions.

ACCESSORIES SUPPLIED: 225A + 100A versions supplied with front terminals for copper cables (FW). 125A and 160A versions supplied with front terminals (FC).

CHARACTERISTICS: adjustable thermal release $I_r = 0.63 \pm 1 \times I_n$

Fixed magnetic release I_i :

25A-40A: $I_i = 600A$

63A-80A: $I_i = 1000A$

100-125A: $I_i = 1500A$

160A: $I_i = 1600A$

MSX 160C - COMPACT MOULDED CASE CIRCUIT BREAKERS UP TO 160 A - 25 KA



GW D9 053

ADJUSTABLE THERMAL AND FIXED MAGNETIC RELEASE

Code	Rated current	Rated voltage	Pack Carton
No. of poles: 3P			
GW D9 041	25 A	525 V	1
GW D9 042	40 A	525 V	1
GW D9 043	63 A	525 V	1
GW D9 044	80 A	525 V	1
GW D9 045	100 A	525 V	1
GW D9 066	125 A	525 V	1
GW D9 067	160 A	525 V	1
No. of poles: 3P+N			
GW D9 051	25 A	525 V	1
GW D9 052	40 A	525 V	1
GW D9 053	63 A	525 V	1
GW D9 054	80 A	525 V	1
GW D9 055	100 A	525 V	1
GW D9 076	125 A	525 V	1
GW D9 077	160 A	525 V	1

NOTES: or mounting on EN 50022 DIN rail, choose the fixing bracket GWD8875. The space taken up on the EN 50022 DIN rail is approximately 4 modules for 3P versions and 6 modules for 3P+N versions.

ACCESSORIES SUPPLIED: 225A + 100A versions supplied with front terminals for copper cables (FW). 125A and 160A versions supplied with front terminals (FC).

CHARACTERISTICS: adjustable thermal release $I_r = 0.63 \pm 1 \times I_n$

Fixed magnetic release I_i :

25A-40A: $I_i = 600A$

63A-80A: $I_i = 1000A$

100-125A: $I_i = 1500A$

160A: $I_i = 1600A$

MSX 250C - COMPACT MOULDED CASE CIRCUIT BREAKERS UP TO 250 A - 16 KA



GW D9 098

ADJUSTABLE THERMAL AND ADJUSTABLE MAGNETIC RELEASE

Code	Rated current	Rated voltage	Pack Carton
No. of poles: 3P			
GW D9 087	160 A	525 V	1
GW D9 088	250 A	525 V	1
No. of poles: 3P+N			
GW D9 097	160 A	525 V	1
GW D9 098	250 A	525 V	1

NOTES: for mounting on EN 50022 DIN rail, choose the fixing bracket GWD8876.

The space taken up on the EN 50022 DIN rail is approximately 6 modules for 3P versions and 8 modules for 3P+N versions.

ACCESSORIES SUPPLIED: supplied with front terminals (FC).

CHARACTERISTICS: adjustable thermal release $I_r = 0.63 \div 1 \times I_n$

Adjustable magnetic release I_i :

160A: $I_i = 5 \div 13 \times I_n$

250A: $I_i = 5 \div 11 \times I_n$

MSX 250C - COMPACT MOULDED CASE CIRCUIT BREAKERS UP TO 250 A - 25 KA



GW D9 118

ADJUSTABLE THERMAL AND ADJUSTABLE MAGNETIC RELEASE

Code	Rated current	Rated voltage	Pack Carton
No. of poles: 3P			
GW D9 107	160 A	525 V	1
GW D9 108	250 A	525 V	1
No. of poles: 3P+N			
GW D9 117	160 A	525 V	1
GW D9 118	250 A	525 V	1

NOTES: for mounting on EN 50022 DIN rail, choose the fixing bracket GWD8876.

The space taken up on the EN 50022 DIN rail is approximately 6 modules for 3P versions and 8 modules for 3P+N versions.

ACCESSORIES SUPPLIED: supplied with front terminals (FC).

CHARACTERISTICS: adjustable thermal release $I_r = 0.63 \div 1 \times I_n$

Adjustable magnetic release I_i :

160A: $I_i = 5 \div 13 \times I_n$

250A: $I_i = 5 \div 11 \times I_n$

MSX - MOULDED CASE CIRCUIT BREAKERS

MSX 125 - MOULDED CASE CIRCUIT BREAKERS UP TO 125 A - 36 KA



GW D9 145

ADJUSTABLE THERMAL AND ADJUSTABLE MAGNETIC RELEASE

Code	Rated current	Rated voltage	Pack Carton
No. of poles: 3P			
GW D9 121	20 A	690 V	1
GW D9 122	32 A	690 V	1
GW D9 123	50 A	690 V	1
GW D9 124	63 A	690 V	1
GW D9 125	100 A	690 V	1
GW D9 126	125 A	690 V	1
No. of poles: 4P			
GW D9 141	20 A	690 V	1
GW D9 142	32 A	690 V	1
GW D9 143	50 A	690 V	1
GW D9 144	63 A	690 V	1
GW D9 145	100 A	690 V	1
GW D9 146	125 A	690 V	1

NOTES: for mounting on EN 50022 DIN rail, choose the fixing bracket GWD8876. The space taken up on the EN 50022 DIN rail is approximately 5 modules for 3P versions and 7 modules for 4P versions.

ACCESSORIES SUPPLIED: supplied with front terminals (FC).

CHARACTERISTICS: Adjustable thermal release $I_r = 0.63 \div 1 \times I_n$

Adjustable magnetic release I_i :

20A \div 100A: $I_i = 6 \div 12 \times I_n$

125A: $I_i = 6 \div 10 \times I_n$



GW D9 215

ADJUSTABLE MAGNETIC RELEASE FOR MOTOR PROTECTION

Code	Rated current	Rated voltage	Pack Carton
No. of poles: 3P			
GW D9 201	20 A	690 V	1
GW D9 202	32 A	690 V	1
GW D9 204	63 A	690 V	1
GW D9 205	100 A	690 V	1
GW D9 206	125 A	690 V	1
No. of poles: 4P			
GW D9 211	20 A	690 V	1
GW D9 212	32 A	690 V	1
GW D9 214	63 A	690 V	1
GW D9 215	100 A	690 V	1
GW D9 216	125 A	690 V	1

NOTES: for mounting on EN 50022 DIN rail, choose the fixing bracket GWD8876. The space taken up on the EN 50022 DIN rail is approximately 5 modules for 3P versions and 7 modules for 4P versions.

ACCESSORIES: supplied with front terminals (FC).

CHARACTERISTICS: Adjustable magnetic release I_i :

20A \div 100A: $I_i = 6 \div 12 \times I_n$

125A: $I_i = 6 \div 10 \times I_n$

MSX 125 - MOULDED CASE CIRCUIT BREAKERS UP TO 125 A - 65 KA



GW D9 175

ADJUSTABLE THERMAL AND ADJUSTABLE MAGNETIC RELEASE

Code	Rated current	Rated voltage	Pack Carton
No. of poles: 3P			
GW D9 151	20 A	690 V	1
GW D9 152	32 A	690 V	1
GW D9 153	50 A	690 V	1
GW D9 154	63 A	690 V	1
GW D9 155	100 A	690 V	1
GW D9 156	125 A	690 V	1
No. of poles: 4P			
GW D9 171	20 A	690 V	1
GW D9 172	32 A	690 V	1
GW D9 173	50 A	690 V	1
GW D9 174	63 A	690 V	1
GW D9 175	100 A	690 V	1
GW D9 176	125 A	690 V	1

NOTES: for mounting on EN 50022 DIN rail, choose the fixing bracket GWD8876. The space taken up on the EN 50022 DIN rail is approximately 5 modules for 3P versions and 7 modules for 4P versions.

ACCESSORIES SUPPLIED: supplied with front terminals (FC).

CHARACTERISTICS: Adjustable thermal release $I_r = 0.63 \div 1 \times I_n$

Adjustable magnetic release I_i :

20A \div 100A: $I_i = 6 \div 12 \times I_n$

125A: $I_i = 6 \div 10 \times I_n$

MSX 160 - MOULDED CASE CIRCUIT BREAKERS 160 A - 36 KA



GW D9 147

ADJUSTABLE THERMAL AND ADJUSTABLE MAGNETIC RELEASE

Code	Rated current	Rated voltage	Pack Carton
No. of poles: 3P			
GW D9 127	160 A	690 V	1
No. of poles: 4P			
GW D9 147	160 A	690 V	1

NOTES: for mounting on EN 50022 DIN rail, choose the fixing bracket GWD8876.

The space taken up on the EN 50022 DIN rail is approximately 6 modules for 3P versions and 8 modules for 4P versions.

ACCESSORIES SUPPLIED: supplied with front terminals (FC).

CHARACTERISTICS: Adjustable thermal release $I_r = 0.63 \div 1 \times I_n$
Adjustable magnetic release: $I_i = 6 \div 13 \times I_n$



GW D9 217

ADJUSTABLE MAGNETIC RELEASE FOR MOTOR PROTECTION

Code	Rated current	Rated voltage	Pack Carton
No. of poles: 3P			
GW D9 207	160 A	690 V	1
No. of poles: 4P			
GW D9 217	160 A	690 V	1

NOTES: for mounting on EN 50022 DIN rail, choose the fixing bracket GWD8876.

The space taken up on the EN 50022 DIN rail is approximately 6 modules for 3P versions and 8 modules for 4P versions.

ACCESSORIES: supplied with front terminals (FC).

CHARACTERISTICS: Adjustable magnetic release: $I_i = 6 \div 13 \times I_n$.

MSX 160 - MOULDED CASE CIRCUIT BREAKERS 160 A - 65 KA



GW D9 177

ADJUSTABLE THERMAL AND ADJUSTABLE MAGNETIC RELEASE

Code	Rated current	Rated voltage	Pack Carton
No. of poles: 3P			
GW D9 157	160 A	690 V	1
No. of poles: 4P			
GW D9 177	160 A	690 V	1

NOTES: for mounting on EN 50022 DIN rail, choose the fixing bracket GWD8876.

The space taken up on the EN 50022 DIN rail is approximately 6 modules for 3P versions and 8 modules for 4P versions.

ACCESSORIES SUPPLIED: supplied with front terminals (FC).

CHARACTERISTICS: Adjustable thermal release $I_r = 0.63 \div 1 \times I_n$
Adjustable magnetic release: $I_i = 6 \div 13 \times I_n$

MSX 250 - MOULDED CASE CIRCUIT BREAKERS 250 A - 36 KA



GW D9 138

ADJUSTABLE THERMAL AND ADJUSTABLE MAGNETIC RELEASE

Code	Rated current	Rated voltage	Pack Carton
No. of poles: 3P			
GW D9 128	250 A	690 V	1
No. of poles: 4P			
GW D9 138	250 A	690 V	1

NOTES: for mounting on EN 50022 DIN rail, choose the fixing bracket GWD8876.

The space taken up on the EN 50022 DIN rail is approximately 6 modules for 3P versions and 8 modules for 4P versions.

ACCESSORIES SUPPLIED: supplied with front terminals (FC).

CHARACTERISTICS: Adjustable thermal release $I_r = 0.63 \div 1 \times I_n$

Adjustable magnetic release: $I_i = 6 \div 10 \times I_n$



GW D9 218

ADJUSTABLE MAGNETIC RELEASE FOR MOTOR PROTECTION

Code	Rated current	Rated voltage	Pack Carton
No. of poles: 3P			
GW D9 208	250 A	690 V	1
No. of poles: 4P			
GW D9 218	250 A	690 V	1

NOTES: for mounting on EN 50022 DIN rail, choose the fixing bracket GWD8876.

The space taken up on the EN 50022 DIN rail is approximately 6 modules for 3P versions and 8 modules for 4P versions.

ACCESSORIES SUPPLIED: supplied with front terminals (FC).

CHARACTERISTICS: Adjustable magnetic release: $I_i = 6 \div 10 \times I_n$.

MSX 250 - MOULDED CASE CIRCUIT BREAKERS 250 A - 65 KA



GW D9 168

ADJUSTABLE THERMAL AND ADJUSTABLE MAGNETIC RELEASE

Code	Rated current	Rated voltage	Pack Carton
No. of poles: 3P			
GW D9 158	250 A	690 V	1
No. of poles: 4P			
GW D9 168	250 A	690 V	1

NOTES: for mounting on EN 50022 DIN rail, choose the fixing bracket GWD8876.

The space taken up on the EN 50022 DIN rail is approximately 6 modules for 3P versions and 8 modules for 4P versions.

ACCESSORIES SUPPLIED: supplied with front terminals (FC).

CHARACTERISTICS: Adjustable thermal release $I_r = 0.63 \div 1 \times I_n$

Adjustable magnetic release: $I_i = 6 \div 10 \times I_n$

MSX 400 - MOULDED CASE CIRCUIT BREAKERS 400 A - 36 KA



GW D9 363

ADJUSTABLE THERMAL AND ADJUSTABLE MAGNETIC RELEASE

Code	Rated current	Rated voltage	Pack Carton
No. of poles: 3P			
GW D9 361	400 A	690 V	1
No. of poles: 3P+N			
GW D9 362	400 A	690 V	1
No. of poles: 4P			
GW D9 363	400 A	690 V	1

ACCESSORIES SUPPLIED: supplied with front terminals (FC).
CHARACTERISTICS: adjustable thermal release $I_r = 0.63 \div 1 \times I_n$
 Adjustable magnetic release $I_i = 6 \div 12 \times I_n$

MSX 400 - MOULDED CASE CIRCUIT BREAKERS 400 A - 50 KA



GW D9 366

ADJUSTABLE THERMAL AND ADJUSTABLE MAGNETIC RELEASE

Code	Rated current	Rated voltage	Pack Carton
No. of poles: 3P			
GW D9 365	400 A	690 V	1
No. of poles: 3P+N			
GW D9 366	400 A	690 V	1
No. of poles: 4P			
GW D9 367	400 A	690 V	1

ACCESSORIES SUPPLIED: supplied with front terminals (FC).
CHARACTERISTICS: adjustable thermal release $I_r = 0.63 \div 1 \times I_n$
 Adjustable magnetic release $I_i = 6 \div 12 \times I_n$

MSXD 125 - MOULDED CASE CIRCUIT BREAKERS WITH RESIDUAL CURRENT PROTECTION

MSXD 125 - MCCB'S WITH RESIDUAL CURRENT PROTECTION UP TO 125 A - 25 KA



GW D9 556

ADJUSTABLE THERMAL, FIXED MAGNETIC AND ADJUSTABLE RESIDUAL CURRENT PROTECTION RELEASE

Code	Rated current	Rated voltage	Pack Carton
No. of poles: 3P+N			
GW D9 551	20 A	525 V	1
GW D9 552	32 A	525 V	1
GW D9 553	50 A	525 V	1
GW D9 554	63 A	525 V	1
GW D9 555	100 A	525 V	1
GW D9 556	125 A	525 V	1

NOTES: for mounting on EN 50022 DIN rail, choose the fixing bracket GWD8876.

The space taken up on the EN 50022 DIN rail is approximately 7 modules.

ACCESSORIES SUPPLIED: supplied with front terminals (FC).

CHARACTERISTICS: Adjustable thermal release $I_r = 0.63 \pm 1 \times I_n$

Fixed magnetic release I_i :

20A ÷ 100A: $I_i = 12 \times I_n$

125A: $I_i = 10 \times I_n$

Residual current circuit breaker tripping (I_{dn}) and delay (dt) thresholds are adjustable:

I_{dn} (A): 0.03 - 0.1 - 0.3 - 0.5 - 1 - 3

dt (ms): 0 - 60 - 200 - 400 - 700

MSXD 125 - MCCB'S WITH RESIDUAL CURRENT PROTECTION UP TO 125 A - 36 KA



GW D9 576

ADJUSTABLE THERMAL, FIXED MAGNETIC AND ADJUSTABLE RESIDUAL CURRENT PROTECTION RELEASE

Code	Rated current	Rated voltage	Pack Carton
No. of poles: 3P+N			
GW D9 571	20 A	525 V	1
GW D9 572	32 A	525 V	1
GW D9 573	50 A	525 V	1
GW D9 574	63 A	525 V	1
GW D9 575	100 A	525 V	1
GW D9 576	125 A	525 V	1

NOTES: for mounting on EN 50022 DIN rail, choose the fixing bracket GWD8876.

The space taken up on the EN 50022 DIN rail is approximately 7 modules.

ACCESSORIES SUPPLIED: supplied with front terminals (FC).

CHARACTERISTICS: Adjustable thermal release $I_r = 0.63 \pm 1 \times I_n$

Fixed magnetic release I_i :

20A ÷ 100A: $I_i = 12 \times I_n$

125A: $I_i = 10 \times I_n$

Residual current circuit breaker tripping (I_{dn}) and delay (dt) thresholds are adjustable:

I_{dn} (A): 0.03 - 0.1 - 0.3 - 0.5 - 1 - 3

dt (ms): 0 - 60 - 200 - 400 - 700

MSXD 160 - MCCB'S WITH RESIDUAL CURRENT PROTECTION 160 A - 25 KA



GW D9 557

ADJUSTABLE THERMAL, FIXED MAGNETIC AND ADJUSTABLE RESIDUAL CURRENT PROTECTION RELEASE

Code	Rated current	Rated voltage	Pack Carton
No. of poles: 3P+N			
GW D9 557	160 A	525 V	1

NOTES: for mounting on EN 50022 DIN rail, choose the fixing bracket GWD8876.

The space taken up on the EN 50022 DIN rail is approximately 8 modules.

ACCESSORIES: supplied with front terminals (FC).

CHARACTERISTICS: Adjustable thermal release $I_r = 0.63 \pm 1 \times I_n$

Fixed magnetic release $I_i = 13 \times I_n$

Residual current circuit breaker tripping (I_{dn}) and delay (dt) thresholds are adjustable:

I_{dn} (A): 0.03 - 0.1 - 0.3 - 0.5 - 1 - 3

dt (ms): 0 - 60 - 200 - 400 - 700

MSXD 160 - MCCB'S WITH RESIDUAL CURRENT PROTECTION 160 A - 36 KA



GW D9 277

ADJUSTABLE THERMAL, FIXED MAGNETIC AND ADJUSTABLE RESIDUAL CURRENT PROTECTION RELEASE

Code	Rated current	Rated voltage	Pack Carton
No. of poles: 3P+N			
GW D9 277	160 A	525 V	1

NOTES: for mounting on EN 50022 DIN rail, choose the fixing bracket GWD8876.

The space taken up on the EN 50022 DIN rail is approximately 8 modules.

ACCESSORIES SUPPLIED: supplied with front terminals (FC).

CHARACTERISTICS: Adjustable thermal release $I_r = 0.63 \div 1 \times I_n$

Fixed magnetic release $I_i = 13 \times I_n$

Residual current circuit breaker tripping (I_{dn}) and delay (dt) thresholds are adjustable:

I_{dn} (A): 0.03 - 0.1 - 0.3 - 0.5 - 1 - 3

dt (ms): 0 - 60 - 200 - 400 - 700

MSXD 250 - MCCB'S WITH RESIDUAL CURRENT PROTECTION 250 A - 25 KA



GW D9 558

ADJUSTABLE THERMAL, FIXED MAGNETIC AND ADJUSTABLE RESIDUAL CURRENT PROTECTION RELEASE

Code	Rated current	Rated voltage	Pack Carton
No. of poles: 3P+N			
GW D9 558	250 A	525 V	1

NOTES: for mounting on EN 50022 DIN rail, choose the fixing bracket GWD8876.

The space taken up on the EN 50022 DIN rail is approximately 8 modules.

ACCESSORIES SUPPLIED: supplied with front terminals (FC).

CHARACTERISTICS: Adjustable thermal release $I_r = 0.63 \div 1 \times I_n$

Fixed magnetic release $I_i = 10 \times I_n$

Residual current circuit breaker tripping (I_{dn}) and delay (dt) thresholds are adjustable:

I_{dn} (A): 0.03 - 0.1 - 0.3 - 0.5 - 1 - 3

dt (ms): 0 - 60 - 200 - 400 - 700

MSXD 250 - MCCB'S WITH RESIDUAL CURRENT PROTECTION 250 A - 36 KA



GW D9 278

ADJUSTABLE THERMAL, FIXED MAGNETIC AND ADJUSTABLE RESIDUAL CURRENT PROTECTION RELEASE

Code	Rated current	Rated voltage	Pack Carton
No. of poles: 3P+N			
GW D9 278	250 A	525 V	1

NOTES: for mounting on EN 50022 DIN rail, choose the fixing bracket GWD8876.

The space taken up on the EN 50022 DIN rail is approximately 8 modules.

ACCESSORIES SUPPLIED: supplied with front terminals (FC).

CHARACTERISTICS: Adjustable thermal release $I_r = 0.63 \div 1 \times I_n$

Fixed magnetic release $I_i = 10 \times I_n$

Residual current circuit breaker tripping (I_{dn}) and delay (dt) thresholds are adjustable:

I_{dn} (A): 0.03 - 0.1 - 0.3 - 0.5 - 1 - 3

dt (ms): 0 - 60 - 200 - 400 - 700

MSXE - ELECTRONIC MOULDED CASE CIRCUIT BREAKERS

MSXE 160 - MCCB'S WITH ELECTRONIC RELEASE UP TO 160 A - 36 KA



GW D9 317

ELECTRONIC RELEASE

Code	Rated current	Electronic release type	Rated voltage	Pack Carton
No. of poles: 3P				
GW D9 302	40 A	LSI	690 V	1
GW D9 306	125 A	LSI	690 V	1
GW D9 307	160 A	LSI	690 V	1
No. of poles: 3P+N				
GW D9 312	40 A	LSI	690 V	1
GW D9 316	125 A	LSI	690 V	1
GW D9 317	160 A	LSI	690 V	1
No. of poles: 4P				
GW D9 322	40 A	LSI	690 V	1
GW D9 326	125 A	LSI	690 V	1
GW D9 327	160 A	LSI	690 V	1

NOTES: it is not possible mounting on EN 50022 DIN rail.

ACCESSORIES SUPPLIED: supplied with front terminals (FC).

CHARACTERISTICS: current regulation field $I_r = 0.4 \div 1 \times I_n$.

Neutral 100% protected for 4P circuit breakers.

MSXE 160 - MCCB'S WITH ELECTRONIC RELEASE UP TO 160 A - 65 KA



GW D9 347

ELECTRONIC RELEASE

Code	Rated current	Electronic release type	Rated voltage	Pack Carton
No. of poles: 3P				
GW D9 332	40 A	LSI	690 V	1
GW D9 336	125 A	LSI	690 V	1
GW D9 337	160 A	LSI	690 V	1
No. of poles: 3P+N				
GW D9 342	40 A	LSI	690 V	1
GW D9 346	125 A	LSI	690 V	1
GW D9 347	160 A	LSI	690 V	1
No. of poles: 4P				
GW D9 352	40 A	LSI	690 V	1
GW D9 356	125 A	LSI	690 V	1
GW D9 357	160 A	LSI	690 V	1

NOTES: it is not possible mounting on EN 50022 DIN rail.

ACCESSORIES SUPPLIED: supplied with front terminals (FC).

CHARACTERISTICS: current regulation field $I_r = 0.4 \div 1 \times I_n$.

Neutral 100% protected for 4P circuit breakers.

MSXE 250 - MCCB'S WITH ELECTRONIC RELEASE 250 A - 36 KA



GW D9 318

ELECTRONIC RELEASE

Code	Rated current	Electronic release type	Rated voltage	Pack Carton
No. of poles: 3P				
GW D9 308	250 A	LSI	690 V	1
No. of poles: 3P+N				
GW D9 318	250 A	LSI	690 V	1
No. of poles: 4P				
GW D9 328	250 A	LSI	690 V	1

NOTES: it is not possible mounting on EN 50022 DIN rail.

ACCESSORIES SUPPLIED: supplied with front terminals (FC).

CHARACTERISTICS: current regulation field $I_r = 0.4 \div 1 \times I_n$.

Neutral 100% protected for 4P circuit breakers.

MSXE 250 - MCCB'S WITH ELECTRONIC RELEASE 250 A - 65 KA



GW D9 348

ELECTRONIC RELEASE

Code	Rated current	Electronic release type	Rated voltage	Pack Carton
No. of poles: 3P				
GW D9 338	250 A	LSI	690 V	1
No. of poles: 3P+N				
GW D9 348	250 A	LSI	690 V	1
No. of poles: 4P				
GW D9 358	250 A	LSI	690 V	1

NOTES: it is not possible mounting on EN 50022 DIN rail.

ACCESSORIES SUPPLIED: supplied with front terminals (FC).

CHARACTERISTICS: current regulation field $I_r = 0.4 \div 1 \times I_n$.

Neutral 100% protected for 4P circuit breakers.

MSXE 400 - MCCB'S WITH ELECTRONIC RELEASE 400 A - 36 KA



GW D9 372

ELECTRONIC RELEASE

Code	Rated current	Electronic release type	Rated voltage	Pack Carton
No. of poles: 3P				
GW D9 371	400 A	LSI	690 V	1
No. of poles: 3P+N				
GW D9 372	400 A	LSI	690 V	1
No. of poles: 4P				
GW D9 373	400 A	LSI	690 V	1
GW D9 374	400 A	LSIG	690 V	1

ACCESSORIES: supplied with front terminals (FC).

CHARACTERISTICS: current regulation field $I_r = 0.4 \div 1 \times I_n$.
Neutral 100% or 50% protected for 4P circuit breakers.

MSXE 400 - MCCB'S WITH ELECTRONIC RELEASE 400 A - 50 KA



GW D9 376

ELECTRONIC RELEASE

Code	Rated current	Electronic release type	Rated voltage	Pack Carton
No. of poles: 3P				
GW D9 375	400 A	LSI	690 V	1
No. of poles: 3P+N				
GW D9 376	400 A	LSI	690 V	1
No. of poles: 4P				
GW D9 377	400 A	LSI	690 V	1
GW D9 378	400 A	LSIG	690 V	1

ACCESSORIES: supplied with front terminals (FC).

CHARACTERISTICS: current regulation field $I_r = 0.4 \div 1 \times I_n$.
Neutral 100% or 50% protected for 4P circuit breakers.

MSXE 630 - MCCB'S WITH ELECTRONIC RELEASE 630 A - 36 KA



GW D9 382

ELECTRONIC RELEASE

Code	Rated current	Electronic release type	Rated voltage	Pack Carton
No. of poles: 3P				
GW D9 381	630 A	LSI	690 V	1
No. of poles: 3P+N				
GW D9 382	630 A	LSI	690 V	1
No. of poles: 4P				
GW D9 383	630 A	LSI	690 V	1
GW D9 384	630 A	LSIG	690 V	1

ACCESSORIES SUPPLIED: supplied with front terminals (FC).

CHARACTERISTICS: current regulation field $I_r = 0.4 \div 1 \times I_n$.
Neutral 100% or 50% protected for 4P circuit breakers.

MSXE 630 - MCCB'S WITH ELECTRONIC RELEASE 630 A - 50 KA



GW D9 386

ELECTRONIC RELEASE

Code	Rated current	Electronic release type	Rated voltage	Pack Carton
No. of poles: 3P				
GW D9 385	630 A	LSI	690 V	1
No. of poles: 3P+N				
GW D9 386	630 A	LSI	690 V	1
No. of poles: 4P				
GW D9 387	630 A	LSI	690 V	1
GW D9 388	630 A	LSIG	690 V	1

ACCESSORIES: supplied with front terminals (FC).

CHARACTERISTICS: current regulation field $I_r = 0.4 \div 1 \times I_n$.
Neutral 100% or 50% protected for 4P circuit breakers.

MSXE 1000 - MCCB'S WITH ELECTRONIC RELEASE UP TO 1000 A - 50 KA



GW D9 408

ELECTRONIC RELEASE

Code	Rated current	Electronic release type	Rated voltage	Pack Carton
No. of poles: 3P				
GW D9 401	800 A	LSI	690 V	1
GW D9 406	1000 A	LSI	690 V	1
No. of poles: 4P				
GW D9 403	800 A	LSI	690 V	1
GW D9 408	1000 A	LSI	690 V	1
GW D9 404	800 A	LSIG	690 V	1
GW D9 409	1000 A	LSIG	690 V	1

ACCESSORIES SUPPLIED: supplied with front terminals (FC) for 800A versions. Supplied with extended front terminals (FB) for 1000A versions. Operating lever extension for manual closing and opening operations.

CHARACTERISTICS: current regulation field $I_r = 0.4 \div 1 \times I_n$.
Neutral 100% or 50% protected.

MSXE 1250 - MCCB'S WITH ELECTRONIC RELEASE 1250 A - 50 KA



GW D9 415

ELECTRONIC RELEASE

Code	Rated current	Electronic release type	Rated voltage	Terminal type	Interlocked	Pack Carton
No. of poles: 3P						
GW D9 411	1250 A	LSI	690 V	Front	No	1
GW D9 411 B	1250 A	LSI	690 V	Front	Yes	1
GW D9 412	1250 A	LSI	690 V	Rear	No	1
GW D9 412 B	1250 A	LSI	690 V	Rear	Yes	1
No. of poles: 4P						
GW D9 415	1250 A	LSI	690 V	Front	No	1
GW D9 415 B	1250 A	LSI	690 V	Front	Yes	1
GW D9 416	1250 A	LSI	690 V	Rear	No	1
GW D9 416 B	1250 A	LSI	690 V	Rear	Yes	1
GW D9 417	1250 A	LSIG	690 V	Front	No	1
GW D9 417 B	1250 A	LSIG	690 V	Front	Yes	1
GW D9 418	1250 A	LSIG	690 V	Rear	No	1
GW D9 418 B	1250 A	LSIG	690 V	Rear	Yes	1

NOTES: the codes with the final letter B indicate circuit breaker with cable mechanical interlock already fitted on it (cable for mechanical interlock to be ordered separately).

ACCESSORIES SUPPLIED: operating lever extension for manual closing and opening operations.

CHARACTERISTICS: current regulation field $I_r = 0.4 \div 1 \times I_n$.
Neutral 100% or 50% protected.

MSXE 1600 - MCCB'S WITH ELECTRONIC RELEASE 1600 A - 50 KA



GW D9 426

ELECTRONIC RELEASE

Code	Rated current	Electronic release type	Rated voltage	Terminal type	Interlocked	Pack Carton
No. of poles: 3P						
GW D9 421	1600 A	LSI	690 V	Front	No	1
GW D9 421 B	1600 A	LSI	690 V	Front	Yes	1
GW D9 422	1600 A	LSI	690 V	Rear	No	1
GW D9 422 B	1600 A	LSI	690 V	Rear	Yes	1
No. of poles: 4P						
GW D9 425	1600 A	LSI	690 V	Front	No	1
GW D9 425 B	1600 A	LSI	690 V	Front	Yes	1
GW D9 426	1600 A	LSI	690 V	Rear	No	1
GW D9 426 B	1600 A	LSI	690 V	Rear	Yes	1
GW D9 427	1600 A	LSIG	690 V	Front	No	1
GW D9 427 B	1600 A	LSIG	690 V	Front	Yes	1
GW D9 428	1600 A	LSIG	690 V	Rear	No	1
GW D9 428 B	1600 A	LSIG	690 V	Rear	Yes	1

NOTES: the codes with the final letter B indicate circuit breaker with cable mechanical interlock already fitted on it (cable for mechanical interlock to be ordered separately).

ACCESSORIES SUPPLIED: operating lever extension for manual closing and opening operations.

CHARACTERISTICS: current regulation field $I_r = 0.4 \div 1 \times I_n$.
Neutral 100% or 50% protected.

MSXM - SWITCH DISCONNECTORS

MSXM 160C - SWITCH DISCONNECTORS 160 A



GW D9 442

SWITCH-DISCONNECTORS

Code	Rated current	Rated voltage	Pack Carton
No. of poles: 3P			
GW D9 441	160 A	690 V	1
No. of poles: 4P			
GW D9 442	160 A	690 V	1

NOTES: for mounting on EN 50022 DIN rail, choose the fixing bracket GWD8875.

The space taken up on the EN 50022 DIN rail is approximately 4 modules for the 3P versions and 6 modules for the 4P versions.

ACCESSORIES SUPPLIED: supplied with front terminals (FC).

MSXM 250C - SWITCH DISCONNECTORS 250 A



GW D9 444

SWITCH-DISCONNECTORS

Code	Rated current	Rated voltage	Pack Carton
No. of poles: 3P			
GW D9 443	250 A	690 V	1
No. of poles: 4P			
GW D9 444	250 A	690 V	1

NOTES: for mounting on EN 50022 DIN rail, choose the fixing bracket GWD8876.

The space taken up on the EN 50022 DIN rail is approximately 6 modules for the 3P versions and 8 modules for the 4P versions.

ACCESSORIES SUPPLIED: supplied with front terminals (FC).

MSXM 400 - SWITCH DISCONNECTORS 400 A



GW D9 446

SWITCH-DISCONNECTORS

Code	Rated current	Rated voltage	Pack Carton
No. of poles: 3P			
GW D9 445	400 A	690 V	1
No. of poles: 4P			
GW D9 446	400 A	690 V	1

ACCESSORIES SUPPLIED: supplied with front terminals (FC).

MSXM 630 - SWITCH DISCONNECTORS 630 A



GW D9 448

SWITCH-DISCONNECTORS

Code	Rated current	Rated voltage	Pack Carton
No. of poles: 3P			
GW D9 447	630 A	690 V	1
No. of poles: 4P			
GW D9 448	630 A	690 V	1

ACCESSORIES SUPPLIED: supplied with front terminals (FC).

MSXM 1000 - SWITCH DISCONNECTORS UP TO 1000 A



GW D9 450

SWITCH-DISCONNECTORS

Code	Rated current	Rated voltage	Pack Carton
No. of poles: 3P			
GW D9 449	800 A	690 V	1
GW D9 451	1000 A	690 V	1
No. of poles: 4P			
GW D9 450	800 A	690 V	1
GW D9 452	1000 A	690 V	1

ACCESSORIES SUPPLIED: supplied with front terminals (FC). Operating lever extension for manual closing and opening operations.

MSXM 1250 - SWITCH DISCONNECTORS 1250 A



GW D9 454

SWITCH-DISCONNECTORS

Code	Rated current	Rated voltage	Terminal type	Interlocked	Pack Carton
No. of poles: 3P					
GW D9 453	1250 A	690 V	Front	No	1
GW D9 453 B	1250 A	690 V	Front	Yes	1
GW D9 459	1250 A	690 V	Rear	No	1
GW D9 459 B	1250 A	690 V	Rear	Yes	1
No. of poles: 4P					
GW D9 454	1250 A	690 V	Front	No	1
GW D9 454 B	1250 A	690 V	Front	Yes	1
GW D9 460	1250 A	690 V	Rear	No	1
GW D9 460 B	1250 A	690 V	Rear	Yes	1

NOTES: the codes with the final letter B indicate MMCB's with mechanical interlock wire already mounted (interlock cable to be ordered separately).

EQUIPMENT: operating lever extension for manual closing and opening operations.

MSXM 1600 - SWITCH DISCONNECTORS 1600 A



GW D9 457

SWITCH-DISCONNECTORS

Code	Rated current	Rated voltage	Terminal type	Interlocked	Pack Carton
No. of poles: 3P					
GW D9 455	1600 A	690 V	Front	No	1
GW D9 455 B	1600 A	690 V	Front	Yes	1
GW D9 457	1600 A	690 V	Rear	No	1
GW D9 457 B	1600 A	690 V	Rear	Yes	1
No. of poles: 4P					
GW D9 456	1600 A	690 V	Front	No	1
GW D9 456 B	1600 A	690 V	Front	Yes	1
GW D9 458	1600 A	690 V	Rear	No	1
GW D9 458 B	1600 A	690 V	Rear	Yes	1

NOTES: the codes with the final letter B indicate MMCB's with mechanical interlock wire already mounted (interlock cable to be ordered separately).

ACCESSORIES SUPPLIED: operating lever extension for manual closing and opening operations.

ACCESSORIES FOR MOULDED CASE CIRCUIT BREAKERS

AUXILIARY CONTACTS



GW D8 501

AUXILIARY CONTACTS OF OPEN/CLOSED POSITION

Code	Type of contact	Pack Carton
Suitable for: MSX/M160c-250c		
GW D8 501	1 Changeover	1
Suitable for: MSX/D/E/M125-1600		
GW D8 504	1 Changeover	1

APPLICATIONS: used in order to signal the position ON or OFF of the MCCB's.
CHARACTERISTICS: they are identified by the grey colour and with the AX symbol on the product.



GW D8 502

AUXILIARY CONTACTS OF FAULT INDICATOR SWITCH

Code	Type of contact	Assembly position	Pack Carton
Suitable for: MSX/M160c-250c			
GW D8 502	1 Changeover	Left	1
GW D8 503	1 Changeover	Right	1
Suitable for: MSX/D/E/M125-1600			
GW D8 505	1 Changeover	-	1

APPLICATIONS: used in order to indicate the circuit breaker tripping status.
NOTES: GW D8 502 must be placed to the left of the circuit breaker lever.
 GW D8 503 must be placed to the right of the circuit breaker lever.
CHARACTERISTICS: they are identified by the grey and black colours and with the AL symbol on the product.

OPENING RELEASES



GW D8 512

SHUNT TRIP RELEASES

Code	Rated voltage (V)	Pack Carton
Suitable for: MSX/M160c-250c		
GW D8 512	200 - 240 V ac	1
GW D8 513	380 - 450 V ac	1
GW D8 514	24V ac/dc	1
Suitable for: MSX/E/M125-1000		
GW D8 519	200 - 240 V ac	1
GW D8 520	380 - 450 V ac	1
GW D8 522	24V ac/dc	1
Suitable for: MSXE/M1250-1600		
GW D8 527	200 - 240 V ac	1
GW D8 528	380 - 450 V ac	1
GW D8 529	24V ac/dc	1

APPLICATIONS: allows the remote release of a MCCB'S when a certain voltage is applied to its terminals. When the release is powered, the contacts and the operating lever of the MCCB's assume the tripped position.
NOTE: The operating voltage range is 85% to 110% in AC and 75% to 125% in DC.
CHARACTERISTICS: they are identified by the grey colour and the SH symbol on the product.



GW D8 510

REMOTE TRIPPING DEVICE FOR MSXD

Code	Suitable for	Pack Carton
GW D8 510	MSXD125-160-250	1

APPLICATIONS: allows the remote tripping of a RCBO's of MSXD series via NO push button connected.
NOTE: voltage-independent release unit.
 The release unit must be positioned external on the right side of the MCCB's.



GW D8 542

UNDER VOLTAGE RELEASES (UV)

Code	Rated voltage (V)	Pack Carton
Suitable for: MSX/M160c-250c		
GW D8 542	200 - 240 V ac	1
GW D8 545	380 - 450 V ac	1
GW D8 546	24 V dc	1
Suitable for: MSX/E/M125-630		
GW D8 552	200 - 240 V ac	1
GW D8 554	380 - 450 V ac	1
GW D8 557	24 V dc	1
Suitable for: MSXE/M1000-1600		
GW D8 564	200 - 240 V ac	1
GW D8 567	380 - 415 V ac	1
GW D8 571	24 V dc	1

APPLICATIONS: allows the remote release of a MCCB'S when the voltage applied to its terminals is between 35% and 70% of its rated voltage. When the release is not powered, the contacts and the circuit breaker operating lever assume the tripped position.

NOTE: they prevent the circuit breaker from closing until the voltage is greater than at least 85% of its rated voltage.

CHARACTERISTICS: They are identified by grey and black colours and with the UV symbol on the product.



GW D8 544

DELAYED UNDER VOLTAGE RELEASES (UV)

Code	Rated voltage (V)	Pack Carton
Suitable for: MSX/M160c-250c		
GW D8 544	200 - 240 V ac	1
GW D8 548	24 V dc	1
Suitable for: MSX/E/M125-630		
GW D8 553	200 - 240 V ac	1
GW D8 555	380 - 415 V ac	1
GW D8 558	24 V dc	1
Suitable for: MSXE/M1000		
GW D8 565	220 - 240 V ac	1
GW D8 568	380 - 415 V ac	1
GW D8 572	24 V dc	1
Suitable for: MSXE/M1250-1600		
GW D8 566	220 - 240 V ac	1
GW D8 569	380 - 415 V ac	1
GW D8 573	24 V dc	1

APPLICATIONS: in order to allow remotely tripping of a circuit breaker when the voltage applied to its terminals is between 35% and 70% of its rated voltage. When the undervoltage release is not supplied, the contacts and the circuit breaker lever assume the circuit breaker tripping status.

NOTE: they prevent the closing of circuit breaker until the voltage exceeds at least 85% of its rated voltage.

The undervoltage release must be mounted outside, to the right of the circuit breaker.

CHARACTERISTICS: They have 500ms delay time.

MOTOR OPERATING DEVICES



GW D8 590

MOTOR OPERATING DEVICES

Code	Rated voltage (V)	Pack Carton
Suitable for: MSX/M250c		
GW D8 581	230 - 240 V ac	1
GW D8 582	24 V dc	1
Suitable for: MSX/D125		
GW D8 584	230 - 240 V ac	1
GW D8 585	24 V dc	1
Suitable for: MSX/D/E160-250		
GW D8 590	230 - 240 V ac	1
GW D8 591	24 V dc	1
Suitable for: MSX/E/M400-630		
GW D8 595	110 - 240 V ac	1
GW D8 596	24 - 48 V dc	1
Suitable for: MSX/E/M1000		
GW D8 598	110 - 240 V ac	1
GW D8 599	24 - 48 V dc	1
Suitable for: MSX/E/M1250-1600		
GW D8 602	230 - 240 V ac	1
GW D8 603	24 V dc	1

APPLICATIONS: allows the MCCB'S remote opening and closing depending on the electrical signals received.

CHARACTERISTICS: to be mounted on the front of the MCCB'S.

ROTARY HANDLES



GW D8 618

DIRECT ROTARY HANDLE

Code	Suitable for	Pack Carton
GW D8 618	MSX/M160c	1
GW D8 619	MSX/M250c	1
GW D8 620	MSX/D125	1
GW D8 621	MSX/D/E160-250	1
GW D8 622	MSX/E/M400-630	1
GW D8 623	MSXE/M1000	1
GW D8 624	MSXE/M1250-1600	1



GW D8 630

EXTENDED ROTARY HANDLE

Code	Colour	Pack Carton
Suitable for: MSX/M160c		
GW D8 625	Black	1
Suitable for: MSX/M250c		
GW D8 626	Black	1
GW D8 627	Red - emergency	1
Suitable for: MSX/D125		
GW D8 628	Black	1
GW D8 629	Red - emergency	1
Suitable for: MSX/D/E160-250		
GW D8 630	Black	1
GW D8 631	Red - emergency	1
Suitable for: MSX/E/M400-630		
GW D8 632	Black	1
GW D8 633	Red - emergency	1
Suitable for: MSXE/M1000		
GW D8 634	Black	1
GW D8 635	Red - emergency	1
Suitable for: MSXE/M1250-1600		
GW D8 636	Black	1
GW D8 637	Red - emergency	1

MECHANICAL INTERLOCK



ZC6

LEVER MECHANICAL INTERLOCKS TYPE

Code	Type	Pack Carton
Suitable for: MSX/M250c		
GW D8 641	Right mechanical interlock	1
GW D8 643	Left mechanical interlock	1
Suitable for: MSX125		
GW D8 644	Right mechanical interlock	1
GW D8 646	Left mechanical interlock	1
Suitable for: MSX/E160-250		
GW D8 647	Right mechanical interlock	1
GW D8 649	Left mechanical interlock	1
Suitable for: MSX/E/M400-630		
GW D8 650	Right mechanical interlock	1
GW D8 652	Left mechanical interlock	1
Suitable for: MSXE/M1000		
GW D8 653	Right mechanical interlock	1
GW D8 655	Left mechanical interlock	1

NOTE: to create the lever interlock system it is necessary to provide and install both the left and right interlocks, depending on the size of the switch. It is suggested to use rotary handles or motor operators for circuit breakers MSX/E/M 400-630 and MSXE/M1000.

CHARACTERISTICS: mechanism to be fixed on the front of both equal size 3 or 4 poles circuit breakers.



GW D8 661

CABLE MECHANICAL INTERLOCKS TYPE

Code	Suitable for	Pack Carton
GW D8 661	MSX/M250c	1
GW D8 662	MSX125	1
GW D8 663	MSX/E160-250	1
GW D8 664	MSX/E/M400-630	1
GW D8 665	MSXE/M1000	1

NOTE: the wire interlock consists of two mechanisms connected by a steel cable. The mechanisms are fixed on two circuit breakers, limited by the length and bending capacity of the wire. To create the wire interlock system it is necessary to provide and install a mechanism for each interlocked circuit breaker.

The cable is to be ordered separately. It is suggested to use rotary handles or motor operators for circuit breakers MSX/E/M 400-630 and MSXE/M 1000.

CHARACTERISTICS: mechanism to be fixed on the front of both 3 or 4 pole circuit breakers (also with different sizes).

The circuit breakers can be placed in separate cubicles and at different heights.



GW D8 666

CABLES FOR MECHANICAL INTERLOCK

Code	Suitable for	Pack Carton
GW D8 666	MSX/D/E/M/c125-1000	1
GW D8 668	MSXE/M1250-1600	1

CHARACTERISTICS: cable length 1m

MECHANICAL BLOCK



GW D8 671

PADLOCKS LEVER LOCK

Code	Suitable for	Pack Carton
GW D8 671	MSX/M160c-250c	1
GW D8 672	MSX/D/E125-250	1
GW D8 673	MSX/E/M400-1000	1
GW D8 674	MSXE/M1250-1600	1

APPLICATIONS: allows the circuit breaker lever to be locked in the ON or OFF status using up to 3 padlocks.

NOTE: the locking devices for models 125A, 160A and 250A accept padlocks with a diameter of 5mm.

Locking devices for models from 400A to 1600A accept padlocks with a diameter of 8mm.

PLUG-IN VERSIONS



GW D8 681

FIXED PART FOR PLUG-IN MCCB

Code	Suitable for MCCB	Pack Carton
Suitable for: MSX125		
GW D8 681	3P	1
GW D8 682	4P	1
Suitable for: MSX/E160-250		
GW D8 683	3P	1
GW D8 684	4P	1
Suitable for: MSX/E/M400-630		
GW D8 685	3P	1
GW D8 686	4P	1
Suitable for: MSXE/M1000 (800A)		
GW D8 687	3P	1
GW D8 688	4P	1

APPLICATIONS: allows the quick replacement of the switch, without the need to interfere with the connections.

NOTE: to obtain the circuit-breaker in plug-in version, in addition to its fixed base, you need to provide the conversion kit.

CHARACTERISTICS: the circuit breaker in the plug-in version is automatically locked in the base when the operating lever is in the ON position. It can't be removed until the operating lever is in the OFF or tripped position.



GW D8 694

CONVERSION KIT FROM FIXED TO PLUG-IN VERSION

Code	Suitable for MCCB	Pack Carton
Suitable for: MSX125		
GW D8 691	3P	1
GW D8 692	4P	1
Suitable for: MSX160-250		
GW D8 693	3P	1
GW D8 694	4P	1
Suitable for: MSXE160-250		
GW D8 695	3P	1
GW D8 696	4P	1
Suitable for: MSX/E/M400		
GW D8 697	3P	1
GW D8 698	4P	1
Suitable for: MSXE/M630		
GW D8 699	3P	1
GW D8 700	4P	1
Suitable for: MSXE/M1000 (800A)		
GW D8 701	3P	1
GW D8 702	4P	1

APPLICATIONS: allows the quick replacement of the of the MCCB's without the need to work on the connections.

NOTE: to obtain the circuit-breaker in plug-in version, in addition to the transformation kit, you need to provide its fixed base.



GW D8 714

TERMINALS FOR FIXED PART

Code	No. of pieces	Pack Carton
Suitable for: MSX125		
GW D8 711	3	1
GW D8 712	4	1
Suitable for: MSX/E160-250		
GW D8 713	3	1
GW D8 714	4	1
Suitable for: MSX/E/M400-630		
GW D8 715	3	1
GW D8 716	4	1
Suitable for: MSXE/M1000 (800A)		
GW D8 717	3	1
GW D8 718	4	1

NOTE: they can be oriented and used as front or rear terminals

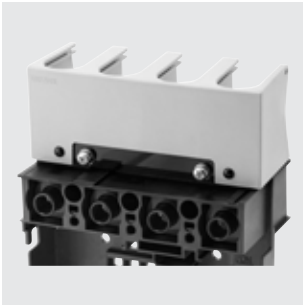

GW D8 722

TERMINAL COVERS FOR FIXED PART TERMINALS

Code	Suitable for MCCB	No. of pieces	Pack Carton
Suitable for: MSX125			
GW D8 719	3P	1	1
GW D8 720	4P	1	1
Suitable for: MSX/E160-250			
GW D8 721	3P	1	1
GW D8 722	4P	1	1
Suitable for: MSX/E/M400-630			
GW D8 723	3P	1	1
GW D8 724	4P	1	1
Suitable for: MSXE/M1000 (800A)			
GW D8 725	3P	1	1
GW D8 726	4P	1	1



GW D8 733

PLUGS FOR INTERNAL ACCESSORIES MOUNTED ON PLUG-IN MCCB'S

Code	Suitable for	Pack Carton
Suitable for: MSX125-630		
GW D8 733	Auxiliary contacts	1
GW D8 734	Opening release	1
Suitable for: MSXE/M1000		
GW D8 735	Auxiliary contacts	1
GW D8 736	Opening release	1

APPLICATIONS: to be considered in case of a MCCB's in plug-in version with internal accessories. Requires 1 plug for each internal accessory (auxiliary contact or opening release).

NOTE: to obtain the MCCB'S in plug-in version with internal accessories, in addition to the socket, a plug must be installed inside the fixed base.

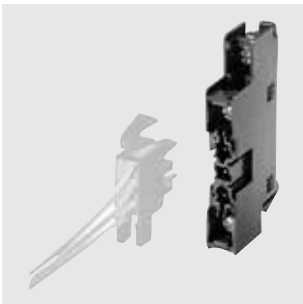

GW D8 731

SOCKETS FOR INTERNAL ACCESSORIES MOUNTED ON PLUG-IN MCCB'S

Code	Suitable for	Pack Carton
GW D8 731	MSX125-1000	1

APPLICATIONS: to be considered in case of a MCCB's in plug-in version with internal accessories. Requires 1 plug for each internal accessory (auxiliary contact or opening trip unit). Identical socket for each accessory type.

NOTE: to obtain the MCCB'S in plug-in version with internal accessories, in addition to the socket, a plug must be installed inside the fixed base.

CONNECTION TERMINALS



GW D8 742

EXTENDED FRONT TERMINALS FC

Code	No. of pieces	Pack Carton
Suitable for: MSX/M160c		
GW D8 741	3	1
GW D8 742	4	1
Suitable for: MSX/M250c		
GW D8 743	3	1
GW D8 744	4	1
Suitable for: MSX/D125		
GW D8 745	3	1
GW D8 746	4	1
Suitable for: MSX/D/E160-250		
GW D8 747	3	1
GW D8 748	4	1
Suitable for: MSX/E/M400		
GW D8 749	3	1
GW D8 750	4	1
Suitable for: MSXE/M630		
GW D8 751	3	1
GW D8 752	4	1
Suitable for: MSXE/M1000 (800A)		
GW D8 754	3	1
GW D8 756	4	1

APPLICATIONS: terminals for the front connection of busbars or cable terminals.



GW D8 761

EXTENDED DIVARICATED FRONT TERMINALS FB

Code	No. of pieces	Pack Carton
Suitable for: MSX/M160c		
GW D8 761	3	1
GW D8 762	4	1
Suitable for: MSX/M250c		
GW D8 763	3	1
GW D8 764	4	1
Suitable for: MSX/E/M400		
GW D8 765	3	1
GW D8 766	4	1
Suitable for: MSXE/M630		
GW D8 767	3	1
GW D8 768	4	1

APPLICATIONS: terminals for the rear connection of busbars or cable terminals.



GW D8 772

FRONT TERMINALS FOR CABLES FW

Code	No. of pieces	Pack Carton
Suitable for: MSX/D125		
GW D8 771	3	1
GW D8 772	4	1

APPLICATIONS: terminals for the front connection of bare wires.



GW D8 784

REAR TERMINALS RC

Code	No. of pieces	Pack Carton
Suitable for: MSX/M160c		
GW D8 783	3	1
GW D8 784	4	1
Suitable for: MSX/M250c		
GW D8 785	3	1
GW D8 786	4	1
Suitable for: MSX/D125		
GW D8 787	3	1
GW D8 788	4	1
Suitable for: MSX/D160-250		
GW D8 789	3	1
GW D8 790	4	1
Suitable for: MSXE160-250		
GW D8 791	3	1
GW D8 792	4	1
Suitable for: MSX/E/M400		
GW D8 793	3	1
GW D8 794	4	1
Suitable for: MSXE/M630		
GW D8 795	3	1
GW D8 796	4	1
Suitable for: MSXE/M1000 (800A)		
GW D8 797	3	1
GW D8 798	4	1
Suitable for: MSXE/M1000 (1000A)		
GW D8 799	3	1
GW D8 800	4	1

APPLICATIONS: terminals for the rear connection of busbars or cable terminals.



GW D8 812

TERMINAL COVERS

Code	For terminals	Suitable for	No. of pieces	Pack Carton
Suitable for: MSX/M160c				
GW D8 811	Front FC and front extended FB	MCCB's 3P	1	1
GW D8 812	Front FC and front extended FB	MCCB's 4P	1	1
GW D8 813	Front extended spread FB	MCCB's 3P	1	1
GW D8 814	Front extended spread FB	MCCB's 4P	1	1
GW D8 815	Rear RC	MCCB's 3P	1	1
GW D8 816	Rear RC	MCCB's 4P	1	1
Suitable for: MSX/M250c				
GW D8 817	Front FC	MCCB's 3P	1	1
GW D8 818	Front FC	MCCB's 4P	1	1
GW D8 819	Front extended FB	MCCB's 3P	1	1
GW D8 820	Front extended FB	MCCB's 4P	1	1
GW D8 821	Front extended spread FB	MCCB's 3P	1	1
GW D8 822	Front extended spread FB	MCCB's 4P	1	1
GW D8 823	Rear RC	MCCB's 3P	1	1
GW D8 824	Rear RC	MCCB's 4P	1	1
Suitable for: MSX/D125				
GW D8 825	Front FC and front extended FB	MCCB's 3P	1	1
GW D8 826	Front FC and front extended FB	MCCB's 4P	1	1
GW D8 827	Front for cables FW	MCCB's 3P	1	1
GW D8 828	Front for cables FW	MCCB's 4P	1	1
GW D8 829	Rear RC	MCCB's 3P	1	1
GW D8 830	Rear RC	MCCB's 4P	1	1
Suitable for: MSX/D160-250				
GW D8 831	Front FC and front extended FB	MCCB's 3P	1	1
GW D8 832	Front FC and front extended FB	MCCB's 4P	1	1
Suitable for: MSX/D/E160-250				
GW D8 835	Rear RC	MCCB's 3P	1	1
GW D8 836	Rear RC	MCCB's 4P	1	1
Suitable for: MSXE160-250				
GW D8 837	Front FC and front extended FB	MCCB's 3P	1	1
GW D8 838	Front FC and front extended FB	MCCB's 4P	1	1
Suitable for: MSX/E/M400-630				
GW D8 839	Front FC and front extended FB	MCCB's 3P	1	1
GW D8 840	Front FC and front extended FB	MCCB's 4P	1	1
GW D8 841	Front extended spread FB	MCCB's 3P	1	1
GW D8 842	Front extended spread FB	MCCB's 4P	1	1
GW D8 843	Rear RC	MCCB's 3P	1	1
GW D8 844	Rear RC	MCCB's 4P	1	1
Suitable for: MSXE/M1000				
GW D8 845	Front FC and front extended FB	MCCB's 3P	1	1
GW D8 846	Front FC and front extended FB	MCCB's 4P	1	1
GW D8 847	Rear RC	MCCB's 3P	1	1
GW D8 848	Rear RC	MCCB's 4P	1	1
Suitable for: MSXE/M1250				
GW D8 849	Front FC and front extended FB	MCCB's 3P	1	1
GW D8 850	Front FC and front extended FB	MCCB's 4P	1	1

APPLICATIONS: prevent direct contact with the under voltage terminals of a circuit breaker.

NOTE: they cannot be mounted together with dividers.

SEALS FOR TERMINAL COVERS

Code	Suitable for	Pack Carton
GW D8 862	MSX/M250c	1
GW D8 863	MSX/D/E/M125-630	1



GW D8 862



GW D8 871

DIVIDERS

Code	Suitable for	No. of pieces	Pack Carton
GW D8 871	MSX/M160c	1	1
GW D8 870	MSX/M250c	1	1
GW D8 872	MSX/D125	1	1
GW D8 869	MSX/D160-250	1	1
GW D8 873	MSXE160-250	1	1
GW D8 874	MSX/E/M400-1600	1	1

APPLICATIONS: ensure insulation between the phases of the circuit breaker terminals.

NOTE: they cannot be mounted with terminal covers.

Dividers are supplied for each circuit breaker (2 pieces for 3P MCCBs and 3 pieces for 3P+N and 4P MCCBs). Additional divider can be ordered individually. All dividers can be mounted on either side (line and load) of a circuit breaker.

BRACKETS FOR FIXING ON DIN RAIL



GW D8 876

BRACKETS FOR FIXING ON DIN RAIL

Code	Suitable for	Pack Carton
GW D8 875	MSX/M160c	1
GW D8 876	MSX/D/M/c125-250	1

APPLICATIONS: allow to install the MCCB'S on DIN rail.

AUTOMATIC SWITCHOVER CONTROL UNIT



GW D8 886

AUTOMATIC SWITCHOVER CONTROL UNIT

Code	Voltage operating	Installation	Pack Carton
GW D8 886	8V ÷ 35V dc	Pannel	1

APPLICATIONS: allows automatic switchover between the power supply network (single-phase or three-phase) and the generator line.

NOTE: for the correct functioning of the switchover control unit it is necessary

- the power supply GWD8887
- 1 two positions built-in toggle handle switch with 2 contacts 1NO+1NC (preferably key)
- 2 fuse holders 3P+N (fuses 10.3x38) GW96312
- 2 fuse holders 2P (fuses 10.3x38) GW96302
- 1 contactor 2NO+2NC GWD6725

In addition, circuit breakers for protection of the power supply network and the generator line must each have the following accessories

- 1 mechanical interlock (lever or cable)
- 1 motor operator
- 2 auxiliary contacts of position (AX)
- 1 auxiliary contact of fault indicator switch (AL)

CHARACTERISTICS: equipped with a 4-line backlit display.



GW D8 887

AUTOMATIC SWITCHOVER CONTROL UNIT

Code	Input voltage	Output current	Pack Carton
GW D8 887	90V ÷ 305V ac	1A a 24V dc	1

APPLICATIONS: supplies direct current power to the automatic switchover control unit GWD8886 when the power supply network fails by taking power from the generator or from the battery (optional).

CHARACTERISTICS: the device can be mounted on DIN rail or plate.



MSX



Scan the QR Code and find out all the technical informations.

AN IDEAL RANGE FOR EVERY REQUIREMENT



The MSX moulded case circuit breaker range includes MCBs, RCCBs, electronic circuit breakers, and rotary disconnect switches.

INTEGRATED RCCB













The MSXD range, with integrated residual current protection, are similar in size to circuit breakers, but with no need for external relays or additional blocks.

DEDICATED AND COMPLETE ACCESSORIES



The MSX range includes a wide range of common accessories that allow streamlined installation and additional features such as remote opening, remote operation, motor control and more.

Selection tables

In [A]	MSS SWITCH DISCONNECTORS									
	MSS 125		MSS 160		MSS 250		MSS 630		MSS125 THREE-WAY SWITCH (I O II)	MSS ATS 160 AUTOMATIC THREE WAY SWITCH
										
	3P	4P	3P	4P	3P	4P	3P	4P	4P	4P
63	GW 97 721	GW 97 724	-	-	-	-	-	-	GW 97 758	GW 97 762
100	GW 97 722	GW 97 725	-	-	-	-	-	-	GW 97 760	GW 97 764
125	GW 97 723	GW 97 726	-	-	-	-	-	-	GW 97 761	-
160	-	-	GW 97 727	GW 97 728	-	-	-	-	-	GW 97 767
250	-	-	-	-	GW 97 729	GW 97 730	-	-	-	-
400	-	-	-	-	-	-	GW 97 731	GW 97 733	-	-
630	-	-	-	-	-	-	GW 97 732	GW 97 734	-	-





DOOR COUPLING ROTARY HANDLES - IP65



MSS 125 - MSS 160		MSS 250 - MSS 630		MSS 125 - THREE-WAY SWITCH (I O II)
Black handle	Red handle	Black handle	Red handle	Black handle
GW 98 521	GW 98 524	GW 98 522	GW 98 525	GW 98 523

Note: all the rotary handles include transmission rods.

AUXILIARY CONTACTS

			
MSS 125 - MSS 160	MSS 250 - MSS 630	MSS 125 - THREE-WAY SWITCH (I O II)	MSS 160 ATS - AUTOMATIC THREE-WAY SWITCH
GW 98 514	GW 98 515	GW 98 516	GW 97 774

TERMINAL COVERS (1 CODE = 1 PIECE)



MSS 160	MSS 250		MSS 630		MSS 160 ATS AUTOMATIC THREE WAY SWITCH
3P - 4P	3P	4P	3P	4P	4P
GW 98 508	GW 98 509	GW 98 510	GW 98 511	GW 98 512	GW 97 773

97 MSS

Rotary switch disconnectors

The MSS rotary control switch disconnectors guarantee robustness and reliability in the control and isolation of circuits up to 630 A. The range consists of four different sizes depending on the current with high performance both in alternating current and in direct current.



MSS - ROTARY SWITCH DISCONNECTORS UP TO 630 A

MSS 125 - SWITCH DISCONNECTORS



GW 97 724

SWITCH DISCONNECTORS

Code	Rated current	Rated voltage	No. of modules EN 50022	Pack Carton
No. of poles: 3P				
GW 97 721	63 A	400 V	6	1
GW 97 722	100 A	400 V	6	1
GW 97 723	125 A	400 V	6	1
No. of poles: 4P				
GW 97 724	63 A	400 V	6	1
GW 97 725	100 A	400 V	6	1
GW 97 726	125 A	400 V	6	1

NOTE: mounting on DIN rail EN 50022 or on plate.

MSS 160 - SWITCH DISCONNECTORS



GW 97 728

SWITCH DISCONNECTORS

Code	Rated current	Rated voltage	No. of modules EN 50022	Pack Carton
No. of poles: 3P				
GW 97 727	160 A	400 V	8	1
No. of poles: 4P				
GW 97 728	160 A	400 V	8	1

NOTE: mounting on DIN rail EN 50022 or on plate.

MSS 250 - SWITCH DISCONNECTORS



GW 97 730

SWITCH DISCONNECTORS

Code	Rated current	Rated voltage	Pack Carton
No. of poles: 3P			
GW 97 729	250 A	400 V	1
No. of poles: 4P			
GW 97 730	250 A	400 V	1

NOTE: mounting on plate.

MSS 630 - SWITCH DISCONNECTORS



GW 97 734

SWITCH DISCONNECTORS

Code	Rated current	Rated voltage	Pack Carton
No. of poles: 3P			
GW 97 731	400 A	400 V	1
GW 97 732	630 A	400 V	1
No. of poles: 4P			
GW 97 733	400 A	400 V	1
GW 97 734	630 A	400 V	1

NOTE: mounting on plate.

MSS 125 - THREE-WAY SWITCH DISCONNECTOR (I O II)



GW 97 761

THREE-WAY SWITCH DISCONNECTOR (I O II)



Code	Rated current	Rated voltage	No. of modules EN 50022	Pack Carton
No. of poles: 4P				
GW 97 758	63 A	400 V	12	1
GW 97 760	100 A	400 V	12	1
GW 97 761	125 A	400 V	12	1

NOTE: mounting on DIN rail EN 50022 or on plate.

MSS 160 ATS - AUTOMATIC THREE-WAY SWITCH DISCONNECTORS



GW 97 767

MONOBLOC AUTOMATIC SWITCHOVER SYSTEM WITH 3 POSITIONS

Code	Rated current	Rated voltage	No. of modules EN 50022	Pack Carton
No. of poles: 4P				
GW 97 762	63 A	230 V	19	1
GW 97 764	100 A	230 V	19	1
GW 97 767	160 A	230 V	19	1

APPLICATIONS:

- line switchover via remote control;
 - automatic inversion - while charged - of the source of two low voltage networks;
 - management of power supply rescue systems, with interruption of the supply to the load during transfer.
- It is possible to force operation in manual mode, via the AUTO/MAN selector.

NOTE: mounting on DIN rail EN 50022 or on plate.

DOOR COUPLING ROTARY HANDLES - IP65



GW 98 522

DOOR COUPLING ROTARY HANDLES - IP65

Code	Handle colour	Length shaft	Pack Carton
Suitable for: MSS 125 / MSS 160			
GW 98 521	Black	200 mm	1
GW 98 524	Red - emergency	200 mm	1
Suitable for: MSS 250 / MSS 630			
GW 98 522	Black	320 mm	1
GW 98 525	Red - emergency	320 mm	1
Suitable for: MSS 125 - Three-way switch disconnecter			
GW 98 523	Black	200 mm	1

NOTE: all the rotary coupling handles include a shaft extension.
APPLICATIONS: the rotary coupling handles include a door locking function.

AUXILIARY CONTACTS



GW 98 516

AUXILIARY CONTACTS

Code	No. of pieces	Max no. of pieces per switch	No. and type of contact	Contact rating	Pack Carton
Suitable for: MSS 125 / MSS 160					
GW 98 514	1	2	1 Changeover	5 A - 250 V	1
Suitable for: MSS 250 / MSS 630					
GW 98 515	1	1	1 Changeover	16 A - 250 V	1
Suitable for: MSS 125 - Three-way switch disconnecter					
GW 98 516	2	2	1 Changeover	5 A - 250 V	1
Suitable for: MSS 160 ATS - Automatic three-way switch disconnecter					
GW 97 774	1	2	3 Changeover	5 A - 250 V	1



GW 97 775

SOCKET-OUTLET CLAMP

Code	No. of elements	Pack Carton
Suitable for: MSS 160 ATS - Automatic three-way switch disconnecter		
GW 97 775	2	1

APPLICATION: makes 2 connection terminals available for wires with a section ≤ 1.5 mm and 2 single-pole.
 Can be assembled in all terminals, without altering the capacity of the power terminals.

TERMINAL COVERS



GW 98 508

TERMINAL COVERS

Code	No. of poles	Number of terminal covers	Pack Carton
Suitable for: MSS 160			
GW 98 508	3P - 4P	1	1
Suitable for: MSS 250			
GW 98 509	3P	1	1
GW 98 510	4P	1	1
Suitable for: MSS 630			
GW 98 511	3P	1	1
GW 98 512	4P	1	1
Suitable for: MSS 160 ATS - Automatic three-way switch disconnecter			
GW 97 773	4P	2	1

NOTE: for upstream and downstream protection, order 2 items with this code.

INSTALLATION ACCESSORIES

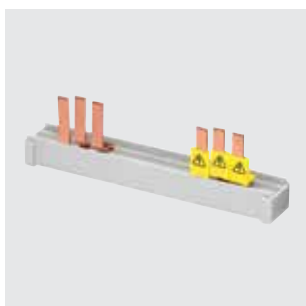

GW 98 517

COMMON OUTPUT POINT BUSBAR

Code	No. of poles	Pack Carton
Suitable for: MSS 125 - Three-way switch disconnecter		
GW 98 517	4P	1
Suitable for: MSS 160 ATS - Automatic three-way switch disconnecter		
GW 97 772	4P	1

APPLICATION: facilitate the creation of a common point upstream or downstream for MSS 125 (GW98517), and output only for MSS 160 ATS (GW97772), avoiding the use of cables. The use of this accessory does not alter the capacity of the power terminals.



97 MSS



Scan the QR Code and find out all the technical informations.

FULL RANGE OF ACCESSORIES

HIGH PERFORMANCE

SEAMLESS INTEGRATION



To meet the most specific needs, the rotary switches can be combined with IP65 watertight reset rotary switches (including reset rods), auxiliary contacts, terminal covers and parallel connections.



The MSS rotary disconnect switches guarantee performance in both AC and DC and ensure maximum robustness, both in the case of short circuits and of numerous operations in critical conditions of use.



With dedicated mounting kits, the MSS disconnect switches integrate seamlessly with all QDX range enclosures. The exceptional installation versatility of the MSS rotary disconnect switches makes them fully compatible with the 46 range distribution boards.



ELECTRICAL DISTRIBUTION BOARDS



47 CVX 160 I

FLUSH-MOUNTING DISTRIBUTION
BOARDS UP TO 160 A

pag. 556



47 CVX 160 E

WALL-MOUNTING DISTRIBUTION
BOARDS UP TO 160 A WITH
EXTRACTABLE FRAME

pag. 566



QDX 630 L

MODULAR DISTRIBUTION BOARDS
UP TO 630A - IP43

pag. 578



QDX 630 H

MONOBLOC AND MODULAR
DISTRIBUTION BOARDS
UP TO 630A - IP55

pag. 598



QDX 1600 H

MODULAR ENCLOSURES
UP TO 1600A - IP55

pag. 620

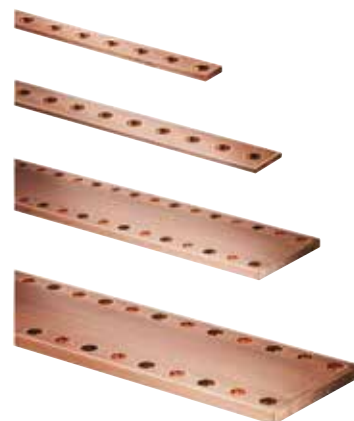





BUSBAR







DISTRIBUTION SYSTEMS FOR
DISTRIBUTION BOARDS

pag. 640

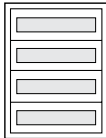
General characteristics

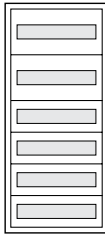





DISTRIBUTION BOARDS AND CABINETS					
					
	CVX 160I	CVX 160E	QDX 630L	QDX 630H	QDX 1600H
Rated current In (A)	160	160	400 (wall-mounting) 630 (floor-mounting)	250 (wall-mounting) 630 (floor-mounting)	1600
Structure	Monobloc (panels and DIN rails included)	monobloc	modular	monobloc (wall-mounting) modular (floor-mounting)	modular
Version	flush-mounting	wall-mounting	wall and floor-mounting	wall and floor-mounting	floor-mounting
External cable compartment			Yes	Yes	Yes
Extractable frame	Yes	Yes			
Degree of protection (IP)	30-40	30-40-55-65	30-43	30-55	30-55
Front panels	plastic	plastic	metal	metal	metal
Functional height (mm)	600 - 800 - 1000	600 - 800 - 1000 - 1200	1000 - 1200 1600 - 1800 - 2000	1000 - 1200 1600 - 1800 - 2000	1800 - 2000
Functional length (mm)	600	600	300 - 600 - 850 (wall-mounting) 400 - 600 - 850 (floor-mounting)	600 - 850 - 600+200 (wall-mounting) 400 - 600 - 850 - 600+300 (floor-mounting)	400 - 600 - 850 - 600+300
Functional depth (mm)	105	140 (without door) 170 (with solid door) 180 (with glass door)	200 - 300	200 - 300 (wall-mounting) 250 - 400 (floor-mounting)	600 - 800
Separation forms	1	1	1 - 2a	1 (wall-mounting) 1 - 2a (floor-mounting)	1-2a







Selection tables



CVX 160 STRUCTURES				
BOARDS WITH DIN RAILS, FRONT PANELS AND ALL FIXING ACCESSORIES INCLUDED				
STRUCTURES				
DIM. FUNCTIONAL (LxH)		600x600 mm	600x800 mm	600x1000 mm
GENERAL CHARACTERISTICS In: up to 160A Capacity: 24 modules * per row Installation: indoor environments Colour: RAL 7035 grey		NO. EN 50022 MODULES (17.5 mm)		
		96	120	144
No. rows for No. modules		4 rows x 24 modules	5 rows x 24 modules	6 rows x 24 modules
				
Front panels with window height:	(mm)	150	200 (first row) 150 (other rows)	200 (first and second row) 150 (second row)
IP 30	 without door	GW 47 072	GW 47 073	GW 47 074
	 glass door	GW 47 082	GW 47 083	GW 47 084
IP 40	 solid door	GW 47 087	GW 47 088	GW 47 089

* EN 50022 modules (17.5 mm)

47 CVX 160 I

CVX 160 I DISTRIBUTION BOARD CONFIGURATION							
	FRONT PANELS				DIN RAIL KIT		
Front panel height (mm)	Window panels	Solid panels	Panel for instruments	Pairs of hinges	EN 50022 rail	Double EN 50022 rail (aluminium)	EN 50035 rail
							
50	-	GW 47 173	-	-	-	-	-
150	GW 47 178	GW 47 174	-	GW 47 191	GW 47 251	GW 47 252	GW 47 253
200	GW 47 179	GW 47 175	Tools 96x96 GW 47 177				

COMPLEMENTARY ITEMS					
Earth bar	Wiring trunking supports	Nuts in cage	Module mask	Document pocket	Security lock with key
					
GW 47 193	GW 47 194 E	GW 47 195	GW 47 291	GW 46 447	GW 47 192

Board functional height (mm)	SPARE DOORS	
	ONLY FOR IP 40	
	glass door	solid door
		
600	GW 47 116	GW 47 121
800	GW 47 117	GW 47 122
1000	GW 47 118	GW 47 123

47 CVX 160 I

Flush-mounting distribution boards up to 160 A

The CVX 160 I range of pre-assembled flush-mounting distribution boards up to 160A allows configurations to be made to suit your needs, from a minimum capacity of 96 modules up to a maximum of 144, with three different heights from 600 mm to 1000 mm.



STRUCTURES

IP30 DISTRIBUTION BOARDS



GW 47 072

PREASSEMBLED DISTRIBUTION BOARDS IN PAINTED SHEET STEEL - COLOUR GREY RAL 7035 COMPLETE WITH OUTFIT FOR MODULAR DEVICES - WITHOUT DOOR

Code	Functional dim. LxHxD (mm)	Box dimensions BxHxD (mm)	Outer dim. LxHxD (mm)	No. of modules EN 50022	Pack Carton
GW 47 072	600x600x105	680x670x105	730x706x25	96 (24x4)	1
GW 47 073	600x800x105	680x870x105	730x906x25	120 (24x5)	1
GW 47 074	600x1000x105	680x1070x105	730x1106x25	144 (24x6)	1

ACCESSORIES SUPPLIED: mortar guard. Service identification label. Self-adhesive label to be filled out for certification in accordance with standard CEI 23-51. Front panels complete with EN 50022 rail (DIN 35) and fixing accessories. Blanking module profile.

NOTES: IP30 distribution boards cannot be fitted with glass or solid doors.

IP40 DISTRIBUTION BOARDS



GW 47 082

PREASSEMBLED DISTRIBUTION BOARDS IN PAINTED SHEET STEEL - COLOUR GREY RAL 7035 COMPLETE WITH OUTFIT FOR MODULAR DEVICES FLAT SMOKED TEMPERED SAFETY GLASS DOOR WITH 2 LOCKS

Code	Functional dim. LxHxD (mm)	Box dimensions BxHxD (mm)	Outer dim. LxHxD (mm)	No. of modules EN 50022	Pack Carton
GW 47 082	600x600x105	680x670x105	730x706x65	96 (24x4)	1
GW 47 083	600x800x105	680x870x105	730x906x65	120 (24x5)	1
GW 47 084	600x1000x105	680x1070x105	730x1106x65	144 (24x6)	1

ACCESSORIES SUPPLIED: mortar guard. Service identification label. Self-adhesive label to be filled out for certification according to standard CEI 23-52. Front panels complete with EN 50022 rail (DIN 35) and fixing accessories. Blanking module profile. 2 double-fin keys.



GW 47 087

PREASSEMBLED DISTRIBUTION BOARDS IN PAINTED SHEET STEEL - COLOUR GREY RAL 7035 COMPLETE WITH OUTFIT FOR MODULAR DEVICES BLANK DOOR IN SHEET METAL WITH 2 LOCKS

Code	Functional dim. LxHxD (mm)	Box dimensions BxHxD (mm)	Outer dim. LxHxD (mm)	No. of modules EN 50022	Pack Carton
GW 47 087	600x600x105	680x670x105	730x706x34	96 (24x4)	1
GW 47 088	600x800x105	680x870x105	730x906x34	120 (24x5)	1
GW 47 089	600x1000x105	680x1070x105	730x1106x34	144 (24x6)	1

ACCESSORIES SUPPLIED: mortar guard. Service identification label. Self-adhesive label to be filled out for certification according to standard CEI 23-51. Front panels complete with EN 50022 rail (DIN 35) and fixing accessories. Blanking module profile. 2 double-fin keys.

FRONT CONFIGURATION

FRONT PANELS



GW 47 179

FRONT PANELS WITH WINDOW FOR MODULAR DEVICES

Code	External dim. LxH (mm)	Pack Carton
Modules: 24		
GW 47 178	600x150	1/10
GW 47 179	600x200	1/10

ACCESSORIES SUPPLIED: blanking module profile, pair of hinges.

CHARACTERISTICS: quick coupling front panel, in Grey RAL 7035 insulating material, with ergonomic Blue RAL 5003 grip, prearrangement of the panels for rotation hinges (included).



GW 47 175

BLANK FRONT PANELS

Code	External dim. LxH (mm)	Pack Carton
Modules: 24		
GW 47 173	600x50	1/10
GW 47 174	600x150	1/10
GW 47 175	600x200	1/10

ACCESSORIES SUPPLIED: pair of hinges.

CHARACTERISTICS: quick coupling front panel, in Grey RAL 7035 insulating material, with ergonomic Blue RAL 5003 grip, prearrangement of the panels, except GW47173, for rotation hinges (included).



GW 47 177

FRONT PANELS FOR MEASURING INSTRUMENTS AND THREE-WAY SWITCHES

Code	External dim. LxH (mm)	3-way switch no. x hole Ø	Instruments N. x dimensions	Pack Carton
Modules: 24				
GW 47 177	600x200	1 Ø9.5 mm	4 96x96 mm	1/10

ACCESSORIES SUPPLIED: pair of hinges.

APPLICATIONS: installation of ammeters, voltmeters, voltmeter/ammeter three-way switches and earth leakage relays for distribution boards.

CHARACTERISTICS: quick coupling front panel, in Grey RAL 7035 insulating material, with ergonomic Blue RAL 5003 grip, prearrangement of the panels for rotation hinges (included).

INTERNAL CONFIGURATION

DIN RAIL KIT



GW 47 251

DIN RAILS FOR MODULAR DEVICES (90 RANGE) AND MOULDED CASE CIRCUIT BREAKERS UP TO 160 A (MSX/M 160C, MSX/D 125, MSX/D 160 RANGE) - COMPLETE WITH BRACKETS AND SUPPORTS FOR ASSEMBLY

Code	Section dim. HxD (mm)	Profile	Material	Pack Carton
Modules: 24				
GW 47 251	35x15	EN 50022 (DIN 35)	Galvanized metal	1/10
GW 47 252	2x(35x7.5)	Double EN 50022 (DIN 35)	Aluminium	1/10
GW 47 253	32x15	EN 50035 (G 32)	Galvanized metal	1/10

NOTES: for the assembly of the MSX moulded case circuit breakers on DIN rail, order the appropriate fixing kit.
Depth adapter GWD3317 is necessary if modular devices are mounted close to MCCB on the same DIN rail.

COMPLEMENTARY ITEMS

ACCESSORIES



GW 47 191

PAIR OF HINGES FOR FRONT PANELS

Code	Fixing type	Opening angle	Suitable for	Pack Carton
GW 47 191	Clip	90°	For panels H higher than 50 mm	1/20

ACCESSORIES SUPPLIED: 1 panel closing cap.



GW 47 194 E

PAIR OF SUPPORTS FOR THE FIXING OF WIRING TRUNKING

Code	Fixing type	Quantity	Pack Carton
GW 47 194 E	Clip on functional profile	2 pieces	1/20

APPLICATIONS: assembly of wiring trunking up to 60 mm in width vertically and up to 40 mm horizontally.

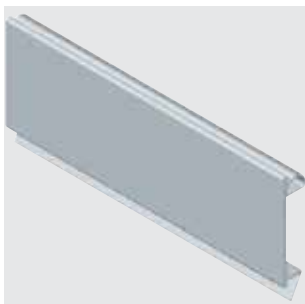

GW 47 291

BLANKING MODULE PROFILE IN PLASTIC MATERIAL - COLOUR GREY RAL 7035

Code	No. of modules EN 50022	Pack Carton
GW 47 291	24	10

CHARACTERISTICS: clip fixing on DIN perforated front panels.

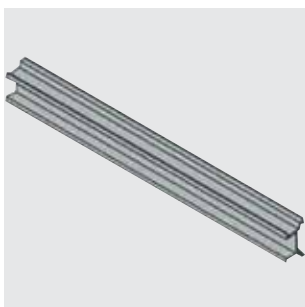

GW D3 317

DEPTH ADAPTER

Code	Length (mm)	Pack Carton
GW D3 317	600	1

CHARACTERISTICS: plastic adapter for compensation of the different installation depths on DIN rail EN 50022 of the modular devices (90 range) and moulded case circuit breakers (MSX range).



GW 47 193

PERFORATED AND THREADED EARTH BUSBAR

Code	Dimensions LxHxD (mm)	N./diam. of threaded holes	Step drilling	For distribution boards	Pack Carton
GW 47 193	575x20x5	24xM6	18 mm	Flush and surface mounting	1/5

ACCESSORIES SUPPLIED: fixing accessories. (2 screws and 2 nuts in cage M6) 24 tin-plated screws M6.



GW 46 447

ADHESIVE DOCUMENT POCKET

Code	Dimensions LxH (mm)	Pack Carton
GW 46 447	230x310	1/10



GW 47 192

SECURITY LOCK

Code	Characteristics	Pack Carton
GW 47 192	Yale type	1/10

NOTE: the lock is supplied with identical keys.



GW 47 195

NUT IN CAGE

Code	Characteristics	Pack Carton
GW 47 195	Galvanised steel	10/100

APPLICATIONS: it is suitable for mounting wiring trunking and accessories on functional profile.

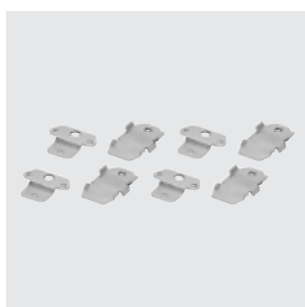

GW 47 197

SET OF 4 METAL BRACKETS

Code	Characteristics	Pack Carton
GW 47 197	For fixing on plasterboard	1/10

SPARE PARTS



GW 47 116

TEMPERED SMOKED-GLASS FLAT SAFETY DOORS FOR IP40 ENCLOSURES

Code	For boards LxH (mm)	Pack Carton
GW 47 116	600x600	1
GW 47 117	600x800	1
GW 47 118	600x1000	1

ACCESSORIES SUPPLIED: 2 mounting pins. 2 double-fin keys.



GW 47 121

SOLID DOORS IN PAINTED SHEET METAL FOR IP40 DISTRIBUTION BOARDS

Code	For boards LxH (mm)	Pack Carton
GW 47 121	600x600	1
GW 47 122	600x800	1
GW 47 123	600x1000	1

ACCESSORIES SUPPLIED: 2 mounting pins. 2 double-fin keys.



47 CVX 160 I



Scan the QR Code and find out all the technical informations.

SCREW AND TOOL-FREE MOUNTING



The rail brackets have been designed for screw-free fitting thanks to coupling on functional profiles. In addition, the innovative support allows the rails to be attached to the brackets and adjusted in depth without the use of screws and tools.

FAST FIXING OF INSULATION PANELS



The plastic front panels allow quick fitting via two 1â „4 turn inserts and require no grounding. A kit is included throughout the range to enable the panels to be hinged.







COMPLETE WITH ACCESSORIES







Once the distribution board size is chosen, a single order code covers the DIN rails and front insulation panels, as well as the metal case and door.

47 CVX 160 E

Selection tables

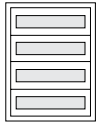
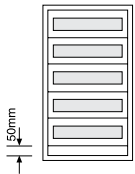
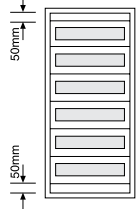
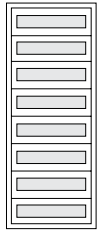
CVX 160 E STRUCTURES					
GENERAL CHARACTERISTICS		STRUCTURES			
In: up to 160 A Capacity: 24 modules per row Installation: indoor environments Colour: RAL 7035 grey		600x600 mm	600x800 mm	600x1000 mm	600x1200 mm
DIM. FUNCTIONAL (LxH)					
IP 30	Without door 	GW 47 001 E	GW 47 002 E	GW 47 003 E	GW 47 004 E
	Glass door 	GW 47 011 E	GW 47 012 E	GW 47 013 E	GW 47 014 E
IP 40	Solid door 	GW 47 021 E	GW 47 022 E	GW 47 023 E	GW 47 024 E
	Glass door 	GW 47 031 E	GW 47 032 E	GW 47 033 E	GW 47 034 E
IP 55	Solid door 	GW 47 041 E	GW 47 042 E	GW 47 043 E	GW 47 044 E
	Solid door 	-	GW 47 062 E	GW 47 063 E	GW 47 064 E

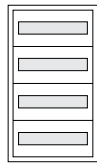
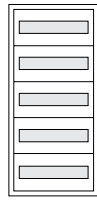
NOTE: the codes do not include DIN rail and front panels.









EXAMPLES OF BOARD CONFIGURATIONS					
NO. ROWS / NO. MODULES MAX	Pitch 150 mm				
	Pitch 200 mm				
		4 rows - 96 modules*	5 rows - 120 modules*	6 rows - 144 modules*	8 rows - 192 modules*
		3 rows - 72 modules*	4 rows - 96 modules*	5 rows - 120 modules*	6 rows - 144 modules*

* EN 50022 modules (17.5 mm)

CVX 160 E DISTRIBUTION BOARD CONFIGURATION



Front panel height (mm)	KIT FOR INSTALLATION OF DEVICE ON DIN RAIL AND FRONT PANELS					DIN RAIL KIT			MOULDED CASE INSTALLATION KIT
	Panels with window rail EN 50022	Window panels	Solid panels	Panel for instruments	Pairs of hinges	EN 50022 rail	Double EN 50022 rail (aluminium)	EN 50035 rail	For moulded case circuit breakers
50	-	-	GW 47 173	-	-	-	-	-	-
150	GW 47 171	GW 47 178	GW 47 174	-	GW 47 191	GW 47 181	GW 47 183	GW 47 182	GW 47 297 (MSX/M 160c)
200	GW 47 172	GW 47 179	GW 47 175	Tools 96x96 GW 47 177					GW 47 298 (MSX/D 125)
									GW 47 299 (MSX/D 160)

COMPLEMENTARY ITEMS

Earth bar	Wiring trunking supports	Caged nuts	Cable gland plate	Module mask	Document pocket	Security lock with key	Earth terminal blocks
							
GW 47 193	GW 47 194 E	GW 47 195	GW 47 198 (Higher - Lower)	GW 47 291	GW 46 447	GW 47 192*	GW 45 538

*Not suitable for boards with IP65 protection degree

SPARE DOORS

Board functional height (mm)	IP 40		IP 55		IP 65
	Glass door	Solid door	Glass door	Solid door	Solid door
600					-
800	GW 47 116	GW 47 121	GW 47 136	GW 47 141	-
800	GW 47 117	GW 47 122	GW 47 137	GW 47 142	GW 47 162
1000	GW 47 118	GW 47 123	GW 47 138	GW 47 143	GW 47 163
1200	GW 47 119	GW 47 124	GW 47 139	GW 47 144	GW 47 164

47 CVX 160 E

Wall-mounting distribution boards up to 160 A with extractable frame

The CVX 160 E range of surface-mounted distribution boards up to 160A can be configured according to any requirement, from a minimum capacity of 72 modules up to a maximum of 192, using the appropriate choice of installation kits with holes every 150 mm or 200 mm.



STRUCTURES

IP30 DISTRIBUTION BOARDS

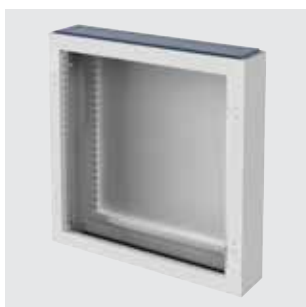

GW 47 001 E

MONOBLOC DISTRIBUTION BOARDS IN PAINTED SHEET STEEL - COLOUR GREY RAL 7035 WITHOUT DOOR - WITH EXTRACTABLE FRAME

Code	Functional dim. LxHxD (mm)	Outer dim. LxHxD (mm)	Pack Carton
GW 47 001 E	600x600x140	700x700x140	1
GW 47 002 E	600x800x140	700x900x140	1
GW 47 003 E	600x1000x140	700x1100x140	1
GW 47 004 E	600x1200x140	700x1300x140	1

ACCESSORIES SUPPLIED: 4pcs brackets complete with screws for wall fixing, 2pcs cable gland plates (upper and lower) complete with fixing screws.

NOTES: IP30 distribution boards cannot be fitted with glass or solid doors.

IP40 DISTRIBUTION BOARDS



GW 47 011 E

MONOBLOC DISTRIBUTION BOARDS IN PAINTED SHEET STEEL - COLOUR GREY RAL 7035 SMOKED FLAT TEMPERED SAFETY GLASS DOOR EQUIPPED WITH 2 LOCKS - WITH EXTRACTABLE FRAME

Code	Functional dim. LxHxD (mm)	Outer dim. LxHxD (mm)	Pack Carton
GW 47 011 E	600x600x180	700x700x180	1
GW 47 012 E	600x800x180	700x900x180	1
GW 47 013 E	600x1000x180	700x1100x180	1
GW 47 014 E	600x1200x180	700x1300x180	1

ACCESSORIES SUPPLIED: 4 brackets complete with screws for wall mounting, 2 cable gland plates (upper and lower) complete with fixing screws, 2 double-fin keys.



GW 47 021 E

MONOBLOC DISTRIBUTION BOARDS IN PAINTED SHEET STEEL - COLOUR GREY RAL 7035 SOLID SHEET METAL DOOR EQUIPPED WITH 2 LOCKS - WITH EXTRACTABLE FRAME

Code	Functional dim. LxHxD (mm)	Outer dim. LxHxD (mm)	Pack Carton
GW 47 021 E	600x600x170	700x700x170	1
GW 47 022 E	600x800x170	700x900x170	1
GW 47 023 E	600x1000x170	700x1100x170	1
GW 47 024 E	600x1200x170	700x1300x170	1

ACCESSORIES SUPPLIED: 4 brackets complete with screws for wall mounting, 2 cable gland plates (upper and lower) complete with fixing screws, 2 double-fin keys.

IP55 DISTRIBUTION BOARDS



GW 47 031 E

MONOBLOC DISTRIBUTION BOARDS IN PAINTED SHEET STEEL - COLOUR GREY RAL 7035 SMOKED FLAT TEMPERED SAFETY GLASS DOOR EQUIPPED WITH 2 LOCKS - WITH EXTRACTABLE FRAME

Code	Functional dim. LxHxD (mm)	Outer dim. LxHxD (mm)	Pack Carton
GW 47 031 E	600x600x180	700x700x180	1
GW 47 032 E	600x800x180	700x900x180	1
GW 47 033 E	600x1000x180	700x1100x180	1
GW 47 034 E	600x1200x180	700x1300x180	1

ACCESSORIES SUPPLIED: 4 brackets complete with screws for wall mounting. 2 cable gland plates (upper and lower) complete with fixing screws. 2 double-fin keys.
CHARACTERISTICS: sealing gaskets applied on the door and the cable gland plates.



GW 47 041 E

MONOBLOC DISTRIBUTION BOARDS IN PAINTED SHEET STEEL - COLOUR GREY RAL 7035 SOLID SHEET METAL DOOR EQUIPPED WITH 2 LOCKS - WITH EXTRACTABLE FRAME

Code	Functional dim. LxHxD (mm)	Outer dim. LxHxD (mm)	Pack Carton
GW 47 041 E	600x600x170	700x700x170	1
GW 47 042 E	600x800x170	700x900x170	1
GW 47 043 E	600x1000x170	700x1100x170	1
GW 47 044 E	600x1200x170	700x1300x170	1

ACCESSORIES SUPPLIED: 4 brackets complete with screws for wall mounting. 2 cable gland plates (upper and lower) complete with fixing screws. 2 double-fin keys.
CHARACTERISTICS: sealing gaskets applied on the door and the cable gland plates.

IP65 DISTRIBUTION BOARDS



GW 47 064 E

MONOBLOC DISTRIBUTION BOARDS IN PAINTED SHEET STEEL - COLOUR GREY RAL 7035 SOLID SHEET METAL DOOR EQUIPPED WITH ROD-MECHANISM LOCK - WITH EXTRACTABLE FRAME

Code	Functional dim. LxHxD (mm)	Outer dim. LxHxD (mm)	Pack Carton
GW 47 062 E	600x800x170	700x900x170	1
GW 47 063 E	600x1000x170	700x1100x170	1
GW 47 064 E	600x1200x170	700x1300x170	1

ACCESSORIES SUPPLIED: 4 brackets complete with screws for wall mounting. Key in zama.
CHARACTERISTICS: sealing gaskets applied on the door. Single lock with rod-mechanism lock with 4 mounting pins.

FRONT CONFIGURATION

INSTALLATION KIT FOR DEVICES ON DIN RAIL



GW 47 172

INSTALLATION KIT FOR MODULAR DEVICES (90 RANGE) AND MOULDED CASE DEVICES UP TO 160 A (MSX/M 160C, MSX/D 125, MSX/D 160 RANGE) - COMPLETE WITH FRONT PANELS WITH WINDOWS AND STANDARD DIN RAIL EN 50022 (DIN 35)

Code	Dimensions LxH (mm)	Section dim. HxD (mm)	Pack Carton
Modules: 24			
GW 47 171	600x150	35x15	1/10
GW 47 172	600x200	35x15	1/8

ACCESSORIES SUPPLIED: blanking module profile; pair of hinges; Standard EN 50022 (DIN 35) DIN rail in galvanised sheet metal with depth adjustment.
FEATURES: quick coupling front panel, in Grey RAL 7035 insulating material, with ergonomic Blue RAL 5003 grip. Option on the panels for rotation hinges (included).
NOTES: for the assembly of the MSX moulded case circuit breakers on DIN rail, order the appropriate fixing kit.
 Depth adapter GWD3317 is necessary if modular devices are mounted close to MCCB on the same DIN rail.

47 CVX 160 E

INSTALLATION KIT FOR FIXED MCCB'S ON PLATE



GW 47 297

INSTALLATION KIT FOR A BOXED RCD UP TO 160A (MSX/M 160C, MSX/D 125, MSX/D 160 SERIES) COMPLETE WITH DRILLED FRONT PANELS AND ATTACHMENT PLATES

Code	Dimensions LxH (mm)	For MCCB	No. of poles	Installation	Pack Carton
Modules: 24					
GW 47 297	600x200	MSX/M160c	3P - 4P	Horizontal	1/5
GW 47 298	600x200	MSX/D125	3P - 4P	Horizontal	1/5
GW 47 299	600x200	MSX/D160	3P - 4P	Horizontal	1/5

COMPONENTS: The kit consists of 1 galvanised steel plate, 1 plastic front panel with 1 pair of hinges and attachment accessories.
CHARACTERISTICS: RAL 7035 Grey front panel, in quick-coupling insulating material with ergonomic RAL 5003 Blue handle.

FRONT PANELS



GW 47 179

FRONT PANELS WITH WINDOW FOR MODULAR DEVICES

Code	Dimensions LxH (mm)	Pack Carton
Modules: 24		
GW 47 178	600x150	1/10
GW 47 179	600x200	1/10

ACCESSORIES SUPPLIED: blanking module profile. Pair of hinges.

CHARACTERISTICS: quick coupling front panel, in Grey RAL 7035 insulating material, with ergonomic Blue RAL 5003 grip; prearrangement of the panels for rotation hinges (included).



GW 47 175

BLANK FRONT PANELS

Code	Dimensions LxH (mm)	Pack Carton
Modules: 24		
GW 47 173	600x50	1/10
GW 47 174	600x150	1/10
GW 47 175	600x200	1/10

ACCESSORIES SUPPLIED: pair of hinges.

CHARACTERISTICS: quick coupling front panel, in Grey RAL 7035 insulating material, with ergonomic Blue RAL 5003 grip. Prearrangement of the panels, except GW47173, for rotation hinges (included).



GW 47 177

FRONT PANELS FOR MEASURING INSTRUMENTS AND THREE-WAY SWITCHES

Code	Dimensions LxH (mm)	3-way switch no. x hole Ø	Instruments N. x dimensions	Pack Carton
Modules: 24				
GW 47 177	600x200	1 Ø9.5 mm	4 96x96 mm	1/10

ACCESSORIES SUPPLIED: pair of hinges.

APPLICATIONS: installation of ammeters, voltmeters, voltmeter/ammeter three-way switches and earth leakage relays for distribution boards.

CHARACTERISTICS: quick coupling front panel, in Grey RAL 7035 insulating material, with ergonomic Blue RAL 5003 grip; prearrangement of the panels for rotation hinges (included).

INTERNAL CONFIGURATION

DIN RAIL KIT



GW 47 181

DIN RAILS FOR MODULAR DEVICES (90 RANGE) AND MOULDED CASE CIRCUIT BREAKERS UP TO 160 A (MSX/M 160C, MSX/D 125, MSX/D 160 RANGE) - COMPLETE WITH BRACKETS AND SUPPORTS FOR ASSEMBLY

Code	Section dim. HxD (mm)	Profile	Material	Pack Carton
Modules: 24				
GW 47 181	35x15	EN 50022 (DIN 35)	Galvanized metal	1/10
GW 47 183	2x(35x7.5)	Double EN 50022 (DIN 35)	Aluminium	1/10
GW 47 182	32x15	EN 50035 (G 32)	Galvanized metal	1/10

NOTES: To mount the MSX moulded case circuit breakers, order the appropriate DIN rail mounting kit.
Stacking of modular and moulded case devices requires the depth adapter GWD3317.

BACK-MOUNTING PLATES



GW 47 186

BACK-MOUNTING PLATES FOR NON-MODULAR DEVICES COMPLETE WITH MOUNTING SUPPORTS

Code	Dimensions LxH (mm)	No. mounting straps	Pack Carton
Modules: 24			
GW 47 186	600x200	2	1/5
GW 47 187	600x400	4	1/5

ACCESSORIES SUPPLIED: support brackets and relative fixing accessories.

CHARACTERISTICS: possibility to adjust the depth of the plate; hot galvanised sheet metal plate 15/10 mm thick.

COMPLEMENTARY ITEMS

ACCESSORIES



GW 47 191

PAIR OF HINGES FOR FRONT PANELS

Code	Fixing type	Opening angle	Suitable for	Pack Carton
GW 47 191	Clip	90°	For panels H higher than 50 mm	1/20

ACCESSORIES SUPPLIED: 1 panel closing cap.



GW 47 194 E

PAIR OF SUPPORTS FOR THE FIXING OF WIRING TRUNKING

Code	Fixing type	Quantity	Pack Carton
GW 47 194 E	Clip on functional profile	2 pieces	1/20

APPLICATIONS: assembly of wiring trunking up to 60 mm in width vertically and up to 40 mm horizontally.

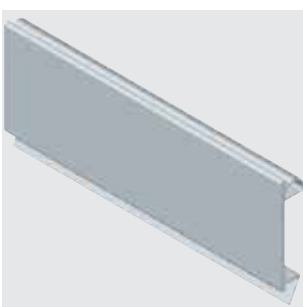

GW 47 291

BLANKING MODULE PROFILE IN PLASTIC MATERIAL - COLOUR GREY RAL 7035

Code	No. of modules EN 50022	Pack Carton
GW 47 291	24	10

CHARACTERISTICS: clip fixing on DIN perforated front panels.

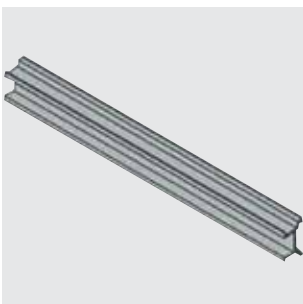

GW D3 317

DEPTH ADAPTER

Code	Length (mm)	Pack Carton
GW D3 317	600	1

CHARACTERISTICS: plastic adapter for compensation of the different installation depths on DIN rail EN 50022 of the modular devices (90 range) and moulded case circuit breakers (MSX range).



GW 47 193

PERFORATED AND THREADED EARTH BUSBAR

Code	Dimensions LxHxD (mm)	N./diam. of threaded holes	Step drilling	For distribution boards	Pack Carton
GW 47 193	575x20x5	24xM6	18 mm	Flush and surface mounting	1/5

ACCESSORIES SUPPLIED: fixing accessories. (2 screws and 2 nuts in cage M6) 24 tin-plated screws M6.



GW 45 538

EARTH TERMINAL BLOCKS

Code	N. terminal and section (mm ²)	Pack Carton
GW 45 538	2x(1x35+11x16+13x10)	1

FEATURES: copper bar with a 20 x 5 section and 6.5 mm hole spacing.



GW 46 447

ADHESIVE DOCUMENT POCKET

Code	Dimensions LxH (mm)	Pack Carton
GW 46 447	230x310	1/10



GW 47 192

SECURITY LOCK

Code	Characteristics	Pack Carton
GW 47 192	Yale type	1/10

NOTE: the lock is supplied with identical keys.
It's not suited for IP65 version.

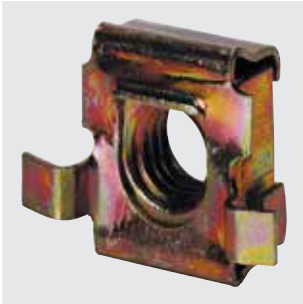

GW 47 195

NUT IN CAGE

Code	Characteristics	Pack Carton
GW 47 195	Galvanised steel	10/100

APPLICATIONS: it is suitable for mounting wiring trunking and accessories on functional profile.

SPARE PARTS

GW 47 116

TEMPERED SMOKED-GLASS FLAT SAFETY DOORS FOR IP40 ENCLOSURES

Code	For boards LxH (mm)	Pack Carton
GW 47 116	600x600	1
GW 47 117	600x800	1
GW 47 118	600x1000	1
GW 47 119	600x1200	1

ACCESSORIES SUPPLIED: 2 mounting pins, 2 double-fin keys.



GW 47 121

SOLID DOORS IN PAINTED SHEET METAL FOR IP40 DISTRIBUTION BOARDS

Code	For boards LxH (mm)	Pack Carton
GW 47 121	600x600	1
GW 47 122	600x800	1
GW 47 123	600x1000	1
GW 47 124	600x1200	1

ACCESSORIES SUPPLIED: 2 mounting pins, 2 double-fin keys.



GW 47 136

TEMPERED SMOKED-GLASS FLAT SAFETY DOORS FOR IP55 ENCLOSURES

Code	For boards LxH (mm)	Pack Carton
GW 47 136	600x600	1
GW 47 137	600x800	1
GW 47 138	600x1000	1
GW 47 139	600x1200	1

ACCESSORIES SUPPLIED: 2 mounting pins, 2 double-fin keys.



GW 47 141

SOLID DOORS IN PAINTED SHEET METAL FOR IP55 DISTRIBUTION BOARDS

Code	For boards LxH (mm)	Pack Carton
GW 47 141	600x600	1
GW 47 142	600x800	1
GW 47 143	600x1000	1
GW 47 144	600x1200	1

ACCESSORIES SUPPLIED: 2 mounting pins, 2 double-fin keys.

47 CVX 160 E



GW 47 164

SOLID DOORS IN PAINTED SHEET STEEL FOR IP65 DISTRIBUTION BOARDS EQUIPPED WITH ROD-MECHANISM CLOSURES

Code	For boards LxH (mm)	Pack Carton
GW 47 162	600x800	1
GW 47 163	600x1000	1
GW 47 164	600x1200	1

ACCESSORIES SUPPLIED: 4 mounting pins. Key in zama.



GW 47 198

CABLE GLAND PLATE - COLOUR BLUE RAL 5003

Code	Description	No. of pieces	Material	Pack Carton
GW 47 198	Top/Bottom plate	1	Plastic	1/10



47 CVX 160 E



Scan the QR Code and find out all the technical informations.

SCREW AND TOOL-FREE MOUNTING



The rail brackets have been designed for screw-free fitting thanks to coupling on functional profiles. In addition, the innovative support allows the rails to be attached to the brackets and adjusted in depth without the use of screws and tools.

FAST FIXING OF INSULATION PANELS



The plastic front panels allow quick fitting via two 4 turn inserts and require no grounding. A kit is included throughout the range to enable the panels to be hinged.







FACILITATED WIRING



The removable frame makes it easier to connect the switches, allowing convenient bench wiring first and then installation in the finished circuit box.

QDX 630 L

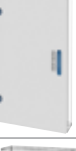
Selection tables

QDX 630L WALL-MOUNTING STRUCTURES									
DIM. FUNCTIONAL (BxH)		600x1000 mm		600x1200 mm		850x1000 mm			
DEPTH		200 mm	300 mm	200 mm	300 mm	200 mm	300 mm		
Modular Capacity	Pitch 150mm	144 mod. (24x6)		192 mod. (24x8)		144 mod. (24x6)	210 mod. (35x6)	144 mod. (35x6)	210 mod. (35x6)
	Pitch 200 mm	120 mod. (24x5)		144 mod. (24x6)		120 mod. (24x5)	175 mod. (35x5)	120 mod. (24x5)	175 mod. (35x5)
Rear Frames		GW D3 015		GW D3 016		GW D3 017			
Bases and headboards		GW D3 001	GW D3 004	GW D3 001	GW D3 004	GW D3 002	GW D3 005		
Front uprights		GW D3 007		GW D3 008		GW D3 007			
Side panels		GW D3 011	GW D3 013	GW D3 012	GW D3 014	GW D3 011	GW D3 013		
Glass doors		GW D3 021		GW D3 022		GW D3 023			
Blind doors		GW D3 025		GW D3 026		GW D3 027			
Internal compartment		-		-		GW D3 031	GW D3 032		
Side-by-side kit									









NOTE: 850mm wide structures can be used as 24-module structures plus internal compartment, adding the appropriate internal compartment kit.

NOTE: The 300mm wide structures are external compartments dedicated to the cables, terminal block or busbar system.

QDX 630L WALL-MOUNTING STRUCTURES							
850x1200 mm				300x1000 mm		300x1200 mm	
200 mm		300 mm		200 mm	300 mm	200 mm	300 mm
192 mod. (24x8)	280 mod. (35x8)	192 mod. (24x8)	280 mod. (35x8)	-		-	
144 mod. (24x6)	210 mod. (35x6)	144 mod. (24x6)	210 mod. (35x6)	-		-	
GW D3 018				GW D3 019		GW D3 020	
GW D3 002		GW D3 005		GW D3 003	GW D3 006	GW D3 003	GW D3 006
GW D3 008				GW D3 009		GW D3 010	
GW D3 012		GW D3 014		GW D3 011	GW D3 013	GW D3 012	GW D3 014
GW D3 024				-		-	
GW D3 028				GW D3 029		GW D3 030	
GW D3 033		GW D3 034		-		-	

GW D3 035

QDX 630 L

QDX 630L FLOOR-MOUNTING STRUCTURES								
DIM. FUNCTIONAL (BxH)		600x1600 mm		600x1800 mm		600x2000 mm		
DEPTH		200 mm	300 mm	200 mm	300 mm	200 mm	300 mm	
Modular Capacity	Pitch 150mm	240 mod. (24x10)		288 mod. (24x12)		312 mod. (24x13)		
	Pitch 200 mm	192 mod. (24x8)		216 mod. (24x9)		240 mod. (24x10)		
Rear Frames		GW D3 059		GW D3 060		GW D3 061		
Bases and headboards		GW D3 041	GW D3 042	GW D3 041	GW D3 042	GW D3 041	GW D3 042	
Front uprights		GW D3 047		GW D3 048		GW D3 049		
Side panels		GW D3 053	GW D3 054	GW D3 055	GW D3 056	GW D3 057	GW D3 058	
Glass doors		GW D3 068		GW D3 069		GW D3 070		
Blind doors		GW D3 074		GW D3 075		GW D3 076		
Internal compartment								
Side-by-side kit								





NOTE: 850mm wide structures can be used as 24-module structures plus internal compartment, adding the appropriate internal compartment kit.

QDX 630L FLOOR-MOUNTING STRUCTURES

QDX 630L FLOOR-MOUNTING STRUCTURES											
850x1600 mm				850x1800 mm				850x2000 mm			
200 mm		300 mm		200 mm		300 mm		200 mm		300 mm	
240 mod. (24x10)	350 mod. (35x10)	240 mod. (24x10)	350 mod. (35x10)	288 mod. (24x12)	420 mod. (35x12)	288 mod. (24x12)	420 mod. (35x12)	312 mod. (24x13)	455 mod. (35x13)	312 mod. (24x13)	455 mod. (35x13)
192 mod. (24x8)	280 mod. (35x8)	192 mod. (24x8)	280 mod. (35x8)	216 mod. (24x9)	315 mod. (35x9)	216 mod. (24x9)	315 mod. (35x9)	240 mod. (24x10)	350 mod. (35x10)	240 mod. (24x10)	350 mod. (35x10)
GW D3 062				GW D3 063				GW D3 064			
GW D3 043		GW D3 044		GW D3 043		GW D3 044		GW D3 043		GW D3 044	
GW D3 047				GW D3 048				GW D3 049			
GW D3 053		GW D3 054		GW D3 055		GW D3 056		GW D3 057		GW D3 058	
GW D3 071				GW D3 072				GW D3 073			
GW D3 077				GW D3 078				GW D3 079			
GW D3 083		GW D3 084		GW D3 085		GW D3 086		GW D3 087		GW D3 088	

GW D3 035

QDX 630 L

QDX 630L EXTERNAL COMPARTMENT							
DIM. FUNCTIONAL (BxH)		400x1600 mm		400x1800 mm		400x2000 mm	
DEPTH		200 mm	300 mm	200 mm	300 mm	200 mm	300 mm
Rear Frames		GW D3 065		GW D3 066		GW D3 067	
Bases and headboards		GW D3 045	GW D3 046	GW D3 045	GW D3 046	GW D3 045	GW D3 046
Front uprights		GW D3 050		GW D3 051		GW D3 052	
Side panels		GW D3 053	GW D3 054	GW D3 055	GW D3 056	GW D3 057	GW D3 058
Blind doors		GW D3 080		GW D3 081		GW D3 082	

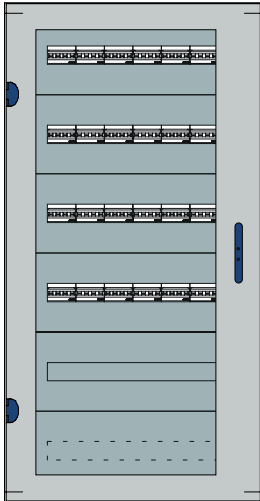

Wall-mounting board IP43 QDX 630 L

Functional dimension (LxHxD): 600x1200x300 mm

External dimension (LxHxD): 680x1260x295 mm

Quantity	Code	Description
1	GW45413	DIN35 PROFILE B600 QDX630L/H/1600H
1	GWD3004	QDX 630L WALL MOUNT. BASE-HEADBOARD 600x300
1	GWD3008	QDX 630L WALL MOUNT. FRONT UPRIGHTS B600/850 H1200
1	GWD3014	QDX 630L WALL MOUNT. SIDE PANELS 1200x300
1	GWD3016	QDX 630L WALL MOUNT. REAR FRAME 600x1200
1	GWD3022	QDX 630L WALL MOUNT. GLASS DOOR 600x1200
5	GWD3302	QDX WINDOW PANEL WITH DIN RAIL. 600x200
5	GWD3313	QDX DIN RAIL MOUNT.BRACKETS 90 RANGE - 220MM
1	GWD3316	QDX DIN RAIL MOUNTING TOOL
1	GWD3318	QDX BLANKING MODULES PROFILE 1000mm
1	GWD3323	QDX BLIND FRONT PANEL 600x200
1	GWD3471	QDX SUPPORTS FOR HORIZ. TERMIN.BLOCK/EARTH BAR

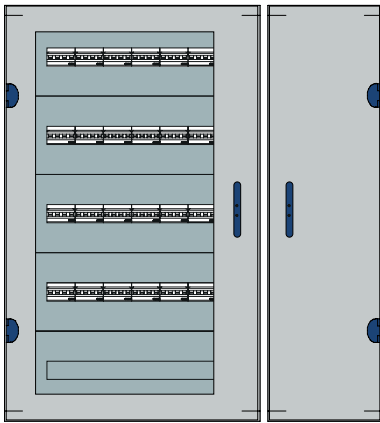

Wall-mounting board IP43 QDX 630 L with external compartment

Functional dimension (LxHxD): (600+300)x1000x200 mm

External dimension (LxHxD): 970x1060x205 mm

Quantity	Code	Description
1	GW47691	GUIDE EN 50 Q22 - DIN 35
1	GWD3001	QDX 630L WALL MOUNT. BASE-HEADBOARD 600x200
1	GWD3003	QDX 630L WALL MOUNT. BASE-HEADBOARD 300x200
1	GWD3007	QDX 630L WALL MOUNT. FRONT UPRIGHTS B600/850 H1000
1	GWD3009	QDX 630L WALL MOUNT. FRONT UPRIGHTS B300 H1000
1	GWD3011	QDX 630L WALL MOUNT. SIDE PANELS 1000x200
1	GWD3015	QDX 630L WALL MOUNT. REAR FRAME 600x1000
1	GWD3019	QDX 630L WALL MOUNT. REAR FRAME 300x1000
1	GWD3021	QDX 630L WALL MOUNT. GLASS DOOR 600x1000
1	GWD3029	QDX 630L WALL MOUNT. BLIND DOOR 300x1000
1	GWD3035	QDX 630L WALL/FLOOR MOUNT. SIDE-BY-SIDE KIT
5	GWD3302	QDX WINDOW PANEL WITH DIN RAIL. 600x200
5	GWD3311	QDX DIN RAIL MOUNT.BRACKETS 90 RANGE - 125MM
1	GWD3316	QDX DIN RAIL MOUNTING TOOL
1	GWD3318	QDX BLANKING MODULES PROFILE 1000mm

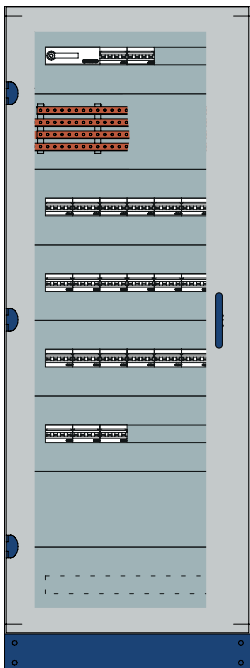

Floor-mounting board IP43 QDX 630 L

Functional dimension (LxHxD): 600x1600x200 mm

External dimension (LxHxD): 680x1760x230 mm

Quantity	Code	Description
1	GW45413	DIN35 PROFILE B600 QDX630L/H/1600H
1	GW45545	HORIZ. FOUR-POLE DIVIDER 250A 24M 21 CONN. - QDX630-1600
1	GWD3041	QDX 630L FLOOR MOUNT. BASE-HEADBOARD 600x200
1	GWD3047	QDX 630L FLOOR MOUNT. FRONT UPRIGHTS B600/850 H1600
1	GWD3053	QDX 630L FLOOR MOUNT. SIDE PANELS 1600x200
1	GWD3059	QDX 630L FLOOR MOUNT. REAR FRAME 600x1600
1	GWD3068	QDX 630L FLOOR MOUNT. GLASS DOOR 600x1600
5	GWD3302	QDX WINDOW PANEL WITH DIN RAIL. 600x200
5	GWD3311	QDX DIN RAIL MOUNT.BRACKETS 90 RANGE - 125MM
1	GWD3316	QDX DIN RAIL MOUNTING TOOL
1	GWD3318	QDX BLANKING MODULES PROFILE 1000mm
3	GWD3323	QDX BLIND FRONT PANEL 600x200
1	GWD3471	QDX SUPPORTS FOR HORIZ. TERMIN.BLOCK/EARTH BAR

QDX 630 L configurazioni

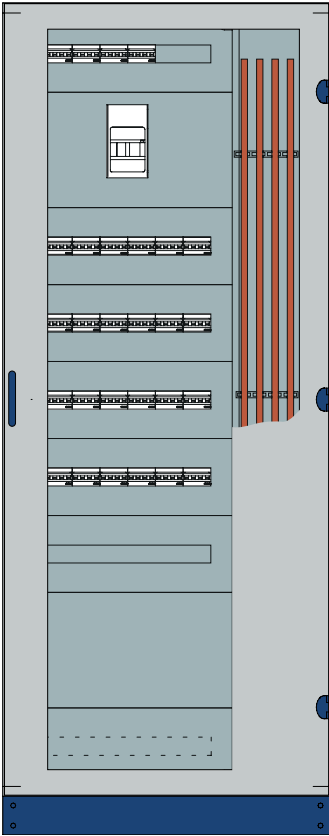

Floor-mounting board IP43 QDX 630 L with internal compartment

Functional dimension (LxHxD): 850x2000x300 mm

External dimension (LxHxD): 880x2160x320 mm

Quantity	Code	Description
1	GW45413	DIN35 PROFILE B600 QDX630L/H/1600H
2	GW45557	2 COPPER FLAT BARS 400 A 30x5 2000mm
1	GWD3044	QDX 630L FLOOR MOUNT. BASE-HEADBOARD 850X300
1	GWD3049	QDX 630L FLOOR MOUNT. FRONT UPRIGHTS B600/850 H2000
1	GWD3058	QDX 630L FLOOR MOUNT. SIDE PANELS 2000x300
1	GWD3064	QDX 630L FLOOR MOUNT. REAR FRAME 850x2000
1	GWD3073	QDX 630L FLOOR MOUNT. GLASS DOOR 850x2000
1	GWD3088	QDX 630L FLOOR MOUNT. INTERN.COMPART. 2000x300
6	GWD3302	QDX WINDOW PANEL WITH DIN RAIL 600x200
6	GWD3313	QDX DIN RAIL MOUNT.BRACKETS 90 RANGE - 220MM
1	GWD3316	QDX DIN RAIL MOUNTING TOOL
1	GWD3318	QDX BLANKING MODULES PROFILE 1000mm
1	GWD3323	QDX BLIND FRONT PANEL 600x200
1	GWD3324	QDX BLIND FRONT PANEL 600x300
1	GWD3428	QDX WIRING TRUNKING VERTICAL SUPPORTS 8 PIECES
1	GWD3471	QDX SUPPORTS FOR HORIZ. TERMIN.BLOCK/EARTH BAR
1	GWD3505	QKIT MSX/E/M400-630 600x300 HORIZ FIX
2	GWD3709	QDX630L BUSBAR-HOLDER INT.COMPARTMENT D300

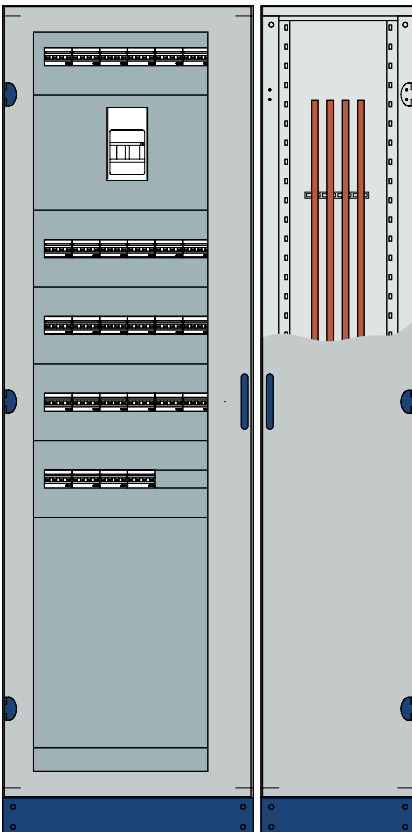

Floor-mounting board IP43 QDX 630 L with external compartment

Functional dimension (LxHxD): 600+400x2000x300 mm

External dimension (LxHxD): 1080x2160x320 mm

Quantity	Code	Description
2	GW45558	2 COPPER FLAT BARS 630 A 30x10 2000mm
1	GWD3035	QDX 630L WALL/FLOOR MOUNT. SIDE-BY-SIDE KIT
1	GWD3042	QDX 630L FLOOR MOUNT. BASE-HEADBOARD 600x300
1	GWD3046	QDX 630L FLOOR MOUNT. BASE-HEADBOARD 400x300
1	GWD3049	QDX 630L FLOOR MOUNT. FRONT UPRIGHTS B600/850 H2000
1	GWD3052	QDX 630L FLOOR MOUNT. FRONT UPRIGHTS B400 H2000
1	GWD3058	QDX 630L FLOOR MOUNT. SIDE PANELS 2000x300
1	GWD3061	QDX 630L FLOOR MOUNT. REAR FRAME 600x2000
1	GWD3067	QDX 630L FLOOR MOUNT. REAR FRAME 400x2000
1	GWD3070	QDX 630L FLOOR MOUNT. GLASS DOOR 600x2000
1	GWD3082	QDX 630L FLOOR MOUNT. BLIND DOOR 400x2000
5	GWD3302	QDX WINDOW PANEL WITH DIN RAIL 600x200
5	GWD3313	QDX DIN RAIL MOUNT.BRACKETS 90 RANGE - 220MM
1	GWD3316	QDX DIN RAIL MOUNTING TOOL
1	GWD3318	QDX BLANKING MODULES PROFILE 1000mm
1	GWD3321	QDX BLIND FRONT PANEL 600x100
1	GWD3326	QDX BLIND FRONT PANEL 600x600
1	GWD3428	QDX WIRING TRUNKING VERTICAL SUPPORTS 8 PIECES
1	GWD3505	KIT MSX/E/M400-630 600x300 HORIZ FIX
2	GWD3708	QDX630L BUSBAR-HOLDER EXT.COMPARTMENT D300

QDX 630 L

Modular distribution boards up to 630A - IP43

The QDX 630 L series of modular boards is available in both wall and floor versions. Both solutions share the same concept, accessories and quick and easy wiring modes. In fact, wiring is possible with the "structure completely open" and subsequently, the assembly of the board is completed.



STRUCTURES - DEGREE OF PROTECTION WITH DOOR IP43

WALL-MOUNTING DISTRIBUTION BOARDS



GW D3 002

BASES AND HEADBOARDS

Code	Functional dim. LxD (mm)	External dim. LxD (mm)	Pack Carton
GW D3 001	600x200	650x205	1
GW D3 002	850x200	850x205	1
GW D3 004	600x300	650x295	1
GW D3 005	850x300	850x295	1

EQUIPMENT: no. 4 wall mounting brackets.



GW D3 018

REAR FRAMES

Code	Functional dim. LxH (mm)	Pack Carton
GW D3 015	600x1000	1
GW D3 016	600x1200	1
GW D3 017	850x1000	1
GW D3 018	850x1200	1

CHARACTERISTICS: bottom of the panel equipped with removable functional frames to create the internal compartment (internal compartment kit must be ordered separately). IP43 gasket already applied on the bottom.



GW D3 008

PAIR OF FRONT UPRIGHTS

Code	Functional dim. H (mm)	External dim H (mm)	Pack Carton
GW D3 007	1000	1060	1
GW D3 008	1200	1260	1

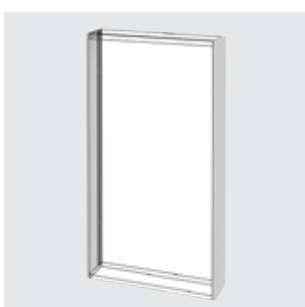

GW D3 012

PAIR OF SIDE PANELS

Code	Functional dim. HxD (mm)	Pack Carton
GW D3 011	1000x200	1
GW D3 012	1200x200	1
GW D3 013	1000x300	1
GW D3 014	1200x300	1

FLOOR-MOUNTING DISTRIBUTION BOARDS



GW D3 044

BASES AND HEADBOARDS

Code	Functional dim. LxD (mm)	External dim. LxD (mm)	Pack Carton
GW D3 041	600x200	650x230	1
GW D3 042	600x300	650x320	1
GW D3 043	850x200	850x230	1
GW D3 044	850x300	850x320	1

ACCESSORIES SUPPLIED: no. 2 wall mounting brackets.
Inspectable plinth (supplied loose) inside the package.
NOTES:H=100 mm plinth height.



GW D3 064

REAR FRAMES

Code	Functional dim. LxH (mm)	Pack Carton
GW D3 059	600x1600	1
GW D3 060	600x1800	1
GW D3 061	600x2000	1
GW D3 062	850x1600	1
GW D3 063	850x1800	1
GW D3 064	850x2000	1

CHARACTERISTICS: bottom of the panel equipped with removable functional frames to create the internal compartment (internal compartment kit must be ordered separately).
IP43 gasket already applied on the bottom.



GW D3 049

PAIR OF FRONT UPRIGHTS

Code	Functional dim. H (mm)	External dim H (mm)	Pack Carton
GW D3 047	1600	1660	1
GW D3 048	1800	1860	1
GW D3 049	2000	2060	1



GW D3 058

PAIR OF SIDE PANELS

Code	Functional dim. HxD (mm)	Pack Carton
GW D3 053	1600x200	1
GW D3 054	1600x300	1
GW D3 055	1800x200	1
GW D3 056	1800x300	1
GW D3 057	2000x200	1
GW D3 058	2000x300	1



GW D3 089

PAIR OF VENTILATED SIDE PANELS

Code	Functional dim. HxD (mm)	Pack Carton
GW D3 089	1600x300	1
GW D3 090	1800x300	1
GW D3 091	2000x300	1

NOTES: In the case of the installation of aerated side panels, the enclosure protection rating is IP30.
Each side panel has 2 surfaces with slots drilling (one lower and one upper) each 58 cm² in size.

DOORS



GW D3 073

GLASS DOORS

Code	Suitable for structures LxH (mm)	Pack Carton
GW D3 021	600x1000	1
GW D3 022	600x1200	1
GW D3 023	850x1000	1
GW D3 024	850x1200	1
GW D3 068	600x1600	1
GW D3 069	600x1800	1
GW D3 070	600x2000	1
GW D3 071	850x1600	1
GW D3 072	850x1800	1
GW D3 073	850x2000	1

ACCESSORIES SUPPLIED: rod-mechanism lock door, equipped with rotary handle with security lock and Yale type key.

CHARACTERISTICS: possibility to assemble the door with reversible opening (right/left).

Smoked tempered glass.



GW D3 079

BLIND DOORS

Code	Suitable for structures LxH (mm)	Pack Carton
GW D3 025	600x1000	1
GW D3 026	600x1200	1
GW D3 027	850x1000	1
GW D3 028	850x1200	1
GW D3 074	600x1600	1
GW D3 075	600x1800	1
GW D3 076	600x2000	1
GW D3 077	850x1600	1
GW D3 078	850x1800	1
GW D3 079	850x2000	1

ACCESSORIES SUPPLIED: rod-mechanism lock door, equipped with rotary handle with security lock and Yale type key.

CHARACTERISTICS: possibility to assemble the door with reversible opening (right/left).

INTERNAL COMPARTMENT



GW D3 088

INTERNAL COMPARTMENTS

Code	Suitable for structures LxHxD (mm)	Pack Carton
GW D3 031	850x1000x200	1
GW D3 032	850x1000x300	1
GW D3 033	850x1200x200	1
GW D3 034	850x1200x300	1
GW D3 083	850x1600x200	1
GW D3 084	850x1600x300	1
GW D3 085	850x1800x200	1
GW D3 086	850x1800x300	1
GW D3 087	850x2000x200	1
GW D3 088	850x2000x300	1

COMPONENTS: Triangular panel key for opening the internal compartment door, 3 crosspieces for attaching cables.

CHARACTERISTICS: Can be mounted on the right or left-hand side of board, B = 850 mm.

EXTERNAL COMPARTMENT



GW D3 046

BASES AND HEADBOARDS

Code	Functional dim. LxD (mm)	External dim. LxD (mm)	Pack Carton
GW D3 003	300x200	290x205	1
GW D3 006	300x300	290x295	1
GW D3 045	400x200	400x230	1
GW D3 046	400x300	400x320	1

COMPONENTS: 3 crosspieces for attaching cables. 4 wall attachment brackets for GWD3003 and GWD3006; 2 wall attachment brackets for GWD3045 and GWD3046.

Inspectable base for GWD3045 and GWD3046, supplied loose inside the package.

NOTES: Base height = 100 mm.

Associating the external compartment with the structure can be carried out using the side attachment kit, to be ordered separately.



GW D3 067

REAR FRAMES

Code	Functional dim. LxH (mm)	Pack Carton
GW D3 019	300x1000	1
GW D3 020	300x1200	1
GW D3 065	400x1600	1
GW D3 066	400x1800	1
GW D3 067	400x2000	1

CHARACTERISTICS: IP43 gasket already applied at bottom.



GW D3 009

PAIR OF FRONT UPRIGHTS

Code	Functional dim. H (mm)	External dim H (mm)	Pack Carton
GW D3 009	1000	1060	1
GW D3 010	1200	1260	1
GW D3 050	1600	1660	1
GW D3 051	1800	1860	1
GW D3 052	2000	2060	1



GW D3 082

BLIND DOORS

Code	Suitable for structures LxH (mm)	Pack Carton
GW D3 029	300x1000	1
GW D3 030	300x1200	1
GW D3 080	400x1600	1
GW D3 081	400x1800	1
GW D3 082	400x2000	1

ACCESSORIES SUPPLIED: triangular insert key for opening the external compartment door.

FEATURES: reversible door opening (right/left).

FRONT CONFIGURATION

DEVICE INSTALLATION ON DIN RAIL

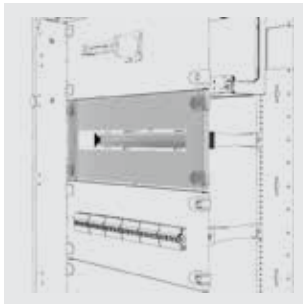

GW D3 302

WINDOW PANELS WITH DIN RAIL

Code	Functional dim. LxH (mm)	Pack Carton
No. modules: 24		
GW D3 301	600x150	1
GW D3 302	600x200	1
GW D3 303	600x300	1
No. modules: 35		
GW D3 304	850x150	1
GW D3 305	850x200	1
GW D3 306	850x300	1

COMPONENTS: Aluminium EN 50022 double rail (DIN 35).

CHARACTERISTICS: RAL 7035 grey painted sheet metal panels equipped with rotation hinges and 1/4 turn lock.

NOTES: Mounting the DIN rail requires brackets (bracket type depends on the depth of the panel), to be ordered separately.

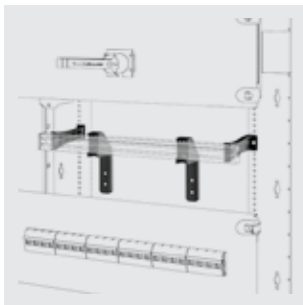

ZC6

PAIR OF DIN RAIL MOUNTING BRACKETS

Code	Suitable for structures D (mm)	Suitable for	Pack Carton
GW D3 311	200	Modular devices range 90	1
GW D3 312	200	MCCB's MSX/D/M/c 160-250	1
GW D3 313	300	Modular devices range 90	1
GW D3 314	300	MCCB's MSX/D/M/c 160-250	1

ACCESSORIES SUPPLIED: no. 1 horizontal wiring trunking support for GWD3311 and no. 2 for horizontal wiring trunking supports for GWD3313. The supports must be mounted on the back of the of the double EN 50022 (DIN 35) rail.

MSX MOULDED CASE CIRCUIT BREAKERS INSTALLATION ON PLATE

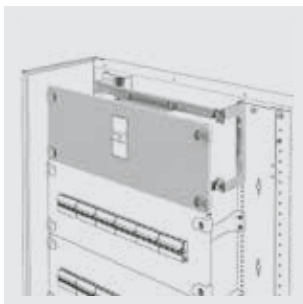

GW D3 504

INSTALLATION KIT FOR MCCB'S UP TO 630 A IN HORIZONTAL POSITION FIXED VERSION

Code	Installation	Suitable for	Functional dim. LxH (mm)	Pack Carton
Functional width: 600 mm				
GW D3 501	Horizontal	MSX/M160c	600x200	1
GW D3 502	Horizontal	MSX/D125	600x200	1
GW D3 503	Horizontal	MSX/D/M/c 160-250	600x200	1
GW D3 504	Horizontal	MSXE160-250	600x200	1
GW D3 505	Horizontal	MSX/E/M400-630	600x300	1
Functional width: 850 mm				
GW D3 509	Horizontal	MSX/M160c	850x200	1
GW D3 510	Horizontal	MSX/D125	850x200	1
GW D3 511	Horizontal	MSX/D/M/c 160-250	850x200	1
GW D3 512	Horizontal	MSXE160-250	850x200	1
GW D3 513	Horizontal	MSX/E/M400-630	850x300	1

ACCESSORIES SUPPLIED: galvanised sheet metal support plate, raiser brackets and pre-drilled panel.

CHARACTERISTICS: RAL 7035 grey painted sheet metal panels equipped with rotation hinges and 1/4 turn lock.

NOTE: The kits are suitable for 3P and 4P MCCB's.

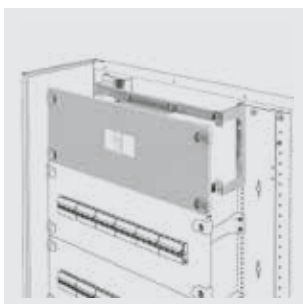

GW D3 517

INSTALLATION KIT FOR MCCB'S UP TO 630 A IN VERTICAL POSITION FIXED VERSION

Code	Installation	Suitable for	Functional dim. LxH (mm)	Pack Carton
Functional width: 600 mm				
GW D3 517	Vertical	MSX/D/M/c 160-250	600x300	1
GW D3 518	Vertical	MSXE160-250	600x300	1
GW D3 519	Vertical	MSX/E/M400-630	600x500	1
Functional width: 850 mm				
GW D3 523	Vertical	MSX/D/M/c 160-250	850x300	1
GW D3 524	Vertical	MSXE160-250	850x300	1
GW D3 525	Vertical	MSX/E/M400-630	850x500	1

ACCESSORIES SUPPLIED: galvanised sheet metal support plate, raiser brackets and pre-drilled panel.

CHARACTERISTICS: RAL 7035 grey painted sheet metal panels equipped with rotation hinges and 1/4 turn lock.

NOTE: The kits are suitable for 3P and 4P MCCB's.

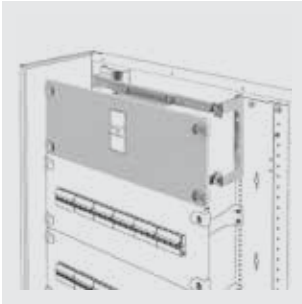

ZC6

INSTALLATION KIT FOR MCCB'S UP TO 630 A FIXED VERSION WITH DIRECT ROTARY HANDLE

Code	Installation	Suitable for	Functional dim. LxH (mm)	Pack Carton
Functional width: 600 mm				
GW D3 531	Horizontal	MSX/M160c	600x200	1
GW D3 532	Horizontal	MSX/M250c	600x200	1
GW D3 533	Horizontal	MSX/D125	600x200	1
GW D3 534	Horizontal	MSX/D160-250	600x200	1
GW D3 535	Horizontal	MSXE160-250	600x200	1
GW D3 536	Horizontal	MSX/E/M400-630	600x300	1

ACCESSORIES SUPPLIED: galvanised sheet metal support plate, raiser brackets and pre-drilled panel.

CHARACTERISTICS: RAL 7035 grey painted sheet metal panels equipped with rotation hinges and 1/4 turn lock.

NOTE: The kits are suitable for 3P and 4P MCCB's.

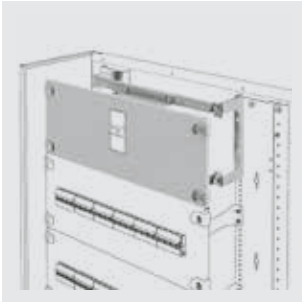

ZC6

INSTALLATION KIT FOR MCCB'S UP TO 630 A FIXED VERSION WITH MOTOR OPERATING DEVICE

Code	Installation	Suitable for	Functional dim. LxH (mm)	Pack Carton
Functional width: 600 mm				
GW D3 541	Horizontal	MSX/D125	600x200	1
GW D3 542	Horizontal	MSX/D/M/c 160-250	600x200	1
GW D3 543	Horizontal	MSXE160-250	600x200	1
GW D3 544	Horizontal	MSX/E/M400-630	600x300	1

ACCESSORIES SUPPLIED: galvanised sheet metal support plate, overhead brackets (if required) and pre-cut panel.

FEATURES: RAL 7035 grey painted sheet metal panels equipped with rotating hinges and 1/4 turn locks.

NOTES: the kits are suitable for 3P and 4P switches.

MSS SWITCH DISCONNECTORS INSTALLATION ON PLATE

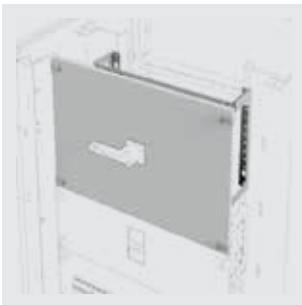

GW D3 553

INSTALLATION KIT FOR SWITCH DISCONNECTORS UP TO 630 A FIXED VERSION

Code	Installation	Suitable for	Functional dim. LxH (mm)	Pack Carton
Functional width: 600 mm				
GW D3 551	Horizontal/Vertical	MSS 250	600x300	1
GW D3 553	Horizontal/Vertical	MSS 630	600x400	1
Functional width: 850 mm				
GW D3 552	Horizontal/Vertical	MSS 250	850x300	1
GW D3 554	Horizontal/Vertical	MSS 630	850x400	1

ACCESSORIES SUPPLIED: galvanised sheet metal support plate, raiser brackets and pre-drilled panel.

CHARACTERISTICS: RAL 7035 grey painted sheet metal panels equipped with rotation hinges and 1/4 turn lock.

NOTE: The kits are suitable for 3P and 4P MCCB's.

FRONT PANELS

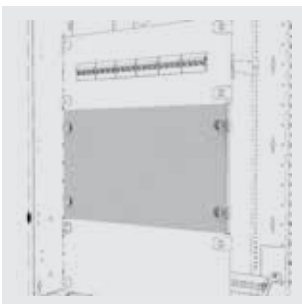

GW D3 324

BLIND FRONT PANELS

Code	Functional dim. LxH (mm)	Pack Carton
GW D3 321	600x100	1
GW D3 322	600x150	1
GW D3 323	600x200	1
GW D3 324	600x300	1
GW D3 325	600x400	1
GW D3 326	600x600	1
GW D3 327	850x100	1
GW D3 328	850x150	1
GW D3 329	850x200	1
GW D3 330	850x300	1
GW D3 331	850x400	1
GW D3 332	850x600	1

CHARACTERISTICS: RAL 7035 grey painted sheet metal panels equipped with rotation hinges and 1/4 turn lock.

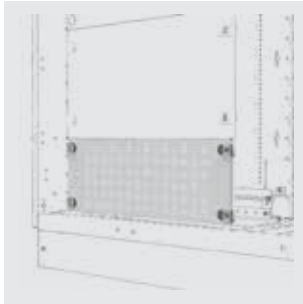

GW D3 333

AERATION FRONT PANELS

Code	Functional dim. LxH (mm)	Pack Carton
GW D3 333	600x200	1
GW D3 334	850x200	1

CHARACTERISTICS: RAL 7035 grey painted sheet metal panels equipped with rotation hinges and 1/4 turn lock.

INTERNAL CONFIGURATION

BACK-MOUNTING PLATES

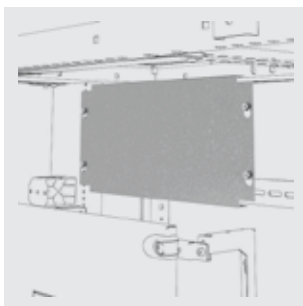

GW D3 336

BACK-MOUNTING PLATE FOR NON-MODULAR DEVICES

Code	Functional dim. LxH (mm)	Pack Carton
GW D3 336	600x200	1
GW D3 337	600x400	1
GW D3 338	600x600	1
GW D3 339	600x800	1
GW D3 340	600x1000	1
GW D3 341	850x200	1
GW D3 342	850x400	1
GW D3 343	850x600	1
GW D3 344	850x800	1
GW D3 345	850x1000	1

DIVIDERS

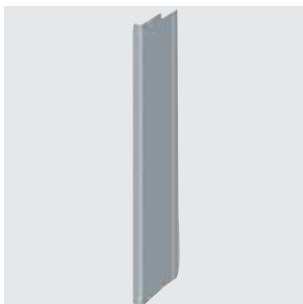

GW D3 351

VERTICAL DIVIDERS

Code	Suitable for structures HxD (mm)	No. of pieces	Pack Carton
GW D3 351	1000x200	1	1
GW D3 352	1200x200	1	1
GW D3 353	1000x300	1	1
GW D3 354	1200x300	1	1
GW D3 355	1600x200	1	1
GW D3 356	1800x200	1	1
GW D3 357	2000x200	1	1
GW D3 358	1600x300	1	1
GW D3 359	1800x300	1	1
GW D3 360	2000x300	1	1

CHARACTERISTICS: plastic dividers to realize Form 2 configuration in the case of busbars mounted in the internal and external compartment.



GW D3 361

HORIZONTAL DIVIDERS

Code	Suitable for structures LxD (mm)	No. of pieces	Pack Carton
GW D3 361	600x200	1	1
GW D3 362	850x200	1	1
GW D3 363	600x300	1	1
GW D3 364	850x300	1	1

CHARACTERISTICS: metal dividers used to divide the distribution board into sections.

COMPLEMENTARY ITEMS

ACCESSORIES



GW D3 316

DIN RAIL MOUNTING TOOL

Code	Suitable for	Pack Carton
GW D3 316	Wall and floor boards	1

CHARACTERISTICS: tool required for mounting and disassembling the double EN 50022 (DIN 35) rail on the brackets.



GW D3 317

DEPTH ADAPTER

Code	Length (mm)	Pack Carton
GW D3 317	600	1

CHARACTERISTICS: plastic adapter for compensation of the different installation depths on DIN rail EN 50022 of the modular devices (90 range) and moulded case circuit breakers (MSX range).

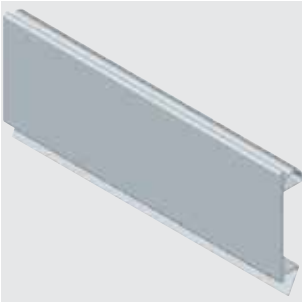

GW D3 318

PAIR OF HOLE DIN ROW COVER

Code	Length (mm)	No. of pieces	Pack Carton
GW D3 318	1000	2	1

CHARACTERISTICS: clip fixing on window panels.



ZC6

DIN PROFILES

Code	Section dim. HxD (mm)	Profile	Pack Carton
Length: 24 modules			
GW 45 413	35x15	EN 50022 (DIN 35)	1
GW 45 414	35x15	EN 50035 (G 32)	1
Length: 35 modules			
GW 45 418	35x15	EN 50022 (DIN 35)	1
GW 45 419	35x15	EN 50035 (G 32)	1
Length: 2000 mm			
GW 47 691	35x15	EN 50022 (DIN 35)	1/5
GW 47 692	32x15	EN 50035 (G 32)	1/5

NOTE: 24 and 35 modules DIN guides have fixing holes.
The 2000 mm DIN guides have no fixing holes.

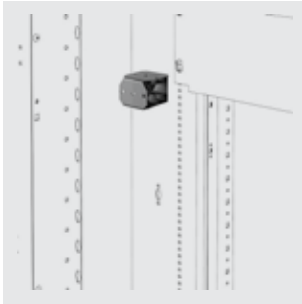

GW D3 426

WIRING VERTICAL TRUNKING SUPPORTS

Code	No. of pieces	Pack Carton
GW D3 426	4	1
GW D3 428	8	1

CHARACTERISTICS: allows the installation of vertical wiring trunking with heights H=40 mm, H=60 mm or H=80 mm.
NOTES: not suitable for distribution boards with functional depth P=200 mm.

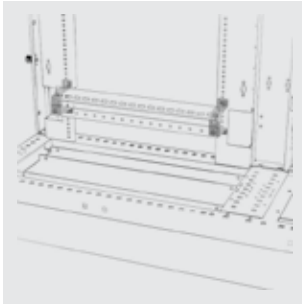

GW D3 471

PAIR OF SUPPORTS FOR HORIZONTAL TERMINAL BLOCK AND EARTH BAR

Code	Suitable for	Pack Carton
GW D3 471	Distribution boards L=600/850 mm	1



GW 46 448

VENTILATION KIT

Code	IP degree	Rated voltage	Fixing hole (mm)	Screws centre distance (mm)	Pack Carton
GW 46 448	IP44	230 V - 50 / 60 Hz	125x117	123x115	1/2

CHARACTERISTICS: the fan takes in air from the outside and introduces it into the distribution board, creating a slight overpressure that prevents foreign particles from entering. Max fan capacity 60 m³/h. Absorbed power equal to 20 W.

APPLICATIONS: forced ventilation in critical thermal conditions.
ACCESSORIES SUPPLIED: drilling template.



GW 46 471

AERATION KIT

Code	IP degree	Fixing hole (mm)	Screws centre distance (mm)	Pack Carton
GW 46 471	IP44	125x117	123x115	1/10

ACCESSORIES SUPPLIED: drilling template.

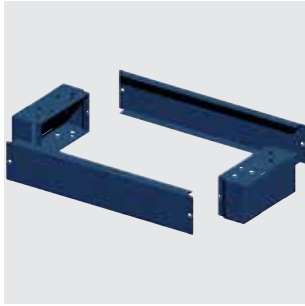

ZC6

ADDITIONAL PLINTHS

Code	Suitable for structures LxD (mm)	Pack Carton
GW D3 401	400x200	1
GW D3 402	600x200	1
GW D3 403	850x200	1
GW D3 404	400x300	1
GW D3 405	600x300	1
GW D3 406	850x300	1

CHARACTERISTICS: additional inspectable plinth (H=100 mm) to facilitate cable entry and/or raise the distribution board



GW D3 035

KIT FOR SIDE-BY-SIDE COUPLING

Code	Suitable for	Pack Carton
GW D3 035	Wall and floor boards	1

ACCESSORIES SUPPLIED: fixing screws and gasket.

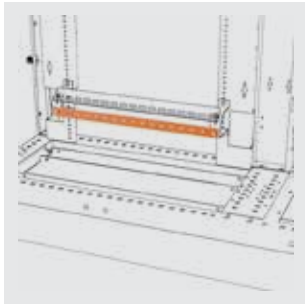

GW 45 565

COPPER EARTH BUSBARS

Code	Suitable for	Installation	Section (mm ²)	Length (mm)	N./diam. of holes	Pack Carton
GW 45 565	Structures L=600 mm	Horizontal	25x4	420	13 Holes M6 and 2 holes ø 6 mm	1
GW 45 566	Structures L=850 mm	Horizontal	25x4	620	21 Holes M6 and 2 holes ø 6 mm	1
GW 45 559	compartment internal/external	Vertical	20x5	1750	68 Holes M6 and 2 holes M12	1



ZC6

EARTH TERMINAL BLOCKS

Code	Suitable for structures L (mm)	N. terminal and section (mm ²)	Pack Carton
GW 45 568	600	2x(1x35+11x16+13x10)	1
GW 45 569	850	2x(1x35+11x16+13x10)	1

FEATURES: copper busbars with a 20 x 5 section and 6.5 mm hole spacing.



GW 46 447

DOCUMENT HOLDER POCKET IN SELF-ADHESIVE INSULATING MATERIAL WITH KIT OF BLANK LABELS

Code	Dimensions LxH (mm)	Pack Carton
GW 46 447	230x310	1/10

CHARACTERISTICS: can be inserted in all GEWISS enclosures from dimension 405x500x200 mm upwards.



GW D3 441

LIFTING EYEBOLTS

Code	Suitable for structures D (mm)	Pack Carton
GW D3 441	200	1
GW D3 442	300	1

NOTES: suitable for wall and floor mounting distribution boards.

SPARE PARTS



GW D3 432

SPARE PART LOCK

Code	Suitable for	Pack Carton
GW D3 431	External compartment door	1
GW D3 432	Glass door / blind door	1

ACCESSORIES SUPPLIED: spare part locks supplied with keys.

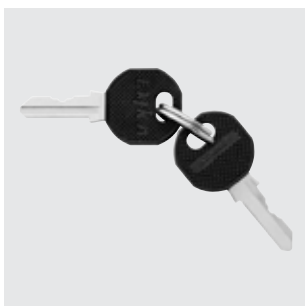

GW D3 439

SPARE PART DOOR KEYS

Codice	Type	Suitable for	Conf. Imb.
GW D3 439	Yale	Wall / floor mounting distribution boards	1
GW D3 440	Triangular	Internal / external compartment	1

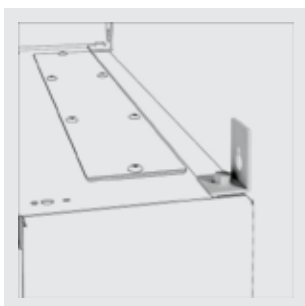

GW D3 452

SPARE PART WALL FIXING BRACKETS

Code	Suitable for	Pack Carton
GW D3 452	Wall-mounting distribuion boards	1
GW D3 453	Floor-mounting distribution boards	1



GW D3 454

SPARE PART SCREWS

Code	Screws type	Pack Carton
GW D3 454	M6x10 (25 pcs)	1
GW D3 455	M6x12 (25 pcs)	1

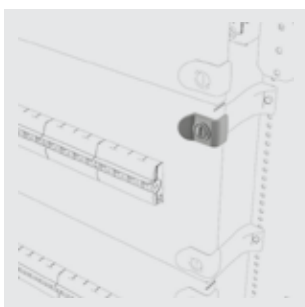

GW D3 457

1/4 TURN LOCKS AND SPARE PART HINGES

Code	Suitable for	No. of pieces	Pack Carton
GW D3 457	Front panels	4 pcs (locks) and 4 pcs (hinges)	1



QDX 630 L



Scan the QR Code and find out all the technical informations.

DIN RAIL: QUICK ASSEMBLY AND DISASSEMBLY



The screw-free snap-in system is simple and immediate thanks to the quick assembly and disassembly of the dual aluminium DIN rails.

FACILITATED MAINTENANCE

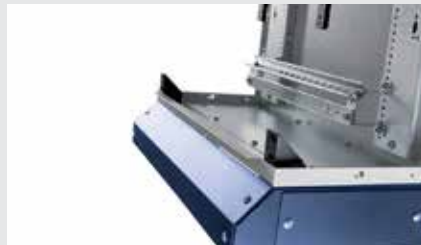

The independent fixing of the front part and the removable sidewalls ensure the best working conditions for the operator.





INTEGRATED GASKET



The IP43 rated seal is already fitted in the distribution board, with no need for an external roll.

QDX 630 H

Selection tables

QDX 630H WALL-MOUNTING STRUCTURES					
DIM. FUNCTIONAL (BxH)		600x1000 mm		600x1200 mm	
DEPTH		200 mm	300 mm	200 mm	300 mm
Modular Capacity	Pitch 150mm	144 mod. (24x6)		192 mod. (24x8)	
	Pitch 200 mm	120 mod. (24x5)		144 mod. (24x6)	
Monobloc structures		GW D3 101	GW D3 107	GW D3 102	GW D3 108
Glass doors		GW D3 113		GW D3 114	
Blind doors		GW D3 117		GW D3 118	
Vertical coupling kit		GW D3 121	GW D3 124	GW D3 121	GW D3 124









* The GW D3 103 and GW D3 104 monobloc structures are equipped with a side compartment (200 mm wide) dedicated to the cables, terminal block or busbar system.

QDX 630H WALL-MOUNTING STRUCTURES

(600+200)x1000 mm		(600+200)x1200 mm		850x1000 mm		850x1200 mm	
200 mm	300 mm	200 mm	300 mm	200 mm	300 mm	200 mm	300 mm
144 mod. (24x6)		192 mod. (24x8)		210 mod. (35x6)		280 mod. (35x8)	
120 mod. (24x5)		144 mod. (24x6)		175 mod. (35x5)		180 mod. (35x6)	
GW D3 103 *	GW D3 109 *	GW D3 104 *	GW D3 110 *	GW D3 105	GW D3 111	GW D3 106	GW D3 112
GW D3 113		GW D3 114		GW D3 115		GW D3 116	
GW D3 117		GW D3 118		GW D3 119		GW D3 120	
GW D3 122	GW D3 125	GW D3 122	GW D3 125	GW D3 123	GW D3 126	GW D3 123	GW D3 126

QDX 630 H

QDX 630H FLOOR-MOUNTING STRUCTURES

DIM. FUNCTIONAL (BxH)		600x1600 mm		600x1800 mm		600x2000 mm	
DEPTH		250 mm	400 mm	250 mm	400 mm	250 mm	400 mm
Modular Capacity	Pitch 150mm	240 mod. (24x10)		288 mod. (24x12)		312 mod. (24x13)	
	Pitch 200 mm	192 mod. (24x8)		216 mod. (24x9)		240 mod. (24x10)	
Bases and headboards		GW D3 131	GW D3 132	GW D3 131	GW D3 132	GW D3 131	GW D3 132
Front uprights		GW D3 147	GW D3 148	GW D3 149	GW D3 150	GW D3 152	GW D3 153
Rear uprights and functional frames							
Side panels		GW D3 178	GW D3 179	GW D3 180	GW D3 181	GW D3 183	GW D3 184
Rear panels		GW D3 187		GW D3 188		GW D3 189	
Glass doors		GW D3 199		GW D3 200		GW D3 201	
Blind doors		GW D3 205		GW D3 206		GW D3 207	
Blind doors for side compartment							
Side-by-side kit							





NOTE: The 600+300mm wide structures have a side compartment (300 mm wide) dedicated to the cables, terminal block or busbar system.

QDX 630H FLOOR-MOUNTING STRUCTURES

(600+300)x1600 mm		(600+300)x1800 mm		(600+300)x2000 mm		850x1600 mm		850x1800 mm		850x2000 mm	
250 mm	400 mm	250 mm	400 mm	250 mm	400 mm	250 mm	400 mm	250 mm	400 mm	250 mm	400 mm
240 mod. (24x10)		288 mod. (24x12)		312 mod. (24x13)		350 mod. (35x10)		420 mod. (35x12)		455 mod. (35x13)	
192 mod. (24x8)		216 mod. (24x9)		240 mod. (24x10)		280 mod. (35x8)		315 mod. (35x9)		350 mod. (35x10)	
GW D3 135	GW D3 136	GW D3 135	GW D3 136	GW D3 135	GW D3 136	GW D3 139	GW D3 140	GW D3 139	GW D3 140	GW D3 139	GW D3 140
GW D3 170	GW D3 156	GW D3 172	GW D3 158	GW D3 175	GW D3 161	GW D3 147	GW D3 148	GW D3 149	GW D3 150	GW D3 152	GW D3 153
	GW D3 171		GW D3 173		GW D3 176						
GW D3 178	GW D3 179	GW D3 180	GW D3 181	GW D3 183	GW D3 184	GW D3 178	GW D3 179	GW D3 180	GW D3 181	GW D3 183	GW D3 184
GW D3 190		GW D3 191		GW D3 192		GW D3 193		GW D3 194		GW D3 195	
GW D3 199		GW D3 200		GW D3 201		GW D3 202		GW D3 203		GW D3 204	
GW D3 205		GW D3 206		GW D3 207		GW D3 208		GW D3 209		GW D3 210	
GW D3 214		GW D3 215		GW D3 216		-		-		-	

GW D3 217

QDX 630 H

QDX 630H EXTERNAL COMPARTMENT							
DIM. FUNCTIONAL (BxH)		400x1600 mm		400x1800 mm		400x2000 mm	
DEPTH		250 mm	400 mm	250 mm	400 mm	250 mm	400 mm
Bases and headboards		GW D3 143	GW D3 144	GW D3 143	GW D3 144	GW D3 143	GW D3 144
Uprights		GW D3 163		GW D3 164		GW D3 166	
Side panels		GW D3 178	GW D3 179	GW D3 180	GW D3 181	GW D3 183	GW D3 184
Rear panels		GW D3 196		GW D3 197		GW D3 198	
Blind doors		GW D3 211		GW D3 212		GW D3 213	

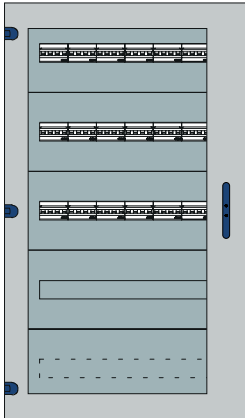

Wall-mounting board IP55 QDX 630 H

Functional dimension (LxHxD): 600x1000x200 mm

External dimension (LxHxD): 620x1060x215 mm

Quantity	Code	Description
1	GW45413	DIN35 PROFILE B600 QDX630L/H/1600H
1	GW3101	QDX 630H WALL MOUNT. CASE 600x1000x200
1	GW3113	QDX 630H WALL MOUNT. GLASS DOOR 600x1000
4	GW3302	QDX WINDOW PANEL WITH DIN RAIL 600x200
4	GW3311	QDX DIN RAIL MOUNT.BRACKETS 90 RANGE - 125MM
1	GW3316	QDX DIN RAIL MOUNTING TOOL
1	GW3318	QDX BLANKING MODULES PROFILE 1000mm
1	GW3323	QDX BLIND FRONT PANEL 600x200
1	GW3471	QDX SUPPORTS FOR HORIZ. TERMIN.BLOCK/EARTH BAR

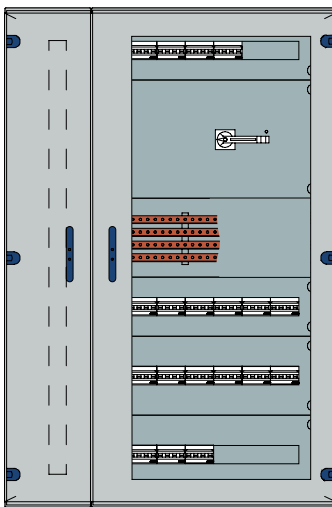

Wall-mounting board IP55 QDX 630 H with side compartment

Functional dimension (LxHxD): (600+200)x1200x300 mm

External dimension (LxHxD): 840x1260x305 mm

Quantity	Code	Description
1	GW45545	HORIZ. FOUR-POLE DIVIDER 250A 24M 21 CONN. - QDX630-1600
1	GW47691	GUIDE EN 50 Q22 - DIN 35
1	GW3110	QDX 630H WALL MOUNT. CASE 600+200x1200x300
1	GW3114	QDX 630H WALL MOUNT. GLASS DOOR 600x1200
2	GW3301	QDX WINDOW PANEL WITH DIN RAIL 600x150
2	GW3302	QDX WINDOW PANEL WITH DIN RAIL 600x200
4	GW3313	QDX DIN RAIL MOUNT.BRACKETS 90 RANGE - 220MM
1	GW3316	QDX DIN RAIL MOUNTING TOOL
1	GW3318	QDX BLANKING MODULES PROFILE 1000mm
1	GW3323	QDX BLIND FRONT PANEL 600x200
2	GW3467	HORIZ. CROSS PIECES B600+200 PARETE QDX630H
1	GW3551	KIT MSS250 600x300 HORIZ/VERT

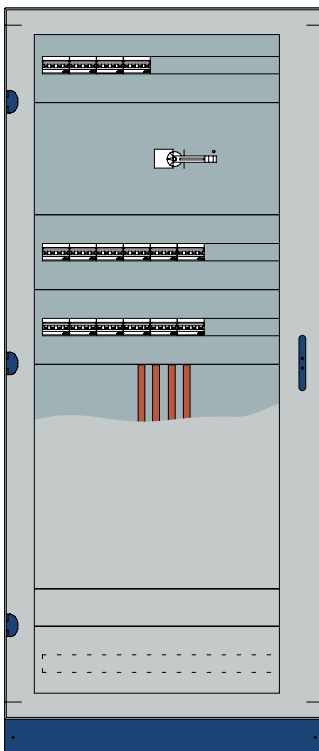

Floor-mounting board IP55 QDX 630 H

Functional dimension (LxHxD): 850x1800x250 mm

External dimension (LxHxD): 900x2000x250 mm

Quantity	Code	Description
1	GW45418	DIN35 PROFILE B850 QDX630L/H/1600H
2	GW45551	2 COPPER FLAT BARS 250 A 20x5 1000mm
1	GW3139	QDX 630H FLOOR MOUNT. BASE-HEADBOARD 850x250
1	GW3149	QDX 630H FLOOR MOUNT. UPRIGHTS 600/850x1800x250
1	GW3180	QDX 630H FLOOR MOUNT. SIDE PANELS 1800x250
1	GW3194	QDX 630H FLOOR MOUNT. REAR PANEL 850x1800
1	GW3203	QDX 630H FLOOR MOUNT. GLASS DOOR 850x1800
3	GW3305	QDX WINDOW PANEL WITH DIN RAIL 850x200
3	GW3311	QDX DIN RAIL MOUNT.BRACKETS 90 RANGE - 125MM
1	GW3316	QDX DIN RAIL MOUNTING TOOL
1	GW3318	QDX BLANKING MODULES PROFILE 1000mm
1	GW3327	QDX BLIND FRONT PANEL 850x100
1	GW3329	QDX BLIND FRONT PANEL 850x200
1	GW3332	QDX BLIND FRONT PANEL 850x850
1	GW3471	QDX SUPPORTS FOR HORIZ. TERMIN.BLOCK/EARTH BAR
1	GW3552	KIT MSS250 850x300 HORIZ/VERT
1	GW3722	QDX630H/1600H BUSBAR-HOLDER 250-400A L850

QDX 630 H configurazioni

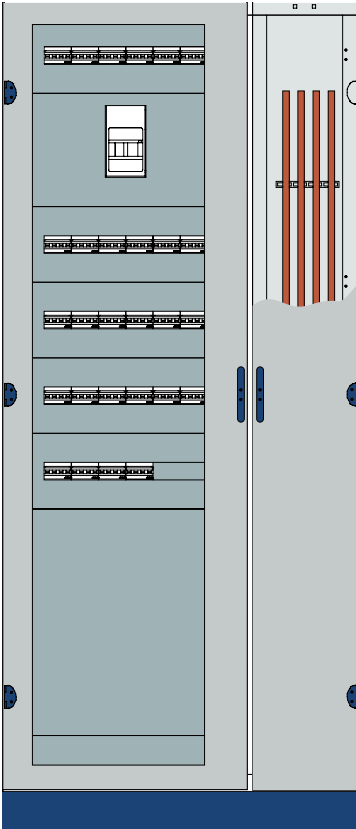

Floor-mounting board IP55 QDX 630 H with side compartment

Functional dimension (LxHxD): (600+300)x2000x400 mm

External dimension (LxHxD): 995x2200x400 mm

Quantity	Code	Description
2	GW45558	2 COPPER FLAT BARS 630 A 30x10 2000mm
1	GWD3136	QDX 630H FLOOR MOUNT. BASE-HEADBOARD 600+300x400
1	GWD3161	QDX 630H FLOOR MOUNT. FRONT UPRIGHTS 600/+300x2000
1	GWD3176	QDX 630H FLOOR MOUNT. UPRIGHTS 600/+300x2000
1	GWD3184	QDX 630H FLOOR MOUNT. SIDE PANELS 2000x400
1	GWD3192	QDX 630H FLOOR MOUNT. REAR PANEL 600+300x2000
1	GWD3201	QDX 630H FLOOR MOUNT. GLASS DOOR 600x2000
1	GWD3216	QDX 630H FLOOR MOUNT. SIDE COMPART.DOOR 600+300x2000
5	GWD3302	QDX WINDOW PANEL WITH DIN RAIL 600x200
5	GWD3313	QDX DIN RAIL MOUNT.BRACKETS 90 RANGE - 220MM
1	GWD3316	QDX DIN RAIL MOUNTING TOOL
1	GWD3318	QDX BLANKING MODULES PROFILE 1000mm
1	GWD3321	QDX BLIND FRONT PANEL 600x100
1	GWD3326	QDX BLIND FRONT PANEL 600x600
1	GWD3428	QDX WIRING TRUNKING VERTICAL SUPPORTS 8 PIECES
1	GWD3505	KIT MSX/E/M400-630 600x300 HORIZ FIX
2	GWD3727	QDX630H BUSBAR-HOLDER INT.COMPART. 630-800A D400

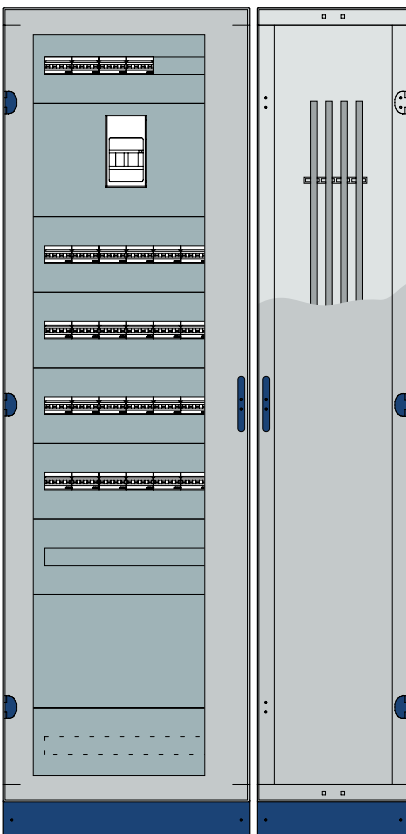

Floor-mounting board IP55 QDX 630 H with external compartment

Functional dimension (LxHxD): (600+400)x2000x400 mm

External dimension (LxHxD): 1100x2200x400 mm

Quantity	Code	Description
1	CW45413	DIN35 PROFILE B600 QDX630L/H/1600H
1	GWD3132	QDX 630H FLOOR MOUNT. BASE-HEADBOARD 600x400
1	GWD3144	QDX 630H FLOOR MOUNT. BASE-HEADBOARD 400x400
1	GWD3153	QDX 630H FLOOR MOUNT. UPRIGHTS 600/850x2000x400
1	GWD3166	QDX 630H FLOOR MOUNT. UPRIGHTS 400x2000
1	GWD3184	QDX 630H FLOOR MOUNT. SIDE PANELS 2000x400
1	GWD3189	QDX 630H FLOOR MOUNT. REAR PANEL 600x2000
1	GWD3198	QDX 630H FLOOR MOUNT. REAR PANEL 400x2000
1	GWD3201	QDX 630H FLOOR MOUNT. GLASS DOOR 600x2000
1	GWD3213	QDX 630H FLOOR MOUNT. BLIND DOOR 400x2000
1	GWD3217	QDX 630-1600H FLOOR MOUNT. SIDE-BY-SIDE KIT
6	GWD3302	QDX WINDOW PANEL WITH DIN RAIL 600x200
6	GWD3313	QDX DIN RAIL MOUNT.BRACKETS 90 RANGE - 220MM
1	GWD3316	QDX DIN RAIL MOUNTING TOOL
1	GWD3318	QDX BLANKING MODULES PROFILE 1000mm
1	GWD3323	QDX BLIND FRONT PANEL 600x200
1	GWD3324	QDX BLIND FRONT PANEL 600x300
1	GWD3428	QDX WIRING TRUNKING VERTICAL SUPPORTS 8 PIECES
2	GWD3468	HORIZ. CROSS PIECES B400 QDX630H
1	GWD3471	QDX SUPPORTS FOR HORIZ. TERMIN.BLOCK/EARTH BAR
1	GWD3505	KIT MSX/E/M400-630 600x300 HORIZ FIX
2	GWD3754	QDX630H/1600H SHAPED BUSBAR-HOLDER AL
2	GWD3791	QDX ALUMINIUM SHAPED BUSBARS 630A 30x40

QDX 630 H

Monobloc and modular distribution boards up to 630A - IP55

The QDX 630 H range of boards is available in two distinct solutions, wall and floor mounting. Monobloc structure in welded sheet metal for wall mounting version and modular structure with fully removable front for floor mounting version. It is ideal in all those applications where maximum protection from external agents is needed.



STRUCTURES - DEGREE OF PROTECTION WITH DOOR IP55

WALL-MOUNTING DISTRIBUTION BOARDS



GW D3 101

CASE

Code	Functional dim. LxD (mm)	External dim. LxD (mm)	Pack Carton
GW D3 101	600x1000x200	620x1060x215	1
GW D3 102	600x1200x200	620x1260x215	1
GW D3 103	(600+200)x1000x200	840x1060x215	1
GW D3 104	(600+200)x1200x200	840x1260x215	1
GW D3 105	850x1000x200	820x1060x215	1
GW D3 106	850x1200x200	820x1260x215	1
GW D3 107	600x1000x300	620x1060x305	1
GW D3 108	600x1200x300	620x1260x305	1
GW D3 109	(600+200)x1000x300	840x1060x305	1
GW D3 110	(600+200)x1200x300	840x1260x305	1
GW D3 111	850x1000x300	820x1060x305	1
GW D3 112	850x1200x300	820x1260x305	1

EQUIPMENT: no. 4 wall mounting brackets.

NOTES: The GWD3103, GWD3104, GWD3109 and GWD3110 cases are equipped with an associated side compartment (200 mm wide) for the cables, terminal block or bar system. To secure the cables in the side compartment, use the pair of GWD3467 crosspieces, to be ordered separately.

The doors of the side compartment for codes GWD3103, GWD3104, GWD3109 and GWD3110 are supplied pre-mounted on the case.

GLASS DOORS

Code	Suitable for structures LxH (mm)	Pack Carton
GW D3 113	600x1000	1
GW D3 114	600x1200	1
GW D3 115	850x1000	1
GW D3 116	850x1200	1

ACCESSORIES SUPPLIED: rod-mechanism lock door, equipped with rotary handle with security lock and Yale type key.

CHARACTERISTICS: possibility to assemble the door with reversible opening (right/left).

Smoked tempered glass.



GW D3 113

BLIND DOORS

Code	Suitable for structures LxH (mm)	Pack Carton
GW D3 117	600x1000	1
GW D3 118	600x1200	1
GW D3 119	850x1000	1
GW D3 120	850x1200	1

ACCESSORIES SUPPLIED: rod-mechanism lock door, equipped with rotary handle with security lock and Yale type key.

CHARACTERISTICS: possibility to assemble the door with reversible opening (right/left).



GW D3 117

FLOOR MOUNTING DISTRIBUTION BOARDS - SINGLE BOARD



GW D3 131

BASE AND HEADBOARD

Code	Functional dim. LxD (mm)	External dim. LxD (mm)	Pack Carton
GW D3 131	600x250	650x250	1
GW D3 132	600x400	650x400	1
GW D3 139	850x250	850x250	1
GW D3 140	850x400	850x400	1

ACCESSORIES SUPPLIED: no. 2 wall mounting brackets.

Inspectable plinth (supplied loose) inside the package.

NOTES:H=100 mm plinth height.



GW D3 152

UPRIGHTS AND FUNCTIONAL FRAMES

Code	Functional dim. HxD (mm)	External dim. HxD (mm)	Pack Carton
GW D3 147	1600x250	1700x250	1
GW D3 148	1600x400	1700x400	1
GW D3 149	1800x250	1900x250	1
GW D3 150	1800x400	1900x400	1
GW D3 152	2000x250	2100x250	1
GW D3 153	2000x400	2100x400	1



GW D3 183

PAIR OF SIDE PANELS

Code	Functional dim. HxD (mm)	Pack Carton
GW D3 178	1600x250	1
GW D3 179	1600x400	1
GW D3 180	1800x250	1
GW D3 181	1800x400	1
GW D3 183	2000x250	1
GW D3 184	2000x400	1

PAIR OF VENTILATED SIDE PANELS

Code	Functional dim. HxD (mm)	Pack Carton
GW D3 218	1600x400	1
GW D3 219	1800x400	1
GW D3 220	2000x400	1

NOTES: In the case of installation of aerated side panels, the enclosure protection rating is IP30.

Each side panel has 2 surfaces with slits (one lower and one upper) each 58 cm² in size.



GW D3 218

REAR PANELS

Code	Functional dim. LxH (mm)	Pack Carton
GW D3 187	600x1600	1
GW D3 188	600x1800	1
GW D3 189	600x2000	1
GW D3 193	850x1600	1
GW D3 194	850x1800	1
GW D3 195	850x2000	1



GW D3 189

FLOOR-MOUNTING DISTRIBUTION BOARDS WITH SIDE COMPARTMENT



GW D3 136

BASES AND HEADBOARD

Code	Functional dim. LxD (mm)	External dim. LxD (mm)	Pack Carton
GW D3 135	(600+300)x250	945x250	1
GW D3 136	(600+300)x400	945x400	1

CHARACTERISTICS: Structures are equipped with an associated side compartment (300 mm wide) for the cables, terminal block or bar system.

COMPONENTS: 2 wall mounting brackets and 4 crosspieces for attaching cables.

Inspectable base supplied loose inside the package.

NOTES: Base height = 100 mm.



GW D3 175

UPRIGHTS AND FUNCTIONAL FRAMES

Code	Functional dim. HxD (mm)	External dim. HxD (mm)	Pack Carton
GW D3 170	1600x250	1700x250	1
GW D3 172	1800x250	1900x250	1
GW D3 175	2000x250	2100x250	1

NOTES: uprights and functional frames suitable only for floor-mounting distribution boards with side compartment with functional depth P=250 mm.



GW D3 161

FRONT UPRIGHTS

Code	Functional dim. HxD (mm)	External dim. HxD (mm)	Pack Carton
GW D3 156	1600x400	1700x400	1
GW D3 158	1800x400	1900x400	1
GW D3 161	2000x400	2100x400	1

NOTES: uprights suitable only for floor-mounting distribution boards with side compartment with functional depth P=400 mm.

To complete the structure you need the rear uprights and functional frames to be ordered separately.



GW D3 176

REAR UPRIGHTS AND REAR FUNCTIONAL FRAMES

Code	Functional dim. HxD (mm)	External dim. HxD (mm)	Pack Carton
GW D3 171	1600x400	1700x400	1
GW D3 173	1800x400	1900x400	1
GW D3 176	2000x400	2100x400	1

NOTES: uprights and functional frames suitable only for floor-mounting distribution boards with side compartment with functional depth P=400 mm.

To complete the structure you need the front uprights and functional frames to be ordered separately.

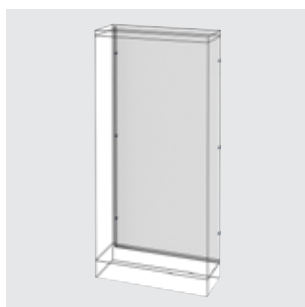

GW D3 192

REAR PANELS

Code	Functional dim. LxH (mm)	Pack Carton
GW D3 190	(600+300)x1600	1
GW D3 191	(600+300)x1800	1
GW D3 192	(600+300)x2000	1

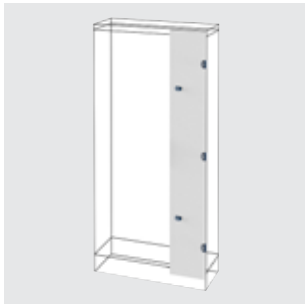

GW D3 216

BLIND DOORS FOR SIDE COMPARTMENT

Code	Suitable for structures LxH (mm)	Pack Carton
GW D3 214	(600+300)x1600	1
GW D3 215	(600+300)x1800	1
GW D3 216	(600+300)x2000	1

ACCESSORIES SUPPLIED: triangular insert key for opening side compartment door.

DOORS



GW D3 201

GLASS DOORS

Code	Suitable for structures LxH (mm)	Pack Carton
GW D3 199	600x1600	1
GW D3 200	600x1800	1
GW D3 201	600x2000	1
GW D3 202	850x1600	1
GW D3 203	850x1800	1
GW D3 204	850x2000	1

ACCESSORIES SUPPLIED: rod-mechanism lock door, equipped with rotary handle with security lock and Yale type key.

CHARACTERISTICS: possibility to assemble the door with reversible opening (right/left).

Smoked tempered glass.



GW D3 207

BLIND DOORS

Code	Suitable for structures LxH (mm)	Pack Carton
GW D3 205	600x1600	1
GW D3 206	600x1800	1
GW D3 207	600x2000	1
GW D3 208	850x1600	1
GW D3 209	850x1800	1
GW D3 210	850x2000	1

ACCESSORIES SUPPLIED: rod-mechanism lock door, equipped with rotary handle with security lock and Yale type key.

CHARACTERISTICS: possibility to assemble the door with reversible opening (right/left).

EXTERNAL COMPARTMENT



GW D3 144

BASES AND HEADBOARDS

Code	Functional dim. LxD (mm)	External dim. LxD (mm)	Pack Carton
GW D3 143	400x250	400x250	1
GW D3 144	400x400	400x400	1

COMPONENTS: 2 wall mounting brackets.

Inspectable base supplied loose inside the package.

NOTES: Base height = 100 mm.

Associating the external compartment with the structure can be carried out using the side attachment kit, to be ordered separately.

To secure the cables in the outer compartment, use the pair of CWD3468 crosspieces, to be ordered separately.

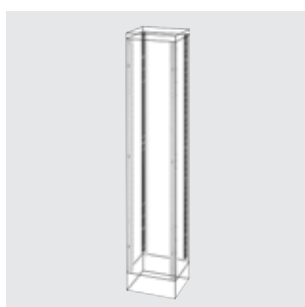

GW D3 166

UPRIGHTS AND FUNCTIONAL FRAMES

Code	Functional dim. LxH (mm)	External dim. HxD (mm)	Pack Carton
GW D3 163	400x1600	400x1700	1
GW D3 164	400x1800	400x1900	1
GW D3 166	400x2000	400x2100	1



GW D3 198

REAR PANELS

Code	Functional dim. LxH (mm)	Pack Carton
GW D3 196	400x1600	1
GW D3 197	400x1800	1
GW D3 198	400x2000	1

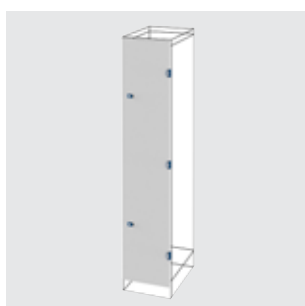

GW D3 213

BLIND DOORS

Code	Suitable for structures LxH (mm)	Pack Carton
GW D3 211	400x1600	1
GW D3 212	400x1800	1
GW D3 213	400x2000	1

ACCESSORIES SUPPLIED: door with triangular panel locks.

CHARACTERISTICS: possibility of mounting the door with reversible opening (right/left).

FRONT CONFIGURATION

DEVICE INSTALLATION ON DIN RAIL

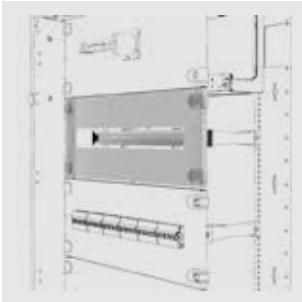

GW D3 302

WINDOW PANELS WITH DIN RAIL

Code	Functional dim. LxH (mm)	Pack Carton
No. modules: 24		
GW D3 301	600x150	1
GW D3 302	600x200	1
GW D3 303	600x300	1
No. modules: 35		
GW D3 304	850x150	1
GW D3 305	850x200	1
GW D3 306	850x300	1

COMPONENTS: Aluminium EN 50022 double rail (DIN 35).

CHARACTERISTICS: RAL 7035 grey painted sheet metal panels equipped with rotation hinges and 1/4 turn lock.

NOTES: Mounting the DIN rail requires brackets (bracket type depends on the depth of the panel), to be ordered separately.

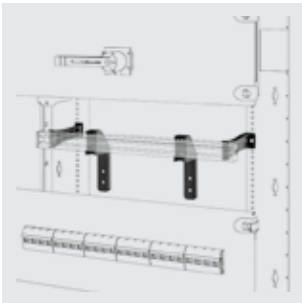

GW D3 313

PAIR OF DIN RAIL MOUNTING BRACKETS

Code	Suitable for structures D (mm)	Suitable for	Pack Carton
GW D3 311	200 / 250	Modular devices range 90	1
GW D3 312	200 / 250	MCCB's MSX/D/M/c 160-250	1
GW D3 313	400	Modular devices range 90	1
GW D3 314	400	MCCB's MSX/D/M/c 160-250	1

ACCESSORIES SUPPLIED: no. 1 horizontal wiring trunking support for CWD3311 and no. 2 for horizontal wiring trunking supports for CWD3313. The supports must be mounted on the back of the of the double EN 50022 (DIN 35) rail.

MSX MOULDED CASE CIRCUIT BREAKERS INSTALLATION ON PLATE

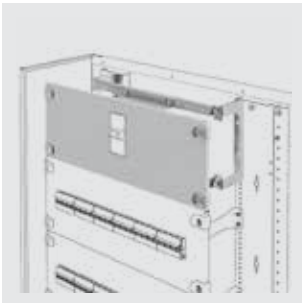

GW D3 504

INSTALLATION KIT FOR MCCB'S UP TO 630 A IN HORIZONTAL POSITION FIXED VERSION

Code	Installation	Suitable for	Functional dim. LxH (mm)	Pack Carton
Functional width: 600 mm				
GW D3 501	Horizontal	MSX/M160c	600x200	1
GW D3 502	Horizontal	MSX/D125	600x200	1
GW D3 503	Horizontal	MSX/D/M/c 160-250	600x200	1
GW D3 504	Horizontal	MSXE160-250	600x200	1
GW D3 505	Horizontal	MSX/E/M400-630	600x300	1
Functional width: 850 mm				
GW D3 509	Horizontal	MSX/M160c	850x200	1
GW D3 510	Horizontal	MSX/D125	850x200	1
GW D3 511	Horizontal	MSX/D/M/c 160-250	850x200	1
GW D3 512	Horizontal	MSXE160-250	850x200	1
GW D3 513	Horizontal	MSX/E/M400-630	850x300	1

ACCESSORIES SUPPLIED: galvanised sheet metal support plate, raiser brackets and pre-drilled panel.

CHARACTERISTICS: RAL 7035 grey painted sheet metal panels equipped with rotation hinges and 1/4 turn lock.

NOTE: The kits are suitable for 3P and 4P MCCB's.

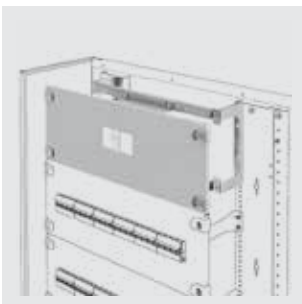

GW D3 517

INSTALLATION KIT FOR MCCB'S UP TO 630 A IN VERTICAL POSITION FIXED VERSION

Code	Installation	Suitable for	Functional dim. LxH (mm)	Pack Carton
Functional width: 600 mm				
GW D3 517	Vertical	MSX/D/M/c 160-250	600x300	1
GW D3 518	Vertical	MSXE160-250	600x300	1
GW D3 519	Vertical	MSX/E/M400-630	600x500	1
Functional width: 850 mm				
GW D3 523	Vertical	MSX/D/M/c 160-250	850x300	1
GW D3 524	Vertical	MSXE160-250	850x300	1
GW D3 525	Vertical	MSX/E/M400-630	850x500	1

ACCESSORIES SUPPLIED: galvanised sheet metal support plate, raiser brackets and pre-drilled panel.

CHARACTERISTICS: RAL 7035 grey painted sheet metal panels equipped with rotation hinges and 1/4 turn lock.

NOTE: The kits are suitable for 3P and 4P MCCB's.

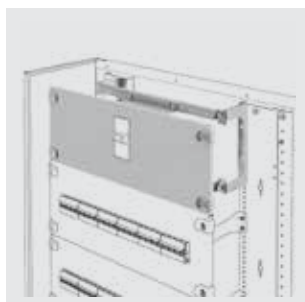

ZC6

INSTALLATION KIT FOR MCCB'S UP TO 630 A FIXED VERSION WITH DIRECT ROTARY HANDLE

Code	Installation	Suitable for	Functional dim. LxH (mm)	Pack Carton
Functional width: 600 mm				
GW D3 531	Horizontal	MSX/M160c	600x200	1
GW D3 532	Horizontal	MSX/M250c	600x200	1
GW D3 533	Horizontal	MSX/D125	600x200	1
GW D3 534	Horizontal	MSX/D160-250	600x200	1
GW D3 535	Horizontal	MSXE160-250	600x200	1
GW D3 536	Horizontal	MSX/E/M400-630	600x300	1

ACCESSORIES SUPPLIED: galvanised sheet metal support plate, raiser brackets and pre-drilled panel.

CHARACTERISTICS: RAL 7035 grey painted sheet metal panels equipped with rotation hinges and 1/4 turn lock.

NOTE: The kits are suitable for 3P and 4P MCCB's.

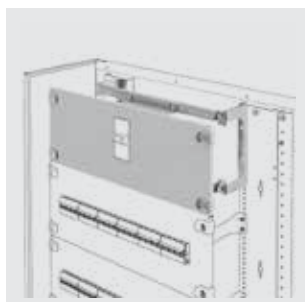

ZC6

INSTALLATION KIT FOR MCCB'S UP TO 630 A FIXED VERSION WITH MOTOR OPERATING DEVICE

Code	Installation	Suitable for	Functional dim. LxH (mm)	Pack Carton
Functional width: 600 mm				
GW D3 541	Horizontal	MSX/D125	600x200	1
GW D3 542	Horizontal	MSX/D/M/c 160-250	600x200	1
GW D3 543	Horizontal	MSXE160-250	600x200	1
GW D3 544	Horizontal	MSX/E/M400-630	600x300	1

ACCESSORIES SUPPLIED: galvanized sheet metal support plate, overhead brackets (if required) and pre-cut panel.

FEATURES: RAL 7035 grey painted sheet metal panels equipped with rotating hinges and 1/4 turn locks.

NOTES: the kits are suitable for 3P and 4P switches.

MSS SWITCH DISCONNECTORS INSTALLATION ON PLATE



GW D3 553

INSTALLATION KIT FOR SWITCH DISCONNECTORS UP TO 630 A FIXED VERSION

Code	Installation	Suitable for	Functional dim. LxH (mm)	Pack Carton
Functional width: 600 mm				
GW D3 551	Horizontal/Vertical	MSS 250	600x300	1
GW D3 553	Horizontal/Vertical	MSS 630	600x400	1
Functional width: 850 mm				
GW D3 552	Horizontal/Vertical	MSS 250	850x300	1
GW D3 554	Horizontal/Vertical	MSS 630	850x400	1

ACCESSORIES SUPPLIED: galvanised sheet metal support plate, raiser brackets and pre-drilled panel.

CHARACTERISTICS: RAL 7035 grey painted sheet metal panels equipped with rotation hinges and 1/4 turn lock.

NOTE: The kits are suitable for 3P and 4P MCCB's.

FRONT PANELS

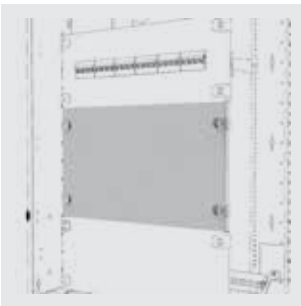

GW D3 324

BLIND FRONT PANELS

Code	Functional dim. LxH (mm)	Pack Carton
GW D3 321	600x100	1
GW D3 322	600x150	1
GW D3 323	600x200	1
GW D3 324	600x300	1
GW D3 325	600x400	1
GW D3 326	600x600	1
GW D3 327	850x100	1
GW D3 328	850x150	1
GW D3 329	850x200	1
GW D3 330	850x300	1
GW D3 331	850x400	1
GW D3 332	850x600	1

CHARACTERISTICS: RAL 7035 grey painted sheet metal panels equipped with rotation hinges and 1/4 turn lock.

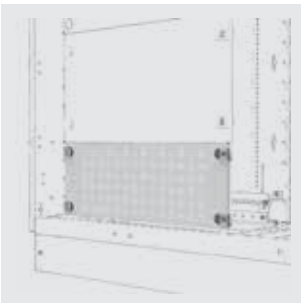

GW D3 333

AERATION FRONT PANELS

Code	Functional dim. LxH (mm)	Pack Carton
GW D3 333	600x200	1
GW D3 334	850x200	1

CHARACTERISTICS: RAL 7035 grey painted sheet metal panels equipped with rotation hinges and 1/4 turn lock.

INTERNAL CONFIGURATION

BACK-MOUNTING PLATES

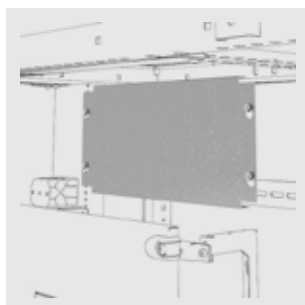

GW D3 336

BACK-MOUNTING PLATE FOR NON-MODULAR DEVICES

Code	Functional dim. LxH (mm)	Pack Carton
GW D3 336	600x200	1
GW D3 337	600x400	1
GW D3 338	600x600	1
GW D3 339	600x800	1
GW D3 340	600x1000	1
GW D3 341	850x200	1
GW D3 342	850x400	1
GW D3 343	850x600	1
GW D3 344	850x800	1
GW D3 345	850x1000	1
GW D3 346	600x1800	1
GW D3 347	600x2000	1
GW D3 348	850x1800	1
GW D3 349	850x2000	1

CHARACTERISTICS: The GWD3346, GWD3347, GWD3348 and GWD3349 bottom plates replace the functional frames and can be adjusted in depth.
NOTES: The GWD3346, GWD3347, GWD3348 and GWD3349 bottom plates are not suitable for boards with a functional depth of 250 mm.

DIVIDERS

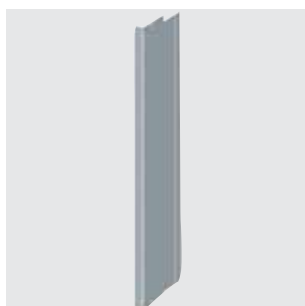

GW D3 366

VERTICAL DIVIDERS

Code	Suitable for structures HxD (mm)	No. of pieces	Pack Carton
GW D3 365	1600x250	1	1
GW D3 366	1800x250	1	1
GW D3 367	2000x250	1	1
GW D3 368	1600x400	1	1
GW D3 369	1800x400	1	1
GW D3 370	2000x400	1	1

CHARACTERISTICS: plastic dividers to realize Form 2 configuration in the case of busbars mounted in the side and external compartment.
NOTES: segregation not suitable for wall-mounting boards.



GW D3 375

HORIZONTAL DIVIDERS

Code	Suitable for structures LxD (mm)	No. of pieces	Pack Carton
GW D3 375	600x200/250	1	1
GW D3 376	850x200/250	1	1
GW D3 377	600x400	1	1
GW D3 378	850x400	1	1

CHARACTERISTICS: metal dividers used to divide the distribution board into sections.
NOTES: GWD3377 and GWD3378 are not suitable for wall-mounting distribution boards.

COMPLEMENTARY ITEMS

ACCESSORIES



GW D3 316

DIN RAIL MOUNTING TOOL

Code	Suitable for	Pack Carton
GW D3 316	Wall and floor boards	1

CHARACTERISTICS: tool required for mounting and disassembling the double EN 50022 (DIN 35) rail on the brackets.

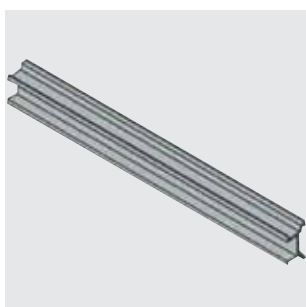

GW D3 317

DEPTH ADAPTER

Code	Length (mm)	Pack Carton
GW D3 317	600	1

CHARACTERISTICS: plastic adapter for compensation of the different installation depths on DIN rail EN 50022 of the modular devices (90 range) and moulded case circuit breakers (MSX range).

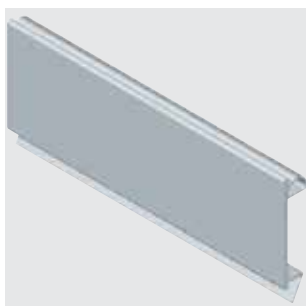

GW D3 318

PAIR OF HOLE DIN ROW COVER

Code	Length (mm)	No. of pieces	Pack Carton
GW D3 318	1000	2	1

CHARACTERISTICS: clip fixing on window panels.



GW D3 226

METAL FRONT FINISHING PROFILES FOR IP30 ENCLOSURES WITHOUT DOOR

Codice	Suitable for structures	No. of pieces	Conf. Imb.
Profile: Horizontal			
GW D3 224	L=600 mm	2	1
GW D3 225	L=850 mm	2	1
Profile: Vertical			
GW D3 226	H=1600 mm	2	1
GW D3 227	H=1800 mm	2	1
GW D3 228	H=2000 mm	2	1



GW 45 413

DIN PROFILES

Code	Section dim. HxD (mm)	Profile	Pack Carton
Length: 24 modules			
GW 45 413	35x15	EN 50022 (DIN 35)	1
GW 45 414	35x15	EN 50035 (G 32)	1
Length: 35 modules			
GW 45 418	35x15	EN 50022 (DIN 35)	1
GW 45 419	35x15	EN 50035 (G 32)	1
Length: 2000 mm			
GW 47 691	35x15	EN 50022 (DIN 35)	1/5
GW 47 692	32x15	EN 50035 (G 32)	1/5

NOTE: 24 and 35 modules DIN guides have fixing holes.
The 2000 mm DIN guides have no fixing holes.

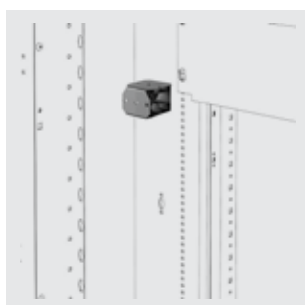

GW D3 426

WIRING VERTICAL TRUNKING SUPPORTS

Code	No. of pieces	Pack Carton
GW D3 426	4	1
GW D3 428	8	1

CHARACTERISTICS: allows the installation of vertical wiring trunkings with heights H=40 mm, H=60 mm or H=80 mm.
NOTES: not suitable for distribution boards with functional depth P= 200/ 250 mm.

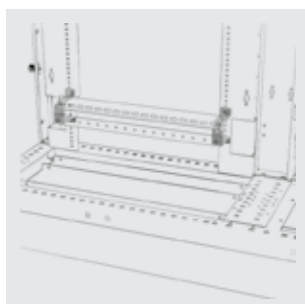

GW D3 471

PAIR OF SUPPORTS FOR HORIZONTAL TERMINAL BLOCK AND EARTH BAR

Code	Suitable for	Pack Carton
GW D3 471	Distribution boards L=600/850 mm	1



GW 46 448

VENTILATION KIT

Code	IP degree	Rated voltage	Fixing hole (mm)	Screws centre distance (mm)	Pack Carton
GW 46 448	IP44	230 V - 50 / 60 Hz	125x117	123x115	1/2

CHARACTERISTICS: the fan takes in air from the outside and introduces it into the distribution board, creating a slight overpressure that prevents foreign particles from entering. Max fan capacity 60 m³/h. Absorbed power equal to 20 W.
APPLICATIONS: forced ventilation in critical thermal conditions.
ACCESSORIES SUPPLIED: drilling template.



GW 46 471

AERATION KIT

Code	IP degree	Fixing hole (mm)	Screws centre distance (mm)	Pack Carton
GW 46 471	IP44	125x117	123x115	1/10

ACCESSORIES SUPPLIED: drilling template.

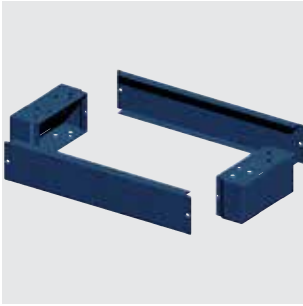

GW D3 407

ADDITIONAL PLINTHS

Code	Suitable for structures LxD (mm)	Pack Carton
GW D3 407	400x250	1
GW D3 408	600x250	1
GW D3 409	850x250	1
GW D3 410	(600+300)x250	1
GW D3 411	400x400	1
GW D3 412	600x400	1
GW D3 413	850x400	1
GW D3 414	(600+300)x400	1

CHARACTERISTICS: additional inspectable plinth (H=100 mm) to facilitate cable entry and/or raise the distribution board



GW D3 217

KIT FOR SIDE-BY-SIDE COUPLING

Code	Suitable for	Pack Carton
GW D3 217	Floor-mounting distribution boards	1

ACCESSORIES SUPPLIED: fixing screws and gasket.



GW D3 121

OVERLAY KIT FOR WALL-MOUNTED BOARDS

Code	Suitable for structures LxD (mm)	Pack Carton
GW D3 121	600x200	1
GW D3 122	(600+200)x200	1
GW D3 123	850x200	1
GW D3 124	600x300	1
GW D3 125	(600+200)x300	1
GW D3 126	850x300	1

NOTES: not suitable for floor-mounting distribution boards.

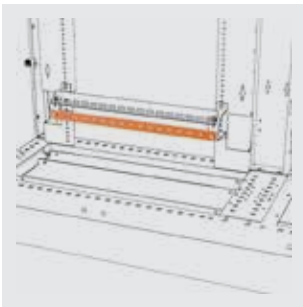

GW 45 565

COPPER EARTH BUSBARS

Code	Suitable for	Installation	Section (mm ²)	Length (mm)	N./diam. of holes	Pack Carton
GW 45 565	Structures L=600 mm	Horizontal	25x4	420	13 Holes M6 and 2 holes ø 6 mm	1
GW 45 566	Structures L=850 mm	Horizontal	25x4	620	21 Holes M6 and 2 holes ø 6 mm	1
GW 45 559	Side compartment/external	Vertical	20x5	1750	68 Holes M6 and 2 holes M12	1

EARTH TERMINAL BLOCKS

Code	Suitable for structures L (mm)	N. terminal and section (mm ²)	Pack Carton
GW 45 568	600	2x(1x35+11x16+13x10)	1
GW 45 569	850	2x(1x35+11x16+13x10)	1

FEATURES: copper busbars with a 20 x 5 section and 6.5 mm hole spacing.



GW 45 568



GW 46 447

DOCUMENT HOLDER POCKET IN SELF-ADHESIVE INSULATING MATERIAL WITH KIT OF BLANK LABELS

Code	Dimensions LxH (mm)	Pack Carton
GW 46 447	230x310	1/10

CHARACTERISTICS: can be inserted in all GEWISS enclosures from dimension 405x500x200 mm upwards.



GW D3 443

LIFTING EYEBOLTS

Code	Suitable for structures D (mm)	Pack Carton
GW D3 443	250	1
GW D3 444	400	1

NOTES: Not suitable for wall-mounting distribution boards.
To lift the wal-mounting distribution boards use the supplied wall mounting brackets.



GW D3 467

PAIR OF CROSSPIECES FOR ATTACHMENT

Code	Type	Suitable for	Pack Carton
GW D3 467	Horizontal	Wall-mounted distribution board with associated side compartment	1
GW D3 468	Horizontal	External compartment	1

SPARE PARTS

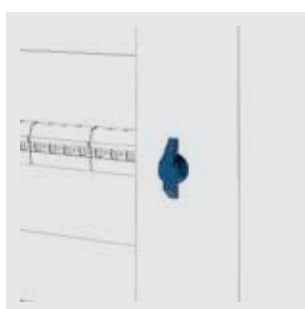

GW D3 434

SPARE PART LOCKS FOR WALL-MOUNTING DISTRIBUTION BOARDS

Code	Suitable to	Pack Carton
GW D3 434	Glass door / blind door	1
GW D3 435	Side compartment door	1

ACCESSORIES SUPPLIED: spare part locks supplied with keys.



GW D3 438

SPARE PART LOCKS FOR FLOOR-MOUNTING DISTRIBUTION BOARDS

Code	Suitable to	Pack Carton
GW D3 437	External compartment door	1
GW D3 438	Glass door / blind door	1

ACCESSORIES SUPPLIED: spare part locks supplied with keys.

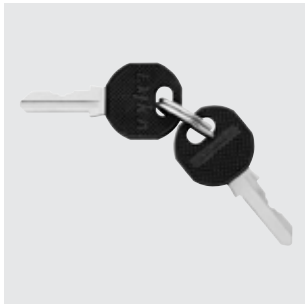

GW D3 439

SPARE PART DOOR KEYS

Codice	Type	Suitable for	Conf. Imb.
GW D3 439	Yale	Wall / floor mounting distribution boards	1
GW D3 440	Triangular	Internal / external compartment	1



GW D3 451

SPARE PART WALL FIXING BRACKETS

Code	Suitable for	Pack Carton
GW D3 451	Wall-mounting distribuion boards	1
GW D3 453	Floor-mounting distribution boards	1



GW D3 454

SPARE PART SCREWS

Code	Screws type	Pack Carton
GW D3 454	M6x10 (25 pcs)	1
GW D3 455	M6x12 (25 pcs)	1

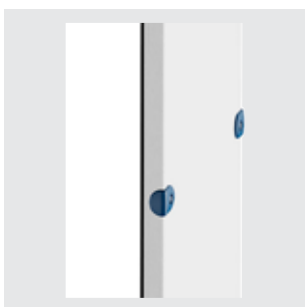

GW D3 456

INSERTS FOR SCREWS

Code	Suitable for	Pack Carton
GW D3 456	Side panels	1

NOTES: Not suitable for wall-mounting distribution boards.

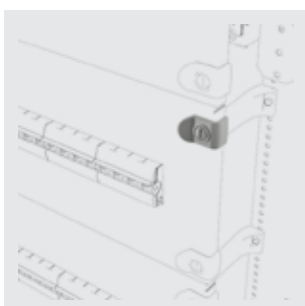

GW D3 457

1/4 TURN LOCKS AND SPARE PART HINGES

Code	Suitable for	No. of pieces	Pack Carton
GW D3 457	Front panels	4 pcs (locks) and 4 pcs (hinges)	1
GW D3 458	Doors for wall-mounting boards	5 pcs (hinges)	1



QDX 630 H



Scan the QR Code and find out all the technical informations.

DIN RAIL: QUICK ASSEMBLY AND DISASSEMBLY



The screw-free snap-in system is simple and immediate thanks to the quick assembly and disassembly of the dual aluminium DIN rails.

EASIER ASSEMBLY AND MAINTENANCE



The side and rear panels can be easily removed in complete safety. The removable front, and fully removable side and rear panels allow the operator to assemble the structure upright.











BUSBAR SYSTEM IN EACH POSITION



The linear bar system (in the switch zone at the bottom of the distribution board) or sloped busbar system (in the cable compartment) is also available in aluminium.

QDX 1600 H

Selection tables

QDX 1600H FLOOR-MOUNTING STRUCTURES				
DIM. FUNCTIONAL (BxH)		600x1800 mm	600x2000 mm	
DEPTH		600 mm	600 mm	800 mm
Modular Capacity	Pitch 150mm	288 mod. (24x12)	312 mod. (24x13)	
	Pitch 200 mm	216 mod. (24x9)	240 mod. (24x10)	
Bases and headboards		GW D3 133	GW D3 133	GW D3 134
Front uprights		GW D3 168	GW D3 169	
Rear uprights and functional frames				
Short rear uprights and functional frames*		GW D3 168R	GW D3 169R6	-
Side panels		GW D3 182	GW D3 185	GW D3 186
Rear panels		GW D3 188	GW D3 189	
Glass doors		GW D3 200	GW D3 201	
Blind doors		GW D3 206	GW D3 207	
Blind doors for side compartment		-	-	-
Side-by-side kit				

NOTE: The 600+300mm wide structures have a side compartment (300 mm wide) dedicated to the cables, terminal block or busbar system.





* Short rear uprights and functional frames are only required in the case of busbars mounted horizontally at the headboard or base

QDX 1600H FLOOR-MOUNTING STRUCTURES

	(600+300)x1800 mm	(600+300)x2000 mm		850x1800 mm	850x2000 mm	
	600 mm	600 mm	800 mm	600 mm	600 mm	800 mm
	288 mod. (24x12)	312 mod. (24x13)		420 mod. (35x12)	455 mod. (35x13)	
	216 mod. (24x9)	240 mod. (24x10)		315 mod. (35x9)	350 mod. (35x10)	
	GW D3 137	GW D3 137	GW D3 138	GW D3 141	GW D3 141	GW D3 142
	GW D3 159	GW D3 162		GW D3 168	GW D3 169	
	GW D3 174	GW D3 177				
	GW D3 174R	GW D8 177R6	-	GW D3 168R	GW D3 169R6	-
	GW D3 182	GW D3 185	GW D3 186	GW D3 182	GW D3 185	GW D3 186
	GW D3 191	GW D3 192		GW D3 194	GW D3 195	
	GW D3 200	GW D3 201		GW D3 203	GW D3 204	
	GW D3 206	GW D3 207		GW D3 209	GW D3 210	
	GW D3 215	GW D3 216		-	-	-

GW D3 217

QDX 1600 H

QDX 1600H EXTERNAL COMPARTMENT				
DIM. FUNCTIONAL (BxH)		400x1800 mm	400x2000 mm	
DEPTH		600 mm	600 mm	800 mm
Bases and headboards		GW D3 145	GW D3 145	GW D3 146
Uprights and functional frames		GW D3 165	GW D3 167	
Side panels		GW D3 182	GW D3 185	GW D3 186
Rear panels		GW D3 197	GW D3 198	
Blind doors		GW D3 212	GW D3 213	

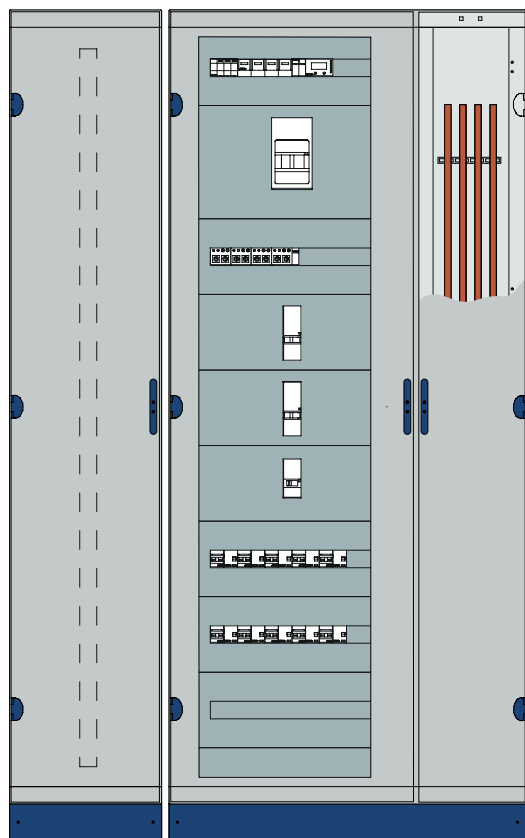
Floor-mounting cabinet IP55 QDX 1600 H with side and external compartment
Functional dimension (LxHxD): 400+(600+300)x2000x600 mm
External dimension (LxHxD): 1395x2200x625 mm

Quantity	Code	Description
2	GW45558	2 COPPER FLAT BARS 630 A 30x10 2000mm
1	GW47691	GUIDE EN 50 022 - DIN 35
1	GWD3137	QDX 1600H FLOOR MOUNT. BASE-HEADBOARD 600+300x600
1	GWD3145	QDX 1600H FLOOR MOUNT. BASE-HEADBOARD 400x600
1	GWD3162	QDX 1600H FLOOR MOUNT. FRONT UPRIGHTS 600+300x2000
1	GWD3167	QDX 1600H FLOOR MOUNT. UPRIGHTS 400x2000
1	GWD3177	DX 1600H FLOOR MOUNT. UPRIGHTS 600+300x2000
1	GWD3185	QDX 630H FLOOR MOUNT. SIDE PANELS 2000x625
1	GWD3192	QDX 630H FLOOR MOUNT. REAR PANEL 600+300x2000
1	GWD3198	QDX 630H FLOOR MOUNT. REAR PANEL 400x2000
1	GWD3201	QDX 630H FLOOR MOUNT. GLASS DOOR 600x2000
1	GWD3213	QDX 630H FLOOR MOUNT. BLIND DOOR 400x2000
1	GWD3216	QDX 630H FLOOR MOUNT. SIDE COMPART.DOOR 600+300x2000
1	GWD3217	QDX 630-1600H FLOOR MOUNT. SIDE-BY-SIDE KIT
5	GWD3302	QDX WINDOW PANEL WITH DIN RAIL 600x200
5	GWD3313	QDX DIN RAIL MOUNT.BRACKETS 90 RANGE - 220MM
1	GWD3316	QDX DIN RAIL MOUNTING TOOL
1	GWD3318	QDX BLANKING MODULES PROFILE 1000mm
1	GWD3321	QDX BLIND FRONT PANEL 600x100
1	GWD3428	QDX WIRING TRUNKING VERTICAL SUPPORTS 8 PIECES
5	GWD3472	QDX1600H SUPPORTS FOR HORIZ. TERMIN.BLOCK P600
1	GWD3501	KIT MSX/M160c 600x200 HORIZ FIX
2	GWD3503	KIT MSX/D/M/c160-250 600x200 HORIZ FIX
1	GWD3505	KIT MSX/E/M400-630 600x300 HORIZ FIX
6	GWD3714	QDX N.20 SCREWS FOR SHAPED BUSBARS M8X25
2	GWD3734	QDX1600H BUSBAR-HOLDER INT/EXT.COMP. 630-800A D600

QDX 1600 H configurazioni

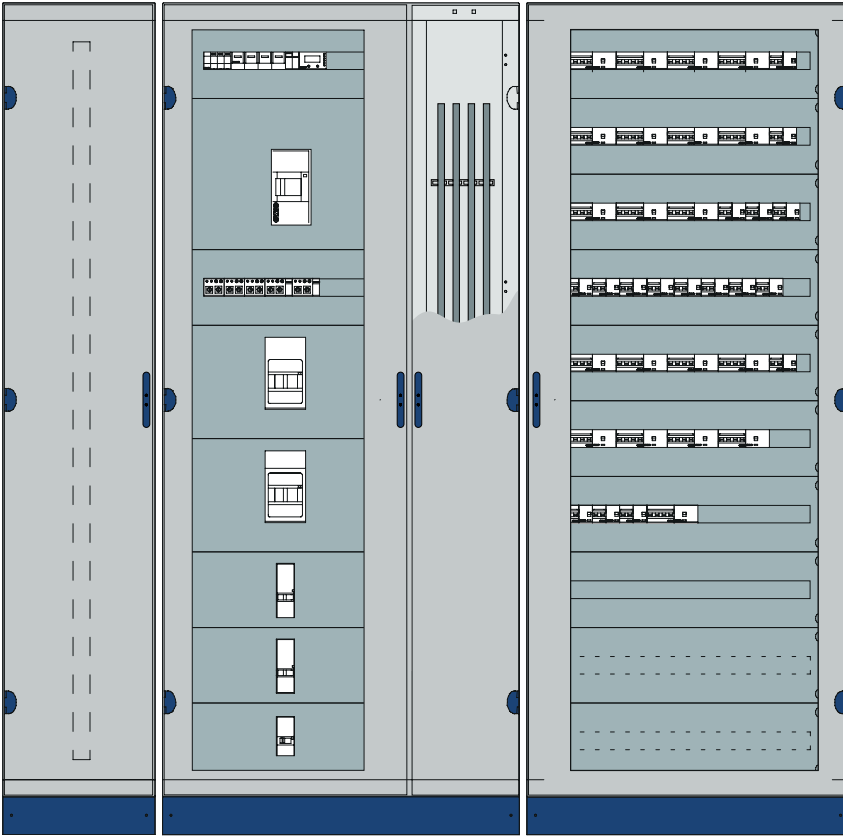

Floor-mounting cabinet IP55 QDX 1600 H

2 columns with side and external compartment

Functional dimension (LxHxD): 400+(600+300)+850x2000x600 mm

External dimension (LxHxD): 2245x2200x625 mm

Quantity	Code	Description
2	GW45418	DIN35 PROFILE B850 QDX630L/H/1600H
1	GW47691	GUIDE EN 50 Q22 - DIN 35
1	GWD3137	QDX 1600H FLOOR MOUNT. BASE-HEADBOARD 600+300x600
1	GWD3141	QDX 1600H FLOOR MOUNT. BASE-HEADBOARD 850x600
1	GWD3145	QDX 1600H FLOOR MOUNT. BASE-HEADBOARD 400x600
1	GWD3162	QDX 1600H FLOOR MOUNT. FRONT UPRIGHTS 600+300x2000
1	GWD3167	QDX 1600H FLOOR MOUNT. UPRIGHTS 400x2000
1	GWD3169	QDX 1600H FLOOR MOUNT. UPRIGHTS 600/850x2000
1	GWD3177	QDX 1600H FLOOR MOUNT. UPRIGHTS 600+300x2000
1	GWD3185	QDX 630H FLOOR MOUNT. SIDE PANELS 2000x625
1	GW03192	QDX 630H FLOOR MOUNT. REAR PANEL 600+300x2000
1	GWD3195	QDX 630H FLOOR MOUNT. REAR PANEL 850x2000
1	GWD3198	QDX 630H FLOOR MOUNT. REAR PANEL 400x2000
1	GWD3201	QDX 630H FLOOR MOUNT. GLASS DOOR 600x2000
1	GWD3204	QDX 630H FLOOR MOUNT. GLASS DOOR 850x2000
1	GWD3213	QDX 630H FLOOR MOUNT. BLIND DOOR 400x2000
1	GWD3216	QDX 630H FLOOR MOUNT. SIDE COMPART.DOOR 600+300x2000
2	GWD3217	QDX 630-1600H FLOOR MOUNT. SIDE-BY-SIDE KIT

Quantity	Code	Description
2	GWD3302	QDX WINDOW PANEL WITH DIN RAIL 600x200
8	GWD3305	QDX WINDOW PANEL WITH DIN RAIL 850x200
10	GWD3313	QDX DIN RAIL MOUNT.BRACKETS 90 RANGE - 220MM
1	GWD3316	QDX DIN RAIL MOUNTING TOOL
1	GWD3318	QDX BLANKING MODULES PROFILE 1000mm
2	GWD3329	QDX BLIND FRONT PANEL 850x200
2	GWD3372	QDX1600H VERTICAL DIVIDER 2000x625
2	GWD3428	QDX WIRING TRUNKING VERTICAL SUPPORTS 8 PIECES
2	GWD3471	QDX SUPPORTS FOR HORIZ. TERMIN.BLOCK/EARTH BAR
5	GWD3472	QDX1600H SUPPORTS FOR HORIZ. TERMIN.BLOCK P600
1	GWD3501	KIT MSX/M160c 600x200 HORIZ FIX
2	GWD3503	KIT MSX/D/M/c160-250 600x200 HORIZ FIX
2	GWD3505	KIT MSX/E/M400-630 600x300 HORIZ FIX
1	GWD3507	KIT MSX/E/M1250 600x400 HORIZ FIX
6	GWD3714	QDX N.20 SCREWS FOR SHAPED BUSBARS M8X25
2	GWD3760	QDX1600H SHAPED BUSBAR-HOLDER AL INT/EXT.COMP. 1600A
2	GWD3794	QDX ALUMINIUM SHAPED BUSBARS 1600A 60x30

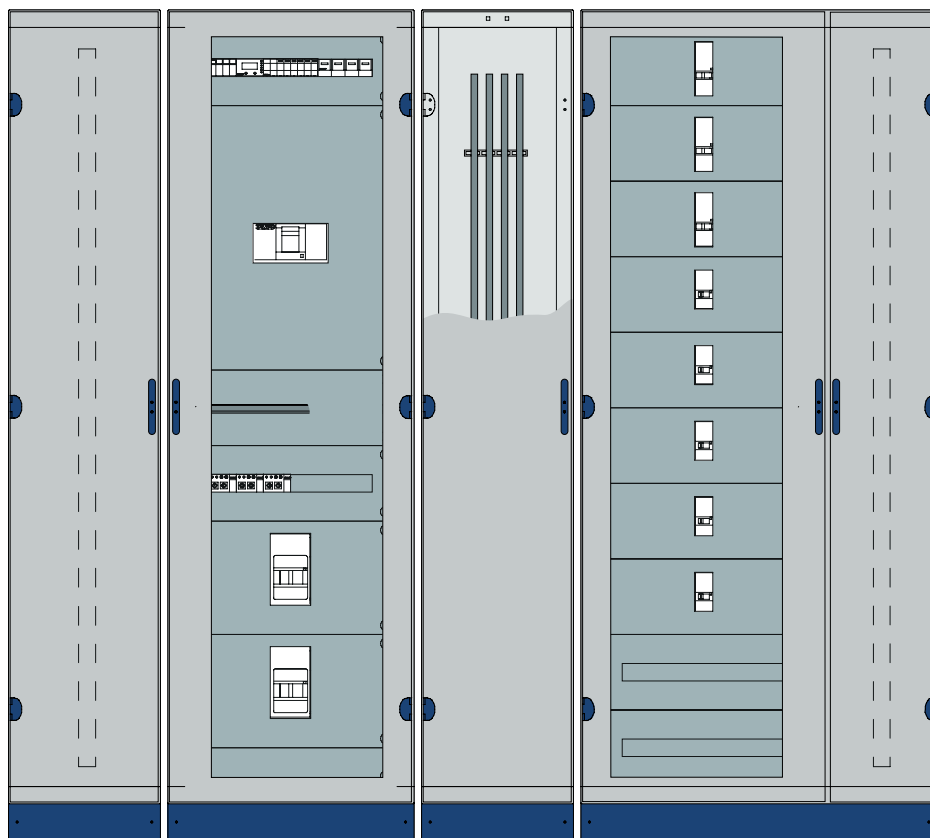
Floor-mounting cabinet IP55 QDX 1600 H
2 columns with side and external compartment
Functional dimension (LxHxD): 400+600+400+(600+300)x2000x800 mm
External dimension (LxHxD): 2445x2200x800 mm

Quantity	Code	Description
2	GW47691	GUIDE EN 50 022 - DIN 35
1	GWD3134	QDX 1600H FLOOR MOUNT. BASE-HEADBOARD 600x800
1	GWD3138	QDX 1600H FLOOR MOUNT. BASE-HEADBOARD 600+300x800
2	GWD3146	QDX 1600H FLOOR MOUNT. BASE-HEADBOARD 400x800
1	GWD3162	QDX 1600H FLOOR MOUNT. FRONT UPRIGHTS 600+300x2000
2	GWD3167	QDX 1600H FLOOR MOUNT. UPRIGHTS 400x2000
1	GWD3169	QDX 1600H FLOOR MOUNT. UPRIGHTS 600/850x2000
1	GWD3177	QDX 1600H FLOOR MOUNT. UPRIGHTS 600+300x2000
1	GWD3186	QDX 630H FLOOR MOUNT. SIDE PANELS 2000x800
1	GWD3189	QDX 630H FLOOR MOUNT. REAR PANEL 600x2000
1	GWD3192	QDX 630H FLOOR MOUNT. REAR PANEL 600+300x2000
2	GWD3198	QDX 630H FLOOR MOUNT. REAR PANEL 400x2000
2	GWD3201	QDX 630H FLOOR MOUNT. GLASS DOOR 600x2000
2	GWD3213	QDX 630H FLOOR MOUNT. BLIND DOOR 400x2000
1	GWD3216	QDX 630H FLOOR MOUNT. SIDE COMPART.DOOR 600+300x2000
3	GWD3217	QDX 630-1600H FLOOR MOUNT. SIDE-BY-SIDE KIT
4	GWD3302	QDX WINDOW PANEL WITH DIN RAIL 600x200
4	GWD3313	QDX DIN RAIL MOUNT.BRACKETS 90 RANGE - 220MM
1	GWD3316	QDX DIN RAIL MOUNTING TOOL

Quantity	Code	Description
1	GWD3318	QDX BLANKING MODULES PROFILE 1000mm
1	GWD3321	QDX BLIND FRONT PANEL 600x100
1	GWD3323	QDX BLIND FRONT PANEL 600x200
2	GWD3428	QDX WIRING TRUNKING VERTICAL SUPPORTS 8 PIECES
2	GWD3472	QDX1600H SUPPORTS FOR HORIZ. TERMIN.BLOCK P600
6	GWD3473	QDX1600H SUPPORTS FOR HORIZ. TERMIN.BLOCK P800
5	GWD3501	KIT MSX/M160c 600x200 HORIZ FIX
3	GWD3503	KIT MSX/D/M/c160-250 600x200 HORIZ FIX
2	GWD3505	KIT MSX/E/M400-630 600x300 HORIZ FIX
1	GWD3522	KIT MSX/E/M1600 600x700 VERT FIX
4	GWD3714	QDX N.20 SCREWS FOR SHAPED BUSBARS M8X25
2	GWD3762	QDX1600H SHAPED BUSBAR-HOLDER AL INT/EXT.COMP. 1600A
2	GWD3763	QDX1600H SHAPED BUSBAR-HOLDER AL 1600A D600-800
1	GWD3767	HORIZ. BARS CROSSPIECES QDX1600H L600
1	GWD3769	HORIZ. BARS CROSSPIECES EXT CABLE COMP. QDX1600H
1	GWD3774	QDX1600H N.4 JOINTS ALUM. SHAPED BUSBARS 1250/1600A
4	GWD3794	QDX ALUMINIUM SHAPED BUSBARS 1600A 60x30

QDX 1600 H

Modular enclosures up to 1600A - IP55

The QDX 1600 H series of cabinets makes robustness its strong point, specifically in all those applications where both a high level of protection from external agents and a high breaking power from the short circuit are required.



STRUCTURES - DEGREE OF PROTECTION WITH DOOR IP55

FLOOR MOUNTING DISTRIBUTION CABINETS - SINGLE BOARD



GW D3 134

BASES AND HEADBOARDS

Code	Functional dim. LxD (mm)	External dim. LxD (mm)	Pack Carton
GW D3 133	600x600	650x625	1
GW D3 134	600x800	650x800	1
GW D3 141	850x600	850x625	1
GW D3 142	850x800	850x800	1

ACCESSORIES: inspectable plinth (supplied loose) inside the package.

NOTES: H=100 mm plinth height.



GW D3 169

UPRIGHTS AND FUNCTIONAL FRAMES

Code	Functional dim. H (mm)	External dim H (mm)	Pack Carton
GW D3 168	1800	1900	1
GW D3 169	2000	2100	1



GW D3 168 R

REDUCED UPRIGHTS AND REDUCED FUNCTIONAL FRAMES

Code	Functional dim. HxD (mm)	External dim. HxD (mm)	Pack Carton
GW D3 168 R	1800x600	1900x625	1
GW D3 169 R6	2000x600	2100x625	1

NOTES: uprights and functional frames to be used only in the case of busbars positioned horizontally at the top or bottom of the distribution board.



GW D3 185

PAIR OF SIDE PANELS

Code	Functional dim. HxD (mm)	Pack Carton
GW D3 182	1800x600	1
GW D3 185	2000x600	1
GW D3 186	2000x800	1



GW D3 222

PAIR OF VENTILATED SIDE PANELS

Code	Functional dim. HxD (mm)	Pack Carton
GW D3 221	1800x600	1
GW D3 222	2000x600	1
GW D3 223	2000x800	1

NOTES: In the case of installation of aerated side panels, the enclosure protection rating is IP30.
Each side panel has 2 surfaces with slits (one lower and one upper) each 58 cm² in size.



GW D3 189

REAR PANELS

Code	Functional dim. LxH (mm)	Pack Carton
GW D3 188	600x1800	1
GW D3 189	600x2000	1
GW D3 194	850x1800	1
GW D3 195	850x2000	1

FLOOR-MOUNTING DISTRIBUTION BOARDS WITH SIDE COMPARTMENT

GW D3 138

BASES AND HEADBOARDS

Code	Functional dim. LxD (mm)	External dim. LxD (mm)	Pack Carton
GW D3 137	(600+300)x600	945x625	1
GW D3 138	(600+300)x800	945x800	1

CHARACTERISTICS: Structures are equipped with an associated side compartment (300 mm wide) for the cables, terminal block or bar system.

COMPONENTS: to secure the cables in the side compartment, use the pair of GWD3461 crosspieces, to be ordered separately.

Inspectable base supplied loose inside the package.

NOTES: Base height = 100 mm.



GW D3 162

FRONT UPRIGHTS

Code	Functional dim. H (mm)	External dim H (mm)	Pack Carton
GW D3 159	1800	1900	1
GW D3 162	2000	2100	1

NOTES: to complete the structure you need the rear uprights and functional frames to be ordered separately.



GW D3 177

REAR UPRIGHTS AND REAR FUNCTIONAL FRAMES

Code	Functional dim. H (mm)	External dim H (mm)	Pack Carton
GW D3 174	1800	1900	1
GW D3 177	2000	2100	1

NOTES: to complete the structure you need the front uprights to be ordered separately.

QDX 1600 H



GW D3 177 R8

REDUCED UPRIGHTS AND REDUCED FUNCTIONAL FRAMES

Code	Functional dim. HxD (mm)	External dim. HxD (mm)	Pack Carton
GW D3 174 R	1800x600	1900x625	1
GW D3 177 R6	2000x600	2100x625	1

NOTES: uprights and functional frames to be used only in the case of busbars positioned horizontally at the top or bottom of the distribution board.



GW D3 192

REAR PANELS

Code	Functional dim. LxH (mm)	Pack Carton
GW D3 191	(600+300)x1800	1
GW D3 192	(600+300)x2000	1

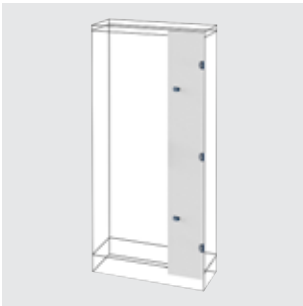

GW D3 216

BLIND DOORS FOR SIDE COMPARTMENT

Code	Suitable for structures LxH (mm)	Pack Carton
GW D3 215	(600+300)x1800	1
GW D3 216	(600+300)x2000	1

ACCESSORIES SUPPLIED: triangular insert key for opening side compartment door.

DOORS



GW D3 201

GLASS DOORS

Code	Suitable for structures LxH (mm)	Pack Carton
GW D3 200	600x1800	1
GW D3 201	600x2000	1
GW D3 203	850x1800	1
GW D3 204	850x2000	1

ACCESSORIES SUPPLIED: rod-mechanism lock door, equipped with rotary handle with security lock and Yale type key.

CHARACTERISTICS: possibility to assemble the door with reversible opening (right/left).

Smoked tempered glass.



GW D3 207

BLIND DOORS

Code	Suitable for structures LxH (mm)	Pack Carton
GW D3 206	600x1800	1
GW D3 207	600x2000	1
GW D3 209	850x1800	1
GW D3 210	850x2000	1

ACCESSORIES SUPPLIED: rod-mechanism lock door, equipped with rotary handle with security lock and Yale type key.

CHARACTERISTICS: possibility to assemble the door with reversible opening (right/left).

EXTERNAL COMPARTMENT



GW D3 146

BASES AND HEADBOARDS

Code	Functional dim. LxD (mm)	External dim. LxD (mm)	Pack Carton
GW D3 145	400x600	400x625	1
GW D3 146	400x800	400x850	1

ACCESSORIES SUPPLIED : to fix the cables in the external compartment, use the pair of crosspieces GWD3462 to be ordered separately. Inspectable plinth (supplied loose) inside the package.
NOTES: H=100 mm plinth height. The external compartment can be put together with the structure by using the special side kit to be ordered separately.



GW D3 167

UPRIGHTS AND FUNCTIONAL FRAMES

Code	Functional dim. LxH (mm)	External dim. LxH (mm)	Pack Carton
GW D3 165	400x1800	400x1900	1
GW D3 167	400x2000	400x2100	1

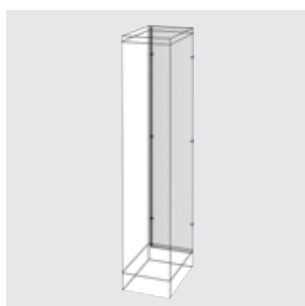

GW D3 198

REAR PANELS

Code	Functional dim. LxH (mm)	Pack Carton
GW D3 197	400x1800	1
GW D3 198	400x2000	1

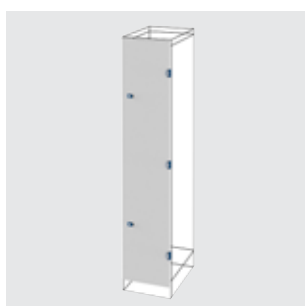

GW D3 213

BLIND DOORS

Code	Suitable for structures LxH (mm)	Pack Carton
GW D3 212	400x1800	1
GW D3 213	400x2000	1

ACCESSORIES SUPPLIED: rod-mechanism lock door, equipped with rotary handle with security lock and Yale type key.
CHARACTERISTICS: possibility to assemble the door with reversible opening (right/left).

FRONT CONFIGURATION

DEVICE INSTALLATION ON DIN RAIL

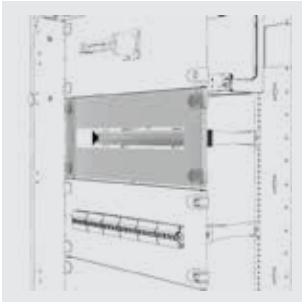

GW D3 302

WINDOW PANELS WITH DIN RAIL

Code	Functional dim. LxH (mm)	Pack Carton
No. modules: 24		
GW D3 301	600x150	1
GW D3 302	600x200	1
GW D3 303	600x300	1
No. modules: 35		
GW D3 304	850x150	1
GW D3 305	850x200	1
GW D3 306	850x300	1

ACCESSORIES SUPPLIED: double EN 50022 (DIN 35) rail in aluminium.

CHARACTERISTICS: RAL 7035 grey painted sheet metal panels equipped with rotation hinges and 1/4 turn lock. **NOTES:** mounting of DIN rail requires brackets (bracket type depends on the depth of the board) to be ordered separately.

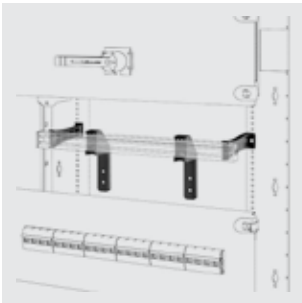

GW D3 313

PAIR OF DIN RAIL MOUNTING BRACKETS

Code	Suitable for structure D (mm)	Suitable for	Pack Carton
GW D3 313	600 / 800	Modular devices range 90	1
GW D3 314	600 / 800	MCCB's MSX/D/M/c 160-250	1

ACCESSORIES SUPPLIED: no. 2 horizontal wiring trunking supports for GWD3313. The supports must be mounted on the back of the of the double EN 50022 (DIN 35) rail.

MSX MOULDED CASE CIRCUIT BREAKERS INSTALLATION ON PLATE

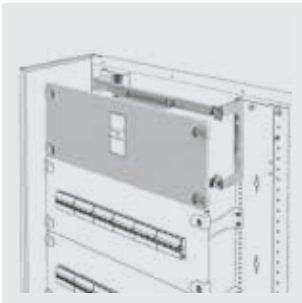

GW D3 504

INSTALLATION KIT FOR MCCB'S UP TO 630 A IN HORIZONTAL POSITION FIXED VERSION

Code	Installation	Suitable for	Functional dim. LxH (mm)	Pack Carton
Functional width: 600 mm				
GW D3 501	Horizontal	MSX/M160c	600x200	1
GW D3 502	Horizontal	MSX/D125	600x200	1
GW D3 503	Horizontal	MSX/D/M/c 160-250	600x200	1
GW D3 504	Horizontal	MSXE160-250	600x200	1
GW D3 505	Horizontal	MSX/E/M400-630	600x300	1
Functional width: 850 mm				
GW D3 509	Horizontal	MSX/M160c	850x200	1
GW D3 510	Horizontal	MSX/D125	850x200	1
GW D3 511	Horizontal	MSX/D/M/c 160-250	850x200	1
GW D3 512	Horizontal	MSXE160-250	850x200	1
GW D3 513	Horizontal	MSX/E/M400-630	850x300	1

ACCESSORIES SUPPLIED: galvanised sheet metal support plate, raiser brackets and pre-drilled panel.

CHARACTERISTICS: RAL 7035 grey painted sheet metal panels equipped with rotation hinges and 1/4 turn lock.

NOTE: The kits are suitable for 3P and 4P MCCB's.

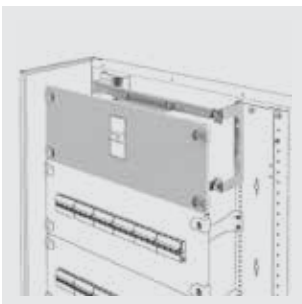

GW D3 506

INSTALLATION KIT FOR MCCB'S UP TO 1600 A IN HORIZONTAL POSITION FIXED VERSION

Code	Installation	Suitable for	Functional dim. LxH (mm)	Pack Carton
Functional width: 600 mm				
GW D3 506	Horizontal	MSXE/M1000	600x400	1
GW D3 507	Horizontal	MSXE/M1250	600x400	1
GW D3 508	Horizontal	MSXE/M 1600	600x400	1
Functional width: 850 mm				
GW D3 514	Horizontal	MSXE/M1000	850x400	1
GW D3 515	Horizontal	MSXE/M1250	850x400	1
GW D3 516	Horizontal	MSXE/M 1600	850x400	1

ACCESSORIES SUPPLIED: galvanised sheet metal support plate, raiser brackets and pre-drilled panel.

CHARACTERISTICS: RAL 7035 grey painted sheet metal panels equipped with rotation hinges and 1/4 turn lock.

NOTE: The kits are suitable for 3P and 4P MCCB's.

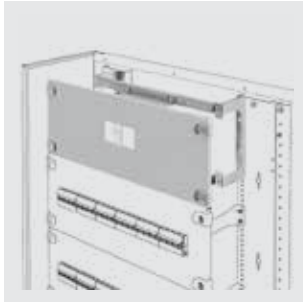

GW D3 517

INSTALLATION KIT FOR MCCB'S UP TO 630 A IN VERTICAL POSITION FIXED VERSION

Code	Installation	Suitable for	Functional dim. LxH (mm)	Pack Carton
Functional width: 600 mm				
GW D3 517	Vertical	MSX/D/M/c 160-250	600x300	1
GW D3 518	Vertical	MSXE160-250	600x300	1
GW D3 519	Vertical	MSX/E/M400-630	600x500	1
Functional width: 850 mm				
GW D3 523	Vertical	MSX/D/M/c 160-250	850x300	1
GW D3 524	Vertical	MSXE160-250	850x300	1
GW D3 525	Vertical	MSX/E/M400-630	850x500	1

ACCESSORIES SUPPLIED: galvanised sheet metal support plate, raiser brackets and pre-drilled panel.
CHARACTERISTICS: RAL 7035 grey painted sheet metal panels equipped with rotation hinges and 1/4 turn lock.
NOTE: The kits are suitable for 3P and 4P MCCB's.

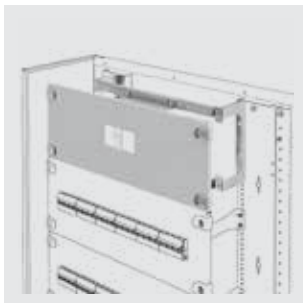

GW D3 520

INSTALLATION KIT FOR MCCB'S UP TO 1600 A IN VERTICAL POSITION FIXED VERSION

Code	Installation	Suitable for	Functional dim. LxH (mm)	Pack Carton
Functional width: 600 mm				
GW D3 520	Vertical	MSXE/M1000	600x600	1
GW D3 521	Vertical	MSXE/M1250	600x700	1
GW D3 522	Vertical	MSXE/M 1600	600x700	1
Functional width: 850 mm				
GW D3 526	Vertical	MSXE/M1000	850x600	1
GW D3 527	Vertical	MSXE/M1250	850x700	1
GW D3 528	Vertical	MSXE/M 1600	850x700	1

ACCESSORIES SUPPLIED: galvanised sheet metal support plate, raiser brackets and pre-drilled panel.
CHARACTERISTICS: RAL 7035 grey painted sheet metal panels equipped with rotation hinges and 1/4 turn lock.
NOTE: The kits are suitable for 3P and 4P MCCB's.

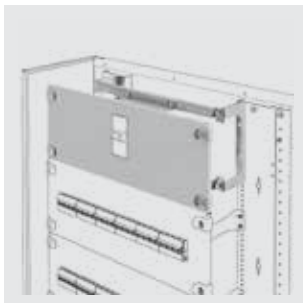

ZC6

INSTALLATION KIT FOR MCCB'S UP TO 630 A FIXED VERSION WITH DIRECT ROTARY HANDLE

Code	Installation	Suitable for	Functional dim. LxH (mm)	Pack Carton
Functional width: 600 mm				
GW D3 531	Horizontal	MSX/M160c	600x200	1
GW D3 532	Horizontal	MSX/M250c	600x200	1
GW D3 533	Horizontal	MSX/D125	600x200	1
GW D3 534	Horizontal	MSX/D160-250	600x200	1
GW D3 535	Horizontal	MSXE160-250	600x200	1
GW D3 536	Horizontal	MSX/E/M400-630	600x300	1

ACCESSORIES SUPPLIED: galvanised sheet metal support plate, raiser brackets and pre-drilled panel.
CHARACTERISTICS: RAL 7035 grey painted sheet metal panels equipped with rotation hinges and 1/4 turn lock.
NOTE: The kits are suitable for 3P and 4P MCCB's.

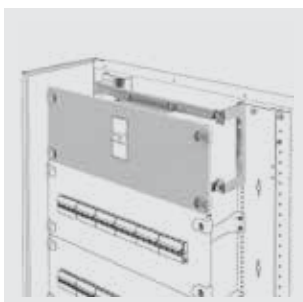

GW D3 537

INSTALLATION KIT FOR MCCB'S UP TO 1600 A FIXED VERSION WITH DIRECT ROTARY HANDLE

Code	Installation	Suitable for	Functional dim. LxH (mm)	Pack Carton
Functional width: 600 mm				
GW D3 537	Horizontal	MSXE/M1000	600x400	1
GW D3 538	Horizontal	MSXE/M1250	600x400	1
GW D3 539	Vertical	MSXE/M 1600	600x700	1

ACCESSORIES SUPPLIED: galvanised sheet metal support plate, raiser brackets and pre-drilled panel.
CHARACTERISTICS: RAL 7035 grey painted sheet metal panels equipped with rotation hinges and 1/4 turn lock.
NOTE: The kits are suitable for 3P and 4P MCCB's.

QDX 1600 H

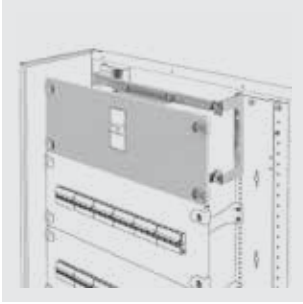

ZC6

INSTALLATION KIT FOR MCCB'S UP TO 630 A FIXED VERSION WITH MOTOR OPERATING DEVICE

Code	Installation	Suitable for	Functional dim. LxH (mm)	Pack Carton
Functional width: 600 mm				
GW D3 541	Horizontal	MSX/D125	600x200	1
GW D3 542	Horizontal	MSX/D/M/c 160-250	600x200	1
GW D3 543	Horizontal	MSXE160-250	600x200	1
GW D3 544	Horizontal	MSX/E/M400-630	600x300	1

ACCESSORIES SUPPLIED: galvanized sheet metal support plate, overhead brackets (if required) and pre-cut panel.

FEATURES: RAL 7035 grey painted sheet metal panels equipped with rotating hinges and 1/4 turn locks.

NOTES: the kits are suitable for 3P and 4P switches.

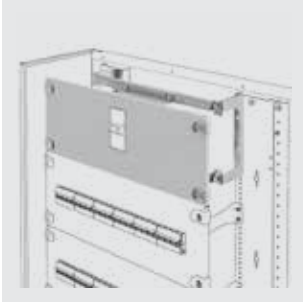

GW D3 545

INSTALLATION KIT FOR MCCB'S UP TO 1600 A FIXED VERSION WITH MOTOR OPERATING DEVICE

Code	Installation	Suitable for	Functional dim. LxH (mm)	Pack Carton
Functional width: 600 mm				
GW D3 545	Horizontal	MSXE/M1000	600x400	1
GW D3 546	Horizontal	MSXE/M1250	600x400	1
GW D3 547	Vertical	MSXE/M 1600	600x700	1

ACCESSORIES SUPPLIED: galvanised sheet metal support plate, raiser brackets and pre-drilled panel.

CHARACTERISTICS: RAL 7035 grey painted sheet metal panels equipped with rotation hinges and 1/4 turn lock.

NOTE: The kits are suitable for 3P and 4P MCCB's.

MSS SWITCH DISCONNECTORS INSTALLATION ON PLATE



GW D3 553

INSTALLATION KIT FOR SWITCH DISCONNECTORS UP TO 630 A FIXED VERSION

Code	Installation	Suitable for	Functional dim. LxH (mm)	Pack Carton
Functional width: 600 mm				
GW D3 551	Horizontal/Vertical	MSS 250	600x300	1
GW D3 553	Horizontal/Vertical	MSS 630	600x400	1
Functional width: 850 mm				
GW D3 552	Horizontal/Vertical	MSS 250	850x300	1
GW D3 554	Horizontal/Vertical	MSS 630	850x400	1

ACCESSORIES SUPPLIED: galvanised sheet metal support plate, raiser brackets and pre-drilled panel.

CHARACTERISTICS: RAL 7035 grey painted sheet metal panels equipped with rotation hinges and 1/4 turn lock.

NOTE: The kits are suitable for 3P and 4P MCCB's.

FRONT PANELS

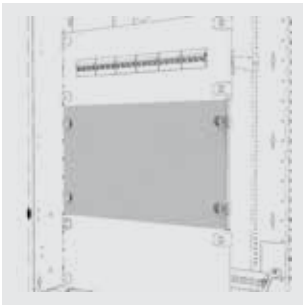

GW D3 324

BLIND FRONT PANELS

Code	Functional dim. LxH (mm)	Pack Carton
GW D3 321	600x100	1
GW D3 322	600x150	1
GW D3 323	600x200	1
GW D3 324	600x300	1
GW D3 325	600x400	1
GW D3 326	600x600	1
GW D3 327	850x100	1
GW D3 328	850x150	1
GW D3 329	850x200	1
GW D3 330	850x300	1
GW D3 331	850x400	1
GW D3 332	850x600	1

CHARACTERISTICS: RAL 7035 grey painted sheet metal panels equipped with rotation hinges and 1/4 turn lock.

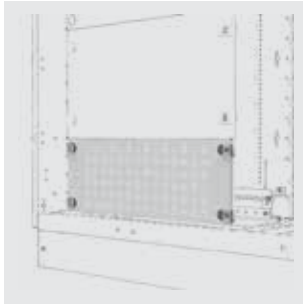

GW D3 333

AERATION FRONT PANELS

Code	Functional dim. LxH (mm)	Pack Carton
GW D3 333	600x200	1
GW D3 334	850x200	1

CHARACTERISTICS: RAL 7035 grey painted sheet metal panels equipped with rotation hinges and 1/4 turn lock.

INTERNAL CONFIGURATION

BACK-MOUNTING PLATES

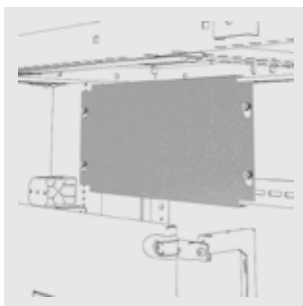

GW D3 336

BACK-MOUNTING PLATE FOR NON-MODULAR DEVICES

Code	Functional dim. LxH (mm)	Pack Carton
GW D3 336	600x200	1
GW D3 337	600x400	1
GW D3 338	600x600	1
GW D3 339	600x800	1
GW D3 340	600x1000	1
GW D3 341	850x200	1
GW D3 342	850x400	1
GW D3 343	850x600	1
GW D3 344	850x800	1
GW D3 345	850x1000	1
GW D3 346	600x1800	1
GW D3 347	600x2000	1
GW D3 348	850x1800	1
GW D3 349	850x2000	1

CHARACTERISTICS: The GWD3346, GWD3347, GWD3348 and GWD3349 bottom plates replace the functional frames and can be adjusted in depth.

DIVIDERS

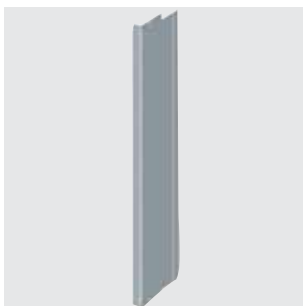

GW D3 371

VERTICAL DIVIDERS

Code	Suitable for structures HxD (mm)	No. of pieces	Pack Carton
GW D3 371	1800x600	1	1
GW D3 372	2000x600	1	1
GW D3 374	2000x800	1	1

CHARACTERISTICS: plastic dividers to realize Form 2 configuration in the case of busbars mounted in the side and external compartment.



GW D3 377

HORIZONTAL DIVIDERS

Code	Suitable for structures LxD (mm)	No. of pieces	Pack Carton
GW D3 377	600x400	1	1
GW D3 378	850x400	1	1

CHARACTERISTICS: metal dividers used to divide the distribution board into sections.

COMPLEMENTARY ITEMS

ACCESSORIES



GW D3 316

DIN RAIL MOUNTING TOOL

Code	Suitable for	Pack Carton
GW D3 316	Floor-mounting distribution boards	1

CHARACTERISTICS: tool required for mounting and disassembling the double EN 50022 (DIN 35) rail on the brackets.



GW D3 317

DEPTH ADAPTER

Code	Length (mm)	Pack Carton
GW D3 317	600	1

CHARACTERISTICS: plastic adapter for compensation of the different installation depths on DIN rail EN 50022 of the modular devices (90 range) and moulded case circuit breakers (MSX range).

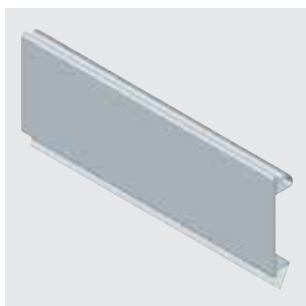

GW D3 318

PAIR OF HOLE DIN ROW COVER

Code	Length (mm)	No. of pieces	Pack Carton
GW D3 318	1000	2	1

CHARACTERISTICS: clip fixing on window panels.



GW D3 228

METAL FRONT FINISHING PROFILES FOR IP30 ENCLOSURES WITHOUT DOOR

Codice	Suitable for structures	No. of pieces	Conf. Imb.
Profile: Horizontal			
GW D3 224	L=600 mm	2	1
GW D3 225	L=850 mm	2	1
Profile: Vertical			
GW D3 227	H=1800 mm	2	1
GW D3 228	H=2000 mm	2	1



GW 45 413

DIN PROFILES

Code	Section dim. HxD (mm)	Profile	Pack Carton
Length: 24 modules			
GW 45 413	35x15	EN 50022 (DIN 35)	1
GW 45 414	35x15	EN 50035 (G 32)	1
Length: 35 modules			
GW 45 418	35x15	EN 50022 (DIN 35)	1
GW 45 419	35x15	EN 50035 (G 32)	1
Length: 2000 mm			
GW 47 691	35x15	EN 50022 (DIN 35)	1/5
GW 47 692	32x15	EN 50035 (G 32)	1/5

NOTE: 24 and 35 modules DIN guides have fixing holes.
The 2000 mm DIN guides have no fixing holes.

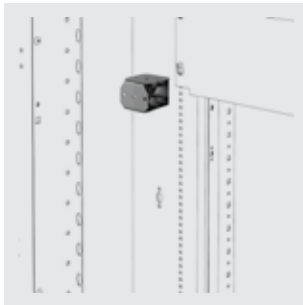

GW D3 426

WIRING VERTICAL TRUNKING SUPPORTS

Code	No. of pieces	Pack Carton
GW D3 426	4	1
GW D3 428	8	1

CHARACTERISTICS: allows the installation of vertical wiring trunking with heights H=40 mm, H=60 mm or H=80 mm.

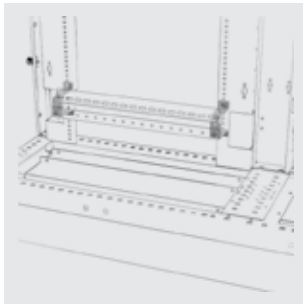

GW D3 471

PAIR OF SUPPORTS FOR HORIZONTAL TERMINAL BLOCK AND EARTH BAR

Code	Suitable for	Pack Carton
GW D3 471	Distribution boards L=600/850 mm	1



GW D3 472

PAIR OF SUPPORTS FOR VERTICAL TERMINAL BLOCK

Code	Suitable for structures D (mm)	Pack Carton
GW D3 472	600	1
GW D3 473	800	1



GW 46 448

VENTILATION KIT

Code	IP degree	Rated voltage	Fixing hole (mm)	Screws centre distance (mm)	Pack Carton
GW 46 448	IP44	230 V - 50 / 60 Hz	125x117	123x115	1/2

CHARACTERISTICS: the fan takes in air from the outside and introduces it into the distribution board, creating a slight overpressure that prevents foreign particles from entering. Max fan capacity 60 m³/h. Absorbed power equal to 20 W.

APPLICATIONS: forced ventilation in critical thermal conditions.

ACCESSORIES SUPPLIED: drilling template.

QDX 1600 H



GW 46 471

AERATION KIT

Code	IP degree	Fixing hole (mm)	Screws centre distance (mm)	Pack Carton
GW 46 471	IP44	125x117	123x115	1/10

ACCESSORIES SUPPLIED: drilling template.



ZC6

ADDITIONAL PLINTHS

Code	Suitable for structures LxD (mm)	Pack Carton
GW D3 415	400x600	1
GW D3 416	600x600	1
GW D3 417	850x600	1
GW D3 418	(600+300)x600	1
GW D3 419	400x800	1
GW D3 420	600x800	1
GW D3 421	850x800	1
GW D3 422	(600+300)x800	1

CHARACTERISTICS: additional inspectable plinth (H=100 mm) to facilitate cable entry and/or raise the distribution board



GW D3 217

KIT FOR SIDE-BY-SIDE COUPLING

Code	Suitable for	Pack Carton
GW D3 217	Floor-mounting distribution boards	1

ACCESSORIES SUPPLIED: fixing screws and gasket.

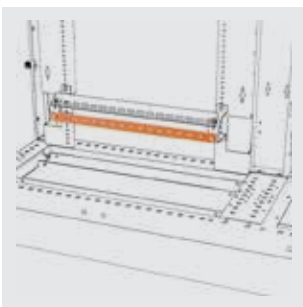

GW 45 565

COPPER EARTH BUSBARS

Code	Suitable for	Installation	Section (mm ²)	Length (mm)	N./diam. of holes	Pack Carton
GW 45 565	Structures L=600 mm	Horizontal	25x4	420	13 Holes M6 and 2 holes ø 6 mm	1
GW 45 566	Structures L=850 mm	Horizontal	25x4	620	21 Holes M6 and 2 holes ø 6 mm	1
GW 45 560	Side compartment/external	Vertical	60x5	1750	140 holes ø 10,5 mm	1



GW 45 568

EARTH TERMINAL BLOCKS

Code	Suitable for structures L (mm)	N. terminal and section (mm ²)	Pack Carton
GW 45 568	600	2x(1x35+11x16+13x10)	1
GW 45 569	850	2x(1x35+11x16+13x10)	1

FEATURES: copper busbars with a 20 x 5 section and 6.5 mm hole spacing.



GW 46 447

DOCUMENT HOLDER POCKET IN SELF-ADHESIVE INSULATING MATERIAL WITH KIT OF BLANK LABELS

Code	Dimensions LxH (mm)	Pack Carton
GW 46 447	230x310	1/10

CHARACTERISTICS: can be inserted in all GEWISS enclosures from dimension 405x500x200 mm upwards.



GW D3 445

LIFTING EYEBOLTS

Code	Suitable for structures D (mm)	Pack Carton
GW D3 445	600 / 800	1



GW D3 461

PAIR OF FIXING CROSSPIECES

Code	Type	Suitable for	Pack Carton
GW D3 461	Horizontal	Side compartment	1
GW D3 462	Horizontal	External compartment	1
GW D3 463	Horizontal	Structures L=600	1
GW D3 464	Horizontal	Structures L=850	1
GW D3 465	Lateral	Structures D=600	1
GW D3 466	Lateral	Structures D=800	1

SPARE PARTS



GW D3 437

SPARE PART LOCK

Code	Suitable to	Pack Carton
GW D3 437	External compartment door	1
GW D3 438	Glass door / blind door	1

ACCESSORIES SUPPLIED: spare part locks supplied with keys.



GW D3 439

SPARE PART DOOR KEYS

Codice	Type	Suitable for	Conf. Imb.
GW D3 439	Yale	Wall / floor mounting distribution boards	1
GW D3 440	Triangular	Internal / external compartment	1



GW D3 454

SPARE PART SCREWS

Code	Screws type	Pack Carton
GW D3 454	M6x10 (25 pcs)	1
GW D3 455	M6x12 (25 pcs)	1

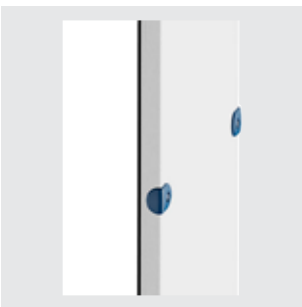

GW D3 456

INSERTS FOR SCREWS

Code	Suitable for	Pack Carton
GW D3 456	Side panels	1

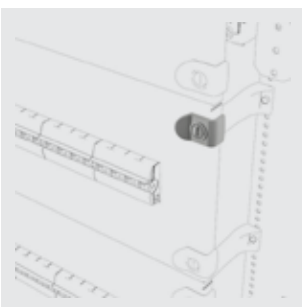

GW D3 457

1/4 TURN LOCKS AND SPARE PART HINGES

Code	Suitable for	No. of pieces	Pack Carton
GW D3 457	Front panels	4 pcs (locks) and 4 pcs (hinges)	1



QDX 1600 H



Scan the QR Code and find out all the technical informations.

DIN RAIL: QUICK ASSEMBLY AND DISASSEMBLY



The screw-free snap-in system is simple and immediate thanks to the quick assembly and disassembly of the dual aluminium DIN rails.

EASIER ASSEMBLY AND MAINTENANCE



The side panels and the rear panel can be easily removed in complete safety. The removable front and fully removable side and rear panels allow the operator to assemble the structure upright.

BUSBAR SYSTEM IN EACH POSITION



Fast, cost-effective and versatile, the universal aluminium busbar system allows the maximum customisation of GEWISS panels, thanks to the various positioning configurations.

47 BUSBAR

QDX 630L WALL MOUNTING AND FLOOR-MOUNTING DISTRIBUTION BOARDS

Selection tables

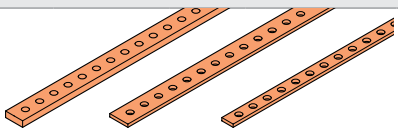
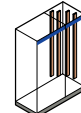
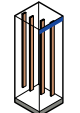
FLAT COPPER BUSBARS											BUSBAR HOLDER WITH CROSSPIECE (1 CODE = 2 PIECES)		
											DEPTH 200 MM		
													
BUSBAR (1 CODE = 2 PIECES)					CENTRE DISTANCE					Internal compartment	External compartment		
Capacity (A) depending on IP rating		Code	Cross-section BxH (mm)	N. bars per phase	Maximum centre distance between busbar holders (mm) depending on max.lcc (kA)						-	B=300 mm	B=400 mm
IP30	IP40/43				6kA	10kA	16kA	20kA	25kA				
300	250	GW 45 551 (1000 mm)	20X5 M6	1	900	500	300	250	-	GW D3 701	GW D3 702	GW D3 707	
		GW 45 555 (1750 mm)											
450	400	GW 45 553 (1000 mm)	30X5 M6	1	1000	650	400	300	-	GW D3 701	GW D3 702	GW D3 707	
		GW 45 557 (1750 mm)											
730	630	GW 45 554 (1000 mm)	30X10 M6	1	1000	1000	950	750	600	-	-	-	
		GW 45 558 (1750 mm)											

⁽¹⁾ Only form 1

QDX 630H WALL MOUNTING DISTRIBUTION BOARDS

Selection tables

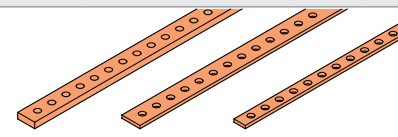
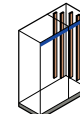
FLAT COPPER BUSBARS											BUSBAR HOLDER WITH CROSSPIECE (1 CODE = 2 PIECES)		
											DEPTH 200 MM		
													
BUSBAR (1 CODE = 2 PIECES)					CENTRE DISTANCE					Side compartment			
Capacity (A) depending on IP rating		Type	Code	Cross-section BxH (mm)	N. bars per phase	Maximum centre distance between busbar holders (mm) depending on max.lcc (kA)					B=600+200 mm		
IP30	IP55					6kA	10kA	16kA	20kA				
300	250	Flat	GW 45 551 (1000 mm)	20x5 M6	1	900	500	300	250	GW D3 702			
			GW 45 555 (1750 mm)										
450	400	Flat	GW 45 553 (1000 mm)	30x5 M6	1	1000	650	400	300	GW D3 702			
			GW 45 557 (1750 mm)										

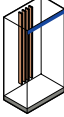
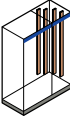
FLAT COPPER BUSBARS			
BUSBAR HOLDER WITH CROSSPIECE (1 CODE = 2 PIECES)			
DEPTH 300 MM			
			
Single distribution board ⁽¹⁾		Internal compartment	
B=600 mm	B=850 mm	B=850 mm	B=400 mm
GW D3 703	GW D3 705	GW D3 709	GW D3 707
GW D3 704	GW D3 706	-	GW D3 708

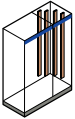
BUSBAR HOLDER WITH CROSSPIECE (1 CODE = 2 PIECES)	
DEPTH 300 MM	
	
Side compartment	
B=600+200 mm	
GW D3 702	

47 BUSBAR

QDX 630H FLOOR-MOUNTING DISTRIBUTION BOARDS

Selection tables

FLAT COPPER BUSBARS											BUSBAR HOLDER WITH CROSSPIECE (1 CODE = 2 PIECES)			
											DEPTH 250 MM			
											Single distribution board ⁽¹⁾	Side compartment	External compartment	
BUSBAR (1 CODE= 2 PIECES)					CENTRE DISTANCE									
Capacity (A) depending on IP rating		Busbar Type	Code	Cross-section BxH (mm)	N. bars per phase	Maximum centre distance between busbar holders (mm) depending on max.lcc (kA)					Single distribution board ⁽¹⁾		Side compartment	External compartment
IP30	IP55					6kA	10kA	16kA	20kA	25kA	B=600 mm	B=850 mm		
300	250	Flat	GW 45 551 (1000 mm)	20X5 M6	1	900	500	300	250	-	GW D3 721	GW D3 722	GW D3 723	GW D3 724
			GW 45 555 (1750 mm)											
450	400	Flat	GW 45 553 (1000 mm)	30X5 M6	1	1000	650	400	300	-	GW D3 721	GW D3 722	GW D3 723	GW D3 724
			GW 45 557 (1750 mm)											
730	630	Flat	GW 45 554 (1000 mm)	30X10 M6	1	1000	1000	950	750	600	-	-	-	-
			GW 45 558 (1750 mm)											

⁽¹⁾ Only form 1

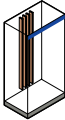
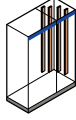
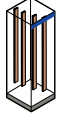
FLAT COPPER BUSBARS				
BUSBAR HOLDER WITH CROSSPIECE (1 CODE = 2 PIECES)				
DEPTH 400 MM				
				
	Single distribution board ⁽¹⁾		Side compartment	External compartment
	B=600 mm	B=850 mm	B=600+300 mm	B=400 mm
	GW D3 721	GW D3 722	GW D3 723	GW D3 724
	GW D3 725	GW D3 726	GW D3 727	GW D3 728

47 BUSBAR

QDX 1600H FLOOR-MOUNTING CABINETS

Selection tables

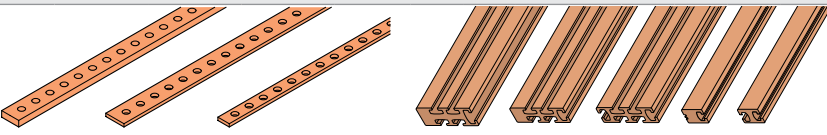
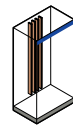
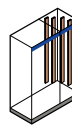
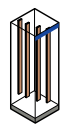
FLAT AND SHAPED COPPER BARS															BUSBAR HOLDER WITH CROSSPIECE (1 CODE = 2 PIECES)						
															DEPTH 600 MM						
																					
BUSBAR (1 CODE= 2 PIECES)					CENTRE DISTANCE										Single distribution board ⁽¹⁾		Side compartment	External compartment			
					Maximum centre distance between busbar holders (mm) depending on max.lcc (kA)										B=600 mm	B=850 mm	B=600+300 mm	B=400 mm			
IP30	IP55	Busbar Type	Code	Cross section BxH (mm)	N. bars per phase	6kA	10kA	16kA	20kA	25kA	35kA	50kA	70kA	85kA	B=600 mm	B=850 mm	B=600+300 mm	B=400 mm			
300	250	Flat	GW 45 551 (1000 mm) GW 45 555 (1750 mm)	20x5 M6	1	900	500	300	250	-	-	-	-	-	GW D3 721	GW D3 722	GW D3 733				
450	400	Flat	GW 45 553 (1000 mm) GW 45 557 (1750 mm)	30x5 M6	1	1000	650	400	300	-	-	-	-								
730	630	Flat	GW45554 (1000 mm) GW45558 (1750 mm)	30x10 M6	1	1000	1000	950	750	600	-	-	-	-				GW D3 729	GW D3 731	GW D3 734	
900	800	Flat	GW 49 678 (1750 mm)	60x5 Ø10.5	1	-	-	650	500	400	250	200	-	-	GW D3 730	GW D3 732	GW D3 735				
1350	1250	Flat	GW 49 679 (1750 mm)	100x5 Ø10.5	1	-	-	850	700	500	350	250	-								
1700	1600	Flat	GW 49 680 (1750 mm)	100x10 Ø10.5	1	-	-	900	900	900	750	500	350	300							
900	800	Shaped	GW D3 781 (1830 mm)	50x30 M8 sealing drive-screws	1	-	-	1000	900	750	500	350	-	-	GW D3 741	GW D3 742	GW D3 743				
1350	1250	Shaped	GW D3 782 (1830 mm)	50x30 M8 sealing drive-screws	1	-	-	1000	1000	900	650	450	300	-							
1700	1600	Shaped	GW D3 783 (1830 mm)	50x30 M8 sealing drive-screws	1	-	-	1000	1000	1000	800	550	400	-							

⁽¹⁾ Only form 1

FLAT AND SHAPED COPPER BARS

BUSBAR HOLDERS AND CROSSPIECES (1 CODE = 2 PIECES)

DEPTH 800 MM												DEPTH 600/800 MM				DEPTH 800 MM		
Single distribution board ⁽¹⁾		Side compartment	External compartment	Busbar holder	Crosspieces			Busbar holder	Crosspieces									
B=600 mm	B=850 mm	B=600+300 mm	B=400 mm	-	B=600 / 600+300 mm	B=850 mm	B=400 mm	-	B=600 mm	B=850 mm	B=400 mm							
GW D3 721	GW D3 722	GW D3 736		-	-	-	-	-	-	-	-							
GW D3 729	GW D3 731	GW D3 737		-	-	-	-	-	-	-	-							
GW D3 730	GW D3 732	GW D3 738		GW D3 745	GW D3 747	GW D3 748	GW D3 749	GW D3 745	GW D3 767	GW D3 768	GW D3 769							
GW D3 741	GW D3 742	GW D3 744		GW D3 746	GW D3 747	GW D3 748	GW D3 749	GW D3 746	GW D3 767	GW D3 768	GW D3 769							

47 BUSBAR

QDX 630H- 1600H FLOOR-MOUNTING DISTRIBUTION BOARDS

Selection tables

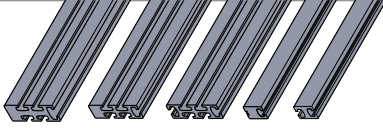
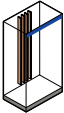
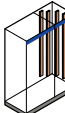
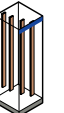
SHAPED ALUMINIUM BUSBARS														BUSBAR HOLDER WITH CROSSPIECE (1 CODE = 2 PIECES)			
												DEPTH 400 MM					
																	
BUSBAR (1 CODE= 2 PIECES)						CENTRE DISTANCE						Single distribution board ⁽¹⁾		Side compartment	External compartment		
Capacity (A) depending on IP rating		Busbar Type	Code	Cross section BxH (mm)	N. bars per phase	Maximum centre distance between busbar holders (mm) depending on max.lcc (kA)						B=600 mm	B=850 mm	B=600+300 mm	B=400 mm		
IP30	IP55					16kA	20kA	25kA	35kA	50kA	70kA						
730	630	Shaped	GW D3 791 (1734 mm)	30x40 M8 sealing drivescrews	1	850	850	850	600	-	-	GW D3 751	GW D3 752	-	-		
												-	-	GW D3 753	GW D3 754		
900	800	Shaped	GW D3 792 (1734 mm)	30x40 M8 sealing drivescrews	1	850	850	850	600	350	-	-	-	-	-		
												-	-	-	-		
1350	1250	Shaped	GWD3793 (1734 mm)	60x30 M8 sealing drivescrews	1	850	850	850	600	350	250	-	-	-	-		
												-	-	-	-		
1700	1600	Shaped	GWD3794 (1734 mm)	60x30 M8 sealing drivescrews	1	850	850	850	600	350	250	-	-	-	-		
												-	-	-	-		

⁽¹⁾ Only form 1

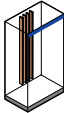
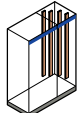
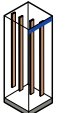
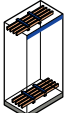
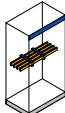
SHAPED ALUMINIUM BUSBARS													
BUSBAR HOLDER WITH CROSSPIECE (1 CODE = 2 PIECES)													
DEPTH 600/800 MM				DEPTH 600/800 MM				DEPTH 800 MM					
													
Single distribution board ⁽¹⁾		Side compartment		External compartment		Busbar holder		Crosspieces		Crosspieces			
B=600 mm	B=850 mm	B=600+300 mm		B=400 mm		-	B=600 / 600+300 mm	B=850 mm	B=400 mm	-	B=600 mm	B=850 mm	B=400 mm
GW D3 755	GW D3 757	-		-		-	-	-	-	-	-	-	-
-	-	GW D3 759 (for 600 mm depth) GW D3 761 (for 800 mm depth)		GW D3 754		GW D3 764	GW D3 765	GW D3 766	GW D3 754	GW D3 767	GW D3 768	GW D3 769	
GW D3 755	GW D3 757	-		-		-	-	-	-	-	-	-	
-	-	GW D3 759 (for 600 mm depth) GW D3 761 (for 800 mm depth)		GW D3 754		GW D3 764	GW D3 765	GW D3 766	GW D3 754	GW D3 767	GW D3 768	GW D3 769	
GW D3 756	GW D3 758	GW D3 760 (for 600 mm depth) GW D3 762 (for 800 mm depth)		GW D3 763		GW D3 764	GW D3 765	GW D3 766	GW D3 763	GW D3 767	GW D3 768	GW D3 769	

Busbar

Distribution systems for distribution boards

The BUSBAR range, in addition to distribution terminal blocks, consists of flat and shaped busbars in copper and aluminium in order to make distribution system inside QDX boards.

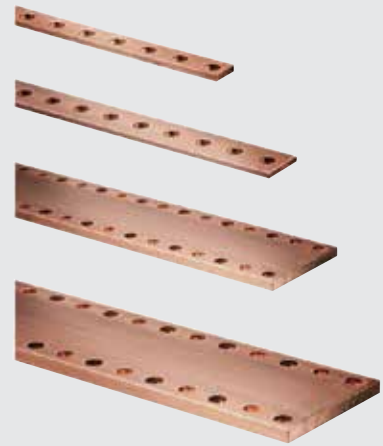

DISTRIBUTION TERMINAL BLOCKS

HORIZONTAL DIVIDER



GW 44 700

HORIZONTAL FOUR-POLE DIVIDER 250 A WITH PRE-DRILLED THREADED M6 BUSBARS

Code	No. of modules EN 50022	Installation	Input connecting capacity	Output connecting capacity	Icw (1s)	Pack Carton
For boards: QDX 630L/H - 1600H						
GW 44 700	16	On profile EN 50022	1xM12	10xM6	17 kA	1/2
GW 45 545	24	On functional profile	1xM8+2xM6	21xM6	23 kA	1
GW 45 546	35	On functional profile	1xM8+2xM6	32xM6	20 kA	1

CHARACTERISTICS: the connection capacity indicated is "per pole"; can also be fixed on the back-mounting plate.

ACCESSORIES SUPPLIED: fixing brackets on functional profile. Complete with protection shield and bolts and screws for cable input and output connections.

NOTES: usable with front panel of a height greater than, or equal to, 200mm.

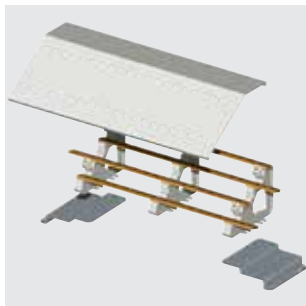

GW 45 547

HORIZONTAL FOUR-POLE DIVIDER 400 A WITH PRE-DRILLED THREADED M6 BUSBARS

Code	No. of modules EN 50022	Installation	Input connecting capacity	Output connecting capacity	Icw (1s)	Pack Carton
For boards: QDX 630L/H - 1600H						
GW 45 547	24	On functional profile	1xM8+2xM6	21xM6	23 kA	1
GW 45 548	35	On functional profile	1xM8+2xM6	32xM6	20 kA	1

CHARACTERISTICS: the indicated connection capacity is "per pole"; can also be fixed on the back-mounting plate.

ACCESSORIES SUPPLIED: fixing brackets on functional profile. Complete with protection shield and bolts and screws for cable input and output connections.

NOTES: an be used with front panel of a height greater than, or equal to, 200mm.

GW45547 and GW45548 are not suitable for P=200 mm QDX 630L and P=250 mm QDX630H distribution boards.

MODULAR DIVIDERS



GW 44 651

SINGLE-POLE MODULAR DISTRIBUTION TERMINAL BLOCK - FIXING ON PLATE OR DIN RAIL - IP20

Code	Outer dim. LxHxD (mm)	No. of modules EN 50022	Input connecting capacity	Output connecting capacity	Icw (1s)	Pack Carton
Rated current (A): 160						
GW 44 651	35x92x49	2	1x(10-70) mm ²	6x(2.5-16) mm ²	10 kA	1/5

CHARACTERISTICS: terminal tightening torque: input cable 4 Nm, output cables 1.5 Nm.
APPLICATIONS: possibility to create 1, 2, 3 and 4-pole distributing frames.



GW 44 652

RIGID JUMPER KIT AND CAP FOR ONE-POLE TERMINAL BLOCK GW44651

Code	Description	Pack Carton
GW 44 652	Jumper kit	1/25



GW 44 693

TWO-POLE DISTRIBUTION TERMINAL BLOCKS WITH TRANSPARENT PROTECTION COVER FIXING ON PLATE OR DIN RAIL EN 50022 - 750V - T 85°C

Code	Outer dim. LxHxD (mm)	No. of modules EN 50022	Input connecting capacity	Output connecting capacity	Icw (1s)	Pack Carton
Rated current (A): 100						
GW 44 691	70x49x50	4	1x(6-35) mm ²	[1x(4-25) + 5x(1.5-10)] mm ²	6 kA	2/40
Rated current (A): 125						
GW 44 693	141x49x50	8	1x(6-35) mm ²	[2x(4-25) + 2x(4-16) + 10x(1.5-10)] mm ²	6 kA	1/12

CHARACTERISTICS: the indicated connection capacity is "per pole" and refers to the fitting of cables with "test prods".



GW 44 699

FOUR-POLE DISTRIBUTION TERMINAL BLOCKS WITH TRANSPARENT PROTECTION COVER. FIXING ON PLATE OR DIN RAIL EN 50022 - 750V - T 85°C

Code	Outer dim. LxHxD (mm)	No. of modules EN 50022	Input connecting capacity	Output connecting capacity	Icw (1s)	Pack Carton
Rated current (A): 100						
GW 44 696	70x88.5x50	4	1x(6-35) mm ²	[1x(4-25) + 5x(1.5-10)] mm ²	6 kA	2/20
Rated current (A): 125						
GW 44 698	141x88.5x50	8	1x(6-35) mm ²	[2x(4-25) + 2x(4-16) + 10x(1.5-10)] mm ²	6 kA	1/10
Rated current (A): 160						
GW 44 699	185x135x75	10	1x(16-50) mm ²	[2x(10-35) + 2x(6-25) + 8x(4-16)] mm ²	10 kA	1/12

CHARACTERISTICS: terminal tightening torque: input cables 4 Nm, output cables 1.5 Nm.
the indicated connection capacity is "per pole" and refers to the fitting of cables with "test prods".

BUSBAR

FLAT BUS-BAR DISTRIBUTION SYSTEMS

FLAT BUSBAR DISTRIBUTION SYSTEMS



GW 45 551

2 FLAT BUSBARS IN PRE-DRILLED ELECTROLYTIC COPPER

Code	Rated current	Section (mm ²)	Length (mm)	Pack Carton
GW 45 551	250 A	20x5	1000	1
GW 45 553	400 A	30x5	1000	1
GW 45 554	630 A	30x10	1000	1
GW 45 555	250 A	20x5	1750	1
GW 45 557	400 A	30x5	1750	1
GW 45 558	630 A	30x10	1750	1
GW 49 678	800 A	60x5	1750	1
GW 49 679	1250 A	100x5	1750	1
GW 49 680	1600 A	100x10	1750	1

NOTE: from GW45551 to GW45558: M6 threaded busbars. GW49678 and GW49680: 10.5 mm through hole busbars.

BUSBAR-HOLDER FOR FLAT BUSBARS

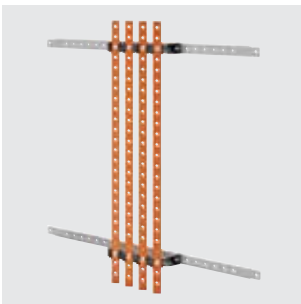

GW D3 706

PAIR OF BUSBAR-HOLDERS WITH CROSSPIECES FOR VERTICAL FLAT BUSBARS FOR QDX 630L DISTRIBUTION BOARDS

Code	Rated current	Section busbars (mm ²)	For boards	Suitable for structures D (mm)	Installation	Pack Carton
GW D3 701	250 A - 400 A	20x5 - 30x5	Wall and floor	200	Internal compartment	1
GW D3 702	250 A - 400 A	20x5 - 30x5	Wall mounting	200	External compartment	1
GW D3 703	250 A - 400 A	20x5 - 30x5	Floor-mounting	300	Structures L=600	1
GW D3 704	630 A	30x10	Floor-mounting	300	Structures L=600	1
GW D3 705	250 A - 400 A	20x5 - 30x5	Floor-mounting	300	Structures L=850	1
GW D3 706	630 A	30x10	Floor-mounting	300	Structures L=850	1
GW D3 707	250 A - 400 A	20x5 - 30x5	Floor-mounting	200 - 300	External compartment	1
GW D3 708	630 A	30x10	Floor-mounting	300	External compartment	1
GW D3 709	250 A - 400 A	20x5 - 30x5	Floor-mounting	300	Internal compartment	1

ACCESSORIES SUPPLIED: Crosspieces and fixing screw to the structure.

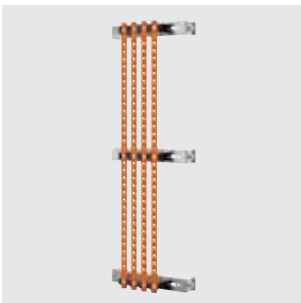

GW D3 724

PAIR OF BUSBAR-HOLDERS WITH CROSSPIECES FOR VERTICAL FLAT BUSBARS FOR QDX 630H DISTRIBUTION BOARDS

Code	Rated current	Section busbars (mm ²)	For boards	Suitable for structures D (mm)	Installation	Pack Carton
GW D3 702	-	-	-	-	-	1
GW D3 721	250 A - 400 A	20x5 - 30x5	Floor-mounting	250 - 400	Structures L=600	1
GW D3 722	250 A - 400 A	20x5 - 30x5	Floor-mounting	250 - 400	Structures L=850	1
GW D3 723	250 A - 400 A	20x5 - 30x5	Floor-mounting	250 - 400	Side compartment	1
GW D3 724	250 A - 400 A	20x5 - 30x5	Floor-mounting	250 - 400	External compartment	1
GW D3 725	630 A	30x10	Floor-mounting	400	Structures L=600	1
GW D3 726	630 A	30x10	Floor-mounting	400	Structures L=850	1
GW D3 727	630 A	30x10	Floor-mounting	400	Side compartment	1
GW D3 728	630 A	30x10	Floor-mounting	400	External compartment	1

ACCESSORIES SUPPLIED: Crosspieces and fixing screw to the structure.



GW D3 729

PAIR OF BUSBAR-HOLDERS WITH CROSSPIECES FOR VERTICAL FLAT BUSBARS FOR QDX 1600H DISTRIBUTION BOARDS

Code	Rated current	Section busbars (mm ²)	For boards	Suitable for structures D (mm)	Installation	Pack Carton
GW D3 721	250 A - 400 A	20x5 - 30x5	Floor-mounting	600 - 800	Structures L=600	1
GW D3 722	250 A - 400 A	20x5 - 30x5	Floor-mounting	600 - 800	Structures L=850	1
GW D3 729	630 A	30x10	Floor-mounting	600 - 800	Structures L=600	1
GW D3 730	800 A - 1250 A - 1600 A	60x5 - 100x5 - 100x10	Floor-mounting	600 - 800	Structures L=600	1
GW D3 731	630 A	30x10	Floor-mounting	600 - 800	Structures L=850	1
GW D3 732	800 A - 1250 A - 1600 A	60x5 - 100x5 - 100x10	Floor-mounting	600 - 800	Structures L=850	1
GW D3 733	250 A - 400 A	20x5 - 30x5	Floor-mounting	600	Side by side / external compartment	1
GW D3 734	630 A	30x10	Floor-mounting	600	Side by side / external compartment	1
GW D3 735	800 A - 1250 A - 1600 A	60x5 - 100x5 - 100x10	Floor-mounting	600	Side by side / external compartment	1
GW D3 736	250 A - 400 A	20x5 - 30x5	Floor-mounting	800	Side by side / external compartment	1
GW D3 737	630 A	30x10	Floor-mounting	800	Side by side / external compartment	1
GW D3 738	800 A - 1250 A - 1600 A	60x5 - 100x5 - 100x10	Floor-mounting	800	Side by side / external compartment	1



GW D3 745

PAIR OF BUSBAR-HOLDERS FOR HORIZONTAL FLAT BUSBARS FOR QDX 1600H DISTRIBUTIONS BOARDS

Code	Rated current	Section busbars (mm ²)	For boards	Suitable for structures D (mm)	Pack Carton
GW D3 745	800 A - 1250 A - 1600 A	60x5 - 100x5 - 100x10	Floor-mounting	600 - 800	1



GW D3 748

PAIR OF CROSSPIECES FOR HORIZONTAL FLAT BUSBARS FOR QDX 1600H DISTRIBUTIONS BOARDS

Code	For busbar holder	Busbars position	Suitable for structures D (mm)	Installation	Pack Carton
GW D3 747	GWD3745	Horizontal base/headboard Position 1	600 - 800	Structure B=600, side by side compartment	1
GW D3 748	GWD3745	Horizontal base/headboard Position 1	600 - 800	Structures L=850	1
GW D3 749	GWD3745	Horizontal base/headboard Position 1	600 - 800	External compartment	1
GW D3 767	GWD3745	Horizontal at any height Position 2	800	Structures L=600	1
GW D3 768	GWD3745	Horizontal at any height Position 2	800	Structures L=850	1
GW D3 769	GWD3745	Horizontal at any height Position 2	800	External compartment	1

BUSBAR

COPPER SHAPED BUSBARS



GW D3 781

PAIR OF COPPER SHAPED BUSBARS FOR QDX 1600H DISTRIBUTION BOARDS

Code	Rated current	Section busbars (mm ²)	Length (mm)	Pack Carton
GW D3 781	800 A	50x15	1830	1
GW D3 782	1250 A	50x31	1830	1
GW D3 783	1600 A	50x32	1830	1

BUSBAR HOLDERS FOR COPPER SHAPED BUSBARS



GW D3 741

PAIR OF BUSBAR-HOLDERS FOR VERTICAL COPPER SHAPED BUSBARS FOR QDX 1600H DISTRIBUTION BOARDS

Code	Rated current	Suitable for structures D (mm)	Installation	Pack Carton
GW D3 741	800 A - 1250 A - 1600 A	600 - 800	Structures L=600	1
GW D3 742	800 A - 1250 A - 1600 A	600 - 800	Structures L=850	1
GW D3 743	800 A - 1250 A - 1600 A	600	Side by side / external compartment	1
GW D3 744	800 A - 1250 A - 1600 A	800	Side by side / external compartment	1



GW D3 746

PAIR OF BUSBAR-HOLDERS FOR HORIZONTAL COPPER SHAPED BUSBARS FOR QDX 1600H DISTRIBUTION BOARDS

Code	Rated current	Suitable for structures D (mm)	Pack Carton
GW D3 746	800 A - 1250 A - 1600 A	600 - 800	1



GW D3 747

PAIR OF CROSSPIECES FOR HORIZONTAL SHAPED BUSBARS FOR QDX 1600H DISTRIBUTION BOARDS

Code	For busbar holder	Busbars position	Suitable for structures D (mm)	Installation	Pack Carton
GW D3 747	GW D3 746	Horizontal base/headboard - Position 1	600 - 800	Structure B=600, side by side compartment	1
GW D3 748	GW D3 746	Horizontal base/headboard - Position 1	600 - 800	Structures L=850	1
GW D3 749	GW D3 746	Horizontal base/headboard - Position 1	600 - 800	External compartment	1
GW D3 767	GW D3 746	Horizontal at any height - Position 2	800	Structures L=600	1
GW D3 768	GW D3 746	Horizontal at any height - Position 2	800	Structures L=850	1
GW D3 769	GW D3 746	Horizontal at any height - Position 2	800	External compartment	1



ALUMINIUM SHAPED BUSBARS



GW D3 791

PAIR OF ALUMINIUM SHAPED BUSBARS FOR QDX 630H- 1600H DISTRIBUTION BOARDS

Code	Rated current	Section busbars (mm ²)	Length (mm)	Pack Carton
GW D3 791	630 A	30x40	1734	1
GW D3 792	800 A	30x40	1734	1
GW D3 793	1250 A	60x30	1734	1
GW D3 794	1600 A	60x30	1734	1

CHARACTERISTICS: anodised aluminium busbars and nickel contact surface, applied with cold spray technology, in order to allow the connection with cables, flexible and rigid busbars.

BUSBAR HOLDERS FOR ALLUMINIUM SHAPED BUSBARS



GW D3 751

PAIR OF BUSBAR-HOLDERS FOR VERTICAL ALUMINIUM SHAPED BUSBARS FOR QDX 630H DISTRIBUTION BOARDS

Code	Rated current	For boards	Suitable for structures D (mm)	Installation	Pack Carton
GW D3 751	630 A	Floor-mounting	400	Structures L=600	1
GW D3 752	630 A	Floor-mounting	400	Structures L=850	1
GW D3 753	630 A	Floor-mounting	400	Side compartment	1
GW D3 754	630 A	Floor-mounting	400	External compartment	1



GW D3 755

PAIR OF BUSBAR-HOLDERS FOR VERTICAL ALUMINIUM SHAPED BUSBARS FOR QDX 1600H DISTRIBUTION BOARDS

Code	Rated current	For boards	Suitable for structures D (mm)	Installation	Pack Carton
GW D3 755	630 A - 800 A	Floor-mounting	600 - 800	Structures L=600	1
GW D3 756	1250 A - 1600 A	Floor-mounting	600 - 800	Structures L=600	1
GW D3 757	630 A - 800 A	Floor-mounting	600 - 800	Structures L=850	1
GW D3 758	1250 A - 1600 A	Floor-mounting	600 - 800	Structures L=850	1
GW D3 759	630 A - 800 A	Floor-mounting	600	Side by side / external compartment	1
GW D3 760	1250 A - 1600 A	Floor-mounting	600	Side by side / external compartment	1
GW D3 761	630 A - 800 A	Floor-mounting	800	Side by side / external compartment	1
GW D3 762	1250 A - 1600 A	Floor-mounting	800	Side by side / external compartment	1



GW D3 763

PAIR OF BUSBAR-HOLDERS FOR HORIZONTAL ALUMINIUM SHAPED BUSBARS FOR QDX 1600H DISTRIBUTION BOARDS

Code	Rated current	Suitable for structures D (mm)	Pack Carton
GW D3 754	630 A - 800 A	600 - 800	1
GW D3 763	1250 A - 1600 A	600 - 800	1



GW D3 764

PAIR OF CROSSPIECES FOR HORIZONTAL ALUMINIUM SHAPED BUSBARS FOR QDX 1600H DISTRIBUTION BOARDS

Code	For busbar-holders	Busbars position	Suitable for structures D (mm)	Installation	Pack Carton
GW D3 764	GWD3754, GWD3763	Horizontal base/headboard Position 1	600 - 800	Structure B=600, side by side compartment	1
GW D3 765	GWD3754, GWD3763	Horizontal base/headboard Position 1	600 - 800	Structures L=850	1
GW D3 766	GWD3754, GWD3763	Horizontal base/headboard Position 1	600 - 800	External compartment	1
GW D3 767	GWD3754, GWD3763	Horizontal at any height Position 2	800	Structures L=600	1
GW D3 768	GWD3754, GWD3763	Horizontal at any height Position 2	800	Structures L=850	1
GW D3 769	GWD3754, GWD3763	Horizontal at any height Position 2	800	External compartment	1

FLEXIBLE STRAPS



GW 47 652

COPPER FLEXIBLE BUSBARS - LENGTH: 2 METRES PER PIECE

Code	Rated current	Quantity	Dimensions (mm)	Section (mm ²)	Pack Carton
GW 47 650	160 A	2	2x15.5x0.8	24,8	1
GW 47 652	250 A	2	3x20x1	60	1
GW 47 653	400 A	2	5x20x1	100	1
GW 47 654	630 A	2	8x24x1	192	1
GW 47 655	1000 A	2	8x40x1	320	1

CHARACTERISTICS: conductor in electrolytic copper with high resistance compound vinyl insulation (duty voltage 1000 V).

ACCESSORIES FOR BUSBARS



GW D3 771

JOINTS FOR COPPER SHAPEHD BUSBARS

Code	For bars (In)	No. of pieces	Pack Carton
GW D3 771	800 A	4	1
GW D3 772	1250/1600 A	4	1

APPLICATIONS: joints for connecting vertical and horizontal busbars.

CHARACTERISTICS: kit consisting of

- 4 copper joints (section 50x10) of length 100 mm
- no. 32 hammer screws, washers and nuts.



GW D3 773

JOINTS FOR ALLUMINIUM SHAPEHD BUSBARS

Code	For bars (In)	Section (mm)	No. of pieces	Pack Carton
GW D3 773	630/800 A	40x8	4	1
GW D3 774	1250/1600 A	80x10	4	1

APPLICATIONS: joints for connecting vertical and horizontal busbars.

CHARACTERISTICS: kit consisting of

- 4 aluminium joints of length
 - 95 mm (phase 1)
 - 125 mm (phase 2)
 - 155 mm (phase 3)
 - 185 mm (neutral)
- no. 12 hammer screws, washers and nuts for GWD3773 or no. 20 hammer screws, washers and nuts for GWD3774.

BUSBAR



GW D3 775

CUT-OUT COUPLING ELEMENTS FOR SHAPED BUSBARS

Code	No. of pieces	Pack Carton
GW D3 775	4	1

APPLICATIONS: joints for connecting the shaped bars (copper and aluminium) with cables with cable terminals.

CHARACTERISTICS: kit consisting of

- no. 4 M6 drilled busbars

- no. 8 25x8 hammer screws, washers and nuts for fixing joints on the bars.



GW D3 776

SUPPORT BASES FOR COPPER SHAPED BUSBARS

Code	Suitable for QDX 1600H structures	No. of pieces	Pack Carton
GW D3 776	B=600 mm	4	1
GW D3 777	B=850 mm	4	1
GW D3 778	P=600 mm	4	1
GW D3 779	P=800 mm	4	1

APPLICATIONS: brackets to hold the bars in vertical position.

CHARACTERISTICS: kit consisting of

- 1 metal bracket

- 4 plastic bases

- 8 fixing screws

- 1 mounting crosspiece (one different for each code).



GW D3 713

ADHESIVES FOR SHAPED BUSBARS

Code	No. pieces per phase (L1 - L2 - L3 - N)	Pack Carton
GW D3 713	10	1

APPLICATIONS: adhesives to identify the phases (L1-L2-L3) and neutral (N) to be applied on copper and aluminium shaped bars.

NOTE: Quantities (10 pieces) refer to each individual phase for a total of 40 pieces.



GW D3 714

M8 DRIVE-SCREWS FOR SHAPED BUSBARS

Code	Length (mm)	For bars (In)	No. of pieces	Pack Carton
GW D3 714	25	Aluminium (630A-800A-1250A-1600A) & copper (800A-1250A)	20	1
GW D3 715	35	Copper (1600A)	20	1

NOTE: no. 20 hammer screws, washers and nuts.

SPARE ACCESSORIES FOR BUSBARS



GW D3 712

PHASE COMPENSATORS FOR LINEAR BUSBAR HOLDERS

Code	Thickness (mm)	No. of pieces	Pack Carton
GW D3 711	5	4	1
GW D3 712	10	4	1

NOTE: GWD3711 suitable for bars with 5mm thickness for linear bar holders.

GWD3712 suitable for 10mm thick busbars for linear busbar holders.



BUSBAR

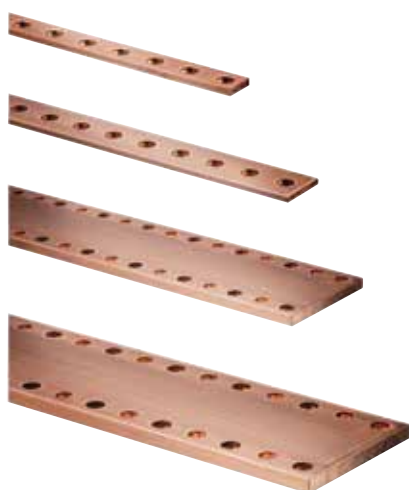

Scan the QR Code and find out all the technical informations.

QUICK CONNECT



Connections to the busbar system are facilitated by the special shape of the contoured busbar section, with a special sliding hammer screw in the profile that allows the connection of junctions at any point on the busbar, avoiding the need to drill holes.

ALUMINUM BAR SYSTEM



Quick, inexpensive, versatile, the universal aluminum bar system allows for maximum customization of GEWISS switchboards, thanks to different positioning configurations.

FLEXIBILITY OF USE



The pre-drilled holes, with 25 mm spacing, on the flat bars allows for quick bar, strap or cable connection. In addition, junctions between flat bars and contoured busbars can be made easily using special joints.



BUILDING

CHORUSMART

Innovative domestic range characterized by a wide choice of materials, shapes and finishes, able to satisfy any need. Four styles of plates (ONE, GEO, LUX, ICE / ICE Touch) made in different colors and materials, with devices modular in four color variants with two glossy finishes (white and painted titanium) and three satin finishes (white, natural beige and black) and four different sizes (1/2 module, 1, 2, 3 modules). Available for built-in installations and wall-mounted and can be integrated with the home automation functions of the KNX wired system and the ZigBee wireless system.



SYSTEM

A range of modular devices ideal for built-in solutions (for rectangular or square boxes), from wall and for special applications. The domestic series stands out for its glossy white or black devices satin finish and the plates in 14 colors and in two different shapes, modern or classic, with a glossy finish. The line includes controls, sockets, protections, indicators, connectors and devices for control, safety and home comfort.



27 COMBI

A complete and versatile system of modular containers, which can be perfectly integrated into the civil series SYSTEM, which is able to meet the high protection installation needs of the residential sectors, tertiary and industrial sectors. The 27 COMBI series is available both in the IP40 version and in the watertight versions with IP55 and IP65 degree of protection, recommended for all outdoor applications subject to conditions severe atmospheric conditions.



PLAYBUS

A range of modular devices for domestic and similar uses, which can be assembled on frames for flush-mounted boxes rectangular up to 18 modules or square. The domestic series is distinguished by the satin black devices and the plates in 5 colors and in two different shapes, modern or classic, with glossy or matt finishes. The line includes controls, sockets, protections, indicators, connectors and devices for control, safety and home comfort.



DAHLIA

A wide choice of plates, realized in technopolymer in seven colors with glossy finish: white, ivory, hemp, cream, light grey, dark grey, anthracite grey. Plates available in different modularities, from 1 to 5 gang, installable indifferently in horizontal or in vertical position.



SMART HOME & BUILDING SOLUTIONS

The GEWISS offer makes it possible to create a wide range of home automation functions (light control, movement roller shutters, climate control, comfort, safety, energy saving, load management, remote control with smartphone/tablet) in the residential and tertiary sector, exploiting various technologies: traditional, wireless ZigBee (radio frequency), KNX bus (Home and Building Automation).



DATA AND ENERGY DISTRIBUTION

The speed and reliability of the networks play an ever more important role in the communication sector. For this reason, GEWISS has created the Data Center range: a complete, integrated range of products for LAN structured network cabling. A solution that stands out for the extreme flexibility it offers in terms of office workstation configuration, as well as the simplicity and speed of wiring and the superior reliability of the connections. GEWISS also offers an extensive range of power take-offs, with plugs, socket-outlets, adapters and multiple mobile sockets.



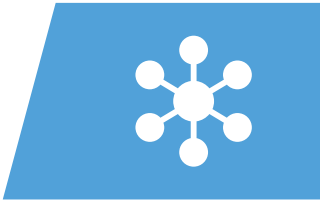

CHORUSMART

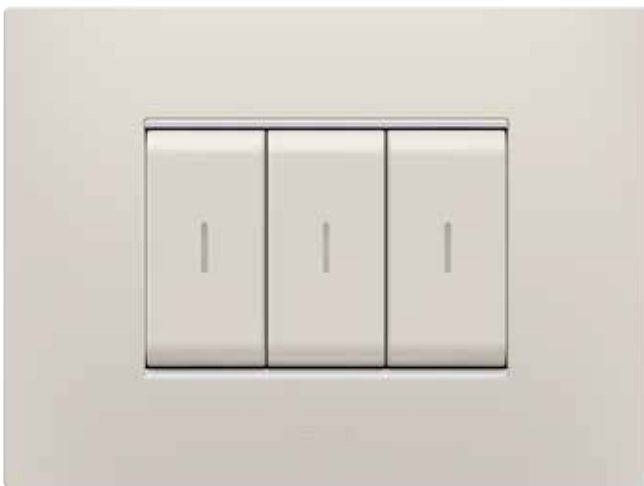

Domestic range

PLATES

pag. 662

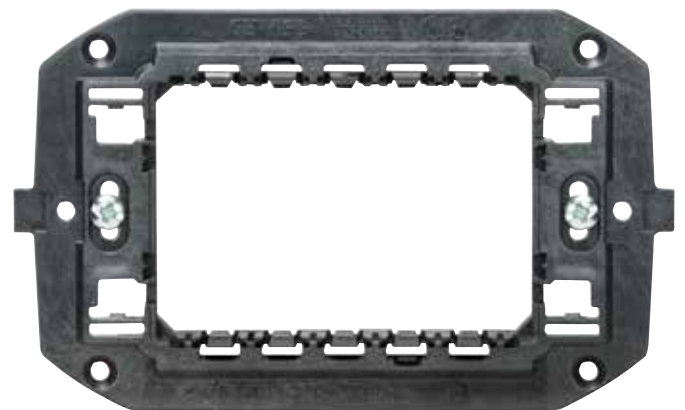

Domestic range

INSTALLATION ACCESSORIES

pag. 734



Domestic range

MODULAR DEVICES

pag. 740



Domestic range

ANTIBACTERIAL RANGE

pag. 932

CHORUSMART - Domestic range

ONE INTERNATIONAL

Technopolymer

WHITE	TONER BLACK	IVORY	HEMP
			
GW 16 122 TB 2 modules	GW 16 122 TN 2 modules	GW 16 122 TI 2 modules	GW 16 122 TC 2 modules
GW 16 123 TB 2+2 modules horiz.	GW 16 123 TN 2+2 modules horiz.	GW 16 123 TI 2+2 modules horiz.	GW 16 123 TC 2+2 modules horiz.
GW 16 124 TB 2+2 modules vert.	GW 16 124 TN 2+2 modules vert.	GW 16 124 TI 2+2 modules vert.	GW 16 124 TC 2+2 modules vert.
GW 16 126 TB 2+2+2 modules horiz.	GW 16 126 TN 2+2+2 modules horiz.	GW 16 126 TI 2+2+2 modules horiz.	GW 16 126 TC 2+2+2 modules horiz.
GW 16 127 TB 2+2+2 modules vert.	GW 16 127 TN 2+2+2 modules vert.	GW 16 127 TI 2+2+2 modules vert.	GW 16 127 TC 2+2+2 modules vert.
GW 16 128 TB 2+2+2+2 modules horiz.	GW 16 128 TN 2+2+2+2 modules horiz.	GW 16 128 TI 2+2+2+2 modules horiz.	GW 16 128 TC 2+2+2+2 modules horiz.
GW 16 129 TB 2+2+2+2 modules vert.	GW 16 129 TN 2+2+2+2 modules vert.	GW 16 129 TI 2+2+2+2 modules vert.	GW 16 129 TC 2+2+2+2 modules vert.

Painted technopolymer

SATIN WHITE	NATURAL BEIGE	SATIN BLACK	TITANIUM ▲
			
GW 16 122 VW 2 modules	GW 16 122 VL 2 modules	GW 16 122 VN 2 modules	GW 16 122 VT 2 modules
GW 16 123 VW 2+2 modules horiz.	GW 16 123 VL 2+2 modules horiz.	GW 16 123 VN 2+2 modules horiz.	GW 16 123 VT 2+2 modules horiz.
GW 16 124 VW 2+2 modules vert.	GW 16 124 VL 2+2 modules vert.	GW 16 124 VN 2+2 modules vert.	GW 16 124 VT 2+2 modules vert.
GW 16 126 VW 2+2+2 modules horiz.	GW 16 126 VL 2+2+2 modules horiz.	GW 16 126 VN 2+2+2 modules horiz.	GW 16 126 VT 2+2+2 modules horiz.
GW 16 127 VW 2+2+2 modules vert.	GW 16 127 VL 2+2+2 modules vert.	GW 16 127 VN 2+2+2 modules vert.	GW 16 127 VT 2+2+2 modules vert.
GW 16 128 VW 2+2+2+2 modules horiz.	GW 16 128 VL 2+2+2+2 modules horiz.	GW 16 128 VN 2+2+2+2 modules horiz.	GW 16 128 VT 2+2+2+2 modules horiz.
GW 16 129 VW 2+2+2+2 modules vert.	GW 16 129 VL 2+2+2+2 modules vert.	GW 16 129 VN 2+2+2+2 modules vert.	GW 16 129 VT 2+2+2+2 modules vert.

TUSCAN RED	TEAL	SOFT COPPER ▲	GOLD ▲
			
GW 16 122 VD 2 modules	GW 16 122 VZ 2 modules	GW 16 122 VX 2 modules	GW 16 122 VO 2 modules
GW 16 123 VD 2+2 modules horiz.	GW 16 123 VZ 2+2 modules horiz.	GW 16 123 VX 2+2 modules horiz.	GW 16 123 VO 2+2 modules horiz.
GW 16 124 VD 2+2 modules vert.	GW 16 124 VZ 2+2 modules vert.	GW 16 124 VX 2+2 modules vert.	GW 16 124 VO 2+2 modules vert.
GW 16 126 VD 2+2+2 modules horiz.	GW 16 126 VZ 2+2+2 modules horiz.	GW 16 126 VX 2+2+2 modules horiz.	GW 16 126 VO 2+2+2 modules horiz.
GW 16 127 VD 2+2+2 modules vert.	GW 16 127 VZ 2+2+2 modules vert.	GW 16 127 VX 2+2+2 modules vert.	GW 16 127 VO 2+2+2 modules vert.
GW 16 128 VD 2+2+2+2 modules horiz.	GW 16 128 VZ 2+2+2+2 modules horiz.	GW 16 128 VX 2+2+2+2 modules horiz.	GW 16 128 VO 2+2+2+2 modules horiz.
GW 16 129 VD 2+2+2+2 modules vert.	GW 16 129 VZ 2+2+2+2 modules vert.	GW 16 129 VX 2+2+2+2 modules vert.	GW 16 129 VO 2+2+2+2 modules vert.

▲ Metallic effect

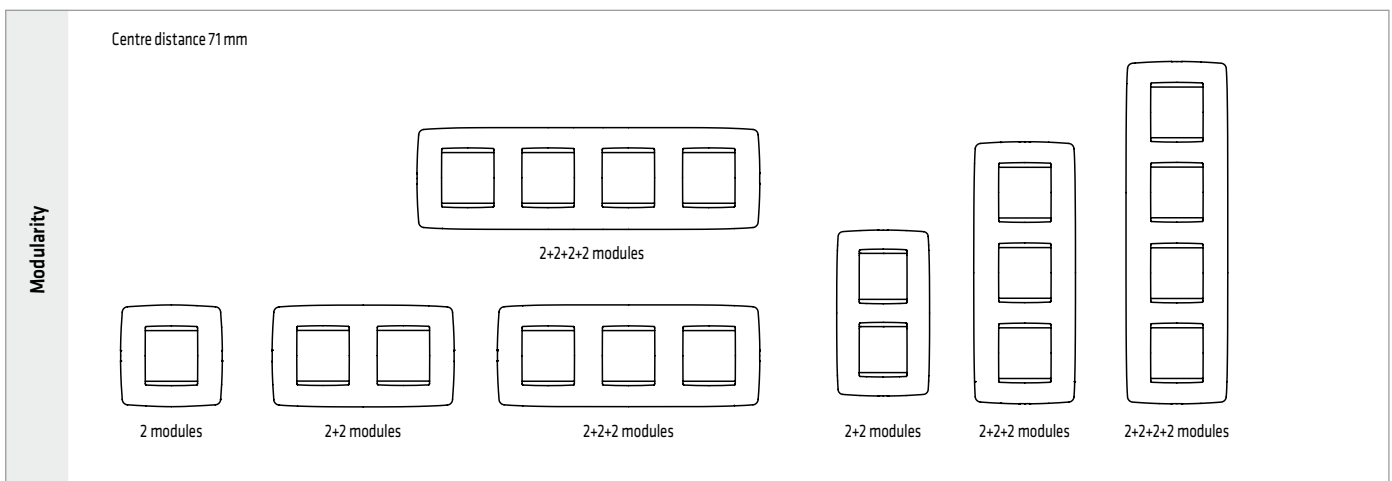

For customized plates please contact our GEWISS Sales Organization

ChoruSmart

ONE International plates

Informal in appearance and classic in geometry, ONE is the ChoruSmart system's range of plates dedicated to those who want to furnish their homes with simple touches. ONE's understated and discreet design enhances any space, bringing harmony and aesthetic consistency to every room. Available in a wide range of colours, ONE comes in every shade you need to give free rein to your imagination



ONE INTERNATIONAL PLATES

TECHNOPOLYMER



GW 16 122 TB

ONE INTERNATIONAL - WHITE

Code	Description	Type	Pack Carton
GW 16 122 TB	2 modules	-	12
GW 16 123 TB	2+2 modules	Horizontal	12
GW 16 124 TB	2+2 modules	Vertical	12
GW 16 126 TB	2+2+2 modules	Horizontal	6
GW 16 127 TB	2+2+2 modules	Vertical	6
GW 16 128 TB	2+2+2+2 modules	Horizontal	1
GW 16 129 TB	2+2+2+2 modules	Vertical	1

CHARACTERISTICS: glossy finish.

NOTE: centre distance 71 mm.

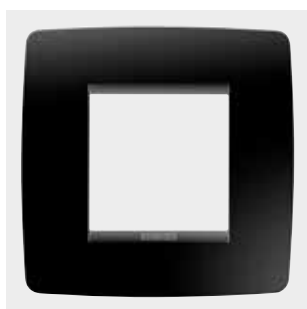

GW 16 122 TN

ONE INTERNATIONAL - TONER BLACK

Code	Description	Type	Pack Carton
GW 16 122 TN	2 modules	-	12
GW 16 123 TN	2+2 modules	Horizontal	12
GW 16 124 TN	2+2 modules	Vertical	12
GW 16 126 TN	2+2+2 modules	Horizontal	6
GW 16 127 TN	2+2+2 modules	Vertical	6
GW 16 128 TN	2+2+2+2 modules	Horizontal	1
GW 16 129 TN	2+2+2+2 modules	Vertical	1

CHARACTERISTICS: glossy finish.

NOTE: centre distance 71 mm.



GW 16 122 TI

ONE INTERNATIONAL - IVORY

Code	Description	Type	Pack Carton
GW 16 122 TI	2 modules	-	12
GW 16 123 TI	2+2 modules	Horizontal	12
GW 16 124 TI	2+2 modules	Vertical	12
GW 16 126 TI	2+2+2 modules	Horizontal	6
GW 16 127 TI	2+2+2 modules	Vertical	6
GW 16 128 TI	2+2+2+2 modules	Horizontal	1
GW 16 129 TI	2+2+2+2 modules	Vertical	1

CHARACTERISTICS: glossy finish.

NOTE: centre distance 71 mm.



GW 16 122 TC

ONE INTERNATIONAL - HEMP

Code	Description	Type	Pack Carton
GW 16 122 TC	2 modules	-	12
GW 16 123 TC	2+2 modules	Horizontal	12
GW 16 124 TC	2+2 modules	Vertical	12
GW 16 126 TC	2+2+2 modules	Horizontal	6
GW 16 127 TC	2+2+2 modules	Vertical	6
GW 16 128 TC	2+2+2+2 modules	Horizontal	1
GW 16 129 TC	2+2+2+2 modules	Vertical	1

CHARACTERISTICS: glossy finish.

NOTE: centre distance 71 mm.

CHORUSMART - Domestic range

PAINTED TECHNOPOLYMER



GW 16 122 VW

ONE INTERNATIONAL - SATIN WHITE

Code	Description	Type	Pack Carton
GW 16 122 VW	2 modules	-	12
GW 16 123 VW	2+2 modules	Horizontal	12
GW 16 124 VW	2+2 modules	Vertical	12
GW 16 126 VW	2+2+2 modules	Horizontal	6
GW 16 127 VW	2+2+2 modules	Vertical	6
GW 16 128 VW	2+2+2+2 modules	Horizontal	1
GW 16 129 VW	2+2+2+2 modules	Vertical	1

CHARACTERISTICS: matt finish.

NOTES: centre distance 71 mm.



GW 16 122 VL

ONE INTERNATIONAL - NATURAL BEIGE

Code	Description	Type	Pack Carton
GW 16 122 VL	2 modules	-	12
GW 16 123 VL	2+2 modules	Horizontal	12
GW 16 124 VL	2+2 modules	Vertical	12
GW 16 126 VL	2+2+2 modules	Horizontal	6
GW 16 127 VL	2+2+2 modules	Vertical	6
GW 16 128 VL	2+2+2+2 modules	Horizontal	1
GW 16 129 VL	2+2+2+2 modules	Vertical	1

CHARACTERISTICS: matt finish.

NOTES: centre distance 71 mm.



GW 16 122 VN

ONE INTERNATIONAL - SATIN BLACK

Code	Description	Type	Pack Carton
GW 16 122 VN	2 modules	-	12
GW 16 123 VN	2+2 modules	Horizontal	12
GW 16 124 VN	2+2 modules	Vertical	12
GW 16 126 VN	2+2+2 modules	Horizontal	6
GW 16 127 VN	2+2+2 modules	Vertical	6
GW 16 128 VN	2+2+2+2 modules	Horizontal	12
GW 16 129 VN	2+2+2+2 modules	Vertical	6

CHARACTERISTICS: matt finish.

NOTE: centre distance 71 mm.



GW 16 122 VT

ONE INTERNATIONAL - TITANIUM

Code	Description	Type	Pack Carton
GW 16 122 VT	2 modules	-	12
GW 16 123 VT	2+2 modules	Horizontal	12
GW 16 124 VT	2+2 modules	Vertical	12
GW 16 126 VT	2+2+2 modules	Horizontal	6
GW 16 127 VT	2+2+2 modules	Vertical	6
GW 16 128 VT	2+2+2+2 modules	Horizontal	1
GW 16 129 VT	2+2+2+2 modules	Vertical	1

CHARACTERISTICS: matt finish, metallic effect.

NOTES: centre distance 71 mm.



GW 16 122 VD

ONE INTERNATIONAL - TUSCAN RED

Code	Description	Type	Pack Carton
GW 16 122 VD	2 modules	-	12
GW 16 123 VD	2+2 modules	Horizontal	12
GW 16 124 VD	2+2 modules	Vertical	12
GW 16 126 VD	2+2+2 modules	Horizontal	6
GW 16 127 VD	2+2+2 modules	Vertical	6
GW 16 128 VD	2+2+2+2 modules	Horizontal	1
GW 16 129 VD	2+2+2+2 modules	Vertical	1

CHARACTERISTICS: matt finish.

NOTES: centre distance 71 mm.



GW 16 122 VZ

ONE INTERNATIONAL - TEAL

Code	Description	Type	Pack Carton
GW 16 122 VZ	2 modules	-	12
GW 16 123 VZ	2+2 modules	Horizontal	12
GW 16 124 VZ	2+2 modules	Vertical	12
GW 16 126 VZ	2+2+2 modules	Horizontal	6
GW 16 127 VZ	2+2+2 modules	Vertical	6
GW 16 128 VZ	2+2+2+2 modules	Horizontal	1
GW 16 129 VZ	2+2+2+2 modules	Vertical	1

CHARACTERISTICS: matt finish.

NOTES: centre distance 71 mm.

CHORUSMART - Domestic range



GW 16 122 VX

ONE INTERNATIONAL - SOFT COPPER

Code	Description	Type	Pack Carton
GW 16 122 VX	2 modules	-	12
GW 16 123 VX	2+2 modules	Horizontal	12
GW 16 124 VX	2+2 modules	Vertical	12
GW 16 126 VX	2+2+2 modules	Horizontal	6
GW 16 127 VX	2+2+2 modules	Vertical	6
GW 16 128 VX	2+2+2+2 modules	Horizontal	1
GW 16 129 VX	2+2+2+2 modules	Vertical	1

CHARACTERISTICS: matt finish, metallic effect.

NOTES: centre distance 71 mm.



GW 16 122 VO

ONE INTERNATIONAL - GOLD

Code	Description	Type	Pack Carton
GW 16 122 VO	2 modules	-	12
GW 16 123 VO	2+2 modules	Horizontal	12
GW 16 124 VO	2+2 modules	Vertical	12
GW 16 126 VO	2+2+2 modules	Horizontal	6
GW 16 127 VO	2+2+2 modules	Vertical	6
GW 16 128 VO	2+2+2+2 modules	Horizontal	1
GW 16 129 VO	2+2+2+2 modules	Vertical	1

CHARACTERISTICS: matt finish, metallic effect.

NOTES: centre distance 71 mm.



ChoruSmart



Scan the QR Code and find out all the technical informations.

REFINED DESIGN



Minimal in shape, classic in style: ONE plates enhance any room, bringing harmony and beauty to every corner of the house.

FINISHES



The ONE plate, with its minimal appearance, is available in various colours and in 2 finishes: glossy and satin, for every need.

HIGHLY CUSTOMISABLE







The plates can be customised through a choice of colours and finishes. This allows the installation to be adapted to the style of the interiors and enhance all applications. Thanks to tampography and lasering, the plates can be customised with lettering, trademarks and logos. Please contact the GEWISS Commercial department to discuss the feasibility of any customisation.





CHORUSMART - Domestic range





GEO INTERNATIONAL

Technopolymer

WHITE	TONER BLACK	IVORY	HEMP
			
GW 16 422 TB 2 modules	GW 16 422 TN 2 modules	GW 16 422 TI 2 modules	GW 16 422 TC 2 modules
GW 16 423 TB 2+2 modules horiz.	GW 16 423 TN 2+2 modules horiz.	GW 16 423 TI 2+2 modules horiz.	GW 16 423 TC 2+2 modules horiz.
GW 16 424 TB 2+2 modules vert.	GW 16 424 TN 2+2 modules vert.	GW 16 424 TI 2+2 modules vert.	GW 16 424 TC 2+2 modules vert.
GW 16 426 TB 2+2+2 modules horiz.	GW 16 426 TN 2+2+2 modules horiz.	GW 16 426 TI 2+2+2 modules horiz.	GW 16 426 TC 2+2+2 modules horiz.
GW 16 427 TB 2+2+2 modules vert.	GW 16 427 TN 2+2+2 modules vert.	GW 16 427 TI 2+2+2 modules vert.	GW 16 427 TC 2+2+2 modules vert.

Painted technopolymer

SATIN WHITE	NATURAL BEIGE	SATIN BLACK	TITANIUM ▲
			
GW 16 422 VW 2 modules	GW 16 422 VL 2 modules	GW 16 422 VN 2 modules	GW 16 422 VT 2 modules
GW 16 423 VW 2+2 modules horiz.	GW 16 423 VL 2+2 modules horiz.	GW 16 423 VN 2+2 modules horiz.	GW 16 423 VT 2+2 modules horiz.
GW 16 424 VW 2+2 modules vert.	GW 16 424 VL 2+2 modules vert.	GW 16 424 VN 2+2 modules vert.	GW 16 424 VT 2+2 modules vert.
GW 16 426 VW 2+2+2 modules horiz.	GW 16 426 VL 2+2+2 modules horiz.	GW 16 426 VN 2+2+2 modules horiz.	GW 16 426 VT 2+2+2 modules horiz.
GW 16 427 VW 2+2+2 modules vert.	GW 16 427 VL 2+2+2 modules vert.	GW 16 427 VN 2+2+2 modules vert.	GW 16 427 VT 2+2+2 modules vert.

TUSCAN RED	TEAL	SOFT COPPER ▲	GOLD ▲
			
GW 16 422 VD 2 modules	GW 16 422 VZ 2 modules	GW 16 422 VX 2 modules	GW 16 422 VO 2 modules
GW 16 423 VD 2+2 modules horiz.	GW 16 423 VZ 2+2 modules horiz.	GW 16 423 VX 2+2 modules horiz.	GW 16 423 VO 2+2 modules horiz.
GW 16 424 VD 2+2 modules vert.	GW 16 424 VZ 2+2 modules vert.	GW 16 424 VX 2+2 modules vert.	GW 16 424 VO 2+2 modules vert.
GW 16 426 VD 2+2+2 modules horiz.	GW 16 426 VZ 2+2+2 modules horiz.	GW 16 426 VX 2+2+2 modules horiz.	GW 16 426 VO 2+2+2 modules horiz.
GW 16 427 VD 2+2+2 modules vert.	GW 16 427 VZ 2+2+2 modules vert.	GW 16 427 VX 2+2+2 modules vert.	GW 16 427 VO 2+2+2 modules vert.

▲ Metallic effect

Modularity

Centre distance 71 mm

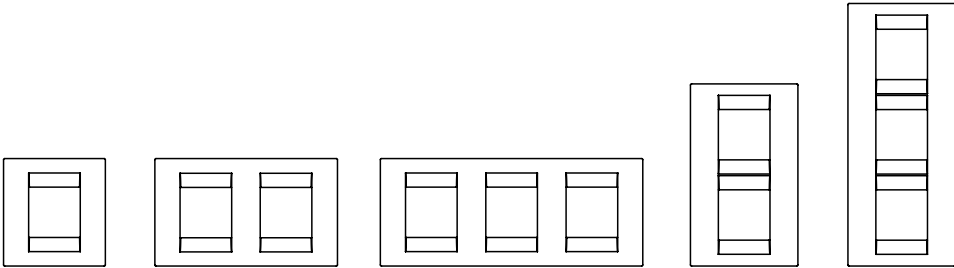

2 modules 2+2 modules 2+2+2 modules 2+2 modules 2+2+2 modules

ChoruSmart

GEO International plates

The GEO plate with clean, regular lines fits perfectly into any environment with its simplicity and style. The materials and colours contribute to creating the right harmony that stands the test of time. Made from technopolymer, GEO resists the impact and stresses of everyday use. The different colours and the simple and light shapes make GEO a young and informal furnishing element that conveys a minimalist style in any space.



GEO INTERNATIONAL PLATES

TECHNOPOLYMER

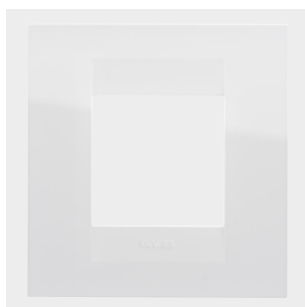

GW 16 422 TB

GEO INTERNATIONAL - WHITE

Code	Description	Type	Pack Carton
GW 16 422 TB	2 modules	-	12
GW 16 423 TB	2+2 modules	Horizontal	12
GW 16 424 TB	2+2 modules	Vertical	12
GW 16 426 TB	2+2+2 modules	Horizontal	6
GW 16 427 TB	2+2+2 modules	Vertical	6

CHARACTERISTICS: glossy finish.

NOTE: centre distance 71 mm.



GW 16 422 TN

GEO INTERNATIONAL - TONER BLACK

Code	Description	Type	Pack Carton
GW 16 422 TN	2 modules	-	12
GW 16 423 TN	2+2 modules	Horizontal	12
GW 16 424 TN	2+2 modules	Vertical	12
GW 16 426 TN	2+2+2 modules	Horizontal	6
GW 16 427 TN	2+2+2 modules	Vertical	6

CHARACTERISTICS: glossy finish.

NOTE: centre distance 71 mm.

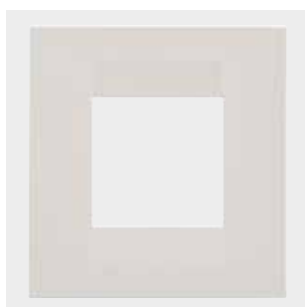

GW 16 422 TI

GEO INTERNATIONAL - IVORY

Code	Description	Type	Pack Carton
GW 16 422 TI	2 modules	-	12
GW 16 423 TI	2+2 modules	Horizontal	12
GW 16 424 TI	2+2 modules	Vertical	12
GW 16 426 TI	2+2+2 modules	Horizontal	6
GW 16 427 TI	2+2+2 modules	Vertical	6

CHARACTERISTICS: glossy finish.

NOTE: centre distance 71 mm.

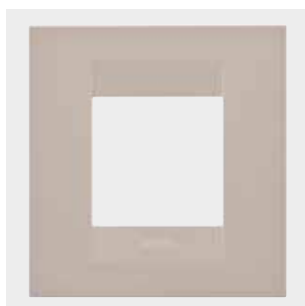

GW 16 422 TC

GEO INTERNATIONAL - HEMP

Code	Description	Type	Pack Carton
GW 16 422 TC	2 modules	-	12
GW 16 423 TC	2+2 modules	Horizontal	12
GW 16 424 TC	2+2 modules	Vertical	12
GW 16 426 TC	2+2+2 modules	Horizontal	6
GW 16 427 TC	2+2+2 modules	Vertical	6

CHARACTERISTICS: glossy finish.

NOTE: centre distance 71 mm.

CHORUSMART - Domestic range

PAINTED TECHNOPOLYMER

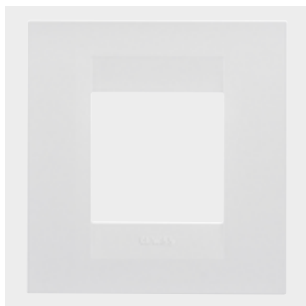

GW 16 422 VW

GEO INTERNATIONAL - SATIN WHITE

Code	Description	Type	Pack Carton
GW 16 422 VW	2 modules	-	12
GW 16 423 VW	2+2 modules	Horizontal	12
GW 16 424 VW	2+2 modules	Vertical	12
GW 16 426 VW	2+2+2 modules	Horizontal	6
GW 16 427 VW	2+2+2 modules	Vertical	6

CHARACTERISTICS: matt finish.

NOTES: centre distance 71 mm.



GW 16 422 VL

GEO INTERNATIONAL - NATURAL BEIGE

Code	Description	Type	Pack Carton
GW 16 422 VL	2 modules	-	12
GW 16 423 VL	2+2 modules	Horizontal	12
GW 16 424 VL	2+2 modules	Vertical	12
GW 16 426 VL	2+2+2 modules	Horizontal	6
GW 16 427 VL	2+2+2 modules	Vertical	6

CHARACTERISTICS: matt finish.

NOTES: centre distance 71 mm.



GW 16 422 VN

GEO INTERNATIONAL - SATIN BLACK

Code	Description	Type	Pack Carton
GW 16 422 VN	2 modules	-	12
GW 16 423 VN	2+2 modules	Horizontal	1/12
GW 16 424 VN	2+2 modules	Vertical	12
GW 16 426 VN	2+2+2 modules	Horizontal	6
GW 16 427 VN	2+2+2 modules	Vertical	6

CHARACTERISTICS: matt finish.

NOTE: centre distance 71 mm.



GW 16 422 VT

GEO INTERNATIONAL - TITANIUM

Code	Description	Type	Pack Carton
GW 16 422 VT	2 modules	-	12
GW 16 423 VT	2+2 modules	Horizontal	12
GW 16 424 VT	2+2 modules	Vertical	12
GW 16 426 VT	2+2+2 modules	Horizontal	6
GW 16 427 VT	2+2+2 modules	Vertical	6

CHARACTERISTICS: matt finish, metallic effect.

NOTES: centre distance 71 mm.



GW 16 122 VD

GEO INTERNATIONAL - TUSCAN RED

Code	Description	Type	Pack Carton
GW 16 422 VD	2 modules	-	12
GW 16 423 VD	2+2 modules	Horizontal	12
GW 16 424 VD	2+2 modules	Vertical	12
GW 16 426 VD	2+2+2 modules	Horizontal	6
GW 16 427 VD	2+2+2 modules	Vertical	6

CHARACTERISTICS: matt finish.

NOTES: centre distance 71 mm.



GW 16 422 VZ

GEO INTERNATIONAL - TEAL

Code	Description	Type	Pack Carton
GW 16 422 VZ	2 modules	-	12
GW 16 423 VZ	2+2 modules	Horizontal	12
GW 16 424 VZ	2+2 modules	Vertical	12
GW 16 426 VZ	2+2+2 modules	Horizontal	6
GW 16 427 VZ	2+2+2 modules	Vertical	6

CHARACTERISTICS: matt finish.

NOTES: centre distance 71 mm.

CHORUSMART - Domestic range



GW 16 422 VX

GEO INTERNATIONAL - SOFT COPPER

Code	Description	Type	Pack Carton
GW 16 422 VX	2 modules	-	12
GW 16 423 VX	2+2 modules	Horizontal	12
GW 16 424 VX	2+2 modules	Vertical	12
GW 16 426 VX	2+2+2 modules	Horizontal	6
GW 16 427 VX	2+2+2 modules	Vertical	6

CHARACTERISTICS: matt finish, metallic effect.

NOTES: centre distance 71 mm.



GW 16 422 VO

GEO INTERNATIONAL - GOLD

Code	Description	Type	Pack Carton
GW 16 422 VO	2 modules	-	12
GW 16 423 VO	2+2 modules	Horizontal	12
GW 16 424 VO	2+2 modules	Vertical	12
GW 16 426 VO	2+2+2 modules	Horizontal	6
GW 16 427 VO	2+2+2 modules	Vertical	6

CHARACTERISTICS: matt finish, metallic effect.

NOTES: centre distance 71 mm.



ChoruSmart



Scan the QR Code and find out all the technical informations.

MINIMAL DESIGN



The colours, and simple, light shapes make GEO a youthful and informal furnishing item that expresses a minimalist style wherever it is placed.

FINISHES



The GEO plate, simple and youthful, is available in various colours and in 2 finishes: glossy and satin, for every need.

HIGHLY CUSTOMISABLE











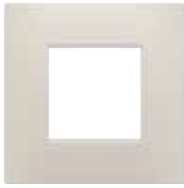
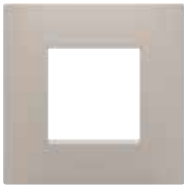

The plates can be customised through a choice of colours and finishes. This allows the installation to be adapted to the style of the interiors and enhance all applications. Thanks to tampography and lasering, the plates can be customised with lettering, trademarks and logos. Please contact the GEWISS Commercial department to discuss the feasibility of any customisation.

CHORUSMART - Domestic range

EGO INTERNATIONAL

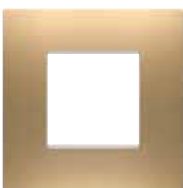
Painted technopolymer

SATIN WHITE		CLAY		NATURAL BEIGE			
							
GW 16 022 PW	2 modules	GW 16 022 CY	2 modules	GW 16 022 NB	2 modules		
GW 16 023 PW	2+2 modules horiz.	GW 16 023 CY	2+2 modules horiz.	GW 16 023 NB	2+2 modules horiz.		
GW 16 024 PW	2+2 modules vert.	GW 16 024 CY	2+2 modules vert.	GW 16 024 NB	2+2 modules vert.		
GW 16 026 PW	2+2+2 modules horiz.	GW 16 026 CY	2+2+2 modules horiz.	GW 16 026 NB	2+2+2 modules horiz.		
DARK SAND		SATIN BLACK					
							
GW 16 022 DS	2 modules	GW 16 022 DB	2 modules				
GW 16 023 DS	2+2 modules horiz.	GW 16 023 DB	2+2 modules horiz.				
GW 16 024 DS	2+2 modules vert.	GW 16 024 DB	2+2 modules vert.				
GW 16 026 DS	2+2+2 modules horiz.	GW 16 026 DB	2+2+2 modules horiz.				
MAGNETIC GRAY ▲		LIGHT BRONZE ▲		STEEL ▲			
							
GW 16 022 GR	2 modules	GW 16 022 BR	2 modules	GW 16 022 ST	2 modules		
GW 16 023 GR	2+2 modules horiz.	GW 16 023 BR	2+2 modules horiz.	GW 16 023 ST	2+2 modules horiz.		
GW 16 024 GR	2+2 modules vert.	GW 16 024 BR	2+2 modules vert.	GW 16 024 ST	2+2 modules vert.		
GW 16 026 GR	2+2+2 modules horiz.	GW 16 026 BR	2+2+2 modules horiz.	GW 16 026 ST	2+2+2 modules horiz.		
SOFT COPPER ▲		GOLD ▲		COPPER ▲		BROWN SHADE ▲	
							
GW 16 022 CS	2 modules	GW 16 022 SG	2 modules	GW 16 022 CP	2 modules	GW 16 022 BS	2 modules
GW 16 023 CS	2+2 modules horiz.	GW 16 023 SG	2+2 modules horiz.	GW 16 023 CP	2+2 modules horiz.	GW 16 023 BS	2+2 modules horiz.
GW 16 024 CS	2+2 modules vert.	GW 16 024 SG	2+2 modules vert.	GW 16 024 CP	2+2 modules vert.	GW 16 024 BS	2+2 modules vert.
GW 16 026 CS	2+2+2 modules horiz.	GW 16 026 SG	2+2+2 modules horiz.	GW 16 026 CP	2+2+2 modules horiz.	GW 16 026 BS	2+2+2 modules horiz.

▲ Metallic effect

Modularity

Centre distance 71 mm

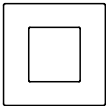
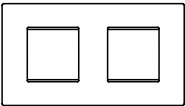
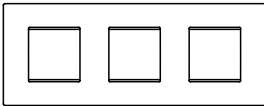
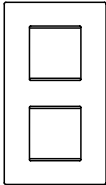
			
2 modules	2+2 modules	2+2+2 modules	2+2 modules

For customized plates please contact our GEWISS Sales Organization

ChoruSmart

EGO INTERNATIONAL plates

With their clean, compact lines, EGO plates make the right impression. Modern shapes with slightly curved surfaces that taper towards the edges convey balance and simplicity. The opalescent profiles inside the plate, in aesthetic continuity with the EGO SMART versions, add a subtle element of unique identity. Every detail is designed to ensure appeal and personality.

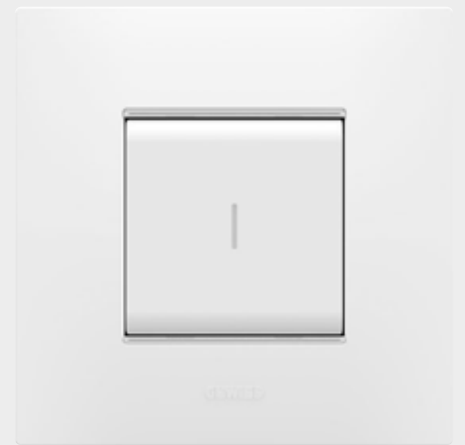

EGO INTERNATIONAL PLATES

PAINTED TECHNOPOLYMER



GW 16 022 PW

EGO INTERNATIONAL - SATIN WHITE

Code	Description	Type	Pack Carton
GW 16 022 PW	2 modules	-	12
GW 16 023 PW	2+2 modules	Horizontal	12
GW 16 024 PW	2+2 modules	Vertical	12
GW 16 026 PW	2+2+2 modules	Horizontal	6

CHARACTERISTICS: matt finish.

NOTE: centre distance 71 mm.



GW 16 022 CY

EGO INTERNATIONAL - CLAY

Code	Description	Type	Pack Carton
GW 16 022 CY	2 modules	-	12
GW 16 023 CY	2+2 modules	Horizontal	12
GW 16 024 CY	2+2 modules	Vertical	12
GW 16 026 CY	2+2+2 modules	Horizontal	6

CHARACTERISTICS: matt finish.

NOTE: centre distance 71 mm.



GW 16 022 NB

EGO INTERNATIONAL - NATURAL BEIGE

Code	Description	Type	Pack Carton
GW 16 022 NB	2 modules	-	12
GW 16 023 NB	2+2 modules	Horizontal	12
GW 16 024 NB	2+2 modules	Vertical	12
GW 16 026 NB	2+2+2 modules	Horizontal	6

CHARACTERISTICS: matt finish.

NOTE: centre distance 71 mm.

CHORUSMART - Domestic range



GW 16 022 DS

EGO INTERNATIONAL - DARK SAND

Code	Description	Type	Pack Carton
GW 16 022 DS	2 modules	-	12
GW 16 023 DS	2+2 modules	Horizontal	12
GW 16 024 DS	2+2 modules	Vertical	12
GW 16 026 DS	2+2+2 modules	Horizontal	6

CHARACTERISTICS: matt finish.

NOTE: centre distance 71 mm.

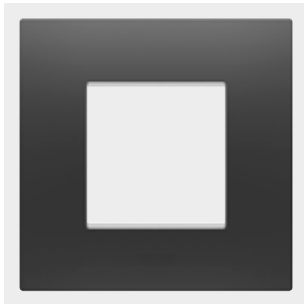

GW 16 022 DB

EGO INTERNATIONAL - SATIN BLACK

Code	Description	Type	Pack Carton
GW 16 022 DB	2 modules	-	12
GW 16 023 DB	2+2 modules	Horizontal	12
GW 16 024 DB	2+2 modules	Vertical	12
GW 16 026 DB	2+2+2 modules	Horizontal	6

CHARACTERISTICS: matt finish.

NOTE: centre distance 71 mm.

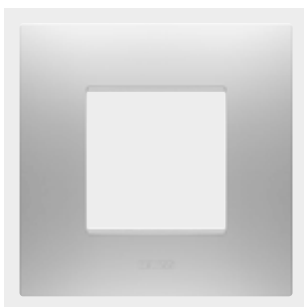

GW 16 022 GR

EGO INTERNATIONAL - MAGNETIC GRAY

Code	Description	Type	Pack Carton
GW 16 022 GR	2 modules	-	12
GW 16 023 GR	2+2 modules	Horizontal	12
GW 16 024 GR	2+2 modules	Vertical	12
GW 16 026 GR	2+2+2 modules	Horizontal	6

CHARACTERISTICS: matt finish, metallic effect.

NOTES: centre distance 71 mm.

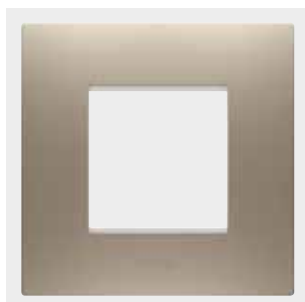

GW 16 022 BR

EGO INTERNATIONAL - LIGHT BRONZE

Code	Description	Type	Pack Carton
GW 16 022 BR	2 modules	-	12
GW 16 023 BR	2+2 modules	Horizontal	12
GW 16 024 BR	2+2 modules	Vertical	12
GW 16 026 BR	2+2+2 modules	Horizontal	6

CHARACTERISTICS: matt finish, metallic effect.

NOTES: centre distance 71 mm.

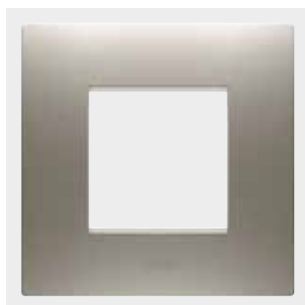

GW 16 022 ST

EGO INTERNATIONAL - STEEL

Code	Description	Type	Pack Carton
GW 16 022 ST	2 modules	-	12
GW 16 023 ST	2+2 modules	Horizontal	12
GW 16 024 ST	2+2 modules	Vertical	12
GW 16 026 ST	2+2+2 modules	Horizontal	6

CHARACTERISTICS: matt finish, metallic effect.

NOTES: centre distance 71 mm.

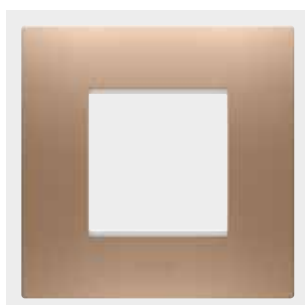

GW 16 022 CS

EGO INTERNATIONAL - SOFT COPPER

Code	Description	Type	Pack Carton
GW 16 022 CS	2 modules	-	12
GW 16 023 CS	2+2 modules	Horizontal	12
GW 16 024 CS	2+2 modules	Vertical	12
GW 16 026 CS	2+2+2 modules	Horizontal	6

CHARACTERISTICS: matt finish, metallic effect.

NOTES: centre distance 71 mm.

CHORUSMART - Domestic range

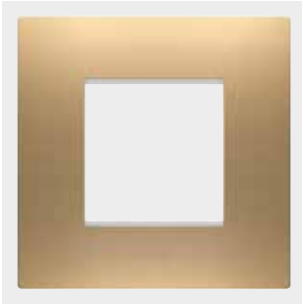

GW 16 022 SG

EGO INTERNATIONAL - GOLD

Code	Description	Type	Pack Carton
GW 16 022 SG	2 modules	-	12
GW 16 023 SG	2+2 modules	Horizontal	12
GW 16 024 SG	2+2 modules	Vertical	12
GW 16 026 SG	2+2+2 modules	Horizontal	6

CHARACTERISTICS: matt finish, metallic effect.

NOTES: centre distance 71 mm.

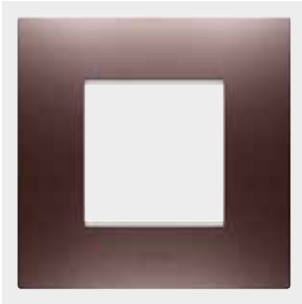

GW 16 022 CP

EGO INTERNATIONAL - COPPER

Code	Description	Type	Pack Carton
GW 16 022 CP	2 modules	-	12
GW 16 023 CP	2+2 modules	Horizontal	12
GW 16 024 CP	2+2 modules	Vertical	12
GW 16 026 CP	2+2+2 modules	Horizontal	6

CHARACTERISTICS: matt finish, metallic effect.

NOTES: centre distance 71 mm.

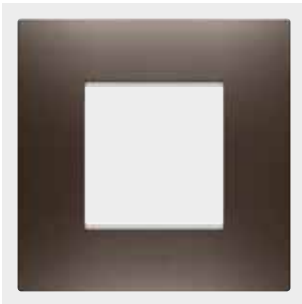

GW 16 022 BS

EGO INTERNATIONAL - BROWN SHADE

Code	Description	Type	Pack Carton
GW 16 022 BS	2 modules	-	12
GW 16 023 BS	2+2 modules	Horizontal	12
GW 16 024 BS	2+2 modules	Vertical	12
GW 16 026 BS	2+2+2 modules	Horizontal	6

CHARACTERISTICS: matt finish, metallic effect.

NOTES: centre distance 71 mm.



ChoruSmart



Scan the QR Code and find out all the technical informations.

ATTENTION TO DETAIL

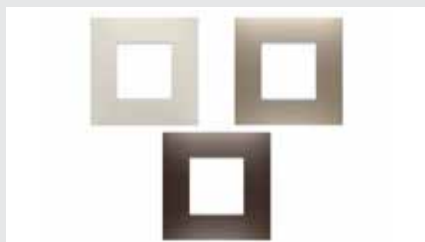

Three thematic lines of plates to match perfectly with ChoruSmart devices. A total of 12 colours, all with satin finishes.

INNOVATION



EGO was designed as a modern plate and has evolved in the EGO SMART version, an innovative concept of SMART HOME.

HIGHLY CUSTOMISABLE















The plates can be customised through a choice of colours and finishes. This allows the installation to be adapted to the style of the interiors and enhance all applications. Thanks to tampography and lasering, the plates can be customised with lettering, trademarks and logos. Please contact the GEWISS Commercial department to discuss the feasibility of any customisation.

CHORUSMART - Domestic range

EGO SMART INTERNATIONAL

Painted technopolymer

	<p>SATIN WHITE</p>  <p>GW 16 022 S PW 2 modules</p>	<p>CLAY</p>  <p>GW 16 022 S CY 2 modules</p>	<p>NATURAL BEIGE</p>  <p>GW 16 022 S NB 2 modules</p>	
	<p>DARK SAND</p>  <p>GW 16 022 S DS 2 modules</p>	<p>SATIN BLACK</p>  <p>GW 16 022 S DB 2 modules</p>		
	<p>MAGNETIC GRAY ▲</p>  <p>GW 16 022 S GR 2 modules</p>	<p>LIGHT BRONZE ▲</p>  <p>GW 16 022 S BR 2 modules</p>	<p>STEEL ▲</p>  <p>GW 16 022 S ST 2 modules</p>	
	<p>SOFT COPPER ▲</p>  <p>GW 16 022 S CS 2 modules</p>	<p>GOLD ▲</p>  <p>GW 16 022 S SG 2 modules</p>	<p>COPPER ▲</p>  <p>GW 16 022 S CP 2 modules</p>	<p>BROWN SHADE ▲</p>  <p>GW 16 022 S BS 2 modules</p>

▲ Metallic effect

Modularity

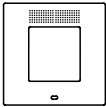

2 modules

For customized plates please contact our GEWISS Sales Organization

ChoruSmart

EGO SMART INTERNATIONAL plates

The EGO SMART plates go beyond pure aesthetics to become an element of interaction with the user and with other ChoruSmart system connected devices. Through RGB LED edge strips and a graphic display, the plates communicate operating statuses and alarms detected by other smart functions controlling your home. The EGO SMART and EGO plates, with their harmonious aesthetics, can be installed within the same system for a seamlessly designed look throughout the interior environment.



EGO SMART INTERNATIONAL PLATES

PAINTED TECHNOPOLYMER



GW 16 022 SPW

EGO SMART INTERNATIONAL PLATES - SATIN WHITE

Code	Description	For support codes	Pack Carton
GW 16 022 SPW	2 modules	GW16821N, GW16822N	1

FEATURES: matt finish. The plate has a dot-matrix display on the upper portion, RGB LED strips (along the outer and inner edges at the top and bottom) and a proximity sensor.

APPLICATIONS: visualisation of dynamic icons on the display indicating the functions associated with the devices installed in the plate; event/alarm signalling using the display (messages) and/or RGB led strips.

NOTES: The plate must be supplied with power by one of the following connected devices, which must be installed within the same box as the plate: GWA1201, GWA1202, GWA1231, GWA1232, GWA1241, GWA1242 or GW1x826, or by a dedicated GWA1700 power supply; The connection cable from the plate to the device powering it is included in the plate package.



GW 16 022 SCY

EGO SMART INTERNATIONAL PLATES - CLAY

Code	Description	For support codes	Pack Carton
GW 16 022 SCY	2 modules	GW16821N, GW16822N	1

FEATURES: matt finish. The plate has a dot-matrix display on the upper portion, RGB LED strips (along the outer and inner edges at the top and bottom) and a proximity sensor.

APPLICATIONS: visualisation of dynamic icons on the display indicating the functions associated with the devices installed in the plate; event/alarm signalling using the display (messages) and/or RGB led strips.

NOTES: the plate must be supplied with power by one of the following connected devices, which must be installed in the same box as the plate: GWA1201, GWA1202, GWA1231, GWA1232, GWA1241, GWA1242 or GW1x826, or by a dedicated GWA1700 power supply; The connection cable from the plate to the device powering it is included in the plate package. Codes not held as stock, for delivery times contact your local representative.



GW 16 022 SNB

EGO SMART INTERNATIONAL PLATES - NATURAL BEIGE

Code	Description	For support codes	Pack Carton
GW 16 022 SNB	2 modules	GW16821N, GW16822N	1

FEATURES: matt finish. The plate has a dot-matrix display on the upper portion, RGB LED strips (along the outer and inner edges at the top and bottom) and a proximity sensor.

APPLICATIONS: visualisation of dynamic icons on the display indicating the functions associated with the devices installed in the plate; event/alarm signalling using the display (messages) and/or RGB led strips.

NOTES: The plate must be supplied with power by one of the following connected devices, which must be installed within the same box as the plate: GWA1201, GWA1202, GWA1231, GWA1232, GWA1241, GWA1242 or GW1x826, or by a dedicated GWA1700 power supply; The connection cable from the plate to the device powering it is included in the plate package.



GW 16 022 SDS

EGO SMART INTERNATIONAL PLATES - DARK SAND

Code	Description	For support codes	Pack Carton
GW 16 022 SDS	2 modules	GW16821N, GW16822N	1

FEATURES: matt finish. The plate has a dot-matrix display on the upper portion, RGB LED strips (along the outer and inner edges at the top and bottom) and a proximity sensor.

APPLICATIONS: visualisation of dynamic icons on the display indicating the functions associated with the devices installed in the plate; event/alarm signalling using the display (messages) and/or RGB led strips.

NOTES: the plate must be supplied with power by one of the following connected devices, which must be installed in the same box as the plate: GWA1201, GWA1202, GWA1231, GWA1232, GWA1241, GWA1242 or GW1x826, or by a dedicated GWA1700 power supply; The connection cable from the plate to the device powering it is included in the plate package. Codes not held as stock, for delivery times contact your local representative.

CHORUSMART - Domestic range



GW 16 022 SDB

EGO SMART INTERNATIONAL PLATES - SATIN BLACK

Code	Description	For support codes	Pack Carton
GW 16 022 SDB	2 modules	GW16821N, GW16822N	1

FEATURES: matt finish. The plate has a dot-matrix display on the upper portion, RGB LED strips (along the outer and inner edges at the top and bottom) and a proximity sensor.

APPLICATIONS: visualisation of dynamic icons on the display indicating the functions associated with the devices installed in the plate; event/alarm signalling using the display (messages) and/or RGB led strips.

NOTES: The plate must be supplied with power by one of the following connected devices, which must be installed within the same box as the plate: GWA1201, GWA1202, GWA1231, GWA1232, GWA1241, GWA1242 or GW1x826, or by a dedicated GWA1700 power supply; The connection cable from the plate to the device powering it is included in the plate package.



GW 16 022 SGR

EGO SMART INTERNATIONAL PLATES - MAGNETIC GRAY

Code	Description	For support codes	Pack Carton
GW 16 022 SGR	2 modules	GW16821N, GW16822N	1

FEATURES: matt finish, metallic effect. The plate has a dot-matrix display on the upper portion, RGB LED strips (along the outer and inner edges at the top and bottom) and a proximity sensor.

APPLICATIONS: visualisation of dynamic icons on the display indicating the functions associated with the devices installed in the plate; event/alarm signalling using the display (messages) and/or RGB led strips.

NOTES: the plate must be powered by one of the following connected devices, which must be installed in the same box as the plate: GWA1201, GWA1202, GWA1231, GWA1232, GWA1241, GWA1242 or GW1x826, or by a dedicated GWA1700 power supply; The connection cable from the plate to the device powering it is included in the plate package.



GW 16 022 SBR

EGO SMART INTERNATIONAL PLATES - LIGHT BRONZE

Code	Description	For support codes	Pack Carton
GW 16 022 SBR	2 modules	GW16821N, GW16822N	1

FEATURES: matt finish, metallic effect. The plate has a dot-matrix display on the upper portion, RGB LED strips (along the outer and inner edges at the top and bottom) and a proximity sensor.

APPLICATIONS: visualisation of dynamic icons on the display indicating the functions associated with the devices installed in the plate; event/alarm signalling using the display (messages) and/or RGB led strips.

NOTES: the plate must be powered by one of the following connected devices, which must be installed in the same box as the plate: GWA1201, GWA1202, GWA1231, GWA1232, GWA1241, GWA1242 or GW1x826, or by a dedicated GWA1700 power supply; The connection cable from the plate to the device powering it is included in the plate package.



GW 16 022 SST

EGO SMART INTERNATIONAL PLATES - STEEL

Code	Description	For support codes	Pack Carton
GW 16 022 SST	2 modules	GW16821N, GW16822N	1

FEATURES: matt finish, metallic effect. The plate has a dot-matrix display on the upper portion, RGB LED strips (along the outer and inner edges at the top and bottom) and a proximity sensor.
APPLICATIONS: visualisation of dynamic icons on the display indicating the functions associated with the devices installed in the plate; event/alarm signalling using the display (messages) and/or RGB led strips.
NOTES: The plate must be supplied with power by one of the following connected devices, which must be installed in the same box as the plate: GWA1201, GWA1202, GWA1231, GWA1232, GWA1241, GWA1242 or GW1x826, or by a dedicated GWA1700 power supply; The connection cable from the plate to the device powering it is included in the plate package.
 Codes not held as stock, for delivery times contact your local representative.



GW 16 022 SCS

EGO SMART INTERNATIONAL PLATES - SOFT COPPER

Code	Description	For support codes	Pack Carton
GW 16 022 SCS	2 modules	GW16821N, GW16822N	1

FEATURES: matt finish, metallic effect. The plate has a dot-matrix display on the upper portion, RGB LED strips (along the outer and inner edges at the top and bottom) and a proximity sensor.
APPLICATIONS: visualisation of dynamic icons on the display indicating the functions associated with the devices installed in the plate; event/alarm signalling using the display (messages) and/or RGB led strips.
NOTES: The plate must be supplied with power by one of the following connected devices, which must be installed in the same box as the plate: GWA1201, GWA1202, GWA1231, GWA1232, GWA1241, GWA1242 or GW1x826, or by a dedicated GWA1700 power supply; The connection cable from the plate to the device powering it is included in the plate package.
 Codes not held as stock, for delivery times contact your local representative.

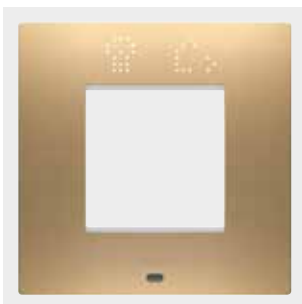

GW 16 022 SSG

EGO SMART INTERNATIONAL PLATES - GOLD

Code	Description	For support codes	Pack Carton
GW 16 022 SSG	2 modules	GW16821N, GW16822N	1

FEATURES: matt finish, metallic effect. The plate has a dot-matrix display on the upper portion, RGB LED strips (along the outer and inner edges at the top and bottom) and a proximity sensor.
APPLICATIONS: visualisation of dynamic icons on the display indicating the functions associated with the devices installed in the plate; event/alarm signalling using the display (messages) and/or RGB led strips.
NOTES: The plate must be supplied with power by one of the following connected devices, which must be installed in the same box as the plate: GWA1201, GWA1202, GWA1231, GWA1232, GWA1241, GWA1242 or GW1x826, or by a dedicated GWA1700 power supply; The connection cable from the plate to the device powering it is included in the plate package.
 Codes not held as stock, for delivery times contact your local representative.

CHORUSMART - Domestic range



GW 16 022 SCP

EGO SMART INTERNATIONAL PLATES - COPPER

Code	Description	For support codes	Pack Carton
GW 16 022 SCP	2 modules	GW16821N, GW16822N	1

FEATURES: matt finish, metallic effect. The plate has a dot-matrix display on the upper portion, RGB LED strips (along the outer and inner edges at the top and bottom) and a proximity sensor.
APPLICATIONS: visualisation of dynamic icons on the display indicating the functions associated with the devices installed in the plate; event/alarm signalling using the display (messages) and/or RGB led strips.

NOTES: The plate must be supplied with power by one of the following connected devices, which must be installed in the same box as the plate: GWA1201, GWA1202, GWA1231, GWA1232, GWA1241, GWA1242 or GW1x826, or by a dedicated GWA1700 power supply; The connection cable from the plate to the device powering it is included in the plate package.
 Codes not held as stock, for delivery times contact your local representative.



GW 16 022 SBS

EGO SMART INTERNATIONAL PLATES - BROWN SHADE

Code	Description	For support codes	Pack Carton
GW 16 022 SBS	2 modules	GW16821N, GW16822N	1

FEATURES: matt finish, metallic effect. The plate has a dot-matrix display on the upper portion, RGB LED strips (along the outer and inner edges at the top and bottom) and a proximity sensor.
APPLICATIONS: visualisation of dynamic icons on the display indicating the functions associated with the devices installed in the plate; event/alarm signalling using the display (messages) and/or RGB led strips.

NOTES: The plate must be supplied with power by one of the following connected devices, which must be installed in the same box as the plate: GWA1201, GWA1202, GWA1231, GWA1232, GWA1241, GWA1242 or GW1x826, or by a dedicated GWA1700 power supply; The connection cable from the plate to the device powering it is included in the plate package.
 Codes not held as stock, for delivery times contact your local representative.



ChoruSmart



Scan the QR Code and find out all the technical informations.

INNOVATION



The plate communicates with the user through simple and immediate visual feedback. The display is dynamic: text messages scroll and icons change shape to indicate the activation and operation of the commanded loads. The edges are illuminated with a coloured beam of light: each colour corresponds to a different signal.

SIMPLICITY



To recognise the associated function, each command can be linked to a different graphic. Lighting icons, messages and colours can be selected from the Home Gateway App with a wide variety of choices.









DOUBLED FUNCTIONS



The EGO SMART plates expands the functions managed from the control point. The manually activated proximity sensor enables the. Shift mode on the plate, doubling the functions of the control units installed, without taking up additional space.

CHORUSMART - Domestic range



LUX INTERNATIONAL

	Technopolymer			
	WHITE	MONOCHROME WHITE	TONER BLACK	TONER BLACK LAVY
Technopolymer				
	GW 16 222 TB	2 modules	GW 16 222 YB	2 modules
	GW 16 223 TB	2+2 modules horiz.	GW 16 223 YB	2+2 modules horiz.
	GW 16 224 TB	2+2 modules vert.	GW 16 224 YB	2+2 modules vert.
	GW 16 226 TB	2+2+2 modules horiz.	GW 16 226 YB	2+2+2 modules horiz.
	GW 16 227 TB	2+2+2 modules vert.	GW 16 227 YB	2+2+2 modules vert.
	GW 16 228 TB	2+2+2+2 modules horiz.	GW 16 228 YB	2+2+2+2 modules horiz.
	GW 16 229 TB	2+2+2+2 modules vert.	GW 16 229 YB	2+2+2+2 modules vert.
	GW 16 222 TN	2 modules	GW 16 222 YN	2 modules
	GW 16 223 TN	2+2 modules horiz.	GW 16 223 YN	2+2 modules horiz.
	GW 16 224 TN	2+2 modules vert.	GW 16 224 YN	2+2 modules vert.
	GW 16 226 TN	2+2+2 modules horiz.	GW 16 226 YN	2+2+2 modules horiz.
GW 16 227 TN	2+2+2 modules vert.	GW 16 227 YN	2+2+2 modules vert.	
GW 16 228 TN	2+2+2+2 modules horiz.	GW 16 228 YN	2+2+2+2 modules horiz.	
GW 16 229 TN	2+2+2+2 modules vert.	GW 16 229 YN	2+2+2+2 modules vert.	
Painted technopolymer	TITANIUM ▲	MONOCHROME TITANIUM ▲	SLATE ▲	ABSOLUTE SLATE ▲
				
	GW 16 222 VT	2 modules	GW 16 222 YT	2 modules
	GW 16 223 VT	2+2 modules horiz.	GW 16 223 YT	2+2 modules horiz.
	GW 16 224 VT	2+2 modules vert.	GW 16 224 YT	2+2 modules vert.
	GW 16 226 VT	2+2+2 modules horiz.	GW 16 226 YT	2+2+2 modules horiz.
	GW 16 227 VT	2+2+2 modules vert.	GW 16 227 YT	2+2+2 modules vert.
	GW 16 228 VT	2+2+2+2 modules horiz.	GW 16 228 YT	2+2+2+2 modules horiz.
	GW 16 229 VT	2+2+2+2 modules vert.	GW 16 229 YT	2+2+2+2 modules vert.
	GW 16 222 VA	2 modules	GW 16 222 YA	2 modules
	GW 16 223 VA	2+2 modules horiz.	GW 16 223 YA	2+2 modules horiz.
	GW 16 224 VA	2+2 modules vert.	GW 16 224 YA	2+2 modules vert.
GW 16 226 VA	2+2+2 modules horiz.	GW 16 226 YA	2+2+2 modules horiz.	
GW 16 227 VA	2+2+2 modules vert.	GW 16 227 YA	2+2+2 modules vert.	
GW 16 228 VA	2+2+2+2 modules horiz.	GW 16 228 YA	2+2+2+2 modules horiz.	
GW 16 229 VA	2+2+2+2 modules vert.	GW 16 229 YA	2+2+2+2 modules vert.	
Metal	MONOCHROME SATIN WHITE	MONOCHROME NATURAL BEIGE	MONOCHROME SATIN BLACK	BRUSHED ALUMINIUM
				
	GW 16 222 XW	2 modules	GW 16 222 XL	2 modules
	GW 16 223 XW	2+2 modules horiz.	GW 16 223 XL	2+2 modules horiz.
	GW 16 224 XW	2+2 modules vert.	GW 16 224 XL	2+2 modules vert.
	GW 16 226 XW	2+2+2 modules horiz.	GW 16 226 XL	2+2+2 modules horiz.
	GW 16 227 XW	2+2+2 modules vert.	GW 16 227 XL	2+2+2 modules vert.
	GW 16 228 XW	2+2+2+2 modules horiz.	GW 16 228 XL	2+2+2+2 modules horiz.
	GW 16 229 XW	2+2+2+2 modules vert.	GW 16 229 XL	2+2+2+2 modules vert.
	GW 16 222 XM	2 modules	GW 16 222 XS	2 modules
	GW 16 223 XM	2+2 modules horiz.	GW 16 223 XS	2+2 modules horiz.
	GW 16 224 XM	2+2 modules vert.	GW 16 224 XS	2+2 modules vert.
	GW 16 226 XM	2+2+2 modules horiz.	GW 16 226 XS	2+2+2 modules horiz.
	GW 16 227 XM	2+2+2 modules vert.	GW 16 227 XS	2+2+2 modules vert.
	GW 16 228 XM	2+2+2+2 modules horiz.	GW 16 228 XS	2+2+2+2 modules horiz.
	GW 16 229 XM	2+2+2+2 modules vert.	GW 16 229 XS	2+2+2+2 modules vert.
	BRUSHED ALUMINIUM LAVY	GOLD	ANTIQUÉ BRASS	
				
GW 16 222 WS	2 modules	GW 16 222 XG	2 modules	
GW 16 223 WS	2+2 modules horiz.	GW 16 223 XG	2+2 modules horiz.	
GW 16 224 WS	2+2 modules vert.	GW 16 224 XG	2+2 modules vert.	
GW 16 226 WS	2+2+2 modules horiz.	GW 16 226 XG	2+2+2 modules horiz.	
GW 16 227 WS	2+2+2 modules vert.	GW 16 227 XG	2+2+2 modules vert.	
GW 16 228 WS	2+2+2+2 modules horiz.	GW 16 228 XG	2+2+2+2 modules horiz.	
GW 16 229 WS	2+2+2+2 modules vert.	GW 16 229 XG	2+2+2+2 modules vert.	
GW 16 222 XQ	2 modules	GW 16 222 XQ	2 modules	
GW 16 223 XQ	2+2 modules horiz.	GW 16 223 XQ	2+2 modules horiz.	
GW 16 224 XQ	2+2 modules vert.	GW 16 224 XQ	2+2 modules vert.	
GW 16 226 XQ	2+2+2 modules horiz.	GW 16 226 XQ	2+2+2 modules horiz.	
GW 16 227 XQ	2+2+2 modules vert.	GW 16 227 XQ	2+2+2 modules vert.	
GW 16 228 XQ	2+2+2+2 modules horiz.	GW 16 228 XQ	2+2+2+2 modules horiz.	
GW 16 229 XQ	2+2+2+2 modules vert.	GW 16 229 XQ	2+2+2+2 modules vert.	

▲ Metallic effect

For customized plates please contact our GEWISS Sales Organization

LUX INTERNATIONAL

Class	NATURAL REFLECTION		PEARLY GRAY	
	Image	Configuration	Image	Configuration
		GW 16 222 GT 2 modules		GW 16 222 GP 2 modules
		GW 16 223 GT 2+2 modules horiz.		GW 16 223 GP 2+2 modules horiz.
		GW 16 224 GT 2+2 modules vert.		GW 16 224 GP 2+2 modules vert.
		GW 16 226 GT 2+2+2 modules horiz.		GW 16 226 GP 2+2+2 modules horiz.
		GW 16 227 GT 2+2+2 modules vert.		GW 16 227 GP 2+2+2 modules vert.
		GW 16 228 GT 2+2+2+2 modules horiz.		GW 16 228 GP 2+2+2+2 modules horiz.
		GW 16 229 GT 2+2+2+2 modules vert.		GW 16 229 GP 2+2+2+2 modules vert.

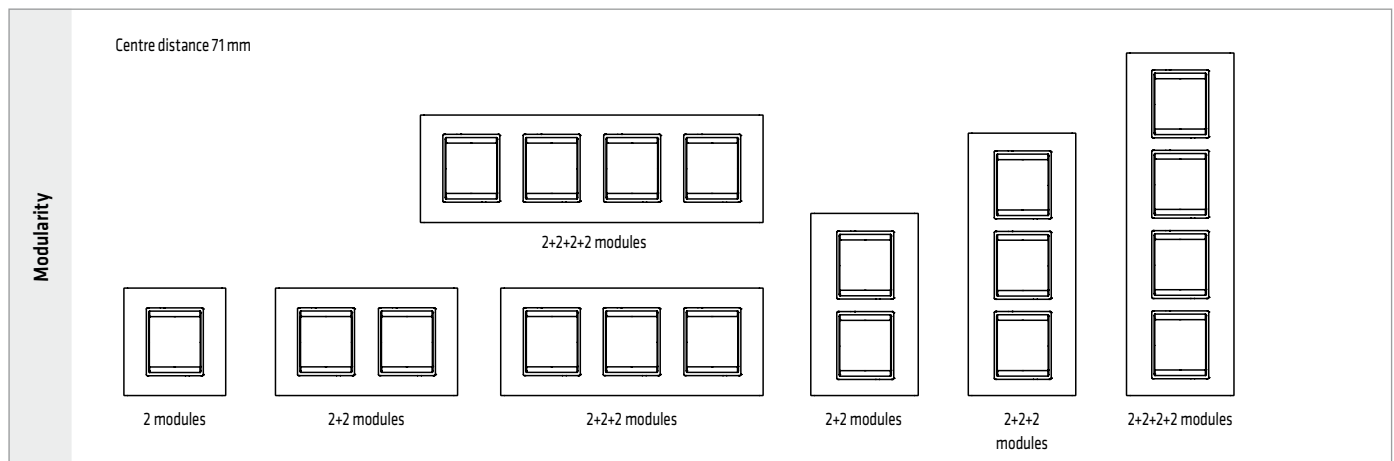

News

For customized plates please contact our GEWISS Sales Organization

ChoruSmart

LUX International plates

LUX plates, with their modern, refined lines, marry the high-tech spirit of modernity with the refined and elegant taste of tradition. Glass and metal versions are added to the classic technopolymer plates. With monochrome variants of the LUX plates, uniformity of colour becomes the distinctive character of each ChoruSmart lighting device.



LUX INTERNATIONAL PLATES

TECHNOPOLYMER



GW 16 222 TB

LUX INTERNATIONAL - WHITE

Code	Description	Type	Pack Carton
GW 16 222 TB	2 modules	-	12
GW 16 223 TB	2+2 modules	Horizontal	6
GW 16 224 TB	2+2 modules	Vertical	6
GW 16 226 TB	2+2+2 modules	Horizontal	1
GW 16 227 TB	2+2+2 modules	Vertical	1
GW 16 228 TB	2+2+2+2 modules	Horizontal	1
GW 16 229 TB	2+2+2+2 modules	Vertical	1

CHARACTERISTICS: glossy finish.

NOTES: Inner frame chromed. Centre distance 71 mm.



GW 16 222 YB

LUX INTERNATIONAL - MONOCHROME WHITE

Code	Description	Type	Pack Carton
GW 16 222 YB	2 modules	-	12
GW 16 223 YB	2+2 modules	Horizontal	6
GW 16 224 YB	2+2 modules	Vertical	6
GW 16 226 YB	2+2+2 modules	Horizontal	1
GW 16 227 YB	2+2+2 modules	Vertical	1
GW 16 228 YB	2+2+2+2 modules	Horizontal	1
GW 16 229 YB	2+2+2+2 modules	Vertical	1

CHARACTERISTICS: glossy finish.

NOTES: inner frame in the same white colour as the plate. Glossy finish. Centre distance 71 mm.



GW 16 222 TN

LUX INTERNATIONAL - TONER BLACK

Code	Description	Type	Pack Carton
GW 16 222 TN	2 modules	-	12
GW 16 223 TN	2+2 modules	Horizontal	6
GW 16 224 TN	2+2 modules	Vertical	6
GW 16 226 TN	2+2+2 modules	Horizontal	1
GW 16 227 TN	2+2+2 modules	Vertical	1
GW 16 228 TN	2+2+2+2 modules	Horizontal	1
GW 16 229 TN	2+2+2+2 modules	Vertical	1

CHARACTERISTICS: glossy finish.

NOTES: Inner frame chromed. Centre distance 71 mm.



GW 16 222 YN

LUX INTERNATIONAL - TONER BLACK LAVY

Code	Description	Type	Pack Carton
GW 16 222 YN	2 modules	-	12
GW 16 223 YN	2+2 modules	Horizontal	6
GW 16 224 YN	2+2 modules	Vertical	6
GW 16 226 YN	2+2+2 modules	Horizontal	1
GW 16 227 YN	2+2+2 modules	Vertical	1
GW 16 228 YN	2+2+2+2 modules	Horizontal	1
GW 16 229 YN	2+2+2+2 modules	Vertical	1

CHARACTERISTICS: glossy finish.

NOTES: inner frame in the same black colour as the plate, matt finish. Centre distance 71 mm.

PAINTED TECHNOPOLYMER



GW 16 222 VT

LUX INTERNATIONAL - TITANIUM

Code	Description	Type	Pack Carton
GW 16 222 VT	2 modules	-	12
GW 16 223 VT	2+2 modules	Horizontal	6
GW 16 224 VT	2+2 modules	Vertical	6
GW 16 226 VT	2+2+2 modules	Horizontal	1
GW 16 227 VT	2+2+2 modules	Vertical	1
GW 16 228 VT	2+2+2+2 modules	Horizontal	1
GW 16 229 VT	2+2+2+2 modules	Vertical	1

CHARACTERISTICS: glossy finish, metallic effect.
NOTES: inner frame chromed. Centre distance 71 mm.



GW 16 222 YT

LUX INTERNATIONAL - MONOCHROME TITANIUM

Code	Description	Type	Pack Carton
GW 16 222 YT	2 modules	-	12
GW 16 223 YT	2+2 modules	Horizontal	6
GW 16 224 YT	2+2 modules	Vertical	6
GW 16 226 YT	2+2+2 modules	Horizontal	1
GW 16 227 YT	2+2+2 modules	Vertical	1
GW 16 228 YT	2+2+2+2 modules	Horizontal	1
GW 16 229 YT	2+2+2+2 modules	Vertical	1

CHARACTERISTICS: glossy finish, metallic effect.
NOTES: inner frame in the same titanium colour as the plate, glossy finish. Centre distance 71 mm.



GW 16 222 VA

LUX INTERNATIONAL - SLATE

Code	Description	Type	Centre distance	Pack Carton
GW 16 222 VA	2 modules	-	-	12
GW 16 223 VA	2+2 modules	Horizontal	71 mm	6
GW 16 224 VA	2+2 modules	Vertical	71 mm	6
GW 16 226 VA	2+2+2 modules	Horizontal	71 mm	1
GW 16 227 VA	2+2+2 modules	Vertical	71 mm	1
GW 16 228 VA	2+2+2+2 modules	Horizontal	71 mm	1
GW 16 229 VA	2+2+2+2 modules	Vertical	71 mm	1

CHARACTERISTICS: glossy finish, metallic effect.
NOTES: inner frame chromed. Centre distance 71 mm.



GW 16 222 YA

LUX INTERNATIONAL - ABSOLUTE SLATE

Code	Description	Type	Pack Carton
GW 16 222 YA	2 modules	-	12
GW 16 223 YA	2+2 modules	Horizontal	6
GW 16 224 YA	2+2 modules	Vertical	6
GW 16 226 YA	2+2+2 modules	Horizontal	1
GW 16 227 YA	2+2+2 modules	Vertical	1
GW 16 228 YA	2+2+2+2 modules	Horizontal	1
GW 16 229 YA	2+2+2+2 modules	Vertical	1

CHARACTERISTICS: glossy finish, metallic effect.
NOTES: inner frame in the same slate colour as the plate, glossy finish. Centre distance 71 mm.

CHORUSMART - Domestic range

METAL



GW 16 222 XW

LUX INTERNATIONAL - MONOCHROME SATIN WHITE

Code	Description	Type	Pack Carton
GW 16 222 XW	2 modules	-	1
GW 16 223 XW	2+2 modules	Horizontal	1
GW 16 224 XW	2+2 modules	Vertical	1
GW 16 226 XW	2+2+2 modules	Horizontal	1
GW 16 227 XW	2+2+2 modules	Vertical	1
GW 16 228 XW	2+2+2+2 modules	Horizontal	1
GW 16 229 XW	2+2+2+2 modules	Vertical	1

CHARACTERISTICS: matt finish.

NOTES: inner frame in same white colour as the plate, matt finish. Centre distance 71 mm.



GW 16 222 XL

LUX INTERNATIONAL - MONOCHROME NATURAL BEIGE

Code	Description	Type	Pack Carton
GW 16 222 XL	2 modules	-	1
GW 16 223 XL	2+2 modules	Horizontal	1
GW 16 224 XL	2+2 modules	Vertical	1
GW 16 226 XL	2+2+2 modules	Horizontal	1
GW 16 227 XL	2+2+2 modules	Vertical	1
GW 16 228 XL	2+2+2+2 modules	Horizontal	1
GW 16 229 XL	2+2+2+2 modules	Vertical	1

CHARACTERISTICS: matt finish.

NOTES: inner frame in same natural beige colour as the plate, matt finish. Centre distance 71 mm.



GW 16 222 XM

LUX INTERNATIONAL - MONOCHROME SATIN BLACK

Code	Description	Type	Pack Carton
GW 16 222 XM	2 modules	-	1
GW 16 223 XM	2+2 modules	Horizontal	1
GW 16 224 XM	2+2 modules	Vertical	1
GW 16 226 XM	2+2+2 modules	Horizontal	1
GW 16 227 XM	2+2+2 modules	Vertical	1
GW 16 228 XM	2+2+2+2 modules	Horizontal	1
GW 16 229 XM	2+2+2+2 modules	Vertical	1

CHARACTERISTICS: matt finish.

NOTES: inner frame in same black colour as the plate, matt finish. Centre distance 71 mm.



GW 16 222 XS

LUX INTERNATIONAL - BRUSHED ALUMINIUM

Code	Description	Type	Pack Carton
GW 16 222 XS	2 modules	-	1
GW 16 223 XS	2+2 modules	Horizontal	1
GW 16 224 XS	2+2 modules	Vertical	1
GW 16 226 XS	2+2+2 modules	Horizontal	1
GW 16 227 XS	2+2+2 modules	Vertical	1
GW 16 228 XS	2+2+2+2 modules	Horizontal	1
GW 16 229 XS	2+2+2+2 modules	Vertical	1

CHARACTERISTICS: matt finish.

NOTES: inner frame in light bronze colour, matt finish. Centre distance 71 mm.



GW 16 222 WS

LUX INTERNATIONAL - BRUSHED ALUMINIUM LAVY

Code	Description	Type	Pack Carton
GW 16 222 WS	2 modules	-	1
GW 16 223 WS	2+2 modules	Horizontal	1
GW 16 224 WS	2+2 modules	Vertical	1
GW 16 226 WS	2+2+2 modules	Horizontal	1
GW 16 227 WS	2+2+2 modules	Vertical	1
GW 16 228 WS	2+2+2+2 modules	Horizontal	1
GW 16 229 WS	2+2+2+2 modules	Vertical	1

CHARACTERISTICS: matt finish.

NOTES: inner frame in black colour, matt finish. Centre distance 71 mm.

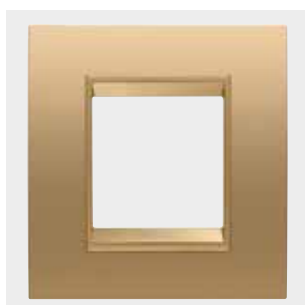

GW 16 222 XG

LUX INTERNATIONAL - GOLD

Code	Description	Type	Pack Carton
GW 16 222 XG	2 modules	-	1
GW 16 223 XG	2+2 modules	Horizontal	1
GW 16 224 XG	2+2 modules	Vertical	1
GW 16 226 XG	2+2+2 modules	Horizontal	1
GW 16 227 XG	2+2+2 modules	Vertical	1
GW 16 228 XG	2+2+2+2 modules	Horizontal	1
GW 16 229 XG	2+2+2+2 modules	Vertical	1

CHARACTERISTICS: matt finish, metallic effect.

NOTES: inner frame in the same gold colour as the plate, matt finish. Centre distance 71 mm.

CHORUSMART - Domestic range



GW 16 222 XQ

LUX INTERNATIONAL - ANTIQUE BRASS

Code	Description	Type	Pack Carton
GW 16 222 XQ	2 modules	-	1
GW 16 223 XQ	2+2 modules	Horizontal	1
GW 16 224 XQ	2+2 modules	Vertical	1
GW 16 226 XQ	2+2+2 modules	Horizontal	1
GW 16 227 XQ	2+2+2 modules	Vertical	1
GW 16 228 XQ	2+2+2+2 modules	Horizontal	1
GW 16 229 XQ	2+2+2+2 modules	Vertical	1

CHARACTERISTICS: matt finish.

NOTES: inner frame in dark bronze colour, matt finish. Centre distance 71 mm.

GLASS



GW 16 222 GT

LUX INTERNATIONAL - NATURAL REFLECTION

Code	Description	Type	Pack Carton
GW 16 222 GT	2 modules	-	1
GW 16 223 GT	2+2 modules	Horizontal	1
GW 16 224 GT	2+2 modules	Vertical	1
GW 16 226 GT	2+2+2 modules	Horizontal	1
GW 16 227 GT	2+2+2 modules	Vertical	1
GW 16 228 GT	2+2+2+2 modules	Horizontal	1
GW 16 229 GT	2+2+2+2 modules	Vertical	1

CHARACTERISTICS: matt finish.

NOTES: inner frame in light bronze colour, matt finish. Centre distance 71 mm. Design variations in the glass plates are a sign of quality and indicate the genuineness of the materials used.



GW 16 222 GP

LUX INTERNATIONAL - PEARLY GRAY

Code	Description	Type	Pack Carton
GW 16 222 GP	2 modules	-	1
GW 16 223 GP	2+2 modules	Horizontal	1
GW 16 224 GP	2+2 modules	Vertical	1
GW 16 226 GP	2+2+2 modules	Horizontal	1
GW 16 227 GP	2+2+2 modules	Vertical	1
GW 16 228 GP	2+2+2+2 modules	Horizontal	1
GW 16 229 GP	2+2+2+2 modules	Vertical	1

CHARACTERISTICS: matt finish.

NOTES: inner frame in light bronze colour, matt finish. Centre distance 71 mm. Design variations in the glass plates are a sign of quality and indicate the genuineness of the materials used.



ChoruSmart



Scan the QR Code and find out all the technical informations.

CONTEMPORARY STYLE



The LUX plate, with its modern shapes, is the perfect blend of modernity and the elegant aesthetics of tradition.

MATERIALS

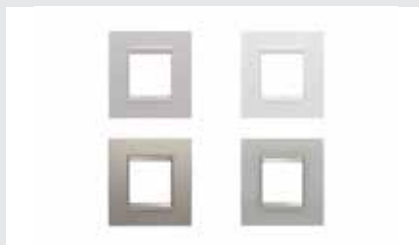

Modern and elegantly designed, LUX plates meet all your needs with their wide variety of materials, from technopolymer to metal and glass.

HIGHLY CUSTOMISABLE





The plates can be customised through a choice of colours and finishes. This allows the installation to be adapted to the style of the interiors and enhance all applications. Thanks to tampography and lasering, the plates can be customised with lettering, trademarks and logos. Please contact the GEWISS Commercial department to discuss the feasibility of any customisation.

CHORUSMART - Domestic range

ONE

Technopolymer

WHITE	TONER BLACK	IVORY	HEMP
			
GW 16 101 TB 1 module	GW 16 101 TN 1 module	GW 16 101 TI 1 module	GW 16 101 TC 1 module
GW 16 102 TB 2 modules	GW 16 102 TN 2 modules	GW 16 102 TI 2 modules	GW 16 102 TC 2 modules
GW 16 103 TB 3 modules	GW 16 103 TN 3 modules	GW 16 103 TI 3 modules	GW 16 103 TC 3 modules
GW 16 104 TB 4 modules	GW 16 104 TN 4 modules	GW 16 104 TI 4 modules	GW 16 104 TC 4 modules
GW 16 106 TB 6 modules	GW 16 106 TN 6 modules	GW 16 106 TI 6 modules	GW 16 106 TC 6 modules
GW 16 109 TB 6 modules large			
GW 16 108 TB 4+4 modules			
GW 16 112 TB 6+6 modules			

Painted technopolymer

SATIN WHITE	NATURAL BEIGE	SATIN BLACK	TITANIUM ▲
			
GW 16 101 VW 1 module	GW 16 101 VL 1 module	GW 16 101 VN 1 module	GW 16 101 VT 1 module
GW 16 102 VW 2 modules	GW 16 102 VL 2 modules	GW 16 102 VN 2 modules	GW 16 102 VT 2 modules
GW 16 103 VW 3 modules	GW 16 103 VL 3 modules	GW 16 103 VN 3 modules	GW 16 103 VT 3 modules
GW 16 104 VW 4 modules	GW 16 104 VL 4 modules	GW 16 104 VN 4 modules	GW 16 104 VT 4 modules
GW 16 106 VW 6 modules	GW 16 106 VL 6 modules	GW 16 106 VN 6 modules	GW 16 106 VT 6 modules
GW 16 108 VW 4+4 modules	GW 16 108 VL 4+4 modules	GW 16 108 VN 4+4 modules	GW 16 108 VT 4+4 modules
GW 16 112 VW 6+6 modules	GW 16 112 VL 6+6 modules	GW 16 112 VN 6+6 modules	GW 16 112 VT 6+6 modules

TUSCAN RED	TEAL	SOFT COPPER ▲	GOLD ▲
			
GW 16 101 VD 1 module	GW 16 101 VZ 1 module	GW 16 101 VX 1 module	GW 16 101 VO 1 module
GW 16 102 VD 2 modules	GW 16 102 VZ 2 modules	GW 16 102 VX 2 modules	GW 16 102 VO 2 modules
GW 16 103 VD 3 modules	GW 16 103 VZ 3 modules	GW 16 103 VX 3 modules	GW 16 103 VO 3 modules
GW 16 104 VD 4 modules	GW 16 104 VZ 4 modules	GW 16 104 VX 4 modules	GW 16 104 VO 4 modules
GW 16 106 VD 6 modules	GW 16 106 VZ 6 modules	GW 16 106 VX 6 modules	GW 16 106 VO 6 modules

▲ Metallic effect

Modularity

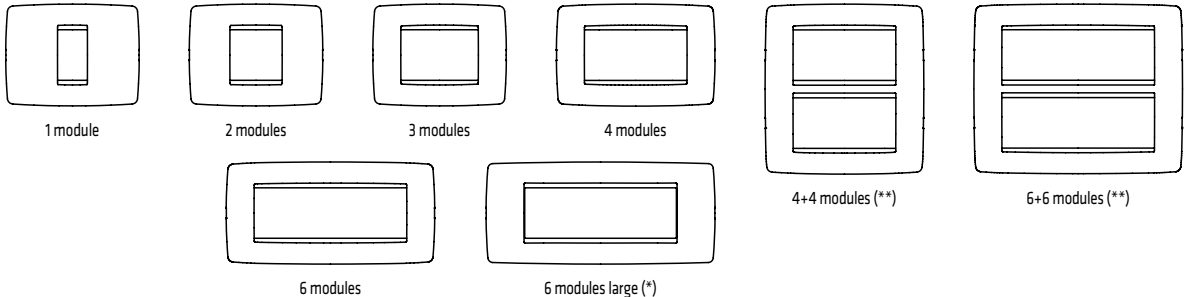

1 module 2 modules 3 modules 4 modules

6 modules 6 modules large (*)

4+4 modules (**)

6+6 modules (**)

(*) White

(**) White, Satin white, Natural beige, Satin black and Titanium

For customized plates please contact our GEWISS Sales Organization

ChoruSmart

ONE plates

An informal appearance and classic shapes: the ONE line of plates in the ChoruSmart system is dedicated to all those who desire a home interior finished with a minimal simplicity. ONE's restrained and discreet design enhances any environment, bringing harmony and aesthetic coherence to all rooms. Available in a wide variety of colour tones, ONE can be fitted in any shade to leave room for the imagination.

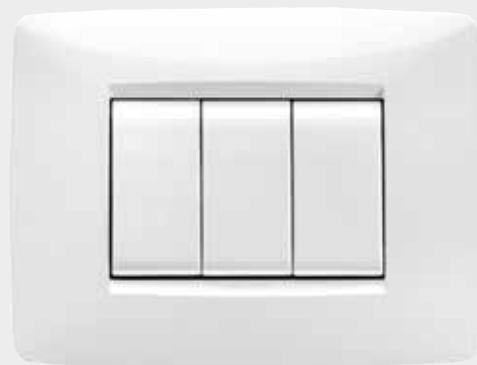

ONE ITALIAN STANDARD PLATES

TECHNOPOLYMER



GW 16 103 TB

ONE - WHITE

Code	Description	Configuration	For support codes	Pack Carton
GW 16 101 TB	1 module	-	GW16802, GW16803, GW16803N	96
GW 16 102 TB	2 modules	-	GW16802, GW16803, GW16803N	96
GW 16 103 TB	3 modules	-	GW16803, GW16803N	96
GW 16 104 TB	4 modules	-	GW16804, GW16804N	12
GW 16 106 TB	6 modules	-	GW16806	12
GW 16 109 TB	6 modules	Large	GW16806	6
GW 16 108 TB	4+4 modules	Overlapping	GW16808	6
GW 16 112 TB	6+6 modules	Overlapping	GW16812	6

CHARACTERISTICS: glossy finish. GW16109TB total width 202 mm.



GW 16 103 TN

ONE - TONER BLACK

Code	Description	For support codes	Pack Carton
GW 16 101 TN	1 module	GW16802, GW16803, GW16803N	12
GW 16 102 TN	2 modules	GW16802, GW16803, GW16803N	12
GW 16 103 TN	3 modules	GW16803, GW16803N	24
GW 16 104 TN	4 modules	GW16804, GW16804N	12
GW 16 106 TN	6 modules	GW16806	6

CHARACTERISTICS: glossy finish.



GW 16 103 TI

ONE - IVORY

Code	Description	For support codes	Pack Carton
GW 16 101 TI	1 module	GW16802, GW16803, GW16803N	12
GW 16 102 TI	2 modules	GW16802, GW16803, GW16803N	12
GW 16 103 TI	3 modules	GW16803, GW16803N	24
GW 16 104 TI	4 modules	GW16804, GW16804N	12
GW 16 106 TI	6 modules	GW16806	6

CHARACTERISTICS: glossy finish.



GW 16 103 TC

ONE - HEMP

Code	Description	For support codes	Pack Carton
GW 16 101 TC	1 module	GW16802, GW16803, GW16803N	12
GW 16 102 TC	2 modules	GW16802, GW16803, GW16803N	12
GW 16 103 TC	3 modules	GW16803, GW16803N	24
GW 16 104 TC	4 modules	GW16804, GW16804N	12
GW 16 106 TC	6 modules	GW16806	6

CHARACTERISTICS: glossy finish.

CHORUSMART - Domestic range

PAINTED TECHNOPOLYMER



GW 16 103 VW

ONE - SATIN WHITE

Code	Description	Configuration	For support codes	Pack Carton
GW 16 101 VW	1 module	-	GW16802, GW16803, GW16803N	96
GW 16 102 VW	2 modules	-	GW16802, GW16803, GW16803N	96
GW 16 103 VW	3 modules	-	GW16803, GW16803N	96
GW 16 104 VW	4 modules	-	GW16804, GW16804N	12
GW 16 106 VW	6 modules	-	GW16806	12
GW 16 108 VW	4+4 modules	Overlapping	GW16808	6
GW 16 112 VW	6+6 modules	Overlapping	GW16812	6

CHARACTERISTICS: matt finish.



GW 16 103 VL

ONE - NATURAL BEIGE

Code	Description	Configuration	For support codes	Pack Carton
GW 16 101 VL	1 module	-	GW16802, GW16803, GW16803N	12
GW 16 102 VL	2 modules	-	GW16802, GW16803, GW16803N	12
GW 16 103 VL	3 modules	-	GW16803, GW16803N	24
GW 16 104 VL	4 modules	-	GW16804, GW16804N	12
GW 16 106 VL	6 modules	-	GW16806	6
GW 16 108 VL	4+4 modules	Overlapping	GW16808	6
GW 16 112 VL	6+6 modules	Overlapping	GW16812	6

CHARACTERISTICS: matt finish.

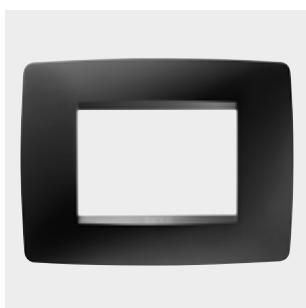

GW 16 103 VN

ONE - SATIN BLACK

Code	Description	Configuration	For support codes	Pack Carton
GW 16 101 VN	1 module	-	GW16802, GW16803, GW16803N	12
GW 16 102 VN	2 modules	-	GW16802, GW16803, GW16803N	12
GW 16 103 VN	3 modules	-	GW16803, GW16803N	24
GW 16 104 VN	4 modules	-	GW16804, GW16804N	12
GW 16 106 VN	6 modules	-	GW16806	6
GW 16 108 VN	4+4 modules	Overlapping	GW16808	6
GW 16 112 VN	6+6 modules	Overlapping	GW16812	6

CHARACTERISTICS: matt finish.



GW 16 103 VT

ONE - TITANIUM

Code	Description	Configuration	For support codes	Pack Carton
GW 16 101 VT	1 module	-	GW16802, GW16803, GW16803N	12
GW 16 102 VT	2 modules	-	GW16802, GW16803, GW16803N	12
GW 16 103 VT	3 modules	-	GW16803, GW16803N	24
GW 16 104 VT	4 modules	-	GW16804, GW16804N	12
GW 16 106 VT	6 modules	-	GW16806	6
GW 16 108 VT	4+4 modules	Overlapping	GW16808	6
GW 16 112 VT	6+6 modules	Overlapping	GW16812	6

CHARACTERISTICS: glossy finish, metallic effect.



GW 16 103 VD

ONE - TUSCAN RED

Code	Description	For support codes	Pack Carton
GW 16 101 VD	1 module	GW16802, GW16803, GW16803N	12
GW 16 102 VD	2 modules	GW16802, GW16803, GW16803N	12
GW 16 103 VD	3 modules	GW16803, GW16803N	24
GW 16 104 VD	4 modules	GW16804, GW16804N	12
GW 16 106 VD	6 modules	GW16806	6

CHARACTERISTICS: matt finish.



GW 16 103 VZ

ONE - TEAL

Code	Description	For support codes	Pack Carton
GW 16 101 VZ	1 module	GW16802, GW16803, GW16803N	12
GW 16 102 VZ	2 modules	GW16802, GW16803, GW16803N	12
GW 16 103 VZ	3 modules	GW16803, GW16803N	24
GW 16 104 VZ	4 modules	GW16804, GW16804N	12
GW 16 106 VZ	6 modules	GW16806	6

CHARACTERISTICS: matt finish.

CHORUSMART - Domestic range



GW 16 103 VX

ONE - SOFT COPPER

Code	Description	For support codes	Pack Carton
GW 16 101 VX	1 module	GW16802, GW16803, GW16803N	12
GW 16 102 VX	2 modules	GW16802, GW16803, GW16803N	12
GW 16 103 VX	3 modules	GW16803, GW16803N	12
GW 16 104 VX	4 modules	GW16804, GW16804N	12
GW 16 106 VX	6 modules	GW16806	6

CHARACTERISTICS: matt finish, metallic effect.

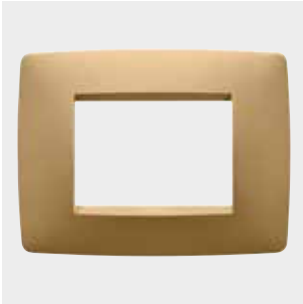

GW 16 103 VO

ONE - GOLD

Code	Description	For support codes	Pack Carton
GW 16 101 VO	1 module	GW16802, GW16803, GW16803N	12
GW 16 102 VO	2 modules	GW16802, GW16803, GW16803N	12
GW 16 103 VO	3 modules	GW16803, GW16803N	12
GW 16 104 VO	4 modules	GW16804, GW16804N	12
GW 16 106 VO	6 modules	GW16806	6

CHARACTERISTICS: matt finish, metallic effect.



ChoruSmart



Scan the QR Code and find out all the technical informations.

REFINED DESIGN

FINISHES

HIGHLY CUSTOMISABLE



Minimal in shape, classic in style: ONE plates enhance any room, bringing harmony and beauty to every corner of the house.



The ONE plate, with its minimal appearance, is available in various colours and in 2 finishes: glossy and satin, for every need.







The plates can be customised through a choice of colours and finishes. This allows the installation to be adapted to the style of the interiors and enhance all applications. Thanks to tampography and lasering, the plates can be customised with lettering, trademarks and logos. Please contact the GEWISS Commercial department to discuss the feasibility of any customisation.



CHORUSMART - Domestic range

GEO

Technopolymer

WHITE	TONER BLACK	IVORY	HEMP
			
GW 16 401 TB 1 module	GW 16 401 TN 1 module	GW 16 401 TI 1 module	GW 16 401 TC 1 module
GW 16 402 TB 2 modules	GW 16 402 TN 2 modules	GW 16 402 TI 2 modules	GW 16 402 TC 2 modules
GW 16 403 TB 3 modules	GW 16 403 TN 3 modules	GW 16 403 TI 3 modules	GW 16 403 TC 3 modules
GW 16 404 TB 4 modules	GW 16 404 TN 4 modules	GW 16 404 TI 4 modules	GW 16 404 TC 4 modules
GW 16 406 TB 6 modules	GW 16 406 TN 6 modules	GW 16 406 TI 6 modules	GW 16 406 TC 6 modules

Painted technopolymer

SATIN WHITE	NATURAL BEIGE	SATIN BLACK	TITANIUM ▲
			
GW 16 401 VW 1 module	GW 16 401 VL 1 module	GW 16 401 VN 1 module	GW 16 401 VT 1 module
GW 16 402 VW 2 modules	GW 16 402 VL 2 modules	GW 16 402 VN 2 modules	GW 16 402 VT 2 modules
GW 16 403 VW 3 modules	GW 16 403 VL 3 modules	GW 16 403 VN 3 modules	GW 16 403 VT 3 modules
GW 16 404 VW 4 modules	GW 16 404 VL 4 modules	GW 16 404 VN 4 modules	GW 16 404 VT 4 modules
GW 16 406 VW 6 modules	GW 16 406 VL 6 modules	GW 16 406 VN 6 modules	GW 16 406 VT 6 modules

TUSCAN RED	TEAL	SOFT COPPER ▲	GOLD ▲
			
GW 16 401 VD 1 module	GW 16 401 VZ 1 module	GW 16 401 VX 1 module	GW 16 401 VO 1 module
GW 16 402 VD 2 modules	GW 16 402 VZ 2 modules	GW 16 402 VX 2 modules	GW 16 402 VO 2 modules
GW 16 403 VD 3 modules	GW 16 403 VZ 3 modules	GW 16 403 VX 3 modules	GW 16 403 VO 3 modules
GW 16 404 VD 4 modules	GW 16 404 VZ 4 modules	GW 16 404 VX 4 modules	GW 16 404 VO 4 modules
GW 16 406 VD 6 modules	GW 16 406 VZ 6 modules	GW 16 406 VX 6 modules	GW 16 406 VO 6 modules

▲ Metallic effect

Modularity

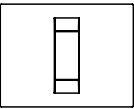
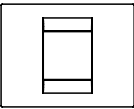
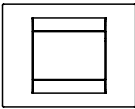
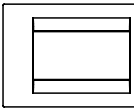
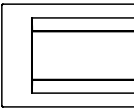
				
1 module	2 modules	3 modules	4 modules	6 modules

ChoruSmart

GEO plates

The GEO plate with clean, regular lines fits perfectly into any environment with its simplicity and style. The materials and colours contribute to creating the right harmony that stands the test of time. Made from technopolymer, GEO resists the impact and stresses of everyday use. The different colours and the simple and light shapes make GEO a young and informal furnishing element that conveys a minimalist style in any space.



GEO ITALIAN STANDARD PLATES

TECHNOPOLYMER

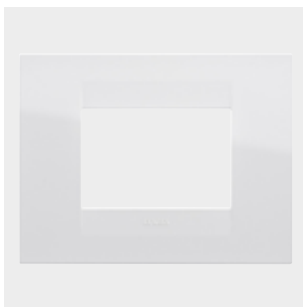

GW 16 403 TB

GEO - WHITE

Code	Description	For support codes	Pack Carton
GW 16 401 TB	1 module	GW16802, GW16803, GW16803N	96
GW 16 402 TB	2 modules	GW16802, GW16803, GW16803N	96
GW 16 403 TB	3 modules	GW16803, GW16803N	96
GW 16 404 TB	4 modules	GW16804, GW16804N	12
GW 16 406 TB	6 modules	GW16806	12

CHARACTERISTICS: glossy finish.

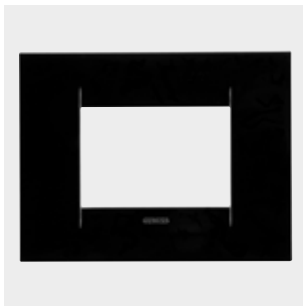

GW 16 403 TN

GEO - TONER BLACK

Code	Description	For support codes	Pack Carton
GW 16 401 TN	1 module	GW16802, GW16803, GW16803N	24
GW 16 402 TN	2 modules	GW16802, GW16803, GW16803N	12
GW 16 403 TN	3 modules	GW16803, GW16803N	24
GW 16 404 TN	4 modules	GW16804, GW16804N	12
GW 16 406 TN	6 modules	GW16806	6

CHARACTERISTICS: glossy finish.

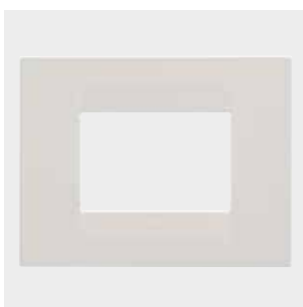

GW 16 403 TI

GEO - IVORY

Code	Description	For support codes	Pack Carton
GW 16 401 TI	1 module	GW16802, GW16803, GW16803N	24
GW 16 402 TI	2 modules	GW16802, GW16803, GW16803N	12
GW 16 403 TI	3 modules	GW16803, GW16803N	24
GW 16 404 TI	4 modules	GW16804, GW16804N	12
GW 16 406 TI	6 modules	GW16806	6

CHARACTERISTICS: glossy finish.



GW 16 403 TC

GEO - HEMP

Code	Description	For support codes	Pack Carton
GW 16 401 TC	1 module	GW16802, GW16803, GW16803N	24
GW 16 402 TC	2 modules	GW16802, GW16803, GW16803N	12
GW 16 403 TC	3 modules	GW16803, GW16803N	24
GW 16 404 TC	4 modules	GW16804, GW16804N	12
GW 16 406 TC	6 modules	GW16806	6

CHARACTERISTICS: glossy finish.

CHORUSMART - Domestic range

PAINTED TECHNOPOLYMER

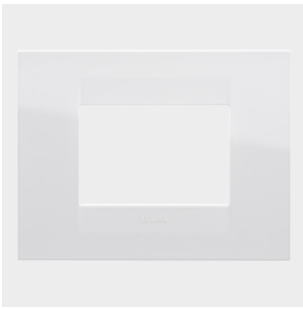

GW 16 403 VW

GEO - SATIN WHITE

Code	Description	For support codes	Pack Carton
GW 16 401 VW	1 module	GW16802, GW16803, GW16803N	96
GW 16 402 VW	2 modules	GW16802, GW16803, GW16803N	96
GW 16 403 VW	3 modules	GW16803, GW16803N	96
GW 16 404 VW	4 modules	GW16804, GW16804N	12
GW 16 406 VW	6 modules	GW16806	12

CHARACTERISTICS: matt finish.

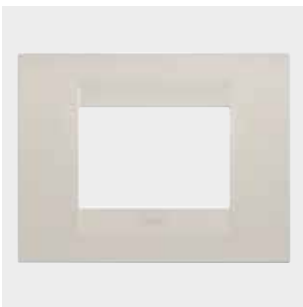

GW 16 403 VL

GEO - NATURAL BEIGE

Code	Description	For support codes	Pack Carton
GW 16 401 VL	1 module	GW16802, GW16803, GW16803N	12
GW 16 402 VL	2 modules	GW16802, GW16803, GW16803N	12
GW 16 403 VL	3 modules	GW16803, GW16803N	12
GW 16 404 VL	4 modules	GW16804, GW16804N	12
GW 16 406 VL	6 modules	GW16806	6

CHARACTERISTICS: matt finish.



GW 16 403 VN

GEO - SATIN BLACK

Code	Description	For support codes	Pack Carton
GW 16 401 VN	1 module	GW16802, GW16803, GW16803N	24
GW 16 402 VN	2 modules	GW16802, GW16803, GW16803N	12
GW 16 403 VN	3 modules	GW16803, GW16803N	24
GW 16 404 VN	4 modules	GW16804, GW16804N	12
GW 16 406 VN	6 modules	GW16806	6

CHARACTERISTICS: matt finish.

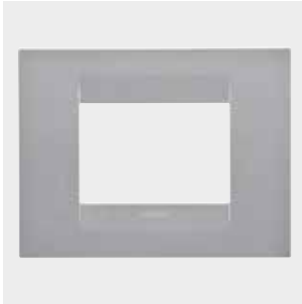

GW 16 403 VT

GEO - TITANIUM

Code	Description	For support codes	Pack Carton
GW 16 401 VT	1 module	GW16802, GW16803, GW16803N	24
GW 16 402 VT	2 modules	GW16802, GW16803, GW16803N	12
GW 16 403 VT	3 modules	GW16803, GW16803N	24
GW 16 404 VT	4 modules	GW16804, GW16804N	12
GW 16 406 VT	6 modules	GW16806	6

CHARACTERISTICS: glossy finish, metallic effect.



GW 16 403 VD

GEO - TUSCAN RED

Code	Description	For support codes	Pack Carton
GW 16 401 VD	1 module	GW16802, GW16803, GW16803N	24
GW 16 402 VD	2 modules	GW16802, GW16803, GW16803N	12
GW 16 403 VD	3 modules	GW16803, GW16803N	24
GW 16 404 VD	4 modules	GW16804, GW16804N	12
GW 16 406 VD	6 modules	GW16806	6

CHARACTERISTICS: matt finish.

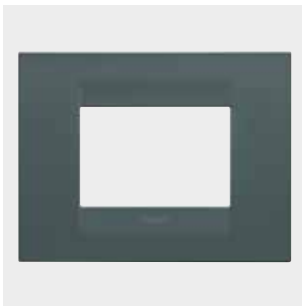

GW 16 403 VZ

GEO - TEAL

Code	Description	For support codes	Pack Carton
GW 16 401 VZ	1 module	GW16802, GW16803, GW16803N	24
GW 16 402 VZ	2 modules	GW16802, GW16803, GW16803N	12
GW 16 403 VZ	3 modules	GW16803, GW16803N	24
GW 16 404 VZ	4 modules	GW16804, GW16804N	12
GW 16 406 VZ	6 modules	GW16806	6

CHARACTERISTICS: matt finish.

CHORUSMART - Domestic range

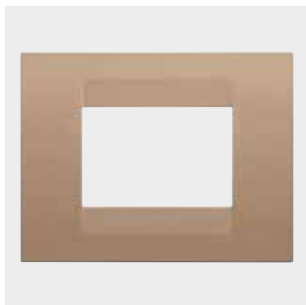

GW 16 403 VX

GEO - PALE COPPER

Code	Description	For support codes	Pack Carton
GW 16 401 VX	1 module	GW16802, GW16803, GW16803N	12
GW 16 402 VX	2 modules	GW16802, GW16803, GW16803N	12
GW 16 403 VX	3 modules	GW16803, GW16803N	12
GW 16 404 VX	4 modules	GW16804, GW16804N	12
GW 16 406 VX	6 modules	GW16806	6

CHARACTERISTICS: matt finish, metallic effect.

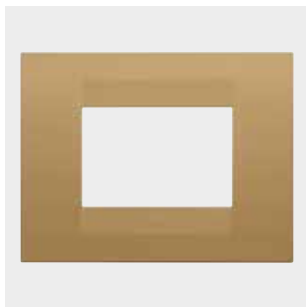

GW 16 403 VO

GEO - GOLD

Code	Description	For support codes	Pack Carton
GW 16 401 VO	1 module	GW16802, GW16803, GW16803N	12
GW 16 402 VO	2 modules	GW16802, GW16803, GW16803N	12
GW 16 403 VO	3 modules	GW16803, GW16803N	12
GW 16 404 VO	4 modules	GW16804, GW16804N	12
GW 16 406 VO	6 modules	GW16806	6

CHARACTERISTICS: matt finish, metallic effect.



ChoruSmart



Scan the QR Code and find out all the technical informations.

MINIMAL DESIGN



The colours, and simple, light shapes make GEO a youthful and informal furnishing item that expresses a minimalist style wherever it is placed.

FINISHES



The GEO Plate, simple and youthful, is available in various colours and in 2 finishes: glossy and satin, for every need.

HIGHLY CUSTOMISABLE















The plates can be customised through a choice of colours and finishes. This allows the installation to be adapted to the style of the interiors and enhance all applications. Thanks to tampography and lasering, the plates can be customised with lettering, trademarks and logos. Please contact the GEWISS Commercial department to discuss the feasibility of any customisation.

CHORUSMART - Domestic range

EGO

Painted technopolymer

	SATIN WHITE	CLAY	NATURAL BEIGE																																										
																																													
	<table border="0"> <tr><td>GW 16 001 PW</td><td>1 module</td></tr> <tr><td>GW 16 002 PW</td><td>2 modules</td></tr> <tr><td>GW 16 003 PW</td><td>3 modules</td></tr> <tr><td>GW 16 004 PW</td><td>4 modules</td></tr> <tr><td>GW 16 007 PW</td><td>7 modules</td></tr> </table>	GW 16 001 PW	1 module	GW 16 002 PW	2 modules	GW 16 003 PW	3 modules	GW 16 004 PW	4 modules	GW 16 007 PW	7 modules	<table border="0"> <tr><td>GW 16 001 CY</td><td>1 module</td></tr> <tr><td>GW 16 002 CY</td><td>2 modules</td></tr> <tr><td>GW 16 003 CY</td><td>3 modules</td></tr> <tr><td>GW 16 004 CY</td><td>4 modules</td></tr> <tr><td>GW 16 007 CY</td><td>7 modules</td></tr> </table>	GW 16 001 CY	1 module	GW 16 002 CY	2 modules	GW 16 003 CY	3 modules	GW 16 004 CY	4 modules	GW 16 007 CY	7 modules	<table border="0"> <tr><td>GW 16 001 NB</td><td>1 module</td></tr> <tr><td>GW 16 002 NB</td><td>2 modules</td></tr> <tr><td>GW 16 003 NB</td><td>3 modules</td></tr> <tr><td>GW 16 004 NB</td><td>4 modules</td></tr> <tr><td>GW 16 007 NB</td><td>7 modules</td></tr> </table>		GW 16 001 NB	1 module	GW 16 002 NB	2 modules	GW 16 003 NB	3 modules	GW 16 004 NB	4 modules	GW 16 007 NB	7 modules											
GW 16 001 PW	1 module																																												
GW 16 002 PW	2 modules																																												
GW 16 003 PW	3 modules																																												
GW 16 004 PW	4 modules																																												
GW 16 007 PW	7 modules																																												
GW 16 001 CY	1 module																																												
GW 16 002 CY	2 modules																																												
GW 16 003 CY	3 modules																																												
GW 16 004 CY	4 modules																																												
GW 16 007 CY	7 modules																																												
GW 16 001 NB	1 module																																												
GW 16 002 NB	2 modules																																												
GW 16 003 NB	3 modules																																												
GW 16 004 NB	4 modules																																												
GW 16 007 NB	7 modules																																												
	DARK SAND	SATIN BLACK																																											
																																													
	<table border="0"> <tr><td>GW 16 001 DS</td><td>1 module</td></tr> <tr><td>GW 16 002 DS</td><td>2 modules</td></tr> <tr><td>GW 16 003 DS</td><td>3 modules</td></tr> <tr><td>GW 16 004 DS</td><td>4 modules</td></tr> <tr><td>GW 16 007 DS</td><td>7 modules</td></tr> </table>	GW 16 001 DS	1 module	GW 16 002 DS	2 modules	GW 16 003 DS	3 modules	GW 16 004 DS	4 modules	GW 16 007 DS	7 modules	<table border="0"> <tr><td>GW 16 001 DB</td><td>1 module</td></tr> <tr><td>GW 16 002 DB</td><td>2 modules</td></tr> <tr><td>GW 16 003 DB</td><td>3 modules</td></tr> <tr><td>GW 16 004 DB</td><td>4 modules</td></tr> <tr><td>GW 16 007 DB</td><td>7 modules</td></tr> </table>			GW 16 001 DB	1 module	GW 16 002 DB	2 modules	GW 16 003 DB	3 modules	GW 16 004 DB	4 modules	GW 16 007 DB	7 modules																					
GW 16 001 DS	1 module																																												
GW 16 002 DS	2 modules																																												
GW 16 003 DS	3 modules																																												
GW 16 004 DS	4 modules																																												
GW 16 007 DS	7 modules																																												
GW 16 001 DB	1 module																																												
GW 16 002 DB	2 modules																																												
GW 16 003 DB	3 modules																																												
GW 16 004 DB	4 modules																																												
GW 16 007 DB	7 modules																																												
	MAGNETIC GRAY ▲	LIGHT BRONZE ▲		STEEL ▲																																									
																																													
	<table border="0"> <tr><td>GW 16 001 GR</td><td>1 module</td></tr> <tr><td>GW 16 002 GR</td><td>2 modules</td></tr> <tr><td>GW 16 003 GR</td><td>3 modules</td></tr> <tr><td>GW 16 004 GR</td><td>4 modules</td></tr> <tr><td>GW 16 007 GR</td><td>7 modules</td></tr> </table>	GW 16 001 GR	1 module	GW 16 002 GR	2 modules	GW 16 003 GR	3 modules	GW 16 004 GR	4 modules	GW 16 007 GR	7 modules	<table border="0"> <tr><td>GW 16 001 BR</td><td>1 module</td></tr> <tr><td>GW 16 002 BR</td><td>2 modules</td></tr> <tr><td>GW 16 003 BR</td><td>3 modules</td></tr> <tr><td>GW 16 004 BR</td><td>4 modules</td></tr> <tr><td>GW 16 007 BR</td><td>7 modules</td></tr> </table>		GW 16 001 BR	1 module	GW 16 002 BR	2 modules	GW 16 003 BR	3 modules	GW 16 004 BR	4 modules	GW 16 007 BR	7 modules	<table border="0"> <tr><td>GW 16 001 ST</td><td>1 module</td></tr> <tr><td>GW 16 002 ST</td><td>2 modules</td></tr> <tr><td>GW 16 003 ST</td><td>3 modules</td></tr> <tr><td>GW 16 004 ST</td><td>4 modules</td></tr> <tr><td>GW 16 007 ST</td><td>7 modules</td></tr> </table>	GW 16 001 ST	1 module	GW 16 002 ST	2 modules	GW 16 003 ST	3 modules	GW 16 004 ST	4 modules	GW 16 007 ST	7 modules											
GW 16 001 GR	1 module																																												
GW 16 002 GR	2 modules																																												
GW 16 003 GR	3 modules																																												
GW 16 004 GR	4 modules																																												
GW 16 007 GR	7 modules																																												
GW 16 001 BR	1 module																																												
GW 16 002 BR	2 modules																																												
GW 16 003 BR	3 modules																																												
GW 16 004 BR	4 modules																																												
GW 16 007 BR	7 modules																																												
GW 16 001 ST	1 module																																												
GW 16 002 ST	2 modules																																												
GW 16 003 ST	3 modules																																												
GW 16 004 ST	4 modules																																												
GW 16 007 ST	7 modules																																												
	SOFT COPPER ▲	GOLD ▲		COPPER ▲	BROWN SHADE ▲																																								
																																													
	<table border="0"> <tr><td>GW 16 001 CS</td><td>1 module</td></tr> <tr><td>GW 16 002 CS</td><td>2 modules</td></tr> <tr><td>GW 16 003 CS</td><td>3 modules</td></tr> <tr><td>GW 16 004 CS</td><td>4 modules</td></tr> <tr><td>GW 16 007 CS</td><td>7 modules</td></tr> </table>	GW 16 001 CS	1 module	GW 16 002 CS	2 modules	GW 16 003 CS	3 modules	GW 16 004 CS	4 modules	GW 16 007 CS	7 modules	<table border="0"> <tr><td>GW 16 001 SG</td><td>1 module</td></tr> <tr><td>GW 16 002 SG</td><td>2 modules</td></tr> <tr><td>GW 16 003 SG</td><td>3 modules</td></tr> <tr><td>GW 16 004 SG</td><td>4 modules</td></tr> <tr><td>GW 16 007 SG</td><td>7 modules</td></tr> </table>		GW 16 001 SG	1 module	GW 16 002 SG	2 modules	GW 16 003 SG	3 modules	GW 16 004 SG	4 modules	GW 16 007 SG	7 modules	<table border="0"> <tr><td>GW 16 001 CP</td><td>1 module</td></tr> <tr><td>GW 16 002 CP</td><td>2 modules</td></tr> <tr><td>GW 16 003 CP</td><td>3 modules</td></tr> <tr><td>GW 16 004 CP</td><td>4 modules</td></tr> <tr><td>GW 16 007 CP</td><td>7 modules</td></tr> </table>	GW 16 001 CP	1 module	GW 16 002 CP	2 modules	GW 16 003 CP	3 modules	GW 16 004 CP	4 modules	GW 16 007 CP	7 modules	<table border="0"> <tr><td>GW 16 001 BS</td><td>1 module</td></tr> <tr><td>GW 16 002 BS</td><td>2 modules</td></tr> <tr><td>GW 16 003 BS</td><td>3 modules</td></tr> <tr><td>GW 16 004 BS</td><td>4 modules</td></tr> <tr><td>GW 16 007 BS</td><td>7 modules</td></tr> </table>	GW 16 001 BS	1 module	GW 16 002 BS	2 modules	GW 16 003 BS	3 modules	GW 16 004 BS	4 modules	GW 16 007 BS	7 modules
GW 16 001 CS	1 module																																												
GW 16 002 CS	2 modules																																												
GW 16 003 CS	3 modules																																												
GW 16 004 CS	4 modules																																												
GW 16 007 CS	7 modules																																												
GW 16 001 SG	1 module																																												
GW 16 002 SG	2 modules																																												
GW 16 003 SG	3 modules																																												
GW 16 004 SG	4 modules																																												
GW 16 007 SG	7 modules																																												
GW 16 001 CP	1 module																																												
GW 16 002 CP	2 modules																																												
GW 16 003 CP	3 modules																																												
GW 16 004 CP	4 modules																																												
GW 16 007 CP	7 modules																																												
GW 16 001 BS	1 module																																												
GW 16 002 BS	2 modules																																												
GW 16 003 BS	3 modules																																												
GW 16 004 BS	4 modules																																												
GW 16 007 BS	7 modules																																												

▲ Metallic effect

Modularity

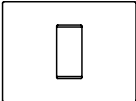
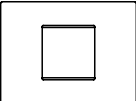
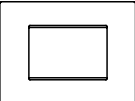
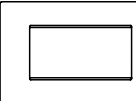
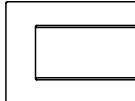
				
1 module	2 modules	3 modules	4 modules	7 modules

For customized plates please contact our GEWISS Sales Organization

ChoruSmart

EGO plates

With their clean, compact lines, EGO plates make the right impression. Modern shapes with slightly curved surfaces that taper towards the edges convey balance and simplicity. The opalescent profiles inside the plate, in aesthetic continuity with the EGO SMART versions, add a subtle element of unique identity. Every detail is designed to ensure appeal and personality.



EGO PLATES

PAINTED TECHNOPOLYMER



GW 16 003 PW

EGO - SATIN WHITE

Code	Description	For support codes	Pack Carton
GW 16 001 PW	1 module	GW16802, GW16803, GW16803N	12
GW 16 002 PW	2 modules	GW16802, GW16803, GW16803N	96
GW 16 003 PW	3 modules	GW16803, GW16803N	96
GW 16 004 PW	4 modules	GW16804, GW16804N	12
GW 16 007 PW	7 modules	GW16807N	6

CHARACTERISTICS: matt finish.



GW 16 003 CY

EGO - CLAY

Code	Description	For support codes	Pack Carton
GW 16 001 CY	1 module	GW16802, GW16803, GW16803N	12
GW 16 002 CY	2 modules	GW16802, GW16803, GW16803N	12
GW 16 003 CY	3 modules	GW16803, GW16803N	24
GW 16 004 CY	4 modules	GW16804, GW16804N	12
GW 16 007 CY	7 modules	GW16807N	6

CHARACTERISTICS: matt finish.



GW 16 003 NB

EGO - NATURAL BEIGE

Code	Description	For support codes	Pack Carton
GW 16 001 NB	1 module	GW16802, GW16803, GW16803N	12
GW 16 002 NB	2 modules	GW16802, GW16803, GW16803N	96
GW 16 003 NB	3 modules	GW16803, GW16803N	96
GW 16 004 NB	4 modules	GW16804, GW16804N	12
GW 16 007 NB	7 modules	GW16807N	6

CHARACTERISTICS: matt finish.

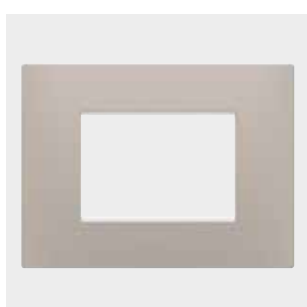

GW 16 003 DS

EGO - DARK SAND

Code	Description	For support codes	Pack Carton
GW 16 001 DS	1 module	GW16802, GW16803, GW16803N	12
GW 16 002 DS	2 modules	GW16802, GW16803, GW16803N	12
GW 16 003 DS	3 modules	GW16803, GW16803N	24
GW 16 004 DS	4 modules	GW16804, GW16804N	12
GW 16 007 DS	7 modules	GW16807N	6

CHARACTERISTICS: matt finish.

CHORUSMART - Domestic range

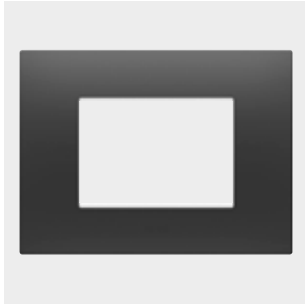

GW 16 003 DB

EGO - SATIN BLACK

Code	Description	For support codes	Pack Carton
GW 16 001 DB	1 module	GW16802, GW16803, GW16803N	12
GW 16 002 DB	2 modules	GW16802, GW16803, GW16803N	12
GW 16 003 DB	3 modules	GW16803, GW16803N	24
GW 16 004 DB	4 modules	GW16804, GW16804N	12
GW 16 007 DB	7 modules	GW16807N	6

CHARACTERISTICS: matt finish.

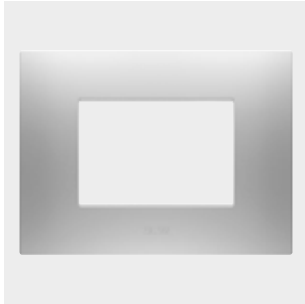

GW 16 003 GR

EGO - MAGNETIC GRAY

Code	Description	For support codes	Pack Carton
GW 16 001 GR	1 module	GW16802, GW16803, GW16803N	12
GW 16 002 GR	2 modules	GW16802, GW16803, GW16803N	12
GW 16 003 GR	3 modules	GW16803, GW16803N	24
GW 16 004 GR	4 modules	GW16804, GW16804N	12
GW 16 007 GR	7 modules	GW16807N	6

CHARACTERISTICS: matt finish, metallic effect.

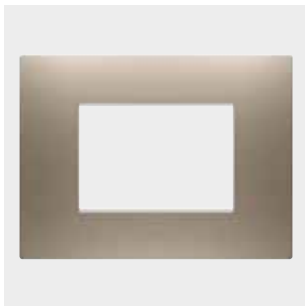

GW 16 003 BR

EGO - LIGHT BRONZE

Code	Description	For support codes	Pack Carton
GW 16 001 BR	1 module	GW16802, GW16803, GW16803N	12
GW 16 002 BR	2 modules	GW16802, GW16803, GW16803N	12
GW 16 003 BR	3 modules	GW16803, GW16803N	12
GW 16 004 BR	4 modules	GW16804, GW16804N	12
GW 16 007 BR	7 modules	GW16807N	6

CHARACTERISTICS: matt finish, metallic effect.

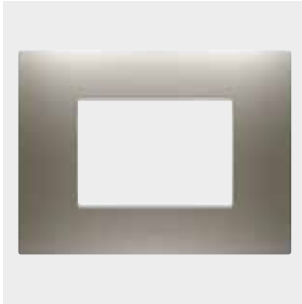

GW 16 003 ST

EGO - STEEL

Code	Description	For support codes	Pack Carton
GW 16 001 ST	1 module	GW16802, GW16803, GW16803N	12
GW 16 002 ST	2 modules	GW16802, GW16803, GW16803N	12
GW 16 003 ST	3 modules	GW16803, GW16803N	12
GW 16 004 ST	4 modules	GW16804, GW16804N	12
GW 16 007 ST	7 modules	GW16807N	6

CHARACTERISTICS: matt finish, metallic effect.

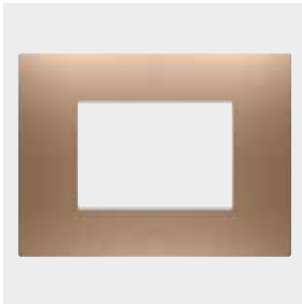

GW 16 003 CS

EGO - SOFT COPPER

Code	Description	For support codes	Pack Carton
GW 16 001 CS	1 module	GW16802, GW16803, GW16803N	12
GW 16 002 CS	2 modules	GW16802, GW16803, GW16803N	12
GW 16 003 CS	3 modules	GW16803, GW16803N	12
GW 16 004 CS	4 modules	GW16804, GW16804N	12
GW 16 007 CS	7 modules	GW16807N	6

CHARACTERISTICS: matt finish, metallic effect.

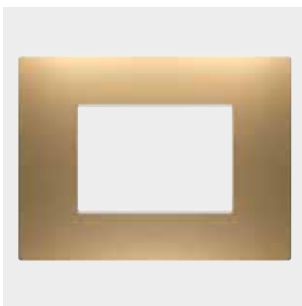

GW 16 003 SG

EGO - GOLD

Code	Description	For support codes	Pack Carton
GW 16 001 SG	1 module	GW16802, GW16803, GW16803N	12
GW 16 002 SG	2 modules	GW16802, GW16803, GW16803N	12
GW 16 003 SG	3 modules	GW16803, GW16803N	12
GW 16 004 SG	4 modules	GW16804, GW16804N	12
GW 16 007 SG	7 modules	GW16807N	6

CHARACTERISTICS: matt finish, metallic effect.

CHORUSMART - Domestic range

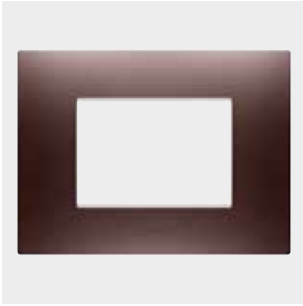

GW 16 003 CP

EGO - COPPER

Code	Description	For support codes	Pack Carton
GW 16 001 CP	1 module	GW16802, GW16803, GW16803N	12
GW 16 002 CP	2 modules	GW16802, GW16803, GW16803N	12
GW 16 003 CP	3 modules	GW16803, GW16803N	12
GW 16 004 CP	4 modules	GW16804, GW16804N	12
GW 16 007 CP	7 modules	GW16807N	6

CHARACTERISTICS: matt finish, metallic effect.

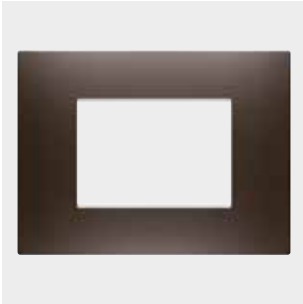

GW 16 003 BS

EGO - BROWN SHADE

Code	Description	For support codes	Pack Carton
GW 16 001 BS	1 module	GW16802, GW16803, GW16803N	12
GW 16 002 BS	2 modules	GW16802, GW16803, GW16803N	12
GW 16 003 BS	3 modules	GW16803, GW16803N	12
GW 16 004 BS	4 modules	GW16804, GW16804N	12
GW 16 007 BS	7 modules	GW16807N	6

CHARACTERISTICS: matt finish, metallic effect.

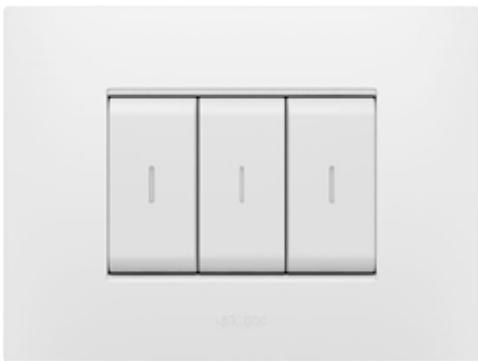

Scan the QR Code and find out all the technical informations.

PRECIOUS FINISHES

INNOVATION

HIGHLY CUSTOMISABLE



Three thematic lines of plates for a perfect match with ChoruSmart devices. A total of 12 colors, all with a satin finish.



EGO was designed as a modern plate and has evolved in the EGO SMART version, an innovative concept of SMART HOME.















The plates can be customised through a choice of colours and finishes. This allows the installation to be adapted to the style of the interiors and enhance all applications. Thanks to tampography and lasering, the plates can be customised with lettering, trademarks and logos. Please contact the GEWISS Commercial department to discuss the feasibility of any customisation.

CHORUSMART - Domestic range

EGO SMART

Painted technopolymer

<p>SATIN WHITE</p>  <p>GW 16 003 S PW 3 modules GW 16 004 S PW 4 modules</p>	<p>CLAY</p>  <p>GW 16 003 S CY 3 modules GW 16 004 S CY 4 modules</p>	<p>NATURAL BEIGE</p>  <p>GW 16 003 S NB 3 modules GW 16 004 S NB 4 modules</p>	
<p>DARK SAND</p>  <p>GW 16 003 S DS 3 modules GW 16 004 S DS 4 modules</p>	<p>SATIN BLACK</p>  <p>GW 16 003 S DB 3 modules GW 16 004 S DB 4 modules</p>		
<p>MAGNETIC GRAY ▲</p>  <p>GW 16 003 S GR 3 modules GW 16 004 S GR 4 modules</p>	<p>LIGHT BRONZE ▲</p>  <p>GW 16 003 S BR 3 modules GW 16 004 S BR 4 modules</p>	<p>STEEL ▲</p>  <p>GW 16 003 S ST 3 modules GW 16 004 S ST 4 modules</p>	
<p>SOFT COPPER ▲</p>  <p>GW 16 003 S CS 3 modules GW 16 004 S CS 4 modules</p>	<p>GOLD ▲</p>  <p>GW 16 003 S SG 3 modules GW 16 004 S SG 4 modules</p>	<p>COPPER ▲</p>  <p>GW 16 003 S CP 3 modules GW 16 004 S CP 4 modules</p>	<p>BROWN SHADE ▲</p>  <p>GW 16 003 S BS 3 modules GW 16 004 S BS 4 modules</p>

▲ Metallic effect

Modularity

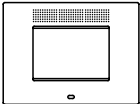
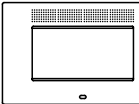
 <p>3 modules</p>	 <p>4 modules</p>
--	--

For customized plates please contact our GEWISS Sales Organization

ChoruSmart

EGO SMART plates

The EGO SMART plates go beyond pure aesthetics to become an element of interaction with the user and with other ChoruSmart system connected devices. Through RGB LED edge strips and a graphic display, the plates communicate operating statuses and alarms detected by other smart functions controlling your home. The EGO SMART and EGO plates, with their harmonious aesthetics, can be installed within the same system for a seamlessly designed look throughout the interior environment.



EGO SMART PLATES

PAINTED TECHNOPOLYMER



GW 16 003 SPW

EGO SMART PLATES - SATIN WHITE

Code	Description	For support codes	Pack Carton
GW 16 003 SPW	3 modules	GW16803N	1
GW 16 004 SPW	4 modules	GW16804N	1

FEATURES: matt finish. The plate has a dot-matrix display on the upper portion, RGB LED strips (along the outer and inner edges at the top and bottom) and a proximity sensor.

APPLICATIONS: visualisation of dynamic icons on the display indicating the functions associated with the devices installed in the plate; event/alarm signalling using the display (messages) and/or RGB led strips.

NOTES: The plate must be supplied with power by one of the following connected devices, which must be installed within the same box as the plate: GWA1201, GWA1202, GWA1231, GWA1232, GWA1241, GWA1242 or GW1x826, or by a dedicated GWA1700 power supply; The connection cable from the plate to the device powering it is included in the plate package.



GW 16 003 SCY

EGO SMART PLATES - CLAY

Code	Description	For support codes	Pack Carton
GW 16 003 SCY	3 modules	GW16803N	1
GW 16 004 SCY	4 modules	GW16804N	1

FEATURES: matt finish. The plate has a dot-matrix display on the upper portion, RGB LED strips (along the outer and inner edges at the top and bottom) and a proximity sensor.

APPLICATIONS: visualisation of dynamic icons on the display indicating the functions associated with the devices installed in the plate; event/alarm signalling using the display (messages) and/or RGB led strips.

NOTES: the plate must be supplied with power by one of the following Smart devices, which must be installed in the same plate box: GWA1201, GWA1202, GWA1231, GWA1232, GWA1241, GWA1242 or GW1x826, or by a dedicated GWA1700 power supply; the connection cable from the plate to the device powering it is included in the plate package. Codes not held as stock, for delivery times contact your local representative.



GW 16 003 SNB

EGO SMART PLATES - NATURAL BEIGE

Code	Description	For support codes	Pack Carton
GW 16 003 SNB	3 modules	GW16803N	1
GW 16 004 SNB	4 modules	GW16804N	1

FEATURES: matt finish. The plate has a dot-matrix display on the upper portion, RGB LED strips (along the outer and inner edges at the top and bottom) and a proximity sensor.

APPLICATIONS: visualisation of dynamic icons on the display indicating the functions associated with the devices installed in the plate; event/alarm signalling using the display (messages) and/or RGB led strips.

NOTES: The plate must be supplied with power by one of the following connected devices, which must be installed within the same box as the plate: GWA1201, GWA1202, GWA1231, GWA1232, GWA1241, GWA1242 or GW1x826, or by a dedicated GWA1700 power supply; The connection cable from the plate to the device powering it is included in the plate package.

CHORUSMART - Domestic range



GW 16 003 SDS

EGO SMART PLATES - DARK SAND

Code	Description	For support codes	Pack Carton
GW 16 003 SDS	3 modules	GW16803N	1
GW 16 004 SDS	4 modules	GW16804N	1

FEATURES: matt finish. The plate has a dot-matrix display on the upper portion, RGB LED strips (along the outer and inner edges at the top and bottom) and a proximity sensor.

APPLICATIONS: visualisation of dynamic icons on the display indicating the functions associated with the devices installed in the plate; event/alarm signalling using the display (messages) and/or RGB led strips.

NOTES: the plate must be supplied with power by one of the following Smart devices, which must be installed in the same box as the plate: GWA1201, GWA1202, GWA1231, GWA1232, GWA1241, GWA1242 or GW1x826, or by a dedicated GWA1700 power supply; The connection cable from the plate to the device powering it is included in the plate package.

Codes not held as stock, for delivery times contact your local representative.

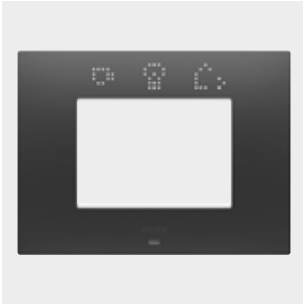

GW 16 003 SDB

EGO SMART PLATES - SATIN BLACK

Code	Description	For support codes	Pack Carton
GW 16 003 SDB	3 modules	GW16803N	1
GW 16 004 SDB	4 modules	GW16804N	1

FEATURES: matt finish. The plate has a dot-matrix display on the upper portion, RGB LED strips (along the outer and inner edges at the top and bottom) and a proximity sensor.

APPLICATIONS: visualisation of dynamic icons on the display indicating the functions associated with the devices installed in the plate; event/alarm signalling using the display (messages) and/or RGB led strips.

NOTES: The plate must be supplied with power by one of the following connected devices, which must be installed within the same box as the plate: GWA1201, GWA1202, GWA1231, GWA1232, GWA1241, GWA1242 or GW1x826, or by a dedicated GWA1700 power supply; The connection cable from the plate to the device powering it is included in the plate package.



GW 16 003 SGR

EGO SMART PLATES - MAGNETIC GRAY

Code	Description	For support codes	Pack Carton
GW 16 003 SGR	3 modules	GW16803N	1
GW 16 004 SGR	4 modules	GW16804N	1

FEATURES: matt finish, metallic effect. The plate has a dot-matrix display on the upper portion, RGB LED strips (along the outer and inner edges at the top and bottom) and a proximity sensor.

APPLICATIONS: visualisation of dynamic icons on the display indicating the functions associated with the devices installed in the plate; event/alarm signalling using the display (messages) and/or RGB led strips.

NOTES: the plate must be powered by one of the following connected devices, which must be installed in the same box as the plate: GWA1201, GWA1202, GWA1231, GWA1232, GWA1241, GWA1242 or GW1x826, or by a dedicated GWA1700 power supply; The connection cable from the plate to the device powering it is included in the plate package.



GW 16 003 SBR

EGO SMART PLATES - LIGHT BRONZE

Code	Description	For support codes	Pack Carton
GW 16 003 SBR	3 modules	GW16803N	1
GW 16 004 SBR	4 modules	GW16804N	1

FEATURES: matt finish, metallic effect. The plate has a dot-matrix display on the upper portion, RGB LED strips (along the outer and inner edges at the top and bottom) and a proximity sensor.
APPLICATIONS: visualisation of dynamic icons on the display indicating the functions associated with the devices installed in the plate; event/alarm signalling using the display (messages) and/or RGB led strips.
NOTES: the plate must be powered by one of the following connected devices, which must be installed in the same box as the plate: GWA1201, GWA1202, GWA1231, GWA1232, GWA1241, GWA1242 or GW1x826, or by a dedicated GWA1700 power supply; The connection cable from the plate to the device powering it is included in the plate package.



GW 16 003 SST

EGO SMART PLATES - STEEL

Code	Description	For support codes	Pack Carton
GW 16 003 SST	3 modules	GW16803N	1
GW 16 004 SST	4 modules	GW16804N	1

FEATURES: matt finish, metallic effect. The plate has a dot-matrix display on the upper portion, RGB LED strips (along the outer and inner edges at the top and bottom) and a proximity sensor.
APPLICATIONS: visualisation of dynamic icons on the display indicating the functions associated with the devices installed in the plate; event/alarm signalling using the display (messages) and/or RGB led strips.
NOTES: the plate must be supplied with power by one of the following Smart devices, which must be installed in the same box as the plate: GWA1201, GWA1202, GWA1231, GWA1232, GWA1241, GWA1242 or GW1x826, or by a dedicated GWA1700 power supply. The connection cable from the plate to the device powering it is included in the plate package.
 Codes not held as stock, for delivery times contact your local representative.

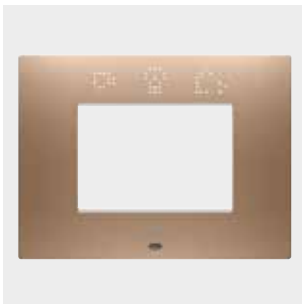

GW 16 003 SCS

EGO SMART PLATES - SOFT COPPER

Code	Description	For support codes	Pack Carton
GW 16 003 SCS	3 modules	GW16803N	1
GW 16 004 SCS	4 modules	GW16804N	1

FEATURES: matt finish, metallic effect. The plate has a dot-matrix display on the upper portion, RGB LED strips (along the outer and inner edges at the top and bottom) and a proximity sensor.
APPLICATIONS: visualisation of dynamic icons on the display indicating the functions associated with the devices installed in the plate; event/alarm signalling using the display (messages) and/or RGB led strips.
NOTES: the plate must be supplied with power by one of the following Smart devices, which must be installed in the same box as the plate: GWA1201, GWA1202, GWA1231, GWA1232, GWA1241, GWA1242 or GW1x826, or by a dedicated GWA1700 power supply; the connection cable from the plate to the device powering it is included in the plate package.
 Codes not held as stock, for delivery times contact your local representative.

CHORUSMART - Domestic range

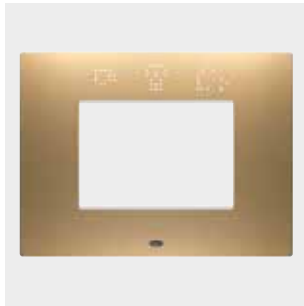

GW 16 003 SSG

EGO SMART PLATES - GOLD

Code	Description	For support codes	Pack Carton
GW 16 003 SSG	3 modules	GW16803N	1
GW 16 004 SSG	4 modules	GW16804N	1

FEATURES: matt finish, metallic effect. The plate has a dot-matrix display on the upper portion, RGB LED strips (along the outer and inner edges at the top and bottom) and a proximity sensor.
APPLICATIONS: visualisation of dynamic icons on the display indicating the functions associated with the devices installed in the plate; event/alarm signalling using the display (messages) and/or RGB led strips.

NOTES: the plate must be supplied with power by one of the following Smart devices, which must be installed in the same box as the plate: GWA1201, GWA1202, GWA1231, GWA1232, GWA1241, GWA1242 or GW1x826, or by a dedicated GWA1700 power supply; the connection cable from the plate to the device powering it is included in the plate package.
 Codes not held as stock, for delivery times contact your local representative.

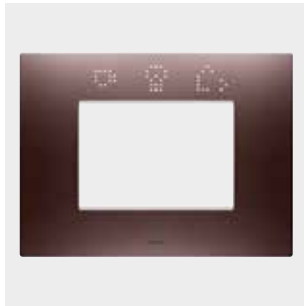

GW 16 003 SCP

EGO SMART PLATES - COPPER

Code	Description	For support codes	Pack Carton
GW 16 003 SCP	3 modules	GW16803N	1
GW 16 004 SCP	4 modules	GW16804N	1

FEATURES: matt finish, metallic effect. The plate has a dot-matrix display on the upper portion, RGB LED strips (along the outer and inner edges at the top and bottom) and a proximity sensor.
APPLICATIONS: visualisation of dynamic icons on the display indicating the functions associated with the devices installed in the plate; event/alarm signalling using the display (messages) and/or RGB led strips.

NOTES: the plate must be supplied with power by one of the following Smart devices, which must be installed in the same box as the plate: GWA1201, GWA1202, GWA1231, GWA1232, GWA1241, GWA1242 or GW1x826, or by a dedicated GWA1700 power supply; the connection cable from the plate to the device powering it is included in the plate package.
 Codes not held as stock, for delivery times contact your local representative.



GW 16 003 SBS

EGO SMART PLATES - BROWN SHADE

Code	Description	For support codes	Pack Carton
GW 16 003 SBS	3 modules	GW16803N	1
GW 16 004 SBS	4 modules	GW16804N	1

FEATURES: matt finish, metallic effect. The plate has a dot-matrix display on the upper portion, RGB LED strips (along the outer and inner edges at the top and bottom) and a proximity sensor.
APPLICATIONS: visualisation of dynamic icons on the display indicating the functions associated with the devices installed in the plate; event/alarm signalling using the display (messages) and/or RGB led strips.

NOTES: the plate must be supplied with power by one of the following Smart devices, which must be installed in the same box as the plate: GWA1201, GWA1202, GWA1231, GWA1232, GWA1241, GWA1242 or GW1x826, or by a dedicated GWA1700 power supply; the connection cable from the plate to the device powering it is included in the plate package.
 Codes not held as stock, for delivery times contact your local representative.



ChoruSmart



Scan the QR Code and find out all the technical informations.

INNOVATION



The plate communicates with the user through simple and immediate visual feedback. The display is dynamic: text messages scroll and icons change shape to indicate the activation and operation of the commanded loads. The edges are illuminated with a coloured beam of light: each colour corresponds to a different signal.

SIMPLICITY



To recognise the associated function, each command can be linked to a different graphic. Lighting icons, messages and colours can be selected from the Home Gateway App with a wide variety of choices.















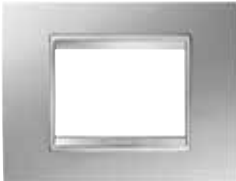

DOUBLED FUNCTIONS



The EGO SMART plate expands the functions managed from the control point. The manually activated proximity sensor enables the. Shift mode on the plate, doubling the functions of the control units installed, without taking up additional space.

CHORUSMART - Domestic range





LUX



Technopolymer	WHITE		MONOCHROME WHITE		TONER BLACK		TONER BLACK LAVY	
								
	GW 16 202 TB	2 modules	GW 16 202 YB	2 modules	GW 16 202 TN	2 modules	GW 16 202 YN	2 modules
	GW 16 203 TB	3 modules	GW 16 203 YB	3 modules	GW 16 203 TN	3 modules	GW 16 203 YN	3 modules
	GW 16 204 TB	4 modules	GW 16 204 YB	4 modules	GW 16 204 TN	4 modules	GW 16 204 YN	4 modules
GW 16 206 TB	6 modules	GW 16 206 YB	6 modules	GW 16 206 TN	6 modules	GW 16 206 YN	6 modules	
Painted technopolymer	TITANIUM ▲		MONOCHROME TITANIUM ▲		SLATE ▲		ABSOLUTE SLATE ▲	
								
	GW 16 202 VT	2 modules	GW 16 202 YT	2 modules	GW 16 202 VA	2 modules	GW 16 202 YA	2 modules
	GW 16 203 VT	3 modules	GW 16 203 YT	3 modules	GW 16 203 VA	3 modules	GW 16 203 YA	3 modules
	GW 16 204 VT	4 modules	GW 16 204 YT	4 modules	GW 16 204 VA	4 modules	GW 16 204 YA	4 modules
GW 16 206 VT	6 modules	GW 16 206 YT	6 modules	GW 16 206 VA	6 modules	GW 16 206 YA	6 modules	
Metal	MONOCHROME SATIN WHITE		MONOCHROME NATURAL BEIGE		MONOCHROME SATIN BLACK			
								
	GW 16 202 XW	2 modules	GW 16 202 XL	2 modules	GW 16 202 XM	2 modules		
	GW 16 203 XW	3 modules	GW 16 203 XL	3 modules	GW 16 203 XM	3 modules		
	GW 16 204 XW	4 modules	GW 16 204 XL	4 modules	GW 16 204 XM	4 modules		
	GW 16 206 XW	6 modules	GW 16 206 XL	6 modules	GW 16 206 XM	6 modules		
	PEARLY BRONZE		ANODIC BROWN		GUNBARREL GREY			
								
	GW 16 202 XP	2 modules	GW 16 202 XV	2 modules	GW 16 202 XF	2 modules		
	GW 16 203 XP	3 modules	GW 16 203 XV	3 modules	GW 16 203 XF	3 modules		
	GW 16 204 XP	4 modules	GW 16 204 XV	4 modules	GW 16 204 XF	4 modules		
	GW 16 206 XP	6 modules	GW 16 206 XV	6 modules	GW 16 206 XF	6 modules		
	MONOCHROME ALUMINIUM		SOFT COPPER		MAGNETIC GRAY			
								
	GW 16 202 XA	2 modules	GW 16 202 XE	2 modules	GW 16 202 XR	2 modules		
GW 16 203 XA	3 modules	GW 16 203 XE	3 modules	GW 16 203 XR	3 modules			
GW 16 204 XA	4 modules	GW 16 204 XE	4 modules	GW 16 204 XR	4 modules			
GW 16 206 XA	6 modules	GW 16 206 XE	6 modules	GW 16 206 XR	6 modules			

▲ Metallic effect

For customized plates please contact our GEWISS Sales Organization

LUX

Metal	BRUSHED ALUMINIUM	BRUSHED ALUMINIUM LAVY	GOLD	ANTIQUE BRASS
				
	GW 16 202 XS 2 modules	GW 16 202 WS 2 modules	GW 16 202 XG 2 modules	GW 16 202 XQ 2 modules
	GW 16 203 XS 3 modules	GW 16 203 WS 3 modules	GW 16 203 XG 3 modules	GW 16 203 XQ 3 modules
	GW 16 204 XS 4 modules	GW 16 204 WS 4 modules	GW 16 204 XG 4 modules	GW 16 204 XQ 4 modules
	GW 16 206 XS 6 modules	GW 16 206 WS 6 modules	GW 16 206 XG 6 modules	GW 16 206 XQ 6 modules

Wood	LIGHT OAK	WALNUT
		
	GW 16 202 WK 2 modules	GW 16 202 WU 2 modules
	GW 16 203 WK 3 modules	GW 16 203 WU 3 modules
	GW 16 204 WK 4 modules	GW 16 204 WU 4 modules
	GW 16 206 WK 6 modules	GW 16 206 WU 6 modules

Glass	NATURAL REFLECTION	PEARLY GRAY
		
	GW 16 202 GT 2 modules	GW 16 202 GP 2 modules
	GW 16 203 GT 3 modules	GW 16 203 GP 3 modules
	GW 16 204 GT 4 modules	GW 16 204 GP 4 modules
	GW 16 206 GT 6 modules	GW 16 206 GP 6 modules

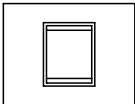
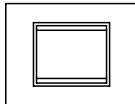
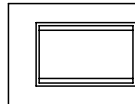
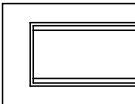
Modularity				
	2 modules	3 modules	4 modules	6 modules

ChoruSmart

LUX plates

LUX plates, with their modern, refined lines, marry the high-tech spirit of modernity with the refined and elegant taste of tradition. Wood, glass and metal versions are added to the classic technopolymer plates. With monochrome variants of the LUX plates, uniformity of colour becomes the distinctive character of each ChoruSmart lighting device.



LUX ITALIAN STANDARD PLATES

TECHNOPOLYMER



GW 16 203 TB

LUX - WHITE

Code	Description	For support codes	Pack Carton
GW 16 202 TB	2 modules	GW16802, GW16803, GW16803N	12
GW 16 203 TB	3 modules	GW16803, GW16803N	12
GW 16 204 TB	4 modules	GW16804, GW16804N	12
GW 16 206 TB	6 modules	GW16806	6

CHARACTERISTICS: glossy finish.

NOTES: inner frame chromed.



GW 16 203 YB

LUX - MONOCHROME WHITE

Code	Description	For support codes	Pack Carton
GW 16 202 YB	2 modules	GW16802, GW16803, GW16803N	12
GW 16 203 YB	3 modules	GW16803, GW16803N	12
GW 16 204 YB	4 modules	GW16804, GW16804N	12
GW 16 206 YB	6 modules	GW16806	6

CHARACTERISTICS: glossy finish.

NOTES: inner frame in the same white colour as the plate, glossy finish.



GW 16 203 TN

LUX - TONER BLACK

Code	Description	For support codes	Pack Carton
GW 16 202 TN	2 modules	GW16802, GW16803, GW16803N	12
GW 16 203 TN	3 modules	GW16803, GW16803N	12
GW 16 204 TN	4 modules	GW16804, GW16804N	12
GW 16 206 TN	6 modules	GW16806	6

CHARACTERISTICS: glossy finish.

NOTES: inner frame chromed.



GW 16 203 YN

LUX - LAVY TONER BLACK

Code	Description	For support codes	Pack Carton
GW 16 202 YN	2 modules	GW16802, GW16803, GW16803N	12
GW 16 203 YN	3 modules	GW16803, GW16803N	12
GW 16 204 YN	4 modules	GW16804, GW16804N	12
GW 16 206 YN	6 modules	GW16806	6

CHARACTERISTICS: glossy finish.

NOTES: inner frame in the same black colour of the plate, matt finish.

PAINTED TECHNOPOLYMER



GW 16 203 VT

LUX - TITANIUM

Code	Description	For support codes	Pack Carton
GW 16 202 VT	2 modules	GW16802, GW16803, GW16803N	12
GW 16 203 VT	3 modules	GW16803, GW16803N	12
GW 16 204 VT	4 modules	GW16804, GW16804N	12
GW 16 206 VT	6 modules	GW16806	6

CHARACTERISTICS: glossy finish, metallic effect.

NOTES: inner frame chromed.



GW 16 203 YT

LUX - MONOCHROME TITANIUM

Code	Description	For support codes	Pack Carton
GW 16 202 YT	2 modules	GW16802, GW16803, GW16803N	12
GW 16 203 YT	3 modules	GW16803, GW16803N	12
GW 16 204 YT	4 modules	GW16804, GW16804N	12
GW 16 206 YT	6 modules	GW16806	6

CHARACTERISTICS: glossy finish, metallic effect.

NOTES: inner frame in the same titanium colour of the plate, glossy finish.



GW 16 203 VA

LUX - SLATE

Code	Description	For support codes	Pack Carton
GW 16 202 VA	2 modules	GW16802, GW16803, GW16803N	6
GW 16 203 VA	3 modules	GW16803, GW16803N	6
GW 16 204 VA	4 modules	GW16804, GW16804N	6
GW 16 206 VA	6 modules	GW16806	6

FEATURES: glossy finish, metallic effect.

NOTES: chrome inner frame.



GW 16 203 YA

LUX - ABSOLUTE SLATE

Code	Description	For support codes	Pack Carton
GW 16 202 YA	2 modules	GW16802, GW16803, GW16803N	12
GW 16 203 YA	3 modules	GW16803, GW16803N	12
GW 16 204 YA	4 modules	GW16804, GW16804N	12
GW 16 206 YA	6 modules	GW16806	6

CHARACTERISTICS: glossy finish, metallic effect.

NOTES: inner frame in the same slate colour of the plate, glossy finish.

CHORUSMART - Domestic range

METAL



GW 16 203 XW

LUX - MONOCHROME SATIN WHITE

Code	Description	For support codes	Pack Carton
GW 16 202 XW	2 modules	GW16802, GW16803, GW16803N	6
GW 16 203 XW	3 modules	GW16803, GW16803N	6
GW 16 204 XW	4 modules	GW16804, GW16804N	6
GW 16 206 XW	6 modules	GW16806	6

CHARACTERISTICS: matt finish.

NOTES: inner frame in same white colour, matt finish.



GW 16 203 XL

LUX - MONOCHROME NATURAL BEIGE

Code	Description	For support codes	Pack Carton
GW 16 202 XL	2 modules	GW16802, GW16803, GW16803N	6
GW 16 203 XL	3 modules	GW16803, GW16803N	6
GW 16 204 XL	4 modules	GW16804, GW16804N	6
GW 16 206 XL	6 modules	GW16806	6

CHARACTERISTICS: matt finish.

NOTES: inner frame in same natural beige colour, matt finish.



GW 16 203 XM

LUX - MONOCHROME SATIN BLACK

Code	Description	For support codes	Pack Carton
GW 16 202 XM	2 modules	GW16802, GW16803, GW16803N	6
GW 16 203 XM	3 modules	GW16803, GW16803N	6
GW 16 204 XM	4 modules	GW16804, GW16804N	6
GW 16 206 XM	6 modules	GW16806	6

CHARACTERISTICS: matt finish.

NOTES: inner frame in same black colour as the plate, matt finish.



GW 16 203 XP

LUX - PEARLY BRONZE

Code	Description	For support codes	Pack Carton
GW 16 202 XP	2 modules	GW16802, GW16803, GW16803N	6
GW 16 203 XP	3 modules	GW16803, GW16803N	6
GW 16 204 XP	4 modules	GW16804, GW16804N	6
GW 16 206 XP	6 modules	GW16806	6

CHARACTERISTICS: glossy finish, metallic effect.

NOTES: inner frame in light bronze colour, matt finish.



GW 16 203 XV

LUX - ANODIC BROWN

Code	Description	For support codes	Pack Carton
GW 16 202 XV	2 modules	GW16802, GW16803, GW16803N	6
GW 16 203 XV	3 modules	GW16803, GW16803N	6
GW 16 204 XV	4 modules	GW16804, GW16804N	6
GW 16 206 XV	6 modules	GW16806	6

CHARACTERISTICS: matt finish, metallic effect.

NOTES: inner frame in dark bronze colour, matt finish.



GW 16 203 XF

LUX - GUNBARREL GREY

Code	Description	For support codes	Pack Carton
GW 16 202 XF	2 modules	GW16802, GW16803, GW16803N	6
GW 16 203 XF	3 modules	GW16803, GW16803N	6
GW 16 204 XF	4 modules	GW16804, GW16804N	6
GW 16 206 XF	6 modules	GW16806	6

CHARACTERISTICS: matt finish, metallic effect.
NOTES: inner frame in the same gunbarrel grey colour as the plate, matt finish.



GW 16 203 XA

LUX - MONOCHROME ALUMINIUM

Code	Description	For support codes	Pack Carton
GW 16 202 XA	2 modules	GW16802, GW16803, GW16803N	6
GW 16 203 XA	3 modules	GW16803, GW16803N	6
GW 16 204 XA	4 modules	GW16804, GW16804N	6
GW 16 206 XA	6 modules	GW16806	6

CHARACTERISTICS: matt finish.
NOTES: inner frame in the same aluminium colour as the plate, matt finish.



GW 16 203 XE

LUX - SOFT COPPER

Code	Description	For support codes	Pack Carton
GW 16 202 XE	2 modules	GW16802, GW16803, GW16803N	6
GW 16 203 XE	3 modules	GW16803, GW16803N	6
GW 16 204 XE	4 modules	GW16804, GW16804N	6
GW 16 206 XE	6 modules	GW16806	6

CHARACTERISTICS: matt finish, metallic effect.
NOTES: inner frame in the same soft copper colour as the plate, matt finish.



GW 16 203 XR

LUX - MAGNETIC GRAY

Code	Description	For support codes	Pack Carton
GW 16 202 XR	2 modules	GW16802, GW16803, GW16803N	6
GW 16 203 XR	3 modules	GW16803, GW16803N	6
GW 16 204 XR	4 modules	GW16804, GW16804N	6
GW 16 206 XR	6 modules	GW16806	6

CHARACTERISTICS: matt finish, metallic effect.
NOTES: inner frame in the same magnetic gray colour as the plate, matt finish.



GW 16 203 XS

LUX - BRUSHED ALUMINIUM

Code	Description	For support codes	Pack Carton
GW 16 202 XS	2 modules	GW16802, GW16803, GW16803N	6
GW 16 203 XS	3 modules	GW16803, GW16803N	6
GW 16 204 XS	4 modules	GW16804, GW16804N	6
GW 16 206 XS	6 modules	GW16806	6

CHARACTERISTICS: matt finish.
NOTES: inner frame in light bronze colour, matt finish.

CHORUSMART - Domestic range



GW 16 203 WS

LUX - LAVY BRUSHED ALUMINIUM

Code	Description	For support codes	Pack Carton
GW 16 202 WS	2 modules	GW16802, GW16803, GW16803N	6
GW 16 203 WS	3 modules	GW16803, GW16803N	6
GW 16 204 WS	4 modules	GW16804, GW16804N	6
GW 16 206 WS	6 modules	GW16806	6

CHARACTERISTICS: matt finish.

NOTES: inner frame in black colour, matt finish.



GW 16 203 XG

LUX - GOLD

Code	Description	For support codes	Pack Carton
GW 16 202 XG	2 modules	GW16802, GW16803, GW16803N	6
GW 16 203 XG	3 modules	GW16803, GW16803N	6
GW 16 204 XG	4 modules	GW16804, GW16804N	6
GW 16 206 XG	6 modules	GW16806	6

CHARACTERISTICS: matt finish, metallic effect.

NOTES: inner frame in the same gold colour as the plate, matt finish.



GW 16 203 XQ

LUX - ANTIQUE BRASS

Code	Description	For support codes	Pack Carton
GW 16 202 XQ	2 modules	GW16802, GW16803, GW16803N	6
GW 16 203 XQ	3 modules	GW16803, GW16803N	6
GW 16 204 XQ	4 modules	GW16804, GW16804N	6
GW 16 206 XQ	6 modules	GW16806	6

CHARACTERISTICS: matt finish.

NOTES: inner frame in dark bronze colour, matt finish.

WOOD



GW 16 203 WK

LUX - LIGHT OAK

Code	Description	For support codes	Pack Carton
GW 16 202 WK	2 modules	GW16802, GW16803, GW16803N	1
GW 16 203 WK	3 modules	GW16803, GW16803N	1
GW 16 204 WK	4 modules	GW16804, GW16804N	1
GW 16 206 WK	6 modules	GW16806	1

CHARACTERISTICS: matt finish.

NOTES: inner frame in light bronze colour, matt finish. Design variations in the wooden plates are a sign of the quality and authenticity of the materials used.



GW 16 203 WU

LUX - WALNUT

Code	Description	For support codes	Pack Carton
GW 16 202 WU	2 modules	GW16802, GW16803, GW16803N	1
GW 16 203 WU	3 modules	GW16803, GW16803N	1
GW 16 204 WU	4 modules	GW16804, GW16804N	1
GW 16 206 WU	6 modules	GW16806	1

CHARACTERISTICS: matt finish.

NOTES: inner frame in dark bronze colour, matt finish. Design variations in the wooden plates are a sign of the quality and authenticity of the materials used.

CHORUSMART - Domestic range

GLASS



GW 16 203 GT

LUX - NATURAL REFLECTION

Code	Description	For support codes	Pack Carton
GW 16 202 GT	2 modules	GW16802, GW16803, GW16803N	1
GW 16 203 GT	3 modules	GW16803, GW16803N	1
GW 16 204 GT	4 modules	GW16804, GW16804N	1
GW 16 206 GT	6 modules	GW16806	1

CHARACTERISTICS: matt finish.

NOTES: inner frame in light bronze colour, matt finish.

Design variations in the glass plates are a sign of quality and indicate the genuineness of the materials used.



GW 16 203 GP

LUX - PEARLY GRAY

Code	Description	For support codes	Pack Carton
GW 16 202 GP	2 modules	GW16802, GW16803, GW16803N	1
GW 16 203 GP	3 modules	GW16803, GW16803N	1
GW 16 204 GP	4 modules	GW16804, GW16804N	1
GW 16 206 GP	6 modules	GW16806	1

CHARACTERISTICS: matt finish.

NOTES: inner frame in light bronze colour, matt finish. Design variations in the glass plates are a sign of quality and indicate the genuineness of the materials used.



ChoruSmart



Scan the QR Code and find out all the technical informations.

CONTEMPORARY STYLE



The LUX plate, with its modern shapes, is the perfect blend of modernity and the elegant aesthetics of tradition.

MATERIALS



Modern and elegantly designed, LUX plates meet all your needs with their wide variety of materials, from technopolymer to metal, wood and glass.



HIGHLY CUSTOMISABLE



The plates can be customised through a choice of colours and finishes. This allows the installation to be adapted to the style of the interiors and enhance all applications. Thanks to tampography and lasering, the plates can be customised with lettering, trademarks and logos. Please contact the GEWISS Commercial department to discuss the feasibility of any customisation.

CHORUSMART - Domestic range

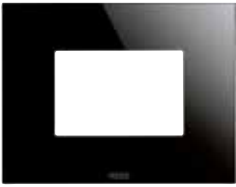
ICE



Class	WHITE	BLACK	NATURAL BEIGE	TITANIUM
				
	GW 16 902 CB 2 modules	GW 16 902 CN 2 modules	GW 16 902 CL 2 modules	GW 16 902 CT 2 modules
	GW 16 903 CB 3 modules	GW 16 903 CN 3 modules	GW 16 903 CL 3 modules	GW 16 903 CT 3 modules
	GW 16 904 CB 4 modules	GW 16 904 CN 4 modules	GW 16 904 CL 4 modules	GW 16 904 CT 4 modules
	GW 16 906 CB 6 modules	GW 16 906 CN 6 modules	GW 16 906 CL 6 modules	GW 16 906 CT 6 modules

ICE TOUCH

Class	WHITE	BLACK	NATURAL BEIGE	TITANIUM
				
	GW 16 955 CB	GW 16 955 CN	GW 16 955 CL	GW 16 955 CT

ICE TOUCH KNX

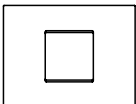
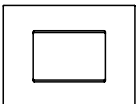
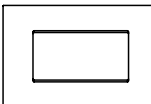
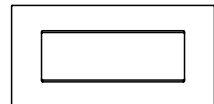
Class	WHITE	BLACK	NATURAL BEIGE	TITANIUM
				
	GW 16 946 CB	GW 16 946 CN	GW 16 946 CL	GW 16 946 CT

Mobility	ICE				ICE TOUCH	ICE TOUCH KNX
						
	2 modules	3 modules	4 modules	6 modules	6 TOUCH AREAS WITH INTERCHANGEABLE SYMBOLS	

ChoruSmart

ICE plates

ICE glass plates meet the most sophisticated technological and aesthetic needs and represent a new frontier for lighting devices. Available in four different colours (white, natural beige, black and titanium), ICE can accommodate all modular devices in the ChoruSmart range. Commands, systems for energy off-take, protection and signalling, comfort, climate control and technical alarms: ICE can meet the needs of any environment.



ICE ITALIAN STANDARD PLATES

GLASS



GW 16 903 CB

ICE - WHITE

Code	Description	For support codes	Pack Carton
GW 16 902 CB	2 modules	GW16802, GW16803, GW16803N	1
GW 16 903 CB	3 modules	GW16803, GW16803N	1
GW 16 904 CB	4 modules	GW16804, GW16804N	1
GW 16 906 CB	6 modules	GW16806	1

CHARACTERISTICS: glossy finish.



GW 16 903 CL

ICE - NATURAL BEIGE

Code	Description	For support codes	Pack Carton
GW 16 902 CL	2 modules	GW16802, GW16803, GW16803N	1
GW 16 903 CL	3 modules	GW16803, GW16803N	1
GW 16 904 CL	4 modules	GW16804, GW16804N	1
GW 16 906 CL	6 modules	GW16806	1

CHARACTERISTICS: glossy finish.

CHORUSMART - Domestic range

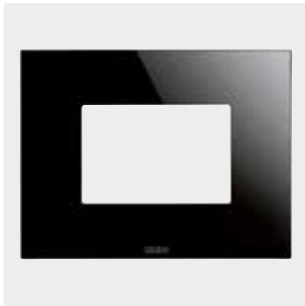

GW 16 903 CN

ICE - BLACK

Code	Description	For support codes	Pack Carton
GW 16 902 CN	2 modules	GW16802, GW16803, GW16803N	1
GW 16 903 CN	3 modules	GW16803, GW16803N	1
GW 16 904 CN	4 modules	GW16804, GW16804N	1
GW 16 906 CN	6 modules	GW16806	1

CHARACTERISTICS: glossy finish.



GW 16 903 CT

ICE - TITANIUM

Code	Description	For support codes	Pack Carton
GW 16 902 CT	2 modules	GW16802, GW16803, GW16803N	1
GW 16 903 CT	3 modules	GW16803, GW16803N	1
GW 16 904 CT	4 modules	GW16804, GW16804N	1
GW 16 906 CT	6 modules	GW16806	1

CHARACTERISTICS: glossy finish.

ICE TOUCH ITALIAN STANDARD PLATES

GLASS



GW 16 955 CB

ICE TOUCH - WHITE

Code	Description	For support codes	Pack Carton
GW 16 955 CB	6 touch areas	GW16803, GW16803N	1

CHARACTERISTICS: glossy finish. The plate is to be used in combination with the touch modules (switch module GW10922, roller shutter module GW10921, dimmer module GW10923, 1-control auxiliary module GW10924, 2-control auxiliary module GW10925).

NOTES: the symbols displayed in the image are purely indicative and may be customised using the icons supplied with the touch plate. The code of the plate is unique and independent of the number of icons used (from 2 to 6).



GW 16 955 CL

ICE TOUCH - NATURAL BEIGE

Code	Description	For support codes	Pack Carton
GW 16 955 CL	6 touch areas	GW16803, GW16803N	1

CHARACTERISTICS: glossy finish. The plate is to be used in combination with the touch modules (switch module GW10922, roller shutter module GW10921, dimmer module GW10923, 1-control auxiliary module GW10924, 2-control auxiliary module GW10925).

NOTES: the symbols displayed in the image are purely indicative and may be customised using the icons supplied with the touch plate. The code of the plate is unique and independent of the number of icons used (from 2 to 6).

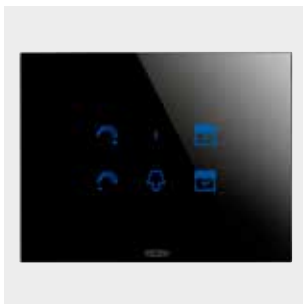

GW 16 955 CN

ICE TOUCH - BLACK

Code	Description	For support codes	Pack Carton
GW 16 955 CN	6 touch areas	GW16803, GW16803N	1

CHARACTERISTICS: glossy finish. The plate is to be used in combination with the touch modules (switch module GW10922, roller shutter module GW10921, dimmer module GW10923, 1-control auxiliary module GW10924, 2-control auxiliary module GW10925).

NOTES: the symbols displayed in the image are purely indicative: they may be customised using the icons supplied with the touch plate. The code of the plate is unique and independent of the number of icons used (from 2 to 6).



GW 16 955 CT

ICE TOUCH - TITANIUM

Code	Description	For support codes	Pack Carton
GW 16 955 CT	6 touch areas	GW16803, GW16803N	1

CHARACTERISTICS: glossy finish. The plate is to be used in combination with the touch modules (switch module GW10922, roller shutter module GW10921, dimmer module GW10923, 1-control auxiliary module GW10924, 2-control auxiliary module GW10925).

NOTES: the symbols displayed in the image are purely indicative: they may be customised using the icons supplied with the touch plate. The code of the plate is unique and independent of the number of icons used (from 2 to 6).

CHORUSMART - Domestic range

ICE TOUCH KNX ITALIAN STANDARD PLATES

GLASS



GW 16 946 CB

ICE TOUCH KNX - WHITE

Code	Description	For support codes	Pack Carton
GW 16 946 CB	6 touch areas	GW16803, GW16803N	1

CHARACTERISTICS: plates made of glass with a glossy finish, to match the KNX touch-panel modules (GWA9421).

NOTES: the symbols shown in the image are purely indicative: they can be customised using the adhesive icons supplied with the touch-panel module. The plate code is unique, regardless of the number of channels to be activated (from 1 to 6).



GW 16 946 CL

ICE TOUCH KNX - NATURAL BEIGE

Code	Description	For support codes	Pack Carton
GW 16 946 CL	6 touch areas	GW16803, GW16803N	1

CHARACTERISTICS: plates made of glass with a glossy finish, to match the KNX touch-panel modules (GWA9421).

NOTES: the symbols shown in the image are purely indicative: they can be customised using the adhesive icons supplied with the touch-panel module. The plate code is unique, regardless of the number of channels to be activated (from 1 to 6).



GW 16 946 CN

ICE TOUCH KNX - BLACK

Code	Description	For support codes	Pack Carton
GW 16 946 CN	6 touch areas	GW16803, GW16803N	1

CHARACTERISTICS: plates made of glass with a glossy finish, to match the KNX touch-panel modules (GWA9421).

NOTES: the symbols shown in the image are purely indicative: they can be customised using the adhesive icons supplied with the touch-panel module. The plate code is unique, regardless of the number of channels to be activated (from 1 to 6).



GW 16 946 CT

ICE TOUCH KNX - TITANIUM

Code	Description	For support codes	Pack Carton
GW 16 946 CT	6 touch areas	GW16803, GW16803N	1

CHARACTERISTICS: plates made of glass with a glossy finish, to match the KNX touch-panel modules (GWA9421).

NOTES: the symbols shown in the image are purely indicative: they can be customised using the adhesive icons supplied with the touch-panel module. The plate code is unique, regardless of the number of channels to be activated (from 1 to 6).



ChoruSmart



Scan the QR Code and find out all the technical informations.

ELEGANT FINISHES

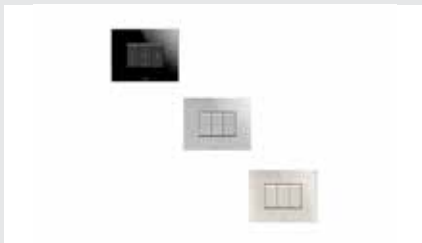

With the ICE Touch and ICE Touch KNX plates, your home responds to every gesture with just a touch of your fingertip. The purity of white, the elegance of natural beige, the rationality of titanium and the allure of black are complemented by the refined luminous symbols that identify the keys selected, enhancing the plate in its purest expression.

ELEGANT AND MODERN



Glass, the material of elegance, encapsulates a heart of pure technology, with touch keys in the traditional or KNX version that enhance every simple gesture

HIGHLY CUSTOMISABLE



The plates can be customised through a choice of colours and finishes. This allows the installation to be adapted to the style of the interiors and enhance all applications. Thanks to tampography and lasering, the plates can be customised with lettering, trademarks and logos. Please contact the GEWISS Commercial department to discuss the feasibility of any customisation.

ChoruSmart

Installation accessories

Wide variety of installation accessories for all modular devices and plates from the ChoruSmart range. Watertight plates with ergonomic membrane and 2 to 4 modules. Self-supporting plates for profiles and panels. Free-standing and surface-mounted panels. Surface-mounted boxes and self-supporting protected watertight enclosures. Supports for rectangular, round and square boxes available in standard and smart versions. Covers for flush-mounted boxes from 2 to 7 modules for painting and finishing.



SPECIAL PLATES AND PANELS

WATERTIGHT PLATES



GW 16 703 TB

WATERTIGHT PLATES - ITALIAN STANDARD - IP55

Code	Description	Colour	Included support	Pack Carton
GW 16 703 TB	3 modules	Glossy white	GW16803	1/24
GW 16 704 TB	4 modules	Glossy white	GW16804	1/24
GW 16 703 TN	3 modules	Glossy black	GW16803	1/12
GW 16 704 TN	4 modules	Glossy black	GW16804	1/12
GW 16 703 VT	3 modules	Glossy Titanium	GW16803	1/12
GW 16 704 VT	4 modules	Glossy Titanium	GW16804	1/12

CHARACTERISTICS: support included. Ergonomic membrane in UV-resistant material. Snap closing system. Opening made easy by wide key.

APPLICATIONS: for installation on rectangular flush-mounting boxes.

NOTES: degree of protection IP55 with closed lid and with installation on smooth, waterproof walls without grooves (smooth tiles, marble).



GW 16 702 TB

WATERTIGHT PLATES - INTERNATIONAL STANDARD - IP55

Code	Description	Colour	Included support	Pack Carton
GW 16 702 TB	2 modules	Glossy white	GW16822	1/24
GW 16 702 TN	2 modules	Glossy black	GW16822	1/12
GW 16 702 VT	2 modules	Glossy Titanium	GW16822	1/12

CHARACTERISTICS: support included. Ergonomic membrane in UV-resistant material. Snap closing system. Opening made easy by wide key.

APPLICATIONS: for installation on round/square flush-mounting boxes.

NOTES: degree of protection IP55 with closed lid and with installation on smooth, waterproof walls without grooves (smooth tiles, marble).

PLATES FOR PROFILES



GW 16 711 TB

SELF-SUPPORTING PLATES FOR PROFILES AND PANELS



Code	Description	Colour Plate	Characteristics	Pack Carton
GW 16 711 TB	1 module	Glossy white	Halogen free	1/48
GW 16 712 TB	2 modules	Glossy white	Halogen free	1/24
GW 16 711 TN	1 module	Glossy black	Halogen free	1/24
GW 16 712 TN	2 modules	Glossy black	Halogen free	1/24
GW 16 711 VT	1 module	Glossy Titanium	Halogen free	1/12
GW 16 712 VT	2 modules	Glossy Titanium	Halogen free	1/12

CHARACTERISTICS: complete with insulating box and supports. Diameter for cable input max. 10mm.

NOTES: the insulating box is equipped with a tug-proof cable fastener device and a corrugated conduit fastener device.

BLANK PLATES



GW 16 723 TB

BLANK PLATES



Code	Description	Colour	For support codes	Characteristics	Pack Carton
GW 16 723 TB	3 modules	Glossy white	GW16802, GW16803, GW16803N	Halogen free	1/24
GW 16 724 TB	4 modules	Glossy white	GW16804, GW16804N	Halogen free	1/24
GW 16 723 TN	3 modules	Glossy black	GW16802, GW16803, GW16803N	Halogen free	1/12
GW 16 724 TN	4 modules	Glossy black	GW16804, GW16804N	Halogen free	1/12

CHARACTERISTICS: support not included for installation on rectangular boxes.

FREE-STANDING AND WALL-MOUNTING ENCLOSURES



GW 16 854

FREE-STANDING AND WALL-MOUNTING ENCLOSURES FOR ONE PLATES

Code	Description	Colour	Support	Outer dim. LxHxD (mm)	Pack Carton
GW 16 854	4 modules	Satin White	GW16804	140x90x69	1/30
GW 16 856	6 modules	Satin White	GW16806	181x90x69	1/15
GW 16 864	4 modules	Satin black	GW16804	140x90x69	1/30
GW 16 866	6 modules	Satin black	GW16806	181x90x69	1/15

CHARACTERISTICS: support and plate not included. Use ONE plates (interchangeability with the entire colour range of plates).

Diameter for cable input max. 10mm.

NOTES: cable gland and safety cable fastener included. For wall-mounting, use wall plugs with a countersunk head, max Ø 3.5mm.

BOXES, ENCLOSURES AND SUPPORTS

WALL-MOUNTING BOXES



GW 16 743

WALL-MOUNTING BOXES FOR MINI-TRUNKING AND TRUNKING USED AS SKIRTING FOR ONE PLATES



Code	Description	Support	Outer dim. LxHxD (mm)	Characteristics	Pack Carton
Colour: Satin White					
GW 16 743	3 modules	GW16803	118x90x46	Halogen free	3/60
GW 16 744	4 modules	GW16804	140x90x46	Halogen free	1/30
Colour: Satin black					
GW 16 773	3 modules	GW16803	118x90x46	Halogen free	3/30
GW 16 774	4 modules	GW16804	140x90x46	Halogen free	1/30

CHARACTERISTICS: support and plate not included. Use ONE plates (interchangeability with the entire colour range of plates). Pre-arranged for mini-trunking with dimensions BxH (mm): 15x8, 15x10, 22x10, 30x15.

NOTES: fitted for fixing the earth terminal GW26407.



GW 16 752

WALL-MOUNTING BOXES FOR MINI-TRUNKING AND TRUNKING USED AS SKIRTING FOR ONE INTERNATIONAL PLATES



Code	Description	Type	Support	Outer dim. LxHxD (mm)	Characteristics	Pack Carton
Colour: Satin White						
GW 16 752	2 modules	-	GW16822	90x90x46	Halogen free	1/30
GW 16 753	2+2 modules	Horizontal	GW16822	161x90x46	Halogen free	1/15
GW 16 754	2+2 modules	Vertical	GW16822	90x161x46	Halogen free	1/15
Colour: Satin black						
GW 16 782	2 modules	-	GW16822	90x90x46	Halogen free	1/30
GW 16 783	2+2 modules	Horizontal	GW16822	161x90x46	Halogen free	1/15
GW 16 784	2+2 modules	Vertical	GW16822	90x161x46	Halogen free	1/15

CHARACTERISTICS: support and plate not included. Use ONE International plates (interchangeability with the entire colour range of the plates).

Pre-arranged for mini-trunking with dimensions BxH (mm): 15x15, 20x20, 22x10, 30x10, 30x15, 35x15, 45x15. GW16754 and GW16784 to be used together with plates with a centre distance of 71mm. GW16752 - GW16782 supplied with 2 fixing screws. GW16753 - GW16754 - GW16783 - GW16784 supplied with 6 fixing screws.

NOTES: fitted for fixing the earth terminal GW26407.

CHORUSMART - Domestic range

ENCLOSURES FOR OUTDOORS



GW 16 503

SELF-SUPPORTING, EMPTY, PROTECTED ENCLOSURES - IP40

Code	Description	Colour	Outer dim. LxHxD (mm)	Pack Carton
GW 16 502	2 modules	Grey RAL 7035	66x82x56	5/80
GW 16 503	3 modules	Grey RAL 7035	99x82x56	3/60
GW 16 504	4 modules	Grey RAL 7035	132x82x56	1/40

CHARACTERISTICS: fitted for fixing the earth terminal GW26407.

NOTES: not suitable for the installation of 1/2 module devices.



GW 16 513

SELF-SUPPORTING, EMPTY, WATERTIGHT ENCLOSURES - IP55

Code	Description	Colour	Outer dim. LxHxD (mm)	Pack Carton
GW 16 512	2 modules	Grey RAL 7035	66x82x69	5/60
GW 16 513	3 modules	Grey RAL 7035	99x82x69	2/40
GW 16 514	4 modules	Grey RAL 7035	132x82x69	1/30

CHARACTERISTICS: fitted for fixing the earth terminal GW26407. Ergonomic membrane, in UV-resistant material, Snap closing system.

NOTES: not suitable for the installation of 1/2 module devices.

COMPLEMENTARY ITEMS



GW 26 407

BRASS TERMINAL FOR THROUGH-LINE EARTH CONDUCTOR

Code	Section (mm ²)	Fixing	Pack Carton
GW 26 407	4	Pressure-operated	200/1600



GW 24 224

SPECIAL SELF-TAPPING SCREWS FOR FIXING THE DEVICES

Code	Dimensions (mm)	Suitable for	Pack Carton
GW 24 224	TC 3.5x17	Wood, plastic, aluminium	500/7000
GW 24 225	TC 3.5x30	Deep-mounted boxes	300/4200
GW 24 229	TC 3.5x50	Deep-mounted boxes	300/4200

SUPPORTS

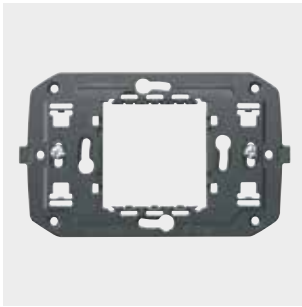

GW 16 802

ITALIAN STANDARD SUPPORTS FOR ONE, GEO, EGO, LUX AND ICE PLATES



Code	Description	Fixing	Characteristics	Pack Carton
GW 16 802	2 modules	2 screws (included)	Halogen free	12/120
GW 16 803	3 modules	2 screws (included)	Halogen free	12/240
GW 16 804	4 modules	2 screws (included)	Halogen free	12/120
GW 16 806	6 modules	4 screws (included)	Halogen free	12/72
GW 16 807 N	7 modules	2 screws (included)	Halogen free	12/72
GW 16 808	4+4 modules	4 screws (included)	Halogen free	12/48
GW 16 812	6+6 modules	4 screws (included)	Halogen free	12/48

CHARACTERISTICS: GW16802 predisposed for fixing on both rectangular 3-module boxes (centre distance 83.5mm) and round/square boxes (centre distance 60mm) equipped with fixing columns. To be completed with 2-module standard plates.

NOTES: GW16808 and GW16812 to be used with white or titanium colour ONE plates. GW16807N to be used with EGO plates.



GW 16 803 N

ITALIAN STANDARD SUPPORTS FOR EGO SMART PLATES



Code	Description	Fixing	Characteristics	Pack Carton
GW 16 803 N	3 modules	2 screws (included)	Halogen free	6/240
GW 16 804 N	4 modules	2 screws (included)	Halogen free	6/120

CHARACTERISTICS: specific supports for 3 and 4 module Italian standard EGO SMART plates; supports are also compatible with the other Italian standard ChoruSmart 3 and 4 module plates ONE, GEO, LUX, ICE and EGO.

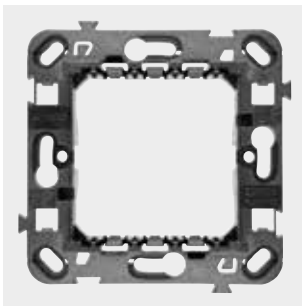

GW 16 822

INTERNATIONAL STANDARD SUPPORTS FOR ONE, GEO, EGO, LUX PLATES



Code	Description	Fixing	Characteristics	Pack Carton
GW 16 821	2 modules	With fixing clutches	Halogen free	12/120
GW 16 822	2 modules	For screws (not included)	Halogen free	20/120
GW 16 823	2 modules	With long fixing clutches	Halogen free	12/120

FEATURES: GW16821 and GW16823 equipped with fixing clutches for installation on round boxes.

GW16831 for boxes with a fixing centre distance of 60.3 mm and dimensions 70 x 70 mm (British Standard).

NOTES: GW16821 and GW16823 supports can be installed on single round boxes or in vertical composition.



GW 16 822 N

INTERNATIONAL STANDARD SUPPORTS FOR EGO SMART PLATES



Code	Description	Fixing	Characteristics	Pack Carton
GW 16 821 N	2 modules	With fixing clutches	Halogen free	20/120
GW 16 822 N	2 modules	For screws (not included)	Halogen free	20/120

FEATURES: GW16821N equipped with fixing clutches for installation on round boxes. Supports specifically for international standard EGO SMART plates; the supports are also compatible with the other ChoruSmart international standard plates, including ONE, GEO, LUX and EGO.

NOTES: GW16822N support can be installed on single round and square boxes or in a horizontal composition; the GW16821N support can be installed on single stand-alone round boxes.

CHORUSMART - Domestic range



GW 16 824

FRENCH STANDARD SUPPORTS



Code	Description	Fixing	Characteristics	Pack Carton
GW 16 824	4 modules	For screws (not incl.) horiz. centre dist. 57mm	Halogen free	12/60
GW 16 825	6 modules	For screws (not incl.) horiz. centre dist. 2x57mm	Halogen free	12/48

CHARACTERISTICS: supports pre-arranged for fixing on French Standard rectangular boxes.

NOTES: GW16824 fit the ChoruSmart 4 modules plates. GW16825 fit the ChoruSmart 6 modules plates.



GW 16 873

PROTECTIVE COVERS FOR PAINTING, FOR CHORUSMART RANGE, ITALIAN STANDARD

Code	Description	Suitable for support	Colour	Pack Carton
GW 16 873	3 modules	GW16802, GW16803, GW16803N	Transparent	120/480
GW 16 874	4 modules	GW16804, GW16804N	Transparent	60/240
GW 16 876	6 modules	GW16806	Transparent	60/240
GW 16 877 N	7 modules	GW16807N	Transparent	60/240

CHARACTERISTICS: total protection during painting and finishing operations.

NOTES: snap-in mounting to facilitate assembly and removal operations.



GW 16 871

PROTECTIVE COVERS FOR PAINTING, FOR CHORUSMART RANGE, INTERNATIONAL STANDARD

Code	Description	Suitable for support	Colour	Pack Carton
GW 16 871	2 modules	GW16821, GW16822, GW16823, GW16831, GW16821N, GW16822N	Transparent	60/480

CHARACTERISTICS: total protection during painting and finishing operations.
NOTES: snap-in mounting to facilitate assembly and removal operations.



GW 16 841

SUPPORTS FOR ASSEMBLING CHORUSMART DEVICES ON DIN EN 50022 RAIL

Code	Description	No. DIN modules	Pack Carton
GW 16 841	1 module	1.5	5/300
GW 16 842	2 modules	3	5/150
GW 16 843	3 modules	4	5/50

CHARACTERISTICS: tool-free manual release system for flush-mounting devices.
NOTES: pay attention when using particularly deep devices (two-pole, three-way switches, movement detectors and IR receivers, relays, German standard socket-outlets with front tightening, quick wiring terminals, British standard socket-outlets, interlocked switched sockets-outlets, shaver sockets-outlets, USB power supplies, MCCB and RCCB, anti-black-out and emergency lamps, ringers and buzzers, thermostats and timed thermostats, programmers, water and gas detectors, timers, dimmers, touch commands, electronic soft-click push buttons with interlock, KNX flush-mounting timed thermostats, etc.) as they may interfere with the DIN rail, preventing the correct passage of the wires.

CHORUSMART - Domestic ranges

COMMAND DEVICES - ROCKERS

One-way switches

- GW 10 001 Glossy white
- GW 15 001 Satin white
- GW 13 001 Sat. natural beige
- GW 12 001 Satin black
- GW 14 001 Glossy titanium
- GW 11 001 Glossy ivory

- GW 10 002 Glossy white
- GW 15 002 Satin white
- GW 13 002 Sat. natural beige
- GW 12 002 Satin black
- GW 14 002 Glossy titanium
- GW 11 002 Glossy ivory

- GW 10 003 Glossy white
- GW 15 003 Satin white
- GW 13 003 Sat. natural beige
- GW 12 003 Satin black
- GW 14 003 Glossy titanium
- GW 11 003 Glossy ivory

- GW 10 021 Glossy white
- GW 15 021 Satin white
- GW 13 021 Sat. natural beige
- GW 12 021 Satin black
- GW 14 021 Glossy titanium

- GW 10 022 Glossy white
- GW 15 022 Satin white
- GW 13 022 Sat. natural beige
- GW 12 022 Satin black
- GW 14 022 Glossy titanium

- GW 10 031 Glossy white
- GW 15 031 Satin white
- GW 13 031 Sat. natural beige
- GW 12 031 Satin black
- GW 14 031 Glossy titanium
- GW 11 031 Glossy ivory

- GW 10 032 Glossy white
- GW 15 032 Satin white
- GW 13 032 Sat. natural beige
- GW 12 032 Satin black
- GW 14 032 Glossy titanium
- GW 11 032 Glossy ivory

- GW 10 033 Glossy white
- GW 15 033 Satin white
- GW 13 033 Sat. natural beige
- GW 12 033 Satin black
- GW 14 033 Glossy titanium
- GW 11 033 Glossy ivory

- GW 10 041 Glossy white
- GW 15 041 Satin white
- GW 13 041 Sat. natural beige
- GW 12 041 Satin black
- GW 14 041 Glossy titanium

- GW 10 042 Glossy white
- GW 15 042 Satin white
- GW 13 042 Sat. natural beige
- GW 12 042 Satin black
- GW 14 042 Glossy titanium

- GW 10 043 Glossy white
- GW 15 043 Satin white
- GW 13 043 Sat. natural beige
- GW 12 043 Satin black
- GW 14 043 Glossy titanium

- GW 10 044 Glossy white
- GW 15 044 Satin white
- GW 13 044 Sat. natural beige
- GW 12 044 Satin black
- GW 14 044 Glossy titanium
- GW 11 044 Glossy ivory

- GW 10 005 Glossy white
- GW 15 005 Satin white
- GW 13 005 Sat. natural beige
- GW 12 005 Satin black
- GW 14 005 Glossy titanium

- GW 10 006 Glossy white
- GW 15 006 Satin white
- GW 13 006 Sat. natural beige
- GW 12 006 Satin black
- GW 14 006 Glossy titanium

- GW 10 007 Glossy white
- GW 15 007 Satin white
- GW 13 007 Sat. natural beige
- GW 12 007 Satin black
- GW 14 007 Glossy titanium

- GW 10 034 Glossy white
- GW 15 034 Satin white
- GW 13 034 Sat. natural beige
- GW 12 034 Satin black
- GW 14 034 Glossy titanium

- GW 10 035 Glossy white
- GW 15 035 Satin white
- GW 13 035 Sat. natural beige
- GW 12 035 Satin black
- GW 14 035 Glossy titanium

Two-way switches

- GW 10 051 Glossy white
- GW 15 051 Satin white
- GW 13 051 Sat. natural beige
- GW 12 051 Satin black
- GW 14 051 Glossy titanium
- GW 11 051 Glossy ivory

- GW 10 052 Glossy white
- GW 15 052 Satin white
- GW 13 052 Sat. natural beige
- GW 12 052 Satin black
- GW 14 052 Glossy titanium
- GW 11 052 Glossy ivory

- GW 10 053 Glossy white
- GW 15 053 Satin white
- GW 13 053 Sat. natural beige
- GW 12 053 Satin black
- GW 14 053 Glossy titanium
- GW 11 053 Glossy ivory

- GW 10 054 Glossy white
- GW 15 054 Satin white
- GW 13 054 Sat. natural beige
- GW 12 054 Satin black
- GW 14 054 Glossy titanium

- GW 10 061 Glossy white
- GW 15 061 Satin white
- GW 13 061 Sat. natural beige
- GW 12 061 Satin black
- GW 14 061 Glossy titanium

- GW 10 071 Glossy white
- GW 15 071 Satin white
- GW 13 071 Sat. natural beige
- GW 12 071 Satin black
- GW 14 071 Glossy titanium
- GW 11 071 Glossy ivory

- GW 10 072 Glossy white
- GW 15 072 Satin white
- GW 13 072 Sat. natural beige
- GW 12 072 Satin black
- GW 14 072 Glossy titanium
- GW 11 072 Glossy ivory

- GW 10 073 Glossy white
- GW 15 073 Satin white
- GW 13 073 Sat. natural beige
- GW 12 073 Satin black
- GW 14 073 Glossy titanium
- GW 11 073 Glossy ivory

- GW 10 081 Glossy white
- GW 15 081 Satin white
- GW 13 081 Sat. natural beige
- GW 12 081 Satin black
- GW 14 081 Glossy titanium

- GW 10 082 Glossy white
- GW 15 082 Satin white
- GW 13 082 Sat. natural beige
- GW 12 082 Satin black
- GW 14 082 Glossy titanium

- GW 10 083 Glossy white
- GW 15 083 Satin white
- GW 13 083 Sat. natural beige
- GW 12 083 Satin black
- GW 14 083 Glossy titanium

Three-way switches

- GW 10 121 Glossy white
- GW 15 121 Satin white
- GW 13 121 Sat. natural beige
- GW 12 121 Satin black
- GW 14 121 Glossy titanium
- GW 11 121 Glossy ivory

- GW 10 122 Glossy white
- GW 15 122 Satin white
- GW 13 122 Sat. natural beige
- GW 12 122 Satin black
- GW 14 122 Glossy titanium

- GW 10 123 Glossy white
- GW 15 123 Satin white
- GW 13 123 Sat. natural beige
- GW 12 123 Satin black
- GW 14 123 Glossy titanium
- GW 11 123 Glossy ivory

Intermediate switches

- GW 10 091 Glossy white
- GW 15 091 Satin white
- GW 13 091 Sat. natural beige
- GW 12 091 Satin black
- GW 14 091 Glossy titanium
- GW 11 091 Glossy ivory

- GW 10 092 Glossy white
- GW 15 092 Satin white
- GW 13 092 Sat. natural beige
- GW 12 092 Satin black
- GW 14 092 Glossy titanium
- GW 11 092 Glossy ivory

- GW 10 093 Glossy white
- GW 15 093 Satin white
- GW 13 093 Sat. natural beige
- GW 12 093 Satin black
- GW 14 093 Glossy titanium

- GW 10 101 Glossy white
- GW 15 101 Satin white
- GW 13 101 Sat. natural beige
- GW 12 101 Satin black
- GW 14 101 Glossy titanium
- GW 11 101 Glossy ivory

- GW 10 102 Glossy white
- GW 15 102 Satin white
- GW 13 102 Sat. natural beige
- GW 12 102 Satin black
- GW 14 102 Glossy titanium
- GW 11 102 Glossy ivory

- GW 10 103 Glossy white
- GW 15 103 Satin white
- GW 13 103 Sat. natural beige
- GW 12 103 Satin black
- GW 14 103 Glossy titanium

- GW 10 111 Glossy white
- GW 15 111 Satin white
- GW 13 111 Sat. natural beige
- GW 12 111 Satin black
- GW 14 111 Glossy titanium

- GW 10 112 Glossy white
- GW 15 112 Satin white
- GW 13 112 Sat. natural beige
- GW 12 112 Satin black
- GW 14 112 Glossy titanium

- GW 10 113 Glossy white
- GW 15 113 Satin white
- GW 13 113 Sat. natural beige
- GW 12 113 Satin black
- GW 14 113 Glossy titanium

(*) supplied without LED signalling unit

740

COMMAND DEVICES - ROCKERS

Push-buttons



GW 10 131 Glossy white
GW 15 131 Satin white
GW 13 131 Sat. natural beige
GW 12 131 Satin black
GW 14 131 Glossy titanium
GW 11 131 Glossy ivory

1M-IP-NO-16 A



GW 10 132 Glossy white
GW 15 132 Satin white
GW 13 132 Sat. natural beige
GW 12 132 Satin black
GW 14 132 Glossy titanium
GW 11 132 Glossy ivory

1M-IP-NO-16 A Illuminable (*)



GW 10 133 Glossy white
GW 15 133 Satin white
GW 13 133 Sat. natural beige
GW 12 133 Satin black
GW 14 133 Glossy titanium
GW 11 133 Glossy ivory

1M-IP-NO-16 A Illuminable (*)



GW 10 136 Glossy white
GW 15 136 Satin white
GW 13 136 Sat. natural beige
GW 12 136 Satin black
GW 14 136 Glossy titanium
GW 11 136 Glossy ivory

1M-IP-NO-16 A With pull-cord



GW 10 137 Glossy white
GW 15 137 Satin white
GW 13 137 Sat. natural beige
GW 12 137 Satin black
GW 14 137 Glossy titanium

1M-IP-NC-16 A



GW 10 138 Glossy white
GW 15 138 Satin white
GW 13 138 Sat. natural beige
GW 12 138 Satin black
GW 14 138 Glossy titanium

1M-IP-NC+NO-16 A Stop



GW 10 139 Glossy white
GW 15 139 Satin white
GW 13 139 Sat. natural beige
GW 12 139 Satin black
GW 14 139 Glossy titanium

1M-IP-NO-NC-16 A Start



GW 10 140 Glossy white
GW 15 140 Satin white
GW 13 140 Sat. natural beige
GW 12 140 Satin black
GW 14 140 Glossy titanium
GW 11 140 Glossy ivory

1M-IP-NO-NO-10 A With interlock



GW 10 141 Glossy white
GW 15 141 Satin white
GW 13 141 Sat. natural beige
GW 12 141 Satin black
GW 14 141 Glossy titanium

1M-IP-NO+NO-16 A Double



GW 10 142 Glossy white
GW 15 142 Satin white
GW 13 142 Sat. natural beige
GW 12 142 Satin black
GW 14 142 Glossy titanium

1M-IP-NO-16 A Green - Illuminable (*)



GW 10 143 Glossy white
GW 15 143 Satin white
GW 13 143 Sat. natural beige
GW 12 143 Satin black
GW 14 143 Glossy titanium

1M-IP-NO-16 A Red - Illuminable (*)



GW 10 144 Glossy white
GW 15 144 Satin white
GW 13 144 Sat. natural beige
GW 12 144 Satin black
GW 14 144 Glossy titanium

1M-IP-NO-16 A Opal - Illuminable (*)



GW 10 151 Glossy white
GW 15 151 Satin white
GW 13 151 Sat. natural beige
GW 12 151 Satin black
GW 14 151 Glossy titanium

1M-IP-NO-16 A Light - Illuminable (*)



GW 10 152 Glossy white
GW 15 152 Satin white
GW 13 152 Sat. natural beige
GW 12 152 Satin black
GW 14 152 Glossy titanium

1M-IP-NO-16 A Key - Illuminable (*)



GW 10 153 Glossy white
GW 15 153 Satin white
GW 13 153 Sat. natural beige
GW 12 153 Satin black
GW 14 153 Glossy titanium
GW 11 153 Glossy ivory

1M-IP-NO-16 A Bell - Illuminable (*)



GW 10 161 Glossy white
GW 15 161 Satin white
GW 13 161 Sat. natural beige
GW 12 161 Satin black
GW 14 161 Glossy titanium

1/2M-IP-NO-10 A



GW 10 162 Glossy white
GW 15 162 Satin white
GW 13 162 Sat. natural beige
GW 12 162 Satin black
GW 14 162 Glossy titanium

1/2M-IP-NO-10 A Illuminable (*)



GW 10 171 Glossy white
GW 15 171 Satin white
GW 13 171 Sat. natural beige
GW 12 171 Satin black
GW 14 171 Glossy titanium
GW 11 171 Glossy ivory

2M-IP-NO-16 A



GW 10 172 Glossy white
GW 15 172 Satin white
GW 13 172 Sat. natural beige
GW 12 172 Satin black
GW 14 172 Glossy titanium
GW 11 172 Glossy ivory

2M-IP-NO-16 A Illuminable (*)



GW 10 173 Glossy white
GW 15 173 Satin white
GW 13 173 Sat. natural beige
GW 12 173 Satin black
GW 14 173 Glossy titanium
GW 11 173 Glossy ivory

2M-IP-NO-16 A Illuminable (*)



GW 10 173 Glossy white
GW 15 173 Satin white
GW 13 173 Sat. natural beige
GW 12 173 Satin black
GW 14 173 Glossy titanium
GW 11 173 Glossy ivory

2M-IP-NO-16 A Illuminable (*)



GW 10 181 Glossy white
GW 15 181 Satin white
GW 13 181 Sat. natural beige
GW 12 181 Satin black
GW 14 181 Glossy titanium

3M-IP-NO-16 A



GW 10 182 Glossy white
GW 15 182 Satin white
GW 13 182 Sat. natural beige
GW 12 182 Satin black
GW 14 182 Glossy titanium

3M-IP-NO-16 A Illuminable (*)



GW 10 183 Glossy white
GW 15 183 Satin white
GW 13 183 Sat. natural beige
GW 12 183 Satin black
GW 14 183 Glossy titanium

3M-IP-NO-16 A Illuminable (*)



GW 10 183 Glossy white
GW 15 183 Satin white
GW 13 183 Sat. natural beige
GW 12 183 Satin black
GW 14 183 Glossy titanium

3M-IP-NO-16 A Illuminable (*)



GW 10 145 Glossy white
GW 15 145 Satin white
GW 13 145 Sat. natural beige
GW 12 145 Satin black
GW 14 145 Glossy titanium

1M-2P-NO-10 A With key



GW 10 134 Glossy white
GW 15 134 Satin white
GW 13 134 Sat. natural beige
GW 12 134 Satin black
GW 14 134 Glossy titanium

1M-2P-NO-16 A



GW 10 135 Glossy white
GW 15 135 Satin white
GW 13 135 Sat. natural beige
GW 12 135 Satin black
GW 14 135 Glossy titanium

1M-2P-NO-16 A Illuminable (*)



GW 10 191 Glossy white
GW 15 191 Satin white
GW 13 191 Sat. natural beige
GW 12 191 Satin black
GW 14 191 Glossy titanium

2M-IP-NO-10 A With illuminated name plate (*)





















GW 10 192 Glossy white
GW 15 192 Satin white
GW 13 192 Sat. natural beige
GW 12 192 Satin black
GW 14 192 Glossy titanium

3M-IP-NO-10 A With illuminated name plate (*)

(*) supplied without LED signalling unit

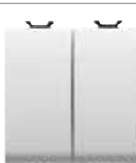
CHORUSMART - Domestic ranges

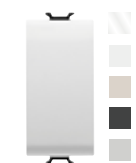
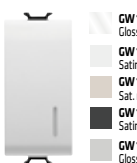
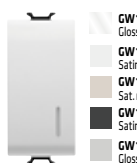
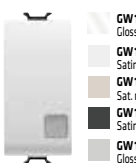
COMMAND DEVICES - ROCKERS

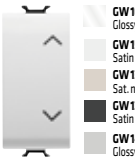
One-way switches (quick wiring)	 <ul style="list-style-type: none"> GW 10 031 F Glossy white GW 15 031 F Satin white GW 13 031 F Sat. natural beige GW 12 031 F Satin black GW 14 031 F Glossy titanium 	 <ul style="list-style-type: none"> GW 10 032 F Glossy white GW 15 032 F Satin white GW 13 032 F Sat. natural beige GW 12 032 F Satin black GW 14 032 F Glossy titanium GW 11 032 F Glossy ivory 	 <ul style="list-style-type: none"> GW 10 033 F Glossy white GW 15 033 F Satin white GW 13 033 F Sat. natural beige GW 12 033 F Satin black GW 14 033 F Glossy titanium 	
	 <ul style="list-style-type: none"> GW 10 034 F Glossy white GW 15 034 F Satin white GW 13 034 F Sat. natural beige GW 12 034 F Satin black GW 14 034 F Glossy titanium 	 <ul style="list-style-type: none"> GW 10 035 F Glossy white GW 15 035 F Satin white GW 13 035 F Sat. natural beige GW 12 035 F Satin black GW 14 035 F Glossy titanium 		
	 <ul style="list-style-type: none"> GW 10 071 F Glossy white GW 15 071 F Satin white GW 13 071 F Sat. natural beige GW 12 071 F Satin black GW 14 071 F Glossy titanium 	 <ul style="list-style-type: none"> GW 10 072 F Glossy white GW 15 072 F Satin white GW 13 072 F Sat. natural beige GW 12 072 F Satin black GW 14 072 F Glossy titanium 	 <ul style="list-style-type: none"> GW 10 073 F Glossy white GW 15 073 F Satin white GW 13 073 F Sat. natural beige GW 12 073 F Satin black GW 14 073 F Glossy titanium 	
	 <ul style="list-style-type: none"> GW 10 101 F Glossy white GW 15 101 F Satin white GW 13 101 F Sat. natural beige GW 12 101 F Satin black GW 14 101 F Glossy titanium 	 <ul style="list-style-type: none"> GW 10 102 F Glossy white GW 15 102 F Satin white GW 13 102 F Sat. natural beige GW 12 102 F Satin black GW 14 102 F Glossy titanium 	 <ul style="list-style-type: none"> GW 10 103 F Glossy white GW 15 103 F Satin white GW 13 103 F Sat. natural beige GW 12 103 F Satin black GW 14 103 F Glossy titanium 	
	 <ul style="list-style-type: none"> GW 10 171 F Glossy white GW 15 171 F Satin white GW 13 171 F Sat. natural beige GW 12 171 F Satin black GW 14 171 F Glossy titanium 	 <ul style="list-style-type: none"> GW 10 172 F Glossy white GW 15 172 F Satin white GW 13 172 F Sat. natural beige GW 12 172 F Satin black GW 14 172 F Glossy titanium 	 <ul style="list-style-type: none"> GW 10 173 F Glossy white GW 15 173 F Satin white GW 13 173 F Sat. natural beige GW 12 173 F Satin black GW 14 173 F Glossy titanium 	
	 <ul style="list-style-type: none"> GW 10 078 F Glossy white GW 15 078 F Satin white GW 13 078 F Sat. natural beige GW 12 078 F Satin black GW 14 078 F Glossy titanium 	 <ul style="list-style-type: none"> GW 10 159 F Glossy white GW 15 159 F Satin white GW 13 159 F Sat. natural beige GW 12 159 F Satin black GW 14 159 F Glossy titanium 	 <ul style="list-style-type: none"> GW 10 160 F Glossy white GW 15 160 F Satin white GW 13 160 F Sat. natural beige GW 12 160 F Satin black GW 14 160 F Glossy titanium 	
Soft-click electronic push-buttons	 <ul style="list-style-type: none"> GW 10 915 Glossy white GW 15 915 Satin white GW 13 915 Sat. natural beige GW 12 915 Satin black GW 14 915 Glossy titanium 	 <ul style="list-style-type: none"> GW 10 912 Glossy white GW 15 912 Satin white GW 13 912 Sat. natural beige GW 12 912 Satin black GW 14 912 Glossy titanium 	 <ul style="list-style-type: none"> GW 10 913 Glossy white GW 15 913 Satin white GW 13 913 Sat. natural beige GW 12 913 Satin black GW 14 913 Glossy titanium 	 <ul style="list-style-type: none"> GW 10 916 Glossy white GW 15 916 Satin white GW 13 916 Sat. natural beige GW 12 916 Satin black GW 14 916 Glossy titanium
	 <ul style="list-style-type: none"> GW 10 917 Glossy white GW 15 917 Satin white GW 13 917 Sat. natural beige GW 12 917 Satin black GW 14 917 Glossy titanium 	 <ul style="list-style-type: none"> GW 10 918 Glossy white GW 15 918 Satin white GW 13 918 Sat. natural beige GW 12 918 Satin black GW 14 918 Glossy titanium 	 <ul style="list-style-type: none"> GW 10 914 Glossy white GW 15 914 Satin white GW 13 914 Sat. natural beige GW 12 914 Satin black GW 14 914 Glossy titanium 	

(*) supplied without LED signalling unit

COMMAND DEVICES - ROCKERS

Lenses with illuminating symbols for rocker button keys

GW 10 501 Neutral	GW 10 502 Light	GW 10 503 Stair light	GW 10 504 Table light	GW 10 505 Bell	GW 10 506 Fan	GW 10 507 Key	GW 10 508 Alarm	GW 10 509 ON	
GW 10 510 OFF	GW 10 511 Nurse	GW 10 512 Waitress	GW 10 513 Dimmer increase	GW 10 514 Dimmer decrease	GW 10 515 UP arrow	GW 10 516 DOWN arrow	GW 10 517 UP-DOWN arrow	GW 10 518 RIGHT-LEFT arrow	
GW 10 531 One	GW 10 532 Two	GW 10 533 Three	GW 10 534 Four	GW 10 535 Five	GW 10 536 Six	GW 10 537 Seven	GW 10 538 Eight	GW 10 539 Nine	GW 10 540 Zero

Interchangeable button keys

General	With label	Key	Bell	Vertical arrow	Horizontal arrow
<ul style="list-style-type: none"> GW 10 541 Glossy white GW 15 541 Satin white GW 13 541 Sat. natural beige GW 12 541 Satin black GW 14 541 Glossy titanium 	<ul style="list-style-type: none"> GW 10 542 Glossy white GW 15 542 Satin white GW 13 542 Sat. natural beige GW 12 542 Satin black GW 14 542 Glossy titanium 	<ul style="list-style-type: none"> GW 10 543 Glossy white GW 15 543 Satin white GW 13 543 Sat. natural beige GW 12 543 Satin black GW 14 543 Glossy titanium 	<ul style="list-style-type: none"> GW 10 544 Glossy white GW 15 544 Satin white GW 13 544 Sat. natural beige GW 12 544 Satin black GW 14 544 Glossy titanium 	<ul style="list-style-type: none"> GW 10 545 Glossy white GW 15 545 Satin white GW 13 545 Sat. natural beige GW 12 545 Satin black GW 14 545 Glossy titanium 	<ul style="list-style-type: none"> GW 10 546 Glossy white GW 15 546 Satin white GW 13 546 Sat. natural beige GW 12 546 Satin black GW 14 546 Glossy titanium

Interchangeable diffusers

GW 10 547 Red	GW 10 548 Green	GW 10 549 Opal	GW 10 550 Amber

Blanking modules

1/2M	1M	2M	3M
<ul style="list-style-type: none"> GW 10 197 Glossy white GW 15 197 Satin white GW 13 197 Sat. natural beige GW 12 197 Satin black GW 14 197 Glossy titanium GW 11 197 Glossy ivory 	<ul style="list-style-type: none"> GW 10 195 Glossy white GW 15 195 Satin white GW 13 195 Sat. natural beige GW 12 195 Satin black GW 14 195 Glossy titanium GW 11 195 Glossy ivory 	<ul style="list-style-type: none"> GW 10 198 Glossy white GW 15 198 Satin white GW 13 198 Sat. natural beige GW 12 198 Satin black GW 14 198 Glossy titanium GW 11 198 Glossy ivory 	<ul style="list-style-type: none"> GW 10 199 Glossy white GW 15 199 Satin white GW 13 199 Sat. natural beige GW 12 199 Satin black GW 14 199 Glossy titanium

Cable outlets

1M	2M
<ul style="list-style-type: none"> GW 10 196 Glossy white GW 15 196 Satin white GW 13 196 Sat. natural beige GW 12 196 Satin black GW 14 196 Glossy titanium GW 11 196 Glossy ivory 	<ul style="list-style-type: none"> GW 10 194 Glossy white GW 15 194 Satin white GW 13 194 Sat. natural beige GW 12 194 Satin black GW 14 194 Glossy titanium

Motion/presence







Motion detector 1M 230V ac - 50/60 Hz	GW 10 595 Ceiling-mounted presence detector 220-240 V ac 50/60 Hz
<ul style="list-style-type: none"> GW 10 594 Glossy white GW 15 594 Satin white GW 13 594 Sat. natural beige GW 12 594 Satin black GW 14 594 Glossy titanium 	

Relays



Latching 1M-1P-10 AX-250 V ac	Latching, 4 sequences 1M-2P-10 AX-250 V ac	Monostable 1M-1P-10 A-250 V ac/1NO/1NC	Call 1M-1P-NO/NC-12 V ac/dc
<ul style="list-style-type: none"> GW 10 721 Glossy white GW 15 721 Satin white GW 13 721 Sat. natural beige GW 12 721 Satin black GW 14 721 Glossy titanium 	<ul style="list-style-type: none"> GW 10 723 Glossy white GW 15 723 Satin white GW 13 723 Sat. natural beige GW 12 723 Satin black GW 14 723 Glossy titanium 	<ul style="list-style-type: none"> GW 10 724 Glossy white GW 15 724 Satin white GW 13 724 Sat. natural beige GW 12 724 Satin black GW 14 724 Glossy titanium 	<ul style="list-style-type: none"> GW 10 726 Glossy white GW 15 726 Satin white GW 13 726 Sat. natural beige GW 12 726 Satin black GW 14 726 Glossy titanium

CHORUSMART - Domestic ranges

ADJUSTMENT

Dimmer		<ul style="list-style-type: none"> GW 10 564 Glossy white GW 15 564 Satin white GW 13 564 Sat. natural beige GW 12 564 Satin black GW 14 564 Glossy titanium GW 11 564 Glossy ivory 		<ul style="list-style-type: none"> GW 10 567 Glossy white GW 15 567 Satin white GW 13 567 Sat. natural beige GW 12 567 Satin black GW 14 567 Glossy titanium GW 11 567 Glossy ivory 		<ul style="list-style-type: none"> GW 10 575 Glossy white GW 15 575 Satin white GW 13 575 Sat. natural beige GW 12 575 Satin black GW 14 575 Glossy titanium
	Resistive 100-900 W Inductive 40-300 VA 230 V ac-50/60 Hz		Resistive 100-500 W Inductive 100-500 VA With two-way switch 230 V ac-50/60 Hz		Universal Resist. 10-160 W - LED 4-160 W Electr. transf. 10-160 W With two-way switch 230 V ac-50/60 Hz	
		<ul style="list-style-type: none"> GW 10 568 Glossy white GW 15 568 Satin white GW 13 568 Sat. natural beige GW 12 568 Satin black GW 14 568 Glossy titanium 		<ul style="list-style-type: none"> GW 10 572 A Glossy white GW 15 572 A Satin white GW 13 572 A Sat. natural beige GW 12 572 A Satin black GW 14 572 A Glossy titanium 		<ul style="list-style-type: none"> GW 10 573 A Glossy white GW 15 573 A Satin white GW 13 573 A Sat. natural beige GW 12 573 A Satin black GW 14 573 A Glossy titanium GW 11 573 A Glossy ivory
	Resistive 60-500 W Inductive 60-500 VA 230 V ac-50 Hz		Res./Ind. 40-300 W Electr. transf. 40-300 W LED 5-150 W 230 V ac-50/60 Hz		Res./Ind. 40-300 W Electr. transf. 40-300 W LED 5-150 W 230 V ac-50/60 Hz	

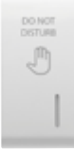
HOTEL COMPONENTS

Badge switches		<ul style="list-style-type: none"> GW 10 039 Glossy white GW 15 039 Satin white GW 13 039 Sat. natural beige GW 12 039 Satin black GW 14 039 Glossy titanium GW 11 039 Glossy ivory 	Interchangeable button keys for rockers		<ul style="list-style-type: none"> GW 10 731 Glossy white GW 15 731 Satin white GW 13 731 Sat. natural beige GW 12 731 Satin black GW 14 731 Glossy titanium 		<ul style="list-style-type: none"> GW 10 732 Glossy white GW 15 732 Satin white GW 13 732 Sat. natural beige GW 12 732 Satin black GW 14 732 Glossy titanium 	Double indicator lamps		<ul style="list-style-type: none"> GW 10 733 Glossy white GW 15 733 Satin white GW 13 733 Sat. natural beige GW 12 733 Satin black GW 14 733 Glossy titanium
	2M-1P-NO-16 AX Illuminable (*)			DND		MUR			DND + MUR	

(*) supplied without LED signalling unit

▲ - Articles designed exclusively for export to a limited number of Countries not belonging to the EU (or candidates for membership) or the European Free Trade Association. Check with Cewiss Customer Service to make sure the product meets the regulation of the Country in question before importing it.

COMMAND DEVICES - AXIAL

Switch modules EVO			Dimmer modules EVO			Roller-shutter modules EVO		
	GW 10 671 1M 100-240 V ac - 50/60 Hz	GW 10 672 2M 100-240 V ac - 50/60 Hz		GW 10 673 1M 100-240 V ac - 50/60 Hz	GW 10 674 2M 100-240 V ac - 50/60 Hz		GW 10 675 1M 100-240 V ac - 50/60 Hz	GW 10 676 2M 100-240 V ac - 50/60 Hz
Auxiliary modules								
	GW 10 677 1 command 1M 100-240 V ac - 50/60 Hz	GW 10 678 1 command 2M 100-240 V ac - 50/60 Hz	GW 10 679 2 commands 1M 100-240 V ac - 50/60 Hz	GW 10 680 2 commands 2M 100-240 V ac - 50/60 Hz				

Interchangeable button keys for axial modules				
	Button key - 1M To be completed with lens	Button key - 2M To be completed with lens	Button key - 1M To be completed with 2 lenses	Button key - 2M To be completed with 2 lenses
	Button key - 1M With diffuser	Button key - 2M With diffuser	Button key - 1M With 2 diffusers	Button key - 2M With 2 diffusers

Lenses with illuminating symbols for axial button keys											































COMMAND DEVICES - TOUCH

Switch module interchangeable symbols		Dimmer module interchangeable symbols		Roller-shutter module interchangeable symbols		Auxiliary modules interchangeable symbols			ICE TOUCH plates in glass	
	GW 10 922 1M 100-240 V ac 50/60 Hz		GW 10 923 1M 100-240 V ac 50/60 Hz		GW 10 921 1M 100-240 V ac 50/60 Hz		GW 10 924 1 command 1M 100-240 V ac 50/60 Hz	GW 10 925 2 commands 1M 100-240 V ac 50/60 Hz		

- GW 16 955 CB Glossy white
- GW 16 955 CL Glossy natural beige
- GW 16 955 CN Glossy black
- GW 16 955 CT Glossy titanium















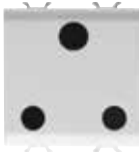
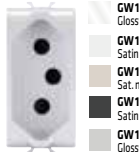
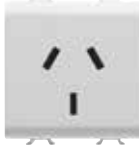

CHORUSMART - Domestic ranges

POWER

Italian	 <ul style="list-style-type: none"> GW 10 201 Glossy white GW 15 201 Satin white GW 13 201 Sat. natural beige GW 12 201 Satin black GW 14 201 Glossy titanium <p>2P+E-10 A-250 V ac</p>	 <ul style="list-style-type: none"> GW 10 203 Glossy white GW 15 203 Satin white GW 13 203 Sat. natural beige GW 12 203 Satin black GW 14 203 Glossy titanium GW 11 203 Glossy ivory <p>2P+E-16 A-250 V ac Dual amperage</p>	 <p>GW 10 213 2P+E-16 A-230 V ac Dual amperage</p>	 <p>GW 10 223 2P+E-16 A-250 V ac Dual amperage</p>	 <p>GW 10 233 2P+E-16 A-250 V ac Dual amperage</p>
	 <ul style="list-style-type: none"> GW 10 208 Glossy white GW 15 208 Satin white GW 13 208 Sat. natural beige GW 12 208 Satin black GW 14 208 Glossy titanium <p>2x2P+E-16 A-250 V ac Dual amperage</p>	 <ul style="list-style-type: none"> GW 10 209 Glossy white GW 15 209 Satin white GW 13 209 Sat. natural beige GW 12 209 Satin black GW 14 209 Glossy titanium <p>3x2P+E-16 A-250 V ac Dual amperage</p>			
Italian/German	 <ul style="list-style-type: none"> GW 10 204 Glossy white GW 15 204 Satin white GW 13 204 Sat. natural beige GW 12 204 Satin black GW 14 204 Glossy titanium <p>2P+E-16 A-250 V ac Dual amperage</p>	 <ul style="list-style-type: none"> GW 10 205 Glossy white GW 15 205 Satin white GW 13 205 Sat. natural beige GW 12 205 Satin black GW 14 205 Glossy titanium <p>2P+E-16 A-250 V ac</p>	 <p>GW 10 214 2P+E-16 A-230 V ac Dual amperage - illuminable (*)</p>	 <p>GW 10 224 2P+E-16 A-230 V ac Dual amperage - illuminable (*)</p>	 <p>GW 10 234 2P+E-16 A-250 V ac Dual amperage - illuminable (*)</p>
	 <ul style="list-style-type: none"> GW 10 241 Glossy white GW 15 241 Satin white GW 13 241 Sat. natural beige GW 12 241 Satin black GW 14 241 Glossy titanium GW 11 241 Glossy ivory <p>2P+E-16 A-250 V ac</p>	 <ul style="list-style-type: none"> GW 10 242 Glossy white GW 15 242 Satin white GW 13 242 Sat. natural beige GW 12 242 Satin black GW 14 242 Glossy titanium GW 11 242 Glossy ivory <p>2P+E-16 A-250 V ac With lid - IP40</p>	 <ul style="list-style-type: none"> GW 10 341 Glossy white GW 15 341 Satin white GW 13 341 Sat. natural beige GW 12 341 Satin black GW 14 341 Glossy titanium <p>2P+E-16 A-250 V ac Front-tightening terminals</p>	 <ul style="list-style-type: none"> GW 10 241F Glossy white GW 15 241F Satin white GW 13 241F Sat. natural beige GW 12 241F Satin black GW 14 241F Glossy titanium <p>2P+E-16 A-250 V ac Quick wiring</p>	
German	 <p>GW 10 251 2P+E-16 A-250 V ac</p>	 <p>GW 10 351 2P+E-16 A-250 V ac Front-tightening terminals</p>	 <p>GW 10 251F 2P+E-16 A-250 V ac Quick wiring</p>		
	 <ul style="list-style-type: none"> GW 10 246 Glossy white GW 15 246 Satin white GW 13 246 Sat. natural beige GW 12 246 Satin black GW 14 246 Glossy titanium GW 11 246 Glossy ivory <p>2P-16 A-250 V ac</p>	 <ul style="list-style-type: none"> GW 10 247 Glossy white GW 15 247 Satin white GW 13 247 Sat. natural beige GW 12 247 Satin black GW 14 247 Glossy titanium GW 11 247 Glossy ivory <p>2P+E-16 A-250 V ac</p>	 <ul style="list-style-type: none"> GW 10 248 Glossy white GW 15 248 Satin white GW 13 248 Sat. natural beige GW 12 248 Satin black GW 14 248 Glossy titanium <p>2P+E-16 A-250 V ac Front-tightening terminals</p>	 <ul style="list-style-type: none"> GW 10 247F Glossy white GW 15 247F Satin white GW 13 247F Sat. natural beige GW 12 247F Satin black GW 14 247F Glossy titanium <p>2P+E-16 A-250 V ac Quick wiring</p>	
French	 <p>GW 10 258 2P+E-16 A-250 V ac Front-tightening terminals</p>	 <p>GW 10 257F 2P+E-16 A-250 V ac Quick wiring</p>	 <p>GW 10 260 Accessory for dedicated lines</p>		
	 <ul style="list-style-type: none"> GW 10 286 Glossy white GW 15 286 Satin white GW 13 286 Sat. natural beige GW 12 286 Satin black GW 14 286 Glossy titanium <p>2P+E-15 A-250/125 V ac</p>	 <ul style="list-style-type: none"> GW 10 287 Glossy white GW 15 287 Satin white GW 13 287 Sat. natural beige GW 12 287 Satin black GW 14 287 Glossy titanium GW 11 287 Glossy ivory <p>2P-15 A-250/125 V ac</p>	 <ul style="list-style-type: none"> GW 10 288 Glossy white GW 15 288 Satin white GW 13 288 Sat. natural beige GW 12 288 Satin black GW 14 288 Glossy titanium GW 11 288 Glossy ivory <p>2P+E-15 A-250/125 V ac</p>	 <ul style="list-style-type: none"> GW 10 310 Glossy white GW 15 310 Satin white GW 13 310 Sat. natural beige GW 12 310 Satin black GW 14 310 Glossy titanium <p>2P+E-13 A-250 V ac 15 A-127 V ac</p>	
USA	Euro-American		Multistandard		

(*) supplied without LED signalling unit

POWER

Swiss	 2P+E-10 A-250 V ac Type 13	<ul style="list-style-type: none"> GW 10 346 Glossy white 	Israeli	 2P+E-16 A-250 V ac Illuminable (*)	<ul style="list-style-type: none"> GW 10 281 Glossy white GW 15 281 Satin white GW 13 281 Sat. natural beige GW 12 281 Satin black GW 14 281 Glossy titanium GW 11 281 Glossy ivory 	 GW 10 291 2P+E-16 A-250 V ac Illuminable (*)	<ul style="list-style-type: none"> GW 10 282 Glossy white GW 15 282 Satin white GW 13 282 Sat. natural beige GW 12 282 Satin black GW 14 282 Glossy titanium 	 2P-10 A-250 V ac
British	 2P+E-13 A-250 V ac	<ul style="list-style-type: none"> GW 10 296 Glossy white GW 15 296 Satin white GW 13 296 Sat. natural beige GW 12 296 Satin black GW 14 296 Glossy titanium 	Indian/South African	 2P+E-15 A-250 V ac	<ul style="list-style-type: none"> GW 10 297 Glossy white GW 15 297 Satin white GW 13 297 Sat. natural beige GW 12 297 Satin black GW 14 297 Glossy titanium 	 2P+E-16 A-250 V ac	<ul style="list-style-type: none"> GW 10 298 Glossy white GW 15 298 Satin white GW 13 298 Sat. natural beige GW 12 298 Satin black GW 14 298 Glossy titanium 	 2P+E-16 A-250 V ac
Australian	 2P+E-10 A-250 V ac	<ul style="list-style-type: none"> GW 10 306 Glossy white GW 15 306 Satin white GW 13 306 Sat. natural beige GW 12 306 Satin black GW 14 306 Glossy titanium 	Argentinian	 2P+E-15 A-250 V ac	<ul style="list-style-type: none"> GW 10 307 Glossy white GW 15 307 Satin white GW 13 307 Sat. natural beige GW 12 307 Satin black GW 14 307 Glossy titanium 	 2P+E-10 A-250 V ac	<ul style="list-style-type: none"> GW 10 301 Glossy white GW 15 301 Satin white GW 13 301 Sat. natural beige GW 12 301 Satin black GW 14 301 Glossy titanium 	
Chinese	 2P+E-10 A-250 V ac	<ul style="list-style-type: none"> GW 10 391 Glossy white GW 15 391 Satin white GW 13 391 Sat. natural beige GW 12 391 Satin black GW 14 391 Glossy titanium 		 2P+E-16 A-250 V ac	<ul style="list-style-type: none"> GW 10 392 Glossy white GW 15 392 Satin white GW 13 392 Sat. natural beige GW 12 392 Satin black GW 14 392 Glossy titanium 			
Interlocked switched socket-outlets	 2P+E-16 A-230 V ac	<ul style="list-style-type: none"> GW 10 311 Glossy white GW 15 311 Satin white GW 13 311 Sat. natural beige GW 12 311 Satin black GW 14 311 Glossy titanium 		 2P+E-16 A-230 V ac	<ul style="list-style-type: none"> GW 10 312 Glossy white GW 15 312 Satin white GW 13 312 Sat. natural beige GW 12 312 Satin black GW 14 312 Glossy titanium 			
Shaver socket-outlet	 2P+E-16 A-230 V ac	<ul style="list-style-type: none"> GW 10 321 Glossy white GW 15 321 Satin white GW 13 321 Sat. natural beige GW 12 321 Satin black GW 14 321 Glossy titanium 		 2P+E-16 A-230 V ac	<ul style="list-style-type: none"> GW 10 322 Glossy white GW 15 322 Satin white GW 13 322 Sat. natural beige GW 12 322 Satin black GW 14 322 Glossy titanium 			
Shaver socket-outlet	 230 V ac-50/60 Hz	<ul style="list-style-type: none"> GW 10 331 Glossy white GW 15 331 Satin white GW 13 331 Sat. natural beige GW 12 331 Satin black GW 14 331 Glossy titanium GW 11 331 Glossy ivory 						

(*) supplied without LED signalling unit

CHORUSMART - Domestic ranges

DATA

TV (IEC male)		<ul style="list-style-type: none"> GW 10 361 Glossy white GW 15 361 Satin white GW 13 361 Sat. natural beige GW 12 361 Satin black GW 14 361 Glossy titanium GW 11 361 Glossy ivory 	0 dB	TV (IEC male)		<ul style="list-style-type: none"> GW 10 362 Glossy white GW 15 362 Satin white GW 13 362 Sat. natural beige GW 12 362 Satin black GW 14 362 Glossy titanium 	5 dB	TV (IEC male)		<ul style="list-style-type: none"> GW 10 363 Glossy white GW 15 363 Satin white GW 13 363 Sat. natural beige GW 12 363 Satin black GW 14 363 Glossy titanium 	10 dB	TV-SAT (F-female)		<ul style="list-style-type: none"> GW 10 371 Glossy white GW 15 371 Satin white GW 13 371 Sat. natural beige GW 12 371 Satin black GW 14 371 Glossy titanium GW 11 371 Glossy ivory 	0 dB	TV-SAT (F-female)		<ul style="list-style-type: none"> GW 10 372 Glossy white GW 15 372 Satin white GW 13 372 Sat. natural beige GW 12 372 Satin black GW 14 372 Glossy titanium 	5 dB	TV-SAT (F-female)		<ul style="list-style-type: none"> GW 10 373 Glossy white GW 15 373 Satin white GW 13 373 Sat. natural beige GW 12 373 Satin black GW 14 373 Glossy titanium 	10 dB
------------------	--	---	------	------------------	--	---	------	------------------	--	---	-------	----------------------	--	---	------	----------------------	--	---	------	----------------------	--	---	-------

TV and TV-SAT accessories		GW 20 277 Terminal resistance 75 ohm	TV-FM-SAT		<ul style="list-style-type: none"> GW 10 381 Glossy white GW 15 381 Satin white GW 13 381 Sat. natural beige GW 12 381 Satin black GW 14 381 Glossy titanium GW 11 381 Glossy ivory 	0 dB	TV-FM-SAT		<ul style="list-style-type: none"> GW 10 382 Glossy white GW 15 382 Satin white GW 13 382 Sat. natural beige GW 12 382 Satin black GW 14 382 Glossy titanium 	0 dB	TV-SAT		<ul style="list-style-type: none"> GW 10 383 Glossy white GW 15 383 Satin white GW 13 383 Sat. natural beige GW 12 383 Satin black GW 14 383 Glossy titanium GW 11 383 Glossy ivory 	0 dB
------------------------------	--	--	-----------	--	---	------	-----------	--	---	------	--------	--	---	------

TV-SAT		<ul style="list-style-type: none"> GW 10 367 Glossy white GW 15 367 Satin white GW 13 367 Sat. natural beige GW 12 367 Satin black GW 14 367 Glossy titanium 	IEC male 0dB	TV-SAT		<ul style="list-style-type: none"> GW 10 377 Glossy white GW 15 377 Satin white GW 13 377 Sat. natural beige GW 12 377 Satin black GW 14 377 Glossy titanium 	F female 0dB	Covers for antenna sockets		<ul style="list-style-type: none"> GW 10 386 Glossy white GW 15 386 Satin white GW 13 386 Sat. natural beige GW 12 386 Satin black GW 14 386 Glossy titanium 	For combined TV-R sockets	Covers for antenna sockets		<ul style="list-style-type: none"> GW 10 387 Glossy white GW 15 387 Satin white GW 13 387 Sat. natural beige GW 12 387 Satin black GW 14 387 Glossy titanium 	For combined TV-R-SAT sockets
--------	--	---	-----------------	--------	--	---	-----------------	-------------------------------	--	---	------------------------------	-------------------------------	--	---	----------------------------------

Telephone sockets		<ul style="list-style-type: none"> GW 10 401 Glossy white GW 15 401 Satin white GW 13 401 Sat. natural beige GW 12 401 Satin black GW 14 401 Glossy titanium GW 11 401 Glossy ivory 	RJ11	British 6 contacts		<ul style="list-style-type: none"> GW 10 406 Glossy white GW 15 406 Satin white GW 13 406 Sat. natural beige GW 12 406 Satin black GW 14 406 Glossy titanium 	British 6 contacts	RJ11		<ul style="list-style-type: none"> GW 10 409 Glossy white GW 15 409 Satin white GW 13 409 Sat. natural beige GW 12 409 Satin black GW 14 409 Glossy titanium 	RJ11	Adapters for optical fiber		GW 38 335 Angled SC/APC
-------------------	--	---	------	--------------------	--	---	--------------------	------	--	---	------	-------------------------------	--	----------------------------

Data sockets		<ul style="list-style-type: none"> GW 10 421 Glossy white GW 15 421 Satin white GW 13 421 Sat. natural beige GW 12 421 Satin black GW 14 421 Glossy titanium GW 11 421 Glossy ivory 	RJ45 cat. 5e UTP	RJ45 cat. 5e FTP		<ul style="list-style-type: none"> GW 10 422 Glossy white GW 15 422 Satin white GW 13 422 Sat. natural beige GW 12 422 Satin black GW 14 422 Glossy titanium GW 11 422 Glossy ivory 	RJ45 cat. 5e FTP	RJ45 cat. 6 UTP		<ul style="list-style-type: none"> GW 10 423 Glossy white GW 15 423 Satin white GW 13 423 Sat. natural beige GW 12 423 Satin black GW 14 423 Glossy titanium GW 11 423 Glossy ivory 	RJ45 cat. 6 UTP	RJ45 cat. 6 FTP		<ul style="list-style-type: none"> GW 10 424 Glossy white GW 15 424 Satin white GW 13 424 Sat. natural beige GW 12 424 Satin black GW 14 424 Glossy titanium GW 11 424 Glossy ivory 	RJ45 cat. 6 FTP	AMP/Keystone Jack adapters		<ul style="list-style-type: none"> GW 10 431 Glossy white GW 15 431 Satin white GW 13 431 Sat. natural beige GW 12 431 Satin black GW 14 431 Glossy titanium GW 11 431 Glossy ivory 	AMP/Keystone Jack adapters	SYSTEMAX Commscope adapters		<ul style="list-style-type: none"> GW 10 438 Glossy white GW 15 438 Satin white GW 13 438 Sat. natural beige GW 12 438 Satin black GW 14 438 Glossy titanium 	SYSTEMAX Commscope adapters
--------------	--	---	---------------------	------------------	--	---	---------------------	-----------------	--	---	--------------------	-----------------	--	---	--------------------	-------------------------------	--	---	-------------------------------	-----------------------------------	--	---	-----------------------------------

Data sockets		<ul style="list-style-type: none"> GW 10 434 Glossy white GW 15 434 Satin white GW 13 434 Sat. natural beige GW 12 434 Satin black GW 14 434 Glossy titanium 	RJ45 Cat. 5e UTP	RJ45 Cat. 5e FTP		<ul style="list-style-type: none"> GW 10 436 Glossy white GW 15 436 Satin white GW 13 436 Sat. natural beige GW 12 436 Satin black GW 14 436 Glossy titanium 	RJ45 Cat. 5e FTP	RJ45 Cat. 6 UTP		<ul style="list-style-type: none"> GW 10 435 Glossy white GW 15 435 Satin white GW 13 435 Sat. natural beige GW 12 435 Satin black GW 14 435 Glossy titanium 	RJ45 Cat. 6 UTP	RJ45 Cat. 6 FTP		<ul style="list-style-type: none"> GW 10 437 Glossy white GW 15 437 Satin white GW 13 437 Sat. natural beige GW 12 437 Satin black GW 14 437 Glossy titanium 	RJ45 Cat. 6 FTP	AMP/Keystone Jack adapters		<ul style="list-style-type: none"> GW 10 433 Glossy white GW 15 433 Satin white GW 13 433 Sat. natural beige GW 12 433 Satin black GW 14 433 Glossy titanium 	AMP/Keystone Jack adapters
--------------	--	---	---------------------	------------------	--	---	---------------------	-----------------	--	---	--------------------	-----------------	--	---	--------------------	----------------------------	--	---	-------------------------------

SELV sockets		<ul style="list-style-type: none"> GW 10 451 Glossy white GW 15 451 Satin white GW 13 451 Sat. natural beige GW 12 451 Satin black GW 14 451 Glossy titanium 	2P-6 A-24V	2P-6 A-24V Polarised		<ul style="list-style-type: none"> GW 10 452 Glossy white GW 15 452 Satin white GW 13 452 Sat. natural beige GW 12 452 Satin black GW 14 452 Glossy titanium 	2P-6 A-24V Polarised	Audio and video sockets		<ul style="list-style-type: none"> GW 10 453 Glossy white GW 15 453 Satin white GW 13 453 Sat. natural beige GW 12 453 Satin black GW 14 453 Glossy titanium 	Dual RCA	For loudspeaker		<ul style="list-style-type: none"> GW 10 454 Glossy white GW 15 454 Satin white GW 13 454 Sat. natural beige GW 12 454 Satin black GW 14 454 Glossy titanium 	For loudspeaker	Speaker connector		<ul style="list-style-type: none"> GW 10 458 Glossy white GW 15 458 Satin white GW 13 458 Sat. natural beige GW 12 458 Satin black GW 14 458 Glossy titanium 	Speaker connector
--------------	--	---	------------	-------------------------	--	---	-------------------------	----------------------------	--	---	----------	-----------------	--	---	-----------------	-------------------	--	---	-------------------

USB and HDMI couplers and sockets		<ul style="list-style-type: none"> GW 10 459 Glossy white GW 15 459 Satin white GW 13 459 Sat. natural beige GW 12 459 Satin black GW 14 459 Glossy titanium 	USB socket	GW 38 056 HDMI coupler		GW 38 057 USB coupler		USB chargers		<ul style="list-style-type: none"> GW 10 447 Glossy white GW 15 447 Satin white GW 13 447 Sat. natural beige GW 12 447 Satin black GW 14 447 Glossy titanium 	Dual USB charger Type A+A-1M-3 A 100-240 V ac - 50/60 Hz	Dual USB charger Type A+C-1M-3 A 100-240 V ac - 50/60 Hz		<ul style="list-style-type: none"> GW 10 449 Glossy white GW 15 449 Satin white GW 13 449 Sat. natural beige GW 12 449 Satin black GW 14 449 Glossy titanium 	Dual USB charger Type A+C-1M-3 A 100-240 V ac - 50/60 Hz
--------------------------------------	--	---	------------	---------------------------	--	--------------------------	--	--------------	--	---	--	--	--	---	--

PROTECTION

Miniature circuit breakers



1P+N-6 A-3 kA
C-characteristic

-  GW 10 461 Glossy white
-  GW 15 461 Satin white
-  GW 13 461 Sat. natural beige
-  GW 12 461 Satin black
-  GW 14 461 Glossy titanium



1P-10 A-3 kA
C-characteristic

-  GW 10 462 Glossy white
-  GW 15 462 Satin white
-  GW 13 462 Sat. natural beige
-  GW 12 462 Satin black
-  GW 14 462 Glossy titanium







1P-16 A-3 kA
C-characteristic

-  GW 10 463 Glossy white
-  GW 15 463 Satin white
-  GW 13 463 Sat. natural beige
-  GW 12 463 Satin black
-  GW 14 463 Glossy titanium



1P+N-6 A-3 kA
C-characteristic

-  GW 10 466 Glossy white
-  GW 15 466 Satin white
-  GW 13 466 Sat. natural beige
-  GW 12 466 Satin black
-  GW 14 466 Glossy titanium







1P+N-10 A-3 kA
C-characteristic

-  GW 10 467 Glossy white
-  GW 15 467 Satin white
-  GW 13 467 Sat. natural beige
-  GW 12 467 Satin black
-  GW 14 467 Glossy titanium







1P+N-16 A-3 kA
C-characteristic

-  GW 10 468 Glossy white
-  GW 15 468 Satin white
-  GW 13 468 Sat. natural beige
-  GW 12 468 Satin black
-  GW 14 468 Glossy titanium

Protection devices







Fuse holder
In MAX-16 A

-  GW 10 491 Glossy white
-  GW 15 491 Satin white
-  GW 13 491 Sat. natural beige
-  GW 12 491 Satin black
-  GW 14 491 Glossy titanium







Surge protection

-  GW 10 492 Glossy white
-  GW 15 492 Satin white
-  GW 13 492 Sat. natural beige
-  GW 12 492 Satin black
-  GW 14 492 Glossy titanium

Residual miniature circuit breakers









1P+N-6 A-3 kA-10 mA
C-characteristic-A type

-  GW 10 482 Glossy white
-  GW 15 482 Satin white
-  GW 13 482 Sat. natural beige
-  GW 12 482 Satin black
-  GW 14 482 Glossy titanium









1P+N-10 A-3 kA-10 mA
C-characteristic-A type

-  GW 10 485 Glossy white
-  GW 15 485 Satin white
-  GW 13 485 Sat. natural beige
-  GW 12 485 Satin black
-  GW 14 485 Glossy titanium









1P+N-16 A-3 kA-10 mA
C-characteristic-A type

-  GW 10 488 Glossy white
-  GW 15 488 Satin white
-  GW 13 488 Sat. natural beige
-  GW 12 488 Satin black
-  GW 14 488 Glossy titanium









1P+N-6 A-3 kA-30 mA
C-characteristic-A type

-  GW 10 483 Glossy white
-  GW 15 483 Satin white
-  GW 13 483 Sat. natural beige
-  GW 12 483 Satin black
-  GW 14 483 Glossy titanium







1P+N-10 A-3 kA-30 mA
C-characteristic-A type

-  GW 10 486 Glossy white
-  GW 15 486 Satin white
-  GW 13 486 Sat. natural beige
-  GW 12 486 Satin black
-  GW 14 486 Glossy titanium











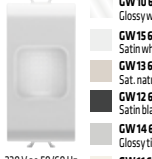











1P+N-16 A-3 kA-30 mA
C-characteristic-A type

-  GW 10 489 Glossy white
-  GW 15 489 Satin white
-  GW 13 489 Sat. natural beige
-  GW 12 489 Satin black
-  GW 14 489 Glossy titanium

CHORUSMART - Domestic ranges

SIGNALLING

Anti black-out lamps	 230 V ac-50/60 Hz Extractable	<ul style="list-style-type: none"> GW 10 661 Glossy white GW 13 661 Sat. natural beige GW 12 661 Satin black GW 14 661 Glossy titanium 	Emergency lamps	 230 V ac-50/60 Hz	<ul style="list-style-type: none"> GW 10 662 Glossy white GW 15 662 Satin white GW 13 662 Sat. natural beige GW 12 662 Satin black GW 14 662 Glossy titanium GW 11 662 Glossy ivory 	 230 V ac-50/60 Hz	<ul style="list-style-type: none"> GW 10 663 Glossy white GW 15 663 Satin white GW 13 663 Sat. natural beige GW 12 663 Satin black GW 14 663 Glossy titanium 	 230 V ac-50/60 Hz	<ul style="list-style-type: none"> GW 10 666 Glossy white GW 15 666 Satin white GW 13 666 Sat. natural beige GW 12 666 Satin black GW 14 666 Glossy titanium 									
	Ringers	 12 V ac-50 Hz		<ul style="list-style-type: none"> GW 10 601 Glossy white GW 15 601 Satin white GW 13 601 Sat. natural beige GW 12 601 Satin black GW 14 601 Glossy titanium 	 230 V ac-50 Hz	<ul style="list-style-type: none"> GW 10 602 Glossy white GW 15 602 Satin white GW 13 602 Sat. natural beige GW 12 602 Satin black GW 14 602 Glossy titanium GW 11 602 Glossy ivory 	 12 V ac/dc Three independent inputs	<ul style="list-style-type: none"> GW 10 611 Glossy white GW 15 611 Satin white GW 13 611 Sat. natural beige GW 12 611 Satin black GW 14 611 Glossy titanium 	 230 V ac-50 Hz Three independent inputs	<ul style="list-style-type: none"> GW 10 612 Glossy white GW 15 612 Satin white GW 13 612 Sat. natural beige GW 12 612 Satin black GW 14 612 Glossy titanium 								
Buzzers	 12 V ac-50 Hz	<ul style="list-style-type: none"> GW 10 606 Glossy white GW 15 606 Satin white GW 13 606 Sat. natural beige GW 12 606 Satin black GW 14 606 Glossy titanium 	 230 V ac-50 Hz	<ul style="list-style-type: none"> GW 10 607 Glossy white GW 15 607 Satin white GW 13 607 Sat. natural beige GW 12 607 Satin black GW 14 607 Glossy titanium 	Single indicator lamps	 1/2M - Opal Illuminable (*)	<ul style="list-style-type: none"> GW 10 641 Glossy white GW 15 641 Satin white GW 13 641 Sat. natural beige GW 12 641 Satin black GW 14 641 Glossy titanium 	 1/2M - Green Illuminable (*)	<ul style="list-style-type: none"> GW 10 642 Glossy white GW 15 642 Satin white GW 13 642 Sat. natural beige GW 12 642 Satin black GW 14 642 Glossy titanium 	 1/2M - Red Illuminable (*)	<ul style="list-style-type: none"> GW 10 643 Glossy white GW 15 643 Satin white GW 13 643 Sat. natural beige GW 12 643 Satin black GW 14 643 Glossy titanium 	 1/2M - Amber Illuminable (*)	<ul style="list-style-type: none"> GW 10 644 Glossy white GW 15 644 Satin white GW 13 644 Sat. natural beige GW 12 644 Satin black GW 14 644 Glossy titanium 	Double indicator lamps	 1M - Opal Illuminable (*)	<ul style="list-style-type: none"> GW 10 628 Glossy white GW 15 628 Satin white GW 13 628 Sat. natural beige GW 12 628 Satin black GW 14 628 Glossy titanium 	 1M - Red/Green Illuminable (*)	<ul style="list-style-type: none"> GW 10 629 Glossy white GW 15 629 Satin white GW 13 629 Sat. natural beige GW 12 629 Satin black GW 14 629 Glossy titanium
Protruding indicator lamps	 2M-12 V ac/dc-230 V ac-50/60 Hz Opal	<ul style="list-style-type: none"> GW 10 631 Glossy white GW 15 631 Satin white GW 13 631 Sat. natural beige GW 12 631 Satin black GW 14 631 Glossy titanium 	 2M-12 V ac/dc-230 V ac-50/60 Hz Green	<ul style="list-style-type: none"> GW 10 632 Glossy white GW 15 632 Satin white GW 13 632 Sat. natural beige GW 12 632 Satin black GW 14 632 Glossy titanium 	 2M-12 V ac/dc-230 V ac-50/60 Hz Red	<ul style="list-style-type: none"> GW 10 633 Glossy white GW 15 633 Satin white GW 13 633 Sat. natural beige GW 12 633 Satin black GW 14 633 Glossy titanium 	 2M-12 V ac/dc-230 V ac-50/60 Hz Amber	<ul style="list-style-type: none"> GW 10 634 Glossy white GW 15 634 Satin white GW 13 634 Sat. natural beige GW 12 634 Satin black GW 14 634 Glossy titanium 	Stair riser lamps	 2M Opal	<ul style="list-style-type: none"> GW 10 651 Glossy white GW 15 651 Satin white GW 13 651 Sat. natural beige GW 12 651 Satin black GW 14 651 Glossy titanium 	 4M Opal	<ul style="list-style-type: none"> GW 10 656 Glossy white GW 15 656 Satin white GW 13 656 Sat. natural beige GW 12 656 Satin black GW 14 656 Glossy titanium 					

(*) supplied without LED signalling unit

ENERGY, CLIMATE AND COMFORT MANAGEMENT

Timed thermostats		<ul style="list-style-type: none"> GW 10 703 Glossy white GW 12 703 Satin black GW 14 703 Glossy titanium 	Thermostats		<ul style="list-style-type: none"> GW 16 970 CB Glossy white GW 16 970 CN Glossy black GW 16 970 CT Glossy titanium 		<ul style="list-style-type: none"> GW 10 705 Glossy white GW 15 705 Satin white GW 13 705 Sat. natural beige GW 12 705 Satin black GW 14 705 Glossy titanium GW 11 705 Glossy ivory 		<ul style="list-style-type: none"> GW 10 709 Glossy white GW 15 709 Satin white GW 13 709 Sat. natural beige GW 12 709 Satin black GW 14 709 Glossy titanium
	230 V ac-50/60 Hz			Thermo ICE WiFi 110-230 V ac-50/60 Hz Wall-mounting		230 V ac-50/60 Hz		100-240 V ac - 50/60 Hz	





Electronic timers		<ul style="list-style-type: none"> GW 10 581 Glossy white GW 12 581 Satin black GW 14 581 Glossy titanium
	230 V ac-50/60 Hz Daily/Weekly	

TECHNICAL ALARMS





Detectors		<ul style="list-style-type: none"> GW 10 711 Glossy white GW 12 711 Satin black GW 14 711 Glossy titanium 		<ul style="list-style-type: none"> GW 10 712 Glossy white GW 15 712 Satin white GW 13 712 Sat. natural beige GW 12 712 Satin black GW 14 712 Glossy titanium 		
	LPG 12 V ac/dc		Methane gas 12 V ac/dc		GW A1 514 Water sensor Zigbee Battery powered	GW A1 521 1-channel actuator Zigbee 230 V ac-50 Hz



Accessories			
	GW A1 541 Wall-mounting support for water sensor	GW 10 720 Power supply 100/240 V ac-50/60 Hz 12 V dc	GW 30 522 Gas solenoid valve 3/4"-230 V ac-12 VA

ACCESSORIES

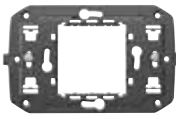
LED signalling units		<ul style="list-style-type: none"> GW 10 881 Blue GW 10 882 White GW 10 883 Red GW 10 884 Green GW 10 885 Amber 	Cartridge lamps			Keys		
	230 V ac-50/60 Hz			GW 10 894 White 12/24 V ac/dc			GW 20 902 White 12 V-56x36	GW 20 903 White 24 V-56x36

STANDARD SUPPORTS FOR ONE, GEO, EGO, LUX AND ICE PLATES

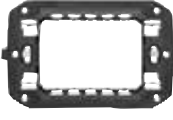
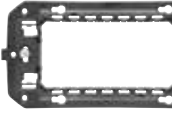
Supports for round/square boxes			Support for round/square and rectangular boxes		Protective covers for painting		
	GW 16 821 With clutches - 2 modules	GW 16 822 For screws (not included) - 2 modules		GW 16 802 For screws - 2 modules		For rectangular supports	GW 16 873 3 modules

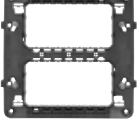
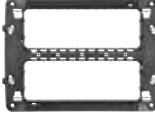
Supports for rectangular boxes						
	GW 16 803 For screws - 3 modules	GW 16 804 For screws - 4 modules	GW 16 806 For screws - 6 modules	GW 16 807 N For screws - 7 modules	GW 16 808 For screws - 4+4 modules	GW 16 812 For screws - 6+6 modules

ChoruSmart

Glossy white modular devices

The ChoruSmart modular devices allow you to create infinite combinations of devices and plates, thanks to a complete range that covers all design, functional and installation needs. Colours and finishes: glossy white, bright and versatile. Unlimited functions in compact spaces: the ChoruSmart range consists of button keys with 1/2, 1, 2 and 3 rocker modules, to optimise space according to needs, and axial buttons in the EVO or SMART version, to meet the latest requirements. Front coupling: front coupling allows the components to be assembled and released quickly and easily, with no need to remove the support, which is the same for all plates and boxes.



COMMAND - GLOSSY WHITE VERSION

COMMAND DEVICES - ROCKERS - SCREW TERMINALS



GW 10 001

ONE-WAY SWITCHES 1P - 250V AC

Code	Description	Button key	Rated power of 230V LED lamps	Pack Carton
No. modules: 1				
GW 10 001	1P - 16AX	Neutral	200 W	12/96
GW 10 002	1P - 16AX illuminable	With diffuser	200 W	12/24
GW 10 003	1P - 16AX illuminable	With replaceable neutral lens	200 W	12/24
No. modules: 1/2				
GW 10 021	1P - 10AX	Neutral	100 W	12/24
GW 10 022	1P - 10AX illuminable	With diffuser	100 W	6/24
No. modules: 2				
GW 10 031	1P - 16AX	Neutral	200 W	6/24
GW 10 032	1P - 16AX illuminable	With diffuser	200 W	6/24
GW 10 033	1P - 16AX illuminable	With replaceable neutral lens	200 W	6/24
No. modules: 3				
GW 10 041	1P - 16AX	Neutral	200 W	4/12
GW 10 042	1P - 16AX illuminable	With diffuser	200 W	4/12
GW 10 043	1P - 16AX illuminable	With replaceable neutral lens	200 W	4/12

CHARACTERISTICS: the illuminable articles use LED signalling units, not included.

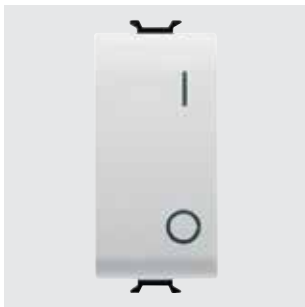

GW 10 004

ONE-WAY SWITCHES 2P - 250V AC

Code	Description	Button key	Symbol	Rated power of 230V LED lamps	Pack Carton
No. modules: 1					
GW 10 004	2P - 16 AX	Neutral	0/1	200 W	12/48
GW 10 005	2P - 16AX illuminable	With replaceable neutral lens	-	200 W	12/24
GW 10 006	2P - 10AX	With key	0/1	100 W	1/12
No. modules: 2					
GW 10 034	2P - 16 AX	Neutral	0/1	200 W	6/24
GW 10 035	2P - 16AX illuminable	With replaceable neutral lens	-	200 W	6/24

CHARACTERISTICS: the illuminable articles use LED signalling units, not included.

NOTES: GW10006 equipped with 2 keys. Key extractable in both positions. Spare keys: GW20901.

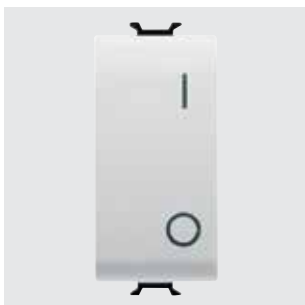

GW 10 007

ONE-WAY SWITCH 2P - 250V AC - HEAVY DUTY LOADS

Code	Description	Button key	Symbol	Rated power of 230V LED lamps	Pack Carton
No. modules: 1					
GW 10 007	2P - 25 AX	Neutral	0/1	250 W	12/24

APPLICATIONS: suitable for particular heavy-duty loads (e.g. fluorescent lamp batteries) or high-consumption devices (e.g. ovens, air-conditioners, boilers, etc.).



GW 10 051

TWO-WAY SWITCHES 1P - 250V AC

Code	Description	Button key	Rated power of 230V LED lamps	Pack Carton
No. modules: 1				
GW 10 051	1P - 16AX	Neutral	200 W	12/96
GW 10 052	1P - 16AX illuminable	With diffuser	200 W	12/24
GW 10 053	1P - 16AX illuminable	With replaceable neutral lens	200 W	12/24
GW 10 054	1P - 10AX	With key	100 W	1/12
No. modules: 1/2				
GW 10 061	1P - 10AX	Neutral	100 W	6/24
No. modules: 2				
GW 10 071	1P - 16AX	Neutral	200 W	6/24
GW 10 072	1P - 16AX illuminable	With diffuser	200 W	6/24
GW 10 073	1P - 16AX illuminable	With replaceable neutral lens	200 W	6/24
No. modules: 3				
GW 10 081	1P - 16AX	Neutral	200 W	4/12
GW 10 082	1P - 16AX illuminable	With diffuser	200 W	4/12
GW 10 083	1P - 16AX illuminable	With replaceable neutral lens	200 W	4/12

CHARACTERISTICS: the illuminable articles use LED signalling units, not included.

NOTES: GW10054 equipped with 2 keys. Key extractable in both positions. Spare keys: GW20901.



GW 10 091

INTERMEDIATE SWITCHES 1P - 250V AC

Code	Description	Button key	Rated power of 230V LED lamps	Pack Carton
No. modules: 1				
GW 10 091	1P - 16AX	Neutral	200 W	12/48
GW 10 092	1P - 16AX illuminable	With diffuser	200 W	12/24
GW 10 093	1P - 16AX illuminable	With replaceable neutral lens	200 W	12/24
No. modules: 2				
GW 10 101	1P - 16AX	Neutral	200 W	6/12
GW 10 102	1P - 16AX illuminable	With diffuser	200 W	6/12
GW 10 103	1P - 16AX illuminable	With replaceable neutral lens	200 W	6/12
No. modules: 3				
GW 10 111	1P - 16AX	Neutral	200 W	4/12
GW 10 112	1P - 16AX illuminable	With diffuser	200 W	4/12
GW 10 113	1P - 16AX illuminable	With replaceable neutral lens	200 W	4/12

CHARACTERISTICS: the illuminable articles use LED signalling units, not included.

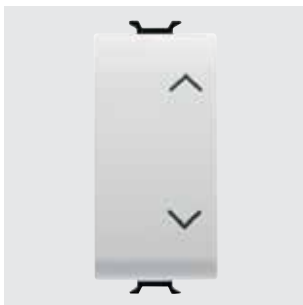

GW 10 121

THREE-WAY SWITCHES 1P - 250V AC

Code	Description	Button key	Symbol	Rated power of 230V LED lamps	Pack Carton
No. modules: 1					
GW 10 121	1P - 10AX	Neutral	UP - DOWN	100 W	12/24
No. modules: 2					
GW 10 123	1P - 10AX	Neutral	UP - DOWN	100 W	6/24

CHARACTERISTICS: three standing positions. Both contacts are open in the central position (OFF).

APPLICATIONS: command of circuits requiring an interlock (e.g. operating motorised devices with direction reversal). 2-user selective control.

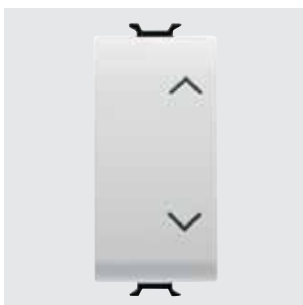

GW 10 122

THREE-WAY SWITCH 2P - 250 V AC

Code	Description	Button key	Symbol	Rated power of 230V LED lamps	Pack Carton
No. modules: 1					
GW 10 122	2P - 10AX	Neutral	UP - DOWN	100 W	12/24

CHARACTERISTICS: three standing positions. Both contacts are open in the central position (OFF). With 6 terminal blocks.

APPLICATIONS: command of circuits requiring an interlock (e.g. operating motorised devices with direction reversal). 2-user selective control.

CHORUSMART - Domestic range



GW 10 131

PUSH-BUTTONS 1P - 250V AC

Code	Description	Button key	Symbol	Pack Carton
No. modules: 1				
GW 10 131	1P NO - 16A	Neutral	-	12/96
GW 10 132	1P NO - 16A illuminable	With diffuser	-	12/24
GW 10 133	1P NO - 16A illuminable	With replaceable neutral lens	-	12/24
GW 10 136	1P NO - 16A	Pull-cord	-	1/12
GW 10 137	1P NC - 16A	Neutral	O red	12/24
GW 10 138	1P NC+NO - 16 A	Stop	Red	12/24
GW 10 139	1P NO+NC - 16 A	Start	Green	12/24
GW 10 140	1P NO+NO - 10A	With interlock	UP - DOWN	12/24
GW 10 141	1P NO+NO - 16 A	Double	-	12/24
GW 10 142	1P NO - 16A illuminable	Green diffuser	-	12/24
GW 10 143	1P NO - 16A illuminable	Red diffuser	-	12/24
GW 10 144	1P NO - 16A illuminable	Opal diffuser	-	12/24
GW 10 151	1P NO - 16A illuminable	With replaceable neutral lens	Light	12/24
GW 10 152	1P NO - 16A illuminable	With replaceable neutral lens	Key	12/24
GW 10 153	1P NO - 16A illuminable	With replaceable neutral lens	Bell	12/24
No. modules: 1/2				
GW 10 161	1P NO - 10A	Neutral	-	6/24
GW 10 162	1P NO - 10A illuminable	With diffuser	-	6/24
No. modules: 2				
GW 10 171	1P NO - 16A	Neutral	-	6/24
GW 10 172	1P NO - 16A illuminable	With diffuser	-	6/24
GW 10 173	1P NO - 16A illuminable	With replaceable neutral lens	-	6/24
No. modules: 3				
GW 10 181	1P NO - 16A	Neutral	-	4/12
GW 10 182	1P NO - 16A illuminable	With diffuser	-	4/12
GW 10 183	1P NO - 16A illuminable	With replaceable neutral lens	-	4/12

CHARACTERISTICS: the illuminable articles use LED signalling units, not included.

GW10136 Cord in insulating material, 140cm long, with red knob.

GW10140 Button with mechanical interlock. Both contacts are open in the central position (OFF); advisable for activating motorised devices with direction reversal (e.g. roller-shutters, curtains, etc.).

GW10141 independent push-buttons that can also be activated simultaneously.

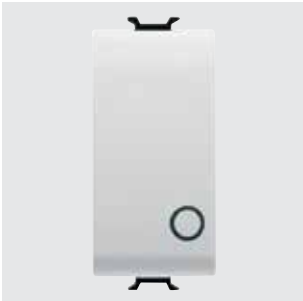

GW 10 134

PUSH-BUTTONS 2P - 250V AC

Code	Description	Button key	Symbol	Pack Carton
No. modules: 1				
GW 10 134	2P NO - 16A	Neutral	O	12/24
GW 10 135	2P NO - 10A illuminable	With replaceable neutral lens	-	12/24
GW 10 145	2P NO - 10A	With key	-	1/12

CHARACTERISTICS: the illuminable articles use LED signalling units, not included.

NOTES: GW10145 equipped with 2 keys. Spare keys: GW30912.



GW 10 191

PUSH-BUTTONS 1P WITH ILLUMINATED NAME PLATE - 250V AC

Code	Description	Lamp voltage	Lamp	Lamp power	Pack Carton
No. modules: 2					
GW 10 191	1P NO - 10A	12-24V ac/dc	Cartridge lamp S6x36 mm	2 W	6/24
No. modules: 3					
GW 10 192	1P NO - 10A	12-24V ac/dc	Cartridge lamp S6x36 mm	2 W	4/16

CHARACTERISTICS: lamp not included.

COMMAND DEVICES - ROCKERS - QUICK WIRING TERMINALS



GW 10 031 F

ONE-WAY SWITCHES 1P - 250V AC

Code	Description	Button key	Rated power of 230V LED lamps	Pack Carton
No. modules: 2				
GW 10 031 F	1P - 16AX	Neutral	200 W	6/24
GW 10 032 F	1P - 16AX illuminable	With diffuser	200 W	6/24
GW 10 033 F	1P - 16AX illuminable	With replaceable neutral lens	200 W	6/24

CHARACTERISTICS: the illuminable articles use LED signalling units, not included.
NOTES: spring quick wiring, no tools necessary.



GW 10 034 F

ONE-WAY SWITCHES 2P - 250V AC

Code	Description	Button key	Symbol	Rated power of 230V LED lamps	Pack Carton
No. modules: 2					
GW 10 034 F	2P - 16 AX	Neutral	0/1	200 W	6/24
GW 10 035 F	2P - 16AX illuminable	With replaceable neutral lens	-	200 W	6/24

CHARACTERISTICS: the illuminable articles use LED signalling units, not included.
NOTES: spring quick wiring, no tools necessary.



GW 10 071 F

TWO-WAY SWITCHES 1P - 250V AC

Code	Description	Button key	Rated power of 230V LED lamps	Pack Carton
No. modules: 2				
GW 10 071 F	1P - 16AX	Neutral	200 W	6/24
GW 10 072 F	1P - 16AX illuminable	With diffuser	200 W	6/24
GW 10 073 F	1P - 16AX illuminable	With replaceable neutral lens	200 W	6/24

CHARACTERISTICS: the illuminable articles use LED signalling units, not included.
NOTES: spring quick wiring, no tools necessary.



GW 10 101 F

INTERMEDIATE SWITCHES 1P - 250V AC

Code	Description	Button key	Rated power of 230V LED lamps	Pack Carton
No. modules: 2				
GW 10 101 F	1P - 16AX	Neutral	200 W	6/12
GW 10 102 F	1P - 16AX illuminable	With diffuser	200 W	6/12
GW 10 103 F	1P - 16AX illuminable	With replaceable neutral lens	200 W	6/12

CHARACTERISTICS: the illuminable articles use LED signalling units, not included.
NOTES: spring quick wiring, no tools necessary.



GW 10 171 F

PUSH-BUTTONS 1P - 250V AC

Code	Description	Button key	Pack Carton
No. modules: 2			
GW 10 171 F	1P NO - 16A	Neutral	6/24
GW 10 172 F	1P NO - 16A illuminable	With diffuser	6/24
GW 10 173 F	1P NO - 16A illuminable	With replaceable neutral lens	6/24

CHARACTERISTICS: the illuminable articles use LED signalling units, not included.
NOTES: spring quick wiring, no tools necessary.

CHORUSMART - Domestic range



GW 10 160 F

COMBINED COMMAND DEVICES - ROCKERS - 250 V AC

Code	Description	Button key	Symbol	Rated power of 230V LED lamps	Pack Carton
No. modules: 2					
GW 10 078 F	Twin two-way switch 1P - 16 AX	Neutral	-	200 W	6/24
GW 10 159 F	Two-way switch 1P - 16 AX / Push-button 1P NO - 16A	Neutral	-	200 W	6/24
GW 10 160 F	Twin push-button 1P NO - 16 A	Neutral	UP - DOWN - STOP	-	6/24

NOTES: spring quick wiring, no tools necessary.

COMMAND DEVICES - AXIAL - SCREW TERMINALS



GW 10 671

AXIAL SWITCH MODULE - EVO

Code	Supply voltage	Output contacts	No. modules	Pack Carton
GW 10 671	100 ÷ 240 V ac - 50/60 Hz	1 NA 5A (AC1) 240 V ac	1	1/12
GW 10 672	100 ÷ 240 V ac - 50/60 Hz	1 NA 5A (AC1) 240 V ac	2	1/6

CHARACTERISTICS: devices for the control of 1 On/Off lighting device through a live output contact. Suitable for the control of incandescent and halogen lamps (240Vac): 1000W, LED lamps (240Vac): 100W, fluorescent lamps (240Vac): 120W, halogen lamps powered by electronic transformers (240Vac): 250VA. Local push button with axial activation for control of the lamps connected to the device.

Equipped with 1 input to replicate the local control of the load via auxiliary module GW10677, GW10678 or NO-type and 1 input buttons for the centralisation OFF function.

APPLICATIONS: Bistable, monostable and timed load. Centralisation function (OFF) by means of a dedicated input, the possibility of being able to switch the load on by means of auxiliary axial modules or NO-type buttons. The devices are equipped with a configurable blue LED that can be set to OFF, location mode or for signalling the connected load status.

NOTE: the devices must be completed with a front button key. GW10671 must be completed with the GW10551S or GW10555S button keys. The GW10672 must be completed with the GW10552S or GW10556S button keys.



GW 10 673

AXIAL DIMMER MODULE - EVO

Code	Supply voltage	Halogen load	Inductive load	LED load	No. modules	Pack Carton
GW 10 673	100 ÷ 240 V ac - 50/60 Hz	4 - 150 W	4 - 150 VA	4 - 150 W	1	1/12
GW 10 674	100 ÷ 240 V ac - 50/60 Hz	4 - 150 W	4 - 150 VA	4 - 150 W	2	1/6

CHARACTERISTICS: trailing edge load drive mode (max. 5 lamps). Two local axial-operated buttons for dimming the connected load.

Equipped with 2 inputs for replicating local control of the load via the auxiliary modules GW10679, GW10680 or NO-type buttons, or for creating the centralisation function.

APPLICATIONS: control of the dimmable load connected to the devices. Using dedicated inputs, load switches can be added via auxiliary axial modules, or NO-type buttons, or the inputs can be set, via programming, for centralised OFF function. The devices are equipped with configurable blue LEDs that can be set to OFF mode, location or signalling of the connected load.

NOTES: To avoid overheating, multiple dimmers cannot be installed side-by-side inside in the same enclosure; insert a blanking module between two electronic devices. If two dimmers are installed in the same box, the maximum loads controlled by each dimmer must be reduced by 50%. The devices must be completed with a front button: GW10673 must be completed with the GW10553S or GW10557S button keys; GW10674 must be completed with the GW10554S or GW10558S button keys.



GW 10 675

AXIAL ROLLER SHUTTER MODULE - EVO

Code	Supply voltage	Max current supplied	No. modules	Pack Carton
GW 10 675	100 ÷ 240 V ac - 50/60 Hz	2,3 A 240 V ac (according to IEC 60669-2-1)	1	1/12
GW 10 676	100 ÷ 240 V ac - 50/60 Hz	2,3 A 240 V ac (according to IEC 60669-2-1)	2	1/6

CHARACTERISTICS: Devices for the control of a motor to operate roller-shutters, curtains, venetian blinds, awnings, etc., through 2 live interlocked output contacts. Two axial-operated local buttons control the motor connected to the device. Equipped with 2 inputs for replicating local control of the motor via the auxiliary module GW10679, GW10680 or NO-type up/down buttons, or for creating the centralisation function.

APPLICATIONS: control of the motor connected to the devices. The dedicated inputs can be used to operate roller-shutters/venetian blinds via the auxiliary axial modules or NO-type up/down buttons, or they can be set, through programming, for centralisation functions (Up/Down). The devices are equipped with blue LEDs which can be configured to facilitate location and to signal the movement of the roller-shutter/Venetian blind.

NOTES: the devices must be completed with a front button key: GW10675 must be completed with the GW10553S or GW10557S button keys; the GW10676 must be completed with the GW10554S or GW10558S button keys.



GW 10 677

1-COMMAND AUXILIARY AXIAL MODULES

Code	Supply voltage	Output contacts	No. modules	Pack Carton
GW 10 677	100 ÷ 240 V ac - 50/60 Hz	1 NO 1 A (AC1) 240 V ac	1	1/12
GW 10 678	100 ÷ 240 V ac - 50/60 Hz	1 NO 1 A (AC1) 240 V ac	2	1/6

CHARACTERISTICS: auxiliary controls to be used in conjunction with the EVO switch modules.

The devices are equipped with configurable blue LEDs that can be set to OFF, location or display of the load status.

APPLICATIONS: when connected to the local inputs of the EVO axial controls, they allow replication of the local load control or the management of centralised controls.

NOTES: the devices must be completed with a front button key: GW10677 must be completed with the GW10551S or GW10555S button keys. GW10678 must be completed with the GW10552S or GW10556S button keys.



GW 10 679

2-COMMAND AUXILIARY AXIAL MODULES

Code	Supply voltage	Output contacts	No. modules	Pack Carton
GW 10 679	100 ÷ 240 V ac - 50/60 Hz	2 NO 1 A (AC1) 240 V ac	1	1/12
GW 10 680	100 ÷ 240 V ac - 50/60 Hz	2 NO 1 A (AC1) 240 V ac	2	1/6

CHARACTERISTICS: auxiliary controls to be used in conjunction with the EVO dimmer and roller-shutter modules.

The devices are equipped with configurable blue LEDs that can be set for location or for displaying the status of the load.

APPLICATIONS: when connected to the local inputs of the EVO axial controls, they allow replication of the local load control or the management of centralised controls.

NOTES: the devices must be completed with a front button key: GW10679 must be completed with the GW10553S or GW10557S button keys. GW10680 must be completed with the GW10554S or GW10558S button keys.

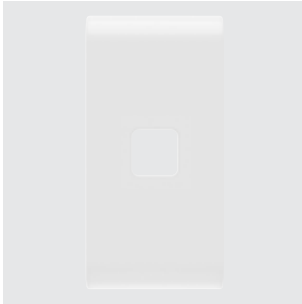

GW 10 551 S

INTERCHANGEABLE BUTTON KEYS FOR AXIAL DEVICES

Code	Colour	Button key	No. modules	Pack Carton
GW 10 551 S	Glossy white	To be completed with lens	1	1/48
GW 10 552 S	Glossy white	To be completed with lens	2	1/48
GW 10 553 S	Glossy white	To be completed with 2 lenses	1	1/48
GW 10 554 S	Glossy white	To be completed with 2 lenses	2	1/48
GW 10 555 S	Glossy white	With 1 diffuser	1	1/48
GW 10 556 S	Glossy white	With 1 diffuser	2	1/48
GW 10 557 S	Glossy white	With 2 diffusers	1	1/48
GW 10 558 S	Glossy white	With 2 diffusers	2	1/48

NOTES: for use to complete the EVO axial modules and auxiliary axial controls.

CHORUSMART - Domestic range

LENSES WITH ILLUMINATED SYMBOL



ZC6

SYMBOLS FOR ILLUMINABLE ROCKER COMMAND DEVICES

Code	Symbol	Pack Carton
Suitable for: General services		
GW 10 501	Neutral	20/240
GW 10 502	Light	20/240
GW 10 503	Stair light	20/240
GW 10 504	Table light	20/240
GW 10 505	Bell	20/240
GW 10 506	Fan	20/240
GW 10 507	Key	20/240
GW 10 508	Alarm	20/240
GW 10 509	ON	20/240
GW 10 510	OFF	20/240
GW 10 511	Nurse	20/240
GW 10 512	Waitress	20/240
GW 10 513	Dimmer increase	20/240
GW 10 514	Dimmer decrease	20/240
GW 10 515	UP arrow	20/240
GW 10 516	DOWN arrow	20/240
GW 10 517	UP - DOWN arrow	20/240
GW 10 518	RIGHT - LEFT arrow	20/240
Suitable for: Numerical services		
GW 10 531	One	20/240
GW 10 532	Two	20/240
GW 10 533	Three	20/240
GW 10 534	Four	20/240
GW 10 535	Five	20/240
GW 10 536	Six	20/240
GW 10 537	Seven	20/240
GW 10 538	Eight	20/240
GW 10 539	Nine	20/240
GW 10 540	Zero	20/240

NOTES: to be used in place of the neutral lens in the illuminable rocker command devices.



ZC6

LENSES WITH ILLUMINATING SYMBOLS FOR AXIAL BUTTON KEYS

Code	Symbol	Pack Carton
GW 10 501 A	Neutral	24
GW 10 502 A	Light	24
GW 10 503 A	Stair light	24
GW 10 504 A	Table light	24
GW 10 505 A	Bell	24
GW 10 506 A	Burglar alarm	24
GW 10 507 A	Key	24
GW 10 508 A	ON OFF	24
GW 10 509 A	ON	24
GW 10 510 A	OFF	24
GW 10 511 A	Socket-outlet	24
GW 10 512 A	Dimmers	24
GW 10 513 A	Dimmer increase	24
GW 10 514 A	Dimmer decrease	24
GW 10 515 A	Arrow	24
GW 10 516 A	Open	24
GW 10 517 A	Close	24
GW 10 518 A	Roller shutter	24
GW 10 519 A	Roller shutter up	24
GW 10 520 A	Roller shutter down	24
GW 10 521 A	Curtain open	24
GW 10 522 A	Curtain close	24
GW 10 523 A	Floor light	24
GW 10 524 A	Ceiling light	24
GW 10 525 A	Wall light	24
GW 10 526 A	Aisle light	24
GW 10 527 A	Scenario	24
GW 10 528 A	Party	24
GW 10 529 A	In	24
GW 10 530 A	Out	24
GW 10 531 A	Good morning	24
GW 10 532 A	Good night	24
GW 10 533 A	TV	24
GW 10 534 A	Heating	24
GW 10 535 A	Cooling	24
GW 10 536 A	Heating/Cooling	24
GW 10 537 A	Comfort	24
GW 10 538 A	Precomfort	24
GW 10 539 A	Economy	24
GW 10 540 A	Auto	24
GW 10 541 A	Do not disturb	24
GW 10 542 A	Make up the room	24

NOTE: for use to customise the interchangeable push buttons for axial controls with 1 and 2 lenses.

INTERCHANGEABLE BUTTON KEYS AND DIFFUSERS FOR ROCKER DEVICES



ZC6

BUTTON KEYS FOR ROCKER CONTROLS AND INTERCHANGEABLE DIFFUSERS FOR INDICATOR LIGHTS

Code	Symbol	Pack Carton
Description: Keys 22x22 mm		
GW 10 541	General	4/48
GW 10 542	With label	4/48
GW 10 543	Key	4/48
GW 10 544	Bell	4/48
GW 10 545	Vertical arrow	4/48
GW 10 546	Horizontal arrow	4/48
Description: Diffusers		
GW 10 547	Red	4/48
GW 10 548	Green	4/48
GW 10 549	Opal diffuser	4/48
GW 10 550	Amber	4/48

APPLICATIONS: replacement diffusers for indicators GW10142, GW10143 and GW10144.

NOTES: the ChoruSmart modular system allows the use of 22 x 22 mm interchangeable buttons in place of the standard buttons fitted on the control devices GW10141, GW10142, GW10143 and GW10144. Symbols/diffusers not suitable for the EVO axial keys.

CHORUSMART - Domestic range

SOFT-CLICK, ROCKER ELECTRONIC PUSH BUTTONS



GW 10 915

UNIVERSAL SOFT-CLICK ELECTRONIC PUSH-BUTTON

Code	Type of contact	Button key	Type of use	No. modules	Pack Carton
GW 10 915	1NO/NC 4A (AC1) 230 V ac - Potential-free Neutral		Relay, dimmer, bus contacts interfaces	1	1/12

CHARACTERISTICS: push-button suitable for connection of KNX BUS contacts interfaces, or the command of bistable relays, electronic one-way switches for heavy duty loads, or dimmers with a remote control input.



GW 10 912

BACKLIT SOFT-CLICK ELECTRONIC PUSH-BUTTON

Code	Supply voltage	Type of contact	Button key	Type of use	Pack Carton
GW 10 912	230 V ac - 50/60 Hz	1NO 4A (AC1) 230 V ac	With diffuser	Relay, dimmer	1/12

CHARACTERISTICS: push-button for controlling latching relays, electronic switches for heavy duty loads, or dimmers with a remote control input. Equipped with amber localisation LED.



GW 10 913

BACKLIT SOFT-CLICK ELECTRONIC PUSH-BUTTONS FOR BUS INPUTS

Code	Type of contact	Button key	Type of use	Pack Carton
No. modules: 1				
GW 10 913	1NO - Potential-free	With diffuser	Bus contacts interfaces	1/12
GW 10 916	1NO - Potential-free	With replaceable neutral lens	Bus contacts interfaces	1/12
No. modules: 2				
GW 10 917	1NO - Potential-free	With diffuser	Bus contacts interfaces	1/6
GW 10 918	1NO - Potential-free	With replaceable neutral lens	Bus contacts interfaces	1/6

CHARACTERISTICS: push-button for BUS inputs, suitable for KNX BUS contact interface connections. Equipped with 2-colour (amber/green) LED with colour selector (can be set up to work as a night-time localisation lamp or to indicate the load status).

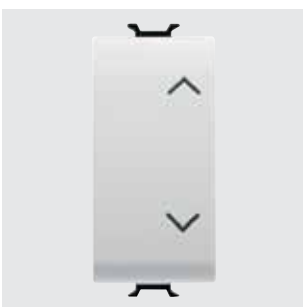

GW 10 914

DOUBLE SOFT-CLICK ELECTRONIC PUSH-BUTTON

Code	Type of contact	Button key	Symbol	No. modules	Pack Carton
GW 10 914	Dual, potential-free and with interlock	Neutral	UP - DOWN	1	1/12

CHARACTERISTICS: double push-button suitable for connecting KNX BUS contact interfaces or electronic control panels for moving roller shutters.

TOUCH COMMAND MODULES



GW 10 922

TOUCH ONE-WAY SWITCH MODULE

Code	Supply voltage	Output contacts	No. modules	Pack Carton
GW 10 922	100 ÷ 240 V ac - 50/60 Hz	1 NA 5A (AC1) 240 V ac	1	1/12

CHARACTERISTICS: device for the On/Off control of 1 lighting device through a live output contact. Suitable for control of incandescent and halogen lamps (240Vac): 1000W, LED lamps (240Vac): 100W, fluorescent lamps (240Vac): 120W, halogen lamps powered by electronic transformers (240Vac): 250VA. Equipped with 1 input for replicating local control of the load via the GW10924 auxiliary touch control modules, NO-type buttons and 1 input for the centralisation of the OFF function. The device is equipped with blue LEDs for easy location that can be set to two different light intensity levels. Excludable built-in buzzer, function identification by means of icons on the ICE touch plates.

APPLICATIONS: bistable, monostable and timed load control. Centralisation function (OFF) through the dedicated input.

NOTES: to be completed with ICE touch plates (codes: GW16955CB, GW16955CL, GW16955CN, GW16955CT).



GW 10 923

TOUCH DIMMER MODULE

Code	Supply voltage	Halogen load	Inductive load	LED load	No. modules	Pack Carton
GW 10 923	100 ÷ 240 V ac - 50/60 Hz	4 - 150 W	4 - 150 VA	4 - 150 W	1	1/12

CHARACTERISTICS: trailing edge load drive mode (max. 5 lamps). Two touch areas for dimming the connected load. Equipped with 2 inputs for replicating local control of the load via the auxiliary touch 2-command modules GW10925, NO-type buttons, or for creating the centralisation function OFF. The device is equipped with blue LEDs for easy location that can be set to two different light intensity levels. Excludable built-in buzzer, function identification by means of icons on the ICE touch plates.

APPLICATIONS: control of the dimmable load connected to the devices. Centralised OFF function, via dedicated inputs.

NOTE: to avoid overheating, multiple products cannot be installed side-by-side inside in the same enclosure; insert a blanking module between two electronic devices. When installing two dimmers in the same box, the maximum loads controlled by each dimmer must be reduced by 50%. To be completed using ICE touch plates (codes: GW16955CB, GW16955CL, GW16955CN, GW16955CT).



GW 10 921

TOUCH ROLLER SHUTTER MODULE

Code	Supply voltage	Maximum output power	No. modules	Pack Carton
GW 10 921	100 ÷ 240 V ac - 50/60 Hz	2,3 A 240 V ac (according to IEC 60669-2-1)	1	1/12

CHARACTERISTICS: Devices for the control of a motor to operate roller-shutters, curtains, venetian blinds, awnings, etc., by means of 2 interlocked live output contacts. Two touch areas for controlling the motor connected to the device. Equipped with 2 inputs for replicating local control of the motor via the touch auxiliary 2-command modules GW10925, NO-type up/down buttons, or for creating a centralisation function (up/down). The device is equipped with blue LEDs for easy location that can be set to two different light intensity levels. Excludable built-in buzzer, function identification by means of icons on the ICE touch plates.

APPLICATIONS: control of the motor connected to the devices. Centralisation function (Up/Down) by means of a dedicated inputs.

NOTES: to be completed with ICE touch plates (codes: GW16955CB, GW16955CL, GW16955CN, GW16955CT).



GW 10 924

1-COMMAND AUXILIARY TOUCH MODULE

Code	Supply voltage	Output contacts	No. modules	Pack Carton
GW 10 924	100 ÷ 240 V ac - 50/60 Hz	100mA 240 V ac	1	1/12

CHARACTERISTICS: suitable for controlling the GW10922 module. The device is equipped with blue LEDs for easy location that can be set to two different light intensity levels. Excludable built-in buzzer, function identification by means of icons on the ICE touch plates.

NOTES: to be completed using ICE touch plates (codes: GW16955CB, GW16955CL, GW16955CN, GW16955CT).



GW 10 925

2-COMMAND AUXILIARY TOUCH MODULE

Code	Supply voltage	Output contacts	No. modules	Pack Carton
GW 10 925	100 ÷ 240 V ac - 50/60 Hz	100mA 240 V ac	1	1/12

CHARACTERISTICS: suitable for controlling the GW10921 and GW10923 modules. The device is equipped with blue LEDs for easy location that can be set to two different light intensity levels. Excludable, built-in buzzer and functions identifiable by the icons on the ICE touch plates.

NOTES: to be completed with ICE touch plates (codes: GW16955CB, GW16955CL, GW16955CN, GW16955CT).

CHORUSMART - Domestic range

ICE TOUCH PLATES



GW 16 955 CB

ICE TOUCH - WHITE

Code	Description	For support codes	Pack Carton
GW 16 955 CB	6 touch areas	GW16803, GW16803N	1

CHARACTERISTICS: glossy finish. The plate is to be used in combination with the touch modules (switch module GW10922, roller shutter module GW10921, dimmer module GW10923, 1-control auxiliary module GW10924, 2-control auxiliary module GW10925).

NOTES: the symbols displayed in the image are purely indicative and may be customised using the icons supplied with the touch plate. The code of the plate is unique and independent of the number of icons used (from 2 to 6).

BLANKING MODULES AND CABLE OUTLET



GW 10 195

BLANKING MODULES

Code	Description	No. modules	Pack Carton
GW 10 195	1 module	1	10/200
GW 10 197	1/2 module	1/2	4/48
GW 10 198	2 modules	2	1/48
GW 10 199	3 modules	3	1/48



GW 10 194

CABLE OUTLET

Code	Description	No. modules	Pack Carton
GW 10 194	2 modules	2	6/48
GW 10 196	1 module	1	1/48

NOTES: GW10196 with anti-traction cable fastener device, cables min 6mm ø, max 10mm ø.

GW10194 with anti-traction cable fastener device, cables min 4mm ø, max 10mm ø. To be installed with the cable output downwards.

MOVEMENT DETECTORS



GW 10 594

MOVEMENT DETECTOR

Code	Supply voltage	Output contacts	Pack Carton
GW 10 594	230V ac - 50/60 Hz	1NO 3 A (AC1) 230 V ac	1/4

CHARACTERISTICS: adjustment of the intervention duration 15 sec - 10 min. Light sensitive threshold adjustment - min. 10 lux - max. inhibited. Suitable for commanding halogen lamps/ resistive loads: 700 W, incandescent lamps: 450 W, low voltage halogen lamps (12 V) controlled by toroidal or electronic transformers: 450 W, uncompensated fluorescent lamps: 2x58 W, motors and gear motors: 400 VA, LED loads: 60 W (max. 10 lamps). Not suitable for compensated fluorescent lamps, for discharge lamps and for all loads not indicated that must be commanded using a support relay.

APPLICATIONS: Energy-saving: command of the lighting of rooms and areas only when people pass through. Comfort and safety: automatic command of circuits without needing to activate one-way switches.

NOTES: do not install the product in watertight plates: the lid membrane does not allow the detector lens to work correctly. Detection beam angle 120°, depth of detection max 8 metres.



GW 10 595

CEILING-MOUNTED PRESENCE DETECTOR

Code	Supply voltage	Installation height (m)	Light sensor	Dimensions HxØ (mm)	Pack Carton
GW 10 595	220/240 V ac - 50/60 Hz	From 2,2 to 6	< 3 ÷ 2000 Lux	44x111,5	1

CHARACTERISTICS: presence sensor, sensing range: 360° circle (max. diameter 18 metres); installable with fixing springs on a surface-mounted or recessed box. Suitable for the control of incandescent/halogen lamps: 1000W, LED lamps : 200W (4 / 23 W - max. 8 lamps).

NOTE: equipped with a surface-mount box capable of holding sensors from IP20 to IP44.

RELAY



GW 10 724

RELAY - 230V AC 50/60HZ

Code	Type	No. of poles	Output contacts	Coil	Pack Carton
No. modules: 1					
GW 10 721	Latching relay	1P	10 AX 250V ac	230V ac - 50/60 Hz	1/12
GW 10 723	Latching relay, 4 seq.	2P	10 AX 250V ac	230V ac - 50/60 Hz	1/12
GW 10 724	Monostable relay	1P	1NO/NC 10A(AC1)/2A(AC15)250V ac	230V ac - 50/60 Hz	1/12

CHARACTERISTICS: GW10721, GW10723 suitable for commanding incandescent/halogen lamps: 1000 W, fluorescent tubes with electronic ballast: 400 W, fluorescent tubes with electromechanical ballast: 360 W, compact fluorescent lamps (CFL): 200 W, LED lamps (230V ac): 200 W, low voltage halogen or LED lamps with electronic ballast: 200 W, low voltage halogen or LED lamps with electromechanical ballast: 400 W.

APPLICATIONS: GW10721, GW10723 command of lighting devices from more than one point, by means of remote NO push-buttons.

GW10721 motor function/stop commands (extractors, air agitators, etc.).

GW10724 as an auxiliary element for commanding special loads, for distance signalling, for electrical separation between the command and use circuits.



GW 10 726

CALL RELAY - 12V AC/DC

Code	Supply voltage	No. of poles	Output contacts	No. modules	Pack Carton
GW 10 726	12V ac/dc	1P	1NO/NC 12 V (max. 1A)	1	1/12

CHARACTERISTICS: inlets for remote NO push-buttons for alarms (e.g. GW10136) and alarm reset (e.g. GW10145). green LED for alarm status signalling.

CHORUSMART - Domestic range

HOTEL COMPONENTS - GLOSSY WHITE VERSION

BADGE SWITCH



GW 10 039

BADGE SWITCH

Code	Description	For badge card max. width	Rated power of 230V LED lamps	No. modules	Pack Carton
GW 10 039	1P NA - 16 AX illuminable	54 mm	200 W	2	1/6

CHARACTERISTICS: the product can be fitted directly in 2-module plates; with plates of a greater modularity, you are advised to use 2 blanking modules for a 1/2 module (one on the right and one on the left).

APPLICATIONS: activation of circuits and services in hotel rooms (e.g. lights, air-conditioner, fridge-bar), indication of room occupied (with badge inserted)

NOTES: badges not included. The article uses LED signalling units, not included.

INTERCHANGEABLE BUTTON KEYS



GW 10 733

INTERCHANGEABLE BUTTON KEYS

Code	Button key	Symbol	No. modules	Pack Carton
GW 10 731	With diffuser	DND	1	4/48
GW 10 732	With diffuser	MUR	1	4/48
GW 10 733	Neutral	DND+MUR	1	4/48

CHARACTERISTICS: with "Do not disturb" (DND) and "Make up the room" (MUR) pad printings. To be used for the customization of the Chorus command devices. GW10731 and GW10732 suitable for one-way switches, two-way switches, intermediate switches and push-buttons. GW10733 suitable for three-way switches and push-buttons with central OFF position.

INDICATOR LIGHT DEVICE



GW 10 736

DOUBLE INDICATOR LAMP

Code	Diffuser colour	Symbol	No. modules	Pack Carton
GW 10 736	Opal diffuser	DND+MUR	1	1/24

CHARACTERISTICS: LED signalling units not included.

POWER - GLOSSY WHITE VERSION

SOCKET-OUTLETS - ITALIAN/GERMAN STANDARD



GW 10 203

ITALIAN STANDARD SOCKET-OUTLETS - 250V AC

Code	Description	Socket-out type	For plug pins	No. modules	Pack Carton
GW 10 201	2P+E - 10A	P11	Ø 4 mm	1	12/96
GW 10 203	2P+E - 16 A Dual amperage	P11-P17	Ø 4 / 5 mm	1	12/96

CHARACTERISTICS: with safety shields.



GW 10 204

ITALIAN/GERMAN STANDARD SOCKET-OUTLETS - 250V AC

Code	Description	Earth pit	Socket-out type	For plug pins	No. modules	Pack Carton
GW 10 204	2P+E - 16 A Dual amperage	Side and central	P40	Ø 4 / 4.8 / 5 mm	2	6/48
GW 10 205	2P+E - 16A	Side and central	P30	Ø 4 / 4.8 mm	2	6/48

CHARACTERISTICS: with safety shields.



GW 10 208

ITALIAN STANDARD DOUBLE SOCKET-OUTLET - 250V AC

Code	Description	Socket-out type	For plug pins	No. modules	Pack Carton
GW 10 208	2x2P+E - 16A Dual amperage	P11-P17	Ø 4 / 5 mm	2	6/24

CHARACTERISTICS: with safety shields. The wiring is carried out via 3 terminals that power the socket-outlets, without using U-bolts.



GW 10 209

ITALIAN STANDARD TRIPLE SOCKET-OUTLET - 250V AC

Code	Description	Socket-out type	For plug pins	No. modules	Pack Carton
GW 10 209	3x2P+E - 16A Dual amperage	P11-P17	Ø 4 / 5 mm	3	4/12

CHARACTERISTICS: with safety shields. The wiring is carried out via 3 terminals that power the socket-outlets, without using U-bolts.

CHORUSMART - Domestic range

SOCKET-OUTLETS FOR DEDICATED LINES - ITALIAN/GERMAN STANDARD



GW 10 213

ITALIAN STANDARD SOCKET-OUTLET FOR DEDICATED LINES - 250V AC

Code	Description	Colour	Socket-out type	For plug pins	No. modules	Pack Carton
GW 10 213	2P+E - 16 A Dual amperage	Red	P11-P17	Ø 4 / 5 mm	1	12/24
GW 10 223	2P+E - 16 A Dual amperage	Green	P11-P17	Ø 4 / 5 mm	1	12/24
GW 10 233	2P+E - 16 A Dual amperage	Orange	P11-P17	Ø 4 / 5 mm	1	12/24

CHARACTERISTICS: with safety shields.



GW 10 214

ITALIAN/GERMAN STANDARD SOCKET-OUTLET FOR DEDICATED LINES - 250V AC

Code	Description	Colour	Socket-out type	For plug pins	No. modules	Pack Carton
GW 10 214	2P+E - 16 A Dual amperage illuminable	Red	P40	Ø 4 / 4.8 / 5 mm	2	6/12
GW 10 224	2P+E - 16 A Dual amperage illuminable	Green	P40	Ø 4 / 4.8 / 5 mm	2	6/12
GW 10 234	2P+E - 16 A Dual amperage illuminable	Orange	P40	Ø 4 / 4.8 / 5 mm	2	6/12

CHARACTERISTICS: with safety shields. Pit of side and central earth contacts. Pre-arranged for housing LED signalling units, not included.

APPLICATIONS: possibility to indicate presence of auxiliary network.

SOCKET-OUTLETS - GERMAN STANDARD



GW 10 241

GERMAN STANDARD SOCKET-OUTLET - 250V AC

Code	Description	For plug pins	No. modules	Pack Carton
GW 10 241	2P+E - 16A	Ø 4.8 mm	2	6/48

CHARACTERISTICS: with safety shields.



GW 10 242

GERMAN STANDARD SOCKET-OUTLET WITH LID IP40 - 250 V AC

Code	Description	For plug pins	No. modules	Pack Carton
GW 10 242	2P+E - 16A	Ø 4.8 mm	2	6/48

CHARACTERISTICS: with safety shields. Equipped with a transparent rigid cover with a glossy finish. IP40 degree of protection with the cover closed.



GW 10 251

GERMAN STANDARD SOCKET-OUTLET FOR DEDICATED LINES - 250V AC

Code	Description	Colour	For plug pins	No. modules	Pack Carton
GW 10 251	2P+E - 16A	Red	Ø 4.8 mm	2	6/12

CHARACTERISTICS: with safety shields.



GW 10 341

GERMAN STANDARD SOCKET-OUTLET WITH FRONT TIGHTENING TERMINALS - 250V AC

Code	Description	For plug pins	No. modules	Pack Carton
GW 10 341	2P+E - 16A	Ø 4.8 mm	2	6/12

CHARACTERISTICS: with safety shields. Front access terminals with screw fixing, side input of the conductors.



GW 10 351

GERMAN STANDARD SOCKET-OUTLET WITH FRONT TIGHTENING TERMINALS FOR DEDICATED LINES - 250V AC

Code	Description	Colour	For plug pins	No. modules	Pack Carton
GW 10 351	2P+E - 16A	Red	Ø 4.8 mm	2	6/12

CHARACTERISTICS: with safety shields. Front access terminals with screw fixing, side input of the conductors.



GW 10 241 F

GERMAN STANDARD SOCKET-OUTLET WITH QUICK WIRING TERMINALS - 250V AC

Code	Description	For plug pins	No. modules	Pack Carton
GW 10 241 F	2P+E - 16A	Ø 4.8 mm	2	6/12

CHARACTERISTICS: with safety shields. Spring quick wiring, no tools necessary.



GW 10 251 F

GERMAN STANDARD SOCKET-OUTLET FOR DEDICATED LINES WITH QUICK WIRING TERMINALS - 250 V AC

Code	Description	Colour	For plug pins	No. modules	Pack Carton
GW 10 251 F	2P+E - 16A	Red	Ø 4.8 mm	2	6/12

CHARACTERISTICS: with safety shields. Spring quick wiring, no tools necessary.

CHORUSMART - Domestic range

SOCKET-OUTLETS - FRENCH STANDARD



GW 10 246

FRENCH STANDARD SOCKET-OUTLETS - 250V AC

Code	Description	For plug pins	No. modules	Pack Carton
GW 10 246	2P - 16A	Ø 4 / 4.8 mm	2	1/24
GW 10 247	2P+E - 16A	Ø 4 / 4.8 mm	2	6/48

CHARACTERISTICS: with safety shields.



GW 10 248

FRENCH STANDARD SOCKET-OUTLET WITH FRONT TIGHTENING TERMINALS - 250V AC

Code	Description	For plug pins	No. modules	Pack Carton
GW 10 248	2P+E - 16A	Ø 4 / 4.8 mm	2	6/12

CHARACTERISTICS: with safety shields. Front access terminals with screw fixing, side input of the conductors.



GW 10 258

FRENCH STANDARD SOCKET-OUTLET FOR DEDICATED LINES, WITH FRONT TIGHTENING TERMINALS - 250V AC

Code	Description	Colour	For plug pins	No. modules	Pack Carton
GW 10 258	2P+E - 16A	Red	Ø 4 / 4.8 mm	2	6/12

CHARACTERISTICS: with safety shields. Front access terminals with screw fixing, side input of the conductors.
To be used in combination with plugs equipped with accessory GW10260



GW 10 247 F

FRENCH STANDARD SOCKET-OUTLET WITH QUICK WIRING TERMINALS - 250 V AC

Code	Description	For plug pins	No. modules	Pack Carton
GW 10 247 F	2P+E - 16A	Ø 4 / 4.8 mm	2	6/12

CHARACTERISTICS: with safety shields. Spring quick wiring, no tools necessary.



GW 10 257 F

FRENCH STANDARD SOCKET-OUTLET FOR DEDICATED LINES WITH QUICK WIRING TERMINALS - 250 V AC

Code	Description	Colour	For plug pins	No. modules	Pack Carton
GW 10 257 F	2P+E - 16A	Red	Ø 4 / 4.8 mm	2	6/12

CHARACTERISTICS: with safety shields. Spring quick wiring, no tools necessary.
To be used in combination with plugs equipped with accessory GW10260.



GW 10 260

FRENCH STANDARD SOCKET-OUTLET ACCESSORY, FOR DEDICATED LINES

Code	Colour	For sockets	Pack Carton
GW 10 260	Red	GW10257F - GW10258	10/100

CHARACTERISTICS: to be fixed directly on the 2P+E French standard plug, to avoid the incorrect insertion in dedicated line circuits.

SOCKET-OUTLETS - ISRAELI STANDARD



GW 10 281

ISRAELI STANDARD SOCKET-OUTLET - 250V AC

Code	Description	For plug pins	No. modules	Pack Carton
GW 10 281	2P+E - 16 A illuminable	Round Ø 4 / 4.4 mm	2	1/24

CHARACTERISTICS: with safety shields. Pre-arranged for housing LED signalling units, not included.



GW 10 291

ISRAELI STANDARD SOCKET-OUTLET FOR DEDICATED LINES - 250V AC

Code	Description	Colour	For plug pins	No. modules	Pack Carton
GW 10 291	2P+E - 16 A illuminable	Red	Round Ø 4 / 4.4 mm	2	1/24

CHARACTERISTICS: with safety shields. Pre-arranged for housing LED signalling units, not included.



GW 10 282

ISRAELI STANDARD SOCKET-OUTLET - 250V AC

Code	Description	For plug pins	No. modules	Pack Carton
GW 10 282	2P - 10 A	Round Ø 4 mm	1	1/48

CHARACTERISTICS: with safety shields.

CHORUSMART - Domestic range

SOCKET-OUTLETS - INTERNATIONAL STANDARD



GW 10 346

SWISS STANDARD SOCKET-OUTLET - 250 V AC

Code	Description	For plug pins	No. modules	Pack Carton
GW 10 346	2P+E - 10A - type 13	Ø 4 mm	2	6/48

CHARACTERISTICS: with safety shields.



GW 10 286

USA STANDARD SOCKET-OUTLET - 250/125V AC

Code	Description	For plug pins	No. modules	Pack Carton
GW 10 286	2P+E - 15A	Flat parallel horizontal	1	12/48



GW 10 288

EURO-AMERICAN STANDARD SOCKET-OUTLET - 250/125V AC

Code	Description	For plug pins	No. modules	Pack Carton
GW 10 287	2P - 15A	Ø 4 mm Flat	1	12/48
GW 10 288	2P+E - 15A	Ø 4 mm Flat	1	12/48

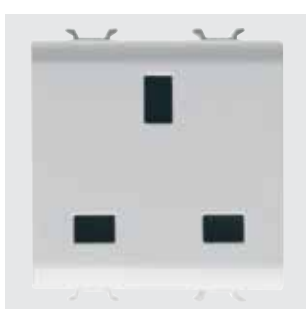

GW 10 296

BRITISH STANDARD SOCKET-OUTLETS - 250V AC

Code	Description	For plug pins	No. modules	Pack Carton
GW 10 296	2P+E - 13 A	Flat	2	6/48
GW 10 297	2P+E - 15A	Ø 7 mm	2	6/48

CHARACTERISTICS: with safety shields.

NOTES: given the size of the plugs, it is not possible to install two or more socket-outlets side-by-side.



GW 10 298

INDIAN-SOUTH AFRICAN STANDARD SOCKET-OUTLET - 250V AC

Code	Description	For plug pins	No. modules	Pack Carton
GW 10 298	2P+E - 16A	Ø 7 mm	2	6/48

CHARACTERISTICS: with safety shields.

NOTES: given the size of the plugs, it is not possible to install two or more socket-outlets side-by-side.



GW 10 299

SOUTH AFRICAN STANDARD SOCKET-OUTLET - 250 V AC

Code	Description	For plug pins	No. modules	Pack Carton
GW 10 299	2P+E - 16A	Round Ø 4,5 mm	1	12/240

CHARACTERISTICS: with safety shields.



GW 10 301

ARGENTINIAN STANDARD SOCKET-OUTLET - 250V AC

Code	Description	For plug pins	No. modules	Pack Carton
GW 10 301	2P+E - 10A	Flat	2	6/48



GW 10 306

AUSTRALIAN STANDARD SOCKET-OUTLETS - 250V AC

Code	Description	For plug pins	No. modules	Pack Carton
GW 10 306	2P+E - 10A	Flat	2	6/48
GW 10 307	2P+E - 15A	Flat	2	6/48

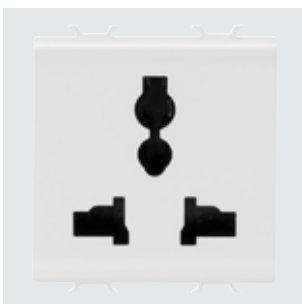

GW 10 310

MULTISTANDARD SOCKET-OUTLET - 250/127V AC

Code	Description	No. modules	Pack Carton
GW 10 310	2P+E - 13A/250 V ac - 15A/127 V ac	2	10/40

CHARACTERISTICS: with safety shields.

APPLICATIONS: suitable for plugs compliant with the following standards: Europlug 2P 2.5A - 250V, British 2P+E 13A - 250V, Italian 2P 10A - 250V, Danish 2P 10A - 250V, Chinese 2P+E 10A - 250V, Argentinean/Australian 2P+E 10A - 250V, Indian 2P+E 6A - 250V, USA 2P+E 15A - 127V. Not suitable for 2P+E German and French sockets because they don't offer earth continuity.

NOTES: the multistandard energy sockets GW1x310 are in compliance with the safety requirements defined by the International Standard IEC 60884-1. These sockets may not be in compliance with the standard sheets used in the country where they are sold, hence their usage could be prohibited or however, restricted only for specific applications. The plugs allowed are listed in the technical datasheet. Please contact directly Gewiss technical service for further information.



GW 10 392

CHINESE STANDARD SOCKET-OUTLETS - 250 V AC

Code	Description	For plug pins	No. modules	Pack Carton
GW 10 391	2P+E - 10A	Flat	2	6/48
GW 10 392	2P+E - 16A	Flat	2	6/48

CHARACTERISTICS: with safety shields.

CHORUSMART - Domestic range

INTERLOCKED SWITCHED SOCKET-OUTLETS



GW 10 311

INTERLOCKED SWITCHED SOCKET-OUTLETS WITH MINIATURE CIRCUIT BREAKER - 230V AC

Code	Description	Socket-out type	Miniature circuit breakers	Breaking capacity	No. modules	Pack Carton
GW 10 311	2P+E - 16A	P17-P11	1P+N 16A	3 kA	2	1/6
GW 10 312	2P+E - 16A	P40	1P+N 16A	3 kA	3	1/4

CHARACTERISTICS: Interlocked switched socket-outlets with automatic miniature circuit breaker (C characteristic). Pits under tension only with plug inserted.

APPLICATIONS: suitable for installation in the system terminations to protect the load.



GW 10 321

INTERLOCKED SWITCHED SOCKET-OUTLETS WITH RESIDUAL MINIATURE CIRCUIT BREAKER - 230V AC

Code	Description	Socket-out type	Miniature circuit breakers	Breaking capacity	I _{dn}	No. modules	Pack Carton
GW 10 321	2P+E - 16A	P17-P11	1P+N 16A	3 kA	10 mA	3	1/4
GW 10 322	2P+E - 16A	P40	1P+N 16A	3 kA	10 mA	4	1/2

CHARACTERISTICS: Interlocked switched socket-outlets with automatic miniature circuit breaker (C characteristic) and residual current circuit breaker (type A). Pits under tension only with plug inserted.

APPLICATIONS: suitable for installation in the system terminations to protect the load.

SHAVER SOCKET-OUTLET



GW 10 331

EURO-AMERICAN STANDARD SHAVER SOCKET-OUTLET WITH INSULATION TRANSFORMER

Code	Supply voltage	For plug pins	Selectable output voltage	Maximum power	No. modules	Pack Carton
GW 10 331	230 V ac - 50/60 Hz	Ø 4 / 5 - 6.3x1.5 mm	120-230V ac	20 VA	3	1/2

CHARACTERISTICS: the socket-outlet is equipped with a self-protection device against overloading.

The output voltage should be selected correctly, consulting the rating of the user device before inserting the plug.

The relevant indicator LED allows the chosen voltage to be clearly seen.

NOTES: not suitable for installation in wall-mounting boxes or free-standing containers.

DATA - GLOSSY WHITE VERSION

TV-SAT SOCKETS



GW 10 361

COAXIAL TV SOCKETS (5-2400 MHZ), CLASS A SHIELDING - MALE IEC CONNECTOR Ø 9.5 MM

Code	Description	Attenuation	No. modules	Pack Carton
GW 10 361	Direct	0 dB	1	1/48
GW 10 362	Through wiring	5 dB	1	1/24
GW 10 363	Through wiring	10 dB	1	1/24
GW 20 277	Terminal resistance 75 ohm	-	-	50/200

CHARACTERISTICS: GW10361 allows the passage of voltage/current of remote power supply and/or control signals towards the user port (max 24V - 500 mA).

GW20277 in combination with feedthrough socket-outlets allows you to make terminal socket-outlets.

APPLICATIONS: Socket-outlets suitable for return channel.

NOTES: the TV 5dB GW10362 coaxial socket-outlet is defined with conditional use: it is a special feedthrough socket-outlet, and must be used as such, with the only difference that the user port (socket-outlet towards the user device) must always be closed with a 75-Ohm load. (TV, VCR, SAT receiver or 75-Ohm termination)



GW 10 371

COAXIAL TV-SAT SOCKETS (5-2400 MHZ), CLASS A SHIELDING - FEMALE F CONNECTOR

Code	Description	Attenuation	No. modules	Pack Carton
GW 10 371	Direct	0 dB	1	1/48
GW 10 372	Through wiring	5 dB	1	1/24
GW 10 373	Through wiring	10 dB	1	1/24
GW 20 277	Terminal resistance 75 ohm	-	-	50/200

CHARACTERISTICS: GW10371 allows the passage of voltage/current of remote power supply and/or control signals towards the user port (max 24V - 500 mA).

GW20277 in combination with feedthrough socket-outlets allows you to make terminal socket-outlets.

APPLICATIONS: Socket-outlets suitable for return channel.

NOTES: the TV-SAT 5dB GW10372 coaxial socket-outlet is defined with conditional use: it is a special feedthrough socket-outlet, and must be used as such, with the only difference that the user port (socket-outlet towards the user device) must always be closed with a 75-Ohm load (TV, VCR, SAT receiver or 75-Ohm termination).



GW 10 382

TV-FM-SAT SOCKETS

Code	Connectors	Description	Attenuation	No. modules	Pack Carton
GW 10 381	TV-FM	Direct	0 dB	2	1/24
GW 10 382	TV-FM-SAT	Direct	0 dB	2	1/24
GW 10 383	TV-SAT	Direct	0 dB	2	1/24

CHARACTERISTICS: TV-FM direct co-axial socket-outlet GW10381: male IEC-type TV connector ø 9.5mm, female IEC-type FM connector ø 9.5mm.

TV-FM-SAT direct co-axial socket-outlet GW10382: male IEC-type TV connector ø 9.5mm, female IEC-type FM connector ø 9.5mm, female F-type SAT connector.

TV-SAT direct co-axial socket-outlet GW10383: male IEC-type TV connector ø 9.5mm, female F-type SAT connector.

NOTES: demixed socket-outlets with input for co-axial cable ø 5mm or 7mm.



GW 10 367

COAXIAL TV SOCKETS (5-2400 MHZ), CLASS A SHIELDING - MALE IEC CONNECTOR Ø 9.5MM

Code	Description	Attenuation	No. modules	Pack Carton
GW 10 367	Direct	0 dB	2	1/24

CHARACTERISTICS: allows the passage of voltage/current of remote power supply and/or control signals towards the user port (max 24V - 500 mA).

APPLICATIONS: socket-outlets suitable for return channel.



GW 10 377

COAXIAL TV-SAT SOCKETS (5-2400 MHZ), CLASS A SHIELDING - FEMALE F CONNECTOR

Code	Description	Attenuation	No. modules	Pack Carton
GW 10 377	Direct	0 dB	2	1/24

CHARACTERISTICS: allows the passage of voltage/current of remote power supply and/or control signals towards the user port (max 24V - 500 mA).

APPLICATIONS: socket-outlets suitable for return channel.



GW 10 386

COVERS FOR TV-SAT-R ANTENNA SOCKETS

Code	Description	No. holes	Pack Carton
GW 10 386	For TV-R base	2	1/24
GW 10 387	For TV/R-SAT base	2	1/24

APPLICATIONS: suitable for integration on the Chorus range of TV-SAT-R standard bases available on the market.

ACCESSORIES SUPPLIED: fixing screws.

CHORUSMART - Domestic range

TELEPHONE SOCKETS



GW 10 401

RJ11 TELEPHONE SOCKETS

Code	Description	Connection	No. modules	Pack Carton
GW 10 401	RJ11	Screw-on terminals	1	1/24

APPLICATIONS: telephone, telefax, modem.



GW 10 409

RJ11 TELEPHONE SOCKET

Code	Description	Connection	No. modules	Pack Carton
GW 10 409	RJ11	Screw-on terminals	2	1/24

APPLICATIONS: telephone, telefax, modem.



GW 10 406

BRITISH STANDARD TELEPHONE SOCKET

Code	Description	Connection	No. modules	Pack Carton
GW 10 406	6 contacts	Screw-on terminals	1	1/24

DATA SOCKETS



GW 10 421

RJ45 SOCKETS

Code	Description	Number pairs	Use category	Cables	Connection	No. modules	Pack Carton
GW 10 421	RJ45	4	5e	UTP	Toolless	1	1/24
GW 10 422	RJ45	4	5e	FTP	Toolless	1	1/24
GW 10 423	RJ45	4	6	UTP	Toolless	1	1/24
GW 10 424	RJ45	4	6	FTP	Toolless	1	1/24

APPLICATIONS: LANs up to 100MHz (e.g. Ethernet, Token Ring networks) for cat. 5e; LANs up to 250MHz (e.g. Videoconference systems, CCTV) for cat. 6.

NOTES: circuit identification label included.



GW 10 431

ADAPTERS FOR HOUSING DATA CONNECTORS

Code	Compatibility	No. modules	Pack Carton
GW 10 431	AMP / Keystone Jack	1	1/48
GW 10 438	SYSTIMAX COMMSCOPE	1	1/48

NOTES: with regard to the technological developments and dimensional variants introduced by connector manufacturers, you are advised to check in advance the full compatibility between the connector and the GEWISS adapter.



GW 10 437

RJ45 SOCKETS

Code	Description	Number pairs	Use category	Cables	Connection	No. modules	Pack Carton
GW 10 434	RJ45	4	5e	UTP	Toolless	2	1/24
GW 10 436	RJ45	4	5e	FTP	Toolless	2	1/24
GW 10 435	RJ45	4	6	UTP	Toolless	2	1/24
GW 10 437	RJ45	4	6	FTP	Toolless	2	1/24

APPLICATIONS: LAN networks up to 100 MHz (e.g. Ethernet or Token Ring networks) for cat. 5e; LAN networks up to 250 MHz (e.g. video conference or video control systems) for cat. 6.

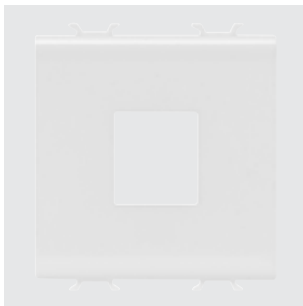

GW 10 433

ADAPTER FOR HOUSING DATA CONNECTORS

Code	Compatibility	No. modules	Pack Carton
GW 10 433	AMP / Keystone Jack	2	4/100

NOTES: due to technological developments and dimensional variants introduced by connector manufacturers, you are advised to check in advance the full compatibility between the data socket and the GEWISS empty enclosure.

ADAPTERS FOR OPTICAL FIBER



GW 38 335

ANGLED SC/APC ADAPTER

Code	Type	Tilt	For connectors	Compatibility	Colour	Pack Carton
GW 38 335	Female/Female	40°	SC/APC	Keystone Jack	Green RAL 6018	1/25

CHARACTERISTICS: cable outlet inclined of 40° to the wall line. With ceramic fiber optic sleeve and dust caps. The front output is protected with safety cap and unmissable cord. Suitable to join two single-mode SC/APC fiber optic patch cables.

NOTES: for adapters (Chorus, System and Dahlia) with Keystone Jack coupling.

CHORUSMART - Domestic range

SOCKET-OUTLETS FOR AUXILIARY CIRCUITS



GW 10 451

SELV SOCKETS

Code	Description	For plug pins	No. modules	Pack Carton
GW 10 451	2P - 6A - 24V	Ø 3 mm	1	12/24
GW 10 452	2P - 6A - 24V polarised	Flat	1	12/24

CHARACTERISTICS: Centre distance 12,4mm.

AUDIO AND VIDEO SOCKETS



GW 10 453

AUDIO AND VIDEO SOCKETS

Code	Description	No. modules	Pack Carton
GW 10 453	Double RCA	1	1/24
GW 10 454	For loudspeaker	1	1/24
GW 10 458	Speaker socket	1	1/24

CHARACTERISTICS: GW10453 double RCA stud connector, red and white, weld-in connection.

GW10454 welding connection. GW10458 front access terminals for inserting 1.5 mm² rigid wires, insulator punching rear connection suitable for cables AWC24 or max 0.25mm².

USB AND HDMI COUPLERS AND SOCKETS



GW 10 459

USB SOCKETS

Code	Description	No. modules	Pack Carton
GW 10 459	USB socket-outlet	1	1/24

CHARACTERISTICS: A-type USB 2.0 female connector, with screw terminals on the back.



GW 38 056

USB AND HDMI COUPLERS

Code	Description	Type	Compatibility	Pack Carton
GW 38 056	HDMI coupler	Female/Female	Keystone Jack	1/48
GW 38 057	USB coupler	Female/Female - A type	Keystone Jack	1/48

NOTES: for adapters designed to house data connectors (ChoruSmart, System and Playbus) with Keystone Jack type coupling and permutation panels.

USB CHARGERS



GW 10 449

USB POWER SUPPLY FOR ELECTRONIC DEVICES

Code	Supply voltage	Output voltage	Max current supplied	Type of port	No. modules	Pack Carton
GW 10 447	100 ÷ 240 V ac - 50/60 Hz	5V dc	3 A	A+A	1	1/10
GW 10 449	100 ÷ 240 V ac - 50/60 Hz	5V dc	3 A	A+C	1	1/10

CHARACTERISTICS: suitable for recharging a single electronic device (e.g. tablet) or two devices simultaneously (e.g. a tablet and smartphone). The division of the current delivered to the two outputs depends on the state of charge of the connected devices.

PROTECTION - GLOSSY WHITE VERSION

MINIATURE CIRCUIT BREAKERS



GW 10 463

MCB - MINIATURE CIRCUIT BREAKERS - C CHARACTERISTIC - 230V AC

Code	Description	Rated current (A)	Breaking capacity	No. modules	Pack Carton
GW 10 461	Single pole (1P)	6	3 kA	1	1/12
GW 10 462	Single pole (1P)	10	3 kA	1	1/12
GW 10 463	Single pole (1P)	16	3 kA	1	1/12
GW 10 466	Two-pole (1P+N)	6	3 kA	1	1/12
GW 10 467	Two-pole (1P+N)	10	3 kA	1	1/12
GW 10 468	Two-pole (1P+N)	16	3 kA	1	1/12



GW 10 488

RCBO - RESIDUAL CURRENT BREAKERS WITH OVERCURRENT PROTECTION - C CHARACTERISTIC - CLASS A - 230V AC - 50/60 HZ

Code	Description	Rated current (A)	Breaking capacity	Idn	No. modules	Pack Carton
GW 10 482	Two-pole (1P+N)	6	3 kA	10 mA	2	1/6
GW 10 483	Two-pole (1P+N)	6	3 kA	30 mA	2	1/6
GW 10 485	Two-pole (1P+N)	10	3 kA	10 mA	2	1/6
GW 10 486	Two-pole (1P+N)	10	3 kA	30 mA	2	1/6
GW 10 488	Two-pole (1P+N)	16	3 kA	10 mA	2	1/6
GW 10 489	Two-pole (1P+N)	16	3 kA	30 mA	2	1/6

PROTECTION DEVICES



GW 10 491

FUSE HOLDER - 250V AC

Code	Rated current (A)	Fuse type	No. modules	Pack Carton
GW 10 491	16	Ø 6.3x32 mm	1	1/12

CHARACTERISTICS: fuse not included.

CHORUSMART - Domestic range



GW 10 492

SURGE PROTECTION DEVICE - 230V AC

Code	Uc	Up	No. modules	Pack Carton
GW 10 492	275 V ac 50/60Hz	1 kV	1	1/12

CHARACTERISTICS: green LED for status signalling.

APPLICATIONS: protection of electronic devices (TV, HI-FI, computer, etc.) from overvoltage (resulting from atmospheric conditions or manoeuvres) that could be channelled from the power supply lines.

INDICATOR - GLOSSY WHITE VERSION

INDICATOR LIGHT DEVICES



GW 10 642

SINGLE INDICATOR LAMPS - 1/2 MODULE

Code	Diffuser colour	Colour meaning	No. modules	Pack Carton
GW 10 641	Opal diffuser	Neutral	1/2	2/48
GW 10 642	Green	Safety	1/2	2/48
GW 10 643	Red	Danger	1/2	2/48
GW 10 644	Amber	Attention	1/2	2/48

CHARACTERISTICS: LED signalling units, not included.

APPLICATIONS: the meaning of the diffusers refers to the recommendations of standard EN60073 with regard to the use of the colours in indicator lights.



GW 10 622

SINGLE INDICATOR LAMPS - 1 MODULE

Code	Diffuser colour	Colour meaning	No. modules	Pack Carton
GW 10 621	Opal diffuser	Neutral	1	1/24
GW 10 622	Green	Safety	1	1/24
GW 10 623	Red	Danger	1	1/24
GW 10 624	Amber	Attention	1	1/24

CHARACTERISTICS: LED signalling units, not included.

APPLICATIONS: the meaning of the diffusers refers to the recommendations of standard EN60073 with regard to the use of the colours in indicator lights.



GW 10 629

DOUBLE INDICATOR LAMPS - 1 MODULE

Code	Diffuser colour	No. modules	Pack Carton
GW 10 628	Opal diffuser	1	1/24
GW 10 629	Red/green	1	1/24

CHARACTERISTICS: LED signalling units, not included.

APPLICATIONS: the meaning of the diffusers refers to the recommendations of standard EN60073 with regard to the use of the colours in indicator lights.



GW 10 633

PROTRUDING INDICATOR LAMPS - 2 MODULES

Code	Supply voltage	Diffuser colour	Lamp	No. modules	Pack Carton
GW 10 631	12V ac/dc - 230V ac 50/60 Hz	Opal diffuser	White LED	2	1/24
GW 10 632	12V ac/dc - 230V ac 50/60 Hz	Green	White LED	2	1/24
GW 10 633	12V ac/dc - 230V ac 50/60 Hz	Red	White LED	2	1/24
GW 10 634	12V ac/dc - 230V ac 50/60 Hz	Amber	White LED	2	1/24

CHARACTERISTICS: highly efficient white LED, powered at 12V ac/dc - 230V ac with double power supply inlet.

APPLICATIONS: suitable for special applications such as the signalling of calls from hospital wards.

NOTES: complete with lamp.



GW 10 656

STAIR RISER LAMP

Code	Supply voltage	Diffuser colour	Lamp	No. modules	Pack Carton
GW 10 651	12V ac/dc - 230V ac 50/60 Hz	Opal diffuser	White LED	2	1/24
GW 10 656	12V ac/dc - 230V ac 50/60 Hz	Opal diffuser	White LED	4	1/2

CHARACTERISTICS: highly efficient white LED, powered at 12V ac/dc - 230V ac with double power supply inlet.

CHORUSMART - Domestic range

ANTI BLACK-OUT AND EMERGENCY LAMPS



GW 10 661

EXTRACTABLE ANTI BLACK-OUT LAMP

Code	Supply voltage	Power supply batteries	Minimum autonomy	Lamp	Pack Carton
GW 10 661	230 V ac - 50/60 Hz	Ni - Mh	2 h	White LED	1/6

CHARACTERISTICS: equipped with a 3-position selector on the front panel, for anti black-out inhibition and night functioning. To be inserted in any socket-outlet of the Italian, German or French type. Highly efficient, white LED lamp.



GW 10 662

ANTI BLACK-OUT LAMP

Code	Supply voltage	Power supply batteries	Minimum autonomy	Lamp	No. modules	Pack Carton
GW 10 662	230 V ac - 50/60 Hz	Ni - Mh	1 h	White LED	1	1/12

CHARACTERISTICS: green LED for the presence of mains voltage signalling. Highly efficient, white LED lamp.



GW 10 663

AUTONOMOUS EMERGENCY LAMPS

Code	Supply voltage	Power supply batteries	Minimum autonomy	Lamp	No. modules	Pack Carton
GW 10 663	230 V ac - 50/60 Hz	Ni - Mh	1 h	White LED	2	1/6
GW 10 666	230 V ac - 50/60 Hz	Ni - Mh	1 h	White LED	4	1/2

CHARACTERISTICS: green mains presence signal LED. Highly efficient, white LED lamps.

APPLICATIONS: compliant with standards EN60598-2-22.

ACOUSTIC SIGNALLING DEVICES



GW 10 601

RINGERS

Code	Supply voltage	Max power consumption	Sound intensity	No. modules	Pack Carton
GW 10 601	12V ac - 50 Hz	8 VA	80 dB (at 1 m)	1	1/24
GW 10 602	230V ac - 50 Hz	8 VA	80 dB (at 1 m)	1	1/24

CHARACTERISTICS: for intermittent use (5 sec. ON / 15 sec. OFF).



GW 10 606

BUZZERS

Code	Supply voltage	Max power consumption	Sound intensity	No. modules	Pack Carton
GW 10 606	12V ac - 50 Hz	8 VA	70 dB (at 1 m)	1	1/24
GW 10 607	230V ac - 50 Hz	8 VA	70 dB (at 1 m)	1	1/24

CHARACTERISTICS: for intermittent use (5 sec. ON / 15 sec. OFF).



GW 10 611

THREE TONE RINGER AND THREE INDEPENDENT INPUTS

Code	Supply voltage	Max power consumption	Sound intensity	No. modules	Pack Carton
GW 10 611	12V ac/dc	3 VA	80 dB (at 1 m)	2	1/6
GW 10 612	230V ac - 50 Hz	6 VA	80 dB (at 1 m)	2	1/6

CHARACTERISTICS: for continuous use. Three tones (alarm, ring and two-tone) with adjustable sound intensity.

APPLICATIONS: it is possible to combine the outdoor call, indoor call and alarm functions with one single device.

ENERGY, TEMPERATURE AND COMFORT MANAGEMENT - GLOSSY WHITE VERSION

TIMER DEVICES



GW 10 581

ELECTRONIC DAILY/WEEKLY TIMER, 1-CHANNEL

Code	Supply voltage	Output contacts	No. modules	Pack Carton
GW 10 581	230 V ac - 50/60 Hz	1NO/NC 8A(AC1)/4A(AC15) 250V ac	2	1/2

CHARACTERISTICS: with rechargeable buffer battery to guarantee the updating of the calendar (date, day, time) in the event of a blackout.

CHORUSMART - Domestic range

TEMPERATURE CONTROL DEVICES



GW 10 703

TIMED THERMOSTAT - DAILY/WEEKLY PROGRAMMING

Code	Supply voltage	Temperature adjustment	Output contacts	No. modules	Pack Carton
GW 10 703	230 V ac - 50/60 Hz	From +5°C to +40°C	1NO/NC 5A(AC1)/2A(AC15) 250V ac	2	1/2

CHARACTERISTICS: with rechargeable buffer battery to guarantee the updating of the calendar (date, day, time) in the event of a blackout.



GW 10 709

CONNECTED THERMOSTAT - ZIGBEE

Code	Supply voltage	Output contacts	No. modules	Pack Carton
GW 10 709	100 ÷ 240 V ac - 50/60 Hz	1 NO / NC 5A (AC1) 240 V ac	2	1/3

FEATURES: flush-mounted thermostat for the control of heating/cooling systems with manual temperature management and possibility of shutdown. Control algorithms for two-way systems: two points (ON/OFF), proportional-integral (PWM). The thermostat can control a solenoid valve for heating or cooling through a local contact or via Zigbee, in which case the solenoid valve must be controlled by a Zigbee actuator. GWA1521, GWA1523, GW1x826, GWA1201, and GWA1202 Zigbee connected actuators can be used.

The thermostat is equipped with integrated temperature and humidity sensors. The thermostat has an input for a NTC sensor (GW10800 and GW1x900 sensors can be used) for external temperature measurement (e.g., for compensation of temperatures measured locally by the thermostat or for protection in case of underfloor heating/cooling).

APPLICATIONS: climate control (heating or cooling) of a housing unit or area; option to manage a daily or weekly heating/cooling profile via the APP. The device measures humidity, if a threshold (defined during configuration) is exceeded, Zigbee can activate a dehumidification system and display/notify the measurement on the APP.

Use in traditional unconnected systems: the connected thermostat can also be used in traditional unconnected installations. In this case, configuration is not carried out via the APP and the NTC sensor input can only be used to compensate for the temperature measurement detected locally by the thermostat.



GW 10 705

THERMOSTAT

Code	Supply voltage	Temperature adjustment	Output contacts	No. modules	Pack Carton
GW 10 705	230 V ac - 50/60 Hz	From +5°C to +35°C	1NO / NC 8A(AC1) 250V ac	2	1/2

CHARACTERISTICS: choice of working mode by means of selector located on the front: summer (air-conditioner), OFF, winter (boiler).

Two-colour front LED to signal the output status (open/closed contact). The lighting up of the LED also indicates mains presence.



GW 16 970 CB

THERMO ICE WI-FI THERMOSTAT - WALL-MOUNTING

Code	Colour	Supply voltage	Temperature adjustment	Output contacts	Dimensions LxHxD (mm)	Pack Carton
GW 16 970 CB	White	110-230V ac - 50/60Hz	From +5°C to +40°C	2NO 6A(AC1) 250V ac	123x95x21	1

CHARACTERISTICS: wall-mounting thermostat to control heating/cooling and humidification/dehumidification systems and manage the temperature in manual mode or on 3 levels (comfort, pre-comfort, economy). Control algorithms for two-way systems: two points (ON/OFF), proportional integral (PWM). Includes 1 input for external NTC temperature sensor (e.g.: protection for flood mounting heating). Equipped with a user interface with touch commands (capacitive) on technopolymer plate and backlit display. The thermostat has built-in proximity, temperature and humidity sensors and a Wi-Fi interface for setting parameters and programming temperature profiles (timed thermostat function) locally or by remote via specific apps (smartphone and tablet).

NOTES: wall-mounting with wall-plugs or on 3-modules rectangular boxes (centre distance 83.5 mm) Plate material; technopolymer.

DIMMER



GW 10 575

UNIVERSAL ROTATING ELECTRONIC REGULATOR

Code	Supply voltage	No. modules	Pack Carton
GW 10 575	230V ac - 50 Hz	1	1/12

CHARACTERISTICS: suitable for dimming incandescent and halogen lamps 230 V ac (10-160 W); low-voltage halogen lamps (12 V ac) with electronic transformers (10-160 W) and LED lamps 230 V ac (4-160W), rotary control with 2-way switch. Equipped with amber-colour-red signalling LED. Can be operated without neutral connection.

NOTES: the installation of more than one dimmer side-by-side in a single container is not permitted. To avoid overheating, insert a blanking module between two dimmers. If installing two dimmers in the same box, the maximum loads that can be controlled by each dimmer must be reduced by 50%.



GW 10 564

ROTATING ELECTRONIC REGULATORS FOR RESISTIVE/INDUCTIVE LOADS

Code	Supply voltage	Resistive load 230V ac	Inductive load 230V ac	No. modules	Pack Carton
GW 10 564	230 V ac - 50/60 Hz	100 - 900 W	40 - 300 VA	1	1/12
GW 10 567	230 V ac - 50/60 Hz	100 - 500 W	100 - 500 VA	1	1/12

CHARACTERISTICS: with signalling led orange. GW10567 rotary command with two-way switch.

GW10564 compliance with the EMC directive is only guaranteed by connecting the regulator to an LC filter with the following characteristics: L=1mH - 5A, C=0.15uF - 275V X2, according to the documentation provided with the product. Item designated solely for export to a limited number of countries outside of the European Union or countries applying to become part of the European Free Trade Area. Contact GEWISS Customer Service to check the product meets the regulations of the country concerned before importing it.

NOTES: to avoid overheating, the side by side installation of several products in a single container is not permitted; insert a blanking module between two electronic devices. If installing two regulators in the same box, the maximum loads that can be commanded by each regulator must be reduced by 50%.



GW 10 572 A

UNIVERSAL ELECTRONIC REGULATORS WITH PUSH-BUTTON

Code	Supply voltage	No. modules	Pack Carton
GW 10 572 A	230V ac - 50/60 Hz	1	1/12
GW 10 573 A	230V ac - 50/60 Hz	2	1/6

CHARACTERISTICS: for the regulation and switching of incandescent and halogen lamps 230V AC (40-300W), low voltage halogen and LED lamps with electronic and winding transformers (40-300W), LED lamps 230V AC with dimmer function (5-150W). Manual selection of the type of load (Leading Edge or Trailing Edge piloting), soft-start function for lamp protection. Possibility to command and regulate from remote control push-buttons with NO contacts. Equipped with orange signalling LED.

NOTES: to avoid overheating, the side-by-side installation of several products in a single container is not permitted; insert a blanking module between two electronic devices. If two regulators are installed in the same box, the maximum loads that can be commanded by each regulator must be reduced by 50%.



GW 10 568

ELECTRONIC REGULATOR WITH BUTTON FOR RESISTIVE/INDUCTIVE LOADS

Code	Supply voltage	Resistive load 230V ac	Inductive load 230V ac	No. modules	Pack Carton
GW 10 568	230V ac - 50 Hz	60 - 500 W	60 - 500 VA	1	1/12

CHARACTERISTICS: possibility to command and regulate from remote control push-buttons with NO contact. With signalling led orange.

NOTES: to avoid overheating, the side by side installation of several products in a single container is not permitted; insert a blanking module between two electronic devices. If installing two regulators in the same box, the maximum loads that can be commanded by each regulator must be reduced by 50%.

CHORUSMART - Domestic range

TECHNICAL ALARMS - GLOSSY WHITE VERSION

GAS DETECTORS



GW 10 711

LPG DETECTOR

Code	Supply voltage	Tripping threshold	Output contacts	No. modules	Pack Carton
GW 10 711	12V ac/dc	9% LIE	1NO/NC 10A(NO)/3A(NC)250V ac	2	1/2

CHARACTERISTICS: relay output for the automatic command of the gas interception solenoid valve (manual reset) GW30522. Sound intensity: 85dB at 1m.



GW 10 712

METHANE GAS DETECTOR

Code	Supply voltage	Tripping threshold	Output contacts	No. modules	Pack Carton
GW 10 712	12V ac/dc	9% LIE	1NO/NC 10A(NO)/3A(NC)250V ac	2	1/2

CHARACTERISTICS: relay output for the automatic command of the gas interception solenoid valve (manual reset) GW30522. Sound intensity: 85dB at 1m.



GW 10 720

POWER SUPPLY UNIT 12VDC

Code	Supply voltage	Output voltage	Max current supplied	Dimensions LxHxD (mm)	Pack Carton
GW 10 720	100 ÷ 240 V ac - 50/60 Hz	12V dc	300 mA	52x33x17	1/10

APPLICATIONS: to be used for powering LPG detectors (GW1x711, GW2x868, GW30520), methane detectors (GW1x712, GW2x867, GW30519); Thermo ICE KNX (GW16974CB, GW16974CN, GW16974CT) thermostats.

ANTI-FLOOD SYSTEM WITH ZIGBEE WIRELESS TRANSMISSION



GW A1 514

ZIGBEE FLOOD ALARM - IP20

Code	Siren output	Temperature sensor	Colour	Dimensions (mm)	Pack Carton
GW A1 514	85 dB/3 m	0...50 °C	White	Ø 60x37	1/6

CHARACTERISTICS: the alarm detects the presence of water and includes a temperature sensor. Powered by CR123-type battery (replaceable).

NOTES: floor-mounting or alternatively wall-mounting possibility through the GWA1541 accessory. To be used in combination with the Zigbee actuator GWA1521 when controlling an electrovalve or a load.



GW A1 521

1-CHANNEL ACTUATOR ZIGBEE

Code	Supply voltage	Output contacts	Dimensions LxHxD (mm)	Pack Carton
GW A1 521	230V ac - 50 Hz	1 NO 10A (AC) 230 V ac	42x40x20	1/4

CHARACTERISTICS: 1-channel actuator for activating loads via the potential-free output contact (NO). Suitable for commanding incandescent lamps (230 V ac): 2300W, loads controlled from toroidal transformers: 450W, loads controlled from electronic transformers: 600W, energy saving lamps (compact fluorescent): 150W, LED lamps (230 V ac): 150W, motors: 500W.

APPLICATIONS: when used with the water sensor, provide the installation of a NO push-button to open the electrovalve manually.

NOTES: installation in flush-mounting boxes, junction boxes, etc..



GW 10 750

BLANKING MODULE FOR HOUSING RF ZIGBEE ACTUATORS

Code	Colour	No. modules	Pack Carton
GW 10 750	Glossy white	1	1/12

CHARACTERISTICS: 1-module blanking module with pad printing. Allows the housing and fast identification of the flush-mounting RF Zigbee actuator.

NOTES: snap-in assembly.

ACCESSORIES



GW A1 541

WALL-MOUNTING SUPPORT FOR FLOOD ALARM

Code	Colour	Support dimension (mm)	Dimensions of probe (mm)	Cable max. length (cm)	Pack Carton
GW A1 541	White	Ø72x25	Ø50x8	85	1/4

APPLICATIONS: to be used for the wall-mounting of the Zigbee flood alarm GWA1514.



GW 30 522

SOLENOID VALVE, WITH MANUAL RESET, NORMALLY OPEN - 230V - 50HZ

Code	Delivery Ø	Material	Power input	Pack Carton
GW 30 522	3/4"	Brass	12 VA	1/2

CHORUSMART - Domestic range

ACCESSORIES

SIGNALLING UNITS



GW 10 881

LED SIGNALLING UNITS - 230 V AC - 0.6 W

Code	Lamp voltage	Lamp power	Lamp	Light emitted	Cable Colour	Pack Carton
GW 10 881	230 V ac - 50/60 Hz	0.6 W	LED	Blue	Blue	50
GW 10 882	230 V ac - 50/60 Hz	0.6 W	LED	White	White	50
GW 10 883	230 V ac - 50/60 Hz	0.6 W	LED	Red	Red	50
GW 10 884	230 V ac - 50/60 Hz	0.6 W	LED	Green	Green	50
GW 10 885	230 V ac - 50/60 Hz	0.6 W	LED	Amber	Orange	50

NOTES: the LED signalling units are supplied with power supply cables (length 10 cm).



GW 10 894

LED SIGNALLING UNITS - 12-24 V AC/DC - 0.6 W

Code	Lamp voltage	Lamp power	Lamp	Light emitted	Cable Colour	Pack Carton
GW 10 894	12-24V ac/dc	0.6 W	LED	White	White	50

NOTES: the LED signalling units are supplied with power supply cables (length 10 cm).



GW 20 902

CARTRIDGE LAMPS - 2W

Code	Lamp voltage	Lamp power	Lamp	Light emitted	Dimensions (mm)	Pack Carton
GW 20 902	12V ac/dc	2 W	Incandescence	White	56x36	50
GW 20 903	24V ac/dc	2 W	Incandescence	White	56x36	50

ACCESSORIES

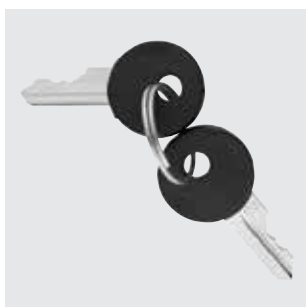

GW 20 901

SET OF 2 KEYS FOR COMMAND DEVICES

Code	Suitable for	Pack Carton
GW 20 901	One-way switches - two-way switches	1/100
GW 30 912	Push-buttons	1/100



ChoruSmart



Scan the QR Code and find out all the technical informations.

INNOVATIVE



ChoruSmart offers the best technologies for an aesthetic and functional experience suitable for every person. In particular, the new EVO axial and touch controls offer the ability to centralize the management of lights and shutters with an extremely simplified installation.

AESTHETIC VARIABILITY



The wide range of options for customising the devices, in terms of colour and modularity, ensures a vast choice of solutions. Six colourways are available: three with a satin finish and three with a glossy finish, for a perfect match between the devices and the plate.

SCALABLE



ChoruSmart began as a traditional domestic series, but with the addition of a few Connected Smart Home or Home&Building Pro elements, it can become smart and suitable for both renovations and new buildings. The combination of colours, materials, finishes and shapes offers something for every taste and need.

ChoruSmart

Satin white modular devices

The CHORUSMART modular devices make it possible to create infinite combination between devices and plates, thanks to a complete range that is able to satisfy all design, functional and installation requirements. Colours and finishes: satin white, distinctive and elegant. Unlimited functions in reduced spaces: the ChoruSmart range consists of rocker button keys with 1/2, 1, 2 and 3 modules, to optimise space as needed, and axial keys in EVO or SMART version, to satisfy even the most modern needs. Front coupling: the front coupling makes the component assembly and release operations simple and quick, enabling these to be completed without removing the support, unique for all the plates and fruits.



COMMAND - SATIN WHITE VERSION

COMMAND DEVICES - ROCKERS - SCREW TERMINALS



GW 15 001

ONE-WAY SWITCHES 1P - 250V AC

Code	Description	Button key	Rated power of 230V LED lamps	Pack Carton
No. modules: 1				
GW 15 001	1P - 16AX	Neutral	200 W	12/96
GW 15 002	1P - 16AX illuminable	With diffuser	200 W	12/24
GW 15 003	1P - 16AX illuminable	With replaceable neutral lens	200 W	12/24
No. modules: 1/2				
GW 15 021	1P - 10AX	Neutral	100 W	12/24
GW 15 022	1P - 10AX illuminable	With diffuser	100 W	6/24
No. modules: 2				
GW 15 031	1P - 16AX	Neutral	200 W	6/24
GW 15 032	1P - 16AX illuminable	With diffuser	200 W	6/24
GW 15 033	1P - 16AX illuminable	With replaceable neutral lens	200 W	6/24
No. modules: 3				
GW 15 041	1P - 16AX	Neutral	200 W	4/12
GW 15 042	1P - 16AX illuminable	With diffuser	200 W	4/12
GW 15 043	1P - 16AX illuminable	With replaceable neutral lens	200 W	4/12

CHARACTERISTICS: the illuminable articles use LED signalling units, not included.

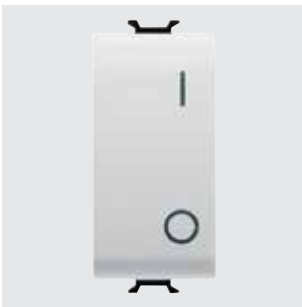

GW 15 004

ONE-WAY SWITCHES 2P - 250V AC

Code	Description	Button key	Symbol	Rated power of 230V LED lamps	Pack Carton
No. modules: 1					
GW 15 004	2P - 16 AX	Neutral	0/1	200 W	12/48
GW 15 005	2P - 16AX illuminable	With replaceable neutral lens	-	200 W	12/24
GW 15 006	2P - 10AX	With key	0/1	100 W	1/12
No. modules: 2					
GW 15 034	2P - 16 AX	Neutral	0/1	200 W	6/24
GW 15 035	2P - 16AX illuminable	With replaceable neutral lens	-	200 W	6/24

CHARACTERISTICS: the illuminable articles use LED signalling units, not included.

NOTES: GW15006 equipped with 2 keys. Key extractable in both positions. Spare keys: GW20901.

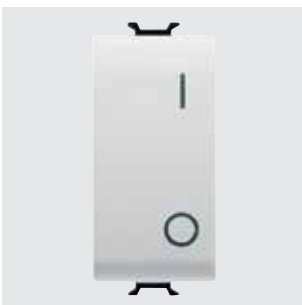

GW 15 007

ONE-WAY SWITCH 2P - 250V AC - HEAVY DUTY LOADS

Code	Description	Button key	Symbol	Rated power of 230V LED lamps	Pack Carton
No. modules: 1					
GW 15 007	2P - 25 AX	Neutral	0/1	250 W	12/24

APPLICATIONS: suitable for particular heavy-duty loads (e.g. LED or fluorescent lamp batteries) or high-consumption devices (e.g. ovens, air-conditioners, boilers, etc.).



GW 15 051

TWO-WAY SWITCHES 1P - 250V AC

Code	Description	Button key	Rated power of 230V LED lamps	Pack Carton
No. modules: 1				
GW 15 051	1P - 16AX	Neutral	200 W	12/96
GW 15 052	1P - 16AX illuminable	With diffuser	200 W	12/24
GW 15 053	1P - 16AX illuminable	With replaceable neutral lens	200 W	12/24
GW 15 054	1P - 10AX	With key	100 W	1/12
No. modules: 1/2				
GW 15 061	1P - 10AX	Neutral	100 W	6/24
No. modules: 2				
GW 15 071	1P - 16AX	Neutral	200 W	6/24
GW 15 072	1P - 16AX illuminable	With diffuser	200 W	6/24
GW 15 073	1P - 16AX illuminable	With replaceable neutral lens	200 W	6/24
No. modules: 3				
GW 15 081	1P - 16AX	Neutral	200 W	4/12
GW 15 082	1P - 16AX illuminable	With diffuser	200 W	4/12
GW 15 083	1P - 16AX illuminable	With replaceable neutral lens	200 W	4/12

CHARACTERISTICS: the illuminable articles use LED signalling units, not included.

NOTES: GW15054 equipped with 2 keys. Key extractable in both positions. Spare keys: GW20901.



GW 15 091

INTERMEDIATE SWITCHES 1P - 250V AC

Code	Description	Button key	Rated power of 230V LED lamps	Pack Carton
No. modules: 1				
GW 15 091	1P - 16AX	Neutral	200 W	12/48
GW 15 092	1P - 16AX illuminable	With diffuser	200 W	12/24
GW 15 093	1P - 16AX illuminable	With replaceable neutral lens	200 W	12/24
No. modules: 2				
GW 15 101	1P - 16AX	Neutral	200 W	6/12
GW 15 102	1P - 16AX illuminable	With diffuser	200 W	6/12
GW 15 103	1P - 16AX illuminable	With replaceable neutral lens	200 W	6/12
No. modules: 3				
GW 15 111	1P - 16AX	Neutral	200 W	4/12
GW 15 112	1P - 16AX illuminable	With diffuser	200 W	4/12
GW 15 113	1P - 16AX illuminable	With replaceable neutral lens	200 W	4/12

CHARACTERISTICS: the illuminable articles use LED signalling units, not included.

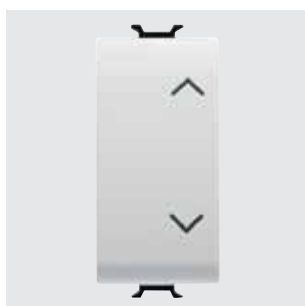

GW 15 121

THREE-WAY SWITCHES 1P - 250V AC

Code	Description	Button key	Symbol	Rated power of 230V LED lamps	Pack Carton
No. modules: 1					
GW 15 121	1P - 10AX	Neutral	UP - DOWN	100 W	12/24
No. modules: 2					
GW 15 123	1P - 10AX	Neutral	UP - DOWN	100 W	6/24

CHARACTERISTICS: three standing positions. Both contacts are open in the central position (OFF).

APPLICATIONS: command of circuits requiring an interlock (e.g. operating motorised devices with direction reversal). 2-user selective control.

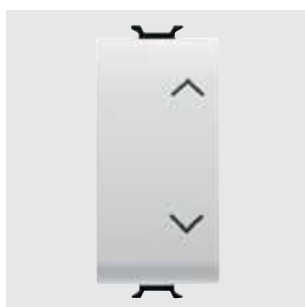

GW 15 122

THREE-WAY SWITCH 2P - 250V AC

Code	Description	Button key	Symbol	Rated power of 230V LED lamps	Pack Carton
No. modules: 1					
GW 15 122	2P - 10AX	Neutral	UP - DOWN	100 W	12/24

CHARACTERISTICS: three standing positions. Both contacts are open in the central position (OFF). With 6 terminal blocks.

APPLICATIONS: command of circuits requiring an interlock (e.g. operating motorised devices with direction reversal). 2-user selective control.

CHORUSMART - Domestic range



GW 15 131

PUSH-BUTTONS 1P - 250V AC

Code	Description	Button key	Symbol	Pack Carton
No. modules: 1				
GW 15 131	1P NO - 16A	Neutral	-	12/96
GW 15 132	1P NO - 16A illuminable	With diffuser	-	12/24
GW 15 133	1P NO - 16A illuminable	With replaceable neutral lens	-	12/24
GW 15 136	1P NO - 16A	Pull-cord	-	1/12
GW 15 137	1P NC - 16A	Neutral	O red	12/24
GW 15 138	1P NC+NO - 16 A	Stop	Red	12/24
GW 15 139	1P NO+NC - 16 A	Start	Green	12/24
GW 15 140	1P NO+NO - 10A	With interlock	UP - DOWN	12/24
GW 15 141	1P NO+NO - 16 A	Double	-	12/24
GW 15 142	1P NO - 16A illuminable	Green diffuser	-	12/24
GW 15 143	1P NO - 16A illuminable	Red diffuser	-	12/24
GW 15 144	1P NO - 16A illuminable	Opal diffuser	-	12/24
GW 15 151	1P NO - 16A illuminable	With replaceable neutral lens	Light	12/24
GW 15 152	1P NO - 16A illuminable	With replaceable neutral lens	Key	12/24
GW 15 153	1P NO - 16A illuminable	With replaceable neutral lens	Bell	12/24
No. modules: 1/2				
GW 15 161	1P NO - 10A	Neutral	-	6/24
GW 15 162	1P NO - 10A illuminable	With diffuser	-	6/24
No. modules: 2				
GW 15 171	1P NO - 16A	Neutral	-	6/24
GW 15 172	1P NO - 16A illuminable	With diffuser	-	6/24
GW 15 173	1P NO - 16A illuminable	With replaceable neutral lens	-	6/24
No. modules: 3				
GW 15 181	1P NO - 16A	Neutral	-	4/12
GW 15 182	1P NO - 16A illuminable	With diffuser	-	4/12
GW 15 183	1P NO - 16A illuminable	With replaceable neutral lens	-	4/12

CHARACTERISTICS: the illuminable articles use LED signalling units, not included.

GW15136 Cord in insulating material, 140cm long, with red knob.

GW15140 Button with mechanical interlock. Both contacts are open in the central position (OFF); advisable for activating motorised devices with direction reversal (e.g. roller-shutters, curtains, etc.).

GW15141 independent push-buttons that can also be activated simultaneously.

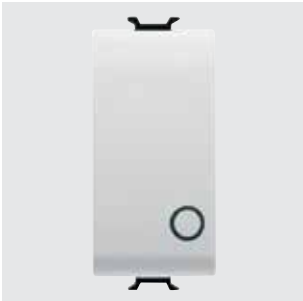

GW 15 134

PUSH-BUTTONS 2P - 250V AC

Code	Description	Button key	Symbol	Pack Carton
No. modules: 1				
GW 15 134	2P NO - 16A	Neutral	O	12/24
GW 15 135	2P NO - 10A illuminable	With replaceable neutral lens	-	12/24
GW 15 145	2P NO - 10A	With key	-	1/12

CHARACTERISTICS: the illuminable articles use LED signalling units, not included.

NOTES: GW15145 equipped with 2 keys. Spare keys: GW30912.



GW 15 191

PUSH-BUTTONS 1P WITH ILLUMINATED NAME PLATE - 250V AC

Code	Description	Lamp voltage	Lamp	Lamp power	Pack Carton
No. modules: 2					
GW 15 191	1P NO - 10A	12-24V ac/dc	Cartridge lamp S6x36 mm	2 W	6/24
No. modules: 3					
GW 15 192	1P NO - 10A	12-24V ac/dc	Cartridge lamp S6x36 mm	2 W	4/16

CHARACTERISTICS: lamp not included.

COMMAND DEVICES - ROCKERS - QUICK WIRING TERMINALS



GW 15 031 F

ONE-WAY SWITCHES 1P - 250V AC

Code	Description	Button key	Rated power of 230V LED lamps	Pack Carton
No. modules: 2				
GW 15 031 F	1P - 16AX	Neutral	200 W	6/24
GW 15 032 F	1P - 16AX illuminable	With diffuser	200 W	6/24
GW 15 033 F	1P - 16AX illuminable	With replaceable neutral lens	200 W	6/24

CHARACTERISTICS: the illuminable articles use LED signalling units, not included.
NOTES: spring quick wiring, no tools necessary.



GW 15 034 F

ONE-WAY SWITCHES 2P - 250V AC

Code	Description	Button key	Symbol	Rated power of 230V LED lamps	Pack Carton
No. modules: 2					
GW 15 034 F	2P - 16 AX	Neutral	0/1	200 W	6/24
GW 15 035 F	2P - 16AX illuminable	With replaceable neutral lens	-	200 W	6/24

CHARACTERISTICS: the illuminable articles use LED signalling units, not included.
NOTES: spring quick wiring, no tools necessary.



GW 15 071 F

TWO-WAY SWITCHES 1P - 250V AC

Code	Description	Button key	Rated power of 230V LED lamps	Pack Carton
No. modules: 2				
GW 15 071 F	1P - 16AX	Neutral	200 W	6/24
GW 15 072 F	1P - 16AX illuminable	With diffuser	200 W	6/24
GW 15 073 F	1P - 16AX illuminable	With replaceable neutral lens	200 W	6/24

CHARACTERISTICS: the illuminable articles use LED signalling units, not included.
NOTES: spring quick wiring, no tools necessary.



GW 15 101 F

INTERMEDIATE SWITCHES 1P - 250V AC

Code	Description	Button key	Rated power of 230V LED lamps	Pack Carton
No. modules: 2				
GW 15 101 F	1P - 16AX	Neutral	200 W	6/12
GW 15 102 F	1P - 16AX illuminable	With diffuser	200 W	6/12
GW 15 103 F	1P - 16AX illuminable	With replaceable neutral lens	200 W	6/12

CHARACTERISTICS: the illuminable articles use LED signalling units, not included.
NOTES: spring quick wiring, no tools necessary.



GW 15 171 F

PUSH-BUTTONS 1P - 250V AC

Code	Description	Button key	Pack Carton
No. modules: 2			
GW 15 171 F	1P NO - 16A	Neutral	6/24
GW 15 172 F	1P NO - 16A illuminable	With diffuser	6/24
GW 15 173 F	1P NO - 16A illuminable	With replaceable neutral lens	6/24

CHARACTERISTICS: the illuminable articles use LED signalling units, not included.
NOTES: spring quick wiring, no tools necessary.

CHORUSMART - Domestic range



GW 15 160 F

COMBINED COMMAND DEVICES - ROCKERS - 250 V AC

Code	Description	Button key	Symbol	Rated power of 230V LED lamps	Pack Carton
No. modules: 2					
GW 15 078 F	Twin two-way switch 1P - 16 AX	Neutral	-	200 W	6/24
GW 15 159 F	Two-way switch 1P - 16 AX / Push-button 1P NO - 16A	Neutral	-	200 W	6/24
GW 15 160 F	Twin push-button 1P NO - 16 A	Neutral	-	-	6/24

NOTES: spring quick wiring, no tools necessary.

COMMAND DEVICES - AXIAL - SCREW TERMINALS



GW 10 671

AXIAL SWITCH MODULE - EVO

Code	Supply voltage	Output contacts	No. modules	Pack Carton
GW 10 671	100 ÷ 240 V ac - 50/60 Hz	1 NA 5A (AC1) 240 V ac	1	1/12
GW 10 672	100 ÷ 240 V ac - 50/60 Hz	1 NA 5A (AC1) 240 V ac	2	1/6

CHARACTERISTICS: devices for the control of 1 On/Off lighting device through a live output contact. Suitable for the control of incandescent and halogen (240Vac): 1000W, LED lamps (240Vac): 100W, fluorescent lamps (240Vac): 120W, halogen lamps powered by electronic transformers (240Vac): 250VA. Local push button with axial activation for control of the lamps connected to the device. Equipped with 1 input to replicate the local control of the load via auxiliary module GW10677, GW10678 or NO-type and 1-input buttons for the centralisation OFF function.

APPLICATIONS: Bistable, monostable and timed load command. Centralisation function (OFF) by means of a dedicated input, the possibility of being able to switch the load on by means of auxiliary axial modules or NO-type buttons. The devices are equipped with a configurable blue LED that can be set to OFF, easy location mode or for signalling the connected load status.

NOTES: the devices must be completed with a front button key: GW10671 must be completed with the GW15551S or GW15555S button keys. The GW10672 must be completed with the GW15552S or GW15556S button keys.



GW 10 673

AXIAL DIMMER MODULE - EVO

Code	Supply voltage	Halogen load	Inductive load	LED load	No. modules	Pack Carton
GW 10 673	100 ÷ 240 V ac - 50/60 Hz	4 - 150 W	4 - 150 VA	4 - 150 W	1	1/12
GW 10 674	100 ÷ 240 V ac - 50/60 Hz	4 - 150 W	4 - 150 VA	4 - 150 W	2	1/6

CHARACTERISTICS: trailing edge load drive mode (max. 5 lamps). Two local axial operated buttons for dimming the connected load.

Equipped with 2 inputs for replicating local control of the load via the auxiliary module GW10679, GW10680 or NO-type buttons or for creating the centralisation function.

APPLICATIONS: control of the dimmable load connected to the devices. The dedicated inputs can be used to add a load switching-on function through auxiliary axial modules or NO-type buttons, or inputs can be set, via programming, for the centralised OFF function. The devices are equipped with blue LEDs that can be set to OFF, location mode or for signalling the connected load.

NOTES: To avoid overheating, multiple dimmers cannot be installed side-by-side inside in the same enclosure. Insert a blanking module between two electronic devices. If two dimmers are installed in the same box, the maximum loads controlled by each dimmer must be reduced by 50%. The devices must be completed with a front button key: GW10673 must be completed with the GW15553S or GW15557S button keys; GW10674 must be completed with the GW15554S or GW15558S button keys.



GW 10 675

AXIAL ROLLER SHUTTER MODULE - EVO

Code	Supply voltage	Max current supplied	No. modules	Pack Carton
GW 10 675	100 ÷ 240 V ac - 50/60 Hz	2,3 A 240 V ac (according to IEC 60669-2-1)	1	1/12
GW 10 676	100 ÷ 240 V ac - 50/60 Hz	2,3 A 240 V ac (according to IEC 60669-2-1)	2	1/6

CHARACTERISTICS: Devices for the control of a motor to operate roller-shutters, curtains, venetian blinds, awnings, etc., through 2 live interlocked output contacts. Two axial-operated local buttons control the motor connected to the device. Equipped with 2 inputs for replicating local control of the motor via the auxiliary module GW10679, GW10680 or NO-type up/down buttons, or for creating the centralisation function.

APPLICATIONS: control of the motor connected to the devices. The dedicated inputs can be used to operate roller-shutters/venetian blinds via the auxiliary axial modules or NO-type up/down buttons, or they can be set, through programming, for centralisation functions (Up/Down). The devices are equipped with blue LEDs which can be configured to facilitate location at night and to signal the movement of the roller-shutter/Venetian blind.

NOTES: the devices must be completed with a front button key: GW10675 must be completed with the GW15553S or GW15557S button keys. GW10676 must be completed with the GW15554S or GW15558S button keys.



GW 10 677

1-COMMAND AUXILIARY AXIAL MODULES

Code	Supply voltage	Output contacts	No. modules	Pack Carton
GW 10 677	100 ÷ 240 V ac - 50/60 Hz	1 NO 1 A (AC1) 240 V ac	1	1/12
GW 10 678	100 ÷ 240 V ac - 50/60 Hz	1 NO 1 A (AC1) 240 V ac	2	1/6

CHARACTERISTICS: auxiliary controls to be used in conjunction with the EVO switch modules.

The devices are equipped with blue LEDs for easy location or for displaying the status of the load.

APPLICATIONS: when connected to the local inputs of the EVO axial controls, they allow replication of the local load control or the management of centralised controls.

NOTES: the devices must be completed with a front button key: GW10677 must be completed with the GW15551S or GW15555S button keys. GW10678 must be completed with the GW15552S or GW15556S button keys.



GW 10 679

2-COMMAND AUXILIARY AXIAL MODULES

Code	Supply voltage	Output contacts	No. modules	Pack Carton
GW 10 679	100 ÷ 240 V ac - 50/60 Hz	2 NO 1 A (AC1) 240 V ac	1	1/12
GW 10 680	100 ÷ 240 V ac - 50/60 Hz	2 NO 1 A (AC1) 240 V ac	2	1/6

CHARACTERISTICS: auxiliary controls to be used in conjunction with the EVO dimmer and roller-shutter modules.

The devices are equipped with blue LEDs for easy location or for displaying the status of the load.

APPLICATIONS: when connected to the local inputs of the EVO axial controls, they allow replication of the local load control or the management of centralised controls.

NOTES: the devices must be completed with a front button key: GW10679 must be completed with the GW15553S or GW15557S button keys. GW10680 must be completed with the GW15554S or GW15558S button keys.

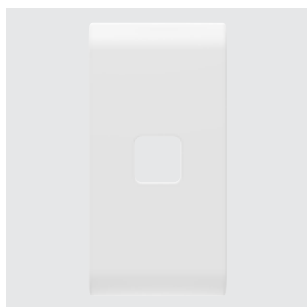

GW 15 551 S

INTERCHANGEABLE BUTTON KEYS FOR AXIAL DEVICES

Code	Colour	Button key	No. modules	Pack Carton
GW 15 551 S	Satin White	To be completed with lens	1	1/48
GW 15 552 S	Satin White	To be completed with lens	2	1/48
GW 15 553 S	Satin White	To be completed with 2 lenses	1	1/48
GW 15 554 S	Satin White	To be completed with 2 lenses	2	1/48
GW 15 555 S	Satin White	With 1 diffuser	1	1/48
GW 15 556 S	Satin White	With 1 diffuser	2	1/48
GW 15 557 S	Satin White	With 2 diffusers	1	1/48
GW 15 558 S	Satin White	With 2 diffusers	2	1/48

NOTES: for use to complete the EVO axial modules and auxiliary axial controls.

LENSES WITH ILLUMINATED SYMBOL



ZCG

SYMBOLS FOR BACKLIT ROCKER COMMAND DEVICES

Code	Symbol	Pack Carton
Suitable for: General services		
GW 10 501	Neutral	20/240
GW 10 502	Light	20/240
GW 10 503	Stair light	20/240
GW 10 504	Table light	20/240
GW 10 505	Bell	20/240
GW 10 506	Fan	20/240
GW 10 507	Key	20/240
GW 10 508	Alarm	20/240
GW 10 509	ON	20/240
GW 10 510	OFF	20/240
GW 10 511	Nurse	20/240
GW 10 512	Waitress	20/240
GW 10 513	Dimmer increase	20/240
GW 10 514	Dimmer decrease	20/240
GW 10 515	UP arrow	20/240
GW 10 516	DOWN arrow	20/240
GW 10 517	UP - DOWN arrow	20/240
GW 10 518	RIGHT - LEFT arrow	20/240
Suitable for: Numerical services		
GW 10 531	One	20/240
GW 10 532	Two	20/240
GW 10 533	Three	20/240
GW 10 534	Four	20/240
GW 10 535	Five	20/240
GW 10 536	Six	20/240
GW 10 537	Seven	20/240
GW 10 538	Eight	20/240
GW 10 539	Nine	20/240
GW 10 540	Zero	20/240

NOTES: to be used in place of the neutral lens in the illuminable rocker command devices.

CHORUSMART - Domestic range



ZC6

LENSES WITH ILLUMINATING SYMBOLS FOR AXIAL BUTTON KEYS

Code	Symbol	Pack Carton
GW 10 501 A	Neutral	24
GW 10 502 A	Light	24
GW 10 503 A	Stair light	24
GW 10 504 A	Table light	24
GW 10 505 A	Bell	24
GW 10 506 A	Burglar alarm	24
GW 10 507 A	Key	24
GW 10 508 A	ON OFF	24
GW 10 509 A	ON	24
GW 10 510 A	OFF	24
GW 10 511 A	Socket-outlet	24
GW 10 512 A	Dimmers	24
GW 10 513 A	Dimmer increase	24
GW 10 514 A	Dimmer decrease	24
GW 10 515 A	Arrow	24
GW 10 516 A	Open	24
GW 10 517 A	Close	24
GW 10 518 A	Roller shutter	24
GW 10 519 A	Roller shutter up	24
GW 10 520 A	Roller shutter down	24
GW 10 521 A	Curtain open	24
GW 10 522 A	Curtain close	24
GW 10 523 A	Floor light	24
GW 10 524 A	Ceiling light	24
GW 10 525 A	Wall light	24
GW 10 526 A	Aisle light	24
GW 10 527 A	Scenario	24
GW 10 528 A	Party	24
GW 10 529 A	In	24
GW 10 530 A	Out	24
GW 10 531 A	Good morning	24
GW 10 532 A	Good night	24
GW 10 533 A	TV	24
GW 10 534 A	Heating	24
GW 10 535 A	Cooling	24
GW 10 536 A	Heating/Cooling	24
GW 10 537 A	Comfort	24
GW 10 538 A	Precomfort	24
GW 10 539 A	Economy	24
GW 10 540 A	Auto	24
GW 10 541 A	Do not disturb	24
GW 10 542 A	Make up the room	24

NOTE: for use to customise the interchangeable push buttons for axial controls with 1 and 2 lenses.

INTERCHANGEABLE BUTTON KEYS AND DIFFUSERS FOR ROCKER DEVICES



ZC6

BUTTON KEYS FOR ROCKER CONTROLS AND INTERCHANGEABLE DIFFUSERS FOR INDICATOR LIGHTS

Code	Symbol	Pack Carton
Description: Keys 22x22 mm		
GW 15 541	General	4/48
GW 15 542	With label	4/48
GW 15 543	Key	4/48
GW 15 544	Bell	4/48
GW 15 545	Vertical arrow	4/48
GW 15 546	Horizontal arrow	4/48
Description: Diffusers		
GW 10 547	Red	4/48
GW 10 548	Green	4/48
GW 10 549	Opal diffuser	4/48
GW 10 550	Amber	4/48

APPLICATIONS: replacement diffusers for indicators GW15142, GW15143 and GW15144.

NOTES: the ChoruSmart modular system allows the use of 22 x 22 mm interchangeable buttons in place of the standard buttons fitted on the control devices GW15141, GW15142, GW15143 and GW15144. Symbols/diffusers not suitable for the EVO axial keys.

SOFT-CLICK, ROCKER ELECTRONIC PUSH BUTTONS



GW 15 915

UNIVERSAL SOFT-CLICK ELECTRONIC PUSH-BUTTON

Code	Type of contact	Button key	Type of use	No. modules	Pack Carton
GW 15 915	1NO/NC 4A (AC1) 230 V ac - Potential-free Neutral		Relay, dimmer, bus contacts interfaces	1	1/12

CHARACTERISTICS: push-button suitable for connection of KNX BUS contacts interfaces, or the command of bistable relays, electronic one-way switches for heavy duty loads, or dimmers with a remote control input.



GW 15 912

BACKLIT SOFT-CLICK ELECTRONIC PUSH-BUTTON

Code	Supply voltage	Type of contact	Button key	Type of use	Pack Carton
GW 15 912	230 V ac - 50/60 Hz	1NO 4A (AC1) 230 V ac	With diffuser	Relay, dimmer	1/12

CHARACTERISTICS: push-button for controlling latching relays, electronic switches for heavy duty loads, or dimmers with a remote control input. Equipped with amber localisation LED.



GW 15 913

BACKLIT ELECTRONIC PUSH-BUTTONS FOR BUS INPUTS

Code	Type of contact	Button key	Type of use	Pack Carton
No. modules: 1				
GW 15 913	1NO - Potential-free	With diffuser	Bus contacts interfaces	1/12
GW 15 916	1NO - Potential-free	With replaceable neutral lens	Bus contacts interfaces	1/12
No. modules: 2				
GW 15 917	1NO - Potential-free	With diffuser	Bus contacts interfaces	1/6
GW 15 918	1NO - Potential-free	With replaceable neutral lens	Bus contacts interfaces	1/6

CHARACTERISTICS: push-button for BUS inputs, suitable for KNX BUS contact interface connections. Equipped with 2-colour (amber/green) LED with colour selector (can be set up to work as a night-time localisation lamp or to indicate the load status).

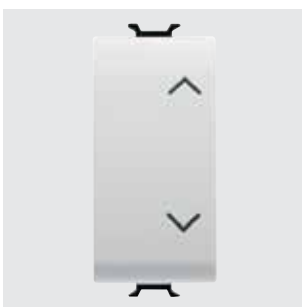

GW 15 914

DOUBLE SOFT-CLICK ELECTRONIC PUSH-BUTTON

Code	Type of contact	Button key	Symbol	No. modules	Pack Carton
GW 15 914	Dual, potential-free and with interlock	Neutral	UP - DOWN	1	1/12

CHARACTERISTICS: double push-button suitable for connecting KNX BUS contact interfaces or electronic control panels for moving roller shutters.

CHORUSMART - Domestic range

TOUCH COMMAND MODULES



GW 10 922

TOUCH ONE-WAY SWITCH MODULE

Code	Supply voltage	Output contacts	No. modules	Pack Carton
GW 10 922	100 ÷ 240 V ac - 50/60 Hz	1 NA 5A (AC1) 240 V ac	1	1/12

CHARACTERISTICS: device for the On/Off control of 1 lighting device through a live output contact. Suitable for control of incandescent and halogen lamps (240Vac): 1000W, LED lamps (240Vac): 100W, fluorescent lamps (240Vac): 120W, halogen lamps powered by electronic transformers (240Vac): 250VA. Equipped with 1 input for replicating local control of the load via the GW10924 auxiliary touch control modules, NO-type buttons and 1 input for the centralisation of the OFF function. The device is equipped with blue LEDs for easy location that can be set to two different light intensity levels. Excludable built-in buzzer, function identification by means of icons on the ICE touch plates.

APPLICATIONS: bistable, monostable and timed load control. Centralisation function (OFF) through the dedicated input.

NOTES: to be completed with ICE touch plates (codes: GW16955CB, GW16955CL, GW16955CN, GW16955CT).



GW 10 923

TOUCH DIMMER MODULE

Code	Supply voltage	Halogen load	Inductive load	LED load	No. modules	Pack Carton
GW 10 923	100 ÷ 240 V ac - 50/60 Hz	4 - 150 W	4 - 150 VA	4 - 150 W	1	1/12

CHARACTERISTICS: trailing edge load drive mode (max. 5 lamps). Two touch areas for dimming the connected load. Equipped with 2 inputs for replicating local control of the load via the auxiliary touch 2-command modules GW10925, NO-type buttons, or for creating the centralisation function OFF. The device is equipped with blue LEDs for easy location that can be set to two different light intensity levels. Excludable built-in buzzer, function identification by means of icons on the ICE touch plates.

APPLICATIONS: control of the dimmable load connected to the devices. Centralised OFF function, via dedicated inputs.

NOTE: to avoid overheating, multiple products cannot be installed side-by-side inside in the same enclosure; insert a blanking module between two electronic devices. When installing two dimmers in the same box, the maximum loads controlled by each dimmer must be reduced by 50%. To be completed using ICE touch plates (codes: GW16955CB, GW16955CL, GW16955CN, GW16955CT).



GW 10 921

TOUCH ROLLER SHUTTER MODULE

Code	Supply voltage	Maximum output power	No. modules	Pack Carton
GW 10 921	100 ÷ 240 V ac - 50/60 Hz	2,3 A 240 V ac (according to IEC 60669-2-1)	1	1/12

CHARACTERISTICS: Devices for the control of a motor to operate roller-shutters, curtains, venetian blinds, awnings, etc., by means of 2 interlocked live output contacts. Two touch areas for controlling the motor connected to the device. Equipped with 2 inputs for replicating local control of the motor via the touch auxiliary 2-command modules GW10925, NO-type up/down buttons, or for creating a centralisation function (up/down). The device is equipped with blue LEDs for easy location that can be set to two different light intensity levels. Excludable built-in buzzer, function identification by means of icons on the ICE touch plates.

APPLICATIONS: control of the motor connected to the devices. Centralisation function (Up/Down) by means of a dedicated inputs.

NOTES: to be completed with ICE touch plates (codes: GW16955CB, GW16955CL, GW16955CN, GW16955CT).

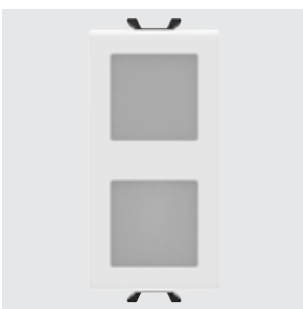

GW 10 924

1-COMMAND AUXILIARY TOUCH MODULE

Code	Supply voltage	Output contacts	No. modules	Pack Carton
GW 10 924	100 ÷ 240 V ac - 50/60 Hz	100mA 240 V ac	1	1/12

CHARACTERISTICS: suitable for controlling the GW10922 module. The device is equipped with blue LEDs for easy location that can be set to two different light intensity levels. Excludable built-in buzzer, function identification by means of icons on the ICE touch plates.

NOTES: to be completed using ICE touch plates (codes: GW16955CB, GW16955CL, GW16955CN, GW16955CT).

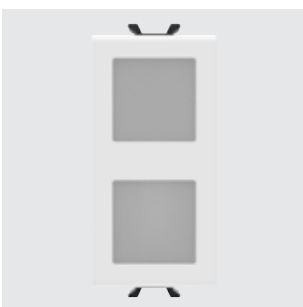

GW 10 925

2-COMMAND AUXILIARY TOUCH MODULE

Code	Supply voltage	Output contacts	No. modules	Pack Carton
GW 10 925	100 ÷ 240 V ac - 50/60 Hz	100mA 240 V ac	1	1/12

CHARACTERISTICS: suitable for controlling the GW10921 and GW10923 modules. The device is equipped with blue LEDs for easy location that can be set to two different light intensity levels. Excludable, built-in buzzer and functions identifiable by the icons on the ICE touch plates.

NOTES: to be completed with ICE touch plates (codes: GW16955CB, GW16955CL, GW16955CN, GW16955CT).

ICE TOUCH PLATES



GW 16 955 CB

ICE TOUCH - WHITE

Code	Description	For support codes	Pack Carton
GW 16 955 CB	6 touch areas	GW16803, GW16803N	1

CHARACTERISTICS: glossy finish. The plate is to be used in combination with the touch modules (switch module GW10922, roller shutter module GW10921, dimmer module GW10923, 1-control auxiliary module GW10924, 2-control auxiliary module GW10925).

NOTES: the symbols displayed in the image are purely indicative and may be customised using the icons supplied with the touch plate. The code of the plate is unique and independent of the number of icons used (from 2 to 6).

BLANKING MODULES AND CABLE OUTLET



GW 15 195

BLANKING MODULES

Code	Description	No. modules	Pack Carton
GW 15 195	1 module	1	10/200
GW 15 197	1/2 module	1/2	4/48
GW 15 198	2 modules	2	1/48
GW 15 199	3 modules	3	1/48



GW 15 194

CABLE OUTLETS

Code	Description	No. modules	Pack Carton
GW 15 194	2 modules	2	6/48
GW 15 196	1 module	1	1/48

NOTES: GW15196 with anti-traction cable fastener device, cables min 6mm ø, max 10mm ø.

GW15194 with anti-traction cable fastener device, cables min 4mm ø, max 10mm ø. To be installed with the cable output downwards.

MOVEMENT DETECTORS



GW 15 594

MOVEMENT DETECTOR

Code	Supply voltage	Output contacts	Pack Carton
GW 15 594	230V ac - 50/60 Hz	1NO 3 A (AC1) 230 V ac	1/4

CHARACTERISTICS: adjustment of the intervention duration 15 sec - 10 min. Light sensitive threshold adjustment - min. 10 lux - max. inhibited.

Suitable for commanding halogen lamps/resistive loads: 700 W, incandescent lamps: 450 W, low voltage halogen lamps (12 V) controlled by toroidal or electronic transformers: 450 W, uncompensated fluorescent lamps: 2x58 W, motors and gear motors: 400 VA, LED loads: 60 W (max. 10 lamps).

Not suitable for compensated fluorescent lamps, for discharge lamps and for all loads not indicated that must be commanded using a support relay.

APPLICATIONS: Energy-saving: command of the lighting of rooms and areas only when people pass through.

Comfort and safety: automatic command of circuits without needing to activate one-way switches.

NOTES: do not install the product in watertight plates: the lid membrane does not allow the detector lens to work correctly. Detection beam angle 120°, depth of detection max 8 metres.

CHORUSMART - Domestic range



GW 10 595

CEILING-MOUNTED PRESENCE DETECTOR

Code	Supply voltage	Installation height (m)	Light sensor	Dimensions HxØ (mm)	Pack Carton
GW 10 595	220/240 V ac - 50/60 Hz	From 2,2 to 6	< 3 ÷ 2000 Lux	44x111,5	1

CHARACTERISTICS: presence sensor, sensing range: 360° circle (max. diameter 18 metres); installable with fixing springs on a surface-mounted or recessed box. Suitable for the control of incandescent/halogen lamps: 1000W, LED lamps: 200W (4 / 23 W - max. 8 lamps).

NOTE: equipped with a surface-mount box capable of holding sensors from IP20 to IP44.

RELAY



GW 15 724

RELAY - 230V AC 50/60HZ

Code	Type	No. of poles	Output contacts	Coil	Pack Carton
No. modules: 1					
GW 15 721	Latching relay	1P	10 AX 250V ac	230V ac - 50/60 Hz	1/12
GW 15 723	Latching relay, 4 seq.	2P	10 AX 250V ac	230V ac - 50/60 Hz	1/12
GW 15 724	Monostable relay	1P	1NO/NC 10A(AC1)/2A(AC15)250V ac	230V ac - 50/60 Hz	1/12

CHARACTERISTICS: GW15721, GW15723 suitable for commanding incandescent/halogen lamps: 1000 W, fluorescent tubes with electronic ballast: 400 W, fluorescent tubes with electromechanical ballast: 360 W, compact fluorescent lamps (CFL): 200 W, LED lamps (230V ac): 200 W, low voltage halogen or LED lamps with electronic ballast: 200 W, low voltage halogen or LED lamps with electromechanical ballast: 400 W.

APPLICATIONS: GW15721, GW15723 command of lighting devices from more than one point, by means of remote NO push-buttons.

GW15721 motor function/stop commands (extractors, air agitators, etc.).

GW15724 as an auxiliary element for commanding special loads, for distance signalling, for electrical separation between the command and use circuits.



GW 15 726

CALL RELAY - 12V AC/DC

Code	Supply voltage	No. of poles	Output contacts	No. modules	Pack Carton
GW 15 726	12V ac/dc	1P	1NO/NC 12 V (max. 1A)	1	1/12

CHARACTERISTICS: inlets for remote NO push-buttons for alarms (e.g. GW15136) and alarm reset (e.g. GW15145), green LED for alarm status signalling.

HOTEL COMPONENTS - SATIN WHITE VERSION

BADGE SWITCH



GW 15 039

BADGE SWITCH

Code	Description	For badge card max. width	Rated power of 230V LED lamps	No. modules	Pack Carton
GW 15 039	1P NA - 16 AX illuminable	54 mm	200 W	2	1/6

CHARACTERISTICS: the product can be fitted directly in 2-module plates; with plates of a greater modularity, you are advised to use 2 blanking modules for a 1/2 module (one on the right and one on the left).

APPLICATIONS: activation of circuits and services in hotel rooms (e.g. lights, air-conditioner, fridge-bar), indication of room occupied (with badge inserted)

NOTES: badges not included. The article uses LED signalling units, not included.

INTERCHANGEABLE BUTTON KEYS



GW 15 733

INTERCHANGEABLE BUTTON KEYS

Code	Button key	Symbol	No. modules	Pack Carton
GW 15 731	With diffuser	DND	1	4/48
GW 15 732	With diffuser	MUR	1	4/48
GW 15 733	Neutral	DND+MUR	1	4/48

CHARACTERISTICS: with "Do not disturb" (DND) and "Make up the room" (MUR) pad printings. To be used for the customization of the Chorus command devices. GW15731 and GW15732 suitable for one-way switches, two-way switches, intermediate switches and push-buttons. GW15733 suitable for three-way switches and push-buttons with central OFF position.

INDICATOR LIGHT DEVICE



GW 15 736

DOUBLE INDICATOR LAMP

Code	Diffuser colour	Symbol	No. modules	Pack Carton
GW 15 736	Opal diffuser	DND+MUR	1	1/24

CHARACTERISTICS: LED signalling units not included.

CHORUSMART - Domestic range

POWER - SATIN WHITE VERSION

SOCKET-OUTLETS - ITALIAN/GERMAN STANDARD



GW 15 203

ITALIAN STANDARD SOCKET-OUTLETS - 250V AC

Code	Description	Socket-out type	For plug pins	No. modules	Pack Carton
GW 15 201	2P+E - 10A	P11	Ø 4 mm	1	12/96
GW 15 203	2P+E - 16 A Dual amperage	P11-P17	Ø 4 / 5 mm	1	12/96

CHARACTERISTICS: with safety shields.



GW 15 204

ITALIAN/GERMAN STANDARD SOCKET-OUTLETS - 250V AC

Code	Description	Earth pit	Socket-out type	For plug pins	No. modules	Pack Carton
GW 15 204	2P+E - 16 A Dual amperage	Side and central	P40	Ø 4 / 4.8 / 5 mm	2	6/48
GW 15 205	2P+E - 16A	Side and central	P30	Ø 4 / 4.8 mm	2	6/48

CHARACTERISTICS: with safety shields.



GW 15 208

ITALIAN STANDARD DOUBLE SOCKET-OUTLET - 250V AC

Code	Description	Socket-out type	For plug pins	No. modules	Pack Carton
GW 15 208	2x2P+E - 16A Dual amperage	P11-P17	Ø 4 / 5 mm	2	6/24

CHARACTERISTICS: with safety shields. The wiring is carried out via 3 terminals that power the socket-outlets, without using U-bolts.



GW 15 209

ITALIAN STANDARD TRIPLE SOCKET-OUTLET - 250V AC

Code	Description	Socket-out type	For plug pins	No. modules	Pack Carton
GW 15 209	3x2P+E - 16A Dual amperage	P11-P17	Ø 4 / 5 mm	3	4/12

CHARACTERISTICS: with safety shields. The wiring is carried out via 3 terminals that power the socket-outlets, without using U-bolts.

SOCKET-OUTLETS FOR DEDICATED LINES - ITALIAN/GERMAN STANDARD



GW 10 213

ITALIAN STANDARD SOCKET-OUTLET FOR DEDICATED LINES - 250V AC

Code	Description	Colour	Socket-out type	For plug pins	No. modules	Pack Carton
GW 10 213	2P+E - 16 A Dual amperage	Red	P11-P17	Ø 4 / 5 mm	1	12/24
GW 10 223	2P+E - 16 A Dual amperage	Green	P11-P17	Ø 4 / 5 mm	1	12/24

CHARACTERISTICS: with safety shields.



GW 10 214

ITALIAN/GERMAN STANDARD SOCKET-OUTLET FOR DEDICATED LINES - 250V AC

Code	Description	Colour	Socket-out type	For plug pins	No. modules	Pack Carton
GW 10 214	2P+E - 16 A Dual amperage illuminable	Red	P40	Ø 4 / 4.8 / 5 mm	2	6/12
GW 10 224	2P+E - 16 A Dual amperage illuminable	Green	P40	Ø 4 / 4.8 / 5 mm	2	6/12

CHARACTERISTICS: with safety shields. Pit of side and central earth contacts. Pre-arranged for housing LED signalling units, not included.

APPLICATIONS: possibility to indicate presence of auxiliary network.

SOCKET-OUTLETS - GERMAN STANDARD



GW 15 241

GERMAN STANDARD SOCKET-OUTLET - 250V AC

Code	Description	For plug pins	No. modules	Pack Carton
GW 15 241	2P+E - 16A	Ø 4.8 mm	2	6/48

CHARACTERISTICS: with safety shields.



GW 15 242

GERMAN STANDARD SOCKET-OUTLET WITH LID IP40 - 250V AC

Code	Description	For plug pins	No. modules	Pack Carton
GW 15 242	2P+E - 16A	Ø 4.8 mm	2	6/48

CHARACTERISTICS: with safety shields. Equipped with a transparent rigid cover with a glossy finish. IP40 degree of protection with the cover closed.

CHORUSMART - Domestic range

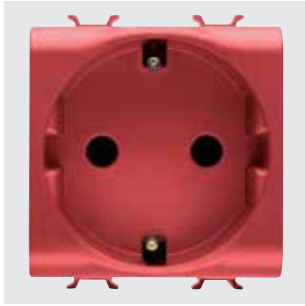

GW 10 251

GERMAN STANDARD SOCKET-OUTLET FOR DEDICATED LINES - 250V AC

Code	Description	Colour	For plug pins	No. modules	Pack Carton
GW 10 251	2P+E - 16A	Red	Ø 4.8 mm	2	6/12

CHARACTERISTICS: with safety shields.



GW 15 341

GERMAN STANDARD SOCKET-OUTLET WITH FRONT TIGHTENING TERMINALS - 250V AC

Code	Description	For plug pins	No. modules	Pack Carton
GW 15 341	2P+E - 16A	Ø 4.8 mm	2	6/12

CHARACTERISTICS: with safety shields. Front access terminals with screw fixing, side input of the conductors.



GW 10 351

GERMAN STANDARD SOCKET-OUTLET WITH FRONT TIGHTENING TERMINALS FOR DEDICATED LINES - 250V AC

Code	Description	Colour	For plug pins	No. modules	Pack Carton
GW 10 351	2P+E - 16A	Red	Ø 4.8 mm	2	6/12

CHARACTERISTICS: with safety shields. Front access terminals with screw fixing, side input of the conductors.



GW 15 241 F

GERMAN STANDARD SOCKET-OUTLET WITH QUICK WIRING TERMINALS - 250V AC

Code	Description	For plug pins	No. modules	Pack Carton
GW 15 241 F	2P+E - 16A	Ø 4.8 mm	2	6/12

CHARACTERISTICS: with safety shields. Spring quick wiring, no tools necessary.

SOCKET-OUTLETS - FRENCH STANDARD



GW 15 246

FRENCH STANDARD SOCKET-OUTLETS - 250V AC

Code	Description	For plug pins	No. modules	Pack Carton
GW 15 246	2P - 16A	Ø 4 / 4.8 mm	2	1/24
GW 15 247	2P+E - 16A	Ø 4 / 4.8 mm	2	6/48

CHARACTERISTICS: with safety shields.



GW 15 248

FRENCH STANDARD SOCKET-OUTLET WITH FRONT TIGHTENING TERMINALS - 250V AC

Code	Description	For plug pins	No. modules	Pack Carton
GW 15 248	2P+E - 16A	Ø 4 / 4.8 mm	2	6/12

CHARACTERISTICS: with safety shields. Front access terminals with screw fixing, side input of the conductors.



GW 15 247 F

FRENCH STANDARD SOCKET-OUTLET WITH QUICK WIRING TERMINALS - 250V AC

Code	Description	For plug pins	No. modules	Pack Carton
GW 15 247 F	2P+E - 16A	Ø 4 / 4.8 mm	2	6/12

CHARACTERISTICS: with safety shields. Spring quick wiring, no tools necessary.

SOCKET-OUTLETS - ISRAELI STANDARD



GW 15 281

ISRAELI STANDARD SOCKET-OUTLET - 250V AC

Code	Description	For plug pins	No. modules	Pack Carton
GW 15 281	2P+E - 16 A illuminable	Round Ø 4 / 4.4 mm	2	1/24

CHARACTERISTICS: with safety shields. Pre-arranged for housing LED signalling units, not included.

CHORUSMART - Domestic range



GW 10 291

ISRAELI STANDARD SOCKET-OUTLET FOR DEDICATED LINES - 250V AC

Code	Description	Colour	For plug pins	No. modules	Pack Carton
GW 10 291	2P+E - 16 A illuminable	Red	Round Ø 4 / 4.4 mm	2	1/24

CHARACTERISTICS: with safety shields. Pre-arranged for housing LED signalling units, not included.



GW 15 282

ISRAELI STANDARD SOCKET-OUTLET - 250V AC

Code	Description	For plug pins	No. modules	Pack Carton
GW 15 282	2P - 10 A	Round Ø 4 mm	1	1/48

CHARACTERISTICS: with safety shields.

SOCKET-OUTLETS - INTERNATIONAL STANDARD



GW 15 286

USA STANDARD SOCKET-OUTLET - 250/125V AC

Code	Description	For plug pins	No. modules	Pack Carton
GW 15 286	2P+E - 15A	Flat parallel horizontal	1	12/48



GW 15 288

EURO-AMERICAN STANDARD SOCKET-OUTLET - 250/125V AC

Code	Description	For plug pins	No. modules	Pack Carton
GW 15 287	2P - 15A	Ø 4 mm Flat	1	12/48
GW 15 288	2P+E - 15A	Ø 4 mm Flat	1	12/48

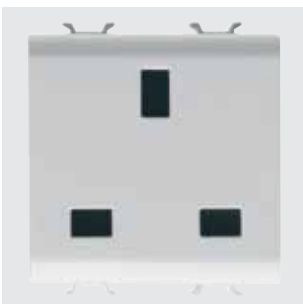

GW 15 296

BRITISH STANDARD SOCKET-OUTLETS - 250V AC

Code	Description	For plug pins	No. modules	Pack Carton
GW 15 296	2P+E - 13 A	Flat	2	6/48
GW 15 297	2P+E - 15A	Ø 7 mm	2	6/48

CHARACTERISTICS: with safety shields.

NOTES: given the size of the plugs, it is not possible to install two or more socket-outlets side-by-side.

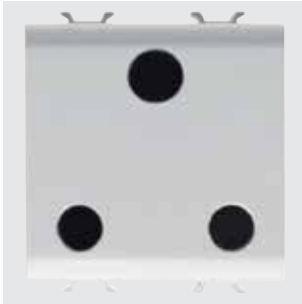

GW 15 298

INDIAN-SOUTH AFRICAN STANDARD SOCKET-OUTLET - 250V AC

Code	Description	For plug pins	No. modules	Pack Carton
GW 15 298	2P+E - 16A	Ø 7 mm	2	6/48

CHARACTERISTICS: with safety shields.

NOTES: given the size of the plugs, it is not possible to install two or more socket-outlets side-by-side.



GW 15 299

SOUTH AFRICAN STANDARD SOCKET-OUTLET - 250V AC

Code	Description	For plug pins	No. modules	Pack Carton
GW 15 299	2P+E - 16A	Round Ø 4,5 mm	1	12/240

CHARACTERISTICS: with safety shields.



GW 15 301

ARGENTINIAN STANDARD SOCKET-OUTLET - 250V AC

Code	Description	For plug pins	No. modules	Pack Carton
GW 15 301	2P+E - 10A	Flat	2	6/48



GW 15 306

AUSTRALIAN STANDARD SOCKET-OUTLETS - 250V AC

Code	Description	For plug pins	No. modules	Pack Carton
GW 15 306	2P+E - 10A	Flat	2	6/48
GW 15 307	2P+E - 15A	Flat	2	6/48

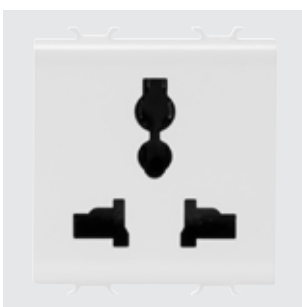

GW 15 310

MULTISTANDARD SOCKET-OUTLET - 250/127V AC

Code	Description	No. modules	Pack Carton
GW 15 310	2P+E - 13A/250 V ac - 15A/127 V ac	2	10/40

CHARACTERISTICS: with safety shields.

APPLICATIONS: suitable for plugs compliant with the following standards: Europlug 2P 2.5A - 250V, British 2P+E 13A - 250V, Italian 2P 10A - 250V, Danish 2P 10A - 250V, Chinese 2P+E 10A - 250V, Argentinean/Australian 2P+E 10A - 250V, Indian 2P+E 6A - 250V, USA 2P+E 15A - 127V. Not suitable for 2P+E German and French sockets because they don't offer earth continuity.

NOTES: the multistandard energy sockets GW15310 are in compliance with the safety requirements defined by the International Standard IEC 60884-1. These sockets may not be in compliance with the standard sheets used in the country where they are sold, hence their usage could be prohibited or however, restricted only for specific applications. The plugs allowed are listed in the technical datasheet. Please contact directly Gewiss technical service for further information.

CHORUSMART - Domestic range



GW 15 392

CHINESE STANDARD SOCKET-OUTLETS - 250V AC

Code	Description	For plug pins	No. modules	Pack Carton
GW 15 391	2P+E - 10A	Flat	2	6/48
GW 15 392	2P+E - 16A	Flat	2	6/48

CHARACTERISTICS: with safety shields.

INTERLOCKED SWITCHED SOCKET-OUTLETS



GW 15 311

INTERLOCKED SWITCHED SOCKET-OUTLETS WITH MINIATURE CIRCUIT BREAKER - 230V AC

Code	Description	Socket-out type	Miniature circuit breakers	Breaking capacity	No. modules	Pack Carton
GW 15 311	2P+E - 16A	P17-P11	1P+N 16A	3 kA	2	1/6
GW 15 312	2P+E - 16A	P40	1P+N 16A	3 kA	3	1/4

CHARACTERISTICS: Interlocked switched socket-outlets with automatic miniature circuit breaker (C characteristic). Pits under tension only with plug inserted.

APPLICATIONS: suitable for installation in the system terminations to protect the load.



GW 15 321

INTERLOCKED SWITCHED SOCKET-OUTLETS WITH RESIDUAL MINIATURE CIRCUIT BREAKER - 230V AC

Code	Description	Socket-out type	Miniature circuit breakers	Breaking capacity	I _{dn}	No. modules	Pack Carton
GW 15 321	2P+E - 16A	P17-P11	1P+N 16A	3 kA	10 mA	3	1/4
GW 15 322	2P+E - 16A	P40	1P+N 16A	3 kA	10 mA	4	1/2

CHARACTERISTICS: Interlocked switched socket-outlets with automatic miniature circuit breaker (C characteristic) and residual current circuit breaker (type A). Pits under tension only with plug inserted.

APPLICATIONS: suitable for installation in the system terminations to protect the load.

SHAVER SOCKET-OUTLET



GW 15 331

EURO-AMERICAN STANDARD SHAVER SOCKET-OUTLET WITH INSULATION TRANSFORMER

Code	Supply voltage	For plug pins	Selectable output voltage	Maximum power	No. modules	Pack Carton
GW 15 331	230 V ac - 50/60 Hz	Ø 4 / 5 - 6.3x1.5 mm	120-230V ac	20 VA	3	1/2

CHARACTERISTICS: the socket-outlet is equipped with a self-protection device against overloading.

The output voltage should be selected correctly, consulting the rating of the user device before inserting the plug.

The relevant indicator LED allows the chosen voltage to be clearly seen.

NOTES: not suitable for installation in wall-mounting boxes or free-standing containers.

DATA - SATIN WHITE VERSION

TV-SAT SOCKETS



GW 15 361

COAXIAL TV SOCKETS (5-2400 MHZ), CLASS A SHIELDING - MALE IEC CONNECTOR Ø 9.5 MM

Code	Description	Attenuation	No. modules	Pack Carton
GW 15 361	Direct	0 dB	1	1/48
GW 15 362	Through wiring	5 dB	1	1/24
GW 15 363	Through wiring	10 dB	1	1/24
GW 20 277	Terminal resistance 75 ohm	-	-	50/200

CHARACTERISTICS: GW15361 allows the passage of voltage/current of remote power supply and/or control signals towards the user port (max 24V - 500 mA).

GW20277 in combination with feedthrough socket-outlets allows you to make terminal socket-outlets.

APPLICATIONS: Socket-outlets suitable for return channel.

NOTES: the TV 5dB GW15362 coaxial socket-outlet is defined with conditional use: it is a special feedthrough socket-outlet, and must be used as such, with the only difference that the user port (socket-outlet towards the user device) must always be closed with a 75-Ohm load. (TV, VCR, SAT receiver or 75-Ohm termination)



GW 15 371

COAXIAL TV-SAT SOCKETS (5-2400 MHZ), CLASS A SHIELDING - FEMALE F CONNECTOR

Code	Description	Attenuation	No. modules	Pack Carton
GW 15 371	Direct	0 dB	1	1/48
GW 15 372	Through wiring	5 dB	1	1/24
GW 15 373	Through wiring	10 dB	1	1/24
GW 20 277	Terminal resistance 75 ohm	-	-	50/200

CHARACTERISTICS: GW15371 allows the passage of voltage/current of remote power supply and/or control signals towards the user port (max 24V - 500 mA).

GW20277 in combination with feedthrough socket-outlets allows you to make terminal socket-outlets.

APPLICATIONS: Socket-outlets suitable for return channel.

NOTES: the TV-SAT 5dB GW15372 coaxial socket-outlet is defined with conditional use: it is a special feedthrough socket-outlet, and must be used as such, with the only difference that the user port (socket-outlet towards the user device) must always be closed with a 75-Ohm load (TV, VCR, SAT receiver or 75-Ohm termination).



GW 15 382

TV-FM-SAT SOCKETS

Code	Connectors	Description	Attenuation	No. modules	Pack Carton
GW 15 381	TV-FM	Direct	0 dB	2	1/24
GW 15 382	TV-FM-SAT	Direct	0 dB	2	1/24
GW 15 383	TV-SAT	Direct	0 dB	2	1/24

CHARACTERISTICS: TV-FM direct co-axial socket-outlet GW15381: male IEC-type TV connector ø 9.5mm, female IEC-type FM connector ø 9.5mm.

TV-FM-SAT direct co-axial socket-outlet GW15382: male IEC-type TV connector ø 9.5mm, female IEC-type FM connector ø 9.5mm, female F-type SAT connector.

TV-SAT direct co-axial socket-outlet GW15383: male IEC-type TV connector ø 9.5mm, female F-type SAT connector.

NOTES: demixed socket-outlets with input for co-axial cable ø 5mm or 7mm.



GW 15 367

COAXIAL TV SOCKETS (5-2400 MHZ), CLASS A SHIELDING - MALE IEC CONNECTOR Ø 9.5MM

Code	Description	Attenuation	No. modules	Pack Carton
GW 15 367	Direct	0 dB	2	1/24

CHARACTERISTICS: allows the passage of voltage/current of remote power supply and/or control signals towards the user port (max 24V - 500 mA).

APPLICATIONS: socket-outlets suitable for return channel.

CHORUSMART - Domestic range



GW 15 377

COAXIAL TV-SAT SOCKETS (5-2400 MHZ), CLASS A SHIELDING - FEMALE F CONNECTOR

Code	Description	Attenuation	No. modules	Pack Carton
GW 15 377	Direct	0 dB	2	1/24

CHARACTERISTICS: allows the passage of voltage/current of remote power supply and/or control signals towards the user port (max 24V - 500 mA).
APPLICATIONS: socket-outlets suitable for return channel.



GW 15 386

COVERS FOR TV-SAT-R ANTENNA SOCKETS

Code	Description	No. holes	Pack Carton
GW 15 386	For TV-R base	2	1/24
GW 15 387	For TV/R-SAT base	2	1/24

APPLICATIONS: suitable for integration on the Chorus range of TV-SAT-R standard bases available on the market.
ACCESSORIES SUPPLIED: fixing screws.

TELEPHONE SOCKETS



GW 15 401

RJ11 TELEPHONE SOCKETS

Code	Description	Connection	No. modules	Pack Carton
GW 15 401	RJ11	Screw-on terminals	1	1/24

APPLICATIONS: telephone, telefax, modem.



GW 15 409

RJ11 TELEPHONE SOCKET

Code	Description	Connection	No. modules	Pack Carton
GW 15 409	RJ11	Screw-on terminals	2	1/24

APPLICATIONS: telephone, telefax, modem.



GW 15 406

BRITISH STANDARD TELEPHONE SOCKET

Code	Description	Connection	No. modules	Pack Carton
GW 15 406	6 contacts	Screw-on terminals	1	1/24

DATA SOCKETS



GW 15 421

RJ45 SOCKETS

Code	Description	Number pairs	Use category	Cables	Connection	No. modules	Pack Carton
GW 15 421	RJ45	4	5e	UTP	Toolless	1	1/24
GW 15 422	RJ45	4	5e	FTP	Toolless	1	1/24
GW 15 423	RJ45	4	6	UTP	Toolless	1	1/24
GW 15 424	RJ45	4	6	FTP	Toolless	1	1/24

APPLICATIONS: LANs up to 100MHz (e.g. Ethernet, Token Ring networks) for cat. 5e; LANs up to 250MHz (e.g. Videoconference systems, CCTV) for cat. 6.
NOTES: circuit identification label included.



GW 15 431

ADAPTERS FOR HOUSING DATA CONNECTORS

Code	Compatibility	No. modules	Pack Carton
GW 15 431	AMP / Keystone Jack	1	1/48
GW 15 438	SYSTIMAX COMMSCOPE	1	1/48

NOTES: with regard to the technological developments and dimensional variants introduced by connector manufacturers, you are advised to check in advance the full compatibility between the connector and the GEWISS adapter.



GW 15 437

RJ45 SOCKETS

Code	Description	Number pairs	Use category	Cables	Connection	No. modules	Pack Carton
GW 15 434	RJ45	4	5e	UTP	Toolless	2	1/24
GW 15 436	RJ45	4	5e	FTP	Toolless	2	1/24
GW 15 435	RJ45	4	6	UTP	Toolless	2	1/24
GW 15 437	RJ45	4	6	FTP	Toolless	2	1/24

APPLICATIONS: LAN networks up to 100 MHz (e.g. Ethernet or Token Ring networks) for cat. 5e; LAN networks up to 250 MHz (e.g. video conference or video control systems) for cat. 6.

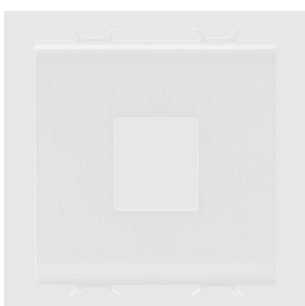

GW 15 433

ADAPTER FOR HOUSING DATA CONNECTORS

Code	Compatibility	No. modules	Pack Carton
GW 15 433	AMP / Keystone Jack	2	4/100

NOTES: due to technological developments and dimensional variants introduced by connector manufacturers, you are advised to check in advance the full compatibility between the data socket and the GEWISS empty enclosure.

CHORUSMART - Domestic range

ADAPTERS FOR OPTICAL FIBER



GW 38 335

ANGLED SC/APC ADAPTER

Code	Type	Tilt	For connectors	Compatibility	Colour	Pack Carton
GW 38 335	Female/Female	40°	SC/APC	Keystone Jack	Green RAL 6018	1/25

CHARACTERISTICS: cable outlet inclined of 40° to the wall line. With ceramic fiber optic sleeve and dust caps. The front output is protected with safety cap and unmissable cord. Suitable to join two single-mode SC/APC fiber optic patch cables.

NOTES: for adapters (Chorus, System and Dahlia) with Keystone Jack coupling.

SOCKET-OUTLETS FOR AUXILIARY CIRCUITS



GW 15 451

SELV SOCKETS

Code	Description	For plug pins	No. modules	Pack Carton
GW 15 451	2P - 6A - 24V	∅ 3 mm	1	12/24
GW 15 452	2P - 6A - 24V polarised	Flat	1	12/24

CHARACTERISTICS: Centre distance 12.4mm.

AUDIO AND VIDEO SOCKETS



GW 15 453

AUDIO AND VIDEO SOCKETS

Code	Description	No. modules	Pack Carton
GW 15 453	Double RCA	1	1/24
GW 15 454	For loudspeaker	1	1/24
GW 15 458	Speaker socket	1	1/24

CHARACTERISTICS: GW15453 double RCA stud connector, red and white, weld-in connection.

GW15454 welding connection. GW15458 front access terminals for inserting 1.5 mm² rigid wires, insulator punching rear connection suitable for cables AWG24 or max 0.25mm².

USB AND HDMI COUPLERS AND SOCKETS



GW 15 459

USB SOCKETS

Code	Description	No. modules	Pack Carton
GW 15 459	USB socket-outlet	1	1/24

CHARACTERISTICS: A-type USB 2.0 female connector, with screw terminals on the back.



GW 38 056

USB AND HDMI COUPLERS

Code	Description	Type	Compatibility	Pack Carton
GW 38 056	HDMI coupler	Female/Female	Keystone Jack	1/48
GW 38 057	USB coupler	Female/Female - A type	Keystone Jack	1/48

NOTES: for adapters designed to house data connectors (Chorus, System, Playbus and Dahlia) with Keystone Jack type coupling and permutation panels.

USB CHARGERS



GW 15 449

USB POWER SUPPLY FOR ELECTRONIC DEVICES

Code	Supply voltage	Output voltage	Max current supplied	Type of port	No. modules	Pack Carton
GW 15 447	100 ÷ 240 V ac - 50/60 Hz	5V dc	3 A	A+A	1	1/10
GW 15 449	100 ÷ 240 V ac - 50/60 Hz	5V dc	3 A	A+C	1	1/10

CHARACTERISTICS: suitable for recharging a single electronic device (e.g. tablet) or two devices simultaneously (e.g. a tablet and smartphone). The division of the current delivered to the two outputs depends on the state of charge of the connected devices.

PROTECTION - SATIN WHITE VERSION

MINIATURE CIRCUIT BREAKERS



GW 15 463

MCB - MINIATURE CIRCUIT BREAKERS - C CHARACTERISTIC - 230V AC

Code	Description	Rated current (A)	Breaking capacity	No. modules	Pack Carton
GW 15 461	Single pole (1P)	6	3 kA	1	1/12
GW 15 462	Single pole (1P)	10	3 kA	1	1/12
GW 15 463	Single pole (1P)	16	3 kA	1	1/12
GW 15 466	Two-pole (1P+N)	6	3 kA	1	1/12
GW 15 467	Two-pole (1P+N)	10	3 kA	1	1/12
GW 15 468	Two-pole (1P+N)	16	3 kA	1	1/12



GW 15 488

RCBO - RESIDUAL CURRENT BREAKERS WITH OVERCURRENT PROTECTION - C CHARACTERISTIC - CLASS A - 230V AC - 50/60 HZ

Code	Description	Rated current (A)	Breaking capacity	I _{Δn}	No. modules	Pack Carton
GW 15 482	Two-pole (1P+N)	6	3 kA	10 mA	2	1/6
GW 15 483	Two-pole (1P+N)	6	3 kA	30 mA	2	1/6
GW 15 485	Two-pole (1P+N)	10	3 kA	10 mA	2	1/6
GW 15 486	Two-pole (1P+N)	10	3 kA	30 mA	2	1/6
GW 15 488	Two-pole (1P+N)	16	3 kA	10 mA	2	1/6
GW 15 489	Two-pole (1P+N)	16	3 kA	30 mA	2	1/6

CHORUSMART - Domestic range

PROTECTION DEVICES



GW 15 491

FUSE HOLDER - 250V AC

Code	Rated current (A)	Fuse type	No. modules	Pack Carton
GW 15 491	16	Ø 6.3x32 mm	1	1/12

CHARACTERISTICS: fuse not included.



GW 15 492

SURGE PROTECTION DEVICE - 230V AC

Code	Uc	Up	No. modules	Pack Carton
GW 15 492	275 V ac 50/60Hz	1 kV	1	1/12

CHARACTERISTICS: green LED for status signalling.

APPLICATIONS: protection of electronic devices (TV, HI-FI, computer, etc.) from overvoltage (resulting from atmospheric conditions or manoeuvres) that could be channelled from the power supply lines.

INDICATOR - SATIN WHITE VERSION

INDICATOR LIGHT DEVICES



GW 15 642

SINGLE INDICATOR LAMPS - 1/2 MODULE

Code	Diffuser colour	Colour meaning	No. modules	Pack Carton
GW 15 641	Opal diffuser	Neutral	1/2	2/48
GW 15 642	Green	Safety	1/2	2/48
GW 15 643	Red	Danger	1/2	2/48
GW 15 644	Amber	Attention	1/2	2/48

CHARACTERISTICS: LED signalling units, not included.

APPLICATIONS: the meaning of the diffusers refers to the recommendations of standard EN60073 with regard to the use of the colours in indicator lights.



GW 15 622

SINGLE INDICATOR LAMPS - 1 MODULE

Code	Diffuser colour	Colour meaning	No. modules	Pack Carton
GW 15 621	Opal diffuser	Neutral	1	1/24
GW 15 622	Green	Safety	1	1/24
GW 15 623	Red	Danger	1	1/24
GW 15 624	Amber	Attention	1	1/24

CHARACTERISTICS: LED signalling units, not included.

APPLICATIONS: the meaning of the diffusers refers to the recommendations of standard EN60073 with regard to the use of the colours in indicator lights.



GW 15 629

DOUBLE INDICATOR LAMPS - 1 MODULE

Code	Diffuser colour	No. modules	Pack Carton
GW 15 628	Opal diffuser	1	1/24
GW 15 629	Red/green	1	1/24

CHARACTERISTICS: LED signalling units, not included.

APPLICATIONS: the meaning of the diffusers refers to the recommendations of standard EN60073 with regard to the use of the colours in indicator lights.



GW 15 633

PROTRUDING INDICATOR LAMPS - 2 MODULES

Code	Supply voltage	Diffuser colour	Lamp	No. modules	Pack Carton
GW 15 631	12V ac/dc - 230V ac 50/60 Hz	Opal diffuser	White LED	2	1/24
GW 15 632	12V ac/dc - 230V ac 50/60 Hz	Green	White LED	2	1/24
GW 15 633	12V ac/dc - 230V ac 50/60 Hz	Red	White LED	2	1/24
GW 15 634	12V ac/dc - 230V ac 50/60 Hz	Amber	White LED	2	1/24

CHARACTERISTICS: highly efficient white LED, powered at 12V ac/dc - 230V ac with double power supply inlet.

APPLICATIONS: suitable for special applications such as the signalling of calls from hospital wards.

NOTES: complete with lamp.



GW 15 656

STAIR RISER LAMP

Code	Supply voltage	Diffuser colour	Lamp	No. modules	Pack Carton
GW 15 651	12V ac/dc - 230V ac 50/60 Hz	Opal diffuser	White LED	2	1/24
GW 15 656	12V ac/dc - 230V ac 50/60 Hz	Opal diffuser	White LED	4	1/2

CHARACTERISTICS: highly efficient white LED, powered at 12V ac/dc - 230V ac with double power supply inlet.

ANTI BLACK-OUT AND EMERGENCY LAMPS



GW 15 662

ANTI BLACK-OUT LAMP

Code	Supply voltage	Power supply batteries	Minimum autonomy	Lamp	No. modules	Pack Carton
GW 15 662	230 V ac - 50/60 Hz	Ni - Mh	1 h	White LED	1	1/12

CHARACTERISTICS: green LED for the presence of mains voltage signalling. Highly efficient, white LED lamp.



GW 15 663

AUTONOMOUS EMERGENCY LAMPS

Code	Supply voltage	Power supply batteries	Minimum autonomy	Lamp	No. modules	Pack Carton
GW 15 663	230 V ac - 50/60 Hz	Ni - Mh	1 h	White LED	2	1/6
GW 15 666	230 V ac - 50/60 Hz	Ni - Mh	1 h	White LED	4	1/2

CHARACTERISTICS: green mains presence signal LED. Highly efficient, white LED lamps.

APPLICATIONS: compliant with standards EN60598-2-22.

CHORUSMART - Domestic range

ACOUSTIC SIGNALLING DEVICES



GW 15 601

RINGERS

Code	Supply voltage	Max power consumption	Sound intensity	No. modules	Pack Carton
GW 15 601	12V ac - 50 Hz	8 VA	80 dB (at 1 m)	1	1/24
GW 15 602	230V ac - 50 Hz	8 VA	80 dB (at 1 m)	1	1/24

CHARACTERISTICS: for intermittent use (5 sec. ON / 15 sec. OFF).



GW 15 606

BUZZERS

Code	Supply voltage	Max power consumption	Sound intensity	No. modules	Pack Carton
GW 15 606	12V ac - 50 Hz	8 VA	70 dB (at 1 m)	1	1/24
GW 15 607	230V ac - 50 Hz	8 VA	70 dB (at 1 m)	1	1/24

CHARACTERISTICS: for intermittent use (5 sec. ON / 15 sec. OFF).



GW 15 611

THREE TONE RINGER AND THREE INDEPENDENT INPUTS

Code	Supply voltage	Max power consumption	Sound intensity	No. modules	Pack Carton
GW 15 611	12V ac/dc	3 VA	80 dB (at 1 m)	2	1/6
GW 15 612	230V ac - 50 Hz	6 VA	80 dB (at 1 m)	2	1/6

CHARACTERISTICS: for continuous use. Three tones (alarm, ring and two-tone) with adjustable sound intensity.

APPLICATIONS: it is possible to combine the outdoor call, indoor call and alarm functions with one single device.

ENERGY, TEMPERATURE AND COMFORT MANAGEMENT - SATIN WHITE VERSION

TEMPERATURE CONTROL DEVICES



GW 15 709

CONNECTED THERMOSTAT - ZIGBEE

Code	Supply voltage	Output contacts	No. modules	Pack Carton
GW 15 709	100 ÷ 240 V ac - 50/60 Hz	1 NO / NC 5A (AC) 240 V ac	2	1/3

FEATURES: flush-mounted thermostat for the control of heating/cooling systems with manual temperature management and possibility of shutdown. Control algorithms for two-way systems: two points (ON/OFF), proportional-integral (PWM). The thermostat can control a solenoid valve for heating or cooling through a local contact or via Zigbee, in which case the solenoid valve must be controlled by a Zigbee actuator. GWA1521, GWA1522, GWA1523, GW1x826, GWA1201, and GWA1202 Zigbee connected actuators can be used.

The thermostat is equipped with integrated temperature and humidity sensors. The thermostat has an input for a NTC sensor (GW10800 and GW1x900 sensors can be used) for external temperature measurement (e.g., for compensation of temperatures measured locally by the thermostat or for protection in case of underfloor heating/cooling).

APPLICATIONS: climate control (heating or cooling) of a housing unit or area; option to manage a daily or weekly heating/cooling profile via the APP. The device measures humidity, if a threshold (defined during configuration) is exceeded, Zigbee can activate a dehumidification system and display/notify the measurement on the APP.

Use in traditional unconnected systems: the connected thermostat can also be used in traditional unconnected installations. In this case, configuration is not carried out via the APP and the NTC sensor input can only be used to compensate for the temperature measurement detected locally by the thermostat.



GW 15 705

THERMOSTAT

Code	Supply voltage	Temperature adjustment	Output contacts	No. modules	Pack Carton
GW 15 705	230 V ac - 50/60 Hz	From +5°C to +35°C	1NO / NC 8A(AC1) 250V ac	2	1/2

CHARACTERISTICS: choice of working mode by means of selector located on the front: summer (air-conditioner), OFF, winter (boiler). Two-colour front LED to signal the output status (open/closed contact). The lighting up of the LED also indicates mains presence.



GW 16 970 CB

THERMO ICE WI-FI THERMOSTAT - WALL-MOUNTING

Code	Colour	Supply voltage	Temperature adjustment	Output contacts	Dimensions LxHxD (mm)	Pack Carton
GW 16 970 CB	White	110-230V ac - 50/60Hz	From +5°C to +40°C	2NO 6A(AC1) 250V ac	123x95x21	1

CHARACTERISTICS: wall-mounting thermostat to control heating/cooling and humidification/dehumidification systems and manage the temperature in manual mode or on 3 levels (comfort, pre-comfort, economy). Control algorithms for two-way systems: two points (ON/OFF), proportional integral (PWM). Includes 1 input for external NTC temperature sensor (e.g.: protection for flood mounting heating). Equipped with a user interface with touch commands (capacitive) on technopolymer plate and backlit display. The thermostat has built-in proximity, temperature and humidity sensors and a Wi-Fi interface for setting parameters and programming temperature profiles (timed thermostat function) locally or by remote via specific apps (smartphone and tablet).
NOTES: wall-mounting with wall-plugs or on 3-modules rectangular boxes (centre distance 83.5 mm) Plate material; technopolymer.

DIMMER



GW 15 575

UNIVERSAL ROTATING ELECTRONIC REGULATOR

Code	Supply voltage	No. modules	Pack Carton
GW 15 575	230V ac - 50 Hz	1	1/12

CHARACTERISTICS: suitable for dimming incandescent and halogen lamps 230 V ac (10-160 W); low-voltage halogen lamps (12 V ac) with electronic transformers (10-160 W) and LED lamps 230 V ac (4-160W), rotary control with 2-way switch. Equipped with amber-colour-red signalling LED. Can be operated without neutral connection.

NOTES: the installation of more than one dimmer side-by-side in a single container is not permitted. To avoid overheating, insert a blanking module between two dimmers. If installing two dimmers in the same box, the maximum loads that can be controlled by each dimmer must be reduced by 50%.



GW 15 564

ROTATING ELECTRONIC REGULATORS FOR RESISTIVE/INDUCTIVE LOADS

Code	Supply voltage	Resistive load 230V ac	Inductive load 230V ac	No. modules	Pack Carton
GW 15 564	230 V ac - 50/60 Hz	100 - 900 W	40 - 300 VA	1	1/12
GW 15 567	230 V ac - 50/60 Hz	100 - 500 W	100 - 500 VA	1	1/12

CHARACTERISTICS: with signalling led orange. GW15567 rotary command with two-way switch.

GW15564 compliance with the EMC directive is only guaranteed by connecting the regulator to an LC filter with the following characteristics: L=1mH - 5A, C=0.15uF - 275V X2, according to the documentation provided with the product. Item designated solely for export to a limited number of countries outside of the European Union or countries applying to become part of the European Free Trade Area. Contact GEWISS Customer Service to check the product meets the regulations of the country concerned before importing it.

NOTES: to avoid overheating, the side by side installation of several products in a single container is not permitted; insert a blanking module between two electronic devices. If installing two regulators in the same box, the maximum loads that can be commanded by each regulator must be reduced by 50%.



GW 15 572 A

UNIVERSAL ELECTRONIC REGULATORS WITH PUSH-BUTTON

Code	Supply voltage	No. modules	Pack Carton
GW 15 572 A	230V ac - 50/60 Hz	1	1/12
GW 15 573 A	230V ac - 50/60 Hz	2	1/6

CHARACTERISTICS: for the regulation and switching of incandescent and halogen lamps 230V AC (40-300W), low voltage halogen and LED lamps with electronic and winding transformers (40-300W), LED lamps 230V AC with dimmer function (5-150W). Manual selection of the type of load (Leading Edge or Trailing Edge piloting), soft-start function for lamp protection. Possibility to command and regulate from remote control push-buttons with NO contacts. Equipped with orange signalling LED.

NOTES: to avoid overheating, the side-by-side installation of several products in a single container is not permitted; insert a blanking module between two electronic devices. If two regulators are installed in the same box, the maximum loads that can be commanded by each regulator must be reduced by 50%.

CHORUSMART - Domestic range



GW 15 568

ELECTRONIC REGULATOR WITH BUTTON FOR RESISTIVE/INDUCTIVE LOADS

Code	Supply voltage	Resistive load 230V ac	Inductive load 230V ac	No. modules	Pack Carton
GW 15 568	230V ac - 50 Hz	60 - 500 W	60 - 500 VA	1	1/2

CHARACTERISTICS: possibility to command and regulate from remote control push-buttons with NO contact. With signalling led orange.

NOTES: to avoid overheating, the side by side installation of several products in a single container is not permitted; insert a blanking module between two electronic devices. If installing two regulators in the same box, the maximum loads that can be commanded by each regulator must be reduced by 50%.

TECHNICAL ALARMS - SATIN WHITE VERSION

GAS DETECTORS



GW 15 712

METHANE GAS DETECTOR

Code	Supply voltage	Tripping threshold	Output contacts	No. modules	Pack Carton
GW 15 712	12V ac/dc	9% LIE	1NO/NC 10A(NO)/3A(NC)250V ac	2	1/2

CHARACTERISTICS: relay output for the automatic command of the gas interception solenoid valve (manual reset) GW30522. Sound intensity: 85dB at 1m.



GW 10 720

POWER SUPPLY UNIT 12VDC

Code	Supply voltage	Output voltage	Max current supplied	Dimensions LxHxD (mm)	Pack Carton
GW 10 720	100 ÷ 240 V ac - 50/60 Hz	12V dc	300 mA	52x33x17	1/10

APPLICATIONS: to be used for powering LPG detectors (GW1x711, GW2x868, GW30520), methane detectors (GW1x712, GW2x867, GW30519); Thermo ICE KNX (GW16974CB, GW16974CN, GW16974CT) thermostats.

ANTI-FLOOD SYSTEM WITH ZIGBEE WIRELESS TRANSMISSION



GW A1 514

ZIGBEE FLOOD ALARM - IP20

Code	Siren output	Temperature sensor	Colour	Dimensions (mm)	Pack Carton
GW A1 514	85 dB/3 m	0...50 °C	White	Ø 60x37	1/6

CHARACTERISTICS: the alarm detects the presence of water and includes a temperature sensor. Powered by CR123-type battery (replaceable).

NOTES: floor-mounting or alternatively wall-mounting possibility through the GWA1541 accessory. To be used in combination with the Zigbee actuator GWA1521 when controlling an electrovalve or a load.



GW A1 521

1-CHANNEL ACTUATOR ZIGBEE

Code	Supply voltage	Output contacts	Dimensions LxHxD (mm)	Pack Carton
GW A1 521	230V ac - 50 Hz	1 NO 10A (AC) 230 V ac	42x40x20	1/4

CHARACTERISTICS: 1-channel actuator for activating loads via the potential-free output contact (NO). Suitable for commanding incandescent lamps (230 V ac): 2300W, loads controlled from toroidal transformers: 450W, loads controlled from electronic transformers: 600W, energy saving lamps (compact fluorescent): 150W, LED lamps (230 V ac): 150W, motors: 500W.

APPLICATIONS: when used with the water sensor, provide the installation of a NO push-button to open the electrovalve manually.

NOTES: installation in flush-mounting boxes, junction boxes, etc..



GW 15 750

BLANKING MODULE FOR HOUSING RF ZIGBEE ACTUATORS

Code	Colour	No. modules	Pack Carton
GW 15 750	Satin White	1	1/12

CHARACTERISTICS: 1-modules blanking module with pad printing. Allows the housing and fast identification of the flush-mounting RF Zigbee actuator.

NOTES: snap-in assembly.

ACCESSORIES



GW A1 541

WALL-MOUNTING SUPPORT FOR FLOOD ALARM

Code	Colour	Support dimension (mm)	Dimensions of probe (mm)	Cable max. length (cm)	Pack Carton
GW A1 541	White	Ø72x25	Ø50x8	85	1/4

APPLICATIONS: to be used for the wall-mounting of the Zigbee flood alarm GWA1514.



GW 30 522

SOLENOID VALVE, WITH MANUAL RESET, NORMALLY OPEN - 230V - 50HZ

Code	Delivery Ø	Material	Power input	Pack Carton
GW 30 522	3/4"	Brass	12 VA	1/2

CHORUSMART - Domestic range

ACCESSORIES

SIGNALLING UNITS



GW 10 881

LED SIGNALLING UNITS - 230V AC - 0.6 W

Code	Lamp voltage	Lamp power	Lamp	Light emitted	Cable Colour	Pack Carton
GW 10 881	230 V ac - 50/60 Hz	0.6 W	LED	Blue	Blue	50
GW 10 882	230 V ac - 50/60 Hz	0.6 W	LED	White	White	50
GW 10 883	230 V ac - 50/60 Hz	0.6 W	LED	Red	Red	50
GW 10 884	230 V ac - 50/60 Hz	0.6 W	LED	Green	Green	50
GW 10 885	230 V ac - 50/60 Hz	0.6 W	LED	Amber	Orange	50

NOTES: the LED signalling units are supplied with power supply cables (length 10 cm).



GW 10 894

LED SIGNALLING UNITS - 12-24V AC/DC - 0.6 W

Code	Lamp voltage	Lamp power	Lamp	Light emitted	Cable Colour	Pack Carton
GW 10 894	12-24V ac/dc	0.6 W	LED	White	White	50

NOTES: the LED signalling units are supplied with power supply cables (length 10 cm).



GW 20 902

CARTRIDGE LAMPS - 2W

Code	Lamp voltage	Lamp power	Lamp	Light emitted	Dimensions (mm)	Pack Carton
GW 20 902	12V ac/dc	2 W	Incandescence	White	56x36	50
GW 20 903	24V ac/dc	2 W	Incandescence	White	56x36	50

ACCESSORIES

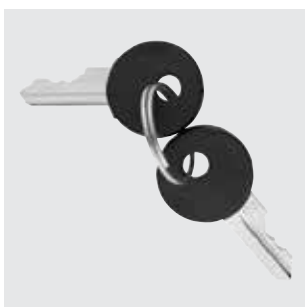

GW 20 901

SET OF 2 KEYS FOR COMMAND DEVICES

Code	Suitable for	Pack Carton
GW 20 901	One-way switches - two-way switches	1/100
GW 30 912	Push-buttons	1/100



ChoruSmart



Scan the QR Code and find out all the technical informations.

INNOVATIVE

AESTHETIC VARIABILITY

SCALABLE



ChoruSmart offers the best technologies for an aesthetic and functional experience suitable for every person. In particular, the new EVO axial and touch controls offer the ability to centralize the management of lights and shutters with an extremely simplified installation.

The wide range of options for customising the devices, in terms of colour and modularity, ensures a vast choice of solutions. Six colourways are available: three with a satin finish and three with a glossy finish, for a perfect match between the devices and the plate.

ChoruSmart began as a traditional domestic series, but with the addition of a few Connected Smart Home or Home&Building Pro elements, it can become smart and suitable for both renovations and new buildings. The combination of colours, materials, finishes and shapes offers something for every taste and need.

ChoruSmart

Satin natural beige modular devices

The ChoruSmart modular devices make it possible to create infinite combination between devices and plates, thanks to a complete range that is able to satisfy all design, functional and installation requirements. Colors and finishes: natural satin beige, warm and enveloping. Unlimited functions in reduced spaces: the ChoruSmart range consists of rocker button keys with 1/2, 1, 2 and 3 modules, to optimise space as needed, and axial keys in EVO or SMART version, to satisfy even the most modern needs. Front coupling: the front coupling makes the component assembly and release operations simple and quick, enabling these to be completed without removing the support, unique for all the plates and fruits.



COMMAND - NATURAL SATIN BEIGE VERSION

COMMAND DEVICES - ROCKERS - SCREW TERMINALS

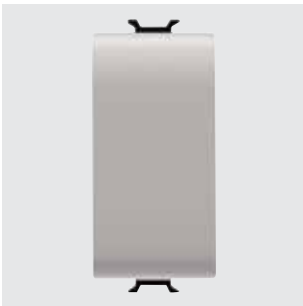

GW 13 001

ONE-WAY SWITCHES 1P - 250V AC

Code	Description	Button key	Rated power of 230V LED lamps	Pack Carton
No. modules: 1				
GW 13 001	1P - 16AX	Neutral	200 W	12/96
GW 13 002	1P - 16AX illuminable	With diffuser	200 W	12/24
GW 13 003	1P - 16AX illuminable	With replaceable neutral lens	200 W	12/24
No. modules: 1/2				
GW 13 021	1P - 10AX	Neutral	100 W	12/24
GW 13 022	1P - 10AX illuminable	With diffuser	100 W	6/24
No. modules: 2				
GW 13 031	1P - 16AX	Neutral	200 W	6/24
GW 13 032	1P - 16AX illuminable	With diffuser	200 W	6/24
GW 13 033	1P - 16AX illuminable	With replaceable neutral lens	200 W	6/24
No. modules: 3				
GW 13 041	1P - 16AX	Neutral	200 W	4/12
GW 13 042	1P - 16AX illuminable	With diffuser	200 W	4/12
GW 13 043	1P - 16AX illuminable	With replaceable neutral lens	200 W	4/12

CHARACTERISTICS: the illuminable articles use LED signalling units, not included.



GW 13 004

ONE-WAY SWITCHES 2P - 250V AC

Code	Description	Button key	Symbol	Rated power of 230V LED lamps	Pack Carton
No. modules: 1					
GW 13 004	2P - 16 AX	Neutral	0/1	200 W	12/48
GW 13 005	2P - 16AX illuminable	With replaceable neutral lens	-	200 W	12/24
GW 13 006	2P - 10AX	With key	0/1	100 W	1/12
No. modules: 2					
GW 13 034	2P - 16 AX	Neutral	0/1	200 W	6/24
GW 13 035	2P - 16AX illuminable	With replaceable neutral lens	-	200 W	6/24

CHARACTERISTICS: the illuminable articles use LED signalling units, not included.

NOTES: GW13006 equipped with 2 keys. Key extractable in both positions. Spare keys: GW20901.

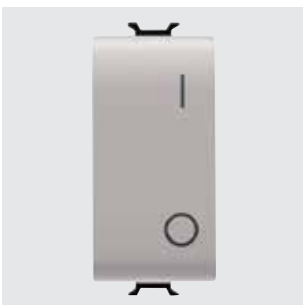

GW 13 007

ONE-WAY SWITCH 2P - 250V AC - HEAVY DUTY LOADS

Code	Description	Button key	Symbol	Rated power of 230V LED lamps	Pack Carton
No. modules: 1					
GW 13 007	2P - 25 AX	Neutral	0/1	250 W	12/24

APPLICATIONS: suitable for particular heavy-duty loads (e.g. LED or fluorescent lamp batteries) or high-consumption devices (e.g. ovens, air-conditioners, boilers, etc.).



GW 13 051

TWO-WAY SWITCHES 1P - 250V AC

Code	Description	Button key	Rated power of 230V LED lamps	Pack Carton
No. modules: 1				
GW 13 051	1P - 16AX	Neutral	200 W	12/96
GW 13 052	1P - 16AX illuminable	With diffuser	200 W	12/24
GW 13 053	1P - 16AX illuminable	With replaceable neutral lens	200 W	12/24
GW 13 054	1P - 10AX	With key	100 W	1/12
No. modules: 1/2				
GW 13 061	1P - 10AX	Neutral	100 W	6/24
No. modules: 2				
GW 13 071	1P - 16AX	Neutral	200 W	6/24
GW 13 072	1P - 16AX illuminable	With diffuser	200 W	6/24
GW 13 073	1P - 16AX illuminable	With replaceable neutral lens	200 W	6/24
No. modules: 3				
GW 13 081	1P - 16AX	Neutral	200 W	4/12
GW 13 082	1P - 16AX illuminable	With diffuser	200 W	4/12
GW 13 083	1P - 16AX illuminable	With replaceable neutral lens	200 W	4/12

CHARACTERISTICS: the illuminable articles use LED signalling units, not included.

NOTES: GW13054 equipped with 2 keys. Key extractable in both positions. Spare keys: GW20901.



GW 13 091

INTERMEDIATE SWITCHES 1P - 250V AC

Code	Description	Button key	Rated power of 230V LED lamps	Pack Carton
No. modules: 1				
GW 13 091	1P - 16AX	Neutral	200 W	12/48
GW 13 092	1P - 16AX illuminable	With diffuser	200 W	12/24
GW 13 093	1P - 16AX illuminable	With replaceable neutral lens	200 W	12/24
No. modules: 2				
GW 13 101	1P - 16AX	Neutral	200 W	6/12
GW 13 102	1P - 16AX illuminable	With diffuser	200 W	6/12
GW 13 103	1P - 16AX illuminable	With replaceable neutral lens	200 W	6/12
No. modules: 3				
GW 13 111	1P - 16AX	Neutral	200 W	4/12
GW 13 112	1P - 16AX illuminable	With diffuser	200 W	4/12
GW 13 113	1P - 16AX illuminable	With replaceable neutral lens	200 W	4/12

CHARACTERISTICS: the illuminable articles use LED signalling units, not included.



GW 13 121

THREE-WAY SWITCHES 1P - 250V AC

Code	Description	Button key	Symbol	Rated power of 230V LED lamps	Pack Carton
No. modules: 1					
GW 13 121	1P - 10AX	Neutral	UP - DOWN	100 W	12/24
No. modules: 2					
GW 13 123	1P - 10AX	Neutral	UP - DOWN	100 W	6/24

CHARACTERISTICS: three standing positions. Both contacts are open in the central position (OFF).

APPLICATIONS: command of circuits requiring an interlock (e.g. operating motorised devices with direction reversal). 2-user selective control.

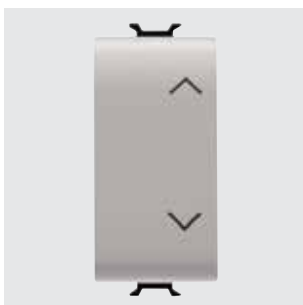

GW 13 122

THREE-WAY SWITCH 2P - 250V AC

Code	Description	Button key	Symbol	Rated power of 230V LED lamps	Pack Carton
No. modules: 1					
GW 13 122	2P - 10AX	Neutral	UP - DOWN	100 W	12/24

CHARACTERISTICS: three standing positions. Both contacts are open in the central position (OFF). With 6 terminal blocks.

APPLICATIONS: command of circuits requiring an interlock (e.g. operating motorised devices with direction reversal). 2-user selective control.

CHORUSMART - Domestic range

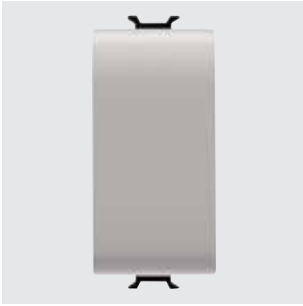

GW 13 131

PUSH-BUTTONS 1P - 250V AC

Code	Description	Button key	Symbol	Pack Carton
No. modules: 1				
GW 13 131	1P NO - 16A	Neutral	-	12/96
GW 13 132	1P NO - 16A illuminable	With diffuser	-	12/24
GW 13 133	1P NO - 16A illuminable	With replaceable neutral lens	-	12/24
GW 13 136	1P NO - 16A	Pull-cord	-	1/12
GW 13 137	1P NC - 16A	Neutral	O red	12/24
GW 13 138	1P NC+NO - 16 A	Stop	Red	12/24
GW 13 139	1P NO+NC - 16 A	Start	Green	12/24
GW 13 140	1P NO+NO - 10A	With interlock	UP - DOWN	12/24
GW 13 141	1P NO+NO - 16 A	Double	-	12/24
GW 13 142	1P NO - 16A illuminable	Green diffuser	-	12/24
GW 13 143	1P NO - 16A illuminable	Red diffuser	-	12/24
GW 13 144	1P NO - 16A illuminable	Opal diffuser	-	12/24
GW 13 151	1P NO - 16A illuminable	With replaceable neutral lens	Light	12/24
GW 13 152	1P NO - 16A illuminable	With replaceable neutral lens	Key	12/24
GW 13 153	1P NO - 16A illuminable	With replaceable neutral lens	Bell	12/24
No. modules: 1/2				
GW 13 161	1P NO - 10A	Neutral	-	6/24
GW 13 162	1P NO - 10A illuminable	With diffuser	-	6/24
No. modules: 2				
GW 13 171	1P NO - 16A	Neutral	-	6/24
GW 13 172	1P NO - 16A illuminable	With diffuser	-	6/24
GW 13 173	1P NO - 16A illuminable	With replaceable neutral lens	-	6/24
No. modules: 3				
GW 13 181	1P NO - 16A	Neutral	-	4/12
GW 13 182	1P NO - 16A illuminable	With diffuser	-	4/12
GW 13 183	1P NO - 16A illuminable	With replaceable neutral lens	-	4/12

CHARACTERISTICS: the illuminable articles use LED signalling units, not included.

GW13136 Cord in insulating material, 140cm long, with red knob.

GW13140 Button with mechanical interlock. Both contacts are open in the central position (OFF); advisable for activating motorised devices with direction reversal (e.g. roller-shutters, curtains, etc.).

GW13141 independent push-buttons that can also be activated simultaneously.



GW 13 134

PUSH-BUTTONS 2P - 250V AC

Code	Description	Button key	Symbol	Pack Carton
No. modules: 1				
GW 13 134	2P NO - 16A	Neutral	O	12/24
GW 13 135	2P NO - 10A illuminable	With replaceable neutral lens	-	12/24
GW 13 145	2P NO - 10A	With key	-	1/12

CHARACTERISTICS: the illuminable articles use LED signalling units, not included.

GW13136 Cord in insulating material, 140cm long, with red knob.

GW13140 Button with mechanical interlock. Both contacts are open in the central position (OFF); advisable for activating motorised devices with direction reversal (e.g. roller-shutters, curtains, etc.).

GW13141 independent push-buttons that can also be activated simultaneously.



GW 13 191

PUSH-BUTTONS 1P WITH ILLUMINATED NAME PLATE - 250V AC

Code	Description	Lamp voltage	Lamp	Lamp power	Pack Carton
No. modules: 2					
GW 13 191	1P NO - 10A	12-24V ac/dc	Cartridge lamp S6x36 mm	2 W	6/24
No. modules: 3					
GW 13 192	1P NO - 10A	12-24V ac/dc	Cartridge lamp S6x36 mm	2 W	4/16

CHARACTERISTICS: lamp not included.

COMMAND DEVICES - ROCKERS - QUICK WIRING TERMINALS



GW 13 031 F

ONE-WAY SWITCHES 1P - 250V AC

Code	Description	Button key	Rated power of 230V LED lamps	Pack Carton
No. modules: 2				
GW 13 031 F	1P - 16AX	Neutral	200 W	6/24
GW 13 032 F	1P - 16AX illuminable	With diffuser	200 W	6/24
GW 13 033 F	1P - 16AX illuminable	With replaceable neutral lens	200 W	6/24

CHARACTERISTICS: the illuminable articles use LED signalling units, not included.

NOTES: spring quick wiring, no tools necessary.

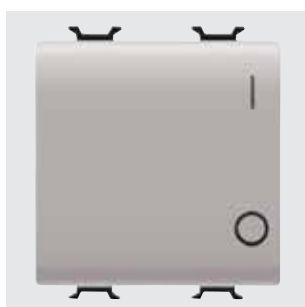

GW 13 034 F

ONE-WAY SWITCHES 2P - 250V AC

Code	Description	Button key	Symbol	Rated power of 230V LED lamps	Pack Carton
No. modules: 2					
GW 13 034 F	2P - 16 AX	Neutral	0/1	200 W	6/24
GW 13 035 F	2P - 16AX illuminable	With replaceable neutral lens	-	200 W	6/24

CHARACTERISTICS: the illuminable articles use LED signalling units, not included.

NOTES: spring quick wiring, no tools necessary.



GW 13 071 F

TWO-WAY SWITCHES 1P - 250V AC

Code	Description	Button key	Rated power of 230V LED lamps	Pack Carton
No. modules: 2				
GW 13 071 F	1P - 16AX	Neutral	200 W	6/24
GW 13 072 F	1P - 16AX illuminable	With diffuser	200 W	6/24
GW 13 073 F	1P - 16AX illuminable	With replaceable neutral lens	200 W	6/24

CHARACTERISTICS: the illuminable articles use LED signalling units, not included.

NOTES: spring quick wiring, no tools necessary.



GW 13 101 F

INTERMEDIATE SWITCHES 1P - 250V AC

Code	Description	Button key	Rated power of 230V LED lamps	Pack Carton
No. modules: 2				
GW 13 101 F	1P - 16AX	Neutral	200 W	6/12
GW 13 102 F	1P - 16AX illuminable	With diffuser	200 W	6/12
GW 13 103 F	1P - 16AX illuminable	With replaceable neutral lens	200 W	6/12

CHARACTERISTICS: the illuminable articles use LED signalling units, not included.

NOTES: spring quick wiring, no tools necessary.

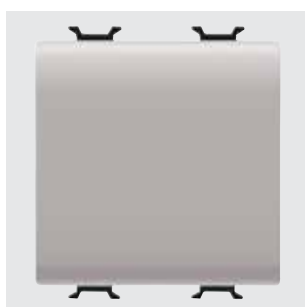

GW 13 171 F

PUSH-BUTTONS 1P - 250V AC

Code	Description	Button key	Pack Carton
No. modules: 2			
GW 13 171 F	1P NO - 16A	Neutral	6/24
GW 13 172 F	1P NO - 16A illuminable	With diffuser	6/24
GW 13 173 F	1P NO - 16A illuminable	With replaceable neutral lens	6/24

CHARACTERISTICS: the illuminable articles use LED signalling units, not included.

NOTES: spring quick wiring, no tools necessary.

CHORUSMART - Domestic range



GW 13 160 F

COMBINED COMMAND DEVICES - ROCKERS - 250 V AC

Code	Description	Button key	Symbol	Rated power of 230V LED lamps	Pack Carton
No. modules: 2					
GW 13 078 F	Twin two-way switch 1P - 16 AX	Neutral	-	200 W	6/24
GW 13 159 F	Two-way switch 1P - 16 AX / Push-button 1P NO - 16A	Neutral	-	200 W	6/24
GW 13 160 F	Twin push-button 1P NO - 16 A	Neutral	UP - DOWN - STOP	-	6/24

NOTES: spring quick wiring, no tools necessary.

COMMAND DEVICES - AXIAL - SCREW TERMINALS



GW 10 671

AXIAL SWITCH MODULE - EVO

Code	Supply voltage	Output contacts	No. modules	Pack Carton
GW 10 671	100 ÷ 240 V ac - 50/60 Hz	1 NA 5A (AC1) 240 V ac	1	1/12
GW 10 672	100 ÷ 240 V ac - 50/60 Hz	1 NA 5A (AC1) 240 V ac	2	1/6

CHARACTERISTICS: devices for the control of 1 On/Off lighting device through a live output contact. Suitable for the control of incandescent and halogen (240Vac): 1000W, LED lamps (240Vac): 100W, fluorescent lamps (240Vac): 120W, halogen lamps powered by electronic transformers (240Vac): 250VA. Local push button with axial activation for control of the lamps connected to the device.

Equipped with 1 input to replicate the local control of the load via auxiliary module GW10677, GW10678 or NO-type and 1 input buttons for the centralisation OFF function.

APPLICATIONS: Bistable, monostable and timed load. Centralisation function (OFF) by means of a dedicated input, the possibility of being able to switch the load on by means of auxiliary axial modules or NO-type buttons. The devices are equipped with a configurable blue LED that can be set to OFF, easy location mode or for signalling the connected load status.

NOTES: the devices must be completed with a front button key: GW10671 must be completed with the GW13551S or GW13555S button keys. The GW10672 must be completed with the GW13552S or GW13556S button keys.



GW 10 673

AXIAL DIMMER MODULE - EVO

Code	Supply voltage	Halogen load	Inductive load	LED load	No. modules	Pack Carton
GW 10 673	100 ÷ 240 V ac - 50/60 Hz	4 - 150 W	4 - 150 VA	4 - 150 W	1	1/12
GW 10 674	100 ÷ 240 V ac - 50/60 Hz	4 - 150 W	4 - 150 VA	4 - 150 W	2	1/6

CHARACTERISTICS: trailing edge load drive mode (max. 5 lamps). Two local axial operated buttons for dimming the connected load.

Equipped with 2 inputs for replicating local control of the load via the auxiliary module GW10679, GW10680 or NO-type buttons or for creating the centralisation function.

APPLICATIONS: control of the dimmable load connected to the devices. The dedicated inputs can be used to add a load switching-on function through auxiliary axial modules or NO-type buttons, or inputs can be set, via programming, for the centralised OFF function. The devices are equipped with configurable blue LEDs that can be set to OFF, location mode or for signalling the connected load.

NOTES: To avoid overheating, multiple dimmers cannot be installed side-by-side inside in the same enclosure. Insert a blanking module between two electronic devices. If two dimmers are installed in the same box, the maximum loads controlled by each dimmer must be reduced by 50%. The devices must be completed with a front button key: GW10673 must be completed with the GW13553S or GW13557S button keys; GW10674 must be completed with the GW13554S or GW13558S button keys.



GW 10 675

AXIAL ROLLER SHUTTER MODULE - EVO

Code	Supply voltage	Max current supplied	No. modules	Pack Carton
GW 10 675	100 ÷ 240 V ac - 50/60 Hz	2,3 A 240 V ac (according to IEC 60669-2-1)	1	1/12
GW 10 676	100 ÷ 240 V ac - 50/60 Hz	2,3 A 240 V ac (according to IEC 60669-2-1)	2	1/6

CHARACTERISTICS: Devices for the control of a motor to operate roller-shutters, curtains, venetian blinds, awnings, etc., through 2 live interlocked output contacts. Two axial-operated local buttons control the motor connected to the device. Equipped with 2 inputs for replicating local control of the motor via the auxiliary module GW10679, GW10680 or NO-type up/down buttons, or for creating the centralisation function.

APPLICATIONS: control of the motor connected to the devices. The dedicated inputs can be used to operate roller-shutters/venetian blinds via the auxiliary axial modules or NO-type up/down buttons, or they can be set, through programming, for centralisation functions (Up/Down). The devices are equipped with blue LEDs which can be configured to facilitate location at night and to signal the movement of the roller-shutter/Venetian blind.

NOTES: the devices must be completed with a front button key: GW10675 must be completed with the GW13553S or GW13557S button keys. GW10676 must be completed with the GW13554S or GW13558S button keys.



GW 10 677

1-COMMAND AUXILIARY AXIAL MODULES

Code	Supply voltage	Output contacts	No. modules	Pack Carton
GW 10 677	100 ÷ 240 V ac - 50/60 Hz	1 NO 1 A (AC1) 240 V ac	1	1/12
GW 10 678	100 ÷ 240 V ac - 50/60 Hz	1 NO 1 A (AC1) 240 V ac	2	1/6

FEATURES: auxiliary controls to be used in conjunction with the EVO switch modules.

The devices are equipped with blue LEDs for easy location or to display the load status.

APPLICATIONS: when connected to the local inputs of the EVO axial controls, they allow replication of the local load control or the management of centralised controls.

NOTES: the devices must be completed with a front button key: GW10677 must be completed with the GW13551S or GW13555S button keys. The GW10678 must be completed with the GW13552S or GW13556S button keys.



GW 10 679

2-COMMAND AUXILIARY AXIAL MODULES

Code	Supply voltage	Output contacts	No. modules	Pack Carton
GW 10 679	100 ÷ 240 V ac - 50/60 Hz	2 NO 1 A (AC1) 240 V ac	1	1/12
GW 10 680	100 ÷ 240 V ac - 50/60 Hz	2 NO 1 A (AC1) 240 V ac	2	1/6

FEATURES: auxiliary controls to be used in conjunction with the EVO dimmer and roller-shutter modules.

The devices are equipped with blue LEDs for easy location or to display the load status.

APPLICATIONS: when connected to the local inputs of the EVO axial controls, they allow replication of the local load control or the management of centralised controls.

NOTES: the devices must be completed with a front button key: GW10679 must be completed with the GW13553S or GW13557S button keys. The GW10680 must be completed with the GW13554S or GW13558S button keys.



GW 13 551 S

INTERCHANGEABLE BUTTON KEYS FOR AXIAL DEVICES

Code	Colour	Button key	No. modules	Pack Carton
GW 13 551 S	Natural satin beige	To be completed with lens	1	1/48
GW 13 552 S	Natural satin beige	To be completed with lens	2	1/48
GW 13 553 S	Natural satin beige	To be completed with 2 lenses	1	1/48
GW 13 554 S	Natural satin beige	To be completed with 2 lenses	2	1/48
GW 13 555 S	Natural satin beige	With 1 diffuser	1	1/48
GW 13 556 S	Natural satin beige	With 1 diffuser	2	1/48
GW 13 557 S	Natural satin beige	With 2 diffusers	1	1/48
GW 13 558 S	Natural satin beige	With 2 diffusers	2	1/48

NOTES: for use for completing EVO axial modules and auxiliary axial controls.

LENSES WITH ILLUMINATED SYMBOL



ZC6

SYMBOLS FOR ILLUMINABLE ROCKER COMMAND DEVICES

Code	Symbol	Pack Carton
Suitable for: General services		
GW 10 501	Neutral	20/240
GW 10 502	Light	20/240
GW 10 503	Stair light	20/240
GW 10 504	Table light	20/240
GW 10 505	Bell	20/240
GW 10 506	Fan	20/240
GW 10 507	Key	20/240
GW 10 508	Alarm	20/240
GW 10 509	ON	20/240
GW 10 510	OFF	20/240
GW 10 511	Nurse	20/240
GW 10 512	Waitress	20/240
GW 10 513	Dimmer increase	20/240
GW 10 514	Dimmer decrease	20/240
GW 10 515	UP arrow	20/240
GW 10 516	DOWN arrow	20/240
GW 10 517	UP - DOWN arrow	20/240
GW 10 518	RIGHT - LEFT arrow	20/240
Suitable for: Numerical services		
GW 10 531	One	20/240
GW 10 532	Two	20/240
GW 10 533	Three	20/240
GW 10 534	Four	20/240
GW 10 535	Five	20/240
GW 10 536	Six	20/240
GW 10 537	Seven	20/240
GW 10 538	Eight	20/240
GW 10 539	Nine	20/240
GW 10 540	Zero	20/240

NOTES: for use in place of the neutral lens in the illuminated tilting control devices.

CHORUSMART - Domestic range



ZC6

LENSES WITH ILLUMINATING SYMBOLS FOR AXIAL BUTTON KEYS

Code	Symbol	Pack Carton
GW 10 501 A	Neutral	24
GW 10 502 A	Light	24
GW 10 503 A	Stair light	24
GW 10 504 A	Table light	24
GW 10 505 A	Bell	24
GW 10 506 A	Burglar alarm	24
GW 10 507 A	Key	24
GW 10 508 A	ON OFF	24
GW 10 509 A	ON	24
GW 10 510 A	OFF	24
GW 10 511 A	Socket-outlet	24
GW 10 512 A	Dimmers	24
GW 10 513 A	Dimmer increase	24
GW 10 514 A	Dimmer decrease	24
GW 10 515 A	Arrow	24
GW 10 516 A	Open	24
GW 10 517 A	Close	24
GW 10 518 A	Roller shutter	24
GW 10 519 A	Roller shutter up	24
GW 10 520 A	Roller shutter down	24
GW 10 521 A	Curtain open	24
GW 10 522 A	Curtain close	24
GW 10 523 A	Floor light	24
GW 10 524 A	Ceiling light	24
GW 10 525 A	Wall light	24
GW 10 526 A	Aisle light	24
GW 10 527 A	Scenario	24
GW 10 528 A	Party	24
GW 10 529 A	In	24
GW 10 530 A	Out	24
GW 10 531 A	Good morning	24
GW 10 532 A	Good night	24
GW 10 533 A	TV	24
GW 10 534 A	Heating	24
GW 10 535 A	Cooling	24
GW 10 536 A	Heating/Cooling	24
GW 10 537 A	Comfort	24
GW 10 538 A	Precomfort	24
GW 10 539 A	Economy	24
GW 10 540 A	Auto	24
GW 10 541 A	Do not disturb	24
GW 10 542 A	Make up the room	24

NOTE: for use to customise the interchangeable push buttons for axial controls with 1 and 2 lenses.

INTERCHANGEABLE BUTTON KEYS AND DIFFUSERS FOR ROCKER DEVICES



ZC6

BUTTON KEYS FOR ROCKER CONTROLS AND INTERCHANGEABLE DIFFUSERS FOR INDICATOR LIGHTS

Code	Symbol	Pack Carton
Description: Keys 22x22 mm		
GW 13 541	General	4/48
GW 13 542	With label	4/48
GW 13 543	Key	4/48
GW 13 544	Bell	4/48
GW 13 545	Vertical arrow	4/48
GW 13 546	Horizontal arrow	4/48
Description: Diffusers		
GW 10 547	Red	4/48
GW 10 548	Green	4/48
GW 10 549	Opal diffuser	4/48
GW 10 550	Amber	4/48

APPLICATIONS: replacement diffusers for indicators GW13142, GW13143 and GW13144.

NOTES: the ChoruSmart modular system allows the use of 22 x 22 mm interchangeable buttons in place of the standard buttons fitted on the control devices GW13141, GW13142, GW13143 and GW13144. Symbols/diffusers not suitable for the EVO axial keys.

SOFT-CLICK, ROCKER ELECTRONIC PUSH BUTTONS



GW 13 915

UNIVERSAL SOFT-CLICK ELECTRONIC PUSH-BUTTON

Code	Type of contact	Button key	Type of use	No. modules	Pack Carton
GW 13 915	1NO/NC 4A (AC1) 230 V ac - Potential-free Neutral		Relay, dimmer, bus contacts interfaces	1	1/12

CHARACTERISTICS: push-button suitable for connection of KNX BUS contacts interfaces, or the command of bistable relays, electronic one-way switches for heavy duty loads, or dimmers with a remote control input.



GW 13 912

BACKLIT SOFT-CLICK ELECTRONIC PUSH-BUTTON

Code	Supply voltage	Type of contact	Button key	Type of use	Pack Carton
GW 13 912	230 V ac - 50/60 Hz	1NO 4A (AC1) 230 V ac	With diffuser	Relay, dimmer	1/12

CHARACTERISTICS: push-button for controlling latching relays, electronic switches for heavy duty loads, or dimmers with a remote control input. Equipped with amber localisation LED.



GW 13 913

BACKLIT SOFT-CLICK ELECTRONIC PUSH-BUTTONS FOR BUS INPUTS

Code	Type of contact	Button key	Type of use	Pack Carton
No. modules: 1				
GW 13 913	1NO - Potential-free	With diffuser	Bus contacts interfaces	1/12
GW 13 916	1NO - Potential-free	With replaceable neutral lens	Bus contacts interfaces	1/12
No. modules: 2				
GW 13 917	1NO - Potential-free	With diffuser	Bus contacts interfaces	1/6
GW 13 918	1NO - Potential-free	With replaceable neutral lens	Bus contacts interfaces	1/6

CHARACTERISTICS: push-button for BUS inputs, suitable for KNX BUS contact interface connections. Equipped with 2-colour (amber/green) LED with colour selector (can be set up to work as a night-time localisation lamp or to indicate the load status).

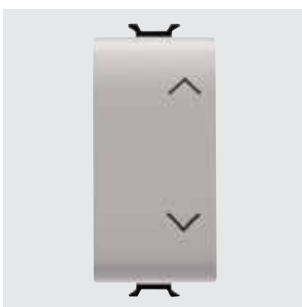

GW 13 914

DOUBLE SOFT-CLICK ELECTRONIC PUSH-BUTTON

Code	Type of contact	Button key	Symbol	No. modules	Pack Carton
GW 13 914	Dual, potential-free and with interlock	Neutral	UP - DOWN	1	1/12

CHARACTERISTICS: double push-button suitable for connecting KNX BUS contact interfaces or electronic control panels for moving roller shutters.

CHORUSMART - Domestic range

TOUCH COMMAND MODULES



GW 10 922

TOUCH ONE-WAY SWITCH MODULE

Code	Supply voltage	Output contacts	No. modules	Pack Carton
GW 10 922	100 ÷ 240 V ac - 50/60 Hz	1 NA 5A (AC1) 240 V ac	1	1/12

CHARACTERISTICS: device for the On/Off control of 1 lighting device through a live output contact. Suitable for control of incandescent and halogen lamps (240Vac): 1000W, LED lamps (240Vac): 100W, fluorescent lamps (240Vac): 120W, halogen lamps powered by electronic transformers (240Vac): 250VA. Equipped with 1 input for replicating local control of the load via the GW10924 auxiliary touch control modules, NO-type buttons and 1 input for the centralisation of the OFF function. The device is equipped with blue LEDs for easy location that can be set to two different light intensity levels. Excludable built-in buzzer, function identification by means of icons on the ICE touch plates.

APPLICATIONS: bistable, monostable and timed load control. Centralisation function (OFF) through the dedicated input.

NOTES: to be completed with ICE touch plates (codes: GW16955CB, GW16955CL, GW16955CN, GW16955CT).



GW 10 923

TOUCH DIMMER MODULE

Code	Supply voltage	Halogen load	Inductive load	LED load	No. modules	Pack Carton
GW 10 923	100 ÷ 240 V ac - 50/60 Hz	4 - 150 W	4 - 150 VA	4 - 150 W	1	1/12

CHARACTERISTICS: trailing edge load drive mode (max. 5 lamps). Two touch areas for dimming the connected load. Equipped with 2 inputs for replicating local control of the load via the auxiliary touch 2-command modules GW10925, NO-type buttons, or for creating the centralisation function OFF. The device is equipped with blue LEDs for easy location that can be set to two different light intensity levels. Excludable built-in buzzer, function identification by means of icons on the ICE touch plates.

APPLICATIONS: control of the dimmable load connected to the devices. Centralised OFF function, via dedicated inputs.

NOTE: to avoid overheating, multiple products cannot be installed side-by-side inside in the same enclosure; insert a blanking module between two electronic devices. When installing two dimmers in the same box, the maximum loads controlled by each dimmer must be reduced by 50%. To be completed using ICE touch plates (codes: GW16955CB, GW16955CL, GW16955CN, GW16955CT).



GW 10 921

TOUCH ROLLER SHUTTER MODULE

Code	Supply voltage	Maximum output power	No. modules	Pack Carton
GW 10 921	100 ÷ 240 V ac - 50/60 Hz	2,3 A 240 V ac (according to IEC 60669-2-1)	1	1/12

CHARACTERISTICS: Devices for the control of a motor to operate roller-shutters, curtains, venetian blinds, awnings, etc., by means of 2 interlocked live output contacts. Two touch areas for controlling the motor connected to the device. Equipped with 2 inputs for replicating local control of the motor via the touch auxiliary 2-command modules GW10925, NO-type up/down buttons, or for creating a centralisation function (up/down). The device is equipped with blue LEDs for easy location that can be set to two different light intensity levels. Excludable built-in buzzer, function identification by means of icons on the ICE touch plates.

APPLICATIONS: control of the motor connected to the devices. Centralisation function (Up/Down) by means of a dedicated inputs.

NOTES: to be completed with ICE touch plates (codes: GW16955CB, GW16955CL, GW16955CN, GW16955CT).

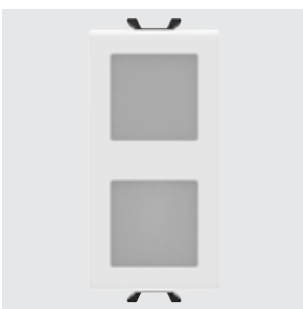

GW 10 924

1-COMMAND AUXILIARY TOUCH MODULE

Code	Supply voltage	Output contacts	No. modules	Pack Carton
GW 10 924	100 ÷ 240 V ac - 50/60 Hz	100mA 240 V ac	1	1/12

CHARACTERISTICS: suitable for controlling the GW10922 module. The device is equipped with blue LEDs for easy location that can be set to two different light intensity levels. Excludable built-in buzzer, function identification by means of icons on the ICE touch plates.

NOTES: to be completed using ICE touch plates (codes: GW16955CB, GW16955CL, GW16955CN, GW16955CT).

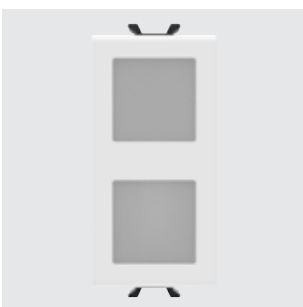

GW 10 925

2-COMMAND AUXILIARY TOUCH MODULE

Code	Supply voltage	Output contacts	No. modules	Pack Carton
GW 10 925	100 ÷ 240 V ac - 50/60 Hz	100mA 240 V ac	1	1/12

CHARACTERISTICS: suitable for controlling the GW10921 and GW10923 modules. The device is equipped with blue LEDs for easy location that can be set to two different light intensity levels. Excludable, built-in buzzer and functions identifiable by the icons on the ICE touch plates.

NOTES: to be completed with ICE touch plates (codes: GW16955CB, GW16955CL, GW16955CN, GW16955CT).

ICE TOUCH PLATES



GW 16 955 CL

ICE TOUCH - NATURAL BEIGE

Code	Description	For support codes	Pack Carton
GW 16 955 CL	6 touch areas	GW16803, GW16803N	1

CHARACTERISTICS: glossy finish. The plate is to be used in combination with the touch modules (switch module GW10922, roller shutter module GW10921, dimmer module GW10923, 1-control auxiliary module GW10924, 2-control auxiliary module GW10925).

NOTES: the symbols displayed in the image are purely indicative and may be customised using the icons supplied with the touch plate. The code of the plate is unique and independent of the number of icons used (from 2 to 6).

BLANKING MODULES AND CABLE OUTLET



GW 13 195

BLANKING MODULES

Code	Description	No. modules	Pack Carton
GW 13 195	1 module	1	10/200
GW 13 197	1/2 module	1/2	4/48
GW 13 198	2 modules	2	1/48
GW 13 199	3 modules	3	1/48



GW 13 194

CABLE OUTLETS

Code	Description	No. modules	Pack Carton
GW 13 194	2 modules	2	6/48
GW 13 196	1 module	1	1/48

NOTES: GW13196 with anti-traction cable fastener device, cables min 6mm ø, max 10mm ø.

GW13194 with anti-traction cable fastener device, cables min 4mm ø, max 10mm ø. To be installed with the cable output downwards.

MOVEMENT DETECTORS



GW 13 594

MOVEMENT DETECTOR

Code	Supply voltage	Output contacts	Pack Carton
GW 13 594	230V ac - 50/60 Hz	1NO 3 A (AC1) 230 V ac	1/4

CHARACTERISTICS: adjustment of the intervention duration 15 sec - 10 min. Light sensitive threshold adjustment - min. 10 lux - max. inhibited.

Suitable for commanding halogen lamps/resistive loads: 700 W, incandescent lamps: 450 W, low voltage halogen lamps (12 V) controlled by toroidal or electronic transformers: 450 W, uncompensated fluorescent lamps: 2x58 W, motors and gear motors: 400 VA, LED loads: 60 W (max. 10 lamps).

Not suitable for compensated fluorescent lamps, for discharge lamps and for all loads not indicated that must be commanded using a support relay.

APPLICATIONS: Energy-saving: command of the lighting of rooms and areas only when people pass through.

Comfort and safety: automatic command of circuits without needing to activate one-way switches.

NOTES: do not install the product in watertight plates: the lid membrane does not allow the detector lens to work correctly. Detection beam angle 120°, depth of detection max 8 metres.

CHORUSMART - Domestic range



GW 10 595

CEILING-MOUNTED PRESENCE DETECTOR

Code	Supply voltage	Installation height (m)	Light sensor	Dimensions HxØ (mm)	Pack Carton
GW 10 595	220/240 V ac - 50/60 Hz	From 2,2 to 6	< 3 ÷ 2000 Lux	44x111,5	1

CHARACTERISTICS: presence sensor, sensing range: 360° circle (max. diameter 18 metres); installable with fixing springs on a surface-mounted or recessed box. Suitable for the control of incandescent/halogen lamps: 1000W, LED lamps: 200W (4 / 23 W - max. 8 lamps).

NOTE: equipped with a surface-mount box capable of holding sensors from IP20 to IP44.

RELAY



GW 13 724

RELAY - 230V AC 50/60HZ

Code	Type	No. of poles	Output contacts	Coil	Pack Carton
No. modules: 1					
GW 13 721	Latching relay	1P	10 AX 250V ac	230V ac - 50/60 Hz	1/12
GW 13 723	Latching relay, 4 seq.	2P	10 AX 250V ac	230V ac - 50/60 Hz	1/12
GW 13 724	Monostable relay	1P	1NO/NC 10A(AC1)/2A(AC15)250V ac	230V ac - 50/60 Hz	1/12

CHARACTERISTICS: GW13721, GW13723 suitable for commanding incandescent/halogen lamps: 1000 W, fluorescent tubes with electronic ballast: 400 W, fluorescent tubes with electromechanical ballast: 360 W, compact fluorescent lamps (CFL): 200 W, LED lamps (230V ac): 200 W, low voltage halogen or LED lamps with electronic ballast: 200 W, low voltage halogen or LED lamps with electromechanical ballast: 400 W.

APPLICATIONS: GW13721, GW13723 command of lighting devices from more than one point, by means of remote NO push-buttons.

GW13721 motor function/stop commands (extractors, air agitators, etc.).

GW13724 as an auxiliary element for commanding special loads, for distance signalling, for electrical separation between the command and use circuits.



GW 13 726

CALL RELAY - 12V AC/DC

Code	Supply voltage	No. of poles	Output contacts	No. modules	Pack Carton
GW 13 726	12V ac/dc	1P	1NO/NC 12 V (max. 1A)	1	1/12

CHARACTERISTICS: inlets for remote NO push-buttons for alarms (e.g. GW13136) and alarm reset (e.g. GW13145), green LED for alarm status signalling.

HOTEL COMPONENTS - NATURAL SATIN BEIGE VERSION

BADGE SWITCH



GW 13 039

BADGE SWITCH

Code	Description	For badge card max. width	Rated power of 230V LED lamps	No. modules	Pack Carton
GW 13 039	1P NA - 16 AX illuminable	54 mm	200 W	2	1/6

CHARACTERISTICS: the product can be fitted directly in 2-module plates; with plates of a greater modularity, you are advised to use 2 blanking modules for a 1/2 module (one on the right and one on the left).

APPLICATIONS: activation of circuits and services in hotel rooms (e.g. lights, air-conditioner, fridge-bar), indication of room occupied (with badge inserted)

NOTES: badges not included. The article uses LED signalling units, not included.

INTERCHANGEABLE BUTTON KEYS



GW 13 733

INTERCHANGEABLE BUTTON KEYS

Code	Button key	Symbol	No. modules	Pack Carton
GW 13 731	With diffuser	DND	1	4/48
GW 13 732	With diffuser	MUR	1	4/48
GW 13 733	Neutral	DND+MUR	1	4/48

CHARACTERISTICS: with "Do not disturb" (DND) and "Make up the room" (MUR) pad printings. To be used for the customization of the Chorus command devices. GW13731 and GW13732 suitable for one-way switches, two-way switches, intermediate switches and push-buttons. GW13733 suitable for three-way switches and push-buttons with central OFF position.

INDICATOR LIGHT DEVICE



GW 13 736

DOUBLE INDICATOR LAMP

Code	Diffuser colour	Symbol	No. modules	Pack Carton
GW 13 736	Opal diffuser	DND+MUR	1	1/24

CHARACTERISTICS: LED signalling units not included.

CHORUSMART - Domestic range

POWER - NATURAL SATIN BEIGE VERSION

SOCKET-OUTLETS - ITALIAN/GERMAN STANDARD



GW 13 203

ITALIAN STANDARD SOCKET-OUTLETS - 250V AC

Code	Description	Socket-out type	For plug pins	No. modules	Pack Carton
GW 13 201	2P+E - 10A	P11	Ø 4 mm	1	12/96
GW 13 203	2P+E - 16 A Dual amperage	P11-P17	Ø 4 / 5 mm	1	12/96

CHARACTERISTICS: with safety shields.



GW 13 204

ITALIAN/GERMAN STANDARD SOCKET-OUTLETS - 250V AC

Code	Description	Earth pit	Socket-out type	For plug pins	No. modules	Pack Carton
GW 13 204	2P+E - 16 A Dual amperage	Side and central	P40	Ø 4 / 4.8 / 5 mm	2	6/48
GW 13 205	2P+E - 16A	Side and central	P30	Ø 4 / 4.8 mm	2	6/48

CHARACTERISTICS: with safety shields.

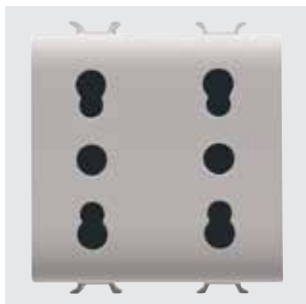

GW 13 208

ITALIAN STANDARD DOUBLE SOCKET-OUTLET - 250V AC

Code	Description	Socket-out type	For plug pins	No. modules	Pack Carton
GW 13 208	2x2P+E - 16A Dual amperage	P11-P17	Ø 4 / 5 mm	2	6/24

CHARACTERISTICS: with safety shields. The wiring is carried out via 3 terminals that power the socket-outlets, without using U-bolts.

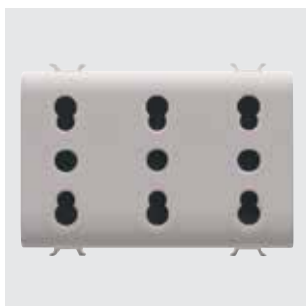

GW 13 209

ITALIAN STANDARD TRIPLE SOCKET-OUTLET - 250V AC

Code	Description	Socket-out type	For plug pins	No. modules	Pack Carton
GW 13 209	3x2P+E - 16A Dual amperage	P11-P17	Ø 4 / 5 mm	3	4/12

CHARACTERISTICS: with safety shields. The wiring is carried out via 3 terminals that power the socket-outlets, without using U-bolts.

SOCKET-OUTLETS FOR DEDICATED LINES - ITALIAN/GERMAN STANDARD



GW 10 213

ITALIAN STANDARD SOCKET-OUTLET FOR DEDICATED LINES - 250V AC

Code	Description	Colour	Socket-out type	For plug pins	No. modules	Pack Carton
GW 10 213	2P+E - 16 A Dual amperage	Red	P11-P17	Ø 4 / 5 mm	1	12/24
GW 10 223	2P+E - 16 A Dual amperage	Green	P11-P17	Ø 4 / 5 mm	1	12/24

CHARACTERISTICS: with safety shields.



GW 10 214

ITALIAN/GERMAN STANDARD SOCKET-OUTLET FOR DEDICATED LINES - 250V AC

Code	Description	Colour	Socket-out type	For plug pins	No. modules	Pack Carton
GW 10 214	2P+E - 16 A Dual amperage illuminable	Red	P40	Ø 4 / 4.8 / 5 mm	2	6/12
GW 10 224	2P+E - 16 A Dual amperage illuminable	Green	P40	Ø 4 / 4.8 / 5 mm	2	6/12

CHARACTERISTICS: with safety shields. Pit of side and central earth contacts. Pre-arranged for housing LED signalling units, not included.

APPLICATIONS: possibility to indicate presence of auxiliary network.

SOCKET-OUTLETS - GERMAN STANDARD



GW 13 241

GERMAN STANDARD SOCKET-OUTLET - 250V AC

Code	Description	For plug pins	No. modules	Pack Carton
GW 13 241	2P+E - 16A	Ø 4.8 mm	2	6/48

CHARACTERISTICS: with safety shields.



GW 13 242

GERMAN STANDARD SOCKET-OUTLET WITH LID IP40 - 250V AC

Code	Description	For plug pins	No. modules	Pack Carton
GW 13 242	2P+E - 16A	Ø 4.8 mm	2	6/48

CHARACTERISTICS: with safety shields. Equipped with a transparent rigid cover with a glossy finish. IP40 degree of protection with the cover closed.

CHORUSMART - Domestic range

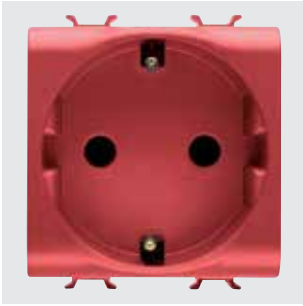

GW 10 251

GERMAN STANDARD SOCKET-OUTLET FOR DEDICATED LINES - 250V AC

Code	Description	Colour	For plug pins	No. modules	Pack Carton
GW 10 251	2P+E - 16A	Red	Ø 4.8 mm	2	6/12

CHARACTERISTICS: with safety shields.



GW 13 341

GERMAN STANDARD SOCKET-OUTLET WITH FRONT TIGHTENING TERMINALS - 250V AC

Code	Description	For plug pins	No. modules	Pack Carton
GW 13 341	2P+E - 16A	Ø 4.8 mm	2	6/12

CHARACTERISTICS: with safety shields. Front access terminals with screw fixing, side input of the conductors.



GW 10 351

GERMAN STANDARD SOCKET-OUTLET WITH FRONT TIGHTENING TERMINALS FOR DEDICATED LINES - 250V AC

Code	Description	Colour	For plug pins	No. modules	Pack Carton
GW 10 351	2P+E - 16A	Red	Ø 4.8 mm	2	6/12

CHARACTERISTICS: with safety shields. Front access terminals with screw fixing, side input of the conductors.



GW 13 241 F

GERMAN STANDARD SOCKET-OUTLET WITH QUICK WIRING TERMINALS - 250V AC

Code	Description	For plug pins	No. modules	Pack Carton
GW 13 241 F	2P+E - 16A	Ø 4.8 mm	2	6/12

CHARACTERISTICS: with safety shields. Spring quick wiring, no tools necessary.

SOCKET-OUTLETS - FRENCH STANDARD



GW 13 246

FRENCH STANDARD SOCKET-OUTLETS - 250V AC

Code	Description	For plug pins	No. modules	Pack Carton
GW 13 246	2P - 16A	Ø 4 / 4.8 mm	2	1/24
GW 13 247	2P+E - 16A	Ø 4 / 4.8 mm	2	6/48

CHARACTERISTICS: with safety shields.



GW 13 248

FRENCH STANDARD SOCKET-OUTLET WITH FRONT TIGHTENING TERMINALS - 250V AC

Code	Description	For plug pins	No. modules	Pack Carton
GW 13 248	2P+E - 16A	Ø 4 / 4.8 mm	2	6/12

CHARACTERISTICS: with safety shields. Front access terminals with screw fixing, side input of the conductors.



GW 13 247 F

FRENCH STANDARD SOCKET-OUTLET WITH QUICK WIRING TERMINALS - 250V AC

Code	Description	For plug pins	No. modules	Pack Carton
GW 13 247 F	2P+E - 16A	Ø 4 / 4.8 mm	2	6/12

CHARACTERISTICS: with safety shields. Spring quick wiring, no tools necessary.

SOCKET-OUTLETS - ISRAELI STANDARD



GW 13 281

ISRAELI STANDARD SOCKET-OUTLET - 250V AC

Code	Description	For plug pins	No. modules	Pack Carton
GW 13 281	2P+E - 16 A illuminable	Round Ø 4 / 4.4 mm	2	1/24

CHARACTERISTICS: with safety shields. Pre-arranged for housing LED signalling units, not included.

CHORUSMART - Domestic range



GW 10 291

ISRAELI STANDARD SOCKET-OUTLET FOR DEDICATED LINES - 250V AC

Code	Description	Colour	For plug pins	No. modules	Pack Carton
GW 10 291	2P+E - 16 A illuminable	Red	Round Ø 4 / 4.4 mm	2	1/24

CHARACTERISTICS: with safety shields. Pre-arranged for housing LED signalling units, not included.



GW 13 282

ISRAELI STANDARD SOCKET-OUTLET - 250V AC

Code	Description	For plug pins	No. modules	Pack Carton
GW 13 282	2P - 10 A	Round Ø 4 mm	1	1/48

CHARACTERISTICS: with safety shields.

SOCKET-OUTLETS - INTERNATIONAL STANDARD



GW 13 286

USA STANDARD SOCKET-OUTLET - 250/125V AC

Code	Description	For plug pins	No. modules	Pack Carton
GW 13 286	2P+E - 15A	Flat parallel horizontal	1	12/48



GW 13 288

EURO-AMERICAN STANDARD SOCKET-OUTLET - 250/125V AC

Code	Description	For plug pins	No. modules	Pack Carton
GW 13 287	2P - 15A	Ø 4 mm Flat	1	12/48
GW 13 288	2P+E - 15A	Ø 4 mm Flat	1	12/48

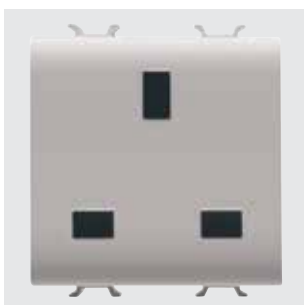

GW 13 296

BRITISH STANDARD SOCKET-OUTLETS - 250V AC

Code	Description	For plug pins	No. modules	Pack Carton
GW 13 296	2P+E - 13 A	Flat	2	6/48
GW 13 297	2P+E - 15A	Ø 7 mm	2	6/48

CHARACTERISTICS: with safety shields.

NOTES: given the size of the plugs, it is not possible to install two or more socket-outlets side-by-side.

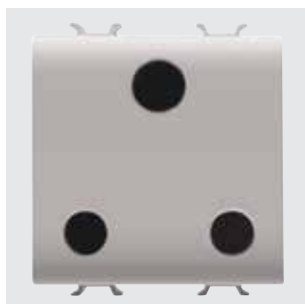

GW 13 298

INDIAN-SOUTH AFRICAN STANDARD SOCKET-OUTLET - 250V AC

Code	Description	For plug pins	No. modules	Pack Carton
GW 13 298	2P+E - 16A	Ø 7 mm	2	6/48

CHARACTERISTICS: with safety shields.

NOTES: given the size of the plugs, it is not possible to install two or more socket-outlets side-by-side.



GW 13 299

SOUTH AFRICAN STANDARD SOCKET-OUTLET - 250V AC

Code	Description	For plug pins	No. modules	Pack Carton
GW 13 299	2P+E - 16A	Round Ø 4,5 mm	1	12/240

CHARACTERISTICS: with safety shields.

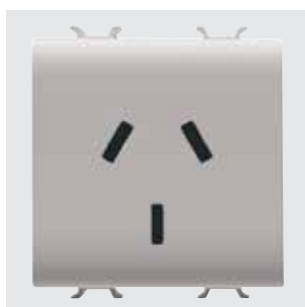

GW 13 301

ARGENTINIAN STANDARD SOCKET-OUTLET - 250V AC

Code	Description	For plug pins	No. modules	Pack Carton
GW 13 301	2P+E - 10A	Flat	2	6/48

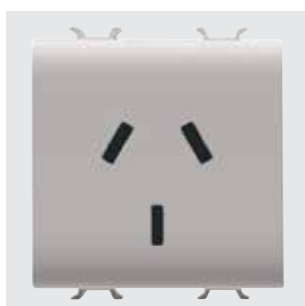

GW 13 306

AUSTRALIAN STANDARD SOCKET-OUTLETS - 250V AC

Code	Description	For plug pins	No. modules	Pack Carton
GW 13 306	2P+E - 10A	Flat	2	6/48
GW 13 307	2P+E - 15A	Flat	2	6/48



GW 13 310

MULTISTANDARD SOCKET-OUTLET - 250/127V AC

Code	Description	No. modules	Pack Carton
GW 13 310	2P+E - 13A/250 V ac - 15A/127 V ac	2	10/40

CHARACTERISTICS: with safety shields.

APPLICATIONS: suitable for plugs compliant with the following standards: Europlug 2P 2.5A - 250V, British 2P+E 13A - 250V, Italian 2P 10A - 250V, Danish 2P 10A - 250V, Chinese 2P+E 10A - 250V, Argentinean/Australian 2P+E 10A - 250V, Indian 2P+E 6A - 250V, USA 2P+E 15A - 127V. Not suitable for 2P+E German and French sockets because they don't offer earth continuity.

NOTES: the multistandard energy sockets GW13310 are in compliance with the safety requirements defined by the International Standard IEC 60884-1. These sockets may not be in compliance with the standard sheets used in the country where they are sold, hence their usage could be prohibited or however, restricted only for specific applications. The plugs allowed are listed in the technical datasheet. Please contact directly Gewiss technical service for further information.

CHORUSMART - Domestic range

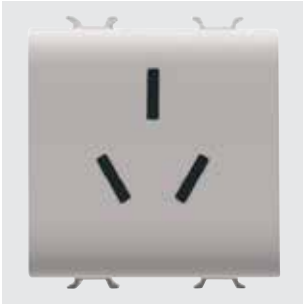

GW 13 392

CHINESE STANDARD SOCKET-OUTLETS - 250V AC

Code	Description	For plug pins	No. modules	Pack Carton
GW 13 391	2P+E - 10A	Flat	2	6/48
GW 13 392	2P+E - 16A	Flat	2	6/48

CHARACTERISTICS: with safety shields.

INTERLOCKED SWITCHED SOCKET-OUTLETS



GW 13 311

INTERLOCKED SWITCHED SOCKET-OUTLETS WITH MINIATURE CIRCUIT BREAKER - 230V AC

Code	Description	Socket-out type	Miniature circuit breakers	Breaking capacity	No. modules	Pack Carton
GW 13 311	2P+E - 16A	P17-P11	1P+N 16A	3 kA	2	1/6
GW 13 312	2P+E - 16A	P40	1P+N 16A	3 kA	3	1/4

CHARACTERISTICS: Interlocked switched socket-outlets with automatic miniature circuit breaker (C characteristic). Pits under tension only with plug inserted.

APPLICATIONS: suitable for installation in the system terminations to protect the load.



GW 13 321

INTERLOCKED SWITCHED SOCKET-OUTLETS WITH RESIDUAL MINIATURE CIRCUIT BREAKER - 230V AC

Code	Description	Socket-out type	Miniature circuit breakers	Breaking capacity	I _{dn}	No. modules	Pack Carton
GW 13 321	2P+E - 16A	P17-P11	1P+N 16A	3 kA	10 mA	3	1/4
GW 13 322	2P+E - 16A	P40	1P+N 16A	3 kA	10 mA	4	1/2

CHARACTERISTICS: Interlocked switched socket-outlets with automatic miniature circuit breaker (C characteristic) and residual current circuit breaker (type A). Pits under tension only with plug inserted.

APPLICATIONS: suitable for installation in the system terminations to protect the load.

SHAVER SOCKET-OUTLET



GW 13 331

EURO-AMERICAN STANDARD SHAVER SOCKET-OUTLET WITH INSULATION TRANSFORMER

Code	Supply voltage	For plug pins	Selectable output voltage	Maximum power	No. modules	Pack Carton
GW 13 331	230 V ac - 50/60 Hz	Ø 4 / 5 - 6.3x1.5 mm	120-230V ac	20 VA	3	1/2

CHARACTERISTICS: the socket-outlet is equipped with a self-protection device against overloading.

The output voltage should be selected correctly, consulting the rating of the user device before inserting the plug.

The relevant indicator LED allows the chosen voltage to be clearly seen.

NOTES: not suitable for installation in wall-mounting boxes or free-standing containers.

DATA - NATURAL SATIN BEIGE VERSION

TV-SAT SOCKETS



GW 13 361

COAXIAL TV SOCKETS (5-2400 MHZ), CLASS A SHIELDING - MALE IEC CONNECTOR Ø 9.5 MM

Code	Description	Attenuation	No. modules	Pack Carton
GW 13 361	Direct	0 dB	1	1/48
GW 13 362	Through wiring	5 dB	1	1/24
GW 13 363	Through wiring	10 dB	1	1/24
GW 20 277	Terminal resistance 75 ohm	-	-	50/200

CHARACTERISTICS: GW13361 allows the passage of voltage/current of remote power supply and/or control signals towards the user port (max 24V - 500 mA). GW20277 in combination with feedthrough socket-outlets allows you to make terminal socket-outlets.

APPLICATIONS: Socket-outlets suitable for return channel.

NOTES: the TV 5dB GW13362 coaxial socket-outlet is defined with conditional use: it is a special feedthrough socket-outlet, and must be used as such, with the only difference that the user port (socket-outlet towards the user device) must always be closed with a 75-Ohm load. (TV, VCR, SAT receiver or 75-Ohm termination)



GW 13 371

COAXIAL TV-SAT SOCKETS (5-2400 MHZ), CLASS A SHIELDING - FEMALE F CONNECTOR

Code	Description	Attenuation	No. modules	Pack Carton
GW 13 371	Direct	0 dB	1	1/48
GW 13 372	Through wiring	5 dB	1	1/24
GW 13 373	Through wiring	10 dB	1	1/24
GW 20 277	Terminal resistance 75 ohm	-	-	50/200

CHARACTERISTICS: GW13371 allows the passage of voltage/current of remote power supply and/or control signals towards the user port (max 24V - 500 mA). GW20277 in combination with feedthrough socket-outlets allows you to make terminal socket-outlets.

APPLICATIONS: Socket-outlets suitable for return channel.

NOTES: the TV-SAT 5dB GW13372 coaxial socket-outlet is defined with conditional use: it is a special feedthrough socket-outlet, and must be used as such, with the only difference that the user port (socket-outlet towards the user device) must always be closed with a 75-Ohm load (TV, VCR, SAT receiver or 75-Ohm termination).



GW 13 382

TV-FM-SAT SOCKETS

Code	Connectors	Description	Attenuation	No. modules	Pack Carton
GW 13 381	TV-FM	Direct	0 dB	2	1/24
GW 13 382	TV-FM-SAT	Direct	0 dB	2	1/24
GW 13 383	TV-SAT	Direct	0 dB	2	1/24

CHARACTERISTICS: TV-FM direct co-axial socket-outlet GW13381: male IEC-type TV connector ø 9.5mm, female IEC-type FM connector ø 9.5mm.

TV-FM-SAT direct co-axial socket-outlet GW13382: male IEC-type TV connector ø 9.5mm, female IEC-type FM connector ø 9.5mm, female F-type SAT connector.

TV-SAT direct co-axial socket-outlet GW13383: male IEC-type TV connector ø 9.5mm, female F-type SAT connector.

NOTES: demixed socket-outlets with input for co-axial cable ø 5mm or 7mm.



GW 13 367

COAXIAL TV SOCKETS (5-2400 MHZ), CLASS A SHIELDING - MALE IEC CONNECTOR Ø 9.5MM

Code	Description	Attenuation	No. modules	Pack Carton
GW 13 367	Direct	0 dB	2	1/24

CHARACTERISTICS: allows the passage of voltage/current of remote power supply and/or control signals towards the user port (max 24V - 500 mA).

APPLICATIONS: socket-outlets suitable for return channel.

CHORUSMART - Domestic range



GW 13 377

COAXIAL TV-SAT SOCKETS (5-2400 MHZ), CLASS A SHIELDING - FEMALE F CONNECTOR

Code	Description	Attenuation	No. modules	Pack Carton
GW 13 377	Direct	0 dB	2	1/24

CHARACTERISTICS: allows the passage of voltage/current of remote power supply and/or control signals towards the user port (max 24V - 500 mA).
APPLICATIONS: socket-outlets suitable for return channel.



GW 13 386

COVERS FOR TV-SAT-R ANTENNA SOCKETS

Code	Description	No. holes	Pack Carton
GW 13 386	For TV-R base	2	1/24
GW 13 387	For TV/R-SAT base	2	1/24

APPLICATIONS: suitable for integration on the Chorus range of TV-SAT-R standard bases available on the market.
ACCESSORIES SUPPLIED: fixing screws.

TELEPHONE SOCKETS



GW 13 401

RJ11 TELEPHONE SOCKETS

Code	Description	Connection	No. modules	Pack Carton
GW 13 401	RJ11	Screw-on terminals	1	1/24

APPLICATIONS: telephone, telefax, modem.



GW 13 409

RJ11 TELEPHONE SOCKET

Code	Description	Connection	No. modules	Pack Carton
GW 13 409	RJ11	Screw-on terminals	2	1/24

APPLICATIONS: telephone, telefax, modem.



GW 13 406

BRITISH STANDARD TELEPHONE SOCKET

Code	Description	Connection	No. modules	Pack Carton
GW 13 406	6 contacts	Screw-on terminals	1	1/24

DATA SOCKETS



GW 13 421

RJ45 SOCKETS

Code	Description	Number pairs	Use category	Cables	Connection	No. modules	Pack Carton
GW 13 421	RJ45	4	5e	UTP	Toolless	1	1/24
GW 13 422	RJ45	4	5e	FTP	Toolless	1	1/24
GW 13 423	RJ45	4	6	UTP	Toolless	1	1/24
GW 13 424	RJ45	4	6	FTP	Toolless	1	1/24

APPLICATIONS: LANs up to 100MHz (e.g. Ethernet, Token Ring networks) for cat. 5e; LANs up to 250MHz (e.g. Videoconference systems, CCTV) for cat. 6.
NOTES: circuit identification label included.



GW 13 431

ADAPTERS FOR HOUSING DATA CONNECTORS

Code	Compatibility	No. modules	Pack Carton
GW 13 431	AMP / Keystone Jack	1	1/48
GW 13 438	SYSTIMAX COMMSCOPE	1	1/48

NOTES: with regard to the technological developments and dimensional variants introduced by connector manufacturers, you are advised to check in advance the full compatibility between the connector and the GEWISS adapter.



GW 13 437

RJ45 SOCKETS

Code	Description	Number pairs	Use category	Cables	Connection	No. modules	Pack Carton
GW 13 434	RJ45	4	5e	UTP	Toolless	2	1/24
GW 13 436	RJ45	4	5e	FTP	Toolless	2	1/24
GW 13 435	RJ45	4	6	UTP	Toolless	2	1/24
GW 13 437	RJ45	4	6	FTP	Toolless	2	1/24

APPLICATIONS: LAN networks up to 100 MHz (e.g. Ethernet or Token Ring networks) for cat. 5e; LAN networks up to 250 MHz (e.g. video conference or video control systems) for cat. 6.

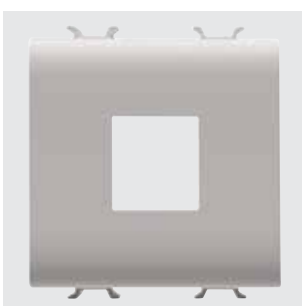

GW 13 433

ADAPTER FOR HOUSING DATA CONNECTORS

Code	Compatibility	No. modules	Pack Carton
GW 13 433	AMP / Keystone Jack	2	4/100

NOTES: due to technological developments and dimensional variants introduced by connector manufacturers, you are advised to check in advance the full compatibility between the data socket and the GEWISS empty enclosure.

CHORUSMART - Domestic range

ADAPTERS FOR OPTICAL FIBER



GW 38 335

ANGLED SC/APC ADAPTER

Code	Type	Tilt	For connectors	Compatibility	Colour	Pack Carton
GW 38 335	Female/Female	40°	SC/APC	Keystone Jack	Green RAL 6018	1/25

CHARACTERISTICS: cable outlet inclined of 40° to the wall line. With ceramic fiber optic sleeve and dust caps. The front output is protected with safety cap and unmissable cord. Suitable to join two single-mode SC/APC fiber optic patch cables.

NOTES: for adapters (Chorus, System and Dahlia) with Keystone Jack coupling.

SOCKET-OUTLETS FOR AUXILIARY CIRCUITS



GW 13 451

SELV SOCKETS

Code	Description	For plug pins	No. modules	Pack Carton
GW 13 451	2P - 6A - 24V	Ø 3 mm	1	12/24
GW 13 452	2P - 6A - 24V polarised	Flat	1	12/24

CHARACTERISTICS: Centre distance 12.4mm.

AUDIO AND VIDEO SOCKETS



GW 13 453

AUDIO AND VIDEO SOCKETS

Code	Description	No. modules	Pack Carton
GW 13 453	Double RCA	1	1/24
GW 13 454	For loudspeaker	1	1/24
GW 13 458	Speaker socket	1	1/24

CHARACTERISTICS: GW13453 double RCA stud connector, red and white, weld-in connection.

GW13454 welding connection. GW13458 front access terminals for inserting 1.5 mm² rigid wires, insulator punching rear connection suitable for cables AWG24 or max 0.25mm².

USB AND HDMI COUPLERS AND SOCKETS



GW 13 459

USB SOCKETS

Code	Description	No. modules	Pack Carton
GW 13 459	USB socket-outlet	1	1/24

CHARACTERISTICS: A-type USB 2.0 female connector, with screw terminals on the back.



GW 38 056

USB AND HDMI COUPLERS

Code	Description	Type	Compatibility	Pack Carton
GW 38 056	HDMI coupler	Female/Female	Keystone Jack	1/48
GW 38 057	USB coupler	Female/Female - A type	Keystone Jack	1/48

NOTES: for adapters designed to house data connectors (Chorus, System, Playbus and Dahlia) with Keystone Jack type coupling and permutation panels.

USB CHARGER



GW 13 449

USB POWER SUPPLY FOR ELECTRONIC DEVICES

Code	Supply voltage	Output voltage	Max current supplied	Type of port	No. modules	Pack Carton
GW 13 447	100 ÷ 240 V ac - 50/60 Hz	5V dc	3 A	A+A	1	1/10
GW 13 449	100 ÷ 240 V ac - 50/60 Hz	5V dc	3 A	A+C	1	1/10

CHARACTERISTICS: suitable for recharging a single electronic device (e.g. tablet) or two devices simultaneously (e.g. a tablet and smartphone). The division of the current delivered to the two outputs depends on the state of charge of the connected devices.

PROTECTION - NATURAL SATIN BEIGE VERSION

MINIATURE CIRCUIT BREAKERS



GW 13 463

MCB - MINIATURE CIRCUIT BREAKERS - C CHARACTERISTIC - 230V AC

Code	Description	Rated current (A)	Breaking capacity	No. modules	Pack Carton
GW 13 461	Single pole (1P)	6	3 kA	1	1/12
GW 13 462	Single pole (1P)	10	3 kA	1	1/12
GW 13 463	Single pole (1P)	16	3 kA	1	1/12
GW 13 466	Two-pole (1P+N)	6	3 kA	1	1/12
GW 13 467	Two-pole (1P+N)	10	3 kA	1	1/12
GW 13 468	Two-pole (1P+N)	16	3 kA	1	1/12



GW 13 488

RCBO - RESIDUAL CURRENT BREAKERS WITH OVERCURRENT PROTECTION - C CHARACTERISTIC - CLASS A - 230V AC - 50/60 HZ

Code	Description	Rated current (A)	Breaking capacity	I _{Δn}	No. modules	Pack Carton
GW 13 482	Two-pole (1P+N)	6	3 kA	10 mA	2	1/6
GW 13 483	Two-pole (1P+N)	6	3 kA	30 mA	2	1/6
GW 13 485	Two-pole (1P+N)	10	3 kA	10 mA	2	1/6
GW 13 486	Two-pole (1P+N)	10	3 kA	30 mA	2	1/6
GW 13 488	Two-pole (1P+N)	16	3 kA	10 mA	2	1/6
GW 13 489	Two-pole (1P+N)	16	3 kA	30 mA	2	1/6

CHORUSMART - Domestic range

PROTECTION DEVICES



GW 13 491

FUSE HOLDER - 250V AC

Code	Rated current (A)	Fuse type	No. modules	Pack Carton
GW 13 491	16	Ø 6.3x32 mm	1	1/12

CHARACTERISTICS: fuse not included.



GW 13 492

SURGE PROTECTION DEVICE - 230V AC

Code	Uc	Up	No. modules	Pack Carton
GW 13 492	275 V ac 50/60Hz	1 kV	1	1/12

CHARACTERISTICS: green LED for status signalling.

APPLICATIONS: protection of electronic devices (TV, HI-FI, computer, etc.) from overvoltage (resulting from atmospheric conditions or manoeuvres) that could be channelled from the power supply lines.

INDICATOR - NATURAL SATIN BEIGE VERSION

INDICATOR LIGHT DEVICES



GW 13 642

SINGLE INDICATOR LAMPS - 1/2 MODULE

Code	Diffuser colour	Colour meaning	No. modules	Pack Carton
GW 13 641	Opal diffuser	Neutral	1/2	2/48
GW 13 642	Green	Safety	1/2	2/48
GW 13 643	Red	Danger	1/2	2/48
GW 13 644	Amber	Attention	1/2	2/48

CHARACTERISTICS: LED signalling units, not included.

APPLICATIONS: the meaning of the diffusers refers to the recommendations of standard EN60073 with regard to the use of the colours in indicator lights.



GW 13 622

SINGLE INDICATOR LAMPS - 1 MODULE

Code	Diffuser colour	Colour meaning	No. modules	Pack Carton
GW 13 621	Opal diffuser	Neutral	1	1/24
GW 13 622	Green	Safety	1	1/24
GW 13 623	Red	Danger	1	1/24
GW 13 624	Amber	Attention	1	1/24

CHARACTERISTICS: LED signalling units, not included.

APPLICATIONS: the meaning of the diffusers refers to the recommendations of standard EN60073 with regard to the use of the colours in indicator lights.



GW 13 629

DOUBLE INDICATOR LAMPS - 1 MODULE

Code	Diffuser colour	No. modules	Pack Carton
GW 13 628	Opal diffuser	1	1/24
GW 13 629	Red/green	1	1/24

CHARACTERISTICS: LED signalling units, not included.

APPLICATIONS: the meaning of the diffusers refers to the recommendations of standard EN60073 with regard to the use of the colours in indicator lights.



GW 13 633

PROTRUDING INDICATOR LAMPS - 2 MODULES

Code	Supply voltage	Diffuser colour	Lamp	No. modules	Pack Carton
GW 13 631	12V ac/dc - 230V ac 50/60 Hz	Opal diffuser	White LED	2	1/24
GW 13 632	12V ac/dc - 230V ac 50/60 Hz	Green	White LED	2	1/24
GW 13 633	12V ac/dc - 230V ac 50/60 Hz	Red	White LED	2	1/24
GW 13 634	12V ac/dc - 230V ac 50/60 Hz	Amber	White LED	2	1/24

CHARACTERISTICS: highly efficient white LED, powered at 12V ac/dc - 230V ac with double power supply inlet.

APPLICATIONS: suitable for special applications such as the signalling of calls from hospital wards.

NOTES: complete with lamp.



GW 13 656

STAIR RISER LAMP

Code	Supply voltage	Diffuser colour	Lamp	No. modules	Pack Carton
GW 13 651	12V ac/dc - 230V ac 50/60 Hz	Opal diffuser	White LED	2	1/24
GW 13 656	12V ac/dc - 230V ac 50/60 Hz	Opal diffuser	White LED	4	1/2

CHARACTERISTICS: highly efficient white LED, powered at 12V ac/dc - 230V ac with double power supply inlet.

ANTI BLACK-OUT AND EMERGENCY LAMPS



GW 13 661

EXTRACTABLE ANTI BLACK-OUT LAMP

Code	Supply voltage	Power supply batteries	Minimum autonomy	Lamp	Pack Carton
GW 13 661	230 V ac - 50/60 Hz	Ni - Mh	2 h	LED	1/6

CHARACTERISTICS: equipped with a 3-position selector on the front panel, for anti black-out inhibition and night functioning.

To be inserted in any socket-outlet of the Italian, German or French type. Highly efficient, white LED lamp.



GW 13 662

ANTI BLACK-OUT LAMP

Code	Supply voltage	Power supply batteries	Minimum autonomy	Lamp	No. modules	Pack Carton
GW 13 662	230 V ac - 50/60 Hz	Ni - Mh	1 h	White LED	1	1/12

CHARACTERISTICS: green LED for the presence of mains voltage signalling. Highly efficient, white LED lamp.

CHORUSMART - Domestic range



GW 13 663

AUTONOMOUS EMERGENCY LAMPS

Code	Supply voltage	Power supply batteries	Minimum autonomy	Lamp	No. modules	Pack Carton
GW 13 663	230 V ac - 50/60 Hz	Ni - Mh	1 h	White LED	2	1/6
GW 13 666	230 V ac - 50/60 Hz	Ni - Mh	1 h	White LED	4	1/2

CHARACTERISTICS: green mains presence signal LED. Highly efficient, white LED lamps.

APPLICATIONS: compliant with standards EN60598-2-22.

ACOUSTIC SIGNALLING DEVICES



GW 13 601

RINGERS

Code	Supply voltage	Max power consumption	Sound intensity	No. modules	Pack Carton
GW 13 601	12V ac - 50 Hz	8 VA	80 dB (at 1 m)	1	1/24
GW 13 602	230V ac - 50 Hz	8 VA	80 dB (at 1 m)	1	1/24

CHARACTERISTICS: for intermittent use (5 sec. ON / 15 sec. OFF).



GW 13 606

BUZZERS

Code	Supply voltage	Max power consumption	Sound intensity	No. modules	Pack Carton
GW 13 606	12V ac - 50 Hz	8 VA	70 dB (at 1 m)	1	1/24
GW 13 607	230V ac - 50 Hz	8 VA	70 dB (at 1 m)	1	1/24

CHARACTERISTICS: for intermittent use (5 sec. ON / 15 sec. OFF).



GW 13 611

THREE TONE RINGER AND THREE INDEPENDENT INPUTS

Code	Supply voltage	Max power consumption	Sound intensity	No. modules	Pack Carton
GW 13 611	12V ac/dc	3 VA	80 dB (at 1 m)	2	1/6
GW 13 612	230V ac - 50 Hz	6 VA	80 dB (at 1 m)	2	1/6

CHARACTERISTICS: for continuous use. Three tones (alarm, ring and two-tone) with adjustable sound intensity.

APPLICATIONS: it is possible to combine the outdoor call, indoor call and alarm functions with one single device.

ENERGY, TEMPERATURE AND COMFORT MANAGEMENT - NATURAL SATIN BEIGE VERSION

TEMPERATURE CONTROL DEVICES



GW 13 709

CONNECTED THERMOSTAT - ZIGBEE

Code	Supply voltage	Output contacts	No. modules	Pack Carton
GW 13 709	100 ÷ 240 V ac - 50/60 Hz	1 NO / NC 5A (AC1) 240 V ac	2	1/3

FEATURES: flush-mounted thermostat for the control of heating/cooling systems with manual temperature management and possibility of shutdown. Control algorithms for two-way systems: two points (ON/OFF), proportional-integral (PWM). The thermostat can control a solenoid valve for heating or cooling through a local contact or via Zigbee, in which case the solenoid valve must be controlled by a Zigbee actuator. GWA1521, GWA1522, GWA1523, GW1x826, GWA1201, and GWA1202 Zigbee connected actuators can be used.

The thermostat is equipped with integrated temperature and humidity sensors. The thermostat has an input for a NTC sensor (GW10800 and GW1x900 sensors can be used) for external temperature measurement (e.g., for compensation of temperatures measured locally by the thermostat or for protection in case of underfloor heating/cooling).

APPLICATIONS: climate control (heating or cooling) of a housing unit or area; option to manage a daily or weekly heating/cooling profile via the APP. The device measures humidity, if a threshold (defined during configuration) is exceeded, Zigbee can activate a dehumidification system and display/notify the measurement on the APP.

Use in traditional unconnected systems: the connected thermostat can also be used in traditional unconnected installations. In this case, configuration is not carried out via the APP and the NTC sensor input can only be used to compensate for the temperature measurement detected locally by the thermostat.



GW 13 705

THERMOSTAT

Code	Supply voltage	Temperature adjustment	Output contacts	No. modules	Pack Carton
GW 13 705	230 V ac - 50/60 Hz	From +5°C to +35°C	1NO / NC 8A(AC1) 250V ac	2	1/2

CHARACTERISTICS: choice of working mode by means of selector located on the front: summer (air-conditioner), OFF, winter (boiler).

Two-colour front LED to signal the output status (open/closed contact). The lighting up of the LED also indicates mains presence.



GW 16 970 CB

THERMO ICE WI-FI THERMOSTAT - WALL-MOUNTING

Code	Colour	Supply voltage	Temperature adjustment	Output contacts	Dimensions LxHxD (mm)	Pack Carton
GW 16 970 CB	White	110-230V ac - 50/60Hz	From +5°C to +40°C	2NO 6A(AC1) 250V ac	123x95x21	1

CHARACTERISTICS: wall-mounting thermostat to control heating/cooling and humidification/dehumidification systems and manage the temperature in manual mode or on 3 levels (comfort, pre-comfort, economy). Control algorithms for two-way systems: two points (ON/OFF), proportional integral (PWM). Includes 1 input for external NTC temperature sensor (e.g.: protection for flood mounting heating). Equipped with a user interface with touch commands (capacitive) on technopolymer plate and backlit display. The thermostat has built-in proximity, temperature and humidity sensors and a Wi-Fi interface for setting parameters and programming temperature profiles (timed thermostat function) locally or by remote via specific apps (smartphone and tablet).

NOTES: wall-mounting with wall-plugs or on 3-modules rectangular boxes (centre distance 83.5 mm) Plate material; technopolymer.

DIMMER



GW 13 575

UNIVERSAL ROTATING ELECTRONIC REGULATOR

Code	Supply voltage	No. modules	Pack Carton
GW 13 575	230V ac - 50 Hz	1	1/12

CHARACTERISTICS: suitable for dimming incandescent and halogen lamps 230 V ac (10-160 W); low-voltage halogen lamps (12 V ac) with electronic transformers (10-160 W) and LED lamps 230 V ac (4-160W), rotary control with 2-way switch. Equipped with amber-colour-red signalling LED. Can be operated without neutral connection.

NOTES: the installation of more than one dimmer side-by-side in a single container is not permitted. To avoid overheating, insert a blanking module between two dimmers. If installing two dimmers in the same box, the maximum loads that can be controlled by each dimmer must be reduced by 50%.

CHORUSMART - Domestic range



GW 13 564

ROTATING ELECTRONIC REGULATORS FOR RESISTIVE/INDUCTIVE LOADS

Code	Supply voltage	Resistive load 230V ac	Inductive load 230V ac	No. modules	Pack Carton
GW 13 564	230 V ac - 50/60 Hz	100 - 900 W	40 - 300 VA	1	1/12
GW 13 567	230 V ac - 50/60 Hz	100 - 500 W	100 - 500 VA	1	1/12

CHARACTERISTICS: with signalling led orange. GW13567 rotary command with two-way switch.

GW13564 compliance with the EMC directive is only guaranteed by connecting the regulator to an LC filter with the following characteristics: L=1mH - 5A, C=0.15uF - 275V X2, according to the documentation provided with the product. Item designated solely for export to a limited number of countries outside of the European Union or countries applying to become part of the European Free Trade Area. Contact GEWISS Customer Service to check the product meets the regulations of the country concerned before importing it.

NOTES: to avoid overheating, the side by side installation of several products in a single container is not permitted; insert a blanking module between two electronic devices. If installing two regulators in the same box, the maximum loads that can be commanded by each regulator must be reduced by 50%.



GW 13 572 A

UNIVERSAL ELECTRONIC REGULATORS WITH PUSH-BUTTON

Code	Supply voltage	No. modules	Pack Carton
GW 13 572 A	230V ac - 50/60 Hz	1	1/12
GW 13 573 A	230V ac - 50/60 Hz	2	1/6

CHARACTERISTICS: for the regulation and switching of incandescent and halogen lamps 230V AC (40-300W), low voltage halogen and LED lamps with electronic and winding transformers (40-300W), LED lamps 230V AC with dimmer function (5-150W). Manual selection of the type of load (Leading Edge or Trailing Edge piloting), soft-start function for lamp protection. Possibility to command and regulate from remote control push-buttons with NO contacts. Equipped with orange signalling LED.

NOTES: to avoid overheating, the side-by-side installation of several products in a single container is not permitted; insert a blanking module between two electronic devices. If two regulators are installed in the same box, the maximum loads that can be commanded by each regulator must be reduced by 50%.



GW 13 568

ELECTRONIC REGULATOR WITH BUTTON FOR RESISTIVE/INDUCTIVE LOADS

Code	Supply voltage	Resistive load 230V ac	Inductive load 230V ac	No. modules	Pack Carton
GW 13 568	230V ac - 50 Hz	60 - 500 W	60 - 500 VA	1	1/12

CHARACTERISTICS: possibility to command and regulate from remote control push-buttons with NO contact. With signalling led orange.

NOTES: to avoid overheating, the side by side installation of several products in a single container is not permitted; insert a blanking module between two electronic devices. If installing two regulators in the same box, the maximum loads that can be commanded by each regulator must be reduced by 50%.

TECHNICAL ALARMS - NATURAL SATIN BEIGE VERSION

GAS DETECTORS



GW 13 712

METHANE GAS DETECTOR

Code	Supply voltage	Tripping threshold	Output contacts	No. modules	Pack Carton
GW 13 712	12V ac/dc	9% LIE	1NO/NC 10A(NO)/3A(NC)250V ac	2	1/2

CHARACTERISTICS: relay output for the automatic command of the gas interception solenoid valve (manual reset) GW30522. Sound intensity: 85dB at 1m.



GW 10 720

POWER SUPPLY UNIT 12VDC

Code	Supply voltage	Output voltage	Max current supplied	Dimensions LxHxD (mm)	Pack Carton
GW 10 720	100 ÷ 240 V ac - 50/60 Hz	12V dc	300 mA	52x33x17	1/10

APPLICATIONS: to be used for powering LPG detectors (GW1x711, GW2x868, GW30520), methane detectors (GW1x712, GW2x867, GW30519); Thermo ICE KNX (GW16974CB, GW16974CN, GW16974CT) thermostats.

ANTI-FLOOD SYSTEM WITH ZIGBEE WIRELESS TRANSMISSION



GW A1 514

ZIGBEE FLOOD ALARM - IP20

Code	Siren output	Temperature sensor	Colour	Dimensions (mm)	Pack Carton
GW A1 514	85 dB/3 m	0...50 °C	White	Ø 60x37	1/6

CHARACTERISTICS: the alarm detects the presence of water and includes a temperature sensor. Powered by CR123-type battery (replaceable).

NOTES: floor-mounting or alternatively wall-mounting possibility through the GWA1541 accessory. To be used in combination with the Zigbee actuator GWA1521 when controlling an electrovalve or a load.



GW A1 521

1-CHANNEL ACTUATOR ZIGBEE

Code	Supply voltage	Output contacts	Dimensions LxHxD (mm)	Pack Carton
GW A1 521	230V ac - 50 Hz	1 NO 10A (AC1) 230 V ac	42x40x20	1/4

CHARACTERISTICS: 1-channel actuator for activating loads via the potential-free output contact (NO). Suitable for commanding incandescent lamps (230 V ac): 2300W, loads controlled from toroidal transformers: 450W, loads controlled from electronic transformers: 600W, energy saving lamps (compact fluorescent): 150W, LED lamps (230 V ac): 150W, motors: 500W.

APPLICATIONS: when used with the water sensor, provide the installation of a NO push-button to open the electrovalve manually.

NOTES: installation in flush-mounting boxes, junction boxes, etc..



GW 13 750

BLANKING MODULE FOR HOUSING RF ZIGBEE ACTUATORS

Code	Colour	No. modules	Pack Carton
GW 13 750	Natural satin beige	1	1/12

CHARACTERISTICS: 1-module blanking module with pad printing. Allows the housing and fast identification of the flush-mounting RF Zigbee actuator.

NOTES: snap-in assembly.

CHORUSMART - Domestic range

ACCESSORIES



GW A1 541

WALL-MOUNTING SUPPORT FOR FLOOD ALARM

Code	Colour	Support dimension (mm)	Dimensions of probe (mm)	Cable max. length (cm)	Pack Carton
GW A1 541	White	Ø72x25	Ø50x8	85	1/4

APPLICATIONS: to be used for the wall-mounting of the Zigbee flood alarm GWA1514.



GW 30 522

SOLENOID VALVE, WITH MANUAL RESET, NORMALLY OPEN - 230V - 50HZ

Code	Delivery Ø	Material	Power input	Pack Carton
GW 30 522	3/4"	Brass	12 VA	1/2

ACCESSORIES

SIGNALLING UNITS



GW 10 881

LED SIGNALLING UNITS - 230V AC - 0.6 W

Code	Lamp voltage	Lamp power	Lamp	Light emitted	Cable Colour	Pack Carton
GW 10 881	230 V ac - 50/60 Hz	0.6 W	LED	Blue	Blue	50
GW 10 882	230 V ac - 50/60 Hz	0.6 W	LED	White	White	50
GW 10 883	230 V ac - 50/60 Hz	0.6 W	LED	Red	Red	50
GW 10 884	230 V ac - 50/60 Hz	0.6 W	LED	Green	Green	50
GW 10 885	230 V ac - 50/60 Hz	0.6 W	LED	Amber	Orange	50

NOTES: the LED signalling units are supplied with power supply cables (length 10 cm).



GW 10 894

LED SIGNALLING UNITS - 12-24V AC/DC - 0.6 W

Code	Lamp voltage	Lamp power	Lamp	Light emitted	Cable Colour	Pack Carton
GW 10 894	12-24V ac/dc	0.6 W	LED	White	White	50

NOTES: the LED signalling units are supplied with power supply cables (length 10 cm).



GW 20 902

CARTRIDGE LAMPS - 2W

Code	Lamp voltage	Lamp power	Lamp	Light emitted	Dimensions (mm)	Pack Carton
GW 20 902	12V ac/dc	2 W	Incandescence	White	56x36	50
GW 20 903	24V ac/dc	2 W	Incandescence	White	56x36	50

CHORUSMART - Domestic range

ACCESSORIES

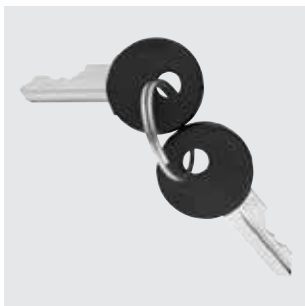

GW 20 901

SET OF 2 KEYS FOR COMMAND DEVICES

Code	Suitable for	Pack Carton
GW 20 901	One-way switches - two-way switches	1/100
GW 30 912	Push-buttons	1/100



ChoruSmart



Scan the QR Code and find out all the technical informations.

INNOVATIVE



ChoruSmart offers the best technologies for an aesthetic and functional experience suitable for every person. In particular, the new EVO axial and touch controls offer the ability to centralize the management of lights and shutters with an extremely simplified installation.

AESTHETIC VARIABILITY



The wide range of options for customising the devices, in terms of colour and modularity, ensures a vast choice of solutions. Six colourways are available: three with a satin finish and three with a glossy finish, for a perfect match between the devices and the plate.

SCALABLE



ChoruSmart began as a traditional domestic series, but with the addition of a few Connected Smart Home or Home&Building Pro elements, it can become smart and suitable for both renovations and new buildings. The combination of colours, materials, finishes and shapes offers something for every taste and need.

ChoruSmart

Black modular devices

The ChoruSmart modular devices make it possible to create infinite combination between devices and plates, thanks to a complete range that is able to satisfy all design, functional and installation requirements. Colors and finishes: satin black, elegant and classy. Unlimited functions in reduced spaces: the ChoruSmart range consists of rocker button keys with 1/2, 1, 2 and 3 modules, to optimise space as needed, and axial keys in EVO or SMART version, to satisfy even the most modern needs. Front coupling: the front coupling makes the component assembly and release operations simple and quick, enabling these to be completed without removing the support, unique for all the plates and fruits.



COMMAND - SATIN BLACK VERSION

COMMAND DEVICES - ROCKERS - SCREW TERMINALS



GW 12 001

ONE-WAY SWITCHES 1P - 250V AC

Code	Description	Button key	Rated power of 230V LED lamps	Pack Carton
No. modules: 1				
GW 12 001	1P - 16AX	Neutral	200 W	12/96
GW 12 002	1P - 16AX illuminable	With diffuser	200 W	12/24
GW 12 003	1P - 16AX illuminable	With replaceable neutral lens	200 W	12/24
No. modules: 1/2				
GW 12 021	1P - 10AX	Neutral	100 W	12/24
GW 12 022	1P - 10AX illuminable	With diffuser	100 W	6/24
No. modules: 2				
GW 12 031	1P - 16AX	Neutral	200 W	6/24
GW 12 032	1P - 16AX illuminable	With diffuser	200 W	6/24
GW 12 033	1P - 16AX illuminable	With replaceable neutral lens	200 W	6/24
No. modules: 3				
GW 12 041	1P - 16AX	Neutral	200 W	4/12
GW 12 042	1P - 16AX illuminable	With diffuser	200 W	4/12
GW 12 043	1P - 16AX illuminable	With replaceable neutral lens	200 W	4/12

CHARACTERISTICS: the illuminable articles use LED signalling units, not included.



GW 12 004

ONE-WAY SWITCHES 2P - 250V AC

Code	Description	Button key	Symbol	Rated power of 230V LED lamps	Pack Carton
No. modules: 1					
GW 12 004	2P - 16 AX	Neutral	0/1	200 W	12/48
GW 12 005	2P - 16AX illuminable	With replaceable neutral lens	-	200 W	12/24
GW 12 006	2P - 10AX	With key	0/1	100 W	1/12
No. modules: 2					
GW 12 034	2P - 16 AX	Neutral	0/1	200 W	6/24
GW 12 035	2P - 16AX illuminable	With replaceable neutral lens	-	200 W	6/24

CHARACTERISTICS: the illuminable articles use LED signalling units, not included.

NOTES: GW12006 equipped with 2 keys. Key extractable in both positions. Spare keys: GW20901.



GW 12 007

ONE-WAY SWITCH 2P - 250V AC - HEAVY DUTY LOADS

Code	Description	Button key	Symbol	Rated power of 230V LED lamps	Pack Carton
No. modules: 1					
GW 12 007	2P - 25 AX	Neutral	0/1	250 W	12/24

APPLICATIONS: suitable for particular heavy-duty loads (e.g. fluorescent lamp batteries) or high-consumption devices. (e.g. ovens, air-conditioners, boilers, etc.)



GW 12 051

TWO-WAY SWITCHES 1P - 250V AC

Code	Description	Button key	Rated power of 230V LED lamps	Pack Carton
No. modules: 1				
GW 12 051	1P - 16AX	Neutral	200 W	12/96
GW 12 052	1P - 16AX illuminable	With diffuser	200 W	12/24
GW 12 053	1P - 16AX illuminable	With replaceable neutral lens	200 W	12/24
GW 12 054	1P - 10AX	With key	100 W	1/12
No. modules: 1/2				
GW 12 061	1P - 10AX	Neutral	100 W	6/24
No. modules: 2				
GW 12 071	1P - 16AX	Neutral	200 W	6/24
GW 12 072	1P - 16AX illuminable	With diffuser	200 W	6/24
GW 12 073	1P - 16AX illuminable	With replaceable neutral lens	200 W	6/24
No. modules: 3				
GW 12 081	1P - 16AX	Neutral	200 W	4/12
GW 12 082	1P - 16AX illuminable	With diffuser	200 W	4/12
GW 12 083	1P - 16AX illuminable	With replaceable neutral lens	200 W	4/12

CHARACTERISTICS: the illuminable articles use LED signalling units, not included.

NOTES: GW12054 equipped with 2 keys. Key extractable in both positions. Spare keys: GW20901.



GW 12 091

INTERMEDIATE SWITCHES 1P - 250V AC

Code	Description	Button key	Rated power of 230V LED lamps	Pack Carton
No. modules: 1				
GW 12 091	1P - 16AX	Neutral	200 W	12/48
GW 12 092	1P - 16AX illuminable	With diffuser	200 W	12/24
GW 12 093	1P - 16AX illuminable	With replaceable neutral lens	200 W	12/24
No. modules: 2				
GW 12 101	1P - 16AX	Neutral	200 W	6/12
GW 12 102	1P - 16AX illuminable	With diffuser	200 W	6/12
GW 12 103	1P - 16AX illuminable	With replaceable neutral lens	200 W	6/12
No. modules: 3				
GW 12 111	1P - 16AX	Neutral	200 W	4/12
GW 12 112	1P - 16AX illuminable	With diffuser	200 W	4/12
GW 12 113	1P - 16AX illuminable	With replaceable neutral lens	200 W	4/12

CHARACTERISTICS: the illuminable articles use LED signalling units, not included.



GW 12 121

THREE-WAY SWITCHES 1P - 250V AC

Code	Description	Button key	Symbol	Rated power of 230V LED lamps	Pack Carton
No. modules: 1					
GW 12 121	1P - 10AX	Neutral	UP - DOWN	100 W	12/24
No. modules: 2					
GW 12 123	1P - 10AX	Neutral	UP - DOWN	100 W	6/24

CHARACTERISTICS: three standing positions. Both contacts are open in the central position (OFF).

APPLICATIONS: command of circuits requiring an interlock (e.g. operating motorised devices with direction reversal). 2-user selective control.



GW 12 122

THREE-WAY SWITCH 2P - 250 V AC

Code	Description	Button key	Symbol	Rated power of 230V LED lamps	Pack Carton
No. modules: 1					
GW 12 122	2P - 10AX	Neutral	UP - DOWN	100 W	12/24

CHARACTERISTICS: three standing positions. Both contacts are open in the central position (OFF). With 6 terminal blocks.

APPLICATIONS: command of circuits requiring an interlock (e.g. operating motorised devices with direction reversal). 2-user selective control.

CHORUSMART - Domestic range



GW 12 131

PUSH-BUTTONS 1P - 250V AC

Code	Description	Button key	Symbol	Pack Carton
No. modules: 1				
GW 12 131	1P NO - 16A	Neutral	-	12/96
GW 12 132	1P NO - 16A illuminable	With diffuser	-	12/24
GW 12 133	1P NO - 16A illuminable	With replaceable neutral lens	-	12/24
GW 12 136	1P NO - 16A	Pull-cord	-	1/12
GW 12 137	1P NC - 16A	Neutral	O red	12/24
GW 12 138	1P NC+NO - 16 A	Stop	Red	12/24
GW 12 139	1P NO+NC - 16 A	Start	Green	12/24
GW 12 140	1P NO+NO - 10A	With interlock	UP - DOWN	12/24
GW 12 141	1P NO+NO - 16 A	Double	-	12/24
GW 12 142	1P NO - 16A illuminable	Green diffuser	-	12/24
GW 12 143	1P NO - 16A illuminable	Red diffuser	-	12/24
GW 12 144	1P NO - 16A illuminable	Opal diffuser	-	12/24
GW 12 151	1P NO - 16A illuminable	With replaceable neutral lens	Light	12/24
GW 12 152	1P NO - 16A illuminable	With replaceable neutral lens	Key	12/24
GW 12 153	1P NO - 16A illuminable	With replaceable neutral lens	Bell	12/24
No. modules: 1/2				
GW 12 161	1P NO - 10A	Neutral	-	6/24
GW 12 162	1P NO - 10A illuminable	With diffuser	-	6/24
No. modules: 2				
GW 12 171	1P NO - 16A	Neutral	-	6/24
GW 12 172	1P NO - 16A illuminable	With diffuser	-	6/24
GW 12 173	1P NO - 16A illuminable	With replaceable neutral lens	-	6/24
No. modules: 3				
GW 12 181	1P NO - 16A	Neutral	-	4/12
GW 12 182	1P NO - 16A illuminable	With diffuser	-	4/12
GW 12 183	1P NO - 16A illuminable	With replaceable neutral lens	-	4/12

CHARACTERISTICS: the illuminable articles use LED signalling units, not included.

GW12136 Cord in insulating material, 140cm long, with red knob.

GW12140 Button with mechanical interlock. Both contacts are open in the central position (OFF); advisable for activating motorised devices with direction reversal (e.g. roller-shutters, curtains, etc.).

GW12141 independent push-buttons that can also be activated simultaneously.



GW 12 134

PUSH-BUTTONS 2P - 250V AC

Code	Description	Button key	Symbol	Pack Carton
No. modules: 1				
GW 12 134	2P NO - 16A	Neutral	O	12/24
GW 12 135	2P NO - 10A illuminable	With replaceable neutral lens	-	12/24
GW 12 145	2P NO - 10A	With key	-	1/12

CHARACTERISTICS: the illuminable articles use LED signalling units, not included.

NOTES: GW12145 equipped with 2 keys. Spare keys: GW30912.



GW 12 191

PUSH-BUTTONS 1P WITH ILLUMINATED NAME PLATE - 250V AC

Code	Description	Lamp voltage	Lamp	Lamp power	Pack Carton
No. modules: 2					
GW 12 191	1P NO - 10A	12-24V ac/dc	Cartridge lamp S6x36 mm	2 W	6/24
No. modules: 3					
GW 12 192	1P NO - 10A	12-24V ac/dc	Cartridge lamp S6x36 mm	2 W	4/16

CHARACTERISTICS: lamp not included.

COMMAND DEVICES - ROCKERS - QUICK WIRING TERMINALS



GW 12 031 F

ONE-WAY SWITCHES 1P - 250V AC

Code	Description	Button key	Rated power of 230V LED lamps	Pack Carton
No. modules: 2				
GW 12 031 F	1P - 16AX	Neutral	200 W	6/24
GW 12 032 F	1P - 16AX illuminable	With diffuser	200 W	6/24
GW 12 033 F	1P - 16AX illuminable	With replaceable neutral lens	200 W	6/24

CHARACTERISTICS: the illuminable articles use LED signalling units, not included.
NOTES: spring quick wiring, no tools necessary.



GW 12 034 F

ONE-WAY SWITCHES 2P - 250V AC

Code	Description	Button key	Symbol	Rated power of 230V LED lamps	Pack Carton
No. modules: 2					
GW 12 034 F	2P - 16 AX	Neutral	0/1	200 W	6/24
GW 12 035 F	2P - 16AX illuminable	With replaceable neutral lens	-	200 W	6/24

CHARACTERISTICS: the illuminable articles use LED signalling units, not included.
NOTES: spring quick wiring, no tools necessary.



GW 12 071 F

TWO-WAY SWITCHES 1P - 250V AC

Code	Description	Button key	Rated power of 230V LED lamps	Pack Carton
No. modules: 2				
GW 12 071 F	1P - 16AX	Neutral	200 W	6/24
GW 12 072 F	1P - 16AX illuminable	With diffuser	200 W	6/24
GW 12 073 F	1P - 16AX illuminable	With replaceable neutral lens	200 W	6/24

CHARACTERISTICS: the illuminable articles use LED signalling units, not included.
NOTES: spring quick wiring, no tools necessary.



GW 12 101 F

INTERMEDIATE SWITCHES 1P - 250V AC

Code	Description	Button key	Rated power of 230V LED lamps	Pack Carton
No. modules: 2				
GW 12 101 F	1P - 16AX	Neutral	200 W	6/12
GW 12 102 F	1P - 16AX illuminable	With diffuser	200 W	6/12
GW 12 103 F	1P - 16AX illuminable	With replaceable neutral lens	200 W	6/12

CHARACTERISTICS: the illuminable articles use LED signalling units, not included.
NOTES: spring quick wiring, no tools necessary.



GW 12 171 F

PUSH-BUTTONS 1P - 250V AC

Code	Description	Button key	Pack Carton
No. modules: 2			
GW 12 171 F	1P NO - 16A	Neutral	6/24
GW 12 172 F	1P NO - 16A illuminable	With diffuser	6/24
GW 12 173 F	1P NO - 16A illuminable	With replaceable neutral lens	6/24

CHARACTERISTICS: the illuminable articles use LED signalling units, not included.
NOTES: spring quick wiring, no tools necessary.

CHORUSMART - Domestic range



GW 12 160 F

COMBINED COMMAND DEVICES - ROCKERS - 250 V AC

Code	Description	Button key	Symbol	Rated power of 230V LED lamps	Pack Carton
No. modules: 2					
GW 12 078 F	Twin two-way switch 1P - 16 AX	Neutral	-	200 W	6/24
GW 12 159 F	Two-way switch 1P - 16 AX / Push-button 1P NO - 16A	Neutral	-	200 W	6/24
GW 12 160 F	Twin push-button 1P NO - 16 A	Neutral	UP - DOWN - STOP	-	6/24

NOTES: spring quick wiring, no tools necessary.

COMMAND DEVICES - AXIAL - SCREW TERMINALS



GW 10 671

AXIAL SWITCH MODULE - EVO

Code	Supply voltage	Output contacts	No. modules	Pack Carton
GW 10 671	100 ÷ 240 V ac - 50/60 Hz	1 NA 5A (AC1) 240 V ac	1	1/12
GW 10 672	100 ÷ 240 V ac - 50/60 Hz	1 NA 5A (AC1) 240 V ac	2	1/6

CHARACTERISTICS: devices for the control of 1 On/Off lighting device through a live output contact. Suitable for the control of incandescent and halogen (240Vac): 1000W, LED lamps (240Vac): 100W, fluorescent lamps (240Vac): 120W, halogen lamps powered by electronic transformers (240Vac): 250VA. Local push button with axial activation for control of the lamps connected to the device.

Equipped with 1 input to replicate the local control of the load via auxiliary module GW10677, GW10678 or NO-type and 1 input buttons for the centralisation OFF function. **APPLICATIONS:** Bistable, monostable and timed load command. Centralisation function (OFF) by means of a dedicated input, the possibility of being able to switch the load on by means of auxiliary axial modules or NO-type buttons. The devices are equipped with a configurable blue LED that can be set to OFF, easy location mode or for signalling the connected load status.

NOTES: the devices must be completed with a front button key: GW10671 must be completed with the GW12551S or GW12555S button keys. The GW10672 must be completed with the GW12552S or GW12556S button keys.



GW 10 673

AXIAL DIMMER MODULE - EVO

Code	Supply voltage	Halogen load	Inductive load	LED load	No. modules	Pack Carton
GW 10 673	100 ÷ 240 V ac - 50/60 Hz	4 - 150 W	4 - 150 VA	4 - 150 W	1	1/12
GW 10 674	100 ÷ 240 V ac - 50/60 Hz	4 - 150 W	4 - 150 VA	4 - 150 W	2	1/6

CHARACTERISTICS: trailing edge load drive mode (max. 5 lamps). Two local axial operated buttons for dimming the connected load.

Equipped with 2 inputs for replicating local control of the load via the auxiliary module GW10679, GW10680 or NO-type buttons or for creating the centralisation function.

APPLICATIONS: control of the dimmable load connected to the devices. The dedicated inputs can be used to add a load switching-on function through auxiliary axial modules or NO-type buttons, or inputs can be set, via programming, for the centralised OFF function. The devices are equipped with configurable blue LEDs that can be set to OFF, location mode or for signalling the connected load.

NOTES: To avoid overheating, multiple dimmers cannot be installed side-by-side inside in the same enclosure. Insert a blanking module between two electronic devices. If two dimmers are installed in the same box, the maximum loads controlled by each dimmer must be reduced by 50%. The devices must be completed with a front button key: GW10673 must be completed with the GW12553S or GW12557S button keys; GW10674 must be completed with the GW12554S or GW12558S button keys.



GW 10 675

AXIAL ROLLER SHUTTER MODULE - EVO

Code	Supply voltage	Max current supplied	No. modules	Pack Carton
GW 10 675	100 ÷ 240 V ac - 50/60 Hz	2,3 A 240 V ac (according to IEC 60669-2-1)	1	1/12
GW 10 676	100 ÷ 240 V ac - 50/60 Hz	2,3 A 240 V ac (according to IEC 60669-2-1)	2	1/6

CHARACTERISTICS: Devices for the control of a motor to operate roller-shutters, curtains, venetian blinds, awnings, etc., through 2 live interlocked output contacts. Two axial-operated local buttons control the motor connected to the device. Equipped with 2 inputs for replicating local control of the motor via the auxiliary module GW10679, GW10680 or NO-type up/down buttons, or for creating the centralisation function.

APPLICATIONS: control of the motor connected to the devices. The dedicated inputs can be used to operate roller-shutters/venetian blinds via the auxiliary axial modules or NO-type up/down buttons, or they can be set, through programming, for centralisation functions (Up/Down). The devices are equipped with blue LEDs which can be configured to facilitate location at night and to signal the movement of the roller-shutter/Venetian blind.

NOTES: the devices must be completed with a front button key: GW10675 must be completed with the GW12553S or GW12557S button keys. GW10676 must be completed with the GW12554S or GW12558S button keys.



GW 10 677

1-COMMAND AUXILIARY AXIAL MODULE

Code	Supply voltage	Output contacts	No. modules	Pack Carton
GW 10 677	100 ÷ 240 V ac - 50/60 Hz	1 NO 1 A (AC1) 240 V ac	1	1/12
GW 10 678	100 ÷ 240 V ac - 50/60 Hz	1 NO 1 A (AC1) 240 V ac	2	1/6

CHARACTERISTICS: auxiliary controls to be used in conjunction with the EVO switch modules.

The devices are equipped with blue LEDs for easy location or for displaying the status of the load.

APPLICATIONS: when connected to the local inputs of the EVO axial controls, they allow replication of the local load control or the management of centralised controls.

NOTES: the devices must be completed with a front button key: GW10677 must be completed with the GW12551S or GW12555S button keys. GW10678 must be completed with the GW12552S or GW12556S button keys.



GW 10 679

2-COMMAND AUXILIARY AXIAL MODULE

Code	Supply voltage	Output contacts	No. modules	Pack Carton
GW 10 679	100 ÷ 240 V ac - 50/60 Hz	2 NO 1 A (AC1) 240 V ac	1	1/12
GW 10 680	100 ÷ 240 V ac - 50/60 Hz	2 NO 1 A (AC1) 240 V ac	2	1/6

CHARACTERISTICS: auxiliary controls to be used in conjunction with the EVO dimmer and roller-shutter modules.

The devices are equipped with blue LEDs for easy location or for displaying the status of the load.

APPLICATIONS: when connected to the local inputs of the EVO axial controls, they allow replication of the local load control or the management of centralised controls.

NOTES: the devices must be completed with a front button key: GW10679 must be completed with the GW12553S or GW12557S button keys. GW10680 must be completed with the GW12554S or GW12558S button keys.



GW 12 551 S

INTERCHANGEABLE BUTTON KEYS FOR AXIAL DEVICES

Code	Colour	Button key	No. modules	Pack Carton
GW 12 551 S	Satin black	To be completed with lens	1	1/48
GW 12 552 S	Satin black	To be completed with lens	2	1/48
GW 12 553 S	Satin black	To be completed with 2 lenses	1	1/48
GW 12 554 S	Satin black	To be completed with 2 lenses	2	1/48
GW 12 555 S	Satin black	With 1 diffuser	1	1/48
GW 12 556 S	Satin black	With 1 diffuser	2	1/48
GW 12 557 S	Satin black	With 2 diffusers	1	1/48
GW 12 558 S	Satin black	With 2 diffusers	2	1/48

NOTES: for use to complete the EVO axial modules and auxiliary axial controls.

LENS WITH ILLUMINATED SYMBOL



ZCG

SYMBOLS FOR ILLUMINABLE ROCKER COMMAND DEVICES

Code	Symbol	Pack Carton
Suitable for: General services		
GW 10 501	Neutral	20/240
GW 10 502	Light	20/240
GW 10 503	Stair light	20/240
GW 10 504	Table light	20/240
GW 10 505	Bell	20/240
GW 10 506	Fan	20/240
GW 10 507	Key	20/240
GW 10 508	Alarm	20/240
GW 10 509	ON	20/240
GW 10 510	OFF	20/240
GW 10 511	Nurse	20/240
GW 10 512	Waitress	20/240
GW 10 513	Dimmer increase	20/240
GW 10 514	Dimmer decrease	20/240
GW 10 515	UP arrow	20/240
GW 10 516	DOWN arrow	20/240
GW 10 517	UP - DOWN arrow	20/240
GW 10 518	RIGHT - LEFT arrow	20/240
Suitable for: Numerical services		
GW 10 531	One	20/240
GW 10 532	Two	20/240
GW 10 533	Three	20/240
GW 10 534	Four	20/240
GW 10 535	Five	20/240
GW 10 536	Six	20/240
GW 10 537	Seven	20/240
GW 10 538	Eight	20/240
GW 10 539	Nine	20/240
GW 10 540	Zero	20/240

NOTES: for use in place of the neutral lens in the illuminated tilting control devices.

CHORUSMART - Domestic range



ZC6

LENSES WITH ILLUMINATING SYMBOLS FOR AXIAL BUTTON KEYS

Code	Symbol	Pack Carton
GW 10 501 A	Neutral	24
GW 10 502 A	Light	24
GW 10 503 A	Stair light	24
GW 10 504 A	Table light	24
GW 10 505 A	Bell	24
GW 10 506 A	Burglar alarm	24
GW 10 507 A	Key	24
GW 10 508 A	ON OFF	24
GW 10 509 A	ON	24
GW 10 510 A	OFF	24
GW 10 511 A	Socket-outlet	24
GW 10 512 A	Dimmers	24
GW 10 513 A	Dimmer increase	24
GW 10 514 A	Dimmer decrease	24
GW 10 515 A	Arrow	24
GW 10 516 A	Open	24
GW 10 517 A	Close	24
GW 10 518 A	Roller shutter	24
GW 10 519 A	Roller shutter up	24
GW 10 520 A	Roller shutter down	24
GW 10 521 A	Curtain open	24
GW 10 522 A	Curtain close	24
GW 10 523 A	Floor light	24
GW 10 524 A	Ceiling light	24
GW 10 525 A	Wall light	24
GW 10 526 A	Aisle light	24
GW 10 527 A	Scenario	24
GW 10 528 A	Party	24
GW 10 529 A	In	24
GW 10 530 A	Out	24
GW 10 531 A	Good morning	24
GW 10 532 A	Good night	24
GW 10 533 A	TV	24
GW 10 534 A	Heating	24
GW 10 535 A	Cooling	24
GW 10 536 A	Heating/Cooling	24
GW 10 537 A	Comfort	24
GW 10 538 A	Precomfort	24
GW 10 539 A	Economy	24
GW 10 540 A	Auto	24
GW 10 541 A	Do not disturb	24
GW 10 542 A	Make up the room	24

NOTE: for use to customise the interchangeable push buttons for axial controls with 1 and 2 lenses.

INTERCHANGEABLE BUTTON KEYS AND DIFFUSERS



ZC6

BUTTON KEYS FOR ROCKER CONTROLS AND INTERCHANGEABLE DIFFUSERS FOR INDICATOR LIGHTS

Code	Symbol	Pack Carton
Description: Keys 22x22 mm		
GW 12 541	General	4/48
GW 12 542	With label	4/48
GW 12 543	Key	4/48
GW 12 544	Bell	4/48
GW 12 545	Vertical arrow	4/48
GW 12 546	Horizontal arrow	4/48
Description: Diffusers		
GW 10 547	Red	4/48
GW 10 548	Green	4/48
GW 10 549	Opal diffuser	4/48
GW 10 550	Amber	4/48

APPLICATIONS: replacement diffusers for indicators GW12142, GW12143 and GW12144.

NOTES: The ChoruSmart modular system allows the use of interchangeable buttons 22 x 22 mm to replace the standard buttons supplied on command devices GW12141, GW12142, GW12143 and GW12144.

SOFT-CLICK, ROCKER ELECTRONIC PUSH BUTTONS



GW 12 915

UNIVERSAL SOFT-CLICK ELECTRONIC PUSH-BUTTON

Code	Type of contact	Button key	Type of use	No. modules	Pack Carton
GW 12 915	1NO/NC 4A (AC1) 230 V ac - Potential-free Neutral		Relay, dimmer, bus contacts interfaces	1	1/12

CHARACTERISTICS: push-button suitable for connection of KNX BUS contact interfaces, or the command of bistable relays, electronic one-way switches for heavy duty loads, or dimmers with a remote control input.



GW 12 912

BACKLIT SOFT-CLICK ELECTRONIC PUSH-BUTTON

Code	Supply voltage	Type of contact	Button key	Type of use	Pack Carton
GW 12 912	230 V ac - 50/60 Hz	1NO 4A (AC1) 230 V ac	With diffuser	Relay, dimmer	1/12

CHARACTERISTICS: push-button for controlling latching relays, electronic switches for heavy duty loads, or dimmers with a remote control input. Equipped with amber localisation LED.



GW 12 913

BACKLIT SOFT-CLICK ELECTRONIC PUSH-BUTTONS FOR BUS INPUTS

Code	Type of contact	Button key	Type of use	Pack Carton
No. modules: 1				
GW 12 913	1NO - Potential-free	With diffuser	Bus contacts interfaces	1/12
GW 12 916	1NO - Potential-free	With replaceable neutral lens	Bus contacts interfaces	1/12
No. modules: 2				
GW 12 917	1NO - Potential-free	With diffuser	Bus contacts interfaces	1/6
GW 12 918	1NO - Potential-free	With replaceable neutral lens	Bus contacts interfaces	1/6

CHARACTERISTICS: push-button for BUS inputs, suitable for KNX BUS contact interface connections. Equipped with 2-colour (amber/green) LED with colour selector (can be set up to work as a night-time localisation lamp or to indicate the load status).



GW 12 914

DOUBLE SOFT-CLICK ELECTRONIC PUSH-BUTTON

Code	Type of contact	Button key	Symbol	No. modules	Pack Carton
GW 12 914	Dual, potential-free and with interlock	Neutral	UP - DOWN	1	1/12

CHARACTERISTICS: double push-button suitable for connecting KNX BUS contact interfaces or electronic control panels for moving roller shutters.

CHORUSMART - Domestic range

TOUCH COMMAND MODULES



GW 10 922

TOUCH ONE-WAY SWITCH MODULE

Code	Supply voltage	Output contacts	No. modules	Pack Carton
GW 10 922	100 ÷ 240 V ac - 50/60 Hz	1 NA 5A (AC1) 240 V ac	1	1/12

CHARACTERISTICS: device for the On/Off control of 1 lighting device through a live output contact. Suitable for control of incandescent and halogen lamps (240Vac): 1000W, LED lamps (240Vac): 100W, fluorescent lamps (240Vac): 120W, halogen lamps powered by electronic transformers (240Vac): 250VA. Equipped with 1 input for replicating local control of the load via the GW10924 auxiliary touch control modules, NO-type buttons and 1 input for the centralisation of the OFF function. The device is equipped with blue LEDs for easy location that can be set to two different light intensity levels. Excludable built-in buzzer, function identification by means of icons on the ICE touch plates.

APPLICATIONS: bistable, monostable and timed load control. Centralisation function (OFF) through the dedicated input.

NOTES: to be completed with ICE touch plates (codes: GW16955CB, GW16955CL, GW16955CN, GW16955CT).



GW 10 923

TOUCH DIMMER MODULE

Code	Supply voltage	Halogen load	Inductive load	LED load	No. modules	Pack Carton
GW 10 923	100 ÷ 240 V ac - 50/60 Hz	4 - 150 W	4 - 150 VA	4 - 150 W	1	1/12

CHARACTERISTICS: trailing edge load drive mode (max. 5 lamps). Two touch areas for dimming the connected load. Equipped with 2 inputs for replicating local control of the load via the auxiliary touch 2-command modules GW10925, NO-type buttons, or for creating the centralisation function OFF. The device is equipped with blue LEDs for easy location that can be set to two different light intensity levels. Excludable built-in buzzer, function identification by means of icons on the ICE touch plates.

APPLICATIONS: control of the dimmable load connected to the devices. Centralised OFF function, via dedicated inputs.

NOTE: to avoid overheating, multiple products cannot be installed side-by-side inside in the same enclosure; insert a blanking module between two electronic devices. When installing two dimmers in the same box, the maximum loads controlled by each dimmer must be reduced by 50%. To be completed using ICE touch plates (codes: GW16955CB, GW16955CL, GW16955CN, GW16955CT).



GW 10 921

TOUCH ROLLER SHUTTER MODULE

Code	Supply voltage	Maximum output power	No. modules	Pack Carton
GW 10 921	100 ÷ 240 V ac - 50/60 Hz	2,3 A 240 V ac (according to IEC 60669-2-1)	1	1/12

CHARACTERISTICS: Devices for the control of a motor to operate roller-shutters, curtains, venetian blinds, awnings, etc., by means of 2 interlocked live output contacts. Two touch areas for controlling the motor connected to the device. Equipped with 2 inputs for replicating local control of the motor via the touch auxiliary 2-command modules GW10925, NO-type up/down buttons, or for creating a centralisation function (up/down). The device is equipped with blue LEDs for easy location that can be set to two different light intensity levels. Excludable built-in buzzer, function identification by means of icons on the ICE touch plates.

APPLICATIONS: control of the motor connected to the devices. Centralisation function (Up/Down) by means of a dedicated inputs.

NOTES: to be completed with ICE touch plates (codes: GW16955CB, GW16955CL, GW16955CN, GW16955CT).

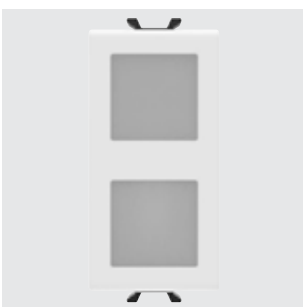

GW 10 924

1-COMMAND AUXILIARY TOUCH MODULE

Code	Supply voltage	Output contacts	No. modules	Pack Carton
GW 10 924	100 ÷ 240 V ac - 50/60 Hz	100mA 240 V ac	1	1/12

CHARACTERISTICS: suitable for controlling the GW10922 module. The device is equipped with blue LEDs for easy location that can be set to two different light intensity levels. Excludable built-in buzzer, function identification by means of icons on the ICE touch plates.

NOTES: to be completed using ICE touch plates (codes: GW16955CB, GW16955CL, GW16955CN, GW16955CT).

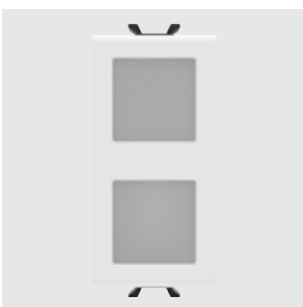

GW 10 925

2-COMMAND AUXILIARY TOUCH MODULE

Code	Supply voltage	Output contacts	No. modules	Pack Carton
GW 10 925	100 ÷ 240 V ac - 50/60 Hz	100mA 240 V ac	1	1/12

CHARACTERISTICS: suitable for controlling the GW10921 and GW10923 modules. The device is equipped with blue LEDs for easy location that can be set to two different light intensity levels. Excludable, built-in buzzer and functions identifiable by the icons on the ICE touch plates.

NOTES: to be completed with ICE touch plates (codes: GW16955CB, GW16955CL, GW16955CN, GW16955CT).

ICE TOUCH PLATES



GW 16 955 CN

ICE TOUCH - BLACK

Code	Description	For support codes	Pack Carton
GW 16 955 CN	6 touch areas	GW16803, GW16803N	1

CHARACTERISTICS: glossy finish. The plate is to be used in combination with the touch modules (switch module GW10922, roller shutter module GW10921, dimmer module GW10923, 1-control auxiliary module GW10924, 2-control auxiliary module GW10925).

NOTES: the symbols displayed in the image are purely indicative: they may be customised using the icons supplied with the touch plate. The code of the plate is unique and independent of the number of icons used (from 2 to 6).

BLANKING MODULES AND CABLE OUTLET



GW 12 195

BLANKING MODULES

Code	Description	No. modules	Pack Carton
GW 12 195	1 module	1	10/200
GW 12 197	1/2 module	1/2	4/48
GW 12 198	2 modules	2	1/48
GW 12 199	3 modules	3	1/48



GW 12 194

CABLE OUTLET

Code	Description	No. modules	Pack Carton
GW 12 194	2 modules	2	6/48
GW 12 196	1 module	1	1/48

NOTES: GW12196 with anti-traction cable fastener device, cables min 6mm ø, max 10mm ø.

GW12194 with anti-traction cable fastener device, cables min 4mm ø, max 10mm ø. To be installed with the cable output downwards.

MOVEMENT DETECTORS



GW 12 594

MOVEMENT DETECTOR

Code	Supply voltage	Output contacts	Pack Carton
GW 12 594	230V ac - 50/60 Hz	1NO 3 A (AC1) 230 V ac	1/4

CHARACTERISTICS: adjustment of the intervention duration 15 sec - 10 min. Light sensitive threshold adjustment - min. 10 lux - max. inhibited.

Suitable for commanding halogen lamps/resistive loads: 700 W, incandescent lamps: 450 W, low voltage halogen lamps (12 V) controlled by toroidal or electronic transformers: 450 W, uncompensated fluorescent lamps: 2x58 W, motors and gear motors: 400 VA, LED loads: 60 W (max. 10 lamps).

Not suitable for compensated fluorescent lamps, for discharge lamps and for all loads not indicated that must be commanded using a support relay.

APPLICATIONS: Energy-saving: command of the lighting of rooms and areas only when people pass through.

Comfort and safety: automatic command of circuits without needing to activate one-way switches.

NOTES: do not install the product in watertight plates: the lid membrane does not allow the detector lens to work correctly. Detection beam angle 120°, depth of detection max 8 metres.

CHORUSMART - Domestic range



GW 10 595

CEILING-MOUNTED PRESENCE DETECTOR

Code	Supply voltage	Installation height (m)	Light sensor	Dimensions HxØ (mm)	Pack Carton
GW 10 595	220/240 V ac - 50/60 Hz	From 2,2 to 6	< 3 ÷ 2000 Lux	44x111,5	1

CHARACTERISTICS: presence sensor, sensing range: 360° circle (max. diameter 18 metres); installable with fixing springs on a surface-mounted or recessed box. Suitable for the control of incandescent/halogen lamps: 1000W, LED lamps: 200W (4 / 23 W - max. 8 lamps).

NOTE: equipped with a surface-mount box capable of holding sensors from IP20 to IP44.

RELAY



GW 12 723

RELAY - 230V AC 50/60HZ

Code	Type	No. of poles	Output contacts	Coil	Pack Carton
No. modules: 1					
GW 12 721	Latching relay	1P	10 AX 250V ac	230V ac - 50/60 Hz	1/12
GW 12 723	Latching relay, 4 seq.	2P	10 AX 250V ac	230V ac - 50/60 Hz	1/12
GW 12 724	Monostable relay	1P	1NO/NC 10A(AC1)/2A(AC15)250V ac	230V ac - 50/60 Hz	1/12

CHARACTERISTICS: GW12721, GW12723 suitable for commanding incandescent/halogen lamps: 1000 W, fluorescent tubes with electronic ballast: 400 W, fluorescent tubes with electromechanical ballast: 360 W, compact fluorescent lamps (CFL): 200 W, LED lamps (230V ac): 200 W, low voltage halogen or LED lamps with electronic ballast: 200 W, low voltage halogen or LED lamps with electromechanical ballast: 400 W.

APPLICATIONS: GW12721, GW12723 command of lighting devices from more than one point, by means of remote NO push-buttons.

GW12721, motor function/stop commands (extractors, air agitators, etc.).

GW12724 as an auxiliary element for commanding special loads, for distance signalling, for electrical separation between the command and use circuits.



GW 12 726

CALL RELAY - 12V AC/DC

Code	Supply voltage	No. of poles	Output contacts	No. modules	Pack Carton
GW 12 726	12V ac/dc	1P	1NO/NC 12 V (max. 1A)	1	1/12

CHARACTERISTICS: inlets for remote NO push-buttons for alarms (e.g. GW12136) and alarm reset (e.g. GW12145), green LED for alarm status signalling.

HOTEL COMPONENTS - SATIN BLACK VERSION

BADGE SWITCH



GW 12 039

BADGE SWITCH

Code	Description	For badge card max. width	Rated power of 230V LED lamps	No. modules	Pack Carton
GW 12 039	1P NA - 16 AX illuminable	54 mm	200 W	2	1/6

CHARACTERISTICS: the product can be fitted directly in 2-module plates; with plates of a greater modularity, you are advised to use 2 blanking modules for a 1/2 module (one on the right and one on the left).

APPLICATIONS: activation of circuits and services in hotel rooms (e.g. lights, air-conditioner, fridge-bar), indication of room occupied (with badge inserted)

NOTES: badges not included. The article uses LED signalling units, not included.

INTERCHANGEABLE BUTTON KEYS



GW 12 733

INTERCHANGEABLE BUTTON KEYS

Code	Button key	Symbol	No. modules	Pack Carton
GW 12 731	With diffuser	DND	1	4/48
GW 12 732	With diffuser	MUR	1	4/48
GW 12 733	Neutral	DND+MUR	1	4/48

CHARACTERISTICS: with "Do not disturb" (DND) and "Make up the room" (MUR) pad printings. To be used for the customization of the Chorus command devices. GW12731 and GW12732 suitable for one-way switches, two-way switches, intermediate switches and push-buttons. GW12733 suitable for three-way switches and push-buttons with central OFF position.

INDICATOR LIGHT DEVICE



GW 12 736

DOUBLE INDICATOR LAMP

Code	Diffuser colour	Symbol	No. modules	Pack Carton
GW 12 736	Opal diffuser	DND+MUR	1	1/24

CHARACTERISTICS: LED signalling units not included.

CHORUSMART - Domestic range

POWER - SATIN BLACK VERSION

SOCKET-OUTLETS - ITALIAN/GERMAN STANDARD



GW 12 203

ITALIAN STANDARD SOCKET-OUTLETS - 250V AC

Code	Description	Socket-out type	For plug pins	No. modules	Pack Carton
GW 12 201	2P+E - 10A	P11	Ø 4 mm	1	12/96
GW 12 203	2P+E - 16 A Dual amperage	P11-P17	Ø 4 / 5 mm	1	12/96

CHARACTERISTICS: with safety shields.



GW 12 204

ITALIAN/GERMAN STANDARD SOCKET-OUTLETS - 250V AC

Code	Description	Earth pit	Socket-out type	For plug pins	No. modules	Pack Carton
GW 12 204	2P+E - 16 A Dual amperage	Side and central	P40	Ø 4 / 4.8 / 5 mm	2	6/48
GW 12 205	2P+E - 16A	Side and central	P30	Ø 4 / 4.8 mm	2	6/48

CHARACTERISTICS: with safety shields.



GW 12 208

ITALIAN STANDARD DOUBLE SOCKET-OUTLET - 250V AC

Code	Description	Socket-out type	For plug pins	No. modules	Pack Carton
GW 12 208	2x2P+E - 16A Dual amperage	P11-P17	Ø 4 / 5 mm	2	6/24

CHARACTERISTICS: with safety shields. The wiring is carried out via 3 terminals that power the socket-outlets, without using U-bolts.



GW 12 209

ITALIAN STANDARD TRIPLE SOCKET-OUTLET - 250V AC

Code	Description	Socket-out type	For plug pins	No. modules	Pack Carton
GW 12 209	3x2P+E - 16A Dual amperage	P11-P17	Ø 4 / 5 mm	3	4/12

CHARACTERISTICS: with safety shields. The wiring is carried out via 3 terminals that power the socket-outlets, without using U-bolts.

SOCKET-OUTLETS FOR DEDICATED LINES - ITALIAN/GERMAN STANDARD



GW 10 213

ITALIAN STANDARD SOCKET-OUTLETS FOR DEDICATED LINES - 250V AC

Code	Description	Colour	Socket-out type	For plug pins	No. modules	Pack Carton
GW 10 213	2P+E - 16 A Dual amperage	Red	P11-P17	Ø 4 / 5 mm	1	12/24
GW 10 223	2P+E - 16 A Dual amperage	Green	P11-P17	Ø 4 / 5 mm	1	12/24
GW 10 233	2P+E - 16 A Dual amperage	Orange	P11-P17	Ø 4 / 5 mm	1	12/24

CHARACTERISTICS: with safety shields.



GW 10 214

ITALIAN/GERMAN STANDARD SOCKET-OUTLETS FOR DEDICATED LINES - 250V AC

Code	Description	Colour	Socket-out type	For plug pins	No. modules	Pack Carton
GW 10 214	2P+E - 16 A Dual amperage illuminable	Red	P40	Ø 4 / 4.8 / 5 mm	2	6/12
GW 10 224	2P+E - 16 A Dual amperage illuminable	Green	P40	Ø 4 / 4.8 / 5 mm	2	6/12
GW 10 234	2P+E - 16 A Dual amperage illuminable	Orange	P40	Ø 4 / 4.8 / 5 mm	2	6/12

CHARACTERISTICS: with safety shields. Pit of side and central earth contacts. Pre-arranged for housing LED signalling units, not included.

APPLICATIONS: possibility to indicate presence of auxiliary network.

SOCKET-OUTLETS - GERMAN STANDARD



GW 12 241

GERMAN STANDARD SOCKET-OUTLET - 250V AC

Code	Description	For plug pins	No. modules	Pack Carton
GW 12 241	2P+E - 16A	Ø 4.8 mm	2	6/48

CHARACTERISTICS: with safety shields.



GW 12 242

GERMAN STANDARD SOCKET-OUTLET WITH LID IP40 - 250 V AC

Code	Description	For plug pins	No. modules	Pack Carton
GW 12 242	2P+E - 16A	Ø 4.8 mm	2	6/48

CHARACTERISTICS: with safety shields. Equipped with a transparent rigid cover with a glossy finish. IP40 degree of protection with the cover closed.

CHORUSMART - Domestic range



GW 10 251

GERMAN STANDARD SOCKET-OUTLET FOR DEDICATED LINES - 250V AC

Code	Description	Colour	For plug pins	No. modules	Pack Carton
GW 10 251	2P+E - 16A	Red	Ø 4.8 mm	2	6/12

CHARACTERISTICS: with safety shields.



GW 12 341

GERMAN STANDARD SOCKET-OUTLET WITH FRONT TIGHTENING TERMINALS - 250V AC

Code	Description	For plug pins	No. modules	Pack Carton
GW 12 341	2P+E - 16A	Ø 4.8 mm	2	6/12

CHARACTERISTICS: with safety shields. Front access terminals with screw fixing, side input of the conductors.



GW 10 351

GERMAN STANDARD SOCKET-OUTLET WITH FRONT TIGHTENING TERMINALS FOR DEDICATED LINES - 250V AC

Code	Description	Colour	For plug pins	No. modules	Pack Carton
GW 10 351	2P+E - 16A	Red	Ø 4.8 mm	2	6/12

CHARACTERISTICS: with safety shields. Front access terminals with screw fixing, side input of the conductors.



GW 12 241 F

GERMAN STANDARD SOCKET-OUTLET WITH QUICK WIRING TERMINALS - 250V AC

Code	Description	For plug pins	No. modules	Pack Carton
GW 12 241 F	2P+E - 16A	Ø 4.8 mm	2	6/12

CHARACTERISTICS: with safety shields. Spring quick wiring, no tools necessary.



GW 10 251 F

GERMAN STANDARD SOCKET-OUTLET FOR DEDICATED LINES WITH QUICK WIRING TERMINALS - 250 V AC

Code	Description	Colour	For plug pins	No. modules	Pack Carton
GW 10 251 F	2P+E - 16A	Red	Ø 4.8 mm	2	6/12

CHARACTERISTICS: with safety shields. Spring quick wiring, no tools necessary.

SOCKET-OUTLETS - FRENCH STANDARD



GW 12 246

FRENCH STANDARD SOCKET-OUTLETS - 250V AC

Code	Description	For plug pins	No. modules	Pack Carton
GW 12 246	2P - 16A	Ø 4 / 4.8 mm	2	1/24
GW 12 247	2P+E - 16A	Ø 4 / 4.8 mm	2	6/48

CHARACTERISTICS: with safety shields.



GW 12 248

FRENCH STANDARD SOCKET-OUTLET WITH FRONT TIGHTENING TERMINALS - 250V AC

Code	Description	For plug pins	No. modules	Pack Carton
GW 12 248	2P+E - 16A	Ø 4 / 4.8 mm	2	6/12

CHARACTERISTICS: with safety shields. Front access terminals with screw fixing, side input of the conductors.



GW 10 258

FRENCH STANDARD SOCKET-OUTLET WITH FRONT TIGHTENING TERMINALS FOR DEDICATED LINES - 250V AC

Code	Description	Colour	For plug pins	No. modules	Pack Carton
GW 10 258	2P+E - 16A	Red	Ø 4 / 4.8 mm	2	6/12

CHARACTERISTICS: with safety shields. Front access terminals with screw fixing, side input of the conductors. To be used in combination with plugs equipped with accessory GW10260.



GW 12 247 F

FRENCH STANDARD SOCKET-OUTLET WITH QUICK WIRING TERMINALS - 250 V AC

Code	Description	For plug pins	No. modules	Pack Carton
GW 12 247 F	2P+E - 16A	Ø 4 / 4.8 mm	2	6/12

CHARACTERISTICS: with safety shields. Spring quick wiring, no tools necessary.



GW 10 257 F

FRENCH STANDARD SOCKET-OUTLET FOR DEDICATED LINES WITH QUICK WIRING TERMINALS - 250 V AC

Code	Description	Colour	For plug pins	No. modules	Pack Carton
GW 10 257 F	2P+E - 16A	Red	Ø 4 / 4.8 mm	2	6/12

CHARACTERISTICS: with safety shields. Spring quick wiring, no tools necessary. To be used in combination with plugs equipped with accessory GW10260.

CHORUSMART - Domestic range



GW 10 260

FRENCH STANDARD SOCKET-OUTLET ACCESSORY, FOR DEDICATED LINES

Code	Colour	For sockets	Pack Carton
GW 10 260	Red	GW10257F - GW10258	10/100

CHARACTERISTICS: to be fixed directly on the 2P+E French standard plug, to avoid the incorrect insertion in dedicated line circuits.

SOCKET-OUTLETS - ISRAELI STANDARD



GW 12 281

ISRAELI STANDARD SOCKET-OUTLET - 250V AC

Code	Description	For plug pins	No. modules	Pack Carton
GW 12 281	2P+E - 16A	Round Ø 4 / 4.4 mm	2	1/24

CHARACTERISTICS: with safety shields.



GW 10 291

ISRAELI STANDARD SOCKET-OUTLET FOR DEDICATED LINES - 250V AC

Code	Description	Colour	For plug pins	No. modules	Pack Carton
GW 10 291	2P+E - 16 A illuminable	Red	Round Ø 4 / 4.4 mm	2	1/24

CHARACTERISTICS: with safety shields. Pre-arranged for housing LED signalling units, not included.



GW 12 282

ISRAELI STANDARD SOCKET-OUTLET - 250V AC

Code	Description	For plug pins	No. modules	Pack Carton
GW 12 282	2P - 10 A	Round Ø 4 mm	1	1/48

CHARACTERISTICS: with safety shields.

SOCKET-OUTLETS - INTERNATIONAL STANDARD



GW 12 286

USA STANDARD SOCKET-OUTLET - 250/125V AC

Code	Description	For plug pins	No. modules	Pack Carton
GW 12 286	2P+E - 15A	Flat parallel horizontal	1	12/48



GW 12 288

EURO-AMERICAN STANDARD SOCKET-OUTLET - 250/125V AC

Code	Description	For plug pins	No. modules	Pack Carton
GW 12 287	2P - 15A	Ø 4 mm Flat	1	12/48
GW 12 288	2P+E - 15A	Ø 4 mm Flat	1	12/48



GW 12 296

BRITISH STANDARD SOCKET-OUTLETS - 250V AC

Code	Description	For plug pins	No. modules	Pack Carton
GW 12 296	2P+E - 13 A	Flat	2	6/48
GW 12 297	2P+E - 15A	Ø 7 mm	2	6/48

CHARACTERISTICS: with safety shields.

NOTES: given the size of the plugs, it is not possible to install two or more socket-outlets side-by-side.



GW 12 298

INDIAN/SOUTH AFRICAN STANDARD SOCKET-OUTLET - 250V AC

Code	Description	For plug pins	No. modules	Pack Carton
GW 12 298	2P+E - 16A	Ø 7 mm	2	6/48

CHARACTERISTICS: with safety shields.

NOTES: given the size of the plugs, it is not possible to install two or more socket-outlets side-by-side.



GW 12 299

SOUTH AFRICAN STANDARD SOCKET-OUTLET - 250 V AC

Code	Description	For plug pins	No. modules	Pack Carton
GW 12 299	2P+E - 16A	Round Ø 4,5 mm	1	12/240

CHARACTERISTICS: with safety shields.

CHORUSMART - Domestic range



GW 12 301

ARGENTINIAN STANDARD SOCKET-OUTLETS - 250V AC

Code	Description	For plug pins	No. modules	Pack Carton
GW 12 301	2P+E - 10A	Flat	2	6/48



GW 12 306

AUSTRALIAN STANDARD SOCKET-OUTLET - 250V AC

Code	Description	For plug pins	No. modules	Pack Carton
GW 12 306	2P+E - 10A	Flat	2	6/48
GW 12 307	2P+E - 15A	Flat	2	6/48



GW 12 310

MULTISTANDARD SOCKET-OUTLET - 250/127V AC

Code	Description	No. modules	Pack Carton
GW 12 310	2P+E - 13A/250 V ac - 15A/127 V ac	2	10/40

CHARACTERISTICS: with safety shields.

APPLICATIONS: suitable for plugs compliant with the following standards: Europlug 2P 2.5A - 250V, British 2P+E 13A - 250V, Italian 2P 10A - 250V, Danish 2P 10A - 250V, Chinese 2P+E 10A - 250V, Argentinean/Australian 2P+E 10A - 250V, Indian 2P+E 6A - 250V, USA 2P+E 15A - 127V. Not suitable for 2P+E German and French sockets because they don't offer earth continuity.

NOTES: the multistandard energy sockets GW1x310 are in compliance with the safety requirements defined by the International Standard IEC 60884-1. These sockets may not be in compliance with the standard sheets used in the country where they are sold, hence their usage could be prohibited or however, restricted only for specific applications. The plugs allowed are listed in the technical datasheet. Please contact directly Gewiss technical service for further information.



GW 12 392

CHINESE STANDARD SOCKET-OUTLETS - 250 V AC

Code	Description	For plug pins	No. modules	Pack Carton
GW 12 391	2P+E - 10A	Flat	2	6/48
GW 12 392	2P+E - 16A	Flat	2	6/48

CHARACTERISTICS: with safety shields.

INTERLOCKED SWITCHED SOCKET-OUTLETS



GW 12 311

INTERLOCKED SWITCHED SOCKET-OUTLETS WITH MINIATURE CIRCUIT BREAKER - 230V AC

Code	Description	Socket-out type	Miniature circuit breakers	Breaking capacity	No. modules	Pack Carton
GW 12 311	2P+E - 16A	P17-P11	1P+N 16A	3 kA	2	1/6
GW 12 312	2P+E - 16A	P40	1P+N 16A	3 kA	3	1/4

CHARACTERISTICS: Interlocked switched socket-outlets with automatic miniature circuit breaker (C characteristic). Pits under tension only with plug inserted.

APPLICATIONS: suitable for installation in the system terminations to protect the load.



GW 12 321

INTERLOCKED SWITCHED SOCKET-OUTLETS WITH RESIDUAL MINIATURE CIRCUIT BREAKER - 230V AC

Code	Description	Socket-out type	Miniature circuit breakers	Breaking capacity	I _{dn}	No. modules	Pack Carton
GW 12 321	2P+E - 16A	P17-P11	1P+N 16A	3 kA	10 mA	3	1/4
GW 12 322	2P+E - 16A	P40	1P+N 16A	3 kA	10 mA	4	1/2

CHARACTERISTICS: Interlocked switched socket-outlets with automatic miniature circuit breaker (C characteristic) and residual current circuit breaker (type A). Pits under tension only with plug inserted.

APPLICATIONS: suitable for installation in the system terminations to protect the load.

SHAVER SOCKET-OUTLET



GW 12 331

EURO-AMERICAN STANDARD SHAVER SOCKET-OUTLET WITH INSULATION TRANSFORMER

Code	Supply voltage	For plug pins	Selectable output voltage	Maximum power	No. modules	Pack Carton
GW 12 331	230 V ac - 50/60 Hz	Ø 4 / 5 - 6.3x1.5 mm	120-230V ac	20 VA	3	1/2

CHARACTERISTICS: the socket-outlet is equipped with a self-protection device against overloading.

The output voltage should be selected correctly, consulting the rating of the user device before inserting the plug.

The relevant indicator LED allows the chosen voltage to be clearly seen.

NOTES: not suitable for installation in wall-mounting boxes or free-standing containers.

DATA - SATIN BLACK VERSION

TV-SAT SOCKETS



GW 12 361

COAXIAL TV SOCKETS (5-2400 MHZ), CLASS A SHIELDING - MALE IEC CONNECTOR Ø 9.5 MM

Code	Description	Attenuation	No. modules	Pack Carton
GW 12 361	Direct	0 dB	1	1/48
GW 12 362	Through wiring	5 dB	1	1/24
GW 12 363	Through wiring	10 dB	1	1/24
GW 20 277	Terminal resistance 75 ohm	-	-	50/200

CHARACTERISTICS: GW12361 allows the passage of voltage/current of remote power supply and/or control signals towards the user port (max 24 V - 500 mA).

GW20277 in combination with feedthrough socket-outlets allows you to make terminal socket-outlets.

APPLICATIONS: Socket-outlets suitable for return channel.

NOTES: the TV 5dB GW12362 coaxial socket-outlet is defined with conditional use: it is a special feedthrough socket-outlet, and must be used as such, with the only difference that the user port (socket-outlet towards the user device) must always be closed with a 75-Ohm load (TV, VCR, SAT receiver or 75-Ohm termination).

CHORUSMART - Domestic range



GW 12 371

COAXIAL TV-SAT SOCKETS (5-2400 MHZ), CLASS A SHIELDING - FEMALE F CONNECTOR

Code	Description	Attenuation	No. modules	Pack Carton
GW 12 371	Direct	0 dB	1	1/48
GW 12 372	Through wiring	5 dB	1	1/24
GW 12 373	Through wiring	10 dB	1	1/24
GW 20 277	Terminal resistance 75 ohm	-	-	50/200

CHARACTERISTICS: GW12371 allows the passage of voltage/current of remote power supply and/or control signals towards the user port (max 24 V - 500 mA).

GW20277 in combination with feedthrough socket-outlets allows you to make terminal socket-outlets.

APPLICATIONS: Socket-outlets suitable for return channel.

NOTES: the TV-SAT 5dB GW12372 coaxial socket-outlet is defined with conditional use: it is a special feedthrough socket-outlet, and must be used as such, with the only difference that the user port (socket-outlet towards the user device) must always be closed with a 75-Ohm load (TV, VCR, SAT receiver or 75-Ohm termination).



GW 12 382

TV-FM-SAT SOCKETS

Code	Connectors	Description	Attenuation	No. modules	Pack Carton
GW 12 381	TV-FM	Direct	0 dB	2	1/24
GW 12 382	TV-FM-SAT	Direct	0 dB	2	1/24
GW 12 383	TV-SAT	Direct	0 dB	2	1/24

CHARACTERISTICS: TV-FM direct co-axial socket-outlet GW12381: male IEC-type TV connector \varnothing 9.5mm, female IEC-type FM connector \varnothing 9.5mm.

TV-FM-SAT direct co-axial socket-outlet GW12382: male IEC-type TV connector \varnothing 9.5mm, female IEC-type FM connector \varnothing 9.5mm, female F-type SAT connector.

TV-SAT direct co-axial socket-outlet GW12383: male IEC-type TV connector \varnothing 9.5mm, female F-type SAT connector.

NOTES: demixed socket-outlets with input for co-axial cable \varnothing 5mm or 7mm.



GW 12 367

COAXIAL TV SOCKETS (5-2400 MHZ), CLASS A SHIELDING - MALE IEC CONNECTOR \varnothing 9.5MM

Code	Description	Attenuation	No. modules	Pack Carton
GW 12 367	Direct	0 dB	2	1/24

CHARACTERISTICS: allows the passage of voltage/current of remote power supply and/or control signals towards the user port (max 24V - 500 mA).

APPLICATIONS: socket-outlets suitable for return channel.



GW 12 377

COAXIAL TV-SAT SOCKETS (5-2400 MHZ), CLASS A SHIELDING - FEMALE F CONNECTOR

Code	Description	Attenuation	No. modules	Pack Carton
GW 12 377	Direct	0 dB	2	1/24

CHARACTERISTICS: allows the passage of voltage/current of remote power supply and/or control signals towards the user port (max 24V - 500 mA).

APPLICATIONS: socket-outlets suitable for return channel.



GW 12 386

COVERS FOR TV-SAT-R ANTENNA SOCKETS

Code	Description	No. holes	Pack Carton
GW 12 386	For TV-R base	2	1/24
GW 12 387	For TV/R-SAT base	2	1/24

APPLICATIONS: suitable for integration on the Chorus range of TV-SAT-R standard bases available on the market.

ACCESSORIES SUPPLIED: fixing screws.

TELEPHONE SOCKETS



GW 12 401

RJ11 TELEPHONE SOCKETS

Code	Description	Connection	No. modules	Pack Carton
GW 12 401	RJ11	Screw-on terminals	1	1/24

APPLICATIONS: telephone, telefax, modem.



GW 12 409

RJ11 TELEPHONE SOCKET

Code	Description	Connection	No. modules	Pack Carton
GW 12 409	RJ11	Screw-on terminals	2	1/24

APPLICATIONS: telephone, telefax, modem.



GW 12 406

BRITISH STANDARD TELEPHONE SOCKET

Code	Description	Connection	No. modules	Pack Carton
GW 12 406	6 contacts	Screw-on terminals	1	1/24

DATA SOCKETS



GW 12 421

RJ45 SOCKETS

Code	Description	Number pairs	Use category	Cables	Connection	No. modules	Pack Carton
GW 12 421	RJ45	4	5e	UTP	Toolless	1	1/24
GW 12 422	RJ45	4	5e	FTP	Toolless	1	1/24
GW 12 423	RJ45	4	6	UTP	Toolless	1	1/24
GW 12 424	RJ45	4	6	FTP	Toolless	1	1/24

APPLICATIONS: LANs up to 100MHz (e.g. Ethernet, Token Ring networks) for cat. 5e; LANs up to 250MHz (e.g. Videoconference systems, CCTV) for cat. 6.

NOTES: circuit identification label included.

CHORUSMART - Domestic range



GW 12 431

ADAPTERS FOR HOUSING DATA CONNECTORS

Code	Compatibility	No. modules	Pack Carton
GW 12 431	AMP / Keystone Jack	1	1/48
GW 12 438	SYSTIMAX COMMSCOPE	1	1/48

NOTES: with regard to the technological developments and dimensional variants introduced by connector manufacturers, you are advised to check in advance the full compatibility between the connector and the GEWISS adapter.



GW 12 437

RJ45 SOCKETS

Code	Description	Number pairs	Use category	Cables	Connection	No. modules	Pack Carton
GW 12 434	RJ45	4	5e	UTP	Toolless	2	1/24
GW 12 436	RJ45	4	5e	FTP	Toolless	2	1/24
GW 12 435	RJ45	4	6	UTP	Toolless	2	1/24
GW 12 437	RJ45	4	6	FTP	Toolless	2	1/24

APPLICATIONS: LAN networks up to 100 MHz (e.g. Ethernet or Token Ring networks) for cat. 5e; LAN networks up to 250 MHz (e.g. video conference or video control systems) for cat. 6.



GW 12 433

ADAPTER FOR HOUSING DATA CONNECTORS

Code	Compatibility	No. modules	Pack Carton
GW 12 433	AMP / Keystone Jack	2	4/100

NOTES: due to technological developments and dimensional variants introduced by connector manufacturers, you are advised to check in advance the full compatibility between the data socket and the GEWISS empty enclosure.

ADAPTERS FOR OPTICAL FIBER



GW 38 335

ANGLED SC/APC ADAPTER

Code	Type	Tilt	For connectors	Compatibility	Colour	Pack Carton
GW 38 335	Female/Female	40°	SC/APC	Keystone Jack	Green RAL 6018	1/25

CHARACTERISTICS: cable outlet inclined of 40° to the wall line. With ceramic fiber optic sleeve and dust caps. The front output is protected with safety cap and unmissable cord. Suitable to join two single-mode SC/APC fiber optic patch cables.

NOTES: for adapters (Chorus, System and Dahlia) with Keystone Jack coupling.

SOCKET-OUTLETS FOR AUXILIARY CIRCUITS



GW 12 451

SELV SOCKETS

Code	Description	For plug pins	No. modules	Pack Carton
GW 12 451	2P - 6A - 24V	Ø 3 mm	1	12/24
GW 12 452	2P - 6A - 24V polarised	Flat	1	12/24

CHARACTERISTICS: Centre distance 12,4mm.

AUDIO AND VIDEO SOCKETS



GW 12 453

AUDIO AND VIDEO SOCKETS

Code	Description	No. modules	Pack Carton
GW 12 453	Double RCA	1	1/24
GW 12 454	For loudspeaker	1	1/24
GW 12 458	Speaker socket	1	1/24

CHARACTERISTICS: GW12453 double RCA stud connector, red and white, weld-in connection.

GW12454 welding connection. GW12458 front access terminals for inserting 1.5 mm² rigid wires, insulator punching rear connection suitable for cables AWG24 or max 0.25mm².

USB AND HDMI COUPLERS AND SOCKETS



GW 12 459

USB SOCKETS

Code	Description	No. modules	Pack Carton
GW 12 459	USB socket-outlet	1	1/24

CHARACTERISTICS: A-type USB 2.0 female connector, with screw terminals on the back.



GW 38 056

USB AND HDMI COUPLERS

Code	Description	Type	Compatibility	Pack Carton
GW 38 056	HDMI coupler	Female/Female	Keystone Jack	1/48
GW 38 057	USB coupler	Female/Female - A type	Keystone Jack	1/48

NOTES: for adapters designed to house data connectors (ChoruSmart, System and Playbus) with Keystone Jack type coupling and permutation panels.

CHORUSMART - Domestic range

USB CHARGERS



GW 12 449

USB POWER SUPPLY FOR ELECTRONIC DEVICES

Code	Supply voltage	Output voltage	Max current supplied	Type of port	No. modules	Pack Carton
GW 12 447	100 ÷ 240 V ac - 50/60 Hz	5V dc	3 A	A+A	1	1/10
GW 12 449	100 ÷ 240 V ac - 50/60 Hz	5V dc	3 A	A+C	1	1/10

CHARACTERISTICS: suitable for recharging a single electronic device (e.g. tablet) or two devices simultaneously (e.g. a tablet and smartphone). The division of the current delivered to the two outputs depends on the state of charge of the connected devices.

PROTECTION - SATIN BLACK VERSION

MINIATURE CIRCUIT BREAKERS



GW 12 463

MCB - MINIATURE CIRCUIT BREAKERS - C CHARACTERISTIC - 230V AC

Code	Description	Rated current (A)	Breaking capacity	No. modules	Pack Carton
GW 12 461	Single pole (1P)	6	3 kA	1	1/12
GW 12 462	Single pole (1P)	10	3 kA	1	1/12
GW 12 463	Single pole (1P)	16	3 kA	1	1/12
GW 12 466	Two-pole (1P+N)	6	3 kA	1	1/12
GW 12 467	Two-pole (1P+N)	10	3 kA	1	1/12
GW 12 468	Two-pole (1P+N)	16	3 kA	1	1/12



GW 12 488

RCBO - RESIDUAL CURRENT BREAKERS WITH OVERCURRENT PROTECTION - C CHARACTERISTIC - CLASS A - 230V AC - 50/60 HZ

Code	Description	Rated current (A)	Breaking capacity	Idn	No. modules	Pack Carton
GW 12 482	Two-pole (1P+N)	6	3 kA	10 mA	2	1/6
GW 12 483	Two-pole (1P+N)	6	3 kA	30 mA	2	1/6
GW 12 485	Two-pole (1P+N)	10	3 kA	10 mA	2	1/6
GW 12 486	Two-pole (1P+N)	10	3 kA	30 mA	2	1/6
GW 12 488	Two-pole (1P+N)	16	3 kA	10 mA	2	1/6
GW 12 489	Two-pole (1P+N)	16	3 kA	30 mA	2	1/6

PROTECTION DEVICES



GW 12 491

FUSE HOLDER - 250V AC

Code	Rated current (A)	Fuse type	No. modules	Pack Carton
GW 12 491	16	Ø 6.3x32 mm	1	1/12

CHARACTERISTICS: fuse not included.



GW 12 492

SURGE PROTECTION DEVICE - 230V AC

Code	Uc	Up	No. modules	Pack Carton
GW 12 492	275 V ac 50/60Hz	1kV	1	1/12

CHARACTERISTICS: green LED for status signalling.

APPLICATIONS: protection of electronic devices (TV, HI-FI, computer, etc.) from overvoltage (resulting from atmospheric conditions or manoeuvres) that could be channelled from the power supply lines.

INDICATOR - SATIN BLACK VERSION

INDICATOR LIGHT DEVICES



GW 12 642

SINGLE INDICATOR LAMPS - 1/2 MODULE

Code	Diffuser colour	Colour meaning	No. modules	Pack Carton
GW 12 641	Opal diffuser	Neutral	1/2	2/48
GW 12 642	Green	Safety	1/2	2/48
GW 12 643	Red	Danger	1/2	2/48
GW 12 644	Amber	Attention	1/2	2/48

CHARACTERISTICS: LED signalling units, not included.

APPLICATIONS: the meaning of the diffusers refers to the recommendations of standard EN60073 with regard to the use of the colours in indicator lights.



GW 12 622

SINGLE INDICATOR LAMPS - 1 MODULE

Code	Diffuser colour	Colour meaning	No. modules	Pack Carton
GW 12 621	Opal diffuser	Neutral	1	1/24
GW 12 622	Green	Safety	1	1/24
GW 12 623	Red	Danger	1	1/24
GW 12 624	Amber	Attention	1	1/24

CHARACTERISTICS: LED signalling units, not included.

APPLICATION: the meaning of the diffusers refers to the recommendations of standard EN60073 with regard to the use of the colours in indicator lights.



GW 12 629

DOUBLE INDICATOR LAMPS - 1 MODULE

Code	Diffuser colour	No. modules	Pack Carton
GW 12 628	Opal diffuser	1	1/24
GW 12 629	Red/green	1	1/24

CHARACTERISTICS: LED signalling units, not included.

APPLICATIONS: the meaning of the diffusers refers to the recommendations of standard EN60073 with regard to the use of the colours in indicator lights.

CHORUSMART - Domestic range



GW 12 633

PROTRUDING INDICATOR LAMPS - 2 MODULES

Code	Supply voltage	Diffuser colour	Lamp	No. modules	Pack Carton
GW 12 631	12V ac/dc - 230V ac 50/60 Hz	Opal diffuser	White LED	2	1/24
GW 12 632	12V ac/dc - 230V ac 50/60 Hz	Green	White LED	2	1/24
GW 12 633	12V ac/dc - 230V ac 50/60 Hz	Red	White LED	2	1/24
GW 12 634	12V ac/dc - 230V ac 50/60 Hz	Amber	White LED	2	1/24

CHARACTERISTICS: highly efficient white LED, powered at 12V ac/dc - 230V ac with double power supply inlet.

APPLICATIONS: suitable for special applications such as the signalling of calls from hospital wards.

NOTES: complete with lamp.



GW 12 656

STAIR RISER LAMP

Code	Supply voltage	Diffuser colour	Lamp	No. modules	Pack Carton
GW 12 651	12V ac/dc - 230V ac 50/60 Hz	Opal diffuser	White LED	2	1/24
GW 12 656	12V ac/dc - 230V ac 50/60 Hz	Opal diffuser	White LED	4	1/2

CHARACTERISTICS: highly efficient white LED, powered at 12V ac/dc - 230V ac with double power supply inlet.

ANTI BLACK-OUT AND EMERGENCY LAMPS



GW 12 661

EXTRACTABLE ANTI BLACK-OUT LAMP

Code	Supply voltage	Power supply batteries	Minimum autonomy	Lamp	Pack Carton
GW 12 661	230 V ac - 50/60 Hz	Ni - Mh	2 h	White LED	1/6

CHARACTERISTICS: equipped with a 3-position selector on the front panel, for anti black-out, inhibition and night functioning.

To be inserted in any socket-outlet of the Italian, German or French type. Highly efficient, white LED lamp.



GW 12 662

ANTI BLACK-OUT LAMP

Code	Supply voltage	Power supply batteries	Minimum autonomy	Lamp	No. modules	Pack Carton
GW 12 662	230 V ac - 50/60 Hz	Ni - Mh	1 h	White LED	1	1/12

CHARACTERISTICS: green LED for the presence of mains voltage signalling. Highly efficient, white LED lamp.



GW 12 663

AUTONOMOUS EMERGENCY LAMPS

Code	Supply voltage	Power supply batteries	Minimum autonomy	Lamp	No. modules	Pack Carton
GW 12 663	230 V ac - 50/60 Hz	Ni - Mh	1 h	White LED	2	1/6
GW 12 666	230 V ac - 50/60 Hz	Ni - Mh	1 h	White LED	4	1/2

CHARACTERISTICS: green mains presence signal LED. Highly efficient, white LED lamps.

APPLICATIONS: compliant with standards EN60598-2-22.

ACOUSTIC SIGNALLING DEVICES



GW 12 601

RINGERS

Code	Supply voltage	Max power consumption	Sound intensity	No. modules	Pack Carton
GW 12 601	12V ac - 50 Hz	8 VA	80 dB (at 1 m)	1	1/24
GW 12 602	230V ac - 50 Hz	8 VA	80 dB (at 1 m)	1	1/24

CHARACTERISTICS: for intermittent use (5 sec. ON / 15 sec. OFF).



GW 12 606

BUZZERS

Code	Supply voltage	Max power consumption	Sound intensity	No. modules	Pack Carton
GW 12 606	12V ac - 50 Hz	8 VA	70 dB (at 1 m)	1	1/24
GW 12 607	230V ac - 50 Hz	8 VA	70 dB (at 1 m)	1	1/24

CHARACTERISTICS: for intermittent use (5 sec. ON / 15 sec. OFF).



GW 12 611

THREE TONE RINGER AND THREE INDEPENDENT INPUTS

Code	Supply voltage	Max power consumption	Sound intensity	No. modules	Pack Carton
GW 12 611	12V ac/dc	3 VA	80 dB (at 1 m)	2	1/6
GW 12 612	230V ac - 50 Hz	6 VA	80 dB (at 1 m)	2	1/6

CHARACTERISTICS: for continuous use. Three tones (alarm, ring and two-tone) with adjustable sound intensity.

APPLICATIONS: it is possible to combine the outdoor call, indoor call and alarm functions with one single device.

ENERGY, TEMPERATURE AND COMFORT MANAGEMENT - SATIN BLACK VERSION

TIMER DEVICES



GW 12 581

ELECTRONIC DAILY/WEEKLY TIMER, 1-CHANNEL

Code	Supply voltage	Output contacts	No. modules	Pack Carton
GW 12 581	230 V ac - 50/60 Hz	1NO/NC 8A(AC1)/4A(AC15) 250V ac	2	1/2

CHARACTERISTICS: with rechargeable buffer battery to guarantee the updating of the calendar (date, day, time) in the event of a blackout.

CHORUSMART - Domestic range

TEMPERATURE CONTROL DEVICES



GW 12 703

TIMED THERMOSTAT - DAILY/WEEKLY PROGRAMMING

Code	Supply voltage	Temperature adjustment	Output contacts	No. modules	Pack Carton
GW 12 703	230 V ac - 50/60 Hz	From +5°C to +40°C	1NO/NC 5A(AC1)/2A(AC15) 250V ac	2	1/2

CHARACTERISTICS: with rechargeable buffer battery to guarantee the updating of the calendar (date, day, time) in the event of a blackout.



GW 12 709

CONNECTED THERMOSTAT - ZIGBEE

Code	Supply voltage	Output contacts	No. modules	Pack Carton
GW 12 709	100 ÷ 240 V ac - 50/60 Hz	1 NO / NC 5A (AC1) 240 V ac	2	1/3

FEATURES: flush-mounted thermostat for the control of heating/cooling systems with manual temperature management and possibility of shutdown. Control algorithms for two-way systems: two points (ON/OFF), proportional-integral (PWM). The thermostat can control a solenoid valve for heating or cooling through a local contact or via Zigbee, in which case the solenoid valve must be controlled by a Zigbee actuator. GWA1521, GWA1522, GWA1523, GW1x826, GWA1201, and GWA1202 Zigbee connected actuators can be used.

The thermostat is equipped with integrated temperature and humidity sensors. The thermostat has an input for a NTC sensor (GW10800 and GW1x900 sensors can be used) for external temperature measurement (e.g., for compensation of temperatures measured locally by the thermostat or for protection in case of underfloor heating/cooling).

APPLICATIONS: climate control (heating or cooling) of a housing unit or area; option to manage a daily or weekly heating/cooling profile via the APP. The device measures humidity, if a threshold (defined during configuration) is exceeded, Zigbee can activate a dehumidification system and display/notify the measurement on the APP.

Use in traditional unconnected systems: the connected thermostat can also be used in traditional unconnected installations. In this case, configuration is not carried out via the APP and the NTC sensor input can only be used to compensate for the temperature measurement detected locally by the thermostat.



GW 12 705

THERMOSTAT

Code	Supply voltage	Temperature adjustment	Output contacts	No. modules	Pack Carton
GW 12 705	230 V ac - 50/60 Hz	From +5°C to +35°C	1NO / NC 8A(AC1) 250V ac	2	1/2

CHARACTERISTICS: choice of working mode by means of selector located on the front: summer (air-conditioner), OFF, winter (boiler).

Two-colour front LED to signal the output status (open/closed contact). The lighting up of the LED also indicates mains presence.



GW 16 970 CN

THERMO ICE WI-FI THERMOSTAT - WALL-MOUNTING

Code	Colour	Supply voltage	Temperature adjustment	Output contacts	Dimensions LxHxD (mm)	Pack Carton
GW 16 970 CN	Black	110-230V ac - 50/60Hz	From +5°C to +40°C	2NO 6A(AC1) 250V ac	123x95x21	1

CHARACTERISTICS: wall-mounting thermostat to control heating/cooling and humidification/dehumidification systems and manage the temperature in manual mode or on 3 levels (comfort, pre-comfort, economy). Control algorithms for two-way systems: two points (ON/OFF), proportional integral (PWM). Includes 1 input for external NTC temperature sensor (e.g.: protection for flood mounting heating). Equipped with a user interface with touch controls (capacitive) on technopolymer plate and backlit display. The thermostat has built-in proximity, temperature and humidity sensors and a Wi-Fi interface for setting parameters and programming temperature profiles (timed thermostat function) locally or remotely via specific apps (smartphone and tablet).

NOTES: wall-mounting with wall-plugs or on 3-modules rectangular boxes (centre distance 83.5 mm) Plate material; technopolymer.

DIMMER



GW 12 575

UNIVERSAL ROTATING ELECTRONIC REGULATOR

Code	Supply voltage	No. modules	Pack Carton
GW 12 575	230V ac - 50 Hz	1	1/12

CHARACTERISTICS: suitable for dimming incandescent and halogen lamps 230 V ac (10-160 W); low-voltage halogen lamps (12 V ac) with electronic transformers (10-160 W) and LED lamps 230 V ac (4-160W), rotary control with 2-way switch. Equipped with amber-colour-red signalling LED. Can be operated without neutral connection.

NOTES: the installation of more than one dimmer side-by-side in a single container is not permitted. To avoid overheating, insert a blanking module between two dimmers. If installing two dimmers in the same box, the maximum loads that can be controlled by each dimmer must be reduced by 50%.



GW 12 564

ROTATING ELECTRONIC REGULATORS FOR RESISTIVE/INDUCTIVE LOADS

Code	Supply voltage	Resistive load 230V ac	Inductive load 230V ac	No. modules	Pack Carton
GW 12 564	230 V ac - 50/60 Hz	100 - 900 W	40 - 300 VA	1	1/12
GW 12 567	230 V ac - 50/60 Hz	100 - 500 W	100 - 500 VA	1	1/12

CHARACTERISTICS: with signalling led orange. GW12567 rotary command with two-way switch.

GW12564 compliance with the EMC directive is only guaranteed by connecting the regulator to an LC filter with the following characteristics: L=1mH - 5A, C=0.15uF - 275V X2, according to the documentation provided with the product. Item designated solely for export to a limited number of countries outside of the European Union or countries applying to become part of the European Free Trade Area. Contact GEWISS Customer Service to check the product meets the regulations of the country concerned before importing it.

NOTES: to avoid overheating, the side by side installation of several products in a single container is not permitted; insert a blanking module between two electronic devices. If installing two regulators in the same box, the maximum loads that can be commanded by each regulator must be reduced by 50%.



GW 12 572 A

UNIVERSAL ELECTRONIC REGULATORS WITH PUSH-BUTTON

Code	Supply voltage	No. modules	Pack Carton
GW 12 572 A	230V ac - 50/60 Hz	1	1/12
GW 12 573 A	230V ac - 50/60 Hz	2	1/6

CHARACTERISTICS: for the regulation and switching of incandescent and halogen lamps 230V AC (40-300W), low voltage halogen and LED lamps with electronic and winding transformers (40-300W), LED lamps 230V AC with dimmer function (5-150W). Manual selection of the type of load (Leading Edge or Trailing Edge piloting), soft-start function for lamp protection. Possibility to command and regulate from remote control push-buttons with NO contacts. Equipped with orange signalling LED.

NOTES: to avoid overheating, the side-by-side installation of several products in a single container is not permitted; insert a blanking module between two electronic devices. If two regulators are installed in the same box, the maximum loads that can be commanded by each regulator must be reduced by 50%.



GW 12 568

ELECTRONIC REGULATOR WITH BUTTON FOR RESISTIVE/INDUCTIVE LOADS

Code	Supply voltage	Resistive load 230V ac	Inductive load 230V ac	No. modules	Pack Carton
GW 12 568	230V ac - 50 Hz	60 - 500 W	60 - 500 VA	1	1/12

CHARACTERISTICS: possibility to command and regulate from remote control push-buttons with NO contact. With signalling led orange.

NOTES: to avoid overheating, the side by side installation of several products in a single container is not permitted; insert a blanking module between two electronic devices. If installing two regulators in the same box, the maximum loads that can be commanded by each regulator must be reduced by 50%.

CHORUSMART - Domestic range

TECHNICAL ALARMS - SATIN BLACK VERSION

GAS DETECTORS



GW 12 711

LPG DETECTOR

Code	Supply voltage	Tripping threshold	Output contacts	No. modules	Pack Carton
GW 12 711	12V ac/dc	9% LIE	1NO/NC 10A(NO)/3A(NC)250V ac	2	1/2

CHARACTERISTICS: relay output for the automatic command of the gas interception solenoid valve (manual reset) GW30522. Sound intensity: 85dB at 1m.



GW 12 712

METHANE GAS DETECTOR

Code	Supply voltage	Tripping threshold	Output contacts	No. modules	Pack Carton
GW 12 712	12V ac/dc	9% LIE	1NO/NC 10A(NO)/3A(NC)250V ac	2	1/2

CHARACTERISTICS: relay output for the automatic command of the gas interception solenoid valve (manual reset) GW30522. Sound intensity: 85dB at 1m.



GW 10 720

POWER SUPPLY UNIT 12VDC

Code	Supply voltage	Output voltage	Max current supplied	Dimensions LxHxD (mm)	Pack Carton
GW 10 720	100 ÷ 240 V ac - 50/60 Hz	12V dc	300 mA	52x33x17	1/10

APPLICATIONS: to be used for powering LPG detectors (GW1x711, GW2x868, GW30520), methane detectors (GW1x712, GW2x867, GW30519); Thermo ICE KNX (GW16974CB, GW16974CN, GW16974CT) thermostats.

ANTI-FLOOD SYSTEM WITH ZIGBEE WIRELESS TRANSMISSION



GW A1 514

ZIGBEE FLOOD ALARM - IP20

Code	Siren output	Temperature sensor	Colour	Dimensions (mm)	Pack Carton
GW A1 514	85 dB/3 m	0...50 °C	White	Ø 60x37	1/6

CHARACTERISTICS: the alarm detects the presence of water and includes a temperature sensor. Powered by CR123-type battery (replaceable).

NOTES: floor-mounting or alternatively wall-mounting possibility through the GWA1541 accessory. To be used in combination with the Zigbee actuator GWA1521 when controlling an electrovalve or a load.



GW A1 521

1-CHANNEL ACTUATOR ZIGBEE

Code	Supply voltage	Output contacts	Dimensions LxHxD (mm)	Pack Carton
GW A1 521	230V ac - 50 Hz	1 NO 10A (AC) 230 V ac	42x40x20	1/4

CHARACTERISTICS: 1-channel actuator for activating loads via the potential-free output contact (NO). Suitable for commanding incandescent lamps (230 V ac): 2300W, loads controlled from toroidal transformers: 450W, loads controlled from electronic transformers: 600W, energy saving lamps (compact fluorescent): 150W, LED lamps (230 V ac): 150W, motors: 500W.

APPLICATIONS: when used with the water sensor, provide the installation of a NO push-button to open the electrovalve manually.

NOTES: installation in flush-mounting boxes, junction boxes, etc..



GW 12 750

BLANKING MODULE FOR HOUSING RF ZIGBEE ACTUATORS

Code	Colour	No. modules	Pack Carton
GW 12 750	Satin black	1	1/12

CHARACTERISTICS: 1-module blanking module with pad printing. Allows the housing and fast identification of the flush-mounting RF Zigbee actuator.

NOTES: snap-in assembly.

ACCESSORIES



GW A1 541

WALL-MOUNTING SUPPORT FOR FLOOD ALARM

Code	Colour	Support dimension (mm)	Dimensions of probe (mm)	Cable max. length (cm)	Pack Carton
GW A1 541	White	Ø72x25	Ø50x8	85	1/4

APPLICATIONS: to be used for the wall-mounting of the Zigbee flood alarm GWA1514.



GW 30 522

SOLENOID VALVE, WITH MANUAL RESET, NORMALLY OPEN - 230V - 50HZ

Code	Delivery Ø	Material	Power input	Pack Carton
GW 30 522	3/4"	Brass	12 VA	1/2

CHORUSMART - Domestic range

ACCESSORIES

SIGNALLING UNITS



GW 10 881

LED SIGNALLING UNITS - 230 V AC - 0.6 W

Code	Lamp voltage	Lamp power	Lamp	Light emitted	Cable Colour	Pack Carton
GW 10 881	230 V ac - 50/60 Hz	0.6 W	LED	Blue	Blue	50
GW 10 882	230 V ac - 50/60 Hz	0.6 W	LED	White	White	50
GW 10 883	230 V ac - 50/60 Hz	0.6 W	LED	Red	Red	50
GW 10 884	230 V ac - 50/60 Hz	0.6 W	LED	Green	Green	50
GW 10 885	230 V ac - 50/60 Hz	0.6 W	LED	Amber	Orange	50

NOTES: the LED signalling units are supplied with power supply cables (length 10 cm).



GW 10 894

LED SIGNALLING UNITS - 12-24 V AC/DC - 0.6 W

Code	Lamp voltage	Lamp power	Lamp	Light emitted	Cable Colour	Pack Carton
GW 10 894	12-24V ac/dc	0.6 W	LED	White	White	50

NOTES: the LED signalling units are supplied with power supply cables (length 10 cm).



GW 20 902

CARTRIDGE LAMPS - 2W

Code	Lamp voltage	Lamp power	Lamp	Light emitted	Dimensions (mm)	Pack Carton
GW 20 902	12V ac/dc	2 W	Incandescence	White	56x36	50
GW 20 903	24V ac/dc	2 W	Incandescence	White	56x36	50

ACCESSORIES



GW 20 901

SET OF 2 KEYS FOR COMMAND DEVICES

Code	Suitable for	Pack Carton
GW 20 901	One-way switches - two-way switches	1/100
GW 30 912	Push-buttons	1/100



ChoruSmart



Scan the QR Code and find out all the technical informations.

INNOVATIVE



ChoruSmart offers the best technologies for an aesthetic and functional experience suitable for every person. In particular, the new EVO axial and touch controls offer the ability to centralize the management of lights and shutters with an extremely simplified installation.

AESTHETIC VARIABILITY



The wide range of options for customising the devices, in terms of colour and modularity, ensures a vast choice of solutions. Six colourways are available: three with a satin finish and three with a glossy finish, for a perfect match between the devices and the plate.

SCALABLE



ChoruSmart began as a traditional domestic series, but with the addition of a few Connected Smart Home or Home&Building Pro elements, it can become smart and suitable for both renovations and new buildings. The combination of colours, materials, finishes and shapes offers something for every taste and need.

ChoruSmart

Glossy titanium modular devices

The ChoruSmart modular devices make it possible to create infinite combination between devices and plates, thanks to a complete range that is able to satisfy all design, functional and installation requirements. Colors and finishes: glossy painted titanium, innovative and trendy. Unlimited functions in reduced spaces: the ChoruSmart range consists of rocker button keys with 1/2, 1, 2 and 3 modules, to optimise space as needed, and axial keys in EVO or SMART version, to satisfy even the most modern needs. Front coupling: the front coupling makes the component assembly and release operations simple and quick, enabling these to be completed without removing the support, unique for all the plates and fruits.



COMMAND - GLOSSY TITANIUM VERSION

COMMAND DEVICES - ROCKERS - SCREW TERMINALS



GW 14 001

ONE-WAY SWITCHES 1P - 250V AC

Code	Description	Button key	Rated power of 230V LED lamps	Pack Carton
No. modules: 1				
GW 14 001	1P - 16AX	Neutral	200 W	12/96
GW 14 002	1P - 16AX illuminable	With diffuser	200 W	12/24
GW 14 003	1P - 16AX illuminable	With replaceable neutral lens	200 W	12/24
No. modules: 1/2				
GW 14 021	1P - 10AX	Neutral	100 W	12/24
GW 14 022	1P - 10AX illuminable	With diffuser	100 W	6/24
No. modules: 2				
GW 14 031	1P - 16AX	Neutral	200 W	6/24
GW 14 032	1P - 16AX illuminable	With diffuser	200 W	6/24
GW 14 033	1P - 16AX illuminable	With replaceable neutral lens	200 W	6/24
No. modules: 3				
GW 14 041	1P - 16AX	Neutral	200 W	4/12
GW 14 042	1P - 16AX illuminable	With diffuser	200 W	4/12
GW 14 043	1P - 16AX illuminable	With replaceable neutral lens	200 W	4/12

CHARACTERISTICS: the illuminable articles use LED signalling units, not included.



GW 14 004

ONE-WAY SWITCHES 2P - 250V AC

Code	Description	Button key	Symbol	Rated power of 230V LED lamps	Pack Carton
No. modules: 1					
GW 14 004	2P - 16 AX	Neutral	0/1	200 W	12/48
GW 14 005	2P - 16AX illuminable	With replaceable neutral lens	-	200 W	12/24
GW 14 006	2P - 10AX	With key	0/1	100 W	1/12
No. modules: 2					
GW 14 034	2P - 16 AX	Neutral	0/1	200 W	6/24
GW 14 035	2P - 16AX illuminable	With replaceable neutral lens	-	200 W	6/24

CHARACTERISTICS: the illuminable articles use LED signalling units, not included.

NOTES: GW14006 equipped with 2 keys. Key extractable in both positions. Spare keys: GW20901.



GW 14 007

ONE-WAY SWITCH 2P - 250V AC - HEAVY DUTY LOADS

Code	Description	Button key	Symbol	Rated power of 230V LED lamps	Pack Carton
No. modules: 1					
GW 14 007	2P - 25 AX	Neutral	0/1	250 W	12/24

APPLICATIONS: suitable for particular heavy-duty loads (e.g. fluorescent lamp batteries) or high-consumption devices (e.g. ovens, air-conditioners, boilers, etc.).



GW 14 051

TWO-WAY SWITCHES 1P - 250V AC

Code	Description	Button key	Rated power of 230V LED lamps	Pack Carton
No. modules: 1				
GW 14 051	1P - 16AX	Neutral	200 W	12/96
GW 14 052	1P - 16AX illuminable	With diffuser	200 W	12/24
GW 14 053	1P - 16AX illuminable	With replaceable neutral lens	200 W	12/24
GW 14 054	1P - 10AX	With key	100 W	1/12
No. modules: 1/2				
GW 14 061	1P - 10AX	Neutral	100 W	6/24
No. modules: 2				
GW 14 071	1P - 16AX	Neutral	200 W	6/24
GW 14 072	1P - 16AX illuminable	With diffuser	200 W	6/24
GW 14 073	1P - 16AX illuminable	With replaceable neutral lens	200 W	6/24
No. modules: 3				
GW 14 081	1P - 16AX	Neutral	200 W	4/12
GW 14 082	1P - 16AX illuminable	With diffuser	200 W	4/12
GW 14 083	1P - 16AX illuminable	With replaceable neutral lens	200 W	4/12

CHARACTERISTICS: the illuminable articles use LED signalling units, not included.

NOTES: GW14054 equipped with 2 keys. Key extractable in both positions. Spare keys: GW20901.



GW 14 091

INTERMEDIATE SWITCHES 1P - 250V AC

Code	Description	Button key	Rated power of 230V LED lamps	Pack Carton
No. modules: 1				
GW 14 091	1P - 16AX	Neutral	200 W	12/48
GW 14 092	1P - 16AX illuminable	With diffuser	200 W	12/24
GW 14 093	1P - 16AX illuminable	With replaceable neutral lens	200 W	12/24
No. modules: 2				
GW 14 101	1P - 16AX	Neutral	200 W	6/12
GW 14 102	1P - 16AX illuminable	With diffuser	200 W	6/12
GW 14 103	1P - 16AX illuminable	With replaceable neutral lens	200 W	6/12
No. modules: 3				
GW 14 111	1P - 16AX	Neutral	200 W	4/12
GW 14 112	1P - 16AX illuminable	With diffuser	200 W	4/12
GW 14 113	1P - 16AX illuminable	With replaceable neutral lens	200 W	4/12

CHARACTERISTICS: the illuminable articles use LED signalling units, not included.



GW 14 121

THREE-WAY SWITCHES 1P - 250V AC

Code	Description	Button key	Symbol	Rated power of 230V LED lamps	Pack Carton
No. modules: 1					
GW 14 121	1P - 10AX	Neutral	UP - DOWN	100 W	12/24
No. modules: 2					
GW 14 123	1P - 10AX	Neutral	UP - DOWN	100 W	6/24

CHARACTERISTICS: three standing positions. Both contacts are open in the central position (OFF).

APPLICATIONS: command of circuits requiring an interlock (e.g. operating motorised devices with direction reversal). 2-user selective control.



GW 14 122

THREE-WAY SWITCH 2P - 250 V AC

Code	Description	Button key	Symbol	Rated power of 230V LED lamps	Pack Carton
No. modules: 1					
GW 14 122	2P - 10AX	Neutral	UP - DOWN	100 W	12/24

CHARACTERISTICS: three standing positions. Both contacts are open in the central position (OFF). With 6 terminal blocks.

APPLICATIONS: command of circuits requiring an interlock (e.g. operating motorised devices with direction reversal). 2-user selective control.

CHORUSMART - Domestic range



GW 14 131

PUSH-BUTTONS 1P - 250V AC

Code	Description	Button key	Symbol	Pack Carton
No. modules: 1				
GW 14 131	1P NO - 16A	Neutral	-	12/96
GW 14 132	1P NO - 16A illuminable	With diffuser	-	12/24
GW 14 133	1P NO - 16A illuminable	With replaceable neutral lens	-	12/24
GW 14 136	1P NO - 16A	Pull-cord	-	1/12
GW 14 137	1P NC - 16A	Neutral	O red	12/24
GW 14 138	1P NC+NO - 16 A	Stop	Red	12/24
GW 14 139	1P NO+NC - 16 A	Start	Green	12/24
GW 14 140	1P NO+NO - 10A	With interlock	UP - DOWN	12/24
GW 14 141	1P NO+NO - 16 A	Double	-	12/24
GW 14 142	1P NO - 16A illuminable	Green diffuser	-	12/24
GW 14 143	1P NO - 16A illuminable	Red diffuser	-	12/24
GW 14 144	1P NO - 16A illuminable	Opal diffuser	-	12/24
GW 14 151	1P NO - 16A illuminable	With replaceable neutral lens	Light	12/24
GW 14 152	1P NO - 16A illuminable	With replaceable neutral lens	Key	12/24
GW 14 153	1P NO - 16A illuminable	With replaceable neutral lens	Bell	12/24
No. modules: 1/2				
GW 14 161	1P NO - 10A	Neutral	-	6/24
GW 14 162	1P NO - 10A illuminable	With diffuser	-	6/24
No. modules: 2				
GW 14 171	1P NO - 16A	Neutral	-	6/24
GW 14 172	1P NO - 16A illuminable	With diffuser	-	6/24
GW 14 173	1P NO - 16A illuminable	With replaceable neutral lens	-	6/24
No. modules: 3				
GW 14 181	1P NO - 16A	Neutral	-	4/12
GW 14 182	1P NO - 16A illuminable	With diffuser	-	4/12
GW 14 183	1P NO - 16A illuminable	With replaceable neutral lens	-	4/12

CHARACTERISTICS: the illuminable articles use LED signalling units, not included.

GW14136 Cord in insulating material, 140cm long, with red knob.

GW14140 Button with mechanical interlock. Both contacts are open in the central position (OFF); advisable for activating motorised devices with direction reversal (e.g. roller-shutters, curtains, etc.).

GW14141 independent push-buttons that can also be activated simultaneously.



GW 14 134

PUSH-BUTTONS 2P - 250V AC

Code	Description	Button key	Symbol	Pack Carton
No. modules: 1				
GW 14 134	2P NO - 16A	Neutral	O	12/24
GW 14 135	2P NO - 10A illuminable	With replaceable neutral lens	-	12/24
GW 14 145	2P NO - 10A	With key	-	1/12

CHARACTERISTICS: the illuminable articles use LED signalling units, not included.

NOTES: GW14145 equipped with 2 keys. Spare keys: GW30912.



GW 14 191

PUSH-BUTTONS 1P WITH ILLUMINATED NAME PLATE - 250V AC

Code	Description	Lamp voltage	Lamp	Lamp power	Pack Carton
No. modules: 2					
GW 14 191	1P NO - 10A	12-24V ac/dc	Cartridge lamp S6x36 mm	2 W	6/24
No. modules: 3					
GW 14 192	1P NO - 10A	12-24V ac/dc	Cartridge lamp S6x36 mm	2 W	4/16

CHARACTERISTICS: lamp not included.

COMMAND DEVICES - ROCKERS - QUICK WIRING TERMINALS



GW 14 031 F

ONE-WAY SWITCHES 1P - 250V AC

Code	Description	Button key	Rated power of 230V LED lamps	Pack Carton
No. modules: 2				
GW 14 031 F	1P - 16AX	Neutral	200 W	6/24
GW 14 032 F	1P - 16AX illuminable	With diffuser	200 W	6/24
GW 14 033 F	1P - 16AX illuminable	With replaceable neutral lens	200 W	6/24

CHARACTERISTICS: the illuminable articles use LED signalling units, not included.

NOTES: spring quick wiring, no tools necessary.



GW 14 034 F

ONE-WAY SWITCHES 2P - 250V AC

Code	Description	Button key	Symbol	Rated power of 230V LED lamps	Pack Carton
No. modules: 2					
GW 14 034 F	2P - 16 AX	Neutral	0/1	200 W	6/24
GW 14 035 F	2P - 16AX illuminable	With replaceable neutral lens	-	200 W	6/24

CHARACTERISTICS: the illuminable articles use LED signalling units, not included..

NOTES: spring quick wiring, no tools necessary.



GW 14 071 F

TWO-WAY SWITCHES 1P - 250V AC

Code	Description	Button key	Rated power of 230V LED lamps	Pack Carton
No. modules: 2				
GW 14 071 F	1P - 16AX	Neutral	200 W	6/24
GW 14 072 F	1P - 16AX illuminable	With diffuser	200 W	6/24
GW 14 073 F	1P - 16AX illuminable	With replaceable neutral lens	200 W	6/24

CHARACTERISTICS: the illuminable articles use LED signalling units, not included.

NOTES: spring quick wiring, no tools necessary.



GW 14 101 F

INTERMEDIATE SWITCHES 1P - 250V AC

Code	Description	Button key	Rated power of 230V LED lamps	Pack Carton
No. modules: 2				
GW 14 101 F	1P - 16AX	Neutral	200 W	6/12
GW 14 102 F	1P - 16AX illuminable	With diffuser	200 W	6/12
GW 14 103 F	1P - 16AX illuminable	With replaceable neutral lens	200 W	6/12

CHARACTERISTICS: the illuminable articles use LED signalling units, not included.

NOTES: spring quick wiring, no tools necessary.



GW 14 171 F

PUSH-BUTTONS 1P - 250V AC

Code	Description	Button key	Pack Carton
No. modules: 2			
GW 14 171 F	1P NO - 16A	Neutral	6/24
GW 14 172 F	1P NO - 16A illuminable	With diffuser	6/24
GW 14 173 F	1P NO - 16A illuminable	With replaceable neutral lens	6/24

CHARACTERISTICS: the illuminable articles use LED signalling units, not included.

NOTES: spring quick wiring, no tools necessary.

CHORUSMART - Domestic range



GW 14 160 F

COMBINED COMMAND DEVICES - ROCKERS - 250 V AC

Code	Description	Button key	Symbol	Rated power of 230V LED lamps	Pack Carton
No. modules: 2					
GW 14 078 F	Twin two-way switch 1P - 16 AX	Neutral	-	200 W	6/24
GW 14 159 F	Two-way switch 1P - 16 AX / Push-button 1P NO - 16A	Neutral	-	200 W	6/24
GW 14 160 F	Twin push-button 1P NO - 16 A	Neutral	UP - DOWN - STOP	-	6/24

NOTES: spring quick wiring, no tools necessary.

COMMAND DEVICES - AXIAL - SCREW TERMINALS



GW 10 671

AXIAL SWITCH MODULE - EVO

Code	Supply voltage	Output contacts	No. modules	Pack Carton
GW 10 671	100 ÷ 240 V ac - 50/60 Hz	1 NA 5A (AC1) 240 V ac	1	1/12
GW 10 672	100 ÷ 240 V ac - 50/60 Hz	1 NA 5A (AC1) 240 V ac	2	1/6

CHARACTERISTICS: devices for the control of 1 On/Off lighting device through a live output contact. Suitable for the control of incandescent and halogen (240Vac): 1000W, LED lamps (240Vac): 100W, fluorescent lamps (240Vac): 120W, halogen lamps powered by electronic transformers (240Vac): 250VA. Local push button with axial activation for control of the lamps connected to the device.

Equipped with 1 input to replicate the local control of the load via auxiliary module GW10677-GW10678 or NO-type and 1 input buttons for the centralisation OFF function.

APPLICATIONS: Bistable, monostable and timed load command. Centralisation function (OFF) by means of a dedicated input, the possibility of being able to switch the load on by means of auxiliary axial modules or NO-type buttons. The devices are equipped with a configurable blue LED that can be set to OFF, easy location mode or for signalling the connected load status.

NOTES: the devices must be completed with a front button key: GW10671 must be completed with the GW14553S or GW14557S button keys. The GW10674 must be completed with the GW14554S or GW14558S button keys.



GW 10 673

AXIAL DIMMER MODULE - EVO

Code	Supply voltage	Halogen load	Inductive load	LED load	No. modules	Pack Carton
GW 10 673	100 ÷ 240 V ac - 50/60 Hz	4 - 150 W	4 - 150 VA	4 - 150 W	1	1/12
GW 10 674	100 ÷ 240 V ac - 50/60 Hz	4 - 150 W	4 - 150 VA	4 - 150 W	2	1/6

CHARACTERISTICS: trailing edge load drive mode (max. 5 lamps). Two local axial operated buttons for dimming the connected load.

Equipped with 2 inputs for replicating local control of the load via the auxiliary module GW10679, GW10680 or NO-type buttons or for creating the centralisation function.

APPLICATIONS: control of the dimmable load connected to the devices. The dedicated inputs can be used to add a load switching-on function through auxiliary axial modules or NO-type buttons, or inputs can be set, via programming, for the centralised OFF function. The devices are equipped with configurable blue LEDs that can be set to OFF, location mode or for signalling the connected load.

NOTES: To avoid overheating, multiple dimmers cannot be installed side-by-side inside in the same enclosure. Insert a blanking module between two electronic devices. If two dimmers are installed in the same box, the maximum loads controlled by each dimmer must be reduced by 50%. The devices must be completed with a front button key: GW10673 must be completed with the GW14553S or GW14557S button keys; GW10674 must be completed with the GW14554S or GW14558S button keys.



GW 10 675

AXIAL ROLLER SHUTTER MODULE - EVO

Code	Supply voltage	Max current supplied	No. modules	Pack Carton
GW 10 675	100 ÷ 240 V ac - 50/60 Hz	2,3 A 240 V ac (according to IEC 60669-2-1)	1	1/12
GW 10 676	100 ÷ 240 V ac - 50/60 Hz	2,3 A 240 V ac (according to IEC 60669-2-1)	2	1/6

CHARACTERISTICS: Devices for the control of a motor to operate roller-shutters, curtains, venetian blinds, awnings, etc., through 2 live interlocked output contacts. Two axial-operated local buttons control the motor connected to the device. Equipped with 2 inputs for replicating local control of the motor via the auxiliary module GW10679, GW10680 or NO-type up/down buttons, or for creating the centralisation function.

APPLICATIONS: control of the motor connected to the devices. The dedicated inputs can be used to operate roller-shutters/venetian blinds via the auxiliary axial modules or NO-type up/down buttons, or they can be set, through programming, for centralisation functions (Up/Down). The devices are equipped with blue LEDs which can be configured to facilitate location at night and to signal the movement of the roller-shutter/Venetian blind.

NOTES: the devices must be completed with a front button key: GW10675 must be completed with the GW14553S or GW14557S button keys. GW10676 must be completed with the GW14554S or GW14558S button keys.



GW 10 677

1-COMMAND AUXILIARY AXIAL MODULES

Code	Supply voltage	Output contacts	No. modules	Pack Carton
GW 10 677	100 ÷ 240 V ac - 50/60 Hz	1 NO 1 A (AC1) 240 V ac	1	1/12
GW 10 678	100 ÷ 240 V ac - 50/60 Hz	1 NO 1 A (AC1) 240 V ac	2	1/6

CHARACTERISTICS: auxiliary controls to be used in conjunction with the EVO switch modules.

The devices are equipped with blue LEDs for easy location or for displaying the status of the load.

APPLICATIONS: when connected to the local inputs of the EVO axial controls, they allow replication of the local load control or the management of centralised controls.

NOTES: the devices must be completed with a front button key: GW10677 must be completed with the GW14551S or GW14555S button keys. GW10678 must be completed with the GW14552S or GW14556S button keys.



GW 10 679

2-COMMAND AUXILIARY AXIAL MODULE

Code	Supply voltage	Output contacts	No. modules	Pack Carton
GW 10 679	100 ÷ 240 V ac - 50/60 Hz	2 NO 1 A (AC1) 240 V ac	1	1/12
GW 10 680	100 ÷ 240 V ac - 50/60 Hz	2 NO 1 A (AC1) 240 V ac	2	1/6

CHARACTERISTICS: auxiliary controls to be used in conjunction with the EVO dimmer and roller-shutter modules.

The devices are equipped with blue LEDs for easy location or for displaying the status of the load.

APPLICATIONS: when connected to the local inputs of the EVO axial controls, they allow replication of the local load control or the management of centralised controls.

NOTES: the devices must be completed with a front button key: GW10679 must be completed with the GW14553S or GW14557S button keys. GW10680 must be completed with the GW14554S or GW14558S button keys.



GW 14 551 S

INTERCHANGEABLE BUTTON KEYS AND DIFFUSERS FOR AXIAL DEVICES

Code	Colour	Button key	No. modules	Pack Carton
GW 14 551 S	Glossy Titanium	To be completed with lens	1	1/48
GW 14 552 S	Glossy Titanium	To be completed with lens	2	1/48
GW 14 553 S	Glossy Titanium	To be completed with 2 lenses	1	1/48
GW 14 554 S	Glossy Titanium	To be completed with 2 lenses	2	1/48
GW 14 555 S	Glossy Titanium	With 1 diffuser	1	1/48
GW 14 556 S	Glossy Titanium	With 1 diffuser	2	1/48
GW 14 557 S	Glossy Titanium	With 2 diffusers	1	1/48
GW 14 558 S	Glossy Titanium	With 2 diffusers	2	1/48

NOTES: for use to complete the EVO axial modules and auxiliary axial controls.

LENS WITH ILLUMINATED SYMBOL



ZCG

SYMBOLS FOR ILLUMINABLE ROCKER COMMAND DEVICES

Code	Symbol	Pack Carton
Suitable for: General services		
GW 10 501	Neutral	20/240
GW 10 502	Light	20/240
GW 10 503	Stair light	20/240
GW 10 504	Table light	20/240
GW 10 505	Bell	20/240
GW 10 506	Fan	20/240
GW 10 507	Key	20/240
GW 10 508	Alarm	20/240
GW 10 509	ON	20/240
GW 10 510	OFF	20/240
GW 10 511	Nurse	20/240
GW 10 512	Waitress	20/240
GW 10 513	Dimmer increase	20/240
GW 10 514	Dimmer decrease	20/240
GW 10 515	UP arrow	20/240
GW 10 516	DOWN arrow	20/240
GW 10 517	UP - DOWN arrow	20/240
GW 10 518	RIGHT - LEFT arrow	20/240
Suitable for: Numerical services		
GW 10 531	One	20/240
GW 10 532	Two	20/240
GW 10 533	Three	20/240
GW 10 534	Four	20/240
GW 10 535	Five	20/240
GW 10 536	Six	20/240
GW 10 537	Seven	20/240
GW 10 538	Eight	20/240
GW 10 539	Nine	20/240
GW 10 540	Zero	20/240

NOTES: for use in place of the neutral lens in the illuminated tilting control devices.

CHORUSMART - Domestic range



ZC6

LENSES WITH ILLUMINATING SYMBOLS FOR AXIAL BUTTON KEYS

Code	Symbol	Pack Carton
GW 10 501 A	Neutral	24
GW 10 502 A	Light	24
GW 10 503 A	Stair light	24
GW 10 504 A	Table light	24
GW 10 505 A	Bell	24
GW 10 506 A	Burglar alarm	24
GW 10 507 A	Key	24
GW 10 508 A	ON OFF	24
GW 10 509 A	ON	24
GW 10 510 A	OFF	24
GW 10 511 A	Socket-outlet	24
GW 10 512 A	Dimmers	24
GW 10 513 A	Dimmer increase	24
GW 10 514 A	Dimmer decrease	24
GW 10 515 A	Arrow	24
GW 10 516 A	Open	24
GW 10 517 A	Close	24
GW 10 518 A	Roller shutter	24
GW 10 519 A	Roller shutter up	24
GW 10 520 A	Roller shutter down	24
GW 10 521 A	Curtain open	24
GW 10 522 A	Curtain close	24
GW 10 523 A	Floor light	24
GW 10 524 A	Ceiling light	24
GW 10 525 A	Wall light	24
GW 10 526 A	Aisle light	24
GW 10 527 A	Scenario	24
GW 10 528 A	Party	24
GW 10 529 A	In	24
GW 10 530 A	Out	24
GW 10 531 A	Good morning	24
GW 10 532 A	Good night	24
GW 10 533 A	TV	24
GW 10 534 A	Heating	24
GW 10 535 A	Cooling	24
GW 10 536 A	Heating/Cooling	24
GW 10 537 A	Comfort	24
GW 10 538 A	Precomfort	24
GW 10 539 A	Economy	24
GW 10 540 A	Auto	24
GW 10 541 A	Do not disturb	24
GW 10 542 A	Make up the room	24

NOTE: for use to customise the interchangeable push buttons for axial controls with 1 and 2 lenses.

INTERCHANGEABLE BUTTON KEYS AND DIFFUSERS FOR ROCKER DEVICES



ZC6

BUTTON KEYS FOR ROCKER CONTROLS AND INTERCHANGEABLE DIFFUSERS FOR INDICATOR LIGHTS

Code	Symbol	Pack Carton
Description: Keys 22x22 mm		
GW 14 541	General	4/48
GW 14 542	With label	4/48
GW 14 543	Key	4/48
GW 14 544	Bell	4/48
GW 14 545	Vertical arrow	4/48
GW 14 546	Horizontal arrow	4/48
Description: Diffusers		
GW 10 547	Red	4/48
GW 10 548	Green	4/48
GW 10 549	Opal diffuser	4/48
GW 10 550	Amber	4/48

APPLICATIONS: diffusers to be used in place of those on the indicator lamps GW14142, GW14143, GW14144.

NOTES: the Chorusmart modular system allows the use of 22 x 22mm interchangeable button keys in place of the standard button keys fitted on the command devices GW14141, GW14142, GW14143, GW14144.

SOFT-CLICK, ROCKER ELECTRONIC PUSH BUTTONS



GW 14 915

UNIVERSAL SOFT-CLICK ELECTRONIC PUSH-BUTTON

Code	Type of contact	Button key	Type of use	No. modules	Pack Carton
GW 14 915	1NO/NC 4A (AC1) 230 V ac - Potential-free Neutral		Relay, dimmer, bus contacts interfaces	1	1/12

CHARACTERISTICS: push-button suitable for connection of KNX BUS contact interfaces, or the command of bistable relays, electronic one-way switches for heavy duty loads, or dimmers with a remote control input.



GW 14 912

BACKLIT SOFT-CLICK ELECTRONIC PUSH-BUTTON

Code	Supply voltage	Type of contact	Button key	Type of use	Pack Carton
GW 14 912	230 V ac - 50/60 Hz	1NO 4A (AC1) 230 V ac	With diffuser	Relay, dimmer	1/12

CHARACTERISTICS: push-button for controlling latching relays, electronic switches for heavy duty loads, or dimmers with a remote control input. Equipped with amber backlit LED.



GW 14 913

BACKLIT SOFT-CLICK ELECTRONIC PUSH-BUTTONS FOR BUS INPUTS

Code	Type of contact	Button key	Type of use	Pack Carton
No. modules: 1				
GW 14 913	1NO - Potential-free	With diffuser	Bus contacts interfaces	1/12
GW 14 916	1NO - Potential-free	With replaceable neutral lens	Bus contacts interfaces	1/12
No. modules: 2				
GW 14 917	1NO - Potential-free	With diffuser	Bus contacts interfaces	1/6
GW 14 918	1NO - Potential-free	With replaceable neutral lens	Bus contacts interfaces	1/6

CHARACTERISTICS: push-button for BUS inputs, suitable for KNX BUS contact interface connections. Equipped with 2-colour (amber/green) LED with colour selector (can be set up to work as a night-time localisation lamp or to indicate the load status).



GW 14 914

DOUBLE SOFT-CLICK ELECTRONIC PUSH-BUTTON

Code	Type of contact	Button key	Symbol	No. modules	Pack Carton
GW 14 914	Dual, potential-free and with interlock	Neutral	UP - DOWN	1	1/12

CHARACTERISTICS: double push-button suitable for connecting KNX BUS contact interfaces or electronic control panels for moving roller shutters.

CHORUSMART - Domestic range

TOUCH COMMAND MODULES



GW 10 922

TOUCH ONE-WAY SWITCH MODULE

Code	Supply voltage	Output contacts	No. modules	Pack Carton
GW 10 922	100 ÷ 240 V ac - 50/60 Hz	1 NA 5A (AC1) 240 V ac	1	1/12

CHARACTERISTICS: device for the On/Off control of 1 lighting device through a live output contact. Suitable for control of incandescent and halogen lamps (240Vac): 1000W, LED lamps (240Vac): 100W, fluorescent lamps (240Vac): 120W, halogen lamps powered by electronic transformers (240Vac): 250VA. Equipped with 1 input for replicating local control of the load via the GW10924 auxiliary touch control modules, NO-type buttons and 1 input for the centralisation of the OFF function. The device is equipped with blue LEDs for easy location that can be set to two different light intensity levels. Excludable built-in buzzer, function identification by means of icons on the ICE touch plates.

APPLICATIONS: bistable, monostable and timed load control. Centralisation function (OFF) through the dedicated input.

NOTES: to be completed with ICE touch plates (codes: GW16955CB, GW16955CL, GW16955CN, GW16955CT).



GW 10 923

TOUCH DIMMER MODULE

Code	Supply voltage	Halogen load	Inductive load	LED load	No. modules	Pack Carton
GW 10 923	100 ÷ 240 V ac - 50/60 Hz	4 - 150 W	4 - 150 VA	4 - 150 W	1	1/12

CHARACTERISTICS: trailing edge load drive mode (max. 5 lamps). Two touch areas for dimming the connected load. Equipped with 2 inputs for replicating local control of the load via the auxiliary touch 2-command modules GW10925, NO-type buttons, or for creating the centralisation function OFF. The device is equipped with blue LEDs for easy location that can be set to two different light intensity levels. Excludable built-in buzzer, function identification by means of icons on the ICE touch plates.

APPLICATIONS: control of the dimmable load connected to the devices. Centralised OFF function, via dedicated inputs.

NOTE: to avoid overheating, multiple products cannot be installed side-by-side inside in the same enclosure; insert a blanking module between two electronic devices. When installing two dimmers in the same box, the maximum loads controlled by each dimmer must be reduced by 50%. To be completed using ICE touch plates (codes: GW16955CB, GW16955CL, GW16955CN, GW16955CT).



GW 10 921

TOUCH ROLLER SHUTTER MODULE

Code	Supply voltage	Maximum output power	No. modules	Pack Carton
GW 10 921	100 ÷ 240 V ac - 50/60 Hz	2,3 A 240 V ac (according to IEC 60669-2-1)	1	1/12

CHARACTERISTICS: Devices for the control of a motor to operate roller-shutters, curtains, venetian blinds, awnings, etc., by means of 2 interlocked live output contacts. Two touch areas for controlling the motor connected to the device. Equipped with 2 inputs for replicating local control of the motor via the touch auxiliary 2-command modules GW10925, NO-type up/down buttons, or for creating a centralisation function (up/down). The device is equipped with blue LEDs for easy location that can be set to two different light intensity levels. Excludable built-in buzzer, function identification by means of icons on the ICE touch plates.

APPLICATIONS: control of the motor connected to the devices. Centralisation function (Up/Down) by means of a dedicated inputs.

NOTES: to be completed with ICE touch plates (codes: GW16955CB, GW16955CL, GW16955CN, GW16955CT).

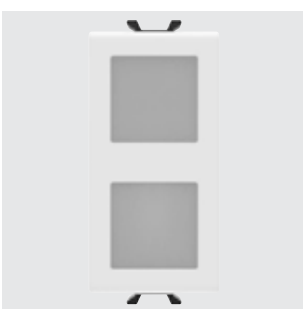

GW 10 924

1-COMMAND AUXILIARY TOUCH MODULE

Code	Supply voltage	Output contacts	No. modules	Pack Carton
GW 10 924	100 ÷ 240 V ac - 50/60 Hz	100mA 240 V ac	1	1/12

CHARACTERISTICS: suitable for controlling the GW10922 module. The device is equipped with blue LEDs for easy location that can be set to two different light intensity levels. Excludable built-in buzzer, function identification by means of icons on the ICE touch plates.

NOTES: to be completed using ICE touch plates (codes: GW16955CB, GW16955CL, GW16955CN, GW16955CT).

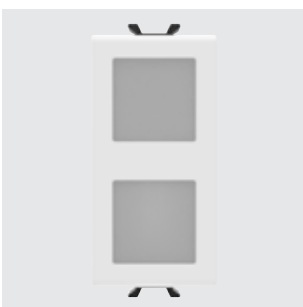

GW 10 925

2-COMMAND AUXILIARY TOUCH MODULE

Code	Supply voltage	Output contacts	No. modules	Pack Carton
GW 10 925	100 ÷ 240 V ac - 50/60 Hz	100mA 240 V ac	1	1/12

CHARACTERISTICS: suitable for controlling the GW10921 and GW10923 modules. The device is equipped with blue LEDs for easy location that can be set to two different light intensity levels. Excludable, built-in buzzer and functions identifiable by the icons on the ICE touch plates.

NOTES: to be completed with ICE touch plates (codes: GW16955CB, GW16955CL, GW16955CN, GW16955CT).

ICE TOUCH PLATES



GW 16 955 CT

ICE TOUCH - TITANIUM

Code	Description	For support codes	Pack Carton
GW 16 955 CT	6 touch areas	GW16803, GW16803N	1

CHARACTERISTICS: glossy finish. The plate is to be used in combination with the touch modules (switch module GW10922, roller shutter module GW10921, dimmer module GW10923, 1-control auxiliary module GW10924, 2-control auxiliary module GW10925).

NOTES: the symbols displayed in the image are purely indicative: they may be customised using the icons supplied with the touch plate. The code of the plate is unique and independent of the number of icons used (from 2 to 6).

BLANKING MODULES AND CABLE OUTLET



GW 14 195

BLANKING MODULES

Code	Description	No. modules	Pack Carton
GW 14 195	1 module	1	10/200
GW 14 197	1/2 module	1/2	4/48
GW 14 198	2 modules	2	1/48
GW 14 199	3 modules	3	1/48



GW 14 194

CABLE OUTLET

Code	Description	No. modules	Pack Carton
GW 14 194	2 modules	2	6/48
GW 14 196	1 module	1	1/48

NOTES: GW14196 with anti-traction cable fastener device, cables min 6mm ø, max 10mm ø.

GW14194 with anti-traction cable fastener device, cables min 4mm ø, max 10mm ø. To be installed with the cable output downwards.

MOVEMENT DETECTORS



GW 14 594

MOVEMENT DETECTOR

Code	Supply voltage	Output contacts	Pack Carton
GW 14 594	230V ac - 50/60 Hz	1NO 3 A (AC1) 230 V ac	1/4

CHARACTERISTICS: adjustment of the intervention duration 15 sec - 10 min. Light sensitive threshold adjustment - min. 10 lux - max. inhibited.

Suitable for commanding halogen lamps/resistive loads: 700 W, incandescent lamps: 450 W, low voltage halogen lamps (12 V) controlled by toroidal or electronic transformers: 450 W, uncompensated fluorescent lamps: 2x58 W, motors and gear motors: 400 VA, LED loads: 60 W (max. 10 lamps).

Not suitable for compensated fluorescent lamps, for discharge lamps and for all loads not indicated that must be commanded using a support relay.

APPLICATIONS: Energy-saving: command of the lighting of rooms and areas only when people pass through.

Comfort and safety: automatic command of circuits without needing to activate one-way switches.

NOTES: do not install the product in watertight plates: the lid membrane does not allow the detector lens to work correctly. Detection beam angle 120°, depth of detection max 8 metres.

CHORUSMART - Domestic range



GW 10 595

CEILING-MOUNTED PRESENCE DETECTOR

Code	Supply voltage	Installation height (m)	Light sensor	Dimensions HxØ (mm)	Pack Carton
GW 10 595	220/240 V ac - 50/60 Hz	From 2,2 to 6	< 3 ÷ 2000 Lux	44x111,5	1

CHARACTERISTICS: presence sensor, sensing range: 360° circle (max. diameter 18 metres); installable with fixing springs on a surface-mounted or recessed box. Suitable for the control of incandescent/halogen lamps: 1000W, LED lamps: 200W (4 / 23 W - max. 8 lamps).

NOTE: equipped with a surface-mount box capable of holding sensors from IP20 to IP44.

RELAY



GW 14 721

RELAY - 230V AC 50/60HZ

Code	Type	No. of poles	Output contacts	Coil	Pack Carton
No. modules: 1					
GW 14 721	Latching relay	1P	10 AX 250V ac	230V ac - 50/60 Hz	1/12
GW 14 723	Latching relay, 4 seq.	2P	10 AX 250V ac	230V ac - 50/60 Hz	1/12
GW 14 724	Monostable relay	1P	1NO/NC 10A(AC1)/2A(AC15)250V ac	230V ac - 50/60 Hz	1/12

GW14721, GW14723 suitable for commanding incandescent/halogen lamps: 1000 W: fluorescent tubes with electronic ballast: 400 W, fluorescent tubes with electromechanical ballast: 360 W, compact fluorescent lamps (CFL): 200 W, LED lamps (230V ac): 200 W, low voltage halogen or LED lamps with electronic ballast: 200 W, low voltage halogen or LED lamps with electromechanical ballast: 400 W, lampade alogene o LED a bassa tensione con trasformatore elettromeccanico: 400 W.

APPLICATIONS: GW14721, GW14723 command of lighting devices from more than one point, by means of remote NO push-buttons.

GW14721, motor function/stop commands (extractors, air agitators, etc.).

GW14724 as an auxiliary element for commanding special loads, for distance signalling, for electrical separation between the command and use circuits.



GW 14 726

CALL RELAY - 12V AC/DC

Code	Supply voltage	No. of poles	Output contacts	No. modules	Pack Carton
GW 14 726	12V ac/dc	1P	1NO/NC 12 V (max. 1A)	1	1/12

CHARACTERISTICS: inlets for remote NO push-buttons for alarms (e.g. GW14136) and alarm reset (e.g. GW14145), green LED for alarm status signalling.

HOTEL COMPONENTS - GLOSSY TITANIUM VERSION

BADGE SWITCH



GW 14 039

BADGE SWITCH

Code	Description	For badge card max. width	Rated power of 230V LED lamps	No. modules	Pack Carton
GW 14 039	1P NA - 16 AX illuminable	54 mm	200 W	2	1/6

CHARACTERISTICS: the product can be fitted directly in 2-module plates; with plates of a greater modularity, you are advised to use 2 blanking modules for a 1/2 module (one on the right and one on the left).

APPLICATIONS: activation of circuits and services in hotel rooms (e.g. lights, air-conditioner, fridge-bar), indication of room occupied (with badge inserted)

NOTES: badges not included. The article uses LED signalling units, not included.

INTERCHANGEABLE BUTTON KEYS



GW 14 733

INTERCHANGEABLE BUTTON KEYS

Code	Button key	Symbol	No. modules	Pack Carton
GW 14 731	With diffuser	DND	1	4/48
GW 14 732	With diffuser	MUR	1	4/48
GW 14 733	Neutral	DND+MUR	1	4/48

CHARACTERISTICS: with "Do not disturb" (DND) and "Make up the room" (MUR) pad printings. To be used for the customization of the Chorus command devices. GW14731 and GW14732 suitable for one-way switches, two-way switches, intermediate switches and push-buttons. GW14733 suitable for three-way switches and push-buttons with central OFF position.

INDICATOR LIGHT DEVICE



GW 14 736

DOUBLE INDICATOR LAMP

Code	Diffuser colour	Symbol	No. modules	Pack Carton
GW 14 736	Opal diffuser	DND+MUR	1	1/24

CHARACTERISTICS: LED signalling units not included.

CHORUSMART - Domestic range

POWER - GLOSSY TIAMIUM VERSION

SOCKET-OUTLETS - ITALIAN/GERMAN STANDARD



GW 14 203

ITALIAN STANDARD SOCKET-OUTLETS - 250V AC

Code	Description	Socket-out type	For plug pins	No. modules	Pack Carton
GW 14 201	2P+E - 10A	P11	Ø 4 mm	1	12/96
GW 14 203	2P+E - 16 A Dual amperage	P11-P17	Ø 4 / 5 mm	1	12/96

CHARACTERISTICS: with safety shields.



GW 14 204

ITALIAN/GERMAN STANDARD SOCKET-OUTLETS - 250V AC

Code	Description	Earth pit	Socket-out type	For plug pins	No. modules	Pack Carton
GW 14 204	2P+E - 16 A Dual amperage	Side and central	P40	Ø 4 / 4.8 / 5 mm	2	6/48
GW 14 205	2P+E - 16A	Side and central	P30	Ø 4 / 4.8 mm	2	6/48

CHARACTERISTICS: with safety shields.



GW 14 208

ITALIAN STANDARD DOUBLE SOCKET-OUTLET - 250V AC

Code	Description	Socket-out type	For plug pins	No. modules	Pack Carton
GW 14 208	2x2P+E - 16A Dual amperage	P11-P17	Ø 4 / 5 mm	2	6/24

CHARACTERISTICS: with safety shields. The wiring is carried out via 3 terminals that power the socket-outlets, without using U-bolts.



GW 14 209

ITALIAN STANDARD TRIPLE SOCKET-OUTLET - 250V AC

Code	Description	Socket-out type	For plug pins	No. modules	Pack Carton
GW 14 209	3x2P+E - 16A Dual amperage	P11-P17	Ø 4 / 5 mm	3	4/12

CHARACTERISTICS: with safety shields. The wiring is carried out via 3 terminals that power the socket-outlets, without using U-bolts.

SOCKET-OUTLETS FOR DEDICATED LINES - ITALIAN/GERMAN STANDARD



GW 10 213

ITALIAN STANDARD SOCKET-OUTLETS FOR DEDICATED LINES - 250V AC

Code	Description	Colour	Socket-out type	For plug pins	No. modules	Pack Carton
GW 10 213	2P+E - 16 A Dual amperage	Red	P11-P17	Ø 4 / 5 mm	1	12/24
GW 10 223	2P+E - 16 A Dual amperage	Green	P11-P17	Ø 4 / 5 mm	1	12/24
GW 10 233	2P+E - 16 A Dual amperage	Orange	P11-P17	Ø 4 / 5 mm	1	12/24

CHARACTERISTICS: with safety shields.



GW 10 214

ITALIAN/GERMAN STANDARD SOCKET-OUTLETS FOR DEDICATED LINES - 250V AC

Code	Description	Colour	Socket-out type	For plug pins	No. modules	Pack Carton
GW 10 214	2P+E - 16 A Dual amperage illuminable	Red	P40	Ø 4 / 4.8 / 5 mm	2	6/12
GW 10 224	2P+E - 16 A Dual amperage illuminable	Green	P40	Ø 4 / 4.8 / 5 mm	2	6/12
GW 10 234	2P+E - 16 A Dual amperage illuminable	Orange	P40	Ø 4 / 4.8 / 5 mm	2	6/12

CHARACTERISTICS: with safety shields. Pit of side and central earth contacts. Pre-arranged for housing LED signalling units, not included.

APPLICATIONS: possibility to indicate presence of auxiliary network.

SOCKET-OUTLETS - GERMAN STANDARD



GW 14 241

GERMAN STANDARD SOCKET-OUTLET - 250V AC

Code	Description	For plug pins	No. modules	Pack Carton
GW 14 241	2P+E - 16A	Ø 4.8 mm	2	6/48

CHARACTERISTICS: with safety shields.



GW 14 242

GERMAN STANDARD SOCKET-OUTLET WITH LID IP40 - 250 V AC

Code	Description	For plug pins	No. modules	Pack Carton
GW 14 242	2P+E - 16A	Ø 4.8 mm	2	6/48

CHARACTERISTICS: with safety shields. Equipped with a transparent rigid cover with a glossy finish. IP40 degree of protection with the cover closed.

CHORUSMART - Domestic range

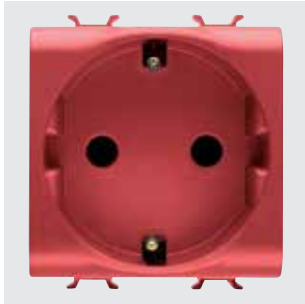

GW 10 251

GERMAN STANDARD SOCKET-OUTLET FOR DEDICATED LINES - 250V AC

Code	Description	Colour	For plug pins	No. modules	Pack Carton
GW 10 251	2P+E - 16A	Red	Ø 4.8 mm	2	6/12

CHARACTERISTICS: with safety shields.



GW 14 341

GERMAN STANDARD SOCKET-OUTLET WITH FRONT TIGHTENING TERMINALS - 250V AC

Code	Description	For plug pins	No. modules	Pack Carton
GW 14 341	2P+E - 16A	Ø 4.8 mm	2	6/12

CHARACTERISTICS: with safety shields. Front access terminals with screw fixing, side input of the conductors.



GW 10 351

GERMAN STANDARD SOCKET-OUTLET WITH FRONT TIGHTENING TERMINALS FOR DEDICATED LINES - 250V AC

Code	Description	Colour	For plug pins	No. modules	Pack Carton
GW 10 351	2P+E - 16A	Red	Ø 4.8 mm	2	6/12

CHARACTERISTICS: with safety shields. Front access terminals with screw fixing, side input of the conductors.



GW 14 241 F

GERMAN STANDARD SOCKET-OUTLET WITH QUICK WIRING TERMINALS - 250V AC

Code	Description	For plug pins	No. modules	Pack Carton
GW 14 241 F	2P+E - 16A	Ø 4.8 mm	2	6/12

CHARACTERISTICS: with safety shields. Spring quick wiring, no tools necessary.



GW 10 251 F

GERMAN STANDARD SOCKET-OUTLET FOR DEDICATED LINES WITH QUICK WIRING TERMINALS - 250 V AC

Code	Description	Colour	For plug pins	No. modules	Pack Carton
GW 10 251 F	2P+E - 16A	Red	Ø 4.8 mm	2	6/12

CHARACTERISTICS: with safety shields. Spring quick wiring, no tools necessary.

SOCKET-OUTLETS - FRENCH STANDARD



GW 14 246

FRENCH STANDARD SOCKET-OUTLETS - 250V AC

Code	Description	For plug pins	No. modules	Pack Carton
GW 14 246	2P - 16A	Ø 4 / 4.8 mm	2	1/24
GW 14 247	2P+E - 16A	Ø 4 / 4.8 mm	2	6/48

CHARACTERISTICS: with safety shields.



GW 14 248

FRENCH STANDARD SOCKET-OUTLET WITH FRONT TIGHTENING TERMINALS - 250V AC

Code	Description	For plug pins	No. modules	Pack Carton
GW 14 248	2P+E - 16A	Ø 4 / 4.8 mm	2	6/12

CHARACTERISTICS: with safety shields. Front access terminals with screw fixing, side input of the conductors.



GW 10 258

FRENCH STANDARD SOCKET-OUTLET WITH FRONT TIGHTENING TERMINALS FOR DEDICATED LINES - 250V AC

Code	Description	Colour	For plug pins	No. modules	Pack Carton
GW 10 258	2P+E - 16A	Red	Ø 4 / 4.8 mm	2	6/12

CHARACTERISTICS: with safety shields. Front access terminals with screw fixing, side input of the conductors. To be used in combination with plugs equipped with accessory GW10260.



GW 14 247 F

FRENCH STANDARD SOCKET-OUTLET WITH QUICK WIRING TERMINALS - 250 V AC

Code	Description	For plug pins	No. modules	Pack Carton
GW 14 247 F	2P+E - 16A	Ø 4 / 4.8 mm	2	6/12

CHARACTERISTICS: with safety shields. Spring quick wiring, no tools necessary.



GW 10 257 F

FRENCH STANDARD SOCKET-OUTLET FOR DEDICATED LINES WITH QUICK WIRING TERMINALS - 250 V AC

Code	Description	Colour	For plug pins	No. modules	Pack Carton
GW 10 257 F	2P+E - 16A	Red	Ø 4 / 4.8 mm	2	6/12

CHARACTERISTICS: with safety shields. Spring quick wiring, no tools necessary. To be used in combination with plugs equipped with accessory GW10260.

CHORUSMART - Domestic range



GW 10 260

FRENCH STANDARD SOCKET-OUTLET ACCESSORY, FOR DEDICATED LINES

Code	Colour	For sockets	Pack Carton
GW 10 260	Red	GW10257F - GW10258	10/100

CHARACTERISTICS: to be fixed directly on the 2P+E French standard plug, to avoid the incorrect insertion in dedicated line circuits.

SOCKET-OUTLETS - ISRAELI STANDARD



GW 14 281

ISRAELI STANDARD SOCKET-OUTLET - 250V AC

Code	Description	For plug pins	No. modules	Pack Carton
GW 14 281	2P+E - 16A	Round Ø 4 / 4.4 mm	2	1/24

CHARACTERISTICS: with safety shields.



GW 10 291

ISRAELI STANDARD SOCKET-OUTLET FOR DEDICATED LINES - 250V AC

Code	Description	Colour	For plug pins	No. modules	Pack Carton
GW 10 291	2P+E - 16 A illuminable	Red	Round Ø 4 / 4.4 mm	2	1/24

CHARACTERISTICS: with safety shields. Pre-arranged for housing LED signalling units, not included.



GW 14 282

ISRAELI STANDARD SOCKET-OUTLET - 250V AC

Code	Description	For plug pins	No. modules	Pack Carton
GW 14 282	2P - 10 A	Round Ø 4 mm	1	1/48

CHARACTERISTICS: with safety shields.

SOCKET-OUTLETS - INTERNATIONAL STANDARD



GW 14 286

USA STANDARD SOCKET-OUTLET - 250/125V AC

Code	Description	For plug pins	No. modules	Pack Carton
GW 14 286	2P+E - 15A	Flat parallel horizontal	1	12/48



GW 14 288

EURO-AMERICAN STANDARD SOCKET-OUTLETS - 250/125V AC

Code	Description	For plug pins	No. modules	Pack Carton
GW 14 287	2P - 15A	Ø 4 mm Flat	1	12/48
GW 14 288	2P+E - 15A	Ø 4 mm Flat	1	12/48



GW 14 296

BRITISH STANDARD SOCKET-OUTLETS - 250V AC

Code	Description	For plug pins	No. modules	Pack Carton
GW 14 296	2P+E - 13 A	Flat	2	6/48
GW 14 297	2P+E - 15A	Ø 7 mm	2	6/48

CHARACTERISTICS: with safety shields.

NOTES: given the size of the plugs, it is not possible to install two or more socket-outlets side-by-side.



GW 14 298

INDIAN/SOUTH AFRICAN STANDARD SOCKET-OUTLET - 250V AC

Code	Description	For plug pins	No. modules	Pack Carton
GW 14 298	2P+E - 16A	Ø 7 mm	2	6/48

CHARACTERISTICS: with safety shields.

NOTES: given the size of the plugs, it is not possible to install two or more socket-outlets side-by-side.



GW 14 299

SOUTH AFRICAN STANDARD SOCKET-OUTLET - 250 V AC

Code	Description	For plug pins	No. modules	Pack Carton
GW 14 299	2P+E - 16A	Round Ø 4,5 mm	1	12/240

CHARACTERISTICS: with safety shields.

CHORUSMART - Domestic range



GW 14 301

ARGENTINEAN STANDARD SOCKET-OUTLET - 250V AC

Code	Description	For plug pins	No. modules	Pack Carton
GW 14 301	2P+E - 10A	Flat	2	6/48



GW 14 306

AUSTRALIAN STANDARD SOCKET-OUTLETS - 250V AC

Code	Description	For plug pins	No. modules	Pack Carton
GW 14 306	2P+E - 10A	Flat	2	6/48
GW 14 307	2P+E - 15A	Flat	2	6/48

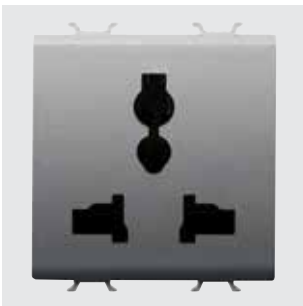

GW 14 310

MULTISTANDARD SOCKET-OUTLET - 250/127 V AC

Code	Description	No. modules	Pack Carton
GW 14 310	2P+E - 13A/250 V ac - 15A/127 V ac	2	10/40

CHARACTERISTICS: with safety shields.

APPLICATIONS: suitable for plugs compliant with the following standards: Europlug 2P 2.5A - 250V, British 2P+E 13A - 250V, Italian 2P 10A - 250V, Danish 2P 10A - 250V, Chinese 2P+E 10A - 250V, Argentinean/Australian 2P+E 10A - 250V, Indian 2P+E 6A - 250V, USA 2P+E 15A - 127V. Not suitable for 2P+E German and French sockets because they don't offer earth continuity.

NOTES: the multistandard energy sockets GW1x310 are in compliance with the safety requirements defined by the International Standard IEC 60884-1. These sockets may not be in compliance with the standard sheets used in the country where they are sold, hence their usage could be prohibited or however, restricted only for specific applications. The plugs allowed are listed in the technical datasheet. Please contact directly Gewiss technical service for further information.



GW 14 392

CHINESE STANDARD SOCKET-OUTLETS - 250 V AC

Code	Description	For plug pins	No. modules	Pack Carton
GW 14 391	2P+E - 10A	Flat	2	6/48
GW 14 392	2P+E - 16A	Flat	2	6/48

CHARACTERISTICS: with safety shields.

INTERLOCKED SWITCHED SOCKET-OUTLETS



GW 14 311

INTERLOCKED SWITCHED SOCKET-OUTLETS WITH MINIATURE CIRCUIT BREAKER - 230V AC

Code	Description	Socket-out type	Miniature circuit breakers	Breaking capacity	No. modules	Pack Carton
GW 14 311	2P+E - 16A	P17-P11	1P+N 16A	3 kA	2	1/6
GW 14 312	2P+E - 16A	P40	1P+N 16A	3 kA	3	1/4

CHARACTERISTICS: Interlocked switched socket-outlets with automatic miniature circuit breaker (C characteristic). Pits under tension only with plug inserted.

APPLICATIONS: suitable for installation in the system terminations to protect the load.



GW 14 321

INTERLOCKED SWITCHED SOCKET-OUTLETS WITH RESIDUAL MINIATURE CIRCUIT BREAKER - 230V AC

Code	Description	Socket-out type	Miniature circuit breakers	Breaking capacity	I _{dn}	No. modules	Pack Carton
GW 14 321	2P+E - 16A	P17-P11	1P+N 16A	3 kA	10 mA	3	1/4
GW 14 322	2P+E - 16A	P40	1P+N 16A	3 kA	10 mA	4	1/2

CHARACTERISTICS: Interlocked switched socket-outlets with automatic miniature circuit breaker (C characteristic) and residual current circuit breaker (type A). Pits under tension only with plug inserted.

APPLICATIONS: suitable for installation in the system terminations to protect the load.

SHAVER SOCKET-OUTLET



GW 14 331

EURO-AMERICAN STANDARD SHAVER SOCKET-OUTLET WITH INSULATION TRANSFORMER

Code	Supply voltage	For plug pins	Selectable output voltage	Maximum power	No. modules	Pack Carton
GW 14 331	230 V ac - 50/60 Hz	Ø 4 / 5 - 6.3x1.5 mm	120-230V ac	20 VA	3	1/2

CHARACTERISTICS: the socket-outlet is equipped with a self-protection device against overloading.

The output voltage should be selected correctly, consulting the rating of the user device before inserting the plug.

The relevant indicator LED allows the chosen voltage to be clearly seen.

NOTES: not suitable for installation in wall-mounting boxes or free-standing containers.

DATA - GLOSSY TITANIUM VERSION

TV-SAT SOCKETS



GW 14 361

COAXIAL TV SOCKETS (5-2400 MHZ), CLASS A SHIELDING - MALE IEC CONNECTOR Ø 9.5 MM

Code	Description	Attenuation	No. modules	Pack Carton
GW 14 361	Direct	0 dB	1	1/48
GW 14 362	Through wiring	5 dB	1	1/24
GW 14 363	Through wiring	10 dB	1	1/24
GW 20 277	Terminal resistance 75 ohm	-	-	50/200

CHARACTERISTICS: GW14361 allows the passage of voltage/current of remote power supply and/or control signals towards the user port (max 24V - 500 mA).

GW20277 in combination with feedthrough socket-outlets allows you to make terminal socket-outlets

APPLICATIONS: Socket-outlets suitable for return channel.

NOTES: the TV 5dB GW14362 coaxial socket-outlet is defined with conditional use: it is a special feedthrough socket-outlet, and must be used as such, with the only difference that the user port (socket-outlet towards the user device) must always be closed with a 75-Ohm load. (TV, VCR, SAT receiver or 75-Ohm termination)

CHORUSMART - Domestic range



GW 14 371

COAXIAL TV-SAT SOCKETS (5-2400 MHZ) CLASS A SHIELDING - FEMALE F CONNECTOR

Code	Description	Attenuation	No. modules	Pack Carton
GW 14 371	Direct	0 dB	1	1/48
GW 14 372	Through wiring	5 dB	1	1/24
GW 14 373	Through wiring	10 dB	1	1/24
GW 20 277	Terminal resistance 75 ohm	-	-	50/200

CHARACTERISTICS: GW14371 allows the passage of voltage/current of remote power supply and/or control signals towards the user port (max 24V - 500mA).

GW20277 in combination with feedthrough socket-outlets allows you to make terminal socket-outlets.

APPLICATIONS: Socket-outlets suitable for return channel.

NOTES: the TV-SAT 5dB GW14372 coaxial socket-outlet is defined with conditional use: it is a special feedthrough socket-outlet, and must be used as such, with the only difference that the user port (socket-outlet towards the user device) must always be closed with a 75-Ohm load (TV, VCR, SAT receiver or 75-Ohm termination).



GW 14 382

TV-FM-SAT SOCKETS

Code	Connectors	Description	Attenuation	No. modules	Pack Carton
GW 14 381	TV-FM	Direct	0 dB	2	1/24
GW 14 382	TV-FM-SAT	Direct	0 dB	2	1/24
GW 14 383	TV-SAT	Direct	0 dB	2	1/24

CHARACTERISTICS: TV-FM direct co-axial socket-outlet GW14381: male IEC-type TV connector ø 9.5mm, female IEC-type FM connector ø 9.5mm.

TV-FM-SAT direct co-axial socket-outlet GW14382: male IEC-type TV connector ø 9.5mm, female IEC-type FM connector ø 9.5mm, female F-type SAT connector.

TV-SAT direct co-axial socket-outlet GW14383: male IEC-type TV connector ø 9.5mm, female F-type SAT connector.

NOTES: demixed socket-outlets with input for co-axial cable Ø 5mm or 7mm.



GW 14 367

COAXIAL TV SOCKETS (5-2400 MHZ), CLASS A SHIELDING - MALE IEC CONNECTOR Ø 9.5MM

Code	Description	Attenuation	No. modules	Pack Carton
GW 14 367	Direct	0 dB	2	1/24

CHARACTERISTICS: allows the passage of voltage/current of remote power supply and/or control signals towards the user port (max 24V - 500 mA).

APPLICATIONS: socket-outlets suitable for return channel.



GW 14 377

COAXIAL TV-SAT SOCKETS (5-2400 MHZ), CLASS A SHIELDING - FEMALE F CONNECTOR

Code	Description	Attenuation	No. modules	Pack Carton
GW 14 377	Direct	0 dB	2	1/24

CHARACTERISTICS: allows the passage of voltage/current of remote power supply and/or control signals towards the user port (max 24V - 500 mA).

APPLICATIONS: socket-outlets suitable for return channel.



GW 14 386

COVERS FOR TV-SAT-R ANTENNA SOCKETS

Code	Description	No. holes	Pack Carton
GW 14 386	For TV-R base	2	1/24
GW 14 387	For TV/R-SAT base	2	1/24

APPLICATIONS: suitable for integration on the Chorus range of TV-SAT-R standard bases available on the market.

ACCESSORIES SUPPLIED: fixing screws.

TELEPHONE SOCKETS



GW 14 401

RJ11 TELEPHONE SOCKETS

Code	Description	Connection	No. modules	Pack Carton
GW 14 401	RJ11	Screw-on terminals	1	1/24

APPLICATIONS: telephone, telefax, modem.



GW 14 409

RJ11 TELEPHONE SOCKET

Code	Description	Connection	No. modules	Pack Carton
GW 14 409	RJ11	Screw-on terminals	2	1/24

APPLICATIONS: telephone, telefax, modem.



GW 14 406

BRITISH STANDARD TELEPHONE SOCKET

Code	Description	Connection	No. modules	Pack Carton
GW 14 406	6 contacts	Screw-on terminals	1	1/24

DATA SOCKETS



GW 14 421

RJ45 SOCKETS

Code	Description	Number pairs	Use category	Cables	Connection	No. modules	Pack Carton
GW 14 421	RJ45	4	5e	UTP	Toolless	1	1/24
GW 14 422	RJ45	4	5e	FTP	Toolless	1	1/24
GW 14 423	RJ45	4	6	UTP	Toolless	1	1/24
GW 14 424	RJ45	4	6	FTP	Toolless	1	1/24

APPLICATIONS: LANs up to 100MHz (e.g. Ethernet, Token Ring networks) for cat. 5e; LANs up to 250MHz (e.g. Videoconference systems, CCTV) for cat. 6.

NOTES: circuit identification label included.

CHORUSMART - Domestic range



GW 14 431

ADAPTERS FOR HOUSING DATA CONNECTORS

Code	Compatibility	No. modules	Pack Carton
GW 14 431	AMP / Keystone Jack	1	1/48
GW 14 438	SYSTIMAX COMMSCOPE	1	1/48

NOTES: with regard to the technological developments and dimensional variants introduced by connector manufacturers, you are advised to check in advance the full compatibility between the connector and the Gewiss adapter.



GW 14 437

RJ45 SOCKETS

Code	Description	Number pairs	Use category	Cables	Connection	No. modules	Pack Carton
GW 14 434	RJ45	4	5e	UTP	Toolless	2	1/24
GW 14 436	RJ45	4	5e	FTP	Toolless	2	1/24
GW 14 435	RJ45	4	6	UTP	Toolless	2	1/24
GW 14 437	RJ45	4	6	FTP	Toolless	2	1/24

APPLICATIONS: LAN networks up to 100 MHz (e.g. Ethernet or Token Ring networks) for cat. 5e; LAN networks up to 250 MHz (e.g. video conference or video control systems) for cat. 6.



GW 14 433

ADAPTER FOR HOUSING DATA CONNECTORS

Code	Compatibility	No. modules	Pack Carton
GW 14 433	AMP / Keystone Jack	2	4/100

NOTES: due to technological developments and dimensional variants introduced by connector manufacturers, you are advised to check in advance the full compatibility between the data socket and the Gewiss empty enclosure.

ADAPTERS FOR OPTICAL FIBER



GW 38 335

ANGLED SC/APC ADAPTER

Code	Type	Tilt	For connectors	Compatibility	Colour	Pack Carton
GW 38 335	Female/Female	40°	SC/APC	Keystone Jack	Green RAL 6018	1/25

CHARACTERISTICS: cable outlet inclined of 40° to the wall line. With ceramic fiber optic sleeve and dust caps. The front output is protected with safety cap and unmissable cord. Suitable to join two single-mode SC/APC fiber optic patch cables.

NOTES: for adapters (Chorus, System and Dahlia) with Keystone Jack coupling.

SOCKET-OUTLETS FOR AUXILIARY CIRCUITS



GW 14 451

SELV SOCKETS

Code	Description	For plug pins	No. modules	Pack Carton
GW 14 451	2P - 6A - 24V	Ø 3 mm	1	12/24
GW 14 452	2P - 6A - 24V polarised	Flat	1	12/24

CHARACTERISTICS: Centre distance 12,4mm.

AUDIO AND VIDEO SOCKETS



GW 14 453

AUDIO AND VIDEO SOCKETS

Code	Description	No. modules	Pack Carton
GW 14 453	Double RCA	1	1/24
GW 14 454	For loudspeaker	1	1/24
GW 14 458	Speaker socket	1	1/24

CHARACTERISTICS: GW14453 double RCA stud connector, red and white, weld-in connection.

GW14454, welding connection. GW14458 front access terminals for inserting 1.5mm² rigid wires, insulator punching rear connection suitable for cables AWC24 or max 0.25mm².

USB AND HDMI COUPLERS AND SOCKETS



GW 14 459

USB SOCKETS

Code	Description	No. modules	Pack Carton
GW 14 459	USB socket-outlet	1	1/24

CHARACTERISTICS: A-type USB 2.0 female connector, with screw terminals on the back.



GW 38 056

USB AND HDMI COUPLERS

Code	Description	Type	Compatibility	Pack Carton
GW 38 056	HDMI coupler	Female/Female	Keystone Jack	1/48
GW 38 057	USB coupler	Female/Female - A type	Keystone Jack	1/48

NOTES: for adapters designed to house data connectors (ChoruSmart, System and Playbus) with Keystone Jack type coupling and permutation panels.

CHORUSMART - Domestic range

USB CHARGERS



GW 14 449

USB POWER SUPPLY FOR ELECTRONIC DEVICES

Code	Supply voltage	Output voltage	Max current supplied	Type of port	No. modules	Pack Carton
GW 14 447	100 ÷ 240 V ac - 50/60 Hz	5V dc	3 A	A+A	1	1/10
GW 14 449	100 ÷ 240 V ac - 50/60 Hz	5V dc	3 A	A+C	1	1/10

CHARACTERISTICS: suitable for recharging a single electronic device (e.g. tablet) or two devices simultaneously (e.g. a tablet and smartphone). The division of the current delivered to the two outputs depends on the state of charge of the connected devices.

PROTECTION - GLOSSY TITANIUM VERSION

MINIATURE CIRCUIT BREAKERS



GW 14 463

MCB - MINIATURE CIRCUIT BREAKERS - C CHARACTERISTIC - 230V AC

Code	Description	Rated current (A)	Breaking capacity	No. modules	Pack Carton
GW 14 461	Single pole (1P)	6	3 kA	1	1/12
GW 14 462	Single pole (1P)	10	3 kA	1	1/12
GW 14 463	Single pole (1P)	16	3 kA	1	1/12
GW 14 466	Two-pole (1P+N)	6	3 kA	1	1/12
GW 14 467	Two-pole (1P+N)	10	3 kA	1	1/12
GW 14 468	Two-pole (1P+N)	16	3 kA	1	1/12



GW 14 488

RCBO - RESIDUAL CURRENT BREAKERS WITH OVERCURRENT PROTECTION - C CHARACTERISTIC - CLASS A - 230V AC - 50/60 HZ

Code	Description	Rated current (A)	Breaking capacity	I _{Δn}	No. modules	Pack Carton
GW 14 482	Two-pole (1P+N)	6	3 kA	10 mA	2	1/6
GW 14 483	Two-pole (1P+N)	6	3 kA	30 mA	2	1/6
GW 14 485	Two-pole (1P+N)	10	3 kA	10 mA	2	1/6
GW 14 486	Two-pole (1P+N)	10	3 kA	30 mA	2	1/6
GW 14 488	Two-pole (1P+N)	16	3 kA	10 mA	2	1/6
GW 14 489	Two-pole (1P+N)	16	3 kA	30 mA	2	1/6

PROTECTION DEVICES



GW 14 491

FUSE HOLDER - 250V AC

Code	Rated current (A)	Fuse type	No. modules	Pack Carton
GW 14 491	16	Ø 6.3x32 mm	1	1/12

CHARACTERISTICS: fuse not included.



GW 14 492

SURGE PROTECTION DEVICE - 230V AC

Code	Uc	Up	No. modules	Pack Carton
GW 14 492	275 V ac 50/60Hz	1kV	1	1/12

CHARACTERISTICS: green LED for status signalling.

APPLICATIONS: protection for electronic devices (TV, Hi-Fi, computer, etc.) from overvoltage of atmospheric origin, or manoeuvres, that could be channelled by the power supply lines.

INDICATOR - GLOSSY TITANIUM VERSION

INDICATOR LIGHT DEVICES



GW 14 642

SINGLE INDICATOR LAMPS - 1/2 MODULE

Code	Diffuser colour	Colour meaning	No. modules	Pack Carton
GW 14 641	Opal diffuser	Neutral	1/2	2/48
GW 14 642	Green	Safety	1/2	2/48
GW 14 643	Red	Danger	1/2	2/48
GW 14 644	Amber	Attention	1/2	2/48

CHARACTERISTICS: LED signalling units, not included.

APPLICATIONS: the meaning of the diffusers refers to the recommendations of standard EN60073 with regard to the use of the colours in indicator lights.



GW 14 622

SINGLE INDICATOR LAMPS - 1 MODULE

Code	Diffuser colour	Colour meaning	No. modules	Pack Carton
GW 14 621	Opal diffuser	Neutral	1	1/24
GW 14 622	Green	Safety	1	1/24
GW 14 623	Red	Danger	1	1/24
GW 14 624	Amber	Attention	1	1/24

CHARACTERISTICS: LED signalling units, not included.

APPLICATIONS: the meaning of the diffusers refers to the recommendations of standard EN60073 with regard to the use of the colours in indicator lights.



GW 14 629

DOUBLE INDICATOR LAMPS - 1 MODULE

Code	Diffuser colour	No. modules	Pack Carton
GW 14 628	Opal diffuser	1	1/24
GW 14 629	Red/green	1	1/24

CHARACTERISTICS: LED signalling units, not included.

APPLICATIONS: the meaning of the diffusers refers to the recommendations of standard EN60073 with regard to the use of the colours in indicator lights.

CHORUSMART - Domestic range



GW 14 633

PROTRUDING INDICATOR LAMPS - 2 MODULES

Code	Supply voltage	Diffuser colour	Lamp	No. modules	Pack Carton
GW 14 631	12V ac/dc - 230V ac 50/60 Hz	Opal diffuser	White LED	2	1/24
GW 14 632	12V ac/dc - 230V ac 50/60 Hz	Green	White LED	2	1/24
GW 14 633	12V ac/dc - 230V ac 50/60 Hz	Red	White LED	2	1/24
GW 14 634	12V ac/dc - 230V ac 50/60 Hz	Amber	White LED	2	1/24

CHARACTERISTICS: highly efficient white LED, powered at 12V ac/dc - 230V ac with double power supply inlet.

APPLICATIONS: suitable for special applications such as the signalling of calls from hospital wards.

NOTES: complete with lamp.



GW 14 656

STAIR RISER LAMP

Code	Supply voltage	Diffuser colour	Lamp	No. modules	Pack Carton
GW 14 651	12V ac/dc - 230V ac 50/60 Hz	Opal diffuser	White LED	2	1/24
GW 14 656	12V ac/dc - 230V ac 50/60 Hz	Opal diffuser	White LED	4	1/2

CHARACTERISTICS: highly efficient white LED, powered at 12V ac/dc - 230V ac with double power supply inlet.

ANTI BLACK-OUT AND EMERGENCY LAMPS



GW 14 661

EXTRACTABLE ANTI BLACK-OUT LAMP

Code	Supply voltage	Power supply batteries	Minimum autonomy	Lamp	Pack Carton
GW 14 661	230 V ac - 50/60 Hz	Ni - Mh	2 h	White LED	1/6

CHARACTERISTICS: equipped with a 3-position selector on the front panel, for anti black-out, inhibition and night functioning.

To be inserted in any socket-outlet of the Italian, German or French type. Highly efficient, white LED lamp.



GW 14 662

ANTI BLACK-OUT LAMP

Code	Supply voltage	Power supply batteries	Minimum autonomy	Lamp	No. modules	Pack Carton
GW 14 662	230 V ac - 50/60 Hz	Ni - Mh	1 h	White LED	1	1/12

CHARACTERISTICS: green LED for the presence of mains voltage signalling. Highly efficient, white LED lamp.



GW 14 663

AUTONOMOUS EMERGENCY LAMPS

Code	Supply voltage	Power supply batteries	Minimum autonomy	Lamp	No. modules	Pack Carton
GW 14 663	230 V ac - 50/60 Hz	Ni - Mh	1 h	White LED	2	1/6
GW 14 666	230 V ac - 50/60 Hz	Ni - Mh	1 h	White LED	4	1/2

CHARACTERISTICS: green mains presence signal LED. Highly efficient, white LED lamps.

APPLICATIONS: compliant with standard EN60598-2-22.

ACOUSTIC SIGNALLING DEVICES



GW 14 601

RINGERS

Code	Supply voltage	Max power consumption	Sound intensity	No. modules	Pack Carton
GW 14 601	12V ac - 50 Hz	8 VA	80 dB (at 1 m)	1	1/24
GW 14 602	230V ac - 50 Hz	8 VA	80 dB (at 1 m)	1	1/24

CHARACTERISTICS: for intermittent use (5 sec. ON / 15 sec. OFF).



GW 14 606

BUZZERS

Code	Supply voltage	Max power consumption	Sound intensity	No. modules	Pack Carton
GW 14 606	12V ac - 50 Hz	8 VA	70 dB (at 1 m)	1	1/24
GW 14 607	230V ac - 50 Hz	8 VA	70 dB (at 1 m)	1	1/24

CHARACTERISTICS: for intermittent use (5 sec. ON / 15 sec. OFF).



GW 14 611

THREE TONE RINGER AND THREE INDEPENDENT INPUTS

Code	Supply voltage	Max power consumption	Sound intensity	No. modules	Pack Carton
GW 14 611	12V ac/dc	3 VA	80 dB (at 1 m)	2	1/6
GW 14 612	230V ac - 50 Hz	6 VA	80 dB (at 1 m)	2	1/6

CHARACTERISTICS: for continuous use. Three tones (alarm, ring and two-tone) with adjustable sound intensity.

APPLICATIONS: it is possible to combine the outdoor call, indoor call and alarm functions with one single device.

ENERGY, TEMPERATURE AND COMFORT MANAGEMENT - GLOSSY TITANIUM VERSION

TIMER DEVICES



GW 14 581

ELECTRONIC DAILY/WEEKLY TIMER, 1-CHANNEL

Code	Supply voltage	Output contacts	No. modules	Pack Carton
GW 14 581	230 V ac - 50/60 Hz	1NO/NC 8A(AC1)/4A(AC15) 250V ac	2	1/2

CHARACTERISTICS: with rechargeable buffer battery to guarantee the updating of the calendar (date, day, time) in the event of a blackout.

CHORUSMART - Domestic range

TEMPERATURE CONTROL DEVICES



GW 14 703

TIMED THERMOSTAT - DAILY/WEEKLY PROGRAMMING

Code	Supply voltage	Temperature adjustment	Output contacts	No. modules	Pack Carton
GW 14 703	230 V ac - 50/60 Hz	From +5°C to +40°C	1NO/NC 5A(AC1)/2A(AC15) 250V ac	2	1/2

CHARACTERISTICS: with rechargeable buffer battery to guarantee the updating of the calendar (date, day, time) in the event of a blackout.



GW 14 709

CONNECTED THERMOSTAT - ZIGBEE

Code	Supply voltage	Output contacts	No. modules	Pack Carton
GW 14 709	100 ÷ 240 V ac - 50/60 Hz	1 NO / NC 5A (AC1) 240 V ac	2	1/3

FEATURES: flush-mounted thermostat for the control of heating/cooling systems with manual temperature management and possibility of shutdown. Control algorithms for two-way systems: two points (ON/OFF), proportional-integral (PWM). The thermostat can control a solenoid valve for heating or cooling through a local contact or via Zigbee, in which case the solenoid valve must be controlled by a Zigbee actuator. GWA1521, GWA1523, GW1x826, GWA1201, and GWA1202 Zigbee connected actuators can be used.

The thermostat is equipped with integrated temperature and humidity sensors. The thermostat has an input for a NTC sensor (GW10800 and GW1x900 sensors can be used) for external temperature measurement (e.g., for compensation of temperatures measured locally by the thermostat or for protection in case of underfloor heating/cooling).

APPLICATIONS: climate control (heating or cooling) of a housing unit or area; option to manage a daily or weekly heating/cooling profile via the APP. The device measures humidity, if a threshold (defined during configuration) is exceeded, Zigbee can activate a dehumidification system and display/notify the measurement on the APP.

Use in traditional unconnected systems: the connected thermostat can also be used in traditional unconnected installations. In this case, configuration is not carried out via the APP and the NTC sensor input can only be used to compensate for the temperature measurement detected locally by the thermostat.



GW 14 705

THERMOSTAT

Code	Supply voltage	Temperature adjustment	Output contacts	No. modules	Pack Carton
GW 14 705	230 V ac - 50/60 Hz	From +5°C to +35°C	1NO / NC 8A(AC1) 250V ac	2	1/2

CHARACTERISTICS: choice of working mode by means of selector located on the front: summer (air-conditioner), OFF, winter (boiler).

Two-colour front LED to signal the output status (open/closed contact). The lighting up of the LED also indicates mains presence.



GW 16 970 CT

THERMO ICE WI-FI THERMOSTAT - WALL-MOUNTING

Code	Colour	Supply voltage	Temperature adjustment	Output contacts	Dimensions LxHxD (mm)	Pack Carton
GW 16 970 CT	Glossy Titanium	110-230V ac - 50/60Hz	From +5°C to +40°C	2NO 6A(AC1) 250V ac	123x95x21	1

CHARACTERISTICS: wall-mounting thermostat to control heating/cooling and humidification/dehumidification systems and manage the temperature in manual mode or on 3 levels (comfort, pre-comfort, economy). Control algorithms for two-way systems: two points (ON/OFF), proportional integral (PWM). Includes 1 input for external NTC temperature sensor (e.g.: protection for flood mounting heating). Equipped with a user interface with touch controls (capacitive) on technopolymer plate and backlit display. The thermostat has built-in proximity, temperature and humidity sensors and a Wi-Fi interface for setting parameters and programming temperature profiles (timed thermostat function) locally or remotely via specific apps (smartphone and tablet).

NOTES: wall-mounting with wall-plugs or on 3-modules rectangular boxes (centre distance 83.5 mm) Plate material; technopolymer.

DIMMER



GW 14 575

UNIVERSAL ROTATING ELECTRONIC REGULATOR

Code	Supply voltage	No. modules	Pack Carton
GW 14 575	230V ac - 50 Hz	1	1/12

CHARACTERISTICS: suitable for dimming incandescent and halogen lamps 230 V ac (10-160 W); low-voltage halogen lamps (12 V ac) with electronic transformers (10-160 W) and LED lamps 230 V ac (4-160W), rotary control with 2-way switch. Equipped with amber-colour-red signalling LED. Can be operated without neutral connection.

NOTES: the installation of more than one dimmer side-by-side in a single container is not permitted. To avoid overheating, insert a blanking module between two dimmers. If installing two dimmers in the same box, the maximum loads that can be controlled by each dimmer must be reduced by 50%.



GW 14 564

ROTATING ELECTRONIC REGULATORS FOR RESISTIVE/INDUCTIVE LOADS

Code	Supply voltage	Resistive load 230V ac	Inductive load 230V ac	No. modules	Pack Carton
GW 14 564	230 V ac - 50/60 Hz	100 - 900 W	40 - 300 VA	1	1/12
GW 14 567	230 V ac - 50/60 Hz	100 - 500 W	100 - 500 VA	1	1/12

CHARACTERISTICS: with signalling led orange. GW14567 rotary command with two-way switch.

GW14564 compliance with the EMC directive is only guaranteed by connecting the regulator to an LC filter with the following characteristics: L=1mH - 5A, C=0.15uF - 275V X2, according to the documentation provided with the product. Item designated solely for export to a limited number of countries outside of the European Union or countries applying to become part of the European Free Trade Area. Contact Gewiss Customer Service to check the product meets the regulations of the country concerned before importing it.

NOTES: to avoid overheating, the side by side installation of several products in a single container is not permitted; insert a blanking module between two electronic devices. If installing two regulators in the same box, the maximum loads that can be commanded by each regulator must be reduced by 50%.



GW 14 572 A

UNIVERSAL ELECTRONIC REGULATORS WITH PUSH-BUTTON

Code	Supply voltage	No. modules	Pack Carton
GW 14 572 A	230V ac - 50/60 Hz	1	1/12
GW 14 573 A	230V ac - 50/60 Hz	2	1/6

CHARACTERISTICS: for the regulation and switching of incandescent and halogen lamps 230V AC (40-300W), low voltage halogen and LED lamps with electronic and winding transformers (40-300W), LED lamps 230V AC with dimmer function (5-150W). Manual selection of the type of load (Leading Edge or Trailing Edge piloting), soft-start function for lamp protection. Possibility to command and regulate from remote control push-buttons with NO contacts. Equipped with orange signalling LED.

NOTES: to avoid overheating, the side-by-side installation of several products in a single container is not permitted; insert a blanking module between two electronic devices. If two regulators are installed in the same box, the maximum loads that can be commanded by each regulator must be reduced by 50%.



GW 14 568

ELECTRONIC REGULATOR WITH BUTTON FOR RESISTIVE/INDUCTIVE LOADS

Code	Supply voltage	Resistive load 230V ac	Inductive load 230V ac	No. modules	Pack Carton
GW 14 568	230V ac - 50 Hz	60 - 500 W	60 - 500 VA	1	1/12

CHARACTERISTICS: possibility to command and regulate from remote control push-buttons with NO contact. With signalling led orange.

NOTES: to avoid overheating, the side by side installation of several products in a single container is not permitted; insert a blanking module between two electronic devices. If installing two regulators in the same box, the maximum loads that can be commanded by each regulator must be reduced by 50%.

CHORUSMART - Domestic range

TECHNICAL ALARMS - GLOSSY TIAMINIUM VERSION

GAS DETECTORS



GW 14 711

LPG DETECTOR

Code	Supply voltage	Tripping threshold	Output contacts	No. modules	Pack Carton
GW 14 711	12V ac/dc	9% LIE	1NO/NC 10A(NO)/3A(NC)250V ac	2	1/2

CHARACTERISTICS: relay output for the automatic command of the gas interception solenoid valve (manual reset) GW30522. Sound intensity: 85dB at 1m.



GW 14 712

METHANE GAS DETECTOR

Code	Supply voltage	Tripping threshold	Output contacts	No. modules	Pack Carton
GW 14 712	12V ac/dc	9% LIE	1NO/NC 10A(NO)/3A(NC)250V ac	2	1/2

CHARACTERISTICS: relay output for the automatic command of the gas interception solenoid valve (manual reset) GW30522. Sound intensity: 85dB at 1m.



GW 10 720

POWER SUPPLY UNIT 12VDC

Code	Supply voltage	Output voltage	Max current supplied	Dimensions LxHxD (mm)	Pack Carton
GW 10 720	100 ÷ 240 V ac - 50/60 Hz	12V dc	300 mA	52x33x17	1/10

APPLICATIONS: to be used for powering LPG detectors (GW1x711, GW2x868, GW30520), methane detectors (GW1x712, GW2x867, GW30519); Thermo ICE KNX (GW16974CB, GW16974CN, GW16974CT) thermostats.

ANTI-FLOOD SYSTEM WITH ZIGBEE WIRELESS TRANSMISSION



GW A1 514

ZIGBEE FLOOD ALARM - IP20

Code	Siren output	Temperature sensor	Colour	Dimensions (mm)	Pack Carton
GW A1 514	85 dB/3 m	0...50 °C	White	Ø 60x37	1/6

CHARACTERISTICS: the alarm detects the presence of water and includes a temperature sensor. Powered by CR123-type battery (replaceable).

NOTES: floor-mounting or alternatively wall-mounting possibility through the GWA1541 accessory. To be used in combination with the Zigbee actuator GWA1521 when controlling an electrovalve or a load.



GW A1 521

1-CHANNEL ACTUATOR ZIGBEE

Code	Supply voltage	Output contacts	Dimensions LxHxD (mm)	Pack Carton
GW A1 521	230V ac - 50 Hz	1 NO 10A (AC) 230 V ac	42x40x20	1/4

CHARACTERISTICS: 1-channel actuator for activating loads via the potential-free output contact (NO). Suitable for commanding incandescent lamps (230 V ac): 2300W, loads controlled from toroidal transformers: 450W, loads controlled from electronic transformers: 600W, energy saving lamps (compact fluorescent): 150W, LED lamps (230 V ac): 150W, motors: 500W.

APPLICATIONS: when used with the water sensor, provide the installation of a NO push-button to open the electrovalve manually.

NOTES: installation in flush-mounting boxes, junction boxes, etc..



GW 14 750

BLANKING MODULE FOR HOUSING RF ZIGBEE ACTUATORS

Code	Colour	No. modules	Pack Carton
GW 14 750	Glossy Titanium	1	1/12

CHARACTERISTICS: 1-module blanking module with pad printing. Allows the housing and fast identification of the flush-mounting RF Zigbee actuator.

NOTES: snap-in assembly.

ACCESSORIES



GW A1 541

WALL-MOUNTING SUPPORT FOR FLOOD ALARM

Code	Colour	Support dimension (mm)	Dimensions of probe (mm)	Cable max. length (cm)	Pack Carton
GW A1 541	White	Ø72x25	Ø50x8	85	1/4

APPLICATIONS: to be used for the wall-mounting of the Zigbee flood alarm GWA1514.



GW 30 522

SOLENOID VALVE, WITH MANUAL RESET, NORMALLY OPEN - 230V - 50HZ

Code	Delivery Ø	Material	Power input	Pack Carton
GW 30 522	3/4"	Brass	12 VA	1/2

CHORUSMART - Domestic range

ACCESSORIES

SIGNALLING UNITS



GW 10 881

LED SIGNALLING UNITS - 230 V AC - 0.6 W

Code	Lamp voltage	Lamp power	Lamp	Light emitted	Cable Colour	Pack Carton
GW 10 881	230 V ac - 50/60 Hz	0.6 W	LED	Blue	Blue	50
GW 10 882	230 V ac - 50/60 Hz	0.6 W	LED	White	White	50
GW 10 883	230 V ac - 50/60 Hz	0.6 W	LED	Red	Red	50
GW 10 884	230 V ac - 50/60 Hz	0.6 W	LED	Green	Green	50
GW 10 885	230 V ac - 50/60 Hz	0.6 W	LED	Amber	Orange	50

NOTES: the LED signalling units are supplied with power supply cables (length 10 cm).



GW 10 894

LED SIGNALLING UNITS - 12-24 V AC/DC - 0.6 W

Code	Lamp voltage	Lamp power	Lamp	Light emitted	Cable Colour	Pack Carton
GW 10 894	12-24V ac/dc	0.6 W	LED	White	White	50

NOTES: the LED signalling units are supplied with power supply cables (length 10 cm).



GW 20 902

CARTRIDGE LAMPS - 2W

Code	Lamp voltage	Lamp power	Lamp	Light emitted	Dimensions (mm)	Pack Carton
GW 20 902	12V ac/dc	2 W	Incandescence	White	56x36	50
GW 20 903	24V ac/dc	2 W	Incandescence	White	56x36	50

ACCESSORIES

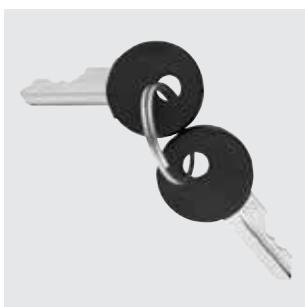

GW 20 901

SET OF KEYS FOR COMMAND DEVICES

Code	Suitable for	Pack Carton
GW 20 901	One-way switches - two-way switches	1/100
GW 30 912	Push-buttons	1/100



ChoruSmart



Scan the QR Code and find out all the technical informations.

INNOVATIVE



ChoruSmart offers the best technologies for an aesthetic and functional experience suitable for every person. In particular, the new EVO axial and touch controls offer the ability to centralize the management of lights and shutters with an extremely simplified installation.

AESTHETIC VARIABILITY



The wide range of options for customising the devices, in terms of colour and modularity, ensures a vast choice of solutions. Six colourways are available: three with a satin finish and three with a glossy finish, for a perfect match between the devices and the plate.

SCALABLE



ChoruSmart began as a traditional domestic series, but with the addition of a few Connected Smart Home or Home&Building Pro elements, it can become smart and suitable for both renovations and new buildings. The combination of colours, materials, finishes and shapes offers something for every taste and need.

ChoruSmart

Glossy ivory modular devices

The ChoruSmart modular devices make it possible to create infinite combination between devices and plates, thanks to a complete range that is able to satisfy all design, functional and installation requirements. Colours and finishes: glossy ivory, bright and versatile. Unlimited functions in reduced spaces: the ChoruSmart range consists of button keys with 1/2, 1, 2 and 3 modules to optimise space as needed. Front coupling: the front coupling makes the component assembly and release operations simple and quick, enabling these to be completed without removing the support.



COMMAND - IVORY VERSION

COMMAND DEVICES - SCREW TERMINALS



GW 11 001

ONE-WAY SWITCHES 1P - 250V AC

Code	Description	Button key	Rated power of 230V LED lamps	Pack Carton
No. modules: 1				
GW 11 001	1P - 16AX	Neutral	200 W	12/96
GW 11 002	1P - 16AX illuminable	With diffuser	200 W	12/24
GW 11 003	1P - 16AX illuminable	With replaceable neutral lens	200 W	12/24
No. modules: 2				
GW 11 031	1P - 16AX	Neutral	200 W	6/24
GW 11 032	1P - 16AX illuminable	With diffuser	200 W	6/24
GW 11 033	1P - 16AX illuminable	With replaceable neutral lens	200 W	6/24

CHARACTERISTICS: the illuminable articles use LED signalling units, not included.

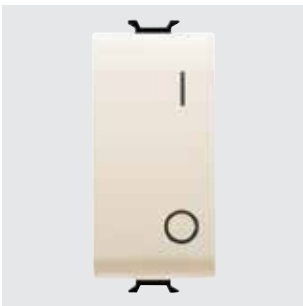

GW 11 004

ONE-WAY SWITCHES 2P - 250V AC

Code	Description	Button key	Symbol	Rated power of 230V LED lamps	Pack Carton
No. modules: 1					
GW 11 004	2P - 16 AX	Neutral	0/1	200 W	12/48



GW 11 051

TWO-WAY SWITCHES 1P - 250V AC

Code	Description	Button key	Rated power of 230V LED lamps	Pack Carton
No. modules: 1				
GW 11 051	1P - 16AX	Neutral	200 W	12/96
GW 11 052	1P - 16AX illuminable	With diffuser	200 W	12/24
GW 11 053	1P - 16AX illuminable	With replaceable neutral lens	200 W	12/24
No. modules: 2				
GW 11 071	1P - 16AX	Neutral	200 W	6/24
GW 11 072	1P - 16AX illuminable	With diffuser	200 W	6/24
GW 11 073	1P - 16AX illuminable	With replaceable neutral lens	200 W	6/24

CHARACTERISTICS: the illuminable articles use LED signalling units, not included.



GW 11 091

INTERMEDIATE SWITCHES 1P - 250V AC

Code	Description	Button key	Rated power of 230V LED lamps	Pack Carton
No. modules: 1				
GW 11 091	1P - 16AX	Neutral	200 W	12/48
GW 11 092	1P - 16AX illuminable	With diffuser	200 W	12/24
No. modules: 2				
GW 11 101	1P - 16AX	Neutral	200 W	6/12
GW 11 102	1P - 16AX illuminable	With diffuser	200 W	6/12

CHARACTERISTICS: the illuminable articles use LED signalling units, not included.

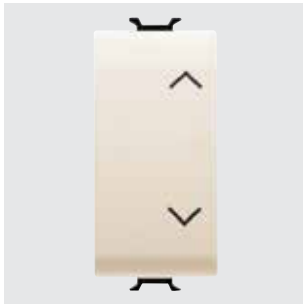

GW 11 121

THREE-WAY SWITCHES 1P - 250V AC

Code	Description	Button key	Symbol	Rated power of 230V LED lamps	Pack Carton
No. modules: 1					
GW 11 121	1P - 10AX	Neutral	UP - DOWN	100 W	12/24
No. modules: 2					
GW 11 123	1P - 10AX	Neutral	UP - DOWN	100 W	6/24

CHARACTERISTICS: three standing positions. Both contacts are open in the central position (OFF).

APPLICATIONS: command of circuits requiring an interlock (e.g. operating motorised devices with direction reversal). 2-user selective control.



GW 11 131

PUSH-BUTTONS 1P - 250V AC

Code	Description	Button key	Symbol	Pack Carton
No. modules: 1				
GW 11 131	1P NO - 16A	Neutral	-	12/96
GW 11 132	1P NO - 16A illuminable	With diffuser	-	12/24
GW 11 133	1P NO - 16A illuminable	With replaceable neutral lens	-	12/24
GW 11 136	1P NO - 16A	Pull-cord	-	1/12
GW 11 140	1P NO+NO - 10A	With interlock	UP - DOWN	12/24
GW 11 153	1P NO - 16A illuminable	With replaceable neutral lens	Bell	12/24
No. modules: 2				
GW 11 171	1P NO - 16A	Neutral	-	6/24
GW 11 172	1P NO - 16A illuminable	With diffuser	-	6/24
GW 11 173	1P NO - 16A illuminable	With replaceable neutral lens	-	6/24

CHARACTERISTICS: the illuminable articles use LED signalling units, not included.

GW11136 Cord in insulating material, 140cm long, with red knob.

GW11140 button with mechanical interlock.

Both contacts are open in the central position (OFF); advisable for activating motorised devices with direction reversal (e.g. roller-shutters, curtains, etc.).

CHORUSMART - Domestic range

BADGE SWITCH



GW 11 039

BADGE SWITCH

Code	Description	For badge card max. width	Rated power of 230V LED lamps	No. modules	Pack Carton
GW 11 039	1P NA - 16 AX illuminable	54 mm	200 W	2	1/6

CHARACTERISTICS: the product can be fitted directly in 2-module plates; with plates of a greater modularity, you are advised to use 2 blanking modules for a 1/2 module (one on the right and one on the left).

APPLICATIONS: activation of circuits and services in hotel rooms (e.g. lights, air-conditioner, fridge-bar), indication of room occupied (with badge inserted).

NOTES: badges not included. The article uses LED signalling units, not included.

BLANKING MODULES AND CABLE OUTLET



GW 11 195

BLANKING MODULES

Code	Description	No. modules	Pack Carton
GW 11 195	1 module	1	10/200
GW 11 197	1/2 module	1/2	4/48
GW 11 198	2 modules	2	1/48



GW 11 196

CABLE OUTLET

Code	Description	No. modules	Pack Carton
GW 11 196	1 module	1	1/48

NOTES: with anti-traction cable fastener device, cables min 6mm ø, max 10mm ø.

POWER - IVORY VERSION

SOCKET-OUTLETS - ITALIAN/GERMAN STANDARD



GW 11 203

ITALIAN STANDARD SOCKET-OUTLETS - 250V AC

Code	Description	Socket-out type	For plug pins	No. modules	Pack Carton
GW 11 203	2P+E - 16 A Dual amperage	P11-P17	Ø 4 / 5 mm	1	12/96

CHARACTERISTICS: with safety shields.

SOCKET-OUTLETS - GERMAN STANDARD



GW 11 241

GERMAN STANDARD SOCKET-OUTLET - 250V AC

Code	Description	For plug pins	No. modules	Pack Carton
GW 11 241	2P+E - 16A	Ø 4.8 mm	2	6/48

CHARACTERISTICS: with safety shields.



GW 11 242

GERMAN STANDARD SOCKET-OUTLET WITH LID IP40 - 250V AC

Code	Description	For plug pins	No. modules	Pack Carton
GW 11 242	2P+E - 16A	Ø 4.8 mm	2	6/48

CHARACTERISTICS: with safety shields. Equipped with a transparent rigid cover with a glossy finish. IP40 degree of protection with the cover closed.

CHORUSMART - Domestic range

SOCKET-OUTLETS - FRENCH STANDARD



GW 11 246

FRENCH STANDARD SOCKET-OUTLETS - 250V AC

Code	Description	For plug pins	No. modules	Pack Carton
GW 11 246	2P - 16A	Ø 4 / 4.8 mm	2	1/24
GW 11 247	2P+E - 16A	Ø 4 / 4.8 mm	2	6/48

CHARACTERISTICS: with safety shields.

SOCKET-OUTLETS - INTERNATIONAL STANDARD



GW 11 288

EURO-AMERICAN STANDARD SOCKET-OUTLETS - 250/125V AC

Code	Description	For plug pins	No. modules	Pack Carton
GW 11 287	2P - 15A	Ø 4 mm Flat	1	12/48
GW 11 288	2P+E - 15A	Ø 4 mm Flat	1	12/48

SHAVER SOCKET-OUTLET



GW 11 331

EURO-AMERICAN STANDARD SHAVER SOCKET-OUTLET WITH INSULATION TRANSFORMER

Code	Supply voltage	For plug pins	Selectable output voltage	Maximum power	No. modules	Pack Carton
GW 11 331	230 V ac - 50/60 Hz	Ø 4 / 5 - 6.3x1.5 mm	120-230V ac	20 VA	3	1/2

CHARACTERISTICS: the socket-outlet is equipped with a self-protection device against overloading.

The output voltage should be selected correctly, consulting the rating of the user device before inserting the plug.

The relevant indicator LED allows the chosen voltage to be clearly seen.

NOTES: not suitable for installation in wall-mounting boxes or free-standing containers.

DATA - IVORY VERSION

TV-SAT SOCKETS



GW 11 361

COAXIAL TV SOCKETS (5-2400 MHz), CLASS A SHIELDING - MALE IEC CONNECTOR Ø 9.5 MM

Code	Description	Attenuation	No. modules	Pack Carton
GW 11 361	Direct	0 dB	1	1/48

CHARACTERISTICS: GW11361 allows the passage of voltage/current of remote power supply and/or control signals towards the user port (max 24V - 500 mA).

APPLICATIONS: socket-outlets suitable for return channel.



GW 11 371

COAXIAL TV-SAT SOCKETS (5-2400 MHZ) CLASS A SHIELDING - FEMALE F CONNECTOR

Code	Description	Attenuation	No. modules	Pack Carton
GW 11 371	Direct	0 dB	1	1/48

CHARACTERISTICS: GW11371 allows the passage of voltage/current of remote power supply and/or control signals towards the user port (max 24V - 500mA).
APPLICATIONS: socket-outlets suitable for return channel.



GW 11 383

TV-FM-SAT SOCKETS

Code	Connectors	Description	Attenuation	No. modules	Pack Carton
GW 11 381	TV-FM	Direct	0 dB	2	1/24
GW 11 383	TV-SAT	Direct	0 dB	2	1/24

CHARACTERISTICS: TV-FM direct co-axial socket-outlet GW11381: male IEC-type TV connector ø 9.5mm, female IEC-type FM connector ø 9.5mm.
 TV-FM-SAT direct co-axial socket-outlet GW11382: male IEC-type TV connector ø 9.5mm, female IEC-type FM connector ø 9.5mm, female F-type SAT connector.
 TV-SAT direct co-axial socket-outlet GW11383: male IEC-type TV connector ø 9.5mm, female F-type SAT connector.
NOTES: demixed socket-outlets with input for co-axial cable Ø 5mm or 7mm.

TELEPHONE SOCKETS



GW 11 401

RJ11 TELEPHONE SOCKETS

Code	Description	Connection	No. modules	Pack Carton
GW 11 401	RJ11	Screw-on terminals	1	1/24

APPLICATIONS: telephone, telefax, modem.

DATA SOCKETS



GW 11 421

RJ45 SOCKETS

Code	Description	Number pairs	Use category	Cables	Connection	No. modules	Pack Carton
GW 11 421	RJ45	4	5e	UTP	Toolless	1	1/24
GW 11 422	RJ45	4	5e	FTP	Toolless	1	1/24
GW 11 423	RJ45	4	6	UTP	Toolless	1	1/24
GW 11 424	RJ45	4	6	FTP	Toolless	1	1/24

APPLICATIONS: LANs up to 100MHz (e.g. Ethernet, Token Ring networks) for cat. 5e; LANs up to 250MHz (e.g. Videoconference systems, CCTV) for cat. 6.
NOTES: circuit identification label included.

CHORUSMART - Domestic range



GW 11 431

ADAPTER FOR HOUSING DATA CONNECTORS

Code	Compatibility	No. modules	Pack Carton
GW 11 431	AMP / Keystone Jack	1	1/48

NOTES: with regard to the technological developments and dimensional variants introduced by connector manufacturers, you are advised to check in advance the full compatibility between the connector and the Gewiss adapter.

ADAPTERS FOR OPTICAL FIBER



GW 38 335

ANGLED SC/APC ADAPTER

Code	Type	Tilt	For connectors	Compatibility	Colour	Pack Carton
GW 38 335	Female/Female	40°	SC/APC	Keystone Jack	Green RAL 6018	1/25

CHARACTERISTICS: cable outlet inclined of 40° to the wall line. With ceramic fiber optic sleeve and dust caps. The front output is protected with safety cap and unmissable cord. Suitable to join two single-mode SC/APC fiber optic patch cables.

NOTES: for adapters (Chorus, System and Dahlia) with Keystone Jack coupling.

USB AND HDMI COUPLERS



GW 38 056

USB AND HDMI COUPLERS

Code	Description	Type	Compatibility	Pack Carton
GW 38 056	HDMI coupler	Female/Female	Keystone Jack	1/48
GW 38 057	USB coupler	Female/Female - A type	Keystone Jack	1/48

NOTES: for adapters designed to house data connectors (ChoruSmart, System and Playbus) with Keystone Jack type coupling and permutation panels.

INDICATOR - IVORY VERSION

INDICATOR LIGHT DEVICES



GW 11 623

SINGLE INDICATOR LAMPS - 1 MODULE

Code	Diffuser colour	Colour meaning	No. modules	Pack Carton
GW 11 623	Red	Danger	1	1/24

CHARACTERISTICS: LED signalling units, not included.

APPLICATIONS: the meaning of the diffusers refers to the recommendations of standard EN60073 with regard to the use of the colours in indicator lights.

ANTI BLACK-OUT AND EMERGENCY LAMPS



GW 11 662

ANTI BLACK-OUT LAMP

Code	Supply voltage	Power supply batteries	Minimum autonomy	Lamp	No. modules	Pack Carton
GW 11 662	230 V ac - 50/60 Hz	Ni - Mh	1 h	LED	1	1/12

CHARACTERISTICS: green LED to indicate mains presence. Highly efficient, white LED lamp.

ACOUSTIC SIGNALLING DEVICES



GW 11 602

RINGERS

Code	Supply voltage	Max power consumption	Sound intensity	No. modules	Pack Carton
GW 11 602	230V ac - 50 Hz	8 VA	80 dB (at 1 m)	1	1/24

CHARACTERISTICS: for intermittent use (5 sec. ON / 15 sec. OFF).

ENERGY MANAGEMENT, CLIMATE AND COMFORT - IVORY VERSION

TEMPERATURE CONTROL DEVICES



GW 11 705

THERMOSTAT

Code	Supply voltage	Temperature adjustment	Output contacts	No. modules	Pack Carton
GW 11 705	230 V ac - 50/60 Hz	From +5°C to +35°C	1NO / NC 8A(AC1) 250V ac	2	1/2

CHARACTERISTICS: choice of working mode by means of selector located on the front: summer (air-conditioner), OFF, winter (boiler). Two-colour front LED to signal the output status (open/closed contact). The lighting up of the LED also indicates mains presence.

DIMMER



GW 11 564

ROTATING ELECTRONIC REGULATORS FOR RESISTIVE/INDUCTIVE LOADS

Code	Supply voltage	Resistive load 230V ac	Inductive load 230V ac	No. modules	Pack Carton
GW 11 564	230 V ac - 50/60 Hz	100 - 900 W	40 - 300 VA	1	1/12
GW 11 567	230 V ac - 50/60 Hz	100 - 500 W	100 - 500 VA	1	1/12

CHARACTERISTICS: with signalling led orange. GW11567 rotary command with two-way switch.

GW11564 compliance with the EMC directive is only guaranteed by connecting the regulator to an LC filter with the following characteristics: L=1mH - 5A, C=0.15uF - 275V X2, according to the documentation provided with the product. Item designated solely for export to a limited number of countries outside of the European Union or countries applying to become part of the European Free Trade Area. Contact Gewiss Customer Service to check the product meets the regulations of the country concerned before importing it.

NOTES: to avoid overheating, the side by side installation of several products in a single container is not permitted; insert a blanking module between two electronic devices. If installing two regulators in the same box, the maximum loads that can be commanded by each regulator must be reduced by 50%.

CHORUSMART - Domestic range



GW 11 573 A

UNIVERSAL ELECTRONIC REGULATOR WITH PUSH-BUTTON

Code	Supply voltage	No. modules	Pack Carton
GW 11 573 A	230 V ac - 50/60 Hz	2	1/6

CHARACTERISTICS: for the regulation and switching of incandescent and halogen lamps 230V AC (40-300W), low voltage halogen lamps with electronic and winding transformers (40-300W), LED lamps 230V AC with dimmer function (5-150W). Manual selection of the type of load (Leading Edge or Trailing Edge piloting), soft-start function for lamp protection. Possibility to command and regulate from remote control push-buttons with NO contacts. Equipped with orange signalling LED.

NOTES: to avoid overheating, the side-by-side installation of several products in a single container is not permitted; insert a blanking module between two electronic devices. If two regulators are installed in the same box, the maximum loads that can be commanded by each regulator must be reduced by 50%.

ACCESSORIES

SIGNALLING UNIT



GW 10 881

LED SIGNALLING UNITS - 230 V AC - 0.6 W

Code	Lamp voltage	Lamp power	Lamp	Light emitted	Cable Colour	Pack Carton
GW 10 881	230 V ac - 50/60 Hz	0.6 W	LED	Blue	Blue	50
GW 10 882	230 V ac - 50/60 Hz	0.6 W	LED	White	White	50
GW 10 883	230 V ac - 50/60 Hz	0.6 W	LED	Red	Red	50
GW 10 884	230 V ac - 50/60 Hz	0.6 W	LED	Green	Green	50
GW 10 885	230 V ac - 50/60 Hz	0.6 W	LED	Amber	Orange	50

NOTES: the LED signalling units are supplied with power supply cables (length 10 cm).



GW 10 894

LED SIGNALLING UNITS - 12-24 V AC/DC - 0.6 W

Code	Lamp voltage	Lamp power	Lamp	Light emitted	Cable Colour	Pack Carton
GW 10 894	12-24V ac/dc	0.6 W	LED	White	White	50

NOTES: the LED signalling units are supplied with power supply cables (length 10 cm).

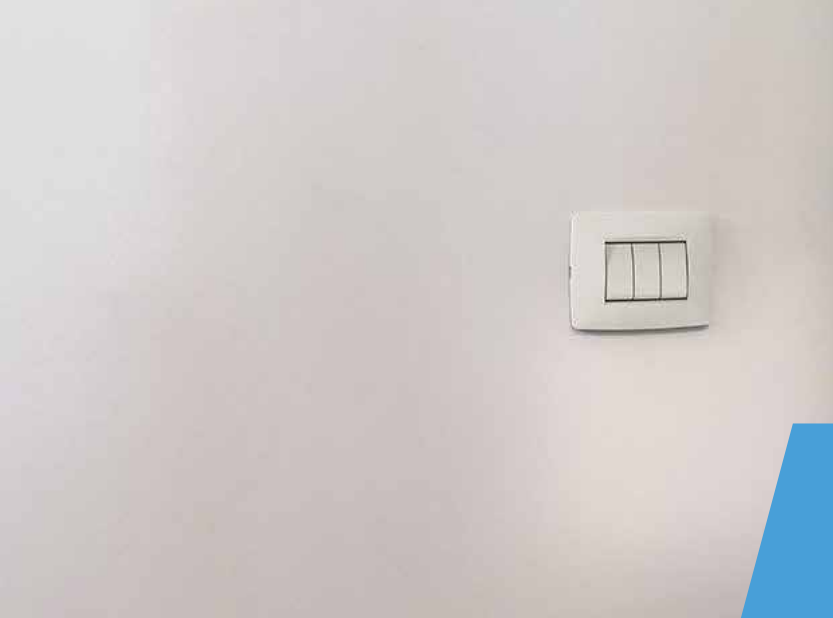

ChoruSmart

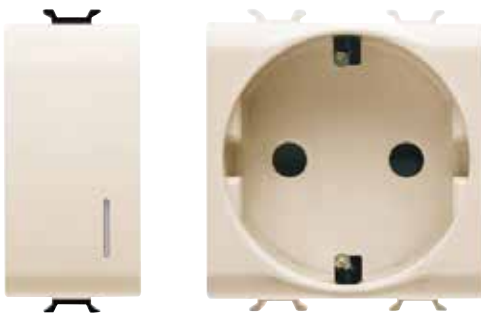

Scan the QR Code and find out all the technical informations.

INNOVATIVE

AESTHETIC VARIABILITY

SCALABLE



ChoruSmart offers the best technologies for an aesthetic and functional experience suitable for every person. In particular, the new EVO axial and touch controls offer the ability to centralize the management of lights and shutters with an extremely simplified installation.

The wide range of options for customising the devices, in terms of colour and modularity, ensures a vast choice of solutions. Six colourways are available: three with a satin finish and three with a glossy finish, for a perfect match between the devices and the plate.

ChoruSmart began as a traditional domestic series, but with the addition of a few Connected Smart Home or Home&Building Pro elements, it can become smart and suitable for both renovations and new buildings. The combination of colours, materials, finishes and shapes offers something for every taste and need.

CHORUSMART - Domestic range - Antibacterial

ONE PLATES - ANTIBACTERIAL WHITE



ONE INTERNATIONAL PLATES - ANTIBACTERIAL WHITE





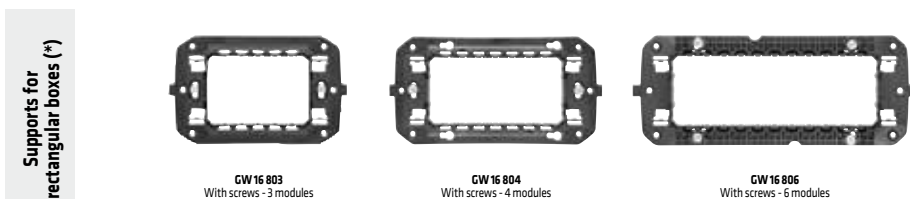
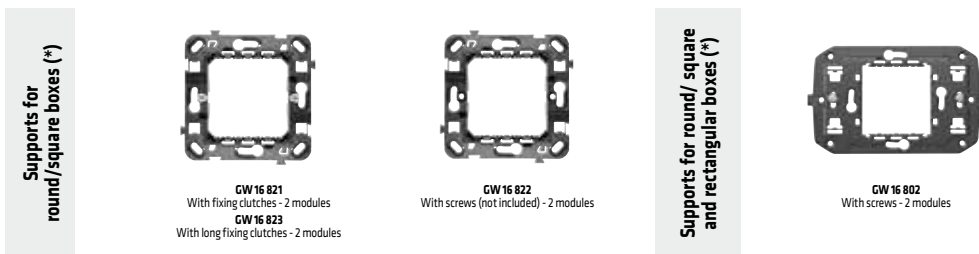













SUPPORTS



















(*) Without antibacterial treatment

COMMAND - ANTIBACTERIAL WHITE

<p>One-way switches</p>				<p>Two-way switches</p>		<p>Intermediate switches</p>		<p>Three-way switches</p>	
<p>GW 10 001 AB 1M-1P-16 AX GW 10 004 AB 1M-2P-16 AX GW 10 007 AB 1M-2P-25 AX For heavy loads GW 10 051 AB 1M-1P-16 AX GW 10 091 AB 1M-1P-16 AX GW 10 122 AB 1M-2P-10 AX Positions 1-0-2</p>									
<p>Push-buttons</p>									
<p>GW 10 131 AB 1M-1P-NA-16 A GW 10 136 AB 1M-1P-NA-16 A With pull-cord GW 10 140 AB 1M-1P-NA-NA-10 A With interlock</p>									
<p>Interchangeable button keys</p>			<p>Lenses with illuminated symbols</p>						
<p>GW 10 738 AB With diffuser GW 10 739 AB With neutral lens GW 10 505 AB Bell GW 10 507 AB Key GW 10 511 AB Nurse</p>									
<p>Blanking modules</p>		<p>Relay</p>							
<p>GW 10 195 AB 1M GW 10 726 AB Call 1M-1P-NO/NC-12 V ac/dc</p>									

POWER - ANTIBACTERIAL WHITE

<p>Italian</p>					<p>Italian/German</p>				
<p>GW 10 201 AB 2P+T-10 A-250 V ac GW 10 203 AB 2P+T-16 A-250 V ac Dual amperage GW 10 213 AB 2P+T-16 A-250 V ac Dual amperage GW 10 233 AB 2P+T-16 A-250 V ac Dual amperage GW 10 204 AB 2P+T-16 A-250 V ac Dual amperage GW 10 214 AB 2P+T-16 A-250 V ac Dual amperage - Illuminable (**) GW 10 224 AB 2P+T-16 A-250 V ac Dual amperage - Illuminable (**)</p>									
<p>German</p>					<p>French</p>				
<p>GW 10 241 AB 2P+T-16 A-250 V ac GW 10 251 AB 2P+T-16 A-250 V ac GW 10 341 AB 2P+T-16 A-250 V ac Front tightening terminals GW 10 351 AB 2P+T-16 A-250 V ac Front tightening terminals GW 10 247 AB 2P+T-16 A-250 V ac</p>									
<p>Israeli</p>				<p>Shaver socket-outlet</p>					
<p>GW 10 281 AB 2P+E-16 A-250 V ac Illuminable (**) GW 10 291 AB 2P+E-16 A-250 V ac Illuminable (**) GW 10 282 AB 2P-10 A-250 V ac GW 10 331 AB 230 V ac-50/60 Hz</p>									

(**) supplied without signalling units

CHORUSMART - Domestic range - Antibacterial

DATA - ANTIBACTERIAL WHITE

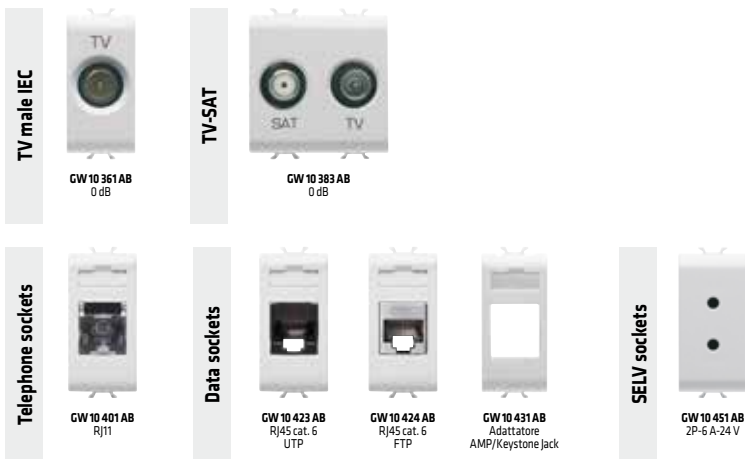

SIGNALLING AND ADJUSTMENT - ANTIBACTERIAL WHITE

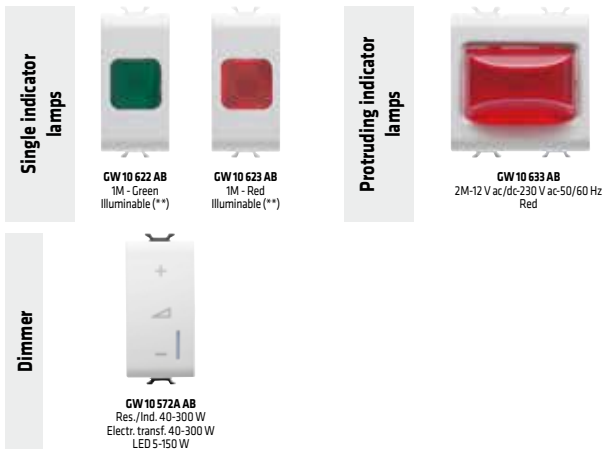

ACCESSORIES

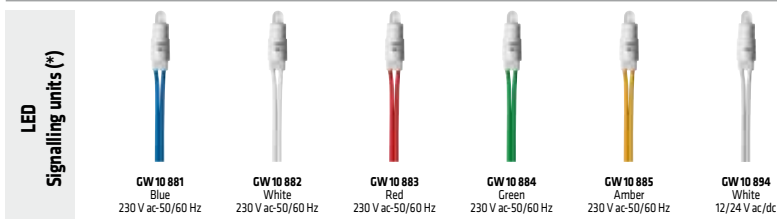

(**) supplied without signalling units

ChoruSmart

Antibacterial range

A range of ChoruSmart modular devices and plates made in antibacterial technopolymer, white colour and glossy finish, suitable for hospitals, structures for aged people, schools and wherever cleanness and hygiene are an essential component. The effectiveness of the antibacterial treatment, based on the addition of silver ions, is able to reduce the bacterial growth by 99% within 24 hours and has been tested according to the ISO 22196 (MRSA and Escherichia coli strains) through certified laboratories.



ONE PLATES - ANTIBACTERIAL

TECHNOPOLYMER



GW 16 103 AB

ONE - WHITE - ANTIBACTERIAL

Code	Description	For support codes	Pack Carton
GW 16 101 AB	1 module	GW16802, GW16803, GW16803N	12
GW 16 102 AB	2 modules	GW16802, GW16803, GW16803N	12
GW 16 103 AB	3 modules	GW16803, GW16803N	12
GW 16 104 AB	4 modules	GW16804, GW16804N	12
GW 16 106 AB	6 modules	GW16806	6

CHARACTERISTICS: with antibacterial treatment. Glossy finish.

ONE INTERNATIONAL PLATES - ANTIBACTERIAL

TECHNOPOLYMER



GW 16 124 AB

ONE INTERNATIONAL - WHITE - ANTIBACTERIAL

Code	Description	Type	Centre distance	Pack Carton
GW 16 122 AB	2 modules	-	-	12
GW 16 123 AB	2+2 modules	Horizontal	71 mm	12
GW 16 124 AB	2+2 modules	Vertical	71 mm	12
GW 16 126 AB	2+2+2 modules	Horizontal	71 mm	6
GW 16 127 AB	2+2+2 modules	Vertical	71 mm	6

CHARACTERISTICS: with antibacterial treatment. Glossy finish.

COMMAND - GLOSSY WHITE VERSION - ANTIBACTERIAL

COMMAND DEVICES - SCREW TERMINALS



GW 10 001 AB

ONE-WAY SWITCH 1P - 250V AC

Code	Description	Button key	Rated power of 230V LED lamps	No. modules	Pack Carton
GW 10 001 AB	1P - 16AX	Neutral	200 W	1	12/96

CHARACTERISTICS: with antibacterial treatment.

CHORUSMART - Domestic range - Antibacterial



GW 10 004 AB

ONE-WAY SWITCHES 2P - 250V AC

Code	Description	Button key	Symbol	Rated power of 230V LED lamps	No. modules	Pack Carton
GW 10 004 AB	2P - 16 AX	Neutral	0/1	200 W	1	12/48
GW 10 007 AB	2P - 25 AX	Neutral	0/1	250 W	1	12/24

CHARACTERISTICS: with antibacterial treatment.

APPLICATIONS: GW10007AB suitable for particular heavy-duty loads (e.g. LED or fluorescent lamp batteries) or high-consumption devices (e.g. ovens, air-conditioners, boilers, etc.).



GW 10 051 AB

TWO-WAY SWITCH 1P - 250V AC

Code	Description	Button key	Rated power of 230V LED lamps	No. modules	Pack Carton
GW 10 051 AB	1P - 16AX	Neutral	200 W	1	12/96

CHARACTERISTICS: with antibacterial treatment.



GW 10 091 AB

INTERMEDIATE SWITCH 1P - 250V AC

Code	Description	Button key	Rated power of 230V LED lamps	No. modules	Pack Carton
GW 10 091 AB	1P - 16AX	Neutral	200 W	1	12/48

CHARACTERISTICS: with antibacterial treatment.

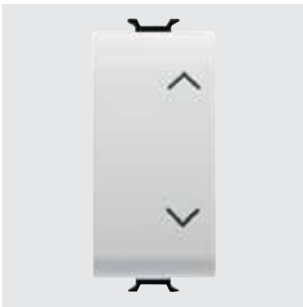

GW 10 122 AB

THREE-WAY SWITCH 2P - 250 V AC

Code	Description	Button key	Symbol	Rated power of 230V LED lamps	No. modules	Pack Carton
GW 10 122 AB	2P - 10AX	Neutral	UP - DOWN	100 W	1	12/24

CHARACTERISTICS: anti-bacterial treatment. Three stable positions. In the central (OFF) position both contacts are open. Equipped with 6 terminals.

APPLICATIONS: circuit commands that require an interlock (e.g. activation of motorised devices with direction inversion). Selective control of 2 circuits.



GW 10 131 AB

PUSH-BUTTONS 1P - 250V AC

Code	Description	Button key	Symbol	No. modules	Pack Carton
GW 10 131 AB	1P NO - 16A	Neutral	-	1	12/96
GW 10 136 AB	1P NO - 16A	Pull-cord	-	1	1/12
GW 10 137 AB	1P NC - 16A	Neutral	0 red	1	12/24
GW 10 140 AB	1P NO+NO - 10A	With interlock	UP - DOWN	1	12/24

CHARACTERISTICS: with antibacterial treatment. GW10136AB cord in insulating material, 140cm long, with red knob.

GW10140AB button with mechanical interlock. Both contacts are open in the central position (OFF); advisable for activating motorised devices with direction reversal (e.g. roller-shutters, curtains, etc.).

INTERCHANGEABLE BUTTON KEYS



GW 10 738 AB

INTERCHANGEABLE BUTTON KEYS

Code	Button key	No. modules	Pack Carton
GW 10 738 AB	With diffuser	1	4/48
GW 10 739 AB	With replaceable neutral lens	1	4/48

CHARACTERISTICS: with antibacterial treatment. Suitable for one-way switches, two-way switches, intermediate switches and push-buttons.

LENSES WITH ILLUMINATED SYMBOL



GW 10 505 AB

LENSES WITH ILLUMINATED SYMBOLS

Code	Symbol	Pack Carton
GW 10 505 AB	Bell	20
GW 10 507 AB	Key	20
GW 10 511 AB	Nurse	20

CHARACTERISTICS: with antibacterial treatment.

NOTES: to be used in place of the neutral lens in the illuminable command devices.

BLANKING MODULE



GW 10 195 AB

BLANKING MODULE

Code	Description	No. modules	Pack Carton
GW 10 195 AB	1 module	1	10/200

CHARACTERISTICS: with antibacterial treatment.

RELAY



GW 10 726 AB

CALL RELAY - 12V AC/DC

Code	Supply voltage	No. of poles	Output contacts	No. modules	Pack Carton
GW 10 726 AB	12V ac/dc	1P	1NO/NC 12 V (max. 1A)	1	1/12

CHARACTERISTICS: with antibacterial treatment. Inlets for remote NO push-buttons for alarms and alarm reset. Green LED for alarm status signalling.

CHORUSMART - Domestic range - Antibacterial

POWER - GLOSSY WHITE VERSION - ANTIBACTERIAL

SOCKET-OUTLETS - ITALIAN/GERMAN STANDARD



GW 10 203 AB

ITALIAN STANDARD SOCKET-OUTLETS - 250V AC

Code	Description	Socket-out type	For plug pins	No. modules	Pack Carton
GW 10 201 AB	2P+E - 10A	P11	Ø 4 mm	1	12/96
GW 10 203 AB	2P+E - 16 A Dual amperage	P11-P17	Ø 4 / 5 mm	1	12/96

CHARACTERISTICS: with antibacterial treatment. With safety shields.



GW 10 204 AB

ITALIAN/GERMAN STANDARD SOCKET-OUTLET - 250V AC

Code	Description	Earth pit	Socket-out type	For plug pins	No. modules	Pack Carton
GW 10 204 AB	2P+E - 16 A Dual amperage	Side and central	P40	Ø 4 / 4.8 / 5 mm	2	6/48

CHARACTERISTICS: with antibacterial treatment. With safety shields.

SOCKET-OUTLETS FOR DEDICATED LINES - ITALIAN/GERMAN STANDARD



GW 10 213 AB

ITALIAN STANDARD SOCKET-OUTLETS FOR DEDICATED LINES - 250V AC

Code	Description	Colour	Socket-out type	For plug pins	No. modules	Pack Carton
GW 10 213 AB	2P+E - 16 A Dual amperage	Red	P11-P17	Ø 4 / 5 mm	1	12/24
GW 10 223 AB	2P+E - 16 A Dual amperage	Green	P11-P17	Ø 4 / 5 mm	1	12/24

CHARACTERISTICS: with antibacterial treatment, satin finish. With safety shields.



GW 10 214 AB

ITALIAN/GERMAN STANDARD SOCKET-OUTLETS FOR DEDICATED LINES - 250V AC

Code	Description	Colour	Socket-out type	For plug pins	No. modules	Pack Carton
GW 10 214 AB	2P+E - 16 A Dual amperage illuminable	Red	P40	Ø 4 / 4.8 / 5 mm	2	6/12
GW 10 224 AB	2P+E - 16 A Dual amperage illuminable	Green	P40	Ø 4 / 4.8 / 5 mm	2	6/12

CHARACTERISTICS: with antibacterial treatment, satin finish. With safety shields. Pit of side and central earth contacts. Pre-arranged for housing LED signalling units, not included.

APPLICATIONS: possibility to indicate presence of auxiliary supply.

SOCKET-OUTLETS - GERMAN STANDARD



GW 10 241 AB

GERMAN STANDARD SOCKET-OUTLET - 250V AC

Code	Description	For plug pins	No. modules	Pack Carton
GW 10 241 AB	2P+E - 16A	Ø 4.8 mm	2	6/48

CHARACTERISTICS: with antibacterial treatment, glossy finish. With safety shields.



GW 10 251 AB

GERMAN STANDARD SOCKET-OUTLET FOR DEDICATED LINES - 250V AC

Code	Description	Colour	For plug pins	No. modules	Pack Carton
GW 10 251 AB	2P+E - 16A	Red	Ø 4.8 mm	2	6/12

CHARACTERISTICS: with antibacterial treatment, satin finish. With safety shields.



GW 10 341 AB

GERMAN STANDARD SOCKET-OUTLET WITH FRONT TIGHTENING TERMINALS - 250V AC

Code	Description	For plug pins	No. modules	Pack Carton
GW 10 341 AB	2P+E - 16A	Ø 4.8 mm	2	6/12

CHARACTERISTICS: with antibacterial treatment, glossy finish. With safety shields. Front access terminals with screw fixing, cables side entry.



GW 10 351 AB

GERMAN STANDARD SOCKET-OUTLET FOR DEDICATED LINES WITH FRONT TIGHTENING TERMINALS - 250V AC

Code	Description	Colour	For plug pins	No. modules	Pack Carton
GW 10 351 AB	2P+E - 16A	Red	Ø 4.8 mm	2	6/12

CHARACTERISTICS: with antibacterial treatment, satin finish. With safety shields. Front access terminals with screw fixing, cables side entry.

CHORUSMART - Domestic range - Antibacterial

SOCKET-OUTLET - FRENCH STANDARD



GW 10 247 AB

FRENCH STANDARD SOCKET-OUTLET - 250V AC

Code	Description	For plug pins	No. modules	Pack Carton
GW 10 247 AB	2P+E - 16A	Ø 4 / 4.8 mm	2	6/48

CHARACTERISTICS: with antibacterial treatment. With safety shields.

SOCKET-OUTLETS - ISRAELI STANDARD



GW 10 281 AB

ISRAELI STANDARD SOCKET-OUTLET - 250V AC

Code	Description	For plug pins	No. modules	Pack Carton
GW 10 281 AB	2P+E - 16 A illuminable	Round Ø 4 / 4.4 mm	2	1/24

CHARACTERISTICS: anti-bacterial treatment, safety shields. Predisposed to house the LED indicator unit - not included.



GW 10 291 AB

ISRAELI STANDARD SOCKET-OUTLET FOR DEDICATED LINES - 250V AC

Code	Description	Colour	For plug pins	No. modules	Pack Carton
GW 10 291 AB	2P+E - 16 A illuminable	Red	Round Ø 4 / 4.4 mm	2	1/24

CHARACTERISTICS: anti-bacterial treatment, safety shields. Predisposed to house the LED indicator unit - not included. Satin finish



GW 10 282 AB

ISRAELI STANDARD SOCKET-OUTLET - 250V AC

Code	Description	For plug pins	No. modules	Pack Carton
GW 10 282 AB	2P - 10 A	Round Ø 4 mm	1	1/48

CHARACTERISTICS: with antibacterial treatment. With safety shields.

SHAVER SOCKET-OUTLET



GW 10 331 AB

EURO-AMERICAN STANDARD SHAVER SOCKET-OUTLET WITH INSULATION TRANSFORMER

Code	Supply voltage	For plug pins	Selectable output voltage	Maximum power	No. modules	Pack Carton
GW 10 331 AB	230 V ac - 50/60 Hz	Ø 4 / 5 - 6.3x1.5 mm	120-230V ac	20 VA	3	1/2

CHARACTERISTICS: with antibacterial treatment. The socket-outlet is equipped with a self-protection device against overloading. The output voltage should be selected correctly, consulting the rating of the user device before inserting the plug. The relevant indicator LED allows the chosen voltage to be clearly seen.

NOTES: not suitable for installation in wall-mounting boxes or free-standing containers.

DATA - GLOSSY WHITE VERSION - ANTIBACTERIAL

TV-SAT SOCKETS



GW 10 361 AB

COAXIAL TV SOCKETS (5-2400 MHZ), CLASS A SHIELDING - MALE IEC CONNECTOR Ø 9.5 MM

Code	Description	Attenuation	No. modules	Pack Carton
GW 10 361 AB	Direct	0 dB	1	1/48

CHARACTERISTICS: with antibacterial treatment. Allows the passage of voltage/current of remote power supply and/or control signals towards the user port (max 24V - 500 mA).

APPLICATIONS: socket-outlets suitable for return channel.



GW 10 383 AB

TV-SAT SOCKET

Code	Connectors	Description	Attenuation	No. modules	Pack Carton
GW 10 383 AB	TV-SAT	Direct	0 dB	2	1/24

CHARACTERISTICS: with antibacterial treatment. Male IEC-type TV connector ø 9.5mm; female F-type SAT connector.

NOTES: demixed socket-outlet with input for co-axial cable Ø 5mm or 7mm.

TELEPHONE SOCKET



GW 10 401 AB

RJ11 TELEPHONE SOCKET

Code	Description	Connection	No. modules	Pack Carton
GW 10 401 AB	RJ11	Screw-on terminals	1	1/24

CHARACTERISTICS: with antibacterial treatment.

APPLICATIONS: telephone, telefax, modem.

CHORUSMART - Domestic range - Antibacterial

DATA SOCKETS



GW 10 423 AB

RJ45 SOCKETS

Code	Description	Number pairs	Use category	Cables	Connection	No. modules	Pack Carton
GW 10 423 AB	RJ45	4	6	UTP	Toolless	1	1/24
GW 10 424 AB	RJ45	4	6	FTP	Toolless	1	1/24

CHARACTERISTICS: with antibacterial treatment.

APPLICATIONS: LANs up to 250MHz (e.g. Videoconference systems, CCTV).

NOTES: circuit identification label included.



GW 10 431 AB

ADAPTERS FOR HOUSING DATA CONNECTORS

Code	Compatibility	No. modules	Pack Carton
GW 10 431 AB	AMP / Keystone Jack	1	1/48

CHARACTERISTICS: with antibacterial treatment.

NOTES: with regard to the technological developments and dimensional variants introduced by connector manufacturers, you are advised to check in advance the full compatibility between the connector and the Gewiss adapter.

SOCKET-OUTLET FOR AUXILIARY CIRCUITS



GW 10 451 AB

SELV SOCKET

Code	Description	For plug pins	No. modules	Pack Carton
GW 10 451 AB	2P - 6A - 24V	Ø 3 mm	1	12/24

CHARACTERISTICS: with antibacterial treatment. Centre distance 12.4 mm.

INDICATOR - WHITE VERSION - ANTIBACTERIAL

INDICATOR LIGHT DEVICES



GW 10 622 AB

SINGLE INDICATOR LAMPS - 1 MODULE

Code	Diffuser colour	Colour meaning	No. modules	Pack Carton
GW 10 622 AB	Green	Safety	1	1/24
GW 10 623 AB	Red	Danger	1	1/24

CHARACTERISTICS: with antibacterial treatment. LED signalling units, not included.

APPLICATIONS: the meaning of the diffusers refers to the recommendations of standard EN60073 with regard to the use of the colours in indicator lights.



GW 10 633 AB

PROTRUDING INDICATOR LAMP - 2 MODULES

Code	Supply voltage	Diffuser colour	Lamp	No. modules	Pack Carton
GW 10 633 AB	12V ac/dc - 230V ac 50/60 Hz	Red	LED	2	1/24

CHARACTERISTICS: with antibacterial treatment. Highly efficient white LED, powered at 12V ac/dc - 230V ac with double power supply inlet.

APPLICATIONS: suitable for special applications such as the signalling of calls from hospital wards.

NOTES: complete with lamp.

REGULATION - GLOSSY WHITE VERSION - ANTIBACTERIAL

DIMMER



GW 10 572 AAB

UNIVERSAL ELECTRONIC REGULATOR WITH PUSH-BUTTON

Code	Supply voltage	No. modules	Pack Carton
GW 10 572 AAB	230V ac - 50/60 Hz	1	1/12

CHARACTERISTICS: with antibacterial treatment. For the regulation and switching of incandescent and halogen lamps 230V ac (40-300W), low voltage halogen and LED lamps with electronic and winding transformers (40-300W), LED lamps 230V ac with dimmer function (5-150W). Manual selection of the type of load (Leading Edge or Trailing Edge piloting), soft-start function for lamp protection. Possibility to command and regulate from remote control push-buttons with NO contacts. Equipped with orange signalling LED.

NOTES: to avoid overheating, the side-by-side installation of several products in a single container is not permitted; insert a blanking module between two electronic devices. If two regulators are installed in the same box, the maximum loads that can be commanded by each regulator must be reduced by 50%.

CHORUSMART - Domestic range - Antibacterial

ACCESSORIES

SIGNALLING UNITS



GW 10 881

LED SIGNALLING UNITS - 230 V AC - 0.6 W

Code	Lamp voltage	Lamp power	Lamp	Light emitted	Cable Colour	Pack Carton
GW 10 881	230 V ac - 50/60 Hz	0.6 W	LED	Blue	Blue	50
GW 10 882	230 V ac - 50/60 Hz	0.6 W	LED	White	White	50
GW 10 883	230 V ac - 50/60 Hz	0.6 W	LED	Red	Red	50
GW 10 884	230 V ac - 50/60 Hz	0.6 W	LED	Green	Green	50
GW 10 885	230 V ac - 50/60 Hz	0.6 W	LED	Amber	Orange	50

NOTES: the LED signalling units are supplied with power supply cables (length 10 cm).



GW 10 894

LED SIGNALLING UNITS - 12-24 V AC/DC - 0.6 W

Code	Lamp voltage	Lamp power	Lamp	Light emitted	Cable Colour	Pack Carton
GW 10 894	12-24V ac/dc	0.6 W	LED	White	White	50

NOTES: the LED signalling units are supplied with power supply cables (length 10 cm).



ChoruSmart



Scan the QR Code and find out all the technical informations.

ANTIBACTERIAL EFFECT

SAFE ENVIRONMENT

EXTENSIVE RANGE



The antibacterial effect is achieved by a special silver ion additive (Biomaster technology) mixed with the technopolymer, which reduces bacterial load growth by 99% over 24 hours.



The antibacterial protection remains effective for the lifetime of the treated product. The active ingredient is incorporated into the material, so it does not diminish or migrate, ensuring the highest efficiency over time.



The ChoruSmart antibacterial range, already complete with Italian and international standard solutions, is increased with addition of flush-mounted enclosures and junction boxes in antibacterial versions, offering a unique solution for the most diverse needs.

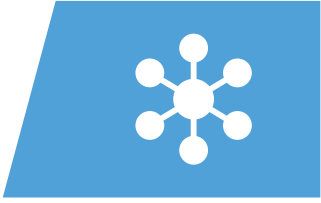

SYSTEM



Domestic range

PLATES

pag. 948



Domestic range

MODULAR DEVICES

pag. 962

SYSTEM - Domestic range

TOP SYSTEM PLATES

Technopolymer	CLOUD WHITE	Painted technopolymer	TITANIUM	Metallised technopolymer	SOFT CHROME
					
	GW 22 501 1 module		GW 22 601 1 module		GW 22 651 1 module
	GW 22 502 2 modules		GW 22 602 2 modules		GW 22 652 2 modules
	GW 22 503 3 modules		GW 22 603 3 modules		GW 22 653 3 modules
	GW 22 504 4 modules		GW 22 604 4 modules		GW 22 654 4 modules
	GW 22 506 6 modules		GW 22 606 6 modules		GW 22 656 6 modules
	GW 22 507 4+4 modules		GW 22 607 4+4 modules		GW 22 657 4+4 modules
GW 22 508 6+6 modules	GW 22 608 6+6 modules				
	TONER BLACK		SLATE		ANTIQUE GOLD
					
	GW 22 511 1 module		GW 22 611 1 module		GW 22 661 1 module
	GW 22 512 2 modules		GW 22 612 2 modules		GW 22 662 2 modules
	GW 22 513 3 modules		GW 22 613 3 modules		GW 22 663 3 modules
	GW 22 514 4 modules		GW 22 614 4 modules		GW 22 664 4 modules
	GW 22 516 6 modules		GW 22 616 6 modules		GW 22 666 6 modules
	GW 22 517 4+4 modules		GW 22 617 4+4 modules		GW 22 667 4+4 modules
			GW 22 618 6+6 modules		

Technopolymer - classic colour	ENGLISH WALNUT
	
	GW 22 671 1 module
	GW 22 672 2 modules
	GW 22 673 3 modules
	GW 22 674 4 modules
	GW 22 676 6 modules
	GW 22 677 4+4 modules

TOP SYSTEM PLATES

Technopolymyer - pastel colours

GERANIUM RED



- GW 22 521 1 module
- GW 22 522 2 modules
- GW 22 523 3 modules
- GW 22 524 4 modules
- GW 22 526 6 modules
- GW 22 527 4+4 modules

VENETIAN GREEN



- GW 22 541 1 module
- GW 22 542 2 modules
- GW 22 543 3 modules
- GW 22 544 4 modules
- GW 22 546 6 modules
- GW 22 547 4+4 modules

SKY BLUE



- GW 22 561 1 module
- GW 22 562 2 modules
- GW 22 563 3 modules
- GW 22 564 4 modules
- GW 22 566 6 modules
- GW 22 567 4+4 modules

CLASSIC BURGUNDY



- GW 22 531 1 module
- GW 22 532 2 modules
- GW 22 533 3 modules
- GW 22 534 4 modules
- GW 22 536 6 modules
- GW 22 537 4+4 modules

RACING GREEN



- GW 22 551 1 module
- GW 22 552 2 modules
- GW 22 553 3 modules
- GW 22 554 4 modules
- GW 22 556 6 modules
- GW 22 557 4+4 modules

JAZZ BLUE



- GW 22 571 1 module
- GW 22 572 2 modules
- GW 22 573 3 modules
- GW 22 574 4 modules
- GW 22 576 6 modules
- GW 22 577 4+4 modules

CORN YELLOW



- GW 22 581 1 module
- GW 22 582 2 modules
- GW 22 583 3 modules
- GW 22 584 4 modules
- GW 22 586 6 modules
- GW 22 587 4+4 modules

Modularity

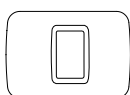

1 module

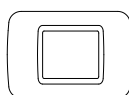

2 modules

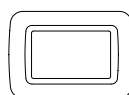

3 modules

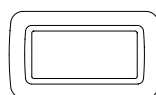

4 modules

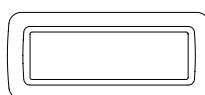

6 modules

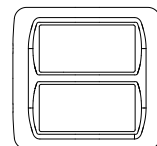

4+4 modules

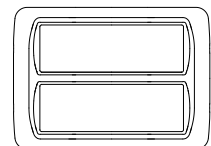







6+6 modules (*)

(*) Cloud white, slate and titanium

SYSTEM - Domestic range

VIRNA PLATES

Technopolymer	CLOUD WHITE	Painted technopolymer	TITANIUM	Metallised technopolymer	SOFT CHROME
					
	GW 22 101 1 module		GW 22 281 1 module		GW 22 251 1 module
	GW 22 102 2 modules		GW 22 282 2 modules		GW 22 252 2 modules
	GW 22 103 3 modules		GW 22 283 3 modules		GW 22 253 3 modules
	GW 22 104 4 modules		GW 22 284 4 modules		GW 22 254 4 modules
	GW 22 106 6 modules		GW 22 286 6 modules		GW 22 256 6 modules
	GW 22 107 4+4 modules		GW 22 287 4+4 modules		GW 22 257 4+4 modules
GW 22 108 6+6 modules	GW 22 288 6+6 modules				
	TONER BLACK		SLATE		ANTIQUE GOLD
					
	GW 22 111 1 module		GW 22 291 1 module		GW 22 261 1 module
	GW 22 112 2 modules		GW 22 292 2 modules		GW 22 262 2 modules
	GW 22 113 3 modules		GW 22 293 3 modules		GW 22 263 3 modules
	GW 22 114 4 modules		GW 22 294 4 modules		GW 22 264 4 modules
	GW 22 116 6 modules		GW 22 296 6 modules		GW 22 266 6 modules
	GW 22 117 4+4 modules		GW 22 297 4+4 modules		GW 22 267 4+4 modules

Technopolymer - classic colour	ENGLISH WALNUT
	
	GW 22 271 1 module
	GW 22 272 2 modules
	GW 22 273 3 modules
	GW 22 274 4 modules
	GW 22 276 6 modules
	GW 22 277 4+4 modules

VIRNA PLATES

Technopolymer - pastel colours

GERANIUM RED



- GW 22 121 1 module
- GW 22 122 2 modules
- GW 22 123 3 modules
- GW 22 124 4 modules
- GW 22 126 6 modules
- GW 22 127 4+4 modules

VENETIAN GREEN



- GW 22 141 1 module
- GW 22 142 2 modules
- GW 22 143 3 modules
- GW 22 144 4 modules
- GW 22 146 6 modules
- GW 22 147 4+4 modules

SKY BLUE



- GW 22 161 1 module
- GW 22 162 2 modules
- GW 22 163 3 modules
- GW 22 164 4 modules
- GW 22 166 6 modules
- GW 22 167 4+4 modules

CLASSIC BURGUNDY



- GW 22 131 1 module
- GW 22 132 2 modules
- GW 22 133 3 modules
- GW 22 134 4 modules
- GW 22 136 6 modules
- GW 22 137 4+4 modules

RACING GREEN



- GW 22 151 1 module
- GW 22 152 2 modules
- GW 22 153 3 modules
- GW 22 154 4 modules
- GW 22 156 6 modules
- GW 22 157 4+4 modules

JAZZ BLUE



- GW 22 171 1 module
- GW 22 172 2 modules
- GW 22 173 3 modules
- GW 22 174 4 modules
- GW 22 176 6 modules
- GW 22 177 4+4 modules

CORN YELLOW



- GW 22 181 1 module
- GW 22 182 2 modules
- GW 22 183 3 modules
- GW 22 184 4 modules
- GW 22 186 6 modules
- GW 22 187 4+4 modules

Modularity

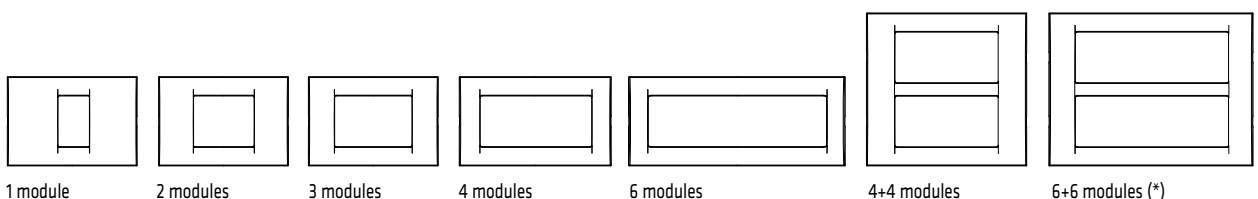

(*) Cloud white, slate and titanium

System

Plates

The technopolymer plates, available in two different shapes, Top System and Virna, and in 14 colour shades are the ideal solution for every installation. Top System: classic forms, resistant materials. A line of simple, functional plates that can enhance every environment, bringing harmony and beauty to the entire home. Virna: plates with unmistakable modern style, created to meet the needs of contemporary design. The elegance of the rectangular form is enhanced by the lightness and simplicity of the lines which surround the command buttons.



TOP SYSTEM PLATES

TECHNOPOLYMER



GW 22 503

TOP SYSTEM - CLOUD WHITE

Code	Description	Configuration	For support codes	Pack Carton
GW 22 501	1 module	-	GW24201	96
GW 22 502	2 modules	-	GW24262	96
GW 22 503	3 modules	-	GW24201	96
GW 22 504	4 modules	-	GW24202	96
GW 22 506	6 modules	-	GW24230	48
GW 22 507	4+4 modules	Overlapping	GW24240	6
GW 22 508	6+6 modules	Overlapping	GW24241	6

CHARACTERISTICS: glossy finish.



GW 22 513

TOP SYSTEM - TONER BLACK

Code	Description	Configuration	For support codes	Pack Carton
GW 22 511	1 module	-	GW24201	96
GW 22 512	2 modules	-	GW24262	12
GW 22 513	3 modules	-	GW24201	96
GW 22 514	4 modules	-	GW24202	12
GW 22 516	6 modules	-	GW24230	8
GW 22 517	4+4 modules	Overlapping	GW24240	6

CHARACTERISTICS: glossy finish.

TECHNOPOLYMER, IN PASTEL COLOURS

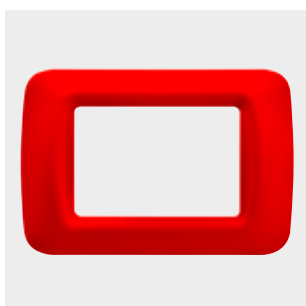

GW 22 523

TOP SYSTEM - GERANIUM RED

Code	Description	Configuration	For support codes	Pack Carton
GW 22 521	1 module	-	GW24201	24
GW 22 522	2 modules	-	GW24262	12
GW 22 523	3 modules	-	GW24201	24
GW 22 524	4 modules	-	GW24202	12
GW 22 526	6 modules	-	GW24230	8
GW 22 527	4+4 modules	Overlapping	GW24240	6

CHARACTERISTICS: glossy finish.

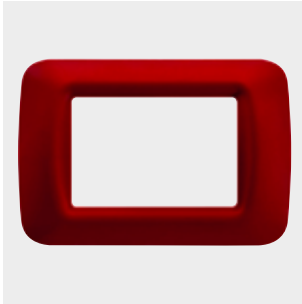

GW 22 533

TOP SYSTEM - CLASSIC BURGUNDY

Code	Description	Configuration	For support codes	Pack Carton
GW 22 531	1 module	-	GW24201	24
GW 22 532	2 modules	-	GW24262	12
GW 22 533	3 modules	-	GW24201	24
GW 22 534	4 modules	-	GW24202	12
GW 22 536	6 modules	-	GW24230	8
GW 22 537	4+4 modules	Overlapping	GW24240	6

CHARACTERISTICS: glossy finish.



GW 22 543

TOP SYSTEM - VENETIAN GREEN

Code	Description	Configuration	For support codes	Pack Carton
GW 22 541	1 module	-	GW24201	24
GW 22 542	2 modules	-	GW24262	12
GW 22 543	3 modules	-	GW24201	24
GW 22 544	4 modules	-	GW24202	12
GW 22 546	6 modules	-	GW24230	8
GW 22 547	4+4 modules	Overlapping	GW24240	6

CHARACTERISTICS: glossy finish.



GW 22 553

TOP SYSTEM - RACING GREEN

Code	Description	Configuration	For support codes	Pack Carton
GW 22 551	1 module	-	GW24201	24
GW 22 552	2 modules	-	GW24262	12
GW 22 553	3 modules	-	GW24201	24
GW 22 554	4 modules	-	GW24202	12
GW 22 556	6 modules	-	GW24230	8
GW 22 557	4+4 modules	Overlapping	GW24240	6

CHARACTERISTICS: glossy finish.



GW 22 563

TOP SYSTEM - SKY BLUE

Code	Description	Configuration	For support codes	Pack Carton
GW 22 561	1 module	-	GW24201	24
GW 22 562	2 modules	-	GW24262	12
GW 22 563	3 modules	-	GW24201	24
GW 22 564	4 modules	-	GW24202	12
GW 22 566	6 modules	-	GW24230	8
GW 22 567	4+4 modules	Overlapping	GW24240	6

CHARACTERISTICS: glossy finish.



GW 22 573

TOP SYSTEM - JAZZ BLUE

Code	Description	Configuration	For support codes	Pack Carton
GW 22 571	1 module	-	GW24201	24
GW 22 572	2 modules	-	GW24262	12
GW 22 573	3 modules	-	GW24201	24
GW 22 574	4 modules	-	GW24202	12
GW 22 576	6 modules	-	GW24230	8
GW 22 577	4+4 modules	Overlapping	GW24240	6

CHARACTERISTICS: glossy finish.

SYSTEM - Domestic range



GW 22 583

TOP SYSTEM - CORN YELLOW

Code	Description	Configuration	For support codes	Pack Carton
GW 22 581	1 module	-	GW24201	24
GW 22 582	2 modules	-	GW24262	12
GW 22 583	3 modules	-	GW24201	24
GW 22 584	4 modules	-	GW24202	12
GW 22 586	6 modules	-	GW24230	8
GW 22 587	4+4 modules	Overlapping	GW24240	6

CHARACTERISTICS: glossy finish.

PAINTED TECHNOPOLYMER



GW 22 603

TOP SYSTEM - TITANIUM

Code	Description	Configuration	For support codes	Pack Carton
GW 22 601	1 module	-	GW24201	12
GW 22 602	2 modules	-	GW24262	12
GW 22 603	3 modules	-	GW24201	12
GW 22 604	4 modules	-	GW24202	12
GW 22 606	6 modules	-	GW24230	8
GW 22 607	4+4 modules	Overlapping	GW24240	6
GW 22 608	6+6 modules	Overlapping	GW24241	6

CHARACTERISTICS: glossy finish.



GW 22 613

TOP SYSTEM - SLATE

Code	Description	Configuration	For support codes	Pack Carton
GW 22 611	1 module	-	GW24201	12
GW 22 612	2 modules	-	GW24262	12
GW 22 613	3 modules	-	GW24201	12
GW 22 614	4 modules	-	GW24202	12
GW 22 616	6 modules	-	GW24230	8
GW 22 617	4+4 modules	Overlapping	GW24240	6
GW 22 618	6+6 modules	Overlapping	GW24241	6

CHARACTERISTICS: glossy finish.

TECHNOPOLYMER, CLASSIC COLOUR



GW 22 673

TOP SYSTEM - ENGLISH WALNUT

Code	Description	Configuration	For support codes	Pack Carton
GW 22 671	1 module	-	GW24201	12
GW 22 672	2 modules	-	GW24262	12
GW 22 673	3 modules	-	GW24201	12
GW 22 674	4 modules	-	GW24202	12
GW 22 676	6 modules	-	GW24230	8
GW 22 677	4+4 modules	Overlapping	GW24240	6

METALLISED TECHNOPOLYMER



GW 22 653

TOP SYSTEM - SOFT CHROME

Code	Description	Configuration	For support codes	Pack Carton
GW 22 651	1 module	-	GW24201	12
GW 22 652	2 modules	-	GW24262	12
GW 22 653	3 modules	-	GW24201	12
GW 22 654	4 modules	-	GW24202	12
GW 22 656	6 modules	-	GW24230	8
GW 22 657	4+4 modules	Overlapping	GW24240	6

CHARACTERISTICS: glossy finish.



GW 22 663

TOP SYSTEM - ANTIQUE GOLD

Code	Description	Configuration	For support codes	Pack Carton
GW 22 661	1 module	-	GW24201	12
GW 22 662	2 modules	-	GW24262	12
GW 22 663	3 modules	-	GW24201	12
GW 22 664	4 modules	-	GW24202	12
GW 22 666	6 modules	-	GW24230	8
GW 22 667	4+4 modules	Overlapping	GW24240	6

CHARACTERISTICS: glossy finish.

VIRNA PLATES

TECHNOPOLYMER



GW 22 103

VIRNA - CLOUD WHITE

Code	Description	Configuration	For support codes	Pack Carton
GW 22 101	1 module	-	GW24201	96
GW 22 102	2 modules	-	GW24262	96
GW 22 103	3 modules	-	GW24201	96
GW 22 104	4 modules	-	GW24202	96
GW 22 106	6 modules	-	GW24230	48
GW 22 107	4+4 modules	Overlapping	GW24240	6
GW 22 108	6+6 modules	Overlapping	GW24241	6

CHARACTERISTICS: glossy finish.

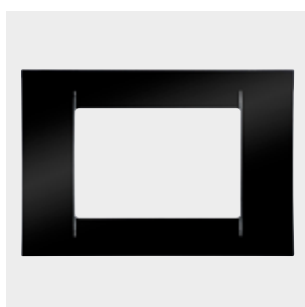

GW 22 113

VIRNA - TONER BLACK

Code	Description	Configuration	For support codes	Pack Carton
GW 22 111	1 module	-	GW24201	96
GW 22 112	2 modules	-	GW24262	12
GW 22 113	3 modules	-	GW24201	96
GW 22 114	4 modules	-	GW24202	12
GW 22 116	6 modules	-	GW24230	8
GW 22 117	4+4 modules	Overlapping	GW24240	6

CHARACTERISTICS: glossy finish.

SYSTEM - Domestic range

TECHNOPOLYMER, IN PASTEL COLOURS

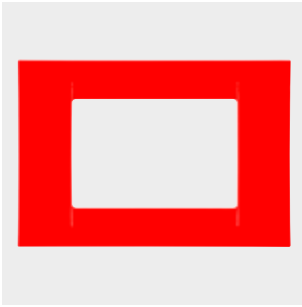

GW 22 123

VIRNA - GERANIUM RED

Code	Description	Configuration	For support codes	Pack Carton
GW 22 121	1 module	-	GW24201	24
GW 22 122	2 modules	-	GW24262	12
GW 22 123	3 modules	-	GW24201	24
GW 22 124	4 modules	-	GW24202	12
GW 22 126	6 modules	-	GW24230	8
GW 22 127	4+4 modules	Overlapping	GW24240	6

CHARACTERISTICS: glossy finish.

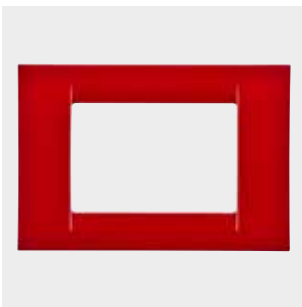

GW 22 133

VIRNA - CLASSIC BURGUNDY

Code	Description	Configuration	For support codes	Pack Carton
GW 22 131	1 module	-	GW24201	24
GW 22 132	2 modules	-	GW24262	12
GW 22 133	3 modules	-	GW24201	24
GW 22 134	4 modules	-	GW24202	12
GW 22 136	6 modules	-	GW24230	8
GW 22 137	4+4 modules	Overlapping	GW24240	6

CHARACTERISTICS: glossy finish.



GW 22 143

VIRNA - VENETIAN GREEN

Code	Description	Configuration	For support codes	Pack Carton
GW 22 141	1 module	-	GW24201	24
GW 22 142	2 modules	-	GW24262	12
GW 22 143	3 modules	-	GW24201	24
GW 22 144	4 modules	-	GW24202	12
GW 22 146	6 modules	-	GW24230	8
GW 22 147	4+4 modules	Overlapping	GW24240	6

CHARACTERISTICS: glossy finish.

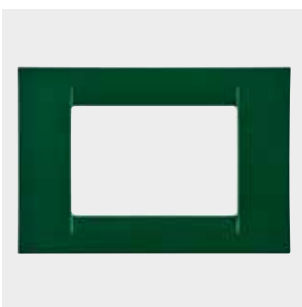

GW 22 153

VIRNA - RACING GREEN

Code	Description	Configuration	For support codes	Pack Carton
GW 22 151	1 module	-	GW24201	24
GW 22 152	2 modules	-	GW24262	12
GW 22 153	3 modules	-	GW24201	24
GW 22 154	4 modules	-	GW24202	12
GW 22 156	6 modules	-	GW24230	8
GW 22 157	4+4 modules	Overlapping	GW24240	6

CHARACTERISTICS: glossy finish.



GW 22 163

VIRNA - SKY BLUE

Code	Description	Configuration	For support codes	Pack Carton
GW 22 161	1 module	-	GW24201	24
GW 22 162	2 modules	-	GW24262	12
GW 22 163	3 modules	-	GW24201	24
GW 22 164	4 modules	-	GW24202	12
GW 22 166	6 modules	-	GW24230	8
GW 22 167	4+4 modules	Overlapping	GW24240	6

CHARACTERISTICS: glossy finish.

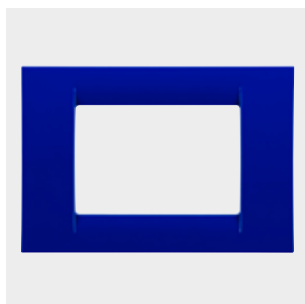

GW 22 173

VIRNA - JAZZ BLUE

Code	Description	Configuration	For support codes	Pack Carton
GW 22 171	1 module	-	GW24201	24
GW 22 172	2 modules	-	GW24262	12
GW 22 173	3 modules	-	GW24201	24
GW 22 174	4 modules	-	GW24202	12
GW 22 176	6 modules	-	GW24230	8
GW 22 177	4+4 modules	Overlapping	GW24240	6

CHARACTERISTICS: glossy finish.



GW 22 183

VIRNA - CORN YELLOW

Code	Description	Configuration	For support codes	Pack Carton
GW 22 181	1 module	-	GW24201	24
GW 22 182	2 modules	-	GW24262	12
GW 22 183	3 modules	-	GW24201	24
GW 22 184	4 modules	-	GW24202	12
GW 22 186	6 modules	-	GW24230	8
GW 22 187	4+4 modules	Overlapping	GW24240	6

CHARACTERISTICS: glossy finish.

PAINTED TECHNOPOLYMER



GW 22 283

VIRNA - TITANIUM

Code	Description	Configuration	For support codes	Pack Carton
GW 22 281	1 module	-	GW24201	12
GW 22 282	2 modules	-	GW24262	12
GW 22 283	3 modules	-	GW24201	24
GW 22 284	4 modules	-	GW24202	12
GW 22 286	6 modules	-	GW24230	8
GW 22 287	4+4 modules	Overlapping	GW24240	6
GW 22 288	6+6 modules	Overlapping	GW24241	6

CHARACTERISTICS: glossy finish.



GW 22 293

VIRNA - SLATE

Code	Description	Configuration	For support codes	Pack Carton
GW 22 291	1 module	-	GW24201	12
GW 22 292	2 modules	-	GW24262	12
GW 22 293	3 modules	-	GW24201	24
GW 22 294	4 modules	-	GW24202	12
GW 22 296	6 modules	-	GW24230	8
GW 22 297	4+4 modules	Overlapping	GW24240	6
GW 22 298	6+6 modules	Overlapping	GW24241	6

CHARACTERISTICS: glossy finish.

TECHNOPOLYMER, CLASSIC COLOUR



GW 22 273

VIRNA - ENGLISH WALNUT

Code	Description	Configuration	For support codes	Pack Carton
GW 22 271	1 module	-	GW24201	12
GW 22 272	2 modules	-	GW24262	12
GW 22 273	3 modules	-	GW24201	24
GW 22 274	4 modules	-	GW24202	12
GW 22 276	6 modules	-	GW24230	8
GW 22 277	4+4 modules	Overlapping	GW24240	6

SYSTEM - Domestic range

METALLISED TECHNOPOLYMER

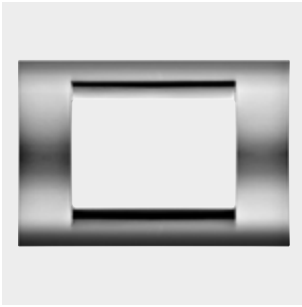

GW 22 253

VIRNA - SOFT CHROME

Code	Description	Configuration	For support codes	Pack Carton
GW 22 251	1 module	-	GW24201	12
GW 22 252	2 modules	-	GW24262	12
GW 22 253	3 modules	-	GW24201	24
GW 22 254	4 modules	-	GW24202	12
GW 22 256	6 modules	-	GW24230	8
GW 22 257	4+4 modules	Overlapping	GW24240	6

CHARACTERISTICS: glossy finish.



GW 22 263

VIRNA - ANTIQUE GOLD

Code	Description	Configuration	For support codes	Pack Carton
GW 22 261	1 module	-	GW24201	12
GW 22 262	2 modules	-	GW24262	12
GW 22 263	3 modules	-	GW24201	24
GW 22 264	4 modules	-	GW24202	12
GW 22 266	6 modules	-	GW24230	8
GW 22 267	4+4 modules	Overlapping	GW24240	6

CHARACTERISTICS: glossy finish.

SPECIAL PLATES, ENCLOSURES AND SUPPORTS

COMPACT SELF-SUPPORTING PLATES



GW 24 001

SELF-SUPPORTING PLATES - CLOUD WHITE



Code	Description	Configuration	For flush mounting box	For wall mounting boxes	Characteristics	Pack Carton
GW 24 001	1 module	-	GW24403, GW24403PM	GW24006	Halogen free	1/120
GW 24 002	2 modules	-	GW24403, GW24403PM	GW24006	Halogen free	1/120
GW 24 003	3 modules	-	GW24403, GW24403PM	GW24006	Halogen free	1/120
GW 24 004	4 modules	-	GW24404, GW24404PM	-	Halogen free	1/60
GW 24 005	3+3 modules	Overlapping	GW24206	GW24007	Halogen free	1/60



GW 24 211

BLANK PLATES FOR RECTANGULAR FLUSH-MOUNTING BOXES



Code	Description	Configuration	Fixing	Colour	Characteristics	Pack Carton
GW 24 211	3 modules	-	With screw	Cloud white	Halogen free	1/120
GW 24 212	3 modules	-	With screw	Toner black	Halogen free	1/120
GW 24 213	4 modules	-	With screw	Cloud white	Halogen free	1/60
GW 24 214	4 modules	-	With screw	Toner black	Halogen free	1/60
GW 24 215	3+3 modules	Overlapping	With screw	Cloud white	Halogen free	1/60
GW 24 216	3+3 modules	Overlapping	With screw	Toner black	Halogen free	1/60

WATERTIGHT PLATES



GW 22 451

SELF-SUPPORTING WATERTIGHT PLATES FOR INSTALLATION ON FLUSH-MOUNTING RECTANGULAR BOXES - IP55

Code	Description	Colour Plate	For flush mounting box	Pack Carton
GW 22 451	3 modules	Cloud white	GW24403, GW24403PM	30
GW 22 452	3 modules	Black	GW24403, GW24403PM	30
GW 22 453	3 modules	Grey RAL 7035	GW24403, GW24403PM	30
GW 22 461	4 modules	Cloud white	GW24404, GW24404PM	30
GW 22 462	4 modules	Black	GW24404, GW24404PM	30
GW 22 463	4 modules	Grey RAL 7035	GW24404, GW24404PM	30

CHARACTERISTICS: ergonomic membrane with notches in UV-resistant material. Snap closing system. Opening made easy by wide key.

PLATES FOR PROFILES



GW 24 008

SELF-SUPPORTING PLATES FOR PROFILES AND PANELS COMPLETE WITH INSULATING BOX

Code	Description	Configuration	Colour Plate	Pack Carton
GW 24 008	1 module	-	Cloud white	1/60
GW 24 009	1 module	-	Toner black	1/60
GW 24 010	2 modules	-	Cloud white	1/60
GW 24 011	2 modules	-	Toner black	1/60
GW 24 022	2+2 modules	Overlapping	Cloud white	1/30
GW 24 023	2+2 modules	Overlapping	Toner black	1/30

CHARACTERISTICS: box colour, Grey RAL7035.

WALL-MOUNTING BOXES



GW 22 471

WALL-MOUNTING BOXES FOR TOP SYSTEM PLATES



Code	Suitable for	Colour	For trunking dim. (mm)	For conduits max Ø (mm)	Characteristics	Pack Carton
GW 22 471	1/2/3 modules TOP SYSTEM	Cloud white	14x8.5 30x13 20x10	16 - 20	Halogen free	3/60
GW 22 472	4 modules TOP SYSTEM	Cloud white	14x8.5 30x13 20x10	16 - 20	Halogen free	3/30

CHARACTERISTICS: fitted for fixing the earth terminal GW26407.



GW 24 006

WALL-MOUNTING BOXES FOR COMPACT SELF-SUPPORTING PLATES



Code	Suitable for	Colour	For trunking dim. (mm)	For conduits max Ø (mm)	Characteristics	Pack Carton
GW 24 006	1/2/3 modules COMPACT	Cloud white	14x8.5 30x13 20x10	16 - 20 - 25	Halogen free	3/60
GW 24 007	3+3 modules COMPACT	Cloud white	14x8.5 30x13 20x10	16 - 20 - 25	Halogen free	3/30

CHARACTERISTICS: fitted for fixing the earth terminal GW26407.

SYSTEM - Domestic range



GW 32 431

WALL-MOUNTING BOXES FOR VIRNA PLATES



Code	Suitable for plates	Colour	For trunking dim. (mm)	For conduits max Ø (mm)	Characteristics	Pack Carton
GW 32 431	1/2/3 modules	Cloud white	15x17 / 22x10 / 25x17	16 - 20	Halogen free	3/60
GW 32 432	1/2/3 modules	Toner black	15x17 / 22x10 / 25x17	16 - 20	Halogen free	3/60

CHARACTERISTICS: fitted for fixing the earth terminal GW26407.

FREE-STANDING AND WALL-MOUNTING ENCLOSURES



GW 24 018

FREE-STANDING AND WALL-MOUNTING ENCLOSURES

Code	Description	Colour	Outer dim. LxHxD (mm)	Pack Carton
GW 24 018	4 modules	Cloud white	126x91x60	1/30
GW 24 019	4 modules	Toner black	126x91x60	1/30
GW 24 020	6 modules	Cloud white	181x91x60	1/20
GW 24 021	6 modules	Toner black	181x91x60	1/20

ACCESSORIES SUPPLIED: cable gland (for max Ø 10 mm cable), cable clamp.

SUPPORTS



GW 24 201

INSULATING SUPPORTS TO INSTALL TOP SYSTEM / VIRNA PLATES ON RECTANGULAR BOXES



Code	Description	Configuration	Fixing	Characteristics	Pack Carton
GW 24 201	3 modules	-	2 screws (included)	Halogen free	10/300
GW 24 202	4 modules	-	2 screws (included)	Halogen free	10/150
GW 24 230	6 modules	-	4 screws (included)	Halogen free	10/100
GW 24 240	4+4 modules	Overlapping	4 screws (included)	Halogen free	10/60
GW 24 241	6+6 modules	Overlapping	4 screws (included)	Halogen free	10/40



GW 24 262

INSULATING SUPPORTS TO INSTALL TOP SYSTEM / VIRNA PLATES ON SQUARE/RECTANGULAR BOXES



Code	Description	Fixing	Characteristics	Pack Carton
GW 24 262	2 modules	2 screws (included)	Halogen free	10/120



GW 26 409

SUPPORTS FOR ASSEMBLING SYSTEM DEVICES ON DIN RAIL

Code	Description	No. DIN modules	Pack Carton
GW 26 409	1 module	1.5	5/300
GW 26 410	2 modules	3	5/150



System

SYSTEM



Scan the QR Code and find out all the technical informations.

TWO LINES, ONE SINGLE OFFER



The System range includes two lines of plates, one more rounded and the other with a squarer design, in a domestic series recognised for its reliability and robustness.

A COMPLETE SOLUTION



The System devices are compatible with a wide range of accessories and can be installed in any electrical installation: flush- and surface-mounted rectangular boxes, flush-mounted square boxes, profiles and DIN rails, floor turrets and 27 Combi enclosures.

INSTALLATION FLEXIBILITY



The domestic System series offers maximum application flexibility. It is highly versatile, with two attachment options, from the front or back of the support, making the mounting and release of devices quick and easy.

SYSTEM WHITE - Domestic range

COMMAND - SYSTEM WHITE

One-way switches														
	GW 20 571 1M-1P-16 AX	GW 20 572 1M-1P-16 AX Backlit 230 V ac	GW 20 583 1M-1P-16 AX Illuminable (*)	GW 20 503 1M-2P-16 AX	GW 20 504 1M-2P-16 AX Backlit 230 V ac	GW 20 584 1M-2P-16 AX Illuminable (*)	GW 20 005 1M-2P-10 AX With key	GW 20 585 1M-2P-25 AX For heavy duty loads						
	Two-way switches						Intermediate switches							
		GW 20 576 1M-1P-16 AX	GW 20 577 1M-1P-16 AX Backlit 230 V ac	GW 20 588 1M-1P-16 AX Illuminable (*)	GW 20 008 1M-1P-10 AX With key	GW 20 589 2M-1P-16 AX Illuminable (*)		GW 20 579 1M-1P-16 AX	GW 20 580 2M-1P-16 AX Illuminable (*)					
		Push-buttons												
			GW 20 510 1M-1P-NO-10 A	GW 20 515 Backlit 230 V ac GW 20 516 Backlit 12/24 V	GW 20 529 1M-1P-NO-10 A Illuminable (*)	GW 20 531 1M-1P-NC-10 A Illuminable (*)		GW 20 511 1M-1P-NO-10 A Key	GW 20 512 1M-1P-NO-10 A Bell	GW 20 513 1M-1P-NO-10 A Light	GW 20 514 1M-1P-NO-10 A Stair light	GW 20 530 1M-2P-NO-10 A With key	GW 20 522 1M-1P-NO+NC-10 A Start	GW 20 523 1M-1P-NC+NO-10 A Stop
														
	GW 20 520 1M-1P-NO+NO-10 A With interlock		GW 20 521 1M-1P-NO+NO-10 A With interlock	GW 20 519 1M-1P-NC-10 A	GW 20 517 1M-2P-NO-10 A	GW 20 591 2M-1P-NO-10 A Illuminable name plate (*)	GW 20 024 3M-1P-NO-10 A Illuminable name plate (*)	GW 20 527 2M-1P-NO-10 A Illuminable (*)	GW 20 518 1M-2P-NO-10 A With pull-cord					
Three-way switches					Miniature lamp		Cartridge lamp							
	GW 20 559 1M-1P-10 AX Positions 1-0-2		GW 20 528 1M-1P-10 AX Positions 1-0-2	GW 20 560 1M-2P-10 AX Positions 1-0-2		GW 10 893 12/24 V ac/dc GW 30 943 230 V ac GW 30 944 230 V ac GW 30 946 110/230 V ac GW 30 947 110/230 V ac		White Red Green Light blue White	GW 20 902 56x36 GW 20 903 56x36 GW 20 904 56x31 GW 20 905 56x31 GW 20 906 56,3x28 GW 20 908 56,3x28	12 V ac/dc 24 V ac/dc 12 V ac/dc 24 V ac/dc 110/230 V ac 110/230 V ac	White White White White Red Green			
	Lenses with illuminated symbol													
GW 20 533 Neutral			GW 20 537	GW 20 538	GW 20 539	GW 20 549	GW 20 550	GW 20 551	GW 20 595	GW 20 561	GW 20 562	GW 20 563	GW 20 564	GW 20 565
														
GW 20 540			GW 20 542	GW 20 592	GW 20 593	GW 20 596	GW 20 597	GW 20 594	GW 20 566	GW 20 567	GW 20 568	GW 20 569	GW 20 570	
General services		Technical services				Numerical services								
Infrared		Relay					Blanking modules and cable output							
	GW 20 821 Movement detector 1M-1NO-3 A		GW 20 071 Latching 1M-1P-10 A-250 V ac	GW 20 072 Latching 1M-2P-10 A-250 V ac	GW 20 074 Monostable 1M-1P-10 A-250 V ac-1NO/NC	GW 20 076 Call 1M-1P-NO/NC-12 V ac/dc		GW 20 056 1M	GW 20 073 2M	GW 20 058 1M Cable output				

(*) supplied without signalling unit

POWER - SYSTEM WHITE

<p>Italian</p>							<p>GW 20 201 2P+E-10 A-250 V ac</p>	<p>GW 20 203 2P+E-16 A-250 V ac Dual amperage</p>	<p>GW 20 295 2P+E-16 A-250 V ac Dual amperage</p>	<p>GW 20 281 2P+E-16 A-250 V ac Dual amperage</p>	<p>GW 20 286 2P+E-16 A-250 V ac Dual amperage</p>	<p>GW 20 291 2x2P+E-16 A-250 V ac Dual amperage</p>			
<p>Italian/German</p>						<p>Swiss</p>		<p>GW 20 205 2P+E-16 A-250 V ac</p>	<p>GW 20 246 2P+E-16 A-250 V ac Dual amperage</p>	<p>GW 20 296 2P+E-16 A-250 V ac Dual amperage</p>	<p>GW 20 282 2P+E-16 A-250 V ac Dual amperage</p>	<p>GW 20 287 2P+E-16 A-250 V ac Dual amperage</p>	<p>GW 20 351 2P+E-10 A-250 V ac Type 12</p>		
<p>German</p>					<p>French</p>				<p>GW 20 265 2P+E-16 A-250 V ac</p>	<p>GW 20 297 2P+E-16 A-250 V ac</p>	<p>GW 20 283 2P+E-16 A-250 V ac</p>	<p>GW 20 288 2P+E-16 A-250 V ac</p>	<p>GW 20 206 2P-16 A-250 V ac</p>	<p>GW 20 207 2P+E-16 A-250 V ac</p>	<p>GW 20 312 2P+E-16 A-250 V ac</p>
<p>British</p>			<p>Australian</p>			<p>GW 20 208 2P+E-13 A-250 V ac</p>	<p>GW 20 209 2P+E-16 A-250 V ac</p>	<p>GW 20 357 2P+E-10 A-250 V ac</p>	<p>GW 20 356 2P+E-15 A-250 V ac</p>						
<p>Euro-american/USA</p>				<p>GW 20 212 2P+E-10/15 A-250/125 V ac</p>	<p>GW 20 214 2P+E-15 A-125 V ac</p>	<p>GW 20 216 2P+E-15 A-250 V ac</p>									
<p>Argentinian</p>		<p>Israeli</p>					<p>GW 20 248 2P+E-10 A-250 V ac</p>	<p>GW 20 220 2P+E-16 A-250 V ac Illuminable (*)</p>	<p>GW 20 298 2P+E-16 A-250 V ac Illuminable (*)</p>	<p>GW 20 299 2P+E-16 A-250 V ac Illuminable (*)</p>	<p>GW 20 320 2P-10 A-250 V ac</p>				
<p>Special sockets</p>				<p>GW 20 239 SELV 2P-6 A-24 V</p>	<p>GW 20 234 SELV 2P-6 A-24 V Polarised</p>	<p>GW 20 241 For loudspeaker</p>									

















(*) supplied without signalling unit

SYSTEM WHITE - Domestic range

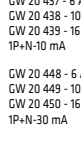
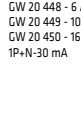
DATA - SYSTEM WHITE

TV-SAT	 F female GW 20 391 - 0 dB GW 20 396 - 5 dB GW 20 392 - 10 dB GW 20 393 - 14 dB	 IEC male GW 20 381 - 0 dB GW 20 386 - 5 dB GW 20 382 - 10 dB GW 20 383 - 14 dB	 IEC female GW 20 228 - 0 dB GW 20 229 - 20 dB GW 20 230 - Term. 20 dB	 GW 20 277 Terminal resistance 75 ohm	Telephone sockets	 GW 20 251 RJ11	 GW 20 235 French 8 contacts	 GW 20 272 British 6 contacts
	Data sockets	 RJ45 - UTP GW 20 685 Cat. 6 GW 20 684 Cat. 6 GW 20 271 Cat. 5e	 RJ45 - FTP GW 20 686 Cat. 6 GW 20 243 Cat. 5e	 Adapters GW 20 266 IBM GW 20 267 SYSTIMAX Commscope GW 20 270 AMP/Keystone Jack		 GW 20 238 Unwired enclosure for SUB-D 9/15/25 PIN		
USB and HDMI couplers		 GW 38 056 HDMI coupler	 GW 38 057 USB coupler	USB power supply	 GW 20 362 Dual USB charger Type A+A - 1M-3 A 100-240 V ac - 50/60 Hz	 GW 20 363 Dual USB charger Type A+C - 1M-3 A 100-240 V ac - 50/60 Hz		

POWER, COMFORT AND CLIMATE MANAGEMENT - SYSTEM WHITE

Dimmer	 GW 20 802 Resistive 100-500 W 230 V ac-50/60 Hz	 GW 20 811 Resistive 100-500 W Inductive 100-500 VA With two-way switch 230 V ac-50/60 Hz	 GW 20 828 Resistive 60-500 W Inductive 60-500 VA 230 V ac-50/60 Hz	Electronic timer	 GW 20 829 For electronic transformers 230 V ac-50/60 Hz	Timer	 GW 20 825 230 V ac-50/60 Hz Daily/Weekly	 GW 20 810 2M
	 GW 20 803 Resistive 100-900 W Inductive 40-300 VA 230 V ac-50/60 Hz	 GW 20 852 Thermostat 230 V ac-50/60 Hz	 GW 20 827 Timed thermostat 230 V ac-50/60 Hz					
Automatic circuit breakers	 Miniature circuit breakers 3 kA C characteristic	 Residual miniature circuit breakers 3 kA C characteristic	 GW 20 431 - 6 A GW 20 432 - 10 A GW 20 433 - 16 A 1P	 GW 20 437 - 6 A GW 20 438 - 10 A GW 20 439 - 16 A 1P+N-10 mA	Protection devices	 GW 20 448 - 6 A GW 20 449 - 10 A GW 20 450 - 16 A 1P+N-30 mA	 GW 20 423 Surge protection device	 GW 20 401 Fuse-holder In MAX-16 A
	 GW 20 434 - 6 A GW 20 435 - 10 A GW 20 436 - 16 A 1P+N	 GW 20 454 - 6 A GW 20 455 - 10 A GW 20 456 - 16 A 1P+N colour red						

HOTEL COMPONENTS - SYSTEM WHITE

Badge switch	 GW 20 820 1P-NO-10 A Backlit 230 V ac	Shaver socket-outlet	 GW 20 841 230 V ac-50/60 Hz	Climate control	 GW 20 853 Thermostat for fan-coil 230 V ac-50/60 Hz	Three-way switch	 GW 20 651 1M-1P-10 AX DND + MUR	Double indicator lamp	 GW 20 656 1M - Opal DND + MUR Illuminable (*)
--------------	--	----------------------	---	-----------------	---	------------------	--	-----------------------	--







▲ = Items designed solely to export to a limited number of countries outside the European Union or proposed as candidate and to the European Free Trade Association. Contact Gewiss customer service to check if the product meets the regulations of the country concerned before importing it.

(*) supplied without signalling unit

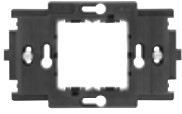
INDICATOR AND TECHNICAL ALARMS - SYSTEM WHITE

Anti black-out lamps	 GW 20 833 230 V ac-50/60 Hz Removable	 GW 20 835 230 V ac-50/60 Hz	Ringers and buzzers	 GW 20 613- 12 V ac GW 20 616- 230 V ac Ringers	 GW 20 617- 12 V ac GW 20 620- 230 V ac Buzzers	 GW 20 643- 230 V ac GW 20 641- 12 V ac/dc Three independent inputs
Indicator lamps	 Flat diffuser Illuminable (*) ● GW 20 603 ● GW 20 604 ● GW 20 605 ○ GW 20 606 ● GW 20 631	 Flat diffuser complete with lamp GW 20 607- 230 V ac GW 20 608- 12/24 V ac/dc	 GW 20 634 Stair riser lamp 2M	 ○ GW 20 601 ● GW 20 623 ● GW 20 626 ● GW 20 625 Flat diffuser 12/24 V ac/dc	 ○ GW 20 602 ● GW 20 627 ● GW 20 628 ● GW 20 629 Protruding diffuser 12/24 V ac/dc	 GW 20 622 Lamp-holder E27
Detectors	 GW A1 514 Flood alarm ZigBee	 GW A1 521 1-channel actuator ZigBee 230 V ac-50 Hz	Accessories	 GW A1 541 Wall-mounting support for flood alarm	 GW 30 522 GAS solenoid valve 3/4" -230 V ac-12 VA	

SUPPORTS

Supports for square and rectangular boxes	 GW 24 262 With screw - 2 modules	Supports for rectangular boxes	 GW 24 201 With screw - 3 modules	 GW 24 202 With screw - 4 modules	 GW 24 230 With screw - 6 modules
			 GW 24 240 With screw - 4+4 modules	 GW 24 241 With screw - 6+6 modules	

(*) supplied without signalling unit

System

Modular devices

The System modular devices make it possible to create infinite combination between devices and plates, thanks to a complete range that is able to satisfy all design, functional and installation requirements. Colour and finiture: glossy white, bright and versatile. Ideal for flush-mounting solutions (for rectangular or square boxes), surface-mounting solutions, and for special applications. The range includes commands, socket-outlets, protection, indicators, connectors and devices for the control, safety and comfort of your home.



COMMAND - SYSTEM WHITE

COMMAND DEVICES



GW 20 571

ONE-WAY SWITCHES - 250V AC

Code	Description	Button key	Symbol	Rated power of 230V LED lamps	No. SYSTEM modules	Pack Carton
GW 20 571	1P - 16AX	Neutral	-	200 W	1	80/320
GW 20 572	1P - 16 AX backlit	With replaceable neutral lens	-	200 W	1	30/60
GW 20 583	1P - 16AX illuminable	With replaceable neutral lens	-	200 W	1	30/60
GW 20 503	2P - 16 AX	Neutral	0/1	200 W	1	30/60
GW 20 504	2P - 16 AX backlit	With replaceable neutral lens	-	200 W	1	30/60
GW 20 584	2P - 16AX illuminable	With replaceable neutral lens	-	200 W	1	30/60
GW 20 005	2P - 10AX	With key	0/1	100 W	1	15/30

CHARACTERISTICS: the illuminable articles use miniature lamp units, not included.

ACCESSORIES SUPPLIED: GW20572, GW20504 - red fluorescent 230Vac (0.4W) signalling unit. GW20005 supplied with 2 keys. The key can be extracted in both positions. Spare keys: GW20901.



GW 20 585

ONE-WAY SWITCH 2P FOR HEAVY-DUTY INSTALLATIONS - 25A - 250V AC

Code	Description	Button key	Symbol	Rated power of 230V LED lamps	No. SYSTEM modules	Pack Carton
GW 20 585	25 AX	Neutral	0/1	250 W	1	15/30

CHARACTERISTICS: suitable for particular heavy-duty loads (e.g. set of fluorescent lamp) or high consumption devices (ovens, air-conditioners, boilers, etc.).



GW 20 576

TWO-WAY SWITCHES 1P - 250V AC

Code	Description	Button key	Rated power of 230V LED lamps	No. SYSTEM modules	Pack Carton
GW 20 576	1P - 16AX	Neutral	200 W	1	80/320
GW 20 577	1P - 16 AX backlit	With replaceable neutral lens	200 W	1	30/60
GW 20 588	1P - 16AX illuminable	With replaceable neutral lens	200 W	1	30/60
GW 20 008	1P - 10AX	With key	100 W	1	15/30

CHARACTERISTICS: the illuminable articles use miniature lamp units, not included.

ACCESSORIES SUPPLIED: GW20577 - red fluorescent 230Vac (0.4W) signalling unit. GW20008 supplied with 2 keys. The key can be extracted in both positions. Spare keys: GW20901.



GW 20 579

INTERMEDIATE SWITCH 1P - 250V AC

Code	Description	Button key	Rated power of 230V LED lamps	No. SYSTEM modules	Pack Carton
GW 20 579	1P - 16AX	Neutral	200 W	1	30/60



GW 20 559

THREE-WAY SWITCH 1P - 250V AC

Code	Description	Button key	Symbol	Rated power of 230V LED lamps	No. SYSTEM modules	Pack Carton
GW 20 559	1P - 10AX	Neutral	UP - DOWN	100 W	1	30/60
GW 20 528	1P - 10AX	With replaceable neutral lens	-	100 W	1	30/60

CHARACTERISTICS: three standing positions. Both contacts are open in the central position (OFF).

GW20528 - not-illuminated product; equipped with neutral lens.

APPLICATIONS: command of circuits requiring an interlock (e.g. operating motorised devices with direction reversal). 2-user selective control.



GW 20 560

THREE-WAY SWITCH 2P - 250 V AC

Code	Description	Button key	Symbol	Rated power of 230V LED lamps	No. SYSTEM modules	Pack Carton
GW 20 560	2P - 10AX	Neutral	UP - DOWN	100 W	1	30/60

CHARACTERISTICS: three standing positions. Both contacts are open in the central position (OFF). With 6 terminal blocks.

APPLICATIONS: command of circuits requiring an interlock (e.g. operating motorised devices with direction reversal). 2-user selective control.



GW 20 510

PUSH-BUTTONS - 250V AC

Code	Description	Button key	Symbol	No. SYSTEM modules	Pack Carton
GW 20 510	1P NO - 10A	Neutral	-	1	80/160
GW 20 511	1P NO - 10A	With symbol	Key	1	15/30
GW 20 512	1P NO - 10A	With symbol	Bell	1	30/60
GW 20 513	1P NO - 10A	With symbol	Light	1	15/30
GW 20 514	1P NO - 10A	With symbol	Stairs	1	15/30
GW 20 515	1P NO - 10 A backlit	With replaceable neutral lens	-	1	30/60
GW 20 516	1P NO - 10 A backlit	With replaceable neutral lens	-	1	30/60
GW 20 529	1P NO - 10A illuminable	With replaceable neutral lens	-	1	30/60
GW 20 531	1P NC - 10 A illuminable	With replaceable neutral lens	-	1	15/30
GW 20 519	1P NC - 10A	Neutral	Circle	1	15/30
GW 20 520	1P NO+NO - 10A	With interlock	Double circles	1	15/30
GW 20 521	1P NO+NO - 10A	With interlock	UP - DOWN	1	30/60
GW 20 522	1P NO - 10A - Aux. NC	Start	Green	1	30/60
GW 20 523	1P NC - 10A - Aux. NO	Stop	Red	1	30/60
GW 20 517	2P NO - 10A	Neutral	Double circle	1	30/60
GW 20 518	2P NO - 10A	With pull-cord	-	1	20/40
GW 20 530	2P NO - 10A	With key	0/1	1	15/30

CHARACTERISTICS: the illuminable articles use miniature lamp units, not included. GW20520, GW20521, both contacts are open in the central position (OFF).

ACCESSORIES SUPPLIED: GW20515 - red fluorescent 230Vac (0.4W) signalling unit. GW20516 - white LED 12/24Vac/dc (0.4W) signalling unit. GW20518, cord in insulating material, 140cm long, with a knob. GW20530 supplied with 2 keys. Spare keys: GW30912.

SYSTEM WHITE - Domestic range



GW 20 024

PUSH-BUTTONS WITH ILLUMINABLE NAME-PLATE - 250V AC

Code	Description	Lamp voltage	Lamp	Lamp power	No. SYSTEM modules	Pack Carton
GW 20 591	1P NO - 10A	12-24V ac/dc	Cartridge lamp S6x36 mm	2 W	2	15/30
GW 20 024	1P NO - 10A	12-24V ac/dc	Cartridge lamp S6x36 mm	2 W	3	20/40

CHARACTERISTICS: supplied without lamp.



GW 20 589

WIDE-BUTTON ILLUMINABLE CONTROL DEVICES - 2M - 250V AC

Code	Description	Button key	Type	Rated power of 230V LED lamps	No. SYSTEM modules	Pack Carton
GW 20 589	1P - 16 AX - illuminable	With diffuser	Switch	200 W	2	15/30
GW 20 580	1P - 16 AX - illuminable	With diffuser	Intermediate switch	200 W	2	1/15
GW 20 527	1P NO - 10 A - illuminable	With diffuser	Push-button	-	2	15/30

CHARACTERISTICS: the illuminable articles use miniature lamp units, not included.

BLANKING MODULES AND OUTLET



GW 20 056

BLANKING MODULES AND CABLE OUTLET

Code	Description	No. SYSTEM modules	Pack Carton
GW 20 056	1 module	1	10/480
GW 20 073	2 modules	2	30/60
GW 20 058	1 module with outlet for cable Ø 4 and Ø 8mm	1	60/120

APPLICATIONS: in addition to their normal use, they permit installing signal socket-outlets, microswitches and LEDs after appropriate drilling/preparation.

LENSES WITH ILLUMINATED SYMBOL



ZC6

SYMBOLS FOR ILLUMINABLE SWITCHES AND PUSH-BUTTONS

Code	Description	Symbol	Pack Carton
Suitable for: General services			
GW 20 533	Neutral	-	20
GW 20 537	Open door	Key	20
GW 20 538	Bell	Bell	20
GW 20 539	Light	Light	20
GW 20 540	Stair light	Stairs	20
GW 20 542	Service	-	20
Suitable for: Technical services			
GW 20 549	Dimmer	-	20
GW 20 550	Ventilation/Extraction	-	20
GW 20 551	Monitor/TV	-	20
GW 20 592	Opening arrows	Opening arrows	20
GW 20 593	Closing arrows	Closing arrows	20
GW 20 594	Off	OFF	20
GW 20 595	On	ON	20
GW 20 596	Up arrow	-	20
GW 20 597	Down arrow	-	20
Suitable for: Numerical services			
GW 20 561	One	1	20
GW 20 562	Two	2	20
GW 20 563	Three	3	20
GW 20 564	Four	4	20
GW 20 565	Five	5	20
GW 20 566	Six	6	20
GW 20 567	Seven	7	20
GW 20 568	Eight	8	20
GW 20 569	Nine	9	20
GW 20 570	Zero	0	20

NOTES: to be used in place of the neutral lens supplied with the illuminable command devices.

MOVEMENT DETECTOR



GW 20 821

IR MOVEMENT DETECTOR

Code	Supply voltage	Output contacts	No. SYSTEM modules	Pack Carton
GW 20 821	230V ac - 50/60Hz	1NO 3A(AC1) 250V ac	1	1/6

CHARACTERISTICS: adjustment of the intervention duration 15 sec - 10 min. Light sensitive threshold adjustment - min. 10 lux - max. inhibited. Sensor with fixed lens. Suitable for commanding halogen lamps/resistive loads: 700 W, incandescent lamps: 450 W, low voltage halogen lamps (12 V) controlled by toroidal or electronic transformers: 450 W, uncompensated fluorescent lamps: 2x58 W, motors and gear motors: 400 VA. Not suitable for compensated fluorescent lamps, for discharge lamps and for all loads not indicated that must be commanded using a support relay.

APPLICATIONS: Energy-saving: command of the lighting of rooms and areas only when people pass through. Comfort and safety: automatic command of circuits without needing to activate one-way switches.

NOTES: do not install the product in watertight plates: the lid membrane does not allow the detector lens to work correctly.

SYSTEM WHITE - Domestic range

RELAY



GW 20 071

LATCHING RELAY

Code	No. of poles	Output contacts	Coil	No. SYSTEM modules	Pack Carton
GW 20 071	1	10 AX 250V ac	230V ac - 50 Hz	1	1/5
GW 20 072	2	10 AX 250V ac	230V ac - 50 Hz	1	1/5

CHARACTERISTICS: suitable for commanding incandescent/halogen lamps: 800 W, fluorescent tubes with electronic ballast: 400 W, fluorescent tubes with electromechanical ballast: 360 W, compact fluorescent lamps (CFL): 200 W, LED lamps (230V ac): 200 W, low voltage halogen or LED lamps with electronic ballast: 200 W, low voltage halogen or LED lamps with electromechanical ballast: 400 W.

APPLICATIONS: command of lighting devices from several points, via push-buttons. Start/stop control of motors (extractors, air agitators, etc.).



GW 20 074

MONOSTABLE RELAY

Code	No. of poles	Output contacts	Coil	No. SYSTEM modules	Pack Carton
GW 20 074	1	1 NO/NC 10A(AC1) / 4A(AC15) 250V ac	230V ac - 50 Hz	1	1/5

APPLICATIONS: As an auxiliary element to control special loads, for remote signalling, and for electrical separation between control and user circuits.



GW 20 076

CALL RELAY - 12V

Code	Supply voltage	No. of poles	Output contacts	No. SYSTEM modules	Pack Carton
GW 20 076	12V ac/dc	1	1NO/NC 12 V (max. 1A)	1	1/5

CHARACTERISTICS: reset button integrated on the front and green mains presence indicator lamp.

POWER - SYSTEM WHITE

SOCKET-OUTLETS - ITALIAN/GERMAN STANDARD



GW 20 203

ITALIAN STANDARD SOCKET-OUTLETS - 250V AC

Code	Description	Type	For plug pins	No. SYSTEM modules	Pack Carton
GW 20 201	2P+E - 10A	P11	Ø 4 mm	1	80/160
GW 20 203	2P+E - 16 A Dual amperage	P17-11	Ø 4 / 5 mm	1	80/320

CHARACTERISTICS: with safety shields.



GW 20 205

ITALIAN/GERMAN STANDARD SOCKET-OUTLETS - 250V AC

Code	Description	Earth pit	Type	For plug pins	No. SYSTEM modules	Pack Carton
GW 20 205	2P+E - 16A	Side and central	P30	Ø 4 / 4.8 mm	2	30/60
GW 20 246	2P+E - 16 A Dual amperage	Side and central	P40	Ø 4 / 4.8 / 5 mm	2	30/120

CHARACTERISTICS: with safety shields.



GW 20 291

ITALIAN STANDARD DUAL SOCKET-OUTLET - 250V AC

Code	Description	Type	For plug pins	Input	No. SYSTEM modules	Pack Carton
GW 20 291	2x2P+E 16A Dual amp.	P17-11	Ø 4 / 5 mm	1x16 A	2	30/60

CHARACTERISTICS: with safety shields. The wiring is carried out via 3 terminals that power the socket-outlets, without using U-bolts.

SYSTEM WHITE - Domestic range

SOCKET-OUTLETS - INTERNATIONAL STANDARD



GW 20 265

GERMAN STANDARD SOCKET-OUTLET - 250V AC

Code	Description	For plug pins	No. SYSTEM modules	Pack Carton
GW 20 265	2P+E - 16A	Ø 4.8 mm	2	30/120

CHARACTERISTICS: with safety shields.



GW 20 206

FRENCH STANDARD SOCKET-OUTLETS - 250V AC

Code	Description	For plug pins	No. SYSTEM modules	Pack Carton
GW 20 206	2P - 16A	Ø 4 / 4.8 mm	2	30/60
GW 20 207	2P+E - 16A	Ø 4 / 4.8 mm	2	30/60

CHARACTERISTICS: with safety shields.



GW 20 208

BRITISH STANDARD SOCKET-OUTLETS - 250V AC

Code	Description	For plug pins	No. SYSTEM modules	Pack Carton
GW 20 208	2P+E - 13 A	Flat	2	30/60
GW 20 209	2P+E - 16A	Ø 7 mm	2	30/60

CHARACTERISTICS: with safety shields.

NOTES: given the size of the plugs, it is not possible to install two or more socket-outlets side-by-side.



GW 20 351

SWISS SOCKET-OUTLET - 250V AC

Code	Description	For plug pins	No. SYSTEM modules	Pack Carton
GW 20 351	2P+E - 10A - type 12	Ø 4 mm	1	30/60

NOTES: contact Gewiss customer service to check if the product meets the regulations of the country concerned before purchasing it. The socket is no longer compliant with Swiss standard SEV1011 of 2009.



GW 20 212

EURO AMERICAN STANDARD SOCKET-OUTLET - 250/125V AC

Code	Description	For plug pins	No. SYSTEM modules	Pack Carton
GW 20 212	2P+E - 15A	Ø 4 mm / flat	1	30/60



GW 20 214

USA STANDARD SOCKET-OUTLETS - 250/125V AC

Code	Description	For plug pins	Shape	No. SYSTEM modules	Pack Carton
GW 20 214	2P+E - 15A - 125V ac	Flat	Parallel horizontal	1	30/60
GW 20 216	2P+E - 15A - 250V ac	Flat	Aligned vertical	1	30/60



GW 20 248

ARGENTINIAN STANDARD SOCKET-OUTLETS - 250V AC

Code	Description	For plug pins	No. SYSTEM modules	Pack Carton
GW 20 248	2P+E - 10A	Flat	2	30/60



GW 20 356

AUSTRALIAN STANDARD SOCKET-OUTLETS - 250V AC

Code	Description	For plug pins	No. SYSTEM modules	Pack Carton
GW 20 357	2P+E - 10A	Flat	2	30/60
GW 20 356	2P+E - 15A	Flat	2	30/60



GW 20 220

ISRAELI STANDARD SOCKET-OUTLETS - 250V AC

Code	Description	For plug pins	No. SYSTEM modules	Pack Carton
GW 20 220	2P+E - 16A	Round Ø 4 / 4.4 mm	2	40/80

CHARACTERISTICS: with safety shields. Pre-arranged for housing miniature lamps, not included.



GW 20 320

ISRAELI STANDARD SOCKET-OUTLET - 250V AC

Code	Description	For plug pins	No. SYSTEM modules	Pack Carton
GW 20 320	2P - 10 A	Round Ø 4 mm	1	30/60

CHARACTERISTICS: with safety shields.

SYSTEM WHITE - Domestic range

SOCKET-OUTLETS FOR DEDICATED LINES



GW 20 281

ITALIAN STANDARD SOCKET-OUTLETS FOR DEDICATED LINES - 250V AC

Code	Description	Colour	Type	For plug pins	No. SYSTEM modules	Pack Carton
GW 20 295	2P+E - 16 A Dual amperage	Red	P17-11	Ø 4 / 5 mm	1	30/60
GW 20 281	2P+E - 16 A Dual amperage	Green	P17-11	Ø 4 / 5 mm	1	30/60
GW 20 286	2P+E - 16 A Dual amperage	Orange	P17-11	Ø 4 / 5 mm	1	30/60

CHARACTERISTICS: with safety shields.



GW 20 282

ITALIAN/GERMAN STANDARD SOCKET-OUTLETS FOR DEDICATED LINES - 250V AC

Code	Description	Earth pit	Colour	Type	For plug pins	No. SYSTEM modules	Pack Carton
GW 20 296	2P+E - 16 A Dual amperage	Side and central	Red	P40	Ø 4 / 4.8 / 5 mm	2	30/60
GW 20 282	2P+E - 16 A Dual amperage	Side and central	Green	P40	Ø 4 / 4.8 / 5 mm	2	15/30
GW 20 287	2P+E - 16 A Dual amperage	Side and central	Orange	P40	Ø 4 / 4.8 / 5 mm	2	15/30

CHARACTERISTICS: with safety shields.

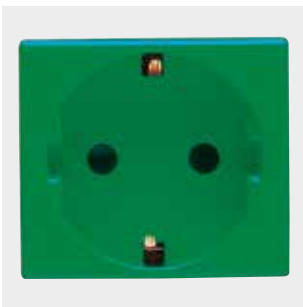

GW 20 283

GERMAN STANDARD SOCKET-OUTLETS FOR DEDICATED LINES - 250V AC

Code	Description	Colour	For plug pins	No. SYSTEM modules	Pack Carton
GW 20 297	2P+E - 16A	Red	Ø 4.8 mm	2	15/30
GW 20 283	2P+E - 16A	Green	Ø 4.8 mm	2	15/30
GW 20 288	2P+E - 16A	Orange	Ø 4.8 mm	2	15/30

CHARACTERISTICS: with safety shields.



GW 20 312

FRENCH STANDARD SOCKET-OUTLET FOR DEDICATED LINES - 250V AC

Code	Description	Colour	For plug pins	No. SYSTEM modules	Pack Carton
GW 20 312	2P+E - 16A	Red	Ø 4 / 4.8 mm	2	15/30

CHARACTERISTICS: with safety shields.



GW 20 298

ISRAELI STANDARD SOCKET-OUTLET FOR DEDICATED LINES - 250V AC

Code	Description	Colour	For plug pins	No. SYSTEM modules	Pack Carton
GW 20 298	2P+E - 16A	Red	Round Ø 4 / 4.4 mm	2	20/40

CHARACTERISTICS: with safety shields. Pre-arranged for housing miniature lamps, not included.



GW 20 299

ISRAELI STANDARD SOCKET-OUTLET FOR SPECIAL REQUIREMENTS - 250V AC

Code	Description	Colour	For plug pins	No. SYSTEM modules	Pack Carton
GW 20 299	2P+E - 16A	Blue	Round Ø 4 / 4.4 mm	2	20/40

CHARACTERISTICS: with safety shields. Pre-arranged for housing miniature lamps, not included.

SYSTEM WHITE - Domestic range

DATA - SYSTEM WHITE

TV-SAT SOCKETS



GW 20 396

COAXIAL TV-SAT SOCKETS (5-2400 MHZ) CLASS A SHIELDING - F FEMALE CONNECTOR

Code	Description	Type	Attenuation	No. SYSTEM modules	Pack Carton
GW 20 391	Direct	With passage of current	0 dB	1	15/30
GW 20 396	Through wiring	-	5 dB	1	15/30
GW 20 392	Through wiring	-	10 dB	1	15/30
GW 20 393	Through wiring	-	14 dB	1	15/30
GW 20 277	Terminal resistance 75 ohm	-	-	-	50/200

CHARACTERISTICS: GW20391 permits carrying a remote power supply voltage/current and/or control signals towards the user port (max 24 V - 500 mA). GW20277 in combination with feedthrough socket-outlets allows you to make terminal socket-outlets.

APPLICATIONS: Socket-outlets suitable for return channel.

NOTES: the TV-SAT 5 dB GW20396 coaxial socket-outlet is defined with conditioned use, it is a special through socket-outlet and as such must be used, with the only difference that the user door (socket-outlet towards the user device) must always be closed with a load of 75 Ohm (TV, VCR, SAT receiver or 75-Ohm termination).



GW 20 386

COAXIAL TV SOCKETS (5-2400 MHZ) CLASS A SHIELDING - IEC MALE CONNECTOR Ø 9.5 MM

Code	Description	Type	Attenuation	No. SYSTEM modules	Pack Carton
GW 20 381	Direct	With passage of current	0 dB	1	15/30
GW 20 386	Through wiring	-	5 dB	1	15/30
GW 20 382	Through wiring	-	10 dB	1	15/30
GW 20 383	Through wiring	-	14 dB	1	15/30
GW 20 277	Terminal resistance 75 ohm	-	-	-	50/200

CHARACTERISTICS: GW20381 permits carrying a remote power supply voltage/current and/or control signals towards the user port (max 24 V - 500 mA). GW20277 in combination with feedthrough socket-outlets allows you to make terminal socket-outlets.

APPLICATIONS: Socket-outlets suitable for return channel.

NOTES: the TV 5 dB GW20386 coaxial socket-outlet is defined with conditioned use, it is a special through socket-outlet and as such must be used, with the only difference that the user door (socket-outlet towards the user device) must always be closed with a load of 75 Ohm (TV, VCR, SAT receiver or 75-Ohm termination).



GW 20 229

RESISTIVE COAXIAL TV SOCKETS (40-860 MHZ) - IEC FEMALE CONNECTOR Ø 9.5MM

Code	Description	Attenuation	No. SYSTEM modules	Pack Carton
GW 20 228	Direct	0 dB	1	30/60
GW 20 229	Branched	20 dB	1	30/60
GW 20 230	Terminated - 75 ohm	20 dB	1	30/60

Items designated solely for export to a limited number of countries outside of the European Union or countries applying to become part of the European Free Trade Area. Contact Gewiss Customer Service to check the product meets the regulations of the country concerned before importing it.

SOCKET-OUTLETS FOR AUXILIARY AND SIGNAL CIRCUITS



GW 20 234

SOCKET-OUTLETS FOR SELV AUXILIARY CIRCUIT

Code	Description	For plug pins	Centre distance	No. SYSTEM modules	Pack Carton
GW 20 239	2P - 6A - 24V	∅ 3 mm	12.4 mm	1	15/30
GW 20 234	2P - 6A - 24V polarized	Flat	12.4 mm	1	15/30



GW 20 241

SIGNAL SOCKET-OUTLET FOR PHONIC CIRCUITS

Code	Description	No. SYSTEM modules	Pack Carton
GW 20 241	For loudspeaker	1	15/30

TELEPHONE SOCKETS



GW 20 251

RJ11 TELEPHONE SOCKETS

Code	Description	Cables type	Connection	No. SYSTEM modules	Pack Carton
GW 20 251	RJ11	Twisted pair	Screw-on terminals	1	15/30

APPLICATIONS: telephone, telefax, modem.



GW 20 235

FRENCH STANDARD TELEPHONE SOCKET

Code	Description	Connection	No. SYSTEM modules	Pack Carton
GW 20 235	French 8 contacts	Screw-on terminals	1	15/30

SYSTEM WHITE - Domestic range



GW 20 272

BRITISH STANDARD TELEPHONE SOCKET

Code	Description	Connection	No. SYSTEM modules	Pack Carton
GW 20 272	British 6 contacts	Screw-on terminals	1	15/30

DATA SOCKETS



GW 20 686

RJ45 SOCKETS

Code	Description	No. pairs	Use category	Cables	Connection	No. SYSTEM modules	Pack Carton
GW 20 271	RJ45	4	5e	UTP	Toolless	1	15/30
GW 20 243	RJ45	4	5e	FTP	Toolless	1	15/30
GW 20 685	RJ45	4	6	UTP	Toolless	1	15/30
GW 20 684	RJ45	4	6	UTP	Toolless	1	1/15
GW 20 686	RJ45	4	6	FTP	Toolless	1	15/30

APPLICATIONS: LANs up to 100MHz (e.g. Ethernet, Token Ring networks) for cat. 5e. LANs up to 250MHz (e.g. Videoconference systems, CCTV) for cat. 6.



GW 20 266

ADAPTERS FOR HOUSING DATA CONNECTORS

Code	Compatibility	No. SYSTEM modules	Pack Carton
GW 20 266	IBM	1	1/120
GW 20 267	SYSTIMAX COMMSCOPE	1	1/120
GW 20 270	AMP / Keystone Jack	1	1/120

NOTES: with regard to the technological developments and dimensional variants introduced by connector manufacturers, you are advised to check in advance the full compatibility between the connector and the Gewiss adapter.

ADAPTERS FOR OPTICAL FIBER



GW 38 335

ANGLED SC/APC ADAPTER

Code	Type	Tilt	For connectors	Compatibility	Colour	Pack Carton
GW 38 335	Female/Female	40°	SC/APC	Keystone Jack	Green RAL 6018	1/25

CHARACTERISTICS: cable outlet inclined of 40° to the wall line. With ceramic fiber optic sleeve and dust caps. The front output is protected with safety cap and unmissable cord. Suitable to join two single-mode SC/APC fiber optic patch cables.

NOTES: for adapters (Chorus, System and Dahlia) with Keystone Jack coupling.

USB AND HDMI COUPLERS



GW 38 056

USB AND HDMI COUPLERS

Code	Description	Type	Compatibility	Pack Carton
GW 38 056	HDMI coupler	Female/Female	Keystone Jack	1/48
GW 38 057	USB coupler	Female/Female - A type	Keystone Jack	1/48

NOTES: for adapters designed to house data connectors (ChoruSmart, System and Playbus) with Keystone Jack type coupling and permutation panels.

USB POWER SUPPLY



GW 20 362

DUAL USB CHARGERS FOR ELECTRONIC DEVICES

Code	Supply voltage	Output voltage	Max current supplied	Type of port	No. modules	Pack Carton
GW 20 362	100-240 V ac - 50-60 Hz	5V dc	3 A	A+A	1	1/10
GW 20 363	100-240 V ac - 50-60 Hz	5V dc	3 A	A+C	1	1/10

CHARACTERISTICS: suitable for recharging a single electronic device (e.g. tablet) or two devices simultaneously (e.g. a tablet and smartphone). The division of the current delivered to the two outputs depends on the state of charge of the connected devices.

ENCLOSURES FOR CONVENTIONAL NETWORKS



GW 20 238

EMPTY ENCLOSURE FOR HOUSING SUB-D CONNECTORS

Code	Description	No. SYSTEM modules	Pack Carton
GW 20 238	SUB-D 9 / 15 / 25 PIN	3	20/40

SYSTEM WHITE - Domestic range

PROTECTION - SYSTEM WHITE

MINIATURE CIRCUIT BREAKERS



GW 20 431

MCB - MINIATURE CIRCUIT BREAKERS - C CHARACTERISTIC - 230V AC

Code	Description	Rated current (A)	No. SYSTEM modules	Pack Carton
Breaking capacity: 3 kA				
GW 20 431	Single pole (1P)	6	1	15/30
GW 20 432	Single pole (1P)	10	1	15/30
GW 20 433	Single pole (1P)	16	1	15/30
GW 20 434	Two-pole (1P+N)	6	1	15/30
GW 20 435	Two-pole (1P+N)	10	1	15/30
GW 20 436	Two-pole (1P+N)	16	1	15/30



GW 20 437

RCBO - RESIDUAL CURRENT BREAKERS WITH OVERCURRENT PROTECTION - C CHARACTERISTIC - CLASS A - 230V AC - 50/60 HZ

Code	Description	I _{dn}	Rated current (A)	No. SYSTEM modules	Pack Carton
Breaking capacity: 3 kA					
GW 20 437	Two-pole (1P+N)	10 mA	6	2	1/15
GW 20 438	Two-pole (1P+N)	10 mA	10	2	1/15
GW 20 439	Two-pole (1P+N)	10 mA	16	2	1/15
GW 20 448	Two-pole (1P+N)	30 mA	6	2	1/15
GW 20 449	Two-pole (1P+N)	30 mA	10	2	1/15
GW 20 450	Two-pole (1P+N)	30 mA	16	2	1/15



GW 20 454

MCB - RED MINIATURE CIRCUIT BREAKERS FOR DEDICATED CIRCUITS - C CHARACTERISTIC - 230V AC

Code	Description	Rated current (A)	No. SYSTEM modules	Pack Carton
Breaking capacity: 3 kA				
GW 20 454	Two-pole (1P+N)	6	1	15/30
GW 20 455	Two-pole (1P+N)	10	1	15/30
GW 20 456	Two-pole (1P+N)	16	1	15/30

PROTECTION DEVICES



GW 20 401

FUSE-HOLDER - 250V AC

Code	Rated current (A)	Fuse type	No. SYSTEM modules	Pack Carton
GW 20 401	16	Ø 6.3 x 32 mm	1	30/60



GW 20 423

SURGE PROTECTION DEVICE - 250V AC

Code	Max. dischargeable energy	Maximum discharge current	No. SYSTEM modules	Pack Carton
GW 20 423	75 J	8 kA (8/20 μs)	1	1/14

APPLICATIONS: protection of electronic equipment (TV - HI-FI - computers, etc.) from overvoltage of atmospheric or manoeuvring origin that may be conveyed by the supply lines.

ENERGY, TEMPERATURE AND COMFORT MANAGEMENT - SYSTEM WHITE

DIMMER



GW 20 802

ROTATING ELECTRONIC REGULATORS FOR RESISTIVE/INDUCTIVE LOADS

Code	Supply voltage	Resistive load 230V ac	Inductive load 230V ac	No. SYSTEM modules	Pack Carton
GW 20 802	230V - 50 / 60 Hz	100-500 W	-	1	1/14
GW 20 803	230V - 50 / 60 Hz	100-900 W	40-300 VA	1	1/14
GW 20 811	230V - 50 / 60 Hz	100-500 W	100-500 VA	1	1/14

CHARACTERISTICS: with signalling led orange. GW20811 rotary command with two-way switch.

GW20803 compliance with the EMC requirements is only guaranteed by connecting the regulator to an LC filter with the following characteristics: L=1mH - 5A, C=0.15uF - 275V X2, according to the documentation provided with the product. Item designated solely for export to a limited number of countries outside of the European Union or countries applying to become part of the European Free Trade Area. Contact Gewiss Customer Service to check the product meets the regulations of the country concerned before importing it.

NOTES: to avoid overheating, the side-by-side installation of several products in a single container is not permitted; insert a blanking module between two electronic devices. If installing two regulators in the same box, the maximum loads that can be commanded by each regulator must be reduced by 50%.



GW 20 828

ELECTRONIC REGULATOR WITH BUTTON FOR RESISTIVE/INDUCTIVE LOADS

Code	Supply voltage	Resistive load 230V ac	Inductive load 230V ac	No. SYSTEM modules	Pack Carton
GW 20 828	230V - 50 / 60 Hz	60-500 W	60-500 VA	1	1/14

CHARACTERISTICS: possibility to command and regulate from remote control push-buttons with NO contact. With signalling led orange.

NOTES: to avoid overheating, the side-by-side installation of several products in a single container is not permitted; insert a blanking module between two electronic devices. If installing two regulators in the same box, the maximum loads that can be commanded by each regulator must be reduced by 50%.



GW 20 829

ELECTRONIC REGULATOR WITH BUTTON FOR ELECTRONIC TRANSFORMERS

Code	Supply voltage	Resistive load 230V ac	Inductive load 230V ac	No. SYSTEM modules	Pack Carton
GW 20 829	230V - 50 / 60 Hz	40-300 W	40-300 VA	1	1/14

CHARACTERISTICS: possibility to command and regulate from remote control push-buttons with NO contact. With signalling led blue. Product extremely silent.

NOTES: to avoid overheating, the side by side installation of several products in a single container is not permitted; insert a blanking module between two electronic devices. If installing two regulators in the same box, the maximum loads that can be commanded by each regulator must be reduced by 50%.

SYSTEM WHITE - Domestic range

ELECTRONIC TIMERS



GW 20 825

ELECTRONIC DAILY/WEEKLY TIMER, 1-CHANNEL

Code	Supply voltage	Output contacts	No. SYSTEM modules	Pack Carton
GW 20 825	230 V ac - 50/60 Hz	1NO/NC 8A(AC1)/4A(AC15) 250V ac	2	1/2

CHARACTERISTICS: with rechargeable buffer battery to guarantee the updating of the calendar (date, day, time) in the event of a blackout.



GW 20 810

ELECTRONIC TIMED BUTTON WITH INPUT FOR REMOTE CONTROL 230V - 50/60HZ

Code	Regulation field	Relay output	No. SYSTEM modules	Pack Carton
GW 20 810	30 s - 15 min	1NO 10A(AC1)/5A(AC15) 250V ac	2	1/4

TEMPERATURE CONTROL DEVICES



GW 20 827

TIMED THERMOSTAT - DAILY/WEEKLY PROGRAMMING

Code	Supply voltage	Temperature adjustment	Output contacts	No. SYSTEM modules	Pack Carton
GW 20 827	230 V ac - 50/60 Hz	From +5°C to +40°C	1NO/NC 5A(AC1)/2A(AC15) 250V ac	2	1/2

CHARACTERISTICS: with rechargeable buffer battery to guarantee the updating of the calendar (date, day, time) in the event of a blackout.



GW 20 852

ELECTRONIC SUMMER/WINTER THERMOSTAT WITH KNOB ADJUSTMENT AND INDICATOR LED - 230V - 50/60HZ

Code	Temperature adjustment	Output contacts	No. SYSTEM modules	Pack Carton
GW 20 852	From +5°C to +30°C	1 NO / NC 8A(AC1) / 2A(AC15) 250V ac	3	1/2

CHARACTERISTICS: option of controlling night-time reduction via remote control (fixed 4°C).



GW 20 853

ELECTRONIC SUMMER/WINTER THERMOSTAT WITH KNOB ADJUSTMENT FOR FAN-COIL, 3-SPEED SELECTOR AND SOLENOID VALVE COMMAND 230V - 50/60HZ

Code	Regulation field	Output solenoid	Output fan	Output contacts	No. SYSTEM modules	Pack Carton
GW 20 853	+5° C / +30° C	Relay NO/NC	Three way switch 1P	5A (AC1) / 2A (AC15)	3	1/2

CHARACTERISTICS: temperature adjustment range: from +5°C to +30°C.
Operating modes: solenoid valve thermostat and fixed ventilation, solenoid valve and thermostat-controlled ventilation, only thermostat-controlled ventilation and unconnected solenoid valve.

SIGNALLING - SYSTEM WHITE

ANTI BLACK-OUT LAMPS



GW 20 833

EXTRACTABLE ANTI BLACK-OUT LAMP

Code	Supply voltage	Power supply batteries	Autonomy	Type of lamp	No. SYSTEM modules	Pack Carton
GW 20 833	230 V ac - 50/60 Hz	Ni-Mh	2 h	White LED	2	1/4

CHARACTERISTICS: equipped with inhibition selector on the front. Replaceable batteries (battery pack 4.8 V 40 mAh).
APPLICATION: according to CEI 64-8 (chapter 37).



GW 20 835

ANTI BLACK-OUT LAMP

Code	Supply voltage	Power supply batteries	Minimum autonomy	Lamp	No. SYSTEM modules	Pack Carton
GW 20 835	230 V ac - 50/60 Hz	Ni-Mh	1 h	White LED	1	1/14

CHARACTERISTICS: green LED for the presence of mains voltage signalling. Highly efficient, white LED lamp.

ACOUSTIC SIGNALLING DEVICES



GW 20 613

BELLS

Code	Supply voltage	Power input	Sound intensity	No. SYSTEM modules	Pack Carton
GW 20 613	12 V - 50 Hz	8 VA	80 dB (at 1 m)	1	15/30
GW 20 616	230V ac - 50Hz	8 VA	80 dB (at 1 m)	1	15/30

CHARACTERISTICS: for intermittent use (5 sec. ON / 15 sec. OFF).

SYSTEM WHITE - Domestic range



GW 20 617

BUZZERS

Code	Supply voltage	Power input	Sound intensity	No. SYSTEM modules	Pack Carton
GW 20 617	12V ac - 50 Hz	8 VA	75 dB (at 1 m)	1	15/30
GW 20 620	230V ac - 50Hz	8 VA	75 dB (at 1 m)	1	15/30

CHARACTERISTICS: for intermittent use (5 sec. ON / 15 sec. OFF).



GW 20 641

ELECTRONIC BELLS WITH 3 DIFFERENT TONES

Code	Supply voltage	Power input	Sound intensity	No. SYSTEM modules	Pack Carton
GW 20 641	12V ac/dc	3 VA	75-90 dB (at 1 m)	2	1/4
GW 20 643	230V ac - 50Hz	3 VA	75-90 dB (at 1 m)	2	1/4

CHARACTERISTICS: for continuous use. Three tones (alarm, ring and two-tone) with adjustable sound intensity using the selector located on the front.

APPLICATIONS: it is possible to combine the outdoor call, indoor call and alarm functions with one single device.

INDICATOR LIGHT DEVICES



GW 20 603

SINGLE INDICATOR LAMPS - 12/24/250V AC

Code	Diffuser colour	Diffuser meaning	Fixing for lamp	No. SYSTEM modules	Pack Carton
Diffuser type: Flat					
GW 20 603	Red	Danger	Cartridge	1	30/60
GW 20 604	Green	Safety	Cartridge	1	30/60
GW 20 605	Yellow	Attention	Cartridge	1	30/60
GW 20 606	Transparent	Neutral	Cartridge	1	30/60
GW 20 631	Light blue	Specific	Cartridge	1	30/60

CHARACTERISTICS: supplied without lamp. They use S6x31 mm and S6.3x28 mm cartridge lamps (max 2 W).

NOTES: the meaning of the diffusers refers to the recommendations of standard EN60073 with regard to the use of the colours in indicator lights.



GW 20 608

DOUBLE INDICATOR LAMPS

Code	Diffuser colour	Lamp voltage	No. SYSTEM modules	Pack Carton
Diffuser type: Flat				
GW 20 607	Red/green	230V ac	1	15/30
GW 20 608	Red/green	12-24V ac/dc	1	15/30

ACCESSORIES SUPPLIED: supplied with LED lamps.



GW 20 634

STAIR RISER LAMP WITH WHITE LED LIGHT - 12/230V AC

Code	Diffuser colour	Lamp	Lamp voltage	No. SYSTEM modules	Pack Carton
GW 20 634	White	Integrated LED	12V ac/dc - 230V ac	2	1/15

CHARACTERISTICS: very bright LED, light adjustment eyelid, 12v ac/dc - 230V ac supply with double supply input.



GW 20 601

STAIR RISER OR SPECIAL USES LAMPS WITH FLAT DIFFUSER - 12/24V

Code	Diffuser colour	Fixing for lamp	No. SYSTEM modules	Pack Carton
GW 20 601	Opal diffuser	Cartridge	3	15/30
GW 20 623	Red	Cartridge	3	15/30
GW 20 625	Yellow	Cartridge	3	15/30
GW 20 626	Light blue	Cartridge	3	15/30

CHARACTERISTICS: Supplied without lamp. Use cartridge lamps of the S6x36mm type (max 2W).

APPLICATIONS: identification of steps, obstacles etc..



GW 20 602

STAIR RISER OR SPECIAL USES LAMPS WITH PROTRUDING DIFFUSER - 12/24V

Code	Diffuser colour	Fixing for lamp	No. SYSTEM modules	Pack Carton
GW 20 602	Opal diffuser	Cartridge	3	1/12
GW 20 627	Red	Cartridge	3	1/12
GW 20 628	Green	Cartridge	3	1/12
GW 20 629	Yellow	Cartridge	3	1/12

CHARACTERISTICS: Supplied without lamp. Use cartridge lamps of the S6x36mm type (max 2W).

APPLICATIONS: signalling.



GW 20 622

LAMP HOLDER

Code	Lampholder type	Power	Colour	No. SYSTEM modules	Pack Carton
GW 20 622	E27	40 W	Black	2	15/30

APPLICATIONS: the product must be installed in compliance with the International CE regulation64-8.

TECHNICAL ALARMS - SYSTEM WHITE

ANTI-FLOOD SYSTEM WITH ZIGBEE® WIRELESS TRANSMISSION



GW A1 514

ZIGBEE FLOOD ALARM - IP20

Code	Siren output	Temperature sensor	Colour	Dimensions (mm)	Pack Carton
GW A1 514	85 dB/3 m	0...50 °C	White	Ø 60x37	1/6

CHARACTERISTICS: the alarm detects the presence of water and includes a temperature sensor. Powered by CR123-type battery (replaceable).

NOTES: floor-mounting or alternatively wall-mounting possibility through the GWA1541 accessory. To be used in combination with the Zigbee actuator GWA1521 when controlling an electrovalve or a load.

SYSTEM WHITE - Domestic range



GW A1 521

1-CHANNEL ACTUATOR ZIGBEE

Code	Supply voltage	Output contacts	Dimensions LxHxD (mm)	Pack Carton
GW A1 521	230V ac - 50 Hz	1 NO 10A (AC1) 230 V ac	42x40x20	1/4

CHARACTERISTICS: 1-channel actuator for activating loads via the potential-free output contact (NO). Suitable for commanding incandescent lamps (230 V ac): 2300W, loads controlled from toroidal transformers: 450W, loads controlled from electronic transformers: 600W, energy saving lamps (compact fluorescent): 150W, LED lamps (230 V ac): 150W, motors: 500W.

APPLICATIONS: when used with the water sensor, provide the installation of a NO push-button to open the electrovalve manually.

NOTES: installation in flush-mounting boxes, junction boxes, etc..

ACCESSORIES



GW A1 541

WALL-MOUNTING SUPPORT FOR FLOOD ALARM

Code	Colour	Support dimension (mm)	Dimensions of probe (mm)	Cable max. length (cm)	Pack Carton
GW A1 541	White	Ø72x25	Ø50x8	85	1/4

APPLICATIONS: to be used for the wall-mounting of the Zigbee flood alarm GWA1514.



GW 30 522

SOLENOID VALVE, WITH MANUAL RESET, NORMALLY OPEN - 230V - 50HZ

Code	Delivery Ø	Material	Power input	Pack Carton
GW 30 522	3/4"	Brass	12 VA	1/2

SPECIAL APPLICATIONS - SYSTEM WHITE

COMPONENTS FOR HOTEL SYSTEMS



GW 20 651

THREE-WAY SWITCH 1P - 250 V AC

Code	Description	Button key	Symbol	Rated power of 230V LED lamps	No. SYSTEM modules	Pack Carton
GW 20 651	1P - 10AX	Neutral	DND+MUR	100 W	1	30/60

CHARACTERISTICS: three standing positions. Both contacts are open in the central position (OFF). With "Do not disturb" (DND) and "Make up the room" (MUR) pad printings.



GW 20 656

DOUBLE INDICATOR LAMP

Code	Diffuser colour	Symbol	Lamp voltage	No. SYSTEM modules	Pack Carton
GW 20 656	Opal diffuser	DND+MUR	230 V ac	1	15/30

CHARACTERISTICS: supplied with LED lamps (red for DND signalling, green for MUR signalling).



GW 20 820

UNIVERSAL BADGE SWITCH WITH BACKLIT LIGHT - 250V AC

Code	Description	For badge card max. width	Type	Rated power of 230V LED lamps	No. SYSTEM modules	Pack Carton
GW 20 820	1P NO - 10A	54 mm	Backlit 230V ac	100 W	3	1/2

CHARACTERISTICS: supplied without badge.

APPLICATIONS: activation of circuits and services in hotel rooms (e.g. lights, air-conditioner, fridge-bar), indication of room occupied (with badge inserted).



GW 20 841

EUROPEAN/AMERICAN STANDARD SHAVER SOCKET WITH INSULATION TRANSFORMER

Code	Supply voltage	For plug pins	Selectable output voltage	Maximum power	No. SYSTEM modules	Pack Carton
GW 20 841	230V ac - 50/60 Hz	Ø 4 / 5 - 6.3x1.5 mm	120 - 230V ac	20 VA	3	1/4

CHARACTERISTICS: the socket-outlet is equipped with a self-protection device against overloading. The output voltage should be selected correctly, consulting the rating of the user device before inserting the plug. The relevant indicator LED allows the chosen voltage to be clearly seen.

NOTES: not suitable for installation in wall-mounting containers of the 27 COMBI range.

ACCESSORIES

SPARE PARTS AND ACCESSORIES



ZC6

MINIATURE LAMPS WITH QUICK COUPLING TERMINALS

Code	Lamp voltage	Lamp power	Lamp	Light emitted	Pack Carton
GW 30 943	230 V ac	0.4 W	Fluorescent	Red	50
GW 30 944	230V ac	0.4 W	Fluorescent	Green	50
GW 30 946	110 / 230V ac	0.6 W	LED	Light blue	50
GW 30 947	110 / 230V ac	0.6 W	LED	White	50
GW 10 893	12-24V ac/dc	0.4 W	LED	White	50

APPLICATIONS: miniature lamps are mounted on all control devices fitted for luminous signalling.

SYSTEM WHITE - Domestic range



GW 10 881

LED SIGNALLING UNITS - 230 V AC - 0.6 W

Code	Lamp voltage	Lamp power	Lamp	Light emitted	Cable Colour	Pack Carton
GW 10 881	230 V ac - 50/60 Hz	0.6 W	LED	Blue	Blue	50
GW 10 882	230 V ac - 50/60 Hz	0.6 W	LED	White	White	50
GW 10 883	230 V ac - 50/60 Hz	0.6 W	LED	Red	Red	50
GW 10 884	230 V ac - 50/60 Hz	0.6 W	LED	Green	Green	50
GW 10 885	230 V ac - 50/60 Hz	0.6 W	LED	Amber	Orange	50

NOTES: the LED signalling units are supplied with power supply cables (length 10 cm).



GW 10 894

LED SIGNALLING UNITS - 12-24 V AC/DC - 0.6 W

Code	Lamp voltage	Lamp power	Lamp	Light emitted	Cable Colour	Pack Carton
GW 10 894	12-24V ac/dc	0.6 W	LED	White	White	50

NOTES: the LED signalling units are supplied with power supply cables (length 10 cm).



GW 20 902

CARTRIDGE LAMPS

Code	Dimensions (mm)	Lamp voltage	Lamp power	Lamp	Light emitted	Pack Carton
GW 20 902	S6x36	12V ac/dc	2 W	Incandescence	White	50
GW 20 903	S6x36	24V ac/dc	2 W	Incandescence	White	50
GW 20 904	S6x31	12V ac/dc	2 W	Incandescence	White	50
GW 20 905	S6x31	24V ac/dc	2 W	Incandescence	White	50
GW 20 906	S6.3x28	110 / 230V ac	0.4 W	Fluorescent	Red	50
GW 20 908	S6.3x28	110 / 230V ac	0.4 W	Fluorescent	Green	50

NOTES: the cartridge lamps are mounted on the stair riser, on the single indicator lamps and on the push-buttons with a name plate.



GW 20 911

MINIATURE FUSES - 250V AC

Code	Dimensions (mm)	Rated current (A)	Rated voltage	Pack Carton
GW 20 911	∅ 5 x 20	2.5	250V ac	20/200
GW 20 921	∅ 6.3 x 32	2	250V ac	10/200
GW 20 922	∅ 6.3 x 32	4	250V ac	10/200
GW 20 923	∅ 6.3 x 32	6	250V ac	10/200
GW 20 924	∅ 6.3 x 32	10	250V ac	10/200
GW 20 925	∅ 6.3 x 32	16	250V ac	10/200



GW 20 901

SET OF 2 KEYS FOR COMMAND DEVICES

Code	Suitable for	Pack Carton
GW 20 901	One-way switches - two-way switches	1/100
GW 30 912	Push-buttons	1/100



System

SYSTEM



Scan the QR Code and find out all the technical informations.

TWO LINES, ONE SINGLE OFFER

INSTALLATION FLEXIBILITY

A COMPLETE SOLUTION



The System range includes two lines of plates, one more rounded and the other with a squarer design, in a domestic series recognised for its reliability and robustness.



The domestic System series offers maximum application flexibility. It is highly versatile, with two attachment options, from the front or back of the support, making the mounting and release of devices quick and easy.



The System devices are compatible with a wide range of accessories and can be installed in any electrical installation: flush- and surface-mounted rectangular boxes, flush-mounted square boxes, profiles and DIN rails, floor turrets and 27 Combi enclosures.

































SYSTEM BLACK - Domestic range

COMMAND - SYSTEM BLACK

One-way switches														
	GW 21 571 1M-1P-16 AX	GW 21 572 1M-1P-16 AX Backlit 230 V ac	GW 21 583 1M-1P-16 AX Illuminable (*)	GW 21 503 1M-2P-16 AX	GW 21 504 1M-2P-16 AX Backlit 230 V ac	GW 21 584 1M-2P-16 AX Illuminable (*)	GW 21 005 1M-2P-10 AX With key	GW 21 585 1M-2P-25 AX For heavy duty loads						
	Two-way switches						Intermediate switches							
		GW 21 576 1M-1P-16 AX	GW 21 577 1M-1P-16 AX Backlit 230 V ac	GW 21 588 1M-1P-16 AX Illuminable (*)	GW 21 008 1M-1P-10 AX With key	GW 21 589 2M-1P-16 AX Illuminable (*)		GW 21 579 1M-1P-16 AX	GW 21 580 2M-1P-16 AX Illuminable (*)					
		Push-buttons												
			GW 21 510 1M-1P-NO-10 A	GW 21 515 Backlit 230 V ac GW 21 516 Backlit 12/24 V	GW 21 529 1M-1P-NO-10 A Illuminable (*)	GW 21 531 1M-1P-NC-10 A Illuminable (*)		GW 21 511 1M-1P-NO-10 A Key	GW 21 512 1M-1P-NO-10 A Bell	GW 21 513 1M-1P-NO-10 A Light	GW 21 514 1M-1P-NO-10 A Stair light	GW 21 530 1M-2P-NO-10 A With key	GW 21 522 1M-1P-NO+NC-10 A Start	GW 21 523 1M-1P-NC+NO-10 A Stop
														
	GW 21 520 1M-1P-NO+NO-10 A With interlock		GW 21 521 1M-1P-NO+NO-10 A With interlock	GW 21 519 1M-1P-NC-10 A	GW 21 517 1M-2P-NO-10 A	GW 21 591 2M-1P-NO-10 A Illuminable name plate (*)	GW 21 024 3M-1P-NO-10 A Illuminable name plate (*)	GW 21 527 2M-1P-NO-10 A Illuminable (*)	GW 21 518 1M-2P-NO-10 A With pull-cord					
Three-way switches				Miniature lamp		Cartridge lamp								
	GW 21 559 1M-1P-10 AX Positions 1-0-2		GW 21 528 1M-1P-10 AX Positions 1-0-2		GW 10 893 GW 30 943 GW 30 944 GW 30 946 GW 30 947		12/24 V ac/dc 230 V ac 230 V ac 110/230 V ac 110/230 V ac	White Red Green Light blue White	GW 20 902 56x36 GW 20 903 56x36 GW 20 904 56x31 GW 20 905 56x31 GW 20 906 56,3x28 GW 20 908 56,3x28	12 V ac/dc 24 V ac/dc 12 V ac/dc 24 V ac/dc 110/230 V ac 110/230 V ac	White White White White Red Green			
Lenses with illuminated symbol														
	GW 20 533 Neutral		GW 20 537	GW 20 538	GW 20 539	GW 20 549	GW 20 550	GW 20 551	GW 20 595	GW 20 561	GW 20 562	GW 20 563	GW 20 564	GW 20 565
														
General services	GW 20 540		GW 20 542	GW 20 592	GW 20 593	GW 20 596	GW 20 597	GW 20 594	GW 20 566	GW 20 567	GW 20 568	GW 20 569	GW 20 570	
Infrared	Relay						Blanking modules and cable output							
		GW 21 821 Movement detector 1M-INO-3 A	GW 21 071 Latching 1M-1P-10 A-250 V ac	GW 21 072 Latching 1M-2P-10 A-250 V ac	GW 21 074 Monostable 1M-1P-10 A-250 V ac-INO/NC	GW 21 076 Call 1M-1P-NO/NC-12 V ac/dc		GW 21 056 1M	GW 21 073 2M	GW 21 058 1M Cable output				

(*) supplied without signalling unit

POWER - SYSTEM BLACK

<p>Italian</p>								
	<p>GW 21 201 2P+E-10 A-250 V ac</p>	<p>GW 21 203 2P+E-16 A-250 V ac Dual amperage</p>	<p>GW 20 295 2P+E-16 A-250 V ac Dual amperage</p>	<p>GW 20 281 2P+E-16 A-250 V ac Dual amperage</p>	<p>GW 20 286 2P+E-16 A-250 V ac Dual amperage</p>	<p>GW 21 291 2x2P+E-16 A-250 V ac Dual amperage</p>		
<p>Italian/German</p>						<p>Swiss</p>		
	<p>GW 21 205 2P+E-16 A-250 V ac</p>	<p>GW 21 246 2P+E-16 A-250 V ac Dual amperage</p>	<p>GW 20 296 2P+E-16 A-250 V ac Dual amperage</p>	<p>GW 20 282 2P+E-16 A-250 V ac Dual amperage</p>	<p>GW 20 287 2P+E-16 A-250 V ac Dual amperage</p>		<p>GW 21 351 2P+E-10 A-250 V ac Type 12</p>	
<p>German</p>					<p>French</p>			
	<p>GW 21 265 2P+E-16 A-250 V ac</p>	<p>GW 20 297 2P+E-16 A-250 V ac</p>	<p>GW 20 283 2P+E-16 A-250 V ac</p>	<p>GW 20 288 2P+E-16 A-250 V ac</p>		<p>GW 21 206 2P-16 A-250 V ac</p>	<p>GW 21 207 2P+E-16 A-250 V ac</p>	<p>GW 20 312 2P+E-16 A-250 V ac</p>
<p>British</p>			<p>Australian</p>					
	<p>GW 21 208 2P+E-13 A-250 V ac</p>	<p>GW 21 209 2P+E-16 A-250 V ac</p>		<p>GW 21 357 2P+E-10 A-250 V ac</p>	<p>GW 21 356 2P+E-15 A-250 V ac</p>			
<p>Euro-american/USA</p>								
	<p>GW 21 212 2P+E-10/15 A-250/125 V ac</p>	<p>GW 21 214 2P+E-15 A-125 V ac</p>	<p>GW 21 216 2P+E-15 A-250 V ac</p>					
<p>Argentinian</p>		<p>Israeli</p>						
	<p>GW 21 248 2P+E-10 A-250 V ac</p>		<p>GW 21 220 2P+E-16 A-250 V ac</p>	<p>GW 20 298 2P+E-16 A-250 V ac Illuminable (*)</p>	<p>GW 20 299 2P+E-16 A-250 V ac Illuminable (*)</p>			
<p>Special sockets</p>								
	<p>GW 21 239 SELV 2P-6 A-24 V</p>	<p>GW 21 234 SELV 2P-6 A-24 V Polarised</p>	<p>GW 21 241 For loudspeaker</p>					









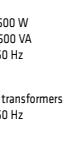

(*) supplied without signalling unit

SYSTEM BLACK - Domestic range

DATA - SYSTEM BLACK

TV-SAT	 <p>F female GW 21 391 - 0 dB GW 21 395 - 5 dB GW 21 392 - 10 dB GW 21 393 - 14 dB</p>	 <p>IEC male GW 21 381 - 0 dB GW 21 386 - 5 dB GW 21 382 - 10 dB GW 21 383 - 14 dB</p>	 <p>IEC female GW 21 228 - 0 dB GW 21 229 - 20 dB GW 21 230 - Term. 20 dB</p>	 <p>GW 20 277 Terminal resistance 75 ohm</p>	Telephone sockets	 <p>GW 21 251 RJ11</p>	 <p>GW 21 235 French 8 contacts</p>	 <p>GW 21 272 British 6 contacts</p>
Data sockets	 <p>RJ45 - UTP</p>	 <p>RJ45 - FTP</p>	 <p>Adapters</p>	 <p>GW 21 238 Unwired enclosure for SUB-D 9/15/25 PIN</p>	<p>GW 21 685 Cat. 6 GW 21 684 Cat. 6 GW 21 271 Cat. 5e</p>	<p>GW 21 686 Cat. 6 GW 21 243 Cat. 5e</p>	<p>GW 21 266 IBM GW 21 267 SYSTIMAX Commscope GW 21 270 AMP/Keystone Jack</p>	
USB and HDMI couplers	 <p>GW 38 056 HDMI coupler</p>	 <p>GW 38 057 USB coupler</p>						

POWER, COMFORT AND CLIMATE MANAGEMENT - SYSTEM BLACK

Dimmer	 <p>GW 21 802 Resistive 100-500 W 230 V ac-50/60 Hz</p> <p>GW 21 811 Resistive 100-500 W Inductive 100-500 VA With two-way switch 230 V ac-50/60 Hz</p>	 <p>GW 21 803 ▲ Resistive 100-900 W Inductive 40-300 VA 230 V ac-50/60 Hz</p>	 <p>GW 21 818 For air agitators Inductive 55-80 VA 230 V ac-50/60 Hz</p>	 <p>GW 21 828 Resistive 60-500 W Inductive 60-500 VA 230 V ac-50/60 Hz</p> <p>GW 21 829 For electronic transformers 230 V ac-50/60 Hz</p>	Electronic timer	 <p>GW 21 825 230 V ac-50/60 Hz Daily/Weekly</p>	Timer	 <p>GW 21 810 2M</p>
Climate control	 <p>GW 21 852 Thermostat 230 V ac-50/60 Hz</p>	 <p>GW 21 827 Timed thermostat 230 V ac-50/60 Hz</p>						
Automatic circuit breakers	 <p>GW 21 431 - 6 A GW 21 432 - 10 A GW 21 433 - 16 A 1P</p> <p>GW 21 434 - 6 A GW 21 435 - 10 A GW 21 436 - 16 A 1P+N</p> <p>GW 20 454 - 6 A GW 20 455 - 10 A GW 20 456 - 16 A 1P+N colour red</p> <p>Miniature circuit breakers 3 kA C characteristic</p>	 <p>GW 21 437 - 6 A GW 21 438 - 10 A GW 21 439 - 16 A 1P+N-10 mA</p> <p>GW 21 448 - 6 A GW 21 449 - 10 A GW 21 450 - 16 A 1P+N-30 mA</p> <p>Residual miniature circuit breakers 3 kA C characteristic</p>	Protection devices	 <p>GW 21 423 Surge protection device</p>	 <p>GW 21 401 Fuse-holder In MAX=16 A</p>			

HOTEL COMPONENTS - BLACK







Badge switch	 <p>GW 21 820 1P-NO-10 A Backlit 230 V ac</p>	Shaver socket-outlet	 <p>GW 21 841 230 V ac-50/60 Hz</p>	Climate control	 <p>GW 21 853 Thermostat for fan-coil 230 V ac-50/60 Hz</p>
---------------------	--	-----------------------------	--	------------------------	---

▲ = Items designed solely to export to a limited number of countries outside the European Union or proposed as candidate and to the European Free Trade Association. Contact Gewiss customer service to check if the product meets the regulations of the country concerned before importing it.

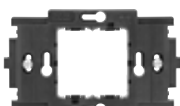
INDICATOR AND TECHNICAL ALARMS - SYSTEM BLACK

<p>Anti black-out lamps</p>			<p>Ringers and buzzers</p>			
	<p>GW 21 833 230 V ac-50/60 Hz Removable</p>	<p>GW 21 835 230 V ac-50/60 Hz</p>		<p>GW 21 613- 12 V ac GW 21 616- 230 V ac Ringers</p>	<p>GW 21 617- 12 V ac GW 21 620- 230 V ac Buzzers</p>	<p>GW 21 643- 230 V ac GW 21 641- 12 V ac/dc Three independent inputs</p>
<p>Indicator lamps</p>						
	<p>● GW 21 603 ● GW 21 604 ● GW 21 605 ○ GW 21 606 ● GW 21 631</p>	<p>GW 21 607- 230 V ac GW 21 608- 12/24 V ac/dc</p>	<p>GW 21 634 Stair riser lamp 2M</p>	<p>○ GW 20 601 ● GW 20 623 ● GW 20 626 ● GW 20 625</p>	<p>○ GW 20 602 ● GW 20 627 ● GW 20 628 ● GW 20 629</p>	<p>GW 20 622 Lamp-holder E27</p>
<p>Detectors</p>			<p>Accessories</p>			
	<p>GW A1 514 Flood alarm ZigBee</p>	<p>GW A1 521 1-channel actuator ZigBee 230 V ac-50 Hz</p>		<p>GW A1 541 Wall-mounting support for flood alarm</p>	<p>GW 30 522 CAS solenoid valve 3/4"-230 V ac-12 VA</p>	

SUPPORTS

<p>Supports for square and rectangular boxes</p>		<p>Supports for rectangular boxes</p>			
	<p>GW 24 262 With screw - 2 modules</p>		<p>GW 24 201 With screw - 3 modules</p>	<p>GW 24 202 With screw - 4 modules</p>	<p>GW 24 230 With screw - 6 modules</p>
					
			<p>GW 24 240 With screw - 4+4 modules</p>	<p>GW 24 241 With screw - 6+6 modules</p>	

(*) supplied without signalling unit

System

Modular devices

The System modular devices allow the creation of infinite combinations of devices and plates, through a complete range that covers all design, functional and installation needs. Colours and finishes: satin black, elegant and classy. Ideal for flush-mounted solutions (for rectangular or square boxes), surface-mounted solutions and special applications. The range includes control units, socket-outlets, breakers, indicators, connectors and devices for the control, safety and comfort of your home.



COMMAND - SYSTEM BLACK

COMMAND DEVICES



GW 21 571

ONE-WAY SWITCHES - 250V AC

Code	Description	Button key	Symbol	Rated power of 230V LED lamps	No. SYSTEM modules	Pack Carton
GW 21 571	1P - 16AX	Neutral	-	200 W	1	80/320
GW 21 572	1P - 16 AX backlit	With replaceable neutral lens	-	200 W	1	30/60
GW 21 583	1P - 16AX illuminable	With replaceable neutral lens	-	200 W	1	30/60
GW 21 503	2P - 16 AX	Neutral	0/1	200 W	1	30/60
GW 21 504	2P - 16 AX backlit	With replaceable neutral lens	-	200 W	1	30/60
GW 21 584	2P - 16AX illuminable	With replaceable neutral lens	-	200 W	1	30/60
GW 21 005	2P - 10AX	With key	0/1	100 W	1	15/30

CHARACTERISTICS: the illuminable articles use miniature lamp units, not included.

ACCESSORIES SUPPLIED: GW21572, GW21504 - red fluorescent 230Vac (0.4W) signalling unit. GW21005 supplied with 2 keys. The key can be extracted in both positions. Spare keys: GW20901.



GW 21 585

ONE-WAY SWITCH 2P FOR HEAVY-DUTY INSTALLATIONS - 25A - 250V AC

Code	Description	Button key	Symbol	Rated power of 230V LED lamps	No. SYSTEM modules	Pack Carton
GW 21 585	25 AX	Neutral	0/1	250 W	1	15/30

CHARACTERISTICS: suitable for particular heavy-duty loads (e.g. set of fluorescent lamp) or high consumption devices (ovens, air-conditioners, boilers, etc.).



GW 21 576

TWO-WAY SWITCHES 1P - 250V AC

Code	Description	Button key	Rated power of 230V LED lamps	No. SYSTEM modules	Pack Carton
GW 21 576	1P - 16AX	Neutral	200 W	1	80/320
GW 21 577	1P - 16 AX backlit	With replaceable neutral lens	200 W	1	30/60
GW 21 588	1P - 16AX illuminable	With replaceable neutral lens	200 W	1	30/60
GW 21 008	1P - 10AX	With key	100 W	1	15/30

CHARACTERISTICS: the illuminable articles use miniature lamp units, not included.

ACCESSORIES SUPPLIED: GW21577 - red fluorescent 230Vac (0.4W) signalling unit. GW21008 supplied with 2 keys. The key can be extracted in both positions. Spare keys: GW20901.



GW 21 579

INTERMEDIATE SWITCHES 1P - 250V AC

Code	Description	Button key	Rated power of 230V LED lamps	No. SYSTEM modules	Pack Carton
GW 21 579	1P - 16AX	Neutral	200 W	1	30/60



GW 21 559

THREE-WAY SWITCH 1P - 250V AC

Code	Description	Button key	Symbol	Rated power of 230V LED lamps	No. SYSTEM modules	Pack Carton
GW 21 559	1P - 10AX	Neutral	UP - DOWN	100 W	1	30/60
GW 21 528	1P - 10AX	With replaceable neutral lens	-	100 W	1	30/60

CHARACTERISTICS: three standing positions. Both contacts are open in the central position (OFF).

GW21528 - not-illuminated product; equipped with neutral lens.

APPLICATIONS: command of circuits requiring an interlock (e.g. operating motorised devices with direction reversal). 2-user selective control.



GW 21 510

PUSH-BUTTONS - 250V AC

Code	Description	Button key	Symbol	No. SYSTEM modules	Pack Carton
GW 21 510	1P NO - 10A	Neutral	-	1	80/160
GW 21 511	1P NO - 10A	With symbol	Key	1	15/30
GW 21 512	1P NO - 10A	With symbol	Bell	1	15/30
GW 21 513	1P NO - 10A	With symbol	Light	1	15/30
GW 21 514	1P NO - 10A	With symbol	Stairs	1	15/30
GW 21 515	1P NO - 10 A backlit	With replaceable neutral lens	-	1	30/60
GW 21 516	1P NO - 10 A backlit	With replaceable neutral lens	-	1	30/60
GW 21 529	1P NO - 10A illuminable	With replaceable neutral lens	-	1	30/60
GW 21 531	1P NC - 10 A illuminable	With replaceable neutral lens	-	1	15/30
GW 21 519	1P NC - 10A	Neutral	Circle	1	15/30
GW 21 520	1P NO+NO - 10A	With interlock	Double circles	1	15/30
GW 21 521	1P NO+NO - 10A	With interlock	UP - DOWN	1	30/60
GW 21 522	1P NO - 10A - Aux. NC	Start	Green	1	30/60
GW 21 523	1P NC - 10A - Aux. NO	Stop	Red	1	30/60
GW 21 517	2P NO - 10A	Neutral	Double circle	1	30/60
GW 21 518	2P NO - 10A	With pull-cord	-	1	20/40
GW 21 530	2P NO - 10A	With key	0/1	1	15/30

CHARACTERISTICS: the illuminable articles use miniature lamp units, not included; GW21520, GW21521, both contacts are open in the central position (OFF).

ACCESSORIES SUPPLIED: GW21515 - red fluorescent 230Vac (0.4W) signalling unit. GW21516 - white LED 12/24Vac/dc (0.4W) signalling unit. GW21518, cord in insulating material, 140cm long, with a knob. GW21530 supplied with 2 keys. Spare keys: GW30912.



GW 21 024

PUSH-BUTTON WITH ILLUMINABLE NAME PLATE - 250V AC

Code	Description	Lamp voltage	Lamp	Lamp power	No. SYSTEM modules	Pack Carton
GW 21 591	1P NO - 10A	12-24V ac/dc	Cartridge lamp S6x36 mm	2 W	2	15/30
GW 21 024	1P NO - 10A	12-24V ac/dc	Cartridge lamp S6x36 mm	2 W	3	20/40

CHARACTERISTICS: supplied without lamp.

SYSTEM BLACK - Domestic range



GW 21 589

WIDE-BUTTON ILLUMINABLE CONTROL DEVICES - 2M - 250V AC

Code	Description	Button key	Type	Rated power of 230V LED lamps	No. SYSTEM modules	Pack Carton
GW 21 589	1P - 16 AX - illuminable	With diffuser	Switch	200 W	2	15/30
GW 21 580	1P - 16 AX - illuminable	With diffuser	Intermediate switch	200 W	2	1/15
GW 21 527	1P NO - 10 A - illuminable	With diffuser	Push-button	-	2	15/30

CHARACTERISTICS: the illuminable articles use miniature lamp units, not included.

BLANKING MODULES AND CABLE OUTLET



GW 21 056

BLANKING MODULES AND CABLE OUTLET

Code	Description	No. SYSTEM modules	Pack Carton
GW 21 056	1 module	1	10/480
GW 21 073	2 modules	2	30/60
GW 21 058	1 module with outlet for cable Ø 4 and Ø 8mm	1	60/120

APPLICATIONS: in addition to their normal use, they permit installing signal socket-outlets, microswitches and LEDs after appropriate drilling/preparation.

LENSES WITH ILLUMINATED SYMBOL



ZC6

SYMBOLS FOR ILLUMINABLE SWITCHES AND PUSH-BUTTONS

Code	Description	Symbol	Pack Carton
Suitable for: General services			
GW 20 533	Neutral	-	20
GW 20 537	Open door	Key	20
GW 20 538	Bell	Bell	20
GW 20 539	Light	Light	20
GW 20 540	Stair light	Stairs	20
GW 20 542	Service	-	20
Suitable for: Technical services			
GW 20 549	Dimmer	-	20
GW 20 550	Ventilation/Extraction	-	20
GW 20 551	Monitor/TV	-	20
GW 20 592	Opening arrows	Opening arrows	20
GW 20 593	Closing arrows	Closing arrows	20
GW 20 594	Off	OFF	20
GW 20 595	On	ON	20
GW 20 596	Up arrow	-	20
GW 20 597	Down arrow	-	20
Suitable for: Numerical services			
GW 20 561	One	1	20
GW 20 562	Two	2	20
GW 20 563	Three	3	20
GW 20 564	Four	4	20
GW 20 565	Five	5	20
GW 20 566	Six	6	20
GW 20 567	Seven	7	20
GW 20 568	Eight	8	20
GW 20 569	Nine	9	20
GW 20 570	Zero	0	20

NOTES: to be used in place of the neutral lens supplied with the illuminable command devices.

MOVEMENT SENSOR



GW 21 821

IR MOVEMENT DETECTOR

Code	Supply voltage	Output contacts	No. SYSTEM modules	Pack Carton
GW 21 821	230V ac - 50/60Hz	1NO 3A(AC1) 250V ac	1	1/6

CHARACTERISTICS: adjustment of the intervention duration 15 sec - 10 min. Light sensitive threshold adjustment - min. 10 lux - max. inhibited. Sensor with fixed lens. Suitable for commanding halogen lamps/resistive loads: 700 W, incandescent lamps: 450 W, low voltage halogen lamps (12 V) controlled by toroidal or electronic transformers: 450 W, uncompensated fluorescent lamps: 2x58 W, motors and gear motors: 400 VA. Not suitable for compensated fluorescent lamps, for discharge lamps and for all loads not indicated that must be commanded using a support relay.

APPLICATIONS: Energy-saving: command of the lighting of rooms and areas only when people pass through.

Comfort and safety: automatic command of circuits without needing to activate one-way switches.

NOTES: do not install the product in watertight plates: the lid membrane does not allow the detector lens to work correctly.

RELAY



GW 21 071

LATCHING RELAY

Code	No. of poles	Output contacts	Coil	No. SYSTEM modules	Pack Carton
GW 21 071	1	10 AX 250V ac	230V ac - 50 Hz	1	1/5
GW 21 072	2	10 AX 250V ac	230V ac - 50 Hz	1	1/5

CHARACTERISTICS: suitable for commanding incandescent/halogen lamps: 800 W, fluorescent tubes with electronic ballast: 400 W, fluorescent tubes with electromechanical ballast: 360 W, compact fluorescent lamps (CFL): 200 W, LED lamps (230V ac): 200 W, low voltage halogen or LED lamps with electronic ballast: 200 W, low voltage halogen or LED lamps with electromechanical ballast: 400 W.

APPLICATIONS: command of lighting devices from several points, via push-buttons. Start/stop control of motors (extractors, air agitators, etc.).



GW 21 074

MONOSTABLE RELAY 230 V AC

Code	No. of poles	Output contacts	Coil	No. SYSTEM modules	Pack Carton
GW 21 074	1	1 NO/NC 10A(AC1) / 4A(AC15) 250V ac	230V ac - 50 Hz	1	1/5

APPLICATIONS: As an auxiliary element to control special loads, for remote signalling, and for electrical separation between control and user circuits.



GW 21 076

CALL RELAY - 12V

Code	Supply voltage	No. of poles	Output contacts	No. SYSTEM modules	Pack Carton
GW 21 076	12V ac/dc	1	1NO/NC 12 V (max. 1A)	1	1/5

CHARACTERISTICS: reset button integrated on the front and green mains presence indicator lamp.

SYSTEM BLACK - Domestic range

POWER - SYSTEM BLACK

SOCKET-OUTLETS - ITALIAN/GERMAN STANDARD



GW 21 203

ITALIAN STANDARD SOCKET-OUTLETS - 250V AC

Code	Description	Type	For plug pins	No. SYSTEM modules	Pack Carton
GW 21 201	2P+E - 10A	P11	Ø 4 mm	1	80/160
GW 21 203	2P+E - 16 A Dual amperage	P17-11	Ø 4 / 5 mm	1	80/320

CHARACTERISTICS: with safety shields.



GW 21 205

ITALIAN/GERMAN STANDARD SOCKET-OUTLETS - 250V AC

Code	Description	Earth pit	Type	For plug pins	No. SYSTEM modules	Pack Carton
GW 21 205	2P+E - 16A	Side and central	P30	Ø 4 / 4.8 mm	2	30/60
GW 21 246	2P+E - 16 A Dual amperage	Side and central	P40	Ø 4 / 4.8 / 5 mm	2	30/120

CHARACTERISTICS: with safety shields.



GW 21 291

ITALIAN STANDARD QUICK WIRING DOUBLE SOCKET-OUTLET - 250V AC

Code	Description	Type	For plug pins	Input	No. SYSTEM modules	Pack Carton
GW 21 291	2x2P+E 16A Dual amp.	P17-11	Ø 4 / 5 mm	1x16 A	2	30/60

CHARACTERISTICS: with safety shields. The wiring is carried out via 3 terminals that power the socket-outlets, without using U-bolts.

SOCKET-OUTLETS - INTERNATIONAL STANDARD



GW 21 265

GERMAN STANDARD SOCKET-OUTLET - 250V AC

Code	Description	For plug pins	No. SYSTEM modules	Pack Carton
GW 21 265	2P+E - 16A	Ø 4.8 mm	2	30/60

CHARACTERISTICS: with safety shields.



GW 21 206

FRENCH STANDARD SOCKET-OUTLETS - 250V AC

Code	Description	For plug pins	No. SYSTEM modules	Pack Carton
GW 21 206	2P - 16A	Ø 4 / 4.8 mm	2	30/60
GW 21 207	2P+E - 16A	Ø 4 / 4.8 mm	2	30/60

CHARACTERISTICS: with safety shields.



GW 21 208

BRITISH STANDARD SOCKET-OUTLETS - 250V AC

Code	Description	For plug pins	No. SYSTEM modules	Pack Carton
GW 21 208	2P+E - 13 A	Flat	2	30/60
GW 21 209	2P+E - 16A	Ø 7 mm	2	30/60

CHARACTERISTICS: with safety shields.

NOTES: given the size of the plugs, it is not possible to install two or more socket-outlets side-by-side.



GW 21 351

SWISS SOCKET-OUTLET - 250V AC

Code	Description	For plug pins	No. SYSTEM modules	Pack Carton
GW 21 351	2P+E - 10A - type 12	Ø 4 mm	1	30/60

NOTES: contact Gewiss customer service to check if the product meets the regulations of the country concerned before purchasing it. The socket is no longer compliant with Swiss standard SEV1011 of 2009.



GW 21 212

EURO AMERICAN STANDARD SOCKET-OUTLET - 250/125V AC

Code	Description	For plug pins	No. SYSTEM modules	Pack Carton
GW 21 212	2P+E - 15A	Ø 4 mm/ flat	1	30/60



GW 21 214

USA STANDARD SOCKET-OUTLETS - 250/125V AC

Code	Description	For plug pins	Shape	No. SYSTEM modules	Pack Carton
GW 21 214	2P+E - 15A 125V ac	Flat	Parallel horizontal	1	30/60
GW 21 216	2P+E - 15A 250V ac	Flat	Aligned vertical	1	30/60

SYSTEM BLACK - Domestic range



GW 21 248

ARGENTINIAN STANDARD SOCKET-OUTLETS - 250V AC

Code	Description	For plug pins	No. SYSTEM modules	Pack Carton
GW 21 248	2P+E - 10A	Flat	2	30/60



GW 21 356

AUSTRALIAN STANDARD SOCKET-OUTLETS - 250V AC

Code	Description	For plug pins	No. SYSTEM modules	Pack Carton
GW 21 357	2P+E - 10A	Flat	2	30/60
GW 21 356	2P+E - 15A	Flat	2	30/60



GW 21 220

ISRAELI STANDARD SOCKET-OUTLET - 250V AC

Code	Description	For plug pins	No. SYSTEM modules	Pack Carton
GW 21 220	2P+E - 16A	Round Ø 4 / 4.4 mm	2	30/60

CHARACTERISTICS: with safety shields.

SOCKET-OUTLETS FOR DEDICATED LINES



GW 20 281

ITALIAN STANDARD SOCKET-OUTLETS FOR DEDICATED LINES - 250V AC

Code	Description	Colour	Type	For plug pins	No. SYSTEM modules	Pack Carton
GW 20 295	2P+E - 16 A Dual amperage	Red	P17-11	Ø 4 / 5 mm	1	30/60
GW 20 281	2P+E - 16 A Dual amperage	Green	P17-11	Ø 4 / 5 mm	1	30/60
GW 20 286	2P+E - 16 A Dual amperage	Orange	P17-11	Ø 4 / 5 mm	1	30/60

CHARACTERISTICS: with safety shields.



GW 20 282

ITALIAN/GERMAN STANDARD SOCKET-OUTLETS FOR DEDICATED LINES - 250V AC

Code	Description	Earth pit	Colour	Type	For plug pins	No. SYSTEM modules	Pack Carton
GW 20 296	2P+E - 16 A Dual amperage	Side and central	Red	P40	Ø 4 / 4.8 / 5 mm	2	30/60
GW 20 282	2P+E - 16 A Dual amperage	Side and central	Green	P40	Ø 4 / 4.8 / 5 mm	2	15/30
GW 20 287	2P+E - 16 A Dual amperage	Side and central	Orange	P40	Ø 4 / 4.8 / 5 mm	2	15/30

CHARACTERISTICS: with safety shields.

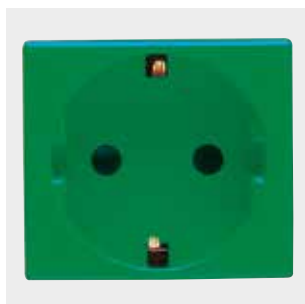

GW 20 283

GERMAN STANDARD SOCKET-OUTLETS FOR DEDICATED LINES - 250V AC

Code	Description	Colour	For plug pins	No. SYSTEM modules	Pack Carton
GW 20 297	2P+E - 16A	Red	∅ 4.8 mm	2	15/30
GW 20 283	2P+E - 16A	Green	∅ 4.8 mm	2	15/30
GW 20 288	2P+E - 16A	Orange	∅ 4.8 mm	2	15/30

CHARACTERISTICS: with safety shields.



GW 20 312

FRENCH STANDARD SOCKET-OUTLETS FOR DEDICATED LINES - 250V AC

Code	Description	Colour	For plug pins	No. SYSTEM modules	Pack Carton
GW 20 312	2P+E - 16A	Red	∅ 4 / 4.8 mm	2	15/30

CHARACTERISTICS: with safety shields.



GW 20 298

ISRAELI STANDARD SOCKET-OUTLETS FOR DEDICATED LINES - 250V AC

Code	Description	Colour	For plug pins	No. SYSTEM modules	Pack Carton
GW 20 298	2P+E - 16A	Red	Round ∅ 4 / 4.4 mm	2	20/40

CHARACTERISTICS: with safety shields. Pre-arranged for housing miniature lamps, not included.



GW 20 299

ISRAELI STANDARD SOCKET-OUTLET FOR SPECIAL REQUIREMENTS - 250V AC

Code	Description	Colour	For plug pins	No. SYSTEM modules	Pack Carton
GW 20 299	2P+E - 16A	Blue	Round ∅ 4 / 4.4 mm	2	20/40

CHARACTERISTICS: with safety shields. Pre-arranged for housing miniature lamps, not included.

SYSTEM BLACK - Domestic range

DATA - SYSTEM BLACK

TV-SAT SOCKETS



GW 21 391

COAXIAL TV-SAT SOCKETS (5-2400 MHZ) CLASS A SHIELDING - F FEMALE CONNECTOR

Code	Description	Type	Attenuation	No. SYSTEM modules	Pack Carton
GW 21 391	Direct	With passage of current	0 dB	1	15/30
GW 21 396	Through wiring	-	5 dB	1	15/30
GW 21 392	Through wiring	-	10 dB	1	15/30
GW 21 393	Through wiring	-	14 dB	1	15/30
GW 20 277	Terminal resistance 75 ohm	-	-	-	50/200

CHARACTERISTICS: GW21391 permits carrying a remote power supply voltage/current and/or control signals towards the user port (max 24 V - 500 mA). GW20277 in combination with feedthrough socket-outlets allows you to make terminal socket-outlets.

APPLICATIONS: socket-outlets suitable for return channel.

NOTES: the TV-SAT 5dB GW21396 coaxial socket is defined with conditioned use. It is a special feedthrough socket and must be used as such, with the only difference being that the user port (socket towards the user device) must always be closed with a 75-Ohm load (TV, VCR, SAT receiver or 75-Ohm termination).



GW 21 381

COAXIAL TV SOCKETS (5-2400 MHZ) CLASS A SHIELDING - IEC MALE CONNECTOR Ø 9.5 MM

Code	Description	Type	Attenuation	No. SYSTEM modules	Pack Carton
GW 21 381	Direct	With passage of current	0 dB	1	15/30
GW 21 386	Through wiring	-	5 dB	1	15/30
GW 21 382	Through wiring	-	10 dB	1	15/30
GW 21 383	Through wiring	-	14 dB	1	15/30
GW 20 277	Terminal resistance 75 ohm	-	-	-	50/200

CHARACTERISTICS: GW21381 permits carrying a remote power supply voltage/current and/or control signals towards the user port (max 24 V - 500 mA). GW20277 in combination with feedthrough socket-outlets allows you to make terminal socket-outlets.

APPLICATIONS: socket-outlets suitable for return channel.

NOTES: the TV 5dB GW21386 coaxial socket is defined with conditioned use. It is a special feedthrough socket and must be used as such, with the only difference being that the user port (socket towards the user device) must always be closed with a 75-Ohm load (TV, VCR, SAT receiver or 75-Ohm termination).



GW 21 228

COAXIAL TV RESISTIVE SOCKETS (40-860 MHZ) IEC FEMALE CONNECTOR Ø 9.5 MM

Code	Description	Attenuation	No. SYSTEM modules	Pack Carton
GW 21 228	Direct	0 dB	1	30/60
GW 21 229	Branched	20 dB	1	30/60
GW 21 230	Terminated - 75 ohm	20 dB	1	30/60

Items designated solely for export to a limited number of countries outside of the European Union or countries applying to become part of the European Free Trade Area. Contact Gewiss Customer Service to check the product meets the regulations of the country concerned before importing it.

SOCKET-OUTLETS FOR AUXILIARY AND SIGNAL CIRCUITS



GW 21 234

SOCKET-OUTLETS FOR SELV AUXILIARY CIRCUITS

Code	Description	For plug pins	Centre distance	No. SYSTEM modules	Pack Carton
GW 21 239	2P - 6A - 24V	Ø 3 mm	12.4 mm	1	15/30
GW 21 234	2P - 6A - 24V polarized	Flat	12.4 mm	1	15/30



GW 21 241

SIGNAL SOCKET-OUTLET FOR PHONIC CIRCUITS

Code	Description	No. SYSTEM modules	Pack Carton
GW 21 241	For loudspeaker	1	15/30

TELEPHONE SOCKETS



GW 21 251

RJ11 TELEPHONE SOCKETS

Code	Description	Cables type	Connection	No. SYSTEM modules	Pack Carton
GW 21 251	RJ11	Twisted pair	Screw-on terminals	1	15/30

APPLICATIONS: telephone, telefax, modem.



GW 21 235

FRENCH STANDARD TELEPHONE SOCKET

Code	Description	Connection	No. SYSTEM modules	Pack Carton
GW 21 235	French 8 contacts	Screw-on terminals	1	15/30



GW 21 272

BRITISH STANDARD TELEPHONE SOCKET

Code	Description	Connection	No. SYSTEM modules	Pack Carton
GW 21 272	British 6 contacts	Screw-on terminals	1	15/30

SYSTEM BLACK - Domestic range

DATA SOCKETS



GW 21 686

RJ45 SOCKETS

Code	Description	No. pairs	Use category	Cables	Connection	No. SYSTEM modules	Pack Carton
GW 21 271	RJ45	4	5e	UTP	Toolless	1	15/30
GW 21 243	RJ45	4	5e	FTP	Toolless	1	15/30
GW 21 685	RJ45	4	6	UTP	Toolless	1	15/30
GW 21 684	RJ45	4	6	UTP	Toolless	1	1/15
GW 21 686	RJ45	4	6	FTP	Toolless	1	15/30

APPLICATIONS: LANs up to 100MHz (e.g. Ethernet, Token Ring networks) for cat. 5e. LANs up to 250MHz (e.g. Videoconference systems, CCTV) for cat. 6.



GW 21 266

ADAPTERS FOR HOUSING DATA CONNECTORS

Code	Compatibility	No. SYSTEM modules	Pack Carton
GW 21 266	IBM	1	1/120
GW 21 267	SYSTIMAX COMMSCOPE	1	1/120
GW 21 270	AMP / Keystone Jack	1	1/120

NOTES: with regard to the technological developments and dimensional variants introduced by connector manufacturers, you are advised to check in advance the full compatibility between the connector and the Gewiss adapter.

ADAPTERS FOR OPTICAL FIBER



GW 38 335

ANGLED SC/APC ADAPTER

Code	Type	Tilt	For connectors	Compatibility	Colour	Pack Carton
GW 38 335	Female/Female	40°	SC/APC	Keystone Jack	Green RAL 6018	1/25

CHARACTERISTICS: cable outlet inclined of 40° to the wall line. With ceramic fiber optic sleeve and dust caps. The front output is protected with safety cap and unmissable cord. Suitable to join two single-mode SC/APC fiber optic patch cables.

NOTES: for adapters (Chorus, System and Dahlia) with Keystone Jack coupling.

USB AND HDMI COUPLERS



GW 38 056

USB AND HDMI COUPLERS

Code	Description	Type	Compatibility	Pack Carton
GW 38 056	HDMI coupler	Female/Female	Keystone Jack	1/48
GW 38 057	USB coupler	Female/Female - A type	Keystone Jack	1/48

NOTES: for adapters designed to house data connectors (ChoruSmart, System and Playbus) with Keystone Jack type coupling and permutation panels.

ENCLOSURES FOR CONVENTIONAL NETWORKS

EMPTY ENCLOSURE FOR HOUSING SUB-D CONNECTORS



GW 21 238

Code	Description	No. SYSTEM modules	Pack Carton
GW 21 238	SUB-D 9 / 15 / 25 PIN	3	20/40

PROTECTION - SYSTEM BLACK

MINIATURE CIRCUIT BREAKERS



GW 21 431

MCB - MINIATURE CIRCUIT BREAKERS - C CHARACTERISTIC - 230V AC

Code	Description	Rated current (A)	No. SYSTEM modules	Pack Carton
Breaking capacity: 3 kA				
GW 21 431	Single pole (1P)	6	1	15/30
GW 21 432	Single pole (1P)	10	1	15/30
GW 21 433	Single pole (1P)	16	1	15/30
GW 21 434	Two-pole (1P+N)	6	1	15/30
GW 21 435	Two-pole (1P+N)	10	1	15/30
GW 21 436	Two-pole (1P+N)	16	1	15/30



GW 21 437

RCBO - RESIDUAL CURRENT BREAKERS WITH OVERCURRENT PROTECTION - C CHARACTERISTIC - CLASS A - 230V AC - 50/60 HZ

Code	Description	I _{dn}	Rated current (A)	No. SYSTEM modules	Pack Carton
Breaking capacity: 3 kA					
GW 21 437	Two-pole (1P+N)	10 mA	6	2	1/15
GW 21 438	Two-pole (1P+N)	10 mA	10	2	1/15
GW 21 439	Two-pole (1P+N)	10 mA	16	2	1/15
GW 21 448	Two-pole (1P+N)	30 mA	6	2	1/15
GW 21 449	Two-pole (1P+N)	30 mA	10	2	1/15
GW 21 450	Two-pole (1P+N)	30 mA	16	2	1/15

SYSTEM BLACK - Domestic range



GW 20 454

MCB - RED MINIATURE CIRCUIT BREAKERS FOR DEDICATED CIRCUITS - C CHARACTERISTIC - 230V AC

Code	Description	Rated current (A)	No. SYSTEM modules	Pack Carton
Breaking capacity: 3 kA				
GW 20 454	Two-pole (1P+N)	6	1	15/30
GW 20 455	Two-pole (1P+N)	10	1	15/30
GW 20 456	Two-pole (1P+N)	16	1	15/30

PROTECTION DEVICES



GW 21 401

FUSE-HOLDER - 250V AC

Code	Rated current (A)	Fuse type	No. SYSTEM modules	Pack Carton
GW 21 401	16	Ø 6.3 x 32 mm	1	30/60



GW 21 423

SURGE PROTECTION DEVICE - 250V AC

Code	Max. dischargeable energy	Maximum discharge current	No. SYSTEM modules	Pack Carton
GW 21 423	75 J	8 kA (8/20 µs)	1	1/14

APPLICATIONS: protection of electronic equipment (TV - HI-FI - computers, etc.) from overvoltage of atmospheric or manoeuvring origin that may be conveyed by the supply lines.

ENERGY, TEMPERATURE AND COMFORT MANAGEMENT - SYSTEM BLACK

DIMMER



GW 21 802

ROTATING ELECTRONIC REGULATORS FOR RESISTIVE/INDUCTIVE LOADS

Code	Supply voltage	Resistive load 230V ac	Inductive load 230V ac	No. SYSTEM modules	Pack Carton
GW 21 802	230V - 50 / 60 Hz	100-500 W	-	1	1/14
GW 21 803	230V - 50 / 60 Hz	100-900 W	40-300 VA	1	1/14
GW 21 811	230V - 50 / 60 Hz	100-500 W	100-500 VA	1	1/14

CHARACTERISTICS: with signalling led orange. GW21811 rotary command with two-way switch.

GW21803 compliance with the EMC directive is only guaranteed by connecting the regulator to an LC filter with the following characteristics: L=1mH - 5A, C=0.15uF - 275V X2, according to the documentation provided with the product. Item designated solely for export to a limited number of countries outside of the European Union or countries applying to become part of the European Free Trade Area. Contact Gewiss Customer Service to check the product meets the regulations of the country concerned before importing it.

NOTES: to avoid overheating, the side-by-side installation of several products in a single container is not permitted; insert a blanking module between two electronic devices. If installing two regulators in the same box, the maximum loads that can be commanded by each regulator must be reduced by 50%.



GW 21 828

ELECTRONIC REGULATOR WITH BUTTON FOR RESISTIVE/INDUCTIVE LOADS

Code	Supply voltage	Resistive load 230V ac	Inductive load 230V ac	No. SYSTEM modules	Pack Carton
GW 21 828	230V - 50 / 60 Hz	60-500 W	60-500 VA	1	1/14

CHARACTERISTICS: possibility to command and regulate from remote control push-buttons with NO contact. With signalling led orange.

NOTES: to avoid overheating, the side-by-side installation of several products in a single container is not permitted; insert a blanking module between two electronic devices. If installing two regulators in the same box, the maximum loads that can be commanded by each regulator must be reduced by 50%.



GW 21 829

ELECTRONIC REGULATOR WITH BUTTON FOR ELECTRONIC TRANSFORMERS

Code	Supply voltage	Resistive load 230V ac	Inductive load 230V ac	No. SYSTEM modules	Pack Carton
GW 21 829	230V - 50 / 60 Hz	40-300 W	40-300 VA	1	1/14

CHARACTERISTICS: possibility to command and regulate from remote control push-buttons with NO contact. With signalling led blue. Product extremely silent.

NOTES: to avoid overheating, the side by side installation of several products in a single container is not permitted; insert a blanking module between two electronic devices. If installing two regulators in the same box, the maximum loads that can be commanded by each regulator must be reduced by 50%.

ELECTRONIC TIMERS



GW 21 825

ELECTRONIC DAILY/WEEKLY TIMER, 1-CHANNEL

Code	Supply voltage	Output contacts	No. SYSTEM modules	Pack Carton
GW 21 825	230 V ac - 50/60 Hz	1NO/NC 8A(AC1)/4A(AC15) 250V ac	2	1/2

CHARACTERISTICS: with rechargeable buffer battery to guarantee the updating of the calendar (date, day, time) in the event of a blackout.



GW 21 810

ELECTRONIC PUSH-BUTTON TIMER WITH REMOTE CONTROL INPUT - 230V - 50/60HZ

Code	Regulation field	Relay output	No. SYSTEM modules	Pack Carton
GW 21 810	30 s - 15 min	1NO 10A(AC1)/5A(AC15) 250V ac	2	1/4

SYSTEM BLACK - Domestic range

TEMPERATURE CONTROL DEVICES



GW 21 827

TIMED THERMOSTAT - DAILY/WEEKLY PROGRAMMING

Code	Supply voltage	Temperature adjustment	Output contacts	No. SYSTEM modules	Pack Carton
GW 21 827	230 V ac - 50/60 Hz	From +5°C to +40°C	1NO/NC 5A(AC1)/2A(AC15) 250V ac	2	1/2

CHARACTERISTICS: with rechargeable buffer battery to guarantee the updating of the calendar (date, day, time) in the event of a blackout.



GW 21 852

SUMMER/WINTER ELECTRONIC THERMOSTAT WITH KNOB ADJUSTMENT AND INDICATOR LED - 230V - 50/60HZ

Code	Temperature adjustment	Output contacts	No. SYSTEM modules	Pack Carton
GW 21 852	From +5°C to +30°C	1 NO / NC 8A(AC1) / 2A(AC15) 250V ac	3	1/2

CHARACTERISTICS: option of controlling night-time reduction via remote control (fixed 4°C).



GW 21 853

SUMMER/WINTER ELECTRONIC THERMOSTAT FOR FAN-COIL, WITH KNOB ADJUSTMENT 3-SPEED SELECTOR AND SOLENOID VALVE CONTROL - 230V - 50/60HZ

Code	Regulation field	Output solenoid	Output fan	Output contacts	No. SYSTEM modules	Pack Carton
GW 21 853	+5° C / +30° C	Relay NO/NC	Three way switch 1P	5A (AC1) / 2A (AC15)	3	1/2

CHARACTERISTICS: temperature adjustment range: from +5°C to +30°C.

operating modes: solenoid valve thermostat and fixed ventilation, solenoid valve and thermostat-controlled ventilation, only thermostat-controlled ventilation and unconnected solenoid valve.

SIGNALLING - SYSTEM BLACK

ANTI BLACK-OUT LAMPS



GW 21 833

EXTRACTABLE ANTI BLACK-OUT LAMP

Code	Supply voltage	Power supply batteries	Autonomy	Type of lamp	No. SYSTEM modules	Pack Carton
GW 21 833	230V - 50/60 Hz	Ni-Mh	2 h	White LED	2	1/4

CHARACTERISTICS: equipped with inhibition selector on the front. Replaceable batteries (battery pack 4.8 V 40 mAh).



GW 21 835

ANTI BLACK-OUT LAMP

Code	Supply voltage	Power supply batteries	Minimum autonomy	Lamp	No. SYSTEM modules	Pack Carton
GW 21 835	230 V ac - 50/60 Hz	Ni - Mh	1 h	White LED	1	1/14

CHARACTERISTICS: green LED for the presence of mains voltage signalling. Highly efficient, white LED lamp.

ACOUSTIC SIGNALLING DEVICES



GW 21 613

BELLS

Code	Supply voltage	Power input	Sound intensity	No. SYSTEM modules	Pack Carton
GW 21 613	12 V - 50 Hz	8 VA	80 dB (at 1 m)	1	15/30
GW 21 616	230V ac - 50Hz	8 VA	80 dB (at 1 m)	1	15/30

CHARACTERISTICS: for intermittent use (5 sec. ON / 15 sec. OFF).



GW 21 617

BUZZERS

Code	Supply voltage	Power input	Sound intensity	No. SYSTEM modules	Pack Carton
GW 21 617	12 V - 50 Hz	8 VA	75 dB (at 1 m)	1	15/30
GW 21 620	230 V - 50 Hz	8 VA	75 dB (at 1 m)	1	15/30

CHARACTERISTICS: for intermittent use (5 sec. ON / 15 sec. OFF).



GW 21 641

ELECTRONIC BELLS WITH 3 DIFFERENT TONES

Code	Supply voltage	Power input	Sound intensity	No. SYSTEM modules	Pack Carton
GW 21 641	12V ac/dc	3 VA	75-90 dB (at 1 m)	2	1/4
GW 21 643	230V ac - 50Hz	3 VA	75-90 dB (at 1 m)	2	1/4

CHARACTERISTICS: for continuous use. Three tones (alarm, ring and two-tone) with adjustable sound intensity using the selector located on the front.

APPLICATIONS: it is possible to combine the outdoor call, indoor call and alarm functions with one single device..

SYSTEM BLACK - Domestic range

INDICATOR LIGHT DEVICES



GW 21 603

SINGLE INDICATOR LAMPS - 12/24/250V AC

Code	Diffuser colour	Diffuser meaning	Fixing for lamp	No. SYSTEM modules	Pack Carton
Diffusor type: Flat					
GW 21 603	Red	Danger	Cartridge	1	30/60
GW 21 604	Green	Safety	Cartridge	1	30/60
GW 21 605	Yellow	Attention	Cartridge	1	30/60
GW 21 606	Transparent	Neutral	Cartridge	1	30/60
GW 21 631	Light blue	Specific	Cartridge	1	30/60

CHARACTERISTICS: Supplied without lamp. They use S6x31 mm and S6.3x28 mm cartridge lamps (max 2 W).

NOTES: the meaning of the diffusers refers to the recommendations of standard EN60073 with regard to the use of the colours in indicator lights.



GW 21 607

DOUBLE INDICATOR LAMPS

Code	Diffuser colour	Lamp voltage	No. SYSTEM modules	Pack Carton
Diffusor type: Flat				
GW 21 607	Red/green	230V ac	1	15/30
GW 21 608	Red/green	12-24V ac/dc	1	15/30

ACCESSORIES SUPPLIED: supplied with LED lamps.



GW 21 634

STAIR RISER LAMP WITH WHITE LED LIGHT - 12/230V AC

Code	Diffuser colour	Lamp	Lamp voltage	No. SYSTEM modules	Pack Carton
GW 21 634	White	Integrated LED	12V ac/dc - 230V ac	2	1/15

CHARACTERISTICS: very bright LED, light adjustment eyelid, 12v ac/dc - 230V ac supply with double supply input.



GW 20 601

STAIR RISER OR SPECIAL USES LAMPS WITH FLAT DIFFUSER - 12/24V

Code	Diffuser colour	Fixing for lamp	No. SYSTEM modules	Pack Carton
GW 20 601	Opal diffuser	Cartridge	3	15/30
GW 20 623	Red	Cartridge	3	15/30
GW 20 625	Yellow	Cartridge	3	15/30
GW 20 626	Light blue	Cartridge	3	15/30

CHARACTERISTICS: supplied without lamp. Use cartridge lamps of the S6x36mm type (max 2W).

APPLICATIONS: identification of steps, obstacles etc..



GW 20 602

STAIR RISER OR SPECIAL USES LAMPS WITH PROTRUDING DIFFUSER - 12/24V

Code	Diffuser colour	Fixing for lamp	No. SYSTEM modules	Pack Carton
GW 20 602	Opal diffuser	Cartridge	3	1/12
GW 20 627	Red	Cartridge	3	1/12
GW 20 628	Green	Cartridge	3	1/12
GW 20 629	Yellow	Cartridge	3	1/12

CHARACTERISTICS: Supplied without lamp Use cartridge lamps of the S6x36mm type (max 2W).

APPLICATIONS: signalling.



GW 20 622

LAMP HOLDER

Code	Lampholder type	Power	Colour	No. SYSTEM modules	Pack Carton
GW 20 622	E27	40 W	Black	2	15/30

APPLICATIONS: the product must be installed in compliance with IEC 64-8.

TECHNICAL ALARMS - SYSTEM BLACK

ANTI-FLOOD SYSTEM WITH ZIGBEE® WIRELESS TRANSMISSION



GW A1 514

ZIGBEE FLOOD ALARM - IP20

Code	Siren output	Temperature sensor	Colour	Dimensions (mm)	Pack Carton
GW A1 514	85 dB/3 m	0...50 °C	White	Ø 60x37	1/6

CHARACTERISTICS: the alarm detects the presence of water and includes a temperature sensor. Powered by CR123-type battery (replaceable).

NOTES: floor-mounting or alternatively wall-mounting possibility through the GWA1541 accessory. To be used in combination with the Zigbee actuator GWA1521 when controlling an electrovalve or a load.



GW A1 521

1-CHANNEL ACTUATOR ZIGBEE

Code	Supply voltage	Output contacts	Dimensions LxHxD (mm)	Pack Carton
GW A1 521	230V ac - 50 Hz	1 NO 10A (AC1) 230 V ac	42x40x20	1/4

CHARACTERISTICS: 1-channel actuator for activating loads via the potential-free output contact (NO). Suitable for commanding incandescent lamps (230 V ac): 2300W, loads controlled from toroidal transformers: 450W, loads controlled from electronic transformers: 600W, energy saving lamps (compact fluorescent): 150W, LED lamps (230 V ac): 150W, motors: 500W.

APPLICATIONS: when used with the water sensor, provide the installation of a NO push-button to open the electrovalve manually.

NOTES: installation in flush-mounting boxes, junction boxes, etc..

SYSTEM BLACK - Domestic range

ACCESSORIES



GW A1 541

WALL-MOUNTING SUPPORT FOR FLOOD ALARM

Code	Colour	Support dimension (mm)	Dimensions of probe (mm)	Cable max. length (cm)	Pack Carton
GW A1 541	White	Ø72x25	Ø50x8	85	1/4

APPLICATIONS: to be used for the wall-mounting of the Zigbee flood alarm GWA1514.



GW 30 522

SOLENOID VALVE, WITH MANUAL RESET, NORMALLY OPEN - 230V - 50HZ

Code	Delivery Ø	Material	Power input	Pack Carton
GW 30 522	3/4"	Brass	12 VA	1/2

SPECIAL APPLICATIONS - SYSTEM BLACK

COMPONENTS FOR HOTEL SYSTEMS



GW 21 820

UNIVERSAL BADGE SWITCH WITH BACKLIT LIGHT - 250V AC

Code	Description	For badge card max. width	Type	Rated power of 230V LED lamps	No. SYSTEM modules	Pack Carton
GW 21 820	1P NO - 10A	54 mm	Backlit 230V ac	100 W	3	1/2

CHARACTERISTICS: supplied without a badge.

APPLICATIONS: activation of circuits and services in hotel rooms (e.g. lights, air-conditioner, fridge-bar), indication of room occupied (with badge inserted).



GW 21 841

EURO-AMERICAN STANDARD SHAVER SOCKET-OUTLET WITH INSULATION TRANSFORMER

Code	Supply voltage	For plug pins	Selectable output voltage	Maximum power	No. SYSTEM modules	Pack Carton
GW 21 841	230V ac - 50/60 Hz	Ø 4 / 5 - 6.3x1.5 mm	120 - 230V ac	20 VA	3	1/4

CHARACTERISTICS: the socket-outlet is equipped with a self-protection device against overloading. The output voltage should be selected correctly, consulting the rating of the user device before inserting the plug. The relevant indicator LED allows the chosen voltage to be clearly seen.

NOTES: not suitable for installation in wall-mounting containers of the 27 COMBI range.

ACCESSORIES

SPARE PARTS AND ACCESSORIES



ZC6

MINIATURE LAMPS WITH QUICK COUPLING TERMINALS

Code	Lamp voltage	Lamp power	Lamp	Light emitted	Pack Carton
GW 30 943	230 V ac	0.4 W	Fluorescent	Red	50
GW 30 944	230V ac	0.4 W	Fluorescent	Green	50
GW 30 946	110 / 230V ac	0.6 W	LED	Light blue	50
GW 30 947	110 / 230V ac	0.6 W	LED	White	50
GW 10 893	12-24V ac/dc	0.4 W	LED	White	50

APPLICATIONS: miniature lamps are mounted on all control devices fitted for luminous signalling.



GW 10 881

LED SIGNALLING UNITS - 230 V AC - 0.6 W

Code	Lamp voltage	Lamp power	Lamp	Light emitted	Cable Colour	Pack Carton
GW 10 881	230 V ac - 50/60 Hz	0.6 W	LED	Blue	Blue	50
GW 10 882	230 V ac - 50/60 Hz	0.6 W	LED	White	White	50
GW 10 883	230 V ac - 50/60 Hz	0.6 W	LED	Red	Red	50
GW 10 884	230 V ac - 50/60 Hz	0.6 W	LED	Green	Green	50
GW 10 885	230 V ac - 50/60 Hz	0.6 W	LED	Amber	Orange	50

NOTES: the LED signalling units are supplied with power supply cables (length 10 cm).



GW 10 894

LED SIGNALLING UNITS - 12-24 V AC/DC - 0.6 W

Code	Lamp voltage	Lamp power	Lamp	Light emitted	Cable Colour	Pack Carton
GW 10 894	12-24V ac/dc	0.6 W	LED	White	White	50

NOTES: the LED signalling units are supplied with power supply cables (length 10 cm).



GW 20 902

CARTRIDGE LAMPS

Code	Dimensions (mm)	Lamp voltage	Lamp power	Lamp	Light emitted	Pack Carton
GW 20 902	S6x36	12V ac/dc	2 W	Incandescence	White	50
GW 20 903	S6x36	24V ac/dc	2 W	Incandescence	White	50
GW 20 904	S6x31	12V ac/dc	2 W	Incandescence	White	50
GW 20 905	S6x31	24V ac/dc	2 W	Incandescence	White	50
GW 20 906	S6.3x28	110 / 230V ac	0.4 W	Fluorescent	Red	50
GW 20 908	S6.3x28	110 / 230V ac	0.4 W	Fluorescent	Green	50

NOTES: the cartridge lamps are mounted on the stair riser, on the single indicator lamps and on the push-buttons with a name plate.

SYSTEM BLACK - Domestic range



GW 20 911

MINIATURE FUSES - 250V AC

Code	Dimensions (mm)	Rated current (A)	Rated voltage	Pack Carton
GW 20 911	Ø 5 x 20	2.5	250V ac	20/200
GW 20 921	Ø 6.3 x 32	2	250V ac	10/200
GW 20 922	Ø 6.3 x 32	4	250V ac	10/200
GW 20 923	Ø 6.3 x 32	6	250V ac	10/200
GW 20 924	Ø 6.3 x 32	10	250V ac	10/200
GW 20 925	Ø 6.3 x 32	16	250V ac	10/200



GW 20 901

SET OF 2 KEYS FOR COMMAND DEVICES

Code	Suitable for	Pack Carton
GW 20 901	One-way switches - two-way switches	1/100
GW 30 912	Push-buttons	1/100



System



Scan the QR Code and find out all the technical informations.

TWO LINES, ONE SINGLE OFFER



The System range includes two lines of plates, one more rounded and the other with a squarer design, in a domestic series recognised for its reliability and robustness.

INSTALLATION FLEXIBILITY



The domestic System series offers maximum application flexibility. It is highly versatile, with two attachment options, from the front or back of the support, making the mounting and release of devices quick and easy.

A COMPLETE SOLUTION



The System devices are compatible with a wide range of accessories and can be installed in any electrical installation: flush- and surface-mounted rectangular boxes, flush-mounted square boxes, profiles and DIN rails, floor turrets and 27 Combi enclosures.

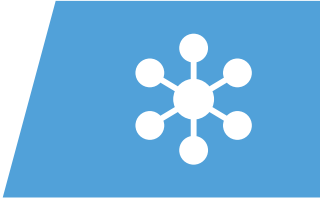

27 COMBI

27 Combi

WALL-MOUNTING ENCLOSURES
AND MODULAR COMPONENTS

pag. 1018





27 COMBI

COMBI SYSTEM 40 ENCLOSURES

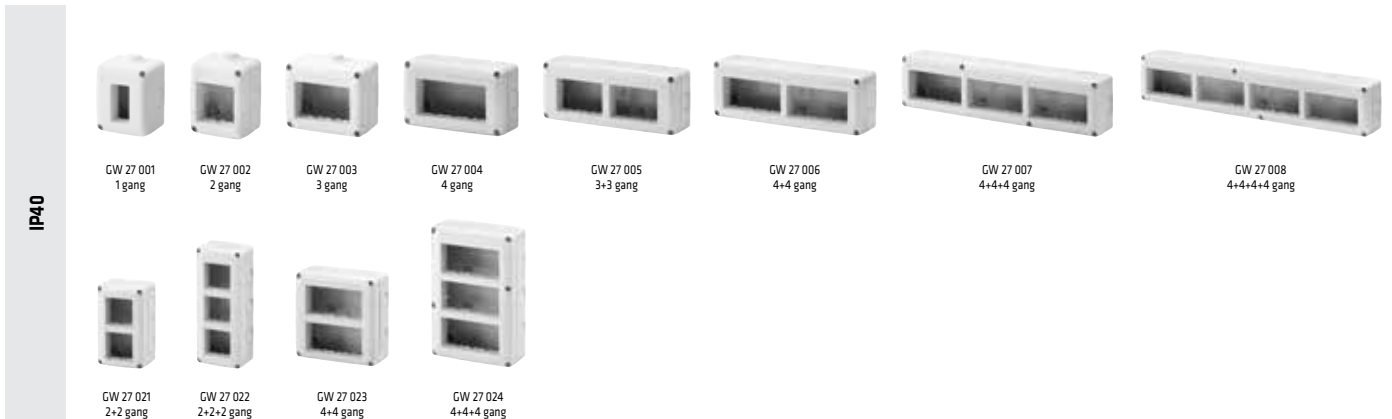

COMBI-DIN ENCLOSURES



ENCLOSURES FOR MINI-TRUNKING USED AS SKIRTING AND FRAMING



ENCLOSURES COMPLETE WITH SYSTEM DEVICES

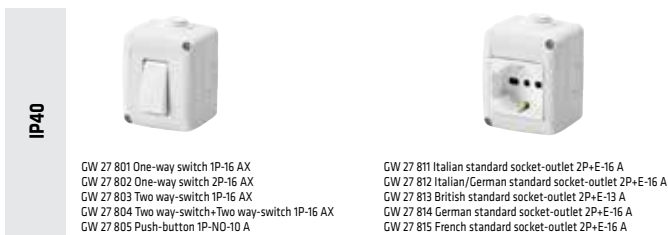







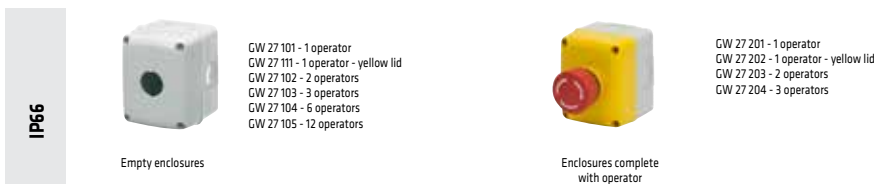

COMPLETE DEVICES



COMBI 22 ENCLOSURES FOR Ø 22MM OPERATORS







COMBI SYSTEM 55/65 ENCLOSURES

IP55							
	GW 27 041 1 gang	GW 27 042 2 gang	GW 27 043 3 gang	GW 27 044 4 gang	GW 27 051 4+4 gang	GW 27 052 4+4+4 gang	
	IP55		IP65				
		GW 27 056 3 gang Pole head		GW 27 062 2 gang	GW 27 057 3 gang Pole arm		

WATERTIGHT COVERS (FOR Q-DIN, Q-BOX)





WATERTIGHT PLATES (FOR RECTANGULAR FLUSH-MOUNTING BOXES)

IP55		IP65		IP55			
	For application on Q-DIN, junction boxes, PTC, IB range flanged lids, Q-BOX and panels		For application on Q-DIN, junction boxes, PTC, IB range flanged lids, Q-BOX and panels		GW 27 401 2 gang 75x85 mm-IP55 Gray RAL 7035	GW 27 403 2 gang 75x85 mm-IP65 Grey RAL 7035	GW 22 451 - 3 gang GW 22 461 - 4 gang Cloud white

ENCLOSURES COMPLETE WITH SYSTEM DEVICES

IP55			
	GW 27 831 One-way switch 1P-16 AX GW 27 832 One-way switch 2P-16 AX GW 27 833 Two way switch 1P-16 AX GW 27 834 Two way switch+Two way switch 1P-16 AX GW 27 835 Push-button 1P-NO-10 A	GW 27 841 Italian standard socket-outlet 2P+E-16 A GW 27 842 Italian/German standard socket-outlet 2P+E-16 A GW 27 843 British standard socket-outlet 2P+E-13 A GW 27 844 German standard socket-outlet 2P+E-16 A GW 27 845 French standard socket-outlet 2P+E-16 A	GW 27 836 Push-button 1P-NO-10 A With illuminable name plate (*)

COMPLETE DEVICES

IP55			IP65		
	● GW 27 415 ● GW 27 416 ● GW 27 417 ● GW 27 418 ● GW 27 419	● GW 27 421 24 V ac ● GW 27 422 230 V ac ● GW 27 423 24 V ac ● GW 27 424 230 V ac		GW 27 431 B IR motion detector 230 V ac	GW 27 432 Light sensitive detector 230 V ac

COMPLEMENTARY ITEMS

Complementary items			
	GW 27 402	GW 26 406	GW 44 622
			
	GW 26 407	GW 27 441 Vertical division GW 27 442 Horizontal division	

(*) supplied without signalling unit

27 Combi

Wall-mounting enclosures and modular components

A complete, versatile system of modular enclosures, perfectly integrated in the SYSTEM domestic range capable to meet the high protection installation requirements of domestic, commercial and industrial sectors. The 27 COMBI range is available both in the IP40 version and in watertight versions with IP55 and IP65 degree of protection, recommended for all outdoor applications which are subjected to extreme atmospheric conditions.



COMBI SYSTEM 40

PROTECTED ENCLOSURES FOR SYSTEM DEVICES



GW 27 001

PROTECTED EMPTY ENCLOSURES FOR FIXED OR MOBILE APPLICATIONS - GREY RAL 7035 - IP40



Code	Description	N. holes Ø 23 with cable gland	No. knockout holes Ø23	Outer dim. LxHxD (mm)	Characteristics	Pack Carton
GW 27 001	1 module	1	3 on sides / 1 on the bottom	66x82x55	Halogen free	5/80
GW 27 002	2 modules	1	3 on sides / 1 on the bottom	66x82x55	Halogen free	5/80
GW 27 003	3 modules	1	3 on sides / 1 on the bottom	99x82x55	Halogen free	3/60
GW 27 004	4 modules	-	8 on sides / 1 on the bottom	132x82x55	Halogen free	2/40

CHARACTERISTICS: Knockout holes removable with tool. Enclosures are customized for fixing the earth terminal GW26407. Complete insulation can be obtained by using the screwcaps GW44622.

ACCESSORIES SUPPLIED: quick entry cable gland for cables with Ø from 4 to 14 mm and conduits Ø 16 and 20 mm.



GW 27 005

PROTECTED EMPTY ENCLOSURES FOR FIXED OR MOBILE APPLICATIONS - GREY RAL 7035 - IP40 HORIZONTAL MULTIPLE CONFIGURATIONS



Code	Description	Configuration	Compartment pre-arrangement	No. knockout holes Ø23	Outer dim. LxHxD (mm)	Characteristics	Pack Carton
GW 27 005	6 modules	Module 3 x 2	2	8 on sides / 2 on the bottom	198x82x55	Halogen free	1/30
GW 27 006	8 modules	Module 4 x 2	2	10 on sides / 2 on the bottom	231x82x55	Halogen free	1/20
GW 27 007	12 modules	Module 4 x 3	3	16 on sides / 3 on the bottom	330x82x55	Halogen free	1/20
GW 27 008	16 modules	Module 4 x 4	2	18 on sides / 4 on the bottom	429x82x55	Halogen free	1/20

CHARACTERISTICS: customized to be divided into compartments using the special functional dividers. Knockout holes removable with tool. Enclosures are customized for fixing the earth terminal GW26407. Complete insulation can be obtained by using the screwcaps GW44622.

ACCESSORIES SUPPLIED: quick entry cable gland for cables with Ø from 4 to 14 mm and conduits Ø 16 and 20 mm.



GW 27 021

PROTECTED EMPTY ENCLOSURES FOR FIXED OR MOBILE APPLICATIONS - GREY RAL 7035 - IP40 VERTICAL MULTIPLE CONFIGURATIONS



Code	Description	Configuration	Compartment pre-arrangement	No. knockout holes Ø23	Outer dim. LxHxD (mm)	Characteristics	Pack Carton
GW 27 021	4 modules	Module 2 x 2	1	8 on sides / 1 on the bottom	82x132x55	Halogen free	2/40
GW 27 022	6 modules	Module 2 x 3	3	8 on sides / 2 on the bottom	82x198x55	Halogen free	1/30
GW 27 023	8 modules	Module 4 x 2	2	10 on sides / 2 on the bottom	132x132x55	Halogen free	1/20
GW 27 024	12 modules	Module 4 x 3	3	12 on sides / 3 on the bottom	132x198x55	Halogen free	1/20

CHARACTERISTICS: customized to be divided into compartments (except for GW27021) using the special functional dividers. Knockout holes removable with tool. Enclosures are customized for fixing the earth terminal GW26407. Complete insulation can be obtained by using the screwcaps GW44622.

ACCESSORIES SUPPLIED: quick entry cable gland for cables with Ø from 4 to 14 mm and conduits Ø 16 and 20 mm.

SELF-SUPPORTING BOXES FOR SYSTEM DEVICES



GW 27 603

SELF-SUPPORTING DEVICE-HOLDER BOXES FOR MINI-TRUNKING FOR CABLES SINGLE AND TWIN-TRUNKING



Code	Description	No. knockout holes Ø23	Outer dim. LxHxD (mm)	Characteristics	Pack Carton
Colour: White RAL 9010					
GW 27 603	1 module	1 on the bottom	120x82x54	Halogen free	10
GW 27 609	2 modules	1 on the bottom	120x82x54	Halogen free	10

CHARACTERISTICS: fitted for mini-trunking with sizes LxH (mm): 15x15, 20x20, 22x10, 30x10, 30x15, 35x15. Knockout holes removable with tool. Complete insulation can be obtained by using the screwcaps GW44622.



GW 27 615

SELF-SUPPORTING DEVICE-HOLDER BOXES FOR MINI-TRUNKING AND TRUNKING USED AS SKIRTING AND FRAMING



Code	Description	Compartment pre-arrangement	No. knockout holes Ø23	Outer dim. LxHxD (mm)	Characteristics	Pack Carton
Colour: White RAL 9010						
GW 27 615	3 modules	1	1 on the bottom	99x82x54	Halogen free	10
GW 27 621	4 modules	1	1 on the bottom	132x82x54	Halogen free	10
GW 27 627	8 modules	2	2 on the bottom	132x132x54	Halogen free	5
Colour: Anthracite RAL 7021						
GW 27 616	3 modules	1	1 on the bottom	99x82x54	Halogen free	10
GW 27 622	4 modules	1	1 on the bottom	132x82x54	Halogen free	10
GW 27 628	8 modules	2	2 on the bottom	132x132x54	Halogen free	5

CHARACTERISTICS: fitted for mini-trunking with sizes LxH (mm): 15x15, 20x20, 22x10, 30x10, 30x15, 35x15. Knockout holes removable with tool. Complete insulation can be obtained by using the screwcaps GW44622. GW27627 and GW27628 fitted for division into compartments using the special functional dividers.

COMBI SYSTEM 55

WATERTIGHT ENCLOSURES FOR SYSTEM DEVICES



GW 27 041

WATERTIGHT EMPTY ENCLOSURES FOR FIXED OR MOBILE APPLICATIONS - GREY RAL 7035 - IP55

Code	Description	N. holes Ø 23 with cable gland	No. knockout holes Ø23	Outer dim. LxHxD (mm)	Pack Carton
GW 27 041	1 module	1	3 on sides / 1 on the bottom	66x82x65	5/60
GW 27 042	2 modules	1	3 on sides / 1 on the bottom	66x82x65	5/60
GW 27 043	3 modules	1	3 on sides / 1 on the bottom	99x82x65	2/40
GW 27 044	4 modules	-	8 on sides / 1 on the bottom	132x82x65	3/30

CHARACTERISTICS: Knockout holes removable with tool. Enclosures are customized for fixing the earth terminal GW26407. Complete insulation can be obtained by using the screwcaps GW44622.

ACCESSORIES SUPPLIED: quick entry cable gland for cables with Ø from 4 to 14 mm and conduits Ø 16 and 20 mm.



GW 27 051

WATERTIGHT EMPTY ENCLOSURES FOR FIXED OR MOBILE APPLICATIONS - GREY RAL 7035 - IP55 VERTICAL MULTIPLE CONFIGURATIONS

Code	Description	Configuration	Compartment pre-arrangement	No. knockout holes Ø23	Outer dim. LxHxD (mm)	Pack Carton
GW 27 051	8 modules	Module 4 x 2	2	10 on sides / 2 on the bottom	132x171x65	1/20
GW 27 052	12 modules	Module 4 x 3	3	12 on sides / 3 on the bottom	132x258x65	1/15

CHARACTERISTICS: customized to be divided into compartments using the special functional dividers. Knockout holes removable with tool. Enclosures are customized for fixing the earth terminal GW26407. Complete insulation can be obtained by using the screwcaps GW44622.

ACCESSORIES SUPPLIED: quick entry cable gland for cables with Ø from 4 to 14 mm and conduits Ø 16 and 20 mm.

27 COMBI



GW 27 056

WATERTIGHT GARDEN ENCLOSURES FOR APPLICATION ON POLE - GREY RAL 7035 - IP55

Code	Description	Fixing	For pole Ø	No. open holes	No. knockouts holes Ø20	Outer dim. LxHxD (mm)	Pack Carton
GW 27 056	3 modules	Pole head	54 - 60 mm	1	-	122x149x85	1/12
GW 27 057	3 modules	Pole arm	54 - 76 mm	1	1	122x164x85	1/12

CHARACTERISTICS: GW27057, complete with 2 holes for screw fixing and 2 slots for fixing with thermoplastic or metal cable ties up to 13mm in height. Knockout holes removable with tool. Enclosures are fit for fixing the earth terminal GW26407. Complete insulation can be obtained by using the screwcaps GW44622.

ACCESSORIES SUPPLIED: cable gland PG13.5.

COMBI SYSTEM 65

WATERTIGHT ENCLOSURES FOR SYSTEM DEVICES



GW 27 062

EMPTY WATERTIGHT ENCLOSURES FOR FIXED OR MOBILE APPLICATIONS - SOLID SMOKED TRANSPARENT DOOR - GREY RAL 7035 - IP65

Code	Description	No. knockout holes Ø23	Door type	Outer dim. LxHxD (mm)	Pack Carton
GW 27 062	2 modules	4 on sides / 1 on the bottom	Rigid	66x82x65	5/60

CHARACTERISTICS: equipped with a transparent rigid door. Knockout holes removable with tool. Enclosures are fit for fixing the earth terminal GW26407. Complete insulation can be obtained by using the screwcaps GW44622.

COMPLETE COMBI SYSTEM ENCLOSURES AND DEVICES

PROTECTED ENCLOSURES COMPLETE WITH SYSTEM DEVICES



GW 27 801

PROTECTED ENCLOSURES COMPLETE WITH SYSTEM DEVICES COLOUR GREY RAL 7035 - IP40 - 250V AC

Code	Description	N. holes Ø 23 with cable gland	No. knockout holes Ø23	Outer dim. LxHxD (mm)	Characteristics	Pack Carton
GW 27 801	One-way switch 1P - 16AX	1	3 on sides / 1 on the bottom	66x82x55	-	5/60
GW 27 802	One-way switch 2P - 16AX	1	3 on sides / 1 on the bottom	66x82x55	-	5/60
GW 27 803	Two-way switch 1P - 16AX	1	3 on sides / 1 on the bottom	66x82x55	-	5/60
GW 27 804	2 x Two-way switch 1P - 16AX	1	3 on sides / 1 on the bottom	66x82x55	-	5/60
GW 27 805	Push-button 1P NO 10A	1	3 on sides / 1 on the bottom	66x82x55	-	5/60
GW 27 811	S.-outlet 2P+E - 16A Dual amp	1	3 on sides / 1 on the bottom	66x82x55	Italian standard	5/80
GW 27 812	S.-outlet 2P+E - 16A Dual amp	1	3 on sides / 1 on the bottom	66x82x55	Italian/German standard	5/80
GW 27 813	Socket-outlet 2P+E - 13A	1	3 on sides / 1 on the bottom	66x82x55	British Standard	5/80
GW 27 814	Socket-outlet 2P+E - 16A	1	3 on sides / 1 on the bottom	66x82x55	German standard	5/80
GW 27 815	Socket-outlet 2P+E - 16A	1	3 on sides / 1 on the bottom	66x82x55	French standard	5/80

CHARACTERISTICS: Knockout holes removable with tool. Enclosures are customized for fixing the earth terminal GW26407. Complete insulation can be obtained by using the screwcaps GW44622. GW27801, GW27802, GW27803, GW27804, rated power of 230V LED lamps: 200W.

ACCESSORIES SUPPLIED: quick entry cable gland for cables with Ø from 4 to 14 mm and conduits Ø 16 and 20 mm.

WATERTIGHT ENCLOSURES COMPLETE WITH SYSTEM DEVICES



GW 27 832

WATERTIGHT ENCLOSURES COMPLETE WITH SYSTEM DEVICES GREY RAL 7035 - IP55- 250V AC

Code	Description	N. holes Ø 23 with cable gland	No. knockout holes Ø23	Outer dim. LxHxD (mm)	Characteristics	Pack Carton
GW 27 831	One-way switch 1P - 16AX	1	3 on sides / 1 on the bottom	66x82x65	-	5/60
GW 27 832	One-way switch 2P - 16AX	1	3 on sides / 1 on the bottom	66x82x65	-	5/60
GW 27 833	Two-way switch 1P - 16AX	1	3 on sides / 1 on the bottom	66x82x65	-	5/60
GW 27 834	2 x Two-way switch 1P - 16AX	1	3 on sides / 1 on the bottom	66x82x65	-	5/60
GW 27 835	Push-button 1P NO 10A	1	3 on sides / 1 on the bottom	66x82x65	-	5/60
GW 27 836	Push-button 1P NO 10A	1	3 on sides / 1 on the bottom	99x82x65	Illuminable name plate	2/40
GW 27 841	S.-outlet 2P+E - 16A Dual amp	1	3 on sides / 1 on the bottom	66x82x65	Italian standard	5/60
GW 27 842	S.-outlet 2P+E - 16A Dual amp	1	3 on sides / 1 on the bottom	66x82x65	Italian/German standard	5/60
GW 27 843	Socket-outlet 2P+E - 13A	1	3 on sides / 1 on the bottom	66x82x65	British Standard	5/60
GW 27 844	Socket-outlet 2P+E - 16A	1	3 on sides / 1 on the bottom	66x82x65	German standard	5/60
GW 27 845	Socket-outlet 2P+E - 16A	1	3 on sides / 1 on the bottom	66x82x65	French standard	5/60

CHARACTERISTICS: IP55 with door closed. Knockout holes removable with tool. Enclosures are customized for fixing the earth terminal GW26407. Complete insulation can be obtained by using the screwcaps GW44622. GW27836 supplied without lamp; 56x36 - 12/24V cartridge lamp required. GW27831, GW27832, GW27833, GW27834, rated power of 230V LED lamps: 200W.

ACCESSORIES SUPPLIED: quick entry cable gland for cables with Ø from 4 to 14 mm and conduits Ø 16 and 20 mm.

COMPLETE DEVICES



GW 26 222

WALL-MOUNTING INDUSTRIAL SOCKET-OUTLETS TO IEC 309 STANDARD - COLOUR GREY RAL 7035 - IP44

Code	Rated current (A)	No. of poles	Rated voltage	Reference h	N. holes Ø 23 with cable gland	No. knockout holes Ø23	Outer dim. LxHxD (mm)	Pack Carton
GW 26 222	16	2P+E	230 V ac	6	1	1 on sides / 1 on the bottom	64x80x97	5/40
GW 26 223	16	3P+E	400V ac	6	1	1 on sides / 1 on the bottom	64x80x97	5/40

rated voltage with alternated current.

CHARACTERISTICS: Knockout holes removable with tool. Enclosures are customized for fixing the earth terminal GW26407.

ACCESSORIES SUPPLIED: quick entry cable gland for cables with Ø from 4 to 14 mm and conduits Ø 16 and 20 mm.



GW 27 415

INDICATOR LAMPS- MAX 15W - GREY RAL 7035 - IP55

Code	Diffuser colour	Rated voltage	Lamp holder type	N. holes Ø 23 with cable gland	No. knockout holes Ø23	Outer dim. LxHxD (mm)	Pack Carton
GW 27 415	Red	230 V ac	E14	1	3 on sides / 1 on the bottom	66x82x95	5/40
GW 27 416	Green	230 V ac	E14	1	3 on sides / 1 on the bottom	66x82x95	5/40
GW 27 417	Yellow	230 V ac	E14	1	3 on sides / 1 on the bottom	66x82x95	5/40
GW 27 418	Transparent	230 V ac	E14	1	3 on sides / 1 on the bottom	66x82x95	5/40
GW 27 419	Light blue	230 V ac	E14	1	3 on sides / 1 on the bottom	66x82x95	5/40

Rated voltage with alternated current. Supplied without lamp.

CHARACTERISTICS: Knockout holes removable with tool. Enclosures are customized for fixing the earth terminal GW26407. Complete insulation can be obtained by using the screwcaps GW44622.

ACCESSORIES SUPPLIED: quick entry cable gland for cables with Ø from 4 to 14 mm and conduits Ø 16 and 20 mm.



GW 27 424

ELECTRONIC FLASHLIGHTS- MAX 25W - GREY RAL 7035 - IP55

Code	Diffuser colour	Rated voltage	Flash frequency	Lamp holder type	N. holes Ø 23 with cable gland	No. knockout holes Ø23	Outer dim. LxHxD (mm)	Pack Carton
GW 27 421	Red	24V ac	1 Hz	E14	1	3 on sides / 1 on the bottom	66x82x95	1/12
GW 27 422	Red	230 V ac	1 Hz	E14	1	3 on sides / 1 on the bottom	66x82x95	1/12
GW 27 423	Yellow	24V ac	1 Hz	E14	1	3 on sides / 1 on the bottom	66x82x95	1/12
GW 27 424	Yellow	230 V ac	1 Hz	E14	1	3 on sides / 1 on the bottom	66x82x95	1/12

Supplied without lamp.

CHARACTERISTICS: Knockout holes removable with tool. Enclosures are customized for fixing the earth terminal GW26407. Complete insulation can be obtained by using the screwcaps GW44622.

ACCESSORIES SUPPLIED: quick entry cable gland for cables with Ø from 4 to 14 mm and conduits Ø 16 and 20 mm.

27 COMBI



GW 26 417

BUZZERS FOR SIGNALLING - GREY RAL 7035 - IP40

Code	Rated voltage	Sound intensity	Frequency impulses of sound	N. holes Ø 23 with cable gland	No. knockout holes Ø23	Outer dim. LxHxD (mm)	Pack Carton
GW 26 417	24V ac	70 dB (at 1 m)	1 Hz	1	1 on sides / 1 on the bottom	64x80x59	1/12
GW 26 427	230 V ac	70 dB (at 1 m)	1 Hz	1	1 on sides / 1 on the bottom	64x80x59	1/12

CHARACTERISTICS: knockout holes removable with tool. Enclosures are customized for fixing the earth terminal GW26407. GW26417 consumption 60mA.

ACCESSORIES SUPPLIED: quick entry cable gland for cables with Ø from 4 to 14 mm and conduits Ø 16 and 20 mm.



GW 27 431 B

INFRARED ADJUSTABLE MOTION DETECTOR 230V - 50 HZ - IP55

Code	Range of action	Duration adjustment	Threshold adjustment	Outer dim. LxHxD (mm)	Pack Carton
GW 27 431 B	12 m	10 sec. - 12 min.	3 - 100 lux	72x88x106	1/10

CHARACTERISTICS: horizontal cover range: 240°; rotating angle of the horizontal detection head: ±90°; sensitivity regulation: 3-12m. Incandescent and halogen lamps: max. 2000W, uncompensated fluorescent lamps: max. 480W, compensated fluorescent lamps: max. 200W, dimmable LED lamps 230V ac and dimmable CFL lamps: max. 8 (7+23W).

ACCESSORIES SUPPLIED: support for installation in corners; cover kit for limiting the detection field.



GW 27 432

LIGHT-SENSITIVE DETECTOR WITH RELAY OUTPUT 230V - 50/60 HZ - IP65

Code	Threshold adjustment	Output contacts	Outer dim. LxHxD (mm)	Pack Carton
GW 27 432	0 - 200 lux	1NO 16 A (AC1) 250 V ac	55x106x45	1/24

CHARACTERISTICS: halogen and incandescent lamps: 23x100W (2300W); uncompensated fluorescent lamps: 12x58W (700W); compensated fluorescent lamps: 5x58W 35uF (290W); LED and energy saving lamps: max. 7 (7+15W).

APPLICATIONS: wall or pole mounting.

SPECIAL ENCLOSURES

COMBI-DIN - PROTECTED DIN-SYSTEM COMBINED ENCLOSURES

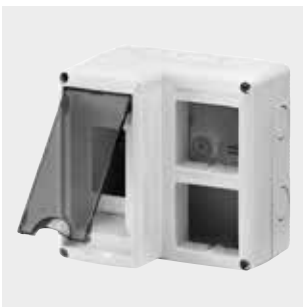

GW 27 071

PROTECTED ENCLOSURES FOR COMBINED INSTALLATION OF DIN MODULAR DEVICES AND SYSTEM SMOKED TRANSPARENT DOOR - GREY RAL 7035 - IP40



Code	No. DIN modules	No. SYSTEM modules	Configuration	Dispersible power (W)	No. knockout holes Ø23	Outer dim. LxHxD (mm)	Characteristics	Pack Carton
GW 27 071	2	4	Module 2 x 2	13	10 on sides / 2 on the bottom	132x132x95	Halogen free	1/8
GW 27 072	4	8	Module 2 x 4	15	12 on sides / 2 on the bottom	231x132x95	Halogen free	1/6
GW 27 073	8	16	Module 4 x 4	18	18 on sides / 2 on the bottom	429x132x95	Halogen free	1/4

CHARACTERISTICS: customized to be divided into 2 vertical compartments (except for GW27071) using the special functional dividers. Knockout holes removable with tool. Enclosures are customized for fixing the earth terminal GW26407. Complete insulation can be obtained by using the screwcaps CW44622.

ACCESSORIES SUPPLIED: quick entry cable gland for cables with Ø from 4 to 14 mm and conduits Ø 16 and 20 mm.

NOTES: dispersible power calculated according to IEC 60670-24.

COMBI-IN - FLUSH-MOUNTING FLANGED COMPONENTS



GW 27 401

SYSTEM 2-MODULES WATERTIGHT CAP - GREY RAL 7035 - IP55

Code	No. SYSTEM modules	Door type	Dimensions LxH (mm)	Pack Carton
GW 27 401	2	With membrane	75x85	3/60

ACCESSORIES SUPPLIED: 4 self-tapping screws. IP55 with door closed.

APPLICATIONS: for Q-DIN boards, junction boxes PTC, flanged lids 66 range, Q-BOX and panels



GW 27 403

SYSTEM 2-MODULES WATERTIGHT CAP - SOLID SMOKED TRANSPARENT DOOR - GREY RAL 7035 - IP65

Code	No. SYSTEM modules	Door type	Dimensions LxH (mm)	Pack Carton
GW 27 403	2	Rigid IK09	75x85	3/60

ACCESSORIES SUPPLIED: 4 self-tapping screws. IP65 with door closed.

APPLICATIONS: for Q-DIN boards, junction boxes, PTC, flanged lids 66 range, Q-BOX and panels.



GW 22 451

SELF-SUPPORTING WATERTIGHT PLATES FOR INSTALLATION ON FLUSH-MOUNTING RECTANGULAR BOXES - IP55

Code	Description	Colour Plate	For flush mounting box	Pack Carton
GW 22 451	3 modules	Cloud white	GW24403, GW24403PM	30
GW 22 452	3 modules	Black	GW24403, GW24403PM	30
GW 22 453	3 modules	Grey RAL 7035	GW24403, GW24403PM	30
GW 22 461	4 modules	Cloud white	GW24404, GW24404PM	30
GW 22 462	4 modules	Black	GW24404, GW24404PM	30
GW 22 463	4 modules	Grey RAL 7035	GW24404, GW24404PM	30

CHARACTERISTICS: ergonomic membrane with notches in UV-resistant material. Snap closing system. Opening made easy by wide key.



GW 26 420

INDUSTRIAL SOCKET-OUTLETS IN COMPLIANCE WITH IEC 309 - GREY RAL 7035 - IP44

Code	Rated current (A)	No. of poles	Rated voltage	Reference h	Outer dim. LxHxD (mm)	Pack Carton
GW 26 420	16	2P+E	230 V ac	6	116x90x45	1/20
GW 26 421	16	3P+E	400V ac	6	116x90x45	1/20

CHARACTERISTICS: for installation on rectangular flush-mounting box GW24403.

COMBI 22 - ENCLOSURES FOR PUSH BUTTONS, CONTROLS AND INDICATORS Ø 22 MM



GW 27 101

EMPTY ENCLOSURES FOR PUSH-BUTTONS, CONTROLS AND INDICATORS Ø 22 MM - GREY RAL 7035 - IP66

Code	No. gangs	Side entries	Top entries	Bottom entries	Outer dim. LxHxD (mm)	Pack Carton
GW 27 101	1	2xØ 23	1xØ 23	1xØ 23	66x82x65	5/60
GW 27 111	1	2xØ 23	1xØ 23	1xØ 23	66x82x65	5/60
GW 27 102	2	6xØ 23	1xØ 23	1xØ 23	132x82x65	2/30
GW 27 103	3	4xØ 23	1xØ 23	1xØ 23	66x171x65	1/20
GW 27 104	6	4xØ 23	3xØ 23	3xØ 23	132x171x65	1/10
GW 27 105	12	4xØ 23	3xØ 23	3xØ 23	264x171x65	1/10

CHARACTERISTICS: degree of protection guaranteed with IP66 operators correctly installed. The hole seat has knockouts for installing operators with any reference. GW27111 with specific yellow lid for assembling emergency push-buttons GW74361, GW74362 and GW74365.

NOTES: the empty containers can be supplied with push-buttons, commands and indicators Ø 22mm and single contacts, type GW74501 and GW74502.



GW 27 202

ENCLOSURES COMPLETE WITH OPERATOR - GREY RAL 7035 - IP66

Code	No. gangs	Contacts	Operators Ø 22	Outer dim. LxHxD (mm)	Pack Carton
GW 27 201	1	1 NO	General (black)	66x82x65	1/30
GW 27 202	1	1 NO - 1 NC	Emergency (red)	66x82x65	1/30
GW 27 203	2	1 NO - 1 NC	Start (green) Stop (red)	132x82x65	1/10
GW 27 204	3	1 NO - 1 NC	Start, stop, indicator	66x171x65	1/10

CHARACTERISTICS: 3-seat flange. Maximum protrusion of the operator from the container: GW27201, GW27203, GW27204 - 20mm; GW27202 - 25mm. GW27202, yellow lid, mushroom-head push-button with retainer. GW27204, direct supply, BA9S coupling included, max 380V-2 W, lamp not included, operators Ø 22 for run (green), stop (red) and signalling (white). Complete insulation, in accordance with Standard IEC 536.

COMPLEMENTARY ITEMS

COMPLEMENTARY ITEMS



GW 27 402

JUNCTION BOX FOR COMBINED ASSEMBLY OF MODULAR CONTAINERS - GREY RAL 7035 - IP55

Code	No. knockout holes Ø23	Lid screws	Outer dim. LxHxD (mm)	Pack Carton
GW 27 402	8 on sides / 1 on the bottom	Stainless steel	132x82x55	2/60

CHARACTERISTICS: knockout holes removable with tool. Enclosures are fit for fixing the earth terminal GW26407. Complete insulation can be obtained by using the screwcaps GW44622.



GW 26 406

WATERPROOF COUPLER FOR ENCLOSURES, DEVICES AND BOXES - IP55

Code	Mounting hole Ø (mm)	Type of pitch	Pack Carton
GW 26 406	23	PG16	25/250

APPLICATIONS: for the combined assembly of enclosures, junction boxes, etc..



GW 27 441

FUNCTIONAL DIVIDER IN INSULATING MATERIAL FOR WALL-MOUNTING MODULAR ENCLOSURES

Code	Suitable for	Pack Carton
GW 27 441	GW27005, GW27006, GW27007, GW27008, GW27022	10/100
GW 27 442	GW27023, GW27024, GW27051, GW27052, GW27072, GW27073, GW27627, GW27628	10/100

APPLICATIONS: circuits with different voltages / Energy-signal division / Division of special circuits.



GW 27 443

FUNCTIONAL DIVIDERS IN METAL FOR MODULAR ENCLOSURES FOR WALL-MOUNTING

Code	Suitable for	Pack Carton
GW 27 443	GW27024, GW27627, GW27628	10/100

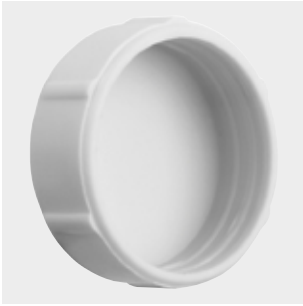

GW 44 622

INSULATING SCREW CAP

Code	Description	Pack Carton
GW 44 622	Screwcap Ø16mm	10/100

APPLICATIONS: used to maintain the double insulation and the original IP degree of protection of the boxes, containers and other GEWISS products.



GW 26 407

BRASS TERMINAL FOR THROUGH-LINE EARTH CONDUCTOR

Code	Section (mm ²)	Fixing	Pack Carton
GW 26 407	4	Pressure-operated	200/1600



27 Combi



Scan the QR Code and find out all the technical informations.

RELIABILITY OVER TIME



The 27 Combi Series provides customised protection for every installation. This complete and versatile system of modular enclosures can be perfectly integrated into the domestic series, with IP40, IP55 and IP65 protection ratings ensuring reliability over the years.

COMBI IP 40: SAFETY AND VERSATILITY



The installation of the modular enclosures is extremely easy, thanks to the possibility to combine different enclosures to make custom configurations and the large internal space for wiring, which can be divided for greater safety with special functional separators.

COMBI IP55: ERGONOMICS AND PROTECTION



The special recessed transparent membrane makes it easy to locate the button keys by touch, while simple upward pressure opens the door. A perfect watertight seal is ensured by the closure system and coupling of the seals.

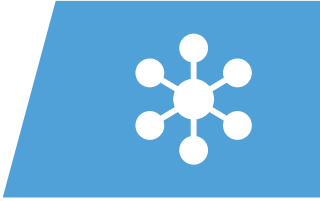

PLAYBUS



Domestic range

PLATES

pag. 1032



Domestic range

MODULAR DEVICES

pag. 1042

PLAYBUS - Domestic range



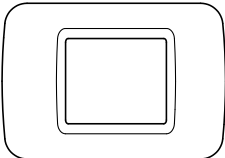
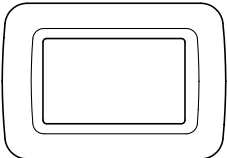
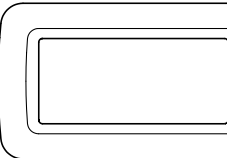
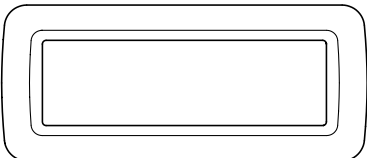

PLAYBUS YOUNG PLATES

Technopolymer	CLOUD WHITE	Painted technopolymer	TITANIUM	Metallised technopolymer	SOFT CHROME																								
																													
	<table border="0"> <tr><td>GW 32 242</td><td>2 modules</td></tr> <tr><td>GW 32 243</td><td>3 modules</td></tr> <tr><td>GW 32 244</td><td>4 modules</td></tr> <tr><td>GW 32 246</td><td>6 modules</td></tr> </table>		GW 32 242		2 modules	GW 32 243	3 modules	GW 32 244	4 modules	GW 32 246	6 modules	<table border="0"> <tr><td>GW 32 702</td><td>2 modules</td></tr> <tr><td>GW 32 703</td><td>3 modules</td></tr> <tr><td>GW 32 704</td><td>4 modules</td></tr> <tr><td>GW 32 706</td><td>6 modules</td></tr> </table>	GW 32 702	2 modules	GW 32 703	3 modules	GW 32 704	4 modules	GW 32 706	6 modules	<table border="0"> <tr><td>GW 32 752</td><td>2 modules</td></tr> <tr><td>GW 32 753</td><td>3 modules</td></tr> <tr><td>GW 32 754</td><td>4 modules</td></tr> <tr><td>GW 32 756</td><td>6 modules</td></tr> </table>	GW 32 752	2 modules	GW 32 753	3 modules	GW 32 754	4 modules	GW 32 756	6 modules
	GW 32 242		2 modules																										
GW 32 243	3 modules																												
GW 32 244	4 modules																												
GW 32 246	6 modules																												
GW 32 702	2 modules																												
GW 32 703	3 modules																												
GW 32 704	4 modules																												
GW 32 706	6 modules																												
GW 32 752	2 modules																												
GW 32 753	3 modules																												
GW 32 754	4 modules																												
GW 32 756	6 modules																												
TONER BLACK	SLATE																												
																													
<table border="0"> <tr><td>GW 32 302</td><td>2 modules</td></tr> <tr><td>GW 32 303</td><td>3 modules</td></tr> <tr><td>GW 32 304</td><td>4 modules</td></tr> <tr><td>GW 32 306</td><td>6 modules</td></tr> </table>	GW 32 302	2 modules	GW 32 303	3 modules	GW 32 304	4 modules	GW 32 306	6 modules	<table border="0"> <tr><td>GW 32 712</td><td>2 modules</td></tr> <tr><td>GW 32 713</td><td>3 modules</td></tr> <tr><td>GW 32 714</td><td>4 modules</td></tr> <tr><td>GW 32 716</td><td>6 modules</td></tr> </table>	GW 32 712	2 modules	GW 32 713	3 modules	GW 32 714	4 modules	GW 32 716	6 modules												
GW 32 302	2 modules																												
GW 32 303	3 modules																												
GW 32 304	4 modules																												
GW 32 306	6 modules																												
GW 32 712	2 modules																												
GW 32 713	3 modules																												
GW 32 714	4 modules																												
GW 32 716	6 modules																												

Modularity				
	2 modules	3 modules	4 modules	6 modules

Design: architect Paolo Villa

PLAYBUS PLATES

Technopolymer	CLOUD WHITE	Painted technopolymer	TITANIUM	Metallised technopolymer	SOFT CHROME
					
	GW 32 022 2 modules GW 32 023 3 modules GW 32 024 4 modules GW 32 026 6 modules GW 32 027 4+4 modules GW 32 028 6+6 modules GW 32 029 6+6+6 modules		GW 32 012 2 modules GW 32 013 3 modules GW 32 014 4 modules GW 32 016 6 modules GW 32 017 4+4 modules GW 32 018 6+6 modules GW 32 019 6+6+6 modules		GW 32 072 2 modules GW 32 073 3 modules GW 32 074 4 modules GW 32 076 6 modules GW 32 077 4+4 modules
	TONER BLACK		SLATE		
					
	GW 32 052 2 modules GW 32 053 3 modules GW 32 054 4 modules GW 32 056 6 modules GW 32 057 4+4 modules		GW 32 002 2 modules GW 32 003 3 modules GW 32 004 4 modules GW 32 006 6 modules GW 32 007 4+4 modules GW 32 008 6+6 modules GW 32 009 6+6+6 modules		

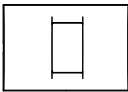
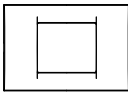
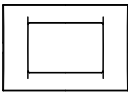
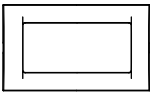
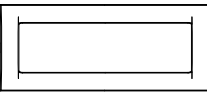
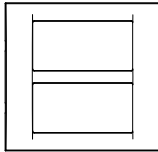
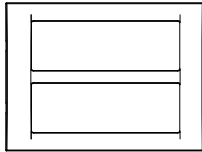
Modularity							
	2 modules	3 modules	4 modules	6 modules	4+4 modules	6+6 modules (*)	6+6+6 modules (*)

(*) Cloud white, slate and titanium

Design: architect Paolo Villa

Playbus

Plates

The technopolymer plates, available in two different shapes, Playbus and Playbus Young, and in 5 colour shades are the ideal solution for every installation. Playbus Young: classic forms, resistant materials. A line of simple, functional plates that can enhance every environment, bringing harmony and beauty to the entire home. Playbus: plates with unmistakable modern style, created to meet the needs of contemporary design. The elegance of the rectangular form is enhanced by the lightness and simplicity of the lines which surround the command buttons.



PLAYBUS YOUNG PLATES

TECHNOPOLYMER, PASTEL COLOUR, SATIN FINISH



GW 32 243

PLAYBUS YOUNG - CLOUD WHITE

Code	Description	For support codes	Pack Carton
GW 32 242	2 modules	GW32402	12
GW 32 243	3 modules	GW32403	96
GW 32 244	4 modules	GW32404	12
GW 32 246	6 modules	GW32406	8



GW 32 303

PLAYBUS YOUNG - TONER BLACK

Code	Description	For support codes	Pack Carton
GW 32 302	2 modules	GW32402	12
GW 32 303	3 modules	GW32403	96
GW 32 304	4 modules	GW32404	12
GW 32 306	6 modules	GW32406	8

PAINTED TECHNOPOLYMER, SATIN FINISH



GW 32 703

PLAYBUS YOUNG - TITANIUM

Code	Description	For support codes	Pack Carton
GW 32 702	2 modules	GW32402	12
GW 32 703	3 modules	GW32403	12
GW 32 704	4 modules	GW32404	12
GW 32 706	6 modules	GW32406	8



GW 32 713

PLAYBUS YOUNG - SLATE

Code	Description	For support codes	Pack Carton
GW 32 712	2 modules	GW32402	12
GW 32 713	3 modules	GW32403	12
GW 32 714	4 modules	GW32404	12
GW 32 716	6 modules	GW32406	8

METALLISED TECHNOPOLYMER



GW 32 753

PLAYBUS YOUNG - SOFT CHROME, SATIN FINISH

Code	Description	For support codes	Pack Carton
GW 32 752	2 modules	GW32402	12
GW 32 753	3 modules	GW32403	12
GW 32 754	4 modules	GW32404	12
GW 32 756	6 modules	GW32406	8

PLAYBUS - Domestic range

PLAYBUS PLATES

TECHNOPOLYMER, PASTEL COLOUR, GLOSSY FINISH



GW 32 023

PLAYBUS - CLOUD WHITE

Code	Description	Configuration	For support codes	Pack Carton
GW 32 022	2 modules	-	GW32402	48
GW 32 023	3 modules	-	GW32403	48
GW 32 024	4 modules	-	GW32404	24
GW 32 026	6 modules	-	GW32406	24
GW 32 027	4+4 modules	Overlapping	GW32407	12
GW 32 028	6+6 modules	Overlapping	GW32408	12
GW 32 029	6+6+6 modules	Overlapping	GW32409	6



GW 32 053

PLAYBUS - TONER BLACK

Code	Description	Configuration	For support codes	Pack Carton
GW 32 052	2 modules	-	GW32402	48
GW 32 053	3 modules	-	GW32403	48
GW 32 054	4 modules	-	GW32404	24
GW 32 056	6 modules	-	GW32406	24
GW 32 057	4+4 modules	Overlapping	GW32407	12

PAINTED TECHNOPOLYMER WITH SCRATCHPROOF VITRIFIED ENAMELLING



GW 32 013

PLAYBUS - TITANIUM

Code	Description	Configuration	For support codes	Pack Carton
GW 32 012	2 modules	-	GW32402	48
GW 32 013	3 modules	-	GW32403	48
GW 32 014	4 modules	-	GW32404	24
GW 32 016	6 modules	-	GW32406	24
GW 32 017	4+4 modules	Overlapping	GW32407	12
GW 32 018	6+6 modules	Overlapping	GW32408	12
GW 32 019	6+6+6 modules	Overlapping	GW32409	6



GW 32 003

PLAYBUS - SLATE

Code	Description	Configuration	For support codes	Pack Carton
GW 32 002	2 modules	-	GW32402	48
GW 32 003	3 modules	-	GW32403	48
GW 32 004	4 modules	-	GW32404	24
GW 32 006	6 modules	-	GW32406	24
GW 32 007	4+4 modules	Overlapping	GW32407	12
GW 32 008	6+6 modules	Overlapping	GW32408	12
GW 32 009	6+6+6 modules	Overlapping	GW32409	6

METALLISED TECHNOPOLYMER



GW 32 073

PLAYBUS - SOFT CHROME, GLOSSY FINISH

Code	Description	Configuration	For support codes	Pack Carton
GW 32 072	2 modules	-	GW32402	48
GW 32 073	3 modules	-	GW32403	48
GW 32 074	4 modules	-	GW32404	24
GW 32 076	6 modules	-	GW32406	24
GW 32 077	4+4 modules	Overlapping	GW32407	12

SPECIAL PLATES, ENCLOSURES AND SUPPORTS

WATERTIGHT PLATES



GW 32 461

SELF-SUPPORTING WATERTIGHT PLATES FOR INSTALLATION ON FLUSH-MOUNTING RECTANGULAR BOXES - IP55

Code	Description	Colour Plate	For flush mounting box	Pack Carton
GW 32 461	3 modules	Cloud white	GW24403, GW24403PM	1/60
GW 32 462	3 modules	Toner black	GW24403, GW24403PM	1/60
GW 32 466	4 modules	Cloud white	GW24404, GW24404PM	1/30
GW 32 467	4 modules	Toner black	GW24404, GW24404PM	1/30

PLATES FOR PROFILES



GW 32 121

PLATES FOR PROFILES AND PANELS COMPLETE WITH INSULATING BOX AND SUPPORTS

Code	Description	Colour Plate	Pack Carton
GW 32 123	1 module	Cloud white	1/30
GW 32 121	1 module	Slate	1/30
GW 32 133	2 modules horizontal	Cloud white	1/30
GW 32 131	2 modules horizontal	Slate	1/30

ACCESSORIES SUPPLIED: the insulating box is equipped with a tug-proof cable fastener device and a corrugated conduit fastener device.

PLAYBUS - Domestic range

TABLETOP AND WALL-MOUNTING CONSOLES

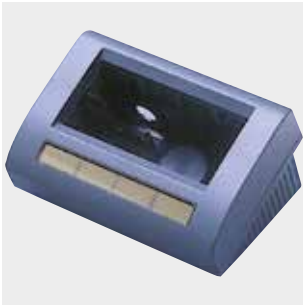

GW 32 411

SELF-SUPPORTING TABLETOP AND WALL-MOUNTING CONSOLES

Code	Description	Colour	Outer dim. LxHxD (mm)	Pack Carton
GW 32 411	4 modules	Black	140x110x80	2/24
GW 32 412	8 modules	Black	240x110x80	2/12

CHARACTERISTICS: the feet are made of soft, slip-proof rubber.

ACCESSORIES SUPPLIED: cable gland, safety cable clamp and housing for command identification labels.

WALL-MOUNTING BOXES



GW 32 431

WALL-MOUNTING BOXES



Code	Suitable for	Colour	Characteristics	Pack Carton
GW 32 431	1/2/3 modules PLAYBUS	Cloud white	Halogen free	3/60
GW 32 432	1/2/3 modules PLAYBUS	Toner black	Halogen free	3/60

CHARACTERISTICS: fitted for fixing the earth terminal GW26407. Suitable for conduit Ø 16 - 20 mm.

PLATES FOR LIFT/EMERGENCY



GW 32 450

SELF-SUPPORTING WIRED PLATES FOR LIFT/EMERGENCY WITH ILLUMINABLE BUTTON SWITCH, TRIANGLE KEY AND BREAKABLE GLASS - IP40

Code	Colour	Suitable for	For flush mounting box	Pack Carton
GW 32 450	White	Lift	GW24403	1/10
GW 32 451	Red	Emergency	GW24403	1/10

The articles are supplied with an 11mm button key already assembled, without a lamp. They use miniature lamp units.

CHARACTERISTICS: contacts supplied 1 NO + 1 NC - 10A (AC1) / 6A (AC15) - 380V AC.

APPLICATIONS: the plates are suitable for the GW40422 security lock, available as an accessory.

ACCESSORIES SUPPLIED: accessory button key, 17mm high, to operate the contacts when glass is broken.



GW 42 216

GLASS BREAKER WITH UNIVERSAL FIXING SUPPORT

Code	Colour	Support dimension (mm)	Pack Carton
GW 42 216	Toner black	70x60	1/10



GW 40 422

CYLINDRICAL SECURITY LOCK

Code	Description	Pack Carton
GW 40 422	Security lock	1/10



GW 32 457

SPARE BREAKABLE GLASS FOR LIFT/EMERGENCY PLATES

Code	Suitable for	Pack Carton
GW 32 457	GW32450, GW32451, GW32452, GW32453	1/10

PLAYBUS - Domestic range

SUPPORTS



GW 32 403

INSULATING SUPPORTS FOR INSTALLATION OF PLAYBUS / PLAYBUS YOUNG PLATES ON RECTANGULAR BOXES



Code	Description	Configuration	Fixing	Characteristics	Pack Carton
GW 32 403	3 modules	-	2 screws (included)	Halogen free	10/150
GW 32 404	4 modules	-	2 screws (included)	Halogen free	10/100
GW 32 406	6 modules	-	4 screws (included)	Halogen free	10/100
GW 32 407	4+4 modules	Overlapping	4 screws (included)	Halogen free	5/50
GW 32 408	6+6 modules	Overlapping	4 screws (included)	Halogen free	5/50
GW 32 409	6+6+6 modules	Overlapping	4 screws (included)	Halogen free	5/25



GW 32 402

INSULATING SUPPORTS FOR INSTALLATION OF PLAYBUS / PLAYBUS YOUNG PLATES ON SQUARE/RECTANGULAR BOXES

Code	Description	Fixing	Characteristics	Pack Carton
GW 32 402	2 modules	2 screws (included)	Halogen free	10/150



GW 32 421

SUPPORTS FOR MOUNTING PLAYBUS DEVICES ON DIN RAIL

Code	Description	No. DIN modules	Pack Carton
GW 32 421	1 module	1.5	5/200



Playbus



Scan the QR Code and find out all the technical informations.

DESIGN AND SAFETY



The Playbus series includes two plate shapes, modern or classic, available in 5 colours with a glossy or satin finish. The use of technopolymer ensures complete and safe electrical insulation together with greater durability of colours and finishes.

INSTALLATION FLEXIBILITY



The Playbus series lets you manage multiple sockets and lines from a single point, thanks to the high-capacity plates, with up to 18 modules and internal circuit separation. The exceptional flexibility of the installations is also ensured by the wide range of accessories available.

CONTROL DEVICES



The control units have three types of backlighting: functional (also visible during the day), night location (discrete luminosity) and iconographic.

PLAYBUS - Domestic range

COMMAND

One-way switches

				
GW 30 001 1M-1P-16 AX General	GW 30 002 1M-1P-16 AX Backlit (*)	GW 30 003 1M-1P-16 AX Indicator (*)	GW 30 004 1M-2P-16 AX General	GW 30 007 1M-2P-10 AX With key

Two-way switches

			Intermediate switch		Three-way switch	
GW 30 011 1M-1P-16 AX General	GW 30 012 1M-1P-16 AX Backlit (*)	GW 30 013 1M-1P-16 AX Indicator (*)		GW 30 015 1M-1P-16 AX General		GW 30 016 1M-1P-10 AX Positions 1-0-2

Push-buttons

								
GW 30 021 1M-1P-NO-16 A General	GW 30 022 1M-1P-NO-16 A Backlit (*)	GW 30 023 1M-1P-NO-16 A Indicator (*)	GW 30 024 1M-1P-NO-16 A Key (*)	GW 30 025 1M-1P-NO-16 A Bell (*)	GW 30 026 1M-1P-NO-16 A Light (*)	GW 30 027 1M-1P-NO-16 A Stair light (*)	GW 30 030 1M-2P-NO-16 A General	GW 30 031 1M-2P-NO-16 A With pull-cord
								
GW 30 033 1M-1P-NO+NO-16 A Double	GW 30 032 1M-2P-NO-10 A With key	GW 30 034 1M-1P-NO+NO-10 A With interlock	GW 30 035 1M-1P-NC-16 A General	GW 30 036 1M-1P-NO-NC-10 A Start	GW 30 037 1M-1P-NC+NO-10 A Stop	GW 30 038 2M-1P-NO-10 A With illuminated name plate (*)		

Miniature lamp



GW 10 893	12/24 V ac/dc	White
GW 30 943	230 V ac	Red
GW 30 944	230 V ac	Green
GW 30 946	110/230 V ac	Light blue
GW 30 947	110/230 V ac	White

Cartridge lamp



GW 20 902	56x36	12 V ac/dc	White
GW 20 903	56x36	24 V ac/dc	White
GW 20 904	56x31	12 V ac/dc	White
GW 20 905	56x31	24 V ac/dc	White
GW 20 906	56,3x28	110/230 V ac	Red
GW 20 908	56,3x28	110/230 V ac	Green

Infrared





























GW 30 121
Movement sensor
230V ac-50/60 Hz

Blanking modules and cable output

	
GW 30 901-1M GW 30 902-2M GW 30 903-3M	GW 30 905 1M

(*) supplied without signalling unit

POWER AND DATA

<p>Italian</p>	 GW 30 201 2P+E-10 A-250 V ac	 GW 30 203 2P+E-16 A-250 V ac Dual amperage	 GW 30 321 2P+E-16 A-250 V ac Dual amperage	 GW 30 331 2P+E-16 A-250 V ac Dual amperage	<p>Israeli</p>	 GW 30 237 2P+E-16 A-250 V ac
<p>Italian/German</p>	 GW 30 210 2P+E-16 A-250 V ac	 GW 30 212 2P+E-16 A-250 V ac Dual amperage	 GW 30 214 2P+E-16 A-250 V ac Dual amperage	<p>Swiss</p>	 GW 30 234 2P+E-10 A-250 V ac Type 13	
<p>German</p>	 GW 30 211 2P+E-16 A-250 V ac	 GW 30 322 2P+T-16 A-250 V ac	<p>French</p>	 GW 30 215 2P-16 A-250 V ac	 GW 30 216 2P+E-16 A-250 V ac	
<p>British</p>	 GW 30 219 2P+E-13 A-250 V ac	 GW 30 220 2P+E-16 A-250 V ac	<p>Australian</p>	 GW 30 342 2P+E-10 A-250 V ac	 GW 30 343 2P+E-15 A-250 V ac	
<p>Euro-American/USA</p>	 GW 30 227 2P+E-10/15 A-250/125 V ac	 GW 30 232 2P+E-15 A-125 V ac				
<p>TV -SAT</p>	 F female GW 30 311 - 0 dB GW 30 316 - 5 dB	 IEC male GW 30 301 - 0 dB GW 30 306 - 5 dB	 GW 20 277 Terminal resistance 75 ohm	<p>Telephone sockets</p>	 GW 30 261 RJ11	
<p>Data sockets</p>	 GW 30 685 Cat. 6 GW 30 267 Cat. 5e RJ45 - UTP	 GW 30 686 Cat. 6 GW 30 266 Cat. 5e RJ45 - FTP	 Adapters	GW 30 286 SYSTIMAX Commscope GW 30 287 AMP/Keystone Jack		

PLAYBUS - Domestic range

POWER, COMFORT AND CLIMATE MANAGEMENT

Dimmer



GW 30 402
Resistive 230 V ac 100-500 W
Resistive 110 V ac 50-250 W



GW 30 403 ▲
Resistive 230 V ac 100-900 W
Resistive 110 V ac 100-500 W
Inductive 230 V ac 40-300 VA
Inductive 110 V ac 20-150 VA

GW 30 404
Resistive 230V ac 40-300W
Resistive 110V ac 20-150W
Inductive 230V ac 40-300VA
Inductive 110V ac 20-150VA
With two-way switch



GW 30 401
Resistive 60-500 W
Inductive 60-500 VA
230 V ac-50/60 Hz

Climate control



GW 30 702
Thermostat
230 V ac-50/60 Hz



GW 30 703
Probe to measure temperature



GW 30 706
Timed thermostat
230 V ac-50/60 Hz

Hotel components



GW 30 430
Universal badge switch
1P-NO-10 A



GW 30 711
Shaver socket-outlet
230 V ac-50/60 Hz

▲ =Items designed solely to export to a limited number of countries outside the European Union or proposed as candidate and to the European Free Trade Association. Contact Gewiss customer service to check if the product meets the regulations of the country concerned before importing it.

PROTECTION, SAFETY AND SIGNALLING

Automatic circuit breakers



Miniature circuit breakers
3 kA
Curve C

GW 30 371 - 6 A
GW 30 372 - 10 A
GW 30 373 - 16 A
1P

GW 30 374 - 6 A
GW 30 375 - 10 A
GW 30 376 - 16 A
1P+N



Miniature circuit breakers
3 kA
Curve C

GW 30 377 - 6 A
GW 30 378 - 10 A
GW 30 379 - 16 A
1P+N-10 mA

Protection devices



GW 30 360
Fuse-holder
In MAX=16 A

Accessories



GW 30 522
GAS solenoid valve
3/4"-230 V ac-12 VA

Ringers and buzzers



GW 30 633 - 12 V ac
GW 30 634 - 230 V ac
Ringers



GW 30 635 - 12 V ac
GW 30 636 - 230 V ac
Buzzers

Anti black-out lamp



GW 30 501
230 V ac-50/60 Hz
Removable

Indicator lamps



GW 30 611
Red
Illuminable (*)



GW 30 612
Green
Illuminable (*)



GW 30 614
Transparent
Illuminable (*)

SUPPORTS

Supports for square and rectangular boxes

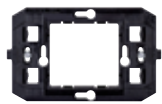

GW 32 402 With screw - 2 modules

Supports for rectangular boxes



GW 32 403
With screw - 3 modules

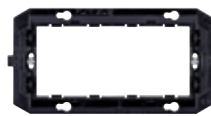

GW 32 404 With screw - 4 modules



GW 32 406 With screw - 6 modules



GW 32 407 With screw - 4+4 modules



GW 32 408 With screw - 6+6 modules



GW 32 409 With screw - 6+6+6 modules

(*) supplied without signalling unit

Playbus

Modular devices

A range of modular devices for domestic and similar uses; can be composed on frames for rectangular flush-mounting boxes of up to 18 modules, or on square versions. Colours and finishes: satin black, elegant and classy. The range includes commands, socket-outlets, protection, indicators, connectors and devices for the control, safety and comfort of your home.



COMMAND

COMMAND DEVICES



GW 30 001

ONE-WAY SWITCHES - 250V AC

Code	Description	Type	Symbol	Rated power of 230V LED lamps	No. Playbus modules	Pack Carton
GW 30 001	1P - 16AX	General	-	200 W	1	24/96
GW 30 002	1P - 16AX illuminable	Night-time backlit	-	200 W	1	24/48
GW 30 003	1P - 16AX illuminable	Functional indicator	-	200 W	1	24/48
GW 30 004	2P - 16 AX	General	0/1	200 W	1	24/48
GW 30 007	2P - 10AX	With key	0/1	100 W	1	1/12

ACCESSORIES SUPPLIED: GW30007: 2 keys. The key can be extracted in both positions. Spare keys: GW20901. Backlit items are supplied without lamp. They use miniature lamp units.



GW 30 011

TWO-WAY SWITCHES - 250V AC

Code	Description	Type	Rated power of 230V LED lamps	No. Playbus modules	Pack Carton
GW 30 011	1P - 16AX	General	200 W	1	24/96
GW 30 012	1P - 16AX illuminable	Night-time backlit	200 W	1	24/48
GW 30 013	1P - 16AX illuminable	Functional indicator	200 W	1	24/48

ACCESSORIES SUPPLIED: backlit items are supplied without lamp. They use miniature lamp units.



GW 30 015

INTERMEDIATE SWITCH - 250V AC

Code	Description	Type	Rated power of 230V LED lamps	No. Playbus modules	Pack Carton
GW 30 015	1P - 16AX	General	200 W	1	24/48



GW 30 016

THREE-WAY SWITCH - 250V AC

Code	Description	Symbol	Rated power of 230V LED lamps	No. Playbus modules	Pack Carton
GW 30 016	1P - 10AX	UP - DOWN	100 W	1	24/48

CHARACTERISTICS: three standing positions. Both contacts are open in the central position (OFF).

APPLICATIONS: command of circuits requiring an interlock (e.g. operating motorised devices with direction reversal), 2-user selective control.



GW 30 021

PUSH-BUTTONS - 250V AC

Code	Description	Type	Symbol	No. Playbus modules	Pack Carton
GW 30 021	1P NO - 16A	General	-	1	24/96
GW 30 022	1P NO - 16A illuminable	Night-time backlit	-	1	12/24
GW 30 023	1P NO - 16A illuminable	Functional indicator	-	1	12/24
GW 30 024	1P NO - 16A illuminable	With symbol	Key	1	12/24
GW 30 025	1P NO - 16A illuminable	With symbol	Bell	1	12/24
GW 30 026	1P NO - 16A illuminable	With symbol	Light	1	12/24
GW 30 027	1P NO - 16A illuminable	With symbol	Stairs	1	12/24
GW 30 030	2P NO - 16A	General	0	1	24/48
GW 30 031	2P NO - 16A	With pull-cord	-	1	4/32
GW 30 032	2P NO - 10A	With key	0/1	1	1/24
GW 30 033	1P NO - 16A double button	Double button 25 x 22.5 mm	-	1	12/24
GW 30 034	1P NO+NO - 10A	With interlock	UP - DOWN	1	12/24
GW 30 035	1P NC - 16A	General	0	1	12/24
GW 30 036	1P NO - 10A - Aux. NC	Start	Green	1	12/24
GW 30 037	1P NC - 10A - Aux. NO	Stop	Red	1	12/24

CHARACTERISTICS: GW30033: independent push-buttons that can also be activated simultaneously. GW30034: three-way push-button with interlock.

Both contacts are open in the central position (OFF).

APPLICATIONS: GW30034: impulse activation of motorised devices with direction reversal (e.g. roller shutters, curtains, etc.).

ACCESSORIES SUPPLIED: GW30031 cord in insulating material, 150cm long, with knob. GW30032 supplied with 2 keys. Spare keys: GW30912.

Backlit items are supplied without lamp. They use miniature lamp units.

PUSH-BUTTON WITH BACKLIT NAME-PLATE - 250V AC

Code	Description	Lamp	Lamp voltage	Lamp power	No. Playbus modules	Pack Carton
GW 30 038	1P NO - 10A illuminable	Cartridge lamp 56x36 mm	12 - 24 V	2 W	2	12/36

APPLICATIONS: in installations on 3 modules plates, the dimensions of the device (only 2 modules) allow another 1 module device to be inserted.

ACCESSORIES SUPPLIED: supplied without lamp.



GW 30 038

PLAYBUS - Domestic range

BLANKING MODULES AND CABLE OUTLET



GW 30 901

BLANKING MODULES AND CABLE OUTLET

Code	Description	No. Playbus modules	Pack Carton
GW 30 901	1 module	1	5/200
GW 30 902	2 modules	2	12/48
GW 30 903	3 modules	3	8/32
GW 30 905	1 module with outlet for cable Ø 4 and Ø 8mm	1	24/48

APPLICATIONS: in addition to their normal use, they permit installing signal socket-outlets, microswitches and LEDs after appropriate drilling/preparation. In addition, it is possible to apply the temperature sensor GW30703 using the special double-sided adhesive.

ACCESSORIES SUPPLIED: GW30905, fastener cable fastener device.

INFRARED MOVEMENT SENSOR



GW 30 121

INFRARED MOVEMENT DETECTORS

Code	Supply voltage	Output contacts	No. Playbus modules	Pack Carton
GW 30 121	230V ac - 50/60Hz	1NO 3A(AC1) 250V ac	1	1/6

CHARACTERISTICS: adjustment of the intervention duration 15 sec - 10 min. Light sensitive threshold adjustment - min. 10 lux - max. inhibited. Sensor with fixed lens. Suitable for commanding halogen lamps/resistive loads: 700 W, incandescent lamps: 450 W, low voltage halogen lamps (12 V) controlled by toroidal or electronic transformers: 450 W, uncompensated fluorescent lamps: 2x58 W, motors and gear motors: 400 VA. Not suitable for compensated fluorescent lamps, for discharge lamps and for all loads not indicated that must be commanded using a support relay.

APPLICATIONS: Energy-saving: command of the lighting of rooms and areas only when people pass through.

Comfort and safety: automatic command of circuits without needing to activate one-way switches.

NOTES: do not install the product in watertight plates: the lid membrane does not allow the detector lens to work correctly.

POWER

SOCKET-OUTLETS - ITALIAN STANDARD



GW 30 203

ITALIAN STANDARD SOCKET-OUTLETS - 250V AC

Code	Description	Type	For plug pins	No. Playbus modules	Pack Carton
GW 30 201	2P+E - 10A	P11	Ø 4 mm	1	24/96
GW 30 203	2P+E - 16 A Dual amperage	P17-11	Ø 4 / 5 mm	1	24/96

CHARACTERISTICS: with safety shields.



GW 30 210

ITALIAN/GERMAN STANDARD SOCKET-OUTLETS - 250V AC

Code	Description	Earth pit	Type	For plug pins	No. Playbus modules	Pack Carton
GW 30 210	2P+E - 16A	Side and central	P30	Ø 4 / 4.8 mm	2	12/48
GW 30 212	2P+E - 16 A Dual amperage	Side and central	P40	Ø 4 / 4.8 / 5 mm	2	12/48

CHARACTERISTICS: with safety shields.

SOCKET-OUTLETS FOR DEDICATED LINES



GW 30 321

ITALIAN STANDARD SOCKET-OUTLETS FOR DEDICATED LINES - 250V AC

Code	Description	Colour	Type	For plug pins	No. Playbus modules	Pack Carton
GW 30 321	2P+E - 16 A Dual amperage	Red	P17-11	Ø 4 / 5 mm	1	24/48
GW 30 331	2P+E - 16 A Dual amperage	Green	P17-11	Ø 4 / 5 mm	1	24/48

CHARACTERISTICS: with safety shields.

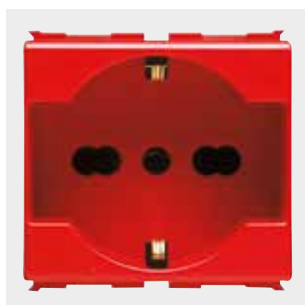

GW 30 214

ITALIAN/GERMAN STANDARD SOCKET-OUTLETS FOR DEDICATED LINES - 250V AC

Code	Description	Earth pit	Colour	Type	For plug pins	No. Playbus modules	Pack Carton
GW 30 214	2P+E - 16 A Dual amperage	Side and central	Red	P40	Ø 4 / 4.8 / 5 mm	2	12/24

CHARACTERISTICS: with safety shields.

PLAYBUS - Domestic range



GW 30 322

GERMAN STANDARD SOCKET-OUTLETS FOR DEDICATED LINES - 250V AC

Code	Description	Colour	For plug pins	No. Playbus modules	Pack Carton
GW 30 322	2P+E - 16A	Red	Ø 4.8 mm	2	12/24

CHARACTERISTICS: with safety shields.

SOCKET-OUTLETS - INTERNATIONAL STANDARD



GW 30 211

GERMAN STANDARD SOCKET-OUTLET - 250V AC

Code	Description	For plug pins	No. Playbus modules	Pack Carton
GW 30 211	2P+E - 16A	Ø 4.8 mm	2	12/48

CHARACTERISTICS: with safety shields.



GW 30 215

FRENCH STANDARD SOCKET-OUTLETS - 250V AC

Code	Description	For plug pins	No. Playbus modules	Pack Carton
GW 30 215	2P - 16A	Ø 4 / 4.8 mm	2	12/48
GW 30 216	2P+E - 16A	Ø 4 / 4.8 mm	2	12/48

CHARACTERISTICS: with safety shields.



GW 30 219

BRITISH STANDARD SOCKET-OUTLETS - 250V AC

Code	Description	For plug pins	No. Playbus modules	Pack Carton
GW 30 219	2P+E - 13 A	Flat	2	12/48
GW 30 220	2P+E - 16A	Ø 7 mm	2	12/48

CHARACTERISTICS: with safety shields.

NOTES: given the size of the plugs, it is not possible to install two or more socket-outlets side-by-side.



GW 30 234

SWISS STANDARD SOCKET-OUTLETS - 250V AC

Code	Description	For plug pins	No. Playbus modules	Pack Carton
GW 30 234	2P+E - 10A - type 13	Ø 4 mm	1	24/48

CHARACTERISTICS: with safety shields.



GW 30 227

EURO AMERICAN STANDARD SOCKET-OUTLETS - 250/125V AC

Code	Description	For plug pins	No. Playbus modules	Pack Carton
GW 30 227	2P+E - 10/15A	Ø 4.8 mm/ flat	1	24/48



GW 30 232

USA STANDARD SOCKET-OUTLETS - 125V AC

Code	Description	For plug pins	No. Playbus modules	Pack Carton
GW 30 232	2P+E - 15A	Flat parallel horizontal	1	24/48



GW 30 343

AUSTRALIAN STANDARD SOCKET-OUTLETS - 250V AC

Code	Description	For plug pins	No. Playbus modules	Pack Carton
GW 30 342	2P+E - 10A	Flat	2	12/48
GW 30 343	2P+E - 15A	Flat	2	12/48



GW 30 237

ISRAELI STANDARD SOCKET-OUTLET - 250V AC

Code	Description	For plug pins	No. Playbus modules	Pack Carton
GW 30 237	2P+E - 16A	Round Ø 4 / 4.4 mm	2	12/48

CHARACTERISTICS: with safety shields.

PLAYBUS - Domestic range

DATA

TV-SAT SOCKETS



GW 30 316

COAXIAL TV-SAT SOCKETS (5-2400 MHZ) CLASS A SHIELDING F FEMALE CONNECTOR

Code	Description	Type	Attenuation	No. Playbus modules	Pack Carton
GW 30 311	Direct	With passage of current	0 dB	1	24/48
GW 30 316	Through wiring	-	5 dB	1	1/24
GW 20 277	Terminal resistance 75 ohm	-	-	-	50/200

CHARACTERISTICS: GW30311 permits carrying a remote power supply voltage/current and/or control signals towards the user port (max 24 V - 500 mA). GW20277 in combination with feedthrough socket-outlets allows you to make terminal socket-outlets.

APPLICATIONS: Socket-outlets suitable for return channel.

NOTES: the TV-SAT 5 dB GW30316 coaxial socket-outlet is defined with conditioned use, it is a special through socket-outlet and as such must be used, with the only difference that the user door (socket-outlet towards the user device) must always be closed with a load of 75 Ohm (TV, VCR, SAT receiver or 75-Ohm termination).



GW 30 306

COAXIAL TV SOCKETS (5-2400 MHZ) CLASS A SHIELDING IEC MALE CONNECTOR Ø 9.5 MM

Code	Description	Type	Attenuation	No. Playbus modules	Pack Carton
GW 30 301	Direct	With passage of current	0 dB	1	24/48
GW 30 306	Through wiring	-	5 dB	1	1/24
GW 20 277	Terminal resistance 75 ohm	-	-	-	50/200

CHARACTERISTICS: GW30301 permits carrying a remote power supply voltage/current and/or control signals towards the user port (max 24 V - 500 mA). GW20277 in combination with feedthrough socket-outlets allows you to make terminal socket-outlets.

APPLICATIONS: Socket-outlets suitable for return channel.

NOTES: the TV 5 dB GW30306 coaxial socket-outlet is defined with conditioned use, it is a special through socket-outlet and as such must be used, with the only difference that the user door (socket-outlet towards the user device) must always be closed with a load of 75 Ohm (TV, VCR, SAT receiver or 75-Ohm termination).

TELEPHONE SOCKETS



GW 30 261

RJ11 TELEPHONE SOCKETS

Code	Description	No. pairs	Cables type	Connection	No. Playbus modules	Pack Carton
GW 30 261	RJ11	2	Twisted pair	Screw-on terminals	1	1/24

APPLICATIONS: telephone, telefax, modem.

DATA SOCKETS



GW 30 685

RJ45 SOCKETS

Code	Description	No. pairs	Use category	Cables type	Connection	No. Playbus modules	Pack Carton
GW 30 686	RJ45	4	6	FTP	Toolless	1	1/12
GW 30 685	RJ45	4	6	UTP	Toolless	1	1/12
GW 30 266	RJ45	4	5e	FTP	Toolless	1	1/24
GW 30 267	RJ45	4	5e	UTP	Toolless	1	1/24

APPLICATIONS: LANs up to 100MHz (e.g. Ethernet, Token Ring networks) for cat. 5e.

LANs up to 250MHz (e.g. Videoconference systems, CCTV) for cat. 6.

ACCESSORIES SUPPLIED: circuit identification label.



GW 30 287

ADAPTERS FOR HOUSING DATA SOCKETSS

Code	Compatibility	No. Playbus modules	Pack Carton
GW 30 286	SYSTIMAX COMMSCOPE	1	1/96
GW 30 287	AMP / Keystone Jack	1	1/96

ACCESSORIES SUPPLIED: circuit identification labels.

NOTES: with regard to the technological developments and dimensional variants introduced by connector manufacturers, you are advised to check in advance the full compatibility between the connector and the empty Gewiss container.

PROTECTION

MINIATURE CIRCUIT BREAKERS



GW 30 371

MINIATURE CIRCUIT BREAKERS - C CHARACTERISTIC - 230V AC

Code	Description	Rated current (A)	Breaking capacity	No. Playbus modules	Pack Carton
GW 30 371	Single pole (1P)	6	3 kA	1	1/12
GW 30 372	Single pole (1P)	10	3 kA	1	1/12
GW 30 373	Single pole (1P)	16	3 kA	1	1/12
GW 30 374	Two-pole (1P+N)	6	3 kA	1	1/12
GW 30 375	Two-pole (1P+N)	10	3 kA	1	1/12
GW 30 376	Two-pole (1P+N)	16	3 kA	1	1/12



GW 30 377

RESIDUAL CURRENT MINIATURE CIRCUIT BREAKERS - CHARACTERISTIC C - CLASS A - 230V AC - 50/60 HZ

Code	Description	I _{dn}	Rated current (A)	Breaking capacity	No. Playbus modules	Pack Carton
GW 30 377	Two-pole (1P+N)	10 mA	6	3 kA	2	1/6
GW 30 378	Two-pole (1P+N)	10 mA	10	3 kA	2	1/6
GW 30 379	Two-pole (1P+N)	10 mA	16	3 kA	2	1/6

PROTECTION DEVICES



GW 30 360

FUSE-HOLDER - 250V AC

Code	Rated current (A)	Fuse type	No. Playbus modules	Pack Carton
GW 30 360	16	Ø 6.3 x 32 mm	1	24/48

PLAYBUS - Domestic range

SIGNALLING

ANTI BLACK-OUT LAMP



GW 30 501

EXTRACTABLE ANTI BLACK-OUT LAMP - 230V - 50/60HZ

Code	Supply voltage	Power supply batteries	Autonomy	Type of lamp	No. Playbus modules	Pack Carton
GW 30 501	230V - 50/60 Hz	Ni-Mh	2 h	White LED	2	1/6

CHARACTERISTICS: equipped with inhibition selector on the front. Use battery pack 4.8 V 40 mAh.

INDICATOR LIGHT DEVICES



GW 30 611

INDICATOR LAMPS - 12/24/250V AC

Code	Diffuser colour	Diffuser meaning	Diffuser type	Fixing for lamp	No. Playbus modules	Pack Carton
Type: Single lamps						
GW 30 611	Red	Danger	Flat	Cartridge	1	24/48
GW 30 612	Green	Safety	Flat	Cartridge	1	24/48
GW 30 614	Transparent	Neutral	Flat	Cartridge	1	24/48

CHARACTERISTICS: supplied without lamp. They use S6x31 mm and S6.3x28 mm cartridge lamps (max 2 W).

NOTES: the meaning of the diffusers refers to the recommendations of standard EN60073 with regard to the use of the colours in indicator lights.

ACOUSTIC SIGNALLING DEVICES



GW 30 634

BELLS

Code	Supply voltage	Max power consumption	Sound intensity	No. Playbus modules	Pack Carton
GW 30 633	12V ac - 50 Hz	8 VA	80 dB (at 1 m)	1	12/24
GW 30 634	230V ac - 50Hz	8 VA	80 dB (at 1 m)	1	12/24

CHARACTERISTICS: for intermittent use (5 sec. ON / 15 sec. OFF).



GW 30 636

BUZZERS

Code	Supply voltage	Max power consumption	Sound intensity	No. Playbus modules	Pack Carton
GW 30 635	12V ac - 50 Hz	8 VA	70 dB (at 1 m)	1	12/24
GW 30 636	230V ac - 50Hz	8 VA	70 dB (at 1 m)	1	12/24

CHARACTERISTICS: for intermittent use (5 sec. ON / 15 sec. OFF).

ENERGY, TEMPERATURE AND COMFORT MANAGEMENT

DIMMER



GW 30 402

ROTATING ELECTRONIC REGULATOR FOR RESISTIVE LOADS

Code	Resistive load 230V ac	Resistive load 110V ac	Control	No. Playbus modules	Pack Carton
GW 30 402	100-500 W	50-250 W	Rotary	1	1/12

CHARACTERISTICS: frequency 50/60 Hz. Equipped with orange signalling LED.

NOTES: the installation of more than one product side-by-side in a single container is not permitted. To avoid overheating, insert a blanking module between two electronic devices. If installing two regulators in the same box, the maximum loads that can be commanded by each regulator must be reduced by 50%.



GW 30 403

ROTATING ELECTRONIC REGULATORS FOR RESISTIVE AND INDUCTIVE LOADS

Code	Resistive load 230V ac	Inductive load 230V ac	Control	No. Playbus modules	Pack Carton
GW 30 403	100-900 W	40-300 VA	Rotary	1	1/12

CHARACTERISTICS: frequency 50/60 Hz. Equipped with orange signalling LED. GW30403: resistive load 110V AC 100-500 W; inductive load 110V AC 20-150 VA.

GW30403 compliance with the EMC directive is only guaranteed by connecting the regulator to an LC filter with the following characteristics: L=1mH - 5A, C=0.15uF - 275V X2, according to the documentation provided with the product. Item designated solely for export to a limited number of countries outside the European Union or countries applying to become part of the European Free Trade Area. Contact Gewiss Customer Service to check the product meets the regulations of the country concerned before importing it.

NOTES: the installation of more than one product side-by-side in a single container is not permitted. To avoid overheating, insert a blanking module between two electronic devices. If installing two regulators in the same box, the maximum loads that can be commanded by each regulator must be reduced by 50%.



GW 30 401

ELECTRONIC REGULATOR WITH BUTTON - FOR RESISTIVE AND INDUCTIVE LOADS

Code	Resistive load 230V ac	Inductive load 230V ac	Control	No. Playbus modules	Pack Carton
GW 30 401	60-500 W	60-500 VA	Push-button	2	1/6

CHARACTERISTICS: frequency 50/60 Hz. Equipped with orange signalling LED.

ACCESSORIES SUPPLIED: quick fuse Ø 5x20 mm - 2.5 A.

NOTES: the installation of more than one product side-by-side in a single container is not permitted.

To avoid overheating, insert a blanking module between two electronic devices. If installing two regulators in the same box, the maximum loads that can be commanded by each regulator must be reduced by 50%.

PLAYBUS - Domestic range

TEMPERATURE CONTROL DEVICES



GW 30 706

TIMED THERMOSTAT - DAILY/WEEKLY PROGRAMMING

Code	Supply voltage	Temperature adjustment	Output contacts	No. Playbus modules	Pack Carton
GW 30 706	230 V ac - 50/60 Hz	From +5°C to +40°C	1NO/NC 5A(AC1)/2A(AC15) 250V ac	2	1/2

CHARACTERISTICS: with rechargeable buffer battery to guarantee the updating of the calendar (date, day, time) in the event of a blackout.
Serial input for connecting the GW90821 GSM remote control.



GW 30 702

ELECTRONIC SUMMER/WINTER THERMOSTAT WITH INPUT FOR REMOTE CONTROL OF NIGHT-TIME REDUCTION 230V - 50/60HZ

Code	Temperature adjustment	Output contacts	No. Playbus modules	Pack Carton
GW 30 702	From +5°C to +40°C	1NO 5A(AC1)/2A (AC15) 250V ac	3	2/4

CHARACTERISTICS: with buffer battery (30 days reserve charge). Input for 1 external probe GW30703 available as accessory, to display the temperature of another environment.
NOTES: customizable temperature setpoints: frost, comfort and night.



GW 30 703

PROBE TO MEASURE INTERNAL/EXTERNAL TEMPERATURE

Code	Suitable for	Outer dim. LxHxD (mm)	Cable length	Pack Carton
GW 30 703	GW30702	39x23x14	10 m	2/12

CHARACTERISTICS: cable extendable up to max 50m (min section 2x0.35mm²).

APPLICATIONS: can be used in bedrooms, bathrooms, kitchens, as a supplementary indoor probe, or outside the home.

ACCESSORIES SUPPLIED: expandable wall plug with screws and double-sided adhesive for wall or smooth surfaces mounting (or on a blanking module).

SPECIAL APPLICATIONS

COMPONENTS FOR HOTEL SYSTEMS



GW 30 430

UNIVERSAL BADGE SWITCH WITH BACKLIT LIGHT - 250V AC

Code	Description	For badge card max. width	Type	Rated power of 230V LED lamps	No. Playbus modules	Pack Carton
GW 30 430	1P NO - 10A	54 mm	Backlit 230V ac	100 W	3	1/2

CHARACTERISTICS: supplied without a badge.

APPLICATIONS: activation of circuits and services in hotel rooms (e.g. lights, air-conditioner, fridge-bar), indication of room occupied (with badge inserted).



GW 30 711

EUROPEAN/AMERICAN STANDARD SHAVER SOCKET WITH INSULATION TRANSFORMER

Code	Supply voltage	For plug pins	Selectable output voltage	Maximum power	No. Playbus modules	Pack Carton
GW 30 711	230V ac - 50/60 Hz	Ø 4 / 5 - 6.3x1.5 mm	120 - 230V ac	20 VA	3	2/4

CHARACTERISTICS: the socket-outlet is equipped with a self-protection device against overloading.

The output voltage should be selected correctly, consulting the rating of the user device before inserting the plug. The relevant indicator LED allows the chosen voltage to be clearly seen.

PLAYBUS - Domestic range

ACCESSORIES

SPARE PARTS AND ACCESSORIES



ZC6

MINIATURE LAMPS WITH QUICK COUPLING TERMINALS

Code	Lamp voltage	Lamp power	Lamp	Light emitted	Pack Carton
GW 30 943	230 V ac	0.4 W	Fluorescent	Red	50
GW 30 944	230V ac	0.4 W	Fluorescent	Green	50
GW 30 946	110 / 230V ac	0.6 W	LED	Light blue	50
GW 30 947	110 / 230V ac	0.6 W	LED	White	50
GW 10 893	12-24V ac/dc	0.4 W	LED	White	50

APPLICATIONS: miniature lamps are mounted on all control devices fitted for luminous signalling.



GW 20 902

CARTRIDGE LAMPS

Code	Dimensions (mm)	Lamp voltage	Lamp power	Lamp	Light emitted	Pack Carton
GW 20 902	56x36	12V ac/dc	2 W	Incandescence	White	50
GW 20 903	56x36	24V ac/dc	2 W	Incandescence	White	50
GW 20 904	56x31	12V ac/dc	2 W	Incandescence	White	50
GW 20 905	56x31	24V ac/dc	2 W	Incandescence	White	50
GW 20 906	56.3x28	110 / 230V ac	0.4 W	Fluorescent	Red	50
GW 20 908	56.3x28	110 / 230V ac	0.4 W	Fluorescent	Green	50

NOTES: the cartridge lamps are mounted on the stair riser, on the single indicator lamps and on the push-buttons with a name plate.



GW 20 911

MINIATURE FUSES - 250V AC

Code	Dimensions (mm)	Rated current (A)	Rated voltage	Pack Carton
GW 20 911	∅ 5 x 20	2.5	250V ac	20/200
GW 20 921	∅ 6.3 x 32	2	250V ac	10/200
GW 20 922	∅ 6.3 x 32	4	250V ac	10/200
GW 20 923	∅ 6.3 x 32	6	250V ac	10/200
GW 20 924	∅ 6.3 x 32	10	250V ac	10/200
GW 20 925	∅ 6.3 x 32	16	250V ac	10/200

SET OF 2 KEYS FOR COMMAND DEVICES



GW 20 901

Code	Suitable for	Pack Carton
GW 20 901	One-way switches - two-way switches	1/100
GW 30 912	Push-buttons	1/100



Playbus



Scan the QR Code and find out all the technical informations.

DESIGN AND SAFETY



The Playbus series includes two plate shapes, modern or classic, available in 5 colours with a glossy or satin finish. The use of technopolymer ensures complete and safe electrical insulation together with greater durability of colours and finishes.

INSTALLATION FLEXIBILITY



The Playbus series lets you manage multiple sockets and lines from a single point, thanks to the high-capacity plates, with up to 18 modules and internal circuit separation. The exceptional flexibility of the installations is also ensured by the wide range of accessories available.

CONTROL DEVICES



The control units have three types of backlighting: functional (also visible during the day), night location (discrete luminosity) and iconographic.

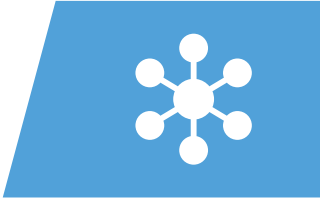

DAHLIA



Domestic range

PLATES

pag. 1062

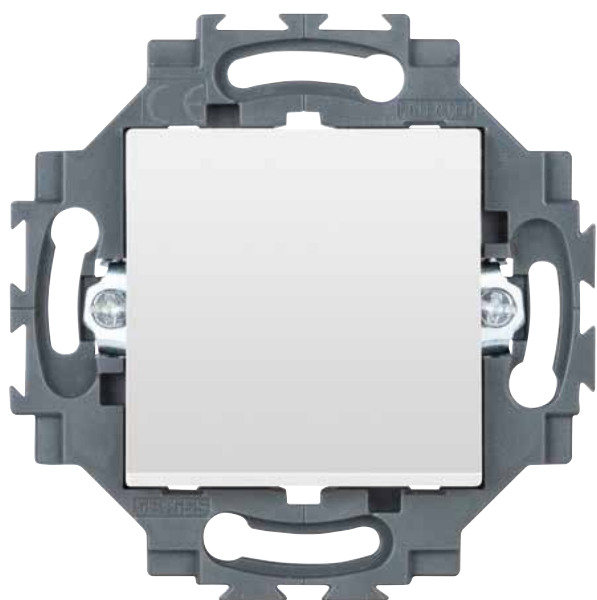

Domestic range

MONOBLOC DEVICES

pag. 1070

DAHLIA - Domestic range

DAHLIA PLATES

Technopolymer

WHITE



GW 35 901 AW	1 gang
GW 35 902 AW	2 gang
GW 35 903 AW	3 gang
GW 35 904 AW	4 gang
GW 35 905 AW	5 gang
GW 35 909 AW	Double

IVORY



GW 35 901 AY	1 gang
GW 35 902 AY	2 gang
GW 35 903 AY	3 gang
GW 35 904 AY	4 gang
GW 35 905 AY	5 gang
GW 35 909 AY	Double

HEMP



GW 35 901 AH	1 gang
GW 35 902 AH	2 gang
GW 35 903 AH	3 gang
GW 35 904 AH	4 gang
GW 35 905 AH	5 gang
GW 35 909 AH	Double

CREAM



GW 35 901 AM	1 gang
GW 35 902 AM	2 gang
GW 35 903 AM	3 gang
GW 35 904 AM	4 gang
GW 35 905 AM	5 gang
GW 35 909 AM	Double

LIGHT GREY



GW 35 901 AG	1 gang
GW 35 902 AG	2 gang
GW 35 903 AG	3 gang
GW 35 904 AG	4 gang
GW 35 905 AG	5 gang
GW 35 909 AG	Double

DARK GREY



GW 35 901 AD	1 gang
GW 35 902 AD	2 gang
GW 35 903 AD	3 gang
GW 35 904 AD	4 gang
GW 35 905 AD	5 gang
GW 35 909 AD	Double

ANTHRACITE GREY



GW 35 901 AN	1 gang
GW 35 902 AN	2 gang
GW 35 903 AN	3 gang
GW 35 904 AN	4 gang
GW 35 905 AN	5 gang
GW 35 909 AN	Double

Modularity

Centre distance 71 mm

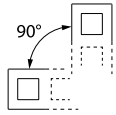

1 gang

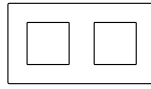

2 gang

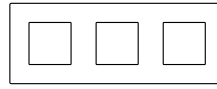

3 gang

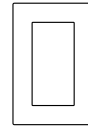

Double

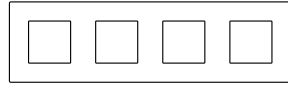

4 gang

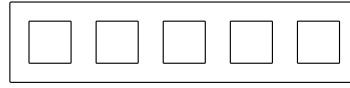

5 gang

DAHLIA - Domestic range

SWITCHES - WHITE

One-way switches quick wiring



GW 35 031 W
1P-10 AX
Illuminable (*)



GW 35 002 W
1P-10 AX
Backlit



GW 35 006 W
1P-10 AX
Backlit



GW 35 003 W
2P-10 AX
Illuminable (*)



GW 35 051 W
1P-10 AX
Double one-way switch

Two-way switches quick wiring

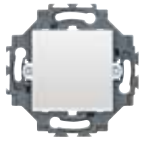

GW 35 071 W
1P-10 AX
Illuminable (*)



GW 35 012 W
1P-10 AX
Backlit



GW 35 016 W
1P-10 AX
Backlit



GW 35 052 W
1P-10 AX
Double two-way switch

Intermediate switch quick wiring

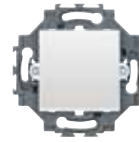

GW 35 015 W
1P-10 AX

Push-buttons quick wiring



GW 35 021 W
1P-10 A
Illuminable (*)



GW 35 022 W
1P-10 A
Backlit



GW 35 026 W
1P-10 A
Backlit

ENERGY SOCKETS - WHITE

German socket-outlet quick wiring



GW 35 206 W
2P+E-16 A-250 V ac
Illuminable (*)

German socket-outlets screw wiring



GW 35 207 W
2P+E-16 A-250 V ac
Illuminable (*)



GW 35 203 W
2P+E-16 A-250 V ac
IP40 - With lid
Illuminable (*)



GW 35 204 W
2P+E-16 A-250 V ac
Double

French socket-outlet quick wiring



GW 35 216 W
2P+E-16 A-250 V ac
Illuminable (*)

French socket-outlets screw wiring



GW 35 212 W
2P+E-16 A-250 V ac
Illuminable (*)



GW 35 213 W
2P+E-16 A-250 V ac
IP40 - With lid
Illuminable (*)



GW 35 214 W
2P+E-16 A-250 V ac
Double

DIMMERS - WHITE



Universal dimmer





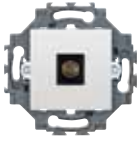
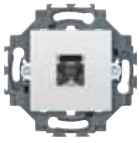
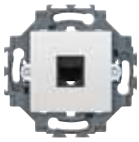
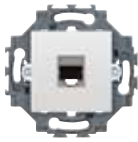
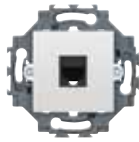
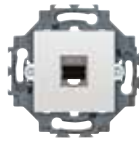
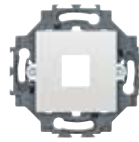

GW 35 301 W
4-160 W
With two-way switch
230 V ac-50 Hz

(*) supplied without LED signalling unit



DATA SOCKETS - WHITE

TV socket	 GW 35 261 W Direct - 0 db							
Telephone socket	 GW 35 251 W RJ11							
Data sockets	 GW 35 271 W RJ45 cat.5e UTP	 GW 35 272 W RJ45 cat.5e FTP	 GW 35 273 W RJ45 cat.6 UTP	 GW 35 274 W RJ45 cat.6 FTP	 GW 35 280 W AMP/Keystone Jack adapter	USB and HDMI couplers	 GW 38 056 HDMI coupler	 GW 38 057 USB coupler

ACCESSORIES

LED signalling unit	 GW 35 981 230 V ac-50/60 Hz	Lenses with illuminated symbol	 GW 35 986 Lens kit	Protective cover	 GW 35 996 For painting	Wall-mounting boxes - IP40	 GW 35 911 1 gang	 GW 35 912 2 gang
----------------------------	---	---------------------------------------	--	-------------------------	--	-----------------------------------	--	--

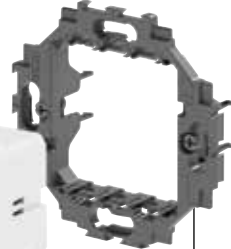
SUPPORTS FOR MODULAR DEVICES

Support	 GW 35 991	<p>All Chorus modular devices (max. 2 modules) can be fitted with GW35991 supports and completed with DAHLIA plates.</p>	 Support GW 35 991
 DAHLIA plates		 Chorus modular devices	

Dahlia devices are suitable for Ø 60 mm round boxes. They can be used with all the Gewiss round boxes. They can be mounted on the Gewiss GW24231 square boxes only with screws (not with claws).

DAHLIA - Domestic range

SWITCHES - IVORY

One-way switches quick wiring



GW 35 001 Y
1P-10 AX
Illuminable (*)



GW 35 002 Y
1P-10 AX
Backlit



GW 35 006 Y
1P-10 AX
Backlit



GW 35 003 Y
2P-10 AX
Illuminable (*)



GW35051Y
1P-10 AX
Double one-way switch

Two-way switches quick wiring

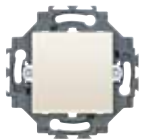

GW 35 011 Y
1P-10 AX
Illuminable (*)

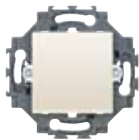

GW 35 012 Y
1P-10 AX
Backlit



GW 35 016 Y
1P-10 AX
Backlit



GW 35 052 Y
1P-10 AX
Double two-way switch

Intermediate switch quick wiring

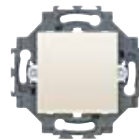

GW 35 015 Y
1P-10 AX

Push-buttons quick wiring

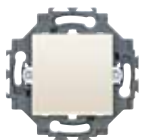

GW 35 021 Y
1P-10 A
Illuminable (*)

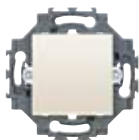

GW 35 022 Y
1P-10 A
Backlit



GW 35 026 Y
1P-10 A
Backlit

ENERGY SOCKETS - IVORY

German socket-outlet quick wiring



GW 35 201 Y
2P+E-16 A-250 V ac
Illuminable (*)

German socket-outlets screw wiring

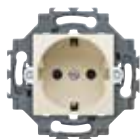

GW 35 202 Y
2P+E-16 A-250 V ac
Illuminable (*)



GW 35 203 Y
2P+E-16 A-250 V ac
IP40 - With lid
Illuminable (*)



GW 35 204 Y
2P+E-16 A-250 V ac
Double

French socket-outlet quick wiring



GW 35 211 Y
2P+E-16 A-250 V ac
Illuminable (*)

French socket-outlets screw wiring



GW 35 212 Y
2P+E-16 A-250 V ac
Illuminable (*)



GW 35 213 Y
2P+E-16 A-250 V ac
IP40 - With lid
Illuminable (*)



GW 35 214 Y
2P+E-16 A-250 V ac
Double

DIMMERS - IVORY



Universal dimmer





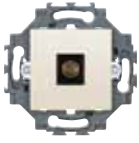
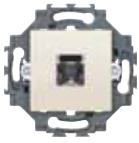
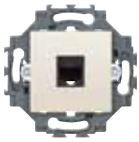
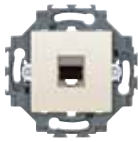
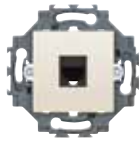
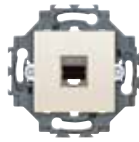
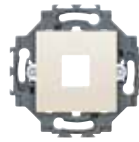

GW 35 301 Y
4-160 W
With two-way switch
230 V ac-50 Hz

(*) supplied without LED signalling unit

DATA SOCKETS - IVORY

TV socket	 GW 35 261 Y Direct - 0 db							
Telephone socket	 GW 35 251 Y RJ11							
Data sockets	 GW 35 271 Y RJ45 cat.5e UTP	 GW 35 272 Y RJ45 cat.5e FTP	 GW 35 273 Y RJ45 cat.6 UTP	 GW 35 274 Y RJ45 cat.6 FTP	 GW 35 280 Y AMP/Keystone Jack adapter	USB and HDMI couplers	 GW 38 056 HDMI coupler	 GW 38 057 USB coupler

ACCESSORIES

LED signalling unit	 GW 35 981 230 V ac-50/60 Hz	Lenses with illuminated symbol	 GW 35 986 Lens kit	Protective cover	 GW 35 996 For painting	Wall-mounting boxes - IP40	 GW 35 911 1 gang	 GW 35 912 2 gang
----------------------------	---	---------------------------------------	--	-------------------------	--	-----------------------------------	--	--

SUPPORTS FOR MODULAR DEVICES

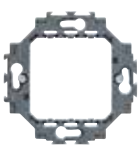
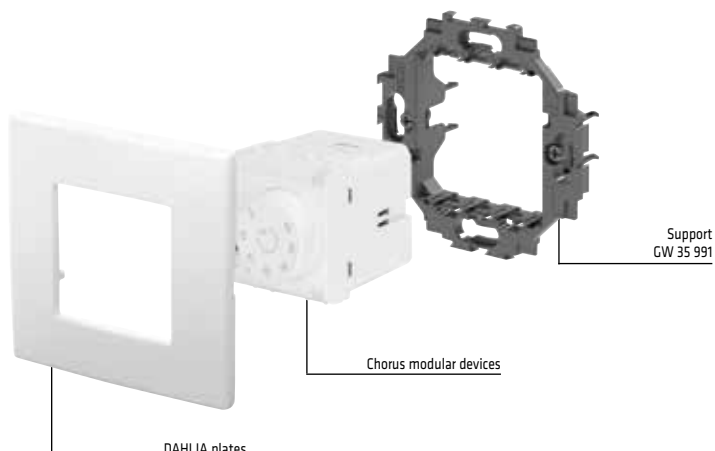
Support	 GW 35 991	<p>All Chorus modular devices (max. 2 modules) can be fitted with GW35991 supports and completed with DAHLIA plates.</p>	 <p>Support GW 35 991</p> <p>Chorus modular devices</p> <p>DAHLIA plates</p>
----------------	--	--	--

Dahlia devices are suitable for Ø 60 mm round boxes. They can be used with all the Gewiss round boxes. They can be mounted on the Gewiss GW24231 square boxes only with screws (not with claws).

Dahlia

Plates

A wide choice of plates, realized in technopolymer in seven colors with glossy finish: white, ivory, hemp, cream, light grey, dark grey, anthracite grey. Plates available in different modularities, from 1 to 5 gang, installable indifferently in horizontal or in vertical position.



DAHLIA PLATES

TECHNOPOLYMER



GW 35 901 AW

DAHLIA - WHITE

Code	Description	Type	Centre distance	Pack Carton
GW 35 901 AW	1 gang	-	-	240
GW 35 902 AW	2 gang	Horizontal/Vertical	71 mm	120
GW 35 903 AW	3 gang	Horizontal/Vertical	71 mm	100
GW 35 904 AW	4 gang	Horizontal/Vertical	71 mm	80
GW 35 905 AW	5 gang	Horizontal/Vertical	71 mm	60
GW 35 909 AW	Double	-	-	120

CHARACTERISTICS: glossy finish. GW35909AW suitable for double socket-outlets GW35204W, GW35204Y, GW35214W and GW35214Y.



GW 35 901 AY

DAHLIA - IVORY

Code	Description	Type	Centre distance	Pack Carton
GW 35 901 AY	1 gang	-	-	240
GW 35 902 AY	2 gang	Horizontal/Vertical	71 mm	120
GW 35 903 AY	3 gang	Horizontal/Vertical	71 mm	100
GW 35 904 AY	4 gang	Horizontal/Vertical	71 mm	80
GW 35 905 AY	5 gang	Horizontal/Vertical	71 mm	60
GW 35 909 AY	Double	-	-	120

CHARACTERISTICS: glossy finish. GW35909AY suitable for double socket-outlets GW35204W, GW35204Y, GW35214W and GW35214Y.



GW 35 901 AH

DAHLIA - HEMP

Code	Description	Type	Centre distance	Pack Carton
GW 35 901 AH	1 gang	-	-	240
GW 35 902 AH	2 gang	Horizontal/Vertical	71 mm	120
GW 35 903 AH	3 gang	Horizontal/Vertical	71 mm	100
GW 35 904 AH	4 gang	Horizontal/Vertical	71 mm	80
GW 35 905 AH	5 gang	Horizontal/Vertical	71 mm	60
GW 35 909 AH	Double	-	-	120

CHARACTERISTICS: glossy finish. GW35909AH suitable for double socket-outlets GW35204W, GW35204Y, GW35214W and GW35214Y.



GW 35 901 AM

DAHLIA - CREAM

Code	Description	Type	Centre distance	Pack Carton
GW 35 901 AM	1 gang	-	-	240
GW 35 902 AM	2 gang	Horizontal/Vertical	71 mm	120
GW 35 903 AM	3 gang	Horizontal/Vertical	71 mm	100
GW 35 904 AM	4 gang	Horizontal/Vertical	71 mm	80
GW 35 905 AM	5 gang	Horizontal/Vertical	71 mm	60
GW 35 909 AM	Double	-	-	120

CHARACTERISTICS: glossy finish. GW35909AM suitable for double socket-outlets GW35204W, GW35204Y, GW35214W and GW35214Y.



GW 35 901 AG

DAHLIA - LIGHT GREY

Code	Description	Type	Centre distance	Pack Carton
GW 35 901 AG	1 gang	-	-	240
GW 35 902 AG	2 gang	Horizontal/Vertical	71 mm	120
GW 35 903 AG	3 gang	Horizontal/Vertical	71 mm	100
GW 35 904 AG	4 gang	Horizontal/Vertical	71 mm	80
GW 35 905 AG	5 gang	Horizontal/Vertical	71 mm	60
GW 35 909 AG	Double	-	-	120

CHARACTERISTICS: glossy finish. GW35909AG suitable for double socket-outlets GW35204W, GW35204Y, GW35214W and GW35214Y.



GW 35 901 AD

DAHLIA - DARK GREY

Code	Description	Type	Centre distance	Pack Carton
GW 35 901 AD	1 gang	-	-	240
GW 35 902 AD	2 gang	Horizontal/Vertical	71 mm	120
GW 35 903 AD	3 gang	Horizontal/Vertical	71 mm	100
GW 35 904 AD	4 gang	Horizontal/Vertical	71 mm	80
GW 35 905 AD	5 gang	Horizontal/Vertical	71 mm	60
GW 35 909 AD	Double	-	-	120

CHARACTERISTICS: glossy finish. GW35909AD suitable for double socket-outlets GW35204W, GW35204Y, GW35214W and GW35214Y.



GW 35 901 AN

DAHLIA - ANTHRACITE GREY

Code	Description	Type	Centre distance	Pack Carton
GW 35 901 AN	1 gang	-	-	240
GW 35 902 AN	2 gang	Horizontal/Vertical	71 mm	120
GW 35 903 AN	3 gang	Horizontal/Vertical	71 mm	100
GW 35 904 AN	4 gang	Horizontal/Vertical	71 mm	80
GW 35 905 AN	5 gang	Horizontal/Vertical	71 mm	60
GW 35 909 AN	Double	-	-	120

CHARACTERISTICS: glossy finish. GW35909AN suitable for double socket-outlets GW35204W, GW35204Y, GW35214W and GW35214Y.

Dahlia

White monobloc devices

With an elegant appearance and classic shapes, the wiring device system Dahlia complements the decor of the home with minimal and essential forms. Colours and finishes: glossy white, bright and versatile. Ideal for flush-mounting solutions (for square and round boxes) and surface-mounting solutions.

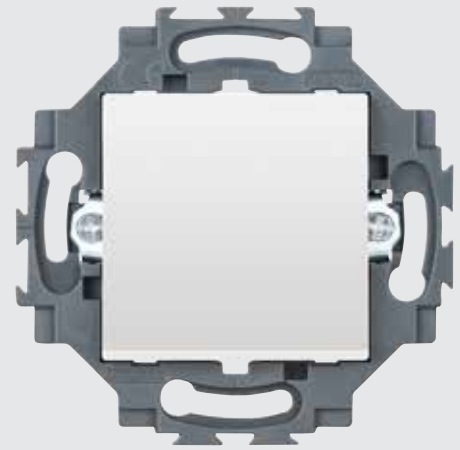

COMMAND - WHITE VERSION

COMMAND DEVICES - QUICK WIRING TERMINALS

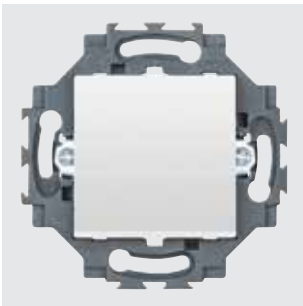

GW 35 001 W

ONE-WAY SWITCHES 1P - 250 V AC

Code	Description	Button key	Rated power of 230V LED lamps	Pack Carton
GW 35 031 W	1P - 10AX illuminable	Neutral	100 W	10/100
GW 35 002 W	1P - 10 AX backlit	Neutral	100 W	10/100
GW 35 006 W	1P - 10 AX backlit	With replaceable neutral lens	100 W	10/100

CHARACTERISTICS: the backlit articles include miniature lamp units with amber led lamp. The illuminable articles are pre-arranged for housing miniature led lamp units (not included).

NOTES: rear access terminals with spring quick wiring, no tools necessary.

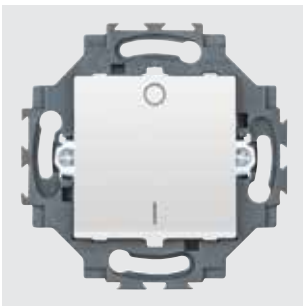

GW 35 003 W

ONE-WAY SWITCH 2P - 250 V AC

Code	Description	Button key	Symbol	Rated power of 230V LED lamps	Pack Carton
GW 35 003 W	2P - 10 AX illuminable	Neutral	0/1	100 W	10/100

CHARACTERISTICS: the illuminable articles are pre-arranged for housing miniature led lamp units (not included).

NOTES: rear access terminals with spring quick wiring, no tools necessary.

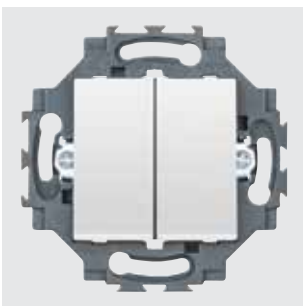

GW 35 051 W

DOUBLE ONE-WAY SWITCH 1P - 250 V AC

Code	Description	Button key	Rated power of 230V LED lamps	Pack Carton
GW 35 051 W	Double 1P - 10 AX	Neutral	100 W	10/100

NOTES: rear access terminals with spring quick wiring, no tools necessary.

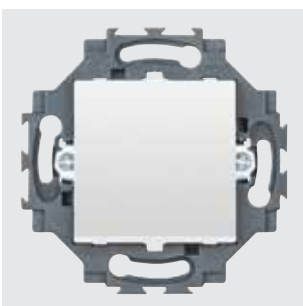

GW 35 011 W

TWO-WAY SWITCHES 1P - 250 V AC

Code	Description	Button key	Rated power of 230V LED lamps	Pack Carton
GW 35 071 W	1P - 10AX illuminable	Neutral	100 W	10/100
GW 35 012 W	1P - 10 AX backlit	Neutral	100 W	10/100
GW 35 016 W	1P - 10 AX backlit	With replaceable neutral lens	100 W	10/100

CHARACTERISTICS: the backlit articles include miniature lamp units with amber led lamp. The illuminable articles are pre-arranged for housing miniature led lamp units (not included).

NOTES: rear access terminals with spring quick wiring, no tools necessary.

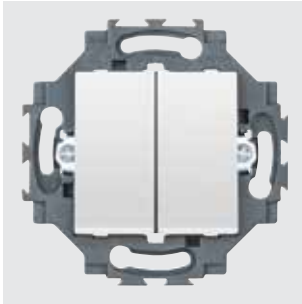

GW 35 052 W

DOUBLE TWO-WAY SWITCH 1P - 250 V AC

Code	Description	Button key	Rated power of 230V LED lamps	Pack Carton
GW 35 052 W	Double 1P - 10 AX	Neutral	100 W	10/100

NOTES: rear access terminals with spring quick wiring, no tools necessary.

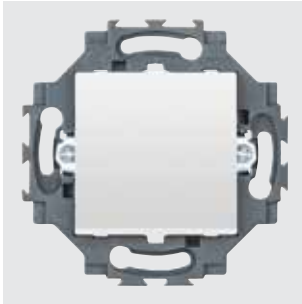

GW 35 015 W

INTERMEDIATE SWITCH 1P - 250 V AC

Code	Description	Button key	Rated power of 230V LED lamps	Pack Carton
GW 35 015 W	1P - 10AX	Neutral	100 W	10/100

NOTES: rear access terminals with spring quick wiring, no tools necessary.

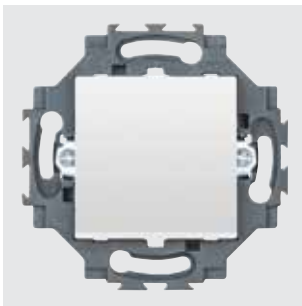

GW 35 021 W

PUSH-BUTTONS 1P - 250 V AC

Code	Description	Button key	Pack Carton
GW 35 021 W	1P - 10A illuminable	Neutral	10/100
GW 35 022 W	1P - 10 A backlit	Neutral	10/100
GW 35 026 W	1P - 10 A backlit	With replaceable neutral lens	10/100

CHARACTERISTICS: the backlit articles include miniature lamp units with amber led lamp. The illuminable articles are pre-arranged for housing miniature led lamp units (not included).

NOTES: rear access terminals with spring quick wiring, no tools necessary.

POWER - WHITE VERSION

GERMAN STANDARD SOCKET-OUTLETS - QUICK WIRING TERMINALS

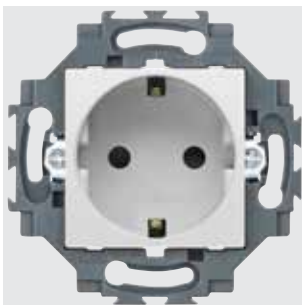

GW 35 206 W

GERMAN STANDARD SOCKET-OUTLET - 250 V AC

Code	Description	For plug pins	Pack Carton
GW 35 206 W	2P+E - 16A	Ø 4.8 mm	10/100

CHARACTERISTICS: with safety shields. Pre-arranged for housing miniature led lamp units (not included).

NOTES: rear access terminals with spring quick wiring, no tools necessary.

DAHLIA - Domestic range

GERMAN STANDARD SOCKET-OUTLETS - SCREW TERMINALS

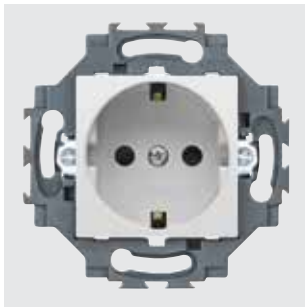

GW 35 207 W

GERMAN STANDARD SOCKET-OUTLETS WITH FRONT TIGHTENING TERMINALS - 250 V AC

Code	Description	Type	For plug pins	Pack Carton
GW 35 207 W	2P+E - 16A	-	Ø 4.8 mm	10/100
GW 35 203 W	2P+E - 16A	With lid	Ø 4.8 mm	10/100
GW 35 204 W	2P+E - 16A	Double	Ø 4.8 mm	6/60

CHARACTERISTICS: with safety shields. GW35203W equipped with rigid transparent lid with glossy finish and degree of protection IP40 with closed lid. GW35207W and GW35203W pre-arranged for housing miniature led lamp units (not included).

NOTES: front access terminals with screw wiring.

FRENCH STANDARD SOCKET-OUTLETS - QUICK WIRING TERMINALS

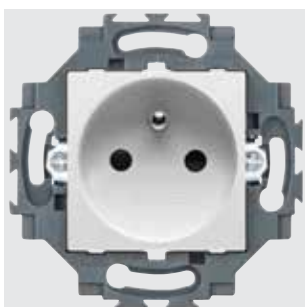

GW 35 216 W

FRENCH STANDARD SOCKET-OUTLET - 250 V AC

Code	Description	For plug pins	Pack Carton
GW 35 216 W	2P+E - 16A	Ø 4 / 4.8 mm	10/100

CHARACTERISTICS: with safety shields. Pre-arranged for housing miniature led lamp units (not included).

NOTES: rear access terminals with spring quick wiring, no tools necessary.

FRENCH STANDARD SOCKET-OUTLETS - SCREW TERMINALS

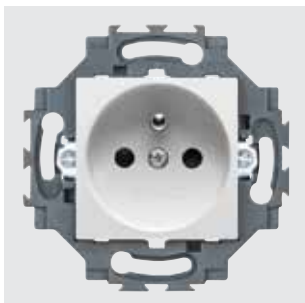

GW 35 212 W

FRENCH STANDARD SOCKET-OUTLETS WITH FRONT TIGHTENING TERMINALS - 250 V AC

Code	Description	Type	For plug pins	Pack Carton
GW 35 212 W	2P+E - 16A	-	Ø 4 / 4.8 mm	10/100
GW 35 213 W	2P+E - 16A	With lid	Ø 4 / 4.8 mm	10/100
GW 35 214 W	2P+E - 16A	Double	Ø 4 / 4.8 mm	6/60

CHARACTERISTICS: with safety shields. GW35213W equipped with rigid transparent lid with glossy finish and degree of protection IP40 with closed lid. GW35212W and GW35213W pre-arranged for housing miniature led lamp units (not included).

NOTES: front access terminals with screw wiring.

DIMMERS - WHITE VERSION

DIMMERS - SCREW TERMINALS

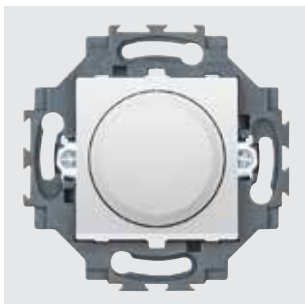

GW 35 301 W

UNIVERSAL ROTATING ELECTRONIC REGULATOR

Code	Supply voltage	Pack Carton
GW 35 301 W	230V ac - 50Hz	6/60

CHARACTERISTICS: for the regulation and switching of incandescent and halogen lamps 230V AC (20-160W), low voltage halogen lamps (12Vac) with electronic transformers (40-160W), LED lamps 230V AC with dimmer functions (4-160W), low voltage LED lamps (12Vac) with electronic transformers (4-110W). Rotary command with two-way switch.

DATA - WHITE VERSION

TV SOCKETS

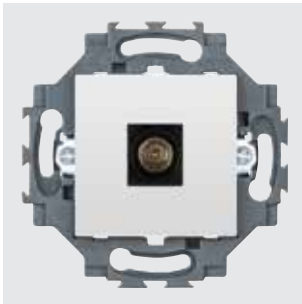

GW 35 261 W

COAXIAL TV SOCKET (5-2400 MHZ), CLASS A SHIELDING - MALE IEC CONNECTOR Ø 9.5 MM

Code	Description	Attenuation	Pack Carton
GW 35 261 W	Direct	0 dB	10/100

CHARACTERISTICS: allows the passage of voltage/current of remote power supply and/or control signals towards the user port (max 24V - 500 mA).
APPLICATIONS: socket-outlet suitable for return channel.

TELEPHONE SOCKETS

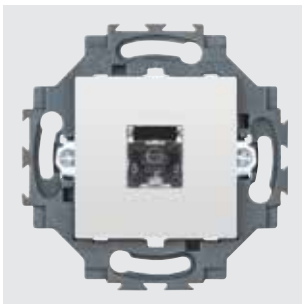

GW 35 251 W

INTERNATIONAL STANDARD TELEPHONE SOCKETS

Code	Description	Connection	Pack Carton
GW 35 251 W	RJ11	Screw-on terminals	10/100

APPLICATIONS: telephone, telefax, modem.

DATA SOCKETS

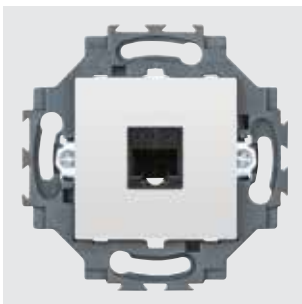

GW 35 271 W

RJ45 SOCKETS

Code	Description	Number pairs	Use category	Cables	Connection	Pack Carton
GW 35 271 W	RJ45	4	5e	UTP	Toolless	10/100
GW 35 272 W	RJ45	4	5e	FTP	Toolless	10/100
GW 35 273 W	RJ45	4	6	UTP	Toolless	10/100
GW 35 274 W	RJ45	4	6	FTP	Toolless	10/100

APPLICATIONS: LAN networks up to 100 MHz (e.g. Ethernet or Token Ring networks) for cat. 5e; LAN networks up to 250 MHz (e.g. video conference or video control systems) for cat. 6.

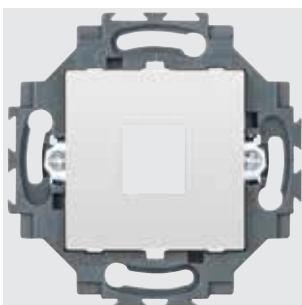

GW 35 280 W

ADAPTER FOR HOUSING DATA CONNECTORS

Code	Compatibility	Pack Carton
GW 35 280 W	AMP / Keystone Jack	10/100

NOTES: with regard to the technological developments and dimensional variants introduced by connector manufacturers, you are advised to check in advance the full compatibility between the connector and the Gewiss adapter.

DAHLIA - Domestic range

ADAPTERS FOR OPTICAL FIBER



GW 38 335

ANGLED SC/APC ADAPTER

Code	Type	Tilt	For connectors	Compatibility	Colour	Pack Carton
GW 38 335	Female/Female	40°	SC/APC	Keystone Jack	Green RAL 6018	1/25

CHARACTERISTICS: cable outlet inclined of 40° to the wall line. With ceramic fiber optic sleeve and dust caps. The front output is protected with safety cap and unmissable cord. Suitable to join two single-mode SC/APC fiber optic patch cables.

NOTES: for adapters (Chorus, System and Dahlia) with Keystone Jack coupling.

USB AND HDMI COUPLERS



GW 38 056

USB AND HDMI COUPLERS

Code	Description	Type	Compatibility	Pack Carton
GW 38 056	HDMI coupler	Female/Female	Keystone Jack	1/48
GW 38 057	USB coupler	Female/Female - A type	Keystone Jack	1/48

NOTES: for adapters designed to house data connectors (ChoruSmart, System and Playbus) with Keystone Jack type coupling and permutation panels.

SUPPORT FOR CHORUS MODULAR DEVICES



GW 35 991

SUPPORT

Code	Description	Fixing	Pack Carton
GW 35 991	For Dahlia plates	With clutches/Screws	20/200

CHARACTERISTICS: support equipped with fixing clutches, also pre-arranged for screw fixing.

APPLICATIONS: suitable for Chorus modular devices.

ACCESSORIES



GW 35 981

MINIATURE LED LAMP UNIT

Code	Lamp voltage	Colour	Power	Pack Carton
GW 35 981	230V ac - 50/60 Hz	Amber	0.6 W	50/500

NOTES: the miniature led lamps are supplied with power supply cables (length 10 cm).

APPLICATIONS: suitable for housing into backlit and illuminable switches and single socket-outlets.



GW 35 986

LENSES WITH ILLUMINATED SYMBOLS

Code	Description	Pack Carton
GW 35 986	Lens kit	1/50

NOTES: to be used in place of the neutral lens in the command devices.

The kit includes: 10 pieces of lens with the "Light" symbol, 10 pieces with the "Stair light" symbol, 10 pieces with the "Key" symbol and 10 pieces with the "Bell" symbol.



GW 35 996

PROTECTIVE COVER FOR PAINTING

Code	Description	Colour	Pack Carton
GW 35 996	1 gang	Transparent	50/800

CHARACTERISTICS: total protection during painting and finishing operations. Snap-in mounting to facilitate assembly and removal operation.

NOTES: available in 5-piece strip.



GW 35 911

WALL-MOUNTING BOXES FOR DAHLIA PLATES

Code	Description	Colour	Pack Carton
GW 35 911	1 gang	White	10/80
GW 35 912	2 gang	White	5/40

CHARACTERISTICS: plate not included. GW35911 requires a Dahlia 1 gang plate (GW35901xx); GW35912 requires a Dahlia 2 gang plate (GW35902xx).

Dahlia

Ivory monobloc devices

With an elegant appearance and classic shapes, the wiring device system Dahlia complements the decor of the home with minimal and essential forms. Colours and finishes: glossy ivory, bright and versatile. Ideal for flush-mounting solutions (for square and round boxes) and surface-mounting solutions.

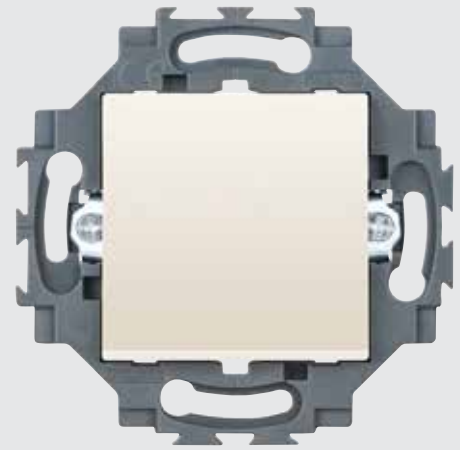

COMMAND - IVORY VERSION

COMMAND DEVICES - QUICK WIRING TERMINALS

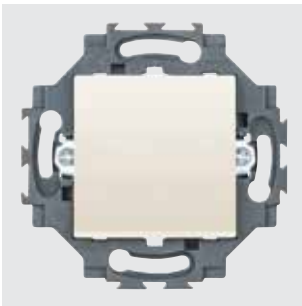

GW 35 001 Y

ONE-WAY SWITCHES 1P - 250 V AC

Code	Description	Button key	Rated power of 230V LED lamps	Pack Carton
GW 35 001 Y	1P - 10AX illuminable	Neutral	100 W	10/100
GW 35 002 Y	1P - 10 AX backlit	Neutral	100 W	10/100
GW 35 006 Y	1P - 10 AX backlit	With replaceable neutral lens	100 W	10/100

CHARACTERISTICS: the backlit articles include miniature lamp units with amber led lamp. The illuminable articles are pre-arranged for housing miniature led lamp units (not included).

NOTES: rear access terminals with spring quick wiring, no tools necessary.

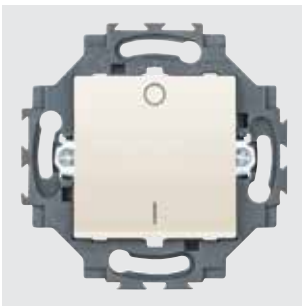

GW 35 003 Y

ONE-WAY SWITCH 2P - 250 V AC

Code	Description	Button key	Symbol	Rated power of 230V LED lamps	Pack Carton
GW 35 003 Y	2P - 10AX illuminable	Neutral	0/1	100 W	10/100

CHARACTERISTICS: the illuminable articles are pre-arranged for housing miniature led lamp units (not included).

NOTES: rear access terminals with spring quick wiring, no tools necessary.

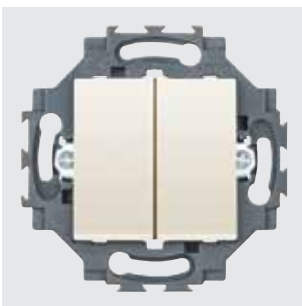

GW 35 051 Y

DOUBLE ONE-WAY SWITCH 1P - 250 V AC

Code	Description	Button key	Rated power of 230V LED lamps	Pack Carton
GW 35 051 Y	Double 1P - 10 AX	Neutral	100 W	10/100

NOTES: rear access terminals with spring quick wiring, no tools necessary.

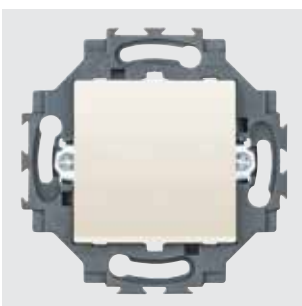

GW 35 011 Y

TWO-WAY SWITCHES 1P - 250 V AC

Code	Description	Button key	Rated power of 230V LED lamps	Pack Carton
GW 35 011 Y	1P - 10AX illuminable	Neutral	100 W	10/100
GW 35 012 Y	1P - 10 AX backlit	Neutral	100 W	10/100
GW 35 016 Y	1P - 10 AX backlit	With replaceable neutral lens	100 W	10/100

CHARACTERISTICS: the backlit articles include miniature lamp units with amber led lamp. The illuminable articles are pre-arranged for housing miniature led lamp units (not included).

NOTES: rear access terminals with spring quick wiring, no tools necessary.

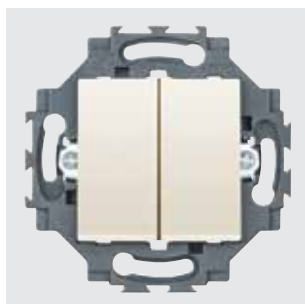

GW 35 052 Y

DOUBLE TWO-WAY SWITCH 1P - 250 V AC

Code	Description	Button key	Rated power of 230V LED lamps	Pack Carton
GW 35 052 Y	Double 1P - 10 AX	Neutral	100 W	10/100

NOTES: rear access terminals with spring quick wiring, no tools necessary.

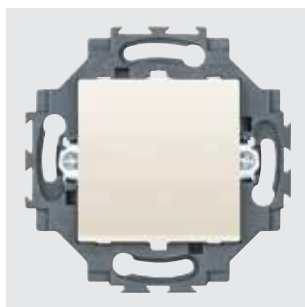

GW 35 015 Y

INTERMEDIATE SWITCH 1P - 250 V AC

Code	Description	Button key	Rated power of 230V LED lamps	Pack Carton
GW 35 015 Y	1P - 10AX	Neutral	100 W	10/100

NOTES: rear access terminals with spring quick wiring, no tools necessary.

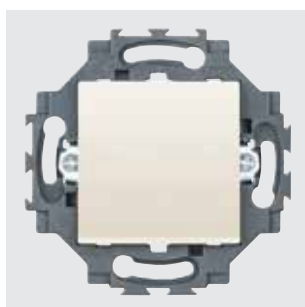

GW 35 021 Y

PUSH-BUTTONS 1P - 250 V AC

Code	Description	Button key	Pack Carton
GW 35 021 Y	1P - 10A illuminable	Neutral	10/100
GW 35 022 Y	1P - 10 A backlit	Neutral	10/100
GW 35 026 Y	1P - 10 A backlit	With replaceable neutral lens	10/100

CHARACTERISTICS: the backlit articles include miniature lamp units with amber led lamp. The illuminable articles are pre-arranged for housing miniature led lamp units (not included).

NOTES: rear access terminals with spring quick wiring, no tools necessary.

DAHLIA - Domestic range

POWER - IVORY VERSION

GERMAN STANDARD SOCKET-OUTLETS - QUICK WIRING TERMINALS

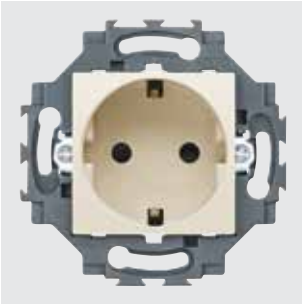

GW 35 201 Y

GERMAN STANDARD SOCKET-OUTLET - 250 V AC

Code	Description	For plug pins	Pack Carton
GW 35 201 Y	2P+E - 16A	Ø 4.8 mm	10/100

CHARACTERISTICS: with safety shields. Pre-arranged for housing miniature led lamp units (not included).

NOTES: rear access terminals with spring quick wiring, no tools necessary.

GERMAN STANDARD SOCKET-OUTLETS - SCREW TERMINALS

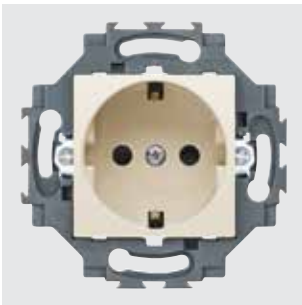

GW 35 202 Y

GERMAN STANDARD SOCKET-OUTLETS WITH FRONT TIGHTENING TERMINALS - 250 V AC

Code	Description	Type	For plug pins	Pack Carton
GW 35 202 Y	2P+E - 16A	-	Ø 4.8 mm	10/100
GW 35 203 Y	2P+E - 16A	With lid	Ø 4.8 mm	10/100
GW 35 204 Y	2P+E - 16A	Double	Ø 4.8 mm	6/60

CHARACTERISTICS: with safety shields. GW35203Y equipped with rigid transparent lid with glossy finish and degree of protection IP40 with closed lid. GW35202Y and GW35203Y pre-arranged for housing miniature led lamp units (not included).

NOTES: front access terminals with screw wiring.

FRENCH STANDARD SOCKET-OUTLETS - QUICK WIRING TERMINALS

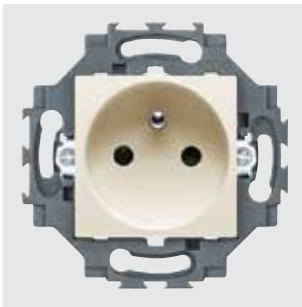

GW 35 211 Y

FRENCH STANDARD SOCKET-OUTLET - 250 V AC

Code	Description	For plug pins	Pack Carton
GW 35 211 Y	2P+E - 16A	Ø 4 / 4.8 mm	10/100

CHARACTERISTICS: with safety shields. Pre-arranged for housing miniature led lamp units (not included).

NOTES: rear access terminals with spring quick wiring, no tools necessary.

FRENCH STANDARD SOCKET-OUTLETS - SCREW TERMINALS

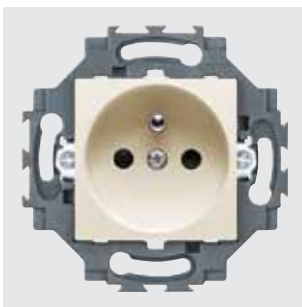

GW 35 212 Y

FRENCH STANDARD SOCKET-OUTLETS WITH FRONT TIGHTENING TERMINALS - 250 V AC

Code	Description	Type	For plug pins	Pack Carton
GW 35 212 Y	2P+E - 16A	-	Ø 4 / 4.8 mm	10/100
GW 35 213 Y	2P+E - 16A	With lid	Ø 4 / 4.8 mm	10/100
GW 35 214 Y	2P+E - 16A	Double	Ø 4 / 4.8 mm	6/60

CHARACTERISTICS: with safety shields. GW35213Y equipped with rigid transparent lid with glossy finish and degree of protection IP40 with closed lid. GW35212Y and GW35213Y pre-arranged for housing miniature led lamp units (not included).

NOTES: front access terminals with screw wiring.

DIMMERS - IVORY VERSION

DIMMERS - SCREW TERMINALS

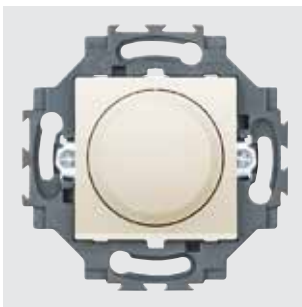

GW 35 301 Y

UNIVERSAL ROTATING ELECTRONIC REGULATOR

Code	Supply voltage	Pack Carton
GW 35 301 Y	230V ac - 50Hz	6/60

CHARACTERISTICS: for the regulation and switching of incandescent and halogen lamps 230V AC (20-160W), low voltage halogen lamps (12Vac) with electronic transformers (40-160W), LED lamps 230V AC with dimmer functions (4-160W), low voltage LED lamps (12Vac) with electronic transformers (4-110W). Rotary command with two-way switch.

DAHLIA - Domestic range

DATA - IVORY VERSION

TV SOCKETS

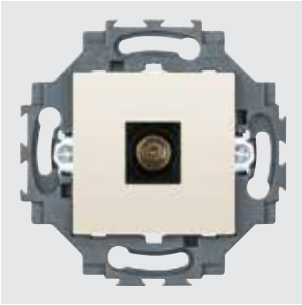

GW 35 261 Y

COAXIAL TV SOCKET (5-2400 MHZ), CLASS A SHIELDING - MALE IEC CONNECTOR Ø 9.5 MM

Code	Description	Attenuation	Pack Carton
GW 35 261 Y	Direct	0 dB	10/100

CHARACTERISTICS: allows the passage of voltage/current of remote power supply and/or control signals towards the user port (max 24V - 500 mA).

APPLICATIONS: socket-outlet suitable for return channel.

TELEPHONE SOCKETS

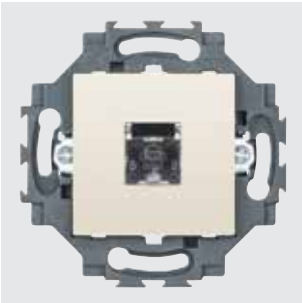

GW 35 251 Y

INTERNATIONAL STANDARD TELEPHONE SOCKETS

Code	Description	Connection	Pack Carton
GW 35 251 Y	RJ11	Screw-on terminals	10/100

APPLICATIONS: telephone, telefax, modem.

DATA SOCKETS

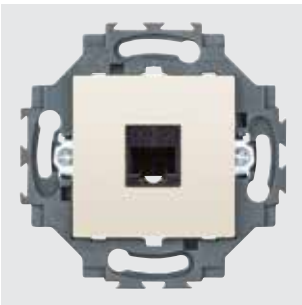

GW 35 271 Y

RJ45 SOCKETS

Code	Description	Number pairs	Use category	Cables	Connection	Pack Carton
GW 35 271 Y	RJ45	4	5e	UTP	Toolless	10/100
GW 35 272 Y	RJ45	4	5e	FTP	Toolless	10/100
GW 35 273 Y	RJ45	4	6	UTP	Toolless	10/100
GW 35 274 Y	RJ45	4	6	FTP	Toolless	10/100

APPLICATIONS: LAN networks up to 100 MHz (e.g. Ethernet or Token Ring networks) for cat. 5e; LAN networks up to 250 MHz (e.g. video conference or video control systems) for cat. 6.

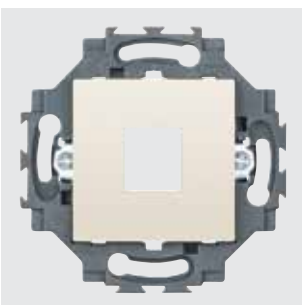

GW 35 280 Y

ADAPTER FOR HOUSING DATA CONNECTORS

Code	Compatibility	Pack Carton
GW 35 280 Y	AMP / Keystone Jack	10/100

NOTES: with regard to the technological developments and dimensional variants introduced by connector manufacturers, you are advised to check in advance the full compatibility between the connector and the Gewiss adapter.

ADAPTERS FOR OPTICAL FIBER



GW 38 335

ANGLED SC/APC ADAPTER

Code	Type	Tilt	For connectors	Compatibility	Colour	Pack Carton
GW 38 335	Female/Female	40°	SC/APC	Keystone Jack	Green RAL 6018	1/25

CHARACTERISTICS: cable outlet inclined of 40° to the wall line. With ceramic fiber optic sleeve and dust caps. The front output is protected with safety cap and unmissable cord. Suitable to join two single-mode SC/APC fiber optic patch cables.

NOTES: for adapters (Chorus, System and Dahlia) with Keystone Jack coupling.

USB AND HDMI COUPLERS



GW 38 056

USB AND HDMI COUPLERS

Code	Description	Type	Compatibility	Pack Carton
GW 38 056	HDMI coupler	Female/Female	Keystone Jack	1/48
GW 38 057	USB coupler	Female/Female - A type	Keystone Jack	1/48

NOTES: for adapters designed to house data connectors (ChoruSmart, System and Playbus) with Keystone Jack type coupling and permutation panels.

SUPPORT FOR CHORUS MODULAR DEVICES

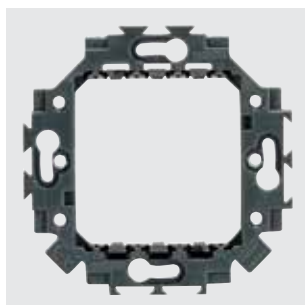

GW 35 991

SUPPORT

Code	Description	Fixing	Pack Carton
GW 35 991	For Dahlia plates	With clutches/Screws	20/200

CHARACTERISTICS: support equipped with fixing clutches, also pre-arranged for screw fixing.

APPLICATIONS: suitable for Chorus modular devices.

ACCESSORIES



GW 35 981

MINIATURE LED LAMP UNIT

Code	Lamp voltage	Colour	Power	Pack Carton
GW 35 981	230V ac - 50/60 Hz	Amber	0.6 W	50/500

NOTES: the miniature led lamps are supplied with power supply cables (length 10 cm).

APPLICATIONS: suitable for housing into backlit and illuminable switches and single socket-outlets.

DAHLIA - Domestic range



GW 35 986

LENSES WITH ILLUMINATED SYMBOLS

Code	Description	Pack Carton
GW 35 986	Lens kit	1/50

NOTES: to be used in place of the neutral lens in the command devices.

The kit includes: 10 pieces of lens with the "Light" symbol, 10 pieces with the "Stair light" symbol, 10 pieces with the "Key" symbol and 10 pieces with the "Bell" symbol.



GW 35 996

PROTECTIVE COVER FOR PAINTING

Code	Description	Colour	Pack Carton
GW 35 996	1 gang	Transparent	50/800

CHARACTERISTICS: total protection during painting and finishing operations. Snap-in mounting to facilitate assembly and removal operation.

NOTES: available in 5-piece strip.



GW 35 911

WALL-MOUNTING BOXES FOR DAHLIA PLATES

Code	Description	Colour	Pack Carton
GW 35 911	1 gang	White	10/80
GW 35 912	2 gang	White	5/40

CHARACTERISTICS: plate not included. GW35911 requires a Dahlia 1 gang plate (GW35901xx); GW35912 requires a Dahlia 2 gang plate (GW35902xx).



Dahlia



Scan the QR Code and find out all the technical informations.

DAHLIA

DAHLIA RANGE

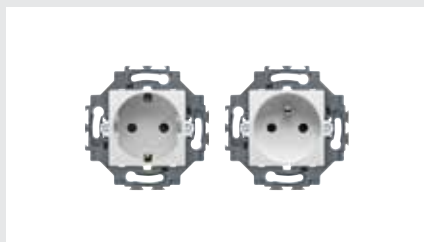

Dahlia wiring devices have been developed for those countries where round boxes are typically used. A wide range of devices available in white and ivory colors, with glossy finish, expandable for enhanced functions thanks to the ChoruSmart modular devices.

DAHLIA PLATES

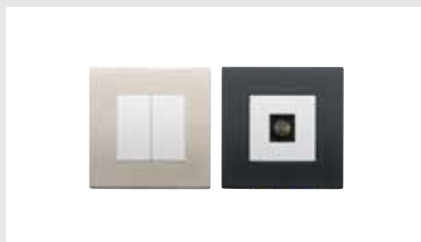

A wide choice of plates, realized in technopolymer in seven colors with glossy finish and in many modularities, installable indifferently in horizontal or in vertical position. A special plate has been designed for the double German and French socket-outlets.

EXPANDABLE WITH CHORUSMART



The special frame support allows the integration of the Dahlia range with the ChoruSmart modular devices, picking up whatever ChoruSmart device you should need. The support has to be completed with Dahlia plates.

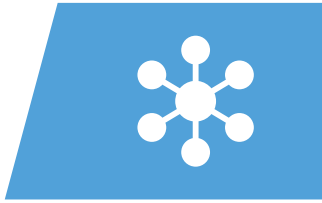

SMART HOME & BUILDING

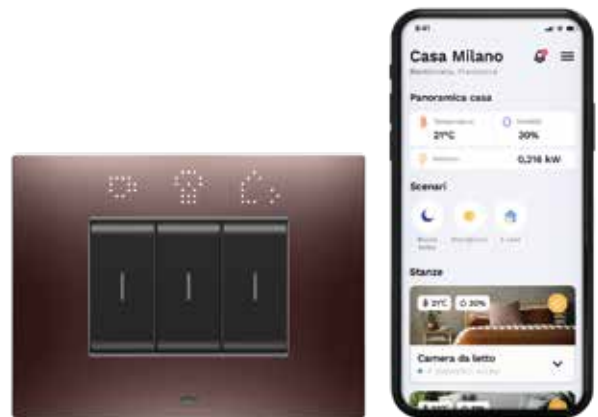

Connected Smart Home

CONNECTED SMART HOME

pag. 1086



Home & Building PRO

HOME & BUILDING PRO

pag. 1106

Connected SMART HOME

SUPERVISION

Gateway



Home Gateway
2M
100-240 V ac - 50/60 Hz

- GW 10 840 Glossy white
- GW 15 840 Satin white
- GW 13 840 Sat. natural beige
- GW 12 840 Satin black
- GW 14 840 Glossy titanium

ECO COMMAND DEVICES

Connected ECO push-button panel module



GW A1 291
4 commands

Interchangeable button keys for ECO push-button panel



Button key - 1M

- GW 10 819 Glossy white
- GW 15 819 Satin white
- GW 13 819 Sat. natural beige
- GW 12 819 Satin black
- GW 14 819 Glossy titanium

Button key - 2M



Button key - 2M

- GW 10 820 Glossy white
- GW 15 820 Satin white
- GW 13 820 Sat. natural beige
- GW 12 820 Satin black
- GW 14 820 Glossy titanium

COMMAND DEVICES - AXIAL

Connected 2-way switch modules



GW A1 201 1M
100-240 V ac - 50/60 Hz

GW A1 202 2M
100-240 V ac - 50/60 Hz

Connected dimmer modules



GW A1 221 1M
100-240 V ac - 50/60 Hz

GW A1 222 2M
100-240 V ac - 50/60 Hz

Connected roller shutter modules



GW A1 231 1M
100-240 V ac - 50/60 Hz

GW A1 232 2M
100-240 V ac - 50/60 Hz

Connected 2 commands modules



GW A1 241 1M
100-240 V ac - 50/60 Hz

GW A1 242 2M
100-240 V ac - 50/60 Hz

Auxiliary modules



GW 10 677 1 command - 1M
100-240 V ac - 50/60 Hz

GW 10 678 1 command - 2M
100-240 V ac - 50/60 Hz

Auxiliary modules



GW 10 679 2 commands - 1M
100-240 V ac - 50/60 Hz

GW 10 680 2 commands - 2M
100-240 V ac - 50/60 Hz

Interchangeable button keys for axial modules



Button key - 1M
To be completed with lens

- GW 10 551 S Glossy white
- GW 15 551 S Satin white
- GW 13 551 S Sat. natural beige
- GW 12 551 S Satin black
- GW 14 551 S Glossy titanium

Button key - 2M



Button key - 2M
To be completed with lens

- GW 10 552 S Glossy white
- GW 15 552 S Satin white
- GW 13 552 S Sat. natural beige
- GW 12 552 S Satin black
- GW 14 552 S Glossy titanium

Button key - 1M



Button key - 1M
To be completed with 2 lenses

- GW 10 553 S Glossy white
- GW 15 553 S Satin white
- GW 13 553 S Sat. natural beige
- GW 12 553 S Satin black
- GW 14 553 S Glossy titanium

Button key - 2M



Button key - 2M
To be completed with 2 lenses

- GW 10 554 S Glossy white
- GW 15 554 S Satin white
- GW 13 554 S Sat. natural beige
- GW 12 554 S Satin black
- GW 14 554 S Glossy titanium

Button key - 1M



Button key - 1M
With diffuser

- GW 10 555 S Glossy white
- GW 15 555 S Satin white
- GW 13 555 S Sat. natural beige
- GW 12 555 S Satin black
- GW 14 555 S Glossy titanium

Button key - 2M



Button key - 2M
With diffuser

- GW 10 556 S Glossy white
- GW 15 556 S Satin white
- GW 13 556 S Sat. natural beige
- GW 12 556 S Satin black
- GW 14 556 S Glossy titanium

Button key - 1M



Button key - 1M
With 2 diffusers

- GW 10 557 S Glossy white
- GW 15 557 S Satin white
- GW 13 557 S Sat. natural beige
- GW 12 557 S Satin black
- GW 14 557 S Glossy titanium

Button key - 2M



Button key - 2M
With 2 diffusers

- GW 10 558 S Glossy white
- GW 15 558 S Satin white
- GW 13 558 S Sat. natural beige
- GW 12 558 S Satin black
- GW 14 558 S Glossy titanium

Lenses with illuminating symbols for axial button keys

GW 10 501 A Neutral	GW 10 502 A Light	GW 10 503 A Stair light	GW 10 504 A Table light	GW 10 505 A Bell	GW 10 506 A Burglar alarm	GW 10 507 A Key	GW 10 508 A ON OFF	GW 10 509 A ON	GW 10 510 A OFF	GW 10 511 A Socket-outlet
GW 10 512 A Dimmer	GW 10 513 A Dimmer increase	GW 10 514 A Dimmer decrease	GW 10 515 A Arrow	GW 10 516 A Open	GW 10 517 A Close	GW 10 518 A Roller shutter	GW 10 519 A Roller shutter up	GW 10 520 A Roller shutter down	GW 10 521 A Curtain open	GW 10 522 A Curtain close
GW 10 523 A Floor light	GW 10 524 A Ceiling light	GW 10 525 A Wall light	GW 10 526 A Aisle light	GW 10 527 A Scenario	GW 10 528 A Party	GW 10 529 A In	GW 10 530 A Out	GW 10 531 A Good morning	GW 10 532 A Good night	GW 10 533 A TV
GW 10 534 A Heating	GW 10 535 A Cooling	GW 10 536 A Heating/Cooling	GW 10 537 A Comfort	GW 10 538 A Precomfort	GW 10 539 A Economy	GW 10 540 A Auto	GW 10 541 A Do not disturb (DND)	GW 10 542 A Make up the room (MUR)		

RECESSED COMMAND DEVICES

Connected contact interfaces



GW A1 501
2-channel potential-free
Battery powered

GW A1 502
2-channel
230Vac - 50Hz

SENSORS

Connected sensors



Motion sensor IM
100-240 V ac - 50/60 Hz

GW A1 511
Motion sensor
Battery powered

GW A1 513
Window sensor
Battery powered

GW A1 512
Smoke sensor
Battery powered

GW A1 514
Water sensor
Battery powered

GW A1 541
Wall-mounting support for water sensor

- GW 10 856 Glossy white
- GW 15 856 Satin white
- GW 13 856 Sat. natural beige
- GW 12 856 Satin black
- GW 14 856 Glossy titanium

ACTUATORS

Connected actuators for generic loads



1-channel 16 A with energy meter IM
100-240 V ac - 50/60 Hz

- GW 10 826 Glossy white
- GW 15 826 Satin white
- GW 13 826 Sat. natural beige
- GW 12 826 Satin black
- GW 14 826 Glossy titanium

RECESSED ACTUATORS

Connected actuators for generic loads



GW A1 521
1-channel 10A potential-free
230Vac - 50Hz

GW A1 522
2-channel 6A
230Vac - 50Hz

GW A1 523
1-channel 10A with power meter
230Vac - 50Hz

Connected actuators for roller shutters



GW A1 531
1-channel 6A
230Vac - 50Hz

SMART PLUG

Connected smart plug



GW A1 526
10A Schuko adapter with power meter
230Vac

LOAD MANAGEMENT

Connected energy meter



GW A1 918
With load management
100-240 V ac - 50/60 Hz

Load management relay



GW A1 916
P-Comfort
230Vac - 50Hz

CLIMATE MANAGEMENT

Connected thermostat



Thermostat 2M
100-240 V ac - 50/60 Hz

- GW 10 709 Glossy white
- GW 15 709 Satin white
- GW 13 709 Sat. natural beige
- GW 12 709 Satin black
- GW 14 709 Glossy titanium

ACCESSORIES

Power supply and connection



GW A1 700
For EGO SMART plates
100-240 V ac - 50/60 Hz

Blanking modules



For housing contact interfaces and actuators Zigbee

Protective covers for painting

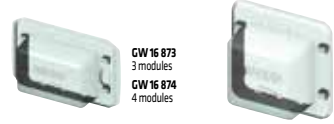

For rectangular supports

GW 16 871
For square supports

SMART SUPPORTS FOR EGO SMART PLATES

Supports for round/square boxes



GW 16 821 N ()**
With clutches - 2 modules



GW 16 822 N ()**
For screws (not included) - 2 modules

Supports for rectangular boxes



GW 16 803 N (*)
For screws - 3 modules



GW 16 804 N (*)
For screws - 4 modules

(*) compatible with the whole range of ONE, GEO, EGO, LUX and ICE plates for rectangular boxes.
(**) compatible with the whole range of ONE International, GEO International, EGO International and LUX International plates for round/square boxes.

Connected Smart Home

Connected Smart Home system

The connected system, based on the Zigbee wireless protocol, offers a full range of solutions for smart homes and small offices that are suitable for both new buildings and renovations. It enables you to control safety, comfort and consumption, through a unique user experience, using the Home Gateway APP and EGO Smart plates. The system integrates with the Google Home IoT platforms, Amazon Alexa and IFTTT, and all functions can be controlled with Google and Alexa voice assistants.



SYSTEM SUPERVISION

GATEWAY



GW 14 840

HOME GATEWAY

Code	Colour	Supply voltage	No. modules	Pack Carton
GW 10 840	Glossy white	100 ÷ 240 V ac - 50/60 Hz	2	1/2
GW 15 840	Satin White	100 ÷ 240 V ac - 50/60 Hz	2	1/2
GW 13 840	Natural satin beige	100 ÷ 240 V ac - 50/60 Hz	2	1/2
GW 12 840	Satin black	100 ÷ 240 V ac - 50/60 Hz	2	1/2
GW 14 840	Glossy Titanium	100 ÷ 240 V ac - 50/60 Hz	2	1/2

CHARACTERISTICS: multiprotocol gateway provided with ZigBee, Wi-Fi and Bluetooth (BLE) interfaces.

APPLICATIONS: the device enables the configuration, supervision, command and control of the smart home installation via the cloud. Management of functions and access to the system's data is done through a cloud platform, via a dedicated app (smartphone and tablet). System configuration is carried out through this device using the same app.

NOTES: an Internet connection is required in the system. The Bluetooth connection is only used when configuring devices.

AXIAL COMMAND DEVICES

CONNECTED 2-WAY SWITCH MODULES



GW A1 201

CONNECTED AXIAL 2-WAY SWITCH MODULES - ZIGBEE

Code	Supply voltage	Output contacts	No. modules	Pack Carton
GW A1 201	100 ÷ 240 V ac - 50/60 Hz	1 NO / NC 2 A (AC1) 240 V ac	1	1/12
GW A1 202	100 ÷ 240 V ac - 50/60 Hz	1 NO / NC 2 A (AC1) 240 V ac	2	1/6

FEATURES: devices for controlling 1 On/Off load through a live output contact, with indicative measurement of the power and energy consumed (measurements also transmitted on ZigBee). Suitable for control of incandescent and halogen lamps (240Vac): 4-500W, LED lamps (240Vac): 4-100W, fluorescent lamps (240Vac): 4-120W, halogen lamps powered by electronic transformers (240Vac): 4-250VA. Local push button with axial activation for control of the lamps connected to the device.

Equipped with 2 inputs (auxiliary axial controls, traditional push-buttons and switches, sensors, etc.) to replicate the local control of the lamp or send ZigBee commands and statuses. The devices are equipped with a blue LED that can be configured to facilitate localisation at night or to signal the local load status and are designed to power the EGO SMART plate within which they are housed.

APPLICATIONS: On/off and timed control of the lamp connected to the devices using the local push-button. The lamp can also be controlled via ZigBee from other devices connected to the network (control unit, scenarios). The inputs can be used to add control points for the local lamp connected to the device, ZigBee commands to other actuators (on/off control and lamp dimming, roller-shutter and Venetian blind control, generic load command, scenarios) or to send sensor statuses over the ZigBee network.

When these devices are used in conjunction with the EGO SMART Plate, an additional ZigBee command can be sent, activated by the push-button on the device when "SHIFT" is enabled from the SMART Plate.

NOTES: The devices must be completed with a front button key: GWA1201 with the GW1x551S or GW1x555S button keys; GWA1202 with the GW1x552S or GW1x556S button keys.

CONNECTED DIMMER MODULES



GW A1 221

CONNECTED AXIAL DIMMER MODULES - ZIGBEE

Code	Supply voltage	Power	No. modules	Pack Carton
GW A1 221	100 ÷ 240 V ac - 50/60 Hz	4-150 W 240 V ac	1	1/12
GW A1 222	100 ÷ 240 V ac - 50/60 Hz	4-150 W 240 V ac	2	1/6

FEATURES: devices for the control of 1 dimmable lighting device. Suitable for incandescent, halogen, LED and fluorescent lamps (240Vac): 4-150W, halogen lamps powered by electronic transformers (240Vac): 4-150VA. Trailing edge load driver mode. Two axial-operated local buttons for dimming the lamp connected to the device. Equipped with 2 inputs (auxiliary axial controls, traditional push-buttons and switches, sensors, etc.) to replicate the local control of the lamp or to send ZigBee commands and statuses. The devices are equipped with two blue LEDs that can be configured to facilitate localisation at night or to display the local load status.

APPLICATIONS: Control of the dimmable lamp connected to the devices via local push-buttons. The lamp can also be controlled via ZigBee by other devices connected to the network (control unit, scenarios). The inputs can be used to add control points for the local lamp connected to the device, ZigBee commands to other actuators (on/off control and lamp dimming, roller-shutter and Venetian blind control, generic load command, scenarios) or to send sensor statuses over the ZigBee network. Use of these devices in conjunction with the EGO SMART plate enables 2 additional ZigBee commands to be sent. These can be activated with the push-buttons on the device when the "SHIFT" feature is enabled from the SMART plate.

NOTES: The devices must be completed with a front button key: GWA1221 must be completed with the GW1x553S or GW1x557S button keys; GWA1222 must be completed with the GW1x554S or GW1x558S button keys.

CONNECTED ROLLER SHUTTER MODULES



GW A1 231

CONNECTED AXIAL ROLLER SHUTTER MODULES - ZIGBEE

Code	Supply voltage	Output contacts	No. modules	Pack Carton
GW A1 231	100 ÷ 240 V ac - 50/60 Hz	2,3 A 240 V ac (according to IEC 60669-2-1)	1	1/12
GW A1 232	100 ÷ 240 V ac - 50/60 Hz	2,3 A 240 V ac (according to IEC 60669-2-1)	2	1/6

CHARACTERISTICS: devices for controlling a motor for roller shutters, curtains, venetian blinds, roller blinds, etc., via 2 interlocked output contacts. Two local push buttons with axial activation enable operation of the motor connected to the device.

Equipped with 2 inputs (auxiliary axial commands, traditional switches and push buttons, sensors etc.) to replicate local control of the motor or for sending ZigBee commands and status.

The devices are equipped with two blue LEDs that can be configured to facilitate localisation at night or to indicate the motor operation in progress and are designed to supply power to the EGO SMART plate within which they are housed.

APPLICATIONS: control of 1 motor connected to the device via local push buttons. The motor can also be controlled via ZigBee by other devices connected to the network (up/down commands, scenarios). Using the inputs, it is possible to add local motor-control points connected to the device, ZigBee commands to other actuators (on/off and lamp dimming control, roller shutter and venetian blind control, generic load control, scenarios) or send sensor status over the ZigBee network.

Using this device in combination with the EGO SMART plate, 2 further ZigBee commands can be sent, activated via the push buttons on the device when the SMART plate has the "SHIFT" function enabled.

NOTES: the devices must be completed with a front push button: GWA1231 must be completed with push buttons GW1x553S or GW1x557S; GWA1232 must be completed with push buttons GW1x554S or GW1x558S.

CONNECTED COMMAND MODULES



GW A1 241

CONNECTED AXIAL 2 COMMANDS MODULES - ZIGBEE

Code	Supply voltage	No. of channels	No. modules	Pack Carton
GW A1 241	100 ÷ 240 V ac - 50/60 Hz	2	1	1/12
GW A1 242	100 ÷ 240 V ac - 50/60 Hz	2	2	1/6

CHARACTERISTICS: devices for the sending of 2 independent ZigBee commands via the operation of 2 local push buttons with axial activation.

Equipped with 2 inputs (auxiliary axial commands, traditional switches and push buttons, sensors etc.) for sending ZigBee commands and status.

The devices are equipped with two blue LEDs that can be configured to facilitate localisation at night or to display the status of the loads with on/off type controls and are designed to supply power to the EGO SMART plate within which they are housed.

APPLICATIONS: sending of 2 ZigBee commands (On/off and lamp dimming commands, roller shutter command, generic load command, scenarios). Using the inputs, it is possible to add ZigBee commands to other actuators (lamp on/off and dimming control, roller shutter and Venetian blind control, generic load control, scenarios) or send sensor status over the ZigBee network.

Using this device in combination with the EGO SMART plate, 2 further ZigBee commands can be sent, activated via the push buttons on the device when the SMART plate has the "SHIFT" function enabled.

NOTES: the devices must be completed with a front push button: GWA1241 must be completed with push buttons GW1x553S or GW1x557S; GWA1242 must be completed with push buttons GW1x554S or GW1x558S.

AUXILIARY MODULES



GW 10 677

1-COMMAND AUXILIARY AXIAL MODULES

Code	Supply voltage	Output contacts	No. modules	Pack Carton
GW 10 677	100 ÷ 240 V ac - 50/60 Hz	1 NO 1 A (AC1) 240 V ac	1	1/12
GW 10 678	100 ÷ 240 V ac - 50/60 Hz	1 NO 1 A (AC1) 240 V ac	2	1/6

CHARACTERISTICS: auxiliary commands to use in combination with ZigBee connected axial commands or to EVO axial commands.

The devices are equipped with a blue LED that can be configured to facilitate localisation at night or to display the status of the load.

APPLICATIONS: connected to the local inputs of the connected axial commands, they enable the replication of local load control or the sending of ZigBee commands; connected to the local inputs of the EVO axial commands, they enable the replication of local load control or the management of centralised controls.

NOTES: the devices must be completed with a front push button: GW10677 must be completed with push buttons GW1x551S or GW1x555S; GW10678 must be completed with push buttons GW1x552S or GW1x556S.

Connected SMART HOME



GW 10 679

2-COMMAND AUXILIARY MODULES

Code	Supply voltage	Output contacts	No. modules	Pack Carton
GW 10 679	100 ÷ 240 V ac - 50/60 Hz	2 NO 1 A (AC1) 240 V ac	1	1/12
GW 10 680	100 ÷ 240 V ac - 50/60 Hz	2 NO 1 A (AC1) 240 V ac	2	1/6

CHARACTERISTICS: auxiliary commands to be used in combination with ZigBee connected axial commands or to EVO axial commands.

The devices are equipped with two blue LEDs that can be configured to facilitate localisation at night or to display the status of the load.

APPLICATIONS: connected to the local inputs of the connected axial commands, they enable the replication of local load control or the sending of ZigBee commands; connected to the local inputs of the EVO axial commands, they enable the replication of local load control or the management of centralised controls.

NOTES: the devices must be completed with a front push button: GWA10679 must be completed with push buttons GW1x553S or GW1x557S; GWA10680 must be completed with push buttons GW1x554S or GW1x558S.

INTERCHANGEABLE BUTTON KEYS AND LENSES FOR AXIAL COMMAND MODULES



GW 14 551 S

INTERCHANGEABLE BUTTON KEYS FOR AXIAL COMMAND MODULES

Code	Colour	Button key	No. modules	Pack Carton
GW 10 551 S	Glossy white	To be completed with lens	1	1/48
GW 15 551 S	Satin White	To be completed with lens	1	1/48
GW 13 551 S	Natural satin beige	To be completed with lens	1	1/48
GW 12 551 S	Satin black	To be completed with lens	1	1/48
GW 14 551 S	Glossy Titanium	To be completed with lens	1	1/48
GW 10 552 S	Glossy white	To be completed with lens	2	1/48
GW 15 552 S	Satin White	To be completed with lens	2	1/48
GW 13 552 S	Natural satin beige	To be completed with lens	2	1/48
GW 12 552 S	Satin black	To be completed with lens	2	1/48
GW 14 552 S	Glossy Titanium	To be completed with lens	2	1/48
GW 10 553 S	Glossy white	To be completed with 2 lenses	1	1/48
GW 15 553 S	Satin White	To be completed with 2 lenses	1	1/48
GW 13 553 S	Natural satin beige	To be completed with 2 lenses	1	1/48
GW 12 553 S	Satin black	To be completed with 2 lenses	1	1/48
GW 14 553 S	Glossy Titanium	To be completed with 2 lenses	1	1/48
GW 10 554 S	Glossy white	To be completed with 2 lenses	2	1/48
GW 15 554 S	Satin White	To be completed with 2 lenses	2	1/48
GW 13 554 S	Natural satin beige	To be completed with 2 lenses	2	1/48
GW 12 554 S	Satin black	To be completed with 2 lenses	2	1/48
GW 14 554 S	Glossy Titanium	To be completed with 2 lenses	2	1/48
GW 10 555 S	Glossy white	With 1 diffuser	1	1/48
GW 15 555 S	Satin White	With 1 diffuser	1	1/48
GW 13 555 S	Natural satin beige	With 1 diffuser	1	1/48
GW 12 555 S	Satin black	With 1 diffuser	1	1/48
GW 14 555 S	Glossy Titanium	With 1 diffuser	1	1/48
GW 10 556 S	Glossy white	With 1 diffuser	2	1/48
GW 15 556 S	Satin White	With 1 diffuser	2	1/48
GW 13 556 S	Natural satin beige	With 1 diffuser	2	1/48
GW 12 556 S	Satin black	With 1 diffuser	2	1/48
GW 14 556 S	Glossy Titanium	With 1 diffuser	2	1/48
GW 10 557 S	Glossy white	With 2 diffusers	1	1/48
GW 15 557 S	Satin White	With 2 diffusers	1	1/48
GW 13 557 S	Natural satin beige	With 2 diffusers	1	1/48
GW 12 557 S	Satin black	With 2 diffusers	1	1/48
GW 14 557 S	Glossy Titanium	With 2 diffusers	1	1/48
GW 10 558 S	Glossy white	With 2 diffusers	2	1/48
GW 15 558 S	Satin White	With 2 diffusers	2	1/48
GW 13 558 S	Natural satin beige	With 2 diffusers	2	1/48
GW 12 558 S	Satin black	With 2 diffusers	2	1/48
GW 14 558 S	Glossy Titanium	With 2 diffusers	2	1/48

NOTES: to be used to complete the ZigBee connected axial commands, EVO axial commands and auxiliary axial commands.



ZC6

LENSES WITH ILLUMINATING SYMBOLS FOR AXIAL BUTTON KEYS

Code	Symbol	Pack Carton
GW 10 501 A	Neutral	24
GW 10 502 A	Light	24
GW 10 503 A	Stair light	24
GW 10 504 A	Table light	24
GW 10 505 A	Bell	24
GW 10 506 A	Burglar alarm	24
GW 10 507 A	Key	24
GW 10 508 A	ON OFF	24
GW 10 509 A	ON	24
GW 10 510 A	OFF	24
GW 10 511 A	Socket-outlet	24
GW 10 512 A	Dimmers	24
GW 10 513 A	Dimmer increase	24
GW 10 514 A	Dimmer decrease	24
GW 10 515 A	Arrow	24
GW 10 516 A	Open	24
GW 10 517 A	Close	24
GW 10 518 A	Roller shutter	24
GW 10 519 A	Roller shutter up	24
GW 10 520 A	Roller shutter down	24
GW 10 521 A	Curtain open	24
GW 10 522 A	Curtain close	24
GW 10 523 A	Floor light	24
GW 10 524 A	Ceiling light	24
GW 10 525 A	Wall light	24
GW 10 526 A	Aisle light	24
GW 10 527 A	Scenario	24
GW 10 528 A	Party	24
GW 10 529 A	In	24
GW 10 530 A	Out	24
GW 10 531 A	Good morning	24
GW 10 532 A	Good night	24
GW 10 533 A	TV	24
GW 10 534 A	Heating	24
GW 10 535 A	Cooling	24
GW 10 536 A	Heating/Cooling	24
GW 10 537 A	Comfort	24
GW 10 538 A	Precomfort	24
GW 10 539 A	Economy	24
GW 10 540 A	Auto	24
GW 10 541 A	Do not disturb	24
GW 10 542 A	Make up the room	24

NOTE: for use to customise the interchangeable push buttons for axial controls with 1 and 2 lenses.

ECO COMMAND DEVICES

ECO CONNECTED PUSH-BUTTON PANEL MODULE



GW A1 291

CONNECTED 4 COMMANDS ECO PUSH BUTTON PANEL - ZIGBEE - FLUSH AND SURFACE MOUNTING

Code	Supply voltage	No. of channels	No. modules	Pack Carton
GW A1 291	None	4	2	1

CHARACTERISTICS: device for sending 4 independent Zigbee commands via activation by the local 4 push buttons.
 The device can be installed both flush (ChoruSmart supports) and surface mounted. For surface mounted installation, it can be completed with ONE, GEO, LUX, ICE and EGO plates in both the 2-gang rectangular version and the international 2-gang version.
 The device does not require power (neither from the mains nor from batteries).
APPLICATIONS: sending 4 Zigbee commands (on/off command and lamp dimming, roller-shutter control, generic load command, scenarios) using local buttons.
NOTES: The push-button panel must be completed with front buttons: with 2 push button keys GW1x819 of 1 module or 1 push button key GW1x820 of 2 modules.
 The device cannot be used to control actuators: GWA1521, GWA1522, GWA1523, GWA1526, GWA1531 and the local relay of GWA1916.
ACCESSORIES SUPPLIED: base and fitting KIT (screws, wall-plugs and bi-adhesive strips) for surface mounting, adapter for flush mounting on ChoruSmart supports.

Connected SMART HOME



GW 14 819

REPLACEABLE PUSH BUTTON KEYS FOR CONNECTED 4-CHANNEL ECO PUSH BUTTON PANEL - ZIGBEE

Code	Colour	No. modules	Pack Carton
GW 10 819	Glossy white	1	2/48
GW 15 819	Satin White	1	2/48
GW 13 819	Natural satin beige	1	2/48
GW 12 819	Satin black	1	2/48
GW 14 819	Glossy Titanium	1	2/48
GW 10 820	Glossy white	2	1/48
GW 15 820	Satin White	2	1/48
GW 13 820	Natural satin beige	2	1/48
GW 12 820	Satin black	2	1/48
GW 14 820	Glossy Titanium	2	1/48

NOTE: to be used to complete the connected push-button panel module ECO ZigBee GWA1291.

RECESSED COMMAND DEVICES

CONNECTED CONTACT INTERFACES



GW A1 501

CONNECTED 2-CHANNELS CONTACT INTERFACES - ZIGBEE

Code	Supply voltage	No. input channels	Input voltage	Max cable length	Dimensions LxHxD (mm)	Pack Carton
GW A1 501	Battery powered	2	Potential-free	15 m	42x40x20	1/4
GW A1 502	230V ac - 50 Hz	2	230V ac	-	42x40x20	1/4

CHARACTERISTICS: interface for the connection of 2 independent input contacts (auxiliary axial commands, push buttons and traditional switches sensors etc.), potential-free (GWA1501) or live (GWA1502). GWA1501 powered by CR2032-type battery (replaceable).

APPLICATIONS: allows commands to be sent for ON-OFF, timed, roller shutters and Venetian blinds, dimmers, scenarios, priority commands and signalling the current state of the contact.

NOTES: installation in flush-mounting boxes, junction boxes or clipped into the ChoruSmart GW1x750 blanking modules.

SENSORS

CONNECTED SENSORS



GW 14 856

CONNECTED MOVEMENT SENSORS - ZIGBEE

Code	Colour	Supply voltage	Output contacts	No. modules	Pack Carton
GW 10 856	Glossy white	100 ÷ 240 V ac - 50/60 Hz	1 NO 2 A (AC1) 240 Vac	1	1/3
GW 15 856	Satin White	100 ÷ 240 V ac - 50/60 Hz	1 NO 2 A (AC1) 240 Vac	1	1/3
GW 13 856	Natural satin beige	100 ÷ 240 V ac - 50/60 Hz	1 NO 2 A (AC1) 240 Vac	1	1/3
GW 12 856	Satin black	100 ÷ 240 V ac - 50/60 Hz	1 NO 2 A (AC1) 240 Vac	1	1/3
GW 14 856	Glossy Titanium	100 ÷ 240 V ac - 50/60 Hz	1 NO 2 A (AC1) 240 Vac	1	1/3

FEATURES: presence sensor with detection based on the set brightness threshold. Fixed lens. Parameters that can be set during configuration via the APP: brightness threshold value, shutdown time after presence detection.

Local live contact for direct control of the load, connectable loads: incandescent and halogen lamps (240Vac): 500W, LED lamps (240Vac): 100W, fluorescent lamps (240Vac): 120W, halogen lamps powered by electronic transformers (240Vac): 250VA.

Equipped with 2 inputs (auxiliary axial controls, traditional push-buttons and switches, sensors, etc.) to replicate the direct control of the lamp/load connected to the local relay or to send Zigbee commands and statuses.

The device has a blue LED to indicate motion detection (regardless of the brightness threshold).

APPLICATIONS: the devices detect a person's movement and send the signal via Zigbee which activates lamps and/or loads. The connected lamp and/or load can be activated directly through the local contact. Energy savings: light control of the environments or areas concerned only when there is traffic/presence of people.

NOTES: do not install the product in watertight plates: the lid membrane does not allow the detector lens to function correctly.



GW A1 511

CONNECTED MOVEMENT SENSOR - ZIGBEE - IP30

Code	Max range	Light sensor	Temperature sensor	Colour	Dimensions LxHxD (mm)	Pack Carton
GW A1 511	6 m	3...70.000 lux	0...50 °C	White	82x82x28	1/2

FEATURES: motion sensor with horizontal detection angle: ±45° and vertical detection angle: ±45°. Includes a brightness sensor and a temperature sensor. CR123 (replaceable) type battery power supply.

NOTES: Wall or shelf installation via included accessories.

For the control of actuations, use the sensor in combination with the connected Zigbee actuators GW1x826, GWA1201 or GWA1202, GWA1221 or GWA1222 (max 5 sensors per actuator) or with the connected Zigbee actuators GWA1526, GWA1521, GWA1522, GWA1523 (max 1 sensor per actuator). The Zigbee-connected actuators GW1x826, GWA1201, GWA1202, GWA1221, GWA1222 can only be controlled in combination with the "Home Gateway" GW1x840.



GW A1 513

CONNECTED WINDOW SENSOR - ZIGBEE - IP40

Code	Sensor type	Temperature sensor	Material	Colour	Dimensions LxHxD (mm)	Pack Carton
GW A1 513	Magnetic	0...50 °C	Plastic	White	76x26x17	1/6

FEATURES: the sensor detects the opening and closing of doors and windows and includes a temperature sensor. Powered with 2 AAA type batteries (replaceable).

NOTES: Installation on doors or windows.

Use the sensor in combination with the connected Zigbee actuators GW1x826, GWA1201 or GWA1202 (max 5 sensors per actuator) or with the ZigBee actuators GWA1521, GWA1522, GWA1523 (max 1 sensor per actuator). The Zigbee-connected actuators GW1x826, GWA1201, GWA1202 can only be controlled in combination with the "Home Gateway" GW1x840.



GW A1 512

CONNECTED SMOKE SENSOR - ZIGBEE - IP20

Code	Siren output	Temperature sensor	Colour	Dimensions (mm)	Pack Carton
GW A1 512	85 dB/3 m	0...50 °C	White	Ø 65x40	1/6

FEATURES: the sensor detects the presence of smoke and includes a temperature sensor. Power supplied by a CR123 type (replaceable) battery.

NOTES: wall or ceiling installation.

To operate a solenoid valve, use the sensor in combination with the connected Zigbee actuators GW1x826, GWA1201 or GWA1202 (max 5 sensors per actuator if the actuator is configured for automatic solenoid reset; unlimited sensors for manual reset) or with Zigbee actuators GWA1521, GWA1522, GWA1523 (max 1 sensor per actuator if the actuator is configured for automatic solenoid reset; unlimited sensors for manual reset). The Zigbee-connected actuators GW1x826, GWA1201, GWA1202 can only be commanded in conjunction with the "Home Gateway" GW1x840.



GW A1 514

CONNECTED WATER SENSOR - ZIGBEE - IP20

Code	Siren output	Temperature sensor	Colour	Dimensions (mm)	Pack Carton
GW A1 514	85 dB/3 m	0...50 °C	White	Ø 60x37	1/6

FEATURES: the sensor detects the presence of water and includes a temperature sensor. CR123 (replaceable) type battery power supply.

NOTES: floor installation or alternative wall mounted option using the accessory GWA1541.

To activate a solenoid valve, use the sensor in combination with the connected Zigbee actuators GW1x826, GWA1201 or GWA1202 (max 5 sensors per actuator if actuator is configured for automatic solenoid reset; unlimited sensors for manual reset) or with Zigbee actuators GWA1521, GWA1522, GWA1523 (max 1 sensor per actuator if actuator is configured for automatic solenoid reset; unlimited sensors for manual reset). Zigbee connected actuators GW1x826, GWA1201, GWA1202 can only be controlled in conjunction with the GW1x840 Home Gateway.



GW A1 541

WALL-MOUNTING SUPPORT FOR FLOOD ALARM

Code	Colour	Support dimension (mm)	Dimensions of probe (mm)	Cable max. length (cm)	Pack Carton
GW A1 541	White	Ø72x25	Ø50x8	85	1/4

APPLICATIONS: to be used for the wall-mounting of the Zigbee flood alarm GWA1514.

Connected SMART HOME

ACTUATORS

CONNECTED ACTUATORS FOR GENERIC LOADS WITH ENERGY METER



GW 14 826

CONNECTED 1-CHANNEL ON/OFF ACTUATORS WITH ENERGY MEASUREMENT - ZIGBEE

Code	Colour	Supply voltage	No. output channels	Output contacts	No. modules	Pack Carton
GW 10 826	Glossy white	100 ÷ 240 V ac - 50/60 Hz	1	1 NO 16 A (AC1) 240 V ac	1	1/12
GW 15 826	Satin White	100 ÷ 240 V ac - 50/60 Hz	1	1 NO 16 A (AC1) 240 V ac	1	1/12
GW 13 826	Natural satin beige	100 ÷ 240 V ac - 50/60 Hz	1	1 NO 16 A (AC1) 240 V ac	1	1/12
GW 12 826	Satin black	100 ÷ 240 V ac - 50/60 Hz	1	1 NO 16 A (AC1) 240 V ac	1	1/12
GW 14 826	Glossy Titanium	100 ÷ 240 V ac - 50/60 Hz	1	1 NO 16 A (AC1) 240 V ac	1	1/12

FEATURES: 1-channel actuator for controlling loads with a live NO output contact and measurement of the power absorbed and the energy consumed (both measurements transmitted via ZigBee). Local push-button and blue LED for control and display of load status.

Controllable Loads: incandescent and halogen lamps (240Vac): 1920W, LED lamps (240Vac): 200W, fluorescent lamps (240Vac): 200W, halogen lamps powered by electronic transformers (240Vac): 500VA.

Equipped with 1 input (auxiliary axial controls, traditional push-buttons and switches, sensors, etc.) to replicate the local control of the load or to send ZigBee commands and statuses.

The devices are designed to supply power to the EGO SMART plate within which they are housed.

APPLICATIONS: On/off and timed control of the load connected to the devices by local push-button. The load can also be controlled via ZigBee from other devices connected to the network (control unit, scenarios). The input can be used to add control points for the connected local load to the devices, send ZigBee commands to other actuators (on/off command and lamp dimming, roller-shutter and Venetian blind control, control of generic loads, scenarios) or send sensor statuses over the ZigBee network.

Automatic load disconnection: the devices can be configured to disconnect the local load when a defined (power) consumption threshold is exceeded during configuration.

Using this device in combination with the EGO SMART plate, 1 further ZigBee command can be sent, activated via the push button on the device when the SMART plate has the "SHIFT" function enabled.

RECESSED ACTUATORS

CONNECTED ACTUATORS FOR GENERIC LOADS



GW A1 521

1-CHANNEL CONNECTED ACTUATOR - ZIGBEE

Code	Supply voltage	No. output channels	Output contacts	Dimensions LxHxD (mm)	Pack Carton
GW A1 521	230V ac - 50 Hz	1	1 NO 10A (AC1) 230 V ac	42x40x20	1/4

CHARACTERISTICS: 1-channel actuator for the activation of loads through a potential-free output contact (NO). Suitable for controlling incandescent lamps (230 V ac): 2300 W, loads driven by toroidal transformers: 450 W, loads driven by electronic transformers: 600 W, fluorescent lamps: (230 V ac): 150 W, motors: 500 W. Equipped with 1 input for local control of the output.

APPLICATIONS: ON-OFF control, timed commands, priority commands and scenario management. If used in combination with the ZigBee GWA1514 water sensor, the installation of a push button (NO) is required for the manual opening of the solenoid valve.

NOTES: installation in flush-mounting boxes, junction boxes or clipped into the ChoruSmart GW1x750 blanking modules.



GW A1 522

2-CHANNEL CONNECTED ACTUATOR - ZIGBEE

Code	Supply voltage	No. output channels	Output contacts	Dimensions LxHxD (mm)	Pack Carton
GW A1 522	230V ac - 50 Hz	2	2 NO 6A (AC1) 230 V ac	42x40x20	1/4

CHARACTERISTICS: 2-channel actuator for the activation of loads through a 230 V output contact (NO). Suitable for controlling incandescent lamps (230 V ac): 1400 W, loads driven by toroidal transformers: 450 W, loads driven by electronic transformers: 600 W, fluorescent lamps: 150 W, LED lamps (230 V ac): 150 W, motors: 500 W. Equipped with 2 inputs for local control of the outputs.

APPLICATIONS: ON-OFF control, timed commands, priority commands and management of scenarios.

NOTES: installation in flush-mounting boxes, junction boxes or clipped into the ChoruSmart GW1x750 blanking modules.

CONNECTED ACTUATORS FOR GENERIC LOADS WITH POWER MEASUREMENT



GW A1 523

1-CHANNEL CONNECTED ACTUATOR WITH POWER METER - ZIGBEE

Code	Supply voltage	No. output channels	Output contacts	Dimensions LxHxD (mm)	Pack Carton
GW A1 523	230V ac - 50 Hz	1	1 NO 10A (AC1) 230 V ac	42x40x20	1/4

CHARACTERISTICS: 1-channel actuator for the activation of loads through a 230 V output contact (NO) and measurement of instantaneous power. Suitable for controlling incandescent lamps (230 V ac): 2300 W, loads driven by toroidal transformers: 450 W, loads driven by electronic transformers: 600 W, fluorescent lamps: (230 V ac): 150 W, motors: 500 W. Equipped with 1 input for local control of the output.

APPLICATIONS: ON-OFF control, timed commands, priority commands and management of scenarios and measurement of instantaneous power.

NOTES: installation in flush-mounting boxes, junction boxes or clipped into the ChoruSmart GW1x750 blanking modules.

CONNECTED ACTUATORS FOR ROLLER SHUTTERS



GW A1 531

1-CHANNEL CONNECTED ACTUATOR FOR ROLLER SHUTTERS - ZIGBEE

Code	Supply voltage	Max current supplied	Dimensions LxHxD (mm)	Pack Carton
GW A1 531	230V ac - 50 Hz	6A-230V ac (compl. 60669-2-1)	42x40x20	1/4

CHARACTERISTICS: 1-channel actuator for the activation of a motor to operate roller shutters, curtains, Venetian blinds, roller blinds etc. via 2 interlocked output contacts 230 V ac. Suitable for the control of motors: 500 W. Equipped with 2 inputs for local control of the outputs.

APPLICATIONS: controlling operation/adjustment/stop, priority commands, scenario management and alarm signalling.

NOTES: installation in flush-mounting boxes, junction boxes or clipped into the ChoruSmart GW1x750 blanking modules.

SMART PLUG

CONNECTED SMART PLUG



GW A1 526

CONNECTED SMART PLUG 230 V AC - GERMAN STANDARD - ZIGBEE

Code	Type of plug	Socket-outlet type	Dimensions ØxH (mm)	Colour	Pack Carton
GW A1 526	2P+E - 10A	2P+E - 10A	41x45	White	1/4

CHARACTERISTICS: adaptor with socket, side earthing and safety shields. It detects power consumed by the connected loads and sends the data on the ZigBee network.

Connected SMART HOME

LOADS MANAGEMENT

CONNECTED ENERGY METER - RECESSED MOUNTING



GW A1 918

CONNECTED ENERGY METER WITH LOAD CONTROL - ZIGBEE

Code	Supply voltage	Measurement	Dimensions LxHxD (mm)	Pack Carton
GW A1 918	100 ÷ 240 V ac - 50/60 Hz	Via A.T.	40x40x20 mm	1/4

FEATURES: measurement: single phase voltage 100-240Vac 50/60 Hz, maximum current 70A min 0.05A. The device measures the power absorbed and the energy consumed (transmitting the measurements via Zigbee), and implements the load control function (max 10 controllable loads) according to EN 61010-1, EN 61010-2-030. A.T. provided in the package.

APPLICATIONS: measurement and monitoring of electrical consumption (power and energy consumed) of a housing unit or area within a building. Load Control Function: automatically disconnects electrical loads to prevent the electrical meter from tripping when the contractual KW limit is exceeded, thus preventing disruption to the user; the load disconnection and connection sequence can be set during configuration via the APP, by priority or by absorption; The loads to be controlled must be controlled by Zigbee-connected actuators: GW1x826, GWA1201, GWA1202, GWA1221, GWA1222, GWA1523, GWA1526, GWA1521 or GWA1522.

NOTES: The module can be installed in flush-mounted boxes, junction boxes or enclosures. It can also be installed on ChoruSmart supports using ChoruSmart blanking module GW1x750, it can be mounted on a DIN rail using DIN rail support GW16841 + ChoruSmart GW1x750 blanking module.

LOAD MANAGEMENT RELAY



GW A1 916

CONNECTED P-COMFORT LOAD MANAGEMENT RELAY - ZIGBEE

Code	Rated voltage (V)	Rated current	Type relay contact	Capacity relay contact	No. of modules EN 50022	Pack Carton
GW A1 916	230V ac	32 A	Changeover (potential free contact)	16 A AC1 250 V ac	2	1/6

APPLICATION: The P-Comfort relay can be installed in electrical systems limited to a maximum power load of 6 kW. In the event of overload due to the simultaneous switching-on of multiple electrical loads, P-Comfort prevents the interruption of electrical power by disconnecting non-preferred loads controlled by ZigBee-connected actuators: GW1x826, GWA1201, GWA1202, GWA1221, GWA1222, GWA1523, GWA1526, GWA1521 or GWA1522, or wired to the relay contact on the device (maximum 10 devices total). The disconnection and reconnection sequence for non-preferred loads can be set by Priority (regardless of load absorption) or by Power (depending on the power absorbed).

NOTES: The Zigbee-connected actuators GW1x826, GWA1201, GWA1202, GWA1221, GWA1222 can only be controlled in combination with the "Home Gateway" GW1x840.

TEMPERATURE ADJUSTMENT

CONNECTED THERMOSTAT



GW 14 709

CONNECTED THERMOSTAT - ZIGBEE

Code	Colour	Supply voltage	Output contacts	No. modules	Pack Carton
GW 10 709	Glossy white	100 ÷ 240 V ac - 50/60 Hz	1 NO / NC 5A (AC1) 240 V ac	2	1/3
GW 15 709	Satin White	100 ÷ 240 V ac - 50/60 Hz	1 NO / NC 5A (AC1) 240 V ac	2	1/3
GW 13 709	Natural satin beige	100 ÷ 240 V ac - 50/60 Hz	1 NO / NC 5A (AC1) 240 V ac	2	1/3
GW 12 709	Satin black	100 ÷ 240 V ac - 50/60 Hz	1 NO / NC 5A (AC1) 240 V ac	2	1/3
GW 14 709	Glossy Titanium	100 ÷ 240 V ac - 50/60 Hz	1 NO / NC 5A (AC1) 240 V ac	2	1/3

FEATURES: flush-mounted thermostat for the control of heating/cooling systems with manual temperature management and possibility of shutdown. Control algorithms for two-way systems: two points (ON/OFF), proportional-integral (PWM). The thermostat can control a solenoid valve for heating or cooling through a local contact or via Zigbee, in which case the solenoid valve must be controlled by a Zigbee actuator. GWA1521, GWA1522, GWA1523, GW1x826, GWA1201, and GWA1202 Zigbee connected actuators can be used.

The thermostat is equipped with integrated temperature and humidity sensors. The thermostat has an input for a NTC sensor (GW10800 and GW1x900 sensors can be used) for external temperature measurement (e.g., for compensation of temperatures measured locally by the thermostat or for protection in case of underfloor heating/cooling).

APPLICATIONS: climate control (heating or cooling) of a housing unit or area; option to manage a daily or weekly heating/cooling profile via the APP. The device measures humidity, if a threshold (defined during configuration) is exceeded, Zigbee can activate a dehumidification system and display/notify the measurement on the APP.

Use in traditional unconnected systems: the connected thermostat can also be used in traditional unconnected installations. In this case, configuration is not carried out via the APP and the NTC sensor input can only be used to compensate for the temperature measurement detected locally by the thermostat.

ACCESSORIES

BLANKING MODULES



GW 14 750

BLANKING MODULES FOR HOUSING ZIGBEE CONTACTS INTERFACES AND ACTUATORS

Code	Colour	No. modules	Pack Carton
GW 10 750	Glossy white	1	1/12
GW 15 750	Satin White	1	1/12
GW 13 750	Natural satin beige	1	1/12
GW 12 750	Satin black	1	1/12
GW 14 750	Glossy Titanium	1	1/12

CHARACTERISTICS: 1-module blanking module with pad-printing. Enables the housing and rapid identification of the recessed connected control devices, of the recessed connected actuators and the connected energy meter with load control.

NOTES: snap-in assembly.

EGO SMART PLATES

PAINTED TECHNOPOLYMER



GW 16 003 SPW

EGO SMART PLATES - SATIN WHITE

Code	Description	For support codes	Pack Carton
GW 16 003 SPW	3 modules	GW16803N	1
GW 16 004 SPW	4 modules	GW16804N	1

FEATURES: matt finish. The plate has a dot-matrix display on the upper portion, RGB LED strips (along the outer and inner edges at the top and bottom) and a proximity sensor.

APPLICATIONS: visualisation of dynamic icons on the display indicating the functions associated with the devices installed in the plate; event/alarm signalling using the display (messages) and/or RGB led strips.

NOTES: the plate must be supplied with power by one of the following connected devices, which must be installed within the same box as the plate: GWA1201, GWA1202, GWA1231, GWA1232, GWA1241, GWA1242 or GW1x826, or by a dedicated GWA1700 power supply; The connection cable from the plate to the device powering it is included in the plate package.



GW 16 003 SCY

EGO SMART PLATES - CLAY

Code	Description	For support codes	Pack Carton
GW 16 003 SCY	3 modules	GW16803N	1
GW 16 004 SCY	4 modules	GW16804N	1

FEATURES: matt finish. The plate has a dot-matrix display on the upper portion, RGB LED strips (along the outer and inner edges at the top and bottom) and a proximity sensor.

APPLICATIONS: visualisation of dynamic icons on the display indicating the functions associated with the devices installed in the plate; event/alarm signalling using the display (messages) and/or RGB led strips.

NOTES: the plate must be supplied with power by one of the following Smart devices, which must be installed in the same plate box: GWA1201, GWA1202, GWA1231, GWA1232, GWA1241, GWA1242 or GW1x826, or by a dedicated GWA1700 power supply; the connection cable from the plate to the device powering it is included in the plate package. Codes not held as stock, for delivery times contact your local representative.



GW 16 003 SNB

EGO SMART PLATES - NATURAL BEIGE

Code	Description	For support codes	Pack Carton
GW 16 003 SNB	3 modules	GW16803N	1
GW 16 004 SNB	4 modules	GW16804N	1

FEATURES: matt finish. The plate has a dot-matrix display on the upper portion, RGB LED strips (along the outer and inner edges at the top and bottom) and a proximity sensor.

APPLICATIONS: visualisation of dynamic icons on the display indicating the functions associated with the devices installed in the plate; event/alarm signalling using the display (messages) and/or RGB led strips.

NOTES: the plate must be supplied with power by one of the following connected devices, which must be installed within the same box as the plate: GWA1201, GWA1202, GWA1231, GWA1232, GWA1241, GWA1242 or GW1x826, or by a dedicated GWA1700 power supply; The connection cable from the plate to the device powering it is included in the plate package.

Connected SMART HOME



GW 16 003 SDS

EGO SMART PLATES - DARK SAND

Code	Description	For support codes	Pack Carton
GW 16 003 SDS	3 modules	GW16803N	1
GW 16 004 SDS	4 modules	GW16804N	1

FEATURES: matt finish. The plate has a dot-matrix display on the upper portion, RGB LED strips (along the outer and inner edges at the top and bottom) and a proximity sensor.

APPLICATIONS: visualisation of dynamic icons on the display indicating the functions associated with the devices installed in the plate; event/alarm signalling using the display (messages) and/or RGB led strips.

NOTES: the plate must be supplied with power by one of the following Smart devices, which must be installed in the same box as the plate: GWA1201, GWA1202, GWA1231, GWA1232, GWA1241, GWA1242 or GW1x826, or by a dedicated GWA1700 power supply; The connection cable from the plate to the device powering it is included in the plate package.

Codes not held as stock, for delivery times contact your local representative.



GW 16 003 SDB

EGO SMART PLATES - SATIN BLACK

Code	Description	For support codes	Pack Carton
GW 16 003 SDB	3 modules	GW16803N	1
GW 16 004 SDB	4 modules	GW16804N	1

FEATURES: matt finish. The plate has a dot-matrix display on the upper portion, RGB LED strips (along the outer and inner edges at the top and bottom) and a proximity sensor.

APPLICATIONS: visualisation of dynamic icons on the display indicating the functions associated with the devices installed in the plate; event/alarm signalling using the display (messages) and/or RGB led strips.

NOTES: The plate must be supplied with power by one of the following connected devices, which must be installed within the same box as the plate: GWA1201, GWA1202, GWA1231, GWA1232, GWA1241, GWA1242 or GW1x826, or by a dedicated GWA1700 power supply; The connection cable from the plate to the device powering it is included in the plate package.



GW 16 003 SGR

EGO SMART PLATES - MAGNETIC GRAY

Code	Description	For support codes	Pack Carton
GW 16 003 SGR	3 modules	GW16803N	1
GW 16 004 SGR	4 modules	GW16804N	1

FEATURES: matt finish, metallic effect. The plate has a dot-matrix display on the upper portion, RGB LED strips (along the outer and inner edges at the top and bottom) and a proximity sensor.

APPLICATIONS: visualisation of dynamic icons on the display indicating the functions associated with the devices installed in the plate; event/alarm signalling using the display (messages) and/or RGB led strips.

NOTES: the plate must be powered by one of the following connected devices, which must be installed in the same box as the plate: GWA1201, GWA1202, GWA1231, GWA1232, GWA1241, GWA1242 or GW1x826, or by a dedicated GWA1700 power supply; The connection cable from the plate to the device powering it is included in the plate package.



GW 16 003 SBR

EGO SMART PLATES - LIGHT BRONZE

Code	Description	For support codes	Pack Carton
GW 16 003 SBR	3 modules	GW16803N	1
GW 16 004 SBR	4 modules	GW16804N	1

FEATURES: matt finish, metallic effect. The plate has a dot-matrix display on the upper portion, RGB LED strips (along the outer and inner edges at the top and bottom) and a proximity sensor.

APPLICATIONS: visualisation of dynamic icons on the display indicating the functions associated with the devices installed in the plate; event/alarm signalling using the display (messages) and/or RGB led strips.

NOTES: the plate must be powered by one of the following connected devices, which must be installed in the same box as the plate: GWA1201, GWA1202, GWA1231, GWA1232, GWA1241, GWA1242 or GW1x826, or by a dedicated GWA1700 power supply; The connection cable from the plate to the device powering it is included in the plate package.



GW 16 003 SST

EGO SMART PLATES - STEEL

Code	Description	For support codes	Pack Carton
GW 16 003 SST	3 modules	GW16803N	1
GW 16 004 SST	4 modules	GW16804N	1

FEATURES: matt finish, metallic effect. The plate has a dot-matrix display on the upper portion, RGB LED strips (along the outer and inner edges at the top and bottom) and a proximity sensor.

APPLICATIONS: visualisation of dynamic icons on the display indicating the functions associated with the devices installed in the plate; event/alarm signalling using the display (messages) and/or RGB led strips.

NOTES: the plate must be supplied with power by one of the following Smart devices, which must be installed in the same box as the plate: GWA1201, GWA1202, GWA1231, GWA1232, GWA1241, GWA1242 or GW1x826, or by a dedicated GWA1700 power supply. The connection cable from the plate to the device powering it is included in the plate package.

Codes not held as stock, for delivery times contact your local representative.

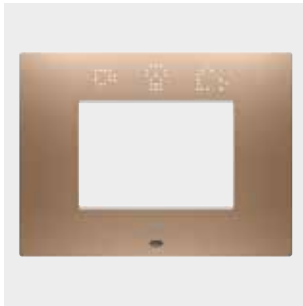

GW 16 003 SCS

EGO SMART PLATES - SOFT COPPER

Code	Description	For support codes	Pack Carton
GW 16 003 SCS	3 modules	GW16803N	1
GW 16 004 SCS	4 modules	GW16804N	1

FEATURES: matt finish, metallic effect. The plate has a dot-matrix display on the upper portion, RGB LED strips (along the outer and inner edges at the top and bottom) and a proximity sensor.
APPLICATIONS: visualisation of dynamic icons on the display indicating the functions associated with the devices installed in the plate; event/alarm signalling using the display (messages) and/or RGB led strips.
NOTES: the plate must be supplied with power by one of the following Smart devices, which must be installed in the same box as the plate: GWA1201, GWA1202, GWA1231, GWA1232, GWA1241, GWA1242 or GW1x826, or by a dedicated GWA1700 power supply; the connection cable from the plate to the device powering it is included in the plate package.
 Codes not held as stock, for delivery times contact your local representative.

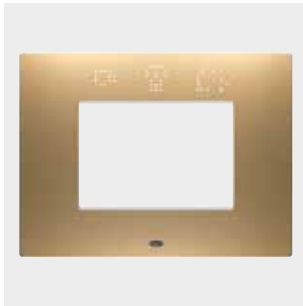

GW 16 003 SSG

EGO SMART PLATES - GOLD

Code	Description	For support codes	Pack Carton
GW 16 003 SSG	3 modules	GW16803N	1
GW 16 004 SSG	4 modules	GW16804N	1

FEATURES: matt finish, metallic effect. The plate has a dot-matrix display on the upper portion, RGB LED strips (along the outer and inner edges at the top and bottom) and a proximity sensor.
APPLICATIONS: visualisation of dynamic icons on the display indicating the functions associated with the devices installed in the plate; event/alarm signalling using the display (messages) and/or RGB led strips.
NOTES: the plate must be supplied with power by one of the following Smart devices, which must be installed in the same box as the plate: GWA1201, GWA1202, GWA1231, GWA1232, GWA1241, GWA1242 or GW1x826, or by a dedicated GWA1700 power supply; the connection cable from the plate to the device powering it is included in the plate package.
 Codes not held as stock, for delivery times contact your local representative.



GW 16 003 SCP

EGO SMART PLATES - COPPER

Code	Description	For support codes	Pack Carton
GW 16 003 SCP	3 modules	GW16803N	1
GW 16 004 SCP	4 modules	GW16804N	1

FEATURES: matt finish, metallic effect. The plate has a dot-matrix display on the upper portion, RGB LED strips (along the outer and inner edges at the top and bottom) and a proximity sensor.
APPLICATIONS: visualisation of dynamic icons on the display indicating the functions associated with the devices installed in the plate; event/alarm signalling using the display (messages) and/or RGB led strips.
NOTES: the plate must be supplied with power by one of the following Smart devices, which must be installed in the same box as the plate: GWA1201, GWA1202, GWA1231, GWA1232, GWA1241, GWA1242 or GW1x826, or by a dedicated GWA1700 power supply; the connection cable from the plate to the device powering it is included in the plate package.
 Codes not held as stock, for delivery times contact your local representative.



GW 16 003 SBS

EGO SMART PLATES - BROWN SHADE

Code	Description	For support codes	Pack Carton
GW 16 003 SBS	3 modules	GW16803N	1
GW 16 004 SBS	4 modules	GW16804N	1

FEATURES: matt finish, metallic effect. The plate has a dot-matrix display on the upper portion, RGB LED strips (along the outer and inner edges at the top and bottom) and a proximity sensor.
APPLICATIONS: visualisation of dynamic icons on the display indicating the functions associated with the devices installed in the plate; event/alarm signalling using the display (messages) and/or RGB led strips.
NOTES: the plate must be supplied with power by one of the following Smart devices, which must be installed in the same box as the plate: GWA1201, GWA1202, GWA1231, GWA1232, GWA1241, GWA1242 or GW1x826, or by a dedicated GWA1700 power supply; the connection cable from the plate to the device powering it is included in the plate package.
 Codes not held as stock, for delivery times contact your local representative.

Connected SMART HOME

EGO SMART INTERNATIONAL PLATES

PAINTED TECHNOPOLYMER



GW 16 022 SPW

EGO SMART INTERNATIONAL PLATES - SATIN WHITE

Code	Description	For support codes	Pack Carton
GW 16 022 SPW	2 modules	GW16821N, GW16822N	1

FEATURES: matt finish. The plate has a dot-matrix display on the upper portion, RGB LED strips (along the outer and inner edges at the top and bottom) and a proximity sensor.
APPLICATIONS: visualisation of dynamic icons on the display indicating the functions associated with the devices installed in the plate; event/alarm signalling using the display (messages) and/or RGB led strips.
NOTES: The plate must be supplied with power by one of the following connected devices, which must be installed within the same box as the plate: GWA1201, GWA1202, GWA1231, GWA1232, GWA1241, GWA1242 or GW1x826, or by a dedicated GWA1700 power supply; The connection cable from the plate to the device powering it is included in the plate package.



GW 16 022 SCY

EGO SMART INTERNATIONAL PLATES - CLAY

Code	Description	For support codes	Pack Carton
GW 16 022 SCY	2 modules	GW16821N, GW16822N	1

FEATURES: matt finish. The plate has a dot-matrix display on the upper portion, RGB LED strips (along the outer and inner edges at the top and bottom) and a proximity sensor.
APPLICATIONS: visualisation of dynamic icons on the display indicating the functions associated with the devices installed in the plate; event/alarm signalling using the display (messages) and/or RGB led strips.
NOTES: the plate must be supplied with power by one of the following connected devices, which must be installed in the same box as the plate: GWA1201, GWA1202, GWA1231, GWA1232, GWA1241, GWA1242 or GW1x826, or by a dedicated GWA1700 power supply; The connection cable from the plate to the device powering it is included in the plate package.
 Codes not held as stock, for delivery times contact your local representative.



GW 16 022 SNB

EGO SMART INTERNATIONAL PLATES - NATURAL BEIGE

Code	Description	For support codes	Pack Carton
GW 16 022 SNB	2 modules	GW16821N, GW16822N	1

FEATURES: matt finish. The plate has a dot-matrix display on the upper portion, RGB LED strips (along the outer and inner edges at the top and bottom) and a proximity sensor.
APPLICATIONS: visualisation of dynamic icons on the display indicating the functions associated with the devices installed in the plate; event/alarm signalling using the display (messages) and/or RGB led strips.
NOTES: The plate must be supplied with power by one of the following connected devices, which must be installed within the same box as the plate: GWA1201, GWA1202, GWA1231, GWA1232, GWA1241, GWA1242 or GW1x826, or by a dedicated GWA1700 power supply; The connection cable from the plate to the device powering it is included in the plate package.



GW 16 022 SDS

EGO SMART INTERNATIONAL PLATES - DARK SAND

Code	Description	For support codes	Pack Carton
GW 16 022 SDS	2 modules	GW16821N, GW16822N	1

FEATURES: matt finish. The plate has a dot-matrix display on the upper portion, RGB LED strips (along the outer and inner edges at the top and bottom) and a proximity sensor.
APPLICATIONS: visualisation of dynamic icons on the display indicating the functions associated with the devices installed in the plate; event/alarm signalling using the display (messages) and/or RGB led strips.
NOTES: the plate must be supplied with power by one of the following connected devices, which must be installed in the same box as the plate: GWA1201, GWA1202, GWA1231, GWA1232, GWA1241, GWA1242 or GW1x826, or by a dedicated GWA1700 power supply; The connection cable from the plate to the device powering it is included in the plate package.
 Codes not held as stock, for delivery times contact your local representative.



GW 16 022 SDB

EGO SMART INTERNATIONAL PLATES - SATIN BLACK

Code	Description	For support codes	Pack Carton
GW 16 022 SDB	2 modules	GW16821N, GW16822N	1

FEATURES: matt finish. The plate has a dot-matrix display on the upper portion, RGB LED strips (along the outer and inner edges at the top and bottom) and a proximity sensor.

APPLICATIONS: visualisation of dynamic icons on the display indicating the functions associated with the devices installed in the plate; event/alarm signalling using the display (messages) and/or RGB led strips.

NOTES: The plate must be supplied with power by one of the following connected devices, which must be installed within the same box as the plate: GWA1201, GWA1202, GWA1231, GWA1232, GWA1241, GWA1242 or GW1x826, or by a dedicated GWA1700 power supply; The connection cable from the plate to the device powering it is included in the plate package.



GW 16 022 SGR

EGO SMART INTERNATIONAL PLATES - MAGNETIC GRAY

Code	Description	For support codes	Pack Carton
GW 16 022 SGR	2 modules	GW16821N, GW16822N	1

FEATURES: matt finish, metallic effect. The plate has a dot-matrix display on the upper portion, RGB LED strips (along the outer and inner edges at the top and bottom) and a proximity sensor.

APPLICATIONS: visualisation of dynamic icons on the display indicating the functions associated with the devices installed in the plate; event/alarm signalling using the display (messages) and/or RGB led strips.

NOTES: the plate must be powered by one of the following connected devices, which must be installed in the same box as the plate: GWA1201, GWA1202, GWA1231, GWA1232, GWA1241, GWA1242 or GW1x826, or by a dedicated GWA1700 power supply; The connection cable from the plate to the device powering it is included in the plate package.



GW 16 022 SBR

EGO SMART INTERNATIONAL PLATES - LIGHT BRONZE

Code	Description	For support codes	Pack Carton
GW 16 022 SBR	2 modules	GW16821N, GW16822N	1

FEATURES: matt finish, metallic effect. The plate has a dot-matrix display on the upper portion, RGB LED strips (along the outer and inner edges at the top and bottom) and a proximity sensor.

APPLICATIONS: visualisation of dynamic icons on the display indicating the functions associated with the devices installed in the plate; event/alarm signalling using the display (messages) and/or RGB led strips.

NOTES: the plate must be powered by one of the following connected devices, which must be installed in the same box as the plate: GWA1201, GWA1202, GWA1231, GWA1232, GWA1241, GWA1242 or GW1x826, or by a dedicated GWA1700 power supply; The connection cable from the plate to the device powering it is included in the plate package.



GW 16 022 SST

EGO SMART INTERNATIONAL PLATES - STEEL

Code	Description	For support codes	Pack Carton
GW 16 022 SST	2 modules	GW16821N, GW16822N	1

FEATURES: matt finish, metallic effect. The plate has a dot-matrix display on the upper portion, RGB LED strips (along the outer and inner edges at the top and bottom) and a proximity sensor.

APPLICATIONS: visualisation of dynamic icons on the display indicating the functions associated with the devices installed in the plate; event/alarm signalling using the display (messages) and/or RGB led strips.

NOTES: The plate must be supplied with power by one of the following connected devices, which must be installed in the same box as the plate: GWA1201, GWA1202, GWA1231, GWA1232, GWA1241, GWA1242 or GW1x826, or by a dedicated GWA1700 power supply; The connection cable from the plate to the device powering it is included in the plate package.

Codes not held as stock, for delivery times contact your local representative.

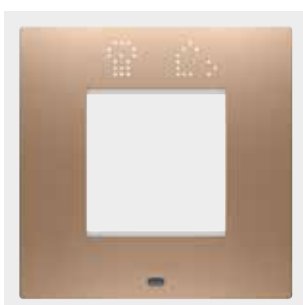

GW 16 022 SCS

EGO SMART INTERNATIONAL PLATES - SOFT COPPER

Code	Description	For support codes	Pack Carton
GW 16 022 SCS	2 modules	GW16821N, GW16822N	1

FEATURES: matt finish, metallic effect. The plate has a dot-matrix display on the upper portion, RGB LED strips (along the outer and inner edges at the top and bottom) and a proximity sensor.

APPLICATIONS: visualisation of dynamic icons on the display indicating the functions associated with the devices installed in the plate; event/alarm signalling using the display (messages) and/or RGB led strips.

NOTES: The plate must be supplied with power by one of the following connected devices, which must be installed in the same box as the plate: GWA1201, GWA1202, GWA1231, GWA1232, GWA1241, GWA1242 or GW1x826, or by a dedicated GWA1700 power supply; The connection cable from the plate to the device powering it is included in the plate package.

Codes not held as stock, for delivery times contact your local representative.

Connected SMART HOME

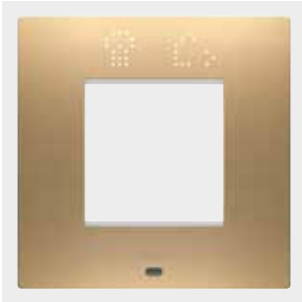

GW 16 022 SSG

EGO SMART INTERNATIONAL PLATES - GOLD

Code	Description	For support codes	Pack Carton
GW 16 022 SSG	2 modules	GW16821N, GW16822N	1

FEATURES: matt finish, metallic effect. The plate has a dot-matrix display on the upper portion, RGB LED strips (along the outer and inner edges at the top and bottom) and a proximity sensor.
APPLICATIONS: visualisation of dynamic icons on the display indicating the functions associated with the devices installed in the plate; event/alarm signalling using the display (messages) and/or RGB led strips.

NOTES: The plate must be supplied with power by one of the following connected devices, which must be installed in the same box as the plate: GWA1201, GWA1202, GWA1231, GWA1232, GWA1241, GWA1242 or GW1x826, or by a dedicated GWA1700 power supply; The connection cable from the plate to the device powering it is included in the plate package.
 Codes not held as stock, for delivery times contact your local representative.



GW 16 022 SCP

EGO SMART INTERNATIONAL PLATES - COPPER

Code	Description	For support codes	Pack Carton
GW 16 022 SCP	2 modules	GW16821N, GW16822N	1

FEATURES: matt finish, metallic effect. The plate has a dot-matrix display on the upper portion, RGB LED strips (along the outer and inner edges at the top and bottom) and a proximity sensor.
APPLICATIONS: visualisation of dynamic icons on the display indicating the functions associated with the devices installed in the plate; event/alarm signalling using the display (messages) and/or RGB led strips.

NOTES: The plate must be supplied with power by one of the following connected devices, which must be installed in the same box as the plate: GWA1201, GWA1202, GWA1231, GWA1232, GWA1241, GWA1242 or GW1x826, or by a dedicated GWA1700 power supply; The connection cable from the plate to the device powering it is included in the plate package.
 Codes not held as stock, for delivery times contact your local representative.



GW 16 022 SBS

EGO SMART INTERNATIONAL PLATES - BROWN SHADE

Code	Description	For support codes	Pack Carton
GW 16 022 SBS	2 modules	GW16821N, GW16822N	1

FEATURES: matt finish, metallic effect. The plate has a dot-matrix display on the upper portion, RGB LED strips (along the outer and inner edges at the top and bottom) and a proximity sensor.
APPLICATIONS: visualisation of dynamic icons on the display indicating the functions associated with the devices installed in the plate; event/alarm signalling using the display (messages) and/or RGB led strips.

NOTES: The plate must be supplied with power by one of the following connected devices, which must be installed in the same box as the plate: GWA1201, GWA1202, GWA1231, GWA1232, GWA1241, GWA1242 or GW1x826, or by a dedicated GWA1700 power supply; The connection cable from the plate to the device powering it is included in the plate package.
 Codes not held as stock, for delivery times contact your local representative.

ACCESSORIES FOR EGO SMART AND EGO SMART INTERNATIONAL PLATES

POWER SUPPLY AND CONNECTION



GW A1 700

POWER AND COMMUNICATION UNIT FOR EGO SMART PLATE - ZIGBEE

Code	Supply voltage	Pack Carton
GW A1 700	100 ÷ 240 V ac - 50/60 Hz	1/4

CHARACTERISTICS: device for power supply and communication of the EGO SMART plates.

NOTES: the device must be placed in the flush-mounting box where the EGO SMART plate it powers is installed; installable in ChoruSmart supports using the blanking module GW1x750. The connection between device and the EGO SMART plate must be made using the cable supplied in the EGO SMART packaging.

This device is unnecessary if one of the following devices is already present in the Smart plate box: GWA1201, GWA1202, GWA1231, GWA1232, GWA1241, GWA1242, GW1x826 (any of these devices can power the EGO SMART plate).

SUPPORTS FOR RECTANGULAR BOXES

ITALIAN STANDARD SUPPORTS FOR EGO SMART PLATES



Code	Description	Fixing	Characteristics	Pack Carton
GW 16 803 N	3 modules	2 screws (included)	Halogen free	6/240
GW 16 804 N	4 modules	2 screws (included)	Halogen free	6/120

CHARACTERISTICS: specific supports for 3 and 4 module Italian standard EGO SMART plates; supports are also compatible with the other Italian standard ChoruSmart 3 and 4 module plates ONE, GEO, LUX, ICE and EGO.



GW 16 803 N

SUPPORTS FOR SQUARE AND ROUND BOXES

INTERNATIONAL STANDARD SUPPORTS FOR EGO SMART PLATES



Code	Description	Fixing	Characteristics	Pack Carton
GW 16 821 N	2 modules	With fixing clutches	Halogen free	20/120
GW 16 822 N	2 modules	For screws (not included)	Halogen free	20/120

FEATURES: GW16821N equipped with fixing clutches for installation on round boxes. Supports specifically for international standard EGO SMART plates; the supports are also compatible with the other ChoruSmart international standard plates, including ONE, GEO, LUX and EGO.

NOTES:The GW16822N support can be installed on single round and square boxes or in a horizontal composition; the GW16821N support can be installed on single stand-alone round boxes.



GW 16 822 N

PROTECTIVE COVERS FOR PAINTING



GW 16 873

PROTECTIVE COVERS FOR PAINTING, FOR CHORUSMART RANGE, ITALIAN STANDARD

Code	Description	Suitable for support	Colour	Pack Carton
GW 16 873	3 modules	GW16802, GW16803, GW16803N	Transparent	120/480
GW 16 874	4 modules	GW16804, GW16804N	Transparent	60/240

CHARACTERISTICS: total protection during painting and finishing operations.

NOTES: snap in fastening to facilitate installation and removal.



GW 16 871

PROTECTIVE COVERS FOR PAINTING FOR INTERNATIONAL STANDARD SUPPORTS

Code	Description	Suitable for support	Colour	Pack Carton
GW 16 871	2 modules	GW16821, GW16822, GW16823, GW16831, GW16821N, GW16822N	Transparent	60/480

CHARACTERISTICS: total protection during painting and finishing operations.

NOTES: snap in fastening to facilitate installation and removal.



Connected Smart Home



Scan the QR Code and find out all the technical informations.

UNIQUE USER EXPERIENCE

A COMPLETE RANGE OF FUNCTIONS

INTEGRATION WITH IOT DEVICES



The user can control all functions with ease via the APP, voice assistants and the innovative EGO SMART plate, which signals abnormal or alarm situations within the home (e.g., water or gas leaks) and allows the user to increase the control possibilities of smart functions.







The system offers a wide range of functions to control safety, comfort and energy to meet all application needs.









Thanks to integration with the Google Home IoT platforms, Amazon Alexa and IFTTT, the system can also interoperate with all IoT devices and systems compatible with these platforms.

Home & Building PRO

HOME&BUILDING PRO SUPERVISION - KNX AND ZIGBEE





Gateway		<p>GW A9 000 without license</p> <p>GW A9 002 with unlimited preloaded license</p>	Touch panels		
	Smart Gateway 12Vdc - 1A	 <p>GW A9 001 Unlimited license for Smart Gateway</p>		<p>GW A9 007 CB 7" panel - White</p>	<p>GW 90 802 A Power-supply 24 V dc-2.5 A 100/240 V ac-50/60 Hz</p>

SYSTEM COMPONENTS - KNX







Self-protected electronic power supplies			Complementary items					
	<p>GW 90 709 320 mA 220-240 V ac - 50/60 Hz</p>	<p>GW 90 710 640 mA 220-240 V ac - 50/60 Hz</p>		<p>GW 90 708 A Line/field coupler</p>	<p>GW 90 706 B KNX/USB interface</p>	<p>GW 90 706 U KNX/USB-stick interface</p>	<p>GW A9 705 KNX/IP interface</p>	<p>GW A9 707 KNX/IP router</p>

COMMAND DEVICES - KNX

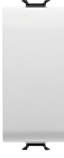
TOUCH push-button panel module with interchangeable symbols		ICE TOUCH KNX glass plates		<p>GW 16 946 CB Glossy white</p> <p>GW 16 946 CL Glossy natural beige</p> <p>GW 16 946 CN Glossy black</p> <p>GW 16 946 CT Glossy titanium</p>
	<p>GW A9 421 KNX 6-channel with interchangeable symbols</p>			

Contact interfaces				
	<p>GW 90 727 KNX 2-channel</p>	<p>GW 90 721 A KNX 4-channel</p>	<p>GW 90 728 KNX 8-channel input module (4 digital + 4 universal)</p>	<p>GW 90 729 KNX 8-channel ac/dc voltage input module</p>

LED signalling units		<p>GW 10 886 Blue</p> <p>GW 10 887 White</p> <p>GW 10 888 Red</p> <p>GW 10 889 Green</p> <p>GW 10 890 Amber</p>	Blanking modules		<p>GW 10 751 Glossy white</p> <p>GW 15 751 Satin white</p> <p>GW 13 751 Sat. natural beige</p> <p>GW 12 751 Satin black</p> <p>GW 14 751 Glossy titanium</p>
	<p>3.3 V dc</p>			<p>For housing contact interfaces</p>	

Soft-click electronic push-buttons		<p>GW 10 915 Glossy white</p> <p>GW 15 915 Satin white</p> <p>GW 13 915 Sat. natural beige</p> <p>GW 12 915 Satin black</p> <p>GW 14 915 Glossy titanium</p>		<p>GW 10 913 Glossy white</p> <p>GW 15 913 Satin white</p> <p>GW 13 913 Sat. natural beige</p> <p>GW 12 913 Satin black</p> <p>GW 14 913 Glossy titanium</p>		<p>GW 10 916 Glossy white</p> <p>GW 15 916 Satin white</p> <p>GW 13 916 Sat. natural beige</p> <p>GW 12 916 Satin black</p> <p>GW 14 916 Glossy titanium</p>
		<p>GW 10 917 Glossy white</p> <p>GW 15 917 Satin white</p> <p>GW 13 917 Sat. natural beige</p> <p>GW 12 917 Satin black</p> <p>GW 14 917 Glossy titanium</p>		<p>GW 10 918 Glossy white</p> <p>GW 15 918 Satin white</p> <p>GW 13 918 Sat. natural beige</p> <p>GW 12 918 Satin black</p> <p>GW 14 918 Glossy titanium</p>		<p>GW 10 914 Glossy white</p> <p>GW 15 914 Satin white</p> <p>GW 13 914 Sat. natural beige</p> <p>GW 12 914 Satin black</p> <p>GW 14 914 Glossy titanium</p>

COMMAND DEVICES - KNX

Push-button panels

- KNX 6-channel with interchangeable symbols**
 - GW 10 783 A Glossy white
 - GW 15 783 A Satin white
 - GW 13 783 A Sat. natural beige
 - GW 12 783 A Satin black
 - GW 14 783 A Glossy titanium
- KNX 6-channel + switch actuator with interchangeable symbols**
 - GW 10 784 A Glossy white
 - GW 15 784 A Satin white
 - GW 13 784 A Sat. natural beige
 - GW 12 784 A Satin black
 - GW 14 784 A Glossy titanium
- KNX 6-channel + roller shutter actuator with interchangeable symbols**
 - GW 10 785 A Glossy white
 - GW 15 785 A Satin white
 - GW 13 785 A Sat. natural beige
 - GW 12 785 A Satin black
 - GW 14 785 A Glossy titanium
- KNX 4-channel with interchangeable symbols**
 - GW 10 787 Glossy white
 - GW 15 787 Satin white
 - GW 13 787 Sat. natural beige
 - GW 12 787 Satin black
 - GW 14 787 Glossy titanium
- KNX 4-channel**
 - GW 10 782 Glossy white
 - GW 15 782 Satin white
 - GW 13 782 Sat. natural beige
 - GW 12 782 Satin black
 - GW 14 782 Glossy titanium

Interchangeable button keys for push-button panels

- Button key - 1M To be completed with lens**
 - GW 10 551 Glossy white
 - GW 15 551 Satin white
 - GW 13 551 Sat. natural beige
 - GW 12 551 Satin black
 - GW 14 551 Glossy titanium
- Button key - 2M To be completed with lens**
 - GW 10 552 Glossy white
 - GW 15 552 Satin white
 - GW 13 552 Sat. natural beige
 - GW 12 552 Satin black
 - GW 14 552 Glossy titanium
- Button key - 1M To be completed with 2 lenses**
 - GW 10 553 Glossy white
 - GW 15 553 Satin white
 - GW 13 553 Sat. natural beige
 - GW 12 553 Satin black
 - GW 14 553 Glossy titanium
- Button key - 2M To be completed with 2 lenses**
 - GW 10 554 Glossy white
 - GW 15 554 Satin white
 - GW 13 554 Sat. natural beige
 - GW 12 554 Satin black
 - GW 14 554 Glossy titanium
- Button key - 1M With 2 diffusers**
 - GW 10 557 Glossy white
 - GW 15 557 Satin white
 - GW 13 557 Sat. natural beige
 - GW 12 557 Satin black
 - GW 14 557 Glossy titanium
- Button key - 1M Complete with 2 lenses DND+MUR**
 - GW 10 559 Glossy white
 - GW 15 559 Satin white
 - GW 13 559 Sat. natural beige
 - GW 12 559 Satin black
 - GW 14 559 Glossy titanium

Lenses with illuminating symbols

GW 10 501 A Neutral	GW 10 502 A Light	GW 10 503 A Stair light	GW 10 504 A Table light	GW 10 505 A Bell	GW 10 506 A Burglar alarm	GW 10 507 A Key	GW 10 508 A ON OFF	GW 10 509 A ON	GW 10 510 A OFF	GW 10 511 A Socket-outlet
GW 10 512 A Dimmer	GW 10 513 A Dimmer increase	GW 10 514 A Dimmer decrease	GW 10 515 A Arrow	GW 10 516 A Open	GW 10 517 A Close	GW 10 518 A Roller shutter	GW 10 519 A Roller shutter up	GW 10 520 A Roller shutter down	GW 10 521 A Curtain open	GW 10 522 A Curtain close
GW 10 523 A Floor light	GW 10 524 A Ceiling light	GW 10 525 A Wall light	GW 10 526 A Aisle light	GW 10 527 A Scenario	GW 10 528 A Party	GW 10 529 A In	GW 10 530 A Out	GW 10 531 A Good morning	GW 10 532 A Good night	GW 10 533 A TV
GW 10 534 A Heating	GW 10 535 A Cooling	GW 10 536 A Heating/Cooling	GW 10 537 A Comfort	GW 10 538 A Precomfort	GW 10 539 A Economy	GW 10 540 A Auto	GW 10 541 A Do not disturb (DND)	GW 10 542 A Make up the room (MUR)		























LIGHT/MOTION SENSORS - KNX

Motion/Presence



- KNX IR motion detector with twilight sensor**
 - GW 10 786 Glossy white
 - GW 15 786 Satin white
 - GW 13 786 Sat. natural beige
 - GW 12 786 Satin black
 - GW 14 786 Glossy titanium
- GW A9 531 A KNX presence detector**
- GW A9 543 Wall-mounting frame for KNX presence detector**
- GW A9 545 Plasterboard-mounting box for KNX presence detector**

Home & Building PRO

ACTUATORS - KNX

Switch actuators		<ul style="list-style-type: none"> GW 10 796 Glossy white GW 15 796 Satin white GW 13 796 Sat. natural beige GW 12 796 Satin black GW 14 796 Glossy titanium 		GW 90 741 KNX 4-channel 10 A 4 NO 230 V ac - 50/60 Hz		GW 90 740 A KNX 4-channel 16 AX 4 NO 230 V ac - 50/60 Hz		GW 90 742 KNX 4-channel 16 AX with manual operation 4 NO 230 V ac - 50/60 Hz		GW A9 108 KNX 8-channel 10 AX 8 NO 230 V ac - 50/60 Hz		GW A9 103 KNX 3-channel 16 AX with energy meter 3 NO 230 V ac - 50/60 Hz				
	Roller shutters actuators		<ul style="list-style-type: none"> GW 10 797 Glossy white GW 15 797 Satin white GW 13 797 Sat. natural beige GW 12 797 Satin black GW 14 797 Glossy titanium 		GW 90 856 KNX 2-channel 6 A 230 V ac - 50/60 Hz		GW 90 857 KNX 4-channel 6 A 230 V ac - 50/60 Hz	Fan-coil actuators		GW A9 140 KNX fan-coil 230 V ac - 50 Hz		GW A9 141 KNX fan-coil 0-10V 100-240 V ac - 50/60 Hz		GW A9 145 Temperature probe sensor		
		Combined actuators		GW 90 730 KNX 4-channel 10 A switch actuator + 4 universal inputs		GW A9 126 KNX 6/12-channel 8 AX switch and roller shutter actuator 12 NO 230 V ac - 50/60 Hz	Dimmer actuators			GW A9 313 For electronic ballasts 1-10V KNX 3-channel 16 AX 230 V ac - 50/60 Hz		GW A9 301 Universal KNX 1-channel 500 VA 230V ac - 50/60 Hz		GW A9 302 Universal KNX 2-channel 300 VA 230V ac - 50/60 Hz		GW A9 303 Universal KNX 2-channel 400W (or 1-channel 800W) 230 V ac - 50 Hz
			Dimmer actuators		GW A9 350 Bleeder				GW 90 764 For CVD LED KNX 4-channel 12-24 V dc		GW 90 765 For CVD LED KNX 4-channel 12-48 V dc		GW 90 766 Booster for CVD LED dimmer 4x10A 12-24 V dc			

TEMPERATURE CONTROL - KNX







Climate control		<ul style="list-style-type: none"> GW 10 794 H Glossy white GW 15 794 H Satin white GW 13 794 H Sat. natural beige GW 12 794 H Satin black GW 14 794 H Glossy titanium 	KNX timed thermostats/programmers with humidity management (*)		<ul style="list-style-type: none"> GW 10 795 H Glossy white GW 15 795 H Satin white GW 13 795 H Sat. natural beige GW 12 795 H Satin black GW 14 795 H Glossy titanium 	KNX thermostats with humidity management (*)						
		<ul style="list-style-type: none"> GW 10 799 Glossy white GW 15 799 Satin white GW 13 799 Sat. natural beige GW 12 799 Satin black GW 14 799 Glossy titanium 	KNX temperature sensors		<ul style="list-style-type: none"> GW 10 799 H Glossy white GW 15 799 H Satin white GW 13 799 H Sat. natural beige GW 12 799 H Satin black GW 14 799 H Glossy titanium 	KNX temperature/humidity sensors		<ul style="list-style-type: none"> GW 10 762 H Glossy white GW 15 762 H Satin white GW 13 762 H Sat. natural beige GW 12 762 H Satin black GW 14 762 H Glossy titanium 	KNX temperature/humidity probe sensors		<ul style="list-style-type: none"> GW 10 900 Glossy white GW 15 900 Satin white GW 13 900 Sat. natural beige GW 12 900 Satin black GW 14 900 Glossy titanium 	Temperature probe sensors
		GW 10 800 Temperature probe sensor	KNX Thermo ICE thermostats		<ul style="list-style-type: none"> GW 16 974 CB Glossy white GW 16 974 CN Glossy black GW 16 974 CT Glossy titanium 	KNX Thermo ICE thermostats 12-24 V ac/dc		<ul style="list-style-type: none"> GW 16 976 CB Glossy white GW 16 976 CN Glossy black GW 16 976 CT Glossy titanium 	KNX Thermo ICE thermostats 110/230 V ac - 50/60 Hz Wall-mounting		GW 10 720 Power supply 100/240 V ac/50/60 Hz 12 V dc	

(*) Not equipped with on boards humidity sensor

WEATHER SENSORS - KNX

Devices				
	GW 90 800 KNX weather station	GW 90 883 KNX wind and rain sensor	GW 90 884 KNX light intensity sensor	GW 90 885 KNX temperature sensor

ENERGY CONTROL - KNX

P-Comfort	KNX energy meters	Traditional energy meters	Interfaces						
				GW A9 916 KNX P-Comfort 230 V ac - 50 Hz	GW A9 801 KNX single-phase direct connection	GW D6 801 Single-phase direct connection GW D6 802 Single-phase direct connection MID	GW D6 807 Three-phase direct connection MID	GW D6 809 Three-phase A.T. connection MID	GW 90 876 KNX interface for traditional energy meters

COMPLEMENTARY ITEMS - KNX

Interfaces			
	GW 90 871 Gateway KNX/DMX	GW 90 872 A (*) Gateway KNX/DALI 64/16	GW 90 873 (**) Gateway KNX/DALI2 multimaster 64/16
	Accessories		
GW 90 807 Connection terminal to BUS (red/black)		GW 90 808 Connection terminal to SELV line (yellow/white)	GW 90 584 KNX BUS cable 2 conductors 1x2x0.8 GW 90 585 KNX BUS cable 4 conductors 2x2x0.8

(*) available until new code GW90873 is entered.
(**) for the date of availability, please contact the GEWISS Sales Organization.

Home & Building PRO

COMMAND DEVICES - ZIGBEE

Contact interfaces



GW A1 501
2-channel potential-free
Battery powered



GW A1 502
2-channel
230Vac - 50Hz

ACTUATORS - ZIGBEE

Switch actuators



GW A1 521
1-channel 10A potential-free
230Vac - 50Hz



GW A1 522
2-channel 6A
230Vac - 50Hz



GW A1 523
1-channel 10A with power meter
230Vac - 50Hz

Roller shutters actuator



GW A1 531
1-channel 6A
230Vac - 50Hz

Smart plug



GW A1 526
10A Schuko adapter
with power meter
230Vac

LOAD MANAGEMENT - ZIGBEE

Load management kit



GW A1 911
P-Comfort + 1 Smart plug



GW A1 912
P-Comfort + 2 Smart plugs

Load management relay



GW A1 916
P-Comfort
230Vac - 50Hz

SENSORS AND ALARMS - ZIGBEE

Sensors



GW A1 511
Motion sensor
Battery powered



GW A1 513
Window sensor
Battery powered

Alarms



GW A1 512
Smoke sensor
Battery powered



GW A1 514
Water sensor
Battery powered

Accessory for water sensor



GW A1 541
Wall-mounting support for
water sensor

ACCESSORIES

ChoruSmart blanking modules



For housing contact interfaces
and actuators
Zigbee

-  **GW 10 750**
Glossy white
-  **GW 15 750**
Satin white
-  **GW 13 750**
Sat. natural beige
-  **GW 12 750**
Satin black
-  **GW 14 750**
Glossy titanium

Home & Building PRO

Home & Building PRO system

Wired system based on the KNX international standard protocol, suitable for advanced automation solutions for residential solutions and small-to-medium offices. The offer is highly customisable, complete with all functions and can be integrated with third-party devices and systems (video intercom, smart locks, entertainment). It can be controlled via the APP, voice assistants or touch panels. With Home and Building PRO, you can also manage ZigBee devices and communicate with the Google Home IoT platforms, Amazon Alexa and IFTTT.



HOME AND BUILDING PRO SUPERVISION - KNX AND ZIGBEE

SMART GATEWAY



GW A9 000

SMART GATEWAY

Code	Supply voltage	Colour	License type	Dimensions (mm)	Pack Carton
GW A9 000	12 V dc - 1 A	White	Without license	171x110x30	1
GW A9 002	12 V dc - 1 A	White	With unlimited license	171x110x30	1

CHARACTERISTICS: multiprotocol gateway provided with KNX, ZigBee, WiFi, Bluetooth (BLE) and LAN interfaces.

APPLICATIONS: the device allows to supervise, command and control the Home&Building automation system through the cloud, ensuring full integration and functional interoperability between different communication protocols. The management of the functions and the access to the data of the system is cloud-based and takes place through a dedicated App (for PC, smartphone and tablet).

ACCESSORIES SUPPLIED: plug power supply and brackets for DIN rail-mounting.

NOTES: table- or DIN rail-mounting.

GWA9000: the access to the cloud services is free of charge for a first period after the purchase. After that period, the payment of the service can be made in a lump sum or with annual tranches. Please, refer to the www.gewiss.com website for more information or contact the Gewiss technical service.

GWA9002: smart gateway includes an unlimited preloaded license.



GW A9 001

SMART GATEWAY LICENSE

Code	Description	Pack Carton
GW A9 001	Unlimited license for Smart Gateway	1

CHARACTERISTICS: extends the license for the access to the GWA9000 Smart Gateway cloud services for an unlimited period.

TOUCH PANELS



GW A9 007 CB

TOUCH PANEL - WITH H&B AUTOMATION SUPERVISION AND VIDEO ENTRYPHONE FUNCTIONS

Code	Supply voltage	Display	Colour	Dimensions LxHxD (mm)	Pack Carton
GW A9 007 CB	12-24 Vdc / PoE	7.6quot;	White	196x128x19	1/16

CHARACTERISTICS: the device combines the function of a command and supervision panel in a H&B automation system (together with Smart Gateway) and of video entryphone indoor unit with speakerphone (together with 2N IP video entryphone outdoor units). Supply voltage via Power over Ethernet - PoE (IEEE 802.3af) or, as an alternative, with external power supply (eg: CW90802). The panel is based on SIP protocol with H.264 video coding.

NOTES: wall-mounting. To fix it, use flush-mounting Ø60mm round (eg: GW24232), square (eg: GW24231) or rectangular (eg: GW24403) boxes with the aid of the supplied wall metal bracket.

Home & Building PRO



GW 90 802 A

POWER SUPPLY 24 V DC - 2,5 A - DIN RAIL MOUNTING

Code	Input voltage	Output voltage	No. DIN modules	Pack Carton
GW 90 802 A	100 ÷ 240 V ac - 50/60 Hz	24V dc - 2.5 A	3	1

CHARACTERISTICS: protected against input overvoltages and output short-circuiting.
NOTES: to supply 7" touch panels.

SYSTEM COMPONENTS - KNX

POWER SUPPLIES



GW 90 710

SELF-PROTECTED ELECTRONIC POWER SUPPLIES 220-240V - IP20 - DIN RAIL MOUNTING

Code	Output voltage	Current supplied (max)	No. DIN modules	Pack Carton
GW 90 709	30V dc +/- 2V (SELV)	320 mA	4	1
GW 90 710	30V dc +/- 2V (SELV)	640 mA	4	1

CHARACTERISTICS: integrated coil to uncouple the power supply from the BUS line.
 Reset push-button for restoring all the devices connected to the BUS line.
APPLICATIONS: the power supply feeds and controls the BUS voltage.
NOTES: equipped with coupling terminal for connection to BUS (with protection lid).
 The maximum number of devices that can be powered is calculated on the basis of their absorption.

COMPLEMENTARY ITEMS



GW 90 708 A

LINE/FIELD COUPLING - IP20 - DIN RAIL MOUNTING

Code	Functions	No. DIN modules	Pack Carton
GW 90 708 A	Coupler - Repeater	2	1/4

APPLICATIONS: for the logic connection and the galvanic separation of lines and areas (fields).
NOTES: equipped with 2 coupling terminals for connection to BUS.



GW 90 706 B

KNX/USB INTERFACE - IP20 - DIN RAIL MOUNTING

Code	Max USB cable length	No. DIN modules	Pack Carton
GW 90 706 B	5 m	1	1

CHARACTERISTICS: equipped with B-type USB port.
APPLICATIONS: for the connection of a PC with a USB port to the KNX BUS.
NOTES: equipped with coupling terminal for connection to bus.



GW 90 706 U

KNX/USB STICK INTERFACE - IP20

Code	Description	Dimensions LxHxD (mm)	Pack Carton
GW 90 706 U	USB key	60x19x13	1

CHARACTERISTICS: equipped with A-type USB connector.
APPLICATIONS: for the connection of a PC with a USB port to the KNX BUS.
NOTES: equipped with screw terminal for connection to the bus.



GW A9 707

KNX/IP ROUTER - IP20 - DIN RAIL MOUNTING

Code	Description	Max power consumption	No. DIN modules	Pack Carton
GW A9 707	KNX/IP router	<500 mW	1	1/8

CHARACTERISTICS: equipped with RJ45 port.
APPLICATIONS: for connecting the KNX lines to the IP backbones and the PC interface via LAN to the KNX BUS. Supports up to 5 simultaneous connections.
NOTES: equipped with coupling terminal for connection to bus.



GW A9 705

KNX/IP INTERFACE - IP20 - DIN RAIL MOUNTING

Code	Description	Max power consumption	No. DIN modules	Pack Carton
GW A9 705	KNX/IP interface	<500 mW	1	1/8

CHARACTERISTICS: equipped with RJ45 port.
APPLICATIONS: for connecting a PC via LAN to the KNX BUS. Supports up to 5 simultaneous connections. To be used with the HAPPY HOME app for smartphones and tablets (available for Android and iOS) to manage the KNX domotic system via LAN and WiFi access points, or from a distance. The app can also be used with the codes GW90767 and GW90767AP.
NOTES: equipped with coupling terminal for connection to bus.

COMMAND DEVICES - KNX

TOUCH PUSH-BUTTON PANELS



GW A9 421

KNX 6-CHANNEL TOUCH PUSH-BUTTON PANEL MODULE WITH INTERCHANGEABLE SYMBOLS

Code	No. channels	No. modules	Pack Carton
GW A9 421	6	3	1

CHARACTERISTICS: KNX module with 6 independent channels. Each channel is associated with an RGB night-time backlight LED or a status display LED for the commanded load. Each channel can be personalised using a set of adhesive icons. To be completed with the glass ICE Touch KNX plate (code GW16946CB, GW16946CN, GW16946CT, GW16946CL). The device's touch commands can only be activated with the plate mounted; therefore, to configure the module the ICE Touch KNX plates or alternative the test plate (GW1695D) must be used. To be configured with ETS software.
APPLICATIONS: used for sending ON-OFF commands with fronts management, switching commands and sequences, timed commands, multiple pressing, priority commands, commands for managing roller shutters (single or double push-button), dimmers (single or double push-button) and scenes (storage and activation).
NOTES: equipped with coupling terminal with protection lid, for connection to BUS, and with set of icons to personalise the functions of each channel.



GW 16 946 CB

ICE TOUCH KNX - WHITE

Code	Description	For support codes	Pack Carton
GW 16 946 CB	6 touch areas	GW16803, GW16803N	1

CHARACTERISTICS: plates made of glass with a glossy finish, to match the KNX touch-panel modules (GWA9421).

NOTES: the symbols shown in the image are purely indicative: they can be customised using the adhesive icons supplied with the touch-panel module. The plate code is unique, regardless of the number of channels to be activated (from 1 to 6).



GW 16 946 CN

ICE TOUCH KNX - BLACK

Code	Description	For support codes	Pack Carton
GW 16 946 CN	6 touch areas	GW16803, GW16803N	1

CHARACTERISTICS: plates made of glass with a glossy finish, to match the KNX touch-panel modules (GWA9421).

NOTES: the symbols shown in the image are purely indicative: they can be customised using the adhesive icons supplied with the touch-panel module. The plate code is unique, regardless of the number of channels to be activated (from 1 to 6).



GW 16 946 CT

ICE TOUCH KNX - TITANIUM

Code	Description	For support codes	Pack Carton
GW 16 946 CT	6 touch areas	GW16803, GW16803N	1

CHARACTERISTICS: plates made of glass with a glossy finish, to match the KNX touch-panel modules (GWA9421).

NOTES: the symbols shown in the image are purely indicative: they can be customised using the adhesive icons supplied with the touch-panel module. The plate code is unique, regardless of the number of channels to be activated (from 1 to 6).



GW 16 946 CL

ICE TOUCH KNX - NATURAL BEIGE

Code	Description	For support codes	Pack Carton
GW 16 946 CL	6 touch areas	GW16803, GW16803N	1

CHARACTERISTICS: plates in glass and with a glossy finish, used to complete the KNX touch panel modules (GWA9421). The plates are equipped with 6 capacitive touch areas.

NOTES: the symbols shown in the image are purely indicative: they can be customised using the adhesive icons supplied with the touch-panel module. The plate code is unique, regardless of the number of channels to be activated (from 1 to 6).



GW 16 950

TEST PLATE FOR KNX 6-CHANNELS TOUCH PANEL MODULES WITH INTERCHANGEABLE SYMBOLS

Code	Description	For support codes	Pack Carton
GW 16 950	Test plate	GW16803, GW16803N	12

CHARACTERISTICS: transparent plastic plate with 6 capacitive touch areas.

NOTES: to be used for configuring the KNX touch panel module (GWA9421) if the KNX ICE touch glass plates are not available in the installation.

CONTACT INTERFACES



GW 90 721 A

KNX 2- AND 4-CHANNEL CONTACTS INTERFACES

Code	No. input channels	No. output channels	Max cable length	Dimensions LxHxD (mm)	Pack Carton
GW 90 727	2	2	10 m	38x32x14	1
GW 90 721 A	4	4	10 m	38x32x14	1

CHARACTERISTICS: BUS interfaces for connecting 2 or 4 push-buttons or conventional potential-free contacts. The reading voltage (SELV) is generated inside the device. For each input, an output is available for powering a low absorption LED (lower than 1mA such as, for example, GW10886, GW10887, GW10888, GW10889, GW10890) for displaying the status of the load commanded. To be configured with ETS software.

APPLICATIONS: for sending ON-OFF commands with fronts management, switching commands and sequences, brief / prolonged contact closure management, timed commands, priority commands, commands for managing roller shutters (single or double push-button), dimmers (single or double push-button), scenes (storage and activation), impulse count, output LED control, acquisition of temperature values via NTC sensor (GW90721A only). Installation in flush-mounting box, junction boxes or embedded in the blanking modules GW1x751. The slot on the plastic casing also allows it to be fixed with screws.

NOTES: equipped with coupling terminal for connection to the BUS, and unshielded cables for connecting the inputs, of length 30 cm extendible to 10m with unshielded twisted cable.



GW 90 728

KNX 8-CHANNEL (4 DIGITAL + 4 UNIVERSAL) INPUT MODULE - IP20 - DIN RAIL MOUNTING

Code	No. input channels	No. universal input channels	No. output channels	No. DIN modules	Pack Carton
GW 90 728	4	4	4	4	1

CHARACTERISTICS: the module has 4 digital inputs for push-buttons or conventional potential-free contacts and 4 universal input channels. The universal input channels can be configured as inputs for push-buttons or conventional potential-free contacts, analogue inputs (0..20mA, 4..20mA, 0..10V, 0..1V), digital inputs for measurement devices with S0 interface, inputs for NTC probe sensors that can be used for controlling the same number of thermoregulation areas. The module is provided also with 4 PWM outputs for LEDs (3.3V) for signalling the status of the loads. The device has 8 amber LEDs for signalling the status of the inputs. To be configured with ETS software.

APPLICATIONS: the input channels are used for sending ON-OFF commands with fronts management, switching commands and sequences, brief / prolonged contact closure management, timed commands, priority commands, thermoregulation commands, commands for managing roller shutters (single or double push-button), dimmers (single or double push-button), scenes (storage and activation), impulse count.

NOTES: equipped with coupling terminal for connection to BUS (with protection lid).



GW 90 729

KNX 8-CHANNEL AC/DC VOLTAGE INPUT MODULE - IP20 - DIN RAIL MOUNTING

Code	No. input channels	Input voltage	Max cable length	No. DIN modules	Pack Carton
GW 90 729	8	24-48 V dc, 24-230 V ac	100 m	4	1

CHARACTERISTICS: BUS interface module for connecting 8 push-buttons or conventional live contacts. The device has 8 amber LEDs for signalling the status of the inputs. To be configured with ETS software.

APPLICATIONS: for sending ON-OFF commands with fronts management, switching commands and sequences, brief / prolonged contact closure management, timed commands, priority commands, commands for managing roller shutters (single or double push-button), dimmers (single or double push-button), scenes (storage and activation), impulse count.

NOTES: equipped with coupling terminal for connection to BUS (with protection lid).



GW 10 886

LED SIGNALLING UNITS

Code	Supply voltage	Lamp	Colour	Cable Colour	Pack Carton
GW 10 886	3.3V dc	LED	Blue	Blue - Black	50
GW 10 887	3.3V dc	LED	White	White - Black	50
GW 10 888	3.3V dc	LED	Red	Red - Black	50
GW 10 889	3.3V dc	LED	Green	Green - Black	50
GW 10 890	3.3V dc	LED	Amber	Amber - Black	50

NOTES: the miniature lamps are equipped with power cables.

If connected with the interfaces GW90721, GW90834, GW90721A, GW90727, GW90834A, GW90833 they do not require the use of a current limiting resistance. In this case, the maximum current consumption is less than 1mA.



GW 14 751

BLANKING MODULES FOR HOUSING 2- AND 4-CHANNEL CONTACTS INTERFACE

Code	Colour	No. modules	Pack Carton
GW 10 751	Glossy white	1	5/200
GW 15 751	Satin White	1	5/200
GW 13 751	Natural satin beige	1	5/200
GW 12 751	Satin black	1	5/200
GW 14 751	Glossy Titanium	1	5/200

CHARACTERISTICS: 1 module blanking module with pad printing KNX/EIB.

Allows the housing and fast identification of the 2- and 4-channel contact interface.

NOTES: embedded coupling.

PUSH-BUTTON PANELS



GW 14 783 A

KNX 6-CHANNEL PUSH-BUTTON PANELS WITH INTERCHANGEABLE SYMBOLS

Code	Colour	No. channels	No. modules	Pack Carton
GW 10 783 A	Glossy white	6	3	1
GW 15 783 A	Satin White	6	3	1
GW 13 783 A	Natural satin beige	6	3	1
GW 12 783 A	Satin black	6	3	1
GW 14 783 A	Glossy Titanium	6	3	1

CHARACTERISTICS: KNX module with 6 independent channels, with replaceable button keys and built-in temperature sensor. Each channel is associated with an amber/green night-time locating LED or a status display LED for the commanded load. To be configured with ETS software. The package includes 3 replaceable button keys (GW1x553) and 10 lenses with illuminated symbols (2 x GW10502A, 1 x GW10509A, 1 x GW10510A, 1 x GW10513A, 1 x GW10514A, 1 x GW10519A, 1 x GW10520A, 1 x GW10529A, 1 x GW10530A). You can still customize the module with other type of replaceable button keys (suited for 1 or 2 lenses, with 2 diffusers, 1- or 2-module) or with other lenses in the catalogue.

APPLICATIONS: allows you to send ON-OFF commands with fronts management, switching commands and sequences, brief/prolonged contact closure management, timed commands, priority commands, commands for roller shutter management (single or double push-button), dimmers (single or double push-button) and scenes (memorisation and activation).

NOTES: equipped with coupling terminal for connection to BUS (with protection lid).



GW 14 784 A

KNX 6-CHANNEL PUSH-BUTTON PANELS WITH INTERCHANGEABLE SYMBOLS + SWITCH ACTUATOR

Code	Colour	No. channels	Output contacts	No. modules	Pack Carton
GW 10 784 A	Glossy white	6+1	1NO/NC 10A(AC1) 230Vac	3	1
GW 15 784 A	Satin White	6+1	1NO/NC 10A(AC1) 230Vac	3	1
GW 13 784 A	Natural satin beige	6+1	1NO/NC 10A(AC1) 230Vac	3	1
GW 12 784 A	Satin black	6+1	1NO/NC 10A(AC1) 230Vac	3	1
GW 14 784 A	Glossy Titanium	6+1	1NO/NC 10A(AC1) 230Vac	3	1

CHARACTERISTICS: KNX module with 6 independent channels, with replaceable button keys and 1-channel switch actuator. Each channel is associated with an amber/green night-time locating LED or a status display LED for the commanded load. One pair of keys can be used for local actuator command. The actuator manages the load via a potential-free output contact (NO). To be configured with ETS software. The package includes 3 replaceable button keys (GW1x553) and 10 lenses with illuminated symbols (2 x GW10502A, 1 x GW10509A, 1 x GW10510A, 1 x GW10513A, 1 x GW10514A, 1 x GW10519A, 1 x GW10520A, 1 x GW10529A, 1 x GW10530A). You can still customize the module with other type of replaceable button keys (suited for 1 or 2 lenses, with 2 diffusers, 1- or 2-module) or with other lenses in the catalogue.

APPLICATIONS: the push-button panel allows you to send ON-OFF commands with fronts management, switching commands and sequences, brief/prolonged contact closure management, timed commands, priority commands, commands for roller shutter management (single or double push-button), dimmers (single or double push-button) and scenes (memorisation and activation). The actuator allows the execution of ON-OFF commands, timed commands with pre-alarm at switch-off, priority commands and scene management commands.

NOTES: equipped with coupling terminal for connection to BUS (with protection lid).



GW 14 785 A

KNX 6-CHANNEL PUSH-BUTTON PANELS WITH INTERCHANGEABLE SYMBOLS + ROLLER SHUTTER ACTUATOR

Code	Colour	No. channels	Max current supplied	No. modules	Pack Carton
GW 10 785 A	Glossy white	6+1	6A-230V ac (compl. 60669-2-1)	3	1
GW 15 785 A	Satin White	6+1	6A-230V ac (compl. 60669-2-1)	3	1
GW 13 785 A	Natural satin beige	6+1	6A-230V ac (compl. 60669-2-1)	3	1
GW 12 785 A	Satin black	6+1	6A-230V ac (compl. 60669-2-1)	3	1
GW 14 785 A	Glossy Titanium	6+1	6A-230V ac (compl. 60669-2-1)	3	1

CHARACTERISTICS: KNX module with 6 independent channels, with replaceable button keys and 1-channel roller shutter actuator. Each channel is associated with an amber/green night-time locating LED or a status display LED for the commanded load. One pair of keys can be used for local actuator command. The actuator manages a motor to move roller-shutters, curtains, venetian blinds, rolling blinds, etc. via 2 potential-free interlocked output contacts (NO). To be configured with ETS software. The package includes 3 replaceable button keys (GW1x553) and 10 lenses with illuminated symbols (2 x GW10502A, 1 x GW10509A, 1 x GW10510A, 1 x GW10513A, 1 x GW10514A, 1 x GW10519A, 1 x GW10520A, 1 x GW10529A, 1 x GW10530A). You can still customize the module with other type of replaceable button keys (suited for 1 or 2 lenses, with 2 diffusers, 1- or 2-module) or with other lenses in the catalogue.

APPLICATIONS: the push-button panel allows you to send ON-OFF commands with fronts management, switching commands and sequences, brief/prolonged contact closure management, timed commands, priority commands, commands for roller shutter management (single or double push-button), dimmers (single or double push-button) and scenes (memorisation and activation). The actuator allows the execution of commands of movements/adjustment/stopping, along with priority commands, scene management and alarm signalling commands.

NOTES: equipped with coupling terminal for connection to BUS (with protection lid).



GW 14 787

KNX 4-CHANNEL PUSH-BUTTON PANELS WITH INTERCHANGEABLE SYMBOLS

Code	Colour	No. channels	No. modules	Pack Carton
GW 10 787	Glossy white	4	2	1
GW 15 787	Satin White	4	2	1
GW 13 787	Natural satin beige	4	2	1
GW 12 787	Satin black	4	2	1
GW 14 787	Glossy Titanium	4	2	1

CHARACTERISTICS: KNX module with 4 independent channels, with replaceable button keys. Each channel is associated with a RGB LED for night-time locating or status display for the commanded load. To be configured with ETS software. The package includes 2 replaceable button keys (GW1x553) and 10 lenses with illuminated symbols (2 x GW10502A, 1 x GW10509A, 1 x GW10510A, 1 x GW10513A, 1 x GW10514A, 1 x GW10519A, 1 x GW10520A, 1 x GW10529A, 1 x GW10530A). You can still customize the module with other type of replaceable button keys (arranged for 1 or 2 lenses, with 2 diffusers, 1 or 2 modules) or with other lenses in the catalogue.

APPLICATIONS: allows you to send ON-OFF commands with fronts management, switching commands and sequences, brief/prolonged contact closure management, timed commands, priority commands, commands for roller shutter management (single or double push-button), dimmers (single or double push-button) and scenes (memorisation and activation).

NOTES: equipped with coupling terminal for connection to BUS (with protection lid).



GW 14 553

REPLACEABLE BUTTON KEYS FOR PUSH-BUTTON PANELS

Code	Colour	Button key	No. modules	Pack Carton
GW 10 551	Glossy white	To be completed with lens	1	4/48
GW 15 551	Satin White	To be completed with lens	1	4/48
GW 13 551	Natural satin beige	To be completed with lens	1	4/48
GW 12 551	Satin black	To be completed with lens	1	4/48
GW 14 551	Glossy Titanium	To be completed with lens	1	4/48
GW 10 552	Glossy white	To be completed with lens	2	4/48
GW 15 552	Satin White	To be completed with lens	2	4/48
GW 13 552	Natural satin beige	To be completed with lens	2	4/48
GW 12 552	Satin black	To be completed with lens	2	4/48
GW 14 552	Glossy Titanium	To be completed with lens	2	4/48
GW 10 553	Glossy white	To be completed with 2 lenses	1	4/48
GW 15 553	Satin White	To be completed with 2 lenses	1	4/48
GW 13 553	Natural satin beige	To be completed with 2 lenses	1	4/48
GW 12 553	Satin black	To be completed with 2 lenses	1	4/48
GW 14 553	Glossy Titanium	To be completed with 2 lenses	1	4/48
GW 10 554	Glossy white	To be completed with 2 lenses	2	4/48
GW 15 554	Satin White	To be completed with 2 lenses	2	4/48
GW 13 554	Natural satin beige	To be completed with 2 lenses	2	4/48
GW 12 554	Satin black	To be completed with 2 lenses	2	4/48
GW 14 554	Glossy Titanium	To be completed with 2 lenses	2	4/48
GW 10 557	Glossy white	With 2 diffusers	1	4/48
GW 15 557	Satin White	With 2 diffusers	1	4/48
GW 13 557	Natural satin beige	With 2 diffusers	1	4/48
GW 12 557	Satin black	With 2 diffusers	1	4/48
GW 14 557	Glossy Titanium	With 2 diffusers	1	4/48

NOTES: to be used to customise the 6 and 4 channels KNX push-button panels (GW1x783A, GW1x784A, GW1x785A, GW1x787).



GW 14 559

REPLACEABLE BUTTON KEYS FOR PUSH-BUTTON PANELS - HOTEL SOLUTIONS

Code	Colour	Button key	Symbol	No. modules	Pack Carton
GW 10 559	Glossy white	Complete of 2 lenses	DND+MUR	1	1/48
GW 15 559	Satin White	Complete of 2 lenses	DND+MUR	1	1/48
GW 13 559	Natural satin beige	Complete of 2 lenses	DND+MUR	1	1/48
GW 12 559	Satin black	Complete of 2 lenses	DND+MUR	1	1/48
GW 14 559	Glossy Titanium	Complete of 2 lenses	DND+MUR	1	1/48

CHARACTERISTICS: equipped with "Do not disturb" and "Make up the room" pad printing. Complete with lenses with illuminated symbols.

NOTES: to be used to customise the 6 and 4 channels KNX push-button panels (GW1x783A, GW1x784A, GW1x785A, GW1x787).



ZC6

LENSES WITH ILLUMINATED SYMBOLS

Code	Symbol	Pack Carton
GW 10 501 A	Neutral	24
GW 10 502 A	Light	24
GW 10 503 A	Stair light	24
GW 10 504 A	Table light	24
GW 10 505 A	Bell	24
GW 10 506 A	Burglar alarm	24
GW 10 507 A	Key	24
GW 10 508 A	ON OFF	24
GW 10 509 A	ON	24
GW 10 510 A	OFF	24
GW 10 511 A	Socket-outlet	24
GW 10 512 A	Dimmers	24
GW 10 513 A	Dimmer increase	24
GW 10 514 A	Dimmer decrease	24
GW 10 515 A	Arrow	24
GW 10 516 A	Open	24
GW 10 517 A	Close	24
GW 10 518 A	Roller shutter	24
GW 10 519 A	Roller shutter up	24
GW 10 520 A	Roller shutter down	24
GW 10 521 A	Curtain open	24
GW 10 522 A	Curtain close	24
GW 10 523 A	Floor light	24
GW 10 524 A	Ceiling light	24
GW 10 525 A	Wall light	24
GW 10 526 A	Aisle light	24
GW 10 527 A	Scenario	24
GW 10 528 A	Party	24
GW 10 529 A	In	24
GW 10 530 A	Out	24
GW 10 531 A	Good morning	24
GW 10 532 A	Good night	24
GW 10 533 A	TV	24
GW 10 534 A	Heating	24
GW 10 535 A	Cooling	24
GW 10 536 A	Heating/Cooling	24
GW 10 537 A	Comfort	24
GW 10 538 A	Precomfort	24
GW 10 539 A	Economy	24
GW 10 540 A	Auto	24
GW 10 541 A	Do not disturb	24
GW 10 542 A	Make up the room	24

NOTES: to be used to customise the buttons for the 6- and 4-channel KNX push-button panel (GW1x783A, GW1x784A, GW1x785A, GW1x787).



GW 14 782

KNX 4-CHANNEL PUSH-BUTTON PANELS

Code	Colour	No. channels	No. modules	Pack Carton
GW 10 782	Glossy white	4	2	1
GW 15 782	Satin White	4	2	1
GW 13 782	Natural satin beige	4	2	1
GW 12 782	Satin black	4	2	1
GW 14 782	Glossy Titanium	4	2	1

CHARACTERISTICS: push-button panel with 4 button keys/4 channels. Each button key is associated with an amber LED for night-time backlight, and a green LED to display the status of the commanded load. To be configured with ETS software.

APPLICATIONS: allows you to send ON-OFF commands with fronts management, switchover commands, timed commands, commands for roller shutter management (single or double push-button), dimmers (single or double push-button) and scenes (memorisation and activation).

NOTES: equipped with coupling terminal with protection lid, for connection to BUS, and with set of icons to personalise the button key functions.

SOFT-CLICK ELECTRONIC PUSH-BUTTONS



GW 14 915

UNIVERSAL SOFT-CLICK ELECTRONIC PUSH-BUTTONS

Code	Colour	Type of contact	Button key	Type of use	No. modules	Pack Carton
GW 10 915	Glossy white	1NO/NC 4A (AC1) 230 V ac - Potential-free	Neutral	Relay, dimmer, bus contacts interfaces 1	1	1/12
GW 15 915	Satin White	1NO/NC 4A (AC1) 230 V ac - Potential-free	Neutral	Relay, dimmer, bus contacts interfaces 1	1	1/12
GW 13 915	Natural satin beige	1NO/NC 4A (AC1) 230 V ac - Potential-free	Neutral	Relay, dimmer, bus contacts interfaces 1	1	1/12
GW 12 915	Satin black	1NO/NC 4A (AC1) 230 V ac - Potential-free	Neutral	Relay, dimmer, bus contacts interfaces 1	1	1/12
GW 14 915	Glossy Titanium	1NO/NC 4A (AC1) 230 V ac - Potential-free	Neutral	Relay, dimmer, bus contacts interfaces 1	1	1/12

CHARACTERISTICS: push-button suitable for connection of KNX BUS contacts interfaces, or the command of bistable relays, electronic one-way switches for heavy duty loads, or dimmers with a remote control input.



GW 14 913

BACKLIT SOFT-CLICK ELECTRONIC PUSH-BUTTONS FOR BUS INPUTS

Code	Colour	Type of contact	Button key	Type of use	No. modules	Pack Carton
GW 10 913	Glossy white	1NO - Potential-free	With diffuser	Bus contacts interfaces 1	1	1/12
GW 15 913	Satin White	1NO - Potential-free	With diffuser	Bus contacts interfaces 1	1	1/12
GW 13 913	Natural satin beige	1NO - Potential-free	With diffuser	Bus contacts interfaces 1	1	1/12
GW 12 913	Satin black	1NO - Potential-free	With diffuser	Bus contacts interfaces 1	1	1/12
GW 14 913	Glossy Titanium	1NO - Potential-free	With diffuser	Bus contacts interfaces 1	1	1/12
GW 10 916	Glossy white	1NO - Potential-free	With replaceable neutral lens	Bus contacts interfaces 1	1	1/12
GW 15 916	Satin White	1NO - Potential-free	With replaceable neutral lens	Bus contacts interfaces 1	1	1/12
GW 13 916	Natural satin beige	1NO - Potential-free	With replaceable neutral lens	Bus contacts interfaces 1	1	1/12
GW 12 916	Satin black	1NO - Potential-free	With replaceable neutral lens	Bus contacts interfaces 1	1	1/12
GW 14 916	Glossy Titanium	1NO - Potential-free	With replaceable neutral lens	Bus contacts interfaces 1	1	1/12
GW 10 917	Glossy white	1NO - Potential-free	With diffuser	Bus contacts interfaces 2	2	1/6
GW 15 917	Satin White	1NO - Potential-free	With diffuser	Bus contacts interfaces 2	2	1/6
GW 13 917	Natural satin beige	1NO - Potential-free	With diffuser	Bus contacts interfaces 2	2	1/6
GW 12 917	Satin black	1NO - Potential-free	With diffuser	Bus contacts interfaces 2	2	1/6
GW 14 917	Glossy Titanium	1NO - Potential-free	With diffuser	Bus contacts interfaces 2	2	1/6
GW 10 918	Glossy white	1NO - Potential-free	With replaceable neutral lens	Bus contacts interfaces 2	2	1/6
GW 15 918	Satin White	1NO - Potential-free	With replaceable neutral lens	Bus contacts interfaces 2	2	1/6
GW 13 918	Natural satin beige	1NO - Potential-free	With replaceable neutral lens	Bus contacts interfaces 2	2	1/6
GW 12 918	Satin black	1NO - Potential-free	With replaceable neutral lens	Bus contacts interfaces 2	2	1/6
GW 14 918	Glossy Titanium	1NO - Potential-free	With replaceable neutral lens	Bus contacts interfaces 2	2	1/6

CHARACTERISTICS: push-button for BUS inputs, suitable for KNX BUS contact interface connections. Equipped with 2-colour (amber/green) LED with colour selector (can be set up to work as a night-time localisation lamp or to indicate the load status).



GW 14 914

DUAL SOFT-CLICK ELECTRONIC PUSH-BUTTONS

Code	Colour	Type of contact	Button key	Symbol	No. modules	Pack Carton
GW 10 914	Glossy white	Dual, potential-free and with interlock	Neutral	UP - DOWN	1	1/12
GW 15 914	Satin White	Dual, potential-free and with interlock	Neutral	UP - DOWN	1	1/12
GW 13 914	Natural satin beige	Dual, potential-free and with interlock	Neutral	UP - DOWN	1	1/12
GW 12 914	Satin black	Dual, potential-free and with interlock	Neutral	UP - DOWN	1	1/12
GW 14 914	Glossy Titanium	Dual, potential-free and with interlock	Neutral	UP - DOWN	1	1/12

CHARACTERISTICS: double push-button suitable for connection of KNX BUS contacts interfaces or electronic control panels for moving roller shutters.

MOVEMENT/LIGHT SENSORS - KNX

MOVEMENT



GW 14 786

KNX IR MOTION DETECTORS WITH TWILIGHT SENSOR

Code	Colour	Recovery time	Threshold adjustment	No. modules	Pack Carton
GW 10 786	Glossy white	10s - 1min	10 - 500 lux	2	1
GW 15 786	Satin White	10s - 1min	10 - 500 lux	2	1
GW 13 786	Natural satin beige	10s - 1min	10 - 500 lux	2	1
GW 12 786	Satin black	10s - 1min	10 - 500 lux	2	1
GW 14 786	Glossy Titanium	10s - 1min	10 - 500 lux	2	1

CHARACTERISTICS: movement sensor with detection conditioned by the light threshold value set. Adjustable lens. Operating range: 10m. Vertical bearing angle: 30°. Horizontal bearing angle: 105°. Light threshold value adjustable by means of the frontal access trimmer or ETS parameter. The cycle time can be set via ETS and modified ($\pm 50\%$) via the front access trimmer.

Front green LED signals movement detection and command entry. To be configured with ETS software.

APPLICATIONS: allows you to send timed commands to the movement detector.

The device is able to manage a safety pause upon the deactivation of the controlled load. For installation indoors.

NOTES: equipped with coupling terminal for connection to BUS (with protection lid).



GW A9 531 A

KNX PRESENCE DETECTOR WITH CONSTANT BRIGHTNESS CONTROL - CEILING MOUNTING

Code	Max. assembly height (m)	Light sensor	Dimensions (mm)	Colour	Pack Carton
GW A9 531 A	6	5...2000 lux	Ø 105x44	White	1

CHARACTERISTICS: with 3 PIR sensors and a 360° circular shape operating range. Max. presence detection range: from 4 up to 8m, max. motion detection range: from 10 to 16m depending on the installation height and the type of approach (tangential or radial). Ceiling installation. To be configured with ETS software.

APPLICATIONS: for environments where it is necessary to send activation commands to actuator devices via the KNX bus according to the movements detected and possibly the light intensity measured.

NOTES: equipped with coupling terminal for connection to BUS.

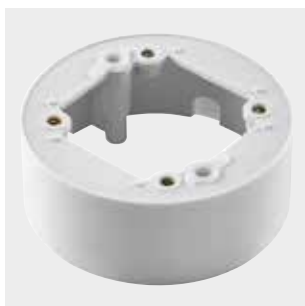

GW A9 543

WALL-MOUNTING FRAME

Code	Suitable for	Dimensions (mm)	Colour	Pack Carton
GW A9 543	GWA9531A	Ø 105x40	White	1

APPLICATIONS: accessory for the KNX presence detector GWA9531A wall installation.



GW A9 545

PLASTERBOARD-MOUNTING BOX

Code	Suitable for	Dimensions (mm)	Pack Carton
GW A9 545	GWA9531A	Ø 78	1

APPLICATIONS: flush-mounting box with spring clip for the KNX presence detector GWA9531A plasterboard installation.

ACTUATORS - KNX

SWITCH ACTUATORS



GW 14 796

KNX 1-CHANNEL 16A SWITCH ACTUATORS

Code	Colour	Output contacts	No. modules	Pack Carton
GW 10 796	Glossy white	1NO/NC 16A(AC1) 230Vac	2	1
GW 15 796	Satin White	1NO/NC 16A(AC1) 230Vac	2	1
GW 13 796	Natural satin beige	1NO/NC 16A(AC1) 230Vac	2	1
GW 12 796	Satin black	1NO/NC 16A(AC1) 230Vac	2	1
GW 14 796	Glossy Titanium	1NO/NC 16A(AC1) 230Vac	2	1

CHARACTERISTICS: 1-channel switch actuator for activating loads via a potential-free output contact (NO/NC).

Equipped with a front push-button for local command, a indicator LED for output contact closure and night-time backlit LED. To be configured with ETS software.

APPLICATIONS: execution of ON-OFF commands, timed commands with pre-alarm at switch-off, priority commands, scene management commands, lockout commands, safety functions, logic functions.

For discharge lamps and compensated fluorescent lamps, use a support relay.

NOTES: equipped with coupling terminal for connection to BUS (with protection lid).



GW 90 741

KNX 4-CHANNEL 10A SWITCH ACTUATOR - IP20 - DIN RAIL MOUNTING

Code	No. output channels	Output contacts	No. DIN modules	Pack Carton
GW 90 741	4	4NO 10A(AC1) 230Vac	4	1

CHARACTERISTICS: 4-channel switch actuator for activating loads via potential-free output contacts (NO). Suitable for commanding incandescent lamps (230Vac): 1500 W, halogen lamps (230Vac): 1500 W, loads controlled from electronic transformers: 600 VA, uncompensated fluorescent lamps: 400 VA, energy saving lamps (compact fluorescent): 8x23 W. Max switchover current 10 A (cos.fi 1). Use a support relay for the compensated fluorescent lamps and for all loads that are not indicated. Equipped with front push-buttons for local implementation, and signalling LED for closure of output contact. To be configured with ETS software.

APPLICATIONS: execution of ON-OFF commands, timed commands with pre-alarm at switch-off, priority commands, scene management commands, lockout commands, safety functions, logic functions.

NOTES: equipped with coupling terminal for connection to BUS (with protection lid).



GW 90 740 A

KNX 4-CHANNEL 16AX SWITCH ACTUATOR - IP20 - DIN RAIL MOUNTING

Code	No. output channels	Output contacts	No. DIN modules	Pack Carton
GW 90 740 A	4	4NO 16AX 230Vac	4	1

CHARACTERISTICS: 4-channel switch actuator for activating loads via potential-free output contacts (NO). Suitable for commanding incandescent lamps (230Vac): 3000 W, halogen lamps (230Vac): 3000 W, loads controlled from toroidal transformers: 3000 W, loads controlled from electronic transformers: 2000 W, energy saving lamps (compact fluorescent): 80x23W. Max switchover current 16A (AC1), 16AX (140µF ref EN 60669-1) fluorescent loads with maximum surge current 400A (200µs). Equipped with front push-buttons for local implementation, and signalling LED for closure of output contact. To be configured with ETS software.

APPLICATIONS: execution of ON-OFF commands, timed commands with pre-alarm at switch-off, priority commands, scene management commands, lockout commands, safety functions, logic functions..

NOTES: equipped with coupling terminal for connection to BUS (with protection lid).



GW 90 742

KNX 4-CHANNEL 16AX SWITCH ACTUATOR WITH MANUAL OPERATION - IP20 - DIN RAIL MOUNTING

Code	No. output channels	Output contacts	No. DIN modules	Pack Carton
GW 90 742	4	4NO 16AX 230Vac	4	1

CHARACTERISTICS: 4-channel switch actuator for activating loads via potential-free output contacts (NO). Suitable for commanding incandescent lamps (230Vac): 3000 W, halogen lamps (230Vac): 3000 W, loads controlled from toroidal transformers: 3000 W, loads controlled from electronic transformers: 2000 W, energy saving lamps (compact fluorescent): 80x23W. Max switchover current 16A (AC1), 16AX (140µF ref. EN 60669-1) fluorescent loads with maximum surge current 400A (200µs). Equipped with front push-buttons for manual activation, and signalling LED for closure of output contact. To be configured with ETS software.

APPLICATIONS: execution of ON-OFF commands, timed commands with pre-alarm at switch-off, priority commands, scene management commands, lockout commands, safety functions, logic functions..

NOTES: equipped with coupling terminal for connection to BUS (with protection lid). Possibility to activate the loads manually, even without the BUS voltage (230Vac auxiliary power supply required).



GW A9 108

KNX 8-CHANNEL 10AX SWITCH ACTUATOR - IP20 - DIN RAIL MOUNTING

Code	No. output channels	Output contacts	No. DIN modules	Pack Carton
GW A9 108	8	8NO 10AX 230Vac	4	1

CHARACTERISTICS: 8-channel switch actuator for activating loads via potential-free output contacts (NO). Suitable for commanding incandescent lamps (230Vac): 2000W, halogen lamps (230Vac): 2000W, loads controlled from toroidal transformers: 1500W, loads controlled from electronic transformers: 1200W, energy saving lamps (compact fluorescent): 40x23W, LED lamps (230Vac): 40x10W. Max switchover current 10A (AC1), 10AX (140µF ref. EN 60669-1) fluorescent loads with maximum surge current 400A (150µs). Equipped with front push-buttons for local implementation, and signalling LED for closure of output contact. To be configured with ETS software.

APPLICATIONS: execution of ON-OFF commands, timed commands with pre-alarm at switch-off, priority commands, scene management commands, lockout commands, safety functions, logic functions, counters.

NOTES: equipped with coupling terminal for connection to BUS (with protection lid).



GW A9 103

KNX 3-CHANNEL 16AX SWITCH ACTUATOR WITH ENERGY METER - IP20 - DIN RAIL MOUNTING

Code	Supply voltage	No. output channels	Output contacts	No. DIN modules	Pack Carton
GW A9 103	230V ac - 50Hz	3	3NO 16AX 230V ac	4	1

CHARACTERISTICS: 3-channel switch actuator for activating loads via potential-free output contacts (NO), with the measure of the power and the energy consumed by each channel. Suitable for commanding incandescent lamps (230Vac): 3000W, halogen lamps (230Vac): 3000W, loads controlled from toroidal transformers: 3000W, loads controlled from electronic transformers: 2000W, energy saving lamps (compact fluorescent): 80x23W. Max switchover current 16 A (AC1), 16 AX (140 µF ref. EN 60669-1) fluorescent loads with maximum surge current 400A (200 µs). Equipped with front push-buttons for local implementation and signalling led for closure of output contact. To be configured with ETS software.

APPLICATIONS: execution of ON-OFF commands, timed commands with pre-alarm at switch-off, priority commands, scene management commands, lockout commands, safety functions, logic functions. Allows the measurement and the sending on the KNX bus of the active energy (exported and imported), instantaneous active and reactive power (exported and imported), voltage, current, power factor and frequency, with the possibility to disconnect the load for each channel independently. Suitable for single-phase systems.

NOTES: equipped with coupling terminal for connection to bus (with protection lid).

ACTUATORS FOR ROLLER SHUTTERS



GW 14 797

KNX 1-CHANNEL 6A ROLLER SHUTTER ACTUATORS

Code	Colour	Max current supplied	No. modules	Pack Carton
GW 10 797	Glossy white	6A-230V ac (compl. 60669-2-1)	2	1
GW 15 797	Satin White	6A-230V ac (compl. 60669-2-1)	2	1
GW 13 797	Natural satin beige	6A-230V ac (compl. 60669-2-1)	2	1
GW 12 797	Satin black	6A-230V ac (compl. 60669-2-1)	2	1
GW 14 797	Glossy Titanium	6A-230V ac (compl. 60669-2-1)	2	1

CHARACTERISTICS: 1-channel actuator to activate a motor to move roller-shutters, curtains, Venetian blinds, rolling blinds, etc. via 2 potential-free interlocked output contacts (NO). Equipped with two front push-buttons for local implementation, two LEDs to signal the closure of the outputs contacts, and two LEDs for night-time localisation. To be configured with ETS software.
NOTES: equipped with coupling terminal for connection to BUS (with protection lid).



GW 90 857

KNX 6A ROLLER SHUTTER ACTUATORS - 230V - IP20 - DIN RAIL MOUNTING

Code	No. channels	Max current supplied	No. DIN modules	Pack Carton
GW 90 856	2	6A-230V ac (compl. 60669-2-1)	4	1
GW 90 857	4	6A-230V ac (compl. 60669-2-1)	4	1

CHARACTERISTICS: 2- and 4-channel actuators to activate motors to move roller-shutters, curtains, venetian blinds, rolling blinds, etc. via respectively 4 and 8 potential-free interlocked output contacts (NO) With 4 (8) frontal push-buttons for local activation, and 4 (8) LEDs indicating output contact closure.

APPLICATIONS: carries out commands of movement/adjustment/stopping, along with priority commands, scene management and alarm signalling commands. Permit the management of different times for up/down movements and for slat adjustment.

NOTES: equipped with coupling terminal for connection to BUS (with protection lid).
 GW90857: possibility to activate the loads manually, even without the BUS voltage.

COMBINED ACTUATORS



GW 90 730

KNX 4-CHANNEL 10A SWITCH ACTUATOR + 4 UNIVERSAL INPUTS - IP 20 - DIN RAIL MOUNTING

Code	No. universal input channels	No. output channels	Output contacts	No. DIN modules	Pack Carton
GW 90 730	4	4	4NO 10A(AC1) 230Vac	4	1

CHARACTERISTICS: the module has 4 relay 10A output channels and 4 universal input channels that can be configured as inputs for push-buttons or conventional potential-free contacts, analogue inputs (0..20mA, 4..20mA, 0..10V, 0..1V), digital inputs for measurement devices with 50 interface (max 1), inputs for NTC probe sensors (max 2) that can be used for controlling the same number of thermoregulation areas. The 4 universal input channels can also be configured as PWM outputs for LEDs (3.3V) for signalling the status of the loads. The 4 relay output channels are suitable for commanding incandescent lamps (230Vac): 1500W, halogen lamps (230Vac): 1500W, loads controlled from electronic transformers: 600 VA, uncompensated fluorescent lamps 400VA, energy saving lamps (compact fluorescent): 8x23W. Max switchover current 10 A (cos.fi 1). Use a support relay for the compensated fluorescent lamps and for all loads that are not indicated. The device has front push-buttons for the local command of the relay outputs, 4 green LEDs for signalling output contact closure, and 4 amber LEDs for signalling the status of the inputs. To be configured with ETS software.

APPLICATIONS: the input channels are used for sending ON-OFF commands with fronts management, switching commands and sequences, brief / prolonged contact closure management, timed commands, priority commands, commands for managing roller shutters (single or double push-button), dimmers (single or double push-button), scenes (storage and activation), impulse count. The output channels are used for the execution of ON-OFF commands, timed commands with pre-alarm at switch-off, priority commands, and scene management commands.

NOTES: equipped with coupling terminal for connection to BUS (with protection lid).



GW A9 126

KNX 12/6-CHANNEL 8AX SWITCH AND ROLLER SHUTTER ACTUATOR WITH MANUAL OPERATION - IP20 - DIN RAIL MOUNTING

Code	No. output channels	Output contacts	No. DIN modules	Pack Carton
GW A9 126	12	12NO 8AX 230Vac	8	1

CHARACTERISTICS: 12-channel switch actuator with potential-free output contacts (NO) for activating 12 loads or 6 shutters/venetian blinds with 230Vac motors. Each single pair of channels can be separately configured for switching loads or roller shutter command. Suitable for commanding incandescent lamps (230Vac): 1500W, halogen lamps (230Vac): 1500W, loads controlled from toroidal transformers: 1200W, loads controlled from electronic transformers: 1000W, energy saving lamps (compact fluorescent): 25x23W, LED lamps (230Vac): 25x10W, motors: 800W. Max switchover currents 8A (AC1), 8AX (140µF ref. EN 60669-1) fluorescent loads with maximum surge current 300A (150µs). Equipped with front push-buttons for manual activation, and signalling LED for closure of output contact. To be configured with ETS software.

APPLICATIONS: execution of ON-OFF commands, timed commands with pre-alarm at switch-off, priority commands, scene management commands, block commands, safety functions, logic functions, counters, output status signal, commands of movement/adjustment/stopping, alarm signalling.

NOTES: equipped with coupling terminal for connection to BUS (with protection lid). Possibility to activate the loads manually, even without the BUS voltage (230Vac auxiliary power supply required).

DIMMER ACTUATORS



GW A9 313

KNX DIMMER ACTUATOR FOR ELECTRONIC BALLAST 1-10V - 3 CHANNELS - IP 20 - DIN RAIL MOUNTING

Code	No. of channels	Output contacts	Max current per channel	No. DIN modules	Pack Carton
GW A9 313	3	16 AX (140µF) - 230 V ac	100 mA	4	1

CHARACTERISTICS: it has 3 output channels 1-10V for commanding ballast with 1-10 V interface and 3 relay On/Off output channels switching the ballast power off. To be configured with ETS software.

APPLICATIONS: execution of ON-OFF commands, relative and absolute light intensity adjustment, scene management, timed commands, priority commands, logic functions.

NOTES: equipped with coupling terminal for connection to BUS (with protection lid).



GW A9 302

KNX UNIVERSAL DIMMER ACTUATORS - IP20 - DIN RAIL MOUNTING

Code	Supply voltage	No. output channels	Power max.	No. DIN modules	Pack Carton
GW A9 301	230V ac - 50/60 Hz	1	500 VA	4	1
GW A9 302	230V ac - 50/60 Hz	2	300VA per channel	4	1

CHARACTERISTICS: for the adjustment and switching of incandescent and halogen lamps 230Vac, low voltage halogen lamps with electronic and winding transformers, LED lamps 230Vac with dimmer function, and CFL lamps with dimmer function. Manual selection of the type of load (Leading Edge or Trailing Edge piloting), soft-start function for lamp protection, front LEDs for signalling the status of the outputs. To be configured with ETS software.

APPLICATIONS: execution of ON-OFF commands, relative and absolute light intensity adjustment, scene management, timed commands, priority commands, logic functions.

NOTES: equipped with coupling terminal for connection to BUS (with protection lid).



GW A9 350

BLEEDER - 230VAC - 50HZ

Code	Description	Dimensions LxHxD (mm)	Pack Carton
GW A9 350	Bleeder	38x32x14	1/48

CHARACTERISTICS: load adapter for dimmable LED lamps. Equipped with 15 cm long cables.

APPLICATIONS: suitable for KNX universal (GWA9301, GWA9302) or traditional (GW1x572, GW1x573) dimmers.



GW A9 303

KNX UNIVERSAL DIMMING ACTUATOR WITH MANUAL OPERATION - IP20 - DIN RAIL MOUNTING

Code	Supply voltage	No. output channels	Power max.	No. DIN modules	Pack Carton
GW A9 303	230V ac - 50 Hz	2	400 W per channel	4	1

CHARACTERISTICS: for the adjustment and switching of incandescent lamps, halogen lamps (high and low voltage), compact adjustable fluorescent lamps (energy saving lamps), 230Vac adjustable LED lamps and fans (max. 100W). Automatic load recognition and light intensity regulation power: 400W per channel or 800W in parallel operation. The device has frontal buttons for manual operation and signalling leds for the operation status of each channel. To be configured via ETS software.

APPLICATIONS: light intensity regulation, regulation value limitations, soft switchover, block function, forced operation, scenarios, status return on channels, operating hour-counter and signalling for assistance, management during mains or bus failure and reset, diagnosis messages.

NOTES: equipped with coupling terminal for connection to BUS. Possibility to activate the loads manually, even without the bus voltage.



GW 90 764

KNX DIMMER ACTUATOR FOR LED LOADS - IP20 - DIN RAIL MOUNTING

Code	Supply voltage	No. output channels	Type of control	No. DIN modules	Pack Carton
GW 90 764	12-24V dc	4	CVD	4	1
GW 90 765	12-48V dc	4	CCD	4	1

CHARACTERISTICS: dimmer in CVD version (control with constant voltage) for regulating RGB(W) LED strips, and in CCD version (control with constant current) for regulating "power" LEDs. 4 front button keys for testing the outputs and 4 front LEDs for signalling the load status and other operating parameters. To be configured with ETS software.

APPLICATIONS: execution of ON-OFF commands, regulation and setting of the light intensity level for each single channel (and the 4 channels simultaneously), selection of feedback on status or light intensity value, scene management, timed sequences, priority commands, logic functions. The 4 outputs can be used to control each of the 4 channels R, G, B and W of a single LED lamp, or up to 4 independent LEDs.

NOTES: equipped with coupling terminal for connection to BUS (with protection lid).



GW 90 766

BOOSTER FOR CVD LED DIMMER ACTUATORS 4X10 A - IP20 - DIN RAIL MOUNTING

Code	Supply voltage	No. output channels	Max current per channel	No. DIN modules	Pack Carton
GW 90 766	12-24V dc	4	10A	4	1/4

CHARACTERISTICS: device used to extend the driving capacity of CVD LED dimmers up to 10 A per channel.

APPLICATIONS: to be used with LED dimmer actuators with CVD KNX control (GW90764).

NOTES: equipped with a coupling terminal for connection to BUS, with protective cover.

FAN COIL ACTUATORS



GW A9 140

KNX FAN COIL ACTUATOR - IP20 - DIN RAIL MOUNTING

Code	Supply voltage	No. input channels	Valves output contacts	Fan relay contacts	Additional relay contacts	No. DIN modules	Pack Carton
GW A9 140	230V ac - 50 Hz	2	0,5A (24-230 V ac), triac	8A (AC1) 250 V ac	16A (AC1) 250 V ac	4	1

CHARACTERISTICS: actuator for the command of fan coils with 2- or 3-point heating/cooling valves and up to 3 fan levels in 2- and 4-pipe systems. Equipped with an additional programmable relay (eg: to control a heating/cooling battery or as a switching output) and two potential-free inputs for windows contact or temperature probe sensor (es: GWA9145) and condensate monitoring. The device has frontal Test buttons (for a simple check of fan levels and heating/cooling switching during the setup steps) and 9 signalling leds for the operation status. Regulation is via an external control variable or the integrated ambient thermostat (in the latter case it is necessary to add the temperature probe sensor). To be configured via ETS software.

APPLICATIONS: KNX timed thermostats and thermostats that can be used with the fan coil actuators GWA9140 and GWA9141:

- THERMO ICE KNX surface-mounting thermostat GW16976CB/CN/CT: for controlling all the functions of the fan coil actuators (that shall be configured to work with kind of used controller "remote controller") and commanding the fan in both automatic and manual mode.

- THERMO ICE KNX flush-mounting thermostat GW16974CB/CN/CT: attention - this thermostat can only be used in KNX-SYSTEM mode (configurable with ETS). For controlling the fan coil actuators (that shall be configured to work with kind of used controller "remote controller") and commanding the fan in automatic mode only - i.e. the thermostat conveys the valve opening request (0..100% byte) to the fan coil actuators, which automatically define the fan speed; the fan speed cannot therefore be controlled via the thermostat.

- Other KNX SYSTEM timed thermostats, thermostats and probes: attention - these models permit only limited use of the control functions of the fan coil actuators (that shall be configured to work with kind of used controller "remote controller"), so their validity should be evaluated for the individual situation on the basis of the application requisites.

- KNX EASY timed thermostats, thermostats and probes: attention - these models cannot be used to control the fan coil actuators.

NOTES: equipped with coupling terminal for connection to BUS.



GW A9 141

KNX FAN COIL ACTUATOR 0-10V - IP20 - DIN RAIL MOUNTING

Code	Supply voltage	No. input channels	Valves and fan output	Fan relay contacts	Additional relay contacts	No. DIN modules	Pack Carton
GW A9 141	100-240 V ac - 50-60 Hz	2	0-10V, max 10mA	6A (AC1) 250 V ac	16A (AC1) 250 V ac	4	1

CHARACTERISTICS: actuator for the command of fan coils with 0-10V proportional heating/cooling valves and up to 3 fan levels (or with 0-10V proportional output) in 2- and 4-pipe systems. Equipped with an additional programmable relay (eg: to control a heating/cooling battery or as a switching output) and two potential-free inputs for windows contact or temperature probe sensor (es: GWA9145) and condensate monitoring. The device has frontal Test buttons (for a simple check of fan levels and heating/cooling switching during the setup steps) and 9 signalling leds for the operation status. Regulation is via an external control variable or the integrated ambient thermostat (in the latter case it is necessary to add the temperature probe sensor). To be configured via ETS software.

APPLICATIONS: KNX timed thermostats and thermostats that can be used with the fan coil actuators GWA9140 and GWA9141:

- THERMO ICE KNX surface-mounting thermostat GW16976CB/CN/CT: for controlling all the functions of the fan coil actuators (that shall be configured to work with kind of used controller "remote controller") and commanding the fan in both automatic and manual mode.

- THERMO ICE KNX flush-mounting thermostat GW16974CB/CN/CT: attention - this thermostat can only be used in KNX-SYSTEM mode (configurable with ETS). For controlling the fan coil actuators (that shall be configured to work with kind of used controller "remote controller") and commanding the fan in automatic mode only - i.e. the thermostat conveys the valve opening request (0..100% byte) to the fan coil actuators, which automatically define the fan speed; the fan speed cannot therefore be controlled via the thermostat.

- Other KNX SYSTEM timed thermostats, thermostats and probes: attention - these models permit only limited use of the control functions of the fan coil actuators (that shall be configured to work with kind of used controller "remote controller"), so their validity should be evaluated for the individual situation on the basis of the application requisites.

- KNX EASY timed thermostats, thermostats and probes: attention - these models cannot be used to control the fan coil actuators.

NOTES: equipped with coupling terminal for connection to BUS.

TEMPERATURE PROBE SENSOR

Code	Capsule diameter (mm)	Capsule length (mm)	Cable length (m)	IP degree	Pack Carton
GW A9 145	6	30	4	IP65	1

CHARACTERISTICS: NTC sensor 100K.

NOTES: to be used in combination with KNX fan coil actuators.



GW A9 145

TEMPERATURE CONTROL - KNX

CLIMATE CONTROL



GW 14 794 H

KNX TIMED THERMOSTATS/PROGRAMMERS WITH HUMIDITY MANAGEMENT

Code	Colour	Output contacts	Humidity sensor	No. modules	Pack Carton
GW 10 794 H	Glossy white	1NO / NC 5A(AC1) 250V ac	Not included	3	1
GW 15 794 H	Satin White	1NO / NC 5A(AC1) 250V ac	Not included	3	1
GW 13 794 H	Natural satin beige	1NO / NC 5A(AC1) 250V ac	Not included	3	1
GW 12 794 H	Satin black	1NO / NC 5A(AC1) 250V ac	Not included	3	1
GW 14 794 H	Glossy Titanium	1NO / NC 5A(AC1) 250V ac	Not included	3	1

CHARACTERISTICS: flush-mounting timed thermostat with humidity management, that can be programmed on a weekly basis to control heating/cooling and humidification/dehumidification systems on the BUS. 3-level temperature profile (comfort, pre-comfort, economy). Control algorithms for 2- or 4-way systems: two points (ON/OFF or 0%/100%), proportional-integral (PWM or continuous), fan coil (max. 3 speeds). Includes: 1 output for commanding the area solenoid valve (or as a generic output for executing ON/OFF commands, timed commands, priority commands or scene management); 1 input for the potential-free contact (for the window contact function, or for managing fronts, dimmers, roller shutters and scenes); 1 input for the external temperature NTC probe sensor (e.g. protection for floor-mounting heating) or, alternatively, as a second input for a potential-free contact. With 10 hour profiles that can be freely used (programmer function) plus another two reserved for the timed thermostat, with 15-minute resolution. Equipped with an extractable front and LCD display with customisable RGB backlighting. To be configured with ETS software.

APPLICATIONS: can be combined with KNX flush-mounting thermostats for local temperature adjustment: In this case, the timed thermostat acts as a master, sending the temperature profile to the BUS.

NOTES: equipped with coupling terminal for connection to BUS. The device requires a back-up power supply from 2 AA alkaline batteries (not included), housed in the extractable front, to guarantee the updating of the calendar (day, time) in the event of a BUS voltage failure. **The device does not have a built-in humidity sensor, so the relative humidity value must be obtained from an external KNX sensor (es: GW1x762H).**



GW 14 795 H

KNX THERMOSTATS WITH HUMIDITY MANAGEMENT

Code	Colour	Output contacts	Humidity sensor	No. modules	Pack Carton
GW 10 795 H	Glossy white	1NO / NC 5A(AC1) 250V ac	Not included	2	1
GW 15 795 H	Satin White	1NO / NC 5A(AC1) 250V ac	Not included	2	1
GW 13 795 H	Natural satin beige	1NO / NC 5A(AC1) 250V ac	Not included	2	1
GW 12 795 H	Satin black	1NO / NC 5A(AC1) 250V ac	Not included	2	1
GW 14 795 H	Glossy Titanium	1NO / NC 5A(AC1) 250V ac	Not included	2	1

CHARACTERISTICS: flush-mounting thermostat with humidity management, to control heating/cooling and humidification/dehumidification systems on the BUS and to manually manage the temperature on three levels (comfort, pre-comfort, economy). Control algorithms for 2- or 4-way systems: two points (ON/OFF or 0%/100%), proportional-integral (PWM or continuous), fan coil (max. 3 speeds). Includes: 1 output for commanding the area solenoid valve (or as a generic output for executing ON/OFF commands, timed commands, priority commands or scene management); 1 input for the potential-free contact (for the window contact function, or for managing fronts, dimmers, roller shutters and scenes); 1 input for the external temperature NTC probe sensor (e.g. protection for floor-mounting heating) or, alternatively, as a second input for a potential-free contact. Equipped with an LCD display with customisable RGB backlighting. To be configured with ETS software.

APPLICATIONS: can be combined with KNX flush-mounting timed thermostats for local temperature adjustment: in this case, the thermostat acts as a Slave, executing the temperature profile sent from the Master (timed thermostat), using the locally defined setpoint values. If the system contains remote elements with their own control logic (e.g. flush-mounting KNX temperature adjustment probes), the thermostat can be used to visualise and set their operating parameters (max. 4 elements).

NOTES: equipped with coupling terminal for connection to BUS. **The device does not have a built-in humidity sensor, so the relative humidity value must be obtained from an external KNX sensor (es: GW1x762H).**



GW 14 799

KNX TEMPERATURE SENSORS

Code	Colour	No. modules	Pack Carton
GW 10 799	Glossy white	1	1
GW 15 799	Satin White	1	1
GW 13 799	Natural satin beige	1	1
GW 12 799	Satin black	1	1
GW 14 799	Glossy Titanium	1	1

CHARACTERISTICS: flush-mounting temperature adjustment probe for controlling heating/cooling systems on the BUS. 3-level temperature profile (comfort, pre-comfort, economy). Control algorithms for 2- or 4-way systems: two points (ON/OFF or 0%/100%), proportional-integral (PWM or continuous), fan coil (max. 3 speeds). Includes: 1 input for the potential-free contact (for the window contact function, or for managing fronts, dimmers, roller shutters and scenes); 1 input for the external temperature NTC probe sensor (e.g. protection for floor-mounting heating) or, alternatively, as a second input for a potential-free contact. Equipped with a front LED signalling the operating status and the load status (solenoid valve). To be configured with ETS software.

APPLICATIONS: can be combined with thermostats GW1x795H or timed thermostats GW1x794H to adjust the temperature in specific areas and for controlling and displaying the probe parameters (the probe does not have a display).

NOTES: it is equipped with coupling terminal for connection to bus.



GW 14 799 H

KNX HUMIDITY/TEMPERATURE SENSORS

Code	Colour	Humidity sensor	No. modules	Pack Carton
GW 10 799 H	Glossy white	Built-in	1	1
GW 15 799 H	Satin White	Built-in	1	1
GW 13 799 H	Natural satin beige	Built-in	1	1
GW 12 799 H	Satin black	Built-in	1	1
GW 14 799 H	Glossy Titanium	Built-in	1	1

CHARACTERISTICS: flush-mounting temperature adjustment probe with humidity sensor for controlling heating/cooling systems and humidification/dehumidification systems on the BUS. 3-level temperature profile (comfort, pre-comfort, economy). Control algorithms for 2- or 4-way systems: two points (ON/OFF or 0%/100%), proportional-integral (PWM or continuous), fan coil (max. 3 speeds). Includes: 1 input for a potential-free contact (for the window contact function, or for managing fronts, dimmers, roller shutters and scenes); 1 input for the external temperature NTC probe sensor (e.g. protection for floor-mounting heating) or, alternatively, as a second input for a potential-free contact. Equipped with a front LED signalling the operating status and the load status (solenoid valve). To be configured with ETS software.

APPLICATIONS: can be combined with thermostats GW1x795H or timed thermostats GW1x794H to adjust the temperature in specific areas and for controlling and displaying the probe parameters (the probe does not have a display).

NOTES: it is equipped with coupling terminal for connection to bus.



GW 14 762 H

KNX TEMPERATURE/HUMIDITY SENSORS

Code	Colour	Humidity sensor	No. modules	Pack Carton
GW 10 762 H	Glossy white	Built-in	1	1
GW 15 762 H	Satin White	Built-in	1	1
GW 13 762 H	Natural satin beige	Built-in	1	1
GW 12 762 H	Satin black	Built-in	1	1
GW 14 762 H	Glossy Titanium	Built-in	1	1

CHARACTERISTICS: flush-mounting temperature/humidity sensor for sending temperature and relative humidity values on the KNX BUS. Temperature range: 0...+45°C. Relative humidity range: 10-95%. Equipped with a front signalling LED. To be configured with ETS software.

NOTES: equipped with coupling terminal for connection to BUS.



GW 10 800

OUTDOOR TEMPERATURE PROBE SENSOR

Code	Capsule diameter (mm)	Capsule length (mm)	Cable length (m)	IP degree	Pack Carton
GW 10 800	5	20	3	IP68	1

CHARACTERISTICS: NTC sensor 10K BETA 3435 1%. Temperature range: -50...+110°C; accuracy: ±1%; capsule material: thermoplastic rubber.

NOTES: for use in combination with timed thermostats, thermostats, flush mounting KNX temperature/humidity sensors, input modules.



GW 14 900

TEMPERATURE PROBE SENSORS

Code	Colour	No. modules	Pack Carton
GW 10 900	Glossy white	1	1
GW 15 900	Satin White	1	1
GW 13 900	Natural satin beige	1	1
GW 12 900	Satin black	1	1
GW 14 900	Glossy Titanium	1	1

CHARACTERISTICS: flush-mounting temperature sensor, NTC 10K±2%, BETA 3977±0.75%, temperature range: -40...+125°C. Equipped with a front signalling LED.

NOTES: for use in combination with timed thermostats, temperature sensors, flush-mounting KNX temperature/humidity sensors, input modules, etc.



GW 16 974 CN

KNX THERMO ICE THERMOSTATS

Code	Colour	Power supply	Dimensions LxHxD (mm)	Pack Carton
GW 16 974 CB	White	12-24V ac/dc	123x95x11	1
GW 16 974 CN	Black	12-24V ac/dc	123x95x11	1
GW 16 974 CT	Titanium	12-24V ac/dc	123x95x11	1

CHARACTERISTICS: flush-mounting thermostat for controlling heating/cooling systems via BUS, and manual or 3-level temperature management (comfort, pre-comfort, economy). Control algorithms for two- or four-way systems: two points (ON/OFF or 0%/100%), proportional-integral (PWM or continuous 0%-100%), fan coil (max. 3 speeds with ON/OFF or 0%/100% control). Allows control of humidification and dehumidification systems if connected to an external humidity sensor (e.g. GW1x762H). Has 1 input for potential-free contact (for window contact function, for managing fronts, dimmers, shutters or scenarios); 1 input for NTC external temperature sensor (e.g. protection for underfloor heating) or, alternatively, as a second input for potential-free contact. Equipped with user interface with touch-type (capacitive) controls on glass plate and rear-projection display. The thermostat has integrated proximity and temperature sensors. Configuration is via ETS software.

APPLICATIONS: option to combine with flush-mounted KNX timed thermostats or KNX control panels for zoned temperature control: in this case, the thermostat acts as a slave, implementing the temperature profile sent from the master.

NOTES: equipped with a coupling terminal for connection to BUS. The thermostats include a front plate, electronic unit and metal support and are designed for screw fastening to either rectangular 3-gang boxes (83.5 mm centre distance) or round/square boxes (60 mm centre distance) equipped with installation columns. Plate materials: glass.



GW 10 720

POWER SUPPLY UNIT 12VDC

Code	Supply voltage	Output voltage	Max current supplied	Dimensions LxHxD (mm)	Pack Carton
GW 10 720	100 ÷ 240 V ac - 50/60 Hz	12V dc	300 mA	52x33x17	1/10

APPLICATIONS: to be used for powering LPG detectors (GW1x711, GW2x868, GW30520), methane detectors (GW1x712, GW2x867, GW30519); Thermo ICE KNX (GW16974CB, GW16974CN, GW16974CT) thermostats.



GW 16 976 CN

KNX THERMO ICE THERMOSTAT - WALL-MOUNTING

Code	Colour	Power supply	Dimensions LxHxD (mm)	Pack Carton
GW 16 976 CB	White	110/230 V ac - 50/60 Hz	123x95x21	1
GW 16 976 CN	Black	110/230 V ac - 50/60 Hz	123x95x21	1
GW 16 976 CT	Titanium	110/230 V ac - 50/60 Hz	123x95x21	1

CHARACTERISTICS: wall-mounting thermostat to control heating/cooling and humidification/dehumidification systems on the BUS and manage the temperature in manual mode or on 3 levels (comfort, pre-comfort, economy). Control algorithms for 2- or 4-way systems: two points (ON/OFF or 0%-100%), proportional-integral (PWM or continuous adjustment), fan coil (max. 3 speeds or with continuous adjustment 0%-100%). Includes 1 input for external NTC temperature sensor (e.g.: protection for flood mounting heating). Equipped with a user interface with touch commands (capacitive) on technopolymer plate and backlit display. The thermostat has built-in proximity, temperature and humidity sensors. The device supports KNX Secure. To be configured with ETS software.

APPLICATIONS: can be combined with KNX flush-mounting timed thermostats or Smart Gateway for local temperature adjustment: in this case, the thermostat acts as the slave by executing the temperature sent by the master. Available a "hotel" operating mode with simplified functionalities and user interface for hotel applications.

NOTES: equipped with coupling terminal for connection to bus. Wall fixing with wall plugs or screw fixing on rectangular 3 modules boxes (centre distance 83.5 mm). Plate material: technopolymer.

ENERGY CONTROL - KNX

P-COMFORT



GW A9 916

KNX LOAD MANAGEMENT RELAY P-COMFORT - IP20 - DIN RAIL MOUNTING

Code	Supply voltage	Rated current	Type relay contact	Capacity relay contact	No. DIN modules	Pack Carton
GW A9 916	230V ac - 50Hz	32 A	Changeover (potential free contact)	16 A AC1 250 V ac	2	1/6

CHARACTERISTICS: load management to control the activation/deactivation of electrical appliances wired to the relay inside the device or connected to KNX actuators, preventing the main line power supply disconnection and avoiding service interruptions. The device supports KNX Secure. To be configured with ETS software.

APPLICATIONS: allows the measurement, the visualisation on the display and the sending on the KNX bus of the active energy (exported and imported), instantaneous active and reactive power (exported and imported), voltage, current, power factor and frequency.

NOTES: equipped with coupling terminal for connection to bus.

KNX- ENERGY METERS



GW A9 801

KNX SINGLE-PHASE ENERGY METER FOR DIRECT CONNECTION - IP20 - DIN RAIL MOUNTING

Code	Supply voltage	Rated current	No. DIN modules	Pack Carton
GW A9 801	230V ac - 50Hz	32 A	2	1/6

CHARACTERISTICS: the device supports KNX Secure. To be configured with ETS software.

APPLICATIONS: allows the measurement, the visualisation on the display and the sending on the KNX bus of the active energy (exported and imported), instantaneous active and reactive power (exported and imported), voltage, current, power factor and frequency.

NOTES: equipped with coupling terminal for connection to bus.

TRADITIONAL ENERGY METERS



GW D6 801

SINGLE-PHASE DIGITAL ENERGY METERS FOR DIRECT CONNECTION - IP20 - DIN RAIL MOUNTING

Code	Type MID	N. digit	Accuracy	I max (A)	Rated voltage (V)	No. of modules EN 50022	Pack Carton
GW D6 801	No	5 unit + 2 decimals	1	40 A	230 ac	1	1/5
GW D6 802	Yes	5 unit + 2 decimals	1	40 A	230 ac	1	1/5

APPLICATION: allows the measurement and visualisation on the display of the active energy values (exported and imported), instantaneous active power (exported and imported), voltage, current, power factor and frequency.

If used with the KNX GW90876 interface, the measured values can be sent on the KNX BUS.

If used with the MODBUS GWD6820 interface, the measured values can be sent on Modbus RS485.

CHARACTERISTICS: the energy meters have an impulse output for remote energy consumption control.



GW D6 809

THREE-PHASE DIGITAL ENERGY METERS - IP20 - DIN RAIL MOUNTING

Code	Type MID	N. digit	Accuracy	Connection	Rated voltage (V)	No. of modules EN 50022	Pack Carton
GW D6 807	Yes	6 unit + 2 decimals 1 (active energy) 2 (reactive energy)		Direct (I max=80 A)	400 ac	4	1/2
GW D6 809	Yes	6 unit + 2 decimals 1 (active energy) 2 (reactive energy)		Using C.T./5 A	400 ac	4	1/2

APPLICATION: allow the measurement and the visualization on display of the active and reactive energy values (exported and imported), and instantaneous active and reactive power values (exported and imported). If used with the KNX GW90876 interface, the measured values can be sent on the KNX BUS.

If used with the MODBUS GWD6820 interface, the measured values can be sent on Modbus RS485.

CHARACTERISTICS: the meters have two impulse outputs for remote energy consumption control.

KNX INTERFACE



GW 90 876

KNX INTERFACE FOR TRADITIONAL ENERGY METER - IP20 - DIN RAIL MOUNTING

Code	No. DIN modules	Pack Carton
GW 90 876	1	1/5

CHARACTERISTICS: to be configured with ETS software.

APPLICATIONS: it communicates the values of energy and power as measured by the GWD6801, GWD6802, GWD6807, GWD6809 energy meters on the KNX bus system. The KNX interface is optically coupled to the energy meter (the two devices have to be installed side-by-side).

NOTE: it is equipped with a coupling terminal for connection to bus.

WEATHER SENSORS - KNX

DEVICES



GW 90 800

KNX WEATHER STATION - IP44

Code	Power supply	Assembly	Dimensions LxHxD (mm)	Pack Carton
GW 90 800	24V ac/dc, max. 100mA	Wall/pole-mounting	96x77x118	1

CHARACTERISTICS: includes the following sensors: rain, temperature (from -40°C to +80°C), luminosity (from 0 lux to 150000 lux), wind (from 0 m/s to 35 m/s). The weather station includes a GPS receiver for determining coordinates, data and hour.

APPLICATIONS: the weather station stores and processes the analogue signals coming from the embedded sensors.

NOTES: equipped with coupling terminal for connection to BUS.



GW 90 883

KNX WIND AND RAIN SENSOR - IP44

Code	Power supply	Current consumption	Measurement interval	Rain sensor heating	Dimensions LxHxD (mm)	Pack Carton
GW 90 883	230 V ac	20 mA	0...70m/s	1.2 W	96x77x118	1

CHARACTERISTICS: with the aid of a combined sensor, the device analyses the conductivity of the rainwater (via the built-in heater, it immediately detects the end of the precipitation) and electronically measures the wind speed. To be configured with ETS software.

APPLICATIONS: detects and analyses the precipitation (rain drops and snow flakes) and wind speed, even in the presence of hail and snow.

NOTES: equipped with coupling terminal for connection to BUS.



GW 90 884

KNX LIGHT INTENSITY SENSOR - IP44

Code	Power supply	Current consumption	Measurement interval	Dimensions LxHxD (mm)	Pack Carton
GW 90 884	KNX BUS voltage	10 mA	0...150000 lux	96x77x118	1

CHARACTERISTICS: the device measures the light intensity. With light-sensitive sensor function. To be configured with ETS software.

APPLICATIONS: detects and analyses the light level.

NOTES: equipped with coupling terminal for connection to BUS.



GW 90 885

KNX TEMPERATURE SENSOR - IP65

Code	Power supply	Current consumption	Measurement interval	Dimensions LxHxD (mm)	Pack Carton
GW 90 885	KNX BUS voltage	5.5 mA	-40...+80°C	65x93x38	1

CHARACTERISTICS: the sensor measures the temperature. The sensor is also equipped with a PI (proportional integral) regulator for heating and air conditioning. To be configured with ETS software.

APPLICATIONS: measures the temperature.

NOTES: equipped with coupling terminal for connection to BUS.

COMPLEMENTARY ITEMS - KNX

INTERFACES



GW 90 871

KNX/DMX GATEWAY - DIN RAIL MOUNTING

Code	Power supply	No. DMX channels	Dimensions LxHxD (mm)	Pack Carton
GW 90 871	9-30V dc, 100mA	512	107x75x31 mm	1

APPLICATIONS: one-way interface that can receive the KNX BUS commands and re-transmit them towards the devices on the DMX BUS. The interface manages up to 512 DMX channels.

NOTES: equipped with coupling terminal for connection to BUS.



GW 90 872 A

KNX/DALI 64/16 IP GATEWAY - DIN RAIL MOUNTING

Code	Power supply	Max no. DALI units	Max no. DALI devices	No. DIN modules	Pack Carton
GW 90 872 A	110-240V ac - 50/60Hz, 100mA	16	64	4	1/4

FEATURES: interface that can control up to 64 lamps managed with the DALI protocol via a KNX bus. The device is equipped with a RJ45 LAN port for configuration and/or access via IP and supplies power to the DALI line. Category 1 device (in accordance with EN 62386-103).

NOTES: equipped with coupling terminal for the bus connection.

Available until inclusion of the new code GW90873



GW 90 873

GATEWAY KNX/DALI2 ADVANCED - MULTIMASTER 64/16 - DIN RAIL MOUNTING

Code	Power supply	Max no. DALI units	Max no. DALI devices	No. DIN modules	Pack Carton
GW 90 873	100 - 240 V ac/dc - 50/60 Hz	16	64 lighting fixtures	4	1/4

FEATURES: gateway capable of controlling up to 64 lamps managed with the DALI protocol via a KNX bus. In addition, up to 8 DALI motion detectors or DALI light sensors can be connected. The device supports DALI2 with multimaster operation in accordance with EN 62386-103 ed. 2. The power required for the connected DALI lamps and sensors is supplied directly by the device and no additional DALI power supplies are required.

The device supports KNX Secure and is configured via ETS software.

The device has an RJ45 LAN port for configuration and/or IP access. Category 1 equipment (in accordance with EN 62386-103).

APPLICATIONS: the device also enables the control of emergency lamps (with Data Type DT1) and lamps with colour control (with Data Type DT8).

NOTES: equipped with a coupling terminal for bus connection.

Contact the GEWISS sales department for the availability date.

ACCESSORIES



GW 90 807

CONNECTION TERMINAL TO BUS

Code	Colour	Pack Carton
GW 90 807	Red - Black	50

APPLICATIONS: for connecting up to 4 pairs of conductors. Can also be used as a junction terminal.



GW 90 808

CONNECTION TERMINAL TO SELV LINE

Code	Colour	Pack Carton
GW 90 808	Yellow - white	50

APPLICATIONS: for connecting up to 4 pairs of conductors. Can also be used as a junction terminal.



GW 90 584

KNX BUS CABLES

Code	Type	Description	Ø (mm)	Colour	CPR class	Pack Carton
GW 90 584	2 conductors 1 x 2 x 0.8	LSZH Cable sheath	5.2	Green	Cca-s1a,d0,a1	100
GW 90 585	4 conductors 2 x 2 x 0.8	LSZH Cable sheath	6.1	Green	Cca-s1a,d0,a1	100

CHARACTERISTICS: GW90584 made of 1 twisted pair of wires: red/black colour used for the power supply and the data transmission of the KNX devices. GW90585 made of 2 twisted pairs of wires: red/black colour used for the power supply and the data transmission of the KNX devices, yellow/white used for another SELV service power supply.

APPLICATIONS: can be installed with the 230V power supply cable, and are recommended for protruding or flush assembly, for arrangement in conduits, in dry environments, and outdoors if protected against direct solar irradiation.

COMMAND DEVICES - ZIGBEE

CONTACT INTERFACES



GW A1 501

CONNECTED 2-CHANNELS CONTACT INTERFACES - ZIGBEE

Code	Supply voltage	No. input channels	Input voltage	Max cable length	Dimensions LxHxD (mm)	Pack Carton
GW A1 501	Battery powered	2	Potential-free	15 m	42x40x20	1/4
GW A1 502	230V ac - 50 Hz	2	230V ac	-	42x40x20	1/4

CHARACTERISTICS: interface for the connection of 2 independent input contacts (auxiliary axial commands, push buttons and traditional switches sensors etc.), potential-free (GWA1501) or live (GWA1502). GWA1501 powered by CR2032-type battery (replaceable).

APPLICATIONS: allows commands to be sent for ON-OFF, timed, roller shutters and Venetian blinds, dimmers, scenarios, priority commands and signalling the current state of the contact.

NOTES: installation in flush-mounting boxes, junction boxes or clipped into the ChoruSmart GW1x750 blanking modules.

ACTUATORS - ZIGBEE

ACTUATORS FOR GENERIC LOADS



GW A1 521

1-CHANNEL CONNECTED ACTUATOR - ZIGBEE

Code	Supply voltage	No. output channels	Output contacts	Dimensions LxHxD (mm)	Pack Carton
GW A1 521	230V ac - 50 Hz	1	1 NO 10A (AC1) 230 V ac	42x40x20	1/4

CHARACTERISTICS: 1-channel actuator for the activation of loads through a potential-free output contact (NO). Suitable for controlling incandescent lamps (230 V ac): 2300 W, loads driven by toroidal transformers: 450 W, loads driven by electronic transformers: 600 W, fluorescent lamps: (230 V ac): 150 W, motors: 500 W. Equipped with 1 input for local control of the output.

APPLICATIONS: ON-OFF control, timed commands, priority commands and scenario management. If used in combination with the ZigBee GWA1514 water sensor, the installation of a push button (NO) is required for the manual opening of the solenoid valve.

NOTES: installation in flush-mounting boxes, junction boxes or clipped into the ChoruSmart GW1x750 blanking modules.

Home & Building PRO



GW A1 522

2-CHANNEL CONNECTED ACTUATOR - ZIGBEE

Code	Supply voltage	No. output channels	Output contacts	Dimensions LxHxD (mm)	Pack Carton
GW A1 522	230V ac - 50 Hz	2	2 NO 6A (AC1) 230 V ac	42x40x20	1/4

CHARACTERISTICS: 2-channel actuator for the activation of loads through a 230 V output contact (NO). Suitable for controlling incandescent lamps (230 V ac): 1400 W, loads driven by toroidal transformers: 450 W, loads driven by electronic transformers: 600 W, fluorescent lamps: 150 W, LED lamps (230 V ac): 150 W, motors: 500 W. Equipped with 2 inputs for local control of the outputs.

APPLICATIONS: ON-OFF control, timed commands, priority commands and management of scenarios.

NOTES: installation in flush-mounting boxes, junction boxes or clipped into the ChoruSmart GW1x750 blanking modules.

ACTUATORS FOR GENERIC LOADS WITH POWER METER



GW A1 523

1-CHANNEL CONNECTED ACTUATOR WITH POWER METER - ZIGBEE

Code	Supply voltage	No. output channels	Output contacts	Dimensions LxHxD (mm)	Pack Carton
GW A1 523	230V ac - 50 Hz	1	1 NO 10A (AC1) 230 V ac	42x40x20	1/4

CHARACTERISTICS: 1-channel actuator for the activation of loads through a 230 V output contact (NO) and measurement of instantaneous power. Suitable for controlling incandescent lamps (230 V ac): 2300 W, loads driven by toroidal transformers: 450 W, loads driven by electronic transformers: 600 W, fluorescent lamps: (230 V ac): 150 W, motors: 500 W. Equipped with 1 input for local control of the output.

APPLICATIONS: ON-OFF control, timed commands, priority commands and management of scenarios and measurement of instantaneous power.

NOTES: installation in flush-mounting boxes, junction boxes or clipped into the ChoruSmart GW1x750 blanking modules.

ACTUATORS FOR ROLLER SHUTTERS



GW A1 531

1-CHANNEL CONNECTED ACTUATOR FOR ROLLER SHUTTERS - ZIGBEE

Code	Supply voltage	Max current supplied	Dimensions LxHxD (mm)	Pack Carton
GW A1 531	230V ac - 50 Hz	6A-230V ac (compl. 60669-2-1)	42x40x20	1/4

CHARACTERISTICS: 1-channel actuator for the activation of a motor to operate roller shutters, curtains, Venetian blinds, roller blinds etc. via 2 interlocked output contacts 230 V ac. Suitable for the control of motors: 500 W. Equipped with 2 inputs for local control of the outputs.

APPLICATIONS: controlling operation/adjustment/stop, priority commands, scenario management and alarm signalling.

NOTES: installation in flush-mounting boxes, junction boxes or clipped into the ChoruSmart GW1x750 blanking modules.

SMART PLUG



GW A1 526

CONNECTED SMART PLUG 230 V AC - GERMAN STANDARD - ZIGBEE

Code	Type of plug	Socket-outlet type	Dimensions ØxH (mm)	Colour	Pack Carton
GW A1 526	2P+E - 10A	2P+E - 10A	41x45	White	1/4

CHARACTERISTICS: adaptor with socket, side earthing and safety shields. It detects power consumed by the connected loads and sends the data on the ZigBee network.

LOAD MANAGEMENT - ZIGBEE

LOAD MANAGEMENT KITS



GW A1 912

PRE-INSTALLED KIT P-COMFORT RF ZIGBEE AND SMART PLUG

Code	Number of smart plugs included	Pack Carton
GW A1 911	1	1
GW A1 912	2	1

CHARACTERISTICS: P-Comfort RF ZigBee provided with the kit is pre-installed to operate in Priority mode: when the power threshold is exceeded, loads connected to the Smart plug 1 are disconnected, then the loads connected to the Smart plug 2 and after all the loads wired to the relay inside the device. The reconnection of non-preferential loads is done following reverse sequence.

P-COMFORT LOAD MANAGEMENT RELAY



GW A1 916

CONNECTED P-COMFORT LOAD MANAGEMENT RELAY - ZIGBEE

Code	Rated voltage (V)	Rated current	Type relay contact	Capacity relay contact	No. of modules EN 50022	Pack Carton
GW A1 916	230V ac	32 A	Changeover (potential free contact)	16 A AC1 250 V ac	2	1/6

APPLICATION: The P-Comfort relay can be installed in electrical systems limited to a maximum power load of 6 kW. In the event of overload due to the simultaneous switching-on of multiple electrical loads, P-Comfort prevents the interruption of electrical power by disconnecting non-preferred loads controlled by ZigBee-connected actuators: GW1x826, GWA1201, GWA1202, GWA1221, GWA1222, GWA1523, GWA1526, GWA1521 or GWA1522, or wired to the relay contact on the device (maximum 10 devices total). The disconnection and reconnection sequence for non-preferred loads can be set by Priority (regardless of load absorption) or by Power (depending on the power absorbed).

NOTES: The Zigbee-connected actuators GW1x826, GWA1201, GWA1202, GWA1221, GWA1222 can only be controlled in combination with the "Home Gateway" GW1x840.

SENSORS AND ALARMS - ZIGBEE

SENSORS



GW A1 511

CONNECTED MOVEMENT SENSOR - ZIGBEE - IP30

Code	Max range	Light sensor	Temperature sensor	Colour	Dimensions LxHxD (mm)	Pack Carton
GW A1 511	6 m	3...70.000 lux	0...50 °C	White	82x82x28	1/2

FEATURES: motion sensor with horizontal detection angle: $\pm 45^\circ$ and vertical detection angle: $\pm 45^\circ$. Includes a brightness sensor and a temperature sensor. CR123 (replaceable) type battery power supply.

NOTES: Wall or shelf installation via included accessories.

For the control of actuators, use the sensor in combination with the connected Zigbee actuators GW1x826, GWA1201 or GWA1202, GWA1221 or GWA1222 (max 5 sensors per actuator) or with the connected Zigbee actuators GWA1526, GWA1521, GWA1522, GWA1523 (max 1 sensor per actuator). The Zigbee-connected actuators GW1x826, GWA1201, GWA1202, GWA1221, GWA1222 can only be controlled in combination with the "Home Gateway" GW1x840.



GW A1 513

CONNECTED WINDOW SENSOR - ZIGBEE - IP40

Code	Sensor type	Temperature sensor	Material	Colour	Dimensions LxHxD (mm)	Pack Carton
GW A1 513	Magnetic	0...50 °C	Plastic	White	76x26x17	1/6

FEATURES: the sensor detects the opening and closing of doors and windows and includes a temperature sensor. Powered with 2 AAA type batteries (replaceable).

NOTES: Installation on doors or windows.

Use the sensor in combination with the connected Zigbee actuators GW1x826, GWA1201 or GWA1202 (max 5 sensors per actuator) or with the ZigBee actuators GWA1521, GWA1522, GWA1523 (max 1 sensor per actuator). The Zigbee-connected actuators GW1x826, GWA1201, GWA1202 can only be controlled in combination with the "Home Gateway" GW1x840.

ALARMS



GW A1 512

CONNECTED SMOKE SENSOR - ZIGBEE - IP20

Code	Siren output	Temperature sensor	Colour	Dimensions (mm)	Pack Carton
GW A1 512	85 dB/3 m	0...50 °C	White	Ø 65x40	1/6

FEATURES: the sensor detects the presence of smoke and includes a temperature sensor. Power supplied by a CR123 type (replaceable) battery.

NOTES: wall or ceiling installation.

To operate a solenoid valve, use the sensor in combination with the connected Zigbee actuators GW1x826, GWA1201 or GWA1202 (max 5 sensors per actuator if the actuator is configured for automatic solenoid reset; unlimited sensors for manual reset) or with Zigbee actuators GWA1521, GWA1522, GWA1523 (max 1 sensor per actuator if the actuator is configured for automatic solenoid reset; unlimited sensors for manual reset). The Zigbee-connected actuators GW1x826, GWA1201, GWA1202 can only be commanded in conjunction with the "Home Gateway" GW1x840.



GW A1 514

CONNECTED WATER SENSOR - ZIGBEE - IP20

Code	Siren output	Temperature sensor	Colour	Dimensions (mm)	Pack Carton
GW A1 514	85 dB/3 m	0...50 °C	White	Ø 60x37	1/6

FEATURES: the sensor detects the presence of water and includes a temperature sensor. CR123 (replaceable) type battery power supply.

NOTES: floor installation or alternative wall mounted option using the accessory GWA1541.

To activate a solenoid valve, use the sensor in combination with the connected Zigbee actuators GW1x826, GWA1201 or GWA1202 (max 5 sensors per actuator if actuator is configured for automatic solenoid reset; unlimited sensors for manual reset) or with Zigbee actuators GWA1521, GWA1522, GWA1523 (max 1 sensor per actuator if actuator is configured for automatic solenoid reset; unlimited sensors for manual reset). Zigbee connected actuators GW1x826, GWA1201, GWA1202 can only be controlled in conjunction with the GW1x840 Home Gateway.



GW A1 541

WALL-MOUNTING SUPPORT FOR FLOOD ALARM

Code	Colour	Support dimension (mm)	Dimensions of probe (mm)	Cable max. length (cm)	Pack Carton
GW A1 541	White	Ø72x25	Ø50x8	85	1/4

APPLICATIONS: to be used for the wall-mounting of the Zigbee flood alarm GWA1514.

ACCESSORIES

ACCESSORIES



GW 14 750

BLANKING MODULES FOR HOUSING ZIGBEE CONTACTS INTERFACES AND ACTUATORS

Code	Colour	No. modules	Pack Carton
GW 10 750	Glossy white	1	1/12
GW 15 750	Satin White	1	1/12
GW 13 750	Natural satin beige	1	1/12
GW 12 750	Satin black	1	1/12
GW 14 750	Glossy Titanium	1	1/12

CHARACTERISTICS: 1-module blanking module with pad-printing. Enables the housing and rapid identification of the recessed connected control devices, of the recessed connected actuators and the connected energy meter with load control.

NOTES: snap-in assembly.



Home & Building PRO



Scan the QR Code and find out all the technical informations.

ADVANCED SOLUTIONS



The system is suitable for the advanced automation of applications within a residential and small-to-medium offices. It is very flexible and allows you to control even very extensive installations with a large number of devices.

KNX INTERNATIONAL STANDARD



The system is based on the international standard protocol KNX, the world most widely used protocol for home and building automation applications, making them very robust and ensuring interoperability between devices from different manufacturers. This ensures reliable solutions free from the risk of technological obsolescence, which is a major difficulty with solutions based on proprietary protocols.

INTEGRATION WITH THIRD-PARTY SYSTEMS

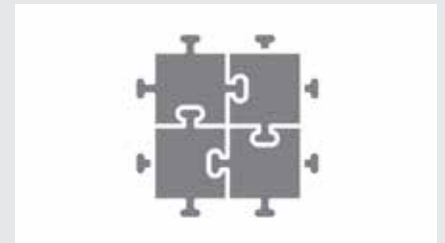

In addition to offering a wide range of functions for controlling safety, comfort and consumption, the system is further complemented by the integration of third-party systems for video intercoms (2N system), access control using Smart Lock (ISEO Argo system) and for entertainment and audio (SONOS system).

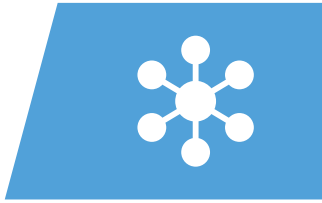

DATA AND ENERGY DISTRIBUTION



Data Center

NETWORK CABLING

pag. 1140



28 Spic

PLUGS, SOCKETS AND ADAPTERS
FOR DOMESTIC AND SIMILAR USES





pag. 1150

Data Center

10" WALL MOUNT RACK CABINETS

10" cabinets		Accessories					
	GW 38 432 Cabinet D=265mm 8U		GW 38 443 Empty patch panel for 8 RJ45 sockets - 1U	GW 38 444 Fixed shelf D=150mm 1U	GW 38 446 Power strip with ita/ger std sockets - 1U	GW 38 445 Blind panel 1U	GW 38 442 Cable management panel with 2 rings - 1U

19" WALL MOUNT RACK CABINETS

Quadri 19"			Spare parts		Accessories		
	GW 38 406 - 6U GW 38 407 - 9U GW 38 408 - 12U GW 38 409 - 15U Cabinets D=400mm	GW 38 418 - 12U GW 38 419 - 15U Cabinets D=600mm		GW 38 590 - 6U GW 38 591 - 9U GW 38 592 - 12U GW 38 593 - 15U Replacement doors		GW 38 471 Replacement lock	GW 38 485 Single fan

19" FLOOR RACK CABINETS

19" cabinets			
	GW 38 451 - 24U GW 38 452 - 30U GW 38 453 - 42U Cabinets 600x600mm	GW 38 461 - 24U GW 38 462 - 30U GW 38 463 - 42U Cabinets 800x800mm	GW 38 464 - 42U Cabinet 800x1000mm

Spare parts				
	GW 38 594 - 24U GW 38 596 - 30U GW 38 598 - 42U Replacement doors for cabinets 600x600mm	GW 38 595 - 24U GW 38 597 - 30U GW 38 599 - 42U Replacement doors for cabinets 800x800mm	GW 38 599 - 42U Replacement door for cabinet 800x1000mm	GW 38 472 Replacement lock

Accessories				
	GW 38 474 - 24U GW 38 475 - 30U GW 38 476 - 42U Pair of posts	GW 38 480 600x600mm GW 38 481 800x800mm GW 38 482 800x1000mm Plinths	GW 38 477 Kit with 8 metal rings for cabinets 800x800mm and 800x1000mm	
				
	GW 38 483 Coupling set for cabinets	GW 38 484 Set of 4 swiveling wheels	GW 38 479 Air circulation unit complete with thermostat	GW 38 558 Earthing set

ACCESSORIES FOR 19" RACK CABINETS

Accessories



GW 38 603 - UTP/FTP
Empty patch panel for
24 RJ45 sockets - 1U



GW 38 612 - SC/LC
GW 38 613 - ST
Empty fiber optic panels for
24 ports - 1U

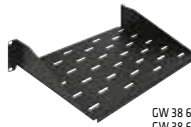

GW 38 607 - D=260mm
GW 38 608 - D=360mm
Fixed shelves - 2U



GW 38 609 - D=410mm
Sliding shelf - 2U



GW 38 606
Power strip with ita/ger std
sockets - 1U



GW 38 601 - 1U
GW 38 602 - 2U
Blind panels



GW 38 610
With brushes - 1U
GW 38 611
With 4 rings - 1U
Cable management panels



GW 38 557
Cage nuts and screws

COMPONENTS AND ACCESSORIES

RJ45 connectors



RJ45 - UTP

GW 38 031 - Cat. 5e
GW 38 032 - Cat. 6
GW 38 033 - Cat. 6a



RJ45 - FTP

GW 38 034 - Cat. 5e
GW 38 035 - Cat. 6
GW 38 036 - Cat. 6a

Couplers



GW 38 056
HDMI



GW 38 057
USB

Patch cords and cables



Copper patch cords - UTP

GW 38 116
Cat. 5e - L=0.5m
GW 38 117
Cat. 5e - L=1m
GW 38 118
Cat. 5e - L=2m
GW 38 119
Cat. 5e - L=5m
GW 38 131
Cat. 6 - L=1m
GW 38 132
Cat. 6 - L=2m
GW 38 133
Cat. 6 - L=5m



Copper patch cords - FTP

GW 38 121
Cat. 5e - L=0.5m
GW 38 122
Cat. 5e - L=1m
GW 38 123
Cat. 5e - L=2m
GW 38 124
Cat. 5e - L=5m

Data Center

Network cabling

A complete system with components and accessories for LAN network cabling set-ups, for both copper wire and fibre optics. The range includes 10" and 19" surface-mounting boards and floor-standing cabinets, with a modern, innovative design, that enable extreme ease of wiring thanks to large internal volumes and lateral space. These solutions reduce installation time and allow for quick configuration at any time for new usage requirements.



COMPONENTS FOR COPPER WIRING

UTP DATA SOCKETS FOR PANEL



GW 38 033

UNSHIELDED RJ45 UTP SOCKETS T568A/B

Code	Description	Use category	Cables type	Pack Carton
GW 38 031	RJ45	5e	UTP	10/50
GW 38 032	RJ45	6	UTP	10/50
GW 38 033	RJ45	6a	UTP	10/50

CHARACTERISTICS: terminals with tool-less etched insulation.

NOTES: for patch panels and adapters designed to house data connectors (ChoruSmart, System and Playbus) with Keystone Jack-type coupling.

UTP PATCH CORDS



GW 38 116

RJ45 - RJ45 UTP UNSHIELDED PATCHCORDS

Code	Description	Use category	Cables type	Cable length	Colour	Pack Carton
GW 38 116	RJ45 - RJ45	5e	UTP 24 AWG	0.5 m	Grey	1/24
GW 38 117	RJ45 - RJ45	5e	UTP 24 AWG	1 m	Grey	1/24
GW 38 118	RJ45 - RJ45	5e	UTP 24 AWG	2 m	Grey	1/24
GW 38 119	RJ45 - RJ45	5e	UTP 24 AWG	5 m	Grey	1/24
GW 38 131	RJ45 - RJ45	6	UTP 24 AWG	1 m	Grey	1/24
GW 38 132	RJ45 - RJ45	6	UTP 24 AWG	2 m	Grey	1/24
GW 38 133	RJ45 - RJ45	6	UTP 24 AWG	5 m	Grey	1/24

PRODUCTION CHARACTERISTICS: 24 AWG copper conductor. Flameproof polyethylene insulation. Plug contacts in phosphorous bronze.

PERFORMANCE CHARACTERISTICS: performance is higher than what is envisaged for cat. 5e.

Compliant with the prescriptions required for applications such as 100BASE-Tx, 155Mbps ATM and Gigabit Ethernet.

ELECTRICAL CHARACTERISTICS AT 20°C: Impedance 100 Ohm +/- 15% 1-100 MHz; Capacity: 13.5 pF/ft at 1 MHz.

FTP DATA SOCKETS FOR PANEL



GW 38 036

SHIELDED RJ45 FTP SOCKETS T568A/B

Code	Description	Use category	Cables type	Pack Carton
GW 38 034	RJ45	5e	FTP	10/50
GW 38 035	RJ45	6	FTP	10/50
GW 38 036	RJ45	6a	FTP	10/50

CHARACTERISTICS: tool-less etching terminals.

NOTES: for permutation panels and adapters designed to house data connectors with Keystone Jack type coupling.

FTP PATCH CORDS



GW 38 121

RJ45 - RJ45 FTP SHIELDED PATCHCORDS

Code	Description	Use category	Cables type	Cable length	Colour	Pack Carton
GW 38 121	RJ45 - RJ45	5e	FTP 24 AWG	0.5 m	Grey	1/24
GW 38 122	RJ45 - RJ45	5e	FTP 24 AWG	1 m	Grey	1/24
GW 38 123	RJ45 - RJ45	5e	FTP 24 AWG	2 m	Grey	1/24
GW 38 124	RJ45 - RJ45	5e	FTP 24 AWG	5 m	Grey	1/24

CONSTRUCTION CHARACTERISTICS: 24 AWG copper conductor. Flameproof polyethylene insulation. Plug contacts in phosphorous bronze.

PERFORMANCE CHARACTERISTICS: performance is higher than what is envisaged for cat. 5e.

Compliant with the prescriptions required for applications such as 100BASE-Tx, 155Mbps ATM and Gigabit Ethernet.

ELECTRICAL CHARACTERISTICS AT 20°C: Impedance 100 Ohm +/- 15% 1-100 MHz. Capacity: 13.5 pF/ft at 1 MHz.

USB AND HDMI COUPLERS



GW 38 056

USB AND HDMI COUPLERS

Code	Description	Type	Compatibility	Pack Carton
GW 38 056	HDMI coupler	Female/Female	Keystone Jack	1/48
GW 38 057	USB coupler	Female/Female - A type	Keystone Jack	1/48

NOTES: for adapters designed to house data connectors (ChoruSmart, System and Playbus) with Keystone Jack type coupling and permutation panels.

ACCESSORIES



GW 38 051

MOUNTING TOOLS

Code	Description	Suitable for	Pack Carton
GW 38 051	Inserter wire	110 Connect (Impact tool)	1

RACK CABINETS

10" WALL MOUNT RACK CABINETS



GW 38 432

10" METAL WALL MOUNT CABINET WITH TRANSPARENT DOOR

Code	Colour	No. uprights	Cabling unity	IP degree	Outer dim. LxHxD (mm)	Pack Carton
GW 38 432	Grey (RAL 7035)	2	8U	IP20	325x400x262	1

CHARACTERISTICS: made from sheet steel, powder coated, texture finish, with upper and lower cable entry. Movable and reversing 180° opening door with tempered glass window. Uprights adjustable in depth. Static load capacity 15Kg.

ACCESSORIES SUPPLIED: lock with 2 keys; earthing set.

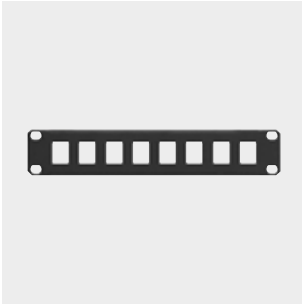

GW 38 443

ACCESSORIES FOR 10" WALL MOUNT CABINET

Code	Description	Characteristics	Load capacity (Kg)	Colour	Cabling unity	Pack Carton
GW 38 442	10" cable management panel With 2 rings	-	-	Black RAL 9005	1U	1/5
GW 38 443	10" empty patch panel	Suitable for 8 UTP/FTP RJ45 sockets	-	Black RAL 9005	1U	1/10
GW 38 444	10" fixed shelf	Depth 150 mm	10	Black RAL 9005	1U	1
GW 38 445	10" blind panel	-	-	Black RAL 9005	1U	1/10
GW 38 446	10" power strip	2 sockets 2P+E - 16 A ita/ger std	-	Grey	1,5 U	1/12

CHARACTERISTICS: GW38442, GW38443, GW38444, GW38445 made from painted sheet steel, wrinkle texture. GW38446 body in plastic material, with dual pole luminous switch, 3m long cable, 90° 2P+E - 16A fre/ger std plug, power max 3500W.

NOTES: GW38443 to be completed with UTP and FTP RJ45 socket-outlets with Keystone Jack coupling (eg: GW38031, GW38032, GW38033, GW38034, GW38035, GW38036). For mounting on 10" wall mount cabinets use the metal small parts kit GW38557.

19" WALL MOUNT RACK CABINETS



GW 38 407

19" METAL WALL MOUNT CABINETS WITH TRANSPARENT DOOR

Code	Colour	No. uprights	Cabling unity	IP degree	Outer dim. LxHxD (mm)	Pack Carton
Depth (mm): 400 mm						
GW 38 406	Grey (RAL 7035)	2	6 U	IP20	600x335x400	1
GW 38 407	Grey (RAL 7035)	2	9U	IP20	600x470x400	1
GW 38 408	Grey (RAL 7035)	2	12 U	IP20	600x605x400	1
GW 38 409	Grey (RAL 7035)	2	15 U	IP20	600x740x400	1
Depth (mm): 600 mm						
GW 38 418	Grey (RAL 7035)	2	12 U	IP20	600x605x600	1
GW 38 419	Grey (RAL 7035)	2	15 U	IP20	600x740x600	1

CHARACTERISTICS: made from sheet steel, powder coated, texture finish, with upper, lower and rear cable entry. Movable and reversing 180° opening door with tempered glass window. Uprights adjustable in depth. Static load capacity 50Kg.

ACCESSORIES SUPPLIED: quick coupling blind side panels, rear panel, roof plate and base; lock with 2 keys; earthing set.

REPLACEMENT DOORS FOR 19" WALL MOUNT CABINETS

Code	Colour	For 19" wall mount cabinets	Pack Carton
GW 38 590	Grey (RAL 7035)	GW38406	1
GW 38 591	Grey (RAL 7035)	GW38407	1
GW 38 592	Grey (RAL 7035)	GW38408, GW38418	1
GW 38 593	Grey (RAL 7035)	GW38409, GW38419	1

CHARACTERISTICS: made from sheet steel, powder coated, texture finish and tempered glass window.

ACCESSORIES SUPPLIED: lock with 2 keys.



GW 38 591

REPLACEMENT LOCK FOR 19" WALL MOUNT CABINETS

Code	Description	Pack Carton
GW 38 471	Security lock	1/30

CHARACTERISTICS: suitable for 19" wall mount cabinets.

ACCESSORIES SUPPLIED: lock with 2 keys.



GW 38 471



GW 38 485

ACCESSORIES FOR 19" WALL MOUNT CABINETS

Code	Description	Characteristics	Pack Carton
GW 38 485	Single fan	220-240 Vac - 50/60 Hz - 28 W	1

19" FLOOR RACK CABINETS



GW 38 453

19" METAL FLOOR RACK CABINETS WITH TRANSPARENT DOOR

Code	Colour	No. uprights	Cabling unity	IP degree	Outer dim. LxHxD (mm)	Pack Carton
Depth (mm): 600 mm						
GW 38 451	Grey (RAL 7035)	2	24 U	IP20	600x1185x600	1
GW 38 452	Grey (RAL 7035)	2	30 U	IP20	600x1485x600	1
GW 38 453	Grey (RAL 7035)	2	42U	IP20	600x1985x600	1
Depth (mm): 800 mm						
GW 38 461	Grey (RAL 7035)	4	24 U	IP20	800x1185x800	1
GW 38 462	Grey (RAL 7035)	4	30 U	IP20	800x1485x800	1
GW 38 463	Grey (RAL 7035)	4	42U	IP20	800x1985x800	1
Depth (mm): 1000 mm						
GW 38 464	Grey (RAL 7035)	4	42U	IP20	800x1985x1000	1

CHARACTERISTICS: made from sheet steel, powder coated, texture finish, with upper and lower cable entry. Movable and reversing 135° opening door with tempered glass window. Uprights adjustable in depth. Static load capacity 1000Kg.

ACCESSORIES SUPPLIED: quick coupling blind side and rear panels, roof plate and base; adjustable levelling feet; lock with 2 keys; earthing set.



GW 38 598

REPLACEMENT DOORS FOR 19" FLOOR RACK CABINETS

Code	Colour	For 19" rack cabinets	Pack Carton
GW 38 594	Grey (RAL 7035)	GW38451	1
GW 38 596	Grey (RAL 7035)	GW38452	1
GW 38 598	Grey (RAL 7035)	GW38453	1
GW 38 595	Grey (RAL 7035)	GW38461	1
GW 38 597	Grey (RAL 7035)	GW38462	1
GW 38 599	Grey (RAL 7035)	GW38463, GW38464	1

CHARACTERISTICS: made from sheet steel, powder coated, texture finish and tempered glass window.

ACCESSORIES SUPPLIED: lock with 2 keys.



GW 38 472

REPLACEMENT LOCK FOR 19" FLOOR RACK CABINETS

Code	Description	Pack Carton
GW 38 472	Security lock	1/5

CHARACTERISTICS: suitable for 19" floor rack cabinets.

ACCESSORIES SUPPLIED: lock with 2 keys.

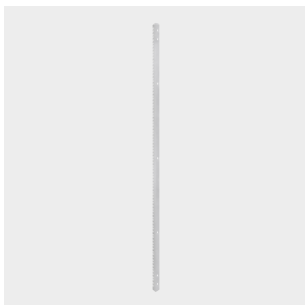

GW 38 476

PAIR OF POSTS FOR 19" FLOOR RACK CABINETS

Code	Cabling unity	Pack Carton
GW 38 474	24 U	1
GW 38 475	30 U	1
GW 38 476	42U	1

CHARACTERISTICS: made from zinc-plated sheet steel. Suitable for 19" floor rack cabinets.



GW 38 480

PLINTHS FOR 19" FLOOR RACK CABINETS

Code	Colour	For 19" rack cabinets	Outer dim. LxHxD (mm)	Pack Carton
GW 38 480	Black RAL 9005	GW38451, GW38452, GW38453	600x100x600	1
GW 38 481	Black RAL 9005	GW38461, GW38462, GW38463	800x100x800	1
GW 38 482	Black RAL 9005	GW38464	800x100x1000	1

CHARACTERISTICS: made from painted sheet steel, wrinkle texture.



GW 38 479

ACCESSORIES FOR 19" FLOOR RACK CABINETS

Code	Description	Characteristics	Colour	Pack Carton
GW 38 477	Kit with 8 metal rings	H 90 mm	Zinc-plated	1/8
GW 38 479	Air circulation unit	220-240 Vac - 50/60 Hz - 2x28 W	Black RAL 9005	1/8
GW 38 483	Coupling set for cabinets	-	-	1/15
GW 38 484	Set of 4 swiveling wheels	Provided with brakes. Load capacity 360 Kg	-	1
GW 38 558	Earthing set	Earth connection cables	-	1/30

CHARACTERISTICS: GW38477 suitable for fixing on the vertical cable management bars for the cabinets GW38461, GW38462, GW38463 and GW38464. GW38479 wrinkle texture, equipped with a pair of fans complete of 3m cable with german std plug and a thermostat.

NOTES: for mounting the air circulation unit GW38479 on 19" floor rack cabinets use the metal small parts kit GW38557.

ACCESSORIES FOR 19" RACK CABINETS

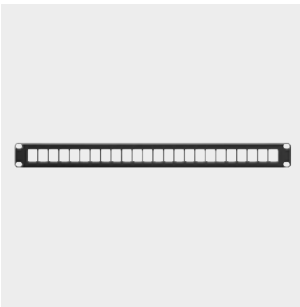

GW 38 603

19" EMPTY PATCH PANEL

Code	Characteristics	Colour	Cabling unity	Pack Carton
GW 38 603	Suitable for 24 UTP/FTP RJ45 sockets	Black RAL 9005	1U	1/10

CHARACTERISTICS: made from painted sheet steel, wrinkle texture.

NOTES: to be completed with UTP and FTP RJ45 socket-outlets with Keystone Jack coupling (eg: GW38031, GW38032, GW38033, GW38034, GW38035, GW38036). For mounting on 19" rack cabinets use the metal small parts kit GW38557.



GW 38 612

19" EMPTY FIBER OPTIC PATCH PANEL DRAWER

Code	Characteristics	Colour	Depth	Cabling unity	Pack Carton
GW 38 612	Suitable for 24 SC/LC couplers	Black RAL 9005	250 mm	1U	1
GW 38 613	Suitable for 24 ST couplers	Black RAL 9005	250 mm	1U	1

CHARACTERISTICS: made from painted sheet steel, wrinkle texture. Optic drawers with easy clip opening.

NOTES: suitable for SC simplex (GW38326), LC duplex or ST simplex couplers. For mounting on 19" rack cabinets use the metal small parts kit GW38557.



GW 38 609

19" RACK SHELVES

Code	Description	Load capacity (Kg)	Colour	Depth	Cabling unity	Pack Carton
GW 38 607	19" fixed shelf	20	Black RAL 9005	260 mm	2U	1/6
GW 38 608	19" fixed shelf	20	Black RAL 9005	360 mm	2U	1/6
GW 38 609	19" sliding shelf	15	Black RAL 9005	410 mm	2U	1/6

CHARACTERISTICS: made from painted sheet steel, wrinkle texture. The load capacity values (Kg) are referred to a uniformly distributed load. GW38609 not suitable for 19" wall mount cabinets with depth of 400mm.

NOTES: for mounting on 19" rack cabinets use the metal small parts kit GW38557.



GW 38 601

19" BLIND PANELS

Code	Colour	Cabling unity	Pack Carton
GW 38 601	Black RAL 9005	1U	1/20
GW 38 602	Black RAL 9005	2U	1/10

CHARACTERISTICS: made from painted sheet steel, wrinkle texture.

NOTES: for mounting on 19" rack cabinets use the metal small parts kit GW38557.



GW 38 611

19" CABLE MANAGEMENT PANELS

Code	Characteristics	Colour	Cabling unity	Pack Carton
GW 38 610	With brushes	Black RAL 9005	1U	1/20
GW 38 611	With 4 rings	Black RAL 9005	1U	1/15

CHARACTERISTICS: made from painted sheet steel, wrinkle texture.

NOTES: for mounting on 19" rack cabinets use the metal small parts kit GW38557.



GW 38 606

19" POWER STRIP

Code	Characteristics	Colour	Cabling unity	Pack Carton
GW 38 606	6 sockets 2P+E - 16 A dual amp. ita/ger std	Black	1U	1/10

CHARACTERISTICS: body in plastic material, with dual pole luminous switch, 3m long cable, 90° 2P+E - 16A fre/ger std plug, power max 3500W.

NOTES: for mounting on 19" rack cabinets use the metal small parts kit GW38557.



GW 38 557

ACCESSORIES FOR RACK CABINETS

Code	Description	Dimensions LxH (mm)	Pack Carton
GW 38 557	Small parts kit	-	1/30
GW 38 473	Alignment adhesive strip	-	1/30
GW 46 447	Self-adhesive document holder	230x310	1/10

ACCESSORIES SUPPLIED: GW38557 kit of cage nuts and 50 M6 screws.



Data Center



Scan the QR Code and find out all the technical informations.

A CABINET FOR ANY REQUIREMENT

HIGH PERFORMANCE

BUDGETING SOFTWARE



The cabinets are available in a wide choice of modules and in a variety of depths (up to 1000mm) to adapt to any application. A wide range of accessories is available for copper and fiber optic cabling.



All the components of the range are made with high quality materials and with particular attention to every detail and finish. The result offers sturdy switchboards and cabinets, with static full load capacity that can reach 1000kg.



GEWISS offers programmes for the estimation of enclosures and cabinets, which can be used from any web-page display device or installed on a PC.

28 SPIC

PLUGS

Italian standard	 <p>GW 28 003 - 10A White GW 28 004 - 10A Slate GW 28 005 - 16A White GW 28 006 - 16A Slate</p> <p>Straight plugs 2P+E - 250 Vac</p>	 <p>GW 28 007 - 10A White GW 28 008 - 10A Slate GW 28 009 - 16A White GW 28 010 - 16A Slate</p> <p>90° plugs 2P+E - 250 Vac</p>	German/french standard	 <p>GW 28 011 - 16A White GW 28 013 - 16A Black</p> <p>Straight plugs 2P+E - 250 Vac</p>	 <p>GW 28 012 - 16A White</p> <p>90° plugs 2P+E - 250 Vac</p>
-------------------------	---	--	-------------------------------	--	--



PORTABLE SOCKET-OUTLETS

Italian standard	 <p>CW 28 203 - 10A White CW 28 204 - 10A Slate CW 28 205 - 16A dual amp. White CW 28 206 - 16A dual amp. Slate</p> <p>Plugs 2P+E - 250 Vac</p>
-------------------------	--



EXTENSION SOCKETS

Italian standard	 <p>GW 28 601 6 outputs extension socket 2P+E - 16A dual amp. - 250 Vac</p>
-------------------------	--

SINGLE ADAPTORS

Italian/german standard	 <p>GW 28 415 2P+E adaptor - 250 Vac 1x 16A ger. std plug 1x 16A dual amp. socket</p>	 <p>GW 28 409 1x 10A plug GW 28 510 1x 16A plug</p> <p>2P+E - 250 Vac adaptor 1x 16A ita/ger std socket</p>
--------------------------------	--	--

MULTIPLE ADAPTORS

Italian standard	 <p>GW 28 421 1x 10A plug - 3x 10A sockets GW 28 423 1x 16A plug - 3x 16A dual amp. sockets</p> <p>3 outputs adaptors 2P+E - 250 Vac</p>	 <p>GW 28 418 1x 10A plug - 3x 10A sockets GW 28 419 1x 16A plug - 3x 16A dual amp. sockets</p> <p>3 outputs flat adaptors 2P+E - 250 Vac</p>	Italian/german standard	 <p>GW 28 416 1x 10A plug - 2x 10A sockets - 1x 16A ita/ger std socket GW 28 417 1x 16A plug - 2x 16A dual amp. sockets - 1x 16A dual amp. ita/ger std socket</p> <p>3 outputs adaptors 2P+E - 250 Vac</p>
-------------------------	---	--	--------------------------------	--

28 Spic

Plugs, sockets and adapters for domestic and similar uses

Range of plugs, socket-outlets, multiple adapters and trailing socket-outlets for the most common power take-off needs in the domestic environment.



PLUGS AND PORTABLE SOCKET-OUTLETS

PLUGS



GW 28 005

STRAIGHT PLUGS - ITALIAN STANDARD - 250V AC

Code	No. of poles	Rated current (A)	Type	Colour	Pack Carton
GW 28 003	2P+E	10	S11	White	25/250
GW 28 004	2P+E	10	S11	Slate	25/250
GW 28 005	2P+E	16	S17	White	25/150
GW 28 006	2P+E	16	S17	Slate	25/150



GW 28 007

90° PLUGS - ITALIAN STANDARD - 250V AC

Code	No. of poles	Rated current (A)	Type	Colour	Pack Carton
GW 28 007	2P+E	10	SPA11	White	25/150
GW 28 008	2P+E	10	SPA11	Slate	25/150
GW 28 009	2P+E	16	SPA17	White	25/250
GW 28 010	2P+E	16	SPA17	Slate	25/250

GW28009 - GW28010: check extractability for side socket-outlets.



GW 28 011

STRAIGHT PLUGS - GERMAN/FRENCH STANDARD - 250V AC



Code	No. of poles	Rated current (A)	Colour	Characteristics	Pack Carton
GW 28 011	2P+E	16	White	Halogen free	25/175
GW 28 013	2P+E	16	Black	Halogen free	25/175

Plug with double earthing contact (side for German standard, middle for French standard).



GW 28 012

90° ANGLE PLUG - GERMAN/FRENCH STANDARD - 250V AC



Code	No. of poles	Rated current (A)	Colour	Characteristics	Pack Carton
GW 28 012	2P+E	16	White	Halogen free	25/175

Plug with double earthing contact (side for German standard, middle for French standard).

28 SPIC

PORTABLE SOCKET-OUTLETS



GW 28 205

ITALIAN STANDARD PORTABLE SOCKET-OUTLETS - 250V AC

Code	No. of poles	Rated current (A)	Type	Colour	Pack Carton
GW 28 203	2P+E	10	P11	White	25/250
GW 28 204	2P+E	10	P11	Slate	25/250
GW 28 205	2P+E	16	Dual amperage P17-11	White	25/150
GW 28 206	2P+E	16	Dual amperage P17-11	Slate	25/150

CHARACTERISTICS: with safety shields.

ADAPTORS AND MULTIPLE TRAILING SOCKET-OUTLETS

ADAPTORS



GW 28 423

ITALIAN STANDARD MULTIPLE ADAPTORS WITH 3 OUTPUTS - 250V AC - 1500W

Code	Type of plug	Socket-outlet type	Colour	Pack Carton
GW 28 421	2P+E 10A (S11)	10A (P11)	White	50/200
GW 28 423	2P+E 16A (S17)	16A dual amper (P17/11)	White	50/200

CHARACTERISTICS: with safety shields.



GW 28 419

ITALIAN STANDARD FLAT MULTIPLE ADAPTORS WITH 3 OUTPUTS - 250V AC - 1500W

Code	Type of plug	Socket-outlet type	Colour	Pack Carton
GW 28 418	2P+E 10A (S11)	10A (P11)	White	40/160
GW 28 419	2P+E 16A (S17)	16A dual amper (P17/11)	White	40/160

CHARACTERISTICS: with safety shields.



GW 28 417

MULTIPLE ADAPTORS WITH 2 OUTPUTS (ITALIAN STANDARD) AND 1 OUTPUT (ITALIAN/GERMAN STANDARD) 250V AC - 1500W

Code	Type of plug	Socket-outlet type	Socket-outlet type	Colour	Pack Carton
GW 28 416	2P+E 10A (S11)	16 A (P30)	10 A (P11)	White	50/200
GW 28 417	2P+E 16A (S17)	16 A (P40)	16A dual amper (P17/11)	White	50/200



GW 28 409

ITALIAN/GERMAN STANDARD SINGLE ADAPTORS WITH 1 OUTPUT - 250V AC - 1500W

Code	Type of plug	Socket-outlet type	Colour	Pack Carton
GW 28 409	2P+E 10A (S11)	16A (P30)	Glossy white	50/200
GW 28 510	2P+E 16A (S17)	16A (P30)	Satin White	50/200

CHARACTERISTICS: socket-outlet with side and central earthing.



GW 28 415

ITALIAN STANDARD SINGLE ADAPTOR WITH 1 OUTPUT - 250V AC - 150W

Code	Type of plug	Socket-outlet type	Colour	Pack Carton
GW 28 415	2P+E 16A German stand.	16A dual amper (P17/11)	White	15/150

CHARACTERISTICS: with safety shields.

EXTENSION SOCKET (WITH SAFETY SHIELDS)



GW 28 601

MULTIPLE SOCKET-OUTLET, 6 OUTPUTS, ITALIAN STANDARD WITH 1.5M CABLE AND STRAIGHT PLUG 2P+E - 16A - 250V AC - 3000W

Code	Type of plug	No. of sockets	Socket-outlet type	Colour	Pack Carton
GW 28 601	2P+E 16A (S17)	6	16A dual amper (P17/11)	White	1/20

CHARACTERISTICS: Cable in PVC type H05VV-F section 3x1 mm².



28 Spic



Scan the QR Code and find out all the technical informations.

ERGONOMIC



Anti-slip ribs allow the best ergonomics during use.

WALKABLE



Designed to withstand shock in accordance with standard 23-50.

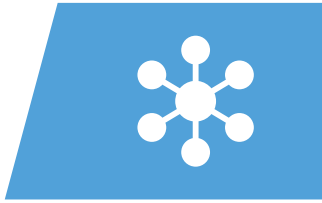

FLUSH-MOUNTING ENCLOSURES



Domo Center

FLUSH-MOUNTING SYSTEM COLUMNS
FOR DISTRIBUTION, HOME & BUILDING
AUTOMATION AND DATA

pag. 1158

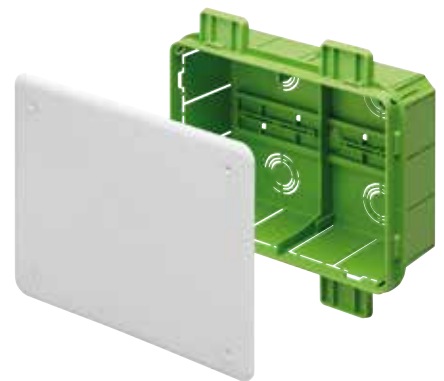

Green Wall

FLUSH-MOUNTING SYSTEM FOR
PLASTERBOARD WALLS

pag. 242



40 CDi

FLUSH-MOUNTING DISTRIBUTION
BOARDS AND ENCLOSURES

pag. 264



48

FLUSH-MOUNTING JUNCTION AND
MODULAR BOXES SYSTEM

pag. 286



24 SC

FLUSH MOUNTING; SURFACE OR
UNDERFLOOR BOXES

pag. 302

DOMO CENTER

RANGE

The versatility of DOMO CENTER makes it possible to perform various functions, such as: energy distribution, networking devices housing, Home and building automation monitoring and control devices Touchscreen 7", and use as an upright column for the distribution of common services to the various floors of the building.

The Domo Center range is divided into 2 parts:

Front configuration kit

These are configurations with predefined heights and types (with and without door) that contain all the components necessary for implementing the system column, with the exception of the back-mounting box that must be purchased separately. Available in the catalogue in several configurations, these kits facilitate the product selection, transport and assembly.

Components

It is possible, however, to create personalised configurations as required by making up the system column using the Domo Center components.



INSTALLATION

DOMO CENTER, comes in two standard dimensions, It is designed for installation in rooms with floor-ceiling heights (with the work completed) of 2700 mm or 2400 mm.

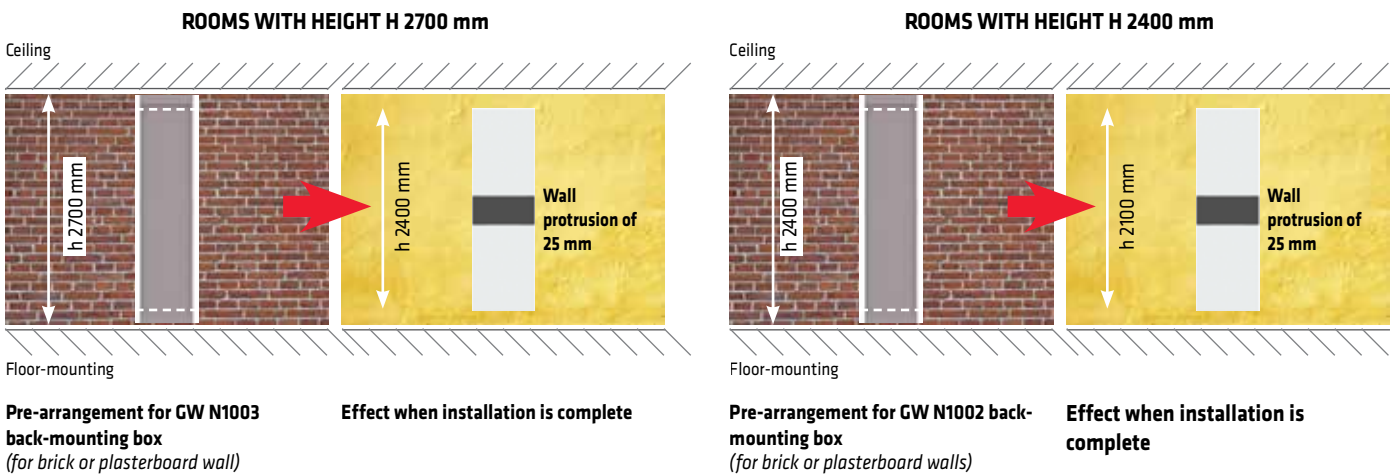

Note: the buffer panels H 150 mm inserted in the upper and lower edge of the flush-mounting back-mounting box are designed to be finished like the wall (both brick and plasterboard).

AN EXAMPLE OF USE AS AN UPRIGHT COLUMN FOR THE DISTRIBUTION OF COMMON SERVICES TO THE VARIOUS FLOORS OF THE BUILDING.

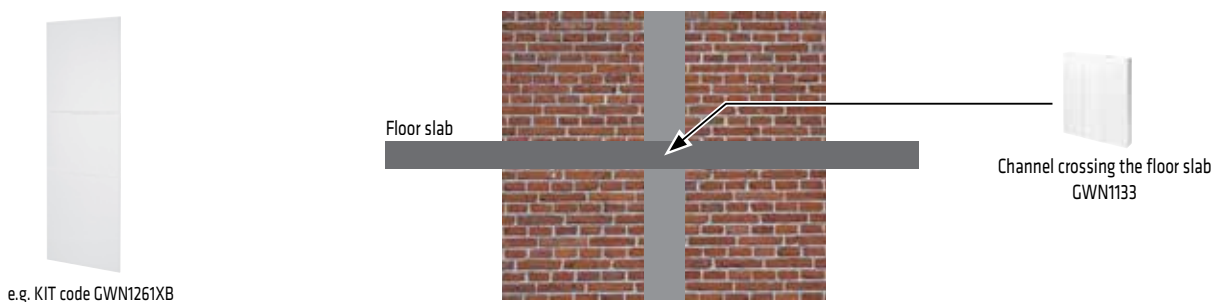

STRUCTURE

The DOMO CENTER can be configured in multiple solutions, with or without a door. Once the back-mounting box (height 2700 or 2400 mm) has been selected, the following aspects must be defined on the basis of its modularity: the internal configuration, the underdoor panels (if necessary) the front configuration until the modularity of the back-mounting box itself is reached. Examples that represent the two types are given below. For each assembly level, there is a description of the components that can be installed and their relative modular dimensions (1U corresponds to overall modular dimensions of h 300 mm).

Version without door



Composition representing code GWN1601XB and flush-mounting back-mounting box GWN1002

- 1 FLUSH-MOUNTING BACK-MOUNTING BOX**
Back-mounting box for masonry or plasterboard, in heights of 2700 mm (8U) and 2400 mm (7U)
- 2 INTERNAL CONFIGURATION ELEMENTS**
Functional frames with DIN rail (1U/2U), functional frames with back-mounting plate (1U/2U), home networking kit (2U)
- 3 FINISH FRAME**
For heights 2400 mm (for a back-mounting box height of 2700 mm) and 2100 mm (for back-mounting box height of 2400 mm)
- 4 FRONT CONFIGURATION ELEMENTS**
40-module enclosure (1U), panels without windows (1U/2U/3U), panels with windows (1U/2U)

Version with door



Composition representing code GWN1401XB and flush-mounting back-mounting box GWN1003

- 1 FLUSH-MOUNTING BACK-MOUNTING BOX**
Back-mounting box for masonry or plasterboard, in heights of 2700 mm (8U) and 2400 mm (7U)
- 2 INTERNAL CONFIGURATION ELEMENTS**
Functional frames with DIN rail (1U/2U), functional frames with back-mounting plate (1U/2U), Home networking kit (2U)
- 3 FINISH FRAME**
For heights 2400 mm (for a back-mounting box height of 2700 mm) and 2100 mm (for back-mounting box height of 2400 mm)
- 4 UNDERDOOR ELEMENTS**
Underdoor panels with windows 2 DIN rail rows (1U), underdoor panels without windows (1U)
- 5 FRONT CONFIGURATION ELEMENTS**
Doors* (5U/6U) and panels without windows (1U/2U/3U)

* For a mirror finish, the door in 7U and 8U modularities includes panels without windows.











HOW TO REQUEST THE MOST SUITABLE CONFIGURATION (KIT)







Contact customer service (sat@gewiss.com) or the sales organisation for configuration and estimate support. To facilitate these requests, the DOMO CENTER Gweb software is freely available on gewiss.com.

DOMO CENTER

KIT PRECONFIGURED A CATALOGUE

DOMO CENTER FRONT CONFIGURATION KIT										
KIT TYPE	VERSION	FOR FLUSH-MOUNTING BACK-MOUNTING BOX (not included in the KIT)		KIT CODE	FINISH (metal)	CAPACITY (unit/modularity/functional height)	INTERNAL CONFIGURATION			
							Function frame with DIN rails		Functional frame with back-mounting plate	
										
							Dimensions (unit/modularity/height)			
1 U 40 M (20x2) H 300 mm		2 U 80 M (20x4) H 600 mm		1 U H 300 mm		2 U H 600 mm				
KIT VERSIONS WITHOUT DOOR	Enclosure	GWN1003 (H 2700 mm)		GWN1201XB	Finish panels and enclosure front white RAL 9003	8 U 320 M 2400 mm		N°4		
		GWN1002 (H 2400 mm)		GWN1601XB		7 U 280 M 2100 mm	N°1	N°3		
	Upright column	GWN1003 (H 2700 mm)		GWN1261XB	Finish panels white RAL 9003	8 U 40 M 2400 mm	N°1		N°1	N°3
		GWN1002 (H 2400 mm)		GWN1661XB		7 U 40 M 2100 mm	N°1			N°3
KIT VERSIONS WITH DOOR	Enclosure with smoked transparent finish door	GWN1003 (H 2700 mm)		GWN1401XB	Finish panels white RAL 9003 and smoked transparent glass door	8 U 320 M 2400 mm		N°4		
		GWN1002 (H 2400 mm)		GWN1801XB		7 U 280 M 2100 mm	N°1	N°3		
	Enclosure with door and mirror finish panels	GWN1003 (H 2700 mm)		GWN1431CP	Door and panels with integral mirror finish on the entire surface	8 U 320 M 2400 mm		N°4		
		GWN1002 (H 2400 mm)		GWN1831CP		7 U 280 M 2100 mm	N°1	N°3		
	Enclosure with metal finish door	GWN1003 (H 2700 mm)		GWN1461XB	Door and panels with white RAL 9003 finish	8 U 320 M 2400 mm		N°4		
		GWN1002 (H 2400 mm)		GWN1861XB		7 U 280 M 2100 mm	N°1	N°3		

KIT COMPLEMENTARY ITEMS

						
Flush-mounting back-mounting boxes* GWN1002 (for H 2400 mm) GWN1003 (for H 2700 mm)	Kit for coupling back-mounting boxes GWN1131	Safety lock GWN1132	Channel crossing the floor slab GWN1133	Separator plate GWN1141 (horizontal) GWN1142 (vertical)	Fixing brackets for Internet Gateway GWN1134	Safety lock kit for white blind metal panels with finishing design GWN1135





* Before installing the front configuration KIT, install the metal flush-mounting back-mounting box.

NOTE: (U) refers to the modular dimensions (e.g. 1U corresponds to overall modular dimensions equal to h 300 mm)





ACCESSORIES SUPPLIED IN THE KIT

FINISH FRAME	Front CONFIGURATION (external finish elements)														
	Enclosure with smoked transparent door	Enclosure function panel with windows (underdoor)	Panel without windows (underdoor)	Door in smoked transparent glass		Door and 2 panels H=300 mm with mirror finish on the entire surface		Finish door		Finish panels with windows	Finish panels without windows				
	Metal white RAL 9003												Metal white RAL 9003		
Dimensions (unit/modularity/height)															
	1U 40 M (20x2) H 300 mm	1U 40 M (20x2) H 300 mm	1U H 300 mm	5U H 1500 mm	6U H 1800 mm	7U H 2100 mm	8U H 2400 mm	5U H 1500 mm	6U H 1800 mm	1U H 300 mm	1U H 300 mm	2U H 600 mm	3U H 900 mm		
N°1	N°2												N°2		
	N°1												N°2		
												N°1	N°2		
											N°1		N°2		
		N°2	N°4		N°1						N°2				
		N°1	N°4	N°1							N°2				
		N°2	N°4				N°1								
		N°1	N°4				N°1								
		N°2	N°4							N°1	N°2				
		N°1	N°4						N°1		N°2				





DOMO CENTER

VERSIONS WITHOUT DOOR (WITH ENCLOSURE AND FINISH PANELS)				INTERNAL CONFIGURATION					FINISH FRAME	
				Function frame with DIN rails	Functional frame with back-mounting plate		Home networking kit		 Element required for fixing front configuration elements	
	1 U 40 M (20x2) H 300 mm	2 U 80 M (20x4) H 600 mm	1 U H 300 mm	2 U H 600 mm	2 U H 600 mm					
	FLUSH-MOUNTING BACK-MOUNTING BOXES 	GWN1002 (dim. back-mounting box LxHxD 590x2400x85 mm) (functional dimensions LxHxD 590x2100x85 mm)	CAPACITY (unit/modularity/functional height)	7 U 280 M (20x14) h 2100 mm	GWN1012	GWN1014	GWN1022	GWN1024		GWN1031F (Note: Closing through blind finish panels)
GWN1003 (dim. back-mounting box LxHxD 590x2700x85 mm) (functional dimensions LxHxD 590x2400x85 mm)		8 U 320 M (20x16) h 2400 mm		Optional: complete windowed panel under door GWN1122XB for home networking kit					GWN1043XB	
VERSIONS WITH DOOR (WITH UNDERDOOR PANELS, DOOR AND FINISH PANELS)				INTERNAL CONFIGURATION					FINISH FRAME	
				Function frame with DIN rails	Functional frame with back-mounting plate		Home networking kit		 Element required for fixing front configuration elements	
FLUSH-MOUNTING BACK-MOUNTING BOXES  <td colspan="1"> GWN1002 (dim. back-mounting box LxHxD 590x2400x85 mm) (functional dimensions LxHxD 590x2100x85 mm) </td> <td colspan="1" rowspan="2"> CAPACITY (unit/modularity/functional height) </td> <td colspan="1">7 U 280 M (20x14) h 2100 mm</td> <td colspan="1" rowspan="2">GWN1012</td> <td colspan="1" rowspan="2">GWN1014</td> <td colspan="1" rowspan="2">GWN1022</td> <td colspan="1" rowspan="2">GWN1024</td> <td colspan="1"> GWN1031F (Note: for an high aesthetic performance and device protection use the underdoor windowed panel code GWN1122XB for networking kit) </td> <td colspan="1">GWN1042XB</td>	GWN1002 (dim. back-mounting box LxHxD 590x2400x85 mm) (functional dimensions LxHxD 590x2100x85 mm)	CAPACITY (unit/modularity/functional height)	7 U 280 M (20x14) h 2100 mm	GWN1012	GWN1014	GWN1022	GWN1024	GWN1031F (Note: for an high aesthetic performance and device protection use the underdoor windowed panel code GWN1122XB for networking kit)		GWN1042XB
	GWN1003 (dim. back-mounting box LxHxD 590x2700x85 mm) (functional dimensions LxHxD 590x2400x85 mm)		8 U 320 M (20x16) h 2400 mm					(Note: closure with underdoor finish panels without windows)		GWN1043XB

NOTE: (U) refers to the modular dimensions (e.g. 1U corresponds to overall modular dimensions equal to h 300 mm)

Front CONFIGURATION (external finish elements)					COMPLEMENTARY ITEMS
Enclosure with smoked transparent door	Finish panels without windows			Finish panels with windows for specific devices	
Metal white RAL 9003					
					
Dimensions (unit/modularity/height)					
1 U 40 M (20x2) H 300 mm	1 U H 300 mm	2 U H 600 mm	3 U H 900 mm	1 U H 300 mm	
GWN1051XB	GWN1062XB	GWN1064XB	GWN1066XB	GWN1071XB (for Touchscreen 7" -> article to be ordered separately)  	

- Safety lock kit for white blind metal panels with finishing design GWN1135 
- Kit for coupling back-mounting boxes GWN1131 
- Channel crossing the floor slab GWN1133 
- Safety lock GWN1132 
- Separator plate GWN1141 (horizontal) GWN1142 (vertical) 
- Fixing brackets for Internet Gateway GWN1134 

Front CONFIGURATION (external finish elements)											COMPLEMENTARY ITEMS
Enclosure function panel with windows (underdoor)	Panel without windows (underdoor)	Finish doors (glass, metal and mirror finishes*) (* For mirrored doors: 2 mirror panels H=300 mm supplied.)						Finish panels without windows			
Metal white RAL 9003								Metal white RAL 9003			
											
Dimensions (unit/modularity/height)											
1 U 40 M (20x2) H 300 mm	1 U H 300 mm	5 U H 1500 mm	6 U H 1800 mm	5 U H 1500 mm	6 U H 1800 mm	7 U H 2100 mm	8 U H 2400 mm	1 U H 300 mm	2 U H 600 mm	3 U H 900 mm	
GWN1121XB	GWN1124XB	GWN1101CF (glass)	GWN1111CF (glass)	GWN1101XB (metal)	GWN1111XB (metal)	GWN1101CP (mirror)	/	GWN1062XB	GWN1064XB	GWN1066XB	
						/	GWN1111CP (mirror)				

- Safety lock kit for white blind metal panels with finishing design GWN1135 
- Kit for coupling back-mounting boxes GWN1131 
- Channel crossing the floor slab GWN1133 
- Safety lock GWN1132 
- Separator plate GWN1141 (horizontal) GWN1142 (vertical) 
- Fixing brackets for Internet Gateway GWN1134 

Domo Center

Flush-mounting system columns for distribution, Home &

DOMO CENTER transforms the domestic systems into furnishing accessories: a modern design solution that blends with the existing context, centralising and rationalising the existing services - from the most traditional to the most advanced, in a single point with a modularity of up to 320 modules. Also available with characteristic full-mirror version.



DOMO CENTER FRONT CONFIGURATION KIT

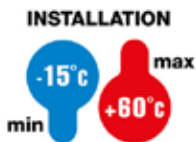

**IP
40**

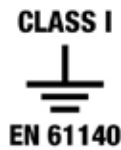

2700 KIT VERSIONS - WITHOUT DOOR



GW N1 201 XB

SYSTEM COLUMN FRONT KIT WITH FINISH PANELS IN WHITE METAL RAL 9003 AND 2 ENCLOSURE - 40 MODULES

Code	For back-mounting box dim. LxHxD (mm)	Outer dim. LxHxD (mm)	No. of modules EN 50022 *	Pack Carton
GW N1 201 XB	590x2700x85	642x2400x25	320 (20x16)	1

*: 320M maximum available modular space.

ACCESSORIES SUPPLIED:

- 4 functional frames for 80 DIN rail modules (20x4), code GWN1014.
- 1 metal frame, code GWN1043XB.
- 2 finish panels without windows, code GWN1066XB.
- 2 enclosures - 40 DIN rail modules (20x2) with door in smoked transparent glass, code GWN1051XB.

NOTES: installation is recommended in areas with a floor-ceiling height of h 2700 mm when the work is complete.
Maximum rated current In = 125 A.

Flush-mounting back-mounting box to be ordered separately. Reference code GWN1003.



GW N1 261 XB

SYSTEM COLUMN FRONT KIT WITH FINISH PANELS IN WHITE METAL RAL 9003 FOR USE AS AN UPRIGHT COLUMN

Code	For back-mounting box dim. LxHxD (mm)	Outer dim. LxHxD (mm)	No. of modules EN 50022 *	Pack Carton
GW N1 261 XB	590x2700x85	642x2400x25	40 (20x2)	1

*: 40M maximum modular space available (e.g. for terminal block for junction, cross-pieces etc.).

SUPPLIED:

- 1 functional frame for 40 DIN rail modules (20x2), code GWN1012.
- 3 functional frames supplied with back-mounting plate, code GWN1024.
- 1 functional frame supplied with back-mounting plate, code GWN1022.
- 1 metal frame, code GWN1043XB.
- 2 finish panels without windows, code GWN1066XB.
- 1 finish panel without windows, code GWN1064XB.

NOTES: installation is recommended in areas with a floor-ceiling height of h 2700 mm when the work is complete.
Maximum rated current In = 125 A.

Flush-mounting back-mounting box to be ordered separately. Reference code GWN1003.

2700 KIT VERSIONS - WITH DOOR



GW N1 401 XB

SYSTEM COLUMN FRONT KIT WITH DOOR IN SMOKED TRANSPARENT GLASS, FINISH PANELS IN WHITE METAL RAL 9003, 2 UNDERDOOR ENCLOSURES 40 M AND UNDERDOOR PANELS WHITE RAL 9003

Code	For back-mounting box dim. LxHxD (mm)	Outer dim. LxHxD (mm)	No. of modules EN 50022 *	Pack Carton
GW N1 401 XB	590x2700x85	642x2400x25	320 (20x16)	1

*: 320M maximum available modular space.

ACCESSORIES SUPPLIED:

- 4 functional frames for 80 DIN rail modules (20x4), code GWN1014.
- 1 metal frame, code GWN1043XB.
- 2 finish panels without windows, code GWN1062XB.
- 2 underdoor enclosures for 40 DIN rail modules (20x2), code GWN1121XB.
- 4 underdoor panels, code GWN1124XB.
- 1 door in transparent smoked glass, code GWN1111CF.

NOTES: installation is recommended in areas with a floor-ceiling height of h 2700 mm when the work is complete.
Maximum rated current In = 125 A.

Flush-mounting back-mounting box to be ordered separately. Reference code GWN1003.



GW N1 431 CP

SYSTEM COLUMN FRONT KIT WITH MIRROR FINISH PANELS AND DOOR, 2 UNDERDOOR ENCLOSURES 40 M AND UNDERDOOR PANELS WHITE RAL 9003

Code	For back-mounting box dim. LxHxD (mm)	Outer dim. LxHxD (mm)	No. of modules EN 50022 *	Pack Carton
GW N1 431 CP	590x2700x85	642x2400x25	320 (20x16)	1

*: 320M maximum available modular space.

CHARACTERISTICS: door and panels in metal with integral mirror finish on the entire surface.

ACCESSORIES SUPPLIED:

- 4 functional frames for 80 DIN rail modules (20x4), code GWN1014.
- 1 metal frame, code GWN1043XB.
- 2 underdoor enclosures for 40 DIN rail modules (20x2), code GWN1121XB.
- 4 underdoor panels, code GWN1124XB.
- 1 door and 2 mirror panels, code GWN1111CP.

NOTES: installation is recommended in areas with a floor-ceiling height of h 2700 mm when the work is complete.
The door pack with mirror finish include also 2 mirror panels with h = 300 mm.

Maximum rated current In = 125 A.

Flush-mounting back-mounting box to be ordered separately. Reference code GWN1003.



GW N1 461 XB

SYSTEM COLUMN FRONT KIT WITH DOOR AND FINISH PANELS IN WHITE METAL RAL 9003, 2 UNDERDOOR ENCLOSURES 40 M AND UNDERDOOR PANELS WHITE RAL 9003

Code	For back-mounting box dim. LxHxD (mm)	Outer dim. LxHxD (mm)	No. of modules EN 50022 *	Pack Carton
GW N1 461 XB	590x2700x85	642x2400x25	320 (20x16)	1

*: 320M maximum available modular space.

ACCESSORIES SUPPLIED:

- 4 functional frames for 80 DIN rail modules (20x4), code GWN1014.
- 1 metal frame, code GWN1043XB.
- 2 finish panels without windows, code GWN1062XB.
- 2 underdoor enclosures for 40 DIN rail modules (20x2), code GWN1121XB.
- 4 underdoor panels, code GWN1124XB.
- 1 metal door, code GWN1111XB.

NOTES: installation is recommended in areas with a floor-ceiling height of h 2700 mm when the work is complete.
Maximum rated current In = 125 A.

Flush-mounting back-mounting box to be ordered separately. Reference code GWN1003.

2400 KIT VERSIONS - WITHOUT DOOR



GW N1 601 XB

SYSTEM COLUMN FRONT KIT WITH FINISH PANELS IN METAL COLOUR RAL 9003 AND 1 ENCLOSURE - 40 MODULES

Code	For back-mounting box dim. LxHxD (mm)	Outer dim. LxHxD (mm)	No. of modules EN 50022 *	Pack Carton
GW N1 601 XB	590x2400x85	642x2100x25	280 (20x14)	1

*: 280M maximum available modular space.

ACCESSORIES SUPPLIED:

- 3 functional frames for 80 DIN rail modules (20x4), code GWN1014.
- 1 functional frame supplied with DIN rails, code GWN1012.
- 1 metal frame, code GWN1042XB.
- 2 finish panels without windows, code GWN1065XB.
- 1 enclosure for 40 DIN rail modules (20x2) with door in smoked transparent glass, code GWN1051XB.

NOTES: installation is recommended in areas with a floor-ceiling height of h 2400 mm when the work is complete.
Maximum rated current In = 125 A.

Flush-mounting back-mounting box to be ordered separately. Reference code GWN1002.

DOMO CENTER



GW N1 661 XB

SYSTEM COLUMN FRONT KIT WITH FINISH PANELS IN WHITE METAL RAL 9003 FOR USE AS AN UPRIGHT COLUMN

Code	For back-mounting box dim. LxHxD (mm)	Outer dim. LxHxD (mm)	No. of modules EN 50022 *	Pack Carton
GW N1 661 XB	590x2400x85	642x2100x25	40 (20x2)	1

*: 40M maximum modular space available (e.g. for terminal block for junction, cross-pieces etc.).

ACCESSORIES SUPPLIED:

- 1 functional frame for 40 DIN rail modules (20x2), code GWN1012.
- 3 functional frames supplied with back-mounting plate, code GWN1024.
- 1 metal frame, code GWN1042XB.
- 2 finish panels without windows, code GWN1066XB.
- 1 finish panel without windows, code GWN1062XB.

NOTES: installation is recommended in areas with a floor-ceiling height of h 2400 mm when the work is complete.

Maximum rated current In = 125 A.

Flush-mounting back-mounting box to be ordered separately. Reference code GWN1002.

2400 KIT VERSIONS - WITH DOOR



GW N1 801 XB

SYSTEM COLUMN FRONT KIT WITH DOOR IN SMOKED TRANSPARENT GLASS, FINISH PANELS IN WHITE METAL RAL 9003, 1 UNDERDOOR ENCLOSURE 40 M AND UNDERDOOR PANELS WHITE RAL 9003

Code	For back-mounting box dim. LxHxD (mm)	Outer dim. LxHxD (mm)	No. of modules EN 50022 *	Pack Carton
GW N1 801 XB	590x2400x85	642x2100x25	280 (20x14)	1

*: 280M maximum available modular space.

ACCESSORIES SUPPLIED:

- 3 functional frames for 80 DIN rail modules (20x4), code GWN1014.
- 1 functional frame supplied with DIN rails, code GWN1012.
- 1 metal frame, code GWN1042XB.
- 2 finish panels without windows, code GWN1062XB.
- 1 underdoor enclosure for 40 DIN rail modules (20x2), code GWN1121XB.
- 4 underdoor panels, code GWN1124XB.
- 1 door in transparent smoked glass, code GWN1101CF.

NOTES: installation is recommended in areas with a floor-ceiling height of h 2400 mm when the work is complete.

Maximum rated current In = 125 A.

Flush-mounting back-mounting box to be ordered separately. Reference code GWN1002.



GW N1 831 CP

SYSTEM COLUMN FRONT KIT WITH MIRROR FINISH PANELS AND DOOR, 1 UNDERDOOR ENCLOSURE 40 M AND UNDERDOOR PANELS WHITE RAL 9003

Code	For back-mounting box dim. LxHxD (mm)	Outer dim. LxHxD (mm)	No. of modules EN 50022 *	Pack Carton
GW N1 831 CP	590x2400x85	642x2100x25	280 (20x14)	1

*: 280M maximum available modular space.

CHARACTERISTICS: door and panels in metal with integral mirror finish on the entire surface.

ACCESSORIES SUPPLIED:

- 3 functional frames for 80 DIN rail modules (20x4), code GWN1014.
- 1 functional frame supplied with DIN rails, code GWN1012.
- 1 metal frame, code GWN1042XB.
- 1 underdoor enclosure for 40 DIN rail modules (20x2), code GWN1121XB.
- 4 underdoor panels, code GWN1124XB.
- 1 door and 2 mirror panels, code GWN1101CP.

NOTES: installation is recommended in areas with a floor-ceiling height of h 2400 mm when the work is complete.

The door pack with mirror finish include also 2 mirror panels with h = 300 mm.

Maximum rated current In = 125 A.

Flush-mounting back-mounting box to be ordered separately. Reference code GWN1002.



GW N1 861 XB

SYSTEM COLUMN FRONT KIT WITH DOOR AND FINISH PANELS IN WHITE METAL RAL 9003, 1 UNDERDOOR ENCLOSURE 40 M AND UNDERDOOR PANELS WHITE RAL 9003

Code	For back-mounting box dim. LxHxD (mm)	Outer dim. LxHxD (mm)	No. of modules EN 50022 *	Pack Carton
GW N1 861 XB	590x2400x85	642x2100x25	280 (20x14)	1

*: 280M maximum available modular space.

ACCESSORIES SUPPLIED:

- 3 functional frames for 80 DIN rail modules (20x4), code GWN1014.
- 1 functional frame supplied with DIN rails, code GWN1012.
- 1 metal frame, code GWN1042XB.
- 2 finish panels without windows, code GWN1062XB.
- 1 underdoor enclosure for 40 DIN rail modules (20x2), code GWN1121XB.
- 4 underdoor panels, code GWN1124XB.
- 1 metal door, code GWN1101XB.

NOTES: installation is recommended in areas with a floor-ceiling height of h 2400 mm when the work is complete.
Maximum rated current In = 125 A.

Flush-mounting back-mounting box to be ordered separately. Reference code GWN1002.

DOMO CENTER COMPONENTS

BACK-MOUNTING BOXES



GW N1 002

METAL FLUSH-MOUNTING BACK-MOUNTING BOX FOR MASONRY AND PLASTERBOARD WALLS

Code	For kit	Functional dim. LxHxD (mm)	Back plate dim. LxHxD (mm)	No. of modules EN 50022	Maximum dispersible power (W)	Pack Carton
GW N1 002	Versions 2400	590x2100x85	590x2400x85	280 (20x14)	800	1
GW N1 003	Versions 2700	590x2400x85	590x2700x85	320 (20x16)	700	1

ACCESSORIES SUPPLIED: adjustable feet, masonry template, casing union band and 2 upper and lower cover panels with h=150 mm.

CHARACTERISTICS: flush-mounting back-mounting box can be obtained with two coupled casings. Rectangular knockouts on the vertical sides and lower and upper heads open for pipe entrance. Adjustable feet from 0 to 205 mm both on the lower side as well as on the upper side for installation adjustment.

APPLICATIONS: flush-mounting back-mounting box, code GWN1002, for applications in areas with a floor-ceiling height of h 2400 mm when the work is complete. flush-mounting back-mounting box, code GWN1003, for applications in areas with a floor-ceiling height of h 2700 mm when the work is complete.

INTERNAL CONFIGURATION



GW N1 014

FUNCTIONAL METAL FRAMES EQUIPPED WITH DIN RAILS FOR MODULAR DEVICES

Code	Height (mm)	No. of modules EN 50022	Pack Carton
GW N1 012	300	40 (20x2)	1
GW N1 014	600	80 (20x4)	1

ACCESSORIES SUPPLIED: vertical wiring trunking 80x60 mm. Screw kit for fixing the frame on the back-mounting box.

CHARACTERISTICS: pre-arrangement for horizontal trunking 30x60 and use of horizontal dividers, code GWN1141.

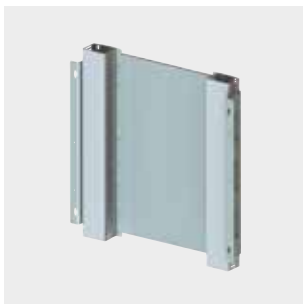

GW N1 024

FUNCTIONAL FRAMES WITH METAL BACK-MOUNTING PLATE FOR FIXING NON-MODULAR DEVICES

Code	Height (mm)	Max load (kg)	Pack Carton
GW N1 022	300	10	1
GW N1 024	600	20	1

ACCESSORIES SUPPLIED: vertical wiring trunking 80x60 mm. Screw kit for fixing the frame on the back-mounting box.

CHARACTERISTICS: pre-arrangement for horizontal trunking 30x60 and use of horizontal dividers, code GWN1141.

DOMO CENTER



GW N1 031 F

MULTIMEDIA BOARD FOR DOMO CENTER

Code	Height (mm)	Pack Carton
GW N1 031 F	600	1

APPLICATIONS: multimedia Boards allow the distribution of the services from the DOMO CENTER through the apartment (e.g. internet, phone, satellite TV, etc.). This version is dedicated to big apartments and villas with a huge amount of services and devices that have to be connected.

FEATURES: the product is compliant to the CEI 306-2 Guide.

ACCESSORIES SUPPLIED: 2 pcs vertical wiring trunking 80x60 mm, 1 kit fixing screws, 1 pc frame with 3 pcs perforated mounting plates (1 pc with 18 Keystone Jack slot), 3 m velcro roll h=16 mm, 6 pcs brackets, 6 pcs self-adhesive cable clips with cable ties, 6 pcs. RJ45 Cat.6 Keystone Jack, 6 pcs patch cord RJ45-RJ45 Cat.6 0.6 m, 1 pc telephone splitter with 5 RJ11 socket and 5 pcs patch cord RJ11-RJ45, 1 pc multiple socket with 4 Italian/German socket 2P+T 16A.

INSTALLATION: the finishing panel GWN1122XB can be used for better aesthetics and protection.

FRAMES



GW N1 043 XB

MODULAR METAL FRAMES FOR FIXING FRONT CONFIGURATION ELEMENTS WHITE RAL 9003

Code	Height (mm)	For back-mounting box	Pack Carton
GW N1 042 XB	2100	GWN1002	1
GW N1 043 XB	2400	GWN1003	1

ACCESSORIES SUPPLIED: fixing template.

CHARACTERISTICS: to fix the frame, it is necessary to first install the internal configuration elements: functional frames and kits for specific functions (network cabling).

FRONT CONFIGURATION



GW N1 051 XB

40 MODULE ENCLOSURE WITH DOOR IN SMOKED TRANSPARENT GLASS FRONT IN WHITE METAL RAL 9003

Code	Colour	No. of modules EN 50022	Pack Carton
GW N1 051 XB	RAL 9003 White	40 (20x2)	1

CHARACTERISTICS: reversible door in smoked glass; magnet closure; can be fitted with a safety lock GWN1132.

Door opening 170°.

ACCESSORIES SUPPLIED: panel for covering the modular devices, 2 module covering masks (6.5 DIN rail modules) white colour.

Panel closure by the tool for board accessibility.



GW N1 062 XB

PANELS WITHOUT WINDOWS WITH DESIGN FINISH IN METAL - WHITE RAL 9003

Code	Description	Height (mm)	Pack Carton
GW N1 062 XB	Panel without windows 300	300	1
GW N1 064 XB	Panel without windows 600	600	1
GW N1 066 XB	Panel without windows 900	900	1

CHARACTERISTICS: magnet closure; hinged panels with reversible opening to 170°;

NOTES: Panel closure by the tool for board accessibility.



GW N1 101 CF

DOOR IN SMOKED TRANSPARENT GLASS

Code	Height (mm)	For functional dimensions (mm)	No. of locks that can be installed	Pack Carton
GW N1 101 CF	1500	2400	2	1
GW N1 111 CF	1800	2400	2	1

CHARACTERISTICS: tempered glass; hinged and reversible door with 170° opening and magnet closure; can be fitted with a safety lock code GWN1132.

NOTES: To foresee 2 blank panels for aesthetic finishing GWN1062XB.



GW N1 101 CP

DOOR AND 2 PANELS WITH MIRROR FINISH

Code	Door height (mm)	Panel height (mm)	For functional dimensions (mm)	No. of locks that can be installed	Pack Carton
GW N1 101 CP	1500	300	2100	2	1
GW N1 111 CP	1800	300	2400	2	1

CHARACTERISTICS: hinged and reversible door with 170° opening and magnet closure; can be fitted with a safety lock code GWN1132. door and panels in metal with integral mirror finish on the entire surface.

ACCESSORIES SUPPLIED: 2 panels with mirror finish h = 300 mm.



GW N1 101 XB

METAL DOOR - WHITE RAL 9003

Code	Height (mm)	For functional dimensions (mm)	No. of locks that can be installed	Pack Carton
GW N1 101 XB	1500	2400	2	1
GW N1 111 XB	1800	2400	2	1

CHARACTERISTICS: hinged and reversible door with 170° opening and magnet closure; can be fitted with a safety lock code GWN1132.

NOTES: To foresee 2 blank panels for aesthetic finishing GWN1062XB.



GW N1 121 XB

UNDERDOOR PANEL WITH WINDOWS IN WHITE METAL RAL 9003

Code	Description	No. of modules EN 50022	Pack Carton
GW N1 121 XB	Panel with windows, 2 DIN rail rows	40 (20x2)	1

NOTES: panel for covering the modular devices.



GW N1 124 XB

UNDERDOOR PANEL WITHOUT WINDOWS IN WHITE METAL RAL 9003

Code	Description	Height (mm)	Closure	Pack Carton
GW N1 124 XB	Removable blank panell	300	With screws	1

NOTES: Panel closure via the tool for board accessibility.

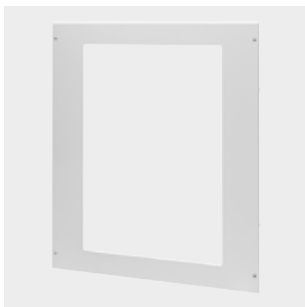

GW N1 122 XB

WINDOWED METAL UNDERDOOR PANEL FOR KIT MULTIMEDIA FULL AND BURGLAR ALARM - WHITE RAL 9003

Code	Description	Height (mm)	Pack Carton
GW N1 122 XB	Removable under door windowed panel for complete QDSA kit GWN1031F	600	1

NOTE: panel closure by the tool for board accessibility. The panels can be used in both without door configuration (under the blank metal panles for aesthetic finishing) and with door configuration (as metal underdoor panels).

COMPLEMENTARY ITEMS



GW N1 131

KIT FOR COUPLING METAL BACK-MOUNTING BOXES

Code	For back-mounting boxes h (mm)	Pack Carton
GW N1 131	2700	1

APPLICATIONS: for side-by-side installation and alignment of two back-mounting boxes.

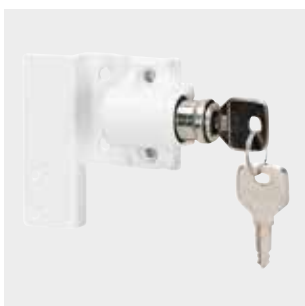

GW N1 132

SECURITY LOCK

Code	Material	Pack Carton
GW N1 132	Metal	1

APPLICATIONS: for closing doors height h 1500/1800 mm and for enclosure door code GWN1051XB. Lock block to be installed on the metal frame.

ACCESSORIES SUPPLIED: 2 keys.

NOTES: all the keys and relative locks with the same product code are identical.



GW N1 133

CHANNEL CROSSING THE FLOOR SLAB AND BACK-MOUNTING BOX COUPLING DEVICE

Code	Material	Dimensions LxHxD (mm)	Pack Carton
GW N1 133	Plastic	500x550x75	1

NOTES: to be used to connect the flush-mounting back-mounting boxes between different floors.



GW N1 134

FIXING BRACKET FOR COUPLING THE INTERNET GATEWAY TO THE DIN RAIL

Code	Description	No. of modules EN 50022	Pack Carton
GW N1 134	Kit for Internet Gateway installation	11	1

NOTES: Internet Gateway code GW90816 to be purchased separately.



GW N1 135

SECURITY LOCK KIT

Code	Description	Pack Carton
GW N1 135	Safety lock kit for white blind metal panels with finishing design	1/10

CHARACTERISTICS: the kit is supplied with 2 safety closings for the frame with relative fixing screws.

APPLICATIONS: the kit has to be used with metal blank underdoor panels for aesthetic finishing GWN1062XB, GWN1064XB, GWN1066XB to allow the opening only to qualified personnel.



GW N1 141

DIVIDERS

Code	Type	Fixing	Characteristics	Pack Carton
GW N1 141	Horizontal divider	On internal frames	-	1
GW N1 142	Vertical divider	On internal frames	3 overlapping modular elements	1

NOTES: the horizontal divider is used for creating internal separation between circuits of differing voltages on several rows within a single casing.

CHARACTERISTICS: vertical divider to be used for back-mounting boxes GWN1002 and GWN1003. Ideal for the segregation of circuits when using the Domo Center as an upright column. Pre-arrangement of up to 3 installable vertical dividers.



GW 40 467 TB

MODULE COVER PROFILE IN PLASTIC

Code	Colour	No. of modules EN 50022	Characteristics	Pack Carton
GW 40 467 TB	White	6.5	Halogen free	50

CHARACTERISTICS: clip fixing on the windows of the front. Can be divided into 1/2 module elements, using scissors.

DOMO CENTER MULTIMEDIA BOARD COMPLEMENTARY ITEMS



GW 38 098

TELEPHONE JACK EXPANSION KIT

Code	Description	Pack Carton
GW 38 098	RJ11 telephone socket and telephone cable	1

ACCESSORIES SUPPLIED: 1 multiple telephone socket-outlet with 5 RJ11 socket-outlets.



Domo Center



Scan the QR Code and find out all the technical informations.

SOLUTIONS IN HARMONY WITH THE INTERIOR



DOMO CENTER transforms domestic systems into items of interior design: the wall-hanging effect, minimal footprints and finishes make it the ideal solution to bring a touch of personality and modernity to your surroundings. Available in versions with or without doors.

MAXIMUM DECORATIVE INTEGRATION



The version with door and mirror-finish panels ensures elegant aesthetic integration even in the most sophisticated settings, ensuring complete cover for all electrical-system equipment. A unique solution from GEWISS.

THE TECHNOLOGICAL CORE OF THE SYSTEM



With its unmatched modular capacity (320M in the largest version), DOMO CENTER is the technological core of an advanced electrical system. A conventional smart home system can be integrated inside it, together with anti-intrusion and Home Networking devices.



 MOBILITY

ELECTRIC VEHICLE CHARGING

The complete range of JOINON charging stations, compliant with the international standard IEC 61851, allows the connection and recharging of all electric cars currently on the market both in domestic and public installations such as rest areas, shopping centers, hotels and petrol stations.



ENERGY AND SERVICES DISTRIBUTION PEDESTALS

The 68 Q-MC range is the innovative energy and services distribution system for environments such as tourist ports, campsites and public spaces (trade fairs, markets, gardens, etc.) that combines an attractive design with total reliability that is maintained over time thanks to its resistance to chemicals and atmospheric agents. The terminals are available both in AISI 316L stainless steel and in thermoplastic material, in blue, white or green colours. The range includes both pre-wired and empty versions, which can be configured as needed.



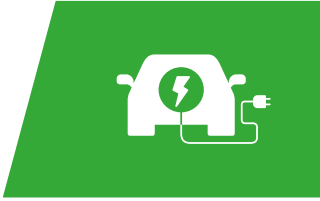

ELECTRIC VEHICLE CHARGING



Joinon

ELECTRIC VEHICLE CHARGING WALLBOX I-CON

pag. 1178



Joinon

ELECTRIC VEHICLE CHARGING STATION I-ON

pag. 1186



Joinon







ELECTRIC VEHICLE CHARGING SOCKET - TYPE2





pag. 1192

CATALOGUE PRECONFIGURED KITS

		JOINON I-CON											
		Flush-mounting / Wall-mounting / Floor-mounting											
FOR PRIVATE / SEMI-PUBLIC SCENARIOS IN AC	TYPE OF INSTALLATION	Flush-mounting / Wall-mounting / Floor-mounting											
	TYPE OF CASING	Thermoplastic (Post-industrial origin)											
	TYPE OF SOCKET	Type 2 Mobile with cable											
	PRODUCT TYPE	Basic					Premium						
	INTEGRATED MID COUNTER	NO		YES		NO		YES					
	DYNAMIC LOAD MANAGEMENT	NO		YES		YES		YES		NO		YES	
	USER RECOGNITION	AUTOSTART	RFID	AUTOSTART	RFID and/or APP			AUTOSTART	RFID	RFID and/or APP			
	REMOTE MANAGEMENT	NO				LAN	LAN + 4G MODEM	NO			LAN	LAN + 4G MODEM	
	MAX CHARGING POWER	4.6 kW	GWJ 3011 A		GWJ 3111 A			GWJ 3211 A					
		7.4 kW	GWJ 3012 A	GWJ 3012 R	GWJ 3112 A	GWJ 3012 L	GWJ 3012 W	GWJ 3212 A	GWJ 3212 R	GWJ 3212 L	GWJ 3212 W		
11 kW		GWJ 3013 A		GWJ 3113 A			GWJ 3213 A						
22 kW		GWJ 3014 A	GJW 3014 R		GJW 3014 L	GJW 3014 W		GJW 3214 R	GJW 3214 L	GJW 3214 W			

		JOINON I-ON									
		Wall-mounting									
FOR SEMI-PUBLIC / PUBLIC SCENARIOS IN AC	TYPE OF CASING	Metal									
	PRODUCT TYPE	Stand-alone					Cloud				
	TYPE OF SOCKET	2 x Type 2 Vandal-proof with shutter		2 x Type 2 Vandal-proof with shutter		2 x Type 2 Vandal-proof with shutter					
	INTEGRATED MID COUNTER	NO		YES							
	USER RECOGNITION	AUTOSTART		RFID			RFID and/or APP				
	REMOTE MANAGEMENT	NO					LAN			LAN + 4G MODEM	
	MAX CHARGING POWER	7.4 kW	GWJ 2101 A		GWJ 2101 R		GWJ 2101 L		GWJ 2101 W		
		11 kW	GWJ 2102 A		GWJ 2102 R		GWJ 2102 L		GWJ 2102 W		
		22 kW	GWJ 2103 A		GWJ 2103 R		GWJ 2103 L		GWJ 2103 W		

										APPLICATION CONTEXT
Flush-mounting / Wall-mounting / Floor-mounting										Private  Condominium  Company  Hotel *****  Restaurants  Malls MALL 
Thermoplastic (Post-industrial origin)										
Type 2 Vandal-proof with shutter										
Basic					Premium					
NO			YES		NO		YES			
NO		YES	YES		YES	NO	YES			
AUTOSTART	RFID	AUTOSTART	RFID and/or APP		AUTOSTART	RFID	RFID and/or APP			
NO			LAN	LAN + 4G MODEM	NO		LAN	LAN + 4G MODEM		
GWJ 3001 A		GWJ 3101 A			GWJ 3201 A					
GWJ 3002 A	GWJ 3002 R	GWJ 3102 A	GWJ 3002 L	GWJ 3002 W	GWJ 3202 A	GWJ 3202 R	GWJ 3202 L	GWJ 3202 W		
GWJ 3003 A					GWJ 3203 A					
GWJ 3004 A	GJW 3004 R	GWJ 3103 A	GJW 3004 L	GJW 3004 W		GJW 3204 R	GJW 3204 L	GJW 3204 W		

										APPLICATION CONTEXT
Stand-alone										Hotel *****  Restaurants  Malls MALL 
Metal										
										
Stand-alone					Cloud					
2 x Type 2 Vandal-proof with shutter		2 x Type 2 Vandal-proof with shutter			2 x Type 2 Vandal-proof with shutter					
NO					Si					
AUTOSTART		RFID			RFID and/or APP					
NO					LAN		LAN + 4G MODEM			
GWJ 1101 A		GWJ 1101 R			GWJ 1101 L		GWJ 1101 W			
GWJ 1102 A		GWJ 1102 R			GWJ 1102 L		GWJ 1102 W			
GWJ 1103 A		GWJ 1103 R			GWJ 1103 L		GWJ 1103 W			



Joinon

electric vehicle charging wallbox I-CON

I-CON wallbox is the JOINON solution for private and semi-public scenarios, in compliance with international standard IEC 61851-1.

It stands out for its elegant and compact design, "one-hand recharge" functionality, Dynamic Load Management (DLM), Back-light, and various installation possibilities: wall-mounting, flush-mounting or floor-mounting.





I-CON CHARGING UNITS FOR ELECTRIC VEHICLES FOR PRIVATE AND/OR PUBLIC ACCESS MODE 3

CHARGING ACTIVATION: AUTOSTART



GW J3 011 A

I-CON WALLBOX - STAND-ALONE CHARGING STATION - IP55

Code	N. of sockets Type 2	Charging power	Protection integrated	Pack Carton
IP 55 IK 10  				
Type of Socket: Type 2 vandal-proof with shutter				
GW J3 001 A	1	4,6 kW	DC Leak 6mA	1
GW J3 002 A	1	7,4 kW	DC Leak 6mA	1
GW J3 003 A	1	11 kW	DC Leak 6mA	1
GW J3 004 A	1	22 kW	DC Leak 6mA	1
Type of Socket: Type 2 mobile with cable				
GW J3 011 A	1	4,6 kW	DC Leak 6mA	1
GW J3 012 A	1	7,4 kW	DC Leak 6mA	1
GW J3 013 A	1	11 kW	DC Leak 6mA	1
GW J3 014 A	1	22 kW	DC Leak 6mA	1

FEATURES: the use of AUTOSTART charging stations is open to anyone; charging sessions start automatically as soon as the electric vehicle is connected. The charging power can be adjusted using a 3-position side selector switch. The front panel is customisable on request. Floor mounting installation can be provided via specific codes GWJ8102 / GWJ8103.



SUPPLIED ACCESSORIES: LED status indicators. Specific versions with mobile connector, equipped with 5 meters flat cable and integrated holder, are available.

CHARGING ACTIVATION: AUTOSTART DLM



GW J3 101 A

I-CON WALLBOX - STAND-ALONE CHARGING STATION DLM + BLUETOOTH - IP55

Code	N. of sockets Type 2	Charging power	Protection integrated	Pack Carton
IP 55 IK 10   				
Type of Socket: Type 2 vandal-proof with shutter				
GW J3 101 A	1	4,6 kW	DC Leak 6mA	1
GW J3 102 A	1	7,4 kW	DC Leak 6mA	1
GW J3 103 A	1	11 kW	DC Leak 6mA	1
Type of Socket: Type 2 mobile with cable				
GW J3 111 A	1	4,6 kW	DC Leak 6mA	1
GW J3 112 A	1	7,4 kW	DC Leak 6mA	1
GW J3 113 A	1	11 kW	DC Leak 6mA	1

FEATURES: the use of AUTOSTART charging stations is open to anyone; charging sessions start automatically as soon as the electric vehicle is connected. Bluetooth connection and App for configuration and local control are available, including charging power limitation and management of deferred charging sessions. «Dynamic Load Management» (DLM) is possible for dedicated products by connecting an external meter (codes GWD6812 for single phase and GWD6817 for three phases, sold separately) via MODBUS RS485. Flush-mounting installation is possible using dedicated code GWJ8101; floor mounting installation can be provided via specific GWJ8102 / GWJ8103 codes.

SUPPLIED ACCESSORIES: LED status indicator. Remote enabling via a NA dry contact. Specific versions with mobile connector, equipped with 5 meters flat cable and integrated holder, are available.



GW J3 211 A

I-CON PREMIUM WALL BOX - STAND-ALONE CHARGING STATION DLM + BLUETOOTH - IP55



Code	N. of sockets Type 2	Charging power	Protection integrated	Pack Carton
Type of Socket: Type 2 vandal-proof with shutter				
GW J3 201 A	1	4,6 kW	DC Leak 6mA	1
GW J3 202 A	1	7,4 kW	DC Leak 6mA	1
GW J3 203 A	1	11 kW	DC Leak 6mA	1
Type of Socket: Type 2 mobile with cable				
GW J3 211 A	1	4,6 kW	DC Leak 6mA	1
GW J3 212 A	1	7,4 kW	DC Leak 6mA	1
GW J3 213 A	1	11 kW	DC Leak 6mA	1

FEATURES:the use of AUTOSTART charging stations is open to anyone; charging sessions start automatically as soon as the electric vehicle is connected. «Dynamic Load Management» (DLM) is possible for dedicated products by connecting an external meter (codes GWD6812 for single phase and GWD6817 for three phases, sold separately) via MODBUS RS485. Customizable front panel on request. Flush-mounting installation is possible using code GWJ8101; floor mounting installation available via specific codes GWJ8102 / GWJ8103.

SUPPLIED ACCESSORIES: LED status indicators. Remote enabling via a NA dry contact. Human interface through information display and slider touch to set up configuration parameters. Specific versions with mobile connector, equipped with 5 meters flat cable and integrated holder, are available.



GW J3 311 A

WALLBOX I-CON PREMIUM - STAND-ALONE CHARGING STATION DLM + BLUETOOTH + BACK-LIGHT - IP55



Code	N. of sockets Type 2	Charging power	Protection integrated	Back-light report	Pack Carton
Type of Socket: Type 2 vandal-proof with shutter					
GW J3 301 A	1	4,6 kW	DC Leak 6mA	Yes	1
GW J3 302 A	1	7,4 kW	DC Leak 6mA	Yes	1
GW J3 303 A	1	11 kW	DC Leak 6mA	Yes	1
Type of Socket: Type 2 mobile with cable					
GW J3 311 A	1	4,6 kW	DC Leak 6mA	Yes	1
GW J3 312 A	1	7,4 kW	DC Leak 6mA	Yes	1
GW J3 313 A	1	11 kW	DC Leak 6mA	Yes	1

FEATURES:the use of AUTOSTART charging stations is open to anyone; charging sessions start automatically as soon as the electric vehicle is connected. «Dynamic Load Management» (DLM) is possible for dedicated products by connecting an external meter (codes GWD6812 for single phase and GWD6817 for three phases, sold separately) via MODBUS RS485. Back-light function: the front status LED is also replicated on the rear side, reflecting the color on the installation wall. Customizable front panel on request. Floor mounting installation can be provided via specific codes GWJ8102 / GWJ8103.

SUPPLIED ACCESSORIES: LED status indicators. Remote enable/disable control with a NA voltage-free contact. Human interface through information display and slider touch to set up configuration parameters. Specific versions with mobile connector, equipped with 5 meters flat cable and integrated holder, are available.

CHARGING ACTIVATION RFID



GW J3 002 R

I-CON WALL BOX - STAND-ALONE CHARGING STATION RFID - IP55



Code	N. of sockets Type 2	Charging power	Protection integrated	RFID	Energy meter	Pack Carton
Type of Socket: Type 2 vandal-proof with shutter						
GW J3 002 R	1	7,4 kW	DC Leak 6mA	Yes	No	1
GW J3 004 R	1	22 kW	DC Leak 6mA	Yes	No	1
Type of Socket: Type 2 mobile with cable						
GW J3 012 R	1	7,4 kW	DC Leak 6mA	Yes	No	1
GW J3 014 R	1	22 kW	DC Leak 6mA	Yes	No	1

FEATURES: Charging stations made to allow RFID card authorization based charging sessions. Parameters settings can be modified via internal SD card, during installation. Flush-mounting installation is possible using code GWJ8101; floor mounting installation available via specific codes GWJ8102 / GWJ8103.



SUPPLIED ACCESSORIES: LED status indicator. 1 RFID MASTER card, 2 RFID USER cards.

Specific versions with mobile connector, equipped with 5 meters flat cable and integrated holder, are available.



GW J3 202 R

I-CON PREMIUM WALLBOX - STAND-ALONE CHARGING STATION RFID - IP55

Code	N. of sockets Type 2	Charging power	Protection integrated	RFID	Energy meter	Pack Carton
IP 55 IK 10  						
Type of Socket: Type 2 vandal-proof with shutter						
GW J3 202 R	1	7.4 kW	DC Leak 6mA	Yes	YES (MID)	1
GW J3 204 R	1	22 kW	DC Leak 6mA	Yes	YES (MID)	1
Type of Socket: Type 2 mobile with cable						
GW J3 212 R	1	7.4 kW	DC Leak 6mA	Yes	YES (MID)	1
GW J3 214 R	1	22 kW	DC Leak 6mA	Yes	YES (MID)	1

FEATURES: Charging stations made to allow RFID card authorization based charging sessions.

Flush-mounting installation is possible using code GWJ8101; floor mounting installation available via specific codes GWJ8102 / GWJ8103.

SUPPLIED ACCESSORIES: LED status indicators. 1 RFID MASTER card, 2 RFID USER cards.

Human interface through display to show charging information and slider touch to set up configuration parameters.



Specific versions with mobile connector, equipped with 5 meters flat cable and integrated holder, are available.

CHARGING ACTIVATION: THROUGH CLOUD MANAGEMENT SOFTWARE AND APPS



GW J3 002 L

I-CON WALL BOX - CLOUD OCPP 1.6 CHARGING STATION - ETHERNET - IP55

Code	N. of sockets Type 2	Charging power	Protection integrated	RFID	Energy meter	Pack Carton
IP 55 IK 10   						
Type of Socket: Type 2 vandal-proof with shutter						
GW J3 002 L	1	7.4 kW	DC Leak 6mA	Yes	YES (MID)	1
GW J3 004 L	1	22 kW	DC Leak 6mA	Yes	YES (MID)	1
Type of Socket: Type 2 mobile with cable						
GW J3 012 L	1	7.4 kW	DC Leak 6mA	Yes	YES (MID)	1
GW J3 014 L	1	22 kW	DC Leak 6mA	Yes	YES (MID)	1

FEATURES: charging stations made to offer a fee-based charging service. Each charging station can be managed through a backend platform and an App that allows Drivers to localize and

enable the charging point. Dynamic Load Management (DLM) is available via Site Controller kit GWJ8031 (purchased separately and managed via JOINON Cloud Platform). Flush-mounting installation is possible using code GWJ8101; floor mounting installation available via specific codes GWJ8102 / GWJ8103.



SUPPLIED ACCESSORIES: LED status indicators. 1 RFID MASTER card, 2 RFID USER cards. Embedded Ethernet kit. Specific versions with mobile connector, equipped with 5 meters flat cable and integrated holder, are available.

NOTE: For JOINON Connected Solutions, Commissioning, Testing, and Post-Sales Service shall be quoted separately.



GW J3 002 W

I-CON WALL BOX - CLOUD OCPP 1.6 CHARGING STATION - ETHERNET + 4G MODEM - IP55

Code	N. of sockets Type 2	Charging power	Protection integrated	RFID	Energy meter	Pack Carton
IP 55 IK 10   						
Type of Socket: Type 2 vandal-proof with shutter						
GW J3 002 W	1	7.4 kW	DC Leak 6mA	Yes	YES (MID)	1
GW J3 004 W	1	22 kW	DC Leak 6mA	Yes	YES (MID)	1
Type of Socket: Type 2 mobile with cable						
GW J3 012 W	1	7.4 kW	DC Leak 6mA	Yes	YES (MID)	1
GW J3 014 W	1	22 kW	DC Leak 6mA	Yes	YES (MID)	1

FEATURES: charging stations made to offer a fee-based charging service. Each charging station can be managed through a backend platform and an App that allows Drivers to localize and enable the charging point. Dynamic Load Management (DLM) is available via Site Controller kit GWJ8031 (purchased separately and managed via JOINON Cloud Platform). Flush-mounting installation is possible using code GWJ8101; floor mounting installation available via specific codes GWJ8102 / GWJ8103.

SUPPLIED ACCESSORIES: LED status indicators. 1 RFID MASTER card, 2 RFID USER cards. Embedded Ethernet + Modem 4G kit.

Specific versions with mobile connector, equipped with 5 meters flat cable and integrated holder, are available.

NOTE: For JOINON Connected Solutions, Commissioning, Testing, and Post-Sales Service shall be quoted separately.



GWJ3 202 L

I-CON WALL PREMIUM BOX - CHARGING STATION CLOUD OCPP 1.6 CHARGING STATION - ETHERNET - IP55

Code	N. of sockets Type 2	Charging power	Protection integrated	RFID	Energy meter	Pack Carton
<div style="display: flex; justify-content: space-around; align-items: center;"> <div style="text-align: center;">IP 55</div> <div style="text-align: center;">IK 10</div> <div style="text-align: center;"></div> <div style="text-align: center;"></div> <div style="text-align: center;"></div> </div>						
Type of Socket: Type 2 vandal-proof with shutter						
GWJ3 202 L	1	7,4 kW	DC Leak 6mA	Yes	YES (MID)	1
GWJ3 204 L	1	22 kW	DC Leak 6mA	Yes	YES (MID)	1
Type of Socket: Type 2 mobile with cable						
GWJ3 212 L	1	7,4 kW	DC Leak 6mA	Yes	YES (MID)	1
GWJ3 214 L	1	22 kW	DC Leak 6mA	Yes	YES (MID)	1

FEATURES: charging stations made to offer a fee-based charging service. Each charging station can be managed through a backend platform and an App that allows Drivers to localize and enable the charging point. Dynamic Load Management (DLM) is available via Site Controller kit GWJ8031 (purchased separately and managed via JOINON Cloud Platform). Flush-mounting installation is possible using code GWJ8101; floor mounting installation available via specific codes GWJ8102 / GWJ8103.

SUPPLIED ACCESSORIES: LED status indicators. 1 RFID MASTER card, 2 RFID USER cards. Human interface through information display and slider touch to set up configuration parameters. Integrated Ethernet kit. Specific versions with mobile connector, equipped with 5 meters flat cable and integrated holder, are available.

NOTE: For JOINON Connected Solutions, Commissioning, Testing, and Post-Sales Service shall be quoted separately.



GWJ3 202 W

I-CON PREMIUM WALLBOX - CHARGING STATION CLOUD OCPP 1.6 CHARGING STATION - ETHERNET + 4G MODEM - IP55

Code	N. of sockets Type 2	Charging power	Protection integrated	RFID	Energy meter	Pack Carton
<div style="display: flex; justify-content: space-around; align-items: center;"> <div style="text-align: center;">IP 55</div> <div style="text-align: center;">IK 10</div> <div style="text-align: center;"></div> <div style="text-align: center;"></div> <div style="text-align: center;"></div> </div>						
Type of Socket: Type 2 vandal-proof with shutter						
GWJ3 202 W	1	7,4 kW	DC Leak 6mA	Yes	YES (MID)	1
GWJ3 204 W	1	22 kW	DC Leak 6mA	Yes	YES (MID)	1
Type of Socket: Type 2 mobile with cable						
GWJ3 212 W	1	7,4 kW	DC Leak 6mA	Yes	YES (MID)	1
GWJ3 214 W	1	22 kW	DC Leak 6mA	Yes	YES (MID)	1

FEATURES: charging stations made to offer a fee-based charging service. Each charging station can be managed through a backend platform and an App that allows Drivers to localize and enable the charging point.

Dynamic Load Management is available via Site Controller kit GWJ8031 (purchased separately and managed via JOINON Cloud Platform).

Flush-mounting installation is possible using code GWJ8101; floor mounting installation available via specific codes GWJ8102 / GWJ8103.

SUPPLIED ACCESSORIES: LED status indicator. 1 RFID MASTER card, 2 RFID USER cards. Human interface through display to show charging information and slider touch to set up configuration parameters. Integrated Ethernet + 4G Modem available.

Specific versions with mobile connector, equipped with 5 meters flat cable and integrated holder, are available.

NOTES: For JOINON Connected Solutions, Commissioning, Testing, and Post-Sales Service shall be quoted separately.

I-CON ACCESSORIES



GW J8 001

RFID CARD

Code	Description	Suitable for	Pack Carton
GW J8 001	RFID card to enable the charging process	WallBox I-CON with RFID reader	1



GW J8 014

COMMUNICATION SYSTEM KIT

Code	Description	Suitable for	Pack Carton
GW J8 014	SIM data Joinon	WallBox I-CON Cloud	1
GW J8 018	Configuration KIT cable	WallBox I-CON	1/5

NOTE: GWJ8018 kit to be used in combination with the configuration software (also available on the website: Cewiss.com) to change the setting of the OCPP parameters necessary for connecting the station with charging platforms and DLM management.



GW J8 101

COMPLEMENTARY ITEM FOR FLUSH-MOUNTING INSTALLATION

Code	Description	Suitable for	Pack Carton
GW J8 101	I-CON flush-mounting box	WallBox I-CON	1

NOTES: is not compatible with WALL BOX I-CON AUTOSTART (Type CWJ30xx A) and WALL BOX I-CON PREMIUM DLM with BACK-LIGHT (Type GWJ 33xx A).



GW J8 102

COMPLEMENTARY ITEM FOR FLOOR-MOUNTING INSTALLATION

Code	Description	Suitable for	Pack Carton
GW J8 102	I-CON floor-mounting support - single-sided	WallBox I-CON	1
GW J8 103	I-CON floor-mounting support - double-sided	WallBox I-CON	1
GW J8 104	I-CON protection cover	WallBox I-CON	1
GW J8 034	Wall-mounting metal support for I-CON	WallBox I-CON	1



GW D6 812

LOAD MANAGEMENT

Code	Description	Suitable for	Pack Carton
GW D6 812	Energy meter single phase for DLM in home field	I-CON Wallbox with DLM READY FUNCTION	1/6
GW D6 817	Energy meter three-phase for DLM in Home field	I-CON Wallbox with DLM READY FUNCTION	1/6
GW J8 031	Site controller for DLM in public field	WallBox I-CON Cloud	1
GW J8 032	Modem	Site Controller	1
GW J8 033	Energy Manager for DLM via OCPP	Site Controller	1

NOTE: Site Controller requires a DC 12-24V power supply and a network switch for wiring all EV charging stations through Ethernet cable. GWJ8032 modem is not necessary if the charging site is already equipped with internet connectivity.



Joinon

ELECTRIC VEHICLE CHARGING



Scan the QR Code and find out all the technical informations.

EASY CHARGING WITH ONE-HAND SYSTEM



I-CON is the first and only home wall box with a one-hand system. As it has no cover, the user can easily connect the charging connector with one hand.

SMART MANAGEMENT



Charging stations equipped with the DLM READY feature can independently and automatically adjust the power output for electric vehicle charging depending on the power available in the home.

BLUETOOTH APP



A configuration APP, designed primarily for the installer, quickly and intuitively starts up and manages the charging station

Joinon

electric vehicle charging station I-ON

I-ON (floor-mounting) and I-ON Wall (wall-mounting) charging stations are the JOINON solutions for public and semi-public scenarios, engineered to resist to impacts, vandalism and atmospheric agents: as a result, IP55 protection and IK10 robustness are guaranteed. The design takes care of urban context and to ergonomical eDriver side ease of use.



I-ON CHARGING UNITS FOR ELECTRIC VEHICLES FOR PRIVATE AND/OR PUBLIC ACCESS MODE 3

CHARGING ACTIVATION: AUTOSTART



GW J1 003 A

I-ON - FLOOR-MOUNTING CHARGING STATION STAND-ALONE - IP55

IP
55

IK
10



Code	N. of sockets Type 2	Charging power	Protection integrated	Power meter	RFID Reader	Pack Carton
GW J1 001 A	2	7,4 kW + 7,4 kW	Magnetohermic + Diff. Type B	No	No	1
GW J1 002 A	2	11 kW + 11 kW	Magnetohermic + Diff. Type B	No	No	1
GW J1 003 A	2	22 kW + 22 kW	Magnetohermic + Diff. Type B	No	No	1

CHARACTERISTICS: The use of the AUTOSTART station is free for anyone, charging starts automatically as soon as the electric vehicle is connected.
ACCESSORIES SUPPLIED: N. 2 TFT Display high visibility, LED to monitor the status of the socket, frontal door completely personalized.



GW J2 103 A

I-ON WALL - SURFACE-MOUNTING CHARGING STATION STAND-ALONE - IP55

IP
55

IK
10



Code	N. of sockets Type 2	Charging power	Protection integrated	Power meter	RFID Reader	Pack Carton
GW J2 101 A	2	7,4 kW + 7,4 kW	No	Currently not present	No	1
GW J2 102 A	2	11 kW + 11 kW	No	Currently not present	No	1
GW J2 103 A	2	22 kW + 22 kW	No	Currently not present	No	1

FEATURES: the use of AUTOSTART charging stations is open to anyone; charging sessions start automatically as soon as the electric vehicle is connected.
SUPPLIED ACCESSORIES: N. 2 TFT high visibility displays, LED indicators for monitoring the status of the socket, customisable front door.
NOTE: Protection devices have to be ordered separately and to be installed upstream.

CHARGING ACTIVATION: RFID



GW J1 003 R

I-ON - FLOOR-MOUNTING CHARGING STATION STAND-ALONE WITH AUTHORIZED ACCESS - IP55

IP
55

IK
10



Code	N. of sockets Type 2	Charging power	Protection integrated	Power meter	RFID Reader	Pack Carton
GW J1 001 R	2	7,4 kW + 7,4 kW	Magnetohermic + Diff. Type B	YES (MID)	Yes	1
GW J1 002 R	2	11 kW + 11 kW	Magnetohermic + Diff. Type B	YES (MID)	Yes	1
GW J1 003 R	2	22 kW + 22 kW	Magnetohermic + Diff. Type B	YES (MID)	Yes	1

CHARACTERISTICS: charging stations that are ideal to ensure reserved access to your charging station through one or more RFID cards.
ACCESSORIES SUPPLIED: 2 x high-visibility TFT Displays, LED to monitor socket status, fully customisable front panel, 1 RFID MASTER card to programme the personal RFID cards (2 supplied).
NOTE: Each domestic type F socket is equipped with dedicated Magnetohermic protection (10A) and contactor.



GW J1 021 R

I-ON - FLOOR-MOUNTING CHARGING STATION STAND-ALONE WITH AUTHORIZED ACCESS - IP54

IP 54 **IK 10**

Code	N. of sockets Type 2	Charging power	Protection integrated	Power meter	RFID Reader	Pack Carton
GW J1 021 R	2 (+2 domestic socket Type F)	7,4 kW + 7,4 kW	Magnetohermic + Diff. Type B	YES (MID)	Yes	1
GW J1 023 R	2 (+2 domestic socket Type F)	22 kW + 22 kW	Magnetohermic + Diff. Type B	YES (MID)	Yes	1

CHARACTERISTICS: charging stations that are ideal to ensure reserved access to your charging station through one or more RFID cards.

ACCESSORIES SUPPLIED: 2 x high-visibility TFT Displays, LED to monitor socket status, fully customisable front panel, 1 RFID MASTER card to programme the personal RFID cards (2 supplied).

NOTE: Each domestic type F socket is equipped with dedicated Magnetohermic protection (10A) and contactor.



GW J2 103 R

WALLBOX I-ON - SURFACE-MOUNTING CHARGING STATION STAND-ALONE WITH AUTHORIZED ACCESS - IP55

IP 55 **IK 10**

Code	N. of sockets Type 2	Charging power	Protection integrated	Power meter	RFID Reader	Pack Carton
GW J2 101 R	2	7,4 kW + 7,4 kW	No	YES (MID)	Yes	1
GW J2 102 R	2	11 kW + 11 kW	No	YES (MID)	Yes	1
GW J2 103 R	2	22 kW + 22 kW	No	YES (MID)	Yes	1

FEATURES: Charging stations made to allow RFID card authorization based charging sessions.

SUPPLIED ACCESSORIES: 2 x high-visibility TFT Displays, LED status indicator for each socket, customisable front panel, 1 x RFID MASTER card to set up USER RFID cards (2 supplied).

NOTES: Protection devices must be ordered separately and installed upstream.



GW J2 121 R

WALLBOX I-ON - SURFACE-MOUNTING CHARGING STATION STAND-ALONE WITH AUTHORIZED ACCESS - IP54

IP 54 **IK 10**

Code	N. of sockets Type 2	Charging power	Protection integrated	Power meter	RFID Reader	Pack Carton
GW J2 121 R	1 (+1 domestic socket Type F)	7,4 kW + 2,3 kW	No	YES (MID)	Yes	1
GW J2 123 R	1 (+1 domestic socket Type F)	22 kW + 2,3 kW	No	YES (MID)	Yes	1

FEATURES: Charging stations made to allow RFID card authorization based charging sessions.

SUPPLIED ACCESSORIES: 2 x high-visibility TFT Displays, LED status indicator for each socket, customisable front panel, 1 x RFID MASTER card to set up USER RFID cards (2 supplied).

NOTES: Protection devices must be ordered separately and installed upstream.

CHARGING ACTIVATION: THROUGH CLOUD MANAGEMENT SOFTWARE AND APPS



GW J1 003 W

I-ON COLUMN - FLOOR-MOUNTING CHARGING STATION CLOUD OCPP 1.6 - IP55

IP 55 **IK 10**

Code	N. of sockets Type 2	Charging power	Protection integrated	Power meter	RFID Reader	Pack Carton
Communication: Ethernet kit						
GW J1 001 L	2	7,4 kW + 7,4 kW	Magnetohermic + Diff. Type B	YES (MID)	Yes	1
GW J1 002 L	2	11 kW + 11 kW	Magnetohermic + Diff. Type B	YES (MID)	Yes	1
GW J1 003 L	2	22 kW + 22 kW	Magnetohermic + Diff. Type B	YES (MID)	Yes	1
Communication: Ethernet Kit and 4G Modem with booster antenna						
GW J1 001 W	2	7,4 kW + 7,4 kW	Magnetohermic + Diff. Type B	YES (MID)	Yes	1
GW J1 002 W	2	11 kW + 11 kW	Magnetohermic + Diff. Type B	YES (MID)	Yes	1
GW J1 003 W	2	22 kW + 22 kW	Magnetohermic + Diff. Type B	YES (MID)	Yes	1

FEATURES: charging stations made to offer a fee-based charging service. Each charging station can be managed through a backend platform and an App that allows Drivers to localize and enable the charging point.

SUPPLIED ACCESSORIES: 2 x high-visibility TFT Displays, LED indicators for monitoring the socket status, customisable front panel, 1 x RFID MASTER Card + 2 RFID USER cards, 1 x OCPP 1.6 JSON communication kit.

NOTES: For JOINON Connected Solutions, Commissioning, Testing, and Post-Sales Service shall be quoted separately. Each domestic type F socket is equipped with dedicated Magnetohermic protection (10A) and contactor.



GW J1 021 W

I-ON COLUMN - FLOOR-MOUNTING CHARGING STATION CLOUD OCPP 1.6 - IP54

IP
54

IK
10



Code	N. of sockets Type 2	Charging power	Protection integrated	Power meter	RFID Reader	Pack Carton
Communication: Ethernet Kit and 4G Modem with booster antenna						
GW J1 021 W	2 (+2 domestic socket Type F)	7,4 kW + 7,4 kW	Magnetothermic + Diff. Type B	YES (MID)	Yes	1
GW J1 023 W	2 (+2 domestic socket Type F)	22 kW + 22 kW	Magnetothermic + Diff. Type B	YES (MID)	Yes	1

FEATURES: charging stations made to offer a fee-based charging service. Each charging station can be managed through a backend platform and an App that allows Drivers to localize and enable the charging point.

SUPPLIED ACCESSORIES: 2 x high-visibility TFT Displays, LED indicators for monitoring the socket status, customisable front panel, 1 x RFID MASTER Card + 2 RFID USER cards, 1 x OCPP 1.6 JSON communication kit.

NOTES: For JOINON Connected Solutions, Commissioning, Testing, and Post-Sales Service shall be quoted separately. Each domestic type F socket is equipped with dedicated Magnetothermic protection (10A) and contactor.



GW J2 103 W

I-ON WALL - SURFACE-MOUNTING CHARGING STATION CLOUD OCPP 1.6 - IP55

IP
55

IK
10



Code	N. of sockets Type 2	Charging power	Protection integrated	Power meter	RFID Reader	Pack Carton
Communication: Ethernet kit						
GW J2 101 L	2	7,4 kW + 7,4 kW	No	YES (MID)	Yes	1
GW J2 102 L	2	11 kW + 11 kW	No	YES (MID)	Yes	1
GW J2 103 L	2	22 kW + 22 kW	No	YES (MID)	Yes	1
Communication: Ethernet Kit and 4G Modem with booster antenna						
GW J2 101 W	2	7,4 kW + 7,4 kW	No	YES (MID)	Yes	1
GW J2 102 W	2	11 kW + 11 kW	No	YES (MID)	Yes	1
GW J2 103 W	2	22 kW + 22 kW	No	YES (MID)	Yes	1

FEATURES: charging stations that are ideal for offering a charging service to the public for a fee. Each charging station can be managed through a backEnd Monitor and related App, allowing Drivers to simply recharge using their MobileApp.

SUPPLIED ACCESSORIES: 2 x high-visibility TFT Displays, LED indicators for monitoring the socket status, customisable front panel, 1 x RFID MASTER card + 2 RFID USER cards, 1 x OCPP 1.6 JSON communication kit.

NOTES: Protection devices must be ordered separately and installed upstream. For JOINON Connected Solutions, Commissioning, Testing, and Post-Sales Service shall be quoted separately.



GW J2 121 W

I-ON WALL - SURFACE-MOUNTING CHARGING STATION CLOUD OCPP 1.6 - IP54

IP
54

IK
10



Code	N. of sockets Type 2	Charging power	Protection integrated	Power meter	RFID Reader	Pack Carton
Communication: Ethernet Kit and 4G Modem with booster antenna						
GW J2 121 W	1 (+1 domestic socket Type F)	7,4 kW + 2,3 kW	No	YES (MID)	Yes	1
GW J2 123 W	1 (+1 domestic socket Type F)	22 kW + 2,3 kW	No	YES (MID)	Yes	1

FEATURES: charging stations that are ideal for offering a charging service to the public for a fee. Each charging station can be managed through a backEnd Monitor and related App, allowing Drivers to simply recharge using their MobileApp.

SUPPLIED ACCESSORIES: 2 x high-visibility TFT Displays, LED indicators for monitoring the socket status, customisable front panel, 1 x RFID MASTER card + 2 RFID USER cards, 1 x OCPP 1.6 JSON communication kit.

NOTES: Protection devices must be ordered separately and installed upstream. For JOINON Connected Solutions, Commissioning, Testing, and Post-Sales Service shall be quoted separately.

I-ON ACCESSORIES



GW J8 001

RFID CARD

Code	Description	Suitable for	Pack Carton
GW J8 001	RFID card to enable the charging process	I-ON and I-ON WALL with RFID reader	1



GW J8 011

COMMUNICATION SYSTEM KIT

Code	Description	Suitable for	Pack Carton
GW J8 011	Joinon ethernet kit	I-ON and I-ON WALL	1
GW J8 012	Joinon ethernet kit + modem 4G + antenna	I-ON and I-ON WALL	1
GW J8 014	SIM data Joinon	I-ON CLOUD and I-ON WALL CLOUD	1
GW J8 015	Column commissioning kit	I-ON CLOUD	1/5
GW J8 016	WALLBOX commissioning kit	I-ON WALL CLOUD	1/5
GW J8 018	Configuration KIT cable	I-ON and I-ON WALL	1/5

NOTES: GWJ8011 and GWJ8012 codes make the upgrade of RFID versions to CLOUD versions possible.

GWJ8015 and GWJ8016 codes include DATA SIM, QR CODE for App based charging authorization and JoinOn instruction stickers.

GWJ8018 kit, in combination with the configuration software (available on the website: Gewiss.com), allows the modification of the OCPP settings for connecting the station with charging platforms and of DLM parameters.



GW J8 021

COMPLEMENTARY ITEMS FOR INSTALLATION

Code	Description	Suitable for	Pack Carton
GW J8 021	Joinon plate for concrete	I-ON	1
GW 46 551	Joinon pole support kit	I-ON WALL	1



GW J8 031

LOAD MANAGEMENT

Code	Description	Suitable for	Pack Carton
GW J8 031	Site controller for DLM in public field	I-ON CLOUD and I-ON WALL CLOUD	1
GW J8 032	Modem	Site Controller	1
GW J8 033	Energy Manager for DLM via OCPP	Site Controller	1

NOTE: Site Controller requires a DC 12-24V power supply and a network switch for wiring all EV charging stations through Ethernet cable.

GWJ8032 modem is not necessary if the charging site is already equipped with internet connectivity.



Scan the QR Code and find out all the technical informations.

EASY CHARGING WITH ONE-HAND SYSTEM



Charging your electric vehicle is even faster and more convenient. With the one-hand charging, you can connect the charging socket with one hand, leaving the other free for unloading the vehicle (grocery bags, packages, luggage and more).

SMART CHARGING MANAGEMENT



Possibility to manage loads dynamically from one or more stations through the OCPP protocol (DYNAMIC LOAD MANAGEMENT) to ensure the best load distribution, avoiding spikes or overloads and optimising power system sizing costs.

DESIGN SUITABLE FOR EVERY NEED



The unique style, with an exclusive hexagonal shape, integrates perfectly into any parking configuration, including back-to-back (two units placed together, one behind the other) with considerable savings on installation costs. High-efficiency RGB LEDs, visible even from a distance and from any side of the charging station. The front of the charging units has an elegant design, suitable for all contexts. If required, the design can be customised to specific customer requirements.

Joinon

Electric vehicle charging socket - Type2

A range of Type 2 electric vehicle charging sockets that meet international standards IEC 62196-1 and IEC 62196-2 and are suitable for use on EV charging units in compliance with IEC 61851. The range includes charging cables for electric vehicles, Type 2 mobile sockets with or without cable, and Type 2 flush-mounted sockets equipped with safety shutters (IPXXD protection), a double drain for water drainage, a vandal-proof system, and an actuator that locks the shutter and interlocks the plug during energy delivery.



TYPE 2 CHARGING SOCKETS FOR ELECTRIC VEHICLES

TYPE 2 CHARGING SOCKETS VANDALPROOF



GWJ5 002 B

TYPE 2 VANDAL-PROOF CHARGING SOCKET WITH SHUTTER - IP55

Code	Sockets Type	No. of poles	Power max.	Locking system	Pack Carton
IP 55 IK 10 GWT 960°C					
Cable entry orientation: Rear Connection					
GWJ5 001 B	Type 2	L1 - N - PE - CP - PP	7,4 kW	Yes	1/12
GWJ5 002 B	Type 2	L1/L2/L3 - N - PE - CP - PP	22 kW	Yes	1/12
GWJ5 003 B	Type 2	L1 - N - PE - CP - PP	7,4 kW	No	1/12
GWJ5 004 B	Type 2	L1/L2/L3 - N - PE - CP - PP	22 kW	No	1/12
Cable entry orientation: Side Connection					
GWJ5 011 B	Type 2	L1 - N - PE - CP - PP	7,4 kW	Yes	1/12
GWJ5 012 B	Type 2	L1/L2/L3 - N - PE - CP - PP	22 kW	Yes	1/12
GWJ5 013 B	Type 2	L1 - N - PE - CP - PP	7,4 kW	No	1/12
GWJ5 014 B	Type 2	L1/L2/L3 - N - PE - CP - PP	22 kW	No	1/12

FEATURES: IEC 62196-2 standard compliant IP55 charging sockets. GWJ50x3B and GWJ50x4B codes are provided without plug entry locking system.

ACCESSORIES: locking actuator for charging process electrical safety, internal water drainage system, 3 x microswitches to control the status and position of the locking actuator.

NOTES: actuator connector to be purchased separately (code GWJ5901).



GWJ5 002 G

TYPE 2 VANDAL-PROOF CHARGING SOCKET WITH SHUTTER AND BLINKING LIGHTING SYSTEM - IP55

Code	Sockets Type	No. of poles	Power max.	Locking system	Pack Carton
IP 55 IK 10 GWT 960°C					
Cable entry orientation: Rear Connection					
GWJ5 001 G	Type 2	L1 - N - PE - CP - PP	7,4 kW	Yes	1/12
GWJ5 002 G	Type 2	L1/L2/L3 - N - PE - CP - PP	22 kW	Yes	1/12
Cable entry orientation: Side Connection					
GWJ5 011 G	Type 2	L1 - N - PE - CP - PP	7,4 kW	Yes	1/12
GWJ5 012 G	Type 2	L1/L2/L3 - N - PE - CP - PP	22 kW	Yes	1/12

FEATURES: IEC 62196-2 standard compliant IP55 charging sockets.

SUPPLIED ACCESSORIES: plug locking actuator for electrical safety, internal water drainage system, 3 x microswitches to control the status and position of the locking actuator. Equipped with internal blinking LED system to improve the insertion ease.

NOTES: Specific actuator connector to be purchased separately (code GWJ5901).



GWJ5 002 L

TYPE 2 VANDAL-PROOF CHARGING SOCKET WITH SHUTTER AND RGB LIGHTING SYSTEM - IP55

Code	Sockets Type	No. of poles	Power max.	Locking system	Pack Carton
IP 55 IK 10 GWT 960°C					
Cable entry orientation: Rear Connection					
GWJ5 002 L	Type 2	L1/L2/L3 - N - PE - CP - PP	22 kW	Yes	1/12
GWJ5 004 L	Type 2	L1/L2/L3 - N - PE - CP - PP	22 kW	No	1/12
Cable entry orientation: Side Connection					
GWJ5 012 L	Type 2	L1/L2/L3 - N - PE - CP - PP	22 kW	Yes	1/12
GWJ5 014 L	Type 2	L1/L2/L3 - N - PE - CP - PP	22 kW	No	1/12

FEATURES: IEC 62196-2 standard compliant IP55 charging sockets.

SUPPLIED ACCESSORIES: locking actuator for charging process electrical safety, internal water drainage system, 3 x microswitches to control the status and position of the locking actuator. Equipped with an internal RGB LED system for identifying the socket status.

NOTES: actuator connector to be purchased separately (code GWJ5901).

TYPE 2 VANDAL-PROOF SOCKET ACCESSORIES



GW J5 901

ACTUATOR CONNECTOR

Code	Description	Suitable for	Pack Carton
GW J5 901	Actuator connector + crimp pins kit	Type 2 vandal-proof charging sockets	1/20

TYPE 2 CHARGING CABLE



GW J5 114 B

TYPE 2 MOBILE CHARGING CONNECTOR WITH CABLE

IP 55 **IK 10**

Code	Sockets Type	No. of poles	Power max.	Cable type/length	Pack Carton
GW J5 111 B	Type 2	L1 - N- PE - CP - PP	4,6 kW	Flat / 5 meters	1
GW J5 112 B	Type 2	L1 - N- PE - CP - PP	7,4 kW	Flat / 5 meters	1
GW J5 113 B	Type 2	L1/L2/L3 - N- PE - CP - PP	11 kW	Flat / 5 meters	1
GW J5 114 B	Type 2	L1/L2/L3 - N- PE - CP - PP	22 kW	Flat / 5 meters	1

CHARACTERISTICS: overmoulded rubber inserts to improve grip.
The product achieves IP55 degree if mated with GWJ5912 holder (sold separately).



GW J5 102 B

TYPE 2 MOBILE CHARGING CONNECTOR

IP 55 **IK 10**

Code	Sockets Type	No. of poles	Power max.	Pack Carton
GW J5 101 B	Type 2	L1 - N- PE - CP - PP	7,4 kW	1
GW J5 102 B	Type 2	L1/L2/L3 - N- PE - CP - PP	22 kW	1

CHARACTERISTICS: overmoulded rubber inserts to improve grip.
The product achieves IP55 degree if mated with GWJ5912 holder (sold separately).

TYPE 2 CHARGING CABLE ACCESSORIES



GW J5 912

COMPLEMENTARY ITEMS FOR TYPE 2 CHARGING CABLE

Code	Description	Pack Carton
GW J5 912	Holder for Type 2 charging cable	1

CHARACTERISTICS: GWJ5912 protects the mobile connector from dust and water and guarantee IP55 degree of protection. It is designed to fit GEWISS type 2 vandal-proof sockets spacing and installation method.

TYPE 2 CHARGING CABLES FOR ELECTRIC VEHICLES

FLAT CHARGING CABLES

**IP
55**

**IK
10**

**GWT
650°C
850°C**



GW J5 815 BL

MONOPHASE

Code	I max (A)	Power max.	Voltage	Frequency	Cable length	Number of poles	Pack Carton
GW J5 815 BL	20 A	4,6 kW	230/250 V	50 - 60 Hz	5 m	L1 - N - PE - CC - CP	1
GW J5 818 BL	20 A	4,6 kW	230/250 V	50 - 60 Hz	8 m	L1 - N - PE - CC - CP	1
GW J5 815 CL	32 A	7,4 kW	230/250 V	50 - 60 Hz	5 m	L1 - N - PE - CC - CP	1
GW J5 818 CL	32 A	7,4 kW	230/250 V	50 - 60 Hz	8 m	L1 - N - PE - CC - CP	1



GW J5 835 AL

THREEPHASE

Code	I max (A)	Power max.	Voltage	Frequency	Cable length	Number of poles	Pack Carton
GW J5 835 AL	16 A	11 kW	380/480 V	50 - 60 Hz	5 m	L1/L2/L3 - N - PE - CC - CP	1
GW J5 838 AL	16 A	11 kW	380/480 V	50 - 60 Hz	8 m	L1/L2/L3 - N - PE - CC - CP	1
GW J5 835 CL	32 A	22 kW	380/480 V	50 - 60 Hz	5 m	L1/L2/L3 - N - PE - CC - CP	1
GW J5 838 CL	32 A	22 kW	380/480 V	50 - 60 Hz	8 m	L1/L2/L3 - N - PE - CC - CP	1



GW J5 815 EV

E.V. READY

Code	I max (A)	Power max.	Voltage	Frequency	Cable length	Number of poles	Pack Carton
GW J5 815 EV	16 A	7,4 kW	230/250 V	50 - 60 Hz	5 m	L1 - N - PE - CC - CP	1
GW J5 818 EV	16 A	7,4 kW	230/250 V	50 - 60 Hz	8 m	L1 - N - PE - CC - CP	1
GW J5 835 EV	32 A	22 kW	380/480 V	50 - 60 Hz	5 m	L1/L2/L3 - N - PE - CC - CP	1
GW J5 838 EV	32 A	22 kW	380/480 V	50 - 60 Hz	8 m	L1/L2/L3 - N - PE - CC - CP	1

SPIRAL CHARGING CABLES

**IP
55**

**IK
10**

**GWT
650°C
850°C**



GW J5 814 CT

SPIRAL

Code	I max (A)	Power max.	Voltage	Frequency	Cable length	Number of poles	Pack Carton
GW J5 814 CT	32 A	7.2 kW	230/250 V	50 - 60 Hz	4 m	L1 - N - PE - CC - CP	1
GW J5 834 CT	32 A	22 kW	380/480 V	50 - 60 Hz	4 m	L1/L2/L3 - N- PE - CC - CP	1

ACCESSORIES FOR CHARGING CABLE



GW J5 913

ACCESSORIES

Code	Description	Pack Carton
GW J5 913	Cable bag in waterproof fabric made from recycled material	10



Joinon

ELECTRIC VEHICLE CHARGING



Scan the QR Code and find out all the technical informations.

EASY CHARGING WITH ONE-HAND SYSTEM



Vandal-proof socket with shutter and without cover, designed to facilitate the start of charging with the one-hand system

LED LIGHTING



The socket is also available in versions with an INTERMITTENT LED lighting system, to facilitate cable insertion, or RGB LED, to highlight the socket status indicator.

THE FUTURE OF CHARGING IS GREEN



Socket and plug are made partially of Renycle®, a range of specialty technopolymers, obtained from recovered nylon, with much lower environmental impact than virgin material, calculated for each formulation through LCA. As a result, it is ideal for projects where sustainability is a key requirement.

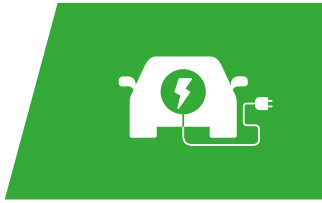

ENERGY AND SERVICES DISTRIBUTION PEDESTALS



68 Q-MC 63X

STAINLESS STEEL DISTRIBUTION
AND SERVICE TERMINALS

pag. 1200



68 Q-MC

TERMINAL SYSTEM FOR ENERGY DISTRIBUTION
AND SERVICE IN INSULATING MATERIAL

pag. 1206

68 Q-MC 63X

WIRED DISTRIBUTION PEDESTALS IN AISI 316L STAINLESS STEEL MATERIAL

EXAMPLE OF APPLICATION									
PORTS	CAMPSITES	URBAN AREAS	GARDENS, PARKS	BLOCK OF FLATS	INDUSTRIAL AREAS	TYPE		STAINLESS STEEL	IP DEGREE
•	•	•	•	•	•	PEDESTAL Q-MC 63X		GW 68 901	IP56
•		•	•					GW 68 902	IP56
•		•						GW 68 903	IP56
•								GW 68 904	IP56
	•	•			•			GW 68 905	IP56

FIRE-FIGHTING PEDESTALS Q-MC 63 X IN AISI 316 L STAINLESS STEEL

	CODE	CONFIGURATION
	GW 68 921	SUITABLE FOR 6 KG FIRE EXTINGUISHER
	GW 68 923	SUITABLE FOR VALVE, LANCE, SUPPORT AND HOSE
	GW 68 779	KIT CONTAINING LANCE, 15M HOSE, SUPPORT AND ACCESSORIES



EMPTY DISTRIBUTION PEDESTAL Q-MC 63 X IN AISI 316 L STAINLESS STEEL

	CODE	CONFIGURATION	SIDE A	SIDE B
	GW 68 931	DOUBLE-SIDED	Empty compartment that can be equipped with 1 panel	Empty compartment that can be equipped with 1 panel

WIRED DISTRIBUTION PEDESTALS IN AISI 316L STAINLESS STEEL MATERIAL

MAIN SWITCH	NO. OF MODULAR PROTECTION AND MONITORING DEVICES		TYPE AND NO. OF SOCKETS INSTALED		
	RESIDUAL CURRENT CIRCUIT BREAKERS 30mA AC		IEC 309 NON-INTERLOCKED	IEC 309 INTERLOCKED	
SWITCH DISCONNECTOR					
4P	2P	4P	2P+E	2P+E	3P+N+T
1 x 32A	4 x 16A			4 x 16A	
1 x 63A	2 x 16A	2 x 16A		2 x 16A	2 x 16A
1 da 80A	2 x 16A	2 x 32A		2 x 16A	2 x 32A
\		2 x 63A			2 x 63A
1 x 32A	6 x 16A		6 x 16A		

COMPONENTS FOR Q-MC 63 X IN AISI 316 L STAINLESS STEEL
TYPES OF PANELS

	FOR SBF INTERLOCKED SOCKET-OUTLETS			FOR IEC 309 NON-INTERLOCKED SOCKET-OUTLETS	
	CODE	TYPE	NO.	TYPE	NO.
	GW 68 745 W	67 IB range Vertical IP67 16/32A	2		
	GW 68 746 W	44 IB range Horizontal IP44 16/32A	2		
	GW 68 747 W	Combibloc range IP44/55 16/32A	2	IEC 309 range, flush-mounting 16A or 85x75mm flanged lids	1
	GW 68 748 W			IEC 309 range, flush-mounting 16/32A or 85x75mm flanged lids	4
	GW 68 749 W	67 IB range Vertical IP67 63A	1		
	GW 68 750 W	BLANK			

68 Q-MC 63X

Stainless steel distribution and service terminals

AISI 316L Class II stainless steel terminals for electricity, water, TV signal, telephone and data distribution. The terminals are distinguished by their design and resistance to mechanical and atmospheric stress. They are suitable for installation in prestigious environments where, in addition to the aesthetic factor, top performance is also required. The range consists of pre-wired and unwired versions, which can be configured as needed.



COMPACT PEDESTALS IN STAINLESS STEEL AISI 316L

WIRED



GW 68 901

QMC 63 X WIRED PEDESTALS IN STAINLESS STEEL AISI 316L, WITH DOUBLE-FACE TAKE-OFF, EQUIPPED WITH VERTICAL INTERLOCKED SOCKET-OUTLETS - CLASS II - IP56

Code	Socket-outlets 2P+E 16A	Socket-outlets 3P+N+E 16A	Socket-outlets 3P+N+E 32A	Socket-outlets 3P+N+E 63A	Pack Carton
GW 68 901	4	-	-	-	1
GW 68 902	2	2	-	-	1
GW 68 903	2	-	2	-	1
GW 68 904	-	-	-	2	1

PROTECTIONS:

GW68901: Board In: 25 A.

Main switch disconnector 4P 32 A;

4 RCBO - MDC Range 2P 230 V 16 A C 6 kA 0.03 A - AC Type for the four 2P+E 16 A 230 V socket-outlets.

GW68902: Board In: 40 A.

Main switch disconnector 4P 63 A;

2 RCBO - MDC Range 2P 230 V 16 A C 6 kA 0.03 A - AC Type for the two 2P+E 16 A 230 V socket-outlets;

2 RCBO - MDC Range 4P 400 V 16 A C characteristic 6 kA 0.03 A - AC Type for the two 3P+N+E 16 A 400 V socket-outlets.

GW68903: Board In: 64 A

Main switch disconnector 4P 80 A;

2 RCBO - MDC Range 2P 230 V 16 A C 6 kA 0.03 A - AC Type for the two 2P+E 16 A 230 V socket-outlets;

2 RCBO - MDC Range 4P 400 V 32 A C characteristic 6 kA 0.03 A - AC Type for the two 3P+N+E 32 A 400 V socket-outlets.

GW68904: Board In: 90 A

2 RCBO MT+BD 4P 400 V 63 A C characteristic 10 kA 0.03 A - AC type for the 2 3P+N+E 63 A 400 V socket-outlets.

CHARACTERISTICS: Head in heat-absorbing thermoplastic material, base in stainless steel with easily removable knock-proof and anti-abrasion protective cover in insulating material.

Power supply terminal block section: GW68901 and GW68902 16 mm², GW68903 and GW68904 35 mm².

ACCESSORIES SUPPLIED: 1 LED lighting lamp 230 V;

GW68901, GW68902 and GW68903: 4 padlockable 1/2" ball valves; GW68904: 2 padlockable 1/2" ball valves.

NOTE: Products will be supplied in the configuration with the new design, as shown in the picture, and with the LED lighting KIT installed as standard, only after having sold out the previous one.



GW 68 905

QMC 63 X WIRED PEDESTAL IN STAINLESS STEEL AISI 316L WITH DOUBLE-FACE TAKE-OFF EQUIPPED WITH IEC 309 SOCKET-OUTLETS - CLASS II - IP56

Code	Socket-outlets 2P+E 16A	Pack Carton
GW 68 905	6	1

Board In: 25 A.

PROTECTIONS: Main switch disconnector 4P 32 A;

6 RCBO - MDC Range 2P 230 V 16 A C characteristic 6 kA 0.03 A - AC Type for the six 2P+E 16 A 230 V socket-outlets.

CHARACTERISTICS: Head in heat-absorbing thermoplastic material, base in stainless steel with easily removable knock-proof and anti-abrasion protective cover in insulating material.

Power supply terminal block section: 16 mm².

ACCESSORIES SUPPLIED: 1 LED lighting lamp 230 V.

NOTE: Products will be supplied in the configuration with the new design, as shown in the picture, and with the LED lighting KIT installed as standard, only after having sold out the previous one.

EMPTY



GW 68 931

EMPTY PEDESTAL IN STAINLESS STEEL AISI 316L WITH DOUBLE-FACE TAKE-OFF QMC 63X - CLASS II - IP56

Code	Type	Possible configuration	Possible configuration	No. of modules EN 50022	Pack Carton
GW 68 931	Double-sided	Side A: 1 panel	Side B: 1 panel	18 (9x2)	1

CHARACTERISTICS: 18-module enclosure with hinged opening, that can be fitted with security lock, for access to modular devices.

prearrangement for lighting kit 16W 230V and water kit with 2 or 4 padlockable 1/2" water taps, available as accessories.

double-face take-off with cable fastener devices on sides A and B.

Head in heat-absorbing thermoplastic material, base in stainless steel with easily removable knock-proof and anti-abrasion protective cover in insulating material.

ACCESSORIES SUPPLIED: junction box for housing power supply terminal block.

COMPLEMENTARY ITEMS FOR COMPACT PEDESTALS

PANELS



GW 68 748 W

FLANGED PANELS PREARRANGED FOR ASSEMBLY OF SOCKET-OUTLETS

Code	No. IB socket-outlets houseable	No of IEC 309 socket-outlets that can be housed	Pack Carton
Colour: White			
GW 68 745 W	2 IB Vert. 16-32A IP67	-	1/2
GW 68 746 W	2 IB Horiz. 16-32A SBF IP44	-	1/2
GW 68 747 W	2 COMBIBLOC 16-32A IP44/55	1 IEC 309 16A 2P+E IP44/67	1/2
GW 68 748 W	-	4 IEC 309 16-32A IP44/67	1/2
GW 68 749 W	1 IB Vert. 63A IP67	-	1/2

ACCESSORIES SUPPLIED: screws for fixing panel.

CHARACTERISTICS: dimensions (LxHxD): 211x276x17 mm.



GW 68 750 W

BLANK PANEL

Code	Description	Pack Carton
Colour: White		
GW 68 750 W	Blank panel	1/2

ACCESSORIES SUPPLIED: screws for fixing panel.

CHARACTERISTICS: dimensions (LxHxD): 211x276x17 mm.

SERVICE COMPLEMENTARY ITEMS



GW 68 789

POWER SUPPLY TERMINAL BLOCKS FOR COMPACT TERMINALS

Code	Terminal blocks	For cables	Terminal type	Rail type	Pack Carton
GW 68 788	3P+N+E	Up to 16 mm ²	Modular	EN 50035	1
GW 68 789	3P+N+E	Up to 35 mm ²	With eyelet	EN 50035	1
GW 68 800	3P+N+E	Up to 70 mm ²	With eyelet	EN 50035	1

68 Q-MC 63X



GW 68 794

WATER KIT WITH LOCKABLE TAPS

Code	Input	Output	Suitable for	Pack Carton
GW 68 793	N. 1 valve 1/2"	N. 2 taps 1/2"	QMC 63 B / 63 C	1
GW 68 794	N. 1 valve 1/2"	N. 4 taps 1/2"	QMC 63 B / 63 C	1

ACCESSORIES SUPPLIED: adjustment fittings and nuts for pedestals.



GW 68 790

LIGHTING KIT FOR COMPACT TERMINALS

Code	Lamp	Lamp power	Voltage	Lamp holder	Pack Carton
Lighting: Ordinary					
GW 68 790	FSS	16 W	230 V - 50 Hz	GR8	1
Lighting: EMERGENCY TYPE M					
GW 68 791	FSS	16 W	230 V - 50 / 60 Hz	GR10	1

ACCESSORIES SUPPLIED: lamp and supply cable.

CHARACTERISTICS: GW68791 permanent emergency lighting, equipped with double supply circuit, keeps the Ni/C storage batteries charged; autonomy 1h



GW 68 990

LIGHTING KIT FOR COMPACT TERMINALS - LED TECHNOLOGY



Code	Lamp	System power	Colour temperature	Pack Carton
Voltage: 220-240 V - 50/60 Hz				
GW 68 990	LED	8.7 W	4000 K	1

CHARACTERISTICS: the lighting KIT with LED technology enables electricity savings of up to 66%.

NOTES: due to the continuous changes with the LED technologies, the technical data can undertake variations.



GW 68 796

FIXING PLATE

Code	Description	Application	Material	Pack Carton
GW 68 796	Plate for fixing	On concrete	Stainless steel	1
GW 68 781	Plate for fixing	On MARTINI pontoon	Stainless steel	1
GW 68 782	Plate for fixing	On INGEMAR pontoon	Stainless steel	1



GW 68 778

SECURITY LOCK WITH KEY

Code	Suitable for	For terminals	Pack Carton
GW 68 778	Enc. door and blank door	Q-MC in stainless steel material	1/5

ACCESSORIES SUPPLIED: 2 keys.

NOTES: all the keys and relative locks with the same product code are identical.



68 Q-MC 63X



Scan the QR Code and find out all the technical informations.

TOTAL INSULATION



The Class II case makes grounding and periodic maintenance unnecessary and increases the safety of the user. It prevents any possibility of coming into contact with live parts which, in the event of a loss of insulation, could be dangerous.

SAFETY FIRST







The water compartment is completely segregated and therefore separate from the electrical circuits: in this way, any water leakage or humidity will not compromise the safety and operation of the product.

ATTENTION TO DETAIL



The head is made of technopolymer to avoid the danger of slight burns after long exposures to the sun and has a scratch-resistant finish. In addition, it also has a handle for portability and two sections for winding around water pipes.

WIRED DISTRIBUTION PEDESTALS IN INSULATING MATERIAL

EXAMPLES OF APPLICATION											MAIN SWITCH				
Ports	Campsites	Urban areas	Gardens, parks	Block of flats	Itinerant road shows	Industrial areas	TYPE		BLUE VERSION	WHITE VERSION	GREEN VERSION	IP DEGREE	SWITCH DISCONNECTOR		
													2P	3P	4P
			•	•			Q-MC 16 B PEDESTAL 	GW 68 841 A	GW 68 841 W		56				
								GW 68 842 A	GW 68 842 W		55				
					•		Q-MC 16 T PEDESTAL 	GW 68 846 A	GW 68 846 W		55				
								GW 68 847 A	GW 68 847 W		55				
•		•		•		•	Q-MC 63 B PEDESTAL 	GW 68 851 A	GW 68 851 W		56			1 x 32A	
								GW 68 852 A	GW 68 852 W		56			1 x 32A	
		•	•	•			Q-MC 63 B PEDESTAL 			GW 68 855 G	56	1 x 40A			
•	•	•		•		•	Q-MC 63 E ELECTRONICS PEDESTAL 	GW 68 876 A	GW 68 876 W		56			1 x 32A	
								GW 68 877 A	GW 68 877 W		56			1 x 32A	
								GW 68 878 A	GW 68 878 W		56			1 x 63A	
•	•							GW 68 874 A	GW 68 874 W		56				
								GW 68 875 A	GW 68 875 W		56				
	•						Q-MC 63 C PEDESTAL 	GW 68 856 A	GW 68 856 W		55	1 x 32A			
								GW 68 857 A	GW 68 857 W		56	1 x 40A			
								GW 68 858 A	GW 68 858 W		55	1 x 32A			
•		•		•		•	Q-MC 125 B PEDESTAL 	GW 68 801 A	GW 68 801 W		44			1 x 32A	
								GW 68 802 A	GW 68 802 W		44			1 x 63A	
								GW 68 803 A	GW 68 803 W		56			1 x 63A	
•	•					•	Q-MC 200 B PEDESTAL 	GW 68 831 A	GW 68 831 W		44			1 x 32A	
								GW 68 832 A	GW 68 832 W		44			1 x 32A	
								GW 68 833 A	GW 68 833 W		44			1 x 32A	
•	•						Q-MC 200 E ELECTRONICS PEDESTAL 	GW 68 867 A	GW 68 867 W		55				
								GW 68 868 A	GW 68 868 W		55				

(*) Residual current device Type A.







WIRED DISTRIBUTION PEDESTALS IN INSULATING MATERIAL

NO. OF MODULAR PROTECTION AND MONITORING DEVICES						TYPE AND NO. SOCKETS INSTALLED					
RESIDUAL CURRENT DEVICE 30mA AC		MINIATURE CIRCUIT BREAKERS C CHARACTERISTIC 6kA		RESIDUAL CURRENT CIRCUIT BREAKERS 30mA AC		IEC 309 NON-INTERLOCKED	IEC 309 INTERLOCKED			SPECIAL SOCKETS	ITA./GER.STD. DOMESTIC SOCKETS
2P	4P	2P	3P	2P	4P	2P+E	2P+E	3P+T	3P+N+T	RJ45+ TV/SAT	2P+E 10/16A
				1 x 16A			2 x 16A				
				1 x 16A			1 x 16A				2
	1 x 40A	4 x 16A				6 x 16A					2
	1 x 40A	3 x 16A	1 x 16A				2 x 16A	1 x 16A			2
				4 x 16A			4 x 16A				
				2 x 16A 2 x 32A			2 x 16A 2 x 32A				
				4x10A*							4
				4 x 16A			4 x 16A				
				3 x 16A	1 x 16A		3 x 16A		1 x 16A		
				4 x 32A			4 x 32A				
					2 x 63A				2 x 63A		
Earth leakage relay with external toroid		MTHP 4P C125 16kA							1 x 125A		
				4 x 6A			4 x 16A				
				8 x 6A		8 x 16A					
				4 x 6A		4 x 16A				2+2	
				4 x 16A			4 x 16A				
				2 x 16A	2 x 16A		2 x 16A		2 x 16A		
				1 x 16A	2 x 25A		1 x 16A		2 x 32A		
				4 x 10A			4 x 16A				
				6 x 10A			6 x 16A				
				8 x 10A			8 x 16A				
Earth leakage relay with external toroid		MTX 4P 250A Type N 36kA				Direct coupling without socket					
		MTX 4P 250A Type N 36kA				1 Interlocked socket-outlet 250A with electric management					



68 Q-MC

FIRE-FIGHTING PEDESTALS			
	BLUE VERSION	WHITE VERSION	CONFIGURATION
	GW 68 721 A	GW 68 721 W	FITTED FOR 6KG FIRE EXTINGUISHER
	GW 68 723 A	GW 68 723 W	FITTED FOR 9KG FIRE EXTINGUISHER
	GW 68 722 A	GW 68 722 W	FITTED FOR LANCE, HOSE AND SUPPORT
	GW 68 779		KIT CONTAINING LANCE, 15M HOSE AND SUPPORT



	BLUE VERSION	WHITE VERSION	TYPE	CONFIGURATION
	GW 68 726 A	GW 68 726 W	standard	FITTED FOR LANCE, HOSE AND SUPPORT
	GW 68 728 A	GW 68 728 W	high capacity	
	GW 68 780			KIT CONTAINING LANCE, 20M HOSE, AND SUPPORT

EMPTY DISTRIBUTION PEDESTALS								
	TYPE	BLUE VERSION	WHITE VERSION	GREEN VERSION	EN 50022 MODULES	TAKE-OFF TYPE	SIDE A	SIDE B
	Q-MC 16 B PEDESTAL	GW 68 701 A	GW 68 701 W	-	18 (9x2)	Single-sided	Empty compartment that can be equipped with 1 panel	Empty compartment that can be equipped with 1 water kit
		GW 68 711 A	GW 68 711 W	-	18 (9x2)	Double-sided	Empty compartment that can be equipped with 1 panel	Empty compartment that can be equipped with 1 panel
	Q-MC 16 T PEDESTAL	GW 68 712 A	GW 68 712 W	-	18 (9x2)	Double-sided	Empty compartment that can be equipped with 1 panel	Empty compartment that can be equipped with 1 panel
	Q-MC 63 B PEDESTAL	GW 68 713 A	GW 68 713 W	GW 68 713 G	18 (9x2)	Double-sided	Empty compartment that can be equipped with 1 panel	Empty compartment that can be equipped with 1 panel
	Q-MC 63 C PEDESTAL	GW 68 714 A	GW 68 714 W	-	18 (9x2)	Double-sided	Empty compartment that can be equipped with 1 panel	Empty compartment that can be equipped with 1 panel
	Q-MC 63 C PEDESTAL	GW 68 716 A	GW 68 716 W	-	36 (9x4)	Double-sided	Empty compartment that can be equipped with 2 panels	Empty compartment that can be equipped with 2 panels
	Q-MC 125 B PEDESTAL	GW 68 715 A	GW 68 715 W	-	14	Single-sided	Empty compartment with blank retractable door that can be equipped with 1 panel	Empty compartment with blank retractable door that can be equipped with 1 panel
	Q-MC 200 B PEDESTAL	GW 68 717 A	GW 68 717 W	-	28 (14x2)	Double-sided	Empty compartment with blank retractable door that can be equipped with 2 panels	Empty compartment with blank retractable door that can be equipped with 2 panels

COMPONENTS FOR Q-MC 16 B, 16 T, 63 B AND 63 C
TYPES OF PANELS

	FOR INTERLOCKED SOCKET-OUTLET ASSEMBLY				FOR NON-INTERLOCKED SOCKET-OUTLET ASSEMBLY		
	BLUE VERSION	WHITE VERSION	GREEN VERSION	TYPE	NO.	TYPE	NO.
 	GW 68 745 A	GW 68 745 W	GW 68 745 G	67 IB range Vertical IP67 16/32A	2		
	GW 68 746 A	GW 68 746 W		44 IB range Horizontal IP44 16/32A	2		
	GW 68 747 A	GW 68 747 W		COMBIBLOC range IP44 or IP55 16/32A	2	IEC309 flush-mounting sockets 16A or 85x75mm flanged lids	1
	GW 68 748 A	GW 68 748 W	GW 68 748 G			IEC309 flush-mounting sockets 16/32A or 85x75mm flanged lids	4
	GW 68 749 A	GW 68 749 W		67 IB range Vertical IP67 63A	1		
	GW 68 750 A	GW 68 750 W	GW 68 750 G			blank	

COMPONENTS FOR Q-MC 125 B AND 200 B
TYPES OF PANELS

	FOR INTERLOCKED SOCKET-OUTLET ASSEMBLY				FOR NON-INTERLOCKED SOCKET-OUTLET ASSEMBLY	
	BLUE VERSION	WHITE VERSION	TYPE	NO.	TYPE	NO.
  		GW 68 731 W	67 IB range Vertical IP67 16/32A	3		
		GW 68 732 W	44 IB range Horizontal IP44 16/32A	4		
		GW 68 733 W	COMBIBLOC range IP44 or IP55 16/32A	3	IEC309 flush-mounting sockets 16/32A or 85x75mm flanged lids	2
		GW 68 734 W			IEC309 flush-mounting sockets 16/32A or 85x75mm flanged lids	6
		GW 68 735 W	67 IB range Vertical IP67 63A	2		
		GW 68 736 W			IEC309 flush-mounting sockets 125A	1
	GW 68 737 A	GW 68 737 W			blank	
	GW 68 741 A	GW 68 741 W			14-module control unit panel EN 50022	

68 Q-MC

Terminal system for energy distribution and service in insulating material

The 68 Q-MC range is an innovative energy and services distribution system made of thermoplastic, for environments such as tourist ports, campsites and public spaces (trade fairs, markets, gardens, etc.). It combines an attractive design with complete reliability over time, thanks to its resistance to chemical and atmospheric agents. The range includes both pre-wired and unwired versions, which can be configured as needed, and is available in light blue and white.



COMPACT PEDESTAL IN INSULATED MATERIAL

WIRED



GW 68 841

QMC 16 B WIRED PEDESTALS WITH SINGLE-FACE TAKE-OFF EQUIPPED WITH VERTICAL INTERLOCKED SOCKET-OUTLETS AND DOMESTIC SOCKET-OUTLETS - IP55 - IP56



Code	Socket-outlet 2P+E 16A	German Std socket-outlet 16A	Pack Carton
Colour: Light blue			
GW 68 841 A	2	-	1
GW 68 842 A	1	2	1
Colour: White			
GW 68 841 W	2	-	1
GW 68 842 W	1	2	1

PROTECTIONS:

GW68841A/W: Board In: 14 A; 1 RCBO - MDC Range 2P 230 V 16 A C 6 kA 0,03 A - AC Type

GW68842A/W: Board In: 14 A; 1 RCBO - MDC Range 2P 230 V 16 A C 6 kA 0,03 A - AC Type

ACCESSORIES SUPPLIED: 1 LED lighting lamp 230V; nr.2 lockable 1/2" water taps.

CHARACTERISTICS: stainless steel cable fastener devices; enclosure with hinged opening that can be fitted with security lock, for access to modular devices.

GW68841A/W: protection degree IP56.

GW68842A/W: protection degree IP55.

Power supply terminal block section: 16 mm². Pedestal dimensions: 445x625x300 mm (LxHxD).



GW 68 846

QMC 16 T TRANSPORTABLE WIRED PEDESTALS WITH DOUBLE-FACE TAKE-OFF EQUIPPED WITH VERTICAL INTERLOCKED AND NON-INTERLOCKED SOCKET-OUTLETS - IP55



Code	Socket-outlet 2P+E 16A	Socket-out 3P+E 16A	German Std socket-outlet 16A	Pack Carton
Colour: Light blue				
GW 68 846 A	6 non-interlocked (4 side A - 2 side B)	-	2 (only side B)	1
GW 68 847 A	2 Interlocked (only side A)	1 Interlocked (only side B)	2 (only side B)	1
Colour: White				
GW 68 846 W	6 non-interlocked (4 side A - 2 side B)	-	2 (only side B)	1
GW 68 847 W	2 Interlocked (only side A)	1 Interlocked (only side B)	2 (only side B)	1

PROTECTIONS:

GW68846A/W: Board In: 25A; Main RCD 4P 40 A 0.03 A AC Type;

3 MCB - MTC Range 2P 230 V 16 A C 6 kA for the six 2P+E 16 A 230 V non-interlocked socket-outlets

1 MCB - MTC Range 2P 230 V 16 A C 6 kA for the two 2P+E 10/16 A 230 V domestic socket-outlets

GW68847A/W: Board In: 25A; Main RCD 4P 40 A 0.03 A AC Type;

2 MCB - MTC Range 2P 230 V 16 A C 6 kA for the two 2P+E 16 A 230 V interlocked socket-outlets

1 MCB - MTC Range 3P 400 V 16 A C 6 kA for the 3P+E 16 A 400 V interlocked socket-outlet;

1 MCB - MTC Range 2P 230 V 16 A C 6 kA for the two 2P+E 10/16 A 230 V domestic socket-outlets

ACCESSORIES SUPPLIED: plug IEC 309 for supply GW68846 and GW68847 3P+N+E 32A 400V; 5 mt of H 07 RN - F cable for supply;

1 LED lighting lamp 16W 230V.

CHARACTERISTICS: enclosure with hinged opening that can be fitted with security lock, for access to modular devices.

Pedestal dimensions: 445x697x346 mm (LxHxD).

NOTE: products will be supplied with the new version, as shown in the picture and with LED lighting lamp, only after having sold out the previous one.



GW 68 851

QMC 63 B WIRED PEDESTALS WITH DOUBLE-FACE TAKE-OFF EQUIPPED WITH VERTICAL INTERLOCKED SOCKET-OUTLETS - IP56



Code	Socket-outlet 2P+E 16A	Socket-out 2P+E 32A	Pack Carton
Colour: Light blue			
GW 68 851 A	4 (2 for side)	-	1
GW 68 852 A	2 (1 for side)	2 (1 for side)	1
Colour: White			
GW 68 851 W	4 (2 for side)	-	1
GW 68 852 W	2 (1 for side)	2 (1 for side)	1

PROTECTIONS:

GW68851A/W: Board In: 25 A; Main switch disconnecter 4P 32 A;
4 RCBO - MDC Range 2P 230 V 16 A C 6 kA 0.03 A - AC Type for the four 2P+E 16 A 230 V socket-outlets.

GW68852A/W: Board In: 25 A; Main switch disconnecter 4P 32 A;
2 RCBO - MDC Range 2P 230 V 16 A C 6 kA 0.03 A - AC Type for the two 2P+E 16 A 230 V socket-outlets;

2 RCBO - MDC Range 2P 230 V 32 A C characteristic 6 kA 0.03 A - AC Type for the two 2P+E 32 A 230 V socket-outlets.

ACCESSORIES SUPPLIED: 1 LED lighting lamp 230 V; 4 padlockable 1/2" ball valves.

CHARACTERISTICS: stainless steel cable fastener devices; enclosure with hinged opening that can be fitted with security lock, for access to modular devices.

Power supply terminal block section: 16 mm². Pedestal dimensions: 445x950x300 mm (LxHxD).

NOTE: Products will be supplied in the configuration with the new design, as shown in the picture, and with the LED lighting KIT installed as standard, only after having sold out the previous one.



GW 68 855 G

QMC 63 B WIRED PEDESTAL WITH DOUBLE FACE TAKE-OFF EQUIPPED WITH DOMESTIC SOCKETS - IP55



Code	German Std socket-outlet 16A	Pack Carton
Colour: Green		
GW 68 855 G	4 (2 for side)	1

PROTECTIONS: Board In: 32A. Main switch 40A 4P.4 RCBO - MDC range 2P 230V 10A C 6kA 0,03A - A type for the 2P+E 230V domestic sockets. **CHARACTERISTICS:** enclosure with hinged opening that can be fitted with security lock for access to modular devices. Stainless steel cable fastener devices. power supply terminal section:16mm². Pedestal dimensions: 445x950x300 mm (LxHxD).



GW 68 856

QMC 63 C WIRED PEDESTALS WITH DOUBLE-SIDED TAKE-OFF EQUIPPED WITH INTERLOCKED COMBIBLOC SOCKET-OUTLETS - IP55



Code	Socket-outlet 2P+E 16A	Pack Carton
Colour: Light blue		
GW 68 856 A	4 (2 for side)	1
Colour: White		
GW 68 856 W	4 (2 for side)	1

Board In: 20A

PROTECTIONS: Main switch disconnecter 2P 32A;

4 RCBO - MDC Range 2P 230 V 6 A C 6 kA 0,03 A - AC Type for the four 2P+E 16 A 230 V interlocked socket-outlets

CHARACTERISTICS: stainless steel cable fastener devices; enclosure with hinged opening that can be fitted with security lock, for access to modular devices.

Power supply terminal block section: 16 mm². Pre-arrangement for LED lighting lamp 230V; pre-arrangement for nr. 2 or 4 padlockable 1/2" water taps.

Pedestal dimensions: 445x1284x300 mm (LxHxD).

68 Q-MC



GW 68 857

QMC 63 C WIRED DOUBLE-SIDED TAKE-OFF PEDESTALS EQUIPPED WITH NON-INTERLOCKED IEC 309 SOCKET-OUTLETS - IP55 - IP56

Code	Socket-outlet 2P+E 16A	Socket-out TV/SAT	Socket-out TEL/DATA	Pack Carton
Colour: Light blue				
GW 68 857 A	8 (4 for side)	-	-	1
GW 68 858 A	4 (2 for side)	4 (2 for side)	4 (2 for side)	1
Colour: White				
GW 68 857 W	8 (4 for side)	-	-	1
GW 68 858 W	4 (2 for side)	4 (2 for side)	4 (2 for side)	1

PROTECTIONS:

GW68857A/W: Board In: 32A; Main switch disconnecter 2P 40A;
 8 RCBO - MDC Range 2P 230 V 6 A C 6 kA 0,03 A - AC Type for the eight 2P+E 16 A 230 V non-interlocked socket-outlets
GW68858A/W: Board In: 25A; Main switch disconnecter 2P 32A;
 4 RCBO - MDC Range 2P 230 V 6 A C 6 kA 0,03 A - AC Type for the four 2P+E 16 A 230 V non-interlocked socket-outlets

CHARACTERISTICS:

enclosure with hinged opening that can be fitted with security lock, for access to modular devices.
 Power supply terminal block section: 16 mm². Pre-arrangement for LED lighting lamp 230V; pre-arrangement for nr. 2 or 4 lockable spherical 1/2" water taps.
 GW68857A/W: protection degree IP56.
 GW68858A/W: protection degree IP55.
 Pedestal dimensions: 445x1284x300 mm (LxHxD).

NOTE: products will be supplied with the new version, as shown in the picture, only after having sold out the previous one.

WIRED WITH ELECTRONIC SYSTEM



GW 68 876

QMC 63 E WIRED PEDESTALS WITH DOUBLE-FACE TAKE-OFF FOR PREPAID, CENTRALISED ELECTRONIC MANAGEMENT SYSTEM WITH VERTICAL INTERLOCKED SWITCHED SOCKET-OUTLETS - IP56

Code	Socket-outlet 2P+E 16A	Socket-outlet 3P+N+E 16A	Socket-out 2P+E 32A	Pack Carton
Colour: Light blue				
GW 68 876 A	4 (2 for side)	-	-	1
GW 68 877 A	3	1	-	1
GW 68 878 A	-	-	4 (2 for side)	1
Colour: White				
GW 68 876 W	4 (2 for side)	-	-	1
GW 68 877 W	3	1	-	1
GW 68 878 W	-	-	4 (2 for side)	1

PROTECTIONS:

GW68876A/W: Board In: 25 A; Main switch disconnecter 4P 32 A;
 4 MDC 2P 16 A 0.03 A one-way switches, class AC 6 kA for the 4 2P+E 16 A 230 V socket-outlets.
GW68877A/W: Board In: 25 A; Main switch disconnecter 4P 32 A;
 3 MDC 2P 16 A 0.03 A one-way switches, class AC 6 kA for the 3 2P+E 16 A 230 V socket-outlets;
 1 MDC 4P 16 A 0.03 A one-way switch, class AC 6 kA for the 3P+N+E 16 A 400 V socket-outlet.

GW68878A/W: Board In: 50 A; Main switch disconnecter 4P 63 A;
 4 MDC 2P 32 A 0.03 A one-way switches, class AC 6 kA for the 4 2P+E 32 A 230 V socket-outlets.

ACCESSORIES SUPPLIED:

1 LED lighting lamp 230 V; 4 padlockable 1/2" ball valves.
CHARACTERISTICS: stainless steel cable fastener devices; enclosure with hinged opening that can be fitted with security lock, for access to modular devices.
 Power supply terminal block section: 16 mm²; Pedestal dimensions: 445x1284x300 mm (LxHxD).

NOTES: for technical-commercial information, please contact your local sales representative or SAT (035 946 111).

products will be supplied with the new version, as shown in the picture and with LED lighting lamp, only after having sold out the previous one.



GW 68 874

QMC 63 E WIRED PEDESTALS WITH DOUBLE-FACE TAKE-OFF FOR PREPAID CENTRALISED ELECTRONIC MANAGEMENT SYSTEM, EQUIPPED WITH VERTICAL INTERLOCKED SOCKET-OUTLETS - IP56



Code	Socket-out 3P+N+E 63A	Socket-out 3P+N+E 125A	Pack Carton
Colour: Light blue			
GW 68 874 A	2 (1 for side)	-	1
GW 68 875 A	-	1	1
Colour: White			
GW 68 874 W	2 (1 for side)	-	1
GW 68 875 W	-	1	1

PROTECTIONS:

GW68874A/W: Board In: 90 A.

2 RCBO MT+BD 4P 400 V 63 A C characteristic 10 kA 0.03 A - AC type for the 2 3P+N+E 63 A 400 V socket-outlets.

GW68875A/W: Board In: 90 A.

1 miniature circuit breaker with earthing residual current relay with separate toroid MTHP 4P 400 V 125 A C characteristic 16 kA for 125 A socket-outlet.

ACCESSORIES SUPPLIED: 1 LED lighting lamp 230 V;

GW68874A/W: 2 padlockable 1/2" ball valves; GW68875A/W: 2 padlockable 1/2" ball valves;

CHARACTERISTICS: stainless steel cable fastener devices; enclosure with hinged opening that can be fitted with security lock, for access to modular devices.

Power supply terminal block section: GW68874A/W 70 mm²; GW68875A/W 70 mm²; Pedestal dimensions: 445x1284x300 mm (LxHxD).

NOTES: for technical-commercial information, please contact your local sales representative or SAT (035 946 111).

ACCESS CONTROL



GW 68 998

SURFACE-MOUNTING TRANSPONDER READER FOR ACCESS CONTROL - IP56

Code	Description	Material	Colour	Pack Carton
GW 68 998	surface-mounting access control	Thermoplastic	Grey RAL 7012	1

APPLICATION: The access control can be integrated in the system with 68 Q-MC terminal boards with electronic management in order to allow the access of people in determined areas, or to enable the use of specific services.

ACCESSORIES SUPPLIED: n. 2 M12 cable gland; screwcaps for double insulation; screws for the sealing of the frontal.

EMPTY



GW 68 701

EMPTY PEDESTALS Q-MC 16 B - IP56

Code	Type	Possible configuration	Possible configuration	No. of modules EN 50022	Pack Carton
Colour: Light blue					
GW 68 701 A	Single-sided	Side A: 1 panel	Side B: 1 water kit	18 (9x2)	1
GW 68 711 A	Double-sided	Side A: 1 panel	Side B: 1 panel	18 (9x2)	1
Colour: White					
GW 68 701 W	Single-sided	Side A: 1 panel	Side B: 1 water kit	18 (9x2)	1
GW 68 711 W	Double-sided	Side A: 1 panel	Side B: 1 panel	18 (9x2)	1

ACCESSORIES SUPPLIED: junction box for housing power supply terminal block.

CHARACTERISTICS: 18-module enclosure with hinged opening, that can be fitted with security lock, for access to modular devices; prearrangement for lighting kit 230V, available as an accessory.

GW68701A/W: single-face take-off with cable fastener devices only on side A; GW68711A/W: double-face take-off with cable fastener devices on sides A and B; Pedestal dimensions: 445x625x300 mm (LxHxD).



GW 68 712

EMPTY TRANSPORTABLE PEDESTAL Q-MC 16 T - IP56

Code	Type	Possible configuration	Possible configuration	No. of modules EN 50022	Pack Carton
Colour: Light blue					
GW 68 712 A	Double-sided	Side A: 1 panel	Side B: 1 panel	18 (9x2)	1
Colour: White					
GW 68 712 W	Double-sided	Side A: 1 panel	Side B: 1 panel	18 (9x2)	1

CHARACTERISTICS: 18-module enclosure with hinged opening, that can be fitted with security lock, for access to modular devices; prearrangement for lighting kit 230V, available as an accessory. Pedestal dimensions: 445x697x346 mm (LxHxD).



GW 68 713

EMPTY PEDESTAL Q-MC 63 B - IP56

Code	Type	Possible configuration	Possible configuration	No. of modules EN 50022	Pack Carton
Colour: Light blue					
GW 68 713 A	Double-sided	Side A: 1 panel	Side B: 1 panel	18 (9x2)	1
Colour: White					
GW 68 713 W	Double-sided	Side A: 1 panel	Side B: 1 panel	18 (9x2)	1
Colour: Green					
GW 68 713 G	Double-sided	Side A: 1 panel	Side B: 1 panel	18 (9x2)	1

ACCESSORIES SUPPLIED: junction box for housing power supply terminal block.

CHARACTERISTICS: 18-module enclosure with hinged opening, that can be fitted with security lock, for access to modular devices; prearrangement for lighting kit 230V and water kit with 2 or 4 padlockable spherical taps of 1/2", available as accessories; double-face take-off with cable fastener devices on sides A and B. Pedestal dimensions: 445x950x300 mm (LxHxD).



GW 68 714

EMPTY PEDESTAL Q-MC 63 C - IP56

Code	Type	Possible configuration	Possible configuration	No. of modules EN 50022	Pack Carton
Colour: Light blue					
GW 68 714 A	Double-sided	Side A: 1 panel	Side B: 1 panel	18 (9x2)	1
GW 68 716 A	Double-sided	Side A: 2 panels	Side B: 2 panels	36 (9x4)	1
Colour: White					
GW 68 714 W	Double-sided	Side A: 1 panel	Side B: 1 panel	18 (9x2)	1
GW 68 716 W	Double-sided	Side A: 2 panels	Side B: 2 panels	36 (9x4)	1

ACCESSORIES SUPPLIED: junction box for housing power supply terminal block.

GW68716A/W dual 18-module enclosure with hinged opening, can be equipped with a security lock.

CHARACTERISTICS: 18-module enclosure with hinged opening, that can be fitted with security lock, for access to modular devices; prearrangement for lighting kit 16W 230V and water kit with 2 or 4 padlockable 1/2" water taps, available as accessories; double-face take-off with cable fastener devices on sides A and B. Pedestal dimensions: 445x1284x300 mm (LxHxD).

COMPLEMENTARY ITEMS FOR PREPAID AND CENTRALISED ELECTRONIC SYSTEM



GW 68 991

TRANSPONDER KEY PROGRAMMING KIT (PREPAID / CENTRALISED SYSTEM)

Code	Description	Pack Carton
GW 68 991	Programming console and s/w for PC with USB key	1

NOTES: To be used with terminal boards with electronic management system and with access control GW68998. for technical-commercial information, please contact your local sales representative or SAT (035 946 111).



GW 68 992

TRANSPONDER KEY (PREPAID / CENTRALISED SYSTEM)

Code	Description	N. Keys	Pack Carton
GW 68 992	Transponder key to encode	1	1/10

NOTES: To be used with terminal boards with electronic management system and with access control GW68998. for technical-commercial information, please contact your local sales representative or SAT (035 946 111).



GW 68 994

RS485/USB INSULATED CONVERTER WITH TERMINAL BLOCK

Code	Description	Pack Carton
GW 68 994	USB/RS485 converter	1

NOTES: To be used with terminal boards with electronic management system and with access control GW68998. for technical-commercial information, please contact your local sales representative or SAT (035 946 111). The converter RS485/USB can manage up to 250 pedestals for line. In case of more lines is necessary to use more converters GW68994. For the use of more lines please verify that the PC has more USB doors available. Use an Hub for have other USB.



GW 68 995

KIT FOR CENTRALISED SYSTEM

Code	Description	Pack Carton
GW 68 995	Management software with USB key and converter	1

COMPOSITION:

1 USB key for PC;

1 USB-RS485 converter;

1 Sw for management To be used with terminal boards with electronic management system and with access control GW68998.

NOTE: for technical-commercial information, please contact your local sales representative or SAT (035 946 111).

General note for centralised system: For the wiring of the pedestals, in a centralised system, is necessary to use an RS485 Bus cable. The cable must be an armed and twisted with a couple of wires 0.22mm² and 120Ohm impedance of the cable.

Some cables suitable for centralised system: BELDEN P/N 9841, ITC/CDT 1457Y and CEAM CPR 6003.

COMPLEMENTARY ITEMS FOR COMPACT PEDESTALS

PANELS



GW 68 748 A

FLANGED PANELS PREARRANGED FOR ASSEMBLY OF SOCKET-OUTLETS

Code	No. IB socket-outlets houseable	No of IEC 309 socket-outlets that can be housed	Pack Carton
Colour: Light blue			
GW 68 745 A	2 IB Vert. 16-32A IP67	-	1/2
GW 68 746 A	2 IB Horiz. 16-32A SBF IP44	-	1/2
GW 68 747 A	2 COMBIBLOC 16-32A IP44/55	1 IEC 309 16A 2P+E IP44/67	1/2
GW 68 748 A	-	4 IEC 309 16-32A IP44/67	1/2
GW 68 749 A	1 IB Vert. 63A IP67	-	1/2
Colour: White			
GW 68 745 W	2 IB Vert. 16-32A IP67	-	1/2
GW 68 746 W	2 IB Horiz. 16-32A SBF IP44	-	1/2
GW 68 747 W	2 COMBIBLOC 16-32A IP44/55	1 IEC 309 16A 2P+E IP44/67	1/2
GW 68 748 W	-	4 IEC 309 16-32A IP44/67	1/2
GW 68 749 W	1 IB Vert. 63A IP67	-	1/2
Colour: Green			
GW 68 745 G	2 IB Vert. 16-32A IP67	-	1/2
GW 68 748 G	-	4 IEC 309 16-32A IP44/67	1/2

ACCESSORIES SUPPLIED: screws for fixing panel.

CHARACTERISTICS: dimensions (LxHxD): 211x276x17 mm.



GW 68 750 A

BLANK PANEL

Code	Description	Pack Carton
Colour: Light blue		
GW 68 750 A	Blank panel	1/2
Colour: White		
GW 68 750 W	Blank panel	1/2
Colour: Green		
GW 68 750 G	Blank panel	1/2

ACCESSORIES SUPPLIED: screws for fixing panel.

CHARACTERISTICS: dimensions (LxHxD): 211x276x17 mm.

SERVICE COMPLEMENTARY ITEMS



GW 68 789

POWER SUPPLY TERMINAL BLOCKS FOR COMPACT TERMINALS

Code	Terminal blocks	For cables	Terminal type	Rail type	Pack Carton
GW 68 788	3P+N+E	Up to 16 mm ²	Modular	EN 50035	1
GW 68 789	3P+N+E	Up to 35 mm ²	With eyelet	EN 50035	1
GW 68 800	3P+N+E	Up to 70 mm ²	With eyelet	EN 50035	1



GW 68 794

WATER KIT WITH LOCKABLE TAPS

Code	Input	Output	Suitable for	Pack Carton
GW 68 792	N. 1 valve 1/2"	N. 2 taps 1/2"	QMC 16 B	1
GW 68 793	N. 1 valve 1/2"	N. 2 taps 1/2"	QMC 63 B / 63 C	1
GW 68 794	N. 1 valve 1/2"	N. 4 taps 1/2"	QMC 63 B / 63 C	1

ACCESSORIES SUPPLIED: adjustment fittings and nuts for pedestals.



GW 68 790

LIGHTING KIT FOR COMPACT TERMINALS

Code	Lamp	Lamp power	Voltage	Lamp holder	Pack Carton
Lighting: Ordinary					
GW 68 790	FSS	16 W	230 V - 50 Hz	GR8	1
Lighting: EMERGENCY TYPE M					
GW 68 791	FSS	16 W	230 V - 50 / 60 Hz	GR10	1

ACCESSORIES SUPPLIED: lamp and supply cable.

CHARACTERISTICS: GW68791 permanent emergency lighting, equipped with double supply circuit, keeps the Ni/C storage batteries charged; autonomy 1h



GW 68 990

LIGHTING KIT FOR COMPACT TERMINALS - LED TECHNOLOGY



Code	Lamp	System power	Colour temperature	Pack Carton
Voltage: 220-240 V - 50/60 Hz				
GW 68 990	LED	8.7 W	4000 K	1

CHARACTERISTICS: the lighting KIT with LED technology enables electricity savings of up to 66%.

NOTES: due to the continuous changes with the LED technologies, the technical data can undertake variations.



GW 68 770

COMPRESSED AIR KIT

Code	Maximum operating pressure	Input	Output	Pack Carton
GW 68 770	6 bar	N. 1 valve 1/2"	1 quick connection valve, female 3/8"	1

ACCESSORIES SUPPLIED: adjustment fittings and nuts for pedestals.



GW 68 796

FIXING PLATE

Code	Description	Application	Material	Pack Carton
GW 68 796	Plate for fixing	On concrete	Stainless steel	1
GW 68 781	Plate for fixing	On MARTINI pontoon	Stainless steel	1
GW 68 782	Plate for fixing	On INGEMAR pontoon	Stainless steel	1



GW 68 776

SECURITY LOCK WITH KEY

Code	Suitable for	For terminals	Pack Carton
GW 68 776	Enc. door and blank door	Q-MC in insulating material	1/5

ACCESSORIES SUPPLIED: 2 keys.

NOTES: all the keys and relative locks with the same product code are identical.

68 Q-MC



GW 68 799

FAULT SIGNALLING DEVICE

Code	Description	Pack Carton
GW 68 799	High efficiency LED with power supply unit	1

STANDARD PEDESTAL IN INSULATED MATERIAL

WIRED



GW 68 801

WIRED PEDESTALS WITH SINGLE-SIDED TAKE-OFF QMC 125 B EQUIPPED WITH HORIZONTAL INTERLOCKED SOCKET-OUTLETS - IP44

Code	Socket-outlet 2P+E 16A		Socket-outlet 3P+N+E 16A		Pack Carton
	16A	16A	16A	16A	
Colour: Light blue					
GW 68 801 A	4				1
GW 68 802 A	2		2		1
Colour: White					
GW 68 801 W	4				1
GW 68 802 W	2		2		1

PROTECTIONS:

GW68801A/W: Board In: 25 A; Main switch disconnecter 4P 32A;
4 RCBO - MDC Range 2P 230 V 16 A C 6 kA 0,03 A - AC Type for the four 2P+E 16 A 230 V socket-outlets
GW68802A/W: Board In: 40 A; Main switch disconnecter 4P 63 A;
2 RCBO - MDC Range 2P 230 V 16 A C 6 kA 0,03 A - AC Type for the two 2P+E 16 A 230 V socket-outlets;
2 RCBO - MDC Range 4P 400 V 16 A C 6 kA 0,03 A - AC Type for the two 3P+N+E 16 A 400 V socket-outlets
ACCESSORIES SUPPLIED: 2 fluorescent lighting lamps 11W 230V;
4 padlockable 1/2" ball valves;
2 supports for flexible conduit GW68762.

CHARACTERISTICS: side A: user socket-outlets, cable guide with cable fastener devices, blank retractable door;

side B: enclosure complete with modular protection equipped with security lock.

Power supply terminal block section: GW68801A/W 16 mm², GW68802A/W 35 mm².

Pedestal dimensions: 600x840x520 mm (LxHxD).

NOTE: products will be supplied with the new version, as shown in the picture, only after having sold out the previous one.



GW 68 803

QMC 125 B WIRED PEDESTAL WITH SINGLE-FACE TAKE-OFF EQUIPPED WITH VERTICAL INTERLOCKED SOCKET-OUTLETS - IP56

Code	Socket-outlet 2P+E 16A		Socket-out 3P+N+E 32A		Pack Carton
	16A	32A	16A	32A	
Colour: Light blue					
GW 68 803 A	1		2		1
Colour: White					
GW 68 803 W	1		2		1

Board In: 50A

PROTECTIONS: Main switch disconnecter 4P 63A;

1 RCBO - MDC Range 2P 230 V 16 A C 6 kA 0,03 A - AC Type for the 2P+E 16 A 230 V socket-outlet;

2 RCBO - MDC Range 4P 400 V 25 A C 6 kA 0,03 A - AC Type for the two 3P+N+E 32 A 400 V socket-outlets

ACCESSORIES SUPPLIED: 2 fluorescent lighting lamp 11W 230V; 4 padlockable 1/2" ball valves; 2 supports for flexible conduit GW68762.

CHARACTERISTICS: side A: user socket-outlets, cable guide with cable fastener devices, blank retractable door;

side B: enclosure complete with modular protection equipped with security lock.

Power supply terminal block section: 35 mm².

Pedestal dimensions: 600x840x520 mm (LxHxD).

NOTE: products will be supplied with the new version, as shown in the picture, only after having sold out the previous one.

EMPTY



GW 68 715

EMPTY PEDESTALS WITH SINGLE-SIDED TAKE-OFF QMC 125 B - IP56

Code	Sides with blank door	Side A standard	Side B standard	Possible configuration	Pack Carton
Colour: Light blue					
GW 68 715 A	A-B	Empty	Empty	1 enclosure	1
Colour: White					
GW 68 715 W	A-B	Empty	Empty	1 enclosure	1

ACCESSORIES SUPPLIED: 2 supports for flexible conduit GW68762; junction box for housing power supply terminal block.

CHARACTERISTICS: blank retractable doors; 14-module enclosure with transparent door (not supplied), pre-arrangement for lighting kit 11W 230V (2 ordinary and 1 emergency) and water kit with 2 or 4 lockable 1/2" water taps, available as accessories.

Single-sided take-off with cable guide and cable fastener devices only on side A.

Pedestal dimensions: 600x840x520 mm (LxHxD).

HIGH CAPACITY PEDESTAL IN INSULATED MATERIAL

WIRED



GW 68 833

WIRED PEDESTALS WITH DOUBLE-SIDED TAKE-OFF QMC 200 B EQUIPPED WITH HORIZONTAL INTERLOCKED SOCKET-OUTLETS - IP44



Code	Socket-outlet 2P+E 16A	Pack Carton
Colour: Light blue		
GW 68 831 A	4 (2 for side)	1
GW 68 832 A	6 (3 for side)	1
GW 68 833 A	8 (4 for side)	1
Colour: White		
GW 68 831 W	4 (2 for side)	1
GW 68 832 W	6 (3 for side)	1
GW 68 833 W	8 (4 for side)	1

PROTECTIONS:

GW68831A/W: Board In: 16A; Main switch disconnecter 4P 32A; 4 RCBO - MDC Range 2P 230 V 10 A C 6 kA 0,03 A - AC Type for the four 2P+E 16 A 230 V socket-outlets

GW68832A/W: Board In: 16A; Main switch disconnecter 4P 32A; 6 RCBO - MDC Range 2P 230 V 10 A C 6 kA 0,03 A - AC Type for the six 2P+E 16 A 230 V socket-outlets

GW68833A/W: Board In: 24A; Main switch disconnecter 4P 32A; 8 RCBO - MDC Range 2P 230 V 10 A C 6 kA 0,03 A - AC Type for the eight 2P+E 16 A 230 V socket-outlets

ACCESSORIES SUPPLIED: 2 plexiglass kits for lateral protection.

CHARACTERISTICS: sides A and B: user socket-outlets, enclosure complete with modular protections equipped with security lock, cable guide with cable fastener devices, blank retractable door; pre-arrangement for lighting kit 11W 230V (2 ordinary and 1 emergency) and water kit with 2 or 4 padlockable 1/2" ball valves, available as accessories

Power supply terminal block section: GW68831A/W 16mm²; GW68832A/W, and GW68833A/W 35mm².

Pedestal dimensions: 600x1540x600 mm (LxHxD).

NOTE: products will be supplied with the new version, as shown in the picture, only after having sold out the previous one.

WIRED WITH ELECTRONIC SYSTEM - HIGH-CURRENT SYSTEMS



GW 68 867 A

QMC 200 E WIRED PEDESTALS WITH SINGLE-FACE TAKE-OFF FOR PREPAID, CENTRALISED ELECTRONIC MANAGEMENT SYSTEM WITH DIRECT 250A COUPLING IN TERMINAL BLOCK - IP55



Code	Type of connection	Pack Carton
Colour: Light blue		
GW 68 867 A	250A direct coupling on terminal block	1
Colour: White		
GW 68 867 W	250A direct coupling on terminal block	1

Board In: 200 A.

PROTECTIONS: 1 miniature circuit breaker with earthing residual current relay with separate toroid MTX 4P 400 V 250 A type N 36 kA.

ACCESSORIES SUPPLIED: nr.2 lockable 1/2" water taps; 2 fluorescent lighting lamps 11 W 230 V, 2 supports for flexible conduit GW68762.

CHARACTERISTICS: stainless steel cable fastener devices; board in stainless steel, can be equipped with security lock for access to the modular devices.

Connection to the power supply network and power take-off via two terminal blocks 185 mm² 4P.

NOTES: for technical-commercial information, please contact your local sales representative or SAT (035 946 111).

Pedestal dimensions: 600x1540x600 mm (LxHxD).



GW 68 868 W

WIRED TERMINALS WITH SINGLE-FACE TAKE-OFF FOR CENTRALISED, PREPAID, ELECTRONIC MANAGEMENT SYSTEM QMC200 E EQUIPPED WITH HIGH-CURRENT SOCKET-OUTLETS 250A - IP55



Code	Type of connection	Pack Carton
Colour: Light blue		
GW 68 868 A	Interlocked socket-outlets 250A	1
Colour: White		
GW 68 868 W	Interlocked socket-outlets 250A	1

Board In: 200 A.

PROTECTIONS: 1 MTX 4 pole 250 A switch type N 36 kA with earthing residual current relay with separate toroid.

ACCESSORIES SUPPLIED: 2 lockable 1/2" water taps; 2 fluorescent lighting lamps 11 W 230 V; 2 supports for flexible conduit GW68762;

CHARACTERISTICS: cable clamp devices in stainless steel, can be equipped with security lock for access to the modular devices.

NOTES: for technical-commercial information, please contact your local sales representative or SAT (035 946 111). Casing dimensions (LxHxD): 600x1540x600 mm.

EMPTY



GW 68 717

EMPTY PEDESTAL WITH DOUBLE-FACE TAKE-OFF QMC 200 B - IP56

Code	Sides with blank door	Side A standard	Side B standard	Possible configuration	Pack Carton
Colour: Light blue					
GW 68 717 A	A-B	Empty	Empty	2 enclosures or 2 panels	1
Colour: White					
GW 68 717 W	A-B	Empty	Empty	2 enclosures or 2 panels	1

ACCESSORIES SUPPLIED: 2 plexiglass kits for lateral protection; junction box for housing power supply terminal block.

CHARACTERISTICS: 2 blank retractable doors; 14+14 module enclosure with transparent door (not supplied);

pre-arrangement for lighting kit 11W 230V (2 ordinary and 1 emergency) and water kit with 2 or 4 lockable spherical taps of 1/2", available as accessories

Double-face take-off with cable guide and cable fastener devices on sides A and B.

Pedestal dimensions: 600x1540x600 mm (LxHxD).

COMPLEMENTARY ITEMS FOR PREPAID AND CENTRALISED ELECTRONIC SYSTEM



GW 68 991

TRANSPONDER KEY PROGRAMMING KIT (PREPAID / CENTRALISED SYSTEM)

Code	Description	Pack Carton
GW 68 991	Programming console and s/w for PC with USB key	1

NOTES: To be used with terminal boards with electronic management system.

for technical-commercial information, please contact your local sales representative or SAT (035 946 111).



GW 68 992

TRANSPONDER KEY (PREPAID / CENTRALISED SYSTEM)

Code	Description	N. Keys	Pack Carton
GW 68 992	Transponder key to encode	1	1/10

NOTES: To be used with terminal boards with electronic management system and with access control GW68998.

for technical-commercial information, please contact your local sales representative or SAT (035 946 111).



GW 68 994

RS485/USB INSULATED CONVERTER WITH TERMINAL BLOCK

Code	Description	Pack Carton
GW 68 994	USB/RS485 converter	1

NOTES: To be used with terminal boards with electronic management system and with access control GW68998. For technical-commercial information, please contact your local sales representative or SAT (035 946 111). The converter RS485/USB can manage up to 250 pedestals for line. In case of more lines is necessary to use more converters GW68994. For the use of more lines please verify that the PC has more USB doors available. Use an Hub for have other USB.



GW 68 995

KIT FOR CENTRALISED SYSTEM

Code	Description	Pack Carton
GW 68 995	Management software with USB key and converter	1

COMPOSITION:
1 USB key for PC;
1 USB-RS485 converter;
1 5w for management.

NOTES: To be used with terminal boards with electronic management system and with access control GW68998. For technical-commercial information, please contact your local sales representative or SAT. **General note for centralised system:** For the wiring of the pedestals, in a centralised system, is necessary to use an RS485 Bus cable. The cable must be an armed and twisted with a couple of wires 0.22mm² and 1200hm impedance of the cable. Some cables suitable for centralised system: BELDEN P/N 9841, ITC/CDT 1457Y and CEAM CPR 6003.

COMPLEMENTARY ITEMS FOR STANDARD AND HIGH CAPACITY PEDESTALS

PANELS



GW 68 731 W

FLANGED PANELS PREARRANGED FOR ASSEMBLY OF SOCKET-OUTLETS - GREY RAL 7035

Code	No. IB socket-outlets houseable	No of IEC 309 socket-outlets that can be housed	Pack Carton
GW 68 731 W	3 IB Vert. 16-32A IP67	-	1/2
GW 68 732 W	4 IB Horiz. 16/32 A IP44	-	1/2
GW 68 733 W	3 COMBIBLOC 16-32A IP44/55	2 IEC 309 16A 2P+E IP44/67	1/2
GW 68 734 W	-	6 IEC 309 16-32A IP44/67	1/2
GW 68 735 W	2 IB Vert. 63 A IP67	-	1/2
GW 68 736 W	-	1 IEC 309 125A IP67	1/2

ACCESSORIES SUPPLIED: fixing screws.
CHARACTERISTICS: dimensions LxHxD: 328x285x21, GW68736W: 328x285x110 mm.
NOTES: GW68736W compatible only with standard, 125B type terminals.



GW 68 737 W

BLANK PANEL

Code	Description	Pack Carton
Colour: Light blue		
GW 68 737 A	Blank panel	1/2
Colour: White		
GW 68 737 W	Blank panel	1/2

ACCESSORIES SUPPLIED: fixing screws.
CHARACTERISTICS: dimensions LxHxD: 328x285x43mm.

68 Q-MC



GW 68 741 W

ENCLOSURE PANELS WITH TRANSPARENT DOOR

Code	Colour	Pack Carton
GW 68 741 A	Light blue	1/2
GW 68 741 W	White	1/2

ACCESSORIES SUPPLIED: 14-module rail EN 50022, panel fixing screws.

CHARACTERISTICS: dimensions LxHxD: 328x285x43mm; transparent door that can be equipped with security lock GW68758.

FLUSH-MOUNTING SOCKET-OUTLETS WITH CLEAN CONTACT - 125 A - IP67



GW 68 785

LOW VOLTAGE SCREW WIRING 10° ANGLED FLUSH-MOUNTING INTERLOCKED SOCKET-OUTLETS 125A



Code	No. of poles	Rated voltage	Colour	Frequency	Reference h	Flange dimensions (mm)	Pack Carton
GW 68 785	3P+E	380 - 415 V	Red	50/60 Hz	6	114x114	1
GW 68 786	3P+N+E	380 - 415 V	Red	50/60 Hz	6	114x114	1

CHARACTERISTICS: the socket-outlets are equipped with a NO contact (mechanically activated by the plug pilot) to allow the creation of the electric interlock circuit. nickel-plated contacts.

SERVICE COMPLEMENTARY ITEMS



GW 68 766

TERMINAL BLOCKS FOR POWER SUPPLY

Code	Terminal blocks	For cables	Terminal type	Rail type	Pack Carton
GW 68 765	3P+N+E	Up to 16 mm ²	Modular	EN 50022	1
GW 68 766	3P+N+E	Up to 35 mm ²	With eyelet	EN 50035	1
GW 68 767	3P+N+E	Up to 70 mm ²	With eyelet	EN 50035	1
GW 68 768	3P+N+E	Up to 120 mm ²	With eyelet	EN 50035	1
GW 68 769	3P+N+E	Up to 185 mm ²	With eyelet	EN 50035	1

CHARACTERISTICS: They permit making supply systems with terminals in series, with the enter-exit type of connection, for power cables up to 185 mm².

All codes include a 6 mm² 2P+E terminal block for the lighting circuit supply.



GW 68 753

WATER KIT WITH LOCKABLE TAPS

Code	Input	Output	Characteristics	Pack Carton
GW 68 753	N. 1 valve 1/2"	N. 4 taps 1/2"	-	1
GW 68 763	N. 1 valve 1/2"	N. 2 taps 1/2"	-	1
GW 68 764	N. 1 valve 1/2"	N. 2 taps 1/2"	With meter	1

ACCESSORIES SUPPLIED: adjustment fittings and nuts for pedestals.

CHARACTERISTICS: GW68764 with 2 meters of diameter 70mm, capacity 1.5m³/h.



GW 68 751

LIGHTING KIT FOR STANDARD AND HIGH CAPACITY PEDESTAL

Code	Lamp	Lamp power	Voltage	Lamp holder	Dimensions LxH (mm)	Pack Carton
Lighting: Ordinary						
GW 68 751	FSD	11 W	230 V - 50 Hz	G23	371x74	1/4
Lighting: Emergency						
GW 68 752	FSD	11 W	230 V - 50 / 60 Hz	2G7	371x74	1

ACCESSORIES SUPPLIED: protection grille, fixing screws, lamp and supply cable.

CHARACTERISTICS: GW68752 permanent emergency lighting kit, equipped with double supply circuit for switching the lamp on and off keeps the Ni/Cd storage batteries charged.



GW 68 770

COMPRESSED AIR KIT

Code	Maximum operating pressure	Input	Output	Pack Carton
GW 68 770	6 bar	N. 1 valve 1/2"	1 quick connection valve, female 3/8"	1

ACCESSORIES SUPPLIED: adjustment fittings and nuts for pedestals.



GW 68 761

FIXING PLATE FOR STANDARD AND HIGH CAPACITY PEDESTAL

Code	Description	Application	Material	Pack Carton
GW 68 761	Plate for fixing	On concrete	Stainless steel	1

ACCESSORIES SUPPLIED: check nuts and non-skid washer.

CHARACTERISTICS: fastening to the terminal is achieved using the threaded pins M8 soldered to the plate.



GW 68 758

SECURITY LOCK WITH HANDLE

Code	Description	N. Keys	Pack Carton
GW 68 758	Security lock with key	2	1/5

CHARACTERISTICS: all keys have a standardised code; can be mounted on the blank doors of the terminals and on the door of the enclosure panels.



GW 68 762 A

SUPPORT FOR FLEXIBLE TUBE / EXTENSION

Code	Description	Pack Carton
Colour: Light blue		
GW 68 762 A	No.1 supports flexible tube	1/2
Colour: White		
GW 68 762 W	No.1 supports flexible tube	1/2

ACCESSORIES SUPPLIED: fixing screws.



GW 68 795

SELF-ADHESIVE PROTECTION KIT

Code	Description	Pack Carton
GW 68 795	White support with transparent protection	1/10



68 Q-MC



Scan the QR Code and find out all the technical informations.

A WORLD OF APPLICATIONS



The 68 Q-MC series of distribution terminals are available in both thermoplastic and stainless steel versions, energy distribution solutions in ports, campsites, parking areas, parks and gardens.

SIMPLE AND INTELLIGENT MANAGEMENT



The electronically managed terminals allow real-time recording and monitoring of consumption. The user interface display and credit management transponder key reader are housed in the head.

Quick Reference

Quick Reference

Code	Quantity		Page
	Pack/carton	Pallet	
DX 10			
DX 10 016 R	100/6400	6400	328
DX 10 020 R	100/5200	5200	328
DX 10 025 R	75/3300	3300	328
DX 10 032 R	50/1800	1800	328
DX 10 040 R	25/1100	1100	328
DX 10 050 R	25/400	400	328
DX 10 116 R	100/6400	6400	328
DX 10 120 R	100/5200	5200	328
DX 10 125 R	75/3300	3300	328
DX 10 132 R	50/1800	1800	328
DX 10 140 R	25/500	500	328
DX 10 150 R	25/400	400	328
DX 15			
DX 15 016 R	100/6400	6400	329
DX 15 020 R	100/5200	5200	329
DX 15 020 X	100/5200	5200	331
DX 15 025 R	75/3300	3300	329
DX 15 025 X	75/3300	3300	331
DX 15 032 R	50/1800	1800	329
DX 15 032 X	50/1800	1800	331
DX 15 040 R	25/1100	1100	329
DX 15 040 X	25/500	500	331
DX 15 050 R	25/400	400	329
DX 15 063 R	20/240	240	329
DX 15 116 R	100/6400	6400	329
DX 15 120 R	100/5200	5200	329
DX 15 125 R	75/3300	3300	329
DX 15 132 R	50/1800	1800	329
DX 15 140 R	25/500	500	329
DX 15 150 R	25/400	400	329
DX 15 163 R	20/240	240	329
DX 15 216 R	100/2800	2800	329
DX 15 220 R	100/5200	5200	329
DX 15 220 X	100/2400	2400	331
DX 15 225 R	75/3300	3300	329
DX 15 225 X	75/1500	1500	331
DX 15 232 R	50/800	800	329
DX 15 232 X	50/800	800	331
DX 15 240 R	25/500	500	329
DX 15 240 X	25/500	500	331
DX 15 250 R	25/400	400	329
DX 15 316 R	100/2800	2800	329
DX 15 320 R	100/2400	2400	329
DX 15 325 R	75/1500	1500	329
DX 15 332 R	50/800	800	329
DX 15 416 R	100/2800	2800	329
DX 15 420 R	100/5200	5200	329
DX 15 420 X	100/2400	2400	331
DX 15 425 R	75/3300	3300	329
DX 15 425 X	75/1500	1500	331
DX 15 432 R	50/800	800	329
DX 15 432 X	50/800	800	331
DX 15 440 R	25/500	500	329
DX 15 440 X	25/500	500	331
DX 15 450 R	25/400	400	329
DX 15 516 R	100/2800	2800	329
DX 15 520 R	100/2400	2400	329
DX 15 525 R	75/1500	1500	329
DX 15 532 R	50/800	800	329
DX 15 616 R	100/2800	2800	330
DX 15 620 R	100/2400	2400	330
DX 15 620 X	100/2400	2400	332
DX 15 625 R	75/1500	1500	330

Code	Quantity		Page
	Pack/carton	Pallet	
DX 15 625 X	75/1500	1500	332
DX 15 632 R	50/800	800	330
DX 15 632 X	50/800	800	332
DX 15 640 R	25/500	500	330
DX 15 640 X	25/500	500	332
DX 15 650 R	25/400	400	330
DX 15 716 R	100/2800	2800	330
DX 15 720 R	100/2400	2400	330
DX 15 725 R	75/1500	1500	330
DX 15 732 R	50/800	800	330
DX 15 816 R	100/2800	2800	330
DX 15 820 R	100/2400	2400	330
DX 15 820 X	100/5200	5200	332
DX 15 825 R	75/1500	1500	330
DX 15 825 X	75/3300	3300	332
DX 15 832 R	50/800	800	330
DX 15 832 X	50/1800	1800	332
DX 15 840 R	25/500	500	330
DX 15 840 X	25/500	500	332
DX 15 850 R	25/400	400	330
DX 15 916 R	100/2800	2800	330
DX 15 920 R	100/2400	2400	330
DX 15 925 R	75/1500	1500	330
DX 15 932 R	50/800	800	330
DX 16			
DX 16 216 R	100/2800	2800	328
DX 16 220 R	100/2400	2400	328
DX 16 220 X	100/2400	2400	331
DX 16 225 R	75/1500	1500	328
DX 16 225 X	75/1500	1500	331
DX 16 232 R	50/800	800	328
DX 16 232 X	50/800	800	331
DX 16 240 R	25/500	500	328
DX 16 240 X	25/500	500	331
DX 16 250 R	25/400	400	328
DX 16 316 R	100/2800	2800	328
DX 16 320 R	100/2400	2400	328
DX 16 325 R	75/1500	1500	328
DX 16 332 R	50/800	800	328
DX 20			
DX 20 016 R	100/6400	6400	334
DX 20 020 R	100/5200	5200	334
DX 20 025 R	75/3300	3300	334
DX 20 032 R	50/1800	1800	334
DX 20 040 R	25/500	500	334
DX 20 050 R	25/400	400	334
DX 20 063 R	20/240	240	334
DX 20 116 R	100/6400	6400	334
DX 20 120 R	100/5200	5200	334
DX 20 125 R	75/3300	3300	334
DX 20 132 R	50/1800	1800	334
DX 20 140 R	25/500	500	334
DX 20 150 R	25/400	400	334
DX 20 163 R	20/240	240	334
DX 20 416 R	100/6400	6400	334
DX 20 420 R	100/5200	5200	334
DX 20 425 R	75/3300	3300	334
DX 20 432 R	50/1800	1800	334
DX 20 440 R	25/500	500	334
DX 20 450 R	25/400	400	334
DX 20 463 R	20/240	240	334
DX 20 516 R	100/6400	6400	334
DX 20 520 R	100/5200	5200	334
DX 20 525 R	75/3300	3300	334

Code	Quantity		Page
	Pack/carton	Pallet	
DX 20 532 R	50/1800	1800	334
DX 20 540 R	25/500	500	334
DX 20 550 R	25/400	400	334
DX 20 563 R	20/240	240	334
DX 22			
DX 22 016 R	100/2800	2800	262
DX 22 016 R	100/2800	2800	335
DX 22 020 R	100/2400	2400	262
DX 22 020 R	100/2400	2400	335
DX 22 025 R	75/1500	1500	262
DX 22 025 R	75/1500	1500	335
DX 22 032 R	50/800	800	262
DX 22 032 R	50/800	800	335
DX 22 040 R	25/500	500	262
DX 22 040 R	25/500	500	335
DX 22 050 R	25/400	400	262
DX 22 050 R	25/400	400	335
DX 22 063 R	20/240	240	262
DX 22 063 R	20/240	240	335
DX 22 116 R	100/2800	2800	262
DX 22 116 R	100/2800	2800	335
DX 22 120 R	100/2400	2400	262
DX 22 120 R	100/2400	2400	335
DX 22 125 R	75/1500	1500	262
DX 22 125 R	75/1500	1500	335
DX 22 132 R	50/800	800	262
DX 22 132 R	50/800	800	335
DX 22 140 R	25/500	500	262
DX 22 140 R	25/500	500	335
DX 22 150 R	25/400	400	262
DX 22 150 R	25/400	400	335
DX 22 163 R	20/240	240	262
DX 22 163 R	20/240	240	335
DX 23			
DX 23 016 R	100/2800	2800	335
DX 23 020 R	100/2400	2400	335
DX 23 025 R	75/1500	1500	335
DX 23 032 R	50/800	800	335
DX 23 040 R	25/500	500	335
DX 23 050 R	25/400	400	335
DX 23 063 R	20/240	240	335
DX 23 116 R	100/2800	2800	335
DX 23 120 R	100/2400	2400	335
DX 23 125 R	75/1500	1500	335
DX 23 132 R	50/800	800	335
DX 23 140 R	25/500	500	335
DX 23 150 R	25/400	400	335
DX 23 163 R	20/240	240	335
DX 23 216 R	100/2800	2800	336
DX 23 220 R	100/5200	5200	336
DX 23 225 R	75/3300	3300	336
DX 23 232 R	50/800	800	336
DX 23 240 R	25/500	500	336
DX 23 250 R	25/400	400	336
DX 23 263 R	20/240	240	336
DX 23 316 R	100/2800	2800	336
DX 23 320 R	100/5200	5200	336
DX 23 325 R	75/3300	3300	336
DX 23 332 R	50/800	800	336
DX 23 340 R	25/500	500	336
DX 23 350 R	25/400	400	336
DX 23 363 R	20/240	240	336

Code	Quantity		Page
	Pack/carton	Pallet	
DX 24			
DX 24 216 R	100/5600	5600	333
DX 24 220 R	100/4400	4400	333
DX 24 225 R	75/2700	2700	333
DX 24 232 R	50/1600	1600	333
DX 24 240 R	25/500	500	333
DX 24 250 R	25/400	400	333
DX 24 263 R	20/240	240	333
DX 24 816	74/2220	2220	314
DX 24 820	48/1344	1344	314
DX 24 825	48/864	864	314
DX 24 832	38/532	532	314
DX 24 840	14/350	350	314

DX 25			
DX 25 116	111/3330	3330	314
DX 25 116 W	111/3330	3330	315
DX 25 120	57/2223	2223	314
DX 25 120 W	57/2223	2223	315
DX 25 125	57/1311	1311	314
DX 25 125 W	57/1311	1311	315
DX 25 132	30/780	780	314
DX 25 132 W	30/780	780	315
DX 25 140	30/540	540	314
DX 25 140 W	30/540	540	315
DX 25 150	15/360	360	314
DX 25 216	74/2220	2220	317
DX 25 220	48/1344	1344	317
DX 25 225	48/864	864	317
DX 25 232	38/532	532	317
DX 25 316	111/3330	3330	317
DX 25 320	57/2223	2223	317
DX 25 325	57/1311	1311	317
DX 25 332	30/780	780	317
DX 25 340	30/540	540	317
DX 25 350	15/360	360	317
DX 25 363	9/180	180	317
DX 25 716	57/3192	3192	317
DX 25 720	57/2223	2223	317
DX 25 725	57/1311	1311	317
DX 25 732	30/780	780	317
DX 25 740	30/540	540	317
DX 25 750	15/360	360	317
DX 25 763	9/180	180	317

DX 26			
DX 26 216	60/4620	4620	318
DX 26 220	46/3542	3542	318
DX 26 225	48/2640	2640	318
DX 26 232	36/1980	1980	318
DX 26 240	30/1080	1080	318
DX 26 250	18/648	648	318
DX 26 263	12/420	420	318
DX 26 316	87/1827	1827	318
DX 26 320	69/1449	1449	318
DX 26 325	60/840	840	318
DX 26 332	36/504	504	318
DX 26 716 W	87/1827	1827	315
DX 26 720 W	69/1449	1449	315
DX 26 725 W	60/840	840	315
DX 26 732 W	36/504	504	315

DX 27			
DX 27 616	74/2220	2220	316
DX 27 620	48/1344	1344	316
DX 27 625	48/864	864	316

Code	Quantity		Page
	Pack/carton	Pallet	
DX 27 632	38/532	532	316
DX 27 640	14/350	350	316
DX 27 650	10/240	240	316
DX 27 663	6/120	120	316
DX 27 716	75/3150	3150	316
DX 27 720	51/2142	2142	316
DX 27 725	51/1224	1224	316
DX 27 732	30/780	780	316
DX 27 740	21/525	525	316
DX 27 750	15/360	360	316
DX 27 763	9/180	180	316

DX 30			
DX 30 008	30/2070	2070	342
DX 30 010	30/1800	1800	342
DX 30 012	30/1800	1800	342
DX 30 014	30/1440	1440	342
DX 30 016	30/1080	1080	342
DX 30 020	30/1080	1080	342
DX 30 022	30/720	720	342
DX 30 025	30/600	600	342
DX 30 028	30/480	480	342
DX 30 032	30/480	480	342
DX 30 035	30/480	480	342
DX 30 040	30/360	360	342
DX 30 050	30/180	180	342
DX 30 060	30/120	120	342
DX 30 108	30/2070	2070	342
DX 30 110	30/1800	1800	342
DX 30 112	30/1800	1800	342
DX 30 114	30/1440	1440	342
DX 30 116	30/1080	1080	342
DX 30 120	30/1080	1080	342
DX 30 122	30/720	720	342
DX 30 125	30/600	600	342
DX 30 128	30/480	480	342
DX 30 132	30/480	480	342
DX 30 135	30/480	480	342
DX 30 140	30/360	360	342
DX 30 150	30/180	180	342
DX 30 160	30/120	120	342
DX 30 812	30/1800	1800	346
DX 30 816	30/1080	1080	346
DX 30 820	30/1080	1080	346
DX 30 825	30/600	600	346

DX 40			
DX 40 016	30/300	18000	319
DX 40 016	30/300	18000	378
DX 40 020	30/450	14400	319
DX 40 020	30/450	14400	378
DX 40 025	20/240	12000	319
DX 40 025	20/240	12000	378
DX 40 032	10/100	5000	319
DX 40 032	10/100	5000	378
DX 40 040	5/25	3000	319
DX 40 040	5/25	3000	378
DX 40 050	15	1800	319
DX 40 050	15	1800	378
DX 40 063	8	400	319
DX 40 063	8	400	378
DX 40 116	30/300	18000	319
DX 40 116	30/300	18000	378
DX 40 120	30/300	9600	319
DX 40 120	30/300	9600	378
DX 40 125	20/100	5400	319

Code	Quantity		Page
	Pack/carton	Pallet	
DX 40 125	20/100	5400	378
DX 40 132	10/50	3000	319
DX 40 132	10/50	3000	378
DX 40 140	5/25	1250	319
DX 40 140	5/25	1250	378
DX 40 150	10	640	319
DX 40 150	10	640	378
DX 40 163	1	168	319
DX 40 163	1	168	378
DX 40 216	30/120	6000	319
DX 40 216	30/120	6000	378
DX 40 220	30/120	2400	319
DX 40 220	30/120	2400	378
DX 40 225	20/60	3840	319
DX 40 225	20/60	3840	378
DX 40 232	10/30	1200	319
DX 40 232	10/30	1200	378
DX 40 316	30/180	18000	319
DX 40 316	30/180	18000	378
DX 40 320	30/120	12000	319
DX 40 320	30/120	12000	378
DX 40 325	20/60	3000	319
DX 40 325	20/60	3000	378
DX 40 332	10/40	2000	319
DX 40 332	10/40	2000	378

DX 43			
DX 43 016	10/300	6000	320
DX 43 016	10/300	6000	379
DX 43 020	10/240	14400	320
DX 43 020	10/240	14400	379
DX 43 025	5/150	9600	320
DX 43 025	5/150	9600	379
DX 43 032	5/120	6000	320
DX 43 032	5/120	6000	379
DX 43 040	5/90	1800	320
DX 43 040	5/90	1800	379
DX 43 050	3/54	1080	320
DX 43 050	3/54	1080	379
DX 43 116	10/100	6400	320
DX 43 116	10/100	6400	379
DX 43 120	10/80	5120	320
DX 43 120	10/80	5120	379
DX 43 125	5/50	3200	320
DX 43 125	5/50	3200	379
DX 43 132	5/30	1920	320
DX 43 132	5/30	1920	379
DX 43 140	5/15	960	320
DX 43 140	5/15	960	379
DX 43 150	8	512	320
DX 43 150	8	512	379
DX 43 216	10/360	21600	320
DX 43 216	10/360	21600	379
DX 43 220	10/300	18000	320
DX 43 220	10/300	18000	379
DX 43 225	5/180	10800	320
DX 43 225	5/180	10800	379
DX 43 232	5/150	7500	320
DX 43 232	5/150	7500	379
DX 43 240	5/30	3600	320
DX 43 240	5/30	3600	379
DX 43 250	5/15	1800	320
DX 43 250	5/15	1800	379
DX 43 316	10/450	9000	320
DX 43 316	10/450	9000	345
DX 43 316	10/450	9000	379

Quick Reference

Code	Quantity		Page
	Pack/carton	Pallet	
DX 43 316	10/450	9000	384
DX 43 320	10/300	18000	320
DX 43 320	10/300	18000	345
DX 43 320	10/300	18000	379
DX 43 320	10/300	18000	384
DX 43 325	5/210	12600	320
DX 43 325	5/210	12600	345
DX 43 325	5/210	12600	379
DX 43 325	5/210	12600	384
DX 43 332	5/120	7200	320
DX 43 332	5/120	7200	345
DX 43 332	5/120	7200	379
DX 43 332	5/120	7200	384
DX 43 340	5/25	1250	320
DX 43 340	5/25	1250	345
DX 43 340	5/25	1250	379
DX 43 340	5/25	1250	384
DX 43 350	5/20	800	320
DX 43 350	5/20	800	345
DX 43 350	5/20	800	379
DX 43 350	5/20	800	384
DX 43 416	10/360	7200	321
DX 43 416	10/360	7200	345
DX 43 416	10/360	7200	380
DX 43 416	10/360	7200	384
DX 43 420	10/240	14400	321
DX 43 420	10/240	14400	345
DX 43 420	10/240	14400	380
DX 43 420	10/240	14400	384
DX 43 425	5/150	9000	321
DX 43 425	5/150	9000	345
DX 43 425	5/150	9000	380
DX 43 425	5/150	9000	384
DX 43 432	5/40	4800	321
DX 43 432	5/40	4800	345
DX 43 432	5/40	4800	380
DX 43 432	5/40	4800	384
DX 43 440	5/20	2400	321
DX 43 440	5/20	2400	345
DX 43 440	5/20	2400	380
DX 43 440	5/20	2400	384
DX 43 516	60	2400	321
DX 43 516	60	2400	380
DX 43 520	40	1600	321
DX 43 520	40	1600	380
DX 43 525	20	800	321
DX 43 525	20	800	380
DX 43 532	20	400	321
DX 43 532	20	400	380
DX 43 540	12	216	321
DX 43 540	12	216	380
DX 43 550	9	162	321
DX 43 550	9	162	380
DX 45			
DX 45 003	3/15	1800	323
DX 45 004	5/60	480	323
DX 45 007	5/60	480	323
DX 45 010	1/16	288	323
DX 47			
DX 47 000	50/450	18000	324
DX 47 001	20/60	6600	324
DX 47 212	10/450	4500	323
DX 47 216	10/450	4500	323
DX 47 220	10/390	3900	323

Code	Quantity		Page
	Pack/carton	Pallet	
DX 47 503	10/300	6000	324
DX 47 506	10/300	6000	324
DX 47 509	10/300	6000	324
DX 47 616	10/390	7800	323
DX 47 620	10/360	7200	323
DX 47 625	10/300	6000	323
DX 51			
DX 51 120	100/1500	30000	373
DX 51 232	100/800	43200	373
DX 51 263	100/400	24000	373
DX 51 306	200/600	76800	373
DX 51 308	200/600	42000	373
DX 51 316	1/10	900	322
DX 51 316	1/10	900	381
DX 51 320	1/10	800	322
DX 51 320	1/10	800	381
DX 51 325	1/5	500	322
DX 51 325	1/5	500	381
DX 51 416	1/10	900	322
DX 51 416	1/10	900	381
DX 51 420	1/10	500	322
DX 51 420	1/10	500	381
DX 51 425	1/5	500	322
DX 51 425	1/5	500	381
DX 51 432	1/5	400	322
DX 51 432	1/5	400	381
DX 51 440	1	200	322
DX 51 440	1	200	381
DX 51 450	1	200	322
DX 51 450	1	200	381
DX 51 600	1/5	200	322
DX 51 600	1/5	200	381
DX 52			
DX 52 016	50/200	10000	336
DX 52 020	50/300	24000	336
DX 52 025	50/200	16000	336
DX 52 032	25/150	9600	336
DX 52 040	10/40	2000	336
DX 52 050	10/40	2000	336
DX 52 063	25	1250	336
DX 52 116	100/500	55000	337
DX 52 120	100/400	44000	337
DX 52 125	50/250	27500	337
DX 52 132	25/125	13750	337
DX 52 140	25/100	11000	337
DX 52 150	25/75	8250	337
DX 52 163	50	5500	337
DX 52 205	1/10	3600	338
DX 52 210	1/10	360	338
DX 52 215	1/10	360	338
DX 52 220	1/10	320	338
DX 52 225	1/10	360	338
DX 52 299	10/200	20000	338
DX 52 305	1/40	720	338
DX 52 310	1/25	400	338
DX 52 315	1/15	240	338
DX 52 320	1/15	240	338
DX 52 325	1/15	270	338
DX 52 399	10/200	20000	338
DX 54			
DX 54 008	20/180	19800	343
DX 54 008	20/180	19800	381
DX 54 010	20/160	17600	343

Code	Quantity		Page
	Pack/carton	Pallet	
DX 54 010	20/160	17600	381
DX 54 012	10/100	11000	343
DX 54 012	10/100	11000	381
DX 54 016	10/150	7500	343
DX 54 016	10/150	7500	381
DX 54 020	10/100	10000	343
DX 54 020	10/100	10000	381
DX 54 022	10/100	5000	343
DX 54 022	10/100	5000	381
DX 54 025	5/60	3000	343
DX 54 025	5/60	3000	381
DX 54 028	5/40	2000	343
DX 54 028	5/40	2000	381
DX 54 032	5/30	1500	343
DX 54 032	5/30	1500	381
DX 54 040	25	1250	343
DX 54 040	25	1250	381
DX 54 050	15	750	343
DX 54 050	15	750	381
DX 54 108	20/180	19800	343
DX 54 108	20/180	19800	381
DX 54 110	20/160	17600	343
DX 54 110	20/160	17600	381
DX 54 112	10/100	11000	343
DX 54 112	10/100	11000	381
DX 54 116	10/150	7500	343
DX 54 116	10/150	7500	381
DX 54 120	10/100	5000	343
DX 54 120	10/100	5000	381
DX 54 122	10/100	5000	343
DX 54 122	10/100	5000	381
DX 54 125	5/60	3000	343
DX 54 125	5/60	3000	381
DX 54 128	5/40	2000	343
DX 54 128	5/40	2000	381
DX 54 132	5/30	1500	343
DX 54 132	5/30	1500	381
DX 54 140	25	1250	343
DX 54 140	25	1250	381
DX 54 150	15	750	343
DX 54 150	15	750	381
DX 54 208	20/180	11880	343
DX 54 208	20/180	11880	382
DX 54 210	20/160	17600	343
DX 54 210	20/160	17600	382
DX 54 212	10/100	11000	343
DX 54 212	10/100	11000	382
DX 54 214	10/150	7500	343
DX 54 214	10/150	7500	382
DX 54 216	10/150	18000	343
DX 54 216	10/150	18000	382
DX 54 220	10/100	12000	343
DX 54 220	10/100	12000	382
DX 54 222	10/100	5000	343
DX 54 222	10/100	5000	382
DX 54 225	5/60	7200	343
DX 54 225	5/60	7200	382
DX 54 228	5/40	4800	343
DX 54 228	5/40	4800	382
DX 54 232	5/30	3600	343
DX 54 232	5/30	3600	382
DX 54 235	5/30	1500	343
DX 54 235	5/30	1500	382
DX 54 240	25	3000	343
DX 54 240	25	3000	382

Code	Quantity		Page
	Pack/carton	Pallet	
DX 54 250	15	1800	343
DX 54 250	15	1800	382
DX 54 308	20/180	19800	343
DX 54 308	20/180	19800	382
DX 54 310	20/160	17600	343
DX 54 310	20/160	17600	382
DX 54 312	10/100	13200	343
DX 54 312	10/100	13200	382
DX 54 314	10/150	7500	343
DX 54 314	10/150	7500	382
DX 54 316	10/150	7500	343
DX 54 316	10/150	7500	382
DX 54 320	10/100	5000	343
DX 54 320	10/100	5000	382
DX 54 322	10/100	3000	343
DX 54 322	10/100	3000	382
DX 54 325	5/60	3000	343
DX 54 325	5/60	3000	382
DX 54 328	5/40	2000	343
DX 54 328	5/40	2000	382
DX 54 332	5/30	1500	343
DX 54 332	5/30	1500	382
DX 54 335	5/30	1500	343
DX 54 335	5/30	1500	382
DX 54 340	25	1250	343
DX 54 340	25	1250	382
DX 54 350	15	750	343
DX 54 350	15	750	382
DX 54 408	20/180	19800	344
DX 54 408	20/180	19800	382
DX 54 410	20/160	17600	344
DX 54 410	20/160	17600	382
DX 54 411	20/160	17600	344
DX 54 411	20/160	17600	382
DX 54 412	10/100	11000	344
DX 54 412	10/100	11000	382
DX 54 413	10/100	11000	344
DX 54 413	10/100	11000	382
DX 54 414	10/150	7500	344
DX 54 414	10/150	7500	382
DX 54 416	10/150	18000	344
DX 54 416	10/150	18000	382
DX 54 417	10/150	6000	344
DX 54 417	10/150	6000	382
DX 54 420	10/100	5000	344
DX 54 420	10/100	5000	382
DX 54 422	10/100	4000	344
DX 54 422	10/100	4000	382
DX 54 425	5/60	3000	344
DX 54 425	5/60	3000	382
DX 54 428	5/40	2000	344
DX 54 428	5/40	2000	382
DX 54 432	5/30	1500	344
DX 54 432	5/30	1500	382
DX 54 435	5/30	1500	344
DX 54 435	5/30	1500	382
DX 54 508	20/180	19800	344
DX 54 508	20/180	19800	382
DX 54 510	20/160	17600	344
DX 54 510	20/160	17600	382
DX 54 511	20/160	17600	344
DX 54 511	20/160	17600	382
DX 54 512	10/100	6600	344
DX 54 512	10/100	6600	382
DX 54 513	10/100	11000	344

Code	Quantity		Page
	Pack/carton	Pallet	
DX 54 513	10/100	11000	382
DX 54 514	10/150	7500	344
DX 54 514	10/150	7500	382
DX 54 516	10/150	7500	344
DX 54 516	10/150	7500	382
DX 54 517	10/150	4500	344
DX 54 517	10/150	4500	382
DX 54 520	10/100	5000	344
DX 54 520	10/100	5000	382
DX 54 522	10/100	4000	344
DX 54 522	10/100	4000	382
DX 54 525	5/60	3000	344
DX 54 525	5/60	3000	382
DX 54 528	5/40	2000	344
DX 54 528	5/40	2000	382
DX 54 532	5/30	1500	344
DX 54 532	5/30	1500	382
DX 54 535	5/30	1500	344
DX 54 535	5/30	1500	382
DX 56			
DX 56 008	20/160	17600	344
DX 56 008	20/160	17600	383
DX 56 010	10/170	8500	344
DX 56 010	10/170	8500	383
DX 56 012	10/150	7500	344
DX 56 012	10/150	7500	383
DX 56 014	10/130	6500	344
DX 56 014	10/130	6500	383
DX 56 016	10/110	4400	344
DX 56 016	10/110	4400	383
DX 56 022	10/50	2500	344
DX 56 022	10/50	2500	383
DX 56 025	10/50	2500	344
DX 56 025	10/50	2500	383
DX 56 028	10/40	2000	344
DX 56 028	10/40	2000	383
DX 56 040	15	750	344
DX 56 040	15	750	383
DX 56 050	12	600	344
DX 56 050	12	600	383
DX 56 208	20/160	17600	344
DX 56 208	20/160	17600	383
DX 56 210	10/170	8500	344
DX 56 210	10/170	8500	383
DX 56 212	10/150	7500	344
DX 56 212	10/150	7500	383
DX 56 214	10/130	3900	344
DX 56 214	10/130	3900	383
DX 56 216	10/110	5500	344
DX 56 216	10/110	5500	383
DX 56 222	10/50	2500	344
DX 56 222	10/50	2500	383
DX 56 225	10/50	2500	344
DX 56 225	10/50	2500	383
DX 56 228	10/40	2000	344
DX 56 228	10/40	2000	383
DX 56 232	3/18	900	344
DX 56 232	3/18	900	383
DX 56 235	3/18	900	344
DX 56 235	3/18	900	383
DX 56 240	15	750	344
DX 56 240	15	750	383
DX 56 250	12	600	344
DX 56 250	12	600	383
DX 56 408	20/160	17600	345

Code	Quantity		Page
	Pack/carton	Pallet	
DX 56 408	20/160	17600	383
DX 56 410	10/170	8500	345
DX 56 410	10/170	8500	383
DX 56 411	10/150	7500	345
DX 56 411	10/150	7500	383
DX 56 412	10/150	7500	345
DX 56 412	10/150	7500	383
DX 56 413	10/150	7500	345
DX 56 413	10/150	7500	383
DX 56 414	10/130	6500	345
DX 56 414	10/130	6500	383
DX 56 415	10/110	5500	345
DX 56 415	10/110	5500	383
DX 56 416	10/110	4400	345
DX 56 416	10/110	4400	383
DX 56 417	10/110	4400	345
DX 56 417	10/110	4400	383
DX 56 422	10/50	2500	345
DX 56 422	10/50	2500	383
DX 56 423	10/50	2500	383
DX 56 425	10/50	2500	345
DX 56 425	10/50	2500	383
DX 56 428	10/40	2000	345
DX 56 428	10/40	2000	383
DX 56 432	3/18	720	345
DX 56 432	3/18	720	383
DX 56 435	3/18	900	345
DX 56 435	3/18	900	383
DX 56 440	15	750	345
DX 56 440	15	750	383
DX 56 450	12	600	345
DX 56 450	12	600	383
DX 59			
DX 59 230	1/6	108	352
DX 59 231	1/6	96	352
DX 59 240	1/6	300	352
DX 59 241	1/4	48	352
DX 59 242	1/4	162	352
DX 59 401	1/60	60	349
DX 59 402	1/60	60	349
DX 59 410	1/5	240	349
DX 59 411	1/5	350	349
DX 59 430	1/5	180	349
DX 59 431	1/5	120	349
DX 59 440	1/10	1600	349
DX 59 450	1/50	5500	349
DX 59 450	1/50	5500	350
DX 59 451	1/10	1440	349
DX 59 452	1/50	8700	351
DX 59 452	1/50	8700	351
DX 59 453	1/20	2200	351
DX 59 453	1/20	2200	351
DX 59 501	1	45	352
DX 59 502	1	18	352
DX 59 511	1/6	108	352
DX 59 520	1/6	108	352
DX 59 551	1/10	1100	352
DX 59 650	1/50	5500	352
DX 59 701	1/36	36	350
DX 59 702	1/36	36	350
DX 59 710	1/5	140	350
DX 59 711	1/5	100	350
DX 59 730	1/5	140	350
DX 59 731	1/5	100	350

Quick Reference

Code	Quantity		Page
	Pack/carton	Pallet	
DX 59 740	1/10	500	350
DX 59 751	1/10	3000	350
DX 59 801	1/18	18	351
DX 59 802	1/18	24	351
DX 59 810	1/5	30	351
DX 59 811	1/5	30	351
DX 59 830	1/5	30	351
DX 59 831	1/5	30	351
DX 59 840	1/10	240	351
DX 59 851	1/10	1600	351
DX 59 901	1/8	8	351
DX 59 902	1/8	8	351
DX 59 910	1/5	100	351
DX 59 911	1/5	20	351
DX 59 930	1/5	60	351
DX 59 931	1/5	60	351
DX 59 940	1/10	80	351
DX 59 951	1/10	1600	351

GW 10			
Code	Quantity		Page
	Pack/carton	Pallet	
GW 10 001	12/96	9216	752
GW 10 001 AB	12/96	9216	935
GW 10 002	12/24	6552	752
GW 10 003	12/24	7728	752
GW 10 004	12/48	7488	752
GW 10 004 AB	12/48	3744	936
GW 10 005	12/24	5904	752
GW 10 006	1/12	2340	752
GW 10 007	12/24	4416	752
GW 10 007 AB	12/24	3744	936
GW 10 021	12/24	8448	752
GW 10 022	6/24	6336	752
GW 10 031	6/24	3744	752
GW 10 031 F	6/24	1152	755
GW 10 032	6/24	3744	752
GW 10 032 F	6/24	2016	755
GW 10 033	6/24	1872	752
GW 10 033 F	6/24	2304	755
GW 10 034	6/24	1872	752
GW 10 034 F	6/24	2304	755
GW 10 035	6/24	1872	752
GW 10 035 F	6/24	1728	755
GW 10 039	1/6	2112	764
GW 10 041	4/12	936	752
GW 10 042	4/12	936	752
GW 10 043	4/12	936	752
GW 10 051	12/96	9216	753
GW 10 051 AB	12/96	4608	936
GW 10 052	12/24	5760	753
GW 10 053	12/24	7728	753
GW 10 054	1/12	2340	753
GW 10 061	6/24	8448	753
GW 10 071	6/24	3744	753
GW 10 071 F	6/24	1728	755
GW 10 072	6/24	3744	753
GW 10 072 F	6/24	2016	755
GW 10 073	6/24	1872	753
GW 10 073 F	6/24	1728	755
GW 10 078 F	6/24	1152	756
GW 10 081	4/12	936	753
GW 10 082	4/12	936	753
GW 10 083	4/12	936	753
GW 10 091	12/48	7488	753
GW 10 091 AB	12/48	3744	936
GW 10 092	12/24	7728	753
GW 10 093	12/24	3312	753

Code	Quantity		Page
	Pack/carton	Pallet	
GW 10 101	6/12	3312	753
GW 10 101 F	6/12	1620	755
GW 10 102	6/12	2208	753
GW 10 102 F	6/12	1620	755
GW 10 103	6/12	2208	753
GW 10 103 F	6/12	1620	755
GW 10 111	4/12	936	753
GW 10 112	4/12	936	753
GW 10 113	4/12	936	753
GW 10 121	12/24	5400	753
GW 10 122	12/24	5904	753
GW 10 122 AB	12/24	2952	936
GW 10 123	6/24	1536	753
GW 10 131	12/96	9216	754
GW 10 131 AB	12/96	4608	936
GW 10 132	12/24	6720	754
GW 10 133	12/24	6720	754
GW 10 134	12/24	4416	754
GW 10 135	12/24	4416	754
GW 10 136	1/12	3744	754
GW 10 136 AB	1/12	1872	936
GW 10 137	12/24	3744	754
GW 10 137 AB	12/24	2880	936
GW 10 138	12/24	3240	754
GW 10 139	12/24	3240	754
GW 10 140	12/24	4920	754
GW 10 140 AB	12/24	5904	936
GW 10 141	12/24	5400	754
GW 10 142	12/24	3240	754
GW 10 143	12/24	3240	754
GW 10 144	12/24	3240	754
GW 10 145	1/12	2340	754
GW 10 151	12/24	7728	754
GW 10 152	12/24	7728	754
GW 10 153	12/24	6720	754
GW 10 159 F	6/24	1728	756
GW 10 160 F	6/24	1152	756
GW 10 161	6/24	8448	754
GW 10 162	6/24	2880	754
GW 10 171	6/24	3744	754
GW 10 171 F	6/24	1344	755
GW 10 172	6/24	1872	754
GW 10 172 F	6/24	3456	755
GW 10 173	6/24	3744	754
GW 10 173 F	6/24	1728	755
GW 10 181	4/12	936	754
GW 10 182	4/12	936	754
GW 10 183	4/12	936	754
GW 10 191	6/24	2304	754
GW 10 192	4/16	1152	754
GW 10 194	6/48	1200	762
GW 10 195	10/200	18000	762
GW 10 195 AB	10/200	18000	937
GW 10 196	1/48	3072	762
GW 10 197	4/48	14976	762
GW 10 198	1/48	4608	762
GW 10 199	1/48	2304	762
GW 10 201	12/96	7200	765
GW 10 201 AB	12/96	2400	938
GW 10 203	12/96	7200	765
GW 10 203 AB	12/96	7200	938
GW 10 204	6/48	3600	505
GW 10 204	6/48	3600	765
GW 10 204 AB	6/48	3600	938
GW 10 205	6/48	3600	765

Code	Quantity		Page
	Pack/carton	Pallet	
GW 10 208	6/24	1872	765
GW 10 209	4/12	936	765
GW 10 213	12/24	7728	766
GW 10 213	12/24	7728	801
GW 10 213	12/24	7728	833
GW 10 213	12/24	7728	867
GW 10 213	12/24	7728	901
GW 10 213 AB	12/24	2952	938
GW 10 214	6/12	3444	766
GW 10 214	6/12	3444	801
GW 10 214	6/12	3444	833
GW 10 214	6/12	3444	867
GW 10 214	6/12	3444	901
GW 10 214 AB	6/12	3444	938
GW 10 223	12/24	2952	766
GW 10 223	12/24	2952	801
GW 10 223	12/24	2952	833
GW 10 223	12/24	2952	867
GW 10 223	12/24	2952	901
GW 10 223 AB	12/24	1476	938
GW 10 224	6/12	1476	766
GW 10 224	6/12	1476	801
GW 10 224	6/12	1476	833
GW 10 224	6/12	1476	867
GW 10 224	6/12	1476	901
GW 10 224 AB	6/12	1476	938
GW 10 233	12/24	7728	766
GW 10 233	12/24	7728	867
GW 10 233	12/24	7728	901
GW 10 234	6/12	1656	766
GW 10 234	6/12	1656	867
GW 10 234	6/12	1656	901
GW 10 241	6/48	3600	766
GW 10 241 AB	6/48	3600	939
GW 10 241 F	6/12	2952	767
GW 10 242	6/48	2400	766
GW 10 246	1/24	2304	768
GW 10 247	6/48	3600	768
GW 10 247 AB	6/48	1200	940
GW 10 247 F	6/12	2952	768
GW 10 248	6/12	1476	768
GW 10 251	6/12	2460	767
GW 10 251	6/12	2460	802
GW 10 251	6/12	2460	834
GW 10 251	6/12	2460	868
GW 10 251	6/12	2460	902
GW 10 251 AB	6/12	2952	939
GW 10 251 F	6/12	1620	767
GW 10 251 F	6/12	1620	868
GW 10 251 F	6/12	1620	902
GW 10 257 F	6/12	1620	768
GW 10 257 F	6/12	1620	869
GW 10 257 F	6/12	1620	903
GW 10 258	6/12	1620	768
GW 10 258	6/12	1620	869
GW 10 258	6/12	1620	903
GW 10 260	10/100	19500	769
GW 10 260	10/100	19500	870
GW 10 260	10/100	19500	904
GW 10 281	1/24	2304	769
GW 10 281 AB	1/24	3072	940
GW 10 282	1/48	4608	769
GW 10 282 AB	1/48	3072	940
GW 10 286	12/48	3744	770
GW 10 287	12/48	7488	770

Code	Quantity		Page
	Pack/carton	Pallet	
GW 10 288	12/48	7488	770
GW 10 291	1/24	2304	769
GW 10 291	1/24	2304	804
GW 10 291	1/24	2304	836
GW 10 291	1/24	2304	870
GW 10 291	1/24	2304	904
GW 10 291 AB	1/24	1536	940
GW 10 296	6/48	3600	770
GW 10 297	6/48	1200	770
GW 10 298	6/48	3600	770
GW 10 299	12/240	5760	771
GW 10 301	6/48	1200	771
GW 10 306	6/48	1200	771
GW 10 307	6/48	1200	771
GW 10 310	10/40	3000	771
GW 10 311	1/6	1170	772
GW 10 312	1/4	800	772
GW 10 321	1/4	352	772
GW 10 322	1/2	246	772
GW 10 331	1/2	312	772
GW 10 331 AB	1/2	156	941
GW 10 341	6/12	3240	767
GW 10 341 AB	6/12	1476	939
GW 10 346	6/48	2784	770
GW 10 351	6/12	1476	767
GW 10 351	6/12	1476	802
GW 10 351	6/12	1476	834
GW 10 351	6/12	1476	868
GW 10 351	6/12	1476	902
GW 10 351 AB	6/12	1476	939
GW 10 361	1/48	4608	772
GW 10 361 AB	1/48	3072	941
GW 10 362	1/24	5400	772
GW 10 363	1/24	3240	772
GW 10 367	1/24	1536	773
GW 10 371	1/48	4608	773
GW 10 372	1/24	3240	773
GW 10 373	1/24	3240	773
GW 10 377	1/24	2304	773
GW 10 381	1/24	1536	773
GW 10 382	1/24	2880	773
GW 10 383	1/24	2880	773
GW 10 383 AB	1/24	1536	941
GW 10 386	1/24	3744	773
GW 10 387	1/24	1872	773
GW 10 391	6/48	1440	771
GW 10 392	6/48	2400	771
GW 10 401	1/24	2304	774
GW 10 401 AB	1/24	1536	941
GW 10 406	1/24	2976	774
GW 10 409	1/24	1536	774
GW 10 421	1/24	2304	774
GW 10 422	1/24	1536	774
GW 10 423	1/24	2304	774
GW 10 423 AB	1/24	1536	942
GW 10 424	1/24	2880	774
GW 10 424 AB	1/24	1536	942
GW 10 431	1/48	4608	775
GW 10 431 AB	1/48	4608	942
GW 10 433	4/100	3000	775
GW 10 434	1/24	1536	775
GW 10 435	1/24	1536	775
GW 10 436	1/24	1536	775
GW 10 437	1/24	1536	775
GW 10 438	1/48	3072	775

Code	Quantity		Page
	Pack/carton	Pallet	
GW 10 447	1/10	1800	777
GW 10 449	1/10	1800	777
GW 10 451	12/24	3240	776
GW 10 451 AB	12/24	2952	942
GW 10 452	12/24	3240	776
GW 10 453	1/24	2976	776
GW 10 454	1/24	3240	776
GW 10 458	1/24	1536	776
GW 10 459	1/24	1728	776
GW 10 461	1/12	3168	777
GW 10 462	1/12	3168	777
GW 10 463	1/12	3168	777
GW 10 466	1/12	3168	777
GW 10 467	1/12	2640	777
GW 10 468	1/12	4224	777
GW 10 482	1/6	1104	777
GW 10 483	1/6	1104	777
GW 10 485	1/6	1104	777
GW 10 486	1/6	1104	777
GW 10 488	1/6	1104	777
GW 10 489	1/6	1104	777
GW 10 491	1/12	4224	777
GW 10 492	1/12	2340	778
GW 10 501	20/240	86400	758
GW 10 501	20/240	86400	793
GW 10 501	20/240	86400	825
GW 10 501	20/240	86400	859
GW 10 501	20/240	86400	893
GW 10 501 A	24	9600	759
GW 10 501 A	24	9600	794
GW 10 501 A	24	9600	826
GW 10 501 A	24	9600	860
GW 10 501 A	24	9600	894
GW 10 501 A	24	9600	1091
GW 10 501 A	24	9600	1118
GW 10 502	20/240	86400	758
GW 10 502	20/240	86400	793
GW 10 502	20/240	86400	825
GW 10 502	20/240	86400	859
GW 10 502	20/240	86400	893
GW 10 502 A	24	9600	759
GW 10 502 A	24	9600	794
GW 10 502 A	24	9600	826
GW 10 502 A	24	9600	860
GW 10 502 A	24	9600	894
GW 10 502 A	24	9600	1091
GW 10 502 A	24	9600	1118
GW 10 503	20/240	86400	758
GW 10 503	20/240	86400	793
GW 10 503	20/240	86400	825
GW 10 503	20/240	86400	859
GW 10 503	20/240	86400	893
GW 10 503 A	24	9600	759
GW 10 503 A	24	9600	794
GW 10 503 A	24	9600	826
GW 10 503 A	24	9600	860
GW 10 503 A	24	9600	894
GW 10 503 A	24	9600	1091
GW 10 503 A	24	9600	1118
GW 10 504	20/240	86400	758
GW 10 504	20/240	86400	793
GW 10 504	20/240	86400	825
GW 10 504	20/240	86400	859
GW 10 504	20/240	86400	893
GW 10 504 A	24	9600	759

Code	Quantity		Page
	Pack/carton	Pallet	
GW 10 504 A	24	9600	794
GW 10 504 A	24	9600	826
GW 10 504 A	24	9600	860
GW 10 504 A	24	9600	894
GW 10 504 A	24	9600	1091
GW 10 504 A	24	9600	1118
GW 10 505	20/240	86400	758
GW 10 505	20/240	86400	793
GW 10 505	20/240	86400	825
GW 10 505	20/240	86400	859
GW 10 505	20/240	86400	893
GW 10 505 A	24	9600	759
GW 10 505 A	24	9600	794
GW 10 505 A	24	9600	826
GW 10 505 A	24	9600	860
GW 10 505 A	24	9600	894
GW 10 505 A	24	9600	1091
GW 10 505 A	24	9600	1118
GW 10 505 AB	20	48000	937
GW 10 506	20/240	86400	758
GW 10 506	20/240	86400	793
GW 10 506	20/240	86400	825
GW 10 506	20/240	86400	859
GW 10 506	20/240	86400	893
GW 10 506 A	24	9600	759
GW 10 506 A	24	9600	794
GW 10 506 A	24	9600	826
GW 10 506 A	24	9600	860
GW 10 506 A	24	9600	894
GW 10 506 A	24	9600	1091
GW 10 506 A	24	9600	1118
GW 10 507	20/240	86400	758
GW 10 507	20/240	86400	793
GW 10 507	20/240	86400	825
GW 10 507	20/240	86400	859
GW 10 507	20/240	86400	893
GW 10 507 A	24	9600	759
GW 10 507 A	24	9600	794
GW 10 507 A	24	9600	826
GW 10 507 A	24	9600	860
GW 10 507 A	24	9600	894
GW 10 507 A	24	9600	1091
GW 10 507 A	24	9600	1118
GW 10 507 AB	20	48000	937
GW 10 508	20/240	86400	758
GW 10 508	20/240	86400	793
GW 10 508	20/240	86400	825
GW 10 508	20/240	86400	859
GW 10 508	20/240	86400	893
GW 10 508 A	24	9600	759
GW 10 508 A	24	9600	794
GW 10 508 A	24	9600	826
GW 10 508 A	24	9600	860
GW 10 508 A	24	9600	894
GW 10 508 A	24	9600	1091
GW 10 508 A	24	9600	1118
GW 10 509	20/240	86400	758
GW 10 509	20/240	86400	793
GW 10 509	20/240	86400	825
GW 10 509	20/240	86400	859
GW 10 509	20/240	86400	893
GW 10 509 A	24	9600	759
GW 10 509 A	24	9600	794
GW 10 509 A	24	9600	826
GW 10 509 A	24	9600	860

Code	Quantity		Page
	Pack/carton	Pallet	
GW 10 530 A	24	9600	1118
GW 10 531	20/240	86400	758
GW 10 531	20/240	86400	793
GW 10 531	20/240	86400	825
GW 10 531	20/240	86400	859
GW 10 531	20/240	86400	893
GW 10 531 A	24	9600	759
GW 10 531 A	24	9600	794
GW 10 531 A	24	9600	826
GW 10 531 A	24	9600	860
GW 10 531 A	24	9600	894
GW 10 531 A	24	9600	1091
GW 10 531 A	24	9600	1118
GW 10 532	20/240	86400	758
GW 10 532	20/240	86400	793
GW 10 532	20/240	86400	825
GW 10 532	20/240	86400	859
GW 10 532	20/240	86400	893
GW 10 532 A	24	9600	759
GW 10 532 A	24	9600	794
GW 10 532 A	24	9600	826
GW 10 532 A	24	9600	860
GW 10 532 A	24	9600	894
GW 10 532 A	24	9600	1091
GW 10 532 A	24	9600	1118
GW 10 533	20/240	86400	758
GW 10 533	20/240	86400	793
GW 10 533	20/240	86400	825
GW 10 533	20/240	86400	859
GW 10 533	20/240	86400	893
GW 10 533 A	24	9600	759
GW 10 533 A	24	9600	794
GW 10 533 A	24	9600	826
GW 10 533 A	24	9600	860
GW 10 533 A	24	9600	894
GW 10 533 A	24	9600	1091
GW 10 533 A	24	9600	1118
GW 10 534	20/240	86400	758
GW 10 534	20/240	86400	793
GW 10 534	20/240	86400	825
GW 10 534	20/240	86400	859
GW 10 534	20/240	86400	893
GW 10 534 A	24	9600	759
GW 10 534 A	24	9600	794
GW 10 534 A	24	9600	826
GW 10 534 A	24	9600	860
GW 10 534 A	24	9600	894
GW 10 534 A	24	9600	1091
GW 10 534 A	24	9600	1118
GW 10 535	20/240	86400	758
GW 10 535	20/240	86400	793
GW 10 535	20/240	86400	825
GW 10 535	20/240	86400	859
GW 10 535	20/240	86400	893
GW 10 535 A	24	9600	759
GW 10 535 A	24	9600	794
GW 10 535 A	24	9600	826
GW 10 535 A	24	9600	860
GW 10 535 A	24	9600	894
GW 10 535 A	24	9600	1091
GW 10 535 A	24	9600	1118
GW 10 536	20/240	86400	758
GW 10 536	20/240	86400	793
GW 10 536	20/240	86400	825
GW 10 536	20/240	86400	859

Code	Quantity		Page
	Pack/carton	Pallet	
GW 10 536	20/240	86400	893
GW 10 536 A	24	9600	759
GW 10 536 A	24	9600	794
GW 10 536 A	24	9600	826
GW 10 536 A	24	9600	860
GW 10 536 A	24	9600	894
GW 10 536 A	24	9600	1091
GW 10 536 A	24	9600	1118
GW 10 537	20/240	86400	758
GW 10 537	20/240	86400	793
GW 10 537	20/240	86400	825
GW 10 537	20/240	86400	859
GW 10 537	20/240	86400	893
GW 10 537 A	24	9600	759
GW 10 537 A	24	9600	794
GW 10 537 A	24	9600	826
GW 10 537 A	24	9600	860
GW 10 537 A	24	9600	894
GW 10 537 A	24	9600	1091
GW 10 537 A	24	9600	1118
GW 10 538	20/240	86400	758
GW 10 538	20/240	86400	793
GW 10 538	20/240	86400	825
GW 10 538	20/240	86400	859
GW 10 538	20/240	86400	893
GW 10 538 A	24	9600	759
GW 10 538 A	24	9600	794
GW 10 538 A	24	9600	826
GW 10 538 A	24	9600	860
GW 10 538 A	24	9600	894
GW 10 538 A	24	9600	1091
GW 10 538 A	24	9600	1118
GW 10 539	20/240	86400	758
GW 10 539	20/240	86400	793
GW 10 539	20/240	86400	825
GW 10 539	20/240	86400	859
GW 10 539	20/240	86400	893
GW 10 539 A	24	9600	759
GW 10 539 A	24	9600	794
GW 10 539 A	24	9600	826
GW 10 539 A	24	9600	860
GW 10 539 A	24	9600	894
GW 10 539 A	24	9600	1091
GW 10 539 A	24	9600	1118
GW 10 540	20/240	86400	758
GW 10 540	20/240	86400	793
GW 10 540	20/240	86400	825
GW 10 540	20/240	86400	859
GW 10 540	20/240	86400	893
GW 10 540 A	24	9600	759
GW 10 540 A	24	9600	794
GW 10 540 A	24	9600	826
GW 10 540 A	24	9600	860
GW 10 540 A	24	9600	894
GW 10 540 A	24	9600	1091
GW 10 540 A	24	9600	1118
GW 10 541	4/48	17280	759
GW 10 541 A	24	28800	759
GW 10 541 A	24	28800	794
GW 10 541 A	24	28800	826
GW 10 541 A	24	28800	860
GW 10 541 A	24	28800	894
GW 10 541 A	24	28800	1091
GW 10 541 A	24	28800	1118
GW 10 542	4/48	17280	759

Code	Quantity		Page
	Pack/carton	Pallet	
GW 10 542 A	24	28800	759
GW 10 542 A	24	28800	794
GW 10 542 A	24	28800	826
GW 10 542 A	24	28800	860
GW 10 542 A	24	28800	894
GW 10 542 A	24	28800	1091
GW 10 542 A	24	28800	1118
GW 10 543	4/48	17280	759
GW 10 544	4/48	17280	759
GW 10 545	4/48	17280	759
GW 10 546	4/48	17280	759
GW 10 547	4/48	17280	759
GW 10 547	4/48	17280	794
GW 10 547	4/48	17280	826
GW 10 547	4/48	17280	860
GW 10 547	4/48	17280	894
GW 10 548	4/48	17280	759
GW 10 548	4/48	17280	794
GW 10 548	4/48	17280	826
GW 10 548	4/48	17280	860
GW 10 548	4/48	17280	894
GW 10 549	4/48	17280	759
GW 10 549	4/48	17280	794
GW 10 549	4/48	17280	826
GW 10 549	4/48	17280	860
GW 10 549	4/48	17280	894
GW 10 549	4/48	17280	1117
GW 10 551 S	1/48	3744	757
GW 10 551 S	1/48	3744	1090
GW 10 552	4/48	17280	1117
GW 10 552 S	1/48	3744	757
GW 10 552 S	1/48	3744	1090
GW 10 553	4/48	17280	1117
GW 10 553 S	1/48	3744	757
GW 10 553 S	1/48	3744	1090
GW 10 554	4/48	17280	1117
GW 10 554 S	1/48	3744	757
GW 10 554 S	1/48	3744	1090
GW 10 555 S	1/48	3744	757
GW 10 555 S	1/48	3744	1090
GW 10 556 S	1/48	3744	757
GW 10 556 S	1/48	3744	1090
GW 10 557	4/48	17280	1117
GW 10 557 S	1/48	3744	757
GW 10 557 S	1/48	3744	1090
GW 10 558 S	1/48	3744	757
GW 10 558 S	1/48	3744	1090
GW 10 559	1/48	5616	1117
GW 10 564	1/12	3744	783
GW 10 567	1/12	1872	783
GW 10 568	1/12	2340	783
GW 10 572 A	1/12	1152	783
GW 10 572 AAB	1/12	768	943
GW 10 573 A	1/6	468	783
GW 10 575	1/12	1872	783
GW 10 581	1/2	156	781
GW 10 594	1/4	800	762
GW 10 595	1	500	763
GW 10 595	1	500	798
GW 10 595	1	500	830

Quick Reference

Code	Quantity		Page
	Pack/carton	Pallet	
GW 10 595	1	500	864
GW 10 595	1	500	898
GW 10 601	1/24	4872	781
GW 10 602	1/24	5400	781
GW 10 606	1/24	5400	781
GW 10 607	1/24	4872	781
GW 10 611	1/6	1584	781
GW 10 612	1/6	1584	781
GW 10 621	1/24	4224	778
GW 10 622	1/24	4224	778
GW 10 622 AB	1/24	3744	943
GW 10 623	1/24	7392	778
GW 10 623 AB	1/24	3744	943
GW 10 624	1/24	4224	778
GW 10 628	1/24	4224	778
GW 10 629	1/24	4224	778
GW 10 631	1/24	1152	779
GW 10 632	1/24	1152	779
GW 10 633	1/24	1728	779
GW 10 633 AB	1/24	1344	943
GW 10 634	1/24	1152	779
GW 10 641	2/48	8448	778
GW 10 642	2/48	8448	778
GW 10 643	2/48	8448	778
GW 10 644	2/48	8448	778
GW 10 651	1/24	1152	779
GW 10 656	1/2	246	779
GW 10 661	1/6	1932	505
GW 10 661	1/6	1932	780
GW 10 662	1/12	3744	780
GW 10 663	1/6	1638	780
GW 10 666	1/2	312	780
GW 10 671	1/12	1152	756
GW 10 671	1/12	1152	792
GW 10 671	1/12	1152	824
GW 10 671	1/12	1152	858
GW 10 671	1/12	1152	892
GW 10 672	1/6	468	756
GW 10 672	1/6	468	792
GW 10 672	1/6	468	824
GW 10 672	1/6	468	858
GW 10 672	1/6	468	892
GW 10 673	1/12	756	756
GW 10 673	1/12	792	792
GW 10 673	1/12	824	824
GW 10 673	1/12	858	858
GW 10 673	1/12	892	892
GW 10 674	1/6	468	756
GW 10 674	1/6	468	792
GW 10 674	1/6	468	824
GW 10 674	1/6	468	858
GW 10 674	1/6	468	892
GW 10 675	1/12	1152	756
GW 10 675	1/12	1152	792
GW 10 675	1/12	1152	824
GW 10 675	1/12	1152	858
GW 10 675	1/12	1152	892
GW 10 676	1/6	468	756
GW 10 676	1/6	468	792
GW 10 676	1/6	468	824
GW 10 676	1/6	468	858
GW 10 676	1/6	468	892
GW 10 677	1/12	1152	756
GW 10 677	1/12	1152	792
GW 10 677	1/12	1152	824

Code	Quantity		Page
	Pack/carton	Pallet	
GW 10 677	1/12	1152	858
GW 10 677	1/12	1152	892
GW 10 677	1/12	1152	1089
GW 10 678	1/6	936	756
GW 10 678	1/6	936	792
GW 10 678	1/6	936	824
GW 10 678	1/6	936	858
GW 10 678	1/6	936	892
GW 10 678	1/6	936	1089
GW 10 679	1/12	1152	757
GW 10 679	1/12	1152	793
GW 10 679	1/12	1152	825
GW 10 679	1/12	1152	859
GW 10 679	1/12	1152	893
GW 10 679	1/12	1152	1090
GW 10 680	1/6	468	757
GW 10 680	1/6	468	793
GW 10 680	1/6	468	825
GW 10 680	1/6	468	859
GW 10 680	1/6	468	893
GW 10 680	1/6	468	1090
GW 10 703	1/2	312	782
GW 10 705	1/2	312	782
GW 10 709	1/3	468	782
GW 10 709	1/3	468	1096
GW 10 711	1/2	312	784
GW 10 712	1/2	312	784
GW 10 720	1/10	15600	784
GW 10 720	1/10	15600	816
GW 10 720	1/10	15600	849
GW 10 720	1/10	15600	884
GW 10 720	1/10	15600	918
GW 10 720	1/10	15600	1129
GW 10 721	1/12	2340	763
GW 10 723	1/12	2340	763
GW 10 724	1/12	2340	763
GW 10 726	1/12	2340	763
GW 10 726 AB	1/12	1872	937
GW 10 731	4/48	5616	764
GW 10 732	4/48	5616	764
GW 10 733	4/48	5616	764
GW 10 736	1/24	2808	764
GW 10 738 AB	4/48	9600	937
GW 10 739 AB	4/48	9600	937
GW 10 750	1/12	1872	492
GW 10 750	1/12	1872	785
GW 10 750	1/12	1872	1097
GW 10 750	1/12	1872	1136
GW 10 751	5/200	10800	1115
GW 10 762 H	1	195	1128
GW 10 782	1	351	1119
GW 10 783 A	1	320	1116
GW 10 784 A	1	117	1116
GW 10 785 A	1	120	1116
GW 10 786	1	351	1120
GW 10 787	1	320	1116
GW 10 794 H	1	195	1127
GW 10 795 H	1	320	1127
GW 10 796	1	200	1121
GW 10 797	1	320	1123
GW 10 799	1	312	1127
GW 10 799 H	1	320	1128
GW 10 800	1	420	1128
GW 10 819	2/48	4608	1092
GW 10 820	1/48	3744	1092

Code	Quantity		Page
	Pack/carton	Pallet	
GW 10 826	1/12	1152	1094
GW 10 840	1/2	320	1088
GW 10 856	1/3	400	1092
GW 10 881	50	17550	786
GW 10 881	50	17550	818
GW 10 881	50	17550	851
GW 10 881	50	17550	886
GW 10 881	50	17550	920
GW 10 881	50	17550	930
GW 10 881	50	17550	944
GW 10 881	50	17550	988
GW 10 881	50	17550	1013
GW 10 882	50	17550	786
GW 10 882	50	17550	818
GW 10 882	50	17550	851
GW 10 882	50	17550	886
GW 10 882	50	17550	920
GW 10 882	50	17550	930
GW 10 882	50	17550	944
GW 10 882	50	17550	988
GW 10 882	50	17550	1013
GW 10 883	50	17550	786
GW 10 883	50	17550	818
GW 10 883	50	17550	851
GW 10 883	50	17550	886
GW 10 883	50	17550	920
GW 10 883	50	17550	930
GW 10 883	50	17550	944
GW 10 883	50	17550	988
GW 10 883	50	17550	1013
GW 10 884	50	17550	786
GW 10 884	50	17550	818
GW 10 884	50	17550	851
GW 10 884	50	17550	886
GW 10 884	50	17550	920
GW 10 884	50	17550	930
GW 10 884	50	17550	944
GW 10 884	50	17550	988
GW 10 884	50	17550	1013
GW 10 885	50	17550	786
GW 10 885	50	17550	818
GW 10 885	50	17550	851
GW 10 885	50	17550	886
GW 10 885	50	17550	920
GW 10 885	50	17550	930
GW 10 885	50	17550	944
GW 10 885	50	17550	988
GW 10 885	50	17550	1013
GW 10 886	50	15600	1115
GW 10 887	50	15600	1115
GW 10 888	50	10000	1115
GW 10 889	50	15600	1115
GW 10 890	50	14000	1115
GW 10 893	50	10000	987
GW 10 893	50	10000	1013
GW 10 893	50	10000	1058
GW 10 894	50	15600	786
GW 10 894	50	15600	818
GW 10 894	50	15600	851
GW 10 894	50	15600	886
GW 10 894	50	15600	920
GW 10 894	50	15600	930
GW 10 894	50	15600	944
GW 10 894	50	15600	988
GW 10 894	50	15600	1013

Code	Quantity		Page
	Pack/carton	Pallet	
GW 10 900	1	160	1128
GW 10 912	1/12	720	760
GW 10 913	1/12	1152	760
GW 10 913	1/12	1152	1119
GW 10 914	1/12	2112	760
GW 10 914	1/12	2112	1119
GW 10 915	1/12	3840	760
GW 10 915	1/12	3840	1119
GW 10 916	1/12	2400	760
GW 10 916	1/12	2400	1119
GW 10 917	1/6	1200	760
GW 10 917	1/6	1200	1119
GW 10 918	1/6	1200	760
GW 10 918	1/6	1200	1119
GW 10 921	1/12	900	761
GW 10 921	1/12	900	796
GW 10 921	1/12	900	828
GW 10 921	1/12	900	862
GW 10 921	1/12	900	896
GW 10 922	1/12	900	761
GW 10 922	1/12	900	796
GW 10 922	1/12	900	828
GW 10 922	1/12	900	862
GW 10 922	1/12	900	896
GW 10 923	1/12	300	761
GW 10 923	1/12	300	796
GW 10 923	1/12	300	828
GW 10 923	1/12	300	862
GW 10 923	1/12	300	896
GW 10 924	1/12	300	761
GW 10 924	1/12	300	796
GW 10 924	1/12	300	828
GW 10 924	1/12	300	862
GW 10 924	1/12	300	896
GW 10 925	1/12	300	761
GW 10 925	1/12	300	796
GW 10 925	1/12	300	828
GW 10 925	1/12	300	862
GW 10 925	1/12	300	896
GW 11			
GW 11 001	12/96	9216	922
GW 11 002	12/24	3840	922
GW 11 003	12/24	7680	922
GW 11 004	12/48	3744	922
GW 11 031	6/24	3744	922
GW 11 032	6/24	1872	922
GW 11 033	6/24	1872	922
GW 11 039	1/6	960	924
GW 11 051	12/96	9216	922
GW 11 052	12/24	3840	922
GW 11 053	12/24	3840	922
GW 11 071	6/24	1872	922
GW 11 072	6/24	1872	922
GW 11 073	6/24	1872	922
GW 11 091	12/48	3744	922
GW 11 092	12/24	3936	922
GW 11 101	6/12	1968	922
GW 11 102	6/12	1968	922
GW 11 121	12/24	3840	923
GW 11 123	6/24	1536	923
GW 11 131	12/96	4608	923
GW 11 132	12/24	3840	923
GW 11 133	12/24	3840	923
GW 11 136	1/12	1920	923
GW 11 140	12/24	3840	923

Code	Quantity		Page
	Pack/carton	Pallet	
GW 11 153	12/24	3840	923
GW 11 171	6/24	1872	923
GW 11 172	6/24	1872	923
GW 11 173	6/24	1872	923
GW 11 195	10/200	18000	924
GW 11 196	1/48	3072	925
GW 11 197	4/48	7488	924
GW 11 198	1/48	3072	924
GW 11 203	12/96	2304	925
GW 11 241	6/48	3600	925
GW 11 242	6/48	1200	925
GW 11 246	1/24	2304	926
GW 11 247	6/48	1200	926
GW 11 287	12/48	7488	926
GW 11 288	12/48	3744	926
GW 11 331	1/2	156	926
GW 11 361	1/48	3072	926
GW 11 371	1/48	3072	927
GW 11 381	1/24	1536	927
GW 11 383	1/24	1536	927
GW 11 401	1/24	1536	927
GW 11 421	1/24	2304	927
GW 11 422	1/24	1536	927
GW 11 423	1/24	1536	927
GW 11 424	1/24	1536	927
GW 11 431	1/48	3072	928
GW 11 564	1/12	1920	929
GW 11 567	1/12	1920	929
GW 11 573 A	1/6	468	930
GW 11 602	1/24	2784	929
GW 11 623	1/24	3840	928
GW 11 662	1/12	1920	929
GW 11 705	1/2	156	929
GW 12			
GW 12 001	12/96	9216	854
GW 12 002	12/24	6720	854
GW 12 003	12/24	7728	854
GW 12 004	12/48	7488	854
GW 12 005	12/24	4416	854
GW 12 006	1/12	3276	854
GW 12 007	12/24	4416	854
GW 12 021	12/24	8448	854
GW 12 022	6/24	6336	854
GW 12 031	6/24	3744	854
GW 12 031 F	6/24	1152	857
GW 12 032	6/24	1872	854
GW 12 032 F	6/24	1152	857
GW 12 033	6/24	1872	854
GW 12 033 F	6/24	1728	857
GW 12 034	6/24	1872	854
GW 12 034 F	6/24	1152	857
GW 12 035	6/24	1872	854
GW 12 035 F	6/24	1728	857
GW 12 039	1/6	1680	864
GW 12 041	4/12	936	854
GW 12 042	4/12	936	854
GW 12 043	4/12	936	854
GW 12 051	12/96	9216	855
GW 12 052	12/24	7728	855
GW 12 053	12/24	4416	855
GW 12 054	1/12	2340	855
GW 12 061	6/24	6336	855
GW 12 071	6/24	3744	855
GW 12 071 F	6/24	1344	857
GW 12 072	6/24	1872	855

Code	Quantity		Page
	Pack/carton	Pallet	
GW 12 072 F	6/24	1152	857
GW 12 073	6/24	1872	855
GW 12 073 F	6/24	1728	857
GW 12 078 F	6/24	1728	858
GW 12 081	4/12	936	855
GW 12 082	4/12	936	855
GW 12 083	4/12	936	855
GW 12 091	12/48	7488	855
GW 12 092	12/24	2952	855
GW 12 093	12/24	4416	855
GW 12 101	6/12	3312	855
GW 12 101 F	6/12	1620	857
GW 12 102	6/12	2208	855
GW 12 102 F	6/12	1620	857
GW 12 103	6/12	2208	855
GW 12 103 F	6/12	1620	857
GW 12 111	4/12	936	855
GW 12 112	4/12	936	855
GW 12 113	4/12	936	855
GW 12 121	12/24	5400	855
GW 12 122	12/24	2952	855
GW 12 123	6/24	1536	855
GW 12 131	12/96	9216	856
GW 12 132	12/24	7728	856
GW 12 133	12/24	6720	856
GW 12 134	12/24	4416	856
GW 12 135	12/24	4416	856
GW 12 136	1/12	3744	856
GW 12 137	12/24	2808	856
GW 12 138	12/24	3240	856
GW 12 139	12/24	3240	856
GW 12 140	12/24	3240	856
GW 12 141	12/24	5904	856
GW 12 142	12/24	3240	856
GW 12 143	12/24	3240	856
GW 12 144	12/24	3240	856
GW 12 145	1/12	2340	856
GW 12 151	12/24	4416	856
GW 12 152	12/24	4416	856
GW 12 153	12/24	3744	856
GW 12 159 F	6/24	1728	858
GW 12 160 F	6/24	1344	858
GW 12 161	6/24	4800	856
GW 12 162	6/24	6336	856
GW 12 171	6/24	3744	856
GW 12 171 F	6/24	1152	857
GW 12 172	6/24	1872	856
GW 12 172 F	6/24	2304	857
GW 12 173	6/24	3744	856
GW 12 173 F	6/24	1152	857
GW 12 181	4/12	936	856
GW 12 182	4/12	936	856
GW 12 183	4/12	936	856
GW 12 191	6/24	2304	856
GW 12 192	4/16	896	856
GW 12 194	6/48	2400	863
GW 12 195	10/200	18000	863
GW 12 196	1/48	3456	863
GW 12 197	4/48	14976	863
GW 12 198	1/48	3072	863
GW 12 199	1/48	2304	863
GW 12 201	12/96	7200	866
GW 12 203	12/96	7200	866
GW 12 204	6/48	3600	866
GW 12 205	6/48	3600	866

Quick Reference

Code	Quantity		Page
	Pack/carton	Pallet	
GW 12 208	6/24	1872	866
GW 12 209	4/12	936	866
GW 12 241	6/48	3600	867
GW 12 241 F	6/12	1620	868
GW 12 242	6/48	4800	867
GW 12 246	1/24	2304	869
GW 12 247	6/48	3600	869
GW 12 247 F	6/12	1476	869
GW 12 248	6/12	1620	869
GW 12 281	1/24	2304	870
GW 12 282	1/48	3072	870
GW 12 286	12/48	3744	871
GW 12 287	12/48	7488	871
GW 12 288	12/48	3744	871
GW 12 296	6/48	1200	871
GW 12 297	6/48	1200	871
GW 12 298	6/48	1200	871
GW 12 299	12/240	5760	871
GW 12 301	6/48	1200	872
GW 12 306	6/48	1200	872
GW 12 307	6/48	1200	872
GW 12 310	10/40	3600	872
GW 12 311	1/6	1170	873
GW 12 312	1/4	880	873
GW 12 321	1/4	352	873
GW 12 322	1/2	246	873
GW 12 331	1/2	312	873
GW 12 341	6/12	3240	868
GW 12 361	1/48	4608	873
GW 12 362	1/24	4320	873
GW 12 363	1/24	3240	873
GW 12 367	1/24	1536	874
GW 12 371	1/48	4608	874
GW 12 372	1/24	3240	874
GW 12 373	1/24	3240	874
GW 12 377	1/24	1536	874
GW 12 381	1/24	1728	874
GW 12 382	1/24	1728	874
GW 12 383	1/24	1728	874
GW 12 386	1/24	1872	874
GW 12 387	1/24	1872	874
GW 12 391	6/48	1440	872
GW 12 392	6/48	2400	872
GW 12 401	1/24	2304	875
GW 12 406	1/24	3240	875
GW 12 409	1/24	720	875
GW 12 421	1/24	2304	875
GW 12 422	1/24	1152	875
GW 12 423	1/24	2304	875
GW 12 424	1/24	1536	875
GW 12 431	1/48	4608	876
GW 12 433	4/100	3000	876
GW 12 434	1/24	1536	876
GW 12 435	1/24	1536	876
GW 12 436	1/24	1536	876
GW 12 437	1/24	1536	876
GW 12 438	1/48	3072	876
GW 12 447	1/10	1800	878
GW 12 449	1/10	1800	878
GW 12 451	12/24	3240	877
GW 12 452	12/24	3240	877
GW 12 453	1/24	3480	877
GW 12 454	1/24	3240	877
GW 12 458	1/24	1536	877
GW 12 459	1/24	1536	877

Code	Quantity		Page
	Pack/carton	Pallet	
GW 12 461	1/12	3168	878
GW 12 462	1/12	3168	878
GW 12 463	1/12	3168	878
GW 12 466	1/12	3168	878
GW 12 467	1/12	1056	878
GW 12 468	1/12	1056	878
GW 12 482	1/6	1104	878
GW 12 483	1/6	1104	878
GW 12 485	1/6	1104	878
GW 12 486	1/6	1104	878
GW 12 488	1/6	1104	878
GW 12 489	1/6	1104	878
GW 12 491	1/12	2640	878
GW 12 492	1/12	2340	879
GW 12 541	4/48	17280	860
GW 12 542	4/48	17280	860
GW 12 543	4/48	17280	860
GW 12 544	4/48	17280	860
GW 12 545	4/48	17280	860
GW 12 546	4/48	17280	860
GW 12 551	4/48	7488	1117
GW 12 551 S	1/48	3744	859
GW 12 551 S	1/48	3744	1090
GW 12 552	4/48	7488	1117
GW 12 552 S	1/48	3744	859
GW 12 552 S	1/48	3744	1090
GW 12 553	4/48	9600	1117
GW 12 553 S	1/48	3744	859
GW 12 553 S	1/48	3744	1090
GW 12 554	4/48	7488	1117
GW 12 554 S	1/48	3744	859
GW 12 554 S	1/48	3744	1090
GW 12 555 S	1/48	3744	859
GW 12 555 S	1/48	3744	1090
GW 12 556 S	1/48	3744	859
GW 12 556 S	1/48	3744	1090
GW 12 557	4/48	7488	1117
GW 12 557 S	1/48	3744	859
GW 12 557 S	1/48	3744	1090
GW 12 558 S	1/48	3744	859
GW 12 558 S	1/48	3744	1090
GW 12 559	1/48	5616	1117
GW 12 564	1/12	2808	883
GW 12 567	1/12	2340	883
GW 12 568	1/12	1872	883
GW 12 572 A	1/12	1152	883
GW 12 573 A	1/6	468	883
GW 12 575	1/12		883
GW 12 581	1/2	156	881
GW 12 594	1/4	800	863
GW 12 601	1/24	5400	881
GW 12 602	1/24	4872	881
GW 12 606	1/24	5400	881
GW 12 607	1/24	4320	881
GW 12 611	1/6	1584	881
GW 12 612	1/6	1584	881
GW 12 621	1/24	4224	879
GW 12 622	1/24	4224	879
GW 12 623	1/24	4224	879
GW 12 624	1/24	4224	879
GW 12 628	1/24	4224	879
GW 12 629	1/24	4224	879
GW 12 631	1/24	1152	880
GW 12 632	1/24	1344	880
GW 12 633	1/24	1152	880

Code	Quantity		Page
	Pack/carton	Pallet	
GW 12 634	1/24	1152	880
GW 12 641	2/48	8448	879
GW 12 642	2/48	8448	879
GW 12 643	2/48	8448	879
GW 12 644	2/48	8448	879
GW 12 651	1/24	1536	880
GW 12 656	1/2	192	880
GW 12 661	1/6	936	880
GW 12 662	1/12	2808	880
GW 12 663	1/6	1170	880
GW 12 666	1/2	156	880
GW 12 703	1/2	312	882
GW 12 705	1/2	312	882
GW 12 709	1/3	468	882
GW 12 709	1/3	468	1096
GW 12 711	1/2	312	884
GW 12 712	1/2	156	884
GW 12 721	1/12	2340	864
GW 12 723	1/12	2340	864
GW 12 724	1/12	2340	864
GW 12 726	1/12	2340	864
GW 12 731	4/48	5616	865
GW 12 732	4/48	5616	865
GW 12 733	4/48	5616	865
GW 12 736	1/24	2808	865
GW 12 750	1/12	1872	492
GW 12 750	1/12	1872	885
GW 12 750	1/12	1872	1097
GW 12 750	1/12	1872	1136
GW 12 751	5/200	10800	1115
GW 12 762 H	1	195	1128
GW 12 782	1	200	1119
GW 12 783 A	1	320	1116
GW 12 784 A	1	117	1116
GW 12 785 A	1	117	1116
GW 12 786	1	195	1120
GW 12 787	1	240	1116
GW 12 794 H	1	117	1127
GW 12 795 H	1	320	1127
GW 12 796	1	195	1121
GW 12 797	1	195	1123
GW 12 799	1	195	1127
GW 12 799 H	1	200	1128
GW 12 819	2/48	4608	1092
GW 12 820	1/48	3744	1092
GW 12 826	1/12	768	1094
GW 12 840	1/2	320	1088
GW 12 856	1/3	400	1092
GW 12 900	1	160	1128
GW 12 912	1/12	720	861
GW 12 913	1/12	720	861
GW 12 913	1/12	720	1119
GW 12 914	1/12	2112	861
GW 12 914	1/12	2112	1119
GW 12 915	1/12	2340	861
GW 12 915	1/12	2340	1119
GW 12 916	1/12	2400	861
GW 12 916	1/12	2400	1119
GW 12 917	1/6	1200	861
GW 12 917	1/6	1200	1119
GW 12 918	1/6	1200	861
GW 12 918	1/6	1200	1119
GW 13			
GW 13 001	12/96	9216	820
GW 13 002	12/24	3744	820

Code	Quantity		Page
	Pack/carton	Pallet	
GW 13 003	12/24	3744	820
GW 13 004	12/48	3744	820
GW 13 005	12/24	2952	820
GW 13 006	1/12	1872	820
GW 13 007	12/24	3744	820
GW 13 021	12/24	4800	820
GW 13 022	6/24	4800	820
GW 13 031	6/24	1872	820
GW 13 031 F	6/24	1344	823
GW 13 032	6/24	1872	820
GW 13 032 F	6/24	1344	823
GW 13 033	6/24	1872	820
GW 13 033 F	6/24	1344	823
GW 13 034	6/24	1872	820
GW 13 034 F	6/24	1344	823
GW 13 035	6/24	1872	820
GW 13 035 F	6/24	1344	823
GW 13 039	1/6	1200	830
GW 13 041	4/12	936	820
GW 13 042	4/12	936	820
GW 13 043	4/12	936	820
GW 13 051	12/96	9216	821
GW 13 052	12/24	3744	821
GW 13 053	12/24	3744	821
GW 13 054	1/12	1872	821
GW 13 061	6/24	4800	821
GW 13 071	6/24	1872	821
GW 13 071 F	6/24	1344	823
GW 13 072	6/24	1872	821
GW 13 072 F	6/24	1344	823
GW 13 073	6/24	1872	821
GW 13 073 F	6/24	1344	823
GW 13 078 F	6/24	1344	824
GW 13 081	4/12	936	821
GW 13 082	4/12	936	821
GW 13 083	4/12	936	821
GW 13 091	12/48	3744	821
GW 13 092	12/24	2952	821
GW 13 093	12/24	2952	821
GW 13 101	6/12	1476	821
GW 13 101 F	6/12	1476	823
GW 13 102	6/12	1476	821
GW 13 102 F	6/12	1476	823
GW 13 103	6/12	1476	821
GW 13 103 F	6/12	1476	823
GW 13 111	4/12	936	821
GW 13 112	4/12	936	821
GW 13 113	4/12	936	821
GW 13 121	12/24	2952	821
GW 13 122	12/24	2952	821
GW 13 123	6/24	1344	821
GW 13 131	12/96	9216	822
GW 13 132	12/24	3744	822
GW 13 133	12/24	3744	822
GW 13 134	12/24	3744	822
GW 13 135	12/24	2952	822
GW 13 136	1/12	1872	822
GW 13 137	12/24	3744	822
GW 13 138	12/24	2952	822
GW 13 139	12/24	2952	822
GW 13 140	12/24	2952	822
GW 13 141	12/24	2952	822
GW 13 142	12/24	2952	822
GW 13 143	12/24	2952	822
GW 13 144	12/24	2952	822

Code	Quantity		Page
	Pack/carton	Pallet	
GW 13 145	1/12	1872	822
GW 13 151	12/24	3744	822
GW 13 152	12/24	3744	822
GW 13 153	12/24	3744	822
GW 13 159 F	6/24	1344	824
GW 13 160 F	6/24	1344	824
GW 13 161	6/24	4800	822
GW 13 162	6/24	4800	822
GW 13 171	6/24	1872	822
GW 13 171 F	6/24	1344	823
GW 13 172	6/24	1872	822
GW 13 172 F	6/24	1344	823
GW 13 173	6/24	1872	822
GW 13 173 F	6/24	1344	823
GW 13 181	4/12	936	822
GW 13 182	4/12	936	822
GW 13 183	4/12	936	822
GW 13 191	6/24	1344	822
GW 13 192	4/16	896	822
GW 13 194	6/48	1200	829
GW 13 195	10/200	18000	829
GW 13 196	1/48	3072	829
GW 13 197	4/48	9600	829
GW 13 198	1/48	3072	829
GW 13 199	1/48	2016	829
GW 13 201	12/96	2400	832
GW 13 203	12/96	7200	832
GW 13 204	6/48	3600	832
GW 13 205	6/48	3600	832
GW 13 208	6/24	1872	832
GW 13 209	4/12	936	832
GW 13 241	6/48	3600	833
GW 13 241 F	6/12	1476	834
GW 13 242	6/48	1200	833
GW 13 246	1/24	1536	835
GW 13 247	6/48	1200	835
GW 13 247 F	6/12	1476	835
GW 13 248	6/12	1476	835
GW 13 281	1/24	2304	835
GW 13 282	1/48	3072	836
GW 13 286	12/48	3744	836
GW 13 287	12/48	3744	836
GW 13 288	12/48	3744	836
GW 13 296	6/48	1200	836
GW 13 297	6/48	1200	836
GW 13 298	6/48	1200	837
GW 13 299	12/240	1920	837
GW 13 301	6/48	1200	837
GW 13 306	6/48	1200	837
GW 13 307	6/48	1200	837
GW 13 310	10/40	1800	837
GW 13 311	1/6	1200	838
GW 13 312	1/4	800	838
GW 13 321	1/4	800	838
GW 13 322	1/2	192	838
GW 13 331	1/2	156	838
GW 13 341	6/12	1476	834
GW 13 361	1/48	3072	839
GW 13 362	1/24	2976	839
GW 13 363	1/24	2976	839
GW 13 367	1/24	1536	839
GW 13 371	1/48	3072	839
GW 13 372	1/24	2976	839
GW 13 373	1/24	2976	839
GW 13 377	1/24	1536	840

Code	Quantity		Page
	Pack/carton	Pallet	
GW 13 381	1/24	1536	839
GW 13 382	1/24	1536	839
GW 13 383	1/24	1536	839
GW 13 386	1/24	1872	840
GW 13 387	1/24	1872	840
GW 13 391	6/48	1200	838
GW 13 392	6/48	1200	838
GW 13 401	1/24	1536	840
GW 13 406	1/24	2976	840
GW 13 409	1/24	1536	840
GW 13 421	1/24	1536	841
GW 13 422	1/24	1536	841
GW 13 423	1/24	1536	841
GW 13 424	1/24	1536	841
GW 13 431	1/48	3072	841
GW 13 433	4/100	5400	841
GW 13 434	1/24	1536	841
GW 13 435	1/24	1536	841
GW 13 436	1/24	1536	841
GW 13 437	1/24	1536	841
GW 13 438	1/48	3072	841
GW 13 447	1/10	1800	843
GW 13 449	1/10	1800	843
GW 13 451	12/24	2952	842
GW 13 452	12/24	2952	842
GW 13 453	1/24	2976	842
GW 13 454	1/24	2976	842
GW 13 458	1/24	1536	842
GW 13 459	1/24	1536	842
GW 13 461	1/12	2400	843
GW 13 462	1/12	2400	843
GW 13 463	1/12	2400	843
GW 13 466	1/12	2400	843
GW 13 467	1/12	2400	843
GW 13 468	1/12	2400	843
GW 13 482	1/6	936	843
GW 13 483	1/6	936	843
GW 13 485	1/6	936	843
GW 13 486	1/6	936	843
GW 13 488	1/6	936	843
GW 13 489	1/6	936	843
GW 13 491	1/12	2400	844
GW 13 492	1/12	1872	844
GW 13 541	4/48	9600	826
GW 13 542	4/48	9600	826
GW 13 543	4/48	9600	826
GW 13 544	4/48	9600	826
GW 13 545	4/48	9600	826
GW 13 546	4/48	9600	826
GW 13 551	4/48	9600	1117
GW 13 551 S	1/48	3744	825
GW 13 551 S	1/48	3744	1090
GW 13 552	4/48	9600	1117
GW 13 552 S	1/48	3744	825
GW 13 552 S	1/48	3744	1090
GW 13 553	4/48	9600	1117
GW 13 553 S	1/48	3744	825
GW 13 553 S	1/48	3744	1090
GW 13 554	4/48	9600	1117
GW 13 554 S	1/48	3744	825
GW 13 554 S	1/48	3744	1090
GW 13 555	4/48	9600	1117
GW 13 555 S	1/48	3744	825
GW 13 555 S	1/48	3744	1090
GW 13 556 S	1/48	3744	825
GW 13 556 S	1/48	3744	1090

Quick Reference

Code	Quantity		Page
	Pack/carton	Pallet	
GW 13 557	4/48	9600	1117
GW 13 557 S	1/48	3744	825
GW 13 557 S	1/48	3744	1090
GW 13 558 S	1/48	3744	825
GW 13 558 S	1/48	3744	1090
GW 13 559	1/48	4608	1117
GW 13 564	1/12	1872	848
GW 13 567	1/12	1872	848
GW 13 568	1/12	1872	848
GW 13 572 A	1/12	768	848
GW 13 573 A	1/6	468	848
GW 13 575	1/12	1404	847
GW 13 594	1/4	800	829
GW 13 601	1/24	2976	846
GW 13 602	1/24	2976	846
GW 13 606	1/24	2976	846
GW 13 607	1/24	2976	846
GW 13 611	1/6	1200	846
GW 13 612	1/6	1200	846
GW 13 621	1/24	3744	844
GW 13 622	1/24	3744	844
GW 13 623	1/24	3744	844
GW 13 624	1/24	3744	844
GW 13 628	1/24	3744	845
GW 13 629	1/24	3744	845
GW 13 631	1/24	1344	845
GW 13 632	1/24	1344	845
GW 13 633	1/24	1344	845
GW 13 634	1/24	1344	845
GW 13 641	2/48	7488	844
GW 13 642	2/48	7488	844
GW 13 643	2/48	7488	844
GW 13 644	2/48	7488	844
GW 13 651	1/24	1536	845
GW 13 656	1/2	192	845
GW 13 661	1/6	936	845
GW 13 662	1/12	1872	845
GW 13 663	1/6	936	846
GW 13 666	1/2	156	846
GW 13 705	1/2	156	847
GW 13 709	1/3	468	847
GW 13 709	1/3	468	1096
GW 13 712	1/2	156	848
GW 13 721	1/12	1872	830
GW 13 723	1/12	1872	830
GW 13 724	1/12	1872	830
GW 13 726	1/12	1872	830
GW 13 731	4/48	9600	831
GW 13 732	4/48	9600	831
GW 13 733	4/48	9600	831
GW 13 736	1/24	3744	831
GW 13 750	1/12	2400	492
GW 13 750	1/12	2400	849
GW 13 750	1/12	2400	1097
GW 13 750	1/12	2400	1136
GW 13 751	5/200	10800	1115
GW 13 762 H	1	200	1128
GW 13 782	1	200	1119
GW 13 783 A	1	200	1116
GW 13 784 A	1	200	1116
GW 13 785 A	1	200	1116
GW 13 786	1	200	1120
GW 13 787	1	200	1116
GW 13 794 H	1	200	1127
GW 13 795 H	1	200	1127

Code	Quantity		Page
	Pack/carton	Pallet	
GW 13 796	1	200	1121
GW 13 797	1	200	1123
GW 13 799	1	200	1127
GW 13 799 H	1	200	1128
GW 13 819	2/48	4608	1092
GW 13 820	1/48	3744	1092
GW 13 826	1/12	768	1094
GW 13 840	1/2	320	1088
GW 13 856	1/3	400	1092
GW 13 900	1	200	1128
GW 13 912	1/12	2400	827
GW 13 913	1/12	2400	827
GW 13 913	1/12	2400	1119
GW 13 914	1/12	1872	827
GW 13 914	1/12	1872	1119
GW 13 915	1/12	2400	827
GW 13 915	1/12	2400	1119
GW 13 916	1/12	2400	827
GW 13 916	1/12	2400	1119
GW 13 917	1/6	1200	827
GW 13 917	1/6	1200	1119
GW 13 918	1/6	1200	827
GW 13 918	1/6	1200	1119
GW 14			
GW 14 001	12/96	9216	888
GW 14 002	12/24	6720	888
GW 14 003	12/24	3744	888
GW 14 004	12/48	7488	888
GW 14 005	12/24	4416	888
GW 14 006	1/12	2340	888
GW 14 007	12/24	4416	888
GW 14 021	12/24	4800	888
GW 14 022	6/24	6336	888
GW 14 031	6/24	3744	888
GW 14 031 F	6/24	1728	891
GW 14 032	6/24	1872	888
GW 14 032 F	6/24	1152	891
GW 14 033	6/24	1872	888
GW 14 033 F	6/24	1728	891
GW 14 034	6/24	1872	888
GW 14 034 F	6/24	1728	891
GW 14 035	6/24	1872	888
GW 14 035 F	6/24	1728	891
GW 14 039	1/6	1200	898
GW 14 041	4/12	936	888
GW 14 042	4/12	936	888
GW 14 043	4/12	936	888
GW 14 051	12/96	9216	889
GW 14 052	12/24	7728	889
GW 14 053	12/24	4416	889
GW 14 054	1/12	2340	889
GW 14 061	6/24	6336	889
GW 14 071	6/24	3744	889
GW 14 071 F	6/24	1152	891
GW 14 072	6/24	1872	889
GW 14 072 F	6/24	1152	891
GW 14 073	6/24	1872	889
GW 14 073 F	6/24	1728	891
GW 14 078 F	6/24	1728	892
GW 14 081	4/12	936	889
GW 14 082	4/12	936	889
GW 14 083	4/12	936	889
GW 14 091	12/48	7488	889
GW 14 092	12/24	3312	889
GW 14 093	12/24	4416	889

Code	Quantity		Page
	Pack/carton	Pallet	
GW 14 101	6/12	3312	889
GW 14 101 F	6/12	1620	891
GW 14 102	6/12	2208	889
GW 14 102 F	6/12	1620	891
GW 14 103	6/12	2208	889
GW 14 103 F	6/12	1620	891
GW 14 111	4/12	936	889
GW 14 112	4/12	936	889
GW 14 113	4/12	936	889
GW 14 121	12/24	5400	889
GW 14 122	12/24	2952	889
GW 14 123	6/24	1872	889
GW 14 131	12/96	9216	890
GW 14 132	12/24	7728	890
GW 14 133	12/24	3744	890
GW 14 134	12/24	4416	890
GW 14 135	12/24	2952	890
GW 14 136	1/12	3744	890
GW 14 137	12/24	4416	890
GW 14 138	12/24	3240	890
GW 14 139	12/24	3240	890
GW 14 140	12/24	5904	890
GW 14 141	12/24	2952	890
GW 14 142	12/24	3240	890
GW 14 143	12/24	3240	890
GW 14 144	12/24	3240	890
GW 14 145	1/12	2340	890
GW 14 151	12/24	4416	890
GW 14 152	12/24	4416	890
GW 14 153	12/24	4416	890
GW 14 159 F	6/24	1728	892
GW 14 160 F	6/24	1728	892
GW 14 161	6/24	6336	890
GW 14 162	6/24	6336	890
GW 14 171	6/24	1872	890
GW 14 171 F	6/24	1728	891
GW 14 172	6/24	1872	890
GW 14 172 F	6/24	2304	891
GW 14 173	6/24	1872	890
GW 14 173 F	6/24	1152	891
GW 14 181	4/12	936	890
GW 14 182	4/12	936	890
GW 14 183	4/12	936	890
GW 14 191	6/24	1344	890
GW 14 192	4/16	1152	890
GW 14 194	6/48	2400	897
GW 14 195	10/200	18000	897
GW 14 196	1/48	3456	897
GW 14 197	4/48	28080	897
GW 14 198	1/48	3456	897
GW 14 199	1/48	2304	897
GW 14 201	12/96	7200	900
GW 14 203	12/96	7200	900
GW 14 204	6/48	3600	900
GW 14 205	6/48	3600	900
GW 14 208	6/24	1872	900
GW 14 209	4/12	936	900
GW 14 241	6/48	3600	901
GW 14 241 F	6/12	1620	902
GW 14 242	6/48	1200	901
GW 14 246	1/24	2304	903
GW 14 247	6/48	3600	903
GW 14 247 F	6/12	1476	903
GW 14 248	6/12	2700	903
GW 14 281	1/24	1536	904

Code	Quantity		Page
	Pack/carton	Pallet	
GW 14 282	1/48	2688	904
GW 14 286	12/48	3744	905
GW 14 287	12/48	7488	905
GW 14 288	12/48	3744	905
GW 14 296	6/48	1200	905
GW 14 297	6/48	1200	905
GW 14 298	6/48	1200	905
GW 14 299	12/240	5760	905
GW 14 301	6/48	1200	906
GW 14 306	6/48	1200	906
GW 14 307	6/48	1200	906
GW 14 310	10/40	1800	906
GW 14 311	1/6	1170	907
GW 14 312	1/4	352	907
GW 14 321	1/4	352	907
GW 14 322	1/2	246	907
GW 14 331	1/2	156	907
GW 14 341	6/12	3240	902
GW 14 361	1/48	5760	907
GW 14 362	1/24	4320	907
GW 14 363	1/24	3240	907
GW 14 367	1/24	1536	908
GW 14 371	1/48	3072	908
GW 14 372	1/24	3240	908
GW 14 373	1/24	3240	908
GW 14 377	1/24	1536	908
GW 14 381	1/24	1152	908
GW 14 382	1/24	1728	908
GW 14 383	1/24	1536	908
GW 14 386	1/24	1872	908
GW 14 387	1/24	1872	908
GW 14 391	6/48	1440	906
GW 14 392	6/48	2400	906
GW 14 401	1/24	2304	909
GW 14 406	1/24	3240	909
GW 14 409	1/24	1536	909
GW 14 421	1/24	2304	909
GW 14 422	1/24	1728	909
GW 14 423	1/24	2880	909
GW 14 424	1/24	1152	909
GW 14 431	1/48	4608	910
GW 14 433	4/100	3000	910
GW 14 434	1/24	1536	910
GW 14 435	1/24	1536	910
GW 14 436	1/24	1536	910
GW 14 437	1/24	1536	910
GW 14 438	1/48	3072	910
GW 14 447	1/10	1800	912
GW 14 449	1/10	1800	912
GW 14 451	12/24	3240	911
GW 14 452	12/24	3240	911
GW 14 453	1/24	3240	911
GW 14 454	1/24	3240	911
GW 14 458	1/24	1728	911
GW 14 459	1/24	1728	911
GW 14 461	1/12	3168	912
GW 14 462	1/12	3168	912
GW 14 463	1/12	3168	912
GW 14 466	1/12	3168	912
GW 14 467	1/12	1056	912
GW 14 468	1/12	1056	912
GW 14 482	1/6	1104	912
GW 14 483	1/6	1104	912
GW 14 485	1/6	1104	912
GW 14 486	1/6	1104	912

Code	Quantity		Page
	Pack/carton	Pallet	
GW 14 488	1/6	1104	912
GW 14 489	1/6	1104	912
GW 14 491	1/12	2640	912
GW 14 492	1/12	2340	913
GW 14 541	4/48	17280	894
GW 14 542	4/48	17280	894
GW 14 543	4/48	17280	894
GW 14 544	4/48	17280	894
GW 14 545	4/48	17280	894
GW 14 546	4/48	17280	894
GW 14 551	4/48	768	1117
GW 14 551 S	1/48	3744	893
GW 14 551 S	1/48	3744	1090
GW 14 552	4/48	7488	1117
GW 14 552 S	1/48	3744	893
GW 14 552 S	1/48	3744	1090
GW 14 553	4/48	5760	1117
GW 14 553 S	1/48	3744	893
GW 14 553 S	1/48	3744	1090
GW 14 554	4/48	1248	1117
GW 14 554 S	1/48	3744	893
GW 14 554 S	1/48	3744	1090
GW 14 555 S	1/48	3744	893
GW 14 555 S	1/48	3744	1090
GW 14 556 S	1/48	3744	893
GW 14 556 S	1/48	3744	1090
GW 14 557	4/48	7680	1117
GW 14 557 S	1/48	3744	893
GW 14 557 S	1/48	3744	1090
GW 14 558 S	1/48	3744	893
GW 14 558 S	1/48	3744	1090
GW 14 559	1/48	5616	1117
GW 14 564	1/12	1872	917
GW 14 567	1/12	2340	917
GW 14 568	1/12	1872	917
GW 14 572 A	1/12	1152	917
GW 14 573 A	1/6	468	917
GW 14 575	1/12	1872	917
GW 14 581	1/2	156	915
GW 14 594	1/4	800	897
GW 14 601	1/24	2976	915
GW 14 602	1/24	2976	915
GW 14 606	1/24	5400	915
GW 14 607	1/24	4320	915
GW 14 611	1/6	1584	915
GW 14 612	1/6	1584	915
GW 14 621	1/24	4224	913
GW 14 622	1/24	4224	913
GW 14 623	1/24	4224	913
GW 14 624	1/24	4224	913
GW 14 628	1/24	4224	913
GW 14 629	1/24	4224	913
GW 14 631	1/24	1152	914
GW 14 632	1/24	1152	914
GW 14 633	1/24	1152	914
GW 14 634	1/24	1152	914
GW 14 641	2/48	8448	913
GW 14 642	2/48	8448	913
GW 14 643	2/48	8448	913
GW 14 644	2/48	8448	913
GW 14 651	1/24	1536	914
GW 14 656	1/2	264	914
GW 14 661	1/6	936	914
GW 14 662	1/12	1872	914
GW 14 663	1/6	960	914

Code	Quantity		Page
	Pack/carton	Pallet	
GW 14 666	1/2	156	914
GW 14 703	1/2	156	916
GW 14 705	1/2	156	916
GW 14 709	1/3	468	916
GW 14 709	1/3	468	1096
GW 14 711	1/2	312	918
GW 14 712	1/2	156	918
GW 14 721	1/12	2340	898
GW 14 723	1/12	2340	898
GW 14 724	1/12	2340	898
GW 14 726	1/12	2340	898
GW 14 731	4/48	5616	899
GW 14 732	4/48	5616	899
GW 14 733	4/48	5616	899
GW 14 736	1/24	2808	899
GW 14 750	1/12	1872	492
GW 14 750	1/12	1872	919
GW 14 750	1/12	1872	1097
GW 14 750	1/12	1872	1136
GW 14 751	5/200	10800	1115
GW 14 762 H	1	195	1128
GW 14 782	1	195	1119
GW 14 783 A	1	117	1116
GW 14 784 A	1	200	1116
GW 14 785 A	1	200	1116
GW 14 786	1	195	1120
GW 14 787	1	156	1116
GW 14 794 H	1	156	1127
GW 14 795 H	1	156	1127
GW 14 796	1	195	1121
GW 14 797	1	200	1123
GW 14 799	1	200	1127
GW 14 799 H	1	200	1128
GW 14 819	2/48	4608	1092
GW 14 820	1/48	3744	1092
GW 14 826	1/12	768	1094
GW 14 840	1/2	320	1088
GW 14 856	1/3	400	1092
GW 14 900	1	160	1128
GW 14 912	1/12	720	895
GW 14 913	1/12	4320	895
GW 14 913	1/12	4320	1119
GW 14 914	1/12	2112	895
GW 14 914	1/12	2112	1119
GW 14 915	1/12	2400	895
GW 14 915	1/12	2400	1119
GW 14 916	1/12	2400	895
GW 14 916	1/12	2400	1119
GW 14 917	1/6	1200	895
GW 14 917	1/6	1200	1119
GW 14 918	1/6	1200	895
GW 14 918	1/6	1200	1119

GW 15			
GW 15 001	12/96	9216	788
GW 15 002	12/24	3744	788
GW 15 003	12/24	3744	788
GW 15 004	12/48	3744	788
GW 15 005	12/24	2952	788
GW 15 006	1/12	1872	788
GW 15 007	12/24	3744	788
GW 15 021	12/24	4800	788
GW 15 022	6/24	4800	788
GW 15 031	6/24	3744	788
GW 15 031 F	6/24	1344	791
GW 15 032	6/24	1872	788

Quick Reference

Code	Quantity		Page	Code	Quantity		Page	Code	Quantity		Page
	Pack/carton	Pallet			Pack/carton	Pallet			Pack/carton	Pallet	
GW 15 032 F	6/24	1344	791	GW 15 172	6/24	1872	790	GW 15 421	1/24	1536	809
GW 15 033	6/24	1872	788	GW 15 172 F	6/24	1344	791	GW 15 422	1/24	1536	809
GW 15 033 F	6/24	1344	791	GW 15 173	6/24	1872	790	GW 15 423	1/24	1536	809
GW 15 034	6/24	1872	788	GW 15 173 F	6/24	1344	791	GW 15 424	1/24	1536	809
GW 15 034 F	6/24	1344	791	GW 15 181	4/12	936	790	GW 15 431	1/48	3072	809
GW 15 035	6/24	1872	788	GW 15 182	4/12	936	790	GW 15 433	4/100	5400	809
GW 15 035 F	6/24	1344	791	GW 15 183	4/12	936	790	GW 15 434	1/24	1536	809
GW 15 039	1/6	1200	798	GW 15 191	6/24	1344	790	GW 15 435	1/24	1536	809
GW 15 041	4/12	936	788	GW 15 192	4/16	896	790	GW 15 436	1/24	1536	809
GW 15 042	4/12	936	788	GW 15 194	6/48	1200	797	GW 15 437	1/24	1536	809
GW 15 043	4/12	936	788	GW 15 195	10/200	18000	797	GW 15 438	1/48	3072	809
GW 15 051	12/96	9216	789	GW 15 196	1/48	3072	797	GW 15 447	1/10	1800	811
GW 15 052	12/24	3744	789	GW 15 197	4/48	9600	797	GW 15 449	1/10	1800	811
GW 15 053	12/24	3744	789	GW 15 198	1/48	3072	797	GW 15 451	12/24	2952	810
GW 15 054	1/12	1872	789	GW 15 199	1/48	2016	797	GW 15 452	12/24	2952	810
GW 15 061	6/24	4800	789	GW 15 201	12/96	2400	800	GW 15 453	1/24	2976	810
GW 15 071	6/24	3744	789	GW 15 203	12/96	7200	800	GW 15 454	1/24	2976	810
GW 15 071 F	6/24	1344	791	GW 15 204	6/48	3600	800	GW 15 458	1/24	1536	810
GW 15 072	6/24	1872	789	GW 15 205	6/48	1200	800	GW 15 459	1/24	1536	810
GW 15 072 F	6/24	1344	791	GW 15 208	6/24	1872	800	GW 15 461	1/12	2400	811
GW 15 073	6/24	1872	789	GW 15 209	4/12	936	800	GW 15 462	1/12	2400	811
GW 15 073 F	6/24	1344	791	GW 15 241	6/48	3600	801	GW 15 463	1/12	2400	811
GW 15 078 F	6/24	1344	792	GW 15 241 F	6/12	1476	802	GW 15 466	1/12	2400	811
GW 15 081	4/12	936	789	GW 15 242	6/48	1200	801	GW 15 467	1/12	2400	811
GW 15 082	4/12	936	789	GW 15 246	1/24	2304	803	GW 15 468	1/12	2400	811
GW 15 083	4/12	936	789	GW 15 247	6/48	3600	803	GW 15 482	1/6	936	811
GW 15 091	12/48	3744	789	GW 15 247 F	6/12	1476	803	GW 15 483	1/6	936	811
GW 15 092	12/24	2952	789	GW 15 248	6/12	1476	803	GW 15 485	1/6	936	811
GW 15 093	12/24	2952	789	GW 15 281	1/24	2304	803	GW 15 486	1/6	936	811
GW 15 101	6/12	1476	789	GW 15 282	1/48	3072	804	GW 15 488	1/6	936	811
GW 15 101 F	6/12	1476	791	GW 15 286	12/48	3744	804	GW 15 489	1/6	936	811
GW 15 102	6/12	1476	789	GW 15 287	12/48	7488	804	GW 15 491	1/12	2400	812
GW 15 102 F	6/12	1476	791	GW 15 288	12/48	3744	804	GW 15 492	1/12	1872	812
GW 15 103	6/12	1476	789	GW 15 296	6/48	1200	804	GW 15 541	4/48	9600	794
GW 15 103 F	6/12	1476	791	GW 15 297	6/48	1200	804	GW 15 542	4/48	9600	794
GW 15 111	4/12	936	789	GW 15 298	6/48	1200	805	GW 15 543	4/48	9600	794
GW 15 112	4/12	936	789	GW 15 299	12/240	1920	805	GW 15 544	4/48	9600	794
GW 15 113	4/12	936	789	GW 15 301	6/48	1200	805	GW 15 545	4/48	9600	794
GW 15 121	12/24	2952	789	GW 15 306	6/48	1200	805	GW 15 546	4/48	9600	794
GW 15 122	12/24	2952	789	GW 15 307	6/48	1200	805	GW 15 551	4/48	9600	1117
GW 15 123	6/24	1344	789	GW 15 310	10/40	3000	805	GW 15 551 S	1/48	3744	793
GW 15 131	12/96	9216	790	GW 15 311	1/6	1200	806	GW 15 551 S	1/48	3744	1090
GW 15 132	12/24	3744	790	GW 15 312	1/4	800	806	GW 15 552	4/48	9600	1117
GW 15 133	12/24	3744	790	GW 15 321	1/4	800	806	GW 15 552 S	1/48	3744	793
GW 15 134	12/24	3744	790	GW 15 322	1/2	192	806	GW 15 552 S	1/48	3744	1090
GW 15 135	12/24	2952	790	GW 15 331	1/2	156	806	GW 15 553	4/48	9600	1117
GW 15 136	1/12	1872	790	GW 15 341	6/12	2952	802	GW 15 553 S	1/48	3744	793
GW 15 137	12/24	3744	790	GW 15 361	1/48	3072	807	GW 15 553 S	1/48	3744	1090
GW 15 138	12/24	2952	790	GW 15 362	1/24	2976	807	GW 15 554	4/48	9600	1117
GW 15 139	12/24	2952	790	GW 15 363	1/24	2976	807	GW 15 554 S	1/48	3744	793
GW 15 140	12/24	5904	790	GW 15 367	1/24	1536	807	GW 15 554 S	1/48	3744	1090
GW 15 141	12/24	2952	790	GW 15 371	1/48	3072	807	GW 15 555 S	1/48	3744	793
GW 15 142	12/24	2952	790	GW 15 372	1/24	2976	807	GW 15 555 S	1/48	3744	1090
GW 15 143	12/24	2952	790	GW 15 373	1/24	2976	807	GW 15 556 S	1/48	3744	793
GW 15 144	12/24	2952	790	GW 15 377	1/24	1536	808	GW 15 556 S	1/48	3744	1090
GW 15 145	1/12	1872	790	GW 15 381	1/24	1536	807	GW 15 557	4/48	9600	1117
GW 15 151	12/24	3744	790	GW 15 382	1/24	1536	807	GW 15 557 S	1/48	3744	793
GW 15 152	12/24	3744	790	GW 15 383	1/24	1536	807	GW 15 557 S	1/48	3744	1090
GW 15 153	12/24	3744	790	GW 15 386	1/24	1872	808	GW 15 558 S	1/48	3744	793
GW 15 159 F	6/24	1344	792	GW 15 387	1/24	1872	808	GW 15 558 S	1/48	3744	1090
GW 15 160 F	6/24	1344	792	GW 15 391	6/48	1200	806	GW 15 559	1/48	4608	1117
GW 15 161	6/24	4800	790	GW 15 392	6/48	1200	806	GW 15 564	1/12	1872	815
GW 15 162	6/24	4800	790	GW 15 401	1/24	2304	808	GW 15 567	1/12	1872	815
GW 15 171	6/24	1872	790	GW 15 406	1/24	2976	808	GW 15 568	1/12	1872	816
GW 15 171 F	6/24	1344	791	GW 15 409	1/24	1536	808	GW 15 572 A	1/12	768	815

Code	Quantity		Page
	Pack/carton	Pallet	
GW 15 573 A	1/6	468	815
GW 15 575	1/12	1404	815
GW 15 594	1/4	800	797
GW 15 601	1/24	2976	814
GW 15 602	1/24	2976	814
GW 15 606	1/24	2976	814
GW 15 607	1/24	2976	814
GW 15 611	1/6	1200	814
GW 15 612	1/6	1200	814
GW 15 621	1/24	3744	812
GW 15 622	1/24	3744	812
GW 15 623	1/24	3744	812
GW 15 624	1/24	3744	812
GW 15 628	1/24	3744	813
GW 15 629	1/24	3744	813
GW 15 631	1/24	1344	813
GW 15 632	1/24	1344	813
GW 15 633	1/24	1344	813
GW 15 634	1/24	1344	813
GW 15 641	2/48	7488	812
GW 15 642	2/48	7488	812
GW 15 643	2/48	7488	812
GW 15 644	2/48	7488	812
GW 15 651	1/24	1536	813
GW 15 656	1/2	192	813
GW 15 662	1/12	1872	813
GW 15 663	1/6	936	813
GW 15 666	1/2	156	813
GW 15 705	1/2	156	815
GW 15 709	1/3	468	814
GW 15 709	1/3	468	1096
GW 15 712	1/2	156	816
GW 15 721	1/12	1872	798
GW 15 723	1/12	1872	798
GW 15 724	1/12	1872	798
GW 15 726	1/12	1872	798
GW 15 731	4/48	9600	799
GW 15 732	4/48	9600	799
GW 15 733	4/48	9600	799
GW 15 736	1/24	3744	799
GW 15 750	1/12	2400	492
GW 15 750	1/12	2400	817
GW 15 750	1/12	2400	1097
GW 15 750	1/12	2400	1136
GW 15 751	5/200	10800	1115
GW 15 762 H	1	200	1128
GW 15 782	1	200	1119
GW 15 783 A	1	200	1116
GW 15 784 A	1	200	1116
GW 15 785 A	1	200	1116
GW 15 786	1	200	1120
GW 15 787	1	200	1116
GW 15 794 H	1	200	1127
GW 15 795 H	1	200	1127
GW 15 796	1	200	1121
GW 15 797	1	200	1123
GW 15 799	1	200	1127
GW 15 799 H	1	200	1128
GW 15 819	2/48	4608	1092
GW 15 820	1/48	3744	1092
GW 15 826	1/12	1152	1094
GW 15 840	1/2	320	1088
GW 15 856	1/3	400	1092
GW 15 900	1	200	1128
GW 15 912	1/12	2400	795

Code	Quantity		Page
	Pack/carton	Pallet	
GW 15 913	1/12	2400	795
GW 15 913	1/12	2400	1119
GW 15 914	1/12	1872	795
GW 15 914	1/12	1872	1119
GW 15 915	1/12	2400	795
GW 15 915	1/12	2400	1119
GW 15 916	1/12	2400	795
GW 15 916	1/12	2400	1119
GW 15 917	1/6	1200	795
GW 15 917	1/6	1200	1119
GW 15 918	1/6	1200	795
GW 15 918	1/6	1200	1119
GW 16			
GW 16 001 BR	12	936	708
GW 16 001 BS	12	936	710
GW 16 001 CP	12	936	710
GW 16 001 CS	12	936	709
GW 16 001 CY	12	936	707
GW 16 001 DB	12	936	708
GW 16 001 DS	12	936	707
GW 16 001 GR	12	936	708
GW 16 001 NB	12	936	707
GW 16 001 PW	12	936	707
GW 16 001 SG	12	936	709
GW 16 001 ST	12	936	709
GW 16 002 BR	12	936	708
GW 16 002 BS	12	936	710
GW 16 002 CP	12	936	710
GW 16 002 CS	12	936	709
GW 16 002 CY	12	936	707
GW 16 002 DB	12	1872	708
GW 16 002 DS	12	936	707
GW 16 002 GR	12	1872	708
GW 16 002 NB	96	1152	707
GW 16 002 PW	96	2304	707
GW 16 002 SG	12	936	709
GW 16 002 ST	12	936	709
GW 16 003 BR	12	1872	708
GW 16 003 BS	12	1872	710
GW 16 003 CP	12	1872	710
GW 16 003 CS	12	1872	709
GW 16 003 CY	24	2016	707
GW 16 003 DB	24	2016	708
GW 16 003 DS	24	2016	707
GW 16 003 NB	96	2304	707
GW 16 003 PW	96	2304	707
GW 16 003 SBR	1	342	715
GW 16 003 SBR	1	342	1098
GW 16 003 SBS	1	342	716
GW 16 003 SBS	1	342	1099
GW 16 003 SCP	1	342	716
GW 16 003 SCP	1	342	1099
GW 16 003 SCS	1	342	715
GW 16 003 SCS	1	342	1099
GW 16 003 SCY	1	342	713
GW 16 003 SCY	1	342	1097
GW 16 003 SDB	1	342	714
GW 16 003 SDB	1	342	1098
GW 16 003 SDS	1	342	714
GW 16 003 SDS	1	342	1098
GW 16 003 SG	12	1872	709
GW 16 003 SGR	1	342	714
GW 16 003 SGR	1	342	1098
GW 16 003 SNB	1	342	713

Code	Quantity		Page
	Pack/carton	Pallet	
GW 16 003 SNB	1	342	1097
GW 16 003 SPW	1	570	713
GW 16 003 SPW	1	570	1097
GW 16 003 SSG	1	342	716
GW 16 003 SSG	1	342	1099
GW 16 003 SST	1	342	715
GW 16 003 SST	1	342	1098
GW 16 003 ST	12	1872	709
GW 16 004 BR	12	1152	708
GW 16 004 BS	12	1152	710
GW 16 004 CP	12	1152	710
GW 16 004 CS	12	1152	709
GW 16 004 CY	12	1152	707
GW 16 004 DB	12	2304	708
GW 16 004 DS	12	1152	707
GW 16 004 GR	12	2304	708
GW 16 004 NB	12	2304	707
GW 16 004 PW	12	2304	707
GW 16 004 SBR	1	342	715
GW 16 004 SBR	1	342	1098
GW 16 004 SBS	1	342	716
GW 16 004 SBS	1	342	1099
GW 16 004 SCP	1	342	716
GW 16 004 SCP	1	342	1099
GW 16 004 SCS	1	342	715
GW 16 004 SCS	1	342	1099
GW 16 004 SCY	1	342	713
GW 16 004 SCY	1	342	1097
GW 16 004 SDB	1	342	714
GW 16 004 SDB	1	342	1098
GW 16 004 SDS	1	342	714
GW 16 004 SDS	1	342	1098
GW 16 004 SG	12	1152	709
GW 16 004 SGR	1	342	714
GW 16 004 SGR	1	342	1098
GW 16 004 SNB	1	342	713
GW 16 004 SNB	1	342	1097
GW 16 004 SPW	1	342	713
GW 16 004 SPW	1	342	1097
GW 16 004 SSG	1	342	716
GW 16 004 SSG	1	342	1099
GW 16 004 SST	1	342	715
GW 16 004 SST	1	342	1098
GW 16 004 ST	12	1152	709
GW 16 007 BR	6	744	708
GW 16 007 BS	6	744	710
GW 16 007 CP	6	744	710
GW 16 007 CS	6	744	709
GW 16 007 CY	6	744	707
GW 16 007 DB	6	1302	708
GW 16 007 DS	6	744	707
GW 16 007 GR	6	1302	708
GW 16 007 NB	6	1302	707
GW 16 007 PW	6	1302	707
GW 16 007 SG	6	744	709
GW 16 007 ST	6	744	709
GW 16 022 BR	12	1152	677
GW 16 022 BS	12	1152	678
GW 16 022 CP	12	1152	678
GW 16 022 CS	12	1152	677
GW 16 022 CY	12	1152	675
GW 16 022 DB	12	2304	676
GW 16 022 DS	12	1152	676
GW 16 022 GR	12	2304	676
GW 16 022 NB	12	2304	675

Quick Reference

Code	Quantity		Page
	Pack/carton	Pallet	
GW 16 022 PW	12	2304	675
GW 16 022 SBR	1	256	682
GW 16 022 SBR	1	256	1101
GW 16 022 SBS	1	256	684
GW 16 022 SBS	1	256	1102
GW 16 022 SCP	1	256	684
GW 16 022 SCP	1	256	1102
GW 16 022 SCS	1	256	683
GW 16 022 SCS	1	256	1101
GW 16 022 SCY	1	256	681
GW 16 022 SCY	1	256	1100
GW 16 022 SDB	1	256	682
GW 16 022 SDB	1	256	1101
GW 16 022 SDS	1	256	681
GW 16 022 SDS	1	256	1100
GW 16 022 SG	12	1152	678
GW 16 022 SGR	1	256	682
GW 16 022 SGR	1	256	1101
GW 16 022 SNB	1	256	681
GW 16 022 SNB	1	256	1100
GW 16 022 SPW	1	256	681
GW 16 022 SPW	1	256	1100
GW 16 022 SSG	1	256	683
GW 16 022 SSG	1	256	1102
GW 16 022 SST	1	256	683
GW 16 022 SST	1	256	1101
GW 16 022 ST	12	1152	677
GW 16 023 BR	12	936	677
GW 16 023 BS	12	936	678
GW 16 023 CP	12	936	678
GW 16 023 CS	12	936	677
GW 16 023 CY	12	936	675
GW 16 023 DB	12	936	676
GW 16 023 DS	12	936	676
GW 16 023 GR	12	936	676
GW 16 023 NB	12	936	675
GW 16 023 PW	12	1872	675
GW 16 023 SG	12	936	678
GW 16 023 ST	12	936	677
GW 16 024 BR	12	936	677
GW 16 024 BS	12	936	678
GW 16 024 CP	12	936	678
GW 16 024 CS	12	936	677
GW 16 024 CY	12	936	675
GW 16 024 DB	12	936	676
GW 16 024 DS	12	936	676
GW 16 024 GR	12	936	676
GW 16 024 NB	12	936	675
GW 16 024 PW	12	936	675
GW 16 024 SG	12	936	678
GW 16 024 ST	12	936	677
GW 16 026 BR	6	744	677
GW 16 026 BS	6	744	678
GW 16 026 CP	6	744	678
GW 16 026 CS	6	744	677
GW 16 026 CY	6	744	675
GW 16 026 DB	6	744	676
GW 16 026 DS	6	744	676
GW 16 026 GR	6	744	676
GW 16 026 NB	6	744	675
GW 16 026 PW	6	744	675
GW 16 026 SG	6	744	678
GW 16 026 ST	6	744	677
GW 16 101 AB	12	1872	935
GW 16 101 TB	96	2304	695

Code	Quantity		Page
	Pack/carton	Pallet	
GW 16 101 TC	12	1872	695
GW 16 101 TI	12	1872	695
GW 16 101 TN	12	1872	695
GW 16 101 VD	12	936	697
GW 16 101 VL	12	1872	696
GW 16 101 VN	12	1872	696
GW 16 101 VO	12	936	698
GW 16 101 VT	12	1872	697
GW 16 101 VW	96	2304	696
GW 16 101 VX	12	936	698
GW 16 101 VZ	12	936	697
GW 16 102 AB	12	1872	935
GW 16 102 TB	96	5760	695
GW 16 102 TC	12	1872	695
GW 16 102 TI	12	1872	695
GW 16 102 TN	12	1872	695
GW 16 102 VD	12	936	697
GW 16 102 VL	12	1872	696
GW 16 102 VN	12	1872	696
GW 16 102 VO	12	936	698
GW 16 102 VT	12	1872	697
GW 16 102 VW	96	2304	696
GW 16 102 VX	12	936	698
GW 16 102 VZ	12	936	697
GW 16 103 AB	12	1872	935
GW 16 103 TB	96	5760	695
GW 16 103 TC	24	2520	695
GW 16 103 TI	24	2016	695
GW 16 103 TN	24	2016	695
GW 16 103 VD	24	2016	697
GW 16 103 VL	24	2016	696
GW 16 103 VN	24	2016	696
GW 16 103 VO	12	1872	698
GW 16 103 VT	24	2016	697
GW 16 103 VW	96	2304	696
GW 16 103 VX	12	1872	698
GW 16 103 VZ	24	2016	697
GW 16 104 AB	12	1872	935
GW 16 104 TB	12	1920	695
GW 16 104 TC	12	1920	695
GW 16 104 TI	12	1920	695
GW 16 104 TN	12	1920	695
GW 16 104 VD	12	1152	697
GW 16 104 VL	12	1872	696
GW 16 104 VN	12	2304	696
GW 16 104 VO	12	936	698
GW 16 104 VT	12	1920	697
GW 16 104 VW	12	1872	696
GW 16 104 VX	12	936	698
GW 16 104 VZ	12	1152	697
GW 16 106 AB	6	1152	935
GW 16 106 TB	12	1152	695
GW 16 106 TC	6	1152	695
GW 16 106 TI	6	1152	695
GW 16 106 TN	6	1152	695
GW 16 106 VD	6	576	697
GW 16 106 VL	6	1152	696
GW 16 106 VN	6	1152	696
GW 16 106 VO	6	576	698
GW 16 106 VT	6	1152	697
GW 16 106 VW	12	1152	696
GW 16 106 VX	6	576	698
GW 16 106 VZ	6	576	697
GW 16 108 TB	6	936	695
GW 16 108 VL	6	936	696

Code	Quantity		Page
	Pack/carton	Pallet	
GW 16 108 VN	6	576	696
GW 16 108 VT	6	468	697
GW 16 108 VW	6	936	696
GW 16 109 TB	6	744	695
GW 16 112 TB	6	576	695
GW 16 112 VL	6	576	696
GW 16 112 VN	6	576	696
GW 16 112 VT	6	384	697
GW 16 112 VW	6	576	696
GW 16 122 AB	12	1152	935
GW 16 122 TB	12	1920	663
GW 16 122 TC	12	1920	663
GW 16 122 TI	12	2304	663
GW 16 122 TN	12	1920	663
GW 16 122 VD	12	1152	665
GW 16 122 VL	12	2304	664
GW 16 122 VN	12	1920	664
GW 16 122 VO	12	1152	666
GW 16 122 VT	12	2304	665
GW 16 122 VW	12	2304	664
GW 16 122 VX	12	1152	666
GW 16 122 VZ	12	1152	665
GW 16 123 AB	12	1152	935
GW 16 123 TB	12	1872	663
GW 16 123 TC	12	936	663
GW 16 123 TI	12	936	663
GW 16 123 TN	12	936	663
GW 16 123 VD	12	936	665
GW 16 123 VL	12	936	664
GW 16 123 VN	12	936	664
GW 16 123 VO	12	936	666
GW 16 123 VT	12	1872	665
GW 16 123 VW	12	936	664
GW 16 123 VX	12	936	666
GW 16 123 VZ	12	936	665
GW 16 124 AB	12	1152	935
GW 16 124 TB	12	936	663
GW 16 124 TC	12	936	663
GW 16 124 TI	12	936	663
GW 16 124 TN	12	1872	663
GW 16 124 VD	12	936	665
GW 16 124 VL	12	936	664
GW 16 124 VN	12	936	664
GW 16 124 VO	12	936	666
GW 16 124 VT	12	936	665
GW 16 124 VW	12	936	664
GW 16 124 VX	12	936	666
GW 16 124 VZ	12	936	665
GW 16 126 AB	6	744	935
GW 16 126 TB	6	930	663
GW 16 126 TC	6	486	663
GW 16 126 TI	6	648	663
GW 16 126 TN	6	744	663
GW 16 126 VD	6	744	665
GW 16 126 VL	6	744	664
GW 16 126 VN	6	1302	664
GW 16 126 VO	6	744	666
GW 16 126 VT	6	1218	665
GW 16 126 VW	6	744	664
GW 16 126 VX	6	744	666
GW 16 126 VZ	6	744	665
GW 16 127 AB	6	744	935
GW 16 127 TB	6	900	663
GW 16 127 TC	6	486	663
GW 16 127 TI	6	450	663

Code	Quantity		Page
	Pack/carton	Pallet	
GW 16 127 TN	6	900	663
GW 16 127 VD	6	744	665
GW 16 127 VL	6	744	664
GW 16 127 VN	6	900	664
GW 16 127 VO	6	744	666
GW 16 127 VT	6	900	665
GW 16 127 VW	6	744	664
GW 16 127 VX	6	744	666
GW 16 127 VZ	6	744	665
GW 16 128 TB	1	600	663
GW 16 128 TC	1	342	663
GW 16 128 TI	1	360	663
GW 16 128 TN	1	684	663
GW 16 128 VD	1	360	665
GW 16 128 VL	1	360	664
GW 16 128 VN	12	684	664
GW 16 128 VO	1	360	666
GW 16 128 VT	1	360	665
GW 16 128 VW	1	360	664
GW 16 128 VX	1	360	666
GW 16 128 VZ	1	360	665
GW 16 129 TB	1	570	663
GW 16 129 TC	1	342	663
GW 16 129 TI	1	342	663
GW 16 129 TN	1	570	663
GW 16 129 VD	1	360	665
GW 16 129 VL	1	360	664
GW 16 129 VO	6	300	664
GW 16 129 VN	1	360	666
GW 16 129 VT	1	342	665
GW 16 129 VW	1	360	664
GW 16 129 VX	1	360	666
GW 16 129 VZ	1	360	665
GW 16 202 GP	1	256	726
GW 16 202 GT	1	256	726
GW 16 202 TB	12	1152	720
GW 16 202 TN	12	1152	720
GW 16 202 VA	6	1476	721
GW 16 202 VT	12	1152	721
GW 16 202 WK	1	256	725
GW 16 202 WS	6	1230	724
GW 16 202 WU	1	256	725
GW 16 202 XA	6	738	723
GW 16 202 XE	6	738	723
GW 16 202 XF	6	738	723
GW 16 202 XG	6	738	724
GW 16 202 XL	6	738	722
GW 16 202 XM	6	738	722
GW 16 202 XP	6	738	722
GW 16 202 XQ	6	738	724
GW 16 202 XR	6	738	723
GW 16 202 XS	6	738	723
GW 16 202 XV	6	738	722
GW 16 202 XW	6	738	722
GW 16 202 YA	12	1152	721
GW 16 202 YB	12	1152	720
GW 16 202 YN	12	768	720
GW 16 202 YT	12	1152	721
GW 16 202 YZ	12	1152	721
GW 16 203 GP	1	256	726
GW 16 203 GT	1	256	726
GW 16 203 TB	12	1152	720
GW 16 203 TN	12	1152	720
GW 16 203 VA	6	1230	721
GW 16 203 VT	12	1152	721
GW 16 203 WK	1	256	725

Code	Quantity		Page
	Pack/carton	Pallet	
GW 16 203 WS	6	1476	724
GW 16 203 WU	1	256	725
GW 16 203 XA	6	1476	723
GW 16 203 XE	6	1476	723
GW 16 203 XF	6	738	723
GW 16 203 XG	6	1476	724
GW 16 203 XL	6	1476	722
GW 16 203 XM	6	1476	722
GW 16 203 XP	6	1476	722
GW 16 203 XQ	6	738	724
GW 16 203 XR	6	1476	723
GW 16 203 XS	6	1476	723
GW 16 203 XV	6	1476	722
GW 16 203 XW	6	1476	722
GW 16 203 YA	12	1152	721
GW 16 203 YB	12	1152	720
GW 16 203 YN	12	768	720
GW 16 203 YT	12	1152	721
GW 16 204 GP	1	256	726
GW 16 204 GT	1	256	726
GW 16 204 TB	12	1152	720
GW 16 204 TN	12	1152	720
GW 16 204 VA	6	1476	721
GW 16 204 VT	12	1152	721
GW 16 204 WK	1	256	725
GW 16 204 WS	6	1476	724
GW 16 204 WU	1	256	725
GW 16 204 XA	6	738	723
GW 16 204 XE	6	738	723
GW 16 204 XF	6	738	723
GW 16 204 XG	6	738	724
GW 16 204 XL	6	738	722
GW 16 204 XM	6	1476	722
GW 16 204 XP	6	1476	722
GW 16 204 XQ	6	738	724
GW 16 204 XR	6	738	723
GW 16 204 XS	6	738	723
GW 16 204 XV	6	738	722
GW 16 204 XW	6	738	722
GW 16 204 YA	12	1152	721
GW 16 204 YB	12	1152	720
GW 16 204 YN	12	768	720
GW 16 204 YT	12	1152	721
GW 16 206 GP	1	192	726
GW 16 206 GT	1	192	726
GW 16 206 TB	6	960	720
GW 16 206 TN	6	960	720
GW 16 206 VA	6	960	721
GW 16 206 VT	6	960	721
GW 16 206 WK	1	192	725
GW 16 206 WS	6	960	724
GW 16 206 WU	1	192	725
GW 16 206 XA	6	576	723
GW 16 206 XE	6	576	723
GW 16 206 XF	6	576	723
GW 16 206 XG	6	576	724
GW 16 206 XL	6	960	722
GW 16 206 XM	6	576	722
GW 16 206 XP	6	576	722
GW 16 206 XQ	6	576	724
GW 16 206 XR	6	576	723
GW 16 206 XS	6	576	723
GW 16 206 XV	6	576	722
GW 16 206 XW	6	576	722
GW 16 206 YA	6	702	721

Code	Quantity		Page
	Pack/carton	Pallet	
GW 16 206 YB	6	1152	720
GW 16 206 YN	6	1152	720
GW 16 206 YT	6	1152	721
GW 16 222 GP	1	256	692
GW 16 222 GT	1	256	692
GW 16 222 TB	12	1920	688
GW 16 222 TN	12	1920	688
GW 16 222 VA	12	1920	689
GW 16 222 VT	12	1920	689
GW 16 222 WS	1	256	691
GW 16 222 XG	1	256	691
GW 16 222 XL	1	256	690
GW 16 222 XM	1	512	690
GW 16 222 XQ	1	256	692
GW 16 222 XS	1	256	691
GW 16 222 XW	1	512	690
GW 16 222 YA	12	1152	689
GW 16 222 YB	12	1152	688
GW 16 222 YN	12	1152	688
GW 16 222 YT	12	1152	689
GW 16 223 GP	1	192	692
GW 16 223 GT	1	192	692
GW 16 223 TB	6	960	688
GW 16 223 TN	6	576	688
GW 16 223 VA	6	960	689
GW 16 223 VT	6	960	689
GW 16 223 WS	1	192	691
GW 16 223 XG	1	192	691
GW 16 223 XL	1	192	690
GW 16 223 XM	1	192	690
GW 16 223 XQ	1	192	692
GW 16 223 XS	1	192	691
GW 16 223 XW	1	192	690
GW 16 223 YA	6	384	689
GW 16 223 YB	6	576	688
GW 16 223 YN	6	576	688
GW 16 223 YT	6	576	689
GW 16 224 GP	1	192	692
GW 16 224 GT	1	192	692
GW 16 224 TB	6	576	688
GW 16 224 TN	6	558	688
GW 16 224 VA	6	576	689
GW 16 224 VT	6	576	689
GW 16 224 WS	1	192	691
GW 16 224 XG	1	192	691
GW 16 224 XL	1	192	690
GW 16 224 XM	1	192	690
GW 16 224 XQ	1	192	692
GW 16 224 XS	1	192	691
GW 16 224 XW	1	192	690
GW 16 224 YA	6	576	689
GW 16 224 YB	6	576	688
GW 16 224 YN	6	576	688
GW 16 224 YT	6	576	689
GW 16 226 GP	1	160	692
GW 16 226 GT	1	160	692
GW 16 226 TB	1	540	688
GW 16 226 TN	1	486	688
GW 16 226 VA	1	360	689
GW 16 226 VT	1	432	689
GW 16 226 WS	1	160	691
GW 16 226 XG	1	160	691
GW 16 226 XL	1	160	690
GW 16 226 XM	1	128	690
GW 16 226 XQ	1	160	692

Quick Reference

Code	Quantity		Page
	Pack/carton	Pallet	
GW 16 226 XS	1	160	691
GW 16 226 XW	1	160	690
GW 16 226 YA	1	3600	689
GW 16 226 YB	1	360	688
GW 16 226 YN	1	360	688
GW 16 226 YT	1	360	689
GW 16 227 GP	1	160	692
GW 16 227 GT	1	160	692
GW 16 227 TB	1	360	688
GW 16 227 TN	1	720	688
GW 16 227 VA	1	720	689
GW 16 227 VT	1	810	689
GW 16 227 WS	1	160	691
GW 16 227 XG	1	160	691
GW 16 227 XL	1	160	690
GW 16 227 XM	1	128	690
GW 16 227 XQ	1	160	692
GW 16 227 XS	1	160	691
GW 16 227 XW	1	160	690
GW 16 227 YA	1	288	689
GW 16 227 YB	1	360	688
GW 16 227 YN	1	360	688
GW 16 227 YT	1	360	689
GW 16 228 GP	1	160	692
GW 16 228 GT	1	160	692
GW 16 228 TB	1	360	688
GW 16 228 TN	1	342	688
GW 16 228 VA	1	384	689
GW 16 228 VT	1	684	689
GW 16 228 WS	1	160	691
GW 16 228 XG	1	160	691
GW 16 228 XL	1	160	690
GW 16 228 XM	1	160	690
GW 16 228 XQ	1	160	692
GW 16 228 XS	1	160	691
GW 16 228 XW	1	160	690
GW 16 228 YA	1	288	689
GW 16 228 YB	1	360	688
GW 16 228 YN	1	360	688
GW 16 228 YT	1	360	689
GW 16 229 GP	1	160	692
GW 16 229 GT	1	160	692
GW 16 229 TB	1	570	688
GW 16 229 TN	1	570	688
GW 16 229 VA	1	570	689
GW 16 229 VT	1	570	689
GW 16 229 WS	1	160	691
GW 16 229 XG	1	160	691
GW 16 229 XL	1	160	690
GW 16 229 XM	1	160	690
GW 16 229 XQ	1	160	692
GW 16 229 XS	1	160	691
GW 16 229 XW	1	160	690
GW 16 229 YA	1	288	689
GW 16 229 YB	1	360	688
GW 16 229 YN	1	360	688
GW 16 229 YT	1	360	689
GW 16 401 TB	96	2304	701
GW 16 401 TC	24	1008	701
GW 16 401 TI	24	1008	701
GW 16 401 TN	24	2016	701
GW 16 401 VD	24	1008	703
GW 16 401 VL	12	1872	702
GW 16 401 VN	24	1512	702
GW 16 401 VO	12	936	704

Code	Quantity		Page
	Pack/carton	Pallet	
GW 16 401 VT	24	3840	703
GW 16 401 VW	96	2304	702
GW 16 401 VX	12	936	704
GW 16 401 VZ	24	1008	703
GW 16 402 TB	96	2304	701
GW 16 402 TC	12	1872	701
GW 16 402 TI	12	1872	701
GW 16 402 TN	12	1872	701
GW 16 402 VD	12	936	703
GW 16 402 VL	12	1872	702
GW 16 402 VN	12	1536	702
GW 16 402 VO	12	936	704
GW 16 402 VT	12	1872	703
GW 16 402 VW	96	2304	702
GW 16 402 VX	12	936	704
GW 16 402 VZ	12	936	703
GW 16 403 TB	96	2304	701
GW 16 403 TC	24	2016	701
GW 16 403 TI	24	2016	701
GW 16 403 TN	24	2016	701
GW 16 403 VD	24	2016	703
GW 16 403 VL	12	1872	702
GW 16 403 VN	24	2016	702
GW 16 403 VO	12	1872	704
GW 16 403 VT	24	2016	703
GW 16 403 VW	96	2304	702
GW 16 403 VX	12	936	704
GW 16 403 VZ	24	1008	703
GW 16 404 TB	12	1872	701
GW 16 404 TC	12	1872	701
GW 16 404 TI	12	1872	701
GW 16 404 TN	12	1872	701
GW 16 404 VD	12	936	703
GW 16 404 VL	12	1872	702
GW 16 404 VN	12	1872	702
GW 16 404 VO	12	936	704
GW 16 404 VT	12	1872	703
GW 16 404 VW	12	1872	702
GW 16 404 VX	12	936	704
GW 16 404 VZ	12	936	703
GW 16 406 TB	12	1152	701
GW 16 406 TC	6	1152	701
GW 16 406 TI	6	1152	701
GW 16 406 TN	6	1152	701
GW 16 406 VD	6	576	703
GW 16 406 VL	6	1152	702
GW 16 406 VN	6	1152	702
GW 16 406 VO	6	576	704
GW 16 406 VT	6	1152	703
GW 16 406 VW	12	1152	702
GW 16 406 VX	6	576	704
GW 16 406 VZ	6	576	703
GW 16 422 TB	12	1920	669
GW 16 422 TC	12	1920	669
GW 16 422 TI	12	1920	669
GW 16 422 TN	12	1920	669
GW 16 422 VD	12	1152	671
GW 16 422 VL	12	2304	670
GW 16 422 VN	12	1920	670
GW 16 422 VO	12	1152	672
GW 16 422 VT	12	2304	671
GW 16 422 VW	12	2304	670
GW 16 422 VX	12	1152	672
GW 16 422 VZ	12	1152	671
GW 16 423 TB	12	1872	669

Code	Quantity		Page
	Pack/carton	Pallet	
GW 16 423 TC	12	936	669
GW 16 423 TI	12	936	669
GW 16 423 TN	12	936	669
GW 16 423 VD	12	936	671
GW 16 423 VL	12	936	670
GW 16 423 VN	1/12	936	670
GW 16 423 VO	12	936	672
GW 16 423 VT	12	936	671
GW 16 423 VW	12	936	670
GW 16 423 VX	12	936	672
GW 16 423 VZ	12	936	671
GW 16 424 TB	12	936	669
GW 16 424 TC	12	936	669
GW 16 424 TI	12	936	669
GW 16 424 TN	12	936	669
GW 16 424 VD	12	936	671
GW 16 424 VL	12	936	670
GW 16 424 VN	12	936	670
GW 16 424 VO	12	936	672
GW 16 424 VT	12	936	671
GW 16 424 VW	12	936	670
GW 16 424 VX	12	936	672
GW 16 424 VZ	12	936	671
GW 16 426 TB	6	558	669
GW 16 426 TC	6	486	669
GW 16 426 TI	6	900	669
GW 16 426 TN	6	1302	669
GW 16 426 VD	6	744	671
GW 16 426 VL	6	744	670
GW 16 426 VN	6	486	670
GW 16 426 VO	6	744	672
GW 16 426 VT	6	744	671
GW 16 426 VW	6	744	670
GW 16 426 VX	6	744	672
GW 16 426 VZ	6	744	671
GW 16 427 TB	6	486	669
GW 16 427 TC	6	486	669
GW 16 427 TI	6	486	669
GW 16 427 TN	6	486	669
GW 16 427 VD	6	744	671
GW 16 427 VL	6	744	670
GW 16 427 VN	6	558	670
GW 16 427 VO	6	744	672
GW 16 427 VT	6	486	671
GW 16 427 VW	6	744	670
GW 16 427 VX	6	744	672
GW 16 427 VZ	6	744	671
GW 16 502	5/80	1200	736
GW 16 503	3/60	960	736
GW 16 504	1/40	600	736
GW 16 512	5/60	900	736
GW 16 513	2/40	600	736
GW 16 514	1/30	480	736
GW 16 702 TB	1/24	768	734
GW 16 702 TN	1/12	900	734
GW 16 702 VT	1/12	504	734
GW 16 703 TB	1/24	576	734
GW 16 703 TN	1/12	504	734
GW 16 703 VT	1/12	504	734
GW 16 704 TB	1/24	576	734
GW 16 704 TN	1/12	384	734
GW 16 704 VT	1/12	384	734
GW 16 711 TB	1/48	768	734
GW 16 711 TN	1/24	768	734
GW 16 711 VT	1/12	900	734

Code	Quantity		Page
	Pack/carton	Pallet	
GW 16 712 TB	1/24	576	734
GW 16 712 TN	1/24	576	734
GW 16 712 VT	1/12	504	734
GW 16 723 TB	1/24	2016	735
GW 16 723 TN	1/12	936	735
GW 16 724 TB	1/24	2304	735
GW 16 724 TN	1/12	1152	735
GW 16 743	3/60	900	306
GW 16 743	3/60	900	735
GW 16 744	1/30	240	306
GW 16 744	1/30	240	735
GW 16 752	1/30	960	306
GW 16 752	1/30	960	735
GW 16 753	1/15	240	306
GW 16 753	1/15	240	735
GW 16 754	1/15	180	306
GW 16 754	1/15	180	735
GW 16 773	3/30	480	306
GW 16 773	3/30	480	735
GW 16 774	1/30	480	306
GW 16 774	1/30	480	735
GW 16 782	1/30	480	306
GW 16 782	1/30	480	735
GW 16 783	1/15	360	306
GW 16 783	1/15	360	735
GW 16 784	1/15	360	306
GW 16 784	1/15	360	735
GW 16 802	12/120	2880	737
GW 16 803	12/240	8640	737
GW 16 803 N	6/240	2400	737
GW 16 803 N	6/240	2400	1103
GW 16 804	12/120	7200	737
GW 16 804 N	6/120	1440	737
GW 16 804 N	6/120	1440	1103
GW 16 806	12/72	2592	737
GW 16 807 N	12/72	720	737
GW 16 808	12/48	768	737
GW 16 812	12/48	768	737
GW 16 821	12/120	2880	737
GW 16 821 N	20/120		737
GW 16 821 N	20/120		1103
GW 16 822	20/120	2880	737
GW 16 822 N	20/120	960	737
GW 16 822 N	20/120	960	1103
GW 16 823	12/120	2880	737
GW 16 824	12/60	2340	738
GW 16 825	12/48	1152	738
GW 16 841	5/300	2400	505
GW 16 841	5/300	2400	739
GW 16 842	5/150	1200	505
GW 16 842	5/150	1200	739
GW 16 843	5/50	800	505
GW 16 843	5/50	800	739
GW 16 854	1/30	240	735
GW 16 856	1/15	300	735
GW 16 864	1/30	240	735
GW 16 866	1/15	180	735
GW 16 871	60/480	15360	739
GW 16 871	60/480	15360	1104
GW 16 873	120/480	19200	738
GW 16 873	120/480	19200	1104
GW 16 874	60/240	3840	738
GW 16 874	60/240	3840	1104
GW 16 876	60/240	3840	738
GW 16 877 N	60/240		738

Code	Quantity		Page
	Pack/carton	Pallet	
GW 16 902 CB	1	256	729
GW 16 902 CL	1	256	729
GW 16 902 CN	1	256	730
GW 16 902 CT	1	256	730
GW 16 903 CB	1	512	729
GW 16 903 CL	1	256	729
GW 16 903 CN	1	512	730
GW 16 903 CT	1	512	730
GW 16 904 CB	1	480	729
GW 16 904 CL	1	256	729
GW 16 904 CN	1	384	730
GW 16 904 CT	1	192	730
GW 16 906 CB	1	216	729
GW 16 906 CL	1	192	729
GW 16 906 CN	1	192	730
GW 16 906 CT	1	192	730
GW 16 946 CB	1	512	732
GW 16 946 CB	1	512	1114
GW 16 946 CL	1	384	732
GW 16 946 CL	1	384	1114
GW 16 946 CN	1	384	732
GW 16 946 CN	1	384	1114
GW 16 946 CT	1	256	732
GW 16 946 CT	1	256	1114
GW 16 950	12	936	1114
GW 16 955 CB	1	512	731
GW 16 955 CB	1	512	762
GW 16 955 CB	1	512	797
GW 16 955 CL	1	256	731
GW 16 955 CL	1	256	829
GW 16 955 CN	1	256	731
GW 16 955 CN	1	256	863
GW 16 955 CT	1	256	731
GW 16 955 CT	1	256	897
GW 16 970 CB	1	256	782
GW 16 970 CB	1	256	815
GW 16 970 CB	1	256	847
GW 16 970 CN	1	256	882
GW 16 970 CT	1	256	916
GW 16 974 CB	1	128	1129
GW 16 974 CN	1	256	1129
GW 16 974 CT	1	128	1129
GW 16 976 CB	1	256	1129
GW 16 976 CN	1	512	1129
GW 16 976 CT	1	512	1129
GW 20			
GW 20 005	15/30	2100	966
GW 20 008	15/30	2100	966
GW 20 024	20/40	3840	968
GW 20 056	10/480	46080	968
GW 20 058	60/120	4320	968
GW 20 071	1/5	1560	970
GW 20 072	1/5	780	970
GW 20 073	30/60	2400	968
GW 20 074	1/5	1560	970
GW 20 076	1/5	1560	970
GW 20 201	80/160	15360	971
GW 20 203	80/320	19200	971
GW 20 205	30/60	5760	971
GW 20 206	30/60	2400	972
GW 20 207	30/60	2160	972
GW 20 208	30/60	2400	972
GW 20 209	30/60	2400	972
GW 20 212	30/60	4320	972
GW 20 214	30/60	4320	973

Code	Quantity		Page
	Pack/carton	Pallet	
GW 20 216	30/60	2280	973
GW 20 220	40/80	14560	973
GW 20 228	30/60	4320	976
GW 20 229	30/60	2280	976
GW 20 230	30/60	2280	976
GW 20 234	15/30	3240	977
GW 20 235	15/30	1920	977
GW 20 238	20/40	1440	979
GW 20 239	15/30	1920	977
GW 20 241	15/30	3840	977
GW 20 243	15/30	2160	978
GW 20 246	30/120	7200	506
GW 20 246	30/120	7200	971
GW 20 248	30/60	2400	973
GW 20 251	15/30	3360	977
GW 20 265	30/120	7200	972
GW 20 266	1/120	3600	978
GW 20 267	1/120	6000	978
GW 20 270	1/120	6000	978
GW 20 271	15/30	2160	978
GW 20 272	15/30	3780	978
GW 20 277	50/200		772
GW 20 277	50/200		773
GW 20 277	50/200		807
GW 20 277	50/200		807
GW 20 277	50/200		839
GW 20 277	50/200		839
GW 20 277	50/200		873
GW 20 277	50/200		874
GW 20 277	50/200		907
GW 20 277	50/200		908
GW 20 277	50/200		976
GW 20 277	50/200		976
GW 20 277	50/200		1002
GW 20 277	50/200		1002
GW 20 277	50/200		1052
GW 20 277	50/200		1052
GW 20 281	30/60	4560	974
GW 20 281	30/60	4560	1000
GW 20 282	15/30	2160	974
GW 20 282	15/30	2160	1000
GW 20 283	15/30	2160	974
GW 20 283	15/30	2160	1001
GW 20 286	30/60	2160	974
GW 20 286	30/60	2160	1000
GW 20 287	15/30	1140	974
GW 20 287	15/30	1140	1000
GW 20 288	15/30	1620	974
GW 20 288	15/30	1620	1001
GW 20 291	30/60	2400	971
GW 20 295	30/60	4320	974
GW 20 295	30/60	4320	1000
GW 20 296	30/60	2160	974
GW 20 296	30/60	2160	1000
GW 20 297	15/30	2160	974
GW 20 297	15/30	2160	1001
GW 20 298	20/40	2880	975
GW 20 298	20/40	2880	1001
GW 20 299	20/40	2880	975
GW 20 299	20/40	2880	1001
GW 20 312	15/30	2160	974
GW 20 312	15/30	2160	1001
GW 20 320	30/60	4320	973
GW 20 351	30/60	4320	972
GW 20 356	30/60	2400	973

Quick Reference

Code	Quantity		Page
	Pack/carton	Pallet	
GW 20 357	30/60	1200	973
GW 20 362	1/10	1800	979
GW 20 363	1/10	1800	979
GW 20 381	15/30	3360	976
GW 20 382	15/30	3360	976
GW 20 383	15/30	1920	976
GW 20 386	15/30	4320	976
GW 20 391	15/30	3360	976
GW 20 392	15/30	1920	976
GW 20 393	15/30	1920	976
GW 20 396	15/30	1920	976
GW 20 401	30/60	4320	980
GW 20 423	1/14	4368	981
GW 20 431	15/30	2100	980
GW 20 432	15/30	2100	980
GW 20 433	15/30	2100	980
GW 20 434	15/30	2100	980
GW 20 435	15/30	2100	980
GW 20 436	15/30	2100	980
GW 20 437	1/15	1080	980
GW 20 438	1/15	2160	980
GW 20 439	1/15	1890	980
GW 20 448	1/15	1080	980
GW 20 449	1/15	1890	980
GW 20 450	1/15	1890	980
GW 20 454	15/30	1260	980
GW 20 454	15/30	1260	1006
GW 20 455	15/30	1260	980
GW 20 455	15/30	1260	1006
GW 20 456	15/30	1260	980
GW 20 456	15/30	1260	1006
GW 20 503	30/60	4320	966
GW 20 504	30/60	4320	966
GW 20 510	80/160	5760	967
GW 20 511	15/30	4320	967
GW 20 512	30/60	4320	967
GW 20 513	15/30	3780	967
GW 20 514	15/30	2880	967
GW 20 515	30/60	4320	967
GW 20 516	30/60	4320	967
GW 20 517	30/60	4320	967
GW 20 518	20/40	1440	967
GW 20 519	15/30	3780	967
GW 20 520	15/30	4320	967
GW 20 521	30/60	4320	967
GW 20 522	30/60	4320	967
GW 20 523	30/60	4320	967
GW 20 527	15/30	2160	968
GW 20 528	30/60	4320	967
GW 20 529	30/60	4320	967
GW 20 530	15/30	1260	967
GW 20 531	15/30	3780	967
GW 20 533	20	45600	969
GW 20 533	20	45600	996
GW 20 537	20	45600	969
GW 20 537	20	45600	996
GW 20 538	20	45600	969
GW 20 538	20	45600	996
GW 20 539	20	45600	969
GW 20 539	20	45600	996
GW 20 540	20	45600	969
GW 20 540	20	45600	996
GW 20 542	20	45600	969
GW 20 542	20	45600	996
GW 20 549	20	45600	969

Code	Quantity		Page
	Pack/carton	Pallet	
GW 20 549	20	45600	996
GW 20 550	20	45600	969
GW 20 550	20	45600	996
GW 20 551	20	45600	969
GW 20 551	20	45600	996
GW 20 559	30/60	4320	967
GW 20 560	30/60	4320	967
GW 20 561	20	45600	969
GW 20 561	20	45600	996
GW 20 562	20	45600	969
GW 20 562	20	45600	996
GW 20 563	20	45600	969
GW 20 563	20	45600	996
GW 20 564	20	45600	969
GW 20 564	20	45600	996
GW 20 565	20	45600	969
GW 20 565	20	45600	996
GW 20 566	20	45600	969
GW 20 566	20	45600	996
GW 20 567	20	45600	969
GW 20 567	20	45600	996
GW 20 568	20	45600	969
GW 20 568	20	45600	996
GW 20 569	20	45600	969
GW 20 569	20	45600	996
GW 20 570	20	45600	969
GW 20 570	20	45600	996
GW 20 571	80/320	19200	966
GW 20 572	30/60	4320	966
GW 20 576	80/320	19200	966
GW 20 577	30/60	4320	966
GW 20 579	30/60	4320	967
GW 20 580	1/15	1890	968
GW 20 583	30/60	2160	966
GW 20 584	30/60	4320	966
GW 20 585	15/30	2520	966
GW 20 588	30/60	4320	966
GW 20 589	15/30	2160	968
GW 20 591	15/30	2160	968
GW 20 592	20	45600	969
GW 20 592	20	45600	996
GW 20 593	20	45600	969
GW 20 593	20	45600	996
GW 20 594	20	45600	969
GW 20 594	20	45600	996
GW 20 595	20	45600	969
GW 20 595	20	45600	996
GW 20 596	20	45600	969
GW 20 596	20	45600	996
GW 20 597	20	45600	969
GW 20 597	20	45600	996
GW 20 601	15/30	720	985
GW 20 601	15/30	720	1010
GW 20 602	1/12	684	985
GW 20 602	1/12	684	1010
GW 20 603	30/60	4320	984
GW 20 604	30/60	4320	984
GW 20 605	30/60	2280	984
GW 20 606	30/60	4320	984
GW 20 607	15/30	1920	984
GW 20 608	15/30	1920	984
GW 20 613	15/30	2100	983
GW 20 616	15/30	2100	983
GW 20 617	15/30	2100	984
GW 20 620	15/30	2100	984

Code	Quantity		Page
	Pack/carton	Pallet	
GW 20 622	15/30	3960	985
GW 20 622	15/30	3960	1011
GW 20 623	15/30	360	985
GW 20 623	15/30	360	1010
GW 20 625	15/30	360	985
GW 20 625	15/30	360	1010
GW 20 626	15/30	360	985
GW 20 626	15/30	360	1010
GW 20 627	1/12	432	985
GW 20 627	1/12	432	1010
GW 20 628	1/12	432	985
GW 20 628	1/12	432	1010
GW 20 629	1/12	432	985
GW 20 629	1/12	432	1010
GW 20 631	30/60	2280	984
GW 20 634	1/15	1080	984
GW 20 641	1/4	624	984
GW 20 643	1/4	624	984
GW 20 651	30/60	2160	986
GW 20 656	15/30	1140	987
GW 20 684	1/15	1890	978
GW 20 685	15/30	2160	978
GW 20 686	15/30	2160	978
GW 20 802	1/14	4368	981
GW 20 803	1/14	3920	981
GW 20 810	1/4	1248	982
GW 20 811	1/14	4368	981
GW 20 820	1/2	624	987
GW 20 821	1/6	1872	969
GW 20 825	1/2	144	982
GW 20 827	1/2	256	982
GW 20 828	1/14	2184	981
GW 20 829	1/14	2184	981
GW 20 833	1/4	1248	506
GW 20 833	1/4	1248	983
GW 20 835	1/14	4368	983
GW 20 841	1/4	448	987
GW 20 852	1/2	272	982
GW 20 853	1/2	144	983
GW 20 901	1/100	19500	786
GW 20 901	1/100	19500	818
GW 20 901	1/100	19500	852
GW 20 901	1/100	19500	886
GW 20 901	1/100	19500	920
GW 20 901	1/100	19500	988
GW 20 901	1/100	19500	1014
GW 20 901	1/100	19500	1058
GW 20 902	50	10000	786
GW 20 902	50	10000	818
GW 20 902	50	10000	851
GW 20 902	50	10000	886
GW 20 902	50	10000	920
GW 20 902	50	10000	988
GW 20 902	50	10000	1013
GW 20 902	50	10000	1058
GW 20 903	50	15600	786
GW 20 903	50	15600	818
GW 20 903	50	15600	851
GW 20 903	50	15600	886
GW 20 903	50	15600	920
GW 20 903	50	15600	988
GW 20 903	50	15600	1013
GW 20 903	50	15600	1058
GW 20 904	50	9750	988
GW 20 904	50	9750	1013

Code	Quantity		Page
	Pack/carton	Pallet	
GW 20 904	50	9750	1058
GW 20 905	50	9750	988
GW 20 905	50	9750	1013
GW 20 905	50	9750	1058
GW 20 906	50	15600	988
GW 20 906	50	15600	1013
GW 20 906	50	15600	1058
GW 20 908	50	15600	988
GW 20 908	50	15600	1013
GW 20 908	50	15600	1058
GW 20 911	20/200	20000	988
GW 20 911	20/200	20000	1014
GW 20 911	20/200	20000	1058
GW 20 921	10/200	20000	988
GW 20 921	10/200	20000	1014
GW 20 921	10/200	20000	1058
GW 20 922	10/200	20000	988
GW 20 922	10/200	20000	1014
GW 20 922	10/200	20000	1058
GW 20 923	10/200	20000	988
GW 20 923	10/200	20000	1014
GW 20 923	10/200	20000	1058
GW 20 924	10/200	20000	988
GW 20 924	10/200	20000	1014
GW 20 924	10/200	20000	1058
GW 20 925	10/200	20000	988
GW 20 925	10/200	20000	1014
GW 20 925	10/200	20000	1058

GW 21

GW 21 005	15/30	1260	994
GW 21 008	15/30	1260	994
GW 21 024	20/40	480	995
GW 21 056	10/480	46080	996
GW 21 058	60/120	2880	996
GW 21 071	1/5	780	997
GW 21 072	1/5	780	997
GW 21 073	30/60	2400	996
GW 21 074	1/5	780	997
GW 21 076	1/5	780	997
GW 21 201	80/160	5760	998
GW 21 203	80/320	19200	998
GW 21 205	30/60	2160	998
GW 21 206	30/60	1200	999
GW 21 207	30/60	2160	999
GW 21 208	30/60	1200	999
GW 21 209	30/60	2160	999
GW 21 212	30/60	4320	999
GW 21 214	30/60	4320	999
GW 21 216	30/60	2280	999
GW 21 220	30/60	2400	1000
GW 21 228	30/60	4320	1002
GW 21 229	30/60	2280	1002
GW 21 230	30/60	2280	1002
GW 21 234	15/30	1920	1002
GW 21 235	15/30	1920	1003
GW 21 238	20/40	480	1005
GW 21 239	15/30	1920	1002
GW 21 241	15/30	1920	1003
GW 21 243	15/30	3780	1004
GW 21 246	30/120	7200	998
GW 21 248	30/60	1200	1000
GW 21 251	15/30	3360	1003
GW 21 265	30/60	2160	998
GW 21 266	1/120	3600	1004
GW 21 267	1/120	3600	1004

Code	Quantity		Page
	Pack/carton	Pallet	
GW 21 270	1/120	6000	1004
GW 21 271	15/30	2160	1004
GW 21 272	15/30	1920	1003
GW 21 291	30/60	1200	998
GW 21 351	30/60	2280	999
GW 21 356	30/60	1200	1000
GW 21 357	30/60	1200	1000
GW 21 381	15/30	3360	1002
GW 21 382	15/30	3360	1002
GW 21 383	15/30	1920	1002
GW 21 386	15/30	3360	1002
GW 21 391	15/30	1920	1002
GW 21 392	15/30	1920	1002
GW 21 393	15/30	1920	1002
GW 21 396	15/30	1920	1002
GW 21 401	30/60	4320	1006
GW 21 423	1/14	2184	1006
GW 21 431	15/30	1260	1005
GW 21 432	15/30	1260	1005
GW 21 433	15/30	1260	1005
GW 21 434	15/30	1260	1005
GW 21 435	15/30	1260	1005
GW 21 436	15/30	2100	1005
GW 21 437	1/15	1080	1005
GW 21 438	1/15	2160	1005
GW 21 439	1/15	1890	1005
GW 21 448	1/15	1080	1005
GW 21 449	1/15	1080	1005
GW 21 450	1/15	1080	1005
GW 21 503	30/60	4320	994
GW 21 504	30/60	4320	994
GW 21 510	80/160	5760	995
GW 21 511	15/30	1920	995
GW 21 512	15/30	3360	995
GW 21 513	15/30	3360	995
GW 21 514	15/30	1920	995
GW 21 515	30/60	4320	995
GW 21 516	30/60	2280	995
GW 21 517	30/60	2280	995
GW 21 518	20/40	1440	995
GW 21 519	15/30	1920	995
GW 21 520	15/30	1920	995
GW 21 521	30/60	4320	995
GW 21 522	30/60	2280	995
GW 21 523	30/60	2280	995
GW 21 527	15/30	2160	996
GW 21 528	30/60	2280	995
GW 21 529	30/60	2160	995
GW 21 530	15/30	1260	995
GW 21 531	15/30	1920	995
GW 21 559	30/60	4320	995
GW 21 571	80/320	19200	994
GW 21 572	30/60	4320	994
GW 21 576	80/320	6400	994
GW 21 577	30/60	4320	994
GW 21 579	30/60	4320	995
GW 21 580	1/15	1080	996
GW 21 583	30/60	2280	994
GW 21 584	30/60	2280	994
GW 21 585	15/30	1260	994
GW 21 588	30/60	2280	994
GW 21 589	15/30	2160	996
GW 21 591	15/30	1080	995
GW 21 603	30/60	4320	1010
GW 21 604	30/60	2280	1010

Code	Quantity		Page
	Pack/carton	Pallet	
GW 21 605	30/60	2280	1010
GW 21 606	30/60	2280	1010
GW 21 607	15/30	1920	1010
GW 21 608	15/30	1920	1010
GW 21 613	15/30	1260	1009
GW 21 616	15/30	3360	1009
GW 21 617	15/30	2100	1009
GW 21 620	15/30	450	1009
GW 21 631	30/60	2280	1010
GW 21 634	1/15	1080	1010
GW 21 641	1/4	624	1009
GW 21 643	1/4	624	1009
GW 21 684	1/15	1080	1004
GW 21 685	15/30	1140	1004
GW 21 686	15/30	1140	1004
GW 21 802	1/14	4368	1006
GW 21 803	1/14	4368	1006
GW 21 810	1/4	624	1007
GW 21 811	1/14	4368	1006
GW 21 820	1/2	312	1012
GW 21 821	1/6	936	997
GW 21 825	1/2	256	1007
GW 21 827	1/2	320	1008
GW 21 828	1/14	2184	1007
GW 21 829	1/14	2184	1007
GW 21 833	1/4	1248	1008
GW 21 835	1/14	4368	1009
GW 21 841	1/4	256	1012
GW 21 852	1/2	256	1008
GW 21 853	1/2	192	1008

GW 22

GW 22 101	96	4032	955
GW 22 102	96	4032	955
GW 22 103	96	5184	955
GW 22 104	96	4032	955
GW 22 106	48	2592	955
GW 22 107	6	576	955
GW 22 108	6	576	955
GW 22 111	96	3456	955
GW 22 112	12	1152	955
GW 22 113	96	4032	955
GW 22 114	12	1152	955
GW 22 116	8	1280	955
GW 22 117	6	576	955
GW 22 121	24	1200	956
GW 22 122	12	1152	956
GW 22 123	24	1872	956
GW 22 124	12	1152	956
GW 22 126	8	720	956
GW 22 127	6	384	956
GW 22 131	24	1800	956
GW 22 132	12	1152	956
GW 22 133	24	1800	956
GW 22 134	12	1152	956
GW 22 136	8	768	956
GW 22 137	6	384	956
GW 22 141	24	2304	956
GW 22 142	12	768	956
GW 22 143	24	1800	956
GW 22 144	12	768	956
GW 22 146	8	720	956
GW 22 147	6	384	956
GW 22 151	24	2304	956
GW 22 152	12	768	956
GW 22 153	24	2304	956

Quick Reference

Code	Quantity		Page
	Pack/carton	Pallet	
GW 22 154	12	768	956
GW 22 156	8	720	956
GW 22 157	6	576	956
GW 22 161	24	1200	956
GW 22 162	12	1152	956
GW 22 163	24	1800	956
GW 22 164	12	1152	956
GW 22 166	8	960	956
GW 22 167	6	576	956
GW 22 171	24	1200	957
GW 22 172	12	1152	957
GW 22 173	24	2304	957
GW 22 174	12	1152	957
GW 22 176	8	960	957
GW 22 177	6	576	957
GW 22 181	24	2304	957
GW 22 182	12	1152	957
GW 22 183	24	1800	957
GW 22 184	12	768	957
GW 22 186	8	768	957
GW 22 187	6	384	957
GW 22 251	12	1152	958
GW 22 252	12	1440	958
GW 22 253	24	768	958
GW 22 254	12	1152	958
GW 22 256	8	960	958
GW 22 257	6	576	958
GW 22 261	12	768	958
GW 22 262	12	768	958
GW 22 263	24	600	958
GW 22 264	12	768	958
GW 22 266	8	960	958
GW 22 267	6	384	958
GW 22 271	12	1440	957
GW 22 272	12	768	957
GW 22 273	24	1200	957
GW 22 274	12	768	957
GW 22 276	8	960	957
GW 22 277	6	576	957
GW 22 281	12	768	957
GW 22 282	12	1152	957
GW 22 283	24	1800	957
GW 22 284	12	1152	957
GW 22 286	8	1536	957
GW 22 287	6	384	957
GW 22 288	6	720	957
GW 22 291	12	1152	957
GW 22 292	12	1152	957
GW 22 293	24	1800	957
GW 22 294	12	1152	957
GW 22 296	8	1024	957
GW 22 297	6	384	957
GW 22 298	6	720	957
GW 22 451	30	3990	959
GW 22 451	30	3990	1025
GW 22 452	30	2700	959
GW 22 452	30	2700	1025
GW 22 453	30	2700	959
GW 22 453	30	2700	1025
GW 22 461	30	2700	959
GW 22 461	30	2700	1025
GW 22 462	30	900	959
GW 22 462	30	900	1025
GW 22 463	30	900	959
GW 22 463	30	900	1025

Code	Quantity		Page
	Pack/carton	Pallet	
GW 22 471	3/60	720	306
GW 22 471	3/60	720	959
GW 22 472	3/30	540	306
GW 22 472	3/30	540	959
GW 22 501	96	5184	952
GW 22 502	96	5184	952
GW 22 503	96	5184	952
GW 22 504	96	5184	952
GW 22 506	48	2016	952
GW 22 507	6	576	952
GW 22 508	6	792	952
GW 22 511	96	1152	952
GW 22 512	12	1152	952
GW 22 513	96	4032	952
GW 22 514	12	1152	952
GW 22 516	8	1280	952
GW 22 517	6	576	952
GW 22 521	24	2304	952
GW 22 522	12	1152	952
GW 22 523	24	1800	952
GW 22 524	12	3840	952
GW 22 526	8	960	952
GW 22 527	6	576	952
GW 22 531	24	2304	953
GW 22 532	12	1152	953
GW 22 533	24	1800	953
GW 22 534	12	1152	953
GW 22 536	8	720	953
GW 22 537	6	384	953
GW 22 541	24	1200	953
GW 22 542	12	1152	953
GW 22 543	24	1800	953
GW 22 544	12	1152	953
GW 22 546	8	960	953
GW 22 547	6	576	953
GW 22 551	24	2304	953
GW 22 552	12	1152	953
GW 22 553	24	1800	953
GW 22 554	12	1152	953
GW 22 556	8	960	953
GW 22 557	6	576	953
GW 22 561	24	1800	953
GW 22 562	12	768	953
GW 22 563	24	1800	953
GW 22 564	12	1152	953
GW 22 566	8	960	953
GW 22 567	6	384	953
GW 22 571	24	2304	953
GW 22 572	12	1152	953
GW 22 573	24	1800	953
GW 22 574	12	1152	953
GW 22 576	8	1920	953
GW 22 577	6	384	953
GW 22 581	24	1800	954
GW 22 582	12	1440	954
GW 22 583	24	1800	954
GW 22 584	12	1152	954
GW 22 586	8	768	954
GW 22 587	6	384	954
GW 22 601	12	1152	954
GW 22 602	12	1152	954
GW 22 603	12	1152	954
GW 22 604	12	1920	954
GW 22 606	8	768	954
GW 22 607	6	576	954

Code	Quantity		Page
	Pack/carton	Pallet	
GW 22 608	6	720	954
GW 22 611	12	1152	954
GW 22 612	12	768	954
GW 22 613	12	1152	954
GW 22 614	12	1152	954
GW 22 616	8	1024	954
GW 22 617	6	384	954
GW 22 618	6	720	954
GW 22 651	12	1152	955
GW 22 652	12	768	955
GW 22 653	12	1152	955
GW 22 654	12	768	955
GW 22 656	8	960	955
GW 22 657	6	576	955
GW 22 661	12	768	955
GW 22 662	12	768	955
GW 22 663	12	1152	955
GW 22 664	12	768	955
GW 22 666	8	960	955
GW 22 667	6	384	955
GW 22 671	12	768	954
GW 22 672	12	768	954
GW 22 673	12	1152	954
GW 22 674	12	768	954
GW 22 676	8	960	954
GW 22 677	6	384	954

GW 24			
Code	Pack/carton	Pallet	Page
GW 24 001	1/120	2880	958
GW 24 002	1/120	2880	958
GW 24 003	1/120	2880	958
GW 24 004	1/60	1920	958
GW 24 005	1/60	480	958
GW 24 006	3/60	1200	307
GW 24 006	3/60	1200	959
GW 24 007	3/30	480	307
GW 24 007	3/30	480	959
GW 24 008	1/60	2400	959
GW 24 009	1/60	1200	959
GW 24 010	1/60	1440	959
GW 24 011	1/60	1440	959
GW 24 018	1/30	540	960
GW 24 019	1/30	540	960
GW 24 020	1/20	360	960
GW 24 021	1/20	360	960
GW 24 022	1/30	720	959
GW 24 023	1/30	720	959
GW 24 201	10/300	12000	960
GW 24 202	10/150	7200	960
GW 24 206	5/150	2400	304
GW 24 208	270	5400	305
GW 24 209	312	16848	305
GW 24 210	152	8208	305
GW 24 211	1/120	2880	308
GW 24 211	1/120	2880	958
GW 24 212	1/120	480	308
GW 24 212	1/120	480	958
GW 24 213	1/60	960	308
GW 24 213	1/60	960	958
GW 24 214	1/60	480	308
GW 24 214	1/60	480	958
GW 24 215	1/60	480	308
GW 24 215	1/60	480	958
GW 24 216	1/60	1200	308
GW 24 216	1/60	1200	958
GW 24 218	50/400	8000	260

Code	Quantity		Page
	Pack/carton	Pallet	
GW 24 218	50/400	8000	308
GW 24 220	50/600	9600	308
GW 24 221	280	4480	305
GW 24 224	500/7000		308
GW 24 224	500/7000		736
GW 24 225	300/4200		308
GW 24 225	300/4200		736
GW 24 227	5/50	1200	308
GW 24 228	5/50	2700	308
GW 24 229	300/4200		308
GW 24 229	300/4200		736
GW 24 230	10/100	3200	960
GW 24 231	5/200	4000	305
GW 24 232	5/200	6000	305
GW 24 233	20/200	14000	305
GW 24 234 PM	5/200	4000	259
GW 24 237	2/24	1296	304
GW 24 237 PM	2/24	288	259
GW 24 238	2/24	720	304
GW 24 239	2/16	192	304
GW 24 240	10/60	960	960
GW 24 241	10/40	640	960
GW 24 262	10/120	9600	960
GW 24 282 PM	2/108	648	259
GW 24 321	200	12800	260
GW 24 321	200	12800	304
GW 24 322	10/100	6400	307
GW 24 323	10/100	5400	307
GW 24 324	10/100	5400	307
GW 24 330	150	5700	304
GW 24 403	15/345	5175	304
GW 24 403 P	200	8000	304
GW 24 403 PM	9/180	5400	259
GW 24 404	5/135	2700	304
GW 24 404 P	50	2000	304
GW 24 404 PM	2/120	4080	259
GW 24 406	3/36	2160	304
GW 24 406 P	50	1000	304
GW 24 406 PM	2/60	1800	259
GW 24 601	1	120	302
GW 24 602	1	30	302
GW 24 606	1	50	302
GW 24 607	1	30	302
GW 24 611	1	50	302
GW 24 612	1	30	302
GW 24 616	1	50	303
GW 24 617	1	30	303
GW 24 621	1	40	303
GW 24 622	1	30	303
GW 24 633	1/30	240	303
GW 26			
GW 26 222	5/40	720	1023
GW 26 223	5/40	720	1023
GW 26 406	25/250	12500	154
GW 26 406	25/250	12500	238
GW 26 406	25/250	12500	1027
GW 26 407	200/1600	60800	736
GW 26 407	200/1600	60800	1028
GW 26 409	5/300	10800	506
GW 26 409	5/300	10800	960
GW 26 410	5/150	5400	506
GW 26 410	5/150	5400	960
GW 26 417	1/12	240	1024
GW 26 420	1/20	360	1025
GW 26 421	1/20	360	1025

Code	Quantity		Page
	Pack/carton	Pallet	
GW 26 427	1/12	720	1024
GW 27			
GW 27 001	5/80	2880	1020
GW 27 002	5/80	2880	1020
GW 27 003	3/60	3000	1020
GW 27 004	2/40	2760	1020
GW 27 005	1/30	1080	1020
GW 27 006	1/20	1000	1020
GW 27 007	1/20	600	1020
GW 27 008	1/20	480	1020
GW 27 021	2/40	1680	1020
GW 27 022	1/30	1080	1020
GW 27 023	1/20	800	1020
GW 27 024	1/20	600	1020
GW 27 041	5/60	4140	1021
GW 27 042	5/60	4140	1021
GW 27 043	2/40	2760	1021
GW 27 044	3/30	2070	1021
GW 27 051	1/20	640	1021
GW 27 052	1/15	480	1021
GW 27 056	1/12	480	1022
GW 27 057	1/12	480	1022
GW 27 062	5/60	1080	1022
GW 27 071	1/8	560	1024
GW 27 072	1/6	288	1024
GW 27 073	1/4	192	1024
GW 27 101	5/60	960	153
GW 27 101	5/60	960	1026
GW 27 102	2/30	480	153
GW 27 102	2/30	480	1026
GW 27 103	1/20	480	153
GW 27 103	1/20	480	1026
GW 27 104	1/10	240	153
GW 27 104	1/10	240	1026
GW 27 105	1/10	120	153
GW 27 105	1/10	120	1026
GW 27 111	5/60	960	153
GW 27 111	5/60	960	1026
GW 27 201	1/30	360	153
GW 27 201	1/30	360	1026
GW 27 202	1/30	540	153
GW 27 202	1/30	540	1026
GW 27 203	1/10	240	153
GW 27 203	1/10	240	1026
GW 27 204	1/10	240	153
GW 27 204	1/10	240	1026
GW 27 401	3/60	5400	111
GW 27 401	3/60	5400	282
GW 27 401	3/60	5400	299
GW 27 401	3/60	5400	1025
GW 27 402	2/60	1440	154
GW 27 402	2/60	1440	1027
GW 27 403	3/60	5400	111
GW 27 403	3/60	5400	282
GW 27 403	3/60	5400	299
GW 27 403	3/60	5400	1025
GW 27 415	5/40	1680	1023
GW 27 416	5/40	720	1023
GW 27 417	5/40	720	1023
GW 27 418	5/40	720	1023
GW 27 419	5/40	720	1023
GW 27 421	1/12	384	1023
GW 27 422	1/12	384	1023
GW 27 423	1/12	240	1023
GW 27 424	1/12	180	1023

Code	Quantity		Page
	Pack/carton	Pallet	
GW 27 431 B	1/10	240	1024
GW 27 432	1/24	432	1024
GW 27 441	10/100	15600	1027
GW 27 442	10/100	35100	1027
GW 27 443	10/100	6400	1027
GW 27 603	10	500	1021
GW 27 609	10	500	1021
GW 27 615	10	500	1021
GW 27 616	10	500	1021
GW 27 621	10	500	1021
GW 27 622	10	500	1021
GW 27 627	5	360	1021
GW 27 628	5	360	1021
GW 27 801	5/60	1080	1022
GW 27 802	5/60	360	1022
GW 27 803	5/60	360	1022
GW 27 804	5/60	360	1022
GW 27 805	5/60	360	1022
GW 27 811	5/80	960	1022
GW 27 812	5/80	960	1022
GW 27 813	5/80	480	1022
GW 27 814	5/80	480	1022
GW 27 815	5/80	480	1022
GW 27 831	5/60	1080	1023
GW 27 832	5/60	1080	1023
GW 27 833	5/60	1080	1023
GW 27 834	5/60	1080	1023
GW 27 835	5/60	1080	1023
GW 27 836	2/40	240	1023
GW 27 841	5/60	1080	1023
GW 27 842	5/60	1080	1023
GW 27 843	5/60	1080	1023
GW 27 844	5/60	1080	1023
GW 27 845	5/60	720	1023
GW 28			
GW 28 003	25/250	18000	1151
GW 28 004	25/250	18000	1151
GW 28 005	25/150	10800	1151
GW 28 006	25/150	10800	1151
GW 28 007	25/150	7500	1151
GW 28 008	25/150	7500	1151
GW 28 009	25/250	6000	1151
GW 28 010	25/250	6000	1151
GW 28 011	25/175	4200	1151
GW 28 012	25/175	4200	1151
GW 28 013	25/175	4200	1151
GW 28 203	25/250	5000	1152
GW 28 204	25/250	5000	1152
GW 28 205	25/150	10800	1152
GW 28 206	25/150	10800	1152
GW 28 409	50/200	2400	1153
GW 28 415	15/150	3600	1153
GW 28 416	50/200	1600	1152
GW 28 417	50/200	1600	1152
GW 28 418	40/160	1280	1152
GW 28 419	40/160	1280	1152
GW 28 421	50/200	2400	1152
GW 28 423	50/200	1600	1152
GW 28 510	50/200	3000	1153
GW 28 601	1/20	360	1154
GW 30			
GW 30 001	24/96	3840	1046
GW 30 002	24/48	2016	1046
GW 30 003	24/48	1920	1046

Quick Reference

Code	Quantity		Page
	Pack/carton	Pallet	
GW 30 004	24/48	3840	1046
GW 30 007	1/12	2340	1046
GW 30 011	24/96	3840	1046
GW 30 012	24/48	2016	1046
GW 30 013	24/48	1920	1046
GW 30 015	24/48	4032	1046
GW 30 016	24/48	1920	1046
GW 30 021	24/96	3840	1047
GW 30 022	12/24	1872	1047
GW 30 023	12/24	1872	1047
GW 30 024	12/24	1872	1047
GW 30 025	12/24	1872	1047
GW 30 026	12/24	1872	1047
GW 30 027	12/24	1872	1047
GW 30 030	24/48	1920	1047
GW 30 031	4/32	1280	1047
GW 30 032	1/24	1872	1047
GW 30 033	12/24	1872	1047
GW 30 034	12/24	3744	1047
GW 30 035	12/24	1872	1047
GW 30 036	12/24	1872	1047
GW 30 037	12/24	1872	1047
GW 30 038	12/36	864	1047
GW 30 121	1/6	1638	1048
GW 30 201	24/96	3840	1049
GW 30 203	24/96	3840	1049
GW 30 210	12/48	1920	1049
GW 30 211	12/48	1920	1050
GW 30 212	12/48	4800	1049
GW 30 214	12/24	1920	1049
GW 30 215	12/48	960	1050
GW 30 216	12/48	1920	1050
GW 30 219	12/48	960	1050
GW 30 220	12/48	960	1050
GW 30 227	24/48	4032	1051
GW 30 232	24/48	2016	1051
GW 30 234	24/48	3840	1050
GW 30 237	12/48	1920	1051
GW 30 261	1/24	3744	1052
GW 30 266	1/24	1872	1052
GW 30 267	1/24	3744	1052
GW 30 286	1/96	1440	1053
GW 30 287	1/96	5760	1053
GW 30 301	24/48	2016	1052
GW 30 306	1/24	1872	1052
GW 30 311	24/48	1920	1052
GW 30 316	1/24	1872	1052
GW 30 321	24/48	2016	1049
GW 30 322	12/24	1728	1050
GW 30 331	24/48	1920	1049
GW 30 342	12/48	960	1051
GW 30 343	12/48	960	1051
GW 30 360	24/48	1920	1053
GW 30 371	1/12	2340	1053
GW 30 372	1/12	2340	1053
GW 30 373	1/12	2340	1053
GW 30 374	1/12	2340	1053
GW 30 375	1/12	2340	1053
GW 30 376	1/12	2520	1053
GW 30 377	1/6	1170	1053
GW 30 378	1/6	1170	1053
GW 30 379	1/6	1170	1053
GW 30 401	1/6	1872	1055
GW 30 402	1/12	3276	1055
GW 30 403	1/12	2340	1055

Code	Quantity		Page
	Pack/carton	Pallet	
GW 30 430	1/2	390	1057
GW 30 501	1/6	1638	1054
GW 30 522	1/2	312	785
GW 30 522	1/2	312	817
GW 30 522	1/2	312	850
GW 30 522	1/2	312	885
GW 30 522	1/2	312	919
GW 30 522	1/2	312	986
GW 30 522	1/2	312	1012
GW 30 611	24/48	1920	1054
GW 30 612	24/48	3840	1054
GW 30 614	24/48	1920	1054
GW 30 633	12/24	1872	1054
GW 30 634	12/24	1872	1054
GW 30 635	12/24	1872	1054
GW 30 636	12/24	1872	1054
GW 30 685	1/12	576	1052
GW 30 686	1/12	288	1052
GW 30 702	2/4	624	1056
GW 30 703	2/12	576	1056
GW 30 706	1/2	156	1056
GW 30 711	2/4	312	1057
GW 30 901	5/200	12000	1048
GW 30 902	12/48	960	1048
GW 30 903	8/32	576	1048
GW 30 905	24/48	1920	1048
GW 30 912	1/100	19500	786
GW 30 912	1/100	19500	818
GW 30 912	1/100	19500	852
GW 30 912	1/100	19500	886
GW 30 912	1/100	19500	920
GW 30 912	1/100	19500	988
GW 30 912	1/100	19500	1014
GW 30 912	1/100	19500	1058
GW 30 943	50	15600	214
GW 30 943	50	15600	987
GW 30 943	50	15600	1013
GW 30 943	50	15600	1058
GW 30 944	50	9750	987
GW 30 944	50	9750	1013
GW 30 944	50	9750	1058
GW 30 945	50	7800	214
GW 30 946	50	9750	987
GW 30 946	50	9750	1013
GW 30 946	50	9750	1058
GW 30 947	50	9750	987
GW 30 947	50	9750	1013
GW 30 947	50	9750	1058
GW 30 951	50		214
GW 30 952	50	9750	214
GW 30 958	10	1560	215
GW 30 959	10	1560	215
GW 30 960	10	1560	215
GW 32			
GW 32 002	48	1344	1036
GW 32 003	48	1344	1036
GW 32 004	24	1200	1036
GW 32 006	24	720	1036
GW 32 007	12	576	1036
GW 32 008	12	1152	1036
GW 32 009	6	450	1036
GW 32 012	48	1344	1036
GW 32 013	48	1344	1036
GW 32 014	24	1728	1036
GW 32 016	24	1200	1036

Code	Quantity		Page
	Pack/carton	Pallet	
GW 32 017	12	480	1036
GW 32 018	12	180	1036
GW 32 019	6	450	1036
GW 32 022	48	672	1036
GW 32 023	48	1344	1036
GW 32 024	24	1152	1036
GW 32 026	24	720	1036
GW 32 027	12	576	1036
GW 32 028	12	180	1036
GW 32 029	6	144	1036
GW 32 052	48	672	1036
GW 32 053	48	1344	1036
GW 32 054	24	1200	1036
GW 32 056	24	1080	1036
GW 32 057	12	576	1036
GW 32 072	48	672	1037
GW 32 073	48	672	1037
GW 32 074	24	720	1037
GW 32 076	24	1080	1037
GW 32 077	12	576	1037
GW 32 121	1/30	450	1037
GW 32 123	1/30	720	1037
GW 32 131	1/30	1200	1037
GW 32 133	1/30	900	1037
GW 32 242	12	960	1034
GW 32 243	96	1152	1034
GW 32 244	12	1344	1034
GW 32 246	8	720	1034
GW 32 302	12	768	1034
GW 32 303	96	3456	1034
GW 32 304	12	1344	1034
GW 32 306	8	768	1034
GW 32 402	10/150	900	1040
GW 32 403	10/150	5400	1040
GW 32 404	10/100	2000	1040
GW 32 406	10/100	1200	1040
GW 32 407	5/50	800	1040
GW 32 408	5/50	800	1040
GW 32 409	5/25	450	1040
GW 32 411	2/24	192	1038
GW 32 412	2/12	192	1038
GW 32 421	5/200	1200	1040
GW 32 431	3/60	960	307
GW 32 431	3/60	960	307
GW 32 431	3/60	960	960
GW 32 431	3/60	960	1038
GW 32 432	3/60	480	307
GW 32 432	3/60	480	307
GW 32 432	3/60	480	960
GW 32 432	3/60	480	1038
GW 32 450	1/10	300	213
GW 32 450	1/10	300	1039
GW 32 451	1/10	500	213
GW 32 451	1/10	500	1039
GW 32 457	1/10	1950	214
GW 32 457	1/10	1950	1039
GW 32 461	1/60	720	1037
GW 32 462	1/60	780	1037
GW 32 466	1/30	600	1037
GW 32 467	1/30	540	1037
GW 32 702	12	960	1034
GW 32 703	12	1440	1034
GW 32 704	12	960	1034
GW 32 706	8	960	1034
GW 32 712	12	960	1035

Code	Quantity		Page
	Pack/carton	Pallet	
GW 32 713	12	1512	1035
GW 32 714	12	960	1035
GW 32 716	8	720	1035
GW 32 752	12	240	1035
GW 32 753	12	1440	1035
GW 32 754	12	960	1035
GW 32 756	8	720	1035

GW 35

GW 35 001 Y	10/100	1200	1076
GW 35 002 W	10/100	1400	1070
GW 35 002 Y	10/100	1400	1076
GW 35 003 W	10/100	1800	1070
GW 35 003 Y	10/100	1800	1076
GW 35 006 W	10/100	5200	1070
GW 35 006 Y	10/100	1200	1076
GW 35 011 Y	10/100	6000	1076
GW 35 012 W	10/100	5000	1070
GW 35 012 Y	10/100	1400	1076
GW 35 015 W	10/100	1800	1071
GW 35 015 Y	10/100	1800	1077
GW 35 016 W	10/100	5200	1070
GW 35 016 Y	10/100	1200	1076
GW 35 021 W	10/100	5200	1071
GW 35 021 Y	10/100	1200	1077
GW 35 022 W	10/100	1200	1071
GW 35 022 Y	10/100	1200	1077
GW 35 026 W	10/100	7200	1071
GW 35 026 Y	10/100	1200	1077
GW 35 031 W	10/100	6000	1070
GW 35 051 W	10/100	6000	1070
GW 35 051 Y	10/100	900	1076
GW 35 052 W	10/100	6000	1071
GW 35 052 Y	10/100	1200	1077
GW 35 071 W	10/100	6000	1070
GW 35 201 Y	10/100	1200	1078
GW 35 202 Y	10/100	5200	1078
GW 35 203 W	10/100	1200	1072
GW 35 203 Y	10/100	1200	1078
GW 35 204 W	6/60	3600	1072
GW 35 204 Y	6/60	1000	1078
GW 35 206 W	10/100	5200	1071
GW 35 207 W	10/100	6000	1072
GW 35 211 Y	10/100	1200	1079
GW 35 212 W	10/100	1200	1072
GW 35 212 Y	10/100	1200	1079
GW 35 213 W	10/100	1200	1072
GW 35 213 Y	10/100	1200	1079
GW 35 214 W	6/60	540	1072
GW 35 214 Y	6/60	540	1079
GW 35 216 W	10/100	5200	1072
GW 35 251 W	10/100	1400	1073
GW 35 251 Y	10/100	1400	1080
GW 35 261 W	10/100	1400	1073
GW 35 261 Y	10/100	1400	1080
GW 35 271 W	10/100	1400	1073
GW 35 271 Y	10/100	1400	1080
GW 35 272 W	10/100	1400	1073
GW 35 272 Y	10/100	1400	1080
GW 35 273 W	10/100	1400	1073
GW 35 273 Y	10/100	1400	1080
GW 35 274 W	10/100	1400	1073
GW 35 274 Y	10/100	1400	1080
GW 35 280 W	10/100	1800	1073
GW 35 280 Y	10/100	1800	1080
GW 35 301 W	6/60	960	1072

Code	Quantity		Page
	Pack/carton	Pallet	
GW 35 301 Y	6/60	960	1079
GW 35 901 AD	240	1920	1069
GW 35 901 AG	240	1920	1069
GW 35 901 AH	240	1920	1068
GW 35 901 AM	240	1920	1068
GW 35 901 AN	240	1920	1069
GW 35 901 AW	240	7200	1068
GW 35 901 AY	240	7200	1068
GW 35 902 AD	120	960	1069
GW 35 902 AG	120	960	1069
GW 35 902 AH	120	960	1068
GW 35 902 AM	120	960	1068
GW 35 902 AN	120	960	1069
GW 35 902 AW	120	2880	1068
GW 35 902 AY	120	960	1068
GW 35 903 AD	100	1200	1069
GW 35 903 AG	100	1200	1069
GW 35 903 AH	100	1200	1068
GW 35 903 AM	100	1200	1068
GW 35 903 AN	100	800	1069
GW 35 903 AW	100	800	1068
GW 35 903 AY	100	1200	1068
GW 35 904 AD	80	960	1069
GW 35 904 AG	80	960	1069
GW 35 904 AH	80	960	1068
GW 35 904 AM	80	960	1068
GW 35 904 AN	80	960	1069
GW 35 904 AW	80	640	1068
GW 35 904 AY	80	960	1068
GW 35 905 AD	60	720	1069
GW 35 905 AG	60	720	1069
GW 35 905 AH	60	720	1068
GW 35 905 AM	60	720	1068
GW 35 905 AN	60	720	1069
GW 35 905 AW	60	720	1068
GW 35 905 AY	60	720	1068
GW 35 909 AD	120	960	1069
GW 35 909 AG	120	960	1069
GW 35 909 AH	120	960	1068
GW 35 909 AM	120	960	1068
GW 35 909 AN	120	960	1069
GW 35 909 AW	120	960	1068
GW 35 909 AY	120	960	1068
GW 35 911	10/80	4160	1075
GW 35 911	10/80	4160	1082
GW 35 912	5/40	2080	1075
GW 35 912	5/40	2080	1082
GW 35 981	50/500		1074
GW 35 981	50/500		1081
GW 35 986	1/50	3000	1075
GW 35 986	1/50	3000	1082
GW 35 991	20/200	10400	1074
GW 35 991	20/200	10400	1081
GW 35 996	50/800	12800	1075
GW 35 996	50/800	12800	1082

GW 38

GW 38 031	10/50	3600	1142
GW 38 032	10/50	3600	1142
GW 38 033	10/50	3600	1142
GW 38 034	10/50	1800	1142
GW 38 035	10/50	3600	1142
GW 38 036	10/50	3600	1142
GW 38 051	1	768	1143
GW 38 056	1/48	6912	776
GW 38 056	1/48	6912	811

Code	Quantity		Page
	Pack/carton	Pallet	
GW 38 056	1/48	6912	843
GW 38 056	1/48	6912	877
GW 38 056	1/48	6912	911
GW 38 056	1/48	6912	928
GW 38 056	1/48	6912	979
GW 38 056	1/48	6912	1004
GW 38 056	1/48	6912	1074
GW 38 056	1/48	6912	1081
GW 38 056	1/48	6912	1143
GW 38 057	1/48	6912	776
GW 38 057	1/48	6912	811
GW 38 057	1/48	6912	843
GW 38 057	1/48	6912	877
GW 38 057	1/48	6912	911
GW 38 057	1/48	6912	928
GW 38 057	1/48	6912	979
GW 38 057	1/48	6912	1004
GW 38 057	1/48	6912	1074
GW 38 057	1/48	6912	1081
GW 38 057	1/48	6912	1143
GW 38 098	1	200	252
GW 38 098	1	200	284
GW 38 098	1	200	1172
GW 38 116	1/24	720	1142
GW 38 117	1/24	576	1142
GW 38 118	1/24	480	1142
GW 38 119	1/24	384	1142
GW 38 121	1/24	720	1143
GW 38 122	1/24	720	1143
GW 38 123	1/24	480	1143
GW 38 124	1/24	384	1143
GW 38 131	1/24	720	1142
GW 38 132	1/24	384	1142
GW 38 133	1/24	216	1142
GW 38 335	1/25	2400	775
GW 38 335	1/25	2400	810
GW 38 335	1/25	2400	842
GW 38 335	1/25	2400	876
GW 38 335	1/25	2400	910
GW 38 335	1/25	2400	928
GW 38 335	1/25	2400	978
GW 38 335	1/25	2400	1004
GW 38 335	1/25	2400	1074
GW 38 335	1/25	2400	1081
GW 38 406	1	16	1144
GW 38 407	1	12	1144
GW 38 408	1	10	1144
GW 38 409	1	8	1144
GW 38 418	1	4	1144
GW 38 419	1	4	1144
GW 38 432	1	12	1143
GW 38 442	1/5	420	1144
GW 38 443	1/10	840	1144
GW 38 444	1	84	1144
GW 38 445	1/10	840	1144
GW 38 446	1/12	84	1144
GW 38 451	1	2	1145
GW 38 452	1	2	1145
GW 38 453	1	1	1145
GW 38 461	1	1	1145
GW 38 462	1	1	1145
GW 38 463	1	1	1145
GW 38 464	1	1	1145
GW 38 471	1/30	2520	1144
GW 38 472	1/5	420	1145

Quick Reference

Code	Quantity		Page
	Pack/carton	Pallet	
GW 38 473	1/30	2520	1148
GW 38 474	1	117	1146
GW 38 475	1	10	1146
GW 38 476	1	10	1146
GW 38 477	1/8	160	1146
GW 38 479	1/8	320	1146
GW 38 480	1	33	1146
GW 38 481	1	27	1146
GW 38 482	1	64	1146
GW 38 483	1/15	600	1146
GW 38 484	1	48	1146
GW 38 485	1	84	1145
GW 38 557	1/30	1200	1148
GW 38 558	1/30	2520	1146
GW 38 590	1	20	1144
GW 38 591	1	20	1144
GW 38 592	1	20	1144
GW 38 593	1	20	1144
GW 38 594	1	10	1145
GW 38 595	1	20	1145
GW 38 596	1	10	1145
GW 38 597	1	10	1145
GW 38 598	1	10	1145
GW 38 599	1	10	1145
GW 38 601	1/20	800	1148
GW 38 602	1/10	400	1148
GW 38 603	1/10	20	1147
GW 38 606	1/10	80	1148
GW 38 607	1/6	12	1147
GW 38 608	1/6	12	1147
GW 38 609	1/6	12	1147
GW 38 610	1/20	800	1148
GW 38 611	1/15	600	1148
GW 38 612	1	49	1147
GW 38 613	1	49	1147

GW 40			
Code	Pack/carton	Pallet	Page
GW 40 001	24	720	186
GW 40 003	24	480	186
GW 40 005	8	200	186
GW 40 007	6	96	186
GW 40 009	4	64	186
GW 40 022	84	2520	189
GW 40 023	36	1800	189
GW 40 024	34	850	189
GW 40 026	24	480	189
GW 40 028	12	288	189
GW 40 030	12	180	189
GW 40 032	9	108	189
GW 40 043	14	392	187
GW 40 043 BS	14	350	187
GW 40 045	9	270	187
GW 40 045 BS	9	225	187
GW 40 047	6	180	187
GW 40 047 BD	6	150	187
GW 40 047 BS	6	120	187
GW 40 049	2	56	187
GW 40 049 BD	2	50	187
GW 40 049 BS	2	56	187
GW 40 051	2	60	187
GW 40 051 BD	2	50	187
GW 40 053	1	24	187
GW 40 053 BD	1	19	187
GW 40 053 BQ	1	19	187
GW 40 063	14	252	188
GW 40 063 BS	14	252	188

Code	Quantity		Page
	Pack/carton	Pallet	
GW 40 065	9	225	188
GW 40 065 BS	9	225	188
GW 40 067	6	150	188
GW 40 067 BD	6	150	188
GW 40 067 BS	6	150	188
GW 40 069	2	36	188
GW 40 069 BD	2	50	188
GW 40 069 BS	2	50	188
GW 40 071	2	50	188
GW 40 071 BD	2	50	188
GW 40 073	1	19	188
GW 40 073 BD	1	19	188
GW 40 073 BQ	1	19	188
GW 40 101	19	570	184
GW 40 101	19	570	196
GW 40 102	12	360	184
GW 40 102 BS	12	288	184
GW 40 103	6	150	131
GW 40 103	6	150	184
GW 40 103 BS	6	120	184
GW 40 104	3	105	131
GW 40 104	3	105	185
GW 40 104 BD	3	75	185
GW 40 104 BS	3	75	185
GW 40 105	2	60	185
GW 40 105 BD	2	50	185
GW 40 105 UD	2	50	185
GW 40 106	3	105	131
GW 40 106	3	105	184
GW 40 106 BS	3	63	184
GW 40 107	2	56	185
GW 40 107 BD	2	50	185
GW 40 107 BS	2	50	185
GW 40 108	1	30	185
GW 40 108 BD	1	24	185
GW 40 108 BT	1	24	185
GW 40 109	1	24	185
GW 40 109 BD	1	19	185
GW 40 109 BQ	1	19	185
GW 40 112	1/12	84	196
GW 40 113	6	72	197
GW 40 114	3	63	197
GW 40 115	2	40	197
GW 40 116	1/3	18	196
GW 40 117	1/2	12	196
GW 40 118	1	7	196
GW 40 119	1	19	196
GW 40 123	6	96	197
GW 40 124	3	66	197
GW 40 125	2	40	197
GW 40 151 N	1	84	203
GW 40 151 N	1	84	276
GW 40 152 N	1	84	203
GW 40 152 N	1	84	276
GW 40 153 N	1	70	203
GW 40 153 N	1	70	276
GW 40 154 N	1	36	203
GW 40 154 N	1	36	276
GW 40 155 N	1	28	203
GW 40 155 N	1	28	276
GW 40 161 N	1	72	203
GW 40 161 N	1	72	276
GW 40 162 N	1	60	203
GW 40 162 N	1	60	276
GW 40 163 N	1	48	203

Code	Quantity		Page
	Pack/carton	Pallet	
GW 40 163 N	1	48	276
GW 40 164 N	1	36	203
GW 40 164 N	1	36	276
GW 40 165 N	1	28	203
GW 40 165 N	1	28	276
GW 40 173 N	1	48	203
GW 40 173 N	1	48	276
GW 40 174 N	1	36	203
GW 40 174 N	1	36	276
GW 40 178 N	1	48	203
GW 40 178 N	1	48	276
GW 40 179 N	1	36	203
GW 40 179 N	1	36	276
GW 40 225 TB	16	320	268
GW 40 225 TN	16	256	268
GW 40 225 VA	16	256	268
GW 40 225 VT	16	256	268
GW 40 229 TB	12	192	268
GW 40 229 TN	12	144	268
GW 40 229 VA	12	144	268
GW 40 229 VT	12	192	268
GW 40 233 TB	5	150	268
GW 40 233 TN	5	100	268
GW 40 233 VA	5	80	268
GW 40 233 VT	5	80	268
GW 40 237 TB	12	360	268
GW 40 237 TN	12	144	268
GW 40 237 VA	12	360	268
GW 40 237 VT	12	360	268
GW 40 239 TB	5	100	268
GW 40 239 TN	5	60	268
GW 40 239 VA	5	60	268
GW 40 239 VT	5	60	268
GW 40 285 TB	16	256	269
GW 40 287 TB	12	144	269
GW 40 289 TB	12	144	269
GW 40 293 TB	5	80	269
GW 40 299 TB	5	60	269
GW 40 336	10	150	196
GW 40 337	6	144	196
GW 40 390 C	1	40	251
GW 40 390 C	1	40	275
GW 40 390 F	1	20	251
GW 40 390 F	1	20	275
GW 40 401	10	3120	99
GW 40 401	10	3120	112
GW 40 401	10	3120	113
GW 40 401	10	3120	191
GW 40 401	10	3120	198
GW 40 401	10	3120	250
GW 40 401	10	3120	282
GW 40 402	10	1080	99
GW 40 402	10	1080	112
GW 40 402	10	1080	113
GW 40 402	10	1080	191
GW 40 402	10	1080	198
GW 40 402	10	1080	250
GW 40 402	10	1080	282
GW 40 404	10	600	191
GW 40 404	10	600	198
GW 40 404	10	600	250
GW 40 404	10	600	282
GW 40 408 B	1/10	3120	99
GW 40 408 B	1/10	3120	112
GW 40 408 B	1/10	3120	113

Code	Quantity		Page
	Pack/carton	Pallet	
GW 40 408 B	1/10	3120	191
GW 40 408 B	1/10	3120	198
GW 40 408 B	1/10	3120	250
GW 40 408 B	1/10	3120	282
GW 40 408 U	1/10	3120	99
GW 40 408 U	1/10	3120	112
GW 40 408 U	1/10	3120	113
GW 40 408 U	1/10	3120	191
GW 40 408 U	1/10	3120	198
GW 40 408 U	1/10	3120	250
GW 40 408 U	1/10	3120	282
GW 40 412 B	1/10	1260	99
GW 40 412 B	1/10	1260	112
GW 40 412 B	1/10	1260	113
GW 40 412 B	1/10	1260	191
GW 40 412 B	1/10	1260	198
GW 40 412 B	1/10	1260	250
GW 40 412 B	1/10	1260	282
GW 40 412 U	1/10	1260	99
GW 40 412 U	1/10	1260	112
GW 40 412 U	1/10	1260	113
GW 40 412 U	1/10	1260	191
GW 40 412 U	1/10	1260	198
GW 40 412 U	1/10	1260	250
GW 40 412 U	1/10	1260	282
GW 40 413	20	1440	99
GW 40 413	20	1440	112
GW 40 413	20	1440	113
GW 40 413	20	1440	191
GW 40 413	20	1440	199
GW 40 413	20	1440	250
GW 40 413	20	1440	282
GW 40 418 B	1/10	600	191
GW 40 418 B	1/10	600	250
GW 40 418 B	1/10	600	282
GW 40 418 U	1/10	600	191
GW 40 418 U	1/10	600	250
GW 40 418 U	1/10	600	282
GW 40 421	10/100	40000	193
GW 40 421	10/100	40000	199
GW 40 421	10/100	40000	283
GW 40 422	1/10	1100	98
GW 40 422	1/10	1100	110
GW 40 422	1/10	1100	193
GW 40 422	1/10	1100	199
GW 40 422	1/10	1100	208
GW 40 422	1/10	1100	215
GW 40 422	1/10	1100	249
GW 40 422	1/10	1100	251
GW 40 422	1/10	1100	283
GW 40 422	1/10	1100	1039
GW 40 422 U	1/10	1260	99
GW 40 422 U	1/10	1260	112
GW 40 422 U	1/10	1260	113
GW 40 422 U	1/10	1260	191
GW 40 422 U	1/10	1260	198
GW 40 422 U	1/10	1260	250
GW 40 422 U	1/10	1260	282
GW 40 423	50	7200	171
GW 40 423	50	7200	177
GW 40 423	50	7200	194
GW 40 423	50	7200	198
GW 40 423	50	7200	216
GW 40 423	50	7200	283
GW 40 423	50	7200	300

Code	Quantity		Page
	Pack/carton	Pallet	
GW 40 425	10	3360	249
GW 40 425	10	3360	252
GW 40 425	10	3360	280
GW 40 428	1/20	840	199
GW 40 451	20	1440	201
GW 40 452	20	1440	201
GW 40 453	20	1440	201
GW 40 454 N	1	4200	204
GW 40 454 N	1	4200	277
GW 40 455 N	1	4200	204
GW 40 455 N	1	4200	277
GW 40 461 N	1	8400	204
GW 40 461 N	1	8400	277
GW 40 463	1/10	3120	201
GW 40 463 N	1	8400	204
GW 40 463 N	1	8400	277
GW 40 467	50	6400	194
GW 40 467	50	6400	198
GW 40 467	50	6400	202
GW 40 467	50	6400	204
GW 40 467	50	6400	208
GW 40 467	50	6400	249
GW 40 467	50	6400	277
GW 40 467	50	6400	283
GW 40 467 TB	50	6400	280
GW 40 467 TB	50	6400	1171
GW 40 467 TN	50	6400	280
GW 40 467 VA	50	6400	280
GW 40 467 VT	50	6400	280
GW 40 468	50	6400	283
GW 40 473	20	320	190
GW 40 473	20	320	198
GW 40 474	20	400	190
GW 40 474	20	400	198
GW 40 479	5	240	280
GW 40 487	10/100	2800	192
GW 40 487	10/100	2800	199
GW 40 487	10/100	2800	249
GW 40 487	10/100	2800	282
GW 40 488	10/100	1800	192
GW 40 488	10/100	1800	199
GW 40 488	10/100	1800	249
GW 40 488	10/100	1800	282
GW 40 492	20	800	192
GW 40 492	20	800	199
GW 40 493	20	400	192
GW 40 493	20	400	199
GW 40 495	20	800	250
GW 40 495	20	800	282
GW 40 496	20	400	250
GW 40 496	20	400	282
GW 40 501	8	144	205
GW 40 502	4	128	205
GW 40 503	4	60	205
GW 40 504	2	72	205
GW 40 506	4	144	205
GW 40 511	4	96	205
GW 40 512	3	180	205
GW 40 516	8	160	206
GW 40 517	4	80	206
GW 40 518	4	192	206
GW 40 519	2	72	206
GW 40 526	8	960	206
GW 40 527	4	576	206
GW 40 528	4	288	206

Code	Quantity		Page
	Pack/carton	Pallet	
GW 40 529	2	144	206
GW 40 531	8	96	207
GW 40 532	4	160	207
GW 40 533	4	48	207
GW 40 534	2	36	207
GW 40 536	8	96	207
GW 40 537	4	80	207
GW 40 538	4	48	207
GW 40 539	2	36	207
GW 40 541	4	48	207
GW 40 542	4	72	207
GW 40 546	20	6240	206
GW 40 591	20	1920	207
GW 40 592	20	1920	207
GW 40 593	20	2560	207
GW 40 594	20	2560	207
GW 40 596	1/10	1280	205
GW 40 597	1/10	1280	205
GW 40 601	60	1200	271
GW 40 602	36	576	271
GW 40 603	21	336	271
GW 40 604	12	240	271
GW 40 604 BS	12	300	271
GW 40 605	8	200	271
GW 40 605 BS	8	160	271
GW 40 605 PM	8	128	248
GW 40 606	6	120	271
GW 40 606 BD	6	90	272
GW 40 606 BS	6	90	272
GW 40 606 PM	6	72	248
GW 40 608	4	80	271
GW 40 608 BS	4	80	271
GW 40 609	3	60	271
GW 40 609 BD	3	45	272
GW 40 609 BS	3	45	272
GW 40 609 PM	3	36	248
GW 40 610	2	48	271
GW 40 610 BD	2	36	272
GW 40 610 BT	2	36	272
GW 40 610 PM	3	24	248
GW 40 611	1	24	271
GW 40 611 BD	1	19	272
GW 40 611 BQ	1	19	272
GW 40 611 PM	1	19	248
GW 40 655	18	288	278
GW 40 657	8	128	278
GW 40 659	6	150	278
GW 40 661	3	48	278
GW 40 671	12	240	270
GW 40 673	16	256	270
GW 40 674	12	192	270
GW 40 677	5	120	270
GW 40 679	5	80	270
GW 40 685	1/12	96	274
GW 40 685 PM	1/12	180	249
GW 40 687	1/5	120	274
GW 40 687 PM	1/5	150	249
GW 40 688	1/5	80	274
GW 40 688	1/5	80	275
GW 40 688 PM	1/5	100	249
GW 40 688 PM	1/5	100	251
GW 40 689	1/3	72	274
GW 40 689	1/3	72	275
GW 40 689 PM	1/3	36	249
GW 40 689 PM	1/3	36	251

Quick Reference

Code	Quantity		Page
	Pack/carton	Pallet	
GW 40 690	1/2	48	274
GW 40 690 PM	1/2	38	249
GW 40 882	36	576	272
GW 40 883	21	336	272
GW 40 884	12	240	272
GW 40 884 BS	12	300	272
GW 40 885	8	128	272
GW 40 885 BS	8	128	272
GW 40 886	6	90	273
GW 40 886 BD	6	90	273
GW 40 886 BS	6	90	273
GW 40 888	4	80	272
GW 40 888 BS	4	100	272
GW 40 889	3	45	273
GW 40 889 BD	3	45	273
GW 40 889 BS	3	45	273
GW 40 890	2	48	273
GW 40 890 BD	2	36	273
GW 40 890 BT	2	36	273
GW 40 891	1	24	273
GW 40 891 BD	1	19	273
GW 40 891 BQ	1	19	273
GW 41			
GW 41 225 TB	16	128	269
GW 41 225 TN	16	128	269
GW 41 225 VA	16	128	269
GW 41 225 VT	16	128	269
GW 41 229 TB	12	192	269
GW 41 229 TN	12	192	269
GW 41 229 VA	12	96	269
GW 41 229 VT	12	96	269
GW 41 233 TB	5	125	269
GW 41 233 TN	5	80	269
GW 41 233 VA	5	40	269
GW 41 233 VT	5	40	269
GW 41 237 TB	12	240	269
GW 41 237 TN	12	240	269
GW 41 237 VA	12	240	269
GW 41 237 VT	12	240	269
GW 41 239 TB	5	60	269
GW 41 239 TN	5	60	269
GW 41 239 VA	5	60	269
GW 41 239 VT	5	60	269
GW 41 885 AB	12	144	248
GW 41 885 AB	12	144	274
GW 41 886 AB	5	75	248
GW 41 886 AB	5	75	274
GW 41 889 AB	3	36	248
GW 41 889 AB	3	36	274
GW 41 890 AB	2	54	248
GW 41 890 AB	2	54	274
GW 41 891 AB	1	19	248
GW 41 891 AB	1	19	274
GW 42			
GW 42 001	32	1024	237
GW 42 002	44	704	237
GW 42 003	32	512	237
GW 42 004	16	512	237
GW 42 005	21	336	237
GW 42 006	16	256	237
GW 42 007	10	160	237
GW 42 008	10	200	237
GW 42 009	8	128	237
GW 42 010	5	80	237

Code	Quantity		Page
	Pack/carton	Pallet	
GW 42 201	1/10	1000	212
GW 42 202	1/10	200	213
GW 42 203	1/10	200	213
GW 42 204	1/10	400	212
GW 42 206	1/10	400	213
GW 42 207	1/10	160	213
GW 42 208	1/10	200	213
GW 42 211	1/10	1440	214
GW 42 212	1/10	1280	214
GW 42 213	1/10	3120	214
GW 42 214	1/10	1440	214
GW 42 216	1/10	1560	214
GW 42 216	1/10	1560	1039
GW 42 231	1/10	240	213
GW 42 232	1/10	200	213
GW 43			
GW 43 021 S	1	120	200
GW 43 022 S	1	91	200
GW 43 023 S	1	48	200
GW 43 024 S	1	36	200
GW 43 040 S	100	31200	202
GW 43 042 S	2/20	6240	201
GW 43 044 S	10/100	3600	202
GW 43 052 S	1/10	1280	202
GW 43 071 S	1/4	364	201
GW 43 072 S	1/6	336	201
GW 43 073 S	1/2	120	201
GW 43 074 S	1/2	96	201
GW 43 111 S	1		201
GW 43 112 S	1	32	201
GW 43 113 S	1	20	201
GW 43 114 S	1	6	201
GW 43 122 S	1/10		202
GW 44			
GW 44 001	5/280	8400	221
GW 44 002	5/135	3780	221
GW 44 003	5/90	4050	221
GW 44 004	66	1980	221
GW 44 005	66	1980	221
GW 44 006	40	1000	221
GW 44 007	24	600	221
GW 44 008	12	300	221
GW 44 009	6	150	221
GW 44 010	4	100	221
GW 44 011	3	60	221
GW 44 024	66	1980	221
GW 44 026	40	1000	221
GW 44 051	5/280	5600	224
GW 44 051 R	5/280	5600	225
GW 44 052	5/135	2700	224
GW 44 053	5/90	1890	224
GW 44 053 R	5/90	2520	225
GW 44 054	66	1980	224
GW 44 054 R	66	1320	225
GW 44 055	66	528	226
GW 44 056	40	800	224
GW 44 056 R	40	640	225
GW 44 057	24	384	226
GW 44 058	12	192	226
GW 44 059	6	96	226
GW 44 060	4	64	226
GW 44 061	3	36	226
GW 44 114	1/45	900	223
GW 44 117	1/16	256	223

Code	Quantity		Page
	Pack/carton	Pallet	
GW 44 118	1/12	144	223
GW 44 119	1/7	84	223
GW 44 120	1/3	60	223
GW 44 137	1/16	128	223
GW 44 138	1/12	144	223
GW 44 139	1/7	84	223
GW 44 140	1/3	60	223
GW 44 204	105	2625	222
GW 44 205	91	2730	222
GW 44 206	50	1250	222
GW 44 207	30	750	222
GW 44 208	14	350	222
GW 44 209	6	180	222
GW 44 210	4	100	222
GW 44 211	3	75	222
GW 44 214	45	900	222
GW 44 215	55	880	222
GW 44 216	24	600	222
GW 44 217	12	360	222
GW 44 218	12	240	222
GW 44 219	7	140	222
GW 44 220	3	75	222
GW 44 221	2	50	222
GW 44 234	105	2625	222
GW 44 236	50	1250	222
GW 44 254	45	360	227
GW 44 255	55	220	227
GW 44 256	24	96	227
GW 44 257	16	240	227
GW 44 258	12	144	227
GW 44 259	7	84	227
GW 44 260	3	48	227
GW 44 261	2	32	227
GW 44 274	105	1680	227
GW 44 275	91	1820	227
GW 44 276	50	800	227
GW 44 276 C	50	800	227
GW 44 277	30	480	227
GW 44 277 C	30	480	227
GW 44 278	14	224	227
GW 44 279	6	120	227
GW 44 280	4	64	227
GW 44 281	3	48	227
GW 44 404	108	1728	228
GW 44 405	108	1728	228
GW 44 406	50	800	228
GW 44 407	32	512	228
GW 44 408	14	224	228
GW 44 409	6	120	228
GW 44 410	4	64	228
GW 44 411	3	48	228
GW 44 414	45	360	228
GW 44 415	55	220	228
GW 44 416	24	384	228
GW 44 417	16	240	228
GW 44 418	12	144	228
GW 44 419	7	84	228
GW 44 420	3	48	228
GW 44 421	2	32	228
GW 44 426	50	800	229
GW 44 427	32	512	229
GW 44 428	14	224	229
GW 44 429	6	120	229
GW 44 430	4	100	229
GW 44 431	3	48	229

Code	Quantity		Page
	Pack/carton	Pallet	
GW 44 436	24	384	229
GW 44 437	16	240	229
GW 44 438	12	144	229
GW 44 439	7	84	229
GW 44 440	3	48	229
GW 44 441	2	32	229
GW 44 601	10/480	14400	389
GW 44 602	10/240	7200	389
GW 44 603	10/160	4800	389
GW 44 604	10/120	2160	389
GW 44 605	3/36	1080	389
GW 44 606	10/100	7000	389
GW 44 607	10/100	7000	389
GW 44 608	10/100	7000	389
GW 44 609	10/100	4000	390
GW 44 610	10/100	4000	390
GW 44 610 C	10/100	4000	390
GW 44 611	10/100	2800	390
GW 44 612	10/100	2800	390
GW 44 613	1/10	1280	390
GW 44 614	1/10	1280	390
GW 44 615	20	2880	229
GW 44 615	20	2880	238
GW 44 616	20	1400	229
GW 44 616	20	1400	238
GW 44 617	20	1000	229
GW 44 617	20	1000	238
GW 44 618	5	520	229
GW 44 619	5	275	229
GW 44 620	10/160	2560	230
GW 44 621	40/480	13440	79
GW 44 621	40/480	13440	109
GW 44 621	40/480	13440	177
GW 44 621	40/480	13440	190
GW 44 621	40/480	13440	198
GW 44 621	40/480	13440	216
GW 44 621	40/480	13440	230
GW 44 622	10/100	14400	78
GW 44 622	10/100	14400	154
GW 44 622	10/100	14400	208
GW 44 622	10/100	14400	216
GW 44 622	10/100	14400	230
GW 44 622	10/100	14400	230
GW 44 622	10/100	14400	1028
GW 44 623	10/100	12800	78
GW 44 623	10/100	12800	194
GW 44 623	10/100	12800	198
GW 44 623	10/100	12800	216
GW 44 623	10/100	12800	230
GW 44 625	20	2560	229
GW 44 625	20	2560	238
GW 44 626	20	1400	111
GW 44 626	20	1400	229
GW 44 626	20	1400	238
GW 44 627	20	1000	111
GW 44 627	20	1000	229
GW 44 627	20	1000	238
GW 44 628	4	320	111
GW 44 628	4	320	229
GW 44 629	5	430	229
GW 44 636	20	1620	176
GW 44 637	20	600	176
GW 44 638	5	260	176
GW 44 639	5	260	176
GW 44 646	20	1400	176
GW 44 647	20	1200	176

Code	Quantity		Page
	Pack/carton	Pallet	
GW 44 648	4	544	176
GW 44 649	5	360	176
GW 44 651	1/5	1960	173
GW 44 651	1/5	1960	392
GW 44 651	1/5	1960	649
GW 44 652	1/25	11550	174
GW 44 652	1/25	11550	392
GW 44 652	1/25	11550	649
GW 44 661	10/450	13500	389
GW 44 662	10/450	10800	389
GW 44 663	10/300	4200	389
GW 44 664	10/240	8640	389
GW 44 665	10/450	12150	389
GW 44 666	5/150	6750	389
GW 44 667	5/150	6750	389
GW 44 671	10/100	7000	256
GW 44 671	10/100	7000	292
GW 44 671	10/100	7000	391
GW 44 672	10/100	7000	256
GW 44 672	10/100	7000	292
GW 44 672	10/100	7000	391
GW 44 673	10/50	4400	256
GW 44 673	10/50	4400	292
GW 44 673	10/50	4400	391
GW 44 674	10/50	3500	256
GW 44 674	10/50	3500	292
GW 44 674	10/50	3500	391
GW 44 675	5/25	2750	256
GW 44 675	5/25	2750	292
GW 44 675	5/25	2750	391
GW 44 676	1/10	1100	256
GW 44 676	1/10	1100	292
GW 44 676	1/10	1100	391
GW 44 681	100	16000	257
GW 44 681	100	16000	293
GW 44 681	100	16000	391
GW 44 682	200	62400	257
GW 44 682	200	62400	293
GW 44 682	200	62400	391
GW 44 683	1/50	2000	298
GW 44 683	1/50	2000	391
GW 44 691	2/40	3600	174
GW 44 691	2/40	3600	392
GW 44 691	2/40	3600	649
GW 44 693	1/12	624	174
GW 44 693	1/12	624	392
GW 44 693	1/12	624	649
GW 44 696	2/20	1280	174
GW 44 696	2/20	1280	392
GW 44 696	2/20	1280	649
GW 44 698	1/10	640	174
GW 44 698	1/10	640	392
GW 44 698	1/10	640	649
GW 44 699	1/12	288	174
GW 44 699	1/12	288	392
GW 44 699	1/12	288	649
GW 44 700	1/2	130	174
GW 44 700	1/2	130	648
GW 44 704	10/100	7000	256
GW 44 704	10/100	7000	292
GW 44 704	10/100	7000	390
GW 44 706	10/100	7000	256
GW 44 706	10/100	7000	292
GW 44 706	10/100	7000	390
GW 44 708	10/100	5000	256

Code	Quantity		Page
	Pack/carton	Pallet	
GW 44 708	10/100	5000	292
GW 44 708	10/100	5000	390
GW 44 720	1/50	2000	256
GW 44 720	1/50	2000	292
GW 44 720	1/50	2000	390
GW 44 808	4	96	175
GW 44 809	4	80	175
GW 44 810	2	50	175
GW 44 811	2	40	175
GW 44 818	4	120	175
GW 44 819	4	80	175
GW 44 820	2	50	175
GW 44 821	2	24	175
GW 44 852	8	144	176
GW 44 853	8	96	176
GW 44 854	8	96	176
GW 44 855	8	192	176

GW 45			
GW 45 413	1	264	592
GW 45 413	1	264	615
GW 45 413	1	264	635
GW 45 414	1	264	592
GW 45 414	1	264	615
GW 45 414	1	264	635
GW 45 418	1	264	592
GW 45 418	1	264	615
GW 45 418	1	264	635
GW 45 419	1	264	592
GW 45 419	1	264	615
GW 45 419	1	264	635
GW 45 538	1	264	573
GW 45 545	1	50	648
GW 45 546	1	30	648
GW 45 547	1	70	648
GW 45 548	1	70	648
GW 45 551	1	340	650
GW 45 553	1	160	650
GW 45 554	1	80	650
GW 45 555	1	250	650
GW 45 557	1	175	650
GW 45 558	1	80	650
GW 45 559	1	40	594
GW 45 559	1	40	616
GW 45 560	1	100	636
GW 45 565	1	400	594
GW 45 565	1	400	616
GW 45 565	1	400	636
GW 45 566	1	40	594
GW 45 566	1	40	616
GW 45 566	1	40	636
GW 45 568	1	264	595
GW 45 568	1	264	616
GW 45 568	1	264	636
GW 45 569	1	264	595
GW 45 569	1	264	616
GW 45 569	1	264	636

GW 46			
GW 46 001 F	1	90	162
GW 46 002 F	1	84	162
GW 46 003 F	1	24	131
GW 46 003 F	1	24	162
GW 46 004 F	1	24	131
GW 46 004 F	1	24	162
GW 46 005 F	1	12	131

Quick Reference

Code	Quantity		Page
	Pack/carton	Pallet	
GW 46 005 F	1	12	162
GW 46 006 F	1	9	131
GW 46 006 F	1	9	162
GW 46 007 F	1	4	162
GW 46 031	1	90	164
GW 46 032	1	60	164
GW 46 033	1	28	164
GW 46 034	1	20	164
GW 46 035	1	18	164
GW 46 036	1	8	164
GW 46 037	1	4	164
GW 46 052	1	60	165
GW 46 054	1	20	165
GW 46 056	1	8	165
GW 46 201 F	1	90	163
GW 46 202 F	1	84	163
GW 46 203 F	1	24	131
GW 46 203 F	1	24	163
GW 46 204 F	1	24	131
GW 46 204 F	1	24	163
GW 46 205 F	1	12	131
GW 46 205 F	1	12	163
GW 46 206 F	1	9	131
GW 46 206 F	1	9	163
GW 46 207 F	1	4	163
GW 46 232	1	60	164
GW 46 233	1	28	164
GW 46 234	1	20	164
GW 46 235	1	18	164
GW 46 236	1	8	164
GW 46 237	1	4	164
GW 46 401	1/5	900	168
GW 46 402	1/5	400	168
GW 46 403	1/5	300	168
GW 46 404	1/4	200	168
GW 46 405	1/2	168	168
GW 46 406	1/2	135	168
GW 46 407	1	40	168
GW 46 408	1/5	1350	168
GW 46 409	1/5	720	168
GW 46 410	1/5	400	168
GW 46 411	1/4	288	168
GW 46 412	1/3	138	168
GW 46 413	1/2	80	168
GW 46 414	1/5	120	166
GW 46 415	1/4	128	166
GW 46 416	1/5	80	166
GW 46 417	1/2	104	166
GW 46 418	1/2	104	166
GW 46 419	1	13	166
GW 46 420 F	1/10	480	166
GW 46 421 F	1/10	360	166
GW 46 422 F	1/10	240	166
GW 46 423 F	1/5	180	166
GW 46 424 F	1/5	90	166
GW 46 425 F	1/10	640	167
GW 46 426 F	1/10	500	167
GW 46 427 F	1/13	468	167
GW 46 428 F	1/5	400	167
GW 46 429 F	1/5	90	167
GW 46 430 F	1/10	500	167
GW 46 431 F	1/10	240	167
GW 46 432 F	1/10	320	167
GW 46 433 F	1/10	320	167
GW 46 434 F	1/10	220	167

Code	Quantity		Page
	Pack/carton	Pallet	
GW 46 435 F	1/10	600	167
GW 46 436 F	1/10	550	167
GW 46 437 F	1/10	330	167
GW 46 438 F	1/10	150	167
GW 46 439 F	1/10	90	167
GW 46 445	10	1100	134
GW 46 445	10	1100	172
GW 46 445	10	1100	178
GW 46 446	20	1280	109
GW 46 446	20	1280	169
GW 46 446	20	1280	177
GW 46 447	1/10	200	134
GW 46 447	1/10	200	173
GW 46 447	1/10	200	563
GW 46 447	1/10	200	573
GW 46 447	1/10	200	595
GW 46 447	1/10	200	617
GW 46 447	1/10	200	637
GW 46 447	1/10	200	1148
GW 46 448	1/2	120	173
GW 46 448	1/2	120	593
GW 46 448	1/2	120	615
GW 46 448	1/2	120	635
GW 46 449	1/10	700	171
GW 46 450	10/100	39000	169
GW 46 451	20	1280	109
GW 46 451	20	1280	169
GW 46 451	20	1280	177
GW 46 461	1/5	1350	168
GW 46 462	1/5	240	168
GW 46 463	1/5	360	168
GW 46 464	1/5	360	168
GW 46 465	1/4	168	168
GW 46 466	1/3	114	168
GW 46 467	1/2	40	168
GW 46 471	1/10	300	173
GW 46 471	1/10	300	593
GW 46 471	1/10	300	615
GW 46 471	1/10	300	636
GW 46 475 F	1/5	140	167
GW 46 476 F	1/5	90	167
GW 46 477 F	1/5	270	167
GW 46 478 F	1/5	140	167
GW 46 479 F	1	48	167
GW 46 501 F	1/6	180	163
GW 46 502 F	1/6	144	163
GW 46 503 F	1/8	72	163
GW 46 504 F	1/8	80	163
GW 46 505 F	1	22	163
GW 46 506 F	1	13	163
GW 46 507 F	1	10	163
GW 46 511 F	1/6	540	163
GW 46 512 F	1/6	144	163
GW 46 513 F	1/8	56	163
GW 46 514 F	1/8	160	163
GW 46 515 F	1	22	163
GW 46 516 F	1	13	163
GW 46 517 F	1	10	163
GW 46 521 F	1/20	1740	171
GW 46 522	10	3120	172
GW 46 522	10	3120	177
GW 46 523	10	1560	172
GW 46 523	10	1560	178
GW 46 524 F	1/4	812	170
GW 46 526	1/20	400	169

Code	Quantity		Page
	Pack/carton	Pallet	
GW 46 530 F	1/10	400	167
GW 46 531 F	1/10	240	167
GW 46 532 F	1/10	240	167
GW 46 533 F	1/10	240	167
GW 46 534 F	1/10	120	167
GW 46 540	1/5	480	169
GW 46 541	1/5	360	169
GW 46 542	1/5	140	169
GW 46 543	1/5	120	169
GW 46 544	1/4	80	169
GW 46 551	1	80	170
GW 46 551	1	80	1189
GW 46 552	1	210	109
GW 46 552	1	210	170
GW 46 553	1	180	109
GW 46 553	1	180	170
GW 46 554	1	140	132
GW 46 554	1	140	170
GW 46 555	1	168	170
GW 46 557 F	1/10	700	170
GW 46 564	1/5	120	166
GW 46 565	1/4	56	166
GW 46 566	1/5	100	166
GW 46 567	1/2	44	166
GW 46 568	1/2	44	166
GW 46 569	1	13	166
GW 46 570 F	1	50	168
GW 46 571 F	1	30	168
GW 46 572 F	1	30	168
GW 46 573 F	1	20	168
GW 46 577 F	1	55	168
GW 46 578 F	1	33	168
GW 46 579 F	1	22	168
GW 46 580	1/5	200	169
GW 46 581	1/5	140	169
GW 46 582	1/5	60	169
GW 46 583	1/5	60	169
GW 46 584	1/2	120	169
GW 46 591	1/10	880	170
GW 46 592 F	1/100	600	172
GW 47			
GW 47 001 E	1	12	568
GW 47 002 E	1	8	568
GW 47 003 E	1	10	568
GW 47 004 E	1	10	568
GW 47 011 E	1	10	568
GW 47 012 E	1	10	568
GW 47 013 E	1	8	568
GW 47 014 E	1	8	568
GW 47 021 E	1	11	568
GW 47 022 E	1	10	568
GW 47 023 E	1	8	568
GW 47 024 E	1	8	568
GW 47 031 E	1	10	569
GW 47 032 E	1	10	569
GW 47 033 E	1	8	569
GW 47 034 E	1	8	569
GW 47 041 E	1	10	569
GW 47 042 E	1	10	569
GW 47 043 E	1	8	569
GW 47 044 E	1	8	569
GW 47 062 E	1	10	569
GW 47 063 E	1	7	569
GW 47 064 E	1	9	569
GW 47 072	1	12	559

Code	Quantity		Page
	Pack/carton	Pallet	
GW 47 073	1	11	559
GW 47 074	1	11	559
GW 47 082	1	10	559
GW 47 083	1	10	559
GW 47 084	1	10	559
GW 47 087	1	12	559
GW 47 088	1	10	559
GW 47 089	1	10	559
GW 47 116	1	10	564
GW 47 116	1	10	575
GW 47 117	1	10	564
GW 47 117	1	10	575
GW 47 118	1	10	564
GW 47 118	1	10	575
GW 47 119	1	10	575
GW 47 121	1	12	564
GW 47 121	1	12	575
GW 47 122	1	12	564
GW 47 122	1	12	575
GW 47 123	1	10	564
GW 47 123	1	10	575
GW 47 124	1	10	575
GW 47 136	1	8	575
GW 47 137	1	8	575
GW 47 138	1	8	575
GW 47 139	1	8	575
GW 47 141	1	10	575
GW 47 142	1	10	575
GW 47 143	1	5	575
GW 47 144	1	10	575
GW 47 162	1	10	576
GW 47 163	1	10	576
GW 47 164	1	9	576
GW 47 171	1/10	240	569
GW 47 172	1/8	192	569
GW 47 173	1/10	360	560
GW 47 173	1/10	360	570
GW 47 174	1/10	180	560
GW 47 174	1/10	180	570
GW 47 175	1/10	360	560
GW 47 175	1/10	360	570
GW 47 177	1/10	250	560
GW 47 177	1/10	250	570
GW 47 178	1/10	300	560
GW 47 178	1/10	300	570
GW 47 179	1/10	300	560
GW 47 179	1/10	300	570
GW 47 181	1/10	480	571
GW 47 182	1/10	240	571
GW 47 183	1/10	240	571
GW 47 186	1/5	60	571
GW 47 187	1/5	80	571
GW 47 191	1/20	2880	562
GW 47 191	1/20	2880	572
GW 47 192	1/10	1440	563
GW 47 192	1/10	1440	574
GW 47 193	1/5	300	563
GW 47 193	1/5	300	573
GW 47 194 E	1/20	800	562
GW 47 194 E	1/20	800	572
GW 47 195	10/100	14400	563
GW 47 195	10/100	14400	574
GW 47 197	1/10	1280	563
GW 47 198	1/10	150	576
GW 47 251	1/10	480	561

Code	Quantity		Page
	Pack/carton	Pallet	
GW 47 252	1/10	120	561
GW 47 253	1/10	180	561
GW 47 291	10	800	171
GW 47 291	10	800	562
GW 47 291	10	800	572
GW 47 297	1/5	35	570
GW 47 298	1/5	35	570
GW 47 299	1/5	35	570
GW 47 650	1	500	655
GW 47 652	1	500	655
GW 47 653	1	500	655
GW 47 654	1	500	655
GW 47 655	1	50	655
GW 47 691	1/5	200	592
GW 47 691	1/5	200	615
GW 47 691	1/5	200	635
GW 47 692	1/5	125	592
GW 47 692	1/5	125	615
GW 47 692	1/5	125	635
GW 48			
GW 48 001	162	3240	289
GW 48 002	114	2280	289
GW 48 003	84	1680	289
GW 48 004	64	1280	289
GW 48 005	49	980	289
GW 48 006	34	680	289
GW 48 006 P	70	840	254
GW 48 006 P	70	840	290
GW 48 006 PM	1/30	600	253
GW 48 007	22	440	289
GW 48 007 P	60	720	254
GW 48 007 P	60	720	290
GW 48 007 PM	1/21	420	253
GW 48 008	17	340	289
GW 48 008 P	50	800	254
GW 48 008 P	50	800	290
GW 48 008 PM	1/14	280	253
GW 48 009	17	204	289
GW 48 009 P	40	360	254
GW 48 009 P	40	360	290
GW 48 009 PM	1/12	240	253
GW 48 010	9	135	289
GW 48 010 P	30	270	290
GW 48 011	5	100	289
GW 48 011 P	25	175	290
GW 48 012	50/300	16200	255
GW 48 012	50/300	16200	291
GW 48 013	10/120	6480	291
GW 48 014	10/100	6400	291
GW 48 015	10/100	5000	291
GW 48 016	10/100	4000	291
GW 48 017	10/100	3600	255
GW 48 017	10/100	3600	291
GW 48 017 AB	1/50	900	254
GW 48 017 AB	1/50	900	290
GW 48 018	10/80	2400	255
GW 48 018	10/80	2400	291
GW 48 018 AB	80/40	200	254
GW 48 018 AB	80/40	200	290
GW 48 019	10/40	1600	255
GW 48 019	10/40	1600	291
GW 48 019 AB	1/20	254	254
GW 48 019 AB	1/20	290	290
GW 48 020	10/40	360	255
GW 48 020	10/40	360	291

Code	Quantity		Page
	Pack/carton	Pallet	
GW 48 020 AB	1/20		254
GW 48 020 AB	1/20		290
GW 48 021	10/30	720	291
GW 48 022	10/20	220	291
GW 48 023	300/4200		255
GW 48 023	300/4200		291
GW 48 024	10/200	5600	298
GW 48 026	5/25	700	281
GW 48 026	5/25	700	298
GW 48 051	10	3120	254
GW 48 051	10	3120	290
GW 48 084	1/10	280	291
GW 48 085	1/8	128	291
GW 48 086	1/10	180	255
GW 48 086	1/10	180	291
GW 48 087	1/5	90	255
GW 48 087	1/5	90	291
GW 48 088	1/5	55	255
GW 48 088	1/5	55	291
GW 48 116	30	600	290
GW 48 116 PM	30	240	254
GW 48 117	20	240	290
GW 48 117 PM	20	80	254
GW 48 118	10	300	290
GW 48 118 PM	10	300	254
GW 48 119	10	800	290
GW 48 119 PM	10	40	254
GW 48 126 PM	1/30	360	253
GW 48 207	8	200	294
GW 48 207 PM	8	128	258
GW 48 211	6	120	294
GW 48 211 PM	6	96	258
GW 48 227	4	100	294
GW 48 231	4	64	294
GW 48 247	1/15	420	258
GW 48 247	1/15	420	295
GW 48 251	1/10	200	258
GW 48 251	1/10	200	295
GW 48 267	1/10	80	258
GW 48 267	1/10	80	295
GW 48 271	1/5	100	258
GW 48 271	1/5	100	295
GW 48 621	1/30	810	300
GW 48 622	1/20	540	300
GW 48 623	1/15	270	300
GW 48 643	1/100	12800	299
GW 48 644	1/10	1280	215
GW 48 644	1/10	1280	283
GW 48 644	1/10	1280	299
GW 48 645	1/100	7000	216
GW 48 645	1/100	7000	250
GW 48 645	1/100	7000	280
GW 48 645	1/100	7000	299
GW 48 651	1/30	810	300
GW 48 671	1/28	448	296
GW 48 672	1/14	224	296
GW 48 673	1/9	135	296
GW 48 681	1/6	252	279
GW 48 681	1/6	252	297
GW 48 682	1/4	96	279
GW 48 682	1/4	96	297
GW 48 686	1/4	160	279
GW 48 686	1/4	160	297
GW 48 691	1/28	448	296

Quick Reference

Code	Quantity		Page
	Pack/carton	Pallet	
GW 49			
GW 49 678	1	90	650
GW 49 679	1	55	650
GW 49 680	1	27	650
GW 50			
GW 50 201	20/60	2400	321
GW 50 201	20/60	2400	380
GW 50 202	20/120	4560	321
GW 50 202	20/120	4560	380
GW 50 203	10/40	800	321
GW 50 203	10/40	800	380
GW 50 204	10/60	960	321
GW 50 204	10/60	960	380
GW 50 205	6/30	1080	321
GW 50 205	6/30	1080	380
GW 50 206	6/36	432	321
GW 50 206	6/36	432	380
GW 50 207	20/60	6000	321
GW 50 207	20/60	6000	380
GW 50 208	20/120	6000	321
GW 50 208	20/120	6000	380
GW 50 209	20/120	2880	321
GW 50 209	20/120	2880	380
GW 50 210	10/20	1280	321
GW 50 210	10/20	1280	380
GW 50 211	6/30	540	321
GW 50 211	6/30	540	380
GW 50 212	6/36	432	321
GW 50 212	6/36	432	380
GW 50 415	25/200	8000	337
GW 50 415	25/200	8000	367
GW 50 416	25/200	14400	337
GW 50 416	25/200	14400	367
GW 50 417	25/150	7200	337
GW 50 417	25/150	7200	367
GW 50 418	10/100	1800	337
GW 50 418	10/100	1800	367
GW 50 419	6/60	1080	337
GW 50 419	6/60	1080	367
GW 50 420	5/50	900	337
GW 50 420	5/50	900	367
GW 50 421	50/700	12600	367
GW 50 422	50/700	12600	367
GW 50 423	25/350	6300	367
GW 50 424	25/350	6300	367
GW 50 425	15/210	3360	367
GW 50 426	10/160	2560	367
GW 50 427	10/90	1440	367
GW 50 428	100/1000		230
GW 50 428	100/1000		367
GW 50 429	100/1000	50000	230
GW 50 429	100/1000	50000	367
GW 50 430	100/1000	30000	230
GW 50 430	100/1000	30000	367
GW 50 431	50/500	21000	230
GW 50 431	50/500	21000	367
GW 50 432	35/350	11200	230
GW 50 432	35/350	11200	367
GW 50 601	100/1800	97200	372
GW 50 602	100/1600	86400	372
GW 50 603	100/900	54000	372
GW 50 604	100/900	32400	372
GW 50 605	100/900	54000	372
GW 50 606	100/900	54000	372

Code	Quantity		Page
	Pack/carton	Pallet	
GW 50 607	100/600	36000	372
GW 50 608	50/450	27000	372
GW 50 609	50/350	18900	372
GW 50 610	100/8000		373
GW 50 611	100/8000		373
GW 50 612	100/8000		373
GW 50 613	100/6000		373
GW 50 614	100/6000		373
GW 50 615	100/6000		373
GW 50 616	100/3000		373
GW 50 617	100/1800	72000	373
GW 50 618	100/2000	32000	373
GW 50 619	50/900	36000	373
GW 50 620	50/1000	6000	373
GW 50 621	100/8000		373
GW 50 622	100/8000		373
GW 50 623	100/4000		373
GW 50 624	100/15000		373
GW 50 625	100/4800		373
GW 50 626	100/1000	16000	374
GW 50 627	100/1000	16000	374
GW 50 628	50/450	27000	372
GW 50 629	50/450	5400	372
GW 50 630	35/350	7000	372
GW 50 631	25/200	4000	372
GW 50 651	75/900	24000	372
GW 50 652	25/250	12000	372
GW 50 653	15/150	7200	372
GW 50 791	1/10	600	376
GW 50 792	10/100	1600	376
GW 50 798	1/10	200	376
GW 50 799	200/4000		376
GW 50 801	100/1600	38400	375
GW 50 802	100/800	24000	375
GW 50 803	100/800	38400	375
GW 50 804	100/800	28800	375
GW 50 805	100/800	26400	375
GW 50 806	100/600	12000	375
GW 50 807	100/600	14400	375
GW 50 808	100/600	14400	375
GW 50 809	100/300	9000	375
GW 50 810	50/300	7200	375
GW 50 811	100/2400	28800	375
GW 50 812	100/2000	36000	375
GW 50 813	100/2000	36000	375
GW 50 814	100/1600	38400	375
GW 50 815	100/1000	30000	375
GW 50 816	50/1000	18000	375
GW 50 817	50/1000	18000	375
GW 50 818	50/600	14400	375
GW 50 819	50/600	7200	375
GW 50 820	50/300	7200	375
GW 50 821	100/2400		375
GW 50 822	100/3500	63000	375
GW 50 823	100/2000	56000	375
GW 50 824	100/1600	38400	375
GW 50 825	100/2000	24000	375
GW 50 826	50/1000	28000	375
GW 50 827	50/800	14400	375
GW 50 828	50/600	14400	375
GW 50 829	50/600	7200	375
GW 50 830	50/300	7200	375
GW 52			
GW 52 001	50/900	81000	364
GW 52 002	50/600	42000	364

Code	Quantity		Page
	Pack/carton	Pallet	
GW 52 003	25/500	27000	364
GW 52 004	25/500	27000	364
GW 52 005	25/375	18750	364
GW 52 006	25/400	9600	364
GW 52 007	25/250	5000	364
GW 52 008	10/130	3120	364
GW 52 009	6/120	1440	364
GW 52 010	5/100	1200	364
GW 52 024	15/300	7200	365
GW 52 025	15/240	4320	365
GW 52 026	15/240	3840	365
GW 52 027	15/135	2160	365
GW 52 028	6/54	972	365
GW 52 029	4/80	480	365
GW 52 042	50/600	25200	364
GW 52 043	50/400	21600	364
GW 52 044	25/300	18000	364
GW 52 045	25/200	11200	364
GW 52 046	25/150	6750	364
GW 52 047	10/120	2400	364
GW 52 048	6/84	2016	364
GW 52 049	5/60	600	364
GW 52 071	50/600	24000	364
GW 52 072	50/400	38400	364
GW 52 073	50/600	36000	364
GW 52 074	25/300	18000	364
GW 52 075	25/300	18000	364
GW 52 076	25/200	11200	364
GW 52 077	25/150	6750	364
GW 52 078	10/120	2400	364
GW 52 079	6/84	2016	364
GW 52 080	5/60	1200	364
GW 52 201	100/4000	64000	388
GW 52 202	100/3000	48000	388
GW 52 203	100/1000	16000	388
GW 52 204	100/3000	24000	388
GW 52 205	100/1200	38400	388
GW 52 206	100/1000	24000	388
GW 52 207	100/500	12000	388
GW 52 208	100/500	4000	388
GW 52 209	100/3000	54000	388
GW 52 210	100/3000	96000	388
GW 52 226	100/3000		387
GW 52 227	100/3000		387
GW 52 228	100/3000		387
GW 52 229	100/3000		387
GW 52 231	1000/20000		385
GW 52 232	1000/20000		385
GW 52 233	100/10000		385
GW 52 234	100/10000		385
GW 52 235	100/10000		385
GW 52 236	100/10000		385
GW 52 237	100/5000		385
GW 52 238	100/5000		385
GW 52 239	100/5000		385
GW 52 240	100/5000		385
GW 52 241	100/1000	50000	385
GW 52 242	50/500	35000	385
GW 52 243	50/500	7500	385
GW 52 251	1000/20000		385
GW 52 252	1000/20000		385
GW 52 253	100/10000		385
GW 52 254	100/10000		385
GW 52 255	100/10000		385
GW 52 256	100/10000		385

Code	Quantity		Page
	Pack/carton	Pallet	
GW 52 257	100/5000		385
GW 52 258	100/5000		385
GW 52 259	100/5000		385
GW 52 260	100/5000		385
GW 52 261	100/1000	55000	385
GW 52 262	50/500	32500	385
GW 52 263	50/500	15000	385
GW 52 271	100/1000	64000	386
GW 52 272	100/1000	27000	386
GW 52 273	100/1000	27000	386
GW 52 281	100/5000		386
GW 52 282	100/2000	54000	386
GW 52 291	100/5000		386
GW 52 292	100/5000		386
GW 52 293	100/2000	54000	386
GW 52 294	100/2000	54000	386
GW 52 341	100/1000	50000	366
GW 52 342	100/1000	50000	366
GW 52 343	100/800	40000	366
GW 52 344	100/800	40000	366
GW 52 345	100/600	30000	366
GW 52 346	100/500	14000	366
GW 52 347	50/250	12500	366
GW 52 348	25/200	10000	366
GW 52 349	25/150	5400	366
GW 52 350	25/100	3600	366
GW 52 352	100/1000	50000	366
GW 52 353	100/1000	50000	366
GW 52 354	100/800	40000	366
GW 52 355	100/800	40000	366
GW 52 356	100/600	16800	366
GW 52 357	100/500	25000	366
GW 52 358	50/250	12500	366
GW 52 359	25/125	4500	366
GW 52 361	100/500		365
GW 52 362	100/500		365
GW 52 363	100/400	20000	365
GW 52 364	100/400	28000	365
GW 52 365	100/300	21000	365
GW 52 366	100/300	21000	365
GW 52 367	50/250	7000	365
GW 52 368	25/150	7500	365
GW 52 369	25/125	6250	365
GW 52 370	10/100	5000	365
GW 52 372	100/500		365
GW 52 373	100/500		365
GW 52 374	100/400	20000	365
GW 52 375	100/400	28000	365
GW 52 376	50/250	17500	365
GW 52 377	50/200	5600	365
GW 52 378	25/150	7500	365
GW 52 379	10/100	4000	365
GW 52 401	1/4	512	230
GW 52 401	1/4	512	377
GW 52 402	10	1280	238
GW 52 402	10	1280	377
GW 52 403	10	1280	377
GW 52 410	1/10	640	387
GW 52 411	1/10	640	388
GW 52 412	1/4	512	377
GW 52 420	1	24	376
GW 52 441	500/2500		365
GW 52 442	500/2500		365
GW 52 443	500/2000		365
GW 52 444	500/2000		365

Code	Quantity		Page
	Pack/carton	Pallet	
GW 52 445	500/2000		365
GW 52 446	500/1500		365
GW 52 447	250/1250	87500	365
GW 52 448	100/1000	70000	365
GW 52 449	50/500		365
GW 52 450	50/400		365
GW 52 452	500/2500		365
GW 52 453	500/2500		365
GW 52 454	500/2000		365
GW 52 455	500/2000		365
GW 52 456	250/1250	87500	365
GW 52 457	50/1250	87500	365
GW 52 458	500/1000	70000	365
GW 52 459	50/500	35000	365
GW 60			
GW 60 001 FH	25	450	22
GW 60 001 H	50	1600	24
GW 60 002 FH	15	240	22
GW 60 002 H	50	800	24
GW 60 003 FH	50	200	22
GW 60 003 H	15	240	24
GW 60 004 FH	50	800	22
GW 60 004 H	50	2400	24
GW 60 005 FH	15	360	22
GW 60 005 H	25	450	24
GW 60 005 WH	15	240	26
GW 60 006 FH	15	240	22
GW 60 006 H	15	360	24
GW 60 006 WH	15	240	26
GW 60 007 FH	15	240	22
GW 60 007 H	15	360	24
GW 60 008 FH	25	450	22
GW 60 008 H	50	1700	24
GW 60 008 WH	15	360	26
GW 60 009 FH	50	400	22
GW 60 009 H	50	1200	24
GW 60 009 WH	15	960	26
GW 60 010 H	15	360	24
GW 60 011 H	15	360	24
GW 60 012 FH	15	240	22
GW 60 012 H	15	360	24
GW 60 013 FH	15	240	22
GW 60 013 H	15	360	24
GW 60 014 FH	15	240	22
GW 60 014 H	15	240	24
GW 60 015 FH	15	360	22
GW 60 015 H	25	1050	24
GW 60 016 FH	15	240	22
GW 60 016 H	50	400	24
GW 60 016 WH	15	240	26
GW 60 017 FH	15	240	22
GW 60 017 H	15	240	24
GW 60 017 WH	15	240	26
GW 60 018 FH	15	240	22
GW 60 018 H	15	360	24
GW 60 019 FH	15	360	22
GW 60 019 H	50	1200	24
GW 60 019 WH	15	360	26
GW 60 020 FH	15	360	22
GW 60 020 H	50	800	24
GW 60 020 WH	15	360	26
GW 60 021 H	15	360	24
GW 60 022 H	15	240	24
GW 60 023 FH	15	240	23
GW 60 023 H	25	450	25

Code	Quantity		Page
	Pack/carton	Pallet	
GW 60 024 FH	15	240	23
GW 60 024 H	15	360	25
GW 60 025 FH	15	180	23
GW 60 025 H	15	180	25
GW 60 026 FH	50	1200	23
GW 60 026 H	50	1600	25
GW 60 027 FH	15	240	23
GW 60 027 H	15	360	25
GW 60 027 WH	15	240	27
GW 60 028 FH	15	270	23
GW 60 028 H	15	270	25
GW 60 028 WH	15	120	27
GW 60 029 FH	15	240	23
GW 60 029 H	15	240	25
GW 60 030 FH	15	360	23
GW 60 030 H	25	1050	25
GW 60 030 WH	15	360	27
GW 60 031 FH	25	200	23
GW 60 031 H	25	600	25
GW 60 031 WH	15	270	27
GW 60 032 H	15	360	25
GW 60 033 H	15	180	25
GW 60 034 FH	15	180	23
GW 60 034 H	15	270	25
GW 60 035 FH	15	90	23
GW 60 035 H	15	270	25
GW 60 036 FH	15	180	23
GW 60 036 H	15	180	25
GW 60 037 FH	15	270	23
GW 60 037 H	15	270	25
GW 60 038 FH	15	180	23
GW 60 038 H	15	270	25
GW 60 038 WH	15	120	27
GW 60 039 FH	15	180	23
GW 60 039 H	15	180	25
GW 60 039 WH	15	120	27
GW 60 040 FH	15	180	23
GW 60 040 H	15	180	25
GW 60 041 FH	15	90	23
GW 60 041 H	15	270	25
GW 60 041 WH	15	270	27
GW 60 042 FH	15	270	23
GW 60 042 H	25	600	25
GW 60 042 WH	15	270	27
GW 60 043 H	15	270	25
GW 60 044 H	15	180	25
GW 60 056 H	1/2	48	29
GW 60 057 H	1/2	48	29
GW 60 058 H	1/2	48	29
GW 60 059 H	1/2	48	29
GW 60 060 H	1/2	128	29
GW 60 061 H	1/2	128	29
GW 60 062 H	1/2	48	29
GW 60 063 H	1/2	48	29
GW 60 064	10/40	2880	53
GW 60 065	10/20	720	53
GW 60 066	10/20	800	53
GW 60 067	10/20	800	53
GW 60 068	10/20	720	53
GW 60 069	10/20	960	53
GW 60 070	10/20	720	53
GW 60 071	10/20	960	53
GW 60 072	10/20	960	53
GW 60 073	10/20	960	53
GW 60 074	10/20	960	53

Quick Reference

Code	Quantity		Page
	Pack/carton	Pallet	
GW 60 075	10/20	800	53
GW 60 076	10/20	720	53
GW 60 077	10/20	960	53
GW 60 078	10/20	960	53
GW 60 079	10/20	960	53
GW 60 080	10/20	960	53
GW 60 081	10/20	960	53
GW 60 082	10/40	1440	30
GW 60 083	10/20	280	30
GW 60 084	10/20	280	30
GW 60 085	10/40	960	30
GW 60 086	10/20	280	30
GW 60 087	10/20	280	30
GW 60 088	10/20	720	30
GW 60 089	10/40	800	30
GW 60 090	10/40	480	30
GW 60 091	10/20	280	30
GW 60 092	10/20	280	30
GW 60 093	8/16	512	30
GW 60 094	8/16	512	30
GW 60 095	8/16	512	30
GW 60 096	8/16	384	30
GW 60 097	8/16	512	30
GW 60 098	8/16	512	30
GW 60 099	8/16	384	30
GW 60 101	8/16	384	30
GW 60 102	8/16	384	30
GW 60 103	8/16	512	30
GW 60 104	8/16	384	30
GW 60 105	10/20	280	30
GW 60 106	10/20	640	30
GW 60 107	10/20	360	30
GW 60 108	10/40	480	30
GW 60 109	10/20	640	30
GW 60 110	10/20	320	30
GW 60 111	10/20	280	30
GW 60 112	10/40	640	30
GW 60 113	10/40	480	30
GW 60 114	10/20	480	30
GW 60 115	10/20	400	30
GW 60 116	8/16	288	30
GW 60 117	8/16	288	30
GW 60 118	8/16	288	30
GW 60 119	8/16	288	30
GW 60 120	8/16	288	30
GW 60 121	8/16	288	30
GW 60 122	8/16	288	30
GW 60 123	8/16	288	30
GW 60 124	8/16	288	30
GW 60 125	8/16	288	30
GW 60 126	8/16	288	30
GW 60 127	10/40	800	53
GW 60 128	10/20	280	53
GW 60 129	10/20	280	53
GW 60 130	10/20	280	53
GW 60 131	10/20	280	53
GW 60 132	10/20	280	53
GW 60 133	10/20	280	53
GW 60 134	10/20	280	53
GW 60 135	10/20	280	53
GW 60 136	10/20	280	53
GW 60 137	10/20	280	53
GW 60 138	10/20	280	53
GW 60 139	10/20	280	53
GW 60 140	10/20	280	53

Code	Quantity		Page
	Pack/carton	Pallet	
GW 60 141	10/20	280	53
GW 60 142	10/20	280	53
GW 60 143	10/20	280	53
GW 60 144	10/20	280	53
GW 60 145 H	25	200	25
GW 60 146	8/16	288	30
GW 60 201	10/20	480	31
GW 60 202	10/20	640	31
GW 60 203	10/20	640	31
GW 60 204	10/20	480	31
GW 60 205	10/20	480	31
GW 60 206	10/20	640	31
GW 60 207	10/20	480	31
GW 60 208	10/20	640	31
GW 60 209	10/20	400	31
GW 60 210	10/20	640	31
GW 60 211	10/20	480	31
GW 60 212	8/16	288	31
GW 60 213	8/16	288	31
GW 60 214	8/16	288	31
GW 60 215	8/16	288	31
GW 60 216	8/16	288	31
GW 60 217	8/16	288	31
GW 60 218	8/16	288	31
GW 60 219	8/16	288	31
GW 60 220	8/16	288	31
GW 60 221	8/16	288	31
GW 60 222	8/16	288	31
GW 60 223	10/20	400	31
GW 60 224	10/20	240	31
GW 60 225	10/20	400	31
GW 60 226	10/20	360	31
GW 60 227	10/20	360	31
GW 60 228	10/20	360	31
GW 60 229	10/20	400	31
GW 60 230	10/20	400	31
GW 60 231	10/20	400	31
GW 60 232	10/20	400	31
GW 60 233	10/20	400	31
GW 60 234	8/16	288	31
GW 60 235	8/16	288	31
GW 60 236	8/16	96	31
GW 60 237	8/16	192	31
GW 60 238	8/16	288	31
GW 60 239	8/16	128	31
GW 60 240	8/16	288	31
GW 60 241	8/16	288	31
GW 60 242	8/16	96	31
GW 60 243	8/16	288	31
GW 60 244	8/16	128	31
GW 60 263	10/120	1440	33
GW 60 264	10/120	1440	33
GW 60 265	10/80	880	33
GW 60 266	8/64	576	33
GW 60 267	8/64	576	33
GW 60 268	8/16	288	31
GW 60 269	5/40	960	33
GW 60 270	5/20	480	33
GW 60 401	10/40	960	32
GW 60 402	10/20	480	32
GW 60 403	10/20	400	32
GW 60 404	10/40	1440	32
GW 60 405	10/20	640	32
GW 60 406	10/20	400	32
GW 60 407	10/20	640	32

Code	Quantity		Page
	Pack/carton	Pallet	
GW 60 408	10/40	640	32
GW 60 409	10/40	480	32
GW 60 410	10/20	640	32
GW 60 411	10/20	400	32
GW 60 412	8/16	512	32
GW 60 413	8/16	384	32
GW 60 414	8/16	320	32
GW 60 415	8/16	1024	32
GW 60 416	8/16	384	32
GW 60 417	8/16	320	32
GW 60 418	8/16	512	32
GW 60 419	8/16	384	32
GW 60 420	8/16	672	32
GW 60 421	8/16	512	32
GW 60 422	8/16	320	32
GW 60 423	10/20	400	32
GW 60 424	10/20	400	32
GW 60 425	10/20	240	32
GW 60 426	10/40	960	32
GW 60 427	10/20	400	32
GW 60 428	10/20	240	32
GW 60 429	10/20	400	32
GW 60 430	10/40	480	32
GW 60 431	10/20	680	32
GW 60 432	10/20	400	32
GW 60 433	10/20	240	32
GW 60 434	8/16	192	32
GW 60 435	8/16	192	32
GW 60 436	8/16	192	32
GW 60 437	8/16	544	32
GW 60 438	8/16	192	32
GW 60 439	8/16	192	32
GW 60 440	8/16	192	32
GW 60 441	8/16	224	32
GW 60 442	8/16	544	32
GW 60 443	8/16	192	32
GW 60 444	8/16	192	32
GW 60 456	1/2	36	33
GW 60 457	1/2	24	33
GW 60 458	1/2	36	33
GW 60 459	1/2	24	33
GW 60 460	1/2	48	33
GW 60 461	1/2	48	33
GW 60 462	1/2	32	33
GW 60 463	1/2	48	33
GW 60 464	10/40	800	54
GW 60 465	10/20	280	54
GW 60 466	10/20	280	54
GW 60 467	10/20	560	54
GW 60 468	10/20	280	54
GW 60 469	10/20	280	54
GW 60 470	10/20	280	54
GW 60 471	10/20	280	54
GW 60 472	10/20	280	54
GW 60 473	10/20	280	54
GW 60 474	10/20	280	54
GW 60 475	10/20	280	54
GW 60 476	10/20	280	54
GW 60 477	10/20	280	54
GW 60 478	10/20	280	54
GW 60 479	10/20	280	54
GW 60 480	10/20	280	54
GW 60 481	10/20	280	54
GW 60 482	8/16	192	32
GW 60 664 H	1/2	48	29

Code	Quantity		Page
	Pack/carton	Pallet	
GW 60 665 H	1/2	48	29
GW 60 666 H	1/2	48	29
GW 60 667 H	1/2	48	29
GW 60 668 H	1/2	48	29
GW 60 669 H	1/2	48	29
GW 60 670 H	1/2	48	29
GW 60 671 H	1/2	48	29
GW 60 672 H	1/2	48	29
GW 60 673 H	1/2	48	29
GW 60 674 H	1/2	48	29
GW 60 675 H	1/2	48	29
GW 60 676 H	1/2	48	29
GW 60 677 H	1/2	48	29
GW 60 701 H	15	240	24
GW 60 702 H	15	240	24
GW 60 703 H	15	240	24
GW 60 704 H	15	240	24
GW 60 705 H	15	240	24
GW 60 706 H	15	240	24
GW 60 707 H	15	240	24
GW 60 708 H	15	240	24
GW 60 709 H	15	240	24
GW 60 710 H	15	240	24
GW 60 711 H	15	240	24
GW 60 712 H	15	240	24
GW 60 713 H	15	240	24
GW 60 714 H	15	240	24
GW 60 715 H	15	240	24
GW 60 716 H	15	240	24
GW 60 717 H	15	240	24
GW 60 718 H	15	240	24
GW 60 719 H	15	240	24
GW 60 720 H	15	240	24
GW 60 721 H	15	240	24
GW 60 722 H	15	240	24
GW 60 723 H	15	240	24
GW 60 724 H	15	240	24
GW 60 725 H	15	240	24
GW 60 726 H	15	240	24
GW 60 727 H	15	240	24
GW 60 728 H	15	240	24
GW 60 729 H	15	240	24
GW 60 730 H	15	240	24
GW 60 731 H	15	240	24
GW 60 732 H	15	240	24
GW 60 733 H	15	240	24
GW 60 734 H	15	240	24
GW 60 735 H	15	240	25
GW 60 736 H	15	240	25
GW 60 737 H	15	180	25
GW 60 738 H	15	240	25
GW 60 739 H	15	240	25
GW 60 740 H	15	180	25
GW 60 741 H	15	240	25
GW 60 742 H	15	240	25
GW 60 743 H	15	180	25
GW 60 744 H	15	240	25
GW 60 745 H	15	180	25
GW 60 746 H	15	240	25
GW 60 747 H	15	180	25
GW 60 748 H	15	240	25
GW 60 749 H	15	240	25
GW 60 750 H	15	240	25
GW 60 751 H	15	240	25
GW 60 752 H	15	180	25

Code	Quantity		Page
	Pack/carton	Pallet	
GW 60 753 H	15	180	25
GW 60 754 H	15	180	25
GW 60 755 H	15	180	25
GW 60 756 H	15	180	25
GW 60 757 H	15	180	25
GW 60 758 H	15	180	25
GW 60 759 H	15	180	25
GW 60 760 H	15	180	25
GW 60 761 H	15	180	25
GW 60 762 H	15	180	25
GW 60 763 H	15	180	25
GW 60 764 H	15	180	25
GW 60 765 H	15	180	25
GW 60 766 H	15	180	25
GW 60 767 H	15	180	25

GW 61			
Code	Quantity		Page
GW 61 013 H	1/4	144	28
GW 61 014 H	1/4	144	28
GW 61 015 H	1/4	144	28
GW 61 016 H	1/4	144	28
GW 61 017 H	1/4	144	28
GW 61 018 H	1/4	144	28
GW 61 019 H	1/4	144	28
GW 61 020 H	1/4	144	28
GW 61 021 H	1/4	144	28
GW 61 045 H	1/4	144	29
GW 61 046 H	1/4	144	29
GW 61 047 H	1/4	144	29
GW 61 048 H	1/4	144	29
GW 61 049 H	1/4	144	29
GW 61 050 H	1/4	48	29
GW 61 051 H	1/4	144	29
GW 61 052 H	1/4	384	29
GW 61 053 H	1/4	384	29
GW 61 054 H	1/4	144	29
GW 61 055 H	1/4	144	29
GW 61 056 H	1/4	48	29
GW 61 057 H	1/4	144	29
GW 61 058 H	1/4	144	29
GW 61 059 H	1/4	144	29
GW 61 060 H	1/4	144	29
GW 61 061 H	1/4	144	29
GW 61 062 H	1/4	144	29
GW 61 063 H	1/4	144	29
GW 61 064 H	1/4	144	29
GW 61 065 H	1/4	96	29
GW 61 066 H	1/4	144	29
GW 61 067 H	1/4	144	29
GW 61 068 H	1/4	144	29
GW 61 445	1/4	48	33
GW 61 446	1/4	48	33
GW 61 447	1/4	48	33
GW 61 448	1/4	96	33
GW 61 449	1/4	48	33
GW 61 450	1/4	48	33
GW 61 451	1/4	48	33
GW 61 452	1/4	96	33
GW 61 453	1/4	288	33
GW 61 454	1/4	48	33
GW 61 455	1/4	48	33

GW 62			
Code	Quantity		Page
GW 62 001 FH	15	360	34
GW 62 001 H	50	1600	36
GW 62 002 FH	15	240	34

Code	Quantity		Page
	Pack/carton	Pallet	
GW 62 002 H	50	400	36
GW 62 003 FH	15	240	34
GW 62 003 H	25	300	36
GW 62 004 FH	50	800	34
GW 62 004 H	50	2400	36
GW 62 005 FH	15	240	34
GW 62 005 H	15	360	36
GW 62 006 FH	15	240	34
GW 62 006 H	15	240	36
GW 62 007 FH	15	240	34
GW 62 007 H	15	240	36
GW 62 008 FH	15	360	34
GW 62 008 H	50	1600	36
GW 62 009 FH	15	360	34
GW 62 009 H	25	1050	36
GW 62 010 H	15	240	36
GW 62 011 H	15	240	36
GW 62 012 FH	15	240	34
GW 62 012 H	15	360	36
GW 62 013 FH	15	240	34
GW 62 013 H	15	240	36
GW 62 014 FH	15	180	34
GW 62 014 H	15	180	36
GW 62 015 FH	15	360	34
GW 62 015 H	25	800	36
GW 62 016 FH	15	240	34
GW 62 016 H	15	360	36
GW 62 017 FH	15	180	34
GW 62 017 H	15	180	36
GW 62 018 FH	15	360	34
GW 62 018 H	15	240	36
GW 62 019 FH	15	360	34
GW 62 019 H	25	800	36
GW 62 020 FH	15	270	34
GW 62 020 H	25	800	36
GW 62 021 H	15	240	36
GW 62 022 H	15	180	36
GW 62 023 FH	15	240	35
GW 62 023 H	50	400	37
GW 62 024 FH	25	300	35
GW 62 024 H	15	180	37
GW 62 025 FH	15	180	35
GW 62 025 H	15	180	37
GW 62 026 FH	50	400	35
GW 62 026 H	50	1200	37
GW 62 027 FH	15	180	35
GW 62 027 H	15	270	37
GW 62 028 FH	15	180	35
GW 62 028 H	15	90	37
GW 62 029 FH	15	240	35
GW 62 029 H	15	240	37
GW 62 030 FH	15	270	35
GW 62 030 H	25	450	37
GW 62 031 FH	25	200	35
GW 62 031 H	25	200	37
GW 62 032 H	15	90	37
GW 62 033 H	25	100	37
GW 62 034 FH	15	180	35
GW 62 034 H	15	270	37
GW 62 035 FH	15	180	35
GW 62 035 H	15	180	37
GW 62 036 FH	15	180	35
GW 62 036 H	15	180	37
GW 62 037 FH	15	270	35
GW 62 037 H	15	270	37

Quick Reference

Code	Quantity		Page
	Pack/carton	Pallet	
GW 62 038 FH	15	180	35
GW 62 038 H	15	270	37
GW 62 039 FH	15	180	35
GW 62 039 H	15	270	37
GW 62 040 FH	15	180	35
GW 62 040 H	15	180	37
GW 62 041 FH	15	270	35
GW 62 041 H	15	270	37
GW 62 042 FH	15	270	35
GW 62 042 H	15	630	37
GW 62 043 H	15	90	37
GW 62 044 H	15	270	37
GW 62 056 H	1/2	48	39
GW 62 057 H	1/2	32	39
GW 62 058 H	1/2	48	39
GW 62 059 H	1/2	32	39
GW 62 060 H	1/2	128	39
GW 62 060 PH	1/2	48	39
GW 62 061 H	1/2	128	39
GW 62 061 PH	1/2	48	39
GW 62 062 H	1/2	48	39
GW 62 063 H	1/2	48	39
GW 62 064	10/40	480	54
GW 62 065	10/20	280	54
GW 62 066	10/20	560	54
GW 62 067	10/20	280	54
GW 62 068	10/20	280	54
GW 62 069	10/20	280	54
GW 62 070	10/20	280	54
GW 62 071	10/20	280	54
GW 62 072	10/20	280	54
GW 62 073	10/20	280	54
GW 62 074	10/20	280	54
GW 62 075	10/20	560	54
GW 62 076	10/20	280	54
GW 62 077	10/20	280	54
GW 62 078	10/20	280	54
GW 62 079	10/20	280	54
GW 62 080	10/20	280	54
GW 62 081	10/20	280	54
GW 62 128 H	25	200	37
GW 62 201 FH	15	360	40
GW 62 201 H	50	800	42
GW 62 202 FH	15	240	40
GW 62 202 H	15	240	42
GW 62 203 FH	15	240	40
GW 62 203 H	15	240	42
GW 62 204	10/100	2000	50
GW 62 205 FH	25	450	40
GW 62 205 H	50	1700	42
GW 62 206 FH	15	240	40
GW 62 206 H	25	450	42
GW 62 207 FH	15	240	40
GW 62 207 H	15	240	42
GW 62 208 FH	15	240	40
GW 62 208 H	15	240	42
GW 62 209 FH	15	360	40
GW 62 209 H	50	800	42
GW 62 210 FH	15	360	40
GW 62 210 H	50	1600	42
GW 62 211 H	15	240	42
GW 62 212 H	15	240	42
GW 62 213 FH	15	120	40
GW 62 213 H	15	360	42
GW 62 214 FH	15	120	40

Code	Quantity		Page
	Pack/carton	Pallet	
GW 62 214 H	15	240	42
GW 62 215 FH	15	120	40
GW 62 215 H	15	120	42
GW 62 216 FH	15	240	40
GW 62 216 H	25	450	42
GW 62 217 FH	15	120	40
GW 62 217 H	15	360	42
GW 62 218 FH	15	120	40
GW 62 218 H	15	120	42
GW 62 219 FH	15	120	40
GW 62 219 H	15	240	42
GW 62 220 FH	15	360	40
GW 62 220 H	15	360	42
GW 62 221 FH	15	240	40
GW 62 221 H	25	1050	42
GW 62 222 H	15	240	42
GW 62 223 H	15	120	42
GW 62 224 FH	15	240	41
GW 62 224 H	25	450	43
GW 62 225 FH	15	240	41
GW 62 225 H	15	360	43
GW 62 226 FH	15	240	41
GW 62 226 H	15	240	43
GW 62 227 FH	25	450	41
GW 62 227 H	50	1700	43
GW 62 228 FH	15	240	41
GW 62 228 H	15	360	43
GW 62 229 FH	15	240	41
GW 62 229 H	15	240	43
GW 62 230 FH	15	240	41
GW 62 230 H	15	240	43
GW 62 231 FH	15	360	41
GW 62 231 H	25	450	43
GW 62 232 FH	15	360	41
GW 62 232 H	25	450	43
GW 62 233 H	15	240	43
GW 62 234 H	15	240	43
GW 62 235 FH	15	180	41
GW 62 235 H	25	200	43
GW 62 236 FH	15	180	41
GW 62 236 H	15	270	43
GW 62 237 FH	15	180	41
GW 62 237 H	15	180	43
GW 62 238 FH	15	90	41
GW 62 238 H	15	270	43
GW 62 239 FH	15	180	41
GW 62 239 H	15	270	43
GW 62 240 FH	15	180	41
GW 62 240 H	15	180	43
GW 62 241 FH	15	180	41
GW 62 241 H	15	180	43
GW 62 242 FH	15	270	41
GW 62 242 H	15	270	43
GW 62 243 FH	15	270	41
GW 62 243 H	15	270	43
GW 62 244 H	15	180	43
GW 62 245 H	15	180	43
GW 62 257 H	1/2	24	45
GW 62 258 H	1/2	72	45
GW 62 259 H	1/2	72	45
GW 62 260 H	1/2	72	45
GW 62 261 H	1/2	72	45
GW 62 261 PH	1/2	72	45
GW 62 262 H	1/2	72	45
GW 62 262 PH	1/2	48	45

Code	Quantity		Page
	Pack/carton	Pallet	
GW 62 263 H	1/2	48	45
GW 62 264 H	1/2	72	45
GW 62 265	10/40	480	55
GW 62 266	10/20	280	55
GW 62 267	10/20	280	55
GW 62 268	10/20	280	55
GW 62 269	10/20	280	55
GW 62 270	10/20	280	55
GW 62 271	10/20	280	55
GW 62 272	10/20	280	55
GW 62 273	10/20	280	55
GW 62 274	10/20	280	55
GW 62 275	10/20	280	55
GW 62 276	10/20	280	55
GW 62 277	10/20	280	55
GW 62 278	10/20	280	55
GW 62 279	10/20	280	55
GW 62 280	10/20	280	55
GW 62 281	10/20	280	55
GW 62 282	10/20	560	55
GW 62 283 H	25	400	43
GW 62 365	10/40	800	55
GW 62 366	10/20	560	55
GW 62 392	1/12	840	50
GW 62 392 H	1/12	840	109
GW 62 393	1/20	2200	50
GW 62 393 H	1/20	2200	109
GW 62 394	1/20	2200	50
GW 62 394 H	1/20	2200	109
GW 62 401	40	240	46
GW 62 402	20	120	46
GW 62 403	20	120	46
GW 62 404	40	720	46
GW 62 405	20	240	46
GW 62 406	20	120	46
GW 62 407	20	120	46
GW 62 408	40	720	46
GW 62 409	40	720	46
GW 62 410	20	120	46
GW 62 411	20	120	46
GW 62 412	16	96	46
GW 62 413	16	96	46
GW 62 414	16	192	46
GW 62 415	16	576	46
GW 62 416	16	192	46
GW 62 417	16	96	46
GW 62 418	16	96	46
GW 62 419	16	192	46
GW 62 420	16	192	46
GW 62 421	14	84	46
GW 62 422	14	84	46
GW 62 423	20	240	47
GW 62 424	20	120	47
GW 62 425	20	120	47
GW 62 426	40	720	47
GW 62 427	20	120	47
GW 62 428	20	120	47
GW 62 429	20	120	47
GW 62 430	40	720	47
GW 62 431	40	720	47
GW 62 432	20	80	47
GW 62 433	20	120	47
GW 62 434	16	96	47
GW 62 435	16	96	47
GW 62 436	16	96	47

Code	Quantity		Page
	Pack/carton	Pallet	
GW 62 437	16	192	47
GW 62 438	16	96	47
GW 62 439	16	96	47
GW 62 440	16	192	47
GW 62 441	16	192	47
GW 62 442	16	576	47
GW 62 443	14	84	47
GW 62 444	14	84	47
GW 62 456	10/40	240	56
GW 62 457	10/20	240	56
GW 62 458	10/20	240	56
GW 62 459	10/20	240	56
GW 62 460	10/20	240	56
GW 62 461	10/20	240	56
GW 62 462	10/20	240	56
GW 62 463	10/20	240	56
GW 62 464	10/20	240	56
GW 62 465	10/20	240	56
GW 62 466	10/20	240	56
GW 62 467	10/20	240	56
GW 62 468	10/20	240	56
GW 62 469	10/20	240	56
GW 62 470	10/20	240	56
GW 62 471	10/20	240	56
GW 62 472	10/20	240	56
GW 62 473	10/20	240	56
GW 62 474	20	760	48
GW 62 475	20	400	48
GW 62 476	20	160	48
GW 62 477	20	760	48
GW 62 478	20	280	48
GW 62 479	20	160	48
GW 62 480	20	280	48
GW 62 481	20	760	48
GW 62 482	20	560	48
GW 62 483	20	160	48
GW 62 484	20	160	48
GW 62 485	16	96	48
GW 62 486	16	96	48
GW 62 487	16	288	48
GW 62 488	16	288	48
GW 62 489	16	288	48
GW 62 490	16	96	48
GW 62 491	16	288	48
GW 62 492	16	288	48
GW 62 493	16	288	48
GW 62 494	16	96	48
GW 62 495	16	96	48
GW 62 496	20	280	49
GW 62 497	20	160	49
GW 62 498	20	160	49
GW 62 499	20	760	49
GW 62 501	20	240	49
GW 62 502	20	160	49
GW 62 503	20	240	49
GW 62 504	20	760	49
GW 62 505	20	560	49
GW 62 506	20	160	49
GW 62 507	20	160	49
GW 62 508	16	128	49
GW 62 509	16	128	49
GW 62 510	16	128	49
GW 62 511	16	288	49
GW 62 512	16	96	49
GW 62 513	16	96	49

Code	Quantity		Page
	Pack/carton	Pallet	
GW 62 514	16	128	49
GW 62 515	16	128	49
GW 62 516	16	288	49
GW 62 517	16	96	49
GW 62 518	16	96	49
GW 62 530	1/2	32	50
GW 62 531	1/2	48	50
GW 62 532	1/2	48	50
GW 62 533	1/2	32	50
GW 62 534	1/2	128	50
GW 62 535	1/2	128	50
GW 62 536	1/2	48	50
GW 62 537	1/2	48	50
GW 62 538	10/20	280	56
GW 62 539	10/20	240	56
GW 62 540	10/20	240	56
GW 62 541	10/20	240	56
GW 62 542	10/20	240	56
GW 62 543	10/20	240	56
GW 62 544	10/20	240	56
GW 62 545	10/20	240	56
GW 62 546	10/20	240	56
GW 62 547	10/20	240	56
GW 62 548	10/20	240	56
GW 62 549	10/20	240	56
GW 62 550	10/20	240	56
GW 62 551	10/20	240	56
GW 62 552	10/20	240	56
GW 62 553	10/20	240	56
GW 62 554	10/20	240	56
GW 62 555	10/20	240	56
GW 62 556	16	192	47
GW 62 557	16	128	49
GW 62 664 H	1/2	48	39
GW 62 665 H	1/2	48	39
GW 62 666 H	1/2	48	39
GW 62 667 H	1/2	48	39
GW 62 668 H	1/2	48	39
GW 62 669 H	1/2	48	39
GW 62 670 H	1/2	48	39
GW 62 671 H	1/2	48	39
GW 62 672 H	1/2	32	39
GW 62 673 H	1/2	48	39
GW 62 674 H	1/2	48	39
GW 62 675 H	1/2	32	39
GW 62 676 H	1/2	48	39
GW 62 677 H	1/2	32	39
GW 62 701 H	15	240	36
GW 62 702 H	15	240	36
GW 62 703 H	15	240	36
GW 62 704 H	15	240	36
GW 62 705 H	15	240	36
GW 62 706 H	15	240	36
GW 62 707 H	15	240	36
GW 62 708 H	15	240	36
GW 62 709 H	15	240	36
GW 62 710 H	15	240	36
GW 62 711 H	15	240	36
GW 62 712 H	15	240	36
GW 62 713 H	15	240	36
GW 62 714 H	15	240	36
GW 62 715 H	15	240	36
GW 62 716 H	15	240	36
GW 62 717 H	15	240	36
GW 62 718 H	15	240	36

Code	Quantity		Page
	Pack/carton	Pallet	
GW 62 719 H	15	240	36
GW 62 720 H	15	180	36
GW 62 721 H	15	240	36
GW 62 722 H	15	240	36
GW 62 723 H	15	180	36
GW 62 724 H	15	240	36
GW 62 725 H	15	240	36
GW 62 726 H	15	180	36
GW 62 727 H	15	240	36
GW 62 728 H	15	180	36
GW 62 729 H	15	240	36
GW 62 730 H	15	180	36
GW 62 731 H	15	240	36
GW 62 732 H	15	240	36
GW 62 733 H	15	240	36
GW 62 734 H	15	240	36
GW 62 735 H	15	240	37
GW 62 736 H	15	180	37
GW 62 737 H	15	180	37
GW 62 738 H	15	240	37
GW 62 739 H	15	180	37
GW 62 740 H	15	180	37
GW 62 741 H	15	240	37
GW 62 742 H	15	180	37
GW 62 743 H	15	180	37
GW 62 744 H	15	180	37
GW 62 745 H	15	270	37
GW 62 746 H	15	180	37
GW 62 747 H	15	180	37
GW 62 748 H	15	240	37
GW 62 749 H	15	180	37
GW 62 750 H	15	240	37
GW 62 751 H	15	240	37
GW 62 752 H	15	180	37
GW 62 753 H	15	180	37
GW 62 754 H	15	180	37
GW 62 755 H	15	180	37
GW 62 756 H	15	180	37
GW 62 757 H	15	180	37
GW 62 758 H	15	180	37
GW 62 759 H	15	180	37
GW 62 760 H	15	180	37
GW 62 761 H	15	180	37
GW 62 762 H	15	180	37
GW 62 763 H	15	180	37
GW 62 764 H	15	180	37
GW 62 765 H	15	180	37
GW 62 766 H	15	180	37
GW 62 767 H	15	180	37
GW 62 801 H	15	240	42
GW 62 802 H	15	240	42
GW 62 803 H	15	240	42
GW 62 804 H	15	240	42
GW 62 805 H	15	240	42
GW 62 806 H	15	240	42
GW 62 807 H	15	240	42
GW 62 808 H	15	240	42
GW 62 809 H	15	240	42
GW 62 810 H	15	240	42
GW 62 811 H	15	240	42
GW 62 812 H	15	240	42
GW 62 813 H	15	240	42
GW 62 814 H	15	240	42
GW 62 815 H	15	240	42
GW 62 816 H	15	240	42

Quick Reference

Code	Quantity		Page
	Pack/carton	Pallet	
GW 62 817 H	15	240	42
GW 62 818 H	15	240	42
GW 62 819 H	15	240	42
GW 62 820 H	15	120	42
GW 62 821 H	15	240	42
GW 62 822 H	15	240	42
GW 62 823 H	15	120	42
GW 62 824 H	15	240	42
GW 62 825 H	15	240	42
GW 62 826 H	15	120	42
GW 62 827 H	15	240	42
GW 62 828 H	15	120	42
GW 62 829 H	15	240	42
GW 62 830 H	15	120	42
GW 62 831 H	15	240	42
GW 62 832 H	15	240	42
GW 62 833 H	15	240	42
GW 62 834 H	15	240	42
GW 62 835 H	15	240	43
GW 62 836 H	15	240	43
GW 62 837 H	15	240	43
GW 62 838 H	15	240	43
GW 62 839 H	15	240	43
GW 62 840 H	15	240	43
GW 62 841 H	15	240	43
GW 62 842 H	15	240	43
GW 62 843 H	15	240	43
GW 62 844 H	15	240	43
GW 62 845 H	15	240	43
GW 62 846 H	15	240	43
GW 62 847 H	15	240	43
GW 62 848 H	15	240	43
GW 62 849 H	15	240	43
GW 62 850 H	15	240	43
GW 62 851 H	15	240	43
GW 62 852 H	15	180	43
GW 62 853 H	15	180	43
GW 62 854 H	15	180	43
GW 62 855 H	15	180	43
GW 62 856 H	15	180	43
GW 62 857 H	15	180	43
GW 62 858 H	15	180	43
GW 62 859 H	15	180	43
GW 62 860 H	15	180	43
GW 62 861 H	15	180	43
GW 62 862 H	15	180	43
GW 62 863 H	15	270	43
GW 62 864 H	15	180	43
GW 62 865 H	15	180	43
GW 62 866 H	15	240	43
GW 62 867 H	15	240	43
GW 62 965 H	1/2	72	45
GW 62 966 H	1/2	72	45
GW 62 967 H	1/2	72	45
GW 62 968 H	1/2	72	45
GW 62 969 H	1/2	72	45
GW 62 970 H	1/2	72	45
GW 62 971 H	1/2	72	45
GW 62 972 H	1/2	72	45
GW 62 973 H	1/2	72	45
GW 62 974 H	1/2	72	45
GW 62 975 H	1/2	72	45
GW 62 976 H	1/2	72	45
GW 62 977 H	1/2	72	45
GW 62 978 H	1/2	72	45

Code	Quantity		Page
	Pack/carton	Pallet	
GW 63			
GW 63 013 H	1/4	56	38
GW 63 014 H	1/4	56	38
GW 63 015 H	1/4	56	38
GW 63 016 H	1/4	112	38
GW 63 017 H	1/4	56	38
GW 63 018 H	1/4	56	38
GW 63 019 H	1/4	56	38
GW 63 020 H	1/4	56	38
GW 63 021 H	1/4	112	38
GW 63 045 H	1/4	112	39
GW 63 046 H	1/4	56	39
GW 63 047 H	1/4	56	39
GW 63 048 H	1/4	112	39
GW 63 048 PH	1/4	112	39
GW 63 049 H	1/4	112	39
GW 63 050 H	1/4	56	39
GW 63 051 H	1/4	56	39
GW 63 052 H	1/4	280	39
GW 63 052 PH	1/4	112	39
GW 63 053 H	1/4	280	39
GW 63 053 PH	1/4	112	39
GW 63 054 H	1/4	112	39
GW 63 055 H	1/4	56	39
GW 63 056 H	1/4	56	39
GW 63 057 H	1/4	56	39
GW 63 058 H	1/4	56	39
GW 63 059 H	1/4	56	39
GW 63 060 H	1/4	56	39
GW 63 061 H	1/4	56	39
GW 63 062 H	1/4	56	39
GW 63 063 H	1/4	56	39
GW 63 064 H	1/4	56	39
GW 63 065 H	1/4	56	39
GW 63 066 H	1/4	56	39
GW 63 067 H	1/4	56	39
GW 63 068 H	1/4	56	39
GW 63 213 H	1/4	128	44
GW 63 214 H	1/4	128	44
GW 63 215 H	1/4	128	44
GW 63 216 H	1/4	128	44
GW 63 217 H	1/4	100	44
GW 63 218 H	1/4	276	44
GW 63 219 H	1/4	128	44
GW 63 220 H	1/4	128	44
GW 63 221 H	1/4	300	44
GW 63 246 H	1/4	128	45
GW 63 247 H	1/4	128	45
GW 63 248 H	1/4	96	45
GW 63 249 H	1/4	288	45
GW 63 249 PH	1/4	128	45
GW 63 250 H	1/4	64	45
GW 63 251 H	1/4	128	45
GW 63 252 H	1/4	128	45
GW 63 253 H	1/4	288	45
GW 63 253 PH	1/4	128	45
GW 63 254 H	1/4	288	45
GW 63 254 PH	1/4	168	45
GW 63 255 H	1/4	100	45
GW 63 256 H	1/4	128	45
GW 63 257 H	1/4	128	45
GW 63 258 H	1/4	128	45
GW 63 259 H	1/4	128	45
GW 63 260 H	1/4	128	45
GW 63 261 H	1/4	128	45

Code	Quantity		Page
	Pack/carton	Pallet	
GW 63 262 H	1/4	128	45
GW 63 263 H	1/4	128	45
GW 63 264 H	1/4	128	45
GW 63 265 H	1/4	128	45
GW 63 266 H	1/4	100	45
GW 63 267 H	1/4	128	45
GW 63 268 H	1/4	128	45
GW 63 269 H	1/4	128	45
GW 63 445	2/4	64	47
GW 63 446	2/4	64	47
GW 63 447	2/4	64	47
GW 63 448	2/4	96	47
GW 63 449	2/4	64	47
GW 63 450	2/4	96	47
GW 63 451	2/4	64	47
GW 63 452	2/4	96	47
GW 63 453	2/4	256	47
GW 63 454	2/4	64	47
GW 63 455	2/4	64	47
GW 63 519	2/4	48	50
GW 63 520	2/4	96	50
GW 63 521	2/4	48	50
GW 63 522	2/4	96	50
GW 63 523	2/4	96	50
GW 63 524	2/4	96	50
GW 63 525	2/4	48	50
GW 63 526	2/4	216	50
GW 63 527	2/4	216	50
GW 63 528	2/4	96	50
GW 63 529	2/4	48	50
GW 64			
GW 64 008	5/20	240	60
GW 64 010	5/20	600	60
GW 64 011	5/10	120	60
GW 64 012	5/10	80	60
GW 64 013	5/10	280	60
GW 64 014	5/10	180	60
GW 64 022	5/10	180	60
GW 64 023	5/10	100	60
GW 64 024	5/10	180	60
GW 64 025	5/10	90	60
GW 64 026	5/10	80	60
GW 64 027	5/10	180	60
GW 64 028	5/10	240	60
GW 64 050	1/6	60	60
GW 64 052	1/6	144	60
GW 64 055	1/3	27	60
GW 64 056	1/3	84	60
GW 64 059	5/10	100	61
GW 64 060	5/10	100	61
GW 64 061	1/5	50	61
GW 64 062	5/10	240	61
GW 64 063	5/10	80	61
GW 64 064	1/5	60	61
GW 64 065	1/2	32	61
GW 64 066	10/20	480	62
GW 64 067	10/20	240	62
GW 64 068	1/4	200	60
GW 64 203	10/40	960	62
GW 64 204	10/40	960	62
GW 64 206	10/40	2880	62
GW 64 207	10/40	480	62
GW 64 208	10/40	1920	63
GW 64 209	10/40	720	63
GW 64 210	10/40	960	62

Code	Quantity		Page
	Pack/carton	Pallet	
GW 64 211	10/40	2880	62
GW 64 212	10/40	2880	62
GW 64 216	10/40	480	62
GW 64 217	10/40	480	62
GW 64 221	5/20	320	63
GW 64 222	5/20	240	63
GW 64 223	5/20	240	63
GW 64 231	5/20	240	63
GW 64 232	5/20	240	64
GW 64 236	5/10	60	63
GW 64 237	5/10	60	64
GW 64 256	1/3	33	64
GW 64 263	1/6	60	64
GW 64 265	5/20	240	64

GW 66			
Code	Quantity		Page
	Pack/carton	Pallet	
GW 66 001	1/12	192	90
GW 66 002	1/12	144	90
GW 66 003	1/12	144	90
GW 66 004	1/12	600	90
GW 66 005	1/12	144	90
GW 66 006	1/12	144	90
GW 66 007	1/12	144	90
GW 66 008	1/12	384	90
GW 66 009	1/12	384	90
GW 66 010	1/12	144	90
GW 66 011	1/12	144	90
GW 66 012	1/12	192	90
GW 66 013	1/12	144	90
GW 66 014	1/12	144	90
GW 66 015	1/12	384	90
GW 66 016	1/12	144	90
GW 66 017	1/12	144	90
GW 66 018	1/12	144	90
GW 66 019	1/12	384	90
GW 66 020	1/12	384	90
GW 66 021	1/12	144	90
GW 66 022	1/12	144	90
GW 66 023	1/12	96	91
GW 66 024	1/12	96	91
GW 66 025	1/12	96	91
GW 66 026	1/12	240	91
GW 66 027	1/12	96	91
GW 66 028	1/12	96	91
GW 66 029	1/12	96	91
GW 66 030	1/12	240	91
GW 66 031	1/12	240	91
GW 66 032	1/12	96	91
GW 66 033	1/12	96	91
GW 66 034	1/12	96	91
GW 66 035	1/12	96	91
GW 66 036	1/12	96	91
GW 66 037	1/12	96	91
GW 66 038	1/12	96	91
GW 66 039	1/12	96	91
GW 66 040	1/12	96	91
GW 66 041	1/12	96	91
GW 66 042	1/12	240	91
GW 66 043	1/12	96	91
GW 66 044	1/12	96	91
GW 66 051 N	1/12	96	73
GW 66 052 N	1/12	96	73
GW 66 053 N	1/12	96	73
GW 66 054 N	1/12	96	73
GW 66 055 N	1/12	96	73
GW 66 056 N	1/12	96	73

Code	Quantity		Page
	Pack/carton	Pallet	
GW 66 057 N	1/12	96	73
GW 66 058 N	1/12	96	73
GW 66 059 N	1/12	96	73
GW 66 062 N	1/12	96	73
GW 66 063 N	1/12	96	73
GW 66 064 N	1/12	96	73
GW 66 065 N	1/12	96	73
GW 66 066 N	1/12	96	73
GW 66 067 N	1/12	96	73
GW 66 068 N	1/12	96	73
GW 66 069 N	1/12	96	73
GW 66 070 N	1/12	96	73
GW 66 101	1/12	144	90
GW 66 102	1/12	144	90
GW 66 103	1/12	144	90
GW 66 104	1/12	384	90
GW 66 105	1/12	144	90
GW 66 106	1/12	144	90
GW 66 107	1/12	144	90
GW 66 108	1/12	384	90
GW 66 109	1/12	384	90
GW 66 110	1/12	144	90
GW 66 111	1/12	144	90
GW 66 112	1/12	144	90
GW 66 113	1/12	144	90
GW 66 114	1/12	144	90
GW 66 115	1/12	192	90
GW 66 116	1/12	144	90
GW 66 117	1/12	144	90
GW 66 118	1/12	144	90
GW 66 119	1/12	384	90
GW 66 120	1/12	384	90
GW 66 121	1/12	144	90
GW 66 122	1/12	144	90
GW 66 123	1/12	96	91
GW 66 124	1/12	96	91
GW 66 125	1/12	96	91
GW 66 126	1/12	240	91
GW 66 127	1/12	96	91
GW 66 128	1/12	96	91
GW 66 129	1/12	96	91
GW 66 130	1/12	240	91
GW 66 131	1/12	240	91
GW 66 132	1/12	96	91
GW 66 133	1/12	96	91
GW 66 134	1/12	96	91
GW 66 135	1/12	96	91
GW 66 136	1/12	96	91
GW 66 137	1/12	240	91
GW 66 138	1/12	96	91
GW 66 139	1/12	96	91
GW 66 140	1/12	96	91
GW 66 141	1/12	240	91
GW 66 142	1/12	240	91
GW 66 143	1/12	96	91
GW 66 144	1/12	96	91
GW 66 151 N	1/12	96	72
GW 66 152 N	1/12	96	72
GW 66 153 N	1/12	96	72
GW 66 154 N	1/12	192	72
GW 66 155 N	1/12	96	72
GW 66 156 N	1/12	96	72
GW 66 157 N	1/12	96	72
GW 66 158 N	1/12	192	72
GW 66 159 N	1/12	192	72

Code	Quantity		Page
	Pack/carton	Pallet	
GW 66 162 N	1/12	96	72
GW 66 163 N	1/12	96	72
GW 66 164 N	1/12	96	72
GW 66 165 N	1/12	96	72
GW 66 166 N	1/12	96	72
GW 66 167 N	1/12	96	72
GW 66 168 N	1/12	96	72
GW 66 169 N	1/12	96	72
GW 66 170 N	1/12	96	72
GW 66 201 N	1/12	96	75
GW 66 202 N	1/12	96	75
GW 66 203 N	1/12	96	75
GW 66 204 N	1/12	192	75
GW 66 205 N	1/12	96	75
GW 66 206 N	1/12	96	75
GW 66 207 N	1/12	96	75
GW 66 208 N	1/12	192	75
GW 66 209 N	1/12	192	75
GW 66 210 N	1/12	96	75
GW 66 211 N	1/12	96	75
GW 66 212 N	1/12	96	75
GW 66 213 N	1/12	96	75
GW 66 214 N	1/12	96	75
GW 66 215 N	1/12	192	75
GW 66 216 N	1/12	96	75
GW 66 217 N	1/12	96	75
GW 66 218 N	1/12	96	75
GW 66 219 N	1/12	192	75
GW 66 220 N	1/12	192	75
GW 66 221 N	1/12	96	75
GW 66 222 N	1/12	96	75
GW 66 223 N	1/12	96	77
GW 66 224 N	1/12	96	77
GW 66 225 N	1/12	96	77
GW 66 226 N	1/12	192	77
GW 66 227 N	1/12	96	77
GW 66 228 N	1/12	96	77
GW 66 229 N	1/12	96	77
GW 66 230 N	1/12	192	77
GW 66 231 N	1/12	192	77
GW 66 232 N	1/12	96	77
GW 66 233 N	1/12	96	77
GW 66 234 N	1/12	96	77
GW 66 235 N	1/12	96	77
GW 66 236 N	1/12	96	77
GW 66 237 N	1/12	96	77
GW 66 238 N	1/12	96	77
GW 66 239 N	1/12	96	77
GW 66 240 N	1/12	96	77
GW 66 241 N	1/12	192	77
GW 66 242 N	1/12	192	77
GW 66 243 N	1/12	96	77
GW 66 244 N	1/12	96	77
GW 66 257 N	1/12	192	75
GW 66 258 N	1/12	96	77
GW 66 259 N	1/4	128	75
GW 66 301 N	1/12	96	74
GW 66 302 N	1/12	96	74
GW 66 303 N	1/12	96	74
GW 66 304 N	1/12	432	74
GW 66 305 N	1/12	96	74
GW 66 306 N	1/12	96	74
GW 66 307 N	1/12	96	74
GW 66 308 N	1/12	288	74
GW 66 309 N	1/12	288	74

Quick Reference

Code	Quantity		Page
	Pack/carton	Pallet	
GW 66 310 N	1/12	96	74
GW 66 311 N	1/12	96	74
GW 66 312 N	1/12	96	74
GW 66 313 N	1/12	96	74
GW 66 314 N	1/12	96	74
GW 66 315 N	1/12	288	74
GW 66 316 N	1/12	96	74
GW 66 317 N	1/12	96	74
GW 66 318 N	1/12	96	74
GW 66 319 N	1/12	288	74
GW 66 320 N	1/12	288	74
GW 66 321 N	1/12	96	74
GW 66 322 N	1/12	96	74
GW 66 323 N	1/12	96	76
GW 66 324 N	1/12	96	76
GW 66 325 N	1/12	96	76
GW 66 326 N	1/12	432	76
GW 66 327 N	1/12	96	76
GW 66 328 N	1/12	96	76
GW 66 329 N	1/12	96	76
GW 66 330 N	1/12	288	76
GW 66 331 N	1/12	288	76
GW 66 332 N	1/12	96	76
GW 66 333 N	1/12	96	76
GW 66 334 N	1/12	96	76
GW 66 335 N	1/12	96	76
GW 66 336 N	1/12	96	76
GW 66 337 N	1/12	288	76
GW 66 338 N	1/12	96	76
GW 66 339 N	1/12	96	76
GW 66 340 N	1/12	96	76
GW 66 341 N	1/12	288	76
GW 66 342 N	1/12	192	76
GW 66 343 N	1/12	96	76
GW 66 344 N	1/12	96	76
GW 66 345 N	1/4	64	76
GW 66 346 N	1/4	64	76
GW 66 347 N	1/4	64	76
GW 66 348 N	1/4	64	76
GW 66 349 N	1/4	64	76
GW 66 350 N	1/4	64	76
GW 66 351 N	1/4	64	76
GW 66 352 N	1/4	128	76
GW 66 353 N	1/4	128	76
GW 66 354 N	1/4	64	76
GW 66 355 N	1/4	64	76
GW 66 357 N	1/12	96	74
GW 66 358 N	1/12	96	76
GW 66 359 N	1/4	128	74
GW 66 388	1	6	130
GW 66 389	1	6	130
GW 66 391	1/2	36	116
GW 66 392	1/2	24	116
GW 66 393	1/2	24	116
GW 66 394	1	18	116
GW 66 395	1	18	116
GW 66 396	1	18	116
GW 66 397	1	18	116
GW 66 401	1/12	192	96
GW 66 402	1/12	192	96
GW 66 403	1/12	192	96
GW 66 404	1/12	336	96
GW 66 405	1/12	192	96
GW 66 406	1/12	192	96
GW 66 407	1/12	192	96

Code	Quantity		Page
	Pack/carton	Pallet	
GW 66 408	1/12	336	96
GW 66 409	1/12	192	96
GW 66 412	1/12	192	96
GW 66 413	1/12	192	96
GW 66 414	1/12	192	96
GW 66 415	1/12	192	96
GW 66 416	1/12	192	96
GW 66 417	1/12	192	96
GW 66 418	1/12	192	96
GW 66 419	1/12	168	96
GW 66 420	1/12	168	96
GW 66 423	1/12	192	96
GW 66 424	1/12	192	96
GW 66 425	1/12	192	96
GW 66 426	1/12	336	96
GW 66 427	1/12	192	96
GW 66 428	1/12	192	96
GW 66 429	1/12	192	96
GW 66 430	1/12	336	96
GW 66 431	1/12	168	96
GW 66 434	1/12	192	96
GW 66 435	1/12	192	96
GW 66 436	1/12	192	96
GW 66 437	1/12	192	96
GW 66 438	1/12	192	96
GW 66 439	1/12	192	96
GW 66 440	1/12	192	96
GW 66 441	1/12	168	96
GW 66 442	1/12	168	96
GW 66 445	1/12	192	97
GW 66 446	1/12	192	97
GW 66 447	1/12	192	97
GW 66 448	1/12	336	97
GW 66 449	1/12	96	97
GW 66 450	1/12	192	97
GW 66 451	1/12	192	97
GW 66 452	1/12	168	97
GW 66 453	1/12	192	97
GW 66 456	1/12	120	97
GW 66 457	1/12	120	97
GW 66 458	1/12	96	97
GW 66 459	1/12	96	97
GW 66 460	1/12	96	97
GW 66 461	1/12	96	97
GW 66 462	1/12	96	97
GW 66 463	1/12	96	97
GW 66 464	1/12	96	97
GW 66 467	1/12	192	97
GW 66 468	1/12	336	97
GW 66 469	1/12	192	97
GW 66 470	1/12	336	97
GW 66 471	1/12	192	97
GW 66 472	1/12	192	97
GW 66 473	1/12	192	97
GW 66 474	1/12	336	97
GW 66 475	1/12	168	97
GW 66 478	1/12	96	97
GW 66 479	1/12	96	97
GW 66 480	1/12	96	97
GW 66 481	1/12	96	97
GW 66 482	1/12	96	97
GW 66 483	1/12	96	97
GW 66 484	1/12	96	97
GW 66 485	1/12	96	97
GW 66 486	1/12	96	97

Code	Quantity		Page
	Pack/carton	Pallet	
GW 66 491	1/12	360	99
GW 66 491	1/12	360	112
GW 66 492	1/6	168	99
GW 66 492	1/6	168	112
GW 66 493	1/4	120	99
GW 66 493	1/4	120	112
GW 66 496	1/12	864	98
GW 66 498	1/12	432	98
GW 66 501	1/6	48	83
GW 66 502	1/6	24	83
GW 66 503	1/6	48	83
GW 66 504	1/6	48	83
GW 66 505	1/6	48	83
GW 66 506	1/6	48	83
GW 66 507	1/6	48	83
GW 66 508	1/6	48	83
GW 66 509	1/6	48	83
GW 66 510	1/6	48	83
GW 66 511	1/6	48	83
GW 66 512	1/6	48	83
GW 66 513	1/6	48	83
GW 66 514	1/6	48	83
GW 66 515	1/6	48	83
GW 66 516	1/6	48	83
GW 66 517	1/6	48	83
GW 66 518	1/6	48	83
GW 66 519	1/6	48	83
GW 66 520	1/6	48	83
GW 66 521	1/6	48	83
GW 66 522	1/6	48	83
GW 66 523	1/6	120	83
GW 66 524	1/3	18	83
GW 66 525	1/3	18	83
GW 66 526	1/3	135	83
GW 66 527	1/3	54	83
GW 66 528	1/3	18	83
GW 66 529	1/3	18	83
GW 66 530	1/3	18	83
GW 66 531	1/3	54	83
GW 66 532	1/3	54	83
GW 66 533	1/3	18	83
GW 66 534	1/3	18	83
GW 66 535	1/6	48	82
GW 66 536	1/6	48	82
GW 66 537	1/6	48	82
GW 66 538	1/6	48	82
GW 66 539	1/6	48	82
GW 66 540	1/6	48	82
GW 66 541	1/6	48	82
GW 66 542	1/6	48	82
GW 66 543	1/6	48	82
GW 66 544	1/6	48	82
GW 66 545	1/6	48	82
GW 66 546	1/6	48	82
GW 66 547	1/6	48	82
GW 66 548	1/6	48	82
GW 66 549	1/6	48	82
GW 66 550	1/6	48	82
GW 66 551	1/6	48	82
GW 66 552	1/6	48	82
GW 66 553	1/6	48	82
GW 66 554	1/6	48	82
GW 66 555	1/6	48	82
GW 66 556	1/6	48	82
GW 66 557	1/6	48	82

Code	Quantity		Page
	Pack/carton	Pallet	
GW 66 581	1	8	89
GW 66 582	1	8	89
GW 66 583	1	8	89
GW 66 584	1	8	89
GW 66 585	1	8	89
GW 66 586	1	12	89
GW 66 591	1	8	89
GW 66 592	1	8	89
GW 66 593	1	8	89
GW 66 594	1	8	89
GW 66 595	1	8	89
GW 66 596	1	8	89
GW 66 673	10/120	4800	112
GW 66 676	1/10	900	92
GW 66 677	1/10	540	94
GW 66 678 N	1/12	1080	78
GW 66 680 N	1/10	160	78
GW 66 681	1/10	420	92
GW 66 681 PM	1/10	360	92
GW 66 681 PM	1/10	360	261
GW 66 682	1/10	240	94
GW 66 682 PM	1/10	240	94
GW 66 682 PM	1/10	240	261
GW 66 683 N	1/10	360	79
GW 66 683 PM	1/10	250	80
GW 66 683 PM	1/10	250	261
GW 66 685	1/10	240	88
GW 66 686	1/10	160	78
GW 66 690	1/6	288	79
GW 66 691	1/6	144	79
GW 66 693	1/6	96	79
GW 66 694	1/6	96	79
GW 66 696	1/6	108	88
GW 66 697	1/2	40	88
GW 66 698	1/2	36	88
GW 66 700	1/6	72	88
GW 66 701	1/10	1280	92
GW 66 701	1/10	1280	110
GW 66 702	1/10	1100	94
GW 66 702	1/10	1100	110
GW 66 703 N	1/10	1100	80
GW 66 703 N	1/10	1100	110
GW 66 705 N	1/10	720	80
GW 66 705 N	1/10	720	110
GW 66 706	1/10	240	88
GW 66 707	1/10	240	89
GW 66 708	1/20	1400	111
GW 66 708	1/20	1400	153
GW 66 708	1/20	1400	282
GW 66 708	1/20	1400	299
GW 66 709 N	1/10	960	80
GW 66 709 N	1/10	960	111
GW 66 715 N	1/10	1000	81
GW 66 715 N	1/10	1000	111
GW 66 716 N	1/10	200	81
GW 66 716 N	1/10	200	111
GW 66 741 N	1/10	360	79
GW 66 742	1/10	120	79
GW 66 743 N	1/10	140	80
GW 66 745	1/20	1400	111
GW 66 745	1/20	1400	153
GW 66 745	1/20	1400	282
GW 66 745	1/20	1400	299
GW 66 781	1/6	108	88
GW 66 782	1/2	40	88

Code	Quantity		Page
	Pack/carton	Pallet	
GW 66 783	1/2	36	88
GW 66 784	1/6	72	88
GW 66 801	1/6	48	86
GW 66 802	1/6	120	86
GW 66 803	1/6	120	86
GW 66 804	1/6	48	86
GW 66 805	1/6	48	86
GW 66 806	1/6	48	86
GW 66 807	1/6	48	86
GW 66 808	1/6	120	86
GW 66 809	1/6	120	86
GW 66 810	1/6	120	86
GW 66 811	1/6	120	86
GW 66 812	1/6	120	86
GW 66 813	1/6	120	86
GW 66 814	1/6	120	86
GW 66 815	1/6	48	86
GW 66 816	1/6	30	86
GW 66 817	1/6	48	86
GW 66 818	1/6	120	86
GW 66 819	1/6	60	86
GW 66 820	1/6	120	86
GW 66 821	1/6	120	86
GW 66 822	1/6	48	86
GW 66 823	1/6	120	86
GW 66 824	1/6	120	84
GW 66 825	1/6	120	84
GW 66 826	1/6	48	84
GW 66 827	1/6	120	84
GW 66 828	1/6	48	84
GW 66 829	1/6	120	84
GW 66 830	1/6	48	84
GW 66 831	1/6	48	84
GW 66 832	1/6	48	84
GW 66 833	1/6	120	84
GW 66 834	1/6	48	84
GW 66 835	1/6	48	84
GW 66 836	1/6	120	84
GW 66 837	1/6	120	84
GW 66 838	1/6	48	84
GW 66 839	1/6	48	84
GW 66 840	1/6	48	84
GW 66 841	1/6	96	84
GW 66 842	1/6	48	84
GW 66 843	1/6	48	84
GW 66 844	1/6	120	84
GW 66 845	1/6	120	84
GW 66 846	1/6	120	84
GW 66 847	1/3	24	87
GW 66 848	1/3	60	87
GW 66 849	1/3	18	87
GW 66 850	1/3	18	87
GW 66 851	1/3	48	87
GW 66 852	1/3	18	87
GW 66 853	1/3	18	87
GW 66 854	1/3	54	87
GW 66 855	1/3	54	87
GW 66 856	1/3	18	87
GW 66 857	1/3	24	87
GW 66 866	1/3	18	85
GW 66 867	1/3	18	85
GW 66 868	1/3	18	85
GW 66 869	1/3	18	85
GW 66 870	1/3	54	85
GW 66 871	1/3	18	85

Code	Quantity		Page
	Pack/carton	Pallet	
GW 66 872	1/3	18	85
GW 66 873	1/3	18	85
GW 66 874	1/3	54	85
GW 66 875	1/3	18	85
GW 66 876	1/3	18	85
GW 66 886	1/4	48	86
GW 66 951	1/6	48	87
GW 66 952	1/6	48	87
GW 66 953	1/6	48	87
GW 66 954	1/6	48	87
GW 66 955	1/6	48	87
GW 66 956	1/6	48	87
GW 66 957	1/6	48	87
GW 66 958	1/6	48	87
GW 66 959	1/6	48	87
GW 66 960	1/6	48	87
GW 66 961	1/6	48	87
GW 66 962	1/6	48	87
GW 66 963	1/6	48	87
GW 66 964	1/6	48	87
GW 66 965	1/6	48	87
GW 66 966	1/6	48	87
GW 66 967	1/6	48	87
GW 66 968	1/6	48	87
GW 66 969	1/6	48	87
GW 66 970	1/6	48	87
GW 66 971	1/6	240	87
GW 66 972	1/6	48	87
GW 66 973	1/6	72	87
GW 66 974	1/6	48	85
GW 66 975	1/6	48	85
GW 66 976	1/6	48	85
GW 66 977	1/6	48	85
GW 66 978	1/6	48	85
GW 66 979	1/6	48	85
GW 66 980	1/6	48	85
GW 66 981	1/6	48	85
GW 66 982	1/6	48	85
GW 66 983	1/6	48	85
GW 66 984	1/6	48	85
GW 66 985	1/6	48	85
GW 66 986	1/6	48	85
GW 66 987	1/6	48	85
GW 66 988	1/6	48	85
GW 66 989	1/6	48	85
GW 66 990	1/6	48	85
GW 66 991	1/6	48	85
GW 66 992	1/6	48	85
GW 66 993	1/6	48	85
GW 66 994	1/6	48	85
GW 66 995	1/6	48	85
GW 66 996	1/6	48	85
GW 66 998	1/4	48	87

GW 67			
GW 67 245 N	1/4	32	77
GW 67 246 N	1/4	32	77
GW 67 247 N	1/4	32	77
GW 67 248 N	1/4	32	77
GW 67 249 N	1/4	32	77
GW 67 250 N	1/4	32	77
GW 67 251 N	1/4	32	77
GW 67 252 N	1/4	64	77
GW 67 253 N	1/4	64	77
GW 67 254 N	1/4	32	77
GW 67 255 N	1/4	32	77

Quick Reference

Code	Quantity		Page
	Pack/carton	Pallet	
GW 67 256 N	1/4	64	75
GW 67 257 N	1/4	64	75
GW 67 258 N	1/4	64	75
GW 67 259 N	1/4	64	75
GW 67 260 N	1/4	64	75
GW 67 261 N	1/4	64	75
GW 67 262 N	1/4	64	75
GW 67 263 N	1/4	128	75
GW 67 264 N	1/4	128	75
GW 67 265 N	1/4	64	75
GW 67 266 N	1/4	64	75
GW 67 356 N	1/4	64	74
GW 67 357 N	1/4	64	74
GW 67 358 N	1/4	64	74
GW 67 359 N	1/4	64	74
GW 67 360 N	1/4	64	74
GW 67 361 N	1/4	64	74
GW 67 362 N	1/4	64	74
GW 67 363 N	1/4	64	74
GW 67 364 N	1/4	128	74
GW 67 365 N	1/4	64	74
GW 67 366 N	1/4	64	74
GW 68			
GW 68 001 N	8	320	106
GW 68 002 N	6	120	106
GW 68 003 N	6	168	106
GW 68 004 N	4	120	107
GW 68 005 N	4	120	107
GW 68 006 N	4	80	93
GW 68 006 N	4	80	107
GW 68 007 N	3	90	107
GW 68 008 N	3	90	107
GW 68 009 N	3	90	93
GW 68 009 N	3	90	107
GW 68 010 N	3	90	81
GW 68 010 N	3	90	107
GW 68 012 N	2	48	107
GW 68 013 N	2	48	107
GW 68 014 N	2	36	95
GW 68 014 N	2	36	107
GW 68 015 N	2	48	81
GW 68 015 N	2	48	108
GW 68 017 N	16	288	106
GW 68 018 N	12	288	106
GW 68 019 N	6	108	93
GW 68 019 N	6	108	106
GW 68 020 N	8	320	106
GW 68 021 N	2	36	107
GW 68 022 N	2	36	81
GW 68 022 N	2	36	108
GW 68 023 N	1/3	108	108
GW 68 024 N	1/3	72	108
GW 68 025 N	6	108	81
GW 68 025 N	6	108	106
GW 68 026 N	8	192	106
GW 68 027 N	6	108	106
GW 68 031 N	4	96	106
GW 68 202 N	1/3	30	114
GW 68 203 N	1	48	128
GW 68 204 N	1	48	128
GW 68 205 N	1/3	48	114
GW 68 206 N	1	28	115
GW 68 207 N	1	28	115
GW 68 208 N	1	18	115
GW 68 212 N	1/8	96	114

Code	Quantity		Page
	Pack/carton	Pallet	
GW 68 216 N	1	48	128
GW 68 217 N	1	77	128
GW 68 223 N	1	28	128
GW 68 224 N	1/2	36	114
GW 68 225 N	1/6	48	114
GW 68 226 N	1/6	48	114
GW 68 227 N	1/8	96	114
GW 68 228 N	1/3	30	114
GW 68 229 N	1	28	115
GW 68 230 N	1	9	115
GW 68 231 N	1	9	115
GW 68 232 N	1/2	18	114
GW 68 233 N	1/2	12	114
GW 68 235 N	1/2	24	130
GW 68 236 N	1	28	130
GW 68 241 N	1	12	127
GW 68 242 N	1	28	128
GW 68 243 N	1	28	128
GW 68 244 N	1	12	128
GW 68 245 N	1	24	128
GW 68 246 N	1	24	128
GW 68 247 N	1	8	128
GW 68 248 N	1	8	129
GW 68 249 N	1	11	129
GW 68 250 N	1	12	129
GW 68 251 N	1	11	129
GW 68 281	1/10	720	111
GW 68 292	1/10	2760	110
GW 68 293	1/10	3120	110
GW 68 294	1/10	3120	110
GW 68 295	1/10	3120	98
GW 68 295	1/10	3120	99
GW 68 295	1/10	3120	113
GW 68 296	1/10	1320	110
GW 68 401 N	1	10	129
GW 68 411 N	1	6	129
GW 68 421 N	1	6	129
GW 68 424 N	1	6	130
GW 68 431	1	30	108
GW 68 432	1	15	109
GW 68 433	1	20	108
GW 68 436 N	1/10	960	110
GW 68 441	1/6	168	81
GW 68 441	1/6	168	93
GW 68 441	1/6	168	95
GW 68 441	1/6	168	98
GW 68 441	1/6	168	237
GW 68 463	1	10	133
GW 68 465	1	9	132
GW 68 466	1	9	132
GW 68 468	1	6	123
GW 68 469	1	6	123
GW 68 471	1	4	125
GW 68 471 F	1	4	127
GW 68 472	1	4	125
GW 68 472 F	1	4	127
GW 68 473	1	4	125
GW 68 473 F	1	4	127
GW 68 474	1	4	125
GW 68 481	1	6	125
GW 68 481 F	1	6	127
GW 68 482	1	6	125
GW 68 482 F	1	6	127
GW 68 483	1	6	125
GW 68 483 F	1	6	127

Code	Quantity		Page
	Pack/carton	Pallet	
GW 68 484	1	6	125
GW 68 484 F	1	6	127
GW 68 491	1	4	124
GW 68 491 F	1	4	126
GW 68 492	1	4	124
GW 68 493	1	4	124
GW 68 493 F	1	4	126
GW 68 494	1	4	124
GW 68 494 F	1	4	126
GW 68 495	1	4	124
GW 68 496	1	4	124
GW 68 497	1	4	124
GW 68 498 F	1	4	126
GW 68 503	1/8	80	133
GW 68 504	1/4	280	133
GW 68 505	1/10	1440	133
GW 68 511	1	6	123
GW 68 511 F	1	6	126
GW 68 512	1	6	123
GW 68 512 F	1	6	126
GW 68 513	1	6	123
GW 68 513 F	1	6	126
GW 68 514	1	6	123
GW 68 514 F	1	6	126
GW 68 521	1	6	122
GW 68 526	1	4	122
GW 68 531	1	6	122
GW 68 536	1	24	122
GW 68 537	1	24	122
GW 68 538	1	15	122
GW 68 539	1	15	122
GW 68 541	1	6	124
GW 68 542	1	6	123
GW 68 543	1	4	124
GW 68 544	1	4	124
GW 68 551	1	48	132
GW 68 552	1	48	132
GW 68 554	1	48	132
GW 68 556	1	48	132
GW 68 559	1	20	132
GW 68 561	1	6	123
GW 68 561 F	1	6	126
GW 68 562	1	6	123
GW 68 562 F	1	6	126
GW 68 563	1	4	123
GW 68 563 F	1	4	126
GW 68 564	1	6	123
GW 68 564 F	1	6	126
GW 68 565	1	6	123
GW 68 565 F	1	6	126
GW 68 566	1	6	123
GW 68 566 F	1	4	126
GW 68 567	1	9	123
GW 68 567 F	1	4	126
GW 68 568	1	6	123
GW 68 568 F	1	6	126
GW 68 569	1	4	123
GW 68 569 F	1	4	126
GW 68 570	1	4	123
GW 68 570 F	1	4	126
GW 68 571	1	6	123
GW 68 571 F	1	6	126
GW 68 572	1	6	123
GW 68 572 F	1	6	126
GW 68 573	1	4	123

Code	Quantity		Page
	Pack/carton	Pallet	
GW 68 573 F	1		126
GW 68 574	1	6	123
GW 68 574 F	1	4	126
GW 68 575	1	8	124
GW 68 575 F	1	4	126
GW 68 576	1	4	124
GW 68 576 F	1	4	126
GW 68 577	1	4	124
GW 68 577 F	1	4	126
GW 68 578	1	4	124
GW 68 578 F	1	4	126
GW 68 579	1	4	124
GW 68 579 F	1	4	126
GW 68 580	1	4	124
GW 68 580 F	1	4	126
GW 68 581	1	4	124
GW 68 582	1		124
GW 68 582 F	1	4	126
GW 68 583	1	4	124
GW 68 583 F	1	4	126
GW 68 584	1	6	125
GW 68 584 F	1	6	127
GW 68 585	1	6	125
GW 68 586	1	6	125
GW 68 586 F	1	6	127
GW 68 587	1	6	125
GW 68 587 F	1	6	127
GW 68 588	1		125
GW 68 588 F	1		127
GW 68 589	1		125
GW 68 589 F	1	6	127
GW 68 590	1		125
GW 68 590 F	1	6	127
GW 68 591	1/20	600	133
GW 68 592	1	6	125
GW 68 592 F	1	6	127
GW 68 593	1	6	125
GW 68 594	1	4	125
GW 68 594 F	1	6	127
GW 68 595	1	4	125
GW 68 595 F	1	4	127
GW 68 596	1		125
GW 68 596 F	1	2	127
GW 68 597	1	4	125
GW 68 597 F	1	4	127
GW 68 598	1	4	125
GW 68 598 F	1	4	127
GW 68 599	1	4	125
GW 68 599 F	1	4	127
GW 68 600	1	4	125
GW 68 600 F	1	2	127
GW 68 701 A	1	10	1214
GW 68 701 W	1	10	1214
GW 68 711 A	1	10	1214
GW 68 711 W	1	10	1214
GW 68 712 A	1	10	1214
GW 68 712 W	1	10	1214
GW 68 713 A	1	6	1214
GW 68 713 G	1	6	1214
GW 68 713 W	1	6	1214
GW 68 714 A	1	8	1214
GW 68 714 W	1	6	1214
GW 68 715 A	1	3	1219
GW 68 715 W	1	3	1219
GW 68 716 A	1	6	1214

Code	Quantity		Page
	Pack/carton	Pallet	
GW 68 716 W	1	6	1214
GW 68 717 A	1	2	1220
GW 68 717 W	1	2	1220
GW 68 731 W	1/2	112	1221
GW 68 732 W	1/2	112	1221
GW 68 733 W	1/2	110	1221
GW 68 734 W	1/2	80	1221
GW 68 735 W	1/2	110	1221
GW 68 736 W	1/2	24	1221
GW 68 737 A	1/2	48	1221
GW 68 737 W	1/2	48	1221
GW 68 741 A	1/2	48	1222
GW 68 741 W	1/2	48	1222
GW 68 745 A	1/2	100	1216
GW 68 745 G	1/2	80	1216
GW 68 745 W	1/2	100	1203
GW 68 745 W	1/2	100	1216
GW 68 746 A	1/2	100	1216
GW 68 746 W	1/2	100	1203
GW 68 746 W	1/2	100	1216
GW 68 747 A	1/2	100	1216
GW 68 747 W	1/2	48	1203
GW 68 747 W	1/2	48	1216
GW 68 748 A	1/2	100	1216
GW 68 748 G	1/2	80	1216
GW 68 748 W	1/2	100	1203
GW 68 748 W	1/2	100	1216
GW 68 749 A	1/2	100	1216
GW 68 749 W	1/2	100	1203
GW 68 749 W	1/2	100	1216
GW 68 750 A	1/2	100	1216
GW 68 750 G	1/2	80	1216
GW 68 750 W	1/2	100	1203
GW 68 750 W	1/2	100	1216
GW 68 751	1/4	48	1223
GW 68 752	1	42	1223
GW 68 753	1	24	1222
GW 68 758	1/5	1560	1223
GW 68 761	1	16	1223
GW 68 762 A	1/2	32	1223
GW 68 762 W	1/2	32	1223
GW 68 763	1	40	1222
GW 68 764	1	21	1222
GW 68 765	1	108	1222
GW 68 766	1	72	1222
GW 68 767	1	72	1222
GW 68 768	1	72	1222
GW 68 769	1	72	1222
GW 68 770	1	110	1217
GW 68 770	1	110	1223
GW 68 776	1/5	1560	1217
GW 68 778	1/5	1560	1204
GW 68 781	1	176	1204
GW 68 781	1	176	1217
GW 68 782	1	16	1204
GW 68 782	1	16	1217
GW 68 785	1	72	46
GW 68 785	1	72	1222
GW 68 786	1	72	46
GW 68 786	1	72	1222
GW 68 788	1	312	1203
GW 68 788	1	312	1216
GW 68 789	1	312	1203
GW 68 789	1	312	1216
GW 68 790	1	50	1204

Code	Quantity		Page
	Pack/carton	Pallet	
GW 68 790	1	50	1217
GW 68 791	1	50	1204
GW 68 791	1	50	1217
GW 68 792	1	110	1216
GW 68 793	1	110	1204
GW 68 793	1	110	1216
GW 68 794	1	72	1204
GW 68 794	1	72	1216
GW 68 795	1/10	1300	1224
GW 68 796	1	28	1204
GW 68 796	1	28	1217
GW 68 799	1	312	1218
GW 68 800	1	110	1203
GW 68 800	1	110	1216
GW 68 801 A	1	3	1218
GW 68 801 W	1	3	1218
GW 68 802 A	1	3	1218
GW 68 802 W	1	3	1218
GW 68 803 A	1	3	1218
GW 68 803 W	1	4	1218
GW 68 831 A	1	2	1219
GW 68 831 W	1	2	1219
GW 68 832 A	1	2	1219
GW 68 832 W	1	2	1219
GW 68 833 A	1	2	1219
GW 68 833 W	1	2	1219
GW 68 841 A	1	10	1210
GW 68 841 W	1	10	1210
GW 68 842 A	1	10	1210
GW 68 842 W	1	8	1210
GW 68 846 A	1	10	1210
GW 68 846 W	1	10	1210
GW 68 847 A	1	10	1210
GW 68 847 W	1	10	1210
GW 68 851 A	1	6	1211
GW 68 851 W	1	6	1211
GW 68 852 A	1	6	1211
GW 68 852 W	1	6	1211
GW 68 855 G	1	6	1211
GW 68 856 A	1	8	1211
GW 68 856 W	1	5	1211
GW 68 857 A	1	6	1212
GW 68 857 W	1	6	1212
GW 68 858 A	1	6	1212
GW 68 858 W	1	6	1212
GW 68 867 A	1	2	1219
GW 68 867 W	1	2	1219
GW 68 868 A	1		1220
GW 68 868 W	1	2	1220
GW 68 874 A	1	6	1213
GW 68 874 W	1	6	1213
GW 68 875 A	1		1213
GW 68 875 W	1	6	1213
GW 68 876 A	1	6	1212
GW 68 876 W	1	6	1212
GW 68 877 A	1	6	1212
GW 68 877 W	1	4	1212
GW 68 878 A	1	6	1212
GW 68 878 W	1	6	1212
GW 68 881 A	1	10	131
GW 68 883 A	1	10	131
GW 68 884 A	1	10	131
GW 68 901	1	6	1202
GW 68 902	1		1202
GW 68 903	1	8	1202

Quick Reference

Code	Quantity		Page
	Pack/carton	Pallet	
GW 68 904	1		1202
GW 68 905	1	6	1202
GW 68 931	1	8	1203
GW 68 990	1	50	1204
GW 68 990	1	50	1217
GW 68 991	1	280	1215
GW 68 991	1	280	1220
GW 68 992	1/10	3120	1215
GW 68 992	1/10	3120	1220
GW 68 994	1	110	1215
GW 68 994	1	110	1221
GW 68 995	1	128	1215
GW 68 995	1	128	1221
GW 68 998	1	48	1213

GW 70			
Code	Pack/carton	Pallet	Page
GW 70 001	1/10	240	144
GW 70 002	1/10	240	144
GW 70 003	1/10	600	144
GW 70 004	1/10	400	144
GW 70 005	1/10	240	144
GW 70 006	1/10	900	144
GW 70 007	1/5	300	144
GW 70 008	1/5	250	144
GW 70 009	1/10	1440	144
GW 70 009	1/10	1440	281
GW 70 009	1/10	1440	298
GW 70 026	1/12	1920	145
GW 70 027	1/12	1920	145
GW 70 028	1/12	1920	145
GW 70 029	1/12	1488	145
GW 70 201	1/24	1200	145
GW 70 202	1/24	1200	145
GW 70 203	1/24	1728	145
GW 70 204	1/24	960	145
GW 70 205	1/24	960	145
GW 70 206	1/24	864	145
GW 70 207	1/12	504	145
GW 70 208	1/12	504	145
GW 70 401 M	1	273	142
GW 70 401 P	1/16	512	140
GW 70 402 M	1	273	142
GW 70 402 NM	1	273	142
GW 70 402 NP	1/16	256	140
GW 70 402 P	1/16	512	140
GW 70 403 M	1	273	142
GW 70 403 P	1/16	512	140
GW 70 404 M	1	273	142
GW 70 404 P	1/16	256	140
GW 70 405 M	1	273	142
GW 70 405 NM	1	273	142
GW 70 405 NP	1/16	256	140
GW 70 405 P	1/16	256	140
GW 70 406 M	1	273	142
GW 70 406 P	1/16	512	140
GW 70 407 M	1	30	142
GW 70 407 NM	1	30	142
GW 70 407 NP	1/6	120	140
GW 70 407 P	1/6	120	140
GW 70 408 M	1	30	142
GW 70 408 P	1/6	240	140
GW 70 413 M	1	273	142
GW 70 413 P	1/16	256	140
GW 70 414 M	1	273	142
GW 70 414 NM	1	273	142
GW 70 414 NP	1/16	256	140

Code	Quantity		Page
	Pack/carton	Pallet	
GW 70 414 P	1/16	256	140
GW 70 415 M	1	273	142
GW 70 415 P	1/16	256	140
GW 70 416 M	1	273	142
GW 70 416 P	1/16	256	140
GW 70 417 M	1	273	142
GW 70 417 NM	1	273	142
GW 70 417 NP	1/16	256	140
GW 70 417 P	1/16	256	140
GW 70 418 M	1	273	142
GW 70 418 P	1/16	256	140
GW 70 419 M	1	30	142
GW 70 419 NM	1	30	142
GW 70 419 NP	1/6	120	140
GW 70 419 P	1/6	120	140
GW 70 420 M	1	30	142
GW 70 420 P	1/6	120	140
GW 70 421 M	1	30	142
GW 70 421 NM	1	30	142
GW 70 421 NP	1	20	140
GW 70 421 P	1	20	140
GW 70 422 M	1	30	142
GW 70 422 P	1	20	140
GW 70 423 M	1	20	142
GW 70 423 NM	1	20	142
GW 70 423 NP	1	20	140
GW 70 423 P	1	20	140
GW 70 424 M	1	20	142
GW 70 424 P	1	20	140
GW 70 425 M	1	20	142
GW 70 425 NM	1	20	142
GW 70 425 NP	1	20	140
GW 70 425 P	1	20	140
GW 70 426 M	1	20	142
GW 70 426 P	1	20	140
GW 70 431 M	1	273	143
GW 70 431 P	1/16	512	141
GW 70 432 M	1	273	143
GW 70 432 NM	1	273	143
GW 70 432 NP	1/16	256	141
GW 70 432 P	1/16	512	141
GW 70 433 M	1	273	143
GW 70 433 P	1/16	512	141
GW 70 434 M	1	273	143
GW 70 434 P	1/16	512	141
GW 70 435 M	1	144	143
GW 70 435 NM	1	273	143
GW 70 435 NP	1/16	256	141
GW 70 435 P	1/16	512	141
GW 70 436 M	1	273	143
GW 70 436 P	1/16	512	141
GW 70 437 M	1	30	143
GW 70 437 NM	1	30	143
GW 70 437 NP	1/6	120	141
GW 70 437 P	1/6	240	141
GW 70 438 M	1	30	143
GW 70 438 P	1/6	240	141
GW 70 441 M	1	273	143
GW 70 441 P	1/16	256	141
GW 70 442 M	1	273	143
GW 70 442 NM	1	273	143
GW 70 442 NP	1/16	256	141
GW 70 442 P	1/16	256	141
GW 70 443 M	1	273	143
GW 70 443 P	1/16	256	141

Code	Quantity		Page
	Pack/carton	Pallet	
GW 70 451	1	72	146
GW 70 452	1	72	146
GW 70 453	1	72	146
GW 70 454	1	72	146
GW 70 455	1	72	146
GW 70 456	1	72	146
GW 70 457	1	72	146
GW 70 458	1	72	146
GW 70 459	1	36	146
GW 70 460	1	36	146
GW 70 471	1	72	146
GW 70 472	1	72	146
GW 70 473	1	72	146
GW 70 474	1	72	146
GW 70 475	1	72	146
GW 70 476	1	72	146
GW 70 477	1	72	146
GW 70 478	1	72	146
GW 70 479	1	36	146
GW 70 480	1	36	146
GW 70 486 M	1	273	143
GW 70 486 P	1/16	256	141
GW 70 487 M	1	273	143
GW 70 487 NM	1	273	143
GW 70 487 NP	1/16	256	141
GW 70 487 P	1/16	256	141
GW 70 488 M	1	273	143
GW 70 488 P	1/16	256	141
GW 70 489 M	1	30	143
GW 70 489 NM	1	30	143
GW 70 489 NP	1/6	120	141
GW 70 489 P	1/6	120	141
GW 70 490 M	1	30	143
GW 70 490 P	1/6	120	141
GW 70 491 M	1	30	143
GW 70 491 NM	1	30	143
GW 70 491 NP	1	20	141
GW 70 491 P	1	20	141
GW 70 492 M	1	30	143
GW 70 492 P	1	20	141
GW 70 493 M	1	20	143
GW 70 493 NM	1	20	141
GW 70 493 NP	1	20	141
GW 70 493 P	1	20	141
GW 70 494 M	1	20	143
GW 70 494 P	1	60	141
GW 70 495 M	1	20	143
GW 70 495 NM	1	20	143
GW 70 495 NP	1	20	141
GW 70 495 P	1	20	141
GW 70 496 M	1	20	143
GW 70 496 P	1	20	141

GW 72			
Code	Pack/carton	Pallet	Page
GW 72 001	10/100	5000	100
GW 72 003	10/100	12500	100
GW 72 005	10/100	12500	100
GW 72 013	10/100	10000	100
GW 72 015	10/100	10000	100
GW 72 021	10/50	5000	100
GW 72 023	10/50	5000	100
GW 72 065	5/20	2000	100
GW 72 092	5/20	2000	100
GW 72 095	5/20	2000	100
GW 72 101	10/100	10000	100
GW 72 101	10/100	10000	477

Code	Quantity		Page
	Pack/carton	Pallet	
GW 72 103	10/30	3000	100
GW 72 103	10/30	3000	477
GW 72 104	10/100	10000	100
GW 72 104	10/100	10000	477
GW 72 105	10/100	10000	100
GW 72 105	10/100	10000	477
GW 72 107	10/100	10000	477
GW 72 108	10/100	10000	477
GW 72 109	10/100	10000	477
GW 72 110	10/100	10000	100
GW 72 110	10/100	10000	477
GW 72 111	10/100	19500	477
GW 72 112	10/100	19500	477
GW 72 113	10/100	19500	477
GW 72 114	10/100	19500	477
GW 72 115	10/100	19500	477
GW 72 116	10/100	19500	477
GW 72 117	10/100	19500	477
GW 72 121	10/100	19500	477
GW 72 122	10/100	19500	100
GW 72 122	10/100	19500	477
GW 72 123	10/100	19500	477
GW 72 124	10/100	4000	477
GW 72 131	10	32000	478
GW 72 131	10	32000	510
GW 72 132	10	32000	478
GW 72 132	10	32000	510
GW 72 133	10	32000	478
GW 72 133	10	32000	510
GW 72 134	10	32000	478
GW 72 134	10	32000	510
GW 72 135	10	32000	478
GW 72 135	10	32000	510
GW 72 136	10	32000	478
GW 72 136	10	32000	510

GW 74			
Code	Pack/carton	Pallet	Page
GW 74 201	10/60	7680	215
GW 74 202	10/60	3840	215
GW 74 301	10/60	1320	148
GW 74 302	10/60	1320	148
GW 74 303	10/60	1320	148
GW 74 304	10/60	1320	148
GW 74 305	10/60	1320	148
GW 74 306	10/60	1320	148
GW 74 311	10/60	1320	148
GW 74 312	10/60	1320	148
GW 74 313	10/60	1320	148
GW 74 314	10/60	1320	148
GW 74 315	10/60	1320	148
GW 74 316	10/60	1320	148
GW 74 341	10/60	1320	148
GW 74 342	10/60	1320	148
GW 74 343	10/60	1320	148
GW 74 344	10/60	1320	148
GW 74 345	10/60	1320	148
GW 74 361	10/60	2640	109
GW 74 361	10/60	2640	149
GW 74 362	10/60	1320	149
GW 74 363	10/60	1320	149
GW 74 364	10/60	1320	149
GW 74 365	10/60	1320	149
GW 74 366	10/60	1320	149
GW 74 367	10/60	1320	149
GW 74 401	10/60	1320	150
GW 74 402	10/60	1320	150

Code	Quantity		Page
	Pack/carton	Pallet	
GW 74 411	10/60	1320	150
GW 74 412	10/60	2640	150
GW 74 421	10/60	1320	150
GW 74 422	10/60	1320	150
GW 74 451	10/60	1320	151
GW 74 452	10/60	1320	151
GW 74 453	10/60	1320	151
GW 74 454	10/60	1320	151
GW 74 455	10/60	1320	151
GW 74 501	1/30	13500	110
GW 74 501	1/30	13500	151
GW 74 501	1/30	13500	154
GW 74 502	1/30	13500	110
GW 74 502	1/30	13500	151
GW 74 502	1/30	13500	154
GW 74 503	1/30	9000	110
GW 74 503	1/30	9000	151
GW 74 504	1/30	9000	110
GW 74 504	1/30	9000	151
GW 74 505	1/30	9000	110
GW 74 505	1/30	9000	151
GW 74 511	1/30	13500	151
GW 74 515	10/100	30000	152
GW 74 516	10/100	30000	152
GW 74 517	10/100	30000	152
GW 74 518	10/100	30000	152
GW 74 521	10/100	13000	152
GW 74 522	5/100	1600	152
GW 74 523	10/100	13000	152
GW 74 524	10/100	1200	152
GW 74 525	10/100	13000	152

GW 76			
Code	Pack/carton	Pallet	Page
GW 76 261	1/40	1680	233
GW 76 262	1/32	1344	233
GW 76 263	1/24	672	233
GW 76 264	1/16	384	233
GW 76 265	1/8	224	233
GW 76 266	1/4	120	233
GW 76 267	1	60	233
GW 76 272	1/10	1950	234
GW 76 273	1/10	1600	234
GW 76 274	1/10	1200	234
GW 76 275	1/5	720	234
GW 76 276	1/5	720	234
GW 76 277	1/5	360	234
GW 76 281	1/40	1680	233
GW 76 282	1/32	1344	233
GW 76 283	1/24	672	233
GW 76 284	1/16	384	233
GW 76 285	1/8	224	233
GW 76 286	1/4	120	233
GW 76 287	1	60	233
GW 76 291	1/40	1680	234
GW 76 292	1/32	1152	234
GW 76 293	1/24	720	234
GW 76 294	1/16	192	234
GW 76 295	1/8	224	234
GW 76 296	1/4	120	234
GW 76 297	1	60	234
GW 76 825	10/100	4800	369
GW 76 826	10/100	4800	369
GW 76 827	10/100	7200	369
GW 76 828	5/50	2400	369
GW 76 829	5/50	3600	369
GW 76 830	5/50	2400	369

Code	Quantity		Page
	Pack/carton	Pallet	
GW 76 831	10/100	7200	369
GW 76 832	10/100	9000	369
GW 76 833	5/50	6000	369
GW 76 834	5/50	3600	369
GW 76 835	2/10	1200	369
GW 76 837	1/50	6000	368
GW 76 839	1/50	18000	368
GW 76 841	1/50	6000	368
GW 76 842	1/50	6000	368
GW 76 843	1/50	6000	368
GW 76 844	1/50	3600	368
GW 76 845	1/10	2500	368
GW 76 846	1/10	960	368
GW 76 847	1/10	720	368
GW 76 848	1/50	12500	368
GW 76 849	1/50	4800	368
GW 76 850	1/10	3850	368
GW 76 851	1/10	2500	368
GW 76 852	1/10	720	368
GW 76 865	10/100	11000	369
GW 76 866	10/100		369
GW 76 867	10/100	12000	369
GW 76 868	5/50	13200	369
GW 76 869	5/50	1800	369
GW 76 870	10/100	4400	369
GW 76 871	10/100	4400	369
GW 76 872	5/50	2200	369
GW 76 873	5/50	2200	369
GW 76 894	50/250	2000	369
GW 76 895	5/40	360	369
GW 76 896	10/100	4800	369
GW 76 897	2/10	1440	369
GW 76 901	10/100	8700	371
GW 76 902	10/100	8700	371
GW 76 903	10/100	15600	371
GW 76 904	10/100	15600	371
GW 76 905	10/100	15600	371
GW 76 906	5/50	7800	371
GW 76 907	5/50	3200	371
GW 76 908	5/50	1500	371
GW 76 909	2/10	580	371
GW 76 910	2/10	1560	371
GW 76 921	10/100	8700	371
GW 76 922	10/100	8700	371
GW 76 923	10/100	15600	371
GW 76 924	10/100	3000	371
GW 76 925	5/50	400	371
GW 76 926	5/50	1500	371
GW 76 927	2/10	580	371
GW 76 928	2/10	1560	371
GW 76 941	25/100	19500	371
GW 76 942	25/100	19500	371
GW 76 943	10/50	7800	371
GW 76 949	25/100	19500	371
GW 76 950	10/50	1000	371
GW 76 951	25/100	21600	370
GW 76 951	25/100	21600	371
GW 76 952	25/100	19500	370
GW 76 952	25/100	19500	371
GW 76 953	25/100	19500	370
GW 76 953	25/100	19500	371
GW 76 954	25/100	19500	370
GW 76 954	25/100	19500	371
GW 76 955	10/50	9750	370
GW 76 955	10/50	9750	371

Quick Reference

Code	Quantity		Page
	Pack/carton	Pallet	
GW 76 956	10/50	9750	370
GW 76 956	10/50	9750	371
GW 76 957	25/100	19500	370
GW 76 957	25/100	19500	371
GW 76 958	25/100	19500	370
GW 76 958	25/100	19500	371
GW 76 959	25/100	19500	370
GW 76 959	25/100	19500	371
GW 76 960	25/100	19500	370
GW 76 960	25/100	19500	371
GW 76 961	25/100	19500	370
GW 76 961	25/100	19500	371
GW 76 962	10/50	6000	370
GW 76 962	10/50	6000	371
GW 76 963	10/50	3600	370
GW 76 963	10/50	3600	371
GW 76 966	100/500		370
GW 76 967	25/125	2250	370
GW 76 972	100/400	28800	370
GW 76 973	100/300	21600	370
GW 76 974	10/100	3000	370
GW 76 975	10/100	6600	370
GW 76 976	10/100	11000	370
GW 76 977	10/100	6600	370
GW 76 978	5/50	3300	370
GW 76 979	5/50	3300	370
GW 76 980	10/100	21600	370
GW 76 981	10/100	21600	370
GW 76 982	10/100	6600	370
GW 76 983	10/100	6600	370
GW 76 984	5/50	3300	370
GW 76 985	5/50	3300	370
GW 76 986	5/50	3300	370

GW 80

GW 80 401	12	480	134
GW 80 403	12	480	134
GW 80 404	12	240	134
GW 80 409	36	720	134
GW 80 411	36	576	134
GW 80 412	36	144	134

GW 90

GW 90 005	6/24	1536	420
GW 90 006	6/24	1536	420
GW 90 007	6/24	1536	420
GW 90 008	6/24	1536	420
GW 90 009	6/24	1536	420
GW 90 010	6/24	1536	420
GW 90 011	6/24		420
GW 90 022	6/24	1536	420
GW 90 025	6/24	3840	420
GW 90 026	6/24	3840	420
GW 90 027	6/24	3840	420
GW 90 028	6/24	3840	420
GW 90 029	6/24	3840	420
GW 90 030	6/24	3840	420
GW 90 031	6/24	1536	420
GW 90 045	6/24	2304	420
GW 90 046	6/24	3840	420
GW 90 047	6/24	3840	420
GW 90 048	6/24	1536	420
GW 90 049	6/24	1536	420
GW 90 050	6/24	1536	420
GW 90 051	6/24	1536	420
GW 90 065	3/12	768	420

Code	Quantity		Page
	Pack/carton	Pallet	
GW 90 066	3/12	768	420
GW 90 067	3/12	768	420
GW 90 068	3/12	768	420
GW 90 069	3/12	768	420
GW 90 070	3/12	768	420
GW 90 071	3/12	768	420
GW 90 085	3/12	768	420
GW 90 086	3/12	768	420
GW 90 087	3/12	768	420
GW 90 088	3/12	768	420
GW 90 089	3/12	768	420
GW 90 090	3/12	768	420
GW 90 091	3/12		420
GW 90 225	6/24	2304	421
GW 90 226	6/24	3840	421
GW 90 227	6/24	3840	421
GW 90 228	6/24	2304	421
GW 90 229	6/24	2304	421
GW 90 230	6/24	1536	421
GW 90 231	6/24	1536	421
GW 90 245	6/24	2304	421
GW 90 246	6/24	3840	421
GW 90 247	6/24	3840	421
GW 90 248	6/24	1536	421
GW 90 249	6/24	1536	421
GW 90 250	6/24	1536	421
GW 90 251	6/24	1536	421
GW 90 265	3/12	768	421
GW 90 266	3/12	768	421
GW 90 267	3/12	1152	421
GW 90 268	3/12	384	421
GW 90 269	3/12	768	421
GW 90 270	3/12	768	421
GW 90 271	3/12	768	421
GW 90 285	3/12	768	421
GW 90 286	3/12	768	421
GW 90 287	3/12	1152	421
GW 90 288	3/12	768	421
GW 90 289	3/12	768	421
GW 90 290	3/12	1152	421
GW 90 291	3/12	768	421
GW 90 325	6/24	1536	422
GW 90 326	6/24	1536	422
GW 90 327	6/24	1536	422
GW 90 328	6/24	3840	422
GW 90 329	6/24	1536	422
GW 90 330	6/24	1536	422
GW 90 331	6/24	1536	422
GW 90 345	6/24		422
GW 90 346	6/24		422
GW 90 347	6/24		422
GW 90 348	6/24	1536	422
GW 90 349	6/24	1152	422
GW 90 350	6/24	1536	422
GW 90 351	6/24	1536	422
GW 90 445	6/24	1536	422
GW 90 446	6/24	2304	422
GW 90 447	6/24	1536	422
GW 90 448	6/24	1536	422
GW 90 449	6/24	1536	422
GW 90 450	6/24	1536	422
GW 90 451	6/24	1536	422
GW 90 584	100	9800	1133
GW 90 585	100	8400	1133
GW 90 602	6/24	2304	420

Code	Quantity		Page
	Pack/carton	Pallet	
GW 90 605	6/24	2304	420
GW 90 606	6/24	3840	420
GW 90 607	6/24	3840	420
GW 90 608	6/24	3840	420
GW 90 609	6/24	1536	420
GW 90 610	6/24	3840	420
GW 90 706 B	1	280	1112
GW 90 706 U	1	312	1113
GW 90 708 A	1/4	280	1112
GW 90 709	1	192	1112
GW 90 710	1	160	1112
GW 90 721 A	1	1248	1115
GW 90 727	1	1120	1115
GW 90 728	1	168	1115
GW 90 729	1	168	1115
GW 90 730	1	280	1124
GW 90 740 A	1	234	1122
GW 90 741	1	224	1121
GW 90 742	1	192	1122
GW 90 764	1	224	1125
GW 90 765	1	128	1125
GW 90 766	1/4	280	1126
GW 90 800	1	40	1131
GW 90 802 A	1		1112
GW 90 807	50	7800	1132
GW 90 808	50	7800	1133
GW 90 856	1	224	1123
GW 90 857	1	224	1123
GW 90 871	1	156	1132
GW 90 872 A	1/4	168	1132
GW 90 873	1/4		1132
GW 90 876	1/5	960	499
GW 90 876	1/5	960	1130
GW 90 883	1	48	1131
GW 90 884	1	48	1131
GW 90 885	1	195	1131
GW 90 893	1/4	220	411
GW 90 896	1/4	168	411
GW 90 898	1/4	280	411
GW 90 901 N	1/4	216	406
GW 90 902 N	1/4	216	406
GW 90 911 B	1/2	114	406
GW 90 912 B	1/2	190	406
GW 90 913	1/4	132	406
GW 90 913 B	1/2	114	406
GW 90 917	1/4		406
GW 90 918	1/4		406
GW 90 919	1/4		406
GW 90 921	1/2	180	407
GW 90 921 B	1/2	190	407
GW 90 922	1/2	180	407
GW 90 922 B	1/2	190	407
GW 90 923	1/2	180	407
GW 90 923 B	1/2	114	407
GW 90 927	1/2	190	407
GW 90 927 B	1/2	114	407
GW 90 928	1/2	160	407
GW 90 928 B	1/2	114	407
GW 90 929	1/2	190	407
GW 90 929 B	1/2	114	407
GW 90 930	1/2	190	407
GW 90 945	1/4	168	412
GW 90 953	1/4	168	412
GW 90 954	1/4	168	412
GW 90 967	1/4	208	408

Code	Quantity		Page
	Pack/carton	Pallet	
GW 90 969	1/4	208	408
GW 90 986	1/4	216	410
GW 90 988	1/4	108	410
GW 90 992	1	280	412
GW 92			
GW 92 001	6/24	1536	425
GW 92 002	6/24	2304	425
GW 92 003	6/24	1536	425
GW 92 004	6/24	2304	425
GW 92 005	6/24	3840	425
GW 92 006	6/24	3840	425
GW 92 007	6/24	3840	425
GW 92 008	6/24	3840	425
GW 92 009	6/24	3840	425
GW 92 010	6/24	3840	425
GW 92 011	6/24	3840	425
GW 92 012	6/24	3840	425
GW 92 013	6/24	3840	425
GW 92 014	6/24	1536	425
GW 92 021	3/12	768	425
GW 92 022	3/12	768	425
GW 92 023	3/12	768	425
GW 92 024	3/12	768	425
GW 92 025	3/12	1152	425
GW 92 026	3/12	1920	425
GW 92 027	3/12	1920	425
GW 92 028	3/12	1920	425
GW 92 029	3/12	1920	425
GW 92 030	3/12	1920	425
GW 92 031	3/12	1920	425
GW 92 032	3/12	1920	425
GW 92 033	3/12	1920	425
GW 92 034	3/12	768	425
GW 92 041	3/12	768	425
GW 92 042	3/12	768	425
GW 92 043	3/12	768	425
GW 92 044	3/12	768	425
GW 92 045	3/12	1152	425
GW 92 046	3/12	1920	425
GW 92 047	3/12	1920	425
GW 92 048	3/12	1920	425
GW 92 049	3/12	1920	425
GW 92 050	3/12	1920	425
GW 92 051	3/12	1152	425
GW 92 052	3/12	1920	425
GW 92 053	3/12	1920	425
GW 92 054	3/12	768	425
GW 92 061	2/8	512	425
GW 92 062	2/8	512	425
GW 92 063	2/8	512	425
GW 92 064	2/8	512	425
GW 92 065	2/8	512	425
GW 92 066	2/8	1280	425
GW 92 067	2/8	1280	425
GW 92 068	2/8	1280	425
GW 92 069	2/8	1280	425
GW 92 070	2/8	1280	425
GW 92 071	2/8	1280	425
GW 92 072	2/8	1280	425
GW 92 073	2/8	1280	425
GW 92 074	2/8	512	425
GW 92 081	1/3	372	425
GW 92 082	1/3	348	425
GW 92 083	1/3	348	425
GW 92 084	1/3	348	425

Code	Quantity		Page
	Pack/carton	Pallet	
GW 92 085	1/3	261	425
GW 92 086	1/3	609	425
GW 92 087	1/3	960	425
GW 92 088	1/3	960	425
GW 92 089	1/3	960	425
GW 92 090	1/3	960	425
GW 92 091	1/3	912	425
GW 92 092	1/3	912	425
GW 92 093	1/3	960	425
GW 92 094	1/3	348	425
GW 92 105	6/24	2304	423
GW 92 106	6/24	3840	423
GW 92 107	6/24	1536	423
GW 92 108	6/24	3840	423
GW 92 109	6/24	3840	423
GW 92 110	6/24	3840	423
GW 92 111	6/24	3840	423
GW 92 112	6/24	3840	423
GW 92 125	3/12	768	423
GW 92 126	3/12	1920	423
GW 92 127	3/12	768	423
GW 92 128	3/12	1920	423
GW 92 129	3/12	768	423
GW 92 130	3/12	768	423
GW 92 131	3/12	768	423
GW 92 132	3/12	768	423
GW 92 145	3/12	768	423
GW 92 146	3/12	1152	423
GW 92 147	3/12	768	423
GW 92 148	3/12	1920	423
GW 92 149	3/12	1920	423
GW 92 150	3/12	768	423
GW 92 151	3/12	768	423
GW 92 152	3/12	768	423
GW 92 165	2/8	512	423
GW 92 166	2/8	512	423
GW 92 167	2/8	512	423
GW 92 168	2/8	1280	423
GW 92 169	2/8	1280	423
GW 92 170	2/8	1280	423
GW 92 171	2/8	768	423
GW 92 172	2/8	768	423
GW 92 185	1/3	348	423
GW 92 186	1/3	372	423
GW 92 187	1/3	348	423
GW 92 188	1/3	372	423
GW 92 189	1/3	348	423
GW 92 190	1/3	348	423
GW 92 191	1/3	522	423
GW 92 192	1/3	372	423
GW 92 205	6/24	3840	426
GW 92 206	6/24	3840	426
GW 92 207	6/24	3840	426
GW 92 208	6/24	3840	426
GW 92 209	6/24	3840	426
GW 92 210	6/24	3840	426
GW 92 211	6/24	3840	426
GW 92 212	6/24	1536	426
GW 92 213	6/24	2304	426
GW 92 214	6/24	1536	426
GW 92 245	3/12	768	426
GW 92 246	3/12	768	426
GW 92 247	3/12	768	426
GW 92 248	3/12	768	426
GW 92 249	3/12	768	426

Code	Quantity		Page
	Pack/carton	Pallet	
GW 92 250	3/12	768	426
GW 92 251	3/12	768	426
GW 92 252	3/12	768	426
GW 92 253	3/12	768	426
GW 92 254	3/12	768	426
GW 92 265	2/8	512	426
GW 92 266	2/8	512	426
GW 92 267	2/8	1280	426
GW 92 268	2/8	512	426
GW 92 269	2/8	768	426
GW 92 270	2/8	768	426
GW 92 271	2/8	512	426
GW 92 272	2/8	512	426
GW 92 273	2/8	512	426
GW 92 274	2/8	512	426
GW 92 285	1/3	609	426
GW 92 286	1/3	348	426
GW 92 287	1/3	651	426
GW 92 288	1/3	348	426
GW 92 289	1/3	348	426
GW 92 290	1/3	348	426
GW 92 291	1/3	348	426
GW 92 292	1/3	348	426
GW 92 293	1/3	348	426
GW 92 294	1/3	348	426
GW 92 305	6/24	1536	424
GW 92 306	6/24	3840	424
GW 92 307	6/24	1536	424
GW 92 308	6/24	3840	424
GW 92 309	6/24	3840	424
GW 92 310	6/24	3840	424
GW 92 311	6/24	3840	424
GW 92 312	6/24	1536	424
GW 92 325	3/12		424
GW 92 326	3/12	768	424
GW 92 327	3/12		424
GW 92 328	3/12		424
GW 92 329	3/12	768	424
GW 92 330	3/12	768	424
GW 92 331	3/12	768	424
GW 92 332	3/12	768	424
GW 92 345	3/12	768	424
GW 92 346	3/12	768	424
GW 92 347	3/12		424
GW 92 348	3/12	768	424
GW 92 349	3/12	768	424
GW 92 350	3/12	768	424
GW 92 351	3/12	768	424
GW 92 352	3/12	768	424
GW 92 365	2/8		424
GW 92 366	2/8	512	424
GW 92 367	2/8		424
GW 92 368	2/8	256	424
GW 92 369	2/8	512	424
GW 92 370	2/8	512	424
GW 92 371	2/8	512	424
GW 92 372	2/8	512	424
GW 92 385	1/3	348	424
GW 92 386	1/3	348	424
GW 92 387	1/3	348	424
GW 92 388	1/3	348	424
GW 92 389	1/3	348	424
GW 92 390	1/3	348	424
GW 92 391	1/3	348	424
GW 92 392	1/3	348	424

Quick Reference

Code	Quantity		Page
	Pack/carton	Pallet	
GW 92 405	6/24	1536	427
GW 92 406	6/24	1536	427
GW 92 407	6/24	1536	427
GW 92 408	6/24	1536	427
GW 92 409	6/24	1536	427
GW 92 410	6/24	1536	427
GW 92 411	6/24	1536	427
GW 92 414	6/24	1536	427
GW 92 445	3/12	768	427
GW 92 446	3/12	768	427
GW 92 447	3/12	768	427
GW 92 448	3/12	768	427
GW 92 449	3/12	768	427
GW 92 450	3/12	768	427
GW 92 451	3/12	768	427
GW 92 454	3/12		427
GW 92 465	2/8	512	427
GW 92 466	2/8	512	427
GW 92 467	2/8	512	427
GW 92 468	2/8	512	427
GW 92 469	2/8	512	427
GW 92 470	2/8	512	427
GW 92 471	2/8	512	427
GW 92 474	2/8		427
GW 92 485	1/3	348	427
GW 92 486	1/3	348	427
GW 92 487	1/3	348	427
GW 92 488	1/3	348	427
GW 92 489	1/3	348	427
GW 92 490	1/3	348	427
GW 92 491	1/3	348	427
GW 92 494	1/3	348	427
GW 92 505	6/24	1536	429
GW 92 506	6/24	2304	429
GW 92 507	6/24	1536	429
GW 92 508	6/24	3840	429
GW 92 509	6/24	2304	429
GW 92 510	6/24	1536	429
GW 92 511	6/24	3840	429
GW 92 512	6/24	1536	429
GW 92 513	6/24	1536	429
GW 92 514	6/24	1536	429
GW 92 545	3/12		429
GW 92 546	3/12	768	429
GW 92 547	3/12	768	429
GW 92 548	3/12	768	429
GW 92 549	3/12	768	429
GW 92 550	3/12	768	429
GW 92 551	3/12	768	429
GW 92 552	3/12	768	429
GW 92 553	3/12	768	429
GW 92 554	3/12	768	429
GW 92 565	2/8	512	429
GW 92 566	2/8	512	429
GW 92 567	2/8	512	429
GW 92 568	2/8	1280	429
GW 92 569	2/8	512	429
GW 92 570	2/8	512	429
GW 92 571	2/8	512	429
GW 92 572	2/8	512	429
GW 92 573	2/8	512	429
GW 92 574	2/8	512	429
GW 92 585	1/3	348	429
GW 92 586	1/3	348	429
GW 92 587	1/3	348	429

Code	Quantity		Page
	Pack/carton	Pallet	
GW 92 588	1/3	348	429
GW 92 589	1/3	348	429
GW 92 590	1/3	348	429
GW 92 591	1/3	348	429
GW 92 592	1/3	348	429
GW 92 593	1/3	348	429
GW 92 594	1/3	348	429
GW 92 605	6/24	1536	428
GW 92 606	6/24	2304	428
GW 92 607	6/24	3840	428
GW 92 608	6/24	3840	428
GW 92 609	6/24	1536	428
GW 92 610	6/24	1536	428
GW 92 611	6/24	1536	428
GW 92 612	6/24	1536	428
GW 92 613	6/24	1536	428
GW 92 614	6/24	1536	428
GW 92 645	3/12	768	428
GW 92 646	3/12	768	428
GW 92 647	3/12	1152	428
GW 92 648	3/12	768	428
GW 92 649	3/12	768	428
GW 92 650	3/12	768	428
GW 92 651	3/12	768	428
GW 92 652	3/12	768	428
GW 92 653	3/12	768	428
GW 92 654	3/12	768	428
GW 92 665	2/8	512	428
GW 92 666	2/8	512	428
GW 92 667	2/8	1280	428
GW 92 668	2/8	768	428
GW 92 669	2/8	512	428
GW 92 670	2/8	768	428
GW 92 671	2/8	512	428
GW 92 672	2/8	512	428
GW 92 673	2/8	512	428
GW 92 674	2/8	512	428
GW 92 685	1/3	348	428
GW 92 686	1/3	348	428
GW 92 687	1/3	348	428
GW 92 688	1/3	348	428
GW 92 689	1/3	348	428
GW 92 690	1/3	609	428
GW 92 691	1/3	348	428
GW 92 692	1/3	348	428
GW 92 693	1/3	372	428
GW 92 694	1/3	348	428
GW 92 701	6/24	1536	430
GW 92 702	6/24	1536	430
GW 92 703	6/24	1536	430
GW 92 704	6/24	1536	430
GW 92 705	6/24	1536	430
GW 92 706	6/24	1536	430
GW 92 707	6/24	1536	430
GW 92 708	6/24	1536	430
GW 92 709	6/24	1536	430
GW 92 710	6/24	1536	430
GW 92 711	6/24	1536	430
GW 92 714	6/24		430
GW 92 741	3/12	768	430
GW 92 742	3/12	768	430
GW 92 743	3/12	768	430
GW 92 744	3/12	768	430
GW 92 745	3/12	768	430
GW 92 746	3/12	768	430

Code	Quantity		Page
	Pack/carton	Pallet	
GW 92 747	3/12	768	430
GW 92 748	3/12	768	430
GW 92 749	3/12	768	430
GW 92 750	3/12	768	430
GW 92 751	3/12	768	430
GW 92 754	3/12		430
GW 92 761	2/8	512	430
GW 92 762	2/8	512	430
GW 92 763	2/8	512	430
GW 92 764	2/8	512	430
GW 92 765	2/8	512	430
GW 92 766	2/8	512	430
GW 92 767	2/8	512	430
GW 92 768	2/8	512	430
GW 92 769	2/8	512	430
GW 92 770	2/8	512	430
GW 92 771	2/8	512	430
GW 92 774	2/8		430
GW 92 781	1/3	348	430
GW 92 782	1/3	348	430
GW 92 783	1/3	348	430
GW 92 784	1/3	348	430
GW 92 785	1/3	348	430
GW 92 786	1/3	348	430
GW 92 787	1/3	348	430
GW 92 788	1/3	348	430
GW 92 789	1/3	348	430
GW 92 790	1/3	348	430
GW 92 791	1/3	372	430
GW 92 794	1/3	348	430
GW 92 805	6/24	1536	431
GW 92 806	6/24	1536	431
GW 92 807	6/24	1536	431
GW 92 808	6/24	1536	431
GW 92 809	6/24	1536	431
GW 92 810	6/24	1536	431
GW 92 811	6/24	1536	431
GW 92 812	6/24	1536	431
GW 92 813	6/24	1536	431
GW 92 845	3/12	768	431
GW 92 846	3/12	768	431
GW 92 847	3/12	768	431
GW 92 848	3/12	768	431
GW 92 849	3/12	768	431
GW 92 850	3/12	768	431
GW 92 851	3/12	768	431
GW 92 852	3/12	768	431
GW 92 853	3/12	768	431
GW 92 865	2/8	512	431
GW 92 866	2/8	512	431
GW 92 867	2/8	512	431
GW 92 868	2/8	512	431
GW 92 869	2/8	512	431
GW 92 870	2/8	512	431
GW 92 871	2/8	512	431
GW 92 872	2/8	512	431
GW 92 873	2/8	512	431
GW 92 885	1/3	348	431
GW 92 886	1/3	348	431
GW 92 887	1/3	348	431
GW 92 888	1/3	348	431
GW 92 889	1/3	348	431
GW 92 890	1/3	372	431
GW 92 891	1/3	372	431
GW 92 892	1/3	348	431

Code	Quantity		Page
	Pack/carton	Pallet	
GW 92 893	1/3	348	431
GW 93			
GW 93 201	1/12	768	434
GW 93 202	1/12	768	434
GW 93 203	1/12	768	434
GW 93 204	1/12	768	434
GW 93 205	1/12	768	434
GW 93 206	1/12	768	434
GW 93 221	1/4	224	434
GW 93 222	1/4	224	434
GW 93 223	1/4	224	434
GW 93 224	1/4	224	434
GW 93 225	1/4	224	434
GW 93 226	1/4	224	434
GW 93 231	1/4	120	434
GW 93 232	1/4	120	434
GW 93 233	1/4	120	434
GW 93 234	1/4	120	434
GW 93 235	1/4	120	434
GW 93 236	1/4	120	434
GW 93 241	1/4	120	434
GW 93 242	1/4	120	434
GW 93 243	1/4	120	434
GW 93 244	1/4	120	434
GW 93 245	1/4	120	434
GW 93 246	1/4	120	434
GW 93 307	1/12	768	432
GW 93 308	1/12	384	432
GW 93 309	1/12	768	432
GW 93 327	1/4	360	432
GW 93 328	1/4	360	432
GW 93 329	1/4	240	432
GW 93 337	1/4	240	432
GW 93 338	1/4	240	432
GW 93 339	1/4	240	432
GW 93 347	1/4	240	432
GW 93 348	1/4	240	432
GW 93 349	1/4	240	432
GW 93 355	1/12	1152	433
GW 93 356	1/12	768	433
GW 93 357	1/12	768	433
GW 93 358	1/12	768	433
GW 93 375	1/4	336	433
GW 93 376	1/4	224	433
GW 93 377	1/4	224	433
GW 93 378	1/4	224	433
GW 93 385	1/4	180	433
GW 93 386	1/4	120	433
GW 93 387	1/4	120	433
GW 93 388	1/4	120	433
GW 93 395	1/4	144	433
GW 93 396	1/4	120	433
GW 93 397	1/4	120	433
GW 93 398	1/4	120	433
GW 94			
GW 94 005	1/6	1302	444
GW 94 006	1/6	1302	444
GW 94 007	1/6	1302	444
GW 94 008	1/6	1302	444
GW 94 009	1/6	1302	444
GW 94 010	1/6	1302	444
GW 94 011	1/6	744	444
GW 94 015	1/6	744	444
GW 94 016	1/6	744	444

Code	Quantity		Page
	Pack/carton	Pallet	
GW 94 017	1/6	1302	444
GW 94 018	1/6	744	444
GW 94 019	1/6	744	444
GW 94 020	1/6	744	444
GW 94 025	1/6	744	444
GW 94 026	1/6	1302	444
GW 94 027	1/6	1302	444
GW 94 028	1/6	744	444
GW 94 029	1/6	744	444
GW 94 030	1/6	744	444
GW 94 031	1/6	744	444
GW 94 035	1/6	744	444
GW 94 036	1/6	744	444
GW 94 037	1/6	744	444
GW 94 038	1/6	744	444
GW 94 039	1/6	744	444
GW 94 040	1/6	744	444
GW 94 045	1/4	464	444
GW 94 046	1/4	464	444
GW 94 047	1/4	464	444
GW 94 048	1/4	464	444
GW 94 049	1/4	464	444
GW 94 050	1/4	464	444
GW 94 051	1/4	464	444
GW 94 055	1/4	464	444
GW 94 056	1/4	464	444
GW 94 057	1/4	464	444
GW 94 058	1/4	464	444
GW 94 059	1/4	464	444
GW 94 060	1/4	464	444
GW 94 065	1/3	348	444
GW 94 066	1/3	348	444
GW 94 067	1/3	348	444
GW 94 068	1/3	348	444
GW 94 069	1/3	348	444
GW 94 070	1/3	348	444
GW 94 071	1/3	348	444
GW 94 075	1/3	348	444
GW 94 076	1/3	348	444
GW 94 077	1/3	348	444
GW 94 078	1/3	348	444
GW 94 079	1/3	348	444
GW 94 080	1/3	348	444
GW 94 105	1/6	744	447
GW 94 106	1/6	744	447
GW 94 107	1/6	744	447
GW 94 108	1/6	744	447
GW 94 109	1/6	744	447
GW 94 110	1/6	744	447
GW 94 111	1/6	744	447
GW 94 115	1/6	744	447
GW 94 116	1/6	744	447
GW 94 117	1/6	744	447
GW 94 118	1/6	744	447
GW 94 119	1/6	744	447
GW 94 120	1/6	744	447
GW 94 125	1/6	744	447
GW 94 126	1/6	1302	447
GW 94 127	1/6	1302	447
GW 94 128	1/6	744	447
GW 94 129	1/6	744	447
GW 94 130	1/6	744	447
GW 94 131	1/6	744	447
GW 94 135	1/6	744	447
GW 94 136	1/6	744	447

Code	Quantity		Page
	Pack/carton	Pallet	
GW 94 137	1/6	744	447
GW 94 138	1/6	744	447
GW 94 139	1/6	744	447
GW 94 140	1/6	744	447
GW 94 145	1/4	464	447
GW 94 146	1/4	464	447
GW 94 147	1/4	464	447
GW 94 148	1/4	464	447
GW 94 149	1/4	464	447
GW 94 150	1/4	464	447
GW 94 151	1/4	464	447
GW 94 155	1/4	464	447
GW 94 156	1/4	464	447
GW 94 157	1/4	464	447
GW 94 158	1/4	464	447
GW 94 159	1/4	464	447
GW 94 160	1/4	464	447
GW 94 165	1/3	348	447
GW 94 166	1/3	348	447
GW 94 167	1/3	609	447
GW 94 168	1/3	348	447
GW 94 169	1/3	348	447
GW 94 170	1/3	348	447
GW 94 171	1/3	348	447
GW 94 175	1/3	348	447
GW 94 176	1/3	348	447
GW 94 177	1/3	348	447
GW 94 178	1/3	348	447
GW 94 179	1/3	348	447
GW 94 180	1/3	348	447
GW 94 205	1/6	744	446
GW 94 206	1/6	744	446
GW 94 207	1/6	744	446
GW 94 208	1/6	744	446
GW 94 209	1/6	744	446
GW 94 210	1/6	744	446
GW 94 211	1/6	744	446
GW 94 215	1/6	744	446
GW 94 216	1/6	744	446
GW 94 217	1/6	744	446
GW 94 218	1/6	744	446
GW 94 219	1/6	744	446
GW 94 220	1/6	744	446
GW 94 225	1/6	744	446
GW 94 226	1/6	744	446
GW 94 227	1/6	744	446
GW 94 228	1/6	744	446
GW 94 229	1/6	744	446
GW 94 230	1/6	744	446
GW 94 231	1/6	744	446
GW 94 235	1/6	744	446
GW 94 236	1/6	744	446
GW 94 237	1/6	744	446
GW 94 238	1/6	744	446
GW 94 239	1/6	744	446
GW 94 240	1/6	744	446
GW 94 245	1/4	464	446
GW 94 246	1/4	464	446
GW 94 247	1/4	464	446
GW 94 248	1/4	464	446
GW 94 249	1/4	464	446
GW 94 250	1/4	464	446
GW 94 251	1/4	464	446
GW 94 255	1/4	464	446
GW 94 256	1/4	464	446

Quick Reference

Code	Quantity		Page
	Pack/carton	Pallet	
GW 94 257	1/4	464	446
GW 94 258	1/4	464	446
GW 94 259	1/4	464	446
GW 94 260	1/4	464	446
GW 94 265	1/3	348	446
GW 94 266	1/3	348	446
GW 94 267	1/3	348	446
GW 94 268	1/3	348	446
GW 94 269	1/3	348	446
GW 94 270	1/3	348	446
GW 94 271	1/3	348	446
GW 94 275	1/3	348	446
GW 94 276	1/3	348	446
GW 94 277	1/3	348	446
GW 94 278	1/3	348	446
GW 94 279	1/3	348	446
GW 94 280	1/3	348	446
GW 94 305	1/6	744	448
GW 94 306	1/6	744	448
GW 94 307	1/6	1302	448
GW 94 308	1/6	744	448
GW 94 309	1/6	744	448
GW 94 310	1/6	744	448
GW 94 311	1/6	744	448
GW 94 315	1/6	744	448
GW 94 316	1/6	744	448
GW 94 317	1/6	744	448
GW 94 318	1/6	744	448
GW 94 319	1/6	744	448
GW 94 320	1/6	744	448
GW 94 325	1/6	744	448
GW 94 326	1/6	744	448
GW 94 327	1/6	744	448
GW 94 328	1/6	744	448
GW 94 329	1/6	744	448
GW 94 330	1/6	744	448
GW 94 331	1/6	744	448
GW 94 335	1/6	744	448
GW 94 336	1/6	744	448
GW 94 337	1/6	744	448
GW 94 338	1/6	744	448
GW 94 339	1/6	744	448
GW 94 340	1/6	744	448
GW 94 345	1/4	464	448
GW 94 346	1/4	464	448
GW 94 347	1/4	464	448
GW 94 348	1/4	464	448
GW 94 349	1/4	464	448
GW 94 350	1/4	464	448
GW 94 351	1/4	464	448
GW 94 355	1/4	464	448
GW 94 356	1/4	464	448
GW 94 357	1/4	464	448
GW 94 358	1/4	464	448
GW 94 359	1/4	464	448
GW 94 360	1/4	464	448
GW 94 365	1/3	348	448
GW 94 366	1/3	348	448
GW 94 367	1/3	651	448
GW 94 368	1/3	348	448
GW 94 369	1/3	348	448
GW 94 370	1/3	348	448
GW 94 371	1/3	348	448
GW 94 375	1/3	348	448
GW 94 376	1/3	348	448

Code	Quantity		Page
	Pack/carton	Pallet	
GW 94 377	1/3	348	448
GW 94 378	1/3	348	448
GW 94 379	1/3	348	448
GW 94 380	1/3	348	448
GW 94 401	1/2	216	457
GW 94 402	1/2	468	457
GW 94 403	1/2	432	457
GW 94 404	1/2	288	457
GW 94 412	1/2	216	457
GW 94 413	1/2	216	457
GW 94 414	1/2	288	457
GW 94 422	1/2	252	457
GW 94 423	1/2	228	457
GW 94 424	1/2	152	457
GW 94 432	1/2	252	457
GW 94 433	1/2	258	457
GW 94 434	1/2	152	457
GW 94 442	1/2	192	457
GW 94 443	1/2	192	457
GW 94 444	1/2	192	457
GW 94 448	1/2	192	457
GW 94 449	1/2	192	457
GW 94 450	1/2	192	457
GW 94 502	1/2	432	457
GW 94 503	1/2	288	457
GW 94 504	1/2	288	457
GW 94 512	1/2	288	457
GW 94 513	1/2	288	457
GW 94 514	1/2	288	457
GW 94 522	1/2	152	457
GW 94 523	1/2	152	457
GW 94 524	1/2	152	457
GW 94 532	1/2	152	457
GW 94 533	1/2	152	457
GW 94 534	1/2	152	457
GW 94 542	1/2	192	457
GW 94 543	1/2	192	457
GW 94 544	1/2	192	457
GW 94 547	1/2	192	457
GW 94 548	1/2	192	457
GW 94 549	1/2	192	457
GW 94 563	1/2	432	458
GW 94 565	1/2	288	458
GW 94 566	1/2	216	458
GW 94 583	1/2	228	458
GW 94 585	1/2	152	458
GW 94 586	1/2	192	458
GW 94 595	1/2	288	458
GW 94 598	1/2	192	458
GW 94 600	1/2	192	458
GW 94 662	1/4	464	461
GW 94 664	1/4	464	461
GW 94 667	1/4	812	461
GW 94 668	1/4	640	461
GW 94 669	1/4	464	461
GW 94 670	1/4	464	461
GW 94 761 K	1/3	348	461
GW 94 766 K	1/3	348	461
GW 94 777 K	1/3	348	461
GW 94 779 K	1/3	348	461
GW 94 867	1/4	464	462
GW 94 869	1/4	640	462
GW 94 885	1/4	464	462
GW 94 897	1/4	868	462
GW 94 898	1/4	640	462

Code	Quantity		Page
	Pack/carton	Pallet	
GW 94 899	1/4	464	462
GW 94 900	1/4	464	462
GW 94 957 K	1/3	348	462
GW 94 959 K	1/3	348	462
GW 94 996 K	1/3	279	463
GW 95			
GW 95 025	1/6	744	452
GW 95 025 MA	1/6	744	453
GW 95 026	1/6	744	452
GW 95 026 MA	1/6	744	453
GW 95 027	1/6	744	452
GW 95 027 MA	1/6	744	453
GW 95 028	1/6	744	452
GW 95 028 MA	1/6	744	453
GW 95 029	1/6	744	452
GW 95 029 MA	1/6	744	453
GW 95 030	1/6	744	452
GW 95 030 MA	1/6	744	453
GW 95 031	1/6	744	452
GW 95 031 MA	1/6	744	453
GW 95 035	1/6	744	452
GW 95 036	1/6	744	452
GW 95 037	1/6	744	452
GW 95 038	1/6	744	452
GW 95 039	1/6	744	452
GW 95 040	1/6	744	452
GW 95 105	1/6	744	451
GW 95 106	1/6	744	451
GW 95 107	1/6	1302	451
GW 95 108	1/6	744	451
GW 95 109	1/6	744	451
GW 95 110	1/6	744	451
GW 95 111	1/6	744	451
GW 95 115	1/6	744	451
GW 95 116	1/6	744	451
GW 95 117	1/6	744	451
GW 95 118	1/6	744	451
GW 95 119	1/6	744	451
GW 95 120	1/6	744	451
GW 95 125	1/6	744	451
GW 95 126	1/6	744	451
GW 95 127	1/6	744	451
GW 95 128	1/6	744	451
GW 95 129	1/6	744	451
GW 95 130	1/6	744	451
GW 95 131	1/6	744	451
GW 95 135	1/6	744	451
GW 95 136	1/6	744	451
GW 95 137	1/6	744	451
GW 95 138	1/6	744	451
GW 95 139	1/6	744	451
GW 95 140	1/6	744	451
GW 95 145	1/4		451
GW 95 146	1/4	464	451
GW 95 147	1/4	464	451
GW 95 148	1/4	496	451
GW 95 149	1/4		451
GW 95 150	1/4	512	451
GW 95 151	1/4		451
GW 95 155	1/4	464	451
GW 95 156	1/4	464	451
GW 95 157	1/4	464	451
GW 95 158	1/4		451
GW 95 159	1/4		451
GW 95 160	1/4	464	451

Code	Quantity		Page
	Pack/carton	Pallet	
GW 95 165	1/3	348	451
GW 95 166	1/3	348	451
GW 95 167	1/3	372	451
GW 95 168	1/3	372	451
GW 95 169	1/3	348	451
GW 95 170	1/3	348	451
GW 95 171	1/3	348	451
GW 95 175	1/3	348	451
GW 95 176	1/3	348	451
GW 95 177	1/3	372	451
GW 95 178	1/3	348	451
GW 95 179	1/3	372	451
GW 95 180	1/3	372	451
GW 95 225	1/6	744	453
GW 95 225 MA	1/6	744	454
GW 95 226	1/6	1302	453
GW 95 226 MA	1/6	744	454
GW 95 227	1/6	1302	453
GW 95 227 MA	1/6	744	454
GW 95 228	1/6	744	453
GW 95 228 MA	1/6	744	454
GW 95 229	1/6	744	453
GW 95 229 MA	1/6	744	454
GW 95 230	1/6	744	453
GW 95 230 MA	1/6	744	454
GW 95 231	1/6	744	453
GW 95 231 MA	1/6	744	454
GW 95 235	1/6	744	453
GW 95 236	1/6	744	453
GW 95 237	1/6	744	453
GW 95 238	1/6	744	453
GW 95 239	1/6	744	453
GW 95 240	1/6	744	453
GW 95 245	1/4	464	453
GW 95 246	1/4	464	453
GW 95 247	1/4	464	453
GW 95 248	1/4	464	453
GW 95 249	1/4	464	453
GW 95 250	1/4	464	453
GW 95 325	1/6	744	455
GW 95 326	1/6	744	455
GW 95 327	1/6	1302	455
GW 95 328	1/6	744	455
GW 95 329	1/6	744	455
GW 95 330	1/6	744	455
GW 95 331	1/6	744	455
GW 95 335	1/6	744	455
GW 95 336	1/6	744	455
GW 95 337	1/6	744	455
GW 95 338	1/6	744	455
GW 95 339	1/6	744	455
GW 95 340	1/6	744	455
GW 95 406	1/2	152	458
GW 95 408	1/2	152	458
GW 95 416	1/2	128	458
GW 95 418	1/2	128	458
GW 95 426	1/2	128	458
GW 95 428	1/2	64	458
GW 95 436	1/2	152	459
GW 95 438	1/2	152	459
GW 95 446	1/2	128	459
GW 95 448	1/2	128	459
GW 95 456	1/2	128	459
GW 95 458	1/2	128	459
GW 95 468	1/2	152	459

Code	Quantity		Page
	Pack/carton	Pallet	
GW 95 470	1/2	152	459
GW 95 478	1/2	128	459
GW 95 480	1/2	128	459
GW 95 488	1/2	128	459
GW 95 490	1/2	64	459
GW 95 512	1/2	128	459
GW 95 601	1	320	461
GW 95 603	1	320	461
GW 95 604	1	320	461
GW 95 606	1	320	462
GW 95 608	1	320	462
GW 95 609	1	320	462
GW 95 696 K	1/3	348	463
GW 95 785	1/6	744	453
GW 95 786	1/6	744	453
GW 95 787	1/6	744	453
GW 95 788	1/6	744	453
GW 95 789	1/6	744	453
GW 95 790	1/6	744	453
GW 95 791	1/6	744	453
GW 95 795	1/6	744	455
GW 95 796	1/6	744	455
GW 95 797	1/6	744	455
GW 95 798	1/6	216	455
GW 95 799	1/6	744	455
GW 95 800	1/6	216	455
GW 95 801	1/6	744	455
GW 95 805	1/6	744	449
GW 95 806	1/6	744	449
GW 95 807	1/6	744	449
GW 95 808	1/6	744	449
GW 95 809	1/6	744	449
GW 95 810	1/6	744	449
GW 95 811	1/6	744	449
GW 95 815	1/3	348	449
GW 95 816	1/3	348	449
GW 95 817	1/3	348	449
GW 95 818	1/3	348	449
GW 95 819	1/3	348	449
GW 95 820	1/3	348	449
GW 95 821	1/3	348	449
GW 95 825	1/6	558	454
GW 95 826	1/6	744	454
GW 95 827	1/6	744	454
GW 95 828	1/6	744	454
GW 95 829	1/6	744	454
GW 95 830	1/6	744	454
GW 95 831	1/6	744	454
GW 95 835	1/6	744	456
GW 95 836	1/6	744	456
GW 95 837	1/6	744	456
GW 95 838	1/6	744	456
GW 95 839	1/6	744	456
GW 95 840	1/6	744	456
GW 95 841	1/6	744	456
GW 95 847	1/6	744	450
GW 95 848	1/6	744	450
GW 95 849	1/6	744	450
GW 95 850	1/6	744	450
GW 95 857	1/3	348	450
GW 95 858	1/3	348	450
GW 95 859	1/3	348	450
GW 95 860	1/3	348	450
GW 95 921	1/2	320	465
GW 95 922	1/2	560	465

Code	Quantity		Page
	Pack/carton	Pallet	
GW 95 923	1/2	320	465
GW 95 924	1/2	560	465
GW 95 925	1/2	320	466
GW 95 926	1/2	320	466
GW 95 928	100	800	466
GW 95 935	1/6	558	450
GW 95 936	1/6	558	450
GW 95 937	1/6	1302	450
GW 95 938	1/6	558	450
GW 95 939	1/6	558	450
GW 95 940	1/6	558	450
GW 95 941	1/6	744	450
GW 95 955	1/6	558	455
GW 95 956	1/6	558	455
GW 95 957	1/6	558	455
GW 95 958	1/6	744	455
GW 95 959	1/6	744	455
GW 95 960	1/6	558	455
GW 95 961	1/6	744	455
GW 95 965	1/6	558	456
GW 95 966	1/6	558	456
GW 95 967	1/6	558	456
GW 95 968	1/6	744	456
GW 95 969	1/6	744	456
GW 95 970	1/6	558	456
GW 95 971	1/6	744	456
GW 95 975	1/6	744	452
GW 95 976	1/6	1302	452
GW 95 977	1/6	1302	452
GW 95 978	1/6	558	452
GW 95 979	1/6	1302	452
GW 95 980	1/6	1302	452
GW 95 981	1/6	1302	452
GW 96			
GW 96 001	1/16	1824	470
GW 96 003	1/12	912	472
GW 96 004	1/12	1392	472
GW 96 005	1	1392	472
GW 96 006	1/16	1216	470
GW 96 009	1/16	1216	470
GW 96 011	1/8	1280	471
GW 96 012	1/8	1920	471
GW 96 014	1/6	744	411
GW 96 015	1/12	2736	472
GW 96 016	1/8	1280	471
GW 96 017	1/8	1280	471
GW 96 018	1/8	1280	471
GW 96 022	10/100	16000	471
GW 96 026	10/100	16000	471
GW 96 038	1/10	15600	472
GW 96 041	10/100	16000	474
GW 96 042	10/100	6400	471
GW 96 104	6/24	1488	483
GW 96 105	6/24	2436	483
GW 96 114	3/12	1152	483
GW 96 115	3/12	1152	483
GW 96 124	2/8	512	483
GW 96 125	2/8	768	483
GW 96 134	1/3	372	483
GW 96 135	1/3	924	483
GW 96 146	6/24	1536	483
GW 96 147	6/24	1536	483
GW 96 148	6/24	1536	483
GW 96 149	6/24	1536	483
GW 96 156	3/12	768	483

Quick Reference

Code	Quantity		Page
	Pack/carton	Pallet	
GW 96 157	3/12	768	483
GW 96 158	3/12	768	483
GW 96 159	3/12	768	483
GW 96 166	2/8	512	483
GW 96 167	2/8	512	483
GW 96 168	2/8	512	483
GW 96 169	2/8	512	483
GW 96 176	1/3	651	483
GW 96 177	1/3	372	483
GW 96 178	1/3	372	483
GW 96 179	1/3	372	483
GW 96 186	1	336	484
GW 96 186	1	336	509
GW 96 187	1	480	484
GW 96 187	1	480	509
GW 96 205	12	2808	477
GW 96 206	12	3240	477
GW 96 207	12	768	477
GW 96 215	6	768	477
GW 96 216	6	1404	477
GW 96 217	6	576	477
GW 96 218	2	360	477
GW 96 220	12	3240	477
GW 96 226	12	2460	477
GW 96 226	12	2460	510
GW 96 227	6	1404	477
GW 96 227	6	1404	510
GW 96 301	6	864	477
GW 96 302	6	1404	477
GW 96 303	6	384	477
GW 96 306	4	512	477
GW 96 307	4	936	477
GW 96 308	4	256	477
GW 96 311	3	320	477
GW 96 312	3	702	477
GW 96 313	3	288	477
GW 96 314	1	480	477
GW 96 321	4	1148	504
GW 96 322	4	640	504
GW 96 323	1	495	504
GW 96 324	1	360	504
GW 96 325	1	480	504
GW 96 331	1/4	464	482
GW 96 332	1	360	482
GW 96 333	1	180	482
GW 96 334	1	180	482
GW 96 335	1	60	482
GW 96 339	1/2	390	493
GW 96 340	1/5	780	493
GW 96 401	12	3168	503
GW 96 402	12	3108	503
GW 96 403	6	1584	503
GW 96 406	12	3168	503
GW 96 407	12	3168	503
GW 96 408	6	1584	503
GW 96 411	4	660	503
GW 96 421	6	1722	504
GW 96 422	6	1722	504
GW 96 423	6	1230	504
GW 96 424	6	1230	504
GW 96 425	6	1230	504
GW 96 426	6	1230	504
GW 96 431	4	656	504
GW 96 432	4	820	504
GW 96 433	4	984	504

Code	Quantity		Page
	Pack/carton	Pallet	
GW 96 434	4	820	504
GW 96 441	1	448	501
GW 96 442	1	448	501
GW 96 443	1	384	501
GW 96 444	1	384	501
GW 96 445	1	384	501
GW 96 446	1	660	501
GW 96 447	1	384	501
GW 96 448	1	396	501
GW 96 449	1	384	501
GW 96 450	1	84	501
GW 96 451	1	108	501
GW 96 452	1	72	501
GW 96 453	1	90	501
GW 96 500	25	11000	475
GW 96 501	25	11000	475
GW 96 503	50	22000	476
GW 96 507 F	1/10	1120	475
GW 96 522	2/8	768	505
GW 96 523	2/8	512	505
GW 96 524	2/8	768	505
GW 96 525	2/8	512	505
GW 96 526	2/8	768	505
GW 96 531	3/12	1392	484
GW 96 532	3/12	1044	484
GW 96 533	3/12	2088	484
GW 96 534	3/12	1440	484
GW 96 535	1/12	1392	484
GW 96 536	1/12	1392	484
GW 96 537	1/12	1392	484
GW 96 538	1/12	1392	484
GW 96 539	3/12	1392	484
GW 96 540	1/12	1044	484
GW 96 541	1/12	1392	484
GW 96 542	1/12	1392	484
GW 96 551	3/12	1392	485
GW 96 552	1/12	1488	485
GW 96 553	3/12	1392	485
GW 96 554	1/12	1392	485
GW 96 555	3/12	1620	485
GW 96 556	1/12	1392	485
GW 96 561	3/12	1044	502
GW 96 562	3/12	1044	502
GW 96 563	1/12	1044	502
GW 96 564	1/12	1044	502
GW 96 565	1/12	1044	502
GW 96 566	1/12	1044	502
GW 96 567	1/12	1044	502
GW 96 568	1/12	1392	502
GW 96 569	1/12	1044	502
GW 96 570	1/12	1044	502
GW 96 571	1/12	1044	502
GW 96 581	3/12	2436	502
GW 96 582	3/12	1392	502
GW 96 583	3/12	1044	502
GW 96 584	3/12	1044	502
GW 96 585	3/12	1044	502
GW 96 586	1/12	1044	502
GW 96 587	1/12	1044	502
GW 96 588	1/12	1044	502
GW 96 589	1/12	1044	502
GW 96 590	1/12	1044	502
GW 96 591	1/12	1044	502
GW 96 592	1/12	1392	502
GW 96 598	1/12	1044	502

Code	Quantity		Page
	Pack/carton	Pallet	
GW 96 751	1/4	464	478
GW 96 752	1/4	464	478
GW 96 753	1/4	464	478
GW 96 754	1/4	464	478
GW 96 755	1/4	464	478
GW 96 756	1/4	464	478
GW 96 757	1/4	464	478
GW 96 758	1/4	464	478
GW 96 759	1/4	464	478
GW 96 760	1/4	464	478
GW 96 761	1/4	464	478
GW 96 762	1/4	464	478
GW 96 763	1/4	464	478
GW 96 764	1/12	1044	479
GW 96 765	1/12	1392	479
GW 96 767	1/6	744	479
GW 96 769	1/6	744	479
GW 96 770	1/6	744	479
GW 96 771	1	64	479
GW 96 781	1/6	1302	504
GW 96 809	1/8	1680	494
GW 96 814	1/8	1280	494
GW 96 815	1/8	1280	494
GW 96 851	1/4	464	485
GW 96 852	1/4	464	485
GW 96 853	1/4	348	485
GW 96 856	1/4	348	485
GW 96 861	1/4	1056	498
GW 96 862	1/4	528	498
GW 96 867	1/4	640	498
GW 96 871	1/4	1056	498
GW 96 872	1/4	1056	498
GW 96 873	1/4	1056	498
GW 96 878	1/4	464	498
GW 96 879	1/4	640	499
GW 96 897	1/4	640	500
GW 96 899	1/2	360	501
GW 96 906	1/8	1280	490
GW 96 907	1/8	1280	490
GW 96 908	1/8	1280	490
GW 96 909	1/8	1280	490
GW 96 951	1/4	464	485
GW 96 952	1/4	464	485
GW 96 953	1/4	464	485
GW 96 961	50	3000	476
GW 96 962	50	3000	476
GW 96 963	10	58000	476
GW 96 964	10	58000	476
GW 96 965	10	58000	476
GW 96 966	10	58000	476
GW 96 967	10	8320	476
GW 96 971	1/10	11600	498
GW 96 972	1/10	11600	498
GW 96 973	1/10	11600	498
GW 96 974	1/10	11600	498
GW 96 975	1/10	11600	498
GW 96 976	1/10	11600	498
GW 96 977	1/10	11600	498
GW 96 978	1/10	11600	498
GW 96 979	1/10	11600	498
GW 96 980	1/10	32000	498
GW 96 981	1/10	32000	498
GW 96 984	50	10850	475
GW 96 985	25	3600	475
GW 96 986	25	5250	475

Code	Quantity		Page
	Pack/carton	Pallet	
GW 96 987	20	3200	475
GW 96 988	50	3500	475
GW 96 988	50	3500	475
GW 96 989	20	1400	475
GW 96 990	20	1400	475
GW 96 991	15	225	475
GW 96 992	50	4650	475
GW 96 993	25	5250	475
GW 96 994	25	5250	475
GW 96 995	20	4200	475
GW 96 996	50	3150	475
GW 96 997	20	1400	475
GW 96 998	20	1260	475
GW 96 999	15	735	475

GW 97

GW 97 721	1	228	549
GW 97 722	1	228	549
GW 97 723	1	456	549
GW 97 724	1	228	549
GW 97 725	1	228	549
GW 97 726	1	504	549
GW 97 727	1	224	549
GW 97 728	1	224	549
GW 97 729	1	126	549
GW 97 730	1	126	549
GW 97 731	1	48	550
GW 97 732	1	48	550
GW 97 733	1	48	550
GW 97 734	1	48	550
GW 97 758	1	32	550
GW 97 760	1	32	550
GW 97 761	1	144	550
GW 97 762	1	24	550
GW 97 764	1	24	550
GW 97 767	1	24	550
GW 97 772	1	150	552
GW 97 773	1	117	552
GW 97 774	1	117	551
GW 97 775	1	117	551

GW 98

GW 98 508	1	960	552
GW 98 509	1	320	552
GW 98 510	1	320	552
GW 98 511	1	320	552
GW 98 512	1	320	552
GW 98 514	1	3900	551
GW 98 515	1	4680	551
GW 98 516	1	1560	551
GW 98 517	1	609	552
GW 98 521	1	1160	551
GW 98 522	1	150	551
GW 98 523	1	1160	551
GW 98 524	1	1160	551
GW 98 525	1	360	551

GW A1

GW A1 201	1/12	768	1088
GW A1 202	1/6	468	1088
GW A1 221	1/12	768	1088
GW A1 222	1/6	468	1088
GW A1 231	1/12	768	1089
GW A1 232	1/6	468	1089
GW A1 241	1/12	1152	1089
GW A1 242	1/6	468	1089

Code	Quantity		Page
	Pack/carton	Pallet	
GW A1 291	1	256	1091
GW A1 501	1/4	640	1092
GW A1 501	1/4	640	1133
GW A1 502	1/4	1280	1092
GW A1 502	1/4	1280	1133
GW A1 511	1/2	256	1093
GW A1 511	1/2	256	1135
GW A1 512	1/6	696	1093
GW A1 512	1/6	696	1136
GW A1 513	1/6	528	1093
GW A1 513	1/6	528	1135
GW A1 514	1/6	792	784
GW A1 514	1/6	792	816
GW A1 514	1/6	792	849
GW A1 514	1/6	792	884
GW A1 514	1/6	792	918
GW A1 514	1/6	792	985
GW A1 514	1/6	792	1011
GW A1 514	1/6	792	1093
GW A1 514	1/6	792	1136
GW A1 521	1/4	1280	785
GW A1 521	1/4	1280	817
GW A1 521	1/4	1280	849
GW A1 521	1/4	1280	885
GW A1 521	1/4	1280	919
GW A1 521	1/4	1280	986
GW A1 521	1/4	1280	1011
GW A1 521	1/4	1280	1094
GW A1 521	1/4	1280	1133
GW A1 522	1/4	1280	1094
GW A1 522	1/4	1280	1134
GW A1 523	1/4	960	492
GW A1 523	1/4	960	1095
GW A1 523	1/4	960	1134
GW A1 526	1/4	1280	492
GW A1 526	1/4	1280	1095
GW A1 526	1/4	1280	1134
GW A1 531	1/4	800	1095
GW A1 531	1/4	800	1134
GW A1 541	1/4	800	785
GW A1 541	1/4	800	817
GW A1 541	1/4	800	850
GW A1 541	1/4	800	885
GW A1 541	1/4	800	919
GW A1 541	1/4	800	986
GW A1 541	1/4	800	1012
GW A1 541	1/4	800	1093
GW A1 541	1/4	800	1136
GW A1 700	1/4	624	1102
GW A1 911	1	180	493
GW A1 911	1	180	1135
GW A1 912	1	234	493
GW A1 912	1	234	1135
GW A1 916	1/6	540	491
GW A1 916	1/6	540	1096
GW A1 916	1/6	540	1135
GW A1 918	1/4	624	1096

GW A9

GW A9 000	1	80	1111
GW A9 001	1	120	1111
GW A9 002	1	152	1111
GW A9 007 CB	1/16	64	1111
GW A9 103	1		1122
GW A9 108	1	224	1122
GW A9 126	1	100	1124

Code	Quantity		Page
	Pack/carton	Pallet	
GW A9 140	1	432	1126
GW A9 141	1	432	1126
GW A9 145	1	810	1126
GW A9 301	1	168	1125
GW A9 302	1	224	1125
GW A9 303	1	2304	1125
GW A9 313	1	168	1125
GW A9 350	1/48	3072	1125
GW A9 421	1	200	1113
GW A9 531 A	1	384	1120
GW A9 543	1	432	1120
GW A9 545	1	450	1120
GW A9 705	1/8	2184	1113
GW A9 707	1/8	936	1113
GW A9 801	1/6	576	1130
GW A9 916	1/6	576	491
GW A9 916	1/6	576	1129

GW D0

GW D0 951	1/4	280	412
GW D0 953	1/4	168	412
GW D0 971	1/4	168	408
GW D0 976	1/4	168	408
GW D0 978	1/4	280	408
GW D0 991	1/4	184	410
GW D0 996	1/4	168	410
GW D0 998	1/4	168	410

GW D3

GW D3 001	1	15	585
GW D3 002	1	18	585
GW D3 003	1	15	588
GW D3 004	1	15	585
GW D3 005	1	10	585
GW D3 006	1	15	588
GW D3 007	1	20	585
GW D3 008	1	36	585
GW D3 009	1	42	588
GW D3 010	1	42	588
GW D3 011	1	200	585
GW D3 012	1	68	585
GW D3 013	1	20	585
GW D3 014	1	20	585
GW D3 015	1	21	585
GW D3 016	1	23	585
GW D3 017	1	18	585
GW D3 018	1	18	585
GW D3 019	1	42	588
GW D3 020	1	42	588
GW D3 021	1	14	587
GW D3 022	1	16	587
GW D3 023	1	14	587
GW D3 024	1	14	587
GW D3 025	1	15	587
GW D3 026	1	16	587
GW D3 027	1	13	587
GW D3 028	1	13	587
GW D3 029	1	16	588
GW D3 030	1	16	588
GW D3 031	1	32	588
GW D3 032	1	20	588
GW D3 033	1	32	588
GW D3 034	1	20	588
GW D3 035	1	200	594
GW D3 041	1	30	586
GW D3 042	1	18	586

Quick Reference

Code	Quantity		Page
	Pack/carton	Pallet	
GW D3 043	1	18	586
GW D3 044	1	12	586
GW D3 045	1	25	588
GW D3 046	1	18	588
GW D3 047	1	36	586
GW D3 048	1	36	586
GW D3 049	1	36	586
GW D3 050	1	42	588
GW D3 051	1	42	588
GW D3 052	1	45	588
GW D3 053	1	68	586
GW D3 054	1	34	586
GW D3 055	1	68	586
GW D3 056	1	32	586
GW D3 057	1	54	586
GW D3 058	1	32	586
GW D3 059	1	21	586
GW D3 060	1	22	586
GW D3 061	1	21	586
GW D3 062	1	18	586
GW D3 063	1	18	586
GW D3 064	1	16	586
GW D3 065	1	36	588
GW D3 066	1	36	588
GW D3 067	1	36	588
GW D3 068	1	16	587
GW D3 069	1	17	587
GW D3 070	1	16	587
GW D3 071	1	13	587
GW D3 072	1	13	587
GW D3 073	1	13	587
GW D3 074	1	16	587
GW D3 075	1	16	587
GW D3 076	1	16	587
GW D3 077	1	13	587
GW D3 078	1	13	587
GW D3 079	1	13	587
GW D3 080	1	26	588
GW D3 081	1	26	588
GW D3 082	1	26	588
GW D3 083	1	32	588
GW D3 084	1	32	588
GW D3 085	1	32	588
GW D3 086	1	32	588
GW D3 087	1	32	588
GW D3 088	1	32	588
GW D3 089	1	20	586
GW D3 090	1	20	586
GW D3 091	1	20	586
GW D3 101	1	7	605
GW D3 102	1	6	605
GW D3 103	1	6	605
GW D3 104	1	5	605
GW D3 105	1	6	605
GW D3 106	1	6	605
GW D3 107	1	5	605
GW D3 108	1	9	605
GW D3 109	1	5	605
GW D3 110	1	4	605
GW D3 111	1	4	605
GW D3 112	1	4	605
GW D3 113	1	24	605
GW D3 114	1	24	605
GW D3 115	1	20	605
GW D3 116	1	20	605

Code	Quantity		Page
	Pack/carton	Pallet	
GW D3 117	1	8	605
GW D3 118	1	24	605
GW D3 119	1		605
GW D3 120	1	20	605
GW D3 121	1	50	616
GW D3 122	1	30	616
GW D3 123	1	30	616
GW D3 124	1	40	616
GW D3 125	1	50	616
GW D3 126	1	50	616
GW D3 131	1	30	606
GW D3 132	1	18	606
GW D3 133	1	5	626
GW D3 134	1	5	626
GW D3 135	1	15	607
GW D3 136	1	12	607
GW D3 137	1	5	627
GW D3 138	1	5	627
GW D3 139	1	18	606
GW D3 140	1	12	606
GW D3 141	1	10	626
GW D3 142	1	5	626
GW D3 143	1	15	609
GW D3 144	1	18	609
GW D3 145	1	10	629
GW D3 146	1	10	629
GW D3 147	1	28	606
GW D3 148	1	20	606
GW D3 149	1	28	606
GW D3 150	1	18	606
GW D3 152	1	30	606
GW D3 153	1	20	606
GW D3 156	1	27	607
GW D3 158	1	27	607
GW D3 159	1	40	627
GW D3 161	1	27	607
GW D3 162	1	48	627
GW D3 163	1	42	609
GW D3 164	1	42	609
GW D3 165	1	48	629
GW D3 166	1	42	609
GW D3 167	1	20	629
GW D3 168	1	16	626
GW D3 168 R	1	16	626
GW D3 169	1	18	626
GW D3 169 R6	1	24	626
GW D3 170	1	20	607
GW D3 171	1	20	607
GW D3 172	1	20	607
GW D3 173	1	20	607
GW D3 174	1	16	627
GW D3 174 R	1		628
GW D3 175	1	14	607
GW D3 176	1	20	607
GW D3 177	1	16	627
GW D3 177 R6	1	20	628
GW D3 178	1	42	606
GW D3 179	1	28	606
GW D3 180	1	42	606
GW D3 181	1	28	606
GW D3 182	1	14	626
GW D3 183	1	42	606
GW D3 184	1	28	606
GW D3 185	1	14	626
GW D3 186	1	13	626

Code	Quantity		Page
	Pack/carton	Pallet	
GW D3 187	1	21	606
GW D3 188	1	22	606
GW D3 188	1	22	627
GW D3 189	1	22	606
GW D3 189	1	22	627
GW D3 190	1	18	607
GW D3 191	1	18	607
GW D3 191	1	18	628
GW D3 192	1	18	607
GW D3 192	1	18	628
GW D3 193	1	18	606
GW D3 194	1	18	606
GW D3 194	1	18	627
GW D3 195	1	18	606
GW D3 195	1	18	627
GW D3 196	1	36	609
GW D3 197	1	36	609
GW D3 197	1	36	629
GW D3 198	1	36	609
GW D3 198	1	36	629
GW D3 199	1	17	608
GW D3 200	1	17	608
GW D3 200	1	17	628
GW D3 201	1	17	608
GW D3 201	1	17	628
GW D3 202	1	13	608
GW D3 203	1	13	608
GW D3 203	1	13	628
GW D3 204	1	14	608
GW D3 204	1	14	628
GW D3 205	1	16	608
GW D3 206	1	16	608
GW D3 206	1	16	628
GW D3 207	1	16	608
GW D3 207	1	16	628
GW D3 208	1	13	608
GW D3 209	1	13	608
GW D3 209	1	13	628
GW D3 210	1	13	608
GW D3 210	1	13	628
GW D3 211	1	26	609
GW D3 212	1	26	609
GW D3 212	1	26	629
GW D3 213	1	26	609
GW D3 213	1	26	629
GW D3 214	1	16	608
GW D3 215	1	32	608
GW D3 215	1	32	628
GW D3 216	1	32	608
GW D3 216	1	32	628
GW D3 217	1	100	616
GW D3 217	1	100	636
GW D3 218	1	20	606
GW D3 219	1	20	606
GW D3 220	1	20	606
GW D3 221	1	10	627
GW D3 222	1	13	627
GW D3 223	1	10	627
GW D3 301	1	120	589
GW D3 301	1	120	610
GW D3 301	1	120	630
GW D3 302	1	200	589
GW D3 302	1	200	610
GW D3 302	1	200	630
GW D3 303	1	50	589

Code	Quantity		Page
	Pack/carton	Pallet	
GW D3 303	1	50	610
GW D3 303	1	50	630
GW D3 304	1	120	589
GW D3 304	1	120	610
GW D3 304	1	120	630
GW D3 305	1	150	589
GW D3 305	1	150	610
GW D3 305	1	150	630
GW D3 306	1	52	589
GW D3 306	1	52	610
GW D3 306	1	52	630
GW D3 311	1	700	589
GW D3 311	1	700	610
GW D3 312	1	100	589
GW D3 312	1	100	610
GW D3 313	1	400	589
GW D3 313	1	400	610
GW D3 313	1	400	630
GW D3 314	1	50	589
GW D3 314	1	50	610
GW D3 314	1	50	630
GW D3 316	1	500	592
GW D3 316	1	500	614
GW D3 316	1	500	634
GW D3 317	1	400	171
GW D3 317	1	400	562
GW D3 317	1	400	572
GW D3 317	1	400	592
GW D3 317	1	400	614
GW D3 317	1	400	634
GW D3 318	1	200	592
GW D3 318	1	200	614
GW D3 318	1	200	634
GW D3 321	1	140	590
GW D3 321	1	140	612
GW D3 321	1	140	632
GW D3 322	1	50	590
GW D3 322	1	50	612
GW D3 322	1	50	632
GW D3 323	1	200	590
GW D3 323	1	200	612
GW D3 323	1	200	632
GW D3 324	1	60	590
GW D3 324	1	60	612
GW D3 324	1	60	632
GW D3 325	1	50	590
GW D3 325	1	50	612
GW D3 325	1	50	632
GW D3 326	1	40	590
GW D3 326	1	40	612
GW D3 326	1	40	632
GW D3 327	1	30	590
GW D3 327	1	30	612
GW D3 327	1	30	632
GW D3 328	1	30	590
GW D3 328	1	30	612
GW D3 328	1	30	632
GW D3 329	1	120	590
GW D3 329	1	120	612
GW D3 329	1	120	632
GW D3 330	1	50	590
GW D3 330	1	50	612
GW D3 330	1	50	632
GW D3 331	1	50	590
GW D3 331	1	50	612

Code	Quantity		Page
	Pack/carton	Pallet	
GW D3 331	1	50	632
GW D3 332	1	50	590
GW D3 332	1	50	612
GW D3 332	1	50	632
GW D3 333	1	30	591
GW D3 333	1	30	612
GW D3 333	1	30	633
GW D3 334	1	30	591
GW D3 334	1	30	612
GW D3 334	1	30	633
GW D3 336	1	50	591
GW D3 336	1	50	613
GW D3 336	1	50	633
GW D3 337	1	50	591
GW D3 337	1	50	613
GW D3 337	1	50	633
GW D3 338	1	50	591
GW D3 338	1	50	613
GW D3 338	1	50	633
GW D3 339	1	20	591
GW D3 339	1	20	613
GW D3 339	1	20	633
GW D3 340	1	10	591
GW D3 340	1	10	613
GW D3 340	1	10	633
GW D3 341	1	64	591
GW D3 341	1	64	613
GW D3 341	1	64	633
GW D3 342	1	20	591
GW D3 342	1	20	613
GW D3 342	1	20	633
GW D3 343	1	20	591
GW D3 343	1	20	613
GW D3 343	1	20	633
GW D3 344	1	20	591
GW D3 344	1	20	613
GW D3 344	1	20	633
GW D3 345	1	20	591
GW D3 345	1	20	613
GW D3 345	1	20	633
GW D3 346	1	10	613
GW D3 346	1	10	633
GW D3 347	1	10	613
GW D3 347	1	10	633
GW D3 348	1	10	613
GW D3 348	1	10	633
GW D3 349	1	10	613
GW D3 349	1	10	633
GW D3 351	1	50	591
GW D3 352	1	200	591
GW D3 353	1	60	591
GW D3 354	1	60	591
GW D3 355	1	20	591
GW D3 356	1	20	591
GW D3 357	1	200	591
GW D3 358	1	20	591
GW D3 359	1	20	591
GW D3 360	1	20	591
GW D3 361	1	240	591
GW D3 362	1	200	591
GW D3 363	1	120	591
GW D3 364	1	120	591
GW D3 365	1	20	613
GW D3 366	1	20	613
GW D3 367	1	20	613

Code	Quantity		Page
	Pack/carton	Pallet	
GW D3 368	1	20	613
GW D3 369	1	20	613
GW D3 370	1	20	613
GW D3 371	1	30	633
GW D3 372	1	30	633
GW D3 374	1	30	633
GW D3 375	1	10	613
GW D3 376	1	24	613
GW D3 377	1	70	613
GW D3 377	1	70	633
GW D3 378	1	24	613
GW D3 378	1	24	633
GW D3 401	1	64	594
GW D3 402	1	64	594
GW D3 403	1	32	594
GW D3 404	1	44	594
GW D3 405	1	28	594
GW D3 406	1	72	594
GW D3 407	1	96	616
GW D3 408	1	40	616
GW D3 409	1	32	616
GW D3 410	1	28	616
GW D3 411	1	48	616
GW D3 412	1	48	616
GW D3 413	1	40	616
GW D3 414	1	28	616
GW D3 415	1	48	636
GW D3 416	1	48	636
GW D3 417	1	40	636
GW D3 418	1	50	636
GW D3 419	1	40	636
GW D3 420	1	40	636
GW D3 421	1	40	636
GW D3 422	1	40	636
GW D3 426	1	200	593
GW D3 426	1	200	615
GW D3 426	1	200	635
GW D3 428	1	130	593
GW D3 428	1	130	615
GW D3 428	1	130	635
GW D3 431	1	20	596
GW D3 432	1	50	596
GW D3 434	1	50	617
GW D3 435	1	50	617
GW D3 437	1	500	617
GW D3 437	1	500	638
GW D3 438	1	88	617
GW D3 438	1	88	638
GW D3 441	1	50	595
GW D3 442	1	50	595
GW D3 443	1	50	617
GW D3 444	1	50	617
GW D3 445	1	400	637
GW D3 451	1	50	618
GW D3 452	1	50	596
GW D3 453	1	50	596
GW D3 453	1	50	618
GW D3 454	1	50	596
GW D3 454	1	50	618
GW D3 454	1	50	638
GW D3 455	1	50	596
GW D3 455	1	50	618
GW D3 455	1	50	638
GW D3 456	1	50	618
GW D3 456	1	50	638

Quick Reference

Code	Quantity		Page
	Pack/carton	Pallet	
GW D3 457	1	50	596
GW D3 457	1	50	618
GW D3 457	1	50	638
GW D3 458	1	50	618
GW D3 461	1	168	637
GW D3 462	1	144	637
GW D3 463	1	132	637
GW D3 464	1	108	637
GW D3 465	1	100	637
GW D3 466	1	120	637
GW D3 467	1	100	617
GW D3 468	1	100	617
GW D3 471	1	300	593
GW D3 471	1	300	615
GW D3 471	1	300	635
GW D3 472	1		635
GW D3 473	1	60	635
GW D3 501	1	80	589
GW D3 501	1	80	610
GW D3 501	1	80	630
GW D3 502	1	56	589
GW D3 502	1	56	610
GW D3 502	1	56	630
GW D3 503	1	80	589
GW D3 503	1	80	610
GW D3 503	1	80	630
GW D3 504	1	80	589
GW D3 504	1	80	610
GW D3 504	1	80	630
GW D3 505	1	60	589
GW D3 505	1	60	610
GW D3 505	1	60	630
GW D3 506	1	24	630
GW D3 507	1	28	630
GW D3 508	1	36	630
GW D3 509	1	50	589
GW D3 509	1	50	610
GW D3 509	1	50	630
GW D3 510	1	50	589
GW D3 510	1	50	610
GW D3 510	1	50	630
GW D3 511	1	60	589
GW D3 511	1	60	610
GW D3 511	1	60	630
GW D3 512	1	50	589
GW D3 512	1	50	610
GW D3 512	1	50	630
GW D3 513	1	40	589
GW D3 513	1	40	610
GW D3 513	1	40	630
GW D3 514	1	18	630
GW D3 515	1	21	630
GW D3 516	1	21	630
GW D3 517	1	60	589
GW D3 517	1	60	610
GW D3 517	1	60	631
GW D3 518	1	48	589
GW D3 518	1	48	610
GW D3 518	1	48	631
GW D3 519	1	26	589
GW D3 519	1	26	610
GW D3 519	1	26	631
GW D3 520	1	12	631
GW D3 521	1	8	631
GW D3 522	1	16	631

Code	Quantity		Page
	Pack/carton	Pallet	
GW D3 523	1	60	589
GW D3 523	1	60	610
GW D3 523	1	60	631
GW D3 524	1	40	589
GW D3 524	1	40	610
GW D3 524	1	40	631
GW D3 525	1	30	589
GW D3 525	1	30	610
GW D3 525	1	30	631
GW D3 526	1	10	631
GW D3 527	1	10	631
GW D3 528	1	16	631
GW D3 531	1	64	590
GW D3 531	1	64	611
GW D3 531	1	64	631
GW D3 532	1	64	590
GW D3 532	1	64	611
GW D3 532	1	64	631
GW D3 533	1	64	590
GW D3 533	1	64	611
GW D3 533	1	64	631
GW D3 534	1	64	590
GW D3 534	1	64	611
GW D3 534	1	64	631
GW D3 535	1	64	590
GW D3 535	1	64	611
GW D3 535	1	64	631
GW D3 536	1	48	590
GW D3 536	1	48	611
GW D3 536	1	48	631
GW D3 537	1	16	631
GW D3 538	1	40	631
GW D3 539	1	20	631
GW D3 541	1	64	590
GW D3 541	1	64	611
GW D3 541	1	64	632
GW D3 542	1	64	590
GW D3 542	1	64	611
GW D3 542	1	64	632
GW D3 543	1	64	590
GW D3 543	1	64	611
GW D3 543	1	64	632
GW D3 544	1	48	590
GW D3 544	1	48	611
GW D3 544	1	48	632
GW D3 545	1	52	632
GW D3 546	1	40	632
GW D3 547	1	20	632
GW D3 551	1	40	590
GW D3 551	1	40	612
GW D3 551	1	40	632
GW D3 552	1	40	590
GW D3 552	1	40	612
GW D3 552	1	40	632
GW D3 553	1	40	590
GW D3 553	1	40	612
GW D3 553	1	40	632
GW D3 554	1	30	590
GW D3 554	1	30	612
GW D3 554	1	30	632
GW D3 701	1	40	650
GW D3 702	1	40	650
GW D3 702	1	40	650
GW D3 703	1	40	650
GW D3 704	1	40	650

Code	Quantity		Page
	Pack/carton	Pallet	
GW D3 705	1	40	650
GW D3 706	1	40	650
GW D3 707	1	40	650
GW D3 708	1	40	650
GW D3 709	1	40	650
GW D3 711	1		656
GW D3 712	1	100	656
GW D3 713	1	40	656
GW D3 714	1	400	656
GW D3 715	1	40	656
GW D3 721	1	40	650
GW D3 721	1	40	650
GW D3 722	1	40	650
GW D3 722	1	40	650
GW D3 723	1	40	650
GW D3 724	1	40	650
GW D3 725	1	40	650
GW D3 726	1	40	650
GW D3 727	1	40	650
GW D3 728	1	40	650
GW D3 729	1	70	650
GW D3 730	1	90	650
GW D3 731	1	50	650
GW D3 732	1	50	650
GW D3 733	1	20	650
GW D3 734	1	60	650
GW D3 735	1	80	650
GW D3 736	1	60	650
GW D3 737	1	50	650
GW D3 738	1	50	650
GW D3 741	1	70	652
GW D3 742	1	50	652
GW D3 743	1	70	652
GW D3 744	1	50	652
GW D3 745	1	20	651
GW D3 746	1	70	652
GW D3 747	1	20	651
GW D3 747	1	20	652
GW D3 748	1	140	651
GW D3 748	1	140	652
GW D3 749	1	30	651
GW D3 749	1	30	652
GW D3 751	1	40	653
GW D3 752	1	40	653
GW D3 753	1	40	653
GW D3 754	1	40	653
GW D3 754	1	40	654
GW D3 755	1	120	653
GW D3 756	1	50	653
GW D3 757	1	50	653
GW D3 758	1	50	653
GW D3 759	1	200	653
GW D3 760	1	50	653
GW D3 761	1	40	653
GW D3 762	1	40	653
GW D3 763	1	80	654
GW D3 764	1	60	654
GW D3 765	1	108	654
GW D3 766	1	30	654
GW D3 767	1	56	651
GW D3 767	1	56	652
GW D3 767	1	56	654
GW D3 768	1	48	651
GW D3 768	1	48	652
GW D3 768	1	48	654

Code	Quantity		Page
	Pack/carton	Pallet	
GW D3 769	1	60	651
GW D3 769	1	60	652
GW D3 769	1	60	654
GW D3 771	1	88	655
GW D3 772	1	88	655
GW D3 773	1	88	655
GW D3 774	1	88	655
GW D3 775	1	40	656
GW D3 776	1	30	656
GW D3 777	1	30	656
GW D3 778	1	30	656
GW D3 779	1	30	656
GW D3 781	1	40	652
GW D3 782	1	60	652
GW D3 783	1	60	652
GW D3 791	1	50	653
GW D3 792	1	50	653
GW D3 793	1	30	653
GW D3 794	1	50	653

GW D4			
GW D4 001	1/6	744	461
GW D4 002	1/6	1302	461
GW D4 003	1/6	744	461
GW D4 004	1/6	744	461
GW D4 011	1/6	744	462
GW D4 012	1/6	744	462
GW D4 013	1/6	1302	462
GW D4 014	1/6	744	462
GW D4 022	1/6	1302	461
GW D4 023	1/6	744	461
GW D4 024	1/6	744	461
GW D4 025	1/6	744	461
GW D4 032	1/6	1302	462
GW D4 033	1/6	744	462
GW D4 034	1/6	744	462
GW D4 035	1/6	744	462
GW D4 042	1/6	744	461
GW D4 043	1/6	744	461
GW D4 044	1/6	744	461
GW D4 045	1/6	744	461
GW D4 052	1/6	744	462
GW D4 053	1/6	744	462
GW D4 054	1/6	744	462
GW D4 055	1/6	744	462
GW D4 062	1/6	744	461
GW D4 072	1/6	744	462
GW D4 102	1/3	372	461
GW D4 103	1/3	348	461
GW D4 104	1/3	348	461
GW D4 111	1/3	348	462
GW D4 112	1/3	651	462
GW D4 113	1/3	348	462
GW D4 114	1/3	372	462
GW D4 122	1/3	651	461
GW D4 123	1/3	372	461
GW D4 124	1/3	372	461
GW D4 125	1/3	372	461
GW D4 132	1/3	651	462
GW D4 133	1/3	261	462
GW D4 134	1/3	651	462
GW D4 135	1/3	348	462
GW D4 142	1/3	372	461
GW D4 143	1/3	348	461
GW D4 144	1/3	372	461
GW D4 145	1/3	348	461

Code	Quantity		Page
	Pack/carton	Pallet	
GW D4 152	1/3	651	462
GW D4 153	1/3	348	462
GW D4 154	1/3	372	462
GW D4 155	1/3	372	462
GW D4 202	1/6	744	463
GW D4 203	1/6	744	463
GW D4 205	1/6	744	463
GW D4 206	1/6	744	463
GW D4 208	1/6	744	463
GW D4 209	1/6	744	463
GW D4 217	1/3	372	463
GW D4 218	1/3	348	463
GW D4 220	1/3	372	463
GW D4 221	1/3	348	463
GW D4 223	1/3	372	463
GW D4 224	1/3	348	463
GW D4 227 P	1/4	168	409
GW D4 227 R	1/4	280	409
GW D4 229 P	1/4	168	409
GW D4 229 R	1/4	280	409
GW D4 234	1/6	744	463
GW D4 235	1/6	744	463
GW D4 237	1/6	744	463
GW D4 238	1/6	744	463
GW D4 249	1/3	372	463
GW D4 250	1/3	348	463
GW D4 252	1/3	372	463
GW D4 253	1/3	348	463
GW D4 261	1/6	696	464
GW D4 265	1/6	696	464
GW D4 269	1/6	696	464
GW D4 281	1/3	348	464
GW D4 285	1/3	348	464
GW D4 289	1/3	348	464
GW D4 302	1/3	372	461
GW D4 304	1/3	372	461
GW D4 307	1/3	348	464
GW D4 312	1/3	348	462
GW D4 314	1/3	348	462
GW D4 317	1/3	351	463
GW D4 322	1/3	651	461
GW D4 324	1/3	348	461
GW D4 327	1/3	348	464
GW D4 332	1/3	348	462
GW D4 334	1/3	348	462
GW D4 337	1/3		463
GW D4 342	1/3	372	461
GW D4 344	1/3	348	461
GW D4 347	1/3	36	464
GW D4 352	1/3	348	462
GW D4 354	1/3	348	462
GW D4 357	1/3	348	463
GW D4 427	1/3	372	460
GW D4 429	1/3	372	460
GW D4 431	1/3	372	460
GW D4 433	1/3	348	460
GW D4 435	1/3	348	460
GW D4 437	1/3	372	460
GW D4 439	1/3	348	460
GW D4 441	1/3	372	460
GW D4 443	1/3	609	460
GW D4 445	1/3	372	460
GW D4 447	1/3	348	460
GW D4 449	1/3	348	460
GW D4 502	1/3	372	464

Code	Quantity		Page
	Pack/carton	Pallet	
GW D4 504	1/3	279	464
GW D4 507	1/3	372	464
GW D4 509	1/3	279	464
GW D4 512	1/3	372	464
GW D4 514	1/3	279	464
GW D4 527	1/3	372	464
GW D4 529	1/3	279	464
GW D4 532	1/3	372	464
GW D4 534	1/3	279	464
GW D4 537	1/3	372	464
GW D4 539	1/3	279	464
GW D4 617	1/6	1302	460
GW D4 627	1/6	1302	460
GW D4 817	1/6	1302	460
GW D4 817 P	1/4	280	407
GW D4 817 R	1/4	280	407
GW D4 827	1/6	1302	460
GW D4 827 P	1/4	280	407
GW D4 827 R	1/4	280	407

GW D6			
GW D6 002	1/16	928	472
GW D6 002	1/16	928	473
GW D6 007	1/16	928	472
GW D6 010	1/16	928	472
GW D6 013	1/8	928	472
GW D6 013	1/8	928	473
GW D6 015	1/8	992	472
GW D6 015	1/8	992	473
GW D6 026	1/50	6000	472
GW D6 026	1/50	6000	473
GW D6 027	1/10	1200	472
GW D6 027	1/10	1200	473
GW D6 401	1	744	480
GW D6 402	1	348	480
GW D6 404	1	348	480
GW D6 405	1	96	480
GW D6 407	1	744	480
GW D6 409	1	348	480
GW D6 411	1	1044	480
GW D6 412	1	1044	480
GW D6 413	1	1044	480
GW D6 417	1	744	480
GW D6 418	1	1302	480
GW D6 419	1	348	480
GW D6 420	1	348	480
GW D6 426	1	480	480
GW D6 426	1	480	509
GW D6 428	1	464	480
GW D6 428	1	464	509
GW D6 430	1	1392	480
GW D6 433	1	1392	481
GW D6 434	1	696	481
GW D6 435	1	696	481
GW D6 436	1	756	481
GW D6 438	1	756	481
GW D6 441	1	696	481
GW D6 442	1	696	481
GW D6 443	1	420	481
GW D6 446	1	696	481
GW D6 448	1	60	481
GW D6 451	1	696	481
GW D6 452	1	696	481
GW D6 453	1	696	481
GW D6 461	1/6		481
GW D6 601	6/24	1920	487

Quick Reference

Code	Quantity		Page
	Pack/carton	Pallet	
GW D6 602	6/24	1920	487
GW D6 603	6/24	1920	487
GW D6 604	6/24	1920	487
GW D6 606	6/24	1920	487
GW D6 608	6/24	1920	487
GW D6 610	6/24	1920	487
GW D6 611	6/24	1920	487
GW D6 617	6/24	1920	487
GW D6 618	6/24	1920	487
GW D6 619	6/24	1920	487
GW D6 624	6/24	1920	487
GW D6 626	3/12	960	487
GW D6 627	3/12	960	487
GW D6 629	3/12	960	487
GW D6 630	3/12	960	487
GW D6 632	3/12	960	487
GW D6 633	3/12	960	487
GW D6 634	3/12	960	487
GW D6 641	6/24	1536	488
GW D6 642	6/24	1536	488
GW D6 643	6/24	1536	488
GW D6 644	6/24	2880	488
GW D6 646	6/24	1536	488
GW D6 647	6/24	1536	488
GW D6 648	6/24	1536	488
GW D6 649	6/24	1536	488
GW D6 650	6/24	1536	488
GW D6 652	6/24	1536	488
GW D6 653	6/24	1536	488
GW D6 654	6/24	1920	488
GW D6 657	6/24	1536	488
GW D6 658	6/24	1536	488
GW D6 659	6/24	1920	488
GW D6 663	3/12	768	488
GW D6 664	3/12	768	488
GW D6 667	3/12	768	488
GW D6 668	3/12	768	488
GW D6 669	3/12	768	488
GW D6 671	1/20	1280	489
GW D6 672	1/20	1600	489
GW D6 676	1/20	1600	489
GW D6 677	1/20	1600	489
GW D6 678	1/20	1600	489
GW D6 701	6/24	1920	486
GW D6 702	6/24	1920	486
GW D6 703	6/24	1920	486
GW D6 705	6/24	1920	486
GW D6 706	6/24	1920	486
GW D6 707	6/24	1920	486
GW D6 708	3/12	960	486
GW D6 709	3/12	480	486
GW D6 711	3/12	960	486
GW D6 712	3/12	960	486
GW D6 713	3/12	960	486
GW D6 714	3/12	960	486
GW D6 715	3/12	1440	486
GW D6 716	3/12	960	486
GW D6 717	3/12	960	486
GW D6 718	3/12	960	486
GW D6 721	2/8	1280	486
GW D6 722	2/8	640	486
GW D6 723	2/8	640	486
GW D6 724	2/8	1280	486
GW D6 725	2/8	640	486
GW D6 726	2/8	768	486

Code	Quantity		Page
	Pack/carton	Pallet	
GW D6 731	2/8	640	486
GW D6 732	2/8	640	486
GW D6 733	2/8	640	486
GW D6 734	2/8	640	486
GW D6 735	2/8	640	486
GW D6 736	2/8	640	486
GW D6 741	6/24	1920	486
GW D6 742	6/24	3840	486
GW D6 743	6/24	1920	486
GW D6 744	6/24	1920	486
GW D6 751	3/12	960	486
GW D6 752	3/12	960	486
GW D6 753	3/12	960	486
GW D6 754	3/12	960	486
GW D6 755	3/12	960	486
GW D6 761	1/12	2160	487
GW D6 762	1/12	960	487
GW D6 763	1/10	1920	488
GW D6 764	1/10	960	488
GW D6 765	1/10	6400	488
GW D6 766	12	1404	474
GW D6 766	12	1404	487
GW D6 766	12	1404	489
GW D6 771	1/12	1488	495
GW D6 772	1/12	1488	495
GW D6 773	1/6	744	495
GW D6 776	1/4	496	495
GW D6 779	1/3	496	496
GW D6 780	1/4	496	496
GW D6 781	1/6	1302	496
GW D6 782	1/3	651	496
GW D6 783	1/3	651	496
GW D6 785	1/4	496	497
GW D6 786	1/3	651	497
GW D6 788	1/3	186	497
GW D6 789	1/3	186	497
GW D6 801	1/5	580	499
GW D6 801	1/5	580	1130
GW D6 802	1/5	800	499
GW D6 802	1/5	800	1130
GW D6 807	1/2	80	499
GW D6 807	1/2	80	1130
GW D6 809	1/2	80	499
GW D6 809	1/2	80	1130
GW D6 812	1/6	744	1184
GW D6 817	1/6	156	1184
GW D6 820	1/5	800	499
GW D6 911	1/6	744	500
GW D6 916	1/6	540	491

GW D8			
GW D8 501	1		537
GW D8 502	1		537
GW D8 503	1		537
GW D8 504	1		537
GW D8 505	1	100	537
GW D8 510	1		537
GW D8 512	1		537
GW D8 513	1		537
GW D8 514	1		537
GW D8 519	1		537
GW D8 520	1		537
GW D8 522	1		537
GW D8 527	1	100	537
GW D8 528	1	100	537
GW D8 529	1	2000	537

Code	Quantity		Page
	Pack/carton	Pallet	
GW D8 542	1		538
GW D8 544	1	372	538
GW D8 545	1		538
GW D8 546	1		538
GW D8 548	1	372	538
GW D8 552	1		538
GW D8 553	1		538
GW D8 554	1		538
GW D8 555	1	372	538
GW D8 557	1		538
GW D8 558	1	360	538
GW D8 564	1	2000	538
GW D8 565	1	100	538
GW D8 566	1	100	538
GW D8 567	1	100	538
GW D8 568	1		538
GW D8 569	1	100	538
GW D8 571	1	100	538
GW D8 572	1	100	538
GW D8 573	1	100	538
GW D8 581	1	144	538
GW D8 582	1	144	538
GW D8 584	1	144	538
GW D8 585	1	120	538
GW D8 590	1	144	538
GW D8 591	1	144	538
GW D8 595	1	36	538
GW D8 596	1	87	538
GW D8 598	1	26	538
GW D8 599	1	8	538
GW D8 602	1	20	538
GW D8 603	1	30	538
GW D8 618	1	120	539
GW D8 619	1	120	539
GW D8 620	1	87	539
GW D8 621	1	87	539
GW D8 622	1	24	539
GW D8 623	1	24	539
GW D8 624	1	20	539
GW D8 625	1	87	539
GW D8 626	1	87	539
GW D8 627	1	87	539
GW D8 628	1	100	539
GW D8 629	1	87	539
GW D8 630	1	87	539
GW D8 631	1	87	539
GW D8 632	1	87	539
GW D8 633	1	87	539
GW D8 634	1	24	539
GW D8 635	1	24	539
GW D8 636	1	24	539
GW D8 637	1	24	539
GW D8 641	1	87	540
GW D8 643	1	87	540
GW D8 644	1	87	540
GW D8 646	1	87	540
GW D8 647	1	87	540
GW D8 649	1	87	540
GW D8 650	1	87	540
GW D8 652	1	87	540
GW D8 653	1	360	540
GW D8 655	1	180	540
GW D8 661	1	224	540
GW D8 662	1	930	540
GW D8 663	1	840	540

Code	Quantity		Page
	Pack/carton	Pallet	
GW D8 664	1		540
GW D8 665	1		540
GW D8 666	1		540
GW D8 668	1	600	540
GW D8 671	1		541
GW D8 672	1		541
GW D8 673	1		541
GW D8 674	1	87	541
GW D8 681	1	72	541
GW D8 682	1	66	541
GW D8 683	1	66	541
GW D8 684	1	66	541
GW D8 685	1	12	541
GW D8 686	1	12	541
GW D8 687	1	6	541
GW D8 688	1	100	541
GW D8 691	1	96	541
GW D8 692	1	96	541
GW D8 693	1	96	541
GW D8 694	1	108	541
GW D8 695	1	66	541
GW D8 696	1	66	541
GW D8 697	1	66	541
GW D8 698	1	66	541
GW D8 699	1	66	541
GW D8 700	1	66	541
GW D8 701	1	66	541
GW D8 702	1		541
GW D8 711	1		542
GW D8 712	1		542
GW D8 713	1		542
GW D8 714	1		542
GW D8 715	1		542
GW D8 716	1		542
GW D8 717	1		542
GW D8 718	1	20	542
GW D8 719	1	744	542
GW D8 720	1	372	542
GW D8 721	1		542
GW D8 722	1		542
GW D8 723	1		542
GW D8 724	1		542
GW D8 725	1		542
GW D8 726	1	50	542
GW D8 731	1		542
GW D8 733	1		542
GW D8 734	1		542
GW D8 735	1		542
GW D8 736	1	100	542
GW D8 741	1		543
GW D8 742	1		543
GW D8 743	1		543
GW D8 744	1		543
GW D8 745	1		543
GW D8 746	1		543
GW D8 747	1		543
GW D8 748	1		543
GW D8 749	1		543
GW D8 750	1		543
GW D8 751	1		543
GW D8 752	1		543
GW D8 754	1	100	543
GW D8 756	1	100	543
GW D8 761	1		543
GW D8 762	1		543

Code	Quantity		Page
	Pack/carton	Pallet	
GW D8 763	1		543
GW D8 764	1		543
GW D8 765	1		543
GW D8 766	1		543
GW D8 767	1		543
GW D8 768	1		543
GW D8 771	1		544
GW D8 772	1		544
GW D8 783	1		544
GW D8 784	1		544
GW D8 785	1		544
GW D8 786	1		544
GW D8 787	1		544
GW D8 788	1		544
GW D8 789	1		544
GW D8 790	1		544
GW D8 791	1		544
GW D8 792	1		544
GW D8 793	1		544
GW D8 794	1		544
GW D8 795	1		544
GW D8 796	1		544
GW D8 797	1	100	544
GW D8 798	1		544
GW D8 799	1	100	544
GW D8 800	1	248	544
GW D8 811	1		545
GW D8 812	1		545
GW D8 813	1		545
GW D8 814	1		545
GW D8 815	1		545
GW D8 816	1		545
GW D8 817	1		545
GW D8 818	1		545
GW D8 819	1		545
GW D8 820	1		545
GW D8 821	1		545
GW D8 822	1		545
GW D8 823	1		545
GW D8 824	1		545
GW D8 825	1	120	545
GW D8 826	1		545
GW D8 827	1		545
GW D8 828	1		545
GW D8 829	1		545
GW D8 830	1		545
GW D8 831	1		545
GW D8 832	1	336	545
GW D8 835	1		545
GW D8 836	1		545
GW D8 837	1		545
GW D8 838	1		545
GW D8 839	1		545
GW D8 840	1	100	545
GW D8 841	1		545
GW D8 842	1		545
GW D8 843	1		545
GW D8 844	1		545
GW D8 845	1	100	545
GW D8 846	1	50	545
GW D8 847	1	100	545
GW D8 848	1	100	545
GW D8 849	1	100	545
GW D8 850	1	50	545
GW D8 862	1		545

Code	Quantity		Page
	Pack/carton	Pallet	
GW D8 863	1		545
GW D8 869	1		546
GW D8 870	1		546
GW D8 871	1	200	546
GW D8 872	1		546
GW D8 873	1		546
GW D8 874	1		546
GW D8 875	1		546
GW D8 876	1	840	546
GW D8 886	1	30	546
GW D8 887	1	30	546

GW D9			
Code	Pack/carton	Pallet	Page
GW D9 001	1	120	523
GW D9 002	1	120	523
GW D9 003	1	120	523
GW D9 004	1	120	523
GW D9 005	1	120	523
GW D9 011	1	120	523
GW D9 012	1	120	523
GW D9 013	1	120	523
GW D9 014	1	120	523
GW D9 015	1	120	523
GW D9 026	1	120	523
GW D9 027	1	120	523
GW D9 036	1	120	523
GW D9 037	1	120	523
GW D9 041	1	120	523
GW D9 042	1	120	523
GW D9 043	1	120	523
GW D9 044	1	120	523
GW D9 045	1	120	523
GW D9 051	1	96	523
GW D9 052	1	120	523
GW D9 053	1	120	523
GW D9 054	1	120	523
GW D9 055	1	120	523
GW D9 066	1	120	523
GW D9 067	1	120	523
GW D9 076	1	120	523
GW D9 077	1	120	523
GW D9 087	1	96	524
GW D9 088	1	96	524
GW D9 097	1	96	524
GW D9 098	1	84	524
GW D9 107	1	96	524
GW D9 108	1	96	524
GW D9 117	1	96	524
GW D9 118	1	96	524
GW D9 121	1	120	525
GW D9 122	1	212	525
GW D9 123	1	212	525
GW D9 124	1	212	525
GW D9 125	1	96	525
GW D9 126	1	96	525
GW D9 127	1	96	526
GW D9 128	1	96	527
GW D9 138	1	96	527
GW D9 141	1	48	525
GW D9 142	1	120	525
GW D9 143	1	96	525
GW D9 144	1	96	525
GW D9 145	1	96	525
GW D9 146	1	96	525
GW D9 147	1	96	526
GW D9 151	1		525

Quick Reference

Code	Quantity		Page
	Pack/carton	Pallet	
GW D9 152	1	165	525
GW D9 153	1	165	525
GW D9 154	1	165	525
GW D9 155	1	165	525
GW D9 156	1	165	525
GW D9 157	1	165	526
GW D9 158	1	165	527
GW D9 168	1	84	527
GW D9 171	1	93	525
GW D9 172	1	84	525
GW D9 173	1	84	525
GW D9 174	1	84	525
GW D9 175	1	84	525
GW D9 176	1	84	525
GW D9 177	1	84	526
GW D9 201	1	120	525
GW D9 202	1	160	525
GW D9 204	1	96	525
GW D9 205	1	87	525
GW D9 206	1	32	525
GW D9 207	1	120	526
GW D9 208	1	120	527
GW D9 211	1	150	525
GW D9 212	1	84	525
GW D9 214	1	150	525
GW D9 215	1	84	525
GW D9 216	1	54	525
GW D9 217	1	84	526
GW D9 218	1	120	527
GW D9 277	1	90	530
GW D9 278	1	96	530
GW D9 302	1		531
GW D9 306	1	96	531
GW D9 307	1	96	531
GW D9 308	1	96	532
GW D9 312	1	96	531
GW D9 316	1	96	531
GW D9 317	1	96	531
GW D9 318	1	96	532
GW D9 322	1	56	531
GW D9 326	1	96	531
GW D9 327	1	64	531
GW D9 328	1	96	532
GW D9 332	1		531
GW D9 336	1	165	531
GW D9 337	1	165	531
GW D9 338	1	165	532
GW D9 342	1	32	531
GW D9 346	1	84	531
GW D9 347	1	84	531
GW D9 348	1	84	532
GW D9 352	1		531
GW D9 356	1	84	531
GW D9 357	1	84	531
GW D9 358	1	84	532
GW D9 361	1	32	528
GW D9 362	1	26	528
GW D9 363	1	26	528
GW D9 365	1	32	528
GW D9 366	1	26	528
GW D9 367	1	14	528
GW D9 371	1	32	533
GW D9 372	1	26	533
GW D9 373	1	26	533
GW D9 374	1	26	533

Code	Quantity		Page
	Pack/carton	Pallet	
GW D9 375	1	32	533
GW D9 376	1	26	533
GW D9 377	1	26	533
GW D9 378	1	13	533
GW D9 381	1	32	533
GW D9 382	1	32	533
GW D9 383	1	26	533
GW D9 384	1	20	533
GW D9 385	1	32	533
GW D9 386	1	26	533
GW D9 387	1	26	533
GW D9 388	1	13	533
GW D9 401	1	4	534
GW D9 403	1	4	534
GW D9 404	1	8	534
GW D9 406	1	4	534
GW D9 408	1	4	534
GW D9 409	1	8	534
GW D9 411	1	4	534
GW D9 411 B	1		534
GW D9 412	1	4	534
GW D9 412 B	1		534
GW D9 415	1	4	534
GW D9 415 B	1	10	534
GW D9 416	1	4	534
GW D9 416 B	1	4	534
GW D9 417	1		534
GW D9 417 B	1		534
GW D9 418	1	4	534
GW D9 418 B	1		534
GW D9 421	1	4	534
GW D9 421 B	1		534
GW D9 422	1	4	534
GW D9 422 B	1		534
GW D9 425	1	4	534
GW D9 425 B	1	10	534
GW D9 426	1	4	534
GW D9 426 B	1	6	534
GW D9 427	1	4	534
GW D9 427 B	1		534
GW D9 428	1	4	534
GW D9 428 B	1	4	534
GW D9 441	1	120	535
GW D9 442	1	120	535
GW D9 443	1	96	535
GW D9 444	1	96	535
GW D9 445	1	32	535
GW D9 446	1	26	535
GW D9 447	1	32	536
GW D9 448	1	26	536
GW D9 449	1	4	536
GW D9 450	1	4	536
GW D9 451	1	4	536
GW D9 452	1	4	536
GW D9 453	1	4	536
GW D9 453 B	1		536
GW D9 454	1	4	536
GW D9 454 B	1	10	536
GW D9 455	1	4	536
GW D9 455 B	1		536
GW D9 456	1	4	536
GW D9 456 B	1		536
GW D9 457	1	4	536
GW D9 457 B	1		536
GW D9 458	1	4	536

Code	Quantity		Page
	Pack/carton	Pallet	
GW D9 458 B	1		536
GW D9 459	1		536
GW D9 459 B	1		536
GW D9 460	1	4	536
GW D9 460 B	1		536
GW D9 551	1	120	529
GW D9 552	1	120	529
GW D9 553	1	96	529
GW D9 554	1	120	529
GW D9 555	1	96	529
GW D9 556	1	96	529
GW D9 557	1	96	529
GW D9 558	1	96	530
GW D9 571	1	120	529
GW D9 572	1	96	529
GW D9 573	1	120	529
GW D9 574	1	120	529
GW D9 575	1	120	529
GW D9 576	1	120	529
GW D9 901	1	28	509
GW D9 902	1	20	509
GW D9 903	1	20	509
GW D9 906	1	28	509
GW D9 907	1	20	509
GW D9 908	1	20	509

GW J1

GW J1 001 A	1	4	1186
GW J1 001 L	1	4	1187
GW J1 001 R	1	4	1186
GW J1 001 W	1	4	1187
GW J1 002 A	1	4	1186
GW J1 002 L	1	4	1187
GW J1 002 R	1	4	1186
GW J1 002 W	1	4	1187
GW J1 003 A	1	4	1186
GW J1 003 L	1	4	1187
GW J1 003 R	1	4	1186
GW J1 003 W	1	4	1187
GW J1 021 R	1	4	1187
GW J1 021 W	1	4	1188
GW J1 023 R	1	4	1187
GW J1 023 W	1	4	1188

GW J2

GW J2 101 A	1	8	1186
GW J2 101 L	1	8	1188
GW J2 101 R	1	8	1187
GW J2 101 W	1	8	1188
GW J2 102 A	1	8	1186
GW J2 102 L	1	8	1188
GW J2 102 R	1	8	1187
GW J2 102 W	1	8	1188
GW J2 103 A	1	8	1186
GW J2 103 L	1	8	1188
GW J2 103 R	1	8	1187
GW J2 103 W	1	8	1188
GW J2 121 R	1	8	1187
GW J2 121 W	1	8	1188
GW J2 123 R	1	8	1187
GW J2 123 W	1	8	1188

GW J3

GW J3 001 A	1	48	1180
GW J3 002 A	1	48	1180
GW J3 002 L	1	48	1182

Code	Quantity		Page
	Pack/carton	Pallet	
GW J3 002 R	1	48	1181
GW J3 002 W	1	48	1182
GW J3 003 A	1	48	1180
GW J3 004 A	1	48	1180
GW J3 004 L	1	48	1182
GW J3 004 R	1	48	1181
GW J3 004 W	1	48	1182
GW J3 011 A	1	36	1180
GW J3 012 A	1	36	1180
GW J3 012 L	1	36	1182
GW J3 012 R	1	36	1181
GW J3 012 W	1	36	1182
GW J3 013 A	1	36	1180
GW J3 014 A	1	36	1180
GW J3 014 L	1	36	1182
GW J3 014 R	1	36	1181
GW J3 014 W	1	36	1182
GW J3 101 A	1	48	1180
GW J3 102 A	1	48	1180
GW J3 103 A	1	48	1180
GW J3 111 A	1	36	1180
GW J3 112 A	1	36	1180
GW J3 113 A	1	36	1180
GW J3 201 A	1	48	1181
GW J3 202 A	1	48	1181
GW J3 202 L	1	48	1183
GW J3 202 R	1	48	1182
GW J3 202 W	1	48	1183
GW J3 203 A	1	48	1181
GW J3 204 L	1	48	1183
GW J3 204 R	1	48	1182
GW J3 204 W	1	48	1183
GW J3 211 A	1	36	1181
GW J3 212 A	1	36	1181
GW J3 212 L	1	36	1183
GW J3 212 R	1	36	1182
GW J3 212 W	1	36	1183
GW J3 213 A	1	36	1181
GW J3 214 L	1	36	1183
GW J3 214 R	1	36	1182
GW J3 214 W	1	36	1183
GW J3 301 A	1	48	1181
GW J3 302 A	1	48	1181
GW J3 303 A	1	36	1181
GW J3 311 A	1	36	1181
GW J3 312 A	1	36	1181
GW J3 313 A	1	36	1181
GW J5			
GW J5 001 B	1/12	96	1192
GW J5 001 G	1/12	96	1192

Code	Quantity		Page
	Pack/carton	Pallet	
GW J5 002 B	1/12	96	1192
GW J5 002 G	1/12	96	1192
GW J5 002 L	1/12	96	1192
GW J5 003 B	1/12	96	1192
GW J5 004 B	1/12	96	1192
GW J5 004 L	1/12	60	1192
GW J5 011 B	1/12	96	1192
GW J5 011 G	1/12	96	1192
GW J5 012 B	1/12	96	1192
GW J5 012 G	1/12	96	1192
GW J5 012 L	1/12	96	1192
GW J5 013 B	1/12	96	1192
GW J5 014 B	1/12	120	1192
GW J5 014 L	1/12	96	1192
GW J5 101 B	1	96	1193
GW J5 102 B	1	96	1193
GW J5 111 B	1	30	1193
GW J5 112 B	1	30	1193
GW J5 113 B	1	30	1193
GW J5 114 B	1	30	1193
GW J5 814 CT	1	30	1195
GW J5 815 BL	1	30	1194
GW J5 815 CL	1	30	1194
GW J5 815 EV	1		1194
GW J5 818 BL	1	30	1194
GW J5 818 CL	1	30	1194
GW J5 818 EV	1		1194
GW J5 834 CT	1	30	1195
GW J5 835 AL	1	30	1194
GW J5 835 CL	1		1194
GW J5 835 EV	1		1194
GW J5 838 AL	1	30	1194
GW J5 838 CL	1		1194
GW J5 838 EV	1		1194
GW J5 901	1/20	6240	1193
GW J5 912	1	84	1193
GW J5 913	10	180	1195
GW J8			
GW J8 001	1	3200	1184
GW J8 001	1	3200	1189
GW J8 011	1	320	1189
GW J8 012	1	200	1189
GW J8 014	1	5000	1184
GW J8 014	1	5000	1189
GW J8 015	1/5	500	1189
GW J8 016	1/5	500	1189
GW J8 018	1/5	1560	1184
GW J8 018	1/5	1560	1189
GW J8 021	1	320	1189
GW J8 031	1	110	1184

Code	Quantity		Page
	Pack/carton	Pallet	
GW J8 031	1	110	1189
GW J8 032	1	110	1184
GW J8 032	1	110	1189
GW J8 033	1	156	1184
GW J8 033	1	156	1189
GW J8 034	1	60	1184
GW J8 101	1	48	1184
GW J8 102	1	12	1184
GW J8 103	1	12	1184
GW J8 104	1	30	1184
GW N1			
GW N1 002	1	6	1167
GW N1 003	1	8	1167
GW N1 012	1	15	1167
GW N1 014	1	30	1167
GW N1 022	1	15	1167
GW N1 024	1	30	1167
GW N1 031 F	1	30	1168
GW N1 042 XB	1	30	1168
GW N1 043 XB	1	30	1168
GW N1 051 XB	1	15	1168
GW N1 062 XB	1	30	1168
GW N1 064 XB	1	30	1168
GW N1 066 XB	1	10	1168
GW N1 101 CF	1	16	1169
GW N1 101 CP	1	16	1169
GW N1 101 XB	1	13	1169
GW N1 111 CF	1	16	1169
GW N1 111 CP	1	16	1169
GW N1 111 XB	1	13	1169
GW N1 121 XB	1	30	1169
GW N1 122 XB	1	20	1170
GW N1 124 XB	1	30	1170
GW N1 131	1	160	1170
GW N1 132	1	160	1170
GW N1 133	1	8	1170
GW N1 134	1	160	1171
GW N1 135	1/10	1600	1171
GW N1 141	1	60	1171
GW N1 142	1	18	1171
GW N1 201 XB	1	1	1164
GW N1 261 XB	1		1164
GW N1 401 XB	1	1	1165
GW N1 431 CP	1	15	1165
GW N1 461 XB	1	1	1165
GW N1 601 XB	1	1	1165
GW N1 661 XB	1		1166
GW N1 801 XB	1	1	1166
GW N1 831 CP	1	1	1166
GW N1 861 XB	1	1	1167

General sales conditions

1. DEFINITIONS

- 1.1 In these General Sales Conditions the terms hereunder have the meaning as specified for each one of them:
- "Gewiss": the company GEWISS S.p.A.;
 - "Purchaser": the subject, natural person or legal entity requesting the purchase of Gewiss products;
 - "Party" or "Parties": Gewiss and/or the Purchaser, individually or jointly considered;
 - "Order" or "Orders": the purchase order or orders sent by the Purchaser to Gewiss;
 - "Order confirmation": the confirmation of the Order sent by Gewiss to the Purchaser;
 - "Products": all the products offered by Gewiss and described in catalogues, drawings, technical sheets or its brochures;
 - "General Conditions": the general sales conditions hereunder.

2. SCOPE OF APPLICATION

- 2.1 The General Conditions apply to all sales made between Gewiss and the Purchaser whose subject matter is the Products and form an integral part of all Contracts entered into between the Parties, regulating their relationship, even where not expressly referred to. These General Conditions replace Gewiss' previous general sales conditions.
- 2.2 The Purchaser cannot demand or take exception to conditions other than those contained in the General Conditions. Therefore, any conditions set out in writing by the Purchaser on the Order shall not be valid, or those in any other phase of the contractual negotiations as well as after the acceptance or knowledge of the General Conditions, as well as any general purchasing conditions of the Purchaser. To this end, the performance, even partial, of the Order by Gewiss or fulfilment of any other obligation in terms of the Purchaser are not valid and cannot be interpreted as tacit or implicit acceptance of any general condition which has not been explicitly signed by Gewiss.
- 2.3 The General Conditions are only valid for contractual relationships between Gewiss and professional operators, thus the Italian Legislative Decree no. 206 of 6th September 2005 (Consumer Law) is not applicable. The General Conditions are valid for the entire period necessary for complete and correct fulfilment of the Contract.
- 2.4 Any special conditions agreed between the Parties shall only be valid where indicated in the Order confirmation, and shall prevail over the General Conditions, constituting a derogation from these.

3. PROCEDURE FOR FINALISING THE SALES CONTRACT

- 3.1 The Order sent by the Purchaser to Gewiss constitutes an irrevocable contractual proposal which is binding for 30 (thirty) days from the time Gewiss learns of it.
- 3.2 Within these 30 (thirty) days period Gewiss, at its sole discretion, reserves the right to accept the Order or not, and send to the Purchaser the Order confirmation.
- 3.3 The Contract shall be considered finalised following the transmission of the Order confirmation or, alternatively, with the performance of the Order by Gewiss; in this case, the Purchaser cannot cancel the Order without previous written approval from Gewiss and/or he cannot refuse the Products. Up to the time of finalising of the Contract under the above conditions, offers and/or estimates made by Gewiss or its agents, representatives and assistants, shall not be binding for Gewiss.
- 3.4 In the event that the Order confirmation differs from the Order, for example but not limited to, the quantity of Products, prices, discounts and delivery terms, such Order confirmation shall be considered as a counterproposal

from GEWISS, and must be expressly accepted by the Purchaser, for the Contract to be considered finalised.

- 3.5 In any case, it is hereby understood that any oral agreement with the Purchaser related to the sale shall not be binding for Gewiss unless confirmed in writing by Gewiss.
- 3.6 In the event that the Order is cancelled by the Purchaser before it is accepted and/or performed by Gewiss, Gewiss may ask the Purchaser to reimburse any expenses or charges incurred to perform the Order and/or part of it as well as compensation for any sustained damages.

4. PRICES

- 4.1 The prices indicated in Gewiss catalogues and price lists are considered VAT excluded for goods delivered EXW Incoterms® 2020 (ex works) of Gewiss, transportation, insurance, packing and assistance expenses excluded.
- 4.2 Such prices are merely given as a guideline and are not binding on Gewiss in any way, who reserves the right to make changes to the same proportionate to increases in labour, raw material and other cost items and for other causes which occur during the catalogue/price list validity period.

5. DELIVERIES

- 5.1 Unless otherwise agreed between the Parties, the Products are delivered to the Purchaser or third party assigned by the Purchaser as per EXW Incoterms® 2020 (ex works) at Gewiss warehouse. Order confirmations are purely indicative and not binding, and do not include transport times.
- 5.2 Gewiss is not liable for any indemnity or claim for compensation against Gewiss for direct or indirect damages due to delays and/or partial dispatch of the deliveries, if not attributable to fraud or gross negligence by Gewiss.
- 5.3 If performance of the Order is obstructed by the occurrence of force majeure events, lack of regular raw material supplies or sub-supplies or other unpredictable circumstances occurring when the Contract is finalised, the delivery dates shall be considered extended, without Gewiss being held liable for the delay and new dates shall be established by the Parties. The Purchaser shall not have the right to refuse the delivery of the Products.
- 5.4 If, once the Products are ready for shipping to the Purchaser, and delivery is not made due to circumstances not attributable to Gewiss or due to force majeure, the delivery shall be considered performed for all extents and purposes with a simple notice of goods ready for picking-up to be notified to the Purchaser by registered letter, fax or e-mail. From the day after sending the above notice, Gewiss shall be due in addition to the agreed upon price, a fee for storage at Gewiss' warehouse totalling 2% of the amount on the invoice for each entire week of delay; in the event of a delay less than a week the percentage shall be calculated in proportion to the days of delay. All risks related to the goods storage period at Gewiss' warehouse are the sole responsibility of the Purchaser. If the Purchaser's refusal to receive the goods lasts for more than 30 (thirty) days from the notice of goods ready for picking-up, Gewiss shall be entitled to terminate the Contract and claim for compensation of damages.

6. RISKS

- 6.1 The risks of the delivery of the Products are regulated by Incoterms® 2020 terms which are agreed by the Parties.
- 6.2 The Purchaser, at the time of receiving the Products, must always, in their own interest, check the quantity and conditions before the acceptance and notify the carrier of any damage immediately and in writing. Otherwise, every dispute related to the quantity and conditions of the

packed and delivered Products shall be refused.

7. QUANTITY AND PACKING

- 7.1 The Orders must comply with the minimum packing quantities. In the event of Orders for lower quantities Gewiss reserves the right to charge the Purchaser, subject to notification, the lump sum of 5.00 Euro for each line of bulk Product Order.
- 7.2 Standard packing are considered included in the sales price, while the costs for any non-standard packing, unless otherwise established between the Parties, shall be charged by Gewiss to the Purchaser.

8. COMPLIANCE WITH PRODUCT STANDARDS

- 8.1 Gewiss guarantees that all Products, which fall under the scope of application of European Directives and Regulations, comply with the essential requirements set out in them, in order to be put on the market and ordered in European Union. Compliance with the Directives and Regulations is indicated by affixing of the graphic symbol "CE".
- 8.2 The exportation in some UE or extra UE Countries can be forbidden or require specific documents, mark or certification. The Purchase shall contact Gewiss for the relevant information.

9. MODIFICATIONS TO PRODUCTS

- 9.1 The indications, measurements, drawings and images of the Products and related components present in Gewiss catalogues, brochures and websites, and in general all Gewiss technical and informational documentation are given as a guideline and example and are not binding in any way.
- 9.2 Gewiss, at any time and with no obligation for prior notice, reserves the right to make all of the modifications that it, at its sole discretion, feels opportune for improving the Product features and performance as well as to meet its own technological and production needs.
- 9.3 The quality and certification marks mentioned on Gewiss paper material shall be considered in force at the date of the printing of the documents. The updated list of marks is available on the site www.gewiss.com or through the Technical Assistance Service. The updated certification list is available on www.gewiss.com or upon request to the Technical Assistance Service.

10. QUALITY, WARRANTIES AND COMPLAINTS

- 10.1 All of the Products have the qualities necessary for the normal intended use of products of the same type, as shown in the technical documentation in effect at the time of sale, which the Purchaser declares to know and accept. In addition, the Products are covered by warranty for their correct operation and warranty for design and manufacturing faults and/or defects for a period of 24 (twenty-four) months from the delivery date, except for normal wear and tear parts. Once this period has elapsed the warranty becomes null and void, even if the Products have not been put into operation for any reason.
- 10.2 The warranty is effective as long as the malfunctioning, faults and/or defects are not the result of: (i) assembly and/or installation errors, (ii) failure to perform or incorrect maintenance, (iii) failure to comply with and/or erroneous compliance with technical specifications contained in the Gewiss catalogue and in any instructions sheets, (iv) natural wear, (v) faults caused by inexperience and/or negligence (vi) poor care, (vii) failure to immediately adopt measures designed to limit inefficiencies, (viii) overloads compared to limits indicated in technical instructions, (ix) interruptions to or suspensions of electricity, (x) unauthorised activities, (xi) tampering by the Customer and/or third parties, (xii) acts of vandalism, (xiii) acts of

terrorism, (xiv) atmospheric events, (xv) fortuitous events or (xvi) force majeure, (xvii) third party's act.

- 10.3 Moreover, the warranty is not effective in case of malfunctioning of the software installed on the Product, due to overloading, interruption and/or suspension of electric energy.
- 10.4 Any complaint due to quality defects, failure to operate or faulty operation or design and manufacturing faults and/or defects of the Products must be notified to Gewiss in writing, subject to forfeiture of the warranty:
- within 8 (eight) days from delivery of the Products in the event of clear faults and/or defects;
 - within 8 (eight) days from discovery of the faults and/or defects becoming evident following delivery but within two years from the delivery.
- 10.5 For the complaint to be accepted, the Purchaser is required to prove in writing the validity of the warranty, the correct storage and installation of the Product, and to supply Gewiss with adequate documentation proving the faults/defects.
- 10.6 The warranty is limited, up to the sole discretion of Gewiss, to replacement of the defective Products or components (both with identical or similar products) or, alternatively, by repairing the defective Products or components. In any case the accessory expenses of the replacement and/or repair are excluded from the warranty.
- 10.7 Both in the case of replacement and repair of the defective Products the original warranty period will continue and shall not be considered renewed.
- 10.8 Gewiss shall not be held liable for any additional warranty obligation, including implicit, resulting from laws and/or regulations in favour of the Purchaser, including implicit warranties for non-compliance, non-saleable defects and/or the suitability of the Products for a special use.

11. LIABILITY

- 11.1 Without prejudice to mandatory limits set by law and with the exclusion of fraud and gross negligence, is explicitly excluded any further liability by Gewiss - either contractual or extracontractual - that may arise from or be related, directly or indirectly, to the Contract, and/or to discrepancies, defects and/or faults in the Products, , by means of example and not limited to loss of profit, loss of savings, loss of reputation, loss of goodwill and/or interruption of plants where the Products are intended to be used.
- 11.2 Gewiss shall not be held liable for Products sold and/or installed in Countries where there are regulations which do not allow their use, or for uses which they are not intended and/or for installations and uses not in compliance with the Products technical specifications indicated in the catalogues and instruction handbooks in effect at the time of the sale.
- 11.3 In the event of revision of the technical specifications and instruction handbook for Products already delivered and/or installed during the warranty period, the Purchaser shall not be covered under warranty for correct operation according to the new technical specifications.
- 11.4 The Purchaser agrees to establish in all contracts regarding the Products a clause limiting Gewiss' liability substantially identical to that envisaged by this article, assuming the complete and sole liability for the additional movement of Products supplied by Gewiss.

12. RETURNS

- 12.1 Return of the Products is not allowed without prior written authorisation from Gewiss, without which the Products shall be delivered again to the Purchaser at the Purchaser expenses and risk.
- 12.2 In the event of authorised return, the Products shall be returned carriage paid at the expense and risk of

the Purchaser to Gewiss warehouses, within the term indicated by Gewiss. The Purchaser shall be credited for the purchase price of the Products, minus a minimum amount of 15% for administrative expenses. However, Gewiss reserves the right not to accept the return or to apply a higher percentage for administrative expenses if the goods are returned after the period indicated above.

- 12.3 In any case, the return of Products not included in the catalogue in effect at the time of the request to return and/or for which significant changes have been made to the technical specifications is prohibited.

13. PAYMENT OF THE PRICE

- 13.1 Payments shall be made in compliance with the "Supply Conditions" in the Gewiss catalogue in effect or according to what is otherwise agreed between the Parties in writing.
- 13.2 The delay, even partial of the payment of the invoices beyond their due date shall cause the immediate charging of interest in accordance with the legal measures in force, in addition to debiting of any bank expenses and fees.
- 13.3 Failure to pay for any reason, as well as failure to fulfil any other obligation by the Purchaser authorises Gewiss shall be entitled, pursuant to Article 1460 of the Italian Civil Code, to immediately suspend the delivery of the Products , as well as demand payment for the entire amount due, without prejudice to its right to withdraw from the Order being performed.
- 13.4 Gewiss also reserves the right to suspend supplies in the event of a significant modification in the Purchaser's economic situation, by means of example but not limited to transfer of the business or proven serious financial difficulty.
- 13.5 Possible collection expenses or stamp duty for payments received by bank transfer or other forms of payment are at the Purchaser charge.
- 13.6 Any discount agreed upon in writing between the Parties, is subject to complete compliance with payment due dates. Failure to pay within the agreed due dates shall result in forfeiture of the discount and the Purchaser who unduly withheld it shall be obligated to reimburse it immediately.
- 13.7 Any complaint from the Purchaser including for late delivery of incomplete supply, shall not give the Purchaser the right to suspend or delay payment of the supply.
- 13.8 The Purchaser cannot claim any non-fulfilment of Gewiss', nor claim the warranty as per article 10 above, if not up to date with payments.
- 13.9 The Parties undertake to act in compliance with the obligations set out in art. 3 of Law 136/2010 to ensure the traceability of financial movements relating to public services and supplies, with the clarification that the violation of these provisions determines the legal termination of the Contract.

14. INTELLECTUAL PROPERTY

- 14.1 Gewiss shall remain the sole owner of the patents, drawings, designs and anything else used to create the Products, which, therefore, the Purchaser agrees not to give to third parties, reproduce or use, without prior authorization of Gewiss. If the creation of the Products is performed by Gewiss based on specific request and technical documentation of the Purchaser, Gewiss shall not be held liable for the violation of industrial property rights by third parties, which shall be the sole responsibility of the Purchaser, who agrees to guarantee and indemnify and hold Gewiss harmless from any claims made against it.
- 14.2 The Purchaser agrees to use Gewiss trademarks solely for the purposes of identifying, advertising and selling the

Products, refraining from registering them of having them registered without prior written approval from Gewiss.

- 14.3 The Purchaser is prevented from registering "gewiss" as domain name as well as any domain which contains words which look like or recall Gewiss.
- 14.4 Possible links to Gewiss' website and the publication on the Purchaser's website of contents which refer to Gewiss shall be authorized in writing by the latter beforehand.

15. CONFIDENTIALITY OBLIGATION

- 15.1 The sales commercial conditions, particularly regarding the budget, incentive and discount conditions, as well as all other documentation or information classified by Gewiss as confidential, have a strictly confidential nature, therefore, the Purchaser agrees not to divulge them or communicate them to third parties, nor to use them for purposes other than the finalising and performance of the Contract, for the period of 5 (five) years after performance of the Order.
- 15.2 Gewiss reserves the right to pursue, including legally, any violations of the aforesaid confidentiality obligation.

16. PRIVACY

- 16.1 Gewiss agrees to collect and process the personal data it may learn of in relation to the execution of the Contract in compliance with the Italian Legislative Decree 196/2003 and subsequent amendments (Legislative Decree 101/2018 for the adaptation of the Italian legislation to EU Reg. no. 679/2016, so called GDPR), with the purposes therein permitted and to fulfil all legal requirements including of a tax or accounting nature. The information is available on the website www.gewiss.com.

17. GEWISS CODE OF ETHICS AND ORGANIZATION, MANAGEMENT AND CONTROL MODEL - ANTI-CORRUPTION POLICY

- 17.1 The commercial relations governed by the General Conditions are based on the principles of legality, transparency, correctness and fairness, in accordance with the contents of the Code of Ethics, the Organisation Management and Control Framework adopted by Gewiss and with the principles of the Anti-Corruption Policy available on the website www.gewiss.com. Any notifications about the violation of the aforesaid Framework may be sent using the "notification procedure" available on the website, to the e-mail address ia-odv@gewiss.com.
- 17.2 If, behaviours are adopted which do not comply with the aforesaid principles, Gewiss shall be entitled to take opportune measures, including cancellation of the Orders and request compensation for damages.

18. APPLICABLE LAW, COURT AND LANGUAGE

- 18.1 All the Contracts finalised by Gewiss, regardless of the Purchaser's nationality and/or place of destination of the Products, are governed by Italian laws.
- 18.2 Application of the Vienna Convention on contracts for the international sale of goods of 11 April 1980 remains expressly excluded, as well as other statutory Conventions concerning international sales and governing conflicts between laws.
- 18.3 Any dispute arising between the Parties shall be submitted to the Italian court and solely to the Court of Gewiss' registered office, without prejudice to Gewiss' right to act at the Purchaser's address.
- 18.4 If these General Conditions are drafted in more than one language, in case of conflicts, the text in Italian shall be decisive.

LED warranty



WARRANTY CONDITIONS FOR GEWISS PRODUCTS WITH LED TECHNOLOGY

1.
This warranty is applicable to the direct sales agreements between any Gewiss Group company (hereinafter "Gewiss") and the purchasers (hereinafter "Purchasers" or, individually, the "Purchaser") of Gewiss lighting products with LED technology (hereinafter "Products" or, individually, the "Product"), being understood that the Products are bought in new conditions, in their original package and complete of their handling instructions.

2.
These warranty conditions operate in derogation from Gewiss general sales conditions and are additional to the warranty rights provided by the law in favour of the Purchaser or contractually agreed in writing between Gewiss and the Purchaser himself.

3.
This warranty covers the Product defects, which can be demonstrated to be determined by raw material defects, or by constructive or manufacturing defects, for the period indicated in the table below, starting from the date of purchase of the Product, being understood that the number of operating hours cannot exceed 4,200 hours per year.

Product	Warranty period
Street lighting ranges: Street, Urban and Road	5 years
Floodlights range: Smart[Pro], Stadium[Pro] and Spatium[Pro]	5 years
Smart[4] range	5 years
Smart[3] range: Smart[3]e, Smart[3] and Smart[3]Plus	5 years
Esalite range	5 years
Elia range	5 years
All other LED products	2 years

Phase out products	Warranty period
Smart[3] Compact and Super lines	3 years
Astrid range, except Astrid 75 LED	5 years
Astrid 75 LED	2 years
Bolla LED	2 years

4.
Products shall not be considered defective when one of the conditions indicated below occurs:

- less than 20% malfunction LEDs in each Product,
- a variation of the light flux not exceeding a value of 0.4%/1,000 of operating hours;
- a failure rate of the driver not exceeding a value of 0.2% per 1,000 of operating hours at an average working temperature not exceeding 35° C; this value shall be increased of a further 0.1% per 1,000 operating hours per each 10° C of average temperature, exceeding 35° C; In any case, the

Products shall never work at a temperature exceeding the declared rated maximum ambient temperature (ta);

- Product components subject to wear and tear (such as batteries) and parties subject to a natural aesthetic decay, which does not affect the functionality or the safety of use of the Product.

5.
Gewiss, if the Product falls within the scope of this warranty, shall choose - at its sole discretion - whether to refund the Purchaser of the purchase price of the Product, or to repair the Product, or replace it with a Product of equivalent price and equivalent performances.

6.
Gewiss, when it chooses to repair the Product, may use new or reconditioned parts, guaranteeing in this case that the substitutive components are equivalent to the substituted ones in terms of performance and reliability. Whatever it is the solution chosen by Gewiss, none of these options involves the change or extension of the original warranty term of validity, i.e. starting from the purchase date of the Product.

7.
The Purchaser, subject to forfeiture of the warranty, shall notify the existence of defects to Gewiss e-mail gestioneresi@gewiss.com no later than thirty days from the discovery of the defect, providing at the same time: (i) a document proving the purchase date (for example: purchase invoice) and (ii) the data indicated on the label of the defected Product, including the production lot. Upon receipt of the notification and of the documents indicated above, Gewiss can ask the Purchaser to promptly return the Product directly to Gewiss, or to a sales point authorized by the same.

8.
In any case, the warranty does not apply when the defectiveness of the Product is determined by:

- fire, Acts of God, vandalism, negligence, installation not properly set up or installation carried out by people not adequately qualified, use not allowed or use different than the purpose for which the Product was intended;
- improper installation and/or non-conform installation to the requirements of the standard IEC 60364 or if existing and more severe according to the national wiring and installation rules and standards, wrong supply voltage and wrong wiring of the products, including for instance: improper protection against the overcurrent, use of improper conductors (type and cross sectional area), improper protection against inrush currents, improper protection against impulsive overvoltage, improper protection against temporary overvoltage, improper protection against electrical shocks, the use of not adequate fixing means or fixing supports/surface;
- unless otherwise declared by Gewiss on either the Products or the

instruction sheets or the packaging or the catalogues, installation outside the following limits (being understood that any additional protection of the Product shall be implemented by the Purchaser at his own expenses): (1) maximum temperature in open air as declared for the Product; (2) minimum temperature in open air as declared for the Product; (3) rapid change of temperature not exceeding 5 K per hour; (4) humidity as for IEC 60598; (5) adequate additional protection of the Product against, ice, frost, hail and condensation; (6) pressure not exceeding the atmospheric pressure; (7) adequate additional protection of the Product against piston air effect (e.g. movements of train and similar vehicles); (8) adequate additional protection of the Product against exposition of thermic irradiation by external sources; (9) altitude $\leq 2,000$ m; (10) indoor/outdoor application as declared for the Product; (11) adequate additional protection of the Product against wind, with the exception of the Products compliant with the standard IEC 60598-2-3 and IEC 60598-2-5 and in any case within the limits defined by those standards; (12) adequate additional protection of the Product against direct free air movement from fans; (13) presence of dust and sand not exceeding the limits defined by first digit of the degree of protection IP declared for the Product; (14) presence of water not exceeding the limits defined by second digit of the degree of protection IP declared for the Product; (15) presence of salt mist only for Products declared for outdoor application and within the limit defined by the clause 11 of this warranty; (16) adequate additional protection of the Product in case of possible contact with oils and other chemical in liquid form, unless otherwise declared for the Product; (17) adequate additional protection of the Product in case of contact with vapour containing chemicals in gas form, unless otherwise declared for the Product; (18) adequate additional protection of the Product in case of exposure to water and vapour containing chloride (e.g. swimming pool); (19) generic mechanical shocks not exceeding the limits defined by the degree of protection IK declared for the Product; (20) mechanical shocks due to balls only if the Product is declared to be in conformity with the standard DIN 18032-3; (21) fixed installations and applications where the level of the vibration are negligible; (22) only fixed installations in case of acceleration; (23) adequate additional protection of the Product in case of flora, moulds and fauna that can damage the Product; (24) adequate additional protection of the Product against direct sun irradiation; (25) electrostatic discharges as for the IEC 61547; (26) radio-frequency electromagnetic fields as for the IEC 61547; (27) power frequency magnetic fields as for the IEC 61547; (28) fast transients as for the IEC 61547; (29) injected currents (radio-frequency common mode) as for the IEC 61547; (30) surges as for the IEC 61547; (31) voltage dips and short interruptions as for the IEC 61547; (32) storage conditions between the maximum and the minimum working temperature declared for the Product; (33) transport conditions as declared for the Product;

d) improper or inadequate maintenance, if allowed or prescribed by Gewiss, or maintenance performed by a person not adequately qualified;

e) Product components subject to wear and tear (such as batteries) and parties subject to a natural aesthetic decay, which does not affect the

functionality or the safety of use of the Product;

f) Product modification or repair performed by the Purchaser or by its delegate, without the express written consent by Gewiss.

With reference to the situations mentioned above, the Purchaser, upon Gewiss request, shall provide appropriate and complete proof about the proper use, the proper installation and maintenance of the Product, such as about the environmental and the installation context of the same.

9.

The warranty does not cover the costs incurred for the elimination of the defects, including - by way of indication only - the costs of disassembly and assembly, transportation or shipping costs of the defective or repaired Product, the rental costs of any lifting device.

10.

Except to the binding extent required by Law and with the exclusion of wilful misconduct and gross negligence, in no event Gewiss shall be liable for damages resulting from any breach, as well as from any direct or indirect damages caused by faults or defects of the Products, or by their malfunction such as by repairs or replacements, among which, by way of example, loss of profits, lack of savings, loss of reputation, loss of goodwill, block of plants in which the Products are destined to work. In any case, Gewiss liability shall not exceed the purchase price of the defective Product.

11.

The warranty is valid if the Products are used in application classes C1-C5 according to the standard ISO 9223. In other cases, please ask to Gewiss sales organization for a customized solution. In case of Products installed within 5 km from the sea side, the corrosion of the Products is covered by warranty only in the event that Customer has purchased Products with Marine Salt Painting which is offered as an option to Customer.

12.

Gewiss reserves the right to modify these warranty conditions at any time, by publishing the new terms on its website www.gewiss.com and on its catalogues.

13.

This warranty is valid from **1st September 2021**.

2023
2024



INSTALLATION



ENERGY



BUILDING



MOBILITY

GEWISS

Visit www.gewiss.com and follow us:

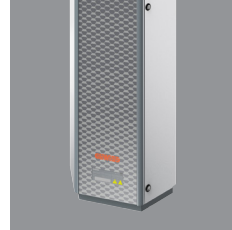
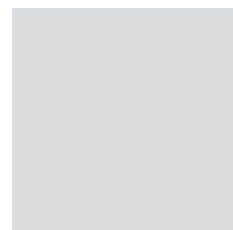
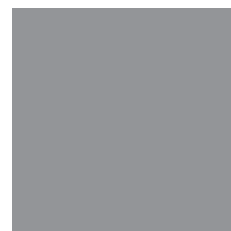

GEWISS S.p.A.

Via Domenico Bosatelli, 1 - 24069 CENATE SOTTO
(Bergamo) - Italy
Tel. +39 035 946 111 - Fax +39 035 945 222
gewiss@gewiss.com - www.gewiss.com

Sole Shareholder company - Bergamo Register of Companies/ VAT / Tax
code (IT) 00385040167
REA 107496 - Share Capital 60,000,000.00 EUR fully paid up

PB11157EN - 01.23