

2025

THE BATHROOM BOOK



SVEDBERGS

Get inspired.

Bathrooms from Dalstorp since 1962

Svedbergs was founded in Dalstorp, Västergötland, as a small forge run by Holger Svedberg in the 1920s. During the 1960s, the focus shifted from agricultural tools to bathroom fittings, and a vision of creating bathrooms centred around Scandinavian design and quality. Still today, we produce our bathroom furniture ourselves in our very own factory, which gives us a unique opportunity to ensure each detail is of the highest quality.



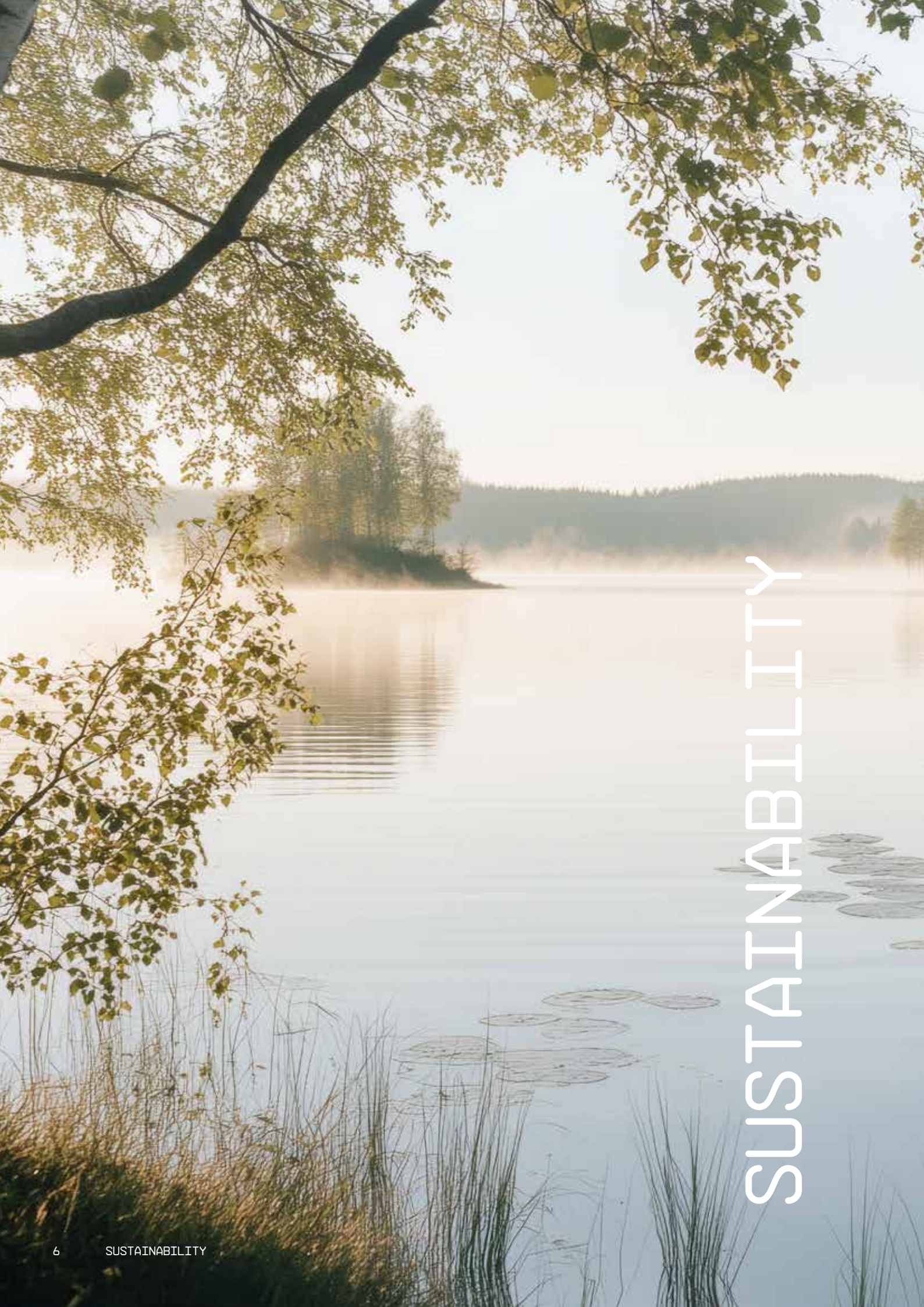

SUSTAINABILITY



Sustainability at every step

At Svedbergs, sustainability is part of all of what we do, from the initial idea and design all the way to recycling. We are working towards creating circular products that retain their value over time.

We strive to ensure sustainability throughout the entire product lifecycle; right from the development phase we take steps to ensure our products can be uninstalled, recycled and upgraded. By using certified wood, we contribute to a reduced climate impact and promote biodiversity. We work actively to reduce our greenhouse gas emissions through careful calculations and a clear reduction plan covering everything from material choices to logistics.

With over 70 per cent of our production operations taking place at our facilities in Dalstorp, we have control over the value chain, which helps ensure we can provide the highest quality. Our suppliers adhere to a strict code of conduct to ensure that human rights, acceptable working environments, and fair working conditions are respected. In order to ensure long-lasting quality, we provide warranties on many of our products. Read more on www.svedbergs.com.

- 100% Forest-certified wood
- 100% Renewable electricity
- 93% Renewable energy
- 70% Production in Dalstorp
- 22% Reduced energy consumption 2018–2023
- 18% Reduced greenhouse gas emissions 2021–2023



Epos 120x45 cm vanity unit in black ash flat front panel, Ise washbasin, Bold mixer, Norra mirror, Mossby bath, Spika bath mixer, Sigyn heated towel rail, Front shelf in black ash



OUR VISION

Inspiring spaces

Here at Svedbergs, a bathroom is more than just a room for hygiene. It is a haven, a place where you can shut the door behind you and step into a world of your very own. Regardless of whether you are seeking relaxation or inspiration, we can create a bathroom that brings together mind and body in perfect harmony.



The Mossby bath is 100% recyclable.

Our range	12
Furniture collections	14
Epos	16
Poem	30
Bloc	40
Intro	46
Washbasins	54
Work tops	58
Washbasin mixers	60
Mirrors	62
Mirror cabinets	66
Storage	69
Washers & Dryers	72
Handles	75
Showers	
Langfoss	77
180°	79
Skoga	83
Shower storage	85
Shower enclosure Ritual	86
Baths	87
Shower and bath mixers	91
Heated towel rails	93
WCs	95
Accessories	97
Product and Purchasing Guide	99



TABLE OF CONTENTS

Poem 100 × 45 cm vanity unit in brown ash, Frame front panel, Lodal mixer, Norra mirror, Sel washbasin, Tall cabinet in brown ash with glass door, Spika bath mixer set, Vaulen bath

Everything you need for your bathroom

We have everything you need to create a complete bathroom. Our warranties on furniture, showers, and shower walls align with our philosophy on quality, choice of materials, and attention to the details. We offer both design and functionality that will stand the test of time.

Furniture collections

Washbasins

Washbasin mixers

Work tops

Mirrors

Mirror cabinets

Storage

Showers



Baths
Shower and bath mixers
Heated towel rails
Washers and dryers

WCs
Handles
Accessories

Choose your furniture range

Choosing the right furniture range is all to do with understanding your wishes and needs when it comes to your bathroom. Our ranges are designed to give you the freedom you need to create a unique atmosphere where functionality and sustainability are combined. Our ready-to-mount furniture makes it easy for you to transform your bathroom into a personal oasis that reflects your own style.



EPOS

For the design conscious. Epos stands out with its modern Scandinavian design and carefully selected materials, functionality and details. With its contemporary design, the range is available in a variety of configurations and colours with plenty of functions to choose from. Pages 16–29

POEM

Our most spacious furniture. The wide range of front panels and choice of materials and colours available in the Poem range make it easy to create unique designs, from simple to lavish bathrooms. Pages 30–39



INTRO

Ideal if you want to try something new. A furniture range with a timeless, clean design. Characterised by practical grip holes and straight lines, and made from powder coated sheet metal. Pages 46–51

BLOC

With its carefully-selected product combinations that offer great value for money, it's easy to choose some great options with this furniture range. Pages 40–45



The EPOS furniture range is an homage to Scandinavian design, where modern aesthetics meet functionality and sustainable materials. Each detail in the Epos range is carefully considered to ensure it will create a bathroom that is both beautiful and practical – a haven of style and comfort in perfect harmony.

EPOS





Epos 200 x 45 cm vanity unit in brown ash, Stripe front panel, Fross washbasin, Ejer mixer, Sirius worktop, tall cabinet with open storage, Ista mirror

Designed in partnership with Interior Designer Halvor Bakke. Modern, with endless options to make it truly your own.



Epos 160 × 45 cm vanity unit in white ash Relief,
Fross washbasin, Ejer mixer, Rem work top,
Valje mirror, Langfoss shower, Amor heated towel rail

MODERN ELEGANCE

With its clean lines and flexible design options, Epos offers you the freedom to create your dream bathroom. Choose between an integrated or counter top washbasin, in a variety of colour palettes and configurations to suit your space and needs. Epos is perfect for medium and larger bathrooms, allowing you to combine modern luxury with timeless elegance.



FOCUS ON DETAILS

The Epos range conveys a consistent sense of quality, with the wood elements in the drawers helping create a sense of warm and natural harmony. The combination of wood and modern design create a uniform look that elevates the aesthetics and functionality of the bathroom.



Discover
the whole
Epos
range



Epos 60×45 cm vanity unit in brown ash, Stripe front panel,
Ise washbasin, Bold mixer, Skuru mirror cabinet

Epos – in partnership with Halvor Bakke

Our Epos furniture range is the result of close collaboration with Halvor Bakke, a Norwegian interior designer and TV personality. With our design team, he has developed a unique range where the potential combinations, colours, forms and functions take centre stage. The design has been developed in a way that takes care to create a bathroom that is not just practical, but also energising and inspiring every time you step inside.

As an interior designer, Halvor is keen to emphasise the importance of a personal touch in the bathroom, as well as making it a natural part of the home. He places real value in the details and aims to create an atmosphere that conveys a sense of joy in being at home.



Halvor Bakke, interior
designer, Oslo

Fronts

Five front options give five different looks. Choose between handles or a push open mechanism to find a style that suits your bathroom.



Flat

Front for a sleek, simple and elegant look. Create your individual style with standard colours, selected colours, real wood veneers and handles.



Flat push

Push open action for an elegant, minimalist style.



Relief

Solid front with integrated solid wood handle. The grip edging mirrors the top edge and accentuates the strong outline. Available in a choice of colours and real wood veneers.



Stripe

An elegant and modern front with clean lines. The channels are also designed to be combined with any handle to create whichever style you choose. Available in brown and black ash.



Stripe Push

Push open action for an elegant, minimalist style.



HANDLES AND KNOBS

Don't forget to purchase handles for your Epos with either Flat or Stripe front. Read more on page 75.

Colours

With four standard colours and four optional colours, it's easy to find your favourite. The optional colours are only available for the Flat and Flat Push open fronts.

Standard colours



White



White ash



Brown ash



Black ash

Optional colours

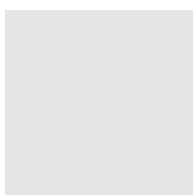

Oat



Sand



Granite



Sage

Worktops

Choose between Danae (beige sandstone), Keon (grey concrete) and Laurent (dark background with gold marbling). Sirius (black) and Rem (light marble look, less pronounced veining) are optional extras.



Danae



Keon



Laurent



Rem



Sirius



COUNTER TOP WASHBASINS

Don't forget to include a washbasin. Go to page 56 to see our counter top washbasins.

Choices

Choose a vanity unit (cross on grey background = open storage).

60 cm



W: 60
H: 45
D: 45

80 cm



W: 80
H: 45
D: 45



W: 60
H: 45
D: 45



W: 80
H: 45
D: 45



W: 60
H: 45
D: 45



W: 80
H: 45
D: 45

Build your Epos

- | | |
|---|---|
| <p>01 Choose a vanity unit.</p> <p>02 Choose a colour.</p> <p>03 Choose a front.</p> <p>04 Choose optional extras (e.g. lighting or electrical sockets)</p> | <p>05 Choose between an integrated or counter top washbasin with work top.</p> <p>06 Choose between handles or a push open mechanism.</p> <p>07 Choose a mixer.</p> |
|---|---|

100 cm



W: 100
H: 45
D: 45



120 cm



W: 120
H: 45
D: 45



W: 100
H: 45
D: 45



W: 120
H: 45
D: 45



W: 100
H: 45
D: 45



W: 120
H: 45
D: 45



W: 120
H: 45
D: 45



Choices

Choose a vanity unit (cross on grey background = open storage).

160 cm

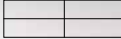

W:160 
H: 45
D: 45



W: 160 
H: 45
D: 45

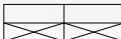

W: 160 
H: 45
D: 45

200 cm



W: 200
H: 45
D: 45



W: 200
H: 45
D: 45



W: 200
H: 45
D: 45



W: 200
H: 45
D: 45





Our design director for Epos

Epos takes a step away from traditional bathrooms and instead explores exclusive, tailor-made looks – and elements perhaps not conventionally associated with bathrooms. Epos is a little like an extension of your home, where design, smart functions and uncompromising details lead the way.

DESIGN YOUR VERY OWN UNIQUE BATHROOM

Epos allows you the freedom to create a bathroom that is unique to you. The range offers a variety of options so that you can tailor each detail to you – from the material and storage solutions to the colour and functions. You choose whether you want drawers, open storage or a combination of both. A light or dark feel, minimalist or with more details. Thanks to the vast number of combinations, you can create a bathroom based entirely around your needs and style, making it an extension of your home.

Regardless of whether you favour a minimalist aesthetic or want to put your own stamp on the space with luxurious details, Epos provides you with the tools you need to make your dream bathroom a reality.



Design Director Johan
Körner of Svedbergs

Epos 160 x 45 cm vanity unit in black ash with open shelves, Stora washbasin, Ejer mixer, Valje mirror

Standard



DRAWER INSERTS

These stylish, functional drawer inserts are included. The bottom of the drawer is made of metal, a practical material that's easy to keep clean. The drawer dividers are solid wood and painted the same colour as the front.



DOUBLE ELECTRICAL SOCKETS

Epos vanity units in widths of 120 cm and 200 cm include double electrical sockets inside a 40 cm wide drawer. For other vanity units, electrical sockets are available as an optional extra.



EASYMOUNT

Our simple EasyMount system requires fewer installation steps. It fixes to the wall with just a few screws, causing less impact on the moisture barrier.

Options



STORAGE

A stylish, practical open drawer. It's made of galvanised sheet metal and available with a wooden front painted the same colour as the unit front. This is an optional extra.



DRAWER LIGHTING

Drawer lighting is practical because it makes your things easier to find. But it also looks good and adds an exclusive touch. Drawer lighting is available as an optional extra for drawers and open storage units.



FLOOR LIGHT

An optional floor light adds an exclusive, cosy feel to the bathroom. The light is installed on the underside of the bathroom unit. Supplement it with a driver kit (optional).



POWER SOCKET

An optional electrical socket can be added to the bottom drawer in Epos units.



DRAWERS

A practical drawer insert can be added to the bottom drawer in Epos units.

For more detailed information on Epos, see page 100.

Rooted in genuine materials and skilful craftsmanship, this furniture series offers a range of looks, from natural Nordic to dark and earthy. A Poem about flexibility and timeless design.

POEM





Poem 120 × 45 cm vanity unit in pure oak profile,
Vette mixer, Hav washbasin, Valje mirror with lighting

The wide range of front panels and choice of materials and colours available in the Poem range make it easy to create unique designs, from the simple to the lavish.



Poem 60x35 cm vanity unit in white, Flat front panel, Tarju mixer, Sarek mirror cabinet, Tall cabinet in white



OUR MOST SPACIOUS FURNITURE

Poem comes with exclusive drawer inserts in the upper drawer. The spaciousness of the lower drawer means there is room for everything you might need.

100% RECYCLABLE

The raw wood materials used for the Poem furniture range are sourced from responsible and sustainably operating forestry providers. Poem can be uninstalled and recycled.



Discover
the whole
Poem
range

Fronts

Five front options give five different looks. Choose between handles or a push open mechanism to find a style that suits your bathroom.



Flat

Front for a sleek, simple and elegant look. Create your individual style with standard colours, optional colours, real wood veneers and handles.



Flat push

Push open action for an elegant, minimalist style.



Profile

Flat design look with integrated concealed grip. Combining solid wood with veneer and adding one of our wood finishes offers a sense of master carpentry.



Edging

Discretely integrated and functional grip edging for a minimalist look. Colour-matched and with a thin silhouette for a refined feel in everything from the colour to the wood veneer.



Frame

Narrow yet distinctive frames made of solid wood with veneer infill, offer a contemporary feel with classic touches. Combined with a push opening mechanism or handle and particularly well suited to natural looks such as ash and oak.



Frame push

Push open action for an elegant, minimalist style.

Colours

With five standard colours and three optional colours, it's easy to find your favourite. The optional colours are only available for the Flat and Flat push open fronts.

Standard colours



White

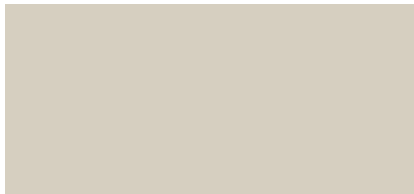

Sand



Pure oak



Brown ash



Black ash

Optional colours

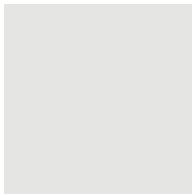

Oat

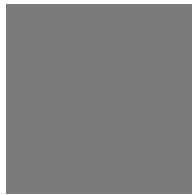

Granite



Sage



HANDLES AND KNOBS

Don't forget to include handles for your furniture. Read more on page 75.

Worktops

Choose between laminate in Quartz (light grey), Mica (dark grey) and Slate (black). Keon (grey concrete) and Sirius (black) are available for Dekton work tops.



Quartz



Mica

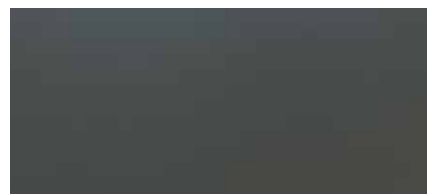

Slate



Keon

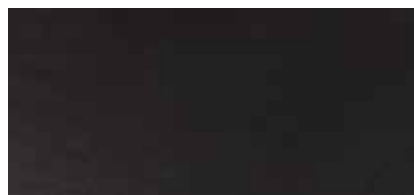

Sirius



COUNTER TOP WASHBASINS

Don't forget to include a washbasin. Go to page 56 to see our counter top washbasins.

Choices

Choose a vanity unit.

50 cm



W: 50
H: 45/57
D: 35

60 cm



W: 60
H: 45/57
D: 35

80 cm



W: 80
H: 45/57
D: 35



W: 60
H: 57
D: 45



W: 80
H: 57
D: 45

160 cm



W: 160
H: 57
D: 45

Build your Poem

- | | |
|---|---|
| <p>01 Choose a vanity unit.</p> <p>02 Choose a colour.</p> <p>03 Choose a front.</p> <p>04 Choose optional extras (e.g. lighting or electrical sockets)</p> | <p>05 Choose between an integrated or counter top washbasin with work top.</p> <p>06 Choose between handles or a push open mechanism.</p> <p>07 Choose a mixer.</p> |
|---|---|

100 cm



W: 100
H: 57
D: 45



120 cm



W: 120
H: 57
D: 45



W: 120
H: 57
D: 45



Standard

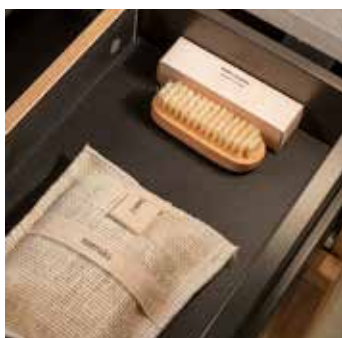

DRAWER INSERTS

Practical drawer compartments with exclusive colour matching with the drawer front in brown ash and pure oak. The other colours come with black edging.



DRAWER SYSTEM

A timeless and functional drawer system. Opens weightlessly, soundlessly and with no resistance. 100% recyclable.



EASYMOUNT

Our simple EasyMount system requires fewer installation steps. It fixes to the wall with just a few screws, causing less impact on the moisture barrier.

Options



DRAWER INSERTS IN THE LOWER DRAWER

A practical drawer insert can be added to the bottom drawer in Poem units.



DRAWER LIGHTING

Drawer lighting is practical because it makes your things easier to find. But it also looks good and adds an exclusive touch. Drawer lighting is available as an optional extra.

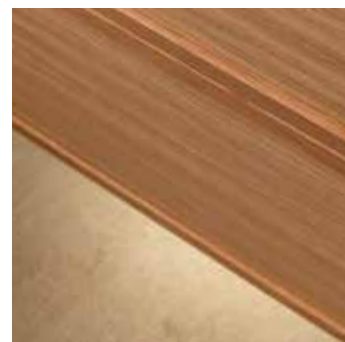

FLOOR LIGHT

An optional floor light adds an exclusive, cosy feel to the bathroom. The light is installed on the underside of the bathroom unit.



POWER SOCKET

An optional electrical socket can be added to the bottom drawer in Poem units

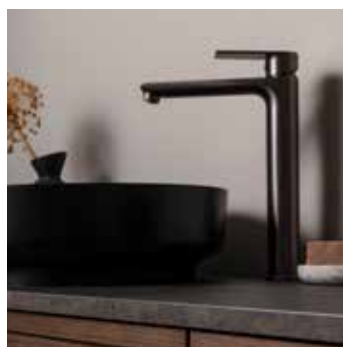

MIXERS

Don't forget to include mixers and traps for your vanity unit.

For more detailed information on Poem, see page 112.



Poem 80×35 cm vanity unit in brown ash, Edging front panel, Tarju mixer, Hav washbasin

Bloc is our simplest furniture range, designed to make choosing your bathroom easy and uncomplicated. The range offers a well-considered solution that makes it easy to create a harmonious environment without the need for compromise. Perfect for those seeking simplicity but not at the expense of quality.

BLOC



Bloc 60 cm vanity unit in white, Skapa washbasin,
Tron mixer, Bloc mirror cabinet

With a hard-wearing surface and a limited number of carefully-selected options, we have made it easier for you to create a smaller or medium-sized bathroom. The result will be a bathroom truly designed to last.



Bloc 60 cm vanity unit in grey, Skapa washbasin, Tron mixer, Bloc mirror cabinet

With its carefully-selected and affordable product combinations, it's easy to choose some great options with this furniture range.



CAREFULLY SELECTED

We select wood sourced from responsible and sustainable forestry providers, ensuring our furniture can be uninstalled and recycled for a sustainable lifecycle. Furthermore, Bloc offers a durable melamine finish.



Discover
the whole
Bloc range

Choose your Bloc

Bloc offers practical and stylish solutions for small, modern bathrooms. Available in sizes from 45 cm to 60 cm, it is ideal for smaller spaces and combines timeless design with high standards and quality, ensuring long-lasting sustainability.

Colours

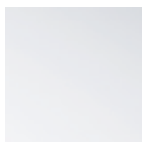

White



Grey

For more detailed information on Bloc, see page 123.



Bloc 60 cm vanity unit in white, Skapa washbasin, Tron mixer

Choices

45 cm



W: 45
H: 57
D: 25



50 cm



W: 45
H: 57
D: 35



W:
50
H: 57
D: 35



55 cm



W: 55
H: 57
D: 35



60 cm



W: 60
H: 57
D: 35



Options



TIVED MIRROR

Our Tived mirror is adapted and dimensioned to work perfectly with the Bloc range.



BLOC MIRROR CABINETS

To create a cohesive look in your bathroom, add a Bloc mirror cabinet. Available in the same colours as our Bloc furniture range.



TRAP

The Easy Clean trap includes a hose and bottom valve in chrome, white or black matt. Alternatively, a standard trap with hose is also a good choice.



MIXERS

Don't forget to include mixers for your vanity unit. We offer mixers adapted to suit the simpler, smaller look of our Bloc range.

A furniture range that stands up to tough wear without compromising on design or function. Intro is made of galvanised sheet metal, using our unique EnduraDry method. This combination provides an exceptionally tight and durable surface finish. The result is a furniture range that will withstand the test of time.

INTRO



Intro 50x35 cm vanity unit in sand, Intro mirror cabinet, Skule mixer, Skapa washbasin

Robust, solid and durable, with a drawer or door in four optional colours. For small to medium-sized bathrooms.



Intro 45 x 35 cm vanity unit in white, Intro white mirror cabinet, Tron mixer, Skoga folding shower screen in polished aluminium, Spika shower mixer set

Ideal if you want an intro to something new. A furniture range with a timeless, clean design. Characterised by practical grip holes and straight lines.



Tron, a functional washbasin mixer suitable for smaller washbasins.



A DURABLE BATHROOM

Integrated handle in the form of a punched hole. The handle is both practical and hard wearing, as well as being easy to keep clean.



Discover the whole Intro range

Choose your Intro

The range is available in several sizes, from 45 cm to 55 cm, making it suitable for small and medium sized bathrooms. You can choose between harmonious colours such as white, slate grey, sage and the warm, natural shade of sand. These colours help you create the perfect atmosphere for your personal style.

Colours

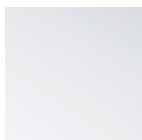

White

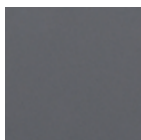

Graphite grey

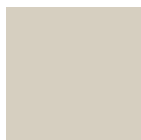

Sand



Sage

For more detailed information on Intro, see page 124.



Choices

45 cm



W: 45 
 H: 50
 D: 35

50 cm



W: 50 
 H: 50
 D: 35

55 cm



W: 55 
 H: 50
 D: 35



W: 50 
 H: 50
 D: 35



W: 55 
 H: 50
 D: 35

Options



INTRO MIRROR CABINET

Complement your furniture with Intro mirror cabinets. Colour matched with the Intro furniture series.



MIXERS

Don't forget to include a mixer for your vanity unit.



WATER TRAP

The Easy Clean trap includes a hose and bottom valve in chrome, white or black matt. Alternatively, a standard trap with hose is also a good choice.



ENAMEL BATHTUB

Complement your furniture with our enamel bathtub. Available in the same colours as the furniture.

Design in 3D

Specify your bathroom's dimensions, choose your wall and floor tiles and position your bathroom furniture. After you've finished, you'll get a full list of the products and inspiring pictures of your dream bathroom.

svedbergs.com/plan-your-bathroom/

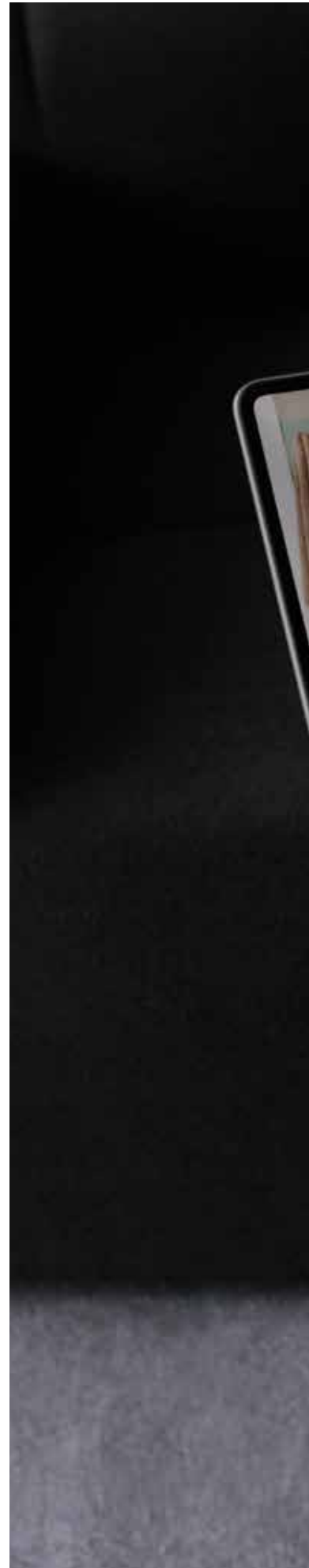

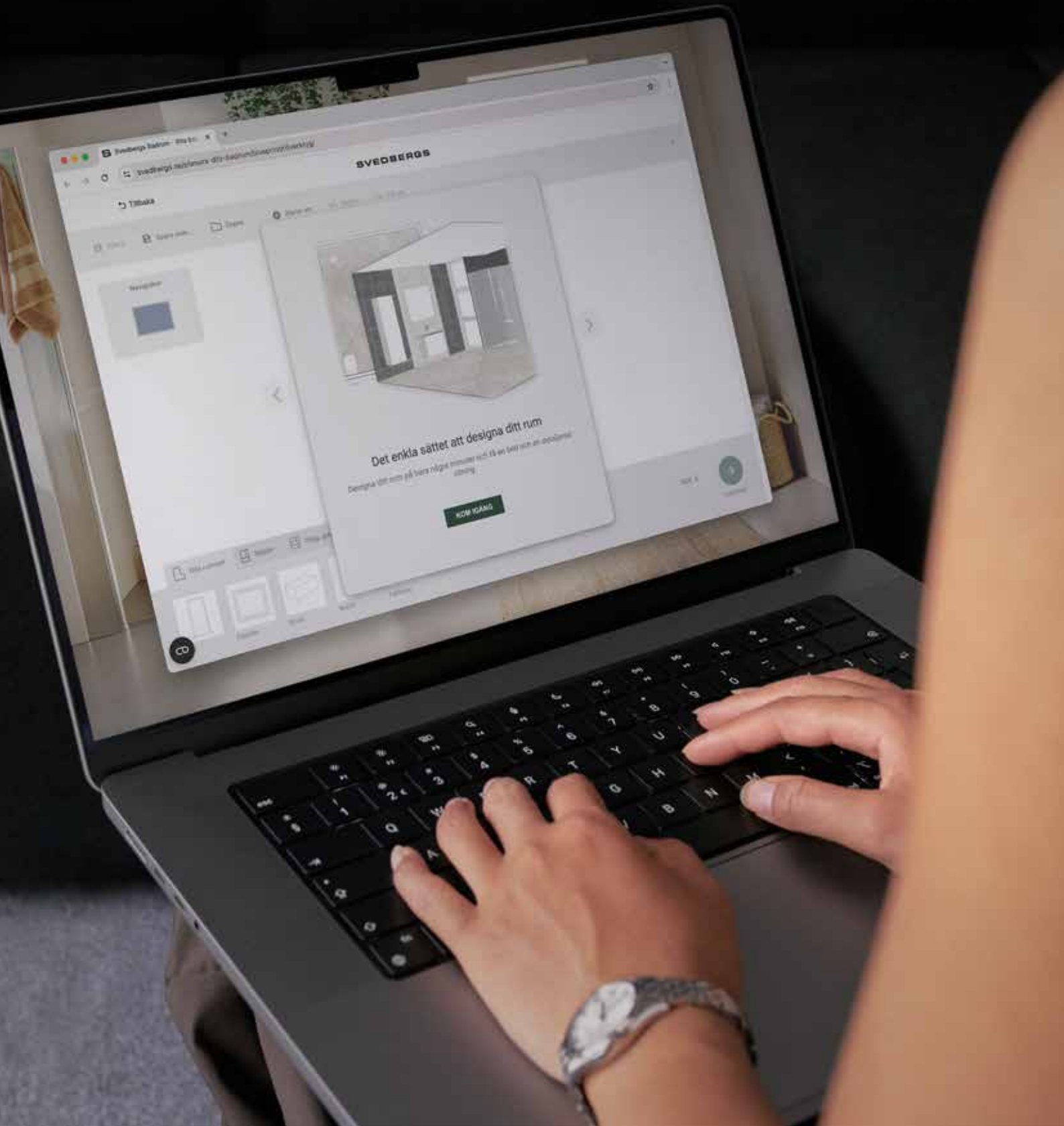

Recessed washbasins

Our washbasins are the crowning glory of our bathrooms, combining design and functionality in beautiful harmony. The almost seamless integration between the bathroom furniture elements offers an elegant, cohesive look. Choose colours and looks and add in a mixer for a great overall look.



Poem 120x45 cm vanity unit with a pure oak profile,
Hav washbasin, Vette washbasin mixer

For more detailed information
on our recessed washbasins,
see page 125.



Discover
recessed
washbasins



Ise

Materials: Mineral composite
Colour: White matt, ash grey
Compatible with Epos.



Floen

Materials: Porcelain
Colour: White
Compatible with Epos.



Sel

Materials: Mineral composite
Colour: White matt, black matt
Works well with the Poem furniture range with a depth of 45 cm.



Hav 45, 35

Materials: Porcelain
Colour: White
Works well with the Poem furniture range with a depth of 45, 35 cm.



Nerby

Materials: Mineral composite
Colour: White
Suitable for the Poem 160×45 furniture range.



Deep

Materials: Porcelain
Colour: White
Works well with the Poem furniture range with a depth of 45 cm.



Skapa 35

Materials: Porcelain
Colour: White
Works well with the Poem, Intro and Bloc furniture ranges with a depth of 35 cm.



Skapa 25

Materials: Porcelain
Colour: White
Works well with the Bloc furniture range with a depth of 25 cm.



Munka

Materials: Mineral composite
Colour: White
Works well with the Poem furniture range with a depth of 35 cm.

Countertop washbasins

Our countertop washbasins make for a beautiful feature in your bathroom. They boost the design and create a more decorative look. Choose colours and styles and add in a mixer for a great overall look.



Discover our
countertop wash-
basins



Myre Stripe Round

Materials: Porcelain

Colour: White



Myre Round

Materials: Porcelain

Colour: White, latte, mocha, anthracite



Myre Rectangular

Materials: Porcelain

Colour: White, latte, mocha, anthracite



Fross Round

Materials: Solid Surface

Colour: White matt, black matt



Fross Rectangular

Materials: Solid Surface

Colour: White matt, black matt



Stora Round

Materials: Sheet metal

Colour: Brushed brass, pencil black

A BEAUTIFUL FEATURE

Our counter top washbasins are available in a wide range of colours and forms, making it easy to create a look that suits your personal style and the design of your bathroom. Choose between rounded or rectangular shapes to create a piece that looks great in your home. The washbasins are also available in different colours, from classic white and soft shades that evoke nature, to more dramatic tones such as pencil black. This gives you the opportunity to create a unique and elegant focal point in the bathroom.

For more detailed information on our counter top washbasins, see page 127.

Worktops

A work top needs to do more than just look good and fit in with the rest of the bathroom. It should also have features that will help it stand the test of time. Dekton offers scratch, stain and UV resistance. Laminate is durable and allows for flexible mixer placement.



Quartz work top

Laminate worktops

Durable laminate work tops. Laminate work tops in sizes 60×45, 80×45, 100×45, 120×45 centre and double, and 160×45 double are reversible, which means you can choose whether to have the mixer hole on the right or left. All other sizes feature the mixer hole on the left. Supplied with an overhang. For free-standing washbasin mixers.



Quartz

Thanks to its grey, sand-coloured background, it creates a warm, inviting atmosphere.

Suitable for use with Poem.



Mica

The discreet dark grey works well with calming, warm browns and dark woods.

Suitable for use with Poem.



Slate

Clean and genuine. A simple colour that is dark and intense. Works best with a matt finish and wood patterns.

Suitable for use with Poem.

Dekton countertops

Dekton is an exceptionally hard, scratch-resistant material that is more resistant to bending than granite. The material is UV-resistant, which makes the surface easy to clean and prevents fading. Choose from Keon, Danae, Laurent, Sirius and Rem. Dekton worktops always feature a mixer hole on the left. The worktops have an overhang. For free-standing washbasin mixers.



Sirius

Has a matt black slate look.

Suitable for use with Epos and Poem.



Keon

Has a grey industrial look.

Suitable for use with Epos and Poem.



Rem

Has a relaxing marble look with a light background and through-coloured edge.

Suitable for use with the Epos range.



Danae

Has a sand-coloured limestone look.

Suitable for use with the Epos range.



Laurent

Has a dark background with gold marbling.

Suitable for use with the Epos range.

For more detailed information on our work tops, see page 128.

Washbasin mixer

While mixers used to just be mixers, today they are so much more – offering everything from water-saving features to design statements.

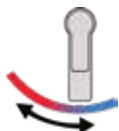

COLD START

Cold start is an energy-saving function that reduces unnecessary hot water use, saving up to 40% of the hot water that would otherwise be used in one year.



FLOW CONTROLLER

All of our mixers are fitted with flow controllers. They are limited to 5–6 L/min, meaning that you save 33–44% of the water you would use with a standard flow.



Discover our washbasin mixers



Bold
Colour: Chrome, black matt



Ejer
Colour: Chrome, brushed brass, pencil black, black matt

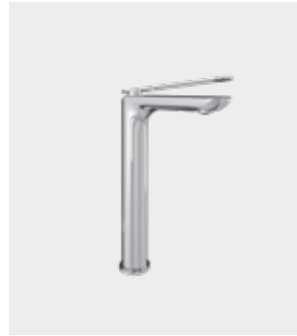

Ejer Independent
Colour: Chrome, brushed brass, pencil black, black matt



Skule knurled
Colour: Chrome, brushed brass, pencil black, black matt



Skule Independent knurled
Colour: Chrome, brushed brass, pencil black, black matt



Skule Smooth
Colour: Chrome, brushed brass, pencil black, black matt



Skule Independent Smooth
Colour: Chrome, brushed brass, pencil black, black matt

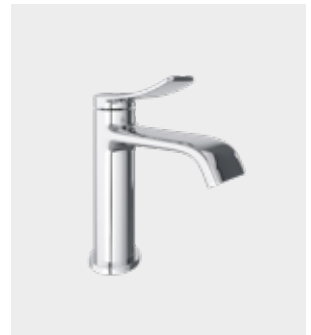

Lodal
Colour: Chrome, pencil black, black matt



Vetle
Colour: Chrome, pencil black, black matt



Halde
Colour: Chrome, brushed brass, pencil black, black matt



Halde Independent
Colour: Chrome, brushed brass, pencil black, black matt



Halde with hand shower
Colour: Chrome, black matt



Free-standing Halde with hand shower
Colour: Chrome, black matt



Tarju
Colour: Chrome, pencil black, black matt



Tron
Colour: Chrome

For more detailed information on our washbasin mixers, see page 130.

Mirrors

Find a mirror that suits the style of your bathroom and also has the functions you need. The right mirror can make a small bathroom look bigger. Use different balances of cool and warm light to create the perfect atmosphere.



Discover our mirrors

Norra

Norra is a mirror that combines the organic shapes of nature with modern design. Inspired by biophilic design, it creates a harmonious and healing atmosphere in your home. With soft curves and natural transitions, Norra challenges traditional shapes and offers a sense of calm and balance. Comes with atmospheric background lighting.

Choose your size

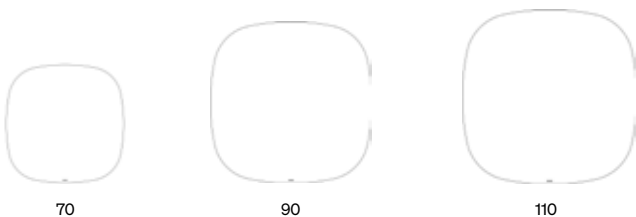

For more detailed information on our mirrors, see page 134.

Ista



Choose your size

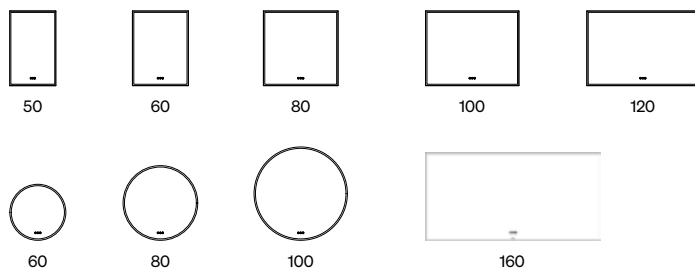

Touch button control

Mirror with functional lighting featuring touch-controlled brightness and colour temperature adjustment. The lighting is dimmable and the light temperature can be adjusted to an optimal level, whether it's for makeup or mood lighting. Available with or without a black frame.

Valje



Choose your size

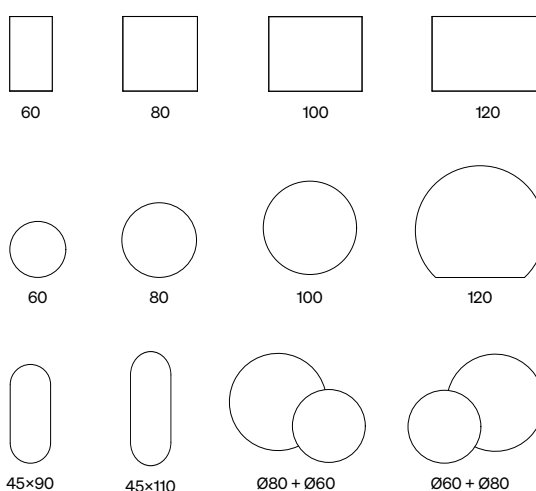

Bringing personality into the room

Mirror with atmospheric background lighting. Choose from a full range of options to find the perfect size and shape for your bathroom, from square or rectangular to round. Add lighting to the rectangular mirrors or a standalone pendant light.



Add lighting to the rectangular mirrors or a standalone pendant light.

Tived



Lighting

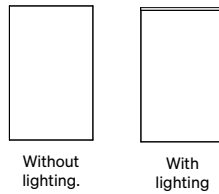

LED lamp

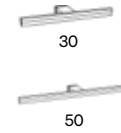

Choose your size

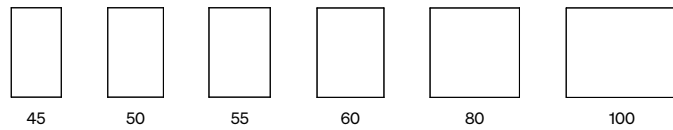

A classic

A classic flat mirror available in three versions and many different widths. Choose a mirror without lighting, with overhead lighting, or with overhead lighting and basin lighting (the light shines down onto the basin). You can also add a shelf and a standalone LED light fixture.



Pendant lighting

One or more pendant lights in a bathroom make for both a beautiful design detail and an extra light source. We have both cylindrical and spherical pendant lights. Compatible with different light sources, choose a spotlight for concentrated lighting or a larger sphere for atmospheric lighting.



Cylinder

Available in black and brass.



Globe

Available in opal or smoky glass.

Mirror cabinets

We could be said to be the inventor of the mirror cabinet. Back in the 1960s, we launched the classic mirror cabinet that still lives on today. Today, the choice is much greater and the details are more sophisticated. The storage solutions are also more carefully designed and have many smart functions.



Skuru mirror cabinet in black ash, Poem vanity unit in black ash, U heated towel rail

For more detailed information on our mirror cabinets and accessories, see page 137.



Discover our mirror cabinets

Skuru

A clean, minimalist style that creates an exclusive atmosphere in your bathroom. This is largely due to the LED lighting, which has a knob for steplessly adjusting the colour temperature and brightness. An electrical socket, basin lighting and a smart magnet for holding small objects such as tweezers are included. Coated using our unique DuraDry method.



White Sand Pure oak White ash Brown ash Black ash



Sarek

A practical bathroom cabinet, only 12 cm deep. Flexible and practical with two moveable glass shelves and an electrical socket in the cabinet ceiling. Energy-efficient LED lighting included, with the option of adding basin lighting. Coated using our unique DuraDry method.



White Sand Pure oak Brown ash Black ash



Bloc

A practical bathroom cabinet, only 12 cm deep. Flexible and practical with two moveable glass shelves and an electrical socket in the cabinet ceiling. Energy-efficient LED lighting included, with the option of adding basin lighting.



White Grey



Intro

Hard-wearing mirror cabinet made of galvanised sheet metal, a material originally designed for the automotive industry. Our unique EnduraDry coating with an environmentally friendly zinc-iron alloy provides excellent protection against rust.



White Graphite grey Sand Sage



Our classics



Dalby
Wooden bathroom cabinet
Solid mirror doors



A60
Wooden bathroom cabinet
Sliding doors in reflective glass



A65
Wooden bathroom cabinet
Sliding doors in reflective glass



Eagle
Metal cabinet
Solid mirror doors



Birdie
Metal cabinet
Left- or right-hinged



Ultima
Metal cabinet
Sliding doors in reflective glass



NY50
Metal cabinet
Door with reflective glass



Twin metal
Metal cabinet
Sliding doors in reflective glass



Medicine cabinet
Left- or right-hinged
Child-proof, two keys

Storage

Modern design with a focus on function and smart solutions. Create an organised bathroom in which every detail has been carefully considered. Everyone's talking about keeping things organised. It sounds easy but it's more tricky in practice. A good starting point is having the right storage solutions. And now they're available. More than ever before. And in a colour and finish to complement your bathroom.



GLASS SHELVES

Glass shelves in your cabinet add a luxurious touch. They're also practical, giving you a better view of the contents.

OPEN STORAGE

Our tall storage units can easily be supplemented with open side storage to increase their total width.

LIGHTING IN CABINET

Having lighting in your cabinet is both welcoming and practical. Practical because it makes your things easier to find.

CHARGING STATION

Once you've had a charging station in your bathroom unit, you'll never look back. For your mobile phone, shaver or hair curler.

FLOOR LIGHT

Lighting both inside and under the cabinets is practical and looks attractive and cosy.



Discover all our storage

Colours

With six standard colours and three optional colours, it's easy to find your favourite. Our optional colours can only be chosen for the Flat front.

Standard colours



White



Sand



Pure oak



White ash



Brown ash



Black ash

Optional colours

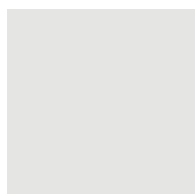

Oat



Granite

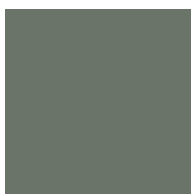

Sage

For more detailed information on our storage, see page 145.

Doors

Seven doors to create different feels for different bathrooms. Choose between wooden and glass doors. Find the right style for you by choosing between a push open system or handles.



Flat

A flat door for a stylish look. Available in standard and optional colours.

Edging

Discretely integrated and functional grip edging for a minimalist look. Available in standard colours, with the exception of white ash.

Glass cabinet matt aluminium

Display door with matt aluminium profile. Available with clear glass, smoked glass and line glass.

Glass cabinet black matt

Glass door with black matt profile. Available with clear glass, smoked glass and line glass.

Choices



Wall cabinet

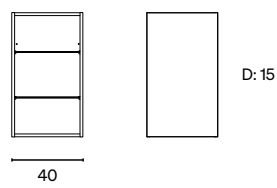
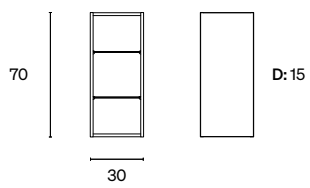

Tall cabinet

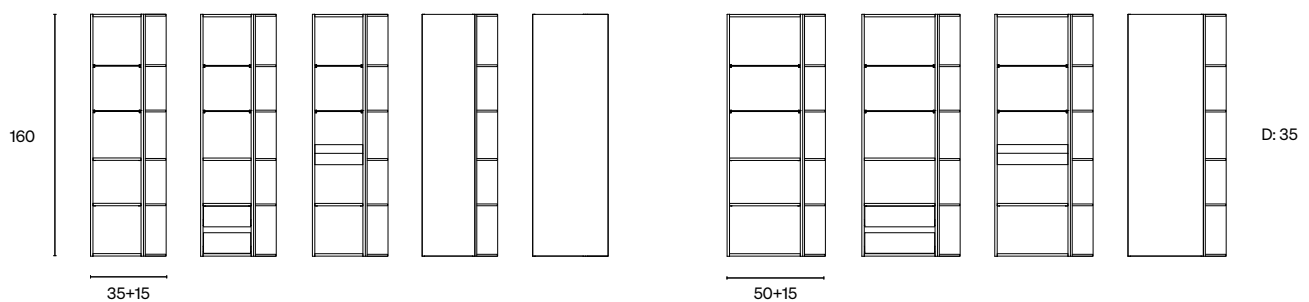
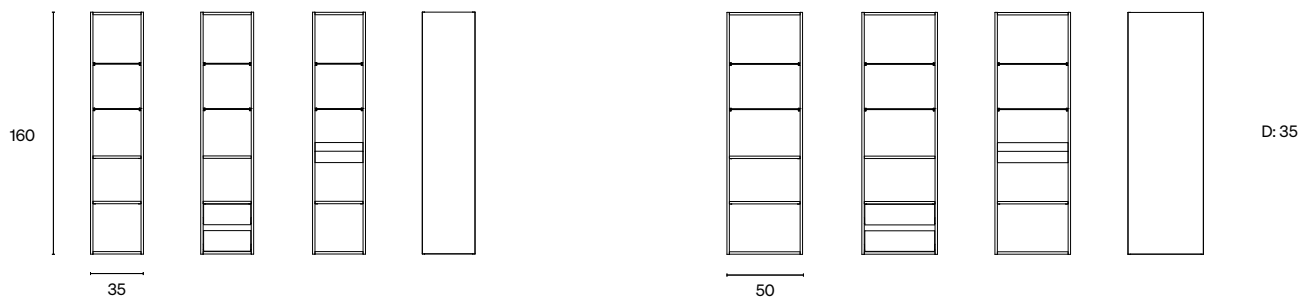
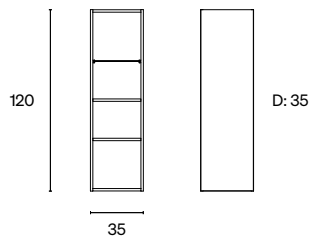

Washers and dryers

A space for creating order in your day-to-day, with smart functions to make daily life easier. Our range offers all kinds of combination options, smart solutions and inserts. Create a personal feel and overall concept with colour matching using our furniture ranges.



Counter top cabinet 72 × 60 cm, Tall cabinet 122 × 60 cm in oat,
Work top white



Discover our
Wash and dry
range

LAUNDRY BASKET

A practical laundry basket that fits perfectly in a laundry cupboard. The baskets come in three sizes – 40, 50 and 60 cm – and are easy to remove from the cabinet and take to the washing machine.

FITTINGS FOR CLEANING CABINETS

Smart extras for our tall cabinets. Available in chrome with the following measurements W: 34 H: 85 D: 13.

ELECTRICAL BOX

Electrical box with three electrical sockets for tall cabinets. A smart accessory certain to come in useful. Available in white.

DECOR PANELS

Decor panels for matching framing of white goods and cabinets. Available in white, sand, pure oak, brown ash and black ash.

LIGHTING

Lighting in the cabinet provides a clear and even light, making it easy to organise your possessions.

For more detailed
information on Wash
and dry, see page 147.

Colours

You can choose between five standard colours and three optional colours. This makes it easy to choose the perfect colour for you and to match your bathroom.

Standard colours



White



Sand



Pure oak



Brown ash



Black ash

Optional colours

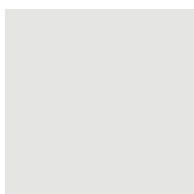

Oat



Granite

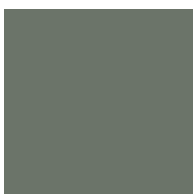

Sage

QUALITY

Real wood veneer. Duradry coating process for extra durability. Manufactured in Sweden. Durable work tops.

Work tops

Choose between seven laminate work tops.

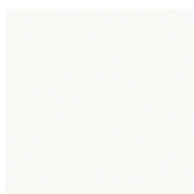

White



Grey

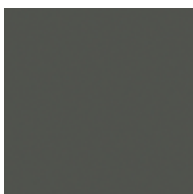

Dark grey



Black



Quartz



Mica

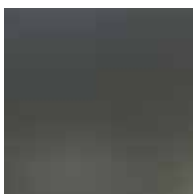

Slate

FLEXIBILITY

A wide variety of combinations are available to create your personal layout. Made-to-measure work tops.

Choices

Wall cabinet



Tall cabinet



Console



Wall cabinet

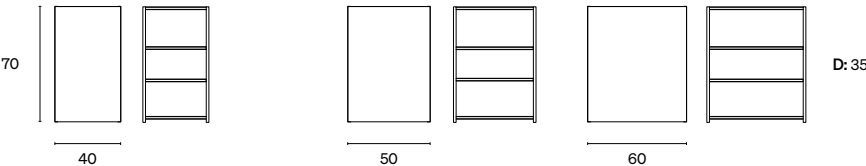

Console

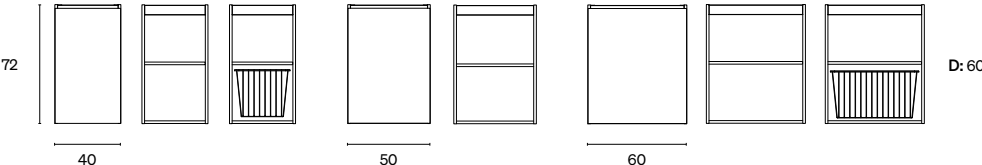

Tall cabinet

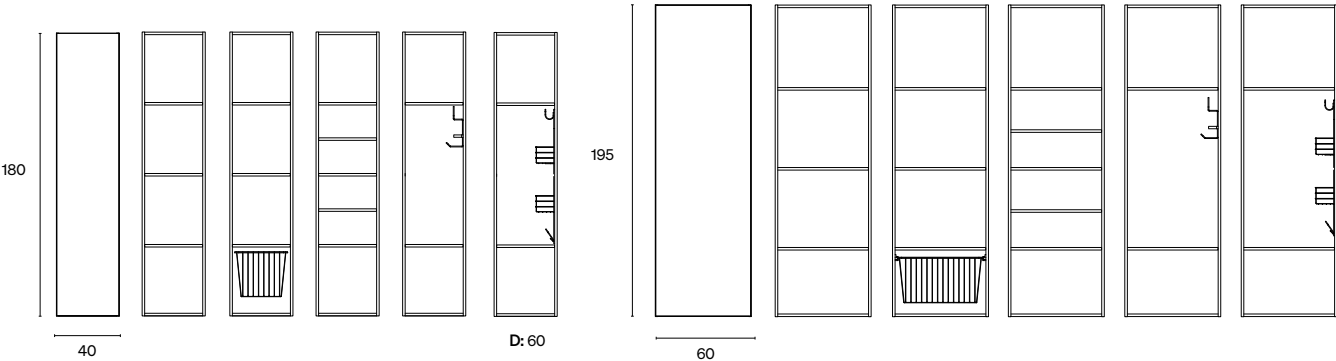
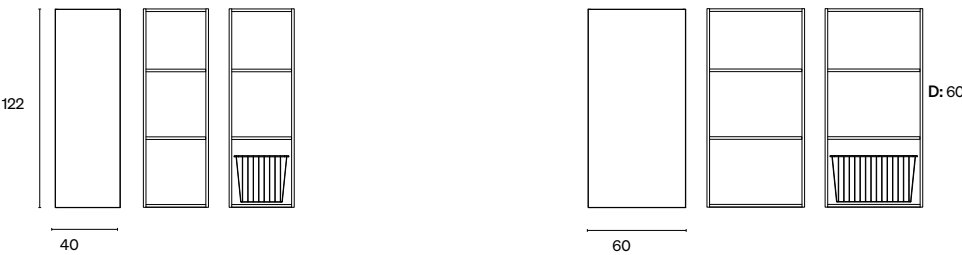

Handles

There are different ways to look at a handle. Perhaps the most common is to see it as a useful device for opening a door, drawer or cabinet. We see it as a key detail that provides real character for your bathroom.



Discover our handles



S5
Colour: Chrome, black matt,
brass



S5
Colour: Chrome, black matt,
brass



M1
Colour: Black matt, pencil
black

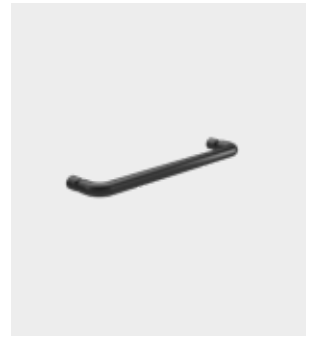

M1
Colour: Black matt, pencil
black



M3
Colour: Stainless, black matt



M3
Colour: Stainless, black matt



E1
Colour: Chrome



T1
Colour: Polished, black matt



L1
Colour: Chrome, black matt,
brass

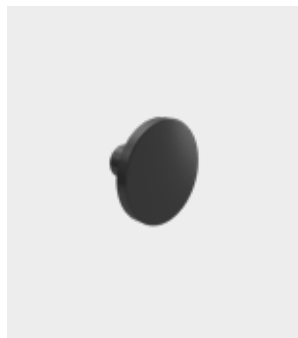

P1
Colour: Chrome, pencil
black, black matt, brushed
brass



S4
Colour: Stainless, white



S4
Colour: Stainless, white



B1
Colour: Chrome



P2
Colour: Chrome

For more detailed
information on our
handles, see page 149.

Langfoss

A pared-back, graphic design look with billowy textiles to soften the look. A shower that envelops your whole body. Thin profiles create a clean, minimalist look. This wave-shaped textile adds a spectacular element to any bathroom. The combination creates a luxurious, cosy experience. Langfoss creates a feeling of exclusivity. The innovative approach focuses on design, space and details. It was inspired by one of Norway's highest waterfalls.

INTEGRATED HANDLE

For Langfoss, we picked a unique handle solution. A milled hole in the glass, paired with an attractive aluminium profile. For a stylish design.

SHOWER HEIGHT

Langfoss is our most exclusive shower set. The shower height of 230 cm creates a spacious hotel look with a hint of luxury.

SHELF

A minimalist display shelf fitted directly onto the glass. The shelf has been designed with the same aesthetics as the shower profiles. Available as accessories.

Glass

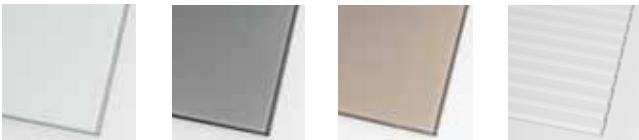

Crystal glass

Smoked glass

Bronze glass

Line glass

Colour profile

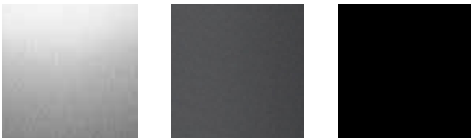

Matt aluminium

Pencil black

Black matt

Textile



Off white

Granite grey

Ash grey

Corner shower

The Langfoss corner shower is available in several possible combinations, each as stylish as the next.



Shower screens

The Langfoss shower screen has profiles and details that create a graphic, minimalist look.



Red Dot Winner 2021

The Red Dot Design Awards are one of the world's most prominent design competitions. Design and product awards are presented for pieces that stand out in terms of innovation, quality and aesthetics.

DESIGN FOR THE DESIGN CONSCIOUS

Langfoss combines elegant design with smart functions, creating a luxurious and exclusive feel. This unique textile provides a sense of elegance. The glass walls are available in a number of finishes, bringing a sophisticated and personal touch to your bathroom. Each detail in the design has been carefully considered, such as the integrated shelves that allow for simple yet stylish storage.

Langfoss is not just visually impressive, it is also sustainable. The range features 6 mm toughened safety glass and is manufactured in Sweden from 100% recyclable materials (including environmentally certified textiles)

For more detailed information on Langfoss, see page 150.



Discover the whole Langfoss range

180°

Large glass panels give an open, exclusive look. Designed for those who value an aesthetic, stylish look. 180° spans everything from standard options to customised special design solutions. We have a solution for everything. For example, you can choose between Bronze or Smoked Glass for a more inviting and exclusive feel. Complement your choices with coloured fittings that either blend in or create stunning contrasts.

TOUGHENED SAFETY GLASS
8 mm toughened safety glass. CE marked. Made in Sweden.

BRONZE GLASS
Bronze glass gives an exclusive spa feel and gives the softest look of all our dark glasses.

HINGES THAT FINISH THE DOOR CLOSING AUTOMATICALLY
Hinges that finish the door closing automatically for an exclusive shower experience.

Colour profile



Matt aluminium



Pencil black



Black matt

Glass



Crystal glass



Smoked glass



Bronze glass



Industrial decor



Special shower

Each home is unique, with its own dimensions, angles and spaces. If you can't find the perfect shower for your space, we can customise the measurements to your requirements and preferences.

Our tailored solutions will ensure you have a shower that does more than just match your bathroom – it will also maximise functionality and harmony in the space. We give extra thought to each detail, so that you can create a shower environment that feels both personal and well considered.



Discover the whole 180° range

For more detailed information on 180°, see page 156.



180° corner shower with pencil black profile and bronze glass,
Yding overhead shower set, Front shower shelf in polished
pencil black, U electric heated towel rail in pencil black

Corner shower

There's a lot to be said for the corner showers in our 180° collection. Maybe the smartest thing of all is that the doors can be folded inwards when the shower is not in use to free up floor space. What's more, the doors finish closing automatically. And that's before even mentioning the corner showers' attractive design.



Shower screens

Our 180° shower collection offers a variety of beautiful and practical shower screens. Which type suits your bathroom best? A solid screen, a screen with a door or a screen for combining with a bath? All three solutions are practical and enhance the design of your bathroom.



Alcove, single and double

If you've already got three walls and want to build an alcove shower, we've got various solutions: single, double and double combination. The large glass panels create a light and airy look and are easy to clean. The handles, hinges, rod and floor mounting enhance the overall look.





Front storage concept

A storage concept running from one surface to the next, keeping your products right where you need them. A horizontal design that ties together different functions into one cohesive whole. A practical storage shelf made of waterproof aluminium, for positioning inside or outside the shower space. Choose from different front options made of wood or metal to match your shower, bath or furniture.

PRACTICAL DESIGN

Available in widths of 70 and 80 cm, this solution is designed to grow practically and be adaptable to the different zones of a bathroom.

Compatible with the Langfoss, Skoga and 180° ranges, offering a harmonious look and simple installation, whereby it can also be glued in place for clean, subtle installation. The four elegant hooks on the underside add to both the aesthetics and functionality, ensuring each detail is well thought out.

For more options for shower area storage, see page 97.



Skoga

It is named after Iceland's largest waterfall and inspired by its natural beauty, power and possibilities. Skoga is characterised by functionality, with a design that is easy to love.

TOUGHENED SAFETY GLASS 6 MM

The various Skoga shower options come with 6 mm toughened safety glass that is CE marked.

RING HANDLE

The various Skoga shower options come with grip holes as standard. The grip holes match the shower profiles.



HANDLES

Skoga handles offer an elegant, airy design with a contemporary look. For those looking for a more ergonomic grip.



Colour profile



Polished aluminium



Matt aluminium

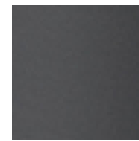

Pencil black



Black matt

Glass



Clear glass



Frosted glass



Semi-frosted



Smoked glass

For all bathrooms

Design, flexibility and now storage, too, are key. The result? Now there's a Skoga for every bathroom. Whether your bathroom is large, small or has an unusual shape.



Discover the whole Skoga range.

Corner shower, round

The soft, flowing design creates calm and harmony. The half-frosted glass panel screens the user from view, but other options are available too. The hinges make the doors easier to open and close, and the seal sits tightly against the floor. The profiles allow for pipe installation.



Corner shower, straight

The design has a stringent, almost graphic feel. The smart lifting hinges make the doors easier to open and close, and the seal sits tightly against the floor to prevent splashing. The doors can be folded inwards to save space when the shower is not in use. The profiles are slim and allow for pipe installation.



Shower screen

Skoga shower screens are available in many versions, but they all convey the same basic style. The hinges make the door easy to open and close and the seal sits tightly against the floor. A rod can be used to transform a moving door into a fixed door. Although the profiles are slim, they still allow for pipe installation.



Alcove, single or double

A shower experience starts long before you turn on the taps, and does not stop until long after the shower is over. With its attractive design, Skoga transforms your alcove shower into a beautiful bathroom feature. And the practical details maximise floor space and minimise splashing.



Folding screen shower

Our folding screen showers are designed to fit all bathrooms and take up as little space as possible. As their name suggests, these showers fold away when not in use. Choose between different models and designs to find the perfect solution for your bathroom.



Skoga storage

Storage with room for everything you need. What really sets it apart is the outwardly slimline look with semi-hidden, generous shelves with practical rails inside. Perfect for everything you need for a shower. A total of five large shelves can be found inside the shower profile, along with a practical hook on the outside for dressing gowns and/or towels. Colours matched with the other details in your bathroom.

For more detailed information on Skoga, see page 164.

Ritual

A closer, more enveloping shower experience. A new ritual to love. Ritual is a complete, practical shower enclosure suitable for bathrooms big and small. The shower enclosure takes up relatively little space, is equipped with safety glass, and boasts generous opening dimensions.

A COMPLETE SOLUTION
Ritual is a complete solution with mixer.

TOUGHENED SAFETY GLASS
The Ritual shower enclosure comes with 4 mm toughened safety glass.



Discover the whole Ritual range

For more detailed information on Ritual, see page 182.

Baths

A natural centre point in the bathroom and something to rest your eyes on. A symbol of inspiration – a wonderful moment of relaxation or revitalisation.

LUCITE

Lucite is our most exclusive material solution, perfect for those who are particularly design conscious. Thanks to its shapeability, Lucite can be adapted to almost any design, making it easy to put your own personal mark on your bathroom. The material meets the requirements of the most stringent environmental certification, CAL65, and is also 100% recyclable – a sustainable premium choice. The high quality surface is both durable and elegant, intended to be combined with sophisticated bathroom design.

ACRYLIC

Acrylic is a popular and functional alternative, combining comfort and durability. It offers a warm, soft and smooth surface, making your bathing experience even more luxurious. Thanks to its low moisture absorption, acrylic is easy to keep clean, and its shapeability allows it to be used to create different styles, with something to suit almost every bathroom. A reliable and affordable option that offers a variety of design options.

ENAMEL

Enamel is a classic natural material that not only offers a timeless aesthetic, but is also known for its extreme durability. Many iconic baths in film and culture have been made of enamel, giving the material an enduring appeal. The robustness of the enamel ensures that the bathtub can withstand scratches and wear, making it the perfect option for those looking for a bath that will last for generations.



Discover our
baths

QUALITY, DESIGN AND FUNCTION.

Free-standing or corner position. We have baths in Lucite, acrylic and enamel. Elements all our baths have in common are excellent quality and finish and the perfect balance of form and function.



Auren bath in white, Front wall shelf in white ash,
Spika bath mixer set.

Independent

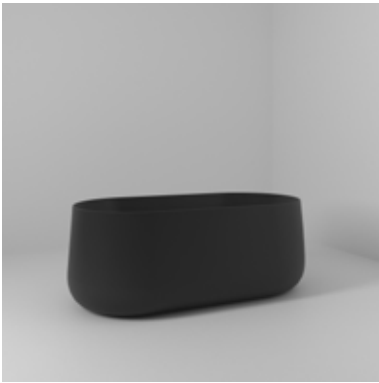

Auren

Auren is an uncompromisingly modern, matt bath placing high priority on design. Thin edges angled gently inwards give a slimlined and modern look.

Materials: Lucite

Colour: White matt, black matt



Ume

Ume offers a bathing depth of 45 cm and a round and ergonomic design that makes it a pleasure to sit in. Supplied complete with drain connection. Add a wall-mounted mixer.

Materials: Lucite

Colour: White



Vaulen

Vaulen has a timeless, sober design that works excellently with most settings. Free-standing, inviting design for a warm, soft bathing experience.

Materials: Lucite

Colour: White matt



Mossby

Contemporary design with the option for storage gives Mossby its unique nature. Corner baths with refined practical surfaces and well-proportioned sizes.

Materials: Lucite

Colour: White matt



Skagen

Skagen is an oval bath with soft, classic shapes. Free-standing baths with curved contours for an ergonomic and generous bathing depth.

Materials: Lucite

Colour: White matt

EASYCLEAN

Our Lucite baths include our practical EasyClean drain connection for simple cleaning. Available in colours to match the finish of the bath.

DRAIN CONNECTION

The drain connection and bottom valve are always included in our baths.

Corner baths



Lule

Form and function all in one bath.

Round and ergonomic. Made of Lucite, which is stronger than acrylic and has a more luxurious surface. Add a mixer for wall or rim mounting.

Materials: Lucite
Colour: White



Ihre

Ihre combines an angular look with rounded elements, creating a perfectly cohesive finished look. Corner baths with a soft interior and pared-back exterior, as well as a functional and space-saving rounded corner.

Materials: Lucite
Colour: White



Torne

Practical baths with plenty of shower space. Perfect if you have a small bathroom and want to take baths as well as showers. Available for right-hand or left-hand installation.

Materials: Acrylic
Colour: White



Kalix

An attractive, simple bath that is ideal for one person. The soft, rounded lines look great and provide exceptional comfort.

Materials: Acrylic
Colour: White



Enamel bathtub

An enamel bath made of enamelled pressed sheet metal. Add an additional front to create a solid front piece. Available in several sizes and also as a sit-up bath.

Material: Enamel
Colour: White, black, graphite grey, sand, sage

For more detailed information on our baths, see page 183.

Shower and bath mixers

Specially developed and adapted shower and bath mixers that go perfectly with the rest of our range. Design and function are key. The finish of our shower and bath mixers ties in with other parts of our range, such as fittings, handles and washbasin mixers, to create a unified look for your bathroom.



Stuur overhead shower set in black matt, 180°
alcove double shower with black matt profile and
clear glass, Front wall shelf in brown ash



Discover our
mixers



Stuur overhead shower set
Colour: Chrome, pencil black, black matt



Yding overhead shower set
Colour: Chrome, pencil black, black matt



Spika shower mixer set
Colour: Chrome, pencil black, black matt

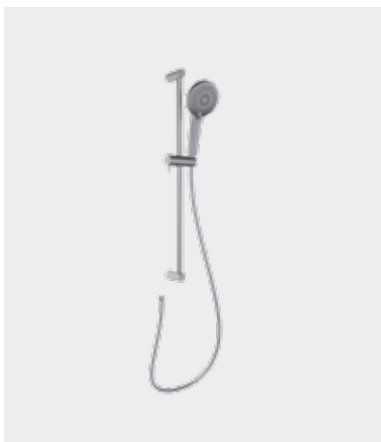

Spika shower set
Colour: Chrome, pencil black, black matt



Spika shower set for baths
Colour: Chrome, pencil black, black matt



Spika thermostatic mixer
Colour: Chrome, pencil black, black matt



Spika bath mixer set
Colour: Chrome, pencil black, black matt



Spika bath mixer
Colour: Chrome, pencil black, black matt

For more detailed information on our shower and bath mixers, see page 187.

Heated towel rails

Wrap your body in a lovely warm bath towel after every shower or bath. We have a large selection of stylishly designed centrally heated towel rails and electric heated towel rails. Choose a towel rail that matches your bathroom and heating system.

ECO MODE

Some of our electric heated towel rails have an Eco mode, which reduces electricity consumption by 50%.

BOOST

Adjustable one-off timer that turns itself off automatically at the end of the time set. Saves both energy and the environment.

TIMER

Scheduled timer, can be set for periods of 1 to 12 hours. Using the timer can reduce energy consumption by up to 95%.



Magnetic

Magnetic is a heated towel rail that you can adapt to create your own look. Move the magnetic hooks around and choose to add in extras based on your own needs and situation.

TOWEL HANGER

Magnetic comes with a fixed bracket at the top on the front. Chrome or white bracket for white fronts and pencil black or black bracket for black fronts.

KNOB

You will receive two knobs with your Magnetic unit. Chrome or white knobs for white fronts and pencil black or black knobs for black fronts as standard. You can purchase more if you wish.

FRONT

Magnetic offers a thin, clean look that you can configure as you wish. The perfect blank canvas.

TOUCH PANEL

Integrated touch panel flush with the metal panel. Can be used to activate Eco mode and a timer to reduce energy consumption.



Discover our heated towel rails



Magnetic electric heated towel rail
 Materials: Stainless steel
 Front panel colour: White, black
 Heated towel rail colour: White, chrome, pencil black, black



U electric heated towel rail
 Materials: Stainless steel
 Colour: Polished, pencil black, black matt

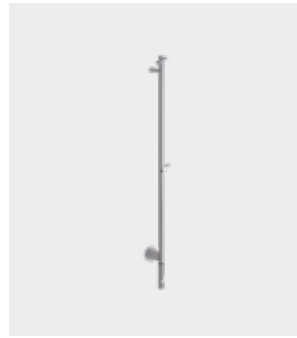

Amor electric heated towel rail
 Materials: Stainless steel
 Colour: Polished, pencil black, black matt

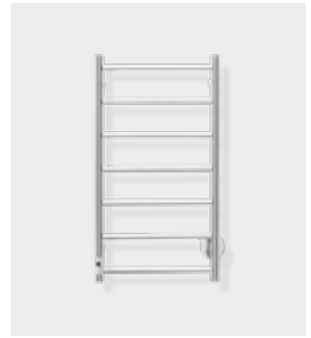

Diana electric heated towel rail
 Materials: Stainless steel
 Colour: Polished, black matt



Loki electric heated towel rail
 Material: Stainless steel
 Colour: Polished



Flora SL electric heated towel rail
 Materials: Stainless steel
 Colour: Polished

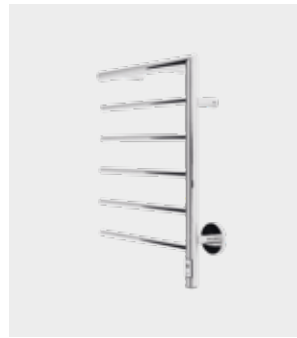

Flora SR electric heated towel rail
 Materials: Stainless steel
 Colour: Polished



Bas heated towel rail
 Materials: Steel
 Central heating
 Colour: Chrome, white matt



Easy heated towel rail
 Materials: Steel
 Central heating
 Colour: Chrome

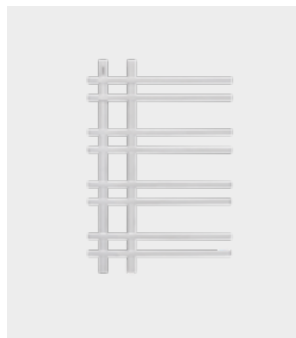

Vento heated towel rail
 Materials: Steel
 Central heating
 Colour: Chrome, black matt

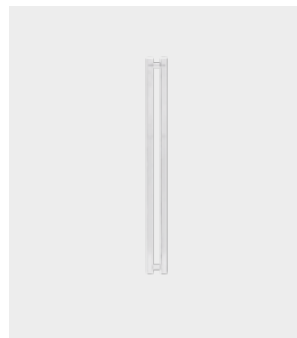

Zaga heated towel rail
 Materials: Steel
 Central heating
 Colour: Chrome, black matt

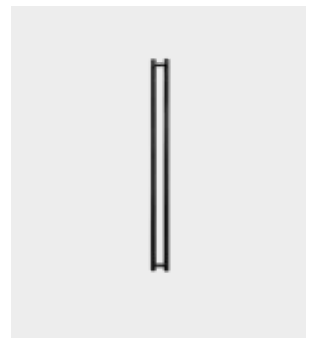

Sigyn heated towel rail
 Materials: Steel
 Central heating
 Colour: Chrome, black matt, white matt

For more detailed information on our heated towel rails, see page 189.

WCs

Svedbergs has been making WCs for decades. Every year we develop and refine the details. Behind the elegantly designed exterior is a combination of modern technology and smart functions that make cleaning easy. Choose between a traditional design or a neat and practical wall-mounted WC.



Alta WC in black, WC flush plate in black



Discover our
WCs

WC

Three ways to buy your WC.



1. Classic WC

Practical WC, model 9085. Comfortable seat height. Easy to clean and removable seat for cleaning.

Colour: White



2. Glass box with WC

WC fixture with glass box. Visible wall mounting. Add a WC bowl (Alta 9072 rimless or Lossen 9071 rimless).

Colour: White, black



3. Built-in WC

WC module. Mounting concealed behind wall. Add a WC bowl (Alta 9072 rimless or Lossen 9071 rimless) and a flush plate.

Flush plate colour: Matt chrome, chrome, black

Choose your wall-mounted WC



WC Lossen

Integrated, light, removable hard seat with soft-close function.

Colour: White



WC Alta

Integrated, light, removable hard seat with soft-close function.

Colour: White, black

For more detailed information on our WCs, see page 193.

Accessories

Your bathroom is nearly ready. Now you just need to choose the accessories. Stylishly designed details such as towel or robe hangers lift the design of your whole bathroom.



Discover our accessories

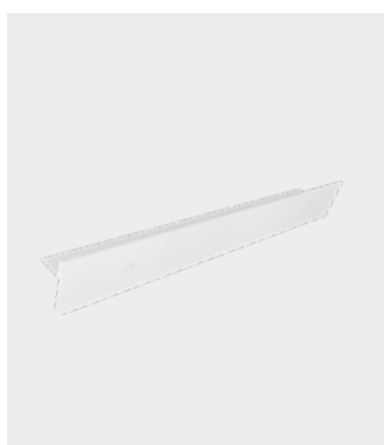

Front shower shelf

Aluminium shelf for placement in or outside the shower.

Colour: Matt aluminium, polished pencil black, black matt, white matt



Front wall shelf

Aluminium shelf with wooden front panel. Intended for use in dry spaces.

Colour: White, sand, pure oak, white ash, brown ash, black ash



Wall shelf

Aluminium shelf for placement in or outside the shower.

Colour: Matt aluminium, polished pencil black, black matt, white matt



1 hook
Colour: Chrome, black matt



2 hooks
Colour: Chrome, black matt



4 hooks
Colour: Chrome, black matt



Toilet roll holder
Colour: Chrome, black matt

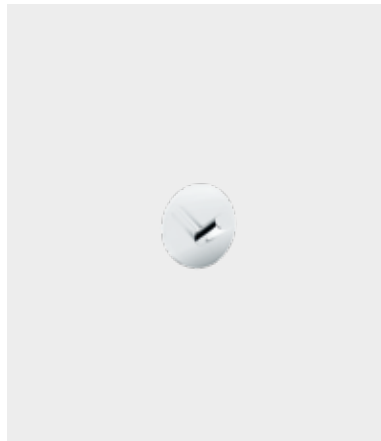

1 hook
Colour: Chrome



2 hooks
Colour: Chrome



4 hooks
Colour: Chrome



Toilet roll holder
Colour: Chrome

For more detailed information on our accessories, see page 194.

Mirror cabinets

We could be said to be the inventor of the mirror cabinet. Back in the 1960s, we launched the classic mirror cabinet that still lives on today. Today, the choice is much greater and the details are more sophisticated. The storage solutions are also more carefully designed and have many smart functions.

For more detailed information on our mirror cabinets and accessories, see page 137.



Discover our mirror cabinets

Product and Purchasing Guide

Furniture collections		Showers	
Epos	100	Langfoss	150
Poem	111	180°	156
Bloc	123	Skoga	164
Intro	124	Shower enclosure Ritual	182
Recessed washbasins	125	Baths	183
Counter top washbasins	127	Shower and bath mixers	187
Work tops	128	Heated towel rails	189
Washbasin mixers	130	WCs	193
Mirrors	134	Accessories	194
Mirror cabinets	137		
Storage	145		
Washers & Dryers	147		
Handles	149		

Epos 60

1. Choose a vanity unit

W: 60 H: 45 D: 45	Incl. 2 drawers 	Incl. one drawer and one open shelf. 
-------------------------	--	---

Front	Order no.	Order no.
White		
Flat	150620	150610
Flat Push open	150620-P	150610-P
Relief	150621	150611
White ash		
Flat	160620	160610
Flat Push open	160620-P	160610-P
Relief	160621	160611
Brown ash		
Flat	170620	170610
Flat Push open	170620-P	170610-P
Relief	170621	170611
Stripe	170622	170612
Stripe Push open	170622-P	170612-P
Black ash		
Flat	140620	140610
Flat Push open	140620-P	140610-P
Relief	140621	140611
Stripe	140622	140612
Stripe Push open	140622-P	140612-P

Washbasin mixer

Go to page 130 to see our washbasin mixers, traps and bottom valves.

Selected colours

Choose from Flat and Flat push open fronts. Add -COL after the item number. The extra charge amount is based on white furniture.

2A. Choose a washbasin



Ise 60
Mineral composite
W:61 H:1,3 D:46

Colour	Order no.
White matt	5060
Ash grey	5061



Floen 60
Porcelain
W:61 H:1,5 D:46

Colour	Order no.
White	5360

2B. Choose a work top

W: 61 H: 1,2 D: 46



Danae
Has a sand-coloured limestone look.

Direction	Order no.
Centre	144063



Keon
Has a grey industrial look.

Direction	Order no.
Centre	130062



Rem
Has a relaxing marble look with a light background and through-coloured edge.

Direction	Order no.
Centre	145063



Sirius
Has a matt black slate look.

Direction	Order no.
Centre	370699

3. Choose accessories

Don't forget to add the finishing touches to your Epos with a range of smart accessories. Want to know more about our accessories? Visit svedbergs.com.

Metal drawer with wooden front

If you choose an Epos with an open lower drawer, you can select a metal drawer in the same colour as your furniture. (The colours white and white ash come with a white metal drawer. All other colours come with a black metal drawer.)

Metal drawer for Epos 60 with open shelf.

B:57 H:10 D:30

Front	Colour	Order no.
Flat	White	5761
Flat	White ash	5763
Flat	Brown ash	5764
Flat	Black ash	5768
Stripe	Brown ash	5766
Stripe	Black ash	5769

More accessories

Choose from a wide range of accessories for Epos.

Options	Order no.
Lower drawer inserts	5950
Electrical socket	1212

Choose lighting

Lighting for Epos 60 with 2 drawers:
Start with a driver kit (1) and choose one upper drawer lighting solution (3), one lower drawer lighting solution (4) and one floor light (2).

Lighting for Epos 60 with 1 drawer:
Start with one driver kit (1) and choose one upper drawer lighting solution (3) and two floor lights (2) for lighting in your open shelf and under the vanity unit.

If the lighting is connected to the mains supply in your bathroom, use the wall switch to turn your vanity unit light on and off.

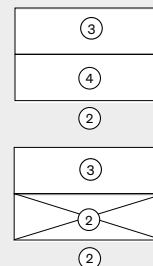

Options	Order no.
① Driver kit lighting	5991
② Lighting open shelf / floor light	5992
③ Top drawer lighting	5993
④ Lighting lower drawer/ 40 cm drawer closed	5994

Epos 80

1. Choose a vanity unit

Front	Order no.	Order no.
White		
Flat	150820	150810
Flat Push open	150820-P	150810-P
Relief	150821	150811
White ash		
Flat	160820	160810
Flat Push open	160820-P	160810-P
Relief	160821	160811
Brown ash		
Flat	170820	170810
Flat Push open	170820-P	170810-P
Relief	170821	170811
Stripe	170822	170812
Stripe Push open	170822-P	170812-P
Black ash		
Flat	140820	140810
Flat Push open	140820-P	140810-P
Relief	140821	140811
Stripe	140822	140812
Stripe Push open	140822-P	140812-P

Washbasin mixer

Go to page 130 to see our washbasin mixers, traps and bottom valves.

Selected colours

Choose from Flat and Flat push open fronts. Add -COL after the item number. The extra charge amount is based on white furniture.

2B. Choose a washbasin



Ise 80
Mineral composite
W:81 H:1,3 D:46

Colour	Order no.
White matt	5080
Ash grey	5180



Floen 80
Porcelain
W:81 H:1,5 D:46

Colour	Order no.
White	5380

2B. Choose a work top

W: 81 H: 1,2 D: 46



Danae
Has a sand-coloured limestone look.

Direction	Order no.
Centre	144083



Keon
Has a grey industrial look.

Direction	Order no.
Centre	130082



Rem
Has a relaxing marble look with a light background and through-coloured edge.

Direction	Order no.
Centre	145083



Sirius
Has a matt black slate look.

Direction	Order no.
Centre	370899

3. Choose accessories

Don't forget to add the finishing touches to your Epos with a range of smart accessories. Want to know more about our accessories? Visit svedbergs.com.

Metal drawer with wooden front

If you choose an Epos with an open lower drawer, you can select a metal drawer in the same colour as your furniture. (The colours white and white ash come with a white metal drawer. All other colours come with a black metal drawer.)

Metal drawer for Epos 80-200 with open shelf.
B:77 H:10 D:30

Front	Colour	Order no.
Flat	White	5781
Flat	White ash	5783
Flat	Brown ash	5784
Flat	Black ash	5788
Stripe	Brown ash	5786
Stripe	Black ash	5789

More accessories

Choose from a wide range of accessories for Epos.

Options	Order no.
Lower drawer inserts	5950
Electrical socket	1212

Choose lighting

Lighting for Epos 80 with 2 drawers:
Start with a driver kit (1) and choose one upper drawer lighting solution (3), one lower drawer lighting solution (4) and one floor light (2).

Lighting for Epos 80 with 1 drawer:
Start with one driver kit (1) and choose one upper drawer lighting solution (3) and two floor lights (2) for lighting in your open shelf and under the vanity unit.

If the lighting is connected to the mains supply in your bathroom, use the wall switch to turn your vanity unit light on and off.

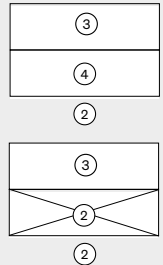

Options	Order no.
① Driver kit lighting	5991
② Lighting open shelf / floor light	5992
③ Top drawer lighting	5993
④ Lighting lower drawer/ 40 cm drawer closed	5994



Laurent
Has a dark background with gold marbling.

Direction	Order no.
Centre	143083

Counter tops come with overhang.
Dekton work tops always come with a mixer hole on the left.

Epos 100 Right

W: 100
H: 45
D: 45

Incl. two drawers. Open side shelf on the left.



Incl. one drawer and one open shelf. Open side shelf on the left.



1. Choose a vanity unit

Front	Order no.	Order no.
White		
Flat	151020H	151010H
Flat Push open	151020H-P	151010H-P
Relief	151021H	151011H
White ash		
Flat	161020H	161010H
Flat Push open	161020H-P	161010H-P
Relief	161021H	161011H
Brown ash		
Flat	171020H	171010H
Flat Push open	171020H-P	171010H-P
Relief	171021H	171011H
Stripe	171022H	171012H
Stripe Push open	171022H-P	171012H-P
Black ash		
Flat	141020H	141010H
Flat Push open	141020H-P	141010H-P
Relief	141021H	141011H
Stripe	141022H	141012H
Stripe Push open	141022H-P	141012H-P

Washbasin mixer

Go to page 130 to see our washbasin mixers, traps and bottom valves.

Selected colours

Choose from Flat and Flat push open fronts. Add -COL after the item number. The extra charge amount is based on white furniture.

2A. Choose a washbasin



Ise 100 Right
Mineral composite
W:101 H:1,3 D:46

Colour	Order no.
White matt	5100-H
Ash grey	5101-H



2B. Choose a work top

W: 101 H: 1,2 D: 46



Danae
Has a sand-coloured limestone look.

Direction	Order no.
Right	144101



Keon
Has a grey industrial look.

Direction	Order no.
Right	141101



Rem
Has a relaxing marble look with a light background and through-coloured edge.

Direction	Order no.
Right	145101



Sirius
Has a matt black slate look.

Direction	Order no.
Right	146101

3. Choose accessories

Don't forget to add the finishing touches to your Epos with a range of smart accessories. Want to know more about our accessories? Visit svedbergs.com.

Metal drawer with wooden front

If you choose an Epos with an open lower drawer, you can select a metal drawer in the same colour as your furniture. (The colours white and white ash come with a white metal drawer. All other colours come with a black metal drawer.)

Metal drawer for Epos 80-200 with open shelf.
B:77 H:10 D:30

Front	Colour	Order no.
Flat	White	5781
Flat	White ash	5783
Flat	Brown ash	5784
Flat	Black ash	5788
Stripe	Brown ash	5786
Stripe	Black ash	5789

More accessories

Choose from a wide range of accessories for Epos.

Options	Order no.
Lower drawer inserts	5950
Electrical socket	1212

Choose lighting

Lighting for Epos 100 with 2 drawers:

Start with a driver kit (1) and choose one upper drawer lighting solution (3), one lower drawer lighting solution (4) and one floor light (2).

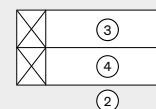

Lighting for Epos 100 with 1 drawer:

Start with one driver kit (1) and choose one upper drawer lighting solution (3) and two floor lights (2) for lighting in your open shelf and under the vanity unit.

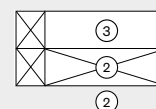

If the lighting is connected to the mains supply in your bathroom, use the wall switch to turn your vanity unit light on and off.

Options	Order no.
① Driver kit lighting	5991
② Lighting open shelf / floor light	5992
③ Top drawer lighting	5993
④ Lighting lower drawer/ 40 cm drawer closed	5994



Laurent
Has a dark background with gold marbling.

Direction	Order no.
Right	143101

Counter tops come with overhang. Dekton work tops always come with a mixer hole on the left.

Epos 100 Left

1. Choose a vanity unit

W: 100 H: 45 D: 45	Incl. two drawers. Open side shelf on the right.	Incl. one drawer and one open shelf. Open side shelf on the right.

Front	Order no.	Order no.
White		
Flat	151020V	151010V
Flat Push open	151020V-P	151010V-P
Relief	151021V	151011V
White ash		
Flat	161020V	161010V
Flat Push open	161020V-P	161010V-P
Relief	161021V	161011V
Brown ash		
Flat	171020V	171010V
Flat Push open	171020V-P	171010V-P
Relief	171021V	171011V
Stripe	171022V	171012V
Stripe Push open	171022V-P	171012V-P
Black ash		
Flat	141020V	141010V
Flat Push open	141020V-P	141010V-P
Relief	141021V	141011V
Stripe	141022V	141012V
Stripe Push open	141022V-P	141012V-P

Washbasin mixer

Go to page 130 to see our washbasin mixers, traps and bottom valves.

Selected colours

Choose from Flat and Flat push open fronts. Add -COL after the item number. The extra charge amount is based on white furniture.

2B. Choose a washbasin



Ise 100, Left
Mineral composite
W:101 H:1,3 D:46

Colour	Order no.
White matt	5100-V
Ash grey	5101-V



2B. Choose a work top

W: 101 H: 1,2 D: 46



Danae
Has a sand-coloured limestone look.

Direction	Order no.
Left	144100



Keon
Has a grey industrial look.

Direction	Order no.
Left	141100



Rem
Has a relaxing marble look with a light background and through-coloured edge.

Direction	Order no.
Left	145100



Sirius
Has a matt black slate look.

Direction	Order no.
Left	146100

3. Choose accessories

Don't forget to add the finishing touches to your Epos with a range of smart accessories. Want to know more about our accessories? Visit svedbergs.com.

Metal drawer with wooden front

If you choose an Epos with an open lower drawer, you can select a metal drawer in the same colour as your furniture. (The colours white and white ash come with a white metal drawer. All other colours come with a black metal drawer.)

Metal drawer for Epos 80-200 with open shelf.
B:77 H:10 D:30

Front	Colour	Order no.
Flat	White	5781
Flat	White ash	5783
Flat	Brown ash	5784
Flat	Black ash	5788
Stripe	Brown ash	5786
Stripe	Black ash	5789

More accessories

Choose from a wide range of accessories for Epos.

Options	Order no.
Lower drawer inserts	5950
Electrical socket	1212

Choose lighting

Lighting for Epos 100 with 2 drawers:

Start with a driver kit (1) and choose one upper drawer lighting solution (3), one lower drawer lighting solution (4) and one floor light (2).

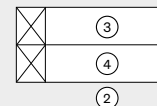

Lighting for Epos 100 with 1 drawer:

Start with one driver kit (1) and choose one upper drawer lighting solution (3) and two floor lights (2) for lighting in your open shelf and under the vanity unit.

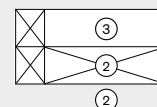

If the lighting is connected to the mains supply in your bathroom, use the wall switch to turn your vanity unit light on and off.

Options	Order no.
① Driver kit lighting	5991
② Lighting open shelf / floor light	5992
③ Top drawer lighting	5993
④ Lighting lower drawer/ 40 cm drawer closed	5994



Laurent
Has a dark background with gold marbling.

Direction	Order no.
Left	143100

Counter tops come with overhang.
Dekton work tops always come with a mixer hole on the left.

Epos 120 Right

W: 120
H: 45
D: 45

Incl. 2+1 drawers. Double electrical socket included in the left 40 drawer.

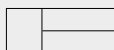

Incl. 1+1 drawers and one open shelf. Double electrical socket included in the left 40 drawer.

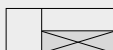

1. Choose a vanity unit

Front	Order no.	Order no.
White		
Flat	1512210H	1512110H
Flat Push open	1512210H-P	1512110H-P
Relief	1512211H	1512111H
White ash		
Flat	1612210H	1612110H
Flat Push open	1612210H-P	1612110H-P
Relief	1612211H	1612111H
Brown ash		
Flat	1712210H	1712110H
Flat Push open	1712210H-P	1712110H-P
Relief	1712211H	1712111H
Stripe	1712212H	1712112H
Stripe Push open	1712212H-P	1712112H-P
Black ash		
Flat	1412210H	1412110H
Flat Push open	1412210H-P	1412110H-P
Relief	1412211H	1412111H
Stripe	1412212H	1412112H
Stripe Push open	1412212H-P	1412112H-P

Washbasin mixer

Go to page 130 to see our washbasin mixers, traps and bottom valves.

Selected colours

Choose from Flat and Flat push open fronts. Add -COL after the item number. The extra charge amount is based on white furniture.

2A. Choose a washbasin



Ise 120 Right
Mineral composite
W:121 H:1,3 D:46



Colour	Order no.
White matt	5120-H
Ash grey	5121-H

2B. Choose a work top

W: 122 H: 1,2 D: 46



Danae
Has a sand-coloured limestone look.

Direction	Order no.
Right	144121



Keon
Has a grey industrial look.

Direction	Order no.
Right	141121



Rem
Has a relaxing marble look with a light background and through-coloured edge.

Direction	Order no.
Right	145121



Sirius
Has a matt black slate look.

Direction	Order no.
Right	146121

3. Choose accessories

Don't forget to add the finishing touches to your Epos with a range of smart accessories. Want to know more about our accessories? Visit svedbergs.com.

Metal drawer with wooden front

If you choose an Epos with an open lower drawer, you can select a metal drawer in the same colour as your furniture. (The colours white and white ash come with a white metal drawer. All other colours come with a black metal drawer.)

Metal drawer for Epos 80-200 with open shelf.
B:77 H:10 D:30

Front	Colour	Order no.
Flat	White	5781
Flat	White ash	5783
Flat	Brown ash	5784
Flat	Black ash	5788
Stripe	Brown ash	5786
Stripe	Black ash	5789

More accessories

Choose from a wide range of accessories for Epos.

Options	Order no.
Lower drawer inserts	5950
Electrical socket	1212

Choose lighting

Lighting for Epos 120 with 2+1 drawers:
Start with a driver kit (1) and choose one upper drawer lighting solution (3), two lower drawer lighting solutions (4) and one floor light (2).

Lighting for Epos 120 with 1+1 drawers:
Start with one driver kit (1) and choose one upper drawer lighting solution (3), one lower drawer lighting solution (4) and two floor lights (2) for lighting in your open shelf and under the vanity unit.

Lighting for Epos 120 with 2+0 drawers:
Start with a driver kit (1) and choose one upper drawer lighting solution (3), one lower drawer lighting solution (4) and one floor light (2).

If the lighting is connected to the mains supply in your bathroom, use the wall switch to turn your vanity unit light on and off.

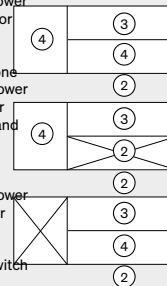

Options	Order no.
① Driver kit lighting	5991
② Lighting open shelf / floor light	5992
③ Top drawer lighting	5993
④ Lighting lower drawer/ 40 cm drawer closed	5994



Laurent
Has a dark background with gold marbling.

Direction	Order no.
Right	143121

Counter tops come with overhang.
Dekton work tops always come with a mixer hole on the left.

Epos 120 Right

W: 120
H: 45
D: 45

Incl. 2+0 drawers and two open shelves. The open 40 shelf is positioned on the left.



1. Choose a vanity unit

Front	Order no.
White	
Flat	1512200H
Flat Push open	1512200H-P
Relief	1512201H
White ash	
Flat	1612200H
Flat Push open	1612200H-P
Relief	1612201H
Brown ash	
Flat	1712200H
Flat Push open	1712200H-P
Relief	1712201H
Stripe	1712202H
Stripe Push open	1712202H-P
Black ash	
Flat	1412200H
Flat Push open	1412200H-P
Relief	1412201H
Stripe	1412202H
Stripe Push open	1412202H-P

Handles and knobs

Don't forget to include handles for your furniture. Read more on page 149.

Sit-on basins

Go to page 127 to see our counter top washbasins and free-standing mixers for the Epos range.

Washbasin mixer

Go to page 130 to see our washbasin mixers, traps and bottom valves.

Selected colours

Choose from Flat and Flat push open fronts. Add -COL after the item number. The extra charge amount is based on white furniture.

3. Choose accessories

Don't forget to add the finishing touches to your Epos with a range of smart accessories. Want to know more about our accessories? Visit svedbergs.com.

Metal drawer with wooden front

If you choose an Epos with an open lower drawer, you can select a metal drawer in the same colour as your furniture. (The colours white and white ash come with a white metal drawer. All other colours come with a black metal drawer.)

Metal drawer for Epos 80-200 with open shelf.
B:77 H:10 D:30

Front	Colour	Order no.
Flat	White	5781
Flat	White ash	5783
Flat	Brown ash	5784
Flat	Black ash	5788
Stripe	Brown ash	5786
Stripe	Black ash	5789

More accessories

Choose from a wide range of accessories for Epos.

Options	Order no.
Lower drawer inserts	5950
Electrical socket	1212

Choose lighting

Lighting for Epos 120 with 2+1 drawers:

Start with a driver kit (1) and choose one upper drawer lighting solution (3), two lower drawer lighting solutions (4) and one floor light (2).

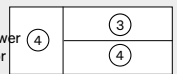

Lighting for Epos 120 with 1+1 drawers:

Start with one driver kit (1) and choose one upper drawer lighting solution (3), one lower drawer lighting solution (4) and two floor lights (2) for lighting in your open shelf and under the vanity unit.

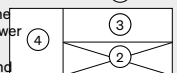

Lighting for Epos 120 with 2+0 drawers:

Start with a driver kit (1) and choose one upper drawer lighting solution (3), one lower drawer lighting solution (4) and one floor light (2).

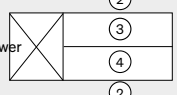

If the lighting is connected to the mains supply in your bathroom, use the wall switch to turn your vanity unit light on and off.

Options	Order no.
① Driver kit lighting	5991
② Lighting open shelf / floor light	5992
③ Top drawer lighting	5993
④ Lighting lower drawer/ 40 cm drawer closed	5994

2B. Choose a washbasin



Ise 120 Right
Mineral composite
W:121 H:1,3 D:46



Colour	Order no.
White matt	5120-H
Ash grey	5121-H

2B. Choose a work top

W: 122 H: 1,2 D: 46



Danae
Has a sand-coloured limestone look.

Direction	Order no.
Right	144121



Keon
Has a grey industrial look.

Direction	Order no.
Right	141121



Laurent
Has a dark background with gold marbling.

Direction	Order no.
Right	143121



Rem
Has a relaxing marble look with a light background and through-coloured edge.

Direction	Order no.
Right	145121



Sirius
Has a matt black slate look.

Direction	Order no.
Right	146121

Counter tops come with overhang.
Dekton work tops always come with a mixer hole on the left.

Epos 120 Left

W: 120 H: 45 D: 45	Incl. 2+1 drawers. Double electrical socket included in the right 40 drawer.	Incl. 1+1 drawers and one open shelf. Double electrical socket included in the right 40 drawer.

1. Choose a vanity unit

Front	Order no.	Order no.
White		
Flat	1512210V	1512110V
Flat Push open	1512210V-P	1512110V-P
Relief	1512211V	1512111V
White ash		
Flat	1612210V	1612110V
Flat Push open	1612210V-P	1612110V-P
Relief	1612211V	1612111V
Brown ash		
Flat	1712210V	1712110V
Flat Push open	1712210V-P	1712110V-P
Relief	1712211V	1712111V
Stripe	1712212V	1712112V
Stripe Push open	1712212V-P	1712112V-P
Black ash		
Flat	1412210V	1412110V
Flat Push open	1412210V-P	1412110V-P
Relief	1412211V	1412111V
Stripe	1412212V	1412112V
Stripe Push open	1412212V-P	1412112V-P

Washbasin mixer

Go to page 130 to see our washbasin mixers, traps and bottom valves.

Selected colours

Choose from Flat and Flat push open fronts. Add -COL after the item number. The extra charge amount is based on white furniture.

2A. Choose a washbasin



Ise 120 Left
Mineral composite
W:121 H:1,3 D:46

Colour	Order no.
White matt	5120-V
Ash grey	5121-V



2B. Choose a work top

W: 122 H: 1,2 D: 46



Danae
Has a sand-coloured limestone look.

Direction	Order no.
Left	144120



Keon
Has a grey industrial look.

Direction	Order no.
Left	141120



Rem
Has a relaxing marble look with a light background and through-coloured edge.

Direction	Order no.
Left	145120



Sirius
Has a matt black slate look.

Direction	Order no.
Left	146120

3. Choose accessories

Don't forget to add the finishing touches to your Epos with a range of smart accessories. Want to know more about our accessories? Visit svedbergs.com.

Metal drawer with wooden front

If you choose an Epos with an open lower drawer, you can select a metal drawer in the same colour as your furniture. (The colours white and white ash come with a white metal drawer. All other colours come with a black metal drawer.)

Metal drawer for Epos 80-200 with open shelf.
B:77 H:10 D:30

Front	Colour	Order no.
Flat	White	5781
Flat	White ash	5783
Flat	Brown ash	5784
Flat	Black ash	5788
Stripe	Brown ash	5786
Stripe	Black ash	5789

More accessories

Choose from a wide range of accessories for Epos.

Options	Order no.
Lower drawer inserts	5950
Electrical socket	1212

Choose lighting

Lighting for Epos 120 with 2+1 drawers:
Start with a driver kit (1) and choose one upper drawer lighting solution (3), two lower drawer lighting solutions (4) and one floor light (2).

Lighting for Epos 120 with 1+1 drawers:
Start with one driver kit (1) and choose one upper drawer lighting solution (3), one lower drawer lighting solution (4) and two floor lights (2) for lighting in your open shelf and under the vanity unit.

Lighting for Epos 120 with 2+0 drawers:
Start with a driver kit (1) and choose one upper drawer lighting solution (3), one lower drawer lighting solution (4) and one floor light (2).

If the lighting is connected to the mains supply in your bathroom, use the wall switch to turn your vanity unit light on and off.

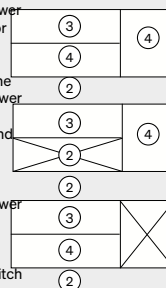

Options	Order no.
① Driver kit lighting	5991
② Lighting open shelf / floor light	5992
③ Top drawer lighting	5993
④ Lighting lower drawer/ 40 cm drawer closed	5994



Laurent 1
Has a dark background with gold marbling.

Direction	Order no.
Left	143120

Counter tops come with overhang.
Dekton work tops always come with a mixer hole on the left.

Epos 120 Left

1. Choose a vanity unit

W: 120 H: 45 D: 45		Incl. 2+0 drawers and two open shelves. The open 40 shelf is positioned on the right.	
Front	Order no.		
White			
Flat	1512200V		
Flat Push open	1512200V-P		
Relief	1512201V		
White ash			
Flat	1612200V		
Flat Push open	1612200V-P		
Relief	1612201V		
Brown ash			
Flat	1712200V		
Flat Push open	1712200V-P		
Relief	1712201V		
Stripe	1712202V		
Stripe Push open	1712202V-P		
Black ash			
Flat	1412200V		
Flat Push open	1412200V-P		
Relief	1412201V		
Stripe	1412202V		
Stripe Push open	1412202V-P		

Handles and knobs
Don't forget to include handles for your furniture. Read more on page 149.

Sit-on basins
Go to page 127 to see our counter top washbasins and free-standing mixers for the Epos range.

Washbasin mixer
Go to page 130 to see our washbasin mixers, traps and bottom valves.

Selected colours
Choose from Flat and Flat push open fronts. Add -COL after the item number. The extra charge amount is based on white furniture.

3. Choose accessories

Don't forget to add the finishing touches to your Epos with a range of smart accessories. Want to know more about our accessories? Visit svedbergs.com.

Metal drawer with wooden front

If you choose an Epos with an open lower drawer, you can select a metal drawer in the same colour as your furniture. (The colours white and white ash come with a white metal drawer. All other colours come with a black metal drawer.)

Metal drawer for Epos 80-200 with open shelf.
B:77 H:10 D:30

Front	Colour	Order no.
Flat	White	5781
Flat	White ash	5783
Flat	Brown ash	5784
Flat	Black ash	5788
Stripe	Brown ash	5786
Stripe	Black ash	5789

More accessories

Choose from a wide range of accessories for Epos.

Options	Order no.
Lower drawer inserts	5950
Electrical socket	1212

Choose lighting

Lighting for Epos 120 with 2+1 drawers:
Start with a driver kit (1) and choose one upper drawer lighting solution (3), two lower drawer lighting solutions (4) and one floor light (2).

Lighting for Epos 120 with 1+1 drawers:
Start with one driver kit (1) and choose one upper drawer lighting solution (3), one lower drawer lighting solution (4) and two floor lights (2) for lighting in your open shelf and under the vanity unit.

Lighting for Epos 120 with 2+0 drawers:
Start with a driver kit (1) and choose one upper drawer lighting solution (3), one lower drawer lighting solution (4) and one floor light (2).

If the lighting is connected to the mains supply in your bathroom, use the wall switch to turn your vanity unit light on and off.

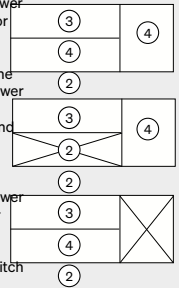

Options	Order no.
① Driver kit lighting	5991
② Lighting open shelf / floor light	5992
③ Top drawer lighting	5993
④ Lighting lower drawer/ 40 cm drawer closed	5994

2B. Choose a washbasin



Ise 120 Left
Mineral composite
W:121 H:1,3 D:46



Colour	Order no.
White matt	5120-V
Ash grey	5121-V

2B. Choose a work top

W: 122 H: 1,2 D: 46



Danae
Has a sand-coloured limestone look.

Direction	Order no.
Left	144120



Keon
Has a grey industrial look.

Direction	Order no.
Left	141120



Laurent
Has a dark background with gold marbling.

Direction	Order no.
Left	143120



Rem
Has a relaxing marble look with a light background and through-coloured edge.

Direction	Order no.
Left	145120



Sirius
Has a matt black slate look.

Direction	Order no.
Left	146120

Counter tops come with overhang.
Dekton work tops always come with a mixer hole on the left.

Epos 160

W: 160
H: 45
D: 45

Incl. 2+2 drawers

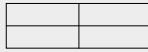

Incl. 1+1 drawers and 2 open shelves.



1. Choose a vanity unit

Front	Order no.	Order no.
White		
Flat	1516220	1516110
Flat Push open	1516220-P	1516110-P
Relief	1516221	1516111
White ash		
Flat	1616220	1616110
Flat Push open	1616220-P	1616110-P
Relief	1616221	1616111
Brown ash		
Flat	1716220	1716110
Flat Push open	1716220-P	1716110-P
Relief	1716221	1716111
Stripe	1716222	1716112
Stripe Push open	1716222-P	1716112-P
Black ash		
Flat	1416220	1416110
Flat Push open	1416220-P	1416110-P
Relief	1416221	1416111
Stripe	1416222	1416112
Stripe Push open	1416222-P	1416112-P

Washbasin mixer

Go to page 130 to see our washbasin mixers, traps and bottom valves.

Selected colours

Choose from Flat and Flat push open fronts. Add -COL after the item number. The extra charge amount is based on white furniture.

2A. Choose a washbasin



Ise 160 Double
Mineral composite
W:160 H:1,5 D:46

Colour	Order no.
White matt	5160-D
Ash grey	5161-D



2B. Choose a work top

W: 160 H: 1,2 D: 46



Right



Left



Double



Danae
Has a sand-coloured limestone look.

Direction	Order no.
Right	144161
Left	144160
Double	144162



Keon
Has a grey industrial look.

Direction	Order no.
Right	141161
Left	141160
Double	141162



Rem
Has a relaxing marble look with a light background and through-coloured edge.

Direction	Order no.
Right	145161
Left	145160
Double	145162



Sirius
Has a matt black slate look.

Direction	Order no.
Right	146161
Left	146160
Double	146162

3. Choose accessories

Don't forget to add the finishing touches to your Epos with a range of smart accessories. Want to know more about our accessories? Visit svedbergs.com.

Metal drawer with wooden front

If you choose an Epos with an open lower drawer, you can select a metal drawer in the same colour as your furniture. (The colours white and white ash come with a white metal drawer. All other colours come with a black metal drawer.)

Metal drawer for Epos 80-200 with open shelf.
B:77 H:10 D:30

Front	Colour	Order no.
Flat	White	5781
Flat	White ash	5783
Flat	Brown ash	5784
Flat	Black ash	5788
Stripe	Brown ash	5786
Stripe	Black ash	5789

More accessories

Choose from a wide range of accessories for Epos.

Options	Order no.
Lower drawer inserts	5950
Electrical socket	1212

Choose lighting

Lighting for Epos 160 with 2+2 drawers:

Start with two driver kits (1) and choose two upper drawer lighting solutions (3), two lower drawer lighting solutions (4) and two floor lights (2).

Lighting for Epos 160 with 1+1 drawers:

Start with two driver kits (1) and choose two upper drawer lighting solutions (3) and four floor lights (2) for lighting in your open shelf and under the vanity unit.

If the lighting is connected to the mains supply in your bathroom, use the wall switch to turn your vanity unit light on and off.

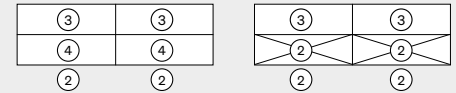

Options	Order no.
① Driver kit lighting	5991
② Lighting open shelf / floor light	5992
③ Top drawer lighting	5993
④ Lighting lower drawer/ 40 cm drawer closed	5994



Laurent 1
Has a dark background with gold marbling.

Direction	Order no.
Right	143161
Left	143160
Double	143162

Counter tops come with overhang.

Dekton work tops always come with a mixer hole on the left.

Epos 200

W: 200
H: 45
D: 45

Incl. 2+1+2 drawers. Double electrical sockets included in the 40 drawer.



Incl. 2+0+2 drawers and 2 open shelves.



1. Choose a vanity unit

Front	Order no.	Order no.
White		
Flat	15202120	15202020
Flat Push open	15202120-P	15202020-P
Relief	15202121	15202021
White ash		
Flat	16202120	16202020
Flat Push open	16202120-P	16202020-P
Relief	16202121	16202021
Brown ash		
Flat	17202120	17202020
Flat Push open	17202120-P	17202020-P
Relief	17202121	17202021
Stripe	17202122	17202022
Stripe Push open	17202122-P	17202022-P
Black ash		
Flat	14202120	14202020
Flat Push open	14202120-P	14202020-P
Relief	14202121	14202021
Stripe	14202122	14202022
Stripe Push open	14202122-P	14202022-P

Washbasin mixer

Go to page 130 to see our washbasin mixers, traps and bottom valves.

Selected colours

Choose from Flat and Flat push open fronts. Add -COL after the item number. The extra charge amount is based on white furniture.

3. Choose accessories

Don't forget to add the finishing touches to your Epos with a range of smart accessories. Want to know more about our accessories? Visit svedbergs.com.

Metal drawer with wooden front

If you choose an Epos with an open lower drawer, you can select a metal drawer in the same colour as your furniture. (The colours white and white ash come with a white metal drawer. All other colours come with a black metal drawer.)

Metal drawer for Epos 80-200 with open shelf.
B:77 H:10 D:30

Front	Colour	Order no.
Flat	White	5781
Flat	White ash	5783
Flat	Brown ash	5784
Flat	Black ash	5788
Stripe	Brown ash	5786
Stripe	Black ash	5789

More accessories

Choose from a wide range of accessories for Epos.

Options	Order no.
Lower drawer inserts	5950
Electrical socket	1212

Choose lighting

Lighting for Epos 200 with 2+1+2 drawers:

Start with two driver kits (1) and choose two upper drawer lighting solutions (3), three lower drawer lighting solutions (4) and two floor lights (2).

Lighting for Epos 200 with 2+0+2 drawers:

Start with two driver kits (1) and choose two upper drawer lighting solutions (3), two lower drawer lighting solutions (4) and two floor lights (2).

If the lighting is connected to the mains supply in your bathroom, use the wall switch to turn your vanity unit light on and off.

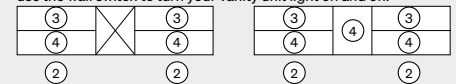

Options	Order no.
① Driver kit lighting	5991
② Lighting open shelf / floor light	5992
③ Top drawer lighting	5993
④ Lighting lower drawer/ 40 cm drawer closed	5994

2B. Choose a work top

W: 200 H: 1,2 D: 46

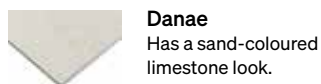

Danae
Has a sand-coloured limestone look.



Keon
Has a grey industrial look.



Laurent
Has a dark background with gold marbling.

Direction	Order no.
Right	144201
Left	144200
Double	144202

Direction	Order no.
Right	141201
Left	141200
Double	141202

Direction	Order no.
Right	143201
Left	143200
Double	143202

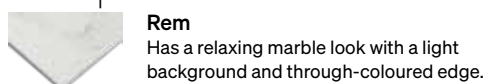

Rem
Has a relaxing marble look with a light background and through-coloured edge.



Sirius
Has a matt black slate look.

Direction	Order no.
Right	145201
Left	145200
Double	145202

Direction	Order no.
Right	146201
Left	146200
Double	146202

Counter tops come with overhang.

Dekton work tops always come with a mixer hole on the left.

Epos 200

W: 200
H: 45
D: 45

Incl. 1+1+1 drawers and 2 open shelves. Double electrical sockets included in the 40 drawer.



1. Choose a vanity unit

Front	Order no.
White	
Flat	15201110
Flat Push open	15201110-P
Relief	15201111
White ash	
Flat	16201110
Flat Push open	16201110-P
Relief	16201111
Brown ash	
Flat	17201110
Flat Push open	17201110-P
Relief	17201111
Stripe	17201112
Stripe Push open	17201112-P
Black ash	
Flat	14201110
Flat Push open	14201110-P
Relief	14201111
Stripe	14201112
Stripe Push open	14201112-P

Handles and knobs

Don't forget to include handles for your furniture. Read more on page 149.

Sit-on basins

Go to page 127 to see our counter top washbasins and free-standing mixers for the Epos range.

Washbasin mixer

Go to page 130 to see our washbasin mixers, traps and bottom valves.

Selected colours

Choose from Flat and Flat push open fronts. Add -COL after the item number. The extra charge amount is based on white furniture.

3. Choose accessories

Don't forget to add the finishing touches to your Epos with a range of smart accessories. Want to know more about our accessories? Visit svedbergs.com.

Metal drawer with wooden front

If you choose an Epos with an open lower drawer, you can select a metal drawer in the same colour as your furniture. (The colours white and white ash come with a white metal drawer. All other colours come with a black metal drawer.)

Metal drawer for Epos 80-200 with open shelf.

B:77 H:10 D:30

Front	Colour	Order no.
Flat	White	5781
Flat	White ash	5783
Flat	Brown ash	5784
Flat	Black ash	5788
Stripe	Brown ash	5786
Stripe	Black ash	5789

More accessories

Choose from a wide range of accessories for Epos.

Options	Order no.
Lower drawer inserts	5950
Electrical socket	1212

Choose lighting

Lighting for Epos 200 with 1+1+1 drawers:

Start with two driver kits (1) and choose two upper drawer lighting solutions (3), one lower drawer lighting solution (2) and four floor lights for lighting in your open shelf and under the vanity unit.

If the lighting is connected to the mains supply in your bathroom, use the wall switch to turn your vanity unit light on and off.

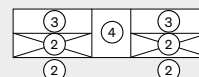

Options	Order no.
① Driver kit lighting	5991
② Lighting open shelf / floor light	5992
③ Top drawer lighting	5993
④ Lighting lower drawer/ 40 cm drawer closed	5994

2B. Choose a work top

W: 200 H: 1.2 D: 46



Right

Left

Double



Danae

Has a sand-coloured limestone look.

Direction	Order no.
Right	144201
Left	144200
Double	144202



Keon

Has a grey industrial look.

Direction	Order no.
Right	141201
Left	141200
Double	141202



Rem

Has a relaxing marble look with a light background and through-coloured edge.

Direction	Order no.
Right	145201
Left	145200
Double	145202



Sirius

Has a matt black slate look.

Direction	Order no.
Right	146201
Left	146200
Double	146202



Laurent

Has a dark background with gold marbling.

Direction	Order no.
Right	143201
Left	143200
Double	143202

Counter tops come with overhang.

Dekton work tops always come with a mixer hole on the left.

Poem 50×35

1. Choose a vanity unit

Front	Order no.	Order no.
White		
Flat	3355111	3355113
Flat Push open	3355111-P	-
Profile	3355611	-
Sand		
Flat	3355121	3355123
Flat Push open	3355121-P	-
Profile	3355621	-
Pure oak		
Flat	3355131	3355133
Flat Push open	3355131-P	-
Profile	3355631	-
Brown ash		
Flat	3355151	3355153
Flat Push open	3355151-P	-
Profile	3355651	-
Black ash		
Flat	3355141	3355143
Flat Push open	3355141-P	-
Profile	3355641	-

2. Choose a washbasin



Hav 50×35

Porcelain. W:52 H:1,7 D:36,5

Colour	Order no.
White	5053



Skapa 50×35

Porcelain, W:51 H:8.5 D:41

Colour	Order no.
White	37350



Munka 50×35

Mineral composite. W:51 H:1,5 D:36

Colour	Order no.
White	52510

Selected colours

Choose from Flat and Flat push open fronts. Add -COL after the item number. The extra charge amount is based on white furniture.

Washbasin mixer

Go to page 130 to see our washbasin mixers, traps and bottom valves.

Handles and knobs

Don't forget to include handles for your furniture. Read more on page 149.

Poem

The Poem furniture range is the most extensive on the market for smaller bathrooms. Choose from two depths, six widths and four different front panel options in five standard colours and three optional colours.

Options

Options	Order no.
Lower drawer inserts	5950
Power sockets, Black	98780

Choose lighting

Lighting for Poem 50×35 with one drawer: Start with a driver kit (1), one lower drawer lighting solution (4) and one floor light (2).

Lighting for Poem 50×35 with two drawers: Start with a driver kit (1) and choose one upper drawer lighting solution (3), one lower drawer lighting solution (4) and one floor light (2).

If the lighting is connected to the mains supply in your bathroom, use the wall switch to turn your vanity unit light on and off.

Poem 50×35 with 1 drawer.

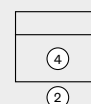

Poem 50×35 with 2 drawers.



Options	Order no.
① Driver kit lighting	5991
② Lighting open shelf / floor light	5992
③ Top drawer lighting	5993
④ Lighting lower drawer/ 40 cm drawer closed	5994

Poem 50×35

1. Choose a vanity unit

W: 50 H: 57 D: 35		Incl. 2 drawers.	
Front	Order no.		
White			
Flat	3355112		
Flat Push open	3355112-P		
Edging	3355312		
Profile	3355612		
Frame	3355412		
Frame Push open	3355412-P		
Sand			
Flat	3355122		
Flat Push open	3355122-P		
Edging	3355322		
Profile	3355622		
Frame	3355422		
Frame Push open	3355422-P		
Pure oak			
Flat	3355132		
Flat Push open	3355132-P		
Edging	3355332		
Profile	3355632		
Frame	3355432		
Frame Push open	3355432-P		
Brown ash			
Flat	3355152		
Flat Push open	3355152-P		
Edging	3355352		
Profile	3355652		
Frame	3355452		
Frame Push open	3355452-P		
Black ash			
Flat	3355142		
Flat Push open	3355142-P		
Edging	3355342		
Profile	3355642		
Frame	3355442		
Frame Push open	3355442-P		

2. Choose a washbasin



Hav 50×35

Porcelain. W:52 H:1,7 D:36,5

Colour	Order no.
White	5053



Skapa 50×35

Porcelain, W:51 H:8.5 D:41

Colour	Order no.
White	37350



Munka 50×35

Mineral composite. W:51 H:1,5 D:36

Colour	Order no.
White	52510

Selected colours

Choose from Flat and Flat push open fronts. Add -COL after the item number. The extra charge amount is based on white furniture.

Washbasin mixer

Go to page 130 to see our washbasin mixers, traps and bottom valves.

Handles and knobs

Don't forget to include handles for your furniture. Read more on page 149.

Poem

The Poem furniture range is the most extensive on the market for smaller bathrooms. Choose from two depths, six widths and four different front panel options in five standard colours and three optional colours.

Options

Options	Order no.
Lower drawer inserts	5950
Power sockets, Black	98780

Choose lighting

Lighting for Poem 50×35 with one drawer: Start with a driver kit (1), one lower drawer lighting solution (4) and one floor light (2).

Lighting for Poem 50×35 with two drawers: Start with a driver kit (1) and choose one upper drawer lighting solution (3), one lower drawer lighting solution (4) and one floor light (2).

If the lighting is connected to the mains supply in your bathroom, use the wall switch to turn your vanity unit light on and off.

Poem 50×35 with 1 drawer.

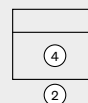

Poem 50×35 with 2 drawers.

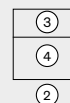

Options	Order no.
① Driver kit lighting	5991
② Lighting open shelf / floor light	5992
③ Top drawer lighting	5993
④ Lighting lower drawer/ 40 cm drawer closed	5994

Poem 60×35

1. Choose a vanity unit

Front	Order no.	Order no.
White		
Flat	3356111	3356113
Flat Push open	3356111-P	-
Profile	3356611	-
Sand		
Flat	3356121	3356123
Flat Push open	3356121-P	-
Profile	3356621	-
Pure oak		
Flat	3356131	3356133
Flat Push open	3356131-P	-
Profile	3356631	-
Brown ash		
Flat	3356151	3356153
Flat Push open	3356151-P	-
Profile	3356651	-
Black ash		
Flat	3356141	3356143
Flat Push open	3356141-P	-
Profile	3356641	-

2. Choose a washbasin



Hav 60×35

Porcelain. W:62 H:1,7 D:36,5

Colour	Order no.
White	5063



Skapa 60×35

Porcelain. W:61 H:8.5 D:41

Colour	Order no.
White	37360



Munka 60×35

Mineral composite. W:61 H:1,5 D:36

Colour	Order no.
White	52610

Selected colours

Choose from Flat and Flat push open fronts. Add -COL after the item number. The extra charge amount is based on white furniture.

Washbasin mixer

Go to page 130 to see our washbasin mixers, traps and bottom valves.

Handles and knobs

Don't forget to include handles for your furniture. Read more on page 149.

Poem

The Poem furniture range is the most extensive on the market for smaller bathrooms. Choose from two depths, six widths and four different front panel options in five standard colours and three optional colours.

Options

Options	Order no.
Lower drawer inserts	5950
Power sockets, Black	98780

Choose lighting

Lighting for Poem 60×35 with one drawer: Start with a driver kit (1), one lower drawer lighting solution (4) and one floor light (2).

Lighting for Poem 60×35 with two drawers: Start with a driver kit (1) and choose one upper drawer lighting solution (3), one lower drawer lighting solution (4) and one floor light (2).

If the lighting is connected to the mains supply in your bathroom, use the wall switch to turn your vanity unit light on and off.

Poem 60×35 with 1 drawer.

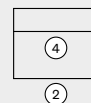

Poem 60×35 with 2 drawers.



Options	Order no.
① Driver kit lighting	5991
② Lighting open shelf / floor light	5992
③ Top drawer lighting	5993
④ Lighting lower drawer/ 40 cm drawer closed	5994

Poem 60×35

1. Choose a vanity unit

W: 60 H: 57 D: 35	Incl. 2 drawers.	
Front	Order no.	
White		
Flat	3356112	
Flat Push open	3356112-P	
Edging	3356312	
Profile	3356612	
Frame	3356412	
Frame Push open	3356412-P	
Sand		
Flat	3356122	
Flat Push open	3356122-P	
Edging	3356322	
Profile	3356622	
Frame	3356422	
Frame Push open	3356422-P	
Pure oak		
Flat	3356132	
Flat Push open	3356132-P	
Edging	3356332	
Profile	3356632	
Frame	3356432	
Frame Push open	3356432-P	
Brown ash		
Flat	3356152	
Flat Push open	3356152-P	
Edging	3356352	
Profile	3356652	
Frame	3356452	
Frame Push open	3356452-P	
Black ash		
Flat	3356142	
Flat Push open	3356142-P	
Edging	3356342	
Profile	3356642	
Frame	3356442	
Frame Push open	3356442-P	

2. Choose a washbasin

	
Hav 60×35 Porcelain. W:62 H:1,7 D:36,5	
Colour	Order no.
White	5063
	
Skapa 60×35 Porcelain. W:61 H:8,5 D:41	
Colour	Order no.
White	37360
	
Munka 60×35 Mineral composite. W:61 H:1,5 D:36	
Colour	Order no.
White	52610

Selected colours

Choose from Flat and Flat push open fronts. Add -COL after the item number. The extra charge amount is based on white furniture.

Washbasin mixer

Go to page 130 to see our washbasin mixers, traps and bottom valves.

Handles and knobs

Don't forget to include handles for your furniture. Read more on page 149.

Poem

The Poem furniture range is the most extensive on the market for smaller bathrooms. Choose from two depths, six widths and four different front panel options in five standard colours and three optional colours.

Options

Options	Order no.
Lower drawer inserts	5950
Power sockets, Black	98780

Choose lighting

Lighting for Poem 60×35 with one drawer: Start with a driver kit (1), one lower drawer lighting solution (4) and one floor light (2).

Lighting for Poem 60×35 with two drawers: Start with a driver kit (1) and choose one upper drawer lighting solution (3), one lower drawer lighting solution (4) and one floor light (2).

If the lighting is connected to the mains supply in your bathroom, use the wall switch to turn your vanity unit light on and off.

Poem 60×35 with 1 drawer.



Poem 60×35 with 2 drawers.

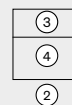

Options	Order no.
① Driver kit lighting	5991
② Lighting open shelf / floor light	5992
③ Top drawer lighting	5993
④ Lighting lower drawer/ 40 cm drawer closed	5994

Poem 80×35

1. Choose a vanity unit

Front	Order no.	Order no.
White		
Flat	3358111	3358113
Flat Push open	3358111-P	-
Profile	3358611	-
Sand		
Flat	3358121	3358123
Flat Push open	3358121-P	-
Profile	3358621	-
Pure oak		
Flat	3358131	3358133
Flat Push open	3358131-P	-
Profile	3358631	-
Brown ash		
Flat	3358151	3358153
Flat Push open	3358151-P	-
Profile	3358651	-
Black ash		
Flat	3358141	3358143
Flat Push open	3358141-P	-
Profile	3358641	-

2. Choose a washbasin



Hav 80×35

Porcelain. W:82 H:X1,7 D:36,5

Colour	Order no.
White	5083



Skapa 80×35

Porcelain. W:81 H:8,5 D:41

Colour	Order no.
White	37380



Munka 80×35

Mineral composite. W:81 H:1,5 D:36

Colour	Order no.
White	52810

Selected colours

Choose from Flat and Flat push open fronts. Add -COL after the item number. The extra charge amount is based on white furniture.

Washbasin mixer

Go to page 130 to see our washbasin mixers, traps and bottom valves.

Handles and knobs

Don't forget to include handles for your furniture. Read more on page 149.

Poem

The Poem furniture range is the most extensive on the market for smaller bathrooms. Choose from two depths, six widths and four different front panel options in five standard colours and three optional colours.

Options

Options	Order no.
Lower drawer inserts	5950
Power sockets, Black	98780

Choose lighting

Lighting for Poem 80×35 with one drawer: Start with a driver kit (1), one lower drawer lighting solution (4) and one floor light (2).

Lighting for Poem 80×35 with two drawers: Start with a driver kit (1) and choose one upper drawer lighting solution (3), one lower drawer lighting solution (4) and one floor light (2).

If the lighting is connected to the mains supply in your bathroom, use the wall switch to turn your vanity unit light on and off.

Poem 80×35 with 1 drawer.

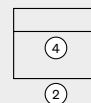

Poem 80×35 with 2 drawers.



Options	Order no.
① Driver kit lighting	5991
② Lighting open shelf / floor light	5992
③ Top drawer lighting	5993
④ Lighting lower drawer/ 40 cm drawer closed	5994

Poem 80×35

1. Choose a vanity unit

W: 80 H: 57 D: 35	Incl. 2 drawers.	
Front	Order no.	
White		
Flat	3358112	
Flat Push open	3358112-P	
Edging	3358312	
Profile	3358612	
Frame	3358412	
Frame Push open	3358412-P	
Sand		
Flat	3358122	
Flat Push open	3358122-P	
Edging	3358322	
Profile	3358622	
Frame	3358422	
Frame Push open	3358422-P	
Pure oak		
Flat	3358132	
Flat Push open	3358132-P	
Edging	3358332	
Profile	3358632	
Frame	3358432	
Frame Push open	3358432-P	
Brown ash		
Flat	3358152	
Flat Push open	3358152-P	
Edging	3358352	
Profile	3358652	
Frame	3358452	
Frame Push open	3358452-P	
Black ash		
Flat	3358142	
Flat Push open	3358142-P	
Edging	3358342	
Profile	3358642	
Frame	3358442	
Frame Push open	3358442-P	

2. Choose a washbasin



Hav 80×35

Porcelain. W:82 H:X1,7 D:36,5

Colour	Order no.
White	5083



Skapa 80×35

Porcelain. W:81 H:8,5 D:41

Colour	Order no.
White	37380



Munka 80×35

Mineral composite. W:81 H:1,5 D:36

Colour	Order no.
White	52810

Selected colours

Choose from Flat and Flat push open fronts. Add -COL after the item number. The extra charge amount is based on white furniture.

Washbasin mixer

Go to page 130 to see our washbasin mixers, traps and bottom valves.

Handles and knobs

Don't forget to include handles for your furniture. Read more on page 149.

Poem

The Poem furniture range is the most extensive on the market for smaller bathrooms. Choose from two depths, six widths and four different front panel options in five standard colours and three optional colours.

Options

Options	Order no.
Lower drawer inserts	5950
Power sockets, Black	98780

Choose lighting

Lighting for Poem 80×35 with one drawer: Start with a driver kit (1), one lower drawer lighting solution (4) and one floor light (2).

Lighting for Poem 80×35 with two drawers: Start with a driver kit (1) and choose one upper drawer lighting solution (3), one lower drawer lighting solution (4) and one floor light (2).

If the lighting is connected to the mains supply in your bathroom, use the wall switch to turn your vanity unit light on and off.

Poem 80×35 with 1 drawer.

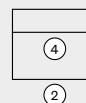

Poem 80×35 with 2 drawers.





Options	Order no.
① Driver kit lighting	5991
② Lighting open shelf / floor light	5992
③ Top drawer lighting	5993
④ Lighting lower drawer/ 40 cm drawer closed	5994

Poem 60×45





1. Choose a vanity unit

W: 60 H: 57 D: 45		Incl. 2 drawers.	
Front	Order no.		
White			
Flat	3456112		
Flat Push open	3456112-P		
Edging	3456312		
Profile	3456612		
Frame	3456412		
Frame Push open	3456412-P		
Sand			
Flat	3456122		
Flat Push open	3456122-P		
Edging	3456322		
Profile	3456622		
Frame	3456422		
Frame Push open	3456422-P		
Pure oak			
Flat	3456132		
Flat Push open	3456132-P		
Edging	3456332		
Profile	3456632		
Frame	3456432		
Frame Push open	3456432-P		
Brown ash			
Flat	3456152		
Flat Push open	3456152-P		
Edging	3456352		
Profile	3456652		
Frame	3456452		
Frame Push open	3456452-P		
Black ash			
Flat	3456142		
Flat Push open	3456142-P		
Edging	3456342		
Profile	3456642		
Frame	3456442		
Frame Push open	3456442-P		

2A. Choose a washbasin

			
Hav 60×45 Porcelain. W:62 H:17 D:47		Deep 60×45 Porcelain. W:61 H:6 D:46	
Colour	Order no.	Colour	Order no.
White	5062	White	6060
			
Sel 60×45 Mineral composite. W:61 H:2 D:46			
Colour	Order no.		
White matt	34560		
Black matt	34660		

2B. Choose a work top ¹

			
Sirius 60×45 Material: Dekton. For free-standing mixers. W: 61 H: 1,2 D: 46.		Keon 60×45 Material: Dekton. For free-standing mixers. W: 61 H: 1,2 D: 46.	
Direction	Order no.	Direction	Order no.
Centre	370699	Centre	130062
			
Quartz 60×45 Material: Laminate. For free-standing mixers. W: 61 H: 2 D: 46.		Mica 60×45 Material: Laminate. For free-standing mixers. W: 61 H: 2 D: 46.	
Direction	Order no.	Direction	Order no.
Centre	20602	Centre	20603
			
Slate 60×45 Material: Laminate. For free-standing mixers. W: 61 H: 2 D: 46.			
Direction	Order no.		
Centre	20601		

Selected colours

Choose from Flat and Flat push open fronts. Add -COL after the item number. The extra charge amount is based on white furniture.

Work top details

¹ Dekton work tops always come with a mixer hole on the left. The laminate work tops are reversible. Counter tops come with overhang.

Poem

The Poem furniture range is the most extensive on the market for smaller bathrooms. Choose from two depths, six widths and four different front panel options in five standard colours and three optional colours.

Options

Options	Order no.
Lower drawer inserts	5950
Power sockets, Black	98780

Choose lighting

Lighting for Poem 60×45 with two drawers:

Start with a driver kit (1) and choose one upper drawer lighting solution (3), one lower drawer lighting solution (4) and one floor light (2).

If the lighting is connected to the mains supply in your bathroom, use the wall switch to turn your vanity unit light on and off.

Poem 60×45
with 2
drawers.

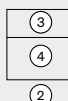







Options	Order no.
① Driver kit lighting	5991
② Lighting open shelf / floor light	5992
③ Top drawer lighting	5993
④ Lighting lower drawer/ 40 cm drawer closed	5994

Poem 80x45











1. Choose a vanity unit

W: 80 H: 57 D: 45		Incl. 2 drawers.	
Front	Order no.		
White			
Flat	3458112		
Flat Push open	3458112-P		
Edging	3458312		
Profile	3458612		
Frame	3458412		
Frame Push open	3458412-P		
Sand			
Flat	3458122		
Flat Push open	3458122-P		
Edging	3458322		
Profile	3458622		
Frame	3458422		
Frame Push open	3458422-P		
Pure oak			
Flat	3458132		
Flat Push open	3458132-P		
Edging	3458332		
Profile	3458632		
Frame	3458432		
Frame Push open	3458432-P		
Brown ash			
Flat	3458152		
Flat Push open	3458152-P		
Edging	3458352		
Profile	3458652		
Frame	3458452		
Frame Push open	3458452-P		
Black ash			
Flat	3458142		
Flat Push open	3458142-P		
Edging	3458342		
Profile	3458642		
Frame	3458442		
Frame Push open	3458442-P		

2A. Choose a washbasin

			
Hav 80x45 Porcelain. W:82 H:17 D:47		Deep 80x45 Porcelain. W:81 H:6 D:46	
Colour	Order no.	Colour	Order no.
White	5082	White	6080
			
Sel 80x45 Mineral composite. W:81 H:2 D:46			
Colour	Order no.		
White matt	34580		
Black matt	34680		

2B. Choose a work top ¹

			
Sirius 80x45 Material: Dekton. For free-standing mixers. W: 81 H: 1,2 D: 46.		Keon 80x45 Material: Dekton. For free-standing mixers. W: 81 H: 1,2 D: 46.	
Direction	Order no.	Direction	Order no.
Centre	370899	Centre	130082
			
Quartz 80x45 Material: Laminate. For free-standing mixers. W: 81 H: 2 D: 46.		Mica 80x45 Material: Laminate. For free-standing mixers. W: 81 H: 2 D: 46.	
Direction	Order no.	Direction	Order no.
Centre	20802	Centre	20803
			
SLATE 80x45 Material: Laminate. For free-standing mixers. W: 81 H: 2 D: 46.			
Direction	Order no.		
Centre	20801		

Selected colours

Choose from Flat and Flat push open fronts. Add -COL after the item number. The extra charge amount is based on white furniture.

Work top details

¹ Dekton work tops always come with a mixer hole on the left. The laminate work tops are reversible. Counter tops come with overhang.

Poem

The Poem furniture range is the most extensive on the market for smaller bathrooms. Choose from two depths, six widths and four different front panel options in five standard colours and three optional colours.

Options

Options	Order no.
Lower drawer inserts	5950
Power sockets, Black	98780

Choose lighting

Lighting for Poem 80x45 with two drawers:- Start with a driver kit (1) and choose one upper drawer lighting solution (3), one lower drawer lighting solution (4) and one floor light (2).

If the lighting is connected to the mains supply in your bathroom, use the wall switch to turn your vanity unit light on and off.

Poem 80x45 with 2 drawers.



Options	Order no.
① Driver kit lighting	5991
② Lighting open shelf / floor light	5992
③ Top drawer lighting	5993
④ Lighting lower drawer / 40 cm drawer closed	5994

Poem 100×45

1. Choose a vanity unit

W: 100 H: 57 D: 45		Incl. 2 drawers.	
Front	Order no.		
White			
Flat	34510112		
Flat Push open	34510112-P		
Edging	34510312		
Profile	34510612		
Frame	34510412		
Frame Push open	34510412-P		
Sand			
Flat	34510122		
Flat Push open	34510122-P		
Edging	34510322		
Profile	34510622		
Frame	34510422		
Frame Push open	34510422-P		
Pure oak			
Flat	34510132		
Flat Push open	34510132-P		
Edging	34510332		
Profile	34510632		
Frame	34510432		
Frame Push open	34510432-P		
Brown ash			
Flat	34510152		
Flat Push open	34510152-P		
Edging	34510352		
Profile	34510652		
Frame	34510452		
Frame Push open	34510452-P		
Black ash			
Flat	34510142		
Flat Push open	34510142-P		
Edging	34510342		
Profile	34510642		
Frame	34510442		
Frame Push open	34510442-P		

2A. Choose a washbasin



Hav 100×45
Porcelain. W:102 H:17 D:47

Colour	Order no.
White	5102



Deep 100×45
Porcelain. W:101 H:6 D:46

Colour	Order no.
White	60100



Sel 100×45
Mineral composite. W:101 H:2 D:46

Colour	Order no.
White matt	34510
Black matt	34610

2B. Choose a work top ¹



Sirius 100×45²
Material: Dekton. For free-standing mixers. W: 101 H: 1,2 D: 46.

Direction	Order no.
Centre	371098



Keon 100×45²
Material: Dekton. For free-standing mixers. W: 101 H: 1,2 D: 46.

Direction	Order no.
Centre	130102



Quartz 100×45
Material: Laminate. For free-standing mixers. W: 101 H: 2 D: 46.

Direction	Order no.
Centre	21012



Mica 100×45
Material: Laminate. For free-standing mixers. W: 101 H: 2 D: 46.

Direction	Order no.
Centre	21013



Slate 100×45
Material: Laminate. For free-standing mixers. W: 101 H: 2 D: 46.

Direction	Order no.
Centre	21011

Selected colours

Choose from Flat and Flat push open fronts. Add -COL after the item number. The extra charge amount is based on white furniture.

Work top details

¹ Dekton work tops always come with a mixer hole on the left. The laminate work tops are reversible. Counter tops come with overhang.

Poem

The Poem furniture range is the most extensive on the market for smaller bathrooms. Choose from two depths, six widths and four different front panel options in five standard colours and three optional colours.

Options

Options	Order no.
Lower drawer inserts	5950
Power sockets, Black	98780

Choose lighting

Lighting for Poem 100×45 with two drawers: Start with a driver kit (1) and choose one upper drawer lighting solution (3), one lower drawer lighting solution (4) and one floor light (2).

If the lighting is connected to the mains supply in your bathroom, use the wall switch to turn your vanity unit light on and off.

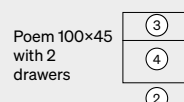

Options	Order no.
① Driver kit lighting	5991
② Lighting open shelf / floor light	5992
③ Top drawer lighting	5993
④ Lighting lower drawer/ 40 cm drawer closed	5994

Poem 120×45

1. Choose a vanity unit

W: 120 H: 57 D: 45		Incl. 2 drawers.	
Front	Order no.		
White			
Flat	34512112		
Flat Push open	34512112-P		
Edging	34512312		
Sand			
Flat	34512122		
Flat Push open	34512122-P		
Edging	34512322		
Pure oak			
Flat	34512132		
Flat Push open	34512132-P		
Edging	34512332		
Brown ash			
Flat	34512152		
Flat Push open	34512152-P		
Edging	34512352		
Black ash			
Flat	34512142		
Flat Push open	34512142-P		
Edging	34512342		

2A. Choose a washbasin



Hav 120×45
Porcelain. W:122 H:17 D:47

Colour	Order no.
White	51221



Sel 120×45
Mineral composite. W:121 H:2 D:46

Colour	Order no.
White matt	34512-C
Black matt	34612-C

2B. Choose a work top ¹



Sirius 120×45²
Material: Dekton. For free-standing mixers. W: 121 H: 1,2 D: 46.

Direction	Order no.
Centre	130130



Keon 120×45²
Material: Dekton. For free-standing mixers. W: 121 H: 1,2 D: 46.

Direction	Order no.
Centre	130131



Quartz 120×45
Material: Laminate. For free-standing mixers. W: 121 H: 2 D: 46.

Direction	Order no.
Centre	21202-C



Mica 120×45
Material: Laminate. For free-standing mixers. W: 121 H: 2 D: 46.

Direction	Order no.
Centre	21203-C



Slate 120×45
Material: Laminate. For free-standing mixers. W: 121 H: 2 D: 46.

Direction	Order no.
Centre	21201-C

Selected colours

Choose from Flat and Flat push open fronts. Add -COL after the item number. The extra charge amount is based on white furniture.

Work top details

¹ Dekton work tops always come with a mixer hole on the left. The laminate work tops are reversible. Counter tops come with overhang.

Poem

The Poem furniture range is the most extensive on the market for smaller bathrooms. Choose from two depths, six widths and four different front panel options in five standard colours and three optional colours.

Options

Options	Order no.
Lower drawer inserts	5950
Power sockets, Black	98780

Choose lighting

Lighting for Poem 120×45 with two drawers:- Start with a driver kit (1) and choose one upper drawer lighting solution (3), one lower drawer lighting solution (4) and one floor light (2).

If the lighting is connected to the mains supply in your bathroom, use the wall switch to turn your vanity unit light on and off.

Poem 120×45 with 2 drawers.



Options	Order no.
① Driver kit lighting	5991
② Lighting open shelf / floor light	5992
③ Top drawer lighting	5993
④ Lighting lower drawer/ 40 cm drawer closed	5994

Poem 120×45 Double

1. Choose a vanity unit

W: 120 H: 57 D: 45		Incl. 4 drawers	
Front	Order no.		
White			
Flat	34512114		
Flat Push open	34512114-P		
Edging	34512314		
Profile	34512614		
Frame	34512414		
Frame Push open	34512414-P		
Sand			
Flat	34512124		
Flat Push open	34512124-P		
Edging	34512324		
Profile	34512624		
Frame	34512424		
Frame Push open	34512424-P		
Pure oak			
Flat	34512134		
Flat Push open	34512134-P		
Edging	34512334		
Profile	34512634		
Frame	34512434		
Frame Push open	34512434-P		
Brown ash			
Flat	34512154		
Flat Push open	34512154-P		
Edging	34512354		
Profile	34512654		
Frame	34512454		
Frame Push open	34512454-P		
Black ash			
Flat	34512144		
Flat Push open	34512144-P		
Edging	34512344		
Profile	34512644		
Frame	34512444		
Frame Push open	34512444-P		

2A. Choose a washbasin



Hav 120×45 Double

Porcelain. W:122 H:17 D:47

Colour/Direction	Order no.
White/Double	51220-1

Sel 120×45

Mineral composite. W:121 H:2 D:46

Colour/Direction	Order no.
White matt/Right	34512-H
White matt/Left	34512-V
White matt/Double	34512-D
Black matt/Right	34612-H
Black matt/Left	34612-V
Black matt/Double	34612-D

2B. Choose a work top¹



Sirius 120×45²

Material: Dekton. For free-standing mixers. W: 121 H: 1,2 D: 46.

Direction	Order no.
Right	130122
Left	130121
Double	130123



Keon 120×45²

Material: Dekton. For free-standing mixers. W: 121 H: 1,2 D: 46.

Direction	Order no.
Right	130125
Left	130124
Double	130126



Quartz 120×45

Material: Laminate. For free-standing mixers. W: 121 H: 2 D: 46.

Direction	Order no.
Right	21202-H
Left	21202-V
Double	21202-D



Mica 120×45

Material: Laminate. For free-standing mixers. W: 121 H: 2 D: 46.

Direction	Order no.
Right	21203-H
Left	21203-V
Double	21203-D

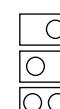

Slate 120×45

Material: Laminate. For free-standing mixers. W: 121 H: 2 D: 46.

Direction	Order no.
Right	21201-H
Left	21201-V
Double	21201-D

Selected colours

Choose from Flat and Flat push open fronts. Add -COL after the item number. The extra charge amount is based on white furniture.

Work top details

¹ Dekton work tops always come with a mixer hole on the left. The laminate work tops are reversible. Counter tops come with overhang.

Poem

The Poem furniture range is the most extensive on the market for smaller bathrooms. Choose from two depths, six widths and four different front panel options in five standard colours and three optional colours.

Options

Options	Order no.
Lower drawer inserts	5950
Power sockets, Black	98780

Choose lighting

Lighting for Poem 120×45 with four drawers:

Start with two driver kits (1) and choose two upper drawer lighting solutions (3), two lower drawer lighting solutions (4) and two floor lights (2).

If the lighting is connected to the mains supply in your bathroom, use the wall switch to turn your vanity unit light on and off.

Poem 120×45
with 4 drawers

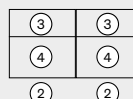

Options	Order no.
① Driver kit lighting	5991
② Lighting open shelf / floor light	5992
③ Top drawer lighting	5993
④ Lighting lower drawer/ 40 cm drawer closed	5994

Poem 160x45

1. Choose a vanity unit

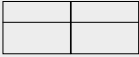
W: 160 H: 57 D: 45		Incl. 4 drawers	
Front	Order no.		
White			
Flat	3451611		
Flat Push open	3451611-P		
Edging	3451631		
Profile	3451661		
Frame	3451641		
Frame Push open	3451641-P		
Sand			
Flat	3451612		
Flat Push open	3451612-P		
Edging	3451632		
Profile	3451662		
Frame	3451642		
Frame Push open	3451642-P		
Pure oak			
Flat	3451613		
Flat Push open	3451613-P		
Edging	3451633		
Profile	3451663		
Frame	3451643		
Frame Push open	3451643-P		
Brown ash			
Flat	3451615		
Flat Push open	3451615-P		
Edging	3451635		
Profile	3451665		
Frame	3451645		
Frame Push open	3451645-P		
Black ash			
Flat	3451614		
Flat Push open	3451614-P		
Edging	3451634		
Profile	3451664		
Frame	3451644		
Frame Push open	3451644-P		

2A. Choose a washbasin



Nerby 160x45 Right/Left

Mineral composite. W:161 H: 2 D: 46

Colour/Direction	Order no.
White/Right	5162-H
White/Left	5162-V

2B. Choose a work top ¹



Sirius 160x45²

Material: Dekton. For free-standing mixers. W: 161 H: 1,2 D: 46.

Direction	Order no.
Right	130134
Left	130133
Double	130135



Keon 160x45²

Material: Dekton. For free-standing mixers. W: 161 H: 1,2 D: 46.

Direction	Order no.
Right	130137
Left	130136
Double	130138



Quartz 160x45

Material: Laminate. For free-standing mixers. W: 161 H: 2 D: 46.

Direction	Order no.
Right	21602-H
Left	21602-V
Double	21602-D



Mica 160x45

Material: Laminate. For free-standing mixers. W: 161 H: 2 D: 46.

Direction	Order no.
Right	21603-H
Left	21603-V
Double	21603-D



Slate 160x45

Material: Laminate. For free-standing mixers. W: 161 H: 2 D: 46.

Direction	Order no.
Right	21601-H
Left	21601-V
Double	21601-D

Selected colours

Choose from Flat and Flat push open fronts. Add -COL after the item number. The extra charge amount is based on white furniture.

Work top details

¹ Dekton work tops always come with a mixer hole on the left. The laminate work tops are reversible. Counter tops come with overhang.

Poem

The Poem furniture range is the most extensive on the market for smaller bathrooms. Choose from two depths, six widths and four different front panel options in five standard colours and three optional colours.

Options

Options	Order no.
Lower drawer inserts	5950
Power sockets, Black	98780

Choose lighting

Lighting for Poem 160x45 with four drawers:

Start with two driver kits (1) and choose two upper drawer lighting solutions (3), two lower drawer lighting solutions (4) and two floor lights (2).



If the lighting is connected to the mains supply in your bathroom, use the wall switch to turn your vanity unit light on and off.

Poem 160x45 with 4 drawers.



Options	Order no.
① Driver kit lighting	5991
② Lighting open shelf / floor light	5992
③ Top drawer lighting	5993
④ Lighting lower drawer/ 40 cm drawer closed	5994

Bloc - 1 door

	W: 45 H: 57 D: 25		45×25 Incl. 1 door.	W: 45 H: 57 D: 35		45×35 Incl. 1 door.
Front	Order no.	Order no.		Order no.		
White						
1 door	545211			545111		
Grey						
1 door	545221			545121		

2. Choose a washbasin







Skapa 45×25
W:46 H:8,5 D:31



Skapa 45×35
W:46 H:8,5 D:41

Colour	Order no.	Order no.
White	37045	37345

Bloc - 2 doors

	W: 50 H: 57 D: 35		50×35 Incl. 2 doors.	W: 55 H: 57 D: 35		55×35 Incl. 2 doors.	W: 60 H: 57 D: 35		60×35 Incl. 2 doors.
Front	Order no.	Order no.	Order no.	Order no.					
White									
2 doors	550112		555112		560112				
Grey									
2 doors	550122		555122		560122				

2. Choose a washbasin



Skapa 50×35
W:51 H:8,5 D:41



Skapa 55×35
W:56 H:8,5 D:41



Skapa 60×35
W:61 H:8,5 D:41

Colour	Order no.	Order no.	Order no.
White	37350	37355	37360

Washbasin mixer
Go to page 130 to see our washbasin mixers, traps and bottom valves.

Bloc mirror cabinet
Choose the Bloc mirror cabinet with or without washbasin lighting. For more information, see page 139.

Handles and knobs
Don't forget to include handles for your furniture. Read more on page 149.

Find out more about Bloc

With the Bloc furniture range, it's easy to choose. Carefully selected and affordable product combinations for small to medium-sized bathrooms. Choose between two different depths, four different widths and a washbasin cupboard with one or two doors.

Always included



1. Soft-closing hinges
2. Quick to install
3. Durable melamine finish
4. Washbasin with large filling volume
5. Delivered ready-assembled



Bloc Accessories

Options	Order no.
Water trap EasyClean Chrome	1214
Water trap EasyClean White	1224
Water trap incl. hose	8988

Intro

1. Choose a vanity unit

	 W: 45 H: 50 D: 35 Metal cabinet. Incl. 2 doors W:45 H:50 D:35	 W: 50 H: 50 D: 35 Metal cabinet. Incl. 2 doors W:50 H:50 D:35	 W: 55 H: 50 D: 35 Metal cabinet. Incl. 2 doors W:55 H:50 D:35
Front	Order no.	Order no.	Order no.
White matt			
2 doors, Integrated handle	294045	294050	294055
Graphite grey			
2 doors, Integrated handle	294245	294250	294255
Sand			
2 doors, Integrated handle	294345	294350	294355
Sage			
2 doors, Integrated handle	294545	294550	294555

	 W: 50 H: 50 D: 35 Metal cabinet. Incl. 2 drawers W:50 H:50 D:35	 W: 55 H: 50 D: 35 Metal cabinet. Incl. 2 drawers W:55 H:50 D:35	
Front	Order no.	Order no.	
White matt			
2 drawers, Integrated handle	- - -	294450	294455
Graphite grey			
2 drawers, Integrated handle	- - -	294650	294655
Sand			
2 drawers, Integrated handle	- - -	294750	294755
Sage			
2 drawers, Integrated handle	- - -	294850	294855

2. Choose a washbasin

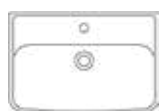

Skapa 45×35
W:46 H:8,5 D:41



Skapa 50×35
W:51 H:8,5 D:41



Skapa 55×35
W:56 H:8,5 D:41

Colour	Order no.	Order no.	Order no.
White	37345	37350	37355

Washbasin mixer

Go to page 130 to see our washbasin mixers, traps and bottom valves.

Find out more about Intro

1. Ready-prepared for connection to water and sewage pipes.
2. With environmentally friendly rustproofing and coatings
3. Choose your preferred trap
4. Made in Sweden

Always included

1. Door/drawerwithintegratedgriphole
2. Soft-closing hinges
3. Delivered ready-assembled

Intro accessories

Options	Order no.
Water trap EasyClean Chrome	1214
Water trap EasyClean White	1224
Water trap EasyClean Black matt	1222
Water trap incl. hose	8988

Ise

Mineral composite
H: 1,3
D: 46
Compatible with Epos.

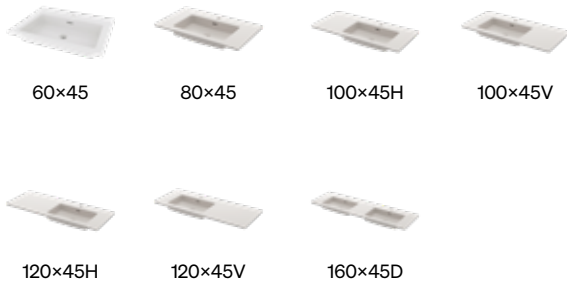

Width	Direction	Colour	Order no.
60	Centre	White matt	5060
	Centre	Ash grey	5061
80	Centre	White matt	5080
	Centre	Ash grey	5180
100	Right	White matt	5100-H
	Left	White matt	5100-V
	Right	Ash grey	5101-H
	Left	Ash grey	5101-V
120	Right	White matt	5120-H
	Left	White matt	5120-V
	Right	Ash grey	5121-H
	Left	Ash grey	5121-V
160	Double	White matt	5160-D
	Double	Ash grey	5161-D

Floen

Porcelain
H: 1,5
D: 46
Compatible with Epos.

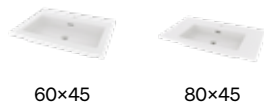

Width	Direction	Colour	Order no.
60	Centre	White	5360
80	Centre	White	5380

Sel

Mineral composite
H: 2
D: 46
Works well with the Poem furniture range with a depth of 45 cm.

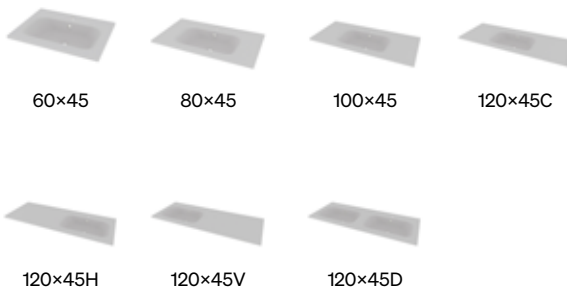

Width	Direction	Colour	Order no.
60	Centre	White matt	34560
	Centre	Black matt	34660
80	Centre	White matt	34580
	Centre	Black matt	34680
100	Centre	White matt	34510
	Centre	Black matt	34610
120	Centre	White matt	34512-C
	Right	White matt	34512-H
	Left	White matt	34512-V
	Double	White matt	34512-D
	Centre	Black matt	34612-C
	Right	Black matt	34612-H
	Left	Black matt	34612-V
	Double	Black matt	34612-D

Hav 45

Porcelain
H: 1,7
D: 47
Works well with the Poem furniture range with a depth of 45 cm.

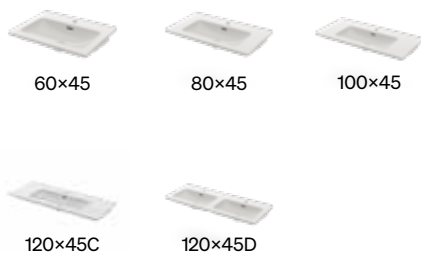

Width	Direction	Colour	Order no.
60	Centre	White	5062
80	Centre	White	5082
100	Centre	White	5102
120	Centre	White	51221
	Double	White	51220-1

Nerby

Mineral composite
H: 1,7
D: 46
Suitable for the Poem 160x45 furniture range.



Width	Riktning	Colour	Order no.
160	Right	White	5162-H
	Left	White	5162-V

Deep

Porcelain

H: 6

D: 46

Works well with the Poem furniture range with a depth of 45 cm.



60×45



80×45



100×45

Width	Direction	Colour	Order no.
60	Centre	White	6060
80	Centre	White	6080
100	Centre	White	60100

Hav 35

Porcelain

H: 1,7

D: 36,5

Works well with the Poem furniture range with a depth of 35 cm.



50×35



60×35



80×35

Width	Direction	Colour	Order no.
50	Centre	White	5053
60	Centre	White	5063
80	Centre	White	5083

Skapa 35

Porcelain

H: 8,5

D: 41

Works well with the Poem, Intro and Bloc furniture ranges with a depth of 35 cm. For bolt or bracket mounting.



45×35



50×35



55×35



60×35



80×35

Width	Direction	Colour	Order no.
45	Centre	White	37345
50	Centre	White	37350
55	Centre	White	37355
60	Centre	White	37360
80	Centre	White	37380

Munka

Mineral composite

H: 1,5

D: 36

Works well with the Poem furniture range with a depth of 35 cm.



50×35



60×35



80×35

Width	Direction	Colour	Order no.
50	Centre	White	52510
60	Centre	White	52610
80	Centre	White	52810

Skapa 25

Porcelain

H: 8,5

D: 31

Works well with the Bloc furniture range with a depth of 25 cm. For bracket mounting.



45×25

Width	Direction	Colour	Order no.
45	Centre	White	37045

Console for washbasin

2 pcs.

Depth	Colour	Order no.
25	White	90030
35	White	9003

Bolt for porcelain washbasins

Colour	Order no.
	90901

Myre Stripe Round

Ø36 Porcelain.
Ø36 H: 12

Colour	Order no.
White	5346

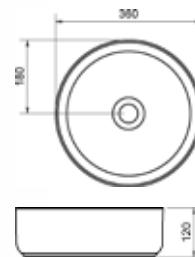

Myre Round

Ø36 Porcelain.
Ø36 H: 12

Colour	Order no.
White	5336
Latte	5337
Mocha	5338
Anthracite	5339

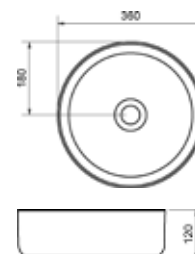

Myre Rectangular

50×36 Porcelain.
W: 50 H: 12 D:36

Colour	Order no.
White	5353
Latte	5354
Mocha	5355
Anthracite	5356

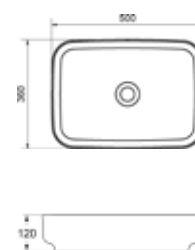

Fross Round

Ø40 Solid Surface.
Ø40 H: 12

Colour	Order no.
White matt	2440
Black matt	8440

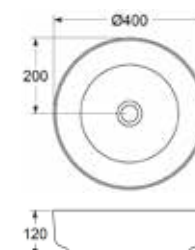

Fross Rectangular

55×35, Solid Surface. W: 55 H: 12 D: 35

Colour	Order no.
White matt	2455
Black matt	8455

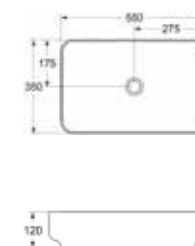

Stora Round

Ø40 Sheet metal.
Ø40 H: 12

Colour	Order no.
Brushed brass	5440
Pencil black	5441

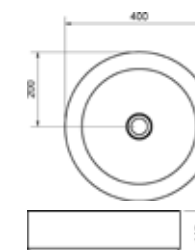

Laminate work tops

Durable laminate work tops. Laminate work tops in sizes 60×45, 80×45, 100×45, 120×45 centre and double, and 160×45 double are reversible, which means you can choose whether to have the mixer hole on the right or left. All other sizes feature the mixer hole on the left. Supplied with an overhang. For free-standing washbasin mixers.

Laminate - Poem

Laminate work tops		Quartz For Poem H:2 D:46	Mica For Poem H:2 D:46	SLATE For Poem H:2 D:46
Width	Direction	Order no.	Order no.	Order no.
60	Centre	20602	20603	20601
80	Centre	20802	20803	20801
100	Centre	21012	21013	21011
120	Centre	21202-C	21203-C	21201-C
	Right	21202-H	21203-H	21201-H
	Left	21202-V	21203-V	21201-V
	Double	21202-D	21203-D	21201-D
160	Right	21602-H	21603-H	21601-H
	Left	21602-V	21603-V	21601-V
	Double	21602-D	21603-D	21601-D

Quartz

Thanks to its grey, sand-coloured background, it creates a warm, inviting atmosphere. A real all-rounder.



Mica

The discreet dark grey works well with calming, warm browns and dark woods.



SLATE

Clean and genuine. A simple colour that is dark and intense. Works best with a matt finish and wood patterns.



Dekton counter tops

The work tops are made of Dekton, an exceptionally hard, scratch-resistant material that is more resistant to bending than granite. The material is UV-resistant, which makes the surface easy to clean and prevents fading. Choose from Keon, Danae, Laurent, Sirius and Rem. Dekton worktops always feature a mixer hole on the left. The worktops have an overhang. For free-standing washbasin mixers.

Dekton - Poem

Dekton counter tops		Sirius For Poem H:1,2 D:46	Keon For Poem H:1,2 D:46
Width	Direction	Order no.	Order no.
60	Centre	370699	130062
80	Centre	370899	130082
100	Centre	371098	130102
120	Centre	130130	130131
	Right	130122	130125
	Left	130121	130124
	Double	130123	130126
160	Right	130134	130137
	Left	130133	130136
	Double	130135	130138

Danae

Has a sand-coloured limestone look.



Keon

Has a grey industrial look.



Dekton - Epos

Dekton counter tops		Rem For Epos H:1,2 D:46	Sirius For Epos H:1,2 D:46
Width	Direction	Order no.	Order no.
60	Centre	145063	370699
80	Centre	145083	370899
100	Right	145101	146101
	Left	145100	146100
120	Right	145121	146121
	Left	145120	146120
160	Right	145161	146161
	Left	145160	146160
	Double	145162	146162
200	Right	145201	146201
	Left	145200	146200
	Double	145202	146202

Laurent

Has a dark background with gold marbling.



Rem

Has a relaxing marble look with a light background and through-coloured edge.



Sirius

Has a matt black slate look.



Dekton counter tops		Danae For Epos H:1,2 D:46	Keon For Epos H:1,2 D:46	Laurent For Epos H:1,2 D:46
Width	Direction	Order no.	Order no.	Order no.
60	Centre	144063	130062	143063
80	Centre	144083	130082	143083
100	Right	144101	141101	143101
	Left	144100	141100	143100
120	Right	144121	141121	143121
	Left	144120	141120	143120
160	Right	144161	141161	143161
	Left	144160	141160	143160
	Double	144162	141162	143162
200	Right	144201	141201	143201
	Left	144200	141200	143200
	Double	144202	141202	143202

Leveranstider

¹Delivery time approx 1-4 weeks.

²Special counter top. Delivery time 7-8 weeks.



Lodal

Incl. flexible connection hose with swivel nuts (G3/8") to facilitate installation. Easy installation, tools included and connection hoses ready-fitted.

Cold start
Flow controller 5L/min
Operating pressure: Up to 10 bar

Colour	Order no.
Chrome	96730
Pencil black	96732
Black matt	96731



Skule Smooth

Incl. flexible connection hose with swivel nuts (G1/2") to facilitate installation. Easy installation, tools included.

Flow controller 6,5L/min
Operating pressure: Up to 10 bar

Colour	Order no.
Chrome	96811
Brushed brass	96844
Pencil black	96845
Black matt	96814



Skule knurled

Incl. flexible connection hose with swivel nuts (G1/2") to facilitate installation. Easy installation, tools included.

Flow controller 6,5L/min
Operating pressure: Up to 10 bar

Colour	Order no.
Chrome	96823
Brushed brass	96840
Pencil black	96841
Black matt	96824



Ejer

Incl. flexible connection hose with swivel nuts (G1/2") to facilitate installation. Easy installation, tools included.

Flow controller 5L/min
Operating pressure: Up to 10 bar
Noise class 1

Colour	Order no.
Chrome	96827
Brushed brass	96829
Pencil black	96906
Black matt	96828



Bold

Incl. flexible connection hose with swivel nuts (G1/2") to facilitate installation. Easy installation, tools included.

Flow controller 4,5L/min
Operating pressure: Up to 10 bar

Colour	Order no.
Chrome	96825
Black matt	96826



Tron

Incl. flexible connection hose with swivel nuts (G3/8") to facilitate installation. Easy installation, tools included and connection hoses ready-fitted.

Cold start
 Flow controller 5L/min
 Operating pressure: Up to 10 bar
 Noise class 1
 Energy class A, 1,3 kWh

Colour	Order no.
Chrome	96830



Tarju

Incl. flexible connection hose with swivel nuts (G3/8") to facilitate installation. Easy installation, tools included and connection hoses ready-fitted.

Cold start
 Flow controller 5L/min
 Operating pressure: Up to 10 bar
 Energy class A, 1,3 kWh
 Noise class 1

Colour	Order no.
Chrome	96736
Pencil black	96738
Black matt	96737



Halde

Incl. flexible connection hose with swivel nuts (G3/8") to facilitate installation. Easy installation, tools included and connection hoses ready-fitted.

Cold start
 Flow controller 5L/min
 Operating pressure: Up to 10 bar
 Energy class A, 1,3 kWh

Colour	Order no.
Chrome	96816
Brushed brass	96834
Pencil black	96881
Black matt	96817



Halde with hand shower

Incl. flexible connection hose with swivel nuts (G3/8") to facilitate installation. Easy installation, tools included and connection hoses ready-fitted.

Flow controller 5L/min
 Operating pressure: Up to 10 bar
 Noise class 1

Colour	Order no.
Chrome	96876
Black matt	96877



Vetle

Incl. flexible connection hose with swivel nuts (G3/8") to facilitate installation. Easy installation, tools included and connection hoses ready-fitted.

Cold start
 Flow controller 5L/min
 Operating pressure: Up to 10 bar
 Energy class A, 1,3 kWh
 Noise class 1

Colour	Order no.
Chrome	96733
Pencil black	96735
Black matt	96734



Halde Independent

Incl. flexible connection hose with swivel nuts (G3/8") to facilitate installation. Easy installation, tools included and connection hoses ready-fitted.

Cold start
Flow controller 5L/min
Operating pressure: Up to 10 bar
Energy class A, 1,3 kWh

Colour	Order no.
Chrome	96816-H
Brushed brass	96837-H
Pencil black	96881-H
Black matt	96817-H



Free-standing Halde with hand shower

Incl. flexible connection hose with swivel nuts (G3/8") to facilitate installation. Easy installation, tools included and connection hoses ready-fitted.

Flow controller 5L/min
Operating pressure: Up to 10 bar
Noise class 1

Colour	Order no.
Chrome	96876-H
Black matt	96877-H



Skule Independent Smooth

Incl. flexible connection hose with swivel nuts (G1/2") to facilitate installation. Easy installation, tools included.

Flow controller 6,5L/min
Operating pressure: Up to 10 bar

Colour	Order no.
Chrome	96811-H
Brushed brass	96844-H
Pencil black	96845-H
Black matt	96814-H



Skule Independent knurled

Incl. flexible connection hose with swivel nuts (G1/2") to facilitate installation. Easy installation, tools included.

Flow controller 6,L/min
Operating pressure: Up to 10 bar

Colour	Order no.
Chrome	96823-H
Brushed brass	96840-H
Pencil black	96841-H
Black matt	96824-H



Ejer Independent

Incl. flexible connection hose with swivel nuts (G1/2") to facilitate installation. Easy installation, tools included.

Flödesbegränsare 5L/min
Operating pressure: Up to 10 bar
Noise class 1

Colour	Order no.
Chrome	96827-H
Brushed brass	96829-H
Pencil black	96906-H
Black matt	96828-H



Trap incl. hose

EasyClean. Complete the look with a pop-up waste

Colour	Order no.
Chrome	1214
White	1224
Black matt	1222



Pop-up waste

Made entirely of metal. Works well with a trap.

Colour	Order no.
Chrome	98813
Brushed brass	96872
Pencil black	96871

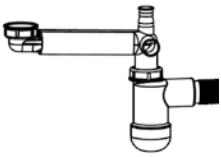

Trap incl. hose

Colour	Order no.
White	8988

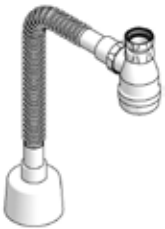

Trap incl. hose

Colour	Order no.
White	8989



Waste kit incl trap

Chrome plated waste cover available for the console and wall hung basins. Wall fixed and floor fixture

Options	Order no.
For waste to floor	99027
For waste to wall	99026

Ista

Mirror with functional lighting featuring touch-controlled brightness and colour temperature adjustment. The lighting is dimmable and the light temperature can be adjusted to an optimal level, whether it's for makeup or mood lighting.



Ista

Frosted lighting
Touch function
Kelvin: 2700-6400
IP44
H:80 D:2,9

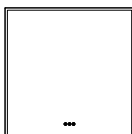

Width	Watt	Lumen	Order no.
50	28,2	846	453050
60	49,1	1385	453060
80	57,1	1560	453080
100	64,8	1815	453100
120	68,4	1915	453120
160	71,5	1658	453160

Ista with black frame

Frosted lighting
Touch function
Kelvin: 2700-6400
IP44
H:80 D:3,6

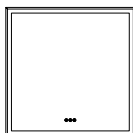

Width	Watt	Lumen	Order no.
60	46,4	720	451060
80	54,7	805	451080
100	61	950	451100
120	67	1065	451120

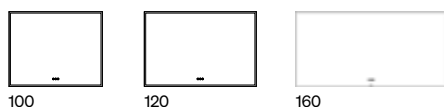

Ista Round

Frosted lighting
Touch function
Kelvin: 2700-6400
IP44
D:2,9

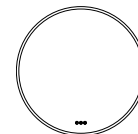

Width	Watt	Lumen	Order no.
60	43,1	1025	454060
80	58,9	1355	454080
100	67,9	1720	454100

Ista round with black frame

Frosted lighting
Touch function
Kelvin: 2700-6400
IP44
D:3,2

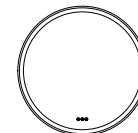

Width	Watt	Lumen	Order no.
60	39,3	610	458060
80	55,8	870	458080
100	65,6	1015	458100

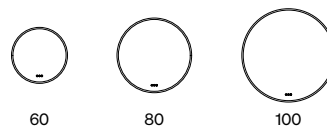

Choose pendant lighting

Cylinder

Black fabric cord 2,5 m.
IP44
E27 Max 40W. Light bulb not included.
Ø6 H:22



Colour	Order no.
Black matt	7520
Brushed brass	7522
Pendant attachment	
Cable cup 1 pendant	7579
Wall mounting 1-3 pendants	7578
Ceiling mounting 3 pendants	7577

Globe

Black fabric cord 2,5 m.
IP44
E14 Max 25W. Light bulb not included.
Ø15



Colour	Order no.
Opal	7523
Smoky	7524
Pendant attachment	
Cable cup 1 pendant	7579
Wall mounting 1-3 pendants	7578
Ceiling mounting 3 pendants	7577

Valje

Mirror with atmospheric background lighting. Choose from a full range of options to find the perfect size and shape for your bathroom, from square or rectangular to round. Add lighting to the rectangular mirrors or a standalone pendant light.

Valje

LED light source behind the mirror
Kelvin: 3000
IP44
H:80 D:2,9



Width	Watt	Lumen	Order no.
60	25,2	440	356060
80	29,3	500	356080
100	32	560	356100
120	35,7	620	356120



60

80

100

120

Valje lighting

Mirror lighting for rectangular Valje
Kelvin: 3000
IP44
H:7 D:6,7



Width	Watt	Lumen	Order no.
60	38,1	325	3160
80	46,7	440	3180
100	53,6	510	3110
120	61,5	610	3112

Valje Oval

LED light source behind the mirror
Kelvin: 3000
IP44
W:45 D:2,5



Height	Watt	Lumen	Order no.
90	15,3	382	359044
110	22,3	415	359045

Choose pendant lighting

Cylinder

Black fabric cord 2,5 m.
IP44
E27 Max 40W. Light bulb not included.
Ø6 H:22



Colour	Order no.
Black matt	7520
Brushed brass	7522
Pendant attachment	
Cable cup 1 pendant	7579
Wall mounting 1-3 pendants	7578
Ceiling mounting 3 pendants	7577



Valje Round

LED light source behind the mirror
Kelvin 3000
IP44
D:2,9

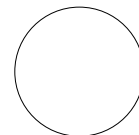

Width	Watt	Lumen	Order no.
60	15	305	358060
80	20	395	358080
100	26,5	525	358100



60

80

100

Valje Round Double

LED light source behind the mirror
Kelvin: 3000
IP44
W:119,9 H:89,74 D:3,4

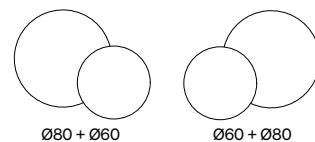

Ø80 + Ø60

Ø60 + Ø80

Width	Watt	Lumen	Order no.
Ø80+ Ø60	25,1	480	359112
Ø60+ Ø80	25,1	480	359212

Valje Rounded

LED light source behind the mirror.
Only for counter tops.
Can not be combined with free-standing Skule.
Kelvin: 2700-6400
IP44
H:112 D:2,9

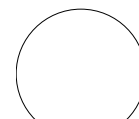

Width	Watt	Lumen	Order no.
120	30,5	580	359120

Globe

Black fabric cord 2,5 m.
IP44
E14 Max 25W. Light bulb not included.
Ø15



Colour	Order no.
Opal	7523
Smoky	7524
Pendant attachment	
Cable cup 1 pendant	7579
Wall mounting 1-3 pendants	7578
Ceiling mounting 3 pendants	7577

Norra

Norra is a mirror that combines the organic shapes of nature with modern design. Inspired by biophilic design, it creates a harmonious and healing atmosphere in your home. With soft curves and natural transitions, Norra challenges traditional shapes and offers a sense of calm and balance. Comes with atmospheric background lighting.

Norra

LED light source behind the mirror
Kelvin: 3000
IP44
H:70/90/110 D:2,9

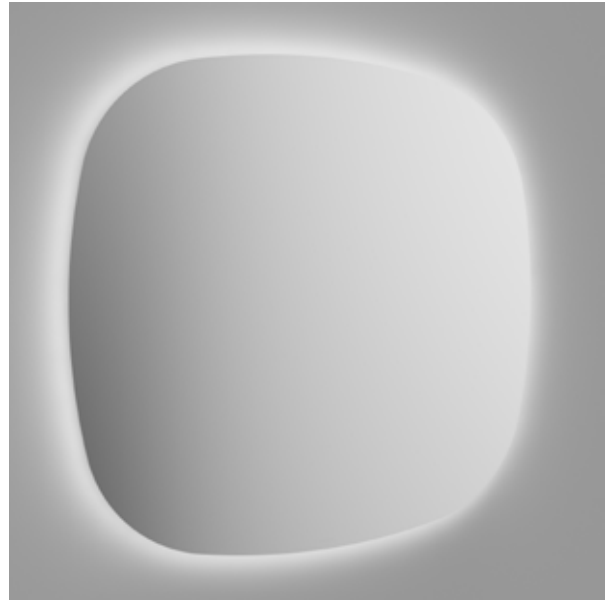

Width	Watt	Lumen	Order no.
70	21,3	568	557070
90	26,2	742	559090
110	30,5	914	551111

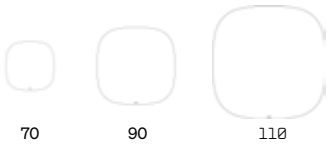

Tived

A classic flat mirror available in three versions and many different widths. Choose a mirror without lighting, with overhead lighting, or with overhead lighting and basin lighting (the light shines down onto the basin). You can also add a shelf and a standalone LED light fixture.



Tived

Light source LED
Kelvin: 3400
IP44
H:80 D:3,5 (With lighting H:82 D:6)

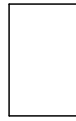

Without lighting.

With lighting

Width	Options	Watt	Lumen	Order no.
	Without lighting.	-	-	766450
45	LED lighting	7,84	570	226045
	LED + Washbasin lighting	11,14	770	226045-TL
	Without lighting.	-	-	766500
50	LED lighting	8,96	670	226050
	LED + Washbasin lighting	12,26	870	226050-TL
	Without lighting.	-	-	766550
55	LED lighting	10	720	226055
	LED + Washbasin lighting	13,3	920	226055-TL
	Without lighting.	-	-	766600
60	LED lighting	12,3	800	226060
	LED + Washbasin lighting	15,6	1000	226060-TL
	Without lighting.	-	-	766800
80	LED lighting	14,7	1080	226080
	LED + Washbasin lighting	18	1280	226080-TL
	Without lighting.	-	-	766100
100	LED lighting	18	1360	226100
	LED + Washbasin lighting	21,3	1560	226100-TL

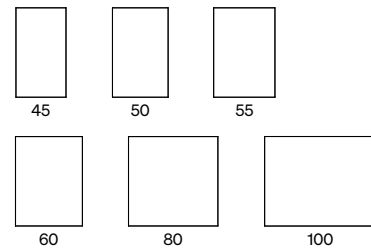

LED-lamp 30

Light source LED: 240 lm
System Effect: 5W.
IP44. Kelvin 3000
W:30



Colour	Order no.
Chrome	7330

LED-lamp 50

Light source LED: 240 lm
System Effect: 5W.
IP44. Kelvin 3000.
W:50



Colour	Order no.
Chrome	7350

Skuru

A clean, minimalist style that creates an exclusive atmosphere in your bathroom. This is largely due to the LED lighting, which has a knob for steplessly adjusting the colour temperature and brightness. An electrical socket, basin lighting and a smart magnet for holding small objects such as tweezers are included. Coated using our unique DuraDry method.



Skuru 50

Upper lighting LED: 320-350 lm
Lower lighting LED: 170-200 lm
System Effect: 11,9W.
Kelvin: 2700-6400.
IP44.
Electrical socket 230 V
W:50 H:72 D:19



Colour	Order no.
White	425050
Sand	422050
Pure oak	421050
Black ash	423050
Brown ash	426050

Skuru 60

Upper lighting LED: 530-600 lm
Lower lighting LED: 250-300 lm
System Effect: 18,9W.
Kelvin: 2700-6400.
IP44.
Electrical socket 230 V
W:60 H:72 D:19

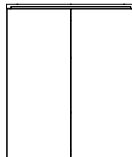

Colour	Order no.
White	425060
Sand	422060
Pure oak	421060
White ash	429060
Brown ash	426060
Black ash	423060

Skuru 80

Upper lighting LED: 530-600 lm
Lower lighting LED: 250-300 lm
System Effect: 18,9W.
Kelvin: 2700-6400.
IP44.
Electrical socket 230 V
W:80 H:72 D:19

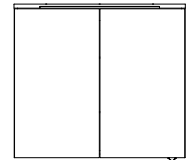

Colour	Order no.
White	425080
Sand	422080
Pure oak	421080
White ash	429080
Brown ash	426080
Black ash	423080

Skuru 100

Upper lighting LED: 530-600 lm
Lower lighting LED: 250-300 lm
System Effect: 18,9W.
Kelvin: 2700-6400.
IP44.
Electrical socket 230 V
W:100 H:72 D:19

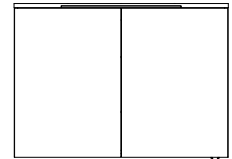

Colour	Order no.
White	425100
Sand	422100
Pure oak	421100
White ash	429100
Brown ash	426100
Black ash	423100

Skuru 120

Upper lighting LED: 2*530-600 lm
Lower lighting LED: 2*250-300 lm
System Effect: 37,3W.
Kelvin: 2700-6400.
IP44.
Electrical socket 230 V
W:120 H:72 D:19

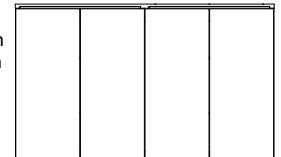

Colour	Order no.
White	425120
Sand	422120
Pure oak	421120
White ash	429120
Brown ash	426120
Black ash	423120

Good to know

Residual current circuit breaker
To order a residual current circuit breaker, add -JFB after the item number.

Selected colours

Add -COL after the item number. The extra charge is based on the price of the white furniture versions.

Find out more about Skuru

1. Dimmable colour temperature (2 700- 6 400K)
2. EasyMount hanging system for fast, simple, safe wall mounting of mirror cabinets
3. Made in Sweden and delivered pre-assembled.

Always included

1. Energy-effective soft, dimmable lighting
2. Knob on cabinet to control the lighting
3. Electrical socket in upper right corner of cabinet, can be changed to left on installation
4. Duradry coating process

Sarek

A practical bathroom cabinet, only 12 cm deep. Flexible and practical with two moveable glass shelves and an electrical socket in the cabinet ceiling. Energy-efficient LED lighting included, with the option of adding basin lighting. Coated using our unique DuraDry method.



Sarek 50

Upper lighting LED: 670 lm
(Lower lighting LED: 200 lm)
System Effect: 8,96W (12,26W).
Kelvin: 3400.
IP44.
Electrical socket 230 V
W:50 H:72 D:15

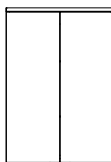

Colour	Options	Order no.
White		225050
White	Washbasin lighting	225050-TL
Sand		222050
Sand	Washbasin lighting	222050-TL
Pure oak		221050
Pure oak	Washbasin lighting	221050-TL
Brown ash		229050
Brown ash	Washbasin lighting	229050-TL
Black ash		223050
Black ash	Washbasin lighting	223050-TL

() = With washbasin lighting

Sarek 55

Upper lighting LED 720 lm
(Lower lighting LED: 200 lm)
System Effect: 10W (13,3W).
Kelvin: 3400.
IP44.
Electrical socket 230 V
W:55 H:72 D:15

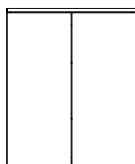

Colour	Options	Order no.
White		225055
White	Washbasin lighting	225055-TL

() = With washbasin lighting

Sarek 60

Upper lighting LED: 800 lm
(Lower lighting LED: 200 lm)
System Effect: 12,3W (15,6W).
Kelvin: 3400.
IP44.
Electrical socket 230 V
W:60 H:72 D:15

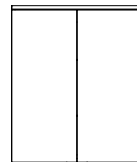

Colour	Options	Order no.
White		225060
White	Washbasin lighting	225060-TL
Sand		222060
Sand	Washbasin lighting	222060-TL
Pure oak		221060
Pure oak	Washbasin lighting	221060-TL
Brown ash		229060
Brown ash	Washbasin lighting	229060-TL
Black ash		223060
Black ash	Washbasin lighting	223060-TL

() = With washbasin lighting

Sarek 80

Upper lighting LED: 1080 lm
(Lower lighting LED: 200 lm)
System Effect: 14,7W (18W).
Kelvin: 3400.
IP44.
Electrical socket 230 V
W:80 H:72 D:15

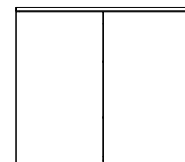

Colour	Options	Order no.
White		225080
White	Washbasin lighting	225080-TL
Sand		222080
Sand	Washbasin lighting	222080-TL
Pure oak		221080
Pure oak	Washbasin lighting	221080-TL
Brown ash		229080
Brown ash	Washbasin lighting	229080-TL
Black ash		223080
Black ash	Washbasin lighting	223080-TL

() = With washbasin lighting

Good to know

Residual current circuit breaker
To order a residual current circuit breaker, add -JFB after the item number.

Selected colours

Add -COL after the item number. The extra charge is based on the price of the white furniture versions.

Find out more about Sarek

1. Space-saving mirror cabinet with depth of 12 cm
2. EasyMount hanging system for fast, simple, safe wall mounting of mirror cabinets
3. Made in Sweden and delivered pre-assembled.

Always included

1. Energy-effective LED lighting 3400 K
2. Two moveable toughened glass shelves
3. Electrical socket in cabinet ceiling
4. DuraDry coating process

Bloc

A practical bathroom cabinet, only 12 cm deep. Flexible and practical with two moveable glass shelves and an electrical socket in the cabinet ceiling. Energy-efficient LED lighting included, with the option of adding basin lighting.



Bloc 45

Upper lighting LED: 570 lm
(Lower lighting LED: 200 lm)
System Effect: 7,84W (11,14W).
Kelvin: 3400.
IP44.
Electrical socket 230 V
W:45 H:72 D:15



Colour	Options	Order no.
White		25451
White	Washbasin lighting	25451-TL
Grey		25452
Grey	Washbasin lighting	25452-TL

() = With washbasin lighting

Bloc 55

Upper lighting LED: 720 lm
(Lower lighting LED: 200 lm)
System Effect: 10W (13,3W).
Kelvin: 3400.
IP44.
Electrical socket 230 V
W:55 H:72 D:15

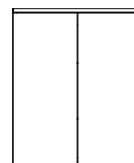

Colour	Options	Order no.
White		25551
White	Washbasin lighting	25551-TL
Grey		25552
Grey	Washbasin lighting	25552-TL

() = With washbasin lighting

Bloc 50

Upper lighting LED: 670 lm
(Lower lighting LED: 200 lm)
System Effect: 8,96W (12,26W).
Kelvin: 3400.
IP44.
Electrical socket 230 V
W:50 H:72 D:15

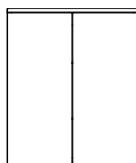

Colour	Options	Order no.
White		25501
White	Washbasin lighting	25501-TL
Grey		25502
Grey	Washbasin lighting	25502-TL

() = With washbasin lighting

Bloc 60

Upper lighting LED: 800 lm
(Lower lighting LED: 200 lm)
System Effect: 12,3W (15,6W).
Kelvin: 3400.
IP44.
Electrical socket 230 V
W:60 H:72 D:15

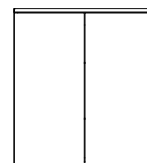

Colour	Options	Order no.
White		25601
White	Washbasin lighting	25601-TL
Grey		25602
Grey	Washbasin lighting	25602-TL

() = With washbasin lighting

Good to know

Residual current circuit breaker
To order a residual current circuit breaker, add -JFB after the item number.

Find out more about Bloc

1. Space-saving mirror cabinet with depth of 12 cm
2. EasyMount hanging system for fast, simple, safe wall mounting of mirror cabinets
3. Made in Sweden and delivered pre-assembled.

Always included

1. Energy-effective LED lighting 3400 K
2. Two moveable toughened glass shelves
3. Electrical socket in cabinet ceiling
4. Durable melamine finish

Dalby

Dalby mirror cabinet with solid reflective glass on the inside and outside. The mirror cabinet has two moveable glass shelves and is available in widths of 40, 55 and 60 cm. Add an optional electrical socket. Mirror cabinet without lighting.



Dalby 55

Without lighting.
W:55 H:70 D:14

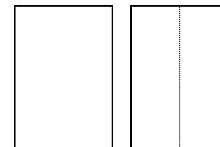

Colour	Options	Order no.
<input type="checkbox"/> White	1 door	26255
<input type="checkbox"/> White	2 doors	26256

Dalby 40

Without lighting.
W:40 H:70 D:14



Colour	Options	Order no.
<input type="checkbox"/> White	1 door	26240

Dalby 60

Without lighting.
W:60 H:70 D:14

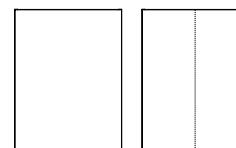

Colour	Options	Order no.
<input type="checkbox"/> White	1 door	26260
<input type="checkbox"/> White	2 doors	26261

Choose accessories

Dovre 55

Light source LED 1602 lm
System Effect: 18,6W.
Kelvin: 3000. IP44.
W:55



Dovre 60

Light source LED: 1650 lm
Systemeffekt: 20W.
Kelvin: 3000. IP44.
W:60



Dovre electrical socket

230 V

Colour	Order no.	Colour	Order no.	Colour	Order no.
<input type="checkbox"/> White matt	70856	<input type="checkbox"/> White matt	70862	<input type="checkbox"/> White	7999

LED-lamp 30

Light source LED: 240 lm
System Effect: 5W.
IP44
W:30



LED-lamp 50

Light source LED 240 lm
System Effect: 5W.
IP44
W:50



Colour	Order no.	Colour	Order no.
<input type="checkbox"/> Chrome	7330	<input type="checkbox"/> Chrome	7350

Flattery Magnifying mirror

5x magnification
15 cm diameter



Order no.
7095

A60

Wooden bathroom cabinet
Sliding doors in reflective glass
Without lighting.
W:60 H:52 D:12,5

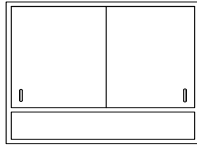

Colour	Order no.
<input type="checkbox"/> White	7060

A65

Wooden bathroom cabinet
Sliding doors in reflective glass
Without lighting.
W:65 H:52 D:12,5

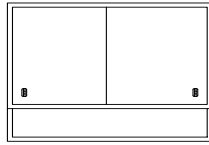

Colour	Order no.
<input type="checkbox"/> White	92

Choose accessories

LED lighting 60

Light source LED: 2800 lm
System Effect: 17,8W.
IP44. White.
W:60 H:7 D:20



Power sockets/R/L	Residual current circuit breaker	Order no.
No	No	376040
Yes/Right	No*	376041
Yes/Left	No*	376042
Yes/Right	Yes	376043
Yes/Left	Yes	376044

LED lighting 65

Light source LED: 2800 lm
System Effect: 17,8W.
IP44. White.
W:65 H:7 D:20



Power sockets/R/L	Residual current circuit breaker	Order no.
No	No	376540
Yes/Right	No*	376541
Yes/Left	No*	376542
Yes/Right	Yes	376543
Yes/Left	Yes	376544

LED-lamp 30

Light source LED: 240 lm
System Effect: 5W.
IP44
W:30



LED-lamp 50

Light source LED: 240 lm
System Effect: 5W.
IP44
W:50



Colour	Order no.	Colour	Order no.
Chrome	7330	Chrome	7350

Flattery Magnifying mirror

5x magnification
15 cm diameter



Order no.
7095

Intro

Hard-wearing mirror cabinet made of galvanised sheet metal, a material originally designed for the automotive industry. Our unique EnduraDry coating with an environmentally friendly zinc-iron alloy provides excellent protection against rust.



Intro 45

Without lighting.
W:45 H:67 D:13,5



Colour	Order no.
White matt	295045
Graphite grey	295245
Sand	295345
Sage	295545

Intro 45 Kit

Light source LED: 1297 lm
System Effect: 15,8W
Electrical socket 230 V
W:45 H:70 D:15

Colour	Order no.
White matt	295047
Graphite grey	295247

Intro 50

Without lighting.
W:50 H:67 D:13,5

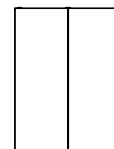

Colour	Order no.
White matt	295050
Graphite grey	295250
Sand	295350
Sage	295550

Intro 50 Kit

Light source LED 1450 lm
System Effect: 18,2W
Electrical socket 230 V
W:50 H:70 D:15

Colour	Order no.
White matt	295052
Graphite grey	295252

Intro 55

Without lighting.
W:55 H:67 D:13,5

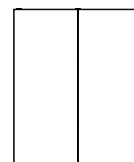

Colour	Order no.
White matt	295055
Graphite grey	295255
Sand	295355
Sage	295555

Intro 55 Kit

Light source LED: 1602 lm
System Effect: 18,2W
Electrical socket 230 V
W:55 H:70 D:15

Colour	Order no.
White matt	295057
Graphite grey	295257

Choose accessories (Lighting and electrical socket included in the Intro Kit.)

Dovre 45

Light source LED: 1297 lm
System Effect: 15,8W.
Kelvin: 3000. IP44.
W:45



Colour	Order no.
White matt	70846
Graphite grey	70847

Dovre 50

Light source LED: 1450 lm
System Effect: 18,2W.
Kelvin: 3000. IP44.
W:50



Colour	Order no.
White matt	70851
Graphite grey	70852

Dovre 55

Light source LED: 1602 lm
System Effect: 18,6W.
Kelvin: 3000. IP44.
W:55



Colour	Order no.
White matt	70856
Graphite grey	70857

Dovre electrical socket

230 V

Colour	Order no.
White	7999

Flattery Magnifying mirror

5x magnification
15 cm diameter



Order no.
7095

NY50

Metal cabinet
 Door with reflective glass
 Without lighting.
 W:40 H:50 D:14

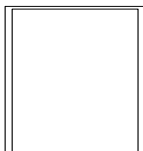

Colour	Order no.
<input type="checkbox"/> White	310

Birdie

Metal cabinet
 Left- or right-hinged
 Without lighting.
 W:40 H:70 D:13,5

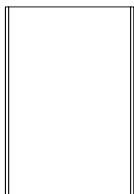

Colour	Order no.
<input type="checkbox"/> White	320

Medicine cabinet

Left- or right-hinged
 Child-proof
 Two keys
 W:36,5 H:49,5 D:16

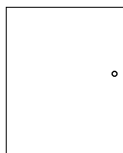

Colour	Order no.
<input type="checkbox"/> White	38

Choose accessories

LED lighting 40

Light source LED: 1400 lm
 System Effect: 10W.
 IP44. White.
 W:40 H:7 D:20



Power sockets/R/L	Residual current circuit breaker	Order no.
No	No	374040
Yes/Right	No*	374041
Yes/Left	No*	374042

Flattery Magnifying mirror

5x magnification
 15 cm diameter



Order no.
7095

I:et

Metal cabinet
Sliding doors in reflective glass
Without lighting.
W:55 H:70 D:12,5

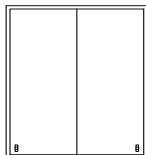

Colour	Order no.
<input type="checkbox"/> White	339

Eagle

Metal cabinet
Solid mirror doors
Without lighting.
W:55 H:70 D:14,5

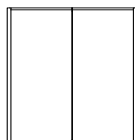

Colour	Order no.
<input type="checkbox"/> White	325

Tvilling 1

Metal cabinet
Sliding doors in reflective glass
Without lighting.
W:65 H:39,5 D:12,5

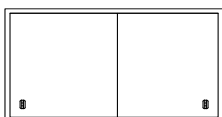

Colour	Order no.
<input type="checkbox"/> White	13

Choose accessories

LED lighting 55

Light source LED: 2800 lm
System Effect: 17,8W.
IP44. White.
W:55 H:7 D:20



Power sockets/R/L	Residual current circuit breaker	Order no.
No	No	375540
Yes/Right	No*	375541
Yes/Left	No*	375542
Yes/Right	Yes	375543
Yes/Left	Yes	375544

LED lighting 65

Light source LED: 2800 lm
System Effect: 17,8W.
IP44. White.
W:65 H:7 D:20



Power sockets/R/L	Residual current circuit breaker	Order no.
No	Nej	376540
Yes/Right	Nej*	376541
Yes/Left	Nej*	376542
Yes/Right	Ja	376543
Yes/Left	Ja	376544

Dovre 55

Ljuskälla LED: 1602 lm
System Effect: 18,6W.
Kelvin: 3000. IP44.
W:55



Colour	Order no.
<input type="checkbox"/> White matt	70856

Flattery Magnifying mirror

5x magnification
15 cm diameter



Order no.
7095

Wall cabinet 30		Wall cabinet 70x30 Incl. 2 glass shelves. W: 30 H: 70 D: 15
------------------------	---	---

Options	Front	Order no.
White		
Carcase		770301
Door	Flat	770301-1
Door	Edging	770301-4
Sand		
Carcase		770309
Door	Flat	770309-1
Door	Edging	770309-4
Pure oak		
Carcase		770307
Door	Flat	770307-1
Door	Edging	770307-4
White ash		
Carcase		770305
Door	Flat	770305-1
Brown ash		
Carcase		770306
Door	Flat	770306-1
Door	Edging	770306-4
Black ash		
Carcase		770308
Door	Flat	770308-1
Door	Edging	770308-4
Wall cabinet 40		Wall cabinet 70x40 Incl. 2 glass shelves. W: 40 H: 70 D: 13

Options	Front	Order no.
White		
Carcase		770401
Door	Flat	770401-1
Door	Edging	770401-4
Sand		
Carcase		770409
Door	Flat	770409-1
Door	Edging	770409-4
Pure oak		
Carcase		770407
Door	Flat	770407-1
Door	Edging	770407-4
White ash		
Carcase		770405
Door	Flat	770405-1
Brown ash		
Carcase		770406
Door	Flat	770406-1
Door	Edging	770406-4
Black ash		
Carcase		770408
Door	Flat	770408-1
Door	Edging	770408-4



Medicine cabinet
Child-proof cabinet, supplied with two keys. Two shelves. Hinges can be mounted on the right or left. B: 36,5 H: 16 D: 49,5

Colour	Order no.
White	38

Tall cabinet 120		Tall cabinet 120x35 Incl. 2 wooded shelves and 1 glass shelf. W: 35 H: 120 D: 33
-------------------------	---	--

Options	Front	Order no.
White		
Carcase		7120351
Top shelf		75135
Charging station		72351
Drawer		74351
Door	Flat	7120351-1
Door	Edging	7120351-4
Sand		
Carcase		7120359
Top shelf		75439
Charging station		72359
Drawer ²		74359
Door	Flat	7120359-1
Door	Edging	7120359-4
Pure oak		
Carcase		7120357
Top shelf		75437
Charging station		72357
Drawer ²		74357
Door	Flat	7120357-1
Door	Edging	7120357-4
White ash		
Carcase		7120355
Top shelf		75535
Charging station		72355
Drawer ²		74355
Door	Flat	7120355-1
Brown ash		
Carcase		7120356
Top shelf		75635
Charging station		72356
Drawer ²		74356
Door	Flat	7120356-1
Door	Edging	7120356-4
Black ash		
Carcase		7120358
Top shelf		75438
Charging station		72358
Drawer ²		74358
Door	Flat	7120358-1
Door	Edging	7120358-4

Options

More accessories for your tall cabinet

Tall cabinet 120x35

Options	Order no.
2 glass shelves.	70335
Low laundry basket. H: 26,5	72535
Tall laundry basket. H: 50	74135
Push-open White ²	12741
Push-open Black ²	12742

Selected colours



Add -COL after the item number. The extra charge is based on the price for white furniture. Frame and door: SEK +2,690 Open storage: SEK +2,690 Other accessories are not available in Svedbergs' selected colour collection.

Handles and knobs

Don't forget to include handles for your furniture. Read more on page 149.

Details

²Not for glass cabinets.

Tall cabinet 160	Tall cabinet 160×35 Incl.2 wooded shelves and 2 glass shelves. W: 35 H: 160 D: 33		Tall cabinet 160×50 Incl.2 wooded shelves and 2 glass shelves. W: 50 H: 160 D: 33	
-------------------------	--	---	--	---

Options	Front	Order no.	Order no.
White			
Carcase		7160351	7160501
Open storage		70601	70601
Charging station		72351	72501
Drawer		74351	74501
Door 35	Flat	7160351-1	-
Door 35	Edging	7160351-4	-
Door 50 ¹	Flat	7160501-1	7160501-1
Door 50 ¹	Edging	7160501-4	7160501-4
Sand			
Carcase		7160359	7160509
Open storage		70609	70609
Charging station		72359	72509
Drawer ²		74359	74509
Door 35	Flat	7160359-1	-
Door 35	Edging	7160359-4	-
Door 50 ¹	Flat	7160509-1	7160509-1
Door 50 ¹	Edging	7160509-4	7160509-4
Pure oak			
Carcase		7160357	7160507
Open storage		70607	70607
Charging station		72357	72507
Drawer ²		74357	74507
Door 35	Flat	7160357-1	-
Door 35	Edging	7160357-4	-
Door 50 ¹	Flat	7160507-1	7160507-1
Door 50 ¹	Edging	7160507-4	7160507-4
White ash			
Carcase		7160355	7160505
Open storage		70605	70605
Charging station		72355	72505
Drawer ²		74355	74505
Door 35	Flat	7160355-1	-
Door 50 ¹	Flat	7160505-1	7160505-1
Brown ash			
Carcase		7160356	7160506
Open storage		70606	70606
Charging station		72356	72506
Drawer ²		74356	74506
Door 35	Flat	7160356-1	-
Door 35	Edging	7160356-4	-
Door 50 ¹	Flat	7160506-1	7160506-1
Door 50 ¹	Edging	7160506-4	7160506-4
Black ash			
Carcase		7160358	7160508
Open storage		70608	70608
Charging station		72358	72508
Drawer ²		74358	74508
Door 35	Flat	7160358-1	-
Door 35	Edging	7160358-4	-
Door 50 ¹	Flat	7160508-1	7160508-1
Door 50 ¹	Edging	7160508-4	7160508-4

Display door for tall cabinets

Profile	Order no.
Matt aluminium/Clear glass	
120×35	7120351-3
160×35	7160351-3
160×50	7160501-3
Matt aluminium/Smoked glass	
120×35	7120353-3
160×35	7160353-3
160×50	7160503-3
Matt aluminium/Line glass	
120×35	7120352-3
160×35	7160352-3
160×50	7160502-3
Black matt/Clear glass	
120×35	7120354-3
160×35	7160354-3
160×50	7160504-3
Black matt/Smoked glass	
120×35	7120356-3
160×35	7160356-3
160×50	7160506-3
Black matt/Line glass	
120×35	7120355-3
160×35	7160355-3
160×50	7160505-3

Options

More accessories for your tall cabinet

Tall cabinet 160×35

Options	Order no.
2 glass shelves.	70335
Low laundry basket. H: 26,5	72535
Tall laundry basket. H: 50	74135
Push-open White 2	12741
Push-open Black 2	12742

Tall cabinet 160×50

Options	Order no.
2 glass shelves.	70350
Low laundry basket. H: 26,5	72550
Tall laundry basket. H: 50	74150
Push-open White 2	12741
Push-open Black 2	12742

Choose lighting

Lighting for tall cabinets with wooden doors:

Start with a driver kit (1) and lighting in the cabinet (3) and a floor light (2).

Lighting for tall cabinets with display doors: Start with a driver kit (1) and choose two floor lights (2), with one to be placed under the tall cabinet and the other inside the cabinet.

If the lighting is connected to the mains supply in your bathroom, use the wall switch to turn the tall cabinet light on and off.

Options	Order no.
① Driver kit lighting	5991
② Floor light ³	5992
③ Lighting in cabinet ³	5994

Details



¹Door 50 can also be used with tall cabinet 160×30 with open storage, to make a tall cabinet with a semi-open side shelf.

²Not for glass cabinets.



³3W. 3000K.

Selected colours

Add -COL after the item number. The extra charge is based on the price for white furniture.

Wall cabinet Washers and dryers			 Wall cabinet 70×40 White carcass incl. 2 wooded shelves. W: 40 H: 68 D: 33	 Wall cabinet 70×50 White carcass incl. 2 wooded shelves. W: 50 H: 68 D: 33	 Wall cabinet 70×60 White carcass incl. 2 wooded shelves. W: 60 H: 68 D: 33
Options	Colour	Order no.	Order no.	Order no.	
	Carcass	White	7270421	7270521	7270621
	Door	White	770401-1	7270501-1	7270601-1
	Door	Sand	770409-1	7270509-1	7270609-1
	Door	Pure oak	770407-1	7270507-1	7270607-1
	Door	Brown ash	770406-1	7270506-1	7270606-1
	Door	Black ash	770408-1	7270508-1	7270608-1

Decor panel Wall cabinet			W: 35 H: 70 D: 1,2	Recess piece Wall cabinet			W: 20 H: 70 D: 1,6
Colour	Order no.	Colour	Order no.				
White	712811	White	712911				
Sand	712874	Sand	712877				
Pure oak	712864	Pure oak	712867				
Brown ash	712869	Brown ash	712872				
Black ash	712819	Black ash	712830				

Console Washers and dryers			 Console 72×40 White carcass incl. 1 wooded shelf. W: 40 H: 72 D: 58	 Console 72×50 White carcass incl. 1 wooded shelf. W: 50 H: 72 D: 58	 Console 72×60 White carcass incl. 1 wooded shelf. W: 60 H: 72 D: 58
Options	Colour	Order no.	Order no.	Order no.	
	Carcass	White	7272401	7272501	7272601
	Door	White	770401-1	7270501-1	7270601-1
	Door	Sand	770409-1	7270509-1	7270609-1
	Door	Pure oak	770407-1	7270507-1	7270607-1
	Door	Brown ash	770406-1	7270506-1	7270606-1
	Door	Black ash	770408-1	7270508-1	7270608-1

Work top Washers and dryers		Made-to-measure, max 240 cm. Delivery time 3-4 weeks. H: 2,8 D: 63	Accessories Work top	
Colour	Order no.	Options	Order no.	
White	BSK100	Wall console	47920	
Light grey	BSK02	Angle bracket	47910	
Dark grey	BSK03			
Black	BSK04			
Quartz	BSK102			
Mica	BSK103			
Slate	BSK101			

Selected colours
The doors and decor panels are available in Svedbergs' selected colour collection. The frame is not available in the selected colour collection.

Choose accessories for the counter top cabinet and wall cabinet

Decor panel for washing machine

Incl. adjustable foot.
W: 63 H: 33 D: 60

Colour	Order no.
White	712411
Sand	712873
Pure oak	712863
Brown ash	712868
Black ash	712419

Laundry basket

Colour: Silver.
H: 33 D: 60



Width	Order no.
40	712844
50	712845
60	712846

Fittings

Push open

Colour	Order no.
Grey	71200

Support legs

2 pcs. H: 10/15 cm (+15 mm)
Chrome.





Height	Order no.
10	71210
15	71215

Electrical box



3 electrical sockets.



Colour	Order no.
White	72

Tall cabinet Washers and dryers		Tall cabinet 122×40 White carcass incl. 2 wooded shelves. W: 40 H: 122 D: 58		Tall cabinet 122×60 White carcass incl. 2 wooded shelves. W: 60 H: 122 D: 58
------------------------------------	---	---	---	---

Options	Färg	Order no.	Order no.
Carcass	White	72122401	72122601
Door	White	72122401-1	72122601-1
Decor panel	White	712821	712821
Door	Sand	72122409-1	72122609-1
Decor panel	Sand	712875	712875
Door	Pure oak	72122407-1	72122607-1
Decor panel	Pure oak	712865	712865
Door	Brown ash	72122406-1	72122606-1
Decor panel	Brown ash	712870	712870
Door	Black ash	72122408-1	72122608-1
Decor panel	Black ash	712829	712829

Tall cabinet Washers and dryers		Tall cabinet 180×40 White carcass incl. 3 wooded shelves. W: 40 H: 180 D: 58		Tall cabinet 195×60 White carcass incl. 3 wooded shelves. W: 60 H: 195 D: 58
------------------------------------	---	---	---	---

Options	Färg	Order no.	Order no.
Carcass	White	72180401	72195601
Door	White	72180401-1	72195601-1
Decor panel ¹	White	712851	712851
Door	Sand	72180409-1	72195609-1
Decor panel ¹	Sand	712876	712876
Door	Pure oak	72180407-1	72195607-1
Decor panel ¹	Pure oak	712866	712866
Door	Brown ash	72180406-1	72195606-1
Decor panel ¹	Brown ash	712871	712871
Door	Black ash	72180408-1	72195608-1
Decor panel ¹	Black ash	712861	712861

Choose lighting

Lighting for tall cabinets with wooden doors: Start with a driver kit (1) and lighting in the cabinet (3) and a floor light (2).

If the lighting is connected to the mains supply in your bathroom, use the wall switch to turn the tall cabinet light on and off.



Options	Order no.
① Driver kit lighting	5991
② Floor light ³	5992
③ Lighting in cabinet ³	5994

Selected colours

The doors and decor panels are available in Svedbergs' selected colour collection. The frame is not available in the selected colour collection.

Details

¹The decor panel has the following measurements W: 60 H: 195 D: 1.2 and must be cut to fit with a tall cabinet with the measurements 180×40.

Choose accessories for your tall cabinet

Fittings for cleaning cabinets

W: 34 H: 85 D: 13



Colour	Order no.
Chrome	40

Vacuum cleaner hose holder

W: 29,5 H: 25,5 D: 10



Colour	Order no.
Chrome	42

Electrical box

3 electrical sockets.



Colour	Order no.
White	72

Laundry basket

Colour: Silver
H: 33 D: 60



Width	Order no.
40	712844
60	712846

Support legs

2 pcs. H: 10/15 cm (+15 mm)
Chrome.



Height	Order no.
10	71210
15	71215

Wooded shelf

2 pcs.
Width: 40/60 cm

Width	Order no.
40	71246
60	71266

Fittings

Push open

Colour	Order no.
Grey	71200

B1

1 pc
128 CC



Colour	CC	Order no.
Chrome	128cc	71394

L1

1-pack
Knob. Knurled



Colour	Order no.
Chrome	22325
Black matt	22326
Brass	22327

M3

1-pack
Knob 55 mm.



Colour	Order no.
Stainless	22457
Black matt	22452

P1

1-pack Ø42 mm.
Knob



Colour	Order no.
Chrome	22309
Pencil black	22313
Black matt	22311
Brushed brass	22312

S4

1-pack
40 mm.



Colour	Order no.
Stainless	22217
White	22211

S5

1-pack
40 mm.



Colour	Order no.
Chrome	22840
Black matt	22842
Brass	22846

T1

1-pack
128/192 CC



Colour	CC	Order no.
Polished	128cc	22380
	192cc	22390
Black matt	128cc	22381
	192cc	22391

E1

1-pack
128/256/480 CC



Colour	CC	Order no.
Chrome	128cc	12368
	256cc	12369
	480cc	12370

M1

1-pack
160 CC



Colour	CC	Order no.
Black matt	160cc	22330
Pencil black	160cc	22331

M3

1-pack
128 CC



Colour	CC	Order no.
Stainless	128cc	22487
Black matt	128cc	22482

P2

1-pack Ø25 mm.
Knob



Colour	Order no.
Chrome	22413

S4

1-pack
160 mm.



Colour	Order no.
Stainless	22227
White	22221

S5

1-pack
120 mm.



Colour	Order no.
Chrome	22810
Black matt	22812
Brass	22816

Drilling guide

Can be used with all
bathroom furniture.

Colour	Order no.
Black	98777

Langfoss Shower screen fixed

- Delivered complete with a curtain rail (max 105 cm), and floor and wall profiles for adjustment up to 20 mm.
- Height: 200/230 cm (201/231 cm top edge with the optional curtain rail).
- Toughened safety glass 6 mm.
- The existing wall profile doesn't allow hole for water pipes, for example.
- Add profiles, a curtain rail and a curtain, available in various colours.
- The shelf that fits onto the glass has the same style.

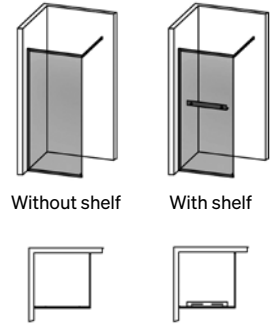

1. Choose a shower

Langfoss shower screen without shelf		80 Height: 200 cm	90 Height: 200 cm.	80 Height: 230 cm.	90 Height: 230 cm.
Profile/glass	Order no.	Order no.	Order no.	Order no.	Order no.
Matt aluminium					
Crystal glass	6782003	6792003	6782303	6792303	6792303
Bronze glass	6082003	6092003	6082303	6092303	6092303
Smoked glass	6982003	6992003	6982303	6992303	6992303
Pencil black					
Crystal glass	6782005	6792005	-	-	-
Bronze glass	6082005	6092005	-	-	-
Smoked glass	6982005	6992005	-	-	-
Black matt					
Crystal glass	6782002	6792002	6782302	6792302	6792302
Bronze glass	6082002	6092002	6082302	6092302	6092302
Smoked glass	6982002	6992002	6982302	6992302	6992302

Langfoss shower screen with shelf		80 Height: 200 cm	90 Height: 200 cm.	80 Height: 230 cm.	90 Height: 230 cm.
Profile/glass	Order no.	Order no.	Order no.	Order no.	Order no.
Matt aluminium					
Crystal glass	6782013	6792013	6782313	6792313	6792313
Bronze glass	6082013	6092013	6082313	6092313	6092313
Smoked glass	6982013	6992013	6982313	6992313	6992313
Pencil black					
Crystal glass	6782015	6792015	-	-	-
Bronze glass	6082015	6092015	-	-	-
Smoked glass	6982015	6992015	-	-	-
Black matt					
Crystal glass	6782012	6792012	6782312	6792312	6792312
Bronze glass	6082012	6092012	6082312	6092312	6092312
Smoked glass	6982012	6992012	6982312	6992312	6992312

Langfoss shower screen, fixed and with line glass

- Delivered complete with a curtain rail (max 105 cm), and floor and wall profiles for adjustment up to 20 mm.
- Height: 200/230 cm (201/231 cm top edge with the optional curtain rail).
- Toughened safety glass 5 mm.
- The existing wall profile doesn't allow hole for water pipes, for example.
- Add profiles, a curtain rail and a curtain, available in various colours.
- The shelf that fits onto the glass has the same style.

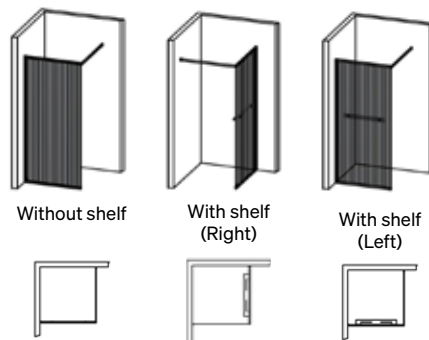

1. Choose a shower

Langfoss shower screen without shelf		80 Height: 200 cm	90 Height: 200 cm.	80 Height: 230 cm.	90 Height: 230 cm.
Profile/glass	Order no.	Order no.	Order no.	Order no.	Order no.
Matt aluminium					
Line glass	6882003	6892003	6882303	6892303	
Pencil black					
Line glass	6882005	6892005	-	-	
Black matt					
Line glass	6882002	6892002	6882302	6892302	
Langfoss shower screen with shelf to the right					
Matt aluminium					
Line glass	6882013-H	6892013-H	6882313-H	6892313-H	
Pencil black					
Line glass	6882015-H	6892015-H	-	-	
Black matt					
Line glass	6882012-H	6892012-H	6882312-H	6892312-H	
Langfoss shower screen with shelf on the left					
Matt aluminium					
Line glass	6882013-V	6892013-V	6882313-V	6892313-V	
Pencil black					
Line glass	6882015-V	6892015-V	-	-	
Black matt					
Line glass	6882012-V	6892012-V	6882312-V	6892312-V	

2. Choose a curtain

Curtain rail



Width:	Colour	Order no.
80	Matt aluminium	683
	Pencil black	684
	Black matt	682
90	Matt aluminium	693
	Pencil black	694
	Black matt	692

Curtain*



Height:	Colour	Order no.
200	Off white	69201
	Granite grey	69202
	Ash grey	69203
	Off white	69231
230	Granite grey	69232
	Ash grey	69233

*For additional colours, please visit svedbergs.com

Profile to accommodate pipework



Height:	Colour	Order no.
200	Matt aluminium	63203
	Pencil black	63204
	Black matt	63202
230	Matt aluminium	63233
	Black matt	63232

Langfoss Corner shower kombi 200 cm

- Supplied complete with an easy-to-install shelf that fits directly onto the glass, curtain rail (max. 105 cm), floor and wall profiles for adjustment up to 20 mm, plus one folding door.
- Height: 200 cm (201 cm top edge with the optional curtain rail).
- No threshold - disabled friendly.
- Toughened safety glass 6 mm.
- Door opening: 74-84 cm.
- The existing wall profile doesn't allow hole for water pipes, for example.
- Self-closing doors.
- For each door follows 4 pcs of inserts to correct irregular walls up to maximum 8mm.
- Closing position is adjustable. Hidden assembly including screws.
- Add profiles, a curtain rail and a curtain, available in various colours.
- The shelf that fits onto the glass has the same style.

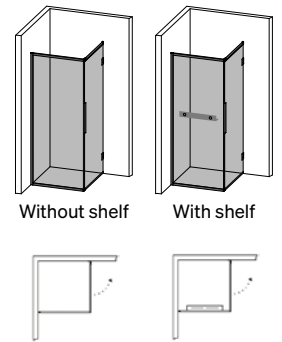

1. Choose a shower

* Length fixed glass

Langfoss corner shower without shelf	80×82* Height: 200 cm Opening dimensions: 74 cm.	80×92* Height: 200 cm. Opening dimensions: 74 cm.	90×82* Height: 200 cm. Opening dimensions: 84 cm.	90×92* Height: 200 cm. Opening dimensions: 84 cm.
Profile/glass	Order no.	Order no.	Order no.	Order no.
Matt aluminium				
Crystal glass	62882003	62892003	62982003	62992003
Bronze glass	60882003	60892003	60982003	60992003
Smoked glass	64882003	64892003	64982003	64992003
Pencil black				
Crystal glass	62882005	62892005	62982005	62992005
Bronze glass	60882005	60892005	60982005	60992005
Smoked glass	64882005	64892005	64982005	64992005
Black matt				
Crystal glass	62882002	62892002	62982002	62992002
Bronze glass	60882002	60892002	60982002	60992002
Smoked glass	64882002	64892002	64982002	64992002

Langfoss corner shower with shelf	80×82* Height: 200 cm Opening dimensions: 74 cm.	80×92* Height: 200 cm. Opening dimensions: 74 cm.	90×82* Height: 200 cm. Opening dimensions: 84 cm.	90×92* Height: 200 cm. Opening dimensions: 84 cm.
Profile/glass	Order no.	Order no.	Order no.	Order no.
Matt aluminium				
Crystal glass	62882013	62892013	62982013	62992013
Bronze glass	60882013	60892013	60982013	60992013
Smoked glass	64882013	64892013	64982013	64992013
Pencil black				
Crystal glass	62882015	62892015	62982015	62992015
Bronze glass	60882015	60892015	60982015	60992015
Smoked glass	64882015	64892015	64982015	64992015
Black matt				
Crystal glass	62882012	62892012	62982012	62992012
Bronze glass	60882012	60892012	60982012	60992012
Smoked glass	64882012	64892012	64982012	64992012

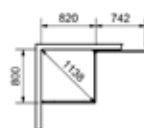

80×82*

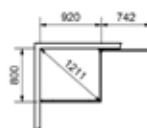

80×92*

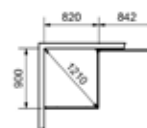

90×82*

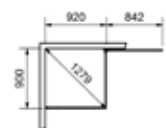

90×92*

Langfoss corner shower combi 200 with line glass

- Supplied complete with an easy-to-install shelf that fits directly onto the glass, curtain rail (max. 105 cm), floor and wall profiles for adjustment up to 20 mm, plus one folding door.
- Height: 200 cm (201 cm top edge with the optional curtain rail).
- No threshold - disabled friendly.
- Toughened safety glass 5/6 mm.
- Door opening: 74-84 cm.
- The existing wall profile doesn't allow hole for water pipes, for example.
- Self-closing doors.
- For each door follows 4 pcs of inserts to correct irregular walls up to maximum 8mm.
- Closing position is adjustable. Hidden assembly including screws.
- Add profiles, a curtain rail and a curtain, available in various colours.
- The shelf that fits onto the glass has the same style.

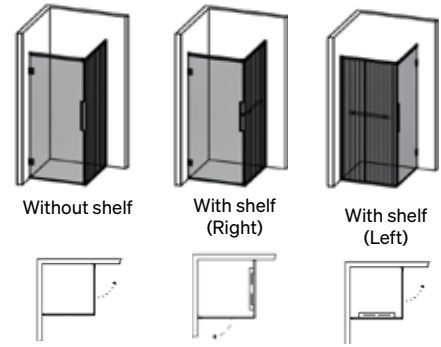

* Length fixed glass

1. Choose a shower

Langfoss corner shower without shelf	80×82* Height: 200 cm Opening dimensions: 74 cm.	80×92* Height: 200 cm. Opening dimensions: 74 cm.	90×82* Height: 200 cm. Opening dimensions: 84 cm.	90×92* Height: 200 cm. Opening dimensions: 84 cm.
Profile/glass	Order no.	Order no.	Order no.	Order no.
Matt aluminium				
Line glass	68882003	68892003	68982003	68992003
Pencil black				
Line glass	68882005	68892005	68982005	68992005
Black matt				
Line glass	68882002	68892002	68982002	68992002
Langfoss corner shower with shelf on the right				
Matt aluminium				
Line glass	68882013-H	68892013-H	68982013-H	68992013-H
Pencil black				
Line glass	68882015-H	68892015-H	68982015-H	68992015-H
Black matt				
Line glass	68882012-H	68892012-H	68982012-H	68992012-H
Langfoss corner shower with shelf on the left				
Matt aluminium				
Line glass	68882013-V	68892013-V	68982013-V	68992013-V
Pencil black				
Line glass	68882015-V	68892015-V	68982015-V	68992015-V
Black matt				
Line glass	68882012-V	68892012-V	68982012-V	68992012-V

2. Choose a curtain

Curtain rail



Width:	Colour	Order no.
80	Matt aluminium	683
	Pencil black	684
	Black matt	682
90	Matt aluminium	693
	Pencil black	694
	Black matt	692

Curtain*



Height:	Colour	Order no.
200	Off white	69201
	Granite grey	69202
	Ash grey	69203

*For additional colours, please visit svedbergs.com

Profile to accommodate pipework



Height:	Colour	Order no.
200	Matt aluminium	63203
	Pencil black	63204
	Black matt	63202

Langfoss Corner shower kombi 230 cm

- Supplied complete with an easy-to-install shelf that fits directly onto the glass, curtain rail (max. 105 cm), floor and wall profiles for adjustment up to 20 mm, plus one folding door.
- Height: 230 cm (231 cm top edge with the optional curtain rail).
- No threshold - disabled friendly.
- Toughened safety glass 6 mm.
- Door opening: 74-84 cm.
- The existing wall profile doesn't allow hole for water pipes, for example.
- Self-closing doors.
- For each door follows 4 pcs of inserts to correct irregular walls up to maximum 8mm.
- Closing position is adjustable. Hidden assembly including screws.
- Add profiles, a curtain rail and a curtain, available in various colours.
- The shelf that fits onto the glass has the same style.

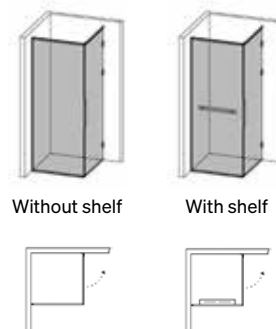

* Length fixed glass

1. Choose a shower

Langfoss corner shower without shelf	80×82* Height: 230 cm Opening dimensions: 74 cm.	80×92* Height: 230 cm. Opening dimensions: 74 cm.	90×82* Height: 230 cm. Opening dimensions: 84 cm.	90×92* Height: 230 cm. Opening dimensions: 84 cm.
Profile/glass	Order no.	Order no.	Order no.	Order no.
Matt aluminium				
Crystal glass	62882303	62892303	62982303	62992303
Bronze glass	60882303	60892303	60982303	60992303
Smoked glass	64882303	64892303	64982303	64992303
Black matt				
Crystal glass	62882302	62892302	62982302	62992302
Bronze glass	60882302	60892302	60982302	60992302
Smoked glass	64882302	64892302	64982302	64992302

Langfoss corner shower with shelf	80×82* Height: 230 cm Opening dimensions: 74 cm.	80×92* Height: 230 cm. Opening dimensions: 74 cm.	90×82* Height: 230 cm. Opening dimensions: 84 cm.	90×92* Height: 230 cm. Opening dimensions: 84 cm.
Profile/glass	Order no.	Order no.	Order no.	Order no.
Matt aluminium				
Crystal glass	62882313	62892313	62982313	62992313
Bronze glass	60882313	60892313	60982313	60992313
Smoked glass	64882313	64892313	64982313	64992313
Black matt				
Crystal glass	62882312	62892312	62982312	62992312
Bronze glass	60882312	60892312	60982312	60992312
Smoked glass	64882312	64892312	64982312	64992312

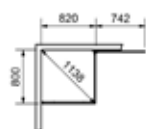

80×82*

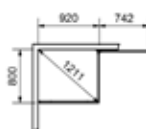

80×92*

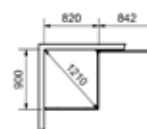

90×82*



90×92*

Front Shower shelf

Aluminium shelf for placement in or outside the shower. Can be glued. Glue kit including fittings available as an accessory. H:10 D:9



Wall shelf

Aluminium shelf for placement in or outside the shower. Can be glued. A glue kit is available as an accessory. H:7,5 D:8,5



Shower storage	70	80	32,5	65
Colour	Order no.	Order no.	Order no.	Order no.
Matt aluminium	6571	6581	6330	6660
Polished pencil black	6573	6583	6329	6659
Black matt	6572	6582	6325	6651
White matt	6570	6580	6324	6650
Options				
Glue kit	97058	97058	97043	97043

Langfoss corner shower combi 230 with line glass

- Supplied complete with an easy-to-install shelf that fits directly onto the glass, curtain rail (max. 105 cm), floor and wall profiles for adjustment up to 20 mm, plus one folding door.
- Height: 230 cm (231 cm top edge with the optional curtain rail).
- No threshold - disabled friendly.
- Toughened safety glass 5/6 mm.
- Door opening: 74-84 cm.
- The existing wall profile doesn't allow hole for water pipes, for example.
- Self-closing doors.
- For each door follows 4 pcs of inserts to correct irregular walls up to maximum 8mm.
- Closing position is adjustable. Hidden assembly including screws.
- Add profiles, a curtain rail and a curtain, available in various colours.
- The shelf that fits onto the glass has the same style.

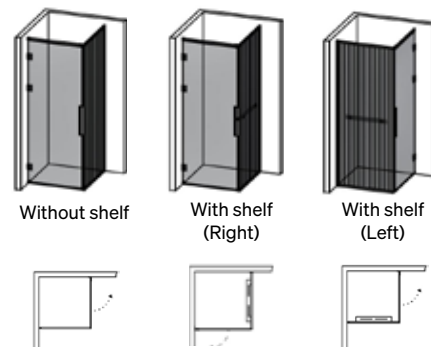

1. Choose a shower

* Length fixed glass

Langfoss corner shower without shelf	80×82* Height: 230 cm Opening dimensions: 74 cm.	80×92* Height: 230 cm. Opening dimensions: 74 cm.	90×82* Height: 230 cm. Opening dimensions: 84 cm.	90×92* Height: 230 cm. Opening dimensions: 84 cm.
Profile/glass	Order no.	Order no.	Order no.	Order no.
Matt aluminium				
Line glass	68882303	68892303	68982303	68992303
Black matt				
Line glass	68882302	68892302	68982302	68992302
Langfoss corner shower with shelf on the right				
Matt aluminium				
Line glass	68882313-H	68892313-H	68982313-H	68992313-H
Black matt				
Line glass	68882312-H	68892312-H	68982312-H	68992312-H
Langfoss corner shower with shelf on the left				
Matt aluminium				
Line glass	68882313-V	68892313-V	68982313-V	68992313-V
Black matt				
Line glass	68882312-V	68892312-V	68982312-V	68992312-V

2. Choose a curtain

Curtain rail



Width:	Colour	Order no.
80	Matt aluminium	683
	Black matt	682
90	Matt aluminium	693
	Black matt	692

Curtain*



Height:	Colour	Order no.
230	Off white	69231
	Granite grey	69232
	Ash grey	69233

*For additional colours, please visit svedbergs.com

Profile to accommodate pipework



Height:	Colour	Order no.
230	Matt aluminium	63233
	Black matt	63232

180° Corner shower door

- Has two opening doors with a magnetic seal.
- Doors can be folded inwards when shower is not in use to maximise floor space.
- No threshold - disabled friendly.
- Toughened safety glass 8 mm.
- Self-closing doors.
- For each door follows 4 pcs of inserts to correct irregular walls up to maximum 8mm.
- Closing position is adjustable. Hidden assembly including screws.
- Height 200 cm.
- Door opening 104-132 cm.

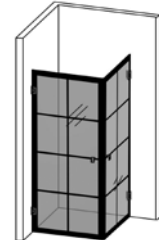
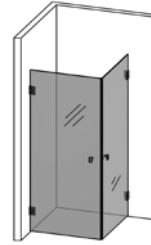

180° Rista with industrial decor.

180° Corner shower door	80×80 Height: 200 cm. Opening dimensions: 104 cm.	80×90 Height: 200 cm. Opening dimensions: 111 cm.	80×100 Height: 200 cm. Opening dimensions: 118 cm.	Made to measure
Profile/glass	Order no.	Order no.	Order no.	Order no.
Chrome				
Clear glass	653788	653789	653781	180-10-1
Bronze glass	653988	653989	653981	180-10-5
Smoked glass	653888	653889	653881	180-10-4
Pencil black				
Clear glass	623788	623789	623781	180-10-1
Bronze glass	623988	623989	623981	180-10-5
Smoked glass	623888	623889	623881	180-10-4
Black matt				
Clear glass	683788	683789	683781	180-10-1
Bronze glass	683988	683989	683981	180-10-5
Smoked glass	683888	683889	683881	180-10-4
Industrial decor	693788	693789	-	-

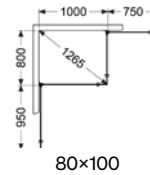
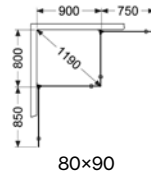
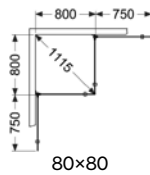

180° Corner shower door	90×90 Height: 200 cm. Opening dimensions: 118 cm.	90×100 Height: 200 cm. Opening dimensions: 125 cm.	100×100 Height: 200 cm. Opening dimensions: 132 cm.	Made to measure
Profile/glass	Order no.	Order no.	Order no.	Order no.
Chrome				
Clear glass	653799	653791	653711	180-10-1
Bronze glass	653999	653991	653911	180-10-5
Smoked glass	653899	653891	653811	180-10-4
Pencil black				
Clear glass	623799	623791	623711	180-10-1
Bronze glass	623999	623991	623911	180-10-5
Smoked glass	623899	623891	623811	180-10-4
Black matt				
Clear glass	683799	683791	683711	180-10-1
Bronze glass	683999	683991	683911	180-10-5
Smoked glass	683899	683891	683811	180-10-4
Industrial decor	693799	-	-	-

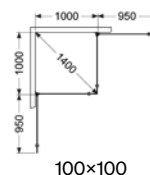
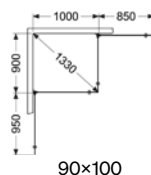
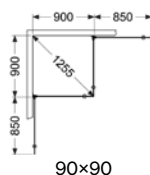

180° Corner shower fixed wall/door

- Has one opening door and a fixed wall incl. rods and floor attachment.
- No threshold - disabled friendly.
- Toughened safety glass 8 mm.
- Self-closing doors.
- For each door follows 4 pcs of inserts to correct irregular walls up to maximum 8mm.
- Closing position is adjustable. Hidden assembly including screws.
- Height 200 cm (201 cm upper edge of rod).
- Door opening 75-95 cm.

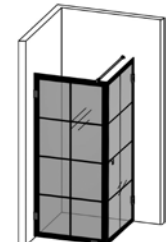
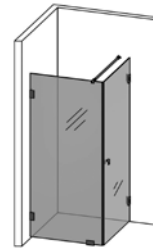

180° Rista with industrial decor.

*Length fixed glass

180° Corner shower fixed wall/door	80×80 Height: 200 cm (201 cm upper edge of rod). Opening dimensions: 75 cm.	80×90* Height: 200 cm (201 cm upper edge of rod). Opening dimensions: 75 cm.	80*×90 Height: 200 cm (201 cm upper edge of rod). Opening dimensions: 85 cm.	Made to measure
Profile/glass	Order no.	Order no.	Order no.	Order no.
Chrome				
Clear glass	654788	654789	654798	180-11-1
Bronze glass	654988	654989	654998	180-11-5
Smoked glass	654888	654889	654898	180-11-4
Pencil black				
Clear glass	624788	624789	624798	180-11-1
Bronze glass	624988	624989	624998	180-11-5
Smoked glass	624888	624889	624898	180-11-4
Black matt				
Clear glass	684788	684789	684798	180-11-1
Bronze glass	684988	684989	684998	180-11-5
Smoked glass	684888	684889	684898	180-11-4
Industrial decor	694788	694789	694798	-

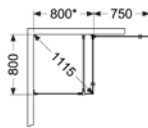

80×80

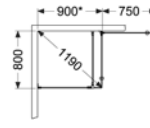

80×90*

* Length fixed glass

180° Corner shower fixed wall/door	80×100* Height: 200 cm (201 cm upper edge of rod). Opening dimensions: 75 cm.	80*×100 Height: 200 cm (201 cm upper edge of rod). Opening dimensions: 95 cm.	90×90 Height: 200 cm (201 cm upper edge of rod). Opening dimensions: 85 cm.	Made to measure
Profile/glass	Order no.	Order no.	Order no.	Order no.
Chrome				
Clear glass	654781	654718	654799	180-11-1
Bronze glass	654981	654918	654999	180-11-5
Smoked glass	654881	654818	654899	180-11-4
Pencil black				
Clear glass	624781	624718	624799	180-11-1
Bronze glass	624981	624918	624999	180-11-5
Smoked glass	624881	624818	624899	180-11-4
Black matt				
Clear glass	684781	684718	684799	180-11-1
Bronze glass	684981	684918	684999	180-11-5
Smoked glass	684881	684818	684899	180-11-4
Industrial decor	-	-	694799	-

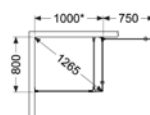

80×100*

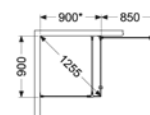

90×90

180° Corner shower fixed wall/door

- Has one opening door and a fixed wall incl. rods and floor attachment.
- No threshold - disabled friendly.
- Toughened safety glass 8 mm.
- Self-closing doors.
- For each door follows 4 pcs of inserts to correct irregular walls up to maximum 8mm.
- Closing position is adjustable. Hidden assembly including screws.
- Height 200 cm (201 cm upper edge of rod).
- Door opening 75-95 cm.

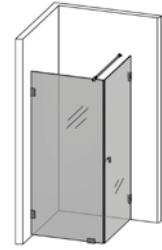

* Length fixed glass

180° Corner shower fixed wall/door	90×100*	90*x100	100×100	Made to measure
	Height: 200 cm (201 cm upper edge of rod). Opening dimensions: 85 cm.	Height: 200 cm (201 cm upper edge of rod). Opening dimensions: 95 cm.	Height: 200 cm (201 cm upper edge of rod). Opening dimensions: 95 cm.	
Profile/glass	Order no.	Order no.	Order no.	Order no.
Chrome				
Clear glass	654791	654719	654711	180-11-1
Bronze glass	654991	654919	654911	180-11-5
Smoked glass	654891	654819	654811	180-11-4
Pencil black				
Clear glass	624791	624719	624711	180-11-1
Bronze glass	624991	624919	624911	180-11-5
Smoked glass	624891	624819	624811	180-11-4
Black matt				
Clear glass	684791	684719	684711	180-11-1
Bronze glass	684991	684919	684911	180-11-5
Smoked glass	684891	684819	684811	180-11-4

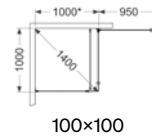
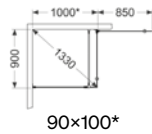

Front Shower shelf

Aluminium shelf for placement in or outside the shower.
Can be glued. Glue kit including fittings available as an accessory.
H:10 D:9



Wall shelf

Aluminium shelf for placement in or outside the shower. Can be glued. A glue kit is available as an accessory. H:7,5 D:8,5



Shower storage	70	80	32,5	65
Colour	Order no.	Order no.	Order no.	Order no.
Matt aluminium	6571	6581	6330	6660
Polished pencil black	6573	6583	6329	6659
Black matt	6572	6582	6325	6651
White matt	6570	6580	6324	6650
Options				
Glue kit	97058	97058	97043	97043

180° Shower screen

- Has one opening door.
- The door can be folded inwards when shower is not in use to maximise floor space.
- No threshold - disabled friendly.
- Toughened safety glass 8 mm.
- Self-closing doors.
- For each door follows 4 pcs of inserts to correct irregular walls up to maximum 8mm.
- Closing position is adjustable. Hidden assembly including screws.
- Height 200 cm.

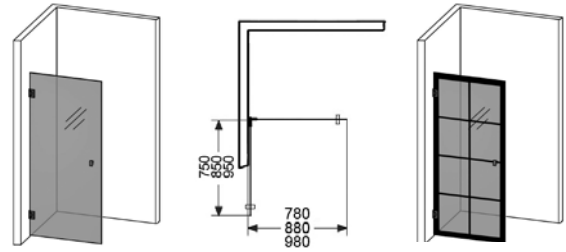

180° Rista with industrial decor.

180° Shower screen	78 Height: 200 cm.	88 Height: 200 cm.	98 Height: 200 cm.	Made to measure
Profile/glass	Order no.	Order no.	Order no.	Order no.
Chrome				
Clear glass	651778	651788	651798	180-01-1
Bronze glass	651978	651988	651998	180-01-5
Smoked glass	651878	651888	651898	180-01-4
Pencil black				
Clear glass	621778	621788	621798	180-01-1
Bronze glass	621978	621988	621998	180-01-5
Smoked glass	621878	621888	621898	180-01-4
Black matt				
Clear glass	681778	681788	681798	180-01-1
Bronze glass	681978	681988	681998	180-01-5
Smoked glass	681878	681888	681898	180-01-4
Industrial decor	691778	691788	-	-

180° Shower screen with foot and bar

- Consists of a fixed wall incl. a bar and floor attachment.
- No threshold - disabled friendly.
- Toughened safety glass 8 mm.
- Concealed mounting & clamping screws.
- For each door follows 4 pcs of inserts to correct irregular walls up to maximum 8mm.
- Height 200 cm (201 cm upper edge of rod).
- Can be mounted against a wall.

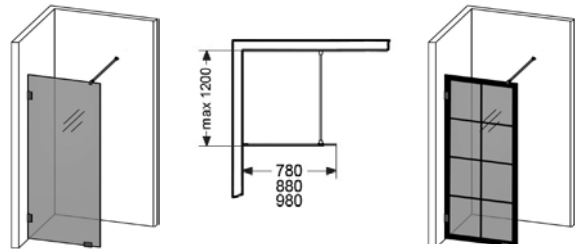

180° Rista with industrial decor.

180° Shower screen with foot and bar	78 Height: 200 cm. (201 cm upper edge of rod)	88 Height: 200 cm. (201 cm upper edge of rod)	98 Height: 200 cm. (201 cm upper edge of rod)	Made to measure
Profile/glass	Order no.	Order no.	Order no.	Order no.
Chrome				
Clear glass	652778	652788	652798	180-02-1
Bronze glass	652978	652988	652998	180-02-5
Smoked glass	652878	652888	652898	180-02-4
Pencil black				
Clear glass	622778	622788	622798	180-02-1
Bronze glass	622978	622988	622998	180-02-5
Smoked glass	622878	622888	622898	180-02-4
Black matt				
Clear glass	682778	682788	682798	180-02-1
Bronze glass	682978	682988	682998	180-02-5
Smoked glass	682878	682888	682898	180-02-4
Industrial decor	692778	692788	-	-

180° Shower screen bath

- Has one opening door.
- The door can be folded inwards when not in use, making maximum use of the bath surface.
- Toughened safety glass 8 mm.
- Self-closing doors.
- For each door follows 4 pcs of inserts to correct irregular walls up to maximum 8mm.
- Closing position is adjustable. Hidden assembly including screws.
- Height 140 cm.

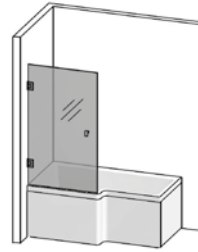

180° Shower screen bath		81	Made to measure
		Height: 140 cm.	
Profile/glass	Order no.	Order no.	
Chrome			
Clear glass	657781	180-05-1	
Pencil black			
Clear glass	627781	180-05-1	
Black matt			
Clear glass	687781	180-05-1	

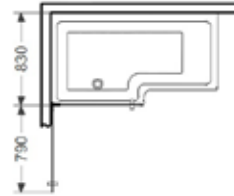

180° Corner shower bath

- Has two opening doors with a magnetic seal.
- The door can be folded inwards when not in use, making maximum use of the bath surface.
- Toughened safety glass 8 mm.
- Self-closing doors.
- For each door follows 4 pcs of inserts to correct irregular walls up to maximum 8mm.
- Closing position is adjustable. Hidden assembly including screws.
- Height 140 cm.

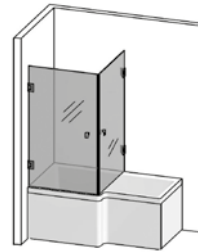

180° Corner shower bath		83×83	Made to measure
		Height: 140 cm. Opening dimensions: 104 cm.	
Profile/glass	Order no.	Order no.	
Chrome			
Clear glass	658788	180-12-1	
Pencil black			
Clear glass	628788	180-12-1	
Black matt			
Clear glass	688788	180-12-1	

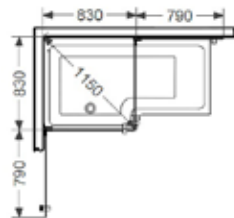

Front Shower shelf

Aluminium shelf for placement in or outside the shower. Can be glued. Glue kit including fittings available as an accessory. H:10 D:9



Wall shelf

Aluminium shelf for placement in or outside the shower. Can be glued. A glue kit is available as an accessory. H:7,5 D:8,5



Shower storage	70	80	32,5	65
Colour	Order no.	Order no.	Order no.	Order no.
Matt aluminium	6571	6581	6330	6660
Polished pencil black	6573	6583	6329	6659
Black matt	6572	6582	6325	6651
White matt	6570	6580	6324	6650
Options				
Glue kit	97058	97058	97043	97043

180° Alcove shower single

- Has one opening door.
- The door can be folded inwards when shower is not in use to maximise floor space.
- No threshold - disabled friendly.
- Toughened safety glass 8 mm. Självstängande gångjärn.
- For each door follows 4 pcs of inserts to correct irregular walls up to maximum 8mm.
- Closing position is adjustable. Hidden assembly including screws.
- Height 200 cm.
- Door opening 75-95 cm.

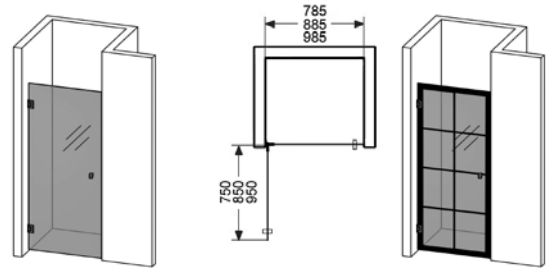

180° Rista with industrial decor.

180° Alcove shower single	78.5 Height: 200 cm. Opening dimensions: 75 cm.	88.5 Height: 200 cm. Opening dimensions: 85 cm.	98.5 Height: 200 cm. Opening dimensions: 95 cm.	Made to measure
Profile/glass	Order no.	Order no.	Order no.	Order no.
Chrome				
Clear glass	651778	651788	651798	180-23-1
Bronze glass	651978	651988	651998	180-23-5
Smoked glass	651878	651888	651898	180-23-4
Pencil black				
Clear glass	621778	621788	621798	180-23-1
Bronze glass	621978	621988	621998	180-23-5
Smoked glass	621878	621888	621898	180-23-4
Black matt				
Clear glass	681778	681788	681798	180-23-1
Bronze glass	681978	681988	681998	180-23-5
Smoked glass	681878	681888	681898	180-23-4
Industrial decor	691778	691788	-	-

180° Alcove shower double

- Has two opening doors.
- Doors can be folded inwards when shower is not in use to maximise floor space.
- No threshold - disabled friendly.
- Toughened safety glass 8 mm. Self-closing doors.
- For each door follows 4 pcs of inserts to correct irregular walls up to maximum 8mm.
- Closing position is adjustable. Hidden assembly including screws.
- Height 200 cm. Door opening 150-190 cm.

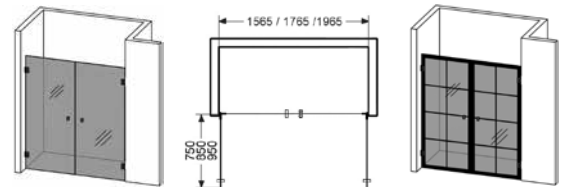

180° Rista with industrial decor.

180° Alcove shower double	156.5 Height: 200 cm. Opening dimensions: 150 cm.	176.5 Height: 200 cm. Opening dimensions: 170 cm.	196.5 Height: 200 cm. Opening dimensions: 190 cm.	Made to measure
Profile/glass	Order no.	Order no.	Order no.	Order no.
Chrome				
Clear glass	655716	655718	655720	180-25-1
Bronze glass	655916	655918	655920	180-25-5
Smoked glass	655816	655818	655820	180-25-4
Pencil black				
Clear glass	625716	625718	625720	180-25-1
Bronze glass	625916	625918	625920	180-25-5
Smoked glass	625816	625818	625820	180-25-4
Black matt				
Clear glass	685716	685718	685720	180-25-1
Bronze glass	685916	685918	685920	180-25-5
Smoked glass	685816	685818	685820	180-25-4
Industrial decor	695716	695718	-	-

180° Alcove shower combined

- Has one opening door and a fixed wall incl. rods and floor attachment.
- The door can be folded inwards when shower is not in use to maximise floor space.
- No threshold - disabled friendly.
- Toughened safety glass 8 mm. Self-closing doors.
- For each door follows 4 pcs of inserts to correct irregular walls up to maximum 8mm.
- Closing position is adjustable. Hidden assembly including screws.
- Height 200 cm (201 cm upper edge of rod).
- Door opening 75-95 cm

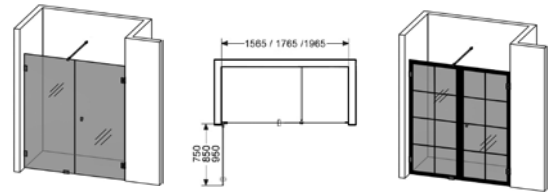

180° Rista with industrial decor.

180° Alcove shower combined	156.5	176.5	196.5	Made to measure
	Height: 200 cm (201 cm upper edge of rod). Opening dimensions: 75 cm.	Height: 200 cm (201 cm upper edge of rod). Opening dimensions: 85 cm.	Height: 200 cm (201 cm upper edge of rod). Opening dimensions: 95 cm.	
Profile/glass	Order no.	Order no.	Order no.	Order no.
Chrome				
Clear glass	656716	656718	656720	180-26-1
Bronze glass	656916	656918	656920	180-26-5
Smoked glass	656816	656818	656820	180-26-4
Pencil black				
Clear glass	626716	626718	626720	180-26-1
Bronze glass	626916	626918	626920	180-26-5
Smoked glass	626816	626818	626820	180-26-4
Black matt				
Clear glass	686716	686718	686720	180-26-1
Bronze glass	686916	686918	686920	180-26-5
Smoked glass	686016	686018	686020	180-26-4
Industrial decor	696716	696718	-	-

180° Special

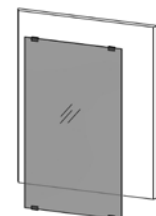
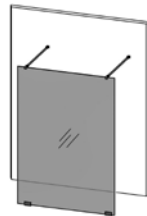

180° Special 3 Shower screen	
Flush with ceiling. 1 Fixed.	
Profile/glass	Order no.
Chrome	
Clear glass	180-03-1
Bronze glass	180-03-5
Smoked glass	180-03-4
Pencil black	
Clear glass	180-03-1
Bronze glass	180-03-5
Smoked glass	180-03-4
Black matt	
Clear glass	180-03-1
Bronze glass	180-03-5
Smoked glass	180-03-4

180° Special 8 Shower screen	
Open. 1 Fixed.	
Profile/glass	Order no.
Chrome	
Clear glass	180-08-1
Bronze glass	180-08-5
Smoked glass	180-08-4
Pencil black	
Clear glass	180-08-1
Bronze glass	180-08-5
Smoked glass	180-08-4
Black matt	
Clear glass	180-08-1
Bronze glass	180-08-5
Smoked glass	180-08-4

180° Special 9 Shower screen	
Gap between screen and ceiling. 1 Fixed.	
Profile/glass	Order no.
Chrome	
Clear glass	180-09-1
Bronze glass	180-09-5
Smoked glass	180-09-4
Pencil black	
Clear glass	180-09-1
Bronze glass	180-09-5
Smoked glass	180-09-4
Black matt	
Clear glass	180-09-1
Bronze glass	180-09-5
Smoked glass	180-09-4

For more information visit www.svedbergs.com. Delivery time: 4-5 weeks after approved drawing.

180° Options

Magnetic strip

Colour	Order no.
Transparent	98180
Smoky	98181

Round list

Colour	Order no.
	98185

Shower Door Sweep 12 mm

Colour	Order no.
Transparent	98186

Shower Door Sweep 23 mm

Colour	Order no.
Transparent	98187

Front Shower shelf

Aluminium shelf for placement in or outside the shower. Can be glued. Glue kit including fittings available as an accessory. H:10 D:9



Wall shelf

Aluminium shelf for placement in or outside the shower. Can be glued. A glue kit is available as an accessory. H:7,5 D:8,5



Shower storage	70	80	32,5	65
Colour	Order no.	Order no.	Order no.	Order no.
Matt aluminium	6571	6581	6330	6660
Polished pencil black	6573	6583	6329	6659
Black matt	6572	6582	6325	6651
White matt	6570	6580	6324	6650
Options				
Glue kit	97058	97058	97043	97043

Skoga Corner shower straight

- Has two opening doors with transparent seals on the bottom edges.
- Doors can be folded inwards when shower is not in use to maximise floor space.
- No threshold - disabled friendly.
- Toughened safety glass 6 mm.
- Wall profile allows for pipe installation 30 mm from the wall.
- The shower walls can be supplemented with 30 or 50 mm wall profiles.
- The measurements are reversible for right or left fitting.
- Height: 198 cm.
- Door opening: 85-127 cm.
- Includes grip holes. Handles are available as accessories.

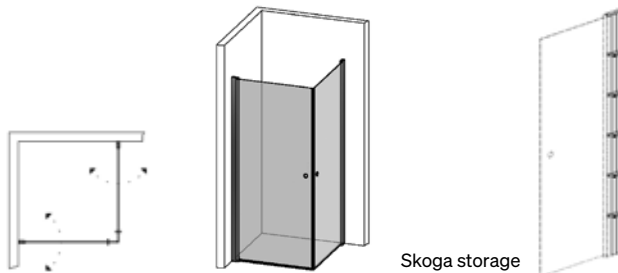

Skoga Corner shower straight	70×70 Height: 198 cm. Opening dimensions: 85 cm.	70×80 Height: 198 cm. Opening dimensions: 93 cm.	70×90 Height: 198 cm. Opening dimensions: 101 cm.	Skoga storage Height: 198 cm. Built out 10 cm from the wall.
Profile/glass	Order no.	Order no.	Order no.	Order no.
Matt aluminium				
Clear glass	63507377	63507378	63507379	6601
Smoked glass	63511377	63511378	63511379	6601
Frosted glass	63508377	63508378	63508379	6601
Polished aluminium				
Clear glass	63507477	63507478	63507479	6600
Smoked glass	63511477	63511478	63511479	6600
Frosted glass	63508477	63508478	63508479	6600
Black matt				
Clear glass	63507277	63507278	63507279	6602
Smoked glass	63511277	63511278	63511279	6602
Frosted glass	63508277	63508278	63508279	6602

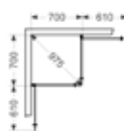

70×70

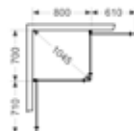

70×80

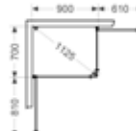

70×90

Skoga Corner shower straight	70×100 Height: 198 cm. Opening dimensions: 109 cm.	80×80 Height: 198 cm. Opening dimensions: 100 cm.	80×90 Height: 198 cm. Opening dimensions: 107 cm.	Skoga storage Height: 198 cm. Built out 10 cm from the wall.
Profile/glass	Order no.	Order no.	Order no.	Order no.
Matt aluminium				
Clear glass	63507371	63507388	63507389	6601
Smoked glass	63511371	63511388	63511389	6601
Frosted glass	63508371	63508388	63508389	6601
Polished aluminium				
Clear glass	63507471	63507488	63507489	6600
Smoked glass	63511471	63511488	63511489	6600
Frosted glass	63508471	63508488	63508489	6600
Pencil black				
Clear glass	-	63507588	63507589	6603
Smoked glass	-	63511588	63511589	6603
Black matt				
Clear glass	63507271	63507288	63507289	6602
Smoked glass	63511271	63511288	63511289	6602
Frosted glass	63508271	63508288	63508289	6602

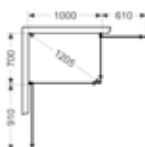

70×100



80×80



80×90

Skoga Corner shower straight

- Has two opening doors with transparent seals on the bottom edges.
- Doors can be folded inwards when shower is not in use to maximise floor space.
- No threshold - disabled friendly.
- Toughened safety glass 6 mm.
- Wall profile allows for pipe installation 30 mm from the wall.
- The shower walls can be supplemented with 30 or 50 mm wall profiles.
- The measurements are reversible for right or left fitting.
- Height: 198 cm.
- Door opening: 85-127 cm.
- Includes grip holes. Handles are available as accessories.

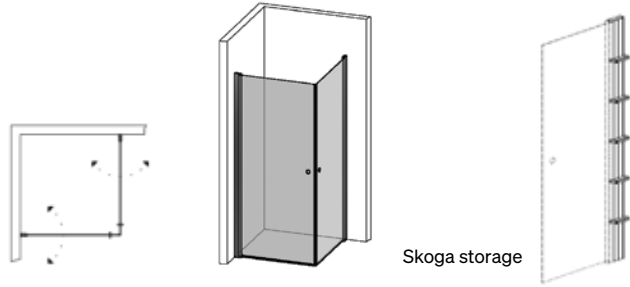

Skoga Corner shower straight	80×100 Height: 198 cm. Opening dimensions: 115 cm.	90×90 Height: 198 cm. Opening dimensions: 114 cm.	90×100 Height: 198 cm. Opening dimensions: 121 cm.	Skoga storage Height: 198 cm. Built out 10 cm from the wall.
Profile/glass	Order no.	Order no.	Order no.	Order no.
Matt aluminium				
Clear glass	63507381	63507399	63507391	6601
Smoked glass	63511381	63511399	63511391	6601
Frosted glass	63508381	63508399	63508391	6601
Polished aluminium				
Clear glass	63507481	63507499	63507491	6600
Smoked glass	63511481	63511499	63511491	6600
Frosted glass	63508481	63508499	63508491	6600
Pencil black				
Clear glass	-	63507599	-	6603
Smoked glass	-	63511599	-	6603
Black matt				
Clear glass	63507281	63507299	63507291	6602
Smoked glass	63511281	63511299	63511291	6602
Frosted glass	63508281	63508299	63508291	6602



80×100



90×90

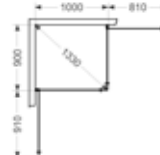

90×100

Skoga Corner shower straight	100×100 Height: 198 cm. Opening dimensions: 127 cm.	Skoga storage Height: 198 cm. Built out 10 cm from the wall.
Profile/glass	Order no.	Order no.
Matt aluminium		
Clear glass	63507311	6601
Smoked glass	63511311	6601
Frosted glass	63508311	6601
Polished aluminium		
Clear glass	63507411	6600
Smoked glass	63511411	6600
Frosted glass	63508411	6600
Black matt		
Clear glass	63507211	6602
Smoked glass	63511211	6602
Frosted glass	63508211	6602

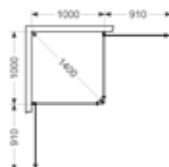

100×100

Skoga storage

Skoga storage is suitable for use with all Skoga profile showers, providing extra vertical storage within the shower. The storage is mounted between the shower and wall, and has five fixed shelves.

NB: Please remember that Skoga storage is built out 10 cm from the wall, meaning that you must subtract 10 cm from the corresponding measurement of your desired shower solution.

Example 1: Skoga corner shower, straight, 90×90 with Skoga storage. Order Skoga corner shower, straight, 80×90 and Skoga storage.

Example 2: Skoga shower screen, fixed, 80, with Skoga storage. Order Skoga shower screen, fixed, 70, and Skoga storage.



Skoga Corner shower combo

- Consists of a fixed screen with curtain rail (max. 105 cm), floor mounting and transparent rubber seal against the floor, plus one folding door (180°) with transparent rubber seal against the floor and between the glass panels.
- No threshold - disabled friendly.
- Toughened safety glass 6 mm.
- Wall profiles allow pipe installation 30 mm from wall.
- Showers can be supplemented with 30 or 50 mm wall profiles.
- Height: 198 cm (201 cm upper edge of rod).
- Door opening: 60-90 cm.
- Includes grip holes. Handles are available as accessories.



Skoga storage

* Length fixed glass

Skoga Corner shower combo	70×73*	70×83*	70×93*	Skoga storage
	Height: 198 cm (201 cm upper edge of rod). Opening dimensions: 60 cm.	Height: 198 cm (201 cm upper edge of rod). Opening dimensions: 60 cm.	Height: 198 cm (201 cm upper edge of rod). Opening dimensions: 60 cm.	Height: 198 cm. Built out 10 cm from the wall.
Profile/glass	Order no.	Order no.	Order no.	Order no.
Matt aluminium				
Clear glass	62007377	62007378	62007379	6601
Smoked glass	62011377	62011378	62011379	6601
Frosted glass	62008377	62008378	62008379	6601
Polished aluminium				
Clear glass	62007477	62007478	62007479	6600
Smoked glass	62011477	62011478	62011479	6600
Frosted glass	62008477	62008478	62008479	6600
Black matt				
Clear glass	62007277	62007278	62007279	6602
Smoked glass	62011277	62011278	62011279	6602
Frosted glass	62008277	62008278	62008279	6602

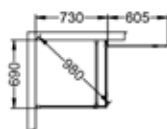

70×73*

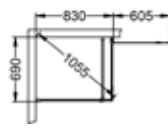

70×83*

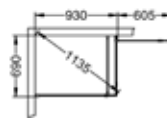

70×93*

* Length fixed glass

Skoga Corner shower combo	80×73*	80×83*	80×93*	Skoga storage
	Height: 198 cm (201 cm upper edge of rod). Opening dimensions: 70 cm.	Height: 198 cm (201 cm upper edge of rod). Opening dimensions: 70 cm.	Height: 198 cm (201 cm upper edge of rod). Opening dimensions: 70 cm.	Height: 198 cm. Built out 10 cm from the wall.
Profile/glass	Order no.	Order no.	Order no.	Order no.
Matt aluminium				
Clear glass	62007387	62007388	62007389	6601
Smoked glass	62011387	62011388	62011389	6601
Frosted glass	62008387	62008388	62008389	6601
Polished aluminium				
Clear glass	62007487	62007488	62007489	6600
Smoked glass	62011487	62011488	62011489	6600
Frosted glass	62008487	62008488	62008489	6600
Black matt				
Clear glass	62007287	62007288	62007289	6602
Smoked glass	62011287	62011288	62011289	6602
Frosted glass	62008287	62008288	62008289	6602

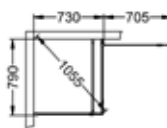

80×73*

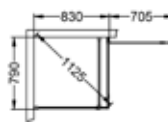

80×83*

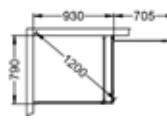

80×93*

Skoga Corner shower combo

- Consists of a fixed screen with curtain rail (max. 105 cm), floor mounting and transparent rubber seal against the floor, plus one folding door (180°) with transparent rubber seal against the floor and between the glass panels.
- No threshold - disabled friendly.
- Toughened safety glass 6 mm.
- Wall profiles allow pipe installation 30 mm from wall.
- Showers can be supplemented with 30 or 50 mm wall profiles.
- Height: 198 cm (201 cm upper edge of rod).
- Door opening: 60-90 cm.
- Includes grip holes. Handles are available as accessories.

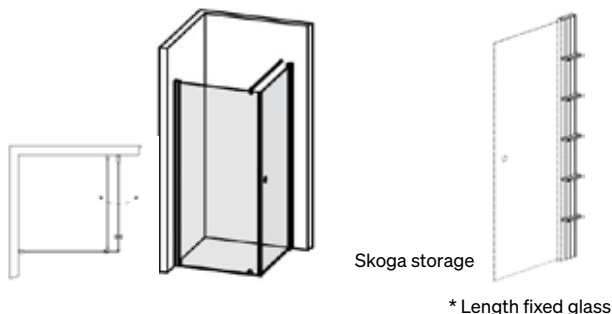

* Length fixed glass

Skoga Corner shower combo	90×73*	90×83*	90×93*	Skoga storage
	Height: 198 cm (201 cm upper edge of rod). Opening dimensions: 80 cm.	Height: 198 cm (201 cm upper edge of rod). Opening dimensions: 80 cm.	Height: 198 cm (201 cm upper edge of rod). Opening dimensions: 80 cm.	Height: 198 cm. Built out 10 cm from the wall.
Profile/glass	Order no.	Order no.	Order no.	Order no.
Matt aluminium				
Clear glass	62007397	62007398	62007399	6601
Smoked glass	62011397	62011398	62011399	6601
Frosted glass	62008397	62008398	62008399	6601
Polished aluminium				
Clear glass	62007497	62007498	62007499	6600
Smoked glass	62011497	62011498	62011499	6600
Frosted glass	62008497	62008498	62008499	6600
Black matt				
Clear glass	62007297	62007298	62007299	6602
Smoked glass	62011297	62011298	62011299	6602
Frosted glass	62008297	62008298	62008299	6602

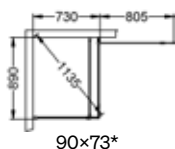

90×73*

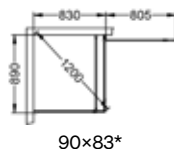

90×83*

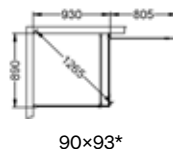

90×93*

* Length fixed glass

Skoga Corner shower combo	100×73*	100×83*	100×93*	Skoga storage
	Height: 198 cm (201 cm upper edge of rod). Opening dimensions: 90 cm.	Height: 198 cm (201 cm upper edge of rod). Opening dimensions: 90 cm.	Height: 198 cm (201 cm upper edge of rod). Opening dimensions: 90 cm.	Height: 198 cm. Built out 10 cm from the wall.
Profile/glass	Order no.	Order no.	Order no.	Order no.
Matt aluminium				
Clear glass	62007317	62007318	62007319	6601
Smoked glass	62011317	62011318	62011319	6601
Frosted glass	62008317	62008318	62008319	6601
Polished aluminium				
Clear glass	62007417	62007418	62007419	6600
Smoked glass	62011417	62011418	62011419	6600
Frosted glass	62008417	62008418	62008419	6600
Black matt				
Clear glass	62007217	62007218	62007219	6602
Smoked glass	62011217	62011218	62011219	6602
Frosted glass	62008217	62008218	62008219	6602

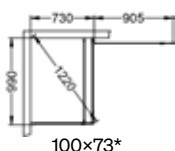

100×73*

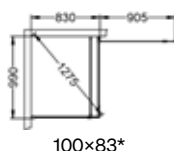

100×83*

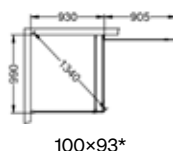

100×93*

Skoga Corner shower round

- Has two opening doors with transparent seals on the bottom edges.
- Doors can be folded inwards when shower is not in use to maximise floor space.
- No threshold - disabled friendly.
- Toughened safety glass 6 mm.
- Wall profile allows for pipe installation 30 mm from the wall.
- The shower walls can be supplemented with 30 or 50 mm wall profiles.
- The measurements are reversible for right or left fitting.
- Height: 198 cm.
- Door opening: 99-114 cm.
- Includes grip holes. Handles are available as accessories.



Skoga storage

Skoga Corner shower round	80×80 Height: 198 cm Opening dimensions: 99 cm.	80×90 Height: 198 cm Opening dimensions: 106 cm.	90×90 Height: 198 cm Opening dimensions: 114 cm.	Skoga storage Height: 198 cm. Built out 10 cm from the wall.
Profile/glass	Order no.	Order no.	Order no.	Order no.
Matt aluminium				
Clear glass	60607388	60607389	60607399	6601
Smoked glass	60611388	60611389	60611399	6601
Frosted glass	60608388	60608389	60608399	6601
Polished aluminium				
Clear glass	60607488	60607489	60607499	6600
Smoked glass	60611488	60611489	60611499	6600
Frosted glass	60608488	60608489	60608499	6600
Pencil black				
Clear glass	60607588	60607589	60607599	6603
Smoked glass	60611588	60611589	60611599	6603
Black matt				
Clear glass	60607288	60607289	60607299	6602
Smoked glass	60611288	60611289	60611299	6602
Frosted glass	60608288	60608289	60608299	6602

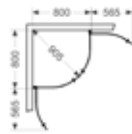

80×80

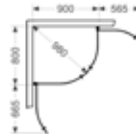

80×90

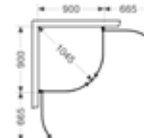

90×90

Front Shower shelf

Aluminium shelf for placement in or outside the shower. Can be glued. Glue kit including fittings available as an accessory. H:10 D:9



Wall shelf

Aluminium shelf for placement in or outside the shower. Can be glued. A glue kit is available as an accessory. H:7,5 D:8,5



Shower storage	70	80	32,5	65
Colour	Order no.	Order no.	Order no.	Order no.
Matt aluminium	6571	6581	6330	6660
Polished pencil black	6573	6583	6329	6659
Black matt	6572	6582	6325	6651
White matt	6570	6580	6324	6650
Options				
Glue kit	97058	97058	97043	97043

Skoga Corner shower round/straight

- Has two opening doors with transparent seals on the bottom edges.
- Toughened safety glass 6 mm.
- Wall profile allows for pipe installation 30 mm from the wall.
- The shower walls can be supplemented with 30 or 50 mm wall profiles.
- The measurements are reversible for right or left fitting.
- Height: 198 cm.
- Door opening: 130-156 cm.
- Includes grip holes. Handles are available as accessories.

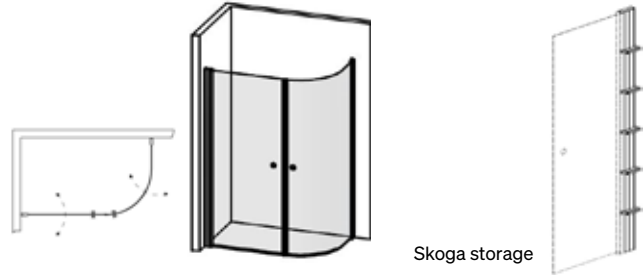

Skoga storage

Skoga Corner shower round/straight	80×117 Height: 198 cm Opening dimensions: 130 cm.	80×127 Height: 198 cm Opening dimensions: 138 cm.	80×137 Height: 198 cm Opening dimensions: 147 cm.	Skoga storage Height: 198 cm. Built out 10 cm from the wall.
Profile/glass	Order no.	Order no.	Order no.	Order no.
Matt aluminium				
Clear glass	60807387	60807388	60807389	6601
Polished aluminium				
Clear glass	60807487	60807488	60807489	6600
Black matt				
Clear glass	60807287	60807288	60807289	6602

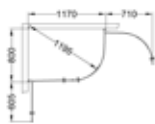

80×117

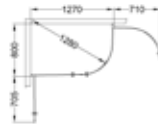

80×127

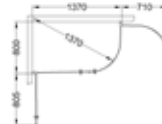

80×137

Skoga Corner shower round/straight	80×147 Height: 198 cm Opening dimensions: 156 cm.	Skoga storage Height: 198 cm. Built out 10 cm from the wall.
Profile/glass	Order no.	Order no.
Matt aluminium		
Clear glass	60807381	6601
Polished aluminium		
Clear glass	60807481	6600
Black matt		
Clear glass	60807281	6602

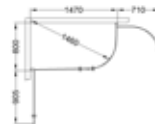

80×147

Skoga Corner shower round

- Consists of two doors with transparent sealing strip at the bottom.
- Can be positioned asymmetrically or symmetrically in a corner, or in the centre of a wall.
- Doors can be folded inwards when shower is not in use to maximise floor space.
- No threshold - disabled friendly.
- Toughened safety glass 6 mm.
- Wall profile allows for pipe installation 30 mm from the wall.
- The shower walls can be supplemented with 30 or 50 mm wall profiles.
- Height: 198 cm.
- Includes grip holes. Handles are available as accessories.

Skoga Corner shower round	90×67 Height: 198 cm	95×80 Height: 198 cm
Profile/glass	Order no.	Order no.
Matt aluminium		
Clear glass	61307379	61307381
Polished aluminium		
Clear glass	61307479	61307481
Black matt		
Clear glass	61307279	61307281



90×67

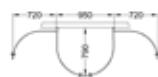

95×80

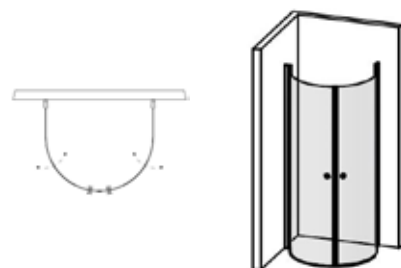

Skoga Shower screen straight

- Shower screen, depth 52-97 cm.
- Toughened safety glass 6 mm.
- Wall profile allows for pipe installation 30 mm from the wall.
- The shower walls can be supplemented with 30 or 50 mm wall profiles.
- Height: 198 cm.
- Includes grip holes. Handles are available as accessories.

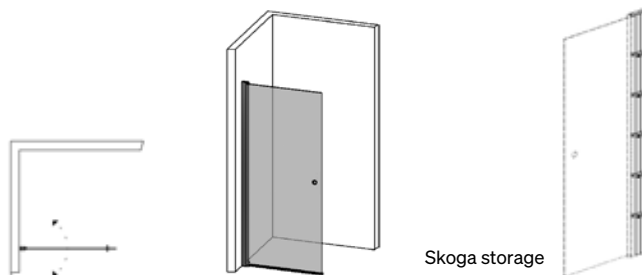

Skoga Shower screen straight	52 Height: 198 cm	57 Height: 198 cm	62 Height: 198 cm	Skoga storage Height: 198 cm. Built out 10 cm from the wall.
------------------------------	----------------------	----------------------	----------------------	--

Profile/glass	Order no.	Order no.	Order no.	Order no.
Matt aluminium				
Clear glass	63307355	63307360	63307365	6601
Frosted glass	63308355	63308360	63308365	6601
Polished aluminium				
Clear glass	63307455	63307460	63307465	6600
Frosted glass	63308455	63308460	63308465	6600

Skoga Shower screen straight	67 Height: 198 cm	77 Height: 198 cm	87 Height: 198 cm	Skoga storage Height: 198 cm. Built out 10 cm from the wall.
------------------------------	----------------------	----------------------	----------------------	--

Profile/glass	Order no.	Order no.	Order no.	Order no.
Matt aluminium				
Clear glass	63307370	63307380	63307390	6601
Smoked glass	63311370	63311380	63311390	6601
Frosted glass	63308370	63308380	63308390	6601
Polished aluminium				
Clear glass	63307470	63307480	63307490	6600
Smoked glass	63311470	63311480	63311490	6600
Frosted glass	63308470	63308480	63308490	6600
Black matt				
Clear glass	63307270	63307280	63307290	6602
Smoked glass	63311270	63311280	63311290	6602
Frosted glass	63308270	63308280	63308290	6602

Skoga Shower screen straight	97 Height: 198 cm	Skoga storage Height: 198 cm. Built out 10 cm from the wall.
------------------------------	----------------------	--

Profile/glass	Order no.	Order no.
Matt aluminium		
Clear glass	63307310	6601
Smoked glass	63311310	6601
Frosted glass	63308310	6601
Polished aluminium		
Clear glass	63307410	6600
Smoked glass	63311410	6600
Frosted glass	63308410	6600
Black matt		
Clear glass	63307210	6602
Smoked glass	63311210	6602
Frosted glass	63308210	6602

Skoga storage

Skoga storage is suitable for use with all Skoga profile showers, providing extra vertical storage within the shower. The storage is mounted between the shower and wall, and has five fixed shelves.

NB: Please remember that Skoga storage is built out 10 cm from the wall, meaning that you must subtract 10 cm from the corresponding measurement of your desired shower solution.

Example 1: Skoga corner shower, straight, 90×90 with Skoga storage. Order Skoga corner shower, straight, 80×90 and Skoga storage.

Example 2: Skoga shower screen, fixed, 80, with Skoga storage. Order Skoga shower screen, fixed, 70, and Skoga storage.



Skoga Shower screen fixed

- Comes complete with curtain rod (max 105 cm), floor mount and transparent seal against the floor.
- Toughened safety glass 6 mm.
- Wall profile allows for pipe installation 30 mm from the wall.
- The shower walls can be supplemented with 30 or 50 mm wall profiles.
- Height: 198 cm (201 cm ovkant stag).

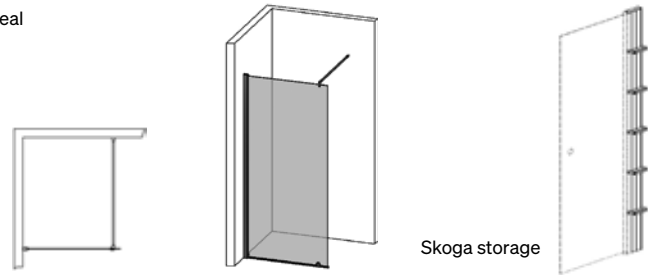

Skoga Shower screen fixed	70 Height: 198 cm (201 cm upper edge of rod).	80 Height: 198 cm (201 cm upper edge of rod).	90 Height: 198 cm (201 cm upper edge of rod).	Skoga storage Height: 198 cm. Built out 10 cm from the wall.
Profile/glass	Order no.	Order no.	Order no.	Order no.
Matt aluminium				
Clear glass	6120037	6120038	6120039	6601
Smoked glass	6120337	6120338	6120339	6601
Frosted glass	6120137	6120138	6120139	6601
Polished aluminium				
Clear glass	6120047	6120048	6120049	6600
Smoked glass	6120347	6120348	6120349	6600
Frosted glass	6120147	6120148	6120149	6600
Black matt				
Clear glass	6120027	6120028	6120029	6602
Smoked glass	6120327	6120328	6120329	6602
Frosted glass	6120127	6120128	6120129	6602

Skoga Shower screen bath

- Has one opening door with transparent seal against edge of bathtub.
- Toughened safety glass 6 mm.
- Wall profile allows for pipe installation 30 mm from the wall.
- Height: 141 cm.

Skoga Shower screen bath	80 Height: 141 cm
Profile/glass	Order no.
Matt aluminium	
Clear glass	63000380
Polished aluminium	
Clear glass	63000480
Black matt	
Clear glass	63000280

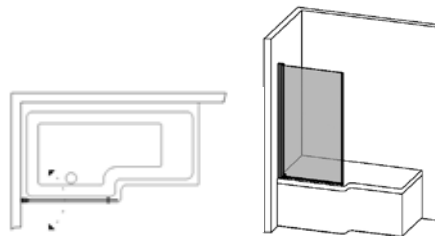

Skoga Alcove shower single

- Single alcove, available in 70-100 cm.
- Shower screens can be adjusted 2,5 cm. See table below.
- For other alcove measurements please supplement with 30 or 50 mm wall profiles.
- Reversible for either right or left orientation.
- No threshold - disabled friendly.
- Toughened safety glass 6 mm.
- Wall profile allows for pipe installation 30 mm from the wall.
- Height: 198 cm.
- Door opening: 60-90 cm.
- Includes grip holes. Handles are available as accessories.

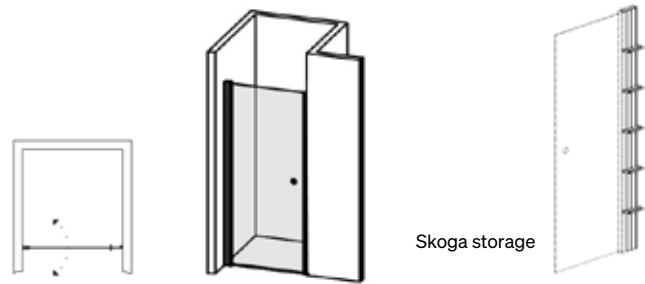

Skoga Alcove shower single	70	80	90	Skoga storage
	Height: 198 cm Opening dimensions: 60 cm.	Height: 198 cm Opening dimensions: 70 cm.	Height: 198 cm Opening dimensions: 80 cm.	Height: 198 cm. Built out 10 cm from the wall.
Profile/glass	Order no.	Order no.	Order no.	Order no.
Matt aluminium				
Clear glass	60107370	60107380	60107390	6601
Smoked glass	60111370	60111380	60111390	6601
Frosted glass	60108370	60108380	60108390	6601
Polished aluminium				
Clear glass	60107470	60107480	60107490	6600
Smoked glass	60111470	60111480	60111490	6600
Frosted glass	60108470	60108480	60108490	6600
Black matt				
Clear glass	60107270	60107280	60107290	6602
Smoked glass	60111270	60111280	60111290	6602
Frosted glass	60108270	60108280	60108290	6602

Skoga Alcove shower single	100	Skoga storage
	Height: 198 cm Opening dimensions: 90 cm.	Height: 198 cm. Built out 10 cm from the wall.
Profile/glass	Order no.	Order no.
Matt aluminium		
Clear glass	60107310	6601
Smoked glass	60111310	6601
Frosted glass	60108310	6601
Polished aluminium		
Clear glass	60107410	6600
Smoked glass	60111410	6600
Frosted glass	60108410	6600
Black matt		
Clear glass	60107210	6602
Smoked glass	60111210	6602
Frosted glass	60108210	6602

Skoga storage

Skoga storage is suitable for use with all Skoga profile showers, providing extra vertical storage within the shower. The storage is mounted between the shower and wall, and has five fixed shelves.

NB: Please remember that Skoga storage is built out 10 cm from the wall, meaning that you must subtract 10 cm from the corresponding measurement of your desired shower solution.

Example 1: Skoga corner shower, straight, 90×90 with Skoga storage. Order Skoga corner shower, straight, 80×90 and Skoga storage.

Example 2: Skoga shower screen, fixed, 80, with Skoga storage. Order Skoga shower screen, fixed, 70, and Skoga storage.



Adjustment measurements Skoga Alcove shower single	
Measurement	Adjustable
70	69,5 - 72
80	79,5 - 82
90	89,5 - 92
100	99,5 - 102

Skoga Alcove shower double

- Double alcove, available in 108-198 cm.
- Shower screens can be adjusted 4 cm. See table below.
- For other alcove measurements please supplement with 30 or 50 mm wall profiles.
- No threshold - disabled friendly.
- Toughened safety glass 6 mm.
- Wall profile allows for pipe installation 30 mm from the wall.
- Height: 198 cm.
- Door opening: 90-180 cm.
- Includes grip holes. Handles are available as accessories.

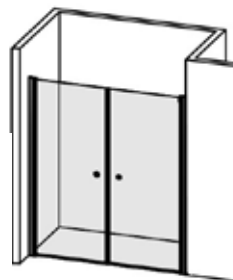
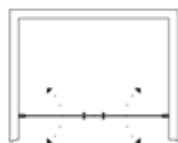

Skoga storage

Skoga Alcove shower double		108	118	128	Skoga storage
		Height: 198 cm Opening dimensions: 90 cm.	Height: 198 cm Opening dimensions: 100 cm.	Height: 198 cm Opening dimensions: 110 cm.	Height: 198 cm. Built out 10 cm from the wall.
Profile/glass	Order no.	Order no.	Order no.	Order no.	Order no.
Matt aluminium					
Clear glass	60207355	60207360	60207365	6601	
Frosted glass	60208355	60208360	60208365	6601	
Polished aluminium					
Clear glass	60207455	60207460	60207465	6600	
Frosted glass	60208455	60208460	60208465	6600	

Skoga Alcove shower double		138	158	178	Skoga storage
		Height: 198 cm Opening dimensions: 120 cm.	Height: 198 cm Opening dimensions: 140 cm.	Height: 198 cm Opening dimensions: 160 cm.	Height: 198 cm. Built out 10 cm from the wall.
Profile/glass	Order no.	Order no.	Order no.	Order no.	Order no.
Matt aluminium					
Clear glass	60207370	60207380	60207390	6601	
Smoked glass	60211370	60211380	60211390	6601	
Frosted glass	60208370	60208380	60208390	6601	
Polished aluminium					
Clear glass	60207470	60207480	60207490	6600	
Smoked glass	60211470	60211480	60211490	6600	
Frosted glass	60208470	60208480	60208490	6600	
Black matt					
Clear glass	60207270	60207280	60207290	6602	
Smoked glass	60211270	60211280	60211290	6602	
Frosted glass	60208270	60208280	60208290	6602	

Skoga Alcove shower double		198	Skoga storage
		Height: 198 cm Opening dimensions: 180 cm.	Height: 198 cm. Built out 10 cm from the wall.
Profile/glass	Order no.	Order no.	Order no.
Matt aluminium			
Clear glass	60207310	6601	
Smoked glass	60211310	6601	
Frosted glass	60208310	6601	
Polished aluminium			
Clear glass	60207410	6600	
Smoked glass	60211410	6600	
Frosted glass	60208410	6600	
Black matt			
Clear glass	60207210	6602	
Smoked glass	60211210	6602	
Frosted glass	60208210	6602	

Adjustment measurements Skoga Alcove shower double		
Measurement	Adjustment	Adjustable
108		105 - 109
118		115 - 119
128		125 - 129
138		135 - 139
158		155 - 159
178		175 - 179
198		195 - 199

Skoga Alcove shower combined

- Double alcove, available in 140-180 cm.
- Shower screens can be adjusted 4 cm. See table below.
- For other alcove measurements please supplement with 30 or 50 mm wall profiles.
- No threshold - disabled friendly.
- Toughened safety glass 6 mm.
- Wall profile allows for pipe installation 30 mm from the wall.
- Height: 198 cm (201 cm upper edge of rod).
- Door opening: 60-80 cm.
- Includes grip holes. Handles are available as accessories.

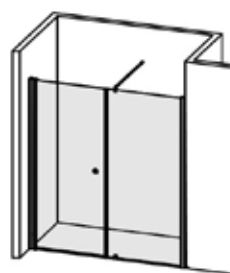
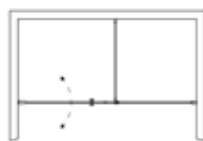

Skoga storage



Skoga Alcove shower combined	140	160	180	Skoga storage
	Height: 198 cm (201 cm upper edge of rod). Opening dimensions: 60 cm.	Height: 198 cm (201 cm upper edge of rod). Opening dimensions: 70 cm.	Height: 198 cm (201 cm upper edge of rod). Opening dimensions: 80 cm.	Height: 198 cm. Built out 10 cm from the wall.
Profile/glass	Order no.	Order no.	Order no.	Order no.
Matt aluminium				
Clear glass	61907377	61907388	61907399	6601
Smoked glass	61911377	61911388	61911399	6601
Frosted glass	61908377	61908388	61908399	6601
Polished aluminium				
Clear glass	61907477	61907488	61907499	6600
Smoked glass	61911477	61911488	61911499	6600
Frosted glass	61908477	61908488	61908499	6600
Black matt				
Clear glass	61907277	61907288	61907299	6602
Smoked glass	61911277	61911288	61911299	6602
Frosted glass	61908277	61908288	61908299	6602

Adjustment measurements
Skoga Alcove shower combined

Measurement	Adjustable
140	139,5 - 143,5
160	159,5 - 163,5
180	179,5 - 183,5

Front Shower shelf

Aluminium shelf for placement in or outside the shower. Can be glued. Glue kit including fittings available as an accessory. H:10 D:9



Wall shelf

Aluminium shelf for placement in or outside the shower. Can be glued. A glue kit is available as an accessory. H:7,5 D:8,5



Shower storage	70	80	32,5	65
Colour	Order no.	Order no.	Order no.	Order no.
Matt aluminium	6571	6581	6330	6660
Polished pencil black	6573	6583	6329	6659
Black matt	6572	6582	6325	6651
White matt	6570	6580	6324	6650
Options				
Glue kit	97058	97058	97043	97043

Skoga Corner shower with folding screen

- Consists of two folding doors (180°) with transparent rubber seal against the floor and between the glass panels.
- The doors can be opened/folded inwards. Practical if you have furniture in front of the doors, and to free up floor space.
- No threshold - disabled friendly.
- Toughened safety glass 6 mm.
- Wall profiles allow pipe installation 30 mm from wall.
- Showers can be supplemented with 30 or 50 mm wall profiles.
- Height: 198 cm.
- Door opening: 85-127 cm.
- Includes grip holes. Handles are available as accessories.

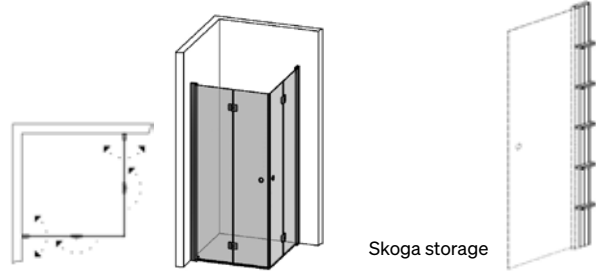

Skoga Corner shower with folding screen	70×70 Height: 198 cm Opening dimensions: 85 cm.	70×80 Height: 198 cm Opening dimensions: 93 cm.	70×90 Height: 198 cm Opening dimensions: 101 cm.	Skoga storage Height: 198 cm. Built out 10 cm from the wall.
Profile/glass	Order no.	Order no.	Order no.	Order no.
Matt aluminium				
Clear glass	61607377	61607378	61607379	6601
Semi-frosted	61609377	61609378	61609379	6601
Polished aluminium				
Clear glass	61607477	61607478	61607479	6600
Semi-frosted	61609477	61609478	61609479	6600
Black matt				
Clear glass	61607277	61607278	61607279	6602
Semi-frosted	61609277	61609278	61609279	6602

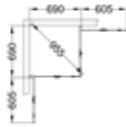

70×70



70×80



70×90

Skoga Corner shower with folding screen	70×100 Height: 198 cm Opening dimensions: 109 cm.	80×80 Height: 198 cm Opening dimensions: 100 cm.	80×90 Height: 198 cm Opening dimensions: 107 cm.	Skoga storage Height: 198 cm. Built out 10 cm from the wall.
Profile/glass	Order no.	Order no.	Order no.	Order no.
Matt aluminium				
Clear glass	61607371	61607388	61607389	6601
Semi-frosted	61609371	61609388	61609389	6601
Polished aluminium				
Clear glass	61607471	61607488	61607489	6600
Semi-frosted	61609471	61609488	61609489	6600
Black matt				
Clear glass	61607271	61607288	61607289	6602
Semi-frosted	61609271	61609288	61609289	6602



70×100



80×80



80×90

¹ Delivery time 2 weeks

² Delivery time 4 weeks.

Skoga Corner shower with folding screen

- Consists of two folding doors (180°) with transparent rubber seal against the floor and between the glass panels.
- The doors can be opened/folded inwards. Practical if you have furniture in front of the doors, and to free up floor space.
- No threshold - disabled friendly.
- Toughened safety glass 6 mm.
- Wall profiles allow pipe installation 30 mm from wall.
- Showers can be supplemented with 30 or 50 mm wall profiles.
- Height: 198 cm.
- Door opening: 85-127 cm.
- Includes grip holes. Handles are available as accessories.

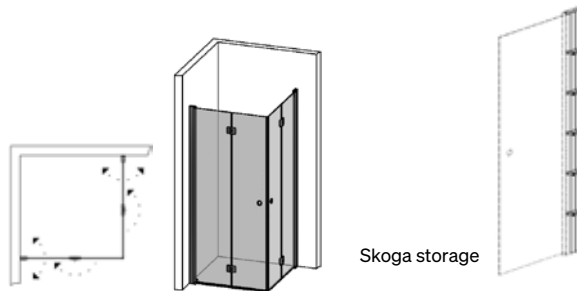

Skoga Corner shower with folding screen	80×100	90×90	90×100	Skoga storage
	Height: 198 cm Opening dimensions: 115 cm.	Height: 198 cm Opening dimensions: 114 cm.	Height: 198 cm Opening dimensions: 121 cm.	Height: 198 cm. Built out 10 cm from the wall.
Profile/glass	Order no.	Order no.	Order no.	Order no.
Matt aluminium				
Clear glass	61607381	61607399	61607391	6601
Semi-frosted	61609381	61609399	61609391	6601
Polished aluminium				
Clear glass	61607481	61607499	61607491	6600
Semi-frosted	61609481	61609499	61609491	6600
Black matt				
Clear glass	61607281	61607299	61607291	6602
Semi-frosted	61609281	61609299	61609291	6602



80×100



90×90



90×100

Skoga Corner shower with folding screen	100×100	Skoga storage
	Height: 198 cm Opening dimensions: 127 cm.	Height: 198 cm. Built out 10 cm from the wall.
Profile/glass	Order no.	Order no.
Matt aluminium		
Clear glass	61607311	6601
Semi-frosted	61609311	6601
Polished aluminium		
Clear glass	61607411	6600
Semi-frosted	61609411	6600
Black matt		
Clear glass	61607211	6602
Semi-frosted	61609211	6602



100×100

Skoga storage

Skoga storage is suitable for use with all Skoga profile showers, providing extra vertical storage within the shower. The storage is mounted between the shower and wall, and has five fixed shelves.

NB: Please remember that Skoga storage is built out 10 cm from the wall, meaning that you must subtract 10 cm from the corresponding measurement of your desired shower solution.

Example 1: Skoga corner shower, straight, 90×90 with Skoga storage. Order Skoga corner shower, straight, 80×90 and Skoga storage.

Example 2: Skoga shower screen, fixed, 80, with Skoga storage. Order Skoga shower screen, fixed, 70, and Skoga storage.



Skoga Corner shower with folding screen, fixed wall/door

- Consists of a fixed screen with curtain rail (max. 105 cm), floor mounting and transparent rubber seal against the floor, plus one folding door (180°) with transparent rubber seal against the floor and between the glass panels.
- The door can be opened/folded inwards. Practical if you have furniture in front of the door.
- No threshold - disabled friendly.
- Toughened safety glass 6 mm.
- Wall profiles allow pipe installation 30 mm from wall.
- Showers can be supplemented with 30 or 50 mm wall profiles.
- Height: 198 cm (201 cm upper edge of rod).
- Door opening: 60-90 cm.
- Includes grip holes. Handles are available as accessories.

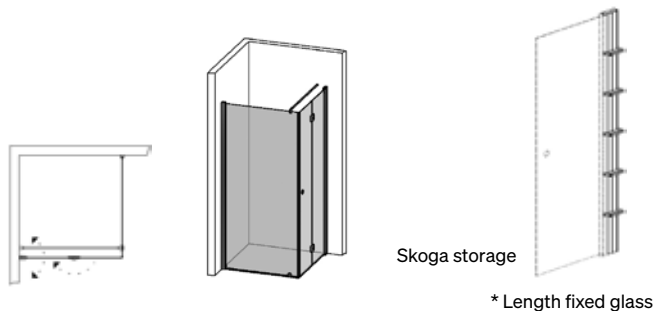

Skoga Corner shower with folding screen, fixed wall/door	70×73*	70×83*	70×93*	Skoga storage
	Height: 198 cm (201 cm upper edge of rod). Opening dimensions: 60 cm.	Height: 198 cm (201 cm upper edge of rod). Opening dimensions: 60 cm.	Height: 198 cm (201 cm upper edge of rod). Opening dimensions: 60 cm.	Height: 198 cm. Built out 10 cm from the wall.
Profile/glass	Order no.	Order no.	Order no.	Order no.
Matt aluminium				
Clear glass	61707377	61707378	61707379	6601
Polished aluminium				
Clear glass	61707477	61707478	61707479	6600
Black matt				
Clear glass	61707277	61707278	61707279	6602

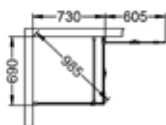

70×73*

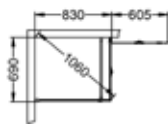

70×83*

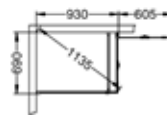

70×93*

* Length fixed glass

Skoga Corner shower with folding screen, fixed wall/door	80×73*	80×83*	80×93*	Skoga storage
	Height: 198 cm (201 cm upper edge of rod). Opening dimensions: 70 cm.	Height: 198 cm (201 cm upper edge of rod). Opening dimensions: 70 cm.	Height: 198 cm (201 cm upper edge of rod). Opening dimensions: 70 cm.	Height: 198 cm. Built out 10 cm from the wall.
Profile/glass	Order no.	Order no.	Order no.	Order no.
Matt aluminium				
Clear glass	61707387	61707388	61707389	6601
Polished aluminium				
Clear glass	61707487	61707488	61707489	6600
Black matt				
Clear glass	61707287	61707288	61707289	6602

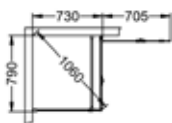

80×73*

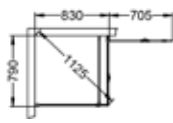

80×83*

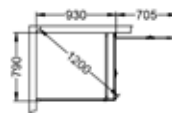

80×93*

Skoga Corner shower with folding screen, fixed wall/door

- Consists of a fixed screen with curtain rail (max. 105 cm), floor mounting and transparent rubber seal against the floor, plus one folding door (180°) with transparent rubber seal against the floor and between the glass panels.
- The door can be opened/folded inwards. Practical if you have furniture in front of the door.
- No threshold - disabled friendly.
- Toughened safety glass 6 mm.
- Wall profiles allow pipe installation 30 mm from wall.
- Showers can be supplemented with 30 or 50 mm wall profiles.
- Height: 198 cm (201 cm upper edge of rod).
- Door opening: 60-90 cm.
- Includes grip holes. Handles are available as accessories.

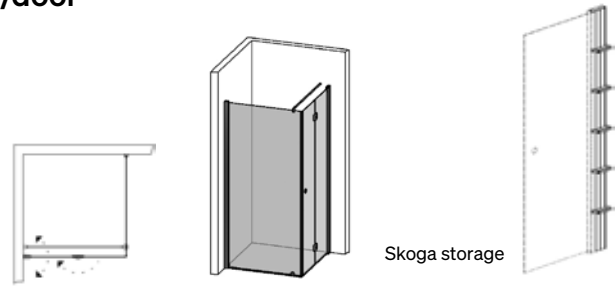

* Length fixed glass

Skoga Corner shower with folding screen, fixed wall/door	90×73*	90×83*	90×93*	Skoga storage
	Height: 198 cm (201 cm upper edge of rod). Opening dimensions: 80 cm.	Height: 198 cm (201 cm upper edge of rod). Opening dimensions: 80 cm.	Height: 198 cm (201 cm upper edge of rod). Opening dimensions: 80 cm.	Height: 198 cm. Built out 10 cm from the wall.
Profile/glass	Order no.	Order no.	Order no.	Order no.
Matt aluminium				
Clear glass	61707397	61707398	61707399	6601
Polished aluminium				
Clear glass	61707497	61707498	61707499	6600
Black matt				
Clear glass	61707297	61707298	61707299	6602

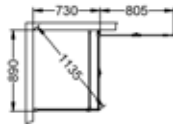

90×73*

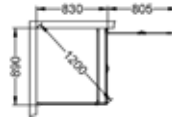

90×83*

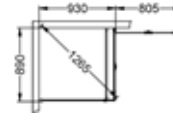

90×93*

* Length fixed glass

Skoga Corner shower with folding screen, fixed wall/door	100×73*	100×83*	100×93*	Skoga storage
	Height: 198 cm (201 cm upper edge of rod). Opening dimensions: 90 cm.	Height: 198 cm (201 cm upper edge of rod). Opening dimensions: 90 cm.	Height: 198 cm (201 cm upper edge of rod). Opening dimensions: 90 cm.	Height: 198 cm. Built out 10 cm from the wall.
Profile/glass	Order no.	Order no.	Order no.	Order no.
Matt aluminium				
Clear glass	61707317	61707318	61707319	6601
Polished aluminium				
Clear glass	61707417	61707418	61707419	6600
Black matt				
Clear glass	61707217	61707218	61707219	6602

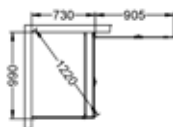

100×73*

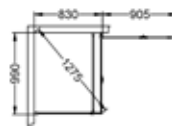

100×83*

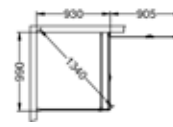

100×93*

Skoga Folding shower screen

- Shower screen, depth 67-97 cm.
- Toughened safety glass 6 mm.
- Wall profiles allow pipe installation 30 mm from wall.
- Showers can be supplemented with 30 or 50 mm wall profiles.
- Height: 198 cm.
- Includes grip holes. Handles are available as accessories.

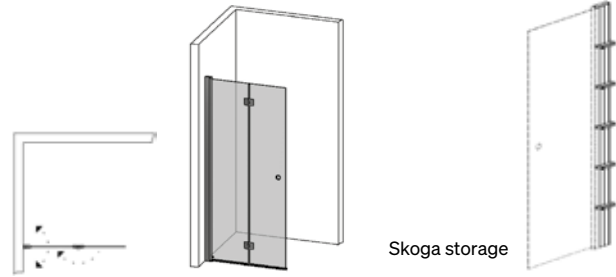

Skoga Folding shower screen	67 Height: 198 cm	77 Height: 198 cm	87 Height: 198 cm	Skoga storage Height: 198 cm. Built out 10 cm from the wall.
Profile/glass	Order no.	Order no.	Order no.	Order no.
Matt aluminium				
Clear glass	61407370	61407380	61407390	6601
Semi-frosted	61409370	61409380	61409390	6601
Polished aluminium				
Clear glass	61407470	61407480	61407490	6600
Semi-frosted	61409470	61409480	61409490	6600
Black matt				
Clear glass	61407270	61407280	61407290	6602
Semi-frosted	61409270	61409280	61409290	6602

Skoga Folding shower screen	97 Height: 198 cm	Skoga storage Height: 198 cm. Built out 10 cm from the wall.
Profile/glass	Order no.	Order no.
Matt aluminium		
Clear glass	61407310	6601
Semi-frosted	61409310	6601
Polished aluminium		
Clear glass	61407410	6600
Semi-frosted	61409410	6600
Black matt		
Clear glass	61407210	6602
Semi-frosted	61409210	6602

Skoga storage

Skoga storage is suitable for use with all Skoga profile showers, providing extra vertical storage within the shower. The storage is mounted between the shower and wall, and has five fixed shelves.

NB: Please remember that Skoga storage is built out 10 cm from the wall, meaning that you must subtract 10 cm from the corresponding measurement of your desired shower solution.

Example 1: Skoga corner shower, straight, 90×90 with Skoga storage. Order Skoga corner shower, straight, 80×90 and Skoga storage.

Example 2: Skoga shower screen, fixed, 80, with Skoga storage. Order Skoga shower screen, fixed, 70, and Skoga storage.



Front Shower shelf

Aluminium shelf for placement in or outside the shower. Can be glued. Glue kit including fittings available as an accessory. H:10 D:9



Wall shelf

Aluminium shelf for placement in or outside the shower. Can be glued. A glue kit is available as an accessory. H:7,5 D:8,5



Shower storage	70	80	32,5	65
Colour	Order no.	Order no.	Order no.	Order no.
Matt aluminium	6571	6581	6330	6660
Polished pencil black	6573	6583	6329	6659
Black matt	6572	6582	6325	6651
White matt	6570	6580	6324	6650
Options				
Glue kit	97058	97058	97043	97043

Skoga Alcove shower with folding screen, single

- Enkel nisch finns från 70-100 cm.
- Shower screens can be adjusted 2,5 cm. See table below.
- For other alcove measurements please supplement with 30 or 50 mm wall profiles.
- No threshold - disabled friendly.
- Toughened safety glass 6 mm.
- Wall profiles allow pipe installation 30 mm from wall.
- Height: 198 cm.
- Door opening: 60-90 cm.
- Includes grip holes. Handles are available as accessories.



Skoga Alcove shower with folding screen, single	70	80	90	Skoga storage
	Height: 198 cm. Opening dimensions: 60 cm.	Height: 198 cm. Opening dimensions: 70 cm.	Height: 198 cm. Opening dimensions: 80 cm.	Height: 198 cm. Built out 10 cm from the wall.
Profile/glass	Order no.	Order no.	Order no.	Order no.
Matt aluminium				
Clear glass	61507370	61507380	61507390	6601
Semi-frosted	61509370	61509380	61509390	6601
Polished aluminium				
Clear glass	61507470	61507480	61507490	6600
Semi-frosted	61509470	61509480	61509490	6600
Black matt				
Clear glass	61507270	61507280	61507290	6602
Semi-frosted	61509270	61509280	61509290	6602

Skoga Alcove shower with folding screen, single	100	Skoga storage
	Height: 198 cm. Opening dimensions: 90 cm.	Height: 198 cm. Built out 10 cm from the wall.
Profile/glass	Order no.	Order no.
Matt aluminium		
Clear glass	61507310	6601
Semi-frosted	61509310	6601
Polished aluminium		
Clear glass	61507410	6600
Semi-frosted	61509410	6600
Black matt		
Clear glass	61507210	6602
Semi-frosted	61509210	6602

Skoga storage

Skoga storage is suitable for use with all Skoga profile showers, providing extra vertical storage within the shower. The storage is mounted between the shower and wall, and has five fixed shelves.

NB: Please remember that Skoga storage is built out 10 cm from the wall, meaning that you must subtract 10 cm from the corresponding measurement of your desired shower solution.

Example 1: Skoga corner shower, straight, 90×90 with Skoga storage. Order Skoga corner shower, straight, 80×90 and Skoga storage.

Example 2: Skoga shower screen, fixed, 80, with Skoga storage. Order Skoga shower screen, fixed, 70, and Skoga storage.



Adjustment measurements	
Skoga Alcove shower with folding screen, single	
Measurement	Adjustable
70	69,5 - 72
80	79,5 - 82
90	89,5 - 92
100	99,5 - 102

Skoga Alcove shower with folding screen, double

- Double alcove, available in 138-198 cm.
- Shower screens can be adjusted 4 cm. See table below.
- For other alcove measurements please supplement with 30 or 50 mm wall profiles.
- No threshold - disabled friendly.
- Toughened safety glass 6 mm.
- Wall profile allows for pipe installation 30 mm from the wall.
- Height: 198 cm.
- Door opening: 120-180 cm.

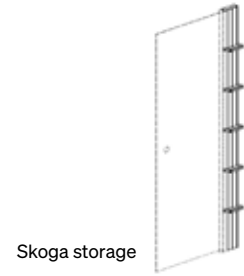
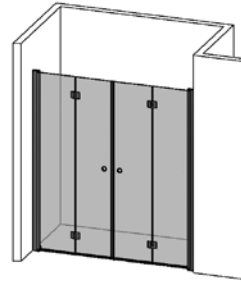
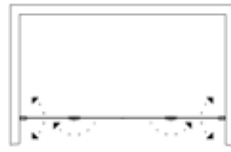

Skoga storage

Skoga Alcove shower with folding screen, double	138	158	178	Skoga storage
	Height: 198 cm. Opening dimensions: 120 cm.	Height: 198 cm. Opening dimensions: 140 cm.	Height: 198 cm. Opening dimensions: 160 cm.	Height: 198 cm. Built out 10 cm from the wall.
Profile/glass	Order no.	Order no.	Order no.	Order no.
Matt aluminium				
Clear glass	60707377	60707388	60707399	6601
Semi-frosted	60709377	60709388	60709399	6601
Polished aluminium				
Clear glass	60707477	60707488	60707499	6600
Semi-frosted	60709477	60709488	60709499	6600
Black matt				
Clear glass	60707277	60707288	60707299	6602
Semi-frosted	60709277	60709288	60709299	6602

Skoga Viknisch dubbel	198	Skoga storage
	Height: 198 cm. Opening dimensions: 180 cm.	Height: 198 cm. Built out 10 cm from the wall.
Profile/glass	Order no.	Order no.
Matt aluminium		
Clear glass	60707311	6601
Semi-frosted	60709311	6601
Polished aluminium		
Clear glass	60707411	6600
Semi-frosted	60709411	6600
Black matt		
Clear glass	60707211	6602
Semi-frosted	60709211	6602

Adjustment measurements Skoga Alcove shower with folding screen, double	
Measurement	Adjustable
138	135 - 139
158	155 - 159
178	175 - 179
198	195 - 199

Adjustment measurements Skoga Alcove shower with folding screen, combi	
Measurement	Adjustable
140	139,5 - 143,5
160	159,5 - 163,5
180	179,5 - 183,5

Skoga Alcove shower with folding screen, combi

- Double alcove, available in 140-180 cm.
- Shower screens can be adjusted 4 cm. See table above.
- For other alcove measurements please supplement with 30 or 50 mm wall profiles.
- No threshold - disabled friendly.
- Toughened safety glass 6 mm.
- Wall profile allows for pipe installation 30 mm from the wall.
- Height: 198 cm, 201 cm upper edge of rod.
- Door opening: 60-80 cm

¹ Delivery time 2 weeks
² Delivery time 4 weeks.

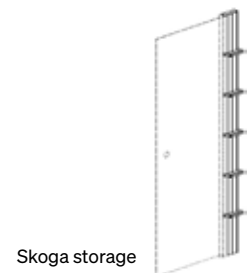
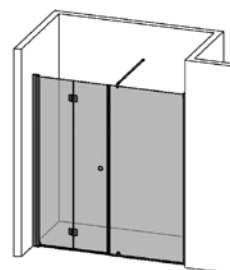

Skoga storage

Skoga Alcove shower with folding screen, combi	140	160	180	Skoga storage
	Height: 198 cm (201 cm upper edge of rod). Opening dimensions: 60 cm.	Height: 198 cm (201 cm upper edge of rod). Opening dimensions: 70 cm.	Height: 198 cm (201 cm upper edge of rod). Opening dimensions: 80 cm.	Height: 198 cm. Built out 10 cm from the wall.
Profile/glass	Order no.	Order no.	Order no.	Order no.
Matt aluminium				
Clear glass	60907377	60907388	60907399	6601
Polished aluminium				
Clear glass	60907477	60907488	60907499	6600
Black matt				
Clear glass	60907277	60907288	60907299	6602

Skoga Options



Skoga Handle

Colour	Order no.
Chrome	60054
Matt chrome	60053
Pencil black	60055
Black matt	60052

Skoga Extension piece 30

Colour	Order no.
Matt aluminium	632103
Polished aluminium	632104
Polished pencil black	632105
Black matt	632102

Floor Seal straight

Options	Order no.
White matt, 50-115 cm	625
White matt, 115-200 cm	635

Floor Seal round

Colour	Order no.
White matt	691

Magnetic profiles (Corner/double alcove)

Colour	Order no.
Transparent	98215
Smoky	98207

Corner bar

Colour	Order no.
Chrome	99357
Black matt	99387

Shower enclosure Ritual Premium

- Supplied complete with cast marble shower tray and drain connection incl. water trap.
- Ready-assembled two-way thermostatic mixer, ready-assembled couplings for water connection, overhead shower and hand shower incl. hose and couplings.
- Toughened safety glass 4 mm.
- Spring action door with eight ball bearings.
- Opening dimensions: 47 cm
- Height: 218 cm. Inside height: 192 cm.
- Minimum ceiling height for installation 225 cm.
- Optional shower seat.

90×90

Height: 218 cm (Inside height: 192 cm)
Opening dimensions: 47 cm

Profile	Glass	Rear wall	Order no.
White	Clear glass	Clear glass	68399
White	Clear glass	Vitglas	68899

Skoga Extension piece 50 mm

Colour	Order no.
Matt aluminium	634103
Polished aluminium	634104
Polished pencil black	634105
Black matt	634102

Rubber seal

Colour	Order no.
Transparent	98210
Smoky	98222

Rubber seal, high (round/straight)

Colour	Order no.
Transparent	65986

Vertical rubber seal for folding door

Colour	Order no.
Transparent	98221

Skoga Special 1

Height unless standard max 198 cm.
Width unless standard max 100 cm.
Glass can be cut diagonally.

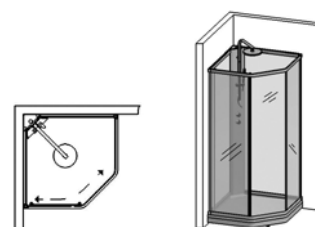

Auren

Materials: Lucite

Positioning: Independent

Depth: 45 cm

Bath water volume: 210 l with 1 person in the bath.

W: 156 **H:** 58 **D:** 81

Weight: 36 kg

Drain connection EasyClean is included.

Colour	Order no.
<input type="checkbox"/> White matt	59803
<input checked="" type="checkbox"/> Black matt	59804

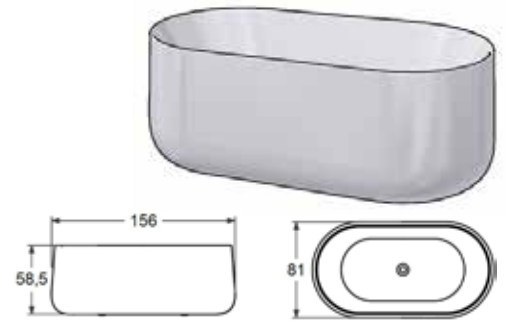

Skagen

Materials: Lucite

Positioning: Independent

Depth: 45 cm

Bath water volume: 185 l with 1 person in the bath.

W: 170 **H:** 68 **D:** 80

Weight: 35 kg

Drain connection EasyClean is included.

Colour	Order no.
<input type="checkbox"/> White matt	59805

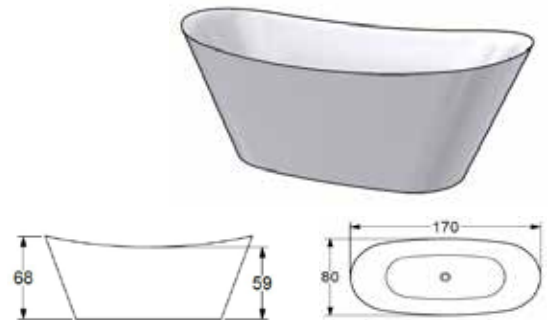

Vaulen

Materials: Lucite

Positioning: Independent

Depth: 44 cm

Bath water volume: 225 l with 1 person in the bath.

W: 160 **H:** 59 **D:** 75

Weight: 40 kg

Drain connection EasyClean is included.

Colour	Order no.
<input type="checkbox"/> White matt	59806

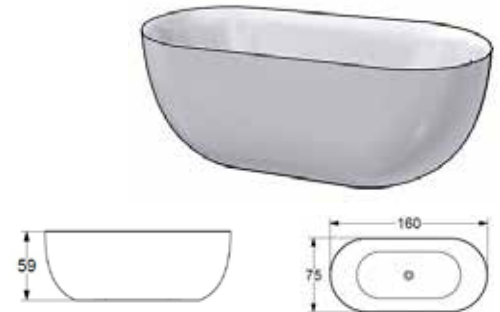

Mossby

Materials: Lucite

Positioning: Independent

Depth: 45 cm

Bath water volume: 290 l with 1 person in the bath.

W: 170 **H:** 60 **D:** 80

Weight: 47 kg

Drain connection EasyClean is included.

Colour	Order no.
<input type="checkbox"/> White matt	59807

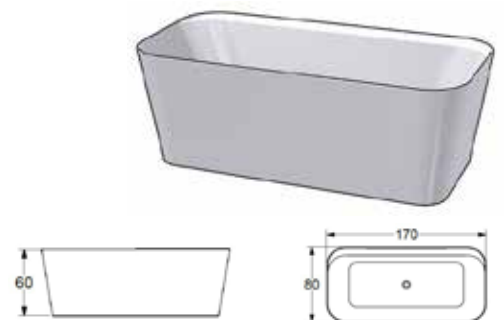

Ume

Materials: Lucite

Positioning: Independent

Depth: 45 cm

Bath water volume: 230 l with 1 person in the bath.

W: 160 H: 60 D: 75

Weight: 33 kg

Drain connection EasyClean is included.

Colour	Order no.
White	59901

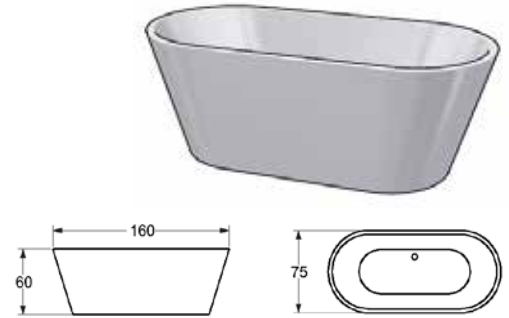

Lule

Materials: Lucite

Positioning: Against wall

Depth: 43 cm

Bath water volume: 210 l with 1 person in the bath.

W: 158 H: 58 D: 86

Weight: 36 kg

Drain connection EasyClean is included.

Colour	Order no.
White	59823
Options	
Incl. Mixer Helag	59823-3

Options: Rim mounted mixer Helag

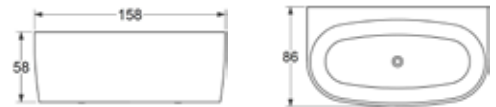
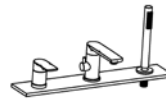

Ihre

Materials: Lucite

Positioning: Corner

Depth: 44 cm

Bath water volume: 185 l with 1 person in the bath.

W: 160 H: 59,5 D: 80

Weight: 37 kg

Drain connection EasyClean is included.

Purchase bath screen.

Colour	Riktning	Order no.
White	Left	59808-V
White	Right	59808-H
Options	Riktning	
Incl. Mixer Helag	Right	59808-H-3
Incl. Mixer Helag	Left	59808-V-3

Options: Rim mounted mixer Helag

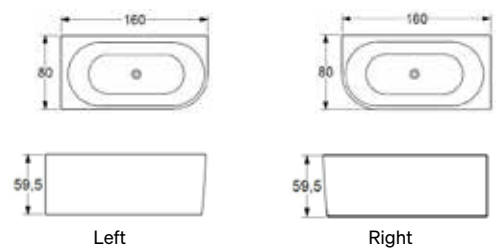
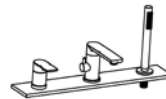

Torne

Materials: Acrylic

Positioning: Corner

Depth: 42 cm

Front panel and waste pipe included.

Select an end panel and shower screen for the bath.

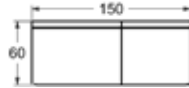
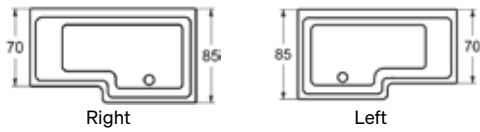

Torne Bath with shower		W: 150 H: 60: D: 85/70 Weight: 42 kg Bath water volume: 180 l with 1 person in the bath.	W: 160 H: 60: D: 85/70 Weight: 42 kg Bath water volume: 210 l with 1 person in the bath.	W: 170 H: 60: D: 85/70 Weight: 43 kg Bath water volume: 230 l with 1 person in the bath.
Direction	Options	Order no.	Order no.	Order no.
Left	Standard	Z150V	Z1600V	Z1700V
Left	Incl. Side panel	Z150VG	Z1600VG	Z1700VG
Right	Standard	Z150H	Z1600H	Z1700H
Right	Incl. Side panel	Z150HG	Z1600HG	Z1700HG
Options drain connection EasyClean				
EasyClean, Chrome		1225	1225	1225

Kalix

Materials: Acrylic

Positioning: Corner

Depth: 42 cm

Front panel and waste pipe included.

Choose an end panel, rim mounted mixer and shower screen for the bath.

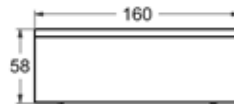
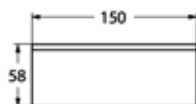
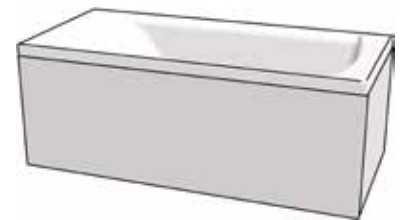

Kalix Bath with shower		W: 150 H: 58 D: 70 Weight: 36 kg Bath water volume: 120 l with 1 person in the bath.	W: 160 H: 58: D: 70 Weight: 37 kg Bath water volume: 160 l with 1 person in the bath.
Tillval		Order no.	Order no.
Standard		Z150-0	Z160-0
Incl. Side panel		Z150G-0	Z160G-0
Incl. Mixer Helag		Z150-3	Z160-3
Incl. Side panel & Mixer Helag		Z150G-3	Z160G-3
Options drain connection EasyClean			
EasyClean, Chrome		1225	1225

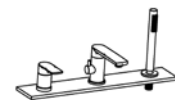

Options: Rim mounted mixer Helag

Enamel bathtub

Materials: Enamel

Positioning: Corner

Depth: 36 cm

Thickness: 1,5 mm

Anti tip device included to guarantee safety. Fixed half front panel on the long side and 2 short side panels. Drain connection is included. Purchase bath screen.

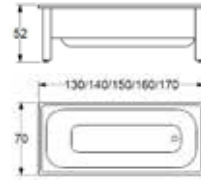

Enamel bathtub	W: 130 H: 52 D: 70 Bath water volume: 150 l with 1 person in the bath.	W: 140 H: 52 D: 70 Bath water volume: 160 l with 1 person in the bath.	W: 150 H: 52 D: 70 Bath water volume: 170 l with 1 person in the bath.
Options	Order no.	Order no.	Order no.
White			
Enamel bathtub	1203	1204	1205
Additional front	12103	12104	12105
Additional side panel	12108	12108	12108
Black			
Enamel bathtub	1231	1241	1251
Additional front	12113	12114	12115
Additional side panel	12118	12118	12118
Graphite grey/Sand/Sage			
Enamel bathtub	1203-RAL	1204-RAL	1205-RAL
Additional front	12103-RAL	12104-RAL	12105-RAL
Additional side panel	12108-RAL	12108-RAL	12108-RAL
Options drain connection EasyClean			
EasyClean, Chrome	1225	1225	1225

Enamel bathtub	W: 160 H: 52 D: 70 Bath water volume: 180 l with 1 person in the bath.	W: 170 H: 52 D: 70 Bath water volume: 190 l with 1 person in the bath.
Options	Order no.	Order no.
White		
Enamel bathtub	1200	1272
Additional front	12106	12107
Additional side panel	12108	12108
Black		
Enamel bathtub	1260	1273
Additional front	12116	12117
Additional side panel	12118	12118
Graphite grey/Sand/Sage		
Enamel bathtub	1200-RAL	1272-RAL
Additional front	12106-RAL	12107-RAL
Additional side panel	12108-RAL	12108-RAL
Options drain connection EasyClean		
EasyClean, Chrome	1225	1225

Sitting bath.

Materials: Enamel

Positioning: Corner

Thickness: 1,5 mm

W: 105 H: 52 D: 70

Anti tip device included to guarantee safety. Fixed half front panel on the long side and 2 short side panels. Drain connection is included.

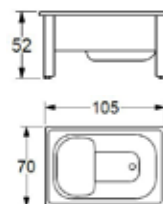

Colour	Order no.
<input type="checkbox"/> White	1250
Options drain connection EasyClean	
EasyClean, Chrome	1225

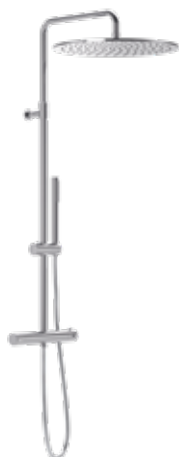

Stuor overhead shower set

Shower head: Ø40 cm
 Height: 195,5 - 233 cm (For mounting at a standard height of 110 cm.)
 Pressure-balanced mixer, which reacts rapidly to temperature and pressure fluctuations, ensuring an even water temperature.
 Energy class A.
 Wall mounting suitable for use in wet environments.
 Smooth 1.5 m hose; hygienic, easy to keep clean and long lasting (compared to braided metal hoses).
 The overhead shower is can be swivelled and the height can be adjusted.

Add a bath spout if you are using with a bath. Add an extension rod (90 cm) if the mixer is to be mounted lower, for example at bath height. This makes it possible to stand and shower in the bath.

	150 cc	160 cc
Options	Order no.	Order no.
Chrome		
Overhead shower set	96852	96862
Wall plate ¹	97018	97016
Bath spout	96885	96885
Extension rod	96888	96888
Pencil black		
Overhead shower set	96859	96869
Wall plate ¹	97021	97020
Bath spout	96884	96884
Extension rod	96887	96887
Black matt		
Overhead shower set	96853	96863
Wall plate ¹	97019	97017
Bath spout	96886	96886
Extension rod	96889	96889



Yding overhead shower set

Shower head: Ø23 cm
 Height: 195,5 - 233 cm (For mounting at a standard height of 110 cm.)
 Pressure-balanced mixer, which reacts rapidly to temperature and pressure fluctuations, ensuring an even water temperature.
 Energy class A.
 Wall mounting suitable for use in wet environments.
 Three-function hand shower, soft comfort, massage or intensive jet spray.
 Smooth 1.5 m hose; hygienic, easy to keep clean and long lasting (compared to braided metal hoses).
 The overhead shower is can be swivelled and the height can be adjusted.

Add a bath spout if you are using with a bath. Add an extension rod (90 cm) if the mixer is to be mounted lower, for example at bath height. This makes it possible to stand and shower in the bath.

	150 cc	160 cc
Options	Order no.	Order no.
Chrome		
Overhead shower set	96850	96860
Wall plate ¹	97018	97016
Bath spout	96885	96885
Extension rod	96888	96888
Pencil black		
Overhead shower set	96858	96868
Wall plate ¹	97021	97020
Bath spout	96884	96884
Extension rod	96887	96887
Black matt		
Overhead shower set	96851	96861
Wall plate ¹	97019	97017
Bath spout	96886	96886
Extension rod	96889	96889



Spika shower mixer set

Pressure adjustment knob with ECO function, saving both energy and water.
 Pressure-balanced mixer, which reacts rapidly to temperature and pressure fluctuations, ensuring an even water temperature.
 Energy class A.
 Wall mounting suitable for use in wet environments.
 Three-function hand shower, soft comfort, massage or intensive jet spray.
 Smooth 1.5 m hose; hygienic, easy to keep clean and long lasting (compared to braided metal hoses).
 Add a bath mixer or shower mixer.

	150 cc	160 cc
Options	Order no.	Order no.
Chrome		
Shower mixer set	97856	97866
Wall plate ¹	97018	97016
Pencil black		
Shower mixer set	97858	97868
Wall plate ¹	97021	97020
Black matt		
Shower mixer set	97857	97867
Wall plate ¹	97019	97017

¹For 16 mm pex pipes.

Spika bath mixer set



Bath mixer with pivoting spout, making it easy to switch the flow of water between the bath spout and the hand shower. Pressure adjustment knob with ECO function, saving both energy and water. Pressure-balanced mixer, which reacts rapidly to temperature and pressure fluctuations, ensuring an even water temperature. Energy class A. Safe water, approved mounting. Smooth 1.5 m hose; hygienic, easy to keep clean and long lasting (compared to braided metal hoses).

	150 cc	160 cc
Options	Order no.	Order no.
Chrome		
Bath mixer set	97958	97968
Wall plate ¹	97018	97016
Pencil black		
Bath mixer set	97951	97961
Wall plate ¹	97021	97020
Black matt		
Bath mixer set	97959	97969
Wall plate ¹	97019	97017

Spika shower set



Three-function hand shower, soft comfort, massage or intensive jet spray. Smooth 1.5 m hose; hygienic, easy to keep clean and long lasting (compared to braided metal hoses). Wall mounting suitable for use in wet environments. Add a bath mixer or shower mixer. Includes soap tray.

Options	Order no.
Chrome	
Shower set	99376
Pencil black	
Shower set	99378
Black matt	
Shower set	99377

Spika shower set for bath



Hand shower with wall mounting. Smooth 1.5 m hose; hygienic, easy to keep clean and long lasting (compared to braided metal hoses). Wall mounting suitable for use in wet environments. Includes soap tray.

Options	Order no.
Chrome	
Shower set for bath	99396
Pencil black	
Shower set for bath	99398
Black matt	
Shower set for bath	99397



Spika thermostatic mixer

Pressure adjustment knob with ECO function, saving both energy and water. Pressure-balanced, which means rapid reaction to temperature and pressure fluctuations, ensuring an even water temperature. Safe water, approved mounting. Add the Spika shower set or shower set for bath.

	150 cc	160 cc
Options	Order no.	Order no.
Chrome		
Thermostatic mixer	96854	96864
Wall plate ¹	97018	97016
Pencil black		
Thermostatic mixer	96756	96766
Wall plate ¹	97021	97020
Black matt		
Thermostatic mixer	96856	96866
Wall plate ¹	97019	97017



Spika bath mixer

The pivoting bath spout takes up less space when the hand shower is being used and is more user friendly. Pressure adjustment knob with ECO function, saving both energy and water. Pressure-balanced, which means rapid reaction to temperature and pressure fluctuations, ensuring an even water temperature. Safe water, approved mounting. Add the Spika shower set or shower set for bath.

	150 cc	160 cc
Options	Order no.	Order no.
Chrome		
Bath mixer	96893	96895
Wall plate ¹	97018	97016
Pencil black		
Bath mixer	96757	96767
Wall plate ¹	97021	97020
Black matt		
Bath mixer	96894	96896
Wall plate ¹	97019	97017

¹For 16 mm pex pipes.



Magnetic Electric heated towel rail

Connection: Electricity
Power output: 120 W
Eco mode
Timer
Boost
Materials: Stainless steel
W: 45 H: 110

Delivered with a 1,5 m long cord with plug and concealed connection. Can be connected to electrical box in the wall. Includes cord holder, one fixed bracket and two knobs. Select extra knobs as accessories.

Colour Front	Colour Bracket	Order no.
White	White	56411
White	Chrome	56413
Black	Pencil black	56414
Black	Black	56412

Options extra knobs		Order no.
Colour		Order no.
White		561
Chrome		563
Pencil black		564
Black		562



U Electric heated towel rail

Connection: Electricity
Power output: 55 W
Eco mode
Materials: Stainless steel
W: 17 H: 123

Delivered with a 1,5 m long cord with plug and concealed connection.

Colour	Order no.
Polished	58751
Pencil black	58753
Black matt	58752



Amor Electric heated towel rail

Connection: Electricity
Power output: 17 W
Timer
Boost
Materials: Stainless steel
W: 10 H: 140

Delivered with a 1,5 m long cord with plug and concealed connection. Can be connected to electrical box in the wall.

Colour	Order no.
Polished	58222
Pencil black	58223
Black matt	57222



Diana Electric heated towel rail

Connection: Electricity
Power output: 56 W
Timer
Boost
Materials: Stainless steel
W: 48 H: 80

Delivered with a 1,5 m long cord with plug and concealed connection. Can be connected to electrical box in the wall.

Colour	Direction	Order no.
Polished	Right	58121-SR
Polished	Left	58121-SL
Black matt	Right	58221-SR
Black matt	Left	58221-SL



Loki Electric heated towel rail

Connection: Electricity
Power output: 56 W
Off/on
Materials: Stainless steel
W: 48 **H:** 80
 Delivered with a 1,5 m long cord with plug and concealed connection. Can be connected to electrical box in the wall.

Colour	Direction	Order no.
Polished	Right	58122-SR
Polished	Left	58122-SL



Flora SL Electric heated towel rail

Connection: Electricity
Power output: 42 W
Timer
Boost
Materials: Stainless steel
W: 50 **H:** 65
 Delivered with a 1,5 m long cord with plug and concealed connection. Can be connected to electrical box in the wall.

Colour	Order no.
Polished	58421-SL



Flora SR Electric heated towel rail

Connection: Electricity
Power output: 42 W
Timer
Boost
Materials: Stainless steel
W: 50 **H:** 65
 Delivered with a 1,5 m long cord with plug and concealed connection. Can be connected to electrical box in the wall.

Colour	Order no.
Polished	58421-SR

Bas Heated towel rail

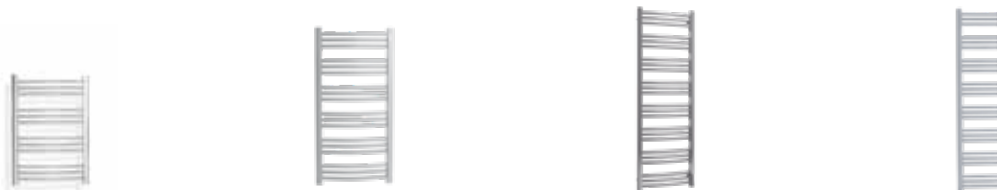

Bas	W: 50 H: 69	W: 50 H: 100	W: 50 H: 142	W: 37 H: 142
Colour	Order no.	Order no.	Order no.	Order no.
Chrome	55699-02	55109-02	56209-02	56309-02
White matt	56311	56312	56313	56314

Easy Heated towel rail



Easy	W: 50 H: 80	W: 50 H: 140
Colour	Order no.	Order no.
Chrome	56802-02	56800-02

Vento Heated towel rail



Vento	W: 55 H: 80	W: 55 H: 120
Colour	Order no.	Order no.
Chrome	50040	50030
Black matt	50041	50031

Zaga Heated towel rail



Zaga	W: 10,8 H: 120	W: 26 H: 120
Colour	Order no.	Order no.
Chrome	55011	55013
Black matt	57011	57013

The heated towel rail is ready to be connected to your central heating system or for electrical connection. You have three options:

1. Electrical connection. Choose an electrical element that is adjustable 30-60° C with a switch. The electrical element is connected externally to any of the bottom corners. When fitting, fill your heated towel rail with water/glycol (90/10) solution.

2. Central heating. Connection to your central heating system (sealed systems only, not tap water system).

3. Dual fuel. Uses both the above alternatives, which is an advantage in the summer when the central heating system is often switched off.

Sigyn Heated towel rail



Sigyn		
	W: 11 H: 120	W: 26 H: 120
Färg	Order no.	Order no.
Chrome	55111	55113
Black matt	57111	57113
White matt	56111	56113



Erica Electric element

Connection: Electricity
 Power output: 300 W
 Timer
 Boost
 Adjustable power with a stepless knob.
 Concealed or visible connection and isolator switch.

Colour	Order no.
Chrome	54041
Black matt	54042



Meg Electric element

Connection: Electricity
 Power output: 300 W
 Adjustable power with five settings.
 Visible connection.

Colour	Order no.
Chrome	54301



Valve

For use with central heating system, not tap water system.

Colour	Order no.
Stainless	54060



Valve

For use with central heating system, not tap water system.

Colour	Order no.
Chrome	54080
Black	54100

WC

Three ways to buy your WC – the choice is yours.

1. Classic WC

Practical WC, model 9085. Comfortable seat height. Easy to clean and removable seat for quick flushing. Condensation-free cistern and easy adjustment of water volume.

WC 9085

Concealed S-trap
6/3 litre flush

Options	Order no.
Seats white	9085
Soft closing seats. White	9085-01
Soft closing seats. Black	9085-51

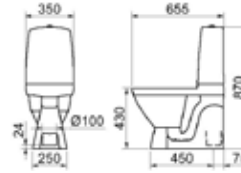

2. Glass box with WC

WC module with glass box. Visible wall mounting. The market's first WC module with an S-bend design. Only 41 cm wide to fit into a existing space. Add a WC bowl (Alta 9072 rimless or Lossen 9071 rimless). Removable seat (with soft-close function) makes cleaning easy.

WC-fixture glass box

Recommended dimensions position 95-140 mm cc.
W: 41 H:100 D:18-20

Options	Order no.
WC-fixture glass box. White	90424
WC-fixture glass box. Black	90425
Options	
Shut-off tap ¹	98987

¹Water connection kit 40 cc with easy accessible shutoff tap, for water connection behind the fixture.

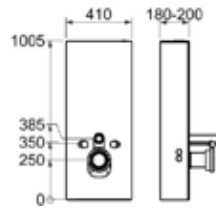

3. Built-in WC

WC module. Suitable for new or remodelled bathrooms. Mounting concealed behind wall. Add a WC bowl (Alta 9072 rimless or Lossen 9071 rimless) and a flush plate. Removable seat (with soft-close function) makes cleaning easy.

WC fixture

Dual flush
W: 50 H:111,5-116,5 D:13,5-22,5

Options	Order no.
WC fixture	90410
Flush plate	
Matt chrome	90413
Chrome	90412
Black	90411



Flush plate



2B & 3B. Choose a wall-mounted toilet

WC Lossen

Rimless
Integrated, easily removable, high density plastic seat, soft closing (white).



Options	Order no.
Soft closing seats. White	9071

WC Alta

Rimless
Integrated, easily removable, high density plastic seat, soft closing (white/black).



Options	Order no.
Soft closing seats. White	9072
Soft closing seats. Black	9077

Front Shower shelf

Aluminium shelf for placement in or outside the shower. Can be glued. Glue kit including fittings available as an accessory.
H:10 D:9



Width:	Colour	Order no.
70	Matt aluminium	6571
	Polished pencil black	6573
	Black matt	6572
	White matt	6570
80	Matt aluminium	6581
	Polished pencil black	6583
	Black matt	6582
	White matt	6580
Options		
Glue kit		97058

Front Wall shelf

Aluminium shelf with wooden front panel. Intended for use in dry spaces. Can be glued. Glue kit including fittings available as an accessory.
H:10 D:10



Width:	Colour Front	Colour Shelf	Order no.
70	White	White matt	6574
	Sand	White matt	6577
	Pure oak	White matt	6575
	White ash	White matt	6576
	Brown ash	Black matt	6578
	Black ash	Black matt	6579
80	White	White matt	6584
	Sand	White matt	6587
	Pure oak	White matt	6585
	White ash	White matt	6586
	Brown ash	Black matt	6588
	Black ash	Black matt	6589
Options			
Glue kit			97058

Wall shelf

Aluminium shelf for placement in or outside the shower. Can be glued. A glue kit is available as an accessory.
H:7,5 D:8,5



Bredd:	Colour	Order no.
32,5	Matt aluminium	6330
	Polished pencil black	6329
	Black matt	6325
	White matt	6324
65	Matt aluminium	6660
	Polished pencil black	6659
	Black matt	6651
	White matt	6650
Tillval		
Glue kit		97043

1 hook

Serie A
Stainless steel
Double-sided tape 3M.
W:4,5 H:4,5 D:3



Colour	Order no.
Chrome	A01-K
Black matt	A01-S

2 hooks

Serie A
Stainless steel
Double-sided tape 3M.
W:9 H:4,5 D:2,9



Colour	Order no.
Chrome	A02-K
Black matt	A02-S

Toilet roll holder

Serie A
Stainless steel
Double-sided tape 3M.
W:13,5 H:11 D:2,8



Colour	Order no.
Chrome	A03-K
Black matt	A03-S

4 hooks

Serie A
Stainless steel
Double-sided tape 3M.
W:18 H:4,5 D:3



Colour	Order no.
Chrome	A04-K
Black matt	A04-S

1 hook

Serie O
Stainless steel
Double-sided tape 3M.
Ø4,9



Colour	Order no.
Chrome	O01-K

2 hooks

Serie O
Stainless steel
Double-sided tape 3M.
W:9,5 H:4,9 D:3



Colour	Order no.
Chrome	O02-K

Toilet roll holder

Serie O
Stainless steel
Double-sided tape 3M.
W:13,5 H:11 D:2,9



Colour	Order no.
Chrome	O03-K

4 hooks

Serie O
Stainless steel
Double-sided tape 3M.
W:19,2 H:4,8 D:3



Colour	Order no.
Chrome	O04-K

Photo: Sebastian Streith, CGI Furniture, Johan Nyberg, Robin De Blanche, Melita Ramic and Mohammed Salih.

Reservations: We are continuously developing our products. For this reason, we at Svedbergs reserve the right to make changes to the design, appearance and prices of products. We also reserve the right to sell out. Wood is a natural material. Because of this, variations in colour and texture between individual doors/front panels and deliveries may occur. For technical printing reasons, the colours of wood and other surfaces in the catalogue may differ from the actual colours. Colour swatches can be requested from Svedbergs dealers.

WE ACCEPT NO RESPONSIBILITY FOR DISCREPANCIES AND PRINTING ERRORS.

SVEDBERGS

Head office

Verkstadvägen 1, 514 63 Dalstorp, SWEDEN

Phone, switchboard +46321 53 30 00

svedbergs.com

info@svedbergs.com

[@svedbergs](#)

EN

