

SVEDBERGS



BATH&ROOM

PRODUCT AND BUYER'S GUIDE 2024

A ROOM TO LIVE & ENJOY

To us, a bathroom means both bath and room. It's about having fewer limits.

A feeling you can't always touch or even capture on a picture. Of course a bathroom is designed for hygiene, but it's just as much an oasis for enjoying the moment. You decide. We give you the options. As soon as you close the door behind you, you'll understand.



Table of contents

Furniture ranges

Epos	12
Poem	32
Bloc	50
Intro	54

Washbasins	58
Work tops	64
Washbasin mixers	66
Mirrors	72
Mirror cabinets	76
Storage	86
Washers & Dryers	92
Handles	98

Showers

Langfoss	100
180°	108
Skoga	120
Shower storage	166
Shower mixers	144
Shower enclosure Ritual	147

Baths

Bath mixers	156
-------------	-----

Heated towel rails	158
WC	164
Accessories	166



A ROOM FOR LIFE

The whole bathroom

Your own inspiring space. With Svedbergs, you can easily put together the feel you want to convey – whatever your budget, tastes or style. We offer matching colours and designs in beautiful harmony. And combined, they create a cohesive whole, a basis, perhaps – ensuring your bathroom meets your needs.

Craftsmanship

Design and details that stand up to close inspection – choose between a well-balanced sharp finish and a soft, inviting atmosphere. Professional pride and a desire to deliver the very best products guaranteed. Close collaboration between people and the processing of materials!

Genuine materials

With our well-tested materials, we offer first-rate durability and recycling with a more sustainable approach. What's more, they are closely intertwined with both craftsmanship and quality – a natural beauty and a more vibrant finish.

Made in Sweden

Made in Dalstorp stands for the highest quality, reliability and performance. Manufactured in our factory to strict standards. Products that withstand the test of time thanks to our long warranty, servicing and support.



THE WHOLE BATHROOM

EASYMOUNT

Simple to install and mount.

ELECTRONIC

Energy-efficient and factory-installed for increased safety.

FRAMES

Made from moisture-resistant particle board.

WORK TOPS

Exceptionally scratch resistant.

DURADRY

A coating method to ensure moisture resistance and a long lifespan.

DRAWERS

Fitted with inserts, fully extendible, soft-closing and easily adjustable.

**FRONTS**

Real wood veneer cut from carefully-selected logs.

READY TO MOUNT

Our products are delivered ready-assembled.

**ENDURADRY**

A coating method for our sheet metal parts, providing an exceptionally tight surface finish.

SUSTAINABILITY

Our focus areas

Reducing our products' environmental impact
Reducing greenhouse gas emissions
Resource efficiency
Corporate social responsibility
Wood from sustainable forestry



PRODUCT

Design
Quality
Functionality
Innovation
Made in Sweden

SOCIAL

Initiative
Development of skills
Diversity & equality
Health & safety
Involvement with the local community

QUALITY

75% produced in our own production facilities
Quality assured
Pre-assembled
Our own coating method



DIGITAL TOOLS

Thinking about renovating your bathroom or building a new one? On our website you can find all of our products and the colours, materials and dimensions available. You will find tools, advice and guides to help you plan your bathroom.

Create your bathroom

Quickly create an image of your bathroom in a few simple clicks – exactly as you want it. Our self-build service allows you to choose between different furniture collections, sizes and colours.

Design in 3D

Specify your bathroom's dimensions, choose your wall and floor tiles and position your bathroom furniture. After you've finished, you'll get a full list of the products and inspiring pictures of your dream bathroom.



Start
designing your
bathroom here

- 100% Forest-certified wood
- 100% Renewable electricity
- 93% Renewable energy
- 19% Reduced energy consumption 2022

WARRANTY

We make your purchase even safer by offering a 20-year warranty on furniture, showers and shower enclosures/ screens. This aligns with our philosophy on quality, choice of materials, and caring about the details.

MATERIALS

WOOD FURNITURE

Real wood veneers

Run your hand over the surface to enjoy the tactile feel. Our handmade fronts are made of real wood veneer and offer a beautiful, moisture-resistant surface.



Panel materials

To ensure a long lifespan for our frames, we always use moisture-resistant materials. All our furniture is made in Sweden and our wood comes from suppliers who prioritise responsible, sustainable forestry.

Melamin

A good value, attractive material that helps your bathroom budget go further. Moisture and stain resistant. Stable and easy to keep clean.



SHEET METAL FURNITURE

Sheet metal

We use galvanised sheet metal, which we powder coat to make it resistant to rust, impact and scratching. The product offers a long lifespan, is rinsable, and requires very little maintenance. In this process, we use environmentally friendly Bonderite NT and solvent-free paints. 100% recyclable.



WORK TOPS

Laminate

A beautiful, durable and scratch-resistant option with water resistant qualities. Made in Sweden and using wood from suppliers who prioritise responsible, sustainable forestry.



Dekton

A hard pressed stone material that can withstand high temperatures. The work top is scratch resistant, does not fade and is easy to clean.

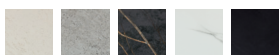

BATHS

Enamel

A clean, natural product associated with baths and able to withstand wear and scratches for decades to come. Underneath the shiny enamel, our baths are made of pressed steel.



Acrylic

The shapability of the material ensures good ergonomics. Hard wearing and easy to keep clean.



Lucite

The material has a durable surface that will maintain its colour over time, with a luxury finish that offers a soft, warm feel. Meets the requirements for the world's most stringent environmental certification.

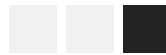

WASHBASINS

Porcelain

A glazed surface to help the material retain its beautiful glossy surface over time. Durable, scratch resistant and easy to keep clean.



Mineral composite

A thin, durable stone material, offering a unique seamless design.

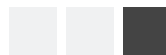

Solid surface

A durable, stone-like material with a premium matt feel. Extremely durable and with great hygiene qualities.



PVD-coated sheet metal

The technology we use makes the surface up to ten times harder than that of a lacquered product, making it durable and scratch resistant.



WC

Porcelain

The scratch-resistant material we use for our WCs has a glazed surface that retains its beautiful shine with time. Our soft-closing seat is removable, hygienic and easy to keep clean.

MIRRORS

Mirrors

Our mirrors are 100% copper free and withstand the test of time well. A safety film on the mirrors to prevent shattering in the event of an accident comes as standard.

SHOWERS

Aluminium

A renewable material that is well suited to wet rooms and is easy to keep clean.

Glass

We use a 100% recyclable safety glass that is easy to keep clean.

Textile

Environmentally labelled wood that creates a cosy feel and absorbs sound. A practical solution for when showering in peace is a priority.

MIXERS

Brass

A copper alloy that has been used for generations to cast mixers. Our brass meets the high requirements set for clean drinking water in the Nordic countries.

HEATED TOWEL RAILS

Steel

Durable materials that will last. Optimal heat insulating properties and easy to keep clean.

COATING METHODS

DuraDry

Our own coating method ensures optimal moisture resistance and a long product life for our wooden furniture.

EnduraDry

The coating we have developed for our sheet metal components is based on nanotechnology. This provides an exceptionally tight and durable surface finish.



EPOS

With its modern and Scandinavian design and attention to materials, functionality and details, Epos is the only range of its kind. Furniture where choice is prioritised and the combinations are endless.

Get a feel for your bathroom and create your own Epos. For the best results, embrace your own mix of colour, design, function and storage. Epos is the result of a successful Scandinavian partnership between our in-house design team and the interior designer Halvor Bakke. Epos – a journey of design and possibilities.



CUSTOMISE YOUR BATHROOM

Design

Designed in collaboration with interior designer Halvor Bakke. Modern and with all kinds of opportunities to tailor your design to your tastes.

Flexibility

Contemporary design with a variety of configurations, colours and functions. Integrated or sit-on washbasins. For medium to large bathrooms.

Functionality

Open, side and semi-open storage for easy access. Practical drawer compartments. Draws that pull all the way out and feature electric sockets. Functional drawers with heat-resistant surfaces.

Quality

Real wood veneer. DuraDry coating process for extra durability. Made in Sweden and sold with a 20-year warranty.

Sustainability

Wood sourced from responsible and sustainable forestry providers. Can be uninstalled and recycled.



STANDARD

Drawer inserts

These stylish, functional drawer inserts are included. The bottom of the drawer is made of metal, a practical material that's easy to keep clean. The drawer dividers are solid wood and painted the same colour as the front.

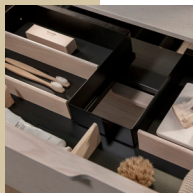

Double electrical sockets

Epos vanity units in widths of 120 cm and 200 cm include double electrical sockets inside a 40 cm wide drawer. For other vanity units, electrical sockets are available as an optional extra.



EasyMount

Our simple EasyMount system requires fewer installation steps. It fixes to the wall with just a few screws, causing less impact on the moisture barrier.



OPTIONS

Metal drawer with wooden front

A stylish, practical open drawer. It's made of galvanised sheet metal and available with a wooden front painted the same colour as the unit front. This is an optional extra.



Drawer inserts in the lower drawer

A practical drawer insert can be added to the bottom drawer in Epos units.



Drawer lighting

Drawer lighting is practical because it makes your things easier to find. But it also looks good and adds an exclusive touch. Drawer lighting is available as an optional extra for drawers and open storage units.



Floor light

An optional floor light adds an exclusive, cosy feel to the bathroom. The light is installed on the underside of the bathroom unit. Supplement it with a driver kit (optional).



Power socket

An optional electrical socket can be added to the bottom drawer in Epos

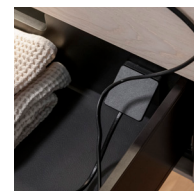

Discover the whole Epos range

FRONTS

Five front options give five different looks. Choose between handles or a push open mechanism to find a style that suits your bathroom.

Flat

Front for a sleek, simple and elegant look. Create your individual style with standard colours, selected colours, real wood veneers and handles.



Flat Push

Push open action for an elegant, minimalist style.



Relief

Solid front with integrated solid wood handle. The grip edging mirrors the top edge and accentuates the strong outline. Available in a choice of colours and real wood veneers.



Stripe

An elegant and modern front with clean lines. The channels are also designed to be combined with any handle to create whichever style you choose. Available in brown and black ash.



Stripe Push

Push open action for an elegant, minimalist style.



HANDLES AND KNOBS

Don't forget to purchase handles for your Epos with either Flat or Stripe front. Read more on page 98.



COLOURS

With four standard colours and four optional colours, it's easy to find your favourite. The optional colours are only available for the Flat and Flat Push open fronts.

Standard colours



White

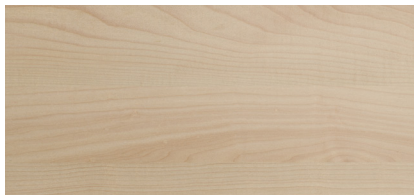

White ash

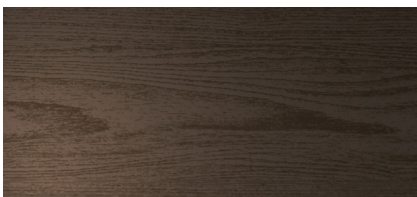

Brown ash

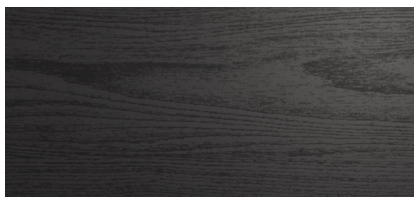

Black ash

Optional colours

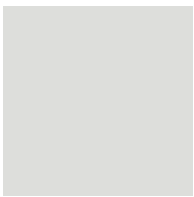

Oat



Sand

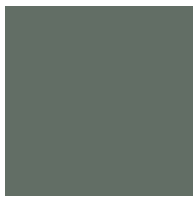

Sage

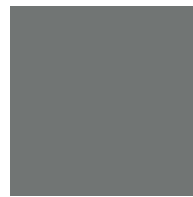

Granite

WORK TOPS

Choose between Danae (beige sandstone), Keon (grey concrete) and Laurent (dark background with gold marbling). Sirius (black) and Rem (light marble look, less pronounced veining) are optional extras.

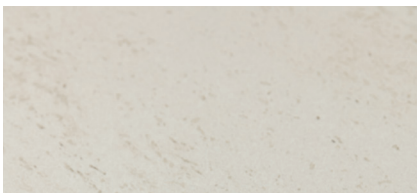

Danae

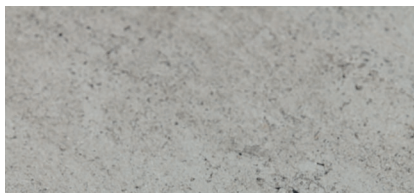

Keon

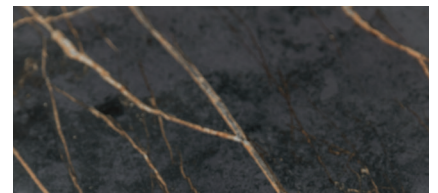

Laurent



Rem

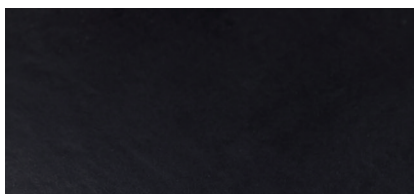

Sirius



SIT-ON BASINS

Don't forget to include a washbasin. Go to page 62 to see our sit-on washbasins.

EPOS CHOICES

Choose a vanity unit (cross on grey background = open storage).

60 cm



W: 60
H: 45
D: 45



80 cm



W: 80
H: 45
D: 45



W: 60
H: 45
D: 45



W: 80
H: 45
D: 45



W: 60
H: 45
D: 45



W: 80
H: 45
D: 45



BUILD YOUR EPOS

- 01** Choose a vanity unit.
- 02** Choose a colour.
- 03** Choose a front.
- 04** Choose optional extras (e.g. lighting or electrical sockets)

- 05** Choose between an integrated or sit-on washbasin with work top.
- 06** Choose between handles or a push open mechanism.
- 07** Choose a mixer.

100 cm



W: 100
H: 45
D: 45

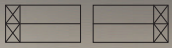

120 cm



W: 120
H: 45
D: 45

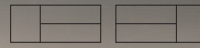

W: 100
H: 45
D: 45



W: 120
H: 45
D: 45



W: 100
H: 45
D: 45



W: 120
H: 45
D: 45



W: 120
H: 45
D: 45

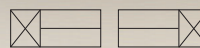

EPOS CHOICES

Choose a vanity unit (cross on grey background = open storage).

160 cm



W:160
H: 45
D: 45

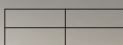

W: 160
H: 45
D: 45



W: 160
H: 45
D: 45



200 cm

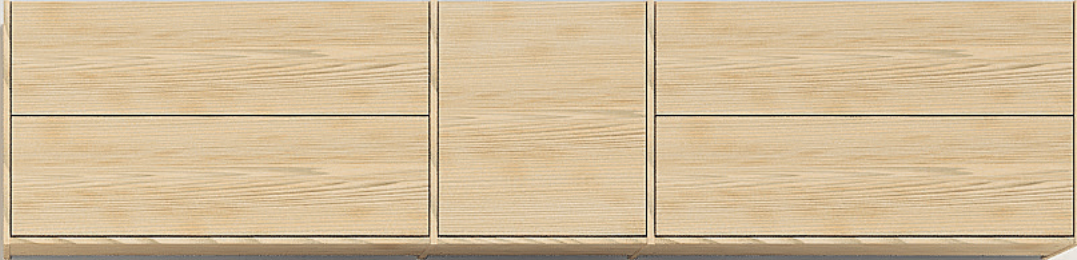

W: 200
H: 45
D: 45



W: 200
H: 45
D: 45



W: 200
H: 45
D: 45



W: 200
H: 45
D: 45



EPOS 60

1. CHOOSE A VANITY UNIT

	Incl. 2 drawers	Incl. one drawer and one open shelf.
W: 60 H: 45 D: 45		
Front	Order no.	Order no.
White		
Flat	150620	150610
Flat push open	150620-P	150610-P
Relief	150621	150611
White ash		
Flat	160620	160610
Flat push open	160620-P	160610-P
Relief	160621	160611
Brown ash		
Flat	170620	170610
Flat push open	170620-P	170610-P
Relief	170621	170611
Stripe	170622	170612
Stripe Push open	170622-P	170612-P
Black ash		
Flat	140620	140610
Flat push open	140620-P	140610-P
Relief	140621	140611
Stripe	140622	140612
Stripe push open	140622-P	140612-P

SELECTED COLOURS

Choose from Flat and Flat push open fronts. Add -COL after the item number. The extra charge amount is based on white furniture.

2A. CHOOSE A WASHBASIN



ISE 60,
Mineral composite
W:61 H:1,3 D:46

Colour	Order no.
White matt	5060
Ash grey	5061



FLOEN 60
Porcelain
W:61 H:1,5 D:46

Colour	Order no.
White	5360



WASHBASIN MIXER
Go to page 66 to see our washbasin mixers, traps and bottom valves.

2B. CHOOSE A WORK TOP

W: 61 H: 1,2 D: 46



DANA E¹
Has a sand-coloured limestone look.

Direction	Order no.
Centre	144063

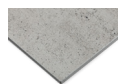

KEON¹
Has a grey industrial look.

Direction	Order no.
Centre	130062

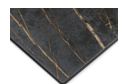

LAURENT¹
Has a dark background with gold marbling.

Direction	Order no.
Centre	143063



REM²
Has a relaxing marble look with a light background and through-coloured edge.

Direction	Order no.
Centre	145063



SIRIUS²
Has a matt black slate look.

Direction	Order no.
Centre	370699

3. CHOOSE ACCESSORIES

Don't forget to add the finishing touches to your Epos with a range of smart accessories. Want to know more about our accessories? Visit svedbergs.com.

Metal drawer with wooden front

If you choose an Epos with an open lower drawer, you can select a metal drawer in the same colour as your furniture. (The colours white and white ash come with a white metal drawer. All other colours come with a black metal drawer.)

Metal drawer for Epos 60 with open shelf.
B:57 H:10 D:30

Front	Colour	Order no.
Flat	White	5761
Flat	White ash	5763
Flat	Brown ash	5764
Flat	Black ash	5768
Stripe	Brown ash	5766
Stripe	Black ash	5769

More accessories

Choose from a wide range of accessories for Epos.

Performance	Order no.
Lower drawer inserts	5950
Electrical socket	1212

CHOOSE LIGHTING

Lighting for Epos 60 with 2 drawers:
Start with a driver kit (1) and choose one upper drawer lighting solution (3), one lower drawer lighting solution (4) and one floor light (2).

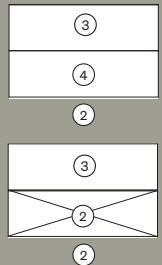

Lighting for Epos 60 with 1 drawer:
Start with one driver kit (1) and choose one upper drawer lighting solution (3) and two floor lights (2) for lighting in your open shelf and under the vanity unit.

If the lighting is connected to the mains supply in your bathroom, use the wall switch to turn your vanity unit light on and off.

	Performance	Order no.
1	Driver kit lighting	5991
2	Lighting open shelf / floor light	5992
3	Top drawer lighting	5993
4	Lighting lower drawer/ 40 cm drawer closed	5994

SIT-ON BASINS



Go to page 62 to see our sit-on washbasins and free-standing mixers for the Epos range.

HANDLES AND KNOBS



Don't forget to include handles for your furniture. Read more on page 98.

Counter tops come with overhang.

Dekton work tops always come with a mixer hole on the left.

¹Delivery time approx 1-4 weeks. ²Special counter top. Delivery time 7-8 weeks.

EPOS 80

1. CHOOSE A VANITY UNIT

	Incl. 2 drawers	Incl. one drawer and one open shelf.
W: 80 H: 45 D: 45		
Front	Order no.	Order no.
White		
Flat	150820	150810
Flat push open	150820-P	150810-P
Relief	150821	150811
White ash		
Flat	160820	160810
Flat push open	160820-P	160810-P
Relief	160821	160811
Brown ash		
Flat	170820	170810
Flat push open	170820-P	170810-P
Relief	170821	170811
Stripe	170822	170812
Stripe Push open	170822-P	170812-P
Black ash		
Flat	140820	140810
Flat push open	140820-P	140810-P
Relief	140821	140811
Stripe	140822	140812
Stripe push open	140822-P	140812-P

SELECTED COLOURS

Choose from Flat and Flat push open fronts. Add -COL after the item number. The extra charge amount is based on white furniture.

2A. CHOOSE A WASHBASIN



ISE 80
Mineral composite
W:81 H:1,3 D:46

Colour	Order no.
White matt	5080
Ash grey	5180



FLOEN 80
Porcelain
W:81 H:1,5 D:46

Colour	Order no.
White	5380



WASHBASIN MIXER
Go to page 66 to see our washbasin mixers, traps and bottom valves.

2B. CHOOSE A WORK TOP

W: 81 H: 1,2 D: 46



DANA E¹
Has a sand-coloured limestone look.

Direction	Order no.
Centre	144083



KEON¹
Has a grey industrial look.

Direction	Order no.
Centre	130082



LAURENT¹
Has a dark background with gold marbling.

Direction	Order no.
Centre	143083

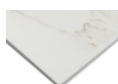

REM²
Has a relaxing marble look with a light background and through-coloured edge.

Direction	Order no.
Centre	145083



SIRIUS²
Has a matt black slate look.

Direction	Order no.
Centre	370899

3. CHOOSE ACCESSORIES

Don't forget to add the finishing touches to your Epos with a range of smart accessories. Want to know more about our accessories? Visit svedbergs.com.

Metal drawer with wooden front

If you choose an Epos with an open lower drawer, you can select a metal drawer in the same colour as your furniture. (The colours white and white ash come with a white metal drawer. All other colours come with a black metal drawer.)

Metal drawer for Epos 80-200 with open shelf.
B:77 H:10 D:30

Front	Colour	Order no.
Flat	White	5781
Flat	White ash	5783
Flat	Brown ash	5784
Flat	Black ash	5788
Stripe	Brown ash	5786
Stripe	Black ash	5789

More accessories

Choose from a wide range of accessories for Epos.

Performance	Order no.
Lower drawer inserts	5950
Electrical socket	1212

CHOOSE LIGHTING

Lighting for Epos 80 with 2 drawers:
Start with a driver kit (1) and choose one upper drawer lighting solution (3), one lower drawer lighting solution (4) and one floor light (2).

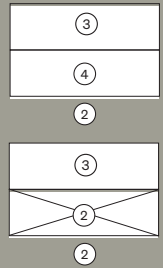

Lighting for Epos 80 with 1 drawer:
Start with one driver kit (1) and choose one upper drawer lighting solution (3) and two floor lights (2) for lighting in your open shelf and under the vanity unit.

If the lighting is connected to the mains supply in your bathroom, use the wall switch to turn your vanity unit light on and off.

	Performance	Order no.
1	Driver kit lighting	5991
2	Lighting open shelf / floor light	5992
3	Top drawer lighting	5993
4	Lighting lower drawer/ 40 cm drawer closed	5994

SIT-ON BASINS



Go to page 62 to see our sit-on washbasins and free-standing mixers for the Epos range.

HANDLES AND KNOBS



Don't forget to include handles for your furniture. Read more on page 98.

Counter tops come with overhang.

Dekton work tops always come with a mixer hole on the left.

¹Delivery time approx 1-4 weeks. ²Special counter top. Delivery time 7-8 weeks.

EPOS 100 RIGHT

1. CHOOSE A VANITY UNIT

Front	Order no.	Incl. two drawers. Open side shelf on the left.	Order no.	Incl. one drawer and one open shelf. Open side shelf on the left.
White				
Flat	151020H		151010H	
Flat push open	151020H-P		151010H-P	
Relief	151021H		151011H	
White ash				
Flat	161020H		161010H	
Flat push open	161020H-P		161010H-P	
Relief	161021H		161011H	
Brown ash				
Flat	171020H		171010H	
Flat push open	171020H-P		171010H-P	
Relief	171021H		171011H	
Stripe	171022H		171012H	
Stripe Push open	171022H-P		171012H-P	
Black ash				
Flat	141020H		141010H	
Flat push open	141020H-P		141010H-P	
Relief	141021H		141011H	
Stripe	141022H		141012H	
Stripe push open	141022H-P		141012H-P	

SELECTED COLOURS

Choose from Flat and Flat push open fronts. Add -COL after the item number. The extra charge amount is based on white furniture.

2A. CHOOSE A WASHBASIN



ISE 100 RIGHT
Mineral composite
W:101 H:1,3 D:46



WASHBASIN MIXER
Go to page 66 to see our washbasin mixers, traps and bottom valves.

Colour	Order no.
White matt	5100-H
Ash grey	5101-H

2B. CHOOSE A WORK TOP

W: 101 H: 1,2 D: 46

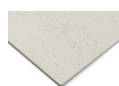

DANA E¹
Has a sand-coloured limestone look.

Direction	Order no.
Right	144101

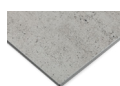

KEON¹
Has a grey industrial look.

Direction	Order no.
Right	141101



LAURENT¹
Has a dark background with gold marbling.

Direction	Order no.
Right	143101



REM²
Has a relaxing marble look with a light background and through-coloured edge.

Direction	Order no.
Right	145101



SIRIUS²
Has a matt black slate look.

Direction	Order no.
Right	146101

3. CHOOSE ACCESSORIES

Don't forget to add the finishing touches to your Epos with a range of smart accessories. Want to know more about our accessories? Visit svedbergs.com.

Metal drawer with wooden front

If you choose an Epos with an open lower drawer, you can select a metal drawer in the same colour as your furniture. (The colours white and white ash come with a white metal drawer. All other colours come with a black metal drawer.)

Metal drawer for Epos 80-200 with open shelf.
B:77 H:10 D:30

Front	Colour	Order no.
Flat	White	5781
Flat	White ash	5783
Flat	Brown ash	5784
Flat	Black ash	5788
Stripe	Brown ash	5786
Stripe	Black ash	5789

More accessories

Choose from a wide range of accessories for Epos.

Performance	Order no.
Lower drawer inserts	5950
Electrical socket	1212

CHOOSE LIGHTING

Lighting for Epos 100 with 2 drawers:
Start with a driver kit (1) and choose one upper drawer lighting solution (3), one lower drawer lighting solution (4) and one floor light (2).

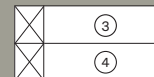

Lighting for Epos 100 with 1 drawer:
Start with one driver kit (1) and choose one upper drawer lighting solution (3) and two floor lights (2) for lighting in your open shelf and under the vanity unit.

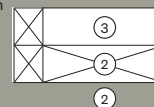

If the lighting is connected to the mains supply in your bathroom, use the wall switch to turn your vanity unit light on and off.

Performance	Order no.
1 Driver kit lighting	5991
2 Lighting open shelf / floor light	5992
3 Top drawer lighting	5993
4 Lighting lower drawer/ 40 cm drawer closed	5994

SIT-ON BASINS

Go to page 62 to see our sit-on washbasins and free-standing mixers for the Epos range.



HANDLES AND KNOBS

Don't forget to include handles for your furniture. Read more on page 98.



Counter tops come with overhang.

Dekton work tops always come with a mixer hole on the left.

¹Delivery time approx 1-4 weeks. ²Special counter top. Delivery time 7-8 weeks.

EPOS 100 LEFT

1. CHOOSE A VANITY UNIT

	Incl. two drawers. Open side shelf on the right.	Incl. one drawer and one open shelf. Open side shelf on the right.
W: 100 H: 45 D: 45		
Front	Order no.	Order no.
White		
Flat	151020V	151010V
Flat push open	151020V-P	151010V-P
Relief	151021V	151011V
White ash		
Flat	161020V	161010V
Flat push open	161020V-P	161010V-P
Relief	161021V	161011V
Brown ash		
Flat	171020V	171010V
Flat push open	171020V-P	171010V-P
Relief	171021V	171011V
Stripe	171022V	171012V
Stripe push open	171022V-P	171012V-P
Black ash		
Flat	141020V	141010V
Flat push open	141020V-P	141010V-P
Relief	141021V	141011V
Stripe	141022V	141012V
Stripe push open	141022V-P	141012V-P

SELECTED COLOURS

Choose from Flat and Flat push open fronts. Add -COL after the item number. The extra charge amount is based on white furniture.

2A. CHOOSE A WASHBASIN



ISE 100, LEFT
Mineral composite
W:101 H:1,3 D:46



Colour	Order no.
White matt	5100-V
Ash grey	5101-V



WASHBASIN MIXER
Go to page 66 to see our washbasin mixers, traps and bottom valves.

2B. CHOOSE A WORK TOP

W: 101 H: 1,2 D: 46



DANA E¹
Has a sand-coloured limestone look.

Direction	Order no.
Left	144100



KEON¹
Has a grey industrial look.

Direction	Order no.
Left	141100



LAURENT¹
Has a dark background with gold marbling.

Direction	Order no.
Left	143100



REM²
Has a relaxing marble look with a light background and through-coloured edge.

Direction	Order no.
Left	145100



SIRIUS²
Has a matt black slate look.

Direction	Order no.
Left	146100



SIT-ON BASINS
Go to page 62 to see our sit-on washbasins and free-standing mixers for the Epos range.



HANDLES AND KNOBS
Don't forget to include handles for your furniture. Read more on page 98.

Counter tops come with overhang.

Dekton work tops always come with a mixer hole on the left.

¹Delivery time approx 1-4 weeks. ²Special counter top. Delivery time 7-8 weeks.

3. CHOOSE ACCESSORIES

Don't forget to add the finishing touches to your Epos with a range of smart accessories. Want to know more about our accessories? Visit svedbergs.com.

Metal drawer with wooden front

If you choose an Epos with an open lower drawer, you can select a metal drawer in the same colour as your furniture. (The colours white and white ash come with a white metal drawer. All other colours come with a black metal drawer.)

Metal drawer for Epos 80-200 with open shelf.
B:77 H:10 D:30

Front	Colour	Order no.
Flat	White	5781
Flat	White ash	5783
Flat	Brown ash	5784
Flat	Black ash	5788
Stripe	Brown ash	5786
Stripe	Black ash	5789

More accessories

Choose from a wide range of accessories for Epos.

Performance	Order no.
Lower drawer inserts	5950
Electrical socket	1212

CHOOSE LIGHTING

Lighting for Epos 100 with 2 drawers:

Start with a driver kit (1) and choose one upper drawer lighting solution (3), one lower drawer lighting solution (4) and one floor light (2).



Lighting for Epos 100 with 1 drawer:

Start with one driver kit (1) and choose one upper drawer lighting solution (3) and two floor lights (2) for lighting in your open shelf and under the vanity unit.

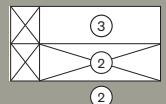

If the lighting is connected to the mains supply in your bathroom, use the wall switch to turn your vanity unit light on and off.

Performance	Order no.
1 Driver kit lighting	5991
2 Lighting open shelf / floor light	5992
3 Top drawer lighting	5993
4 Lighting lower drawer/ 40 cm drawer closed	5994

EPOS 120 RIGHT

W: 120 H: 45 D: 45	Incl. 2+1 drawers. Double electrical socket included in the left 40 drawer.	Incl. 1+1 drawers and one open shelf. Double electrical socket included in the left 40 drawer.
Front	Order no.	Order no.
White		
Flat	1512210H	1512110H
Flat push open	1512210H-P	1512110H-P
Relief	1512211H	1512111H
White ash		
Flat	1612210H	1612110H
Flat push open	1612210H-P	1612110H-P
Relief	1612211H	1612111H
Brown ash		
Flat	1712210H	1712110H
Flat push open	1712210H-P	1712110H-P
Relief	1712211H	1712111H
Stripe	1712212H	1712112H
Stripe push open	1712212H-P	1712112H-P
Black ash		
Flat	1412210H	1412110H
Flat Push open	1412210H-P	1412110H-P
Relief	1412211H	1412111H
Stripe	1412212H	1412112H
Stripe push open	1412212H-P	1412112H-P

1. CHOOSE A VANITY UNIT

SELECTED COLOURS

Choose from Flat and Flat push open fronts. Add -COL after the item number. The extra charge amount is based on white furniture.

2A. CHOOSE A WASHBASIN



ISE 120 RIGHT
Mineral composite
W:121 H 1,3 D:46



Colour	Order no.
White matt	5120-H
Ash grey	5121-H



WASHBASIN MIXER
Go to page 66 to see our washbasin mixers, traps and bottom valves.

2B. CHOOSE A WORK TOP

W: 122 H: 1,2 D: 46



DANA E¹
Has a sand-coloured limestone look.

Direction	Order no.
Right	144121



KEON¹
Has a grey industrial look.

Direction	Order no.
Right	141121



LAURENT¹
Has a dark background with gold marbling.

Direction	Order no.
Right	143121



REM²
Has a relaxing marble look with a light background and through-coloured edge.

Direction	Order no.
Right	145121



SIRIUS²
Has a matt black slate look.

Direction	Order no.
Right	146121

3. CHOOSE ACCESSORIES

Don't forget to add the finishing touches to your Epos with a range of smart accessories. Want to know more about our accessories? Visit svedbergs.com.

Metal drawer with wooden front

If you choose an Epos with an open lower drawer, you can select a metal drawer in the same colour as your furniture. (The colours white and white ash come with a white metal drawer. All other colours come with a black metal drawer.)

Metal drawer for Epos 80-200 with open shelf.
B:77 H:10 D:30

Front	Colour	Order no.
Flat	White	5781
Flat	White ash	5783
Flat	Brown ash	5784
Flat	Black ash	5788
Stripe	Brown ash	5786
Stripe	Black ash	5789

More accessories

Choose from a wide range of accessories for Epos.

Performance	Order no.
Lower drawer inserts	5950
Electrical socket	1212

CHOOSE LIGHTING

Lighting for Epos 120 with 2+1 drawers:
Start with a driver kit (1) and choose one upper drawer lighting solution (3), two lower drawer lighting solutions (4) and one floor light (2).

Lighting for Epos 120 with 1+1 drawers:
Start with one driver kit (1) and choose one upper drawer lighting solution (3), one lower drawer lighting solution (4) and two floor lights (2) for lighting in your open shelf and under the vanity unit.

Lighting for Epos 120 with 2+0 drawers.
Start with a driver kit (1) and choose one upper drawer lighting solution (3), one lower drawer lighting solution (4) and one floor light (2).

If the lighting is connected to the mains supply in your bathroom, use the wall switch to turn your vanity unit light on and off.

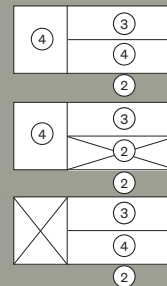

Performance	Order no.
① Driver kit lighting	5991
② Lighting open shelf / floor light	5992
③ Top drawer lighting	5993
④ Lighting lower drawer/ 40 cm drawer closed	5994

SIT-ON BASINS



Go to page 62 to see our sit-on washbasins and free-standing mixers for the Epos range.

HANDLES AND KNOBS



Don't forget to include handles for your furniture. Read more on page 98.

Counter tops come with overhang.

Dekton work tops always come with a mixer hole on the left.

¹Delivery time approx 1-4 weeks. ²Special counter top. Delivery time 7-8 weeks.

EPOS 120 RIGHT

W: 120
H: 45
D: 45

Incl. 2+0 drawers and two open shelves. The open 40 shelf is positioned on the left.



Front Order no.

White

Flat 1512200H

Flat push open 1512200H-P

Relief 1512201H

White ash

Flat 1612200H

Flat push open 1612200H-P

Relief 1612201H

Brown ash

Flat 1712200H

Flat push open 1712200H-P

Relief 1712201H

Stripe 1712202H

Stripe push open 1712202H-P

Black ash

Flat 1412200H

Flat push open 1412200H-P

Relief 1412201H

Stripe 1412202H

Stripe push open 1412202H-P

SELECTED COLOURS

Choose from Flat and Flat push open fronts. Add -COL after the item number. The extra charge amount is based on white furniture.

1. CHOOSE A VANITY UNIT

2A. CHOOSE A WASHBASIN



ISE 120 RIGHT
Mineral composite
W:121 H:1,3 D:46

Colour	Order no.
White matt	5120-H
Ash grey	5121-H



WASHBASIN MIXER

Go to page 66 to see our washbasin mixers, traps and bottom valves.

2B. CHOOSE A WORK TOP

W: 122 H: 1,2 D: 46



DANA E ¹
Has a sand-coloured limestone look.

Direction	Order no.
Right	144121



KEON ¹
Has a grey industrial look.

Direction	Order no.
Right	141121



LAURENT ¹
Has a dark background with gold marbling.

Direction	Order no.
Right	143121



REM ²
Has a relaxing marble look with a light background and through-coloured edge.

Direction	Order no.
Right	145121



SIRIUS ²
Has a matt black slate look.

Direction	Order no.
Right	146121

3. CHOOSE ACCESSORIES

Don't forget to add the finishing touches to your Epos with a range of smart accessories. Want to know more about our accessories? Visit svedbergs.com.

Metal drawer with wooden front

If you choose an Epos with an open lower drawer, you can select a metal drawer in the same colour as your furniture. (The colours white and white ash come with a white metal drawer. All other colours come with a black metal drawer.)

Metal drawer for Epos 80-200 with open shelf.
B:77 H:10 D:30

Front	Colour	Order no.
Flat	White	5781
Flat	White ash	5783
Flat	Brown ash	5784
Flat	Black ash	5788
Stripe	Brown ash	5786
Stripe	Black ash	5789

More accessories

Choose from a wide range of accessories for Epos.

Performance	Order no.
Lower drawer inserts	5950
Electrical socket	1212

CHOOSE LIGHTING

Lighting for Epos 120 with 2+1 drawers: Start with a driver kit (1) and choose one upper drawer lighting solution (3), two lower drawer lighting solutions (4) and one floor light (2).

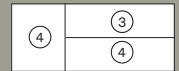

Lighting for Epos 120 with 1+1 drawers: Start with one driver kit (1) and choose one upper drawer lighting solution (3), one lower drawer lighting solution (4) and two floor lights (2) for lighting in your open shelf and under the vanity unit.

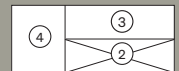

Lighting for Epos 120 with 2+0 drawers: Start with a driver kit (1) and choose one upper drawer lighting solution (3), one lower drawer lighting solution (4) and one floor light (2).

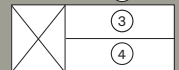

If the lighting is connected to the mains supply in your bathroom, use the wall switch to turn your vanity unit light on and off.

Performance	Order no.
1 Driver kit lighting	5991
2 Lighting open shelf / floor light	5992
3 Top drawer lighting	5993
4 Lighting lower drawer/ 40 cm drawer closed	5994

SIT-ON BASINS



Go to page 62 to see our sit-on washbasins and free-standing mixers for the Epos range.

HANDLES AND KNOBS



Don't forget to include handles for your furniture. Read more on page 98.

Counter tops come with overhang.

Dekton work tops always come with a mixer hole on the left.

¹Delivery time approx 1-4 weeks. ²Special counter top. Delivery time 7-8 weeks.

EPOS 120 LEFT

Front	Order no.	Order no.
White		
Flat	1512210V	1512110V
Flat push open	1512210V-P	1512110V-P
Relief	1512211V	1512111V
White ash		
Flat	1612210V	1612110V
Flat push open	1612210V-P	1612110V-P
Relief	1612211V	1612111V
Brown ash		
Flat	1712210V	1712110V
Flat push open	1712210V-P	1712110V-P
Relief	1712211V	1712111V
Stripe	1712212V	1712112V
Stripe push open	1712212V-P	1712112V-P
Black ash		
Flat	1412210V	1412110V
Flat push open	1412210V-P	1412110V-P
Relief	1412211V	1412111V
Stripe	1412212V	1412112V
Stripe push open	1412212V-P	1412112V-P

1. CHOOSE A VANITY UNIT

SELECTED COLOURS

Choose from Flat and Flat push open fronts. Add -COL after the item number. The extra charge amount is based on white furniture.

2A. CHOOSE A WASHBASIN



ISE 120 LEFT
Mineral composite
W:121 H:1,3 D:46

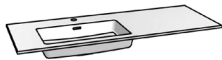

Colour	Order no.
White matt	5120-V
Ash grey	5121-V



WASHBASIN MIXER
Go to page 66 to see our washbasin mixers, traps and bottom valves.

2B. CHOOSE A WORK TOP

W: 122 H: 1,2 D: 46



DANA E¹
Has a sand-coloured limestone look.

Direction	Order no.
Left	144120



KEON¹
Has a grey industrial look.

Direction	Order no.
Left	141120



LAURENT¹
Has a dark background with gold marbling.

Direction	Order no.
Left	143120



REM²
Has a relaxing marble look with a light background and through-coloured edge.

Direction	Order no.
Left	145120



SIRIUS²
Has a matt black slate look.

Direction	Order no.
Left	146120

3. CHOOSE ACCESSORIES

Don't forget to add the finishing touches to your Epos with a range of smart accessories. Want to know more about our accessories? Visit svedbergs.com.

Metal drawer with wooden front

If you choose an Epos with an open lower drawer, you can select a metal drawer in the same colour as your furniture. (The colours white and white ash come with a white metal drawer. All other colours come with a black metal drawer.)

Metal drawer for Epos 80-200 with open shelf.
B:77 H:10 D:30

Front	Colour	Order no.
Flat	White	5781
Flat	White ash	5783
Flat	Brown ash	5784
Flat	Black ash	5788
Stripe	Brown ash	5786
Stripe	Black ash	5789

More accessories

Choose from a wide range of accessories for Epos.

Performance	Order no.
Lower drawer inserts	5950
Electrical socket	1212

CHOOSE LIGHTING

Lighting for Epos 120 with 2+1 drawers: Start with a driver kit (1) and choose one upper drawer lighting solution (3), two lower drawer lighting solutions (4) and one floor light (2).

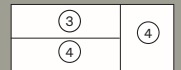

Lighting for Epos 120 with 1+1 drawers: Start with one driver kit (1) and choose one upper drawer lighting solution (3), one lower drawer lighting solution (4) and two floor lights (2) for lighting in your open shelf and under the vanity unit.

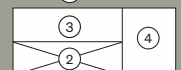

Lighting for Epos 120 with 2+0 drawers: Start with a driver kit (1) and choose one upper drawer lighting solution (3), one lower drawer lighting solution (4) and one floor light (2).

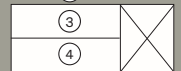

If the lighting is connected to the mains supply in your bathroom, use the wall switch to turn your vanity unit light on and off.

Performance	Order no.
1 Driver kit lighting	5991
2 Lighting open shelf / floor light	5992
3 Top drawer lighting	5993
4 Lighting lower drawer/ 40 cm drawer closed	5994

SIT-ON BASINS



Go to page 62 to see our sit-on washbasins and free-standing mixers for the Epos range.

HANDLES AND KNOBS



Don't forget to include handles for your furniture. Read more on page 98.

Counter tops come with overhang.

Dekton work tops always come with a mixer hole on the left.

Delivery time approx 1-4 weeks. ²Special counter top. Delivery time 7-8 weeks.

EPOS 120 LEFT

W: 120
H: 45
D: 45

Incl. 2+0 drawers and two open shelves. The open 40 shelf is positioned on the right.



Front Order no.

White

Flat 1512200V

Flat push open 1512200V-P

Relief 1512201V

White ash

Flat 1612200V

Flat push open 1612200V-P

Relief 1612201V

Brown ash

Flat 1712200V

Flat push open 1712200V-P

Relief 1712201V

Stripe 1712202V

Stripe push open 1712202V-P

Black ash

Flat 1412200V

Flat push open 1412200V-P

Relief 1412201V

Stripe 1412202V

Stripe push open 1412202V-P

SELECTED COLOURS

Choose from Flat and Flat push open fronts. Add -COL after the item number. The extra charge amount is based on white furniture.

1. CHOOSE A VANITY UNIT

2A. CHOOSE A WASHBASIN



ISE 120 LEFT
Mineral composite
W:121 H:1,3 D:46



Colour	Order no.
White matt	5120-V
Ash grey	5121-V



WASHBASIN MIXER
Go to page 66 to see our washbasin mixers, traps and bottom valves.

2B. CHOOSE A WORK TOP

W: 122 H: 1,2 D: 46



DANA E ¹
Has a sand-coloured limestone look.

Direction	Order no.
Left	144120

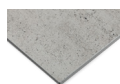

KEON ¹
Has a grey industrial look.

Direction	Order no.
Left	141120



LAURENT ¹
Has a dark background with gold marbling.

Direction	Order no.
Left	143120



REM ²
Has a relaxing marble look with a light background and through-coloured edge.

Direction	Order no.
Left	145120



SIRIUS ²
Has a matt black slate look.

Direction	Order no.
Left	146120

3. CHOOSE ACCESSORIES

Don't forget to add the finishing touches to your Epos with a range of smart accessories. Want to know more about our accessories? Visit svedbergs.com.

Metal drawer with wooden front

If you choose an Epos with an open lower drawer, you can select a metal drawer in the same colour as your furniture. (The colours white and white ash come with a white metal drawer. All other colours come with a black metal drawer.)

Metal drawer for Epos 80-200 with open shelf.
B:77 H:10 D:30

Front	Colour	Order no.
Flat	White	5781
Flat	White ash	5783
Flat	Brown ash	5784
Flat	Black ash	5788
Stripe	Brown ash	5786
Stripe	Black ash	5789

More accessories

Choose from a wide range of accessories for Epos.

Performance	Order no.
Lower drawer inserts	5950
Electrical socket	1212

CHOOSE LIGHTING

Lighting for Epos 120 with 2+1 drawers: Start with a driver kit (1) and choose one upper drawer lighting solution (3), two lower drawer lighting solutions (4) and one floor light (2).

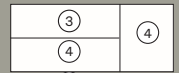

Lighting for Epos 120 with 1+1 drawers: Start with one driver kit (1) and choose one upper drawer lighting solution (3), one lower drawer lighting solution (4) and two floor lights (2) for lighting in your open shelf and under the vanity unit.

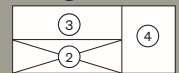

Lighting for Epos 120 with 2+0 drawers: Start with a driver kit (1) and choose one upper drawer lighting solution (3), one lower drawer lighting solution (4) and one floor light (2).

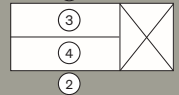

If the lighting is connected to the mains supply in your bathroom, use the wall switch to turn your vanity unit light on and off.

Performance	Order no.
1 Driver kit lighting	5991
2 Lighting open shelf / floor light	5992
3 Top drawer lighting	5993
4 Lighting lower drawer/ 40 cm drawer closed	5994

SIT-ON BASINS



Go to page 62 to see our sit-on washbasins and free-standing mixers for the Epos range.

HANDLES AND KNOBS



Don't forget to include handles for your furniture. Read more on page 98.



Counter tops come with overhang.

Dekton work tops always come with a mixer hole on the left.

¹Delivery time approx 1-4 weeks. ²Special counter top. Delivery time 7-8 weeks.

EPOS 160

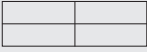
1. CHOOSE A VANITY UNIT

W: 160 H: 45 D: 45	Incl. 2+2 drawers 	Incl. 1+1 drawers and 2 open shelves. 
Front	Order no.	Order no.
White		
Flat	1516220	1516110
Flat push open	1516220-P	1516110-P
Relief	1516221	1516111
White ash		
Flat	1616220	1616110
Flat push open	1616220-P	1616110-P
Relief	1616221	1616111
Brown ash		
Flat	1716220	1716110
Flat push open	1716220-P	1716110-P
Relief	1716221	1716111
Stripe	1716222	1716112
Stripe push open	1716222-P	1716112-P
Black ash		
Flat	1416220	1416110
Flat push open	1416220-P	1416110-P
Relief	1416221	1416111
Stripe	1416222	1416112
Stripe push open	1416222-P	1416112-P

SELECTED COLOURS

Choose from Flat and Flat push open fronts. Add -COL after the item number. The extra charge amount is based on white furniture.

2A. CHOOSE A WASHBASIN



ISE 160 DOUBLE
Mineral composite
W:160 H:1,5 D:46

Colour	Order no.
White matt	5160-D
Ash grey	5161-D

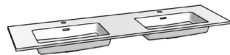

WASHBASIN MIXER
Go to page 66 to see our washbasin mixers, traps and bottom valves.

2B. CHOOSE A WORK TOP

W: 160 H: 1,2 D: 46



Right



Left



Double



DANA E¹
Has a sand-coloured limestone look.

Direction	Order no.
Right	144161
Left	144160
Double	144162

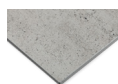

KEON¹
Has a grey industrial look.

Direction	Order no.
Right	141161
Left	141160
Double	141162

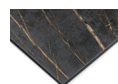

LAURENT¹
Has a dark background with gold marbling.

Direction	Order no.
Right	143161
Left	143160
Double	143162



REM²
Has a relaxing marble look with a light background and through-coloured edge.

Direction	Order no.
Right	145161
Left	145160
Double	145162



SIRIUS²
Has a matt black slate look.

Direction	Order no.
Right	146161
Left	146160
Double	146162

3. CHOOSE ACCESSORIES

Don't forget to add the finishing touches to your Epos with a range of smart accessories. Want to know more about our accessories? Visit svedbergs.com.

Metal drawer with wooden front

If you choose an Epos with an open lower drawer, you can select a metal drawer in the same colour as your furniture. (The colours white and white ash come with a white metal drawer. All other colours come with a black metal drawer.)

Metal drawer for Epos 80-200 with open shelf.
B:77 H:10 D:30

Front	Colour	Order no.
Flat	White	5781
Flat	White ash	5783
Flat	Brown ash	5784
Flat	Black ash	5788
Stripe	Brown ash	5786
Stripe	Black ash	5789

More accessories

Choose from a wide range of accessories for Epos.

Performance	Order no.
Lower drawer inserts	5950
Electrical socket	1212

CHOOSE LIGHTING

Lighting for Epos 160 with 2+2 drawers:

Start with two driver kits (1) and choose two upper drawer lighting solutions (3), two lower drawer lighting solutions (4) and two floor lights (2).

Lighting for Epos 160 with 1+1 drawers:

Start with two driver kits (1) and choose two upper drawer lighting solutions (3) and four floor lights (2) for lighting in your open shelf and under the vanity unit.

If the lighting is connected to the mains supply in your bathroom, use the wall switch to turn your vanity unit light on and off.

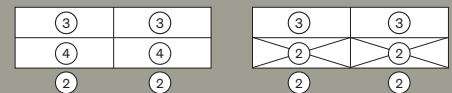

Performance	Order no.
1 Driver kit lighting	5991
2 Lighting open shelf / floor light	5992
3 Top drawer lighting	5993
4 Lighting lower drawer/ 40 cm drawer closed	5994



SIT-ON BASINS
Go to page 62 to see our sit-on washbasins and free-standing mixers for the Epos range.



HANDLES AND KNOBS
Don't forget to include handles for your furniture. Read more on page 98.

Counter tops come with overhang. Dekton work tops always come with a mixer hole on the left.

¹Delivery time approx 1-4 weeks. ²Special counter top. Delivery time 7-8 weeks.

EPOS 200

1. CHOOSE A VANITY UNIT

W: 200 H: 45 D: 45	Incl. 2+1+2 drawers. Double electrical sockets included in the 40 drawer.	Incl. 2+0+2 drawers and 2 open shelves.
Front	Order no.	Order no.
White		
Flat	15202120	15202020
Flat push open	15202120-P	15202020-P
Relief	15202121	15202021
White ash		
Flat	16202120	16202020
Flat push open	16202120-P	16202020-P
Relief	16202121	16202021
Brown ash		
Flat	17202120	17202020
Flat push open	17202120-P	17202020-P
Relief	17202121	17202021
Stripe	17202122	17202022
Stripe Push open	17202122-P	17202022-P
Black ash		
Flat	14202120	14202020
Flat push open	14202120-P	14202020-P
Relief	14202121	14202021
Stripe	14202122	14202022
Stripe push open	14202122-P	14202022-P

SELECTED COLOURS

Choose from Flat and Flat push open fronts. Add -COL after the item number. The extra charge amount is based on white furniture.

3. CHOOSE ACCESSORIES

Don't forget to add the finishing touches to your Epos with a range of smart accessories. Want to know more about our accessories? Visit svedbergs.com.

Metal drawer with wooden front

If you choose an Epos with an open lower drawer, you can select a metal drawer in the same colour as your furniture. (The colours white and white ash come with a white metal drawer. All other colours come with a black metal drawer.)

Metal drawer for Epos 80-200 with open shelf.
B:77 H:10 D:30

Front	Colour	Order no.
Flat	White	5781
Flat	White ash	5783
Flat	Brown ash	5784
Flat	Black ash	5788
Stripe	Brown ash	5786
Stripe	Black ash	5789

More accessories

Choose from a wide range of accessories for Epos.

Performance	Order no.
Lower drawer inserts	5950
Electrical socket	1212

CHOOSE LIGHTING

Lighting for Epos 200 with 2+1+2 drawers:

Start with two driver kits (1) and choose two upper drawer lighting solutions (3), three lower drawer lighting solutions (4) and two floor lights (2).

Lighting for Epos 200 with 2+0+2 drawers:

Start with two driver kits (1) and choose two upper drawer lighting solutions (3), two lower drawer lighting solutions (4) and two floor lights (2).

If the lighting is connected to the mains supply in your bathroom, use the wall switch to turn your vanity unit light on and off.



Performance	Order no.
① Driver kit lighting	5991
② Lighting open shelf / floor light	5992
③ Top drawer lighting	5993
④ Lighting lower drawer/ 40 cm drawer closed	5994



WASHBASIN MIXER
Go to page 66 to see our washbasin mixers, traps and bottom valves.

2B. CHOOSE A WORK TOP

W: 200 H: 1,2 D: 46



Right



Left



Double



DANA E¹
Has a sand-coloured limestone look.

Direction	Order no.
Right	144201
Left	144200
Double	144202



KEON¹
Has a grey industrial look.

Direction	Order no.
Right	141201
Left	141200
Double	141202



LAURENT¹
Has a dark background with gold marbling.

Direction	Order no.
Right	143201
Left	143200
Double	143202



REM²
Has a relaxing marble look with a light background and through-coloured edge.

Direction	Order no.
Right	145201
Left	145200
Double	145202



SIRIUS²
Has a matt black slate look.

Direction	Order no.
Right	146201
Left	146200
Double	146202



SIT-ON BASINS
Go to page 62 to see our sit-on washbasins and free-standing mixers for the Epos range.



HANDLES AND KNOBS
Don't forget to include handles for your furniture. Read more on page 98.

Counter tops come with overhang. Dekton work tops always come with a mixer hole on the left.

¹Delivery time approx 1-4 weeks. ²Special counter top. Delivery time 7-8 weeks.

EPOS 200

Incl. 1+1+1 drawers and 2 open shelves. Double electrical sockets included in the 40 drawer.

W: 200
H: 45
D: 45

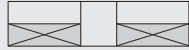

Front Order no.

White

Flat 15201110

Flat Push open 15201110-P

Relief 15201111

White ash

Flat 16201110

Flat Push open 16201110-P

Relief 16201111

Brown ash

Flat 17201110

Flat Push open 17201110-P

Relief 17201111

Stripe 17201112

Stripe Push open 17201112-P

Black ash

Flat 14201110

Flat Push open 14201110-P

Relief 14201111

Stripe 14201112

Stripe Push open 14201112-P

SELECTED COLOURS

Choose from Flat and Flat Push open fronts. Add -COL after the item number. The extra charge amount is based on white furniture.

1. CHOOSE A VANITY UNIT

3. CHOOSE ACCESSORIES

Don't forget to add the finishing touches to your Epos with a range of smart accessories. Want to know more about our accessories? Visit svedbergs.com.

Metal drawer with wooden front

If you choose an Epos with an open lower drawer, you can select a metal drawer in the same colour as your furniture. (The colours white and white ash come with a white metal drawer. All other colours come with a black metal drawer.)

Metal drawer for Epos 80-200 with open shelf.
B:77 H:10 D:30

Front	Colour	Order no.
Flat	White	5781
Flat	White ash	5783
Flat	Brown ash	5784
Flat	Black ash	5788
Stripe	Brown ash	5786
Stripe	Black ash	5789

More accessories

Choose from a wide range of accessories for Epos.

Performance	Order no.
Lower drawer inserts	5950
Electrical socket	1212

CHOOSE LIGHTING

Lighting for Epos 200 with 1+1+1 drawers:

Start with two driver kits (1) and choose two upper drawer lighting solutions (3), one lower drawer lighting solution (2) and four floor lights for lighting in your open shelf and under the vanity unit.

If the lighting is connected to the mains supply in your bathroom, use the wall switch to turn your vanity unit light on and off.

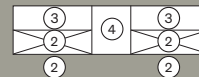

Performance	Order no.
① Driver kit lighting	5991
② Lighting open shelf / floor light	5992
③ Top drawer lighting	5993
④ Lighting lower drawer/ 40 cm drawer closed	5994



WASHBASIN MIXER
Go to page 66 to see our washbasin mixers, traps and bottom valves.

2B. CHOOSE A WORK TOP

W: 200 H: 1,2 D: 46



Right



Left



Double



DANA E¹
Has a sand-coloured limestone look.

Direction Order no.

Right 144201

Left 144200

Double 144202



KEON¹
Has a grey industrial look.

Direction Order no.

Right 141201

Left 141200

Double 141202



LAURENT¹
Has a dark background with gold marbling.

Direction Order no.

Right 143201

Left 143200

Double 143202



REM²
Has a relaxing marble look with a light background and through-coloured edge.

Direction Order no.

Right 145201

Left 145200

Double 145202



SIRIUS²
Has a matt black slate look.

Direction Order no.

Right 146201

Left 146200

Double 146202



SIT-ON BASINS
Go to page 62 to see our sit-on washbasins and free-standing mixers for the Epos range.



HANDLES AND KNOBS
Don't forget to include handles for your furniture. Read more on page 98.

Counter tops come with overhang.

Dekton work tops always come with a mixer hole on the left.

¹Delivery time approx 1-4 weeks. ²Special counter top. Delivery time 7-8 weeks.

COUNTER TOP WASHBASINS FOR EPOS

Myre Ø36, porcelain



Stripe, White

Order no.
5346



White

Order no.
5336



Latte

Order no.
5337



Mocha

Order no.
5338



Anthracite

Order no.
5339

Myre 50×36 porcelain



White

Order no.
5353



Latte

Order no.
5354



Mocha

Order no.
5355



Anthracite

Order no.
5356

Fross round, Solid Surface



White matt

Order no.
2440



Black matt

Order no.
8440

Fross rectangular, Solid Surface



White matt

Order no.
2455



Black matt

Order no.
8455

Stora Ø40, sheet metal



Brushed brass

Order no.
5440



Pencil black

Order no.
5441

POEM

Rooted in genuine materials and skilful craftsmanship, this furniture series offers a range of looks, from natural Nordic to dark and earthy. A Poem about flexibility and timeless design.

Materials offering a natural wood feel, details that exude a contemporary edge, and an air of exclusive design for bathrooms big to small. In the Poem range, variety is key. With the Poem range's front looks and choices of material and colour, we are unique in offering a scalable design experience for bathrooms simple to lavish.



CHOOSE YOUR BATHROOM

Design

Timeless design with a focus on integrated grips, genuine materials and craftsmanship.

Flexibility

A variety of looks, from natural Nordic to dark and earthy. Choose between an integrated or counter top washbasin. For bathrooms big to small.

Functionality

Tall frame for more volume. Practical drawer compartments. Drawers that are fully extendible. EasyMount for simple mounting.

Quality

Real wood veneer. DuraDry coating process for extra durability. Made in Sweden and sold with a 20-year warranty.

Sustainability

Wood sourced from responsible and sustainable forestry providers. Can be uninstalled and recycled.



STANDARD

Drawer inserts

Practical drawer compartments with exclusive colour matching with the drawer front in brown ash and pure oak. The other colours come with black edging.



Drawer system

A timeless and functional drawer system. Opens weightlessly, soundlessly and with no resistance. 100% recyclable.



EasyMount

Our simple EasyMount system requires fewer installation steps. It fixes to the wall with just a few screws, causing less impact on the moisture barrier.



OPTIONS

Drawer inserts in the lower drawer

A practical drawer insert can be added to the bottom drawer in Poem units.

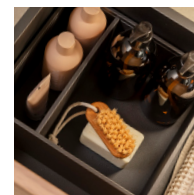

Drawer lighting

Drawer lighting is practical because it makes your things easier to find. But it also looks good and adds an exclusive touch. Drawer lighting is available as an optional extra.

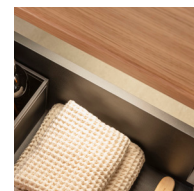

Floor light

An optional floor light adds an exclusive, cosy feel to the bathroom. The light is installed on the underside of the bathroom unit. Supplement it with a driver kit (optional).



Power socket

An electrical socket can be added as an optional accessory to the bottom drawer in Poem.

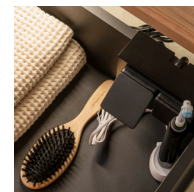

Mixers

Don't forget to include mixers and traps for your vanity unit.

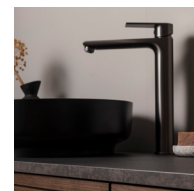

Discover the whole Poem range

FRONTS

Six front options give six different looks. Choose between handles or a push open mechanism to find a style that suits your bathroom.

Flat

Front for a sleek, simple and elegant look. Create your individual style with standard colours, optional colours, real wood veneers and handles.



Flat push

Push open action for an elegant, minimalist style.



Profile

Flat design look with integrated concealed grip. Combining solid wood with veneer and adding one of our wood finishes offers a sense of master carpentry.



Frame

Narrow yet distinctive frames made of solid wood with veneer infill, offer a contemporary feel with classic touches. Combined with a push opening mechanism or handle and particularly well suited to natural looks such as ash and oak.



Frame push

Push open action for an elegant, minimalist style.



Edging

Discretely integrated and functional grip edging for a minimalist look. Colour-matched and with a thin silhouette for a refined feel in everything from the colour to the wood veneer.



HANDLES AND KNOBS
Don't forget to purchase handles for your Poem with either a flat or framed front. Read more on page 98.



COLOURS

With five standard colours and three optional colours, it's easy to find your favourite. The optional colours are only available for the Flat and Flat push open fronts.

Standard colours



White



Sand



Pure oak

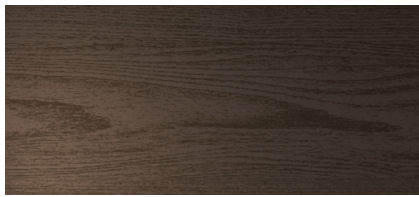

Brown ash



Black ash

Optional colours

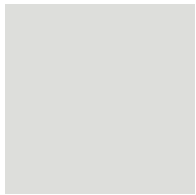

Oat



Sage



Granite

WORKTOPS

Choose between laminate in Quartz (light grey), Mica (dark grey) and Slate (black). Keon (grey concrete) and Sirius (black) in Dekton.



Quartz



Mica

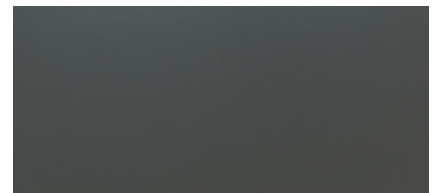

Slate

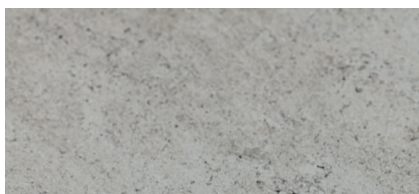

Keon

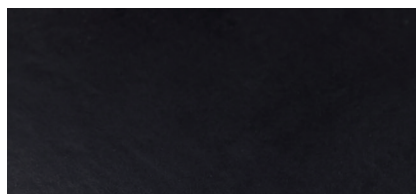

Sirius



SIT-ON BASINS

Don't forget to include a washbasin. Go to page 62 to see our sit-on washbasins.

POEMS CHOICES

50 cm



W: 50
H: 45/57
D: 35



60 cm



W: 60
H: 45/57
D: 35

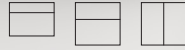

80 cm



W: 80
H: 45/57
D: 35

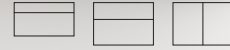

W: 60
H: 57
D: 45



W: 80
H: 57
D: 45



160 cm



W: 160
H: 57
D: 45

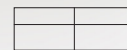

CREATE YOUR POEM

- 01** Choose a vanity unit.
- 02** Choose a colour.
- 03** Choose a front.
- 04** Choose optional extras (e.g. lighting or electrical sockets)

- 05** Choose between an integrated or sit-on washbasin with work top.
- 06** Choose between handles or a push open mechanism.
- 07** Choose a mixer.

100 cm



W: 100
H: 57
D: 45



120 cm



W: 120
H: 57
D: 45



W: 120
H: 57
D: 45









POEM 50X35

1. CHOOSE A VANITY UNIT

Front	Order no.	Order no.
White		
Flat	3355111	3355113
Flat push open	3355111-P	-
Profile	3355611	-
Sand		
Flat	3355121	3355123
Flat push open	3355121-P	-
Profile	3355621	-
Pure oak		
Flat	3355131	3355133
Flat push open	3355131-P	-
Profile	3355631	-
Brown ash		
Flat	3355151	3355153
Flat push open	3355151-P	-
Profile	3355651	-
Black ash		
Flat	3355141	3355143
Flat push open	3355141-P	-
Profile	3355641	-

2. CHOOSE A WASHBASIN

	
HAV 50X35 Porcelain, W:52 H:1,7 D:36,5	
Colour	Order no.
White	5053
	
SKAPA 50X35 Porcelain, W:51 H:8.5 D:41	
Colour	Order no.
White	37350
	
MUNKA 50X35 Mineral composite, W:51 H:1,5 D:36	
Colour	Order no.
White	52510

SELECTED COLOURS
Choose from Flat and Flat push open fronts. Add -COL after the item number. The extra charge amount is based on white furniture.



WASHBASIN MIXER
Go to page 66 to see our washbasin mixers, traps and bottom valves.

HANDLES AND KNOBS
Don't forget to include handles for your furniture. Read more on page 98.

POEM

The Poem furniture range is the most extensive on the market for smaller bathrooms. Choose from two depths, six widths and four different front panel options in five standard colours and three optional colours.

Optional

Performance	Order no.
Lower drawer inserts	5950
Power sockets, Black	98780

CHOOSE LIGHTING

Lighting for Poem 50x35 with one drawer:
Start with a driver kit (1), one lower drawer lighting solution (4) and one floor light (2).

Lighting for Poem 50x35 with two drawers:
Start with a driver kit (1) and choose one upper drawer lighting solution (3), one lower drawer lighting solution (4) and one floor light (2).

If the lighting is connected to the mains supply in your bathroom, use the wall switch to turn your vanity unit light on and off.

Poem 50x35 with 1 drawer.



Poem 50x35 with 2 drawers.





Performance	Order no.
1 Driver kit lighting	5991
2 Lighting open shelf / floor light	5992
3 Top drawer lighting	5993
4 Lighting lower drawer/ 40 cm drawer closed	5994

POEM 50X35

1. CHOOSE A VANITY UNIT

W: 50 H: 57 D: 35	Incl. 2 drawers.	
Front	Order no.	
White		
Flat	3355112	
Flat push open	3355112-P	
Edging	3355312	
Profile	3355612	
Frame	3355412	
Frame push open	3355412-P	
Sand		
Flat	3355122	
Flat push open	3355122-P	
Edging	3355322	
Profile	3355622	
Frame	3355422	
Frame push open	3355422-P	
Pure oak		
Flat	3355132	
Flat push open	3355132-P	
Edging	3355332	
Profile	3355632	
Frame	3355432	
Frame push open	3355432-P	
Brown ash		
Flat	3355152	
Flat push open	3355152-P	
Edging	3355352	
Profile	3355652	
Frame	3355452	
Frame push open	3355452-P	
Black ash		
Flat	3355142	
Flat push open	3355142-P	
Edging	3355342	
Profile	3355642	
Frame	3355442	
Frame push open	3355442-P	

2. CHOOSE A WASHBASIN

	
HAVA 50X35 Porcelain. W:52 H:1,7 D:36,5	
Colour	Order no.
White	5053
	
SKAPA 50X35 Porcelain, W:51 H:8.5 D:41	
Colour	Order no.
White	37350
	
MUNKA 50X35 Mineral composite. W:51 H:1,5 D:36	
Colour	Order no.
White	52510

SELECTED COLOURS
Choose from Flat and Flat push open fronts.
Add -COL after the item number. The extra charge amount is based on white furniture.



WASHBASIN MIXER
Go to page 66 to see our washbasin mixers, traps and bottom valves.

HANDLES AND KNOBS
Don't forget to include handles for your furniture. Read more on page 98.

POEM

The Poem furniture range is the most extensive on the market for smaller bathrooms. Choose from two depths, six widths and four different front panel options in five standard colours and three optional colours.

Optional

Performance	Order no.
Lower drawer inserts	5950
Power sockets, Black	98780

CHOOSE LIGHTING

Lighting for Poem 50x35 with one drawer:
Start with a driver kit (1), one lower drawer lighting solution (4) and one floor light (2).

Lighting for Poem 50x35 with two drawers:
Start with a driver kit (1) and choose one upper drawer lighting solution (3), one lower drawer lighting solution (4) and one floor light (2).

If the lighting is connected to the mains supply in your bathroom, use the wall switch to turn your vanity unit light on and off.

Poem 50x35 with 1 drawer.



Poem 50x35 with 2 drawers.



Performance	Order no.
1 Driver kit lighting	5991
2 Lighting open shelf / floor light	5992
3 Top drawer lighting	5993
4 Lighting lower drawer/ 40 cm drawer closed	5994

POEM 60X35

1. CHOOSE A VANITY UNIT

Front	Order no.	Order no.
White		
Flat	3356111	3356113
Flat push open	3356111-P	-
Profile	3356611	-
Sand		
Flat	3356121	3356123
Flat push open	3356121-P	-
Profile	3356621	-
Pure oak		
Flat	3356131	3356133
Flat push open	3356131-P	-
Profile	3356631	-
Brown ash		
Flat	3356151	3356153
Flat push open	3356151-P	-
Profile	3356651	-
Black ash		
Flat	3356141	3356143
Flat push open	3356141-P	-
Profile	3356641	-

2. CHOOSE A WASHBASIN



HAV 60X35
Porcelain. W:62 H:1,7 D:36,5

Colour	Order no.
White	5063



SKAPA 60X35
Porcelain. W:61 H:8,5 D:41

Colour	Order no.
White	37360



MUNKA 60X35
Mineral composite. W:61 H:1,5 D:36

Colour	Order no.
White	52610

SELECTED COLOURS
Choose from Flat and Flat push open fronts. Add -COL after the item number. The extra charge amount is based on white furniture.



WASHBASIN MIXER
Go to page 66 to see our washbasin mixers, traps and bottom valves.

HANDLES AND KNOBS
Don't forget to include handles for your furniture. Read more on page 98.

POEM

The Poem furniture range is the most extensive on the market for smaller bathrooms. Choose from two depths, six widths and four different front panel options in five standard colours and three optional colours.

Optional

Performance	Order no.
Lower drawer inserts	5950
Power sockets, Black	98780

CHOOSE LIGHTING

Lighting for Poem 60x35 with one drawer:
Start with a driver kit (1), one lower drawer lighting solution (4) and one floor light (2).

Lighting for Poem 60x35 with two drawers:
Start with a driver kit (1) and choose one upper drawer lighting solution (3), one lower drawer lighting solution (4) and one floor light (2).

If the lighting is connected to the mains supply in your bathroom, use the wall switch to turn your vanity unit light on and off.

Poem 60x35 with 1 drawer.



Poem 60x35 with 2 drawers.





Performance	Order no.
1 Driver kit lighting	5991
2 Lighting open shelf / floor light	5992
3 Top drawer lighting	5993
4 Lighting lower drawer/ 40 cm drawer closed	5994

POEM 60X35

1. CHOOSE A VANITY UNIT

W: 60 H: 57 D: 35	Incl. 2 drawers.	
Front	Order no.	
White		
Flat	3356112	
Flat push open	3356112-P	
Edging	3356312	
Profile	3356612	
Frame	3356412	
Frame push open	3356412-P	
Sand		
Flat	3356122	
Flat push open	3356122-P	
Edging	3356322	
Profile	3356622	
Frame	3356422	
Frame push open	3356422-P	
Pure oak		
Flat	3356132	
Flat push open	3356132-P	
Edging	3356332	
Profile	3356632	
Frame	3356432	
Frame push open	3356432-P	
Brown ash		
Flat	3356152	
Flat push open	3356152-P	
Edging	3356352	
Profile	3356652	
Frame	3356452	
Frame push open	3356452-P	
Black ash		
Flat	3356142	
Flat push open	3356142-P	
Edging	3356342	
Profile	3356642	
Frame	3356442	
Frame push open	3356442-P	

2. CHOOSE A WASHBASIN

	
HAVA 60X35 Porcelain. W:62 H:1,7 D:36,5	
Colour	Order no.
White	5063
	
SKAPA 60X35 Porcelain. W:61 H:8,5 D:41	
Colour	Order no.
White	37360
	
MUNKA 60X35 Mineral composite. W:61 H:1,5 D:36	
Colour	Order no.
White	52610

SELECTED COLOURS
Choose from Flat and Flat push open fronts.
Add -COL after the item number. The extra charge amount is based on white furniture.



WASHBASIN MIXER
Go to page 66 to see our washbasin mixers, traps and bottom valves.

HANDLES AND KNOBS
Don't forget to include handles for your furniture. Read more on page 98.

POEM

The Poem furniture range is the most extensive on the market for smaller bathrooms. Choose from two depths, six widths and four different front panel options in five standard colours and three optional colours.

Optional

Performance	Order no.
Lower drawer inserts	5950
Power sockets, Black	98780

CHOOSE LIGHTING

Lighting for Poem 60x35 with one drawer:
Start with a driver kit (1), one lower drawer lighting solution (4) and one floor light (2).

Lighting for Poem 60x35 with two drawers:
Start with a driver kit (1) and choose one upper drawer lighting solution (3), one lower drawer lighting solution (4) and one floor light (2).

If the lighting is connected to the mains supply in your bathroom, use the wall switch to turn your vanity unit light on and off.

Poem 60x35 with 1 drawer.



Poem 60x35 with 2 drawers.



Performance	Order no.
1 Driver kit lighting	5991
2 Lighting open shelf / floor light	5992
3 Top drawer lighting	5993
4 Lighting lower drawer/ 40 cm drawer closed	5994

POEM 80X35

1. CHOOSE A VANITY UNIT

Front	Order no.	Order no.
White		
Flat	3358111	3358113
Flat push open	3358111-P	-
Profile	3358611	-
Sand		
Flat	3358121	3358123
Flat push open	3358121-P	-
Profile	3358621	-
Pure oak		
Flat	3358131	3358133
Flat push open	3358131-P	-
Profile	3358631	-
Brown ash		
Flat	3358151	3358143
Flat push open	3358151-P	-
Profile	3358651	-
Black ash		
Flat	3358141	3358153
Flat push open	3358141-P	-
Profile	3358641	-

2. CHOOSE A WASHBASIN



HAV 80X35
Porcelain. W:82 H:X1,7 D:36,5

Colour	Order no.
White	5083



SKAPA 80X35
Porcelain. W:82 H:8,5 D:41

Colour	Order no.
White	37380



MUNKKA 80X35
Mineral composite. W:81 H:1,5 D:36

Colour	Order no.
White	52810

SELECTED COLOURS
Choose from Flat and Flat push open fronts. Add -COL after the item number. The extra charge amount is based on white furniture.



WASHBASIN MIXER
Go to page 66 to see our washbasin mixers, traps and bottom valves.

HANDLES AND KNOBS
Don't forget to include handles for your furniture. Read more on page 98.

POEM

The Poem furniture range is the most extensive on the market for smaller bathrooms. Choose from two depths, six widths and four different front panel options in five standard colours and three optional colours.

Optional

Performance	Order no.
Lower drawer inserts	5950
Power sockets, Black	98780

CHOOSE LIGHTING

Lighting for Poem 80x35 with one drawer:
Start with a driver kit (1), one lower drawer lighting solution (4) and one floor light (2).

Lighting for Poem 80x35 with two drawers:
Start with a driver kit (1) and choose one upper drawer lighting solution (3), one lower drawer lighting solution (4) and one floor light (2).

If the lighting is connected to the mains supply in your bathroom, use the wall switch to turn your vanity unit light on and off.

Poem 80x35 with 1 drawer.



Poem 80x35 with 2 drawers.



Performance	Order no.
1 Driver kit lighting	5991
2 Lighting open shelf / floor light	5992
3 Top drawer lighting	5993
4 Lighting lower drawer/ 40 cm drawer closed	5994

POEM 80X35

1. CHOOSE A VANITY UNIT

W: 80 H: 57 D: 35	Incl. 2 drawers.	
Front	Order no.	
White		
Flat	3358112	
Flat push open	3358112-P	
Edging	3358312	
Profile	3358612	
Frame	3358412	
Frame push open	3358412-P	
Sand		
Flat	3358122	
Flat push open	3358122-P	
Edging	3358322	
Profile	3358622	
Frame	3358422	
Frame push open	3358422-P	
Pure oak		
Flat	3358132	
Flat push open	3358132-P	
Edging	3358332	
Profile	3358632	
Frame	3358432	
Frame push open	3358432-P	
Brown ash		
Flat	3358152	
Flat push open	3358152-P	
Edging	3358352	
Profile	3358652	
Frame	3358452	
Frame push open	3358452-P	
Black ash		
Flat	3358142	
Flat push open	3358142-P	
Edging	3358342	
Profile	3358642	
Frame	3358442	
Frame push open	3358442-P	

2. CHOOSE A WASHBASIN

	
HAVA 80X35 Porcelain. W:82 H:1,7 D:36,5	
Colour	Order no.
White	5083
	
SKAPA 80X35 Porcelain. W:81 H:8,5 D:41	
Colour	Order no.
White	37380
	
MUNKA 80X35 Mineral composite. W:81 H:1,5 D:36	
Colour	Order no.
White	52810

SELECTED COLOURS
Choose from Flat and Flat push open fronts.
Add -COL after the item number. The extra charge amount is based on white furniture.



WASHBASIN MIXER
Go to page 66 to see our washbasin mixers, traps and bottom valves.

HANDLES AND KNOBS
Don't forget to include handles for your furniture. Read more on page 98.

POEM

The Poem furniture range is the most extensive on the market for smaller bathrooms. Choose from two depths, six widths and four different front panel options in five standard colours and three optional colours.

Optional

Performance	Order no.
Lower drawer inserts	5950
Power sockets, Black	98780

CHOOSE LIGHTING

Lighting for Poem 80x35 with one drawer:
Start with a driver kit (1), one lower drawer lighting solution (4) and one floor light (2).

Lighting for Poem 80x35 with two drawers:
Start with a driver kit (1) and choose one upper drawer lighting solution (3), one lower drawer lighting solution (4) and one floor light (2).

If the lighting is connected to the mains supply in your bathroom, use the wall switch to turn your vanity unit light on and off.

Poem 80x35 with 1 drawer.







Poem 80x35 with 2 drawers.



Performance	Order no.
1 Driver kit lighting	5991
2 Lighting open shelf / floor light	5992
3 Top drawer lighting	5993
4 Lighting lower drawer/ 40 cm drawer closed	5994

POEM 60X45

1. CHOOSE A VANITY UNIT

W: 60 H: 57 D: 45	Incl. 2 drawers.	
Front	Order no.	
White		
Flat	3456112	
Flat push open	3456112-P	
Edging	3456312	
Profile	3456612	
Frame	3456412	
Frame push open	3456412-P	
Sand		
Flat	3456122	
Flat push open	3456122-P	
Edging	3456322	
Profile	3456622	
Frame	3456422	
Frame push open	3456422-P	
Pure oak		
Flat	3456132	
Flat push open	3456132-P	
Edging	3456332	
Profile	3456632	
Frame	3456432	
Frame push open	3456432-P	
Brown ash		
Flat	3456152	
Flat push open	3456152-P	
Edging	3456352	
Profile	3456652	
Frame	3456452	
Frame push open	3456452-P	
Black ash		
Flat	3456142	
Flat push open	3456142-P	
Edging	3456342	
Profile	3456642	
Frame	3456442	
Frame push open	3456442-P	

2A. CHOOSE A WASHBASIN



HAU 60X45
Porcelain. W:62 H:1,7 D:47

Colour	Order no.
White	5062



DEEP 60X45
Porcelain. W:61 H:6 D:46

Colour	Order no.
White	6060



SEL 60X45
Mineral composite. W:61 H:2 D:46

Colour	Order no.
White matt	34560
Black matt	34660



SELECTED COLOURS

Choose from Flat and Flat push open fronts. Add -COL after the item number. The extra charge amount is based on white furniture.



WASHBASIN MIXER
Go to page 66 to see our washbasin mixers, traps and bottom valves.

2B. CHOOSE A WORK TOP ¹



SIRIUS 60X45
Material: Dekton. For free-standing mixers. W: 61 H: 1,2 D: 46.

Direction	Order no.
Centre	370699

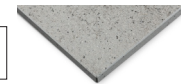

KEON 60X45
Material: Dekton. For free-standing mixers. W: 61 H: 1,2 D: 46.

Direction	Order no.
Centre	130062



QUARTZ 60X45
Material: Laminate. For free-standing mixers. W: 61 H: 2 D: 46.

Direction	Order no.
Centre	20602

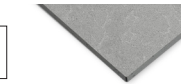

MICA 60X45
Material: Laminate. For free-standing mixers. W: 61 H: 2 D: 46.

Direction	Order no.
Centre	20603



SLATE 60X45
Material: Laminate. For free-standing mixers. W: 61 H: 2 D: 46.

Direction	Order no.
Centre	20601



SIT-ON BASINS
Go to page 123 to see our counter top washbasins.

HANDLES AND KNOBS
Don't forget to include handles for your furniture. Read more on page 98.

WORK TOP DETAILS
¹ Dekton work tops always come with a mixer hole on the left. The laminate work tops are reversible. Counter tops come with overhang.

POEM

The Poem furniture range is the most extensive on the market for smaller bathrooms. Choose from two depths, six widths and four different front panel options in five standard colours and three optional colours.

Optional

Performance	Order no.
Lower drawer inserts	5950
Power sockets, Black	98780

CHOOSE LIGHTING

Lighting for Poem 60x45 with two drawers: Start with a driver kit (1) and choose one upper drawer lighting solution (3), one lower drawer lighting solution (4) and one floor light (2).

If the lighting is connected to the mains supply in your bathroom, use the wall switch to turn your vanity unit light on and off.





Poem 60x45 with 2 drawers.



Performance	Order no.
1 Driver kit lighting	5991
2 Lighting open shelf / floor light	5992
3 Top drawer lighting	5993
4 Lighting lower drawer/ 40 cm drawer closed	5994

POEM 80X45

1. CHOOSE A VANITY UNIT

W: 80 H: 57 D: 45	Incl. 2 drawers.	
Front	Order no.	
White		
Flat	3458112	
Flat push open	3458112-P	
Edging	3458312	
Profile	3458612	
Frame	3458412	
Frame push open	3458412-P	
Sand		
Flat	3458122	
Flat push open	3458122-P	
Edging	3458322	
Profile	3458622	
Frame	3458422	
Frame push open	3458422-P	
Pure oak		
Flat	3458132	
Flat push open	3458132-P	
Edging	3458332	
Profile	3458632	
Frame	3458432	
Frame push open	3458432-P	
Brown ash		
Flat	3458152	
Flat Push open	3458152-P	
Edging	3458352	
Profile	3458652	
Frame	3458452	
Frame push open	3458452-P	
Black ash		
Flat	3458142	
Flat Push open	3458142-P	
Edging	3458342	
Profile	3458642	
Frame	3458442	
Frame push open	3458442-P	

2A. CHOOSE A WASHBASIN



HAV 80X45
Porcelain. W:82 H:1,7 D:47

Colour	Order no.
White	5082



DEEP 80X45
Porcelain. W:81 H:6 D:46

Colour	Order no.
White	6080



SEL 80X45
Mineral composite. W:81 H:2 D:46

Colour	Order no.
White matt	34580
Black matt	34680



SELECTED COLOURS

Choose from Flat and Flat push open fronts. Add -COL after the item number. The extra charge amount is based on white furniture.



WASHBASIN MIXER

Go to page 66 to see our washbasin mixers, traps and bottom valves.

2B. CHOOSE A WORK TOP ¹



SIRIUS 80X45
Material: Dekton. For free-standing mixers. W: 81 H: 1,2 D: 46.

Direction	Order no.
Centre	370899

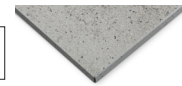

KEON 80X45
Material: Dekton. For free-standing mixers. W: 81 H: 1,2 D: 46.

Direction	Order no.
Centre	130082

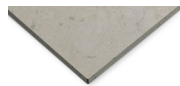

QUARTZ 80X45
Material: Laminate. For free-standing mixers. W: 81 H: 2 D: 46.

Direction	Order no.
Centre	20802

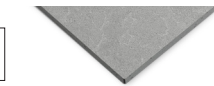

MICA 80X45
Material: Laminate. For free-standing mixers. W: 81 H: 2 D: 46.

Direction	Order no.
Centre	20803



SLATE 80X45
Material: Laminate. For free-standing mixers. W: 81 H: 2 D: 46.

Direction	Order no.
Centre	20801



SIT-ON BASINS

Go to page 123 to see our counter top washbasins.

HANDLES AND KNOBS

Don't forget to include handles for your furniture. Read more on page 98.

WORK TOP DETAILS

¹ Dekton work tops always come with a mixer hole on the left. The laminate work tops are reversible. Counter tops come with overhang.

POEM

The Poem furniture range is the most extensive on the market for smaller bathrooms. Choose from two depths, six widths and four different front panel options in five standard colours and three optional colours.

Optional

Performance	Order no.
Lower drawer inserts	5950
Power sockets, Black	98780

CHOOSE LIGHTING

Lighting for Poem 80x45 with two drawers:- Start with a driver kit (1) and choose one upper drawer lighting solution (3), one lower drawer lighting solution (4) and one floor light (2).

If the lighting is connected to the mains supply in your bathroom, use the wall switch to turn your vanity unit light on and off.



Poem 80x45 with 2 drawers.



Performance	Order no.
1 Driver kit lighting	5991
2 Lighting open shelf / floor light	5992
3 Top drawer lighting	5993
4 Lighting lower drawer/ 40 cm drawer closed	5994

POEM 100X45

1. CHOOSE A VANITY UNIT

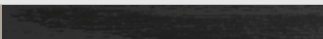
W: 100 H: 57 D: 45	Incl. 2 drawers.	
Front	Order no.	
White		
Flat	34510112	
Flat push open	34510112-P	
Edging	34510312	
Profile	34510612	
Frame	34510412	
Frame push open	34510412-P	
Sand		
Flat	34510122	
Flat push open	34510122-P	
Edging	34510322	
Profile	34510622	
Frame	34510422	
Frame push open	34510422-P	
Pure oak		
Flat	34510132	
Flat Push open	34510132-P	
Edging	34510332	
Profile	34510632	
Frame	34510432	
Frame push open	34510432-P	
Brown ash		
Flat	34510152	
Flat Push open	34510152-P	
Edging	34510352	
Profile	34510652	
Frame	34510452	
Frame push open	34510452-P	
Black ash		
Flat	34510142	
Flat push open	34510142-P	
Edging	34510342	
Profile	34510642	
Frame	34510442	
Frame push open	34510442-P	

2A. CHOOSE A WASHBASIN



HAV 100X45
Porcelain. W:102 H:17 D:47

Colour	Order no.
White	5102



DEEP 100X45
Porcelain. W:101 H:6 D:46

Colour	Order no.
White	60100



SEL 100X45
Mineral composite. W:101 H:2 D:46

Colour	Order no.
White matt	34510
Black matt	34610



SELECTED COLOURS
Choose from Flat and Flat push open fronts. Add -COL after the item number. The extra charge amount is based on white furniture.



WASHBASIN MIXER
Go to page 66 to see our washbasin mixers, traps and bottom valves.

HANDLES AND KNOBS
Don't forget to include handles for your furniture. Read more on page 98.

2B. CHOOSE A WORK TOP ¹



SIRIUS 100X45²
Material: Dekton. For free-standing mixers. W: 101 H: 1,2 D: 46.

Direction	Order no.
Centre	371098

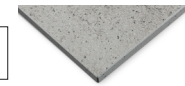

KEON 100X45²
Material: Dekton. For free-standing mixers. W: 101 H: 1,2 D: 46.

Direction	Order no.
Centre	130102

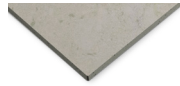

QUARTZ 100X45
Material: Laminate. For free-standing mixers. W: 101 H: 2 D: 46.

Direction	Order no.
Centre	21012

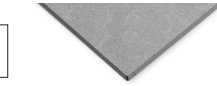

MICA 100X45
Material: Laminate. For free-standing mixers. W: 101 H: 2 D: 46.

Direction	Order no.
Centre	21013

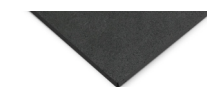

SLATE 100X45
Material: Laminate. For free-standing mixers. W: 101 H: 2 D: 46.

Direction	Order no.	RSK	Price
Centre	21011	8933835	99 999



SIT-ON BASINS
Go to page 123 to see our counter top washbasins.

WORK TOP DETAILS
¹ Dekton work tops always come with a mixer hole on the left. The laminate work tops are reversible. Counter tops come with overhang.
²Delivery time approx 1-4 weeks.

POEM

The Poem furniture range is the most extensive on the market for smaller bathrooms. Choose from two depths, six widths and four different front panel options in five standard colours and three optional colours.

Optional

Performance	Order no.
Lower drawer inserts	5950
Power sockets, Black	98780

CHOOSE LIGHTING

Lighting for Poem 100x45 with two drawers:

Start with a driver kit (1) and choose one upper drawer lighting solution (3), one lower drawer lighting solution (4) and one floor light (2).

If the lighting is connected to the mains supply in your bathroom, use the wall switch to turn your vanity unit light on and off.

Poem 100x45 with 2 drawers



Performance	Order no.
1 Driver kit lighting	5991
2 Lighting open shelf / floor light	5992
3 Top drawer lighting	5993
4 Lighting lower drawer/ 40 cm drawer closed	5994

POEM 120X45

1. CHOOSE A VANITY UNIT

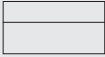
W: 120 H: 57 D: 45	Incl. 2 drawers.	
Front	Order no.	
White		
Flat	34512112	
Flat push open	34512112-P	
Edging	34512312	
Sand		
Flat	34512122	
Flat push open	34512122-P	
Edging	34512322	
Pure oak		
Flat	34512132	
Flat push open	34512132-P	
Edging	34512332	
Brown ash		
Flat	34512152	
Flat push open	34512152-P	
Edging	34512352	
Black ash		
Flat	34512142	
Flat push open	34512142-P	
Edging	34512342	

2A. CHOOSE A WASHBASIN



HAV 120X45
Porcelain. W:122 H:17 D:47

Colour	Order no.
White	51221



SEL 120X45
Mineral composite. W:121 H:2 D:46

Colour	Order no.
White matt	34512-C
Black matt	34612-C

SELECTED COLOURS
Choose from Flat and Flat push open fronts. Add -COL after the item number. The extra charge amount is based on white furniture.



WASHBASIN MIXER
Go to page 66 to see our washbasin mixers, traps and bottom valves.

HANDLES AND KNOBS
Don't forget to include handles for your furniture. Read more on page 98.

2B. CHOOSE A WORK TOP ¹



SIRIUS 120X45²
Material: Dekton. For free-standing mixers. W: 121 H: 1,2 D: 46.

Direction	Order no.
Centre	130130

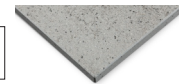

KEON 120X45²
Material: Dekton. For free-standing mixers. W: 121 H: 1,2 D: 46.

Direction	Order no.
Centre	130131

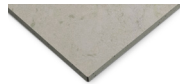

QUARTZ 120X45
Material: Laminate. For free-standing mixers. W: 121 H: 2 D: 46.

Direction	Order no.
Centre	21202-C

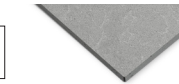

MICA 120X45
Material: Laminate. For free-standing mixers. W: 121 H: 2 D: 46.

Direction	Order no.
Centre	21203-C



SLATE 120X45
Material: Laminate. For free-standing mixers. W: 121 H: 2 D: 46.

Direction	Order no.
Centre	21201-C



SIT-ON BASINS
Go to page 123 to see our counter top washbasins.

WORK TOP DETAILS
¹ Dekton work tops always come with a mixer hole on the left. The laminate work tops are reversible. Counter tops come with overhang.
²Delivery time approx 1-4 weeks.

POEM

The Poem furniture range is the most extensive on the market for smaller bathrooms. Choose from two depths, six widths and four different front panel options in five standard colours and three optional colours.

Optional

Performance	Order no.
Lower drawer inserts	5950
Power sockets, Black	98780

CHOOSE LIGHTING

Lighting for Poem 120x45 with two drawers:-

Start with a driver kit (1) and choose one upper drawer lighting solution (3), one lower drawer lighting solution (4) and one floor light (2).

If the lighting is connected to the mains supply in your bathroom, use the wall switch to turn your vanity unit light on and off.

Poem 120x45 with 2 drawers.



Performance	Order no.
1 Driver kit lighting	5991
2 Lighting open shelf / floor light	5992
3 Top drawer lighting	5993
4 Lighting lower drawer/ 40 cm drawer closed	5994

POEM 120X45 DOUBLE

1. CHOOSE A VANITY UNIT

W: 120 H: 57 D: 45	Incl. 4 drawers	
Front	Order no.	
White		
Flat	34512114	
Flat push open	34512114-P	
Edging	34512314	
Profile	34512614	
Frame	34512414	
Frame push open	34512414-P	
Sand		
Flat	34512124	
Flat push open	34512124-P	
Edging	34512324	
Profile	34512624	
Frame	34512424	
Frame push open	34512424-P	
Pure oak		
Flat	34512134	
Flat push open	34512134-P	
Edging	34512334	
Profile	34512634	
Frame	34512434	
Frame push open	34512434-P	
Brown ash		
Flat	34512154	
Flat push open	34512154-P	
Edging	34512354	
Profile	34512654	
Frame	34512454	
Frame push open	34512454-P	
Black ash		
Flat	34512144	
Flat push open	34512144-P	
Edging	34512344	
Profile	34512644	
Frame	34512444	
Frame push open	34512444-P	

2A. CHOOSE A WASHBASIN

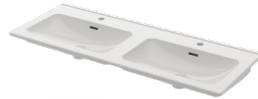

HAV 120X45 DOUBLE
Porcelain. W:122 H:17 D:47

Colour/Direction	Order no.
White/Double	51220-1



WASHBASIN MIXER
Go to page 66 to see our washbasin mixers, traps and bottom valves.



SEL 120X45
Mineral composite. W:121 H:2 D:46

Colour/Direction	Order no.
White matt/Right	34512-H
White matt/Left	34512-V
White matt/Double	34512-D
Black matt/Right	34612-H
Black matt/Left	34612-V
Black matt/Double	34612-D

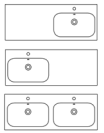

2B. CHOOSE A WORK TOP ¹



SIRIUS 120X45²
Material: Dekton. For free-standing mixers. W: 121 H: 1,2 D: 46.

Direction	Order no.
Right	130122
Left	130121
Double	130123

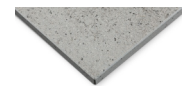

KEON 120X45²
Material: Dekton. For free-standing mixers. W: 121 H: 1,2 D: 46.

Direction	Order no.
Right	130125
Left	130124
Double	130126

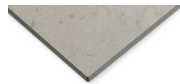

QUARTZ 120X45
Material: Laminate. For free-standing mixers. W: 121 H: 2 D: 46.

Direction	Order no.
Right	21202-H
Left	21202-V
Double	21202-D

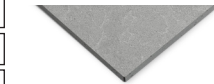

MICA 120X45
Material: Laminate. For free-standing mixers. W: 121 H: 2 D: 46.

Direction	Order no.
Right	21203-H
Left	21203-V
Double	21203-D



SLATE 120X45
Material: Laminate. For free-standing mixers. W: 121 H: 2 D: 46.

Direction	Order no.
Right	21201-H
Left	21201-V
Double	21201-D



SELECTED COLOURS

Choose from Flat and Flat push open fronts. Add -COL after the item number. The extra charge amount is based on white furniture.

SIT-ON BASINS



Go to page 123 to see our counter top washbasins.

HANDLES AND KNOBS

Don't forget to include handles for your furniture. Read more on page 98.

WORK TOP DETAILS

¹ Dekton work tops always come with a mixer hole on the left. The laminate work tops are reversible. Counter tops come with overhang.

²Delivery time approx 1-4 weeks.

POEM

The Poem furniture range is the most extensive on the market for smaller bathrooms. Choose from two depths, six widths and four different front panel options in five standard colours and three optional colours.

Optional

Performance	Order no.
Lower drawer inserts	5950
Power sockets, Black	98780

CHOOSE LIGHTING

Lighting for Poem 120x45 with four drawers:

Start with two driver kits (1) and choose two upper drawer lighting solutions (3), two lower drawer lighting solutions (4) and two floor lights (2).

If the lighting is connected to the mains supply in your bathroom, use the wall switch to turn your vanity unit light on and off.

Poem 120x45 with 4 drawers

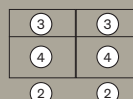

Performance	Order no.
1 Driver kit lighting	5991
2 Lighting open shelf / floor light	5992
3 Top drawer lighting	5993
4 Lighting lower drawer/ 40 cm drawer closed	5994

POEM 160X45

1. CHOOSE A VANITY UNIT

W: 160 H: 57 D: 45	Incl. 4 drawers	
Front	Order no.	
White		
Flat	3451611	
Flat push open	3451611-P	
Edging	3451631	
Profile	3451661	
Frame	3451641	
Frame push open	3451641-P	
Sand		
Flat	3451612	
Flat push open	3451612-P	
Edging	3451632	
Profile	3451662	
Frame	3451642	
Frame push open	3451642-P	
Pure oak		
Flat	3451613	
Flat Push open	3451613-P	
Edging	3451633	
Profile	3451663	
Frame	3451643	
Frame push open	3451643-P	
Brown ash		
Flat	3451615	
Flat push open	3451615-P	
Edging	3451635	
Profile	3451665	
Frame	3451645	
Frame push open	3451645-P	
Black ash		
Flat	3451614	
Flat push open	3451614-P	
Edging	3451634	
Profile	3451664	
Frame	3451644	
Frame push open	3451644-P	

2A. CHOOSE A WASHBASIN



NERBY 160X45 RIGHT/LEFT
Mineral composite. W:161 H: 2 D: 46

Colour/Direction	Order no.
White/Right	5162-H
White/Left	5162-V

SELECTED COLOURS
Choose from Flat and Flat push open fronts. Add -COL after the item number. The extra charge amount is based on white furniture.



WASHBASIN MIXER
Go to page 66 to see our washbasin mixers, traps and bottom valves.

2B. CHOOSE A WORK TOP ¹



SIRIUS 160X45²
Material: Dekton. For free-standing mixers. W: 161 H: 1,2 D: 46.

Direction	Order no.
Right	130134
Left	130133
Double	130135



KEON 160X45²
Material: Dekton. For free-standing mixers. W: 161 H: 1,2 D: 46.

Direction	Order no.
Right	130137
Left	130136
Double	130138



QUARTZ 160X45
Material: Laminate. For free-standing mixers. W: 161 H: 2 D: 46.

Direction	Order no.
Right	21602-H
Left	21602-V
Double	21602-D



MICA 160X45
Material: Laminate. For free-standing mixers. W: 161 H: 2 D: 46.

Direction	Order no.
Right	21603-H
Left	21603-V
Double	21603-D



SLATE 160X45
Material: Laminate. For free-standing mixers. W: 161 H: 2 D: 46.

Direction	Order no.
Right	21601-H
Left	21601-V
Double	21601-D



SIT-ON BASINS
Go to page 123 to see our counter top washbasins.

HANDLES AND KNOBS
Don't forget to include handles for your furniture. Read more on page 98.

WORK TOP DETAILS
¹ Dekton work tops always come with a mixer hole on the left. The laminate work tops are reversible. Counter tops come with overhang. ²Delivery time approx 1-4 weeks.

POEM

The Poem furniture range is the most extensive on the market for smaller bathrooms. Choose from two depths, six widths and four different front panel options in five standard colours and three optional colours.

Optional

Performance	Order no.
Lower drawer inserts	5950
Power sockets, Black	98780

CHOOSE LIGHTING

Lighting for Poem 160x45 with four drawers:
Start with two driver kits (1) and choose two upper drawer lighting solutions (3), two lower drawer lighting solutions (4) and two floor lights (2).
If the lighting is connected to the mains supply in your bathroom, use the wall switch to turn your vanity unit light on and off.

Poem 160x45 with 4 drawers.

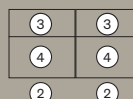

Performance	Order no.
1 Driver kit lighting	5991
2 Lighting open shelf / floor light	5992
3 Top drawer lighting	5993
4 Lighting lower drawer/ 40 cm drawer closed	5994

BLOC

With its carefully-selected and affordable product combinations, it's easy to choose some great options with this furniture range.

With a hard-wearing surface and a limited number of carefully-selected options, we have made it easier for you to create a smaller or medium-sized bathroom. The result will be a bathroom truly designed to last.



A CAREFULLY CONSIDERED BATHROOM

Design

Furniture on a simpler scale.

Flexibility

Carefully selected product combinations in white or grey. For small to medium-sized bathrooms.

Functionality

A washbasin with a large filling volume. Soft-closing hinges. Simple installation.

Quality

Durable melamine finish. Made in Sweden and sold with a 20-year warranty.

Sustainability

Wood sourced from responsible and sustainable forestry providers. Can be uninstalled and recycled.

STANDARD

Soft-closing hinges

Bloc doors come with soft-closing hinges. Choose between one and two doors.

COLOURS

Bloc comes in two colours – white and grey.



White



Grey



OPTIONS

Bloc mirror cabinets

To create a cohesive look in your bathroom, add a Bloc mirror cabinet. Available in the same colours as our Bloc furniture range.

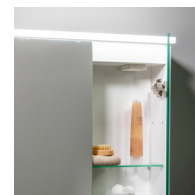

Mixers

Don't forget to include mixers for your vanity unit. We offer mixers adapted to suit the simpler, smaller look of our Bloc range.

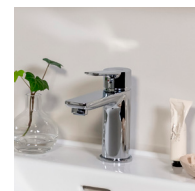

Tived mirror

Our Tived mirror is adapted and dimensioned to work perfectly with the Bloc range.

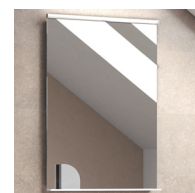

Trap

The Easy Clean trap includes a hose and bottom valve in chrome, white or black matt. Alternatively, a standard trap with hose is also a good choice.



Discover the whole Bloc range

BLOCS CHOICES

45 cm



W: 45
H: 57
D: 25



50 cm



W: 45
H: 57
D: 35



50 cm



W: 50
H: 57
D: 35



55 cm

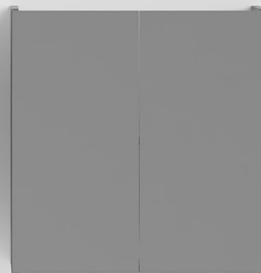

W: 55
H: 57
D: 35





60 cm





W: 60
H: 57
D: 35



BLOC - 1 DOOR

	W: 45 H: 57 D: 25	45X25 Incl. 1 door.		Order no.
White				
1 door	545211			
Grey				
1 door	545221			

	W: 45 H: 57 D: 35	45X35 Incl. 1 door.		Order no.
White				
1 door	545111			
Grey				
1 door	545121			



WASHBASIN MIXER
Go to page 66 to see our washbasin mixers, traps and bottom valves.

2. CHOOSE A WASHBASIN

		
	SKAPA 45X25 W:46 H:8,5 D:31	SKAPA 45X35 W:46 H:8,5 D:41
Colour	Order no.	Order no.
White	37045	37345







HANDLES AND KNOBS
Don't forget to include handles for your furniture. Read more on page 98.





BLOC MIRROR CABINET
Choose the Bloc mirror cabinet with or without washbasin lighting. For more information, see page 80.

BLOC - 2 DOORS

	W: 50 H: 57 D: 35	50X35 Incl. 2 doors.		Order no.
White				
2 doors	550112	555112	560112	
Grey				
2 doors	550122	555122	560122	

	W: 55 H: 57 D: 35	55X35 Incl. 2 doors.		Order no.
White				
2 doors	550112	555112	560112	
Grey				
2 doors	550122	555122	560122	

	W: 60 H: 57 D: 35	60X35 Incl. 2 doors.		Order no.
White				
2 doors	550112	555112	560112	
Grey				
2 doors	550122	555122	560122	

2. CHOOSE A WASHBASIN

			
	SKAPA 50X35 W:51 H:8,5 D:41	SKAPA 55X35 W:56 H:8,5 D:41	SKAPA 60X35 W:61 H:8,5 D:41
Colour	Order no.	Order no.	Order no.
White	37350	37355	37360

FIND OUT MORE ABOUT BLOC

With the Bloc furniture range, it's easy to choose. Carefully selected and affordable product combinations for small to medium-sized bathrooms. Choose between two different depths, four different widths and a washbasin cupboard with one or two doors.

ALWAYS INCLUDED

1. Soft-closing hinges
2. Quick to install
3. Durable melamine finish
4. Washbasin with large filling volume
5. Delivered ready-assembled

BLOC ACCESSORIES

Performance	Order no.
Water trap EasyClean Chrome	1214
Water trap EasyClean White	1224
Water trap incl. hose	8988

INTRO

Ideal if you want an intro to something new. A furniture range with a timeless, clean design. Characterised by practical grip holes and straight lines.

Intro stands up to tough wear without compromising on design or function. Intro is made of galvanised sheet metal, using our unique EnduraDry method. This combination provides an exceptionally tight and durable surface finish. The result is a furniture range that will withstand the test of time.



A DURABLE BATHROOM

Design

Clean lines and pared-back design, with a focus on practical considerations.

Flexibility

Robust, solid and durable, with a drawer or door in four optional colours. For small to medium-sized bathrooms.

Functionality

Washbasin with large filling volume. Grip holes that are easy to keep clean.

Quality

Galvanised sheet metal. EnduraDry coating process for extreme durability. Made in Sweden and sold with a 20-year warranty.

Sustainability

Extra long lifespan. Awarded the highest rating for durability by RISE Research Institutes of Sweden.



STANDARD

Integrated handle

Integrated handle in the form of a punched hole. The handle is both practical and hard wearing, as well as being easy to keep clean.

Soft-closing hinge and drawer

The Intro door with soft-closing hinges and Intro drawer with soft-closing drawer rail and full extension (the drawer can be pulled out to its full length).

COLOURS

Intro comes in four colours: white, graphite grey, sand and sage.

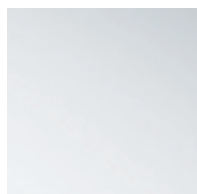

White

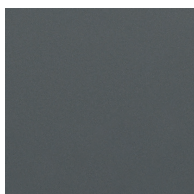

Graphite grey

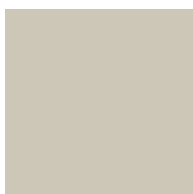

Sand



Sage

OPTIONS

Intro mirror cabinet

Complement your furniture with Intro mirror cabinets. Colour matched with the Intro furniture series.

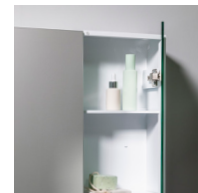

Trap

The Easy Clean trap includes a hose and bottom valve in chrome, white or black matt. Alternatively, a standard trap with hose is also a good choice.



Mixers

Don't forget to include a mixer for your vanity unit.



Enamel bathtub

Complement your furniture with our enamel bathtub. Available in the same colours as the furniture.



Discover the whole Intro range

INTRO CHOICES

45 cm



W: 45
H: 50
D: 35



50 cm

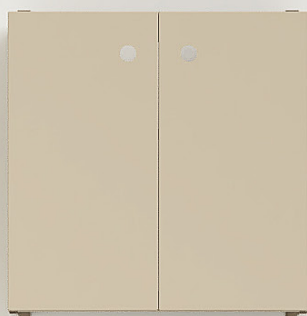

W: 50
H: 50
D: 35



55 cm



W: 55
H: 50
D: 35



W: 50
H: 50
D: 35



W: 55
H: 50
D: 35



INTRO

1. CHOOSE A VANITY UNIT

Front	W: 45 H: 50 D: 35 Metal cabinet. Incl. 2 doors W:45 H:50 D:35	W: 50 H: 50 D: 35 Metal cabinet. Incl. 2 doors W:50 H:50 D:35	W: 55 H: 50 D: 35 Metal cabinet. Incl. 2 doors W:55 H:50 D:35
White matt			
2 doors, Integrated handle	294045	294050	294055
Graphite grey			
2 doors, Integrated handle	294245	294250	294255
Sand			
2 doors, Integrated handle	294345	294350	294355
Sage			
2 doors, Integrated handle	294545	294550	294555
Front	W: 50 H: 50 D: 35 Metal cabinet. Incl. 2 drawers W:50 H:50 D:35	W: 55 H: 50 D: 35 Metal cabinet. Incl. 2 drawers W:55 H:50 D:35	
White matt			
2 drawers, Integrated handle	-	294450	
Graphite grey			
2 drawers, Integrated handle	-	294650	
Sand			
2 drawers, Integrated handle	-	294750	
Sage			
2 drawers, Integrated handle	-	294850	

2. CHOOSE A WASHBASIN

Colour	Order no.	Order no.	Order no.
White	37345	37350	37355



WASHBASIN MIXER
Go to page 66 to see our washbasin mixers, traps and bottom valves.

FIND OUT MORE ABOUT INTRO

1. Ready-prepared for connection to water and sewage pipes.
2. With environmentally friendly rustproofing and coatings
3. Choose your preferred trap
4. Made in Sweden

ALWAYS INCLUDED

1. Door/drawer with integrated grip hole
2. Soft-closing hinges
3. Delivered ready-assembled
4. 20 years guarantee

INTRO ACCESSORIES

Performance	Order no.
Water trap EasyClean Chrome	1214
Water trap EasyClean White	1224
Water trap EasyClean Black matt	1222
Water trap incl. hose	8988

INTEGRATED WASHBASINS

Our washbasins are both the crowning glory of our bathrooms and a combination of design and functionality in beautiful harmony.

The almost seamless integration between the bathroom furniture elements offers an elegant, cohesive look. Choose colours and looks and add in a mixer for a great overall look.





ISE

Mineral composite
H: 1,3
D: 46
Compatible with Epos.



Width	Direction	Colour	Order no.
60	Centre	White matt	5060
	Centre	Ash grey	5061
80	Centre	White matt	5080
	Centre	Ash grey	5180
100	Right	White matt	5100-H
	Left	White matt	5100-V
	Right	Ash grey	5101-H
	Left	Ash grey	5101-V
120	Right	White matt	5120-H
	Left	White matt	5120-V
	Right	Ash grey	5121-H
	Left	Ash grey	5121-V
160	Double	White matt	5160-D
	Double	Ash grey	5161-D

FLOEN

Porcelain
H: 1,5
D: 46
Compatible with Epos.



Width	Direction	Colour	Order no.
60	Centre	White	5360
80	Centre	White	5380

SEL

Mineral composite
H: 2
D: 46
Works well with the Poem furniture range with a depth of 45 cm.

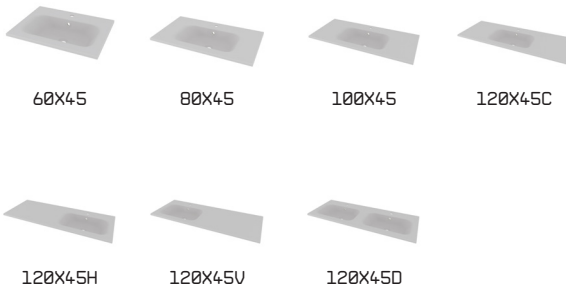

Width	Direction	Colour	Order no.
60	Centre	White matt	34560
	Centre	Black matt	34660
80	Centre	White matt	34580
	Centre	Black matt	34680
100	Centre	White matt	34510
	Centre	Black matt	34610
120	Centre	White matt	34512-C
	Right	White matt	34512-H
	Left	White matt	34512-V
	Double	White matt	34512-D
	Centre	Black matt	34612-C
	Right	Black matt	34612-H
	Left	Black matt	34612-V
	Double	Black matt	34612-D

HAU 45

Porcelain
H: 1,7
D: 47
Works well with the Poem furniture range with a depth of 45 cm.



Width	Direction	Colour	Order no.
60	Centre	White	5062
80	Centre	White	5082
100	Centre	White	5102
120	Centre	White	51221
	Double	White	51220-1

NERBY

Mineral composite
H: 1,7
D: 46
Suitable for the Poem 160x45 furniture range.



Width	Direction	Colour	Order no.
160	Right	White	5162-H
	Left	White	5162-V

DEEP

Porcelain
H: 6
D: 46
Works well with the Poem furniture range with a depth of 45 cm.



Width	Direction	Colour	Order no.
60	Centre	White	6060
80	Centre	White	6080
100	Centre	White	60100

HAV 35

Porcelain
H: 1,7
D: 36,5
Works well with the Poem furniture range with a depth of 35 cm.



Width	Direction	Colour	Order no.
50	Centre	White	5053
60	Centre	White	5063
80	Centre	White	5083

SKAPA 35

Porcelain
H: 8,5
D: 41
Works well with the Poem, Intro and Bloc furniture ranges with a depth of 35 cm. For bolt or bracket mounting.



Width	Direction	Colour	Order no.
45	Centre	White	37345
50	Centre	White	37350
55	Centre	White	37355
60	Centre	White	37360
80	Centre	White	37380

MUNKA

Mineral composite
H: 1,5
D: 36
Works well with the Poem furniture range with a depth of 35 cm.



Width	Direction	Colour	Order no.
50	Centre	White	52510
60	Centre	White	52610
80	Centre	White	52810

SKAPA 25

Porcelain
H: 8,5
D: 31
Works well with the Bloc furniture range with a depth of 25 cm. For bracket mounting.



Width	Direction	Colour	Order no.
45	Centre	White	37045

Console for washbasin

2 pcs.

Depth	Colour	Order no.
25	White	90030
35	White	9003

Bolt for porcelain washbasins

Colour	Order no.
	90901



SIT-ON BASINS
Go to page 62 to see our counter top washbasins.



WASHBASIN MIXER
Go to page 66 to see our washbasin mixers, traps and bottom valves.

SIT-ON BASINS

Our sit-on basins make for a beautiful feature in your bathroom.

They boost the design and create a more decorative look. Choose colours and styles and add in a mixer for a great overall look.



Sit-on
basins

MYRE STRIPE ROUND

Ø36 Porcelain.
Ø36 H: 12

Colour	Order no.
White	5346

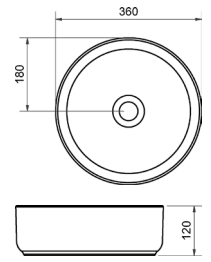

MYRE ROUND

Ø36 Porcelain.
Ø36 H: 12

Colour	Order no.
White	5336
Latte	5337
Mocha	5338
Anthracite	5339

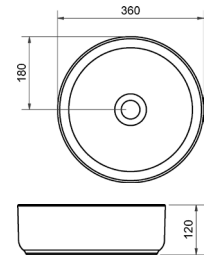

MYRE RECTANGULAR

50×36 Porcelain.
W: 50 H: 12 D:36

Colour	Order no.
White	5353
Latte	5354
Mocha	5355
Anthracite	5356

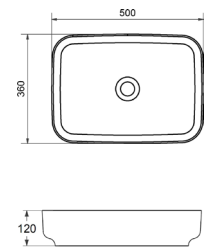

FROSS ROUND

Ø40 Solid Surface.
Ø40 H: 12

Colour	Order no.
White matt	2440
Black matt	8440

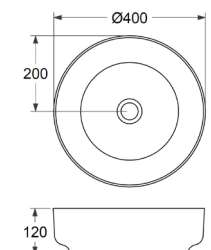

FROSS RECTANGULAR

55×35, Solid Surface. W: 55 H: 12 D: 35
Solid Surface display shelf available as an accessory.

Options	Colour	Order no.
Washbasin	White matt	2455
Shelf	White matt	2441
Washbasin	Black matt	8455
Shelf	Black matt	8441



Shelf for Fross rectangular.

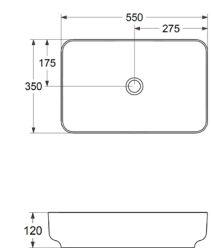

STORA ROUND

Ø40 Sheet metal.
Ø40 H: 12

Colour	Order no.
Brushed brass	5440
Pencil black	5441

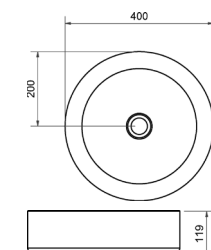

WORK TOPS

A work top needs to do more than just look good and fit in with the rest of the bathroom. It should also have features that will help it stand the test of time.

Dekton offers scratch, stain and UV resistance. Laminate is durable and allows for flexible mixer placement.



LAMINATE WORK TOPS

Durable laminate work tops. Laminate work tops in sizes 60×45, 80×45, 100×45, 120×45 centre and double, and 160×45 double are reversible, which means you can choose whether to have the mixer hole on the right or left. All other sizes feature the mixer hole on the left. Supplied with an overhang. For free-standing washbasin mixers.

LAMINATE – POEM

Laminate work tops		QUARTZ For Poem H:2 D:46	MICA For Poem H:2 D:46	SLATE For Poem H:2 D:46
Width	Direction	Order no.	Order no.	Order no.
60	Centre	20602	20603	20601
80	Centre	20802	20803	20801
100	Centre	21012	21013	21011
120	Centre	21202-C	21203-C	21201-C
	Right	21202-H	21203-H	21201-H
	Left	21202-V	21203-V	21201-V
	Double	21202-D	21203-D	21201-D
160	Right	21602-H	21603-H	21601-H
	Left	21602-V	21603-V	21601-V
	Double	21602-D	21603-D	21601-D

QUARTZ

Thanks to its grey, sand-coloured background, it creates a warm, inviting atmosphere. A real all-rounder.

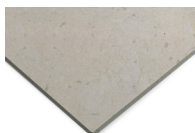

MICA

The discreet dark grey works well with calming, warm browns and dark woods.

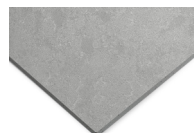

SLATE

Clean and genuine. A simple colour that is dark and intense. Works best with a matt finish and wood patterns.



DEKTON COUNTER TOPS

The work tops are made of Dekton, an exceptionally hard, scratch-resistant material that is more resistant to bending than granite. The material is UV-resistant, which makes the surface easy to clean and prevents fading. Choose from Keon, Danae, Laurent, Sirius and Rem. Dekton worktops always feature a mixer hole on the left. The worktops have an overhang. For free-standing washbasin mixers.

DEKTON – POEM

Dekton counter tops		SIRIUS For Poem H:1,2 D:46	KEON For Poem H:1,2 D:46
Width	Direction	Order no.	Order no.
60	Centre	370699	130062
80	Centre	370899	130082
100	Centre ¹	371098	130102
120	Centre ¹	130130	130131
	Right ¹	130122	130125
	Left ¹	130121	130124
	Double ¹	130123	130126
160	Right ¹	130134	130137
	Left ¹	130133	130136
	Double ¹	130135	130138

DANAE

Has a sand-coloured limestone look.



KEON

Has a grey industrial look.



DEKTON – EPOS

Dekton counter tops		REM ² For Epos H:1,2 D:46	SIRIUS ² For Epos H:1,2 D:46
Width	Direction	Order no.	Order no.
60	Centre	145063	370699
80	Centre	145083	370899
100	Right	145101	146101
	Left	145100	146100
120	Right	145121	146121
	Left	145120	146120
160	Right	145161	146161
	Left	145160	146160
	Double	145162	146162
200	Right	145201	146201
	Left	145200	146200
	Double	145202	146202

LAURENT

Has a dark background with gold marbling.



REM

Has a relaxing marble look with a light background and through-coloured edge.



SIRIUS

Has a matt black slate look.



Dekton counter tops		DANAE ¹ For Epos H:1,2 D:46	KEON ¹ For Epos H:1,2 D:46	LAURENT ¹ For Epos H:1,2 D:46
Width	Direction	Order no.	Order no.	Order no.
60	Centre	144063	130062	143063
80	Centre	144083	130082	143083
100	Right	144101	141101	143101
	Left	144100	141100	143100
120	Right	144121	141121	143121
	Left	144120	141120	143120
160	Right	144161	141161	143161
	Left	144160	141160	143160
	Double	144162	141162	143162
200	Right	144201	141201	143201
	Left	144200	141200	143200
	Double	144202	141202	143202

DELIVERY TIMES
¹Delivery time approx 1-4 weeks. ²Special counter top. Delivery time 7-8 weeks.

WASHBASIN MIXER

While mixers used to just be mixers, today they are so much more – offering everything from water-saving features to design statements.

Of course it's important for design to look good, but don't forget about practicality. Consider choosing functions that make life easier, more comfortable or more environmentally friendly.



MIXERS FOR ALL TASTES AND STYLES

Design

Our washbasin mixers go perfectly with our furniture and are available in colours to complement the rest of the range.

Flexibility

Selected models that work well with Svedbergs' other ranges. With a wide variety of appearances, from standard to design.

Functionality

Easy to install, flexible hoses included with swivel nuts.

Quality

Our mixers are type approved and certified for our markets. Our control units are tested with 70,000 opening and closing cycles, ensuring a long service life.

Sustainability

We use approved brass and offer cold start and flow control features.



SMART FUNCTIONS

—

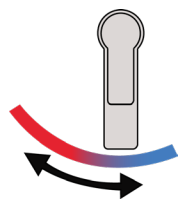

Cold start

Cold start is an energy-saving function that reduces unnecessary hot water use, saving up to 40% of the hot water that would otherwise be used in one year.



Flow controller

All of our mixers are fitted with flow controllers. They are limited to 5–6 L/min, meaning that you save 33–44% of the water you would use with a standard flow.



Warranty

All our washbasin mixers come with material warranties of up to five years.



Discover our washbasin mixers



TRON

Incl. flexible connection hose with swivel nuts (G3/8") to facilitate installation. Easy installation, tools included and connection hoses ready-fitted.

Cold start
Flow controller 5 L/min
Operating pressure: Up to 10 bar
Noise class 1
Energy class A, 1,3 kWh

Colour	Order no.
Chrome	96830



TARJU

Incl. flexible connection hose with swivel nuts (G3/8") to facilitate installation. Easy installation, tools included and connection hoses ready-fitted.

Cold start
Flow controller 5 L/min
Operating pressure: Up to 10 bar
Energy class A, 1,3 kWh
Noise class 1

Colour	Order no.
Chrome	96736
Pencil black	96738
Black matt	96737



HALDE

Incl. flexible connection hose with swivel nuts (G3/8") to facilitate installation. Easy installation, tools included and connection hoses ready-fitted.

Cold start
Flow controller 5 L/min
Operating pressure: Up to 10 bar
Energy class A, 1,3 kWh

Colour	Order no.
Chrome	96816
Brushed brass	96834
Pencil black	96881
Black matt	96817



HALDE WITH HAND SHOWER

Incl. flexible connection hose with swivel nuts (G3/8") to facilitate installation. Easy installation, tools included and connection hoses ready-fitted.

Flow controller 5 L/min
Operating pressure: Up to 10 bar
Noise class 1

Colour	Order no.
Chrome	96876
Black matt	96877



VETLE

Incl. flexible connection hose with swivel nuts (G3/8") to facilitate installation. Easy installation, tools included and connection hoses ready-fitted.

Cold start
Flow controller 5 L/min
Operating pressure: Up to 10 bar
Energy class A, 1,3 kWh
Noise class 1

Colour	Order no.
Chrome	96733
Pencil black	96735
Black matt	96734



LODAL

Incl. flexible connection hose with swivel nuts (G3/8") to facilitate installation. Easy installation, tools included and connection hoses ready-fitted.

Cold start
Flow controller 5 L/min
Operating pressure: Up to 10 bar

Colour	Order no.
Chrome	96730
Pencil black	96732
Black matt	96731



SKULE SMOOTH

Incl. flexible connection hose with swivel nuts (G1/2") to facilitate installation. Easy installation, tools included.

Flow controller 6,5 L/min
Operating pressure: Up to 10 bar

Colour	Order no.
Chrome	96811
Brushed brass	96844
Pencil black	96845
Black matt	96814



SKULE KNURLED

Incl. flexible connection hose with swivel nuts (G1/2") to facilitate installation. Easy installation, tools included.

Flow controller 6,5 L/min
Operating pressure: Up to 10 bar

Colour	Order no.
Chrome	96823
Brushed brass	96840
Pencil black	96841
Black matt	96824



EJER

Incl. flexible connection hose with swivel nuts (G1/2") to facilitate installation. Easy installation, tools included.

Flow controller 5 L/min
Operating pressure: Up to 10 bar
Noise class 1

Colour	Order no.
Chrome	96827
Brushed brass	96829
Pencil black	96906
Black matt	96828



BOLD

Incl. flexible connection hose with swivel nuts (G1/2") to facilitate installation. Easy installation, tools included.

Flow controller 4,5 L/min
Operating pressure: Up to 10 bar

Colour	Order no.
Chrome	96825
Black matt	96826



HALDE INDEPENDENT

Incl. flexible connection hose with swivel nuts (G3/8") to facilitate installation. Easy installation, tools included and connection hoses ready-fitted.

Cold start
Flow controller 5 L/min
Operating pressure: Up to 10 bar
Energy class A, 1,3 kWh

Colour	Order no.
Chrome	96816-H
Brushed brass	96837-H
Pencil black	96881-H
Black matt	96817-H



FREE-STANDING HALDE WITH HAND SHOWER

Incl. flexible connection hose with swivel nuts (G3/8") to facilitate installation. Easy installation, tools included and connection hoses ready-fitted.

Flow controller 5 L/min
Operating pressure: Up to 10 bar
Noise class 1

Colour	Order no.
Chrome	96876-H
Black matt	96877-H



SKULE INDEPENDENT SMOOTH

Incl. flexible connection hose with swivel nuts (G1/2") to facilitate installation. Easy installation, tools included.

Flow controller 6,5 L/min
Operating pressure: Up to 10 bar

Colour	Order no.
Chrome	96811-H
Brushed brass	96844-H
Pencil black	96845-H
Black matt	96814-H



SKULE INDEPENDENT KNURLED

Incl. flexible connection hose with swivel nuts (G1/2") to facilitate installation. Easy installation, tools included.

Flow controller 6 L/min
Operating pressure: Up to 10 bar

Colour	Order no.
Chrome	96823-H
Brushed brass	96840-H
Pencil black	96841-H
Black matt	96824-H



EJER INDEPENDENT

Incl. flexible connection hose with swivel nuts (G1/2") to facilitate installation. Easy installation, tools included.

Flow controller 5 L/min
Operating pressure: Up to 10 bar
Noise class 1

Colour	Order no.
Chrome	96827-H
Brushed brass	96829-H
Pencil black	96906-H
Black matt	96828-H



TRAP INCL . HOSE

EasyClean. Complete the look with a pop-up waste

Colour	Order no.
Chrome	1214
White	1224
Black matt	1222



POP-UP WASTE

Made entirely of metal. Works well with a trap.

Colour	Order no.
Chrome	98813
Brushed brass	96872
Pencil black	96871

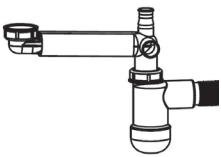

TRAP INCL . HOSE

Colour	Order no.
White	8988

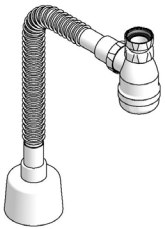

TRAP INCL . HOSE

Colour	Order no.
White	8989

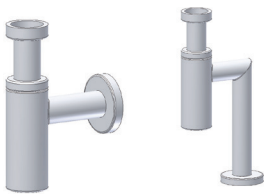

WASTE KIT INCL TRAP

Chrome plated waste cover available for the console and wall hung basins. Wall fixed and floor fixture

Performance	Order no.
For waste to floor	99027
For waste to wall	99026

MIRRORS

Find a mirror that suits the style of your bathroom and also has the functions you need.

The right mirror can make a small bathroom look bigger. Use different balances of cool and warm light to create the perfect atmosphere.



ISTA

Mirror with functional lighting featuring touch-controlled brightness and colour temperature adjustment. The lighting is dimmable and the light temperature can be adjusted to an optimal level, whether it's for makeup or mood lighting.



ISTA

Frosted lighting
Touch function
Kelvin: 2700-6400
IP44
H:80 D:2,9

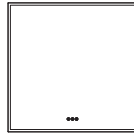

Width	Watt	Lumen	Order no.
50	28,2	846	453050
60	49,1	1385	453060
80	57,1	1560	453080
100	64,8	1815	453100
120	68,4	1915	453120

ISTA WITH BLACK FRAME

Frosted lighting
Touch function
Kelvin: 2700-6400
IP44
H:80 D:3,6

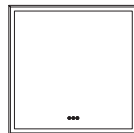

Width	Watt	Lumen	Order no.
60	46,4	720	451060
80	54,7	805	451080
100	61	950	451100
120	67	1065	451120

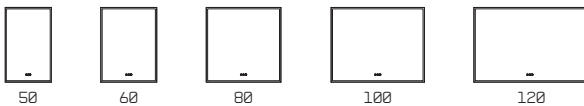

ISTA ROUND

Frosted lighting
Touch function
Kelvin: 2700-6400
IP44
D:2,9

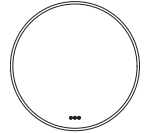

Width	Watt	Lumen	Order no.
60	43,1	1025	454060
80	58,9	1355	454080
100	67,9	1720	454100

ISTA ROUND WITH BLACK FRAME

Frosted lighting
Touch function
Kelvin: 2700-6400
IP44
D:3,2

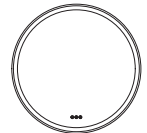

Width	Watt	Lumen	Order no.
60	39,3	610	458060
80	55,8	870	458080
100	65,6	1015	458100

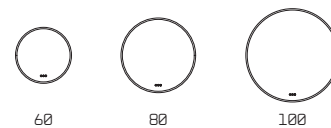

CHOOSE PENDANT LIGHTING

CYLINDER

Black fabric cord 2,5 m.
IP44
E27 Max 40W. Light not included.
Ø6 H:22



Colour	Order no.
White matt	7521
Black matt	7520
Brushed brass	7522
Pendant attachment	
Cable cup 1 pendant	7579
Wall mounting 1-3 pendants	7578
Ceiling mounting 3 pendants	7577

GLOBE

Black fabric cord 2,5 m.
IP44
E14 Max 25W. Light not included.
Ø15

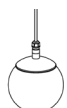

Colour	Order no.
Opal	7523
Smoky	7524
Pendant attachment	
Cable cup 1 pendant	7579
Wall mounting 1-3 pendants	7578
Ceiling mounting 3 pendants	7577

VALJE

Mirror with atmospheric background lighting. Choose from a full range of options to find the perfect size and shape for your bathroom, from square or rectangular to round. Add lighting to the rectangular mirrors or a standalone pendant light.

VALJE

LED light source behind the mirror
Kelvin: 3000
IP44
H:80 D:2,9



Width	Watt	Lumen	Order no.
60	25,2	440	356060
80	29,3	500	356080
100	32	560	356100
120	35,7	620	356120

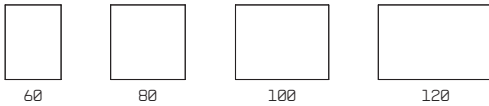

LIGHTING VALJE

Mirror lighting for rectangular Valje
Kelvin: 3000
IP44
H:7 D:6,7



Width	Watt	Lumen	Order no.
60	38,1	325	3160
80	46,7	440	3180
100	53,6	510	3110
120	61,5	610	3112

VALJE OVAL

LED light source behind the mirror
Kelvin: 3000
IP44
W:45 D:2,5



Height	Watt	Lumen	Order no.
90	15,3	382	359044
110	22,3	415	359045

CHOOSE PENDANT LIGHTING

CYLINDER

Black fabric cord 2,5 m.
IP44
E27 Max 40W. Light bulb not included.
Ø6 H:22



Colour	Order no.
White matt	7521
Black matt	7520
Brushed brass	7522
Pendant attachment	
Cable cup 1 pendant	7579
Wall mounting 1-3 pendants	7578
Ceiling mounting 3 pendants	7577

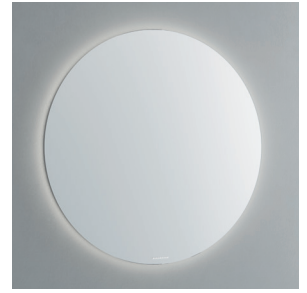

VALJE ROUND

LED light source behind the mirror
Kelvin 3000
IP44
D:2,9

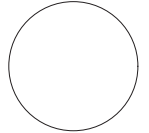

Width	Watt	Lumen	Order no.
60	15	305	358060
80	20	395	358080
100	26,5	525	358100

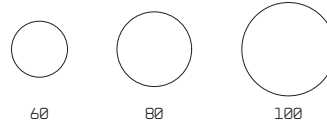

VALJE ROUND DOUBLE

LED light source behind the mirror
Kelvin: 3000
IP44
W:119,9 H:89,74 D:3,4

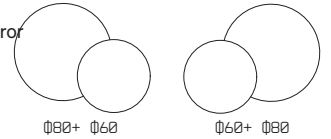

Width	Watt	Lumen	Order no.
Ø80+ Ø60	25,1	480	359112
Ø60+ Ø80	25,1	480	359212

VALJE ROUNDED

LED light source behind the mirror. Only for counter tops. Can not be combined with free-standing Skule. Kelvin: 2700-6400
IP44
H:112 D:2,9

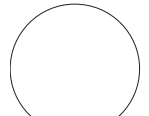

Width	Watt	Lumen	Order no.
120	30,5	580	359120

GLOBE

Black fabric cord 2,5 m.
IP44
E14 Max 25W. Light bulb not included. Ø15

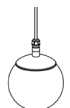

Colour	Order no.
Opal	7523
Smoky	7524
Pendant attachment	
Cable cup 1 pendant	7579
Wall mounting 1-3 pendants	7578
Ceiling mounting 3 pendants	7577

TIVED

A classic flat mirror available in three versions and many different widths. Choose a mirror without lighting, with overhead lighting, or with overhead lighting and basin lighting (the light shines down onto the basin). You can also add a shelf and a standalone LED light fixture.



TIVED

Light source LED
Kelvin: 3400
IP44
H:80 D:3,5 (With lighting H:82 D:6)



Without light

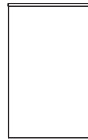

With lighting

Width	Performance	Watt	Lumen	Order no.
45	Without lighting	-	-	766450
	LED lighting	7,84	570	226045
	LED + Washbasin lighting	11,14	770	226045-TL
50	Without lighting	-	-	766500
	LED lighting	8,96	670	226050
	LED + Washbasin lighting	12,26	870	226050-TL
55	Without lighting	-	-	766550
	LED lighting	10	720	226055
	LED + Washbasin lighting	13,3	920	226055-TL
60	Without lighting	-	-	766600
	LED lighting	12,3	800	226060
	LED + Washbasin lighting	15,6	1000	226060-TL
80	Without lighting	-	-	766800
	LED lighting	14,7	1080	226080
	LED + Washbasin lighting	18	1280	226080-TL
100	Without lighting	-	-	766100
	LED lighting	18	1360	226100
	LED + Washbasin lighting	21,3	1560	226100-TL

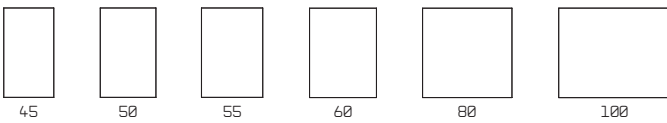

TIVED SHELF

Mounted at the bottom of the Tived mirror. Not for washbasin lighting.



Width	Colour	Order no.
45	White matt	3446
	Black matt	3445
50	White matt	3451
	Black matt	3450
55	White matt	3456
	Black matt	3455
60	White matt	3461
	Black matt	3460
80	White matt	3481
	Black matt	3480
100	White matt	3411
	Black matt	3410

LED-LAMP 30

Light source LED: 240 lm
System Effect: 5W.
IP44. Kelvin 3000
W:30



Colour	Order no.
Chrome	7330
Black matt	7337

LED-LAMP 50

Light source LED: 240 lm
System Effect: 5W.
IP44. Kelvin 3000.
W:50



Colour	Order no.
Chrome	7350
Black matt	7357

MIRROR CABINETS

We could be said to be the inventor of the mirror cabinet. Back in the 1960s, we launched the classic mirror cabinet that still lives on today.

Today, the choice is much greater and the details are more sophisticated. The storage solutions are also more carefully designed and have many smart functions.



Mirror
cabinets

SKURU

A clean, minimalist style that creates an exclusive atmosphere in your bathroom. This is largely due to the LED lighting, which has a knob for steplessly adjusting the colour temperature and brightness. An electrical socket, basin lighting and a smart magnet for holding small objects such as tweezers are included. Coated using our unique DuraDry method.



White Sand Pure oak White ash Brown ash Black ash



SAREK

A practical bathroom cabinet, only 12 cm deep. Flexible and practical with two moveable glass shelves and an electrical socket in the cabinet ceiling. Energy-efficient LED lighting included, with the option of adding basin lighting. Coated using our unique DuraDry method.



White Sand Pure oak Brown ash Black ash



BLOC

A practical bathroom cabinet, only 12 cm deep. Flexible and practical with two moveable glass shelves and an electrical socket in the cabinet ceiling. Energy-efficient LED lighting included, with the option of adding basin lighting.



White Grey



INTRO

Hard-wearing mirror cabinet made of galvanised sheet metal, a material originally designed for the automotive industry. Our unique EnduraDry coating with an environmentally friendly zinc-iron alloy provides excellent protection against rust.



White Graphite grey Sand Salvie



SKURU

A clean, minimalist style that creates an exclusive atmosphere in your bathroom. This is largely due to the LED lighting, which has a knob for steplessly adjusting the colour temperature and brightness. An electrical socket, basin lighting and a smart magnet for holding small objects such as tweezers are included. Coated using our unique DuraDry method.



SKURU 80

Upper lighting LED: 530-600 lm
 Lower lighting LED: 250-300 lm
 System Effect: 18,9W.
 Kelvin: 2,700-6,400.
 IP44.
 Electrical socket 230 V
 W:80 H:72 D:19

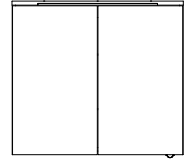

Colour	Order no.
White	425080
Sand	422080
Pure oak	421080
White ash	429080
Brown ash	426080
Black ash	423080

SKURU 50

Upper lighting LED: 320-350 lm
 Lower lighting LED: 170-200 lm
 System Effect: 11,9W.
 Kelvin: 2,700-6,400.
 IP44.
 Electrical socket 230 V
 W:50 H:72 D:19



Colour	Order no.
White	425050
Sand	422050
Pure oak	421050
Black ash	423050
Brown ash	426050

SKURU 100

Upper lighting LED: 530-600 lm
 Lower lighting LED: 250-300 lm
 System Effect: 18,9W.
 Kelvin: 2,700-6,400.
 IP44.
 Electrical socket 230 V
 W:100 H:72 D:19

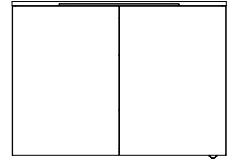

Colour	Order no.
White	425100
Sand	422100
Pure oak	421100
White ash	429100
Brown ash	426100
Black ash	423100

SKURU 60

Upper lighting LED: 530-600 lm
 Lower lighting LED: 250-300 lm
 System Effect: 18,9W.
 Kelvin: 2,700-6,400.
 IP44.
 Electrical socket 230 V
 W:60 H:72 D:19

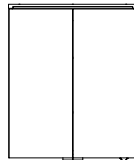

Colour	Order no.
White	425060
Sand	422060
Pure oak	421060
White ash	429060
Brown ash	426060
Black ash	423060

SKURU 120

Upper lighting LED: 2*530-600 lm
 Lower lighting LED: 2*250-300 lm
 System Effect: 37,3W.
 Kelvin: 2,700-6,400.
 IP44.
 Electrical socket 230 V
 W:120 H:72 D:19

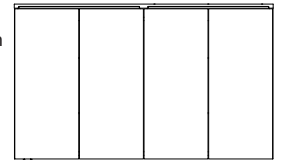

Colour	Order no.
White	425120
Sand	422120
Pure oak	421120
White ash	429120
Brown ash	426120
Black ash	423120

GOOD TO KNOW

Residual current circuit breaker
 To order a residual current circuit breaker, add -JFB after the item number.

Selected colours
 Add -COL after the item number. The extra charge is based on the price of the white furniture versions.

FIND OUT MORE ABOUT SKURU

1. Dimmable colour temperature (2,700- 6,400 K)
2. EasyMount hanging system for fast, simple, safe wall mounting of mirror cabinets
3. Made in Sweden and delivered pre-assembled with a 20-year warranty.

ALWAYS INCLUDED

1. Energy-effective soft, dimmable lighting
2. Knob on cabinet to control the lighting
3. Electrical socket in upper right corner of cabinet, can be changed to left on installation
4. Duradry coating process

SAREK

A practical bathroom cabinet, only 12 cm deep. Flexible and practical with two moveable glass shelves and an electrical socket in the cabinet ceiling. Energy-efficient LED lighting included, with the option of adding basin lighting. Coated using our unique DuraDry method.

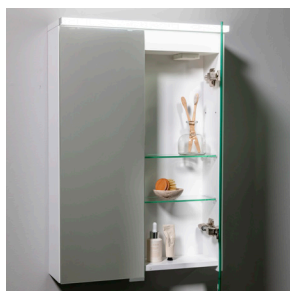

SAREK 50

Upper lighting LED: 670 lm
(Lower lighting LED: 200 lm)
System Effect: 8,96W (12,26W).
Kelvin: 3,400.
IP44.
Electrical socket 230 V
W:50 H:72 D:15

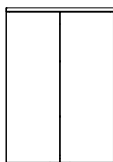

Colour	Options	Order no.
White		225050
White	Washbasin lighting	225050-TL
Sand		222050
Sand	Washbasin lighting	222050-TL
Pure oak		221050
Pure oak	Washbasin lighting	221050-TL
Brown ash		229050
Brown ash	Washbasin lighting	229050-TL
Black ash		223050
Black ash	Washbasin lighting	223050-TL

() = With washbasin lighting

SAREK 55

Upper lighting LED 720 lm
(Lower lighting LED: 200 lm)
System Effect: 10W (13,3W).
Kelvin: 3,400.
IP44.
Electrical socket 230 V
W:55 H:72 D:15

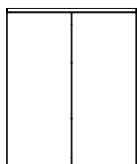

Colour	Options	Order no.
White		225055
White	Washbasin lighting	225055-TL

() = With washbasin lighting

SAREK 60

Upper lighting LED: 800 lm
(Lower lighting LED: 200 lm)
System Effect: 12,3W (15,6W).
Kelvin: 3,400.
IP44.
Electrical socket 230 V
W:60 H:72 D:15

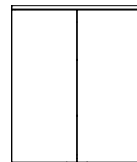

Colour	Options	Order no.
White		225060
White	Washbasin lighting	225060-TL
Sand		222060
Sand	Washbasin lighting	222060-TL
Pure oak		221060
Pure oak	Washbasin lighting	221060-TL
Brown ash		229060
Brown ash	Washbasin lighting	229060-TL
Black ash		223060
Black ash	Washbasin lighting	223060-TL

() = With washbasin lighting

SAREK 80

Upper lighting LED: 1080 lm
(Lower lighting LED: 200 lm)
System Effect: 14,7W (18W).
Kelvin: 3,400.
IP44.
Electrical socket 230 V
W:80 H:72 D:15

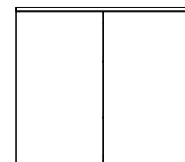

Colour	Options	Order no.
White		225080
White	Washbasin lighting	225080-TL
Sand		222080
Sand	Washbasin lighting	222080-TL
Pure oak		221080
Pure oak	Washbasin lighting	221080-TL
Brown ash		229080
Brown ash	Washbasin lighting	229080-TL
Black ash		223080
Black ash	Washbasin lighting	223080-TL

() = With washbasin lighting

GOOD TO KNOW

Residual current circuit breaker
To order a residual current circuit breaker, add -JFB after the item number.

Selected colours
Add -COL after the item number. The extra charge is based on the price of the white furniture versions.

FIND OUT MORE ABOUT SAREK

1. Space-saving mirror cabinet with depth of 12 cm
2. EasyMount hanging system for fast, simple, safe wall mounting of mirror cabinets
3. Made in Sweden and delivered pre-assembled with a 20-year warranty.

ALWAYS INCLUDED

1. Energy-effective LED lighting 3,400 K
2. Two moveable toughened glass shelves
3. Electrical socket in cabinet ceiling
4. Duradry coating process

BLOC

A practical bathroom cabinet, only 12 cm deep. Flexible and practical with two moveable glass shelves and an electrical socket in the cabinet ceiling. Energy-efficient LED lighting included, with the option of adding basin lighting.

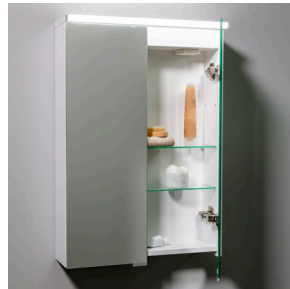
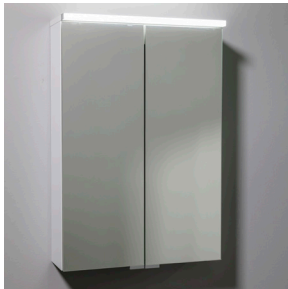

BLOC 45

Upper lighting LED: 570 lm
(Lower lighting LED: 200 lm)
System Effect: 7,84W (11,14W).
Kelvin: 3,400.
IP44.
Electrical socket 230 V
W:45 H:72 D:15



Colour	Options	Order no.
White		25451
White	Washbasin lighting	25451-TL
Grey		25452
Grey	Washbasin lighting	25452-TL

() = With washbasin lighting

BLOC 55

Upper lighting LED: 720 lm
(Lower lighting LED: 200 lm)
System Effect: 10W (13,3W).
Kelvin: 3,400.
IP44.
Electrical socket 230 V
W:55 H:72 D:15

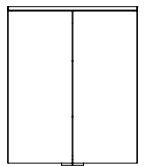

Colour	Options	Order no.
White		25551
White	Washbasin lighting	25551-TL
Grey		25552
Grey	Washbasin lighting	25552-TL

() = With washbasin lighting

BLOC 50

Upper lighting LED 670 lm
(Lower lighting LED: 200 lm)
System Effect: 8,96W (12,26W).
Kelvin: 3,400.
IP44.
Electrical socket 230 V
W:50 H:72 D:15

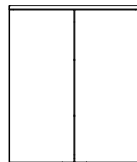

Colour	Options	Order no.
White		25501
White	Washbasin lighting	25501-TL
Grey		25502
Grey	Washbasin lighting	25502-TL

() = With washbasin lighting

BLOC 60

Upper lighting LED: 800 lm
(Lower lighting LED: 200 lm)
System Effect: 12,3W (15,6W).
Kelvin: 3,400.
IP44.
Electrical socket 230 V
W:60 H:72 D:15

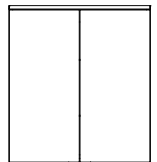

Colour	Options	Order no.
White		25601
White	Washbasin lighting	25601-TL
Grey		25602
Grey	Washbasin lighting	25602-TL

() = With washbasin lighting

GOOD TO KNOW

Residual current circuit breaker
To order a residual current circuit breaker, add -JFB after the item number.

FIND OUT MORE ABOUT BLOC

1. Space-saving mirror cabinet with depth of 12 cm
2. EasyMount hanging system for fast, simple, safe wall mounting of mirror cabinets
3. Made in Sweden and delivered pre-assembled with a 20-year warranty.

ALWAYS INCLUDED

1. Energy-effective LED lighting 3,400 K
2. Two moveable toughened glass shelves
3. Electrical socket in cabinet ceiling
4. Durable melamine finish

DALBY

Dalby mirror cabinet with solid reflective glass on the inside and outside. The mirror cabinet has two moveable glass shelves and is available in widths of 40, 55 and 60 cm. Add an optional electrical socket. Mirror cabinet without lighting.

DALBY 55

Without lighting.
W:55 H:70 D:15

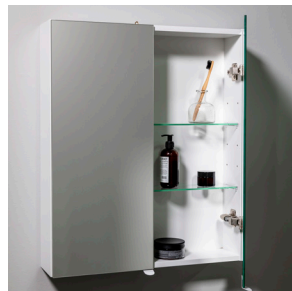
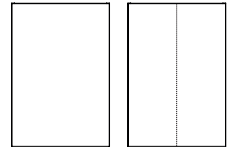

Colour	Options	Order no.
White	1 door	26055
White	2 doors	26056

DALBY 40

Without lighting.
W:40 H:70 D:15

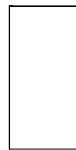

DALBY 60

Without lighting.
W:60 H:70 D:15

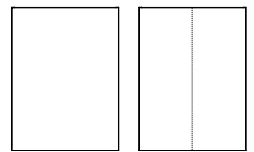

Colour	Options	Order no.
White	1 door	26040

Colour	Options	Order no.
White	1 door	26060
White	2 doors	26061

CHOOSE ACCESSORIES

DOVRE 55

Light source LED 1602 lm
System Effect: 18,6W.
Kelvin: 3000. IP44.
W:55



DOVRE 60

Light source LED: 1650 lm
Systemeffekt: 20W.
Kelvin: 3000. IP44.
W:60



DOVRE ELECTRICAL SOCKET

230 V

Colour	Order no.
White matt	70856

Colour	Order no.
White matt	70862

Colour	Order no.
White	7999

LED-LAMP 30

Light source LED: 240 lm
System Effect: 5W.
IP44
W:30



LED-LAMP 50

Light source LED 240 lm
System Effect: 5W.
IP44
W:50



Colour	Order no.
Chrome	7330
Black matt	7337

Colour	Order no.
Chrome	7350
Black matt	7357

FLATTERY
MAGNIFYING MIRROR 
5x magnification
15 cm diameter

Order no.
7095

A60

Wooden bathroom cabinet
Sliding doors in reflective glass
Without lighting.
W:60 H:52 D:12,5

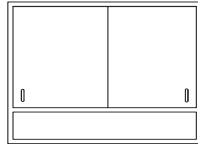

Colour	Order no.
White	7000

A65

Wooden bathroom cabinet
Sliding doors in reflective glass
Without lighting.
W:65 H:52 D:12,5

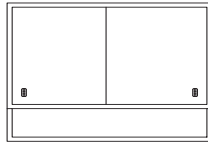

Colour	Order no.
White	90

CHOOSE ACCESSORIES

LED LIGHTING 60

Light source LED: 2800 lm
System Effect: 17,8W.
IP44. White.
W:60 H:7 D:20

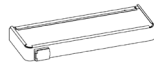

Power sockets/R/L	Residual current circuit breaker	Order no.
No	No	376040
Yes/Right	No*	376041
Yes/Left	No*	376042
Yes/Right	Yes	376043
Yes/Left	Yes	376044

LED LIGHTING 65

Light source LED: 2800 lm
System Effect: 17,8W.
IP44. White.
W:65 H:7 D:20

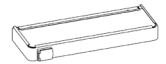

Power sockets/R/L	Residual current circuit breaker	Order no.
No	No	376540
Yes/Right	No*	376541
Yes/Left	No*	376542
Yes/Right	Yes	376543
Yes/Left	Yes	376544

LED-LAMP 30

Light source LED: 240 lm
System Effect: 5W.
IP44
W:30



Colour	Order no.
Chrome	7330
Black matt	7337

LED-LAMP 50

Light source LED: 240 lm
System Effect: 5W.
IP44
W:50



Colour	Order no.
Chrome	7350
Black matt	7357

FLATTERY
MAGNIFYING MIRROR
5x magnification
15 cm diameter



Order no.
7095

INTRO

Hard-wearing mirror cabinet made of galvanised sheet metal, a material originally designed for the automotive industry. Our unique EnduraDry coating with an environmentally friendly zinc-iron alloy provides excellent protection against rust.



INTRO 50
Without lighting.
W:50 H:67 D:13,5

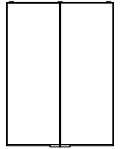

Colour	Order no.
White matt	295050
Graphite grey	295250
Sand	295350
Sage	295550

INTRO 50 KIT
Light source LED 1450 lm
System Effect: 18,2W
Electrical socket 230 V
W:50 H:70 D:15

Colour	Order no.
White matt	295052
Graphite grey	295252

INTRO 45
Without lighting.
W:45 H:67 D:13,5

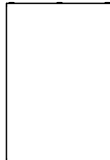

Colour	Order no.
White matt	295045
Graphite grey	295245
Sand	295345
Sage	295545

INTRO 45 KIT
Light source LED: 1297 lm
System Effect: 15,8W
Electrical socket 230 V
W:45 H:70 D:15

Colour	Order no.
White matt	295047
Graphite grey	295247

INTRO 55
Without lighting.
W:55 H:67 D:13,5

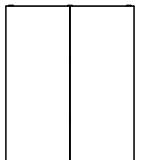

Colour	Order no.
White matt	295055
Graphite grey	295255
Sand	295355
Sage	295555

INTRO 55 KIT
Light source LED: 1,602 lm
System Effect: 18,2W
Electrical socket 230 V
W:55 H:70 D:15

Colour	Order no.
White matt	295057
Graphite grey	295257

CHOOSE ACCESSORIES (Lighting and electrical socket included in the Intro Kit.)

DOVRE 45
Light source LED: 1297 lm
System Effect: 15,8W.
Kelvin: 3000. IP44.
W:45



Colour	Order no.
White matt	70846
Graphite grey	70847

DOVRE 50
Light source LED: 1450 lm
System Effect: 18,2W.
Kelvin: 3000. IP44.
W:50



Colour	Order no.
White matt	70851
Graphite grey	70852

DOVRE 55
Light source LED: 1602 lm
System Effect: 18,6W.
Kelvin: 3000. IP44.
W:55



Colour	Order no.
White matt	70856
Graphite grey	70857

DOVRE ELECTRICAL SOCKET
230 V

Colour	Order no.
White	7999

**FLATTERY
MAGNIFYING MIRROR**
5x magnification
15 cm diameter



Order no.
7095

NY50

Metal cabinet
 Door with reflective glass
 Without lighting.
 W:40 H:50 D:14

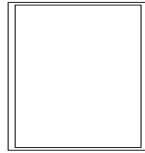

Colour	Order no.
White	310

BIRDIE

Metal cabinet
 Left- or right-hinged
 Without lighting.
 W:40 H:70 D:13,5

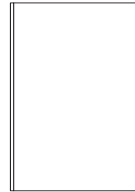

Colour	Order no.
White	320

MEDICINE CABINET

Left- or right-hinged
 Child-proof
 Two keys
 W:36,5 H:49,5 D:16

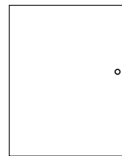

Colour	Order no.
White	38

CHOOSE ACCESSORIES

LED LIGHTING 40

Light source LED: 1,400 lm
 System Effect: 10W.
 IP44. White.
 W:40 H:7 D:20

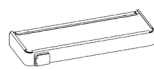

Power sockets/R/L	Residual current circuit breaker	Order no.
No	No	374040
Yes/Right	No*	374041
Yes/Left	No*	374042

FLATTERY
 MAGNIFYING MIRROR
 5x magnification
 15 cm diameter



Order no.
7095

I:ET

Metal cabinet
Sliding doors in reflective glass
Without lighting.
W:55 H:70 D:12,5

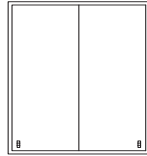

Colour	Order no.
White	339

EAGLE

Metal cabinet
Solid mirror doors
Without lighting.
W:55 H:70 D:14,5

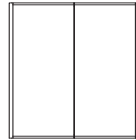

Colour	Order no.
White	325

TVILLING 1

Metal cabinet
Sliding doors in reflective glass
Without lighting.
W:65 H:39,5 D:12,5



Colour	Order no.
White	13

CHOOSE ACCESSORIES

LED LIGHTING 55

Light source LED: 2,800 lm
System Effect: 17,8W.
IP44. White.
W:55 H:7 D:20

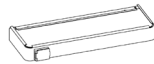

Power sockets/R/L	Residual current circuit breaker	Order no.
No	No	375540
Yes/Right	No*	375541
Yes/Left	No*	375542
Yes/Right	Yes	375543
Yes/Left	Yes	375544

LED LIGHTING 65

Light source LED: 2,800 lm
System Effect: 17,8W.
IP44. White.
W:65 H:7 D:20

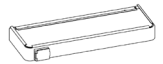

Power sockets/R/L	Residual current circuit breaker	Order no.
No	No	376540
Yes/Right	No*	376541
Yes/Left	No*	376542
Yes/Right	Yes	376543
Yes/Left	Yes	376544

DOVRE 55

Light source LED: 1,602 lm
System Effect: 18,6W.
Kelvin: 3000. IP44.
W:55



Colour	Order no.
White matt	70856

FLATTERY
MAGNIFYING MIRROR
5x magnification
15 cm diameter



Order no.
7095

STORAGE

Modern design with a focus on function and smart solutions. Create an organised bathroom in which every detail has been carefully considered.

Everyone's talking about keeping things organised. It sounds easy but it's more tricky in practice. A good starting point is having the right storage solutions. And now they're available. More than ever before. And in a colour and finish to complement your bathroom.



CREATE YOUR PERFECT BATHROOM

Design

A modern look for a timeless feel, focusing on craftsmanship and real wood veneer.

Flexibility

Choose from a range of widths, heights and configurations, with open storage solutions also available.

Functionality

Soft-closing hinges. Heat-resistant sheet metal and integrated electric sockets for a charging station.

Quality

Real wood veneer. Duradry coating process for extra durability. Manufactured in Sweden and provided with a 20-year warranty.

Sustainability

Wood sourced from responsible and sustainable forestry providers. Can be uninstalled and recycled.



OPTIONS

Charging station

Once you've had a charging station in your bathroom unit, you'll never look back. For your mobile phone, shaver or hair curler.



Drawers

Pull-out drawers provide an easy overview of the contents.



Lighting in cabinet

Having lighting in your cabinet is both welcoming and practical. Practical because it makes your things easier to find.

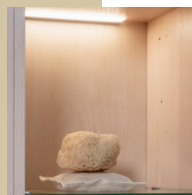

Floor light

Lighting both inside and under the cabinets is practical and looks attractive and cosy.



Glass shelves

Glass shelves in your cabinet add a luxurious touch. They're also practical, giving you a better view of the contents.



Open storage

Our tall storage units can easily be supplemented with open side storage to increase their total width.



Laundry basket

Our practical laundry basket is easy to lift out and carry to the washing machine.



Handle

The right handles can enhance the character and style of your bathroom.

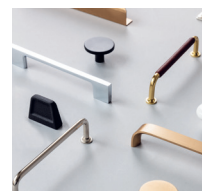

Discover all our storage

Wall cabinet

Tall cabinet



Wall cabinet

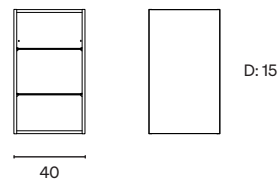
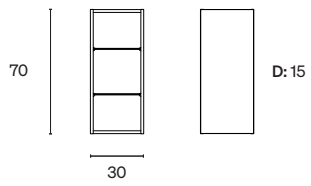

Tall cabinet

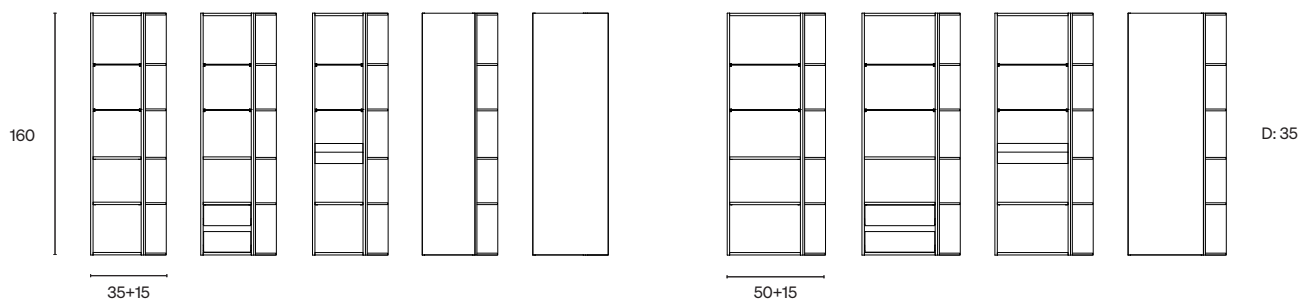
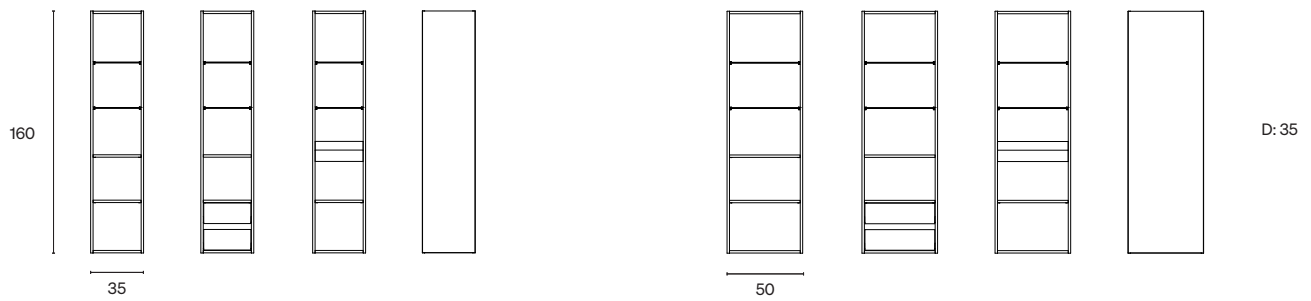
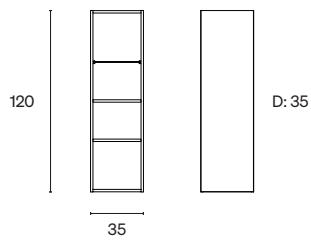

COLOURS

With six standard colours and three optional colours, it's easy to find your favourite. Our optional colours can only be chosen for the Flat front.

Standard colours



White



Sand



Pure oak

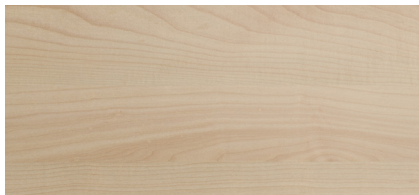

White ash

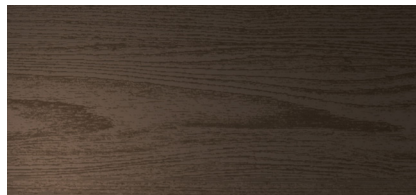

Brown ash

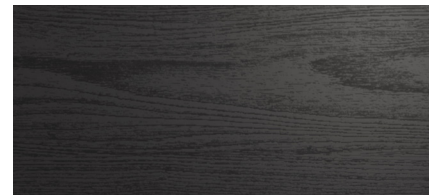

Black ash

Optional colours

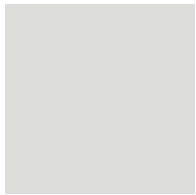

Oat



Salvie



Granite

DOORS

Seven doors to create different feels for different bathrooms. Choose between wooden and glass doors. Find the right style for you by choosing between a push open system or handles.

Flat

A flat door for a stylish look.
Available in standard and optional colours.



Glass cabinet matt aluminium

Display door with matt aluminium profile. Available with clear glass, smoked glass and line glass.





Glass cabinet black matt

Glass door with black matt profile. Available with clear glass, smoked glass and line glass.



WALL CABINET 30		Wall cabinet 70×30 Incl. 2 glass shelves. W: 30 H: 70 D: 15
Performance	Order no.	
White		
Carcase	770301	
Door	770301-1	
Sand		
Carcase	770309	
Door	770309-1	
Pure oak		
Carcase	770307	
Door	770307-1	
White ash		
Carcase	770305	
Door	770305-1	
Brown ash		
Carcase	770306	
Door	770306-1	
Black ash		
Carcase	770308	
Door	770308-1	

WALL CABINET 40		Wall cabinet 70×40 Incl. 2 glass shelves. W: 40 H: 70 D: 13
Performance	Order no.	
White		
Carcase	770401	
Door	770401-1	
Sand		
Carcase	770409	
Door	770409-1	
Pure oak		
Carcase	770407	
Door	770407-1	
White ash		
Carcase	770405	
Door	770405-1	
Brown ash		
Carcase	770406	
Door	770406-1	
Black ash		
Carcase	770408	
Door	770408-1	

TALL CABINET 120		Tall cabinet 120×35 Incl. 2 wooded shelves and 1 glass shelf. W: 35 H: 120 D: 33
Performance	Order no.	
White		
Carcase	7120351	
Top shelf	75135	
Charging station	72351	
Drawer	74351	
Door	7120351-1	
Sand		
Carcase	7120359	
Top shelf	75439	
Charging station	72359	
Drawer ²	74359	
Door	7120359-1	
Pure oak		
Carcase	7120357	
Top shelf	75437	
Charging station	72357	
Drawer ²	74357	
Door	7120357-1	
White ash		
Carcase	7120355	
Top shelf	75535	
Charging station	72355	
Drawer ²	74355	
Door	7120355-1	
Brown ash		
Carcase	7120356	
Top shelf	75635	
Charging station	72356	
Drawer ²	74356	
Door	7120356-1	
Black ash		
Carcase	7120358	
Top shelf	75438	
Charging station	72358	
Drawer ²	74358	
Door	7120358-1	

OPTIONAL

More accessories for your tall cabinet

Tall cabinet 120×35

Performance	Order no.
2 glass shelves.	70335
Low laundry basket. H: 26,5	72535
Tall laundry basket. H: 50	74135
Push-open White ²	12741
Push-open Black ²	12742

CHOOSE LIGHTING

Lighting for tall cabinets with wooden doors:

Start with a driver kit (1) and lighting in the cabinet (3) and a floor light (2).

3

Lighting for tall cabinets with display doors:

Start with a driver kit (1) and choose two floor lights (2), with one to be placed under the tall cabinet and the other inside the cabinet.

2

If the lighting is connected to the mains supply in your bathroom, use the wall switch to turn the tall cabinet light on and off.

Performance	Order no.
1 Driver kit lighting	5991
2 Floor light ³	5992
3 Lighting in cabinet ³	5994

SELECTED COLOURS

Add -COL after the item number. The extra charge is based on the price for white furniture. Frame, door and open storage. Other accessories are not available in Svedbergs' selected colour collection.

HANDLES AND KNOBS

Don't forget to include handles for your furniture. Read more on page 98.

DETAILS

²Not for glass cabinets.



³3W. 3000K.

DISPLAY DOOR FOR TALL CABINETS 120

120×35

Profile	Order no.
Matt aluminium/Clear glass	7120351-3
Matt aluminium/Smoked glass	7120353-3
Matt aluminium/Line glass	7120352-3
Black matt/Clear glass	7120354-3
Black matt/Smoked glass	7120356-3
Black matt/Line glass	7120355-3

Medicine cabinet		Child-proof cabinet, supplied with two keys. Two shelves. Hinges can be mounted on the right or left. W: 36,5 H: 16 D: 49,5
Colour	Order no.	
White	38	

TALL CABINET 160		Tall cabinet 160x35 Incl.2 wooded shelves and 2 glass shelves. W: 35 H: 160 D: 33		Tall cabinet 160x50 Incl.2 wooded shelves and 2 glass shelves. W: 50 H: 160 D: 33
Performance	Order no.		Order no.	
White				
Carcase	7160351		7160501	
Open storage	70601		70601	
Charging station	72351		72501	
Drawer	74351		74501	
Door 35	7160351-1		-	
Door 50 ¹	7160501-1		7160501-1	
Sand				
Carcase	7160359		7160509	
Open storage	70609		70609	
Charging station	72359		72509	
Drawer ²	74359		74509	
Door 35	7160359-1		-	
Door 50 ¹	7160509-1		7160509-1	
Pure oak				
Carcase	7160357		7160507	
Open storage	70607		70607	
Charging station	72357		72507	
Drawer ²	74357		74507	
Door 35	7160357-1		-	
Door 50 ¹	7160507-1		7160507-1	
White ash				
Carcase	7160355		7160505	
Open storage	70605		70605	
Charging station	72355		72505	
Drawer ²	74355		74505	
Door 35	7160355-1		-	
Door 50 ¹	7160505-1		7160505-1	
Brown ash				
Carcase	7160356		7160506	
Open storage	70606		70606	
Charging station	72356		72506	
Drawer ²	74356		74506	
Door 35	7160356-1		-	
Door 50 ¹	7160506-1		7160506-1	
Black ash				
Carcase	7160358		7160508	
Open storage	70608		70608	
Charging station	72358		72508	
Drawer ²	74358		74508	
Door 35	7160358-1		-	
Door 50 ¹	7160508-1		7160508-1	

DISPLAY DOOR FOR TALL CABINETS 160

	160x35	160x50
Profile	Order no.	Order no.
Matt aluminium/Clear glass	7160351-3	7160501-3
Matt aluminium/Smoked glass	7160353-3	7160503-3
Matt aluminium/Line glass	7160352-3	7160502-3
Black matt/Clear glass	7160354-3	7160504-3
Black matt/Smoked glass	7160356-3	7160506-3
Black matt/Line glass	7160355-3	7160505-3

CREATE YOUR PERFECT BATHROOM

Modules and combinations of the storage solutions we offer.

Tall cabinet 160x35



Carcase
+ Door 35



Carcase
+ Open storage
+ Door 35



Carcase
+ Open storage
+ Door 50

Tall cabinet 160x50



Carcase
+ Door 50



Carcase
+ Open storage
+ Door 50

OPTIONAL

More accessories for your tall cabinet

Tall cabinet 160x35

Performance	Order no.
2 glass shelves.	70335
Low laundry basket. H: 26,5	72535
Tall laundry basket. H: 50	74135
Push-open White 2	12741
Push-open Black 2	12742

Tall cabinet 160x50

Performance	Order no.
2 glass shelves.	70350
Low laundry basket. H: 26,5	72550
Tall laundry basket. H: 50	74150
Push-open White 2	12741
Push-open Black 2	12742

CHOOSE LIGHTING

Lighting for tall cabinets with wooden doors:

Start with a driver kit (1) and lighting in the cabinet (3) and a floor light (2).

Lighting for tall cabinets with display doors: Start with a driver kit (1) and choose two floor lights (2), with one to be placed under the tall cabinet and the other inside the cabinet.

If the lighting is connected to the mains supply in your bathroom, use the wall switch to turn the tall cabinet light on and off.



Performance	Order no.
1 Driver kit lighting	5991
2 Floor light ³	5992
3 Lighting in cabinet ³	5994

SELECTED COLOURS

Add -COL after the item number. The extra charge is based on the price for white furniture. Frame, door and open storage. Other accessories are not available in Svedbergs' selected colour collection.

HANDLES AND KNOBS

Don't forget to include handles for your furniture. Read more on page 98.

DETAILS

¹ Door 50 can also be used with tall cabinet 160x30 with open storage, to make a tall cabinet with a semi-open side shelf.

² Not for glass cabinets.

³ 3W. 3000K.

WASHERS & DRYERS

A space for creating order in your day-to-day, with smart functions to make daily life easier.

Our range offers all kinds of combination options, smart solutions and inserts. Create a personal feel and overall concept with colour matching using our furniture ranges.



A LAUNDRY ROOM FULL OF POSSIBILITIES

Design

Practical, simple and stylish, for a timeless, artisan look with real wood veneer.

Flexibility

A wide variety of combinations are available to create your personal layout. Made-to-measure work tops.

Functionality

Smart accessories and decor. Built in using decor panels and recess pieces.

Quality

Real wood veneer. Duradry coating process for extra durability. Manufactured in Sweden and provided with a 20-year warranty. Durable work tops.

Sustainability

Wood sourced from responsible and sustainable forestry providers. Can be uninstalled and recycled.



OPTIONS

Fittings for cleaning cabinets

Smart extras for our tall cabinets. Available in chrome with the following measurements W: 34 H: 85 D: 13.

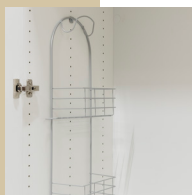

Electrical box

Electrical box with three electrical sockets for tall cabinets. A smart accessory certain to come in useful. Available in white.



Vacuum cleaner hose holder

Complement your tall cabinet with a chrome vacuum cleaner hose holder. Available in the following dimensions W: 29.5 H: 25.5 D: 10.



Support legs

Support legs for both wall and tall cabinets. Available in two heights: 10 and 15 cm.



Laundry basket

A practical laundry basket that fits perfectly in a laundry cupboard. The baskets come in three sizes – 40, 50 and 60 cm – and are easy to remove from the cabinet and take to the washing machine.



Wooded shelf

Two wooden shelves to pair perfectly with your tall cabinet. Available in widths of 40 and 60 cm.



Decor panels

Decor panels for matching framing of white goods and cabinets. Available in white, sand, pure oak, brown ash and black ash.



Lighting

If the lighting is connected to the mains supply in your bathroom, we would recommend floor lighting and lighting inside the cabinets. Don't forget a driver kit.



Discover our
Wash & Dry
range

Wall cabinet

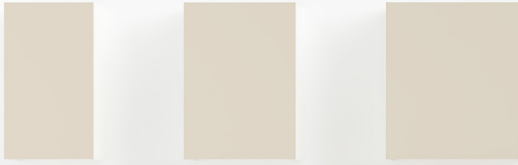

Tall cabinet

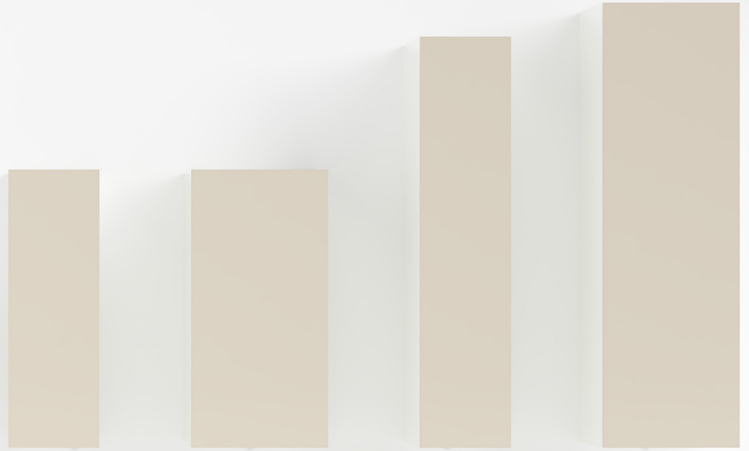

Console

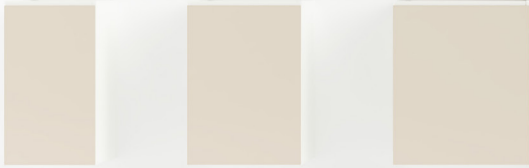

Wall cabinet

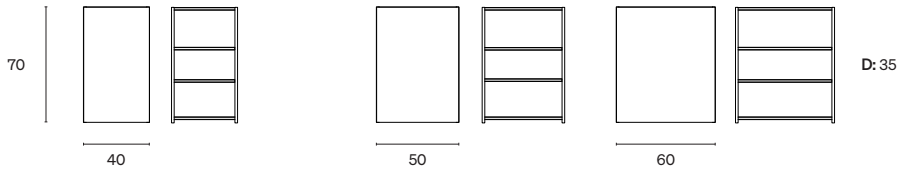

Console

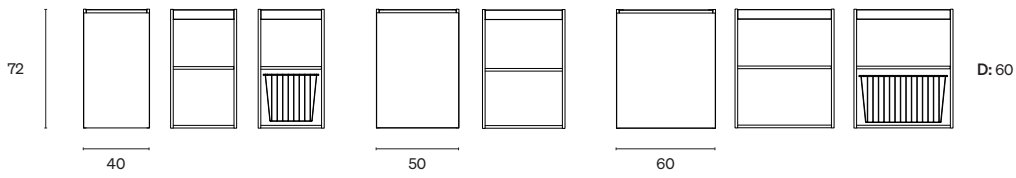

Tall cabinet

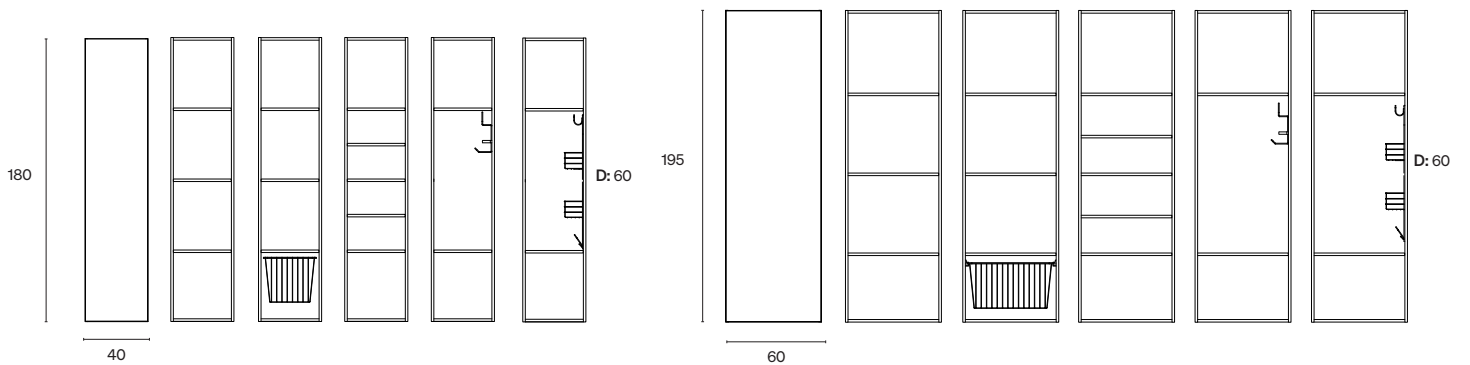
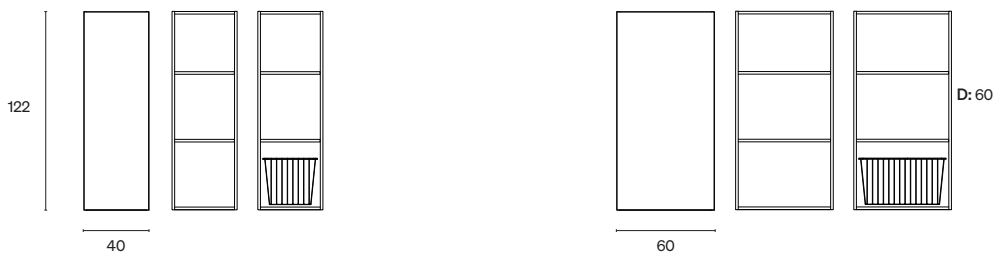

COLOURS AND WORK TOPS

In our Washers & Dryers concept, you can choose from six standard colours and three optional colours. This makes it easy to find a colour that works for you and also matches your bathroom. You can also choose from seven laminate work tops.

Standard colours



White



Sand



Pure oak

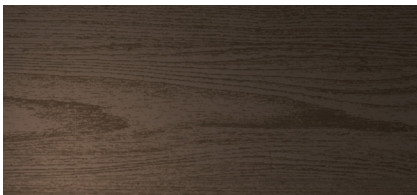

Brown ash

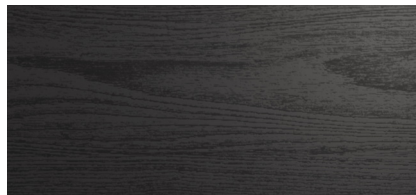

Black ash

Optional colours

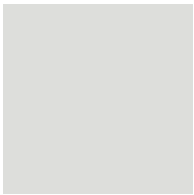

Oat



Sage

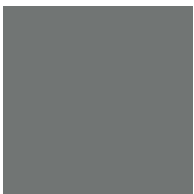

Granite

Worktops

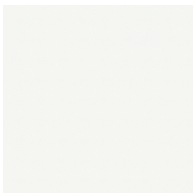

White

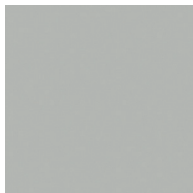

Grey



Dark grey



Black



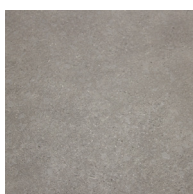

Quartz



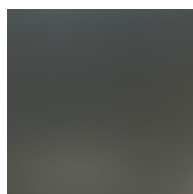

Mica



Slate

WALL CABINET WASHERS & DRYERS		Wall cabinet 70×40 White carcass incl. 2 wooded shelves. W: 40 H: 68 D: 33		Wall cabinet 70×50 White carcass incl. 2 wooded shelves. W: 50 H: 68 D: 33		Wall cabinet 70×60 White carcass incl. 2 wooded shelves. W: 60 H: 68 D: 33
Performance	Colour	Order no.	Order no.	Order no.	Order no.	Order no.
Carcass	White	7270421	7270521	7270621	7270421	7270521
Door	White	770401-1	7270501-1	7270601-1	770401-1	7270501-1
Door	Sand	770409-1	7270509-1	7270609-1	770409-1	7270509-1
Door	Pure oak	770407-1	7270507-1	7270607-1	770407-1	7270507-1
Door	Brown ash	770406-1	7270506-1	7270606-1	770406-1	7270506-1
Door	Black ash	770408-1	7270508-1	7270608-1	770408-1	7270508-1

DECOR PANEL WALL CABINET	W: 35 H: 70 D: 1,2	RECESS PIECE WALL CABINET	W: 20 H: 70 D: 1,6
Colour	Order no.	Colour	Order no.
White	712811	White	712911
Sand	712874	Sand	712877
Pure oak	712864	Pure oak	712867
Brown ash	712869	Brown ash	712872
Black ash	712819	Black ash	712830

CONSOLE WASHERS & DRYERS		Console 72×40 White carcass incl. 1 wooded shelf. W: 40 H: 72 D: 58		Console 72×50 White carcass incl. 1 wooded shelf. W: 50 H: 72 D: 58		Console 72×60 White carcass incl. 1 wooded shelf. W: 60 H: 72 D: 58
Performance	Colour	Order no.	Order no.	Order no.	Order no.	Order no.
Carcass	White	7272401	7272501	7272601	7272401	7272501
Door	White	770401-1	7270501-1	7270601-1	770401-1	7270501-1
Door	Sand	770409-1	7270509-1	7270609-1	770409-1	7270509-1
Door	Pure oak	770407-1	7270507-1	7270607-1	770407-1	7270507-1
Door	Brown ash	770406-1	7270506-1	7270606-1	770406-1	7270506-1
Door	Black ash	770408-1	7270508-1	7270608-1	770408-1	7270508-1

WORK TOP WASHERS & DRYERS	Made-to-measure, max 240 cm. Delivery time 3-4 weeks. H: 2,8 D: 63	ACCESSORIES WORK TOP	
Colour	Order no.	Performance	Order no.
White	BSK100	Wall console	47920
Light grey	BSK02	Angle bracket	47910
Dark grey	BSK03		
Black	BSK04		
Quartz	BSK102		
Mica	BSK103		
Slate	BSK101		

SELECTED COLOURS
The doors and decor panels are available in Svedbergs' selected colour collection. The frame is not available in the selected colour collection.

HANDLES AND KNOBS
Don't forget to include handles for your furniture. Read more on page 98.

CHOOSE ACCESSORIES FOR THE COUNTER TOP CABINET AND WALL CABINET

Decor panel for washing machine

Incl. adjustable foot.
W: 63 H: 33 D: 60

Colour	Order no.
White	712411
Sand	712873
Pure oak	712863
Brown ash	712868
Black ash	712419

Laundry basket

Colour: Silver.
H: 33 D: 60

Width	Order no.
40	712844
50	712845
60	712846

Fittings Push open

Colour	Order no.
Grey	71200



Support legs

2 pcs. H: 10/15 cm (+15 mm)
Chrome.



Height	Order no.
10	71210
15	71215



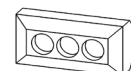

Electrical box 3 electrical sockets.

Colour	Order no.
White	72



TALL CABINET WASHERS & DRYERS		 Tall cabinet 122×40 White carcass incl. 2 wooded shelves. W: 40 H: 122 D: 58	 Tall cabinet 122×60 White carcass incl. 2 wooded shelves. W: 60 H: 122 D: 58
Performance	Färg	Order no.	Order no.
Carcass	White	72122401	72122601
Door	White	72122401-1	72122601-1
Decor panel	White	712821	712821
Door	Sand	72122409-1	72122609-1
Decor panel	Sand	712875	712875
Door	Pure oak	72122407-1	72122607-1
Decor panel	Pure oak	712865	712865
Door	Brown ash	72122406-1	72122606-1
Decor panel	Brown ash	712870	712870
Door	Black ash	72122408-1	72122608-1
Decor panel	Black ash	712829	712829

TALL CABINET WASHERS & DRYERS		 Tall cabinet 180×40 White carcass incl. 3 wooded shelves. W: 40 H: 180 D: 58	 Tall cabinet 195×60 White carcass incl. 3 wooded shelves. W: 60 H: 195 D: 58
Performance	Färg	Order no.	Order no.
Carcass	White	72180401	72195601
Door	White	72180401-1	72195601-1
Decor panel ¹	White	712851	712851
Door	Sand	72180409-1	72195609-1
Decor panel ¹	Sand	712876	712876
Door	Pure oak	72180407-1	72195607-1
Decor panel ¹	Pure oak	712866	712866
Door	Brown ash	72180406-1	72195606-1
Decor panel ¹	Brown ash	712871	712871
Door	Black ash	72180408-1	72195608-1
Decor panel ¹	Black ash	712861	712861

CHOOSE LIGHTING

Lighting for tall cabinets with wooden doors: Start with a driver kit (1) and lighting in the cabinet (3) and a floor light (2).

If the lighting is connected to the mains supply in your bathroom, use the wall switch to turn the tall cabinet light on and off.

Performance	Order no.
① Driver kit lighting	5991
② Floor light ³	5992
③ Lighting in cabinet ³	5994

SELECTED COLOURS

The doors and decor panels are available in Svedbergs' selected colour collection. The frame is not available in the selected colour collection.

HANDLES AND KNOBS

Don't forget to include handles for your furniture. Read more on page 98.

DETAILS

¹The decor panel has the following measurements W: 60 H: 195 D: 1.2 and must be cut to fit with a tall cabinet with the measurements 180×40.

CHOOSE ACCESSORIES FOR YOUR TALL CABINET

Fittings for cleaning cabinets
W: 34 H: 85 D: 13



Colour	Order no.
Chrome	40

Vacuum cleaner hose holder
W: 29,5 H: 25,5 D: 10



Colour	Order no.
Chrome	42

Electrical box
3 electrical sockets.

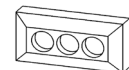

Colour	Order no.
White	72

Laundry basket
Colour: Silver
H: 33 D: 60



Width	Order no.
40	712844
60	712846

Support legs
2 pcs. H: 10/15 cm (+15 mm)
Chrome.



Height	Order no.
10	71210
15	71215

Wooded shelf
2 pcs.
Width: 40/60 cm

Width	Order no.
40	71246
60	71266

Fittings
Push open

Colour	Order no.
Grey	71200

HANDLES

There are different ways to look at a handle. Perhaps the most common is to see it as a useful device for opening a door, drawer or cabinet.

But there's also the aesthetic aspect. Handles should be attractive and suit the style of the bathroom. Handles are available from many places, but you're best off getting them from us.



B1

1 pc
128 CC



Colour	CC	Order no.
Chrome	128cc	71394
White	128cc	71384
Black	128cc	71385

G1

1 pc
32 CC



Colour	CC	Order no.
Black	32cc	22301

G1

1 pc
160 CC



Colour	CC	Order no.
Black	160cc	22300

L1

1 pc
160 CC



Colour	CC	Order no.
Chrome	160cc	22320
Black matt	160cc	22321
Brass	160cc	22322

E1

1 pc
128/256/480 CC



Colour	CC	Order no.
Chrome	128cc	12368
	256cc	12369
	480cc	12370
White	128cc	12371
	256cc	12372
	480cc	12373
Black	128cc	12374
	256cc	12375
	480cc	12376
Brass	128cc	12392
	256cc	12393
	480cc	12394

H1

1 pc
64 CC

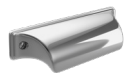

Colour	CC	Order no.
Polished	64cc	22360
Black matt	64cc	22361

L1

1 pc Ø42 mm.
Knob, Knurled



Colour	Order no.
Chrome	22325
Black matt	22326
Brass	22327

M1

1 pc
160 CC



Colour	CC	Order no.
Black matt	160cc	22330
Pencil black	160cc	22331

M2

1 pc
160 CC



Colour	CC	Order no.
Chrome	160cc	22350
Black matt	160cc	22351
Brushed brass	160cc	22352

O1

1 pc Oval 38×28 mm
Knob



Colour	Order no.
Steel	12931
Brass	12932

P1

1 pc Ø42 mm.
Knob



Colour	Order no.
Brushed Stainless Steel	22310
Pencil black	22313
Black matt	22311
Brushed brass	22312

P2

1 pc Ø25 mm.
Knob



Colour	Order no.
Chrome	22413
Brushed Stainless Steel	22410
White matt	22412
Black matt	22411
Brushed brass	22414

S1

1 pc
20 CC



Colour	CC	Order no.
Brushed Stainless Steel	20cc	22342
Brushed Charcoal Black	20cc	22343
Brushed Black	20cc	22340
Brushed brass	20cc	22341

S1

1 pc
2*80 CC



Colour	CC	Order no.
Brushed Stainless Steel	2*80cc	22347
Brushed Charcoal Black	2*80cc	22348
Brushed Black	2*80cc	22345
Brushed brass	2*80cc	22346

S2

1 pc
128 CC



Colour	CC	Order no.
Chrome	128cc	71392
White	128cc	71387
Black	128cc	71388

T1

1 pc
128/192 CC



Colour	CC	Order no.
Polished	128cc	22380
	192cc	22390
Black matt	128cc	22381
	192cc	22391
Brass	128cc	22382
	192cc	22392

T1

1 pc
128/192 CC



Colour	CC	Order no.
Polished/ Black leather	128cc	22385
	192cc	22395
Black/ Black leather	128cc	22386
	192cc	22396
Brass/ Brown leather	128cc	22387
	192cc	22397

V1

1 pc Ø35 mm
Knob



Colour	Order no.
White	22370

DRILLING GUIDE

Can be used with all
bathroom furniture.

Colour	Order no.
Black	98777

LANGFOSS

A pared-back, graphic design look with billowy textiles to soften the look. A shower that envelops your whole body. Thin profiles create a clean, minimalist look.

A NEW WAY OF LOOKING AT SHOWERS

Design

Red Dot winner 2021. Graphic and minimalist, with an open feel and textiles to bring added softness.

Flexibility

A corner shower and shower screen available in two heights. Textiles in thirty different colours. Display shelf.

Functionality

Reversible for positioning on the right or left. Doors with integrated space-saving grips. Textiles and Line Glass for a secluded shower experience. A shelf for easy access. Easy to install.

Quality

6 mm toughened safety glass. CE marked, made in Sweden and sold with a 20-year warranty.

Sustainability

100% recyclable. Oeko-Tex certified and environmentally labelled textiles with an EU Ecolabel.

This wave-shaped textile adds a spectacular element to any bathroom. The combination creates a luxurious, cosy experience. Langfoss creates a feeling of exclusivity. The innovative approach focuses on design, space and details. It was inspired by one of Norway's highest waterfalls.

STANDARD

Integrated handle

For Langfoss, we picked a unique handle solution. A milled hole in the glass, paired with an attractive aluminium profile. For a stylish design.

Hinges that finish the door closing automatically

Hinges that finish the door closing automatically for an exclusive shower experience.

Shower height

Langfoss is our most exclusive shower set. The shower height of 230 cm creates a spacious hotel look with a hint of luxury.



OPTIONS

Shelf

A minimalist display shelf fitted directly onto the glass. The shelf has been designed with the same aesthetics as the shower profiles.

Textile

The billowing yet practical fabric comes in three standard colours. It is also available in a number of other colours as an optional extra.

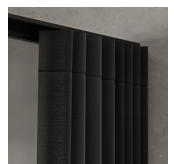

Pipe installation profile

For surface-mounted pipes, do not forget to add a pipe installation profile.



Discover the
whole Langfoss
range



COLOR PROFILE



Matt aluminium



Pencil black



Black matt

GLASS



Crystal glass

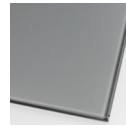

Smoked glass

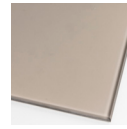

Bronze glass



Line glass

TEXTILE

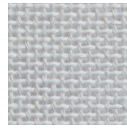

Off white

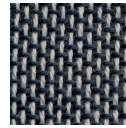

Granite grey



Ash grey

CORNER SHOWER

The Langfoss corner shower is available in several possible combinations, each as stylish as the next.



SHOWER SCREENS

The Langfoss shower screen has profiles and details that create a graphic, minimalist look.



LANGFOSS SHOWER SCREEN FIXED

- Delivered complete with a curtain rail (max 105 cm), and floor and wall profiles for adjustment up to 20 mm.
- Height: 200/230 cm (201/231 cm top edge with the optional curtain rail).
- Toughened safety glass 6 mm.
- The existing wall profile doesn't allow hole for water pipes, for example.
- Add profiles, a curtain rail and a curtain, available in various colours.
- The shelf that fits onto the glass has the same style.

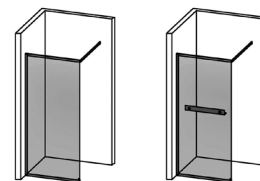

Without shelf

With shelf



1. CHOOSE A SHOWER

Langfoss shower screen without shelf	Height: 200 cm		Height: 230 cm.	
	80	90	80	90
Profile/glass	Order no.	Order no.	Order no.	Order no.
Matt aluminium				
Crystal glass	6782003	6792003	6782303	6792303
Bronze glass	6082003	6092003	6082303	6092303
Smoked glass	6982003	6992003	6982303	6992303
Pencil black				
Crystal glass	6782005	6792005	-	-
Bronze glass	6082005	6092005	-	-
Smoked glass	6982005	6992005	-	-
Black matt				
Crystal glass	6782002	6792002	6782302	6792302
Bronze glass	6082002	6092002	6082302	6092302
Smoked glass	6982002	6992002	6982302	6992302

Langfoss shower screen with shelf	Height: 200 cm		Height: 230 cm.	
	80	90	80	90
Profile/glass	Order no.	Order no.	Order no.	Order no.
Matt aluminium				
Crystal glass	6782013	6792013	6782313	6792313
Bronze glass	6082013	6092013	6082313	6092313
Smoked glass	6982013	6992013	6982313	6992313
Pencil black				
Crystal glass	6782015	6792015	-	-
Bronze glass	6082015	6092015	-	-
Smoked glass	6982015	6992015	-	-
Black matt				
Crystal glass	6782012	6792012	6782312	6792312
Bronze glass	6082012	6092012	6082312	6092312
Smoked glass	6982012	6992012	6982312	6992312

LANGFOSS SHOWER SCREEN, FIXED AND WITH LINE GLASS

- Delivered complete with a curtain rail (max 105 cm), and floor and wall profiles for adjustment up to 20 mm.
- Height: 200/230 cm (201/231 cm top edge with the optional curtain rail).
- Toughened safety glass 5 mm.
- The existing wall profile doesn't allow hole for water pipes, for example.
- Add profiles, a curtain rail and a curtain, available in various colours.
- The shelf that fits onto the glass has the same style.

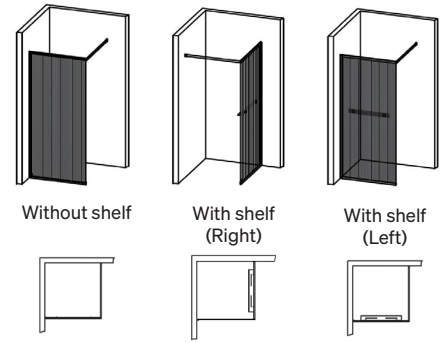

1. CHOOSE A SHOWER

Langfoss shower screen without shelf	80		90		80		90	
	Height: 200 cm		Height: 200 cm.		Height: 230 cm.		Height: 230 cm.	
Profile/glass	Order no.	Order no.	Order no.	Order no.	Order no.	Order no.	Order no.	Order no.
Matt aluminium								
Line glass	6882003	6892003	6882303	6892303				
Pencil black								
Line glass	6882005	6892005	-	-				
Black matt								
Line glass	6882002	6892002	6882302	6892302				
Langfoss shower screen with shelf to the right								
Matt aluminium								
Line glass	6882013-H	6892013-H	6882313-H	6892313-H				
Pencil black								
Line glass	6882015-H	6892015-H	-	-				
Black matt								
Line glass	6882012-H	6892012-H	6882312-H	6892312-H				
Langfoss shower screen with shelf on the left								
Matt aluminium								
Line glass	6882013-V	6892013-V	6882313-V	6892313-V				
Pencil black								
Line glass	6882015-V	6892015-V	-	-				
Black matt								
Line glass	6882012-V	6892012-V	6882312-V	6892312-V				

2. CHOOSE A CURTAIN

CURTAIN RAIL



Width:	Colour	Order no.
80	Matt aluminium	683
	Pencil black	684
	Black matt	682
90	Matt aluminium	693
	Pencil black	694
	Black matt	692

CURTAIN*



Height:	Colour	Order no.
200	Off white	69201
	Granite grey	69202
	Ash grey	69203
230	Off white	69231
	Granite grey	69232
	Ash grey	69233

*For additional colours, please visit svedbergs.com

PROFILE TO ACCOMMODATE PIPEWORK

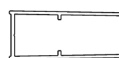

Height:	Colour	Order no.
200	Matt aluminium	63203
	Pencil black	63204
	Black matt	63202
230	Matt aluminium	63233
	Black matt	63232



SHOWER STORAGE
Go to page 106 to see the options available for shower area storage.

LANGFOSS CORNER SHOWER COMBI 200 CM

- Supplied complete with an easy-to-install shelf that fits directly onto the glass, curtain rail (max. 105 cm), floor and wall profiles for adjustment up to 20 mm, plus one folding door.
- Height: 200 cm (201 cm top edge with the optional curtain rail).
- No threshold - disabled friendly.
- Toughened safety glass 6 mm.
- Door opening: 74-84 cm.
- The existing wall profile doesn't allow hole for water pipes, for example.
- Self-closing doors.
- For each door follows 4 pcs of inserts to correct irregular walls up to maximum 8mm.
- Closing position is adjustable. Hidden assembly including screws.
- Add profiles, a curtain rail and a curtain, available in various colours.
- The shelf that fits onto the glass has the same style.

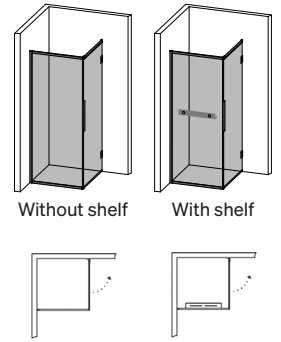

1. CHOOSE A SHOWER

* Length fixed glass

Langfoss corner shower without shelf	80X82* Height: 200 cm Opening dimensions: 74 cm.	80X92* Height: 200 cm. Opening dimensions: 74 cm.	90X82* Height: 200 cm. Opening dimensions: 84 cm.	90X92* Height: 200 cm. Opening dimensions: 84 cm.
Profile/glass	Order no.	Order no.	Order no.	Order no.
Matt aluminium				
Crystal glass	62882003	62892003	62982003	62992003
Bronze glass	60882003	60892003	60982003	60992003
Smoked glass	64882003	64892003	64982003	64992003
Pencil black				
Crystal glass	62882005	62892005	62982005	62992005
Bronze glass	60882005	60892005	60982005	60992005
Smoked glass	64882005	64892005	64982005	64992005
Black matt				
Crystal glass	62882002	62892002	62982002	62992002
Bronze glass	60882002	60892002	60982002	60992002
Smoked glass	64882002	64892002	64982002	64992002

Langfoss corner shower with shelf	80X82* Height: 200 cm Opening dimensions: 74 cm.	80X92* Height: 200 cm. Opening dimensions: 74 cm.	90X82* Height: 200 cm. Opening dimensions: 84 cm.	90X92* Height: 200 cm. Opening dimensions: 84 cm.
Profile/glass	Order no.	Order no.	Order no.	Order no.
Matt aluminium				
Crystal glass	62882013	62892013	62982013	62992013
Bronze glass	60882013	60892013	60982013	60992013
Smoked glass	64882013	64892013	64982013	64992013
Pencil black				
Crystal glass	62882015	62892015	62982015	62992015
Bronze glass	60882015	60892015	60982015	60992015
Smoked glass	64882015	64892015	64982015	64992015
Black matt				
Crystal glass	62882012	62892012	62982012	62992012
Bronze glass	60882012	60892012	60982012	60992012
Smoked glass	64882012	64892012	64982012	64992012

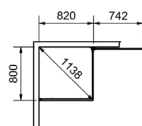

80X82*

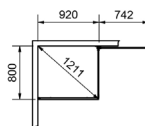

80X92*

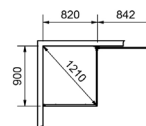

90X82*

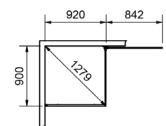

90X92*

LANGFOSS CORNER SHOWER COMBI 200 WITH LINE GLASS

- Supplied complete with an easy-to-install shelf that fits directly onto the glass, curtain rail (max. 105 cm), floor and wall profiles for adjustment up to 20 mm, plus one folding door.
- Height: 200 cm (201 cm top edge with the optional curtain rail).
- No threshold - disabled friendly.
- Toughened safety glass 5/6 mm.
- Door opening: 74-84 cm.
- The existing wall profile doesn't allow hole for water pipes, for example.
- Self-closing doors.
- For each door follows 4 pcs of inserts to correct irregular walls up to maximum 8mm.
- Closing position is adjustable. Hidden assembly including screws.
- Add profiles, a curtain rail and a curtain, available in various colours.
- The shelf that fits onto the glass has the same style.

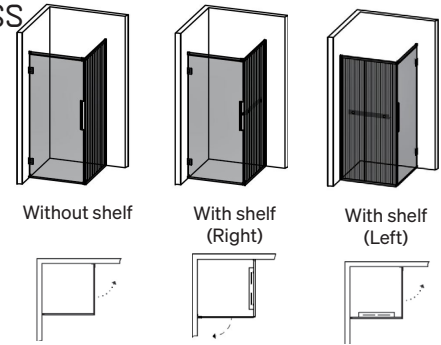

* Length fixed glass

1. CHOOSE A SHOWER

Langfoss corner shower without shelf Profile/glass	80X82* Height: 200 cm Opening dimensions: 74 cm. Order no.	80X92* Height: 200 cm. Opening dimensions: 74 cm. Order no.	90X82* Height: 200 cm. Opening dimensions: 84 cm. Order no.	90X92* Height: 200 cm. Opening dimensions: 84 cm. Order no.
Matt aluminium				
Line glass	68882003	68892003	68982003	68992003
Pencil black				
Line glass	68882005	68892005	68982005	68992005
Black matt				
Line glass	68882002	68892002	68982002	68992002
Langfoss corner shower with shelf on the right				
Matt aluminium				
Line glass	68882013-H	68892013-H	68982013-H	68992013-H
Pencil black				
Line glass	68882015-H	68892015-H	68982015-H	68992015-H
Black matt				
Line glass	68882012-H	68892012-H	68982012-H	68992012-H
Langfoss corner shower with shelf on the left				
Matt aluminium				
Line glass	68882013-V	68892013-V	68982013-V	68992013-V
Pencil black				
Line glass	68882015-V	68892015-V	68982015-V	68992015-V
Black matt				
Line glass	68882012-V	68892012-V	68982012-V	68992012-V

2. CHOOSE A CURTAIN

CURTAIN RAIL

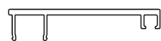

Width:	Colour	Order no.
80	Matt aluminium	683
	Pencil black	684
	Black matt	682
90	Matt aluminium	693
	Pencil black	694
	Black matt	692

CURTAIN*



Height:	Colour	Order no.
200	Off white	69201
	Granite grey	69202
	Ash grey	69203

*For additional colours, please visit svedbergs.com

PROFILE TO ACCOMMODATE PIPEWORK



Height:	Colour	Order no.
200	Matt aluminium	63203
	Pencil black	63204
	Black matt	63202



SHOWER STORAGE
Go to page 106 to see the options available for shower area storage.

LANGFOSS CORNER SHOWER COMBI 230 CM

- Supplied complete with an easy-to-install shelf that fits directly onto the glass, curtain rail (max. 105 cm), floor and wall profiles for adjustment up to 20 mm, plus one folding door.
- Height: 230 cm (231 cm top edge with the optional curtain rail).
- No threshold - disabled friendly.
- Toughened safety glass 6 mm.
- Door opening: 74-84 cm.
- The existing wall profile doesn't allow hole for water pipes, for example.
- Self-closing doors.
- For each door follows 4 pcs of inserts to correct irregular walls up to maximum 8mm.
- Closing position is adjustable. Hidden assembly including screws.
- Add profiles, a curtain rail and a curtain, available in various colours.
- The shelf that fits onto the glass has the same style.

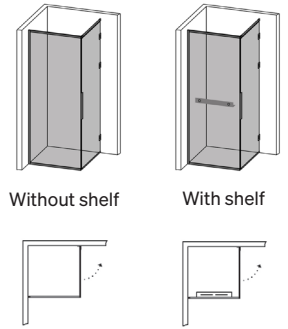

1. CHOOSE A SHOWER

* Length fixed glass

Langfoss corner shower without shelf	80X82* Height: 230 cm Opening dimensions: 74 cm.	80X92* Height: 230 cm. Opening dimensions: 74 cm.	90X82* Height: 230 cm. Opening dimensions: 84 cm.	90X92* Height: 230 cm. Opening dimensions: 84 cm.
Profile/glass	Order no.	Order no.	Order no.	Order no.
Matt aluminium				
Crystal glass	62882303	62892303	62982303	62992303
Bronze glass	60882303	60892303	60982303	60992303
Smoked glass	64882303	64892303	64982303	64992303
Black matt				
Crystal glass	62882302	62892302	62982302	62992302
Bronze glass	60882302	60892302	60982302	60992302
Smoked glass	64882302	64892302	64982302	64992302

Langfoss corner shower with shelf	80X82* Height: 230 cm Opening dimensions: 74 cm.	80X92* Height: 230 cm. Opening dimensions: 74 cm.	90X82* Height: 230 cm. Opening dimensions: 84 cm.	90X92* Height: 230 cm. Opening dimensions: 84 cm.
Profile/glass	Order no.	Order no.	Order no.	Order no.
Matt aluminium				
Crystal glass	62882313	62892313	62982313	62992313
Bronze glass	60882313	60892313	60982313	60992313
Smoked glass	64882313	64892313	64982313	64992313
Black matt				
Crystal glass	62882312	62892312	62982312	62992312
Bronze glass	60882312	60892312	60982312	60992312
Smoked glass	64882312	64892312	64982312	64992312

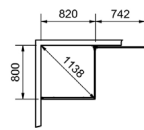

80X82*

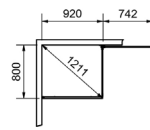

80X92*

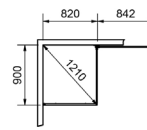

90X82*

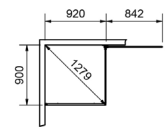

90X92*

FRONT SHOWER SHELF

Aluminium shelf for placement in or outside the shower. Can be glued. Glue kit including fittings available as an accessory. H:10 D:9



WALL SHELF

Aluminium shelf for placement in or outside the shower. Can be glued. A glue kit is available as an accessory. H:7,5 D:8,5



Shower storage	70	80	32,5	65
Colour	Order no.	Order no.	Order no.	Order no.
Matt aluminium	6571	6581	6330	6660
Polished pencil black	6573	6583	6329	6659
Black matt	6572	6582	6325	6651
White matt	6570	6580	6324	6650
Optional				
Glue kit	97058	97058	97043	97043

LANGFOSS CORNER SHOWER COMBI 230 WITH LINE GLASS

- Supplied complete with an easy-to-install shelf that fits directly onto the glass, curtain rail (max. 105 cm), floor and wall profiles for adjustment up to 20 mm, plus one folding door.
- Height: 230 cm (231 cm top edge with the optional curtain rail).
- No threshold - disabled friendly.
- Toughened safety glass 5/6 mm.
- Door opening: 74-84 cm.
- The existing wall profile doesn't allow hole for water pipes, for example.
- Self-closing doors.
- For each door follows 4 pcs of inserts to correct irregular walls up to maximum 8mm.
- Closing position is adjustable. Hidden assembly including screws.
- Add profiles, a curtain rail and a curtain, available in various colours.
- The shelf that fits onto the glass has the same style.

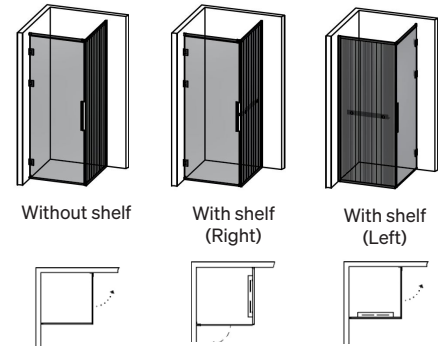

1. CHOOSE A SHOWER

* Length fixed glass

Langfoss corner shower without shelf	80X82* Height: 230 cm Opening dimensions: 74 cm.	80X92* Height: 230 cm. Opening dimensions: 74 cm.	90X82* Height: 230 cm. Opening dimensions: 84 cm.	90X92* Height: 230 cm. Opening dimensions: 84 cm.
Profile/glass	Order no.	Order no.	Order no.	Order no.
Matt aluminium				
Line glass	68882303	68892303	68982303	68992303
Black matt				
Line glass	68882302	68892302	68982302	68992302
Langfoss corner shower with shelf on the right				
Matt aluminium				
Line glass	68882313-H	68892313-H	68982313-H	68992313-H
Black matt				
Line glass	68882312-H	68892312-H	68982312-H	68992312-H
Langfoss corner shower with shelf on the left				
Matt aluminium				
Line glass	68882313-V	68892313-V	68982313-V	68992313-V
Black matt				
Line glass	68882312-V	68892312-V	68982312-V	68992312-V

2. CHOOSE A CURTAIN

CURTAIN RAIL



Width:	Colour	Order no.
80	Matt aluminium	683
	Black matt	682
90	Matt aluminium	693
	Black matt	692

CURTAIN*



Height:	Colour	Order no.
230	Off white	69231
	Granite grey	69232
	Ash grey	69233

*For additional colours, please visit svedbergs.com

PROFILE TO ACCOMMODATE PIPEWORK



Height:	Colour	Order no.
230	Matt aluminium	63233
	Black matt	63232

180°

Large glass panels give an open, exclusive look. Designed for those who value an aesthetic, stylish look.

MAXIMUM GLASS MINIMUM FITTINGS

Design

Large glass panels create an open, exclusive look.

Flexibility

Corner shower, alcove shower and shower screen.
Shower screen for a bath. Customised special solutions.

Functionality

Foldable and space-saving. Reversible for positioning on the right or left.

Quality

8 mm toughened safety glass. CE marked. Made in Sweden and sold with a 20-year warranty.

Sustainability

100% recyclable.

180° spans everything from standard options to customised special design solutions. We have a solution for everything. For example, you can choose between Bronze or Smoked Glass for a more inviting and exclusive feel. Complement your choices with coloured fittings that either blend in or create stunning contrasts.

STANDARD

Toughened safety glass 8 mm

Our 180° shower set comes with 8 mm toughened safety glass.



Hinges that finish the door closing automatically

Hinges that finish the door closing automatically for an exclusive shower experience.



OPTIONS

Bronze glass

Bronze glass gives an exclusive spa feel and gives the softest look of all our dark glasses.

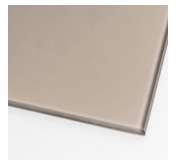

Shower seat Relax

The seat's surface is comfortable and easy to keep clean, as well as offering a stylish, modern look.



Made to measure

If you can't find the model you're looking for, we can customise a solution from the 180° range to meet your needs.



Discover the whole 180° range



COLOR PROFILE



Chrome



Pencil black



Black matt

GLASS



Clear glass

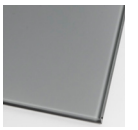

Smoked
glass

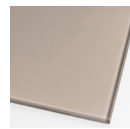

Bronze glass



Industrial decor

CORNER SHOWER

There's a lot to be said for the corner showers in our 180° collection. Maybe the smartest thing of all is that the doors can be folded inwards when the shower is not in use to free up floor space. What's more, the doors finish closing automatically. And that's before even mentioning the corner showers' attractive design.



SHOWER SCREENS

Our 180° shower collection offers a variety of beautiful and practical shower screens. Which type suits your bathroom best? A solid screen, a screen with a door or a screen for combining with a bath? All three solutions are practical and enhance the design of your bathroom.



ALCOVE, SINGLE AND DOUBLE

If you've already got three walls and want to build an alcove shower, we've got various solutions: single, double and double combination. The large glass panels create a light and airy look and are easy to clean. The handles, hinges, rod and floor mounting enhance the overall look.



SPECIAL SHOWER

All homes have their own unique features, dimensions and angles. If you can't find a shower that fits, we can customise all the measurements to your requirements and preferences.



FRONT

A storage concept running from one surface to the next, keeping your products right where you need them. A horizontal design that ties together different functions into one cohesive whole. A practical storage shelf made of waterproof aluminium, for positioning inside or outside the shower space. Choose from different front options made of wood or metal to match your shower, bath or furniture.

- Width 70 & 80 cm.
- Can grow from one zone to the next.
- Creates connections between different product types.
- Works well with a variety of colours and finishes.
- Compatible with Langfoss, Skoga and 180°.
- Easy to install – can be glued.
- Four hooks underneath.

See more shower space storage options on page 114.



180° CORNER SHOWER DOOR

- Has two opening doors with a magnetic seal.
- Doors can be folded inwards when shower is not in use to maximise floor space.
- No threshold - disabled friendly.
- Toughened safety glass 8 mm.
- Self-closing doors.
- Each door is provided with four inserts to even out irregularities in the wall, up to max. 8 mm.
- Closing position is adjustable.
- Height 200 cm.
- Door opening 104-132 cm.

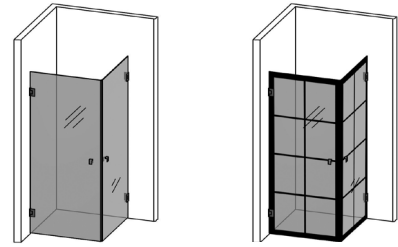

180° Rista with industrial decor.

180° Corner shower door	80X80 Height: 200 cm. Opening dimensions: 104 cm.	80X90 Height: 200 cm. Opening dimensions: 111 cm.	80X100 Height: 200 cm. Opening dimensions: 118 cm.	MADE TO MEASURE
Profile/glass	Order no.	Order no.	Order no.	Order no.
Chrome				
Clear glass	653788	653789	653781	180-10-1
Bronze glass	653988	653989	653981	180-10-5
Smoked glass	653888	653889	653881	180-10-4
Pencil black				
Clear glass	623788	623789	623781	180-10-1
Bronze glass	623988	623989	623981	180-10-5
Smoked glass	623888	623889	623881	180-10-4
Black matt				
Clear glass	683788	683789	683781	180-10-1
Bronze glass	683988	683989	683981	180-10-5
Smoked glass	683888	683889	683881	180-10-4
Industrial decor	693788	693789	-	-

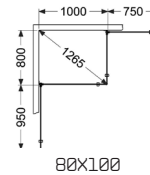
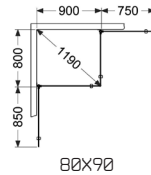
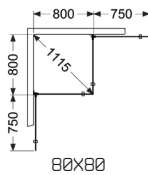

180° Corner shower door	90X90 Height: 200 cm. Opening dimensions: 118 cm.	90X100 Height: 200 cm. Opening dimensions: 125 cm.	100X100 Height: 200 cm. Opening dimensions: 132 cm.	MADE TO MEASURE
Profile/glass	Order no.	Order no.	Order no.	Order no.
Chrome				
Clear glass	653799	653791	653711	180-10-1
Bronze glass	653999	653991	653911	180-10-5
Smoked glass	653899	653891	653811	180-10-4
Pencil black				
Clear glass	623799	623791	623711	180-10-1
Bronze glass	623999	623991	623911	180-10-5
Smoked glass	623899	623891	623811	180-10-4
Black matt				
Clear glass	683799	683791	683711	180-10-1
Bronze glass	683999	683991	683911	180-10-5
Smoked glass	683899	683891	683811	180-10-4
Industrial decor	693799	-	-	-

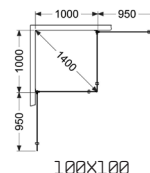
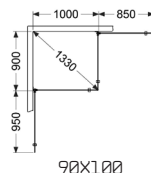
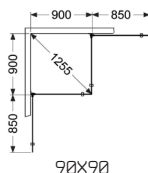

180° CORNER SHOWER FIXED WALL/DOOR

- Has one opening door and a fixed wall incl. rods and floor attachment.
- No threshold - disabled friendly.
- Toughened safety glass 8 mm.
- Self-closing doors.
- Each door is provided with four inserts to even out irregularities in the wall, up to max. 8 mm.
- Closing position is adjustable.
- Height 200 cm (201 cm upper edge of rod).
- Door opening 75-95 cm.

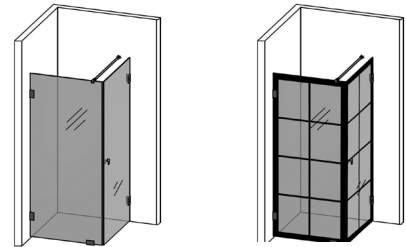

180° Rista with industrial decor.

*Length fixed glass

180° Corner shower fixed wall/door	80X80	80X90*	80*X90	MADE TO MEASURE
Profile/glass	Order no.	Order no.	Order no.	Order no.
Chrome				
Clear glass	654788	654789	654798	180-11-1
Bronze glass	654988	654989	654998	180-11-5
Smoked glass	654888	654889	654898	180-11-4
Pencil black				
Clear glass	624788	624789	624798	180-11-1
Bronze glass	624988	624989	624998	180-11-5
Smoked glass	624888	624889	624898	180-11-4
Black matt				
Clear glass	684788	684789	684798	180-11-1
Bronze glass	684988	684989	684998	180-11-5
Smoked glass	684888	684889	684898	180-11-4
Industrial decor	694788	694789	694798	-

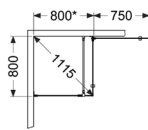

80X80

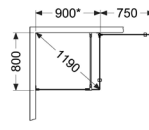

80X90*

* Length fixed glass

180° Corner shower fixed wall/door	80X100*	80*X100	90X90	MADE TO MEASURE
Profile/glass	Order no.	Order no.	Order no.	Order no.
Chrome				
Clear glass	654781	654718	654799	180-11-1
Bronze glass	654981	654918	654999	180-11-5
Smoked glass	654881	654818	654899	180-11-4
Pencil black				
Clear glass	624781	624718	624799	180-11-1
Bronze glass	624981	624918	624999	180-11-5
Smoked glass	624881	624818	624899	180-11-4
Black matt				
Clear glass	684781	684718	684799	180-11-1
Bronze glass	684981	684918	684999	180-11-5
Smoked glass	684881	684818	684899	180-11-4
Industrial decor	-	-	694799	-

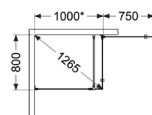

80X100*

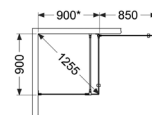

90X90

180° CORNER SHOWER FIXED WALL/DOOR

- Has one opening door and a fixed wall incl. rods and floor attachment.
- No threshold - disabled friendly.
- Toughened safety glass 8 mm.
- Self-closing doors.
- Each door is provided with four inserts to even out irregularities in the wall, up to max. 8 mm.
- Closing position is adjustable.
- Height 200 cm (201 cm upper edge of rod).
- Door opening 75-95 cm.

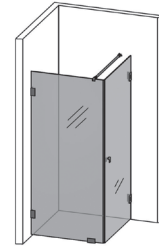

* Length fixed glass

180° Corner shower fixed wall/door	90X100*	90°X100	100X100	MADE TO MEASURE
	Height: 200 cm (201 cm upper edge of rod). Opening dimensions: 85 cm.	Height: 200 cm (201 cm upper edge of rod). Opening dimensions: 95 cm.	Height: 200 cm (201 cm upper edge of rod). Opening dimensions: 95 cm.	
Profile/glass	Order no.	Order no.	Order no.	Order no.
Chrome				
Clear glass	654791	654719	654711	180-11-1
Bronze glass	654991	654919	654911	180-11-5
Smoked glass	654891	654819	654811	180-11-4
Pencil black				
Clear glass	624791	624719	624711	180-11-1
Bronze glass	624991	624919	624911	180-11-5
Smoked glass	624891	624819	624811	180-11-4
Black matt				
Clear glass	684791	684719	684711	180-11-1
Bronze glass	684991	684919	684911	180-11-5
Smoked glass	684891	684819	684811	180-11-4

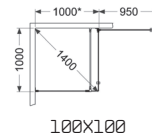
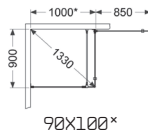

FRONT SHOWER SHELF

Aluminium shelf for placement in or outside the shower. Can be glued. Glue kit including fittings available as an accessory. H:10 D:9



WALL SHELF

Aluminium shelf for placement in or outside the shower. Can be glued. A glue kit is available as an accessory. H:7,5 D:8,5



Shower storage	70	80	32,5	65
Colour	Order no.	Order no.	Order no.	Order no.
Matt aluminium	6571	6581	6330	6660
Polished pencil black	6573	6583	6329	6659
Black matt	6572	6582	6325	6651
White matt	6570	6580	6324	6650
Optional				
Glue kit	97058	97058	97043	97043

180° SHOWER SCREEN

- Has one opening door.
- The door can be folded inwards when shower is not in use to maximise floor space.
- No threshold - disabled friendly.
- Toughened safety glass 8 mm.
- Self-closing doors.
- Each door is provided with four inserts to even out irregularities in the wall, up to max. 8 mm.
- Closing position is adjustable.
- Height 200 cm.

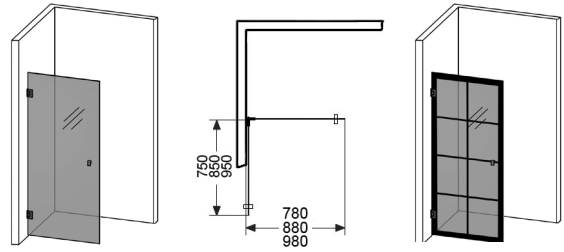

180° Rista with industrial decor.

180° Shower screen	78 Height: 200 cm.	88 Height: 200 cm.	98 Height: 200 cm.	MADE TO MEASURE
Profile/glass	Order no.	Order no.	Order no.	Order no.
Chrome				
Clear glass	651778	651788	651798	180-01-1
Bronze glass	651978	651988	651998	180-01-5
Smoked glass	651878	651888	651898	180-01-4
Pencil black				
Clear glass	621778	621788	621798	180-01-1
Bronze glass	621978	621988	621998	180-01-5
Smoked glass	621878	621888	621898	180-01-4
Black matt				
Clear glass	681778	681788	681798	180-01-1
Bronze glass	681978	681988	681998	180-01-5
Smoked glass	681878	681888	681898	180-01-4
Industrial decor	691778	691788	-	-

180° SHOWER SCREEN WITH FOOT AND BAR

- Consists of a fixed wall incl. a bar and floor attachment.
- No threshold - disabled friendly.
- Toughened safety glass 8 mm.
- Concealed mounting & clamping screws.
- Each door is provided with four inserts to even out irregularities in the wall, up to max. 8 mm.
- Height 200 cm (201 cm upper edge of rod).
- Can be mounted against a wall.

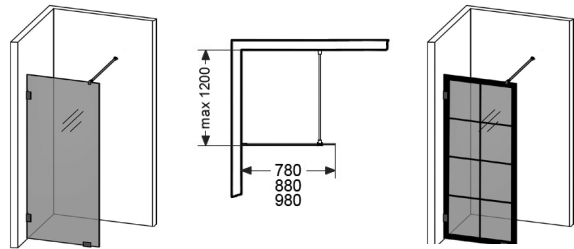

180° Rista with industrial decor.

180° Shower screen with foot and bar	78 Height: 200 cm. (201 cm upper edge of rod)	88 Height: 200 cm. (201 cm upper edge of rod)	98 Height: 200 cm. (201 cm upper edge of rod)	MADE TO MEASURE
Profile/glass	Order no.	Order no.	Order no.	Order no.
Chrome				
Clear glass	652778	652788	652798	180-02-1
Bronze glass	652978	652988	652998	180-02-5
Smoked glass	652878	652888	652898	180-02-4
Pencil black				
Clear glass	622778	622788	622798	180-02-1
Bronze glass	622978	622988	622998	180-02-5
Smoked glass	622878	622888	622898	180-02-4
Black matt				
Clear glass	682778	682788	682798	180-02-1
Bronze glass	682978	682988	682998	180-02-5
Smoked glass	682878	682888	682898	180-02-4
Industrial decor	692778	692788	-	-

180° SHOWER SCREEN BATH

- Has one opening door.
- The door can be folded inwards when not in use, making maximum use of the bath surface.
- Toughened safety glass 8 mm.
- Self-closing doors.
- Each door is provided with four inserts to even out irregularities in the wall, up to max. 8 mm.
- Closing position is adjustable.
- Height 140 cm.

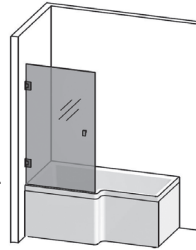

180° Shower screen bath	81		MADE TO MEASURE
	Height: 140 cm.		
Profile/glass	Order no.	RSK	Order no.
Chrome			
Clear glass	657781	7330921	180-05-1
Pencil black			
Clear glass	627781	7377619	180-05-1
Black matt			
Clear glass	687781	7331568	180-05-1

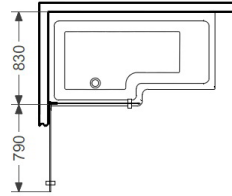

180° CORNER SHOWER BATH

- Has two opening doors with a magnetic seal.
- The door can be folded inwards when not in use, making maximum use of the bath surface.
- Toughened safety glass 8 mm.
- Self-closing doors.
- Each door is provided with four inserts to even out irregularities in the wall, up to max. 8 mm.
- Closing position is adjustable.
- Height 140 cm.

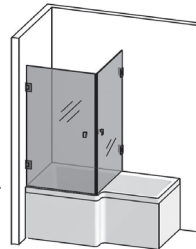

180° Corner shower bath	83X83		MADE TO MEASURE
	Height: 140 cm. Opening dimensions: 104 cm.		
Profile/glass	Order no.	RSK	Order no.
Chrome			
Clear glass	658788	7330924	180-12-1
Pencil black			
Clear glass	628788	7311041	180-12-1
Black matt			
Clear glass	688788	7331571	180-12-1

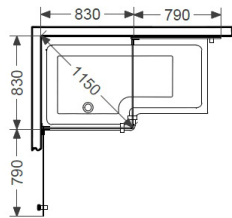

FRONT SHOWER SHELF

Aluminium shelf for placement in or outside the shower. Can be glued. Glue kit including fittings available as an accessory. H:10 D:9



WALL SHELF

Aluminium shelf for placement in or outside the shower. Can be glued. A glue kit is available as an accessory. H:7,5 D:8,5



Shower storage	70	80	32,5	65
Colour	Order no.	Order no.	Order no.	Order no.
Matt aluminium	6571	6581	6330	6660
Polished pencil black	6573	6583	6329	6659
Black matt	6572	6582	6325	6651
White matt	6570	6580	6324	6650
Optional				
Glue kit	97058	97058	97043	97043

180° ALCOVE SHOWER SINGLE

- Has one opening door.
- The door can be folded inwards when shower is not in use to maximise floor space.
- No threshold - disabled friendly.
- Toughened safety glass 8 mm. Self-closing hinges.
- Each door is provided with four inserts to even out irregularities in the wall, up to max. 8 mm.
- Closing position is adjustable.
- Height 200 cm.
- Door opening 75-95 cm.

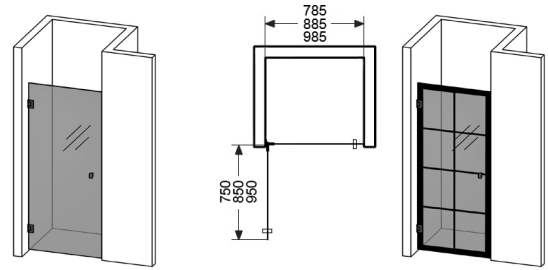

180° Rista with industrial decor.

180° Alcove shower single	78.5 Height: 200 cm. Opening dimensions: 75 cm.	88.5 Height: 200 cm. Opening dimensions: 85 cm.	98.5 Height: 200 cm. Opening dimensions: 95 cm.	MADE TO MEASURE
Profile/glass	Order no.	Order no.	Order no.	Order no.
Chrome				
Clear glass	651778	651788	651798	180-23-1
Bronze glass	651978	651988	651998	180-23-5
Smoked glass	651878	651888	651898	180-23-4
Pencil black				
Clear glass	621778	621788	621798	180-23-1
Bronze glass	621978	621988	621998	180-23-5
Smoked glass	621878	621888	621898	180-23-4
Black matt				
Clear glass	681778	681788	681798	180-23-1
Bronze glass	681978	681988	681998	180-23-5
Smoked glass	681878	681888	681898	180-23-4
Industrial decor	691778	691788	-	-

180° ALCOVE SHOWER DOUBLE

- Has two opening doors.
- Doors can be folded inwards when shower is not in use to maximise floor space.
- No threshold - disabled friendly.
- Toughened safety glass 8 mm. Self-closing doors.
- Each door is provided with four inserts to even out irregularities in the wall, up to max. 8 mm.
- Closing position is adjustable.
- Height 200 cm. Door opening 150-190 cm.

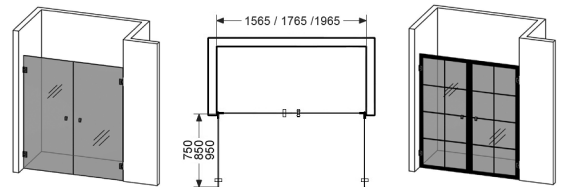

180° Rista with industrial decor.

180° Alcove shower double	156.5 Height: 200 cm. Opening dimensions: 150 cm.	176.5 Height: 200 cm. Opening dimensions: 170 cm.	196.5 Height: 200 cm. Opening dimensions: 190 cm.	MADE TO MEASURE
Profile/glass	Order no.	Order no.	Order no.	Order no.
Chrome				
Clear glass	655716	655718	655720	180-25-1
Bronze glass	655916	655918	655920	180-25-5
Smoked glass	655816	655818	655820	180-25-4
Pencil black				
Clear glass	625716	625718	625720	180-25-1
Bronze glass	625916	625918	625920	180-25-5
Smoked glass	625816	625818	625820	180-25-4
Black matt				
Clear glass	685716	685718	685720	180-25-1
Bronze glass	685916	685918	685920	180-25-5
Smoked glass	685816	685818	685820	180-25-4
Industrial decor	695716	695718	-	-

180° ALCOVE SHOWER COMBINED

- Has one opening door and a fixed wall incl. rods and floor attachment.
- The door can be folded inwards when shower is not in use to maximise floor space.
- No threshold - disabled friendly.
- Toughened safety glass 8 mm. Self-closing doors.
- Each door is provided with four inserts to even out irregularities in the wall, up to max. 8 mm.
- Closing position is adjustable.
- Height 200 cm (201 cm upper edge of rod).
- Door opening 75-95 cm

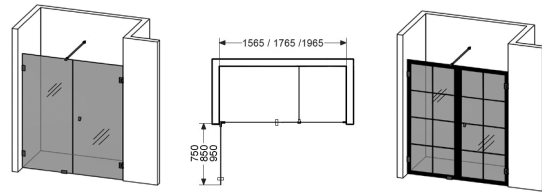

180° Rista with industrial decor.

180° Alcove shower combined	156.5	176.5	196.5	MADE TO MEASURE
Profile/glass	Order no.	Order no.	Order no.	Order no.
Chrome				
Clear glass	656716	656718	656720	180-26-1
Bronze glass	656916	656918	656920	180-26-5
Smoked glass	656816	656818	656820	180-26-4
Pencil black				
Clear glass	626716	626718	626720	180-26-1
Bronze glass	626916	626918	626920	180-26-5
Smoked glass	626816	626818	626820	180-26-4
Black matt				
Clear glass	686716	686718	686720	180-26-1
Bronze glass	686916	686918	686920	180-26-5
Smoked glass	686016	686018	686020	180-26-4
Industrial decor	696716	696718	-	-

180° SPECIAL



180° Special 3	SHOWER SCREEN
Profile/glass	Order no.
Chrome	
Clear glass	180-03-1
Bronze glass	180-03-5
Smoked glass	180-03-4
Pencil black	
Clear glass	180-03-1
Bronze glass	180-03-5
Smoked glass	180-03-4
Black matt	
Clear glass	180-03-1
Bronze glass	180-03-5
Smoked glass	180-03-4

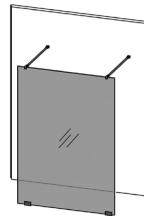

180° Special 8	SHOWER SCREEN
Profile/glass	Order no.
Chrome	
Clear glass	180-08-1
Bronze glass	180-08-5
Smoked glass	180-08-4
Pencil black	
Clear glass	180-08-1
Bronze glass	180-08-5
Smoked glass	180-08-4
Black matt	
Clear glass	180-08-1
Bronze glass	180-08-5
Smoked glass	180-08-4

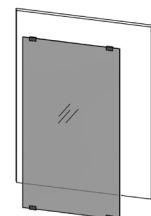

180° Special 9	SHOWER SCREEN
Profile/glass	Order no.
Chrome	
Clear glass	180-09-1
Bronze glass	180-09-5
Smoked glass	180-09-4
Pencil black	
Clear glass	180-09-1
Bronze glass	180-09-5
Smoked glass	180-09-4
Black matt	
Clear glass	180-09-1
Bronze glass	180-09-5
Smoked glass	180-09-4

For more information visit www.svedbergs.com. Delivery time: 4-5 weeks after approved drawing.

180° OPTIONAL

MAGNETIC STRIP

Colour	Order no.
Transparent	98180
Smoky	98181

ROUND LIST

Colour	Order no.
	98185

SHOWER DOOR SWEEP 12 MM

Colour	Order no.
Transparent	98186

SHOWER DOOR SWEEP 23 MM

Colour	Order no.
Transparent	98187

SHOWER SEAT RELAX.

Folding.



Colour	Order no.
White	6292

FRONT SHOWER SHELF

Aluminium shelf for placement in or outside the shower. Can be glued. Glue kit including fittings available as an accessory. H:10 D:9



WALL SHELF

Aluminium shelf for placement in or outside the shower. Can be glued. A glue kit is available as an accessory. H:7,5 D:8,5



Shower storage	70	80	32,5	65
Colour	Order no.	Order no.	Order no.	Order no.
Matt aluminium	6571	6581	6330	6660
Polished pencil black	6573	6583	6329	6659
Black matt	6572	6582	6325	6651
White matt	6570	6580	6324	6650
Optional				
Glue kit	97058	97058	97043	97043

SKOGA

It is named after Iceland's largest waterfall and inspired by its natural beauty, power and possibilities. Skoga is characterised by functionality, with a design that is easy to love.

Design, flexibility and now storage, too, are key. The result? Now there's a Skoga for every bathroom. Whether your bathroom is large, small or has an unusual shape.

FOCUS ON FUNCTION

Design

Slimline, practical and with a good seal, not to mention the focus on function and flexibility.

Flexibility

Corner shower, alcove shower, folding screen shower and shower screen. Corner showers and shower screens for baths. Integrated space-saving Skoga storage.

Functionality

Foldable and space-saving. Reversible for positioning on the right or left. Lifting mounting to make opening, closing and cleaning easier. Pre-prepared for adhesive mounting. Easy to install.

Quality

6 mm toughened safety glass. CE marked. Made in Sweden and sold with a 20-year warranty.

Sustainability

100% recyclable.

STANDARD

Ring handle

The various Skoga shower options come with grip holes as standard. The grip holes match the shower profiles.

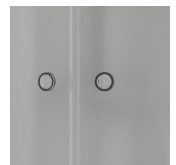

Toughened safety glass 6 mm

Skoga comes with 6 mm toughened safety glass.



OPTIONS

Handles

Skoga handles offer an elegant, airy design with a contemporary look. For those looking for a more ergonomic grip.



Skoga shower storage

Skoga storage is suitable for use with all Skoga profile showers, providing extra vertical storage within the shower.



Shower seat Relax

The seat's surface is comfortable and easy to keep clean, as well as offering a stylish, modern look.



Discover the whole Skoga range.



COLOR PROFILE



Polished
aluminium



Matt aluminium



Pencil black



Black matt

GLASS



Clear glass



Frosted
glass



Semi-
frosted



Smoked
glass

CORNER SHOWER, ROUND

The soft, flowing design creates calm and harmony. The half-frosted glass panel screens the user from view, but other options are available too. The hinges make the doors easier to open and close, and the seal sits tightly against the floor. The profiles allow for pipe installation.



CORNER SHOWER, STRAIGHT

The design has a stringent, almost graphic feel. The smart lifting hinges make the doors easier to open and close, and the seal sits tightly against the floor to prevent splashing. The doors can be folded inwards to save space when the shower is not in use. The profiles are slim and allow for pipe installation.



SHOWER SCREEN

Skoga shower screens are available in many versions, but they all convey the same basic style. The hinges make the door easy to open and close and the seal sits tightly against the floor. A rod can be used to transform a moving door into a fixed door. Although the profiles are slim, they still allow for pipe installation.

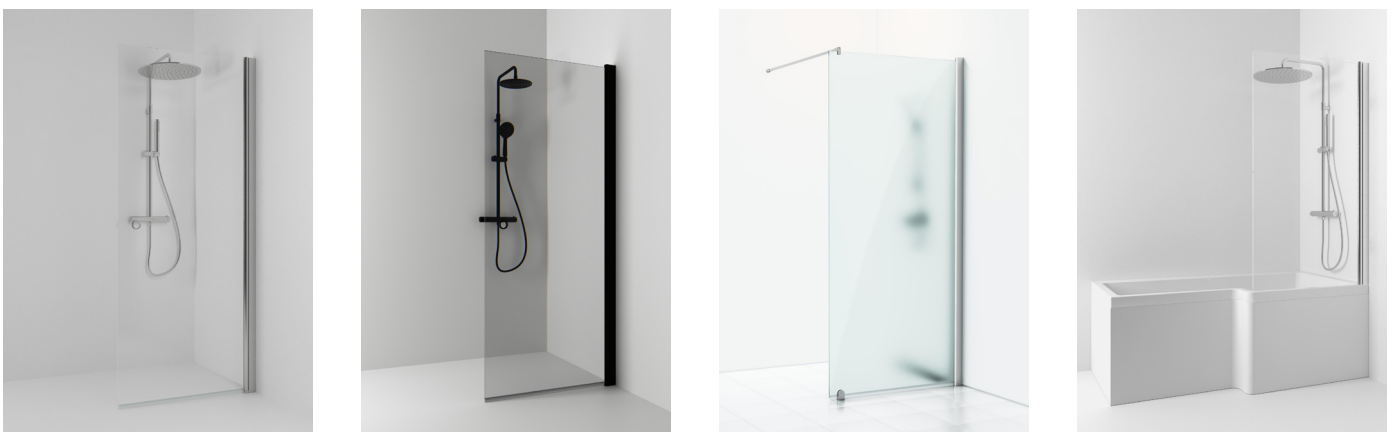

ALCOVE, SINGLE OR DOUBLE

A shower experience starts long before you turn on the taps, and does not stop until long after the shower is over. With its attractive design, Skoga transforms your alcove shower into a beautiful bathroom feature. And the practical details maximise floor space and minimise splashing.

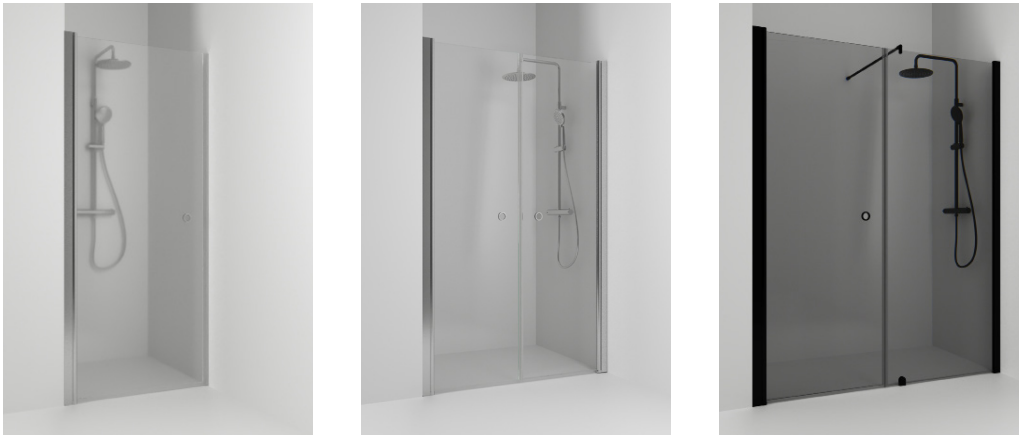

FOLDING SCREEN SHOWER

Our folding screen showers are designed to fit all bathrooms and take up minimum space. As their name suggests, these showers fold away when not in use. Choose between different models and designs to find the perfect solution for your bathroom.

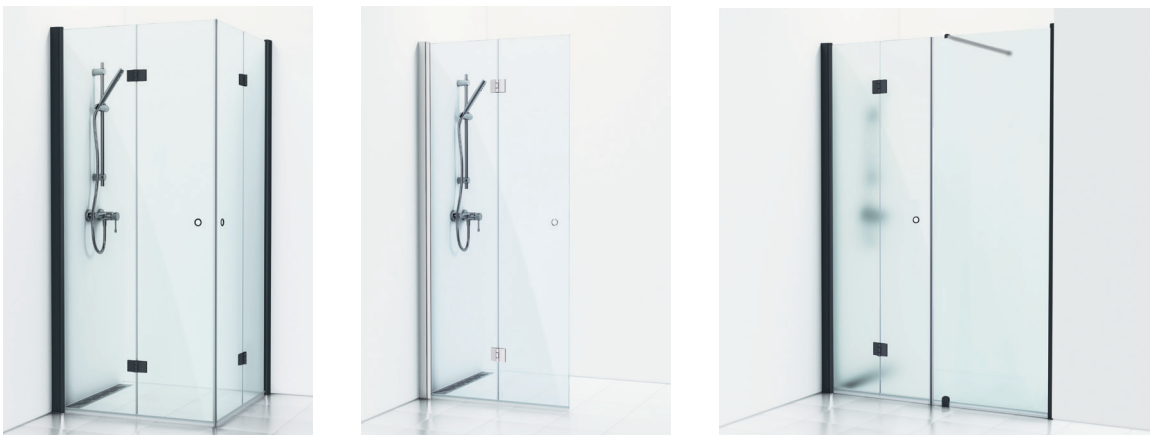

SKOGA STORAGE

What really sets Skoga apart is the outwardly slimline look with semi-hidden, generous shelves with practical rails inside. A total of five large shelves can be found inside the shower profile, along with a practical hook on the outside for dressing gowns and/or towels. Colours matched with the other details in your bathroom.



SKOGA CORNER SHOWER STRAIGHT

- Has two opening doors with transparent seals on the bottom edges.
- Doors can be folded inwards when shower is not in use to maximise floor space.
- No threshold - disabled friendly.
- Toughened safety glass 6 mm.
- Wall profile allows for pipe installation 30 mm from the wall.
- The shower walls can be supplemented with 30 or 50 mm wall profiles.
- The measurements are reversible for right or left fitting.
- Height: 198 cm.
- Door opening: 85-127 cm.
- Includes grip holes. Handles are available as accessories.

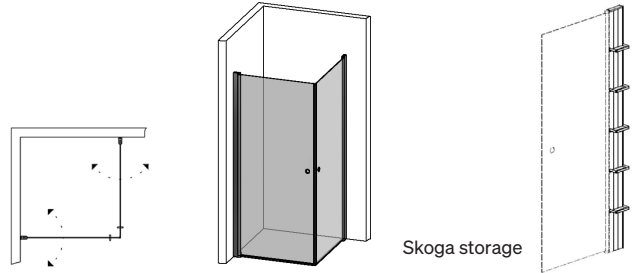

Skoga Corner shower straight	70X70 Height: 198 cm. Opening dimensions: 85 cm.	70X80 Height: 198 cm. Opening dimensions: 93 cm.	70X90 Height: 198 cm. Opening dimensions: 101 cm.	SKOGA STORAGE Height: 198 cm. Built out 10 cm from the wall.
Profile/glass	Order no.	Order no.	Order no.	Order no.
Matt aluminium				
Clear glass	63507377	63507378	63507379	6601
Smoked glass	63511377 ²	63511378 ²	63511379 ²	6601
Frosted glass	63508377 ²	63508378 ²	63508379 ²	6601
Polished aluminium				
Clear glass	63507477	63507478	63507479	6600
Smoked glass	63511477 ²	63511478 ²	63511479 ²	6600
Frosted glass	63508477 ²	63508478 ²	63508479 ²	6600
Black matt				
Clear glass	63507277 ¹	63507278 ¹	63507279 ¹	6602
Smoked glass	63511277 ²	63511278 ²	63511279 ²	6602
Frosted glass	63508277 ²	63508278 ²	63508279 ²	6602

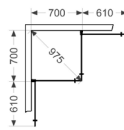

70X70

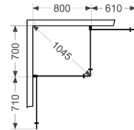

70X80

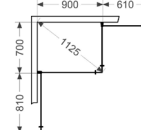

70X90

¹ Delivery time 2 weeks.
² Delivery time 4 weeks.

Skoga Corner shower straight	70X100 Height: 198 cm. Opening dimensions: 109 cm.	80X80 Height: 198 cm. Opening dimensions: 100 cm.	80X90 Height: 198 cm. Opening dimensions: 107 cm.	SKOGA STORAGE Height: 198 cm. Built out 10 cm from the wall.
Profile/glass	Order no.	Order no.	Order no.	Order no.
Matt aluminium				
Clear glass	63507371	63507388	63507389	6601
Smoked glass	63511371 ²	63511388	63511389	6601
Frosted glass	63508371 ²	63508388	63508389	6601
Polished aluminium				
Clear glass	63507471	63507488	63507489	6600
Smoked glass	63511471 ²	63511488	63511489	6600
Frosted glass	63508471 ²	63508488	63508489	6600
Pencil black				
Clear glass	-	63507588	63507589	6603
Smoked glass	-	63511588	63511589	6603
Black matt				
Clear glass	63507271 ¹	63507288	63507289	6602
Smoked glass	63511271 ²	63511288	63511289	6602
Frosted glass	63508271 ²	63508288	63508289	6602

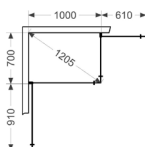

70X100

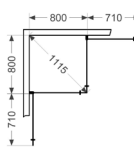

80X80

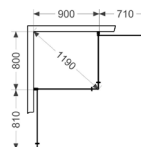

80X90

¹ Delivery time 2 weeks.
² Delivery time 4 weeks.

SKOGA CORNER SHOWER STRAIGHT

- Has two opening doors with transparent seals on the bottom edges.
- Doors can be folded inwards when shower is not in use to maximise floor space.
- No threshold - disabled friendly.
- Toughened safety glass 6 mm.
- Wall profile allows for pipe installation 30 mm from the wall.
- The shower walls can be supplemented with 30 or 50 mm wall profiles.
- The measurements are reversible for right or left fitting.
- Height: 198 cm.
- Door opening: 85-127 cm.
- Includes grip holes. Handles are available as accessories.

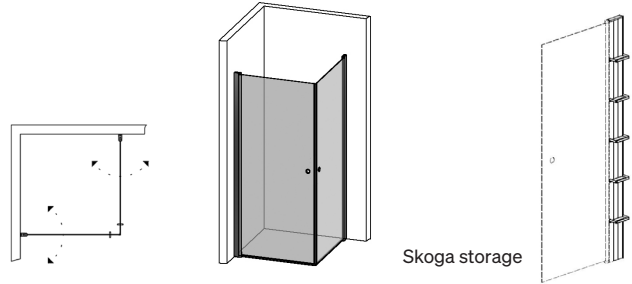

Skoga Corner shower straight	80X100 Height: 198 cm. Opening dimensions: 115 cm.	90X90 Height: 198 cm. Opening dimensions: 114 cm.	90X100 Height: 198 cm. Opening dimensions: 121 cm.	SKOGA STORAGE Height: 198 cm. Built out 10 cm from the wall.
Profile/glass	Order no.	Order no.	Order no.	Order no.
Matt aluminium				
Clear glass	63507381	63507399	63507391	6601
Smoked glass	63511381 ²	63511399	63511391 ²	6601
Frosted glass	63508381 ²	63508399	63508391 ²	6601
Polished aluminium				
Clear glass	63507481	63507499	63507491	6600
Smoked glass	63511481 ²	63511499	63511491 ²	6600
Frosted glass	63508481 ²	63508499	63508491 ²	6600
Pencil black				
Clear glass	-	63507599	-	6603
Smoked glass	-	63511599	-	6603
Black matt				
Clear glass	63507281 ¹	63507299	63507291 ¹	6602
Smoked glass	63511281 ²	63511299	63511291 ²	6602
Frosted glass	63508281 ²	63508299	63508291 ²	6602

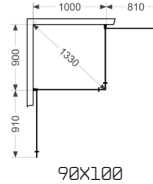
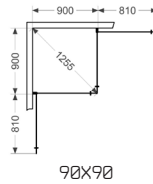
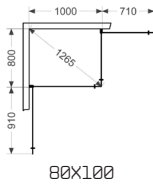

¹ Delivery time 2 weeks.
² Delivery time 4 weeks.

Skoga Corner shower straight	100X100 Height: 198 cm. Opening dimensions: 127 cm.	SKOGA STORAGE Height: 198 cm. Built out 10 cm from the wall.
Profile/glass	Order no.	Order no.
Matt aluminium		
Clear glass	63507311	6601
Smoked glass	63511311 ²	6601
Frosted glass	63508311 ²	6601
Polished aluminium		
Clear glass	63507411	6600
Smoked glass	63511411 ²	6600
Frosted glass	63508411 ²	6600
Black matt		
Clear glass	63507211 ¹	6602
Smoked glass	63511211 ²	6602
Frosted glass	63508211 ²	6602

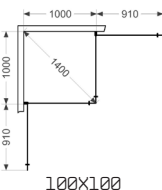

SKOGA STORAGE

Skoga storage is suitable for use with all Skoga profile showers, providing extra vertical storage within the shower. The storage is mounted between the shower and wall, and has five fixed shelves.

NB: Please remember that Skoga storage is built out 10 cm from the wall, meaning that you must subtract 10 cm from the corresponding measurement of your desired shower solution.

Example 1: Skoga corner shower, straight, 90x90 with Skoga storage. Order Skoga corner shower, straight, 80x90 and Skoga storage.

Example 2: Skoga shower screen, fixed, 80, with Skoga storage. Order Skoga shower screen, fixed, 70, and Skoga storage.

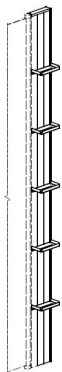

SKOGA CORNER SHOWER COMBI

- Consists of a fixed screen with curtain rail (max. 105 cm), floor mounting and transparent rubber seal against the floor, plus one folding door (180°) with transparent rubber seal against the floor and between the glass panels.
- No threshold - disabled friendly.
- Toughened safety glass 6 mm.
- Wall profiles allow pipe installation 30 mm from wall.
- Showers can be supplemented with 30 or 50 mm wall profiles.
- Height: 198 cm (201 cm upper edge of rod).
- Door opening: 60-90 cm.
- Includes grip holes. Handles are available as accessories.

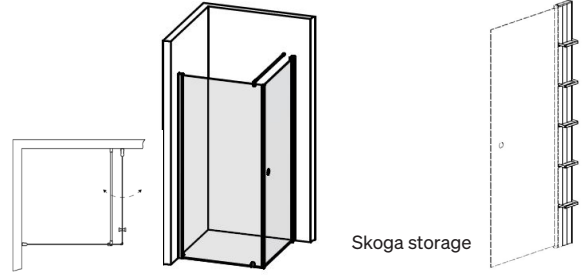

* Length fixed glass

Skoga Corner shower combo	70X73*	70X83*	70X93*	SKOGA STORAGE
Profile/glass	Order no.	Order no.	Order no.	Order no.
Matt aluminium				
Clear glass	62007377 ¹	62007378 ¹	62007379 ¹	6601
Smoked glass	62011377 ²	62011378 ²	62011379 ²	6601
Frosted glass	62008377 ²	62008378 ²	62008379 ²	6601
Polished aluminium				
Clear glass	62007477 ¹	62007478 ¹	62007479 ¹	6600
Smoked glass	62011477 ²	62011478 ²	62011479 ²	6600
Frosted glass	62008477 ²	62008478 ²	62008479 ²	6600
Black matt				
Clear glass	62007277 ¹	62007278 ¹	62007279 ¹	6602
Smoked glass	62011277 ²	62011278 ²	62011279 ²	6602
Frosted glass	62008277 ²	62008278 ²	62008279 ²	6602

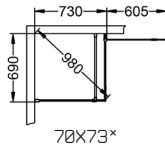

70X73*

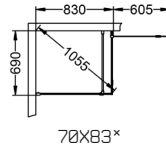

70X83*

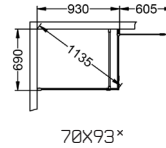

70X93*

¹ Delivery time 2 weeks.
² Delivery time 4 weeks.

* Length fixed glass

Skoga Corner shower combo	80X73*	80X83*	80X93*	SKOGA STORAGE
Profile/glass	Order no.	Order no.	Order no.	Order no.
Matt aluminium				
Clear glass	62007387 ¹	62007388	62007389	6601
Smoked glass	62011387 ²	62011388	62011389	6601
Frosted glass	62008387 ²	62008388	62008389	6601
Polished aluminium				
Clear glass	62007487 ¹	62007488	62007489	6600
Smoked glass	62011487 ²	62011488	62011489	6600
Frosted glass	62008487 ²	62008488	62008489	6600
Black matt				
Clear glass	62007287 ¹	62007288	62007289	6602
Smoked glass	62011287 ²	62011288	62011289	6602
Frosted glass	62008287 ²	62008288	62008289	6602

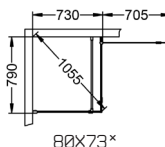

80X73*

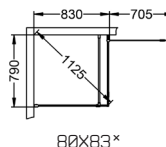

80X83*

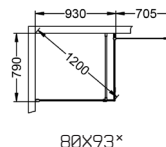

80X93*

¹ Delivery time 2 weeks.
² Delivery time 4 weeks.

SKOGA CORNER SHOWER COMBI

- Consists of a fixed screen with curtain rail (max. 105 cm), floor mounting and transparent rubber seal against the floor, plus one folding door (180°) with transparent rubber seal against the floor and between the glass panels.
- No threshold - disabled friendly.
- Toughened safety glass 6 mm.
- Wall profiles allow pipe installation 30 mm from wall.
- Showers can be supplemented with 30 or 50 mm wall profiles.
- Height: 198 cm (201 cm upper edge of rod).
- Door opening: 60-90 cm.
- Includes grip holes. Handles are available as accessories.



Skoga Corner shower combo	90X73*	90X83*	90X93*	SKOGA STORAGE
Profile/glass	Order no.	Order no.	Order no.	Order no.
Matt aluminium				
Clear glass	62007397 ¹	62007398	62007399	6601
Smoked glass	62011397 ²	62011398	62011399	6601
Frosted glass	62008397 ²	62008398	62008399	6601
Polished aluminium				
Clear glass	62007497 ¹	62007498	62007499	6600
Smoked glass	62011497 ²	62011498	62011499	6600
Frosted glass	62008497 ²	62008498	62008499	6600
Black matt				
Clear glass	62007297 ¹	62007298	62007299	6602
Smoked glass	62011297 ²	62011298	62011299	6602
Frosted glass	62008297 ²	62008298	62008299	6602

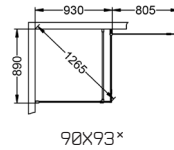
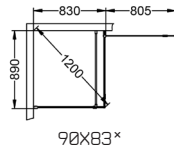
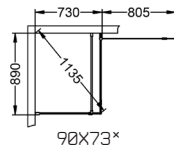

¹ Delivery time 2 weeks.
² Delivery time 4 weeks.

Skoga Corner shower combo	100X73*	100X83*	100X93*	SKOGA STORAGE
Profile/glass	Order no.	Order no.	Order no.	Order no.
Matt aluminium				
Clear glass	62007317 ¹	62007318 ¹	62007319 ¹	6601
Smoked glass	62011317 ²	62011318 ²	62011319 ²	6601
Frosted glass	62008317 ²	62008318 ²	62008319 ²	6601
Polished aluminium				
Clear glass	62007417 ¹	62007418 ¹	62007419 ¹	6600
Smoked glass	62011417 ²	62011418 ²	62011419 ²	6600
Frosted glass	62008417 ²	62008418 ²	62008419 ²	6600
Black matt				
Clear glass	62007217 ¹	62007218 ¹	62007219 ¹	6602
Smoked glass	62011217 ²	62011218 ²	62011219 ²	6602
Frosted glass	62008217 ²	62008218 ²	62008219 ²	6602

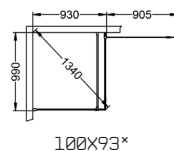
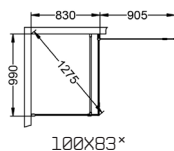
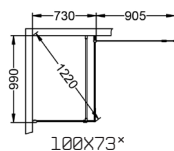

¹ Delivery time 2 weeks.
² Delivery time 4 weeks.

SKOGA CORNER SHOWER ROUND

- Has two opening doors with transparent seals on the bottom edges.
- Doors can be folded inwards when shower is not in use to maximise floor space.
- No threshold - disabled friendly.
- Toughened safety glass 6 mm.
- Wall profile allows for pipe installation 30 mm from the wall.
- The shower walls can be supplemented with 30 or 50 mm wall profiles.
- The measurements are reversible for right or left fitting.
- Height: 198 cm.
- Door opening: 99-114 cm.
- Includes grip holes. Handles are available as accessories.



Skoga Corner shower round	80X80 Height: 198 cm Opening dimensions: 99 cm.	80X90 Height: 198 cm Opening dimensions: 106 cm.	90X90 Height: 198 cm Opening dimensions: 114 cm.	SKOGA STORAGE Height: 198 cm. Built out 10 cm from the wall.
Profile/glass	Order no.	Order no.	Order no.	Order no.
Matt aluminium				
Clear glass	60607388	60607389	60607399	6601
Smoked glass	60611388	60611389	60611399	6601
Frosted glass	60608388	60608389	60608399	6601
Polished aluminium				
Clear glass	60607488	60607489	60607499	6600
Smoked glass	60611488	60611489	60611499	6600
Frosted glass	60608488	60608489	60608499	6600
Pencil black				
Clear glass	60607588	60607589	60607599	6603
Smoked glass	60611588	60611589	60611599	6603
Black matt				
Clear glass	60607288	60607289	60607299	6602
Smoked glass	60611288	60611289	60611299	6602
Frosted glass	60608288	60608289	60608299	6602

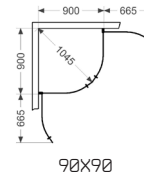
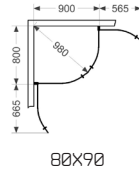
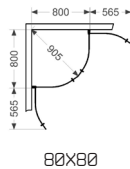

¹ Delivery time 2 weeks.
² Delivery time 4 weeks.

FRONT SHOWER SHELF

Aluminium shelf for placement in or outside the shower. Can be glued. Glue kit including fittings available as an accessory. H:10 D:9



WALL SHELF

Aluminium shelf for placement in or outside the shower. Can be glued. A glue kit is available as an accessory. H:7,5 D:8,5



Shower storage	70	80	32,5	65
Colour	Order no.	Order no.	Order no.	Order no.
Matt aluminium	6571	6581	6330	6660
Polished pencil black	6573	6583	6329	6659
Black matt	6572	6582	6325	6651
White matt	6570	6580	6324	6650
Optional				
Glue kit	97058	97058	97043	97043

SKOGA CORNER SHOWER ROUND/STRAIGHT

- Has two opening doors with transparent seals on the bottom edges.
- Toughened safety glass 6 mm.
- Wall profile allows for pipe installation 30 mm from the wall.
- The shower walls can be supplemented with 30 or 50 mm wall profiles.
- The measurements are reversible for right or left fitting.
- Height: 198 cm.
- Door opening: 130-156 cm.
- Includes grip holes. Handles are available as accessories.

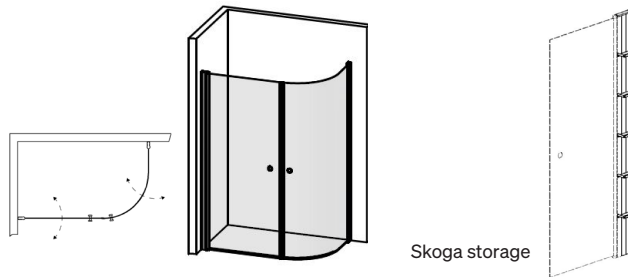

Skoga Corner shower round/straight	80X117 Height: 198 cm Opening dimensions: 130 cm.	80X127 Height: 198 cm Opening dimensions: 138 cm.	80X137 Height: 198 cm Opening dimensions: 147 cm.	SKOGA STORAGE Height: 198 cm. Built out 10 cm from the wall.
Profile/glass	Order no.	Order no.	Order no.	Order no.
Matt aluminium				
Clear glass	60807387 ¹	60807388	60807389	6601
Polished aluminium				
Clear glass	60807487	60807488	60807489	6600
Black matt				
Clear glass	60807287	60807288	60807289	6602

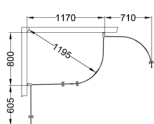

80X117

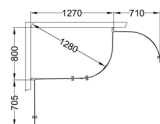

80X127

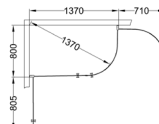

80X137

¹ Delivery time 2 weeks.
² Delivery time 4 weeks.

Skoga Corner shower round/straight	80X147 Height: 198 cm Opening dimensions: 156 cm.	SKOGA STORAGE Height: 198 cm. Built out 10 cm from the wall.
Profile/glass	Order no.	Order no.
Matt aluminium		
Clear glass	60807381 ¹	6601
Polished aluminium		
Clear glass	60807481	6600
Black matt		
Clear glass	60807281	6602

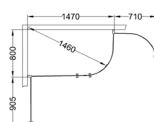

80X147

SKOGA CORNER SHOWER ROUND

- Consists of two doors with transparent sealing strip at the bottom.
- Can be positioned asymmetrically or symmetrically in a corner, or in the centre of a wall.
- Doors can be folded inwards when shower is not in use to maximise floor space.
- No threshold - disabled friendly.
- Toughened safety glass 6 mm.
- Wall profile allows for pipe installation 30 mm from the wall.
- The shower walls can be supplemented with 30 or 50 mm wall profiles.
- Height: 198 cm.
- Includes grip holes. Handles are available as accessories.

Skoga Corner shower round	90X67 Height: 198 cm	95X80 Height: 198 cm
Profile/glass	Order no.	Order no.
Matt aluminium		
Clear glass	61307379 ¹	61307381
Polished aluminium		
Clear glass	61307479 ¹	61307481
Black matt		
Clear glass	61307279 ¹	61307281

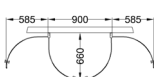

90X67

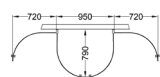

95X80

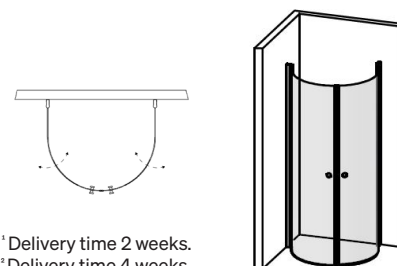

¹ Delivery time 2 weeks.
² Delivery time 4 weeks.

SKOGA SHOWER SCREEN STRAIGHT

- Shower screen, depth 52-97 cm.
- Toughened safety glass 6 mm.
- Wall profile allows for pipe installation 30 mm from the wall.
- The shower walls can be supplemented with 30 or 50 mm wall profiles.
- Height: 198 cm.
- Includes grip holes. Handles are available as accessories.

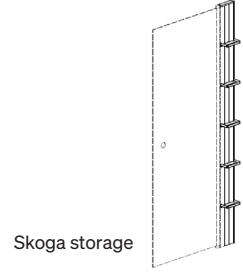
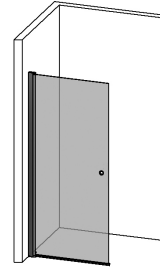
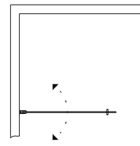

Skoga storage

Skoga Shower screen straight	52 Height: 198 cm	57 Height: 198 cm	62 Height: 198 cm	SKOGA STORAGE Height: 198 cm. Built out 10 cm from the wall.
Profile/glass	Order no.	Order no.	Order no.	Order no.
Matt aluminium				
Clear glass	63307355 ¹	63307360 ¹	63307365 ¹	6601
Frosted glass	63308355 ²	63308360 ²	63308365 ²	6601
Polished aluminium				
Clear glass	63307455 ¹	63307460 ¹	63307465 ¹	6600
Frosted glass	63308455 ²	63308460 ²	63308465 ²	6600

Skoga Shower screen straight	67 Height: 198 cm	77 Height: 198 cm	87 Height: 198 cm	SKOGA STORAGE Height: 198 cm. Built out 10 cm from the wall.
Profile/glass	Order no.	Order no.	Order no.	Order no.
Matt aluminium				
Clear glass	63307370	63307380	63307390	6601
Smoked glass	63311370 ²	63311380	63311390	6601
Frosted glass	63308370 ²	63308380	63308390	6601
Polished aluminium				
Clear glass	63307470	63307480	63307490	6600
Smoked glass	63311470 ²	63311480	63311490	6600
Frosted glass	63308470 ²	63308480	63308490	6600
Black matt				
Clear glass	63307270 ¹	63307280	63307290	6602
Smoked glass	63311270 ²	63311280	63311290	6602
Frosted glass	63308270 ²	63308280	63308290	6602

Skoga Shower screen straight	97 Height: 198 cm	SKOGA STORAGE Height: 198 cm. Built out 10 cm from the wall.
Profile/glass	Order no.	Order no.
Matt aluminium		
Clear glass	63307310	6601
Smoked glass	63311310 ²	6601
Frosted glass	63308310 ²	6601
Polished aluminium		
Clear glass	63307410	6600
Smoked glass	63311410 ²	6600
Frosted glass	63308410 ²	6600
Black matt		
Clear glass	63307210 ¹	6602
Smoked glass	63311210 ²	6602
Frosted glass	63308210 ²	6602

¹ Delivery time 2 weeks.
² Delivery time 4 weeks.

SKOGA STORAGE

Skoga storage is suitable for use with all Skoga profile showers, providing extra vertical storage within the shower. The storage is mounted between the shower and wall, and has five fixed shelves.

NB: Please remember that Skoga storage is built out 10 cm from the wall, meaning that you must subtract 10 cm from the corresponding measurement of your desired shower solution.

Example 1: Skoga corner shower, straight, 90×90 with Skoga storage. Order Skoga corner shower, straight, 80×90 and Skoga storage.

Example 2: Skoga shower screen, fixed, 80, with Skoga storage. Order Skoga shower screen, fixed, 70, and Skoga storage.

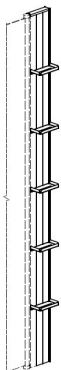

SKOGA SHOWER SCREEN FIXED

- Comes complete with curtain rod (max 105 cm), floor mount and transparent seal against the floor.
- Toughened safety glass 6 mm.
- Wall profile allows for pipe installation 30 mm from the wall.
- The shower walls can be supplemented with 30 or 50 mm wall profiles.
- Height: 198 cm (201 cm upper edge of rod).

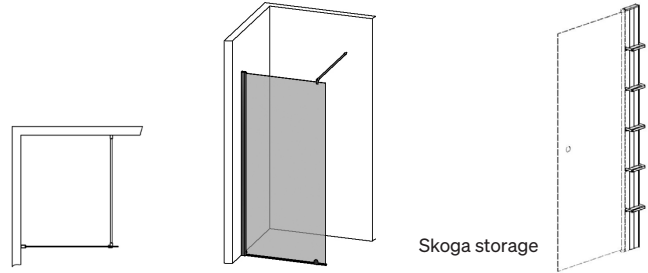

Skoga Shower screen fixed	70 Height: 198 cm (201 cm upper edge of rod).	80 Height: 198 cm (201 cm upper edge of rod).	90 Height: 198 cm (201 cm upper edge of rod).	SKOGA STORAGE Height: 198 cm. Built out 10 cm from the wall.
Profile/glass	Order no.	Order no.	Order no.	Order no.
Matt aluminium				
Clear glass	6120037	6120038	6120039	6601
Smoked glass	6120337 ²	6120338	6120339	6601
Frosted glass	6120137 ²	6120138 ¹	6120139	6601
Polished aluminium				
Clear glass	6120047	6120048	6120049	6600
Smoked glass	6120347 ²	6120348	6120349	6600
Frosted glass	6120147 ²	6120148	6120149	6600
Black matt				
Clear glass	6120027 ¹	6120028	6120029	6602
Smoked glass	6120327 ²	6120328	6120329	6602
Frosted glass	6120127 ²	6120128 ¹	6120129 ¹	6602

¹ Delivery time 2 weeks.

² Delivery time 4 weeks.

SKOGA SHOWER SCREEN BATH

- Has one opening door with transparent seal against edge of bathtub.
- Toughened safety glass 6 mm.
- Wall profile allows for pipe installation 30 mm from the wall.
- Height: 141 cm.

Skoga Shower screen bath	80 Height: 141 cm
Profile/glass	Order no.
Matt aluminium	
Clear glass	63000380
Polished aluminium	
Clear glass	63000480
Black matt	
Clear glass	63000280

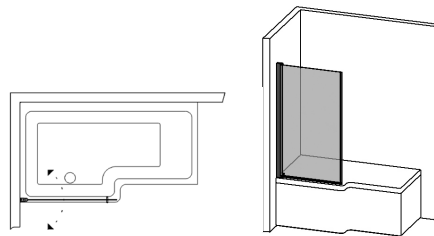

SKOGA ALCOVE SHOWER SINGLE

- Single alcove, available in 70-100 cm.
- Shower screens can be adjusted 2,5 cm. See table below.
- For other alcove measurements please supplement with 30 or 50 mm wall profiles.
- Reversible for either right or left orientation.
- No threshold - disabled friendly.
- Toughened safety glass 6 mm.
- Wall profile allows for pipe installation 30 mm from the wall.
- Height: 198 cm.
- Door opening: 60-90 cm.
- Includes grip holes. Handles are available as accessories.

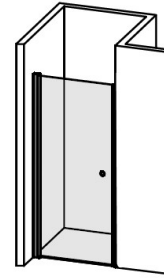
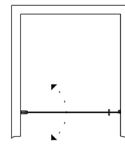

Skoga storage

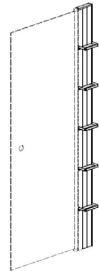

Skoga Alcove shower single	70 Height: 198 cm Opening dimensions: 60 cm.	80 Height: 198 cm Opening dimensions: 70 cm.	90 Height: 198 cm Opening dimensions: 80 cm.	SKOGA STORAGE Height: 198 cm. Built out 10 cm from the wall.
Profile/glass	Order no.	Order no.	Order no.	Order no.
Matt aluminium				
Clear glass	60107370	60107380	60107390	6601
Smoked glass	60111370 ²	60111380	60111390	6601
Frosted glass	60108370 ²	60108380	60108390	6601
Polished aluminium				
Clear glass	60107470	60107480	60107490	6600
Smoked glass	60111470 ²	60111480	60111490	6600
Frosted glass	60108470 ²	60108480	60108490	6600
Black matt				
Clear glass	60107270 ¹	60107280	60107290	6602
Smoked glass	60111270 ²	60111280	60111290	6602
Frosted glass	60108270 ²	60108280	60108290	6602

Skoga Alcove shower single	100 Height: 198 cm Opening dimensions: 90 cm.	SKOGA STORAGE Height: 198 cm. Built out 10 cm from the wall.
Profile/glass	Order no.	Order no.
Matt aluminium		
Clear glass	60107310	6601
Smoked glass	60111310 ²	6601
Frosted glass	60108310 ²	6601
Polished aluminium		
Clear glass	60107410	6600
Smoked glass	60111410 ²	6600
Frosted glass	60108410 ²	6600
Black matt		
Clear glass	60107210 ¹	6602
Smoked glass	60111210 ²	6602
Frosted glass	60108210 ²	6602

¹ Delivery time 2 weeks.

² Delivery time 4 weeks.

SKOGA STORAGE

Skoga storage is suitable for use with all Skoga profile showers, providing extra vertical storage within the shower. The storage is mounted between the shower and wall, and has five fixed shelves.

NB: Please remember that Skoga storage is built out 10 cm from the wall, meaning that you must subtract 10 cm from the corresponding measurement of your desired shower solution.

Example 1: Skoga corner shower, straight, 90x90 with Skoga storage. Order Skoga corner shower, straight, 80x90 and Skoga storage.

Example 2: Skoga shower screen, fixed, 80, with Skoga storage. Order Skoga shower screen, fixed, 70, and Skoga storage.

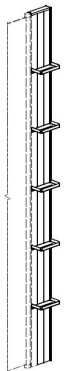

Adjustment measurements Skoga Alcove shower single	
Measurement	Adjustable
70	69.5 - 72
80	79.5 - 82
90	89.5 - 92
100	99.5 - 102

SKOGA ALCOVE SHOWER DOUBLE

- Double alcove, available in 108-198 cm.
- Shower screens can be adjusted 4 cm. See table below.
- For other alcove measurements please supplement with 30 or 50 mm wall profiles.
- No threshold - disabled friendly.
- Toughened safety glass 6 mm.
- Wall profile allows for pipe installation 30 mm from the wall.
- Height: 198 cm.
- Door opening: 90-180 cm.
- Includes grip holes. Handles are available as accessories.

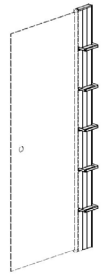
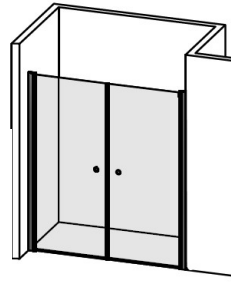
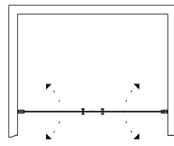

Skoga storage

Skoga Alcove shower double	108 Height: 198 cm Opening dimensions: 90 cm.	118 Height: 198 cm Opening dimensions: 100 cm.	128 Height: 198 cm Opening dimensions: 110 cm.	SKOGA STORAGE Height: 198 cm. Built out 10 cm from the wall.
Profile/glass	Order no.	Order no.	Order no.	Order no.
Matt aluminium				
Clear glass	60207355 ¹	60207360 ¹	60207365 ¹	6601
Frosted glass	60208355 ²	60208360 ²	60208365 ²	6601
Polished aluminium				
Clear glass	60207455 ¹	60207460 ¹	60207465 ¹	6600
Frosted glass	60208455 ²	60208460 ²	60208465 ²	6600

Skoga Alcove shower double	138 Height: 198 cm Opening dimensions: 120 cm.	158 Height: 198 cm Opening dimensions: 140 cm.	178 Height: 198 cm Opening dimensions: 160 cm.	SKOGA STORAGE Height: 198 cm. Built out 10 cm from the wall.
Profile/glass	Order no.	Order no.	Order no.	Order no.
Matt aluminium				
Clear glass	60207370	60207380	60207390	6601
Smoked glass	60211370 ¹	60211380	60211390	6601
Frosted glass	60208370 ²	60208380	60208390	6601
Polished aluminium				
Clear glass	60207470	60207480	60207490	6600
Smoked glass	60211470 ¹	60211480	60211490	6600
Frosted glass	60208470 ²	60208480	60208490	6600
Black matt				
Clear glass	60207270 ¹	60207280	60207290	6602
Smoked glass	60211270 ¹	60211280	60211290	6602
Frosted glass	60208270 ²	60208280	60208290	6602

Skoga Alcove shower double	198 Height: 198 cm Opening dimensions: 180 cm.	SKOGA STORAGE Height: 198 cm. Built out 10 cm from the wall.
Profile/glass	Order no.	Order no.
Matt aluminium		
Clear glass	60207310 ¹	6601
Smoked glass	60211310	6601
Frosted glass	60208310 ²	6601
Polished aluminium		
Clear glass	60207410	6600
Smoked glass	60211410 ¹	6600
Frosted glass	60208410 ²	6600
Black matt		
Clear glass	60207210 ¹	6602
Smoked glass	60211210 ¹	6602
Frosted glass	60208210 ²	6602

¹ Delivery time 2 weeks.
² Delivery time 4 weeks.

Adjustment measurements Skoga Alcove shower double	
Measurement	Adjustable
108	105 - 109
118	115 - 119
128	125 - 129
138	135 - 139
158	155 - 159
178	175 - 179
198	195 - 199

SKOGA ALCOVE SHOWER COMBINED

- Double alcove, available in 140-180 cm.
- Shower screens can be adjusted 4 cm. See table below.
- For other alcove measurements please supplement with 30 or 50 mm wall profiles.
- No threshold - disabled friendly.
- Toughened safety glass 6 mm.
- Wall profile allows for pipe installation 30 mm from the wall.
- Height: 198 cm (201 cm upper edge of rod).
- Door opening: 60-80 cm.
- Includes grip holes. Handles are available as accessories.

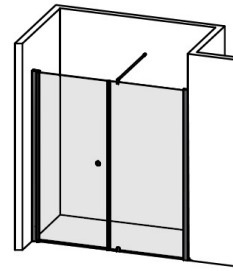
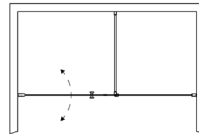

Skoga storage

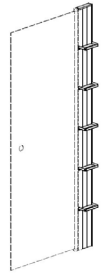

Skoga Alcove shower combined	140	160	180	SKOGA STORAGE
	Height: 198 cm (201 cm upper edge of rod). Opening dimensions: 60 cm.	Height: 198 cm (201 cm upper edge of rod). Opening dimensions: 70 cm.	Height: 198 cm (201 cm upper edge of rod). Opening dimensions: 80 cm.	Height: 198 cm. Built out 10 cm from the wall.
Profile/glass	Order no.	Order no.	Order no.	Order no.
Matt aluminium				
Clear glass	61907377	61907388	61907399	6601
Smoked glass	61911377 ²	61911388	61911399	6601
Frosted glass	61908377 ²	61908388	61908399	6601
Polished aluminium				
Clear glass	61907477	61907488	61907499	6600
Smoked glass	61911477 ²	61911488	61911499	6600
Frosted glass	61908477 ²	61908488	61908499	6600
Black matt				
Clear glass	61907277 ¹	61907288	61907299	6602
Smoked glass	61911277 ²²	61911288	61911299	6602
Frosted glass	61908277 ²	61908288	61908299	6602

Adjustment measurements Skoga Alcove shower combined	
Measurement	Adjustable
140	139,5 - 143,5
160	159,5 - 163,5
180	179,5 - 183,5

¹ Delivery time 2 weeks.
² Delivery time 4 weeks.

FRONT SHOWER SHELF

Aluminium shelf for placement in or outside the shower. Can be glued. Glue kit including fittings available as an accessory. H:10 D:9



WALL SHELF

Aluminium shelf for placement in or outside the shower. Can be glued. A glue kit is available as an accessory. H:7,5 D:8,5



Shower storage	70	80	32,5	65
Colour	Order no.	Order no.	Order no.	Order no.
Matt aluminium	6571	6581	6330	6660
Polished pencil black	6573	6583	6329	6659
Black matt	6572	6582	6325	6651
White matt	6570	6580	6324	6650
Optional				
Glue kit	97058	97058	97043	97043

SKOGA CORNER SHOWER WITH FOLDING SCREEN

- Consists of two folding doors (180°) with transparent rubber seal against the floor and between the glass panels.
- The doors can be opened/folded inwards. Practical if you have furniture in front of the doors, and to free up floor space.
- No threshold - disabled friendly.
- Toughened safety glass 6 mm.
- Wall profiles allow pipe installation 30 mm from wall.
- Showers can be supplemented with 30 or 50 mm wall profiles.
- Height: 198 cm.
- Door opening: 85-127 cm.
- Includes grip holes. Handles are available as accessories.

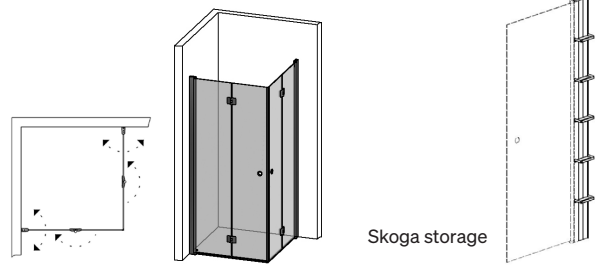

Skoga Corner shower with folding screen	70X70 Height: 198 cm Opening dimensions: 85 cm.	70X80 Height: 198 cm Opening dimensions: 93 cm.	70X90 Height: 198 cm Opening dimensions: 101 cm.	SKOGA STORAGE Height: 198 cm. Built out 10 cm from the wall.
Profile/glass	Order no.	Order no.	Order no.	Order no.
Matt aluminium				
Clear glass	61607377	61607378	61607379	6601
Semi-frosted	61609377 ¹	61609378 ¹	61609379 ¹	6601
Polished aluminium				
Clear glass	61607477	61607478	61607479	6600
Semi-frosted	61609477 ¹	61609478 ¹	61609479 ¹	6600
Black matt				
Clear glass	61607277 ¹	61607278 ¹	61607279 ¹	6602
Semi-frosted	61609277 ¹	61609278 ¹	61609279 ¹	6602

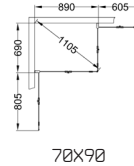
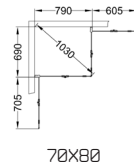
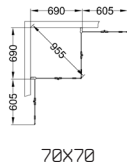

¹ Delivery time 2 weeks.
² Delivery time 4 weeks.

Skoga Corner shower with folding screen	70X100 Height: 198 cm Opening dimensions: 109 cm.	80X80 Height: 198 cm Opening dimensions: 100 cm.	80X90 Height: 198 cm Opening dimensions: 107 cm.	SKOGA STORAGE Height: 198 cm. Built out 10 cm from the wall.
Profile/glass	Order no.	Order no.	Order no.	Order no.
Matt aluminium				
Clear glass	61607371	61607388	61607389	6601
Semi-frosted	61609371 ¹	61609388	61609389	6601
Polished aluminium				
Clear glass	61607471	61607488	61607489	6600
Semi-frosted	61609471 ¹	61609488	61609489	6600
Black matt				
Clear glass	61607271 ¹	61607288	61607289	6602
Semi-frosted	61609271 ¹	61609288	61609289	6602

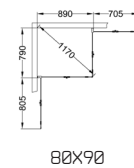
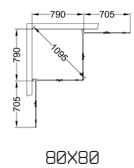
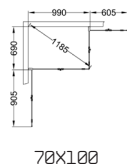

¹ Delivery time 2 weeks.
² Delivery time 4 weeks.

SKOGA CORNER SHOWER WITH FOLDING SCREEN

- Consists of two folding doors (180°) with transparent rubber seal against the floor and between the glass panels.
- The doors can be opened/folded inwards. Practical if you have furniture in front of the doors, and to free up floor space.
- No threshold - disabled friendly.
- Toughened safety glass 6 mm.
- Wall profiles allow pipe installation 30 mm from wall.
- Showers can be supplemented with 30 or 50 mm wall profiles.
- Height: 198 cm.
- Door opening: 85-127 cm.
- Includes grip holes. Handles are available as accessories.

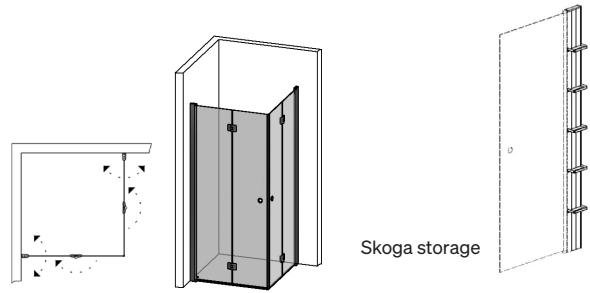

Skoga Corner shower with folding screen	80X100 Height: 198 cm Opening dimensions: 115 cm.	90X90 Height: 198 cm Opening dimensions: 114 cm.	90X100 Height: 198 cm Opening dimensions: 121 cm.	SKOGA STORAGE Height: 198 cm. Built out 10 cm from the wall.
Profile/glass	Order no.	Order no.	Order no.	Order no.
Matt aluminium				
Clear glass	61607381	61607399	61607391	6601
Semi-frosted	61609381 ¹	61609399	61609391 ¹	6601
Polished aluminium				
Clear glass	61607481	61607499	61607491	6600
Semi-frosted	61609481 ¹	61609499	61609491 ¹	6600
Black matt				
Clear glass	61607281 ¹	61607299	61607291 ¹	6602
Semi-frosted	61609281 ¹	61609299	61609291 ¹	6602

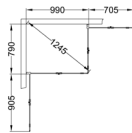

80X100

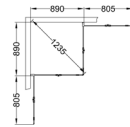

90X90

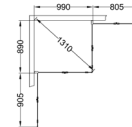

90X100

¹ Delivery time 2 weeks.
² Delivery time 4 weeks.

Skoga Corner shower with folding screen	100X100 Height: 198 cm Opening dimensions: 127 cm.	SKOGA STORAGE Height: 198 cm. Built out 10 cm from the wall.
Profile/glass	Order no.	Order no.
Matt aluminium		
Clear glass	61607311	6601
Semi-frosted	61609311 ¹	6601
Polished aluminium		
Clear glass	61607411	6600
Semi-frosted	61609411 ¹	6600
Black matt		
Clear glass	61607211 ¹	6602
Semi-frosted	61609211 ¹	6602

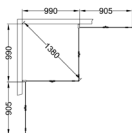

100X100

SKOGA STORAGE

Skoga storage is suitable for use with all Skoga profile showers, providing extra vertical storage within the shower. The storage is mounted between the shower and wall, and has five fixed shelves.

NB: Please remember that Skoga storage is built out 10 cm from the wall, meaning that you must subtract 10 cm from the corresponding measurement of your desired shower solution.

Example 1: Skoga corner shower, straight, 90x90 with Skoga storage. Order Skoga corner shower, straight, 80x90 and Skoga storage.

Example 2: Skoga shower screen, fixed, 80, with Skoga storage. Order Skoga shower screen, fixed, 70, and Skoga storage.

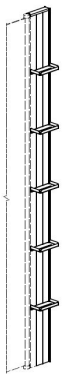

SKOGA CORNER SHOWER WITH FOLDING SCREEN, FIXED WALL/DOOR

- Consists of a fixed screen with curtain rail (max. 105 cm), floor mounting and transparent rubber seal against the floor, plus one folding door (180°) with transparent rubber seal against the floor and between the glass panels.
- The door can be opened/folded inwards. Practical if you have furniture in front of the door.
- No threshold - disabled friendly.
- Toughened safety glass 6 mm.
- Wall profiles allow pipe installation 30 mm from wall.
- Showers can be supplemented with 30 or 50 mm wall profiles.
- Height: 198 cm (201 cm upper edge of rod).
- Door opening: 60-90 cm.
- Includes grip holes. Handles are available as accessories.

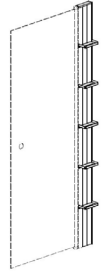
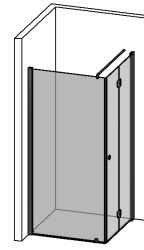
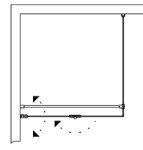

Skoga storage

* Length fixed glass

Skoga Corner shower with folding screen, fixed wall/door	70X73*	70X83*	70X93*	SKOGA STORAGE
Profile/glass	Order no.	Order no.	Order no.	Order no.
Matt aluminium				
Clear glass	61707377	61707378	61707379	6601
Polished aluminium				
Clear glass	61707477	61707478	61707479	6600
Black matt				
Clear glass	61707277 ¹	61707278 ¹	61707279 ¹	6602

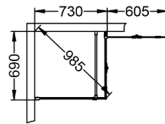

70X73*

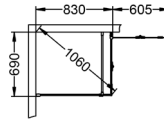

70X83*

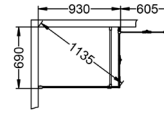

70X93*

¹ Delivery time 2 weeks.
² Delivery time 4 weeks.

Skoga Corner shower with folding screen, fixed wall/door	80X73*	80X83*	80X93*	SKOGA STORAGE
Profile/glass	Order no.	Order no.	Order no.	Order no.
Matt aluminium				
Clear glass	61707387	61707388	61707389	6601
Polished aluminium				
Clear glass	61707487	61707488	61707489	6600
Black matt				
Clear glass	61707287 ¹	61707288	61707289	6602

* Length fixed glass

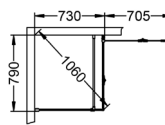

80X73*

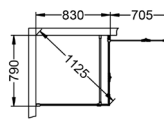

80X83*

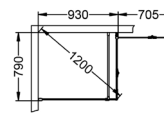

80X93*

¹ Delivery time 2 weeks.
² Delivery time 4 weeks.

SKOGA CORNER SHOWER WITH FOLDING SCREEN, FIXED WALL/DOOR

- Consists of a fixed screen with curtain rail (max. 105 cm), floor mounting and transparent rubber seal against the floor, plus one folding door (180°) with transparent rubber seal against the floor and between the glass panels.
- The door can be opened/folded inwards. Practical if you have furniture in front of the door.
- No threshold - disabled friendly.
- Toughened safety glass 6 mm.
- Wall profiles allow pipe installation 30 mm from wall.
- Showers can be supplemented with 30 or 50 mm wall profiles.
- Height: 198 cm (201 cm upper edge of rod).
- Door opening: 60-90 cm.
- Includes grip holes. Handles are available as accessories.

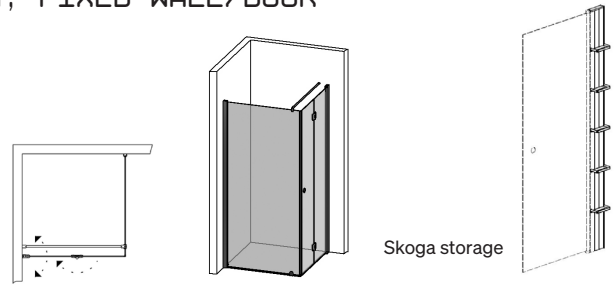

* Length fixed glass

Skoga Corner shower with folding screen, fixed wall/door	90X73*	90X83*	90X93*	SKOGA STORAGE
Profile/glass	Order no.	Order no.	Order no.	Order no.
Matt aluminium				
Clear glass	61707397	61707398	61707399	6601
Polished aluminium				
Clear glass	61707497	61707498	61707499	6600
Black matt				
Clear glass	61707297 ¹	61707298	61707299	6602

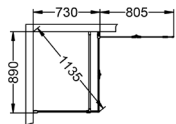

90X73*

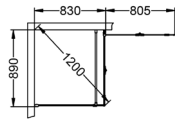

90X83*

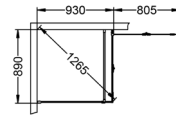

90X93*

¹ Delivery time 2 weeks.
² Delivery time 4 weeks.

* Length fixed glass

Skoga Corner shower with folding screen, fixed wall/door	100X73*	100X83*	100X93*	SKOGA STORAGE
Profile/glass	Order no.	Order no.	Order no.	Order no.
Matt aluminium				
Clear glass	61707317	61707318	61707319	6601
Polished aluminium				
Clear glass	61707417	61707418	61707419	6600
Black matt				
Clear glass	61707217 ¹	61707218 ¹	61707219 ¹	6602

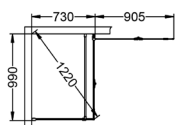

100X73*

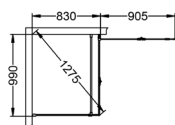

100X83*

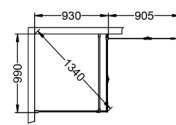

100X93*

¹ Delivery time 2 weeks.
² Delivery time 4 weeks.

SKOGA FOLDING SHOWER SCREEN

- Shower screen, depth 67-97 cm.
- Toughened safety glass 6 mm.
- Wall profiles allow pipe installation 30 mm from wall.
- Showers can be supplemented with 30 or 50 mm wall profiles.
- Height: 198 cm.
- Includes grip holes. Handles are available as accessories.

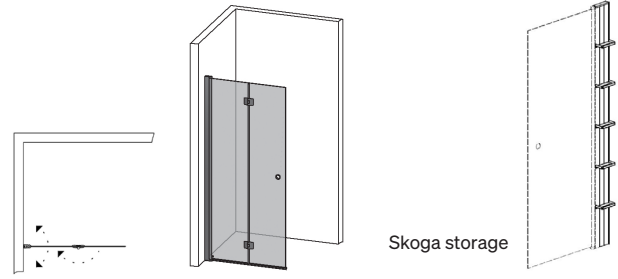

Skoga Folding shower screen	67 Height: 198 cm	77 Height: 198 cm	87 Height: 198 cm	SKOGA STORAGE Height: 198 cm. Built out 10 cm from the wall.
Profile/glass	Order no.	Order no.	Order no.	Order no.
Matt aluminium				
Clear glass	61407370	61407380	61407390	6601
Semi-frosted	61409370 ¹	61409380	61409390	6601
Polished aluminium				
Clear glass	61407470	61407480	61407490	6600
Semi-frosted	61409470 ¹	61409480	61409490	6600
Black matt				
Clear glass	61407270 ¹	61407280	61407290	6602
Semi-frosted	61409270 ¹	61409280	61409290	6602

¹ Delivery time 2 weeks.

² Delivery time 4 weeks.

Skoga Folding shower screen	97 Height: 198 cm	SKOGA STORAGE Height: 198 cm. Built out 10 cm from the wall.
Profile/glass	Order no.	Order no.
Matt aluminium		
Clear glass	61407310	6601
Semi-frosted	61409310 ¹	6601
Polished aluminium		
Clear glass	61407410	6600
Semi-frosted	61409410 ¹	6600
Black matt		
Clear glass	61407210 ¹	6602
Semi-frosted	61409210 ¹	6602

SKOGA STORAGE

Skoga storage is suitable for use with all Skoga profile showers, providing extra vertical storage within the shower. The storage is mounted between the shower and wall, and has five fixed shelves.

NB: Please remember that Skoga storage is built out 10 cm from the wall, meaning that you must subtract 10 cm from the corresponding measurement of your desired shower solution.

Example 1: Skoga corner shower, straight, 90x90 with Skoga storage. Order Skoga corner shower, straight, 80x90 and Skoga storage.

Example 2: Skoga shower screen, fixed, 80, with Skoga storage. Order Skoga shower screen, fixed, 70, and Skoga storage.

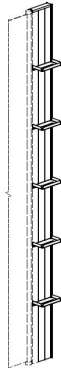

FRONT SHOWER SHELF

Aluminium shelf for placement in or outside the shower. Can be glued. Glue kit including fittings available as an accessory. H:10 D:9



WALL SHELF

Aluminium shelf for placement in or outside the shower. Can be glued. A glue kit is available as an accessory. H:7,5 D:8,5



Shower storage	70	80	32, 5	65
Colour	Order no.	Order no.	Order no.	Order no.
Matt aluminium	6571	6581	6330	6660
Polished pencil black	6573	6583	6329	6659
Black matt	6572	6582	6325	6651
White matt	6570	6580	6324	6650
Optional				
Glue kit	97058	97058	97043	97043

SKOGA ALCOVE SHOWER WITH FOLDING SCREEN, SINGLE

- Single alcove available in 70–100 cm.
- Shower screens can be adjusted 2,5 cm. See table below.
- For other alcove measurements please supplement with 30 or 50 mm wall profiles.
- No threshold - disabled friendly.
- Toughened safety glass 6 mm.
- Wall profiles allow pipe installation 30 mm from wall.
- Height: 198 cm.
- Door opening: 60-90 cm.
- Includes grip holes. Handles are available as accessories.

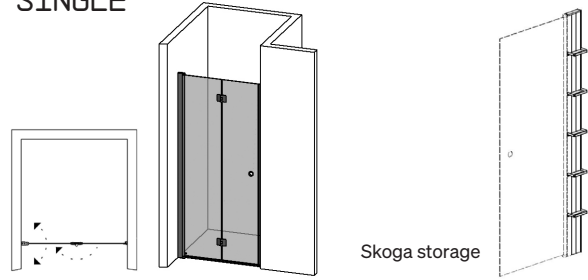

Skoga Alcove shower with folding screen, single	70 Height: 198 cm. Opening dimensions: 60 cm.	80 Height: 198 cm. Opening dimensions: 70 cm.	90 Height: 198 cm. Opening dimensions: 80 cm.	SKOGA STORAGE Height: 198 cm. Built out 10 cm from the wall.
Profile/glass	Order no.	Order no.	Order no.	Order no.
Matt aluminium				
Clear glass	61507370	61507380	61507390	6601
Semi-frosted	61509370 ¹	61509380	61509390	6601
Polished aluminium				
Clear glass	61507470	61507480	61507490	6600
Semi-frosted	61509470 ¹	61509480	61509490	6600
Black matt				
Clear glass	61507270	61507280	61507290	6602
Semi-frosted	61509270 ¹	61509280	61509290	6602

¹ Delivery time 2 weeks.
² Delivery time 4 weeks.

Skoga Alcove shower with folding screen, single	100 Height: 198 cm. Opening dimensions: 90 cm.	SKOGA STORAGE Height: 198 cm. Built out 10 cm from the wall.
Profile/glass	Order no.	Order no.
Matt aluminium		
Clear glass	61507310	6601
Semi-frosted	61509310 ¹	6601
Polished aluminium		
Clear glass	61507410	6600
Semi-frosted	61509410 ¹	6600
Black matt		
Clear glass	61507210	6602
Semi-frosted	61509210 ¹	6602

SKOGA STORAGE

Skoga storage is suitable for use with all Skoga profile showers, providing extra vertical storage within the shower. The storage is mounted between the shower and wall, and has five fixed shelves.

NB: Please remember that Skoga storage is built out 10 cm from the wall, meaning that you must subtract 10 cm from the corresponding measurement of your desired shower solution.

Example 1: Skoga corner shower, straight, 90×90 with Skoga storage. Order Skoga corner shower, straight, 80×90 and Skoga storage.

Example 2: Skoga shower screen, fixed, 80, with Skoga storage. Order Skoga shower screen, fixed, 70, and Skoga storage.

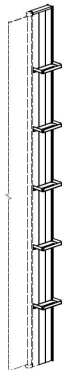

Adjustment measurements Skoga Alcove shower with folding screen, single	
Measurement	Adjustable
70	69,5 - 72
80	79,5 - 82
90	89,5 - 92
100	99,5 - 102

SKOGA ALCOVE SHOWER WITH FOLDING SCREEN, DOUBLE

- Double alcove, available in 138-198 cm.
- Shower screens can be adjusted 4 cm. See table below.
- For other alcove measurements please supplement with 30 or 50 mm wall profiles.
- No threshold - disabled friendly.
- Toughened safety glass 6 mm.
- Wall profile allows for pipe installation 30 mm from the wall.
- Height: 198 cm.
- Door opening: 120-180 cm.

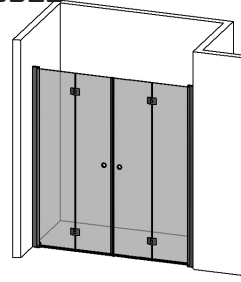
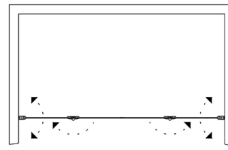

Skoga storage

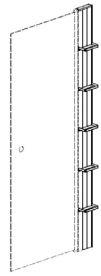

Skoga Alcove shower with folding screen, double	138	158	178	SKOGA STORAGE
Profile/glass	Order no.	Order no.	Order no.	Order no.
Matt aluminium				
Clear glass	60707377	60707388	60707399	6601
Semi-frosted	60709377 ¹	60709388	60709399	6601
Polished aluminium				
Clear glass	60707477	60707488	60707499	6600
Semi-frosted	60709477 ¹	60709488	60709499	6600
Black matt				
Clear glass	60707277 ¹	60707288	60707299	6602
Semi-frosted	60709277 ¹	60709288	60709299	6602

Skoga Alcove shower with folding screen, double	198	SKOGA STORAGE
Profile/glass	Order no.	Order no.
Matt aluminium		
Clear glass	60707311	6601
Semi-frosted	60709311 ¹	6601
Polished aluminium		
Clear glass	60707411	6600
Semi-frosted	60709411 ¹	6600
Black matt		
Clear glass	60707211 ¹	6602
Semi-frosted	60709211 ¹	6602

Adjustment measurements Skoga Alcove shower with folding screen, double	
Measurement	Adjustable
138	135 - 139
158	155 - 159
178	175 - 179
198	195 - 199

Adjustment measurements Skoga Alcove shower with folding screen, combi	
Measurement	Adjustable
140	139.5 - 143,5
160	159.5 - 163,5
180	179.5 - 183,5

¹ Delivery time 2 weeks.
² Delivery time 4 weeks.

SKOGA ALCOVE SHOWER WITH FOLDING SCREEN, COMBI

- Double alcove, available in 140-180 cm.
- Shower screens can be adjusted 4 cm. See table above.
- For other alcove measurements please supplement with 30 or 50 mm wall profiles.
- No threshold - disabled friendly.
- Toughened safety glass 6 mm.
- Wall profile allows for pipe installation 30 mm from the wall.
- Height: 198 cm, 201 cm upper edge of rod.
- Door opening: 60-80 cm

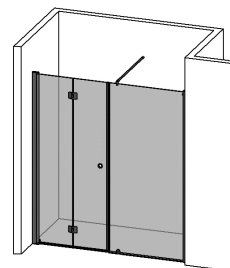
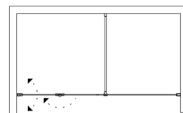

Skoga storage

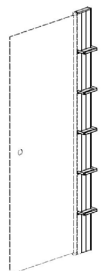

Skoga Alcove shower with folding screen, combi	140	160	180	SKOGA STORAGE
Profile/glass	Order no.	Order no.	Order no.	Order no.
Matt aluminium				
Clear glass	60907377	60907388	60907399	6601
Polished aluminium				
Clear glass	60907477	60907488	60907499	6600
Black matt				
Clear glass	60907277 ²	60907288	60907299	6602

SKOGA OPTIONAL



SKOGA HANDLE

Colour	Order no.
Chrome	60054
Matt chrome	60053
Pencil black	60055
Black matt	60052

SKOGA EXTENSION PIECE 30

Colour	Order no.
Matt aluminium	632103
Polished aluminium	632104
Polished pencil black	632105
Black matt	632102

FLOOR SEAL STRAIGHT

Performance	Order no.
White matt, 50-115 cm	625
White matt, 115-200 cm	635

FLOOR SEAL ROUND

Colour	Order no.
White matt	691

MAGNETIC PROFILES (CORNER/DOUBLE ALCOVE)

Colour	Order no.
Transparent	98215
Smoky	98207

CORNER BAR

Colour	Order no.
Chrome	99357
Black matt	99387

SHOWER SEAT RELAX.



Folding.

Colour	Order no.
White	6292

SKOGA EXTENSION PIECE 50 MM

Colour	Order no.
Matt aluminium	634103
Polished aluminium	634104
Polished pencil black	634105
Black matt	634102

RUBBER SEAL

Colour	Order no.
Transparent	98210
Smoky	98222

RUBBER SEAL, HIGH (ROUND/STRAIGHT)

Colour	Order no.
Transparent	65986

VERTICAL RUBBER SEAL FOR FOLDING DOOR

Colour	Order no.
Transparent	98221

SKOGA SPECIAL 1

Height unless standard max 198 cm.
Width unless standard max 100 cm.
Glass can be cut diagonally.

FRONT SHOWER SHELF

Aluminium shelf for placement in or outside the shower. Can be glued. Glue kit including fittings available as an accessory. H:10 D:9



Shower storage	70	80	32,5	65
Colour	Order no.	Order no.	Order no.	Order no.
Matt aluminium	6571	6581	6330	6660
Polished pencil black	6573	6583	6329	6659
Black matt	6572	6582	6325	6651
White matt	6570	6580	6324	6650
Optional				
Glue kit	97058	97058	97043	97043

WALL SHELF

Aluminium shelf for placement in or outside the shower. Can be glued. A glue kit is available as an accessory. H:7,5 D:8,5



SKOGA STORAGE

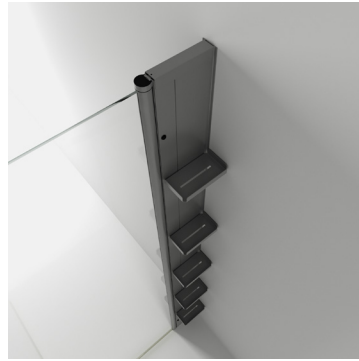

SHOWER MIXERS

Specially developed and adapted shower mixers that go perfectly with the rest of our range.

Design and function are key. The finish of our shower mixers ties in with other parts of our range, such as fittings, handles and washbasin mixers, to create a unified look for your bathroom.

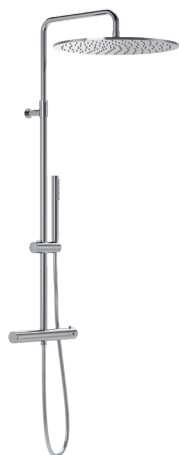

STUOR OVERHEAD SHOWER SET

Shower head: Ø40 cm
Height: 195,5 - 233 cm (For mounting at a standard height of 110 cm.)
Pressure-balanced mixer, which reacts rapidly to temperature and pressure fluctuations, ensuring an even water temperature.
Energy class A.
Wall mounting suitable for use in wet environments.
Smooth 1.5 m hose; hygienic, easy to keep clean and long lasting (compared to braided metal hoses).
The overhead shower is can be swivelled and the height can be adjusted.

Add a bath spout if you are using with a bath. Add an extension rod (90 cm) if the mixer is to be mounted lower, for example at bath height. This makes it possible to stand and shower in the bath.

	150 CC	160 CC
Performance	Order no.	Order no.
Chrome		
Overhead shower set	96852	96862
Wall plate ¹	97018	97016
Bath spout	96885	96885
Extension rod	96888	96888
Pencil black		
Overhead shower set	96859	96869
Wall plate ¹	97021	97020
Bath spout	96884	96884
Extension rod	96887	96887
Black matt		
Overhead shower set	96853	96863
Wall plate ¹	97019	97017
Bath spout	96886	96886
Extension rod	96889	96889



YDING OVERHEAD SHOWER SET

Shower head: Ø23 cm
Height: 195,5 - 233 cm (For mounting at a standard height of 110 cm.)
Pressure-balanced mixer, which reacts rapidly to temperature and pressure fluctuations, ensuring an even water temperature.
Energy class A.
Wall mounting suitable for use in wet environments.
Three-function hand shower, soft comfort, massage or intensive jet spray.
Smooth 1.5 m hose; hygienic, easy to keep clean and long lasting (compared to braided metal hoses).
The overhead shower is can be swivelled and the height can be adjusted.

Add a bath spout if you are using with a bath. Add an extension rod (90 cm) if the mixer is to be mounted lower, for example at bath height. This makes it possible to stand and shower in the bath.

	150 CC	160 CC
Performance	Order no.	Order no.
Chrome		
Overhead shower set	96850	96860
Wall plate ¹	97018	97016
Bath spout	96885	96885
Extension rod	96888	96888
Pencil black		
Overhead shower set	96858	96868
Wall plate ¹	97021	97020
Bath spout	96884	96884
Extension rod	96887	96887
Black matt		
Overhead shower set	96851	96861
Wall plate ¹	97019	97017
Bath spout	96886	96886
Extension rod	96889	96889

¹For 16 mm pex pipes.



SPIKA SHOWER MIXER SET

Pressure adjustment knob with ECO function, saving both energy and water. Pressure-balanced mixer, which reacts rapidly to temperature and pressure fluctuations, ensuring an even water temperature. Energy class A. Wall mounting suitable for use in wet environments. Three-function hand shower, soft comfort, massage or intensive jet spray. Smooth 1.5 m hose; hygienic, easy to keep clean and long lasting (compared to braided metal hoses). Add a bath mixer or shower mixer.

	150 CC	160 CC
Performance	Order no.	Order no.
Chrome		
Shower mixer set	97856	97866
Wall plate ¹	97018	97016
Pencil black		
Shower mixer set	97858	97868
Wall plate ¹	97021	97020
Black matt		
Shower mixer set	97857	97867
Wall plate ¹	97019	97017



SPIKA SHOWER SET

Three-function hand shower, soft comfort, massage or intensive jet spray. Smooth 1.5 m hose; hygienic, easy to keep clean and long lasting (compared to braided metal hoses). Wall mounting suitable for use in wet environments. Add a bath mixer or shower mixer. Includes soap tray.

Performance	Order no.
Chrome	
Shower set	99376
Pencil black	
Shower set	99378
Black matt	
Shower set	99377



SPIKA SHOWER SET FOR BATH

Hand shower with wall mounting. Smooth 1.5 m hose; hygienic, easy to keep clean and long lasting (compared to braided metal hoses). Wall mounting suitable for use in wet environments. Includes soap tray.

Performance	Order no.
Chrome	
Shower set for bath	99396
Pencil black	
Shower set for bath	99398
Black matt	
Shower set for bath	99397



SPIKA THERMOSTATIC MIXER

Pressure adjustment knob with ECO function, saving both energy and water. Pressure-balanced, which means rapid reaction to temperature and pressure fluctuations, ensuring an even water temperature. Safe water, approved mounting. Add the Spika shower set or shower set for bath.

	150 CC	160 CC
Performance	Order no.	Order no.
Chrome		
Thermostatic mixer	96854	96864
Wall plate ¹	97018	97016
Pencil black		
Thermostatic mixer	96756	96766
Wall plate ¹	97021	97020
Black matt		
Thermostatic mixer	96856	96866
Wall plate ¹	97019	97017

¹For 16 mm pex pipes.



RITUAL

A closer, more enveloping shower experience. A new ritual to love.

Ritual is a complete, practical shower enclosure suitable for bathrooms big and small. The shower enclosure takes up relatively little space, is equipped with safety glass, and boasts generous opening dimensions.



A PRACTICAL SOLUTION

Design

A functional and practical look.

Flexibility

Shower enclosure with clear glass. Choose from clear or white glass for the rear wall.

Functionality

A practical shower enclosure that does not take up much space and is easy to clean, with the drain easily cleaned from within the enclosure.

Quality

4 mm toughened safety glass. CE marked.

Sustainability

Made in Sweden and sold with a 20-year warranty.



Discover the whole Ritual range

STANDARD

Toughened safety glass

The Ritual shower enclosure comes with 4 mm toughened safety glass.



A complete solution

Ritual is a complete solution with mixer.



Sliding door

The door to Ritual is sliding and has eight ball bearing runners.

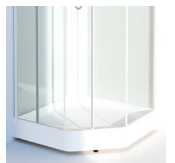

OPTIONS

Shower seat Relax

The seat's surface is comfortable and easy to keep clean, as well as offering a stylish, modern look.



SHOWER ENCLOSURE RITUAL PREMIUM

- Supplied complete with cast marble shower tray and drain connection incl. water trap.
- Ready-assembled two-way thermostatic mixer, ready-assembled couplings for water connection, overhead shower and hand shower incl. hose and couplings.
- Toughened safety glass 4 mm.
- Spring action door with eight ball bearings.
- Opening dimensions: 47 cm
- Height: 218 cm. Inside height: 192 cm.
- Minimum ceiling height for installation 225 cm.
- Optional shower seat.

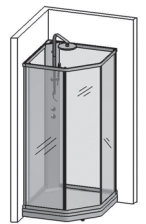
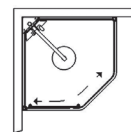

90X90			
Height: 218 cm (Inside height: 192 cm)			
Opening dimensions: 47 cm			
Profile	Glass	Rear wall	Order no.
White	Clear glass	Clear glass	68399
White	Clear glass	White glass	68899

SHOWER SEAT RELAX Folding.

Colour	Order no.
White	6292



BATHS

A natural centre point in the bathroom and something to rest your eyes on. A symbol of inspiration – a wonderful moment of relaxation or revitalisation.

BEAUTIFUL YET PRACTICAL BATHS

Design

From stylishly simple to soft and inviting with thin edges and a silky matt finish.

Flexibility

Independent, corner and mid-wall models.

Functionality

A luxurious bathing depth and adjustable feet for sloping floors. Easy Clean pop-up for straight-forward cleaning.

Quality

Approved under the relevant EN standard. Provided with a five-year warranty.

Sustainability

100% recyclable. Environmentally certified in accordance with CAL65.

Independent or corner position. We have baths in Lucite, acrylic and enamel. One thing all our baths have in common is excellent quality and finish and the perfect balance of form and function.

STANDARD

EasyClean

Our Lucite baths include our practical EasyClean drain connection for simple cleaning. Available in colours to match the finish of the bath.



Drain connection

The drain connection and bottom valve are always included in our baths.

Adjustable feet

Adjustable feet are included with our baths – perfect for sloping floors.

OPTIONS

EasyClean

EasyClean is available as an accessory for our acrylic and enamel baths. Available in chrome.



Front and side panel

Some of our baths can be complemented with either a front or an end panel.



Rim mounted mixer

For our Lule, Ihre and Kalix baths, rim mounted mixers can also be purchased separately.



Discover all our baths

COLOURS



White



White matt



Black matt

MATERIALS

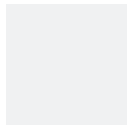

Lucite

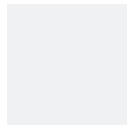

Acrylic

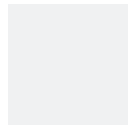

Enamel



INDEPENDENT



Auren

Auren is an uncompromisingly modern, matt bath placing high priority on design. With thin edges that are angled slightly inwards, it combines a slimline, contemporary look with an ergonomic bathing experience. Available in white matt and black matt. Material: Lucite

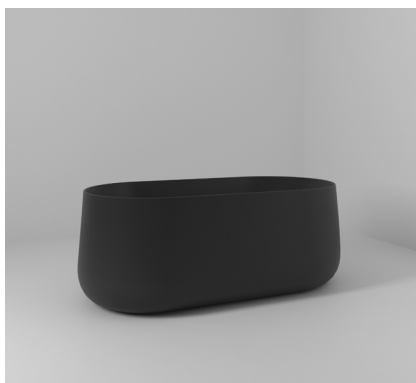

Auren



Ume

Ume offers a bathing depth of 45 cm and a round and ergonomic design that makes it a pleasure to sit in. Supplied complete with drain connection. Add a wall-mounted mixer. Glossy white. Material: Lucite



Vaulen

Vaulen has a timeless, sober design that works excellently with most settings. Independent, inviting design with a silky matt white finish for a warm, soft bathing experience. Material: Lucite



Mossby

Contemporary design with the option for storage gives Mossby its unique nature. Corner baths with refined practical surfaces and in well-proportioned size with a silky matt finish. Material: Lucite



Skagen

Skagen is an oval bath with soft, classic shapes. Independent baths in a silky matt white with curved contours for an ergonomic and generous bathing depth. Material: Lucite

LUCITE

Lucite is a hard-wearing and practical material. The luxurious surface finish offers a warm, soft feel, and is available as either glossy or matt Lucite. Our Lucite baths meet the requirements of the world's strictest environmental certification, CAL65, and are 100% recyclable.

CORNER



Lule

Form and function all in one bath. Round and ergonomic. Made of Lucite, which is stronger than acrylic and has a more luxurious surface. Add a mixer for wall or rim mounting. Glossy white. Material: Lucite



Ihre

Ihre combines an angular look with rounded elements, creating a perfectly cohesive finished look. Corner baths with a soft interior and pared-back exterior, as well as a functional and space-saving rounded corner. Glossy white. Material: Lucite



Torne

Three practical baths with plenty of shower space. Perfect if you have a small bathroom but want to take baths as well as showers. Available for right-hand or left-hand installation (the large picture shows right-hand version). Can be supplemented with a shower screen. Available in three sizes: 150, 160 and 170 cm. Glossy white. Material: Acrylic



Kalix

An attractive, simple bath that is ideal for one person. The soft, rounded lines look great and provide exceptional comfort. Available to order with rim-mounted mixer. Available in two sizes, 150 and 160 cm. Material: Acrylic



Enamel bathtub

An enamel bath made of enamelled pressed sheet metal. Add an additional front to create a solid front piece. Available in several sizes and also as a sit-up bath. Material: Enamel

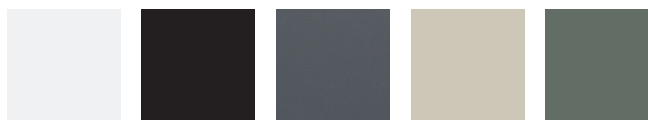

White

Black

Graphite
grey

Sand

Sage

AUREN

Materials: Lucite
Positioning: Independent
Depth: 45 cm
Bath water volume: 210 l with 1 person in the bath.
W: 156 **H:** 58 **D:** 81
Weight: 36 kg
 Drain connection EasyClean is included.

Colour	Order no.
White matt	59803
Black matt	59804

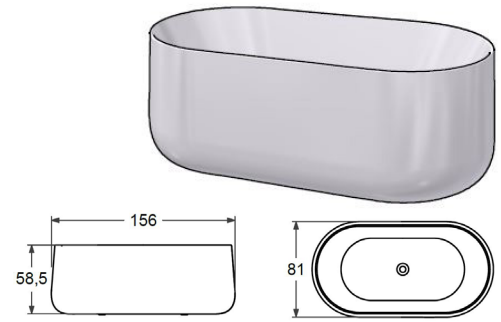

SKAGEN

Materials: Lucite
Positioning: Independent
Depth: 45 cm
Bath water volume: 185 l with 1 person in the bath.
W: 170 **H:** 68 **D:** 80
Weight: 35 kg
 Drain connection EasyClean is included.

Colour	Order no.
White matt	59805

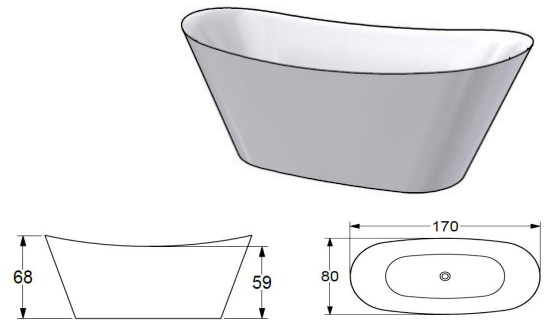

VAULEN

Materials: Lucite
Positioning: Independent
Depth: 44 cm
Bath water volume: 225 l with 1 person in the bath.
W: 160 **H:** 59 **D:** 75
Weight: 40 kg
 Drain connection EasyClean is included.

Colour	Order no.
White matt	59806

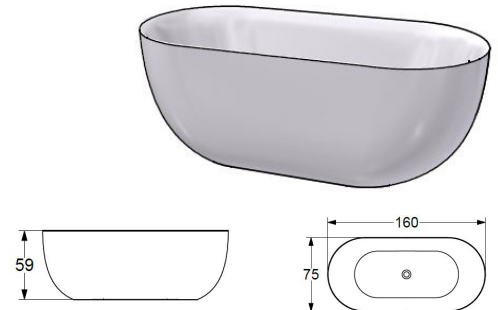

MOSSBY

Materials: Lucite
Positioning: Independent
Depth: 45 cm
Bath water volume: 290 l with 1 person in the bath.
W: 170 **H:** 60 **D:** 80
Weight: 47 kg
 Drain connection EasyClean is included.

Colour	Order no.
White matt	59807

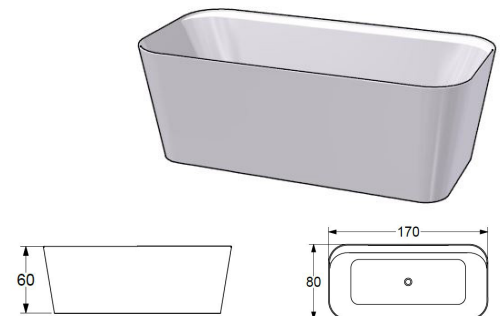

UME

Materials: Lucite
 Positioning: Independent
 Depth: 45 cm
 Bath water volume: 230 l with 1 person in the bath.
 W: 160 H: 60 D: 75
 Weight: 33 kg
 Drain connection EasyClean is included.

Colour	Order no.
White	59901

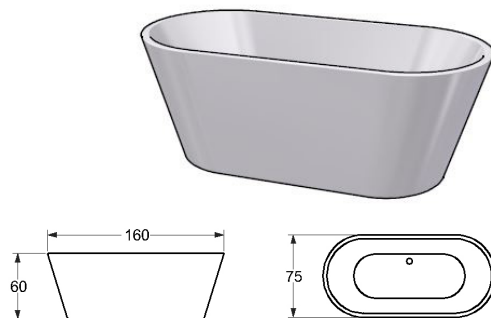

LULE

Materials: Lucite
 Positioning: Against wall
 Depth: 43 cm
 Bath water volume: 210 l with 1 person in the bath.
 W: 158 H: 58 D: 86
 Weight: 36 kg
 Drain connection EasyClean is included.

Colour	Order no.
White	59823
Optional	
Incl. Mixer Helag	59823-3

Optional: Rim mounted mixer Helag

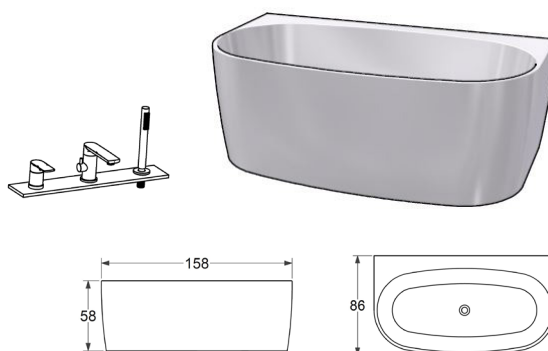

IHRE

Materials: Lucite
 Positioning: Corner
 Depth: 44 cm
 Bath water volume: 185 l with 1 person in the bath.
 W: 160 H: 59,5 D: 80
 Weight: 37 kg
 Drain connection EasyClean is included.
 Purchase bath screen.

Colour	Riktning	Order no.
White	Left	59808-V
White	Right	59808-H
Optional	Riktning	
Incl. Mixer Helag	Right	59808-H-3
Incl. Mixer Helag	Left	59808-V-3

Optional: Rim mounted mixer Helag

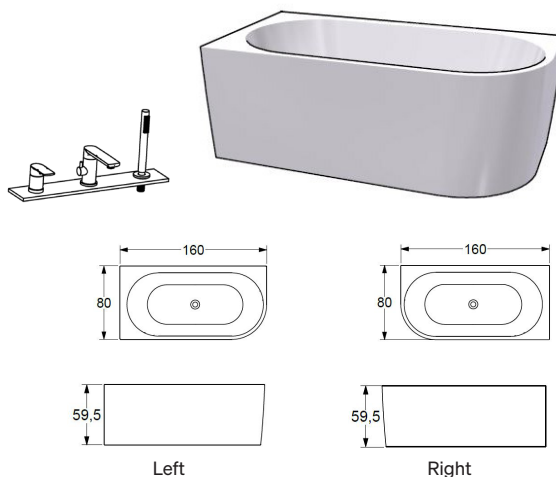

TORNE

Materials: Acrylic

Positioning: Corner

Depth: 42 cm

Front panel and waste pipe included.

Select an end panel and shower screen for the bath.

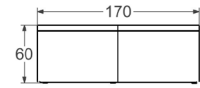
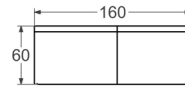
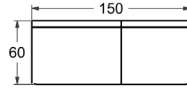
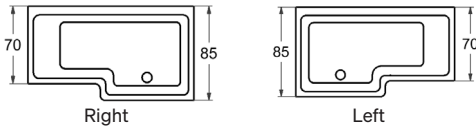
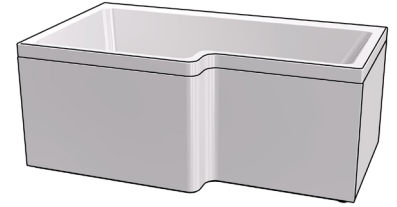

Torne Bath with shower		W: 150 H: 60: D: 85/70 Weight: 42 kg Bath water volume: 180 l with 1 person in the bath.	W: 160 H: 60: D: 85/70 Weight: 42 kg Bath water volume: 210 l with 1 person in the bath.	W: 170 H: 60: D: 85/70 Weight: 43 kg Bath water volume: 230 l with 1 person in the bath.
Direction	Options	Order no.	Order no.	Order no.
Left	Standard	Z150V	Z1600V	Z1700V
Left	Incl. Side panel	Z150VG	Z1600VG	Z1700VG
Right	Standard	Z150H	Z1600H	Z1700H
Right	Incl. Side panel	Z150HG	Z1600HG	Z1700HG
Optional drain connection EasyClean				
EasyClean, Chrome		1225	1225	1225

KALIX

Materials: Acrylic

Positioning: Corner

Depth: 42 cm

Front panel and waste pipe included.

Choose an end panel, rim mounted mixer and shower screen for the bath.

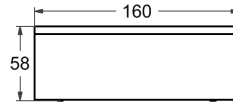
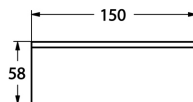
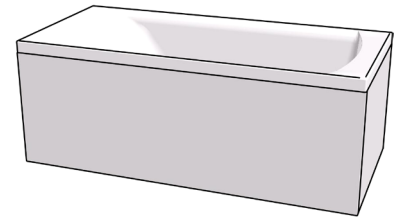

Kalix Bath with shower		W: 150 H: 58 D: 70 Weight: 36 kg Bath water volume: 120 l with 1 person in the bath.	W: 160 H: 58: D: 70 Weight: 37 kg Bath water volume: 160 l with 1 person in the bath.
Options	Order no.	Order no.	
Standard	Z150-0	Z160-0	
Incl. Side panel	Z150G-0	Z160G-0	
Incl. Mixer Helag	Z150-3	Z160-3	
Incl. Side panel & Mixer Helag	Z150G-3	Z160G-3	
Optional drain connection EasyClean			
EasyClean, Chrome		1225	

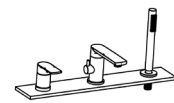

Optional: Rim mounted mixer Helag

ENAMEL BATHTUB

Materials: Enamel
Positioning: Corner
Depth: 36 cm
Thickness: 1,5 mm

Anti tip device included to guarantee safety.
 Fixed half front panel on the long side and 2 short side panels. Drain connection is included.
 Purchase bath screen.

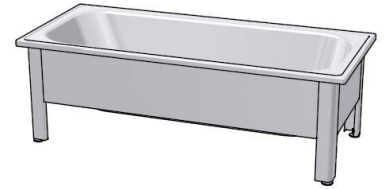
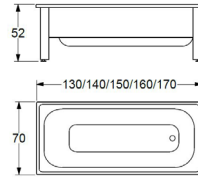

Enamel bathtub	W: 130 H: 52 D: 70 Bath water volume: 150 l with 1 person in the bath.	W: 140 H: 52 D: 70 Bath water volume: 160 l with 1 person in the bath.	W: 150 H: 52 D: 70 Bath water volume: 170 l with 1 person in the bath.
Performance	Order no.	Order no.	Order no.
White			
Enamel bathtub	1203	1204	1205
Additional front	12103	12104	12105
Additional side panel	12108	12108	12108
Black			
Enamel bathtub	1231	1241	1251
Additional front	12113	12114	12115
Additional side panel	12118	12118	12118
Graphite grey/Sand/Sage			
Enamel bathtub	1203-RAL	1204-RAL	1205-RAL
Additional front	12103-RAL	12104-RAL	12105-RAL
Additional side panel	12108-RAL	12108-RAL	12108-RAL
Optional drain connection EasyClean			
EasyClean, Chrome	1225	1225	1225

Enamel bathtub	W: 160 H: 52 D: 70 Bath water volume: 180 l with 1 person in the bath.	W: 170 H: 52 D: 70 Bath water volume: 190 l with 1 person in the bath.
Performance	Order no.	Order no.
White		
Enamel bathtub	1200	1272
Additional front	12106	12107
Additional side panel	12108	12108
Black		
Enamel bathtub	1260	1273
Additional front	12116	12117
Additional side panel	12118	12118
Graphite grey/Sand/Sage		
Enamel bathtub	1200-RAL	1272-RAL
Additional front	12106-RAL	12107-RAL
Additional side panel	12108-RAL	12108-RAL
Optional drain connection EasyClean		
EasyClean, Chrome	1225	1225

SITTING BATH

Materials: Enamel
Positioning: Corner
Thickness: 1,5 mm
W: 105 **H:** 52 **D:** 70

Anti tip device included to guarantee safety. Fixed half front panel on the long side and 2 short side panels. Drain connection is included.

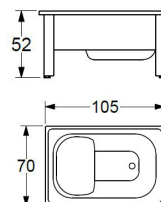

Colour	Order no.
White	1250
Optional drain connection EasyClean	
EasyClean, Chrome	1225

BATH MIXERS

Specially developed and adapted bath mixers that go perfectly with the rest of our range.

Design and function are key. The finish of our bath mixers ties in with other parts of our range, such as handles and fittings, to create a fully cohesive bathroom.

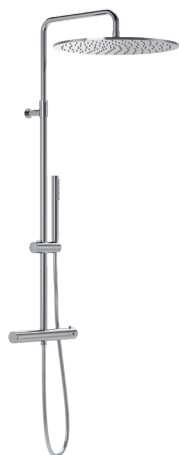

STUOR OVERHEAD SHOWER SET

Shower head: Ø40 cm
Height: 195,5 - 233 cm (For mounting at a standard height of 110 cm.)
Pressure-balanced mixer, which reacts rapidly to temperature and pressure fluctuations, ensuring an even water temperature.
Energy class A.
Wall mounting suitable for use in wet environments.
Smooth 1.5 m hose; hygienic, easy to keep clean and long lasting (compared to braided metal hoses).
The overhead shower is can be swivelled and the height can be adjusted.

Add a bath spout if you are using with a bath. Add an extension rod (90 cm) if the mixer is to be mounted lower, for example at bath height. This makes it possible to stand and shower in the bath.

	150 CC	160 CC
Performance	Order no.	Order no.
Chrome		
Overhead shower set	96852	96862
Wall plate ¹	97018	97016
Bath spout	96885	96885
Extension rod	96888	96888
Pencil black		
Overhead shower set	96859	96869
Wall plate ¹	97021	97020
Bath spout	96884	96884
Extension rod	96887	96887
Black matt		
Overhead shower set	96853	96863
Wall plate ¹	97019	97017
Bath spout	96886	96886
Extension rod	96889	96889



YDING OVERHEAD SHOWER SET

Shower head: Ø23 cm
Height: 195,5 - 233 cm (For mounting at a standard height of 110 cm.)
Pressure-balanced mixer, which reacts rapidly to temperature and pressure fluctuations, ensuring an even water temperature.
Energy class A.
Wall mounting suitable for use in wet environments.
Three-function hand shower, soft comfort, massage or intensive jet spray.
Smooth 1.5 m hose; hygienic, easy to keep clean and long lasting (compared to braided metal hoses).
The overhead shower is can be swivelled and the height can be adjusted.

Add a bath spout if you are using with a bath. Add an extension rod (90 cm) if the mixer is to be mounted lower, for example at bath height. This makes it possible to stand and shower in the bath.

	150 CC	160 CC
Performance	Order no.	Order no.
Chrome		
Overhead shower set	96850	96860
Wall plate ¹	97018	97016
Bath spout	96885	96885
Extension rod	96888	96888
Pencil black		
Overhead shower set	96858	96868
Wall plate ¹	97021	97020
Bath spout	96884	96884
Extension rod	96887	96887
Black matt		
Overhead shower set	96851	96861
Wall plate ¹	97019	97017
Bath spout	96886	96886
Extension rod	96889	96889

¹For 16 mm pex pipes.

SPIKA BATH MIXER SET



Bath mixer with pivoting spout, making it easy to switch the flow of water between the bath spout and the hand shower. Pressure adjustment knob with ECO function, saving both energy and water. Pressure-balanced mixer, which reacts rapidly to temperature and pressure fluctuations, ensuring an even water temperature. Energy class A. Safe water, approved mounting. Smooth 1.5 m hose; hygienic, easy to keep clean and long lasting (compared to braided metal hoses).

	150 CC	160 CC
Performance	Order no.	Order no.
Chrome		
Bath mixer set	97958	97968
Wall plate ¹	97018	97016
Pencil black		
Bath mixer set	97951	97961
Wall plate ¹	97021	97020
Black matt		
Bath mixer set	97959	97969
Wall plate ¹	97019	97017

SPIKA SHOWER SET FOR BATH



Hand shower with wall mounting. Smooth 1.5 m hose; hygienic, easy to keep clean and long lasting (compared to braided metal hoses). Wall mounting suitable for use in wet environments. Includes soap tray.

Performance	Order no.
Chrome	
Shower set for bath	99396
Pencil black	
Shower set for bath	99398
Black matt	
Shower set for bath	99397

SPIKA SHOWER SET



Three-function hand shower, soft comfort, massage or intensive jet spray. Smooth 1.5 m hose; hygienic, easy to keep clean and long lasting (compared to braided metal hoses). Wall mounting suitable for use in wet environments. Add a bath mixer or shower mixer. Includes soap tray.

Performance	Order no.
Chrome	
Shower set	99376
Pencil black	
Shower set	99378
Black matt	
Shower set	99377

SPIKA BATH MIXER



The pivoting bath spout takes up less space when the hand shower is being used and is more user friendly. Pressure adjustment knob with ECO function, saving both energy and water. Pressure-balanced, which means rapid reaction to temperature and pressure fluctuations, ensuring an even water temperature. Safe water, approved mounting. Add the Spika shower set or shower set for bath.

	150 CC	160 CC
Performance	Order no.	Order no.
Chrome		
Bath mixer	96893	96895
Wall plate ¹	97018	97016
Pencil black		
Bath mixer	96757	96767
Wall plate ¹	97021	97020
Black matt		
Bath mixer	96894	96896
Wall plate ¹	97019	97017

¹For 16 mm pex pipes.

HEATED TOWEL RAILS

Wrap your body in a lovely warm bath towel after every shower or bath.

—

We have a large selection of stylishly designed centrally heated towel rails and electric heated towel rails. Choose a towel rail that matches your bathroom and heating system.

MAGNETIC

Magnetic is a heated towel rail that you can adapt to create your own look. Move the magnetic hooks around and choose to add in extras based on your own needs and situation.



Bracket

Magnetic comes with a fixed bracket at the top on the front. Chrome or white bracket for white fronts and pencil black or black bracket for black fronts.



Knob

You will receive two knobs with your Magnetic unit. Chrome or white knobs for white fronts and pencil black or black knobs for black fronts as standard. You can purchase more if you wish.

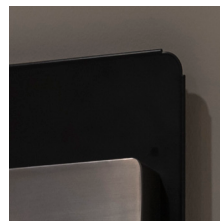

Front

Magnetic offers a thin, clean look that you can configure as you wish. The perfect blank canvas.

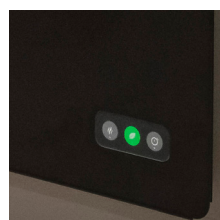

Touch panel

Integrated touch panel flush with the metal panel. Can be used to activate Eco mode and a timer to reduce energy consumption.

BEAUTIFULLY WARM TOWELS

Design

From simple to technologically advanced adaptable solutions with design at the forefront.

Flexibility

Electric heated towel rails that encompass everything from pared-back design and traditional ladder forms to more exclusive looks and water-heated towel rails perfect for bathrooms big and small.

Functionality

Energy saving features and smart installation with either visible or concealed connections.

Quality

Certified by an independent third party. Metal wall mounting for maximum safety and durability over time.

Sustainability

Timer and Eco mode to reduce your electricity consumption.



SMART FUNCTIONS

Heated towel rail

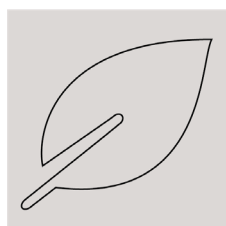

Eco mode

Some of our electric heated towel rails have an Eco mode, which reduces electricity consumption by 50%.

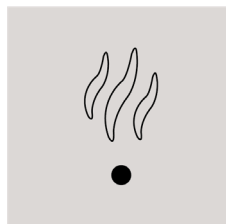

Boost

Adjustable one-off timer that turns itself off automatically at the end of the time set. Saves both energy and the environment.

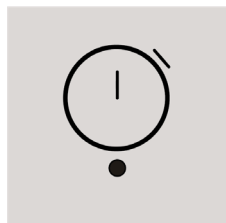

Timer

Scheduled timer, can be set for periods of 1 to 12 hours. Using the timer can reduce energy consumption by up to 95%.

Centrally heated towel rail



Radiator valves and electric elements

By connecting one of our centrally heated towel rails to an existing central heating system and an electric element, you get the best of both worlds.



Discover our heated towel rails



MAGNETIC
ELECTRIC HEATED TOWEL RAIL

Connection: Electricity
Power output: 120 W
Eco mode
Timer
Boost
Materials: Stainless steel
W: 45 H: 110

Delivered with a 1,5 m long cord with plug and concealed connection. Can be connected to electrical box in the wall. Includes cord holder, one fixed bracket and two knobs.
Select extra knobs as accessories.

Colour Front	Colour Bracket	Order no.
White	White	56411
White	Chrome	56413
Black	Pencil black	56414
Black	Black	56412
Optional extra knobs		
Colour	Order no.	
White	561	
Chrome	563	
Pencil black	564	
Black	562	



U
ELECTRIC HEATED TOWEL RAIL

Connection: Electricity
Power output: 55 W
Eco mode
Materials: Stainless steel
W: 17 H: 123

Delivered with a 1,5 m long cord with plug and concealed connection.

Colour	Order no.
Polished	58751
Pencil black	58753
Black matt	58752



AMOR
ELECTRIC HEATED TOWEL RAIL

Connection: Electricity
Power output: 17 W
Timer
Boost
Materials: Stainless steel
W: 10 H: 140

Delivered with a 1,5 m long cord with plug and concealed connection. Can be connected to electrical box in the wall.

Colour	Order no.
Polished	58222
Pencil black	58223
Black matt	57222



DIANA
ELECTRIC HEATED TOWEL RAIL

Connection: Electricity
Power output: 56 W
Timer
Boost
Materials: Stainless steel
W: 48 H: 80

Delivered with a 1,5 m long cord with plug and concealed connection. Can be connected to electrical box in the wall.

Colour	Direction	Order no.
Polished	Right	58121-SR
Polished	Left	58121-SL
Black matt	Right	58221-SR
Black matt	Left	58221-SL



LOKI
ELECTRIC HEATED TOWEL RAIL

Connection: Electricity
Power output: 56 W
Off/on
Materials: Stainless steel
W: 48 **H:** 80
 Delivered with a 1,5 m long cord with plug and concealed connection. Can be connected to electrical box in the wall.

Colour	Direction	Order no.
Polished	Right	58122-SR
Polished	Left	58122-SL



FLORA SL
ELECTRIC HEATED TOWEL RAIL

Connection: Electricity
Power output: 42 W
Timer
Boost
Materials: Stainless steel
W: 50 **H:** 65
 Delivered with a 1,5 m long cord with plug and concealed connection. Can be connected to electrical box in the wall.

Colour	Order no.
Polished	58421-SL



FLORA SR
ELECTRIC HEATED TOWEL RAIL

Connection: Electricity
Power output: 42 W
Timer
Boost
Materials: Stainless steel
W: 50 **H:** 65
 Delivered with a 1,5 m long cord with plug and concealed connection. Can be connected to electrical box in the wall.

Colour	Order no.
Polished	58421-SR

BAS HEATED TOWEL RAIL



Bas	W: 50 H: 69	W: 50 H: 100	W: 50 H: 142	W: 37 H: 142
Colour	Order no.	Order no.	Order no.	Order no.
Chrome	55699-02	55109-02	56209-02	56309-02
White matt	56311	56312	56313	56314

EASY HEATED TOWEL RAIL



Easy	W: 50 H: 80	W: 50 H: 140
Colour	Order no.	Order no.
Chrome	56802-02	56800-02

The heated towel rail is ready to be connected to your central heating system or for electrical connection. You have three options:

1. Electrical connection. Choose an electrical element that is adjustable 30-60° C with a switch. The electrical element is connected externally to any of the bottom corners. When fitting, fill your heated towel rail with water/glycol (90/10) solution.

2. Central heating. Connection to your central heating system (sealed systems only, not tap water system).

3. Dual fuel. Uses both the above alternatives, which is an advantage in the summer when the central heating system is often switched off.

VENTO HEATED TOWEL RAIL



Vento	W: 55 H: 80	W: 55 H: 120
Colour	Order no.	Order no.
Chrome	50040	50030
Black matt	50041	50031

ZAGA HEATED TOWEL RAIL



Zaga	W: 10,8 H: 120	W: 26 H: 120
Colour	Order no.	Order no.
Chrome	55011	55013
Black matt	57011	57013

SIGYN HEATED TOWEL RAIL



Sigyn	W: 11 H: 120	W: 26 H: 120
Colour	Order no.	Order no.
Chrome	55111	55113
Black matt	57111	57113
White matt	56111	56113



ERICA ELECTRIC ELEMENT

Connection: Electricity
 Power output: 300 W
 Timer
 Boost
 Adjustable power with a stepless knob.
 Concealed or visible connection and isolator switch.

Colour	Order no.
Chrome	54041
Black matt	54042
White matt	54043



MEG ELECTRIC ELEMENT

Connection: Electricity
 Power output: 300 W
 Adjustable power with five settings.
 Visible connection.

Colour	Order no.
Chrome	54301



VALVE

For use with central heating system, not tap water system.

Colour	Order no.
Stainless	54060



VALVE

For use with central heating system, not tap water system.

Colour	Order no.
Chrome	54080
Black	54100

WC & TOILET

Svedbergs has been making WCs for decades. Every year we develop and refine the details. Behind the white, elegantly designed exterior is a combination of modern technology and smart functions that make cleaning easy. Choose between a traditional design or a neat and practical wall-mounted WC.



WC

Three ways to buy your WC – the choice is yours.

1. CLASSIC WC

Practical WC, model 9085. Comfortable seat height. Easy to clean and removable seat for quick flushing. Condensation-free cistern and easy adjustment of water volume.

WC 9085

Concealed S-trap
6/3 litre flush

Performance	Order no.
Seat white	9085
Soft closing seats. White	9085-01
Soft closing seats. Black	9085-51

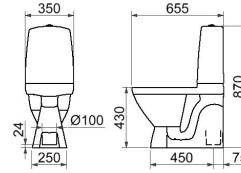

2. GLASS BOX WITH WC

WC module with glass box. Visible wall mounting. The market's first WC module with an S-bend design. Only 41 cm wide to fit into an existing space. Add a WC bowl (Alta 9072 rimless or Lossen 9071 rimless). Removable seat (with soft-close function) makes cleaning easy.

WC-FIXTURE GLASS BOX

Recommended dimensions position 95-140 mm cc.
W: 41 H:100 D:18-20

Performance	Order no.
WC-fixture glass box. White	90424
WC-fixture glass box. Black	90425
Optional	
Shut-off tap ¹	98987

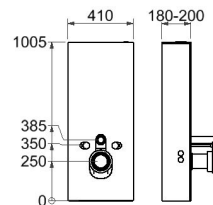

¹Water connection kit 40 cc with easy accessible shutoff tap, for water connection behind the fixture.

3. BUILT-IN WC

WC module. Suitable for new or remodelled bathrooms. Mounting concealed behind wall. Add a WC bowl (Alta 9072 rimless or Lossen 9071 rimless) and a flush plate. Removable seat (with soft-close function) makes cleaning easy.

WC FIXTURE

Dual flush
W: 50 H:111,5-116,5 D:13,5-22,5

Performance	Order no.
WC fixture	90410
Flush plate	
Matt chrome	90413
Chrome	90412
Black	90411



Flush plate



2B & 3B. CHOOSE A WALL-MOUNTED TOILET

WC LOSSEN

Rimless
Integrated, easily removable, high density plastic seat, soft closing (white).

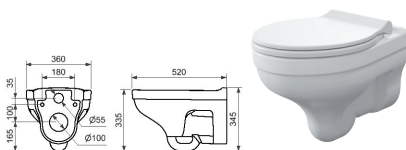

Performance	Order no.
Soft closing seats. White	9071

WC ALTA

Rimless
Integrated, easily removable, high density plastic seat, soft closing (white/black).

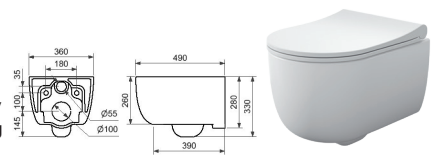

Performance	Order no.
Soft closing seat. White	9072
Soft closing seat. Black	9077

ACCESSORIES

Your bathroom is nearly ready. Now you just need to choose the accessories. These include beautiful, well-designed details like our hangers for towels or bathrobes. Things that lift the design of your whole bathroom.



FRONT SHOWER SHELF

Aluminium shelf for placement in or outside the shower. Can be glued. Glue kit including fittings available as an accessory. H:10 D:9



Width:	Colour	Order no.
70	Matt aluminium	6571
	Polished pencil black	6573
	Black matt	6572
	White matt	6570
80	Matt aluminium	6581
	Polished pencil black	6583
	Black matt	6582
	White matt	6580
Optional		
Glue kit		97058

FRONT WALL SHELF

Aluminium shelf with wooden front panel. Intended for use in dry spaces. Can be glued. Glue kit including fittings available as an accessory. H:10 D:10

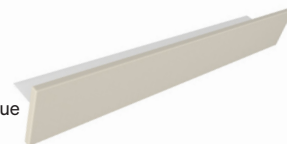

Width:	Colour Front	Colour Shelf	Order no.
70	White	White matt	6574
	Sand	White matt	6577
	Pure oak	White matt	6575
	White ash	White matt	6576
	Brown ash	Black matt	6578
	Black ash	Black matt	6579
80	White	White matt	6584
	Sand	White matt	6587
	Pure oak	White matt	6585
	White ash	White matt	6586
	Brown ash	Black matt	6588
	Black ash	Black matt	6589
Optional			
Glue kit			97058

WALL SHELF

Aluminium shelf for placement in or outside the shower. Can be glued. A glue kit is available as an accessory. H:7,5 D:8,5



Width	Colour	Order no.
32,5	Matt aluminium	6330
	Polished pencil black	6329
	Black matt	6325
	White matt	6324
65	Matt aluminium	6660
	Polished pencil black	6659
	Black matt	6651
	White matt	6650
Tillval		
Glue kit		97043

1 HOOK

Serie A
Stainless steel
Double-sided tape 3M.
W:4,5 H:4,5 D:3



Colour	Order no.
Chrome	A01-K
Black matt	A01-S

2 HOOKS

Serie A
Stainless steel
Double-sided tape 3M.
W:9 H:4,5 D:2,9



Colour	Order no.
Chrome	A02-K
Black matt	A02-S

TOILET ROLL HOLDER

Serie A
Stainless steel
Double-sided tape 3M.
W:13,5 H:11 D:2,8



4 HOOKS

Serie A
Stainless steel
Double-sided tape 3M.
W:18 H:4,5 D:3



Colour	Order no.
Chrome	A03-K
Black matt	A03-S

Colour	Order no.
Chrome	A04-K
Black matt	A04-S

1 HOOK

Serie O
Stainless steel
Double-sided tape 3M.
Ø4,9



Colour	Order no.
Chrome	O01-K

2 HOOKS

Serie O
Stainless steel
Double-sided tape 3M.
W:9,5 H:4,9 D:3



Colour	Order no.
Chrome	O02-K

TOILET ROLL HOLDER

Serie O
Stainless steel
Double-sided tape 3M.
W:13,5 H:11 D:2,9



Colour	Order no.
Chrome	O03-K

4 HOOKS

Serie O
Stainless steel
Double-sided tape 3M.
W:19,2 H:4,8 D:3



Colour	Order no.
Chrome	O04-K







Photo: Sebastian Streith, CGI Furniture, Johan Nyberg, Robin De Blanche & Melita Ramic & Mohammed Salih.

Reservations: We are continuously developing our products. For this reason, we at Svedbergs reserve the right to make changes to the design, appearance and prices of products. We also reserve the right to sell out. Wood is a natural material. Because of this, variations in colour and texture between individual doors/front panels and deliveries may occur. For technical printing reasons, the colours of wood and other surfaces in the catalogue may differ from the actual colours. Colour swatches can be requested from Svedbergs dealers.

WE ACCEPT NO RESPONSIBILITY FOR DISCREPANCIES AND PRINTING ERRORS.



SVEDBERGS

Head office

Verkstadsvägen 1, 514 63 Dalstorp, SWEDEN

Phone, switchboard +46321 53 30 00

svedbergs.com

info@svedbergs.com

[@svedbergs](#)

Showroom

Dalstorp, open: Mon-Fri kl 08.00-16.30

EN



7 1392533 076281 >