

DRE

door catalogue

2024

EDITION 2



DRE doors Nestor 3
cashmere matt

ON PROMOTION



NEW HINGES



WHITE DOOR FRAMES



SARA ECO 2



The above price applies to a set of doors, consisting of DRE aluminum door frame in standard aluminum color and a door leaf primed with varnish in the 202 standard with two hinges.

*Sara ECO 2 doors with DRE aluminum door frames in aluminum and white colors are available from stock in selected configurations.

TABLE OF CONTENTS

DOORS IN ACRYLIC LAMINATES

ILIS	4
NELLA	6
VETRO D2	8
SILIA	10

FRAME CONSTRUCTION DOORS

NEW Vetro E-Synchro.....	12
NEW Estra	14
Verano.....	16
Ena	17
Triesta.....	18
Solte	19
NEW Reva.....	20
Fosca	22
NEW Nestor	24
NEW Auri	26
Elsa.....	28
Premium	30
Piano	32
Scala	34
Verso	36
Vetro A.....	38
Vetro B	40
Vetro D	42
Lumio.....	44
Vico.....	46

FRAME CONSTRUCTION DOORS PAINTED

Berge	48
Even.....	50
Nestor	52
NEW Vetro E.....	54

PANEL CONSTRUCTION DOORS

NEW Nova -Cell	56
Wood.....	58
Claro.....	60
Grafi.....	62
Lux	66
NEW Nova -Synchro	68
Rivia.....	70
Galeria Alu.....	72
Arte B.....	74
Carla	75
Finea and Finea B.....	76
Deco	78
Modern	80
Kanon.....	82
Plus	84
Standard	86
Fano.....	88
Arte.....	90

PANEL DOORS PAINTED

UNI	92
Fargo.....	94
BINITO.....	96

PANEL CONSTRUCTION DOORS CPL LAMINATE

Standard Invest	98
Standard CPL.....	100

PANEL DOORS WITH VARIABLE HEIGHTS

Standard 10	101
Modern	102
Plus	103

SLIDING SYSTEM

Wall mounted sliding system.....	104
Glass doors sliding system	106

wall-mounted sliding system SPAZIO CD	107
Cassette tunnel cover PA	108
door frameless cassette B01	110

DOORS WITH HIDDEN DOOR FRAME

Profi	111-112
NEW SARA ECO 2	113
NEW DRE aluminum door frames.....	115

FOLDING DOORS

Folde.....	117
------------	-----

SIDE PANELS

Panel construction	118
Frame construction	119

TRANSOM LIGHTS AND SIDELIGHTS

TRANSOM LIGHTS AND SIDELIGHTS	120
-------------------------------------	-----

INETRIOR ENTRANCE DOOR LEAVES

Enter/Solid	122
SOLID RC2.....	126

TECHNICAL DOOR LEAVES

Athos fire resistant door leaves EI30.....	128
FORCA anti-burglary,RC3, fire resistant.....	130
Forca B RC3 anti-burglary door leaves	131
Fire resistant door leaves OLIMP EI30 EI 60	132
Metal fire resistant door frame.....	134
Wooden fire resistant door frame.....	135

DOOR LEAVES WITH SOUND INSULATION RATE

Enter Acoustic Rw=32dB.....	136
-----------------------------	-----

GLASS DOORS

NEW Galla.....	137
Hardware for glass doors.....	138
Glass doors technical informations	139

DOOR FRAMES













fixed rebated door frames	140
fixed non-rebated door frames	141
Adjustable door frames.....	142-143
Adjustable non-rebated door frames.....	144-145
Rebated adjustable door frames with variable heights.....	146
Adjustable non-rebated door frames with variable heights.....	147
Adjustable door frames with inverted rebate	148
Adjustable tunnel	149
Adjustable non-rebated door frames with architrave panels	150
Extension panels.....	152
Metal fixed door frame	154
Adjustable metal door frame	156
adjustable metal door frame non-rebated.....	159
Hybrid metal door frame	160
Hybrid metal door frame non-rebated.....	162
Small angular steel frames.....	163

ACCESSORIES, ADDITIONAL INFORMATIONS

Door handles and accessories	164
Glass panes patterns	173
Decors.....	174
Architraves and skirting boards.....	176
Ventilation accessories and other.....	177
Technical informations	178-186



ILIS 3 - cubanit

glossy STANDARD	 bianco	 magnolia	 moro	 vino *
	 cubanit	 gabbiano	 bigio	*while stock lasts
STANDARD MATT	 mat bianco	 mat cemento	 mat moro	
XTREME MATT	 white U1027	 anthracite* U1290		

STANDARD OPTIONS

- » edge whitout rebate
- » door leaf coated with high Glossy laminate, STANDARD MATT or Xtreme Matt
- » stiles and rails made of MDF
- » a magnetic lock with a simple key, a toilet lock, a cylinder lock or a magnetic economic lock and hinges in black (for moro and moro matt decors), white (for bianco, bianco matt, white decors) and steel for other decors.
- » glass pane MAT DRE 4 mm thick in ILIS 1-3
- » core made of 20 mm MDF board in ILIS 4
- » complex safe 8 mm glass pane MAT DRE in ILIS 5
- » sockets for 2 recessed Estetic 80 hinges (hinges constitute a part of the door frame)

OPTION WITHOUT EXTRA CHARGE

- » glass pane DECORMAT BROWN, DECORMAT GRAPHITE and 4 mm transparent glass in ILIS 1 - 3
- » complex safe 8 mm glass pane transparent in ILIS 5
- » holes for ventilation sleeves
- » sliding door - 2043 mm height

Sliding system - it is possible to use SPAZIO CD sliding system with a standard door leaf height of 2043 mm.

Glossy laminate. 0.7-0.8 mm of thickness is a modern laminate with a high degree of gloss, giving the effect of a mirror reflection. It is characterized by a perfectly smooth surface with increased scratch resistance.

Xtreme Matt laminate with a thickness of 0.8 mm is an innovative laminate with a matt, non-reflective structure. The Xtreme Matt surface is durable, scratch-resistant and easy to care for. The structure has been additionally reinforced with the Anti-Finger-Print property, which protects the surface fingerprints against and traces of grease.

STANDARD MATT Laminate with the 0,7-0.8 mm of thickness, the same properties as a high-gloss surface. The only difference is the degree of gloss of the hardcoat layer. Thanks to the pore-free hardcoat coating, the laminate can be used in rooms with the highest hygienic requirements.

OPTIONS AVAILABLE WITH EXTRA CHARGE

- » door leaf „100”
- » ventilation undercut
- » recuperative undercutting -15mm
- » cover-up strip for double leaf non-rebated door
- » double leaf door door leaf price x2
- » **NOTE:** third Estetic 80 hinge for non-rebated doors (extra charge is added to the price of the door frame)



ILIS 1

ILIS 2

ILIS 3

ILIS 4

ILIS 5



NELLA 4 - white

glossy STANDARD	 bianco	 magnolia	 moro	 vino *
	 cubanit	 gabbiano	 b'gio	*while stock last
	 mat bianco	 mat cemento	 mat moro	
	 white	 anthracite*		
	U1027	U1290		

STANDARD OPTIONS

- » edge whitout rebate
- » door leaf coated with high Glossy laminate, STANDARD MATT or Xtreme Matt
- » stiles and rails made of MDF
- » a magnetic lock with a simple key, a toilet lock, a cylinder lock or a magnetic economic lock and hinges in black (for moro and moro matt decors), white (for bianco, bianco matt, white decors) and steel for other decors.
- » glass pane MAT DRE 4 mm thick
- » sockets for 2 recessed Estetic 80 hinges (hinges constitute a part of the door frame)

OPTION WITHOUT EXTRA CHARGE

- » glass pane DECORMAT BROWN, DECORMAT GRAPHITE and transparent glass pane
- » holes for ventilation sleeves
- » sliding door - 2043 mm height

OPTIONS AVAILABLE WITH EXTRA CHARGE

- » door leaf „100”
- » ventilation undercut
- » recuperative undercutting -15mm
- » cover strip for double leaf door
- » double leaf door door leaf price x2
- » **NOTE:** third Estetic 80 hinge for non-rebated doors (extra charge is added to the price of the door frame)

Sliding system - it is possible to use SPAZIO CD sliding system with a standard door leaf height of 2043 mm.

Glossy laminate. 0.7-0.8 mm of thickness is a modern laminate with a high degree of gloss, giving the effect of a mirror reflection. It is characterized by a perfectly smooth surface with increased scratch resistance.

Xtreme Matt laminate with a thickness of 0.8 mm is an innovative laminate with a matt, non-reflective structure. The Xtreme Matt surface is durable, scratch-resistant and easy to care for. The structure has been additionally reinforced with the Anti-Finger-Print property, which protects the surface fingerprints against and traces of grease.

STANDARD MATT Laminate with the 0,7-0.8 mm of thickness, the same properties as a high-gloss surface. The only difference is the degree of gloss of the hardcoat layer. Thanks to the pore-free hardcoat coating, the laminate can be used in rooms with the highest hygienic requirements.



NELLA 1

NELLA 2

NELLA 3

NELLA 4

NELLA 5

NELLA 6

NELLA 7



Vetro D2 - bigio

glossy STANDARD	 bianco	 magnolia	 moro	 vino *
	 cubanit	 gabbiano*	 bigio	*while stock last
STANDARD MATT	 mat bianco	 mat cemento	 mat moro	
	 white	 anthracite*		
	U1027	U1290		

STANDARD OPTIONS

- » edge whitout rebate
- » door leaf coated with high Glossy laminate, STANDARD MATT or Xtreme Matt
- » door leaf frame made of MDF, narrow element with constant width, wide element with variable width
- » core made of perforated chipboard
- » a magnetic lock with a simple key, a toilet lock, a cylinder lock or a magnetic economic lock and hinges in black (for moro and moro matt decors), white (for bianco, bianco matt, white decors) and steel for other decors.
- » complex safe MAT DRE 8 mm glass
- » sockets for 2 recessed Estetic 80 hinges (hinges constitute a part of the door frame)

OPTION WITHOUT EXTRA CHARGE

- » complex safe transparent 8 mm glass pane
- » sliding door - 2043 mm height
- » 8 mm black laminated glass pane

OPTIONS AVAILABLE WITH EXTRA CHARGE

- » door leaf „100”
- » ventilation undercut
- » cover-up strip for double leaf non-rebated door
- » double leaf door door leaf price x2

NOTE: third Estetic 80 hinge for non-rebated doors (extra charge is added to the price of the door frame)

NOTE: VETRO D2 sliding door leaves do not fit the sliding system with PA frame cassette.

NOTE: There is no possibility to shorten door leaf.

VETRO D2 – meets ventilation requirements for widths "80" - "100" with ventilation undercut

ventilation undercut

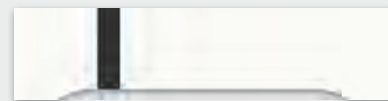

Sliding system - it is possible to use SPAZIO CD sliding system with a standard door leaf height of 2043 mm.

Glossy laminate. 0.7-0.8 mm of thickness is a modern laminate with a high degree of gloss, giving the effect of a mirror reflection. It is characterized by a perfectly smooth surface with increased scratch resistance.

Xtreme Matt laminate with a thickness of 0.8 mm is an innovative laminate with a matt, non-reflective structure. The Xtreme Matt surface is durable, scratch-resistant and easy to care for. The structure has been additionally reinforced with the Anti-Finger-Print property, which protects the surface fingerprints against and traces of grease.

STANDARD MATT Laminate with the 0,7-0.8 mm of thickness, the same properties as a high-gloss surface. The only difference is the degree of gloss of the hardcoat layer. Thanks to the pore-free hardcoat coating, the laminate can be used in rooms with the highest hygienic requirements.



VETRO D2
bianco



VETRO D2
moro



VETRO D2
cubanit



VETRO D2
gabbiano



SILIA 10 - cemento matt

glossy STANDARD					
	bianco	magnolia	moro	vino*	
	glossy METALLIC				*while stock last
		cubanit	gabbiano*	bigjo	
STANDARD MATT					
	mat bianco	mat cemento	mat moro		
	XTREME MATT				
white		anthracite*			
	U1027	U1290			

There is possibility to choose an edge banding pattern.
Available only in decor bianco.

EDGE BANDING PATTERNS



theme 1

theme 2

theme 3

STANDARD OPTIONS

- » edge whitout rebate
- » core made of perforated chipboard
- » door leaf coated with high Glossy laminate, STANDARD MATT or Xtreme Matt
- » edge banding in door leaf colour
- » a magnetic lock with a simple key, a toilet lock, a cylinder lock or a magnetic economic lock and hinges in black (for moro and moro matt decors), white (for bianco, bianco matt, white decors) and steel for other decors.
- » sockets for 2 recessed Estetic 80 hinges (hinges constitute a part of the door frame)

OPTIONS AVAILABLE WITH EXTRA CHARGE

- » edge motif 1, 2 or 3 (only bianco color)
- » door leaf „100”
- » ventilation undercut
- » recuperative undercutting -15mm
- » cover strip for double leaf door
- » aluminum ventilation grille
- » double leaf door door leaf price x2
- » **NOTE:** third Estetic 80 hinge for non-rebated doors (extra charge is added to the price of the door frame)

OPTION WITHOUT EXTRA CHARGE

- » holes for ventilation sleeves
- » sliding door - 2043 mm height

Metal BULAJ, in steel or black color
 - available only with matt or transparent glass.

Sliding system - it is possible to use SPAZIO CD sliding system with a standard door leaf height of 2043 mm.

Glossy laminate. 0.7-0.8 mm of thickness is a modern laminate with a high degree of gloss, giving the effect of a mirror reflection. It is characterized by a perfectly smooth surface with increased scratch resistance.

Xtreme Matt laminate with a thickness of 0.8 mm is an innovative laminate with a matt, non-reflective structure. The Xtreme Matt surface is durable, scratch-resistant and easy to care for. The structure has been additionally reinforced with the Anti-Finger-Print property, which protects the surface fingerprints against and traces of grease.

STANDARD MATT Laminate with the 0,7-0.8 mm of thickness, the same properties as a high-gloss surface. The only difference is the degree of gloss of the hardcoat layer. Thanks to the pore-free hardcoat coating, the laminate can be used in rooms with the highest hygienic requirements.



SILIA 10
bianco

SILIA 10
magnolia

SILIA 10
gabbiano

Metal Bulaj
bigio



VETRO E - natural halifax oak

EGGER 3 mm laminates 1st group

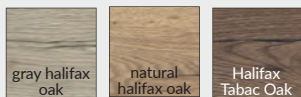

CLEAF 4 mm laminates 2nd group

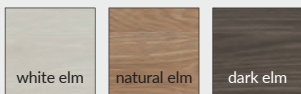

Horizontal cross-section of rebated VETRO E doors

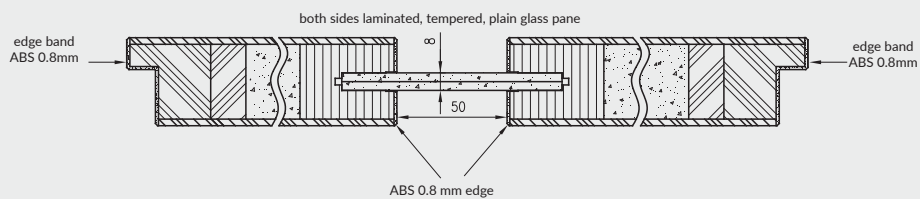

Horizontal cross-section of non-rebated VETRO E doors

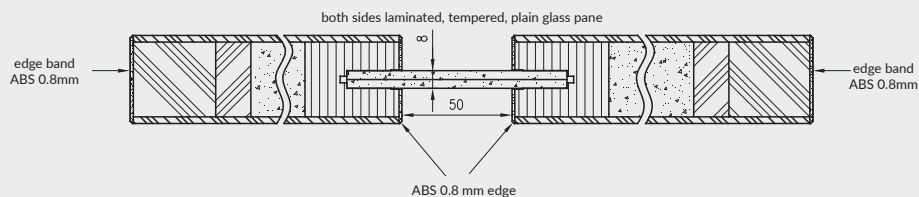

STANDARD OPTIONS

- » door leaf surface is coated with laminated, synchronous 3 mm or 4 mm thick board
- » reinforced MDF frame
- » core made of tubular chipboard
- » DECORMAT tempered laminated 8 mm glass pane with fixed width (regardless the width of the door leaf) or laminated black tempered 8 mm glass pane (opaque) with fixed width (regardless the door leaf width)

REBATED DOOR LEAF

- » straight edge in black **Fig. 1**
- » for natural halifax oak decor, the edge in the color of the door leaf or black
- » 3 silver screw-in pivot hinges
- » single-point mortise simple key lock, bathroom lock, cylinder lock or economic lock

NON-REBATED DOOR LEAF (extra charge)

- » edge without rebate in black **Fig. 2**
- » for natural halifax oak decor, the edge in the color of the door leaf or black
- » sockets for 2 Estetic 80 recessed hinges in steel, black or white color (hinges constitute a part of the door frame)
- » magnetic simple key lock, bathroom lock, cylinder insert lock or economic lock in steel, black or white color

DOOR FRAMES

- » for door leaves from the Vetro E collection in synchronous laminates, we recommend door frames in black matt foil 2 and in CPL laminate natural halifax oak in a longitudinal arrangement, in the second CPL price group

OPTIONS AVAILABLE WITH EXTRA CHARGE

- » ventilation undercut
- » non-rebated door leaf

NOTE: third Estetic 80 hinge for non-rebated doors (extra charge is added to the price of the door frame)



SLIDING DOOR LEAF

- » edge without rebate **fig. 2**
- » socket for hook lock and/or for handles

NOTE: sliding VETRO E door leaves do not fit the sliding system with the PA door frame cassette.

NOTE: There is no possibility to shorten door leaf.

VETRO E - meets ventilation requirements for widths "80" - "100" with ventilation undercut

NOTE: It is required to use together with VETRO rebated door leaf model door frames equipped with 3 hinges.



VETRO E
gray halifax oak

VETRO E
natural halifax oak

VETRO E
Halifax Tabac Oak

VETRO E
white elm

VETRO E
natural elm

VETRO E
dark elm



ESTRA 13 - cashmere matt

	NEW							
Decor DRE-Cell	white matt	light gray matt	dark olive matt	dark blue matt	black matt 2	cashmere matt	warm gray matt	sage oak
Decor 3D	grand oak	elm	american walnut	ebony*	Polish oak 3D			

*while stock last

STANDARD OPTIONS

- » stiles made of wood-based panels
- » glass pane MAT DRE 4 mm thick
- » 16mm flat panels
- » Estra 7-9 models have black glass pane frame and black muntin frame
- » Estra 10 model with a mirror
- » Estra 12-14 models have a glazing bar in the color of the door leaf

OPTIONS WITHOUT EXTRA CHARGE

- » glass pane DECORMAT BROWN, DECORMAT GRAPHITE and transparent glass pane
- » holes for ventilation sleeves

REBATED DOOR LEAF

- » straight edge **fig. 1**
- » 3 silver screw-in pivot hinges
- » single-point mortise simple key lock, bathroom lock, cylinder lock or economic lock

NON-REBATED OPENING DOOR LEAF (extra charge)

- » edge without rebate **fig. 2**
- » sockets for 2 recessed Estetic 80 hinges (hinges constitute a part of the door frame)
- » magnetic simple key lock, bathroom lock, cylinder lock or economic lock

SLIDING DOOR LEAF

- » edge without rebate **fig. 2**
- » socket for hook lock and/or for handles

DOOR LEAF WITH INVERTED REBATE (extra charge)

- » active single leaf door
- » straight edge **fig 3**
- » sockets for two recessed Estetic 1821 hinges (hinges constitute a part of the door frame)
- » magnetic simple key lock, bathroom lock, cylinder lock or economic lock

NOTE: This option is available only for matt foil decors

OPTIONS AVAILABLE WITH EXTRA CHARGE

- » plastic ventilation sleeves 1 pc.
- » non-rebated door leaf
- » door leaf „90” and „100”
- » ventilation undercut
- » recuperative undercutting -15mm
- » door leaf with inverted rebate
- » cover strip for double non-rebated door leaf
- » double leaf door door leaf price x2

NOTE: third Estetic 80 hinge for non-rebated doors (extra charge is added to the price of the door frame)

NOTE: It is required to use door frame equipped with 3 hinges together with rebated door leaf ESTRA.

* Note: Selected configurations of white matt rebated ESTRA 5 model are available in stock.

fig. 1



fixed edge

fig. 2



edge without rebate

fig. 3



edge with inverted rebate

Estra 10 door in the "obverse" variant

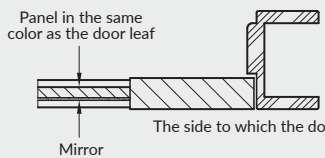

The side to which the door opens

Estra 10 door in the "reverse" variant

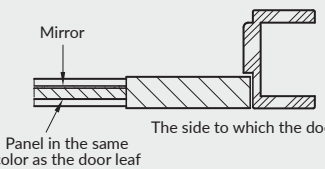

The side to which the door opens



STANDARD OPTIONS

- » stiles made of wood-based panels
- » glass pane MAT DRE 4 mm thick

OPTIONS WITHOUT EXTRA CHARGE

- » glass pane DECORMAT BROWN, DECORMAT GRAPHITE and transparent glass pane
- » holes for ventilation sleeves

OPTIONS AVAILABLE WITH EXTRA CHARGE

- » plastic ventilation sleeves 1 pc.
- » non-rebated door leaf
- » door leaf „90” and „100”
- » ventilation undercut
- » recuperative undercutting -15mm
- » cover strip for double non-rebated door leaf
- » double leaf door door leaf price x2
- » **NOTE:** third Estetic 80 hinge for non-rebated doors (extra charge is added to the price of the door frame)

REBATED DOOR LEAF

- » straight edge **fig. 1**
- » 3 silver screw-in pivot hinges
- » single-point mortise simple key lock, bathroom lock, cylinder lock or economic lock

NON-REBATED DOOR LEAF (EXTRA CHARGE)

- » edge without rebate **fig. 2**
- » sockets for 2 recessed Estetic 80 hinges (hinges constitute a part of the door frame)
- » magnetic simple key lock, bathroom lock, cylinder lock or economic lock

SLIDING DOOR LEAF

- » edge without rebate **fig. 2**
- » socket for hook lock and/or for handles

NOTE: It is required to use door frame equipped with 3 hinges together with VERANO rebated door leaf model.

fig. 1



fig. 2

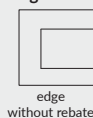

Decor DRE-Cell



STANDARD OPTIONS

- » stiles made of wood-based panels
- » glass pane MAT DRE 4 mm thick

OPTIONS WITHOUT EXTRA CHARGE

- » glass pane DECORMAT BROWN, DECORMAT GRAPHITE and transparent glass pane
- » holes for ventilation sleeves

OPTIONS AVAILABLE WITH EXTRA CHARGE

- » plastic ventilation sleeves 1 pc.
- » non-rebated door leaf
- » door leaf „90” and „100”
- » ventilation undercut
- » recuperative undercutting -15mm
- » cover strip for double non-rebated door leaf
- » double leaf door door leaf price x2
- » **NOTE:** third Estetic 80 hinge for non-rebated doors (extra charge is added to the price of the door frame)

REBATED DOOR LEAF

- » straight edge **fig. 1**
- » 3 silver screw-in pivot hinges
- » single-point mortise simple key lock, bathroom lock, cylinder lock or economic lock

fig. 1



NON-REBATED DOOR LEAF (EXTRA CHARGE)

- » edge without rebate **fig. 2**
- » sockets for 2 recessed Estetic 80 hinges (hinges constitute a part of the door frame)
- » magnetic simple key lock, bathroom lock, cylinder lock or economic lock

fig. 2



SLIDING DOOR LEAF

- » edge without rebate **fig. 2**
- » socket for hook lock and/or for handles

NOTE: It is required to use door frames equipped with 3 hinges together with ENA rebated door leaf model



STANDARD OPTIONS

- » stiles made of wood-based panels
- » glass pane MAT DRE 4 mm thick

OPTIONS WITHOUT EXTRA CHARGE

- » glass pane DECORMAT BROWN, DECORMAT GRAPHITE and transparent glass pane
- » holes for ventilation sleeves

OPTIONS AVAILABLE WITH EXTRA CHARGE

- » plastic ventilation sleeves 1 pc.
- » non-rebated door leaf
- » door leaf „90” and „100”
- » ventilation undercut
- » recuperative undercutting -15mm
- » cover strip for double non-rebated door leaf
- » double leaf door door leaf price x2
- » **NOTE:** third Estetic 80 hinge for non-rebated doors (extra charge is added to the price of the door frame)

REBATED DOOR LEAF

- » straight edge **fig. 1**
- » 3 silver screw-in pivot hinges
- » single-point mortise simple key lock, bathroom lock, cylinder lock or economic lock

NON-REBATED DOOR LEAF (EXTRA CHARGE)

- » edge without rebate **fig. 2**
- » sockets for 2 recessed Estetic 80 hinges (hinges constitute a part of the door frame)
- » magnetic simple key lock, bathroom lock, cylinder lock or economic lock

SLIDING DOOR LEAF

- » edge without rebate **fig. 2**
- » socket for hook lock and/or for handles

NOTE: It is required to use door frame equipped with 3 hinges together with TRIESTA rebated door leaf model. Left door unit is mirror reflection of the right door leaf unit..

fig. 1



fixed edge

fig. 2



edge without rebate



TRIESTA 0



TRIESTA 1



TRIESTA 2



TRIESTA 3

Decor
DRE-Cell

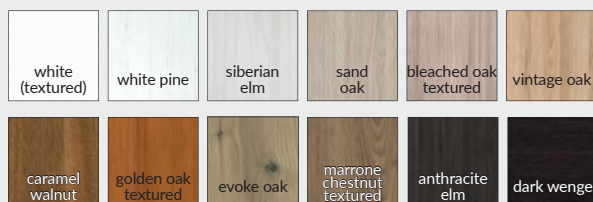



REVA 1 - white pine

Decor DRE-Cell gr.1	white (textured)	white matt	white pine	siberian elm	sand oak	bleached oak textured	vintage oak	
	anthracite elm	dark wenge	marrone chestnut textured	black matt 2	evoke oak	caramel walnut	golden oak textured	
Decor 3D	grand oak	elm	american walnut	ebony*	Polish oak 3D	<i>*while stock last</i>		
	light gray matt	dark olive matt	dark blue matt	cashmere matt	warm gray matt	sage oak		
NEW								

STANDARD OPTIONS

- » stiles made of wood-based panels
- » glass pane MAT DRE 4 mm thick
- » flat inserts (REVA 5-7)

OPTIONS WITHOUT EXTRA CHARGE

- » glass pane DECORMAT BROWN, DECORMAT GRAPHITE and transparent glass pane
- » holes for ventilation sleeves

REBATED DOOR LEAF

- » straight edge **fig. 1**
- » 3 silver screw-in pivot hinges
- » single-point mortise simple key lock, bathroom lock, cylinder lock or economic lock

NON-REBATED DOOR LEAF (EXTRA CHARGE)

- » edge without rebate **fig. 2**
- » sockets for 2 recessed Estetic 80 hinges (hinges constitute a part of the door frame)
- » magnetic simple key lock, bathroom lock, cylinder lock or economic lock

SLIDING DOOR LEAF

- » edge without rebate **fig. 2**
- » socket for hook lock and/or for handles

NOTE: Rebated "40" side panels available..

NOTE: It is required to use door frame equipped with 3 hinges together with REVA rebated door leaf model.

OPTIONS AVAILABLE WITH EXTRA CHARGE

- » plastic ventilation sleeves 1 pc.
- » non-rebated door leaf
- » door leaf „90" and „100"
- » ventilation undercut
- » recuperative undercutting -15mm
- » cover strip for double non-rebated door leaf
- » black VSG 22.1 safe, complex glass pane REVA 1
REVA 2
REVA 3.4
REVA 5
REVA 7
- » double leaf door door leaf price x2
- » NOTE: third Estetic 80 hinge for non-rebated doors (extra charge is added to the price of the door frame)

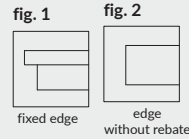



FOSCA 0 - grand oak

Decor DRE-Cell	white (textured)	white matt	white pine	siberian elm	sand oak	bleached oak textured	vintage oak	caramel walnut
	anthracite elm	dark wenge	marrone chestnut textured	black matt 2	light gray matt	evoke oak	golden oak textured	
Decor 3D	grand oak	elm	american walnut	ebony*	Polish oak 3D	<i>*while stock last</i>		

STANDARD OPTIONS

- » stiles made of wood-based panels
- » glass pane MAT DRE 4 mm thick
- » flat panel insert coated with silver laminate (FOSCA 1-3) or in door leaf colour (FOSCA 4-6)

OPTION WITHOUT EXTRA CHARGE

- » glass pane DECORMAT BROWN, DECORMAT GRAPHITE and transparent glass pane
- » holes for ventilation sleeves

OPTIONS AVAILABLE WITH EXTRA CHARGE

- » plastic ventilation sleeves 1 pc.
- » non-rebated door leaf
- » door leaf „90” and „100”
- » ventilation undercut
- » recuperative undercutting -15mm
- » cover strip for double non-rebated door leaf
- » double leaf door door leaf price x2
- » **NOTE:** third Estetic 80 hinge for non-rebated doors (extra charge is added to the price of the door frame)

REBATED DOOR LEAF

- » straight edge **fig. 1**
- » 3 silver screw-in pivot hinges
- » single-point mortise simple key lock, bathroom lock, cylinder lock or economic lock

NON-REBATED DOOR LEAF (EXTRA CHARGE)

- » edge without rebate **fig. 2**
- » sockets for 2 recessed Estetic 80 hinges (hinges constitute a part of the door frame)
- » magnetic simple key lock, bathroom lock, cylinder lock or economic lock

SLIDING SYSTEM DOOR LEAF

- » edge without rebate **fig. 2**
- » socket for hook lock and/or for handles

NOTE: There is possibility to make rebated „40” side panels.

NOTE: It is required to use door frame equipped with 3 hinges together with FOSCA rebated door leaf model.

fig. 1



fixed edge

fig. 2



edge without rebate

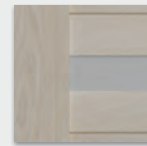

FOSCA 1-3
(4 mm thick HDF board covered with silver laminate)

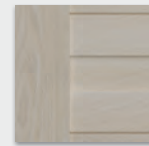

FOSCA 4-6
(4mm HDF insert coated in door leaf colour)



FOSCA 0
(5 glass panes)

FOSCA 1
(3 glass panes, 2 HDF panels)

FOSCA 2
(1 glass pane, 4 HDF panels)

FOSCA 3
(5 HDF panels)

FOSCA 4
(3 glass panes, 2 HDF panels)

FOSCA 5
(1 glass pane, 4 HDF panels)

FOSCA 6
(5 HDF panels)



NESTOR 1 - black matt 2

	NEW							
DRE-Cell decor	white matt	light gray matt	dark olive matt	dark blue matt	black matt 2	cashmere matt	warm gray matt	sage oak
	white pine	sand oak	vintage oak	anthracite elm	dark wenge	siberian elm	caramel walnut	
Decor 3D	Polish oak 3D							

DOOR HANDLE WITH A BACKPLATE FOR

The promotion applies to rebated and non-rebated door leaves from NESTOR collection in DRE-Cell and 3D foil. Door handle model and finishing color to choose from: WEGA, ATRIA, ARCTUS, POLARIS, ORION, ZETA, AVIOR, MIMOSA and ALTAIR door handles and a backplate with a simple key lock or cylinder lock or toilet lock. The promotion lasts while stocks last.



STANDARD OPTIONS

- » stiles made of wood-based panels
- » glass pane MAT DRE 4 mm thick
- » profiled 19mm MDF panels

OPTIONS WITHOUT EXTRA CHARGE

- » glass pane DECORMAT BROWN, DECORMAT GRAPHITE and transparent glass pane
- » holes for ventilation sleeves

REBATED DOOR LEAF

- » straight edge **fig. 1**
- » 3 silver screw-in pivot hinges
- » single-point mortise simple key lock, bathroom lock, cylinder lock or economic lock

NON-REBATED DOOR LEAF (EXTRA CHARGE)

- » edge without rebate **fig. 2**
- » sockets for 2 recessed Estetic 80 hinges (hinges constitute a part of the door frame)
- » magnetic simple key lock, bathroom lock, cylinder lock or economic lock

SLIDING DOOR LEAF

- » edge without rebate **fig. 2**
- » socket for hook lock and/or for handles

DOOR LEAF WITH INVERTED REBATE (extra charge)

- » active single leaf door
- » straight edge **fig 3**
- » sockets for two recessed Estetic 1821 hinges (hinges constitute a part of the door frame)
- » magnetic simple key lock, bathroom lock, cylinder lock or economic lock

NOTE: This option is available only for matt foil decors

OPTIONS AVAILABLE WITH EXTRA CHARGE

- » plastic ventilation sleeves 1 pc.
- » non-rebated door leaf
- » door leaf „90” and „100”
- » ventilation undercut
- » recuperative undercutting -15mm
- » door leaf with inverted rebate
- » cover strip for double non-rebated door leaf
- » double leaf door door leaf price x2

NOTE: third Estetic 80 hinge for non-rebated doors (extra charge is added to the price of the door frame)

NOTE: It is required to use together with NESTOR rebated door leaf model door frames equipped with 3 hinges.

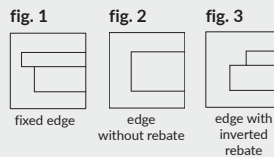



AURI 8 - American walnut

Decor DRE-Cell gr.1	white (textured)	white matt	white pine	siberian elm	sand oak	bleached oak textured	vintage oak	
	anthracite elm	dark wenge	marrone chestnut textured	black matt 2	evoke oak	caramel walnut	golden oak textured	
Decor 3D	grand oak	elm	american walnut	ebony*	Polish oak 3D	<i>*while stock last</i>		
	light gray matt	dark olive matt	dark blue matt	cashmere matt	warm gray matt	sage oak		
NEW								

STANDARD OPTIONS

- » stiles made of wood-based panels
- » glass pane MAT DRE 4 mm thick
- » flat inserts (AURI 6-8)

OPTIONS WITHOUT EXTRA CHARGE

- » glass pane DECORMAT BROWN, DECORMAT GRAPHITE and transparent glass pane
- » holes for ventilation sleeves

REBATED DOOR LEAF

- » straight edge **fig. 1**
- » 3 silver screw-in pivot hinges
- » single-point mortise simple key lock, bathroom lock, cylinder lock or economic lock

NON-REBATED DOOR LEAF (EXTRA CHARGE)

- » edge without rebate **fig. 2**
- » sockets for 2 recessed Estetic 80 hinges (hinges constitute a part of the door frame)
- » magnetic simple key lock, bathroom lock, cylinder lock or economic lock

SLIDING DOOR LEAF

- » edge without rebate **fig. 2**
- » socket for hook lock and/or for handles

NOTE: Rebated "40" side panels available..

It is required to use door frame equipped with 3 hinges together with AURI rebated door leaf model.





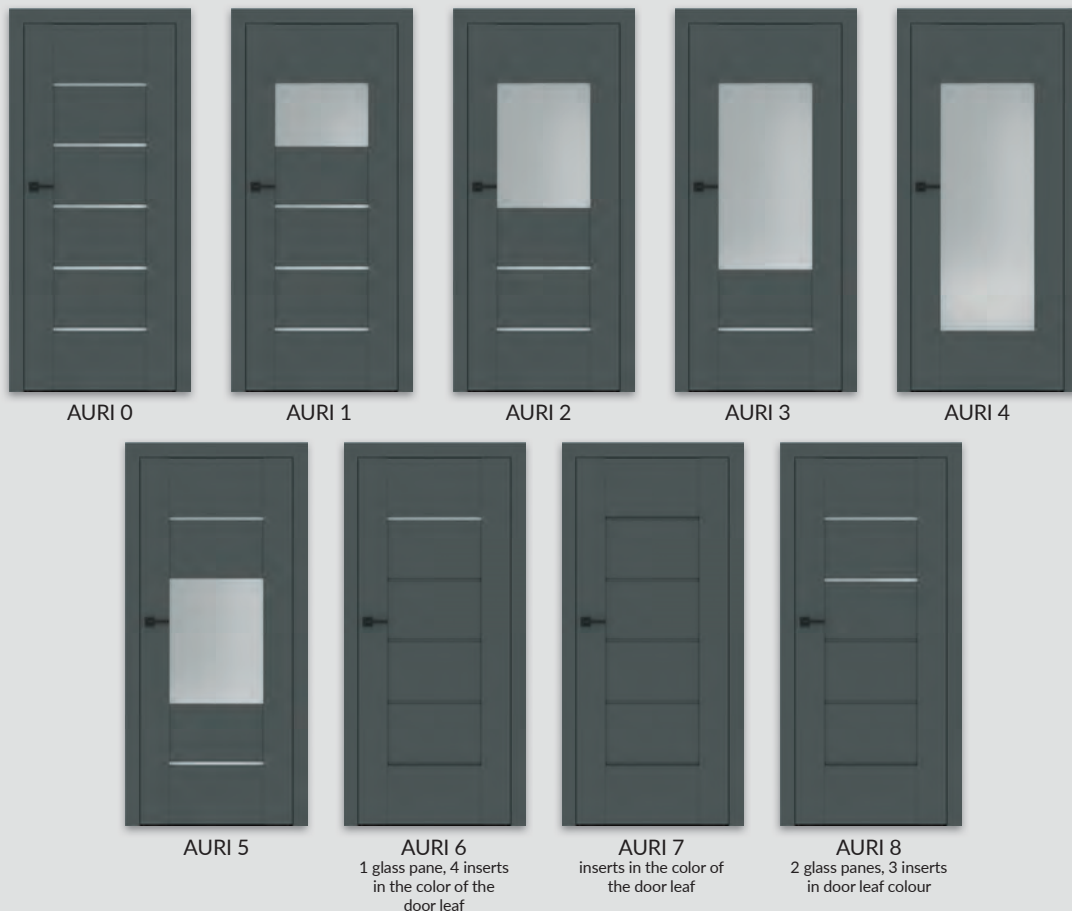
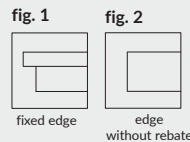

OPTIONS AVAILABLE WITH EXTRA CHARGE

- » plastic ventilation sleeves 1 pc.
- » non-rebated door leaf
- » door leaf „90” and „100”
- » ventilation undercut
- » recuperative undercutting -15mm
- » cover strip for double non-rebated door leaf
- » black VSG 22.1 safety composite glass AURI 0
AURI 1
AURI 2, 5
AURI 3
AURI 4
AURI 6
AURI 8
- » double leaf door door leaf price x2
- » **NOTE:** third Estetic 80 hinge for non-rebated doors (extra charge is added to the price of the door frame)
- » **Note:** Selected configurations of AURI 0 rebated model in the evoke oak color are available from stock.





ELSA A3 and ELSA 0 - sand oak

DRE-Cell decor	 white matt	 white pine	 sand oak	 vintage oak	 anthracite elm	 dark wenge
Decor 3D	 Polish oak 3D					

DOOR HANDLE WITH A BACKPLATE

The promotion applies to rebated and non-rebated door leaves from ELSA collection in DRE-Cell and 3D foil. Door handle model and finishing color to choose from: WEGA, ATRIA, ARCTUS, POLARIS, ORION, ZETA, AVIOR, MIMOSA and ALTAIR door handles and a backplate with a simple key lock or cylinder lock or toilet lock. The promotion lasts while stocks last.



STANDARD OPTIONS

- » stiles made of wood-based panels
- » glass pane MAT DRE 4 mm thick
- » flat panel insert (ELSA A), profiled 19 mm MDF panels (ELSA B)

OPTIONS WITHOUT EXTRA CHARGE

- » glass pane DECORMAT BROWN, DECORMAT GRAPHITE and transparent glass pane
- » holes for ventilation sleeves

OPTIONS AVAILABLE WITH EXTRA CHARGE

- » plastic ventilation sleeves 1 pc.
- » non-rebated door leaf
- » door leaf „90” and „100”
- » ventilation undercut
- » recuperative undercutting -15mm
- » cover strip for double non-rebated door leaf
- » double leaf door door leaf price x2
- » **NOTE:** third Estetic 80 hinge for non-rebated doors (extra charge is added to the price of the door frame)

REBATED DOOR LEAF

- » straight edge **fig. 1**
- » 3 silver screw-in pivot hinges
- » single-point mortise simple key lock, bathroom lock, cylinder lock or economic lock

NON-REBATED DOOR LEAF (EXTRA CHARGE)

- » edge without rebate **fig. 2**
- » sockets for 2 recessed Estetic 80 hinges (hinges constitute a part of the door frame)
- » magnetic simple key lock, bathroom lock, cylinder lock or economic lock

SLIDING DOOR LEAF

- » edge without rebate **fig. 2**
- » socket for hook lock and/or for handles

NOTE: Rebated "40" side panels available..

It is required to use door frame equipped with 3 hinges together with ELSA rebated door leaf model.

ELSA collection is divided into A and B:
A - flat panel insert in door leaf colour
B - 19 mm convex panel insert in door leaf colour

fig. 1



fixed edge

fig. 2



edge without rebate



cross-section of ELSA A



cross-section of ELSA B





Premium 4 - marrone chestnut structure

Decor DRE-Cell	white (textured)	white matt	white pine	siberian elm	sand oak	bleached oak textured	vintage oak	
	evoke oak	light gray matt	black matt 2	marrone chestnut textured	caramel walnut	anthracite elm	dark wenge	golden oak textured
Decor 3D	grand oak	elm	american walnut	ebony*	Polish oak 3D	*while stock last		

STANDARD OPTIONS

- » stiles made of wood-based panels
- » glass pane MAT DRE 4 mm thick

OPTION WITHOUT EXTRA CHARGE

- » glass pane DECORMAT BROWN, DECORMAT GRAPHITE and transparent glass pane
- » holes for ventilation sleeves

REBATED DOOR LEAF

- » straight edge **fig. 1**
- » 3 silver screw-in pivot hinges
- » single-point mortise simple key lock, bathroom lock, cylinder lock or economic lock

NON-REBATED DOOR LEAF (EXTRA CHARGE)

- » edge without rebate **fig. 2**
- » sockets for 2 recessed Estetic 80 hinges (hinges constitute a part of the door frame)
- » magnetic simple key lock, bathroom lock, cylinder lock or economic lock

SLIDING SYSTEM DOOR LEAF

- » edge without rebate **fig. 2**
- » socket for hook lock and/or for handles

NOTE: There is possibility to make rebated „40” side panels.
NOTE: It is required to use door frame equipped with 3 hinges together with PREMIUM rebated door leaf model.

OPTIONS AVAILABLE WITH EXTRA CHARGE

- » plastic ventilation sleeves 1 pc.
- » non-rebated door leaf
- » door leaf „90” and „100”
- » ventilation undercut
- » recuperative undercutting -15mm
- » cover strip for double non-rebated door leaf
- » double leaf door door leaf price x2
- » **NOTE:** third Estetic 80 hinge for non-rebated doors (extra charge is added to the price of the door frame)

fig. 1



fig. 2



In PREMIUM 12 and 13 models, from the top edge there are used two glass panes.

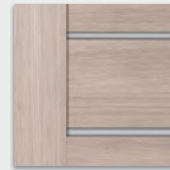

PREMIUM 0-3
(4 mm glass pane)



* PREMIUM 4-7, 12
(4 mm HDF inserts in door leaf colour)



** PREMIUM 8-11, 13 (4mm HDF inserts , coated with a silver laminate)



PREMIUM 0
PREMIUM 4*
PREMIUM 8**



PREMIUM 1
PREMIUM 5*
PREMIUM 9**



PREMIUM 2
PREMIUM 6*
PREMIUM 10**



PREMIUM 3
PREMIUM 7*
PREMIUM 11**



PREMIUM 12
2 glass panes, 6
inserts in the colour of
the door leaf



PREMIUM 13
2 glass panes, 6
inserts coated with a
silver laminate



PIANO 0 - Polish oak 3D

Decor DRE-Cell	white (textured)	white matt	white pine	siberian elm	sand oak	bleached oak textured	vintage oak	caramel walnut
	anthracite elm	dark wenge	marrone chestnut textured	black matt 2	light gray matt	evoke oak	golden oak textured	
Decor 3D	grand oak	elm	american walnut	ebony*	Polish oak 3D	<i>*while stock last</i>		

STANDARD OPTIONS

- » stiles made of wood-based panels
- » glass pane MAT DRE 4 mm thick
- » filling with convex panel thickness 16 mm (PIANO 1-2, PIANO 5-6) or 19 mm convex panel (PIANO 9-12)

OPTION WITHOUT EXTRA CHARGE

- » glass pane DECORMAT BROWN, DECORMAT GRAPHITE and transparent glass pane
- » holes for ventilation sleeves

OPTIONS AVAILABLE WITH EXTRA CHARGE

- » plastic ventilation sleeves 1 pc.
- » non-rebated door leaf
- » door leaf „90” and „100”
- » ventilation undercut
- » recuperative undercutting -15mm
- » cover strip for double non-rebated door leaf
- » double leaf door door leaf price x2
- » **NOTE:** third Estetic 80 hinge for non-rebated doors (extra charge is added to the price of the door frame)

REBATED DOOR LEAF

- » straight edge **fig. 1**
- » 3 silver screw-in pivot hinges
- » single-point mortise simple key lock, bathroom lock, cylinder lock or economic lock

NON-REBATED DOOR LEAF (EXTRA CHARGE)

- » edge without rebate **fig. 2**
- » sockets for 2 recessed Estetic 80 hinges (hinges constitute a part of the door frame)
- » magnetic simple key lock, bathroom lock, cylinder lock or economic lock

SLIDING SYSTEM DOOR LEAF

- » edge without rebate **fig. 2**
- » socket for hook lock and/or for handles

NOTE: There is possibility to make rebated „40” side panels.
It is required to use door frame equipped with 3 hinges together with PIANO rebated door leaf model.

fig. 1



fig. 2

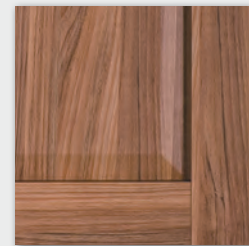
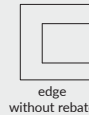

panel PIANO 9-12



PIANO 0

PIANO 1

PIANO 2

PIANO 3

PIANO 4

PIANO 5

PIANO 6



PIANO 9

PIANO 10

PIANO 11

PIANO 12



SCALA 0, SCALA B2 - white matt

Decor DRE-Cell	white (textured)	white matt	white pine	siberian elm	sand oak	bleached oak textured	vintage oak	caramel walnut
	anthracite elm	dark wenge	marrone chestnut textured	black matt 2	light gray matt	evoked oak	golden oak textured	
Decor 3D	grand oak	elm	american walnut	ebony*	Polish oak 3D	<i>*while stock last</i>		

DOOR HANDLE WITH A BACKPLATE

The promotion applies to rebated and non-rebated door leaves from SCALA collection in DRE-Cell and 3D foil. Door handle model and finishing color to choose from: WEGA, ATRIA, ARCTUS, POLARIS, ORION, ZETA, AVIOR, MIMOSA and ALTAIR door handles and a backplate with a simple key lock or cylinder lock or toilet lock. The promotion lasts while stocks last.



STANDARD OPTIONS

- » stiles made of wood-based panels
- » glass pane MAT DRE 4 mm thick
- » flat panel insert (SCALA A), 19 mm profiled MDF panels (SCALA B)

OPTIONS WITHOUT EXTRA CHARGE

- » glass pane DECORMAT BROWN, DECORMAT GRAPHITE and transparent glass pane
- » holes for ventilation sleeves

OPTIONS AVAILABLE WITH EXTRA CHARGE

- » plastic ventilation sleeves 1 pc.
- » non-rebated door leaf
- » door leaf „90” and „100”
- » ventilation undercut
- » recuperative undercutting -15mm
- » cover strip for double non-rebated door leaf
- » double leaf door door leaf price x2
- » **NOTE:** third Estetic 80 hinge for non-rebated doors (extra charge is added to the price of the door frame)

REBATED DOOR LEAF

- » straight edge **fig. 1**
- » 3 silver screw-in pivot hinges
- » single-point mortise simple key lock, bathroom lock, cylinder lock or economic lock

NON-REBATED DOOR LEAF (EXTRA CHARGE)

- » edge without rebate **fig. 2**
- » sockets for 2 recessed Estetic 80 hinges (hinges constitute a part of the door frame)
- » magnetic simple key lock, bathroom lock, cylinder lock or economic lock

SLIDING DOOR LEAF

- » edge without rebate **fig. 2**
- » socket for hook lock and/or for handles

NOTE: Rebated "40" side panels available..

It is required to use door frame equipped with 3 hinges together with SCALA rebated door leaf model.

SCALA collection is divided into A and B:
A - flat panel insert in door leaf colour
B - convex panel insert in door leaf colour

fig. 1



fig. 2

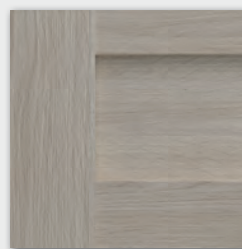
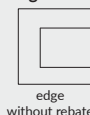

panel SCALA A, A1-A7



panel SCALA B, B1-B7





VERSO 0 - white pine

Decor
DRE-Cell



STANDARD OPTIONS

- » stiles made of wood-based panels
- » glass pane MAT DRE 4 mm thick

OPTIONS WITHOUT EXTRA CHARGE

- » glass pane DECORMAT BROWN, DECORMAT GRAPHITE and transparent glass pane
- » holes for ventilation sleeves

OPTIONS AVAILABLE WITH EXTRA CHARGE

- » plastic ventilation sleeves 1 pc.
- » non-rebated door leaf
- » door leaf „90” and „100”
- » ventilation undercut
- » recuperative undercutting -15mm
- » cover strip for double non-rebated door leaf
- » double leaf door door leaf price x2
- » **NOTE:** third Estetic 80 hinge for non-rebated doors (extra charge is added to the price of the door frame)

REBATED DOOR LEAF

- » straight edge **fig. 1**
- » 3 silver screw-in pivot hinges
- » single-point mortise simple key lock, bathroom lock, cylinder lock or economic lock

NON-REBATED DOOR LEAF (EXTRA CHARGE)

- » edge without rebate **fig. 2**
- » sockets for 2 recessed Estetic 80 hinges (hinges constitute a part of the door frame)
- » magnetic simple key lock, bathroom lock, cylinder lock or economic lock

SLIDING DOOR LEAF

- » edge without rebate **fig. 2**
- » socket for hook lock and/or for handles

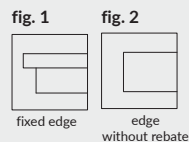

VERSO 0



VERSO 1



VERSO 2



VERSO 3



VERSO 4

* Note: selected configurations of the VERSO model are available as stock orders, rebated in white matt.



VETRO A1 - dark wenge

Decor DRE-Cell	white (textured)	white matt	white pine	siberian elm	sand oak	bleached oak textured	vintage oak	caramel walnut
	anthracite elm	dark wenge	marrone chestnut textured	black matt 2	light gray matt	evoke oak	toffee oak***	golden oak textured
Decor 3D	grand oak	elm	american walnut	ebony*	Polish oak 3D	*** decor available only in horizontal wood grain *while stock last		

NOTE: It is possible to order non-rebated door leaf in Dre-Cell white matt colour

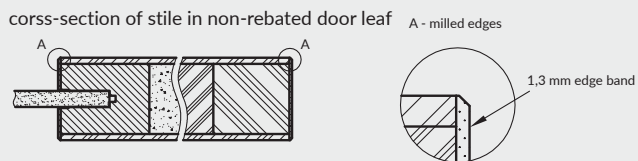

VETRO collection glass panes have obverse and reverse sides (important in two door leaves opening inversely). Presented horizontal cross-sections shows the arrangement of glass pane in the obverse version. When choosing a reverse version, glass pane is rotated by 180° around the vertical axis.

Horizontal cross-section of door leaf VETRO A1-A4, A12-A15

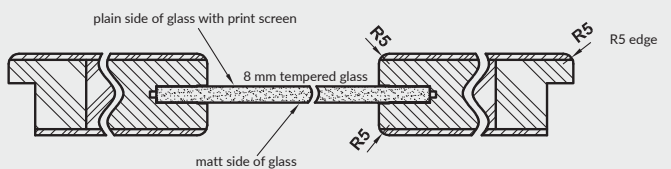

Horizontal cross-section of door leaf VETRO A5, A10 - A11

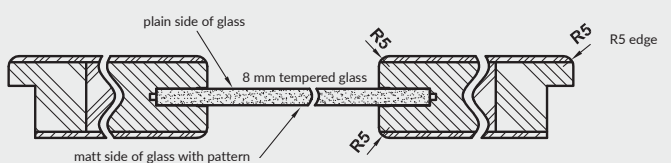

STANDARD OPTIONS

- » reinforced MDF frame
- » core made of tubular chipboard
- » 8 mm tempered glass

OPTIONS WITHOUT EXTRA CHARGE

- » there is possibility to make ventilation undercut (A)
- » door leaf with revers positioning of glass pane
- » VETRO A1 four possible types of glass pane: DECORMAT, DECORMAT BROWN, DECORMAT GRAPHITE and transparent glass

REBATED DOOR LEAF

- » R5 edge **fig. 1**
- » 3 silver screw-in pivot hinges
- » single-point mortise simple key lock, bathroom lock, cylinder lock or economic lock

NON-REBATED DOOR LEAF (extra charge)

ONLY WHITE MATT

- » edge without rebate **fig. 2**
- » sockets for 2 recessed Estetic 80 hinges (hinges constitute a part of the door frame)
- » magnetic simple key lock, bathroom lock, cylinder lock or economic lock

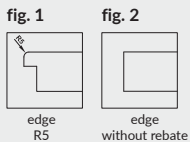

OPTIONS AVAILABLE WITH EXTRA CHARGE - AVAILABLE ONLY IN WHITE MATT DRE- CELL DECOR

- » non-rebated door leaf
- » **NOTE:** third Estetic 80 hinge for non-rebated doors (extra charge is added to the price of the door frame)

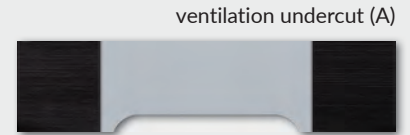

SLIDING DOOR LEAF

- » edge without rebate **fig. 2**
- » socket for hook lock and/or for handles

NOTE: Door leaf VETRO A in sliding version is not complementary product to sliding system hidden in the wall PA.

NOTE: There is no possibility to shorten door leaf.

NOTE: It is required to use door frame equipped with 3 hinges together with VETRO rebated door leaf model. VETRO A - „80“-„100“ with ventilation undercut fulfill ventilation requirements.





VETRO B14 - evoke oak

Decor DRE-Cell	white (textured)	white matt	white pine	siberian elm	sand oak	bleached oak textured	vintage oak	caramel walnut
	golden oak textured	anthracite elm	dark wenge	marrone chestnut textured	black matt 2	light gray matt	evoke oak	toffee oak*** *
Decor 3D	grand oak	elm	american walnut	ebony*	Polish oak 3D	*** decor available only in horizontal wood grain *while stock last		

NOTE: It is possible to order non-rebated door leaf in Dre-Cell white matt colour

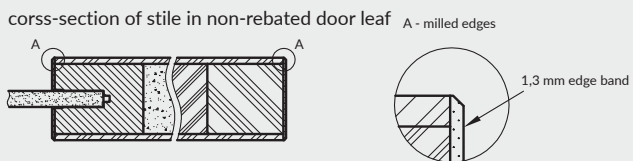

VETRO collection glass panes have obverse and reverse sides (important in two door leaves opening inversely). Presented horizontal cross-sections shows the arrangement of glass pane in the obverse version. When choosing a reverse version, glass pane is rotated by 180° around the vertical axis.

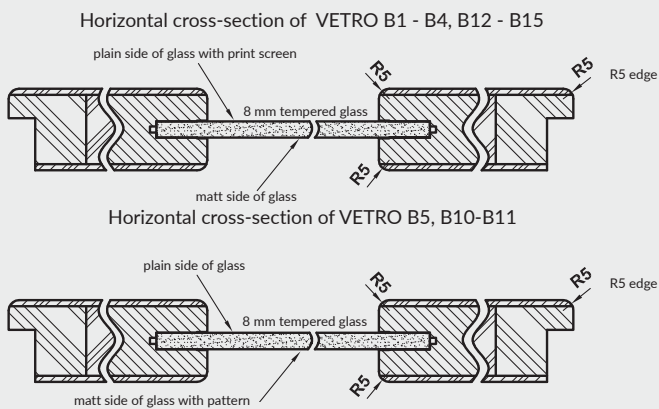

STANDARD OPTIONS

- » reinforced MDF frame
- » core made of tubular chipboard
- » 8 mm tempered glass

OPTIONS WITHOUT EXTRA CHARGE

- » there is possibility to make ventilation undercut (B)
- » VETRO B1 four possible types of glass pane: DECORMAT, DECORMAT BROWN, DECORMAT GRAPHITE and transparent glass
- » door leaf with revers positioning of glass pane

OPTIONS AVAILABLE WITH EXTRA CHARGE - AVAILABLE ONLY IN WHITE MATT DRE- CELL DECOR

- » non-rebated door leaf
- » **NOTE:** third Estetic 80 hinge for non-rebated doors (extra charge is added to the price of the door frame)

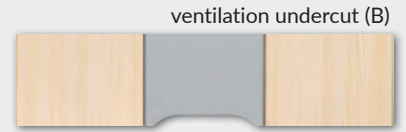

VETRO B - doesn't fulfill ventilation requirements

REBATED DOOR LEAF

- » R5 edge **fig. 1**
- » 3 silver screw-in pivot hinges
- » single-point mortise simple key lock, bathroom lock, cylinder lock or economic lock

NON-REBATED DOOR LEAF (extra charge)

ONLY WHITE MATT

- » edge without rebate **fig. 2**
- » sockets for 2 recessed Estetic 80 hinges (hinges constitute a part of the door frame)
- » magnetic simple key lock, bathroom lock, cylinder lock or economic lock

fig. 1



edge R5

fig. 2



edge without rebate

SLIDING DOOR LEAF

- » edge without rebate **fig. 2**
- » socket for hook lock and/or for handles

NOTE: Door leaf VETRO B in sliding version with "70" width is not complementary product to sliding system hidden in the wall PA..

NOTE: There is no possibility to shorten door leaf.

NOTE: It is required to use door frame equipped with 3 hinges together with VETRO rebated door leaf model.
VETRO B - doesn't fulfill ventilation requirements.





VETRO D1 - anthracite elm

Decor DRE-Cell	white (textured)	white matt	white pine	siberian elm	sand oak	bleached oak textured	vintage oak	caramel walnut
	anthracite elm	dark wenge	marrone chestnut textured	black matt 2	light gray matt	evoke oak	toffee oak***, *	golden oak textured
Decor 3D	grand oak	elm	american walnut	ebony*	Polish oak 3D	*** decor available only in horizontal wood grain *while stock last		

NOTE: It is possible to order non-rebated door leaf in Dre-Cell white matt colour

VETRO collection glass panes have obverse and reverse sides (important in two door leaves opening inversely). Presented horizontal cross-sections shows the arrangement of glass pane in the obverse version. When choosing a reverse version, glass pane is rotated by 180° around the vertical axis..

cross-section of stile in non-rebated door leaf

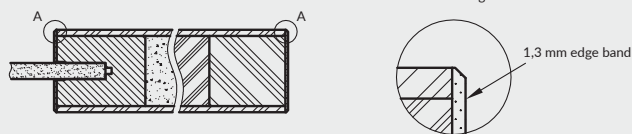

Horizontal cross-section of VETRO D1

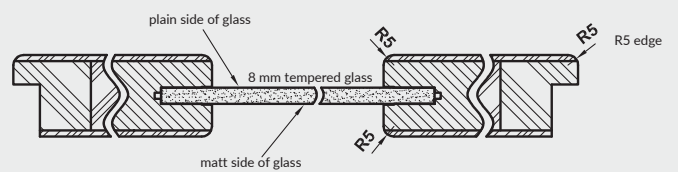

STANDARD OPTIONS

- » reinforced MDF frame: narrow element with fixed width, wide element with variable width
- » core made of tubular chipboard
- » 8 mm tempered glass with fixed width, (regardless of the door leaf width)

OPTIONS WITHOUT EXTRA CHARGE

- » door leaf with revers positioning of glass pane

OPTIONS AVAILABLE WITH EXTRA CHARGE

- » ventilation undercut
- » black tempered laminated glass pane

REBATED DOOR LEAF

- » R5 edge **fig. 1**
- » 3 silver screw-in pivot hinges
- » single-point mortise simple key lock, bathroom lock, cylinder lock or economic lock

NON-REBATED DOOR LEAF (extra charge)

ONLY WHITE MATT

- » edge without rebate **fig. 2**
- » sockets for 2 recessed Estetic 80 hinges (hinges constitute a part of the door frame)
- » magnetic simple key lock, bathroom lock, cylinder lock or economic lock

fig. 1



edge
R5

fig. 2



edge
without rebate

OPTIONS AVAILABLE WITH EXTRA CHARGE - AVAILABLE ONLY IN WHITE MATT DRE- CELL DECOR

- » non-rebated door leaf
- » **NOTE:** third Estetic 80 hinge for non-rebated doors (extra charge is added to the price of the door frame)

ventilation undercut



SLIDING DOOR LEAF

- » edge without rebate **fig. 2**
- » socket for hook lock and/or for handles

NOTE: Door leaf VETRO D in sliding version is not complementary product to sliding system hidden in the wall PA..

NOTE: There is no possibility to shorten door leaf.

VETRO D - widths "80" - "100" with ventilation undercut fulfill ventilation requirements.

NOTE: It is required to use door frame equipped with 3 hinges together with VETRO rebated door leaf model.



VETRO D1
glass pane
transparent

VETRO D1
decormat

VETRO D1
decormat brown

VETRO D1
decormat
graphite



LUMIO 1 - alpine white

FINISH
decor



bleached
craft oak

riviera oak

rustic oak

STANDARD OPTIONS

- » stiles made of wood-based panels
- » glass pane MAT DRE 4 mm thick
- » flat inserts (LUMIO 7-9)

OPTIONS WITHOUT EXTRA CHARGE

- » glass pane DECORMAT BROWN, DECORMAT GRAPHITE and transparent glass pane
- » holes for ventilation sleeves
- » 4mm HDF flat panel gloss black lacquered in LUMIO 1, 7, 9 models - instead of a glass pane

REBATED DOOR LEAF

- » straight edge **fig. 1**
- » 3 silver screw-in pivot hinges
- » single-point mortise simple key lock, bathroom lock, cylinder lock or economic lock

NOTE: 3 hinges door frames should be used with LUMIO rebated door leaves

OPTIONS AVAILABLE WITH EXTRA CHARGE

- » plastic ventilation sleeves 1 pc.
- » door leaf „90" and „100"
- » ventilation undercut
- » recuperative undercutting -15mm
- » black VSG 22.1 safety composite glass
- LUMIO 1
- LUMIO 2
- LUMIO 3, 6
- LUMIO 4
- LUMIO 5
- LUMIO 7
- LUMIO 9
- » double leaf door door leaf price x2

fig. 1



* Note: Selected configurations of LUMIO 1 and LUMIO 9 models are available from stock, rebated in alpine white





VICO 7 - riviera oak

FINISH
decor

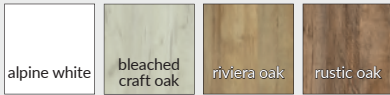

STANDARD OPTIONS

- » stiles made of wood-based panels
- » glass pane MAT DRE 4 mm thick
- » flat inserts (VICO 5-7)

OPTIONS WITHOUT EXTRA CHARGE

- » glass pane DECORMAT BROWN, DECORMAT GRAPHITE and transparent glass pane
- » holes for ventilation sleeves
- » 4mm HDF flat panel gloss black lacquered in VICO 1, 5, 7 models - instead of a glass pane

REBATED DOOR LEAF

- » straight edge **fig. 1**
- » 3 silver screw-in pivot hinges
- » single-point mortise simple key lock, bathroom lock, cylinder lock or economic lock

NOTE: 3 hinges door frames should be used with rebated door leaves VICO

OPTIONS AVAILABLE WITH EXTRA CHARGE

- » plastic ventilation sleeves 1 pc.
- » door leaf „90” and „100”
- » ventilation undercut
- » recuperative undercutting -15mm
- » black VSG 22.1 safety composite glass VICO 1 2 VICO 3,4 VICO 5 VICO 7 VICO
- » double leaf door door leaf price x2

fig. 1





BERGE 6 - white

Decor
painted



white acrylic UV varnish - RAL 9003
ecru - RAL 9001
latte - Flugger 4362, NCS S1505-Y50R
ashen - RAL 7035

STANDARD OPTIONS

- » door leaf painted with acrylic UV varnish
- » stiles made of wood-based panels
- » glass pane MAT DRE 4 mm thick
- » profiled 19mm MDF panels

OPTIONS WITHOUT EXTRA CHARGE

- » glass pane DECORMAT BROWN, DECORMAT GRAPHITE and transparent glass pane
- » holes for ventilation sleeves

REBATED DOOR LEAF

- » straight edge **fig. 1**
- » 3 silver screw-in pivot hinges
- » single-point mortise simple key lock, bathroom lock, cylinder lock or economic lock

NON-REBATED DOOR LEAF (EXTRA CHARGE)

- » edge without rebate **fig. 2**
- » sockets for 2 recessed Estetic 80 hinges (hinges constitute a part of the door frame)
- » magnetic simple key lock, bathroom lock, cylinder insert lock or economic lock in steel, black or white color

SLIDING DOOR LEAF

- » edge without rebate **fig. 2**
- » socket for hook lock and/or for handles

NOTE: It is required to use door frame equipped with 3 hinges together with BERGE rebated door leaf model.

OPTIONS AVAILABLE WITH EXTRA CHARGE

- » plastic ventilation sleeves 1 pc.
- » non-rebated door leaf
- » door leaf „90” and „100”
- » ventilation undercut
- » recuperative undercutting -15mm
- » cover strip for double non-rebated door leaf
- » double leaf door door leaf price x2
- » **NOTE:** third Estetic 80 hinge for non-rebated doors (extra charge is added to the price of the door frame)

fig. 1



fig. 2

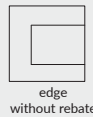

To ensure the highest quality of painted products, before painting process, both, door leaf and door frames are coated with special material which constitutes solid base..





EVEN 0, 3 - white

Decor
painted



white acrylic UV varnish - RAL 9003
ecru - RAL 9001
latte - Flügger 4362, NCS S1505-Y50R
ashen - RAL 7035

STANDARD OPTIONS

- » door leaf painted with acrylic UV varnish
- » stiles made of wood-based panels
- » glass pane MAT DRE 4 mm thick

OPTIONS WITHOUT EXTRA CHARGE

- » glass pane DECORMAT BROWN, DECORMAT GRAPHITE and transparent glass pane
- » holes for ventilation sleeves

REBATED DOOR LEAF

- » straight edge **fig. 1**
- » 3 silver screw-in pivot hinges
- » single-point mortise simple key lock, bathroom lock, cylinder lock or economic lock

NON-REBATED DOOR LEAF (EXTRA CHARGE)

- » edge without rebate **fig. 2**
- » sockets for 2 recessed Estetic 80 hinges (hinges constitute a part of the door frame)
- » magnetic simple key lock, bathroom lock, cylinder insert lock or economic lock in steel, black or white color

SLIDING DOOR LEAF

- » edge without rebate **fig. 2**
- » socket for hook lock and/or for handles

NOTE: It is required to use door frame equipped with 3 hinges together with rebated door leaf.

OPTIONS AVAILABLE WITH EXTRA CHARGE

- » plastic ventilation sleeves 1 pc.
- » non-rebated door leaf
- » door leaf „90” and „100”
- » ventilation undercut
- » recuperative undercutting -15mm
- » cover strip for double non-rebated door leaf
- » double leaf door door leaf price x2
- » **NOTE:** third Estetic 80 hinge for non-rebated doors (extra charge is added to the price of the door frame)

fig. 1



fig. 2

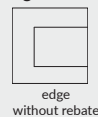

To ensure the highest quality of painted products, before painting process, both, door leaf and door frames are coated with special material which constitutes solid base..





NESTOR 12 - white

Decor
painted



white acrylic UV varnish - RAL 9003
ecru - RAL 9001
latte - Flügger 4362, NCS S1505-Y50R
ashen - RAL 7035

STANDARD OPTIONS

- » door leaf painted with acrylic UV varnish
- » stiles made of wood-based panels
- » glass pane MAT DRE 4 mm thick
- » profiled 19mm MDF panels

OPTIONS WITHOUT EXTRA CHARGE

- » glass pane DECORMAT BROWN, DECORMAT GRAPHITE and transparent glass pane
- » holes for ventilation sleeves

REBATED DOOR LEAF

- » straight edge **fig. 1**
- » 3 silver screw-in pivot hinges
- » single-point mortise simple key lock, bathroom lock, cylinder lock or economic lock

NON-REBATED DOOR LEAF (EXTRA CHARGE)

- » edge without rebate **fig. 2**
- » sockets for 2 recessed Estetic 80 hinges (hinges constitute a part of the door frame)
- » magnetic simple key lock, bathroom lock, cylinder insert lock or economic lock in steel, black or white color

SLIDING DOOR LEAF

- » edge without rebate **fig. 2**
- » socket for hook lock and/or for handles

DOOR LEAF WITH INVERTED REBATE (extra charge)

- » active single leaf door
- » straight edge **fig 3**
- » sockets for two recessed Estetic 1821 hinges (hinges constitute a part of the door frame)
- » magnetic simple key lock, bathroom lock, cylinder lock or economic lock

OPTIONS AVAILABLE WITH EXTRA CHARGE

- » plastic ventilation sleeves 1 pc.
- » non-rebated door leaf
- » door leaf „90” and „100”
- » ventilation undercut
- » recuperative undercutting -15mm
- » door leaf with inverted rebate
- » cover strip for double non-rebated door leaf
- » double leaf door door leaf price x2

NOTE: third Estetic 80 hinge for non-rebated doors (extra charge is added to the price of the door frame)

NOTE: It is required to use together with NESTOR rebated door leaf model door frames equipped with 3 hinges.

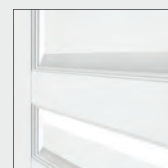
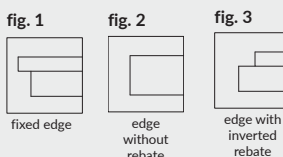

panel
NESTOR

To ensure the highest quality of painted products, before painting process, both, door leaf and door frames are coated with special material which constitutes solid base.





VETRO E - latte

Decor painted



white acrylic UV varnish - RAL 9003
 ecru - RAL 9001
 latte - Flugger 4362, NCS S1505-Y50R
 ashen - RAL 7035

Horizontal cross-section of rebated VETRO E doors

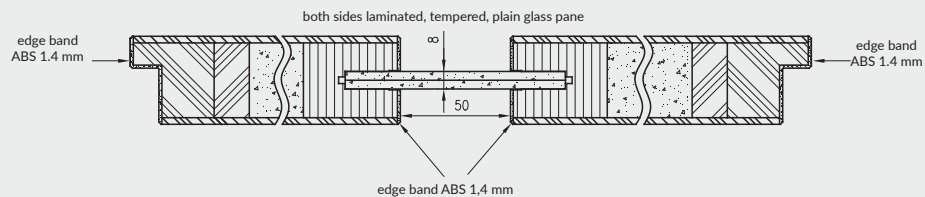

Horizontal cross-section of non-rebated VETRO E doors

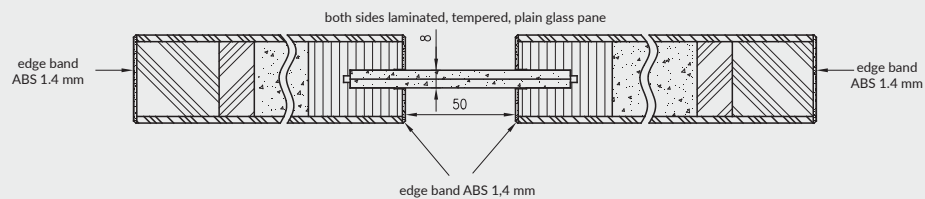

STANDARD OPTIONS

- » door leaf painted with acrylic UV varnish
- » reinforced MDF frame: narrow element with fixed width, wide element with variable width
- » core made of tubular chipboard
- » DECORMAT tempered laminated 8 mm glass pane with fixed width (regardless the width of the door leaf) or laminated black tempered 8 mm glass pane (opaque) with fixed width (regardless the door leaf width)

REBATED DOOR LEAF

- » straight edge **fig. 1**
- » 3 silver screw-in pivot hinges
- » single-point mortise simple key lock, bathroom lock, cylinder lock or economic lock

NON-REBATED DOOR LEAF (extra charge)

- » edge without rebate **fig. 2**
- » sockets for 2 recessed Estetic 80 hinges (hinges constitute a part of the door frame)
- » magnetic simple key lock, bathroom lock, cylinder insert lock or economic lock in steel, black or white color

NOTE: There is no possibility to shorten door leaf.

VETRO E - widths "80" - "100" with ventilation undercut fulfill ventilation requirements.

To ensure the highest quality of painted products, before painting process, both, door leaf and door frames are coated with special material which constitutes solid base..

OPTIONS AVAILABLE WITH EXTRA CHARGE

- » **NOTE:** third Estetic 80 hinge for non-rebated doors (extra charge is added to the price of the door frame)
- » ventilation undercut
- » non-rebated door leaf

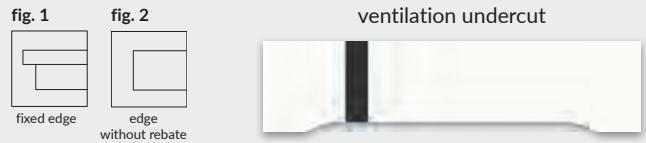

SLIDING DOOR LEAF

- » edge without rebate **fig. 2**
- » socket for hook lock and/or for handles

NOTE: sliding VETRO E door leaves do not fit the sliding system with the PA door frame cassette.

NOTE: There is no possibility to shorten door leaf.

VETRO E - meets ventilation requirements for widths "80" - "100" with ventilation undercut

NOTE: It is required to use together with VETRO rebated door leaf model door frames equipped with 3 hinges.



VETRO E
white
(black glass pane)



VETRO E
ecru
(black glass pane)



VETRO E
latte
(DECORMAT glass
pane)



VETRO E
ashen
(DECORMAT glass
pane)



NOVA 80 - sage oak, brushed gold inlay

	NEW								
Decor 1 group	antique copper	oxide concrete	white matt	light gray matt	dark olive matt	dark blue matt	cashmere matt	warm gray matt	sage oak
Decor 2 group	black ST								
Inlays	brushed steel	brushed gold	moro matt						

Possible model options:

M1 - FULL DOOR LEAF, WITHOUT GLAZING

NOVA 20 - MDF bulaj

NOVA 30 - STEEL BULAJ (AVAILABLE ONLY MAT OR TRANSPARENT GLASS PANE)

NOVA 40 - MDF frame in black matt 2 foil

NOVA 50 - 80 Vertical inlays made of laminate: brushed steel, brushed gold or moro matt

steel BULAJ NOVA 30 - in the steel or black colour. Available only MAT or transparent glass pane..

STANDARD OPTIONS

- » door leaf frame made of softwood
- » core made of „honeycomb“
- » glass pane MAT DRE 4 mm thick
- » the edge in the color of the door leaf or black
- » concrete oxide and antique copper decors available only with black edge

OPTIONS WITHOUT EXTRA CHARGE

- » ventilation sleeves
- » three hinges - applies to rebated door leaf
- » DECORMAT BROWN, DECORMAT GRAPHITE glass pane and transparent glass

REBATED DOOR LEAF

- » straight edge fig. 1
- » 2 screw-in hinges in silver or black color
- » silver or black deadbolt lock with a simple key, bathroom lock, cylinder lock or economic lock

NON-REBATED DOOR LEAF (EXTRA CHARGE)

- » edge without rebate fig. 2
- » sockets for 2 recessed Estetic 80 hinges (hinges constitute a part of the door frame)
- » magnetic simple key lock, bathroom lock, cylinder insert lock or economic lock in steel, black or white color

SLIDING DOOR LEAF

- » edge without rebate fig. 2
- » socket for hook lock and/or for handles

DOOR LEAF WITH INVERTED REBATE (extra charge)

- » active single leaf door
- » straight edge fig 3
- » sockets for two recessed Estetic 1821 hinges (hinges constitute a part of the door frame)
- » magnetic simple key lock, bathroom lock, cylinder lock or economic lock
- » does not apply to door leaves with antique copper or oxide concrete decors

DOOR FRAMES

- » for door leaves from NOVA collection it is recommended to use door frames in the same colour as door leaf or in black matt 2 decor

OPTIONS AVAILABLE WITH EXTRA CHARGE

- » Silent 37dB package (dropping seal + acoustic filling) - NOVA 10, 50 - 80
- » stabilising insert tubular chipboard
- » non-rebated door leaf
- » door leaf "90", "100"
- » ventilation undercut
- » recuperative undercutting -15mm
- » door leaf with inverted rebate
- » plastic ventilation grille
- » aluminum ventilation grille
- » It is possible to purchase a metal BULAJ in black color separately.
- » **NOTE:** third Estetic 80 hinge for non-rebated doors (extra charge is added to the price of the door frame)

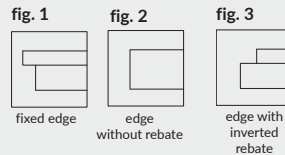

NOTE: the Silent package applies to rebated and non-rebated single leaf door.





WOOD M1 design W2 - dark oak

Decor

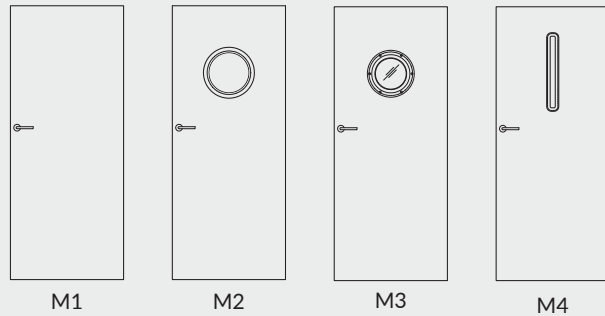
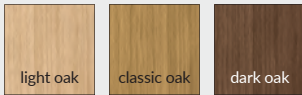

Model options with possibility to choose graphic patterns W1-W4 :

- M1 - full door leaf, without glazing
- M2 - MDF bulaj in black matt decor
- M3 - steel BULAJ in steel or black colour (only MATT or transparent glass pane available)
- M4 - MDF frame in black matt decor

STANDARD OPTIONS

- » door leaf surface coated with the primer material, overprinted with the pattern and varnished
- » matt lacquer
- » door leaf frame made of MDF
- » stabilising insert honeycomb
- » glass pane MAT DRE 4 mm thick

NON-REBATED DOOR LEAF

- » edge without rebate in the colour of the door leaf
- » sockets for 2 recessed Estetic 80 hinges in steel, black or white color (hinges constitute a part of the door frame)
- » magnetic simple key lock, bathroom lock, cylinder insert lock or economic lock in steel, black or white color

DOOR FRAMES

- » for the door leaves from the WOOD collection, we recommend to use lacquered frames made in the DRE-PRINT technology in the colour of door leaf unit

OPTION WITHOUT EXTRA CHARGE

- » holes for ventilation sleeves
- » glass pane DECORMAT BROWN, DECORMAT GRAPHITE and transparent glass pane

OPTIONS AVAILABLE WITH EXTRA CHARGE

- » door leaf „100”
- » stabilising insert tubular chipboard
- » ventilation undercut
- » **NOTE : third Estetic 80 hinge for non-rebated doors (extra charge is added to the price of the door frame)**
- » aluminum ventilation grille

fig. 1



edge
without rebate

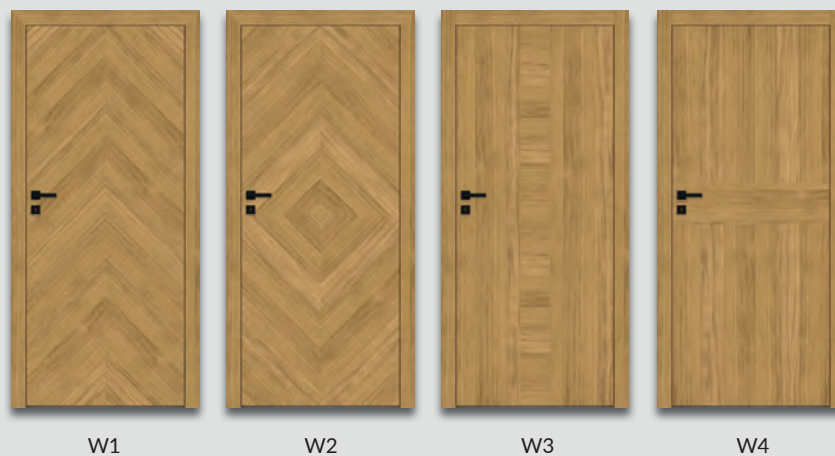

W1

W2

W3

W4



CLARO M1

Decor



HIGH GLOSS LACQUER AS STANDARD

- » door leaf surface is coated with primer material and varnished
- » gloss varnish
- » door leaf frame made of MDF
- » core made of perforated chipboard
- » 4mm DRE MATT glass pane

MATT LACQUER AS STANDARD

- » door leaf surface is coated with primer material and varnished
- » matt lacquer
- » door leaf frame made of MDF
- » core made of „honeycomb”
- » 4mm DRE MATT glass pane

NON-REBATED DOOR LEAF

- » edge without rebate in white or black colour fig.1
- » sockets for 2 recessed Estetic 80 hinges in white, steel or black color (hinges constitute a part of the door frame)
- » magnetic simple key lock, bathroom lock, cylinder insert lock or economic lock in steel, black or white color

DOOR FRAMES

- » for DRE-CLARO collection , we recommend to use white, black lacquered door frames made in DRE-PRINT technology, or door frames in black matt 2

OPTION WITHOUT EXTRA CHARGE

- » holes for ventilation sleeves
- » glass pane DECORMAT BROWN, DECORMAT GRAPHITE and transparent glass pane

OPTIONS AVAILABLE WITH EXTRA CHARGE

- » door leaf „100”
- » ventilation undercut
- » stabilising insert tubular chipboard in matt lacquered door leaves
- » **NOTE : third Estetic 80 hinge for non-rebated doors (extra charge is added to the price of the door frame)**
- » aluminum ventilation grille

fig. 1

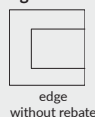

white edgeband,
white lock

black edgeband,
black lock



M 1 - CLARO

M 2 - CLARO

M 3 - CLARO

M 4 - CLARO

Possible model options:

- M1 - full door leaf, without glazing
- M2 - MDF bulaj in black matt decor
- M3 - steel bulaj (matt or transparent glass pane)
- M4 - MDF frame in black matt decor

steel BULAJ M3 - in steel or black colour. Only MATT or transparent glass pane available.



GRAFI M4-G2

STANDARD HIGH GLOSS LACQUERED DOOR LEAF

- » door leaf surface coated with the primer material, overprinted with the pattern and varnished (colour of the door leaf primed surface - white)
- » high gloss lacquer
- » door leaf frame made of MDF
- » core made of tubular chipboard
- » MAT DRE glass pane 4 mm thick (model M2, M4)

STANDARD MATT LACQUERED DOOR LEAF

- » door leaf surface coated with the primer material, overprinted with the pattern and varnished (colour of the door leaf primed surface - white)
- » matt lacquer
- » door leaf frame made of MDF
- » core made of „honeycomb”
- » MAT DRE glass pane 4 mm thick (model M2, M4)

NON-REBATED DOOR LEAF

- » edge without rebate in white or black colour fig.1
- » sockets for 2 recessed Estetic 80 hinges in white, steel or black color (hinges constitute a part of the door frame)
- » magnetic simple key lock, bathroom lock, cylinder insert lock or economic lock in steel, black or white color

DOOR FRAMES

- » for GRAFI collection , we recommend to use white, black lacquered door frames made in DRE-PRINT technology, or door frames in black matt 2

OPTION WITHOUT EXTRA CHARGE

- » holes for ventilation sleeves
- » DECORMAT BROWN, DECORMAT GRAPHITE glass pane and transparent glass

OPTIONS AVAILABLE WITH EXTRA CHARGE

- » door leaf „100”
- » ventilation undercut
- » stabilising insert tubular chipboard in matt lacquered door leaves
- » **NOTE : third Estetic 80 hinge for non-rebated doors (extra charge is added to the price of the door frame)**
- » aluminum ventilation grille

fig. 1



edge without rebate



white edgeband, white lock



black edgeband, black lock

Model options with possibility to choose graphic patterns G1-G25 :

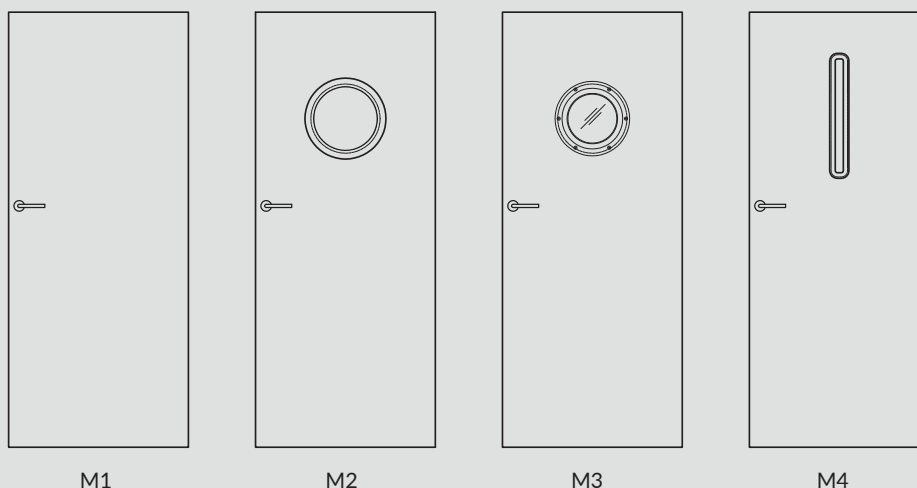

- M1 - full door leaf, without glazing
- M2 - MDF bulaj in black matt decor
- M3 - steel BULAJ in steel or black colour (only MATT or transparent glass pane available)
- M4 - MDF frame in black matt decor

Graphic patterns available on pages 64-65, scaling of graphic patterns G1-G25 in door leaf widths available on the website www.dre.pl



G1



G2



G3

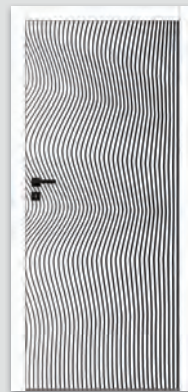

G4



G5



G6



G7

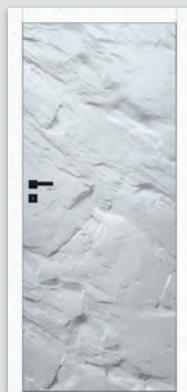

G8



G9

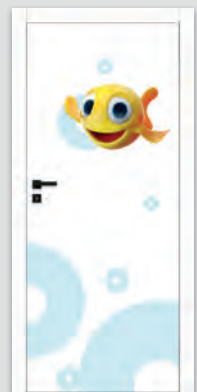

G10

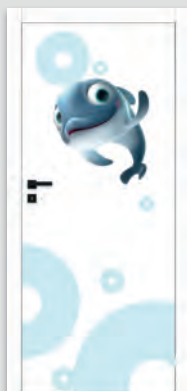

G11

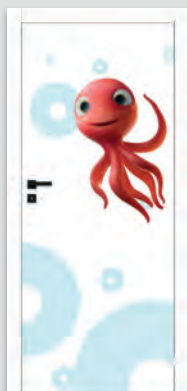

G12

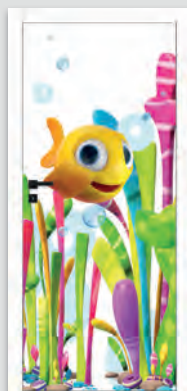

G13

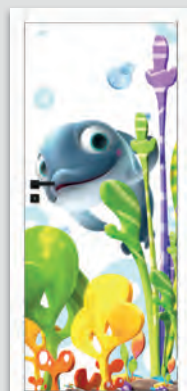

G14

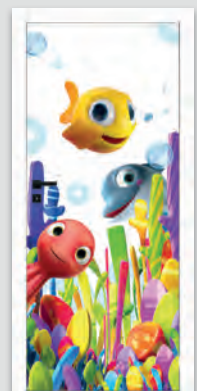

G15



G16



G17*



G18*



G19

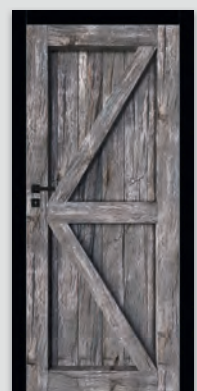

G20*



GRAFI M1 G16



G21

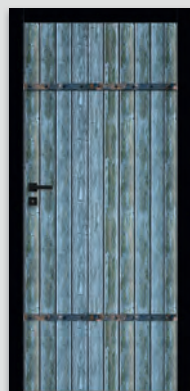

G22



G23



G24 *



G25

* pattern versions available for the right and left door leaf

Door leaf width: single leaf door „60”÷”100”

Technical information: door frames: pp. 140, accessories: pp. 164-172 and 177, door leaves: pp. 178-186.



LUX 10 birch

Decor

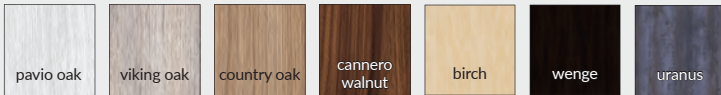

STANDARD OPTIONS

- » door leaf surface is coated with primer material in the colour of decor and varnished
- » high gloss lacquer
- » door leaf frame made of MDF
- » core made of perforated chipboard
- » MAT DRE glass pane 4 mm thick (model LUX 20, LUX 40)

NON-REBATED DOOR LEAF

- » edge without rebate in black colour fig.1
- » sockets for 2 recessed Estetic 80 hinges in black, white or steel color (hinges constitute a part of the door frame)
- » magnetic simple key lock, bathroom lock, cylinder insert lock or economic lock in steel, black or white color

DOOR FRAMES

for door leaves from LUX collection we recommend to use door frames lacquered in the same colour as the door leaf unit or in black matt decor 2

OPTION WITHOUT EXTRA CHARGE

- » holes for ventilation sleeves
- » DECORMAT BROWN, DECORMAT GRAPHITE glass pane and transparent glass

OPTIONS AVAILABLE WITH EXTRA CHARGE

- » door leaf „100”
- » ventilation undercut
- » **NOTE:** third Estetic 80 hinge for non-rebated doors (extra charge is added to the price of the door frame)
- » aluminum ventilation grille

fig. 1

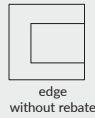

edge
without rebate



black edgeband,
black lock



LUX 10

LUX 20

LUX 30

LUX 40

steel BULAJ LUX 30- in the steel or black colour. Available only MAT or transparent glass pane.



Nova 10 - natural halifax oak

EGGER 3 mm laminates 1st group			
	gray oak halifax	natural oak halifax	Halifax Tabac Oak
	CLEAF 4 mm laminates 2nd group		
white elm		natural elm	dark elm
Inlays			
	brushed steel	brushed gold	moro matt

STANDARD OPTIONS

- » door leaf surface is coated with laminated, synchronous 3 mm or 4 mm thick board
- » door leaf frame made of softwood
- » core made of „honeycomb“
- » glass pane MAT DRE 4 mm thick
- » edgeband in black colour
- » for natural halifax oak decor, the edge in the color of the door leaf or black
- » NOVA 50 - 80 Vertical inlays made of laminate: brushed steel, brushed gold or moro matt

OPTIONS WITHOUT EXTRA CHARGE

- » ventilation sleeves
- » three hinges - applies to rebated door leaf
- » DECORMAT BROWN, DECORMAT GRAPHITE glass pane and transparent glass

REBATED DOOR LEAF

- » straight edge fig. 1
- » 2 screw-in hinges in silver or black color
- » silver or black deadbolt lock with a simple key, bathroom lock, cylinder lock or economic lock

NON-REBATED DOOR LEAF (EXTRA CHARGE)

- » edge without rebate fig. 2
- » sockets for 2 recessed Estetic 80 hinges (hinges constitute a part of the door frame)
- » magnetic simple key lock, bathroom lock, cylinder insert lock or economic lock in steel, black or white color

SLIDING DOOR LEAF

- » edge without rebate fig. 2
- » socket for hook lock and/or for handles

DOOR FRAMES

- » for door leaves from NOVA collection, we recommend door frames in the DRE-CELL black matt 2 foil and in CPL natural halifax oak laminate for door leaves made in the natural halifax oak laminate, in a longitudinal arrangement in the second CPL price group

OPTIONS AVAILABLE WITH EXTRA CHARGE

- » Silent package 37dB (dropping gasket + acoustic insert) - NOVA 10, 1st group Egger laminates
- » stabilising insert tubular chipboard
- » non-rebated door leaf
- » "100" door leaves
- » ventilation undercut
- » recuperative undercutting -15mm
- » plastic ventilation grille
- » aluminum ventilation grille
- » It is possible to purchase a metal BULAJ in black color separately.

» **NOTE:** third Estetic 80 hinge for non-rebated doors (extra charge is added to the price of the door frame)

NOTE: the Silent package applies to rebated and non-rebated single leaf door.

steel BULAJ NOVA 30 - in the steel or black colour. Available only MAT or transparent glass pane.

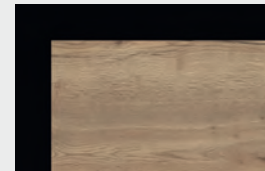
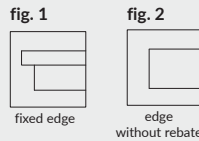

The option of combining the door frame in the DRE-Cell black matt 2 foil and natural halifax oak laminate

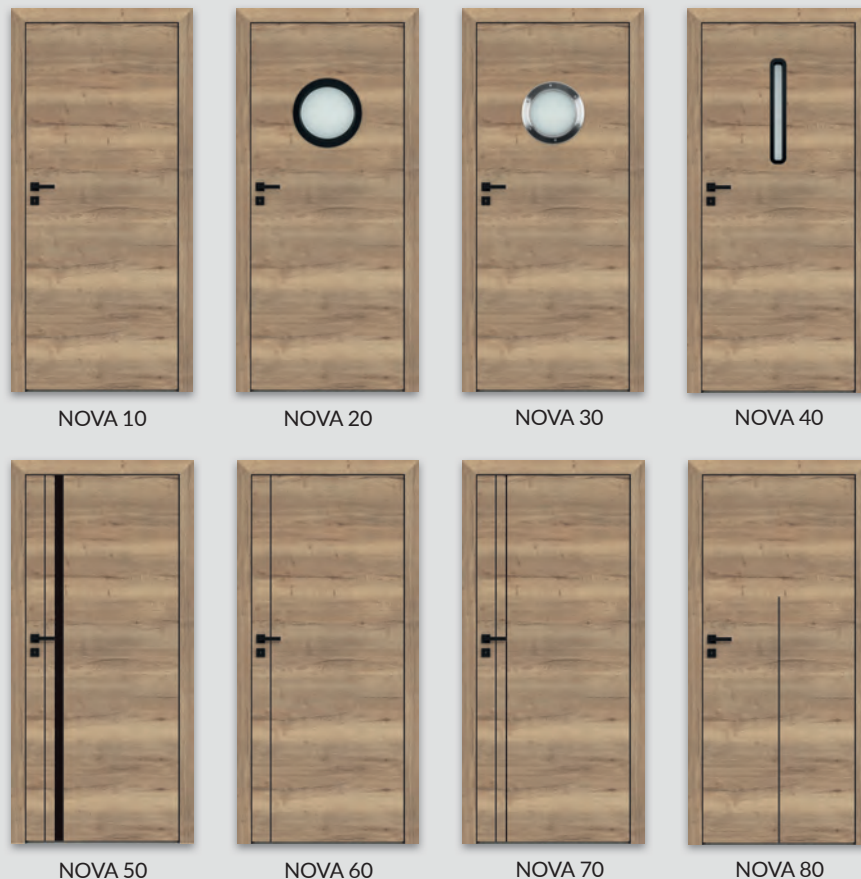



RIVIA 10 - marrone chestnut / black ST

Decor DRE-Cell	white matt	white pine	siberian elm	silver	sand oak	bleached oak textured	vintage oak	golden oak textured
	walnut	caramel walnut	anthracite elm	dark wenge	toffee oak * **	marrone chestnut textured	evoke oak	light gray matt
Decor 3D	grand oak	elm	american walnut	ebony*	Polish oak 3D	*while stock last **decor available only in horizontal graining		



Rivia 20 white matt base



Rivia 20 black ST base

STANDARD OPTIONS

- » door leaf frame made of softwood
- » core made of tubular chipboard
- » glass pane white bark 4 mm thick

OPTIONS WITHOUT EXTRA CHARGE

- » glass pane „chinchila” or „window blind”
- » ventilation sleeves
- » three hinges - applies to rebated door leaf

REBATED DOOR LEAF

- » straight edge, flat uniform glass pane frame **fig. 1**
- » 2 silver screw-in pivot hinges
- » single-point mortise simple key lock, bathroom lock, cylinder lock or economic lock

NON-REBATED DOOR LEAF (EXTRA CHARGE)

- » edge without rebate, flat uniform glass pane frame , **rys. 2**
- » sockets for 2 recessed Estetic 80 hinges (hinges constitute a part of the door frame)
- » magnetic simple key lock, bathroom lock, cylinder lock or economic lock

SLIDING DOOR LEAF

- » edge without rebate, flat uniform glass pane frame **fig. 2**
- » socket for hook lock and/or for handles

NOTE: The door leaf is made in white matt or black ST with a choice of center stripe decor. The edge of the door leaf is in the color of the central stripe. RIVIA 40 - BULAJ is covered with white or black PVC foil, RIVIA 50 - BULAJ is covered with silver foil.

By default , the configurator selects the colour of the door frame in the same colour as the middle strip of the door leaf unit.

*** In RIVIA 70 and 120 models, the insert in the selected color has vertical graining, except for the toffee oak color. In other models, inserts have horizontal graining.

OPTIONS AVAILABLE WITH EXTRA CHARGE

- » glass pane MAT DRE, DECORMAT BROWN, DECORMAT GRAPHITE, (applies to door leaf)
RIVIA 20, 30
RIVIA 40, 50
- » white frost VSG 22.1 safe, complex glass pane RIVIA 20, 30
RIVIA 40, 50
- » non-rebated door leaf
- » door leaf width "90" and "100"
- » ventilation undercut
- » recuperative undercutting -15mm
- » plastic ventilation grille
- » aluminum ventilation grille
- » **NOTE:** third Estetic 80 hinge for non-rebated doors (extra charge is added to the price of the door frame)

fig. 1

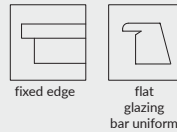
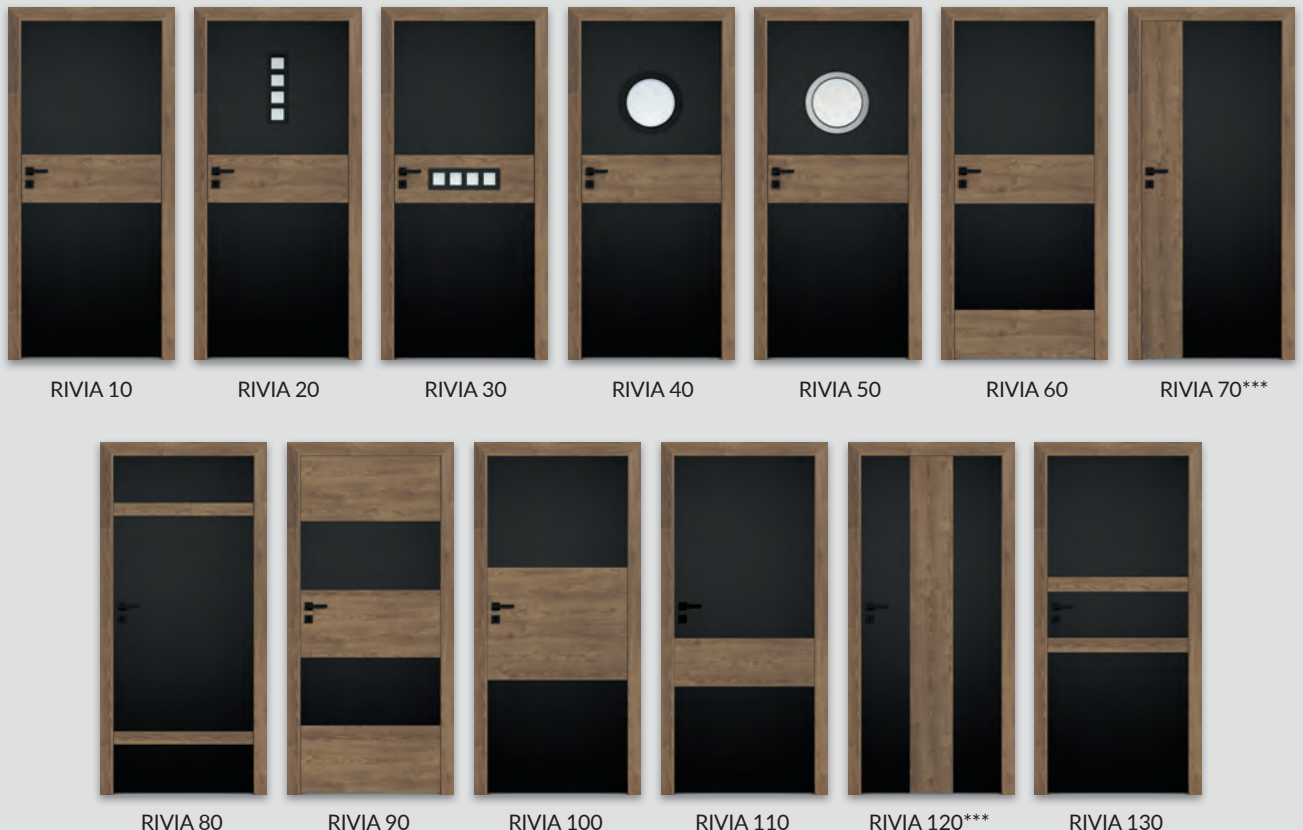
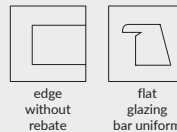

fig. 2





GALERIA ALU 20 - anthracite elm

Decor DRE-Cell	white matt	white (textured)	white pine	siberian elm	silver	sand oak	bleached oak textured	vintage oak	caramel walnut
	golden oak textured	walnut	anthracite elm	dark wenge	toffee oak***, **	marrone chestnut textured	evoke oak	light gray matt	
Decor 3D	grand oak	elm	american walnut	ebony**	Polish oak 3D				
	white	milky white	ashen	gray dark	concrete 2	gray oak	welsh oak		
Laminate CPL *	acacia	celini walnut	walnut	honey oak	chestnut	roasted walnut	black ST		

* laminate available in models 10, 20, 30, 50, 60

**while stock last

*** decor available only in horizontal wood grain

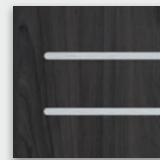

8mm inserts located in one plane with the door leaf surface on both sides

STANDARD OPTIONS

- » door leaf frame made of softwood
- » core made of tubular chipboard
- » edge with radius R 2,5 mm used in 0,15-0,20 mm CPL laminates
- » decorative inserts 8 mm
- » glass pane white bark 4 mm thick

OPTIONS WITHOUT EXTRA CHARGE

- » glass pane „chinchila” or „window blind”
- » ventilation sleeves
- » three hinges - applies to rebated door leaf

REBATED DOOR LEAF

- » straight edge, flat glass pane frame **fig. 1**
- » 2 silver screw-in pivot hinges
- » single-point mortise simple key lock, bathroom lock, cylinder lock or economic lock
- » straight edge or edge with radius R 2,5 mm made in directforming (in CPL laminate) **fig 3**

NON-REBATED DOOR LEAF (EXTRA CHARGE)

- » edge without rebate, flat glass pane frame **fig. 2**
- » sockets for 2 recessed Estetic 80 hinges (hinges constitute a part of the door frame)
- » magnetic simple key lock, bathroom lock, cylinder lock or economic lock

SLIDING DOOR LEAF

- » edge without rebate, flat glass pane frame **fig. 2**
- » socket for hook lock and/or for handles

Note: passive door leaf GALERIA ALU 20, 21, 22, 23, 24, 25, 60 without horizontal inserts in a uniform grain.

NOTE: the Silent package applies to rebated and non-rebated single leaf door.

OPTIONS AVAILABLE WITH EXTRA CHARGE

- » Silent package 37dB (dropping seal + acoustic insert) - GALERIA ALU 10 - 60
- » glass pane MAT DRE, DECORMAT BROWN, DECORMAT GRAPHITE, (applies to door leaf)
GALERIA ALU 11, 13, 23
GALERIA ALU 21
GALERIA ALU 24, 25
GALERIA ALU 12, 22
- » white frost VSG 22.1 safe, complex glass pane
GALERIA ALU 11
GALERIA ALU 13, 23
GALERIA ALU 21
GALERIA ALU 24
GALERIA ALU 25
GALERIA ALU 12
GALERIA ALU 22
- » non-rebated door leaf
- » door leaf "90" and "100"
- » ventilation undercut
- » recuperative undercutting -15mm
- » plastic ventilation grille
- » aluminum ventilation grille
- » cover strip for double non-rebated door leaf
- » double leaf door leaf price x2
- » NOTE: third Estetic 80 hinge for non-rebated doors (extra charge is added to the price of the door frame)

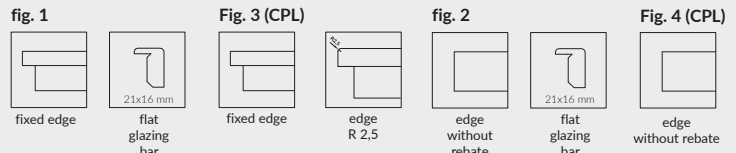

STANDARD OPTIONS

- » door leaf frame made of softwood
- » core made of „honeycomb“
- » glass pane white bark 4 mm thick

OPTIONS WITHOUT EXTRA CHARGE

- » glass pane „chinchila“ or „window blind“
- » ventilation sleeves
- » three hinges - applies to rebated door leaf

REBATED DOOR LEAF

- » straight edge, flat glass pane frame **fig. 1**
- » 2 silver screw-in pivot hinges
- » single-point mortise simple key lock, bathroom lock, cylinder lock or economic lock

NON-REBATED DOOR LEAF (EXTRA CHARGE)

- » edge without rebate, flat glass pane frame , **fig. 2**
- » sockets for 2 recessed Estetic 80 hinges (hinges constitute a part of the door frame)
- » magnetic simple key lock, bathroom lock, cylinder lock or economic lock

SLIDING DOOR LEAF

- » edge without rebate, flat glass pane frame **fig. 2**
- » socket for hook lock and/or for handles

OPTIONS AVAILABLE WITH EXTRA CHARGE

- » glass pane MAT DRE, DECORMAT BROWN, DECORMAT GRAPHITE (applies to the door leaf)
ARTE B 10, 20, 30
ARTE B 40, 50
ARTE B 60
- » white frost VSG 22.1 safe, complex glass pane
ARTE B 10, 20, 30
ARTE B 40, 50
ARTE B 60
- » stabilising insert tubular chipboard
- » non-rebated door leaf
- » door leaf "90" and "100"
- » ventilation undercut
- » recuperative undercutting -15mm
- » plastic ventilation grille
- » aluminum ventilation grille
- » cover strip for double non-rebated door leaf
- » double leaf door leaf price x2
- » **NOTE:** third Estetic 80 hinge for non-rebated doors (extra charge is added to the price of the door frame)

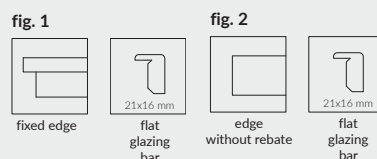

Decor DRE-Cell	white matt	white (textured)	white pine	siberian elm	silver	sand oak	bleached oak textured	vintage oak	caramel walnut
	golden oak textured	walnut	anthracite elm	dark wenge	toffee oak***	marrone chestnut textured	light gray matt	evoked oak	
Decor 3D	grand oak	elm	american walnut	ebony*	Polish oak 3D	*** decor available only in horizontal wood grain *while stock last			

STANDARD OPTIONS

- » door leaf frame made of softwood
- » core made of „honeycomb“
- » glass pane white bark 4 mm thick

OPTIONS WITHOUT EXTRA CHARGE

- » glass pane „chinchila“ or „window blind“
- » ventilation sleeves
- » three hinges - applies to rebated door leaf

REBATED DOOR LEAF

- » straight edge, flat glass pane frame, 19 mm MDF profiled panels **fig. 1**
- » 2 silver screw-in pivot hinges
- » single-point mortise simple key lock, bathroom lock, cylinder lock or economic lock

NON-REBATED DOOR LEAF (EXTRA CHARGE)

- » edge without rebate, flat glass pane frame, 19 mm MDF profiled panels **fig. 2**
- » sockets for 2 recessed Estetic 80 hinges (hinges constitute a part of the door frame)
- » magnetic simple key lock, bathroom lock, cylinder lock or economic lock

SLIDING DOOR LEAF

- » edge without rebate, flat glass pane frame, 19 mm MDF profiled panels **fig. 2**
- » socket for hook lock and/or for handles

OPTIONS AVAILABLE WITH EXTRA CHARGE

- » glass pane MAT DRE, DECORMAT BROWN, DECORMAT GRAPHITE (applies to door leaf)
CARLA 20
CARLA 30
CARLA 40
- » white frost VSG 22.1 safe, complex glass pane
CARLA 20
CARLA 30
CARLA 40
- » stabilising insert tubular chipboard
- » non-rebated door leaf
- » door leaf "90" and "100"
- » ventilation undercut
- » recuperative undercutting -15mm
- » plastic ventilation grille
- » aluminum ventilation grille
- » cover strip for double non-rebated door leaf
- » double leaf door leaf price x2
- » **NOTE:** third Estetic 80 hinge for non-rebated doors (extra charge is added to the price of the door frame)

fig. 1



fig. 2



white matt	white (textured)	white pine	siberian elm	silver	sand oak	bleached oak textured	vintage oak	caramel walnut	Decor DRE-Cell
	golden oak textured	walnut	anthracite elm	dark wenge	toffee oak***, *	marrone chestnut textured	light gray matt	evoke oak	
*** decor available only in horizontal wood grain *while stock last									Decor 3D
	grand oak	elm	american walnut	ebony*	Polish oak 3D				



FINEA 40 vintage oak

Decor DRE-Cell	white matt	white (textured)	white pine	siberian elm	silver	sand oak	bleached oak textured	vintage oak	caramel walnut
	golden oak textured	walnut	anthracite elm	dark wenge	toffee oak***, *	marrone chestnut textured	light gray matt	evoke oak	
Decor 3D	grand oak	elm	american walnut	ebony*	Polish oak 3D				

*while stock last

*** decor available only in horizontal wood grain

STANDARD OPTIONS

- » door leaf frame made of softwood
- » core made of tubular chipboard
- » glass pane white bark 4 mm thick

OPTIONS WITHOUT EXTRA CHARGE

- » glass pane „chinchila” or „window blind”
- » ventilation sleeves
- » three hinges - applies to rebated door leaf

REBATED DOOR LEAF

- » straight edge, flat glass pane frame **fig. 1**
- » 2 silver screw-in pivot hinges
- » single-point mortise simple key lock, bathroom lock, cylinder lock or economic lock

NON-REBATED DOOR LEAF (EXTRA CHARGE)

- » edge without rebate, flat glass pane frame **fig. 2**
- » sockets for 2 recessed Estetic 80 hinges (hinges constitute a part of the door frame)
- » magnetic simple key lock, bathroom lock, cylinder lock or economic lock

SLIDING DOOR LEAF

- » edge without rebate, flat glass pane frame **fig. 2**
- » socket for hook lock and/or for handles

OPTIONS AVAILABLE WITH EXTRA CHARGE

- » glass pane MAT DRE, DECORMAT BROWN, DECORMAT GRAPHITE (applies to door leaf)
FINEA 20, FINEA B 20
FINEA 30, 50, 60, FINEA B 30, 50, 60
- » white frost VSG 22.1 safe, complex glass pane
FINEA 20, FINEA B 20
FINEA 30, FINEA B 30
FINEA 50, 60, FINEA B 50, 60
- » non-rebated door leaf
- » door leaf width "90" and "100"
- » ventilation undercut
- » recuperative undercutting -15mm
- » plastic ventilation grille
- » aluminum ventilation grille
- » **NOTE:** third Estetic 80 hinge for non-rebated doors (extra charge is added to the price of the door frame)

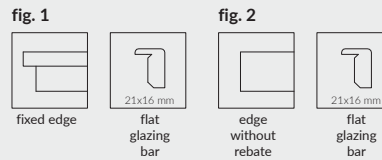

FINEA 10
FINEA B 10*

FINEA 20
FINEA B 20*

FINEA 30
FINEA B 30*

FINEA 40
FINEA B 40*

FINEA 50
FINEA B 50*

FINEA 60
FINEA B 60*

* FINEA B panels available only with horizontal wood grain



panels wood grain in FINEA



panels horizontal wood grain
FINEA B



DECO 20 - concrete 2 with a black SLIM frame

Decor DRE-Cell	white matt	white (textured)	white pine	siberian elm	silver	sand oak	bleached oak textured	vintage oak	caramel walnut
	golden oak textured	walnut	anthracite elm	dark wenge	elm toffee*** *	marrone chestnut textured	light gray matt	evoke oak	
Decor 3D	grand oak	elm	american walnut	ebony*	Polish oak 3D				
CPL Lami- nate	white	milky white	ashen	gray dark	concrete 2	gray oak	welsh oak		
	acacia	celini walnut	walnut	honey oak	chestnut	roasted walnut	black ST		

*** decor available only in horizontal wood grain

*while stock last

STANDARD OPTIONS

- » door leaf frame made of softwood
- » edge radius R 2.5 mm for CPL laminates 0.15-0.2 mm except for white, milky white, gray
- » core made of „honeycomb”
- » glass pane white bark 4 mm thick
- » flat 4mm HDF panel in DECO 40

OPTIONS WITHOUT EXTRA CHARGE

- » glass pane „chinchila” or „window blind”
- » ventilation sleeves
- » three hinges - applies to rebated door leaf

REBATED DOOR LEAF

- » straight edge, flat glass pane frame **Fig. 1** in the leaf decor or black Slim
- » 2 silver screw-in pivot hinges
- » single-point mortise simple key lock, bathroom lock, cylinder lock or economic lock
- » rounded glass pane frame, straight edge or edge with radius R 2,5 mm made in directforming (in CPL laminate)

NON-REBATED DOOR LEAF (EXTRA CHARGE)

- » non-rebated edge, flat glass pane frame **Fig. 2** in the leaf decor or black Slim
- » sockets for 2 recessed Estetic 80 hinges (hinges constitute a part of the door frame)
- » magnetic simple key lock, bathroom lock, cylinder lock or economic lock
- » edge without rebate, rounded glass pane frame (in CPL laminate) **fig. 5**

SLIDING DOOR LEAF

- » non-rebated edge and a choice of: flat glass pane frame in the leaf decor or black Slim, **fig. 2** or a rounded glass pane frame **fig. 3**
- » socket for hook lock and/or for handles
- » edge without rebate, rounded glass pane frame (in CPL laminate) **fig. 5**

OPTIONS AVAILABLE WITH EXTRA CHARGE

- » glass pane MAT DRE, DECORMAT BROWN, DECORMAT GRAPHITE DECO 10, 20, 30
- » white frost VSG 22.1 safe, complex glass pane DECO 10, 20, 30
- » stabilising insert tubular chipboard
- » non-rebated door leaf
- » door leaf "90" and "100"
- » ventilation undercut
- » recuperative undercutting -15mm
- » plastic ventilation grille
- » aluminum ventilation grille
- » cover strip for double non-rebated door leaf
- » double leaf door leaf price x2
- » **NOTE:** third Estetic 80 hinge for non-rebated doors (extra charge is added to the price of the door frame)

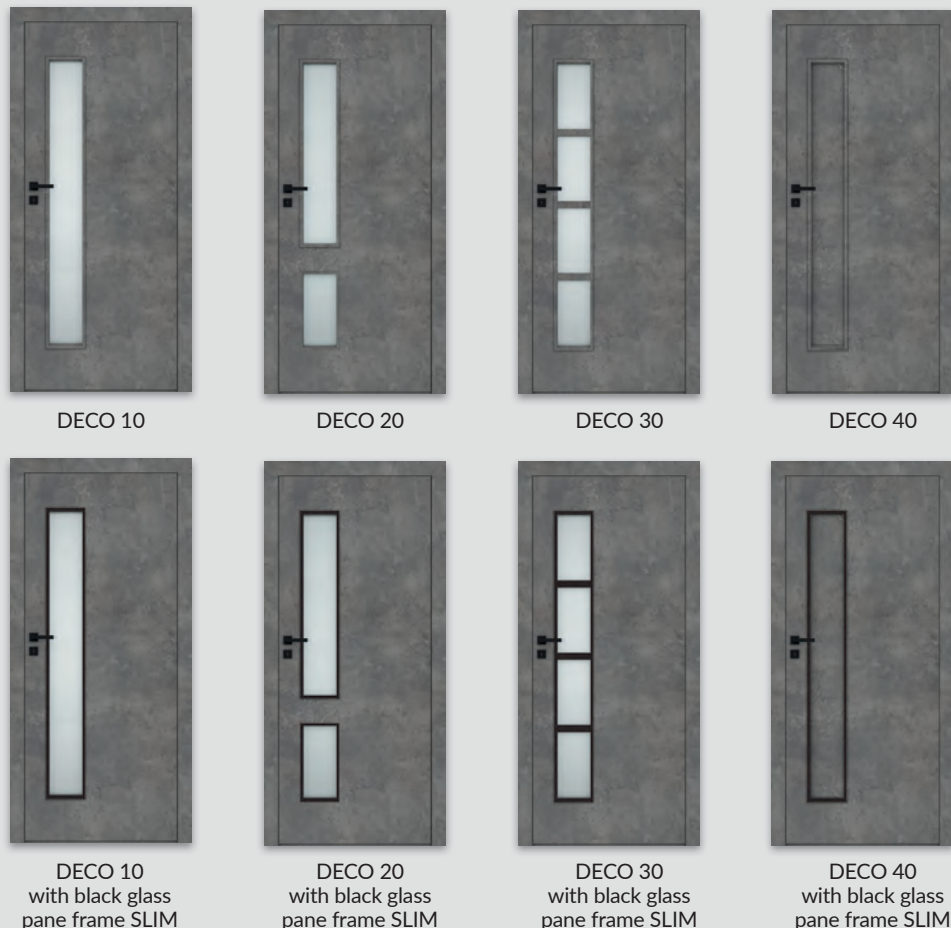
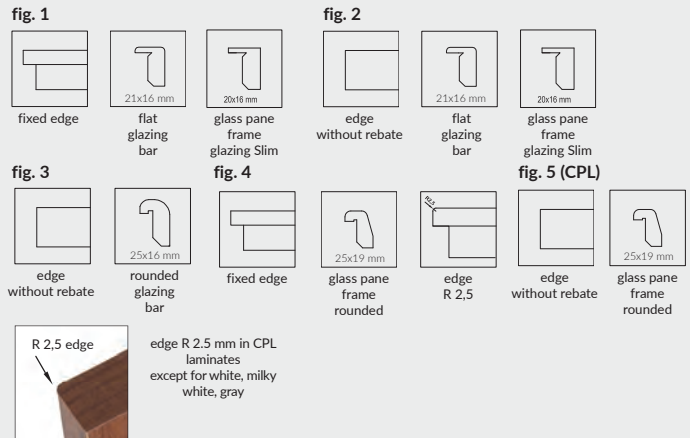



MODERN 20 - white matt

Decor DRE-Cell	white matt	white (textured)	white pine	siberian elm	silver	sand oak	bleached oak textured	vintage oak	caramel walnut
	golden oak textured	walnut	anthracite elm	dark wenge	elm toffee***, *	marrone chestnut textured	light gray matt	evoke oak	
Decor 3D	grand oak	elm	american walnut	ebony*	Polish oak 3D				

*** decor available only in horizontal wood grain

*while stock last

STANDARD OPTIONS

- » door leaf frame made of softwood
- » core made of „honeycomb”
- » glass pane white bark 4 mm thick

OPTIONS WITHOUT EXTRA CHARGE

- » glass pane „chinchila” or „window blind”
- » ventilation sleeves
- » three hinges - applies to rebated door leaf

REBATED DOOR LEAF

- » straight edge, flat glass pane frame in the door leaf decor or black Slim, flat HDF panels, thickness 4 mm **fig. 1**
- » 2 silver screw-in pivot hinges
- » single-point mortise simple key lock, bathroom lock, cylinder lock or economic lock

NON-REBATED DOOR LEAF (EXTRA CHARGE)

- » non-rebated edge, flat glass pane frame in the door leaf decor or black Slim, flat HDF panels, thickness 4 mm **fig. 2**
- » sockets for 2 recessed Estetic 80 hinges (hinges constitute a part of the door frame)
- » magnetic simple key lock, bathroom lock, cylinder lock or economic lock

SLIDING DOOR LEAF

- » non-rebated edge and a choice of: flat glass pane frame in the door leaf decor or black Slim, flat HDF panels, thickness 4 mm **fig. 2** or a rounded glass pane frame, profiled MDF panels, thickness 19 mm **fig. 3**
- » socket for hook lock and/or for handles

OPTIONS AVAILABLE WITH EXTRA CHARGE

- » glass pane MAT DRE, DECORMAT BROWN, DECORMAT GRAPHITE, (applies to door leaf) MODERN 20 MODERN 30 MODERN 40 MODERN 50
- » white frost VSG 22.1 safe, complex glass pane MODERN 20 MODERN 30 MODERN 40 MODERN 50
- » stabilising insert tubular chipboard
- » non-rebated door leaf
 - » door leaf "90" and "100"
 - » ventilation undercut
 - » recuperative undercutting -15mm
 - » plastic ventilation grille
 - » aluminum ventilation grille
 - » cover strip for double non-rebated door leaf
 - » double leaf door leaf price x2
 - » **NOTE:** third Estetic 80 hinge for non-rebated doors (extra charge is added to the price of the door frame)

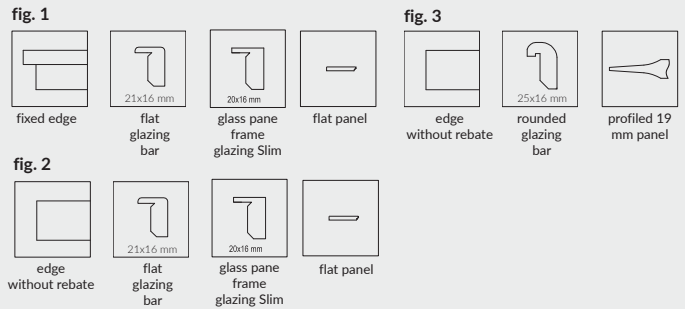



KANON 10 - American walnut, black glass pane frames

Decor DRE-Cell	white matt	white (textured)	white pine	siberian elm	silver	sand oak	bleached oak textured	vintage oak	caramel walnut
	golden oak textured	walnut	anthracite elm	dark wenge	toffee oak***, *	marrone chestnut textured	light gray matt	evoke oak	
Decor 3D	grand oak	elm	american walnut	ebony*	Polish oak 3D				

*** decor available only in horizontal wood grain

*while stock last

STANDARD OPTIONS

- » door leaf frame made of softwood
- » core made of „honeycomb”
- » glass pane white bark 4 mm thick

OPTIONS WITHOUT EXTRA CHARGE

- » glass pane „chinchila” or „window blind”
- » ventilation sleeves
- » three hinges - applies to rebated door leaf

REBATED DOOR LEAF

- » straight edge, flat glass pane frame in the door leaf decor or black Slim, flat HDF panels, thickness 4 mm **fig. 1**
- » 2 silver screw-in pivot hinges
- » single-point mortise simple key lock, bathroom lock, cylinder lock or economic lock

NON-REBATED DOOR LEAF (EXTRA CHARGE)

- » non-rebated edge, flat glass pane frame in the door leaf decor or black Slim, flat HDF panels, thickness 4 mm **fig. 2**
- » sockets for 2 recessed Estetic 80 hinges (hinges constitute a part of the door frame)
- » magnetic simple key lock, bathroom lock, cylinder lock or economic lock

SLIDING DOOR LEAF

- » non-rebated edge and a choice of: flat glass pane frame in the door leaf decor or black Slim, flat HDF panels, thickness 4 mm **fig. 2** or a rounded glass pane frame, profiled MDF panels, thickness 19 mm **fig. 3**
- » socket for hook lock and/or for handles

OPTIONS AVAILABLE WITH EXTRA CHARGE

- » glass pane MAT DRE, DECORMAT BROWN, DECORMAT GRAPHITE, (applies to door leaf)
KANON 20
KANON 30
KANON 40
- » white frost VSG 22.1 safe, complex glass pane
KANON 20
KANON 30
KANON 40
- » stabilising insert tubular chipboard
- » non-rebated door leaf
- » door leaf "90" and "100"
- » ventilation undercut
- » recuperative undercutting -15mm
- » plastic ventilation grille
- » aluminum ventilation grille
- » cover strip for double non-rebated door leaf
- » double leaf door leaf price x2
- » **NOTE:** third Estetic 80 hinge for non-rebated doors (extra charge is added to the price of the door frame)

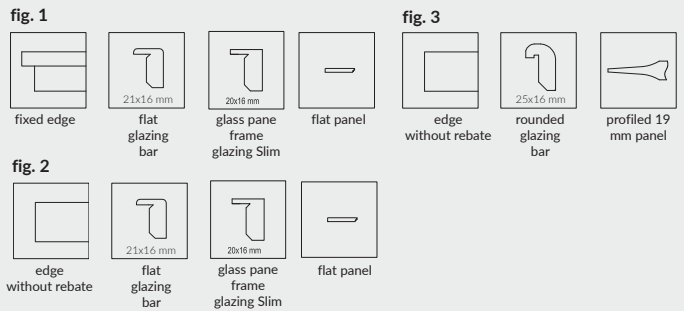

KANON 10



KANON 20



KANON 30



KANON 40



KANON 10
with black glass
pane frame SLIM



KANON 20
with black glass
pane frame SLIM



KANON 30
with black glass
pane frame SLIM



KANON 40
with black glass
pane frame SLIM



PLUS 30 - white matt

Decor DRE-Cell	white matt	white (textured)	white pine	siberian elm	silver	sand oak	bleached oak textured	vintage oak	caramel walnut
	golden oak textured	walnut	anthracite elm	dark wenge	toffee oak***, *	marrone chestnut textured	light gray matt	evoked oak	
Decor 3D	grand oak	elm	american walnut	ebony*	Polish oak 3D				

*** decor available only in horizontal wood grain

*while stock last

STANDARD OPTIONS

- » door leaf frame made of softwood
- » core made of „honeycomb“
- » glass pane white bark 4 mm thick

OPTIONS WITHOUT EXTRA CHARGE

- » glass pane „chinchila“ or „window blind“
- » ventilation sleeves
- » three hinges - applies to rebated door leaf

REBATED DOOR LEAF

- » edge without rebate, flat glass pane frame, flat 4 mm HDF panels fig. 1
- » 2 silver screw-in pivot hinges
- » single-point mortise simple key lock, bathroom lock, cylinder lock or economic lock

NON-REBATED DOOR LEAF (EXTRA CHARGE)

- » edge without rebate, flat glass pane frame, flat 4 mm HDF panels fig. 2
- » sockets for 2 recessed Estetic 80 hinges (hinges constitute a part of the door frame)
- » magnetic simple key lock, bathroom lock, cylinder lock or economic lock

SLIDING DOOR LEAF

- » edge without rebate, flat 4 mm HDF panels and optional: flat glass pane frame, fig. 2 or rounded glass pane frame fig. 3
- » socket for hook lock and/or for handles

OPTIONS AVAILABLE WITH EXTRA CHARGE

- » glass pane MAT DRE, DECORMAT BROWN, DECORMAT GRAPHITE (applies to door leaf)
- PLUS 20
- PLUS 40, 50, 60, 70, 80
- PLUS 30
- » opal glass VSG 22.1, safety composite
- PLUS 20, 50, 60
- PLUS 30
- PLUS 40
- PLUS 70, 80
- » stabilising insert tubular chipboard
- » non-rebated door leaf
- » door leaf "90" and "100"
- » ventilation undercut
- » recuperative undercutting -15mm
- » plastic ventilation grille
- » aluminum ventilation grille
- » cover strip for double non-rebated door leaf
- » double leaf door leaf price x2
- » **NOTE:** third Estetic 80 hinge for non-rebated doors (extra charge is added to the price of the door frame)

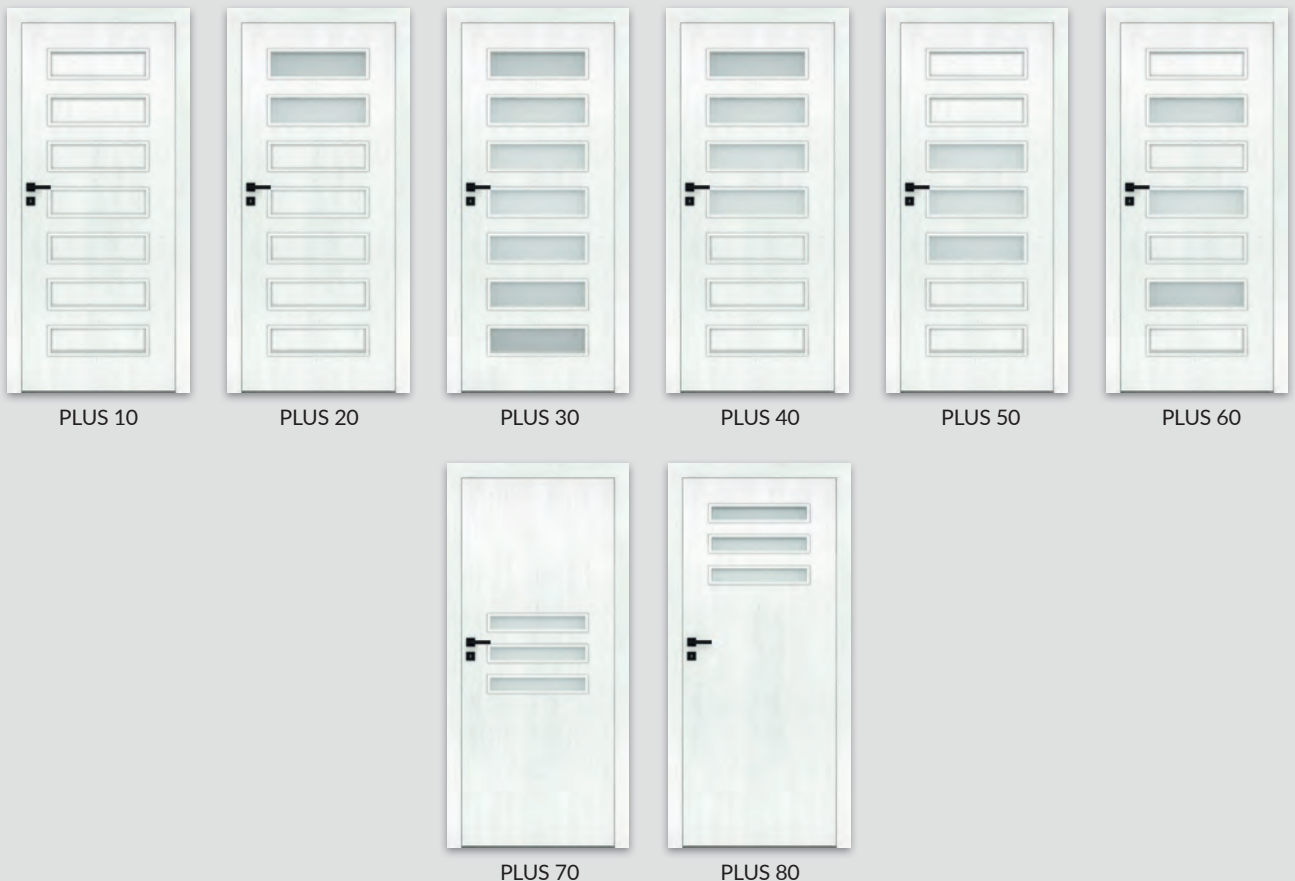
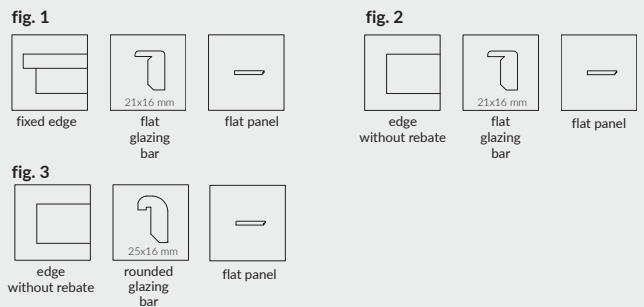



STANDARD 10 - evoke oak

Decor DRE-Cell	white matt	white (textured)	white pine	siberian elm	silver	sand oak	bleached oak textured	vintage oak	caramel walnut
	golden oak textured	walnut	anthracite elm	dark wenge	toffee oak***, *	marrone chestnut textured	light gray matt	evoke oak	
Decor 3D	grand oak	elm	american walnut	ebony*	Polish oak 3D				

*** decor available only in horizontal wood grain

*while stock last

STANDARD OPTIONS

- » door leaf frame made of softwood
- » core made of „honeycomb“
- » glass pane white bark 4 mm thick

OPTIONS WITHOUT EXTRA CHARGE

- » glass pane „chinchila“ or „window blind“
- » ventilation sleeves
- » three hinges - applies to rebated door leaf

REBATED DOOR LEAF

- » straight edge, flat glass pane frame **fig. 1**
- » 2 silver screw-in pivot hinges
- » single-point mortise simple key lock, bathroom lock, cylinder lock or economic lock
- » **All orders in the investment standard require approval of The Investment Department. The investment standard is defined by door frame passage, with opened door leaf at 90 degree, respectively for interior doors: "80" 800 mm, "90" 900 mm.**

NON-REBATED DOOR LEAF (EXTRA CHARGE)

- » edge without rebate, flat glass pane frame **fig. 2**
- » sockets for 2 recessed Estetic 80 hinges (hinges constitute a part of the door frame)
- » magnetic simple key lock, bathroom lock, cylinder lock or economic lock

SLIDING DOOR LEAF

- » edge without rebate and optional: flat glass pane frame fig.2 or rounded glass pane frame fig. 3
- » socket for hook lock and/or for handles

NOTE: the Silent package applies to rebated and non-rebated single leaf door.

NOTE: Selected configurations of STANDARD 10 rebated model in the evoke oak color, are available from stock.

OPTIONS AVAILABLE WITH EXTRA CHARGE

- » Silent package 37dB (dropping seal + acoustic insert) - STANDARD 10
- » glass pane MAT DRE, DECORMAT BROWN, DECORMAT GRAPHITE (applies to door leaf)
STANDARD 20, 20s, 40, 40s, BULAJ MDF
STANDARD 50, 50s
STANDARD 30, 30s
STANDARD 60
- » white frost VSG 22.1 safe, complex glass pane
STANDARD 20, 20s, 40, 40s
STANDARD 50, 50s, MDF BULAJ
STANDARD 30, 30s
STANDARD 60
- » stabilising insert tubular chipboard
- » non-rebated door leaf
 - » door leaf "90" and "100"
 - » rebated door leaf "110" (only STANDARD 10)
- » upper single point mortise lock (only STANDARD 10 with tubular chipboard and fixed door frame)
- » ventilation undercut
- » recuperative undercutting -15mm
- » plastic ventilation grille
- » aluminum ventilation grille
- » cover strip for double non-rebated door leaf
- » double leaf door door leaf price x 2
- » there is possibility to purchase metal BULAJ separately in black or steel colour
- » **NOTE:** third Estetic 80 hinge for non-rebated doors (extra charge is added to the price of the door frame)

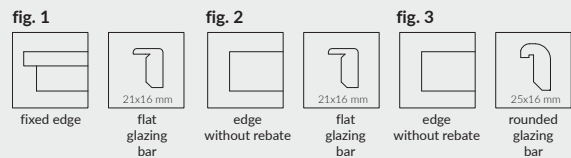

black steel Bulaj *



steel Bulaj *



additional upper single point mortise lock (available only in STANDARD 10 door leaf model with core made of perforated chipboard and fixed door frame)

* only MATT or transparent glass pane available



FANO 10 - elm

DRE-Cell decor	white matt	white (textured)	white pine	siberian elm	silver	sand oak	bleached oak textured	vintage oak	caramel walnut
	golden oak textured	walnut	anthracite elm	dark wenge	toffee oak***, *	marrone chestnut textured	light gray matt	evoked oak	
Decor 3D	grand oak	elm	american walnut	ebony*	Polish oak 3D				

*** decor available only in horizontal wood grain

*while stock last

STANDARD OPTIONS

- » door leaf frame made of softwood
- » core made of „honeycomb”
- » glass pane white bark 4 mm thick

OPTIONS WITHOUT EXTRA CHARGE

- » glass pane „chinchila” or „window blind”
- » ventilation sleeves
- » three hinges - applies to rebated door leaf

REBATED DOOR LEAF

- » straight edge, flat glass pane frame **fig. 1**
- » 2 silver screw-in pivot hinges
- » single-point mortise simple key lock, bathroom lock, cylinder lock or economic lock

NON-REBATED DOOR LEAF (EXTRA CHARGE)

- » edge without rebate, flat glass pane frame, 19 mm MDF profiled panels **fig. 2**
- » sockets for 2 recessed Estetic 80 hinges (hinges constitute a part of the door frame)
- » magnetic simple key lock, bathroom lock, cylinder lock or economic lock

SLIDING DOOR LEAF

- » edge without rebate, rounded glass pane frame or flat glass pane frame, profiled 19 mm MDF panel **fig. 3**
- » socket for hook lock and/or for handles

OPTIONS AVAILABLE WITH EXTRA CHARGE

- » glass pane MAT DRE, DECORMAT BROWN, DECORMAT GRAPHITE (applies to door leaf)
FANO 20, 20s
FANO 30, 30s
- » white frost VSG 22.1 safe, complex glass pane
FANO 20, 20s
FANO 30, 30s
- » stabilising insert tubular chipboard
- » non-rebated door leaf
- » door leaf "90" and "100"
- » ventilation undercut
- » recuperative undercutting -15mm
- » plastic ventilation grille
- » aluminum ventilation grille
- » cover strip for double non-rebated door leaf
- » double leaf door leaf price x2
- » **NOTE:** third Estetic 80 hinge for non-rebated doors (extra charge is added to the price of the door frame)

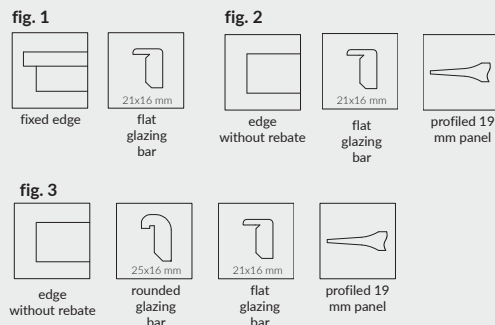



ARTE 40 - sand oak

DRE-Cell
decor

white matt	white (textured)	white pine	siberian elm	silver	sand oak	bleached oak textured	vintage oak	caramel walnut
golden oak textured	walnut	anthracite elm	dark wenge	toffee oak***, *	marrone chestnut textured	light gray matt	evoke oak	

Decor 3D

grand oak	elm	american walnut	ebony*	Polish oak 3D
-----------	-----	-----------------	--------	---------------

*** decor available only in horizontal wood grain

*while stock last

STANDARD OPTIONS

- » door leaf frame made of softwood
- » core made of „honeycomb“
- » glass pane white bark 4 mm thick

OPTIONS WITHOUT EXTRA CHARGE

- » glass pane „chinchila“ or „window blind“
- » ventilation sleeves
- » three hinges - applies to rebated door leaf

REBATED DOOR LEAF

- » straight edge, flat glass pane frame **fig. 1**
- » 2 silver screw-in pivot hinges
- » single-point mortise simple key lock, bathroom lock, cylinder lock or economic lock

NON-REBATED DOOR LEAF (EXTRA CHARGE)

- » edge without rebate, flat glass pane frame **fig. 2**
- » sockets for 2 recessed Estetic 80 hinges (hinges constitute a part of the door frame)
- » magnetic simple key lock, bathroom lock, cylinder lock or economic lock

SLIDING DOOR LEAF

- » edge without rebate, rounded glass pane frame or flat glass pane frame **fig. 3**
- » socket for hook lock and/or for handles

OPTIONS AVAILABLE WITH EXTRA CHARGE

- » glass pane MAT DRE, DECORMAT BROWN, DECORMAT GRAPHITE (applies to door leaf)
- ARTE 10-30, 90
- ARTE 40, 50
- ARTE 80
- » white frost VSG 22.1 safe, complex glass pane
- ARTE 10, 20, 30
- ARTE 40, 50
- ARTE 80
- ARTE 90
- » stabilising insert tubular chipboard
- » non-rebated door leaf
- » door leaf "90" and "100"
- » ventilation undercut
- » recuperative undercutting -15mm
- » plastic ventilation grille
- » aluminum ventilation grille
- » cover strip for double non-rebated door leaf
- » double leaf door leaf price x2
- » **NOTE:** third Estetic 80 hinge for non-rebated doors (extra charge is added to the price of the door frame)

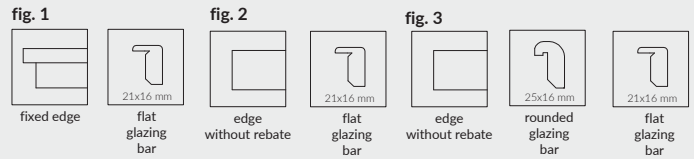



UNI 10 - ashen

Decor



white acrylic UV varnish - RAL 9003
ecru - RAL 9001
latte - Flugger 4362, NCS S1505-Y50R
ashen - RAL 7035

STANDARD OPTIONS

- » door leaf painted with acrylic UV varnish
- » door leaf frame made of MDF
- » core made of „honeycomb”
- » glass pane white bark 4 mm thick

OPTIONS WITHOUT EXTRA CHARGE

- » glass pane „chinchila” or „window blind”
- » ventilation sleeves
- » third hinge to rebated door leaf

NOTE: To ensure highest quality of painted products, before painting process, both, door leaf and door frames are coated with special material which constitutes solid base.

REBATED DOOR LEAF

- » straight edge **fig. 1**
- » 2 silver screw-in pivot hinges
- » single-point mortise simple key lock, bathroom lock, cylinder lock or economic lock

NON-REBATED DOOR LEAF (EXTRA CHARGE)

- » edge without rebate **fig. 2**
- » sockets for 2 recessed Estetic 80 hinges (hinges constitute a part of the door frame)
- » magnetic simple key lock, bathroom lock, cylinder insert lock or economic lock in steel, black or white color

SLIDING DOOR LEAF

- » edge without rebate **fig. 2**
- » socket for hook lock and/or for handles

* Note: selected configurations of white rebated UNI 10 model are available from stock.

NOTE: the Silent package applies to rebated and non-rebated single leaf door.

DOOR LEAF WITH INVERTED REBATE (extra charge)

- » active single leaf door
- » straight edge **fig 3**
- » sockets for two recessed Estetic 1821 hinges (hinges constitute a part of the door frame)
- » magnetic simple key lock, bathroom lock, cylinder lock or economic lock

OPTIONS AVAILABLE WITH EXTRA CHARGE

- » Silent 37dB package (dropping seal + acoustic insert) - UNI 10
- » glass pane MAT DRE, DECORMAT BROWN, DECORMAT GRAPHITE (applies to door leaf BULAJ MDF)
- » white frost VSG 22.1 safe, complex glass pane BULAJ MDF
- » stabilising insert tubular chipboard
- » core made of full chipboard
- » door leaf "90" and "100"
- » ventilation undercut
- » recuperative undercutting -15mm
- » non-rebated door leaf
- » door leaf with inverted rebate
- » cover strip for double non-rebated door leaf
- » plastic ventilation grille
- » aluminum ventilation grille
- » double leaf door leaf price x2
- » there is possibility to purchase metal BULAJ separately in black or steel colour
- » **NOTE:** third Estetic 80 hinge for non-rebated doors (extra charge is added to the price of the door frame)

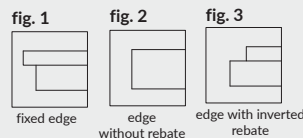

UNI 10



BULAJ MDF



BULAJ
metal



black steel Bulaj *



steel Bulaj *

* only MATT or transparent glass pane available



FARGO 10 - ashen

Decor



white acrylic UV varnish - RAL 9003
 ecru - RAL 9001
 latte - Flugger 4362, NCS S1505-Y50R
 ashen - RAL 7035

STANDARD OPTIONS

- » door leaf painted with acrylic UV varnish
- » door leaf frame made of MDF
- » core made of „honeycomb”

OPTIONS WITHOUT EXTRA CHARGE

- » ventilation sleeves
- » three hinges - applies to rebated door leaf

NOTE: To ensure highest quality of painted products, before painting process, both, door leaf and door frames are coated with special material which constitutes solid base.

REBATED DOOR LEAF

- » straight edge **fig. 1**
- » 2 silver screw-in pivot hinges
- » single-point mortise simple key lock, bathroom lock, cylinder lock or economic lock

NON-REBATED DOOR LEAF (EXTRA CHARGE)

- » edge without rebate **fig. 2**
- » sockets for 2 recessed Estetic 80 hinges (hinges constitute a part of the door frame)
- » magnetic simple key lock, bathroom lock, cylinder insert lock or economic lock in steel, black or white color

SLIDING DOOR LEAF

- » edge without rebate **fig. 2**
- » socket for hook lock and/or for handles

DOOR LEAF WITH INVERTED REBATE (extra charge)

- » active single leaf door
- » straight edge **fig 3**
- » sockets for two recessed Estetic 1821 hinges (hinges constitute a part of the door frame)
- » magnetic simple key lock, bathroom lock, cylinder lock or economic lock

OPTIONS AVAILABLE WITH EXTRA CHARGE

- » Silent package 37dB (dropping seal + acoustic insert) - FARGO 10 - 60
- » door leaf "90" and "100"
- » tubular chipboard
- » core made of full chipboard
- » ventilation undercut
- » recuperative undercutting -15mm
- » non-rebated door leaf
- » door leaf with inverted rebate
- » cover strip for double non-rebated door leaf
- » plastic ventilation grille
- » aluminum ventilation grille
- » double leaf door

leaf price x2

NOTE: third Estetic 80 hinge for non-rebated doors (extra charge is added to the price of the door frame)

NOTE: the Silent package applies to rebated and non-rebated single leaf door.

fig. 2



edge without rebate

fig. 1



fixed edge

fig. 3



edge with inverted rebate



milling type in FARGO collection



FARGO 10



FARGO 20



FARGO 30



FARGO 40



FARGO 50



FARGO 60



BINITO 20 white acrylic UV lacquer

Decor



white acrylic UV varnish - RAL 9003
 ecru - RAL 9001
 latte - Flugger 4362, NCS S1505-Y50R
 ashen - RAL 7035

DOOR HANDLE WITH A BACKPLATE FOR

The promotion applies to rebated and non-rebated door leaves from BINITO collection. Door handle model and finishing color to choose from: WEGA, ATRIA, ARCTUS, POLARIS, ORION, ZETA, AVIOR, MIMOSA and ALTAIR door handles and a backplate with a simple key lock or cylinder lock or toilet lock. The promotion lasts while stocks last.



types of milling in BINITO collection

STANDARD OPTIONS

- » door leaf painted with acrylic UV varnish
- » door leaf frame made of MDF
- » core made of „honeycomb”
- » glass pane white bark 4 mm thick

OPTIONS WITHOUT EXTRA CHARGE

- » glass pane „chinchila” or „window blind”
- » ventilation sleeves
- » three hinges - applies to rebated door leaf

NOTE: To ensure highest quality of painted products, before painting process, both, door leaf and door frames are coated with special material which constitutes solid base.

REBATED DOOR LEAF

- » straight edge, flat glass pane frame **fig. 1**
- » 2 silver screw-in pivot hinges
- » single-point mortise simple key lock, bathroom lock, cylinder lock or economic lock

NON-REBATED DOOR LEAF (EXTRA CHARGE)

- » edge without rebate, flat glass pane frame **fig. 2**
- » sockets for 2 recessed Estetic 80 hinges (hinges constitute a part of the door frame)
- » magnetic simple key lock, bathroom lock, cylinder insert lock or economic lock in steel, black or white color

SLIDING DOOR LEAF

- » edge without rebate, flat glass pane frame **fig. 2**
- » socket for hook lock and/or for handles

DOOR LEAF WITH INVERTED REBATE (extra charge)

- » active single leaf door
- » straight edge **fig. 3**
- » sockets for two recessed Estetic 1821 hinges (hinges constitute a part of the door frame)
- » magnetic simple key lock, bathroom lock, cylinder lock or economic lock

OPTIONS AVAILABLE WITH EXTRA CHARGE

- » Silent package 37dB (dropping seal + acoustic insert) - BINITO 10 - 90
- » glass pane MAT DRE, DECORMAT BROWN, DECORMAT GRAPHITE
BINITO 11, 23
BINITO 21, 100
BINITO 24, 110
- » white frost VSG 22.1 safe, complex glass pane
BINITO 11
BINITO 23
BINITO 21, 100
BINITO 24
BINITO 110
- » door leaf "90" and "100"
- » tubular chipboard
- » core made of full chipboard
- » non-rebated door leaf
- » ventilation undercut
- » recuperative undercutting -15mm
- » door leaf with inverted rebate
- » cover strip for double non-rebated door leaf
- » plastic ventilation grille
- » aluminum ventilation grille
- » double leaf door
- » **NOTE:** third Estetic 80 hinge for non-rebated doors (extra charge is added to the price of the door frame)

leaf price x2

NOTE: the Silent package applies to rebated and non-rebated single leaf door.

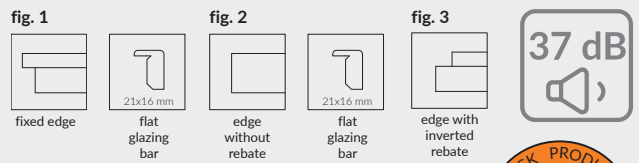

* Note: selected configurations of the BINITO 20 model are available as stock orders, rebated in white matt.

Door leaves width: single leaf door „60”÷„100”, rebated double leaf door „120” ÷ „200”, non-rebated double leaf door „120” ÷ „180”.
Technical information: door frames: pp. 140-163, accessories: pp. 164-172 and 177, door leaves: pp. 178-186.



BULAJ INVEST metal - honey oak

CPL laminate 1st group	milky white	white	ashen								
CPL laminate 2nd group	gray dark	concrete 2	gray oak	welsh oak	acacia	celini walnut	walnut	honey oak	chestnut	roasted walnut	black ST
Finish foil	alpine white	bleached craft oak	riviera oak	rustic oak							

STANDARD OPTIONS

- » door leaf frame made of MDF
- » core made of „honeycomb“
- » transparent glass, thickness 4 mm

OPTIONS WITHOUT EXTRA CHARGE

- » ventilation sleeves
- » three hinges - applies to rebated door leaf

REBATED DOOR LEAF

- » straight edge
- » edge with radius R 2.5 mm made by directforming **available in CPL 2nd group Fig. 1 (rounded glass pane frame in CPL laminates)**
- » straight edge **fig. 2 (Slim glass pane frame in Finish foils)**
- » 2 silver screw-in pivot hinges
- » single-point mortise simple key lock, bathroom lock, cylinder lock or economic lock
- » **All orders in the investment standard require approval of The Investment Department. The investment standard is defined by door frame passage, with opened door leaf at 90 degree, respectively for interior doors: "80" 800 mm, "90" 900 mm.**

OPTIONS AVAILABLE WITH EXTRA CHARGE

- » Silent package 37dB (dropping seal + acoustic insert) - STANDARD INVEST 10
- » glass pane MAT DRE (applies to door leaf) STANDARD INVEST 20, 70, 80, BULAJ MDF STANDARD INVEST 60
- » stabilising insert tubular chipboard
- » "100" door leaves
- » ventilation undercut
- » recuperative undercutting -15mm
- » plastic ventilation grille
- » aluminum ventilation grille
- » there is possibility to purchase metal BULAJ separately in black or steel colour

* Note: Selected configurations of rebated alpine white STANDARD INVEST 10 model are available from stock.

fig. 1

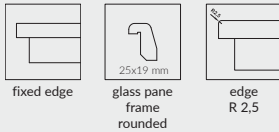
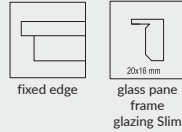

fig. 2



STANDARD INVEST 10

STANDARD INVEST 20

STANDARD INVEST 60

STANDARD INVEST 70

STANDARD INVEST 80

BULAJ INVEST MDF

steel BULAJ INVEST



black steel Bulaj *



steel Bulaj *



R 2,5 mm edge

* only MATT or transparent glass pane available

STANDARD OPTIONS

- » edge radius R 2.5 mm only for laminates 0.15-0.20 mm from CPL 2nd group
- » straight edge for laminates 0.15-0.20 mm and 0.7 mm
- » door leaf frame made of softwood
- » core made of „honeycomb“
- » glass pane white bark 4 mm thick
- » CPL laminate 0.15 - 0.2mm or 0.7mm

OPTIONS WITHOUT EXTRA CHARGE

- » glass pane „chinchila“ or „window blind“
- » ventilation sleeves
- » three hinges - applies to rebated door leaf

REBATED DOOR LEAF

- » straight edge
- » edge with radius R 2.5 mm made by directforming available in 2nd group of CPL 0.15-0.20 mm laminates **Fig. 1**
- » straight edge for laminates 0.7 mm **fig.1**
- » 2 silver screw-in pivot hinges
- » single-point mortise simple key lock, bathroom lock, cylinder lock or economic lock
- » **All orders in the investment standard require approval of The Investment Department. The investment standard is defined by door frame passage, with opened door leaf at 90 degree, respectively for interior doors: "80" 800 mm, "90" 900 mm.**

NON-REBATED DOOR LEAF (EXTRA CHARGE)

- » edge without rebate, rounded glass pane frame **fig. 2**
- » sockets for 2 recessed Estetic 80 hinges (hinges constitute a part of the door frame)
- » magnetic simple key lock, bathroom lock, cylinder lock or economic lock

SLIDING DOOR LEAF

- » edge without rebate, rounded glass pane frame **fig. 2**
- » socket for hook lock and/or for handles

NOTE: colours equivalent: W0118 - WHITE

NOTE: the Silent package applies to rebated and non-rebated single leaf door.

OPTIONS AVAILABLE WITH EXTRA CHARGE

- » Silent package 37dB (dropping seal + acoustic insert) - STANDARD 10 CPL
- » glass pane MAT DRE, DECORMAT BROWN, DECORMAT GRAPHITE (applies to door leaf) STANDARD 20, BULAJ MDF STANDARD 60
- » white frost VSG 22.1 safe, complex glass pane STANDARD 20 STANDARD 60 BULAJ MDF
- » stabilising insert tubular chipboard
- » "100" door leaves
- » door leaf "110" (only STANDARD 10) laminates 0.15 - 0.20 mm
- » non-rebated door leaf
- » upper single point mortise lock (available only in STANDARD 10 door leaf model with tubular chipboard and fixed door frame)
- » plastic ventilation grille
- » aluminum ventilation grille
- » cover strip for double non-rebated door leaf
- » ventilation undercut
- » recuperative undercutting -15mm
- » double leaf door leaf price x2
- » there is possibility to purchase metal BULAJ separately in black or steel colour
- » **NOTE: third Estetic 80 hinge for non-rebated doors (extra charge is added to the price of the door frame)**

0.7 mm CPL laminate is also available in the "110" door leaf width and in Standard CPL 20, 60 models, BULAJ MDF, steel BULAJ - to place an order, please contact the Customer Service Department.

fig. 1

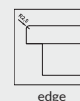

fig. 2



steel or black steel BULAJ (available only MAT or transparent glass pane)



STANDARD OPTIONS

- » door leaf frame made of softwood
- » core made of „honeycomb“

OPTIONS WITHOUT EXTRA CHARGE

- » ventilation sleeves

REBATED DOOR LEAF

- » straight edge with the edging band
- » edge with radius R 2.5 mm made by directforming **available in CPL 2nd group Fig. 1**
- » 3 silver screw-in pivot hinges
- » single-point mortise simple key lock, bathroom lock, cylinder lock or economic lock

NON-REBATED DOOR LEAF (EXTRA CHARGE)

- » edge without rebate **fig. 2**
- » sockets for 2 recessed Estetic 80 hinges (hinges constitute a part of the door frame)
- » magnetic simple key lock, bathroom lock, cylinder lock or economic lock

OPTIONS AVAILABLE WITH EXTRA CHARGE

- » Silent 37dB package (1983) (dropping seal + acoustic filling) - STANDARD 10
- » Silent 37dB package (2110 and 2240) (dropping seal + acoustic filling) - STANDARD 10
- » filling: tubular chipboard (1983)
- » tubular chipboard (2110 and 2240)
- » door leaf "90" - "100" (1983) DRE - CELL
- » door leaf "90" - "100" (2110 and 2240) DRE - CELL
- » door leaf "90" - "100" (1983) DRE - CELL
- » door leaf "100" (2110 and 2240) DRE - CPL
- » non-rebated door leaf
- » ventilation undercut
- » plastic ventilation grille
- » aluminum ventilation grille
- » cover strip for double non-rebated door leaf
- » double leaf door leaf price x2
- » **NOTE:** third Estetic 80 hinge for non-rebated doors (extra charge is added to the price of the door frame)

CPL 0.7 mm laminate also available - to place an order, please contact the Customer Service Department.

Door leaf, dependent on selected height option - 1983 mm, 2110 mm or 2240 mm is dedicated to door frames with three hinges in corresponding heights.

NOTE: colours equivalent: W0118 - WHITE

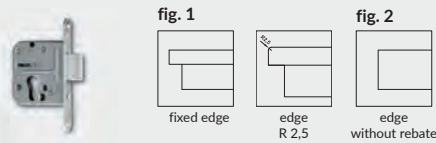

additional upper single point mortise lock (available only in STANDARD 10 door leaf model with core made of perforated chipboard and fixed door frame)



R 2,5 mm edge in CPL laminate



*** decor available only in horizontal graining
*while stock last

white matt	white (textured)	white pine	siberian elm	silver	sand oak	bleached oak textured	vintage oak	caramel walnut	Decor DRE-Cell		
golden oak textured	walnut	anthracite elm	dark wenge	elm toffee*** *	marrone chestnut textured	light gray matt	evoke oak				
							milky white	white	ashen	CPL laminate 1st group	
black ST	gray dark	concrete 2	gray oak	welsh oak	acacia	celini walnut	walnut	honey oak	chestnut	roasted walnut	CPL laminate 2nd group

STANDARD OPTIONS

- » door leaf frame made of softwood
- » core made of „honeycomb”
- » glass pane white bark 4 mm thick

OPTIONS WITHOUT EXTRA CHARGE

- » glass pane „chinchila” or „window blind”
- » ventilation sleeves

REBATED DOOR LEAF

- » straight edge, flat glass pane frame (in CPL laminate - rounded glass frame pane) flat 4 mm HDF panels **fig. 1**
- » 3 silver screw-in pivot hinges
- » single-point mortise simple key lock, bathroom lock, cylinder lock or economic lock

NON-REBATED DOOR LEAF (EXTRA CHARGE)

- » edge without rebate, flat glass pane frame (in CPL - rounded glass pane frame), flat 4 mm HDF panels **fig. 2**
- » sockets for 2 recessed Estetic 80 hinges (hinges constitute a part of the door frame)
- » magnetic simple key lock, bathroom lock, cylinder lock or economic lock

NOTE: colours equivalent: W0118 - WHITE

NOTE: In rebated door leaves with CPL laminates there is possibility to choose a door leaf with an edge radius R=2.5 mm, except for white, milky white and gray laminates.

NOTE: Different heights are available in all models of MODERN collection.

Door leaf, dependent on selected height option - 1983 mm, 2110 mm or 2240 mm is dedicated to door frames with three hinges in corresponding heights.

OPTIONS AVAILABLE WITH EXTRA CHARGE

- » glass pane MAT DRE, DECORMAT BROWN, DECORMAT GRAPHITE, (applies to door leaf)
MODERN 20
MODERN 30
MODERN 40
MODERN 50
- » white frost VSG 22.1 safe, complex glass pane p. 77
- » filling: tubular chipboard (1983 and 2043) tubular chipboard (2110 and 2240)
- » door leaf „90” and „100” (1983 and 2043)
- » door leaf „90” and „100” (2110 and 2240)
- » non-rebated door leaf
- » ventilation undercut
- » plastic ventilation grille
- » aluminum ventilation grille
- » cover strip for double non-rebated door leaf
- » double leaf door leaf price x2
- » **NOTE:** third Estetic 80 hinge for non-rebated doors (extra charge is added to the price of the door frame)

NOTE: collection MODERN 10-50 coated with CPL laminate in standard height is available in sliding version.

fig. 1



fixed edge



21x16 mm

flat glazing bar



25x19 mm

glass pane frame rounded glass pane frame (CPL)



flat panel

fig. 2



edge without rebate



21x16 mm

flat glazing bar



25x19 mm

glass pane frame rounded glass pane frame (CPL)



flat panel



198 MODERN 30

standard height

211 MODERN 30

224 MODERN 30

Decor DRE-Cell

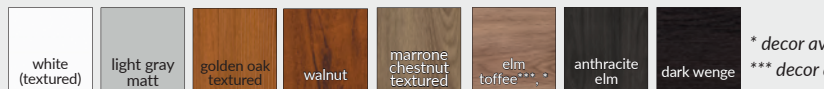

* decor available while supplies last

*** decor available only in horizontal wood grain

CPL laminate 1st group

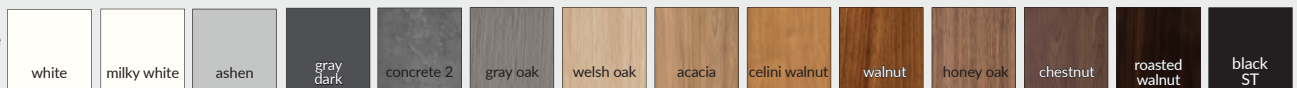

STANDARD OPTIONS

- » door leaf frame made of softwood
- » core made of „honeycomb“
- » glass pane white bark 4 mm thick

OPTIONS WITHOUT EXTRA CHARGE

- » glass pane „chinchila“ or „window blind“
- » ventilation sleeves

REBATED DOOR LEAF

- » straight edge, flat glass pane frame (in CPL laminate - rounded glass frame pane) flat 4 mm HDF panels **fig. 1**
- » 3 silver screw-in pivot hinges
- » single-point mortise simple key lock, bathroom lock, cylinder lock or economic lock

NON-REBATED DOOR LEAF (EXTRA CHARGE)

- » edge without rebate, flat glass pane frame (in CPL laminate - rounded glass pane frame), flat 4mm HDF panels **fig. 2**
- » sockets for 2 recessed Estetic 80 hinges (hinges constitute a part of the door frame)
- » magnetic simple key lock, bathroom lock, cylinder lock or economic lock

NOTE: colours equivalent: W0118 - WHITE

NOTE: In rebated door leaves with CPL laminates there is possibility to choose a door leaf with an edge radius R=2.5 mm, except for white, milky white and gray laminates.

NOTE: Different heights are available in all models of PLUS collection.

Door leaf, dependent on selected height option - 1983 mm, 2110 mm or 2240 mm is dedicated to door frames with three hinges in corresponding heights.

OPTIONS AVAILABLE WITH EXTRA CHARGE

- » glass pane MAT DRE, DECORMAT BROWN, DECORMAT GRAPHITE (applies to door leaf)
PLUS 20
PLUS 40, 50, 60, 70, 80
PLUS 30
- » white frost VSG 22.1 safe, complex glass pane p. 81
- » filling: tubular chipboard (1983 and 2043) tubular chipboard (2110 and 2240)
- » door leaf „90“ and „100“ (1983 and 2043)
- » door leaf "90" and "100" (2110 and 2240)
- » non-rebated door leaf
- » ventilation undercut
- » plastic ventilation grille
- » aluminum ventilation grille
- » cover strip for double non-rebated door leaf
- » double leaf door leaf price x2
- » NOTE: third Estetic 80 hinge for non-rebated doors (extra charge is added to the price of the door frame)

NOTE: collection PLUS 10-80 coated with CPL laminate in standard height is available in sliding version.

fig. 1

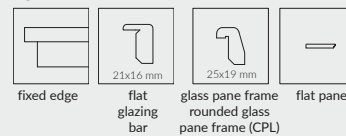
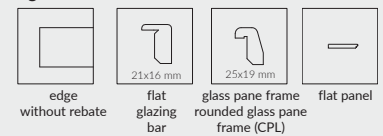

fig. 2



198 PLUS 30

standard height

211 PLUS 30

224 PLUS 30



* decor available while supplies last

*** decor available only in horizontal wood grain



ENA - white matt

DRE sliding system is designed to be used together in one set with single or double leaf door, which are available in our sales offer in sliding version. Sliding system is available in colours which constitute standard finishing colours of door leaf unit: DRE - Cell, 3D foil, CPL laminates, and painted doors with the exception of the following collections: Enter, Enter Akustic, Solid, Solid RC2, Forca B, fire resistant doors, glass doors, and doors with different heights.

In our sale offer there are available two different types of sliding system:

NS - system mounted directly on the wall

NT - sliding system mounted together with adjustable tunnel

There are two options of NT sliding system:

- » mounted together with adjustable tunnel with 63 mm architrave
- » mounted together with adjustable tunnel with 80 mm architrave

Set of sliding system comprises of: sliding guide bar with hardware (LEON SN 150, 180, 200), spacing board, masking strip, and fender beam (fender beam is available for single leaf - for doors with hook lock option in fender beam there is milling for latch).

In the system mounted with adjustable tunnel, NT, set contains 2 additional 16 mm spacing boards with cross-sections adapted to the width of architraves (63 mm or 80 mm). There are differences in cross-sections of NS and NT masking element.

To complete entire set of sliding doors it is necessary to purchase sliding leaf unit in following dimensions:

Single leaf door: „60“, „70“, „80“, „90“, „100“

Double leaf door: „2x60“, „2x70“, „2x80“, „2x90“, „2x100“

Door leaf might be equipped with sockets for lock and/or handle - those accessories must be purchased separately.

In the system mounted with adjustable tunnel NT, it is necessary to purchase adjustable tunnel separately.

CPL 2nd group laminate applies to the natural halifax oak laminate with horizontal graining.



ACCESSORIES

- » round handle 1 pcs.
- » oval handle 1 pcs.
- » Hook lock with key, with two round or oval handles
- » toilet hook lock with two round handles
- » hook lock with cylinder lock insert with two round handles
- » One set of door handle for single leaf door consist of 2 pcs.

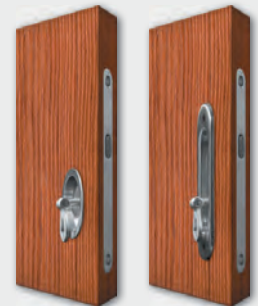

hook lock with a key and a handle round
hook lock with key and handle oval

masking strip with guide bar

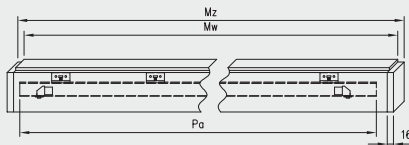

Masking strip and guide bar for double sliding system is made by connecting two elements of single system.

Single sliding system

Dimension door [mm]	Masking strip		Guide bar
	Mz	Mw	Pa
644, 744	1620	1588	1500
844	1920	1888	1800
944	2120	2088	2000
1044	2160	2128	2000

double leaf door sliding system

Dimension door [mm]	Masking strip		Guide bar
	Mz	Mw	Pa
2 x 644	2 x 1519	2 x 1503	2 x 1500
2 x 744	2 x 1519	2 x 1503	2 x 1500
2 x 844	2 x 1819	2 x 1803	2 x 1800
2 x 944	2 x 2019	2 x 2003	2 x 2000
2 x 1044	2 x 2063	2 x 2047	2 x 2000

NS - vertical cross-section

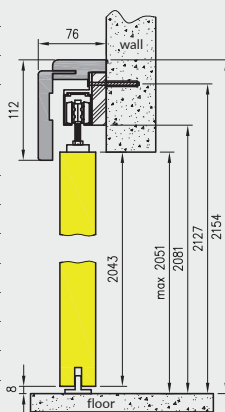

NT - vertical cross-section for tunnel with 63 mm architrave

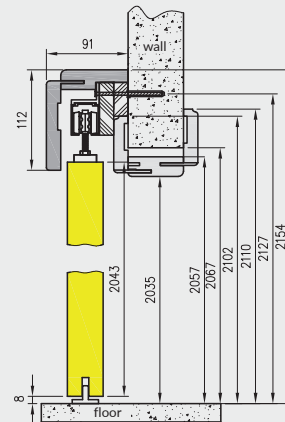

NT - vertical cross-section for tunnel with 80 mm architrave

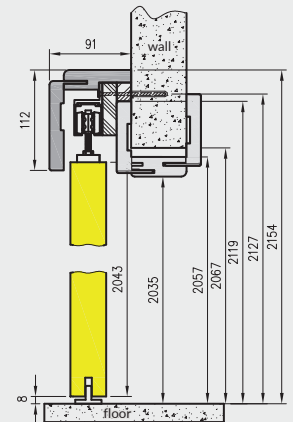

Height of sliding door leaf unit - 2043 mm
total height of sliding system - 2154 mm

Single sliding system

symbol	"60"	"70"	"80"	"90"	"100"
A	602	702	802	902	1002
C	646	746	846	946	1046
D	664	764	864	964	1064
E	752	852	952	1052	1152
E*	786	886	986	1086	1186
S	644	744	844	944	1044

double leaf door sliding system

symbol	"120"	"140"	"160"	"180"	"200"
A	1200	1400	1600	1800	2000
C	1244	1444	1644	1844	2044
D	1264	1464	1664	1864	2064
E	1350	1550	1750	1950	2150
E*	1384	1584	1784	1984	2184
S**	644	744	844	944	1044

E* applies to tunnel with T80 architrave
S** width of single leaf door

NS - horizontal cross-section (left system)

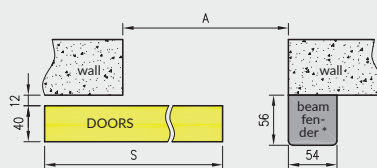

NT - horizontal cross-section (left system)

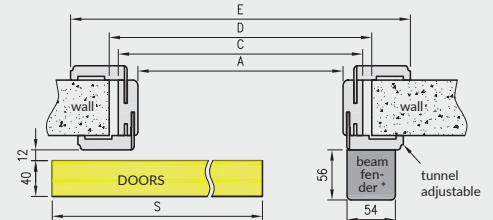

* is not available in double leaf system

NOTE: In double sliding system masking strip is connected on length, by two single elements.

Sliding system for glass doors "Spazio", is made of anodized aluminum, and used as a complete and complementary solution together with finished door frame. Whole set comprises of - guide channel with straight or oval blende, hardware designed to hang sliding glass pane and bottom door guide.

There are two options of Spazio System (only difference is in the shape of external blende):

- » Spazio TP - with straight blende
- » Spazio TO - with oval blende

PRICE

- » Price of the sliding system for glass doors

To complete the whole system it is recommended to buy glass door leaf in sliding version from Galla collection. There is designed for this solution round handle.

OPTIONS AVAILABLE WITH EXTRA CHARGE

- » door handle (two-sided)



door handle
(stainless steel)

Note: There is no possibility to make ventilation option.

Prices of GALLA glass doors on page 137

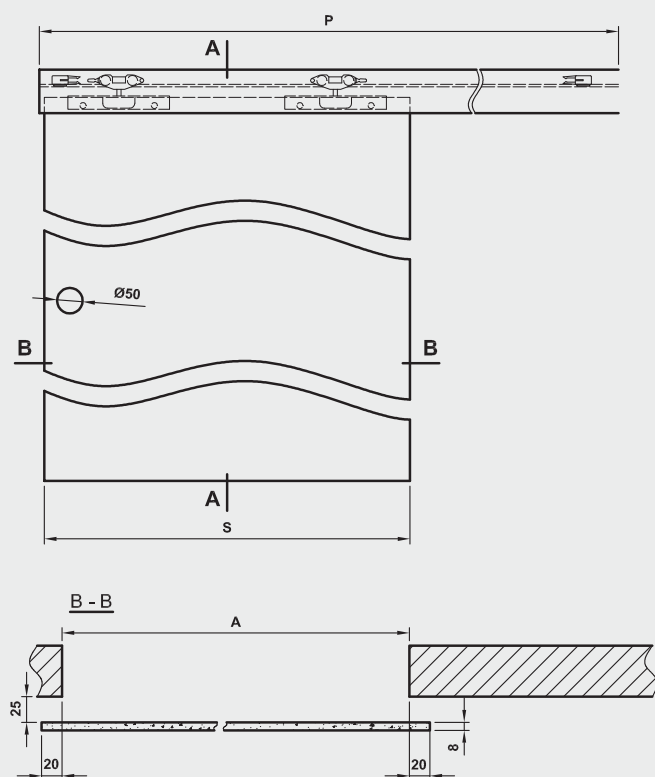
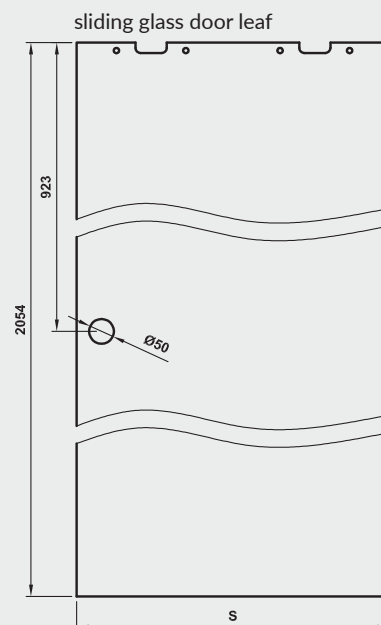

A - A vertical cross-section of Spazio TP

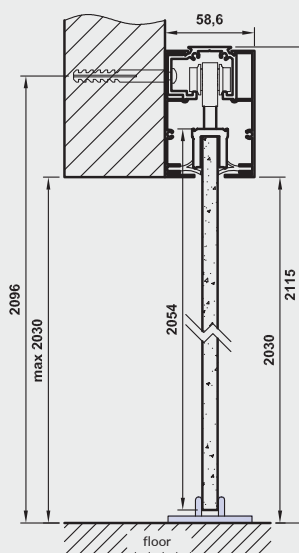

A - A vertical cross-section of Spazio TO

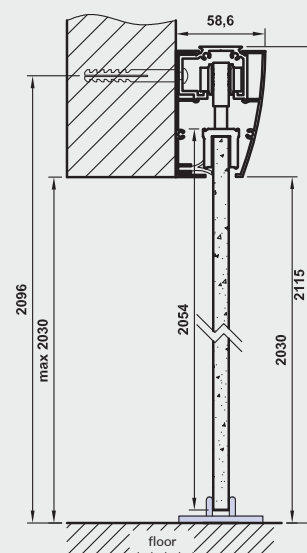

Dimensions

	S	A	P
"60"	630	590	1340
"70"	730	690	1540
"80"	830	790	1740
"90"	930	890	1940

S - width of door leaf unit
A - width of wall passage
P - length of guide channel

SLIDING SYSTEM SPAZIO CD MOUNTED ON-WALL

SLIDING SYSTEM DOOR LEAF
interior door leaves



SPAZIO CD

On-wall mounted sliding system with anodized guide channel and rectangular blende. Is designated for panel doors and frame construction doors.

In order to have a completed system, you must purchase a sliding door from our wide offer in a version with a handle. The holder must be purchased separately (information on page 105).

WHOLE SET COMPRISES OF:

- » guide channel with side caps
- » system sliding trolleys
- » door leaf hangers
- » bottom stopper
- » assembly kit (screws and bolts)

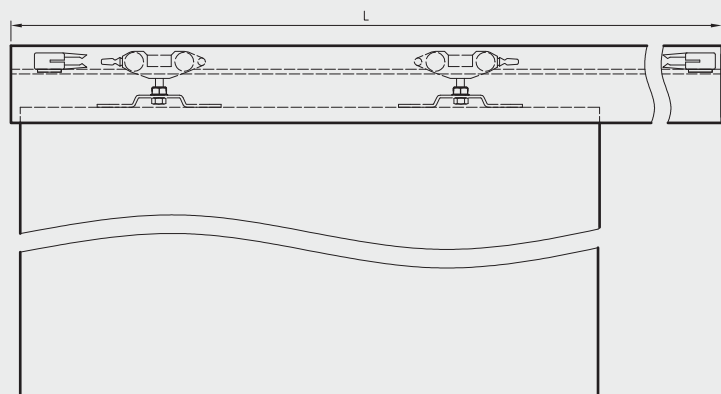

vertical cross-section

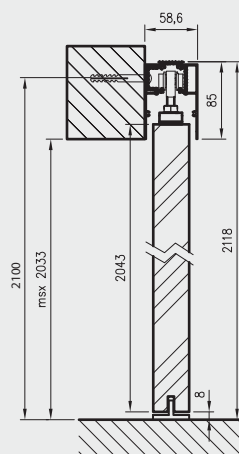

A - width of wall passage
S - width of door leaf unit
L - length of guide channel

	A	S	L
"60"	600	644	1370
"70"	700	744	1570
"80"	800	844	1770
"90"	900	944	1970
"100"	1000	1044	2170

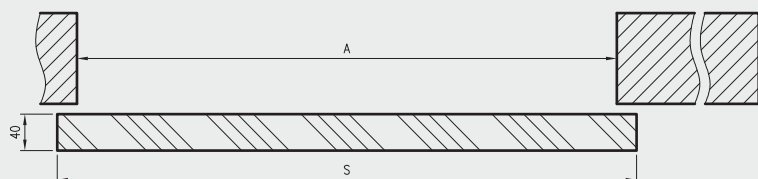



Sliding system doors hidden in the wall (pocket system) PA - STANDARD 10 vintage oak

Decor DRE-Cell	white (textured)	white matt	white pine	siberian elm	silver	evoked oak	vintage oak	sand oak	bleached oak textured	walnut
	caramel walnut	golden oak textured	toffee oak***	marrone chestnut textured	anthracite elm	dark wenge	antique copper	oxide concrete	black matt 2	
	light gray matt	dark olive matt	dark blue matt	cashmere matt	warm gray matt	sage oak	NEW			
Decor 3D	grand oak	elm	american walnut	ebony*	Polish oak 3D					
	*** decor available only in horizontal wood grain									
Decor painted	white	ecru	latte	ashen						
	*while stock last									

white acrylic UV varnish - RAL 9003
 ecru - RAL 9001
 latte - Flugger 4362, NCS S1505-Y50R
 ashen - RAL 7035

SLIDING SYSTEM DOORS HIDDEN IN THE WALL (POCKET SYSTEM)

SLIDING SYSTEM DOOR LEAF
interior door leaves

PA DOOR FRAME CASSETTE

System assembly involves embedding the cassette in the construction of profiles used to build a plasterboard wall (or other construction) with a thickness of:

- » 100 mm for the PA 100 mm door frame cassette
- » 125 mm for the PA 125 mm door frame cassette

Next, wide surfaces construction with the usage of 12.5mm plasterboards (plasterboards must be purchased separately) and finishing these surfaces and assembly of Tunnel Cassette Cover.

NOTE: VETRO A, VETRO D, VETRO D2, VETRO E and VETRO B door leaves with a width of "70" do not fit the 100 mm and 125 mm PA cassettes.

In addition, the 100 mm PA cassettes cannot be used with door leaves with locks and panel construction doors with glazing or panels

THE SET INCLUDES:

- » cassette elements made of aluminum elements and accessories for its assembly
- » elements that allow for decorative built-up jambs - so called Tunnel Cassette Cover with the architraves 80mm width

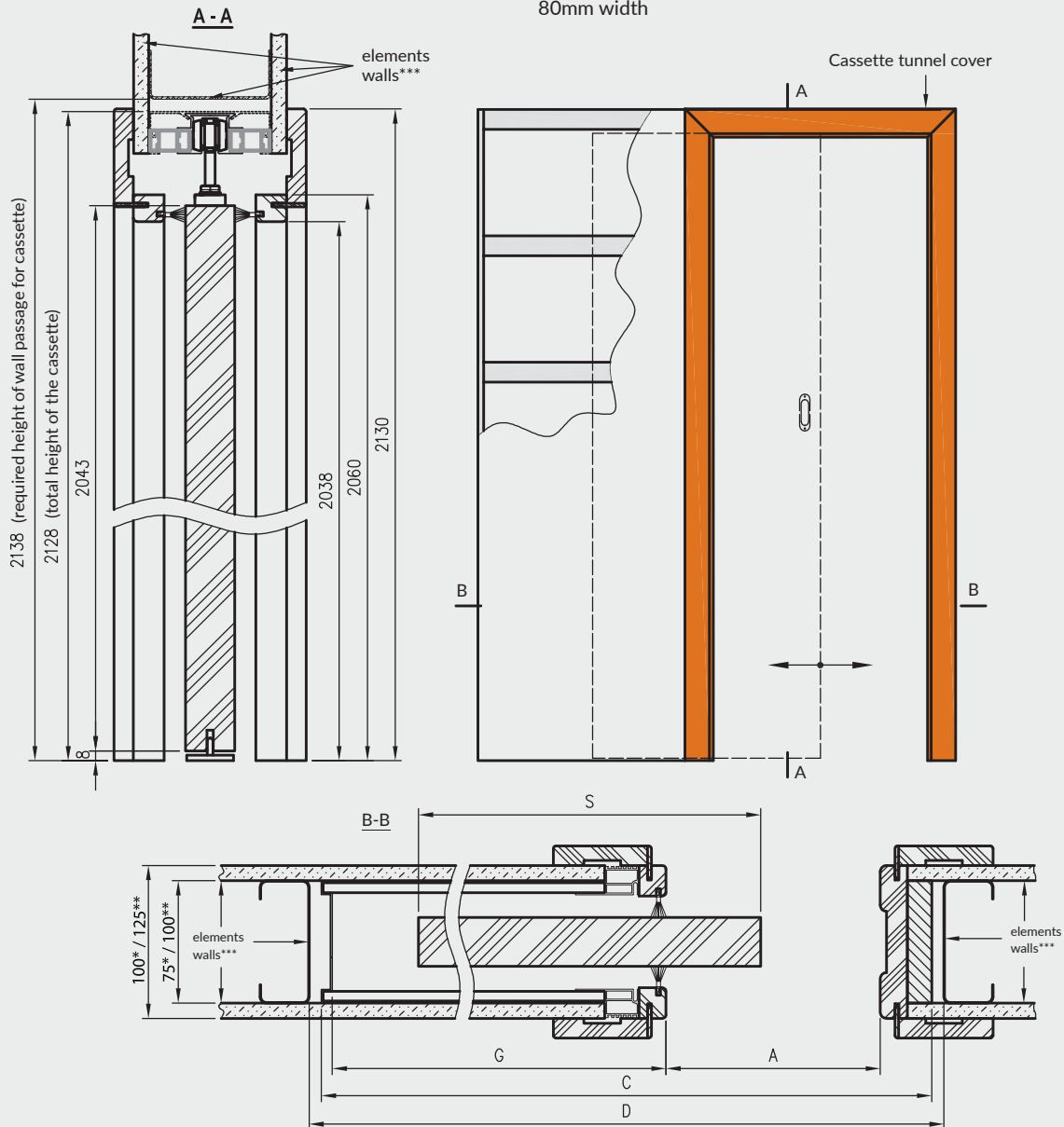

Width	A	S	C	D	G
60	600	644	1310	1330	656
70	700	744	1510	1530	756
80	800	844	1710	1730	856
90	900	944	1910	1930	956
100	1000	1044	2110	2130	1056

* dimensions refer to the 100mm PA cassette

** dimensions refer to 125mm PA cassette

*** wall elements are not components of the product

C - total width of cassette

D - width of walls passage prepared for cassette

G - depth of ready cassette

DOOR FRAMELESS CASSETTE B01

SLIDING SYSTEM DOOR LEAF
interior door leaves

DOOR FRAMELESS CASSETTE B01

Door frameless cassette with the possibility of assembly and disassembly of the door leaf after assembly and processing of the cassette. The assembly of the system involves embedding the cassette in the construction of profiles used to build a plasterboard wall (or other structure) with a thickness of:

- » 100 mm for the B01 100 mm door frameless cassette
- » 125 mm for the B01 125 mm door frameless cassette

Then covering wide surfaces with 12.5 mm plasterboards (plasterboards must be purchased separately) and finishing these surfaces.

LIST OF DOOR COLLECTIONS AND MODELS AVAILABLE IN THE DOOR FRAMELESS CASSETTE SYSTEM B01:

ESTRA; VERANO; ENA; TRIESTA; SOLTE; REVA; FOSCA; NESTOR; AURI; ELSA; PREMIUM; PIANO; SCALA; VERSO; BERGE; EVEN; NOVA 10; RIVIA 10, RIVIA 60-130; GALERIA ALU 10, 20, 30, 50, 60; FINEA 10, 40; STANDARD 10, UNI 10; FARGO 10-60; BINITO 10-90
The door leaves have additional milling on the upper edge. Door leaves with locks and panel construction door leaves with glazing and panels cannot be used with door frameless cassettes B01.

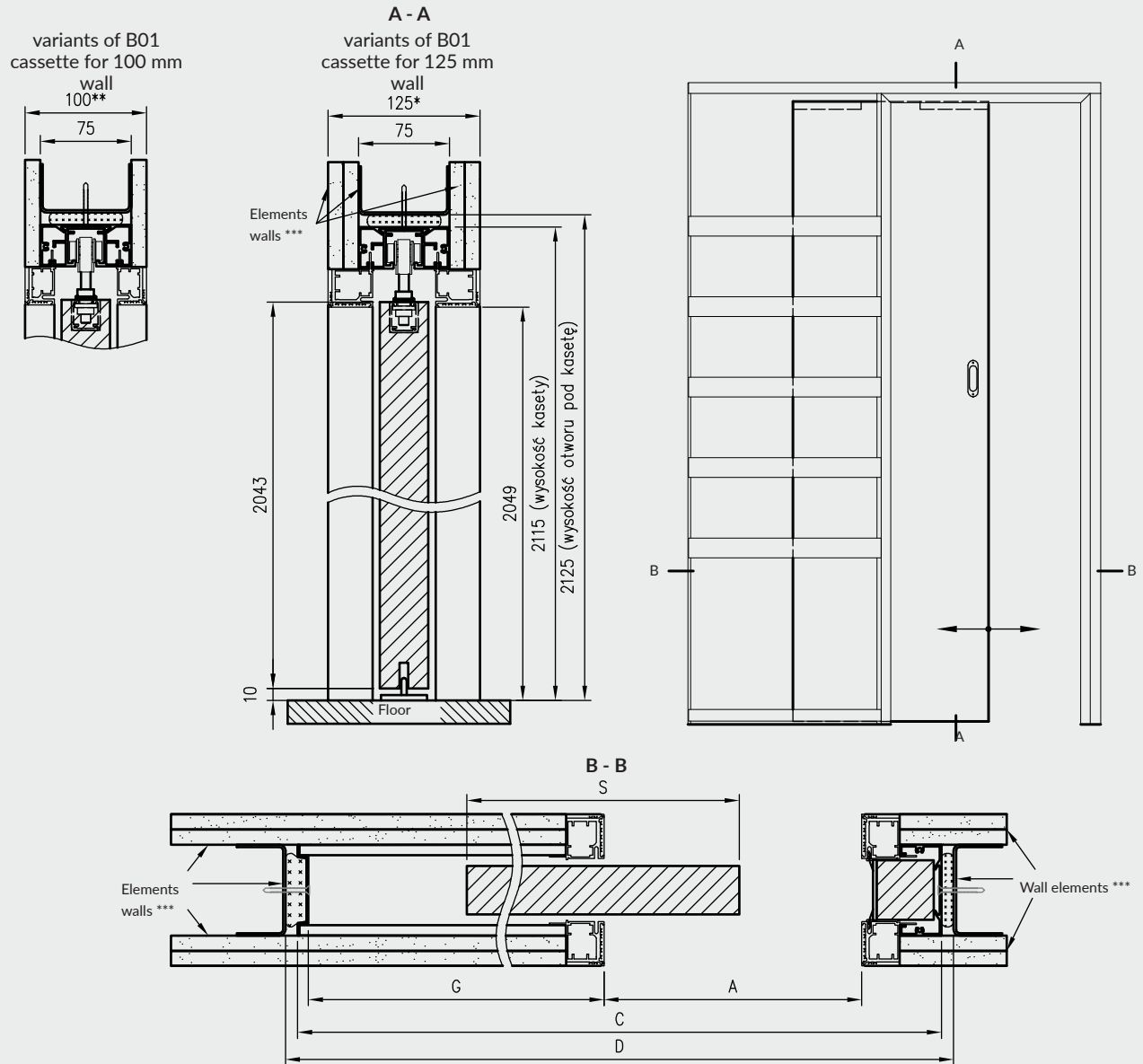

Width	S	A	C	D	G
60	644	626	1360	1380	659
70	744	726	1560	1580	759
80	844	826	1760	1780	859
90	944	926	1960	1980	959
100	1044	1026	2160	2180	1059

* variant of B01 cassette for 125 mm wall

** variant of B01 cassette for 100 mm wall

*** wall elements are not components of the product

S - door leaf width

A - width of the door frame passage

C - total width of cassette

D - width of walls passage prepared for cassette

G - depth of ready cassette



NON-REBATED - OPENED OUTWARDS AND INVERTED REBATE - OPENED INWARDS

The PROFI system door with an aluminum door frame and a 50 mm thick door leaf is an innovative solution that allows for creative interior design with the usage of invisible doors, with the option of finishing the door leaf surface in the same colors as the walls.

PROFI DOOR STRUCTURE INCLUDES:

Aluminum door frame, "invisible" after assembly process, build in the wall or overlaid with plasterboards. After detailing process, the only visible part is the rebate of the door frame, prepared for future painting, e.g. in the colors of the walls.

Non-rebated panel construction door leaf and inverted rebate in two finishing options:

- » Wide surfaces of the door leaf primed and ready for painting or wallpapering (e.g. in the color of the walls). The edges of the leaf are covered with the edge band that can be also painted. Painting should be done on your own or you shall choose a painted decor.
- » Wide surfaces of the door leaf and edges painted with white acrylic UV varnish.

OPTIONS AVAILABLE WITH EXTRA CHARGE

- » ventilation undercut
- » dropping seal
- » Silent package 37dB (dropping seal + acoustic insert) - Standard 2043
- » Silent package 37dB (dropping seal + acoustic insert) - Standard 2240

Non-rebated door frame profile



Inverted door frame profile rebates

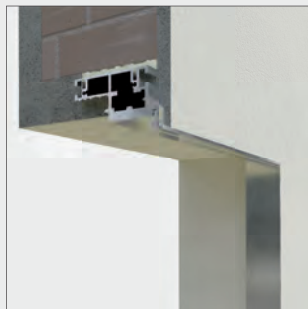

Door leaf decors:



Decor



Decor painted

white acrylic UV varnish - RAL 9003

Extra charge for the third Estetic 80 hinge



NON-REBATED - OPENED OUTWARDS IN THE 2043, 2240 STANDARD NORMS

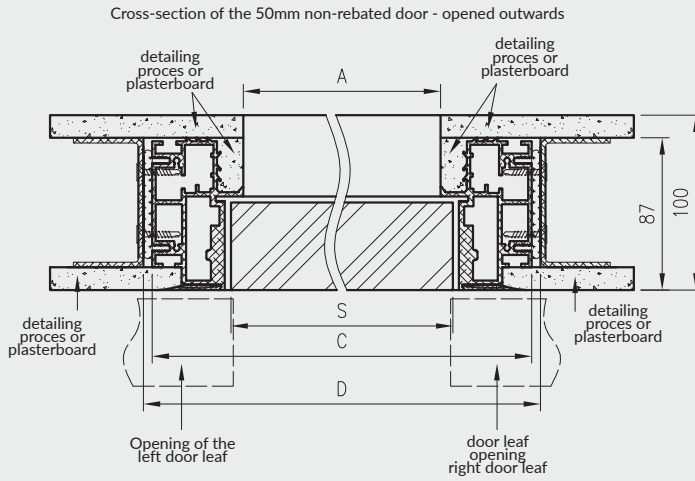

Vertical section of 50mm non-rebated door opened outwards

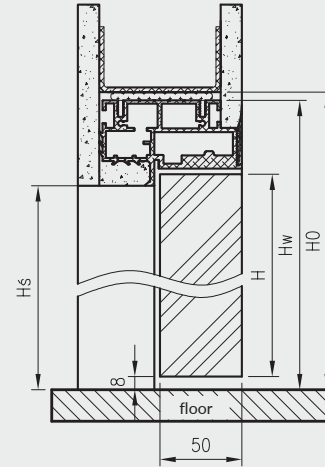

Profi door width dimensions

	S	A	C	D
"60"	600	586	690	700
"70"	700	686	790	800
"80"	800	786	890	900
"90"	900	886	990	1000
"100"	1000	986	1090	1100

Dimensions of non-rebated door leaves

standard	H	H _S	hw	H ₀
2043	2043	2044	2096	2101
2240	2240	2241	2293	2298

INVERTED REBATE - OPENED INWARDS IN THE 2043, 2240 STANDARD NORMS

Cross-section of 50mm inverted rebate door - opened inwards

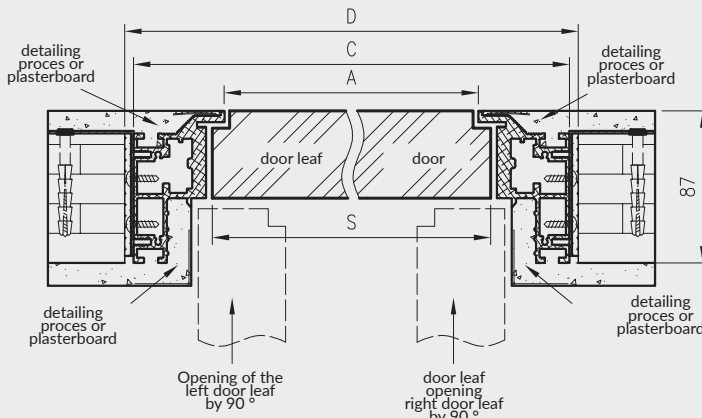

Vertical section of 50mm inverted rebate door - opened inwards

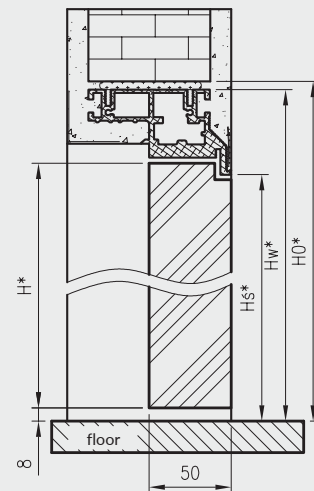

Profi door width dimensions

	S	A	C	D
"60"	600	586	690	700
"70"	700	686	790	800
"80"	800	786	890	900
"90"	900	886	990	1000
"100"	1000	986	1090	1100

height dimensions of rebated doors

standard	H	H _S	hw	H ₀
2043	2053	2054	2106	2111
2240	2250	2251	2303	2308

S - door leaf width
A - width of passage in door frame unit
C - external width of door frame
D - required width of wall opening
H₀ - height of the wall opening



Door leaf decors

cashmere matt	warm gray matt	sage oak	dark olive matt	dark blue matt	white (textured)	white matt	white pine	siberian elm	light gray matt	silver	Decor DRE-Cell 1 group
NEW											
											Decor DRE-Cell 2 group
											Decor 3D
											Decor painted
											Laminate CPL
											Decor

* decor with a door leaf edge in black colour
 **while stock last
 *** decor available only in horizontal wood grain

Available colours of aluminum door frames

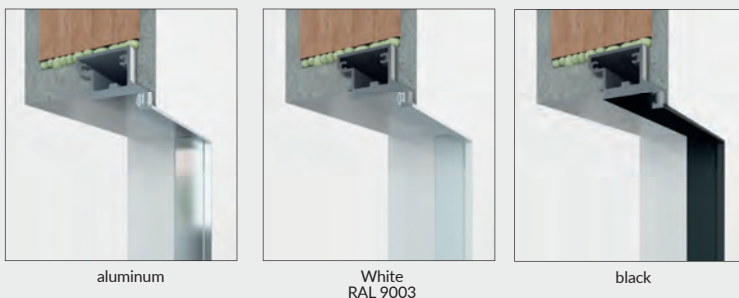

white acrylic UV varnish - RAL 9003
 ecru - RAL 9001
 latte - Flugger 4362, NCS S1505-Y50R
 ashen - RAL 7035

NON-REBATED - OPENED OUTWARDS AND INVERTED REBATE - OPENED INWARDS

Sara Eco 2 door leaf is an innovative solution for creative interior design with the use of "invisible" doors. This unique construction gives possibility to finish surface of door leaf in the colors of the walls.

CONSTRUCTION OF SARA ECO 2 DOOR LEAF COMPRISES OF:

Aluminum door frame, "invisible" after assembly process, build in the wall or overlayed with plasterboards. After detailing process, the only visible part is the rebate of the door frame, prepared for future painting, e.q. in the colors of the walls.

Non-rebated panel construction door leaf and inverted rebate in two finishing options:

- » wide surfaces of door leaf are primed and ready for painting or paperhanging (e.q. in the colour of the walls). Edges of the leaf are covered with a paintable edge band. Painting is to be done at one-s discretion or optional choose painted decor.
- » Wide door leaf surfaces covered with foils from DRE-Cell, 3D, CP black ST groups or with painting foil in the group of painted decors, the edges of the door leaf covered with the edging in the color of the foil (except for antique copper and concrete oxide colors).

OPTIONS AVAILABLE WITH EXTRA CHARGE WITH PRIMER

- » ventilation undercut
- » recuperative undercutting -15mm
- » tubular chipboard in standard 202
- » tubular chipboard in 220 standard
- » tubular chipboard in standard 240
- » solid chipboard in standard 202
- » solid chipboard in standard 220
- » solid chipboard, standard 240

STANDARD OPTION

- » door leaf frame made of softwood
- » sockets for 2 or 3 recessed hinges, new hinges with increased load capacity up to 60 kg are used in white and black door frame colors
- » core made of „honeycomb“
- » white or silver simple key magnetic lock, toilet lock, cylinder lock or economic lock

OPTIONS AVAILABLE WITH EXTRA CHARGE IN DRE-CELL, 3D AND PAINTED

- » ventilation undercut
- » recuperative undercutting -15mm
- » plastic ventilation grille
- » aluminum ventilation grille
- » dropping seal
- » tubular chipboard in standard 202
- » tubular chipboard in 220 standard
- » tubular chipboard in standard 240
- » solid chipboard in standard 202
- » solid chipboard in standard 220
- » solid chipboard, standard 240

Price of the door frame includes 2 or 3 hidden concealed hinges.

Note: in the option with a tubular chipboard or solid chipboard in standard 202, there are required 3 hinges.

SARA ECO 2 door leaves in the primer with DRE aluminum door frames in aluminum and white color are available from stock in selected configurations.

NON-REBATED - OUTWARD OPENING, DRE DOOR FRAME

Horizontal cross-section of the Sara Eco 2 non-rebated door - opening outwards

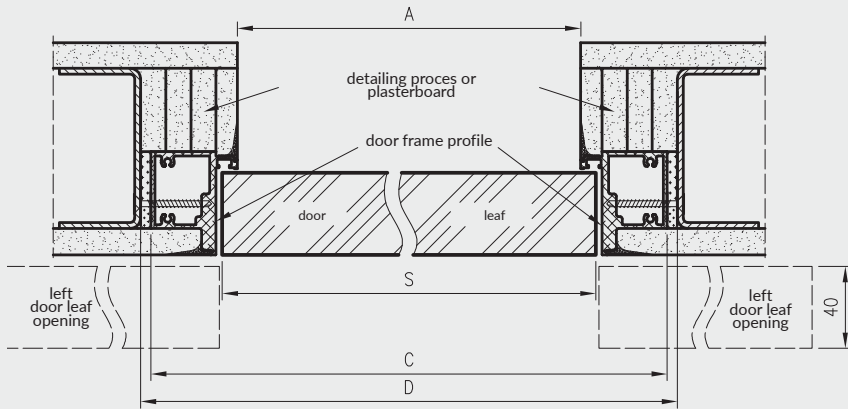

Vertical cross-section of the Sara Eco 2 non-rebated door leaves - opening outwards

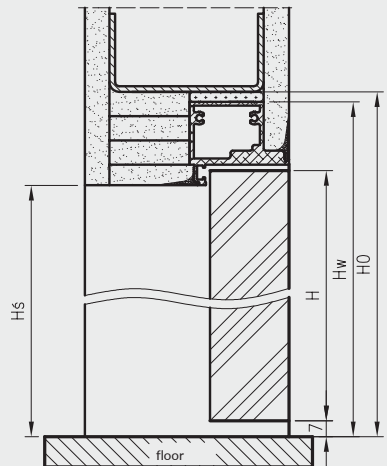

Dimensions of the door leaf width Sara Eco 2

	S	A	C	D
"60"	620	605	690	700
"70"	720	705	790	800
"80"	820	805	890	900
"90"	920	905	990	1000
"100"	1020	1005	1090	1100

height dimensions of rebated doors

standard	H	Hs	hw	H0
202x	2020	2020	2062	2070
220X	2200	2200	2242	2250
240X	2400	2400	2442	2450

DRE profile for non-rebated outward opening doors

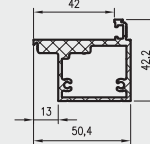

INVERTED REBATE - INWARD OPENING, DRE DOOR FRAME

Cross-section of Sara Eco 2 with inverted rebate - opened inwards

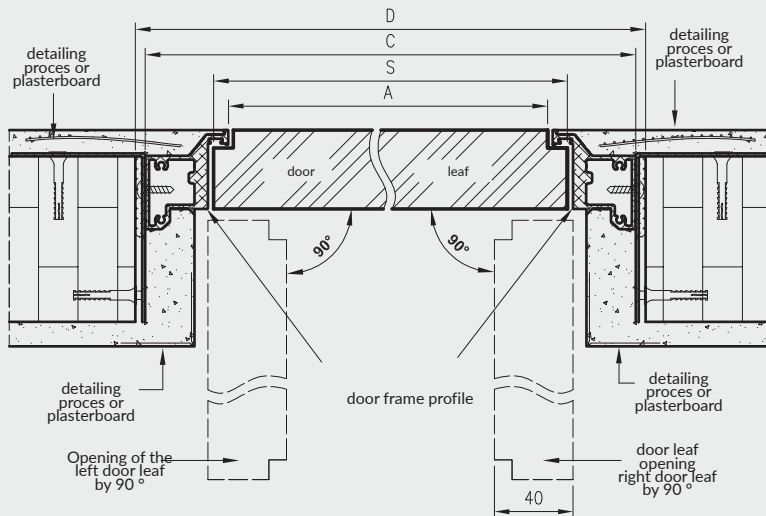

Vertical section of Sara Eco 2 with inverted rebate - opened inwards

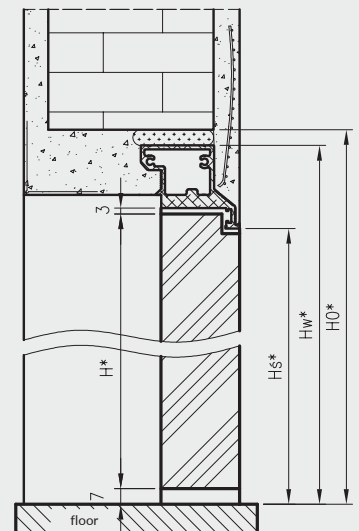

Dimensions of the door leaf width Sara Eco 2

	S	A	C	D
"60"	620	605	690	700
"70"	720	705	790	800
"80"	820	805	890	900
"90"	920	905	990	1000
"100"	1020	1005	1090	1100

S - door leaf width
A - width of passage in door frame unit
C - external width of door frame
D - required width of wall opening

height dimensions of rebated doors

standard	H*	Hs*	Hw*	H0*
202x	2030	2030	2072	2080
220X	2210	2210	2252	2260
240X	2410	2410	2452	2460

DRE profile for doors with inverted rebate opened inwards

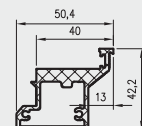



folding doors FOLDE 10 - white matt

Decor DRE-Cell	white matt	white (textured)	white pine	siberian elm	silver	sand oak	bleached oak textured	vintage oak	caramel walnut
	golden oak textured	walnut	anthracite elm	dark wenge	toffee oak***, *	marrone chestnut textured	light gray matt	evoke oak	
Decor 3D	grand oak	elm	american walnut	ebony*	Polish oak 3D				

*** decor available only in horizontal wood grain

*while stock last

In folding doors during opening process of door leaf unit, doors fold into position parallel to each other. The complete set of folding doors comprises of:

- » two-elements door leaf connected by 3 hidden recessed hinges
- » adjustable door frame for folding doors

STANDARD OPTIONS

- » door leaf frame made of softwood
- » core made of „honeycomb“
- » straight edge **fig. 1**
- » single-point mortise simple key lock, bathroom lock, cylinder lock or economic lock
- » 3 hidden recessed ISTAR hinges installed between two-elements of door leaf unit

OPTIONS AVAILABLE WITH EXTRA CHARGE

- » core made of tubular chipboard
- » door leaf "90" and "100"

fig. 1



fixed edge

Cross-section of folding doors in closed position*
(right doors, left doors are mirror reflection)

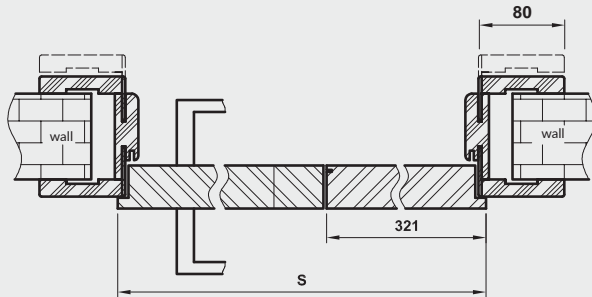

Dimensions

	S	A	B	C	D	E
"80"	844	806	830	850	880	990
"90"	944	906	930	950	980	1090
"100"	1044	1006	1030	1050	1080	1190

D - required width of wall opening

NOTE: There is no possibility to shorten door leaf.

Cross-section of folding doors
in opened position*

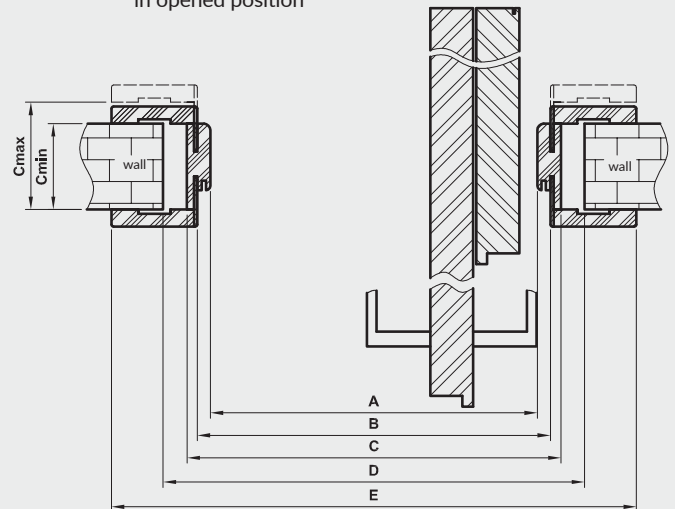

*NOTE: When doors are fully opened, the door fittings slightly reduce the clear opening by approx. 10 cm. (this value doesn't take into account door handle)

Cmin	Max
95	115
120	140
140	160
160	180
180	200
200	220
220	240
240	260
260	280
280	300

vertical cross-section

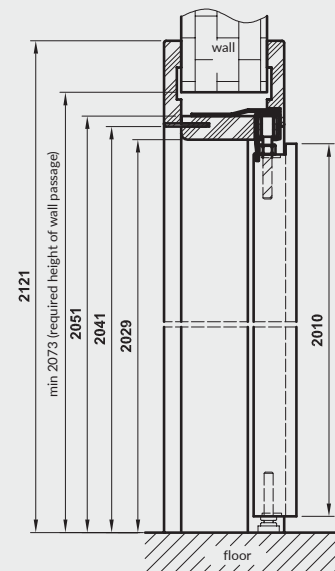

STANDARD OPTIONS

- » stiles made of wood-based panels
- » glass pane 4 mm: MAT DRE, decormat brown, decormat graphite or transparent glass
- » 3 silver screw-in pivot hinges
- » latch strike plate and two flush bolts
- » straight edge **fig. 1**

fig. 1



OPTIONS AVAILABLE WITH EXTRA CHARGE

- » door frame for door leaf with side panel +30%

NOTE: Price of side panel is equal to the price of corresponding door leaf model.

There is possibility to make side panels to all frame construction door leaf, available in presented collections, in following combinations: „60+40“; „70+40“; „80+40“; „90+40“; „100+40“

NOTE: There is no possibility to shorten side panels.



white (textured)	white matt	white pine	light gray matt	siberian elm	sand oak	bleached oak textured	marrone chestnut textured	Decor DRE-Cell
	golden oak textured	anthracite elm	evoke oak	black matt 2	dark wenge	caramel walnut	vintage oak	
			elm	american walnut	ebony*	Polish oak 3D	grand oak	Decor 3D

*while stock last

TRANSOM LIGHTS / SIDELIGHTS



Possible configuration of transom lights/side lights



TRANSOM LIGHTS AND SIDELIGHTS

Transom lights/ sidelights are fixed, unpenable, glazed partition between rooms or spaces that may constitute an independent structure or a supplement for interior doors (except for glass doors) with a fixed door frames. Transom lights/sidelights are manufactured and delivered as a set of components ready for assembly. Set contains the following:

- » two horizontal and two vertical main beams
- » set of cover and instalation strips
- » set of gaskets
- » main beam couplers

Transom lights/sidelights are used in interior doors with a fixed door frames and they come in the following decors DRE-Cell, 3D , CPL laminate 0,15-0,20 mm and painted.

NOTE: Our product doesn't come with the glass pane, which should be purchased separately. We reccomend to use tempered glass pane with a thickness of 4 mm. Assembly of transom lights/sidelights should be performed once the "wet" construction are completed.

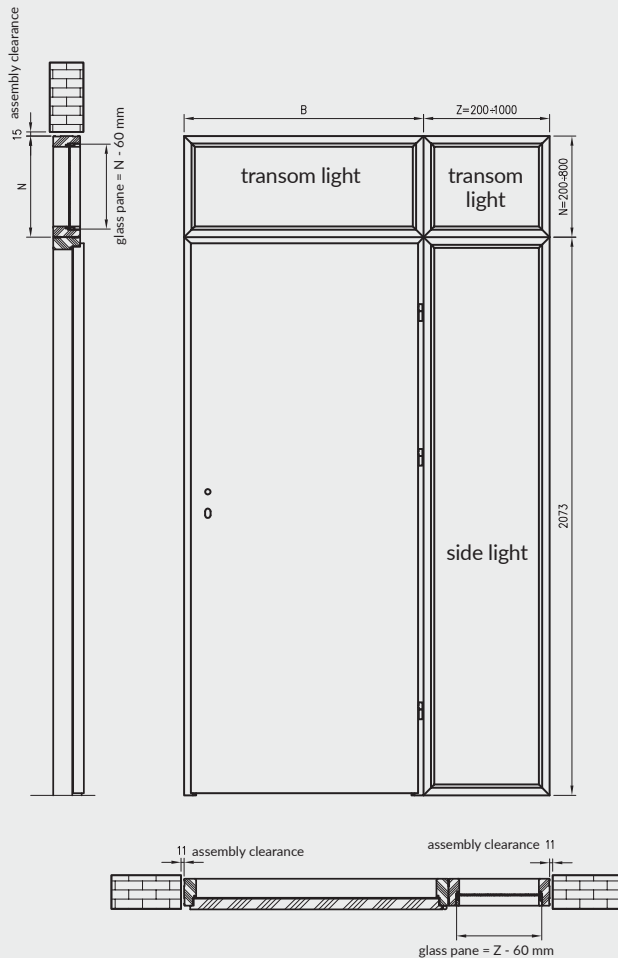
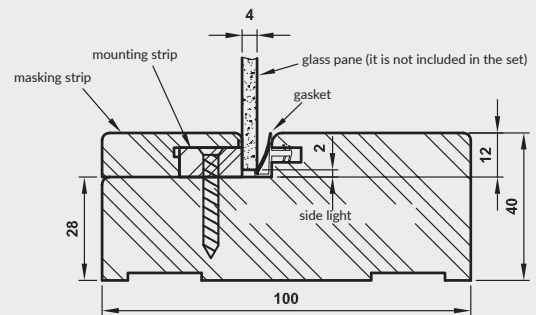

Fig. A cross-section of the transom light/sidelights



Dimensions of transom lights/sidelights

range of products	height total	width total	length of the perimeter
side light	2073 mm	Z	$2 \cdot 2073 + 2 \cdot Z$
sidelight	N	Z	$2 \cdot N + 2 \cdot Z$
transom light	N	B	$2 \cdot N + 2 \cdot B$

available options of transom lights heights

„N” = 200-800 mm.

available options of the width of transom and side lights

„Z” = 200-1000 mm.

Width of the upper "B" transom lights is adjusted to the width of the fixed door frames; the available options of the width of fixed door frames; available options of the widths can be found in the following tables:

The transom lights are mounted on the single-leaf door frame

	"60"	"70"	"80"	"90"	"100"	"110"
B	688	788	888	988	1088	1188

Transoms mounted with the door frame in double-leaf doors

	„100d"	„110d"	„120"	„130"	„140"	„150"	„160"	„170"	„180"	„190"	„200"
B	1123	1223	1323	1423	1523	1623	1723	1823	1923	2023	2123

Price of the transom lights/sidelights is calculated per one meter of circumference measured on the outer side of the transom lights/sidelights.

To place an order please contact the Investment Department - phn. 55 236 42 59.

NOTE: height of the sidelight is adapted to the standard height of the fixed door frame. Therefore, we do not reccomend shortening door frames in configuration with the sidelight.

ENTER/SOLID

REBATED DOOR LEAVES
interior entrance



STANDARD OPTIONS

- » door leaf frame made of MDF additionally reinforced with two flat metal bars
- » core made of tubular chipboard
- » external HDF board - flat or with decorative milling
- » 3 silver screw-in pivot hinges
- » straight edge **Fig. 1** or edge R 2.5 mm (in CPL laminates, except for white, milky white, gray) **Fig. 2**

REBATED DOOR LEAF MODEL ENTER:

- » bottom deadbolt lock adapted for door lock cylinder
- » upper deadbolt lock adapted for door lock cylinder
- » Door leaves are available in the investment dimension "90E" (door frame passage with opened door leaf at 90 degree = 900mm)

REBATED DOOR LEAF SOLID

- » multipoint mortise lock
- » hinges reinforced with anti-thrust bolts
- » Door leaves are available in the investment dimension "90E" (door frame passage with opened door leaf at 90 degree = 900mm)

APPLICATION

Door leaf ENTER and SOLID can be used as internal entrance door in multifamily and in public utility buildings.

CONSTRUCTION

Construction door leaf frame is made of MDF, additionally reinforced with two flat metal bars. Core is made of perforated chipboard. Door leaf unit has increased acoustic insulation (Rw=32dB). External HDF board is ennobled with DRE-Cell veneer - optional - flat finishing or decorative milling. **Door leaf models ENTER/SOLID are available with 0,7 mm CPL laminate - to place an order and for more information please contact Customer Service Department.**

NOTE: ENTER 0 and SOLID 0 - door leaves in CPL laminates as a standard with an edge radius R 2.5 mm except for white, milky white, gray.

It is recommended to use together with door leaf collection ENTER/SOLID fixed door frame
ENTER/SOLID or metal door frames.

fig. 1



straight edge

fig. 2



R 2,5 edge

* door handle and upper backplate METRO, set of cylinder lock inserts- single key system



ENTER/SOLID 0



ENTER/SOLID 1



ENTER/SOLID 2

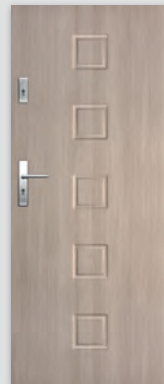

ENTER/SOLID 3



ENTER/SOLID 4



ENTER/SOLID 5



ENTER/SOLID 6



ENTER/SOLID 7



ENTER/SOLID 8



ENTER/SOLID 9



ENTER/SOLID 10



ENTER/SOLID 11



OPTIONS AVAILABLE WITH EXTRA CHARGE

- » viewfinder - included separately
- » digital viewfinder DDS1 - included separately
- » digital viewfinder DDS2 - separately
- » stainless steel threshold - width 70 mm
- » resignation from the second lock (Enter)
- » dropping seal

*** decor available only in horizontal wood grain
*while stock last

				light gray matt	white matt	silver	Decor DRE-Cell 1
white (textured)	white pine	siberian elm	sand oak	bleached oak textured	vintage oak	caramel walnut	Decor DRE-Cell 2
walnut	toffee oak***	marrone chestnut textured	evoke oak	golden oak textured	anthracite elm	dark wenge	
		grand oak	elm	american walnut	ebony*	Polish oak 3D	Decor 3D
white	milky white	ashen	gray dark	concrete 2	gray oak	welsh oak	Laminate CPL
acacia	celini walnut	walnut	honey oak	chestnut	roasted walnut	black ST	

ENTER/SOLID

REBATED DOOR LEAVES
interior entrance



STANDARD OPTIONS

- » door leaf frame made of MDF additionally reinforced with two flat metal bars
- » core made of tubular chipboard
- » external HDF board - flat or with decorative milling
- » 3 silver screw-in pivot hinges
- » straight edge Fig. 1 or edge R 2.5 mm (in CPL laminates, except for white, milky white, gray) Fig. 2

REBATED DOOR LEAF MODEL ENTER:

- » bottom deadbolt lock adapted for door lock cylinder
- » upper deadbolt lock adapted for door lock cylinder
- » Door leaves are available in the investment dimension "90E" (door frame passage with opened door leaf at 90 degree = 900mm)

REBATED DOOR LEAF SOLID

- » multipoint mortise lock
- » hinges reinforced with anti-thrust bolts
- » Door leaves are available in the investment dimension "90E" (door frame passage with opened door leaf at 90 degree = 900mm)

APPLICATION

Door leaf ENTER and SOLID can be used as internal entrance door in multifamily and in public utility buildings.

It is recommended to use together with door leaf collection ENTER/SOLID fixed door frame ENTER/SOLID or metal door frames.

CONSTRUCTION

Construction door leaf frame is made of MDF, additionally reinforced with two flat metal bars. Core is made of perforated chipboard. Door leaf unit has increased acoustic insulation (Rw=32dB). External HDF board is ennobled with DRE-Cell veneer - optional - flat finishing or decorative milling.

fig. 1



straight edge

fig. 2



R 2,5 edge



ENTER/SOLID 12



ENTER/SOLID 13



ENTER/SOLID 14



ENTER/SOLID 15



ENTER/SOLID 16



ENTER/SOLID 17



ENTER/SOLID 18



ENTER/SOLID 19*



ENTER/SOLID 20*



ENTER/SOLID 21**

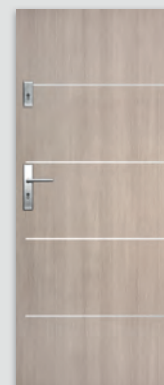

ENTER/SOLID 22**



ENTER/SOLID 23**

* in models 19 and 20 veneer is glued in strips with variable wood grain.

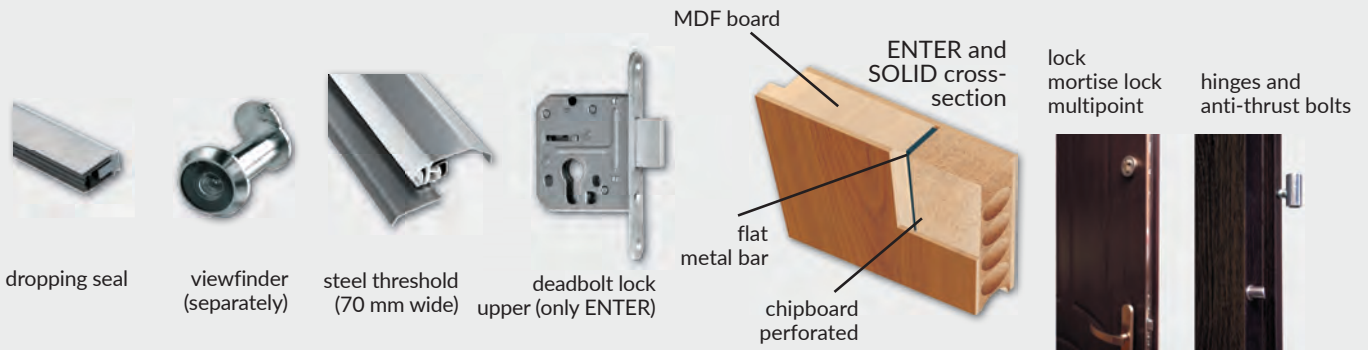

NOTE: models ENTER 21-23 and SOLID 21-23 - door leaves in CPL laminates and edge with R 2,5 mm radius as a standard.

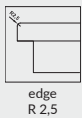

R 2,5 mm edge
in CPL laminate



**in 21-23 models there are 8mm inserts located in one plane with the door leaf surface on both sides



digital viewfinder DDS1 (separately)

digital viewfinder DDS2 (separately)

*** decor available only in horizontal wood grain
*while stock last

				light gray matt	white matt	silver	Decor DRE-Cell 1
white (textured)	white pine	siberian elm	sand oak	bleached oak textured	vintage oak	caramel walnut	Decor DRE-Cell 2
walnut	toffee oak***	marrone chestnut textured	evoked oak	golden oak textured	anthracite elm	dark wenge	
		grand oak	elm	american walnut	ebony*	Polish oak 3D	Decor 3D
white	milky white	ashen	gray dark	concrete 2	gray oak	welsh oak	Laminate CPL
acacia	celini walnut	walnut	honey oak	chestnut	roasted walnut	black ST	



SOLID RC2 - gray oak CPL

STANDARD OPTION:

- » door leaf frame made of soft wood
- » core made of full chipboard
- » straight edge
- » multipoint mortise lock
- » anti-thrust bolts
- » 3 triple hinges
- » HDF external board with aluminum sheet

SOLID RC2 door has an acoustic insulation class of $R_w=32dB$ and a burglary resistance class of RC2 according to PN-EN 1627:2012, provided that the door leaf is completed with a steel door frame, steel threshold and a separately purchased dedicated set of fittings: handles, long backplates and cylinder inserts. Photo of the door handle and a long backplate p. 166.

APPLICATION

Door leaf SOLID RC2 can be used as internal entrance door in multifamily buildings and in public utility buildings. It can be used together with door frames:

- » OSS (fixed steel door frame) information and prices - page 154
- » OSR (adjustable steel door frame) information and prices - page 156
- » OSH (hybrid steel door frame) information and prices - page 160

OPTIONS AVAILABLE WITH EXTRA CHARGE

- » viewfinder - separately
- » "100" door leaves
- » steel threshold
- » ONTARIO door handle
- » ONTARIO backplate
- » cylinder lock insert (price for 2 pcs.)

OPTIONS WITHOUT EXTRA CHARGE

Door leaves are available in the investment dimension "90E"
(door frame passage with opened door leaf at 90 degree
= 900mm)



SOLID RC2



threefold hinge E878

				white	milky white	ashen	gray dark	concrete 2	gray oak	welsh oak	Laminate CPL
				acacia	celini walnut	walnut	honey oak	chestnut	roasted walnut	black ST	
white matt	light gray matt	dark gray matt	brown matt	white semigloss	light gray semi-gloss	DARK GRAY semi-gloss	semigloss brown	beige semigloss	black matt	Black semi-gloss	Available colours metal door frames
RAL 9003	RAL 7047	RAL 7024	RAL 8017	RAL 9003	RAL 7047	RAL 7024	RAL 8017	RAL 1001	RAL 9005	RAL 9005	

Door frames colours are in two gloss scale (matt/low structure, semi gloss/plain).

FIRE RESISTANT DOOR LEAF ATHOS

REBATED

Interior entrance door



ATHOS TECHNICAL DOORS MEET THE FOLLOWING REQUIREMENTS:

- » fire resistance class: EI30 with a steel door frame
- » fire resistance class: EI30 with a wooden door frame
- » smoke proof class: Sa, S₂₀₀
- » mechanical resistance class: 3
- » sound insulation class: RW=32 dB
- » acoustic insulation class: Rw = 37 dB with a wooden door frame and wooden threshold

APPLICATION

Interior entrance fire-resistance doors, are used in residential housing, public utility buildings and collective residential buildings, as well as commercial and technical premises.

STANDARD OPTION

- » door leaf frame made of soft wood
- » core made of full chipboard
- » straight edge
- » single-point mortise lock adapted for cylinder lock
- » 3 triple hinges
- » anti-theft pins

DOOR FRAMES

- » fixed steel door frame, page 154
- » adjustable steel door frame p. 156
- » hybrid steel door frame, page 160
- » wooden door frame p. 129

OPTIONS AVAILABLE WITH EXTRA CHARGE

- » DORMA TS-71 selfcloser
- » DORMA TS-90 selfcloser
- » GEZE TS 2000 selfcloser
- » door leaf "100" (for 0.7 mm laminate)
- » door leaves "100" "110" (for 0.15-0.2 mm laminates)
- » viewfinder
- » wooden threshold

In order to comply with the conditions of the National Technical Assessment, doors with fire resistance EI 30 should be equipped with a selfcloser.

NOTE: The price of the door leaf does not include the price of a steel frame or a wooden frame.

Door leaves with a width of "110" in 0.7 mm laminates available after individual pricing by the Contract Department.



ATHOS 10

Laminate
CPL



CONSTRUCTION

OD ATHOS wooden door frame is made of glued pine wood, covered with CPL O, 15-0.2 mm laminate on the exposition side. Frame beams, with a fixed width of 100mm, are cut at an angle of 90°. An intumescent gasket with fire-resistant properties is glued in the channel, milled in the notch of the beams.

APPLICATION

OD ATHOS wooden door frames are dedicated to Athos door leaves, which as a set, installed in accordance with the National Technical Assessment No. 2018/0633, they constitute a partition with fire resistance EI 30. Moreover, equipped with a fixed threshold, they meet the acoustic insulation criteria in accordance with the class $R_w = 37$ dB, and in the configuration with a dropping seal, without a fixed threshold, $R_w = 32$ dB

SET CONTAINS

- » Main beams (lintel, latch plate beam with the main lock catch and main beam with the hinges with milled holes for the yokes and three-part hinges and mounted anti-theft bolt sockets), rebate gasket, three hinges (middle part of the three-part hinge) + 3 hinge yokes, a set of elements to be assembled door frame according to the attached instructions. The door frames are packed in cardboard boxes.

Assortment of wooden frames:

- » OD ATHOS - for Athos door with a fixed threshold
- » OD ATHOS UO - for Athos doors with a dropping seal

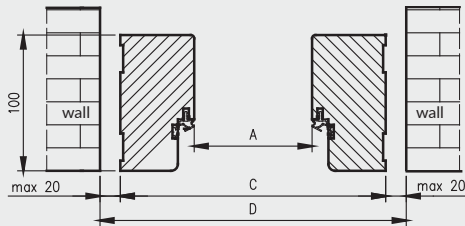

OD dimensions for Athos doors

width.	A	C	D
"80"	802	910	934
"90"	902	1010	1034
"90E"	917	1025	1049
"100"	1002	1110	1134
"110"	1102	1210	1234

D - width of the assembly hole

Wooden door frame for Athos door with a fixed threshold

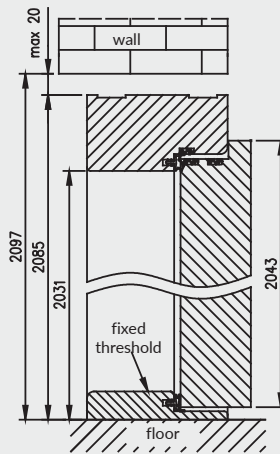

Wooden door frame for Athos door with dropping seal *

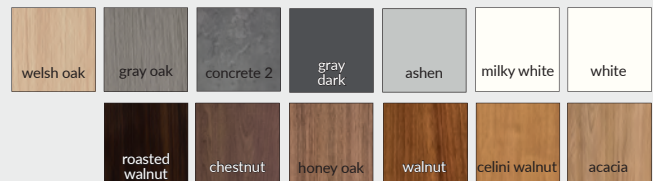
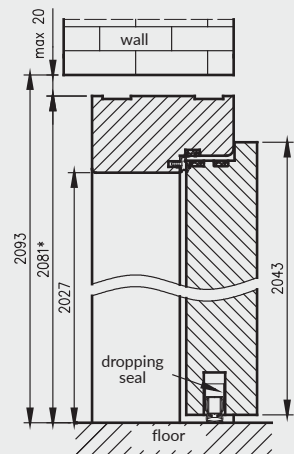

Laminate
CPL

FORCA TECHNICAL DOORS MEET THE FOLLOWING REQUIREMENTS:

- » anti-burglary class: RC3 (according to PN-EN 1627:2012)
- » fire resistance class: EI₂30
- » smoke proof class: Sa, S₂₀₀
- » mechanical resistance class: 3
- » acoustic insulation class: Rw = 37 dB with a steel frame and a metal threshold

APPLICATION

Interior entrance, fire resistance and anti-burglary doors are used in residential housing, public utility buildings and collective residential buildings as well as commercial and technical premises. Doors are sold only as a complete set with metal door frame, metal threshold, door handle, backplate and two cylinder lock inserts.

STANDARD OPTION

- » door leaf frame made of soft wood
- » core made of full chipboard
- » straight edge
- » steel strings
- » 5-point mortise lock
- » 3 triple hinges
- » anti-theft pins

DOOR FRAMES

- » fixed steel door frame, page 155
- » adjustable steel door frame p. 157
- » hybrid steel door frame, page 161

OPTIONS AVAILABLE WITH EXTRA CHARGE

- » steel threshold
- » handle-handle F1 color*
- » long backplate F1 color*
- » patent cylinder x 2 pcs.
- » DORMA TS-71 selfcloser
- » DORMA TS-90 selfcloser
- » GEZE TS 2000 selfcloser
- » door leaf "100"
- » viewfinder

In order to meet the conditions of the National Technical Assessment for doors with fire resistance of EI 30 and anti-burglary - a door closer and a DIVA handle with a long backplate must be used. Photo of the door handle and rosette - page 171.

NOTE: The price of the door leaf should be increased by the price of steel door frame, steel threshold, door handle, backplate and two pcs. of cylinder lock inserts..

* - F8 black anode color, available for contract orders, after consultation and individual price verification with the Investment Department.



FORCA 10



CPL Lami-
nate



FORCA B TECHNICAL DOORS MEET THE FOLLOWING REQUIREMENTS:

- » anti-burglary class: RC3 (according to PN-EN 1627:2012)
- » mechanical resistance class: 3
- » acoustic insulation class: $R_w = 37$ dB with a steel frame and a metal threshold

APPLICATION

Interior entrance, fire resistance and anti-burglary doors are used in residential housing, public utility buildings and collective residential buildings as well as commercial and technical premises. Doors are sold only as a complete set with metal door frame, metal threshold, door handle, backplate and two cylinder lock inserts.

- » door leaf frame made of soft wood
- » core made of full chipboard
- » straight edge
- » steel strings
- » 5-point mortise lock
- » 3 triple hinges
- » anti-theft pins

DOOR FRAMES

- » fixed steel door frame, page 155
- » adjustable steel door frame p. 157
- » hybrid steel door frame, page 161

OPTIONS AVAILABLE WITH EXTRA CHARGE

- » steel threshold
- » handle-handle F1 color*
- » long backplate F1 color*
- » patent cylinder x 2 pcs.
- » door leaf "100"
- » viewfinder

NOTE: The price of the door leaf should be increased by the price of steel door frame, steel threshold, door handle, backplate and two pcs. of cylinder lock inserts..

* - F8 black anode color, available for contract orders, after consultation and individual price verification with the Investment Department.



FORCA B 10

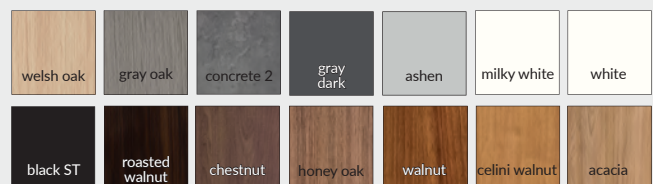

CPL Lami-
nate



OLIMP 10 - white

CPL Lami-
nate

white	milky white	ashen	gray dark	concrete 2	gray oak	welsh oak
acacia	celini walnut	walnut	honey oak	chestnut	roasted walnut	

STANDARD OPTIONS

- » core made of Halspan chipboard 44 mm in EI30 or 54 mm in EI60 with additional pine wood strips attached circumferentially
- » straight edge, rounded glass pane frame **fig.1**
- » transparent fire - resistance glass pane (variable width dependent upon the size of the door leaf)
- » intumescent smoke-proof gasket
- » 3 hinges
- » cylinder lock
- » dropping seal

fig. 1

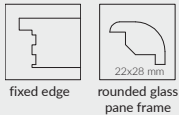

fire-resistant ventilation grille.



GEZE TS 2000 self closer



DORMA self closer
TS-71



DORMA TS-90 impuls self closer



Acoustic sound insulation class for single leaf door $R_w=32$ dB

NOTE: In door leaf with fire-resistance EI30 there are used three triple hinges, while in door leaf with fire resistance EI60 there are used VX7939 hinges.

OPTIONS AVAILABLE WITH EXTRA CHARGE

- » viewfinder
- » DORMA TS-71 selfcloser
- » DORMA TS-90 selfcloser
- » GEZE TS 2000 selfcloser
- » fire resistance ventilation grille.

APPLICATION

Fire-resistance doors are used as interior entrance doors in residential housing, public utility buildings and collective residential buildings. In order to comply with the conditions of the National Technical Assessment self closer should be applied in doors with fire-resistance EI30 and EI60.



OLIMP 10



OLIMP 20

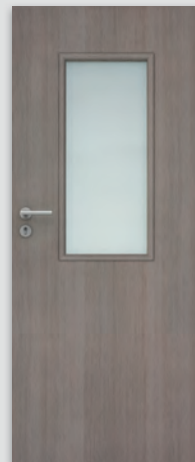

OLIMP 30

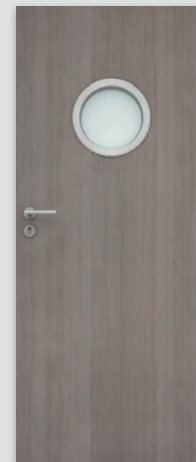

OLIMP 40

OLIMP EI 60 STEEL FIXED DOOR FRAME

DOOR FRAME CONSTRUCTION

Steel door frame made of 1.5 mm thick structural carbon steel sheet, welded construction, powder coated.

APPLICATION

Door frame is applied to the interior entrance fire-resistance doors OLIMP EI60.

STANDARD OPTIONS

- » 3 hinges
- » gasket with enhanced flame-resistance properties

OLIMP EI-60 door leaf vertical cross-section

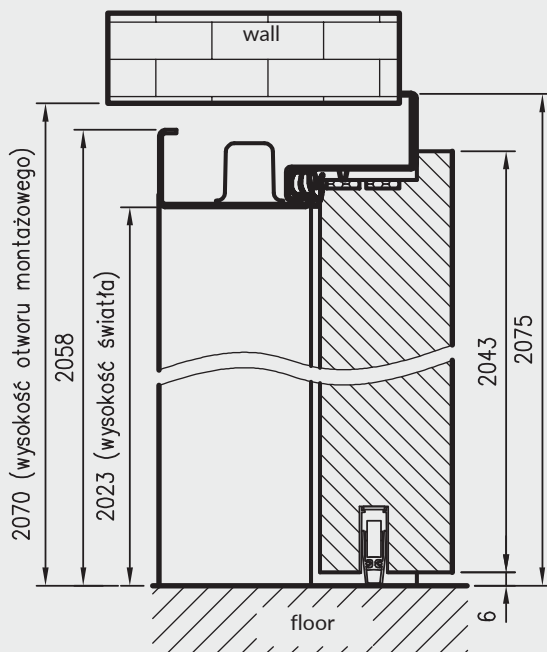

Olimp EI60 dimensions for single leaf doors

	A	C	D	E
"80"	797	867	884	901
"90"	897	967	984	1001
"90E"	926	996	1013	1030
"100"	997	1067	1084	1101
"110"	1097	1167	1184	1201

horizontal cross-section of door frame mounted in the wall

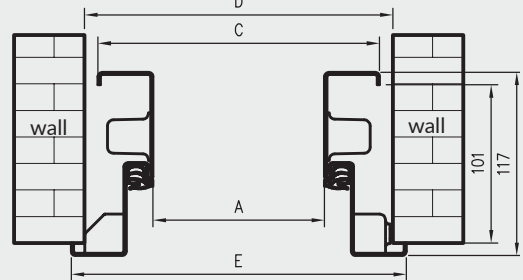

D - width of the assembly hole

door frame profile

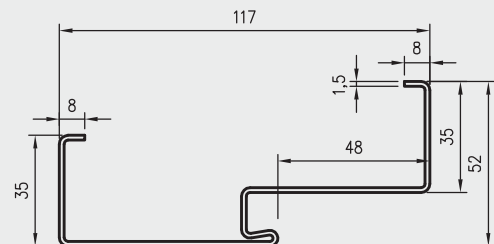

threefold hinge



Hinge SIMONSWERK VX 7939/160 (for door widths "100" and "110")

AVAILABLE COLOURS

Door frame is powder coated in two gloss scale (matt / low structure or semi-gloss / plain). There are available colours:

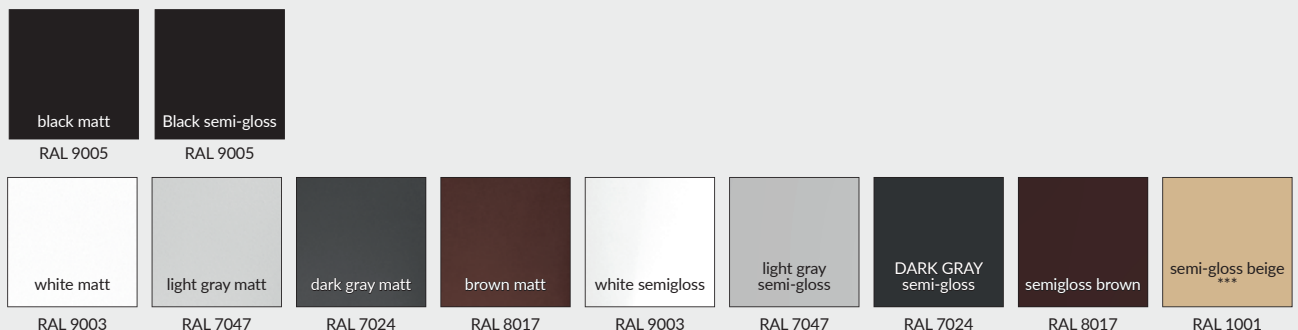

*** beige colour is available only in semi-gloss

WOODEN FIRE RESISTANT DOOR FRAME

For OLIMP EI 30 and EI 60 doors

CONSTRUCTION

Fixed wooden door frame with a cross-section of 54x100 mm (54x120mm for Olimp EI 60 doors) made of coniferous plywood laminated with a 0.2mm CPL laminate in the color of the door leaf.

APPLICATION

The door frame is used for interior fire-resistant entrance doors:

- OD OLIMP EI30 wooden door frame - for Olimp EI 30 doors
- OD OLIMP EI60 wooden door frame - for Olimp EI 60 doors

STANDARD OPTIONS

- » 3 hinges
- » gasket with enhanced flame-resistance properties
- » latch strike plate
- » mounting kit

Cross-section of the wooden door frame for OLIMP EI30 doors

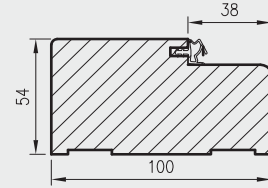

Cross-section of the wooden door frame for OLIMP EI60 doors

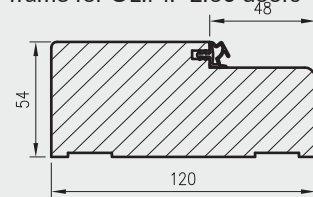

vertical cross-section of fire-resistance door leaf.

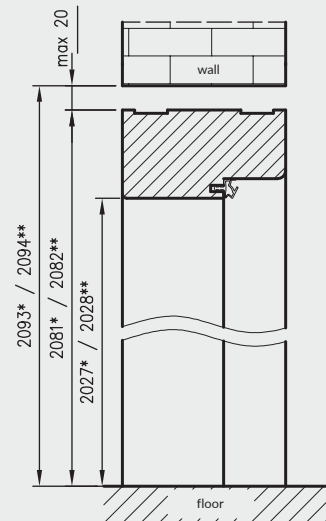

horizontal cross-section door frame in the wall

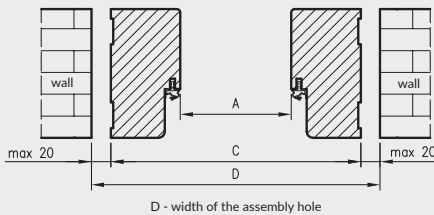

D - width of the assembly hole

* dimensions of OD OLIMP EI 30 wooden door frame

** dimensions of OD OLIMP EI 60 wooden door frame

OD OLIMP EI30 wooden door frame for single-leaf doors

	A	C	D
80	802	910	934
90	902	1010	1034
90E	917	1025	1049
100	1002	1110	1134
110	1102	1210	1234

OD OLIMP EI60 wooden door frame for single-leaf doors

	A	C	D
80	804	912	936
90	904	1012	1036
90E	933	1041	1065
100	1004	1112	1136
110	1104	1212	1236



Laminate
CPL

ENTER ACOUSTIC TECHNICAL DOORS MEET THE FOLLOWING REQUIREMENTS:

- » mechanical resistance class: 3
- » sound insulation class $R_w = 32\text{dB}$

APPLICATION

Door leaf ENTER ACOUSTIC are designed to be used as interior entrance door in multifamily buildings and in public utility buildings

STANDARD OPTION:

- » door leaf frame made of MDF additionally reinforced with two flat metal bars
- » core made of tubular chipboard
- » flat external HDF board
- » dropping seal
- » 3 silver screw-in pivot hinges
- » R2.5mm edge (available only in CPL laminates, except for white, milky white and gray laminates) or straight edge
- » bottom deadbolt lock adapted for door lock cylinder
- » Door leaves are available in the investment dimension "90E" (door frame passage with opened door leaf at 90 degree = 900mm)

DOOR FRAMES:

- » hybrid steel door frame, page 160
- » adjustable steel door frame p. 156
- » fixed steel door frame, page 154
- » fixed rebated door frame p. 140
- » adjustable door frame with T80 architrave, T63 p. 142

OPTIONS AVAILABLE WITH EXTRA CHARGE:

- » viewfinder - included separately
- » door leaves "110" except for 0.7 mm laminates

Door leaves with a width of "110" in 0.7 mm laminates available after individual pricing by the Contract Department.

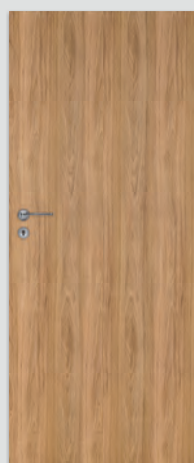

ENTER 0 ACOUSTIC

Decor DRE-Cell 1	silver	white matt	light gray matt																			
Decor DRE-Cell 2	dark wenge	anthracite elm	golden oak textured	caramel walnut	vintage oak	bleached oak textured	sand oak															
	evoked oak	marrone chestnut textured	toffee oak***	walnut	siberian elm	white pine	white (textured)															
Decor 3D	Polish oak 3D	ebony*	american walnut	elm	grand oak																	
CPL Laminate	roasted walnut	chestnut	honey oak	walnut	celini walnut	acacia	welsh oak	gray oak	concrete 2	gray dark	ashen	milky white	white	black ST								

* decor available while stocks last *** decor only in horizontal grain



GALLA 1
transparent



GALLA 1
decormat



GALLA 1
decormat brown



GALLA 1
decormat graphite

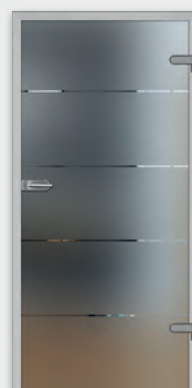

GALLA 2
sand blasted glass
transparent strips

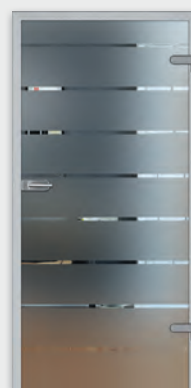

GALLA 3
sand blasted glass
transparent strips



GALLA 10
decormat
screen printing



GALLA 10
transparent glass
screen printing



GALLA 11
decormat
screen printing



GALLA 11
transparent glass
screen printing



GALLA 12
decormat
screen printing



GALLA 13
decormat
screen printing

Door leaf is made of tempered, 8mm glass pane.

OPTIONS AVAILABLE WITH EXTRA CHARGE

» ventilation undercut available in swing door leaf (in "80" and "90" meets ventilation requirements)

FITTINGS FOR GLASS DOORS

DOOR LEAF

SELECTION OF LOCKS FOR GLASS DOORS

Glass door locks are universal, they can be configured for left or right sided doors.

In the case of locks in the "toilet" version (with a bathroom knob) - the term "left" or "right" refers to the direction of opening the door: into the bathroom - left lock or into the corridor - right lock (see Fig. 1-4):

Fig. 1-2. For bathroom doors, select the left lock. Fig. 3-4. Doors opening to the corridor, select the right lock

fig. 1 right door leaf /blockade outside



fig. 2 left door leaf/blockade outside

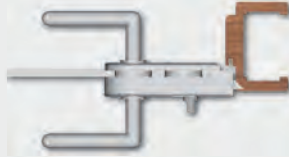
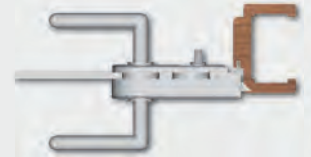

fig. 3 right door leaf/blockade inside



fig. 4 left door leaf/blockade inside



HARDWARE



silver lock

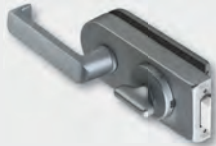

silver lock toilet***



silver lock simple key lock



silver lock cylinder lock**



silver hinge



steel lock



steel lock ***



steel lock simple key lock



steel lock cylinder lock**



steel hinge



black lock



black lock ***



black lock simple key lock



black lock cylinder lock**



hinge black

** It is necessary to purchase cylinder insert 21/26 separately (see details in the above table)

** Toilet lock - selection of toilet lock see details above

DOOR LEAF DIMENSIONS AND PLACEMENT OF HARDWARE

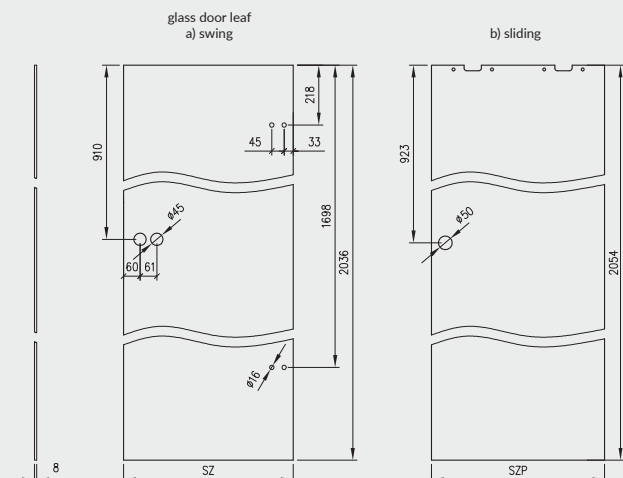

The leaf is a glass pane, made of safe, uniform tempered glass, 8 mm thickness, with holes for mounting:

- » hinges and lock in swing doors leaf
- » round door handle and hardware adapted for sliding system in the sliding door leaf

APPLICATION

Glass door leaf are used as interior doors in residential housing, public utility buildings and collective residential buildings.

OPENING DIRECTION OF GLASS DOOR LEAF

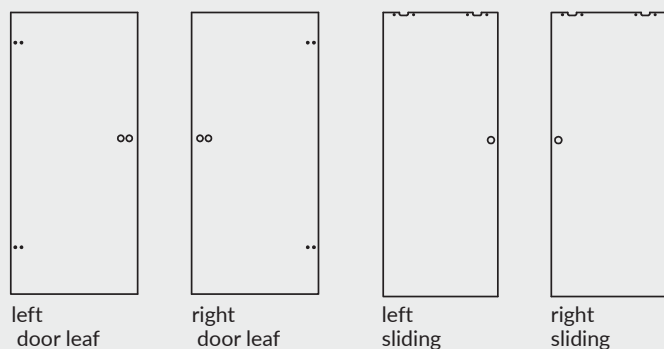

There are two different sides of glass pane in Galla door leaves (does not refer to transparent Galla1).

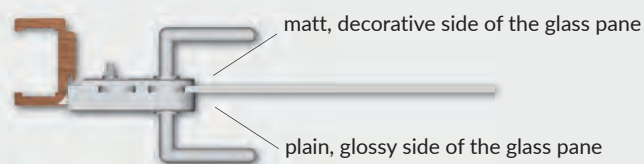

DOOR LEAF WIDTH

Symbol of the door dimension	SZ	SZP
"60"	617	630
"70"	717	730
"80"	817	830
"90"	917	930

SZ - width of glass swing door leaf

SZP - width of glass sliding door leaf

DOOR LEAF HEIGHT

2036 mm - height of glass swing door leaf

2054 mm - height of glass sliding door leaf

NOTE: There is no possibility to shorten glass door leaf.

CLEARANCE BETWEEN DOOR LEAF AND FLOOR

Standard clearance between door leaf unit and ready floor is 8 mm.

NOTES REFERED TO HINGE

DOOR FRAMES applied to glass doors should be equipped with two pivotø 15 mm.

FULFILMENT OF VENTILATION REQUIREMENTS FOR GLASS DOORS

symbol dim. DOORS	doors with ventilation undercut	
	ventilation surface of the undercut and the clearance 8 mm [m ²]	required clearance to meet ventilation requirements [in mm]
"90"	0,027	2
"80"	0,024	5,5
"70"	0,021	10*
"60"	0,017	16*

* - door leaf „60" and „70" doesnt meet ventilation requirements.

Ventilation undercut (only active door leaf)

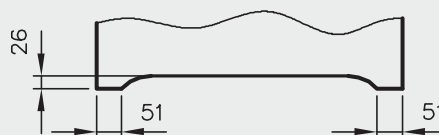

In order to meet ventilation requirement - total ventilation surface 0,022 m², there must be used ventilation undercut in active glass door leaf with "80" - "90" width and standard clearance between door leaf and floor (8mm)

FIXED DOOR FRAMES

REBATED

CONSTRUCTION

Fixed door frame is made of high-quality wood-based board and it is coated with ecological, wood-like decorative DRE-Cell veneer, 3D veneer, 0,15 - 0,20 mm CPL, finish veneer or painted.

Door frames has fixed width of 100 mm.

APPLICATION

Fixed door frame can be used in the following types of doors:

- » ENTER entrance doors (equipped with 3 ø 13,5 mm hinges and additional upper latch plate)
- » SOLID entrance doors (equipped with 3 ø 13,5 mm hinges and 4 hooks for the latch and latches of the flat multi-point lock)
- » glass doors ("OPC" they are equipped with two hinges ø 15 mm, special latch plate and rubber seal strip)
- » other rebated doors (using 2 or 3 hinges ø 13.5 mm, 3 hinges for frame and panel construction doors with a width of "90" and wider)

Masking architraves are used in fixed door frames and SOFT door frames, whereas for natura fixed SOFT door frames angular architrave are used.

THE SET CONTAINS

Main beam (one horizontal and two vertical elements), door seal, a set of hinges, all necessary components for the installation of door frames in accordance with the supplied instruction. Door frames are packed in cardboard boxes.



OP profile

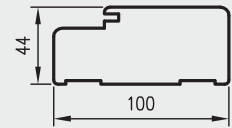

OP SOFT profile

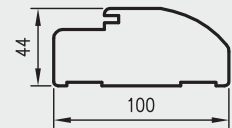

OP vertical cross-section for rebated door leaf

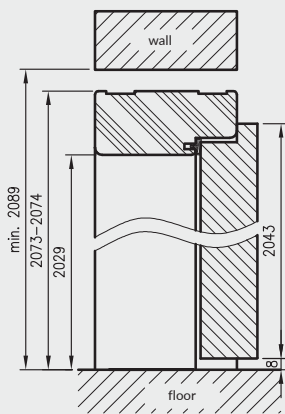

OP vertical cross-section for glass doors

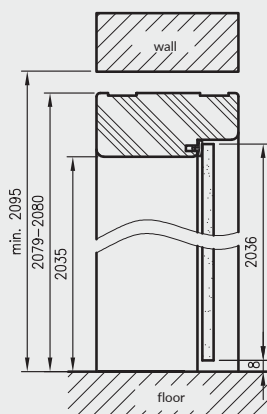

required height of wall passage 2089 mm (2095 mm for glass doors)

OP Horizontal cross section

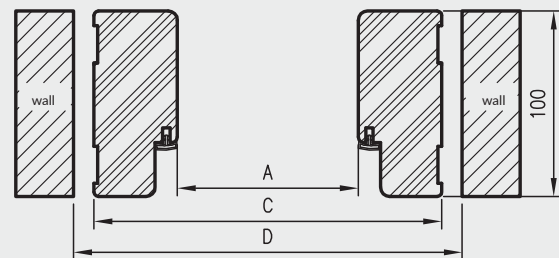

for single-leaf doors

	A	C	D
"60"	600	688	712
"70"	700	788	812
"80"	800	888	912
"90"	900	988	1012
"90E"	904	992	1016
"100"	1000	1088	1112
"110"	1100	1188	1212

for rebated door leaf double-leaf doors

	A	C	D
„100d"	1035	1123	1147
„110d"	1135	1223	1247
„120"	1235	1323	1347
„130"	1335	1423	1447
„140"	1435	1523	1547
„150"	1535	1623	1647
„160"	1635	1723	1747
„170"	1735	1823	1847
„180"	1835	1923	1947
„190"	1935	2023	2047
„200"	2035	2123	2147

* door frames for glass doors, width "60" - "90"
D - required width of wall opening

OPTIONS AVAILABLE WITH EXTRA CHARGE

- » ENTER door frame (with deadbolt catch)
- » door frame SOLID
- » door frame for double leaf door:

+30%

FIXED DOOR FRAMES

NON-REBATED

CONSTRUCTION

Fixed non-rebated door frame is made of high-quality wood-based board and it is coated with ecological, wood-like decorative DRE-Cell veneer, 3D veneer, 0,15 - 0,20 mm CPL or painted. Door frames has fixed width of 100 mm.

APPLICATION

Fixed non-rebated door frame can be applied to all DRE collections which are available in non-rebated option.

SET CONTAINS

Main beam (one horizontal and two vertical elements), door seal, a set of hinges, all necessary components for the installation of door frames in accordance with the supplied instruction. Door frames are packed in cardboard boxes.



OPB vertical cross-section

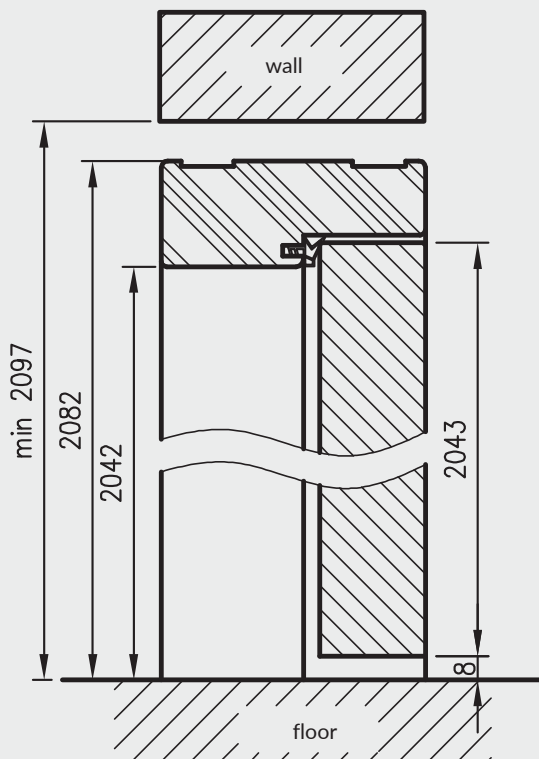

required height of the wall opening 2097 mm

D - required width of wall opening

OPB Horizontal cross section

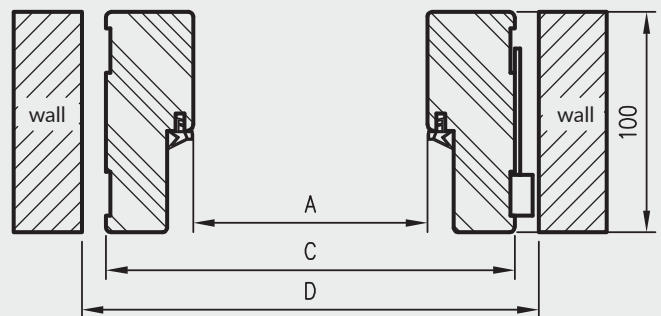

OPB profile

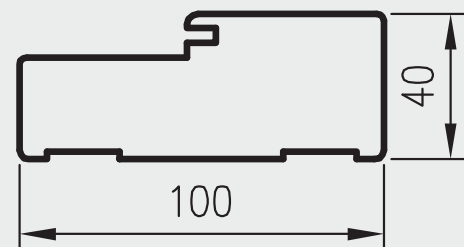

for single-leaf doors

	A	C	D
"60"	627	707	730
"70"	727	807	830
"80"	827	907	930
"90"	927	1007	1030
"100"	1027	1107	1130

for double-leaf doors

	A	C	D
„120"	1274	1354	1380
„130"	1374	1454	1480
„140"	1474	1554	1580
„150"	1574	1654	1680
„160"	1674	1754	1780
„170"	1774	1854	1880
„180"	1874	1954	1980

Prices include 2 hinges with assembly plates.

Price of the double-leaf door frame: + 50% (if 3 hinges are used, there is extra charge)

» Additional payment for the third hinge Estetic 80

ADJUSTABLE DOOR FRAMES

REBATED WITH T80 OR T63 ARCHITRAVE

CONSTRUCTION

Adjustable door frame with T80 or T63 architrave is equipped with angle architraves with small rounding radii of the cross profile. It is made of high-quality wood-based board. On the display side, it is entirely covered with wood-like decorative foil DRE-Cell Decor, 3D foil, and CPL laminate 0.15 - 0.2 mm or painted **. Its design allows for use on walls with a thickness of 60 - 320 mm. Connecting at an 90° angle is available with T80 architrave in **white matt, black matt 2, white painted UV acrylic, white pine, sand oak, vintage oak, 3D Polish oak.**

****NOTE:** To ensure the highest quality of painted door frames, before painting process they are coated with special material which constitutes solid base.

APPLICATION

Adjustable door frame can be applied for:

- » interior door leaves - rebated and for glass door leaves (ORC)
- » entrance doors ENTER (includes 3 hinges ø 13, 5 mm, additional latch plate - extra charge)

SET CONTAINS

Main beam (one horizontal and two vertical elements together with masking elements), door seal, set of hinges, all necessary components for the installation of door frames in accordance with the supplied instruction. Door frames are packed in cardboard boxes.

Door frames are packed in cardboard boxes.

Door frames used as a set with frame construction doors and door frames with size "90" and wider, should be equipped with three hinges. Door frames for glass door "ORC" are equipped with two hinges ø 15 mm, special latch plate and rubber seal strip.



OR (adjustable rebated door frame) with T63



OR (adjustable rebated door frame) with T80

Price of adjustable door frame for double leaf door: +30%

The door frame for wall thickness 060-075 has got a shallower milling on the movable architrave side during assembly it is necessary to shorten the tongue of the architrave.

Extra charge for a 90° connection angle in color **white matt, black matt 2, white UV acrylic varnish, white pine, sand oak, vintage oak, 3D Polish oak**

Extra charge for reinforcement for self closer applies to door frames with 45 degrees connection angle

ADJUSTABLE DOOR FRAMES

REBATED WITH T80 OR T63 ARCHITRAVE

OR/ORC cross-section with T63 architrave

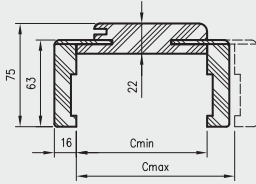

OR/ORC cross-section with T80 architrave

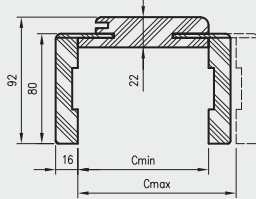

OR/ORC horizontal cross-section

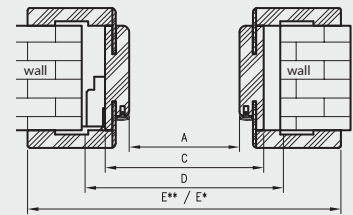

D - required width of wall opening

vertical cross-section of rebated door leaf with OR

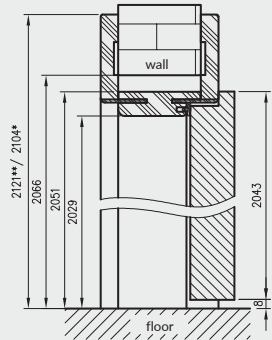

vertical cross-section of glass doors with ORC

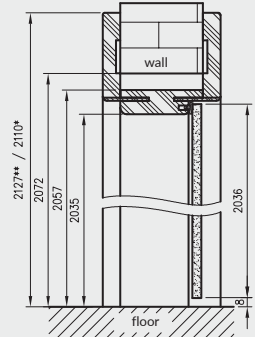

for double-leaf doors

	A	C	D	E**	E*
100d	1035	1079	1115	1219	1185
110d	1135	1179	1215	1319	1285
120	1235	1279	1315	1419	1385
130	1335	1379	1415	1519	1485
140	1435	1479	1515	1619	1585
150	1535	1579	1615	1719	1685
160	1635	1679	1715	1819	1785
170	1735	1779	1815	1919	1885
180	1835	1879	1915	2019	1985
190	1935	1979	2015	2119	2085
200	2035	2079	2115	2219	2185

for single-leaf doors

	A	C	D	E**	E*
60	602	646	680	786	752
70	702	746	780	886	852
80	802	846	880	986	952
90	902	946	980	1086	1052
90E	906	950	984	1090	1056
100	1002	1046	1080	1186	1152
110	1102	1146	1180	1286	1252

Adjustable door frame connection at an angle of 90° T80 architrave

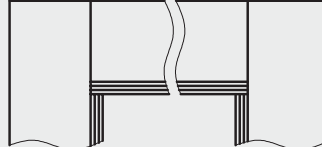

Joining at an angle of 90° is available in white matt, black matt 2, white painted acrylic UV, white pine, sand oak, 3D Polish oak, vintage oak.

* dimension refer to door frame with T63 architrave

** dimension refer to door frame with T80 architrave

required wall passage height 2066 mm (2072 mm for glass doors)

Black ST decor available only with T80 architrave

Price of adjustable door frame for double leaf door: +30%

The door frame for wall thickness 060-075 has got a shallower milling on the movable architrave side during assembly it is necessary to shorten the tongue of the architrave.

Extra charge for a 90° connection angle in color white matt, black matt 2, white UV acrylic varnish, white pine, sand oak, vintage oak, 3D Polish oak

Extra charge for reinforcement for self closer applies to door frames with 45 degrees connection angle

2nd group CPL - CPL laminate natural halifax oak.

NON-REBATED ADJUSTABLE DOOR FRAMES

NON-REBATED WITH T80 OR T63 ARCHITRAVE

CONSTRUCTION

The non-rebated adjustable door frame is made of high-quality wood-based board. On the display side, it is entirely covered with wood-like decorative foil DRE-Cell Decor, 3D foil, CPL laminate or painted**. Its design is adapted to a door leaf thickness of 40 mm and allows for use on walls with a thickness of 75 - 320 mm. Possibility to choose beam connection angle of 90° with T80 architrave in white matt, black matt 2, UV acrylic painted white, white pine, sand oak, vintage oak, 3D Polish oak, lacquered white, lacquered black, decors from the LUX and WOOD collections

**NOTE: To ensure the highest quality of painted and lacquered door frames, before varnishing or painting process they are coated with special material which constitutes solid base.

APPLICATION

The adjustable non-rebated door frame with Estetic 80 hinges is applicable to all DRE collections in the non-rebated version with Estetic 80 hinges.

SET CONTAINS

Main beam (one horizontal and two vertical elements) with wide angular architrave (80 mm) with small rounding angles of the cross-section profile (R2), door seal, a set of hinges, all necessary components for the installation of door frames in accordance with the supplied instruction. Door frames are packed in cardboard boxes.



Prices include 2 hinges with assembly plates.

- » Price of the door frame for double-leaf doors: +50% (with 3 Estetic 80 hinges,extra charge)
- » Extra charge for the third Estetic 80 hinge
- » Price of the door frame for double-leaf doors: +50% (with 3 plate hinges, extra charge)
- » Extra charge for the third plate hinge
- » Extra charge for 90° connection angle in white matt, black matt 2, white UV acrylic varnish, white pine, sand oak, vintage oak, 3D Polish oak, white varnish, black varnish and decors from the LUX, WOOD collection, acrylic laminates (standard gloss, metallic gloss, STANDARD MATT, xtreme matt)
- » Extra charge for reinforcement for self closer applies to door frames with 45 degrees connection angle

NON-REBATED ADJUSTABLE DOOR FRAMES

NON-REBATED WITH T80 OR T63 ARCHITRAVE

ORB cross-section 095-300

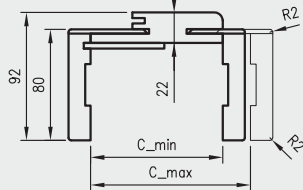

ORB cross-section 075

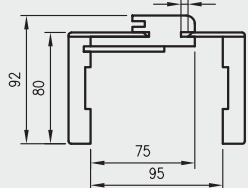

Vertical section of the door non-rebated door leaf

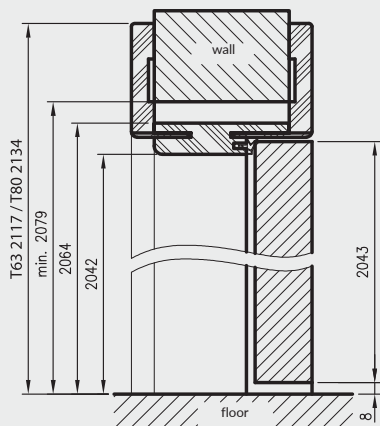

required wall passage height 2079 mm

ORB connection at 45

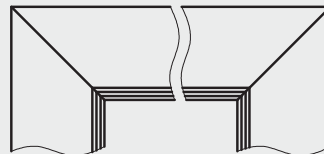

Adjustable non-rebated door frame connection at an angle of 90°** T80 architrave

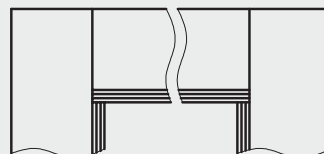

** connection at 90° is available in white matt, black matt 2, white acrylic UV varnish, white pine, sand oak, Polish oak 3D, white varnish, black varnish and LUX and WOOD collections

ORB horizontal cross-section

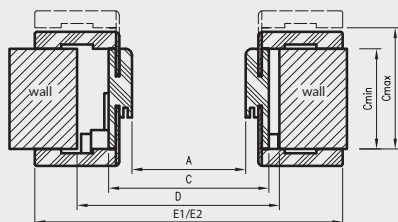

D - required width of wall opening

E1 - dimension for T63 architrave

E2 - dimension for T80 architrave

*075-095 door frame has a different cross section, for 75-89 mm wall thickness, it is necessary to shorten the tongue of the adjustable architrave.

for double-leaf doors

	A	C	D	E1	E2
120	1274	1318	1350	1424	1458
130	1374	1418	1450	1524	1558
140	1474	1518	1550	1624	1658
150	1574	1618	1650	1724	1758
160	1674	1718	1750	1824	1858
170	1774	1818	1850	1924	1958
180	1874	1918	1950	2024	2058

for single-leaf doors

	A	C	D	E1	E2
60	627	671	700	777	811
70	727	771	800	877	911
80	827	871	900	977	1011
90	927	971	1000	1077	1111
100	1027	1071	1100	1177	1211

Black ST decor and laminates: standard gloss, metallic gloss, STANDARD MATT, xtreme matt available only with T80 architrave

Prices include 2 hinges with assembly plates.

» Price of the door frame for double-leaf doors: +50% (extra charge when using 3 Estetic 80 hinges)

» Extra charge for the third Estetic 80 hinge

» Price of the door frame for double-leaf doors: +50% (extra charge when using 3 plate hinges)

» Extra charge for third plate hinge

» Extra charge for a 90° connection angle in white matt, black matt 2, white UV acrylic varnish, white pine, sand oak, 3D Polish oak, vintage oak, white varnish, black varnish and decors from the LUX, WOOD collection, acrylic laminates

(standard gloss, metallic gloss, STANDARD MATT, xtreme matt)

» Extra charge for reinforcement for self closer applies to door frames with 45 degrees connection angle

ADJUSTABLE DOOR FRAMES

REBATED WITH VARIABLE HEIGHTS WITH T80 OR T63 ARCHITRAVE

Due to customer interest in doors in non-standard dimensions, we have introduced Modern and Plus collections and Standard 10 door leaf model with an adjustable door frame in 3 additional height variants.

APPLICATION

The adjustable door frame with variable heights can be used for Standard 10, Modern, Plus rebated door leaves in three additional door leaf height options: 1983 mm, 2110 mm and 2240 mm.

SET CONTAINS

Main beam (one horizontal and two vertical elements together with masking elements), door seal, set of hinges, all necessary components for the installation of door frames in accordance with the supplied instruction. Door frames are packed in cardboard boxes.

Door frames are packed in cardboard boxes.

All rebated door frames in 3 additional height options should be equipped with 3 hinges.



OR vertical cross-section

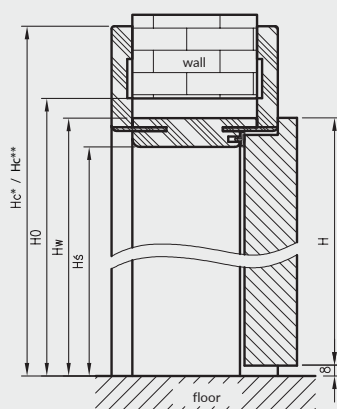

H	H ^S	hw	H0	hc **	hc *
1983	1969	1991	2006	2061	2044
2110	2096	2118	2133	2188	2171
2240	2226	2248	2263	2318	2301

Hc* - door leaf height with T63 architrave
Hc** - door leaf height with T80 architrave

for single-leaf doors

	A	C	D	E**	E*
60	602	646	680	786	752
70	702	746	780	886	852
80	802	846	880	986	952
90	902	946	980	1086	1052
100	1002	1046	1080	1186	1152

for double-leaf doors

	A	C	D	E**	E*
120	1235	1279	1315	1419	1385
130	1335	1379	1415	1519	1485
140	1435	1479	1515	1619	1585
150	1535	1579	1615	1719	1685
160	1635	1679	1715	1819	1785
170	1735	1779	1815	1919	1885
180	1835	1879	1915	2019	1985
190	1935	1979	2015	2119	2085
200	2035	2079	2115	2219	2185

OR cross-section with T80 architrave

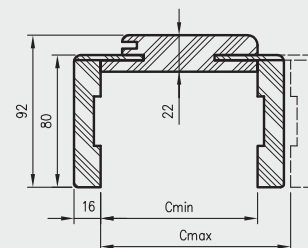

OR horizontal cross-section

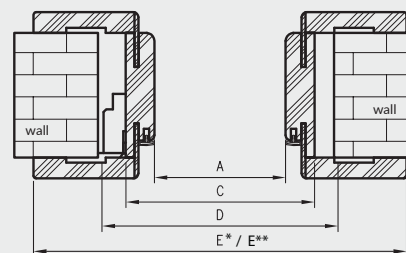

D - required width of wall opening
H - door leaf height
H0 - required the wall passage height

Black ST decor available only with T80 architrave

Extra charge for reinforcement for self closer applies to door frames with 45 degrees connection angle
Price of adjustable door frame for double leaf door: +30%.

NON-REBATED ADJUSTABLE DOOR FRAMES

NON-REBATED WITH VARIABLE HEIGHTS WITH T80 OR T63 ARCHITRAVE

By the fact of interest expressed by our clients in non-rebated doors of custom sizes, we have introduced to our offer collections MODERN, PLUS and STANDARD 10 door leaf model with non-rebated adjustable door frame in 3 additional heights. Construction of the door frame is the same as in the non-rebated adjustable door frame (they vary only in height).

APPLICATION

Non-rebated adjustable door frame with variable heights can be used with non-rebated STANDARD 10, MODERN and PLUS door leaf model which are available in three additional door leaf height options: 1983 mm, 2110 mm and 2240 mm.

SET CONTAINS

Main beam (one horizontal and two vertical elements together with masking elements), door seal, set of hinges, all necessary components for the installation of door frames in accordance with the supplied instruction. Door frames are packed in cardboard boxes.

Door frames are packed in cardboard boxes.

All door frames in 3 additional height options can be equipped with 2 or 3 hinges.



ORB cross-section 095-300

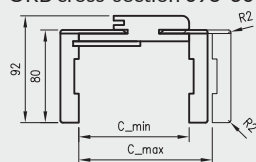

ORB cross-section 075

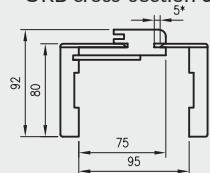

ORB vertical cross-section

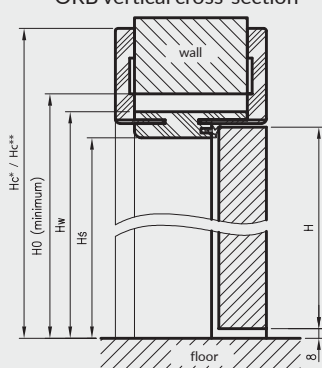

H	HŚ	hw	H0	hc **	hc *
1983	1982	2004	2019	2074	2057
2110	2109	2131	2146	2201	2184
2240	2239	2261	2276	2331	2314

H0 - required the wall passage height

ORB horizontal cross-section

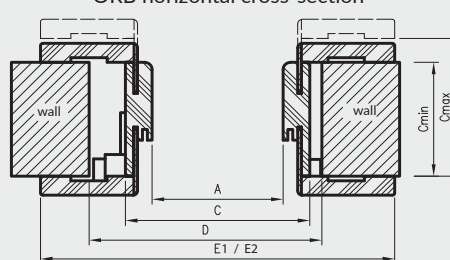

E1 - dimension for T63 architrave
E2 - dimension for T80 architrave

for double-leaf doors

	A	C	D	E2	E1
120	1274	1318	1350	1458	1424
130	1374	1418	1450	1558	1524
140	1474	1518	1550	1658	1624
150	1574	1618	1650	1758	1724
160	1674	1718	1750	1858	1824
170	1774	1818	1850	1958	1924
180	1874	1918	1950	2058	2024

*NOTE: 075-095 door frame has a different cross-section, for a 75-89 mm wall thickness, it will be necessary to shorten pen of the adjustable angle element.

D - required width of wall passage

Black ST decor and laminates: standard gloss, metallic gloss, STANDARD MATT, xtreme matt available only with T80 architrave

Prices for door leaf heights 1983 and 2043 on pages 144-145

for single-leaf doors

	A	C	D	E2	E1
60	627	671	700	811	777
70	727	771	800	911	877
80	827	871	900	1011	977
90	927	971	1000	1111	1077
100	1027	1071	1100	1211	1177

Prices include 2 hinges with assembly plates.

Price of the double-leaf door frame: + 50% (if 3 hinges are used, there is extra charge)

» Additional payment for the third hinge Estetic 80

» Extra charge for reinforcement for self closer applies to door frames with 45 degrees connection angle

» Extra charge for joining at an angle of 90° (standard gloss, metallic gloss, STANDARD MATT, xtreme matt)

NON-REBATED ADJUSTABLE DOOR FRAMES

FOR DOOR LEAVES WITH INVERTED REBATE

CONSTRUCTION

The adjustable door frame with inverted rebate is made of high-quality wood-based board. On the display side, it is covered with ecological, wood-like decorative foil DRE Cell, CP black ST or painted with the highest quality acrylic UV varnishes. To ensure high quality of painted door frames, before painting, they are covered with a special material constituting a uniform base. Its design is adapted to a door leaf thickness of 40 mm and allows for use on walls with a thickness of 90 - 290 mm. Joining at an angle of 45 degrees.

APPLICATION

The door frame with inverted rebate is suitable for selected collections: Estra, Nestor, Nova Cell Uni, Binito, Fargo.

THE SET CONTAINS

Main beam (horizontal and two vertical elements), architrave T80 (horizontal and vertical elements), door seal, set of two Estetic 1821 hinges, magnetic lock latch, door frame assembling set with the manual. Door frames are packed in cardboard packaging.



vertical cross-section of ORO

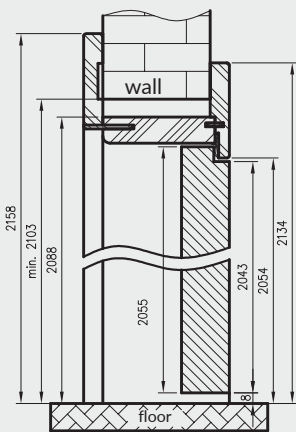

door frame profile

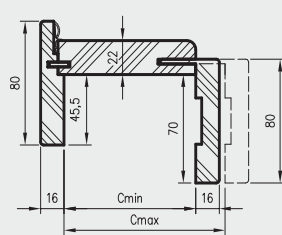

left door leaf

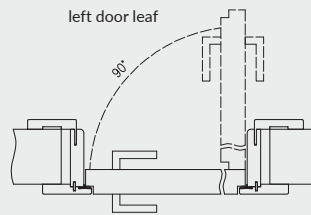

right door leaf

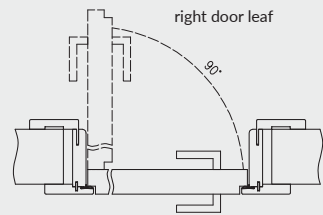

horizontal cross-section of ORO

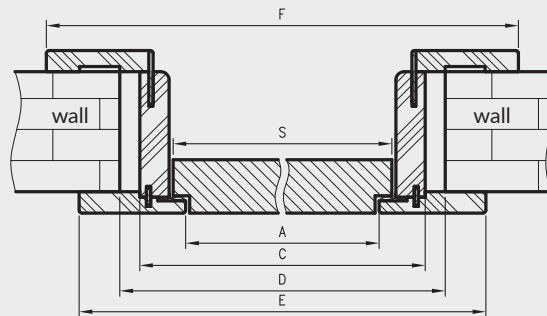

Estetic 1821 hinge

DRE-Cell decor



CPL decor

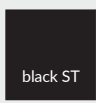

Decor painted

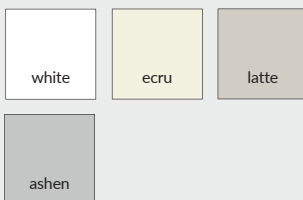

white acrylic UV varnish - RAL 9003
 ecru - RAL 9001
 latte - Flugger 4362, NCS S1505-Y50R
 ashen - RAL 7035

Required height of the wall opening = 2103 mm
 D - required width of wall passage

	A	C	D	E	F	S
60	625	694	724	785	834	644
70	725	794	824	885	934	744
80	825	894	924	985	1034	844
90	925	994	1024	1085	1134	944
100	1025	1094	1124	1185	1234	1044

ADJUSTABLE TUNNEL

WITH ARCHITRAVE T63, T80

Adjustable tunnel is a decorative cover of wall passage. It can be used as a separate solution or as an integral part of the sliding wall-mounted system NT.

The adjustable tunnel is a product which is, at first glance visually similar to adjustable door frames, but with a few differences:

- » there is no possibility to mount any hinges
- » there is no latch strike plate
- » there is no channel for a gasket different heights and spans of the front and rear architraves (values E and F in tables)

tunnel cross-section with T80 architrave

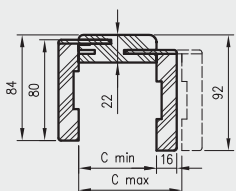

tunnel cross-section with T63 architrave

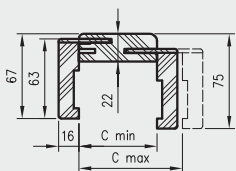

NOTE: To ensure the highest quality of painted tunnels, before painting process they are coated with special material which constitutes solid base..

vertical cross-section of adjustable tunnel with T80 architrave

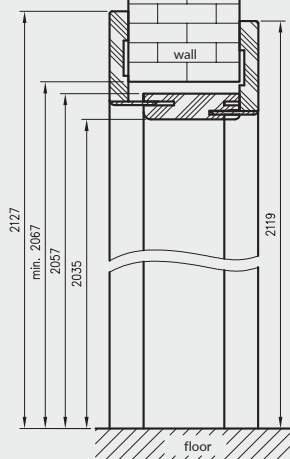

Vertical section of the adjustable tunnel with T63 architrave

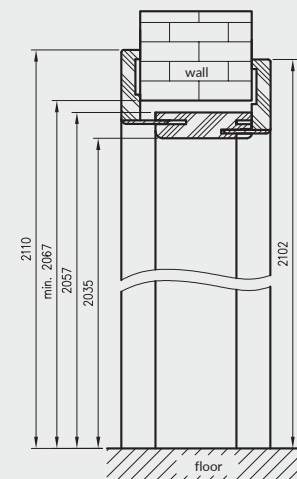

required height of wall opening 2067 mm

Single adjustable tunnel

symbol	60	70	80	90	100
A	602	702	802	902	1002
C	646	746	846	946	1046
D	664	764	864	964	1064
E*	752	852	952	1052	1152
E**	786	886	986	1086	1186
F*	736	836	936	1036	1136
F**	770	870	970	1070	1170

D - required width of wall opening
*refers to Adjustable Tunnel with T63
**refers to Adjustable Tunnel with T80 architrave

Adjustable tunnel cross section

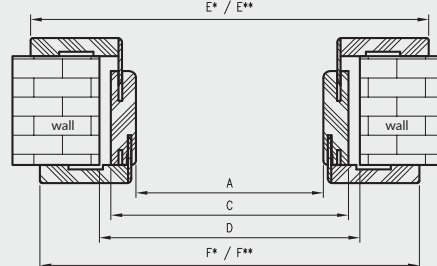

Black ST decor available only with T80 architrave

OPTIONS AVAILABLE WITH EXTRA CHARGE

Tunnel for double leaf door: +30%

Double adjustable tunnel

symbol	120	130	140	150	160	170	180	190	200	symbol	120	130	140	150	160	170	180	190	200
A	1200	1300	1400	1500	1600	1700	1800	1900	2000	E**	1384	1484	1584	1684	1784	1884	1984	2084	2184
C	1244	1344	1444	1544	1644	1744	1844	1944	2044	F*	1334	1434	1534	1634	1734	1834	1934	2034	2134
D	1264	1364	1464	1564	1664	1764	1864	1964	2064	F**	1368	1468	1568	1668	1768	1868	1968	2068	2168
E*	1350	1450	1550	1650	1750	1850	1950	2050	2150	2nd group CPL - CPL laminate natural halifax oak.									



UNI 10 - white

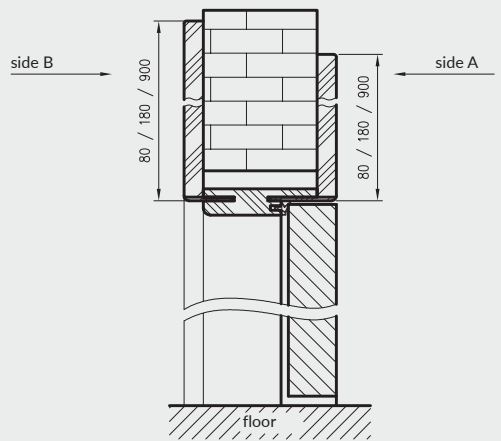

Decor

white	ecru	latte	ashen

white acrylic UV varnish - RAL 9003
 ecru - RAL 9001
 latte - Flugger 4362, NCS S1505-Y50R
 ashen - RAL 7035

Price of the set	=	price of two vertical beams	+	price of the horizontal beam with architrave panels
------------------	---	-----------------------------	---	---

NON-REBATED ADJUSTABLE DOOR FRAMES

WITH ARCHITRAVE PANELS

CONSTRUCTION

Adjustable non-rebated door frame is made of a high-quality wood-based MDF board. On its visual side it is entirely coated with a foil and in next step is painted. Its construction allows to be used with door leaf with the thickness of 40 mm and its design allows to be used on walls with span 75-320. On horizontal beam there are made special architrave panels in three optional dimensions: 80 mm, 180 mm or 900 mm.

APPLICATION

Adjustable non-rebated door frame with architrave panels can be used with all DRE non-rebated painted collections.

SET CONTAINS

Main beam with wide architrave (80 mm) with small rounding angles of the cross-section profile (R2), horizontal beam with architrave panels in 3 optional dimensions, door gasket, a set of hinges, all necessary components for the installation of door frames in accordance with the supplied instruction. Door frames are packed in cardboard boxes.



horizontal cross-section of the lintel

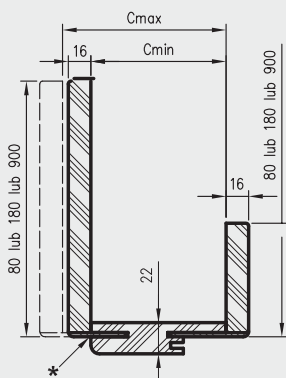

cross-section of vertical beam

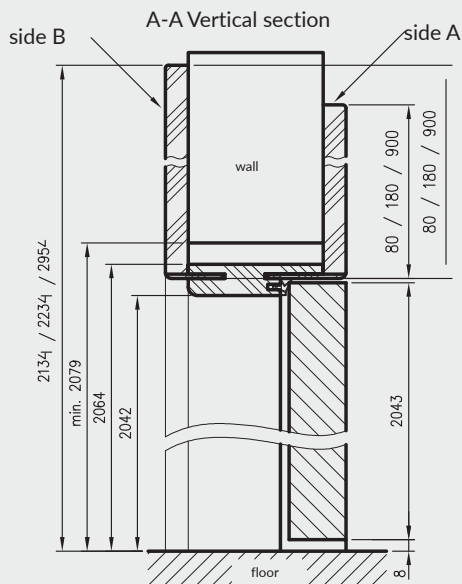
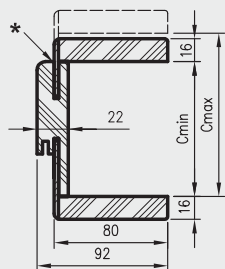

Required height of the wall opening = 2079 mm

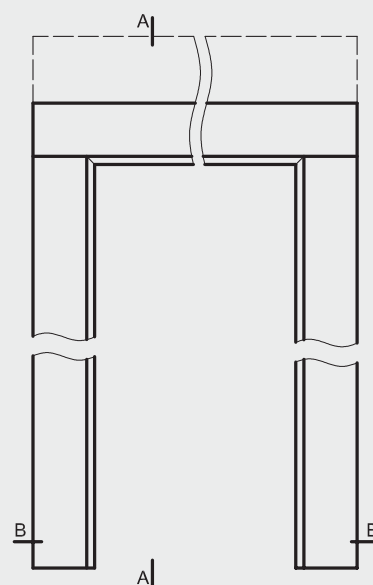

B-B Horizontal cross-section

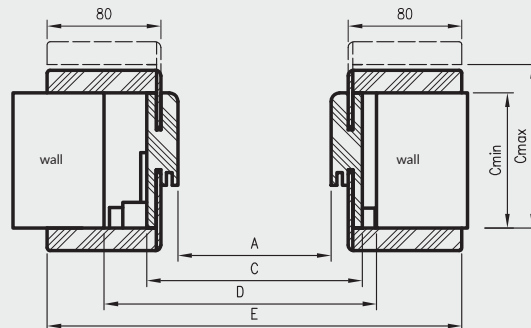

D - required width of wall opening

*NOTE: 075-095 door frame has a different cross-section, shallow milling for architrave, for a 75-89 mm wall thickness, it will be necessary to shorten the tongue of the adjustable masking architrave.

** - third hinge, option at extra charge

for single-leaf doors

	A	C	D	E
60	627	671	700	811
70	727	771	800	911
80	827	871	900	1011
90	927	971	1000	1111
100	1027	1071	1100	1211

EXTENSION PANELS

APPLICATION

Extension panel it is a component of decorative cover of wall passage but also it can be used as extension to install door frames in walls, which are thicker than 320mm. Panel is an extension of middle parts of adjustable door frames and adjustable tunnels. It might be used together with architraves from previous orders of door frames and adjustable tunnels with connection of main beams at 45 degree. Connection angle 90° for adjustable rebated door frame panels is available in white matt, black matt2, white UV acrylic varnish, white pine, vintage oak, sand oak, Polish 3D oak
 Connection angle 90° for adjustable non-rebated door frame panels is available in white matt, black matt2, white UV acrylic varnish, white pine, sand oak, vintage oak, 3D Polish oak, acrylic laminates (standard gloss, metallic gloss, STANDARD MATT, xtreme matt)
 Extension panels with variable heights are available in Cell and CPL veneer groups and laminates: metallic gloss, STANDARD MATT, standard gloss, xtreme matt.

SET CONTAINS

- » two vertical beams
- » horizontal beam
- » three connecting tongues
- » accessories used to connect main beams

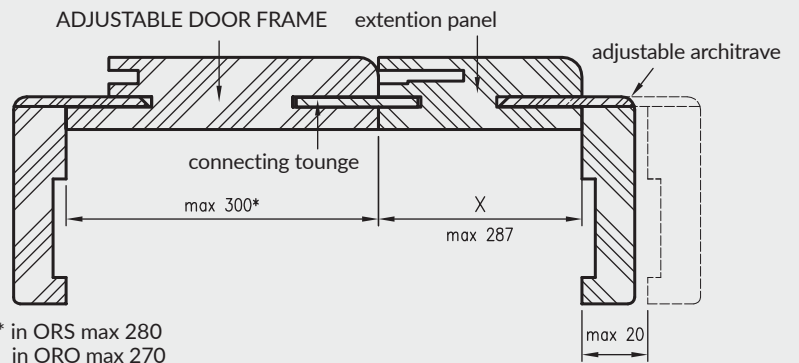
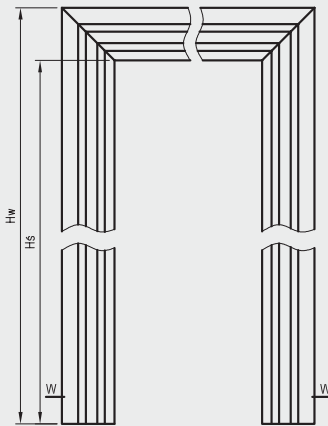

* in ORS max 280
 in ORO max 270
 in TUN max 287

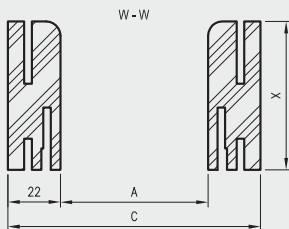

options of the width of panels cross-section

X	062	082	107	127	147	167	187	207	227	247	267	287
---	-----	-----	-----	-----	-----	-----	-----	-----	-----	-----	-----	-----

EXTENSION PANELS

Dimensions of extension panels OR - adjustable door frames for rebated doors

height options					for single-leaf doors							for double-leaf doors										
	PL	198x	211x	224X	"60"	"70"	"80"	"90"	"100"	"110"	"100d"	"110d"	"120"	"130"	"140"	"150"	"160"	"170"	"180"	"190"	"200"	
HŚ	2029	1969	2096	2226	A	602	702	802	902	1002	1102	1035	1135	1235	1335	1435	1535	1635	1735	1835	1935	2035
hw	2051	1991	2118	2248	C	646	746	846	946	1046	1146	1079	1179	1279	1379	1479	1579	1679	1779	1879	1979	2079

Dimensions of the ORB extension panels connected at 45° - non-rebated adjustable door frames for non-rebated doors connected at 45°

height options					for single-leaf doors						for double-leaf doors						
	PL	198x	211x	224X	"60"	"70"	"80"	"90"	"100"	"120"	"130"	"140"	"150"	"160"	"170"	"180"	
HŚ	2042	1982	2109	2239	A	627	727	827	927	1027	1274	1374	1474	1574	1674	1774	1874
hw	2064	2004	2131	2261	C	671	771	871	971	1071	1318	1418	1518	1618	1718	1818	1918

Dimensions of TUN extension panels - adjustable tunnels

		for single-leaf doors					for double-leaf doors									
	PL	"60"	"70"	"80"	"90"	"100"	"120"	"130"	"140"	"150"	"160"	"170"	"180"	"190"	"200"	
HŚ	2035	A	602	702	802	902	1002	1200	1300	1400	1500	1600	1700	1800	1900	2000
hw	2057	C	646	746	846	946	1046	1244	1344	1444	1544	1644	1744	1844	1944	2044

Dimensions of the ORC extension panels - adjustable door frames for glass doors

	PL	"60"	"70"	"80"	"90"	
HŚ	2035	A	600	700	800	900
hw	2057	C	644	744	844	944

Dimensions of the ORS extension panels - adjustable door frames for folding doors

	PL	"80"	"90"	"100"	
HŚ	2029	A	806	906	1006
hw	2051	C	850	950	1050

Dimensions of ORO extension panels - adjustable door frames for door leaves with inverted rebates

	PL	"60"	"70"	"80"	"90"	"100"	
HŚ	2066	A	650	750	850	950	1050
hw	2088	C	694	794	894	994	1094

OPTIONS AVAILABLE WITH EXTRA CHARGE

- » panel for double doors: +30%
- » Extra charge for connecting at an angle of 90°

STEEL FIXED DOOR FRAMES

CONSTRUCTION

metal door frames are made of steel low carbon sheet with 1,5 mm thickness, secured with lacquered, organic protective surface. Door frame consist of two vertical elements: latch plate beam and beam with the hinges (in door frame for double leaf door there are two vertical elements with the hinges) and lintel. Those elements are permanently welded together. Vertical beams with hinges are equipped with sockets for the hinges, while beams for latch plates are equipped with cuts for locks tongue and cuts for dead bolt of dedicated door leaf lock (set includes gasket). Door frame profile, its dimentions, equipment and available colours depends on selected options - type of the door leaf.

APPLICATION / TYPES OF OSS DOOR FRAMES (FIXED STEEL DOOR FRAMES)

OSS_STAND	OSS For rebated interior doors
OSSB_STAND	OSS for non-rebated interior doors
OSS_GLASS	OSS for interior glass doors
OSS_ENTER	OSS for the Enter door, Enter Akustik, Revos
OSS_SOLID	OSS for solid doors
OSS_SOLID_RC2	OSS for Solid RC2 door leaf
OSS_ATHOS	OSS for Athos door leaf
OSS_FORCA	OSS for Forca or Forca B door leaf
OSS_OLIMP_EI30	OSS for Olimp EI-30 door leaf

All frames are designed to be mounted on the finished floor.



STANDARD OPTIONS IN OSS

- » sockets for 2, 3, 4 or 6 hinges
- » socket for latch plate of main lock

STANDARD OPTIONS IN OSSB

- » sockets for 2 or 4 hinges
- » magnetic lock latch

STANDARD OPTIONS IN OSS GLASS

- » sockets for 2 hinges
- » socket for latch plate of main lock

STANDARD OPTIONS IN OSS ENTER

- » sockets for 3 hinges
- » socket for main lock or additionally for upper lock

STANDARD OPTIONS IN OSS SOLID

- » sockets for 3 hinges
- » additional sockets for anti-thrust bolts
- » sockets for latch bolts of multi-point lock used in SOLID model

STANDARD OPTIONS IN OSS SOLID RC2

- » sockets for 3 triple hinges
- » additional sockets for anti-thrust bolts
- » sockets for latch bolts of multi-point lock used in SOLID model

STANDARD OPTIONS IN OSS ATHOS, FORCA, FORCA B

- » sockets for 3 triple hinges
- » additional sockets for anti-thrust bolts
- » sockets for latch plates of five point mortise lock (FORCA, FORCA B)
- » socket for latch plate of main lock (ATHOS)

STANDARD OPTIONS FOR OSS OLIMP EI30

- » socket for latch plate of main lock
- » sockets for 3 three-part hinges

AVAILABLE COLOURS

Door frame is powder coated in two gloss scale (matt / low structure or semi-gloss / plain). There are available colours:



*** beige colour is available only in semi-gloss

STEEL FIXED DOOR FRAMES

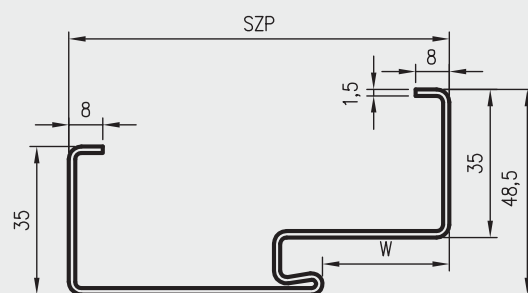
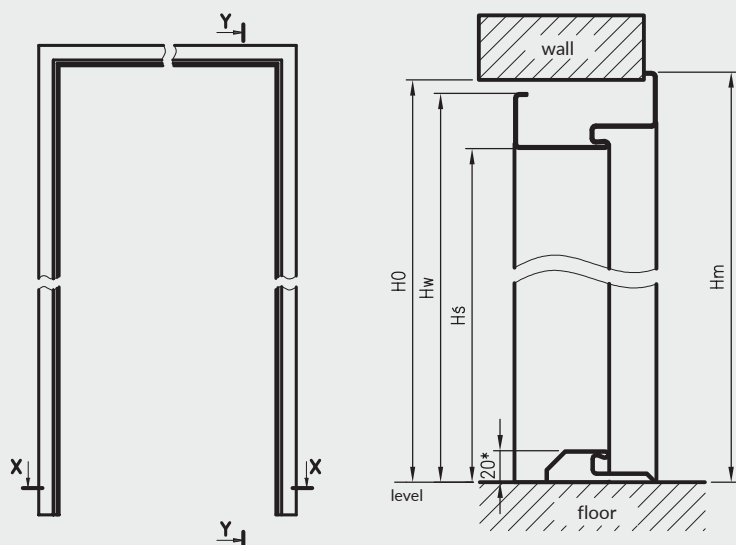

type of the door frame	H_0	H_s	h_w	h_m	W	SZP
OSSB STAND	2084	2040,5	2075,5	2089	46	106
OSS STAND						
OSS ENTER	2071	2027,5*	2062,5	2076	30	90
OSS SOLID						
OSS SOLID RC2						
OSS glass doors	2077	2033,5	2068,5	2082	30	90
OSS ATHOS	2073	2029,5*	2064,5	2078	38	117
OSS FORCA						
OSS OLIMP EI30	2070	2025,5	2060,5	2074		

H_0 - height of the wall opening

H_s - height of the door frame passage

* - with the use of a steel threshold - the actual height of the door frame passage will be reduced by 20mm from the floor

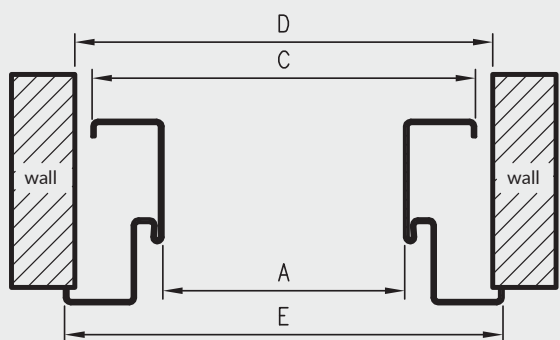

D - width of the assembly hole

OSS OLIMP EI30 for single leaf door

symbol width.	A	C	D	E
"80"	802	872	889	899
"90"	902	972	989	999
"90E"	917	987	1004	1014
"100"	1002	1072	1089	1099
"110"	1102	1172	1189	1199

OSS width dimensions

symbol width.	A	C	D	E	OSS STAND	OSS glass doors	OSS ENTER	OSS SOLID	OSS SOLID RC2	OSS ATHOS	OSS FORCA
"60"	600	670	687	697	●	●					
"70"	700	770	787	797	●	●	●				
"80"	800	870	887	897	●	●	●	●	●	●	●
"90"	900	970	987	997	●	●	●	●	●	●	●
"90E"	904	974	991	1001	●		●	●	●		●
"90E"	915	985	1002	1012						●	●
"100"	1000	1070	1087	1097	●		●	●	●	●	●
"110"	1100	1170	1187	1197	●		●	●	●	●	●

**** - investment dimension "90E" different for technical and remaining doors

OSS STAND dimensions for double leaf doors

symbol width.	A	C	D	E
„100D"	1032	1102	1119	1129
„110D"	1132	1202	1219	1129
„120"	1232	1302	1319	1329
„130"	1332	1402	1419	1429
„140"	1432	1502	1519	1529
„150"	1532	1602	1619	1629
„160"	1632	1702	1719	1729
„170"	1732	1802	1819	1829
„180"	1832	1902	1919	1929
„190"	1932	2002	2019	2029
„200"	2032	2102	2119	2129

OSSB STAND for single leaf door

symbol width.	A	C	D	E
"60"	624	694	711	721
"70"	724	794	811	821
"80"	824	894	911	921
"90"	924	994	1011	1021
"100"	1024	1094	1111	1121

OSSB STAND for double leaf doors

symbol width.	A	C	D	E
„120"	1271	1341	1358	1368
„130"	1371	1441	1458	1468
„140"	1471	1541	1558	1568
„150"	1571	1641	1658	1668
„160"	1671	1741	1758	1768
„170"	1771	1841	1858	1868
„180"	1871	1941	1958	1968

* - STAND steel fixed door frames for double leaf door "100d" - "200" width

** - OSS FORCA B - OSS FORCA option for Forca B doors (without fire resistance)

*** - steel fixed non-rebated OSSB STAND single-leaf door frames with 3 hinges, extra charge, for double-leaf doors with 6 hinges, extra charge of

ADJUSTABLE METAL DOOR FRAME

The essence of the adjustable door frame is that its construction allows to instal door frame, without additional finishing work. Angular architrave allows for additional adjustment in the range + 30mm.

APPLICATION / TYPES OF OSR (ADJUSTABLE STEEL DOOR FRAMES)

OSR_STAND	OSR For rebated interior doors
OSRB_STAND	OSR for non-rebated interior doors
OSR_GLASS	OSR For interior glass doors
OSR_ENTER	OSR for the door leaf Enter, Enter Akustik, Revos
OSR_SOLID	OSS for solid doors
OSR_SOLID_RC2	OSR for Solid RC2
OSR_ATHOS	OSR for Athos door leaf
OSR_FORCA	OSR for Forca or Forca B door leaf
OSR_OLIMP EI 30	OSS for Olimp EI-30 door leaf
OSR_OLIMP EI 60	steel adjustable door frame OSR for Olimp EI 60 doors



All frames are designed to be mounted on the finished floor.

The door frames are suitable for walls with a thickness of 95-305 mm, 103-313 mm in the case of adjustable steel door frame OSR FORCA, adjustable steel door frame OSR ATHOS and adjustable steel door frame OSR OLIMP EI30 or 113-323 mm in the case of adjustable steel door frame OSR OLIMP EI 60. For a given wall thickness, select the appropriate door frame variant, the range of which Cmin - Cmax will contain the thickness of the finished wall

CONSTRUCTION

metal door frames are made of steel low carbon sheet with 1,5 mm thickness, powder painted. Door frame consist of two vertical elements: latch plate beam and beam with the hinges (in door frame for double leaf door there are two vertical elements with the hinges) and lintel. Those elements are permanently welded together. Vertical beams with hinges are equipped with sockets for the hinges, while beams for latch plates are equipped with cuts for locks tongue and cuts for dead bolt of dedicated door leaf lock (set includes gasket). External and internal side of the door frame is secured with lacquered, organic protective surface. Door frame profile, its dimentions, equipment and available colours depends on selected options - type of the door leaf.

STANDARD OPTIONS IN OSR STAND

- » sockets for 2, 3, 4 or 6 hinges
- » socket for latch plate of main lock

STANDARD OPTIONS IN OSRB STAND

- » sockets for 2 or 4 hinges
- » magnetic lock latch

STANDARD OPTIONS IN OSR GLASS DOORS

- » sockets for 2 hinges
- » socket for latch plate of main lock

STANDARD OPTIONS IN OSR ENTER

- » sockets for 3 hinges
- » socket for main lock or additionally for upper lock

STANDARD OPTIONS IN OSR SOLID

- » sockets for 3 hinges
- » additional sockets for anti-thrust bolts
- » sockets for latch bolts of multi-point lock used in SOLID model

STANDARD OPTIONS IN OSR SOLID RC2

- » sockets for 3 triple hinges
- » additional sockets for anti-thrust bolts
- » sockets for latch bolts of multi-point lock used in SOLID model

STANDARD OPTIONS IN OSR ATHOS, FORCA, FORCA B

- » sockets for 3 triple hinges
- » additional sockets for anti-thrust bolts
- » sockets for latch plates of five point mortise lock (FORCA, FORCA B)
- » socket for latch plate of main lock (ATHOS)

STANDARD OPTIONS FOR OSR OLIMP EI30

- » sockets for 3 threefold hinges
- » socket for latch plate of main lock

AS STANDARD STEEL ADJUSTABLE DOOR FRAME OSR OLIMP EI 60

- » sockets for 3 pcs. of three-part or object hinges
- » socket for latch plate of main lock

AVAILABLE COLOURS

Door frame is powder coated in two gloss scale (matt / low structure or semi-gloss / plain). There are available colours:



*** beige colour is available only in semi-gloss

ADJUSTABLE METAL DOOR FRAME

REBATED

Adjustable steel rebated door frames - dimensions

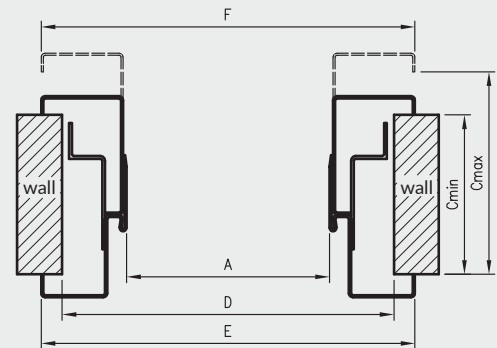
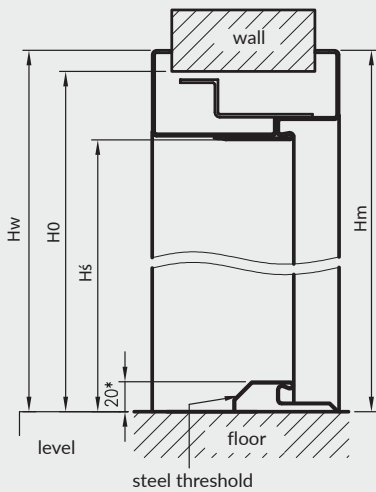

* - with the use of a steel threshold - the actual height of the door frame passage will be reduced by 20mm from the floor

D - width of the wall opening

OSR door frame profile with the T57 architrave

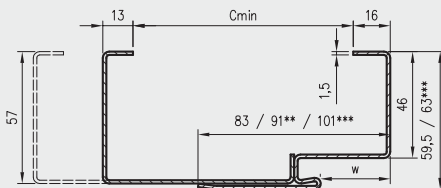

** 91 for steel adjustable door frame OSR ATHOS, OSR FORCA, OSR FORCA B and OSR OLIMP EI 30

*** applies to steel adjustable door frame OSR Olimp EI 60

OSR OLIMP EI30 for single leaf door

symbol width.	A	D	E	F
"80"	802	892	921	921
"90"	902	992	1021	1021
"90E"	917	1007	1036	1036
"100"	1002	1092	1121	1121
"110"	1102	1192	1221	1221

OSR OLIMP EI60 for single leaf door

symbol width.	A	D	E	F
"80"	797	894	923	916
"90"	897	994	1023	1016
"90E"	926	1023	1052	1045
"100"	997	1094	1123	1116
"110"	1097	1194	1223	1216

OSR width dimensions

symbol width.	A	D	E	OSR_STAND	OSR_GLASS DOORS	OSR_ENTER	OSR_SOLID	OSR_SOLID_RC2	OSR_ATHOS	OSR_FORCA
"60"	600	690	719	•	•					
"70"	700	790	819	•	•	•				
"80"	800	890	919	•	•	•	•	•	•	•
"90"	900	990	1019	•	•	•	•	•	•	•
"90E"	904	994	1023	•		•	•	•		
"90E"	915	1005	1034						•	•
"100"	1000	1090	1119	•		•	•	•	•	•
"110"	1100	1190	1219	•		•			•	

**** - investment dimension "90E" different for technical and remaining doors

OSR STAND dimensions for double leaf doors

symbol width.	A	D	E	F
"100D"	1032	1122	1151	1151
"110D"	1132	1222	1251	1251
"120"	1232	1322	1351	1351
"130"	1332	1422	1451	1451
"140"	1432	1522	1551	1551
"150"	1532	1622	1651	1651
"160"	1632	1722	1751	1751
"170"	1732	1822	1851	1851
"180"	1832	1922	1951	1951
"190"	1932	2022	2051	2051
"200"	2032	2122	2151	2151

type of the door frame	H0	Hs	hw	hm	W
OSR_STAND					
OSR_ENTER	2073	2027,5*	2088	2087	30
OSR_SOLID					
OSR_SOLID_RC2					
OSR_GLASS DOORS	2079	2033,5	2094	2093	30
OSR_ATHOS	2073	2027,5*	2088	2087	38
OSR_FORCA					
OSR OLIMP EI30	2073	2027,5	2088	2087	
OSR OLIMP EI60	2072	2023	2083,5	2086	48

H0 - height of the wall opening

Hs - height of the door frame passage

* - with the use of a steel threshold - the actual height of the door frame passage will be reduced by 20mm from the floor

ADJUSTABLE METAL DOOR FRAME

REBATED



ADJUSTABLE METAL DOOR FRAMES

NON-REBATED

Adjustable steel non-rebated door frames - dimensions

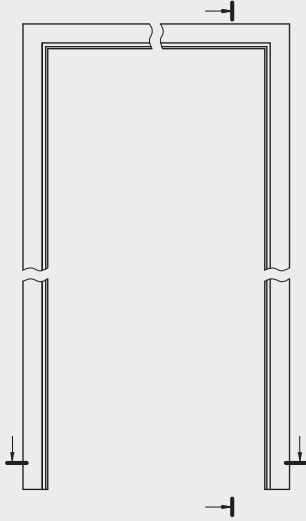

Vertical section of the OSRB

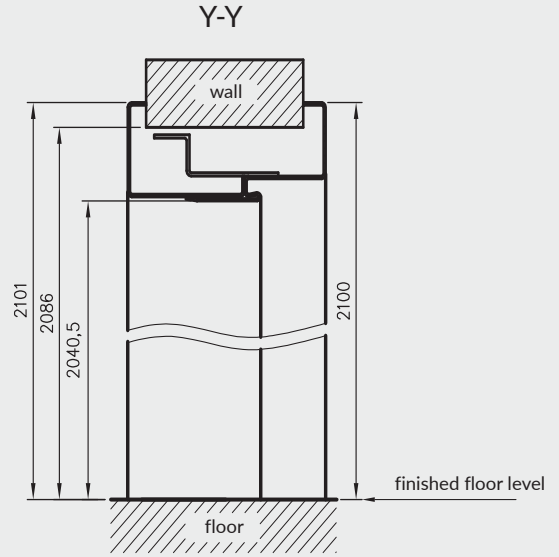

OSRB horizontal cross-section

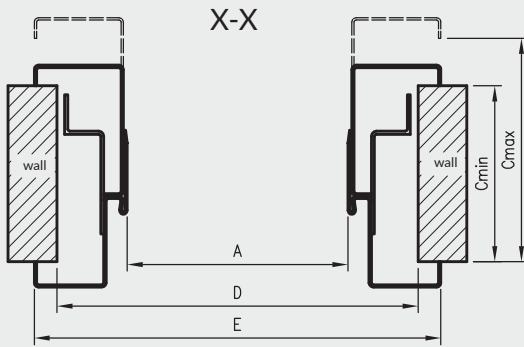

D - width of the assembly hole

adjustable steel non-rebated door frame profile

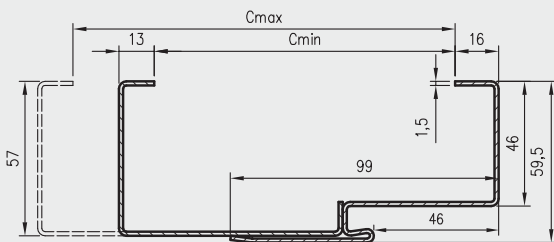

Dimensions for single leaf doors

symbol width.	A	D	E
"60"	624	714	743
"70"	724	814	843
"80"	824	914	943
"90"	924	1014	1043
"100"	1024	1114	1143

Dimensions for double leaf doors

symbol width.	A	D	E
„120"	1271	1361	1390
„130"	1371	1461	1490
„140"	1471	1561	1590
„150"	1571	1661	1690
„160"	1671	1761	1790
„170"	1771	1861	1890
„180"	1871	1961	1990

Note: Extra charge for reinforcement for the door self closer .

HYBRID STEEL DOOR FRAMES

CONSTRUCTION:

Hybrid steel door frames are a solution combining the solidity of a metal structure with additional functionality allowing for full construction of the door frame using wood-based door frame elements finished with CPL laminate. The hybrid door frame is a combination of a fixed-width metal door frame, a wood-based panel available in 11 width variants and a masking architrave. This solution allows for the installation of a door frame with a thickness of 137-337 mm (145-345 for technical doors and 155-355 for Olimp EI60 doors) and adjustment with an architrave up to 20 mm.

Door frame profile dimensions and equipment depend on selected option - door leaf model.

APPLICATION / TYPES OF OSH DOOR FRAMES (HYBRID STEEL DOOR FRAMES)

OSH_STAND	OSH for rebated interior door leaf
OSHB_STAND	OSH for non-rebated interior doors
OSH_GLASS	OSH For interior glass doors
OSH_ENTER	OSH for the door Enter, Enter Akustik, Revos
OSH_SOLID	OSH for Solid doors
OSH_SOLID_RC2	OSH for Solid RC2
OSH_ATHOS	OSH for the Athos door leaf
OSH_FORCA	OSH for Forca or Forca B door leaf
OSH_OLIMP EI 30	OSH for Olimp EI-30 door leaf
OSH_OLIMP EI 60	OSH for Olimp EI 60 doors

All frames are designed to be mounted on the finished floor.

STANDARD OPTIONS IN OSH STAND

- » sockets for 2 or 3 hinges
- » socket for latch plate of main lock
- In the door frame for double leaf doors - sockets for 4 or 6 hinges

STANDARD OPTIONS IN OSHB STAND

- » sockets for 2 or 4 hinges
- » magnetic lock latch

STANDARD OPTIONS IN OSH GLASS

- » sockets for 2 hinges
- » socket for latch plate of main lock

STANDARD OPTIONS IN OSH ENTER

- » sockets for 3 hinges
- » socket for main lock or additionally for upper lock

STANDARD OPTIONS IN OSH SOLID

- » sockets for 3 hinges
- » additional sockets for anti-thrust bolts
- » sockets for latch bolts of multi-point lock used in SOLID model

STANDARD OPTIONS IN OSH SOLID RC2

- » sockets for 3 triple hinges
- » additional sockets for anti-thrust bolts
- » sockets for latch bolts of multi-point lock used in SOLID model

STANDARD OPTIONS IN OSH ATHOS, FORCA

- » sockets for 3 triple hinges
- » additional sockets for anti-thrust bolts
- » sockets for latch plates of five point mortise lock (FORCA, FORCA B)
- » socket for latch plate of main lock (ATHOS)

STANDARD OPTIONS FOR OSH OLIMP EI30

- » socket for latch plate of main lock
- » sockets for 3 triple hinges

AVAILABLE COLOURS

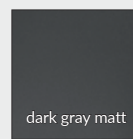
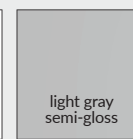
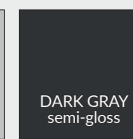
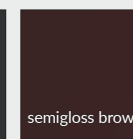

Door frame is powder coated in two gloss scale (matt / low structure or semi-gloss / plain). There are available colours:

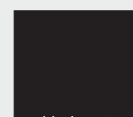
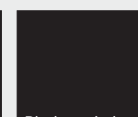
 white matt RAL 9003	 light gray matt RAL 7047	 dark gray matt RAL 7024	 brown matt RAL 8017	 white semigloss RAL 9003	 light gray semi-gloss RAL 7047	 DARK GRAY semi-gloss RAL 7024	 semigloss brown RAL 8017	 semi-gloss beige *** RAL 1001
---	--	---	---	--	--	--	--	---

 black matt RAL 9005	 Black semi-gloss RAL 9005
---	---

*** beige colour is available only in semi-gloss

Adjustable panel with a masking architrave coated with CPL laminate from the list below:

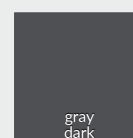
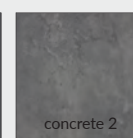
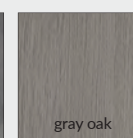
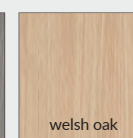
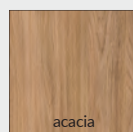
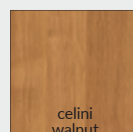
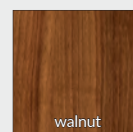
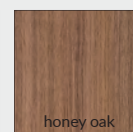
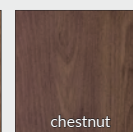
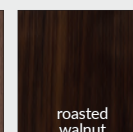
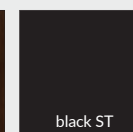
CPL Lami-nate	 white	 milky white	 ashen	 gray dark	 concrete 2	 gray oak	 welsh oak
	 acacia	 celini walnut	 walnut	 honey oak	 chestnut	 roasted walnut	 black ST



AS A STANDARD STEEL HYBRID DOOR FRAME OSH OLIMP EI60

- » socket for latch plate of main lock
- » sockets for 3 pcs. of three-part or object hinges

HYBRID STEEL DOOR FRAMES

REBATED

Hybrid steel rebated door frames - dimensions

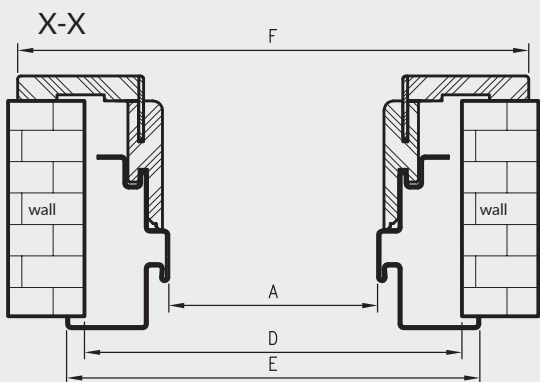
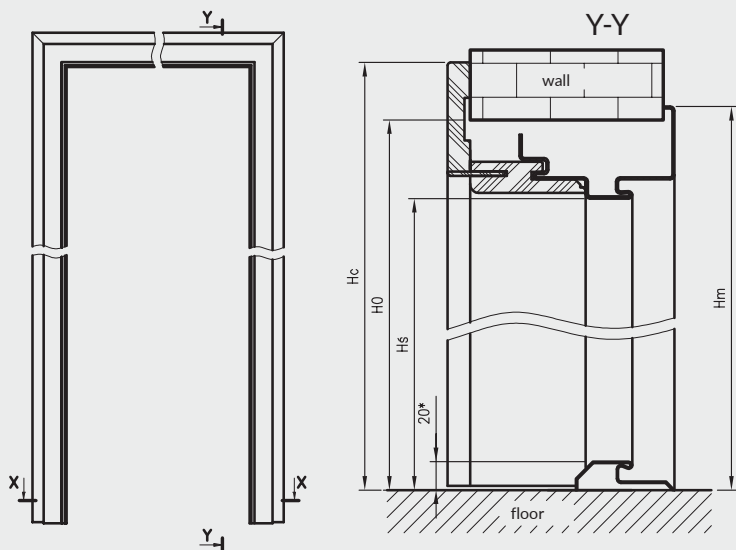

door frame profile

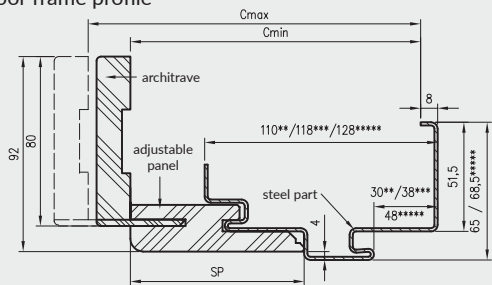

type of the door frame	H0	Hs	hm	HC
OSH_STAND	2083	2027,5*	2092,5	2124
OSH_ENTER				
OSH_SOLID				
OSH_SOLID RC2	2089	2033,5	2098,5	2130
OSH_glass doors				
OSH_ATHOS	2085	2029,5*	2094,5	2126
OSH_FORCA				
OSH OLIMP EI30	2081	2025,5	2090	2122
OSH OLIMP EI60	2082	2023	2091,5	2119

H0 - height of the wall opening

Hs - height of the door frame passage

* - when using a steel threshold - actual

the height of the clear passage will decrease by 20mm from the given one

Dimensions of the door frame width

symbol width.	A	D	E	F	OSH_STAND	OSH_glass doors	OSH_ENTER	OSH_SOLID	OSH_SOLID RC2	OSH_ATHOS	OSH_FORCA
"70"	700	810	830	892	•	•	•				
"80"	800	910	930	992	•	•	•	•	•	•	•
"90"	900	1010	1030	1092	•	•	•	•	•	•	•
"90E"	904	1014	1034	1096	•			•	•		
"90E"	915	1025	1045	1107						•	•
"100"	1000	1110	1130	1192	•		•	•	•	•	•
"110"	1100	1210	1230	1292	•	•				•	

**** - investment dimension "90E" different for technical and remaining doors

D - width of the assembly hole

Select the appropriate option of the adjustable panel with masking architrave (Cmin) for a specific wall thickness

OSH OLIMP EI30 dimensions for single leaf door

symbol width	A	D	E	F
"80"	802	912	932	994
"90"	902	1012	1032	1094
"90E"	917	1027	1047	1109
"100"	1002	1112	1132	1194
"110"	1102	1212	1232	1294

Dimensions OSH OLIMP EI60 for single leaf door

symbol width	A	D	E	F
"80"	797	907	934	989
"90"	897	1007	1034	1089
"90E"	926	1036	1063	1118
"100"	997	1107	1134	1189
"110"	1097	1207	1234	1289

OSH STAND dimensions for double leaf doors

symbol width	A	D	E	F
"100b"	1032	1142	1162	1224
"110b"	1132	1242	1262	1324
"120"	1232	1342	1362	1424
"130"	1332	1442	1462	1524
"140"	1432	1542	1562	1624
"150"	1532	1642	1662	1724
"160"	1632	1742	1762	1824
"170"	1732	1842	1862	1924
"180"	1832	1942	1962	2024
"190"	1932	2042	2062	2124
"200"	2032	2142	2162	2224

** - dimensions for remaining OSH frames

*** - dimensions for OSH ATHOS, OSH FORCA and OSH OLIMP EI 30

**** - dimensions for OSH OLIMP EI 60

Door Frame price = price of the metal part + price of an adjustable panel with a architrave

HYBRID STEEL DOOR FRAMES

NON-REBATED

Steel Hybrid non-rebated door frames - dimensions

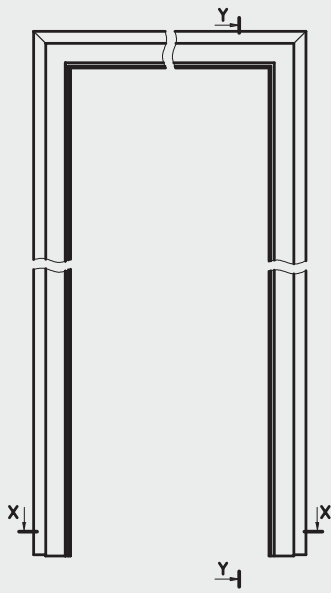

Y-Y Vertical cross-section of OSHB

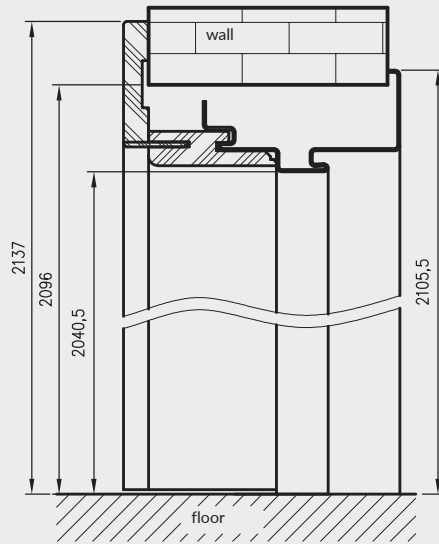

OSHB horizontal cross-section X-X

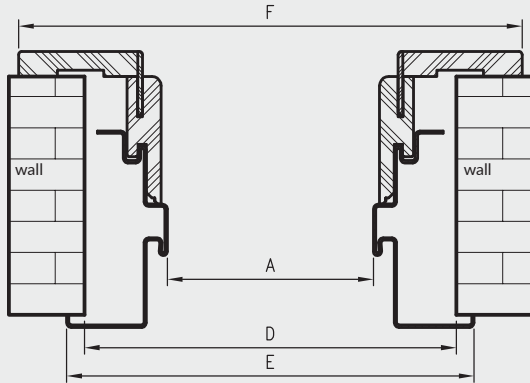

D - width of the assembly hole

hybrid steel non-rebated door frame profile

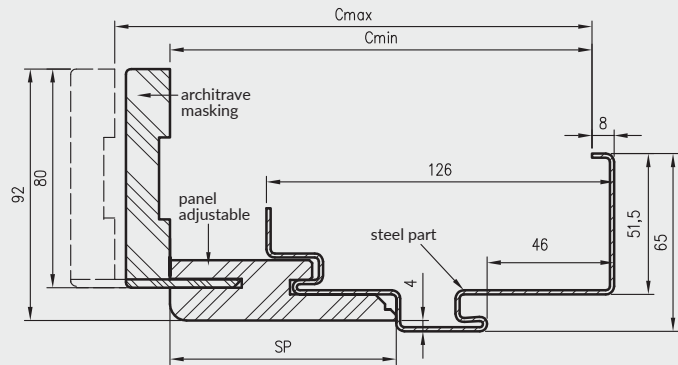

Select the appropriate option of the adjustable panel with masking architrave (Cmin) for a specific wall thickness

Dimensions for single leaf doors

symbol width.	A	D	E	F
"60"	624	734	754	816
"70"	724	834	854	916
"80"	824	934	954	1016
"90"	924	1034	1054	1116
"100"	1024	1134	1154	1216

Dimensions for double leaf doors

symbol width.	A	D	E	F
„120"	1271	1381	1401	1463
„130"	1371	1481	1501	1563
„140"	1471	1581	1601	1663
„150"	1571	1681	1701	1763
„160"	1671	1781	1801	1863
„170"	1771	1881	1901	1963
„180"	1871	1981	2001	2063

SMALL ANGULAR STEEL DOOR FRAMES

CONSTRUCTION:

The steel door frames are made of 1.2 mm thick low-carbon steel sheet, protected with a varnish, organic protective coating. The door frame consists of two stands: latch strike plate and hinge, and a lintel, permanently connected by welding. Hinged racks are equipped with hinge sockets (2-3 pcs.), while hook racks have cutouts for the tongue and latches of the dedicated door leaf lock (the set includes a covering gasket).

APPLICATION

Small Angular Steel Door Frame - door frame designed for rebated interior doors

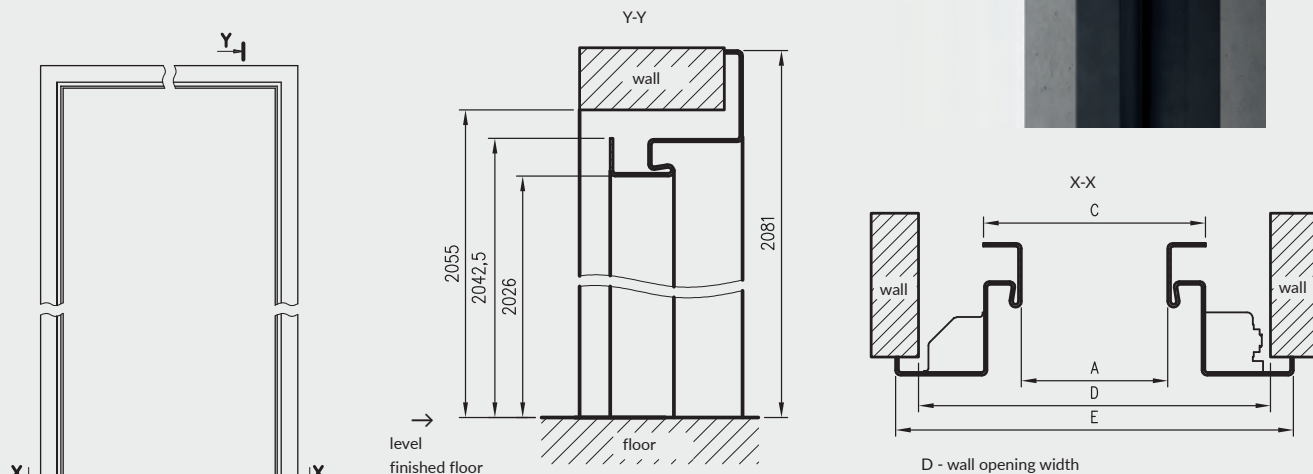

small angular steel door frame profile

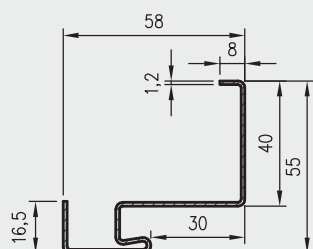

Dimensions for single leaf doors

symbol width.	A	C	D	E
"60"	600	633	690	710
"70"	700	733	790	810
"80"	800	833	890	910
"90"	900	933	990	1010
"90E"	904	937	994	1014
"100"	1000	1033	1090	1110

Note: Extra charge for reinforcement for the door self closer ,

AVAILABLE COLOURS

Door frame is powder coated in two gloss scale (matt / low structure or semi-gloss / plain). There are available colours:



*** beige colour is available only in semi-gloss

DOOR HANDLES



POLARIS door handle - chrome
inserts in DRE-Cell, 3D and CPL colors
inserts in acrylic laminates



simple key
backplate



cylinder lock
backplate



backplate for
toilet lock



POLARIS door handle - black matt
inserts in DRE-Cell, 3D and CPL colors
inserts in acrylic laminates



simple key
backplate



cylinder lock
backplate



backplate for
toilet lock



WEGA door handle - satin nickel



simple key
backplate



cylinder lock
backplate



backplate for
toilet lock



WEGA door handle - black matt



simple key
backplate



cylinder lock
backplate



backplate for
toilet lock



ATRIA door handle - satin nickel



simple key
backplate



cylinder lock
backplate



backplate for
toilet lock



ATRIA door handle - black matt



simple key
backplate



cylinder lock
backplate



backplate for
toilet lock



ORION door handle - satin nickel



simple key
backplate



cylinder lock
backplate



backplate for
toilet lock

DOOR HANDLES



ORION door handle - black matt



simple key backplate



cylinder lock backplate



backplate for toilet lock



ARCTUS door handle - satin nickel



simple key backplate



cylinder lock backplate



backplate for toilet lock



ALTAIR door handle - graphite



simple key backplate



cylinder lock backplate



backplate for toilet lock

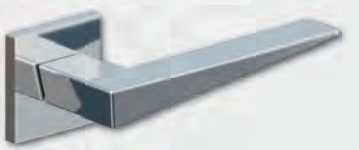

AVIOR door handle - shiny chrome



simple key backplate



cylinder lock backplate



backplate for toilet lock



MIMOSA door handle -black matt



simple key backplate



cylinder lock backplate



backplate for toilet lock



ZETA door handle - satin nickel



simple key backplate



cylinder lock backplate



backplate for toilet lock

DOOR HANDLES



door handle MEDA - shiny chrome inserts in DRE-Cell, 3D and CPL colors inserts in acrylic laminates



simple key backplate



cylinder lock backplate



backplate for toilet lock



QUBIK door handle - black with antibacterial coating*



simple key backplate



cylinder lock backplate



backplate for toilet lock*



CUBE SLIM door handle - brushed chrome



simple key backplate



cylinder lock backplate



backplate for toilet lock



the CUBE SLIM handle - shiny brass



backplate with simple key



backplate for cylinder lock



backplate for toilet lock



TOTAL door handle - brushed nickel matt 170 | 209.1



simple key backplate



backplate for cylinder lock



backplate for toilet lock



IBIZA door handle - black matt



simple key backplate



cylinder lock backplate



backplate for toilet lock



CUBE door handle - shiny chrome



simple key backplate



backplate for cylinder lock



backplate for toilet lock

* - the handle and the toilet knobs are covered with an antibacterial coating

DOOR HANDLES



CUBE door handle - brushed nickel



simple key backplate



backplate for cylinder lock



backplate for toilet lock



CUBE door handle - black matt



simple key backplate



backplate for cylinder lock



backplate for toilet lock



MONDO door handle - satin nickel



backplate for simple key



backplate for cylinder lock



backplate for toilet lock



door handle TREND - satin nickel



backplate for simple key



backplate for cylinder lock



backplate for toilet lock



door handle LINEA - shiny chrome



simple key backplate



cylinder lock backplate



backplate for toilet lock



LINEA door handle - nickel satin



backplate for simple key



backplate for cylinder lock



backplate for toilet lock



ZOJA door handle - brushed brass



simple key backplate



cylinder lock backplate



bathroom lock backplate.

DOOR HANDLES



door handle BELLA SLIM - glossy brass



simple key backplate

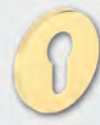

cylinder lock backplate



backplate for toilet lock



door handle ZORBA - shiny chrome/satin



simple key backplate



backplate for cylinder lock



backplate for toilet lock



QUIK Fit door handle - black



simple key backplate



cylinder lock backplate



bathroom lock backplate



DIVA door handle - black matt



simple key backplate



cylinder lock backplate



bathroom lock backplate



PROXIMA door handle - stainless steel



backplate for simple key



backplate for cylinder lock



backplate for toilet lock



TOPAZ door handle - stainless steel



simple key backplate



backplate for cylinder lock



backplate for toilet lock



TOPAZ door handle - stainless steel, black matt



simple key backplate



backplate for cylinder lock



backplate for toilet lock



handle JOWISZ - stainless steel



backplate for simple key



backplate for cylinder lock



backplate for toilet lock

DOOR HANDLES



LUNA SLIM door handle - brushed chrome



LUNA slim door handle - shiny brass



IBIZA door handle - graphite/chrome



door handle IBIZA - nickel satin



door handle IBIZA - shiny chrome



handle BETA - nickel satin



EUROPA door handle - nickel satin



TOMA door handle - black



simple key backplate



backplate for cylinder lock



backplate for toilet lock



simple key backplate



backplate for cylinder lock



backplate for toilet lock



simple key backplate



cylinder lock backplate



backplate for toilet lock



backplate for simple key



backplate for cylinder lock



backplate for toilet lock



simple key backplate



cylinder lock backplate



backplate for toilet lock



simple key backplate



cylinder lock backplate



backplate for toilet lock



simple key backplate



cylinder lock backplate



backplate for toilet lock



simple key backplate



cylinder lock backplate



backplate for toilet lock

DOOR HANDLES



STARK Fit door handle - black



simple key backplate



cylinder lock backplate



backplate for toilet lock



WARNA door handle - satin nickel



simple key backplate



cylinder lock backplate



backplate for toilet lock



door handle ALVA LUX - black matt



simple key backplate



cylinder lock backplate



backplate for toilet lock



PEM LUX door handle - black matt



simple key backplate



cylinder lock backplate



backplate for toilet lock



AS LUX door handle - titanium



simple key backplate



cylinder lock backplate



backplate for toilet lock



LEA LUX door handle - gold matt



simple key backplate



cylinder lock backplate



backplate for toilet lock



FOKUS door handle - nickel satin velvet



simple key backplate



cylinder lock backplate



backplate for toilet lock



UNO door handle - stainless steel



simple key backplate



backplate for cylinder lock



backplate for toilet lock

DOOR HANDLES



ROMAN door handle - chrome/nickel lacquered



simple key backplate



cylinder lock backplate



backplate for toilet lock



TIK-QR door handle - anthracite



simple key backplate



cylinder lock backplate



backplate for toilet lock



QUBIK door handle - lacquered nickel



simple key backplate



cylinder lock backplate



backplate for toilet lock



LIBRA door handle - satin nickel



simple key backplate



cylinder lock backplate.



backplate for toilet lock

Note: long backplates do not fit doors with magnetic lock



ZORBA door handle with long backplate - shiny chrome /



ZORBA door handle with a long simple key backplate - shiny chrome/satin (spacing 72 mm)



ZORBA door handle with oblong backplate for cylinder lock - shiny chrome/satin (span 72 mm)



ZORBA door handle with oblong bathroom backplate - shiny chrome / satin (spacing 72 mm)



door handle SHARK black and inox



backplate SHARK black and inox



door handle DIVA and backplate for door leaves FORCA 10 and FORCA B 10 silver F1 door handle long backplate



ONTARIO door handle and backplate for SOLID RC2 model silver colour F1 door handle long backplate



DOOR HANDLES



STAR TEC technical handle - class IV - stainless steel matt price for a set (handle + backplate for cylinder lock)

door leaf thickness up to 55 mm



backplate for cylinder lock



PEGAZ door handle (span 72 mm) black matt with cylinder lock



door handle TOM with oblong backplate for cylinder lock (span 72 mm) matt chrome

exterior backplate

interior backplate

NOTE:
selection of left or right door handle*.
Door handle in set with backplate is adapted to door leaf with two locks except for SOLID collection.



handle METRO (span 72 mm) stainless steel for cylinder lock

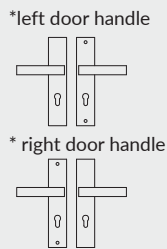

upper backplate METRO stainless steel for cylinder lock



exterior TOTAL door handle with oblong backplate (span 72 mm) inox plus -

NOTE:
Door handle in set with backplate is adapted to door leaf SOLID with two locks.



short upper backplate TOTAL short inox plus

Note: long backplates do not fit doors with magnetic lock

CYLINDER LOCK INSERTS



insert 26/41 - nickel matt



insert 26/41 - satin brass



set of cylinder lock inserts ZN 30/40+30G/40 SN or ZN 30/40+40G/30 SN satin nickel



set of cylinder lock inserts ZN 30/40+30G/40 SB or ZN 30/40+40G/30 SB brass satin



set of inserts ZN 27/40+27G/40 or ZN 27/40+40G/27 satin nickel



insert 30/30 - satin nickel



insert 35/35 - satin nickel



insert 30/40 - satin

SELF-CLOSER

DORMA TS-90 impuls self closer
Price.....



DORMA TS-71 selfcloser
Price.....



GEZE TS 2000 selfcloser
Price.....



GLASS PANE PATTERNS



mat dre

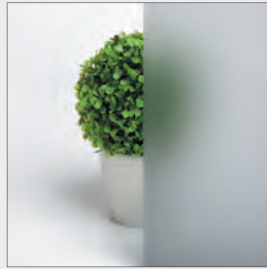

decormat graphite

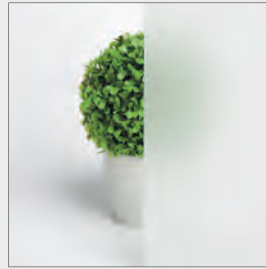

white frost laminated VSG 22.1, plain on both sides



decormat brown



window blind



chinchila



white bark



VSG black



pattern 2 VETRO

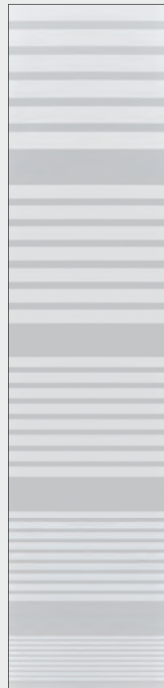

pattern 3 VETRO



pattern 4 VETRO



pattern 11 VETRO



pattern 12 VETRO

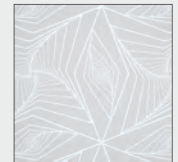

pattern 13 VETRO



pattern 14 VETRO

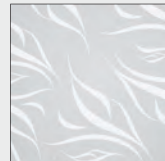

pattern 15 VETRO



pattern 10 VETRO



pattern 5 VETRO

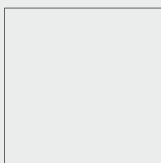

pattern 1 VETRO transparent

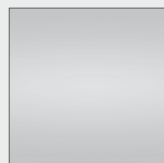

pattern 1 VETRO decormat

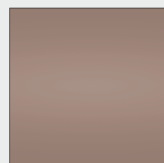

pattern 1 VETRO decormat brown

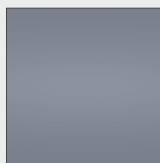

pattern 1 VETRO decormat graphite



pattern VETRO E, VETRO D1 black opaque laminated glass



VETRO pattern E laminated glass decormat

PRICES

Prices and availability of glass panes are presented on pages with door leaves. The glass in the door leaves of our collections have obverse and reverse (except VSG 22.1 and VETRO E, VETRO D1).

VENEER COLOURS



white (wood grain structure)	white matt	white pine	siberian elm	silver	sand oak
bleached oak textured	vintage oak	light gray mat	marrone chestnut textured	evoke oak	toffee oak *,***
anthracite elm	golden oak textured	walnut	caramel walnut	dark wenge	oxide concrete
antique copper	black matt 2	dark olive matt	dark blue matt	NEW cashmere matt	NEW warm gray matt
NEW sage oak					



bianco	magnolia	moro	vino *	cubanit	gabbiano
bigio	mat bianco	mat cemento	mat moro	white U1027	anthracite* U1290



american walnut	ebony*	elm	Polish oak 3D	grand oak
-----------------	--------	-----	---------------	-----------

* decor available while stocks last,
**decor available only in horizontal wood grain



gray halifax oak	natural oak halifax	Tabac Oak Halifax	white elm	natural elm	dark elm
------------------	---------------------	-------------------	-----------	-------------	----------

VENEER COLOURS

					
milky white	gray oak	welsh oak	walnut	celini walnut	concrete 2
CPL 0,2 mm thick CPL 0,7 mm thick	CPL 0,2 mm thick CPL 0,7 mm thick	CPL 0,2 mm thick CPL 0,7 mm thick	CPL 0,2 mm thick CPL 0,7 mm thick	CPL 0,2 mm thick CPL 0,7 mm thick	CPL 0,2 mm thick CPL 0,7 mm thick





					
acacia	honey oak	chestnut	roasted walnut	ashen	DARK GRAY
CPL 0,2 mm thick CPL 0,7 mm thick	CPL 0,2 mm thick CPL 0,7 mm thick	CPL 0,2 mm thick CPL 0,7 mm thick	CPL 0,2 mm thick CPL 0,7 mm thick	CPL 0,2 mm thick CPL 0,7 mm thick	CPL 0,2 mm thick CPL 0,7 mm thick

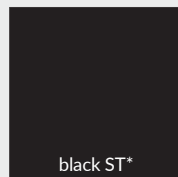
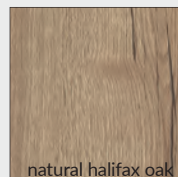

* Black ST decor - Tecofoil protected twice with pigmented, matt varnish. Decor assigned to the CPL price group, however, it is not a CPL laminate.

		
white	black ST*	natural halifax oak
W0118 CPL 0,15 mm thick CPL 0,7 mm thick		CPL 0,15 mm thick Door frames only

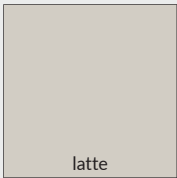
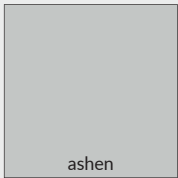
** RAL, NCS, FLUGGER values are approximate values and closest to the color of the door leaf

			
white	ecru	latte	ashen
UV acrylic lacquer RAL=9003**	RAL=9001**	Flugger = 4362 NCS = S1505-Y50R**	RAL=7035**

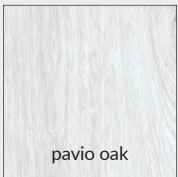
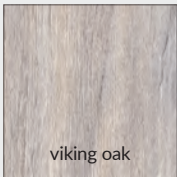
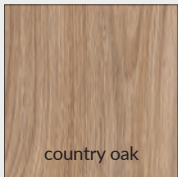
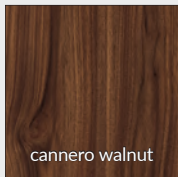
LUX collection decors

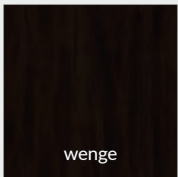
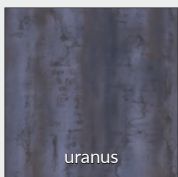
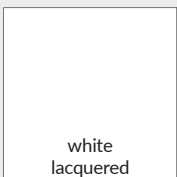
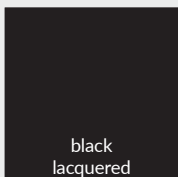
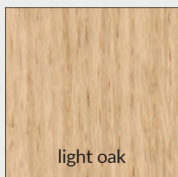
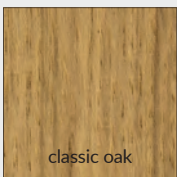
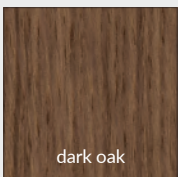
					
pavio oak	viking oak	country oak	cannero walnut	birch	wenge
					
uranus	white lacquered	black lacquered	light oak	classic oak	dark oak

Decors from CLARO and GRAFI collections

WOOD collection decors

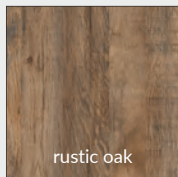
			
alpine white	bleached craft oak	riviera oak	rustic oak



ARCHITRAVES AND SKIRTING BOARDS

KT2 ARCHITRAVE

KT2 architrave 80 mm and 63 mm increases the adjustment range of the standard adjustable door frame by additional 15 mm. It must be ordered additionally as a separate accessory. The price of this architrave is available at Distributor.

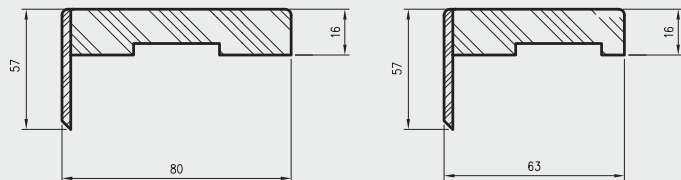

ARCHITRAVES

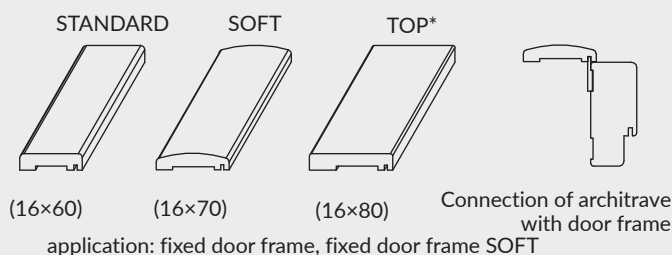

Set contains (for one side of the door):

horizontal and two vertical masking architraves, plastic latch strike plates, pins and clamp clips. Masking architraves are packed in a cardboard box.

QUARTER ROUNDS

Quarter round is used to cover the angular connection between the wall and the door frame. A single item constitutes a trade unit. prices of quarter rounds

Quarter rounds require cutting before the assembly.



SKIRTING BOARDS



The length of the skirting boards is 2.62 m (except LPP4W). Skirting boards need to be trimmed prior to installation.

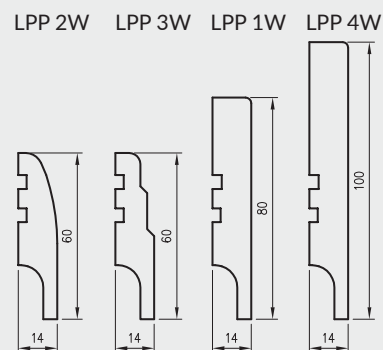

Lenght of LPP4W is 2,40 mb
It is made of moisture resistant board.

VENTILATION GRILLE

There is possibility to instal bathroom plastic ventilation grille, which is available in the following colours: white, beige, calvados, brown, silver, creamy, gray, black and ashen (except for frame construction doors, sliding doors, fire resistant doors and SOLID, ENTER) or aluminum ventilation grille

- » plastic ventilation grille
- » aluminum ventilation grille

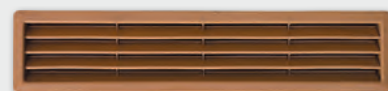

plastic ventilation grille



aluminum ventilation grille

VENTILATION ACCESSORIES AND OTHER

VENTILATION SLEEVES FOR PANEL DOORS

There is possibility to purchase a set (5 pcs) of ventilation sleeves.
DRE-Cell Decor, 3D foil, CPL laminate.



VENTILATION SLEEVES FOR FRAME CONSTRUCTION DOOR LEAF

For frame construction doors, except for VETRO with plastic sleeves (3 sleeves for doors "60", 4 sleeves for doors "70", 5 sleeves for doors "80"- "100")

PLASTIC VENTILATION SLEEVES

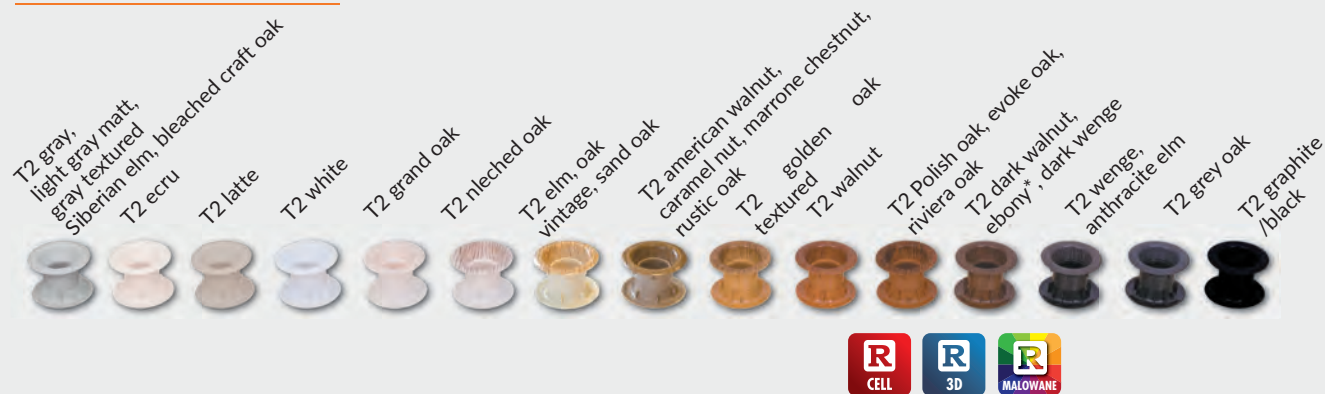

VENTILATION UNDERCUT

In all collections (except SOLID, SOLID RC2, ENTER, FIRE resistant door leaves, sliding doors, folding), ventilation undercut can be made upon request.



ventilation undercut

13.5 MM HINGE FOR REBATED DOORS

» (set of lower and upper part)
13.5 mm diameter hinge in black.



HINGE COVERS

» (set consist of 2 pcs. for 1 hinge)
Plastic hinge covers are adjusted to hinges with diameter of 13.5 mm.

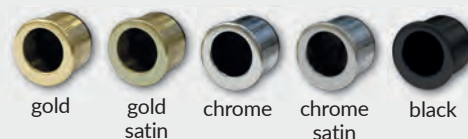

TECHNICAL INFORMATIONS

DOOR LEAF DIMENSION AND PLACEMENT OF HINGES

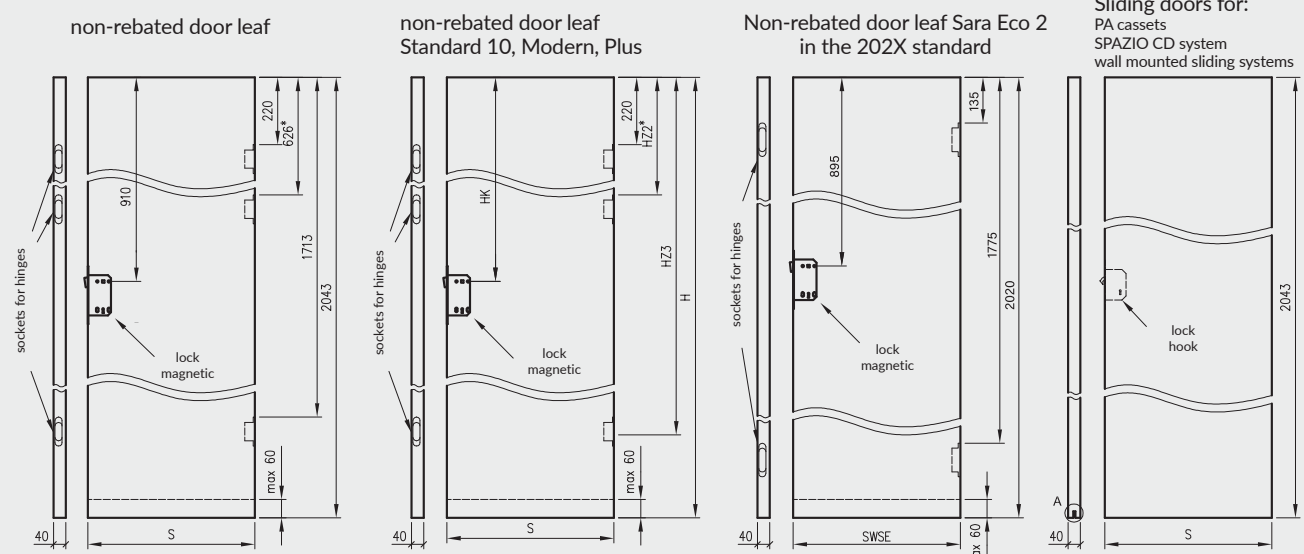
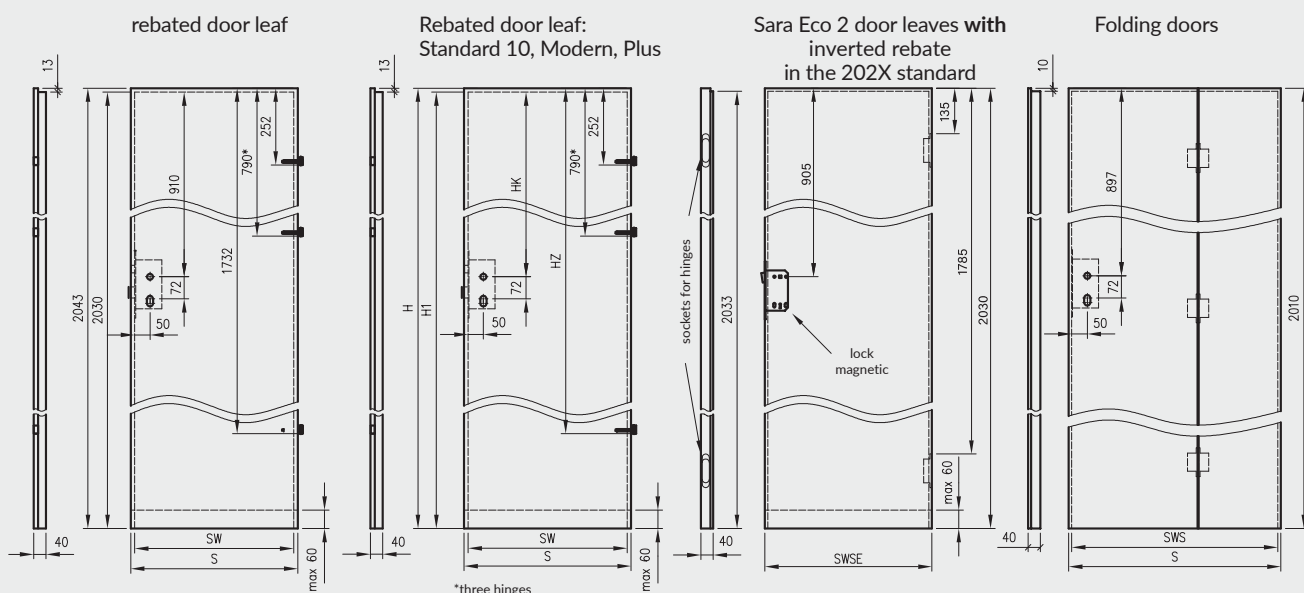

* in case

Note: magnetic locks in two variants of spacing: 85mm for a cylinder lock insert or 90mm for a simple key and toilet lock insert

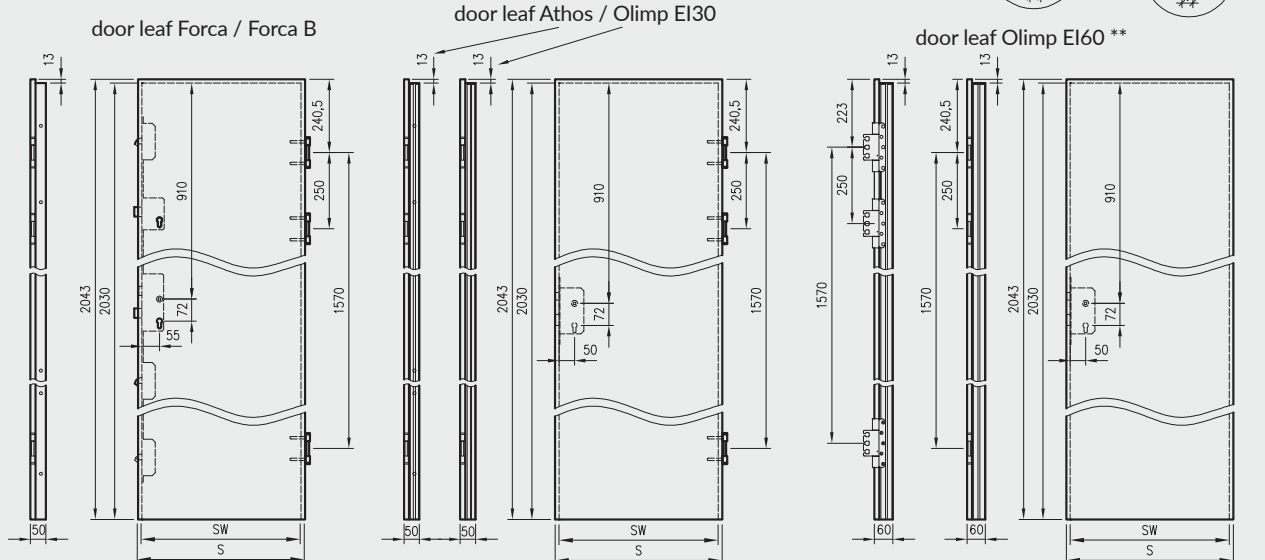
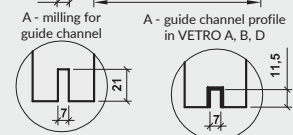

** Olimp EI60 two options of hinges (depending on the width of the door)

TECHNICAL INFORMATIONS

DOOR LEAF WIDTH

Symbol of the door dimension	S	SW	SWSE	SWS
"60"	644	618	620	-
"70"	744	718	720	-
"80"	844	818	820	824
"90"	944	918	920	924
"100"	1044	1018	1020	1024
"110*"	1144	1118	-	-

S - total door leaf width
 SW - width in the rebate (refers to rebated door leaf)
 SWSE - Sara Eco 2 leaf width
 SWS - width in the rebate of folding door leaf
 * - width "110" is only available in door leaves Standard 10, Athos, Enter Acoustic and Olimp

NOTE: Total width of "40" side panels is 444 mm.

ADDITIONAL LEAF WIDTHS

Symbol of the door dimension	S	SW
"90E" for OLIMP EI30, ATHOS, FORCA, FORCA B.	959	933
"90E" for OLIMP EI60	973	947
"90E" for STANDARD, ENTER, ENTER AKUSTIK, SOLID, SOLID RC2	948	922

The investment standard "90E" provides 900mm passage in the door frame with the door leaf opened at an angle of 90 degrees

DIMENSIONS OF THE DOOR LEAF WITH 4 VARIABLE HEIGHTS

(refers to door leaf STANDARD 10 and collections MODERN and PLUS)

H	H1	HK	HZ	HZ2	HZ3
1983	1970	850	1672	606	1653
2043	2030	910	1732	626	1713
2110	2097	977	1799	647	1780
2240	2227	1107	1929	691	1910

H - total height of the door leaf
 H1 - door leaf height in the rebate
 HK - distance from the top rebate of door leaf to the axis of the handle
 HZ - distance from the upper edge of the door leaf to the mounting point of the third hinge

DOOR LEAF HEIGHT

2043 mm - total height of rebated and non-rebated door leaf (2010 for folding doors)
 2030 mm - height of the rebated door leaves in the rebate (2020 for Sara Eco 2 door leaves with the inverted rebate, 2000 for folded doors)
 2055 mm - total height of the door leaves with inverted rebate
 1983, 2043, 2110, 2240 mm - total possible height of STANDARD 10 door leaf and MODERN and PLUS collection (1970, 2030, 2097, 2227 mm - measured in the door leaf rebate)

SHORTENING OF DOOR LEAF

There is possibility to shorten the door leaf on your own, up to 60 mm (there is no possibility to shorten following door leaf: VETRO, FIRE RESISTANT DOORS, FORCA B, door leaf of all collections in the sliding version, passive doors, glass doors, folding doors and door leaves with dropping seal)..

Note: The door leaf with recuperative undercutting - 15 mm, is adapted to shortening on your own, up to 45 mm Max.

CLEARANCE BETWEEN DOOR LEAF AND FLOOR

standard clearance between door leaf and finished floor is 8 mm high (15 mm in FOLDE door leaf, 5-6 mm in OLIMP door leaf).

NOTES REFERED TO HINGE

In rebated door leaf: frame construction doors, entrance (Enter, Enter Acoustic, Solid) and in the other collections with size wider than "90", 3 screw-in pivot hinges of \varnothing 13,5 mm are mounted. For other interior rebated leaves, there is possibility to choose 2 or 3 hinges.

In SOLID RC2, FORCA, FORCA B, ATHOS and OLIMP EI30 door leaf there are mounted 3 threefold hinges.

The OLIMP EI60 leaves, depending on the width, are equipped with 3 three-part hinges or 3 SIMONSWERK hinges VX 7939/160.

Non-rebated door leaf come with pre-milled sockets for two or three hidden concealed hinges which are attached together with non-rebated door frame.

Sara Eco 2 door leaves with inverted rebate and non-rebated doors have milled sockets for recessed hinges, which are packed together with the door frame.

Folding doors come with 3 hidden recessed hinges which join two parts of door leaf.

Door leaves with inverted rebate have sockets for two concealed hinges, which are packed together with door frame.

Non-rebated door leaf

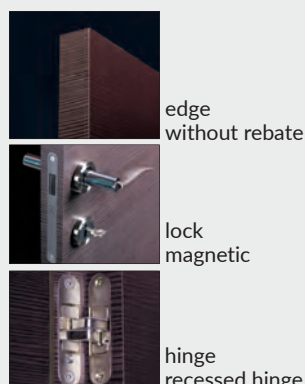

REBATED DOOR LEAF

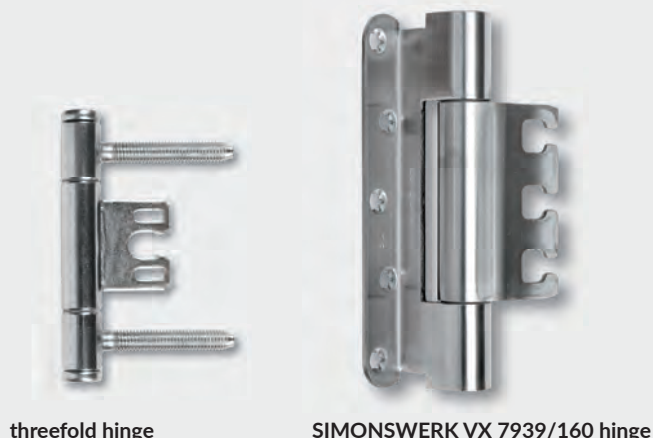
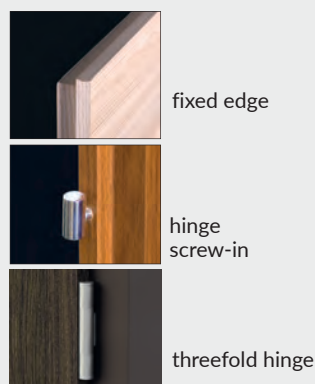

TECHNICAL INFORMATIONS

DOOR LEAF THICKNESS AND SELECTION OF CYLINDER INSERT

Door leaf type	Door leaf thickness	proportion in the door leaf (W0/Z0)	recommended** dimension of the cylinder insert (W/Z)	Refers to cylinder insert with door knob	
				Cylinder insert with a knob on the inside (W/Z)	Cylinder Insert with a door knob outside (W/Z)
rebated door leaf	40	14 / 26	25 / 40 ; 26 / 36 26 / 41 ; 30 / 40	25G/40; 26G/36 26G/41; 30G/40 27G/40	25/40G; 26/36G 26/41G; 30/40G 27/40G
Sara Eco 2 inverted rebate door leaves	40	24 / 16	35 / 30 ; 36 / 26 36 / 31 ; 40 / 30	35G/30; 36G/26 36G/31; 40G/30	35/30G; 36/26G 36/31G; 40/30G
Non-rebated door leaf	40	20 / 20	31 / 31 ; 30 / 30 35 / 35	31G/31; 30G/30 35G / 35	
Profi non-rebated door leaves	50	25/25	35/35; 36/36 40/40; 41/41	35G/35 ; 36G/36 41G/41 ; 40G/40	
Non-rebated door leaf Sara Eco 2	40	16 / 24	30 / 35 ; 26 / 36 31 / 36 ; 30 / 40	30G/35; 26G/36 31G/36; 30G/40	30/35G; 26/36G 31/36G; 30/40G
Door leaf with inverted rebate	40	27 / 13	40 / 25 ; 41 / 26	40G/25; 41G/26	40/25G; 41/26G
Profi Door leaf with inverted rebate	50	30/20	40/30; 41/31 45/35	40G/30 ; 41G/31 45G/35	40/30G ; 41/31G 45/35G
Folding doors	40	17/23	30/35; 31/36 30/40	30G/35; 31G/36 30G / 40	30/35G; 31/36G 30 / 40G
fire resistance Athos	50	21 / 29	31 / 41 ; 35 / 40	31G/41; 35G/40	31/41G; 35/40G
Olimp EI30	50	18 / 32	30 / 45 ; 31 / 46	30G/45; 31G/46	30/45G; 31/46G
Olimp EI60	60	28 / 32	40 / 45 ; 41 / 46	40G/45; 41G/46	40/45G; 41 / 46G
fire resistance FORCA	50	22 / 28	35 / 40		
SOLID RC2	40,6	14 / 26,6	26 / 40 ; 26 / 41 30 / 40		

Cylinder inserts are reversible - that is 25/40 = 40/25, 26G/36 = 36/26G

**recommended dimensions (assuming that backplate is 10 mm thick, and patented cylinder doesn't exceed 5 mm above backplate).

fig. selection of cylinder insert dimension

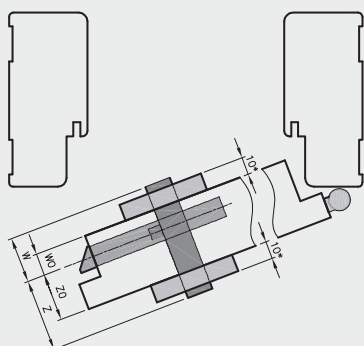
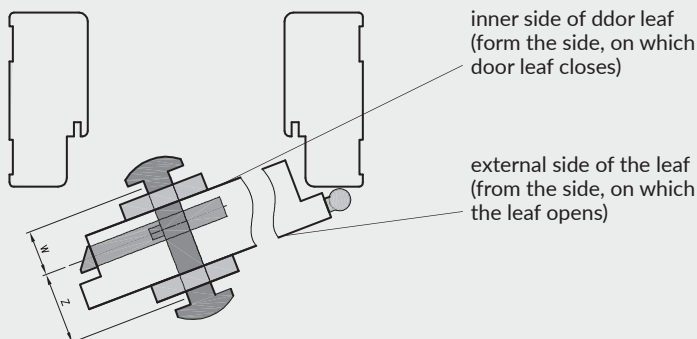

fig. selection of cylinder insert dimension with door knob



Dimension of cylinder insert is calculated using the following formula:

$$WO + \text{backplate thickness} + 2 \div 3\text{mm} / ZO + \text{backplate thickness} + 2 \div 3\text{mm}$$

where:

WO and ZO - values have been presented in the table above
 thickness of the backplate - measured (presented values in above table assume that backplate is 10mm thick)

Selection of backplate with door knob - if we want to mount a knob on:

- the inner side of door leaf - symbol of the door knob must be next to "W" dimension (see column 5 in the table)

- the external side of the leaf - symbol of the door knob must be next to "Z" dimension (see column 6 in the table)

TECHNICAL INFORMATIONS

SINGLE LEAF REBATED DOOR

We offer left, right and central door leaf

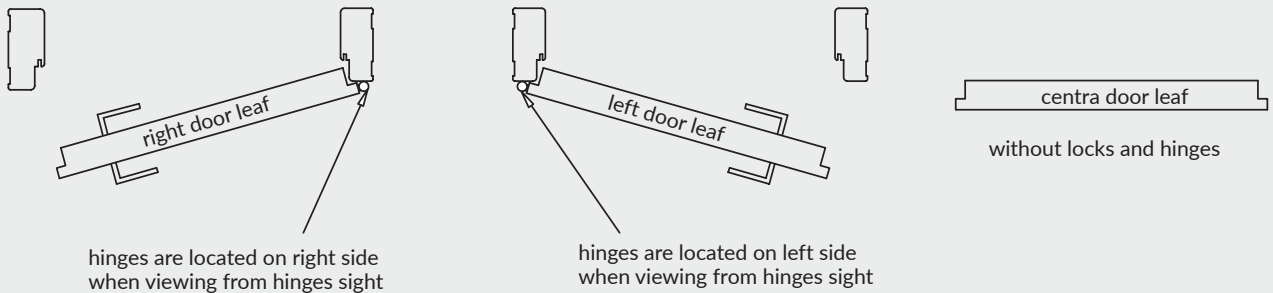

DOUBLE LEAF REBATED DOOR

We offer double leaf doors: the right - then right door leaf becomes an active one and left door leaf becomes inactive, and double left leaf - left leaf is an active one and the right one is inactive.

An active door leaf has a rebate and a lock as a standard option. In double leaf door there is available only straight edge.

Inactive door leaf comes with a "counter rebate" and additionally is equipped with a latch strike plate and a flush bolt as a standard fitting (A)

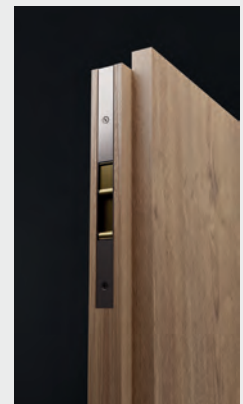

flush bolt (A)

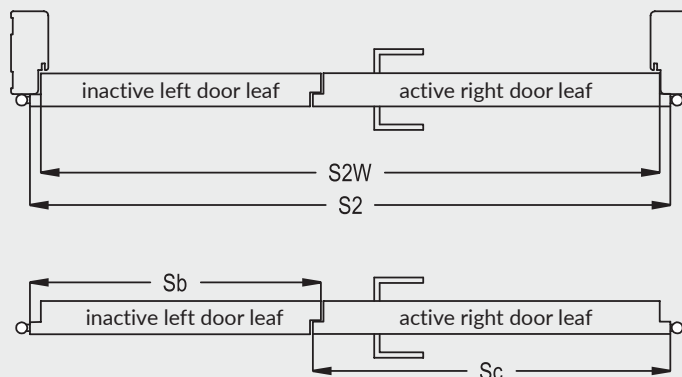

Only door frames produced by DRE fit double-leaf doors, that is the reason that we recommend to our customers to buy doors as a complementary sets. Whole DRE set comprises of 2 door leaf and door frame.

$$\boxed{\text{price of double leaf door}} = \boxed{\text{leaf price} \times 2} + \boxed{\text{price of the fire resistance}}$$

Symbol of door dimension	dimension in [mm]		
	S2	S2W	combination* Sc+Sb
"100d"	1078	1052	644+444
"110d"	1178	1152	744+444
"120"	1278	1252	844+444; 644+644
"130"	1378	1352	944+444; 744+644; 644+744
"140"	1478	1452	1044+444; 844+644; 744+744; 644+844
"150"	1578	1552	944+644; 844+744; 744+844; 644+944
"160"	1678	1652	1044+644; 944+744; 844+844; 744+944; 644+1044
"170"	1778	1752	1044+744; 944+844; 844+944; 744+1044
"180"	1878	1852	1044+844; 944+944; 844+1044
"190"	1978	1952	1044+944; 944+1044
"200"	2078	2052	1044+1044

combination* possible combination of active (Sc) and inactive (Sb) leaf width

TECHNICAL INFORMATIONS

NON-REBATED DOOR LEAF - SLIDING VERSION

We offer left, right and central door leaf (door leaf without a lock and handle)

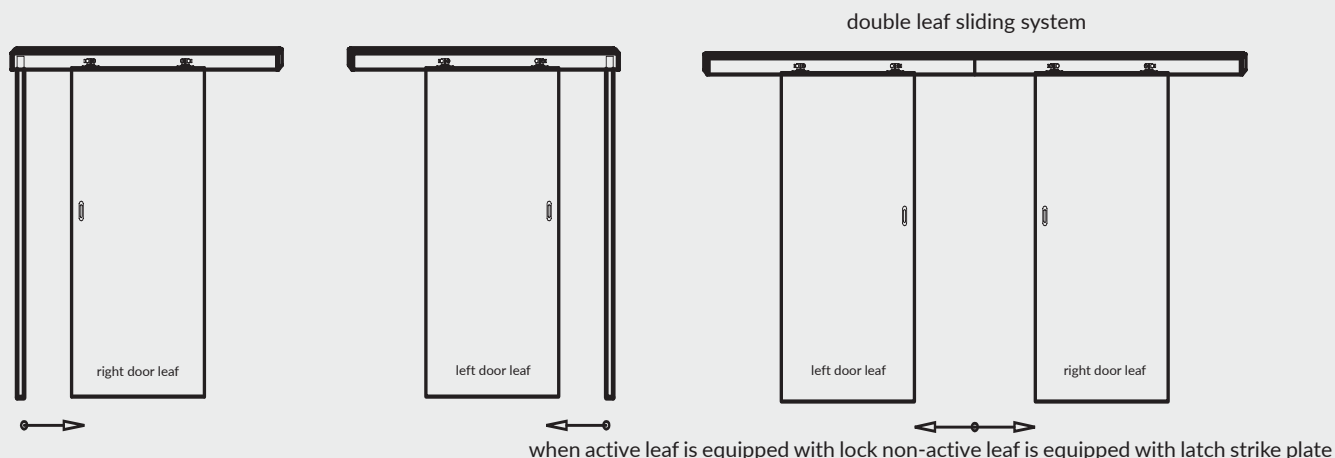

SINGLE LEAF DOOR NON-REBATED

We offer left, right and central door leaf

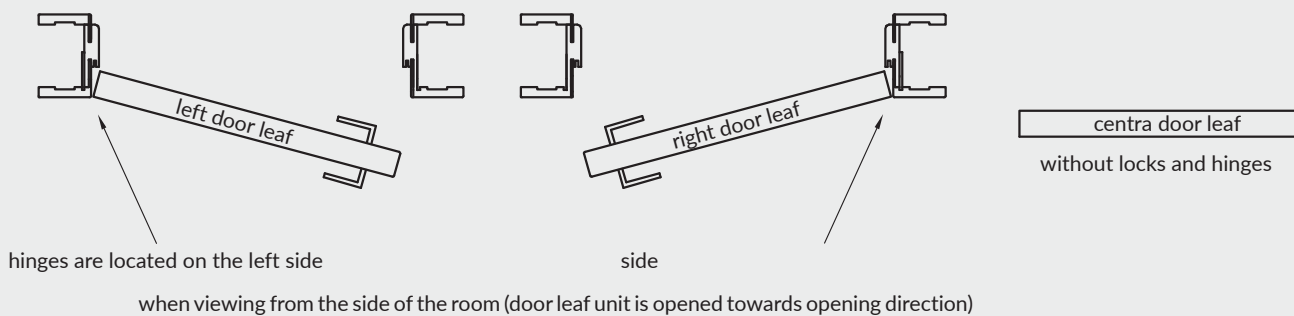

DOUBLE LEAF NON-REBATED DOOR

We offer double leaf doors: the right - then right door leaf becomes an active one and left door leaf becomes inactive, and double left leaf - left leaf is an active one and the right one is inactive.

An active door leaf has lock as a standard option. Inactive door leaf is equipped with a latch strike plate and a flush bolt as a standard fitting.

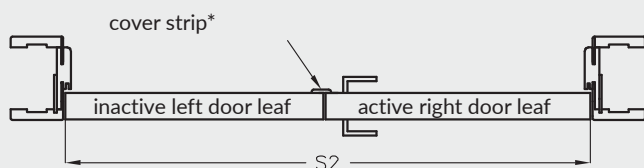

* for double leaf non-rebated doors there is possibility to purchase cover stripe width of cover stripe 30 mm

$$\boxed{\text{price of double leaf door}} = \boxed{\text{leaf price} \times 2} + \boxed{\text{price of the fire resistance}}$$

Symbol of door dimension	dimension in [mm]	
	S2	combination* Sc+Sb
"120"	1291	644+644
"130"	1391	744+644; 644+744
"140"	1491	844+644; 744+744; 644+844
"150"	1591	944+644; 844+744; 744+844; 644+944
"160"	1691	1044+644; 944+744; 844+844; 744+944; 644+1044
"170"	1791	1044+744; 944+844; 844+944; 744+1044
"180"	1891	1044+844; 944+944; 844+1044

combination* - possible combination of active (Sc) and inactive (Sb) leaf width

TECHNICAL INFORMATIONS

CONSTRUCTION OF PANEL DOORS

- » door leaf frame made of coniferous wood or MDF
- » Core: stabilising insert "honeycomb" (A), perforated chipboard (B) and in fire proof doors: chipboard
- » 3 mm HDF external board or 4 mm HDF external board (Finea, Finea B, Enter, Enter Akustik, Solid)
- » type of edge straight or without rebate

External boards of door leaf is finished with:

- a) in DRE-Cell decor collection - decorative foil based on the polypropylene
- b) in 3D foil - 3D foil based on decorative paper
- c) in CPL laminate - CPL laminate th. 0.15-0.2mm or 0.7 mm

Fire resistant door leaf Olimp EI30

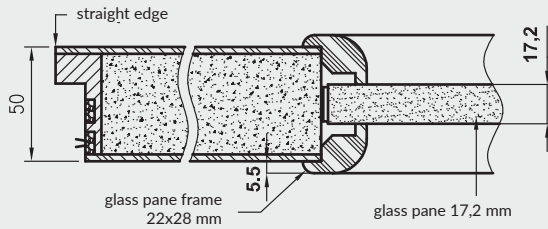

Fire resistant door leaf Olimp EI60

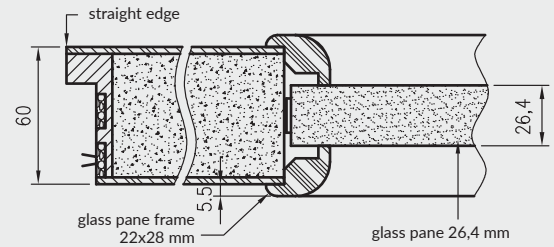

Anti-burglary door and fire-resistant door leaf Forca EI30

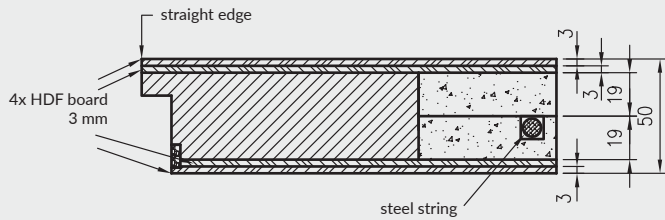

Anti-burglary door leaf Forca B

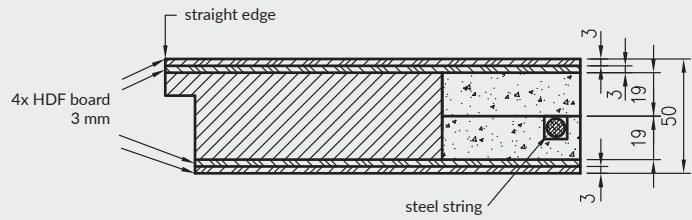

Anti-burglary door leaf SOLID RC2

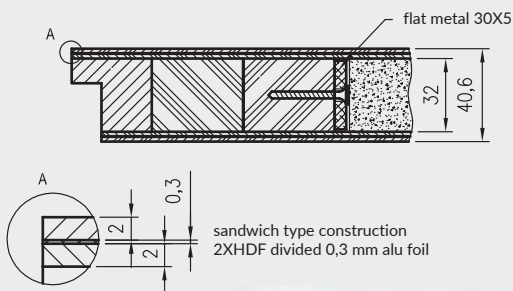

Fire-resistant door leaf Forca EI30

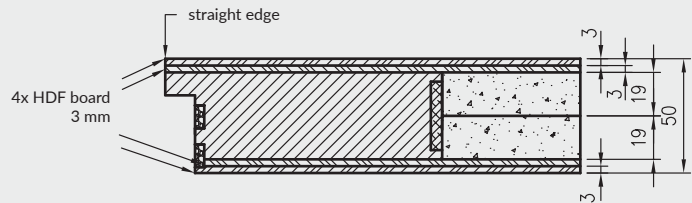

(A) stabilising insert "honeycomb"



(B) perforated chipboard

TECHNICAL INFORMATIONS

FRAME CONSTRUCTION DOORS (IS NOT REFERRED TO VETRO A,B,C,D,F)

Frame construction door leaf is entirely made of wood-based panels:

vertical stiles made of wood-based panels - 40 mm

external horizontal stiles made of wood-based panels - 35 mm

horizontal rails (interior):

- wood-based panels - 22 mm in Lumio, Vico, Auri, Piano, Even, Premium, Fosca, Verso, Reva, Solte, Trieste*, Ena*, Verano* door leaves (*in Ena 1-2, Trieste 1-2, 1-2, Verano 1-2, a glass pane frame by the large glass pane made of wood-based panels - 35 mm, while in the Ena 3-5, Verano 3-5, 3-5 and Trieste 3, two glass pane frames by the large glass panes made of wood-based panels - 35mm.)

- wood-based panels - 35 mm in Nestor, Elsa, Scala, Berge, Estra door leaves.

Horizontal cross-section of door leaf
Lumio, Vico, Auri, Verano, Piano, Premium, Fosca,
Verso, Ena, Even, Trieste, Reva, Solte

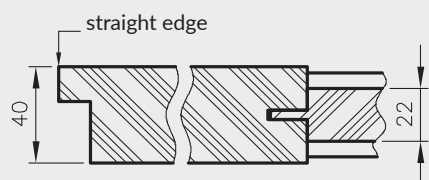

Horizontal cross-section of ELSA

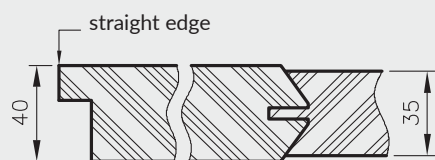

Horizontal cross-section of Ena, Verano and
Trieste doors (cross-section at the height of
the rail and stile set by the large glass pane)

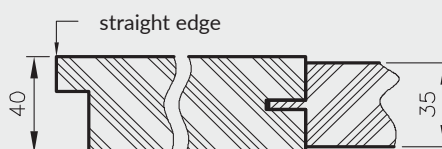

Horizontal cross-section of Nestor

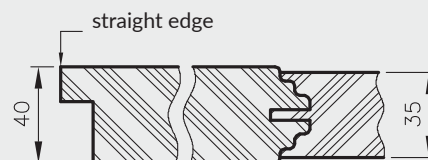

Horizontal cross section of the door leaf Scala, Berge

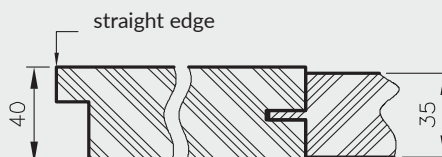

FILLINGS OF FRAME CONSTRUCTION DOOR LEAF:

Scala A; - 4 mm glass pane, flat 4 mm HDF board

Scala B - 4 mm glass pane, 19 mm MDF profiled board

Elsa A - 4 mm glass pane, flat 4 mm HDF board

Elsa B - 4 mm glass pane, 19 mm MDF profiled board

Premium 1-3 - 4 mm glass pane

Premium 4-7, 12 - 4 mm glass pane, 4 mm HDF marquetrys made in door leaf colour

Premium 8-11, 13 - 4 mm glass pane, 4 mm HDF marquetrys coated with silver laminate

Piano 1-6 - 4 mm glass pane, 16 mm MDF profiled board

Piano 9-12 - 4 mm glass pane, 19 mm MDF profiled board

Fosca 1-3 - 4 mm glass pane, 4 mm HDF board coated with silver laminate

Fosca 4-6 - 4 mm HDF board coated with veneer in door leaf colour

Nestor, Berge - 4 mm glass, 19 mm profiled MDF panel

Ena, Trieste, Auri, Verano, Even, Reva, Solte, Verso - 4 mm glass pane

Estra - 4 mm glass, 16 mm flat MDF panel, undercut

profile of 19 mm MDF board
(Scala B, Piano 9-12, Elsa B,
Nestor, Berge)

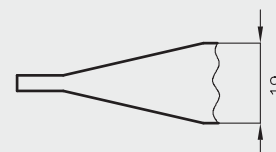

profile of 16 mm MDF
(Piano 1, 2, 5, 6)

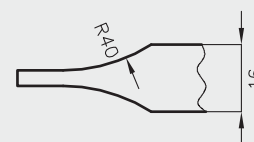

TECHNICAL INFORMATIONS

KICK PLATES

Kick plates so called „OKOPNIKI” it is finishing solution for selected panel door models with straight edge. We offer door leaf covered with thin 0.6 mm metal sheets made of stainless steel optional bottom and middle panels. It is also possible that both of panels are installed at the same time on the selected door leaf. Height of the panel is 300 mm. Door leaf with kick plates must be filled with perforated chipboard.



door leaf model with bottom panel

door leaf model with middle panel

door leaf model with bottom and middle panel

There is possibility to order door leaf with bottom panel and ventilation undercut.

NOTE: If you wish to place an order, please contact the Customer Service Department.

REMAINING TECHNICAL INFORMATIONS:

1. While maintaining the standard dimensions of door leaves and door frames, the gap between the "ready" floor and the lower edge of the door leaf is 8 mm. In order to reduce the above gap, the door frame should be shortened appropriately from the bottom (does not apply to FOLDE and OLIMP).

2. Note! Prior to the purchase and assembly of construction woodwork, check whether the selected type of joinery meet technical requirements of the project and technical drawings, it is particularly necessary to make sure that the construction of walls and ceilings allows for the mounting of construction woodwork of weight specified in the table below:

	door leaf			Door frames		other products	
	interior	entrance	fire-resistance	adjustable	fixed	Adjustable tunnel	Sliding system
Max weight	50 kg*	50 kg*	105 kg*	40 kg	20 kg	40 kg	20 kg

* max weight of single leaf door

3. Door leaf is wrapped in shrink film and the edges are additionally protected with Styrofoam or cardboard inserts.

4. Price of door leaf does not include door handles, backplates and cylinders insert (with the exception of SCALA A and B collections in rebated and non-rebated versions in DRE-Cell veneer and 3D veneer also excluding NESTOR and ELSA collections in rebated and non-rebated version in DRE-Cell veneer and 3D veneer, where handle and backplate come 1).

5. It is possible to purchase doors and door frames CENTRA (in this option there is no sockets for the lock and hinges - option is not available for fire doors, ENTER/SOLID, ENTER ACOUSTIC, SOLID RC2, FORCA B, Sara Eco 2, FOLDE) at a price of a similar product equipped with hardware and pre-milled sockets. CENTRA door frames come with door seal. Set does not include hardware.

CROSS-SECTIONS OF ALUMINUM FRAMES

DRE profile for non-rebated outward opening doors

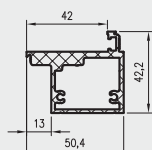

DRE profile for doors with inverted rebate opened inwards

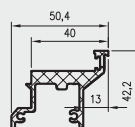

TECHNICAL INFORMATIONS

6. Under the current regulations, doors to the bathroom, wash room and a separate toilets must be opened to the outwards have width of at least 0,8 meter and height of 2 meter and also have on the bottom part openings with their total surface not smaller than 0,022 m², in order to fulfill correct air circulation. Door ventilation surface is the sum of the available ventilation components: ventilation grille (ensures the ventilation surface of 0.022 m² in all widths of doors) or ventilation undercut or ventilation sleeves, and the surface of the ground clearance between door leaf and the floor.

Ensuring ventilation surface for rebated doors**

Symbol of door leaf dimension	doors with ventilation sleeves		doors with ventilation undercut	
	ventilation surface of sleeves and the clearance 8 mm [m ²]	required clearance to meet ventilation requirements [in mm]	ventilation surface of the undercut and the clearance 8 mm [m ²]	required clearance to meet ventilation requirements [in mm]
"100"	0,011	19*	0,033	0
"90"	0,010	21*	0,029	1
"80"	0,009	24*	0,025	4
"70"	0,008	28*	0,021	14*
"60"	0,007	33*	0,018	35*

Ensuring ventilation surface for Sara Eco 2 doors and all non-rebated doors

Symbol of door leaf dimension	doors with ventilation sleeves		doors with ventilation undercut	
	ventilation surface of sleeves and the clearance 8 mm [m ²]	required clearance to meet ventilation requirements [in mm]	ventilation surface of the undercut and the clearance 8 mm [m ²]	required clearance to meet ventilation requirements [in mm]
"100"	0,0112	19*	0,033	0
"90"	0,0104	21*	0,029	1
"80"	0,0096	23*	0,025	4
"70"	0,0082	27*	0,021	12*
"60"	0,0074	32*	0,018	31*

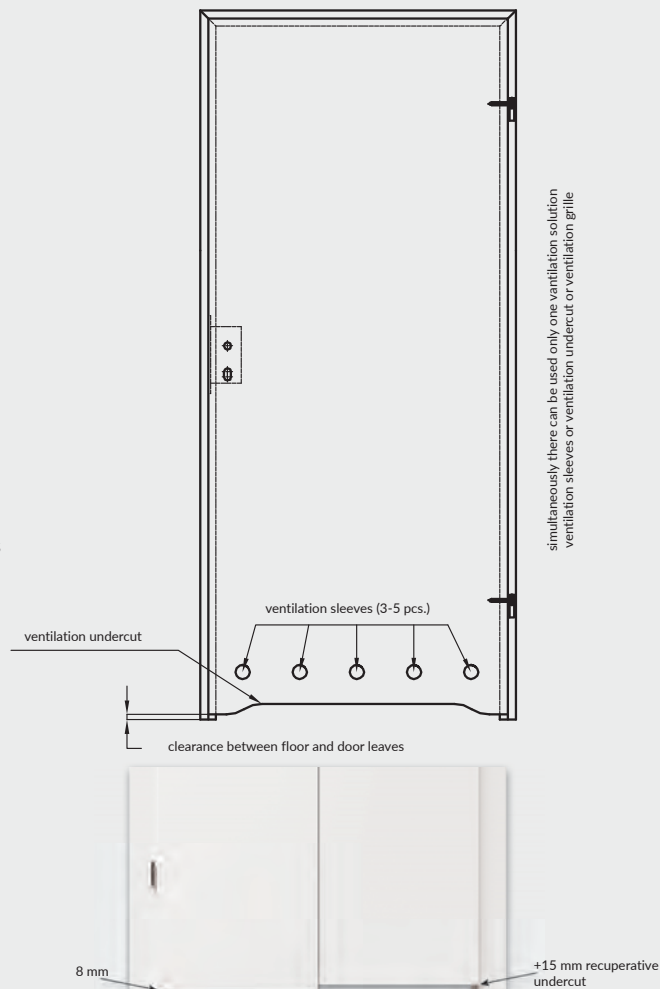

The above - stated required clearance height of the space under the door assures total ventilation surface of 0.022 m².

The standard clearance for door leaf is 8mm high.

* it is necessary to increase the clearance to the specified height by shortening door leaf at the bottom (when such a shortening is possible - see**)

** Exceptions that are not included in the table (door leaf that can not be shortened):

- collection Vetro A, D and E - the use of ventilation undercut in the door with a width of "80" - "100" and a standard ground clearance of the door (8 mm) will fulfill ventilation requirements.
 - Vetro B collection - does not meet the ventilation requirements.
 - sliding door leaf - due to design of the sliding system (distance from the wall/tunnel - about 12 mm), door leaf meet ventilation requirement without need for additional options.
- there is no possibility to shorten double leaf doors and folding doors FOLDE.

VENTILATION UNDERCUT

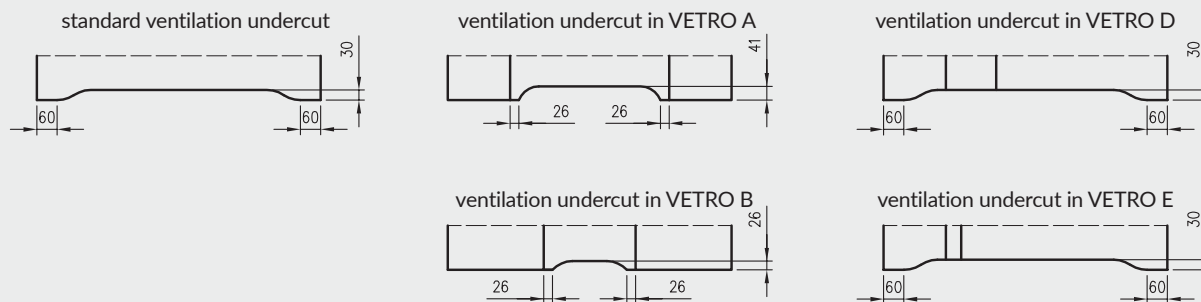



EXPLANATIONS:

GALLA 1 decormat - glass door sliding system

- | | | | |
|--|---|--|--|
| | panel doors , DRE - Cell veneer | | PROFI panel construction doors |
| | frame construction doors, DRE - Cell veneer | | panel doors Sara Eco 2 |
| | entrance doors, DRE - Cell veneer | | smoke-proof technical doors |
| | panel doors, 3D veneer | | fire resistant technical doors |
| | frame construction doors , 3D veneer | | anti-burglary doors |
| | entrance doors, 3D veneer | | panel construction doors, lacquered |
| | panel doors, Finish foil | | panel construction doors, synchronous laminate |
| | panel doors, painted | | frame construction doors, synchronous laminate |
| | frame construction doors, painted | | frame construction doors, glossy |
| | panel doors, laminate CPL | | panel construction doors, glossy |
| | entrance doors, laminate CPL | | frame construction doors, STANDARD MATT |
| | technical doors, laminate CPL | | panel construction doors, STANDARD MATT |
| | glass doors | | frame construction doors, xtreme matt |
| | | | panel construction doors, xtreme matt |

Presented prices of the door leaves doesn't include prices of the door frames and door handles.

The price list is valid from June 17, 2024.

Producer provides 24 months of warranty for door leaves and door frames.

pictures and visualisations used in the catalog present door leaf in the width of 80 cm (it doesn't refer to side panels). In the case of other door leaf widths, the proportions of the placement of the design of the collection, glazing, frames, millings, graphics will change. More technical informations and informations referred to assembly process are available in product guarantee card.

This product catalogue shall not constitute an offer under the regulations of the Civil Code and is published only for information purposes. Information provided in this catalogue was up-to-date on the day the catalogue was published. Due to the company policy of constant development DRE reserves the right to introduce (without prior notice) of changes to technical parameters, equipment, extended warranty conditions and product specification. The actual colours may vary from the colours printed in this catalogue. We reserve the right to errors in print.

Technical approvals:

- National Technical Assessment ITB-KOT-2019/0860 edition 2 (sliding system)
- National Technical Assessment ITB-KOT-2018/0633 release 2 (FORCA, ATHOS fire doors)
- National Technical Assessment ITB-KOT-2022/2051, edition 1 (glass door)
- National Technical Assessment ITB-KOT-2021/1945 edition 1 (folding and sliding glass doors)
- National Technical Assessment ITB-KOT-2017/0011 edition 2 (ENTER / SOLID / SOLID RC2)
- National Technical Assessment ITB-KOT-2018/0407 edition 2 (OLIMP)
- PN-EN 14351-2: 2018-E12 (interior doors)
- National Technical Assessment ITB-KOT-2019/1132 edition 1 (SARA door leaf)
- National Technical Assessment ITB-KOT-2019/0805 edition 2 (steel door frames)

DRE

wybór
architektów



DYSTRIBUTOR

DRE

82-300 Elbląg - Gronowo Górne, ul. Nefrytowa 4
Headquarters: phone 55 236 42 58
Customer service department: phone 55 236 42 43 to 48
fax 55 236 42 51
Marketing department: phone 55 236 42 40
working hours: 8:00 - 16:00
e-mail: dre@dre.pl, eksport@dre.pl www.dre.pl