

PRODUCT CATALOGUE 2024

AIR CONDITIONERS LINEUP

The FUJITSU GENERAL Way

Our mission

Living together for our future

Through innovation and technology, we deliver a brighter future with peace of mind to our customers and societies around the world.

Our philosophy

Act spontaneously

We embrace new challenges by investing in ourselves for personal growth, and through continuous creativity with a spontaneous attitude.

Develop our team

We respect and value our people, and optimize their abilities through fostering culture and diversity, and utilizing a collaborative effort focused on communication.

Value integrity

To achieve our goals, we always act with integrity and shared ethics.

CONTENTS

004 OUR MESSAGE

- 006 Sustainable
- 008 Cleanliness
- 010 Future
- 012 Comfort
- 014 Control
- 016 Design
- 018 History
- 020 Worldwide locations
- 022 Global business activities
- 024 Project references
- 026 Global development & Production bases
- 028 High-quality development & Production Facilities
- 030 2024 New Products

034 SOLUTIONS

- 036 For Light Commercial Use
- 044 For Commercial Use
- 046 For Apartments & Houses

PRODUCT LINEUP

SPLIT & MULTI-SPLIT

VRF

VENTILATION

CONTROL SYSTEM & OPTIONAL PARTS

AIR TO WATER

SUPPORT

- Sp-002 VRF Support
- Sp-004 HVAC System design Support Tool
- Sp-006 Air To Water Support Tool
- Sp-008 Quick Service & Maintenance
- Sp-010 AIRSTAGE Service Monitor Tool
- Sp-012 Service Tool
- Sp-013 Web monitoring tool

OUR MESSAGE





for Sustainable



for Cleanliness



for Future

**Innovation
and
Globalization**



for Comfort



for Control



for Design

We create comfortable lives for people around the world with "made-in-Japan quality" and innovative manufacturing.



History



Worldwide locations



Global business activities



Project references



Global development & Production bases



High-quality development & Production facilities



Sustainable

Sustainable management

We see the challenge of expanding our business by contributing to the realization of a sustainable society as a core element of our growth strategy, and we are working on "sustainable management," based on the three pillars of "harmonious coexistence with our planet," "social contribution," and "care for employees."

Basic policy on sustainable management

The sustainable development goals (SDGs) of the UN will drive business creation in the coming years. The key principle of the SDGs, "Leave no one behind," is synonymous with our own corporate philosophy of "Living together for our future." The promotion of sustainable management is carried out from a medium- to long-term perspective, with a promise to shape a sustainable society for the children and society of the future. We will pursue business growth by accelerating this transformation.

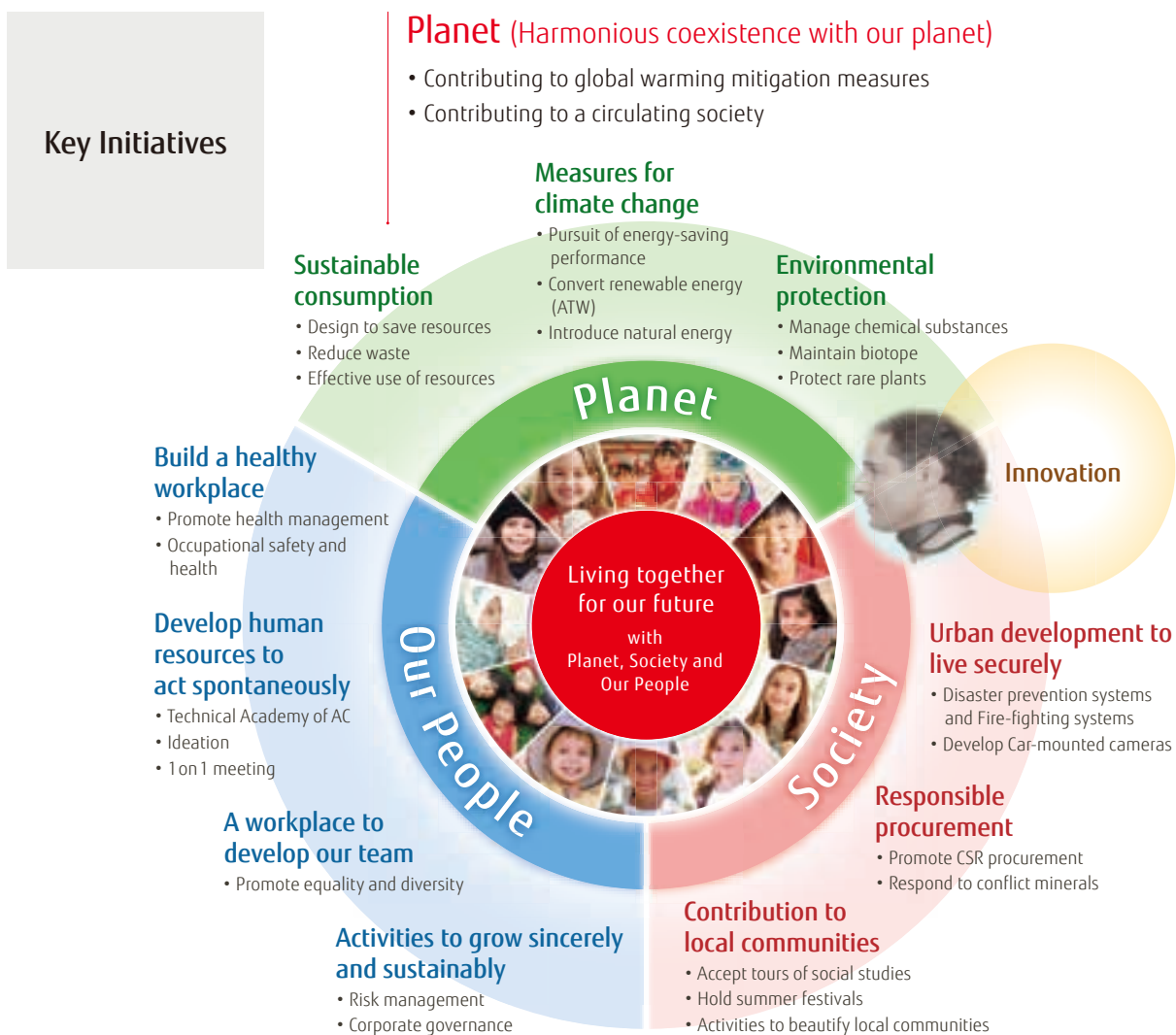

Our People (Care for employees)

- Strategic implementation of health and productivity management
- Creating flexible work styles under COVID-19
- Enhancing human resource development

Society (Social contribution)

Fostering innovation to address social issues (Providing a healthy, clean, and safe society and environment)



Cleanliness

Think about air quality

Fresh air is essential for comfortable air conditioning. Fujitsu General offers a wide range of air conditioning products with air purification functions, such as ventilation systems equipped with high-performance filters and heat exchangers.



Collecting dust particles to clean the air



Silver Ion Filter

The Silver ion filter helps to keep indoor air free from viruses, bacteria and molds.

Notice: Not a result of experiments in an actual use environment. Silver ion filter inhibits activity or growth of microorganism, but do not prevent infection.

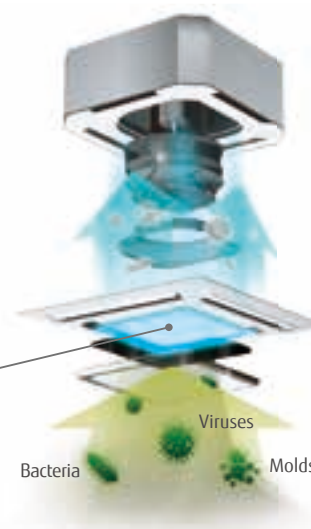
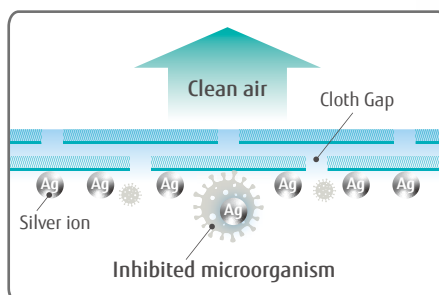

Different filters are used on each side



Ion Deodorization Filter

Deodorizes the air by decomposing absorbed odors using the oxidizing and odor-reducing effects of ions generated by ultra-fine particle ceramic.

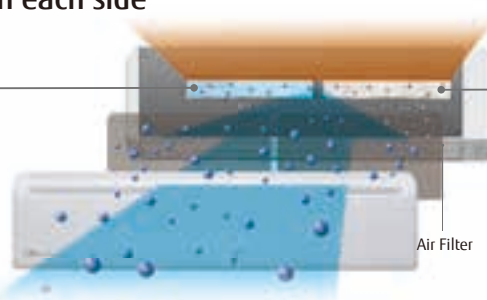
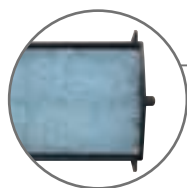

Apple-catechin Filter

The Apple-catechin filter uses static electricity to remove fine particles and dust from the air.

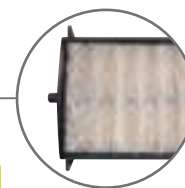

Ventilation with adequate airflow with reduced temperature changes

Heat Exchange Ventilation

When a room is cooled or heated, the exhausted cooling or heating energy is recovered by heat exchange ventilation.

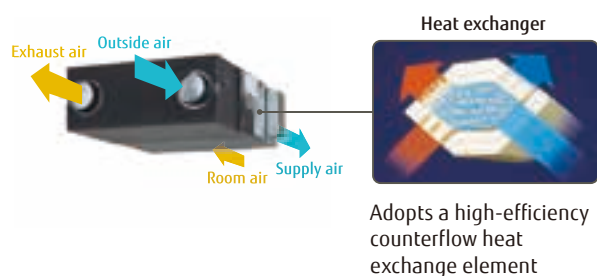



Future

The green refrigerant

Throughout our research and development process, we are constantly striving to create products that we can be proud of in the future. The technologies we have cultivated through these efforts are incorporated into our environmentally friendly products, and are recognized in the European market, which has extremely strict environmental regulations.

R32 refrigerant with reduced global warming potential

- **Zero** Ozone Depletion Potential (ODP^{*1})
- High environmental properties
- High performance
- Economically efficient

*1 **ODP (Ozone Depleting Potential)**: a relative value that indicates the impact per unit weight of ozone-depleting substances released into the atmosphere when CFC-11 (trichlorofluoromethane, CCl3F) is fixed at 1.0

*2 **GWP (Global Warming Potential)**: a measurement that indicates how much other greenhouse gases are capable of warming the Earth based on carbon dioxide. This is the integrated value of radiant energy given to the Earth (i.e., the estimated impact on global warming) expressed as a ratio to CO₂.

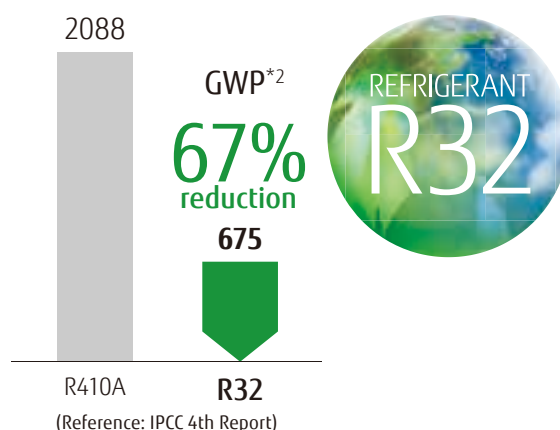

Low GWP to a wide range of projects

We are continuously working to develop products that use R32 refrigerant and have R32 products in all product categories in our lineup (Split, Multi-Split, VRF, and ATW). This allows us to realize environmentally and regulatory friendly system designs for a wide range of projects from residential to light commercial.



New energy labelling requirement 626/2011/EU

Our air conditioners have reached the **"Class A+++"** ranking, the highest energy efficiency level that is now shown on energy labels in Europe.

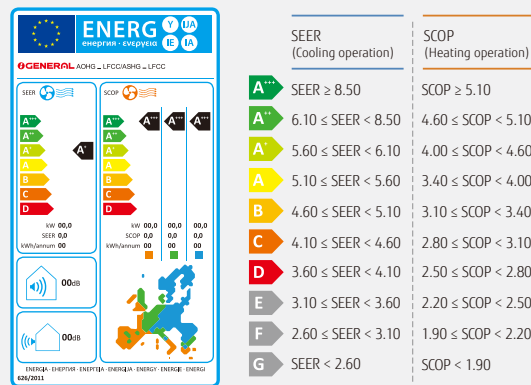

Fujitsu General's Environmental Vision

Medium-Term Environmental Plan: Target and Measure

	Target	Measure
Reduction of Our Own Environmental Impact Achieve	<p>Achieve carbon neutrality by FY2025</p> <p>[Old Target] Greenhouse gas emissions from our Group's business activities: Completely eliminate by FY2030</p>	<ol style="list-style-type: none"> 1. Renewable energy conversion: Existing plants (by FY2023) 2. Renewable energy conversion: All Group companies (by FY2025) → Achieved 1 and 2 ahead of schedule (April 2022) 3. Shift to use of renewable energy for all other energy used (by FY2025)
Through Our Supply Network	Reduction of 30% for total greenhouse gas emissions through our supply Network by FY2035 (vs. FY2018)	<ul style="list-style-type: none"> • Promotion of green electricity use by our suppliers • Reduction of material consumption and product weight
For our Customers and Society	Reduce greenhouse gas emissions from the use of our products. Reduction of 30% by FY2030 (vs. FY2013)	<ul style="list-style-type: none"> • Replace constant-speed A/C with inverter A/C (India and Middle East) • Enhance energy efficiency



Comfort

Comfortable airflow design

Pursuing the potential of air conditioners and true comfort, Fujitsu General has developed and commercialized numerous world-first technologies, and these concepts are reflected in the design of our products.

Cassette type 3D flow Series

3 individually controlled air outlet ports

The Comfortable airflow setting enables the right and left air outlet ports as well as the wide center port to work together to provide a comfortable room environment.

*1: Announced 2018. In room air conditioner for the home (Our company's investigation)

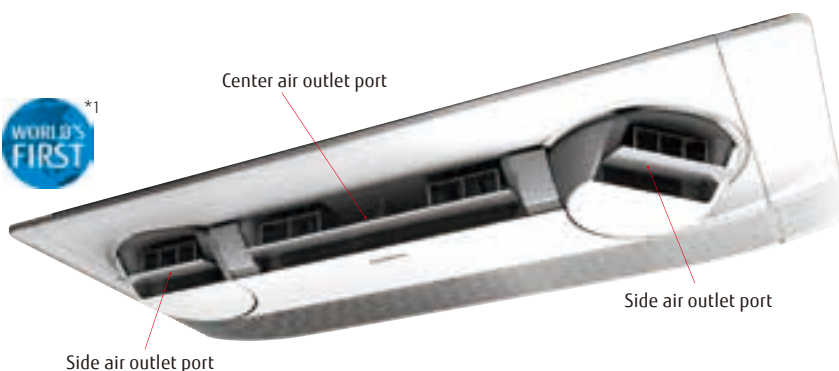

Cassette type One-way flow Series

Wide airflow range created by triangle design and large flap

A large flap with a wide range of movements, equipped with louvers arranged triangularly, sends air into every corner of the room.

Cassette type Circular flow Series

Unique circular flow design

This Series realizes a Circular Flow to blow a large airflow in a 360° direction by using a high-performance DC fan motor, turbo fan, and a unique seamless airflow louver design.

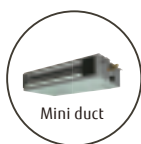

Auto louver grille kit for Mini duct and Slim duct

Flexible Control

The optional clean-looking flat Auto louver grille kit blends into any interior and provides a comfortable airflow.





Control

Operation from anywhere

Using the Internet of Things (IoT), Fujitsu General is actively providing services that allow users to control their air conditioners from their smartphones. We are also expanding our open co-creation activities with external partners to deepen the development of new functions and services using IoT and artificial intelligence (AI) to develop safe and convenient air conditioners.



User-friendly screen display enables easy operation.

With the WLAN adapter and the AIRSTAGE Mobile app, you can control the heating and cooling of your home anytime, anywhere.



Software application for WLAN Adapter

"AIRSTAGE Mobile" is a software application that allows users to control Fujitsu General air conditioners from anywhere with a mobile device while out or on the move.



AIRSTAGE Mobile

Download Free

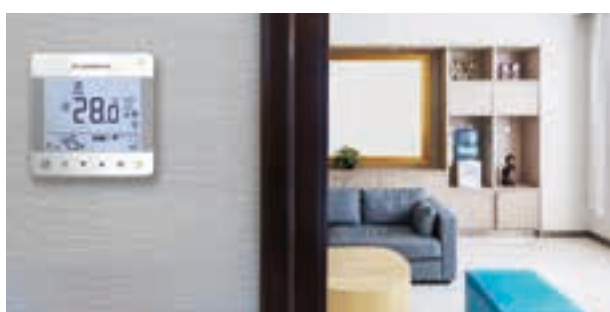

Compact wired remote controller

Large screen and simple display

- Large screen, yet compact in size
- Large, easy-to-read letters are used.
- The controls are simple and easy to understand.



Central remote controller for VRF system

The central remote controller uses a touch panel screen to display multiple menus on the top screen. Just touch the menu you want to operate, and the necessary window will pop up, and allow intuitive operation.

Remote monitoring and operation

The central remote controller enables monitoring and control of a tenant's air conditioner anytime, anywhere.

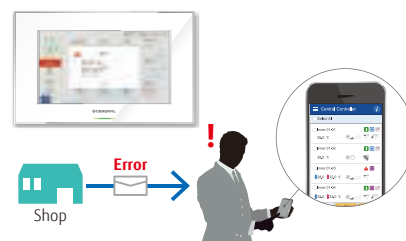



Design

Harmonizes with the installation space

Fujitsu General offers a wide range of products for the European market, including models with unique textural designs, award-winning models that integrate with room interiors, and Cassette type models with different designs that match office spaces. We also have a lineup of models with elegant designs, such as the Ceiling type models with its beautiful curved surface.





Light Elegant Design

New Ceiling type design

The light, elegant and three-dimensional expression achieved by the curved surface gives a sense of comfort and well-being.



reddot winner 2020



New "Elegant & Smart" Square Design

New Wall-mounted type design

Smart design with ridges and subtle shade

*Image is KN Series

NEW

Sleek and Stylish Design

New designed wired remote controller

When not in use, the controller is a part of the interior decor. This is achieved by using mirrors, glass, and clear panel, and it appears to be on with the wall.



reddot winner 2024



GOOD DESIGN



NEW

Stylish design

New outdoor unit for Air to Water Future Release

A design that offers a sophisticated style that is quiet and blends in with the outdoor landscape.





History

Yaou Shoten Ltd. established in 1936

Overseas air conditioning business since 1971

Starts air conditioning business in Japan in 1960

1971 Air conditioner exports to the Middle East.

1977 "Super Power, Super Quiet" Series released

1982 Window type 3 Super Series released

AL/AX Series



1985 Large wall-mounted type and multi-split air conditioner released.



***1,*2 1991** World's first air conditioner equipped with lambda-shaped heat exchanger

1994 World's first air conditioner with power diffuser

2001 AIRSTAGE Series released VRF air conditioners for large buildings

AIRSTAGE™



***3 2002** Air conditioner with the world's first automatic self-cleaning filter system

nocria™



2004 Standalone Compact VRF AIRSTAGE J Series released



2006 VRF Heat Pump type Maximum 42 HP AIRSTAGE V Series released

AIRSTAGE V™



2009 VRF Heat Pump Modular type Maximum 48 HP AIRSTAGE V-II Series released

2009 Air to water system released

WATERSTAGE™



1950 ~

1970 ~

2000 ~

Manufacturing Company Establishment

1955 Head Office established in Kawasaki

1964 Electronic components factory in Ichinoseki



1977 Air conditioner manufacturing company in Hamamatsu (now Hamamatsu business office)

1991 Air conditioner manufacturing company in Thailand

1994 Air conditioner manufacturing company in Shanghai, China

1998 Air conditioner motor manufacturing company in Thailand

2006 VRF air conditioner manufacturing, sale, and service company in China

2007 Air Conditioner Technology Building becomes operational on the premises of the Kawasaki Headquarters. Air conditioner R&D Center in Kawasaki

2009 Compressor Factory begins operation in Thailand



Fujitsu General (UK) Co., Ltd. (UK)



Fujitsu General (EURO) GmbH

Sales & service maintenance company established

1976 North America sales company

1977 Europe sales company (UK)

1978 Australia sales company and Europe sales company (Germany)

1980 Brazil sales company

1997 Asia sales company (Singapore)

1998 Middle East sales company (UAE) and New Zealand sales company

2000 Air conditioner manufacturing and sale technical partnership in India

2002 Taiwan sales company

2006 China sales company

*1: Announced 1991. In room air conditioner for the home (Our company's investigation) *2: Announced 1994. In the category of room air conditioners for the home (Our company's investigation). *3: Announced 2002. In the category of room air conditioners for the home (Our company's investigation).

For Light commercial use

2011 Compact 2 Fan type VRF AIRSTAGE J-II Series released

2014 Compact 1 Fan type VRF AIRSTAGE J-IIS Series released

2016 Compact 2 Fan type VRF AIRSTAGE J-III Series released

2017-19 Compact VRF AIRSTAGE J-IIIIL Series for light commercial use released

2020 Compact & lightweight outdoor unit AIRSTAGE J-IVL, J-IV, J-IVS Series released



2019

New cassette style released
3D Flow Cassette

For Commercial use

2012 VRF AIRSTAGE VR-II Series released

2014-15 VRF AIRSTAGE VR-III Series released

2020 Heat Recovery Modular type VRF AIRSTAGE VR-IV Series & AIRSTAGE Air handling unit released

2022 Energy-saving operation model VRF V-IV Series released



VRF **V-IV**

For Residential use

2011 Hi-spec Design model LT Series & LU Series released

2017 Flagship Wall-mounted type "nocría X" released

2017-19 Added to this lineup recently are the environment-friendly R32 refrigerant models. (Split & Multi-split type)

2022 Harmonizes beautifully design model KE Series released



nocría X



For Commercial use

VRF **J-VS**



2024 New VRF products with R32 refrigerant released

For Light commercial use

For Residential use

Split & Multi-split
New Wall-mounted type & Duct type with high-energy saving released



New "Elegant & Smart" Square Design model released

Cooling-enhanced type
High-efficiency operation even at high outdoor temperatures



Wired Remote Controller
Simple and stylish design that harmonizes with the installation space



2010 ~

2024 What's New

2012 Joint venture in Thailand to manufacture compressors



2016 Commercial use air conditioner R&D Center in Thailand

2019 New building constructed at Kawasaki Head Office to strengthen development capabilities



2020 Building IoT-based manufacturing in Thailand



2023 FGAI R&D New Office:
FGAI Research & Development office moved to the new office in New jersey, USA



2016 THE AIRSTAGE on Broadway in New York



2023 Communication Lounge EURO:
New lounge in Dusseldorf, Germany



*4: Announced 2018. In room air conditioner for the commercial (Our company's investigation) *5: Announced 2012. In room air conditioner for the home (Our company's investigation)



Worldwide locations

Under a system of five bases in Europe, the Middle East, Asia and Oceania, North and South America, and Japan, the company promotes Globalization from a worldwide perspective while emphasizing the actual conditions in each region.



JAPAN Head Office



Technology research building (Japan)



• Air conditioner solution center
"THE AIRSTAGE" in Manhattan, New York

• Fujitsu General America, Inc.

• Fujitsu General Do Brasil Ltda.

18 Overseas Sales Companies



Fujitsu General Sales & Trading (Shanghai) Co., Ltd.



Fujitsu General (Taiwan) Co., Ltd. (Taiwan)



Fujitsu General (Thailand) Co., Ltd. Bangkok Office (Thailand)



Fujitsu General Electronics (Suzhou) Co., Ltd.



Fujitsu General South East Europe S.A. (Greece)



Fujitsu General (EURO) GmbH (Germany)



Fujitsu General Air Conditioning (UK) Ltd. (U.K.)



Fujitsu General (Italia) S.p.A (Italy)



Fujitsu General (India) Private Ltd. (India)

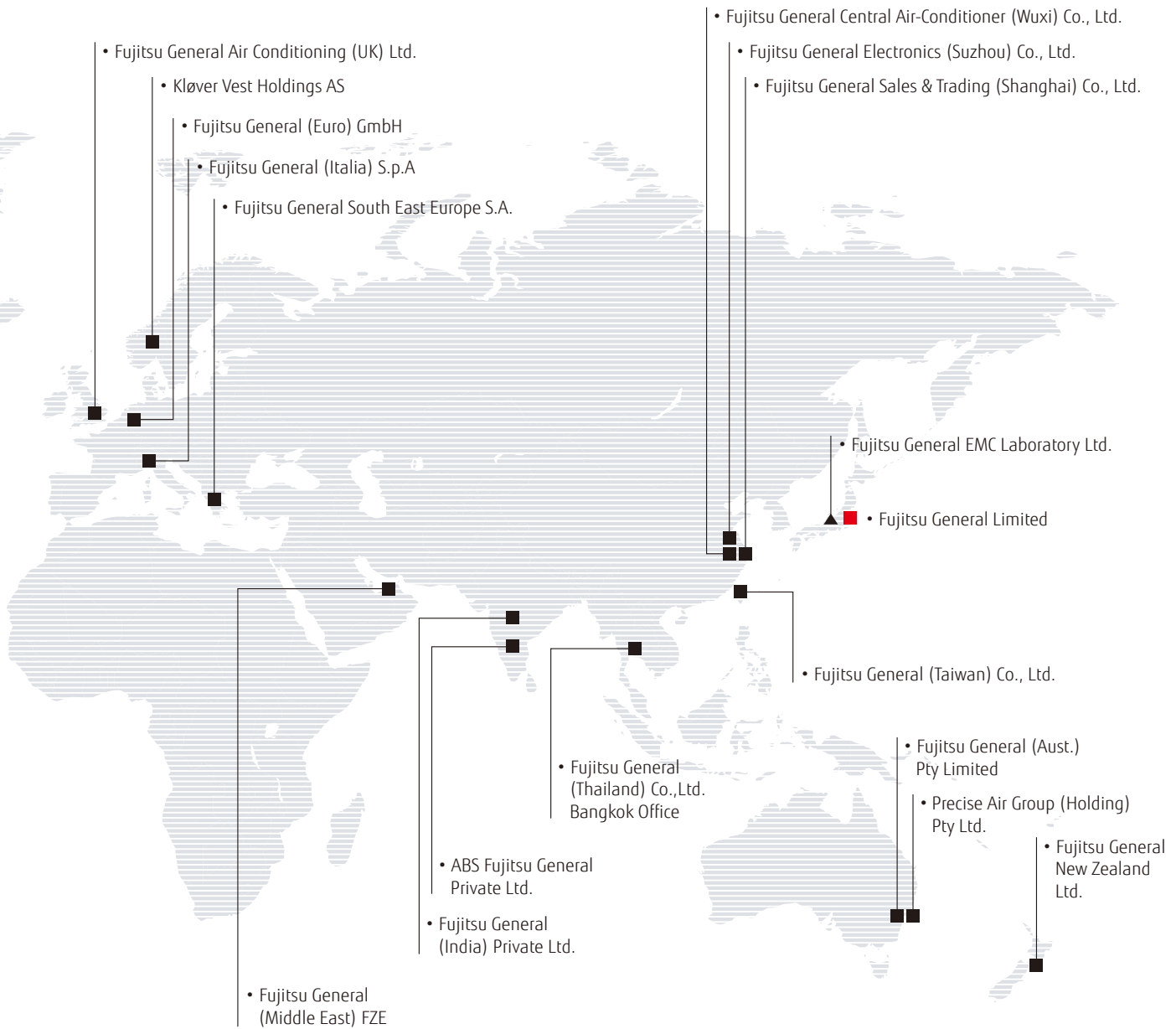

Fujitsu General (Aust.) Pty Ltd. (Australia)



Precise Air Group (Holding) Pty Ltd. (Australia)



Fujitsu General New Zealand Ltd. (New Zealand)



Fujitsu General (Middle East) FZE (U.A.E.)



FUJITSU GENERAL SOLUTION CENTER "THE AIRSTAGE" (U.S.A.)



ABS Fujitsu General Private Ltd. (India)



Fujitsu General Do Brasil Ltda. (Brasil)



Fujitsu General America, Inc. (U.S.A.)



Kløver Vest Holdings AS (Norway)



Global business activities



We have been recognized for our activities in advertising, human resource development and customer service, as well as for our community-based social contribution activities in each region, winning numerous awards and achieving a high level of customer satisfaction.

North and South Americas



AHR Expo



HVAC trade shows in Brazil



Distributor conference in USA



Call center

Middle East



Exhibition



Training in Kuwait



Launch event in Oman

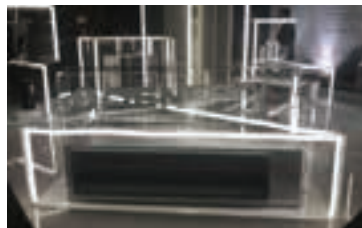

New product seminar in UAE

Europe



HVAC trade show in Germany



Training in Germany

International authoritative design awards



The NEWS Dealer Design Awards



Gold Award (Category: HVAC & PLUMBING) in Reader's Choice Awards



TOP OF MIND 2016 First prize in "MARCA DE EQUIPAMENTO DE AR-CONDICIONADO" category of "CLIMATIZACAO" division



Superbrands is the world's largest independent arbiter of branding.



The iF Product Design Award is given annually by iF International Forum Design GmbH for industrial products from around the world.



The Plus X Award is the world's largest innovation award for technology, sports and lifestyle.

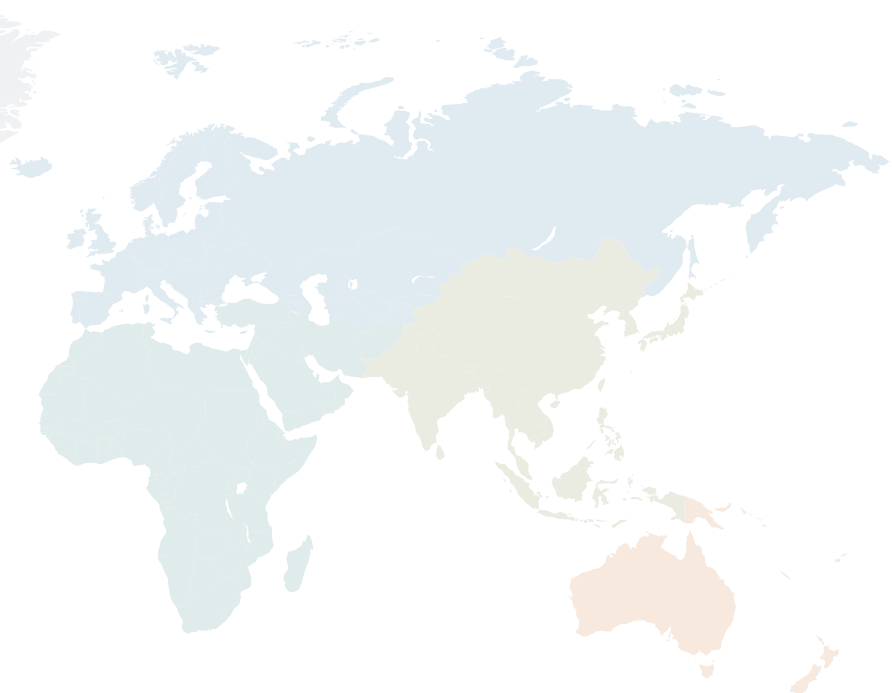

Asia



Thanksgiving party in Taiwan



Exhibition in India



Opening ceremony in India



New product presentation seminar in Singapore



Service training in Vietnam

Oceania

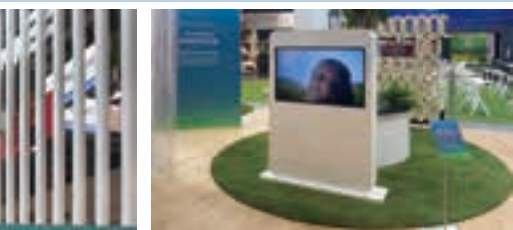

HVAC trade show in Germany



HVAC trade show in Australia



Training seminar in Italy



Launch event in New Zealand



Event in the United Kingdom



Launch event in New Zealand



A product design competition that has been held since 1955. Products that win the award are given the "Red Dot" seal, a sign of international recognition of quality.



One of the famous design award in the world. Designs are judged on innovation and aesthetics, as well as their benefit to users, clients/brands, and society.



ProductReview.com.au's annual awards are selected from products and services that have been well-rated by the ProductReview community.



Voted by Australians as the 'Most Trusted Brand' - Air Conditioning Category 5 Years Running'



China State Construction Engineering Luban Prize



The Good Design Award is an award sponsored by the Japan Institute of Design Promotion, and is given once a year to items of outstanding design.



Project references

Introduced in over 50 countries worldwide

Highly popular for their excellent quality, energy efficiency, and ease of installation, Fujitsu General's products are installed in a wide range of buildings around the world, including high-rise office buildings, stores, hotels, public facilities, schools, hospitals, and residences.



1



2

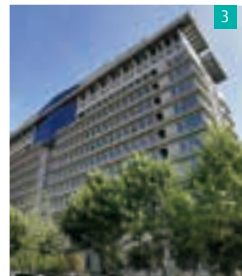

3



4



5



6



7



8

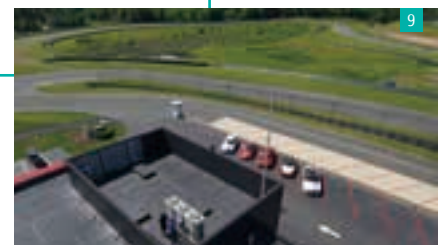

9



For Light commercial use

- 1 Shop in Europe
- 2 Factory in Europe
- 3 School in Asia
- 4 Hospital in Asia
- 5 Office in Asia
- 6 Shop in Oceania
- 7 Office in Oceania
- 8 School in the Middle East
- 9 Public facility in the United States



11



10

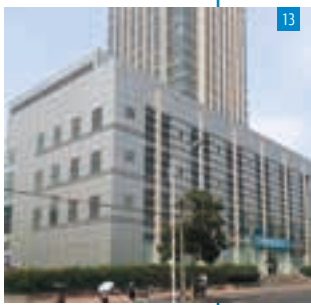

13



12



16



For Commercial use

- 10 Public Square in Asia
- 11 Hotel in Asia
- 12 Hotel in Asia
- 13 Public facility in Asia
- 14 Apartment in Oceania
- 15 Apartment in Oceania
- 16 Hotel in the Middle East
- 17 Hotel in the Middle East



14

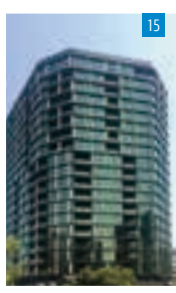

15

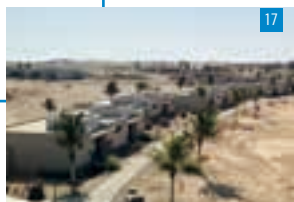

17



18



20



For Residential use

- 18 Villa in the Africa
- 19 Residence in Oceania
- 20 Residence in the United States
- 21 Villa in the Middle East



19



21



Global development & Production bases

We have established R&D bases in five countries from Japan, Europe, Asia, China, and North America to pursue environmental properties and comfort according to the needs of each region.

- • Head office
- • R&D center
- • Manufacturing companies



• Fujitsu General (Euro) GmbH
— R&D center

• FGHP

• North America R&D Center
— R&D center

R&D center & Technology Research Building



R&D center in Fujitsu General (EURO) GmbH (Germany)



North America R&D Center (USA)



Fujitsu General Air Conditioning R&D (Thailand) Co., Ltd. (Thailand)



R&D center in Fujitsu General (Shanghai)



JAPAN Head office, R&D center and 60 m height difference testing tower (Japan)

Technology research building in Japan Head office

Constructing IoT-based manufacturing

We are implementing a real-time IoT-enabled system to immediately visualize and analyze various information such as facility operating status, assembly line production progress, and parts inventory and transportation status. This will further enhance the accuracy of production and shipping forecasts in the Head Office and factory management departments. The system will also help improve activities by employees at production sites, with the aim of improving the efficiency of the production process, the efficiency of parts distribution operations, and the utilization rates of the facilities.



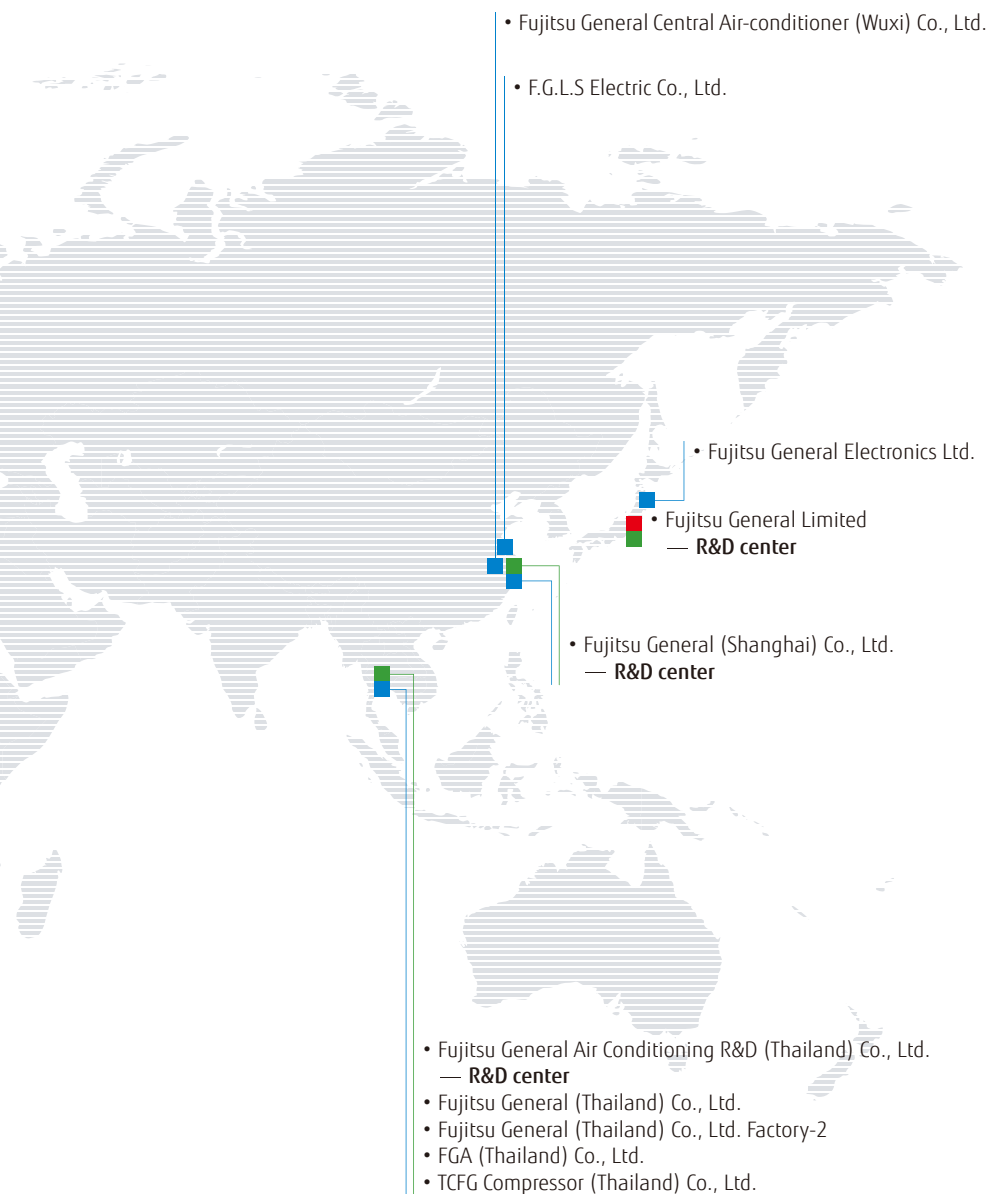

Overseas manufacturing companies



Fujitsu General (Shanghai) Co., Ltd. (China)



F.G.L.S. Electric Co., Ltd. (China)



Fujitsu General Central Air-conditioner (Wuxi) Co., Ltd. (China)



Fujitsu General Electronics Ltd. (Japan)



Fujitsu General (Thailand) Co., Ltd. (Thailand) Factory-2



Fujitsu General (Thailand) Co., Ltd. (Thailand)

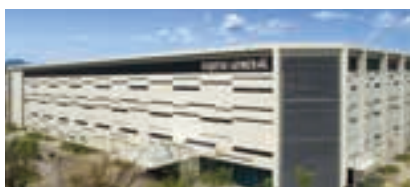

Fujitsu General Air Conditioning R&D (Thailand) Co., Ltd. (Thailand)



FGA (Thailand) Co., Ltd. (Thailand)



TCFG Compressor (Thailand) Co., Ltd. (Thailand)



High-quality development & Production facilities

Advanced Research Facilities and Equipment

Performance tests



Airflow measurement room
Measure the airflow of air conditioners, from compact room air conditioner models to variable refrigerant flow (VRF) systems.



Calorimeter
Measure the temperature, humidity, and airflow at the inlet and outlet of the air conditioner to evaluate its cooling and heating capacity.

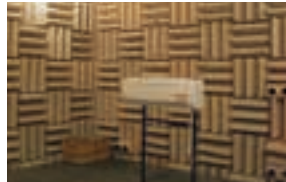

Silent room
Measure the operating sounds of air conditioners on walls and ceilings with reduced sound reflection.

Fujitsu General is one of Japan's leading manufacturers with R&D centers in Japan. The research and development conducted in these facilities contributes to providing our customers with the highest quality and performance.

Reliability tests



Constant temperature room
Verify product performance in cooling and heating operations under various temperature and humidity conditions.



Practical test room
Check whether the performance of the air conditioner can be sustained under the conditions of the actual housing environment.



Shower test room
Check if the electrical box of the outdoor unit is protected from strong wind and rain, such as during a typhoon.

Transportation and Handling Tests



Compressibility test



Vibration test



Technology research building
in Japan Head office

Testing laboratory

Fujitsu General EMC Laboratory Limited

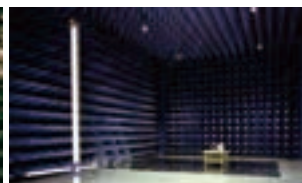

60-m Height Difference testing tower

Tests oil circulation in a compressor for reliability.



Certification of ISO 9001 and ISO 14001

■ ISO 9001
 ■ ISO 14001
 () Number of companies

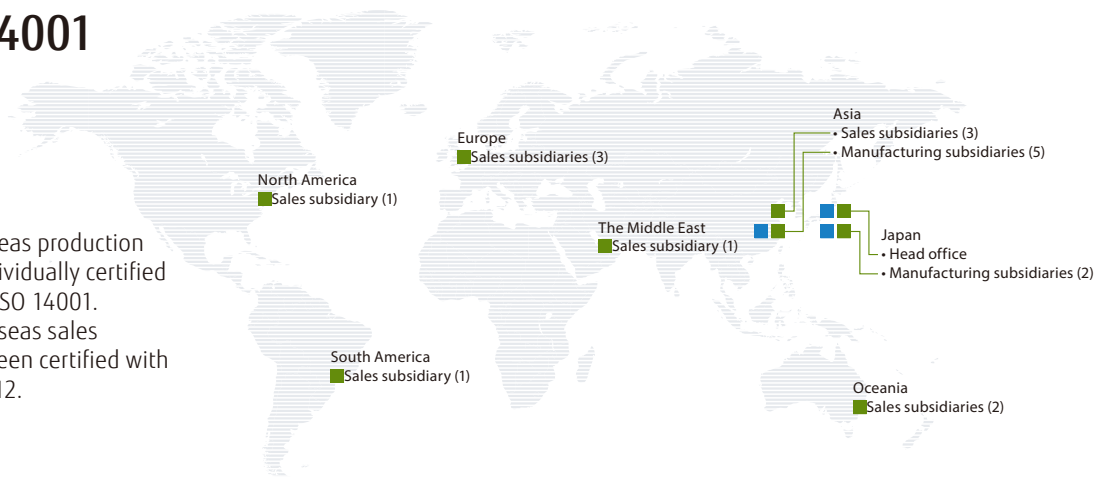

The Group's 5 overseas production subsidiaries are individually certified with ISO 9001 and ISO 14001. The Group's 11 overseas sales subsidiaries have been certified with ISO 14001 since 2012.

Product Quality Assurance

All Fujitsu General plants are ISO 9001 certified and operate under a unified quality control system. We deliver to customers all over the world high-quality products that have passed stringent quality inspections.

Receiving inspection

We require all our parts suppliers to submit test reports to ensure that all parts we receive from them meet our quality standards. Our in-house test department inspects incoming parts to ensure their compliance with RoHS as required by the EU. We also conduct 100% inspection of main parts to prevent defective parts from making it to assembly lines.

Quality inspection of products

We carry out stringent quality inspections in all production processes performed in our plants. To keep the quality of our products high, inspectors check their quality from start to finish on production lines.





Split, Wall-mounted type
Built-in W-LAN adapter models



ECO Range
Compact Size (Cooling-enhanced type)

S-032-033

- 7-12 classes, 3 models
- Elegant & smart square design
- High energy saving
- Comfortable airflow & Quiet operation
- Smart device control
- Easy access to the flare pipe connection

2024 New Products



SPLIT



MULTI-SPLIT



Wall-mounted type Built-in W-LAN adapter models

Designer Range, Standard Range

S-016, 020 M-006, 022

- Improved energy efficiency from the current products
- 7-14 classes, 8 models
- High energy saving
- Built-in WLAN adapter
- Comfortable airflow & Quiet operation
- Easy access to the flare pipe connection



KG Series Designer Range
High Spec & Design



KM Series Standard Range
High-Efficiency & Comfort



Smart Device control

You need to install the "AIRSTAGE Mobile" app on your smart device in order to control the air conditioner.

ECO Range

S-022-023 M-006, 023

- 5-12 classes, 4 models *5 class only for multi-split
- Elegant & smart square design
- High energy saving
- Comfortable airflow & Quiet operation
- Built-in WLAN adapter
- Easy access to the flare pipe connection



KN Series ECO Range
Compact Size



Impression of Soft Black

Soft Black is a natural black color with a relatively gentle tone and no strong contrast. A Soft Black harmonizes with the environment and creates a warm atmosphere.

Soft black color models

S-020 M-022

- Soft Black
- 7-14 classes, 4 models
- High energy saving
- Built-in WLAN adapter
- Easy access to the flare pipe connection



Wireless R.C.



KM Series Standard Range
High-Efficiency & Comfort



Medium static pressure duct

High-efficiency & Comfort

S-040-043 M-007, 025

- 12-54 classes *Multi-split is only 12-22 classes
- Slim & Compact design
- High energy saving
- Easy maintenance
- Drain hose as standard
- Wide range of static pressures



12-18 class



22 /24 class
*Multi-split is only 12-22 classes



30-54 class



VRF

VRF J-VS

Heat Pump for Small-capacity type

Outdoor unit

V-020-025

- **Sustainable:** R32 refrigerant with reduced global warming potential
- **Saving CO2:** Top class high energy saving
- **Small Body:** Easy carriage and installation
- **Situational Piping Design:** Long pipe length, Up to 13 indoor units* can be connected
- **Sightliness installation:** External static pressure, cooling piping system

*: 6 HP model



Indoor unit

V-058-065

- 4 - 24 classes, 3 type, 34 models
- Compact & Slim design
- Flexible installation



Compact Cassette

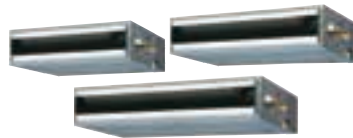

Low Static Pressure Duct
Slim Duct/Slim Concealed Floor



Wall-mounted type



CONTROL SYSTEM

Wired remote controller

Design type

C-010-011

- Harmonizes with the Installation Space
- Intuitive operation
- Status LED Colors
- Refrigerant cycle monitor
- Logo Display
- AIRSTAGE Remo Set application (free download)
- Initial Settings / Indoor Unit Function





AIR TO WATER

New Monobloc system

Comfort series

Future Release

- 5-10 kW classes, 3 Models
- High energy efficiency
- Quiet operation
- Easy installation & maintenance



SUPPORT

AIRSTAGE Service Monitor Tool

for Single-split, Multi-split, Air to water

Sp-010-011

- Improved work efficiency
- Bluetooth communication
- Compact and lightweight design
- New application with simple design
- Refrigerant cycle graph display

UTY-ASSXZ1



AIRSTAGE Service Monitor Tool

*Android only.
You need to install the "AIRSTAGE Service Monitor Tool" app on your smart device.



From Business to private spaces
SOLUTIONS

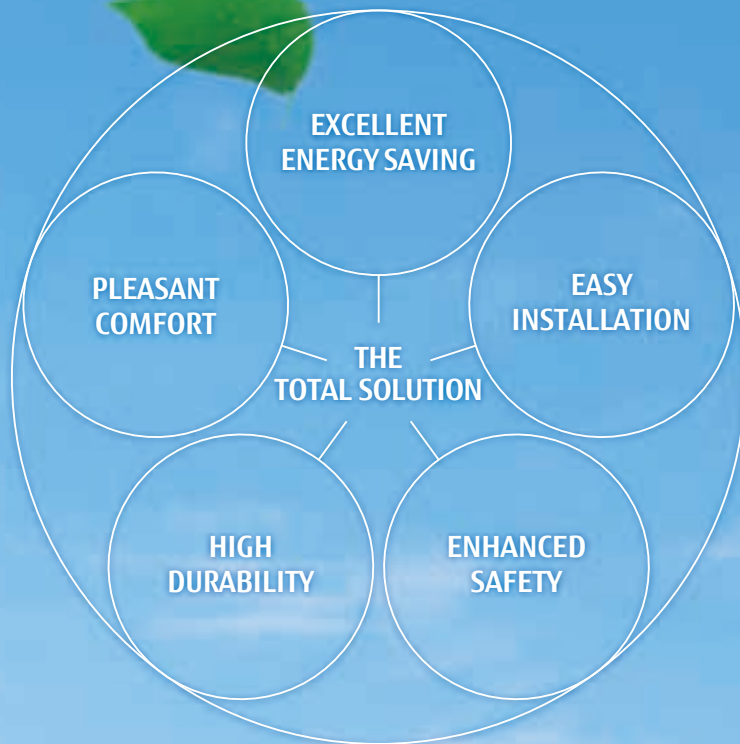

Key solution points

Fujitsu General's total solutions are tailored to each property's unique needs.

Fujitsu General provides the best control solutions for buildings.

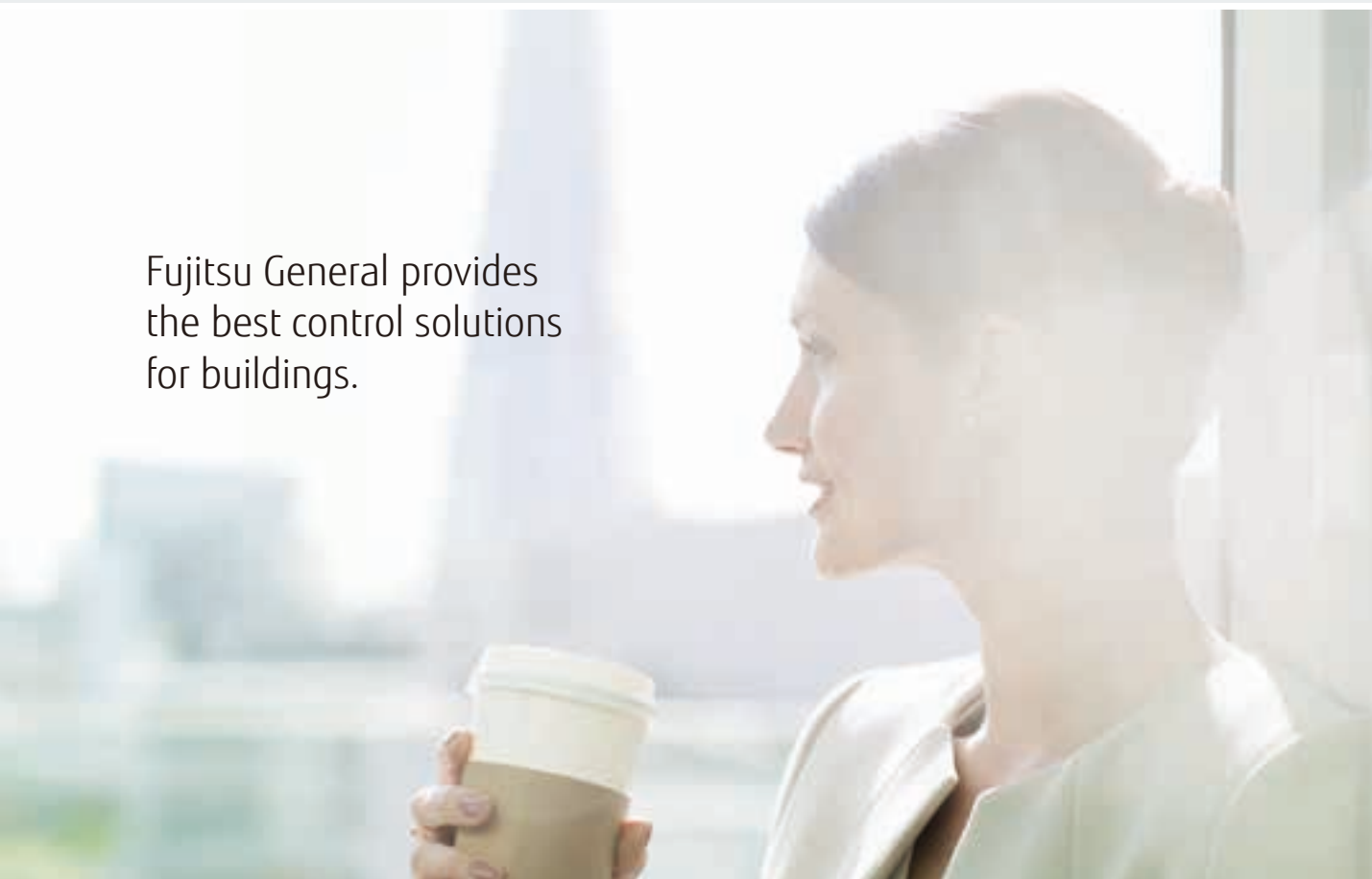

Target buildings

A casual conversation with a colleague at work

A presentation in a large meeting room

A restaurant you stop by Your living room

We have a comprehensive lineup of air conditioners ideal for all these situations—from business to private spaces.

Fujitsu General's air conditioners are used in all aspects of everyday life.



For Light commercial use

Comfortable and economical air conditioning systems, ideal for small and midsize commercial buildings

036 Restaurants, Shops

038 Small offices

040 Hotels

042 Schools



For Commercial use

Single and modular VRF systems for high efficiency, comfort, design flexibility, ease of installation, and high reliability

044 Large Buildings



For Residences

Smart air conditioning systems with extensive control options for comfort and convenience of use

046 Residences



Restaurant, shops

For Light commercial use

Fujitsu General provides perfect total air conditioning systems that offer seamless support by tenant, by purpose, and by customer visit frequency in shops and restaurants with multiple lighting and a high density of customers.



Single split For Restaurants

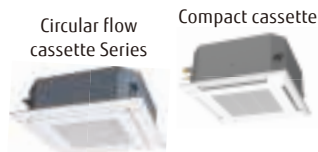
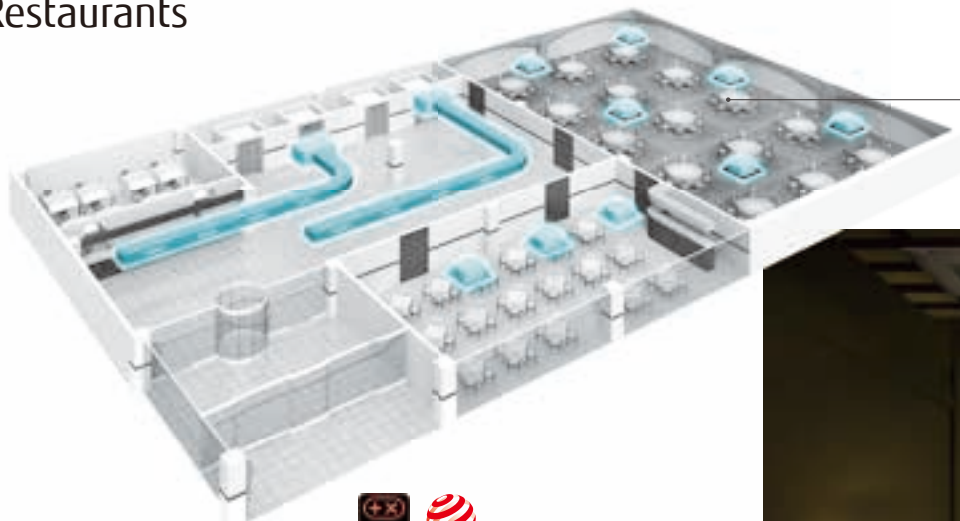

Circular flow
cassette Series

Compact cassette



Ceiling type

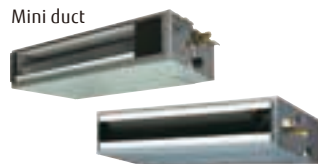

Mini duct

Slim duct



Medium static
pressure duct



High static pressure duct



NEW

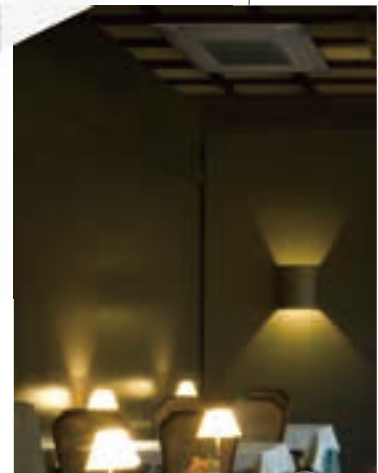

Circular flow
cassette Series
For ambience with
dimmed lighting

For rooms with
bright interiors

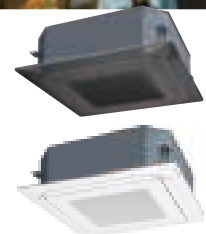

Two panel colors

Both black and white panels are available for Cassette type. Black panels are suitable for dark places such as atmospheric restaurants. White panels, by contrast, are more appropriate for use in brightly lit spaces such as offices. (Available for Single split and VRF indoor units)



Simultaneous multi-split For Shops

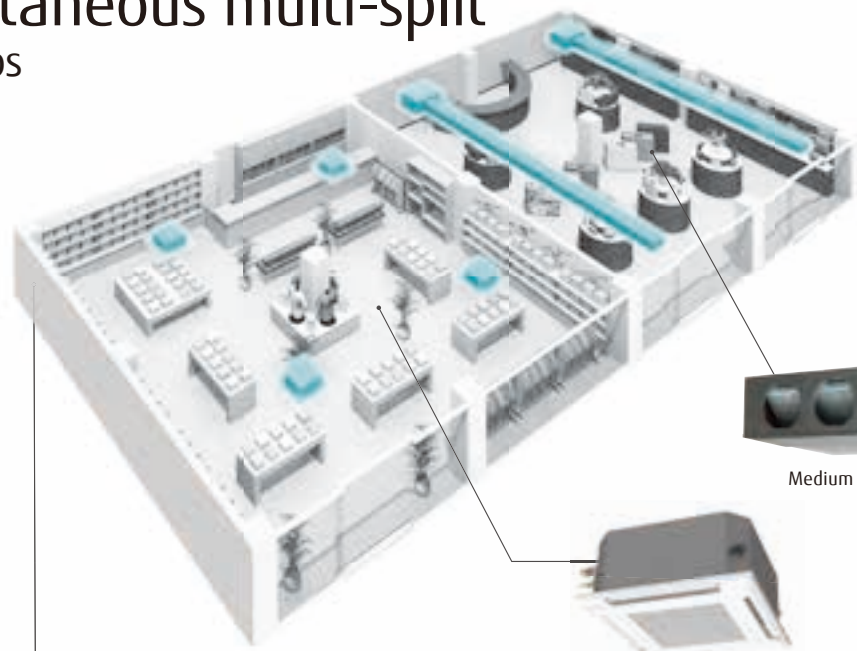

Various indoor unit lineup

You can choose from 3 types of indoor units to suit the atmosphere and layout of your shop.

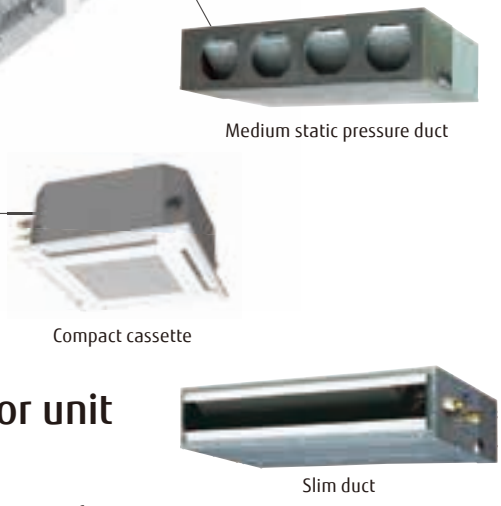

Small, lightweight outdoor unit

Models equipped with the new R32 refrigerant. Compared to current models, the outdoor unit is more compact and easier to install. (45/54 models)
Compact cassette Series for grid ceiling were added to the lineup of indoor units to improve ease of installation.

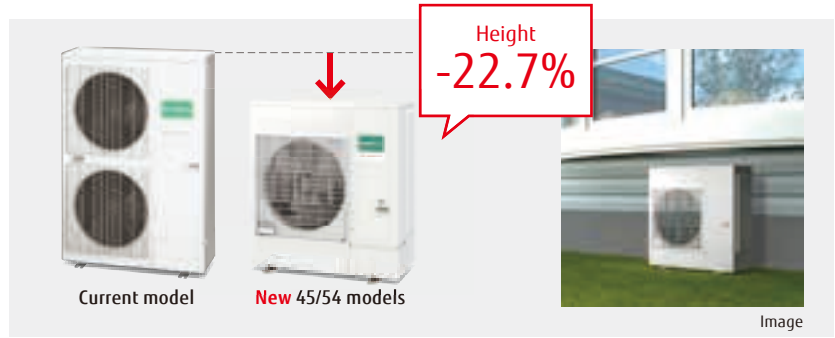



Small offices

For Light commercial use

Fujitsu General offers a perfect total air conditioning system for small office buildings with multiple small rooms, taking into consideration energy savings, low noise, comfortable air volume, usage and purpose, and centralized control.

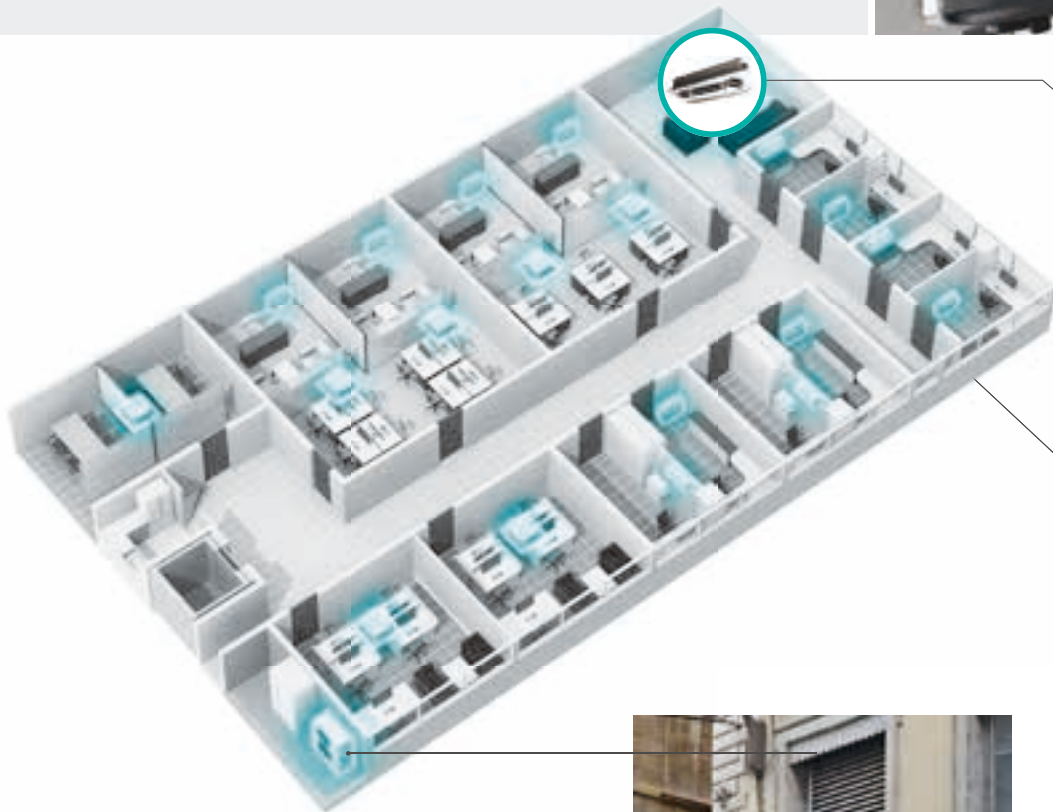

J-IV Series

J-IVL Series

J-IVL Series High-capacity model

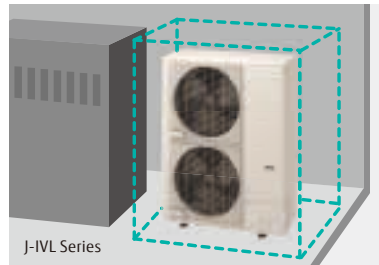
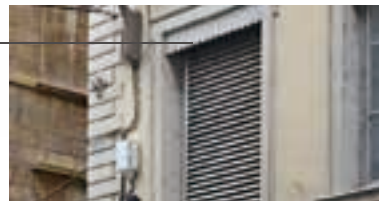

J-IVL Series

Compact outdoor unit with low noise design

Takes up little space even when installed in a machine room or on the roof. Sufficient static pressure can be maintained even with louvers. Low-noise mode suffices even for nighttime operations at low noise levels.

VRF J Series compact outdoor units with up to 18 HP

Suitable for the buildings with multiple small rooms. Up to 42 indoor units* can be connected.

*Only J-IVL Series 18 HP model



Breakthrough 3D flow cassette with innovative pursuit of comfort

The left and right air outlet ports with a maximum rotation angle of 100° and the wide central air outlet port create a comfortable space with less uneven temperature.



Wide lineup of indoor units of low-capacity class

Various low-capacity 1.1 kW indoor units are available for small rooms and spaces.



Wall-mounted type



Compact floor type



Central remote controller with improved operability

Controls the temperature of each room easily, and manages and sets the operation control for a week. Energy-saving management by setting upper and lower temperature limits and operating prohibitions.



NEW

Central remote controller UTY-DCGGZ3

Remote Management

Remote monitoring / Remote operation

New central remote controller can control your tenant's air conditioner anytime and anywhere. When the central remote controller manages the indoor units of some tenants, air conditioning of each tenant can be managed separately online.

Increased the Number of Accounts

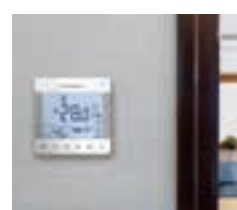

Compact wired remote controller

Compact size with a large screen for easy operation. The stylish design harmonizes with the interior.



Hotels

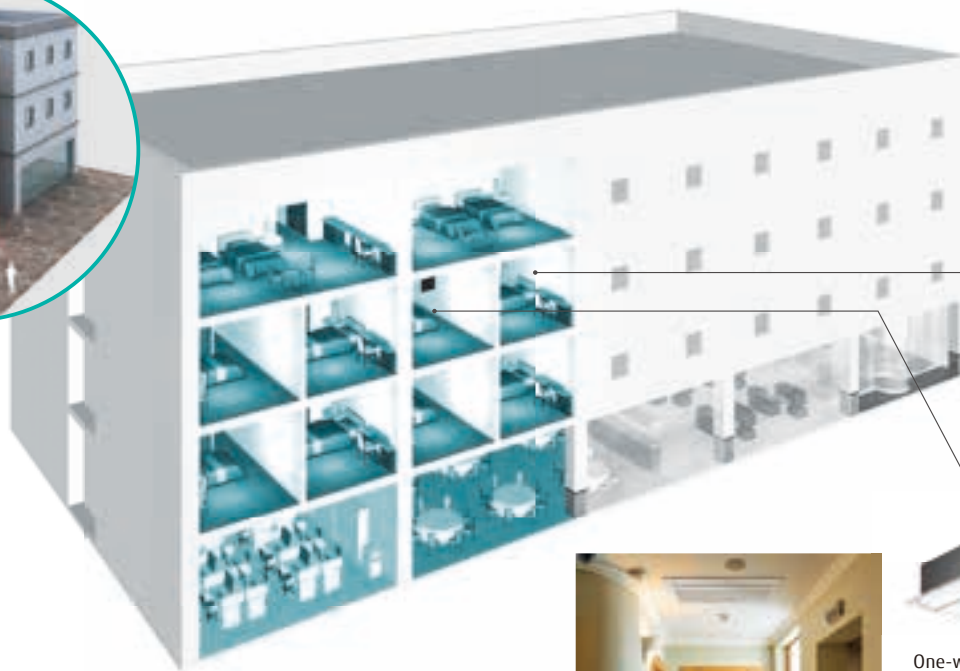
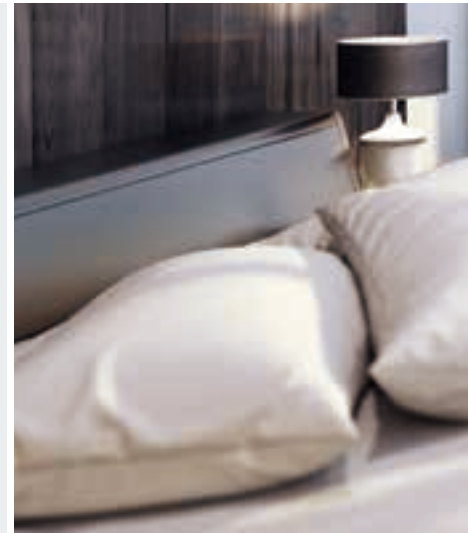

For Light commercial use

Fujitsu General offers total air conditioning systems perfect for low-rise, small hotels that take into account energy savings, external appearance, safety, and ease of installation.



One-way flow cassette Series
Compact chassis with low noise operation The low operating noise makes the model ideal for use in the corridor of a hotel.

Select the product best suited to the characteristics of the property.

	 Split	 VRF J-VS	 VRF VR-IV
Project size	Small	Middle	Large
Individual Air conditioning	Great	Good	Great
Reduction of installation space	Fair	Great	Great
Landscape (hide outdoor unit)	Fair*	Great	Fair
Maintenance (individualized)	Great	Good	Fair

*Depends on pipe length constraints

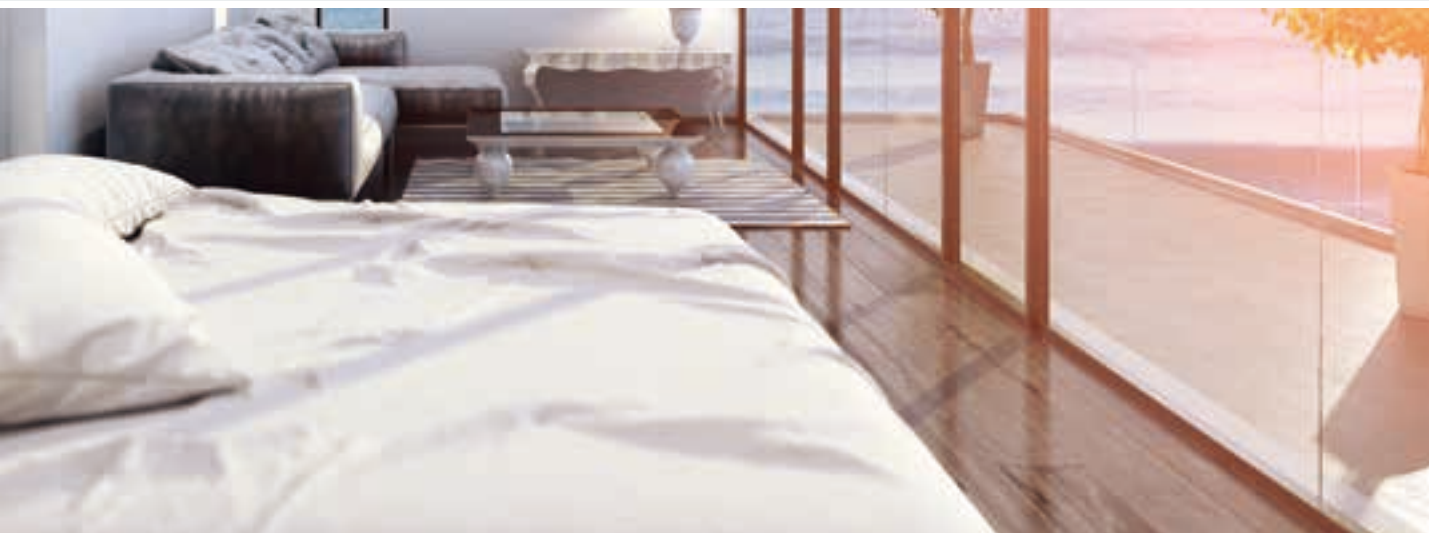

Guest room air conditioning with superior comfort, energy efficiency, and ease of installation

Space saving

Mini duct type with a height of 198 mm and a depth of 450 mm. Easily installed in a narrow ceiling space.



Mini duct

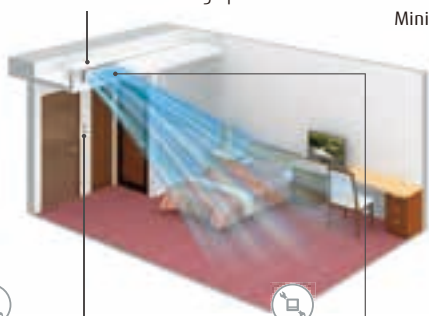

Card key switch available
Linked to a card key to prevent people from forgetting to turn off the air conditioner.



External connection switch



Comfortable airflow by switching the up/down airflow direction
The Auto louver grille kit creates comfortable airflow by adjusting the air direction.



Auto louver grille kit



Ventilation of each room can be achieved relatively inexpensively by combining an appropriate duct fan (locally procured) through a hole for fresh air in the indoor unit. If the airflow required to ventilate the room is not sufficient, use ERV (Energy Recovery Ventilator).

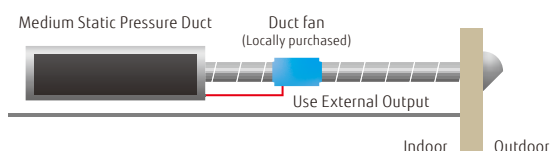

Centralized control of air conditioning for shared spaces

Centralized control of air conditioning for shared spaces Lobbies, hallways, and other common spaces are centrally controlled for air conditioning. Central Remote Controller can manage VRF products, but Split products can also be managed together via Network converter.

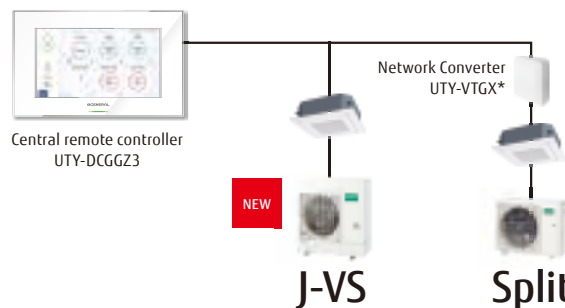

*Some functions will not be available.



Wired remote controller (design type) with sophisticated design. The touch panel can be easily operated by swiping vertically and horizontally.



NEW

Wired remote controller (design type) UTY-RVRG

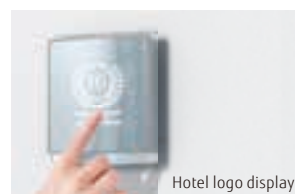

Hotel logo display



Large space air conditioning for the reception area and lobby

Duct type Big duct Series suitable for large spaces with high ceilings





Schools

For Light commercial use

Fujitsu General offers indoor units that allow multiple connections with a compact design that reduces the installation area and increases the flexibility for selecting installation locations, making them perfect for midsize educational institutions. One single outdoor unit is able to cover an entire school building.

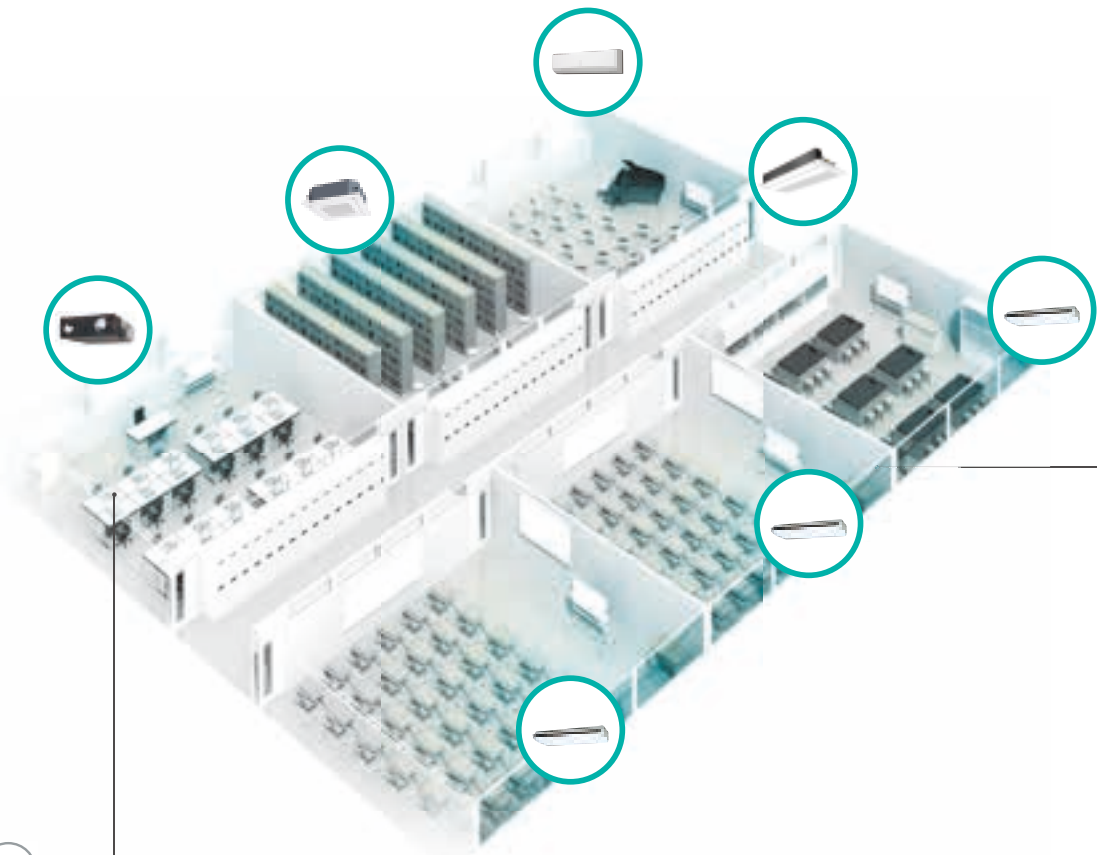

Centralized control of both air conditioning and ventilation equipment

Centralized control is also possible to stop the operation of not only air conditioners but also lighting and ventilation equipment. These features are useful for managing the energy efficiency of the entire building.

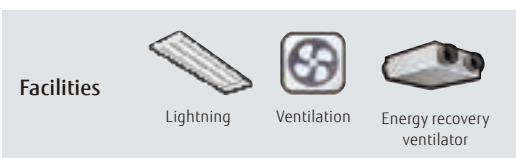

System controller Lite



One-way flow cassette Series



Mini duct



Ceiling type



Wall-mounted type

Wide variety of indoor units

Support complex applications for regular classrooms, special classrooms and auditoriums. Ventilators can also be added easily.

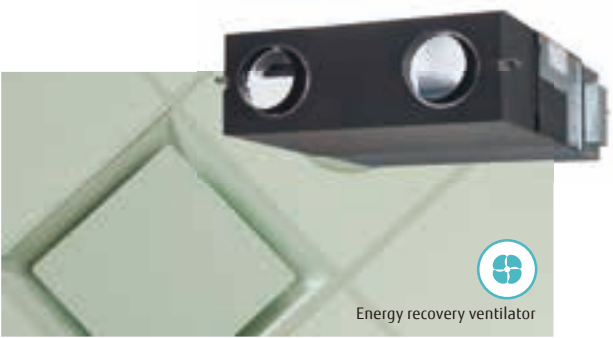

Energy recovery ventilator



Circular flow cassette Series

Comfortable room air conditioning without airflow sensation

Circular flow cassette blows air in all directions at a uniform temperature.



Individual airflow direction control to prevent people from being exposed to airflow

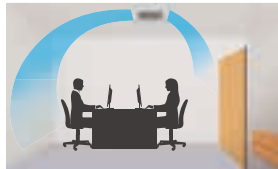
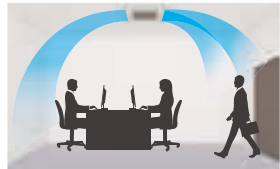

Energy-saving operation when unattended, in conjunction with a Human sensor.

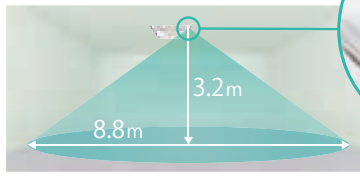

Human sensor (option)



Large buildings

For Commercial use

Fujitsu General offers modular VRF systems that pursue high efficiency, comfort, design flexibility, ease of installation, and reliability for high-rise buildings.



Abundant lineup optimized for the operating environment

The VRF system meets a variety of needs, including energy-saving models and models with compatibility to outdoor temperatures of up to 46°C.

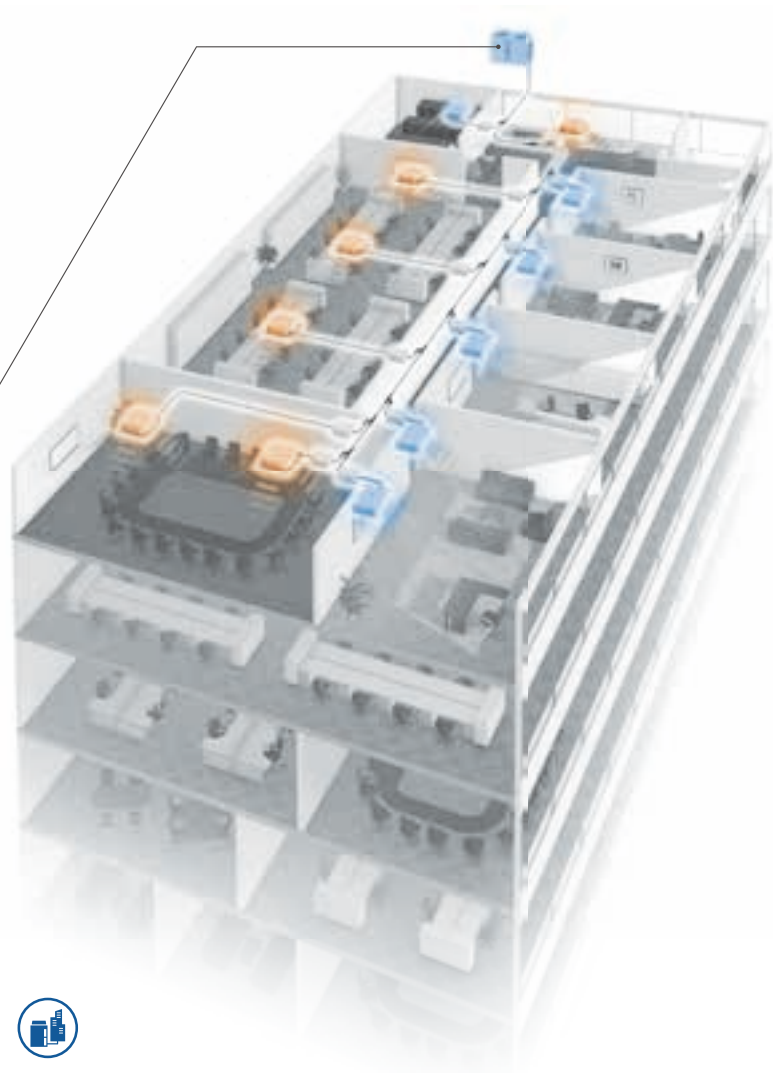

VRF VR-IV

Smart, cutting-edge design Extensive lineup from 8 HP to 48 HP with the capacity ratio of indoor units connectable up to 150%.

34 models with 8 to 48 HP

- Space saving combination: 21 models from 8 to 48 HP
- Energy efficient combination: 13 models from 16 to 44 HP

VRF V-IV

34 models from 8 to 48 HP

- Space saving combination: 21 models from 10 to 48 HP
- Energy efficient combination: 13 models from 16 to 46 HP



Height difference up to 110 m

The height difference between the outdoor unit and the indoor unit is normally 50 m for the V-IV Series, but can be extended to 110 m by installing the Pressure sensor kit.

* Can only be connected to the V-IV Series



Pressure sensor kit



Centralized control

Not only indoor units in the building, but also facilities such as ventilation can be controlled easily by anyone



System controller
(UTY-APGXZ1)
System controller Lite
(UTY-ALGXZ1 & UTY-PLGXZ2)

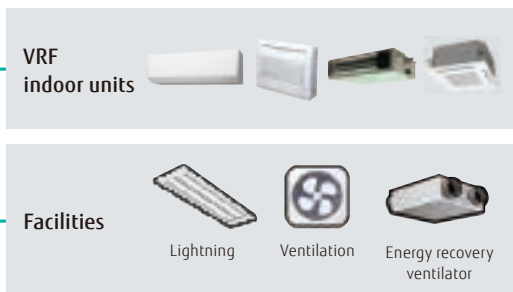
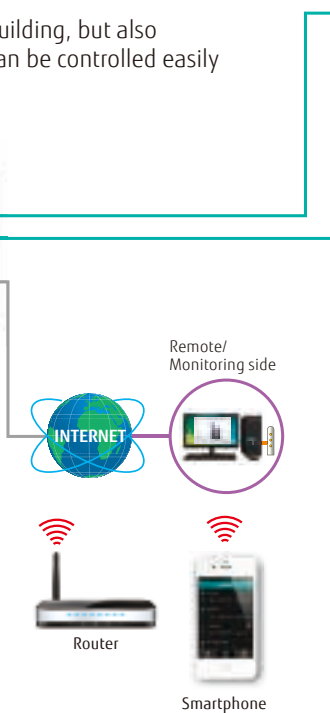

Linkage with various BMS

Linking with MODBUS®, BACnet®, KNX® and other interfaces allows centralized control of equipment other than air conditioning.

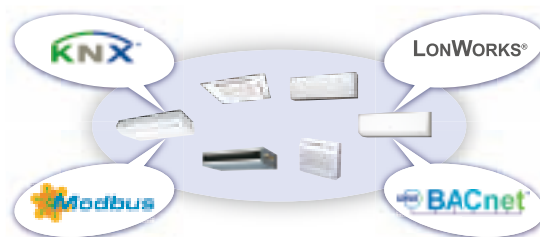

High system flexibility

The industry-leading high static pressure, long pipe design, and connection capacity enable flexible installation on each floor and installation of various indoor units.

82* Pa

*: V-IV Series, 80Pa for VR-IV Series

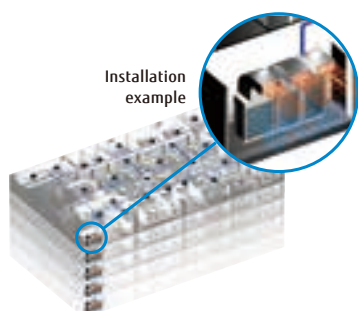

Prompt service support

Web monitoring tool and System controller remotely monitor the air conditioning of the entire building. Self-diagnosis in cooperation with the management company enables quick response in case of an emergency.

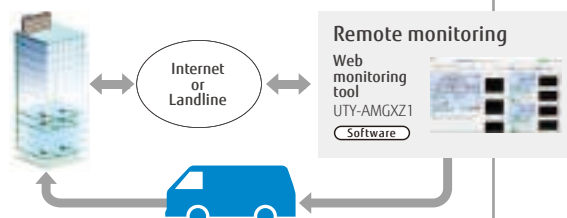



Residences

For Apartments & Houses

From the living room, where the whole family relaxes, to bedrooms, children's rooms and other small rooms, Fujitsu General has designed systems suited to spaces that reflect the rhythm of life.

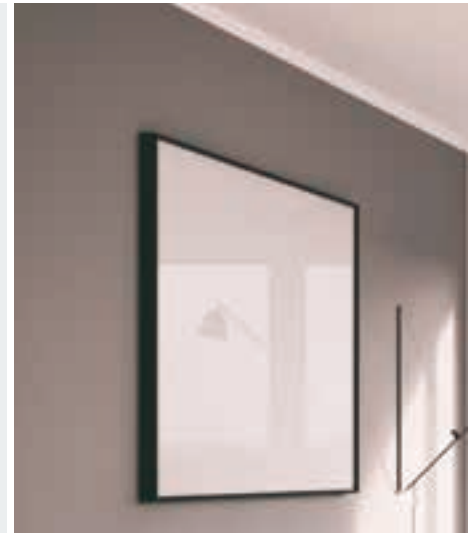

A variety of indoor units to suit the characteristics of each room



For Living & Dining room

Cool beauty design model

This series features a special European-style design. The light, elegant and three-dimensional expression achieved by the curved surface is beautiful from all angles.



For Large rooms

Standard & Comfort model

The basic functions and powerful, comfortable airflow volume controls are optimal for large spaces.



For Bedrooms or Home offices

ECO Range, Compact size

High performance and compact design suitable for bedrooms, home offices and other small spaces





Outdoor units suitable for residential environments



R32 Multi-split type released

Models are now available with environment-friendly R32 refrigerant. A number of products with improved external design have been added to the indoor unit lineup.

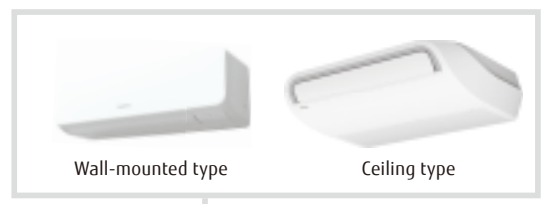

Wall-mounted type

Ceiling type



Operated by smart speaker

Simply talk to the smart speaker to operate the air conditioner and check its operating status while doing other things.

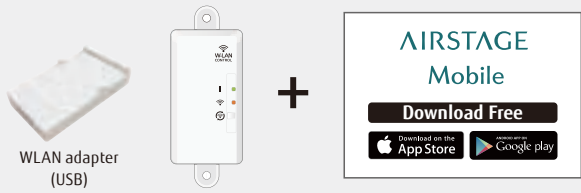

With the WLAN adapter and the AIRSTAGE Mobile app, you can control the heating and cooling of your home anytime, anywhere.



Light Commercial & Residential

SPLIT & MULTI-SPLIT

Energy saving design to provide a comfortable indoor environment while being environment-friendly.

These are air conditioners that are both user-friendly and environment-friendly. Fujitsu General air conditioners cater to a wide range of needs, from living rooms, bedrooms, stores, small offices, through to hotels.

SPLIT

- Refrigerant R32 models
 - Wall-mounted type
 - Cassette
 - Duct
 - Floor
 - Ceiling
- Refrigerant R410A models
 - Duct

MULTI-SPLIT

- Refrigerant R32 models
 - 2-unit to 5-unit Multi-split
 - Simultaneous Multi-split Twin/Triple
- Refrigerant R410A models
 - 6-unit Multi-split
 - Simultaneous Multi-split Twin/Triple/Double Twin



SPLIT & MULTI-SPLIT

Light Commercial &
Residential



Light Commercial & Residential SPLIT

- S-004 Split Overview
- S-006 Indoor Units Lineup
- S-010 Features
- S-015 Features Explanation
- S-060 Wall-mounted Specifications
- S-063 ECO Series Lineup Specifications
- S-068 Feature Summary



Refrigerant R32 models

Wall-mounted type - Built in W-LAN adapter model

- S-016 Designer Range
 - High Spec & Design
 - Cool Beauty Design
- S-020 Standard Range - High-Efficiency & Comfort
- S-022 ECO Range - Compact Size

Wall-mounted type

- S-024 Standard Range
 - High-Efficiency & Large Rooms
- S-028 ECO Range
 - Compact Size
 - Comfort for Large Rooms
 - Cooling-enhanced type

Cassette

- S-034 Compact 4-way Flow Range - Compact Size
- S-036 Circular Flow Range - Comfort for Large Rooms

Duct

- S-038 Slim Duct - Slim Design
- S-040 Medium Static Pressure Duct
 - High-Efficiency & Comfort
 - Compact Size
 - Standard
- S-050 High Static Pressure Duct

Floor, Ceiling

- S-056 Floor - Compact Size
- S-058 Ceiling



Refrigerant R410A models

Duct

- S-052 High Static Pressure Duct
- S-054 Big Duct





Split Overview

Fujitsu General provides its customers with 5 types and 149 models of air conditioning systems perfect for various customer applications and layouts. Added to this lineup recently are the environment-friendly R32 refrigerant models.



Wall-mounted type, Designer Series, Cool Beauty Design

Existing pipes can be reused if they meet our guidelines

Please consult with our regional sales subsidiaries for details.

Cautions when reusing the existing pipes

- The thickness of the pipes must be 0.8 mm or thicker in accordance with the pipe diameter.
- Use flares that have been reworked to be compatible with the new refrigerant, and are compliant with ISO 14903.
- Select suitable wiring in accordance with the installation manual of the new air conditioning unit.
- When pump-down is not possible or when the inner pipe walls are dirty, make sure to clean the pipes before connecting new ones.
- When using different diameters pipes from the standard sizes,
 - The performance may not reach the published specification value.
 - Dedicated flare nuts compliant with ISO 14903 should be procured locally.
 - Restrictions apply to pipe lengths, refrigerant volumes, and room sizes.



Wall-mounted type

Simple and easy to install, all models, are expertly designed to control airflow and save energy. The design, with its flat and simple appeal, perfectly matches room interiors. Many of the models in the lineup adopt the new environmentally friendly R32 refrigerant.



Duct

The main unit is hidden in the wall, making the room look neat and tidy. Mini Duct and Slim Duct models are also available for installation in narrow spaces between beams or above the ceiling. Large models, suitable for air conditioning vast spaces, allow multiple outlets to be installed in just one unit, and are perfect for atypical room layouts.



Cassette

The Cassette type, which blends in perfectly with the interior design, blows air in all four directions to create an even air-conditioning for the entire space. We have a variety of series including Compact models with a uniquely designed panel to match grid ceilings, and Circular Flow models that send airflow in a 360° direction.



Floor



























The compact and slim design makes this model suitable for installation in commercial as well as residential buildings. This model is also recommended as a heating device because it delivers a warm airflow from both the top and bottom outlets.



Ceiling

As with the wall-mounted unit, ceiling installation is very easy, and the unit's thin structure with a height of just 240 mm allows neat installation. The powerful airflow that can reach far away from the wide outlet is perfect for large meeting rooms, audiovisual rooms, and other rectangular spaces with a lot of depth.

Indoor Units Lineup

Type	Range	Refrigerant	Model	Class		
				7	9	12
Wall-mounted type Built in WLAN adapter model	Designer Range High Spec & Design	 Cooling & Heating	 NEW 	ASHH07KGTG	ASHH09KGTG	ASHH12KGTG
	Designer Range Cool Beauty Design	 Cooling & Heating	 	ASHG07KETF ASHG07KETF-B	ASHG09KETF ASHG09KETF-B	ASHG12KETF ASHG12KETF-B
	Standard Range High-Efficiency & Comfort	 Cooling & Heating	 NEW 	ASHH07KMCG ASHH07KMCG-B	ASHH09KMCG ASHH09KMCG-B	ASHH12KMCG ASHH12KMCG-B
	ECO Range Compact Size	 Cooling & Heating	 NEW 	ASHH07KNCA	ASHH09KNCA	ASHH12KNCA
Wall-mounted type	Standard Range High-Efficiency & Large Rooms	 Cooling & Heating	 			
	Standard Range High-Efficiency & Large Rooms	 Cooling & Heating	 			
	ECO Range Compact Size	 Cooling & Heating	 	ASHG07KPCE	ASHG09KPCE	ASHG12KPCE
	ECO Range Comfort for Large Rooms	 Cooling & Heating	 			
	ECO Range Cooling-enhanced	 Cooling & Heating	 NEW 	ASHH07KLTA	ASHH09KLTA	ASHH12KLTA



























FUJITSU GENERAL (Euro) GmbH participates in the ECP program for AC. Check ongoing validity of certificate: www.eurovent-certification.com

Class										
14	18	22	24	30	36	45	54	60	72	90
ASHH14KGTG										
ASHG14KETF ASHG14KETF-B										
ASHH14KMG ASHH14KMG-B										
	ASHG18KMTE		ASHG24KMTE							
				ASHH30KMTB	ASHH36KMTB					
	ASHG18KLCA		ASHG24KLCA							

SPLIT

Indoor Units Lineup

Type	Range	Refrigerant	Model		Class			
					7	9	12	
Cassette	Compact 4-way Flow Range Compact Size	 Cooling & Heating				AUXG09KVLA	AUXG12KVLA	
	Circular Flow Range Comfort for Large Rooms	 Cooling & Heating	 18/22/24	 30/36/45/54				
Duct	Slim Duct	 Cooling & Heating	 09/12/14	 18		ARXG09KLLAP	ARXG12KLLAP	
	Medium Static Pressure Duct High-Efficiency & Comfort	 Cooling & Heating	 12/14/18	 22/24	 <small>NEW</small> 30/36/45/54		ARXH12KMTAP	
	Medium Static Pressure Duct Compact Size	 Cooling & Heating	 12/14	 18/22/24/30	 36/45/54			ARXG12KHTAP
	Medium Static Pressure Duct Standard	 Cooling & Heating						
	High Static Pressure Duct	Cooling & Heating	 Cooling & Heating					
			 Cooling & Heating					
Big Duct	 Cooling & Heating							
Floor Compact & Comfort	 Cooling & Heating					AGHG09KVCA	AGHG12KVCA	
Ceiling	 Cooling & Heating	 18/22	 24/30	 36/45/54				



FUJITSU GENERAL (Euro) GmbH participates in the ECP program for AC. Check ongoing validity of certificate: www.eurovent-certification.com

Class										
14	18	22	24	30	36	45	54	60	72	90
AUXG14KVLA	AUXG18KVLA	AUXG22KVLA	AUXG24KVLA							
	AUXG18KRLB	AUXG22KRLB	AUXG24KRLB	AUXG30KRLB	AUXG36KRLB	AUXG45KRLB	AUXG54KRLB			
ARXG14KLLAP	ARXG18KLLAP									
ARXH14KMTAP	ARXH18KMTAP	ARXH22KMTAP	ARXH24KMTAP	ARXH30KMTAP	ARXH36KMTAP	ARXH45KMTAP	ARXH54KMTAP			
ARXG14KHTAP	ARXG18KHTAP	ARXG22KHTAP	ARXG24KHTAP	ARXG30KHTAP	ARXG36KHTAP	ARXG45KHTAP	ARXG54KHTAP			
		ARXG22KMLB	ARXG24KMLA	ARXG30KMLA	ARXG36KMLA	ARXG45KMLA				
						ARXG45KHTB	ARXG54KHTB			
								ARHG60LHTA		
									ARHG72LHTA	ARHG90LHTA
AGHG14KVCA										
	ABHG18KRTA	ABHG22KRTA	ABHG24KRTA	ABHG30KRTA	ABHG36KRTA	ABHG45KRTA	ABHG54KRTA			

SPLIT

Features

High-Efficiency

All DC Inverter Technology



DC twin-rotary compressor

DC twin-rotary compressor

A high-efficiency 2-cylinder rotary compressor with a DC inverter optimizes the internal structure of the compressor to achieve higher energy efficiency compared to similar compressors.

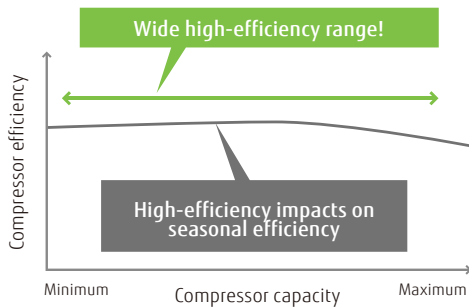

DC fan motor

The DC fan motor produces high power, a wide operating range, and high-efficiency.



DC fan motor

Sine-wave DC inverter control

High-efficiency operation is realized by using sine-wave DC inverter control.

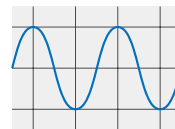

Heat Exchanger for Wall-mounted type

High-density multipath heat exchanger

Thinner and denser heat exchangers and multipath efficiency technology have substantially improved heat exchange performance.

High-performance sub-cool heat exchanger

A counter-type bypass circuit has been incorporated to achieve a higher performance. (Large multi-split type, VRF)

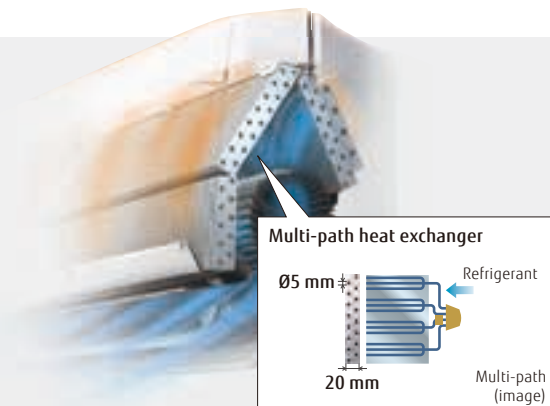

Multi-path heat exchanger
 Ø5 mm
 20 mm
 Refrigerant
 Multi-path (image)

High Energy Saving



Human sensor control

The Human sensor monitors the movements of people in a room and operates the air conditioner at a lower capacity when people leave the room. When people come back to the room, it automatically returns to the previous operating mode.

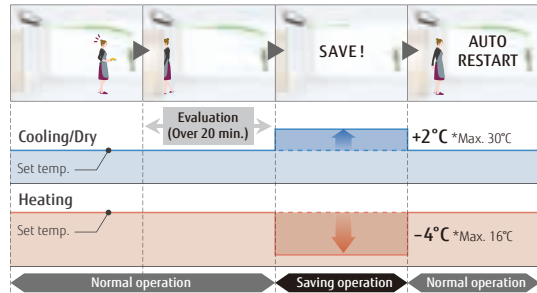

Economy operation

Limits maximum operation, reducing the power consumption, and thereby suppressing the maximum load.

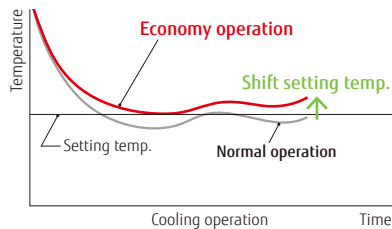

Setting temperature range limitation

The minimum and maximum temperature range can be set giving further energy savings while considering the comfort of the occupants.

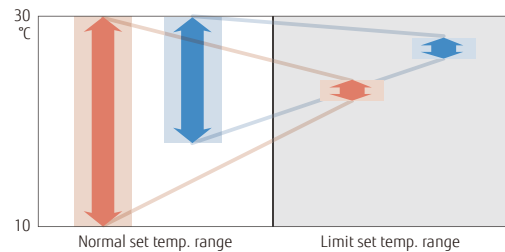

Set temperature auto return

- The set temperature automatically returns to the previously set temperature.
- The time range in which the set temperature can be changed is from 10 to 120 minutes.

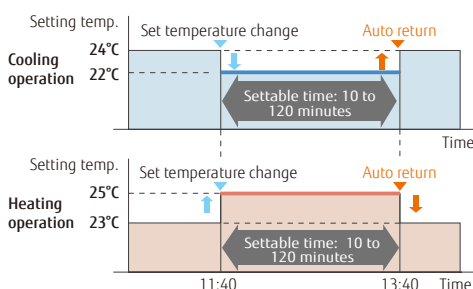

Auto-off timer

- The indoor unit is automatically turned off when it reaches a preset operating time frame.
- The time frame of the Auto-off timer can be flexibly scheduled.
- Auto-off times can be set from 30 to 240 minutes.

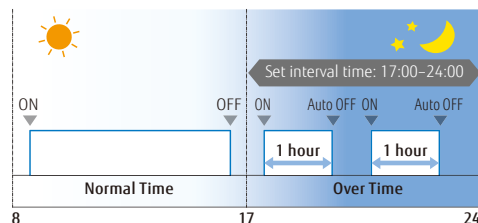

More Comfort



Power diffuser

These three technologies enable precise wind direction control and improve ventilation efficiency; our airflow control offers a more comfortable environment.

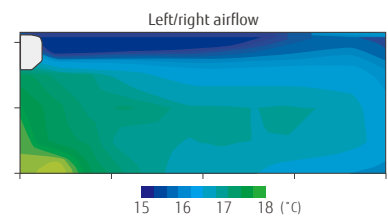
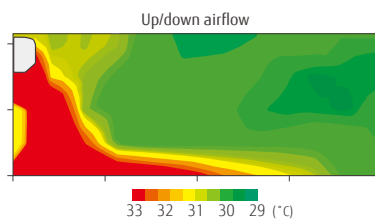

Wireless LAN control

Users can control their air conditioners from anywhere with their mobile devices while out or on the move.

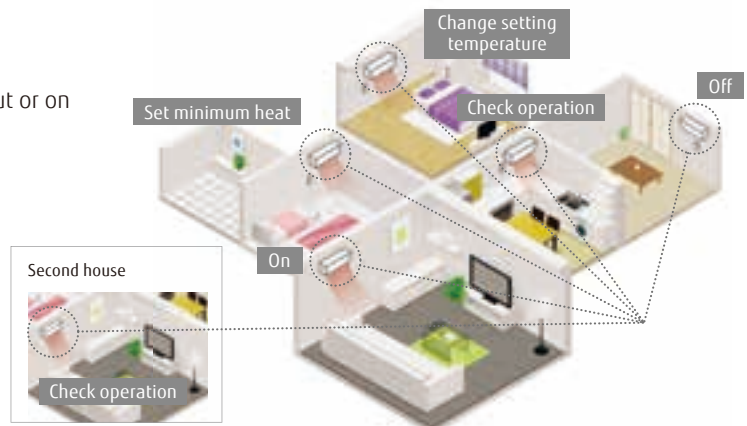



Powerful operation

Maximum airflow and maximum compressor speed are maintained for the period necessary to reach the set temperature quickly.

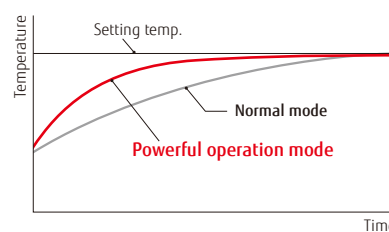

10°C heat

After a person has left the room, the system switches to minimum heating operation to maintain the room temperature. (Maintained at 10°C)

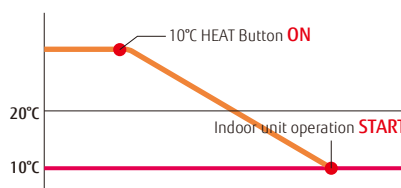

Uniform air conditioning

Circular airflow to achieve uniform air conditioning without temperature unevenness in workspaces





Quiet and Comfort Control

Low Noise Technology

Outdoor unit fan

Outdoor unit fan design with a small separation vortex, minimized air volume by fan control, and top-class low noise

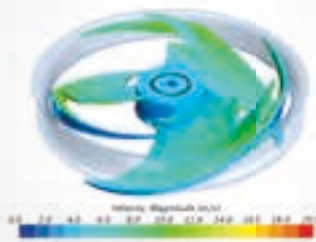

Air stabilizer in Duct

Low-noise duct structure with a built-in air stabilizer

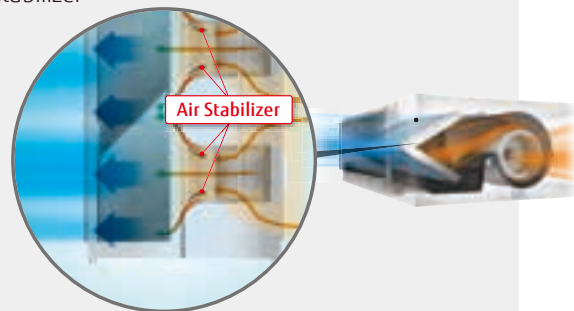

Outdoor unit low noise operation

Users can choose low noise levels, depending on the installation environment. Operation time can be set by timer.

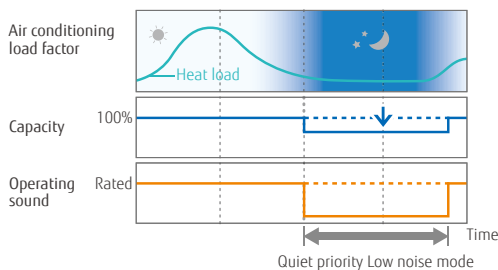

Auto changeover

In an auto setting, the system automatically switches between cooling and heating modes according to the set temperature and room temperature.

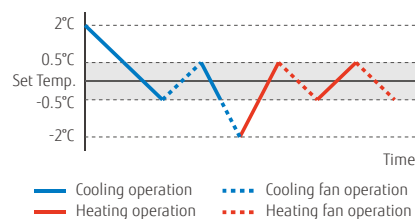

Fresh air intake for Cassette, Duct, Ceiling

Fresh air is taken in by a fan connected to an external control unit.



Fresh air intake kit

Feature Explanation

Energy-Saving Features



Save Human sensor

The Human sensor detects the movement of people in the room and determines whether to switch to energy saving operation.



Setting temperature range limitation

Sets the minimum and maximum limits on room temperature to establish the right balance between energy saving and a comfortable environment.



Human sensor control

The Human sensor (option) detects movement of people in the room and decides whether to save energy or stop the unit.



Set temperature auto return

The setting temperature automatically returns to the previously set temperature.



Economy operation

The thermostat setting is adjusted automatically according to the room temperature to avoid unnecessary cooling or heating.

Features for Comfort



Power diffuser

An additional louver that opens based on input from monitoring sensors to quickly enhance immediate comfort needs.



Outdoor unit low noise operation

The noise level of the outdoor unit can be selected.



Double swing automatic

Complex swing action of the louver enables automatic swing in both the left/right and up/down directions.



Connectable fresh air duct

Outside air can be introduced by attaching a locally purchased duct to the fresh air knockout and an optional part.



Individual airflow direction control

Each louver of a 4-way Cassette type can be controlled individually to provide comfortable airflow.



Powerful operation

Operation at maximum air flow and compressor speed, that quickly makes the room comfortable.



Auto changeover

The unit automatically switches between heating and cooling modes based on the temperature setting and the room temperature.



Automatic fan speed

A micro-computer automatically adjusts the airflow to follow the changes in room temperature.



Fresh air intake

Fresh air can be taken in by a fan connected to an external control unit.



10°C Heat

The room temperature can be set to go no lower than 10°C, thus ensuring that the room does not get too cold when not occupied.



UP/DOWN swing louver

The vertical louver automatically swings up and down.



Auto restart

In the event of a temporary power failure, the air conditioner will automatically restart in the same operating mode as before, once the power supply is restored.



Connectable distributing duct

Locally purchased branch ducts can be attached to the systems to distribute the airflow.

Convenience Features



Auto-off timer

Automatically stops operation when a fixed time has elapsed from the start of operation.



Weekly timer

Different ON-OFF times can be set for each day.



External error output



Multi System Control

Operation using "Lead Lag Operation", "Back up operation", "Lag Operation" is possible. (Page C-011)



Sleep timer

A micro-computer gradually changes the room temperature automatically to promote a comfortable night's sleep.



Weekly & Temperature setback timer

Weekly & Temperature setback timer can set the temperature for 2-time spans and for each day of the week.



External ON/OFF input



Special Cooling

Special Cooling" is a function that supports the operation of "Multi System Control".



Program timer

This digital timer allows selection of one of four options: ON, OFF, ON + OFF, or OFF + ON.



Filter sign

Indicates the filter cleaning period by blinking.



Wireless LAN control

The optional WLAN adapter enables the air conditioner to be operated by smartphone or tablet PC from outside the home.

Clean Features



Ion deodorization filter

The filter deodorizes by powerfully decomposing absorbed odors using the oxidizing and reducing effects of ions generated by an ultra-fine-particle ceramic.



Washable panel

Since the front panel is easy to remove, maintenance is also easy.



Apple-catechin filter

The Apple-catechin filter uses static electricity to clean fine particles and dust from the air.



Silver Ion Filter

The Silver ion filter helps to keep indoor air free from viruses, bacteria and molds.



Long-life filter

Installation / Support



Automatic airflow adjustment

Automatically detects required airflow in each application case and adjusts the volume.



Drain pump as standard



Blue fin



Refrigerant cycle monitor

The values of each sensor and actuator can be displayed, and the status of the refrigeration cycle can be checked.



All DC models

NEW

Wall-mounted type

Built-in WLAN adapter model
Designer Range
High Spec & Design

KG Series



High energy saving

Top class high efficiency is achieved by high efficient lambda-shaped heat exchanger, large cross flow fan and new refrigerant.



*07/09/12 models

SEER
9.80*

*07 model

SCOP
5.20*

*07/09/12 models



Hybrid-heat exchanger

The large hybrid heat exchanger has greatly improved the heat exchange efficiency to achieve top-level SEER and SCOP.

Ø 5mm
High-density
heat exchanger



Ø 7mm
Large heat
exchanger

Ø107 Large cross-flow fan

The large-diameter fan generates air volume efficiently even at reduced power.

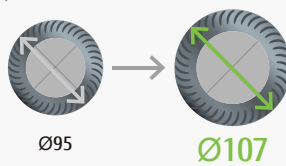

Human sensor

The Human sensor monitors the movements of people in a room and operates the air conditioner at a lower capacity when people leave the room. When people come back to the room, it automatically returns to the previous operating mode.

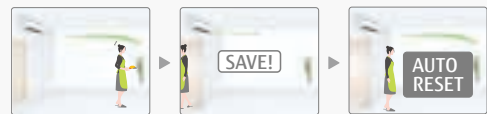

Comfortable airflow & Quiet operation

The large louver and the new air-blowing structure create a comfortable air flow that spreads all the way down to the user's feet with quiet operation.



Quiet & Comfort

19 dB(A)

(07/09/12 models)

Cooling only

Smart device control

A WLAN adapter is included as standard equipment. By installing the AIRSTAGE mobile app on your smart device, you can check and control the operating status of the air conditioner from anywhere indoors or outdoors.

* See page G-020 for details on smart device control.



AIRSTAGE
Mobile

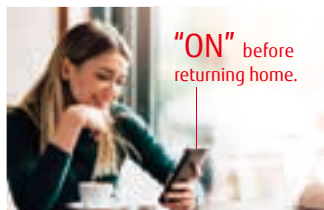

Refrigerant cycle monitor (Option)

Wired Remote Controller (Touch Panel) will support to display some sensor values for maintenance and service support.

*Wired remote controller (UTY-RNRG25 or UTY-RVRG) is required.

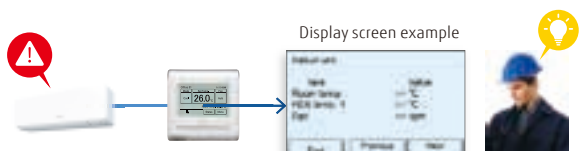



Model: ASHH07KGTG / ASHH09KGTG / ASHH12KGTG / ASHH14KGTG



WLAN adapter (Built-in)



Wireless RC



Specifications

Model name	Indoor unit			ASHH07KGTG	ASHH09KGTG	ASHH12KGTG	ASHH14KGTG
	Outdoor unit			AOHH07KCGG	AOHH09KCGG	AOHH12KCGG	AOHH14KCGG
Power Source				Single phase, ~230 V, 50 Hz			
Capacity	Cooling	Rated	kW	2.0	2.5	3.4	4.2
		Min.-Max.		0.9-3.3	0.9-3.6	0.9-4.1	0.9-4.5
	Heating	Rated		2.5	2.8	4.0	5.4
		Min.-Max.		0.9-5.2	0.9-5.4	0.9-6.1	0.9-6.4
Input Power	Cooling/Heating		kW	0.400 / 0.500	0.550 / 0.600	0.870 / 0.910	1.220 / 1.450
EER	Cooling			5.00	4.55	3.91	3.44
COP	Heating		W/W	5.00	4.67	4.40	3.72
Pdesign	Cooling/Heating (-10°C)		kW	2.0 / 2.3	2.5 / 2.4	3.4 / 2.5	4.2 / 4.0
SEER	Cooling			9.80	9.40	8.40	8.00
SCOP	Heating (Average)		W/W	5.20	5.20	5.20	4.60
Energy Efficiency Class	Cooling			A+++	A+++	A+++	A++
	Heating (Average)			A+++	A+++	A+++	A++
Max. Operating Current	Cooling/Heating		A	6.5 / 9.0	6.5 / 9.0	6.5 / 9.0	9.0 / 10.5
Annual Energy Consumption	Cooling		kWh/a	71	93	135	184
	Heating			618	646	673	1,217
Moisture Removal			l/h	1.1	1.3	1.6	1.7
Sound Pressure Level	Indoor (Cooling)	H/M/L/Q	dB(A)	36 / 32 / 29 / 19	38 / 34 / 29 / 19	40 / 35 / 30 / 19	43 / 36 / 30 / 20
	Indoor (Heating)	H/M/L/Q		38 / 34 / 31 / 20	39 / 34 / 31 / 20	42 / 38 / 33 / 21	44 / 39 / 33 / 24
	Outdoor (Cooling/Heating)	High		42 / 43	44 / 45	50 / 50	50 / 50
Sound Power Level	Indoor (Cooling/Heating)	High		49 / 51	52 / 52	56 / 58	57 / 59
	Outdoor (Cooling/Heating)	High		56 / 56	58 / 58	65 / 66	65 / 66
Airflow Rate	Indoor/Outdoor (Cooling)	High	m³/h	570 / 1,390	640 / 1,480	680 / 1,800	750 / 1,800
	Indoor/Outdoor (Heating)	High		610 / 1,350	630 / 1,420	750 / 1,690	780 / 1,690
Net Dimensions H x W x D	Indoor		mm	270 x 834 x 215	270 x 834 x 215	270 x 834 x 215	270 x 834 x 215
	Outdoor		mm	542 x 799 x 290	542 x 799 x 290	542 x 799 x 290	542 x 799 x 290
Weight	Indoor		kg	10	10	10	10
	Outdoor		kg	30	30	31	32
Connection Pipe Diameter (Liquid/Gas)			mm	6.35 / 9.52	6.35 / 9.52	6.35 / 9.52	6.35 / 9.52
Drain Hose Diameter (I.D./O.D.)			mm	13.8 / 15 to 16.8	13.8 / 15 to 16.8	13.8 / 15 to 16.8	13.8 / 15 to 16.8
Max. Pipe Length (Pre-Charge)			m	20 (15)	20 (15)	20 (15)	20 (15)
Max. Height Difference				15	15	15	15
Operating Range	Cooling		°CDB	-10 to 50	-10 to 50	-10 to 50	-10 to 50
	Heating			-15 to 24	-15 to 24	-15 to 24	-15 to 24
Refrigerant	Type (Global Warming Potential)			R32 (675)	R32 (675)	R32 (675)	R32 (675)
	Charge		kg (CO2eq-T)	0.75 (0.506)	0.75 (0.506)	0.85 (0.574)	0.85 (0.574)

Optional parts

* For optional parts compatibility of Intesis devices, please refer to the optional parts compatibility list page C-050 to C-053 and C-066.

- Wired Remote Controller (Design type): UTY-RVRG Simple remote controller: UTY-RSRG Network Converter for single split (DC power supply type): UTY-VTGX
- Compact wired remote controller: UTY-RCRGZ1 External switch controller: UTY-TERX Network Converter for single split (AC power supply type): UTY-VTGXV
- Wired remote controller (touch panel): UTY-RNRGZ5 Communication kit: UTY-TWRXZ2 Silver Ion filter: UTR-FA16-5
- Wired remote controller: UTY-RLRG External connect kit: UTY-XWZX External input and output PCB*1: UTY-XCSXZ2
- Simple remote controller (without operation mode): UTY-RHRG UTY-XWZXZ5

*1 It is required when 2 or more external input and output ports are used.

Dimensions

(Unit: mm)

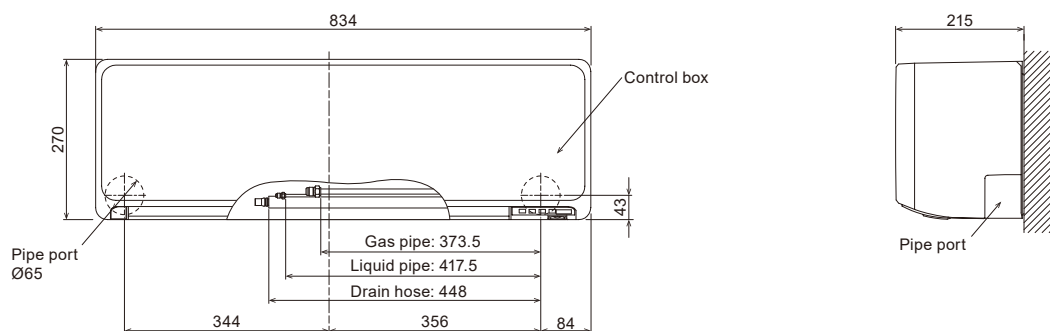

Wall-mounted type

Built-in WLAN adapter model
Designer Range
Cool Beauty Design



KE Series



Cool beauty design

We have designed this series exclusively for the European market. The exterior design harmonizes beautifully with any decor and adds comfortable elegance to the room. The light, elegant and three-dimensional expression achieved by the curved surface is beautiful from any angle.



CMF: COLOR MATERIAL FINISH

The texture of the front panel expresses the craftsmanship of Europe, and changes its expression with the changing light of the day.

High energy saving

Top class high efficiency is achieved by high efficient lambda-shaped heat exchanger, large cross flow fan and new refrigerant.



Hybrid-heat exchanger

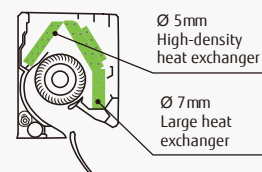

Ø107 Large cross-flow fan



Smart device control

A WLAN adapter is included as standard equipment. By installing the AIRSTAGE mobile app on your smart device, you can check and control the operating status of the air conditioner from anywhere indoors or outdoors.

* See page G-020 for details on smart device control.

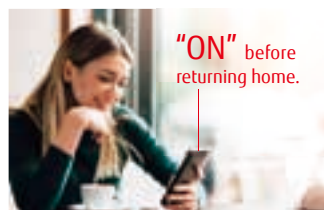

Comfortable airflow & Quiet operation

The large louver and the new air-blowing structure create a comfortable air flow that spreads all the way down to the user's feet with quiet operation.



20 dB(A)
Cooling only



**Model: ASHG07KETF / ASHG09KETF / ASHG12KETF / ASHG14KETF (Peal white X White)
ASHG07KETF-B / ASHG09KETF-B / ASHG12KETF-B / ASHG14KETF-B (Silver X Dark gray)**



Peal white X White



Silver X Dark gray



WLAN adapter (Built-in)



Wireless RC



For ASHG07/09/12KETF
ASHG07/09/12KETF-B



For ASHG14KETF
ASHG14KETF-B

Specifications

Model name	Indoor unit			ASHG07KETF ASHG07KETF-B	ASHG09KETF ASHG09KETF-B	ASHG12KETF ASHG12KETF-B	ASHG14KETF ASHG14KETF-B
	Outdoor unit			AOHG07KETA	AOHG09KETA	AOHG12KETA	AOHG14KETA
Power Source	Single phase, ~230 V, 50 Hz						
Capacity	Cooling	Rated	kW	2.0	2.5	3.4	4.2
		Min.-Max.		0.9 - 3.0	0.9 - 3.2	0.9 - 3.9	0.9 - 4.4
	Heating	Rated		2.5	2.8	4.0	5.4
		Min.-Max.		0.9 - 3.4	0.9 - 4.0	0.9 - 5.3	0.9 - 6.0
Input Power	Cooling/Heating		kW	0.450/0.555	0.630/0.620	0.935/0.960	1.220/1.410
EER	Cooling	W/W	4.43	3.97	3.65	3.44	
			4.52	4.52	4.17	3.83	
COP	Heating	W/W	2.0/2.3	2.5/2.4	3.4/2.5	4.2/4.0	
			7.40	7.40	7.30	6.90	
Pdesign	Cooling/Heating (-10°C)		kW	2.0/2.3	2.5/2.4	3.4/2.5	4.2/4.0
	Heating (Average)		W/W	4.10	4.10	4.40	4.10
SEER	Cooling	W/W	4.10	4.10	4.40	4.10	
			4.10	4.10	4.40	4.10	
SCOP	Heating (Average)		W/W	4.10	4.10	4.40	4.10
	Heating (Average)		W/W	4.10	4.10	4.40	4.10
Energy Efficiency Class	Cooling		A++	A++	A++	A++	
	Heating (Average)		A+	A+	A+	A+	
Max. Operating Current	Cooling/Heating		A	6.5/9.0	6.5/9.0	6.5/9.0	6.5/9.0
	Cooling		kWh/a	95	118	163	213
Annual Energy Consumption	Heating		kWh/a	785	819	795	1,367
	Moisture Removal		l/h	1.0	1.3	1.8	2.1
Sound Pressure Level	Indoor (Cooling)	H/M/L/Q	dB(A)	38/33/29/20	40/34/29/20	40/35/30/20	43/36/30/20
	Indoor (Heating)	H/M/L/Q		41/35/31/22	42/36/31/22	42/38/33/22	44/39/33/24
Outdoor (Cooling/Heating)	High	46/46		46/46	50/50	50/50	
Indoor (Cooling/Heating)	High	54/56		55/57	55/58	57/59	
Sound Power Level	Outdoor (Cooling/Heating)	High	61/61	61/62	65/65	65/66	
	Indoor/Outdoor (Cooling)	High	650/1,650	700/1,650	700/1,700	770/1,680	
Airflow Rate	Indoor/Outdoor (Heating)	High	720/1,450	750/1,450	770/1,470	800/1,580	
	Net Dimensions	Indoor	mm	295 × 950 (wall side: 840) × 230			
H x W x D	Outdoor	mm	541 × 663 × 290	541 × 663 × 290	541 × 663 × 290	542 × 799 × 290	
	Weight	Indoor	kg	11	11	11	11.5
Connection Pipe Diameter (Liquid/Gas)	Outdoor	kg	23	23	25	31	
	Connection Pipe Diameter (Liquid/Gas)	mm	6.35/9.52	6.35/9.52	6.35/9.52	6.35/9.52	
Drain Hose Diameter (I.D./O.D.)	mm	13.8/15.0 to 16.8	13.8/15.0 to 16.8	13.8/15.0 to 16.8	13.8/15.0 to 16.8		
Max. Pipe Length (Pre-Charge)	m	20 (15)	20 (15)	20 (15)	20 (15)		
Max. Height Difference	°CDB	15	15	15	15		
Operating Range	Cooling	°CDB	-10 to 46	-10 to 46	-10 to 46	-10 to 46	
	Heating	°CDB	-15 to 24	-15 to 24	-15 to 24	-15 to 24	
Refrigerant	Type (Global Warming Potential)	kg (CO2eq-T)	R32 (675)	R32 (675)	R32 (675)	R32 (675)	
	Charge	kg (CO2eq-T)	0.6 (0.405)	0.6 (0.405)	0.7 (0.473)	0.85 (0.574)	

Optional parts

* For optional parts compatibility of Intesis devices, please refer to the optional parts compatibility list page C-050 to C-053 and C-066.

Wired Remote Controller (Design type): UTY-RVRG

Compact wired remote controller: UTY-RCRGZ1

Wired remote controller (touch panel): UTY-RNRGZ5

Wired remote controller: UTY-RLRG

Simple remote controller (without operation mode): UTY-RHRG

Simple remote controller: UTY-RSRG

Communication kit: UTY-TWRXZ2

External connect kit: UTY-XWZX

External switch controller: UTY-TERX

Network Converter for single split (DC power supply type): UTY-VTGX

Network Converter for single split (AC power supply type): UTY-VTGXV

Silver Ion filter: UTR-FA16-5

External input and output PCB*: UTY-XCSXZ2

*1 It is required when 2 or more external input and output ports are used.

Dimensions

(Unit: mm)

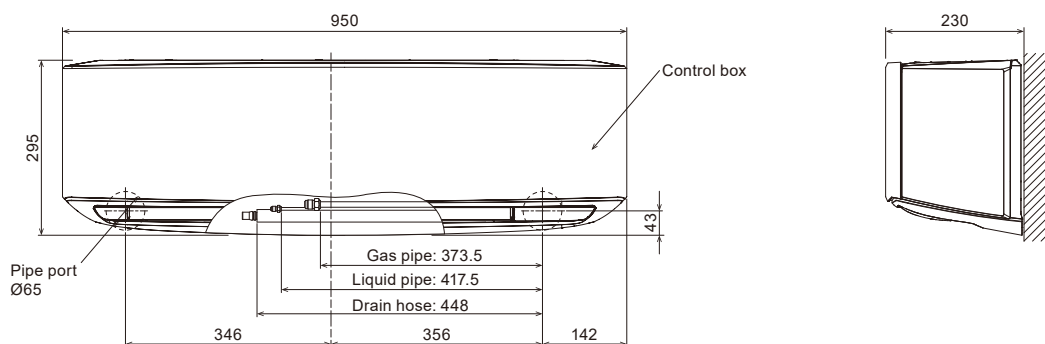

NEW

Wall-mounted type

Built-in WLAN adapter model
Standard Range
High-Efficiency & Comfort

KM Series



Slim & stylish square design

The slim and stylish square design of this indoor unit is realized by using a high-density, multipath heat exchanger and a high-efficiency wind blower.

Warm & gentle color option

Both white and soft black color are relatively gentle tones and no strong contrast, each color harmonize with the environment and create a warm atmosphere.



High energy saving

High-efficiency has been achieved by the lambda-shaped heat exchanger, large cross-flow fan, and the new refrigerant.

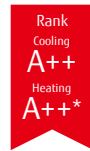

*07/09/12 models

SEER 8.40*

*07/09 models

SCOP 4.60*

*07/09/12 models

Comfortable airflow & Quiet operation

The large louver and the new air-blowing structure create a comfortable air flow that spreads all the way down to the user's feet with quiet operation.



Quiet & Comfort
20 dB(A)
Cooling only

Smart device control

A WLAN adapter is included as standard equipment. By installing the AIRSTAGE mobile app on your smart device, you can check and control the operating status of the air conditioner from anywhere indoors or outdoors.

* See page G-020 for details on smart device control.

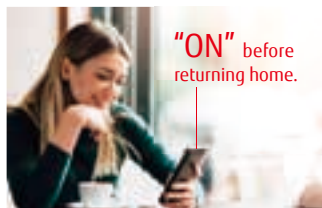

Refrigerant cycle monitor (Option)

Wired Remote Controller (Touch Panel) will support to display some sensor values for maintenance and service support.

*Wired remote controller (UTY-RNRG25 or UTY-RVRG) is required.

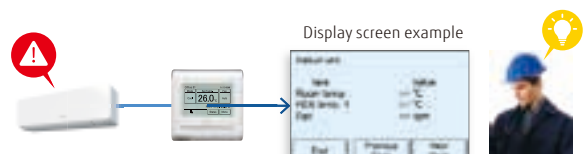



**Model: ASHH07KMCG / ASHH09KMCG / ASHH12KMCG / ASHH14KMCG
ASHH07KMCG-B / ASHH09KMCG-B / ASHH12KMCG-B / ASHH14KMCG-B**



Specifications

Model name		Indoor unit		ASHH07KMCG ASHH07KMCG-B	ASHH09KMCG ASHH09KMCG-B	ASHH12KMCG ASHH12KMCG-B	ASHH14KMCG ASHH14KMCG-B
		Outdoor unit		AOHH07KMCG	AOHH09KMCG	AOHH12KMCG	AOHH14KMCG
Power Source				Single phase, ~230 V, 50 Hz			
Capacity	Cooling	Rated	kW	2.0	2.5	3.4	4.2
		Min.-Max.		0.9-3.0	0.9-3.2	0.9-3.9	0.9-4.4
	Heating	Rated	2.5	2.8	4.0	5.4	
		Min.-Max.	0.9-3.4	0.9-4.0	0.9-5.3	0.9-6.0	
Input Power	Cooling/Heating		kW	0.450 / 0.555	0.650 / 0.620	0.960 / 1.020	1.220 / 1.410
EER	Cooling		W/W	4.43	3.85	3.54	3.44
COP	Heating		W/W	4.52	4.52	3.92	3.83
Pdesign	Cooling/Heating (-10°C)		kW	2.0 / 2.3	2.5 / 2.4	3.4 / 2.5	4.2 / 4.0
SEER	Cooling		W/W	8.40	8.40	7.70	7.10
SCOP	Heating (Average)		W/W	4.60	4.60	4.60	4.10
Energy Efficiency Class	Cooling			A++	A++	A++	A++
	Heating (Average)			A++	A++	A++	A+
Max. Operating Current	Cooling/Heating		A	6.5 / 9.0	6.5 / 9.0	6.5 / 9.0	6.5 / 9.0
Annual Energy Consumption	Cooling		kWh/a	83	104	155	207
	Heating		kWh/a	700	730	761	1,366
Moisture Removal			l/h	1.0	1.3	1.8	2.1
Sound Pressure Level	Indoor (Cooling)	H/M/L/Q	dB(A)	38 / 33 / 29 / 20	40 / 34 / 29 / 20	40 / 35 / 30 / 20	43 / 36 / 30 / 20
	Indoor (Heating)	H/M/L/Q		41 / 35 / 31 / 22	42 / 36 / 31 / 22	42 / 38 / 33 / 22	44 / 39 / 33 / 24
Sound Power Level	Outdoor (Cooling/Heating)	High	dB(A)	46 / 46	46 / 46	50 / 50	50 / 50
	Indoor (Cooling/Heating)	High		54 / 56	55 / 57	55 / 58	57 / 59
Airflow Rate	Outdoor (Cooling/Heating)	High	m³/h	61 / 61	61 / 62	65 / 65	65 / 66
	Indoor/Outdoor (Cooling)	High		650 / 1,650	700 / 1,650	700 / 1,700	770 / 1,680
Net Dimensions H x W x D	Indoor		mm	270 × 834 × 215	270 × 834 × 215	270 × 834 × 215	270 × 834 × 215
	Outdoor		mm	541 × 663 × 290	541 × 663 × 290	541 × 663 × 290	542 × 799 × 290
Weight	Indoor		kg	10	10	10	10
	Outdoor		kg	22	22	24	31
Connection Pipe Diameter (Liquid/Gas)			mm	6.35 / 9.52	6.35 / 9.52	6.35 / 9.52	6.35 / 9.52
Drain Hose Diameter (I.D./O.D.)			mm	13.8 / 15 to 16.8	13.8 / 15 to 16.8	13.8 / 15 to 16.8	13.8 / 15 to 16.8
Max. Pipe Length (Pre-Charge)			m	20 (15)	20 (15)	20 (15)	20 (15)
Max. Height Difference			m	15	15	15	15
Operating Range	Cooling		°CDB	-10 to 50	-10 to 50	-10 to 50	-10 to 50
	Heating			-15 to 24	-15 to 24	-15 to 24	-15 to 24
Refrigerant	Type (Global Warming Potential)			R32 (675)	R32 (675)	R32 (675)	R32 (675)
	Charge		kg (CO2eq-T)	0.60 (0.405)	0.60 (0.405)	0.70 (0.473)	0.85 (0.574)

Optional parts

* For optional parts compatibility of Inesis devices, please refer to the optional parts compatibility list page C-050 to C-053 and C-066.

Wired Remote Controller (Design type): UTY-RVRG	Simple remote controller: UTY-RSRG	Network Converter for single split (DC power supply type): UTY-VTGX
Compact wired remote controller: UTY-RCRGZ1	Communication kit: UTY-TWRXZ2	Network Converter for single split (AC power supply type): UTY-VTGXV
Wired remote controller (touch panel): UTY-RNRGZ5	External connect kit: UTY-XWZX	Silver Ion filter: UTR-FA16-5
Wired remote controller: UTY-RLRG	External switch controller: UTY-XWZX5	External input and output PCB*1: UTY-XCSXZ2
Simple remote controller (without operation mode): UTY-RHRG		

*1 It is required when 2 or more external input and output ports are used.

Dimensions

(Unit: mm)

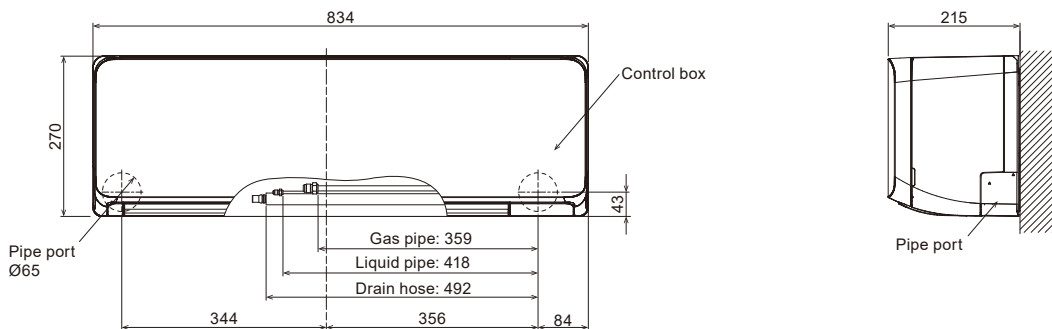

NEW

Wall-mounted type

Built-in WLAN adapter model
ECO Range
Compact Size



KN Series



Elegant & smart square design

An elegant and smart type in the eco range. The delicate shading of the ridge line makes the unit an accessory for the room.



High energy saving

The size of the heat exchanger has increased to improve performance, making it more powerful despite its compact size.

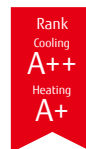

SEER 7.8* SCOP 4.4

* 07 model

Comfortable airflow & Quiet operation

The large louver and the new air-blowing structure create a comfortable air flow that spreads all the way down to the user's feet with quiet operation.



Quiet & Comfort
20 dB(A)
Cooling only

Smart device control

A WLAN adapter is included as standard equipment. By installing the AIRSTAGE mobile app on your smart device, you can check and control the operating status of the air conditioner from anywhere indoors or outdoors.

* See page G-020 for details on smart device control.



AIRSTAGE Mobile

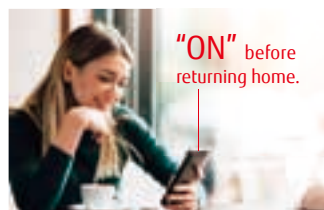

Highly efficient operation even at high outdoor temperatures

Operation Range
MAX 50°C
(Cooling operation)

Even when installed in areas with high outdoor air temperatures (Max. 50°C*), it is comfortable because it can cool the interior well.

* suction temperature of the outdoor unit





Model: ASHH07KNCA / ASHH09KNCA / ASHH12KNCA



WLAN adapter (Built-in)



Wireless RC



Specifications

Model name	Indoor unit		ASHH07KNCA	ASHH09KNCA	ASHH12KNCA
	Outdoor unit		AOHH07KNCA	AOHH09KNCA	AOHH12KNCA
Power Source			Single phase, ~230 V, 50 Hz		
Capacity	Cooling	Rated	2.0	2.5	3.4
		Min.-Max.	0.9-2.9	0.9-3.1	0.9-3.8
	Heating	Rated	2.5	2.8	3.8
		Min.-Max.	0.9-3.4	0.9-4.0	0.9-4.8
Input Power	Cooling/Heating		0.50 / 0.58	0.74 / 0.70	1.05 / 1.02
EER	Cooling		4.00	3.38	3.24
COP	Heating		4.31	4.00	3.73
Pdesign	Cooling/Heating (-10°C)		2.0 / 2.3	2.5 / 2.4	3.4 / 2.5
SEER	Cooling		7.8	7.4	7.0
SCOP	Heating (Average)		4.4	4.4	4.4
Energy Efficiency Class	Cooling		A++	A++	A++
	Heating (Average)		A+	A+	A+
Max. Operating Current	Cooling/Heating		6.5 / 9.0	6.5 / 9.0	6.5 / 9.0
Annual Energy Consumption	Cooling		90	118	170
	Heating		731	763	795
Moisture Removal			1.0	1.0	1.4
Sound Pressure Level	Indoor (Cooling)	H/M/L/Q	36 / 33 / 29 / 20	38 / 35 / 29 / 20	40 / 36 / 32 / 20
	Indoor (Heating)	H/M/L/Q	38 / 33 / 30 / 22	38 / 33 / 30 / 22	39 / 35 / 31 / 22
Sound Power Level	Outdoor (Cooling/Heating)	High	43 / 44	44 / 45	49 / 49
	Indoor (Cooling/Heating)	High	51 / 52	53 / 52	55 / 53
Airflow Rate	Indoor/Outdoor (Cooling)	High	530 / 1,430	580 / 1,430	600 / 1,460
	Indoor/Outdoor (Heating)	High	580 / 1,390	580 / 1,390	600 / 1,360
Net Dimensions H x W x D	Indoor	mm	270 x 784 x 222	270 x 784 x 222	270 x 784 x 222
	Outdoor	mm	541 x 663 x 290	541 x 663 x 290	541 x 663 x 290
Weight	Indoor	kg	9	9	9
	Outdoor	kg	22	22	24
Connection Pipe Diameter (Liquid/Gas)			6.35 / 9.52	6.35 / 9.52	6.35 / 9.52
Drain Hose Diameter (I.D./O.D.)			13.8 / 15 to 16.8	13.8 / 15 to 16.8	13.8 / 15 to 16.8
Max. Pipe Length (Pre-Charge)			20 (15)	20 (15)	20 (15)
Max. Height Difference			15	15	15
Operating Range	Cooling		-10 to 50	-10 to 50	-10 to 50
	Heating		-15 to 24	-15 to 24	-15 to 24
Refrigerant	Type (Global Warming Potential)		R32 (675)	R32 (675)	R32 (675)
	Charge		0.57 (0.385)	0.57 (0.385)	0.65 (0.439)

Optional parts

* For optional parts compatibility of Intesis devices, please refer to the optional parts compatibility list page C-050 to C-053 and C-066.

Silver Ion Filter: UTR-FA16-5

Dimensions

(Unit: mm)

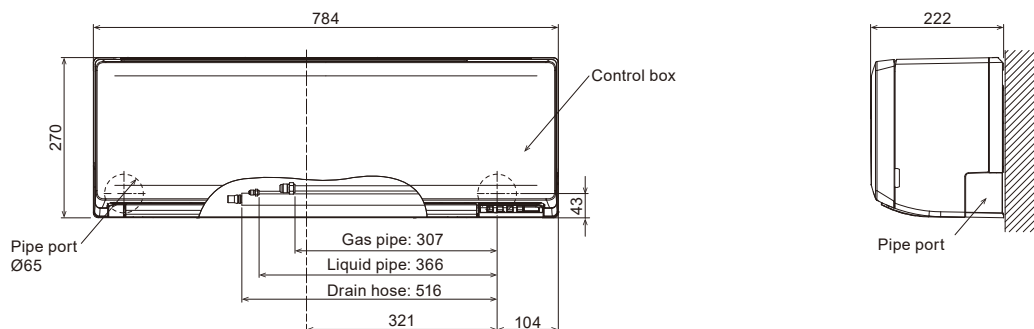

Wall-mounted type

Standard Range

High-Efficiency & Large Rooms

KM Series



High energy saving

High-efficiency has been achieved by the lambda-shaped heat exchanger, large cross-flow fan, and the new refrigerant.



SEER ^{*1} 7.8 SCOP ^{*1} 4.6

^{*1}18 model

Hybrid-heat exchanger

The large hybrid heat exchanger has greatly improved the heat exchange efficiency to achieve top-level SEER and SCOP.

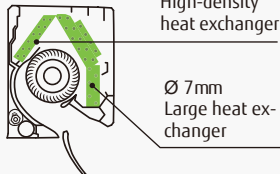

Ø107 Large cross-flow fan

The large-diameter fan generates air volume efficiently even at reduced power.

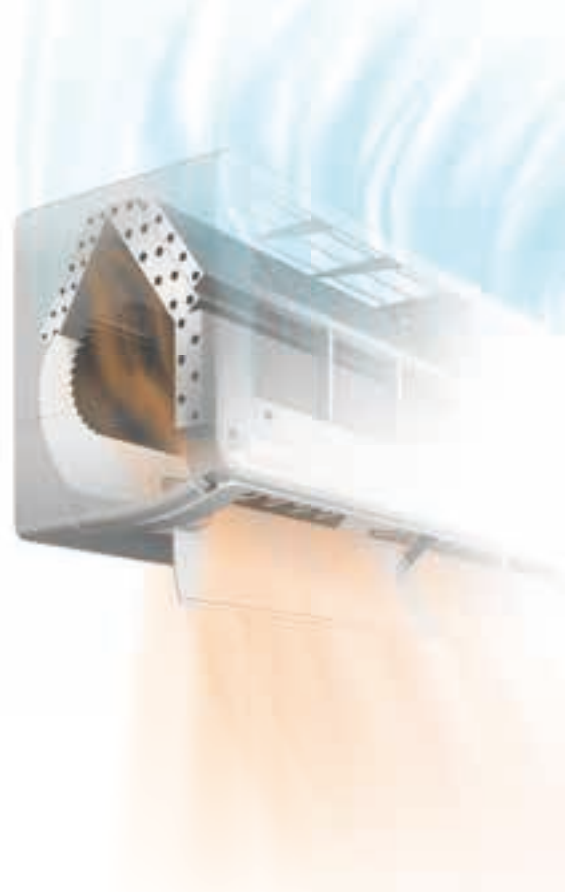
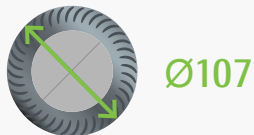

Smart device control (Option)

With the optional WLAN adapter installed in the air conditioner, you can control it from anywhere with your smart device.

^{*} For more information about smart device control, please refer to the page C-020.



AIRSTAGE Mobile

You need to install the AIRSTAGE Mobile app on your smart device in order to control the air conditioner.



WLAN adapter (USB)



Easy access to the flare pipe connection

Installation when left outlet piping is easier by removable under cover of the indoor unit chassis. Installation when center outlet piping is easier by design change of wall hook bracket.

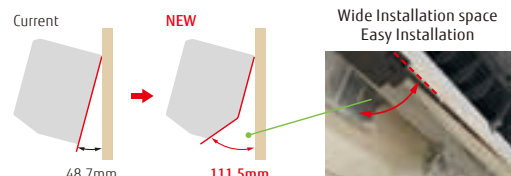



Model: ASHG18KMTE / ASHG24KMTE



Wireless RC



For ASHG18KMTE



For ASHG24KMTE

Specifications

Model name	Indoor unit		ASHG18KMTE		ASHG24KMTE	
	Outdoor unit		AOHG18KMTA		AOHG24KMTA	
Power Source	Single phase, ~230 V, 50 Hz					
Capacity	Cooling	Rated	kW	5.2	7.1	
		Min.-Max.		0.9-6.0	0.9-8.3	
	Heating	Rated		6.3	8.0	
		Min.-Max.		0.9-8.7	0.9-10.1	
Input Power	Cooling/Heating		kW	1.39/1.56	2.08/1.91	
EER	Cooling		W/W	3.74	3.41	
COP	Heating		W/W	4.04	4.19	
Pdesign	Cooling/Heating (-10°C)		kW	5.2/4.8	7.1/7.1	
SEER	Cooling		W/W	7.77	7.30	
SCOP	Heating (Average)		W/W	4.60	4.20	
Energy Efficiency Class	Cooling			A++	A++	
	Heating (Average)			A++	A+	
Max. Operating Current	Cooling/Heating		A	9.5/13.5	13.5/16.0	
Annual Energy Consumption	Cooling		kWh/a	234	340	
	Heating		kWh/a	1,460	2,362	
Moisture Removal			l/h	1.7	2.7	
Sound Pressure Level	Indoor (Cooling)	H/M/L/Q	dB(A)	45/40/35/29	49/40/35/29	
	Indoor (Heating)	H/M/L/Q		46/40/35/29	49/40/35/29	
Outdoor (Cooling/Heating)	High	50/50		54/52		
Sound Power Level	Indoor (Cooling/Heating)	High		60/61	65/65	
	Outdoor (Cooling/Heating)	High	65/65	67/66		
Airflow Rate	Indoor/Outdoor (Cooling)	High	m³/h	980/2,350	1,170/3,240	
	Indoor/Outdoor (Heating)	High	m³/h	1,020/2,100	1,170/2,820	
Net Dimensions H x W x D	Indoor	mm	280 x 980 x 240	280 x 980 x 240		
	Outdoor	mm	632 x 799 x 290	716 x 820 x 315		
Weight	Indoor	kg	12.5	12.5		
	Outdoor	kg	36	42		
Connection Pipe Diameter (Liquid/Gas)			mm	6.35/12.70	6.35/12.70	
Drain Hose Diameter (I.D./O.D.)			mm	13.8/15.8 to 16.7	13.8/15.8 to 16.7	
Max. Pipe Length (Pre-Charge)			m	25 (15)	30 (15)	
Max. Height Difference			m	20	25	
Operating Range	Cooling		°CDB	-10 to 46	-10 to 46	
	Heating		°CDB	-15 to 24	-15 to 24	
Refrigerant	Type (Global Warming Potential)			R32 (675)	R32 (675)	
	Charge		kg (CO2eq-T)	1.02 (0.689)	1.32 (0.891)	

Optional parts

* For optional parts compatibility of Intesis devices, please refer to the optional parts compatibility list page C-050 to C-053 and C-066.

Wired Remote Controller (Design type):	UTY-RVRG	External connect kit:	UTY-XWZX25	Network Converter for single split (DC power supply type):	UTY-VTGX
Compact wired remote controller:	UTY-RCRGZ1	Communication kit:	UTY-TWRXZ2	Network Converter for single split (AC power supply type):	UTY-VTGXV
Wired remote controller (touch panel):	UTY-RNRGZ5	External input and output PCB*1:	UTY-XCSXZ2	Silver Ion filter:	UTR-FA16-5
Wired remote controller:	UTY-RLRG	WLAN adapter:	UTY-TFSXF2	External switch controller:	UTY-TERX
Simple remote controller (without operation mode):	UTY-RHRG		UTY-TFSXH3		
Simple remote controller:	UTY-RSRG		FG-AC-WIF1Z1		

*1 It is required when 2 or more external input and output ports are used.

Dimensions

(Unit: mm)

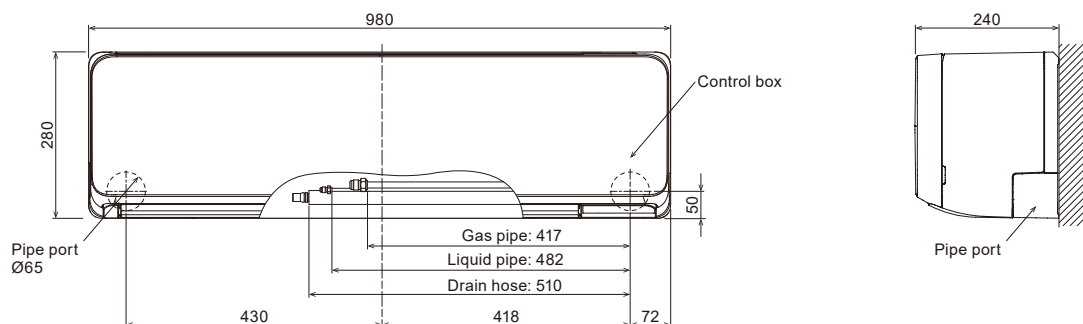

Wall-mounted type

Standard Range

High-Efficiency & Large Rooms



Special Cooling

When it is necessary to be constantly cooled such as rooms with a high heat load, it is possible to operate the cooling with keeping performance even when the outside temperature is low.

- *Wired remote controller (UTY-RNRGZ5) is required.
- *Please note that we will not provide compensation for any damages suffered to your appliances or data as a result of using this function.
- *Please use it in low-humidity environments. Condensation and other problems may be caused when used in high-humidity environments.



Human sensor

The Human sensor monitors the movements of people in a room and operates the air conditioner at a lower capacity when people leave the room. When people come back to the room, it automatically returns to the previous operating mode.



Refrigerant cycle monitor (Option)

Wired Remote Controller (Touch Panel) will support to display some sensor values for maintenance and service support.

*Wired remote controller (UTY-RNRGZ5 or UTY-RVRG) is required.

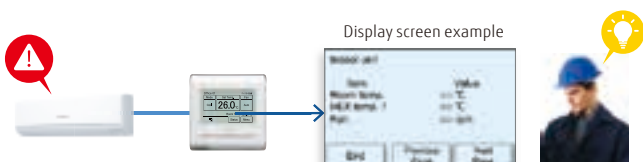

Smart device control (Option)

With the optional WLAN adapter installed in the air conditioner, you can control it from anywhere with your smart device.

* For more information about smart device control, please refer to the page C-020.



Model: ASHH30KMTB / ASHH36KMTB



Wireless RC



Specifications

Model name	Indoor unit		ASHH30KMTB		ASHH36KMTB	
	Outdoor unit		AOHH30KMTB		AOHH36KMTB	
Power Source	Single phase, ~230V, 50Hz					
Capacity	Cooling	Rated	kW	8.0	9.4	
		Min.-Max.		2.9-9.0	2.9-10.0	
	Heating	Rated		8.8	10.1	
		Min.-Max.		2.2-11.8	2.7-12.6	
Input Power	Cooling/Heating		kW	2.33/2.20	3.16/2.73	
EER	Cooling		W/W	3.43	2.97	
COP	Heating		W/W	4.00	3.70	
Pdesign	Cooling/Heating (-10°C)		kW	8.0/6.5	9.4/7.1	
SEER	Cooling		W/W	6.68	6.10	
SCOP	Heating (Average)		W/W	4.50	4.50	
Energy Efficiency Class	Cooling			A++	A++	
	Heating (Average)			A+	A+	
Max. Operating Current	Cooling/Heating		A	21.0/21.0	21.5/21.5	
Annual Energy Consumption	Cooling		kWh/a	419	534	
	Heating		kWh/a	1,994	2,189	
Moisture Removal			l/h	2.6	3.8	
Sound Pressure Level	Indoor (Cooling)	H/M/L/Q	dB(A)	50/44/40/33		50/44/40/33
	Indoor (Heating)	H/M/L/Q		49/44/39/33		49/44/39/33
Outdoor (Cooling/Heating)	High	53/55		55/55		
Outdoor (Cooling/Heating)	High	65/65		65/65		
Sound Power Level	Indoor (Cooling/Heating)	High	68/69		70/70	
	Outdoor (Cooling/Heating)	High	1,330/3,750		1,330/3,750	
Airflow Rate	Indoor/Outdoor (Cooling)	High	1,330/3,750		1,330/3,750	
Net Dimensions H x W x D	Indoor	mm	340 x 1,150 x 280		340 x 1,150 x 280	
	Outdoor	mm	788 x 940 x 320		788 x 940 x 320	
Weight	Indoor	kg	18.5		18.5	
	Outdoor	kg	52.0		52.0	
Connection Pipe Diameter (Liquid/Gas)			mm	9.52/15.88		
Drain Hose Diameter (I.D./O.D.)				13.8/15.8 to 16.7		
Max. Pipe Length (Pre-Charge)			m	50(30)		
Max. Height Difference				30		
Operating Range	Cooling		°CDB	-15to46		
	Heating		°CDB	-15to24		
Refrigerant	Type (Global Warming Potential)			R32(675)		
	Charge		kg (CO2eq-T)	1.90(1.283)		

Optional parts

* For optional parts compatibility of Intesis devices, please refer to the optional parts compatibility list page C-050 to C-053 and C-066.

Wired Remote Controller (Design type):	UTY-RVRG	External connect kit:	UTY-XWZX25	Network Converter for single split (DC power supply type):	UTY-VTGX
Compact wired remote controller:	UTY-RCRGZ1	Communication kit:	UTY-TWRXZ2	Network Converter for single split (AC power supply type):	UTY-VTGXV
Wired remote controller (touch panel):	UTY-RNRGZ5	External input and output PCB*1:	UTY-XCSXZ2	Silver Ion Filter:	UTR-FA13-3
Wired remote controller:	UTY-RLRG	WLAN adapter:	UTY-TFSXF2	External switch controller:	UTY-TERX
Simple remote controller (without operation mode):	UTY-RHRG		UTY-TFSXH3		
Simple remote controller:	UTY-RSRG		FG-AC-WIF1Z1		

*1 It is required when 2 or more external input and output ports are used.

Dimensions

(Unit: mm)

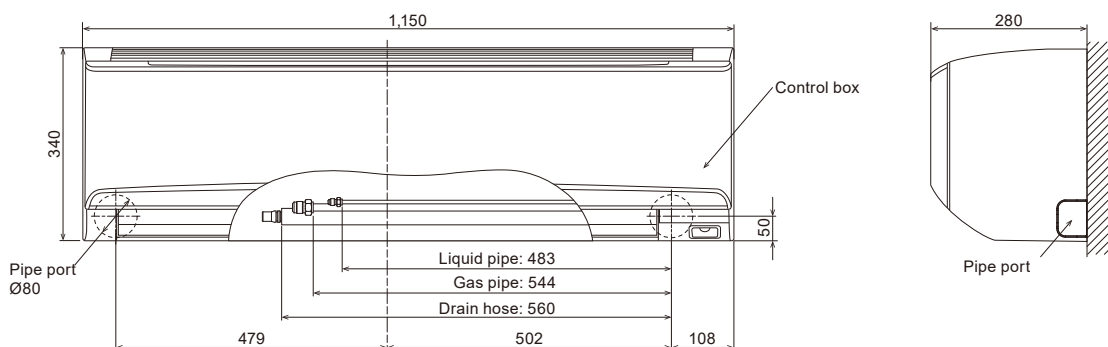

Wall-mounted type

ECO Range

Compact Size

KP Series



Slim & stylish square design

The slim and stylish square design of this indoor unit is realized by using a high-density, multipath heat exchanger and a high-efficiency wind blower.



High energy saving

High-efficiency has been achieved by the lambda-shaped heat exchanger, large cross-flow fan, and the new refrigerant.



Comfortable airflow & Quiet operation

The large louver and the new air-blowing structure create a comfortable air flow that spreads all the way down to the user's feet with quiet operation.



Smart device control (Option)

With the optional WLAN adapter installed in the air conditioner, you can control it from anywhere with your smart device.

* For more information about smart device control, please refer to the page C-020.



AIRSTAGE
Mobile

You need to install the AIRSTAGE Mobile app on your smart device in order to control the air conditioner.



WLAN adapter (USB)



Easy access to the flare pipe connection

Installation when left outlet piping is easier by removable under cover of the indoor unit chassis. Installation when center outlet piping is easier by design change of wall hook bracket.

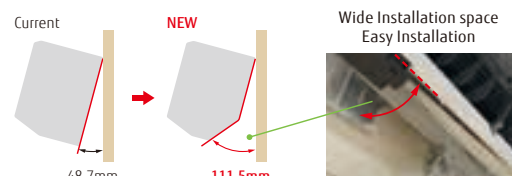



Model: ASHG07KPCE / ASHG09KPCE / ASHG12KPCE



Wireless RC



Specifications

Model name	Indoor unit		ASHG07KPCE	ASHG09KPCE	ASHG12KPCE
	Outdoor unit		AOHG07KPCA	AOHG09KPCA	AOHG12KPCA
Power Source			Single phase, ~230 V, 50 Hz		
Capacity	Cooling	Rated	2.0	2.5	3.4
		Min.-Max.	0.9-2.8	0.9-3.0	0.9-3.7
	Heating	Rated	2.5	2.8	3.8
		Min.-Max.	0.9-3.4	0.9-3.8	0.9-4.8
Input Power	Cooling/Heating		0.48/0.63	0.71/0.79	1.00/1.14
EER	Cooling		4.17	3.52	3.40
COP	Heating		3.97	3.54	3.33
Pdesign	Cooling/Heating (-10°C)		2.0/2.2	2.5/2.4	3.4/2.5
SEER	Cooling		6.70	6.70	6.30
SCOP	Heating (Average)		4.00	4.00	4.10
Energy Efficiency Class	Cooling		A++	A++	A++
	Heating (Average)		A+	A+	A+
Max. Operating Current	Cooling/Heating		6.5/9.0	6.5/9.0	6.5/9.0
Annual Energy Consumption	Cooling		104	131	189
	Heating		769	840	853
Moisture Removal			1.0	1.3	1.8
Sound Pressure Level	Indoor (Cooling)	H/M/L/Q	45/38/31/22	45/38/31/22	46/40/33/22
	Indoor (Heating)	H/M/L/Q	45/40/36/26	45/40/36/26	46/40/35/27
	Outdoor (Cooling/Heating)	High	45/46	47/47	49/51
Sound Power Level	Indoor (Cooling/Heating)	High	57/58	58/58	59/59
	Outdoor (Cooling/Heating)	High	57/58	59/59	62/62
	Indoor/Outdoor (Cooling)	High	580/1,650	580/1,650	630/1,700
Airflow Rate	Indoor/Outdoor (Heating)	High	580/1,450	580/1,450	630/1,470
	Indoor	mm	270 × 784 × 224	270 × 784 × 224	270 × 784 × 224
Net Dimensions H x W x D	Outdoor	mm	541 × 663 × 290	541 × 663 × 290	541 × 663 × 290
	Indoor	kg	8	8	8
Weight	Outdoor	kg	23	23	25
	Connection Pipe Diameter (Liquid/Gas)		6.35/9.52	6.35/9.52	6.35/9.52
Drain Hose Diameter (I.D./O.D.)		mm	11.8/15.0 to 16.8	11.8/15.0 to 16.8	11.8/15.0 to 16.8
Max. Pipe Length (Pre-Charge)		m	20 (15)	20 (15)	20 (15)
Max. Height Difference			15	15	15
Operating Range	Cooling	°CDB	-10 to 46	-10 to 46	-10 to 46
	Heating		-15 to 24	-15 to 24	-15 to 24
Refrigerant	Type (Global Warming Potential)		R32 (675)	R32 (675)	R32 (675)
	Charge	kg (CO2eq-T)	0.55 (0.371)	0.55 (0.371)	0.59 (0.398)

Optional parts

* For optional parts compatibility of Intesis devices, please refer to the optional parts compatibility list page C-050 to C-053 and C-066.

WLAN adapter: UTY-TFSXF2

UTY-TFSXH3

Silver Ion Filter: UTR-FA16-5

Dimensions

(Unit: mm)

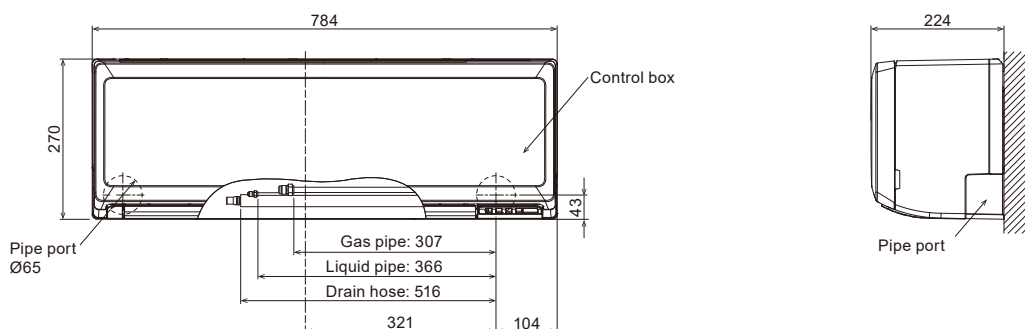

Wall-mounted type

ECO Range

Comfort for Large Rooms

KL Series



Narrow width & Compact design

Compact and versatile. Powerful airflow is realized despite the 790-mm width compact design for small spaces such as bedrooms or home offices.



Economy operation

Set temperature automatically increases or decreases by 1°C. The thermostat setting is adjusted automatically according to the room temperature to avoid unnecessary cooling or heating.

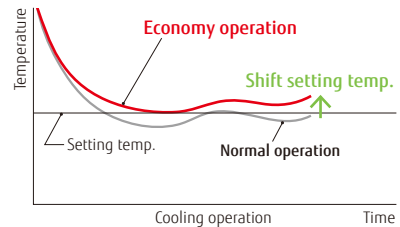

Powerful operation

In powerful operation mode, the compressor operates at maximum speed for 20 minutes to provide a powerful airflow. Rapid cooling and heating makes the room comfortable quickly.

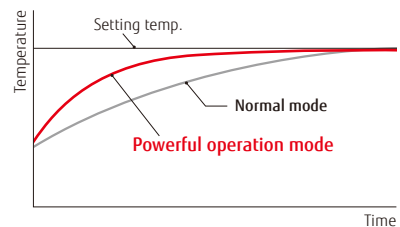

ON-OFF programmable timer

You can set ON/OFF or OFF/ON times depending on your lifestyle needs. (Setting time: 0.5, 1, 1.5, 2, 2.5, ----9.5, 10, 11, 12 hours)

Low ambient operation

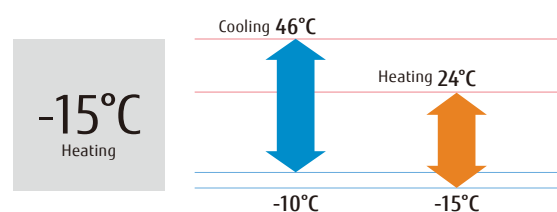



Model: ASHG18KLCA / ASHG24KLCA



Wireless RC



For ASHG18KLCA



For ASHG24KLCA

Specifications

Model name	Indoor unit		Outdoor unit		ASHG18KLCA	ASHG24KLCA
					AOHG18KLCA	AOHG24KLCA
Power Source					Single phase, ~230 V, 50 Hz	
Capacity	Cooling	Rated	kW	5.2		7.1
		Min.-Max.		0.9-5.5		0.9-7.7
	Heating	Rated		6.3		8.0
		Min.-Max.		0.6-7.6		0.9-9.0
Input Power	Cooling/Heating		kW	1.685/1.80		2.42/2.225
EER	Cooling		W/W	3.09		2.93
COP	Heating		W/W	3.50		3.60
Pdesign	Cooling/Heating (-10°C)		kW	5.20/4.80		7.10/7.10
SEER	Cooling		W/W	7.20		7.10
SCOP	Heating (Average)		W/W	4.30		4.00
Energy Efficiency Class	Cooling			A++		A++
	Heating (Average)			A+		A+
Max. Operating Current	Cooling/Heating		A	9.5/13.5		13.5/17.5
Annual Energy Consumption	Cooling		kWh/a	253		350
	Heating		kWh/a	1563		2485
Moisture Removal			l/h	1.9		3.1
Sound Pressure Level	Indoor (Cooling)	H/M/L/Q	dB(A)	47/44/40/35		51/45/38/33
	Indoor (Heating)	H/M/L/Q		50/45/41/37		52/45/41/37
Outdoor (Cooling/Heating)	High	50/56		55/57		
Sound Power Level	Indoor (Cooling/Heating)	High		60/65		64/65
Airflow Rate	Outdoor (Cooling/Heating)	High	61/66		65/67	
	Indoor/Outdoor (Cooling)	High	865/1,830		1,040/2,885	
Net Dimensions H x W x D	Indoor/Outdoor (Heating)	High	995/2,265		1,040/3,030	
	Indoor	mm	293 × 790 × 249		293 × 790 × 249	
Weight	Outdoor	mm	542 × 799 × 290		632 × 799 × 290	
	Indoor	kg	9.5		10.0	
Connection Pipe Diameter (Liquid/Gas)	Outdoor	kg	33		38	
	Indoor	mm	6.35/9.52		6.35/12.70	
Drain Hose Diameter (I.D./O.D.)			mm	13.8/15.8 to 16.7		13.8/15.8 to 16.7
Max. Pipe Length (Pre-Charge)			m	25 (15)		30 (15)
Max. Height Difference			m	20		25
Operating Range	Cooling		°CDB	-10 to 46		-10 to 46
	Heating			-15 to 24		-15 to 24
Refrigerant	Type (Global Warming Potential)			R32 (675)		R32 (675)
	Charge		kg (CO2eq-T)	0.85 (0.574)		1.10 (0.743)

Optional parts

* For optional parts compatibility of Intesis devices, please refer to the optional parts compatibility list page C-050 to C-053 and C-066.

Silver Ion Filter: UTR-FA16-5

Dimensions

(Unit: mm)

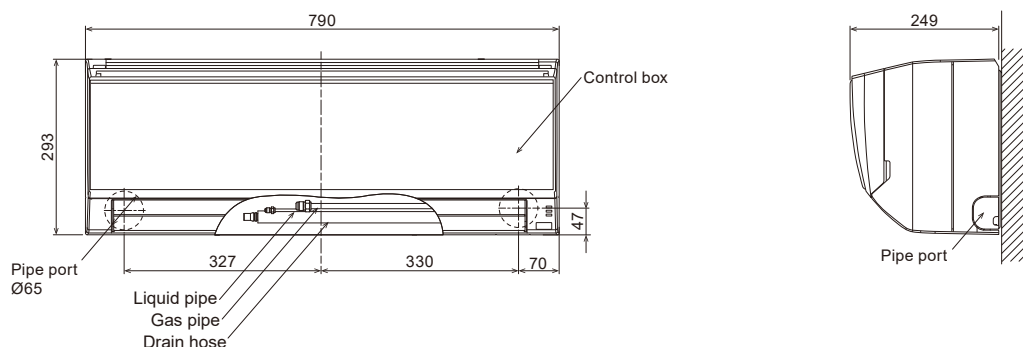

NEW

Wall-mounted type

ECO Range

Cooling-enhanced type

KL Series



Highly efficient operation even at high outdoor temperatures

Even when installed in areas with high outdoor air temperatures (Max. 52°C*), it is comfortable because it can cool the interior well.

*suction temperature of the outdoor unit



SEER
7.1^{*}
*07 model

Operation Range
MAX 52°C
(Cooling operation)



MINIMAL SMART design

The new smart design eliminates mechanical elements and offers a sophisticated, premium impression. Its compact size, with a width of 770 mm, allows for flexible installation in limited room space.



Comfortable airflow & Quiet operation

The large louver and the new air-blowing structure create a comfortable air flow that spreads all the way down to the user's feet with quiet operation.



Quiet & Comfort
21 dB(A)
Cooling only

Smart device control (Option)

With the optional WLAN adapter installed in the air conditioner, you can control it from anywhere with your smart device.

* For more information about smart device control, please refer to the page C-020.



AIRSTAGE
Mobile

You need to install the AIRSTAGE Mobile app on your smart device in order to control the air conditioner.



WLAN
adapter (USB)





Model: ASHH07KLTA / ASHH09KLTA / ASHH12KLTA



Wireless RC



Specifications

Model name	Indoor unit		ASHH07KLTA	ASHH09KLTA	ASHH12KLTA
	Outdoor unit		AOHH07KLTA	AOHH09KLTA	AOHH12KLTA
Power Source			Single phase, -230 V, 50 Hz		
Capacity	Cooling	Rated	2.0	2.5	3.4
		Min.-Max.	0.9-2.8	0.9-3.0	0.9-3.7
	Heating	Rated	2.4	2.5	3.4
		Min.-Max.	0.9-3.3	0.9-3.5	0.9-3.7
Input Power	Cooling/Heating		0.54 / 0.64	0.76 / 0.67	1.05 / 0.915
EER	Cooling		3.70	3.29	3.24
COP	Heating		3.75	3.73	3.72
Pdesign	Cooling/Heating (-10°C)		2.0 / 2.2	2.5 / 2.3	3.4 / 2.5
SEER	Cooling		7.10	6.80	6.70
SCOP	Heating (Average)		4.10	4.10	4.10
Energy Efficiency Class	Cooling		A++	A++	A++
	Heating (Average)		A+	A+	A+
Max. Operating Current	Cooling/Heating		6.0 / 6.0	6.0 / 6.0	7.0 / 7.0
Annual Energy Consumption	Cooling		99	129	178
	Heating		752	786	854
Moisture Removal			0.18	0.55	1.26
Sound Pressure Level	Indoor (Cooling)	H/M/L/Q	41 / 36 / 29 / 21	43 / 36 / 29 / 21	43 / 37 / 30 / 21
	Indoor (Heating)	H/M/L/Q	41 / 37 / 32 / 23	43 / 37 / 32 / 23	43 / 37 / 32 / 23
Sound Power Level	Outdoor (Cooling/Heating)	High	47 / 47	47 / 47	50 / 50
	Indoor (Cooling/Heating)	High	54 / 55	55 / 55	55 / 56
Airflow Rate	Indoor/Outdoor (Cooling)	High	600 / 1,650	620 / 1,650	620 / 1,700
	Indoor/Outdoor (Heating)	High	600 / 1,450	620 / 1,450	640 / 1,470
Net Dimensions H x W x D	Indoor	mm	250 × 770 × 218	250 × 770 × 218	250 × 770 × 218
	Outdoor	mm	541 × 663 × 290	541 × 663 × 290	541 × 663 × 290
Weight	Indoor	kg	7.0	7.0	7.5
	Outdoor	kg	19	19	22
Connection Pipe Diameter (Liquid/Gas)			6.35 / 9.52	6.35 / 9.52	6.35 / 9.52
Drain Hose Diameter (I.D./O.D.)			13.8 / 15 to 16.8	13.8 / 15 to 16.8	13.8 / 15 to 16.8
Max. Pipe Length (Pre-Charge)			20 (15)	20 (15)	20 (15)
Max. Height Difference			15	15	15
Operating Range	Cooling		10 to 52	10 to 52	10 to 52
	Heating		-15 to 24	-15 to 24	-15 to 24
Refrigerant	Type (Global Warming Potential)		R32 (675)	R32 (675)	R32 (675)
	Charge		0.53(0.358)	0.53(0.358)	0.60(0.405)

Optional parts

* For optional parts compatibility of Intesis devices, please refer to the optional parts compatibility list page C-050 to C-053 and C-066.

WLAN adapter: UTY-TFSXF2

UTY-TFSXH3

Silver Ion Filter: UTR-FA16-5

Dimensions

(Unit: mm)

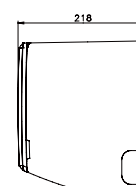
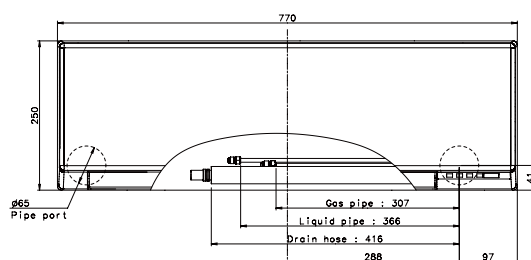

Compact Cassette

Compact 4-way Flow Range
Compact Size



Compact and stylish panel design

The compact and stylish panel fits nicely into a grid-type ceiling. Its linear design is a perfect fit into a grid of 620 mm x 620 mm in the ceiling.



Easy maintenance

You can access the unit for maintenance simply by removing a ceiling panel next to the grille. As no inspection hole needs to be cut through the ceiling, no additional construction cost is incurred.

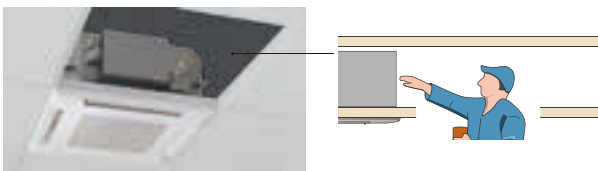

The air inlet grille can be installed to open in any direction for easy maintenance.



Flexible installation

The unit fits nicely into the decor of a grid-type ceiling and can be installed near the lighting or a ventilation opening.



Link up with a variety of central control system (Option)

Centralized control including facilities and equipment in addition to air conditioning is possible by linking up with MODBUS, KNX interfaces.





Model: AUXG09KVLA / AUXG12KVLA / AUXG14KVLA / AUXG18KVLA / AUXG22KVLA / AUXG24KVLA



For AUXG9/12/14KVLA

For AUXG18/22KVLA

For AUXG24KVLA

Specifications

Model name	Indoor unit			AUXG09KVLA	AUXG12KVLA	AUXG14KVLA	AUXG18KVLA	AUXG22KVLA	AUXG24KVLA
	Outdoor unit			AOHG09KBTB	AOHG12KBTB	AOHG14KBTB	AOHG18KBTB	AOHG22KBTB	AOHG24KBTB
Power Source				Single phase, ~230 V, 50 Hz					
Capacity	Cooling	Rated	kW	2.5	3.5	4.3	5.2	6.0	6.8
		Min.-Max.		0.9-3.2	0.9-4.4	0.9-5.4	0.9-5.9	0.9-6.7	0.9-8.0
	Heating	Rated		3.2	4.1	5.0	6.0	7.0	7.5
		Min.-Max.		0.9-4.7	0.9-5.7	0.9-6.5	0.9-7.5	0.9-8.0	0.9-9.1
Input Power	Cooling/Heating		kW	0.55/0.79	0.93/1.08	1.28/1.32	1.60/1.66	1.82/1.87	2.21/2.03
EER	Cooling		W/W	4.57	3.76	3.36	3.25	3.30	3.08
COP	Heating		W/W	4.05	3.80	3.79	3.61	3.74	3.69
Pdesign	Cooling/Heating (-10°C)		kW	2.5/2.6	3.5/3.4	4.3/3.8	5.2/4.4	6.0/4.8	6.8/6.0
SEER	Cooling		W/W	6.70	6.60	6.50	6.60	6.60	6.10
SCOP	Heating (Average)		W/W	4.40	4.30	4.40	4.20	4.30	4.00
Energy Efficiency Class	Cooling			A++	A++	A++	A++	A++	A++
	Heating (Average)			A+	A+	A+	A+	A+	A+
Max. Operating Current	Cooling/Heating		A	7.9/7.9	9.7/9.7	10.2/10.2	12.1/12.1	12.6/12.6	13.6/13.6
Annual Energy Consumption	Cooling		kWh/a	131	186	231	275	318	390
	Heating		kWh/a	826	1,106	1,208	1,466	1,562	2,097
Moisture Removal			l/h	0.6	1.2	1.5	2.2	2.6	2.7
Sound Pressure Level	Indoor (Cooling)	H/M/L/Q	dB(A)	33/31/29/27	37/34/30/27	38/34/30/27	38/34/30/26	44/42/36/30	49/44/36/30
	Indoor (Heating)	H/M/L/Q		34/32/29/27	37/34/31/29	43/38/34/30	43/38/34/30	45/43/40/33	49/45/40/33
Outdoor (Cooling/Heating)	High	46/46		47/47	49/49	50/50	51/51	53/54	
Outdoor (Cooling/Heating)	High	46/47		49/49	50/55	50/55	56/57	59/61	
Sound Power Level	Indoor (Cooling/Heating)	High	59/59	61/61	62/62	62/62	63/63	65/66	
	Outdoor (Cooling/Heating)	High	540/1,480	600/1,580	680/1,670	680/2,160	830/2,240	930/2,700	
Airflow Rate	Indoor/Outdoor (Cooling)	High	540/1,410	600/1,520	800/1,580	800/1,830	860/1,960	930/2,700	
	Indoor/Outdoor (Heating)	High	245 × 570 × 570	245 × 570 × 570	245 × 570 × 570	245 × 570 × 570	245 × 570 × 570	245 × 570 × 570	
Net Dimensions H x W x D	Indoor	mm	542 × 799 × 290	542 × 799 × 290	542 × 799 × 290	632 × 799 × 290	632 × 799 × 290	716 × 820 × 315	
	Outdoor	mm	15	15	15	15	16	16	
Weight	Indoor	kg	32	33	33	36	38	42	
	Outdoor	kg	6.35/9.52	6.35/9.52	6.35/9.52	6.35/12.70	6.35/12.70	6.35/12.70	
Connection Pipe Diameter (Liquid/Gas)			mm	25/32	25/32	25/32	25/32	25/32	25/32
Drain Hose Diameter (I.D./O.D.)			mm	20 (15)	25 (15)	25 (15)	30 (20)	30 (20)	30 (20)
Max. Pipe Length (Pre-Charge)			m	15	20	20	20	25	25
Max. Height Difference			°CDB	-15 to 46	-15 to 46	-15 to 46	-15 to 46	-15 to 46	-15 to 46
			°CDB	-15 to 24	-15 to 24	-15 to 24	-15 to 24	-15 to 24	-15 to 24
Operating Range	Cooling		°CDB	-15 to 46	-15 to 46	-15 to 46	-15 to 46	-15 to 46	-15 to 46
	Heating		°CDB	-15 to 24	-15 to 24	-15 to 24	-15 to 24	-15 to 24	-15 to 24
Refrigerant	Type (Global Warming Potential)			R32 (675)	R32 (675)	R32 (675)	R32 (675)	R32 (675)	R32 (675)
	Charge		kg (CO2eq-T)	0.85 (0.574)	0.85 (0.574)	0.85 (0.574)	1.02 (0.689)	1.25 (0.844)	1.25 (0.844)
Cassette Grille	Model name			UTG-UFGF-W	UTG-UFGF-W	UTG-UFGF-W	UTG-UFGF-W	UTG-UFGF-W	UTG-UFGF-W
	Dimensions (H × W × D)		mm	49 × 620 × 620	49 × 620 × 620	49 × 620 × 620	49 × 620 × 620	49 × 620 × 620	49 × 620 × 620
	Weight		kg	2.3	2.3	2.3	2.3	2.3	2.3

Optional parts

* For optional parts compatibility of Intesis devices, please refer to the optional parts compatibility list page C-050 to C-053 and C-066.

Wired Remote Controller (Design type): UTY-RVRG
 Compact wired remote controller: UTY-RCRGZ1
 Wired remote controller (touch panel): UTY-RNRGZ5
 Wired remote controller: UTY-RLRG
 UTY-RNNGM
 UTY-RVNGM

Wireless remote controller: UTY-LNTG
 External switch controller: UTY-TERX
 WLAN adapter: UTY-TFSXZ1
 FG-RC-WIF1Z2
 UTY-TFSX13
 FG-AC-WIF1Z1

Network Converter for single split (DC power supply type): UTY-VTGX
 Network Converter for single split (AC power supply type): UTY-VTGXV
 Insulation kit for high humidity: UTZ-KXGC
 External input and output PCB: UTY-XCSX
 External input and output PCB box: UTZ-GXRA
 Silver Ion Filter: UTD-HFAA
 Fresh air intake kit: UTZ-VXAA
 External connect kit: UTY-XWZXX

Simple remote controller (without operation mode): UTY-RHRG
 Simple remote controller: UTY-RSRG
 Air Outlet Shutter Plate: UTR-YDZB
 Cassette Grille: UTG-UFGF-W

Dimensions

(Unit: mm)

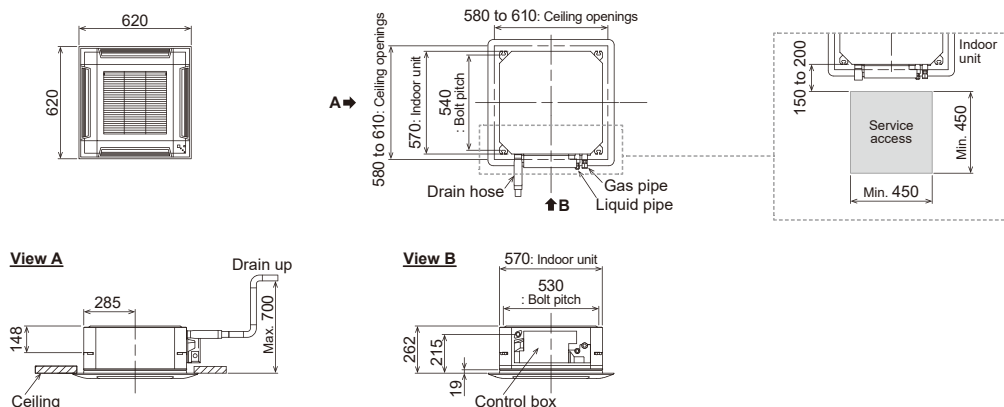

Cassette

Circular Flow Range

Comfort for Large Rooms



UTG-UKGA-B
Black Grille



(30/36/45/54)

Unique circular flow design

The Cassette model realizes a Circular Flow to blow a large airflow in a 360° direction by using a high-performance DC fan motor, turbo fan, and a unique seamless airflow louver design.



Airflows avoid blowing cool air directly at the occupants in the room, providing more comfortable air conditioning.

Provides efficient air conditioning based on the room layout

Individual louver control

Each louver can be controlled individually with a wired remote controller equipped with a touch panel to provide different directional airflows according to the room layout.

*Wired remote controller (touch panel) (UTY-RNRGZ3) only

The Human sensor yields more energy savings.
Energy saving operation starts automatically by detecting the motion of a person. Two modes of save operation mode and stop mode can be selected.

Compact and lightweight outdoor unit

The outdoor units for the 45,000 BTU and 54,000 BTU models have been completely redesigned. Easier installation is achieved for this compact and lightweight outdoor unit.

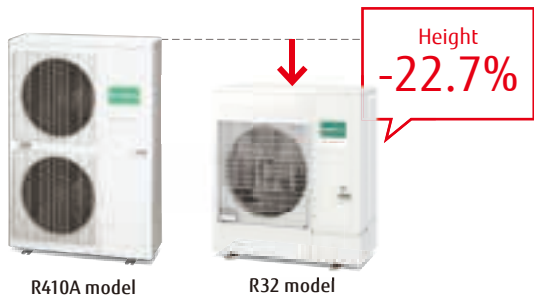

R410A model

R32 model

Link up with a variety of central control system (Option)

Centralized control including facilities and equipment in addition to air conditioning is possible by linking up with MODBUS, KNX interfaces.



Central Control System

Various cassette grilles

Both black and white grilles are available. Three types of grilles are available: a white grille with a remote controller; a white grille without a remote controller; and a black grille without a remote controller. Select to match the atmosphere and/or usage of the room.



UTG-UKGA-W
White Grille
Wired remote controller
(touch panel)



UTG-UKGA-B
Black Grille



UTG-UKGC-W
White Grille



**Model: AUXG18KRLB / AUXG22KRLB / AUXG24KRLB / AUXG30KRLB / AUXG36KRLB / AUXG45KRLB / AUXG54KRLB
AUXG36KRLB [3-phase] / AUXG45KRLB [3-phase] / AUXG54KRLB [3-phase]**



AUXG18/22/24KRLB

AUXG30/36/45/54KRLB

For AUXG18/22KRLB

For AUXG24KRLB

For AUXG30/36KRLB

For AUXG45/54KRLB

Specifications

Model name	Indoor unit			AUXG18KRLB	AUXG22KRLB	AUXG24KRLB	AUXG30KRLB	AUXG36KRLB	AUXG45KRLB	AUXG54KRLB	AUXG36KRLB	AUXG45KRLB	AUXG54KRLB
	Outdoor unit			AOHG18KBTB	AOHG22KBTB	AOHG24KBTB	AOHG30KBTB	AOHG36KBTB	AOHG45KBTB	AOHG54KBTB	AOHG36KRTA	AOHG45KRTA	AOHG54KRTA
Power Source	Single phase, ~230 V, 50 Hz										3-phase, ~400 V, 50 Hz		
Capacity	Cooling	Rated	kW	5.2	6.0	6.8	8.5	9.5	12.1	13.4	9.5	12.1	13.4
		Min.-Max.		0.9-5.9	0.9-6.7	0.9-8.0	2.8-10.0	2.8-11.2	4.0-14.0	4.5-14.5	2.8-11.2	4.0-14.0	4.5-14.5
Capacity	Heating	Rated	kW	6.0	7.0	7.5	10.0	10.8	13.5	13.7	10.8	13.5	15.5
		Min.-Max.		0.9-7.5	0.9-8.0	0.9-9.1	2.7-11.2	2.7-12.7	4.2-16.2	4.7-16.5	2.7-12.7	4.2-16.2	4.7-16.5
Input Power	Cooling/Heating		kW	1.36/1.58	1.71/1.82	1.89/1.90	2.44/2.51	2.91/2.45	3.61/3.21	4.41/4.16	2.91/2.45	3.61/3.21	4.41/4.16
EER	Cooling		W/W	3.82	3.51	3.60	3.98	3.26	3.35	3.04	3.26	3.35	3.04
COP	Heating		W/W	3.80	3.85	3.95	3.49	4.40	4.20	3.73	4.40	4.20	3.73
Pdesign	Cooling/Heating (-10°C)		kW	5.2/4.4	6.0/4.8	6.8/6.0	8.5/8.0	9.5/8.7	-	-	9.5/8.7	-	-
SEER	Cooling		W/W	7.00	7.00	6.60	6.70	6.55	-	-	6.55	-	-
SCOP	Heating (Average)		W/W	4.30	4.40	4.20	4.30	4.30	-	-	4.30	-	-
Energy Efficiency Class	Cooling			A++	A++	A++	A++	A++	-	-	A++	-	-
Energy Efficiency Class	Heating (Average)			A+	A+	A+	A+	A+	-	-	A+	-	-
Max. Operating Current	Cooling/Heating		A	12.1/12.1	12.6/12.6	13.6/13.6	22.6/22.6	22.6/22.6	28.5/28.5	28.5/28.5	10.5/10.5	14.0/14.0	14.0/14.0
Annual Energy Consumption	Cooling		kWh/a	260	300	360	444	507	-	-	507	-	-
	Heating		kWh/a	1,431	1,527	1,999	2,601	2,828	-	-	2,828	-	-
Moisture Removal			l/h	1.5	2.2	2.7	2.5	3.3	4.5	5.0	3.3	4.5	5.0
Sound Pressure Level	Indoor (Cooling)	H/M/L/Q	dB(A)	33/32/31/28	33/32/31/28	35/33/32/29	40/38/36/33	44/41/38/34	46/42/39/35	47/43/40/36	44/41/38/34	46/42/39/35	47/43/40/36
	Indoor (Heating)	H/M/L/Q		33/32/31/28	33/32/31/28	35/33/32/29	40/38/36/33	44/41/38/34	46/42/39/35	47/43/40/36	44/41/38/34	46/42/39/35	47/43/40/36
Sound Power Level	Indoor (Cooling/Heating)	High	dB(A)	50/50	51/51	53/54	53/55	55/55	57/57	57/59	55/55	57/57	57/59
	Outdoor (Cooling/Heating)	High		47/47	49/49	49/49	54/54	58/58	60/60	61/61	58/58	60/60	61/61
Airflow Rate	Indoor/Outdoor (Cooling)	High	m³/h	1,050/2,160	1,050/2,240	1,150/2,700	1,600/3,750	1,870/3,750	2,000/4,450	2,100/4,450	1,870/3,750	2,000/4,450	2,100/4,450
	Indoor/Outdoor (Heating)	High		1,050/1,830	1,050/1,960	1,150/2,700	1,600/3,750	1,870/3,750	2,000/4,450	2,100/4,450	1,870/3,750	2,000/4,450	2,100/4,450
Net Dimensions H x W x D	Indoor	mm	mm	246 × 840 × 840	246 × 840 × 840	246 × 840 × 840	288 × 840 × 840	288 × 840 × 840	288 × 840 × 840	288 × 840 × 840	288 × 840 × 840	288 × 840 × 840	288 × 840 × 840
	Outdoor	mm		632 × 799 × 290	632 × 799 × 290	716 × 820 × 315	788 × 940 × 320	788 × 940 × 320	998 × 940 × 320	998 × 940 × 320	998 × 940 × 320	788 × 940 × 320	998 × 940 × 320
Weight	Indoor	kg	kg	23	23	24	26	29	29	29	29	29	29
	Outdoor	kg		36	38	42	52	52	67	67	53	67	67
Connection Pipe Diameter (Liquid/Gas)			mm	6.35/12.70	6.35/12.70	6.35/12.70	9.52/15.88	9.52/15.88	9.52/15.88	9.52/15.88	9.52/15.88	9.52/15.88	9.52/15.88
Drain Hose Diameter (I.D./O.D.)			mm	25/32	25/32	25/32	25/32	25/32	25/32	25/32	25/32	25/32	25/32
Max. Pipe Length (Pre-Charge)			m	30 (20)	30 (20)	30 (20)	50 (30)	50 (30)	50 (30)	50 (30)	50 (30)	50 (30)	50 (30)
Max. Height Difference			m	20	25	25	30	30	30	30	30	30	30
Operating Range	Cooling	°CDB	°CDB	-15 to 46	-15 to 46	-15 to 46	-15 to 46	-15 to 46	-15 to 46	-15 to 46	-15 to 46	-15 to 46	-15 to 46
	Heating			-15 to 24	-15 to 24	-15 to 24	-15 to 24	-15 to 24	-15 to 24	-15 to 24	-15 to 24	-15 to 24	-15 to 24
Refrigerant	Type (Global Warming Potential)			R32 (675)	R32 (675)	R32 (675)	R32 (675)	R32 (675)	R32 (675)	R32 (675)	R32 (675)	R32 (675)	R32 (675)
	Charge	kg (CO2eq-T)		1.02 (0.689)	1.25 (0.844)	1.25 (0.844)	1.90 (1.283)	1.90 (1.283)	2.70 (1.823)	2.70 (1.823)	1.90 (1.283)	2.70 (1.823)	2.70 (1.823)
Cassette Grille	Variation	UTG-UKGA-W: White wired remote controller (touch panel) UTG-UKGC-W: White/UTG-UKGA-B*: Black UTG-UKGC-W: White/UTG-UKGA-B*: Black											
	Dimensions (H × W × D)	mm		53 × 950 × 950	53 × 950 × 950	53 × 950 × 950	53 × 950 × 950	53 × 950 × 950	53 × 950 × 950	53 × 950 × 950	53 × 950 × 950	53 × 950 × 950	53 × 950 × 950
Weight			kg	6.0	6.0	6.0	6.0	6.0	6.0	6.0	6.0	6.0	6.0

*1: IR Receiver kit and Human sensor kit cannot be connected.

Optional parts

* For optional parts compatibility of Intesis devices, please refer to the optional parts compatibility list page C-050 to C-053 and C-066.

Wired Remote Controller (Design type):	UTY-RVRG	WLAN adapter:	UTY-TFSXZ1	Cassette Grille:	UTG-UKGA-B
Compact wired remote controller:	UTY-RCRGZ1		FG-RC-WIF1Z2		UTG-UKGA-W
Wired remote controller (touch panel):	UTY-RNRGZ5		UTY-TFSXJ3		UTG-UKGC-W
Wired remote controller:	UTY-RLRG		FG-AC-WIF1Z1	Network Converter for single split (DC power supply type):	UTY-VTGX
	UTY-RNNGM	External input and output PCB:	UTY-XCSX	Network Converter for single split (AC power supply type):	UTY-VTGXV
	UTY-RVNGM	External input and output PCB box:	UTZ-GXRA	Silver Ion Filter:	UTD-HFRA
Simple remote controller (without operation mode):	UTY-RHRG	Insulation kit for high humidity:	UTZ-KXRA	External connect kit:	UTY-XWZXXG
Simple remote controller:	UTY-RSRG	Fresh air intake kit:	UTZ-VXRA		
Human sensor kit:	UTY-SHZXC	Wide Panel:	UTG-AKXA-W	(Outdoor unit 30/36/45/54)	
External switch controller:	UTY-TERX	Panel Spacer:	UTG-BKXA-W	External connect kit:	UTY-XWZXX3
IR receiver unit	UTY-LBTGC	Air Outlet Shutter Plate:	UTR-YDZK		

Dimensions

(Unit: mm)

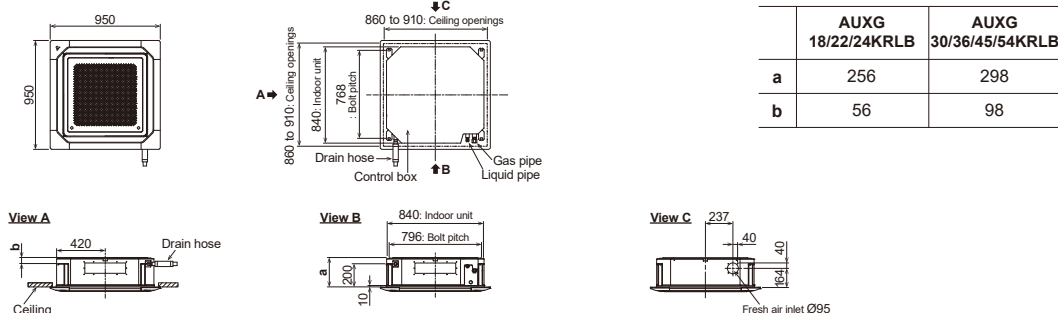

Slim Duct

Slim Design



Slim design

The slim design fits nicely into narrow spaces under the ceiling. Drain hose as standard accessory



Compact and lightweight outdoor unit

The compact and lightweight outdoor unit offers greater flexibility in the choice of installation location. This makes it easier to use this outdoor unit.



Wide range of static pressures

The use of a DC fan motor makes it possible to adjust the static pressure between 0 and 90 Pa. The static pressure range can be changed by a remote controller.



Static pressure range
0 to 90 Pa

Auto louver grille kit (Option)

The optional clean-looking flat Auto louver blends into any interior and provides a comfortable airflow.

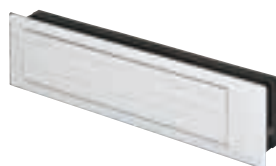

Link up with a variety of central control system (Option)

Centralized control including facilities and equipment in addition to air conditioning is possible by linking up with MODBUS, KNX interfaces.



Model: ARXG09KLLAP / ARXG12KLLAP / ARXG14KLLAP / ARXG18KLLAP



ARXG09/12/14KLLAP



ARXG18KLLAP



For ARXG09/12/14KLLAP



For ARXG18KLLAP

Specifications

Model name	Indoor unit		ARXG09KLLAP	ARXG12KLLAP	ARXG14KLLAP	ARXG18KLLAP
	Outdoor unit		AOHG09KBTB	AOHG12KBTB	AOHG14KBTB	AOHG18KBTB
Power Source			Single phase, ~230 V, 50 Hz			
Capacity	Cooling	Rated	2.5	3.5	4.3	5.2
		Min.-Max.	0.9-3.2	0.9-4.4	0.9-5.4	0.9-5.9
Capacity	Heating	Rated	3.2	4.1	5.0	6.0
		Min.-Max.	0.9-4.7	0.9-5.7	0.9-6.5	0.9-7.5
Input Power	Cooling/Heating		0.60/0.79	0.93/1.08	1.28/1.32	1.55/1.62
EER	Cooling		4.17	3.76	3.36	3.35
COP	Heating		4.05	3.80	3.79	3.70
Pdesign	Cooling/Heating (-10°C)		2.5/2.6	3.5/3.4	4.3/3.8	5.2/4.4
SEER	Cooling		6.20	6.10	5.80	6.20
SCOP	Heating		4.30	4.00	3.90	4.10
Energy Efficiency Class	Cooling		A++	A++	A+	A++
	Heating		A+	A+	A	A+
Max. Operating Current	Cooling/Heating		7.9/7.9	9.7/9.7	10.2/10.2	12.1/12.1
Annual Energy Consumption	Cooling		141	201	259	293
	Heating		845	1,189	1,362	1,501
Moisture Removal			0.7	1.3	1.5	2.0
Sound Pressure Level	Indoor (Cooling)	H/M/L/Q	28/27/26/25	29/28/26/25	32/30/28/26	32/30/29/27
	Indoor (Heating)	H/M/L/Q	28/26/25/24	29/28/26/24	32/30/28/25	32/30/29/27
Sound Power Level	Outdoor (Cooling/Heating)	High	46/46	47/47	49/49	50/50
	Indoor (Cooling/Heating)	High	57/57	58/58	60/60	58/58
Airflow Rate	Outdoor (Cooling/Heating)	High	59/59	61/61	62/62	62/62
	Indoor/Outdoor (Cooling)	High	600/1,480	650/1,580	800/1,670	940/2,160
Airflow Rate	Indoor/Outdoor (Heating)	High	600/1,410	650/1,520	800/1,580	940/1,830
	Static pressure range (Standard)		Pa	0 to 90 (25)	0 to 90 (25)	0 to 90 (25)
Net Dimensions	Indoor	mm	198 × 700 × 620	198 × 700 × 620	198 × 700 × 620	198 × 900 × 620
H x W x D	Outdoor	mm	542 × 799 × 290	542 × 799 × 290	542 × 799 × 290	632 × 799 × 290
	Weight	Indoor	kg	17	17	17
Weight	Outdoor	kg	32	33	33	36
	Connection Pipe Diameter (Liquid/Gas)		mm	6.35/9.52	6.35/9.52	6.35/9.52
Drain Hose Diameter (I.D./O.D.)			25/32	25/32	25/32	25/32
Max. Pipe Length (Pre-Charge)		m	20 (15)	25 (15)	25 (15)	30 (20)
Max. Height Difference			15	20	20	20
Operating Range	Cooling	°CDB	-15 to 46	-15 to 46	-15 to 46	-15 to 46
	Heating		-15 to 24	-15 to 24	-15 to 24	-15 to 24
Refrigerant	Type (Global Warming Potential)		R32 (675)	R32 (675)	R32 (675)	R32 (675)
	Charge	kg (CO2eq-T)	0.85 (0.574)	0.85 (0.574)	0.85 (0.574)	1.02 (0.689)

Optional parts

* For optional parts compatibility of Intesis devices, please refer to the optional parts compatibility list page C-050 to C-053 and C-066.

Wired Remote Controller (Design type):	UTY-RVRG	WLAN adapter:	UTY-TFSXZ1	Network Converter for single split (DC power supply type):	UTY-VTGX
Compact wired remote controller:	UTY-RCRGZ1		FG-RC-WIF1Z2	Network Converter for single split (AC power supply type):	UTY-VTGXV
Wired remote controller (touch panel):	UTY-RNRGZ5		UTY-TFSXJ3	External connect kit:	UTY-XWZXZG
Wired remote controller:	UTY-RLRG		FG-AC-WIF1Z1	Remote sensor unit:	UTY-XSZZXZ1
	UTY-RNNGM	Silver Ion Filter:	UTD-HFTA (09-14)	Auto Louver Grille Kit:	UTD-GXTA-W (09-14)
	UTY-RVNGM		UTD-HFTB (18)		UTD-GXTB-W (18)
Simple remote controller (without operation mode):	UTY-RHRG	External switch controller:	UTY-TERX		
Simple remote controller:	UTY-RSRG	IR receiver unit:	UTY-LBTGM		

Dimensions

(Unit: mm)

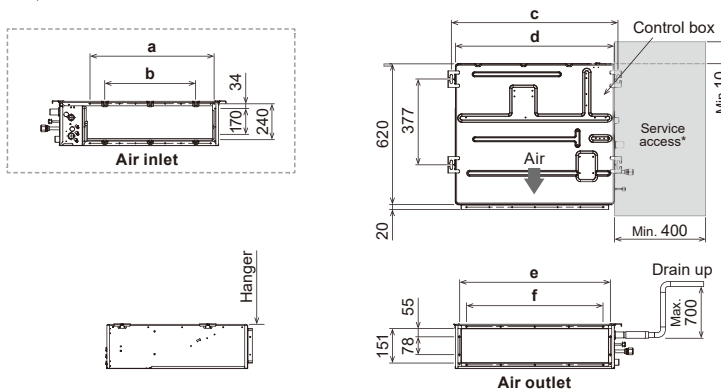

	ARXG 09 / 12 / 14KLLAP	ARXG18KLLAP
a	574	774
b	P200×2=400	P200×3=600
c	734	934
d	700	900
e	650	850
f	P100×6=600	P100×8=800

*The design of the service access depends on the installation method. Refer to the installation manual for more information.

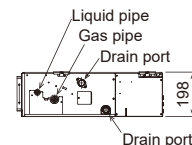

NEW

Medium Static Pressure Duct

High-Efficiency & Comfort



Slim & Compact design

The new product has reduced the height to 240 mm, making it more compact. The slim design fits nicely into narrow spaces under the ceiling.

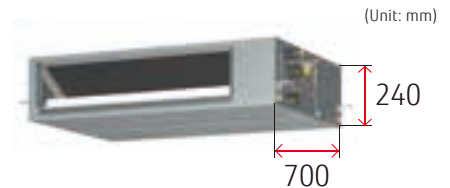

High energy saving

The new model has achieved high energy efficiency rank with a compact design.

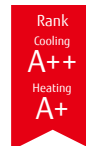

SEER
6.50^{*1}
*1: 12/22 models

SCOP
4.20^{*2}
*2: 12/22/24 models

Easy maintenance

The indoor units have large panels on both sides providing easy maintenance in narrow spaces.



Easy inspection of drain hose
The whole drain hose can be removed for easy replacement and cleaning.



Easy cleaning of the heat exchanger



Filter change
Filter can be installed and removed easily.
*Long life filter is available as optional parts.

Drain hose as standard

A drain hose is a standard accessory, making it easy to design drainage even in narrow spaces under the ceiling.



Wide range of static pressures

Static pressures can be changed in the range of 30 to 150 Pa.

Static pressure range
30 to 150 Pa



Model: ARXH12KMTAP / ARXH14KMTAP / ARXH18KMTAP / ARXH22KMTAP / ARXH24KMTAP



ARXH12/14/18KMTAP

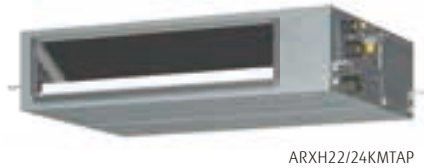

ARXH22/24KMTAP



for ARXH12/14KMTAP For ARXH18/22KMTAP For ARXH24KMTAP

Specifications

Model name	Indoor unit		ARXH12KMTAP	ARXH14KMTAP	ARXH18KMTAP	ARXH22KMTAP	ARXH24KMTAP
	Outdoor unit		AOHG12KBTB	AOHG14KBTB	AOHG18KBTB	AOHG22KBTB	AOHG24KBTB
Power Source			Single phase, ~230 V, 50 Hz				
Capacity	Cooling	Rated	3.5	4.3	5.2	6.0	6.8
		Min.-Max.	0.9-4.4	0.9-5.4	0.9-5.9	0.9-6.7	0.9-8.0
	Heating	Rated	4.1	5.0	6.0	7.0	7.5
		Min.-Max.	0.9-5.7	0.9-6.5	0.9-7.5	0.9-8.0	0.9-9.1
Input Power	Cooling/Heating		kW 0.930 / 1.080	1.260 / 1.320	1.580 / 1.740	1.67 / 1.84	1.89 / 1.87
EER	Cooling		W/W 3.76	3.40	3.30	3.60	3.60
COP	Heating		W/W 3.80	3.79	3.45	3.80	4.01
Pdesign	Cooling/Heating (-10°C)		kW 3.5 / 3.4	4.3 / 3.8	5.2 / 4.4	6.0 / 4.8	6.8 / 6.0
SEER	Cooling		W/W 6.50	6.10	6.20	6.50	6.40
SCOP	Heating (Average)		W/W 4.20	4.00	4.10	4.20	4.20
Energy Efficiency Class	Cooling		A++	A++	A++	A++	A++
	Heating (Average)		A+	A+	A+	A+	A+
Max. Operating Current	Cooling/Heating		A 9.7 / 9.7	10.2 / 10.2	12.1 / 12.1	12.6 / 12.6	13.6 / 13.6
Annual Energy Consumption	Cooling		kWh/a 196	255	301	331	380
	Heating		kWh/a 1,133	1,330	1,501	1,598	1,999
Moisture Removal			l/h 1.3	1.3	2.0	1.5	2.2
Sound Pressure Level	Indoor (Cooling)	H/M/L/Q	29 / 27 / 25 / 23	32 / 29 / 27 / 25	33 / 30 / 28 / 26	32 / 28 / 25 / 24	34 / 30 / 28 / 26
	Indoor (Heating)	H/M/L/Q	29 / 27 / 25 / 23	32 / 29 / 27 / 25	33 / 30 / 28 / 26	32 / 28 / 25 / 24	34 / 30 / 28 / 26
	Outdoor (Cooling/Heating)	High	47 / 47	49 / 49	50 / 50	51 / 51	53 / 54
Sound Power Level	Indoor (Cooling/Heating)	High	58 / 58	59 / 59	60 / 60	58 / 58	60 / 60
	Outdoor (Cooling/Heating)	High	61 / 61	62 / 62	62 / 62	63 / 63	65 / 66
Airflow Rate	Indoor/Outdoor (Cooling)	High	m³/h 650 / 1,580	800 / 1,670	840 / 2,160	1,150 / 2,240	1,230 / 2,700
	Indoor/Outdoor (Heating)	High	m³/h 650 / 1,520	800 / 1,580	840 / 1,830	1,150 / 1,960	1,230 / 2,700
Static pressure range (Standard)			Pa 30 to 150 (40)	30 to 150 (40)	30 to 150 (40)	30 to 150 (40)	30 to 150 (50)
Net Dimensions H x W x D	Indoor	mm	240 × 700 × 700	240 × 700 × 700	240 × 700 × 700	240 × 1,000 × 700	240 × 1,000 × 700
	Outdoor	mm	542 × 799 × 290	542 × 799 × 290	632 × 799 × 290	632 × 799 × 290	716 × 820 × 315
Weight	Indoor	kg	24	24	24	31	31
	Outdoor	kg	33	33	36	38	42
Connection Pipe Diameter (Liquid/Gas)			mm 6.35 / 9.52	6.35 / 9.52	6.35 / 12.7	6.35 / 12.70	6.35 / 12.70
Drain Hose Diameter (I.D./O.D.)			mm 25 / 32	25 / 32	25 / 32	25 / 32	25 / 32
Max. Pipe Length (Pre-Charge)			m 25 (15)	25 (15)	30 (20)	30 (20)	30 (20)
Max. Height Difference			m 20	20	20	25	25
Operating Range	Cooling	°CDB	-15 to 46	-15 to 46	-15 to 46	-15 to 46	-15 to 46
	Heating	°CDB	-15 to 24	-15 to 24	-15 to 24	-15 to 24	-15 to 24
Refrigerant	Type (Global Warming Potential)		R32 (675)	R32 (675)	R32 (675)	R32 (675)	R32 (675)
	Charge	kg (CO2eq-1)	0.85 (0.574)	0.85 (0.574)	1.02 (0.689)	1.25 (0.844)	1.25 (0.844)

Optional parts

* For optional parts compatibility of Intesis devices, please refer to the optional parts compatibility list page C-050 to C-053 and C-066.

Wired Remote Controller (Design type):	UTY-RVRG	Silver ion filter:	UTD-HFNC (12/14/18)	External input and output PCB:	UTY-XCSX
Compact wired remote controller:	UTY-RCRGZ1	UTD-HFNB (22/24)	UTD-HFNB (22/24)	External input and output PCB bracket:	UTZ-GXDA
Wired remote controller (touch panel):	UTY-RNRGZ5	Long-life filter:	UTD-LFDC (12/14/18)	Network Converter for single split (DC power supply type):	UTY-VTGX
Wired remote controller:	UTY-RLRG	UTD-LFDB (22/24)	UTD-LFDB (22/24)	Network Converter for single split (AC power supply type):	UTY-VTGXV
Simple remote controller (without operation mode):	UTY-RHRG	MODBUS converter:	UTY-VMSX	External connect kit:	UTY-XWZXZG
Simple remote controller:	UTY-RSRG	KNX converter:	UTY-VKSX	IR receiver unit:	UTY-LBTGM
Remote sensor unit:	UTY-XSZX	WLAN adapter:	UTY-TFSXZ1	External switch controller:	UTY-TERX
	UTY-XSZXZ1		UTY-TFSXJ3		

Dimensions

(Unit: mm)

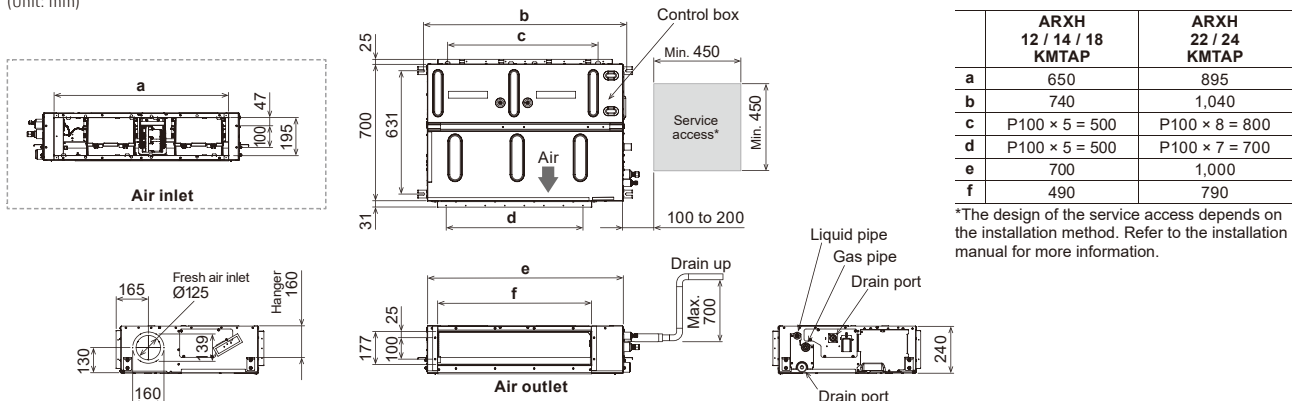

NEW

Medium Static Pressure Duct

High-Efficiency & Comfort



Slim & Compact design

The new product has reduced the height to 240 mm, making it more compact. The slim design fits nicely into narrow spaces under the ceiling.

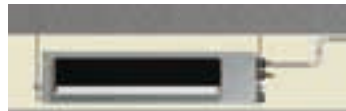

High energy saving

The new model has achieved high energy efficiency rank with a compact design.

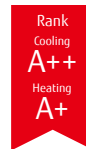

SEER
6.23^{*1}

*1: 30 model

SCOP
4.10^{*2}

*2: 36 model

Easy maintenance

The indoor units have large panels on both sides providing easy maintenance in narrow spaces.



Easy inspection of drain hose
The whole drain hose can be removed for easy replacement and cleaning.



Easy cleaning of the heat exchanger



Filter change
Filter can be installed and removed easily.
*Long life filter is available as optional parts.

Drain hose as standard

A drain hose is a standard accessory, making it easy to design drainage even in narrow spaces under the ceiling.



Wide range of static pressures

Static pressures can be changed in the range of 30 to 150 Pa.

Static pressure range
30 to 150 Pa

**Model: ARXH30KMTAP / ARXH36KMTAP / ARXH45KMTAP / ARXH54KMTAP
ARXH36KMTAP [3-phase] / ARXH45KMTAP [3-phase] / ARXH54KMTAP [3-phase]**



ARXH30/36/45/54KMTAP



For ARXH30/36KMTAP For ARXH45/54KMTAP

Specifications

Model name	Indoor unit			ARXH30KMTAP	ARXH36KMTAP	ARXH45KMTAP	ARXH36KMTAP	ARXH45KMTAP	ARXH54KMTAP
	Outdoor unit			AOHG30KBTB	AOHG36KBTB	AOHG45KBTB	AOHG36KRTA	AOHG45KRTA	AOHG54KRTA
Power Source				Single phase, ~230 V, 50 Hz			3-phase, ~400 V, 50 Hz		
Capacity	Cooling	Rated	kW	8.5	9.5	12.1	9.5	12.1	13.4
		Min.-Max.		2.8-10.0	2.8-11.2	4.0-13.5	2.8-11.2	4.0-13.5	4.5-14.5
	Heating	Rated	10.0	10.8	13.5	10.8	13.5	15.5	
		Min.-Max.	2.7-11.2	2.7-12.7	4.2-16.2	2.7-12.7	4.2-16.2	4.7-16.5	
Input Power	Cooling/Heating		kW	2.57 / 2.50	2.97 / 2.70	3.87 / 3.73	2.97 / 2.70	3.87 / 3.73	4.62 / 4.65
EER	Cooling		W/W	3.31	3.20	3.13	3.20	3.13	2.90
COP	Heating		W/W	4.00	4.00	3.62	4.00	3.62	3.33
Pdesign	Cooling/Heating (-10°C)		kW	8.5 / 8.0	9.5 / 8.7	-	9.5 / 8.7	-	-
SEER	Cooling		W/W	6.23	6.10	-	6.10	-	-
SCOP	Heating (Average)		W/W	4.00	4.10	-	4.10	-	-
Energy Efficiency Class	Cooling			A++	A++	-	A++	-	-
	Heating (Average)			A+	A+	-	A+	-	-
Max. Operating Current	Cooling/Heating		A	22.6 / 22.6	22.6 / 22.6	28.5 / 28.5	10.5 / 10.5	14.0 / 14.0	14.0 / 14.0
Annual Energy Consumption	Cooling		kWh/a	485	553	-	553	-	-
	Heating		kWh/a	2,795	2,970	-	2,970	-	-
Moisture Removal			l/h	1.8	2.0	4.0	2.0	4.0	5.0
Sound Pressure Level	Indoor (Cooling)	H/M/L/Q	dB(A)	38 / 34 / 31 / 28	38 / 34 / 31 / 28	40 / 36 / 32 / 29	38 / 34 / 31 / 28	40 / 36 / 32 / 29	40 / 36 / 32 / 29
	Indoor (Heating)	H/M/L/Q		38 / 34 / 31 / 28	38 / 34 / 31 / 28	40 / 36 / 32 / 29	38 / 34 / 31 / 28	40 / 36 / 32 / 29	40 / 36 / 32 / 29
Sound Power Level	Outdoor (Cooling/Heating)	High	dB(A)	53 / 55	55 / 55	57 / 57	55 / 55	57 / 57	57 / 59
	Indoor (Cooling/Heating)	High		64 / 64	65 / 65	67 / 67	65 / 65	67 / 67	67 / 67
Airflow Rate	Outdoor (Cooling/Heating)	High	m³/h	68 / 69	70 / 70	71 / 71	70 / 70	71 / 71	73 / 73
	Indoor/Outdoor (Cooling)	High		1,950 / 3,750	2,070 / 3,750	2,160 / 4,450	2,070 / 3,750	2,160 / 4,450	2,160 / 4,450
Static pressure range (Standard)	Indoor/Outdoor (Heating)	High	m³/h	1,950 / 3,750	2,070 / 3,750	2,160 / 4,450	2,070 / 3,750	2,160 / 4,450	2,160 / 4,450
	Indoor/Outdoor (Heating)	High		1,950 / 3,750	2,070 / 3,750	2,160 / 4,450	2,070 / 3,750	2,160 / 4,450	2,160 / 4,450
Static pressure range (Standard)			Pa	30 to 150 (50)	30 to 150 (50)	30 to 150 (60)	30 to 150 (50)	30 to 150 (60)	30 to 150 (60)
Net Dimensions	Indoor		mm	240 × 1,400 × 700	240 × 1,400 × 700	240 × 1,400 × 700	240 × 1,400 × 700	240 × 1,400 × 700	240 × 1,400 × 700
H x W x D	Outdoor		mm	788 × 940 × 320	788 × 940 × 320	998 × 940 × 320	788 × 940 × 320	998 × 940 × 320	998 × 940 × 320
	Indoor		kg	42	42	42	42	42	42
Weight	Outdoor		kg	52	52	67	53	67	67
			kg	52	52	67	53	67	67
Connection Pipe Diameter (Liquid/Gas)			mm	9.52 / 15.88	9.52 / 15.88	9.52 / 15.88	9.52/15.88	9.52/15.88	9.52/15.88
Drain Hose Diameter (I.D./O.D.)			mm	25 / 32	25 / 32	25 / 32	25/32	25/32	25/32
Max. Pipe Length (Pre-Charge)			m	50 (30)	50 (30)	50 (30)	50 (30)	50 (30)	50 (30)
Max. Height Difference			m	30	30	30	30	30	30
Operating Range	Cooling		°CDB	-15 to 46	-15 to 46	-15 to 46	-15 to 46	-15 to 46	-15 to 46
	Heating		°CDB	-15 to 24	-15 to 24	-15 to 24	-15 to 24	-15 to 24	-15 to 24
Refrigerant	Type (Global Warming Potential)			R32 (675)	R32 (675)	R32 (675)	R32 (675)	R32 (675)	R32 (675)
	Charge		kg (CO2eq-1)	1.90 (1.283)	1.90 (1.283)	2.70 (1.823)	1.90 (1.283)	2.70 (1.823)	2.70 (1.823)

Optional parts

* For optional parts compatibility of Intesis devices, please refer to the optional parts compatibility list page C-050 to C-053 and C-066.

Wired Remote Controller (Design type):	UTY-RVRG	IR receiver unit:	UTY-LBTGM	External input and output PCB:	UTY-XCSX
Compact wired remote controller:	UTY-RCRGZ1	Silver ion filter:	UTD-HFNA	External input and output PCB bracket:	UTZ-GXDA
Wired remote controller (touch panel):	UTY-RNRGZ5	Long-life filter:	UTD-LFDA	Network Converter for single split (DC power supply type):	UTY-VTGX
Wired remote controller:	UTY-RLRG	MODBUS converter:	UTY-VMSX	Network Converter for single split (AC power supply type):	UTY-VTGXV
Simple remote controller (without operation mode):	UTY-RHRG	KNX converter:	UTY-VKSX	External connect kit:	UTY-XWZXZG
Simple remote controller:	UTY-RSRG	WLAN adapter:	UTY-TFSXJ1		
Remote sensor unit:	UTY-XSZX		UTY-TFSXJ3	(Outdoor unit)	
	UTY-XSZXZ1	External switch controller:	UTY-TERX	External connect kit:	UTY-XWZXZ3

Dimensions

(Unit: mm)

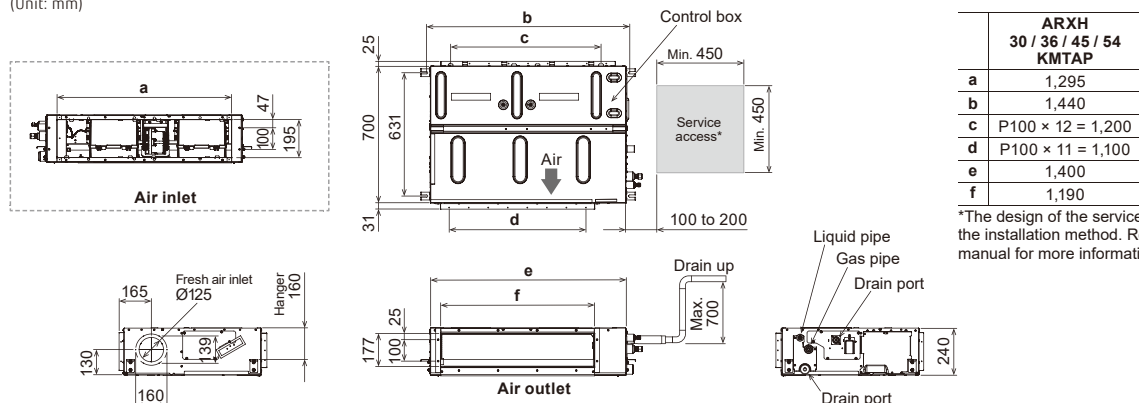

Medium Static Pressure Duct

Compact Size



(30)

High-efficiency & Quiet operation

The combination of the V-shaped heat exchanger, air stabilizer, and the high-efficiency DC fan motor enable high-efficiency and quiet operation.

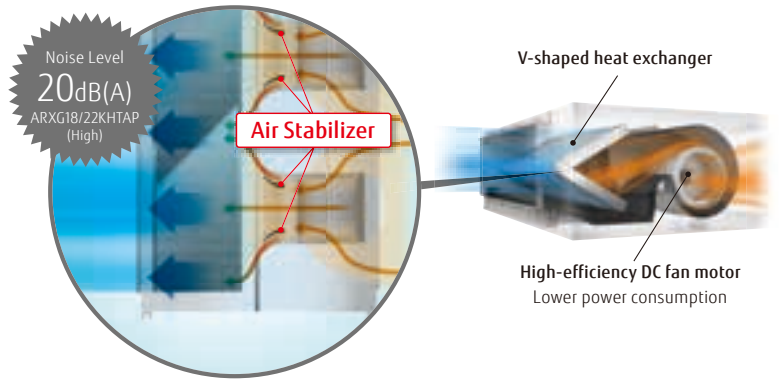

Small, lightweight outdoor unit

The outdoor unit in this series is smaller and lighter than previous-generation outdoor units. It can be installed in a narrow space.

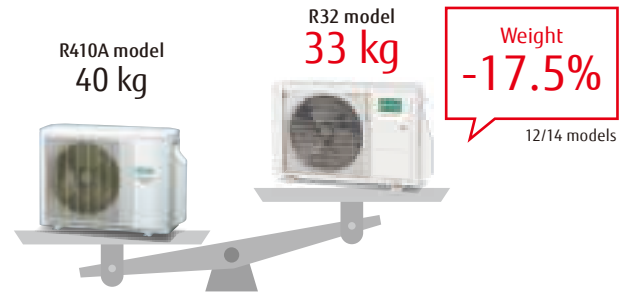

Automatic airflow adjustment function

This unique and innovative function detects required air flow in each application case and automatically adjust the volume.

Automatically adjust !



Link up with a variety of central control system (Option)

Centralized control including facilities and equipment in addition to air conditioning is possible by linking up with MODBUS, KNX interfaces.



Model: ARXG12KHTAP / ARXG14KHTAP / ARXG18KHTAP / ARXG22KHTAP / ARXG24KHTAP / ARXG30KHTAP

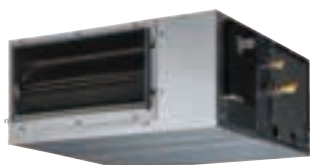

ARXG12/14KHTAP



ARXG18/22/24/30KHTAP



For ARXG12/14KHTAP For ARXG18/22KHTAP For ARXG24KHTAP For ARXG30KHTAP

Specifications

Model name	Indoor unit		ARXG12KHTAP	ARXG14KHTAP	ARXG18KHTAP	ARXG22KHTAP	ARXG24KHTAP	ARXG30KHTAP
	Outdoor unit		AOHG12KBTB	AOHG14KBTB	AOHG18KBTB	AOHG22KBTB	AOHG24KBTB	AOHG30KBTB
Power Source			Single phase, ~230 V, 50 Hz					
Capacity	Cooling	Rated	3.5	4.3	5.2	6.0	6.8	8.5
		Min.-Max.	0.9-4.4	0.9-5.4	0.9-5.9	0.9-6.7	0.9-8.0	2.8-10.0
	Heating	Rated	4.1	5.0	6.0	7.0	7.5	10.0
		Min.-Max.	0.9-5.7	0.9-6.5	0.9-7.5	0.9-8.0	0.9-9.1	2.7-11.2
Input Power	Cooling/Heating	kW	0.87/1.00	1.17/1.25	1.36/1.56	1.71/1.81	1.89/1.85	2.65/2.63
EER	Cooling	W/W	4.02	3.68	3.82	3.51	3.60	3.21
COP	Heating	W/W	4.10	4.00	3.85	3.87	4.06	3.80
Pdesign	Cooling/Heating (-10°C)	kW	3.5/3.4	4.3/3.8	5.2/4.4	6.0/4.8	6.8/6.0	8.5/8.0
SEER	Cooling	W/W	6.30	6.20	6.50	6.50	6.50	6.23
SCOP	Heating (Average)	W/W	4.10	4.00	4.10	4.20	4.10	4.00
Energy Efficiency Class	Cooling		A++	A++	A++	A++	A++	A++
	Heating (Average)		A+	A+	A+	A+	A+	A+
Max. Operating Current	Cooling/Heating	A	9.7/9.7	10.2/10.2	12.1/12.1	12.6/12.6	13.6/13.6	22.6/22.6
Annual Energy Consumption	Cooling	kWh/a	194	243	280	323	366	477
	Heating	kWh/a	1,159	1,328	1,501	1,597	2,048	2,796
Moisture Removal		l/h	0.7	0.9	1.2	1.5	1.8	2.3
Sound Pressure Level	Indoor (Cooling)	H/M/L/Q	32/27/26/24	33/28/27/25	28/25/22/20	28/25/22/20	32/28/24/21	36/33/30/29
	Indoor (Heating)	H/M/L/Q	32/27/26/24	33/28/27/25	28/25/22/20	28/25/22/20	32/28/24/21	36/33/30/29
	Outdoor (Cooling/Heating)	High	47/47	49/49	50/50	51/51	53/54	53/55
Sound Power Level	Indoor (Cooling/Heating)	High	57/58	59/60	54/54	57/57	57/57	63/65
	Outdoor (Cooling/Heating)	High	61/61	62/62	62/62	63/63	65/66	68/69
Airflow Rate	Indoor/Outdoor (Cooling)	High	850/1,580	950/1,670	1,050/2,160	1,050/2,240	1,360/2,700	1,700/3,750
	Indoor/Outdoor (Heating)	High	850/1,520	950/1,580	1,050/1,830	1,050/1,960	1,360/2,700	1,700/3,750
Static pressure range (Standard)		Pa	30 to 200 (35)	30 to 200 (35)	30 to 200 (35)	30 to 200 (35)	30 to 200 (35)	30 to 200 (47)
Net Dimensions	Indoor	mm	300 × 700 × 700	300 × 700 × 700	300 × 1,000 × 700	300 × 1,000 × 700	300 × 1,000 × 700	300 × 1,000 × 700
H x W x D	Outdoor	mm	542 × 799 × 290	542 × 799 × 290	632 × 799 × 290	632 × 799 × 290	716 × 820 × 315	788 × 940 × 320
	Weight	kg	27	27	35	35	36	36
Connection Pipe Diameter (Liquid/Gas)	Indoor	kg	33	33	36	38	42	52
	Outdoor	kg	33	33	36	38	42	52
Connection Pipe Diameter (Liquid/Gas)		mm	6.35/9.52	6.35/9.52	6.35/12.70	6.35/12.70	6.35/12.70	9.52/15.88
Drain Hose Diameter (I.D./O.D.)		mm	25/32	25/32	25/32	25/32	25/32	25/32
Max. Pipe Length (Pre-Charge)		m	25 (15)	25 (15)	30 (20)	30 (20)	30 (20)	50 (30)
Max. Height Difference		m	20	20	20	25	25	30
Operating Range	Cooling	°CDB	-15 to 46	-15 to 46	-15 to 46	-15 to 46	-15 to 46	-15 to 46
	Heating	°CDB	-15 to 24	-15 to 24	-15 to 24	-15 to 24	-15 to 24	-15 to 24
Refrigerant	Type (Global Warming Potential)		R32 (675)	R32 (675)	R32 (675)	R32 (675)	R32 (675)	R32 (675)
	Charge	kg (CO2eq-1)	0.85 (0.574)	0.85 (0.574)	1.02 (0.689)	1.25 (0.844)	1.25 (0.844)	1.90 (1.283)

Optional parts

* For optional parts compatibility of Intesis devices, please refer to the optional parts compatibility list page C-050 to C-053 and C-066.

Wired Remote Controller (Design type):	UTY-RVRG	Long-life filter:	UTD-LFNB (18-30)	External input and output PCB:	UTY-XCSX
Compact wired remote controller:	UTY-RCRGZ1		UTD-LFNC (12-14)	External connect kit:	UTY-XWZXZG
Wired remote controller (touch panel):	UTY-RNRGZ5	Silver Ion Filter:	UTD-HFNB (18-30)	External input and output PCB bracket:	UTZ-GXNA
Wired remote controller:	UTY-RLRG		UTD-HFNC (12/14)	Network Converter for single split (DC power supply type):	UTY-VTIGX
	UTY-RNNGM	WLAN adapter:	UTY-TFSXZ1	Network Converter for single split (AC power supply type):	UTY-VTIGXV
	UTY-RVNGM		FG-RC-WIF12Z	External switch controller:	UTY-TERX
Simple remote controller (without operation mode):	UTY-RHRG		UTY-TFSXJ3		
Simple remote controller:	UTY-RSRG		FG-AC-WIF1Z1	(Outdoor unit 30)	
Remote sensor unit:	UTY-XSZXZ1	IR receiver unit:	UTY-LBTGM	External connect kit:	UTY-XWZXZ3

Dimensions

(Unit: mm)

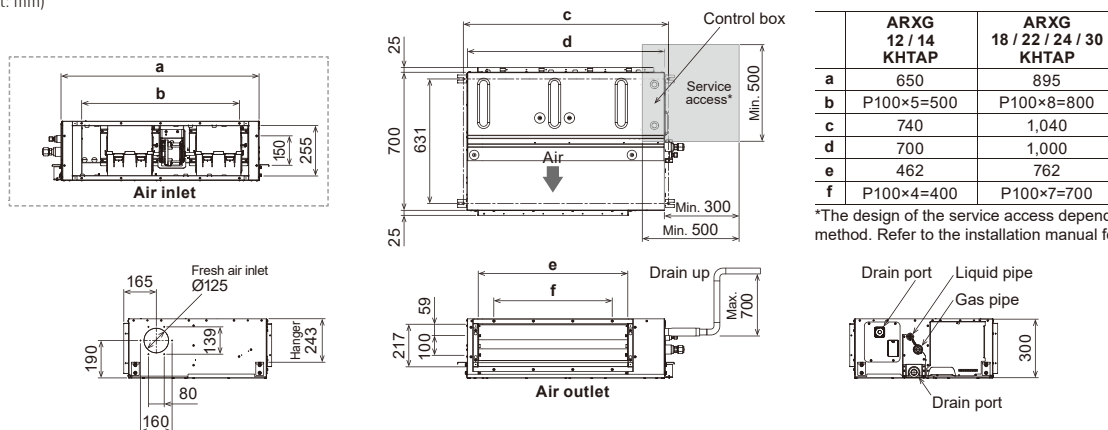

Medium Static Pressure Duct

Compact Size



(36/45/54)

High-efficiency & Quiet operation

The combination of the V-shaped heat exchanger, air stabilizer, and the high-efficiency DC fan motor enable high-efficiency and quiet operation.

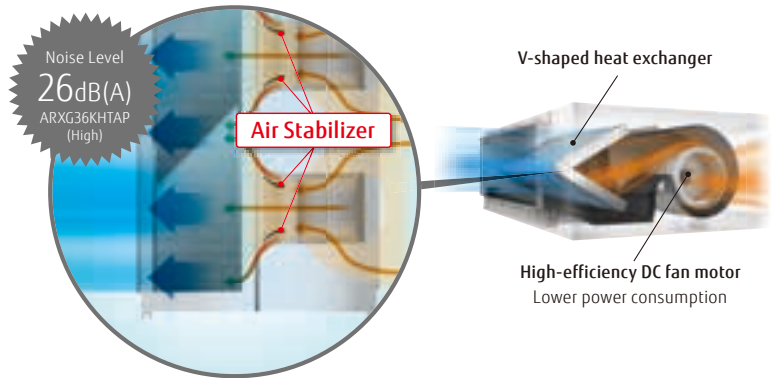

Small, lightweight outdoor unit

The outdoor unit in this series is smaller and lighter than previous-generation outdoor units. It can be installed in a narrow space.

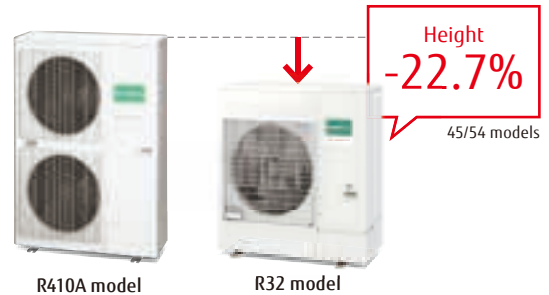

Automatic airflow adjustment function

This unique and innovative function detects required air flow in each application case and automatically adjust the volume.

Automatically adjust !



Link up with a variety of central control system (Option)

Centralized control including facilities and equipment in addition to air conditioning is possible by linking up with MODBUS, KNX interfaces.



Model: ARXG36KHTAP / ARXG45KHTAP / ARXG54KHTAP
ARXG36KHTAP [3-phase] / ARXG45KHTAP [3-phase] / ARXG54KHTAP [3-phase]



ARXG36/45/54KHTAP



For ARXG36KHTAP



For ARXG45/54KHTAP

Specifications

Model name	Indoor unit			ARXG36KHTAP	ARXG45KHTAP	ARXG54KHTAP	Outdoor unit		
	Outdoor unit			AOHG36KBTB	AOHG45KBTB	AOHG54KBTB	AOHG36KRTA	AOHG45KRTA	AOHG54KRTA
Power Source				Single phase, ~230 V, 50 Hz			3-phase, ~400 V, 50 Hz		
Capacity	Cooling	Rated	kW	9.5	12.1	13.4	9.5	12.1	13.4
		Min.-Max.		2.8-11.2	4.0-14.0	4.5-14.5	2.8-11.2	4.0-14.0	4.5-14.5
Capacity	Heating	Rated	kW	10.8	13.5	15.5	10.8	13.5	15.5
		Min.-Max.		2.7-12.7	4.2-16.2	4.7-16.5	2.7-12.7	4.2-16.2	4.7-16.5
Input Power	Cooling/Heating		kW	2.86/2.48	3.53/3.37	4.42/3.89	2.86/2.48	3.53/3.37	4.42/3.89
EER	Cooling		W/W	3.32	3.43	3.03	3.32	3.43	3.03
COP	Heating		W/W	4.35	4.01	3.98	4.35	4.01	3.98
Pdesign	Cooling/Heating (-10°C)		kW	9.5/8.7	-	-	9.5/8.7	-	-
SEER	Cooling		W/W	6.10	-	-	6.10	-	-
SCOP	Heating (Average)		W/W	4.20	-	-	4.20	-	-
Energy Efficiency Class	Cooling			A++	-	-	A++	-	-
	Heating (Average)			A+	-	-	A+	-	-
Max. Operating Current	Cooling/Heating		A	22.6/22.6	28.5/28.5	28.5/28.5	10.5/10.5	14.0/14.0	14.0/14.0
Annual Energy Consumption	Cooling		kWh/a	544	-	-	544	-	-
	Heating		kWh/a	2,898	-	-	2,898	-	-
Moisture Removal			l/h	2.0	2.6	3.7	2.0	2.6	3.7
Sound Pressure Level	Indoor (Cooling)	H/M/L/Q	dB(A)	36/31/28/26	39/35/31/29	39/35/31/29	36/31/28/26	39/35/31/29	39/35/31/29
	Indoor (Heating)	H/M/L/Q		33/31/28/26	39/35/31/29	39/35/31/29	33/31/28/26	39/35/31/29	39/35/31/29
Sound Power Level	Outdoor (Cooling/Heating)	High	dB(A)	55/55	57/57	57/59	55/55	57/57	57/59
	Indoor (Cooling/Heating)	High		64/63	67/69	67/69	64/63	67/69	67/69
Airflow Rate	Outdoor (Cooling/Heating)	High	m³/h	70/70	71/71	73/73	70/70	71/71	73/73
	Indoor/Outdoor (Cooling)	High		2,050/3,750	2,550/4,450	2,550/4,450	2,050/3,750	2,550/4,450	2,550/4,450
Static pressure range (Standard)	Indoor/Outdoor (Heating)	High	m³/h	1,850/3,750	2,550/4,450	2,550/4,450	1,850/3,750	2,550/4,450	2,550/4,450
	Indoor/Outdoor (Heating)	High		30 to 200 (47)	30 to 200 (60)	30 to 200 (60)	30-200 (47)	30-200 (60)	30-200 (60)
Net Dimensions	Indoor	mm	300 × 1,400 × 700	300 × 1,400 × 700	300 × 1,400 × 700	300 × 1,400 × 700	300 × 1,400 × 700	300 × 1,400 × 700	
H x W x D	Outdoor	mm	788 × 940 × 320	998 × 940 × 320	998 × 940 × 320	788 × 940 × 320	998 × 940 × 320	998 × 940 × 320	
	Indoor	kg	46	46	46	46	46	46	
Weight	Outdoor	kg	52	67	67	53	67	67	
	Indoor	kg	46	46	46	46	46	46	
Connection Pipe Diameter (Liquid/Gas)			mm	9.52/15.88	9.52/15.88	9.52/15.88	9.52/15.88	9.52/15.88	
Drain Hose Diameter (I.D./O.D.)			mm	25/32	25/32	25/32	25/32	25/32	
Max. Pipe Length (Pre-Charge)			m	50 (30)	50 (30)	50 (30)	50 (30)	50 (30)	
Max. Height Difference			m	30	30	30	30	30	
Operating Range	Cooling	°CDB	-15 to 46	-15 to 46	-15 to 46	-15 to 46	-15 to 46	-15 to 46	
	Heating	°CDB	-15 to 24	-15 to 24	-15 to 24	-15 to 24	-15 to 24	-15 to 24	
Refrigerant	Type (Global Warming Potential)		R32 (675)	R32 (675)	R32 (675)	R32 (675)	R32 (675)	R32 (675)	
	Charge	kg (CO2eq-1)	1.90 (1.283)	2.70 (1.823)	2.70 (1.823)	1.90 (1.283)	2.70 (1.823)	2.70 (1.823)	

Optional parts

* For optional parts compatibility of Intesis devices, please refer to the optional parts compatibility list page C-050 to C-053 and C-066.

Wired Remote Controller (Design type):	UTY-RVRG	Long-life filter:	UTD-LFNA	External input and output PCB:	UTY-XCSX
Compact wired remote controller:	UTY-RCRGZ1	Silver Ion Filter:	UTD-HFNA	External input and output PCB bracket:	UTZ-GXNA
Wired remote controller (touch panel):	UTY-RNRGZ5		UTY-TFSXZ1	Network Converter for single split (DC power supply type):	UTY-VTGV
Wired remote controller:	UTY-RLRG	WLAN adapter:	FG-RC-WIF1Z2	Network Converter for single split (AC power supply type):	UTY-VTGVX
	UTY-RNNGM		UTY-TFSXJ3		
	UTY-RVNGM		FG-AC-WIF1Z1	(Outdoor unit 36/45/54)	
Simple remote controller (without operation mode):	UTY-RHRG	External switch controller:	UTY-TERX	External connect kit:	UTY-XWZXZ3
Simple remote controller:	UTY-RSRG	IR receiver unit:	UTY-LBTGM		
Remote sensor unit:	UTY-XSZXZ1	External connect kit:	UTY-XWZXZG		

Dimensions

(Unit: mm)

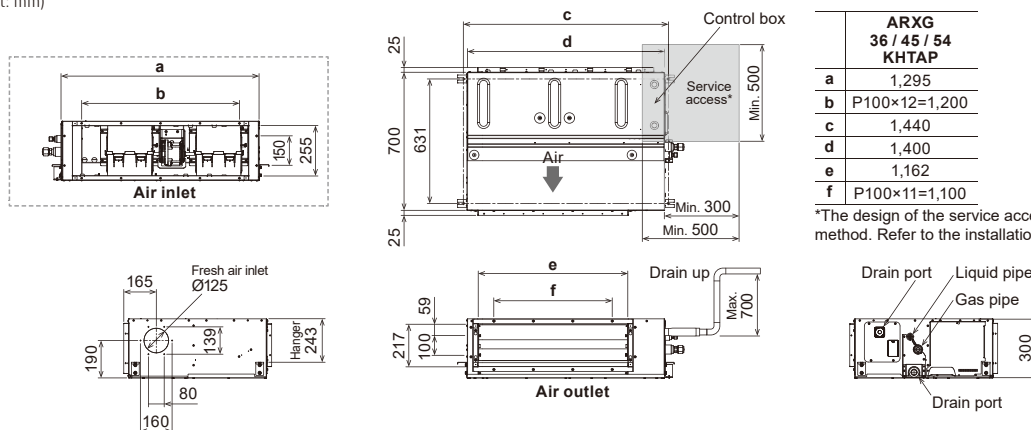

Medium Static Pressure Duct Standard



(30/36/45)

Easy maintenance

Structural improvement is attained by making the bottom panel in two pieces—front and rear. The internal fan casing is also manufactured in two pieces—upper and lower. As a result, the motor and fan can be easily accessed and maintained by removing the rear panel and the lower casing while leaving the main chassis in place.

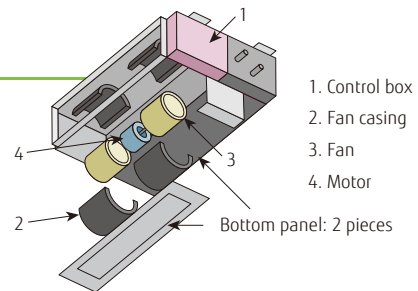

See below for case of rear-suction type

Slim & Compact design

Indoor Unit

The slim and compact design of the indoor unit, with the control box mounted on the side, allows installation in narrow spaces.

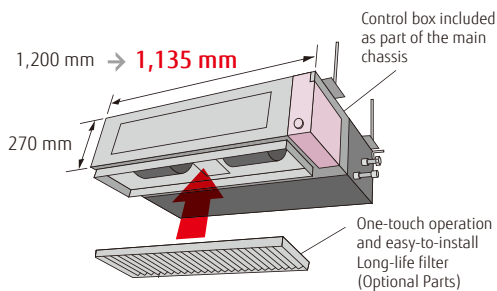

Outdoor Unit

The outdoor units for the 45,000 BTU and 54,000 BTU models have been completely redesigned. Easier installation is achieved for this compact and lightweight outdoor unit.

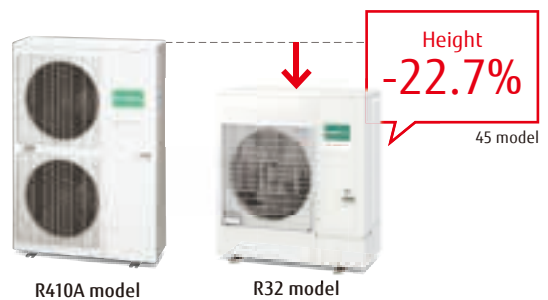

Two-direction drain piping

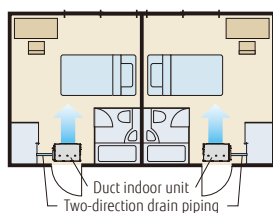

Link up with a variety of central control system (Option)

Centralized control including facilities and equipment in addition to air conditioning is possible by linking up with MODBUS, KNX interfaces.



**Model: ARXG22KMLB / ARXG24KMLA / ARXG30KMLA / ARXG36KMLA / ARXG45KMLA
ARXG36KMLA [3-phase] / ARXG45KMLA [3-phase]**



For ARXG22KMLB For ARXG24KMLA For ARXG30/36KMLA For ARXG45KMLA

Specifications

Model name	Indoor unit			ARXG22KMLB	ARXG24KMLA	ARXG30KMLA	ARXG36KMLA	ARXG45KMLA	ARXG36KMLA	ARXG45KMLA	
	Outdoor unit			AOHG22KBTB	AOHG24KBTB	AOHG30KBTB	AOHG36KBTB	AOHG45KBTB	AOHG36KRTA	AOHG45KRTA	
Power Source				Single phase, ~230 V, 50 Hz					3-phase, ~400 V, 50 Hz		
Capacity	Cooling	Rated	kW	6.0	6.8	8.5	9.5	12.1	9.5	12.1	
		Min.-Max.		0.9-6.7	0.9-8.0	2.8-10.0	2.8-11.2	4.0-13.0	2.8-11.2	4.0-13.0	
Capacity	Heating	Rated	kW	7.0	7.5	10.0	10.8	13.5	10.8	13.5	
		Min.-Max.		0.9-8.0	0.9-9.1	2.7-11.2	2.7-12.7	4.2-15.2	2.7-12.7	4.2-15.2	
Input Power	Cooling/Heating		kW	1.78/1.87	2.14/1.97	2.65/2.63	2.97/2.88	4.22/3.84	2.97/2.88	4.22/3.84	
EER	Cooling		W/W	3.37	3.18	3.21	3.20	2.87	3.20	2.87	
COP	Heating		W/W	3.74	3.80	3.80	3.75	3.52	3.75	3.52	
Pdesign	Cooling/Heating (-10°C)		kW	6.0/4.8	6.8/6.0	8.5/8.0	9.5/8.7	-	9.5/8.7	-	
SEER	Cooling		W/W	6.10	6.20	6.23	6.10	-	6.10	-	
SCOP	Heating		W/W	4.10	4.10	4.00	4.00	-	4.00	-	
Energy Efficiency Class	Cooling			A++	A++	A++	A++	-	A++	-	
	Heating			A+	A+	A+	A+	-	A+	-	
Max. Operating Current	Cooling/Heating		A	12.6/12.6	13.6/13.6	22.6/22.6	22.6/22.6	28.5/28.5	10.5/10.5	14.0/14.0	
Annual Energy Consumption	Cooling		kWh/a	344	384	477	545	-	545	-	
	Heating		kWh/a	1,637	2,045	2,797	3,044	-	3,044	-	
Moisture Removal			l/h	2.1	2.5	2.5	3.0	4.0	3.0	4.0	
Sound Pressure Level	Indoor (Cooling)	H/M/L/Q	dB(A)	31/29/27/25	31/29/27/25	39/35/30/26	39/35/30/26	42/38/32/28	39/35/30/26	42/38/32/28	
	Indoor (Heating)	H/M/L/Q		31/29/27/25	31/29/27/25	42/35/30/26	42/35/30/26	42/38/32/28	42/35/30/26	42/38/32/28	
	Outdoor (Cooling/Heating)	High		51/51	53/54	53/55	55/55	57/57	55/55	57/57	
Sound Power Level	Indoor (Cooling/Heating)	High	dB(A)	60/62	60/62	65/69	65/70	68/70	65/70	68/70	
	Outdoor (Cooling/Heating)	High		63/63	65/66	68/69	70/70	71/71	70/70	71/71	
Airflow Rate	Indoor/Outdoor (Cooling)	High	m³/h	1,100/2,240	1,100/2,700	1,900/3,750	1,900/3,750	2,100/4,450	1,900/3,750	2,100/4,450	
	Indoor/Outdoor (Heating)	High		1,100/1,960	1,100/2,700	2,100/3,750	2,100/3,750	2,100/4,450	2,100/3,750	2,100/4,450	
Static pressure range (Standard)			Pa	30 to 150 (35)	30 to 150 (35)	30 to 150 (47)	30 to 150 (47)	30 to 150 (60)	30-150 (47)	30-150 (60)	
Net Dimensions	Indoor		mm	270 × 1,135 × 700	270 × 1,135 × 700	270 × 1,135 × 700	270 × 1,135 × 700	270 × 1,135 × 700	270 × 1,135 × 700	270 × 1,135 × 700	
H x W x D	Outdoor		mm	632 × 799 × 290	716 × 820 × 315	788 × 940 × 320	788 × 940 × 320	998 × 940 × 320	788 × 940 × 320	998 × 940 × 320	
	Indoor		kg	35	35	38	38	39	38	39	
Weight	Outdoor		kg	38	42	52	52	67	53	67	
	Indoor		kg	35	35	38	38	39	38	39	
Connection Pipe Diameter (Liquid/Gas)			mm	6.35/12.70	6.35/12.70	9.52/15.88	9.52/15.88	9.52/15.88	9.52/15.88	9.52/15.88	
Drain Hose Diameter (I.D./O.D.)			mm	35/7/38.1	35/7/38.1	35/7/38.1	35/7/38.1	35/7/38.1	35/7/38.1	35/7/38.1	
Max. Pipe Length (Pre-Charge)			m	30 (20)	30 (20)	50 (30)	50 (30)	50 (30)	50 (30)	50 (30)	
Max. Height Difference			°CDB	25	25	30	30	30	30	30	
Operating Range	Cooling		°CDB	-15 to 46	-15 to 46	-15 to 46	-15 to 46	-15 to 46	-15 to 46	-15 to 46	
	Heating		°CDB	-15 to 24	-15 to 24	-15 to 24	-15 to 24	-15 to 24	-15 to 24	-15 to 24	
Refrigerant	Type (Global Warming Potential)			R32 (675)	R32 (675)	R32 (675)	R32 (675)	R32 (675)	R32 (675)	R32 (675)	
	Charge		kg (CO2eq-T)	1.25 (0.844)	1.25 (0.844)	1.90 (1.283)	1.90 (1.283)	2.70 (1.823)	1.90 (1.283)	2.70 (1.823)	

Optional parts

* For optional parts compatibility of Intesis devices, please refer to the optional parts compatibility list page C-050 to C-053 and C-066.

Wired Remote Controller (Design type):	UTY-RV/RG	WLAN adapter:	UTY-TFSXZ1	Network Converter for single split (DC power supply type):	UTY-VT/GX
Compact wired remote controller:	UTY-RCRGZ1		FG-RC-WIF1Z2	Network Converter for single split (AC power supply type):	UTY-VT/GXV
Wired remote controller (touch panel):	UTY-RNRGZ5		UTY-TFSXJ3	Long-life filter:	UTD-LF25NA
Wired remote controller:	UTY-RLRG		FG-AC-WIF1Z1	Silver Ion Filter:	UTD-HFND
	UTY-RNNGM	Flange (Round):	UTD-RF204	External connect kit:	UTY-XWZXZG
	UTY-RVNGM	Flange (Square):	UTD-SF045T		
Simple remote controller (without operation mode):	UTY-RHRG	IR receiver unit:	UTY-LBTGM	(Outdoor unit 30/36/45)	
Simple remote controller:	UTY-RSRG	Remote sensor unit:	UTY-XSXZ1	External connect kit:	UTY-XWZXZ3
External switch controller:	UTY-TERX	Drain pump unit:	UTZ-PX1NBA		

Dimensions

(Unit: mm)

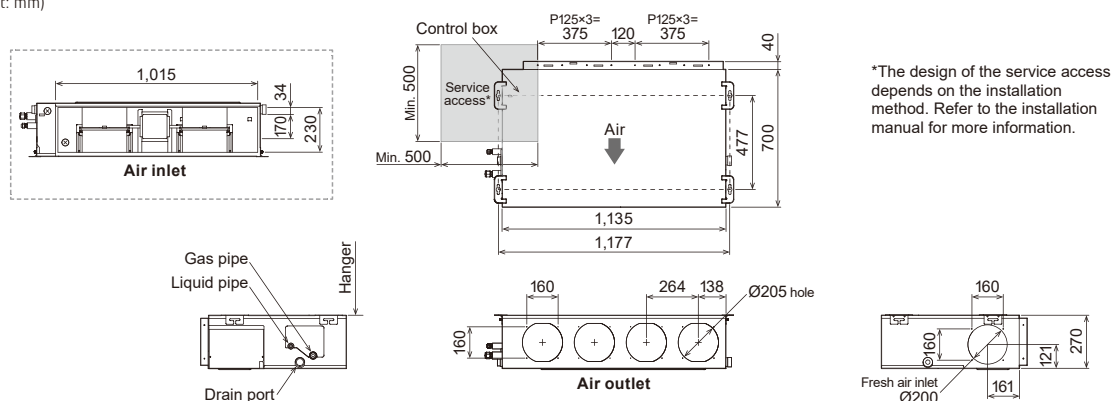

*The design of the service access depends on the installation method. Refer to the installation manual for more information.

High Static Pressure Duct



Easy installation (Compact & Lightweight)

The indoor and outdoor units are designed to be compact and light by reducing the basic chassis size and the overall material weight.

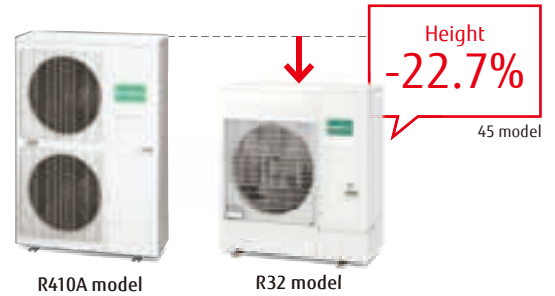
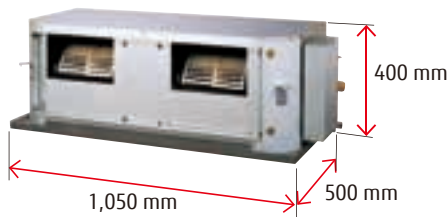

Design also suits high static pressure

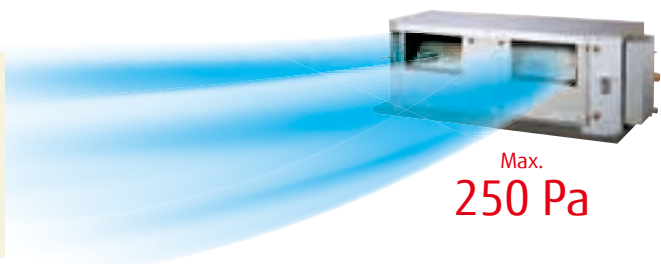
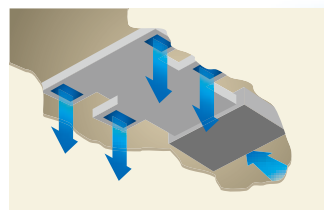

Low noise

Slanted corners at the top help reduce turbulent airflow. Low noise is realized by adopting a plastic case and a plastic fan.

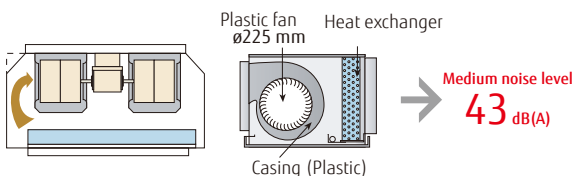

Link up with a variety of central control system (Option)

Centralized control including facilities and equipment in addition to air conditioning is possible by linking up with MODBUS, KNX interfaces.



Model: ARXG45KHTB / ARXG54KHTB
ARXG45KHTB [3-phase] / ARXG54KHTB [3-phase]



Specifications

Model name	Indoor unit		ARXG45KHTB	ARXG54KHTB	ARXG45KHTB	ARXG54KHTB
	Outdoor unit		AOHG45KHTB	AOHG54KHTB	AOHG45KRTA	AOHG54KRTA
Power Source	Single phase, ~230 V, 50 Hz			3-phase, ~400 V, 50 Hz		
Capacity	Cooling	Rated	12.1	13.4	12.1	13.4
		Min.-Max.	4.0-14.0	5.0-14.5	4.0-14.0	5.0-14.5
	Heating	Rated	13.5	15.5	13.5	15.5
		Min.-Max.	5.0-16.2	5.5-18.0	5.0-16.2	5.5-18.0
Input Power	Cooling/Heating		4.16/3.61	4.77/4.18	4.16/3.61	4.77/4.18
EER	Cooling		2.91	2.81	2.91	2.81
COP	Heating		3.74	3.71	3.74	3.71
Pdesign	Cooling/Heating (-10°C)		-	-	-	-
SEER	Cooling		-	-	-	-
SCOP	Heating		-	-	-	-
Energy Efficiency Class	Cooling		-	-	-	-
	Heating		-	-	-	-
Max. Operating Current	Cooling/Heating		28.5/28.5	28.5/28.5	14.0/14.0	14.0/14.0
Annual Energy Consumption	Cooling		-	-	-	-
	Heating		-	-	-	-
Moisture Removal			1.5	2.0	1.5	2.0
Sound Pressure Level	Indoor (Cooling)	H/M/L	47/43/40	47/43/40	47/43/40	47/43/40
	Indoor (Heating)	H/M/L	47/43/40	47/43/40	47/43/40	47/43/40
	Outdoor (Cooling/Heating)	High	57/57	57/59	57/57	57/59
Sound Power Level	Indoor (Cooling/Heating)	High	75/74	75/74	75/74	75/74
	Outdoor (Cooling/Heating)	High	71/71	73/73	71/71	73/73
Airflow Rate	Indoor/Outdoor (Cooling)	High	3,350/4,450	3,350/4,450	3,350/4,450	3,350/4,450
	Indoor/Outdoor (Heating)	High	3,350/4,450	3,350/4,450	3,350/4,450	3,350/4,450
Static pressure range (Standard)			100 to 250 (100)	100 to 250 (100)	100 to 250 (100)	100 to 250 (100)
Net Dimensions H x W x D	Indoor	mm	400 x 1,050 x 500	400 x 1,050 x 500	400 x 1,050 x 500	400 x 1,050 x 500
	Outdoor	mm	998 x 940 x 320	998 x 940 x 320	998 x 940 x 320	998 x 940 x 320
Weight	Indoor	kg	46	46	46	46
	Outdoor	kg	67	67	67	67
Connection Pipe Diameter (Liquid/Gas)			9.52/15.88	9.52/15.88	9.52/15.88	9.52/15.88
Drain port Diameter (I.D./O.D.)			23.4/25.4	23.4/25.4	23.4/25.4	23.4/25.4
Max. Pipe Length (Pre-Charge)			50 (30)	50 (30)	50 (30)	50 (30)
Max. Height Difference			30	30	30	30
Operating Range	Cooling	°CDB	-15 to 46	-15 to 46	-15 to 46	-15 to 46
	Heating	°CDB	-15 to 24	-15 to 24	-15 to 24	-15 to 24
Refrigerant	Type (Global Warming Potential)		R32 (675)	R32 (675)	R32 (675)	R32 (675)
	Charge	kg (CO ₂ eq-T)	2.70 (1.823)	2.70 (1.823)	2.70 (1.823)	2.70 (1.823)

Optional parts

* For optional parts compatibility of Intesis devices, please refer to the optional parts compatibility list page C-050 to C-053 and C-066.

Wired Remote Controller (Design type): UTY-RVRG
 Compact wired remote controller: UTY-RCRGZ1
 Wired remote controller (touch panel): UTY-RNRGZ5
 Wired remote controller: UTY-RLRG
 Simple remote controller: UTY-RSRG
 UTY-RHRG
 IR Receiver unit: UTY-LBTGM

Remote sensor unit: UTY-XSXZ1
 Long-life filter: UTD-LF60KA
 External switch controller: UTY-TERX
 WLAN adapter: UTY-TFSXZ1
 UTY-TFSXJ3
 FG-AC-WIF1Z1
 External input and output PCB: UTY-XCSX+UTZ-GXEA

Network Converter for single split (DC power supply type): UTY-VTGX
 Network Converter for single split (AC power supply type): UTY-VTGVX
 Silver Ion Filter: UTD-HFKB
 External connect kit: UTY-XWZXZG
(Outdoor unit)
 External connect kit: UTY-XWZXZ3

Dimensions

(Unit: mm)

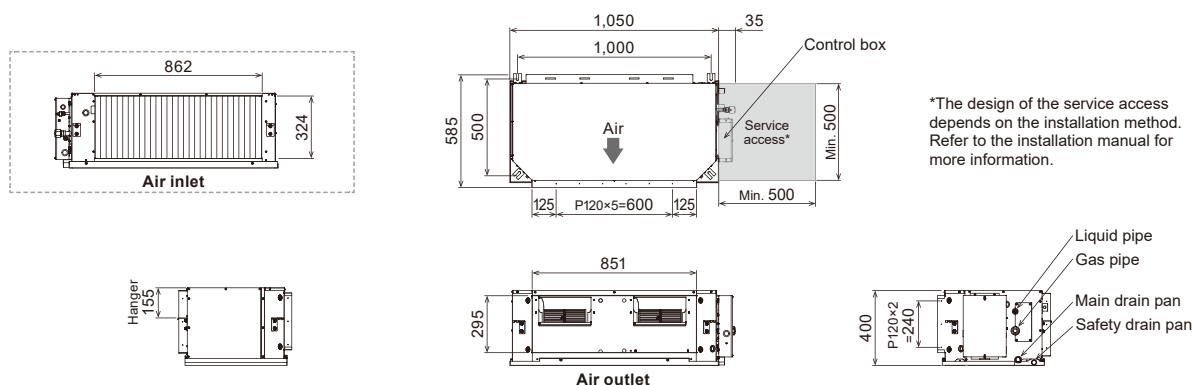

High Static Pressure Duct



High energy efficiency

Much greater efficiency is achieved by the use of all-DC inverter technology.

Design also corresponding to high static pressure

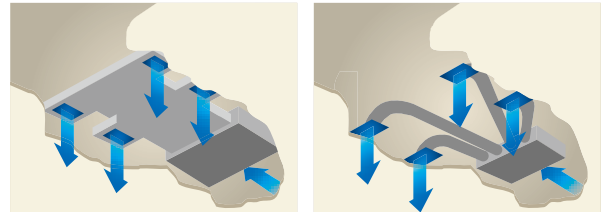
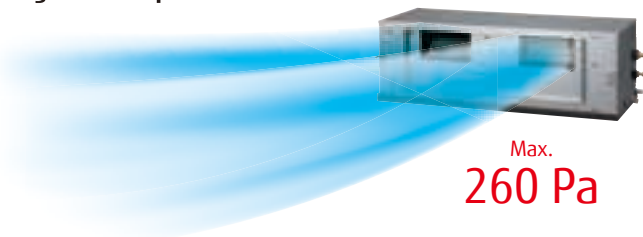

Easy installation (Compact & Lightweight)

The indoor unit is designed to be compact and light by reducing the basic chassis size and the overall material weight.



Low noise

Slanted corners at the top help reduce turbulent airflow. Low noise is realized by adopting a plastic case and a plastic fan.

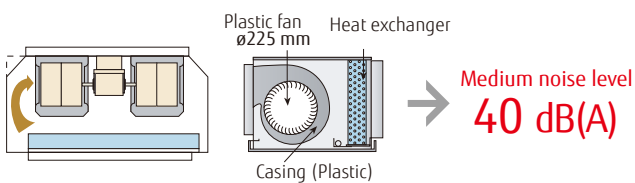

Link up with a variety of central control system (Option)

Centralized control including facilities and equipment in addition to air conditioning is possible by linking up with MODBUS, KNX interfaces.



Model: ARHG60LHTA [3-phase]



Wired RC



Specifications

Model name	Indoor unit		Outdoor unit		ARHG60LHTA	AOHG60LATT
	Indoor unit		Outdoor unit		3-phase, ~400 V, 50 Hz	
Power Source					3-phase, ~400 V, 50 Hz	
Capacity	Cooling	Rated	kW	15.0		
		Min.-Max.		6.2-17.5		
	Heating	Rated		18.0		
		Min.-Max.		6.2-20.0		
Input Power	Cooling/Heating		kW	4.70/5.15		
EER	Cooling		W/W	3.19		
COP	Heating			3.50		
Max. Operating Current	Cooling/Heating		A	12.5 /12.5		
Moisture Removal			l/h	2.0		
Sound Pressure	Indoor (Cooling)	H/M/L/Q	dB(A)	45/40/36/-		
	Indoor (Heating)	H/M/L/Q		45/40/36/-		
	Outdoor (Cooling/Heating)	High		56/58		
Airflow Rate	Indoor/Outdoor (Cooling)	High	m³/h	3,550/6,900		
	Indoor/Outdoor (Heating)	High		3,550/7,300		
Static pressure range (Standard)			Pa	60 to 260 (60)		
Net Dimensions H x W x D	Indoor	mm		425 x 1,250 x 490		
	Outdoor	mm		1,290 x 900 x 330		
Weight	Indoor	kg		54		
	Outdoor	kg		104		
Connection Pipe Diameter (Liquid/Gas)			mm	9.52/15.88		
Drain Hose Diameter (I.D./O.D.)				23.4/25.4		
Max. Pipe Length (Pre-Charge)			m	75 (30)		
Max. Height Difference				30		
Operating Range	Cooling	°CDB		-15 to 46		
	Heating	°CDB		-15 to 24		
Refrigerant	Type (Global Warming Potential)			R410A (2,088)		
	Charge	kg (CO2eq-T)		3.45 (7.204)		

Optional parts

* For optional parts compatibility of Intesis devices, please refer to the optional parts compatibility list page C-050 to C-053 and C-066.

- | | |
|--------------------------------------|--|
| Wired remote controller: UTY-RNNGM | Network Converter for single split (DC power supply type): UTY-VTGX |
| Wired remote controller: UTY-RVNGM | Network Converter for single split (AC power supply type): UTY-VTGXV |
| External switch controller: UTY-TERX | External connect kit: UTD-ECSSA |
| WLAN adapter: UTY-TFNXZ1 | |
| | (Outdoor unit) |
| Remote sensor unit: UTY-XSZXZ1 | External connect kit: UTY-XWZXZ2 |
| IR receiver unit: UTY-LRHGM | |

Dimensions

(Unit: mm)

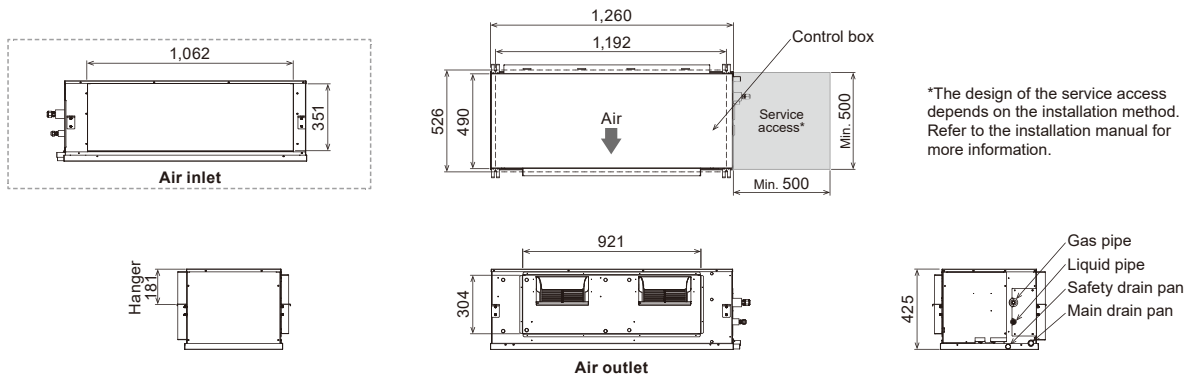

Big Duct



Splittable, lightweight, and compact design

The indoor unit can be split into a fan unit and a heat exchanger unit to make installation easier.

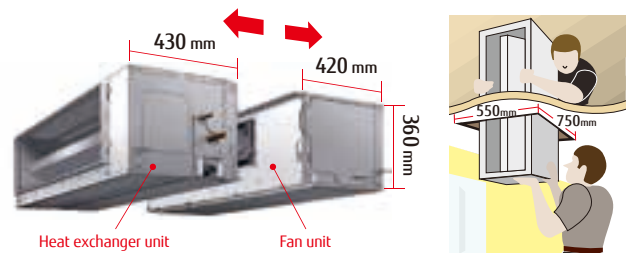

Quiet operation

The combination of a V-shaped heat exchanger, an air stabilizer, and a high-efficiency DC fan motor enables this compact unit to operate quietly.

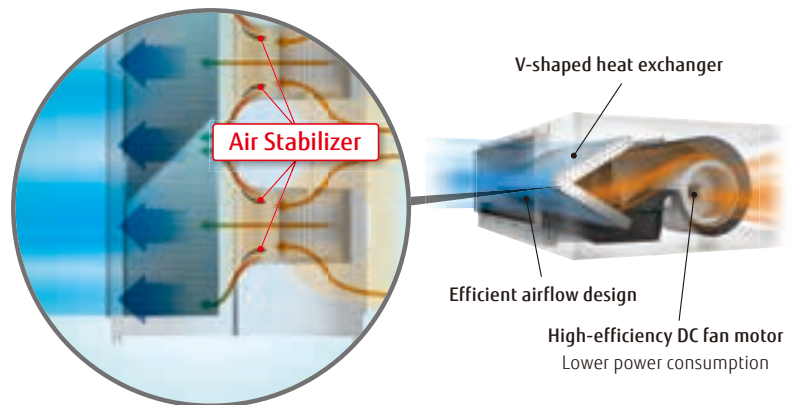

Automatic airflow adjustment function

The optimum airflow can be set automatically to facilitate faster installation.

Automatically adjust !



Link up with a variety of central control system (Option)

Centralized control including facilities and equipment in addition to air conditioning is possible by linking up with MODBUS, KNX interfaces.



Model: ARHG72LHTA / ARHG90LHTA

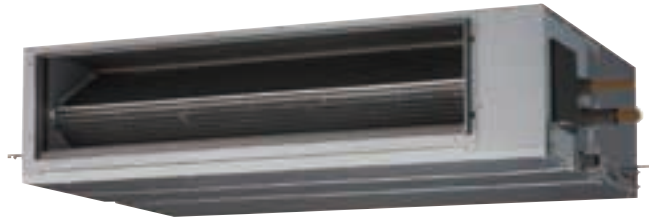

Wired RC



Specifications

Model name	Indoor unit		ARHG72LHTA	ARHG90LHTA
	Outdoor unit		AOHG72LRLA	AOHG90LRLA
Power Source	Indoor		Single phase, ~230 V, 50 Hz	
	Outdoor		3-phase, ~400 V, 50 Hz	
Capacity	Cooling	Rated	19.0	22.0
		Min.-Max.	8.4-20.9	10.3-24.2
	Heating	Rated	22.4	27.0
		Min.-Max.	7.2-24.6	8.5-29.7
Input Power	Cooling/Heating		6.46/6.59	7.77/8.18
EER	Cooling		2.94	2.83
COP	Heating		3.40	3.30
Max. Operating Current	Indoor (Cooling/Heating)		-	-
	Outdoor (Cooling/Heating)		-	-
Moisture Removal			4.5	6.0
Sound Pressure	Indoor (Cooling)	H/M/L/Q	46/43/41/39	47/44/42/40
	Indoor (Heating)	H/M/L/Q	46/43/41/39	47/44/42/40
Airflow Rate	Outdoor (Cooling/Heating)	High	55/55	55/57
	Indoor/Outdoor (Cooling)	High	4,300/8,400	4,300/8,400
	Indoor/Outdoor (Heating)	High	4,300/8,400	4,300/9,000
Static pressure range (Standard)			50 to 150 (72)	50 to 200 (72)
Net Dimensions H x W x D	Indoor		360 × 1,400 × 850	360 × 1,400 × 850
	Outdoor		1,428 × 1,080 × 480	1,428 × 1,080 × 480
Weight	Indoor		69	80
	Outdoor		165	174
Connection Pipe Diameter (Liquid/Gas)			12.7/25.4	12.7/25.4
Drain Hose Diameter (I.D./O.D.)			25/32	25/32
Max. Pipe Length (Pre-Charge)			100 (30)	100 (30)
Max. Height Difference			30	30
Operating Range	Cooling		-15 to 46	-15 to 46
	Heating		-20 to 24	-20 to 24
Refrigerant	Type (Global Warming Potential)		R410A (2,088)	R410A (2,088)
	Charge		5.6 (11.693)	7.1 (14.825)

Optional parts

* For optional parts compatibility of Intesis devices, please refer to the optional parts compatibility list page C-050 to C-053 and C-066.

Wired Remote Controller (Design type):	UTY-RVRG	WLAN adapter:	UTY-TFSXZ1	Network Converter for single split (DC power supply type):	UTY-VTGX
Compact wired remote controller:	UTY-RCRGZ1		FG-RC-WIF1Z2	Network Converter for single split (AC power supply type):	UTY-VTGXV
Wired remote controller (touch panel):	UTY-RNRGZ5		UTY-TFSXJ3	IR receiver unit:	UTY-LBTGM
Wired remote controller:	UTY-RLRG	External input and output PCB:	FG-AC-WIF1Z1	Silver Ion Filter:	UTY-LRHGM
	UTY-RNNGM	Remote sensor unit:	UTY-XCSX		UTD-HFKA
	UTY-RVNGM	Long-life filter	UTD-LFKA	(Outdoor unit)	
Simple remote controller (without operation mode):	UTY-RHRG	External connect kit:	UTY-XWZXZG	External connect kit:	UTY-XWZXZ3
Simple remote controller:	UTY-RSRG	Drain pump unit:	UTZ-PX1NAB		
External switch controller:	UTY-TERX				

Dimensions

(Unit: mm)

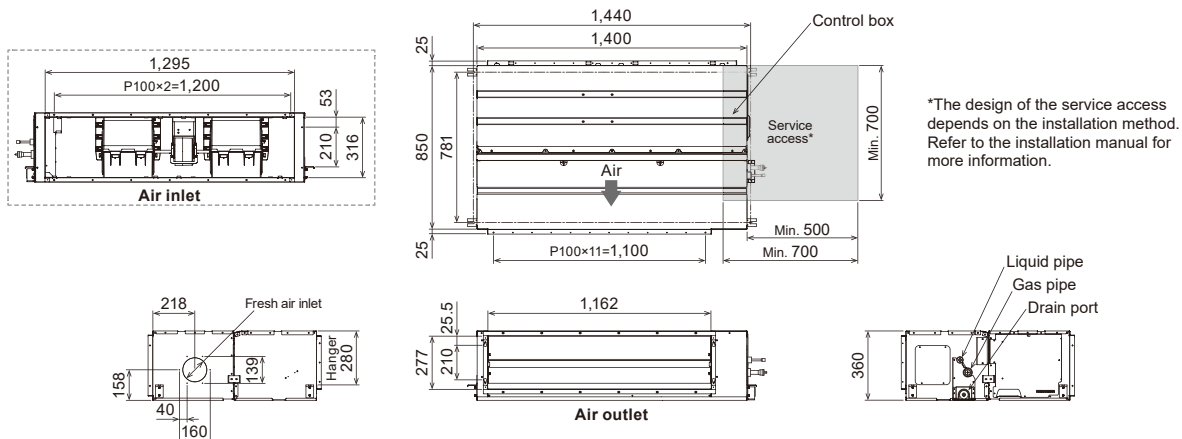

Floor

Compact Size



High energy saving

The Floor 09 class achieves a top-class SEER of 8.50 and an A+++ seasonal efficiency rank for cooling. The Floor 09 class achieves an improved SCOP of 4.30 and an A+ seasonal efficiency rank for heating.



SEER 8.50^{*1} SCOP 4.30^{*1}

*1: 09 model

Flexible & easy installation

The compact and whole-surface suction design provides flexible installation options, including floor-standing, embedded, half concealed, and wall mount installation to match the room layout.

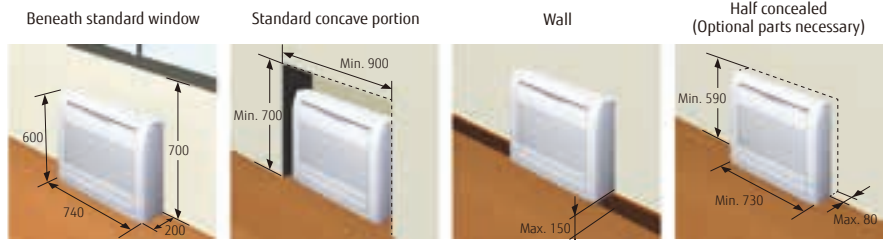

(Unit: mm)

* Concaved position installation with concealment is prohibited.

Low ambient operation

Factory-guaranteed cooling operation down to -10°C ambient temperature.

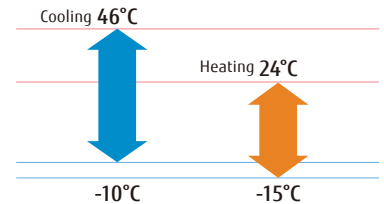

Smart device control (Option)

With the optional WLAN adapter installed in the air conditioner, you can control it from anywhere with your smart device.

* See page C-020 for details on smart device control.



AIRSTAGE Mobile



10°C heat

The room temperature can be set to go no lower than 10°C, thus ensuring that the room does not get too cold when not occupied.

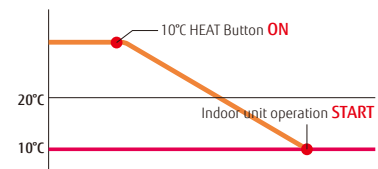



Model: AGHG09KVCA / AGHG12KVCA / AGHG14KVCA



Wireless RC



For AGHG09/12KVCA



For AGHG14KVCA

Specifications

Model name	Indoor unit		AGHG09KVCA	AGHG12KVCA	AGHG14KVCA
	Outdoor unit		AOHG09KVCA	AOHG12KVCA	AOHG14KVCA
Power Source			Single phase, ~230 V, 50 Hz		
Capacity	Cooling	Rated	2.5	3.5	4.2
		Min.-Max.	0.9-3.5	0.9-4.0	0.9-5.2
	Heating	Rated	3.5	4.5	5.2
		Min.-Max.	0.9-5.1	0.9-5.3	0.9-6.3
Input Power	Cooling/Heating		0.53/0.81	0.88/1.22	1.06/1.41
EER	Cooling		4.70	4.00	3.95
COP	Heating		4.30	3.70	3.70
Pdesign	Cooling/Heating (-10°C)		2.50/2.60	3.50/3.50	4.20/4.20
SEER	Cooling		8.50	8.20	8.10
SCOP	Heating (Average)		4.30	4.10	4.00
Energy Efficiency Class	Cooling		A+++	A++	A++
	Heating (Average)		A+	A+	A+
Max. Operating Current	Cooling/Heating		7.0/8.5	7.0/8.5	11.0/12.0
Annual Energy Consumption	Cooling		103	149	181
	Heating (Average)		845	1,192	1,466
Moisture Removal			1.3	1.8	2.1
Sound Pressure Level	Indoor (Cooling)	H/M/L/Q	40/35/29/22	40/35/29/22	44/38/31/22
	Indoor (Heating)	H/M/L/Q	41/35/29/22	41/35/29/22	43/37/29/22
	Outdoor (Cooling/Heating)	High	43/47	45/51	51/50
Sound Power Level	Indoor (Cooling/Heating)	High	53/54	53/54	57/56
	Outdoor (Cooling/Heating)	High	58/61	61/64	63/63
	Indoor/Outdoor (Cooling)	High	570/1,530	570/1,530	650/2,210
Airflow Rate	Indoor/Outdoor (Heating)	High	600/1,510	600/1,510	650/2,100
	Indoor	mm	600 × 740 × 200	600 × 740 × 200	600 × 740 × 200
Net Dimensions H x W x D	Outdoor	mm	542 × 799 × 290	542 × 799 × 290	632 × 799 × 290
	Indoor	kg	14	14	14
Weight	Outdoor	kg	31	31	38
	Connection Pipe Diameter (Liquid/Gas)		6.35/9.52	6.35/9.52	6.35/9.52
Drain Hose Diameter (I.D./O.D.)		mm	13.8/15.8 to 16.7	13.8/15.8 to 16.7	13.8/15.8 to 16.7
Max. Pipe Length (Pre-Charge)		m	20 (15)	20 (15)	20 (15)
Max. Height Difference			15	15	15
Operating Range	Cooling	°CDB	-10 to 46	-10 to 46	-10 to 46
	Heating		-15 to 24	-15 to 24	-15 to 24
Refrigerant	Type (Global Warming Potential)		R32 (675)	R32 (675)	R32 (675)
	Charge	kg (CO2eq-T)	0.85 (0.574)	0.85 (0.574)	0.94 (0.635)

Optional parts

* For optional parts compatibility of Intesis devices, please refer to the optional parts compatibility list page C-050 to C-053 and C-066.

Wired Remote Controller (Design type):	UTY-RVRC	External switch controller:	UTY-TERX	Network Converter for single split (DC power supply type):	UTY-VTGX
Compact wired remote controller:	UTY-RCRGZ1	WLAN adapter:	UTY-TFSXZ1	Network Converter for single split (AC power supply type):	UTY-VTGXV
Wired remote controller (touch panel):	UTY-RNRGZ5		FG-AC-WIF1Z1	Silver Ion Filter:	UTR-FA03-5
Wired remote controller:	UTY-RLRG		UTY-TFSXJ3	External connect kit:	UTY-XWZXZ5
Simple remote controller (without operation mode):	UTY-RHRG	Half concealed kit:	UTR-STA		
Simple remote controller:	UTY-RSRG	Communication kit:	UTY-TWRXZ3		

Dimensions

(Unit: mm)

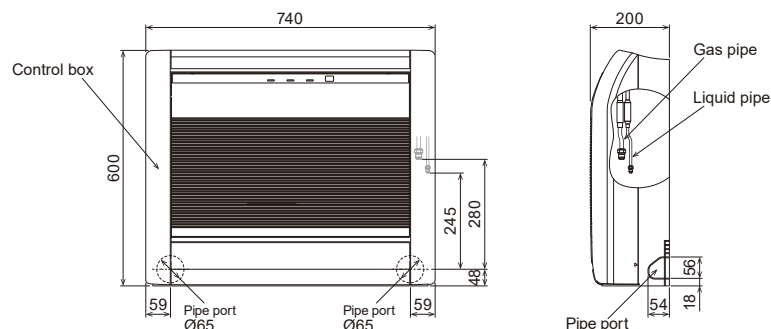

Ceiling



reddot winner 2020



(30/36/45/54)

Light elegant design

The light-elegant, gently curved surface gives a sense of comfort and well-being.



Easy installation

The indoor unit can be easily installed under the ceiling thanks to the uniquely designed mounting kit.

1. Set mounting brackets

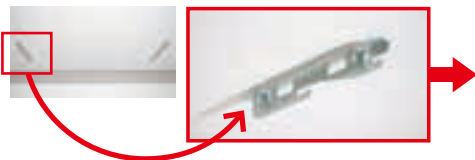

2. Hold up the ceiling unit and fit to the mounting brackets

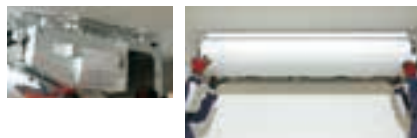

3. Attach with screws

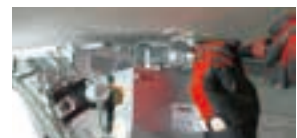

Easy maintenance

The front panel can be opened without removing it for safe & speedy maintenance.



The drain pan can be removed for cleaning.



Components in the control box can be easily accessed from the wide side opening.



Flexible installation

The drain hose and pipe can be contained in the casing and connected in the right, left, angled, or downward direction.



Link up with a variety of central control system (Option)

Centralized control including facilities and equipment in addition to air conditioning is possible by linking up with MODBUS, KNX interfaces.



Central Control System

**Model: ABHG18KRTA / ABHG22KRTA / ABHG24KRTA / ABHG30KRTA / ABHG36KRTA / ABHG45KRTA
ABHG36KRTA [3-phase] / ABHG45KRTA [3-phase] / ABHG54KRTA [3-phase]**



Specifications

Model name	Indoor unit			ABHG18KRTA	ABHG22KRTA	ABHG24KRTA	ABHG30KRTA	ABHG36KRTA	ABHG45KRTA	ABHG36KRTA	ABHG45KRTA	ABHG54KRTA
	Outdoor unit			AOHG18KBTB	AOHG22KBTB	AOHG24KBTB	AOHG30KBTB	AOHG36KBTB	AOHG45KBTB	AOHG36KBTB	AOHG45KBTB	AOHG54KBTB
Power Source				Single phase, ~230 V, 50 Hz						3-phase, ~400 V, 50 Hz		
Capacity	Cooling	Rated	kW	5.2	6.0	6.8	8.5	9.5	12.1	9.5	12.1	13.4
		Min.-Max.		0.9-5.9	0.9-6.7	0.9-8.0	2.8-10.0	2.8-11.2	4.0-13.5	2.8-11.2	4.0-13.5	4.5-14.5
Input Power	Cooling/Heating	Rated	kW	6.0	7.0	7.5	10.0	10.8	13.5	10.8	13.5	15.5
		Min.-Max.		0.9-7.5	0.9-8.0	0.9-9.1	2.7-11.2	2.7-12.7	4.2-16.2	2.7-12.7	4.2-16.2	4.7-16.5
EER	Cooling		W/W	3.35	3.21	3.18	3.21	3.21	2.87	2.96/2.88	4.22/3.84	4.45/4.43
COP	Heating		W/W	3.70	3.59	3.81	3.61	3.75	3.52	3.75	3.52	3.50
Pdesign	Cooling/Heating (-10°C)		kW	5.2/4.4	6.0/4.8	6.8/6.0	8.5/8.0	9.5/8.7	-	9.5/8.7	-	-
SEER	Cooling		W/W	6.2	6.1	6.2	6.1	6.37	-	6.37	-	-
SCOP	Heating (Average)		W/W	4.1	4.0	4.1	4.0	4.21	-	4.21	-	-
Energy Efficiency Class	Cooling			A+	A+	A+	A+	A+	-	A+	-	-
	Heating (Average)			A+	A+	A+	A+	A+	-	A+	-	-
Max. Operating Current	Cooling/Heating		A	12.1/12.1	12.6/12.6	13.6/13.6	22.6/22.6	22.6/22.6	28.5/28.5	10.5/10.5	14.0/14.0	14.0/14.0
Annual Energy Consumption	Cooling		kWh/a	293	344	384	486	524	-	524	-	-
	Heating		kWh/a	1,501	1,677	2,042	2,796	2,904	-	2,904	-	-
Moisture Removal			l/h	2.0	2.5	2.2	3.0	2.6	4.5	2.6	4.5	5.0
Sound Pressure Level	Indoor (Cooling)	H/M/L/Q	dB(A)	38/36/33/31	42/37/34/31	41/36/32/29	45/40/35/32	44/40/37/32	45/41/39/34	44/40/37/32	45/41/39/34	48/44/41/38
	Indoor (Heating)	H/M/L/Q		38/36/33/31	42/37/34/31	41/36/32/29	45/40/35/32	44/40/37/32	45/41/39/34	44/40/37/32	45/41/39/34	48/44/41/38
Sound Power Level	Outdoor (Cooling/Heating)	High	dB(A)	50/50	51/51	53/54	53/55	55/55	57/57	55/55	57/57	57/59
	Indoor (Cooling/Heating)	High		53/53	57/57	56/56	60/60	59/59	60/60	59/59	60/60	63/63
Airflow Rate	Indoor/Outdoor (Cooling)	High	m³/h	840/2,160	900/2,240	1,230/2,700	1,400/3,750	1,850/3,750	1,900/4,450	1,850/3,750	1,900/4,450	2,100/4,450
	Indoor/Outdoor (Heating)	High		840/1,830	900/1,960	1,230/2,700	1,400/3,750	1,800/3,750	1,850/4,450	1,800/3,750	1,850/4,450	2,100/4,450
Net Dimensions H x W x D	Indoor	mm	mm	235 × 1,080 × 705	235 × 1,080 × 705	235 × 1,390 × 705	235 × 1,390 × 705	235 × 1,700 × 705	235 × 1,700 × 705	235 × 1,700 × 705	235 × 1,700 × 705	235 × 1,700 × 705
	Outdoor	mm		632 × 799 × 290	632 × 799 × 290	716 × 820 × 315	788 × 940 × 320	788 × 940 × 320	998 × 940 × 320	788 × 940 × 320	998 × 940 × 320	998 × 940 × 320
Weight	Indoor	kg	kg	24	24	31	31	38	38	38	38	38
	Outdoor	kg		36	38	42	52	52	67	53	67	67
Connection Pipe Diameter (Liquid/Gas)			mm	6.35/12.7	6.35/12.7	6.35/12.7	9.52/15.88	9.52/15.88	9.52/15.88	9.52/15.88	9.52/15.88	9.52/15.88
Drain Hose Diameter (I.D./O.D.)			mm	25/32	25/32	25/32	25/32	25/32	25/32	25/32	25/32	25/32
Max. Pipe Length (Pre-Charge)			m	30 (20)	30 (20)	30 (20)	50 (30)	50 (30)	50 (30)	50 (30)	50 (30)	50 (30)
Max. Height Difference			m	20	25	25	30	30	30	30	30	30
Operating Range	Cooling	°CDB	°CDB	-15 to 46	-15 to 46	-15 to 46	-15 to 46	-15 to 46	-15 to 46	-15 to 46	-15 to 46	-15 to 46
	Heating			-15 to 24	-15 to 24	-15 to 24	-15 to 24	-15 to 24	-15 to 24	-15 to 24	-15 to 24	-15 to 24
Refrigerant	Type (Global Warming Potential)			R32 (675)	R32 (675)	R32 (675)	R32 (675)	R32 (675)	R32 (675)	R32 (675)	R32 (675)	R32 (675)
	Charge	kg (CO2eq-T)		1.02 (0.689)	1.25 (0.844)	1.25 (0.844)	1.90 (1.283)	1.90 (1.283)	2.70 (1.823)	1.90 (1.283)	2.70 (1.823)	2.70 (1.823)

Optional parts

* For optional parts compatibility of Intesis devices, please refer to the optional parts compatibility list page C-050 to C-053 and C-066.

Wired Remote Controller (Design type):	UTY-RVRG	WLAN adapter:	UTY-TFSXZ1	Network Converter for single split (DC power supply type):	UTY-VTGV
Compact wired remote controller:	UTY-RCRGZ1		UTY-TFSXJ3	Network Converter for single split (AC power supply type):	UTY-VTGXV
Wired remote controller (touch panel):	UTY-RNRGZ5		FG-AC-WIF1Z1	External switch controller:	UTY-TERX
Wired remote controller:	UTY-RLRG	Drain pump unit:	UTR-DPB24T	External connect kit:	UTY-XWZXZG
Simple remote controller (without operation mode):	UTY-RHRG	IR receiver unit:	UTY-LBTGH		
Simple remote controller:	UTY-RSRG	L-type piping kit:	UTP-FX24A (18/22/24)	(Outdoor unit 30/36/45/54)	
External input and output PCB:	UTY-XCSX		UTP-FX35A (30/36/45/54)	External connect kit:	UTY-XWZXZ3
External input and output PCB box:	UTZ-GXEA	Communication kit:	UTY-TWRXZ3		

Dimensions

(Unit: mm)

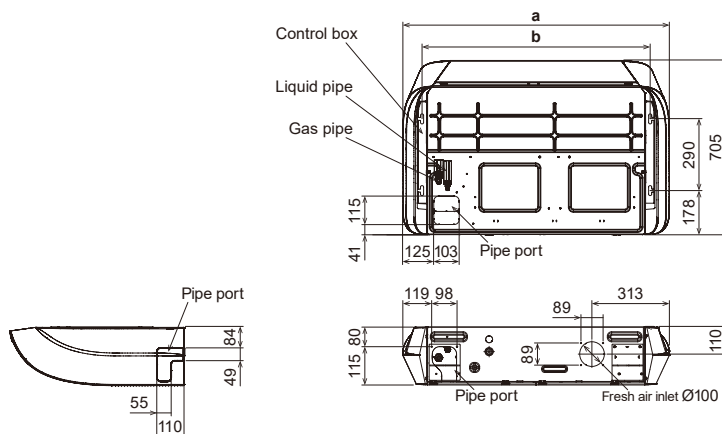

	ABHG 18/22KRTA	ABHG 24/30KRTA	ABHG 36/45/54 KRTA
a	1,080	1,390	1,700
b	923	1,233	1,543

Wall-mounted Specifications



**Designer Series
High-Spec & Design (WLAN adapter Internal Models)**

Model name	Indoor unit		ASHG07KGTG	ASHG09KGTG	ASHG12KGTG	ASHG14KGTG
	Outdoor unit		AOHG07KGCB	AOHG09KGCB	AOHG12KGCB	AOHG14KGCB
Power Source			Single phase, ~230 V, 50 Hz			
Capacity	Cooling	Rated	2.0	2.5	3.4	4.2
		Min.-Max.	0.9-3.2	0.9-3.4	0.9-4.1	0.9-4.5
Capacity	Heating	Rated	2.5	2.8	4.0	5.4
		Min.-Max.	0.9-5.2	0.9-5.4	0.9-6.1	0.9-6.4
Input Power	Cooling/Heating		0.400/0.500	0.555/0.560	0.805/0.910	1.175/1.350
EER	Cooling		5.00	4.50	4.22	3.57
COP	Heating		5.00	5.00	4.40	4.00
Pdesign	Cooling/Heating (-10°C)		2.0/2.3	2.5/2.4	3.4/2.5	4.2/4.0
SEER	Cooling		8.10	8.90	8.70	7.90
SCOP	Heating (Average)		5.30	5.20	5.20	4.50
Energy Efficiency Class	Cooling		A++	A+++	A+++	A++
	Heating (Average)		A+++	A+++	A+++	A+
Max. Operating Current	Cooling/Heating		6.5/9.0	6.5/9.0	6.5/9.0	9.0/10.5
Annual Energy Consumption	Cooling		86	98	137	186
	Heating		606	645	673	1,242
Moisture Removal			l/h	1.0	1.3	1.8
Sound Pressure Level	Indoor (Cooling)	H/M/L/Q	38/33/29/19	40/34/29/19	40/35/30/19	43/36/30/20
	Indoor (Heating)	H/M/L/Q	41/35/31/21	42/36/31/21	42/38/33/21	44/39/33/24
Sound Power Level	Outdoor (Cooling/Heating)	High	46/46	46/48	50/50	50/50
	Indoor (Cooling/Heating)	High	54/56	55/57	56/58	57/59
Airflow Rate	Indoor/Outdoor (Cooling)	High	650/1,610	700/1,610	700/1,680	770/1,680
	Indoor/Outdoor (Heating)	High	720/1,560	750/1,610	770/1,580	800/1,580
Net Dimensions H x W x D	Indoor		270 × 834 × 215	270 × 834 × 215	270 × 834 × 215	270 × 834 × 215
	Outdoor		542 × 799 × 290	542 × 799 × 290	542 × 799 × 290	542 × 799 × 290
Weight	Indoor		kg	10	10	10
	Outdoor		kg	30	30	31
Connection Pipe Diameter (Liquid/Gas)			6.35/9.52			
Drain Hose Diameter (I.D./O.D.)			13.8/15.0 to 16.8			
Max. Pipe Length (Pre-Charge)			20 (15)			
Max. Height Difference			15			
Operating Range	Cooling		°CDB			
	Heating		-10 to 46			
Refrigerant	Type (Global Warming Potential)		R32 (675)			
	Charge	kg (CO2eq-T)	0.75 (0.506)	0.75 (0.506)	0.85 (0.574)	0.85 (0.574)

**Designer Series
High Spec & Design (WLAN adapter Option Models)**

Model name	Indoor unit		ASHG07KGTE	ASHG09KGTE	ASHG12KGTE	ASHG14KGTE
	Outdoor unit		AOHG07KGC A	AOHG09KGC A	AOHG12KGC A	AOHG14KGC A
Power Source			Single phase, ~230 V, 50 Hz			
Capacity	Cooling	Rated	2.0	2.5	3.4	4.2
		Min.-Max.	0.9-3.2	0.9-3.4	0.9-4.1	0.9-4.5
Capacity	Heating	Rated	2.5	2.8	4.0	5.4
		Min.-Max.	0.9-5.2	0.9-5.4	0.9-6.1	0.9-6.4
Input Power	Cooling/Heating		0.400/0.500	0.555/0.560	0.805/0.910	1.175/1.350
EER	Cooling		5.00	4.50	4.22	3.57
COP	Heating		5.00	5.00	4.40	4.00
Pdesign	Cooling/Heating (-10°C)		2.0/2.3	2.5/2.4	3.4/2.5	4.2/4.0
SEER	Cooling		9.10	9.20	9.20	8.30
SCOP	Heating (Average)		5.30	5.20	5.20	4.50
Energy Efficiency Class	Cooling		A+++	A+++	A+++	A++
	Heating (Average)		A+++	A+++	A+++	A+
Max. Operating Current	Cooling/Heating		6.5/9.0	6.5/9.0	6.5/9.0	9.0/10.5
Annual Energy Consumption	Cooling		77	95	129	177
	Heating		607	645	672	1,242
Moisture Removal			l/h	1.0	1.3	1.8
Sound Pressure Level	Indoor (Cooling)	H/M/L/Q	38/33/29/19	40/34/29/19	40/35/30/19	43/36/30/20
	Indoor (Heating)	H/M/L/Q	41/35/31/21	42/36/31/21	42/38/33/21	44/39/33/24
Sound Power Level	Outdoor (Cooling/Heating)	High	46/46	46/48	50/50	50/50
	Indoor (Cooling/Heating)	High	54/56	55/57	56/58	57/59
Airflow Rate	Indoor/Outdoor (Cooling)	High	650/1,610	700/1,610	700/1,680	770/1,680
	Indoor/Outdoor (Heating)	High	720/1,560	750/1,610	770/1,580	800/1,580
Net Dimensions H x W x D	Indoor		270 × 834 × 215	270 × 834 × 215	270 × 834 × 215	270 × 834 × 215
	Outdoor		542 × 799 × 290	542 × 799 × 290	542 × 799 × 290	542 × 799 × 290
Weight	Indoor		kg	10	10	10
	Outdoor		kg	30	30	31
Connection Pipe Diameter (Liquid/Gas)			6.35/9.52			
Drain Hose Diameter (I.D./O.D.)			13.8/15.0 to 16.8			
Max. Pipe Length (Pre-Charge)			20 (15)			
Max. Height Difference			15			
Operating Range	Cooling		°CDB			
	Heating		-10 to 46			
Refrigerant	Type (Global Warming Potential)		R32 (675)			
	Charge	kg (CO2eq-T)	0.75 (0.506)	0.75 (0.506)	0.85 (0.574)	0.85 (0.574)

Designer Series
Cool Beauty Design



Model name	Indoor unit			ASHG07KETE ASHG07KETE-B	ASHG09KETE ASHG09KETE-B	ASHG12KETE ASHG12KETE-B	ASHG14KETE ASHG14KETE-B
	Outdoor unit			AOHG07KETA	AOHG09KETA	AOHG12KETA	AOHG14KETA
Power Source				Single phase, ~230 V, 50 Hz			
Capacity	Cooling	Rated	kW	2.0	2.5	3.4	4.2
		Min.-Max.		0.9 - 3.0	0.9 - 3.2	0.9 - 3.9	0.9 - 4.4
	Heating	Rated		2.5	2.8	4.0	5.4
		Min.-Max.		0.9 - 3.4	0.9 - 4.0	0.9 - 5.3	0.9 - 6.0
Input Power	Cooling/Heating		kW	0.450/0.555	0.630/0.620	0.935/0.960	1.220/1.410
EER	Cooling		W/W	4.43	3.97	3.65	3.44
COP	Heating		W/W	4.52	4.52	4.17	3.83
Pdesign	Cooling/Heating (-10°C)		kW	2.0/2.3	2.5/2.4	3.4/2.5	4.2/4.0
SEER	Cooling		W/W	7.40	7.40	7.30	6.90
SCOP	Heating (Average)		W/W	4.10	4.10	4.40	4.10
Energy Efficiency Class	Cooling			A++	A++	A++	A++
	Heating (Average)			A+	A+	A+	A+
Max. Operating Current	Cooling/Heating		A	6.5/9.0	6.5/9.0	6.5/9.0	6.5/9.0
Annual Energy Consumption	Cooling		kWh/a	95	118	163	213
	Heating			785	819	795	1,367
Moisture Removal			l/h	1.0	1.3	1.8	2.1
Sound Pressure Level	Indoor (Cooling)	H/M/L/Q	dB(A)	38/33/29/20	40/34/29/20	40/35/30/20	43/36/30/20
	Indoor (Heating)	H/M/L/Q		41/35/31/22	42/36/31/22	42/38/33/22	44/39/33/24
Sound Power Level	Outdoor (Cooling/Heating)	High		46/46	46/46	50/50	50/50
	Indoor (Cooling/Heating)	High		54/56	55/57	55/58	57/59
Airflow Rate	Outdoor (Cooling/Heating)	High	61/61	61/62	65/65	65/66	
	Indoor/Outdoor (Cooling)	High	650/1,650	700/1,650	700/1,700	770/1,680	
Net Dimensions H x W x D	Indoor		mm	295 x 950 (wall side: 840) x 230			
	Outdoor		mm	541 x 663 x 290	541 x 663 x 290	541 x 663 x 290	542 x 799 x 290
Weight	Indoor		kg	11	11	11	11.5
	Outdoor		kg	23	23	25	31
Connection Pipe Diameter (Liquid/Gas)			mm	6.35/9.52	6.35/9.52	6.35/9.52	6.35/9.52
Drain Hose Diameter (I.D./O.D.)			mm	13.8/15.0 to 16.8	13.8/15.0 to 16.8	13.8/15.0 to 16.8	13.8/15.0 to 16.8
Max. Pipe Length (Pre-Charge)			m	20 (15)	20 (15)	20 (15)	20 (15)
Max. Height Difference			°CDB	15	15	15	15
Operating Range	Cooling		°CDB	-10 to 46	-10 to 46	-10 to 46	-10 to 46
	Heating			-15 to 24	-15 to 24	-15 to 24	-15 to 24
Refrigerant	Type (Global Warming Potential)			R32 (675)	R32 (675)	R32 (675)	R32 (675)
	Charge		kg (CO2eq-T)	0.6 (0.405)	0.6 (0.405)	0.7 (0.473)	0.85 (0.574)

Standard Series
High-Efficiency & Comfort



Model name	Indoor unit	W-LAN Adapter Internal Models	ASHG07KMCF	ASHG09KMCF	ASHG12KMCF	ASHG14KMCF	
		W-LAN Adapter Option Models	ASHG07KMCE	ASHG09KMCE	ASHG12KMCC	ASHG14KMCC	
Outdoor unit		AOHG07KMCC	AOHG09KMCC	AOHG12KMCC	AOHG14KMCC		
Power Source				Single phase, ~230 V, 50 Hz			
Capacity	Cooling	Rated	kW	2.0	2.5	3.4	4.2
		Min.-Max.		0.9-3.0	0.9-3.2	0.9-3.9	0.9-4.4
	Heating	Rated		2.5	2.8	4.0	5.4
		Min.-Max.		0.9-3.4	0.9-4.0	0.9-5.3	0.9-6.0
Input Power	Cooling/Heating		kW	0.450/0.555	0.630/0.620	0.935/0.960	1.220/1.410
EER	Cooling		W/W	4.43	3.97	3.65	3.44
COP	Heating		W/W	4.52	4.52	4.17	3.83
Pdesign	Cooling/Heating (-10°C)		kW	2.0/2.3	2.5/2.4	3.4/2.5	4.2/4.0
SEER	Cooling		W/W	7.40	7.40	7.30	6.90
SCOP	Heating (Average)		W/W	4.10	4.10	4.40	4.10
Energy Efficiency Class	Cooling			A++	A++	A++	A++
	Heating (Average)			A+	A+	A+	A+
Max. Operating Current	Cooling/Heating		A	6.5/9.0	6.5/9.0	6.5/9.0	6.5/9.0
Annual Energy Consumption	Cooling		kWh/a	95	118	163	213
	Heating			785	819	795	1367
Moisture Removal			l/h	1.0	1.3	1.8	2.1
Sound Pressure Level	Indoor (Cooling)	H/M/L/Q	dB(A)	38/33/29/20	40/34/29/20	40/35/30/20	43/36/30/20
	Indoor (Heating)	H/M/L/Q		41/35/31/22	42/36/31/22	42/38/33/22	44/39/33/24
Sound Power Level	Outdoor (Cooling/Heating)	High		46/46	46/46	50/50	50/50
	Indoor (Cooling/Heating)	High		54/56	55/57	55/58	57/59
Airflow Rate	Outdoor (Cooling/Heating)	High	61/61	61/62	65/65	65/66	
	Indoor/Outdoor (Cooling)	High	650/1,650	700/1,650	700/1,700	770/1,680	
Net Dimensions H x W x D	Indoor		mm	270 x 834 x 222	270 x 834 x 222	270 x 834 x 222	270 x 834 x 222
	Outdoor		mm	541 x 663 x 290	541 x 663 x 290	541 x 663 x 290	542 x 799 x 290
Weight	Indoor		kg	10	10	10	10
	Outdoor		kg	22	22	24	31
Connection Pipe Diameter (Liquid/Gas)			mm	6.35/9.52	6.35/9.52	6.35/9.52	6.35/9.52
Drain Hose Diameter (I.D./O.D.)			mm	13.8/15.0 to 16.8	13.8/15.0 to 16.8	13.8/15.0 to 16.8	13.8/15.0 to 16.8
Max. Pipe Length (Pre-Charge)			m	20 (15)	20 (15)	20 (15)	20 (15)
Max. Height Difference			°CDB	15	15	15	15
Operating Range	Cooling		°CDB	-10 to 46	-10 to 46	-10 to 46	-10 to 46
	Heating			-15 to 24	-15 to 24	-15 to 24	-15 to 24
Refrigerant	Type (Global Warming Potential)			R32 (675)	R32 (675)	R32 (675)	R32 (675)
	Charge		kg (CO2eq-T)	0.6 (0.405)	0.6 (0.405)	0.7 (0.473)	0.85 (0.574)

ECO Series Lineup Specifications



Compact Cassette



Model name	Indoor unit		AUXG09KVLA	AUXG12KVLA	AUXG14KVLA	AUXG18KVLA	AUXG22KVLA	AUXG24KVLA
	Outdoor unit		AOHG09KATA	AOHG12KATA	AOHG14KATA	AOHG18KATA	AOHG22KATA	AOHG24KATA
Power Source			Single phase, ~230 V, 50 Hz					
Capacity	Cooling	Rated	2.5	3.5	4.3	5.2	6.0	6.8
		Min.-Max.	0.9-2.7	0.9-3.7	0.9-4.5	0.9-5.4	0.9-6.3	0.9-7.4
Capacity	Heating	Rated	3.2	4.1	5.0	6.0	7.0	7.5
		Min.-Max.	0.9-3.9	0.9-4.4	0.9-5.3	0.9-6.3	0.9-7.4	0.9-8.6
Input Power	Cooling/Heating		0.68/0.88	1.09/1.17	1.37/1.42	1.69/1.72	1.95/2.00	2.26/2.08
EER	Cooling		3.68	3.21	3.14	3.08	3.08	3.01
COP	Heating		3.64	3.50	3.52	3.49	3.50	3.61
Pdesign	Cooling/Heating (-10°C)		2.5/2.3	3.5/2.8	4.3/3.2	5.2/3.8	6.0/4.4	6.8/5.4
SEER	Cooling		6.2	6.1	6.1	6.1	6.1	5.9
SCOP	Heating		4.0	4.0	4.0	3.9	3.9	3.8
Energy Efficiency Class	Cooling		A++	A++	A++	A++	A++	A+
Energy Efficiency Class	Heating		A+	A+	A+	A	A	A
Max. Operating Current	Cooling/Heating		6.9/6.9	7.7/7.7	9.2/9.2	10.1/10.1	11.6/11.6	12.6/12.6
Annual Energy Consumption	Cooling		141	201	247	298	344	403
	Heating		804	979	1,120	1,362	1,578	1,988
Moisture Removal			0.6	1.2	1.5	2.2	2.6	2.7
Sound Pressure Level	Indoor (Cooling)	H/M/L/Q	33/31/29/27	37/34/30/27	38/34/30/27	38/34/30/26	44/42/36/30	49/44/36/30
	Indoor (Heating)	H/M/L/Q	34/32/29/27	37/34/31/29	43/38/34/30	43/38/34/30	45/43/40/33	49/45/40/33
Sound Power Level	Outdoor (Cooling/Heating)	High	47/48	49/50	50/51	51/52	52/53	54/55
	Indoor (Cooling/Heating)	High	46/47	49/49	50/55	50/55	56/57	59/61
Sound Power Level	Outdoor (Cooling/Heating)	High	60/60	62/62	63/63	63/64	64/65	66/67
	Indoor/Outdoor (Cooling)	High	540/1,610	600/1,630	680/1,670	680/1,710	830/2,240	930/2,885
Airflow Rate	Indoor/Outdoor (Heating)	High	540/1,550	600/1,410	800/1,580	800/1,840	860/2,240	930/2,350
	Indoor	mm	245 × 570 × 570	245 × 570 × 570	245 × 570 × 570	245 × 570 × 570	245 × 570 × 570	245 × 570 × 570
Net Dimensions H x W x D	Outdoor	mm	541 × 663 × 290	541 × 663 × 290	542 × 799 × 290	542 × 799 × 290	632 × 799 × 290	632 × 799 × 290
	Indoor	kg	15	15	15	15	16	16
Weight	Outdoor	kg	23	25	32	33	36	38
	Connection Pipe Diameter (Liquid/Gas)	mm	6.35/9.52	6.35/9.52	6.35/9.52	6.35/12.70	6.35/12.70	6.35/12.70
Drain port Diameter (I.D./O.D.)		25/32	25/32	25/32	25/32	25/32	25/32	
Max. Pipe Length (Pre-Charge)		15 (15)	15 (15)	20 (15)	20 (15)	25 (15)	25 (20)	
Max. Height Difference		15	15	15	15	20	20	
Operating Range	Cooling	°CDB	-10 to 46	-10 to 46	-10 to 46	-10 to 46	-10 to 46	-10 to 46
	Heating	°CDB	-15 to 24	-15 to 24	-15 to 24	-15 to 24	-15 to 24	-15 to 24
Refrigerant	Type (Global Warming Potential)		R32 (675)	R32 (675)	R32 (675)	R32 (675)	R32 (675)	R32 (675)
	Charge	kg (CO2eq-T)	0.6 (0.405)	0.7 (0.473)	0.85 (0.574)	0.9 (0.608)	1.1 (0.743)	1.25 (0.844)
Cassette Grille	Model name		UTG-UFGF-W	UTG-UFGF-W	UTG-UFGF-W	UTG-UFGF-W	UTG-UFGF-W	UTG-UFGF-W
	Dimensions (H × W × D)	mm	49 × 620 × 620	49 × 620 × 620	49 × 620 × 620	49 × 620 × 620	49 × 620 × 620	49 × 620 × 620
Cassette Grille	Weight	kg	2.3	2.3	2.3	2.3	2.3	2.3

Circular Cassette (Slim type)



Model name	Indoor unit		AUXG18KRLB	AUXG22KRLB	AUXG24KRLB
	Outdoor unit		AOHG18KATA	AOHG22KATA	AOHG24KATA
Power Source			Single phase, ~230 V, 50 Hz		
Capacity	Cooling	Rated	5.2	6.0	6.8
		Min.-Max.	0.9-5.4	0.9-6.3	0.9-7.4
Capacity	Heating	Rated	6.0	7.0	7.5
		Min.-Max.	0.9-6.3	0.9-7.4	0.9-8.6
Input Power	Cooling/Heating		1.60/1.66	1.85/1.93	2.12/1.97
EER	Cooling		3.25	3.24	3.21
COP	Heating		3.61	3.63	3.81
Pdesign	Cooling/Heating (-10°C)		5.2/3.8	6.0/4.4	6.8/5.4
SEER	Cooling		6.2	6.2	6.1
SCOP	Heating		4.1	4.1	4.0
Energy Efficiency Class	Cooling		A++	A++	A++
Energy Efficiency Class	Heating		A+	A+	A+
Max. Operating Current	Cooling/Heating		10.1/10.1	11.6/11.6	12.6/12.6
Annual Energy Consumption	Cooling		293	338	390
	Heating		1,297	1,502	1,887
Moisture Removal			1.5	2.2	2.7
Sound Pressure Level	Indoor (Cooling)	H/M/L/Q	33/32/31/28	33/32/31/28	35/33/32/29
	Indoor (Heating)	H/M/L/Q	33/32/31/28	33/32/31/28	35/33/32/29
Sound Power Level	Outdoor (Cooling/Heating)	High	51/52	52/53	54/55
	Indoor (Cooling/Heating)	High	47/47	49/49	49/49
Sound Power Level	Outdoor (Cooling/Heating)	High	63/64	64/65	66/67
	Indoor/Outdoor (Cooling)	High	1,050/1,710	1,050/2,240	1,150/2,885
Airflow Rate	Indoor/Outdoor (Heating)	High	1,050/1,840	1,050/2,240	1,150/2,350
	Indoor	mm	246 × 840 × 840	246 × 840 × 840	246 × 840 × 840
Net Dimensions H x W x D	Outdoor	mm	542 × 799 × 290	632 × 799 × 290	632 × 799 × 290
	Indoor	kg	23	23	24
Weight	Outdoor	kg	33	36	38
	Connection Pipe Diameter (Liquid/Gas)	mm	6.35/12.70	6.35/12.70	6.35/12.70
Drain port Diameter (I.D./O.D.)		25/32	25/32	25/32	
Max. Pipe Length (Pre-Charge)		20 (15)	25 (15)	25 (20)	
Max. Height Difference		15	20	20	
Operating Range	Cooling	°CDB	-10 to 46	-10 to 46	-10 to 46
	Heating	°CDB	-15 to 24	-15 to 24	-15 to 24
Refrigerant	Type (Global Warming Potential)		R32 (675)	R32 (675)	R32 (675)
	Charge	kg (CO2eq-T)	0.9 (0.608)	1.1 (0.743)	1.25 (0.844)
Cassette Grille	Model name		UTG-UKGA-W: White wired remote controller (touch panel) UTG-UKGC-W: White/UTG-UKGA-B*1: Black		
	Dimensions (H × W × D)	mm	53 × 950 × 950	53 × 950 × 950	53 × 950 × 950
	Weight	kg	6.0	6.0	6.0

*1: IR Receiver kit and Human sensor kit cannot be connected.

Circular Cassette (Large type)



Model name	Indoor unit		AUXG30KRLB	AUXG36KRLB	AUXG45KRLB	AUXG54KRLB	AUXG36KRLB	AUXG45KRLB	AUXG54KRLB
	Outdoor unit		AOHG30KATA	AOHG36KATA	AOHG45KATA	AOHG54KATA	AOHG36KQTA	AOHG45KQTA	AOHG54KQTA
Power Source			Single phase, ~230 V, 50 Hz				3-phase, ~400 V, 50 Hz		
Capacity	Cooling	Rated	8.5	9.5	12.1	13.4	9.5	12.1	13.4
		Min.-Max.	2.8-9.6	2.8-10.6	4.0-12.6	4.5-13.8	2.8-10.6	4.0-12.6	4.5-13.8
Capacity	Heating	Rated	10.0	10.8	13.5	13.7	10.8	13.5	13.7
		Min.-Max.	2.7-10.8	2.7-12.5	4.2-15.0	4.7-16.0	2.7-12.5	4.2-15.0	4.7-16.0
Input Power	Cooling/Heating		2.56/2.64	3.06/2.58	4.32/3.77	4.87/4.86	3.06/2.58	4.32/3.77	4.87/4.86
EER	Cooling		3.32	3.10	2.80	2.75	3.10	2.80	2.75
COP	Heating		3.79	4.19	3.58	3.19	4.19	3.58	3.19
Pdesign	Cooling/Heating (-10°C)		8.5/8.0	9.5/8.7	-	-	9.5/8.7	-	-
SEER	Cooling		6.1	6.1	-	-	6.1	-	-
SCOP	Heating		4.0	4.0	-	-	4.0	-	-
Energy Efficiency Class	Cooling		A++	A++	-	-	A++	-	-
Energy Efficiency Class	Heating		A+	A+	-	-	A+	-	-
Max. Operating Current	Cooling/Heating		22.5/22.5	22.5/22.5	28.1/28.1	28.1/28.1	10.5/10.5	13.6/13.6	13.6/13.6
Annual Energy Consumption	Cooling		488	545	-	-	545	-	-
	Heating		2,794	3,044	-	-	3,044	-	-
Moisture Removal			2.5	3.3	4.5	5.0	3.3	4.5	5.0
Sound Pressure Level	Indoor (Cooling)	H/M/L/Q	40/38/36/33	44/41/38/34	46/42/39/35	47/43/40/36	44/41/38/34	46/42/39/35	47/43/40/36
	Indoor (Heating)	H/M/L/Q	40/38/36/33	44/41/38/34	46/42/39/35	47/43/40/36	44/41/38/34	46/42/39/35	47/43/40/36
Sound Power Level	Outdoor (Cooling/Heating)	High	53/55	55/55	58/59	58/61	55/55	60/60	61/61
	Indoor (Cooling/Heating)	High	54/54	58/58	60/60	61/61	58/58	-/-	-/-
Airflow Rate	Indoor/Outdoor (Cooling)	High	1,600/3,750	1,870/3,750	2,000/4,450	2,100/4,450	1,870/3,750	2,000/4,450	2,100/4,450
	Indoor/Outdoor (Heating)	High	1,600/3,750	1,870/3,750	2,000/4,450	2,100/4,780	1,870/3,750	2,000/4,450	2,100/4,780
Net Dimensions	Indoor	mm	288 × 840 × 840	288 × 840 × 840	288 × 840 × 840	288 × 840 × 840	288 × 840 × 840	288 × 840 × 840	288 × 840 × 840
H x W x D	Outdoor	mm	788 × 940 × 320	788 × 940 × 320	998 × 940 × 320	998 × 940 × 320	788 × 940 × 320	998 × 940 × 320	998 × 940 × 320
Weight	Indoor	kg	26	29	29	29	29	29	29
	Outdoor	kg	52	52	61	63	53	62	63
Connection Pipe Diameter (Liquid/Gas)			9.52/15.88	9.52/15.88	9.52/15.88	9.52/15.88	9.52/15.88	9.52/15.88	9.52/15.88
Drain port Diameter (I.D./O.D.)			25/32	25/32	25/32	25/32	25/32	25/32	25/32
Max. Pipe Length (Pre-Charge)			30 (30)	30 (30)	30 (30)	30 (30)	30 (30)	30 (30)	30 (30)
Max. Height Difference			30	30	30	30	30	30	30
Operating Range	Cooling		-10 to 46	-10 to 46	-10 to 46	-10 to 46	-10 to 46	-10 to 46	-10 to 46
	Heating		-15 to 24	-15 to 24	-15 to 24	-15 to 24	-15 to 24	-15 to 24	-15 to 24
Refrigerant	Type (Global Warming Potential)		R32 (675)	R32 (675)	R32 (675)	R32 (675)	R32 (675)	R32 (675)	R32 (675)
Refrigerant	Charge		1.90 (1.283)	1.90 (1.283)	2.4 (1.620)	2.4 (1.620)	1.90 (1.283)	2.4 (1.620)	2.4 (1.620)
Cassette Grille	Model name		UTG-UKGA-W: White wired remote controller (touch panel) UTG-UKGC-W: White/UTG-UKGA-B*1: Black						
	Dimensions (H × W × D)		53 × 950 × 950	53 × 950 × 950	53 × 950 × 950	53 × 950 × 950	53 × 950 × 950	53 × 950 × 950	53 × 950 × 950
	Weight		6.0	6.0	6.0	6.0	6.0	6.0	6.0

*1: IR Receiver kit and Human sensor kit cannot be connected.

Slim Duct

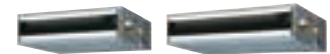

Model name	Indoor unit		ARXG09KLLAP	ARXG12KLLAP	ARXG14KLLAP	ARXG18KLLAP
	Outdoor unit		AOHG09KATA	AOHG12KATA	AOHG14KATA	AOHG18KATA
Power Source			Single phase, ~230 V, 50 Hz			
Capacity	Cooling	Rated	2.5	3.5	4.3	5.2
		Min.-Max.	0.9-2.7	0.9-3.7	0.9-4.5	0.9-5.4
Capacity	Heating	Rated	3.2	4.1	5.0	6.0
		Min.-Max.	0.9-3.9	0.9-4.4	0.9-5.3	0.9-6.3
Input Power	Cooling/Heating		0.69/0.88	1.09/1.17	1.37/1.42	1.66/1.71
EER	Cooling		3.62	3.21	3.14	3.13
COP	Heating		3.64	3.50	3.52	3.51
Pdesign	Cooling/Heating (-10°C)		2.5/2.3	3.5/2.8	4.3/3.2	5.2/3.8
SEER	Cooling		5.9	5.8	5.6	5.8
SCOP	Heating		3.8	3.8	3.8	3.8
Energy Efficiency Class	Cooling		A+	A+	A+	A+
Energy Efficiency Class	Heating		A	A	A	A
Max. Operating Current	Cooling/Heating		6.9/6.9	7.7/7.7	9.2/9.2	10.1/10.1
Annual Energy Consumption	Cooling		148	211	269	313
	Heating		847	1,031	1,177	1,398
Moisture Removal			0.7	1.3	1.5	2.0
Sound Pressure Level	Indoor (Cooling)	H/M/L/Q	28/27/26/25	29/28/26/25	32/30/28/26	32/30/29/27
	Indoor (Heating)	H/M/L/Q	28/26/25/24	29/28/26/24	32/30/28/25	32/30/29/27
Sound Power Level	Outdoor (Cooling/Heating)	High	47/48	49/50	50/51	51/52
	Indoor (Cooling/Heating)	High	57/57	58/58	60/60	58/58
Airflow Rate	Indoor/Outdoor (Cooling)	High	600/1,610	650/1,630	800/1,670	940/1,710
	Indoor/Outdoor (Heating)	High	600/1,550	650/1,410	800/1,580	940/1,840
Static pressure range (Standard)			0 to 90 (25)	0 to 90 (25)	0 to 90 (25)	0 to 90 (25)
Net Dimensions	Indoor	mm	198 × 700 × 620	198 × 700 × 620	198 × 700 × 620	198 × 900 × 620
H x W x D	Outdoor	mm	541 × 663 × 290	541 × 663 × 290	542 × 799 × 290	542 × 799 × 290
Weight	Indoor	kg	17	17	17	20
	Outdoor	kg	23	25	32	33
Connection Pipe Diameter (Liquid/Gas)			6.35/9.52	6.35/9.52	6.35/9.52	6.35/12.70
Drain port Diameter (I.D./O.D.)			25/32	25/32	25/32	25/32
Max. Pipe Length (Pre-Charge)			15 (15)	15 (15)	20 (15)	20 (15)
Max. Height Difference			15	15	15	15
Operating Range	Cooling		-10 to 46	-10 to 46	-10 to 46	-10 to 46
	Heating		-15 to 24	-15 to 24	-15 to 24	-15 to 24
Refrigerant	Type (Global Warming Potential)		R32 (675)	R32 (675)	R32 (675)	R32 (675)
Refrigerant	Charge		0.6 (0.405)	0.7 (0.473)	0.85 (0.574)	0.9 (0.608)

Medium Static Pressure Duct (High-Efficiency & Comfort)



Model name	Indoor unit		ARXH12KMTAP	ARXH14KMTAP	ARXH18KMTAP	ARXH22KMTAP	ARXH24KMTAP	
	Outdoor unit		AOHG12KATA	AOHG14KATA	AOHG18KATA	AOHG22KATA	AOHG24KATA	
Power Source			Single phase, ~230 V, 50 Hz					
Capacity	Cooling	Rated	3.5	4.3	5.2	6.0	6.8	
		Min.-Max.	0.9-3.7	0.9-4.5	0.9-5.4	0.9-6.3	0.9-7.4	
	Heating	Rated	4.1	5.0	6.0	7.0	7.5	
		Min.-Max.	0.9-4.4	0.9-5.3	0.9-6.3	0.9-7.4	0.9-8.6	
Input Power	Cooling/Heating		1.060 / 1.170	1.340 / 1.420	1.730 / 1.820	1.85 / 1.97	2.06 / 1.97	
EER	Cooling		3.30	3.21	3.00	3.24	3.30	
COP	Heating		3.50	3.52	3.30	3.55	3.81	
Pdesign	Cooling/Heating (-10°C)		3.5 / 2.8	4.3 / 3.2	5.2 / 3.8	6.0 / 4.4	6.8 / 5.4	
SEER	Cooling		6.00	5.80	5.90	6.00	6.00	
SCOP	Heating (Average)		3.90	3.90	3.90	3.90	3.90	
Energy Efficiency Class	Cooling		A+	A+	A+	A+	A+	
	Heating (Average)		A	A	A	A	A	
Max. Operating Current	Cooling/Heating		7.7 / 7.7	9.2 / 9.2	10.1 / 10.1	11.6 / 11.6	12.6 / 12.6	
Annual Energy Consumption	Cooling		212	267	316	358	405	
	Heating		1,005	1,148	1,363	1,578	1,936	
Moisture Removal			1.3	1.3	2.0	1.5	2.2	
Sound Pressure Level	Indoor (Cooling)	H/M/L/Q	29 / 27 / 25 / 23	32 / 29 / 27 / 25	33 / 30 / 28 / 26	32 / 28 / 25 / 24	34 / 30 / 28 / 26	
	Indoor (Heating)	H/M/L/Q	29 / 27 / 25 / 23	32 / 29 / 27 / 25	33 / 30 / 28 / 26	32 / 28 / 25 / 24	34 / 30 / 28 / 26	
Sound Power Level	Outdoor (Cooling/Heating)	High	49 / 50	50 / 51	51 / 52	52 / 53	54 / 55	
	Indoor (Cooling/Heating)	High	58 / 58	59 / 59	60 / 60	58 / 58	60 / 60	
Airflow Rate	Indoor/Outdoor (Cooling)	High	650 / 1,630	800 / 1,670	840 / 1,710	1,150 / 2,240	1,230 / 2,885	
	Indoor/Outdoor (Heating)	High	650 / 1,410	800 / 1,580	840 / 1,840	1,150 / 2,240	1,230 / 2,350	
Static pressure range (Standard)			Pa	30 to 150 (40)	30 to 150 (40)	30 to 150 (40)	30 to 150 (50)	
Net Dimensions H x W x D	Indoor		mm	240 × 700 × 700	240 × 700 × 700	240 × 700 × 700	240 × 1,000 × 700	
	Outdoor		mm	541 × 663 × 290	542 × 799 × 290	542 × 799 × 290	632 × 799 × 290	
Weight	Indoor		kg	24	24	24	31	
	Outdoor		kg	25	32	33	36	
Connection Pipe Diameter (Liquid/Gas)			mm	6.35 / 9.52	6.35 / 9.52	6.35 / 12.7	6.35 / 12.70	
Drain Hose Diameter (I.D./O.D.)			mm	25 / 32	25 / 32	25 / 32	25 / 32	
Max. Pipe Length (Pre-Charge)			m	15 (15)	20 (15)	20 (15)	25 (15)	
Max. Height Difference				15	15	15	20	
Operating Range	Cooling		°CDB	-10 to 46	-10 to 46	-10 to 46	-10 to 46	
	Heating		°CDB	-15 to 24	-15 to 24	-15 to 24	-15 to 24	
Refrigerant	Type (Global Warming Potential)			R32 (675)	R32 (675)	R32 (675)	R32 (675)	
	Charge	kg (CO2eq-T)		0.70 (0.473)	0.85 (0.574)	0.90 (0.608)	1.10 (0.743)	

Medium Static Pressure Duct (High-Efficiency & Comfort)



Model name	Indoor unit		ARXH30KMTAP	ARXH36KMTAP	ARXH45KMTAP	ARXH36KMTAP	ARXH45KMTAP
	Outdoor unit		AOHG30KATA	AOHG36KATA	AOHG45KATA	AOHG36KQTA	AOHG45KQTA
Power Source			Single phase, ~230 V, 50 Hz			3-phase, ~400 V, 50 Hz	
Capacity	Cooling	Rated	8.5	9.5	12.1	9.5	12.1
		Min.-Max.	2.8-9.6	2.8-10.6	4.0-12.6	2.8-10.6	4.0-12.6
	Heating	Rated	10.0	10.8	13.5	10.8	13.5
		Min.-Max.	2.7-10.8	2.7-12.5	4.2-15.0	2.7-12.5	4.2-15.0
Input Power	Cooling/Heating		2.69 / 2.63	3.13 / 2.88	4.84 / 4.18	3.13 / 2.88	4.84 / 4.18
EER	Cooling		3.16	3.04	2.50	3.04	2.50
COP	Heating		3.80	3.75	3.23	3.75	3.23
Pdesign	Cooling/Heating (-10°C)		8.5 / 8.0	9.5 / 8.7	-	9.5 / 8.7	-
SEER	Cooling		5.80	5.60	-	5.60	-
SCOP	Heating (Average)		3.90	3.90	-	3.90	-
Energy Efficiency Class	Cooling		A+	A+	-	A+	-
	Heating (Average)		A	A	-	A	-
Max. Operating Current	Cooling/Heating		A	22.5 / 22.5	28.1 / 28.1	10.5 / 10.5	13.6 / 13.6
Annual Energy Consumption	Cooling		520	601	-	601	-
	Heating		2,867	3,118	-	3,118	-
Moisture Removal			1.8	2.0	4.0	2.0	4.0
Sound Pressure Level	Indoor (Cooling)	H/M/L/Q	38 / 34 / 31 / 28	38 / 34 / 31 / 28	40 / 36 / 32 / 29	38 / 34 / 31 / 28	40 / 36 / 32 / 29
	Indoor (Heating)	H/M/L/Q	38 / 34 / 31 / 28	38 / 34 / 31 / 28	40 / 36 / 32 / 29	38 / 34 / 31 / 28	40 / 36 / 32 / 29
Sound Power Level	Outdoor (Cooling/Heating)	High	53 / 55	55 / 55	58 / 59	55 / 55	58 / 59
	Indoor (Cooling/Heating)	High	64 / 64	65 / 65	67 / 67	65 / 65	67 / 67
Airflow Rate	Indoor/Outdoor (Cooling)	High	1,950 / 3,750	2,070 / 3,750	2,160 / 4,450	2,070 / 3,750	2,160 / 4,450
	Indoor/Outdoor (Heating)	High	1,950 / 3,750	2,070 / 3,750	2,160 / 4,450	2,070 / 3,750	2,160 / 4,450
Static pressure range (Standard)			Pa	30 to 150 (50)	30 to 150 (50)	30 to 150 (50)	30 to 150 (60)
Net Dimensions H x W x D	Indoor		mm	240 × 1,400 × 700	240 × 1,400 × 700	240 × 1,400 × 700	240 × 1,400 × 700
	Outdoor		mm	788 × 940 × 320	788 × 940 × 320	998 × 940 × 320	788 × 940 × 320
Weight	Indoor		kg	42	42	42	42
	Outdoor		kg	52	52	61	53
Connection Pipe Diameter (Liquid/Gas)			mm	9.52 / 15.88	9.52 / 15.88	9.52 / 15.88	9.52 / 15.88
Drain Hose Diameter (I.D./O.D.)			mm	25 / 32	25 / 32	25 / 32	25 / 32
Max. Pipe Length (Pre-Charge)			m	30 (30)	30 (30)	30 (30)	30 (30)
Max. Height Difference				30	30	30	30
Operating Range	Cooling		°CDB	-10 to 46	-10 to 46	-10 to 46	-10 to 46
	Heating		°CDB	-15 to 24	-15 to 24	-15 to 24	-15 to 24
Refrigerant	Type (Global Warming Potential)			R32 (675)	R32 (675)	R32 (675)	R32 (675)
	Charge	kg (CO2eq-T)		1.90 (1.283)	1.90 (1.283)	2.40 (1.620)	1.90 (1.283)

Medium Static Pressure Duct (Standard)















































Model name	Indoor unit			ARXG22KMLB	ARXG24KMLA	ARXG30KMLA	ARXG36KMLA	ARXG45KMLA	ARXG36KMLA	ARXG45KMLA	
	Outdoor unit			AOHG22KATA	AOHG24KATA	AOHG30KATA	AOHG36KATA	AOHG45KATA	AOHG36KQTA	AOHG45KQTA	
Power Source				Single phase, ~230 V, 50 Hz					3-phase, ~400 V, 50 Hz		
Capacity	Cooling	Rated	kW	6.0	6.8	8.5	9.5	12.1	9.5	12.1	
		Min.-Max.		0.9-6.3	0.9-7.4	2.8-9.6	2.8-10.6	4.0-12.6	2.8-10.6	4.0-12.6	
	Rated	7.0		7.5	10.0	10.8	13.5	10.8	13.5		
	Min.-Max.	0.9-7.4		0.9-8.6	2.7-10.8	2.7-12.5	4.2-15.0	2.7-12.5	4.2-15.0		
Input Power	Cooling/Heating		kW	1.92/2.00	2.19/2.00	2.78/2.77	3.13/3.03	4.84/4.18	3.13/3.03	4.84/4.18	
	Cooling			W/W	3.13	3.11	3.06	3.04	2.50	3.04	2.50
EER	Cooling		W/W		3.50	3.75	3.61	3.56	3.23	3.56	3.23
	Heating			kW	6.0/4.4	6.8/5.4	8.5/8.0	9.5/8.7	-	9.5/8.7	-
COP	Cooling/Heating (-10°C)		W/W		5.8	5.9	5.8	5.6	-	5.6	-
	Cooling			W/W	3.8	3.9	3.9	3.9	-	3.9	-
Pdesign	Cooling/Heating (-10°C)		kW		6.0/4.4	6.8/5.4	8.5/8.0	9.5/8.7	-	9.5/8.7	-
	Cooling			W/W	5.8	5.9	5.8	5.6	-	5.6	-
SEER	Cooling		W/W		3.8	3.9	3.9	3.9	-	3.9	-
	Heating			W/W	3.8	3.9	3.9	3.9	-	3.9	-
SCOP	Cooling		W/W		5.8	5.9	5.8	5.6	-	5.6	-
	Heating			W/W	3.8	3.9	3.9	3.9	-	3.9	-
Energy Efficiency Class	Cooling		W/W		A+	A+	A+	A+	-	A+	-
	Heating			W/W	A	A	A	A	-	A	-
Max. Operating Current	Cooling/Heating		A		11.6/11.6	12.6/12.6	22.5/22.5	22.5/22.5	28.1/28.1	10.5/10.5	13.6/13.6
	Cooling			kWh/a	362	403	513	594	-	594	-
Annual Energy Consumption	Cooling		kWh/a		1,620	1,935	2,871	3,122	-	3,122	-
	Heating			kWh/a	1,620	1,935	2,871	3,122	-	3,122	-
Moisture Removal	Cooling		l/h		2.1	2.5	2.5	3.0	4.0	3.0	4.0
	Heating			l/h	2.1	2.5	2.5	3.0	4.0	3.0	4.0
Sound Pressure Level	Indoor (Cooling)	H/M/L/Q	dB(A)		31/29/27/25	31/29/27/25	39/35/30/26	39/35/30/26	42/38/32/28	39/35/30/26	42/38/32/28
		H/M/L/Q		31/29/27/25	31/29/27/25	42/35/30/26	42/35/30/26	42/38/32/28	42/35/30/26	42/38/32/28	
	High	52/53		54/55	53/55	55/55	58/59	55/55	58/59		
	High	60/62		60/62	65/69	65/70	68/70	65/70	68/70		
Sound Power Level	Indoor (Cooling/Heating)	High	dB(A)	64/65	66/67	68/69	70/70	72/73	70/70	72/73	
		High		60/62	60/62	65/69	65/70	68/70	65/70	68/70	
	High	64/65		66/67	68/69	70/70	72/73	70/70	72/73		
	High	60/62		60/62	65/69	65/70	68/70	65/70	68/70		
Airflow Rate	Indoor/Outdoor (Cooling)	High	m³/h	1,100/2,240	1,100/2,885	1,900/3,750	1,900/3,750	2,100/4,450	1,900/3,750	2,100/4,450	
	Indoor/Outdoor (Heating)	High		1,100/2,240	1,100/2,350	2,100/3,750	2,100/3,750	2,100/4,450	2,100/3,750	2,100/4,450	
Static pressure range (Standard)	Cooling		Pa	30 - 150 (35)	30 - 150 (35)	30 - 150 (47)	30 - 150 (47)	30 - 150 (60)	30 - 150 (47)	30 - 150 (60)	
	Heating			Pa	30 - 150 (35)	30 - 150 (35)	30 - 150 (47)	30 - 150 (47)	30 - 150 (60)	30 - 150 (47)	30 - 150 (60)
Net Dimensions H x W x D	Indoor		mm		270 × 1,135 × 700	270 × 1,135 × 700	270 × 1,135 × 700	270 × 1,135 × 700	270 × 1,135 × 700	270 × 1,135 × 700	270 × 1,135 × 700
	Outdoor			mm	632 × 799 × 290	632 × 799 × 290	788 × 940 × 320	788 × 940 × 320	998 × 940 × 320	788 × 940 × 320	998 × 940 × 320
Weight	Indoor		kg		35	35	38	38	39	38	39
	Outdoor			kg	36	38	52	52	61	53	62
Connection Pipe Diameter (Liquid/Gas)					mm	6.35/12.70	6.35/12.70	9.52/15.88	9.52/15.88	9.52/15.88	9.52/15.88
Drain port Diameter (I.D./O.D.)				mm		25/32	25/32	25/32	25/32	25/32	25/32
Max. Pipe Length (Pre-Charge)					m	25 (15)	25 (20)	30 (30)	30 (30)	30 (30)	30 (30)
Max. Height Difference				m		20	20	30	30	30	30
Operating Range	Cooling		°CDB		-10 to 46	-10 to 46	-10 to 46	-10 to 46	-10 to 46	-10 to 46	-10 to 46
	Heating			°CDB	-15 to 24	-15 to 24	-15 to 24	-15 to 24	-15 to 24	-15 to 24	-15 to 24
Refrigerant	Type (Global Warming Potential)				kg (CO2eq-T)	R32 (675)	R32 (675)	R32 (675)	R32 (675)	R32 (675)	R32 (675)
	Charge			kg (CO2eq-T)		1.1 (0.743)	1.25 (0.844)	1.90 (1.283)	1.90 (1.283)	2.4 (1.620)	1.9 (1.283)

Ceiling













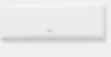

Model name	Indoor unit			ABHG18KRTA	ABHG22KRTA	ABHG24KRTA	ABHG30KRTA	ABHG36KRTA	ABHG45KRTA	ABHG36KRTA	ABHG45KRTA
	Outdoor unit			AOHG18KATA	AOHG22KATA	AOHG24KATA	AOHG30KATA	AOHG36KATA	AOHG45KATA	AOHG36KQTA	AOHG45KQTA
Power Source				Single phase, ~230 V, 50 Hz					3-phase, ~400 V, 50 Hz		
Capacity	Cooling	Rated	kW	5.2	6.0	6.8	8.5	9.5	12.1	9.5	12.1
		Min.-Max.		0.9-5.4	0.9-6.3	0.9-7.4	2.8-9.6	2.8-10.6	4.0-12.6	2.8-10.6	4.0-12.6
	Rated	6.0		7.0	7.5	10.0	10.8	13.5	10.8	13.5	
	Min.-Max.	0.9-6.3		0.9-7.4	0.9-8.6	2.7-10.8	2.7-12.5	4.2-15.0	2.7-12.5	4.2-15.0	
Input Power	Cooling/Heating		kW	1.66/1.71	1.95/2.09	2.19/2.00	2.78/2.86	3.13/3.03	4.84/4.18	3.13/3.03	4.84/4.18
	Cooling			W/W	3.13	3.08	3.11	3.06	3.04	2.50	3.04
EER	Cooling		W/W		3.51	3.35	3.75	3.5	3.56	3.23	3.56
	Heating			kW	5.2/3.8	6.0/4.4	6.8/5.4	8.5/8.0	9.5/8.7	-	9.5/8.7
COP	Cooling/Heating (-10°C)		W/W		5.8	5.6	6.0	5.8	5.6	-	5.6
	Cooling			W/W	3.8	3.8	3.9	3.9	3.9	-	3.9
Pdesign	Cooling/Heating (-10°C)		kW		5.2/3.8	6.0/4.4	6.8/5.4	8.5/8.0	9.5/8.7	-	9.5/8.7
	Cooling			W/W	5.8	5.6	6.0	5.8	5.6	-	5.6
SEER	Cooling		W/W		3.8	3.8	3.9	3.9	3.9	-	3.9
	Heating			W/W	3.8	3.8	3.9	3.9	3.9	-	3.9
SCOP	Cooling		W/W		5.8	5.6	6.0	5.8	5.6	-	5.6
	Heating			W/W	3.8	3.8	3.9	3.9	3.9	-	3.9
Energy Efficiency Class	Cooling		W/W		A+	A+	A+	A+	A+	-	A+
	Heating			W/W	A	A	A	A	A	-	A
Max. Operating Current	Cooling/Heating		A		10.1/10.1	11.6/11.6	12.6/12.6	22.5/22.5	22.5/22.5	28.1/28.1	10.5/10.5
	Cooling			kWh/a	538	375	679	512	594	-	594
Annual Energy Consumption	Cooling		kWh/a		1,398	1,618	1,935	2,871	3,117	-	3,117
	Heating			kWh/a	1,398	1,618	1,935	2,871	3,117	-	3,117
Moisture Removal	Cooling		l/h		2.0	2.5	2.2	3.0	2.6	4.5	2.6
	Heating			l/h	2.0	2.5	2.2	3.0	2.6	4.5	2.6
Sound Pressure Level	Indoor (Cooling)	H/M/L/Q	dB(A)		38/36/33/31	42/37/34/31	41/36/32/29	45/40/35/32	44/40/37/32	45/41/39/34	44/40/37/32
		H/M/L/Q		38/36/33/31	42/37/34/31	41/36/32/29	45/40/35/32	44/40/37/32	45/41/39/34	44/40/37/32	45/41/39/34
	High	51/52		52/53	54/55	53/55	55/55	58/59	55/55	58/59	
	High	63/64		64/65	66/67	68/69	70/70	72/73	70/70	72/73	
Sound Power Level	Indoor (Cooling/Heating)	High	dB(A)	63/64	64/65	66/67	68/69	70/70	72/73	70/70	72/73
		High		53/53	57/57	56/56	60/60	59/59	60/60	59/59	60/60
	High	63/64		64/65	66/67	68/69	70/70	72/73	70/70	72/73	
	High	53/53		57/57	56/56	60/60	59/59	60/60	59/59	60/60	
Airflow Rate	Indoor/Outdoor (Cooling)	High	m³/h	840/1,710	900/2,240	1,230/2,885	1,400/3,750	1,850/3,750	1,900/4,450	1,850/3,750	1,900/4,450
	Indoor/Outdoor (Heating)	High		840/1,840	900/2,240	1,230/2,350	1,400/3,750	1,800/3,750	1,850/4,450	1,800/3,750	1,850/4,450
Net Dimensions H x W x D	Indoor		mm	235 × 1,080 × 705	235 × 1,080 × 705	235 × 1,390 × 705	235 × 1,390 × 705	235 × 1,700 × 705	235 × 1,700 × 705	235 × 1,700 × 705	235 × 1,700 × 705
	Outdoor			mm	542 × 799 × 290	632 × 799 × 290	632 × 799 × 290	788 × 940 × 320	788 × 940 × 320	988 × 940 × 320	788 × 940 × 320
Weight	Indoor		kg		24	24	31	31	38	38	38
	Outdoor			kg	33	36	38	52	52	61	53
Connection Pipe Diameter (Liquid/Gas)					mm	6.35/12.7	6.35/12.7	6.35/12.7	9.52/15.88	9.52/15.88	9.52/15.88
Drain port Diameter (I.D./O.D.)				mm		25/32	25/32	25/32	25/32	25/32	25/32
Max. Pipe Length (Pre-Charge)					m	20 (15)	25 (15)	25 (20)	30 (30)	30 (30)	30 (30)
Max. Height Difference				m		15	20	20	30	30	30
Operating Range	Cooling		°CDB		-10 to 46	-10 to 46	-10 to 46	-10 to 46	-10 to 46	-10 to 46	-10 to 46
	Heating			°CDB	-15 to 24	-15 to 24	-15 to 24	-15 to 24	-15 to 24	-15 to 24	-15 to 24
Refrigerant	Type (Global Warming Potential)				kg (CO2eq-T)	R32 (675)	R32 (675)	R32 (675)	R32 (675)	R32 (675)	R32 (675)
	Charge			kg (CO2eq-T)		0.9 (0.608)	1.1 (0.743)	1.25 (0.844)	1.90 (1.283)	1.90 (1.283)	2.40 (1.620)

Feature Summary

Type		Wall-mounted type		
Series		Designer Range		Standard Range
				 
Model name		ASHH07/09/12/14KGTG, ASHG07/09/12/14KGTG, ASHG07/09/12/14KGTGTE	ASHG07/09/12/14KETF ASHG07/09/12/14KETF-B, ASHG07/09/12/14KETE ASHG07/09/12/14KETE-B	ASHH07/09/12/14KMCG, ASHH07/09/12/14KMCG-B, ASHG07/09/12/14KMCF, ASHG07/09/12/14KMCE
				
Energy-Saving Features	 Save Human sensor	<input checked="" type="checkbox"/>		
	 Human sensor control			
	 Economy operation	<input checked="" type="checkbox"/>	<input checked="" type="checkbox"/>	<input checked="" type="checkbox"/>
	 Setting temperature range limitation	<input type="checkbox"/>	<input type="checkbox"/>	<input type="checkbox"/>
	 Set temperature auto return	<input type="checkbox"/>	<input type="checkbox"/>	<input type="checkbox"/>
Features for Comfort	 Power diffuser			
	 Powerful operation	<input checked="" type="checkbox"/>	<input checked="" type="checkbox"/>	<input checked="" type="checkbox"/>
	 10°C Heat	<input checked="" type="checkbox"/>	<input checked="" type="checkbox"/>	<input checked="" type="checkbox"/>
	 Outdoor unit low noise operation	<input checked="" type="checkbox"/>	<input checked="" type="checkbox"/>	<input checked="" type="checkbox"/>
	 Auto changeover	<input checked="" type="checkbox"/>	<input checked="" type="checkbox"/>	<input checked="" type="checkbox"/>
	 UP/DOWN swing louver	<input checked="" type="checkbox"/>	<input checked="" type="checkbox"/>	<input checked="" type="checkbox"/>
	 Double swing automatic			
	 Automatic fan speed	<input checked="" type="checkbox"/>	<input checked="" type="checkbox"/>	<input checked="" type="checkbox"/>
	 Auto restart	<input checked="" type="checkbox"/>	<input checked="" type="checkbox"/>	<input checked="" type="checkbox"/>
	 Connectable fresh air duct			
	 Fresh air intake			
	 Connectable distributing duct			
	 Individual airflow direction control			
Convenience Features	 Auto-off timer	<input type="checkbox"/>	<input type="checkbox"/>	<input type="checkbox"/>
	 Sleep timer	<input checked="" type="checkbox"/>	<input checked="" type="checkbox"/>	<input checked="" type="checkbox"/>
	 Program timer	<input checked="" type="checkbox"/>	<input checked="" type="checkbox"/>	<input checked="" type="checkbox"/>
	 Weekly timer	<input checked="" type="checkbox"/>	<input checked="" type="checkbox"/>	<input type="checkbox"/>
	 Weekly & Temperature setback timer	<input type="checkbox"/>	<input type="checkbox"/>	<input type="checkbox"/>
	 Filter sign	<input checked="" type="checkbox"/>	<input checked="" type="checkbox"/>	<input checked="" type="checkbox"/>
	 External error output	<input type="checkbox"/>	<input type="checkbox"/>	<input type="checkbox"/>
	 External ON/OFF input	<input type="checkbox"/>	<input type="checkbox"/>	<input type="checkbox"/>
	 Wireless LAN control	<input checked="" type="checkbox"/> (KGTG, KGTG) <input type="checkbox"/> (KGTE)	<input checked="" type="checkbox"/> (KETF, KETF-B) <input type="checkbox"/> (KETE, KETE-B)	<input checked="" type="checkbox"/> (KMCF, KMCG, KMCG-B) <input type="checkbox"/> (KMCE)
	 Multi system control			
 Special cooling				
Clean Features	 Ion deodorization filter	<input checked="" type="checkbox"/>	<input checked="" type="checkbox"/>	<input checked="" type="checkbox"/>
	 Apple-catechin filter	<input checked="" type="checkbox"/>	<input checked="" type="checkbox"/>	<input checked="" type="checkbox"/>
	 Long-life filter			
	 Washable panel	<input checked="" type="checkbox"/>	<input checked="" type="checkbox"/>	<input checked="" type="checkbox"/>
	 Silver Ion Filter	<input type="checkbox"/>	<input type="checkbox"/>	<input type="checkbox"/>
Installation/Support	 Automatic airflow adjustment			
	 Drain pump as standard			
	 Blue fin			
	 Refrigerant cycle monitor	<input type="checkbox"/> (KGTG)		<input type="checkbox"/> (KMCG, KMCG-B)

*1 For details of Multi System Control function, refer to C-013. *2 Wired remote controller (UTY-RNRGZ5) is required to use Special Cooling function.

Wall-mounted type					
Standard Range		ECO Range			
					
ASHG18/24KMTE	ASHH30/36KMTB	ASHH07/09/12KNCA	ASHG07/09/12KPCE	ASHG18/24KLCA	ASHH07/09/12KLTA
					
	●				
●	●	●	●	●	●
○	○				
○	○				
●	●	●	●	●	●
●	●	●			
●	●				
●	●	●	●	●	●
●	●	●	●	●	●
●	●	●	●	●	●
●	●	●	●	●	●
●	●	●	●	●	●
○	○				
●	●	●	●	●	●
●	●	●	●	●	●
●	●	● ^{*3}			
○	○				
●	●	●	●	●	●
○	○				
○	○				
○	○	●	○		○
	○				
	● ^{*2}				
●	●				
●	●				
●	●	●	●	●	●
○	○	○	○	○	○
	●	●			●
	○	○			○

*3: It is only available on the AIRSTAGE Mobile application and wired remote controller. It can not be used via wireless remote controller.

○: Optional function

Feature Summary

Type	Cassette		Duct			
Series	Compact 4-way Flow Series	Circular Flow Series	Slim (With drain pump)	Medium Static Pressure (High-Efficiency & Comfort)	Medium Static Pressure (Compact size)	
Model name	AUXG 09/12/14/18/22/24 KVLA	AUXG 18/22/24/30/36/45/54 KRLB	ARXG 09/12/14/18 KLLAP	ARXH 12/14/18/22/24/ 30/36/45/54 KMTAP	ARXG 12/14/18/22/ 24/30/36/45/54 KHTAP	
Energy-Saving Features	Save Human sensor					
	Human sensor control		○			
	Economy operation	●	●	○	●	
	Setting temperature range limitation	○	●	○	○	●
	Set temperature auto return	●	●	●	○	●
Features for Comfort	Power diffuser					
	Powerful operation					
	10°C Heat	●	○	○	○	○
	Outdoor unit low noise operation		○ (45/54)			○ (45/54)
	Auto changeover	●	●	●	●	●
	UP/DOWN swing louver	●	●	○		
	Double swing automatic					
	Automatic fan speed	●	●	●	●	●
	Auto restart	●	●	●	●	●
	Connectable fresh air duct		●		●	●
	Fresh air intake	○	○	○	○	○
	Connectable distributing duct		●			
	Individual airflow direction control		●			
Convenience Features	Auto-off timer	●	●	●	●	●
	Sleep timer	●	○	○	○	○
	Program timer	●	○	○	●	○
	Weekly timer	●	●	●	○	●
	Weekly & Temperature setback timer	○		●		
	Filter sign	●	●	●	●	●
	External error output		○		●	○
	External ON/OFF input	●	●	●	●	●
	Wireless LAN control	○	○	○	○	○
	Multi system control					
Special cooling						
Clean Features	Ion deodorization filter					
	Apple-catechin filter					
	Long-life filter			○	○	
	Washable panel					
Installation/Support	Silver Ion Filter	○	○	○	○	
	Automatic airflow adjustment				●	●
	Drain pump as standard	●	●	●	●	●
	Blue fin		● (30/36/45/54)		● (30/36/45/54)	● (30/36/45/54)
Refrigerant cycle monitor				○		

*1 For details of Multi System Control function, refer to C-013. *2 Wired remote controller (UTY-RNRGZ5) is required to use Special Cooling function.

Medium Static Pressure (Standard)	Duct			Floor	Ceiling
	High Static Pressure		Big		
ARXG22KMLB ARXG24/30/36/45KMLA	ARXG45/54KHTB	ARHG60LHTA	ARHG72/90LHTA	AGHG09/12/14KVCA	ABHG 18/22/24/30/36/45/54 KRTA
●	●	●	●	●	●
○	○	○	●	○	●
●	○	○	●	○	●
				●	
○	○	○	○	●	○
○ (45) (36/MLA)		○	○	●	○
●	●	●	●	●	●
				●	●
●	●	●	●	●	●
●	●	●	●	●	●
○	○	○	○		○
●					
●	●	○	●	○	●
○	○	○	○	●	○
○	○	○	○	●	○
●	●		●	●	●
●	●	●	●	●	●
●	●	●	●	●	●
●	○		○	○	○
●	●	○	●	○	●
○	○	○	○	○	○
				●	
				●	
○	○	○	○		
○	○		○	○	
○			●		
○			○		○
● (30/36/45)	●	●	●		● (30/36/45/54)

*3: It is only available on the AIRSTAGE Mobile application and wired remote controller. It can not be used via wireless remote controller.

○: Optional function



Light Commercial & Residential MULTI-SPLIT

- M-002 Multi-split Overview
- M-004 Multi-split Outdoor Units Lineup
- M-006 2-unit to 5-unit Multi-split Connectable Indoor Units
- M-008 6-unit Multi-split Connectable Indoor Units
- M-010 Simultaneous Multi-split Connectable Indoor Units
- M-044 Feature Summary



Refrigerant type R32 models

- M-012 2-unit to 5-unit Multi-split
 - M-018 Simultaneous Multi-split Twin/Triple
-
- M-022 2-unit to 5-unit Multi-split Indoor Units Specifications
-
- M-028 2-unit to 5-unit Multi-split Combination Table



Refrigerant type R410A models

- M-016 6-unit Multi-split
 - M-020 Simultaneous Multi-split Twin/Triple/Double Twin
-
- M-026 6-unit Multi-split Indoor Units Specifications
-
- M-038 6-unit Multi-split Combination Table





A single outdoor unit drives multiple indoor units, offering greater flexibility in system configuration.

If you wish to keep an entire floor or two or more rooms comfortable, we recommend you choose a multi-split air conditioning system with a single outdoor unit. Choose one that meets your air conditioning requirements from the variety of models we offer. You can mix and match indoor and outdoor units as you wish to build the system that best suits your needs.

Multi-split Overview

Multi-split's space-saving outdoor unit allows for connections of up to eight indoor units for multiple rooms. Added to the lineup are models compatible with the new R32 refrigerant, offering environmentally friendly comfort in homes, offices, stores, and various other settings.



3-unit, 4-unit, 5-unit Multi-split Types



3-unit 18/24 class



4-unit 30 class
5-unit 36 class



2-unit Multi-split



14 class



18 class

2-unit to 6-unit Multi-split

Recommended for residences, offices, and other situations where multiple rooms require air conditioning. Each of the 2 to 6 connected indoor units can also be operated individually. Operation control, time scheduling for each room, and energy-saving options can be set on both individual and central remote controllers. The outdoor unit is designed to save space and is flexible enough to be installed on a balcony or underneath a waist-high window.

6-unit Multi-split



6-unit 45 class

Twin / Triple



Twin 36 class
(Single-phase/3-phase)



Twin/Triple 45/54 class
(Single-phase/3-phase)



Twin / Triple / Double Twin











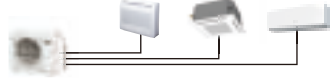
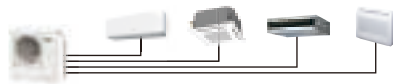
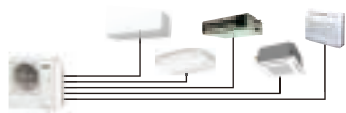

72/90 class
(3-phase)

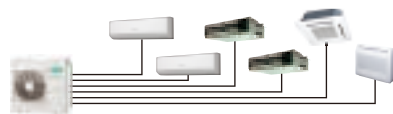
Simultaneous Multi-split Type

Suitable for a small building, the entrance hall of a small office, meeting rooms, educational facilities, and other roomy areas where multiple indoor units need to be operated simultaneously. Up to 4 indoor units can be operated simultaneously, making the system perfect for air conditioning not only offices with large spaces, but also spaces with atypical layouts.

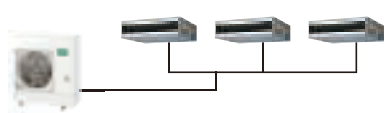
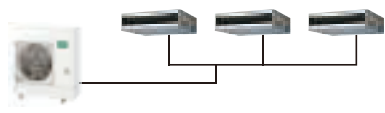
Multi-split Outdoor Units Lineup

		Class		14	18
		Cooling rated capacity (kW)		4.0	5.0
2-unit, 3-unit, 4-unit, 5-unit Multi-split	2-unit Multi-split Up to 2 units			AOHG14KBTA2	AOHG18KBTA2
	3-unit Multi-split Up to 3 units				
	4-unit Multi-split Up to 4 units				
	5-unit Multi-split Up to 5 units				
6-unit Multi-split	6-unit Multi-split Up to 6 units				
Simultaneous Multi-split	Twin Single-phase				
	Twin 3-phase				
	Twin/Triple Single-phase				
	Twin/Triple 3-phase				
	Twin/Triple/ Double Twin 3-phase				

Notes: **1. 2-unit Multi-split:** Connectable indoor units are 2 units.
 AOHG14KBTA2: Total capacity of indoor units connected must be between 4.0 kW and 6.0 kW.
 AOHG18KBTA2: Total capacity of indoor units connected must be between 4.0 kW and 7.5 kW.
2. 3-unit Multi-split: Connectable indoor units are 2 to 3 units.
 AOHG18KBTA3: Total capacity of indoor units connected must be between 4.0 kW and 8.5 kW.
 AOHG24KBTA3: Total capacity of indoor units connected must be between 4.0 kW and 10.5 kW.

3. 4-unit Multi-split: Connectable indoor units are 2 to 4 units.
 AOHG30KBTA4: Total capacity of indoor units connected must be between 7.5 kW and 14.0 kW.
4. 5-unit Multi-split: Connectable indoor units are 2 to 5 units.
 AOHG36KBTA5: Total capacity of indoor units connected must be between 7.5 kW and 15.5 kW.



FUJITSU GENERAL (Euro) GmbH participates in the ECP program for AC. Check ongoing validity of certificate: www.eurovent-certification.com
*Models so marked are not ECC certified.

18 5.4	24 6.8	30 8.0	36 10.0	45 12.5	45 14.0	54 14.0	72 19.0	90 22.0
AOHG18KBTA3	AOHG24KBTA3							
		AOHG30KBTA4						
			AOHG36KBTA5*1					
				AOHG45LBA6*				
			AOHG36KBTB	AOHG45KBTB				
			AOHG36KRTA	AOHG45KRTA				
						AOHG54KBTB		
						AOHG54KRTA		
							AOHG72LRLA	AOHG90LRLA

MULTI-SPLIT

5. 6-unit Multi-split: Connectable indoor units are 2 to 6 units
AOHG45LBA6: Total capacity of indoor units connected must be between 9.5 kW and 18.0 kW.

Cooling rated capacity: *1: 9.5 kW

2-unit to 5-unit Multi-split Connectable Indoor Units



Type	2-unit		3-unit		4-unit	5-unit	
Model name	AOHG14KBT2	AOHG18KBT2	AOHG18KBT3	AOHG24KBT3	AOHG30KBT4	AOHG36KBT5	
Multi-split Type Outdoor Unit							
Capacity (kW)	Cooling	4.0	5.0	5.4	6.8	8.0	9.5
	Heating	4.4	5.6	6.8	8.0	9.6	10.6

Indoor Unit	BTU	kW Class	2-unit	3-unit	3-unit	4-unit	5-unit
 ASHH07/09/12/14KGTG ASHG07/09/12/14KGTG	7,000	2.0	●	●	●	●	●
	9,000	2.5	●	●	●	●	●
	12,000	3.5	●	●	●	●	●
	14,000	4.0	—	●	●	●	●
 ASHG07/09/12/14KETF ASHG07/09/12/14KETF-B ASHG07/09/12/14KETE ASHG07/09/12/14KETE-B	7,000	2.0	●	●	●	●	●
	9,000	2.5	●	●	●	●	●
	12,000	3.5	●	●	●	●	●
	14,000	4.0	—	●	●	●	●
 ASHH07/09/12/14KMCG ASHH07/09/12/14KMCG-B ASHG07/09/12/14KMCE	7,000	2.0	●	●	●	●	●
	9,000	2.5	●	●	●	●	●
	12,000	3.5	●	●	●	●	●
	14,000	4.0	—	●	●	●	●
 ASHH05/07/09/12KNCA	5,000	1.5	●*	●*	●*	●*	●*
	7,000	2.0	●	●	●	●	●
	9,000	2.5	●	●	●	●	●
	12,000	3.5	●	●	●	●	●
 ASHG18/22/24KMTE	18,000	5.0	—	—	—	●	●
	22,000	6.0	—	—	—	●	●
	24,000	7.0	—	—	—	●	●
 AGHG09/12/14KVCA	9,000	2.5	●	●	●	●	●
	12,000	3.5	●	●	●	●	●
	14,000	4.0	—	●	●	●	●
 AUXG07/09/12/14/18/22KVLA	7,000	2.0	●	●	●	●	●
	9,000	2.5	●	●	●	●	●
	12,000	3.5	●	●	●	●	●
	14,000	4.0	—	●	●	●	●
	18,000	5.0	—	—	—	●	●
	22,000	6.0	—	—	—	●	●

*Please consult your dealer for compatible outdoor units with 5kW models.



Type	2-unit		3-unit		4-unit	5-unit	
Model name	AOHG14KBTA2	AOHG18KBTA2	AOHG18KBTA3	AOHG24KBTA3	AOHG30KBTA4	AOHG36KBTA5	
Multi-split Type Outdoor Unit							
Capacity (kW)	Cooling	4.0	5.0	5.4	6.8	8.0	9.5
	Heating	4.4	5.6	6.8	8.0	9.6	10.6

Indoor Unit	BTU	kW Class						
 ARXG07/09/12/14/18KSLAP	7,000	2.0	●	●	●	●	●	●
	9,000	2.5	●	●	●	●	●	●
	12,000	3.5	●	●	●	●	●	●
	14,000	4.0	–	●	●	●	●	●
	18,000	5.0	–	–	–	●	●	●
 ARXG07/09/12/14/18KLLAP	7,000	2.0	●	●	●	●	●	●
	9,000	2.5	●	●	●	●	●	●
	12,000	3.5	●	●	●	●	●	●
	14,000	4.0	–	●	●	●	●	●
	18,000	5.0	–	–	–	●	●	●
 ARXH12/14/18/22KMTAP	12,000	3.5	●	●	●	●	●	●
	14,000	4.0	–	●	●	●	●	●
	18,000	5.0	–	–	–	●	●	●
	22,000	6.0	–	–	–	–	●	●
 ARXG22KMLB	22,000	6.0	–	–	–	–	●	●
 ABHG18/22KRTA	18,000	5.0	–	–	–	●	●	●
	22,000	6.0	–	–	–	–	●	●

6-unit Multi-split Connectable Indoor Units



Type	6-unit	
Model name	AOHG45LBLA6	
Multi-split Type Outdoor Unit		
Capacity (kW)	Cooling	12.5
	Heating	13.5

Indoor Unit	BTU	kW Class	
 ASHG07/09/12/14LMCA	7,000	2.0	●
	9,000	2.5	●
 ASHG07/09/12/14LUCA	12,000	3.5	●
	14,000	4.0	●
 ASHG18/24LF	18,000	5.0	●
	24,000	7.0	●
 AGHG09/12/14LV	9,000	2.5	●
	12,000	3.5	●
	14,000	4.0	●
 AUHG07/09/12/14/18LV	7,000	2.0	●
	9,000	2.5	●
	12,000	3.5	●
	14,000	4.0	●
 ABHG14LVTA ABHG18LVTB	14,000	4.0	●
	18,000	5.0	●
 ARHG07/09/12/14/18SLAP	7,000	2.0	●
	9,000	2.5	●
	12,000	3.5	●
	14,000	4.0	●
 ARHG07/09/12/14/18LL	18,000	5.0	●
	7,000	2.0	●
	9,000	2.5	●
	12,000	3.5	●
 ARHG07/09/12/14/18LL	14,000	4.0	●
	18,000	5.0	●
	7,000	2.0	●



Simultaneous Multi-split Connectable Indoor Units



Type	4HP		5HP		6HP	
Model name	AOHG36KBTB	AOHG36KRTA	AOHG45KBTB	AOHG45KRTA	AOHG54KBTB	AOHG54KRTA
Simultaneous Multi-split Type Outdoor Unit						
Capacity (kW)	Cooling	9.5	12.1	13.4	13.4	13.4
	Heating	10.8	13.5	15.5	15.5	15.5

Indoor Unit	BTU	kW Class	Twin			Triple
 AUXG18/22/24KVLA	18,000	5.0	● × 2	–	–	● × 3
	22,000	6.5	–	● × 2	–	–
	24,000	7.0	–	–	● × 2	–
 ARXG18KLLAP	18,000	5.0	● × 2	–	–	● × 3
	 ARXG22KMLB ARXG24KMLA	22,000	6.5	–	● × 2	–
24,000		7.0	–	–	● × 2	–
Separation tube			UTP-SX236A (18/22/24)			UTP-SX354A (18)

Note : Please be aware that 2-wired group control is not possible with Simultaneous Multi-split.



Type	8HP	10HP	
Model name	AOHG72LRLA	AOHG90LRLA	
Simultaneous Multi-split Outdoor Unit			
Capacity (kW)	Cooling	19.0	22.0
	Heating	22.4	27.0

Indoor Unit	BTU	kW Class	Twin	Triple	Double Twin	Twin	Triple	Double Twin
 AUHG18/22/24LV	18,000	5.0	–	–	● × 4	–	–	–
	22,000	6.5	–	–	–	–	–	● × 4
	24,000	7.0	–	● × 3	–	–	–	–
 AUHG30/36/45LR	30,000	8.8	–	–	–	–	● × 3	–
	36,000	10.6	● × 2	–	–	–	–	–
	45,000	12.5	–	–	–	● × 2	–	–
 ARHG18LLTB	18,000	5.0	–	–	● × 4	–	–	–
 ARHG22/24/30/36/45LM	22,000	6.5	–	–	–	–	–	● × 4
	24,000	7.0	–	● × 3	–	–	–	–
	30,000	8.8	–	–	–	–	● × 3	–
	36,000	10.6	● × 2	–	–	–	–	–
	45,000	12.5	–	–	–	● × 2	–	–
 ABHG18/22/24LV	18,000	5.0	–	–	● × 4	–	–	–
	22,000	6.5	–	–	–	–	–	● × 4
	24,000	7.0	–	● × 3	–	–	–	–
 ABHG30/36/45LR	30,000	8.8	–	–	–	–	● × 3	–
	36,000	10.6	● × 2	–	–	–	–	–
	45,000	12.5	–	–	–	● × 2	–	–
Separation tube			UTP-SX272A × 1	UTP-SX372A × 1	UTP-SX272A × 1, UTP-SX236A × 2	UTP-SX272A × 1	UTP-SX372A × 1	UTP-SX272A × 1, UTP-SX254A × 2

2-unit,
3-unit,
4-unit,
5-unit,
Multi-split



High energy saving

With the adoption of a high-efficiency DC twin-rotary compressor, all models achieved an energy efficiency scale of A+++ for cooling and A++ for heating.

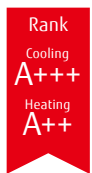

SEER 8.7*

SCOP 4.7

*: 2-unit 14 class

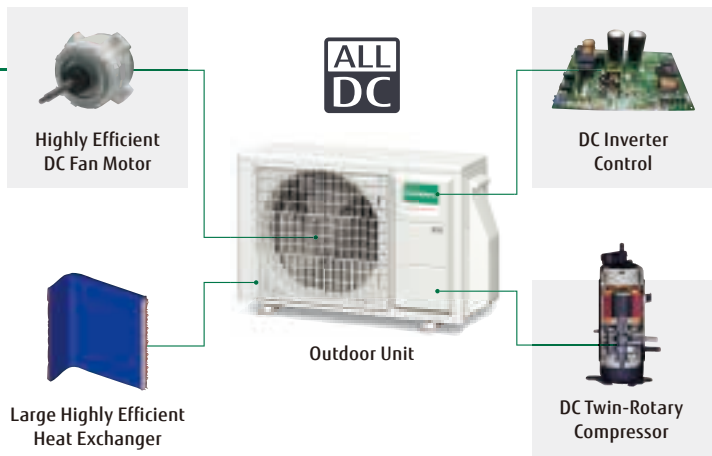

R32 refrigerant model

In addition to its high energy efficiency, the R32 refrigerant has a larger volumetric capacity than the R410A refrigerant, which means the R32 refrigerant models require less refrigerant charge than the R410A models.

	Pre-charge refrigerant amount (kg)	
	R32	R410A
2-unit 14 class	0.9	1.25
2-unit 18 class	1.02	1.30
3-unit 18 class	1.8	2.2
3-unit 24 class	1.8	2.2
4-unit 30 class	2.2	3.3
5-unit 36 class	2.5	4.0

Quiet operation

The sound power level is reduced by up to 7 dB compared to the current R410 models.

Sound Power Level

*3-unit 24 class (cooling)

61 dB(A)

68 dB(A)



R32 model

R410 model

Space-saving installation

Multiple indoor units can be connected to 1 outdoor unit by long piping as well. Unlike a single type, the outdoor unit can be installed in the most space-saving location.

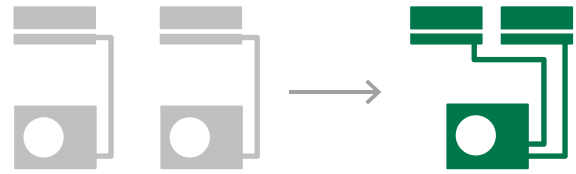

Compact design

Unlike a single type, the outdoor unit can be installed in the most space-saving location.

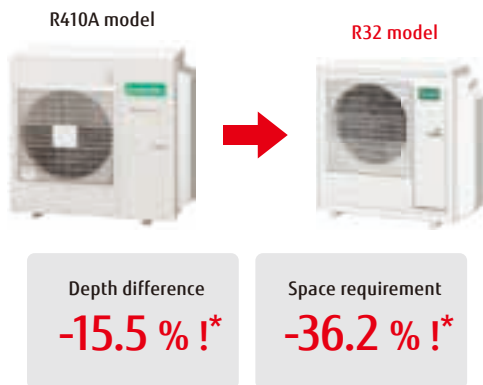

*: Compared with current 5-unit multi models

Easy evacuation

All connected pipes and indoor units can be evacuated quickly via our centralized valve method. Requires evacuation only once.

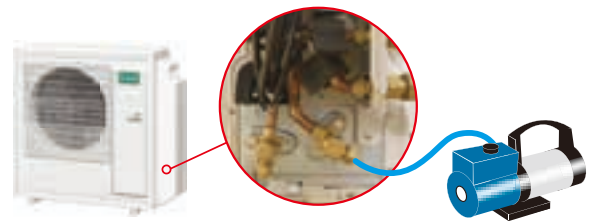

Wide range of indoor units with various models

We offer 41 models in 5 types in a capacity range from 2.0 kW to 6.0 kW. Wide range of requirements can be realized from private homes through to large shops and hotels



Models equipped with the New R32 Refrigerant

Wall-mounted type with sophisticated design

Designer Series



Standard Series



Middle and small capacity models are available. This makes installation easier in small spaces.



MULTI-SPLIT

2-unit: AOHG14KBTA2 / AOHG18KBTA2

3-unit: AOHG18KBTA3 / AOHG24KBTA3

4-unit: AOHG30KBTA4

5-unit: AOHG36KBTA5



Specifications (2-unit)

Model name				AOHG14KBTA2	AOHG18KBTA2
Power Source				Single phase, ~230 V, 50 Hz	
Rated Capacity	Cooling	Rated	kW	4.0	5.0
		Min.-Max.		1.4-4.6	1.7-5.8
EER	Heating	Rated	W/W	4.4	5.6
		Min.-Max.		1.1-5.5	1.8-6.6
COP	Cooling	W/W	4.12	4.03	
					Heating
Sound Pressure Level (High)	Cooling	dB(A)	47	47	
					Heating
Sound Power Level (High)	Cooling	dB(A)	60	60	
					Heating
Airflow Rate	Cooling/Heating		m ³ /h	1,670/1,670	1,960/2,020
Net Dimensions H × W × D			mm	542 × 799 × 290	632 × 799 × 290
Weight			kg	33	37
Connection Pipe Diameter	Liquid		mm	6.35 × 2	
	Gas			9.52 × 2	
Max. Pipe Length	Total/Each		m	30/20	
	Between Outdoor Unit and Each Indoor Unit			15	
Max. Height Difference	Between Indoor Units		m	10	
	Cooling			-10 to 46	
Operating Range	Heating		-15 to 24		
	Type (Global Warming Potential)		R32 (675)		
Refrigerant	Charge		kg (CO ₂ eq-T)		
	0.9 (0.608)		1.02 (0.689)		

Specifications (3-unit)

Model name				AOHG18KBTA3	AOHG24KBTA3
Power Source				Single phase, ~230 V, 50 Hz	
Rated Capacity	Cooling	Rated	kW	5.4	6.8
		Min.-Max.		1.8-7.0	1.8-8.5
EER	Heating	Rated	W/W	6.8	8.0
		Min.-Max.		2.0-8.0	2.0-9.2
COP	Cooling	W/W	4.78	3.90	
					Heating
Sound Pressure Level (High)	Cooling	dB(A)	46	48	
					Heating
Sound Power Level (High)	Cooling	dB(A)	59	61	
					Heating
Airflow Rate	Cooling/Heating		m ³ /h	2,220/2,160	2,270/2,730
Net Dimensions H × W × D			mm	716 × 820 × 315	716 × 820 × 315
Weight			kg	46	46
Connection Pipe Diameter	Liquid		mm	6.35 × 3	
	Gas			9.52 × 3	
Max. Pipe Length	Total/Each		m	50/25	
	Between Outdoor Unit and Each Indoor Unit			15	
Max. Height Difference	Between Indoor Units		m	10	
	Cooling			-10 to 46	
Operating Range	Heating		-15 to 24		
	Type (Global Warming Potential)		R32 (675)		
Refrigerant	Charge		kg (CO ₂ eq-T)		
	1.8 (1.215)		1.8 (1.215)		

Specifications (4-unit, 5-unit)

Model name				AOHG30KBTA4	AOHG36KBTA5
Power Source				Single phase, ~230 V, 50 Hz	
Rated Capacity	Cooling	Rated	kW	8.0	9.5
		Min.-Max.		2.4-10.1	3.0-11.0
EER	Heating	Rated	W/W	9.6	10.6
		Min.-Max.		3.0-11.2	3.5-12.0
COP	Cooling	W/W	3.90	3.80	
					Heating
Sound Pressure Level (High)	Cooling	dB(A)	50	52	
					Heating
Sound Power Level (High)	Cooling	dB(A)	63	65	
					Heating
Airflow Rate	Cooling/Heating		m ³ /h	2,400/2,950	2,450/2,900
Net Dimensions H × W × D			mm	884 × 820 × 315	884 × 820 × 315
Weight			kg	55	59
Connection Pipe Diameter	Liquid		mm	6.35 × 4	
	Gas			9.52 × 2, 12.70 × 2 adapter [12.70 → 9.52] × 2	
Max. Pipe Length*	Total/Each		m	70/25	
	Between Outdoor Unit and Each Indoor Unit			15	
Max. Height Difference	Between Indoor Units		m	10	
	Cooling			-10 to 46	
Operating Range	Heating		-15 to 24		
	Type (Global Warming Potential)		R32 (675)		
Refrigerant	Charge		kg (CO ₂ eq-T)		
	2.2 (1.485)		2.5 (1.688)		

*Length not applicable when floor units are connected. For details, refer to the installation manual.

Dimensions

(Unit: mm)

2-unit: AOHG14KBTA2

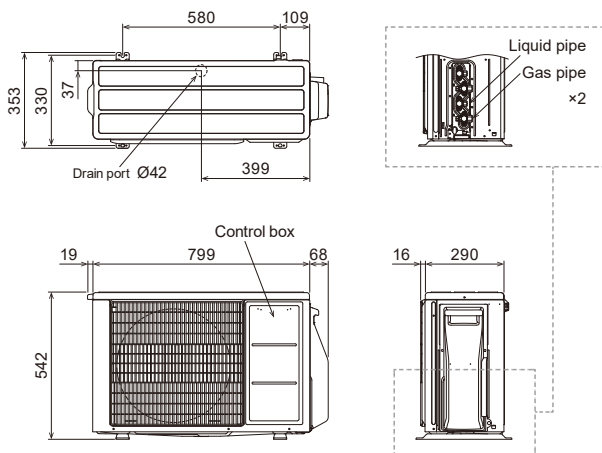

2-unit: AOHG18KBTA2

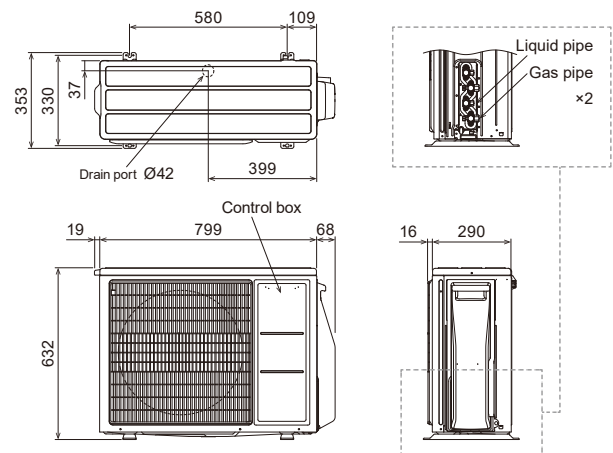

3-unit: AOHG18KBTA3 / AOHG24KBTA3

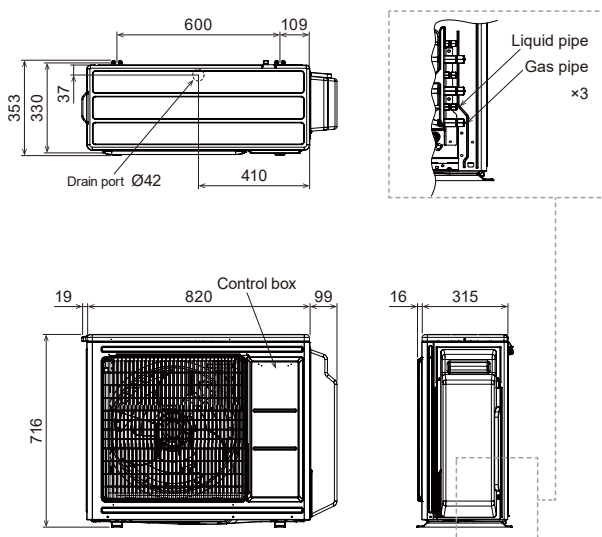

4-unit: AOHG30KBTA4 5-unit: AOHG36KBTA5

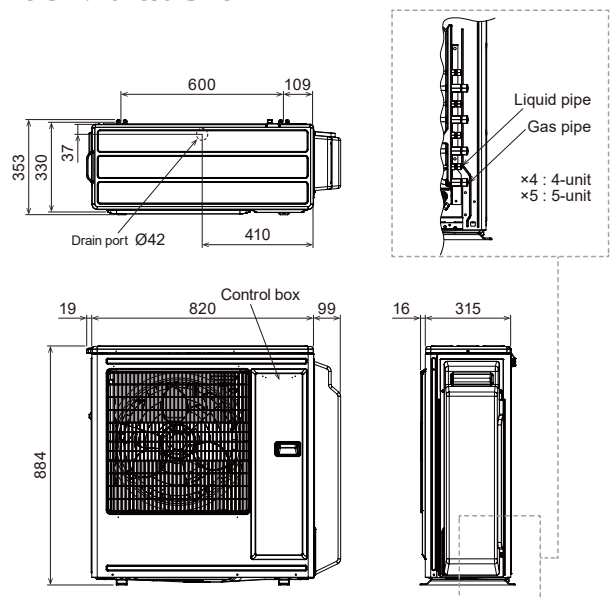

6-unit Multi-split



A wide variety of models to choose from

We offer 26 models in 5 types in a capacity range from 2.0 kW to 7.0 kW. Wide range of requirements can be realized from private homes through to large shops and hotels.

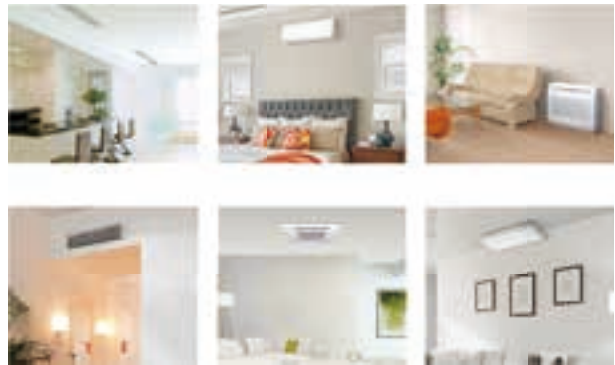

Compact design

Multiple indoor units can be connected to 1 outdoor unit by long piping as well. Unlike a single type, the outdoor unit can be installed in the most space-saving location.



Easy installation

All connected pipes and indoor units can be evacuated quickly via our centralized valve method. Requires evacuation only once.



Central & Individual control

- Batched control of up to 6 indoor units. Unified setting of room temperature, airflow volume, and local control restrictions across units.
- Language can be selected from English, French, German, Greek, Italian, Portuguese, Russian, Spanish, or Turkish.
- Large backlit LED screen
- Large easy-to-see operation panel

Max. Controllable
1 multi-system

Max. Controllable
6 indoor units





Specifications

Model name			AOHG45LBLA6	
Power Source			Single phase, ~230 V, 50 Hz	
Rated Capacity	Cooling	Rated	kW	12.5
		Min.-Max.		3.5-14.0
	Heating	Rated		13.5
		Min.-Max.		3.5-16.0
EER	Cooling	W/W	3.50	
COP	Heating		4.00	
Sound Pressure Level (High)	Cooling	dB(A)	53	
	Heating		55	
Sound Power Level (High)	Cooling	-		
	Heating	-		
Airflow Rate	Cooling/Heating	m ³ /h	4,200/4,200	
Net Dimensions H × W × D			mm	998 × 970 × 370
Weight			kg	94
Connection Pipe Diameter	Liquid	mm	6.35 × 6	
	Gas		9.52 × 4, 12.70 × 2	
Max. Pipe Length	Total/Each		80/25	
Max. Height Difference	Between Outdoor Unit and Each Indoor Unit.	m	15	
	Between Indoor Units.		10	
Operating Range	Cooling	°CDB	-10 to 46	
	Heating		-15 to 24	
Refrigerant	Type (Global Warming Potential)		R410A (2,088)	
	Charge	kg (CO ₂ eq-T)	4.00 (8.352)	

Dimensions

(Unit: mm)

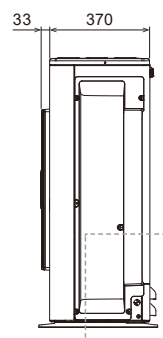
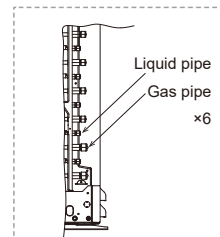
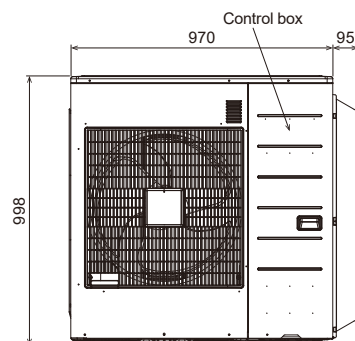
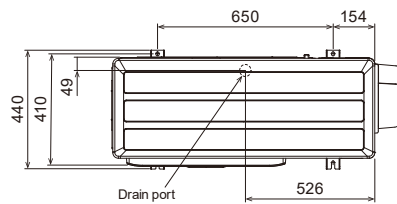

Simultaneous Multi-split Type

Twin / Triple



Meets a variety of installation needs from offices to commercial spaces, with up to 3 indoor units in the same room connected to an outdoor unit.

Select indoor units according to floor layout and heat load estimated by the number of people working in the room and the direction and intensity of sunlight entering the room. Perfect airflow distribution can be achieved for optimum comfort.

Installation according to floor layout

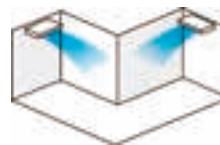

Installation according to lighting conditions

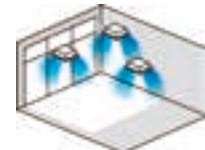

Design flexibility

Slim & Compact Design

The outdoor unit in this series is 22.7% shorter* than a twin-fan outdoor unit. The reduced height makes it easy to install in tight spaces.

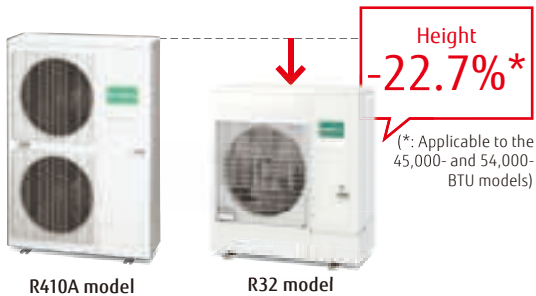

Flexible installation

Pipe length of up to 50 m and a height difference of up to 30 m can be accommodated. Multi-split systems can be installed in large residences and multi-story buildings.

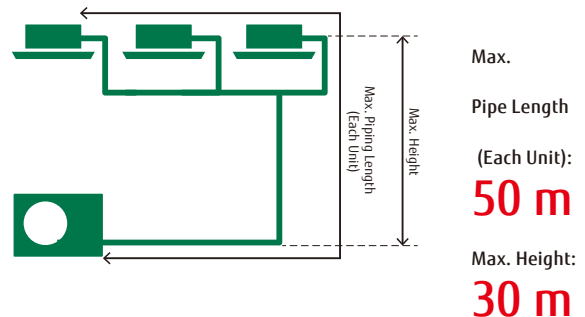

New lineup of indoor units

The indoor units, available in 6 models of 3 types, can be selected according to room size and conditions.



Compact Cassette



Slim Duct



Duct

Note : Please be aware that 2-wired group control is not possible with Simultaneous Multi-split.

Model: AOHG36KBTB / AOHG45KBTB / AOHG54KBTB
 AOHG36KRTA [3-phase] / AOHG45KRTA [3-phase] / AOHG54KRTA [3-phase]



36

45/54

Specifications (Indoor units/Outdoor units)

Indoor Units Model name				Compact Cassette		
				AUXG18KVLA	AUXG22KVLA	AUXG24KVLA
Power Source				Single phase, ~230 V, 50 Hz		
Airflow Rate	Cooling	H/M/L/Q	m ³ /h	680/580/490/410	830/740/600/450	930/830/600/450
	Heating	H/M/L/Q		800/680/580/450	860/760/700/530	930/850/700/530
Net Dimensions H × W × D				mm		
Weight				kg		
Cassette Grille				UTG-UFGF-W		

Indoor Units Model name				Duct		
				ARXG18KLLAP	ARXG22KMLB	ARXG24KMLA
Power Source				Single phase, ~230 V, 50 Hz		
Airflow Rate	Cooling	H/M/L/Q	m ³ /h	940/880/820/750	1,100/910/750/580	1,100/910/750/580
	Heating	H/M/L/Q		940/880/820/750	1,100/910/750/580	1,100/910/750/580
Net Dimensions H × W × D				mm		
Weight				kg		

Outdoor Units Model name			AOHG36KBTB	AOHG45KBTB	AOHG54KBTB	AOHG36KRTA	AOHG45KRTA	AOHG54KRTA
Capacity	Cooling	kW	9.5	12.1	13.4	9.5	12.1	13.4
	Heating		10.8	13.5	15.5	10.8	13.5	15.5
Power Source			Single phase, ~230 V, 50 Hz			3-phase, ~400 V, 50 Hz		
Pdesign	Cooling	kW	9.5	-	-	9.5	-	-
	Heating (-10°C)		8.7	-	-	8.7	-	-
SEER	Cooling	W/W	6.10	-	-	6.10	-	-
SCOP	Heating		4.00	-	-	4.00	-	-
Annual Energy Consumption	Cooling	kWh/a	545	-	-	545	-	-
	Heating		3,044	-	-	3,044	-	-
Energy Efficiency Class	Cooling		A++	-	-	A++	-	-
	Heating		A+	-	-	A+	-	-
Sound Pressure Level (High)	Cooling	dB(A)	55	57	57	55	57	57
	Heating		55	57	59	55	57	59
Sound Power Level (High)	Cooling	dB(A)	70	71	73	70	71	73
	Heating		70	71	73	70	71	73
Airflow Rate	Cooling/Heating	m ³ /h	3,750/3,750	4,450/4,450	4,450/4,450	3,750/3,750	4,450/4,450	4,450/4,450
Net Dimensions H × W × D			mm			mm		
Weight			kg			kg		
Connection Pipe Diameter (Liquid/Gas)			mm			mm		
Max. Pipe Length (Pre-Charge)			m			m		
Max. Height Difference			m			m		
Operating Range	Cooling	°CDB	-15 to 46	-15 to 46	-15 to 46	-15 to 46	-15 to 46	-15 to 46
	Heating		-15 to 24	-15 to 24	-15 to 24	-15 to 24	-15 to 24	-15 to 24
Refrigerant	Type (Global Warming Potential)		R32 (675)	R32 (675)	R32 (675)	R32 (675)	R32 (675)	R32 (675)
	Charge	kg (CO2eq-T)	1.90 (1.283)	2.70 (1.823)	2.70 (1.823)	1.90 (1.283)	2.70 (1.823)	2.70 (1.823)
Separation tube			UTP-SX236A (Twin)			UTP-SX236A (Twin)		

- Indoor units of different types and capacity cannot be connected.
- The above specifications apply when used with a cassette type indoor unit.

Dimensions

(Unit: mm)

AOHG36KBTB / AOHG36KRTA

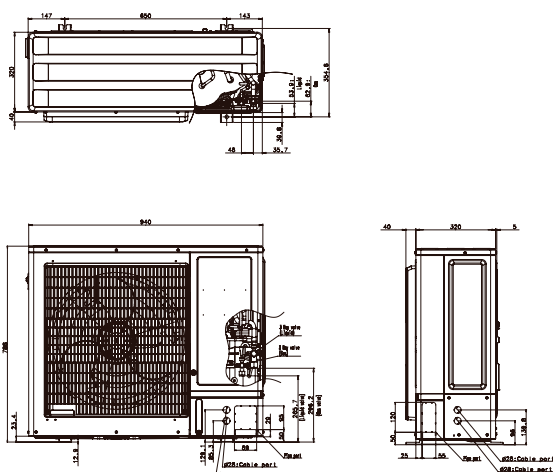

AOHG45KBTB / AOHG54KBTB AOHG45KRTA / AOHG54KRTA

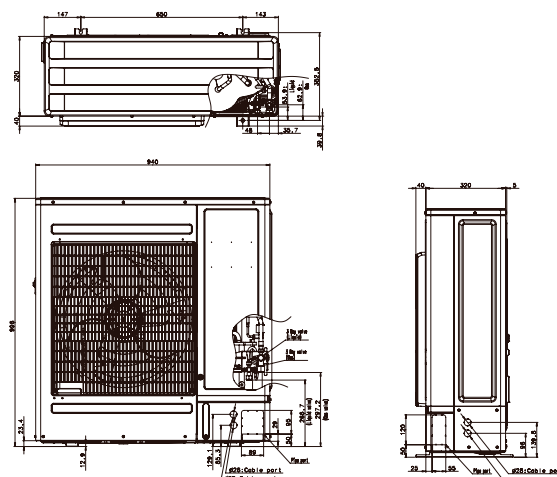

Simultaneous Multi-split Type

Twin / Triple / Double Twin



Meets a variety of installation needs from an open-plan office to a retail store, with up to 4 indoor units connected to an outdoor unit.

Select indoor units according to floor layout and heat load estimated by the number of people working in the room and the direction and intensity of sunlight entering the room. Perfect airflow distribution can be achieved for optimum comfort.

Installation according to floor layout

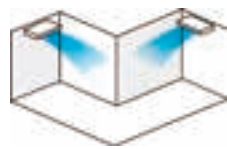

Installation according to lighting conditions



Installation according to layout and lighting conditions



Installation according to large space

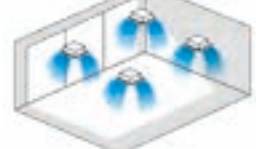

Simultaneous control

Up to 16 indoor units can be controlled simultaneously with a wired remote controller.

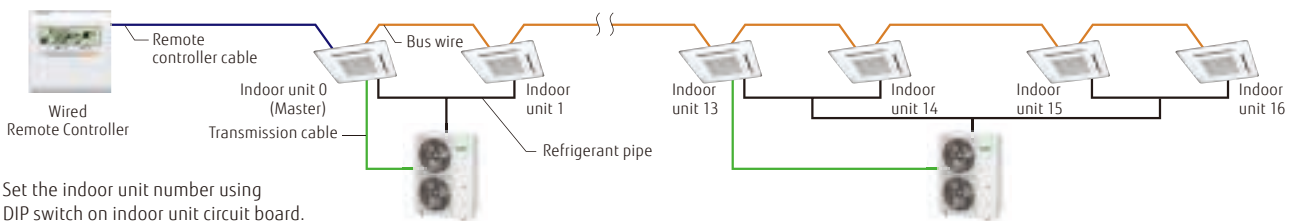

Set the indoor unit number using DIP switch on indoor unit circuit board.

*The following functions are not provided by a wireless remote controller: Timer operation, Sleep Timer operation, 10°C Heat operation

Indoor unit lineup

The indoor units, available in 18 models of 6 types, can be selected according to room size and conditions.



Compact Cassette



Cassette



Slim Duct



Duct



Floor/Ceiling Universal



Ceiling

Model: AOHG72LRLA [3-phase] / AOHG90LRLA [3-phase]



Specifications (Indoor units/Outdoor units)

Indoor Units Model name				Compact Cassette, Cassette					
				AUHG18VLB	AUHG22LVA	AUHG24LVA	AUHG30LRE	AUHG36LRE	AUHG45LRLA
Power Source				Single phase, ~230 V, 50 Hz					
Airflow Rate	Cooling	H/M/L/Q	m ³ /h	750/610/520/410	930/830/600/450	930/830/600/450	1,600/1,400/1,270/1,150	1,800/1,400/1,270/1,150	1,900/1,640/1,460/1,250
	Heating	H/M/L/Q		800/710/600/450	930/860/700/530	930/830/600/450	1,800/1,400/1,270/1,150	1,800/1,400/1,270/1,150	1,900/1,640/1,460/1,250
Net Dimensions H × W × D			mm	245 × 570 × 570	245 × 570 × 570	245 × 570 × 570	288 × 840 × 840	288 × 840 × 840	288 × 840 × 840
Weight			kg	15	16	16	26	26	26
Cassette Grille				UTG-UFGD-W			UTG-UGGA-W		

Indoor Units Model name				Duct					
				ARHG18LTB	ARHG22LMLA	ARHG24LMLA	ARHG30LMLE	ARHG36LMLE	ARHG45LMLA
Power Source				Single phase, ~230 V, 50 Hz					
Airflow Rate	Cooling	H/M/L/Q	m ³ /h	940/880/820/750	1,100/910/750/580	1,100/910/750/580	1,900/1,620/1,270/980	1,900/1,620/1,270/980	2,100/1,750/1,350/1,070
	Heating	H/M/L/Q		940/880/820/750	1,100/910/750/580	1,100/910/750/580	2,100/1,620/1,270/980	2,100/1,620/1,270/980	2,100/1,750/1,350/1,070
Net Dimensions H × W × D			mm	198 × 900 × 620	270 × 1135 × 700	270 × 1135 × 700	270 × 1135 × 700	270 × 1135 × 700	270 × 1135 × 700
Weight			kg	23	38	40	40	40	40 (88)

Indoor Units Model name				Floor/Ceiling, Ceiling					
				ABHG18LVTB	ABHG22LVTA	ABHG24LVTA	ABHG30LRTE	ABHG36LRTE	ABHG45LRTA
Power Source				Single phase, ~230 V, 50 Hz					
Airflow Rate	Cooling	H/M/L/Q	m ³ /h	780/700/560/500	980/820/680/540	980/820/680/540	1,660/1,500/1,200/1,000	1,900/1,500/1,200/1,000	2,100/1,700/1,400/1,100
	Heating	H/M/L/Q		780/700/560/500	980/820/680/540	980/820/680/540	1,660/1,500/1,200/1,000	1,900/1,500/1,200/1,000	2,100/1,700/1,400/1,100
Net Dimensions H × W × D			mm	199 × 990 × 655	199 × 990 × 655	199 × 990 × 655	240 × 1660 × 700	240 × 1660 × 700	240 × 1660 × 700
Weight			kg	27	27	27	46	46	46

Outdoor Units Model name			AOHG72LRLA		AOHG90LRLA	
Capacity	Cooling	kW	19.0		22.0	
	Heating		22.4		27.0	
Power Source			3-phase, ~400 V, 50 Hz			
Sound Pressure Level (High)	Cooling/Heating	dB(A)	55/55		55/57	
Airflow Rate	Cooling/Heating	m ³ /h	8,400/8,400		8,400/9,000	
Net Dimensions H × W × D			mm		1,428 × 1,080 × 480	
Weight			kg		172	
Connection Pipe Diameter (Liquid/Gas)			mm		12.7/25.4	
Max. Pipe Length (Pre-Charge)			m		100 (30)	
Max. Height Difference			m		30	
Operating Range	Cooling	°CDB	-15 to 46		-15 to 46	
	Heating		-20 to 24		-20 to 24	
Refrigerant	Type (Global Warming Potential)	R410A (2,088)		R410A (2,088)		
	Charge	kg (CO ₂ eq-T)	5.6 (11.693)		7.1 (14.825)	
Separation tube			UTP-SX272A × 1 (Twin)	UTP-SX372A × 1 (Triple)	UTP-SX272A × 1 (Twin) UTP-SX236A × 2 (Double Twin)	UTP-SX272A × 1 (Twin) UTP-SX372A × 1 (Triple) UTP-SX254A × 2 (Double Twin)

*: That specification is not fixed yet.

- Indoor units of different types and capacity cannot be connected.
- The above specifications apply when used with a cassette type indoor unit.

Dimensions

(Unit: mm)

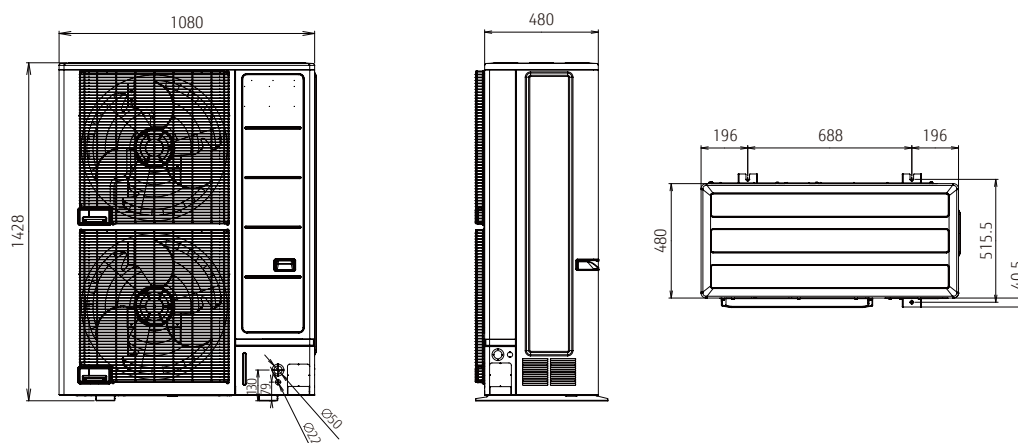

2-unit to 5-unit Multi-split Indoor Units Specifications



Wall-mounted type

Model name		Indoor unit		ASHH07KGTG ASHG07KGTE	ASHH09KGTG ASHG09KGTE	ASHH12KGTG ASHG12KGTE	ASHH14KGTG ASHG14KGTE
kW Class		kW		2.0	2.5	3.5	4.0
Power Source				Single phase, ~230 V, 50 Hz			
Sound Pressure Level	Cooling	H/M/L/Q	dB(A)	38/33/29/21	40/34/29/21	40/35/30/21	43/36/30/21
	Heating			41/35/31/22	42/36/31/22	42/38/33/22	44/39/33/24
Sound Power Level	Cooling	H	dB(A)	54	55	56	57
	Heating			56	57	58	59
Airflow Rate	Cooling	H/M/L/Q	m ³ /h	650/540/430/270	700/560/430/270	700/560/430/270	770/600/450/280
	Heating			720/580/460/330	750/610/470/330	770/640/520/330	800/660/520/340
Net Dimensions		mm		270 × 834 × 215	270 × 834 × 215	270 × 834 × 215	270 × 834 × 215
Weight		kg		10	10	10	10
Connection Pipe Diameter		Liquid/Gas		6.35/9.52	6.35/9.52	6.35/9.52	6.35/9.52



Wall-mounted type

Model name		Indoor unit		ASHG07KETF ASHG07KETF-B ASHG07KETE ASHG07KETE-B	ASHG09KETF ASHG09KETF-B ASHG09KETE ASHG09KETE-B	ASHG12KETF ASHG12KETF-B ASHG12KETE ASHG12KETE-B	ASHG14KETF ASHG14KETF-B ASHG14KETE ASHG14KETE-B
kW Class		kW		2.0	2.5	3.5	4.0
Power Source				Single phase, ~230 V, 50 Hz			
Sound Pressure Level	Cooling	H/M/L/Q	dB(A)	38/33/29/21	40/34/29/21	40/35/30/21	43/36/30/21
	Heating			41/35/31/22	42/36/31/22	42/38/33/22	44/39/33/24
Sound Power Level	Cooling	H	dB(A)	54	55	55	57
	Heating			56	57	58	59
Airflow Rate	Cooling	H/M/L/Q	m ³ /h	650/540/430/270	700/560/430/270	700/560/430/270	770/600/450/280
	Heating			720/580/460/330	750/610/470/330	770/640/520/330	800/660/520/340
Net Dimensions		mm		295 × 950 (wall side: 840) × 230	295 × 950 (wall side: 840) × 230	295 × 950 (wall side: 840) × 230	295 × 950 (wall side: 840) × 230
Weight		kg		11	11	11	11.5
Connection Pipe Diameter		Liquid/Gas		6.35/9.52	6.35/9.52	6.35/9.52	6.35/9.52



Wall-mounted type

Model name		Indoor unit		ASHH07KMCG ASHH07KMCG-B ASHG07KMCE	ASHH09KMCG ASHH09KMCG-B ASHG09KMCE	ASHH12KMCG ASHH12KMCG-B ASHG12KMCE	ASHH14KMCG ASHH14KMCG-B ASHG14KMCE
kW Class		kW		2.0	2.5	3.5	4.0
Power Source				Single phase, ~230 V, 50 Hz			
Sound Pressure Level	Cooling	H/M/L/Q	dB(A)	38/33/29/21	40/34/29/21	40/35/30/21	43/36/30/21
	Heating			41/35/31/22	42/36/31/22	42/38/33/22	44/39/33/24
Sound Power Level	Cooling	H	dB(A)	54	55	55	57
	Heating			56	57	58	59
Airflow Rate	Cooling	H/M/L/Q	m ³ /h	650/540/430/320	700/560/430/320	700/560/430/320	770/600/450/310
	Heating			720/580/460/330	750/610/470/330	780/640/520/330	820/660/520/340
Net Dimensions		mm		270 × 834 × 215	270 × 834 × 215	270 × 834 × 215	270 × 834 × 215
Weight		kg		10	10	10	10
Connection Pipe Diameter		Liquid/Gas		6.35/9.52	6.35/9.52	6.35/9.52	6.35/9.52





Wall-mounted type

NEW



Model name		Indoor unit		ASHH05KNCA	ASHH07KNCA	ASHH09KNCA	ASHH12KNCA
kW Class		kW		1.5	2.0	2.5	3.5
Power Source		Single phase, ~230 V, 50 Hz					
Sound Pressure Level	Cooling	H/M/L/Q	dB(A)	34 / 33 / 29 / 21	36 / 33 / 29 / 21	41 / 35 / 29 / 21	42 / 36 / 32 / 21
	Heating			34 / 32 / 30 / 22	36 / 33 / 30 / 22	41 / 34 / 30 / 22	42 / 35 / 31 / 22
Sound Power Level	Cooling	H	dB(A)	50	51	56	57
	Heating			50	51	56	57
Airflow Rate	Cooling	H/M/L/Q	m³/h	500 / 450 / 390 / 250	530 / 460 / 390 / 250	640 / 500 / 390 / 250	660 / 520 / 440 / 250
	Heating			500 / 450 / 420 / 280	530 / 460 / 420 / 280	640 / 500 / 420 / 280	660 / 520 / 440 / 280
Net Dimensions		mm		270 × 784 × 222	270 × 784 × 222	270 × 784 × 222	270 × 784 × 222
Weight		kg		9	9	9	9
Connection Pipe Diameter		Liquid/Gas		6.35 / 9.52	6.35 / 9.52	6.35 / 9.52	6.35 / 9.52

Wall-mounted type



Model name		Indoor unit		ASHG18KMTE	ASHG22KMTE	ASHG24KMTE	
kW Class		kW		5.0	6.0	7.0	
Power Source		Single phase, ~230 V, 50 Hz					
Sound Pressure Level	Cooling	H/M/L/Q	dB(A)	45/40/35/29	48/40/35/29	49/40/35/29	
	Heating			46/40/35/29	48/40/35/29	49/40/35/29	
Sound Power Level	Cooling	H	dB(A)	60	62	65	
	Heating			61	62	65	
Airflow Rate	Cooling	H/M/L/Q	m³/h	980/810/640/510	1,060/810/640/510	1,170/850/640/510	
	Heating			1,020/850/640/510	1,060/850/640/510	1,170/850/640/510	
Net Dimensions		mm		280 × 980 × 240	280 × 980 × 240	280 × 980 × 240	
Weight		kg		12.5	12.5	12.5	
Connection Pipe Diameter		Liquid/Gas		6.35/12.70	6.35/12.70	6.35/12.70	

Floor



Model name		Indoor unit		AGHG09KVCA	AGHG12KVCA	AGHG14KVCA	
kW Class		kW		2.5	3.5	4.0	
Power Source		Single phase, ~230 V, 50 Hz					
Sound Pressure Level	Cooling	H/M/L/Q	dB(A)	39/34/28/22	42/36/30/22	44/38/31/22	
	Heating			39/35/30/22	42/38/32/22	44/39/33/22	
Sound Power Level	Cooling	H	dB(A)	52	55	56	
	Heating			52	55	56	
Airflow Rate	Cooling	H/M/L/Q	m³/h	530/440/360/270	600/490/380/270	650/520/400/270	
	Heating			530/460/380/270	600/510/410/270	650/540/430/270	
Net Dimensions		mm		600 × 740 × 200	600 × 740 × 200	600 × 740 × 200	
Weight		kg		14	14	14	
Connection Pipe Diameter		Liquid/Gas		6.35/9.52	6.35/9.52	6.35/9.52	

2-unit to 5-unit Multi-split Indoor Units Specifications

Ceiling



Model name	Indoor unit			ABHG18KRTA	ABHG22KRTA
kW Class	kW			5.0	6.0
Power Source				Single phase, ~230 V, 50 Hz	
Sound Pressure Level	Cooling	H/M/L/Q	dB(A)	38/36/33/31	
	Heating			38/36/33/31	
Sound Power Level	Cooling	H	dB(A)	53	
	Heating			53	
Airflow Rate	Cooling	H/M/L/Q	m ³ /h	840/790/710/650	
	Heating			840/790/710/650	
Net Dimensions	mm			235 × 1,080 × 705	
Weight	kg			24	
Connection Pipe Diameter	Liquid/Gas	mm		6.35/12.70	

Compact Cassette Grid Type



Model name	Indoor unit			AUXG07KVLA	AUXG09KVLA	AUXG12KVLA	AUXG14KVLA	AUXG18KVLA	AUXG22KVLA
kW Class	kW			2.0	2.5	3.5	4.0	5.0	6.0
Power Source				Single phase, ~230 V, 50 Hz					
Sound Pressure Level	Cooling	H/M/L/Q	dB(A)	33/31/29/27	33/31/29/27	37/34/31/28	38/35/32/29	38/35/32/29	44/42/36/30
	Heating			34/32/29/27	34/32/29/27	37/34/31/28	43/38/34/30	43/38/34/30	45/43/40/33
Sound Power Level	Cooling	H	dB(A)	46	46	49	50	50	56
	Heating			47	47	49	55	55	57
Airflow Rate	Cooling	H/M/L/Q	m ³ /h	540/490/440/390	540/490/440/390	610/530/470/410	680/580/490/410	680/580/490/410	830/740/600/450
	Heating			540/490/440/390	540/490/440/390	610/530/470/410	790/680/580/450	790/680/580/450	860/760/700/530
Net Dimensions	mm			245 × 570 × 570		245 × 570 × 570		245 × 570 × 570	
Weight	kg			15		15		16	
Panel				UTG-UFGF-W		UTG-UFGF-W		UTG-UFGF-W	
Connection Pipe Diameter	Liquid/Gas	mm		6.35/9.52		6.35/9.52		6.35/12.70	

Mini duct



Model name	Indoor unit			ARXG07KSLAP	ARXG09KSLAP	ARXG12KSLAP	ARXG14KSLAP	ARXG18KSLAP
kW Class	kW			2.0	2.5	3.5	4.0	5.0
Power Source				Single phase, ~230 V, 50 Hz				
Sound Pressure Level	Cooling	H/M/L/Q	dB(A)	29/26/24/23	29/26/24/23	31/27/25/23	35/30/27/23	33/29/26/23
	Heating			29/26/24/23	29/26/24/23	31/27/25/23	35/30/27/23	33/29/26/23
Sound Power Level	Cooling	H	dB(A)	52	54	55	60	58
	Heating			53	56	57	62	59
Airflow Rate	Cooling	H/M/L/Q	m ³ /h	550/440/390/360	600/450/400/360	650/490/430/360	800/640/530/360	940/750/540/480
	Heating			550/440/390/360	600/450/400/360	650/490/430/360	800/640/530/360	940/750/540/480
Net Dimensions	mm			198 × 700 × 450		198 × 700 × 450		198 × 900 × 450
Weight	kg			15.5		15.5		18.5
Connection Pipe Diameter	Liquid/Gas	mm		6.35/9.52		6.35/9.52		6.35/12.70
External static pressure	Pa			0 to 30		0 to 30		0 to 50
Drain pump				Standard		Standard		Standard

Slim duct



Model name	Indoor unit			ARXG07KLLAP	ARXG09KLLAP	ARXG12KLLAP	ARXG14KLLAP	ARXG18KLLAP
kW Class	kW			2.0	2.5	3.5	4.0	5.0
Power Source				Single phase, ~230 V, 50 Hz				
Sound Pressure Level	Cooling	H/M/L/Q	dB(A)	28/26/25/24	28/27/26/25	29/28/27/26	32/30/28/26	32/30/29/27
	Heating			28/26/25/24	28/26/25/24	29/28/27/24	32/30/28/25	32/30/29/27
Sound Power Level	Cooling	H	dB(A)	57	57	58	60	58
	Heating			57	57	58	60	58
Airflow Rate	Cooling	H/M/L/Q	m ³ /h	550/490/470/440	600/550/500/450	650/600/550/480	800/700/600/480	940/880/820/750
	Heating			550/490/470/440	600/550/500/450	650/600/550/480	800/700/600/480	940/880/820/750
Net Dimensions	mm			198 × 700 × 620		198 × 700 × 620		198 × 900 × 620
Weight	kg			16		17		20
Connection Pipe Diameter	Liquid/Gas	mm		6.35/9.52		6.35/9.52		6.35/12.70
External static pressure	Pa			0 to 90		0 to 90		0 to 90
Drain pump				Standard		Standard		Standard

Medium Static Pressure Duct

NEW



Model name		Indoor unit		ARXH12KMTAP	ARXH14KMTAP	ARXH18KMTAP	ARXH22KMTAP
kW Class		kW		3.5	4.0	5.0	6.0
Power Source				Single-phase, ~230V, 50Hz			
Sound Pressure Level	Cooling	H/M/L/Q	dB(A)	29 / 27 / 25 / 23	32 / 29 / 27 / 25	33 / 30 / 28 / 26	32/28/25/24
	Heating			29 / 27 / 25 / 23	32 / 29 / 27 / 25	33 / 30 / 28 / 26	32/28/25/24
Sound Power Level	Cooling	H	dB(A)	58	59	60	58
	Heating			58	59	60	58
Airflow Rate	Cooling	H/M/L/Q	m ³ /h	650 / 520 / 460 / 390	800 / 640 / 560 / 480	840 / 720 / 630 / 540	1,150 / 920 / 800 / 700
	Heating			650 / 520 / 460 / 390	800 / 640 / 560 / 480	840 / 720 / 630 / 540	1,150 / 920 / 800 / 700
Net Dimensions			mm	240 × 700 × 700	240 × 700 × 700	240 × 700 × 700	240 × 1,000 × 700
Weight			kg	24	24	24	31
Connection Pipe Diameter		Liquid/Gas	mm	6.35 / 9.52	6.35 / 9.52	6.35 / 12.7	6.35/12.70
External static pressure			Pa	30 to 150	30 to 150	30 to 150	30 to 150
Drain pump				Standard	Standard	Standard	Standard

Medium Static Pressure Duct



Model name		Indoor unit		ARXG22KMLB
kW Class		kW		6.0
Power Source				Single phase, ~230 V, 50 Hz
Sound Pressure Level	Cooling	H/M/L/Q	dB(A)	31/29/27/25
	Heating			31/29/27/25
Sound Power Level	Cooling	H	dB(A)	60
	Heating			62
Airflow Rate	Cooling	H/M/L/Q	m ³ /h	1,100/910/750/580
	Heating			1,100/910/750/580
Net Dimensions			mm	270 × 1,135 × 700
Weight			kg	35
Connection Pipe Diameter		Liquid/Gas	mm	6.35/12.70
External static pressure			Pa	30 to 150
Drain pump				Option

6-unit Multi-split Indoor Units Specifications

Compact wall-mounted



Model name	Indoor unit			ASHG07LUCA	ASHG09LUCA	ASHG12LUCA	ASHG14LUCA
kW Class	kW			2.0	2.5	3.5	4.0
Power Source	Single phase, ~230 V, 50 Hz						
Sound Pressure Level	Cooling	H/M/L/Q	dB(A)	35/30/28/21	36/32/28/21	37/34/31/21	41/36/33/25
	Heating			35/30/28/21	36/32/28/21	37/34/31/21	41/36/34/27
Sound Power Level	Cooling	H	dB(A)	53	54	55	59
	Heating			53	54	55	59
Airflow Rate	Cooling	H/M/L/Q	m ³ /h	570/520/470/330	600/550/470/330	660/600/530/330	710/640/570/390
	Heating			570/520/470/330	600/550/470/330	660/600/530/330	710/640/590/430
Net Dimensions	mm			282 × 870 × 185	282 × 870 × 185	282 × 870 × 185	282 × 870 × 185
Weight	kg			9.5	9.5	9.5	9.5
Connection Pipe Diameter	Liquid/Gas	mm		6.35/9.52	6.35/9.52	6.35/9.52	6.35/12.70

Wall-mounted type



Model name	Indoor unit			ASHG18LFCA	ASHG24LFCC
kW Class	kW			5.0	7.0
Power Source	Single phase, ~230 V, 50 Hz				
Sound Pressure Level	Cooling	H/M/L/Q	dB(A)	43/37/33/26	49/42/37/33
	Heating			42/37/33/25	48/42/37/33
Sound Power Level	Cooling	H	dB(A)	58	64
	Heating			58	64
Airflow Rate	Cooling	H/M/L/Q	m ³ /h	900/740/620/550	1,120/900/740/620
	Heating			900/740/620/550	1,100/900/740/620
Net Dimensions	mm			320 × 998 × 238	320 × 998 × 238
Weight	kg			14	14
Connection Pipe Diameter	Liquid/Gas	mm		6.35/12.70	6.35/15.88

Compact wall-mounted



Model name	Indoor unit			ASHG07LMCA	ASHG09LMCA	ASHG12LMCA	ASHG14LMCA
kW Class	kW			2.0	2.5	3.5	4.0
Power Source	Single phase, ~230 V, 50 Hz						
Sound Pressure Level	Cooling	H/M/L/Q	dB(A)	36/32/29/21	37/33/29/21	40/36/30/21	42/38/33/25
	Heating			36/32/29/22	37/33/29/22	40/36/31/22	42/38/35/27
Sound Power Level	Cooling	H	dB(A)	51	52	54	56
	Heating			51	52	55	57
Airflow Rate	Cooling	H/M/L/Q	m ³ /h	560/500/430/310	600/520/430/310	660/560/450/310	730/600/530/360
	Heating			560/500/430/330	600/520/430/330	660/560/470/330	730/615/560/375
Net Dimensions	mm			268 × 840 × 203	268 × 840 × 203	268 × 840 × 203	268 × 840 × 203
Weight	kg			8.5	8.5	8.5	8.5
Connection Pipe Diameter	Liquid/Gas	mm		6.35/9.52	6.35/9.52	6.35/9.52	6.35/12.70

Floor



Model name	Indoor unit			AGHG09LVCA	AGHG12LVCA	AGHG14LVCA
kW Class	kW			2.5	3.5	4.0
Power Source	Single phase, ~230 V, 50 Hz					
Sound Pressure Level	Cooling	H/M/L/Q	dB(A)	39/34/28/22	42/36/30/22	44/38/31/22
	Heating			39/35/30/22	42/38/32/22	44/39/33/22
Sound Power Level	Cooling	H	dB(A)	52	55	56
	Heating			52	55	56
Airflow Rate	Cooling	H/M/L/Q	m ³ /h	530/440/360/270	600/490/380/270	650/520/400/270
	Heating			530/460/380/270	600/510/410/270	650/540/430/270
Net Dimensions	mm			600 × 740 × 200	600 × 740 × 200	600 × 740 × 200
Weight	kg			14	14	14
Connection Pipe Diameter	Liquid/Gas	mm		6.35/9.52	6.35/9.52	6.35/12.70

Floor ceiling



Model name	Indoor unit			ABHG14LVTA	ABHG18LVTB
kW Class		kW		4.0	5.0
Power Source	Single phase, ~230 V, 50 Hz				
Sound Pressure Level	Cooling	H/M/L/Q	dB(A)	36/34/33/29 (Under ceiling) 39/37/36/32 (Floor console)	41/38/34/32 (Under ceiling) 44/41/37/35 (Floor console)
	Heating			36/34/33/29 (Under ceiling) 39/37/36/32 (Floor console)	41/38/34/32 (Under ceiling) 44/41/37/35 (Floor console)
Sound Power Level	Cooling	H	dB(A)	51	55
	Heating			51	55
Airflow Rate	Cooling	H/M/L/Q	m ³ /h	640/590/540/480	780/700/560/500
	Heating			640/590/540/480	780/700/560/500
Net Dimensions	mm			199 × 990 × 655	199 × 990 × 655
Weight	kg			27	27
Connection Pipe Diameter	Liquid/Gas	mm		6.35/12.70	6.35/12.70

Compact cassette

Model name	Indoor unit			AUHG07LVLA	AUHG09LVLA	AUHG12LVLB	AUHG14LVLB	AUHG18LVLB
kW Class		kW		2.0	2.5	3.5	4.0	5.0
Power Source	Single phase, ~230 V, 50 Hz							
Sound Pressure Level	Cooling	H/M/L/Q	dB(A)	33/31/29/27	33/31/29/27	37/33/31/28	40/35/32/29	42/37/33/29
	Heating			34/32/29/27	34/32/29/27	37/33/31/28	40/37/34/29	44/40/37/30
Sound Power Level	Cooling	H	dB(A)	46	46	49	52	54
	Heating			47	47	49	52	56
Airflow Rate	Cooling	H/M/L/Q	m ³ /h	540/490/440/390	540/490/440/390	610/530/470/410	680/580/490/410	750/610/520/410
	Heating			540/490/440/390	540/490/440/390	610/530/470/410	700/620/550/430	800/710/600/450
Net Dimensions	mm			245 × 570 × 570	245 × 570 × 570	245 × 570 × 570	245 × 570 × 570	245 × 570 × 570
Weight	kg			15	15	15	15	15
Panel	UTG-UFGD-W							
Connection Pipe Diameter	Liquid/Gas	mm		6.35/9.52	6.35/9.52	6.35/9.52	6.35/12.70	6.35/12.70

Mini duct

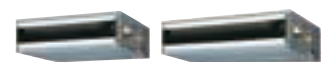
Model name	Indoor unit			ARHG07LSLAP	ARHG09LSLAP	ARHG12LSLAP	ARHG14LSLAP	ARHG18LSLAP
kW Class		kW		2.0	2.5	3.5	4.0	5.0
Power Source	Single phase, ~230 V, 50 Hz							
Sound Pressure Level	Cooling	H/M/L/Q	dB(A)	29/26/24/23	29/26/24/23	31/27/25/23	35/30/27/23	33/29/26/23
	Heating			29/26/24/23	29/26/24/23	31/27/25/23	35/30/27/23	33/29/26/23
Sound Power Level	Cooling	H	dB(A)	52	54	55	60	58
	Heating			53	56	57	62	59
Airflow Rate	Cooling	H/M/L/Q	m ³ /h	550/440/390/360	600/450/400/360	650/490/430/360	800/640/530/360	940/750/540/480
	Heating			550/440/390/360	600/450/400/360	650/490/430/360	800/640/530/360	940/750/540/480
Net Dimensions	mm			198 × 700 × 450	198 × 700 × 450	198 × 700 × 450	198 × 700 × 450	198 × 900 × 450
Weight	kg			15.5				18.5
Connection Pipe Diameter	Liquid/Gas	mm		6.35/9.52			6.35/12.70	
External static pressure	Pa			0 to 30			0 to 50	
Drain pump	Standard							

Slim duct

Model name	Indoor unit			ARHG07LLTA	ARHG09LLTA	ARHG12LLTB	ARHG14LLTB	ARHG18LLTB
kW Class		kW		2.0	2.5	3.5	4.0	5.0
Power Source	Single phase, ~230 V, 50 Hz							
Sound Pressure Level	Cooling	H/M/L/Q	dB(A)	28/26/25/24	28/27/26/25	29/28/27/26	32/30/28/26	32/31/30/29
	Heating			28/26/25/24	28/26/25/24	29/28/27/24	33/30/28/25	33/32/31/29
Sound Power Level	Cooling	H	dB(A)	57	57	58	60	58
	Heating			57	57	58	61	59
Airflow Rate	Cooling	H/M/L/Q	m ³ /h	550/490/470/440	600/550/500/450	650/600/550/480	800/700/600/480	940/880/820/750
	Heating			550/490/470/440	600/550/500/450	650/600/550/480	800/700/600/480	940/880/820/750
Net Dimensions	mm			198 × 700 × 620	198 × 700 × 620	198 × 700 × 620	198 × 700 × 620	198 × 900 × 620
Weight	kg			17	19	19	19	23
Connection Pipe Diameter	Liquid/Gas	mm		6.35/9.52	6.35/9.52	6.35/9.52	6.35/12.7	6.35/12.70
External static pressure	Pa			0 to 90				
Drain pump	Standard							

2-unit Multi-split Combination Table-Cooling/Heating

2-unit Multi-split cooling

AOHG14KBTA2	Combination of Indoor Units		Cooling Operation						Seasonal Data		
			Cooling Capacity			Input Power (Min. - Max.)	EER	Pdesign	SEER	Energy efficiency class	
			Unit 1	Unit 2	Total Capacity (Min. - Max.)						
2-unit connection	7	7	2.00	2.00	4.00 (1.4-4.6)	0.97 (0.25-1.20)	4.12	4.0	8.7	A+++	
	7	9	1.75	2.25	4.00 (1.4-4.6)	0.97 (0.25-1.20)	4.12	4.0	8.7	A+++	
	7	12	1.47	2.53	4.00 (1.4-4.6)	0.97 (0.25-1.20)	4.12	4.0	8.7	A+++	
	9	9	2.00	2.00	4.00 (1.4-4.6)	0.97 (0.25-1.20)	4.12	4.0	8.7	A+++	
	9	12	1.71	2.29	4.00 (1.4-4.6)	0.97 (0.25-1.20)	4.12	4.0	8.7	A+++	

- Notes: •7: 7000 Btu/h/9: 9000 Btu/h/12: 12000 Btu/h models
- The above specifications apply when connected with a wall-mounted [KG/KM] unit.
 - 2 or more indoor units should be connected.
 - Cooling capacity is determined based on 27°CDB/19°CWB (indoor temperature) and 35°CDB (outdoor temperature).
 - Pipe Length: 5 m, Height difference: 0 m (Outdoor unit to Indoor unit)
 - Total capacity of indoor units connected must be between 4.0 kW and 6.0 kW.
 - Please refer to the Design & Technical manual for the combination manual for the combination tables with 5kW model.

AOHG18KBTA2	Combination of Indoor Units		Cooling Operation						Seasonal Data		
			Cooling Capacity			Input Power (Min. - Max.)	EER	Pdesign	SEER	Energy efficiency class	
			Unit 1	Unit 2	Total Capacity (Min. - Max.)						
2-unit connection	7	7	2.00	2.00	4.00 (1.7-5.0)	0.92 (0.25-1.23)	4.35	4.0	8.8	A+++	
	7	9	2.00	2.50	4.50 (1.7-5.7)	1.07 (0.25-1.45)	4.22	4.5	8.7	A+++	
	7	12	1.84	3.16	5.00 (1.7-5.8)	1.24 (0.25-1.55)	4.03	5.0	8.6	A+++	
	7	14	1.67	3.33	5.00 (1.7-5.8)	1.24 (0.25-1.55)	4.03	5.0	8.6	A+++	
	9	9	2.50	2.50	5.00 (1.7-5.8)	1.24 (0.25-1.55)	4.03	5.0	8.6	A+++	
	9	12	2.14	2.86	5.00 (1.7-5.8)	1.24 (0.25-1.55)	4.03	5.0	8.6	A+++	
	9	14	1.96	3.04	5.00 (1.7-5.8)	1.24 (0.25 - 1.55)	4.03	5.0	8.6	A+++	
	12	12	2.50	2.50	5.00 (1.7-5.8)	1.24 (0.25-1.55)	4.03	5.0	8.6	A+++	
	12	14	2.31	2.69	5.00 (1.7-5.8)	1.24 (0.25-1.55)	4.03	5.0	8.6	A+++	

- Notes: •7: 7000 Btu/h/9:9000 Btu/h/12: 12000 Btu/h/14: 14000 Btu/h models
- The above specifications apply when connected with a wall-mounted [KG/KM] unit.
 - 2 or more indoor units should be connected.
 - Cooling capacity is determined based on 27°CDB/19°CWB (indoor temperature) and 35°CDB (outdoor temperature).
 - Pipe Length: 5 m, Height difference: 0 m (Outdoor unit to Indoor unit)
 - Total capacity of indoor units connected must be between 4.0 kW and 7.5 kW.
 - Please refer to the Design & Technical manual for the combination tables with 5kW model.

2-unit Multi-split heating

AOHG14KBTA2	Combination of Indoor Units		Heating Operation							
			Heating Capacity			Input Power (Min. - Max.)	COP	Seasonal Data		
			Unit 1 kW	Unit 2 kW	Total Capacity (Min. - Max.) kW			Pdesign kW	SCOP	Energy efficiency class
2-unit connection	7	7	2.20	2.20	4.40 (1.1-5.5)	0.95 (0.25-1.65)	4.63	3.5	4.7	A++
	7	9	1.92	2.48	4.40 (1.1-5.5)	0.95 (0.25-1.65)	4.63	3.5	4.7	A++
	7	12	1.62	2.78	4.40 (1.1-5.5)	0.95 (0.25-1.65)	4.63	3.5	4.7	A++
	9	9	2.20	2.20	4.40 (1.1-5.5)	0.95 (0.25-1.65)	4.63	3.5	4.7	A++
	9	12	1.89	2.51	4.40 (1.1-5.5)	0.95 (0.25-1.65)	4.63	3.5	4.7	A++

Notes: •7: 7000 Btu/h/9: 9000 Btu/h/12: 12000 Btu/h models

- The above specifications apply when connected with a wall-mounted [KG/KM] unit.
- 2 or more indoor units should be connected.
- Heating capacity is determined based on 20°CDB (indoor temperature) and 7°CDB/6°CWB (outdoor temperature).
- Pipe Length: 5 m, Height difference: 0 m (Outdoor unit to Indoor unit)
- Total capacity of indoor units connected must be between 4.0 kW and 6.0 kW.
- Please refer to the Design & Technical manual for the combination tables for the combination tables with 5kW model.

AOHG18KBTA2	Combination of Indoor Units		Heating Operation							
			Heating Capacity			Input Power (Min. - Max.)	COP	Seasonal Data		
			Unit 1 kW	Unit 2 kW	Total Capacity (Min. - Max.) kW			Pdesign kW	SCOP	Energy efficiency class
2-unit connection	7	7	2.40	2.40	4.80 (1.7-5.6)	0.99 (0.25-1.35)	4.85	3.8	4.7	A++
	7	9	2.40	3.00	5.40 (1.7-6.4)	1.15 (0.25-1.60)	4.70	4.0	4.7	A++
	7	12	2.06	3.54	5.60 (1.7-7.0)	1.22 (0.25-1.80)	4.59	4.2	4.7	A++
	7	14	1.87	3.73	5.60 (1.7-7.0)	1.22 (0.25-1.80)	4.59	4.2	4.7	A++
	9	9	2.80	2.80	5.60 (1.7-7.0)	1.22 (0.25-1.80)	4.59	4.2	4.7	A++
	9	12	2.40	3.20	5.60 (1.7-7.0)	1.22 (0.25-1.80)	4.59	4.2	4.7	A++
	9	14	2.19	3.41	5.60 (1.7-7.0)	1.22 (0.25-1.80)	4.59	4.2	4.7	A++
	12	12	2.80	2.80	5.60 (1.7-7.0)	1.22 (0.25-1.80)	4.59	4.2	4.7	A++
	12	14	2.58	3.02	5.60 (1.7-7.0)	1.22 (0.25-1.80)	4.59	4.2	4.7	A++

Notes: •7: 7000 Btu/h/9:9000 Btu/h/12: 12000 Btu/h/14: 14000 Btu/h models

- The above specifications apply when connected with a wall-mounted [KG/KM] unit.
- 2 or more indoor units should be connected.
- Heating capacity is determined based on 20°CDB (indoor temperature) and 7°CDB/6°CWB (outdoor temperature).
- Pipe Length: 5 m, Height difference: 0 m (Outdoor unit to Indoor unit)
- Total capacity of indoor units connected must be between 4.0 kW and 7.5 kW.
- Please refer to the Design & Technical manual for the combination tables with 5kW model.

3-unit Multi-split Combination Table-Cooling/Heating

3-unit Multi-split cooling

AOHG18KBTA3	Combination of Indoor Units			Cooling Operation							Seasonal Data		
				Cooling Capacity				Input Power (Min. - Max.)	EER	Pdesign kW	SEER	Energy efficiency	
				Unit 1 kW	Unit 2 kW	Unit 3 kW	Total Capacity (Min. - Max.) kW						
2-unit connection	7	7	-	2.00	2.00	-	4.00 (1.8-5.0)	0.86 (0.35-1.35)	4.65	4.0	8.3	A++	
	7	9	-	2.00	2.50	-	4.50 (1.8-5.7)	1.03 (0.35-1.50)	4.36	4.5	8.2	A++	
	7	12	-	1.99	3.41	-	5.40 (1.8-6.8)	1.41 (0.35-1.81)	3.83	5.4	8.0	A++	
	7	14	-	1.80	3.60	-	5.40 (1.8-7.0)	1.41 (0.35-1.90)	3.83	5.4	8.0	A++	
	9	9	-	2.50	2.50	-	5.00 (1.8-6.4)	1.23 (0.35-1.70)	4.06	5.0	8.1	A++	
	9	12	-	2.31	3.09	-	5.40 (1.8-7.0)	1.41 (0.35-1.90)	3.83	5.4	8.0	A++	
	9	14	-	2.11	3.29	-	5.40 (1.8-7.0)	1.41 (0.35-1.90)	3.83	5.4	8.0	A++	
	12	12	-	2.70	2.70	-	5.40 (1.8-7.0)	1.41 (0.35-1.90)	3.83	5.4	8.0	A++	
3-unit connection	12	14	-	2.49	2.91	-	5.40 (1.8-7.0)	1.41 (0.35-1.90)	3.83	5.4	8.0	A++	
	14	14	-	2.70	2.70	-	5.40 (1.8-7.0)	1.41 (0.35-1.90)	3.83	5.4	8.0	A++	
	7	7	7	1.80	1.80	1.80	5.40 (1.8-7.0)	1.13 (0.35-1.90)	4.78	5.4	8.6	A+++	
	7	7	9	1.64	1.64	2.12	5.40 (1.8-7.0)	1.13 (0.35-1.90)	4.78	5.4	8.6	A+++	
	7	7	12	1.45	1.45	2.50	5.40 (1.8-7.0)	1.13 (0.35-1.90)	4.78	5.4	8.6	A+++	
	7	7	14	1.35	1.35	2.70	5.40 (1.8-7.0)	1.13 (0.35-1.90)	4.78	5.4	8.6	A+++	
	7	9	9	1.52	1.94	1.94	5.40 (1.8-7.0)	1.13 (0.35-1.90)	4.78	5.4	8.6	A+++	
	7	9	12	1.35	1.74	2.31	5.40 (1.8-7.0)	1.13 (0.35-1.90)	4.78	5.4	8.6	A+++	
3-unit connection	7	9	14	1.26	1.62	2.52	5.40 (1.8-7.0)	1.13 (0.35-1.90)	4.78	5.4	8.6	A+++	
	9	9	9	1.80	1.80	1.80	5.40 (1.8-7.0)	1.13 (0.35-1.90)	4.78	5.4	8.6	A+++	
	9	9	12	1.62	1.62	2.16	5.40 (1.8-7.0)	1.13 (0.35-1.90)	4.78	5.4	8.6	A+++	

AOHG24KBTA3	Combination of Indoor Units			Cooling Operation							Seasonal Data		
				Cooling Capacity				Input Power (Min. - Max.)	EER	Pdesign kW	SEER	Energy efficiency	
				Unit 1 kW	Unit 2 kW	Unit 3 kW	Total Capacity (Min. - Max.) kW						
2-unit connection	7	7	-	2.00	2.00	-	4.00 (1.8-5.0)	0.86 (0.35-1.35)	4.65	4.0	8.3	A++	
	7	9	-	2.00	2.50	-	4.50 (1.8-5.7)	1.03 (0.35-1.54)	4.36	4.5	8.2	A++	
	7	12	-	2.00	3.50	-	5.50 (1.8-6.8)	1.46 (0.35-1.85)	3.77	5.5	8.0	A++	
	7	14	-	2.00	4.00	-	6.00 (1.8-7.5)	1.73 (0.35-2.20)	3.48	6.0	7.6	A++	
	7	18	-	1.90	4.90	-	6.80 (1.8-8.5)	2.26 (0.35-2.65)	3.01	6.8	6.9	A++	
	9	9	-	2.50	2.50	-	5.00 (1.8-6.4)	1.23 (0.35-1.74)	4.06	5.0	8.1	A++	
	9	12	-	2.50	3.50	-	6.00 (1.8-7.5)	1.73 (0.35-2.20)	3.48	6.0	7.6	A++	
	9	14	-	2.50	4.00	-	6.50 (1.8-8.2)	2.04 (0.35-2.46)	3.19	6.5	7.2	A++	
	9	18	-	2.27	4.53	-	6.80 (1.8-8.5)	2.26 (0.35-2.65)	3.01	6.8	6.9	A++	
	12	12	-	3.40	3.40	-	6.80 (1.8-8.5)	2.26 (0.35-2.65)	3.01	6.8	6.9	A++	
	12	14	-	3.14	3.66	-	6.80 (1.8-8.5)	2.26 (0.35-2.65)	3.01	6.8	6.9	A++	
	12	18	-	2.72	4.08	-	6.80 (1.8-8.5)	2.26 (0.35-2.65)	3.01	6.8	6.9	A++	
	14	14	-	3.40	3.40	-	6.80 (1.8-8.5)	2.26 (0.35-2.65)	3.01	6.8	6.9	A++	
	14	18	-	2.98	3.82	-	6.80 (1.8-8.5)	2.26 (0.35-2.65)	3.01	6.8	6.9	A++	
3-unit connection	7	7	7	2.00	2.00	2.00	6.00 (1.8-7.5)	1.37 (0.35-2.20)	4.37	6.0	8.6	A+++	
	7	7	9	2.00	2.00	2.50	6.50 (1.8-8.2)	1.59 (0.35-2.46)	4.08	6.5	8.5	A+++	
	7	7	12	1.83	1.83	3.14	6.80 (1.8-8.5)	1.74 (0.35-2.65)	3.90	6.8	8.5	A+++	
	7	7	14	1.70	1.70	3.40	6.80 (1.8-8.5)	1.74 (0.35-2.65)	3.90	6.8	8.5	A+++	
	7	7	18	1.49	1.49	3.82	6.80 (1.8-8.5)	1.74 (0.35-2.65)	3.90	6.8	8.5	A+++	
	7	9	9	1.90	2.45	2.45	6.80 (1.8-8.5)	1.74 (0.35-2.65)	3.90	6.8	8.5	A+++	
	7	9	12	1.70	2.19	2.91	6.80 (1.8-8.5)	1.74 (0.35-2.65)	3.90	6.8	8.5	A+++	
	7	9	14	1.59	2.04	3.17	6.80 (1.8-8.5)	1.74 (0.35-2.65)	3.90	6.8	8.5	A+++	
	7	9	18	1.40	1.80	3.60	6.80 (1.8-8.5)	1.74 (0.35-2.65)	3.90	6.8	8.5	A+++	
	7	12	12	1.54	2.63	2.63	6.80 (1.8-8.5)	1.74 (0.35-2.65)	3.90	6.8	8.5	A+++	
	7	12	14	1.44	2.47	2.89	6.80 (1.8-8.5)	1.74 (0.35-2.65)	3.90	6.8	8.5	A+++	
	7	14	14	1.36	2.72	2.72	6.80 (1.8-8.5)	1.74 (0.35-2.65)	3.90	6.8	8.5	A+++	
	9	9	9	2.27	2.27	2.27	6.80 (1.8-8.5)	1.74 (0.35-2.65)	3.90	6.8	8.5	A+++	
	9	9	12	2.04	2.04	2.72	6.80 (1.8-8.5)	1.74 (0.35-2.65)	3.90	6.8	8.5	A+++	
	9	9	14	1.91	1.91	2.98	6.80 (1.8-8.5)	1.74 (0.35-2.65)	3.90	6.8	8.5	A+++	
	9	9	18	1.70	1.70	3.40	6.80 (1.8-8.5)	1.74 (0.35-2.65)	3.90	6.8	8.5	A+++	
	9	12	12	1.86	2.47	2.47	6.80 (1.8-8.5)	1.74 (0.35-2.65)	3.90	6.8	8.5	A+++	
	9	12	14	1.75	2.33	2.72	6.80 (1.8-8.5)	1.74 (0.35-2.65)	3.90	6.8	8.5	A+++	
12	12	12	2.27	2.27	2.27	6.80 (1.8-8.5)	1.74 (0.35-2.65)	3.90	6.8	8.5	A+++		

- Notes: •7: 7000 Btu/h/9: 9000 Btu/h/12: 12000 Btu/h/14: 14000 Btu/h/18: 18000 Btu/h models
 •The above specifications apply when connected with a wall-mounted [KG/KM] unit.
 •2 or more indoor units should be connected.
 •Cooling capacity is determined based on 27°CDB/19°CWB (indoor temperature) and 35°CDB (outdoor temperature).
 •Pipe Length: 5 m, Height difference: 0 m (Outdoor unit to Indoor unit)
 •Total capacity of indoor units connected must be between 4.0 kW and 10.5 kW.
 •Please refer to the Design & Technical manual for the combination tables with 5kW model.

3-unit Multi-split heating

AOHG18KBTA3	Combination of Indoor Units			Heating Operation								
				Heating Capacity				Input Power (Min. - Max.)	COP	Seasonal Data		
				Unit 1 kW	Unit 2 kW	Unit 3 kW	Total Capacity (Min. - Max.) kW			Pdesign kW	SCOP	Energy efficiency
2-unit connection	7	7	-	2.40	2.40	-	4.80 (2.0-5.6)	1.00 (0.25-1.30)	4.80	4.0	4.2	A+
	7	9	-	2.40	3.00	-	5.40 (2.0-6.4)	1.21 (0.25-1.48)	4.45	4.0	4.2	A+
	7	12	-	2.40	4.20	-	6.60 (2.0-7.6)	1.66 (0.25-1.76)	3.98	5.0	4.0	A+
	7	14	-	2.27	4.53	-	6.80 (2.0-8.0)	1.77 (0.25-1.85)	3.84	5.0	4.0	A+
	9	9	-	3.00	3.00	-	6.00 (2.0-7.2)	1.44 (0.25-1.67)	4.17	4.5	4.1	A+
	9	12	-	2.91	3.89	-	6.80 (2.0-8.0)	1.77 (0.25-1.85)	3.84	5.0	4.0	A+
	9	14	-	2.66	4.14	-	6.80 (2.0-8.0)	1.77 (0.25-1.85)	3.84	5.0	4.0	A+
	12	12	-	3.40	3.40	-	6.80 (2.0-8.0)	1.77 (0.25-1.85)	3.84	5.0	4.0	A+
	12	14	-	3.14	3.66	-	6.80 (2.0-8.0)	1.77 (0.25-1.85)	3.84	5.0	4.0	A+
3-unit connection	14	14	-	3.40	3.40	-	6.80 (2.0-8.0)	1.77 (0.25-1.85)	3.84	5.0	4.0	A+
	7	7	7	2.27	2.27	2.27	6.80 (2.0-8.0)	1.39 (0.25-1.85)	4.89	5.0	4.7	A++
	7	7	9	2.07	2.07	2.66	6.80 (2.0-8.0)	1.39 (0.25-1.85)	4.89	5.0	4.7	A++
	7	7	12	1.83	1.83	3.14	6.80 (2.0-8.0)	1.39 (0.25-1.85)	4.89	5.0	4.7	A++
	7	7	14	1.70	1.70	3.40	6.80 (2.0-8.0)	1.39 (0.25-1.85)	4.89	5.0	4.7	A++
	7	9	9	1.90	2.45	2.45	6.80 (2.0-8.0)	1.39 (0.25-1.85)	4.89	5.0	4.7	A++
	7	9	12	1.70	2.19	2.91	6.80 (2.0-8.0)	1.39 (0.25-1.85)	4.89	5.0	4.7	A++
	7	9	14	1.59	2.04	3.17	6.80 (2.0-8.0)	1.39 (0.25-1.85)	4.89	5.0	4.7	A++
	9	9	9	2.27	2.27	2.27	6.80 (2.0-8.0)	1.39 (0.25-1.85)	4.89	5.0	4.7	A++
9	9	12	2.04	2.04	2.72	6.80 (2.0-8.0)	1.39 (0.25-1.85)	4.89	5.0	4.7	A++	

AOHG24KBTA3	Combination of Indoor Units			Heating Operation								
				Heating Capacity				Input Power (Min. - Max.)	COP	Seasonal Data		
				Unit 1 kW	Unit 2 kW	Unit 3 kW	Total Capacity (Min. - Max.) kW			Pdesign kW	SCOP	Energy efficiency
2-unit connection	7	7	-	2.40	2.40	-	4.80 (2.0-5.6)	1.00 (0.25-1.30)	4.80	4.0	4.2	A+
	7	9	-	2.40	3.00	-	5.40 (2.0-6.4)	1.21 (0.25-1.48)	4.45	4.0	4.2	A+
	7	12	-	2.40	4.20	-	6.60 (2.0-7.6)	1.66 (0.25-1.76)	3.98	5.0	4.0	A+
	7	14	-	2.40	4.80	-	7.20 (2.0-8.4)	1.86 (0.25-2.07)	3.87	5.4	4.0	A+
	7	18	-	2.16	5.54	-	7.70 (2.0-9.2)	2.01 (0.25-2.35)	3.83	5.8	4.0	A+
	9	9	-	3.00	3.00	-	6.00 (2.0-7.2)	1.44 (0.25-1.67)	4.17	4.5	4.1	A+
	9	12	-	3.00	4.20	-	7.20 (2.0-8.4)	1.86 (0.25-2.07)	3.87	5.4	4.0	A+
	9	14	-	2.96	4.74	-	7.70 (2.0-9.2)	2.01 (0.25-2.35)	3.83	5.8	4.0	A+
	9	18	-	2.57	5.13	-	7.70 (2.0-9.2)	2.01 (0.25-2.35)	3.83	5.8	4.0	A+
	12	12	-	3.85	3.85	-	7.70 (2.0-9.2)	2.01 (0.25-2.35)	3.83	5.8	4.0	A+
	12	14	-	3.55	4.15	-	7.70 (2.0-9.2)	2.01 (0.25-2.35)	3.83	5.8	4.0	A+
	12	18	-	3.08	4.62	-	7.70 (2.0-9.2)	2.01 (0.25-2.35)	3.83	5.8	4.0	A+
	14	14	-	3.85	3.85	-	7.70 (2.0-9.2)	2.01 (0.25-2.35)	3.83	5.8	4.0	A+
	14	18	-	3.37	4.33	-	7.70 (2.0-9.2)	2.01 (0.25-2.35)	3.83	5.8	4.0	A+
3-unit connection	7	7	7	2.40	2.40	2.40	7.20 (2.0-8.4)	1.61 (0.25-2.07)	4.48	5.4	4.7	A++
	7	7	9	2.40	2.40	3.00	7.80 (2.0-9.2)	1.76 (0.25-2.35)	4.42	5.8	4.6	A++
	7	7	12	2.15	2.15	3.70	8.00 (2.0-9.2)	1.82 (0.25-2.35)	4.40	6.0	4.6	A++
	7	7	14	2.00	2.00	4.00	8.00 (2.0-9.2)	1.82 (0.25-2.35)	4.40	6.0	4.6	A++
	7	7	18	1.75	1.75	4.50	8.00 (2.0-9.2)	1.82 (0.25-2.35)	4.40	6.0	4.6	A++
	7	9	9	2.24	2.88	2.88	8.00 (2.0-9.2)	1.82 (0.25-2.35)	4.40	6.0	4.6	A++
	7	9	12	2.00	2.57	3.43	8.00 (2.0-9.2)	1.82 (0.25-2.35)	4.40	6.0	4.6	A++
	7	9	14	1.87	2.40	3.73	8.00 (2.0-9.2)	1.82 (0.25-2.35)	4.40	6.0	4.6	A++
	7	9	18	1.65	2.12	4.23	8.00 (2.0-9.2)	1.82 (0.25-2.35)	4.40	6.0	4.6	A++
	7	12	12	1.80	3.10	3.10	8.00 (2.0-9.2)	1.82 (0.25-2.35)	4.40	6.0	4.6	A++
	7	12	14	1.70	2.91	3.39	8.00 (2.0-9.2)	1.82 (0.25-2.35)	4.40	6.0	4.6	A++
	7	14	14	1.60	3.20	3.20	8.00 (2.0-9.2)	1.82 (0.25-2.35)	4.40	6.0	4.6	A++
	9	9	9	2.67	2.67	2.67	8.00 (2.0-9.2)	1.82 (0.25-2.35)	4.40	6.0	4.6	A++
	9	9	12	2.40	2.40	3.20	8.00 (2.0-9.2)	1.82 (0.25-2.35)	4.40	6.0	4.6	A++
	9	9	14	2.25	2.25	3.50	8.00 (2.0-9.2)	1.82 (0.25-2.35)	4.40	6.0	4.6	A++
	9	9	18	2.00	2.00	4.00	8.00 (2.0-9.2)	1.82 (0.25-2.35)	4.40	6.0	4.6	A++
	9	12	12	2.18	2.91	2.91	8.00 (2.0-9.2)	1.82 (0.25-2.35)	4.40	6.0	4.6	A++
	9	12	14	2.06	2.74	3.20	8.00 (2.0-9.2)	1.82 (0.25-2.35)	4.40	6.0	4.6	A++
12	12	12	2.67	2.67	2.67	8.00 (2.0-9.2)	1.82 (0.25-2.35)	4.40	6.0	4.6	A++	

- Notes: •7: 7000 Btu/h/9: 9000 Btu/h/12: 12000 Btu/h/14: 14000 Btu/h/18: 18000 Btu/h models
 •The above specifications apply when connected with a wall-mounted [KG/KM] unit.
 •2 or more indoor units should be connected.
 •Heating capacity is determined based on 20°CDB (indoor temperature) and 7°CDB/6°CWB (outdoor temperature).
 •Pipe Length: 5 m, Height difference: 0 m (Outdoor unit to Indoor unit)
 •Total capacity of indoor units connected must be between 4.0 kW and 10.5 kW.
 •Please refer to the Design & Technical manual for the combination tables with 5kW model.

4-unit Multi-split Combination Table-Cooling/Heating

4-unit Multi-split cooling

AOHG30KBT4	Combination of Indoor Units		Cooling Operation												
			Cooling Capacity					Input Power (Min. - Max.)	EER	Seasonal Data					
			Unit 1 kW	Unit 2 kW	Unit 3 kW	Unit 4 kW	Total Capacity (Min. - Max.) kW			Pdesign kW	SEER	Energy efficiency			
2-unit connection	7	22	-	-	2.00	6.00	-	-	-	8.00 (2.4-10.1)	2.67 (0.45-3.25)	3.00	8.0	7.5	A++
	7	24	-	-	1.81	6.19	-	-	-	8.00 (2.4-10.1)	2.67 (0.45-3.25)	3.00	8.0	7.5	A++
	9	22	-	-	2.32	5.68	-	-	-	8.00 (2.4-10.1)	2.67 (0.45-3.25)	3.00	8.0	7.5	A++
	9	24	-	-	2.18	5.82	-	-	-	8.00 (2.4-10.1)	2.67 (0.45-3.25)	3.00	8.0	7.5	A++
	12	18	-	-	3.20	4.80	-	-	-	8.00 (2.4-10.1)	2.67 (0.45-3.25)	3.00	8.0	7.5	A++
	12	22	-	-	2.82	5.18	-	-	-	8.00 (2.4-10.1)	2.67 (0.45-3.25)	3.00	8.0	7.5	A++
	12	24	-	-	2.67	5.33	-	-	-	8.00 (2.4-10.1)	2.67 (0.45-3.25)	3.00	8.0	7.5	A++
	14	18	-	-	3.50	4.50	-	-	-	8.00 (2.4-10.1)	2.67 (0.45-3.25)	3.00	8.0	7.5	A++
	14	22	-	-	3.11	4.89	-	-	-	8.00 (2.4-10.1)	2.67 (0.45-3.25)	3.00	8.0	7.5	A++
	14	24	-	-	2.95	5.05	-	-	-	8.00 (2.4-10.1)	2.67 (0.45-3.25)	3.00	8.0	7.5	A++
	18	18	-	-	4.00	4.00	-	-	-	8.00 (2.4-10.1)	2.67 (0.45-3.25)	3.00	8.0	7.5	A++
	18	22	-	-	3.60	4.40	-	-	-	8.00 (2.4-10.1)	2.67 (0.45-3.25)	3.00	8.0	7.5	A++
	18	24	-	-	3.43	4.57	-	-	-	8.00 (2.4-10.1)	2.67 (0.45-3.25)	3.00	8.0	7.5	A++
	22	22	-	-	4.00	4.00	-	-	-	8.00 (2.4-10.1)	2.67 (0.45-3.25)	3.00	8.0	7.5	A++
	22	24	-	-	3.83	4.17	-	-	-	8.00 (2.4-10.1)	2.67 (0.45-3.25)	3.00	8.0	7.5	A++
	24	24	-	-	4.00	4.00	-	-	-	8.00 (2.4-10.1)	2.67 (0.45-3.25)	3.00	8.0	7.5	A++
	3-unit connection	7	7	12	-	2.00	2.00	3.50	-	7.50 (2.4-9.3)	2.10 (0.45-2.84)	3.57	7.5	8.1	A++
		7	7	14	-	2.00	2.00	4.00	-	8.00 (2.4-10.1)	2.32 (0.45-3.25)	3.45	8.0	8.0	A++
		7	7	18	-	1.75	1.75	4.50	-	8.00 (2.4-10.1)	2.32 (0.45-3.25)	3.45	8.0	8.0	A++
		7	7	22	-	1.56	1.56	4.88	-	8.00 (2.4-10.1)	2.32 (0.45-3.25)	3.45	8.0	8.0	A++
		7	7	24	-	1.47	1.47	5.06	-	8.00 (2.4-10.1)	2.32 (0.45-3.25)	3.45	8.0	8.0	A++
		7	9	9	-	2.00	2.50	2.50	-	7.00 (2.4-8.9)	1.90 (0.45-2.65)	3.69	7.0	8.2	A++
		7	9	12	-	2.00	2.50	3.50	-	8.00 (2.4-10.1)	2.32 (0.45-3.25)	3.45	8.0	8.0	A++
		7	9	14	-	1.87	2.40	3.73	-	8.00 (2.4-10.1)	2.32 (0.45-3.25)	3.45	8.0	8.0	A++
7		9	18	-	1.64	2.12	4.24	-	8.00 (2.4-10.1)	2.32 (0.45-3.25)	3.45	8.0	8.0	A++	
7		9	22	-	1.47	1.89	4.64	-	8.00 (2.4-10.1)	2.32 (0.45-3.25)	3.45	8.0	8.0	A++	
7		9	24	-	1.40	1.80	4.80	-	8.00 (2.4-10.1)	2.32 (0.45-3.25)	3.45	8.0	8.0	A++	
7		12	12	-	1.80	3.10	3.10	-	8.00 (2.4-10.1)	2.32 (0.45-3.25)	3.45	8.0	8.0	A++	
7		12	14	-	1.70	2.91	3.39	-	8.00 (2.4-10.1)	2.32 (0.45-3.25)	3.45	8.0	8.0	A++	
7		12	18	-	1.51	2.59	3.90	-	8.00 (2.4-10.1)	2.32 (0.45-3.25)	3.45	8.0	8.0	A++	
7		12	22	-	1.37	2.34	4.29	-	8.00 (2.4-10.1)	2.32 (0.45-3.25)	3.45	8.0	8.0	A++	
7		12	24	-	1.30	2.23	4.47	-	8.00 (2.4-10.1)	2.32 (0.45-3.25)	3.45	8.0	8.0	A++	
7		14	14	-	1.60	3.20	3.20	-	8.00 (2.4-10.1)	2.32 (0.45-3.25)	3.45	8.0	8.0	A++	
7		14	18	-	1.44	2.87	3.69	-	8.00 (2.4-10.1)	2.32 (0.45-3.25)	3.45	8.0	8.0	A++	
7		14	22	-	1.30	2.60	4.10	-	8.00 (2.4-10.1)	2.32 (0.45-3.25)	3.45	8.0	8.0	A++	
7		14	24	-	1.24	2.49	4.27	-	8.00 (2.4-10.1)	2.32 (0.45-3.25)	3.45	8.0	8.0	A++	
7		18	18	-	1.30	3.35	3.35	-	8.00 (2.4-10.1)	2.32 (0.45-3.25)	3.45	8.0	8.0	A++	
7		18	22	-	1.19	3.06	3.75	-	8.00 (2.4-10.1)	2.32 (0.45-3.25)	3.45	8.0	8.0	A++	
7		18	24	-	1.14	2.94	3.92	-	8.00 (2.4-10.1)	2.32 (0.45-3.25)	3.45	8.0	8.0	A++	
9		9	9	-	2.50	2.50	2.50	-	7.50 (2.4-9.6)	2.10 (0.45-3.01)	3.57	7.5	8.1	A++	
9		9	12	-	2.40	2.40	3.20	-	8.00 (2.4-10.1)	2.32 (0.45-3.25)	3.45	8.0	8.0	A++	
9		9	14	-	2.25	2.25	3.50	-	8.00 (2.4-10.1)	2.32 (0.45-3.25)	3.45	8.0	8.0	A++	
9		9	18	-	2.00	2.00	4.00	-	8.00 (2.4-10.1)	2.32 (0.45-3.25)	3.45	8.0	8.0	A++	
9		9	22	-	1.80	1.80	4.40	-	8.00 (2.4-10.1)	2.32 (0.45-3.25)	3.45	8.0	8.0	A++	
9		9	24	-	1.71	1.71	4.58	-	8.00 (2.4-10.1)	2.32 (0.45-3.25)	3.45	8.0	8.0	A++	
9		12	12	-	2.18	2.91	2.91	-	8.00 (2.4-10.1)	2.32 (0.45-3.25)	3.45	8.0	8.0	A++	
9		12	14	-	2.06	2.74	3.20	-	8.00 (2.4-10.1)	2.32 (0.45-3.25)	3.45	8.0	8.0	A++	
9		12	18	-	1.85	2.46	3.69	-	8.00 (2.4-10.1)	2.32 (0.45-3.25)	3.45	8.0	8.0	A++	
9		12	22	-	1.67	2.23	4.10	-	8.00 (2.4-10.1)	2.32 (0.45-3.25)	3.45	8.0	8.0	A++	
9		12	24	-	1.60	2.13	4.27	-	8.00 (2.4-10.1)	2.32 (0.45-3.25)	3.45	8.0	8.0	A++	
9		14	14	-	1.94	3.03	3.03	-	8.00 (2.4-10.1)	2.32 (0.45-3.25)	3.45	8.0	8.0	A++	
9		14	18	-	1.76	2.73	3.51	-	8.00 (2.4-10.1)	2.32 (0.45-3.25)	3.45	8.0	8.0	A++	
9		14	22	-	1.60	2.49	3.91	-	8.00 (2.4-10.1)	2.32 (0.45-3.25)	3.45	8.0	8.0	A++	
9		14	24	-	1.53	2.38	4.09	-	8.00 (2.4-10.1)	2.32 (0.45-3.25)	3.45	8.0	8.0	A++	
9		18	18	-	1.60	3.20	3.20	-	8.00 (2.4-10.1)	2.32 (0.45-3.25)	3.45	8.0	8.0	A++	
12		12	12	-	2.67	2.67	2.67	-	8.00 (2.4-10.1)	2.32 (0.45-3.25)	3.45	8.0	8.0	A++	
12		12	14	-	2.53	2.53	2.94	-	8.00 (2.4-10.1)	2.32 (0.45-3.25)	3.45	8.0	8.0	A++	
12		12	18	-	2.29	2.29	3.42	-	8.00 (2.4-10.1)	2.32 (0.45-3.25)	3.45	8.0	8.0	A++	
12		12	22	-	2.09	2.09	3.82	-	8.00 (2.4-10.1)	2.32 (0.45-3.25)	3.45	8.0	8.0	A++	
12		12	24	-	2.00	2.00	4.00	-	8.00 (2.4-10.1)	2.32 (0.45-3.25)	3.45	8.0	8.0	A++	
12		14	14	-	2.40	2.80	2.80	-	8.00 (2.4-10.1)	2.32 (0.45-3.25)	3.45	8.0	8.0	A++	
12		14	18	-	2.18	2.55	3.27	-	8.00 (2.4-10.1)	2.32 (0.45-3.25)	3.45	8.0	8.0	A++	
12		14	22	-	2.00	3.00	3.00	-	8.00 (2.4-10.1)	2.32 (0.45-3.25)	3.45	8.0	8.0	A++	
14		14	14	-	2.67	2.67	2.67	-	8.00 (2.4-10.1)	2.32 (0.45-3.25)	3.45	8.0	8.0	A++	
14		14	18	-	2.43	2.43	3.14	-	8.00 (2.4-10.1)	2.32 (0.45-3.25)	3.45	8.0	8.0	A++	
7		7	7	7	2.00	2.00	2.00	2.00	8.00 (2.4-10.1)	2.05 (0.45-3.25)	3.90	8.0	8.5	A+++	
7		7	7	9	1.87	1.87	1.87	2.39	8.00 (2.4-10.1)	2.05 (0.45-3.25)	3.90	8.0	8.5	A+++	
7		7	7	12	1.70	1.70	1.70	2.90	8.00 (2.4-10.1)	2.05 (0.45-3.25)	3.90	8.0	8.5	A+++	
7	7	7	14	1.60	1.60	1.60	3.20	8.00 (2.4-10.1)	2.05 (0.45-3.25)	3.90	8.0	8.5	A+++		
7	7	7	18	1.44	1.44	1.44	3.68	8.00 (2.4-10.1)	2.05 (0.45-3.25)	3.90	8.0	8.5	A+++		
7	7	9	9	1.75	1.75	2.25	2.25	8.00 (2.4-10.1)	2.05 (0.45-3.25)	3.90	8.0	8.5	A+++		
7	7	9	12	1.60	1.60	2.06	2.74	8.00 (2.4-10.1)	2.05 (0.45-3.25)	3.90	8.0	8.5	A+++		
7	7	9	14	1.51	1.51	1.95	3.03	8.00 (2.4-10.1)	2.05 (0.45-3.25)	3.90	8.0	8.5	A+++		
7	7	9	18	1.37	1.37	1.76	3.50	8.00 (2.4-10.1)	2.05 (0.45-3.25)	3.90	8.0	8.5	A+++		
7	7	12	12	1.47	1.47	2.53	2.53	8.00 (2.4-10.1)	2.05 (0.45-3.25)	3.90	8.0	8.5	A+++		
7	7	12	14	1.40	1.40	2.40	2.80	8.00 (2.4-10.1)	2.05 (0.45-3.25)	3.90	8.0	8.5	A+++		
7	7	12	18	1.27	1.27	2.18	3.28	8.00 (2.4-10.1)	2.05 (0.45-3.25)	3.90	8.0	8.5	A+++		
7	7	14	14	1.33	1.33	2.67	2.67	8.00 (2.4-10.1)	2.05 (0.45-3.25)	3.90	8.0	8.5	A+++		
7	7	14	18	1.22	1.22	2.43	3.13	8.00 (2.4-10.1)	2.05 (0.45-3.25)	3.90	8.0	8.5	A+++		
7	9	9	9	1.64	2.12	2.12	2.12	8.00 (2.4-10.1)	2.05 (0.45-3.25)	3.90	8.0	8.5	A+++		
7	9	9	12	1.51	1.95	1.95	2.59	8.00 (2.4-10.1)	2.05 (0.45-3.25)	3.90	8.0	8.5	A+++		
7	9	9	14	1.43	1.85	1.85	2.87	8.00 (2.4-10.1)	2.05 (0.45-3.25)	3.90	8.0	8.5	A+++		
7	9	9	18	1.30	1.67	1.67	3.36	8.00 (2.4-10.1)	2.05 (0.45-3.25)	3.90	8.0	8.5	A+++		
7	9	12	12	1.40	1.80	2.40	2.40	8.00 (2.4-10.1)	2.05 (0.45-3.25)	3.90	8.0	8.5	A+++		
7	9	12	14	1.33	1.71	2.29	2.67	8.00 (2.4-10.1)	2.05 (0.45-3.25)	3.90	8.0	8.5	A+++		
7	9	12	18	1.21	1.57	2.09	3.13	8.00 (2.4-10.1)	2.05 (0.45-3.25)	3.90	8.0	8.5	A+++		
7	9	14	14	1.26	1.64	2.55	2.55	8.00 (2.4-10.1)	2.05 (0.45-3.25)	3.90	8.0	8.5	A+++		
7	9	14	18	1.17	1.50	2.33	3.00	8.00 (2.4-10.1)	2.05 (0.45-3.25)	3.90	8.0	8.5	A+++		
7	12	12	12	1.31	2.23	2.23	2.23	8.00 (2.4-10.1)	2.05 (0.45-3.25)	3.90	8.0	8.5	A+++		
7	12	12	14	1.24											

4-unit Multi-split heating

AOHG30KBTA4	Combination of Indoor Units		Heating Operation											
			Heating Capacity					Input Power (Min. - Max.)	COP	Seasonal Data				
			Unit 1 kW	Unit 2 kW	Unit 3 kW	Unit 4 kW	Total Capacity (Min. - Max.) kW			Pdesign kW	SCOP	Energy efficiency		
2-unit connection	7	22	-	-	2.40	7.20	-	-	9.60 (3.0-11.2)	2.47 (0.30-2.95)	3.89	6.5	4.1	A+
	7	24	-	-	2.17	7.43	-	-	9.60 (3.0-11.2)	2.47 (0.30-2.95)	3.89	6.5	4.1	A+
	9	22	-	-	2.79	6.81	-	-	9.60 (3.0-11.2)	2.47 (0.30-2.95)	3.89	6.5	4.1	A+
	9	24	-	-	2.62	6.98	-	-	9.60 (3.0-11.2)	2.47 (0.30-2.95)	3.89	6.5	4.1	A+
	12	18	-	-	3.84	5.76	-	-	9.60 (3.0-11.2)	2.47 (0.30-2.95)	3.89	6.5	4.1	A+
	12	22	-	-	3.39	6.21	-	-	9.60 (3.0-11.2)	2.47 (0.30-2.95)	3.89	6.5	4.1	A+
	12	24	-	-	3.20	6.40	-	-	9.60 (3.0-11.2)	2.47 (0.30-2.95)	3.89	6.5	4.1	A+
	14	18	-	-	4.20	5.40	-	-	9.60 (3.0-11.2)	2.47 (0.30-2.95)	3.89	6.5	4.1	A+
	14	22	-	-	3.73	5.87	-	-	9.60 (3.0-11.2)	2.47 (0.30-2.95)	3.89	6.5	4.1	A+
	14	24	-	-	3.54	6.06	-	-	9.60 (3.0-11.2)	2.47 (0.30-2.95)	3.89	6.5	4.1	A+
	18	18	-	-	4.80	4.80	-	-	9.60 (3.0-11.2)	2.47 (0.30-2.95)	3.89	6.5	4.1	A+
	18	22	-	-	4.32	5.28	-	-	9.60 (3.0-11.2)	2.47 (0.30-2.95)	3.89	6.5	4.1	A+
	18	24	-	-	4.11	5.49	-	-	9.60 (3.0-11.2)	2.47 (0.30-2.95)	3.89	6.5	4.1	A+
	22	22	-	-	4.80	4.80	-	-	9.60 (3.0-11.2)	2.47 (0.30-2.95)	3.89	6.5	4.1	A+
	22	24	-	-	4.59	5.01	-	-	9.60 (3.0-11.2)	2.47 (0.30-2.95)	3.89	6.5	4.1	A+
	24	24	-	-	4.80	4.80	-	-	9.60 (3.0-11.2)	2.47 (0.30-2.95)	3.89	6.5	4.1	A+
3-unit connection	7	7	12	-	2.40	2.40	4.20	-	9.00 (3.0-10.4)	2.11 (0.30-2.60)	4.27	6.0	4.4	A+
	7	7	14	-	2.40	2.40	4.80	-	9.60 (3.0-11.2)	2.27 (0.30-2.95)	4.22	6.5	4.3	A+
	7	7	18	-	2.10	2.10	5.40	-	9.60 (3.0-11.2)	2.27 (0.30-2.95)	4.22	6.5	4.3	A+
	7	7	22	-	1.87	1.87	5.86	-	9.60 (3.0-11.2)	2.27 (0.30-2.95)	4.22	6.5	4.3	A+
	7	7	24	-	1.77	1.77	6.06	-	9.60 (3.0-11.2)	2.27 (0.30-2.95)	4.22	6.5	4.3	A+
	7	9	9	-	2.40	3.00	3.00	-	8.40 (3.0-10.0)	1.94 (0.30-2.45)	4.32	6.0	4.4	A+
	7	9	12	-	2.40	3.00	4.20	-	9.60 (3.0-11.2)	2.27 (0.30-2.95)	4.22	6.5	4.3	A+
	7	9	14	-	2.24	2.88	4.48	-	9.60 (3.0-11.2)	2.27 (0.30-2.95)	4.22	6.5	4.3	A+
	7	9	18	-	1.98	2.54	5.08	-	9.60 (3.0-11.2)	2.27 (0.30-2.95)	4.22	6.5	4.3	A+
	7	9	22	-	1.77	2.27	5.56	-	9.60 (3.0-11.2)	2.27 (0.30-2.95)	4.22	6.5	4.3	A+
	7	9	24	-	1.68	2.16	5.76	-	9.60 (3.0-11.2)	2.27 (0.30-2.95)	4.22	6.5	4.3	A+
	7	12	12	-	2.16	3.72	3.72	-	9.60 (3.0-11.2)	2.27 (0.30-2.95)	4.22	6.5	4.3	A+
	7	12	14	-	2.04	3.49	4.07	-	9.60 (3.0-11.2)	2.27 (0.30-2.95)	4.22	6.5	4.3	A+
	7	12	18	-	1.82	3.11	4.67	-	9.60 (3.0-11.2)	2.27 (0.30-2.95)	4.22	6.5	4.3	A+
	7	12	22	-	1.64	2.81	5.15	-	9.60 (3.0-11.2)	2.27 (0.30-2.95)	4.22	6.5	4.3	A+
	7	12	24	-	1.56	2.68	5.36	-	9.60 (3.0-11.2)	2.27 (0.30-2.95)	4.22	6.5	4.3	A+
	7	14	14	-	1.92	3.84	3.84	-	9.60 (3.0-11.2)	2.27 (0.30-2.95)	4.22	6.5	4.3	A+
	7	14	18	-	1.72	3.45	4.43	-	9.60 (3.0-11.2)	2.27 (0.30-2.95)	4.22	6.5	4.3	A+
	7	14	22	-	1.56	3.13	4.91	-	9.60 (3.0-11.2)	2.27 (0.30-2.95)	4.22	6.5	4.3	A+
	7	14	24	-	1.49	2.99	5.12	-	9.60 (3.0-11.2)	2.27 (0.30-2.95)	4.22	6.5	4.3	A+
	7	18	18	-	1.56	4.02	4.02	-	9.60 (3.0-11.2)	2.27 (0.30-2.95)	4.22	6.5	4.3	A+
	7	18	22	-	1.43	3.68	4.49	-	9.60 (3.0-11.2)	2.27 (0.30-2.95)	4.22	6.5	4.3	A+
	7	18	24	-	1.37	3.53	4.70	-	9.60 (3.0-11.2)	2.27 (0.30-2.95)	4.22	6.5	4.3	A+
	9	9	9	-	3.00	3.00	3.00	-	9.00 (3.0-10.8)	2.11 (0.30-2.76)	4.27	6.0	4.4	A+
	9	9	12	-	2.88	2.88	3.84	-	9.60 (3.0-11.2)	2.27 (0.30-2.95)	4.22	6.5	4.3	A+
	9	9	14	-	2.70	2.70	4.20	-	9.60 (3.0-11.2)	2.27 (0.30-2.95)	4.22	6.5	4.3	A+
	9	9	18	-	2.40	2.40	4.80	-	9.60 (3.0-11.2)	2.27 (0.30-2.95)	4.22	6.5	4.3	A+
	9	9	22	-	2.16	2.16	5.28	-	9.60 (3.0-11.2)	2.27 (0.30-2.95)	4.22	6.5	4.3	A+
	9	9	24	-	2.06	2.06	5.48	-	9.60 (3.0-11.2)	2.27 (0.30-2.95)	4.22	6.5	4.3	A+
	9	12	12	-	2.62	3.49	3.49	-	9.60 (3.0-11.2)	2.27 (0.30-2.95)	4.22	6.5	4.3	A+
	9	12	14	-	2.47	3.29	3.84	-	9.60 (3.0-11.2)	2.27 (0.30-2.95)	4.22	6.5	4.3	A+
	9	12	18	-	2.22	2.95	4.43	-	9.60 (3.0-11.2)	2.27 (0.30-2.95)	4.22	6.5	4.3	A+
	9	12	22	-	2.01	2.68	4.91	-	9.60 (3.0-11.2)	2.27 (0.30-2.95)	4.22	6.5	4.3	A+
	9	12	24	-	1.92	2.56	5.12	-	9.60 (3.0-11.2)	2.27 (0.30-2.95)	4.22	6.5	4.3	A+
	9	14	14	-	2.34	3.63	3.63	-	9.60 (3.0-11.2)	2.27 (0.30-2.95)	4.22	6.5	4.3	A+
	9	14	18	-	2.11	3.28	4.21	-	9.60 (3.0-11.2)	2.27 (0.30-2.95)	4.22	6.5	4.3	A+
	9	14	22	-	1.92	2.99	4.69	-	9.60 (3.0-11.2)	2.27 (0.30-2.95)	4.22	6.5	4.3	A+
	9	14	24	-	1.84	2.86	4.90	-	9.60 (3.0-11.2)	2.27 (0.30-2.95)	4.22	6.5	4.3	A+
	9	18	18	-	1.92	3.84	3.84	-	9.60 (3.0-11.2)	2.27 (0.30-2.95)	4.22	6.5	4.3	A+
	12	12	12	-	3.20	3.20	3.20	-	9.60 (3.0-11.2)	2.27 (0.30-2.95)	4.22	6.5	4.3	A+
	12	12	14	-	3.03	3.03	3.54	-	9.60 (3.0-11.2)	2.27 (0.30-2.95)	4.22	6.5	4.3	A+
	12	12	18	-	2.74	2.74	4.12	-	9.60 (3.0-11.2)	2.27 (0.30-2.95)	4.22	6.5	4.3	A+
	12	12	22	-	2.50	2.50	4.60	-	9.60 (3.0-11.2)	2.27 (0.30-2.95)	4.22	6.5	4.3	A+
	12	12	24	-	2.40	2.40	4.80	-	9.60 (3.0-11.2)	2.27 (0.30-2.95)	4.22	6.5	4.3	A+
	12	14	14	-	2.88	3.36	3.36	-	9.60 (3.0-11.2)	2.27 (0.30-2.95)	4.22	6.5	4.3	A+
	12	14	18	-	2.62	3.05	3.93	-	9.60 (3.0-11.2)	2.27 (0.30-2.95)	4.22	6.5	4.3	A+
	12	18	18	-	2.40	3.60	3.60	-	9.60 (3.0-11.2)	2.27 (0.30-2.95)	4.22	6.5	4.3	A+
	14	14	14	-	3.20	3.20	3.20	-	9.60 (3.0-11.2)	2.27 (0.30-2.95)	4.22	6.5	4.3	A+
14	14	18	-	2.92	2.92	3.76	-	9.60 (3.0-11.2)	2.27 (0.30-2.95)	4.22	6.5	4.3	A+	
7	7	7	7	2.40	2.40	2.40	2.40	9.60 (3.0-11.2)	2.11 (0.30-2.95)	4.55	6.5	4.6	A++	
7	7	7	9	2.24	2.24	2.24	2.88	9.60 (3.0-11.2)	2.11 (0.30-2.95)	4.55	6.5	4.6	A++	
7	7	7	12	2.04	2.04	2.04	3.48	9.60 (3.0-11.2)	2.11 (0.30-2.95)	4.55	6.5	4.6	A++	
7	7	7	14	1.92	1.92	1.92	3.84	9.60 (3.0-11.2)	2.11 (0.30-2.95)	4.55	6.5	4.6	A++	
7	7	7	18	1.72	1.72	1.72	4.44	9.60 (3.0-11.2)	2.11 (0.30-2.95)	4.55	6.5	4.6	A++	
7	7	9	9	2.10	2.10	2.70	2.70	9.60 (3.0-11.2)	2.11 (0.30-2.95)	4.55	6.5	4.6	A++	
7	7	9	12	1.92	1.92	2.47	3.29	9.60 (3.0-11.2)	2.11 (0.30-2.95)	4.55	6.5	4.6	A++	
7	7	9	14	1.82	1.82	2.34	3.62	9.60 (3.0-11.2)	2.11 (0.30-2.95)	4.55	6.5	4.6	A++	
7	7	9	18	1.64	1.64	2.11	4.21	9.60 (3.0-11.2)	2.11 (0.30-2.95)	4.55	6.5	4.6	A++	
7	7	12	12	1.77	1.77	3.03	3.03	9.60 (3.0-11.2)	2.11 (0.30-2.95)	4.55	6.5	4.6	A++	
7	7	12	14	1.68	1.68	2.88	3.36	9.60 (3.0-11.2)	2.11 (0.30-2.95)	4.55	6.5	4.6	A++	
7	7	12	18	1.53	1.53	2.62	3.92	9.60 (3.0-11.2)	2.11 (0.30-2.95)	4.55	6.5	4.6	A++	
7	7	14	14	1.60	1.60	3.20	3.20	9.60 (3.0-11.2)	2.11 (0.30-2.95)	4.55	6.5	4.6	A++	
7	7	14	18	1.46	1.46	2.92	3.76	9.60 (3.0-11.2)	2.11 (0.30-2.95)	4.55	6.5	4.6	A++	
7	9	9	9	1.98	2.54	2.54	2.54	9.60 (3.0-11.2)	2.11 (0.30-2.95)	4.55	6.5	4.6	A++	
7	9	9	12	1.81	2.34	2.34	3.11	9.60 (3.0-11.2)	2.11 (0.30-2.95)	4.55	6.5	4.6	A++	
7	9	9	14	1.71	2.22	2.22	3.45	9.60 (3.0-11.2)	2.11 (0.30-2.95)	4.55	6.5	4.6	A++	
7	9	9	18	1.56	2.01	2.01	4.02	9.60 (3.0-11.2)	2.11 (0.30-2.95)	4.55	6.5	4.6	A++	
7	9	12	12	1.68	2.16	2.88	2.88	9.60 (3.0-11.2)	2.11 (0.30-2.95)	4.55	6.5	4.6	A++	
7	9	12	14	1.60	2.06	2.74	3.20	9.60 (3.0-11.2)	2.11 (0.30-2.95)	4.55	6.5	4.6	A++	
7	9	12	18	1.46	1.88	2.50	3.76	9.60 (3.0-11.2)	2.11 (0.30-2.95)	4.55	6.5	4.6	A++	
7	9	14	14	1.54	1.96	3.05	3.05	9.60 (3.0-11.2)	2.11 (0.30-2.95)	4.55	6.5	4.6	A++	
7	9	14	18	1.40	1.80	2.80	3.60	9.60 (3.0-11.2)	2.11 (0.30-2.95)	4.55	6.5	4.6	A++	
7	12	12	12	1.56	2.68	2.68	2.68	9.60 (3.0-11.2)	2.11 (0.30-2.95)	4.55	6.5	4.6	A++	
7	12	12	14	1.49	2.56	2.56	2.99	9.60 (3.0-11.2)	2.11 (0.30-2.95)	4.55	6.5	4.6	A++	
7	12	12	18	1.37	2.35	2.35	3.							

5-unit Multi-split Combination Table-cooling

5-unit Multi-split cooling

AOHG36KBTAS	Combination of Indoor Units					Cooling Operation											
						Cooling Capacity					Total Capacity (Min. - Max.)	Input Power (Min. - Max.)	EER	Seasonal Data			
						Unit 1 kW	Unit 2 kW	Unit 3 kW	Unit 4 kW	Unit 5 kW				kW	kW	kW	Pdesign kW
2-unit connection	7	24	-	-	-	2.00	7.00	-	-	-	9.00 (3.0-11.0)	2.91 (0.30-3.45)	3.09	9.0	7.9	A++	
	9	22	-	-	-	2.50	6.00	-	-	-	8.50 (3.0-11.0)	2.67 (0.30-3.45)	3.18	8.5	7.9	A++	
	9	24	-	-	-	2.50	7.00	-	-	-	9.50 (3.0-11.0)	3.17 (0.30-3.45)	3.00	9.5	7.8	A++	
	12	22	-	-	-	3.50	6.00	-	-	-	9.50 (3.0-11.0)	3.17 (0.30-3.45)	3.00	9.5	7.8	A++	
	12	24	-	-	-	3.17	6.33	-	-	-	9.50 (3.0-11.0)	3.17 (0.30-3.45)	3.00	9.5	7.8	A++	
	14	22	-	-	-	3.69	5.81	-	-	-	9.50 (3.0-11.0)	3.17 (0.30-3.45)	3.00	9.5	7.8	A++	
	14	24	-	-	-	3.50	6.00	-	-	-	9.50 (3.0-11.0)	3.17 (0.30-3.45)	3.00	9.5	7.8	A++	
	18	18	-	-	-	4.75	4.75	-	-	-	9.50 (3.0-11.0)	3.17 (0.30-3.45)	3.00	9.5	7.8	A++	
	18	22	-	-	-	4.27	5.23	-	-	-	9.50 (3.0-11.0)	3.17 (0.30-3.45)	3.00	9.5	7.8	A++	
	18	24	-	-	-	4.07	5.43	-	-	-	9.50 (3.0-11.0)	3.17 (0.30-3.45)	3.00	9.5	7.8	A++	
	22	22	-	-	-	4.75	4.75	-	-	-	9.50 (3.0-11.0)	3.17 (0.30-3.45)	3.00	9.5	7.8	A++	
	22	24	-	-	-	4.54	4.96	-	-	-	9.50 (3.0-11.0)	3.17 (0.30-3.45)	3.00	9.5	7.8	A++	
	24	24	-	-	-	4.75	4.75	-	-	-	9.50 (3.0-11.0)	3.17 (0.30-3.45)	3.00	9.5	7.8	A++	
	3-unit connection	7	7	14	-	-	2.00	2.00	4.00	-	-	8.00 (3.0-10.0)	2.26 (0.30-2.88)	3.54	8.0	8.2	A++
		7	7	18	-	-	2.00	2.00	5.00	-	-	9.00 (3.0-11.0)	2.68 (0.30-3.45)	3.36	9.0	8.1	A++
		7	7	22	-	-	1.85	1.85	5.80	-	-	9.50 (3.0-11.0)	2.91 (0.30-3.45)	3.27	9.5	8.0	A++
		7	7	24	-	-	1.75	1.75	6.00	-	-	9.50 (3.0-11.0)	2.91 (0.30-3.45)	3.27	9.5	8.0	A++
		7	9	12	-	-	2.00	2.50	3.50	-	-	8.00 (3.0-10.0)	2.26 (0.30-2.88)	3.54	8.0	8.2	A++
		7	9	14	-	-	2.00	2.50	4.00	-	-	8.50 (3.0-10.7)	2.46 (0.30-3.27)	3.45	8.5	8.1	A++
		7	9	18	-	-	2.00	2.50	5.00	-	-	9.50 (3.0-11.0)	2.91 (0.30-3.45)	3.27	9.5	8.0	A++
		7	9	22	-	-	1.75	2.25	5.50	-	-	9.50 (3.0-11.0)	2.91 (0.30-3.45)	3.27	9.5	8.0	A++
		7	9	24	-	-	1.66	2.14	5.70	-	-	9.50 (3.0-11.0)	2.91 (0.30-3.45)	3.27	9.5	8.0	A++
		7	12	12	-	-	2.00	3.50	3.50	-	-	9.00 (3.0-11.0)	2.68 (0.30-3.45)	3.36	9.0	8.1	A++
		7	12	14	-	-	2.00	3.50	4.00	-	-	9.50 (3.0-11.0)	2.91 (0.30-3.45)	3.27	9.5	8.0	A++
7		12	18	-	-	1.80	3.08	4.62	-	-	9.50 (3.0-11.0)	2.91 (0.30-3.45)	3.27	9.5	8.0	A++	
7		12	22	-	-	1.62	2.78	5.10	-	-	9.50 (3.0-11.0)	2.91 (0.30-3.45)	3.27	9.5	8.0	A++	
7		12	24	-	-	1.55	2.65	5.30	-	-	9.50 (3.0-11.0)	2.91 (0.30-3.45)	3.27	9.5	8.0	A++	
7		14	14	-	-	1.90	3.80	3.80	-	-	9.50 (3.0-11.0)	2.91 (0.30-3.45)	3.27	9.5	8.0	A++	
7		14	18	-	-	1.71	3.41	4.38	-	-	9.50 (3.0-11.0)	2.91 (0.30-3.45)	3.27	9.5	8.0	A++	
7		14	22	-	-	1.55	3.09	4.86	-	-	9.50 (3.0-11.0)	2.91 (0.30-3.45)	3.27	9.5	8.0	A++	
7		14	24	-	-	1.47	2.96	5.07	-	-	9.50 (3.0-11.0)	2.91 (0.30-3.45)	3.27	9.5	8.0	A++	
7		18	18	-	-	1.54	3.98	3.98	-	-	9.50 (3.0-11.0)	2.91 (0.30-3.45)	3.27	9.5	8.0	A++	
7		18	22	-	-	1.41	3.64	4.45	-	-	9.50 (3.0-11.0)	2.91 (0.30-3.45)	3.27	9.5	8.0	A++	
7		18	24	-	-	1.36	3.49	4.65	-	-	9.50 (3.0-11.0)	2.91 (0.30-3.45)	3.27	9.5	8.0	A++	
9		9	9	-	-	2.50	2.50	2.50	-	-	7.50 (3.0-9.6)	2.07 (0.30-2.70)	3.63	7.5	8.2	A++	
9		9	12	-	-	2.50	2.50	3.50	-	-	8.50 (3.0-10.7)	2.46 (0.30-3.27)	3.45	8.5	8.1	A++	
9		9	14	-	-	2.50	2.50	4.00	-	-	9.00 (3.0-11.0)	2.68 (0.30-3.45)	3.36	9.0	8.1	A++	
9		9	18	-	-	2.38	2.38	4.74	-	-	9.50 (3.0-11.0)	2.91 (0.30-3.45)	3.27	9.5	8.0	A++	
9		9	22	-	-	2.14	2.14	5.22	-	-	9.50 (3.0-11.0)	2.91 (0.30-3.45)	3.27	9.5	8.0	A++	
9		9	24	-	-	2.04	2.04	5.42	-	-	9.50 (3.0-11.0)	2.91 (0.30-3.45)	3.27	9.5	8.0	A++	
9		12	12	-	-	2.50	3.50	3.50	-	-	9.50 (3.0-11.0)	2.91 (0.30-3.45)	3.27	9.5	8.0	A++	
9		12	14	-	-	2.44	3.26	3.80	-	-	9.50 (3.0-11.0)	2.91 (0.30-3.45)	3.27	9.5	8.0	A++	
9		12	18	-	-	2.19	2.92	4.39	-	-	9.50 (3.0-11.0)	2.91 (0.30-3.45)	3.27	9.5	8.0	A++	
9		12	22	-	-	1.99	2.65	4.86	-	-	9.50 (3.0-11.0)	2.91 (0.30-3.45)	3.27	9.5	8.0	A++	
9		12	24	-	-	1.90	2.53	5.07	-	-	9.50 (3.0-11.0)	2.91 (0.30-3.45)	3.27	9.5	8.0	A++	
9		14	14	-	-	2.32	3.59	3.59	-	-	9.50 (3.0-11.0)	2.91 (0.30-3.45)	3.27	9.5	8.0	A++	
9		14	18	-	-	2.09	3.24	4.17	-	-	9.50 (3.0-11.0)	2.91 (0.30-3.45)	3.27	9.5	8.0	A++	
9		14	22	-	-	1.90	2.96	4.64	-	-	9.50 (3.0-11.0)	2.91 (0.30-3.45)	3.27	9.5	8.0	A++	
9		14	24	-	-	1.82	2.83	4.85	-	-	9.50 (3.0-11.0)	2.91 (0.30-3.45)	3.27	9.5	8.0	A++	
9		18	18	-	-	1.90	3.80	3.80	-	-	9.50 (3.0-11.0)	2.91 (0.30-3.45)	3.27	9.5	8.0	A++	
9		18	22	-	-	1.74	3.49	4.27	-	-	9.50 (3.0-11.0)	2.91 (0.30-3.45)	3.27	9.5	8.0	A++	
9		18	24	-	-	1.68	3.35	4.47	-	-	9.50 (3.0-11.0)	2.91 (0.30-3.45)	3.27	9.5	8.0	A++	
12		12	12	-	-	3.17	3.17	3.17	-	-	9.50 (3.0-11.0)	2.91 (0.30-3.45)	3.27	9.5	8.0	A++	
12		12	14	-	-	3.00	3.00	3.50	-	-	9.50 (3.0-11.0)	2.91 (0.30-3.45)	3.27	9.5	8.0	A++	
12		12	18	-	-	2.71	2.71	4.08	-	-	9.50 (3.0-11.0)	2.91 (0.30-3.45)	3.27	9.5	8.0	A++	
12		12	22	-	-	2.48	2.48	4.54	-	-	9.50 (3.0-11.0)	2.91 (0.30-3.45)	3.27	9.5	8.0	A++	
12		12	24	-	-	2.38	2.38	4.74	-	-	9.50 (3.0-11.0)	2.91 (0.30-3.45)	3.27	9.5	8.0	A++	
12		14	14	-	-	2.84	3.33	3.33	-	-	9.50 (3.0-11.0)	2.91 (0.30-3.45)	3.27	9.5	8.0	A++	
12		14	18	-	-	2.59	3.02	3.89	-	-	9.50 (3.0-11.0)	2.91 (0.30-3.45)	3.27	9.5	8.0	A++	
12		14	22	-	-	2.38	2.77	4.35	-	-	9.50 (3.0-11.0)	2.91 (0.30-3.45)	3.27	9.5	8.0	A++	
12		14	24	-	-	2.28	2.66	4.56	-	-	9.50 (3.0-11.0)	2.91 (0.30-3.45)	3.27	9.5	8.0	A++	
12		18	18	-	-	2.38	3.56	3.56	-	-	9.50 (3.0-11.0)	2.91 (0.30-3.45)	3.27	9.5	8.0	A++	
12		18	22	-	-	2.19	3.29	4.02	-	-	9.50 (3.0-11.0)	2.91 (0.30-3.45)	3.27	9.5	8.0	A++	
12		18	24	-	-	2.11	3.17	4.22	-	-	9.50 (3.0-11.0)	2.91 (0.30-3.45)	3.27	9.5	8.0	A++	
14		14	14	-	-	3.17	3.17	3.17	-	-	9.50 (3.0-11.0)	2.91 (0.30-3.45)	3.27	9.5	8.0	A++	
14		14	18	-	-	2.89	2.89	3.72	-	-	9.50 (3.0-11.0)	2.91 (0.30-3.45)	3.27	9.5	8.0	A++	
14		14	22	-	-	2.66	2.66	4.18	-	-	9.50 (3.0-11.0)	2.91 (0.30-3.45)	3.27	9.5	8.0	A++	
14		14	24	-	-	2.56	2.56	4.38	-	-	9.50 (3.0-11.0)	2.91 (0.30-3.45)	3.27	9.5	8.0	A++	
14		18	18	-	-	2.66	3.42	3.42	-	-	9.50 (3.0-11.0)	2.91 (0.30-3.45)	3.27	9.5	8.0	A++	
18		18	18	-	-	3.17	3.17	3.17	-	-	9.50 (3.0-11.0)	2.91 (0.30-3.45)	3.27	9.5	8.0	A++	
4-unit connection		7	7	7	7	-	-	2.00	2.00	2.00	2.00	8.00 (3.0-10.0)	2.11 (0.30-2.88)	3.80	8.0	8.5	A+++
		7	7	7	9	-	-	2.00	2.00	2.00	2.50	8.50 (3.0-10.7)	2.29 (0.30-3.27)	3.71	8.5	8.4	A++
		7	7	7	12	-	-	2.00	2.00	2.00	3.50	9.50 (3.0-11.0)	2.69 (0.30-3.45)	3.53	9.5	8.3	A++
	7	7	7	14	-	-	1.90	1.90	1.90	3.80	9.50 (3.0-11.0)	2.69 (0.30-3.45)	3.53	9.5	8.3	A++	
	7	7	7	18	-	-	1.71	1.71	1.71	4.37	9.50 (3.0-11.0)	2.69 (0.30-3.45)	3.53	9.5	8.3	A++	
	7	7	7	22	-	-	1.55	1.55	1.55	4.85	9.50 (3.0-11.0)	2.69 (0.30-3.45)	3.53	9.5	8.3	A++	
	7	7	7	24	-	-	1.48	1.48	1.48	5.06	9.50 (3.0-11.0)	2.69 (0.30-3.45)	3.53	9.5	8.3	A++	
	7	7	9	9	-	-	2.00	2.00	2.50	2.50	9.00 (3.0-11.0)	2.49 (0.30-3.45)	3.62	9.0	8.4	A++	
	7	7	9	12	-	-	1.90	1.90	2.44	3.26	9.50 (3.0-11.0)	2.69 (0.30-3.45)	3.53	9.5	8.3	A++	
	7	7	9	14	-	-	1.80	1.80	2.31	3.59	9.50 (3.0-11.0)	2.69 (0.30-3.45)	3.53	9.5	8.3	A++	
	7	7	9	18	-	-	1.62	1.62	2.09	4.17	9.50 (3.0-11.0)	2.69 (0.30-3.45)	3.53	9.5	8.3	A++	
	7	7	9	22	-	-	1.48	1.48	1.90	4.64	9.50 (3.0-11.0)	2.69 (0.30-3.45)	3.53	9.5	8.3	A++	
	7	7	9	24	-	-	1.41	1.41	1.82	4.86	9.50 (3.0-11.0)	2.69 (0.30-3.45)	3.53	9.5	8.3	A++	
	7	7	12	12	-	-	1.75	1.75	3.00								



5-unit Multi-split cooling

AOHG36KBTAS	Combination of Indoor Units					Cooling Operation							Seasonal Data			
						Cooling Capacity					Total Capacity (Min. - Max.)	Input Power (Min. - Max.)	EER	Pdesign	SEER	Energy efficiency
						Unit 1	Unit 2	Unit 3	Unit 4	Unit 5						
4-unit connection	7	14	14	18	-	1.25	2.51	2.51	3.23	-	9.50 (3.0-11.0)	2.69 (0.30-3.45)	3.53	9.5	8.3	A++
	9	9	9	12	-	2.38	2.38	2.38	2.38	-	9.50 (3.0-11.0)	2.69 (0.30-3.45)	3.53	9.5	8.3	A++
	9	9	9	12	-	2.19	2.19	2.19	2.93	-	9.50 (3.0-11.0)	2.69 (0.30-3.45)	3.53	9.5	8.3	A++
	9	9	9	14	-	2.09	2.09	2.09	3.23	-	9.50 (3.0-11.0)	2.69 (0.30-3.45)	3.53	9.5	8.3	A++
	9	9	9	18	-	1.90	1.90	1.90	3.80	-	9.50 (3.0-11.0)	2.69 (0.30-3.45)	3.53	9.5	8.3	A++
	9	9	9	22	-	1.74	1.74	1.74	4.28	-	9.50 (3.0-11.0)	2.69 (0.30-3.45)	3.53	9.5	8.3	A++
	9	9	9	24	-	1.68	1.68	1.68	4.46	-	9.50 (3.0-11.0)	2.69 (0.30-3.45)	3.53	9.5	8.3	A++
	9	9	12	12	-	2.04	2.04	2.71	2.71	-	9.50 (3.0-11.0)	2.69 (0.30-3.45)	3.53	9.5	8.3	A++
	9	9	12	14	-	1.94	1.94	2.59	3.03	-	9.50 (3.0-11.0)	2.69 (0.30-3.45)	3.53	9.5	8.3	A++
	9	9	12	18	-	1.78	1.78	2.38	3.56	-	9.50 (3.0-11.0)	2.69 (0.30-3.45)	3.53	9.5	8.3	A++
	9	9	12	22	-	1.64	1.64	2.19	4.03	-	9.50 (3.0-11.0)	2.69 (0.30-3.45)	3.53	9.5	8.3	A++
	9	9	12	24	-	1.58	1.58	2.11	4.23	-	9.50 (3.0-11.0)	2.69 (0.30-3.45)	3.53	9.5	8.3	A++
	9	9	14	14	-	1.86	1.86	2.89	2.89	-	9.50 (3.0-11.0)	2.69 (0.30-3.45)	3.53	9.5	8.3	A++
	9	9	14	18	-	1.71	1.71	2.66	3.42	-	9.50 (3.0-11.0)	2.69 (0.30-3.45)	3.53	9.5	8.3	A++
	9	9	18	18	-	1.58	1.58	3.17	3.17	-	9.50 (3.0-11.0)	2.69 (0.30-3.45)	3.53	9.5	8.3	A++
	9	12	12	12	-	1.91	2.53	2.53	2.53	-	9.50 (3.0-11.0)	2.69 (0.30-3.45)	3.53	9.5	8.3	A++
	9	12	12	14	-	1.81	2.43	2.43	2.83	-	9.50 (3.0-11.0)	2.69 (0.30-3.45)	3.53	9.5	8.3	A++
	9	12	12	18	-	1.67	2.24	2.24	3.35	-	9.50 (3.0-11.0)	2.69 (0.30-3.45)	3.53	9.5	8.3	A++
	9	12	14	14	-	1.74	2.34	2.71	2.71	-	9.50 (3.0-11.0)	2.69 (0.30-3.45)	3.53	9.5	8.3	A++
	9	12	14	18	-	1.61	2.15	2.51	3.23	-	9.50 (3.0-11.0)	2.69 (0.30-3.45)	3.53	9.5	8.3	A++
	9	14	14	14	-	1.67	2.61	2.61	2.61	-	9.50 (3.0-11.0)	2.69 (0.30-3.45)	3.53	9.5	8.3	A++
	12	12	12	12	-	2.38	2.38	2.38	2.38	-	9.50 (3.0-11.0)	2.69 (0.30-3.45)	3.53	9.5	8.3	A++
	12	12	12	14	-	2.28	2.28	2.28	2.66	-	9.50 (3.0-11.0)	2.69 (0.30-3.45)	3.53	9.5	8.3	A++
	12	12	12	18	-	2.11	2.11	2.11	3.17	-	9.50 (3.0-11.0)	2.69 (0.30-3.45)	3.53	9.5	8.3	A++
12	12	14	14	-	2.19	2.19	2.56	2.56	-	9.50 (3.0-11.0)	2.69 (0.30-3.45)	3.53	9.5	8.3	A++	
12	14	14	14	-	2.12	2.46	2.46	2.46	-	9.50 (3.0-11.0)	2.69 (0.30-3.45)	3.53	9.5	8.3	A++	
5-unit connection	7	7	7	7	7	1.90	1.90	1.90	1.90	1.90	9.50 (3.0-11.0)	2.50 (0.30-3.45)	3.80	9.5	8.5	A+++
	7	7	7	7	9	1.80	1.80	1.80	1.80	2.30	9.50 (3.0-11.0)	2.50 (0.30-3.45)	3.80	9.5	8.5	A+++
	7	7	7	7	12	1.66	1.66	1.66	1.66	2.86	9.50 (3.0-11.0)	2.50 (0.30-3.45)	3.80	9.5	8.5	A+++
	7	7	7	7	14	1.58	1.58	1.58	1.58	3.18	9.50 (3.0-11.0)	2.50 (0.30-3.45)	3.80	9.5	8.5	A+++
	7	7	7	7	18	1.45	1.45	1.45	1.45	3.70	9.50 (3.0-11.0)	2.50 (0.30-3.45)	3.80	9.5	8.5	A+++
	7	7	7	7	22 ¹	1.33	1.33	1.33	1.33	4.18	9.50 (3.0-11.0)	2.50 (0.30-3.45)	3.80	9.5	8.5	A+++
	7	7	7	7	24	1.28	1.28	1.28	1.28	4.38	9.50 (3.0-11.0)	2.50 (0.30-3.45)	3.80	9.5	8.5	A+++
	7	7	7	9	9	1.70	1.70	1.70	2.20	2.20	9.50 (3.0-11.0)	2.50 (0.30-3.45)	3.80	9.5	8.5	A+++
	7	7	7	9	12	1.58	1.58	1.58	2.04	2.72	9.50 (3.0-11.0)	2.50 (0.30-3.45)	3.80	9.5	8.5	A+++
	7	7	7	9	14	1.51	1.51	1.51	1.94	3.03	9.50 (3.0-11.0)	2.50 (0.30-3.45)	3.80	9.5	8.5	A+++
	7	7	7	9	18	1.39	1.39	1.39	1.77	3.56	9.50 (3.0-11.0)	2.50 (0.30-3.45)	3.80	9.5	8.5	A+++
	7	7	7	9	22 ¹	1.28	1.28	1.28	1.64	4.02	9.50 (3.0-11.0)	2.50 (0.30-3.45)	3.80	9.5	8.5	A+++
	7	7	7	9	24	1.23	1.23	1.23	1.58	4.23	9.50 (3.0-11.0)	2.50 (0.30-3.45)	3.80	9.5	8.5	A+++
	7	7	7	12	12	1.48	1.48	1.48	2.53	2.53	9.50 (3.0-11.0)	2.50 (0.30-3.45)	3.80	9.5	8.5	A+++
	7	7	7	12	14	1.41	1.41	1.41	2.43	2.84	9.50 (3.0-11.0)	2.50 (0.30-3.45)	3.80	9.5	8.5	A+++
	7	7	7	12	18	1.30	1.30	1.30	2.24	3.36	9.50 (3.0-11.0)	2.50 (0.30-3.45)	3.80	9.5	8.5	A+++
	7	7	7	14	14	1.36	1.36	1.36	2.71	2.71	9.50 (3.0-11.0)	2.50 (0.30-3.45)	3.80	9.5	8.5	A+++
	7	7	7	14	18	1.25	1.25	1.25	2.51	3.24	9.50 (3.0-11.0)	2.50 (0.30-3.45)	3.80	9.5	8.5	A+++
	7	7	9	9	9	1.63	1.63	2.08	2.08	2.08	9.50 (3.0-11.0)	2.50 (0.30-3.45)	3.80	9.5	8.5	A+++
	7	7	9	9	12	1.51	1.51	1.94	1.94	2.60	9.50 (3.0-11.0)	2.50 (0.30-3.45)	3.80	9.5	8.5	A+++
	7	7	9	9	14	1.45	1.45	1.86	1.86	2.88	9.50 (3.0-11.0)	2.50 (0.30-3.45)	3.80	9.5	8.5	A+++
	7	7	9	9	18	1.33	1.33	1.71	1.71	3.42	9.50 (3.0-11.0)	2.50 (0.30-3.45)	3.80	9.5	8.5	A+++
	7	7	9	9	22 ¹	1.23	1.23	1.58	1.58	3.88	9.50 (3.0-11.0)	2.50 (0.30-3.45)	3.80	9.5	8.5	A+++
	7	7	9	12	12	1.41	1.41	1.82	2.43	2.43	9.50 (3.0-11.0)	2.50 (0.30-3.45)	3.80	9.5	8.5	A+++
	7	7	9	12	14	1.36	1.36	1.74	2.33	2.71	9.50 (3.0-11.0)	2.50 (0.30-3.45)	3.80	9.5	8.5	A+++
	7	7	9	12	18	1.25	1.25	1.61	2.15	3.24	9.50 (3.0-11.0)	2.50 (0.30-3.45)	3.80	9.5	8.5	A+++
	7	7	9	14	14	1.30	1.30	1.68	2.61	2.61	9.50 (3.0-11.0)	2.50 (0.30-3.45)	3.80	9.5	8.5	A+++
	7	7	12	12	12	1.33	1.33	2.28	2.28	2.28	9.50 (3.0-11.0)	2.50 (0.30-3.45)	3.80	9.5	8.5	A+++
	7	7	12	12	14	1.28	1.28	2.19	2.19	2.56	9.50 (3.0-11.0)	2.50 (0.30-3.45)	3.80	9.5	8.5	A+++
	7	7	12	14	14	1.23	1.23	2.12	2.46	2.46	9.50 (3.0-11.0)	2.50 (0.30-3.45)	3.80	9.5	8.5	A+++
	7	9	9	9	9	1.54	1.99	1.99	1.99	1.99	9.50 (3.0-11.0)	2.50 (0.30-3.45)	3.80	9.5	8.5	A+++
	7	9	9	9	12	1.44	1.86	1.86	1.86	2.48	9.50 (3.0-11.0)	2.50 (0.30-3.45)	3.80	9.5	8.5	A+++
	7	9	9	9	14	1.39	1.78	1.78	1.78	2.77	9.50 (3.0-11.0)	2.50 (0.30-3.45)	3.80	9.5	8.5	A+++
	7	9	9	9	18	1.28	1.64	1.64	1.64	3.30	9.50 (3.0-11.0)	2.50 (0.30-3.45)	3.80	9.5	8.5	A+++
	7	9	9	12	12	1.36	1.74	1.74	2.33	2.33	9.50 (3.0-11.0)	2.50 (0.30-3.45)	3.80	9.5	8.5	A+++
	7	9	9	12	14	1.29	1.68	1.68	2.24	2.61	9.50 (3.0-11.0)	2.50 (0.30-3.45)	3.80	9.5	8.5	A+++
	7	9	9	14	14	1.26	1.61	1.61	2.51	2.51	9.50 (3.0-11.0)	2.50 (0.30-3.45)	3.80	9.5	8.5	A+++
	7	9	12	12	12	1.28	1.65	2.19	2.19	2.19	9.50 (3.0-11.0)	2.50 (0.30-3.45)	3.80	9.5	8.5	A+++
	7	9	12	12	14	1.23	1.58	2.11	2.11	2.47	9.50 (3.0-11.0)	2.50 (0.30-3.45)	3.80	9.5	8.5	A+++
	9	9	9	9	9	1.90	1.90	1.90	1.90	1.90	9.50 (3.0-11.0)	2.50 (0.30-3.45)	3.80	9.5	8.5	A+++
	9	9	9	9	12	1.78	1.78	1.78	1.78	2.38	9.50 (3.0-11.0)	2.50 (0.30-3.45)	3.80	9.5	8.5	A+++
	9	9	9	9	14	1.71	1.71	1.71	1.71	2.66	9.50 (3.0-11.0)	2.50 (0.30-3.45)	3.80	9.5	8.5	A+++
	9	9	9	9	18	1.58	1.58	1.58	1.58	3.18	9.50 (3.0-11.0)	2.50 (0.30-3.45)	3.80	9.5	8.5	A+++
	9	9	9	12	12	1.68	1.68	1.68	2.23	2.23	9.50 (3.0-11.0)	2.50 (0.30-3.45)	3.80	9.5	8.5	A+++
	9	9	9	12	14	1.61	1.61	1.61	2.15	2.52	9.50 (3.0-11.0)	2.50 (0.30-3.45)	3.80	9.5	8.5	A+++
	9	9	12	12	12	1.57	1.57	2.12	2.12	2.12	9.50 (3.0-11.0)	2.50 (0.30-3.45)	3.80	9.5	8.5	A+++

Notes: *7: 7000 Btu/h/9: 9000 Btu/h/12: 12000 Btu/h/14: 14000 Btu/h/18: 18000 Btu/h/22: 22000 Btu/h/24: 24000 Btu/h models

- The above specifications apply when connected with wall-mounted [KG/KM] unit.
- 2 or more indoor units should be connected.
- Cooling capacity is determined based on 27°CDB/19°CWB (indoor temperature) and 35°CDB (outdoor temperature).
- Pipe Length: 5 m, Height difference: 0 m (Outdoor unit to Indoor unit)
- Total capacity of indoor units connected must be between 7.5 kW and 15.5 kW.
- Please refer to the Design & Technical manual for the combination tables with 5kW model.
- *1: For Model 22, only wall-mounted indoor units are connectable.

5-unit Multi-split Combination Table-Heating

5-unit Multi-split heating

AOHG36KBTAS	Combination of Indoor Units					Heating Operation							Seasonal Data			
						Heating Capacity					Total Capacity (Min. - Max.)	Input Power (Min. - Max.)	COP	Pdesign	SCOP	Energy efficiency
						Unit 1	Unit 2	Unit 3	Unit 4	Unit 5						
2-unit connection	7	24	-	-	-	2.39	8.21	-	-	-	10.60 (3.5-12.0)	2.65 (0.25-3.25)	4.00	7.0	4.3	A+
	9	22	-	-	-	3.00	7.20	-	-	-	10.20 (3.5-12.0)	2.52 (0.25-3.25)	4.04	6.8	4.3	A+
	9	24	-	-	-	2.89	7.71	-	-	-	10.60 (3.5-12.0)	2.65 (0.25-3.25)	4.00	7.0	4.3	A+
	12	22	-	-	-	3.74	6.86	-	-	-	10.60 (3.5-12.0)	2.65 (0.25-3.25)	4.00	7.0	4.3	A+
	12	24	-	-	-	3.53	7.07	-	-	-	10.60 (3.5-12.0)	2.65 (0.25-3.25)	4.00	7.0	4.3	A+
	14	22	-	-	-	4.12	6.48	-	-	-	10.60 (3.5-12.0)	2.65 (0.25-3.25)	4.00	7.0	4.3	A+
	14	24	-	-	-	3.91	6.69	-	-	-	10.60 (3.5-12.0)	2.65 (0.25-3.25)	4.00	7.0	4.3	A+
	18	18	-	-	-	5.30	5.30	-	-	-	10.60 (3.5-12.0)	2.65 (0.25-3.25)	4.00	7.0	4.3	A+
	18	22	-	-	-	4.77	5.83	-	-	-	10.60 (3.5-12.0)	2.65 (0.25-3.25)	4.00	7.0	4.3	A+
	18	24	-	-	-	4.54	6.06	-	-	-	10.60 (3.5-12.0)	2.65 (0.25-3.25)	4.00	7.0	4.3	A+
	22	22	-	-	-	5.30	5.30	-	-	-	10.60 (3.5-12.0)	2.65 (0.25-3.25)	4.00	7.0	4.3	A+
	22	24	-	-	-	5.07	5.53	-	-	-	10.60 (3.5-12.0)	2.65 (0.25-3.25)	4.00	7.0	4.3	A+
	24	24	-	-	-	5.30	5.30	-	-	-	10.60 (3.5-12.0)	2.65 (0.25-3.25)	4.00	7.0	4.3	A+
	7	7	14	-	-	2.40	2.40	4.80	-	-	9.60 (3.5-11.2)	2.25 (0.25-2.87)	4.26	6.5	4.5	A+
	7	7	18	-	-	2.32	2.32	5.96	-	-	10.60 (3.5-12.0)	2.54 (0.25-3.25)	4.18	7.0	4.4	A+
	7	7	22	-	-	2.06	2.06	6.48	-	-	10.60 (3.5-12.0)	2.54 (0.25-3.25)	4.18	7.0	4.4	A+
	7	7	24	-	-	1.95	1.95	6.70	-	-	10.60 (3.5-12.0)	2.54 (0.25-3.25)	4.18	7.0	4.4	A+
	7	9	12	-	-	2.40	3.00	4.20	-	-	9.60 (3.5-11.2)	2.25 (0.25-2.87)	4.26	6.5	4.5	A+
	7	9	14	-	-	2.40	3.00	4.80	-	-	10.20 (3.5-12.0)	2.42 (0.25-3.25)	4.21	6.8	4.4	A+
	7	9	18	-	-	2.18	2.81	5.61	-	-	10.60 (3.5-12.0)	2.54 (0.25-3.25)	4.18	7.0	4.4	A+
	7	9	22	-	-	1.95	2.51	6.14	-	-	10.60 (3.5-12.0)	2.54 (0.25-3.25)	4.18	7.0	4.4	A+
	7	9	24	-	-	1.85	2.39	6.36	-	-	10.60 (3.5-12.0)	2.54 (0.25-3.25)	4.18	7.0	4.4	A+
	7	12	12	-	-	2.40	4.10	4.10	-	-	10.60 (3.5-12.0)	2.54 (0.25-3.25)	4.18	7.0	4.4	A+
	7	12	14	-	-	2.25	3.85	4.50	-	-	10.60 (3.5-12.0)	2.54 (0.25-3.25)	4.18	7.0	4.4	A+
7	12	18	-	-	2.00	3.44	5.16	-	-	10.60 (3.5-12.0)	2.54 (0.25-3.25)	4.18	7.0	4.4	A+	
7	12	22	-	-	1.81	3.10	5.69	-	-	10.60 (3.5-12.0)	2.54 (0.25-3.25)	4.18	7.0	4.4	A+	
7	12	24	-	-	1.72	2.96	5.92	-	-	10.60 (3.5-12.0)	2.54 (0.25-3.25)	4.18	7.0	4.4	A+	
7	14	14	-	-	2.12	4.24	4.24	-	-	10.60 (3.5-12.0)	2.54 (0.25-3.25)	4.18	7.0	4.4	A+	
7	14	18	-	-	1.90	3.81	4.89	-	-	10.60 (3.5-12.0)	2.54 (0.25-3.25)	4.18	7.0	4.4	A+	
7	14	22	-	-	1.73	3.45	5.42	-	-	10.60 (3.5-12.0)	2.54 (0.25-3.25)	4.18	7.0	4.4	A+	
7	14	24	-	-	1.65	3.30	5.65	-	-	10.60 (3.5-12.0)	2.54 (0.25-3.25)	4.18	7.0	4.4	A+	
7	18	18	-	-	1.72	4.44	4.44	-	-	10.60 (3.5-12.0)	2.54 (0.25-3.25)	4.18	7.0	4.4	A+	
7	18	22	-	-	1.58	4.06	4.96	-	-	10.60 (3.5-12.0)	2.54 (0.25-3.25)	4.18	7.0	4.4	A+	
7	18	24	-	-	1.51	3.89	5.20	-	-	10.60 (3.5-12.0)	2.54 (0.25-3.25)	4.18	7.0	4.4	A+	
9	9	9	-	-	3.00	3.00	3.00	-	-	9.00 (3.5-10.8)	2.09 (0.25-2.70)	4.31	6.0	4.5	A+	
9	9	12	-	-	3.00	3.00	4.20	-	-	10.20 (3.5-12.0)	2.42 (0.25-3.25)	4.21	6.8	4.4	A+	
9	9	14	-	-	2.98	2.98	4.64	-	-	10.60 (3.5-12.0)	2.54 (0.25-3.25)	4.18	7.0	4.4	A+	
9	9	18	-	-	2.65	2.65	5.30	-	-	10.60 (3.5-12.0)	2.54 (0.25-3.25)	4.18	7.0	4.4	A+	
9	9	22	-	-	2.39	2.39	5.82	-	-	10.60 (3.5-12.0)	2.54 (0.25-3.25)	4.18	7.0	4.4	A+	
9	9	24	-	-	2.27	2.27	6.06	-	-	10.60 (3.5-12.0)	2.54 (0.25-3.25)	4.18	7.0	4.4	A+	
9	12	12	-	-	2.90	3.85	3.85	-	-	10.60 (3.5-12.0)	2.54 (0.25-3.25)	4.18	7.0	4.4	A+	
9	12	14	-	-	2.73	3.63	4.24	-	-	10.60 (3.5-12.0)	2.54 (0.25-3.25)	4.18	7.0	4.4	A+	
9	12	18	-	-	2.45	3.26	4.89	-	-	10.60 (3.5-12.0)	2.54 (0.25-3.25)	4.18	7.0	4.4	A+	
9	12	22	-	-	2.22	2.96	5.42	-	-	10.60 (3.5-12.0)	2.54 (0.25-3.25)	4.18	7.0	4.4	A+	
9	12	24	-	-	2.12	2.83	5.65	-	-	10.60 (3.5-12.0)	2.54 (0.25-3.25)	4.18	7.0	4.4	A+	
9	14	14	-	-	2.58	4.01	4.01	-	-	10.60 (3.5-12.0)	2.54 (0.25-3.25)	4.18	7.0	4.4	A+	
9	14	18	-	-	2.33	3.62	4.65	-	-	10.60 (3.5-12.0)	2.54 (0.25-3.25)	4.18	7.0	4.4	A+	
9	14	22	-	-	2.12	3.30	5.18	-	-	10.60 (3.5-12.0)	2.54 (0.25-3.25)	4.18	7.0	4.4	A+	
9	14	24	-	-	2.03	3.16	5.41	-	-	10.60 (3.5-12.0)	2.54 (0.25-3.25)	4.18	7.0	4.4	A+	
9	18	18	-	-	2.12	4.24	4.24	-	-	10.60 (3.5-12.0)	2.54 (0.25-3.25)	4.18	7.0	4.4	A+	
9	18	22	-	-	1.95	3.89	4.76	-	-	10.60 (3.5-12.0)	2.54 (0.25-3.25)	4.18	7.0	4.4	A+	
9	18	24	-	-	1.87	3.74	4.99	-	-	10.60 (3.5-12.0)	2.54 (0.25-3.25)	4.18	7.0	4.4	A+	
12	12	12	-	-	3.53	3.53	3.53	-	-	10.60 (3.5-12.0)	2.54 (0.25-3.25)	4.18	7.0	4.4	A+	
12	12	14	-	-	3.35	3.35	3.90	-	-	10.60 (3.5-12.0)	2.54 (0.25-3.25)	4.18	7.0	4.4	A+	
12	12	18	-	-	3.03	3.03	4.54	-	-	10.60 (3.5-12.0)	2.54 (0.25-3.25)	4.18	7.0	4.4	A+	
12	12	22	-	-	2.77	2.77	5.06	-	-	10.60 (3.5-12.0)	2.54 (0.25-3.25)	4.18	7.0	4.4	A+	
12	12	24	-	-	2.65	2.65	5.30	-	-	10.60 (3.5-12.0)	2.54 (0.25-3.25)	4.18	7.0	4.4	A+	
12	14	14	-	-	3.18	3.71	3.71	-	-	10.60 (3.5-12.0)	2.54 (0.25-3.25)	4.18	7.0	4.4	A+	
12	14	18	-	-	2.89	3.37	4.34	-	-	10.60 (3.5-12.0)	2.54 (0.25-3.25)	4.18	7.0	4.4	A+	
12	14	22	-	-	2.65	3.09	4.86	-	-	10.60 (3.5-12.0)	2.54 (0.25-3.25)	4.18	7.0	4.4	A+	
12	14	24	-	-	2.54	2.97	5.09	-	-	10.60 (3.5-12.0)	2.54 (0.25-3.25)	4.18	7.0	4.4	A+	
12	18	18	-	-	2.64	3.98	3.98	-	-	10.60 (3.5-12.0)	2.54 (0.25-3.25)	4.18	7.0	4.4	A+	
12	18	22	-	-	2.45	3.67	4.48	-	-	10.60 (3.5-12.0)	2.54 (0.25-3.25)	4.18	7.0	4.4	A+	
12	18	24	-	-	2.36	3.53	4.71	-	-	10.60 (3.5-12.0)	2.54 (0.25-3.25)	4.18	7.0	4.4	A+	
14	14	14	-	-	3.53	3.53	3.53	-	-	10.60 (3.5-12.0)	2.54 (0.25-3.25)	4.18	7.0	4.4	A+	
14	14	18	-	-	3.23	3.23	4.14	-	-	10.60 (3.5-12.0)	2.54 (0.25-3.25)	4.18	7.0	4.4	A+	
14	14	22	-	-	2.97	2.97	4.66	-	-	10.60 (3.5-12.0)	2.54 (0.25-3.25)	4.18	7.0	4.4	A+	
14	14	24	-	-	2.85	2.85	4.90	-	-	10.60 (3.5-12.0)	2.54 (0.25-3.25)	4.18	7.0	4.4	A+	
14	18	18	-	-	2.06	3.82	3.82	-	-	10.60 (3.5-12.0)	2.54 (0.25-3.25)	4.18	7.0	4.4	A+	
18	18	18	-	-	3.53	3.53	3.53	-	-	10.60 (3.5-12.0)	2.54 (0.25-3.25)	4.18	7.0	4.4	A+	
7	7	7	7	-	2.40	2.40	2.40	2.40	-	9.60 (3.5-11.2)	2.17 (0.25-2.87)	4.27	6.5	4.6	A++	
7	7	7	9	-	2.40	2.40	2.40	3.00	-	10.20 (3.5-12.0)	2.33 (0.25-3.25)	4.37	6.8	4.5	A+	
7	7	7	12	-	2.25	2.25	2.25	3.85	-	10.60 (3.5-12.0)	2.44 (0.25-3.25)	4.34	7.0	4.5	A+	
7	7	7	14	-	2.12	2.12	2.12	4.24	-	10.60 (3.5-12.0)	2.44 (0.25-3.25)	4.34	7.0	4.5	A+	
7	7	7	18	-	1.90	1.90	1.90	4.90	-	10.60 (3.5-12.0)	2.44 (0.25-3.25)	4.34	7.0	4.5	A+	
7	7	7	22	-	1.73	1.73	1.73	5.41	-	10.60 (3.5-12.0)	2.44 (0.25-3.25)	4.34	7.0	4.5	A+	
7	7	7	24	-	1.65	1.65	1.65	5.65	-	10.60 (3.5-12.0)	2.44 (0.25-3.25)	4.34	7.0	4.5	A+	
7	7	9	9	-	2.32	2.32	2.98	2.98	-	10.60 (3.5-12.0)	2.44 (0.25-3.25)	4.34	7.0	4.5	A+	
7	7	9	12	-	2.12	2.12	2.73	3.63	-	10.60 (3.5-12.0)	2.44 (0.25-3.25)	4.34	7.0	4.5	A+	
7	7	9	14	-	2.01	2.01										

5-unit Multi-split heating

AOHG36KBTAS	Combination of Indoor Units					Heating Operation							Seasonal Data			
						Heating Capacity					Total Capacity (Min. - Max.)	Input Power (Min. - Max.)	COP	Pdesign	SCOP	Energy efficiency
						Unit 1	Unit 2	Unit 3	Unit 4	Unit 5						
4-unit connection	7	14	14	18	-	1.40	2.80	2.80	3.60	-	10.60 (3.5-12.0)	2.44 (0.25-3.25)	4.34	7.0	4.5	A+
	9	9	9	9	-	2.65	2.65	2.65	2.65	-	10.60 (3.5-12.0)	2.44 (0.25-3.25)	4.34	7.0	4.5	A+
	9	9	9	12	-	2.45	2.45	2.45	3.25	-	10.60 (3.5-12.0)	2.44 (0.25-3.25)	4.34	7.0	4.5	A+
	9	9	9	14	-	2.33	2.33	2.33	3.61	-	10.60 (3.5-12.0)	2.44 (0.25-3.25)	4.34	7.0	4.5	A+
	9	9	9	18	-	2.12	2.12	2.12	4.24	-	10.60 (3.5-12.0)	2.44 (0.25-3.25)	4.34	7.0	4.5	A+
	9	9	9	22	-	1.95	1.95	1.95	4.75	-	10.60 (3.5-12.0)	2.44 (0.25-3.25)	4.34	7.0	4.5	A+
	9	9	9	24	-	1.87	1.87	1.87	4.99	-	10.60 (3.5-12.0)	2.44 (0.25-3.25)	4.34	7.0	4.5	A+
	9	9	12	12	-	2.27	2.27	3.03	3.03	-	10.60 (3.5-12.0)	2.44 (0.25-3.25)	4.34	7.0	4.5	A+
	9	9	12	14	-	2.17	2.17	2.89	3.37	-	10.60 (3.5-12.0)	2.44 (0.25-3.25)	4.34	7.0	4.5	A+
	9	9	12	18	-	1.99	1.99	2.64	3.98	-	10.60 (3.5-12.0)	2.44 (0.25-3.25)	4.34	7.0	4.5	A+
	9	9	12	22	-	1.83	1.83	2.45	4.49	-	10.60 (3.5-12.0)	2.44 (0.25-3.25)	4.34	7.0	4.5	A+
	9	9	12	24	-	1.77	1.77	2.35	4.71	-	10.60 (3.5-12.0)	2.44 (0.25-3.25)	4.34	7.0	4.5	A+
	9	9	14	14	-	2.07	2.07	3.23	3.23	-	10.60 (3.5-12.0)	2.44 (0.25-3.25)	4.34	7.0	4.5	A+
	9	9	14	18	-	1.91	1.91	2.96	3.82	-	10.60 (3.5-12.0)	2.44 (0.25-3.25)	4.34	7.0	4.5	A+
	9	9	18	18	-	1.77	1.77	3.53	3.53	-	10.60 (3.5-12.0)	2.44 (0.25-3.25)	4.34	7.0	4.5	A+
	9	12	12	12	-	2.11	2.83	2.83	2.83	-	10.60 (3.5-12.0)	2.44 (0.25-3.25)	4.34	7.0	4.5	A+
	9	12	12	14	-	2.02	2.71	2.71	3.16	-	10.60 (3.5-12.0)	2.44 (0.25-3.25)	4.34	7.0	4.5	A+
	9	12	12	18	-	1.87	2.49	2.49	3.75	-	10.60 (3.5-12.0)	2.44 (0.25-3.25)	4.34	7.0	4.5	A+
	9	12	14	14	-	1.94	2.60	3.03	3.03	-	10.60 (3.5-12.0)	2.44 (0.25-3.25)	4.34	7.0	4.5	A+
	9	12	14	18	-	1.80	2.40	2.80	3.60	-	10.60 (3.5-12.0)	2.44 (0.25-3.25)	4.34	7.0	4.5	A+
	9	14	14	14	-	1.87	2.91	2.91	2.91	-	10.60 (3.5-12.0)	2.44 (0.25-3.25)	4.34	7.0	4.5	A+
	12	12	12	12	-	2.65	2.65	2.65	2.65	-	10.60 (3.5-12.0)	2.44 (0.25-3.25)	4.34	7.0	4.5	A+
	12	12	12	14	-	2.54	2.54	2.54	2.98	-	10.60 (3.5-12.0)	2.44 (0.25-3.25)	4.34	7.0	4.5	A+
	12	12	12	18	-	2.36	2.36	2.36	3.52	-	10.60 (3.5-12.0)	2.44 (0.25-3.25)	4.34	7.0	4.5	A+
12	12	14	14	-	2.45	2.45	2.85	2.85	-	10.60 (3.5-12.0)	2.44 (0.25-3.25)	4.34	7.0	4.5	A+	
12	14	14	14	-	2.35	2.75	2.75	2.75	-	10.60 (3.5-12.0)	2.44 (0.25-3.25)	4.34	7.0	4.5	A+	
5-unit connection	7	7	7	7	7	2.12	2.12	2.12	2.12	2.12	10.60 (3.5-12.0)	2.36 (0.25-3.25)	4.50	7.0	4.6	A++
	7	7	7	7	9	2.01	2.01	2.01	2.01	2.56	10.60 (3.5-12.0)	2.36 (0.25-3.25)	4.50	7.0	4.6	A++
	7	7	7	7	12	1.86	1.86	1.86	1.86	3.16	10.60 (3.5-12.0)	2.36 (0.25-3.25)	4.50	7.0	4.6	A++
	7	7	7	7	14	1.77	1.77	1.77	1.77	3.52	10.60 (3.5-12.0)	2.36 (0.25-3.25)	4.50	7.0	4.6	A++
	7	7	7	7	18	1.61	1.61	1.61	1.61	4.16	10.60 (3.5-12.0)	2.36 (0.25-3.25)	4.50	7.0	4.6	A++
	7	7	7	7	22*	1.48	1.48	1.48	1.48	4.68	10.60 (3.5-12.0)	2.36 (0.25-3.25)	4.50	7.0	4.6	A++
	7	7	7	7	24	1.43	1.43	1.43	1.43	4.88	10.60 (3.5-12.0)	2.36 (0.25-3.25)	4.50	7.0	4.6	A++
	7	7	7	9	9	1.90	1.90	1.90	2.45	2.45	10.60 (3.5-12.0)	2.36 (0.25-3.25)	4.50	7.0	4.6	A++
	7	7	7	9	12	1.77	1.77	1.77	2.26	3.03	10.60 (3.5-12.0)	2.36 (0.25-3.25)	4.50	7.0	4.6	A++
	7	7	7	9	14	1.69	1.69	1.69	2.16	3.37	10.60 (3.5-12.0)	2.36 (0.25-3.25)	4.50	7.0	4.6	A++
	7	7	7	9	18	1.55	1.55	1.55	1.99	3.96	10.60 (3.5-12.0)	2.36 (0.25-3.25)	4.50	7.0	4.6	A++
	7	7	7	9	22**	1.43	1.43	1.43	1.83	4.48	10.60 (3.5-12.0)	2.36 (0.25-3.25)	4.50	7.0	4.6	A++
	7	7	7	9	24	1.37	1.37	1.37	1.77	4.72	10.60 (3.5-12.0)	2.36 (0.25-3.25)	4.50	7.0	4.6	A++
	7	7	7	12	12	1.64	1.64	1.64	2.84	2.84	10.60 (3.5-12.0)	2.36 (0.25-3.25)	4.50	7.0	4.6	A++
	7	7	7	12	14	1.58	1.58	1.58	2.70	3.16	10.60 (3.5-12.0)	2.36 (0.25-3.25)	4.50	7.0	4.6	A++
	7	7	7	12	18	1.45	1.45	1.45	2.49	3.76	10.60 (3.5-12.0)	2.36 (0.25-3.25)	4.50	7.0	4.6	A++
	7	7	7	14	14	1.52	1.52	1.52	3.02	3.02	10.60 (3.5-12.0)	2.36 (0.25-3.25)	4.50	7.0	4.6	A++
	7	7	7	14	18	1.40	1.40	1.40	2.80	3.60	10.60 (3.5-12.0)	2.36 (0.25-3.25)	4.50	7.0	4.6	A++
	7	7	9	9	9	1.82	1.82	2.32	2.32	2.32	10.60 (3.5-12.0)	2.36 (0.25-3.25)	4.50	7.0	4.6	A++
	7	7	9	9	12	1.69	1.69	2.17	2.17	2.88	10.60 (3.5-12.0)	2.36 (0.25-3.25)	4.50	7.0	4.6	A++
	7	7	9	9	14	1.61	1.61	2.07	2.07	3.24	10.60 (3.5-12.0)	2.36 (0.25-3.25)	4.50	7.0	4.6	A++
	7	7	9	9	18	1.48	1.48	1.91	1.91	3.82	10.60 (3.5-12.0)	2.36 (0.25-3.25)	4.50	7.0	4.6	A++
	7	7	9	9	22**	1.37	1.37	1.77	1.77	4.32	10.60 (3.5-12.0)	2.36 (0.25-3.25)	4.50	7.0	4.6	A++
	7	7	9	12	12	1.58	1.58	2.02	2.71	2.71	10.60 (3.5-12.0)	2.36 (0.25-3.25)	4.50	7.0	4.6	A++
	7	7	9	12	14	1.51	1.51	1.95	2.60	3.03	10.60 (3.5-12.0)	2.36 (0.25-3.25)	4.50	7.0	4.6	A++
	7	7	9	12	18	1.40	1.40	1.80	2.40	3.60	10.60 (3.5-12.0)	2.36 (0.25-3.25)	4.50	7.0	4.6	A++
	7	7	9	14	14	1.45	1.45	1.88	2.91	2.91	10.60 (3.5-12.0)	2.36 (0.25-3.25)	4.50	7.0	4.6	A++
	7	7	12	12	12	1.49	1.49	2.54	2.54	2.54	10.60 (3.5-12.0)	2.36 (0.25-3.25)	4.50	7.0	4.6	A++
	7	7	12	12	14	1.43	1.43	2.45	2.45	2.84	10.60 (3.5-12.0)	2.36 (0.25-3.25)	4.50	7.0	4.6	A++
	7	7	12	14	14	1.37	1.37	2.36	2.75	2.75	10.60 (3.5-12.0)	2.36 (0.25-3.25)	4.50	7.0	4.6	A++
	7	9	9	9	9	1.72	2.22	2.22	2.22	2.22	10.60 (3.5-12.0)	2.36 (0.25-3.25)	4.50	7.0	4.6	A++
	7	9	9	9	12	1.61	2.07	2.07	2.07	2.78	10.60 (3.5-12.0)	2.36 (0.25-3.25)	4.50	7.0	4.6	A++
	7	9	9	9	14	1.54	1.99	1.99	1.99	3.09	10.60 (3.5-12.0)	2.36 (0.25-3.25)	4.50	7.0	4.6	A++
	7	9	9	9	18	1.43	1.83	1.83	1.83	3.68	10.60 (3.5-12.0)	2.36 (0.25-3.25)	4.50	7.0	4.6	A++
	7	9	9	12	12	1.50	1.95	1.95	2.60	2.60	10.60 (3.5-12.0)	2.36 (0.25-3.25)	4.50	7.0	4.6	A++
	7	9	9	12	14	1.45	1.87	1.87	2.49	2.92	10.60 (3.5-12.0)	2.36 (0.25-3.25)	4.50	7.0	4.6	A++
	7	9	9	14	14	1.40	1.80	1.80	2.80	2.80	10.60 (3.5-12.0)	2.36 (0.25-3.25)	4.50	7.0	4.6	A++
	7	9	12	12	12	1.42	1.83	2.45	2.45	2.45	10.60 (3.5-12.0)	2.36 (0.25-3.25)	4.50	7.0	4.6	A++
	7	9	12	12	14	1.36	1.77	2.36	2.36	2.75	10.60 (3.5-12.0)	2.36 (0.25-3.25)	4.50	7.0	4.6	A++
	9	9	9	9	9	2.12	2.12	2.12	2.12	2.12	10.60 (3.5-12.0)	2.36 (0.25-3.25)	4.50	7.0	4.6	A++
	9	9	9	9	12	1.99	1.99	1.99	1.99	2.64	10.60 (3.5-12.0)	2.36 (0.25-3.25)	4.50	7.0	4.6	A++
	9	9	9	9	14	1.91	1.91	1.91	1.91	2.96	10.60 (3.5-12.0)	2.36 (0.25-3.25)	4.50	7.0	4.6	A++
	9	9	9	9	18	1.77	1.77	1.77	1.77	3.52	10.60 (3.5-12.0)	2.36 (0.25-3.25)	4.50	7.0	4.6	A++
	9	9	9	12	12	1.88	1.88	1.88	2.48	2.48	10.60 (3.5-12.0)	2.36 (0.25-3.25)	4.50	7.0	4.6	A++
	9	9	9	12	14	1.80	1.80	1.80	2.40	2.80	10.60 (3.5-12.0)	2.36 (0.25-3.25)	4.50	7.0	4.6	A++
	9	9	12	12	12	1.76	1.76	2.36	2.36	2.36	10.60 (3.5-12.0)	2.36 (0.25-3.25)	4.50	7.0	4.6	A++

Notes: *7: 7000 Btu/h/9: 9000 Btu/h/12: 12000 Btu/h/14: 14000 Btu/h/18: 18000 Btu/h/22: 22000 Btu/h/24: 24000 Btu/h models

- The above specifications apply when connected with a wall-mounted [KG/KM] unit.
- 2 or more indoor units should be connected.
- Heating capacity is determined based on 20°CDB (indoor temperature) and 7°CDB/6°CWB (outdoor temperature).
- Pipe Length: 5 m, Height difference: 0 m (Outdoor unit to Indoor unit)
- Total capacity of indoor units connected must be between 7.5 kW and 15.5 kW.
- Please refer to the Design & Technical manual for the combination tables with 5kW model.
- *1: For Model 22, only wall-mounted indoor units are connectable.

6-unit Multi-split Combination Table-Cooling

6-unit Multi-split cooling

AOHG45LBLA6	Combination of Indoor Units						Cooling Operation							EER		
							Cooling Capacity						Total Capacity (Min. - Max.)		Input Power (Min. - Max.)	
							Unit 1 kW	Unit 2 kW	Unit 3 kW	Unit 4 kW	Unit 5 kW	Unit 6 kW				
2-unit connection	12	24	-	-	-	-	3.50	7.00	-	-	-	-	10.5 (3.5-11.5)	3.06 (0.8-3.32)	3.43	
	14	24	-	-	-	-	4.00	7.00	-	-	-	-	11.0 (3.5-12.1)	3.28 (0.8-3.70)	3.35	
	18	18	-	-	-	-	5.00	5.00	-	-	-	-	10.0 (3.5-11.5)	2.92 (0.8-3.32)	3.42	
	18	24	-	-	-	-	5.00	7.00	-	-	-	-	12.0 (3.5-13.4)	3.75 (0.8-4.46)	3.20	
	24	24	-	-	-	-	6.25	6.25	-	-	-	-	12.5 (3.5-14.0)	4.01 (0.8-4.84)	3.12	
	7	7	24	-	-	-	2.00	2.00	7.00	-	-	-	11.0 (3.5-12.1)	3.19 (0.8-3.70)	3.45	
	7	9	18	-	-	-	2.00	2.50	5.00	-	-	-	9.5 (3.5-10.8)	2.55 (0.8-2.93)	3.73	
	7	9	24	-	-	-	2.00	2.50	7.00	-	-	-	11.5 (3.5-12.7)	3.41 (0.8-4.08)	3.37	
	7	12	18	-	-	-	2.00	3.50	5.00	-	-	-	10.5 (3.5-11.8)	3.02 (0.8-3.51)	3.48	
	7	12	24	-	-	-	2.00	3.50	6.90	-	-	-	12.4 (3.5-13.7)	3.82 (0.8-4.65)	3.25	
	7	14	14	-	-	-	2.00	4.00	4.00	-	-	-	10.0 (3.5-11.1)	2.81 (0.8-3.13)	3.56	
	3-unit connection	7	14	18	-	-	-	2.00	4.00	5.00	-	-	-	11.0 (3.5-12.4)	3.23 (0.8-3.89)	3.41
7		14	24	-	-	-	1.94	3.89	6.67	-	-	-	12.5 (3.5-14.0)	3.89 (0.8-4.84)	3.21	
7		18	18	-	-	-	2.00	5.00	5.00	-	-	-	12.0 (3.5-13.7)	3.69 (0.8-4.65)	3.25	
7		18	24	-	-	-	1.79	4.59	6.12	-	-	-	12.5 (3.5-14.0)	3.87 (0.8-4.84)	3.23	
7		24	24	-	-	-	1.60	5.45	5.45	-	-	-	12.5 (3.5-14.0)	3.93 (0.8-4.84)	3.26	
9		9	18	-	-	-	2.50	2.50	5.00	-	-	-	10.0 (3.5-11.5)	2.84 (0.8-3.32)	3.52	
9		9	24	-	-	-	2.50	2.50	7.00	-	-	-	12.0 (3.5-13.4)	3.65 (0.8-4.46)	3.29	
9		12	14	-	-	-	2.50	3.50	4.00	-	-	-	10.0 (3.5-11.1)	2.81 (0.8-3.13)	3.56	
9		12	18	-	-	-	2.50	3.50	5.00	-	-	-	11.0 (3.5-12.4)	3.23 (0.8-3.89)	3.41	
9		12	24	-	-	-	2.50	3.33	6.67	-	-	-	12.5 (3.5-14.0)	3.89 (0.8-4.84)	3.21	
9		14	14	-	-	-	2.50	4.00	4.00	-	-	-	10.5 (3.5-11.8)	3.02 (0.8-3.51)	3.48	
9		14	18	-	-	-	2.50	4.00	5.00	-	-	-	11.5 (3.5-13.0)	3.45 (0.8-4.27)	3.33	
9		14	24	-	-	-	2.40	3.72	6.38	-	-	-	12.5 (3.5-14.0)	3.88 (0.8-4.84)	3.22	
9		18	18	-	-	-	2.50	5.00	5.00	-	-	-	12.5 (3.5-14.0)	3.89 (0.8-4.84)	3.21	
9		18	24	-	-	-	2.21	4.41	5.88	-	-	-	12.5 (3.5-14.0)	3.86 (0.8-4.84)	3.24	
9		24	24	-	-	-	1.98	5.26	5.26	-	-	-	12.5 (3.5-14.0)	3.82 (0.8-4.84)	3.27	
12		12	12	-	-	-	3.50	3.50	3.50	-	-	-	10.5 (3.5-11.5)	2.98 (0.8-3.32)	3.52	
12		12	14	-	-	-	3.50	3.50	4.00	-	-	-	11.0 (3.5-12.1)	3.19 (0.8-3.70)	3.45	
12		12	18	-	-	-	3.50	3.50	5.00	-	-	-	12.0 (3.5-13.4)	3.65 (0.8-4.46)	3.29	
12		12	24	-	-	-	3.13	3.13	6.24	-	-	-	12.5 (3.5-14.0)	3.87 (0.8-4.84)	3.23	
12		14	14	-	-	-	3.50	4.00	4.00	-	-	-	11.5 (3.5-12.7)	3.41 (0.8-4.08)	3.37	
12		14	18	-	-	-	3.50	4.00	5.00	-	-	-	12.5 (3.5-14.0)	3.89 (0.8-4.84)	3.21	
12		14	24	-	-	-	3.00	3.50	6.00	-	-	-	12.5 (3.5-14.0)	3.86 (0.8-4.84)	3.24	
12		18	18	-	-	-	3.12	4.69	4.69	-	-	-	12.5 (3.5-14.0)	3.87 (0.8-4.84)	3.23	
12		18	24	-	-	-	2.78	4.17	5.55	-	-	-	12.5 (3.5-14.0)	3.85 (0.8-4.84)	3.25	
12		24	24	-	-	-	2.50	5.00	5.00	-	-	-	12.5 (3.5-14.0)	3.81 (0.8-4.84)	3.28	
14		14	14	-	-	-	4.00	4.00	4.00	-	-	-	12.0 (3.5-13.4)	3.65 (0.8-4.46)	3.29	
14		14	18	-	-	-	3.80	3.80	4.90	-	-	-	12.5 (3.5-14.0)	3.88 (0.8-4.84)	3.22	
14		14	24	-	-	-	3.37	3.37	5.76	-	-	-	12.5 (3.5-14.0)	3.85 (0.8-4.84)	3.25	
14		18	18	-	-	-	3.50	4.50	4.50	-	-	-	12.5 (3.5-14.0)	3.86 (0.8-4.84)	3.24	
14		18	24	-	-	-	3.13	4.02	5.35	-	-	-	12.5 (3.5-14.0)	3.83 (0.8-4.84)	3.26	
14		24	24	-	-	-	2.82	4.84	4.84	-	-	-	12.5 (3.5-14.0)	3.80 (0.8-4.84)	3.29	
18		18	18	-	-	-	4.17	4.17	4.17	-	-	-	12.5 (3.5-14.0)	3.85 (0.8-4.84)	3.25	
18		18	24	-	-	-	3.75	3.75	5.00	-	-	-	12.5 (3.5-14.0)	3.81 (0.8-4.84)	3.28	
4-unit connection		7	7	7	14	-	-	2.00	2.00	2.00	4.00	-	-	10.0 (3.5-11.1)	2.50 (0.8-3.13)	4.00
		7	7	7	18	-	-	2.00	2.00	2.00	5.00	-	-	11.0 (3.5-12.4)	3.06 (0.8-3.89)	3.59
		7	7	7	24	-	-	1.94	1.94	1.94	6.68	-	-	12.5 (3.5-14.0)	3.77 (0.8-4.84)	3.32
		7	7	9	12	-	-	2.00	2.00	2.50	3.50	-	-	10.0 (3.5-11.1)	2.50 (0.8-3.13)	4.00
		7	7	9	14	-	-	2.00	2.00	2.50	4.00	-	-	10.5 (3.5-11.8)	2.79 (0.8-3.51)	3.76
		7	7	9	18	-	-	2.00	2.00	2.50	5.00	-	-	11.5 (3.5-12.7)	3.33 (0.8-4.27)	3.45
		7	7	9	24	-	-	1.86	1.86	2.39	6.39	-	-	12.5 (3.5-14.0)	3.75 (0.8-4.84)	3.33
		7	7	12	12	-	-	2.00	2.00	3.50	3.50	-	-	11.0 (3.5-12.1)	3.00 (0.8-3.70)	3.67
		7	7	12	14	-	-	2.00	2.00	3.50	4.00	-	-	11.5 (3.5-12.7)	3.27 (0.8-4.08)	3.52
		7	7	12	18	-	-	2.00	2.00	3.50	5.00	-	-	12.5 (3.5-14.0)	3.78 (0.8-4.84)	3.31
		7	7	12	24	-	-	1.75	1.75	3.00	6.00	-	-	12.5 (3.5-14.0)	3.74 (0.8-4.84)	3.34
		7	7	14	14	-	-	2.00	2.00	4.00	4.00	-	-	12.0 (3.5-13.4)	3.51 (0.8-4.46)	3.42
		7	7	14	18	-	-	1.90	1.90	3.80	4.90	-	-	12.5 (3.5-14.0)	3.77 (0.8-4.84)	3.32
		7	7	14	24	-	-	1.68	1.68	3.37	5.77	-	-	12.5 (3.5-14.0)	3.73 (0.8-4.84)	3.35
	7	7	18	18	-	-	1.75	1.75	4.50	4.50	-	-	12.5 (3.5-14.0)	3.74 (0.8-4.84)	3.34	
	7	7	18	24	-	-	1.56	1.56	4.02	5.36	-	-	12.5 (3.5-14.0)	3.70 (0.8-4.84)	3.38	
	7	7	24	24	-	-	1.41	1.41	4.84	4.84	-	-	12.5 (3.5-14.0)	3.67 (0.8-4.84)	3.41	
	7	9	9	9	-	-	2.00	2.50	2.50	2.50	-	-	9.5 (3.5-10.8)	2.31 (0.8-2.93)	4.11	
	7	9	9	12	-	-	2.00	2.50	2.50	3.50	-	-	10.5 (3.5-11.8)	2.79 (0.8-3.51)	3.76	
	7	9	9	14	-	-	2.00	2.50	2.50	4.00	-	-	11.0 (3.5-12.4)	3.06 (0.8-3.89)	3.59	
	7	9	9	18	-	-	2.00	2.50	2.50	5.00	-	-	12.0 (3.5-13.7)	3.57 (0.8-4.65)	3.36	
	7	9	9	24	-	-	1.79	2.30	2.30	6.11	-	-	12.5 (3.5-14.0)	3.74 (0.8-4.84)	3.34	
	7	9	12	12	-	-	2.00	2.50	3.50	3.50	-	-	11.5 (3.5-12.7)	3.27 (0.8-4.08)	3.52	
	7	9	12	14	-	-	2.00	2.50	3.50	4.00	-	-	12.0 (3.5-13.4)	3.51 (0.8-4.46)	3.43	
	7	9	12	18	-	-	1.90	2.45	3.26	4.89	-	-	12.5 (3.5-14.0)	3.77 (0.8-4.84)	3.32	
	7	9	12	24	-	-	1.68	2.16	2.88	5.78	-	-	12.5 (3.5-14.0)	3.73 (0.8-4.84)	3.35	
	7	9	14	14	-	-	2.00	2.50	4.00	4.00	-	-	12.5 (3.5-14.0)	3.78 (0.8-4.84)	3.31	
	7	9	14	18	-	-	1.82	2.34	3.65	4.69	-	-	12.5 (3.5-14.0)	3.75 (0.8-4.84)	3.33	
	7	9	14	24	-	-	1.62	2.08	3.24	5.56	-	-	12.5 (3.5-14.0)	3.71 (0.8-4.84)	3.37	
	7	9	18	18	-	-	1.68	2.16	4.33	4.33	-	-	12.5 (3.5-14.0)	3.73 (0.8-4.84)	3.35	
	7	9	18	24	-	-	1.51	1.94	3.88	5.17	-	-	12.5 (3.5-14.0)	3.69 (0.8-4.84)	3.39	
	7	12	12	12	-	-	1.90	3.50	3.50	3.50	-	-	12.4 (3.5-13.7)	3.69 (0.8-4.65)	3.36	
	7	12	12	14	-	-	1.94	3.33	3.33	3.90	-	-	12.5 (3.5-14.0)	3.77 (0.8-4.84)	3.32	
	7	12	12	18	-	-	1.79	3.06	3.06	4.59	-	-	12.5 (3.5-14.0)	3.74 (0.8-4.84)	3.34	
	7	12	12	24	-	-	1.59	2.73	2.73	5.45	-	-	12.5 (3.5-14.0)	3.71 (0.8-4.84)	3.37	
	7	12	14	14	-	-	1.87	3.19	3.72	3.72	-	-	12.5 (3.5-14.0)	3.75 (0.8-4.84)	3.33	
	7	12	14	18	-	-	1.72	2.94	3.43	4.41	-	-	12.5 (3.5-14.0)	3.73 (0.8-4.84)	3.35	
	7	12	14	24	-	-	1.54	2.63	3.07	5.26	-	-	12.5 (3.5-14.0)	3.70 (0.8-4.84)	3.38	
	7	12	18	18	-	-	1.59	2.73	4.09	4.09	-	-	12.5 (3.5-14.0)	3.71 (0.8-4.84)	3.37	
	7	12	18	24	-	-	1.43	2.46	3.69	4.92	-	-	12.5 (3.5-14.0)	3.68 (0.8-4.84)	3.40	
	7	14	14	14	-	-	1.79	3.57	3.57	3.57	-	-	12.5 (3.5-14.0)	3.74 (0.8-4.84)	3.34	
	7	14	14	18	-	-	1.65	3.30	3.30	4.25	-	-	12.5 (3.5-14.0)	3.72 (0.8-4.84)	3.36	
	7	14	14	24	-	-	1.48	2.97	2.97	5.08	-	-	12.5			

6-unit Multi-split Multi Combination Table-Cooling/Heating

6-unit Multi-split cooling

AOHG45LBLA6	Combination of Indoor Units	Cooling Operation									
		Cooling Capacity						Total Capacity (Min. - Max.)	Input Power (Min. - Max.)	EER	
		Unit 1	Unit 2	Unit 3	Unit 4	Unit 5	Unit 6				
		kW	kW	kW	kW	kW	kW	kW			
6-unit connection	7 7 7 7 7 7	2.00	2.00	2.00	2.00	2.00	2.00	12.0 (3.5-13.4)	3.32 (0.8-4.46)	3.61	
	7 7 7 7 7 9	2.00	2.00	2.00	2.00	2.00	2.50	12.5 (3.5-14.0)	3.57 (0.8-4.84)	3.50	
	7 7 7 7 7 12	1.86	1.86	1.86	1.86	1.86	3.20	12.5 (3.5-14.0)	3.55 (0.8-4.84)	3.52	
	7 7 7 7 7 14	1.79	1.79	1.79	1.79	1.79	3.55	12.5 (3.5-14.0)	3.54 (0.8-4.84)	3.53	
	7 7 7 7 7 18	1.65	1.65	1.65	1.65	1.65	4.25	12.5 (3.5-14.0)	3.51 (0.8-4.84)	3.56	
	7 7 7 7 7 24	1.48	1.48	1.48	1.48	1.48	5.10	12.5 (3.5-14.0)	3.48 (0.8-4.84)	3.59	
	7 7 7 7 9 9	1.90	1.90	1.90	1.90	2.45	2.45	12.5 (3.5-14.0)	3.56 (0.8-4.84)	3.51	
	7 7 7 7 9 12	1.79	1.79	1.79	1.79	2.29	3.05	12.5 (3.5-14.0)	3.54 (0.8-4.84)	3.53	
	7 7 7 7 9 14	1.72	1.72	1.72	1.72	2.20	3.42	12.5 (3.5-14.0)	3.53 (0.8-4.84)	3.54	
	7 7 7 7 9 18	1.59	1.59	1.59	1.59	2.05	4.09	12.5 (3.5-14.0)	3.50 (0.8-4.84)	3.57	
	7 7 7 7 9 24	1.43	1.43	1.43	1.43	1.85	4.93	12.5 (3.5-14.0)	3.47 (0.8-4.84)	3.60	
	7 7 7 7 12 12	1.68	1.68	1.68	1.68	2.89	2.89	12.5 (3.5-14.0)	3.52 (0.8-4.84)	3.55	
	7 7 7 7 12 14	1.62	1.62	1.62	1.62	2.78	3.24	12.5 (3.5-14.0)	3.51 (0.8-4.84)	3.56	
	7 7 7 7 12 18	1.51	1.51	1.51	1.51	2.59	3.87	12.5 (3.5-14.0)	3.48 (0.8-4.84)	3.59	
	7 7 7 7 14 14	1.56	1.56	1.56	1.56	3.13	3.13	12.5 (3.5-14.0)	3.50 (0.8-4.84)	3.57	
	7 7 7 7 14 18	1.46	1.46	1.46	1.46	2.92	3.74	12.5 (3.5-14.0)	3.47 (0.8-4.84)	3.60	
	7 7 7 9 9 9	1.82	1.82	1.82	2.34	2.34	2.34	12.5 (3.5-14.0)	3.55 (0.8-4.84)	3.52	
	7 7 7 9 9 12	1.72	1.72	1.72	2.21	2.21	2.92	12.5 (3.5-14.0)	3.53 (0.8-4.84)	3.54	
	7 7 7 9 9 14	1.65	1.65	1.65	2.12	2.12	3.31	12.5 (3.5-14.0)	3.51 (0.8-4.84)	3.56	
	7 7 7 9 9 18	1.54	1.54	1.54	1.97	1.97	3.94	12.5 (3.5-14.0)	3.49 (0.8-4.84)	3.58	
	7 7 7 9 12 12	1.62	1.62	1.62	2.08	2.78	2.78	12.5 (3.5-14.0)	3.51 (0.8-4.84)	3.56	
	7 7 7 9 12 14	1.56	1.56	1.56	2.01	2.68	3.13	12.5 (3.5-14.0)	3.50 (0.8-4.84)	3.57	
	7 7 7 9 12 18	1.46	1.46	1.46	1.88	2.50	3.74	12.5 (3.5-14.0)	3.47 (0.8-4.84)	3.60	
	7 7 7 9 14 14	1.51	1.51	1.51	1.93	3.02	3.02	12.5 (3.5-14.0)	3.48 (0.8-4.84)	3.59	
	7 7 7 9 12 12 12	1.54	1.54	1.54	2.63	2.63	2.63	12.5 (3.5-14.0)	3.49 (0.8-4.84)	3.58	
	7 7 7 9 12 12 14	1.48	1.48	1.48	2.54	2.54	2.98	12.5 (3.5-14.0)	3.48 (0.8-4.84)	3.59	
	7 7 7 9 12 14 14	1.43	1.43	1.43	2.47	2.87	2.87	12.5 (3.5-14.0)	3.47 (0.8-4.84)	3.60	
	7 7 9 9 9 9 9	1.75	1.75	2.25	2.25	2.25	2.25	12.5 (3.5-14.0)	3.53 (0.8-4.84)	3.54	
	7 7 9 9 9 9 12	1.65	1.65	2.12	2.12	2.12	2.84	12.5 (3.5-14.0)	3.51 (0.8-4.84)	3.56	
	7 7 9 9 9 9 14	1.59	1.59	2.05	2.05	2.05	3.17	12.5 (3.5-14.0)	3.50 (0.8-4.84)	3.57	
	7 7 9 9 9 9 18	1.48	1.48	1.91	1.91	1.91	3.81	12.5 (3.5-14.0)	3.48 (0.8-4.84)	3.59	
	7 7 9 9 9 12 12	1.56	1.56	2.01	2.01	2.68	2.68	12.5 (3.5-14.0)	3.50 (0.8-4.84)	3.57	
	7 7 9 9 9 12 14	1.51	1.51	1.94	1.94	2.59	3.01	12.5 (3.5-14.0)	3.48 (0.8-4.84)	3.59	
	7 7 9 9 9 12 18	1.41	1.41	1.81	1.81	2.42	3.64	12.5 (3.5-14.0)	3.46 (0.8-4.84)	3.61	
	7 7 9 9 9 14 14	1.46	1.46	1.88	1.88	2.91	2.91	12.5 (3.5-14.0)	3.47 (0.8-4.84)	3.60	
	7 7 9 9 12 12 12	1.48	1.48	1.92	2.54	2.54	2.54	12.5 (3.5-14.0)	3.48 (0.8-4.84)	3.59	
	7 7 9 9 12 12 14	1.43	1.43	1.85	2.46	2.46	2.87	12.5 (3.5-14.0)	3.47 (0.8-4.84)	3.60	
	7 7 9 9 12 12 18	1.41	1.41	2.42	2.42	2.42	2.42	12.5 (3.5-14.0)	3.46 (0.8-4.84)	3.61	
	7 9 9 9 9 9 9	1.70	2.16	2.16	2.16	2.16	2.16	12.5 (3.5-14.0)	3.52 (0.8-4.84)	3.55	
	7 9 9 9 9 9 12	1.59	2.05	2.05	2.05	2.05	2.71	12.5 (3.5-14.0)	3.50 (0.8-4.84)	3.57	
7 9 9 9 9 9 14	1.54	1.97	1.97	1.97	1.97	3.08	12.5 (3.5-14.0)	3.49 (0.8-4.84)	3.58		
7 9 9 9 9 12 12	1.50	1.94	1.94	1.94	2.59	2.59	12.5 (3.5-14.0)	3.48 (0.8-4.84)	3.59		
7 9 9 9 9 12 14	1.46	1.88	1.88	1.88	2.50	2.90	12.5 (3.5-14.0)	3.47 (0.8-4.84)	3.60		
7 9 9 9 12 12 12	1.44	1.84	1.84	2.46	2.46	2.46	12.5 (3.5-14.0)	3.47 (0.8-4.84)	3.60		
9 9 9 9 9 9 9	2.08	2.08	2.08	2.08	2.08	2.08	12.5 (3.5-14.0)	3.51 (0.8-4.84)	3.56		
9 9 9 9 9 9 12	1.97	1.97	1.97	1.97	2.65	2.65	12.5 (3.5-14.0)	3.49 (0.8-4.84)	3.58		
9 9 9 9 9 12 12	1.88	1.88	1.88	1.88	2.49	2.49	12.5 (3.5-14.0)	3.47 (0.8-4.84)	3.60		

- Notes:
- 7: 7000 Btu/h/9: 9000 Btu/h/12: 12000 Btu/h/14: 14000 Btu/h/18: 18000 Btu/h/24: 24000 Btu/h models
 - The above specifications apply when connected with a wall-mounted unit.
 - 2 or more indoor units should be connected.
 - Cooling capacity is determined based on 27°CDB/19°CWB (indoor temperature) and 35°CDB (outdoor temperature).
 - Pipe Length: 5 m, Height difference: 0 m (Outdoor unit to Indoor unit)
 - Total capacity of indoor units connected must be between 9.5 kW and 18.0 kW.



6-unit Multi-split heating

AOHG45LBLA6	Combination of Indoor Units						Heating Operation									
							Heating Capacity						Total Capacity (Min. - Max.)	Input Power (Min. - Max.)	COP	
							Unit 1	Unit 2	Unit 3	Unit 4	Unit 5	Unit 6				kW
2 Units	12	24	-	-	-	-	4.07	8.13	-	-	-	-	12.2 (3.5-13.1)	3.41 (0.7-3.54)	3.58	
	14	24	-	-	-	-	4.61	7.89	-	-	-	-	12.5 (3.5-13.8)	3.56 (0.7-3.76)	3.51	
	18	18	-	-	-	-	6.10	6.10	-	-	-	-	12.2 (3.5-13.1)	3.41 (0.7-3.54)	3.58	
	18	24	-	-	-	-	5.66	7.54	-	-	-	-	13.2 (3.5-15.3)	3.78 (0.7-4.20)	3.49	
	24	24	-	-	-	-	6.75	6.75	-	-	-	-	13.5 (3.5-16.0)	3.89 (0.7-4.41)	3.47	
	7	7	24	-	-	-	2.30	2.30	7.90	-	-	-	12.5 (3.5-13.8)	3.43 (0.7-3.76)	3.64	
	7	9	18	-	-	-	2.35	3.02	6.03	-	-	-	11.4 (3.5-12.4)	2.98 (0.7-3.33)	3.83	
	7	9	24	-	-	-	2.24	2.88	7.68	-	-	-	12.8 (3.5-14.5)	3.54 (0.7-3.98)	3.62	
	7	12	18	-	-	-	2.33	3.99	5.98	-	-	-	12.3 (3.5-13.5)	3.35 (0.7-3.65)	3.67	
	7	12	24	-	-	-	2.17	3.71	7.42	-	-	-	13.3 (3.5-15.6)	3.69 (0.7-4.30)	3.60	
	7	14	14	-	-	-	2.40	4.80	4.80	-	-	-	12.0 (3.5-12.7)	3.15 (0.7-3.44)	3.81	
	7	14	18	-	-	-	2.28	4.56	5.86	-	-	-	12.7 (3.5-14.2)	3.49 (0.7-3.87)	3.64	
	7	14	24	-	-	-	2.10	4.20	7.20	-	-	-	13.5 (3.5-16.0)	3.75 (0.7-4.41)	3.60	
	7	18	18	-	-	-	2.16	5.57	5.57	-	-	-	13.3 (3.5-15.6)	3.69 (0.7-4.30)	3.60	
	7	18	24	-	-	-	1.93	4.96	6.61	-	-	-	13.5 (3.5-16.0)	3.74 (0.7-4.41)	3.61	
	7	24	24	-	-	-	1.72	5.89	5.89	-	-	-	13.5 (3.5-16.0)	3.72 (0.7-4.41)	3.63	
	3-unit connection	9	9	18	-	-	-	3.05	3.05	6.10	-	-	-	12.2 (3.5-13.1)	3.28 (0.7-3.54)	3.77
		9	9	24	-	-	-	2.83	2.83	7.54	-	-	-	13.2 (3.5-15.3)	3.64 (0.7-4.20)	3.63
		9	12	14	-	-	-	3.09	4.11	4.80	-	-	-	12.0 (3.5-12.7)	3.15 (0.7-3.44)	3.81
		9	12	18	-	-	-	2.93	3.91	5.86	-	-	-	12.7 (3.5-14.2)	3.49 (0.7-3.87)	3.64
		9	12	24	-	-	-	2.70	3.60	7.20	-	-	-	13.5 (3.5-16.0)	3.75 (0.7-4.41)	3.60
		9	14	14	-	-	-	3.00	4.65	4.65	-	-	-	12.3 (3.5-13.5)	3.35 (0.7-3.65)	3.67
		9	14	18	-	-	-	2.85	4.44	5.71	-	-	-	13.0 (3.5-14.9)	3.59 (0.7-4.09)	3.62
		9	14	24	-	-	-	2.59	4.02	6.89	-	-	-	13.5 (3.5-16.0)	3.74 (0.7-4.41)	3.61
9		18	18	-	-	-	2.70	5.40	5.40	-	-	-	13.5 (3.5-16.0)	3.75 (0.7-4.41)	3.60	
9		18	24	-	-	-	2.38	4.76	6.36	-	-	-	13.5 (3.5-16.0)	3.73 (0.7-4.41)	3.62	
9		24	24	-	-	-	2.14	5.68	5.68	-	-	-	13.5 (3.5-16.0)	3.71 (0.7-4.41)	3.64	
12		12	12	-	-	-	4.07	4.07	4.07	-	-	-	12.2 (3.5-13.1)	3.28 (0.7-3.54)	3.72	
12		12	14	-	-	-	3.94	3.95	4.61	-	-	-	12.5 (3.5-13.8)	3.43 (0.7-3.76)	3.64	
12		12	18	-	-	-	3.77	3.77	5.66	-	-	-	13.2 (3.5-15.3)	3.64 (0.7-4.20)	3.63	
12		12	24	-	-	-	3.38	3.38	6.74	-	-	-	13.5 (3.5-16.0)	3.74 (0.7-4.41)	3.61	
12		14	14	-	-	-	3.84	4.48	4.48	-	-	-	12.8 (3.5-14.5)	3.54 (0.7-3.98)	3.62	
12		14	18	-	-	-	3.68	4.30	5.52	-	-	-	13.5 (3.5-16.0)	3.75 (0.7-4.41)	3.60	
12		14	24	-	-	-	3.24	3.78	6.48	-	-	-	13.5 (3.5-16.0)	3.74 (0.7-4.41)	3.61	
12		18	18	-	-	-	3.38	5.06	5.06	-	-	-	13.5 (3.5-16.0)	3.74 (0.7-4.41)	3.61	
12		18	24	-	-	-	3.00	4.50	6.00	-	-	-	13.5 (3.5-16.0)	3.72 (0.7-4.41)	3.63	
12		24	24	-	-	-	2.70	5.40	5.40	-	-	-	13.5 (3.5-16.0)	3.71 (0.7-4.41)	3.64	
14		14	14	-	-	-	4.40	4.40	4.40	-	-	-	13.2 (3.5-15.3)	3.64 (0.7-4.20)	3.63	
14		14	18	-	-	-	4.11	4.11	5.28	-	-	-	13.5 (3.5-16.0)	3.75 (0.7-4.41)	3.60	
14		14	24	-	-	-	3.63	3.63	6.24	-	-	-	13.5 (3.5-16.0)	3.73 (0.7-4.41)	3.62	
14	18	18	-	-	-	3.78	4.86	4.86	-	-	-	13.5 (3.5-16.0)	3.74 (0.7-4.41)	3.61		
14	18	24	-	-	-	3.38	4.34	5.78	-	-	-	13.5 (3.5-16.0)	3.72 (0.7-4.41)	3.63		
18	24	24	-	-	-	3.04	5.23	5.23	-	-	-	13.5 (3.5-16.0)	3.70 (0.7-4.41)	3.65		
18	18	18	-	-	-	4.50	4.50	4.50	-	-	-	13.5 (3.5-16.0)	3.72 (0.7-4.41)	3.63		
18	18	24	-	-	-	4.05	4.05	5.40	-	-	-	13.5 (3.5-16.0)	3.71 (0.7-4.41)	3.64		
4-unit connection	7	7	7	14	-	-	2.40	2.40	2.40	4.80	-	-	12.0 (3.5-12.7)	2.98 (0.7-3.44)	4.03	
	7	7	7	18	-	-	2.28	2.28	2.28	5.86	-	-	12.7 (3.5-14.2)	3.35 (0.7-3.87)	3.79	
	7	7	7	24	-	-	2.10	2.10	2.10	7.20	-	-	13.5 (3.5-16.0)	3.61 (0.7-4.41)	3.74	
	7	7	9	12	-	-	2.40	2.40	3.09	4.11	-	-	12.0 (3.5-12.7)	2.98 (0.7-3.44)	4.03	
	7	7	9	14	-	-	2.33	2.33	2.99	4.65	-	-	12.3 (3.5-13.5)	3.19 (0.7-3.65)	3.86	
	7	7	9	18	-	-	2.22	2.22	2.85	5.71	-	-	13.0 (3.5-14.9)	3.46 (0.7-4.09)	3.76	
	7	7	9	24	-	-	2.01	2.01	2.59	6.89	-	-	13.5 (3.5-16.0)	3.60 (0.7-4.41)	3.75	
	7	7	12	12	-	-	2.30	2.30	3.95	3.95	-	-	12.5 (3.5-13.8)	3.28 (0.7-3.76)	3.81	
	7	7	12	14	-	-	2.24	2.24	3.84	4.48	-	-	12.8 (3.5-14.5)	3.41 (0.7-3.98)	3.75	
	7	7	12	18	-	-	2.15	2.15	3.68	5.52	-	-	13.5 (3.5-16.0)	3.61 (0.7-4.41)	3.74	
	7	7	12	24	-	-	1.89	1.89	3.24	6.48	-	-	13.5 (3.5-16.0)	3.60 (0.7-4.41)	3.75	
	7	7	14	14	-	-	2.20	2.20	4.40	4.40	-	-	13.2 (3.5-15.3)	3.52 (0.7-4.20)	3.75	
	7	7	14	18	-	-	2.05	2.05	4.11	5.29	-	-	13.5 (3.5-16.0)	3.61 (0.7-4.41)	3.74	
	7	7	14	24	-	-	1.82	1.82	3.63	6.23	-	-	13.5 (3.5-16.0)	3.59 (0.7-4.41)	3.76	
	7	7	18	18	-	-	1.89	1.89	4.86	4.86	-	-	13.5 (3.5-16.0)	3.60 (0.7-4.41)	3.75	
	7	7	18	24	-	-	1.69	1.69	4.34	5.78	-	-	13.5 (3.5-16.0)	3.58 (0.7-4.41)	3.77	
	7	7	24	24	-	-	1.52	1.52	5.23	5.23	-	-	13.5 (3.5-16.0)	3.56 (0.7-4.41)	3.79	
	7	9	9	9	-	-	2.34	3.02	3.02	3.02	-	-	11.4 (3.5-12.4)	2.82 (0.7-3.33)	4.04	
	7	9	9	12	-	-	2.33	2.99	2.99	3.99	-	-	12.3 (3.5-13.5)	3.19 (0.7-3.65)	3.86	
	7	9	9	14	-	-	2.28	2.93	2.93	4.56	-	-	12.7 (3.5-14.2)	3.35 (0.7-3.87)	3.79	
	7	9	9	18	-	-	2.17	2.78	2.78	5.57	-	-	13.3 (3.5-15.6)	3.56 (0.7-4.30)	3.74	
	7	9	9	24	-	-	1.93	2.48	2.48	6.61	-	-	13.5 (3.5-16.0)	3.60 (0.7-4.41)	3.75	
	7	9	12	12	-	-	2.24	2.88	3.84	3.84	-	-	12.8 (3.5-14.5)	3.41 (0.7-3.98)	3.75	
	7	9	12	14	-	-	2.20	2.83	3.77	4.40	-	-	13.2 (3.5-15.3)	3.52 (0.7-4.20)	3.75	
	7	9	12	18	-	-	2.05	2.64	3.52	5.29	-	-	13.5 (3.5-16.0)	3.61 (0.7-4.41)	3.74	
	7	9	12	24	-	-	1.82	2.34	3.12	6.22	-	-	13.5 (3.5-16.0)	3.59 (0.7-4.41)	3.76	
	7	9	14	14	-	-	2.15	2.75	4.30	4.30	-	-	13.5 (3.5-16.0)	3.61 (0.7-4.41)	3.74	
	7	9	14	18	-	-	1.97	2.53	3.94	5.06	-	-	13.5 (3.5-16.0)	3.60 (0.7-4.41)	3.75	
	7	9	14	24	-	-	1.75	2.25	3.50	6.00	-	-	13.5 (3.5-16.0)	3.58 (0.7-4.41)	3.77	
	7	9	18	18	-	-	1.82	2.34	4.67	4.67	-	-	13.5 (3.5-16.0)	3.59 (0.7-4.41)	3.76	
	7	9	18	24	-	-	1.63	2.09	4.19	5.59	-	-	13.5 (3.5-16.0)	3.57 (0.7-4.41)	3.78	
	7	12	12	12	-	-	2.17	3.71	3.71	3.71	-	-	13.3 (3.5-15.6)	3.56 (0.7-4.30)	3.74	
	7	12	12	14	-	-	2.10	3.60	3.60	4.20	-	-	13.5 (3.5-16.0)	3.61 (0.7-4.41)	3.74	
	7	12	12	18	-	-	1.93	3.31	3.31	4.95	-	-	13.5 (3.5-16.0)	3.60 (0.7-4.41)	3.75	
	7	12	12	24	-	-	1.72	2.95	2.95	5.88	-	-	13.5 (3.5-16.0)	3.58 (0.7-4.41)	3.77	
	7	12	14	14	-	-	2.01	3.45	4.02	4.02	-	-	13.5 (3.5-16.0)	3.60 (0.7-4.41)	3.75	
	7	12	14	18	-	-	1.85	3.18	3.71	4.76	-	-	13.5 (3.5-16.0)	3.59 (0.7-4.41)	3.76	
	7	12	14	24	-	-	1.66	2.84	3.32	5.68	-	-	13.5 (3.5-16.0)	3.57 (0.7-4.41)	3.78	
	7	12	18	18	-	-	1.72	2.94	4.42	4.42	-	-	13.5 (3.5-16.0)	3.58 (0.7-4.41)	3.77	
	7	12	18	24	-	-	1.55	2.66	3.98	5.31	-	-	13.5 (3.5-16.0)	3.56 (0.7-4.41)	3.79	
	7	14	14	14	-	-	1.92	3.86	3.86	3.86	-	-	13.5 (3.5-16.0)	3.60 (0.7-4.41)	3.75	
	7	14	14	18	-	-	1.78	3.57	3.57	4.58	-	-	13.5 (3.5-16.0)	3.59 (0.7-4.41)	3.76	
	7	14	14	24	-	-	1.60	3.20	3.20	5.50	-	-	13.5 (3.5-16.0)	3.57 (

6-unit Multi-split Combination Table-Heating

6-unit Multi-split heating

AOHG45LBLA6	Combination of Indoor Units						Heating Operation									
							Heating Capacity						Total Capacity (Min. - Max.)	Input Power (Min. - Max.)	COP	
							Unit 1	Unit 2	Unit 3	Unit 4	Unit 5	Unit 6				kW
						kW	kW	kW	kW	kW	kW	kW	kW			
4-unit connection	12	12	12	12	-	-	3.38	3.38	3.38	3.38	-	-	13.5 (3.5-16.0)	3.60 (0.7-4.4)	3.75	
	12	12	12	14	-	-	3.24	3.24	3.24	3.78	-	-	13.5 (3.5-16.0)	3.60 (0.7-4.4)	3.75	
	12	12	12	18	-	-	3.00	3.00	3.00	4.50	-	-	13.5 (3.5-16.0)	3.58 (0.7-4.4)	3.77	
	12	12	12	24	-	-	2.70	2.70	2.70	5.40	-	-	13.5 (3.5-16.0)	3.57 (0.7-4.4)	3.78	
	12	12	14	14	-	-	3.12	3.12	3.63	3.63	-	-	13.5 (3.5-16.0)	3.59 (0.7-4.4)	3.76	
	12	12	14	18	-	-	2.89	2.89	3.38	4.34	-	-	13.5 (3.5-16.0)	3.58 (0.7-4.4)	3.77	
	12	12	14	24	-	-	2.61	2.61	3.05	5.23	-	-	13.5 (3.5-16.0)	3.56 (0.7-4.4)	3.79	
	12	12	18	18	-	-	2.70	2.70	4.05	4.05	-	-	13.5 (3.5-16.0)	3.57 (0.7-4.4)	3.78	
	12	14	14	14	-	-	3.00	3.50	3.50	3.50	-	-	13.5 (3.5-16.0)	3.58 (0.7-4.4)	3.77	
	12	14	14	18	-	-	2.79	3.26	3.26	4.19	-	-	13.5 (3.5-16.0)	3.57 (0.7-4.4)	3.78	
	12	14	18	18	-	-	2.61	3.05	3.92	3.92	-	-	13.5 (3.5-16.0)	3.56 (0.7-4.4)	3.79	
	7	7	7	7	7	-	-	2.40	2.40	2.40	2.40	2.40	-	12.0 (3.5-12.7)	2.82 (0.7-3.4)	4.26
	7	7	7	7	9	-	-	2.33	2.33	2.33	2.33	2.98	-	12.3 (3.5-13.5)	3.03 (0.7-3.65)	4.06
	7	7	7	7	12	-	-	2.24	2.24	2.24	2.24	3.84	-	12.8 (3.5-14.5)	3.29 (0.7-3.98)	3.89
	7	7	7	7	14	-	-	2.20	2.20	2.20	2.20	4.40	-	13.2 (3.5-15.3)	3.40 (0.7-4.20)	3.88
	7	7	7	7	18	-	-	2.05	2.05	2.05	2.05	5.30	-	13.5 (3.5-16.0)	3.49 (0.7-4.4)	3.87
	7	7	7	7	24	-	-	1.82	1.82	1.82	1.82	6.22	-	13.5 (3.5-16.0)	3.47 (0.7-4.4)	3.89
	7	7	7	9	9	-	-	2.28	2.28	2.28	2.93	2.93	-	12.7 (3.5-14.2)	3.23 (0.7-3.87)	3.93
	7	7	7	9	12	-	-	2.20	2.20	2.20	2.83	3.77	-	13.2 (3.5-15.3)	3.40 (0.7-4.20)	3.88
	7	7	7	9	14	-	-	2.15	2.15	2.15	2.76	4.29	-	13.5 (3.5-16.0)	3.49 (0.7-4.4)	3.87
	7	7	7	9	18	-	-	1.97	1.97	1.97	2.53	5.06	-	13.5 (3.5-16.0)	3.48 (0.7-4.4)	3.88
	7	7	7	9	24	-	-	1.75	1.75	1.75	2.25	6.00	-	13.5 (3.5-16.0)	3.46 (0.7-4.4)	3.90
	7	7	7	12	12	-	-	2.10	2.10	2.10	3.60	3.60	-	13.5 (3.5-16.0)	3.49 (0.7-4.4)	3.87
	7	7	7	12	14	-	-	2.01	2.01	2.01	3.45	4.02	-	13.5 (3.5-16.0)	3.48 (0.7-4.4)	3.88
	7	7	7	12	18	-	-	1.85	1.85	1.85	3.18	4.77	-	13.5 (3.5-16.0)	3.47 (0.7-4.4)	3.89
	7	7	7	12	24	-	-	1.66	1.66	1.66	2.84	5.68	-	13.5 (3.5-16.0)	3.45 (0.7-4.4)	3.91
	7	7	7	14	14	-	-	1.93	1.93	1.93	3.86	3.86	-	13.5 (3.5-16.0)	3.48 (0.7-4.4)	3.88
	7	7	7	14	18	-	-	1.78	1.78	1.78	3.57	4.59	-	13.5 (3.5-16.0)	3.47 (0.7-4.4)	3.89
	7	7	7	14	24	-	-	1.60	1.60	1.60	3.20	5.50	-	13.5 (3.5-16.0)	3.45 (0.7-4.4)	3.91
	7	7	7	18	18	-	-	1.66	1.66	1.66	4.26	4.26	-	13.5 (3.5-16.0)	3.45 (0.7-4.4)	3.91
	7	7	9	9	9	-	-	2.22	2.22	2.85	2.85	2.85	-	13.0 (3.5-14.9)	3.34 (0.7-4.09)	3.89
	7	7	9	9	12	-	-	2.15	2.15	2.76	2.76	3.68	-	13.5 (3.5-16.0)	3.49 (0.7-4.4)	3.87
	7	7	9	9	14	-	-	2.05	2.05	2.64	2.64	4.12	-	13.5 (3.5-16.0)	3.49 (0.7-4.4)	3.87
	7	7	9	9	18	-	-	1.89	1.89	2.43	2.43	4.86	-	13.5 (3.5-16.0)	3.48 (0.7-4.4)	3.88
	7	7	9	9	24	-	-	1.69	1.69	2.17	2.17	5.78	-	13.5 (3.5-16.0)	3.46 (0.7-4.4)	3.90
	7	7	9	12	12	-	-	2.01	2.01	2.58	3.45	3.45	-	13.5 (3.5-16.0)	3.48 (0.7-4.4)	3.88
	7	7	9	12	14	-	-	1.93	1.93	2.48	3.31	3.85	-	13.5 (3.5-16.0)	3.48 (0.7-4.4)	3.88
	7	7	9	12	18	-	-	1.78	1.78	2.29	3.06	4.59	-	13.5 (3.5-16.0)	3.47 (0.7-4.4)	3.89
	7	7	9	12	24	-	-	1.60	1.60	2.06	2.75	5.49	-	13.5 (3.5-16.0)	3.45 (0.7-4.4)	3.91
	7	7	9	14	14	-	-	1.85	1.85	2.38	3.71	3.71	-	13.5 (3.5-16.0)	3.47 (0.7-4.4)	3.89
7	7	9	14	18	-	-	1.72	1.72	2.21	3.44	4.41	-	13.5 (3.5-16.0)	3.46 (0.7-4.4)	3.90	
7	7	9	14	24	-	-	1.55	1.55	1.99	3.10	5.31	-	13.5 (3.5-16.0)	3.44 (0.7-4.4)	3.92	
7	7	9	18	18	-	-	1.60	1.60	2.06	4.12	4.12	-	13.5 (3.5-16.0)	3.45 (0.7-4.4)	3.91	
7	7	12	12	12	-	-	1.89	1.89	3.24	3.24	3.24	-	13.5 (3.5-16.0)	3.48 (0.7-4.4)	3.88	
7	7	12	12	14	-	-	1.82	1.82	3.12	3.12	3.62	-	13.5 (3.5-16.0)	3.47 (0.7-4.4)	3.89	
7	7	12	12	18	-	-	1.69	1.69	2.89	4.34	4.34	-	13.5 (3.5-16.0)	3.46 (0.7-4.4)	3.90	
7	7	12	12	24	-	-	1.52	1.52	2.61	2.61	5.24	-	13.5 (3.5-16.0)	3.44 (0.7-4.4)	3.92	
7	7	12	14	14	-	-	1.75	1.75	3.00	3.50	3.50	-	13.5 (3.5-16.0)	3.46 (0.7-4.4)	3.90	
7	7	12	14	18	-	-	1.63	1.63	2.79	3.26	4.19	-	13.5 (3.5-16.0)	3.45 (0.7-4.4)	3.91	
7	7	12	18	18	-	-	1.52	1.52	2.62	3.92	3.92	-	13.5 (3.5-16.0)	3.44 (0.7-4.4)	3.92	
7	7	14	14	14	-	-	1.68	1.68	3.38	3.38	3.38	-	13.5 (3.5-16.0)	3.46 (0.7-4.4)	3.90	
7	7	14	14	18	-	-	1.58	1.58	3.15	3.15	4.04	-	13.5 (3.5-16.0)	3.45 (0.7-4.4)	3.91	
7	9	9	9	9	-	-	2.18	2.78	2.78	2.78	2.78	-	13.3 (3.5-15.6)	3.44 (0.7-4.30)	3.87	
7	9	9	9	12	-	-	2.05	2.64	2.64	2.64	3.53	-	13.5 (3.5-16.0)	3.49 (0.7-4.4)	3.87	
7	9	9	9	14	-	-	1.97	2.53	2.53	2.53	3.94	-	13.5 (3.5-16.0)	3.48 (0.7-4.4)	3.88	
7	9	9	9	18	-	-	1.82	2.34	2.34	2.34	4.66	-	13.5 (3.5-16.0)	3.47 (0.7-4.4)	3.89	
7	9	9	9	24	-	-	1.63	2.09	2.09	2.09	5.60	-	13.5 (3.5-16.0)	3.45 (0.7-4.4)	3.91	
7	9	9	12	12	-	-	1.92	2.48	2.48	3.31	3.31	-	13.5 (3.5-16.0)	3.48 (0.7-4.4)	3.88	
7	9	9	12	14	-	-	1.85	2.38	2.38	3.18	3.71	-	13.5 (3.5-16.0)	3.47 (0.7-4.4)	3.89	
7	9	9	12	18	-	-	1.72	2.21	2.21	2.95	4.41	-	13.5 (3.5-16.0)	3.46 (0.7-4.4)	3.90	
7	9	9	12	24	-	-	1.55	1.99	1.99	2.66	5.31	-	13.5 (3.5-16.0)	3.44 (0.7-4.4)	3.92	
7	9	9	14	14	-	-	1.78	2.29	2.29	3.57	3.57	-	13.5 (3.5-16.0)	3.47 (0.7-4.4)	3.89	
7	9	9	14	18	-	-	1.66	2.13	2.13	3.32	4.26	-	13.5 (3.5-16.0)	3.45 (0.7-4.4)	3.91	
7	9	9	18	18	-	-	1.56	1.99	1.99	3.98	3.98	-	13.5 (3.5-16.0)	3.44 (0.7-4.4)	3.92	
7	9	12	12	12	-	-	1.82	2.32	3.12	3.12	3.12	-	13.5 (3.5-16.0)	3.47 (0.7-4.4)	3.89	
7	9	12	12	14	-	-	1.75	2.25	3.00	3.00	3.50	-	13.5 (3.5-16.0)	3.46 (0.7-4.4)	3.90	
7	9	12	12	18	-	-	1.63	2.09	2.79	2.79	4.20	-	13.5 (3.5-16.0)	3.45 (0.7-4.4)	3.91	
7	9	12	14	14	-	-	1.69	2.17	2.88	3.38	3.38	-	13.5 (3.5-16.0)	3.46 (0.7-4.4)	3.90	
7	9	12	14	18	-	-	1.58	2.03	2.70	3.15	4.04	-	13.5 (3.5-16.0)	3.45 (0.7-4.4)	3.91	
7	9	14	14	14	-	-	1.63	2.09	3.26	3.26	3.26	-	13.5 (3.5-16.0)	3.45 (0.7-4.4)	3.91	
7	9	14	14	18	-	-	1.52	1.96	3.05	3.05	3.92	-	13.5 (3.5-16.0)	3.44 (0.7-4.4)	3.92	
7	12	12	12	12	-	-	1.70	2.95	2.95	2.95	2.95	-	13.5 (3.5-16.0)	3.46 (0.7-4.4)	3.90	
7	12	12	12	14	-	-	1.66	2.84	2.84	2.84	3.32	-	13.5 (3.5-16.0)	3.45 (0.7-4.4)	3.91	
7	12	12	12	18	-	-	1.55	2.66	2.66	2.66	3.97	-	13.5 (3.5-16.0)	3.44 (0.7-4.4)	3.92	
7	12	12	14	14	-	-	1.60	2.75	2.75	3.20	3.20	-	13.5 (3.5-16.0)	3.45 (0.7-4.4)	3.91	
7	12	14	14	14	-	-	1.55	2.65	3.10	3.10	3.10	-	13.5 (3.5-16.0)	3.44 (0.7-4.4)	3.92	
9	9	9	9	9	-	-	2.70	2.70	2.70	2.70	2.70	-	13.5 (3.5-16.0)	3.49 (0.7-4.4)	3.87	
9	9	9	9	12	-	-	2.53	2.53	2.53	2.53	3.38	-	13.5 (3.5-16.0)	3.48 (0.7-4.4)	3.88	
9	9	9	9	14	-	-	2.43	2.43	2.43	2.43	3.78	-	13.5 (3.5-16.0)	3.48 (0.7-4.4)	3.88	
9	9	9	9	18	-	-	2.25	2.25	2.25	2.25	4.50	-	13.5 (3.5-16.0)	3.46 (0.7-4.4)	3.90	
9	9	9	9	24	-	-	2.03	2.03	2.03	2.03	5.38	-	13.5 (3.5-16.0)	3.45 (0.7-4.4)	3.91	
9	9	9	12	12	-	-	2.38	2.38	2.38	3.18	3.18	-	13.5 (3.5-16.0)	3.47 (0.7-4.4)	3.89	
9	9	9	12	14	-	-	2.29	2.29	2.29	3.06	3.57	-	13.5 (3.5-16.0)	3.47 (0.7-4.4)	3.89	
9	9	9	12	18	-	-	2.13	2.13	2.13	2.84	4.27	-	13.5 (3.5-16.0)	3.45 (0.7-4.4)	3.91	
9	9	9	14	14	-	-	2.21	2.21	2.21	3.44	3.44	-	13.5 (3.5-16.0)	3.46 (0.7-4.4)	3.90	
9	9	9	14													

6-unit Multi-split heating







AOHG45LBLA6	Combination of Indoor Units	Heating Capacity							Total Capacity (Min. - Max.)	Input Power (Min. - Max.)	COP					
		Unit 1	Unit 2	Unit 3	Unit 4	Unit 5	Unit 6									
		kW	kW	kW	kW	kW	kW									
7	7	7	7	7	7	7	7	2.20	2.20	2.20	2.20	2.20	2.20	13.2 (3.5-15.3)	3.28 (0.7-4.20)	4.02
7	7	7	7	7	7	9	9	2.15	2.15	2.15	2.15	2.15	2.15	13.5 (3.5-16.0)	3.37 (0.7-4.41)	4.00
7	7	7	7	7	7	12	12	2.01	2.01	2.01	2.01	2.01	3.45	13.5 (3.5-16.0)	3.37 (0.7-4.41)	4.00
7	7	7	7	7	7	14	14	1.93	1.93	1.93	1.93	1.93	3.85	13.5 (3.5-16.0)	3.37 (0.7-4.41)	4.00
7	7	7	7	7	7	18	18	1.78	1.78	1.78	1.78	1.78	4.60	13.5 (3.5-16.0)	3.37 (0.7-4.41)	4.00
7	7	7	7	7	7	24	24	1.60	1.60	1.60	1.60	1.60	5.50	13.5 (3.5-16.0)	3.37 (0.7-4.41)	4.00
7	7	7	7	7	9	9	9	2.05	2.05	2.05	2.05	2.05	2.65	13.5 (3.5-16.0)	3.37 (0.7-4.41)	4.00
7	7	7	7	7	9	12	12	1.93	1.93	1.93	1.93	2.48	3.30	13.5 (3.5-16.0)	3.37 (0.7-4.41)	4.00
7	7	7	7	7	9	14	14	1.85	1.85	1.85	1.85	2.38	3.72	13.5 (3.5-16.0)	3.37 (0.7-4.41)	4.00
7	7	7	7	7	9	18	18	1.72	1.72	1.72	1.72	2.21	4.41	13.5 (3.5-16.0)	3.37 (0.7-4.41)	4.00
7	7	7	7	7	9	24	24	1.55	1.55	1.55	1.55	1.99	5.31	13.5 (3.5-16.0)	3.37 (0.7-4.41)	4.00
7	7	7	7	7	12	12	12	1.82	1.82	1.82	1.82	3.11	3.11	13.5 (3.5-16.0)	3.37 (0.7-4.41)	4.00
7	7	7	7	7	12	14	14	1.75	1.75	1.75	1.75	3.00	3.50	13.5 (3.5-16.0)	3.37 (0.7-4.41)	4.00
7	7	7	7	7	12	18	18	1.63	1.63	1.63	1.63	2.79	4.19	13.5 (3.5-16.0)	3.37 (0.7-4.41)	4.00
7	7	7	7	7	14	14	14	1.69	1.69	1.69	1.69	3.37	3.37	13.5 (3.5-16.0)	3.37 (0.7-4.41)	4.00
7	7	7	7	7	14	18	18	1.58	1.58	1.58	1.58	3.15	4.03	13.5 (3.5-16.0)	3.37 (0.7-4.41)	4.00
7	7	7	9	9	9	9	9	1.97	1.97	1.97	2.53	2.53	2.53	13.5 (3.5-16.0)	3.37 (0.7-4.41)	4.00
7	7	7	9	9	9	12	12	1.85	1.85	1.85	2.38	2.38	3.19	13.5 (3.5-16.0)	3.37 (0.7-4.41)	4.00
7	7	7	9	9	9	14	14	1.78	1.78	1.78	2.29	2.29	3.58	13.5 (3.5-16.0)	3.37 (0.7-4.41)	4.00
7	7	7	9	9	9	18	18	1.66	1.66	1.66	2.13	2.13	4.26	13.5 (3.5-16.0)	3.37 (0.7-4.41)	4.00
7	7	7	9	9	12	12	12	1.75	1.75	1.75	2.25	3.00	3.00	13.5 (3.5-16.0)	3.37 (0.7-4.41)	4.00
7	7	7	9	12	14	14	14	1.69	1.69	1.69	2.17	2.89	3.37	13.5 (3.5-16.0)	3.37 (0.7-4.41)	4.00
7	7	7	9	12	18	18	18	1.58	1.58	1.58	2.03	2.70	4.03	13.5 (3.5-16.0)	3.37 (0.7-4.41)	4.00
7	7	7	9	14	14	14	14	1.63	1.63	1.63	2.09	3.26	3.26	13.5 (3.5-16.0)	3.37 (0.7-4.41)	4.00
7	7	7	12	12	12	12	12	1.66	1.66	1.66	2.84	2.84	2.84	13.5 (3.5-16.0)	3.37 (0.7-4.41)	4.00
7	7	7	12	12	14	14	14	1.60	1.60	1.60	2.75	2.75	3.20	13.5 (3.5-16.0)	3.37 (0.7-4.41)	4.00
7	7	7	12	14	14	14	14	1.55	1.55	1.55	2.65	3.10	3.10	13.5 (3.5-16.0)	3.37 (0.7-4.41)	4.00
7	7	9	9	9	9	9	9	1.89	1.89	2.43	2.43	2.43	2.43	13.5 (3.5-16.0)	3.37 (0.7-4.41)	4.00
7	7	9	9	9	9	12	12	1.78	1.78	2.29	2.29	2.29	3.07	13.5 (3.5-16.0)	3.37 (0.7-4.41)	4.00
7	7	9	9	9	9	14	14	1.72	1.72	2.21	2.21	2.21	3.43	13.5 (3.5-16.0)	3.37 (0.7-4.41)	4.00
7	7	9	9	9	9	18	18	1.60	1.60	2.06	2.06	2.06	4.12	13.5 (3.5-16.0)	3.37 (0.7-4.41)	4.00
7	7	9	9	12	12	12	12	1.69	1.69	2.17	2.17	2.89	2.89	13.5 (3.5-16.0)	3.37 (0.7-4.41)	4.00
7	7	9	9	12	14	14	14	1.63	1.63	2.09	2.09	2.79	3.27	13.5 (3.5-16.0)	3.37 (0.7-4.41)	4.00
7	7	9	9	12	18	18	18	1.52	1.52	1.96	1.96	2.61	3.93	13.5 (3.5-16.0)	3.37 (0.7-4.41)	4.00
7	7	9	9	14	14	14	14	1.58	1.58	2.03	2.03	3.14	3.14	13.5 (3.5-16.0)	3.37 (0.7-4.41)	4.00
7	7	9	12	12	12	12	12	1.60	1.60	2.05	2.75	2.75	2.75	13.5 (3.5-16.0)	3.37 (0.7-4.41)	4.00
7	7	9	12	12	14	14	14	1.55	1.55	1.99	2.66	2.66	3.09	13.5 (3.5-16.0)	3.37 (0.7-4.41)	4.00
7	7	12	12	12	12	12	12	1.53	1.53	2.61	2.61	2.61	3.01	13.5 (3.5-16.0)	3.37 (0.7-4.41)	4.00
7	9	9	9	9	9	9	9	1.80	2.34	2.34	2.34	2.34	2.34	13.5 (3.5-16.0)	3.37 (0.7-4.41)	4.00
7	9	9	9	9	12	12	12	1.72	2.21	2.21	2.21	2.21	2.94	13.5 (3.5-16.0)	3.37 (0.7-4.41)	4.00
7	9	9	9	9	14	14	14	1.66	2.13	2.13	2.13	2.13	3.32	13.5 (3.5-16.0)	3.37 (0.7-4.41)	4.00
7	9	9	9	12	12	12	12	1.65	2.09	2.09	2.09	2.79	2.79	13.5 (3.5-16.0)	3.37 (0.7-4.41)	4.00
7	9	9	9	12	14	14	14	1.58	2.03	2.03	2.03	2.69	3.14	13.5 (3.5-16.0)	3.37 (0.7-4.41)	4.00
7	9	9	12	12	12	12	12	1.54	1.99	1.99	2.66	2.66	2.66	13.5 (3.5-16.0)	3.37 (0.7-4.41)	4.00
9	9	9	9	9	9	9	9	2.25	2.25	2.25	2.25	2.25	2.25	13.5 (3.5-16.0)	3.37 (0.7-4.41)	4.00
9	9	9	9	9	12	12	12	2.13	2.13	2.13	2.13	2.13	2.85	13.5 (3.5-16.0)	3.37 (0.7-4.41)	4.00
9	9	9	9	12	12	12	12	2.03	2.03	2.03	2.03	2.69	2.69	13.5 (3.5-16.0)	3.37 (0.7-4.41)	4.00

- Notes:
- 7: 7000 Btu/h/9: 9000 Btu/h/12: 12000 Btu/h/14: 14000 Btu/h/18: 18000 Btu/h/24: 24000 Btu/h models
 - The above specifications apply when connected with a wall-mounted unit.
 - 2 or more indoor units should be connected.
 - Heating capacity is determined based on 20°CDB (indoor temperature) and 7°CDB/6°CWB (outdoor temperature).
 - Pipe Length: 5 m, Height difference: 0 m (Outdoor unit to Indoor unit)
 - Total capacity of indoor units connected must be between 7.5 kW and 15.5 kW.

Feature Summary

Type		Wall-mounted type		
Series		Designer Series		Standard Series
Model name				
	ASHH07/09/12/14KGTG ASHG07/09/12/14KGTE	ASHG07/09/12/14KETF, ASHG07/09/12/14KETF-B, ASHG07/09/12/14KETE, ASHG07/09/12/14KETE-B	ASHH07/09/12/14KMCG ASHH07/09/12/14KMCG-B ASHG07/09/12/14KMCE	
Refrigerant				
Energy-saving Features	 Save Occupancy sensor	●		
	 Economy operation	●	●	●
	 Setting temperature range limitation	○	○	○
	 Set temperature auto return	○	○	○
Features for Comfort	 Power diffuser			
	 Powerful operation	●	●	●
	 10°C Heat	●	●	●
	 Outdoor unit low noise operation	●	●	●
	 Auto changeover	●	●	●
	 UP/DOWN swing louver	●	●	●
	 Double swing automatic			
	 Automatic fan speed	●	●	●
	 Auto restart	●	●	●
	 Connectable fresh air duct			
	 Fresh air intake			
	 Connectable distributing duct			
	Convenience Features	 Auto-off timer	○	○
 Sleep timer		●	●	●
 Program timer		●	●	●
 Weekly timer		●	●	○
 Weekly & Temperature setback timer		○	○	○
 Filter sign		●	●	●
 External error output		○	○	○
 External ON/OFF input		○	○	○
 Wireless LAN control	● (KGTG), ○ (KGTE)	● (KETF, KETF-B), ○ (KETE, KETE-B)	● (KMCG, KMCG-B), ○ (KMCE)	
Clean Features	 Ion deodorization filter	●	●	●
	 Apple-catechin filter	●	●	●
	 Long-life filter			
	 Washable panel	●	●	●
	 Silver Ion Filter	○	○	○
Installation / Support	 Automatic airflow adjustment			
	 Drain pump as standard			
	 Blue fin			
	 Refrigerant cycle monitor			

○ : Optional function

Wall-mounted type				
Standard Series		Designer Series	Standard Series	
				
ASHH05/07/09/12KNCA	ASHG18/22/24KMTE	ASHG07/09/12/14LUCA	ASHG07/09/12/14LMCA	ASHG18LFCA, ASHG24LFCC
				
●	●	●	●	●
	○	○	○	○
	○	○	○	○
			●	●
●	●			
●	●	●	●	●
●	●			
●	●	●	●	●
●	●			
●	●	●	●	●
●	●			
●	○	○	○	○
●	●	●	●	●
●	●	●	●	●
○	●	●		
	○	○	○	○
●	●	●	●	●
	○	○	○	○
	○	○	○	○
●	○	○	○	○
	●	●	●	●
	●	●	●	●
●	●		●	●
○	○	○	○	○
●				●
				(30)

Feature Summary

Type		Cassette			Duct		
Series		Compact 4-way Flow Grid type Series	Compact 4-way Flow Series	4-way Flow Series	Mini (With drain pump)		Slim (With drain pump)
Model name		 AUXG 07/09/12/ 14/18/22/24 KVLA	 AUHG07/09LVLA, AUHG12/14/18LVLB, AUHG22/24LVLA	 AUHG30/36LRLE, AUHG36/45LRLA	 ARXG 07/09/12/14/18 KSLAP	 ARHG 07/09/12/14/18 LSLAP	 ARXG 07/09/12/14/18 KLLAP
Refrigerant							
Energy-saving Features	 Save Occupancy sensor						
	 Economy operation	●	●	●	●	●	●
	 Setting temperature range limitation	○	○	○	●	●	○
	 Set temperature auto return	●	○	○	●	●	●
Features for Comfort	 Power diffuser						
	 Powerful operation						
	 10°C Heat	●	●	○	○	○	○
	 Outdoor unit low noise operation						
	 Auto changeover	●	●	●	●	●	●
	 UP/DOWN swing louver	●	●	●	○	○	○
	 Double swing automatic						
	 Automatic fan speed	●	●	●	●	●	●
	 Auto restart	●	●	●	●	●	●
	 Connectable fresh air duct		○	●			
	 Fresh air intake	○	○	○			○
 Connectable distributing duct							
Convenience Features	 Auto-off timer	●	○	○	●	●	●
	 Sleep timer	●	●	○	○	○	○
	 Program timer	●	●	○	○	○	○
	 Weekly timer	●	●		●	●	●
	 Weekly & Temperature setback timer	○	○	●			●
	 Filter sign	●	●	●	●	●	●
	 External error output				○	○	
	 External ON/OFF input	●	○	○	●	●	●
 Wireless LAN control	○	○	○	○	○	○	
Clean Features	 Ion deodorization filter						
	 Apple-catechin filter						
	 Long-life filter						
	 Washable panel						
	 Silver Ion Filter	○	○	○	○	○	○
Installation / Support	 Automatic airflow adjustment						
	 Drain pump as standard	●	●	●	●	●	●
	 Blue fin			● (45/54)			
	 Refrigerant cycle monitor						

○ : Optional function

Duct				Floor	Floor/Ceiling	Ceiling	
Slim (With drain pump)	Medium Static Pressure						
ARHG07/09LLTA, ARHG12/14/18LLTB	ARXH 12/14/18/22 KMTAP	ARXG22KMLB, ARXG24KMLA	ARHG 22/24/36/45 LMLA, ARHG 30/36LMLE	AGHG09/12/14KVCA	AGHG09/12/14LVCA	ABHG14/22/24LVTA, ABHG18LVTB	ABHG18/22KRTA ABHG30/36LRTE, ABHG36/45LRTA
●	○	●	●	●	●	●	●
○	○	○	○	○	○	○	●
○	○	●	○	○	○	○	●
				●			
○	○	○	○	●	●	●	○
			○ (45) (36LMLA)	●			○
●	●	●	●	●	●	●	●
○				●	●	●	
●	●	●	●	●	●	●	●
●	●	●	●	●	●	●	●
	●	●	●			●	●
○	○	○	○			○	○
		●	●				
○	●	●	○	○	○	○	●
○	○	○	○	●	●	●	●
○	●	○	○	●	●	●	●
○	○	○	○	○	○	○	○
				●	●		
	○	○	○	●	●		
○	○	○	○	○	○		
○	●	○	○			○	○
●	●	○	○			○	○
			○ (45)			○ (30/36/45/54)	○ (45)
	○						

Light Commercial & Commercial, Residential

VRF

VRF systems provide air conditioning solutions that meet the requirements of a diverse range of buildings.

VRF systems provide air conditioning solutions for large residences as well as large commercial buildings.

- V-002 VRF Series Overview
- V-004 VRF Outdoor Units Lineup
- V-006 Features

VRF Outdoor Units



VRF J Series Heat Pump for Small-capacity type

- V-020 VRF J-VS
- V-026 VRF J-IVS
- V-030 VRF J-IV
- V-034 VRF J-IVL



VRF V Series Heat Recovery Modular type

- V-040 VRF VR-IV

Heat Pump Modular type

- V-050 VRF V-IV

VRF INDOOR UNITS

- V-058 VRF Indoor Unit Lineup for J-VS
- V-066 VRF Indoor Unit Lineup for J-IVS, J-IV, J-IVL, VR-IV, V-IV





VRF

VRF

Light Commercial
& Commercial,
Residential



FUJITSU GENERAL (Euro) GmbH participates in the ECP program for VRF. Check ongoing validity of certificate: www.eurovent-certification.com

FUJITSU GENERAL LIMITED

VRF Series Overview

Recommended VRF products for various buildings



NEW VRF **J-VS**



Maximum 6 HP Heat Pump

This product uses R32, a new environmentally friendly refrigerant. With TOP-class energy efficiency and compact design, it can be installed in a limited and narrow space without being conspicuous. Indoor unit connectable up to 130%.

- Sustainable(R32)
- Saving CO2
- Small Body
- Situational Piping Design
- Sightliness installation



Page
V-020

VRF **J-IVS**



Maximum 6 HP Heat Pump

The 998 mm compact design does not obstruct the view even when installed underneath a waist-high window, ideal for large houses and retail stores. Indoor unit connectable up to 130%.

- Spaces saving and low sound level design
- Flexible system configuration for homes, stores, and small buildings



Page
V-026

VRF **J-IV**



Maximum 6 HP Heat Pump

J-IV is connectable with up to 14 indoor units (Indoor unit connectable up to 150%) making it suitable for commercial facilities housing a number of small stores.

- High energy efficiency
- Flexible system configuration for small and midsize buildings



Page
V-030

VRF **J-IVL**



Maximum 18 HP Heat Pump

J-IVL is an outdoor unit with a slim design. Its flexibility in installation makes it ideal for midsize office buildings and hotels. With the newly added 14/16/18 HP models, up to 42 indoor units* are connectable, making them ideal for hotels and educational facilities with many rooms.

- Slim Outdoor Unit
- Small room application
- Class-leading Low Operating Sound



Page
V-034



VRF **VR-IV**



Maximum **48 HP** Heat Recovery

Smart, cutting-edge design
Available in a wide range of models from 8 to 48 HP in 2 HP increments with the capacity ratio of indoor units connectable up to 150%.

- Excellent energy saving
- High design flexibility for placement in any building
- Easy installation and maintenance



Page
V-040

VRF **V-IV**



Maximum **48 HP** Heat Pump

Smart, cutting-edge design
Extensive lineup from 8 HP to 48 HP with the capacity ratio of indoor units connectable up to 150%.

- Simultaneous cooling and heating operation using a single refrigerant system
- Annual cooling operation
- Accommodating changes in temperature difference



Page
V-050

Design Simulator











































When installing air conditioning equipment in each room of a building, it is necessary to select an indoor unit suitable for the heat load in the room and derive an outdoor unit that can cover the capacity of all indoor units. In addition, remote controls and converters are selected according to how the customer will manage the air conditioner, and in some cases, a design combined with options may be required to comply with established standards. The "Design Simulator" can be used to facilitate the selection of such complex equipment and the output of system drawings and estimates. (Software for PC)



For more information



VRF Outdoor Units Lineup

Capacity (kW)		Refrigerant	12.1	14.0	15.1-15.5	22.4	28.0	33.5	40.0	45.0	50.0-50.4	55.9	61.5
HP			4	5	6	8	10	12	14	16	18	20	22
NEW	J-VS Series												
			AJH040 KCTAH	AJH045 KCTAH	AJH054 KCTAH								
	J-IVS Series												
	J-IVS Series		AJH040 LCLDH	AJH045 LCLDH	AJH054 LCLDH								
	J-IV Series												
	J-IV Series		AJH040 LBLDH, AJH040 LELDH	AJH045 LBLDH, AJH045 LELDH	AJH054 LBLDH, AJH054 LELDH								
	J-IVL Series												
	J-IVL Series					AJH072 LELDH	AJH090 LELDH	AJH108 LELDH	AJH126 LELDH	AJH144 LELDH	AJH162 LELDH		
VR-IV Series Heat Recovery	Space Saving												
	Set Model					AJH072 GALDH	AJH090 GALDH	AJH108 GALDH	AJH126 GALDH	AJH144 GALDH	AJH162 GALDH	AJH180 GALDH	AJH198 GALDH
VR-IV Series Heat Recovery	Energy Efficiency												
	Set Model									AJH144 GALDHH			AJH198 GALDHH
V-IV Series Heat Pump	Space Saving												
	Set Model					AJH072 LALDH	AJH090 LALDH	AJH108 LALDH	AJH126 LALDH	AJH144 LALDH	AJH162 LALDH	AJH180 LALDH	AJH198 LALDH
V-IV Series Heat Pump	Energy Efficiency												
	Set Model									AJH144 LALDHH		AJH180 LALDHH	

Features

High-efficiency

High-efficiency is achieved significantly by the use of a DC twin-rotary compressor, inverter technology, and a large heat exchanger.

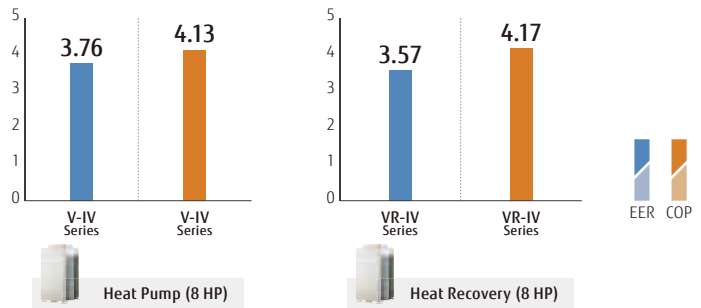

* These specifications are determined by ducted combination.

ALL DC High-efficiency design with top-class SEER/SCOP

All the VRF Series, including the J-IVL Series, have DC technology to achieve high-efficiency operation. This enhances the durability and reliability of the VRF Series.

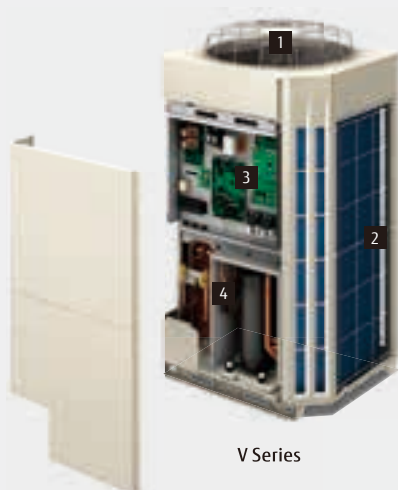
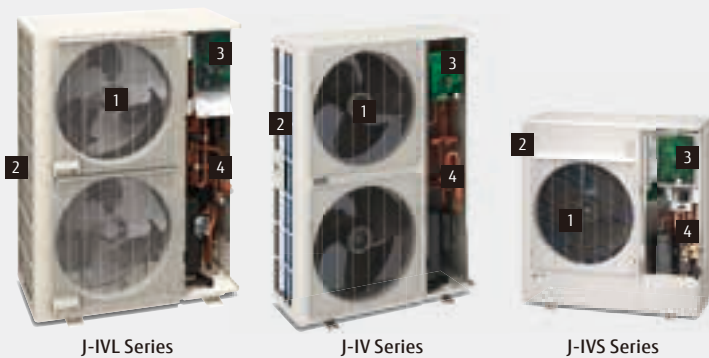

Efficient control of operation



Setting temperature range limitation

Sets the minimum and maximum limits on room temperature to establish an optimum balance between energy-saving performance and a comfortable environment.

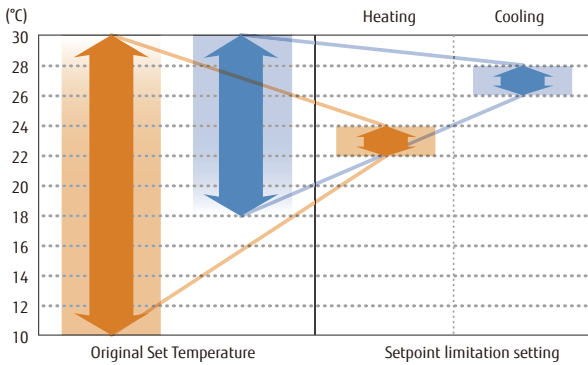

Auto-off timer

The wired remote controller is equipped with an auto-off timer function that automatically stops operation after a fixed period of time has elapsed from the start of operation to avoid wasting energy. The function also allows you to set the interval for stopping operations.

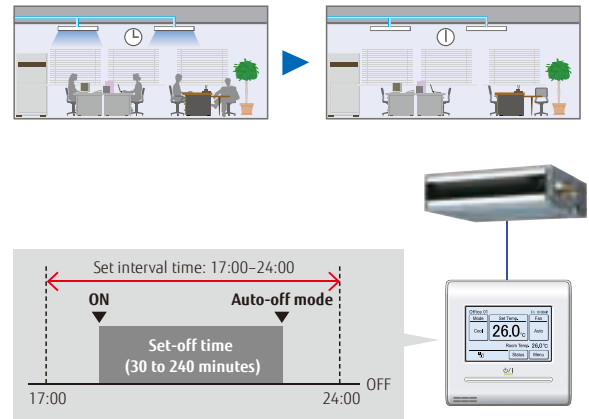

Energy-saving management

A variety of energy-saving operations can be set and managed depending on the season, climate, and time period. Excellent energy-saving operation using the system controller.



Screen image shows Energy Manager software (option)

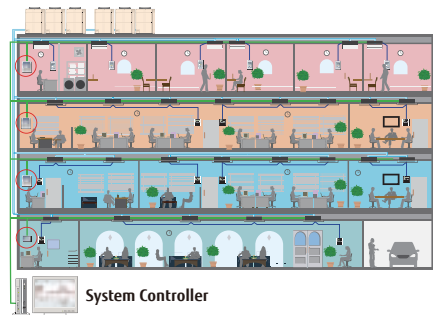

Capacity-saving mode

Operation capacity can be reduced in 5 steps from the rated capacity. This mode cuts down on peak power consumption and eases the maximum load on the unit.

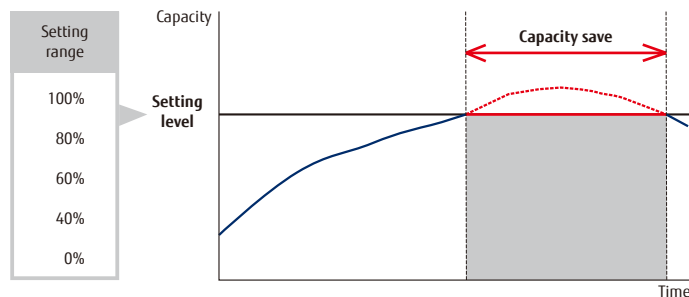



Intelligent refrigerant control

Fujitsu General is proposing outdoor units equipped with refrigerant control function. The refrigerant control operates with subtle control corresponding to the heat load of the room and offers a more comfortable environment. The refrigerant control can also provide increased energy savings.

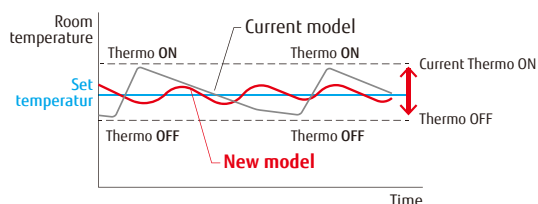

Current refrigerant control

Thermostat-ON/OFF occurs frequently.
→ Frequent changes in room temperature interfere with comfort. The compressor starts and stops repeatedly, wasting energy.

New refrigerant control

The thermostat is turned on and off less frequently than under current control to maintain the room temperature at the target temperature. Compared to current control, the compressor will run longer, thus saving energy.

Current model



The outdoor unit supplies constant capacity regardless of the demand of the indoor unit.

New model

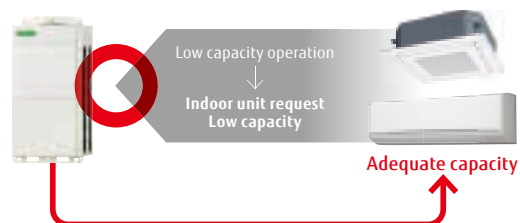

The outdoor unit provides sufficient capacity to meet the demands of the indoor unit.

* The improvements due to the control and the actual sine wave vary depending on the combination of the indoor unit and system operating conditions.

More Comfort



Auto changeover

In Auto setting, the air conditioner switches between cooling and heating modes automatically according to the set temperature and the room temperature.

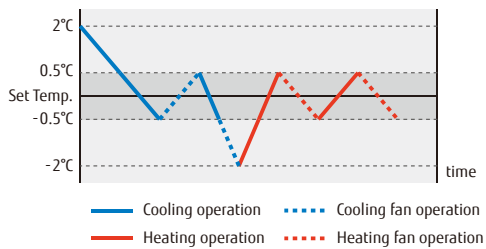

Auto changeover settings enable the indoor unit to easily switch between cooling and heating regardless of the operating mode of other indoor units. These settings can be made using a wired remote controller for a specific indoor unit. Provides a comfortable environment all year round.

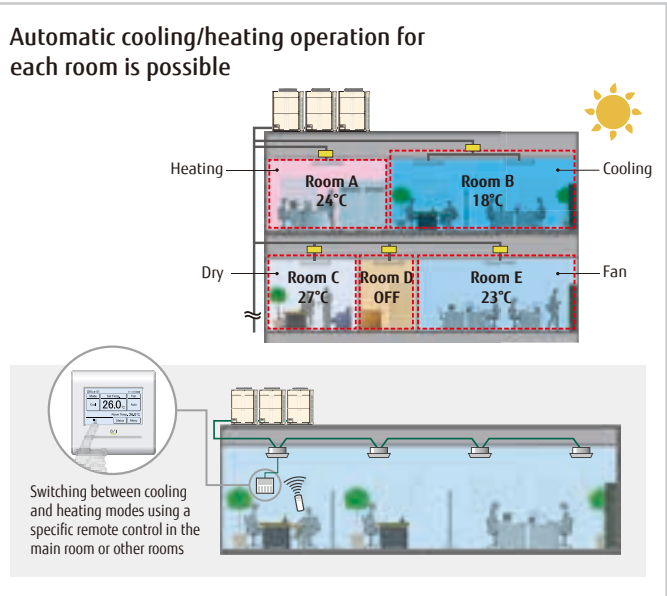

Precise control of refrigerant flow

The combination of DC inverter control and individual control of electronic expansion valves of an indoor unit enables precise and smooth control of the refrigerant flow. This means the room temperature can be set in increments of 0.5°C.

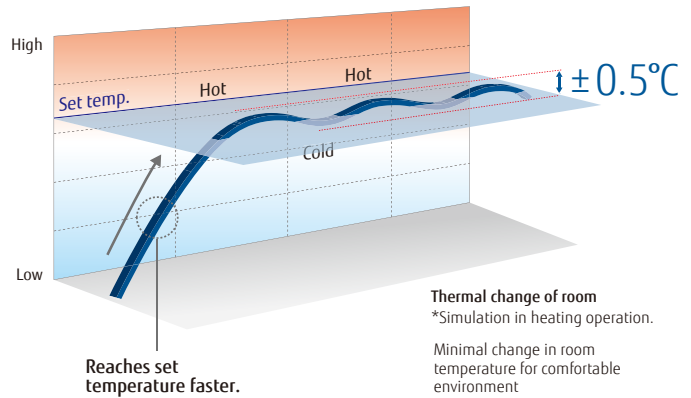

Quiet operation



Quiet operation

Two low noise modes can be switched over automatically between one in which low noise is prioritized over performance, and the other in which performance is prioritized over low noise, depending on the room temperature and outdoor temperature. This feature can be controlled by external input from the outdoor unit or a system controller.

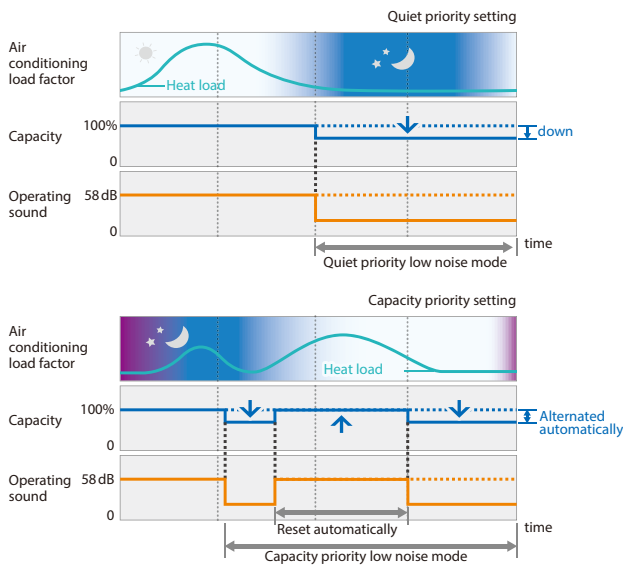

Non-stop oil recovery operation

A comfortable room condition is maintained during oil recovery mode because the product continues to operate without stopping the cooling or heating operation.

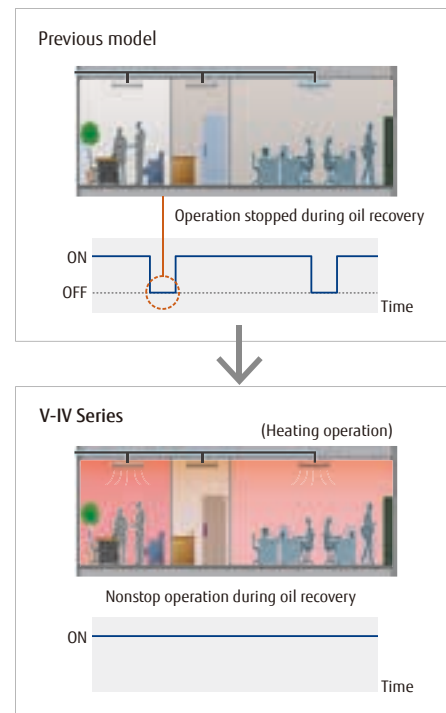

NEW Switching room temperature sensing position for improved heating comfort (Option)

The optional remote sensor kit (UTY-XSZXZ1) can be connected to the indoor unit to improve comfort by installing the unit at a height appropriate for the living environment.

Connectable products

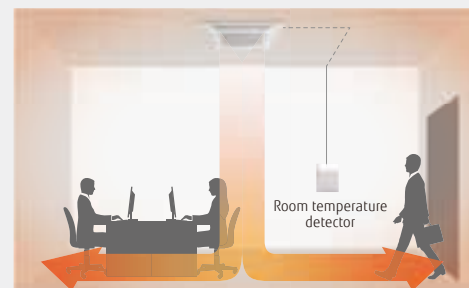

High Reliability

Outdoor unit rotation

The compressor starting order is rotated to equalize the cumulative running time of each unit.

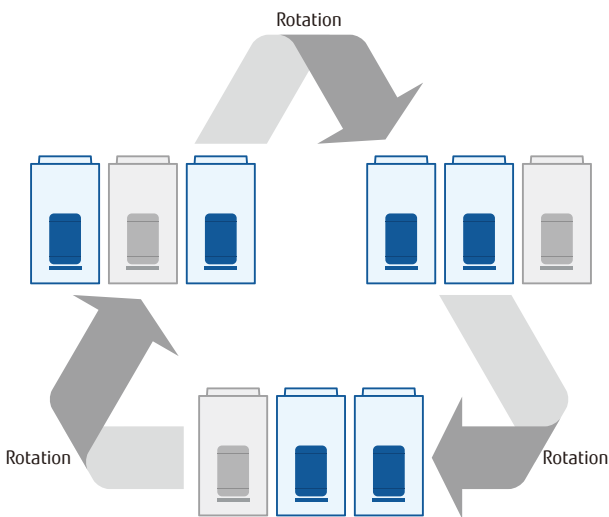

The start and stop timings are alternated among connected compressors.

Backup operation

If one compressor fails, the other compressors will initiate backup operation*.

Note: Backup operation may not be possible depending on the cause of failure.

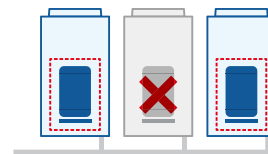

Advanced refrigerant control

Compressor control logic controls the inverter speed to balance the mass airflow rate of refrigerant in each outdoor unit.

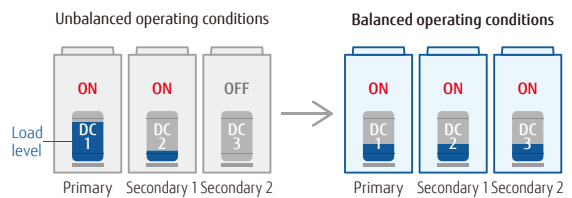

Protection against liquid flowback

The use of a large accumulator means that refrigerant that has not been completely vaporized stays inside the accumulator to ensure no liquid refrigerant is fed into the compressor.

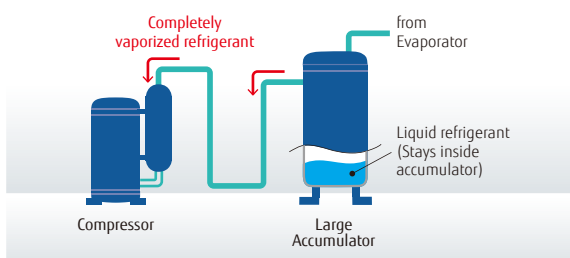

Blue fin heat exchanger

The anti-corrosion blue fin treatment is applied to the heat exchanger of the outdoor unit.

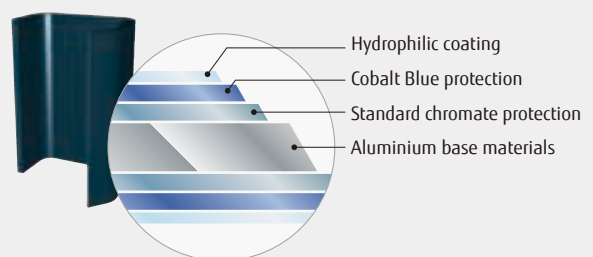



Design Flexibility



Class-leading compact design



An industry-leading compact outdoor unit with optimal airflow pattern design. (Up to 18 HP)

VRF J Series Compact Outdoor Unit



Long pipe design



Pipe design suitable for long and narrow office buildings with elevation differences and low-rise stores with long distances (VRF J-IVL Series)

VRF J-VS Series

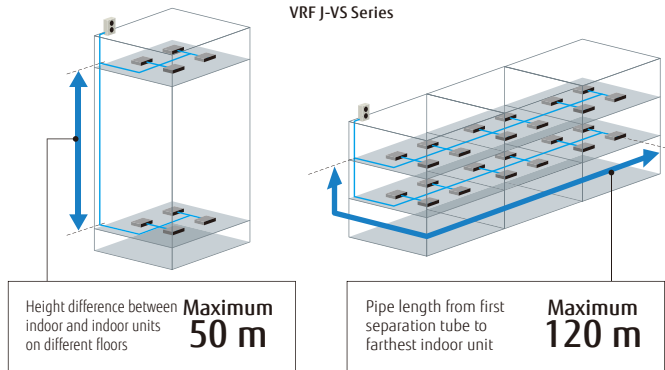

Max. allowable overall pipe length: 1,000 m







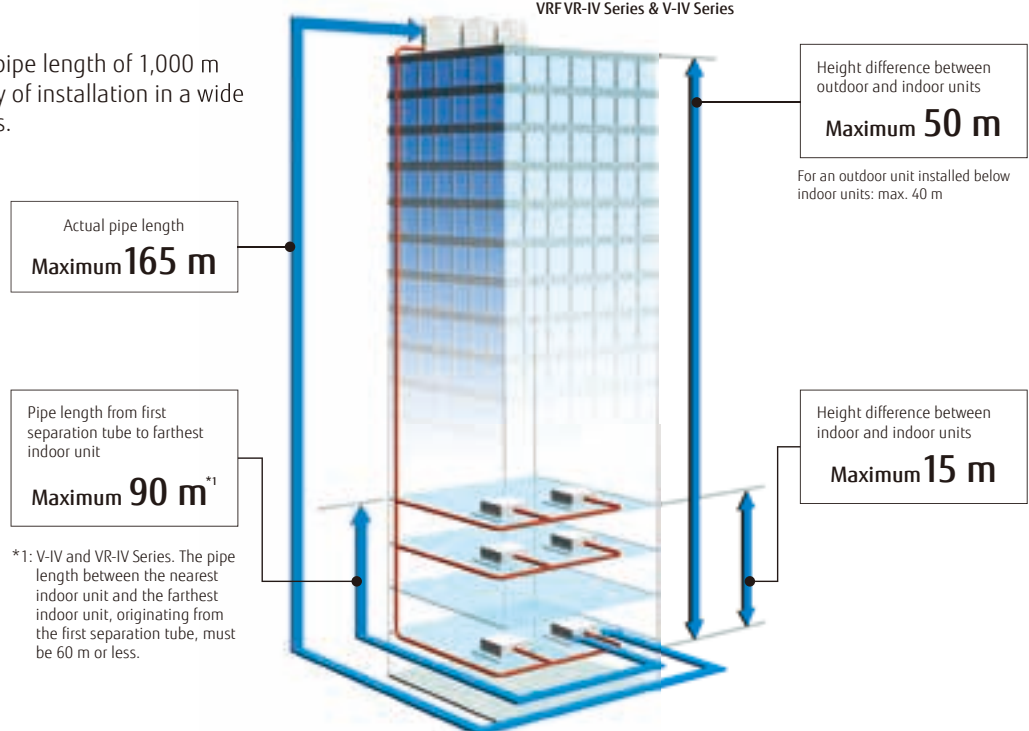

The class-leading pipe length of 1,000 m increases flexibility of installation in a wide variety of buildings.

VRF VR-IV Series & V-IV Series



High-capacity connection

Series	Connectable indoor unit capacity range	Connectable indoor units
 VRF J-VS Series Heat pump type	50% to 130%	up to 13 ^{*5}
 VRF J-IVS Series Heat pump type	50% to 130%	up to 13 ^{*5}
 VRF J-IV Series Heat pump type	50% to 150%	up to 14 ^{*5}
 VRF J-IVL Series 14/16/18 HP Heat pump type	50% to 150%	up to 42 ^{*3}
 VRF J-IVL Series 8/10/12 HP Heat pump type	50% to 150%	up to 30 ^{*4}
 VRF VR-IV Series Heat Recovery Modular type	25% ^{*5} to 150%	up to 64
 VRF V-IV Series Heat Pump Modular type	50% to 150% ^{*2}	up to 64

*2: The maximum capacity of the combination that includes the 18-HP outdoor unit is below 150%.

*3: J-IVL Series 18-HP model only.

*4: J-IVL Series 12-HP model only.

*5: 6-HP model only.



Designed for low refrigerant charge

The optimal design of the indoor and outdoor units reduces the amount of refrigerant required and can be easily installed in a room as small as 15 m².



Various optional parts

- Fresh air intake kit to bring in fresh air
- Comfortable temperature control with a remote sensor
- DX kit links ventilation equipment and air handling units.

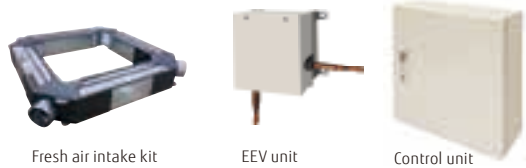

Low ambient operation

Our refrigeration cycle technology enables cooling operation even at -15°C.

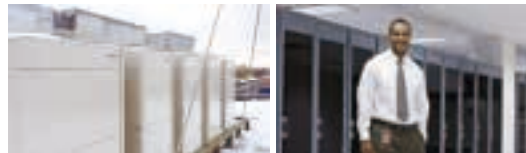

Wide operating temperature range

All outdoor units have a wide operating temperature range and can operate in extreme temperature conditions.

*6: When multiple outdoor units are connected, their operating temperature range is from -5°C to 46°C in cooling.

*7: The operating range is -15°C to 46°C only for systems with all indoor units rated at 5.6 kW or more.

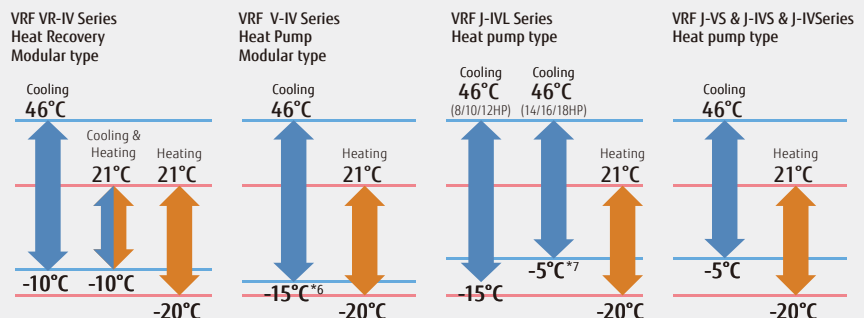

Easy Installation

Easily transported

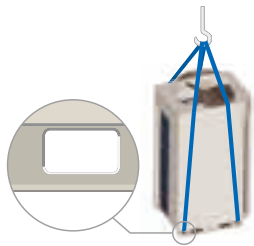

A lifting strap can be hooked onto an outdoor unit
Design of outdoor unit allows for lifting straps to be used

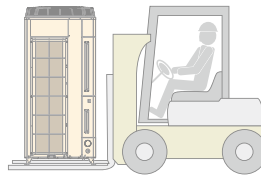

Transportable by forklift
The outdoor unit can be lifted and transported by forklift.

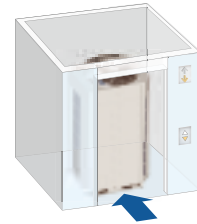

Fits into a small elevator.

Easy access

The removable L-shaped front panel provides more room for installation and service work. Multiple installations can be performed easily and efficiently even in tight spaces.

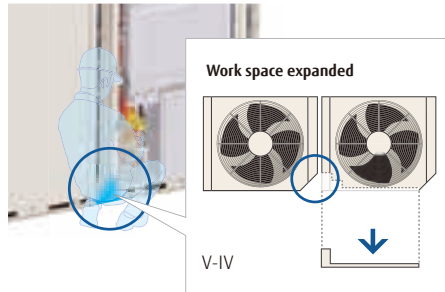

Front access reduces installation intervals

Flexible pipe connection

Piping and wiring can be accessed from the front, left, right, and bottom.

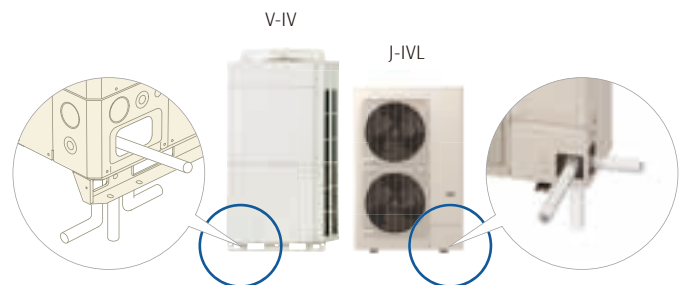



Simplified wiring work

The communication wiring can be installed seamlessly among indoor, outdoor, and RB units, which makes the installation of the wiring system easier.

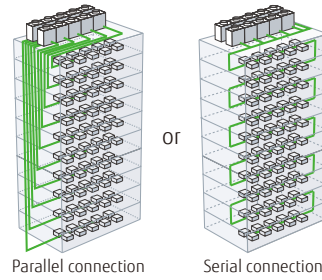

Maximum wiring length:
3,600 m

Note: The automatic address setting is not available on a serially connected multiple refrigerant system.

Vacuum mode function for easy evacuation

The vacuum mode function enables all expansion valves of an indoor unit to be opened fully, allowing for easier evacuation of air inside pipe lines and indoor units.

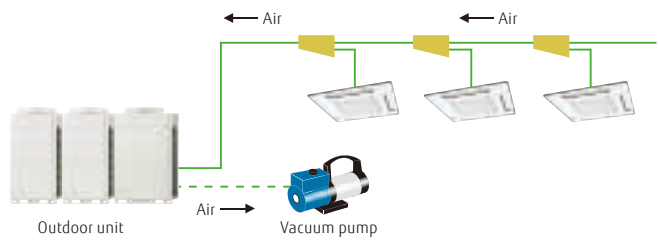

Automatic address setting

Addresses of connected indoor units, RB units, and Signal amplifier can all be set automatically from the PCB in the outdoor unit.

Address is set automatically by the outdoor unit.



Press the push button on the outdoor unit.

Addresses can be set manually from an indoor unit or a remote controller.

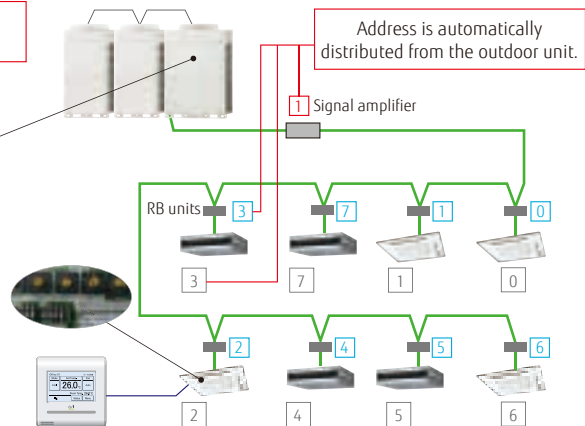

Address is automatically distributed from the outdoor unit.

Easy commissioning with Tools

• Service Tool (UTY-ASGXZ1)

The Service Tool checks the refrigerant temperature and pressure, and the operating status of the electronic expansion valves, making it easy to determine if the units are connected properly.



NEW • Central Remote Controller (UTY-DCGGZ3)

After the VRF system has been installed. Conveniently, the "test run" required to verify proper system operation can be performed from a nearby Central RC.



Easy Service and Maintenance

Designed for easy maintenance

A 7-segment indicator lamp panel provides detailed information on the function setting status, refrigerant temperature and pressure, compressor operation time, and other factors, facilitating self-diagnosis for each unit.

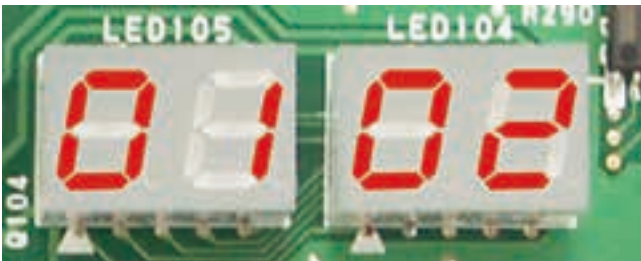

Easy-to-read 7-segment indicator lamp

Shows the following detailed operation and error status without need of any special tools.

Error status can be checked on an outdoor unit's display

- System operation mode
- Discharge temperature and pressure
- Compressor operation status
- Address, type, and number of outdoor unit

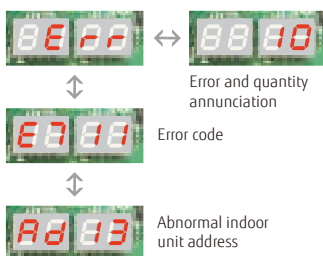

- Error status can easily be checked on an outdoor unit's display.

Movable PCB panel

Enables easier access behind the PCB for maintenance work.

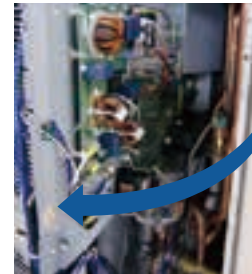



The error status can be checked via a wired remote controller for indoor units.

Error codes are displayed on an LCD screen.

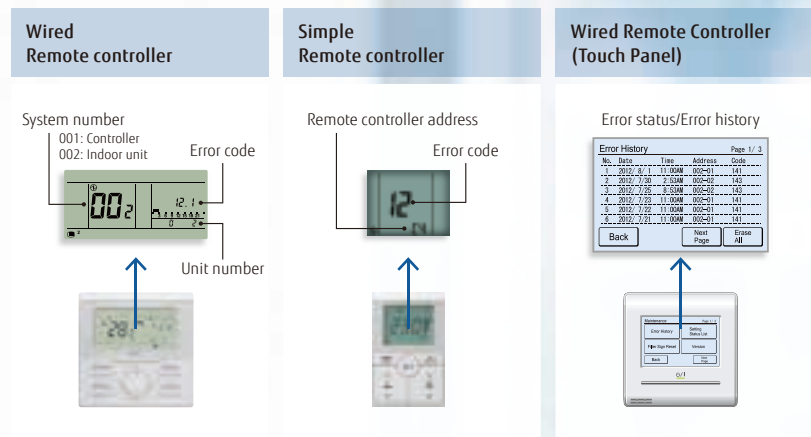

Error diagnosis by Service tool

Connection to Service tool

- A detailed operation status and recent error history can be checked and analyzed using Service tool.
- The last 5 minutes of operation status can be recorded continuously.

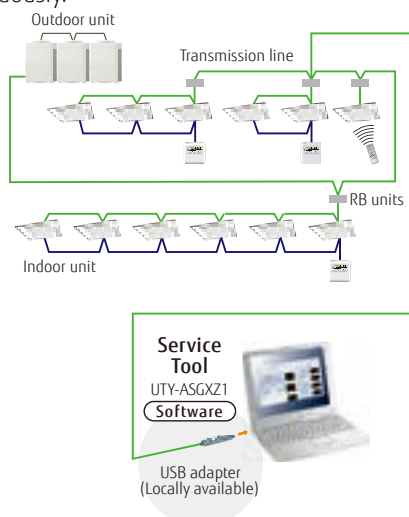

Remote monitoring

The Web Monitoring system enables the monitoring of the system's operation status at any time via the internet to ensure trouble-free operation. The operating VRF network system in the building can be monitored real time over the internet.

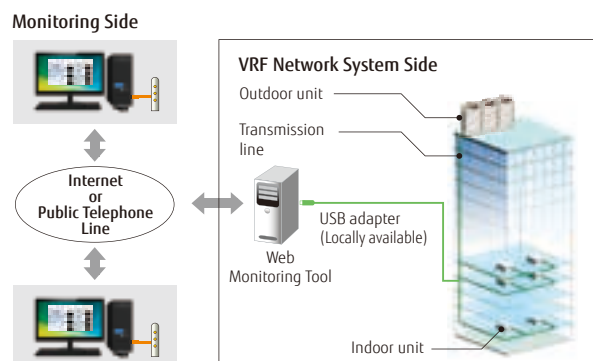



Heat Pump

for Small-capacity type

VRF J-VS

System configuration example

- Suitable for air conditioning small and medium-size buildings. One refrigerant system is used for each outdoor unit.
- Multiple indoor units are connected with separation tubes and headers.

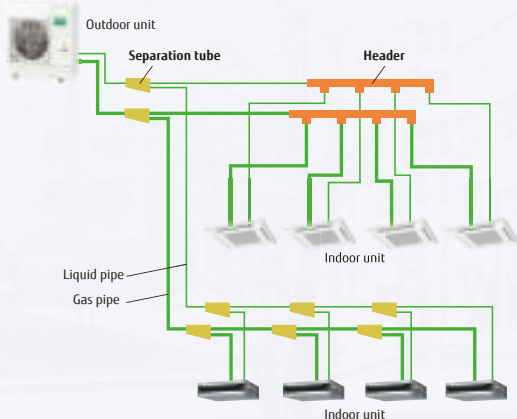

This product uses R32, a new environmentally friendly refrigerant. With TOP-class energy efficiency and compact design, it can be installed in a limited and narrow space without being conspicuous.

for SHOP

for LARGE APARTMENT

for OFFICE



R32 refrigerant with reduced global warming potential

- **Zero** Ozone Depletion Potential (ODP^{*1})
- High environmental properties
- High performance
- Economically efficient

GWP^{*2}

(Reference: IPCC 4th Report)

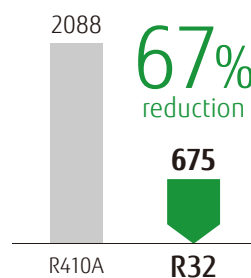

^{*1} ODP (Ozone Depleting Potential): a relative value that indicates the impact per unit weight of ozone-depleting substances released into the atmosphere when CFC-11 (trichlorofluoromethane, CCl₃F) is fixed at 1.0

^{*2} GWP (Global Warming Potential): a measurement that indicates how much other greenhouse gases are capable of warming the Earth based on carbon dioxide. This is the integrated value of radiant energy given to the Earth (i.e., the estimated impact on global warming) expressed as a ratio to CO₂.

Sustainable

European F-Gas Regulation Plan

The European Union has tightened F-gas rules as part of European Green Deal policy, which aims for Europe climate neutral by 2050. The F-gas Regulation mainly includes

- (1) Reducing the total volume of HFCs and phasing out HFC in 2050.
- (2) The GWP limits for certain products are required to be strengthened.

Fujitsu General as one of its proactive efforts to preserve the global environment, we are working on technological development to achieve the best balance between refrigerants with lower GWP and energy efficiency of equipment adopting safety measures.

2029	2033	2035	2050
<p>Available at J-VS</p> <p>Split AC & HP Over 12 kW: GWP 750 and above prohibited 12 kW or less: GWP 150 and above prohibited</p>	<p>Split AC & HP Over 12 kW: GWP 150 and above prohibited</p>	<p>Split AC & HP HFC use prohibited</p>	<p>an economy with net-zero greenhouse gas emissions.</p>

Refrigerant saving design

Refrigerant saving design the compact indoor unit, piping design, and optimization of heat exchanger volume significantly reduce the system refrigerant volume.

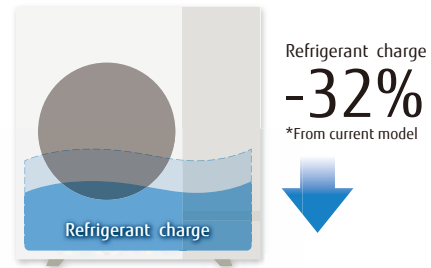

Enhanced disaster safety measures

The system is designed to meet the environmental safety requirements specified in the IEC 603352-40 standard for the use of R32 refrigerant. The environment requiring safety measures is determined by the size of the room in relation to the amount of refrigerant required. For example, if the system is designed for maximum pipe length and the refrigerant charge is 6 kg, safety measures are required for rooms of 15 m² or less.

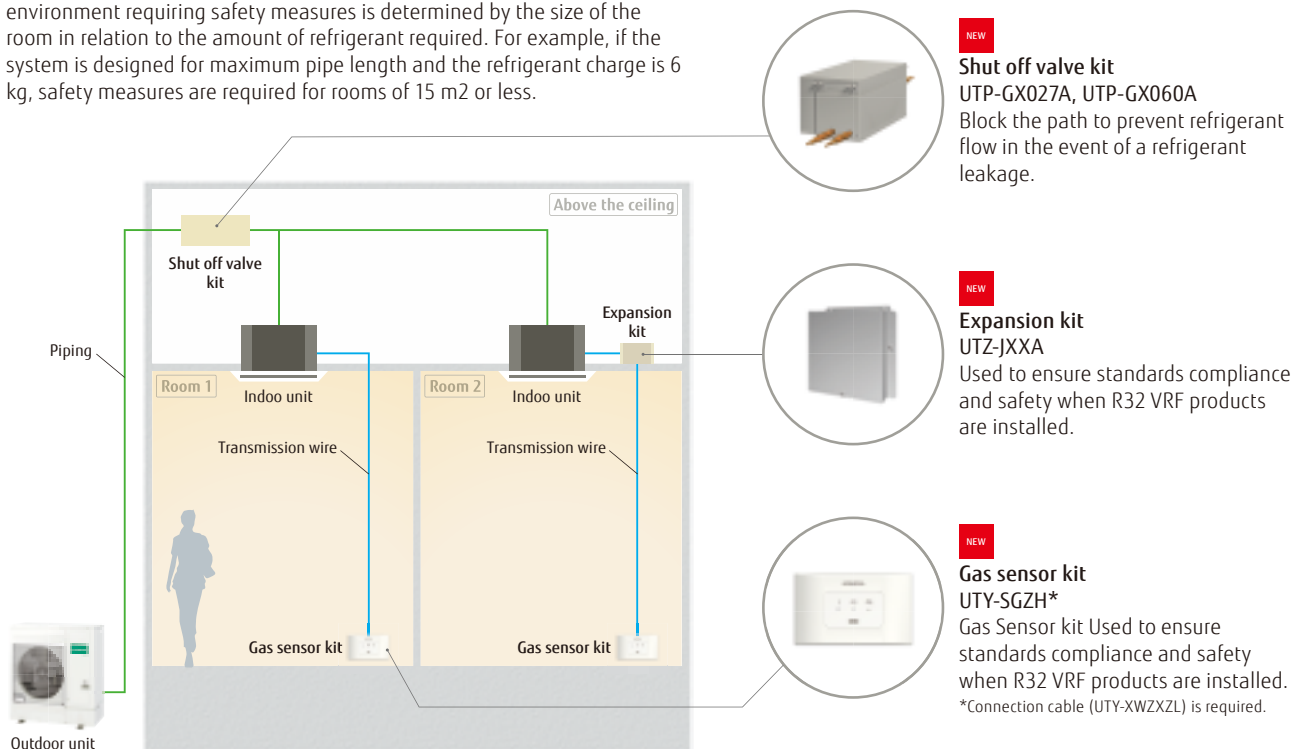

Saving CO2

TOP Class High Energy Saving

The use of large heat exchanger and a high-efficiency Rotary compressor achieves class-leading SEER/SCOP in all models.

SEER
8.27

*045 model

SCOP
5.37

*040 model

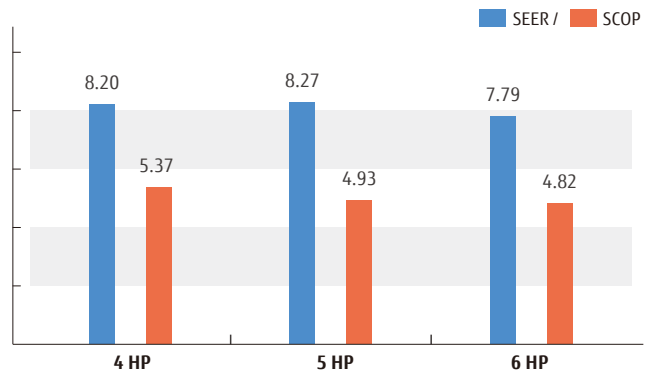

More Energy-Saving compressor control

When the room temperature approaches the set temperature after the start of operation, the capacity required for the outdoor unit becomes lower. The minimum compressor speed at this time can now be controlled at a lower value than with conventional products, enabling more energy-efficient operation.

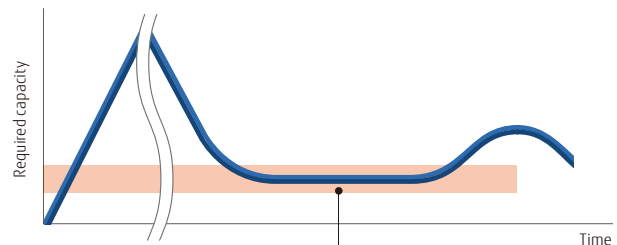

Can be operated at a lower rps than the current model.

Minimum, **15 rps**
↓
Low power consumption

Small Body

Easy to carry, easy to install

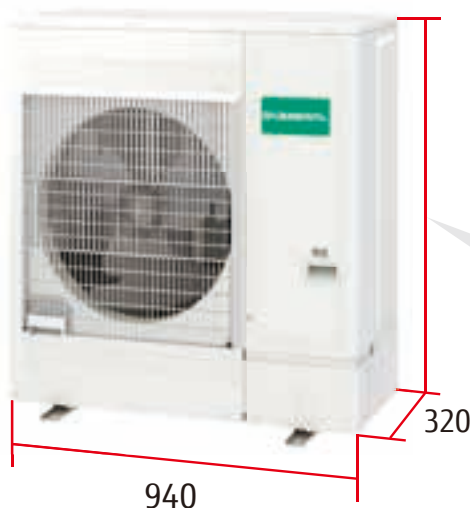

Light
74kg

Height difference
998mm

Small, lightweight outdoor unit

The outdoor units in this series are much more compact than conventional outdoor units of comparable capacity. They can be installed on a balcony, fitting below the height of the railing. With a height of less than 1 m, they can be installed in tight spaces such as under windows.



Low noise design

Significantly low noise levels are achieved by the use of a DC twin-rotary compressor, inverter technology, and an advanced airflow pattern design.

Situational Piping Design

Long pipe length

Our advanced refrigerant control technology extends the maximum allowable length of refrigerant piping to 120 m. This provides high flexibility in system design.

Long piping lengths are achieved by installing a large-capacity accumulator. No liquid refrigerant is supplied to the compressor even when the required amount of refrigerant is charged in the long piping.

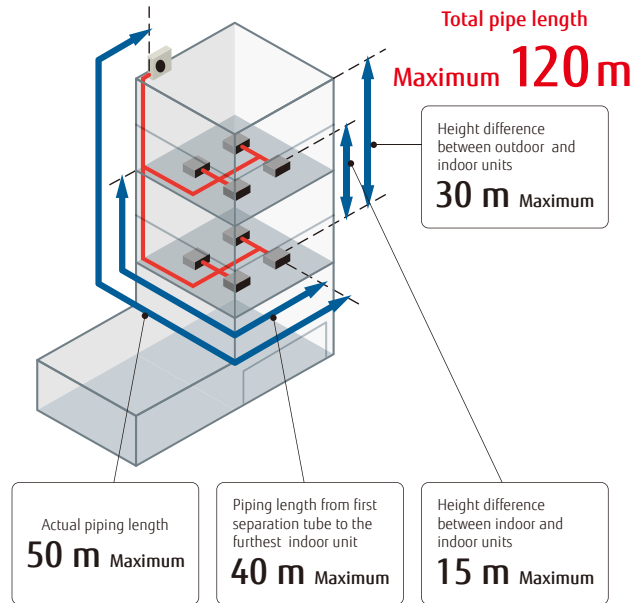
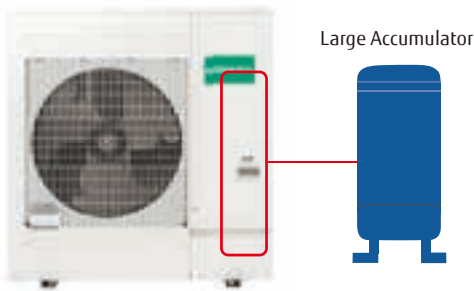

Up to 13 indoor units* can be connected

The combination of smaller but sufficiently powerful indoor units and a new outdoor unit with an optimized heat exchanging structure makes it possible to connect up to 13 indoor units, which is the best in its class.

*: 6 HP model

Rating Capacity range (HP)	4	5	6
Max. Connectable indoor unit	1-11	1-12	1-13

Sightliness installation

External static pressure

External static pressure measures up to 30 Pa for 4/5/6 HP models. Even if the outdoor unit is installed in a small space to hide it, the grille and duct airflow path required for exhaust air can be installed up to a static pressure value of 30 Pa.

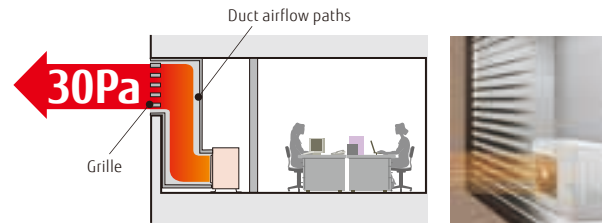

Cooling piping system

New Heat Rejection Technology Cooling piping system "Cooling piping system" is adopted to ensure reliability in high outside air. Even when the outdoor unit is installed in an environment where heat tends to stay (small space), the cooling system using refrigerant can reduce damage caused by heat from PCBs.

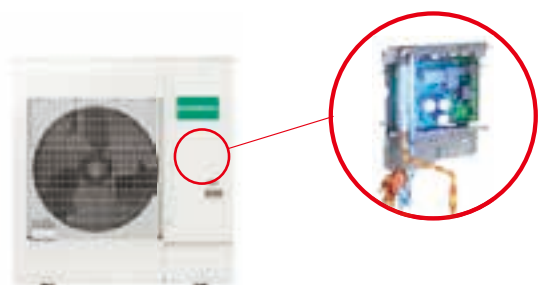



Specifications

Rated capacity range	HP	4	5	6	
Model name		AJH040KCTAH	AJH045KCTAH	AJH054KCTAH	
Maximum connectable indoor units		1-11	1-12	1-13	
Power source		Single phase, ~230 V, 50 Hz			
Capacity	Cooling	12.1	14.0	15.1	
	Nominal Heating	12.1	14.0	15.1	
	Max. Heating	13.6	16.0	16.5	
Input power	Cooling	3.15	3.82	4.48	
	Nominal Heating	2.55	2.91	3.20	
	Max. Heating	3.09	3.62	3.90	
EER	Cooling	3.84	3.66	3.37	
COP	Nominal Heating	4.74	4.80	4.71	
	Max. Heating	4.40	4.41	4.22	
SEER	Cooling	8.20	8.27	7.79	
SCOP	Heating	5.37	4.93	4.82	
ηc	Cooling	325.0	328.0	308.6	
ηh	Heating	212.0	194.0	189.8	
Airflow rate		m ³ /h	4,240	4,450	4,450
Sound pressure level/ Power level	Cooling	dB(A)	52 / 70	53 / 71	54 / 72
	Heating		54 / 71	55 / 72	56 / 73
Heat exchanger fin			Blue fin	Blue fin	
Net Dimensions	Height	mm	998	998	998
	Width		940	940	940
	Depth		320	320	320
Weight		kg	74	74	74
Refrigerant	Type (Global Warming Potential)		R32 (675)	R32 (675)	R32 (675)
	Charge	kg (CO ₂ eq-T)	2.7 (1.823)	2.7 (1.823)	2.7 (1.823)
Connection pipe diameter	Liquid	mm	9.52	9.52	9.52
	Gas		15.88	15.88	15.88
Total pipe length		m	120	120	120
Max. height difference			30	30	30
Operating Range	Cooling	°C	-5 to 46	-5 to 46	-5 to 46
	Heating		-20 to 21	-20 to 21	-20 to 21

Note: Specifications are based on the following conditions.

Cooling: Indoor temperature of 27°CDB/19°CWB, and outdoor temperature of 35°CDB/24°CWB.

Heating: Indoor temperature of 20°CDB/(15°CWB), and outdoor temperature of 7°CDB/6°CWB.

Pipe length: 7.5 m; Height difference between outdoor unit and indoor unit: 0 m.

The protective function may work when using it outside the operation range.

Dimensions

(Unit: mm)

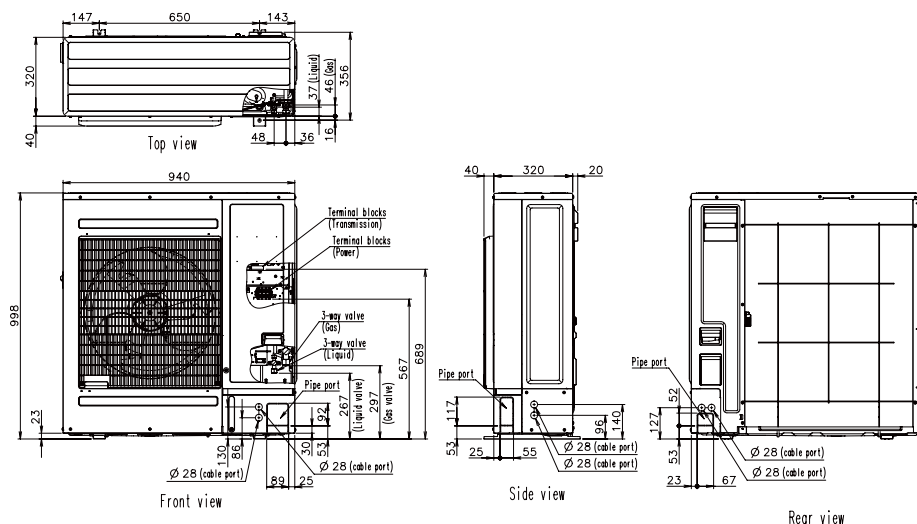



Heat Pump

for Small-capacity type

VRF J-IVS

System configuration example

- Suitable for air conditioning small and medium-size buildings. One refrigerant system is used for each outdoor unit.
- Multiple indoor units are connected with separation tubes and headers.

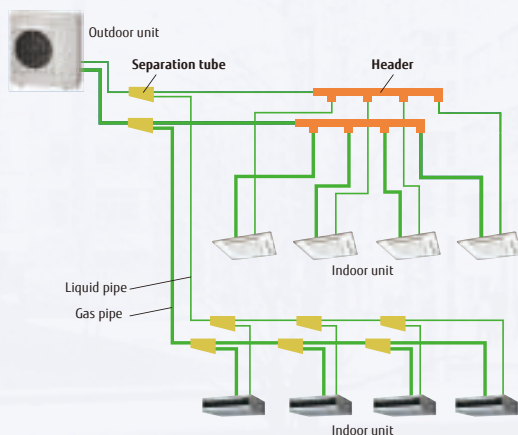

New intelligent refrigerant control

Fujitsu General is proposing outdoor units equipped with refrigerant control function. The refrigerant control operates with suitable control corresponding to the heat load of the room and offers a more comfortable environment. The refrigerant control can also provide increased energy savings.

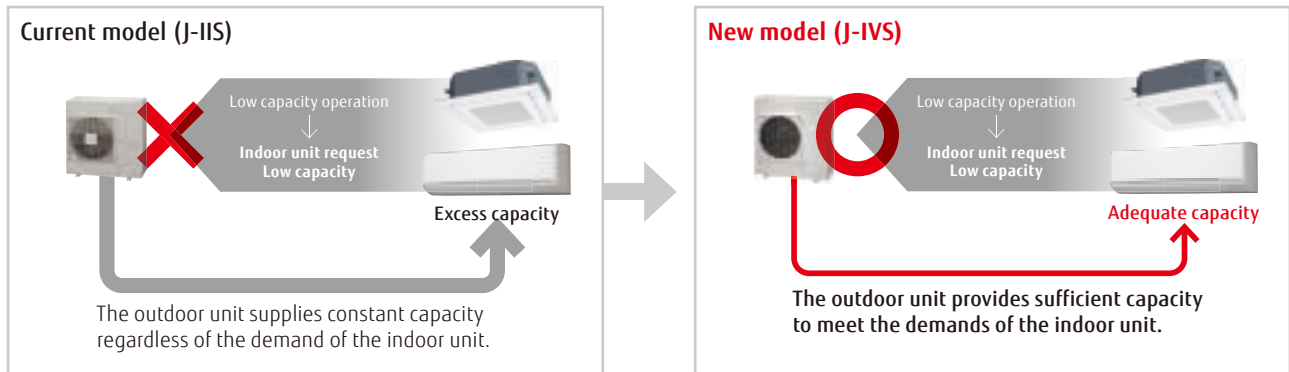

* The improvements due to the control and the actual sine wave vary depending on the combination of the indoor unit and system operating conditions.

External static pressure

External static pressure measures up to 25 Pa for 4/5/6 HP models.



Advanced high-efficiency technology

- Large propeller fan**
A large propeller fan with an optimized blade angle achieves both high performance and low noise operation.
- DC fan motor**
A small, multi-stage DC fan motor provides high-efficiency and low noise operation.
- Large heat exchanger**
The large 3-row heat exchanger substantially improves heat-exchanging performance.
- High heat-transfer copper tube (Improved lead angle)**
- DC inverter control**
The active filter module improves efficiency.
- Compact and high-performance DC twin-rotary compressor**
High-efficiency is achieved across compressor loads. Especially good performance is achieved in the low- to medium-load range.

Additional callouts for the compressor include: Low noise rubber, High-efficiency compressor motor, Optimized refrigerant flow design, and Highly accurate parts.

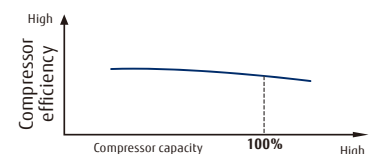

Easy to carry, easy to install

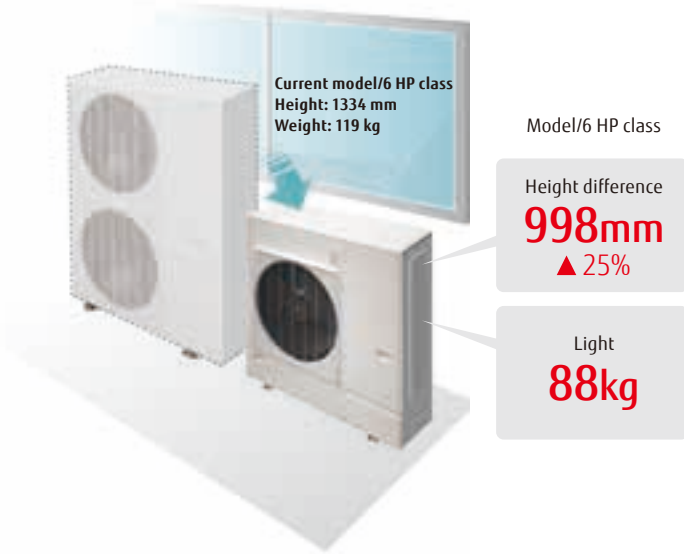

Small, lightweight outdoor unit

The outdoor units in this series are much more compact than conventional outdoor units of comparable capacity. They can be installed on a balcony, fitting below the height of the railing. With a height of less than 1 m, they can be installed in tight spaces such as under windows.



Low noise design

Significantly low noise levels are achieved by the use of a DC twin-rotary compressor, inverter technology, and an advanced airflow pattern design.

Long pipe length

Our advanced refrigerant control technology extends the maximum allowable length of refrigerant piping to 80 m. This provides high flexibility in system design.

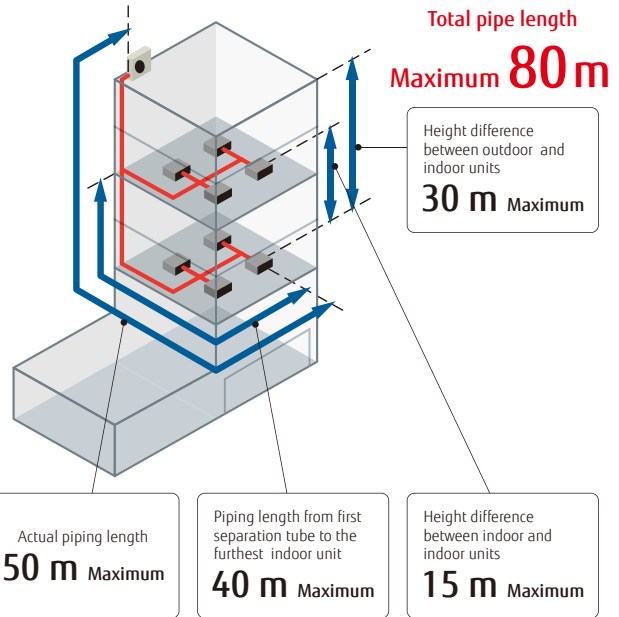

Up to 13 indoor units* can be connected

The combination of smaller but sufficiently powerful indoor units and a new outdoor unit with an optimized heat exchanging structure makes it possible to connect up to 13 indoor units, which is the best in its class.

*: 6 HP model

Model	Current model (J-IIS)			New model (J-IVS)		
	4	5	6	4	5	6
Rating Capacity range (HP)	4	5	6	4	5	6
Max. Connectable indoor unit	1-7	1-8	1-8	1-11	1-12	1-13

Non-stop oil recovery operation

A comfortable room condition is maintained during oil recovery mode because the product continues to operate without stopping the cooling or heating operation.

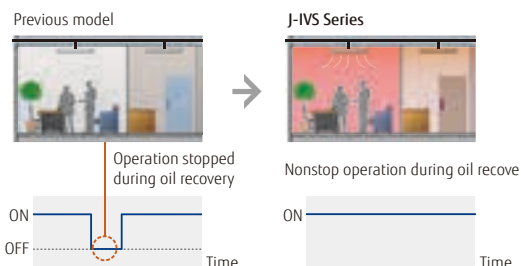

Easier installation

Connection check function: Wiring connections and address settings can be checked thanks to the quick check run function.

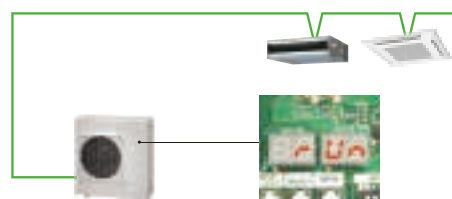

- Displays the number of each connected indoor unit.
- Displays the duplicate address number assigned to an indoor unit.



Specifications

Rated capacity range		HP	4	5	6
Model name			AJH040LCLDH	AJH045LCLDH	AJH054LCLDH
Maximum connectable indoor units			1-11	1-12	1-13
Power source			Single phase, ~230 V, 50 Hz		
Capacity	Cooling	kW	12.1	14.0	15.1
	Nominal Heating		12.1	14.0	15.1
	Max. Heating		13.6	16.0	16.5
Input power	Cooling	kW	3.75	4.71	5.55
	Nominal Heating		3.22	3.77	4.33
	Max. Heating		3.99	5.04	5.32
EER	Cooling	W/W	3.22	2.97	2.72
COP	Nominal Heating		3.75	3.71	3.48
	Max. Heating		3.40	3.17	3.10
SEER	Cooling		5.83	5.58	5.47
SCOP	Heating		3.82	3.96	3.99
η_c	Cooling	%	230.2	220.2	215.8
	Heating		149.8	155.4	156.6
Airflow rate		m ³ /h	4,240	4,400	4,400
Sound pressure level/ Power level	Cooling	dB(A)	53 / 67	53 / 69	54 / 70
	Heating		54 / 68	56 / 69	56 / 70
Heat exchanger fin			Blue fin	Blue fin	Blue fin
Net Dimensions	Height	mm	998	998	998
	Width		970	970	970
	Depth		370	370	370
Weight		kg	88	88	88
Refrigerant	Type (Global Warming Potential)		R410A (2,088)	R410A (2,088)	R410A (2,088)
	Charge	kg (CO ₂ eq-T)	4.0 (8.4)	4.0 (8.4)	4.0 (8.4)
Connection pipe diameter	Liquid	mm	9.52	9.52	9.52
	Gas		15.88	15.88	15.88
Total pipe length		m	80	80	80
Max. height difference		m	30	30	30
Operating Range	Cooling	°C	-5 to 46	-5 to 46	-5 to 46
	Heating		-20 to 21	-20 to 21	-20 to 21

Note: Specifications are based on the following conditions.
 Cooling: Indoor temperature of 27°CDB/19°CWB, and outdoor temperature of 35°CDB/24°CWB.
 Heating: Indoor temperature of 20°CDB/(15°CWB), and outdoor temperature of 7°CDB/6°CWB.
 Pipe length: 7.5 m; Height difference between outdoor unit and indoor unit: 0 m.
 The protective function may work when using it outside the operation range.

Dimensions

(Unit: mm)

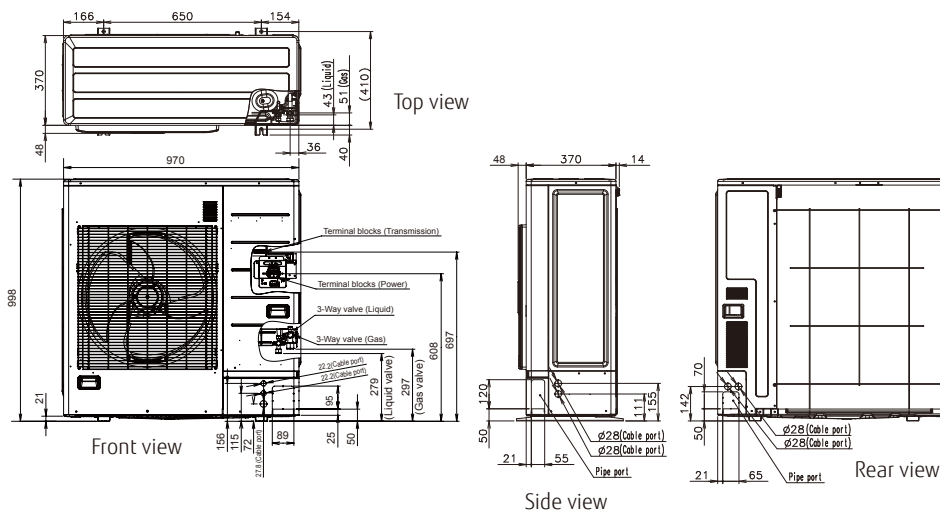



Heat Pump

for Small-capacity type

VRF J-IV

System configuration example

- Suitable for air conditioning small and medium-size buildings. One refrigerant system is used for each outdoor unit.
- Multiple indoor units are connected with separation tubes and headers.

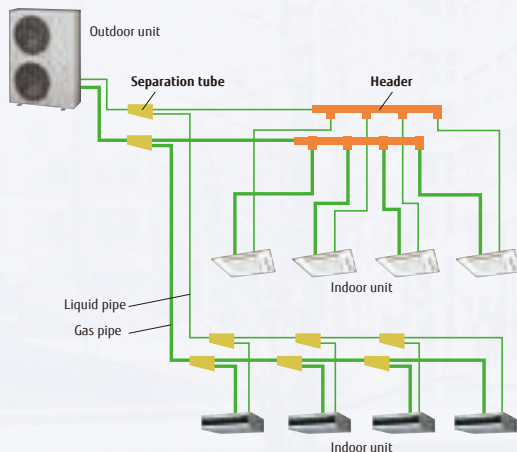

New intelligent refrigerant control

Fujitsu General is proposing outdoor units equipped with refrigerant control function. The refrigerant control operates with suitable control corresponding to the heat load of the room and offers a more comfortable environment. The refrigerant control can also provide increased energy savings.

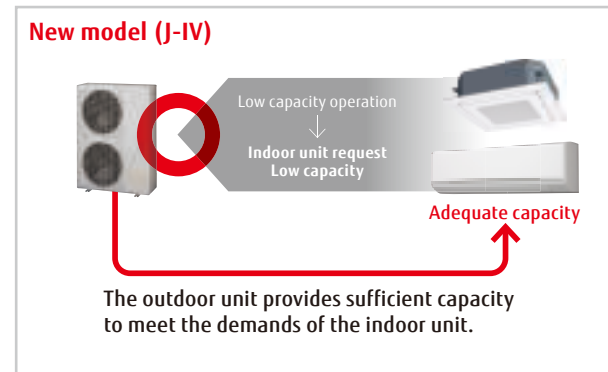
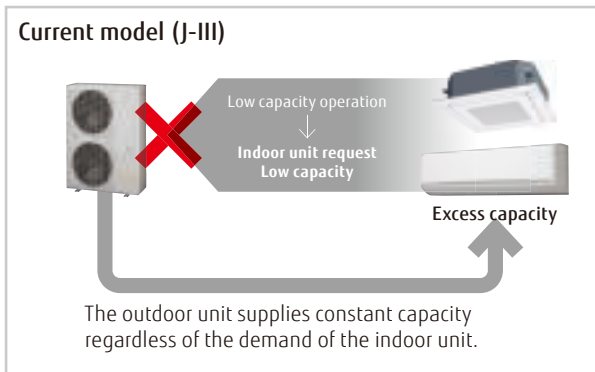

* The improvements due to the control and the actual sine wave vary depending on the combination of the indoor unit and system operating conditions.

External static pressure

External static pressure measures up to 30 Pa for 4/5/6 HP.



Advanced high-efficiency technology

Large propeller fan
A large propeller fan with an optimized blade angle achieves both high performance and low noise operation.

DC fan motor
A small, multi-stage DC fan motor contributes to high-efficiency and low noise operation.

Large heat exchanger
The large 3-row heat exchanger substantially improves heat-exchanging performance.

DC twin-rotary compressor
High-efficiency is achieved across compressor loads. Especially good performance is achieved in the low- to medium-load range.

Subcooling heat exchanger
The dual-tube heat exchanger improves cooling performance.

DC inverter control
The active filter module improves efficiency.

High-efficiency compressor motor
Optimized refrigerant flow design
Highly accurate parts

Pressure
Effect
Cooling performance improved
Enthalpy

High
Compressor efficiency
DC Twin-Rotary Compressor
Compressor capacity High

Efficiency in actual operating conditions

The use of a large heat exchanger and a high-efficiency Scroll compressor achieves class-leading EER/COP (Max. Heating) in all models.

High EER/COP (Maximum Heating)

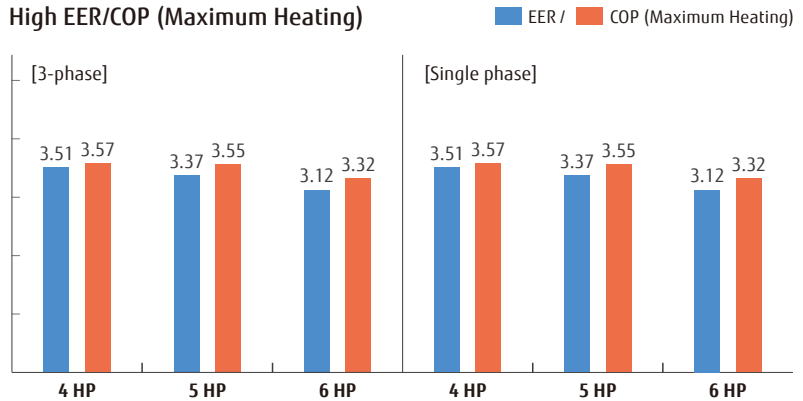

* These specifications are determined by cassette combination.

Long pipe length

Our advanced refrigerant control technology allows us to achieve a total refrigerant pipe length of 180 m. This provides high flexibility in system design.

Total pipe length
Maximum 180 m

Height difference between outdoor and indoor units
Maximum 50 m
For an outdoor unit installed below indoor units: max. 40 m

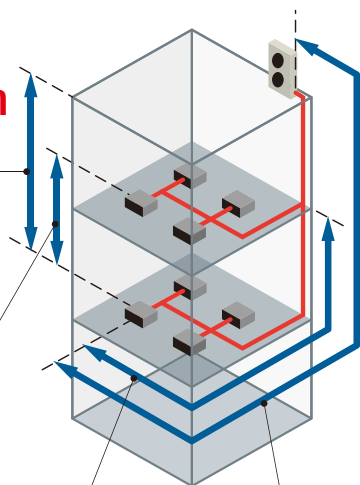

Height difference between indoor and indoor units
Maximum 15 m

Pipe length from first separation tube to farthest indoor unit
Maximum 40 m

Actual pipe length
Maximum 120 m

Up to 14 indoor units* can be connected

The combination of smaller but sufficiently powerful indoor units and outdoor units with an optimized heat exchanging structure makes it possible to connect up to 14 indoor units, which is the best in its class.

*: 6 HP model

Model	Current model (J-III)			New model (J-IV)		
	4	5	6	4	5	6
Rating Capacity range (HP)	4	5	6	4	5	6
Max. Connectable indoor unit	1-9	1-10	1-13	1-11	1-12	1-14

Non-stop oil recovery operation

A comfortable room condition is maintained during oil recovery mode because the product continues to operate without stopping the cooling or heating operation.

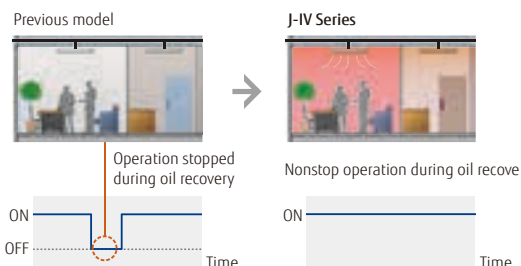

Easier installation

Connection check function: Wiring connections and address settings can be checked thanks to the quick check run function.

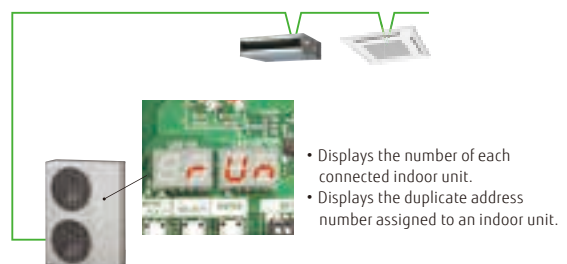

4,5,6HP: AJH040BLBDH / AJH045LBDH / AJH054LBDH AJH040LELDH [3-phase] / AJH045LELDH [3-phase] / AJH054LELDH [3-phase]



Specifications

Rated capacity range		HP	4	5	6
Model name			AJH040BLBDH	AJH045LBDH	AJH054LBDH
Maximum connectable indoor units			1-11	1-12	1-14
Power source			Single phase, ~230 V, 50 Hz		
Capacity	Cooling	kW	12.1	14.0	15.5
	Nominal Heating		12.1	14.0	15.5
	Max. Heating		13.6	16.0	18.0
Input power	Cooling	kW	3.44	4.15	4.96
	Nominal Heating		3.14	3.60	4.17
	Max. Heating		3.80	4.50	5.41
EER	Cooling		3.51	3.37	3.12
COP	Nominal Heating	W/W	3.85	3.88	3.71
	Max. Heating		3.57	3.55	3.32
	SEER		Cooling	6.50	6.30
SCOP	Heating		3.83	3.93	3.94
η_c	Cooling	%	257.0	249.0	240.0
η_h	Heating		150.0	154.0	155.0
Airflow rate		m ³ /h	6,200	6,600	7,000
Sound pressure level/ Power level	Cooling	dB(A)	50 / 65	52 / 66	53 / 67
	Heating		52 / 67	55 / 69	56 / 69
Heat exchanger fin			Blue fin	Blue fin	Blue fin
Net Dimensions	Height	mm	1,334	1,334	1,334
	Width		970	970	970
	Depth		370	370	370
Weight		kg	117	117	119
Refrigerant	Type (Global Warming Potential)		R410A (2,088)	R410A (2,088)	R410A (2,088)
	Charge	kg (CO ₂ eq-T)	4.8 (10.0)	5.3 (11.1)	5.3 (11.1)
Connection pipe diameter	Liquid	mm	9.52	9.52	9.52
	Gas		15.88	15.88	19.05
Total pipe length		m	180	180	180
Max. height difference			50/40 (Outdoor unit: Upper/Lower)		
Operating Range	Cooling	°C	-5 to 46	-5 to 46	-5 to 46
	Heating		-20 to 21	-20 to 21	-20 to 21

		4	5	6
Model name		AJH040LELDH	AJH045LELDH	AJH054LELDH
Maximum connectable indoor units		1-11	1-12	1-14
Power source		3-phase, ~400 V, 50 Hz		
Capacity	Cooling	12.1	14.0	15.5
	Nominal Heating	12.1	14.0	15.5
	Max. Heating	13.6	16.0	18.0
Input power	Cooling	3.44	4.15	4.96
	Nominal Heating	3.14	3.60	4.17
	Max. Heating	3.80	4.50	5.41
EER	Cooling	3.51	3.37	3.12
COP	Nominal Heating	3.85	3.88	3.71
	Max. Heating	3.57	3.55	3.32
	SEER	Cooling	6.50	6.30
SCOP	Heating	3.83	3.93	3.94
η_c	Cooling	257.0	249.0	240.0
η_h	Heating	150.0	154.0	155.0
Airflow rate		6,200	6,600	7,000
Sound pressure level/ Power level	Cooling	50 / 65	52 / 66	53 / 67
	Heating	52 / 67	55 / 69	56 / 69
Heat exchanger fin		Blue fin	Blue fin	Blue fin
Net Dimensions	Height	1,334	1,334	1,334
	Width	970	970	970
	Depth	370	370	370
Weight		118	119	119
Refrigerant	Type (Global Warming Potential)	R410A (2,088)	R410A (2,088)	R410A (2,088)
	Charge	kg (CO ₂ eq-T)	4.8 (10.0)	5.3 (11.1)
Connection pipe diameter	Liquid	9.52	9.52	9.52
	Gas	15.88	15.88	19.05
Total pipe length		180	180	180
Max. height difference		50/40 (Outdoor unit: Upper/Lower)		
Operating Range	Cooling	-5 to 46	-5 to 46	-5 to 46
	Heating	-20 to 21	-20 to 21	-20 to 21

Note: Specifications are based on the following conditions.

Cooling: Indoor temperature of 27°CDB/19°CWB, and outdoor temperature of 35°CDB/24°CWB.

Heating: Indoor temperature of 20°CDB/(15°CWB), and outdoor temperature of 7°CDB/6°CWB.

Pipe length: 7.5 m; Height difference between outdoor unit and indoor unit: 0 m.

The protective function may work when using it outside the operation range.

Dimensions

(Unit: mm)

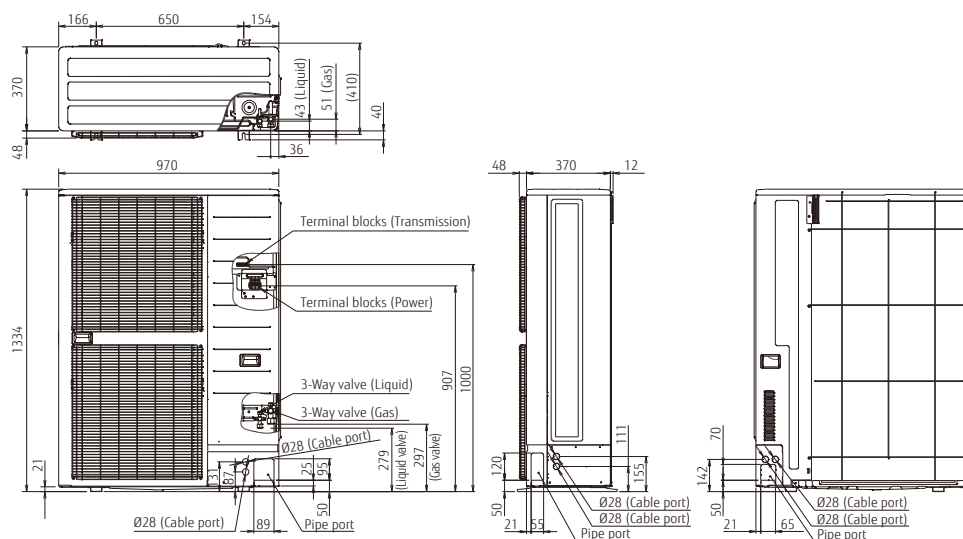



Heat Pump

for Small-capacity type

VRF J-IVL

System configuration example

- Suitable for air conditioning small and medium-size buildings. One refrigerant system is used for each outdoor unit.
- Multiple indoor units are connected with separation tubes and headers.

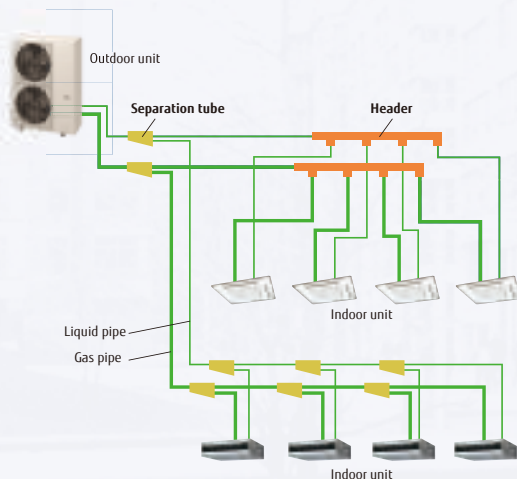

New intelligent refrigerant control

Fujitsu General is proposing outdoor units equipped with refrigerant control function. The refrigerant control operates with suitable control corresponding to the heat load of the room and offers a more comfortable environment. The refrigerant control can also provide increased energy savings.

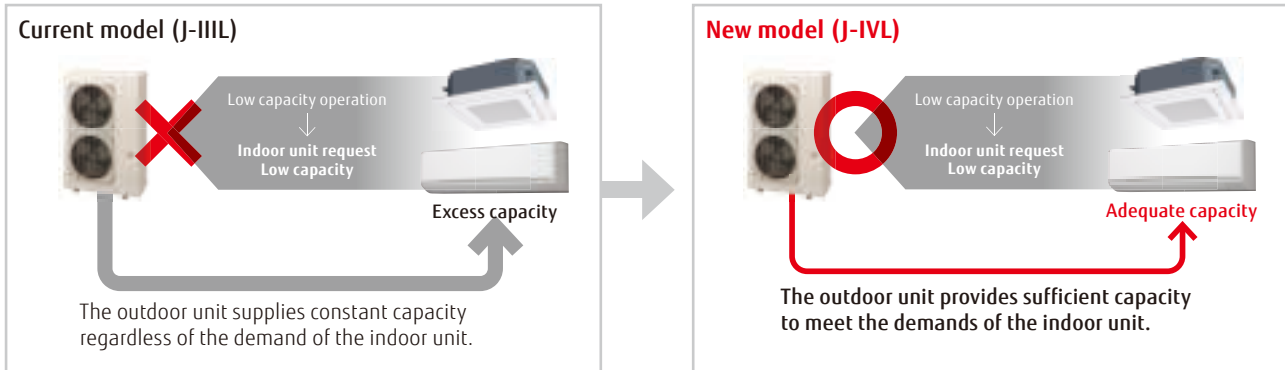

* The improvements due to the control and the actual sine wave vary depending on the combination of the indoor unit and system operating conditions.

External static pressure

External static pressure is available up to 60 Pa for 14/16/18 HP. (30 Pa for 8/10 HP, 40 Pa for 12 HP)

Capacities are slightly decreased relative to the rated values during high static pressure operations.



Advanced high-efficiency technology

Ø570 mm

Large propeller fan

A large-diameter propeller fan with our proprietary blade design reduces draft loss, which results in high-efficiency and low noise operation.

DC fan motor

A small, multi-stage DC fan motor provides high-efficiency and low noise operation.

Large heat exchanger

The large 2.6-row heat exchanger substantially improves heat-exchanging performance.

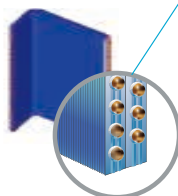

15 to 130 rps

DC inverter control

The active filter module improves efficiency.

Subcooling heat exchanger

The dual-tube heat exchanger improves cooling performance.

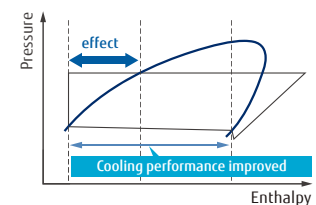

Scroll compressor

The combination of a scroll compressor with a wide rotational frequency range from 15 to 130 rps and our proprietary sensorless sine-wave control that smoothly controls the input power into the motor achieves more energy-efficient and quieter operation.



Fujitsu General offers a perfect total air conditioning system for small office buildings with multiple small rooms, taking into consideration energy savings, low noise, comfortable air volume, usage and purpose, and centralized control.

VRF J-IVL

Image: 8/10/12 HP models

Slim & Compact design

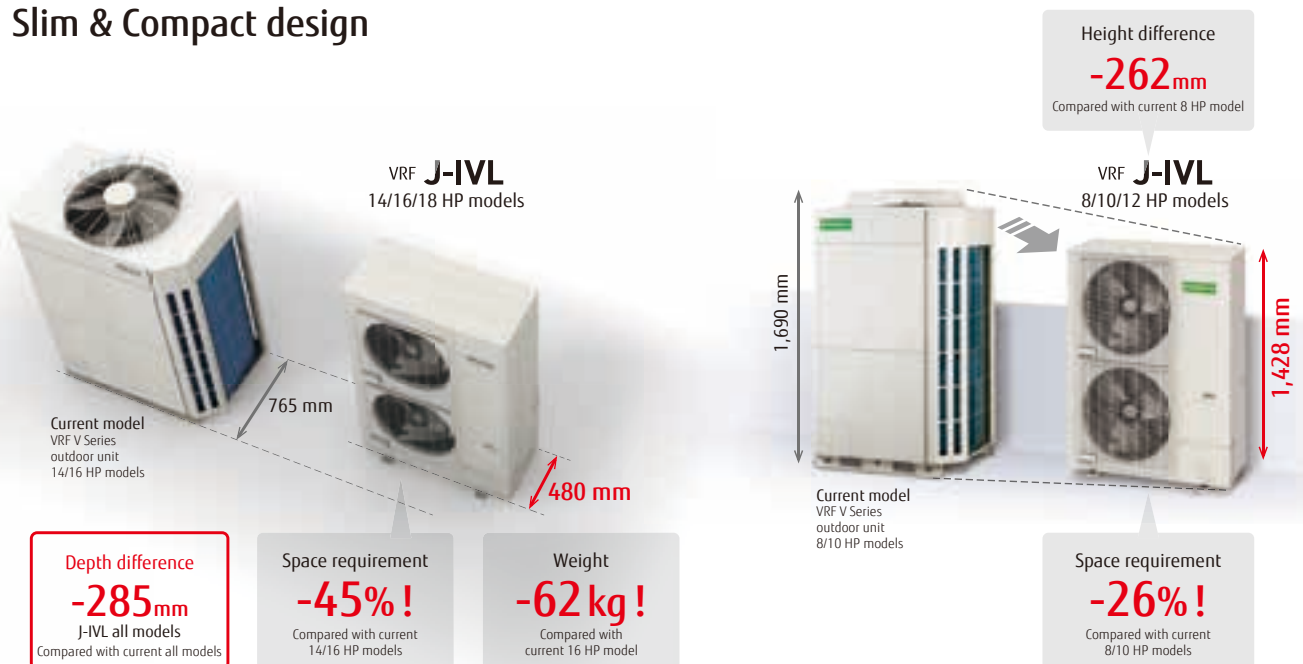

Various installation methods



VRF V Series outdoor unit



VRF J Series outdoor unit

Installation

Low noise level in consideration of nearby residents

Front air discharge type with a width of about 1,000 mm, allowing for flexible installation even in narrow spaces.



VRF V Series outdoor unit



VRF J Series outdoor unit

Narrow space behind building

Space saving

Small and thin, allowing for direct ground or wall mounting installations even in narrow alleys.



VRF V Series outdoor unit



VRF J Series outdoor unit

Installation on the back street of a building

Flexible installation

Slim, low-body front air discharge meets the requirements for installation even in tight spaces. Installation flexibility without blocking the windows of buildings contributes to substantial space savings, even when multiple units are installed.

Efficiency in actual operating conditions

The use of a large heat exchanger and a high-efficiency Scroll compressor achieves class-leading EER/COP (Max. Heating) in all models.

High EER/COP (Maximum Heating)

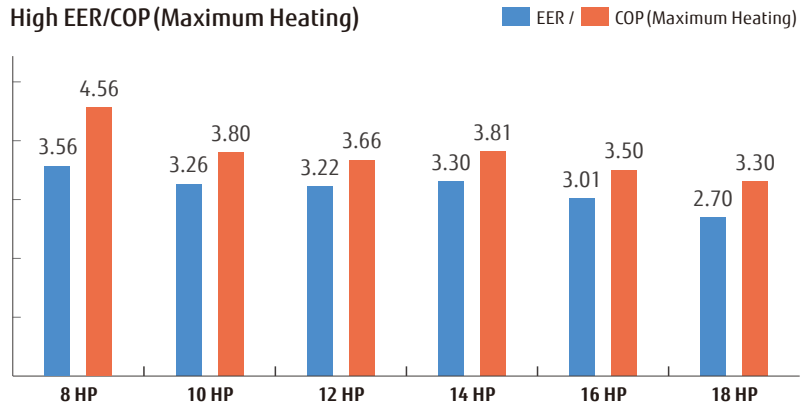

* These specifications are determined by cassette combination.

Long pipe length

Our advanced refrigerant control technology extends the maximum allowable length of refrigerant piping to 400 m. This provides high flexibility in system design.

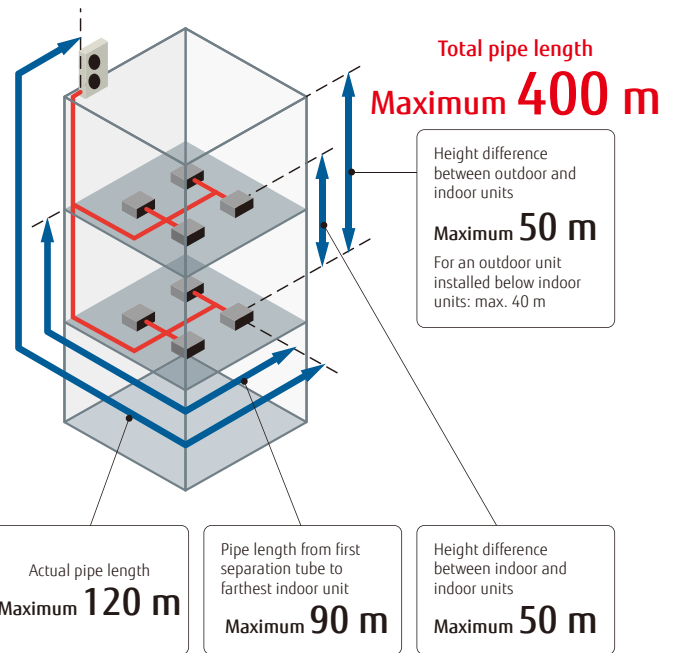

Up to 42 indoor units* can be connected.

The combination of smaller but sufficiently powerful indoor units and a new outdoor unit with an optimized heat exchanging structure makes it possible to connect up to 42 indoor units, which is the best in its class. *: 18 HP model



Class-leading low operating sound

The top-class low operating noise makes it ideal for use in densely populated areas. These low operating sound models are ideal for installation in densely populated areas.

Sound Power Level

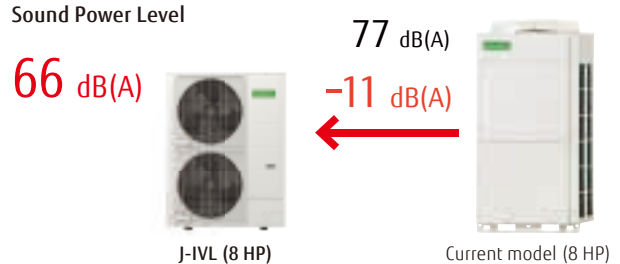

8,10,12 HP: AJH072LELDH / AJH090LELDH / AJH108LELDH
 14,16,18 HP: AJH126LELDH / AJH144LELDH / AJH162LELDH



8, 10, 12 HP

14, 16, 18 HP

Specifications

Rated capacity range		HP	8	10	12	14	16	18
Model name			AJH072LELDH	AJH090LELDH	AJH108LELDH	AJH126LELDH	AJH144LELDH	AJH162LELDH
Maximum connectable indoor units			1-20	1-25	1-30	1-36	1-40	1-42
Power source			3-phase, ~400V, 50Hz					
Capacity	Cooling	kW	22.4	28.0	33.5	40.0	45.0	50.0
	Nominal Heating		22.4	28.0	33.5	40.0	45.0	50.0
	Max. Heating		25.0	31.5	37.5	45.0	50.0	55.0
Input power	Cooling	kW	6.30	8.59	10.42	12.12	14.96	18.52
	Nominal Heating		4.65	6.61	8.18	9.71	11.81	13.66
	Max. Heating		5.45	8.29	10.25	11.81	14.29	16.66
EER	Cooling		3.56	3.26	3.22	3.30	3.01	2.70
COP	Nominal Heating	W/W	4.82	4.24	4.10	4.12	3.81	3.66
	Max. Heating		4.56	3.80	3.66	3.81	3.50	3.30
SEER	Cooling		7.62	7.50	7.27	7.27	7.00	6.29
SCOP	Heating		3.89	3.61	3.63	3.53	3.51	3.54
η_c	Cooling	%	301.8	297.0	287.8	287.8	277.0	248.6
η_h	Heating		152.6	141.4	142.2	138.2	137.4	138.6
Airflow rate		m ³ /h	8,400	9,000	11,000/12,100	13,000	14,000	14,800/15,300
Sound pressure level/ Power level	Cooling	dB(A)	52/66	54/69	59/73	62/75	64/77	65/79
	Heating		54/66	57/70	62/75	63/76	65/78	68/82
Net Dimensions	Height	mm	1,428	1,428	1,428	1,638	1,638	1,638
	Width		1,080	1,080	1,080	1,080	1,080	1,080
	Depth		480	480	480	480	480	480
Weight		kg	170	177	178	213	213	217
Refrigerant	Type (Global Warming Potential)		R410A (2,088)	R410A (2,088)	R410A (2,088)	R410A (2,088)	R410A (2,088)	R410A (2,088)
	Charge	kg (CO ₂ eq-T)	7.0 (14.6)	7.5 (15.7)	7.5 (15.7)	11.0 (23.0)	11.0 (23.0)	11.8 (24.6)
Connection pipe diameter	Liquid	mm	9.52	9.52	12.70	12.70	12.70	12.70
	Gas		19.05	22.20	28.58	28.58	28.58	28.58
Total pipe length		m	400	400	400	400	400	
Max. height difference			50/40 (Outdoor unit: Upper/Lower)					
Operating Range	Cooling	°C	-15 to 46	-15 to 46	-15 to 46	-5 to 46*	-5 to 46*	-5 to 46*
	Heating		-20 to 21	-20 to 21	-20 to 21	-20 to 21	-20 to 21	-20 to 21

Note: Specifications are based on the following conditions.

Cooling: Indoor temperature of 27°CDB / 19°CWB, and outdoor temperature of 35°CDB / 24°CWB.

Heating: Indoor temperature of 20°CDB / (15°CWB), and outdoor temperature of 7°CDB / 6°CWB.

Pipe length: 7.5 m; Height difference between outdoor unit and indoor unit: 0 m.

* The cooling operation range of -15 to 46°C is allowed only when all of the indoor units connected to the system are higher than capacity of 5.6kW.

Dimensions

(Unit: mm)

8, 10, 12 HP

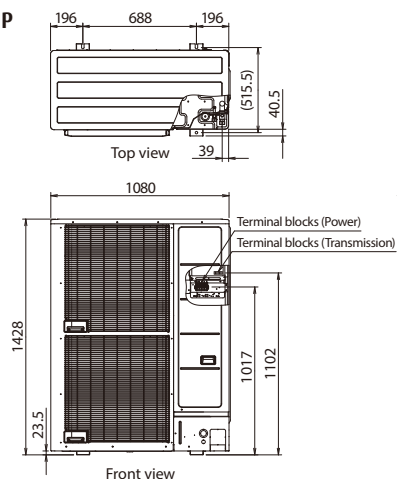

14, 16, 18 HP

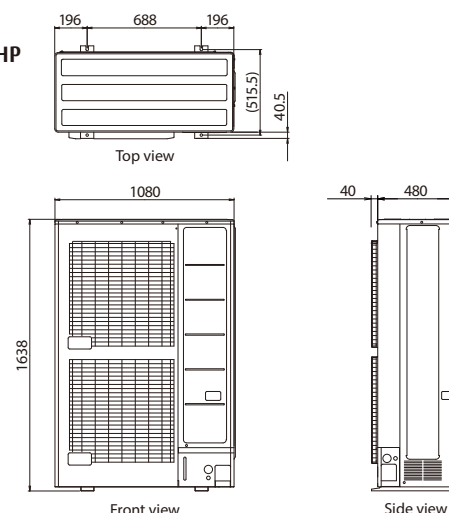



Heat Recovery

Modular type

VRF VR-IV

Highly energy-efficient operation

Our heat recovery systems achieve high operating energy efficiency by drawing heat from the room to be cooled and transferring it as energy for rooms that are to be heated.

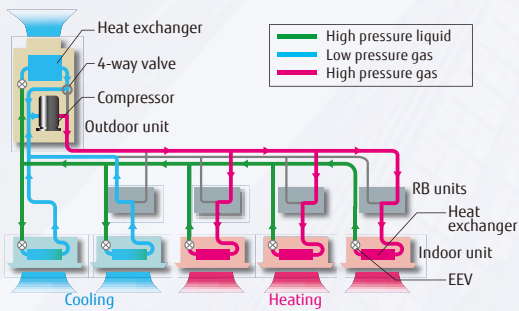

Our heat recovery systems achieve high operating energy efficiency by drawing heat from the room to be cooled and transferring it as energy for rooms that are to be heated.

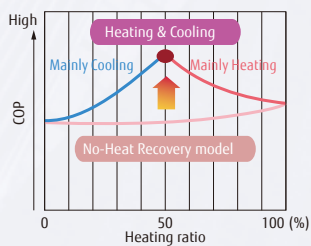

New intelligent refrigerant control

Fujitsu General is proposing outdoor units equipped with refrigerant control function. The refrigerant control operates with suitable control corresponding to the heat load of the room and offers a more comfortable environment. The refrigerant control can also provide increased energy savings.

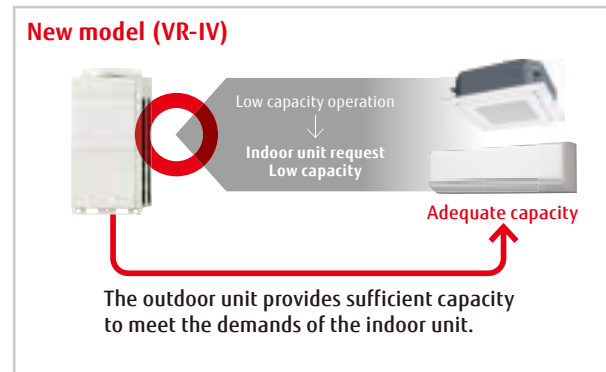
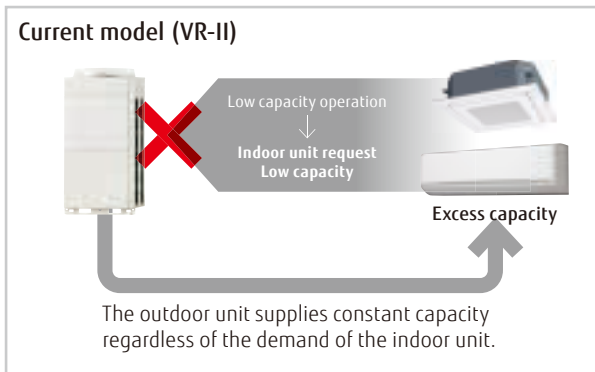

* The improvements due to the control and the actual sine wave vary depending on the combination of the indoor unit and system operating conditions.

Increase in the number of connectable indoor units

Capacity range of connectable indoor units

New model (VR-IV)	25%* to 150%
Current model (VR-II)	50% to 150%

*: For modular type, 25% to 49.9% operation in the entire system is available. (by one unit operation)

Increased number of connectable indoor units and space saving combinations

	(Unit)										
HP	10	12	14	16	...	28	30	32	...	48	
New model (VR-IV)	21	26	30	34	...	60	64	64	...	64	
Current model (VR-II)	15	16	17	21	...	42	45	48	...	64	

The energy-saving technology that boosted operation efficiency

- Powerful large propeller fan**
 The fan uses CFD* technology to achieve both high performance and low noise operation.
 *CFD: Computational Fluid Dynamics
- 3-phase DC fan motor**
 The use of a DC fan motor with sophisticated driver control improves energy efficiency substantially. In addition, this motor operates quietly.
- Subcooling heat exchanger**
 High heat exchange efficiency is achieved by using an internal projection-shape double-pipe construction.
- High-efficient, large-capacity DC twin-rotary compressor**
 Large-capacity high-efficient DC twin-rotary compressor with excellent intermediate capability.
- Sine-wave DC inverter control**
 High-efficiency is realized by the adoption of reduced switching loss IPM.
- 4-face heat exchanger**
 The 4-face heat exchanger increases the effective surface area and significantly improves heat-exchanging efficiency.
- Front intake port (Corner cut air inlet structure)**
 In multiple outdoor unit installations, the unique front intake design improves airflow into the heat exchanger.

Extended connection ratio (applicable to multiple tenants)

Especially useful when starting partial air conditioning in a building under construction
Installation can be added flexibly for each tenant.

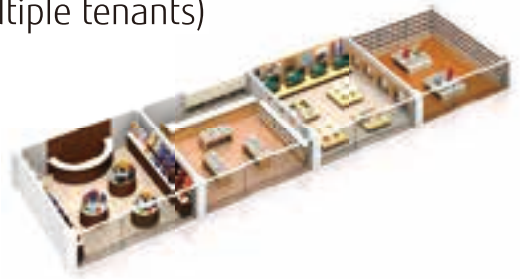

Stand-alone

Current model (VR-II)

Example) 50% of 12HP minimum connected indoor unit capacity is required

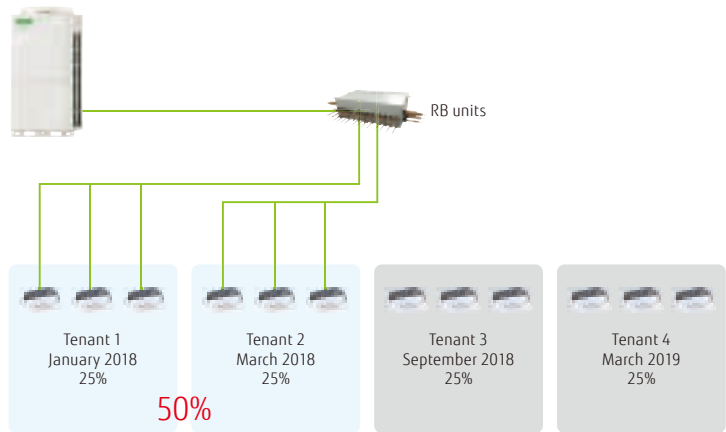

Installation is possible even for tenants who have not yet started operations.

New model (VR-IV)

Example) 25% of 12HP minimum connected indoor unit capacity is required

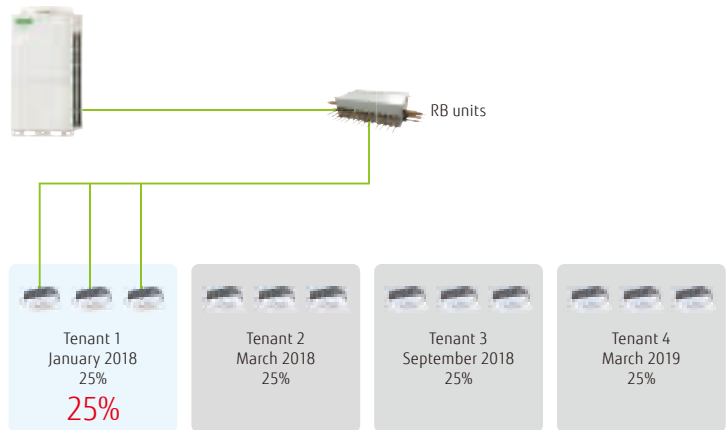

Installation and commissioning can be added flexibly to meet the opening dates of other tenants.

Modular type

One outdoor unit operates effectively for the capacities of connectable indoor units in the entire system. (Each of the multiple outdoor units does not dare to operate at 25% capacity: any one of the outdoor units will operate at 50% and the remaining units will each output 0%, i.e., stop operating.)

Example: One 10HP outdoor unit performs 25% of the total 20HP outdoor units system.
One 10HP outdoor unit performs 50% of its capacity
→ Two outdoor units do not perform 25% of the operation.

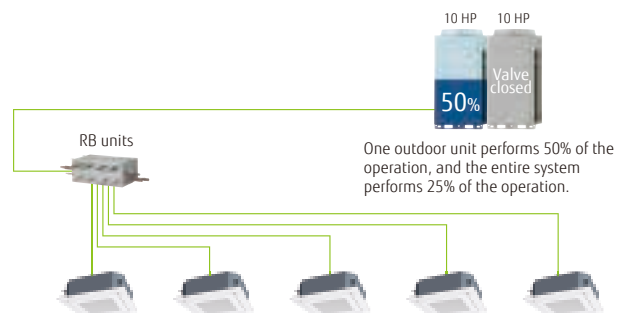

Additional installation is possible without changing the main pipe.

A main pipe of a diameter that can be used for the final system is installed at the beginning of the installation. Duplication of the work will be avoided as there is no need to change the main pipe as in the previous model.

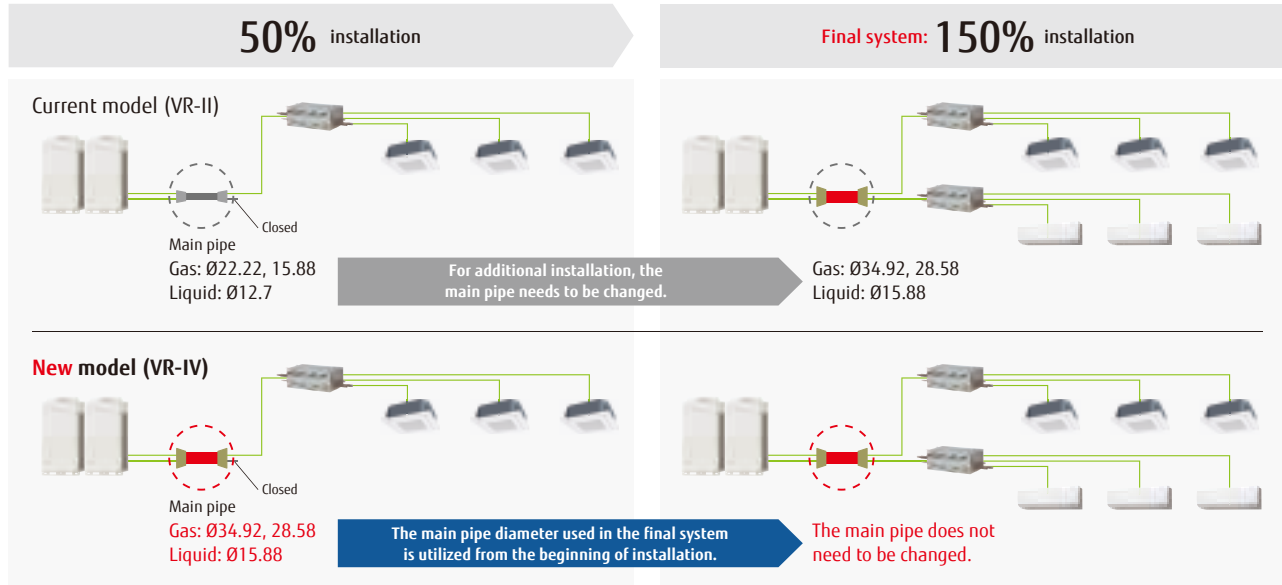

All-inverter compressor

Large-capacity DC inverter compressor

Large-capacity high-efficient DC twin-rotary compressor with excellent intermediate capability.



High-efficiency compressor speed control

The compressor speed control in 0.1 Hz increments ensures a comfortable space with less change in room temperature and less energy loss.

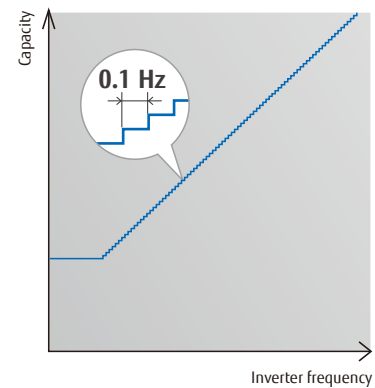

Efficiency in actual operating conditions

Class-leading high COP (Maximum) The use of our proprietary heat exchanger structure and high-efficiency DC twin-rotary compressors achieves the class-leading coefficient of performance (COP) in every combination.

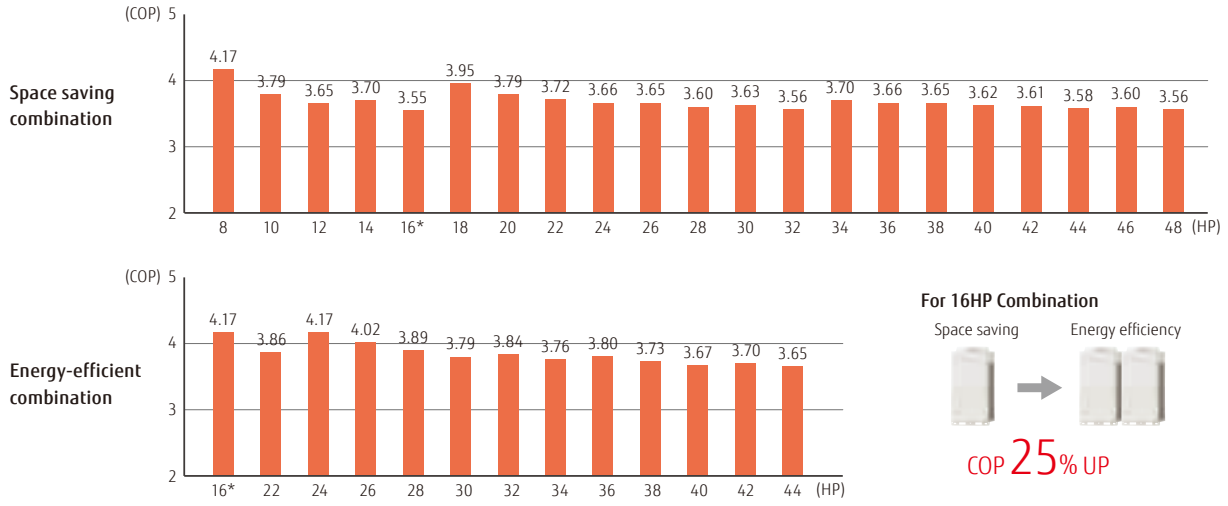

* These specifications are determined by Cassette combination.
 *Multiple outdoor units are not certified by Eurovent.

Multiple outdoor operation control

When multiple outdoor units are connected, each compressor carries out sophisticated operation. Instead of operating one compressor at full load to distribute the refrigerant to one heat exchanger, all compressors operate at partial load to distribute the refrigerant to all heat exchangers, thereby improving the efficiency of the entire system.

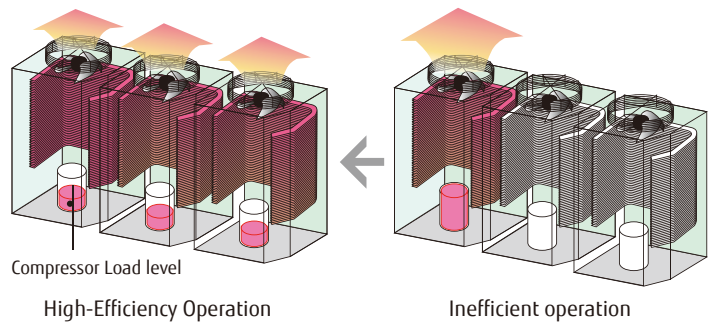

Heat exchanger refrigerant control

The heat exchanger in the outdoor unit is divided into two parts, upper and lower. The efficiency of the heat exchanger has been improved by adopting an optimum refrigerant path control where the refrigerant is distributed more into the top heat exchanger as this is where there is a greater air flow intake.

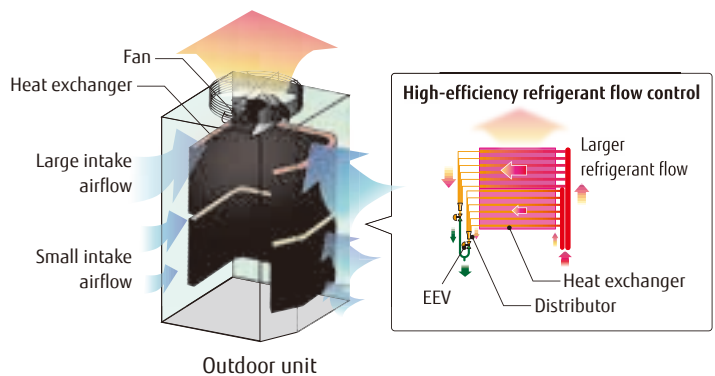

Flexible pipe connection

More flexible refrigerant pipe work is possible due to the use of various piping and RB unit connections, for adjustments to the floor layout and building structure.

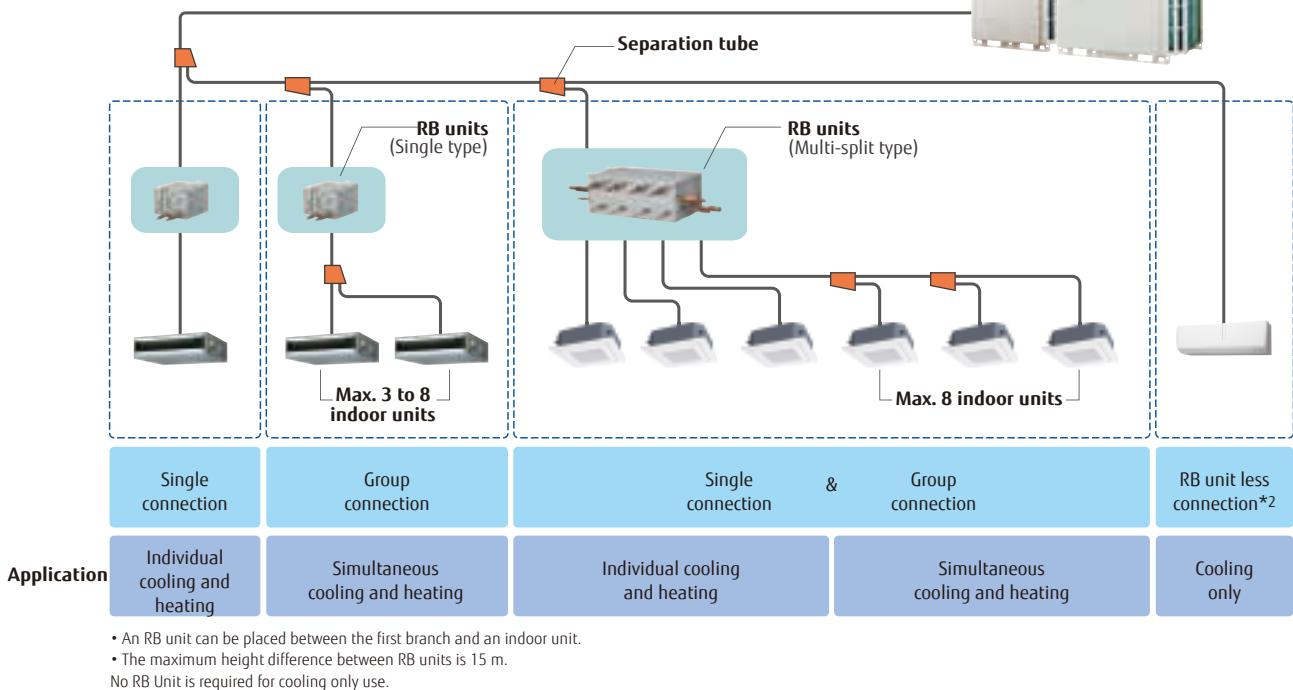

Flexible installation of RB unit

Small and slim design with a height of 198 mm makes it easy to install in tight spaces with height constraints.

- A drain pipe is not required.
- Different positions of a control box can be chosen to accommodate installation conditions.
- Series connection for simplified installation

*: RB unit (single type)



An RB unit can be installed on either side of the control box.



An RB unit can be installed on top of the control box to save space.

*: RB unit (single type)



RB units (Multi-split type/8-branch)



RB units (Multi-split type/12-branch)

Easy maintenance in tight spaces

Maintenance can be performed from the side.

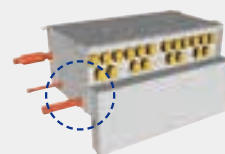
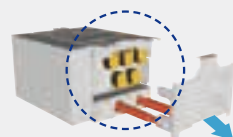

The electrical box can be accessed and serviced by sliding down the front cover.

Parts can be accessed and replaced easily even in tight spaces inside the ceiling.

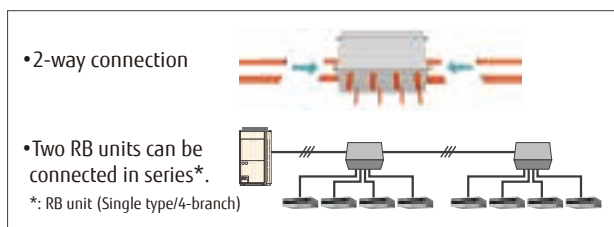
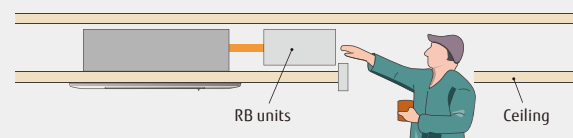



Outdoor units lineup • Combinations other than those listed below are not recommended.

Space saving combination

<p>22.4kW (8HP)</p>  <p>AJH072GALDH UNIT : AJH072GALDH</p>	<p>28.0kW (10HP)</p>  <p>AJH090GALDH UNIT : AJH090GALDH</p>	<p>33.5kW (12HP)</p>  <p>AJH108GALDH UNIT : AJH108GALDH</p>	<p>40.0kW (14HP)</p>  <p>AJH126GALDH UNIT : AJH126GALDH</p>	<p>45.0kW (16HP)</p>  <p>AJH144GALDH UNIT : AJH144GALDH</p>
<p>50.4kW (18HP)</p>  <p>AJH162GALDH UNIT : AJH090/072GALDH</p>	<p>56.0kW (20HP)</p>  <p>AJH180GALDH UNIT : AJH090/090GALDH</p>	<p>61.5kW (22HP)</p>  <p>AJH198GALDH UNIT : AJH108/090GALDH</p>	<p>67.0kW (24HP)</p>  <p>AJH216GALDH UNIT : AJH108/108GALDH</p>	<p>73.0kW (26HP)</p>  <p>AJH234GALDH UNIT : AJH144/090GALDH</p>
<p>78.5kW (28HP)</p>  <p>AJH252GALDH UNIT : AJH144/108GALDH</p>	<p>85.0kW (30HP)</p>  <p>AJH270GALDH UNIT : AJH144/126GALDH</p>	<p>90.0kW (32HP)</p>  <p>AJH288GALDH UNIT : AJH144/144GALDH</p>	<p>95.0kW (34HP)</p>  <p>AJH306GALDH UNIT : AJH108/108/090GALDH</p>	<p>100.5kW (36HP)</p>  <p>AJH324GALDH UNIT : AJH108/108/108GALDH</p>
<p>106.5kW (38HP)</p>  <p>AJH342GALDH UNIT : AJH144/108/090GALDH</p>	<p>112.0kW (40HP)</p>  <p>AJH360GALDH UNIT : AJH144/108/108GALDH</p>	<p>118.0kW (42HP)</p>  <p>AJH378GALDH UNIT : AJH144/144/090GALDH</p>	<p>123.5kW (44HP)</p>  <p>AJH396GALDH UNIT : AJH144/144/108GALDH</p>	<p>130.0kW (46HP)</p>  <p>AJH414GALDH UNIT : AJH144/144/126GALDH</p>
<p>135.0kW (48HP)</p>  <p>AJH432GALDH UNIT : AJH144/144/144GALDH</p>				

Energy efficiency combination

<p>44.8kW (16HP)</p>  <p>AJH144GALDHH UNIT : AJH072/072GALDH</p>	<p>62.4kW (22HP)</p>  <p>AJH198GALDHH UNIT : AJH126/072GALDH</p>	<p>67.2kW (24HP)</p>  <p>AJH216GALDHH UNIT : AJH072/072/072GALDH</p>	<p>72.8kW (26HP)</p>  <p>AJH234GALDHH UNIT : AJH090/072/072GALDH</p>	<p>78.4kW (28HP)</p>  <p>AJH252GALDHH UNIT : AJH090/090/072GALDH</p>
<p>84.0kW (30HP)</p>  <p>AJH270GALDHH UNIT : AJH090/090/090GALDH</p>	<p>90.4kW (32HP)</p>  <p>AJH288GALDHH UNIT : AJH126/090/072GALDH</p>	<p>96.0kW (34HP)</p>  <p>AJH306GALDHH UNIT : AJH126/090/090GALDH</p>	<p>102.4kW (36HP)</p>  <p>AJH324GALDHH UNIT : AJH126/126/072GALDH</p>	<p>108.0kW (38HP)</p>  <p>AJH342GALDHH UNIT : AJH126/126/090GALDH</p>
<p>113.0kW (40HP)</p>  <p>AJH360GALDHH UNIT : AJH144/126/090GALDH</p>	<p>120.0kW (42HP)</p>  <p>AJH378GALDHH UNIT : AJH126/126/126GALDH</p>	<p>125.0kW (44HP)</p>  <p>AJH396GALDHH UNIT : AJH144/126/126GALDH</p>		

8,10,12HP : AJH072GALDH / AJH090GALDH / AJH108GALDH
 14,16HP : AJH126GALDH / AJH144GALDH



8, 10, 12 HP

14, 16 HP

Dimensions

(Unit: mm)

8, 10, 12 HP

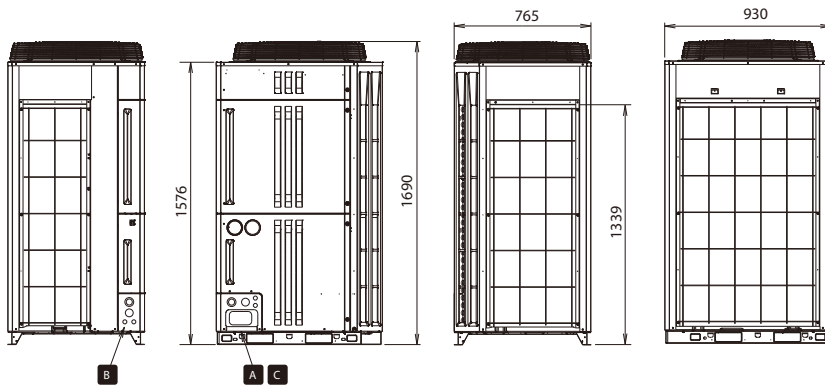
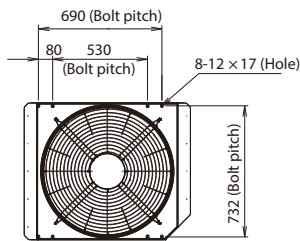

14, 16 HP

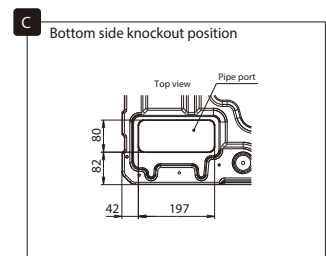
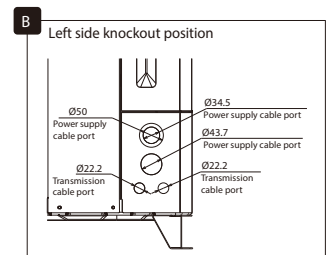
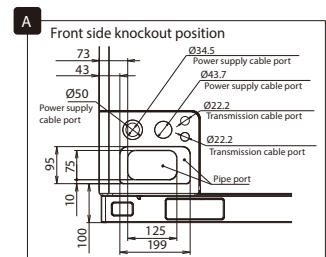
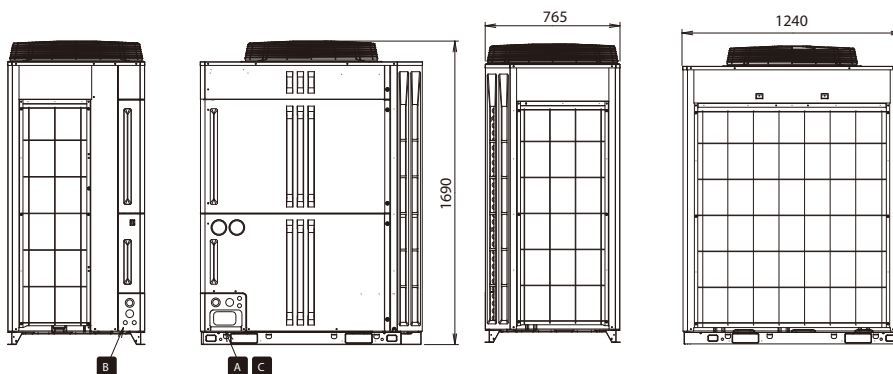
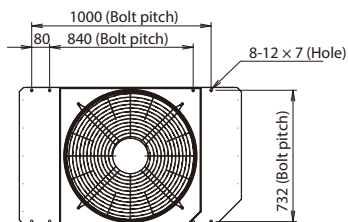

Outdoor units specifications

Space saving combination

Rated capacity range		HP	8	10	12	14	16	18	20	22	24
Model name			AJH072GALDH	AJH090GALDH	AJH108GALDH	AJH126GALDH	AJH144GALDH	AJH162GALDH	AJH180GALDH	AJH198GALDH	AJH216GALDH
Unit 1			AJH072GALDH	AJH090GALDH	AJH108GALDH	AJH126GALDH	AJH144GALDH	AJH090GALDH	AJH090GALDH	AJH108GALDH	AJH108GALDH
Unit 2								AJH072GALDH	AJH090GALDH	AJH090GALDH	AJH090GALDH
Unit 3											AJH090GALDH
Maximum connectable indoor units*1			17	21	26	30	34	39	43	47	52
Connectable capacity range of indoor units		kW	5.6-33.6	7.0-42.0	8.4-50.2	10.0-60.0	11.3-67.5	12.6-75.6*3	14.0-84.0*3	15.4-92.2*3	16.8-100.5*3
Power source			3-phase, 4-wire, 400 V, 50Hz								
Capacity	Cooling	kW	22.4	28.0	33.5	40.0	45.0	50.4	56.0	61.5	67.0
	Nominal Heating		22.4	28.0	33.5	40.0	42.0	50.4	56.0	61.5	67.0
	Max. Heating		25.0	31.5	37.5	45.0	48.0	56.5	63.0	69.0	75.0
Input power	Cooling	kW	6.26	9.53	11.89	13.16	16.71	15.79	19.06	21.42	23.78
	Nominal Heating		5.37	7.38	9.16	10.80	11.81	12.75	14.76	16.54	18.32
	Max. Heating		6.25	8.96	11.48	13.95	14.98	15.21	17.92	20.44	22.96
EER	Cooling		3.57	2.93	2.81	3.03	2.69	3.19	2.94	2.87	2.82
COP	Nominal Heating	W/W	4.17	3.79	3.65	3.70	3.55	3.95	3.79	3.72	3.66
	Max. Heating		4.00	3.51	3.26	3.22	3.20	3.71	3.52	3.38	3.27
SEER	Cooling		7.16	6.61	6.73	6.76	6.27	6.89	6.61	6.67	6.73
SCOP	Heating		3.78	3.76	3.86	4.31	4.41	3.77	3.76	3.81	3.86
ηc	Cooling	%	283.0	261.0	266.0	267.0	248.0	272.0	261.0	263.5	266.0
ηh	Heating		148.0	147.0	151.0	169.0	173.0	147.5	147.0	149.0	151.0
Air flow rate	High	m³/h	11,100	11,100	11,100	13,000	13,000	11,100×2	11,100×2	11,100×2	11,100×2
Sound pressure level*2/	Cooling	dB(A)	56 / 77	58 / 78	59 / 79	60 / 82	61 / 82	60 / 81	61 / 81	62 / 82	62 / 82
	Power level		Heating	58 / 79	59 / 79	63 / 82	62 / 83	63 / 83	62 / 82	62 / 82	64 / 84
Max. External static pressure		Pa	80	80	80	80	80	80	80	80	80
Compressor motor output		kW	7.5	7.5	7.5	11.0	11.0	7.5 × 2	7.5 × 2	7.5 × 2	7.5 × 2
Heat exchanger fin			Blue fin	Blue fin	Blue fin	Blue fin	Blue fin	Blue fin	Blue fin	Blue fin	Blue fin
Net Dimensions	Height	mm	1,690	1,690	1,690	1,690	1,690	1,690	1,690	1,690	1,690
	Width		930	930	930	1,240	1,240	930 × 2	930 × 2	930 × 2	930 × 2
	Depth		765	765	765	765	765	765	765	765	765
Weight		kg	262	262	262	286	286	262 × 2	262 × 2	262 × 2	262 × 2
Refrigerant	Type (Global Warming Potential)		R410A (2,088)	R410A (2,088)	R410A (2,088)	R410A (2,088)	R410A (2,088)	R410A (2,088)	R410A (2,088)	R410A (2,088)	R410A (2,088)
	Charge	kg (CO2eq-T)	11.8 (24.6)	11.8 (24.6)	11.8 (24.6)	11.8 (24.6)	11.8 (24.6)	11.8 × 2 (24.6 × 2)	11.8 × 2 (24.6 × 2)	11.8 × 2 (24.6 × 2)	11.8 × 2 (24.6 × 2)
Connection pipe diameter	Liquid	mm	12.70	12.70	12.70	12.70	12.70	15.88	15.88	15.88	15.88
	Discharge Gas		15.88	19.05	19.05	22.22	22.22	22.22	22.22	28.58	28.58
	Suction Gas		22.22	22.22	28.58	28.58	28.58	28.58	28.58	34.92	34.92
Operating Range	Cooling	°CDB	-10 to 46	-10 to 46	-10 to 46	-10 to 46	-10 to 46	-10 to 46	-10 to 46	-10 to 46	-10 to 46
	Heating		-20 to 21	-20 to 21	-20 to 21	-20 to 21	-20 to 21	-20 to 21	-20 to 21	-20 to 21	-20 to 21
	Cooling/Heating		-10 to 21	-10 to 21	-10 to 21	-10 to 21	-10 to 21	-10 to 21	-10 to 21	-10 to 21	-10 to 21

Energy Efficiency Combination

Rated capacity range		HP	16	22	24	26	28	30
Model name			AJH144GALDHH	AJH198GALDHH	AJH216GALDHH	AJH234GALDHH	AJH252GALDHH	AJH270GALDHH
Unit 1			AJH072GALDH	AJH126GALDH	AJH072GALDH	AJH090GALDH	AJH090GALDH	AJH090GALDH
Unit 2			AJH072GALDH	AJH072GALDH	AJH072GALDH	AJH072GALDH	AJH090GALDH	AJH090GALDH
Unit 3						AJH072GALDH	AJH072GALDH	AJH090GALDH
Maximum connectable indoor units*1			34	47	52	56	60	64
Connectable capacity range of indoor units		kW	11.2-67.2*3	15.6-93.6*3	16.8-100.8*3	18.2-109.2*3	19.6-117.6*3	21.0-126.0*3
Power source			3-phase, 4-wire, 400 V, 50Hz					
Capacity	Cooling	kW	44.8	62.4	67.2	72.8	78.4	84.0
	Nominal Heating		44.8	62.4	67.2	72.8	78.4	84.0
	Max. Heating		50.0	70.0	75.0	81.5	88.0	94.5
Input power	Cooling	kW	12.52	19.42	18.78	22.05	25.32	28.59
	Nominal Heating		10.74	16.17	16.11	18.12	20.13	22.14
	Max. Heating		12.50	20.20	18.75	21.46	24.17	26.88
EER	Cooling		3.58	3.21	3.58	3.30	3.10	2.94
COP	Nominal Heating	W/W	4.17	3.86	4.17	4.02	3.89	3.79
	Max. Heating		4.00	3.47	4.00	3.80	3.64	3.52
SEER	Cooling		7.16	6.96	7.16	6.98	6.79	6.61
SCOP	Heating		3.78	4.05	3.78	3.77	3.77	3.76
ηc	Cooling	%	283.0	275.0	283.0	275.7	268.3	261.0
ηh	Heating		148.0	158.5	148.0	147.7	147.3	147.0
Air flow rate	High	m³/h	11,100×2	13,000×11,100	11,100×3	11,100×3	11,100×3	11,100×3
Sound pressure level*2/	Cooling	dB(A)	59 / 80	61 / 83	61 / 83	62 / 82	62 / 82	63 / 83
	Power level		Heating	61 / 82	63 / 84	63 / 84	63 / 84	63 / 84
Max. External static pressure		Pa	80	80	80	80	80	80
Compressor motor output		kW	7.5 × 2	11.0 + 7.5	7.5 × 3	7.5 × 3	7.5 × 3	7.5 × 3
Heat exchanger fin			Blue fin	Blue fin	Blue fin	Blue fin	Blue fin	Blue fin
Net Dimensions	Height	mm	1,690	1,690	1,690	1,690	1,690	1,690
	Width		930 × 2	1,240 + 930	930 × 3	930 × 3	930 × 3	930 × 3
	Depth		765	765	765	765	765	765
Weight		kg	262 × 2	286 + 262	262 × 3	262 × 3	262 × 3	262 × 3
Refrigerant	Type (Global Warming Potential)		R410A (2,088)	R410A (2,088)	R410A (2,088)	R410A (2,088)	R410A (2,088)	R410A (2,088)
	Charge	kg (CO2eq-T)	11.8 × 2 (24.6 × 2)	11.8 × 2 (24.6 × 2)	11.8 × 3 (24.6 × 3)	11.8 × 3 (24.6 × 3)	11.8 × 3 (24.6 × 3)	11.8 × 3 (24.6 × 3)
Connection pipe diameter	Liquid	mm	12.70	15.88	15.88	15.88	15.88	19.05
	Discharge Gas		22.22	28.58	28.58	28.58	28.58	28.58
	Suction Gas		28.58	34.92	34.92	34.92	34.92	34.92
Operating Range	Cooling	°CDB	-10 to 46	-10 to 46	-10 to 46	-10 to 46	-10 to 46	-10 to 46
	Heating		-20 to 21	-20 to 21	-20 to 21	-20 to 21	-20 to 21	-20 to 21
	Cooling/Heating		-10 to 21	-10 to 21	-10 to 21	-10 to 21	-10 to 21	-10 to 21

Note: Specifications are based on the following conditions.
 Cooling: Indoor temperature of 27°CDB/19°CWB, and outdoor temperature of 35°CDB/24°CWB.
 Heating: Indoor temperature of 20°CDB/15°CWB, and outdoor temperature of 7°CDB/6°CWB.
 Pipe length: 7.5 m; Height difference between outdoor unit and indoor unit: 0 m.

When cooling operation is be conducted at an outdoor air temperature below -5°C, the outdoor unit must be installed in a position that is higher than or equal to that of the indoor units.
 * These specifications are determined by ducted combination.
 * Multiple outdoor units are not certified by Eurotest.

26	28	30	32	34	36	38	40	42	44	46	48
AJH234GALDH	AJH252GALDH	AJH270GALDH	AJH288GALDH	AJH306GALDH	AJH324GALDH	AJH342GALDH	AJH360GALDH	AJH378GALDH	AJH396GALDH	AJH414GALDH	AJH432GALDH
AJH144GALDH AJH090GALDH	AJH144GALDH AJH108GALDH	AJH144GALDH AJH126GALDH	AJH144GALDH AJH144GALDH	AJH108GALDH AJH108GALDH AJH090GALDH	AJH108GALDH AJH108GALDH AJH108GALDH	AJH144GALDH AJH108GALDH AJH090GALDH	AJH144GALDH AJH108GALDH AJH108GALDH	AJH144GALDH AJH144GALDH AJH090GALDH	AJH144GALDH AJH144GALDH AJH108GALDH	AJH144GALDH AJH144GALDH AJH126GALDH	AJH144GALDH AJH144GALDH AJH144GALDH
56 18.3-109.5*3	60 19.7-117.7*3	64 21.3-127.5*3	64 22.5-135.0*3	64 23.8-142.5*3	64 25.2-150.7*3	64 26.7-159.7*3	64 28.0-168.0*3	64 29.5-177.0*3	64 30.9-185.2*3	64 32.5-195.0*3	64 33.8-202.5*3
3-phase, 4-wire, 400 V, 50Hz											
73.0	78.5	85.0	90.0	95.0	100.5	106.5	112.0	118.0	123.5	130.0	135.0
70.0	75.5	82.0	84.0	95.0	100.5	103.5	109.0	112.0	117.5	124.0	126.0
79.5	85.5	93.0	96.0	106.5	112.5	117.0	123.0	127.5	133.5	141.0	144.0
26.24	28.60	29.87	33.42	33.31	35.67	38.13	40.49	42.95	45.31	46.58	50.13
19.19	20.97	22.61	23.62	25.70	27.48	28.35	30.13	31.00	32.78	34.42	35.43
23.94	26.46	28.93	29.96	31.92	34.44	35.42	37.94	38.92	41.44	43.91	44.94
2.78	2.74	2.85	2.69	2.85	2.82	2.79	2.77	2.75	2.73	2.79	2.69
3.65	3.60	3.63	3.56	3.70	3.66	3.65	3.62	3.61	3.58	3.60	3.56
3.32	3.23	3.21	3.20	3.34	3.27	3.30	3.24	3.28	3.22	3.21	3.20
6.44	6.50	6.52	6.27	6.69	6.73	6.54	6.58	6.38	6.42	6.43	6.27
4.09	4.14	4.36	4.41	3.83	3.86	4.01	4.04	4.19	4.23	4.38	4.41
254.5	257.0	257.5	248.0	264.3	266.0	258.3	260.0	252.3	254.0	254.3	248.0
160.0	162.0	171.0	173.0	149.7	151.0	157.0	158.3	164.3	165.7	171.7	173.0
13,000+11,100	13,000+11,100	13,000×2	13,000×2	11,100×3	11,100×3	13,000+11,100×2	13,000+11,100×2	13,000×2+11,100	13,000×2+11,100	13,000×3	13,000×3
63 / 83	63 / 84	64 / 85	64 / 85	63 / 83	64 / 84	64 / 85	65 / 85	65 / 86	65 / 86	65 / 87	66 / 87
64 / 84	66 / 86	66 / 86	66 / 86	67 / 86	68 / 87	67 / 86	68 / 87	67 / 87	68 / 87	67 / 88	68 / 88
80	80	80	80	80	80	80	80	80	80	80	80
11.0 × 7.5	11.0 × 7.5	11.0 × 2	11.0 × 2	7.5 × 3	7.5 × 3	11.0 × 7.5 × 2	11.0 × 7.5 × 2	11.0 × 2 + 7.5	11.0 × 2 + 7.5	11.0 × 3	11.0 × 3
Blue fin	Blue fin	Blue fin	Blue fin	Blue fin	Blue fin	Blue fin	Blue fin	Blue fin	Blue fin	Blue fin	Blue fin
1,690	1,690	1,690	1,690	1,690	1,690	1,690	1,690	1,690	1,690	1,690	1,690
1,240 × 930	1,240 × 930	1,240 × 2	1,240 × 2	930 × 3	930 × 3	1,240 × 930 × 2	1,240 × 930 × 2	1,240 × 2 + 930	1,240 × 2 + 930	1,240 × 3	1,240 × 3
765	765	765	765	765	765	765	765	765	765	765	765
286 × 262	286 × 262	286 × 2	286 × 2	262 × 3	262 × 3	286 × 262 × 2	286 × 262 × 2	286 × 2 + 262	286 × 2 + 262	286 × 3	286 × 3
R410A (2,088)	R410A (2,088)	R410A (2,088)	R410A (2,088)	R410A (2,088)	R410A (2,088)	R410A (2,088)	R410A (2,088)	R410A (2,088)	R410A (2,088)	R410A (2,088)	R410A (2,088)
11.8 × 2 (24.6 × 2)	11.8 × 2 (24.6 × 2)	11.8 × 2 (24.6 × 2)	11.8 × 2 (24.6 × 2)	11.8 × 3 (24.6 × 3)	11.8 × 3 (24.6 × 3)	11.8 × 3 (24.6 × 3)	11.8 × 3 (24.6 × 3)	11.8 × 3 (24.6 × 3)	11.8 × 3 (24.6 × 3)	11.8 × 3 (24.6 × 3)	11.8 × 3 (24.6 × 3)
15.88	15.88	19.05	19.05	19.05	19.05	19.05	19.05	19.05	19.05	19.05	19.05
28.58	28.58	28.58	28.58	28.58	28.58	34.92	34.92	34.92	34.92	34.92	34.92
34.92	34.92	34.92	34.92	34.92	41.27	41.27	41.27	41.27	41.27	41.27	41.27
-10 to 46	-10 to 46	-10 to 46	-10 to 46	-10 to 46	-10 to 46	-10 to 46	-10 to 46	-10 to 46	-10 to 46	-10 to 46	-10 to 46
-20 to 21	-20 to 21	-20 to 21	-20 to 21	-20 to 21	-20 to 21	-20 to 21	-20 to 21	-20 to 21	-20 to 21	-20 to 21	-20 to 21
-10 to 21	-10 to 21	-10 to 21	-10 to 21	-10 to 21	-10 to 21	-10 to 21	-10 to 21	-10 to 21	-10 to 21	-10 to 21	-10 to 21

32	34	36	38	40	42	44
AJH288GALDHH	AJH306GALDHH	AJH324GALDHH	AJH342GALDHH	AJH360GALDHH	AJH378GALDHH	AJH396GALDHH
AJH126GALDH AJH090GALDH AJH072GALDH	AJH126GALDH AJH090GALDH AJH090GALDH	AJH126GALDH AJH090GALDH AJH072GALDH	AJH126GALDH AJH126GALDH AJH090GALDH	AJH144GALDH AJH126GALDH AJH090GALDH	AJH126GALDH AJH126GALDH AJH126GALDH	AJH144GALDH AJH126GALDH AJH126GALDH
64 22.6-135.6*3	64 24.0-144.0*3	64 25.6-153.6*3	64 27.0-162.0*3	64 28.3-169.5*3	64 30.0-180.0*3	64 31.3-187.5*3
3-phase, 4-wire, 400 V, 50Hz						
90.4	96.0	102.4	108.0	113.0	120.0	125.0
90.4	96.0	102.4	108.0	110.0	120.0	122.0
101.5	108.0	115.0	121.5	124.5	135.0	138.0
28.95	32.22	32.58	35.85	39.40	39.48	43.03
23.55	25.56	26.97	28.98	29.99	32.40	33.41
29.16	31.87	34.15	36.86	37.89	41.85	42.88
3.12	2.98	3.14	3.01	2.87	3.04	2.90
3.84	3.76	3.80	3.73	3.67	3.70	3.65
3.48	3.39	3.37	3.30	3.29	3.23	3.22
6.84	6.66	6.89	6.71	6.55	6.76	6.60
3.95	3.94	4.13	4.13	4.16	4.31	4.34
270.3	263.0	272.3	265.0	258.7	267.0	260.7
154.7	154.3	162.0	161.7	163.0	169.0	170.3
13,000+11,100×2	13,000+11,100×2	13,000×2+11,100	13,000×2+11,100	13,000×2+11,100	13,000×3	13,000×3
63 / 84	64 / 85	64 / 86	64 / 86	65 / 86	65 / 87	65 / 87
65 / 86	65 / 86	66 / 87	66 / 87	66 / 87	67 / 88	67 / 88
80	80	80	80	80	80	80
11.0 × 7.5 × 2	11.0 × 7.5 × 2	11.0 × 2 + 7.5	11.0 × 2 + 7.5	11.0 × 2 + 7.5	11.0 × 3	11.0 × 3
Blue fin	Blue fin	Blue fin	Blue fin	Blue fin	Blue fin	Blue fin
1,690	1,690	1,690	1,690	1,690	1,690	1,690
1,240 × 930 × 2	1,240 × 930 × 2	1,240 × 2 + 930	1,240 × 2 + 930	1,240 × 2 + 930	1,240 × 3	1,240 × 3
765	765	765	765	765	765	765
286 × 262 × 2	286 × 262 × 2	286 × 2 + 262	286 × 2 + 262	286 × 2 + 262	286 × 3	286 × 3
R410A (2,088)	R410A (2,088)	R410A (2,088)	R410A (2,088)	R410A (2,088)	R410A (2,088)	R410A (2,088)
11.8 × 3 (24.6 × 3)	11.8 × 3 (24.6 × 3)	11.8 × 3 (24.6 × 3)	11.8 × 3 (24.6 × 3)	11.8 × 3 (24.6 × 3)	11.8 × 3 (24.6 × 3)	11.8 × 3 (24.6 × 3)
19.05	19.05	19.05	19.05	19.05	19.05	19.05
28.58	28.58	28.58	34.92	34.92	34.92	34.92
34.92	34.92	41.27	41.27	41.27	41.27	41.27
-10 to 46	-10 to 46	-10 to 46	-10 to 46	-10 to 46	-10 to 46	-10 to 46
-20 to 21	-20 to 21	-20 to 21	-20 to 21	-20 to 21	-20 to 21	-20 to 21
-10 to 21	-10 to 21	-10 to 21	-10 to 21	-10 to 21	-10 to 21	-10 to 21

*1: Minimum connectable indoor unit number is 2.

*2: The noise level is the value measured in an anechoic room. When measured in an actual installation, the measured value is typically larger than the indicated value due to ambient noise and reflections.

*3: If the capacity range of the connectable indoor units is between 25% and 49.9%, do not open the three-way valve except for the unit to be operated. In addition, do not connect the power line.



Heat Pump

Modular type

VRF V-IV

System configuration example

- Suitable for air conditioning midsize and large buildings. Connecting each outdoor unit makes it possible to create a high-capacity system.
- Multiple indoor units are connected with separation tubes and headers.

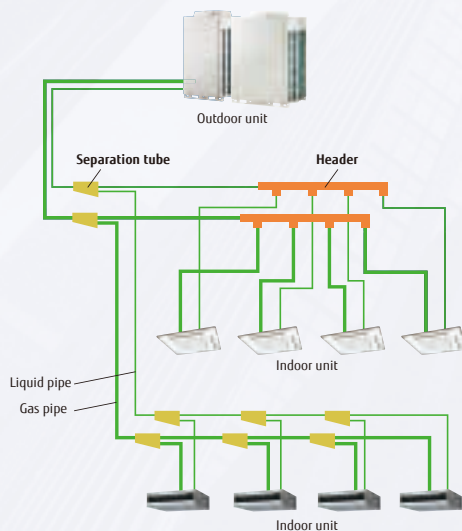

New intelligent refrigerant control

Fujitsu General is proposing outdoor units equipped with refrigerant control function. The refrigerant control operates with subtle control corresponding to the heat load of the room and offers a more comfortable environment. The refrigerant control can also provide increased energy savings.

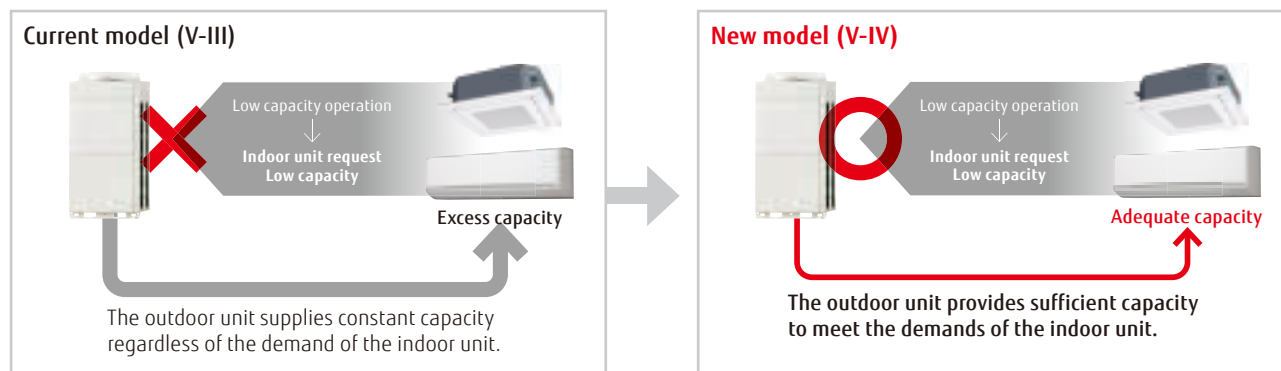

* The improvements due to the control and the actual sine wave vary depending on the combination of the indoor unit and system operating conditions.

Efficiency in actual operating conditions

The use of our proprietary heat exchanger structure and high-efficiency DC twin-rotary compressors achieves the class-leading coefficient of performance (COP) in every combination.

Space saving combination

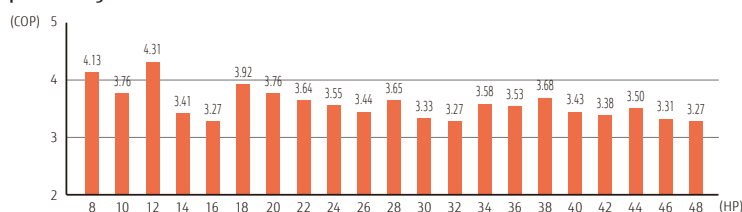

Energy efficiency combination

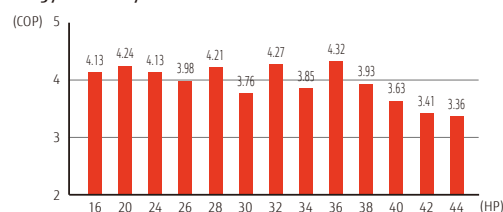

* These specifications are determined by Cassette combination. *Multiple outdoor units are not certified by Eurovent.

The energy-saving technology that boosted operation efficiency



- 

Powerful large propeller fan
The fan uses CFD* technology to achieve both high performance and low noise operation. *CFD: Computational Fluid Dynamics
- 

3-phase DC fan motor
The use of a DC fan motor with sophisticated driver control improves energy efficiency substantially. In addition, low noise is realized by the DC fan motor.
- 

Sine-wave DC inverter control
High-efficiency is realized by the adoption of reduced switching loss IPM.
- 

4-face heat exchanger
The 4-face heat exchanger increases the effective surface area and significantly improves heat-exchanging efficiency.
- 









Subcooling heat exchanger
High heat exchange efficiency is achieved by using an internal projection-shape double-pipe construction.
- 

High-efficient, large-capacity DC twin-rotary compressor
Large-capacity high-efficient DC twin-rotary compressor with excellent intermediate capability.
- 













Front intake port (Corner cut air inlet structure)
In multiple outdoor unit installations, the unique front intake design improves airflow into the heat exchanger.

Outdoor units lineup • Combinations other than those listed below are not recommended.

Space saving combination

<p>22.4 kW (8 HP)</p>  <p>AJH072LALDH UNIT: AJH072LALDH</p>	<p>28.0 kW (10 HP)</p>  <p>AJH090LALDH UNIT: AJH090LALDH</p>	<p>33.5 kW (12 HP)</p>  <p>AJH108LALDH UNIT: AJH108LALDH</p>	<p>40.0 kW (14 HP)</p>  <p>AJH126LALDH UNIT: AJH126LALDH</p>	<p>45.0 kW (16 HP)</p>  <p>AJH144LALDH UNIT: AJH144LALDH</p>
<p>50.4 kW (18 HP)</p>  <p>AJH162LALDH UNIT: AJH090/072LALDH</p>	<p>56.0 kW (20 HP)</p>  <p>AJH180LALDH UNIT: AJH090/090LALDH</p>	<p>62.4 kW (22 HP)</p>  <p>AJH198LALDH UNIT: AJH126/072LALDH</p>	<p>68.0 kW (24 HP)</p>  <p>AJH216LALDH UNIT: AJH126/090LALDH</p>	<p>73.0 kW (26 HP)</p>  <p>AJH234LALDH UNIT: AJH144/090LALDH</p>
<p>78.5 kW (28 HP)</p>  <p>AJH252LALDH UNIT: AJH144/108LALDH</p>	<p>85.0 kW (30 HP)</p>  <p>AJH270LALDH UNIT: AJH144/126LALDH</p>	<p>90.0 kW (32 HP)</p>  <p>AJH288LALDH UNIT: AJH144/144LALDH</p>	<p>95.4 kW (34 HP)</p>  <p>AJH306LALDH UNIT: AJH144/090/072LALDH</p>	<p>101.0 kW (36 HP)</p>  <p>AJH324LALDH UNIT: AJH144/090/090LALDH</p>
<p>106.5 kW (38 HP)</p>  <p>AJH342LALDH UNIT: AJH144/108/090LALDH</p>	<p>113.0 kW (40 HP)</p>  <p>AJH360LALDH UNIT: AJH144/126/090LALDH</p>	<p>118.0 kW (42 HP)</p>  <p>AJH378LALDH UNIT: AJH144/144/090LALDH</p>	<p>123.5 kW (44 HP)</p>  <p>AJH396LALDH UNIT: AJH144/144/108LALDH</p>	<p>130.0 kW (46 HP)</p>  <p>AJH414LALDH UNIT: AJH144/144/126LALDH</p>
<p>135.0 kW (48 HP)</p>  <p>AJH432LALDH UNIT: AJH144/144/144LALDH</p>				

Energy efficiency combination

<p>44.8 kW (16 HP)</p>  <p>AJH144LALDHH UNIT: AJH072/072LALDH</p>	<p>55.9 kW (20 HP)</p>  <p>AJH180LALDHH UNIT: AJH108/072LALDH</p>	<p>67.2 kW (24 HP)</p>  <p>AJH216LALDHH UNIT: AJH072/072/072LALDH</p>	<p>72.8 kW (26 HP)</p>  <p>AJH234LALDHH UNIT: AJH090/072/072LALDH</p>	<p>78.3 kW (28 HP)</p>  <p>AJH252LALDHH UNIT: AJH108/072/072LALDH</p>
<p>84.8 kW (30 HP)</p>  <p>AJH270LALDHH UNIT: AJH126/072/072LALDH</p>	<p>89.4 kW (32 HP)</p>  <p>AJH288LALDHH UNIT: AJH108/108/072LALDH</p>	<p>95.9 kW (34 HP)</p>  <p>AJH306LALDHH UNIT: AJH126/108/072LALDH</p>	<p>100.5 kW (36 HP)</p>  <p>AJH324LALDHH UNIT: AJH108/108/108LALDH</p>	<p>107.0 kW (38 HP)</p>  <p>AJH342LALDHH UNIT: AJH126/108/108LALDH</p>
<p>113.5 kW (40 HP)</p>  <p>AJH360LALDHH UNIT: AJH126/126/108LALDH</p>	<p>120.0 kW (42 HP)</p>  <p>AJH378LALDHH UNIT: AJH126/126/126LALDH</p>	<p>125.0 kW (44 HP)</p>  <p>AJH396LALDHH UNIT: AJH144/126/126LALDH</p>		

8, 10 HP: AJH072LALDH / AJH090LALDH
 12, 14, 16 HP: AJH108LALDH / AJH126LALDH / AJH144LALDH



8, 10 HP

12, 14, 16 HP

Dimensions

(Unit: mm)

8, 10 HP

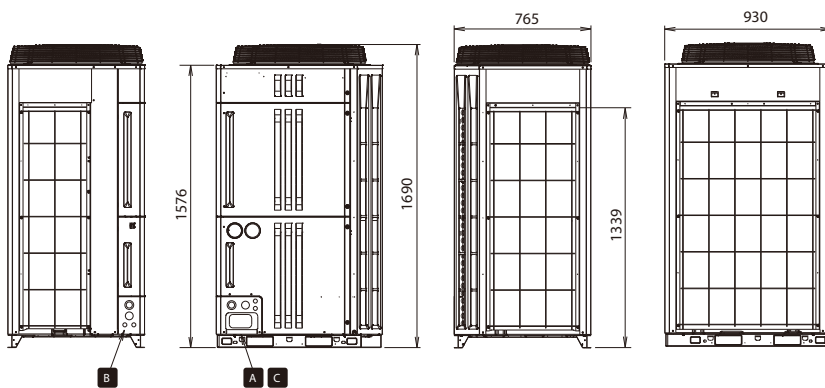
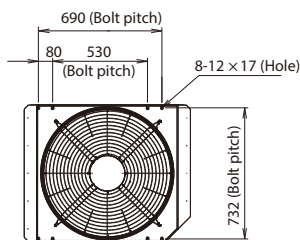

12, 14, 16 HP

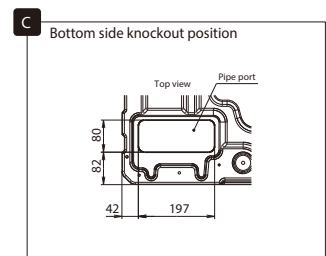
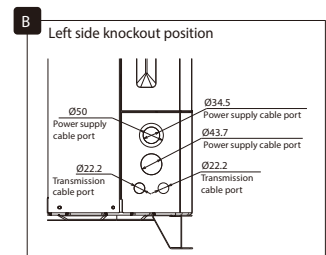
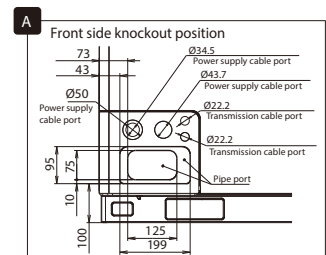
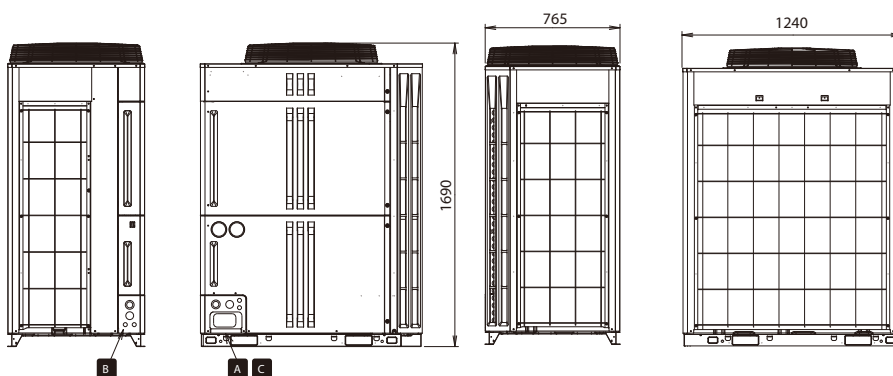
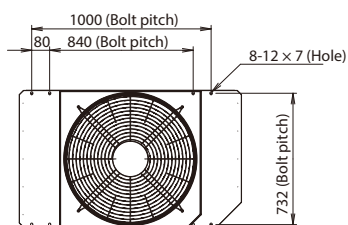

Outdoor unit specifications

Space saving combination

Rated capacity range		HP	8	10	12	14	16	18	20	22	24
Model name			AJH072LALDH	AJH090LALDH	AJH108LALDH	AJH126LALDH	AJH144LALDH	AJH162LALDH	AJH180LALDH	AJH198LALDH	AJH216LALDH
Unit 1			AJH072LALDH	AJH090LALDH	AJH108LALDH	AJH126LALDH	AJH144LALDH	AJH090LALDH	AJH090LALDH	AJH126LALDH	AJH126LALDH
Unit 2								AJH072LALDH	AJH090LALDH	AJH072LALDH	AJH090LALDH
Unit 3											
Maximum connectable indoor units*1			17	21	26	30	34	39	43	47	52
Connectable capacity range of indoor units		kW	11.2-33.6	14.0-42.0	16.8-50.2	20.0-60.0	22.5-67.5	25.2-75.6	28.0-84.0	31.2-93.6	34.0-102.0
Power source		3-phase, 4-wire, ~400 V, 50 Hz									
Capacity	Cooling	kW	22.4	28.0	33.5	40.0	45.0	50.4	56.0	62.4	68.0
	Nominal Heating		22.4	28.0	33.5	40.0	45.0	50.4	56.0	62.4	68.0
	Max. Heating		25.0	31.5	37.5	45.0	48.0	56.5	63.0	70.0	76.5
Input power	Cooling	kW	5.95	9.06	9.54	13.18	16.74	15.01	18.12	19.13	22.24
	Nominal Heating		5.42	7.44	7.76	11.74	13.76	12.86	14.88	17.16	19.18
	Max. Heating		6.26	8.98	9.48	14.00	15.02	15.24	17.96	20.26	22.98
EER	Cooling	W/W	3.76	3.09	3.51	3.03	2.68	3.36	3.09	3.26	3.06
	Nominal Heating		4.13	3.76	4.31	3.41	3.27	3.92	3.76	3.64	3.55
	Max. Heating		3.99	3.50	3.95	3.21	3.19	3.71	3.51	3.46	3.33
SEER	Cooling		7.09	6.56	7.33	6.67	6.18	6.83	6.56	6.64	6.62
	Heating		3.83	3.80	4.19	4.19	4.27	3.82	3.80	4.05	4.00
SCOP			281.0	259.0	290.0	264.0	244.0	270.0	259.0	262.5	261.5
ηc	Cooling	%	150.0	149.0	165.0	165.0	168.0	149.5	149.0	159.0	157.0
ηh	Heating										
Air flow rate	High	m³/h	11,100	11,100	13,000	13,000	13,700	11,100×2	11,100 × 2	13,000 + 11,100	13,000 + 11,100
Sound pressure level*2/	Cooling	dB(A)	58 / 79	58 / 79	58 / 81	62 / 84	63 / 86	61 / 82	61 / 82	63 / 85	63 / 85
	Heating		59 / 80	60 / 81	60 / 83	64 / 85	65 / 87	63 / 84	63 / 84	65 / 86	65 / 86
Power level											
Max. External static pressure		Pa	82	82	82	82	82	82	82	82	82
Compressor motor output		kW	7.5	7.5	11.0	11.0	11.0	7.5×2	7.5 × 2	11.0 + 7.5	11.0 + 7.5
Heat exchanger fin			Blue fin	Blue fin	Blue fin	Blue fin	Blue fin	Blue fin	Blue fin	Blue fin	Blue fin
Net Dimensions	Height	mm	1,690	1,690	1,690	1,690	1,690	1,690	1,690	1,690	1,690
	Width		930	930	1,240	1,240	1,240	930 × 2	930 × 2	1,240 + 930	1,240 + 930
	Depth		765	765	765	765	765	765	765	765	765
Weight		kg	252	252	275	275	275	252 × 2	252 × 2	275 + 252	275 + 252
Refrigerant	Type (Global Warming Potential)		R410A (2,088)	R410A (2,088)	R410A (2,088)	R410A (2,088)	R410A (2,088)	R410A (2,088)	R410A (2,088)	R410A (2,088)	R410A (2,088)
	Charge	kg (CO2eq-T)	11.7 (24.4)	11.7 (24.4)	11.8 (24.6)	11.8 (24.6)	11.8 (24.6)	11.7 × 2 (24.4 × 2)	11.7 × 2 (24.4 × 2)	11.8 + 11.7 (24.6 + 24.4)	11.8 + 11.7 (24.6 + 24.4)
Connection pipe diameter	Liquid	mm	12.70	12.70	12.70	12.70	12.70	15.88	15.88	15.88	15.88
	Gas		22.22	22.22	28.58	28.58	28.58	28.58	28.58	34.92	34.92
Operating Range	Cooling	°CDB	-15 to 46	-15 to 46	-15 to 46	-15 to 46	-15 to 46	-15 to 46	-5 to 46	-5 to 46	-5 to 46
	Heating		-20 to 21	-20 to 21	-20 to 21	-20 to 21	-20 to 21	-20 to 21	-20 to 21	-20 to 21	-20 to 21

Energy Efficiency Combination

Rated capacity range		HP	16	20	24	26	28	30
Model name			AJH144LALDHH	AJH180LALDHH	AJH216LALDHH	AJH234LALDHH	AJH252LALDHH	AJH270LALDHH
Unit 1			AJH072LALDH	AJH108LALDH	AJH072LALDH	AJH090LALDH	AJH108LALDH	AJH126LALDH
Unit 2			AJH072LALDH	AJH072LALDH	AJH072LALDH	AJH072LALDH	AJH072LALDH	AJH072LALDH
Unit 3					AJH072LALDH	AJH072LALDH	AJH072LALDH	AJH072LALDH
Maximum connectable indoor units*1			34	43	52	56	60	64
Connectable capacity range of indoor units		kW	22.4-67.2	28.0-83.8	33.6-100.8	36.4-109.2	39.2-117.4	42.4-127.2
Power source		3-phase, 4-wire, ~400 V, 50 Hz						
Capacity	Cooling	kW	44.8	55.9	67.2	72.8	78.3	84.8
	Nominal Heating		44.8	55.9	67.2	72.8	78.3	84.8
	Max. Heating		50.0	62.5	75.0	81.5	87.5	95.0
Input power	Cooling	kW	11.90	15.49	17.85	20.96	21.44	25.08
	Nominal Heating		10.84	13.18	16.26	18.28	18.60	22.58
	Max. Heating		12.52	15.74	18.78	21.50	22.00	26.52
EER	Cooling	W/W	3.76	3.61	3.76	3.47	3.65	3.38
	Nominal Heating		4.13	4.24	4.13	3.98	4.21	3.76
	Max. Heating		3.99	3.97	3.99	3.79	3.98	3.58
SEER	Cooling		7.09	7.21	7.09	6.91	7.17	6.79
	Heating		3.83	4.01	3.83	3.82	3.95	3.98
SCOP			281.0	285.5	281.0	273.7	284.0	275.3
ηc	Cooling	%	150.0	157.5	150.0	149.7	155.0	155.0
ηh	Heating							
Air flow rate	High	m³/h	11,100 × 2	13,000 + 11,100	11,100 × 3	11,000 × 3	13,000 + 11,100 × 2	13,000 + 11,100 × 2
Sound pressure level*2/	Cooling	dB(A)	61 / 82	61 / 83	63 / 84	63 / 84	63 / 85	65 / 86
	Heating		62 / 83	63 / 85	64 / 85	64 / 85	64 / 86	66 / 87
Power level								
Max. External static pressure		Pa	82	82	82	82	82	82
Compressor motor output		kW	7.5 × 2	11.0 + 7.5	7.5 × 3	7.5 × 3	11.0 + 7.5 × 2	11.0 + 7.5 × 2
Heat exchanger fin			Blue fin	Blue fin	Blue fin	Blue fin	Blue fin	Blue fin
Net Dimensions	Height	mm	1,690	1,690	1,690	1,690	1,690	1,690
	Width		930 × 2	1,240 + 930	930 × 3	930 × 3	1,240 + 930 × 2	1,240 + 930 × 2
	Depth		765	765	765	765	765	765
Weight		kg	252 × 2	275 + 252	252 × 3	252 × 3	275 + 252 × 2	275 + 252 × 2
Refrigerant	Type (Global Warming Potential)		R410A (2,088)	R410A (2,088)	R410A (2,088)	R410A (2,088)	R410A (2,088)	R410A (2,088)
	Charge	kg (CO2eq-T)	11.7 × 2 (24.4 × 2)	11.8 + 11.7 (24.6 + 24.4)	11.7 × 3 (24.4 × 3)	11.7 × 3 (24.4 × 3)	11.8 + 11.7 × 2 (24.6 + 24.4 × 2)	11.8 + 11.7 × 2 (24.6 + 24.4 × 2)
Connection pipe diameter	Liquid	mm	12.70	15.88	15.88	15.88	15.88	19.05
	Gas		28.58	28.58	34.92	34.92	34.92	34.92
Operating Range	Cooling	°CDB	-5 to 46	-5 to 46	-5 to 46	-5 to 46	-5 to 46	-5 to 46
	Heating		-20 to 21	-20 to 21	-20 to 21	-20 to 21	-20 to 21	-20 to 21

Note: Specifications are subject to the following conditions:
 Cooling: Indoor temperature of 27°CDB/19°CWB, and outdoor temperature of 35°CDB/24°CWB.
 Heating: Indoor temperature of 20°CDB/15°CWB, and outdoor temperature of 7°CDB/6°CWB.
 Pipe length: 7.5 m; Height difference between outdoor unit and indoor unit: 0 m.

When cooling operation is to be conducted at an outdoor air temperature below -5°C, the outdoor unit must be installed in a position that is higher than or equal to that of the indoor units.
 * These specifications are determined by ducted combination.
 *Multiple outdoor units are not certified by Eurovent.

26	28	30	32	34	36	38	40	42	44	46	48
AJH234LALDH	AJH252LALDH	AJH270LALDH	AJH288LALDH	AJH306LALDH	AJH324LALDH	AJH342LALDH	AJH360LALDH	AJH378LALDH	AJH396LALDH	AJH414LALDH	AJH432LALDH
AJH144LALDH AJH090LALDH	AJH144LALDH AJH108LALDH	AJH144LALDH AJH126LALDH	AJH144LALDH AJH144LALDH	AJH144LALDH AJH090LALDH AJH072LALDH	AJH144LALDH AJH090LALDH AJH090LALDH	AJH144LALDH AJH108LALDH AJH090LALDH	AJH144LALDH AJH126LALDH AJH090LALDH	AJH144LALDH AJH144LALDH AJH090LALDH	AJH144LALDH AJH144LALDH AJH108LALDH	AJH144LALDH AJH144LALDH AJH126LALDH	AJH144LALDH AJH144LALDH AJH144LALDH
56	60	64	64	64	64	64	64	64	64	64	64
36.5-109.5	39.3-117.7	42.5-127.5	45.0-135.0	47.7-143.1	50.5-151.5	53.3-159.7	56.5-169.5	59.0-177.0	61.8-185.2	65.0-195.0	67.5-202.5

3-phase, 4-wire, ~400 V, 50 Hz

73.0	78.5	85.0	90.0	95.4	101.0	106.5	113.0	118.0	123.5	130.0	135.0
73.0	78.5	85.0	90.0	95.4	101.0	106.5	113.0	118.0	123.5	130.0	135.0
79.5	85.5	93.0	96.0	104.5	111.0	117.0	124.5	127.5	133.5	141.0	144.0
25.80	26.28	29.92	33.48	31.75	34.86	35.34	38.98	42.54	43.02	46.66	50.22
21.20	21.52	25.50	27.52	26.62	28.64	28.96	32.94	34.96	35.28	39.26	41.28
24.00	24.50	29.02	30.04	30.26	32.98	33.48	38.00	39.02	39.52	44.04	45.06
2.83	2.99	2.84	2.69	3.00	2.90	3.01	2.90	2.77	2.87	2.79	2.69
3.44	3.65	3.33	3.27	3.58	3.53	3.68	3.43	3.38	3.50	3.31	3.27
3.31	3.49	3.20	3.20	3.45	3.37	3.49	3.28	3.27	3.38	3.20	3.20
6.37	6.76	6.43	6.18	6.61	6.43	6.69	6.47	6.31	6.56	6.34	6.18
4.04	4.23	4.23	4.27	3.97	3.96	4.09	4.09	4.11	4.24	4.24	4.27
251.5	267.0	254.0	244.0	261.3	254.0	264.3	255.7	249.0	259.3	250.7	244.0
158.5	166.5	166.5	168.0	155.7	155.3	160.7	160.7	161.7	167.0	167.0	168.0
13,700 + 11,100	13,700 + 13,000	13,700 + 13,000	13,700 × 2	13,700 + 11,100 × 2	13,700 + 11,100 × 2	13,700 + 13,000 + 11,100	13,700 + 13,000 + 11,100	13,700 × 2 + 11,100	13,700 × 2 + 13,000	13,700 × 2 + 13,000	13,700 × 3
64 / 87	64 / 87	66 / 88	66 / 89	65 / 87	65 / 87	65 / 88	66 / 89	67 / 89	67 / 90	67 / 90	68 / 91
66 / 88	66 / 88	68 / 89	68 / 90	67 / 89	67 / 89	67 / 89	68 / 90	69 / 91	69 / 91	69 / 91	70 / 92
82	82	82	82	82	82	82	82	82	82	82	82
11.0 × 7.5	11.0 × 2	11.0 × 2	11.0 × 2	11.0 × 7.5 × 2	11.0 × 7.5 × 2	11.0 × 2 + 7.5	11.0 × 2 + 7.5	11.0 × 2 + 7.5	11.0 × 3	11.0 × 3	11.0 × 3
Blue fin	Blue fin	Blue fin	Blue fin	Blue fin	Blue fin	Blue fin	Blue fin	Blue fin	Blue fin	Blue fin	Blue fin
1,690	1,690	1,690	1,690	1,690	1,690	1,690	1,690	1,690	1,690	1,690	1,690
1,240 × 930	1,240 × 2	1,240 × 2	1,240 × 2	1,240 × 930 × 2	1,240 × 930 × 2	1,240 × 2 + 930	1,240 × 2 + 930	1,240 × 2 + 930	1,240 × 3	1,240 × 3	1,240 × 3
765	765	765	765	765	765	765	765	765	765	765	765
275 × 252	275 × 2	275 × 2	275 × 2	275 + 252 × 2	275 + 252 × 2	275 × 2 + 252	275 × 2 + 252	275 × 2 + 252	275 × 3	275 × 3	275 × 3
R410A (2,088)	R410A (2,088)	R410A (2,088)	R410A (2,088)	R410A (2,088)	R410A (2,088)	R410A (2,088)	R410A (2,088)	R410A (2,088)	R410A (2,088)	R410A (2,088)	R410A (2,088)
11.8 × 11.7 (24.6 × 24.4)	11.8 × 2 (24.6 × 2)	11.8 × 2 (24.6 × 2)	11.8 × 2 (24.6 × 2)	11.8 + 11.7 × 2 (24.6 × 24.4 × 2)	11.8 + 11.7 × 2 (24.6 × 24.4 × 2)	11.8 × 2 + 11.7 (24.6 × 2 + 24.4)	11.8 × 2 + 11.7 (24.6 × 2 + 24.4)	11.8 × 2 + 11.7 (24.6 × 2 + 24.4)	11.8 × 3 (24.6 × 3)	11.8 × 3 (24.6 × 3)	11.8 × 3 (24.6 × 3)
15.88	15.88	19.05	19.05	19.05	19.05	19.05	19.05	19.05	19.05	19.05	19.05
34.92	34.92	34.92	34.92	34.92	41.27	41.27	41.27	41.27	41.27	41.27	41.27
-5 to 46	-5 to 46	-5 to 46	-5 to 46	-5 to 46	-5 to 46	-5 to 46	-5 to 46	-5 to 46	-5 to 46	-5 to 46	-5 to 46
-20 to 21	-20 to 21	-20 to 21	-20 to 21	-20 to 21	-20 to 21	-20 to 21	-20 to 21	-20 to 21	-20 to 21	-20 to 21	-20 to 21

32	34	36	38	40	42	44
AJH288LALDHH	AJH306LALDHH	AJH324LALDHH	AJH342LALDHH	AJH360LALDHH	AJH378LALDHH	AJH396LALDHH
AJH108LALDH AJH108LALDH AJH072LALDH	AJH126LALDH AJH108LALDH AJH072LALDH	AJH108LALDH AJH108LALDH AJH108LALDH	AJH126LALDH AJH108LALDH AJH108LALDH	AJH126LALDH AJH126LALDH AJH108LALDH	AJH126LALDH AJH126LALDH AJH126LALDH	AJH144LALDH AJH126LALDH AJH126LALDH
64	64	64	64	64	64	64
44.7-134.1	48.0-143.8	50.3-150.7	53.5-160.5	56.8-170.2	60.0-180.0	62.5-187.5

3-phase, 4-wire, ~400 V, 50 Hz

89.4	95.9	100.5	107.0	113.5	120.0	125.0
89.4	95.9	100.5	107.0	113.5	120.0	125.0
100.0	107.5	112.5	120.0	127.5	135.0	138.0
25.03	28.67	28.62	32.26	35.90	39.54	43.10
20.94	24.92	23.28	27.26	31.24	35.22	37.24
25.22	29.74	28.44	32.96	37.48	42.00	43.02
3.57	3.34	3.51	3.32	3.16	3.03	2.90
4.27	3.85	4.32	3.93	3.63	3.41	3.36
3.97	3.61	3.96	3.64	3.40	3.21	3.21
7.25	7.03	7.33	7.11	6.89	6.67	6.51
4.07	4.07	4.19	4.19	4.19	4.19	4.22
287.0	278.3	290.0	281.3	272.7	264.0	257.3
160.0	160.0	165.0	165.0	165.0	165.0	166.0
13,000 × 2 + 11,100	13,000 × 2 + 11,100	13,000 × 3	13,000 × 3	13,000 × 3	13,000 × 3	13,700 + 13,000 × 2
63 / 85	65 / 87	63 / 86	65 / 87	66 / 88	67 / 89	67 / 90
64 / 87	66 / 88	65 / 88	67 / 89	68 / 89	69 / 90	69 / 91
82	82	82	82	82	82	82
11.0 × 2 + 7.5	11.0 × 2 + 7.5	11.0 × 3	11.0 × 3	11.0 × 3	11.0 × 3	11.0 × 3
Blue fin	Blue fin	Blue fin	Blue fin	Blue fin	Blue fin	Blue fin
1,690	1,690	1,690	1,690	1,690	1,690	1,690
1,240 × 2 + 930	1,240 × 2 + 930	1,240 × 3	1,240 × 3	1,240 × 3	1,240 × 3	1,240 × 3
765	765	765	765	765	765	765
275 × 2 + 252	275 × 2 + 252	275 × 3	275 × 3	275 × 3	275 × 3	275 × 3
R410A (2,088)	R410A (2,088)	R410A (2,088)	R410A (2,088)	R410A (2,088)	R410A (2,088)	R410A (2,088)
11.8 × 2 + 11.7 (24.6 × 2 + 24.4)	11.8 × 2 + 11.7 (24.6 × 2 + 24.4)	11.8 × 3 (24.6 × 3)	11.8 × 3 (24.6 × 3)	11.8 × 3 (24.6 × 3)	11.8 × 3 (24.6 × 3)	11.8 × 3 (24.6 × 3)
19.05	19.05	19.05	19.05	19.05	19.05	19.05
34.92	34.92	41.27	41.27	41.27	41.27	41.27
-5 to 46	-5 to 46	-5 to 46	-5 to 46	-5 to 46	-5 to 46	-5 to 46
-20 to 21	-20 to 21	-20 to 21	-20 to 21	-20 to 21	-20 to 21	-20 to 21

*1 Minimum connectable indoor unit number is 2.

However, the ARXC72 and ARXC90 can be used with a signal connection.

*2 The noise level is the value measured in an anechoic room.

When measured in an actual installation, the measured value is typically larger than the indicated value due to ambient noise and reflections.

* These specifications are determined by ducted combination.

VRF INDOOR UNITS

17 types and 95 models available to meet the requirements of any building design.

Indoor units for the VRF Systems are compact, highly efficient, quiet, and user-friendly. Fujitsu General offers a variety of types and capacities for its indoor units that are easy to install and maintain. In addition, a variety of optional parts are available to provide an even more desirable air conditioning experience to users.







- V-058 VRF Indoor Unit Lineup for J-VS
- V-060 Compact Cassette Grid type
- V-062 Low Static Pressure Duct Slim Duct/Slim Concealed Floor
- V-064 Wall-mounted type

- V-066 VRF Indoor Unit Lineup for J-IVS, J-IV, J-IVL, VR-IV, V-IV
- V-068 Compact Cassette Grid type
- V-070 Cassette Slim type Circular Flow
- V-072 Cassette Large type Circular Flow
- V-074 Cassette One-way Flow type
- V-076 3D Flow Cassette
- V-078 Low Static Pressure Duct Mini Duct
- V-080 Low Static Pressure Duct Slim Duct/Slim Concealed Floor
- V-082 Low Static Pressure Duct
- V-084 Medium Static Pressure Duct
- V-086 High Static Pressure Duct
- V-088 Compact Floor
- V-090 Floor/Ceiling
- V-092 Ceiling
- V-094 Wall-mounted (EEV Internal/external)





VRF Indoor Unit Lineup for J-vs

Capacity range (kW)				1.1	1.7
Class				4	5
Cassette	Compact type	Compact Grid type/Standard type		AUXB004HLAH	AUXB005HLAH
		High Efficiency* ¹			
Duct	Low Static Pressure Duct	Slim Duct (With drain pump)	 004 - 014 018 024	ARXD004HLAH	ARXD005HLAH
		High Efficiency* ¹	 009 - 014		
Wall-mounted type		Wall-mounted type	 004 - 014	ASHA004HCAH	ASHA005HCAH
		Wall-mounted type (EEV external)	 004 - 014	ASHE004HCAH	ASHE005HCAH
				This model requires the EV kit to be connected.	



	2.2 7	2.8 9	3.6 12	4.0 14	4.5 14	5.6 18	7.1 24
AUXB007HLAH		AUXB009HLAH	AUXB012HLAH		AUXB014HLAH	AUXB018HLAH	
		AUXN009HLAH	AUXN012HLAH		AUXN014HLAH		
ARXD007HLAH		ARXD009HLAH	ARXD012HLAH		ARXD014HLAH	ARXD018HLAH	ARXD024HLAH
		ARXP009HLAH	ARXP012HLAH		ARXP014HLAH		
ASHA007HCAH		ASHA009HCAH	ASHA012HCAH	ASHA014HCAH			
ASHE007HCAH		ASHE009HCAH	ASHE012HCAH	ASHE014HCAH			
This model requires the EV kit to be connected.							

*1: Production by order
 Specifications and design are subject to change without notice.
 *Products other than ducts can be connected to J-IV, J-IVS, J-IVL, V-IV, VR-IV

Compact Cassette

Grid type



Compact and stylish panel

The compact and stylish panel fits nicely into a grid type ceiling. The linear design is a perfect fit into a grid of 620 mm × 620 mm in the ceiling.

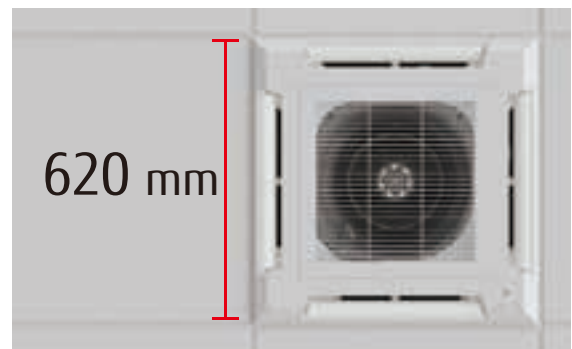

Easy maintenance

You can access the unit for maintenance just by removing a ceiling panel right next to the grille. As no inspection hole needs to be cut through the ceiling, no additional construction cost is incurred.



The air inlet grille can be installed to open in any direction for easy maintenance.



Flexible installation

The unit fits nicely into the decor of a grid type ceiling and can be installed near a lighting or a ventilation opening.



High ceiling mode

The cassette can be installed up to a height of 3.0 m. (012/014/018).

Model code	Maximum height from floor to ceiling (m)	
	Standard mode	High ceiling mode
004	2.7	-
005	2.7	-
007	2.7	-
009	2.7	-
012	2.7	3.0
014	2.7	3.0
018	2.7	3.0

**Model: AUXB004HLAH / AUXB005HLAH / AUXB007HLAH / AUXB009HLAH
 AUXB012HLAH / AUXB014HLAH / AUXB018HLAH
 AUXN009HLAH / AUXN012HLAH / AUXN014HLAH * Production by order**



Specifications

Model name			AUXB004HLAH	AUXB005HLAH	AUXB007HLAH	AUXB009HLAH	AUXB012HLAH	AUXB014HLAH	AUXB018HLAH	AUXN009HLAH	AUXN012HLAH	AUXN014HLAH	
Power source			Single phase, 220-240V, 50Hz						Single phase, 220-240V, 50Hz				
Capacity	Cooling	kW	1.1	1.7	2.2	2.8	3.6	4.5	5.6	2.8	3.6	4.5	
	Heating		1.3	1.9	2.8	3.2	4.1	5.0	6.3	3.2	4.1	5.0	
Input power			W	21	21	23	24	27	33	50	41	71	81
Airflow rate (Cooling / Heating)*	High	m ³ /h	530	530	540	550	600	680	820	750	970	1,030	
	Med-High		490 / 480	490 / 480	500	520	560	620	660	550	600	680	
	Med		450 / 430	450 / 430	460	480	520	560	590	480	520	560	
	Med-Low		420 / 380	420 / 380	420	440	480	500	520	440	480	500	
	Low		390 / 340	390 / 340	390	400	430	440	460	400	430	440	
Sound pressure level (Cooling / Heating)*	Quiet	dB(A)	350 / 300	350 / 300	350	350	390	390	400	350	390	390	
	High		34	34	34	35	37	39	45	42	49	50	
	Med-High		32 / 31	32 / 31	32	33	34	37	39	35	37	39	
	Med		30 / 29	30 / 29	30	31	33	34	36	31	33	34	
	Med-Low		28 / 26	28 / 26	28	29	31	32	33	29	31	32	
Low	27 / 24	27 / 24	27	27	29	30	30	27	29	30			
Quiet	25 / 21	25 / 21	25	25	27	27	27	25	27	27			
Net Dimensions (H × W × D)			mm						245 × 570 × 570				
Weight			kg						14.5, 14.5, 15, 15, 15.5, 15.5, 17, 15, 15.5, 15.5				
Connection pipe diameter	Liquid (Flare)	mm	6.35						6.35, 6.35, 6.35, 6.35				
	Gas (Flare)		9.52						9.52, 12.70, 12.70, 12.70, 9.52, 12.70, 12.70				
Drain Hose Diameter (I.D./O.D.)			25 / 32						25 / 32, 25 / 32, 25 / 32, 25 / 32				
Cassette Grille	Model name	UTG-UFGH-W						UTG-UFGH-W					
	Net Dimensions (H × W × D)	mm						49 × 620 × 620					
	Weight	kg						2.3, 2.3, 2.3, 2.3, 2.3, 2.3, 2.3, 2.3					

Note: Specifications are subject to the following conditions:
 Cooling: Indoor temperature of 27°CDB/19°CWB, and outdoor temperature of 35°CDB/24°CWB.
 Heating: Indoor temperature of 20°CDB/(15°CWB), and outdoor temperature of 7°CDB/6°CWB.
 Pipe length: 7.5 m; Height difference between outdoor unit and indoor unit: 0 m. Voltage: 230 [V]
 *The value is the same for cooling and heating if there is one value.

Optional parts

*For more details, please refer to the chapter "Optional parts".

- | | | | |
|-----------------------------------|------------|---------------------------|-------------------------|
| Wireless remote controller: | UTY-LNVG | WLAN adapter: | UTY-TFSXZ1, UTY-TFSXJ3, |
| Fresh Air Intake Kit: | UTZ-VXAA | | FG-AC-WIF1Z1 |
| Insulation kit for high humidity: | UTZ-KXGC | Gas sensor kit: | UTY-SGZH |
| Silver Ion Filter: | UTD-HFAA | Expansion kit: | UTZ-JXXA |
| Remote sensor kit: | UTY-XSZXZ1 | Air Outlet Shutter Plate: | UTR-YDZB |
| Cassette Grille: | UTG-UFGH-W | | |

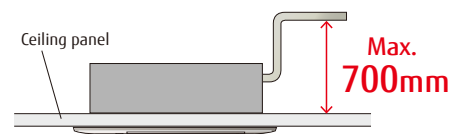

Dimensions

(Unit: mm)

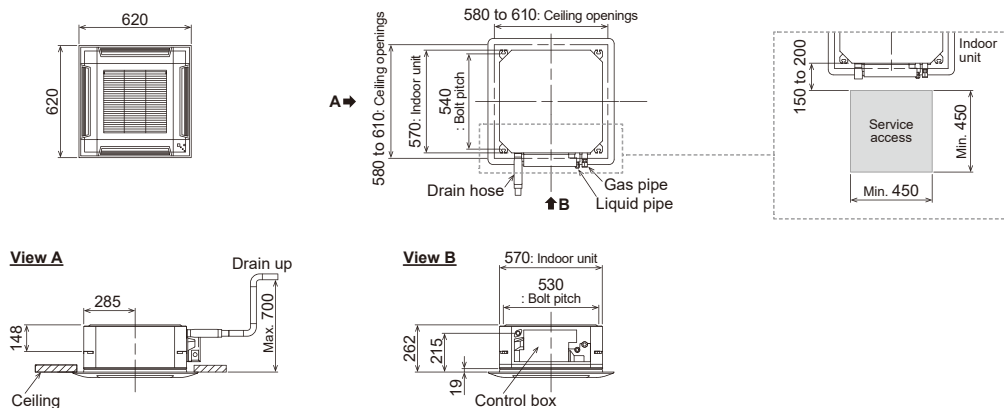

NEW

Low Static Pressure Duct Slim Duct



Slim design

Slim design allows for installation in a tight ceiling space.

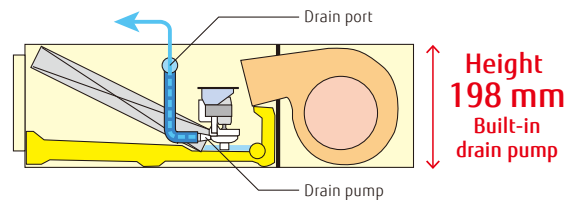

Air intake

Air intake direction can be selected to match the installation site.

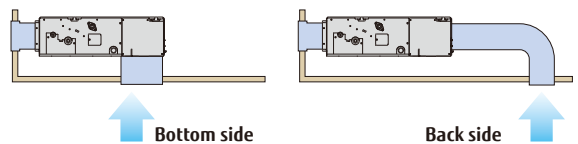

Wide range of static pressures

The use of a DC fan motor makes it possible to adjust the static pressure between 0 and 90 Pa. The static pressure range can be changed by a remote controller.



Static pressure range
0 to 90 Pa

* 024 model static pressure range is 0 to 50 Pa.

Auto louver grille kit (Option)

The optional clean-looking flat Auto louver blends into any interior and provides a comfortable airflow.



Filter (Accessory)

ARXD004-018

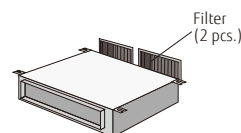

ARXD024

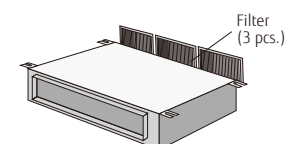

**Model: ARXD004HLAH / ARXD005HLAH / ARXD007HLAH / ARXD009HLAH
 ARXD012HLAH / ARXD014HLAH / ARXD018HLAH / ARXD024HLAH
 ARXP009HLAH / ARXP012HLAH / ARXP014HLAH * Production by order**



ARXD004/005/007/009/012/014HLAH
 ARXP009/012/014HLAH



ARXK018HLAH

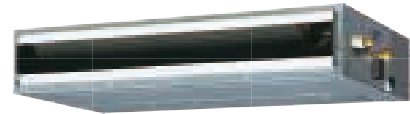

ARXK024HLAH

Specifications

Model name		ARXD004HLAH	ARXD005HLAH	ARXD007HLAH	ARXD009HLAH	ARXD012HLAH	ARXD014HLAH	ARXD018HLAH	ARXD024HLAH	ARXP009HLAH	ARXP012HLAH	ARXP014HLAH	
Power source		Single phase, 220-240V, 50Hz									Single phase, 220-240V, 50Hz		
Capacity	Cooling	1.1	1.7	2.2	2.8	3.6	4.5	5.6	7.1	2.8	3.6	4.5	
	Heating	1.3	1.9	2.8	3.2	4.0	5.0	6.3	8.0	3.2	4.0	5.0	
Input power		38	38	41	47	48	84	76	107	77	128	128	
Airflow rate	High	530	530	550	600	580	790	930	1,250	770	940	940	
	Med-High	480	480	520	550	550	720	880	1,180	630	810	810	
	Med	440	440	480	500	520	640	780	1,060	530	660	660	
	Med-Low	410	410	450	460	480	560	670	930	480	580	580	
	Low	370	370	400	400	430	470	580	810	430	490	490	
Quiet	320	320	360	360	350	370	510	640	380	390	390		
Static pressure range		0 to 90	0 to 90	0 to 90	0 to 90	0 to 90	0 to 90	0 to 90	0 to 50	0 to 25	0 to 25	0 to 25	
Standard static pressure		25	25	25	25	25	25	25	25	25	25	25	
Sound pressure level	High	26	26	28	29	30	34	34	35	36	40	40	
	Med-High	26	26	26	27	28	32	31	32	32	38	38	
	Med	25	25	25	25	27	30	29	30	28	33	33	
	Med-Low	24	24	24	24	26	28	27	27	27	31	31	
	Low	22	22	22	22	24	25	25	24	25	27	27	
Quiet	21	21	21	21	22	22	23	23	21	23	24		
Net Dimensions (H × W × D)		198 × 700 × 620						198 × 900 × 620		198 × 1,100 × 620		198 × 700 × 620	
Weight		16	16	16.5	16.5	17	17	21	25	16.5	17	17	
Connection pipe diameter	Liquid (Flare)	6.35	6.35	6.35	6.35	6.35	6.35	6.35	9.52	6.35	6.35	6.35	
	Gas (Flare)	9.52	9.52	9.52	9.52	12.70	12.70	12.70	15.88	9.52	12.70	12.70	
Drain Hose Diameter (I.D./O.D.)		25/32	25/32	25/32	25/32	25/32	25/32	25/32	25/32	25/32	25/32	25/32	

Note: Specifications are subject to the following conditions:
 Cooling: Indoor temperature of 27°CDB/19°CWB, and outdoor temperature of 35°CDB/24°CWB.
 Heating: Indoor temperature of 20°CDB/15°CWB, and outdoor temperature of 7°CDB/6°CWB.
 Pipe length: 7.5 m; Height difference between outdoor unit and indoor unit: 0 m. Voltage: 230 [V]
 *1: This value is under cooling operation.

Optional parts

*For more details, please refer to the chapter "Optional parts".

Wireless remote controller:	UTY-LNVG*	Auto Louver Grille Kit:	UTD-GXTA-W (004-014)
Remote sensor unit:	UTY-XSZXZ1		UTD-GXTB-W (018)
IR receiver unit:	UTY-TRHX		UTD-GXTC-W (024)
WLAN adapter:	UTY-TFSXJ3	Silver Ion Filter:	UTD-HFTA (004-014)
	UTY-TFSXZ1		UTD-HFTB (018)
	FG-AC-WIF1Z1		UTD-HFTC (024)
Expansion kit:	UTZ-JXXA	Gas sensor kit:	UTY-SGZCH

*IR receiver unit (UTY-TRHX) is required.

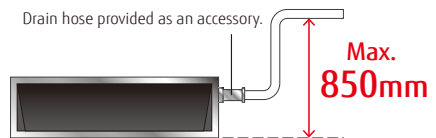

Dimensions

(Unit: mm)

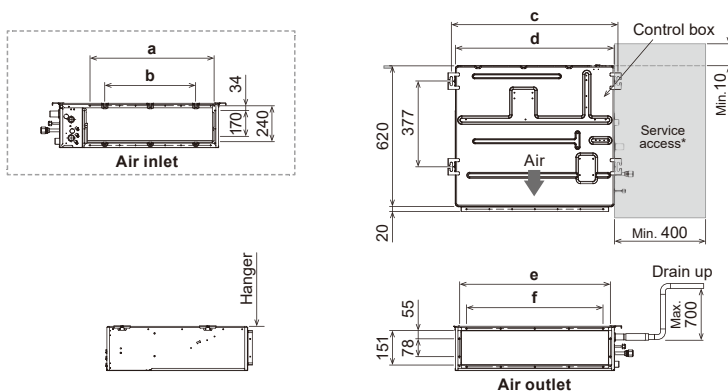

	ARXD 004-014HLAH	ARXD018HLAH	ARXD024HLAH
a	574	774	974
b	P200×2=400	P200×3=600	P200×4=800
c	734	934	1,134
d	700	900	1,100
e	650	850	1,050
f	P100×6=600	P100×8=800	P100×10=1,000

*The design of the service access depends on the installation method. Refer to the installation manual for more information.

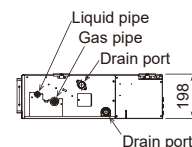

NEW

Wall-mounted type



Highly-efficiency, compact design

The 004-014 models share the same design. The high-density and large heat exchanger achieves a highly-efficiency and compact design. The compact body blends in well with conference rooms and offices, providing comfortable air conditioning.

High-density heat exchanger



Slim tube design: 5 mm

Greater heat-exchanging capacity is achieved through the use of a high-density heat exchanger and a sub-heat exchanger.

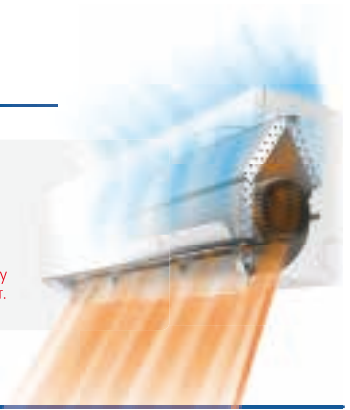

More comfortable airflow

The unique power diffuser provides comfortable air conditioning.

Heating

The vertical airflow provides powerful floor-level heating.



Cooling

The left/right airflow avoids blowing cool air directly at the occupants in a room.



Quiet operation & 6-Step fan speed control

The airflow pattern achieves significant noise reduction. Multistep airflow adjustment to suit the environment

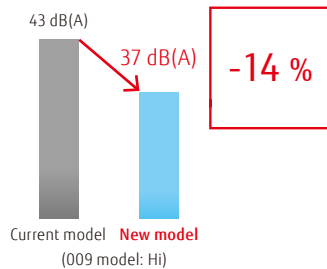

- 6-Step Speed
- High
- Med-High
- Med
- Med-Low
- Low
- Quiet



* Remote controller is compatible with the following:
UTY-RNRGZ5 / UTY-RLRG / UTY-RSRG / UTY-RHRG / UTY-DCCGZ3 / UTY-ALGXZ1 / UTY-APGXZ1

The Occupancy sensor contributes to further energy savings.

Energy saving operation starts automatically by detecting the motion of a person. Two modes of save operation mode and stop mode can be selected.

*If you want to use the Occupancy sensor control function, you need an setting device that can set the Occupancy sensor control function. For example: Wired RC (Touch panel).

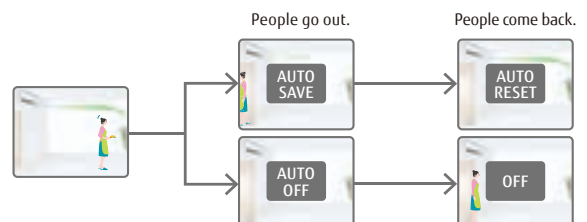

**Model: ASHA004HCAH / ASHA005HCAH / ASHA007HCAH
ASHA009HCAH / ASHA012HCAH / ASHA014HCAH**

**[external EEV]
ASHE004HCAH / ASHE005HCAH / ASHE007HCAH
ASHE009HCAH / ASHE012HCAH / ASHE014HCAH**



Specifications

Model name			ASHA004HCAH	ASHA005HCAH	ASHA007HCAH	ASHA009HCAH	ASHA012HCAH	ASHA014HCAH	ASHE004HCAH	ASHE005HCAH	ASHE007HCAH	ASHE009HCAH	ASHE012HCAH	ASHE014HCAH
Power source			Single phase, 220-240V, 50Hz						Single phase, 220-240V, 50Hz					
Capacity	Cooling	kW	1.1	1.7	2.2	2.8	3.6	4.0	1.1	1.7	2.2	2.8	3.6	4.0
	Heating		1.3	1.9	2.8	3.2	4.0	4.5	1.3	1.9	2.8	3.2	4.0	4.5
Input power			12	12	16	19	25	35	12	12	16	19	25	35
Airflow rate	High	m ³ /h	450	450	550	590	660	770	450	450	550	590	660	770
	Med-High		430	430	490	550	590	710	430	430	490	550	590	710
	Med		400	400	450	490	550	650	400	400	450	490	550	650
	Med-Low		380	380	390	420	510	590	380	380	390	420	510	590
	Low		360	360	360	360	450	530	360	360	360	360	450	530
	Quiet		310	310	320	320	320	320	310	310	320	320	320	320
Sound pressure level	High	dB(A)	31	31	34	37	40	44	31	31	34	37	40	44
	Med-High		30	30	32	34	37	42	30	30	32	34	37	42
	Med		28	28	30	32	34	40	28	28	30	32	34	40
	Med-Low		27	27	28	29	33	37	27	27	28	29	33	37
	Low		26	26	26	26	30	34	26	26	26	26	30	34
	Quiet		22	22	22	22	22	22	22	22	22	22	22	22
Net Dimensions (H × W × D)			mm 268 × 840 × 203						mm 268 × 840 × 203					
Weight			kg 8						kg 8					
Connection pipe diameter	Liquid (Flare)	mm	6.35	6.35	6.35	6.35	6.35	6.35	6.35	6.35	6.35	6.35	6.35	6.35
	Gas (Flare)		9.52	9.52	9.52	9.52	12.70	12.70	9.52	9.52	9.52	9.52	12.70	12.70
Drain Hose Diameter (I.D./O.D.)			mm 13.8/15.8 to 16.7						mm 13.8/15.8 to 16.7					
EV kit (optional)			-						UTR-EV09XC			UTR-EV14XC		

Note: Specifications are subject to the following conditions:

Cooling: Indoor temperature of 27°CDB/19°CWB, and outdoor temperature of 35°CDB/24°CWB.

Heating: Indoor temperature of 20°CDB/(15°CWB), and outdoor temperature of 7°CDB/6°CWB.

Pipe length: 7.5 m; Height difference between outdoor unit and indoor unit: 0 m. Voltage: 230 [V]

When connecting ASH*004G**H, ASH*007G**H, ASH*009G**H to an outdoor unit other than the outdoor unit of the J-IVL Series, the gas pipe diameter should be Ø12.70 mm.

Optional parts *For more details, please refer to the chapter "Optional parts".







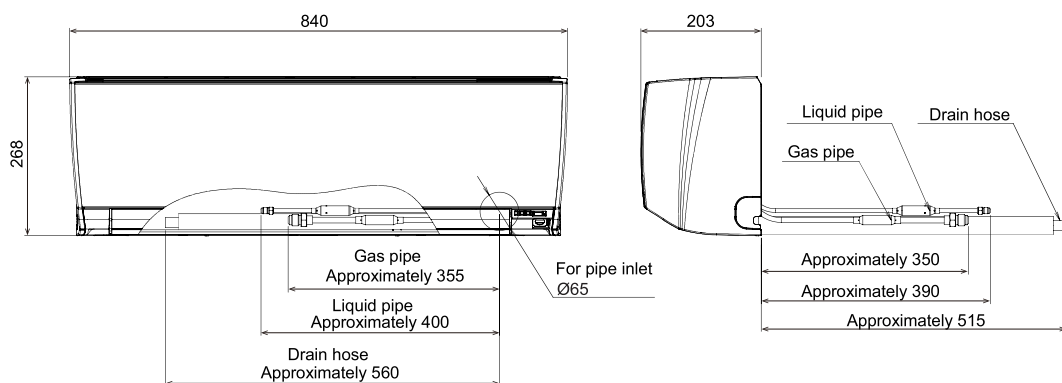







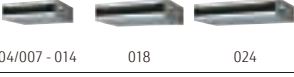

Wireless remote controller: UTY-LNVG
WLAN adapter: UTY-TFSXZ1, UTY-TFSXJ3, FG-AC-WIF1Z1
Silver Ion Filter: UTR-FA16-5
Remote sensor kit: UTY-XSZXZ1
Gas sensor kit: UTY-SGZH
Expansion kit: UTZ-JXXA

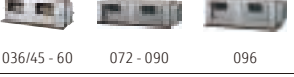
Dimensions

(Unit: mm)



VRF Indoor Unit Lineup for J-IVS J-IV J-IVL VR-IV V-IV

Capacity range (kW)				1.1	2.2	2.8	3.6
Class				4	7	9	12
Cassette	Compact type	Compact Grid type/Standard type		AUXB 004 GLEH	AUXB 007 GLEH	AUXB 009 GLEH	AUXB 012 GLEH
	Slim type	Circular Flow					
	Large type	Circular Flow					
	One-way Flow type	One-way Flow	 004 - 012 014 - 024	AUXV 004 GLEH	AUXV 007 GLEH	AUXV 009 GLEH	AUXV 012 GLEH
	3D Flow type	3D Flow					
Duct	Low Static Pressure Duct	Mini Duct (With drain pump)	 004 - 014 018 024	ARXK 004 GLGH	ARXK 007 GLGH	ARXK 009 GLGH	ARXK 012 GLGH
		Slim Duct (With drain pump)	 04/007 - 014 018 024	ARXD 04 GALH*2	ARXD 007 GLEH	ARXD 009 GLEH	ARXD 012 GLEH
		High Efficiency*3					
	Medium static pressure duct	Normal					
	High Static Pressure Duct	Normal	 036/45 - 60 072 - 090 096				
Floor	Floor (*Same as Ceiling models)						ABHA 012 GTEH
	Slim Concealed Floor (*Same as Slim Duct models)	 04/007 - 014 018 024	ARXD 04 GALH*2	ARXD 007 GLEH	ARXD 009 GLEH	ARXD 012 GLEH	
	Compact Floor		AGHA 004 GCGH	AGHA 007 GCGH	AGHA 009 GCGH	AGHA 012 GCGH	
	Compact Floor (EEV external)		AGHE 004 GCEH	AGHE 007 GCEH	AGHE 009 GCEH	AGHE 012 GCEH	
				This model requires the EV kit to be connected.			
Ceiling		 012 - 024 030 - 054					ABHA 012 GTEH
Wall-mounted type	Wall-mounted type	 004 - 014 18 - 24 030 - 034	ASHA 004 GCGH	ASHA 007 GCGH	ASHA 009 GCGH	ASHA 012 GCGH	
	Wall-mounted type (EEV external)	 004 - 014	ASHE 004 GCEH	ASHE 007 GCEH	ASHE 009 GCEH	ASHE 012 GCEH	
				This model requires the EV kit to be connected.			

	4.0	4.5	5.6	7.1	9.0	10.0	11.2	12.5	14.0	18.0	22.4	25.0	28.0
	14	14	18	24	30	34	36	45	54	60	72	90	96
		AUXB 014 GLEH	AUXB 018 GLEH	AUXB 024 GLEH									
			AUXM 018 GLEH	AUXM 024 GLEH	AUXM 030 GLEH								
			AUXK 018 GLEH	AUXK 024 GLEH	AUXK 030 GLEH	AUXK 034 GLEH	AUXK 036 GLEH	AUXK 045 GLEH	AUXK 054 GLEH				
		AUXV 014 GLEH	AUXV 018 GLEH	AUXV 024 GLEH									
			AUXS 018 GLEH	AUXS 024 GLEH									
		ARXK 014 GLGH	ARXK 018 GLGH	ARXK 024 GLGH									
		ARXD 014 GLEH	ARXD 018 GLEH	ARXD 024 GLEH									
			ARXP 018 GLFH		ARXP 030 GLFH								
				ARXA 024 GLEH	ARXA 030 GLEH		ARXA 036 GLEH	ARXA 045 GLEH					
							ARXC 036 GTEH	ARXC 045 GTEH		ARXC 060 GTEH*1	ARXC 072 GTEH*1	ARXC 090 GTEH*1	ARXC 096 GTEH*1
		ABHA 014 GTEH	ABHA 018 GTEH	ABHA 024 GTEH									
		ARXD 014 GLEH	ARXD 018 GLEH	ARXD 024 GLEH									
	AGHA 014 GCGH												
	AGHE 014 GCEH												
		ABHA 014 GTEH	ABHA 018 GTEH	ABHA 024 GTEH	ABHA 030 GTEH		ABHA 036 GTEH	ABHA 045 GTEH	ABHA 054 GTEH				
	ASHA 014 GCGH		ASHA 18 GBCH	ASHA 24 GBCH	ASHA 030 GTEH	ASHA 034 GTEH							
	ASHE 014 GCEH												

*1: ARXC060/072/090/096G cannot be connected to J-IVS/J-IV Series.
 *2: ARXD04GALH cannot be connected to J-IVS/J-IV/J-IVL/VR-IV Series.
 *3: Production by order
 Specifications and design are subject to change without notice.

Compact Cassette

Grid type



Compact and stylish panel

The compact and stylish panel fits nicely into a grid type ceiling. The linear design is a perfect fit into a grid of 620 mm × 620 mm in the ceiling.

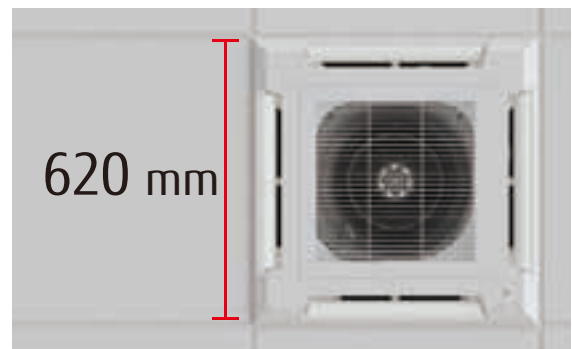

Easy maintenance

You can access the unit for maintenance just by removing a ceiling panel right next to the grille. As no inspection hole needs to be cut through the ceiling, no additional construction cost is incurred.



The air inlet grille can be installed to open in any direction for easy maintenance.



Flexible installation

The unit fits nicely into the decor of a grid type ceiling and can be installed near a lighting or a ventilation opening.



High ceiling mode

The cassette can be installed up to a height of 3.0 m. (012/014/018/024).

Model code	Maximum height from floor to ceiling (m)	
	Standard mode	High ceiling mode
004	2.7	-
007	2.7	-
009	2.7	-
012	2.7	3.0
014	2.7	3.0
018	2.7	3.0
024	2.7	3.0

**Model: AUXB004GLEH / AUXB007GLEH / AUXB009GLEH
AUXB012GLEH / AUXB014GLEH / AUXB018GLEH
AUXB024GLEH**



Specifications

Model name			AUXB004GLEH	AUXB007GLEH	AUXB009GLEH	AUXB012GLEH	AUXB014GLEH	AUXB018GLEH	AUXB024GLEH
Power source			Single phase, ~230 V, 50 Hz						
Capacity	Cooling	kW	1.1	2.2	2.8	3.6	4.5	5.6	7.1
	Heating		1.3	2.8	3.2	4.1	5.0	6.3	8.0
Input power		W	23	25	25	29	35	36	84
Airflow rate	High	m ³ /h	530/530	540	550	600	680	710	1,030
	Med-High		490/480	500	520	560	620	660	910
	Med		450/430	460	480	520	560	590	790
	Med-Low		420/380	420	440	480	500	520	680
	Low		390/340	390	400	430	440	460	560
	Quiet		350/300	350	350	390	390	400	450
Sound pressure level	High	dB(A)	34/34	34	35	37	38	41	50
	Med-High		32/31	32	33	34	37	39	46
	Med		30/29	30	31	33	34	36	43
	Med-Low		28/26	28	29	31	32	33	39
	Low		27/24	27	27	29	30	30	35
	Quiet		25/21	25	25	27	27	27	30
Net Dimensions (H × W × D)		mm	245 × 570 × 570	245 × 570 × 570	245 × 570 × 570	245 × 570 × 570	245 × 570 × 570	245 × 570 × 570	245 × 570 × 570
Weight		kg	14.5	15	15	15	15	17	17
Connection pipe diameter	Liquid (Flare)	mm	6.35	6.35	6.35	6.35	6.35	6.35	9.52
	Gas (Flare)		9.52	9.52	9.52	12.70	12.70	12.70	15.88
Drain Hose Diameter (I.D./O.D.)			25/32						
Cassette Grille	Model name		UTG-UFGE-W/UTG-UFGE-W						
	Net Dimensions (H × W × D)	mm	49 × 620 × 620/50 × 700 × 700						
	Weight	kg	2.3/2.6						

Note: Specifications are subject to the following conditions:

Cooling: Indoor temperature of 27°CDB/19°CWB, and outdoor temperature of 35°CDB/24°CWB.

Heating: Indoor temperature of 20°CDB/(15°CWB), and outdoor temperature of 7°CDB/6°CWB.

Pipe length: 7.5 m; Height difference between outdoor unit and indoor unit: 0 m. Voltage: 230 [V]

*1: This value is under cooling operation.

Optional parts

*For more details, please refer to the chapter "Optional parts".

Air Outlet Shutter Plate:	UTR-YDZB	Cassette Grille:	UTG-UFGE-W, UTG-UFGE-W
Fresh Air Intake Kit:	UTZ-VXAA	External power supply unit:	UTZ-GXXA, UTZ-GXXC*
Insulation kit for high humidity:	UTZ-KXGC	WLAN adapter:	UTY-TFSXZ1, UTY-TFSXJ3, FG-AC-WIF1Z1
Silver Ion Filter:	UTD-HFAA		
Remote sensor kit:	UTY-XSZXZ1		

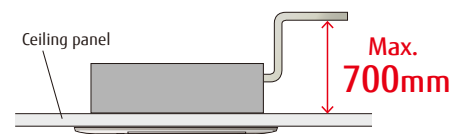

Dimensions

(Unit: mm)

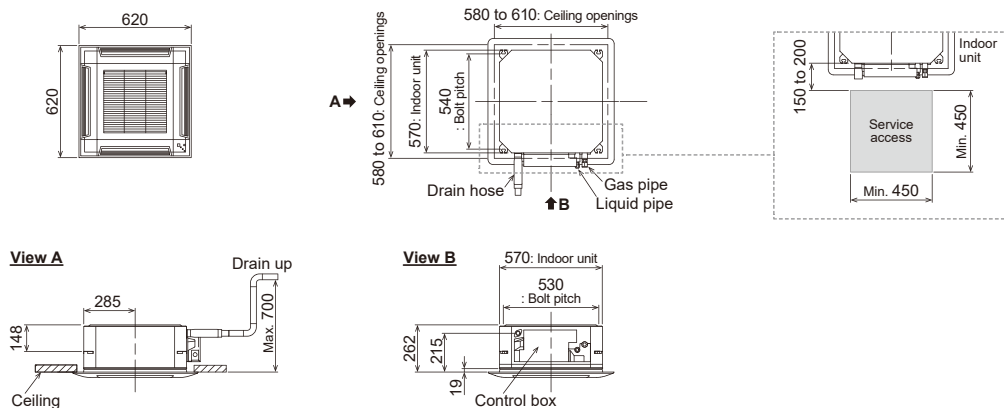

Cassette Slim type Circular Flow



Unique circular flow design

This Cassette type air conditioner is equipped with a high performance DC fan motor, a turbo fan, and a louver to propel powerful airflows in all directions.

- Ø7 mm high-density heat exchanger
- New DC fan motor
- High-efficiency turbo fan
- Seamless airflow louver

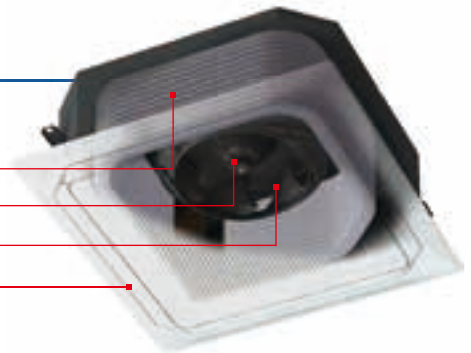

Uniform temperature air conditioning

Achieve a comfortable air conditioning spread to every corner of the room thanks to the circular flow and wide vertical airflow.



Individual louver control

Each louver can be set individually by the Touch panel wired remote controller so the user can enjoy the comfort of different directional airflows according to the room layout.

* UTY-RNRGZ5 Wired remote controller with touch panel and UTY-DCGGZ3 Central remote controller only

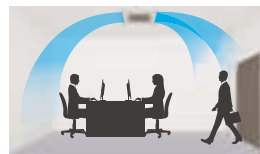

Comfortable air conditioning by preventing direct blowing of cold air and by providing swinging air flow simultaneously.

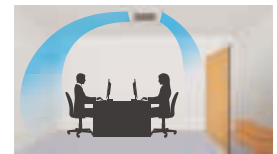

Provides efficient air conditioning based on the room layout

The Human sensor contributes to further energy savings.

Energy saving operation starts automatically by detecting the motion of a person. Two modes of save operation mode and stop mode can be selected.

* UTY-RNRGZ5 Wired remote controller with touch panel and UTY-DCGGZ3 Central remote controller only



Human sensor (Optional)

2 modes are available to choose from:

- Auto economy mode** The air conditioner switches to operate on reduced power when it detects that the room is unoccupied.
- Auto-off mode** The air conditioner stops operating when it detects that the room is unoccupied.



Specifications

Model name			AUXM018GLEH	AUXM024GLEH	AUXM030GLEH
Power source			Single phase, ~230 V, 50 Hz		
Capacity	Cooling	kW	5.6	7.1	9.0
	Heating		6.3	8.0	10.0
Input power		W	20	25	49
Airflow rate	High	m³/h	1,050	1,120	1,470
	Med-High		930	1,050	1,160
	Med		900	930	1,070
	Med-Low		870	900	930
	Low		810	870	900
	Quiet		780	780	780
Sound pressure level	High	dB(A)	33	35	40
	Med-High		32	33	36
	Med		31	32	34
	Med-Low		30	31	32
	Low		29	30	31
	Quiet		28	28	28
Dimensions (H × W × D)		mm	246 × 840 × 840		
Weight		kg	24.0	24.5	24.5
Connection pipe diameter	Liquid (Flare)	mm	6.35	9.52	9.52
	Gas (Flare)		12.70	15.88	15.88
Drain Hose Diameter (I.D./O.D.)			25/32		
Cassette Grille			UTG-UKGC-W/UTG-UKGA-B		
Model name			53 × 950 × 950		
Dimensions (H × W × D)		mm			
Weight		kg	6.0		

Note: Specifications are subject to the following conditions:

Cooling: Indoor temperature of 27°CDB/19°CWB, and outdoor temperature of 35°CDB/24°CWB.

Heating: Indoor temperature of 20°CDB/15°CWB, and outdoor temperature of 7°CDB/6°CWB.

Pipe length: 7.5 m; Height difference between outdoor unit and indoor unit: 0 m. Voltage: 230 [V].

When AUX*018GLEH is connected to an outdoor unit other than one of the J-IVL Series, the pipe diameter should be Ø9.52/Ø15.88 mm (Liquid/Gas).

When connecting AUXK036GLEH, AUXK045GLEH, and AUXK054GLEH to an outdoor unit other than the outdoor unit of the J-IVL Series, the gas pipe diameter should be Ø19.05 mm.

Optional parts

*For more details, please refer to the chapter "Optional parts".

Human sensor Kit: UTY-SHZXC
 Wide Panel: UTG-AKXA-W
 Panel Spacer: UTG-BKXA-W
 Fresh air intake kit: UTZ-VXRA

Air Outlet Shutter Plate: UTR-YDZK
 Insulation kit for high humidity: UTZ-KXRA
 Cassette Grille: UTG-UKGC-W, UTG-UKGA-B
 External power supply unit: UTZ-GXXA, UTZ-GXXC*

IR Receiver Unit: UTY-LBHXD
 WLAN adapter: UTY-TFSXZ1, UTY-TFSXJ3, FG-AC-WIF1Z1
 Silver Ion Filter: UTD-HFRA
 Remote sensor kit: UTY-XSZXZ1

Dimensions

(Unit: mm)

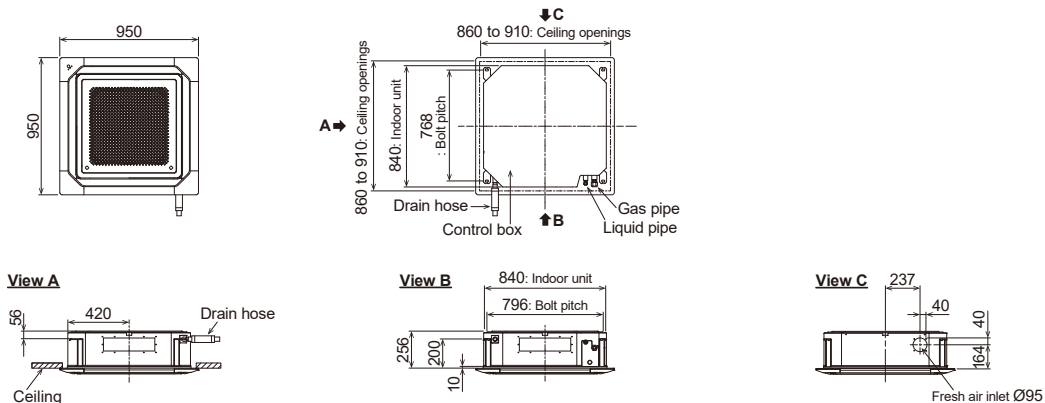

Cassette Large type Circular Flow



Unique circular flow design

This Cassette type air conditioner is equipped with a high performance DC fan motor, a turbo fan, and a louver to propel powerful airflows in all directions.

- Ø7 mm high-density heat exchanger
- New DC fan motor
- High-efficiency turbo fan
- Seamless airflow louver

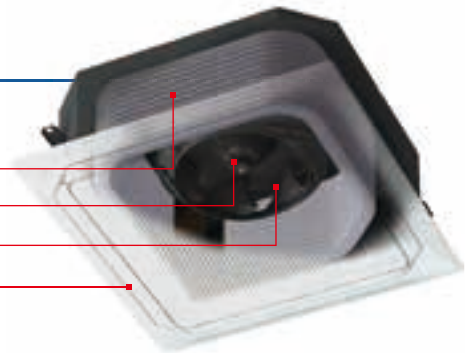

Uniform temperature air conditioning

Achieve a comfortable air conditioning spread to every corner of the room by circular flow and wide vertical airflow.



Individual louver control

Each louver can be set individually by the Touch panel wired remote controller so the user can enjoy the comfort of different directional airflows according to the room layout.

* UTY-RNRGZ5 Wired remote controller with touch panel and UTY-DCGGZ3 Central remote controller only

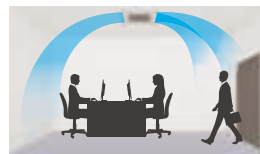

Comfortable air conditioning by preventing direct blowing of cold air and by providing swinging air flow simultaneously.

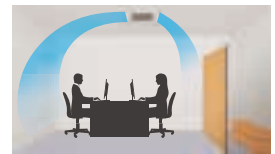

Provides efficient air conditioning based on the room layout

The Human sensor contributes to further energy savings.

Energy saving operation starts automatically by detecting the motion of a person. Two modes of save operation mode and stop mode can be selected.

* UTY-RNRGZ5 Wired remote controller with touch panel and UTY-DCGGZ3 Central remote controller only



Human sensor (Optional)

2 modes are available to choose from:

- Auto economy mode** The air conditioner switches to operate on reduced power when it detects that the room is unoccupied.
- Auto-off mode** The air conditioner stops operating when it detects that the room is unoccupied.

**Model: AUXK018GLEH / AUXK024GLEH / AUXK030GLEH
AUXK034GLEH / AUXK036GLEH / AUXK045GLEH
AUXK054GLEH**

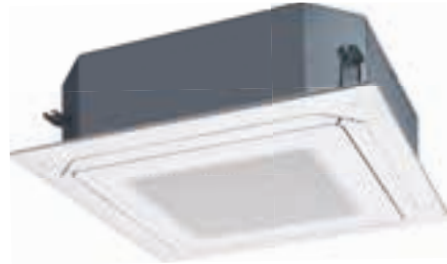

Specifications

Model name			AUXK018GLEH	AUXK024GLEH	AUXK030GLEH	AUXK034GLEH	AUXK036GLEH	AUXK045GLEH	AUXK054GLEH
Power source			Single phase, ~230 V, 50 Hz						
Capacity	Cooling	kW	5.6	7.1	9.0	10.0	11.2	12.5	14.0
	Heating		6.3	8.0	10.0	11.2	12.5	14.0	16.0
Input power		W	40	40	47	47	61	89	116
Airflow rate	High	m ³ /h	1,420	1,420	1,440	1,440	1,620	1,820	2,040
	Med-High		1,360	1,360	1,400	1,400	1,500	1,590	1,800
	Med		1,300	1,300	1,340	1,340	1,400	1,500	1,590
	Med-Low		1,270	1,270	1,300	1,300	1,340	1,400	1,440
	Low		1,200	1,200	1,280	1,280	1,280	1,300	1,300
	Quiet		1,150	1,150	1,150	1,150	1,150	1,150	1,150
Sound pressure level	High	dB(A)	38	38	39	39	41	44	47
	Med-High		37	37	38	38	40	42	45
	Med		36	36	37	37	38	40	42
	Med-Low		35	35	36	36	37	38	39
	Low		34	34	35	35	36	36	36
	Quiet		33	33	33	33	33	33	33
Dimensions (H × W × D)		mm	288 × 840 × 840						
Weight		kg	26.5	26.5	29.5	29.5	29.5	29.5	29.5
Connection pipe diameter	Liquid (Flare)	mm	6.35	9.52	9.52	9.52	9.52	9.52	9.52
	Gas (Flare)		12.70	15.88	15.88	15.88	15.88	15.88	15.88
Drain Hose Diameter (I.D./O.D.)			25/32						
Cassette Grille	Model name		UTG-UKGC-W/UTG-UKGA-B						
	Dimensions (H × W × D)		53 × 950 × 950						
	Weight		6.0						

Note: Specifications are subject to the following conditions:

Cooling: Indoor temperature of 27°CDB/19°CWB, and outdoor temperature of 35°CDB/24°CWB.

Heating: Indoor temperature of 20°CDB/(15°CWB), and outdoor temperature of 7°CDB/6°CWB.

Pipe length: 7.5 m; Height difference between outdoor unit and indoor unit: 0 m. Voltage: 230 [V].

When AUX*018GLEH is connected to an outdoor unit other than one of the J-IVL Series, the pipe diameter should be Ø9.52/Ø15.88 mm (Liquid/Gas).

When connecting AUXK036GLEH, AUXK045GLEH, and AUXK054GLEH to an outdoor unit other than the outdoor unit of the J-IVL Series, the gas pipe diameter should be Ø19.05 mm.

Optional parts

*For more details, please refer to the chapter "Optional parts".

Human sensor Kit: UTY-SHZXC
Wide Panel: UTG-AKXA-W
Panel Spacer: UTG-BKXA-W
Fresh air intake kit: UTZ-VXRA

Air Outlet Shutter Plate: UTR-YDZK
Insulation kit for high humidity: UTZ-KXRA
Cassette Grille: UTG-UKGC-W, UTG-UKGA-B
External power supply unit: UTZ-GXXA, UTZ-GXXC*

IR Receiver Unit: UTY-LBHXD
WLAN adapter: UTY-TFSXZ1, UTY-TFSXJ3, FG-AC-WIF1Z1
Silver Ion Filter: UTD-HFRA
Remote sensor kit: UTY-XSZXZ1

Dimensions

(Unit: mm)

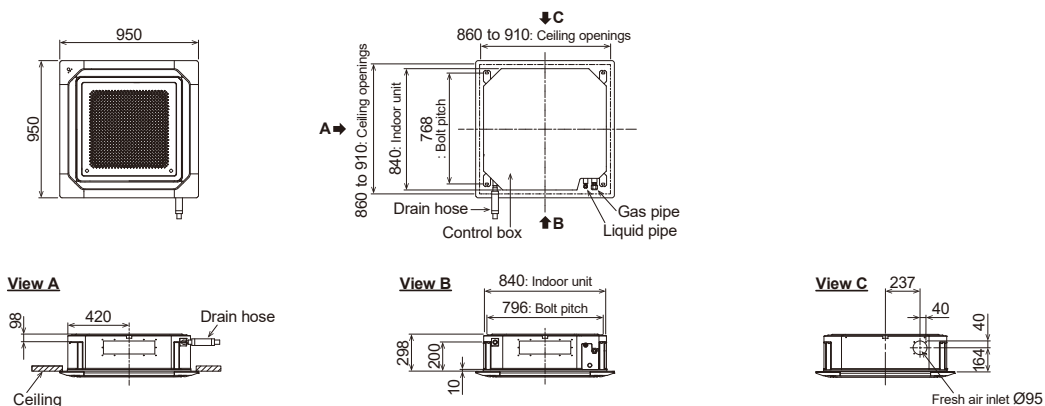

Cassette

One-way Flow type



Compact chassis size

The compact size allows easy installation in a variety of commercial facilities and environments.

- The height of the chassis is less than 200 mm for all models.
- All 4 to 12 kBTu models are less than 1,000 mm wide.
- The depth of the chassis is 570 mm, which fits nicely into a grid type ceiling.

Dimensions (Panel size) (Unit: mm)

	4	7	9	12	14	18	24
H		198 (43)				198 (43)	
W		785 (950)				1,190 (1,360)	
D		570 (620)				570 (620)	

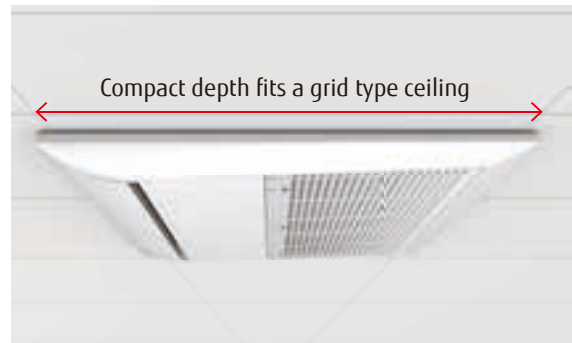

Wide airflow range

A large flap with a wide range of movements, equipped with louvers arranged triangularly, sends air into every corner of the room.



In cooling mode, the left/right airflow reaches every corner of the room without directly touching the human body to provide comfortable air conditioning.



In heating mode, warm air is directed downward toward the floor to warm the feet and lower body, while the head is kept relatively cool.

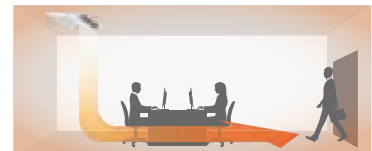

Note: This is a conceptual drawing. The performance of an air conditioner may vary depending on where it is installed, the size of the room, and its distance from the wall.

Quiet mode

The low operating noise makes the model ideal for use in hotel rooms.

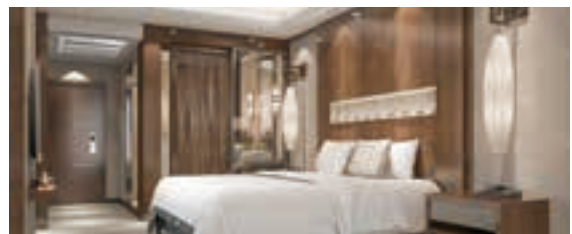

**Model: AUXV004GLEH / AUXV007GLEH / AUXV009GLEH
AUXV012GLEH / AUXV014GLEH / AUXV018GLEH
AUXV024GLEH**



AUXV004/007/009/012GLEH



AUXV014/018/024GLEH

Specifications

Model name			AUXV004GLEH	AUXV007GLEH	AUXV009GLEH	AUXV012GLEH	AUXV014GLEH	AUXV018GLEH	AUXV024GLEH	
Power source			Single phase, ~230 V, 50 Hz							
Capacity	Cooling	kW	1.1	2.2	2.8	3.6	4.5	5.6	7.1	
	Heating		1.3	2.8	3.2	4.0	5.0	6.3	8.0	
Input power			W	30/30	42/42	42/42	60/60	38/38	56/56	99/99
Airflow rate*	High	m ³ /h	460	550	550	670	720	890	1,150	
	Med-High		440	440	440	520	660	840	1,020	
	Med		420	420	420	480	630	770	940	
	Med-Low		400	400	400	450	600	710	790	
	Low		380	380	380	410	580	660	700	
Sound pressure level*	Quiet	dB(A)	360	360	360	360	550	580	610	
	High		38	42	42	45	37	44	49	
	Med-High		37	37	37	41	36	43	47	
	Med		36	36	36	39	35	40	45	
	Med-Low		35	35	35	38	34	38	42	
	Low		33	33	33	36	33	36	39	
	Quiet		32	32	32	32	32	34	36	
Net Dimensions (H × W × D)			mm	198 × 785 × 570	198 × 785 × 570	198 × 785 × 570	198 × 785 × 570	198 × 1,190 × 570	198 × 1,190 × 570	198 × 1,190 × 570
Weight			kg	18	19	19	19	26	26	27
Connection pipe diameter	Liquid (Flare)	mm	6.35	6.35	6.35	6.35	6.35	6.35	6.35	9.52
	Gas (Flare)		9.52	9.52	9.52	12.70	12.70	12.70	12.70	15.88
Drain Hose Diameter (I.D./O.D.)				25/32						
Cassette Grille	Model name		UTG-UNGA-W				UTG-UNGB-W			
	Net Dimensions (H × W × D)	mm	43 × 950 × 620				43 × 1,360 × 620			
	Weight	kg	6.5				8.5			

Note: Specifications are subject to the following conditions:

Cooling: Indoor temperature of 27°CDB/19°CWB, and outdoor temperature of 35°CDB/24°CWB.

Heating: Indoor temperature of 20°CDB/15°CWB, and outdoor temperature of 7°CDB/6°CWB.

Pipe length: 7.5 m; Height difference between outdoor unit and indoor unit: 0 m. Voltage: 230 [V]

Optional parts *For more details, please refer to the chapter "Optional parts".

WLAN adapter: UTY-TFSXZ1, UTY-TFSXJ3, FG-AC-WIF1Z1
 IR Receiver Unit: UTY-TRHX
 Cassette Grille: UTG-UNGA-W (004-012),
 UTG-UNGB-W (014-024)
 External power supply unit: UTZ-GXXA, UTZ-GXXC*
 Remote sensor kit: UTY-XSZXZ1

Flexible Installation

The L-shaped pipe kit allows for more flexible installation.

Equipped with a built-in drain pump as standard, which enables a maximum pipe height difference of 700 m from the ceiling.

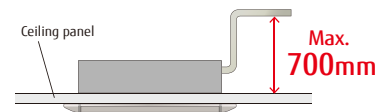

Dimensions

(Unit: mm)

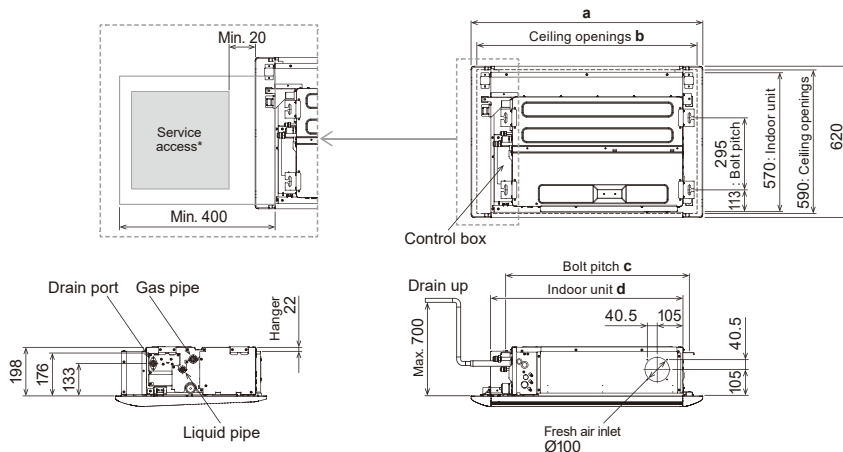

	AUXV 004 / 007 / 009 / 012 GLEH	AUXV 014 / 018 / 024 GLEH
a	950	1,360
b	920	1,330
c	752	1,152
d	785	1,190

*The design of the service access depends on the installation method. Refer to the installation manual for more information.

3D Flow Cassette



3 individually controlled air outlet ports

The Comfortable airflow setting enables the left and right air outlet ports as well as the wide center port to work together to provide a comfortable room environment.

Temperature distribution during cooling and heating (when set to Comfortable airflow)



Testing conditions: Model AUXS024GLEH running cooling operation with the air volume set to "Hi" to maintain the room temperature at 18°C with the outdoor temperature at 35°C, tested in our 40m² environmental test room



Testing conditions: Model AUXS024GLEH running heating operation with the air volume set to "Hi" to maintain the room temperature at 30°C with the outdoor temperature at 7°C, tested in our 40m² environmental test room

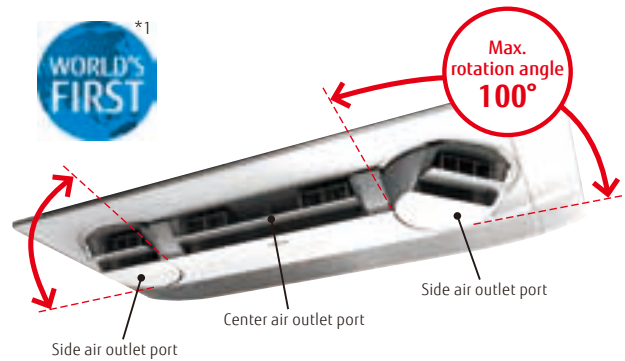

*1: Announced 2018. In the category of room air conditioners for the home (source: Fujitsu General Limited).

Individual airflow setting

The individual airflow setting function optimizes the airflow direction to match the room layout.

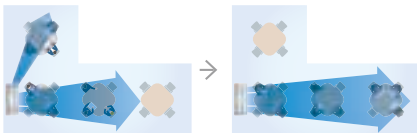

Adjusts airflows from the side air outlet ports to match the layout and usage of the room to minimize the amount of wasted airflow.



The airflow is optimally controlled to provide improved comfort in a narrow room.

Individual control of air outlet ports

Individual airflow can be set using a Wired remote controller with touch panel and Central remote controller*. The airflow from each air outlet port can be set individually.



Wired remote controller with Touch Panel
UTY-RNRGZ5



Central remote controller
UTY-DCGGZ3

* Feature available only on UTY-RNRGZ5 Wired remote controller with touch panel and UTY-DCGGZ3 Central remote controller

High energy saving

The structural design to take in a larger volume of air and blow air out more smoothly reduces air blowing loss and achieves class-leading energy-saving performance.

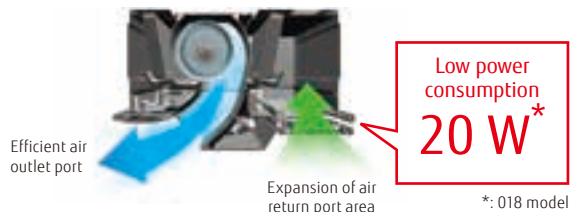

Low power consumption
20 W*

*: 018 model



Specifications

Model name			AUXS018GLEH	AUXS024GLEH
Power source			Single phase, ~230 V, 50 Hz	
Capacity	Cooling	kW	5.60	7.10
	Heating		6.30	8.00
Input power		W	20/28	34/43
Airflow rate*	High	m³/h	750/870	950/1,040
	Med-High		710/830	890/990
	Med		690/780	860/930
	Med-Low		660/740	810/880
	Low		630/700	770/840
	Quiet		540/540	540/540
Sound pressure level*	High	dB(A)	38/41	43/46
	Med-High		36/40	42/45
	Med		35/39	41/43
	Med-Low		35/37	40/42
	Low		33/36	38/40
	Quiet		29/29	29/29
Net Dimensions (H × W × D)		mm	200 × 1,240 × 500	200 × 1,240 × 500
Weight		kg	25	25
Connection pipe diameter	Liquid (Flare)	mm	6.35	9.52
	Gas (Flare)		12.70	15.88
Drain Hose Diameter (I.D./O.D.)			25/32	
Cassette Grille	Model name		UTG-USGA-W	
	Net Dimensions (H × W × D)	mm	85 × 1,350 × 580	
	Weight	kg	11.5	

Note: Specifications are subject to the following conditions:
 Cooling: Indoor temperature of 27°CDB/19°CWB, and outdoor temperature of 35°CDB/24°CWB.
 Heating: Indoor temperature of 20°CDB/15°CWB, and outdoor temperature of 7°CDB/6°CWB.
 Pipe length: 7.5 m; Height difference between outdoor unit and indoor unit: 0 m. Voltage: 230 [V]
 *: Applicable to cooling and heating operation

Optional parts *For more details, please refer to the chapter "Optional parts".

- WLAN adapter: UTY-TFSXZ1, UTY-TFSXJ3, FG-AC-WIF1Z1
- IR Receiver Unit: UTY-TRHX
- Cassette Grille: UTG-USGA-W
- External power supply unit: UTZ-GXXA, UTZ-GXXC*
- Remote sensor kit: UTY-XSZXZ1

Dimensions

(Unit: mm)

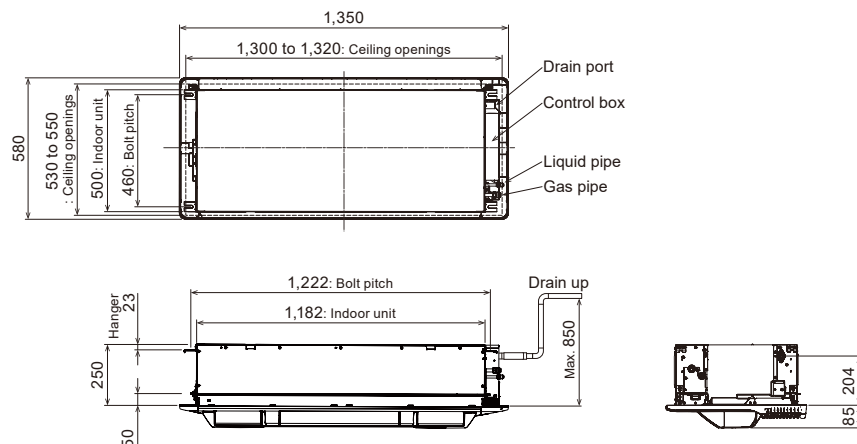

Low Static Pressure Duct Mini Duct (With drain pump)

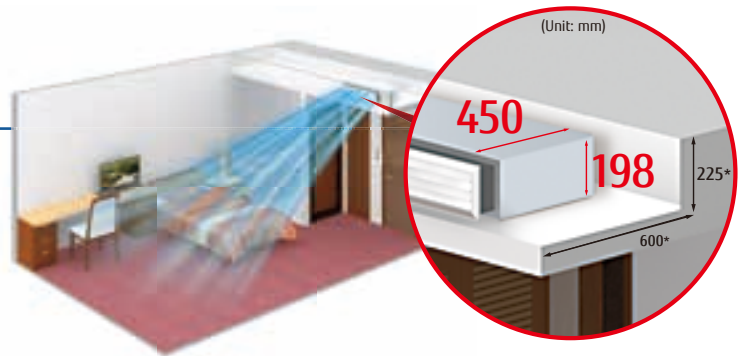

Space saving design

- Fits into a space 198 mm high and 450 mm deep
- 30% smaller than previous-generation models
- Weighs 16 kg, 10% lighter

*: Minimum clearance requirement

Optimum airflow path and low noise operation

The stabilized airflow reduces the noise level significantly.

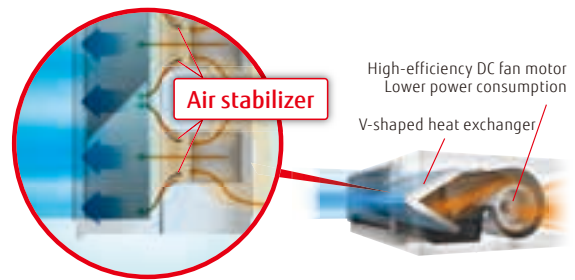

6-speed control*

Multistep airflow adjustment allows installation in a quiet location.

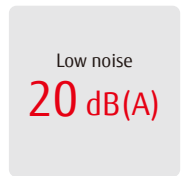

at 04 model

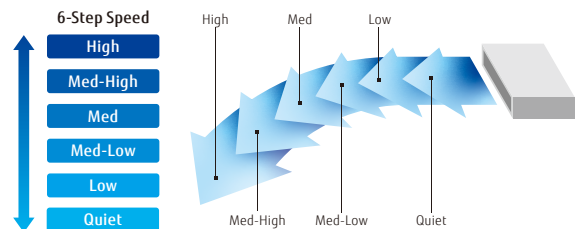

* Remote controller is compatible with the following:
UTY-RNRGZ5/UTY-RLRG/UTY-RSRG/UTY-RHRG/UTY-DCCGGZ2/UTY-ALGXZ1/UTY-APGXZ1

Easy to design and maintain for drain

Indoor unit design for easy maintenance Parts can be replaced from the side of the unit where maintenance is easier.

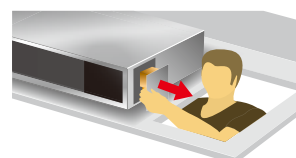

A drain pump is built into the unit as standard:
Parts can be accessed and replaced through the side of the unit for easy maintenance.

**Model: ARXK004GLGH / ARXK007GLGH / ARXK009GLGH
ARXK012GLGH / ARXK014GLGH / ARXK018GLGH
ARXK024GLGH**

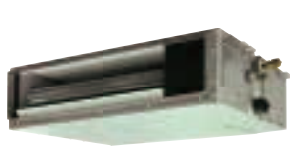

ARXK004/007/009/012/014GLGH

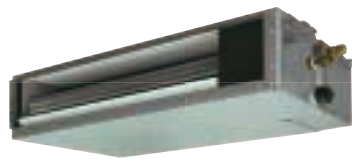

ARXK018GLGH



ARXK024GLGH

Specifications

Model name			ARXK004GLGH	ARXK007GLGH	ARXK009GLGH	ARXK012GLGH	ARXK014GLGH	ARXK018GLGH	ARXK024GLGH
Power source			Single phase, ~230 V, 50 Hz						
Capacity	Cooling	kW	1.1	2.2	2.8	3.6	4.5	5.6	7.1
	Heating		1.3	2.8	3.2	4.0	5.0	6.3	8.0
Input power			26	28	28	35	66	73	80
Airflow rate	High	m ³ /h	460	460	460	550	760	930	1,160
	Med-High		440	440	440	520	660	840	1,060
	Med		420	420	420	480	560	740	960
	Med-Low		400	400	400	450	490	640	860
	Low		370	370	370	410	410	540	750
	Quiet		340	340	340	340	340	470	610
Static pressure range			0 to 30	0 to 30	0 to 30	0 to 30	0 to 50	0 to 50	0 to 50
Standard static pressure			10	10	10	10	15	15	15
Sound pressure level	High	dB(A)	25	26	26	29	34	33	32
	Med-High		24	25	25	27	31	30	30
	Med		23	24	24	26	28	28	28
	Med-Low		22	23	23	25	26	26	27
	Low		21	22	22	24	24	24	25
Quiet	20	21	21	22	22	22	22		
Net Dimensions (H × W × D)			mm 198 × 700 × 450	198 × 700 × 450	198 × 700 × 450	198 × 700 × 450	198 × 700 × 450	198 × 900 × 450	198 × 1,100 × 450
Weight			kg 14.5	15.5	15.5	16	16	19	22.5
Connection pipe diameter	Liquid (Flare)	mm	6.35	6.35	6.35	6.35	6.35	6.35	9.52
	Gas (Flare)		9.52	9.52	9.52	12.70	12.70	12.70	15.88
Drain Hose Diameter (I.D./O.D.)			25/32						

Note: Specifications are subject to the following conditions:

Cooling: Indoor temperature of 27°CDB/19°CWB, and outdoor temperature of 35°CDB/24°CWB.

Heating: Indoor temperature of 20°CDB/15°CWB, and outdoor temperature of 7°CDB/6°CWB.

Pipe length: 7.5 m; Height difference between outdoor unit and indoor unit: 0 m. Voltage: 230 [V].

Optional parts

*For more details, please refer to the chapter "Optional parts".

Remote sensor unit: UTY-XSZXZ1

IR receiver unit: UTY-TRHX

Silver Ion Filter: UTD-HFTA (004-014)

UTD-HFTB (018)

UTD-HFTC (024)

External power supply unit: UTZ-GXXA, UTZ-GXXC*

Auto Louver Grille Kit: UTD-GXTA-W (004-014)

UTD-GXTB-W (018)

UTD-GXTC-W (024)

WLAN adapter:

FG-AC-WIF1Z1

UTY-TFSXJ3, UTY-TFSXZ1 (007-024)

Auto Louver Grille Kit (Optional)

The slim design of the unit provides comfortable cooling and heating air conditioning over a wide area.

The optional automatic louver grille, which fits nicely into any interior decor, provides comfortable air conditioning (Optional)



Dimensions

(Unit: mm)

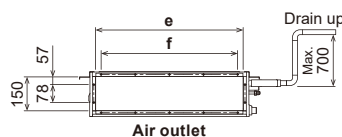
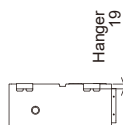
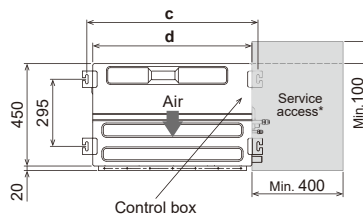
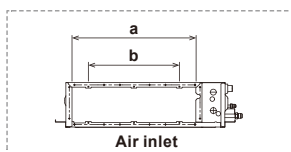

	ARXK 004-014GLGH	ARXK018GLGH	ARXK024GLGH
a	575	775	975
b	P200×2=400	P200×3=600	P200×4=800
c	752	952	1,152
d	700	900	1,100
e	650	850	1,050
f	P100×6=600	P100×8=800	P100×10=1,000

*The design of the service access depends on the installation method. Refer to the installation manual for more information.

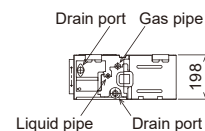

Low Static Pressure Duct Slim Duct/Slim Concealed Floor



Slim design

Slim design allows for installation in a tight ceiling space.

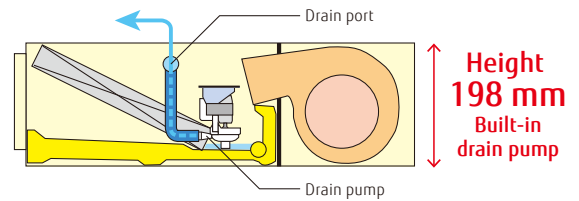

Air intake

Air intake direction can be selected to match the installation site.

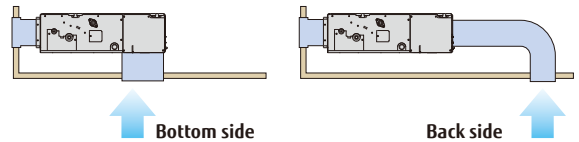

Flexible installation

Ceiling concealed

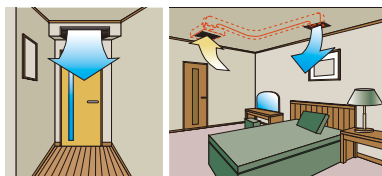

Floor concealed

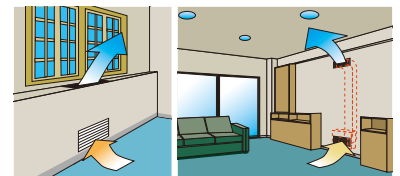

Wide range of static pressures

The use of a DC fan motor makes it possible to adjust the static pressure between 0 and 90 Pa. The static pressure range can be changed by a remote controller.



Static pressure range
0 to 90 Pa

*024 model static pressure range is 0 to 50 Pa.

Filter (Accessory)

ARXD04/007/009/012/014/018 ARXD024

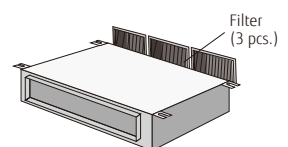
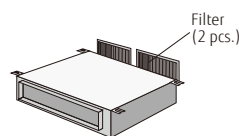

**Model: ARXD04GALH / ARXD007GLEH / ARXD009GLEH
ARXD012GLEH / ARXD014GLEH / ARXD018GLEH
ARXD024GLEH**



ARXD04GALH
ARXD007/009/012/014GLEH



ARXD018GLEH



ARXD024GLEH

Slim
Concealed
Floor



Specifications

Model name			ARXD04GALH*	ARXD007GLEH	ARXD009GLEH	ARXD012GLEH	ARXD014GLEH	ARXD018GLEH	ARXD024GLEH	
Power source			Single phase, ~230 V, 50 Hz							
Capacity	Cooling	kW	1.1	2.2	2.8	3.6	4.5	5.6	7.1	
	Heating		1.3	2.8	3.2	4.0	5.0	6.3	8.0	
Input power			W	40	44	50	54	92	83	122
Airflow rate	High	m ³ /h	510	550	600	600	800	940	1,330	
	Med-High		-	480	510	530	680	820	1,140	
	Med		400/470* ¹	440	460	490	600	730	1,020	
	Med-Low		-	410	420	450	520	630	900	
	Low		320/440* ¹	370	370	410	440	540	780	
	Quiet		-	320	320	340	340	470	610	
Static pressure range			Pa	0 to 90	0 to 90	0 to 90	0 to 90	0 to 90	0 to 50	
Standard static pressure				25	25	25	25	25	25	
Sound pressure level	High	dB(A)	26	28	29	30	34	34	35	
	Med-High		-	26	27	28	32	31	31	
	Med		21/25* ¹	25	25	27	30	29	29	
	Med-Low		-	24	24	26	28	27	27	
	Low		20/22* ¹	22	22	24	25	25	24	
	Quiet		-	21	21	22	22	23	21	
Net Dimensions (H × W × D)			mm	198 × 700 × 620	198 × 700 × 620	198 × 700 × 620	198 × 700 × 620	198 × 700 × 620	198 × 700 × 620	198 × 1,100 × 620
Weight			kg	17	17	17	18	18	22	26
Connection pipe diameter	Liquid (Flare)	mm	6.35	6.35	6.35	6.35	6.35	6.35	6.35	9.52
	Gas (Flare)		12.70	9.52	9.52	12.70	12.70	12.70	15.88	
Drain Hose Diameter (I.D./O.D.)						25/32				

Note: Specifications are subject to the following conditions:

Cooling: Indoor temperature of 27°CDB/19°CWB, and outdoor temperature of 35°CDB/24°CWB.

Heating: Indoor temperature of 20°CDB/15°CWB, and outdoor temperature of 7°CDB/6°CWB.

Pipe length: 7.5 m; Height difference between outdoor unit and indoor unit: 0 m. Voltage: 230 [V].

*1: This value is under cooling operation.

*: ARXD04GALH cannot be connected to J-IVS/J-IVJ-IVL/VR-IV Series.

Optional parts

*For more details, please refer to the chapter "Optional parts".

Remote sensor unit: UTY-XSZZ1

IR receiver unit: UTB-YWC (04)

UTY-TRHX (007-024)

WLAN adapter: UTY-TFSXJ3 (007-024)

UTY-TFSXZ1 (007-024)

FG-RC-WIF1Z2 (04)

FG-AC-WIF1Z1 (007-024)

External power supply unit: UTZ-GXXA, UTZ-GXXC*

Auto Louver Grille Kit: UTD-GXTA-W (04, 007-014)

UTD-GXTB-W (018)

UTD-GXTC-W (024)

Silver Ion Filter: UTD-HFTA (04, 007-014)

UTD-HFTB (018)

UTD-HFTC (024)

Drain hose provided as an accessory.

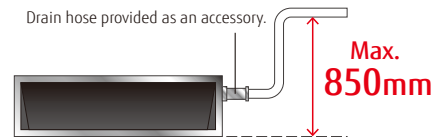

Dimensions

(Unit: mm)

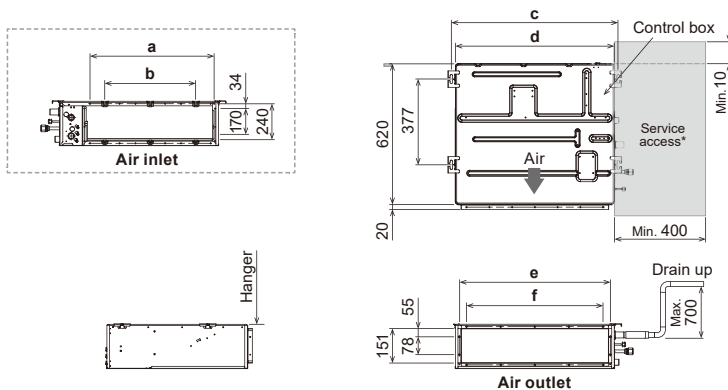

	ARXD04GALH ARXD007-014GLEH	ARXD018GLEH	ARXD024GLEH
a	574	774	974
b	P200×2=400	P200×3=600	P200×4=800
c	734	934	1,134
d	700	900	1,100
e	650	850	1,050
f	P100×6=600	P100×8=800	P100×10=1,000

*The design of the service access depends on the installation method. Refer to the installation manual for more information.

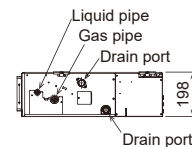

Low Static Pressure Duct

High Efficiency



Slim & Compact design

The slim and compact design of the indoor unit, with the control box mounted on the side, allows installation in narrow spaces.

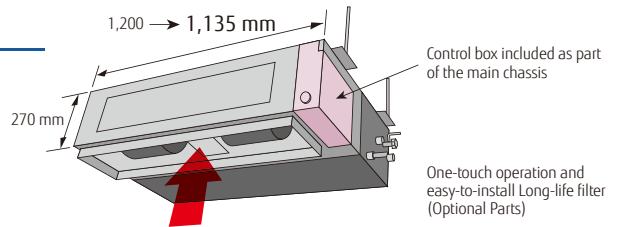

Easy maintenance

Structural improvement has been developed by making the bottom panel in two pieces, front and rear. The internal fan casing is also manufactured in two pieces—upper and lower. The motor and fan can be easily accessed and maintained by removing the rear panel and the lower casing with the main chassis remaining in place.

See below for rear-suction type

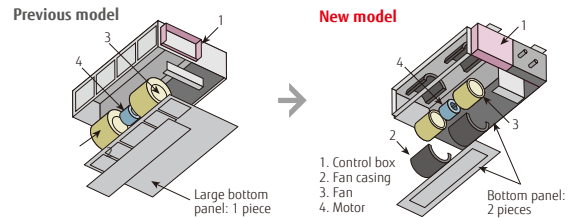

Installation styles

Embedded in Ceiling

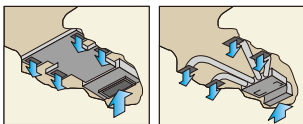

Hanging from Ceiling

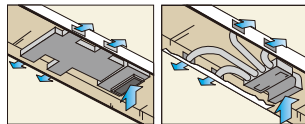

A drain pipe can be installed on either the left or right side of the unit

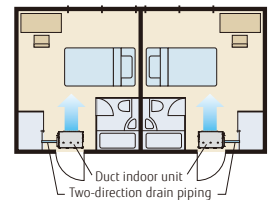

High-efficiency DC fan motor achieves low-energy consumption.

Improved motor efficiency from previous model.



Wide range of static pressures

Static pressures can be changed in the range of 0 to 150 Pa.

Static pressure range
0 to 80 Pa



Specifications

Model name			ARXP018GLFH	ARXP030GLFH
Power source			Single-phase, ~220V, 50Hz	
Capacity	Cooling	kW	5.6	9.0
	Heating		6.3	10.0
Input power		W	128	228
Airflow rate	High	m³/h	1,540 / 1,440	1,940 / 1,660
	Med-High		1,460 / 1,380	1,810 / 1,580
	Med		1,380 / 1,320	1,680 / 1,510
	Med-Low		1,300 / 1,260	1,550 / 1,440
	Low		1,220 / 1,200	1,420 / 1,370
	Quiet		1,150 / 1,150	1,300 / 1,300
Static pressure range		Pa	0 to 80	0 to 80
Standard static pressure			40	50
Sound pressure level	High	dB(A)	35 / 34	39 / 36
	Med-High		34 / 32	38 / 35
	Med		32 / 31	36 / 34
	Med-Low		31 / 30	34 / 33
	Low		29 / 29	32 / 31
	Quiet		28 / 28	30 / 30
Net Dimensions (H × W × D)		mm	270 × 1,135 × 700	270 × 1,135 × 700
Weight		kg	40	40
Connection pipe diameter	Liquid (Flare)	mm	6.35	9.52
	Gas (Flare)		12.70	15.88
Drain Hose Diameter (I.D./O.D.)			25/32	

Note: Specifications are subject to the following conditions:
 Cooling: Indoor temperature of 27°CDB/19°CWB, and outdoor temperature of 35°CDB/24°CWB.
 Heating: Indoor temperature of 20°CDB/(15°CWB), and outdoor temperature of 7°CDB/6°CWB.
 Pipe length: 7.5 m; Height difference between outdoor unit and indoor unit: 0 m. Voltage: 230 [V].

Optional parts

*For more details, please refer to the chapter "Optional parts".

- | | | | |
|-----------------------------|---------------------|--------------------|--------------------------------------|
| Long-life filter: | UTD-LF25NA | IR receiver unit: | UTY-TRHX |
| Flange (square): | UTD-SF045T | Drain pump unit: | UTZ-PX1NBA |
| Flange (round): | UTD-RF204 | WLAN adapter: | UTY-TFSXZ1, UTY-TFSXJ3, FG-AC-WIF1Z1 |
| External power supply unit: | UTZ-GXXA, UTZ-GXXC* | Silver Ion Filter: | UTD-HFND |
| Remote sensor unit: | UTY-XSZXZ1 | | |

Dimensions

(Unit: mm)

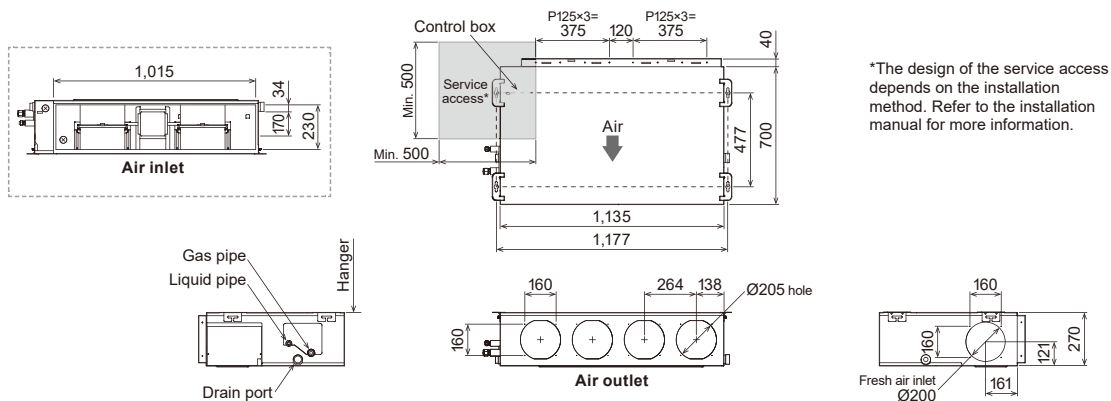

*The design of the service access depends on the installation method. Refer to the installation manual for more information.

Medium Static Pressure Duct

Normal



Slim & Compact design

The slim and compact design of the indoor unit, with the control box mounted on the side, allows installation in narrow spaces.

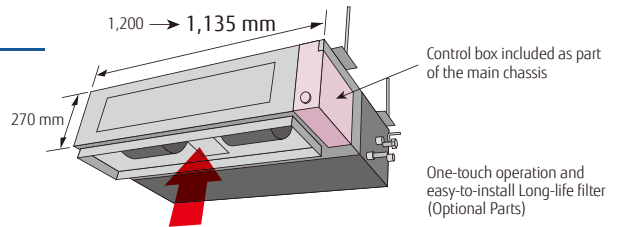

Easy maintenance

Structural improvement has been developed by making the bottom panel in two pieces, front and rear. The internal fan casing is also manufactured in two pieces—upper and lower. The motor and fan can be easily accessed and maintained by removing the rear panel and the lower casing with the main chassis remaining in place.

See below for rear-suction type

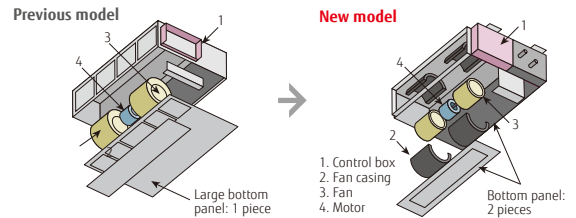

Installation styles

Embedded in Ceiling

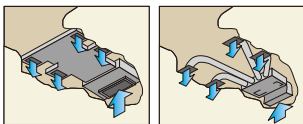

Hanging from Ceiling

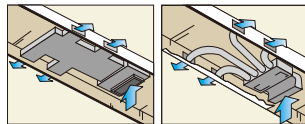

A drain pipe can be installed on either the left or right side of the unit

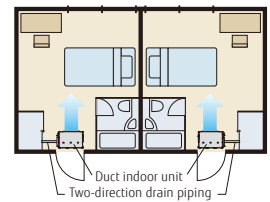

High-efficiency DC fan motor achieves low-energy consumption.

Improved motor efficiency from previous model.



Wide range of static pressures

Static pressures can be changed in the range of 0 to 150 Pa.

Static pressure range
0 to 150 Pa



Specifications

Model name		ARXA024GLEH	ARXA030GLEH	ARXA036GLEH	ARXA045GLEH
Power source		Single phase, ~230 V, 50 Hz			
Capacity	Cooling	7.1	9.0	11.2	12.5
	Heating	8.0	10.0	12.5	14.0
Input power	W	94	108	194	240
Airflow rate	High	1,280	1,410	1,840	1,970
	Med-High	1,180	1,350	1,750	1,910
	Med	1,090	1,280	1,660	1,860
	Med-Low	1,000	1,240	1,600	1,780
	Low	920	1,190	1,530	1,710
	Quiet	840	1,150	1,470	1,640
Static pressure range	Pa	0 to 150	0 to 150	0 to 150	0 to 150
Standard static pressure		40	50	50	60
Sound pressure level	High	31	34	37	41
	Med-High	29	33	36	40
	Med	27	32	35	38
	Med-Low	26	31	35	38
	Low	24	30	34	37
	Quiet	23	29	33	36
Net Dimensions (H × W × D)	mm	270 × 1,135 × 700	270 × 1,135 × 700	270 × 1,135 × 700	270 × 1,135 × 700
Weight	kg	36	40	40	40
Connection pipe diameter	Liquid (Flare)	9.52	9.52	9.52	9.52
	Gas (Flare)	15.88	15.88	15.88	15.88
Drain Hose Diameter (I.D./O.D.)		25/32			

Note: Specifications are subject to the following conditions:
 Cooling: Indoor temperature of 27°CDB/19°CWB, and outdoor temperature of 35°CDB/24°CWB.
 Heating: Indoor temperature of 20°CDB/(15°CWB), and outdoor temperature of 7°CDB/6°CWB.
 Pipe length: 7.5 m; Height difference between outdoor unit and indoor unit: 0 m. Voltage: 230 [V].

Optional parts

*For more details, please refer to the chapter "Optional parts".

- Long-life filter: UTD-LF25NA
- Flange (square): UTD-SF045T
- Flange (round): UTD-RF204
- External power supply unit: UTZ-GXXA, UTZ-GXXC*
- Remote sensor unit: UTY-XSZXZ1
- IR receiver unit: UTY-TRHX
- Drain pump unit: UTZ-PX1NBA
- WLAN adapter: UTY-TFSXZ1, UTY-TFSXJ3, FG-AC-WIF1Z1
- Silver Ion Filter: UTD-HFND

Dimensions

(Unit: mm)

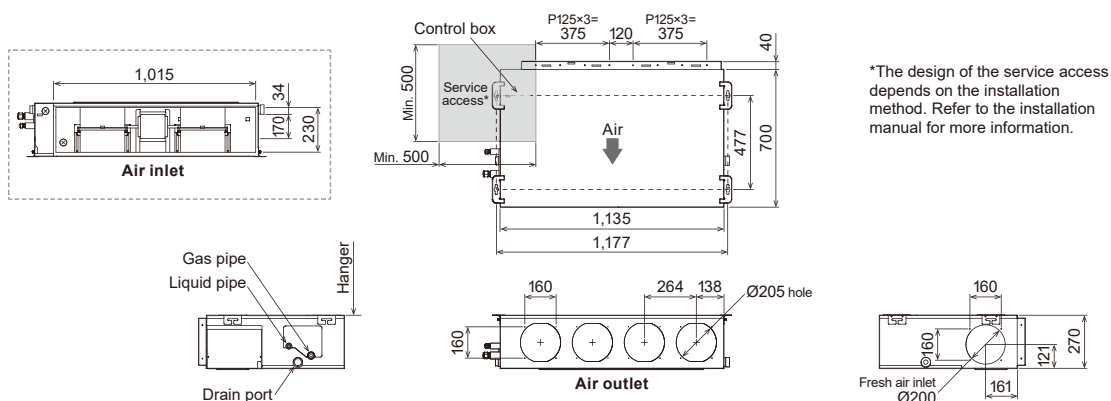

*The design of the service access depends on the installation method. Refer to the installation manual for more information.

High Static Pressure Duct

Normal



Static pressure mode selection

The use of a DC fan motor makes it possible to adjust the static pressure between 0 to 200 Pa (ARXC036) / 250Pa (ARXC045/060) / 300 Pa (ARXC072/090/096)

MAX. 200 Pa (036type) MAX. 250 Pa (045/060type)



(ARXC036/045/060 type)

MAX. 300 Pa



(ARXC072/090 type)

MAX. 300 Pa



(ARXC096 type)

Easy installation (Compact & Lightweight)

The indoor unit is designed to be compact and light by reducing the basic chassis size and the overall material weight.

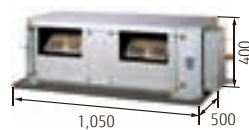

(ARXC036/045/060 type)



(ARXC072/090 type)



(ARXC096 type)

(Unit: mm)

Low noise

Models: ARXC036/ARXC045/ARXC060

The corners of the front panel and fan casing of the indoor unit are shaved to reduce air turbulence. The use of a plastic case and fan reduces the noise level generated by the unit.

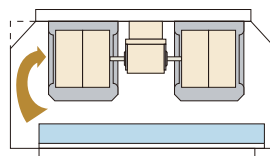

ARXC036GTEH:

Plastic fan [42 dB(A)]

* Model: Material
(Actual noise measurement value measured at 100 Pa)

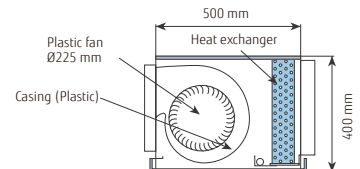

High-efficiency DC fan motor achieves low energy consumption.

Improved motor efficiency compared to the previous model



(ARXC036/045/060 type)



(ARXC072/090/096 type)

**Model: ARXC036GTEH / ARXC045GTEH / ARXC060GTEH
ARXC072GTEH / ARXC090GTEH / ARXC096GTEH**



ARXC036/045/060GTEH



ARXC072/090GTEH



ARXC096GTEH

Specifications

Model name			ARXC036GTEH	ARXC045GTEH	ARXC060GTEH*	ARXC072GTEH*	ARXC090GTEH*	ARXC096GTEH*
Power source			Single phase, ~230 V, 50 Hz					
Capacity	Cooling	kW	11.2	12.5	18.0	22.4	25.0	28.0
	Heating		12.5	14.0	20.0	25.0	28.0	31.5
Input power		W	207	715	730	681	819	838
Air flow rate	High	m ³ /h	1,990	3,500	3,500	3,900	4,300	4,850
	Med		1,680	3,000	3,000	3,300	4,000	4,250
	Low		1,330	2,460	2,460	3,000	3,500	3,600
Static pressure range		Pa	0 to 200	100 to 250	100 to 250	0 to 300	0 to 300	0 to 300
Standard static pressure			100	100	100	150	150	150
Sound pressure level	High	dB(A)	42	49	49	47	48	48
	Med		36	45	45	43	46	45
	Low		32	42	42	40	44	42
Net Dimensions (H × W × D)		mm	400 × 1,050 × 500	400 × 1,050 × 500	400 × 1,050 × 500	450 × 1,587 × 700	450 × 1,587 × 700	550 × 1,587 × 700
Weight		kg	40	46	46	84	84	105
Connection pipe diameter	Liquid	mm	9.52 (Flare)	9.52 (Flare)	9.52 (Flare)	9.52 (Flare)	9.52 (Flare)	9.52 (Brazing)
	Gas		15.88 (Flare)	15.88 (Flare)	15.88 (Flare)	19.05 (Flare)	19.05 (Flare)	22.22 (Brazing)
Drain Hose Diameter (I.D./O.D.)			25/32					

Note: Specifications are based on the following conditions:
Cooling: Indoor temperature of 27°CDB/19°CWB, and outdoor temperature of 35°CDB/24°CWB.
Heating: Indoor temperature of 20°CDB/15°CWB, and outdoor temperature of 7°CDB/6°CWB.
Pipe length: 7.5 m; Height difference between outdoor unit and indoor unit: 0 m. Voltage: 230 [V]
*: ARXC060/072/090/096G cannot be connected to J-IVJ-IVS Series.

Optional parts

*For more details, please refer to the chapter "Optional parts".

Long-life filter:	UTD-LF60KA (036/045/060)	WLAN adapter:	UTY-TFSXZ1, UTY-TFSXJ3, FG-AC-WIF1Z1
IR receiver unit:	UTY-TRHX	Silver Ion Filter:	UTD-HFKB (036/045/060)
External power supply unit:	UTZ-GXXA, UTZ-GXXC*	Remote sensor unit:	UTY-XSXXZ1

Dimensions

(Unit: mm)

Models: ARXC036/ARXC045/ARXC060

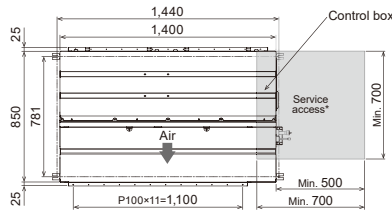
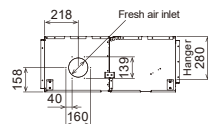
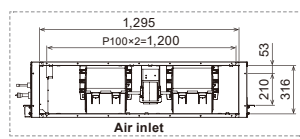

*The design of the service access depends on the installation method. Refer to the installation manual for more information.

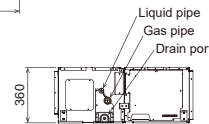

Models: ARXC072/ARXC090/ARXC096

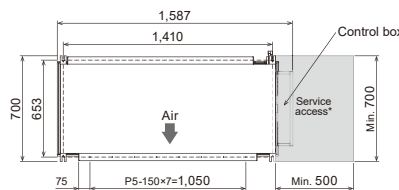
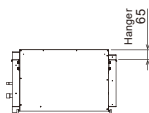
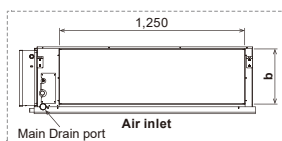

	ARXC072 / 090 GTEH	ARXC096 GTEH
a	450	550
b	370	470

*The design of the service access depends on the installation method. Refer to the installation manual for more information.

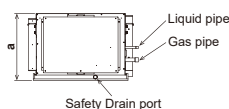
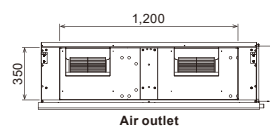

Compact floor



2-fan and wide airflow

A 2-fan individual vertical airflow cools or warms the entire room comfortably.

Cooling

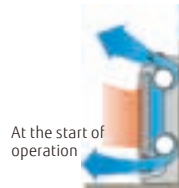

Prevents cold air from falling

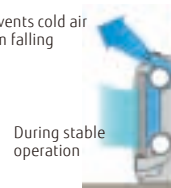

Heating

Prevents cold drafts from windows

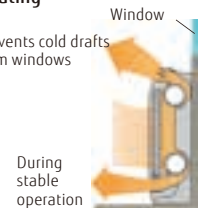

Flexible and easy installation

The compact and whole-surface suction design provides flexible installation options, including floor-standing, embedded, partially embedded, and wall-mounted installation to match the room layout.

Beneath standard window

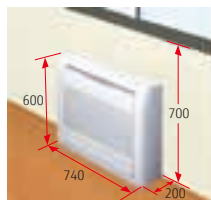

Concealed within wall

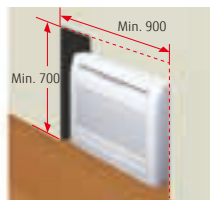

Wall

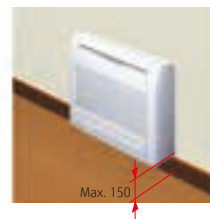

Half concealed (Optional parts necessary)

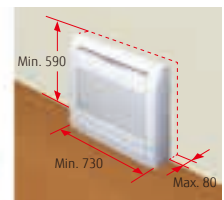

(Unit: mm)

Quiet operation

6-fan speed control for quiet operation (via 2-wire controller)

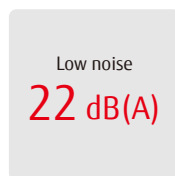

004/007/009 models

6-Step Speed

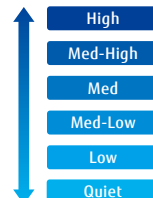

* Remote controller is compatible with the following:
UTY-RNRGZ5 / UTY-RLRG / UTY-RSRG / UTY-RHRG / UTY-DCGGZ3 / UTY-ALGXZ1 / UTY-APGXZ1

Flexible pipe connection enables draining and piping in 6 directions

The drain hose and pipe can be connected to the unit in the right, left, straight in depth, or downward direction.

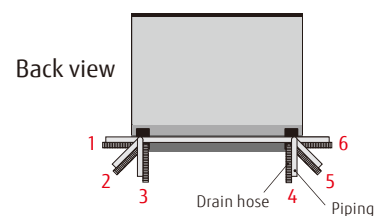

**Model: AGHA004GCGH / AGHA007GCGH / AGHA009GCGH
AGHA012GCGH / AGHA014GCGH**

**[external EEV]
AGHE004GCEH / AGHE007GCEH / AGHE009GCEH
AGHE012GCEH / AGHE014GCEH**



Specifications

Model name			AGHA004GCGH	AGHA007GCGH	AGHA009GCGH	AGHA012GCGH	AGHA014GCGH	AGHE004GCEH	AGHE007GCEH	AGHE009GCEH	AGHE012GCEH	AGHE014GCEH
Power source			Single phase, ~230 V, 50 Hz					Single phase, ~230 V, 50 Hz				
Capacity	Cooling	kW	1.1	2.2	2.8	3.6	4.0	1.1	2.2	2.8	3.6	4.0
	Heating		1.3	2.8	3.2	4.0	4.5	1.3	2.8	3.2	4.0	4.5
Input power			W					W				
			12/14	16	17	22	29	14	16	17	22	29
Airflow rate	High	m ³ /h	380/430	470	500	590	670	380/430	470	500	590	670
	Med-High		350	420	450	520	590	350	420	450	520	590
	Med		320	390	400	470	520	320	390	400	470	520
	Med-Low		310	360	360	420	450	310	360	360	420	450
	Low		280	330	330	390	390	280	330	330	390	390
	Quiet		210	270	270	340	340	210	270	270	340	340
Sound pressure level	High	dB(A)	35/36	37	38	42	46	35/36	37	38	42	46
	Med-High		33	35	36	39	42	33	35	36	39	42
	Med		31	33	34	37	39	31	33	34	37	39
	Med-Low		30	31	31	35	36	30	31	31	35	36
	Low		28	29	29	33	33	28	29	29	33	33
	Quiet		22	22	22	30	30	22	22	22	30	30
Net Dimensions (H × W × D)			mm					mm				
			600 × 740 × 200					600 × 740 × 200				
Weight			kg					kg				
			15.0					14.5				
Connection pipe diameter	Liquid (Flare)	mm	6.35	6.35	6.35	6.35	6.35	6.35	6.35	6.35	6.35	6.35
	Gas (Flare)		9.52	9.52	9.52	12.70	12.70	9.52	9.52	9.52	12.70	12.70
Drain Hose Diameter (I.D./O.D.)			13.8/15.8 to16.7					13.8/15.8 to16.7				
EV kit (optional)								UTR-EV09XB		UTR-EV14XB		

Note: Specifications are subject to the following conditions:

Cooling: Indoor temperature of 27°CDB/19°CWB, and outdoor temperature of 35°CDB/24°CWB.

Heating: Indoor temperature of 20°CDB/(15°CWB), and outdoor temperature of 7°CDB/6°CWB.

Pipe length: 7.5 m; Height difference between outdoor unit and indoor unit: 0 m. Voltage: 230 [V]

When connecting AGHA004/007/009GCGH, AGHE004/007/009GCEH to an outdoor unit other than an outdoor unit of the J-IVL Series, the gas pipe diameter should be Ø12.70 mm.

Optional parts

*For more details, please refer to the chapter "Optional parts".

Partially concealing kit: UTR-STA
 External power supply unit: UTZ-GXXA, UTZ-GXXC*
 WLAN adapter: UTY-TFSXZ1, UTY-TFSXJ3, FG-AC-WIF1Z1
 Silver Ion Filter: UTR-FA03-5

Dimensions

(Unit: mm)

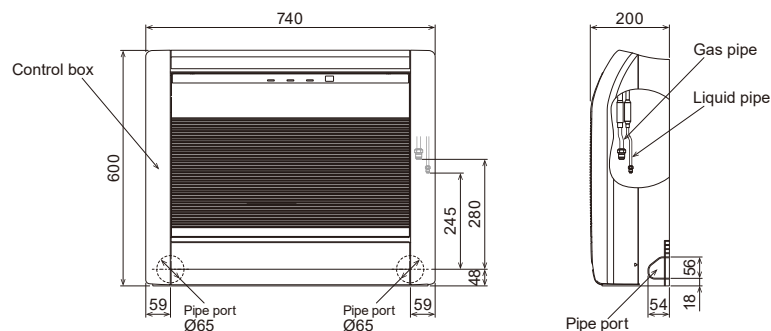

Floor/Ceiling



Flexible installation

Example of floor standing installation

Floor standing console with the back against the wall



Example of ceiling installation

Under ceiling



Double auto swing

The combination of horizontal and vertical swings enables 3-dimensional control of the airflow direction.

RIGHT and LEFT SWING

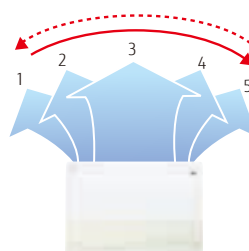

UP and DOWN SWING

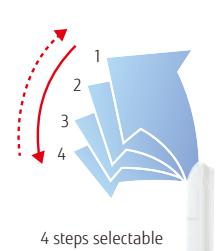

High-power DC fan motor

- High power
- Wide rotation range
- High-efficiency



Compact design

Symmetrical, slim and compact design.

(Unit: mm)

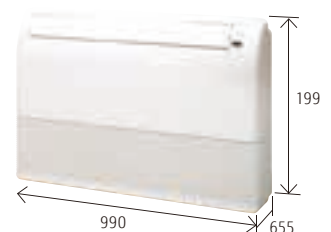

Model: ABHA012GTEH / ABHA014GTEH / ABHA018GTEH / ABHA024GTEH



Floor standing



Specifications

Model name		ABHA012GTEH	ABHA014GTEH	ABHA018GTEH	ABHA024GTEH	
Power source		Single phase, ~230 V, 50 Hz				
Capacity	Cooling	3.6	4.5	5.6	7.1	
	Heating	4.0	5.0	6.3	8.0	
Input power		30	42	74	99	
Airflow rate	High	660	780	1,000	1,000	
	Med-High	620	740	910	930	
	Med	580	690	830	870	
	Med-Low	550	640	750	800	
	Low	520	600	660	740	
	Quiet	490	550	580	680	
Sound pressure level	High	36	40	46	47	
	Med-High	34	39	44	45	
	Med	33	38	42	43	
	Med-Low	31	36	40	41	
	Low	29	35	37	39	
	Quiet	28	34	35	37	
Net Dimensions (H × W × D)		mm	199 × 990 × 655	199 × 990 × 655	199 × 990 × 655	199 × 990 × 655
Weight		kg	25	26	26	27
Connection pipe diameter	Liquid (Flare)	mm	6.35	6.35	6.35	9.52
	Gas (Flare)	mm	12.70	12.70	12.70	15.88
Drain Hose Diameter (I.D./O.D.)			25/32			

Note: Specifications are subject to the following conditions:

Cooling: Indoor temperature of 27°CDB/19°CWB, and outdoor temperature of 35°CDB/24°CWB.

Heating: Indoor temperature of 20°CDB/15°CWB, and outdoor temperature of 7°CDB/6°CWB.

Pipe length: 7.5 m; Height difference between outdoor unit and indoor unit: 0 m. Voltage: 230 [V]

Optional parts

*For more details, please refer to the chapter "Optional parts".

External power supply unit: UTZ-GXXA, UTZ-GXXC*

WLAN adapter: UTY-TFSXZ1, UTY-TFSXJ3, FG-AC-WIF1Z1

Dimensions

(Unit: mm)

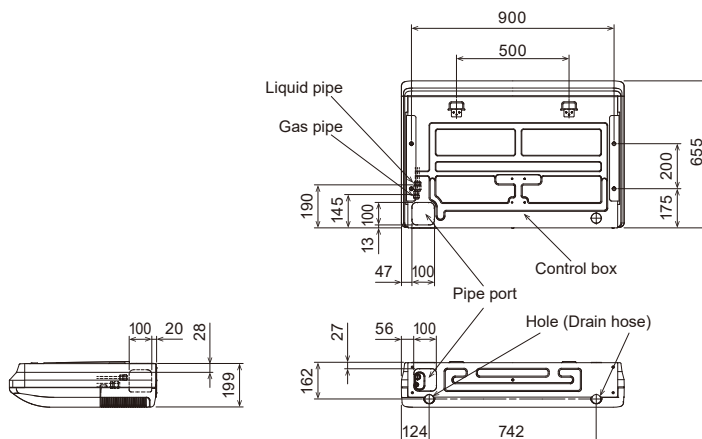

Ceiling



Installation

Open

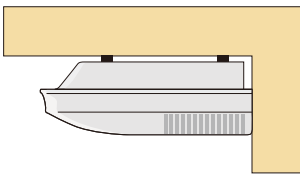

General installation with indoor unit installed on the ceiling

Concealed

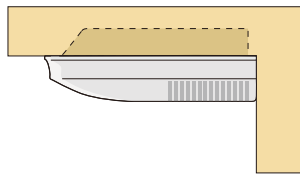

Installation with indoor unit embedded into the ceiling

Wall-mounted type (Locally Available)

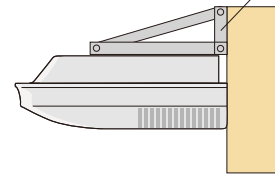

Wall-mounting brackets are used to mount the indoor unit on the wall. (Locally available) This type of installation is used when the ceiling space is insufficient.

Double auto swing and wide airflow

Auto airflow direction and auto swing

Left/Right

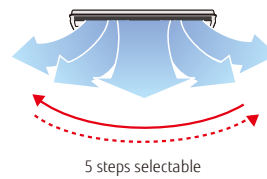

Up/Down

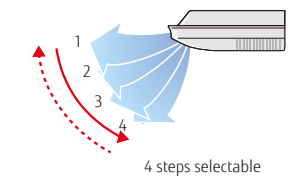

High-power DC fan motor

- High power
- Wide rotation range
- High-efficiency



Long airflow

Long airflow provides comfort in every corner of a large room.

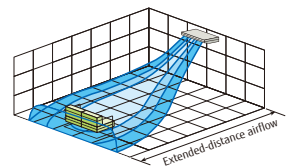

Fresh air intake

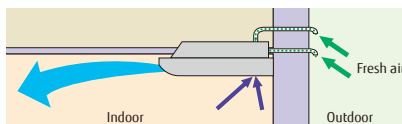

Slim & Compact design

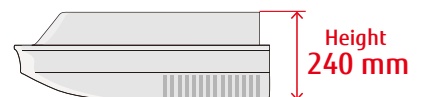



Specifications

Model name		ABHA030GTEH	ABHA036GTEH	ABHA045GTEH	ABHA054GTEH	
Power source		Single phase, ~230 V, 50 Hz				
Capacity	Cooling	9.0	11.2	12.5	14.0	
	Heating	10.0	12.5	14.0	16.0	
Input power		66	85	131	180	
Airflow rate	High	1,630	1,690	2,010	2,270	
	Med-High	1,520	1,560	1,840	2,070	
	Med	1,420	1,450	1,690	1,860	
	Med-Low	1,320	1,360	1,530	1,660	
	Low	1,220	1,270	1,380	1,470	
	Quiet	1,140	1,170	1,230	1,280	
Sound pressure level	High	42	45	48	51	
	Med-High	40	41	46	49	
	Med	39	39	45	46	
	Med-Low	37	38	41	43	
	Low	35	36	38	40	
	Quiet	33	34	35	36	
Net Dimensions (H × W × D)		mm	240 × 1,660 × 700	240 × 1,660 × 700	240 × 1,660 × 700	240 × 1,660 × 700
Weight		kg	46	48	48	48
Connection pipe diameter	Liquid (Flare)	mm	9.52	9.52	9.52	9.52
	Gas (Flare)	mm	15.88	15.88	15.88	15.88
Drain Hose Diameter (I.D./O.D.)			25/32			

Note: Specifications are subject to the following conditions:
 Cooling: Indoor temperature of 27°CDB/19°CWB, and outdoor temperature of 35°CDB/24°CWB.
 Heating: Indoor temperature of 20°CDB/15°CWB, and outdoor temperature of 7°CDB/6°CWB.
 Pipe length: 7.5 m; Height difference between outdoor unit and indoor unit: 0 m. Voltage: 230 [V]

Optional parts *For more details, please refer to the chapter "Optional parts".

- Drain pump unit: UTR-DPB24T
- Flange: UTD-RF204
- External power supply unit: UTZ-GXXA, UTZ-GXXC*
- WLAN adapter: UTY-TFSXZ1, UTY-TFSXJ3, FG-AC-WIF1Z1

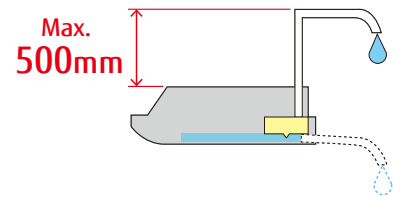

Dimensions

(Unit: mm)

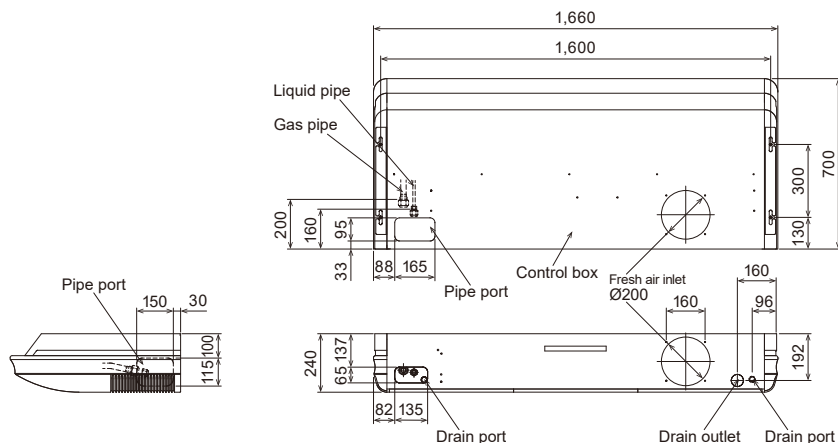

Wall-mounted type



Highly-efficiency, compact design

The 004-014 models share the same design. The high-density and large heat exchanger achieves a highly-efficiency and compact design. The compact body blends in well with conference rooms and offices, providing comfortable air conditioning.

High-density heat exchanger



Slim tube design: 5 mm

Greater heat-exchanging capacity is achieved through the use of a high-density heat exchanger and a sub-heat exchanger.

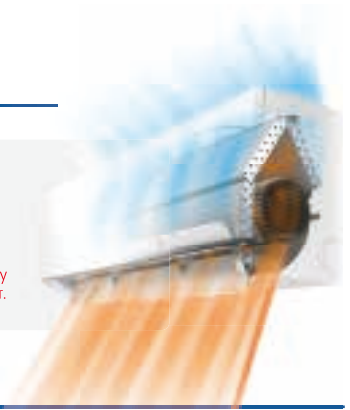

More comfortable airflow

The unique power diffuser provides comfortable air conditioning.

Heating

The vertical airflow provides powerful floor-level heating.



Cooling

The left/right airflow avoids blowing cool air directly at the occupants in a room.



Quiet operation & 6-Step fan speed control

The airflow pattern achieves significant noise reduction. Multistep airflow adjustment to suit the environment

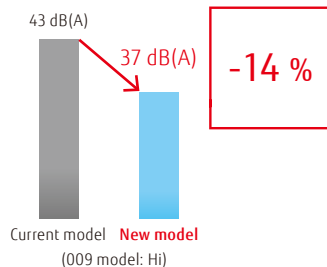

- 6-Step Speed
- High
- Med-High
- Med
- Med-Low
- Low
- Quiet



* Remote controller is compatible with the following: UTY-RNRGZ5 / UTY-RLRG / UTY-RSRG / UTY-RHRG / UTY-DCCGZ3 / UTY-ALGXZ1 / UTY-APGXZ1

The Human sensor contributes to further energy savings.

Energy saving operation starts automatically by detecting the motion of a person. Two modes of save operation mode and stop mode can be selected.

*If you want to use the Human sensor control' function, you need an setting device that can set the Human sensor control' function. For example: Wired RC (Touch panel).

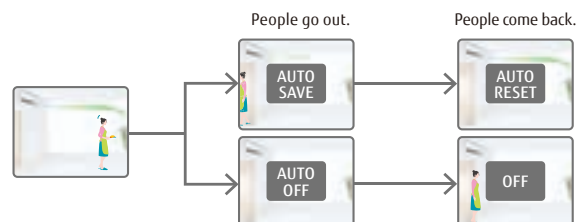

**Model: ASHA004GCGH / ASHA007GCGH / ASHA009GCGH
ASHA012GCGH / ASHA014GCGH**

**[external EEV]
ASHE004GCEH / ASHE007GCEH / ASHE009GCEH
ASHE012GCEH / ASHE014GCEH**



Specifications

Model name			ASHA004GCGH	ASHA007GCGH	ASHA009GCGH	ASHA012GCGH	ASHA014GCGH	ASHE004GCEH	ASHE007GCEH	ASHE009GCEH	ASHE012GCEH	ASHE014GCEH
Power source			Single phase, ~230 V, 50 Hz					Single phase, ~230 V, 50 Hz				
Capacity	Cooling	kW	1.1	2.2	2.8	3.6	4.0	1.1	2.2	2.8	3.6	4.0
	Heating		1.3	2.8	3.2	4.0	4.5	1.3	2.8	3.2	4.0	4.5
Input power		W	12	19	20	25	36	12	19	34	25	36
Airflow rate	High	m ³ /h	450	550	610	690	800	450	550	610	690	800
	Med-High		430	510	560	610	740	430	510	560	610	740
	Med		400	470	510	560	680	400	470	510	560	680
	Med-Low		380	410	440	530	610	380	410	440	530	610
	Low		360	360	360	470	550	360	360	360	470	550
	Quiet		310	310	310	330	330	310	310	310	330	330
Sound pressure level	High	dB(A)	31	34	37	40	44	31	35	43	40	44
	Med-High		30	32	35	37	42	30	32	38	37	42
	Med		28	30	32	35	40	28	30	34	35	40
	Med-Low		27	28	29	33	37	27	27	29	33	37
	Low		26	26	26	30	34	26	24	24	30	34
	Quiet		22	22	22	24	24	22	22	22	24	24
Net Dimensions (H × W × D)		mm	268 × 840 × 203					268 × 840 × 203				
Weight		kg	8.0	8.5	8.5	8.5	8.5	8.0	8.5	8.5	8.5	8.5
Connection pipe diameter	Liquid (Flare)	mm	6.35	6.35	6.35	6.35	6.35	6.35	6.35	6.35	6.35	6.35
	Gas (Flare)		9.52	9.52	9.52	12.70	12.70	9.52	9.52	9.52	12.70	12.70
Drain Hose Diameter (I.D./O.D.)			13.8/15.8 to16.7					13.8/15.8 to16.7				
EV kit (optional)			-					UTR-EV09XB		UTR-EV14XB		

Note: Specifications are subject to the following conditions:

Cooling: Indoor temperature of 27°CDB/19°CWB, and outdoor temperature of 35°CDB/24°CWB.

Heating: Indoor temperature of 20°CDB/(15°CWB), and outdoor temperature of 7°CDB/6°CWB.

Pipe length: 7.5 m; Height difference between outdoor unit and indoor unit: 0 m. Voltage: 230 [V]

When connecting ASH*004G**H, ASH*007G**H, ASH*009G**H to an outdoor unit other than the outdoor unit of the J-IVL Series, the gas pipe diameter should be Ø12.70 mm.

Optional parts *For more details, please refer to the chapter "Optional parts".

External power supply unit: UTZ-GXXA, UTZ-GXXC*

WLAN adapter: UTY-TFSXZ1, UTY-TFSXJ3, FG-AC-WIF1Z1

Silver Ion Filter: UTR-FA16-5

Remote sensor kit: UTY-XSZXZ1

Dimensions

(Unit: mm)

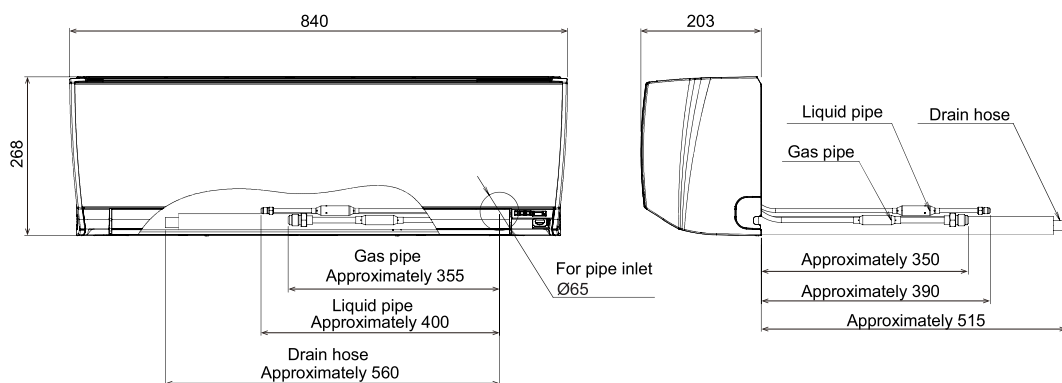

Wall-mounted type



Powerful & Comfort airflow

Powerful Airflow

(ASHA030GTEH)

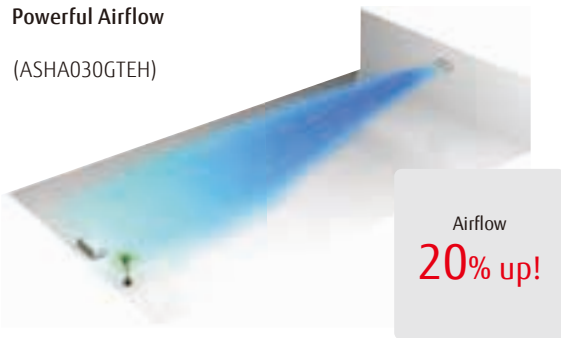

Power diffuser

(ASHA18/24GBCH)

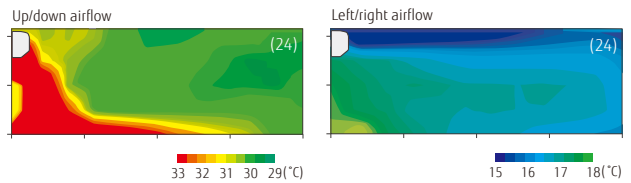

The Human sensor contributes to further energy savings. (ASHA030/034GTEH only)

Energy saving operation starts automatically by detecting the motion of a person. Two modes of save operation mode and stop mode can be selected.

*If you want to use the Human sensor control function, you need an setting device that can set the Human sensor control function. For example: Wired RC (Touch panel).

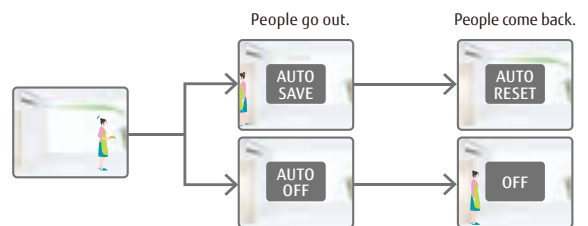

6-step fan speed control for quiet operation

The airflow pattern achieves significant noise reduction. A 6-step sound level setting allows for multiple-step silent operations.

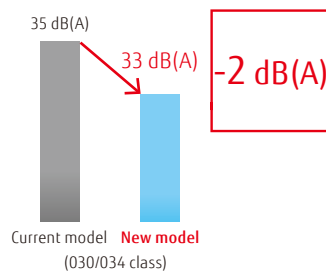

- 6-Step Speed
- High
 - Med-High
 - Med
 - Med-Low
 - Low
 - Quiet



* Remote controller is compatible with the following:
 UTY-RNRGZ5 / UTY-RLRG / UTY-RSRG / UTY-RHRG / UTY-DCCGZ3 / UTY-ALGXZ1 / UTY-APGXZ1

Model: ASHA18GBCH / ASHA24GBCH
ASHA030GTEH / ASHA034GTEH



ASHA18/24GBCH



ASHA030/034GTEH

Specifications

Model name			ASHA18GBCH	ASHA24GBCH	ASHA030GTEH	ASHA034GTEH
Power source			Single phase, ~230 V, 50 Hz			
Capacity	Cooling	kW	5.6	7.1	9.0	10.0
	Heating		6.3	8.0	10.0	11.2
Input power		W	32	60	74	103
Airflow rate	High	m ³ /h	840	1,100	1,440	1,620/1,520
	Med-High		-	-	1,200	1,300
	Med		770	910	1,050	1,120
	Med-Low		-	-	940	980
	Low		690	730	890	890
	Quiet		-	-	700	700
Sound pressure level	High	dB(A)	41	48	53	55/54
	Med-High		-	-	49	51
	Med		39	43	45	47
	Med-Low		-	-	42	43
	Low		35	35	39	39
	Quiet		-	-	33	33
Net Dimensions (H × W × D)		mm	320 × 998 × 238	320 × 998 × 238	340 × 1,150 × 280	340 × 1,150 × 280
Weight		kg	15	15	18	18
Connection pipe diameter	Liquid (Flare)	mm	6.35	9.52	9.52	9.52
	Gas (Flare)		12.70	15.88	15.88	15.88
Drain Hose Diameter (I.D./O.D.)			12/16		13.8/15.8 to16.7	

Note: Specifications are subject to the following conditions:

Cooling: Indoor temperature of 27°CDB/19°CWB, and outdoor temperature of 35°CDB/24°CWB.

Heating: Indoor temperature of 20°CDB/15°CWB, and outdoor temperature of 7°CDB/6°CWB.

Pipe length: 7.5 m; Height difference between outdoor unit and indoor unit: 0 m. Voltage: 230 [V].

When connecting ASHA18GBCH to an outdoor unit other than the outdoor unit of the J-IVL Series, the pipe diameter should be Ø9.52/Ø15.88 mm (Liquid/Gas).

Optional parts

*For more details, please refer to the chapter "Optional parts".

External power supply unit: UTZ-GXXA (030/034), UTZ-GXXC* (030/034)

Silver Ion Filter: UTR-FA13-3

WLAN adapter: UTY-TFSXJ3 (030/034), UTY-TFSXZ1 (030/034)

Remote sensor kit: UTY-XSZXZ1

FG-RC-WIF1Z2 (18/24), FG-AC-WIF1Z1 (030/034)

Dimensions

(Unit: mm)

Models: ASHA18/ASHA24

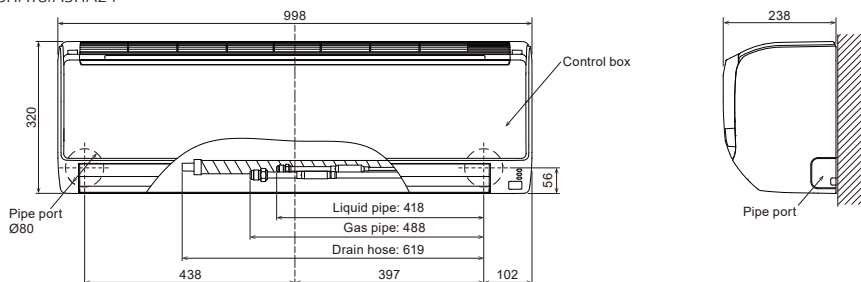

Models: ASHA030/ASHA034

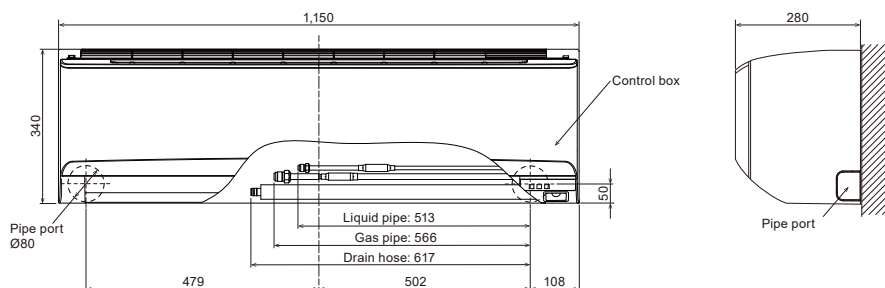



Residential, Commercial & Light Commercial

VENTILATION

VENTILATION Lineup

- Vn-002 Energy Recovery Ventilator
- Vn-004 DX kit for Air handling applications
 - for VRF Outdoor unit
- Vn-006 DX kit for Air handling applications
 - for Single Split Outdoor Units

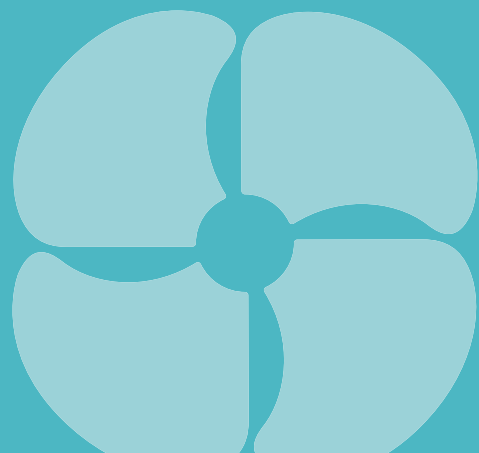

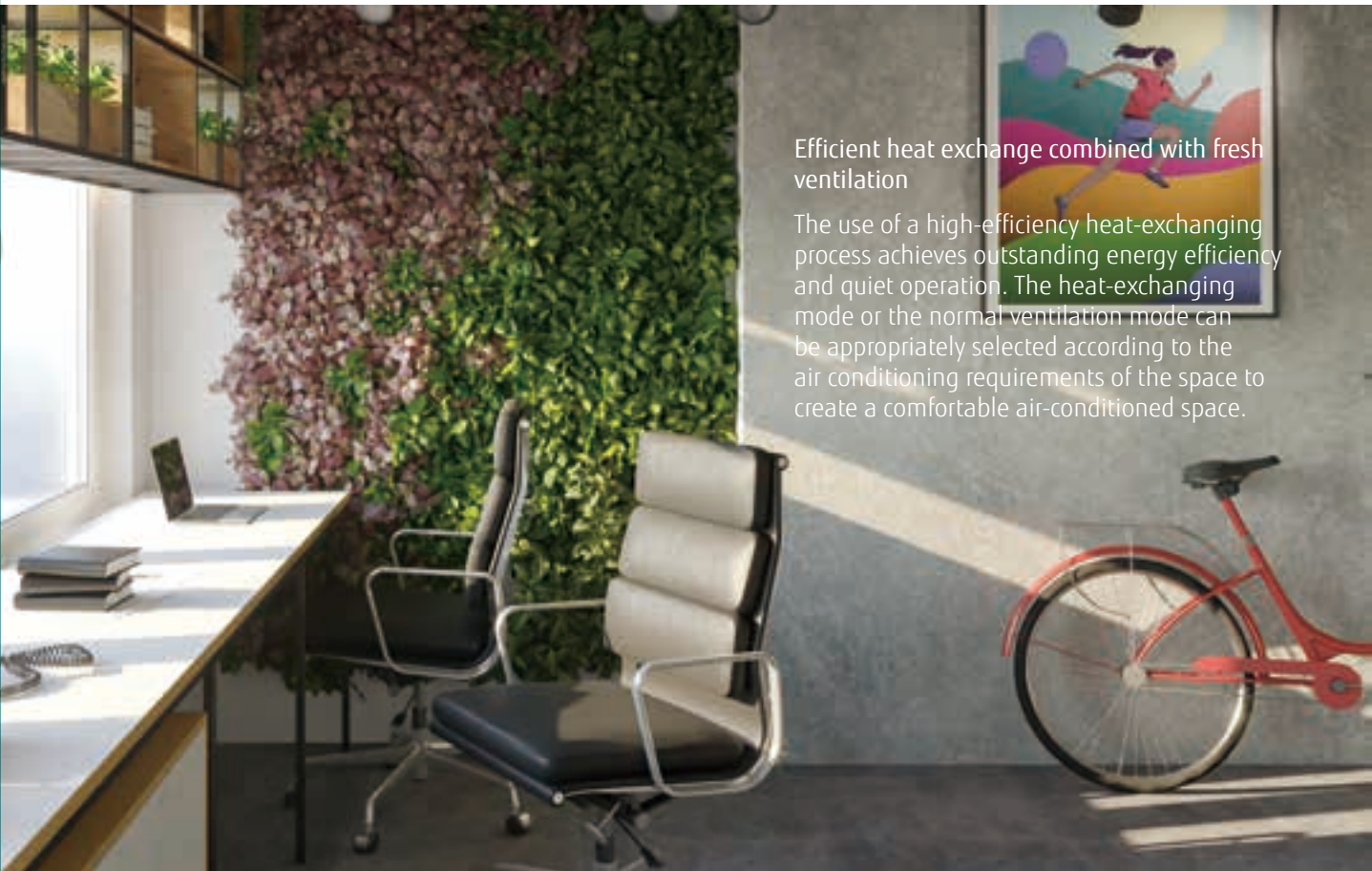









Efficient heat exchange combined with fresh ventilation

The use of a high-efficiency heat-exchanging process achieves outstanding energy efficiency and quiet operation. The heat-exchanging mode or the normal ventilation mode can be appropriately selected according to the air conditioning requirements of the space to create a comfortable air-conditioned space.

Lineup

Airflow rate (m ³ /h)	250	350	500	800	1000
Energy Recovery Ventilator	 UTZ-BD025C	 UTZ-BD035C	 UTZ-BD050C	 UTZ-BD080C	 UTZ-BD100C

Connectable capacity class (kW)	5.0	6.3	8.0	10.0	12.5	14.0	20.0	25.0	40.0	50.0
DX kit for Air handling applications for VRF Outdoor unit	 EEV unit UTP-VX30A	 Control unit UTY-VDGX	 EEV unit UTP-VX60A	 Control unit UTY-VDGX	 EEV unit UTP-VX90A	 Control unit UTY-VDGX	 EEV unit UTP-VX90A × 2	 Control unit UTY-VDGX		

Connectable capacity class (kW)	2.5 - 22.0	
DX kit for Air handling applications for Single Split Outdoor Units	 UTY-XDZX	

Energy Recovery Ventilator



The energy recovery ventilator unit provides energy efficiency for comfort and improved savings.

Heat exchange ventilation and normal ventilation

Heat exchange ventilation

When a room is cooled or heated, the exhausted cooling or heating energy is recovered by heat exchange ventilation.

Normal ventilation

Used when the indoor space does not require cooling or heating, i.e., when there is little temperature difference between the indoor and outdoor environments.

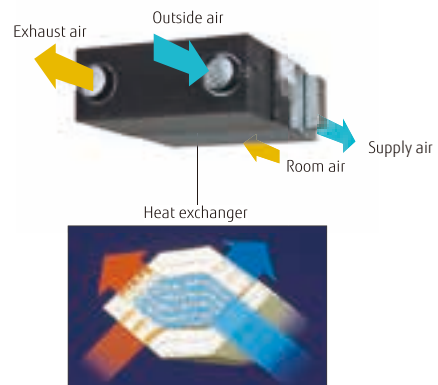

A high-efficiency counter-flow heat-exchanging element is used in the setup.

Energy efficiency and ecology

The use of a counter-flow heat-exchanging element, designed to recover up to 77% of heat from the outgoing air, significantly reduces energy consumption. The air conditioning load is reduced by approximately 20%, which results in substantial savings in energy cost.

Comparison of heat-exchanging elements

Air flows in a straight line through a crossflow element. In contrast, air flows for a longer time (a longer distance) through a counter-flow element to achieve more consistent heat-exchanging performance.

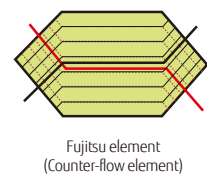
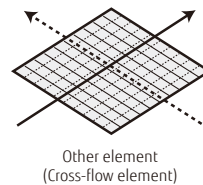

Quiet operation

Significantly lower noise levels are achieved by reducing pressure loss.

25.5dB
(UTZ-BD035C)

Extended range of external static pressure

The use of a powerful fan motor improves the external static pressure. This allows it to be installed in a variety of buildings.

Slim design for easier installation

The use of a counter-flow heat-exchanging element made it possible to design a quieter, slimmer unit.

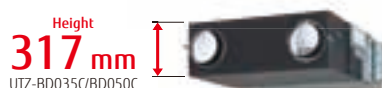
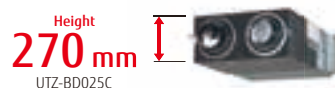

Reverse-mountable direct air supply and exhaust system

Simplifies the duct design, due to its straight ducts for air supply and exhaust. Since each unit can be mounted facing opposite directions, only one inspection hole is needed for two units. This makes duct work easier and more flexible.

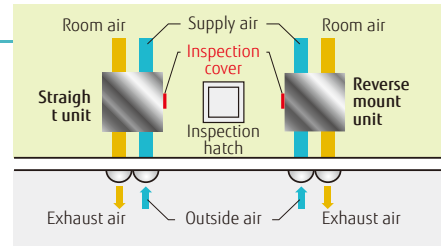

Simple remote operation

Easy operation with connected liquid crystal switch

- Power On/Off
- Air volume High/Low
- Heat exchange ventilation and normal ventilation
- On/Off Timer
- Clean filter display



Model: UTZ-BD025C/UTZ-BD035C/UTZ-BD050C/UTZ-BD080C/UTZ-BD100C



UTZ-BD025C



UTZ-BD035C



UTZ-BD050C



UTZ-BD080C



UTZ-BD100C

Specifications

Rated flow rate			250 m ³ /h	350 m ³ /h	500 m ³ /h	800 m ³ /h	1000 m ³ /h	
Model name			UTZ-BD025C	UTZ-BD035C	UTZ-BD050C	UTZ-BD080C	UTZ-BD100C	
Power source			Single phase, ~220 to 240 V, 50 Hz					
Heat Exchange Ventilation	Input power	(Extra high)/High/Low	W	128/123/96	190/185/168	289/225/185	418/378/295	464/432/311
	Airflow rate	(Extra high)/High/Low	m ³ /h	250/25/190	350/350/240	500/500/440	800/800/630	1,000/1,000/700
	External static pressure	(Extra high)/High/Low	Pa	105/95/45	140/60/45	120/60/35	140/110/55	105/80/75
	Temperature exchange efficiency	(Extra high)/High/Low	%	75/75/77	75/75/78	75/75/76	75/75/76	75/75/79
	Energy exchange efficiency cooling	(Extra high)/High/Low	%	63/63/65	66/66/71	62/62/64	65/65/68	65/65/70
	Energy exchange efficiency heat pump	(Extra high)/High/Low	%	70/70/72	69/69/73	67/67/69	71/71/74	71/71/76
Normal Ventilation	Sound pressure level	(Extra high)/High/Low	dB*	31.5/30.5/26.5	33.0/31.0/25.5	37.5/35.5/32.5	37.5/37.0/34.5	38.5/37.5/34.5
	Input power	(Extra high)/High/Low	W	128/123/96	190/185/168	289/225/185	418/378/295	464/432/311
	Airflow rate	(Extra high)/High/Low	m ³ /h	250/25/190	350/350/240	500/500/440	800/800/630	1,000/1,000/700
	External static pressure	(Extra high)/High/Low	Pa	105/95/45	140/60/45	120/60/35	140/110/55	105/80/75
	Energy exchange efficiency	(Extra high)/High/Low	%	75/75/77	75/75/78	75/75/76	75/75/76	75/75/79
	Sound pressure level	(Extra high)/High/Low	dB*	31.5/30.5/26.5	33.0/31.0/25.5	38.5/38.0/32.5	37.5/37.0/34.5	40.5/39.5/36.5
Dimensions	W × D × H	mm	882 × 599 × 270	1,050 × 804 × 317	1,090 × 904 × 317	1,322 × 884 × 388	1,322 × 1,134 × 388	
Weight		kg	29	49	57	71	83	
Outlet duct diameter		mm	150	150	200	250	250	
Operating range		°C	-10 to 40	-10 to 40	-10 to 40	-10 to 40	-10 to 40	
Maximum humidity		%	85	85	85	85	85	

* Noise level measured 1.5 m below the center of the unit

Dimensions

(Unit: mm)

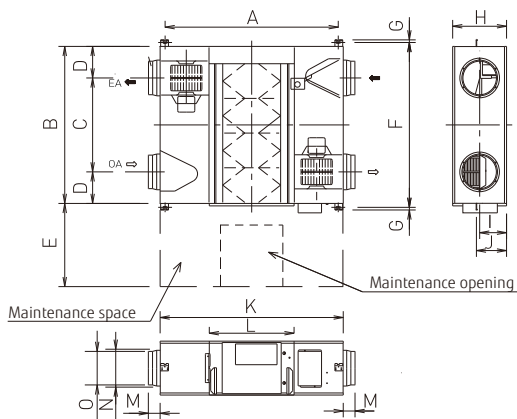

	UTZ-BD025C	UTZ-BD035C	UTZ-BD050C	UTZ-BD080C	UTZ-BD100C
A	810	978	1,018	1,250	1,250
B	599	804	904	884	1,134
C	315	580	640	428	678
D	142	112	132	228	228
E	600	600	600	600	600
F	655	860	960	940	1,190
G	19	19	19	19	19
H	270	317	317	388	388
I	135	159	159	194	194
J	159	182	182	218	218
K	882	1,050	1,090	1,322	1,322
L	414	470	470	612	612
M	95	70	70	85	85
N	Ø164	Ø164	Ø210	Ø258	Ø258
O	Ø144	Ø144	Ø194	Ø242	Ø242

DX kit

for Air handling applications
for VRF Outdoor unit



With these kits, air handling units (AHUs) and fan coil units (FCUs) from other manufacturers can be incorporated into Fujitsu General VRF systems, or one AHU can be connected to one Fujitsu General VRF dedicated outdoor unit to control outdoor ventilation and room temperatures.

Multiple temperature sensors optimally control an Air handling unit and a fan coil unit.

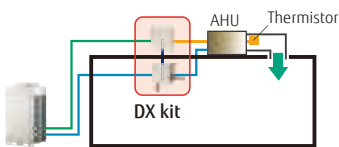

When connected to an Air handling unit, the temperature of supply air is controlled by a discharge air sensor.

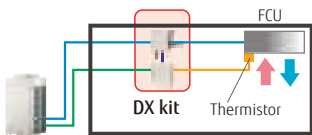

When connected to a fan coil unit, the room temperature is controlled by the discharge air sensor.

Application as part of a VRF system

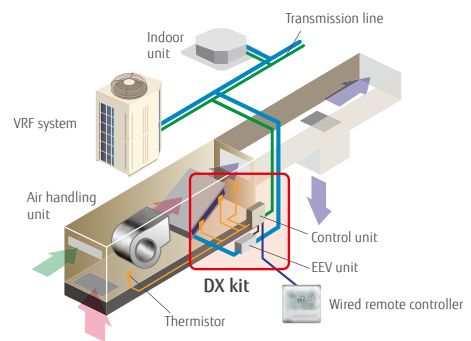

Supports a wide range of capacity classes

- Two EEV units can be connected in parallel to large-capacity units of up to 20 HP (50 kW). (UTP-LX180A separation tube required)
- Connectable capacity range: 5 kW to 50 kW

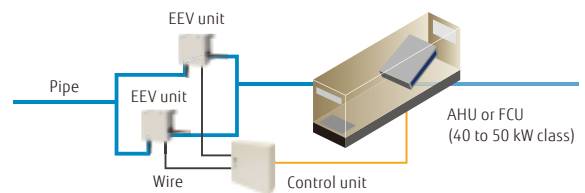

A variety of control options that meet application requirements

Central control enabled by our VRF controllers or central management controllers

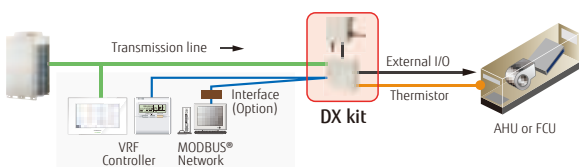

Central control from external controllers

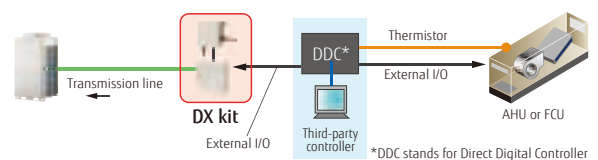

*DDC stands for Direct Digital Controller

Summary of functions

Inputs

- On/Off
- Setting temperature
- Capacity demand
- Heating/Cooling operation modes
- Fault information

Outputs

- On/Off indication
- Fan On/Off indication
- Thermostat On/Off indication
- Defrost indication
- Fault indication

MODBUS® Control

Can be controlled via a MODBUS®-enabled BMS using an optional interface.

Installation requirements

- Connectable VRF Series: All VRF Series
- Capacity range of connectable DX kit systems with outdoor units: 50 to 100% of capacity
- Capacity range of connectable DX kit systems with indoor units: 30% or less of capacity
- Max. wire length from a control unit: 10 m
- Max. pipe length between EEV unit and indoor unit: 5 m
- A control unit (IP54 class) and an EEV unit can be installed outdoors.

Optional separation tube to connect two EEV units: UTP-LX180A



Connectable capacity

• Single connection

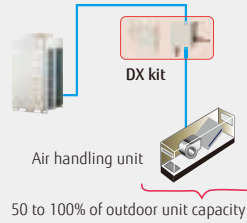

• Mixed connection

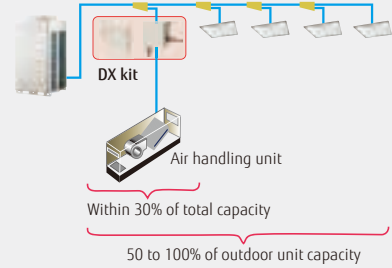

Pipe and wire length

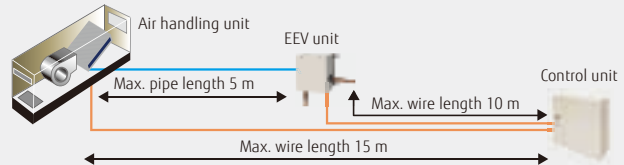

Control unit: UTY-VDGX

EEV unit: UTP-VX30A/UTP-VX60A/UTP-VX90A

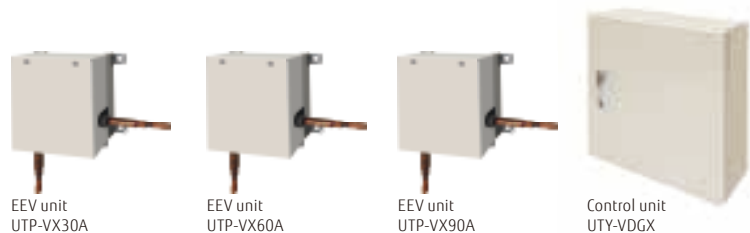

Specifications

Connectable capacity class		5.0 kW	6.3 kW	8.0 kW	10.0 kW	12.5 kW	14.0 kW	20.0 kW	25.0 kW	40.0 kW	50.0 kW
Capacity	Cooling	5.6	6.3	8.0	10.0	12.5	14.0	22.4	25.0	40.0	50.4
	Heating	6.3	7.1	9.0	11.2	14.0	16.0	25.0	28.0	45.0	56.5

Control unit		UTY-VDGX	
Power source	V/Ø/Hz	230/1/50	
Dimensions (H × W × D)	mm	400 × 400 × 120	

EEV unit		UTP-VX30A	UTP-VX60A	UTP-VX90A	UTP-VX90A × 2
Connection pipe diameter (Liquid)	mm	Ø9.53	Ø12.70	Ø12.70	Ø12.70
Dimensions (H × W × D)	mm	160 × 220 × 90			

Note: Specifications are based on the following conditions.

Cooling: Indoor temperature of 27°CDB/19°CWB, and outdoor temperature of 35°CDB/24°CWB.

Heating: Indoor temperature of 20°CDB/(15°CWB), and outdoor temperature of 7°CDB/6°CWB.

Pipe length: 7.5 m Voltage: 230 [V].

DX kit

for Air handling applications
for Single Split Outdoor Units



With this kit, other manufacturers' Air handling units (AHUs) and fan coil units (FCUs) can be incorporated into Fujitsu General Split outdoor units.

Flexible connectivity

This kit allows connections to third-party equipment. This control unit can also be used in conjunction with Fujitsu General single-split outdoor units, providing a perfect solution when a stand-alone Air handling unit is needed.

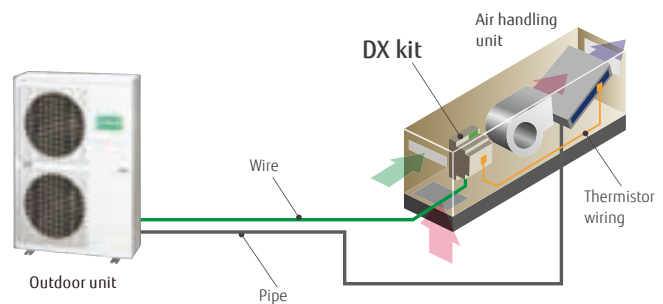

Supports a wide range of capacity classes

Capable of connecting large capacities in the range of 2.5 kW to 22.0 kW (Nominal)



Mobile devices allow for operation from anywhere

Can be operated and managed remotely using your smartphone or tablet.

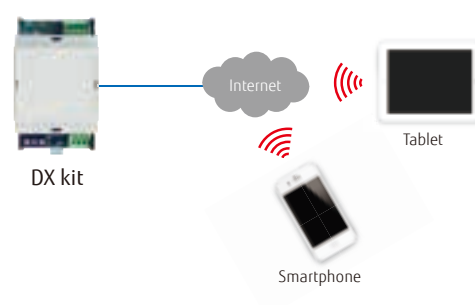

Summary of functions

Inputs

- On/Off
- Heating/Cooling operation modes
- Capacity demand (analogue 0 to 10 V)
- Heat exchanger temperature

Outputs

- Status of Compressor, Defrost, and Errors (Potential free relays)
- Status indicator with LED

Wireless LAN Control

Wireless LAN control through cloud connectivity enables secure remote monitoring and control from anywhere.

Easy installation

- Compact DIN rail mountable enclosure for easy installation
- No expansion devise required
- No separate external power supply required

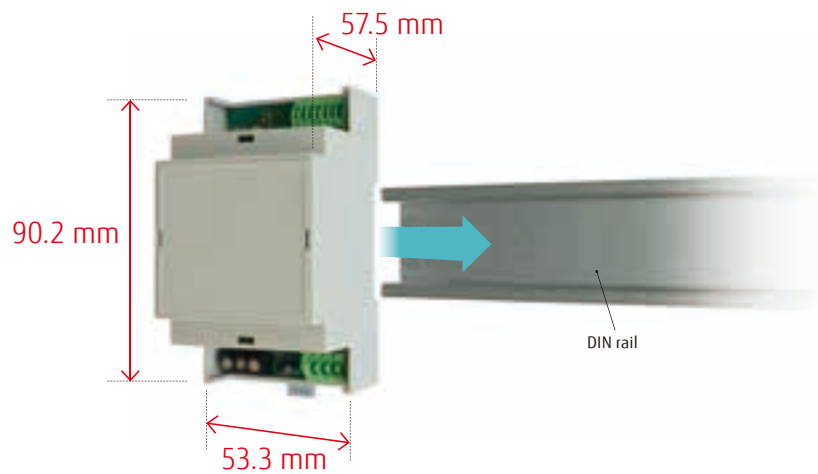

Model: UTY-XDZX



Specifications

R410A models

BTU			12	14	18	24	30	36	45	54	60	72	90
Capacity (Nominal)	Cooling	kW	3.5	4.3	5.2	6.8	8.5	9.4	12.1	13.3	15.0	19.0	22.0
	Heating		4.1	5.0	6.0	7.8	10.0	10.8	13.3	15.8	18.0	22.4	27.0

R32 models

BTU			09	12	14	18	22	24	30	36	45	54
Capacity (Nominal)	Cooling	kW	2.5	3.5	4.3	5.2	6.0	6.8	8.5	9.4	12.1	13.3
	Heating		3.2	4.1	5.0	6.0	7.0	7.5	10.0	10.8	13.3	15.8

Model name		UTY-XDZX	
Power source	V/Ø/Hz	230/1/50	
Dimensions (H × W × D)	mm	90.2 × 53.3 × 57.5	
Weight	g	110	

Note: Specifications are based on the following conditions.
 Cooling: Indoor temperature of 27°CDB/19°CWB, and outdoor temperature of 35°CDB/24°CWB.
 Heating: Indoor temperature of 20°CDB/15°CWB, and outdoor temperature of 7°CDB/6°CWB.
 Pipe length: 5.0 m Voltage: 230 [V].



Light Commercial & Commercial, Residential

CONTROL SYSTEM & OPTIONAL PARTS

- C-002 Control System Overview
- C-006 Best control solution for each building structure
- C-008 Comparison table of controllers
- C-050 Controller System List
- C-058 Optional Parts Overview
- C-066 Optional parts list
- C-070 Function list

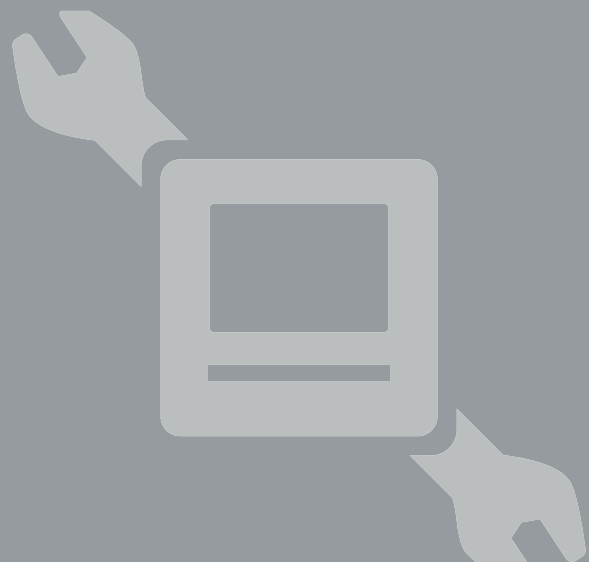

A wide product lineup to meet a variety of needs

We can flexibly meet customer needs through a variety of offerings including wired and wireless individual remote controllers, central remote controllers that simultaneously control multiple indoor units, and a variety of converters that link with other systems.

CONTROL SYSTEM

INDIVIDUAL CONTROL

- C-010 Wired remote controller (Design type)
- C-012 Wired remote controller (with touch panel)
- C-014 Wired remote controller / Compact wired remote controller
- C-015 Wired remote controller
- C-016 Simple remote controller
- C-017 Wireless remote controller
- C-018 IR receiver unit

CONVERTERS/ADAPTERS

- C-020 WLAN adapter
- C-024 Multiple protocol WLAN adapter

CENTRALIZED CONTROL

- C-025 Home central remote controller
- C-026 Central remote controller
- C-028 Touch panel controller
- C-032 System controller **Software** / System controller lite **Software**

CONVERTERS/ADAPTERS

- C-036 MODBUS® converter for indoor unit
- C-037 MODBUS® interface
- C-038 MODBUS® converter for VRF
- C-039 BACnet® interface
- C-040 BACnet® gateway **Software**
- C-041 BACnet® gateway **Hardware**
- C-042 BACnet®/MODBUS® router
- C-043 BACnet®/MODBUS® cloud device
- C-044 KNX® converter for indoor unit / KNX® converter for VRF
- C-045 KNX® interface
- C-046 Network converter for single-split type
- C-047 Network converter for LONWORKS™
- C-048 External switch controller / Signal amplifier

Optional parts

- C-060 Silver ion filter
- C-061 Auto louver grille kit
- C-062 Pressure sensor kit
- C-063 External power supply unit
AIR BEAM radiation air outlet unit
- C-064 Gas sensor kit
- C-074 Separation tube and other piping products



SPLIT



MULTI-SPLIT



VRF J Series



VRF V Series

Control System Overview

for Split & Multi-split

All indoor units* are equipped with a wireless or wired remote controller as standard. Additional options are available, such as individual remote controllers and central remote controllers. The easy-to-operate central remote controller makes it simple to control the operation mode, temperature, airflow volume, timer, and other functions of each indoor unit from a single location.

* Except for some products

Air Conditioning Individual control



Wired remote controller

A built-in thermo sensor monitors and controls room temperature accurately.



Wireless remote controller

Simple and versatile operations with a choice of 4 different types of timers



Simple remote controller

Compact remote controller with basic functionality

For Ceiling type

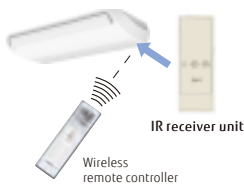

For Duct type

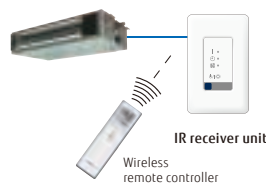

For Cassette type

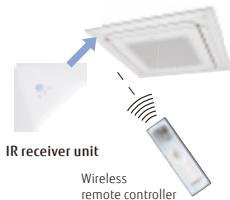

IR receiver unit

This IR receiver unit enables a wireless remote controller to control a duct-type indoor unit.



Air Conditioning Centralized control



Home central remote controller for 5 & 6-unit Multi-split type
Enables individual and central control.



Converters/Adapters

For external control via BMS/Home Automation Systems

MODBUS® converter
for indoor units
UTY-VMSX



MODBUS® interface
for indoor units



KNX® converter
for indoor units
UTY-VKSX



KNX® interface
for indoor units



WLAN adapter



Network converter

DC power supply
type
UTY-VTGX



AC power supply
type
UTY-VTGXV



Online Control (Wireless Control via Smartphone/Tablet)

With the WLAN adapter and the AIRSTAGE Mobile app, you can control the heating and cooling of your home anytime, anywhere.

WLAN adapter

The dedicated WLAN adapter enables the air conditioner to be operated by smartphone or tablet computer.



WLAN adapter
USB



AIRSTAGE
Mobile

Download Free



Simple, user-friendly interface design

The designed screen display makes it easier than ever to operate.

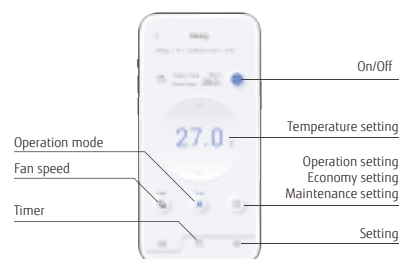

Control System Overview

for VRF

To meet the diverse needs of customers, we offer a variety of control options for our VRF systems, such as individual control, centralized control, and building management system (BMS) options.

Air Conditioning Individual control

NEW **Wired remote controller (Design type)**
UTY-RVRG

Wired remote controller (with touch panel)
UTY-RNRGZ5

Wired remote controller
UTY-RLRG

Compact wired remote controller
UTY-RCRGZ1

Simple remote controller
UTY-RSRG
UTY-RHRG
Without operation mode

NEW **Wireless Remote Controller**
UTY-LNVG
UTY-LNHG

IR receiver unit
UTB-YWC for duct type
UTY-TRHX for One-way flow cassette Series/3D flow cassette Series/duct type
UTY-LBHXD for Circular flow cassette Series

For Duct type
For One-way flow cassette Series/3D-flow cassette Series/duct type
for Circular flow cassette Series

Air Conditioning Centralized control

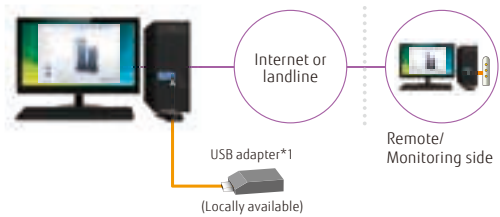

System controller **Software**
UTY-APGXZ1/UTY-ALGXZ1 (Lite version)

Up to
1600^{*2}
Indoor units

*1: Echelon® U10 USB Network Interface
*2: The Lite version controls up to 400 indoor units.

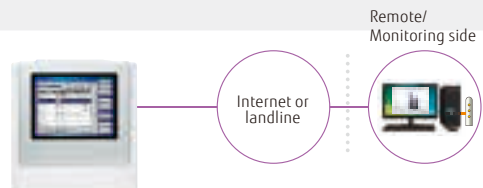

Touch panel controller
UTY-DTGGZ1

Up to
400
Indoor units

NEW **Central remote controller**
UTY-DCGGZ3

Up to
100
Indoor units



Converters/Adapters

For external control via BMS/Home Automation Systems

BACnet® gateway
UTY-ABGXZ1 **Software**



VTY-VBGX **Hardware**



BACnet® interface
for Indoor units
FG-IR-BMG1Z1



Network converter
(For LONWORKS™)
UTY-VLGX



MODBUS® converter
for Indoor units
UTY-VMSX



for VRF
UTY-VMGX



KNX® converter
for Indoor units
UTY-VK SX



for VRF
UTY-VK GX



WLAN adapter
UTY-TFSXJ3 / UTY-TFSXZ1



External switch controller
UTY-TERX



Card-key
(Locally available)



Internet device



BMS/BAS^{*3}



BMS^{*3}, Home automation system



*3: BMS/BAS: Building Management System/Building Automation System

Converters/Adapters

for system expansion

Network converter
DC power supply type
UTY-VTGX

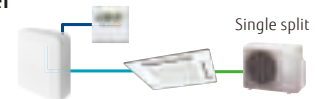

Network converter
AC power supply type
UTY-VTGXV



Signal amplifier
UTY-VSGXZ1



Best control solution for each building structure

Fujitsu General provides the best control solutions suitable for various building structures.











SHOP

Type	Individual control				Centralized control			Integrating control (Interface)		
	Wired remote controller	Central remote controller	Touch panel controller	System controller	Network converter for LONWORKS™	MODBUS® Converter	KNX® converter			
	UTY-RVRG UTY-RNRGZ5 UTY-RLRG UTY-RVNGM UTY-RCRGZ1	UTY-DCGGZ3	UTY-DTGGZ1	UTY-APGXZ1 UTY-ALGXZ1	UTY-VLGX	UTY-VMGX	UTY-VKGX			
Automatic control of air conditioning (Schedule timer, Weekly timer, etc.)	•	•	•	•						
Controls limited to staff: Remote controller prohibition, Setting temperature range limitation, etc.		•	•	•	•	•	•			•
Group control		•	•	•						
Advanced energy saving: Peak cut, Operation of indoor unit rotation, etc.				•						
Remote monitoring management		•	•	•						
Manage multiple sites		•	•	•						
Monitor energy consumption				•						
Control third-party products				•						
Integrate Fujitsu General air conditioning into BMS							•	•		•

HOTEL

Type	Individual control			Centralized control			Integrating control (Interface)				
	Wired remote controller	Simple remote controller	Wireless remote controller	Central remote controller	Touch panel controller	System controller	BACnet® gateway	Network converter for LONWORKS™	MODBUS® converter	KNX® converter	External switch controller
	UTY-RVRG UTY-RNRGZ5 UTY-RLRG UTY-RCRGZ1	UTY-RSRG UTY-RHRG	UTY-LNVG UTY-LNHG UTY-LNTG	UTY-DCGGZ3	UTY-DTGGZ1	UTY-APGXZ1 UTY-ALGXZ1	UTY-ABGXZ1 UTY-VBGX	UTY-VLGX	UTY-VMGX	UTY-VKGX	UTY-TERX
Local control for hotel guests	•	•	•								
Centralized air conditioning control for common areas				•	•	•	•	•	•	•	
Limited control for hotel guests				•	•	•	•	•	•	•	
Remote monitoring management				•	•	•					
Advanced energy saving: Peak cut, Operation of indoor unit rotation, etc.						•	•				
Monitor energy consumption						•					
Control third-party products						•					
Integrate Fujitsu General air conditioning into BMS							•	•	•	•	
Interlock with window contact											•
Interlock with key card											•

OFFICE

Type	Individual control			Centralized control			Integrating control (Interface)				
											
	Wired remote controller UTY-RVRG UTY-RNRGZ5 UTY-RLRG UTY-RCRGZ1	Simple remote controller UTY-RSRG UTY-RHRG	Wireless remote controller UTY-LNVG UTY-LNHG UTY-LNTG	Central remote controller UTY-DCGGZ3	Touch panel controller UTY-DTGGZ1	System controller UTY-APGXZ1 UTY-ALGXZ1	BACnet® gateway UTY-ABGXZ1 UTY-VBGX	Network converter for LonWorks™ UTY-VLGX	MODBUS® converter UTY-VMGX	KNX® converter UTY-VKGX	External switch controller UTY-TERX
Local control for office staff	•	•	•	•							
Automatic control of air conditioning (Schedule timer, Weekly timer, etc.)	•		•	•	•	•	•				
Centralized air conditioning control for management				•	•	•	•	•	•	•	
Controls limited to staff: Remote controller prohibition, Setting temperature range limitation, etc.				•	•	•	•	•	•	•	
Advanced energy saving: Peak cut, Operation of indoor unit rotation, etc.						•	•				
Remote monitoring management				•	•	•					
Electricity charge apportionment					•	•	•				
Monitor energy consumption						•					
Control third-party products						•					
Integrate Fujitsu General air conditioning into BMS							•	•	•	•	
Interlock with door contact											•
Interlock with Human sensor for meeting room				•							•

Comparison table of controllers

Item							
	Wired remote controller (Design type)	Wired remote controller (with touch panel)	Wired remote controller	Wired remote controller	Compact wired remote controller	Simple Remote Controller	
Model name	UTY-RVRG	UTY-RNRGZ5	UTY-RLRG	UTY-RVNGM	UTY-RCRGZ1	UTY-RSRG	
Maximum number of controllable remote controller groups	1	1	1	1	1	1	
Maximum number of controllable indoor units	16	16	16	16	1	16	
Maximum number of controllable groups	—	—	—	—	—	—	
Air conditioning control functions	ON/OFF	●	●	●	●	●	
	Operation mode setting	●	●	●	●	●	
	Fan speed control	●	●	●	●	●	
	Room temperature setting	●	●	●	●	●	
	Setting temperature range limitation	●	●	●	●	—	
	Test operation	●	●	●	●	●	
	Vertical louver setting	●	●	●	●	●	
	Horizontal louver setting	●	●	●	●	—	
	Individual louver control	●	●	—	—	●	
	Group setting	—	—	—	—	—	
	Remote controller prohibition	—	—	—	—	—	
	Anti-freeze setting	●	●	—	—	●	
	Set temperature auto return	●	●	●	●	—	
	Economy mode setting	●	●	●	●	—	
	Human sensor control	●	●	—	—	—	
Displayed items	Error	●	●	●	●	●	
	Defrosting	●	●	●	●	●	
	Current time	●	●	●	●	—	
	Day of week	●	●	●	●	—	
	Remote controller prohibition	●	●	●	●	●	
	Address display	●	●	●	●	●	
	Room temperature	●	●	—	●	●	
	Multiple language support	●	●	—	●	—	
	Setting for daylight saving time	●	●	—	●	—	
	Name registration	●	●	—	—	—	
	Backlighting	●	●	—	●	●	
	2D floor layout/3D building display	—	—	—	—	—	
	Refrigerant leak detector	—	—	—	—	—	
	Refrigerant Cycle Monitor	●	●	—	—	—	
	Logo Display	●	—	—	—	—	
Limited Visibility of Settings	●	—	—	—	—		
Timer	Schedule timer	Period	Week	Week	Week	Week	—
		ON/OFF, Temp, Low noise mode*5, Times per day	8	8	4	8	—
	ON/OFF timer	—	●	●	●	●(OFF only)	—
	Sleep timer	—	—	—	—	—	—
	Program timer	—	—	—	—	—	—
	Auto-off timer	●	●	●	●	—	—
Day off	●	●	●	●	—	—	
Minimum unit of timer setting (minutes)	1 • 10	10 • 30	30	30	—	—	
Control	Remote monitoring management system	—	—	—	—	—	
	Electricity charge apportionment	—	—	—	—	—	
	Error history	●	●	●	●	—	
	Emergency stop	—	—	—	—	—	
	Remote monitoring management	—	—	—	—	—	
	Energy-saving management	—	—	—	—	—	
	E-mail notification in case of failure	—	—	—	—	—	
Key lock	● Child lock	● Child lock	● Child lock	● Child lock	—	—	
Low noise mode	—	—	—	—	—	—	

Wired remote controller (Design type)

UTY-RVRG



NEW



Up to
16 indoor units
Up to
1 group



reddot winner 2024



Simple and stylish design that harmonizes with the space

- The new stylish design controller, UTY-RVRG, enables intuitive operation with touch screen. It is compatible with many 2-wired indoor units.

Harmonizes with the Installation Space

When not in use, the controller is a part of the interior décor. This is achieved by using mirrors, glass, and clear panels, and it appears to be one with the wall. The sleek and stylish design won the 2022 Good Design Award and was selected as a finalist for the 2023 IDEA award.



Intuitive operation

The touch screen is easily operated by swiping vertically and horizontally, and users can operate the controller without using manuals.

Temp. Setting



Operation Mode



Status LED Colors

When not in use, the operation mode is indicated through LED lamp colors shown under the controller. The LED lamp can be switched ON and OFF to avoid glare at night.



Blue: Cooling



Red: Heating



Green: Dry



Purple: Auto

Features: Wired Remote Controller (Design type)

Refrigerant cycle monitor

The controller will display specific sensor values of outdoor and indoor units for maintenance and service support.

* Display screen example

* This function is only supported by split units, using the H-Serial communication protocol! Example: ASHH30KMTB



Logo Display

The controller can display hotel logos when not in use. Images are sent via Bluetooth® connection where data is saved in the flash memory built into each controller.

* Color display available

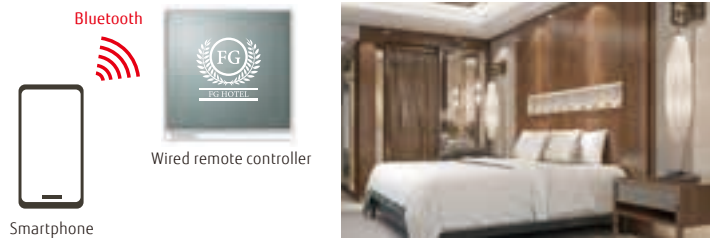

AIRSTAGE Remo Set application (free download)

Set up your new Wired Remote Controller via Bluetooth from your smartphone (or directly at the controller).

Features:

- Initial configuration
- Function setting
- Custom logo import
- Copy settings between controllers

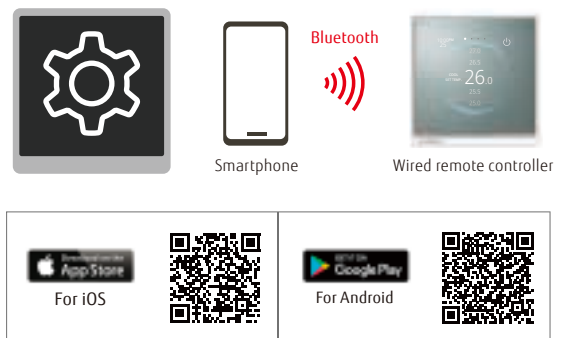

Initial Settings / Indoor Unit Function

The initial controller settings and indoor unit function settings can be sent from a smartphone by pairing with the controller via Bluetooth. It also can read the setting values of a paired controller, and send a copy of them to one or more additional controllers, significantly reducing installation time.

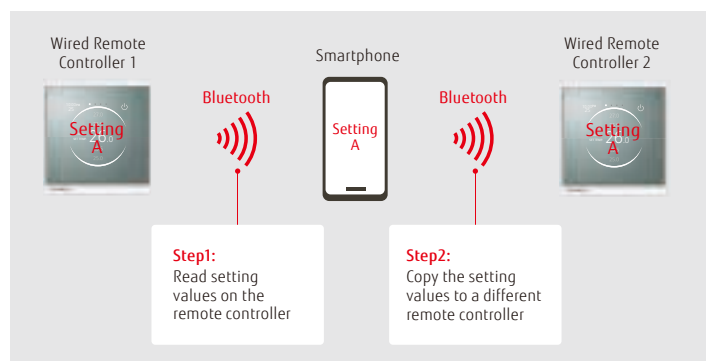

*Smartphone : Wired Remote Controller = 1 : 1

Specifications

Model name	UTY-RVRG
Power Source	DC12V
Dimensions (H × W × D) (mm)	121.5 × 116 × 26
Weight (g)	225

Wired remote controller (with touch panel)

UTY-RNRGZ5



Up to
16 indoor units
Up to
1 group

Easy operation due to large high-resolution STN-LCD touch panel screen

- Touch screen LCD
- Built-in daily/weekly timer (ON/OFF, temperature, modes)
- Backlit screen for easy operation in the dark.
- Room temperature display
- Controls up to 16 indoor units
- Supports 12 languages: Chinese, Dutch, English, French, German, Greek, Italian, Polish, Portuguese, Russian, Spanish, and Turkish
- Nonpolar 2-core type

High performance and compact size

A single remote controller controls each connected indoor unit and provides a weekly timer function and a variety of energy-saving options.



Accurate control for comfort

A thermo sensor built into the remote controller monitors room temperature accurately.



Room temperature display
Room temperature sensor

Energy saving controls

Custom Auto

- Maintains 2 separate setpoints for heating and cooling operations.
- Automatically switches between heating and cooling modes.

* Not available for some models

Auto-off timer

- While the Auto-off timer is activated, if the set off time is specified as, for example, one hour, the power will automatically turn off one hour after the start of operation.
- A desired time frame can be specified for the Auto-off timer.
- The off-time can be set from 30 to 240 minutes.

2-setting weekly timer

Set temperature auto return

Setting temperature range limitation

Cooling set temp. 27°C, Heating set temp. 26°C

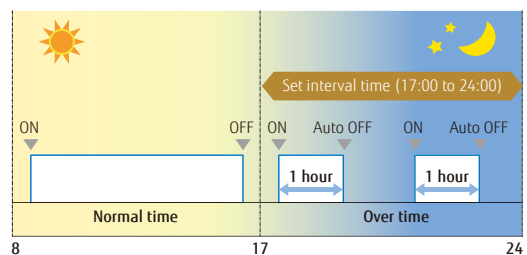
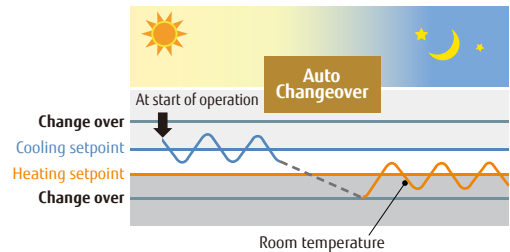

e.g.) Between 17:00 and 24:00 (over time hours), when the 1 hour set off time has elapsed, the system will automatically turn off the indoor unit as it

Features: Wired Remote Controller (Touch Panel)

Refrigerant cycle monitor (Option)

Wired Remote Controller (Touch Panel) will support to display some sensor values for maintenance and service support.

* This function is only supported by split units, using the H-Serial communication protocol! Example: ASHH30KMTB



Multi System Control*1

1) Lead Lag Operation

Standby Indoor Unit can be selected in lead lag operation. By this, the Indoor units will last longer than operating by nonstop.

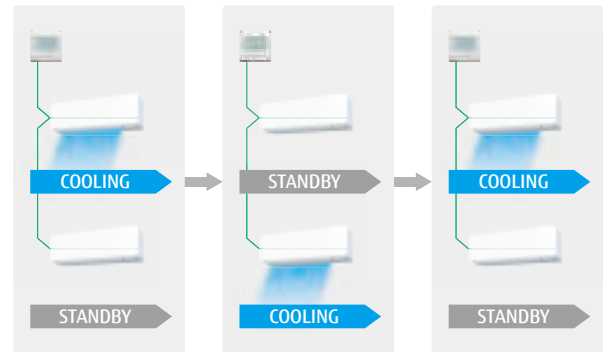

2) Back up operation

In case of unexpected Indoor unit error, other Indoor units will start providing back up operation.

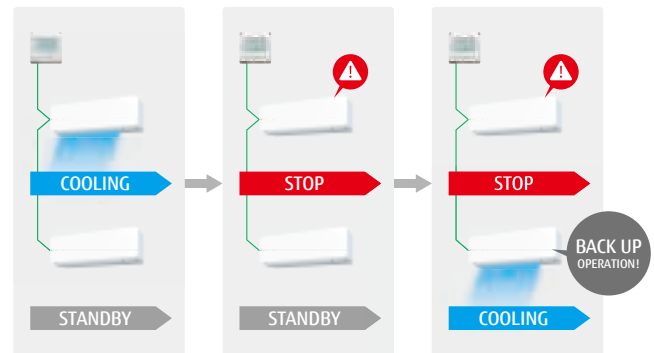

3) Lag Operation

In case of unexpected room temperature rise, other Indoor Units will start providing lag operation.

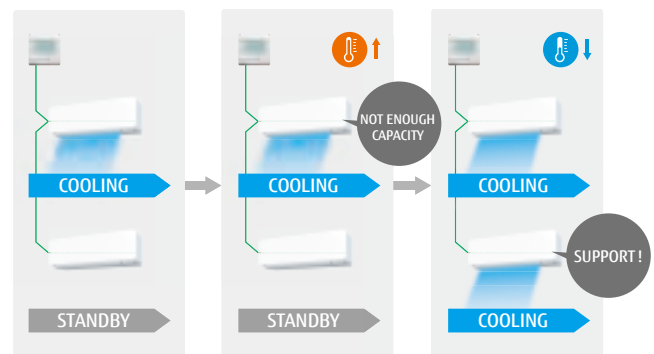

*1: "Lead Lag Setting" is an easy-to-use function for room temperature control when using multiple indoor units, while reducing the burden placed on each indoor unit.

If you wish to make use of this function, ensure you use indoor units equipped with a "Special Cooling" function.

For Split products with "Special Cooling" function, refer to S-068 to S-071.

If you use indoor units that do not have a "Special Cooling" function, under certain conditions, there is a chance that "Backup operation" may not operate correctly, and the "Lead Lag Setting" function will not give the expected results.

Additionally, for rooms that require strict conditions, such as server rooms, please consider other appropriate measures.

Please note that we will not provide compensation for any damages suffered to your appliances or data as a result of using this function.

For more details, please confirm with your nearest retail store.

Specifications

Model name	UTY-RNRGZ5
Power Source	DC 12 V
Dimensions (H × W × D) (mm)	120 × 120 × 20.4
Weight (g)	220

DC 12 V is supplied by the indoor unit.

Wired remote controller

UTY-RLRG



- ON/OFF/Weekly timer settings
- A built-in thermo sensor monitors and controls room temperature accurately.
- When something goes wrong, an error code is displayed.
- 16 error codes from the most recent one will be kept in the history. (Last 16 error codes can be accessed)
- Nonpolar 2-core type

Up to
16 indoor units
Up to
1 group

High performance and compact size

A single remote controller controls each connected indoor unit and provides a weekly timer function and a variety of energy-saving options.



Visually intuitive operation

- The operation mode, set temperature, and fan speed are shown prominently on the top screen.
- Each function to be set is indicated by an icon.
- The control guide makes it simple and straightforward to operate a remote controller.

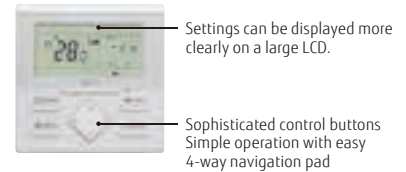

Compact wired remote controller

UTY-RCRGZ1



- Simple design that matches stylish interiors
- The body of the controller, which is easy to install, is designed to conform to the European standard junction box.
- Can be operated both by wireless and wired remote controller.
- Nonpolar 2-core type

Up to
1 indoor units
Up to
1 group

Large screen and simple display

- Large screen but compact size
- Large, easy-to-read letters are used.
- The controls are simple and easy to understand.

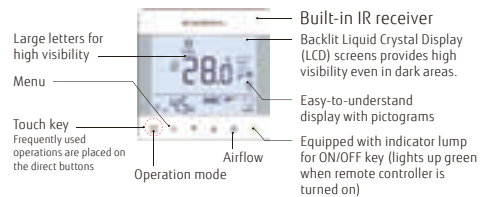

System overview

VRF connection

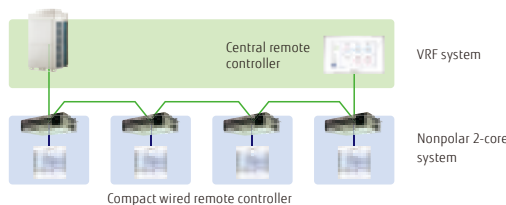

RAC connection

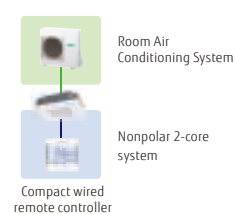

Specifications

Model name	UTY-RLRG	UTY-RCRGZ1
Power source	12 V DC	12 V DC
Dimensions (H × W × D) (mm)	120 × 120 × 17	86 × 86 × 44
Weight (g)	170	135

12 V DC supplied by an indoor unit

Wired remote controller

UTY-RVNGM



Hi-grade individual control with a wide range of functions.

- 3.7-inch backlit LCD screen.
- Supports energy-saving functions with simple operation.
- Supports 9 languages:
English, French, German, Greek, Italian, Portuguese, Russian, Spanish, and Turkish

Up to
16 indoor units
Up to
1 group

Visually intuitive operation

- Each function is displayed as an icon.
- Main functions are indicated by large icons: "Mode," "Set Temp," and "Fan"
- Easy operation with control guide display
- Simple operation with easy 4-way navigation pad

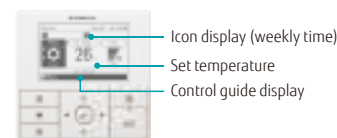

High performance and compact size

- A single remote controller controls each connected indoor unit and provides a variety of energy-saving options.



Wired remote controller

UTY-RNNGM



- Simple operation with Built-in Weekly/Daily Timer.
- Control up to 16 indoor units.
- Up to 2 Wired remote controllers can be connected to a single indoor unit.

Up to
16 indoor units
Up to
1 group

Accurate control for comfort

A thermo sensor built into the remote controller monitors room temperature accurately. The wired remote controller and an optional Remote sensor can be installed in any location to meet any requirement.

Examples of sensor changes

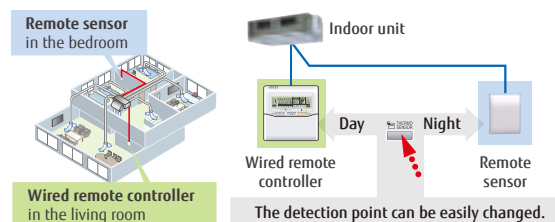

The temperature displayed is the set temperature.

Built-in timer

Weekly timer: ON/OFF time can be set to operate twice for each day of the week.

Temperature setback timer: Sets the time to change the temperature setting and the time to hold the setting for each day of the week.

At "Weekly timer" + "Temperature setback timer" setup

Specifications

Model name	UTY-RVNGM	UTY-RNNGM
Power source	12 V DC	12 V DC
Dimensions (H × W × D) (mm)	120 × 120 × 21.3	120 × 120 × 18
Weight (g)	220	160

12 V DC supplied by an indoor unit

Simple remote controller

UTY-RSRG / UTY-RHRG (without operation mode)



UTY-RSRG

UTY-RHRG
(Without operation mode)

Compact remote controller with basic functionality

- Up to 16 indoor units can be controlled with one remote controller.
- Suitable for hotels or offices as it is easily operated with no complex functions.
- Simple design that matches stylish interiors
- Large LCD screen and easy-to-use control buttons
- Backlight: White backlight makes it easy to operate in the dark.
- Nonpolar 2-core type

Up to
16 indoor units
Up to
1 group

Supports a variety of applications

- **Vertical louver control:** Adjusts the vertical airflow direction of a duct-type indoor unit with an auto louver or a cassette type installed in a hotel room or a conference room.



- **Setting temperature range limitation:** Enables an indoor unit to operate in an energy-saving manner in a small building not equipped with a central remote controller.

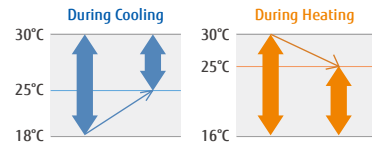

- **Built-in room temperature sensor:** Monitors and controls room temperature accuracy.

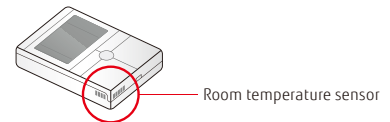

Wireless remote controller

UTY-LNTG



Up to
16 indoor units
Up to
1 group
Up to
4 different daily timers

Simple and versatile operations with a choice of 4 different types of timers

- Controls up to 16 indoor units.

Built-in timer

4 timer programs: ON/OFF/Program/Sleep
 Program timer: Sets ON/OFF time once for every 24 hours.
 Sleep timer: Adjusts the set temperature automatically while the sleep timer is on.

Easy installation and operation

Different codes can be assigned to up to 4 indoor units to prevent a mix-up.
 Wide and precise transmitting range

Specifications

Model name	UTY-RSRG	UTY-RHRG	UTY-LNTG
Power source	12 V DC	12 V DC	3.0V (1.5V R03/LR03/AAA x 2)
Dimensions (H × W × D) (mm)	120 × 75 × 19.4	120 × 75 × 19.4	205 × 61 × 17
Weight (g)	120	120	125

12 V DC supplied by an indoor unit

Wireless remote controller

UTY-LNVG



NEW



Up to
16 indoor units
Up to
1 group
Up to
4 different daily timers

New stylish design with backlight

- It has adopted a new simple and stylish design.
- The built-in backlight allows the screen to be seen even in dark rooms.

Built-in timer

4 timer programs: ON/OFF/Program/Sleep
 Program timer: Sets ON/OFF time once for every 24 hours.
 Sleep timer: Adjusts the set temperature automatically while the sleep timer is on.

Error diagnosis

It can detect the reason for system errors easily.
 When an error is detected, the error code number can be checked using the remote controller display.

Precise control

The setting temperature can be adjusted precisely depending on the environment as the controller can set the temperature via 0.5 °C*.

*Depends on the indoor unit

Wireless remote controller

UTY-LNHG



Up to
16 indoor units
Up to
1 group
Up to
4 different daily timers

Simple and versatile operations with a choice of 4 different types of timers

- Controls up to 16 indoor units.

Built-in timer

4 timer programs: ON/OFF/Program/Sleep
 Program timer: Sets ON/OFF time once for every 24 hours.
 Sleep timer: Adjusts the set temperature automatically while the sleep timer is on.

Easy installation and operation

Different codes can be assigned to up to 4 indoor units to prevent a mix-up.
 Wide and precise transmitting range

Specifications

Model name	UTY-LNVG	UTY-LNHG
Battery	3.0V (1.5V R03/LR03/AAA x 2)	3.0V (1.5V R03/LR03/AAA x 2)
Dimensions (H × W × D) (mm)	181 × 58 × 17	170 × 56 × 19
Weight (g)	116	85

12 V DC supplied by an indoor unit

IR receiver unit for duct type

UTY-LRHGM / UTY-LBTGM

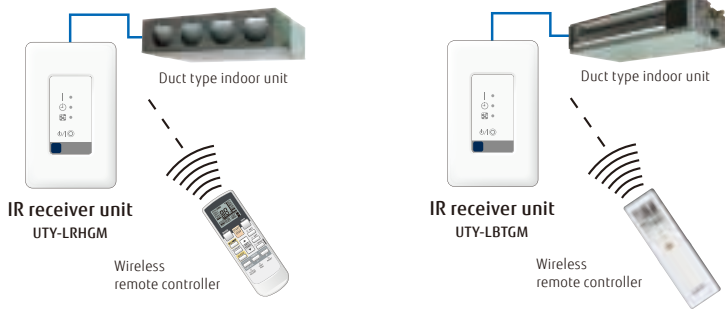

The wireless remote controller controls duct type indoor units.

IR receiver unit for Cassette

UTY-LBTGC



Cassette type indoor unit can be controlled with a Wireless remote controller.

IR receiver unit for ceiling type

UTY-LBTGH

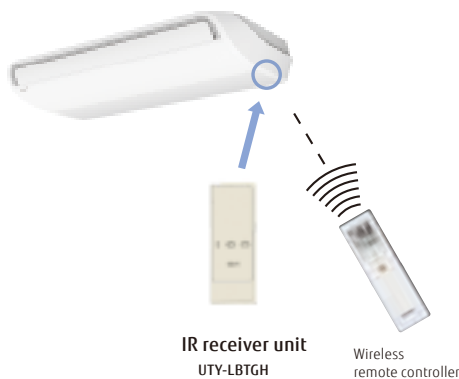

The wireless remote controller controls ceiling type indoor units.

Specifications

< Wireless Remote Controller >

Model name	UTY-LRHGM	UTY-LBTGM	UTY-LBTGC	UTY-LBTGH
Battery	1.5 V (R03/LR03/AAA)	1.5 V (R03/LR03/AAA)	1.5 V (R03/LR03/AAA)	1.5 V (R03/LR03/AAA)
Dimensions (H × W × D) (mm)	170 × 56 × 19	205 × 61 × 17	205 × 61 × 17	205 × 61 × 17
Weight (g)	85	125	125	125

< IR Receiver Unit >

Battery	DC5V	DC5V	DC5V	DC5V
Dimensions (H × W × D) (mm)	145 × 90 × 30	145 × 90 × 30	-*	-*
Weight (g)	150	150	140	100

DC 5 V is supplied the indoor unit.

*It will replace the parts of the indoor unit to be connected.

IR receiver unit for duct type

UTB-YWC / UTY-TRHX



The wireless remote controller controls duct type* indoor units.

*Large airflow duct types do not work with this IR receiver unit.



*A separate wireless remote control (model: UTY-LNHG) is required.

IR receiver unit for Cassette

UTY-LBHXD / UTY-TRHX



Cassette type indoor unit can be controlled with a Wireless remote controller.

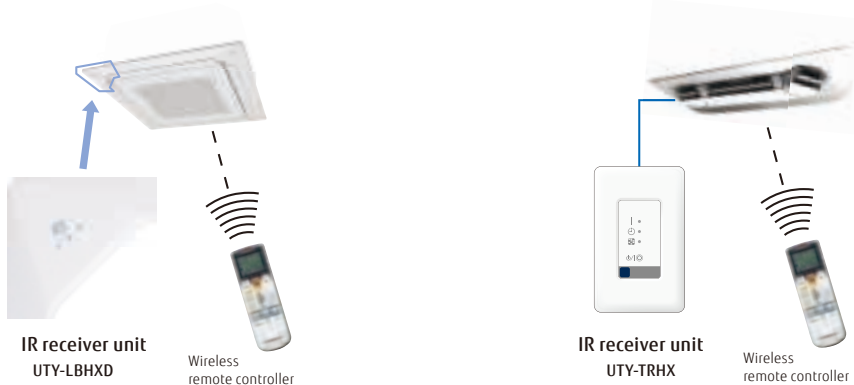

*A separate wireless remote control (model: UTY-LNVG or UTY-LNHG) is required.

Specifications

< Wireless Remote Controller >

Model name	UTB-YWC	UTY-LBHXD	UTY-TRHX
Battery	1.5 V (R03/LR03/AAA)	1.5 V (R03/LR03/AAA)	1.5 V (R03/LR03/AAA)
Dimensions (H × W × D) (mm)	170 × 56 × 19	170 × 56 × 19	170 × 56 × 19
Weight (g)	85	85	85

< IR Receiver Unit >

	DC5V	DC5V	DC5V
Battery	DC5V	DC5V	DC5V
Dimensions (H × W × D) (mm)	145 × 90 × 30	-*	145 × 90 × 30
Weight (g)	150	140	150

DC 5 V is supplied the indoor unit.

*It will replace the parts of the indoor unit to be connected.

WLAN adapter

UTY-TFSXH3 / UTY-TFSXJ3



USB type for single split models
UTY-TFSXH3



UTY-TFSXJ3
(CN connector type)

Up to
1 indoor units



AIRSTAGE Mobile

“AIRSTAGE Mobile” is an application software that enables you to manage the Fujitsu General’s air conditioner(s) with a mobile device from anywhere.

- Maximum 5 accounts per 1 indoor unit
- Room / Outdoor temperature display
- Can be used for a Single / Multi and VRF indoor units.
- No separate external power supply required
- “AIRSTAGE Mobile” is an application software that enables you to operate the Fujitsu General’s air conditioners with a mobile device.

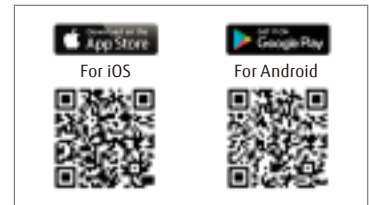

User Friendly for Everyone

Enjoy easy-to-use centralized operation of air conditioners via a smartphone anytime, anywhere



Image*



House Owner



Shop Owner



Commercial Building Owner

Main Functions

- ON / OFF
- Operation mode
- Fan speed
- Louver position
- Set temperature control
- Weekly timer
- Room temperature display
- Outdoor temperature display
- Error display

*Contents of display differ depending on the type of indoor unit.

New Design!

Ease of use is pursued to achieve a stylish design.

The more legible and accessible timer UI enables effortless schedule management.



Mode change



Fan speed change



Weekly timer



Features: AIRSTAGE Mobile

Centralized operation for flexible remote management of all air conditioners

AIRSTAGE Mobile is ideal for a wide range of applications, from large residential buildings to smaller commercial spaces such as offices and stores. Anyone who has a smartphone and an adapter can easily manage the system at a low cost.

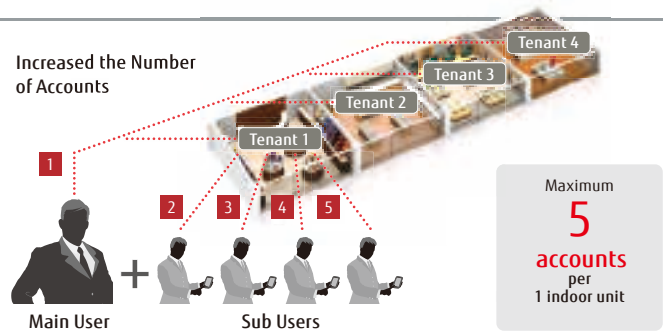

Hierarchical group management

Multiple air conditioners can be combined into a single group for centralized operation. Several groups can also be organized at once. Grouping the air conditioners by building, floor, or room makes it easy for users to monitor their operation status and operate them quickly.



Operate air conditioner and check its operation status just by talking to it

Connecting with a smart speaker allows the user to operate the air conditioner and check its operation status just by talking to it.

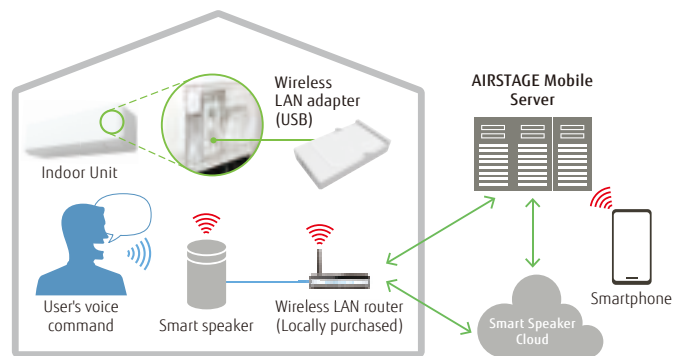

* The new WLAN adapters for AIRSTAGE Mobile are upper compatible for the indoor units that can connect the following WLAN adapters for FGLair.

	CN connector type	USB type
for FGLair	UTY-TFSXZ1	UTY-TFSXF2
for AIRSTAGE Mobile	UTY-TFSXJ3	UTY-TFSXH3

Specifications

Model name	UTY-TFSXJ3(CN connector type)	UTY-TFSXH3
Dimensions (H × W × D) (mm)	71 × 38 × 15	56.7 × 34 × 9.72
Weight (g)	35	30

WLAN adapter

UTY-TFNXZ1 / UTY-TFSXZ1 / UTY-TFSXF2



USB type for single-split models
UTY-TFSXF2



UTY-TFNXZ1
(3-wire RC-line type)
UTY-TFSXZ1
(CN connector type)

Up to
1 indoor units



- This interface provides the most advanced solution for the remote management of an air conditioning system by using smartphones, tablets, and computers.
- No separate external power supply required
- Can be used for a Single / Multi and VRF indoor units.

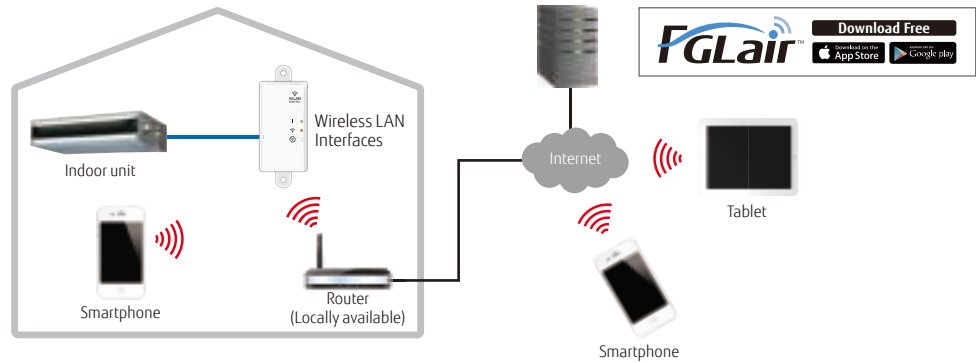

Basic control

- Turning the units on and off
- Mode control (Heat, Cool, Dry, Auto, Fan)
- Fan speed control
- Louver position (airflow direction setting)
- Timer operation setting (Weekly timer)
- Economy mode setting

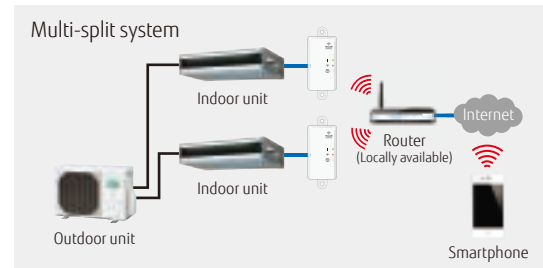

Multiple air conditioning management

- Manage multiple air conditioning systems in different locations.

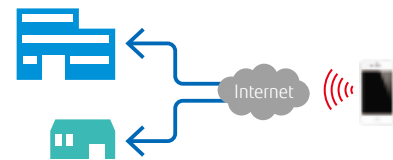

Error alert and e-mail notice

- E-mail notification alerts
- Air conditioning malfunction alert
- Enables quick service response when errors occur.

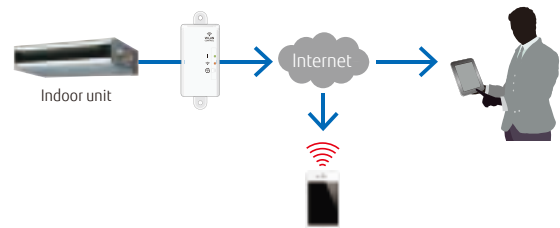

WLAN adapter (USB type) UTY-TFSXF2

A compact USB type is available. No need for specialized installation. Easily installed on the indoor unit.



Specifications

Model name	UTY-TFNXZ1 (3-wire RC-line type)	UTY-TFSXZ1 (CN connector type)	UTY-TFSXF2
Dimensions (H × W × D) (mm)	71 × 38 × 15	71 × 38 × 15	56.7 × 34 × 9.72
Weight (g)	35	35	30

WLAN adapter

FG-RC-WIF1Z2 / FG-IR-WIF1Z1 / FG-AC-WIF1Z1



Intesis
BY THE WAY OF INNOVATION



FG-RC-WIF1Z2
(3-wire RC-line type)

AC Cloud Control

- This interface provides the most advanced solution for the remote management of an air conditioning system by using smartphones, tablets, and computers.
- No separate external power supply required

Intesis
BY THE WAY OF INNOVATION



FG-AC-WIF1Z1
(CN connector type)

Installation example

[3-wire RC-line type/CN connector type]

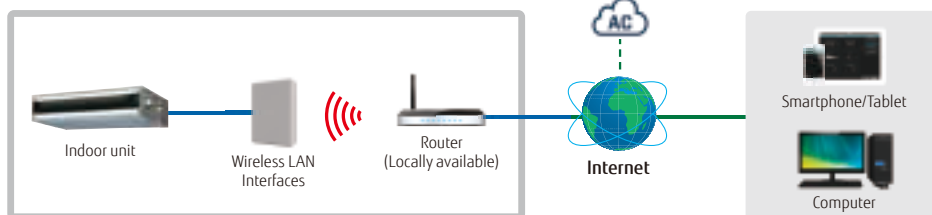

[IR type] Connection to wall-mounted type

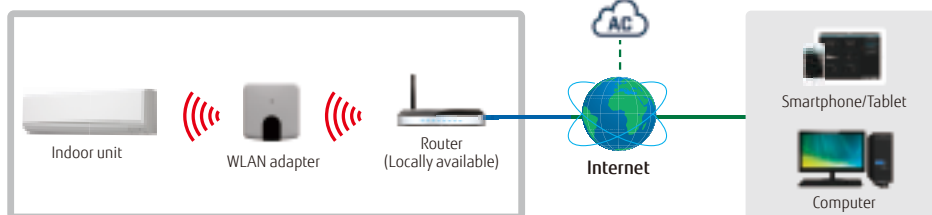

Intesis
BY THE WAY OF INNOVATION



FG-IR-WIF1Z1
(IR type)

Up to
1 indoor units

[IR type] Connects to the product with the optional receiver kit

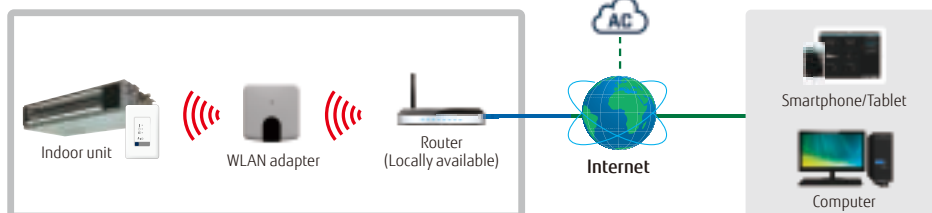

*IR receiver required.

Basic control

- Turning air conditioner on and off
- Mode select (Heat, Cool, Dry, Auto, Fan)
- Louver position (airflow direction setting)
- Fan speed control
- Room temperature display
- Setting temperature
- Multiple language support
- One single scene is created.

Advanced control (optional functions)

- Climate-based operation modes (ECO, Comfort, and Powerful) (to be available in the future)
- Schedule functions (ON/OFF, modes, set temperature, fan speed, louver position)
- Setting temperature range limitation
- Multiple Scenes and Calendars are created.
- Smart Speaker compatibility
- Advanced internet service connections

Notification and operation history

- E-mail notification alerts
- Air conditioning malfunction alert
- Connectivity monitoring and alert
- Operation history (to be available in the future)

Specifications

Model name	FG-RC-WIF1Z2 (3-wire RC-line type)	FG-AC-WIF1Z1 (CN connector type)	FG-IR-WIF1Z1 (IR type)
Number of controllable groups	1	1	1
Dimensions (H × W × D) (mm)	108 × 70 × 28	81 × 78 × 28	127 × 50 × 17
Weight (g)	80	76	80

Multiple protocol WLAN adapter

FG-RC-WMP1Z1 / FG-IR-WMP1Z1 / FG-AC-WMP1Z1



Intesis
BY THE POWER OF INTEL



FG-RC-WMP1Z1
(3-wire RC-line type)

Intesis
BY THE POWER OF INTEL



FG-AC-WMP1Z1
(CN connector type)

Intesis
BY THE POWER OF INTEL



FG-IR-WMP1Z1
(IR type)

Up to

1 indoor units

AC Cloud Control

- Air conditioner control of Home Automation systems via wireless LAN connection.
- No separate external power supply required

Installation example

[3-wire RC-line type/CN connector type]

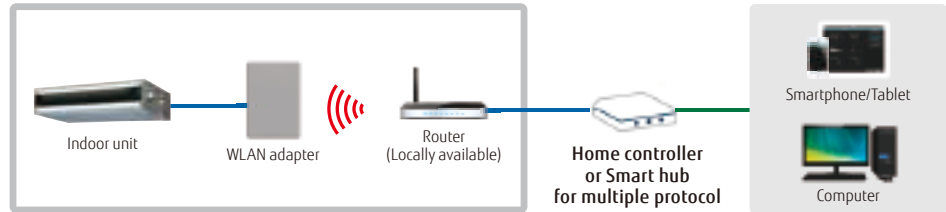

[IR type]

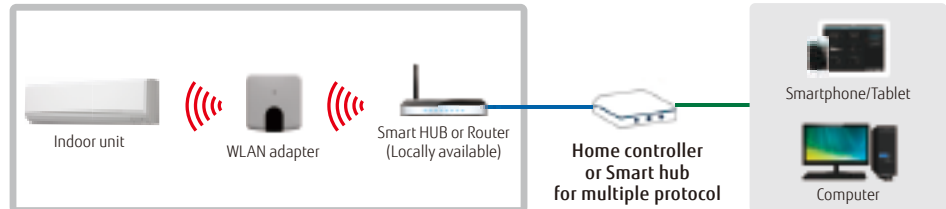

*IR receiver required for other than wall-mounted type.

Specifications

Model name	FG-RC-WMP1Z1 (3-wire RC-line type)	FG-AC-WMP1Z1 (CN connector type)	FG-IR-WMP1Z1 (IR type)
Number of controllable groups	1	1	1
Dimensions (H × W × D) (mm)	70 × 100 × 28	127 × 50 × 17	81 × 78 × 28
Weight (g)	98	80	76

Multiple protocol LAN adapter

FG-TL-MBS16Z1



Intesis
BY THE POWER OF INTEL



FG-TL-MBS16Z1
(VRF type)

Up to

16 indoor units

Installation example

[VRF type]

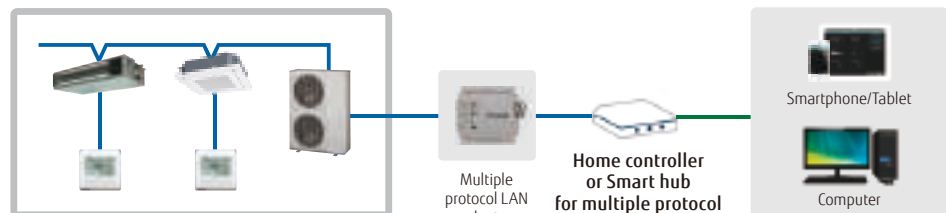

*No separate external power supply required

Specifications

Model name	FG-TL-MBS16Z1 (VRF type)
Power supply	9 to 36 V DC, Max.: 140 mA or 24 V AC 50/60 Hz, Max.: 127 mA.*
Input power (W)	1.7
Dimensions (H × W × D) (mm)	90 × 88 × 56
Weight (g)	330

*24 V DC power supply is recommended.

Home central remote controller

UTY-DMMGM / UTY-DMMGM1



Up to
1 multi-split system
Up to
6 indoor units

For 5-unit and 6-unit multi-split type

- Batched control of up to 6 indoor units For all indoor units connected to the remote controllers, the Home central remote controller sets room temperature, airflow volume, and remote controller prohibition from other remote controllers at once.
- Supports 9 languages: English, French, German, Greek, Italian, Portuguese, Russian, Spanish, and Turkish.
- Large backlit LED screen
- Large, easy-to-see operation panel

Example of system configuration

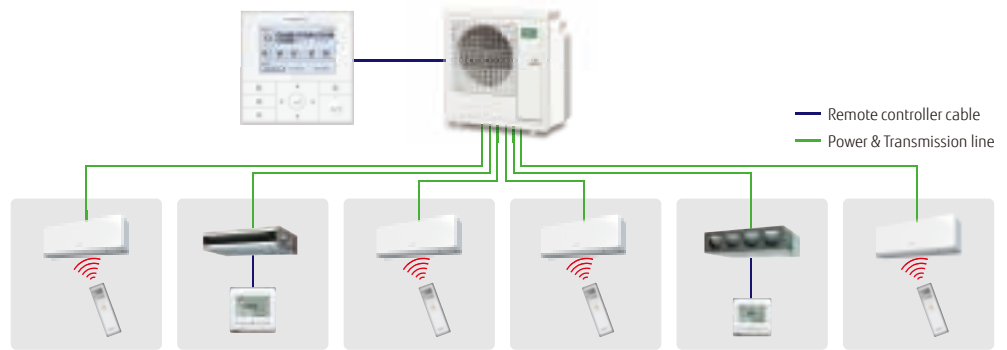

Home central remote controller

Weekly timer

Up to 4 ON/OFF settings can be programmed per day. Two weekly patterns can be set, one for the cooling season and the other for the heating season.

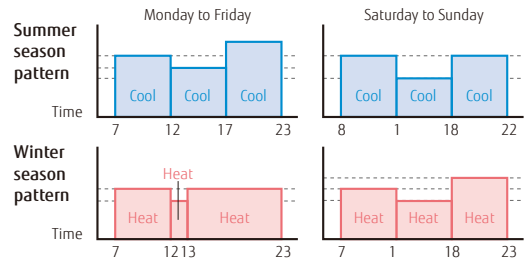

Low noise operation

You can choose from 4 low noise levels depending on the installation environment. ON/OFF timing of low noise mode can be set with the timer.

10 °C heat operation

When you leave the house, the air conditioner runs a minimum heating operation to maintain the room temperature at 10°C.

*Consult your dealer for conditions of use.

Economy operation

When you select energy-saving economy mode, the temperature setting for the indoor unit increases (during cooling operation) or decreases (during heating operation) by 1°C and the maximum electric value of the outdoor unit is suppressed.

Prohibiting local control, including settings such as child lock

The Home central remote controller is equipped with a lock function to prevent unauthorized operation from the remote controllers of the indoor unit in each room. The Home central remote controller is equipped with a child lock to prevent children from accidentally turning the air conditioner on or off or changing its settings.

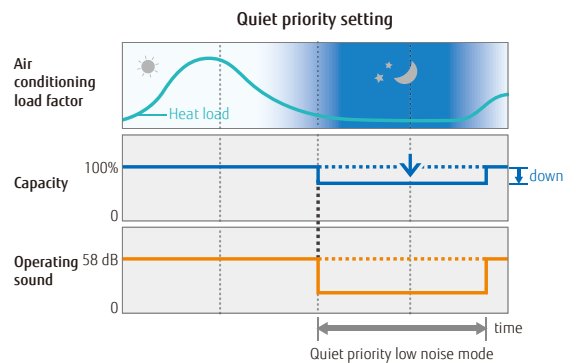

Specifications

Model name	UTY-DMMGM/UTY-DMMGM1
Power source	12 V DC
Dimensions (H × W × D) (mm)	120 × 120 × 21.3
Weight (g)	220

12 V DC supplied by an indoor unit

Central remote controller

UTY-DCGGZ3



NEW



Up to **100** indoor units
Up to **50** groups

For tenants in small to midsize commercial premises

- Individual control and monitoring of up to 100 indoor units
- 7.0inch TFT color screen
- Visually intuitive operation
- Room temperature display by indoor unit sensor & remote controller sensor
- 50 Remote Controller Groups Display & remote controller group rename
- Supports 14 languages: Chinese (Simplified/Traditional), Dutch, English, French, German, Greek, Italian, Polish, Portuguese, Russian, Spanish, Turkish, and Thai (Remote Management only)

Easy operation

Air conditioning management by detecting room temperatures of each room

The room temperature detected with indoor unit sensor or remote controller sensor can be displayed. New model can detect the room temperature by indoor units sensors even if wired remote controllers are not connected to the indoor units.



Not connected wired remote controller

: Indoor Unit Sensor

Thermistor

Connected wired remote controller

: Remote Controller Sensor / other sensors

Thermistor

*Room temperature is displayed only when indoor unit operates.

50 Remote Controller Groups Display

The group display and the 50 remote controller groups display can be switched easily. Users can choose which display is better, depending on the situation.

Group Display

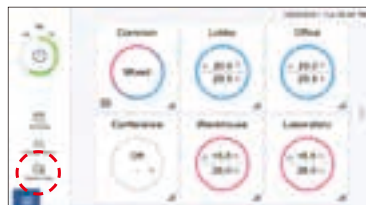

Manage & Monitor
by each Groups

50 Remote Controller Groups Display



Manage & Monitor
by 50 Remote Controller Groups



Remote Controller Groups Rename

The remote controller group names can be changed. Users can know easily where the air conditioning is located by changing the remote controller group names.

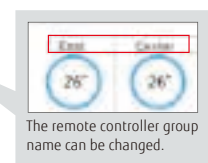

Features: Central Remote Controller

- Easy intuitive operation from the touch panel display.
- All functions can be accessed through the monitoring screen showing a pop-up window for detailed operation.



Monitoring screen



Individual setting

Added individual wind direction control

Individual wind direction control has been added.
Circular flow cassette / 3D Flow cassette



Circular flow cassette

Human sensor Compatible

Human sensor setting

- Auto save
- Auto on / off
- Auto off detection time
- Enable and disable



Remote Management

Remote monitoring / Remote operation

New central remote controller can control your tenant's air conditioner anytime and anywhere.

When the central remote controller manages the indoor units of some tenants, air conditioning of each tenant can be managed separately online.

Increased the Number of Accounts

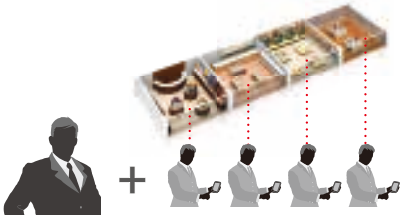

Administrator (Building owner) + Online users (Tenant owner)

Maximum
30
accounts

Trouble support function

Display error details

Display descriptive explanation when an error occurs



All indoor unit groups display

Display error details

- Indoor unit error
- Outdoor unit error
- Central remote controller error

Sensor value monitoring function

Monitor sensor data of indoor unit / outdoor unit, send mail

Notify room temperature by email*

Notify by e-mail when the temperature around the air conditioner is too high or too low

*:This function is available only when using wired remote controller.

NEW Schedule management

Annual schedule

- An annual schedule can be arranged for each remote controller group or user-defined group.
- Allows for the programming of special settings for weekends, holidays, and store closings throughout the year.



low noise schedule

Low noise operation of outdoor units can be scheduled.

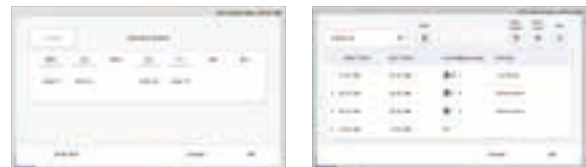

Automatic return to set temperature

A function that automatically returns the changed temperature to its original value over time.

Specifications

Model name	UTY-DCG6Z3
Power Supply	100-240 V 50/60 Hz
Dimensions (H × W × D) (mm)	134.6 × 216.2 × 37.9
Weight (g)	800

Touch panel controller

UTY-DTGGZ1



- Large 7.5-inch TFT color LCD screen
- Touch screen operation
- Stylish design to fit nicely into any room environment
- Controls up to 400 indoor units.
- Icon or list view can be selected in monitoring mode.
- Supports 7 languages: Chinese, English, French, German, Polish, Russian, and Spanish.
- Mounted with LAN adapter for remote control & operation, external input/output with emergency stop and batch ON/OFF

Up to
400 indoor units

Up to
100 outdoor units

Up to
400 groups

Easy operation

- Wide range of simple-to-understand icons
- Operate by pressing the icons on the screen with your finger or a stylus.
- The color on the back identifies the current control operation; blue is for monitoring and green is for operational control.



Easy maintenance

- The flat touch panel can be easily cleaned.
- Touch panel controller with non-glare coating to prevent finger marks
- Front cover for easy removal.



Easy installation

- The touch panel controller can be mounted on a wall.
- Flat back surface enables easy installation anywhere on a wall.
- No additional parts or components required for installation



Controls up to 400 indoor units.

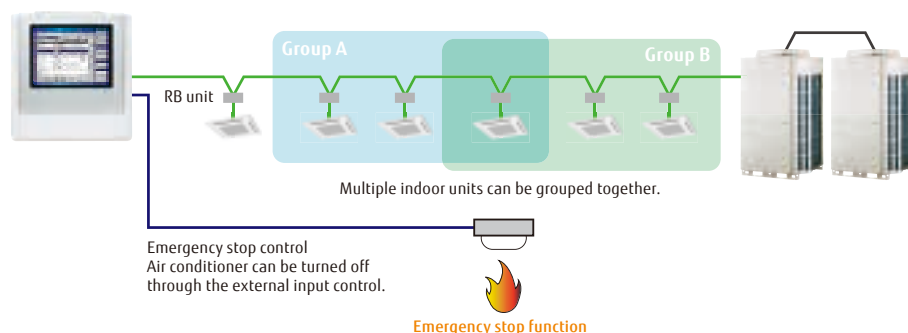

Features:

Control & monitoring

- Control and monitor Fujitsu General air conditioners via LAN or internet.
- Users and tenants can manage their assigned equipment from anywhere by computer or tablet.
- When something goes wrong, an error notice is sent by e-mail for prompt troubleshooting.

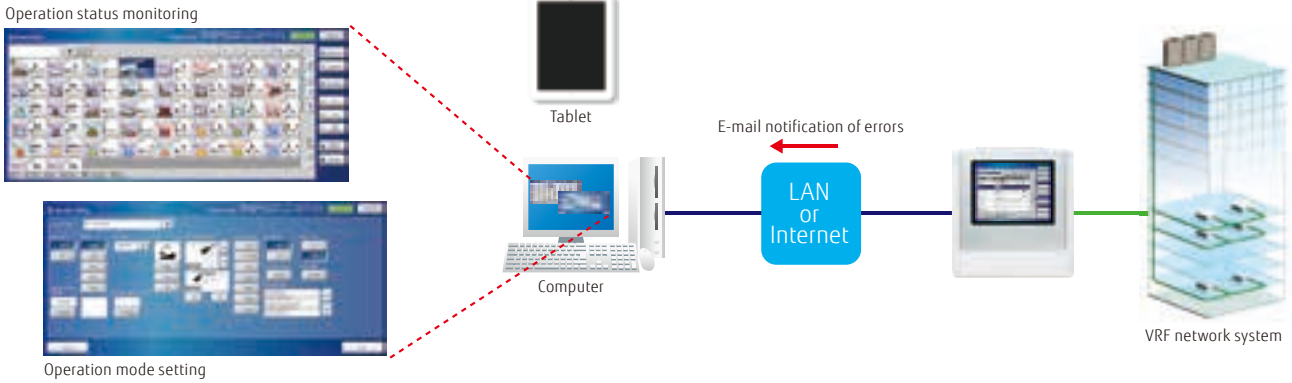

Smartphone

Model name	Browser
Nexus 6P (Android 7.1.1)	Google Chrome 5.5
iPhone 7 (iOS 10.1)	Safari 10

Tablet

Model name	Browser
iPad Pro 9.7 inch (iOS 10.2.1)	Safari 10

Flexible access permissions can be granted to users at each point level.

The administrator can register multiple users and permit them to access any indoor unit and any functions.

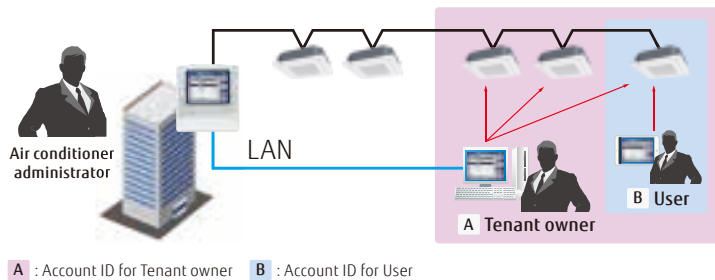

Additional languages

Supports 7 languages as standard: Chinese, English, French, German, Polish, Russian, and Spanish. Create a language database to integrate additional languages into the remote device. The added languages will only be displayed on the remote device and cannot be added to the Touch panel controller.

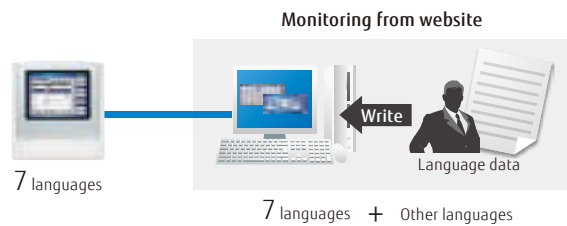

Electricity charge apportionment
(Option: UTY-PTGXA)

- Energy cost can be calculated and allocated to each billing user in proportion to the amount of energy used for air conditioning.

- Apportionment charge/bill calculation
- Tenant (block) setting
- Common facilities apportionment setting
- Rated power consumption allotment
- Individual calculations for cooling and heating
- Electricity meter supported

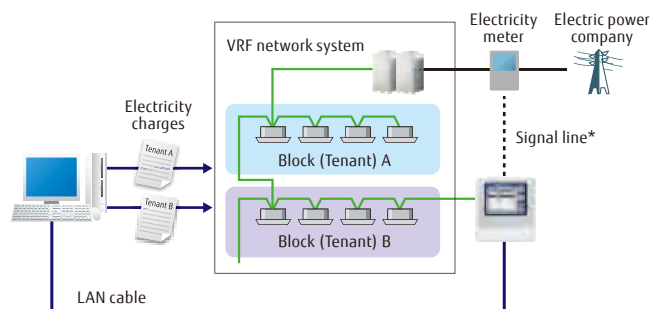

* An electricity usage meter can be connected to an external input connector of the Touch panel controller. In that case, the meter cannot be connected to an outdoor unit at the same time.

Features:

Automatic setting for daylight saving time

Functions provided

- 1) Schedule setting for daylight saving time
 - It prevents the user from forgetting to set daylight saving time. In addition, it saves time and effort for the user.

Automatic clock adjustment

- 2) Time can be set for all controllers in a batch automatically.

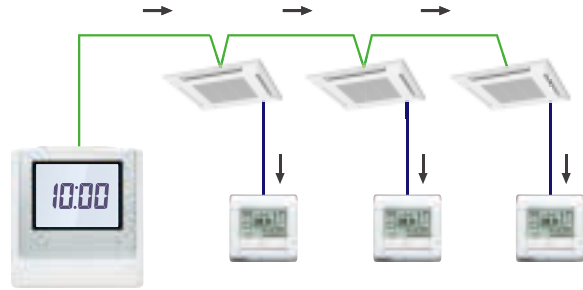

Outdoor unit low noise operation

You can choose from 4 low noise levels depending on the installation environment. ON/OFF timing of low noise mode can be set with the timer.

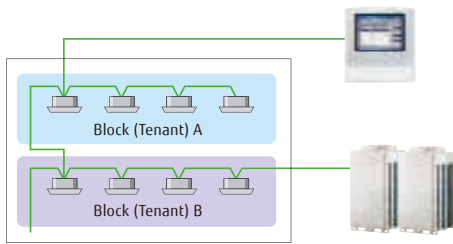

Quiet priority setting

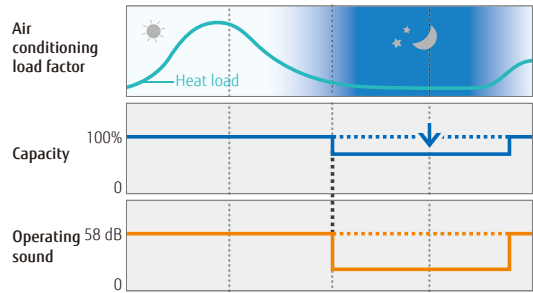

Energy-saving controls

Custom Auto

- Maintains 2 separate setpoints for heating and cooling operations.
- Automatically switches between heating and cooling modes.

* Not available for some models



Cooling set temp. 28 °C, Heating set temp. 18 °C

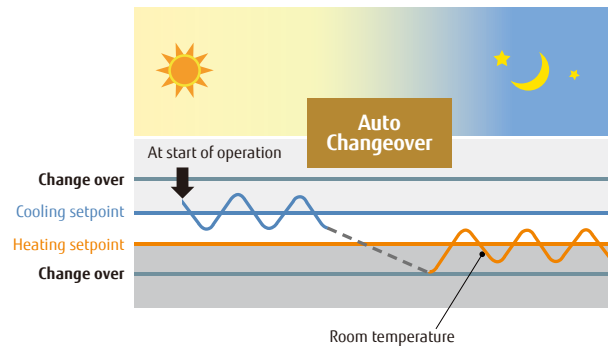



Refrigerant leak detector

Refrigerant leakage status is indicated by the management equipment. A pop-up message is displayed to notify the user, and the refrigerant is shut off.



Pop-up highlighting

FUNCTIONS SUMMARY



	 UTY-DTGGZ1	 Monitoring side
Air conditioning control functions		
ON/OFF	●	●
Operation mode setting*	●	●
Fan speed control	●	●
Room temperature setting	●	●
Setting temperature range limitation	●	●
Test operation	●	●
Vertical louver setting	●	●
Horizontal louver setting	●	●
Individual louver control	●*1	●
Group setting	●	●
Remote controller prohibition	●	●
Anti-freeze setting	●	●
Set temperature auto return	—	●
Energy-saving controls	—	●
Economy mode setting	●	●
Human sensor control	—	●
Displayed items		
Error	●	●
Defrosting	●	●
Current time	●	●
Day of week	●	●
Remote controller prohibition	●	●
Cooling/heating priority	●	●
Address display	●	●
Room temperature	●*3	●*3
Multiple language support	●	●
Setting for daylight saving time	●	●
Time zone setting	●	●
Name registration	●	●
Backlighting	●	●
Language setting	7	7+other
Filter sign reset	●	●
Memory operations	●	●
Refrigerant leak detector	●	●

●: Supported ○: Optional function —: Not supported

*1 Only setting cancellation can be operated.

*2 Only available for external input control.

*3 Available only when using a Wired remote controller.

	 UTY-DTGGZ1	 Monitoring side
Timer		
	Period	Year
Schedule timer	ON/OFF, Temp, Mode, Times per day	20
ON/OFF timer		—
Sleep timer		—
Program timer		—
Auto-off timer		●
Day off		●
Minimum unit of timer setting (minutes)	10	10
Control		
Remote monitoring management system	●	●
Electricity charge apportionment	○	○
Error history	●	●
Emergency stop	●*2	●*2
Remote monitoring management	—	●
Energy-saving management	—	—
E-mail notification in case of failure	—	●
Key lock	● Password setting	—
Low noise mode	●	●

Specifications

Model name	UTY-DTGGZ1
Power supply	Single phase ~100 to 240 V 50/60 Hz
Dimensions (H × W × D) (mm)	260 × 246 × 54
Weight (g)	2,150
Interfaces	Transmission/LAN/USB/EXT IN/EXT OUT/Reset SW

System controller

UTY-APGXZ1 **Software**



Up to
4 VRF network systems
Up to
400 outdoor units
Up to
1,600 indoor units

System controller enables advanced integrated monitoring and control of VRF network systems operating in small to large buildings.

- Up to 1,600 indoor units and 400 outdoor units on up to 4 VRF network systems can be controlled.
- To accommodate facility management needs, the system controller offers—in addition to precise air conditioning control—remote central control, electricity charge apportionment, schedule management, and energy-saving options for VRF network systems.
- Supports 7 languages: Chinese, English, French, German, Polish, Russian, and Spanish.

System controller lite

UTY-ALGXZ1 **Software**



Up to
1 VRF network systems
Up to
100 outdoor units
Up to
400 indoor units

System controller Lite offers a set of standard functions to manage air conditioners operating in a small or midsize building.

- Up to 400 indoor units and 100 outdoor units on a VRF network system can be controlled.
- In addition to precise air conditioning control, a variety of applications are available as options to offer a wider range of control.
- Supports 7 languages: Chinese, English, French, German, Polish, Russian, and Spanish.

Visually intuitive operation

Click & Operate: The visual representation of the property is shown on the screen from the perspective most suitable for operation (Click & Operate) You can select from among 4 display options: site, building, floor, and list.

Freely define groups for batched control: Indoor units can be grouped for simplified batch control from the tree menu. They can be grouped by organizational hierarchy, such as by division, department, and section.

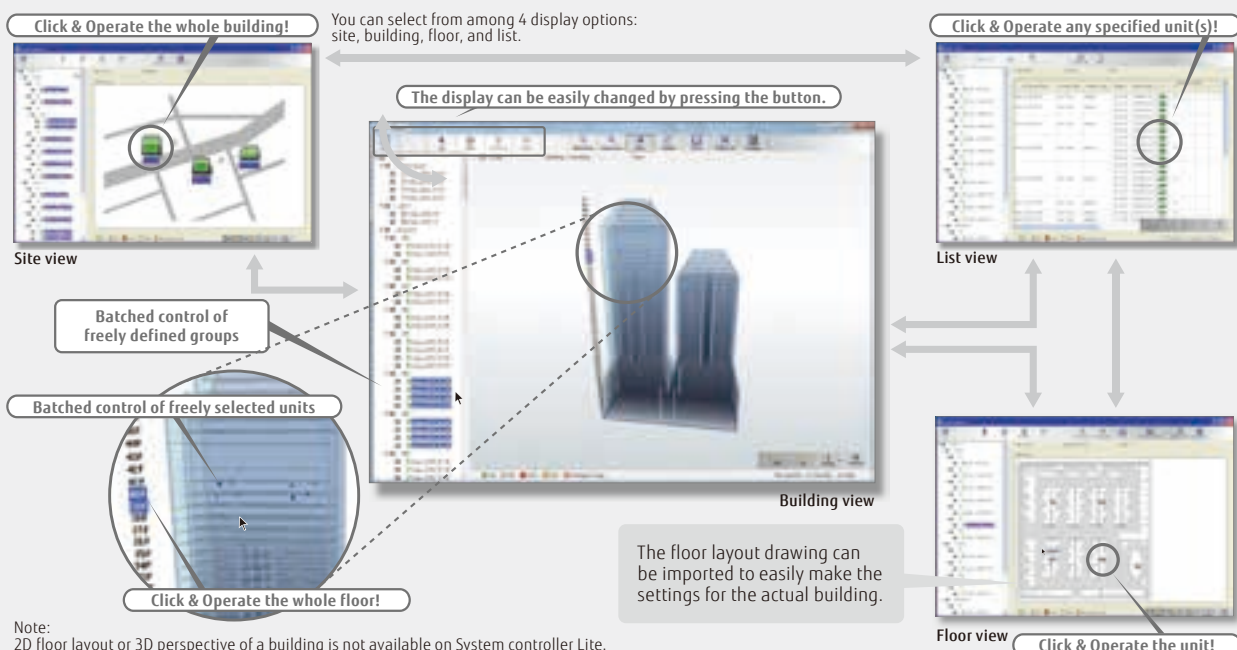

Features:

Third-party devices connected via MODBUS® can be controlled.

Standard for System Controller **Option** for System controller Lite UTY-PLGXX2

When a MODBUS® adapter (locally available) is connected to a computer, electrical equipment and devices supported by MODBUS® can be monitored and controlled centrally from the computer. The central control can reduce wasted energy throughout an entire building resulting from a failure to turn equipment off during or after work, as well as reduce the need for on-site patrols.

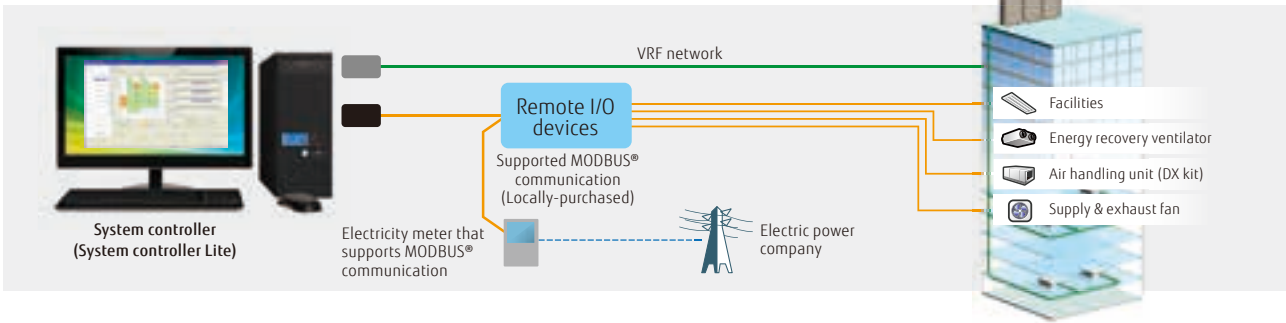

Wide-ranging operation and data management

Standard System controller and System controller Lite

Schedule management

- An annual schedule can be arranged for each remote controller group or user-defined group.
- ON/OFF, operation mode, remote controller prohibition, and temperature settings can be programmed for up to 143 times per day at 10-minute intervals and for up to 101 configurations for each remote controller group.
- Settings can be programmed for a period that spans midnight.
- Allows for the programming of special settings for weekends, holidays, and store closings throughout the year.
- Low noise operation of outdoor units can be scheduled.

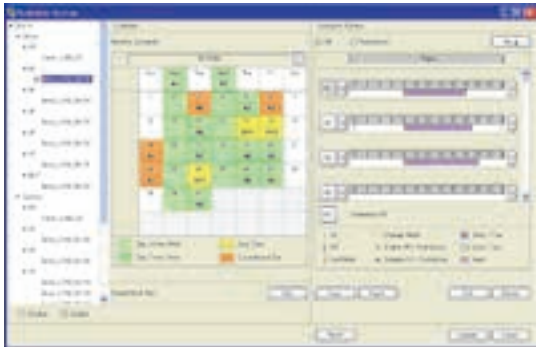

Wide-ranging control of indoor and outdoor units

- The operation status and mode of each indoor unit are displayed.
- Turn on and off each indoor unit and switch its operation mode.
- Setting temperature range limitation
- Low noise setting of outdoor units

Remote controller prohibition

Prohibits the operation mode, temperature setting, or ON/OFF of an indoor unit.

Error alert and e-mail notice

When something goes wrong, an error message is shown in a popup on a computer display with a chime, and an e-mail notice is sent. Errors of the past one year are logged and can be reviewed.

Operation and control history

A history of operation status and control can be maintained and retrieved.

Importing and exporting databases

Only an administrator is authorized to import and export registration, layout, and image data.

Automatic clock adjustment

Time can be set for all controllers in batch automatically.

Electricity charge apportionment

Standard on System controller

Option System controller Lite UTY-PLGXA2

Electricity charge apportionment method

This is a method to calculate monthly energy costs to be allocated to each tenant based on the amount of energy used by their air conditioners. The first step is to determine exactly how much energy is consumed by air conditioners in each tenant space. The second step is to divide the total energy charge billed by an electric power company based on the amount of energy used by each tenant to determine the energy cost to be allocated to each of them. (See figure on right)

The calculation takes into consideration such factors as the number of unused rooms and nighttime electricity rate, which are shown in detail on an energy cost allocation schedule.

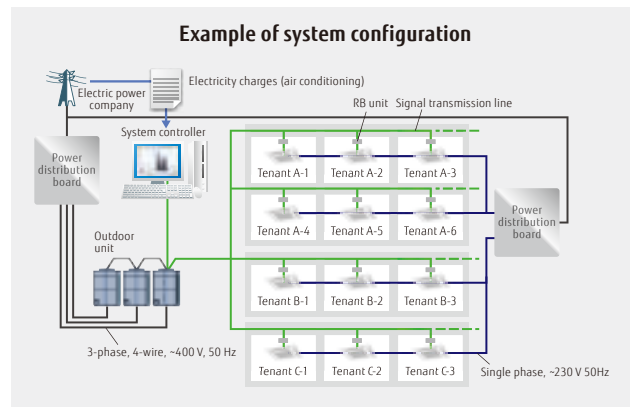

Features:

Remote monitoring management

- Standard** on System controller
- Option** System controller Lite UTY-PLGXR2

The System controller can be used on site or remotely over networks for remote central control. The System controller requires 2 software programs working together: The VRF controller runs on site and communicates with the VRF system; The VRF explorer, which runs at a remote location, provides a user interface and communicates with the VRF controller. The VRF controller and the VRF explorer run on a single computer or on different computers connected on a network. A computer running VRF explorer can centrally control up to 10 VRF system sites having up to 20 buildings each.

On site central control

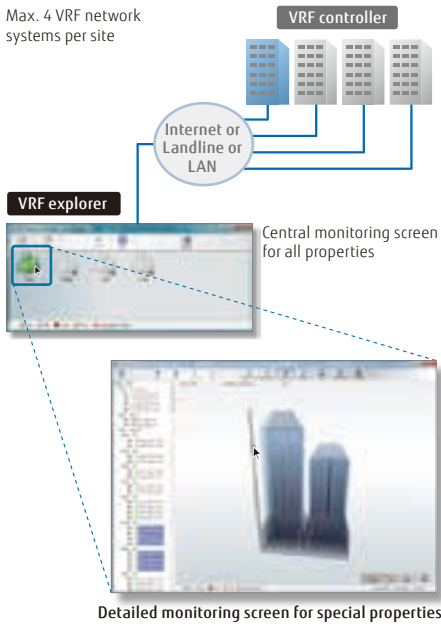

Remote central control

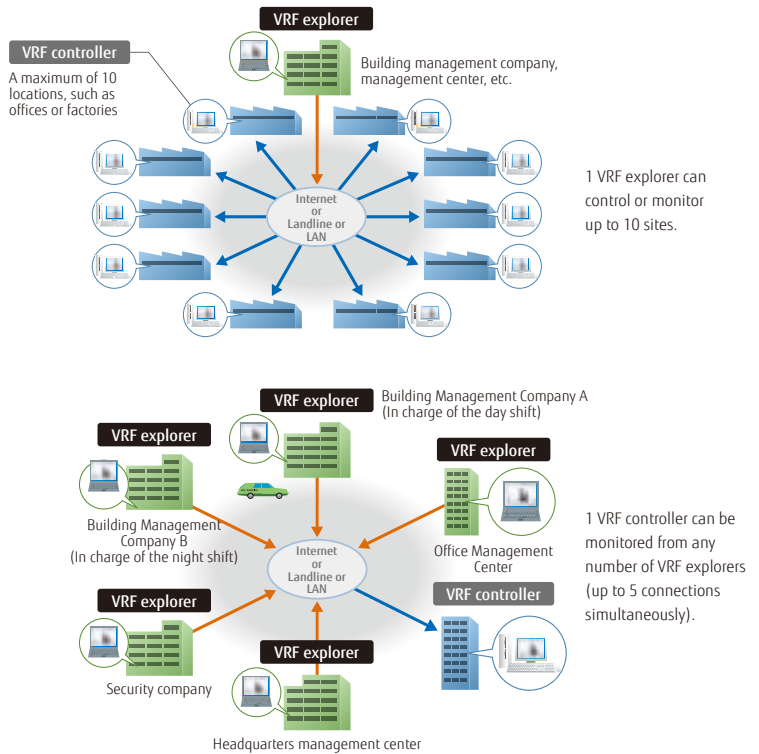

Energy-saving management

- Option** System controller UTY-PEGXZ1
- Option** System controller Lite UTY-PLGXZ2

A variety of energy-saving options can be selected depending on the season, weather, and time of day. Excellent energy-saving operation is performed while keeping users comfortable.



Main screen for energy-saving management

Energy saving graph data: This chart compares the energy consumption for the current month with the previous month and with the same month of the previous year to keep track of the energy-saving performance.

Indoor unit rotation

Indoor units can be automatically rotated to operate within a group in accordance with a predetermined annual schedule to reduce power consumption while keeping users comfortable. The operation stoppage rate can be selected for an indoor unit.

Peak-cut mode

The system controller monitors the connected power meter and controls the energy to maintain the target power consumption set for each time period by changing the set temperature of the indoor units or turning off the thermostat so as to keep the users comfortable. Indoor units to be controlled can be grouped in many ways, and the control level can be set for each group.

Capacity saving for outdoor unit

The upper limit on the capacity of an outdoor unit can be adjusted to reduce power consumption during a hot summer or cold winter by averaging out the power-saving performance of each refrigerant system. The upper limit on capacity can be set at 50% of the rated capacity or more.

Summary of functions

Functions	Type	System controller			System controller Lite				
		UTY-APGXZ1	Option UTY-PEGXZ1	UTY-ALGXZ1	Option UTY-PLGXR2	Option UTY-PLGXA2	Option UTY-PLGXE2	Option UTY-PLGXX2	
Specifications	Max. number of VRF networks supported	4	—	1	—	—	—	—	
	Max. number of indoor unit and remote controller groups per VRF network	400	—	400	—	—	—	—	
	Max. number of outdoor units per VRF network	100	—	100	—	—	—	—	
	Max. number of indoor units and remote controller groups per System controller	1600	—	400	—	—	—	—	
	Max. number of outdoor units per System controller	400	—	100	—	—	—	—	
Site supervision	Multiple site display	10	—	10	—	—	—	—	
	Number of buildings per site	20	—	—	—	—	—	—	
	Number of floors per site	200	—	—	—	—	—	—	
	Number of floors per building	50	—	—	—	—	—	—	
	3D graphical layout view	●	—	—	—	—	—	—	
	2D graphical layout view	●	—	—	—	—	—	—	
	List display	●	—	●	—	—	—	—	
	Tree display	●	—	●	—	—	—	—	
Error management	Group display	●	—	●	—	—	—	—	
	Error notification	●	—	●	—	—	—	—	
	Audible alarm	●	—	●	—	—	—	—	
History	E-mail notification of errors	●	—	●	—	—	—	—	
	Error history	●	—	●	—	—	—	—	
Operation control	Operation history	●	—	●	—	—	—	—	
	Control history	●	—	●	—	—	—	—	
	Individual control	ON/OFF	●	—	●	—	—	—	—
		Operation mode*	●	—	●	—	—	—	—
		Room temperature	●	—	●	—	—	—	—
		Fan speed	●	—	●	—	—	—	—
		Airflow direction	●	—	●	—	—	—	—
		Economy mode	●	—	●	—	—	—	—
		Setting temperature range limitation	●	—	●	—	—	—	—
	Anti-freeze	●	—	●	—	—	—	—	
	Individual management	Low noise setting of outdoor units	●	—	●	—	—	—	—
		Remote controller prohibition	●	—	●	—	—	—	—
		Setting temperature range limitation	●	—	●	—	—	—	—
	Other	Filter sign reset	●	—	●	—	—	—	—
		memory operations	●	—	●	—	—	—	—
Schedule	Pattern operations	●	—	●	—	—	—	—	
	Annual Schedule	●	—	●	—	—	—	—	
	Setting for a specific date	●	—	●	—	—	—	—	
	ON/OFF per day	72	—	72	—	—	—	—	
	ON/OFF per week	504	—	504	—	—	—	—	
	Day off	●	—	●	—	—	—	—	
	Minimum unit of timer setting (minutes)	10	—	10	—	—	—	—	
Remote monitoring management	Weekly schedule for low noise mode	●	—	●	—	—	—	—	
	Web Operation	●	—	●	—	—	—	—	
	Remote monitoring	●	—	●	—	—	—	—	
	Remote operation control	●	—	●	—	—	—	—	
Electricity charge apportionment	Remote function setting	●	—	●	—	—	—	—	
	Apportionment charge/bill calculation	●	—	●	—	●	—	—	
	Tenant (block) setting	●	—	●	—	●	—	—	
	Common facilities apportionment setting	●	—	●	—	●	—	—	
	Rated power consumption allotment	●	—	●	—	●	—	—	
Energy-saving management	Individual calculations for cooling and heating	—	●	—	—	●	—	—	
	Electricity meter supported	—	●	—	—	●	—	—	
	Indoor unit rotation	—	●	—	—	—	●	—	
	Peak cut control	—	●	—	—	—	●	—	
	Capacity saving for outdoor unit	—	●	—	—	—	●	—	
	Record of energy-saving operation	—	●	—	—	—	●	—	
	Information on energy saving	—	●	—	—	—	●	—	
Control of external devices	Power consumption monitor	—	●	—	—	●	—	—	
	Electricity meter supported	—	●	—	—	●	—	—	
Others	Monitor	●	—	●	—	—	●	—	
	Control	●	—	●	—	—	●	—	
	Importing and exporting databases	●	—	●	—	—	—	—	
	Automatic clock adjustment	●	—	●	—	—	—	—	
	Multiple language support	7 languages	—	7 languages	—	—	—	—	
Power shutdown	Refrigerant leak detector	●	—	●	—	—	—	—	
	Power shutdown	●	—	●	—	—	—	—	

●●: Available - : Not available

Computer requirements

The specifications required for the computer are shown in the table below:

	System controller	System controller Lite
Operating system	<ul style="list-style-type: none"> Microsoft® Windows® 7 Home Premium (32-bit or 64-bit) SP1, Windows® 7 Professional (32-bit or 64-bit) SP1 Microsoft® Windows® 8.1 (32-bit or 64-bit), Windows® 8.1 Pro (32-bit or 64-bit) Microsoft® Windows® 10 Home (32-bit or 64-bit), Windows® 10 Pro (32-bit or 64-bit) Supports 7 languages: English, Chinese, French, German, Russian, Spanish, and Polish	<ul style="list-style-type: none"> Microsoft® Windows® 7 Home Premium (32-bit or 64-bit) SP1, Windows® 7 Professional (32-bit or 64-bit) SP1 Microsoft® Windows® 8.1 (32-bit or 64-bit), Windows® 8.1 Pro (32-bit or 64-bit) Microsoft® Windows® 10 Home (32-bit or 64-bit), Windows® 10 Pro (32-bit or 64-bit) Supports 7 languages: English, Chinese, French, German, Russian, Spanish, and Polish
CPU	Intel® Core™ i3 2 GHz or higher	Intel® Core™ i3 2 GHz or higher
Memory	<ul style="list-style-type: none"> 2 GB or more (for Windows® 7 [32-bit]) 4 GB or more (for Windows® 7 [64-bit], Windows® 8.1, and Windows® 10) 	<ul style="list-style-type: none"> 2 GB or more (for Windows® 7 [32-bit]) 4 GB or more (for Windows® 7 [64-bit], Windows® 8.1, and Windows® 10)
HDD	40 GB or more of free space	40 GB or more of free space
Displayed items	1024 × 768 or higher resolution	1024 × 768 or higher resolution
Interfaces	<ul style="list-style-type: none"> Ethernet port (for getting access to the internet using LAN) or a modem (for getting access to the internet via landline) Up to 6 USB ports (Only required for a server computer working as a VRF controller) - Maximum of 2 USB ports are required to connect to a White-USB-key/WibuKey - Up to 4 USB ports required to connect to an Echelon® U10 USB network interface * Maximum number of required USB ports depends on the applicable system configuration. 	<ul style="list-style-type: none"> Ethernet port (for getting access to the internet using LAN) or a modem (for getting access to the internet via landline) Up to 6 USB ports (Only required for a server computer working as a VRF controller) - Maximum of 4 USB ports are required to connect to a White-USB-key/WibuKey - 1 USB port is required for an Echelon® U10 USB Network interface * The maximum number of required USB ports depends on the applicable system configuration.
Graphic accelerator	Microsoft® DirectX® 9.0c compatible	Microsoft® DirectX® 9.0c compatible
Software	Adobe® Acrobat Reader® 9.0 or later	Adobe® Acrobat Reader® 9.0 or later

• Echelon® U10 USB Network interface - TP/FT-10 Channel (Model name: 75010R) (Required for each VRF Network)

Packing list

Type	For System controller			For System controller Lite			
	System controller	Option Energy manager	System controller Lite	Remote access	Electricity charge apportionment	Energy saving	Centralized control
Model name	UTY-APGXZ1	UTY-PEGXZ1	UTY-ALGXZ1	UTY-PLGXR2	UTY-PLGXA2	UTY-PLGXE2	UTY-PLGXX2
White-USB-key	1	1	1	1	1	1	1

*1: Software protection key to be inserted in a USB slot running System controller or System controller Lite.

System controller or System controller Lite may only run on a PC with a WHITE-USB-KEY. However, a WHITE-USB-KEY is not required for remote VRF explorer software.

MODBUS® converter for indoor unit

UTY-VMSX



Up to
1 indoor unit

MODBUS® converter enables air conditioners to be fully integrated into a MODBUS® network.

- Simple installation due to small and compact size.
- No separate external power supply required.
- The MODBUS® converter must be connected to an indoor unit on a one-to-one basis.
- The MODBUS® converter enables central monitoring and control of air conditioners from BMS, central, or home controller.

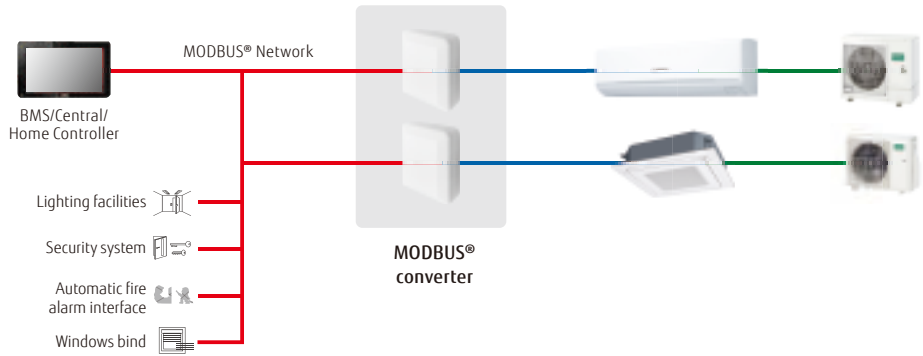

Easy Installation

Easy to install with minimal wiring and without the need for a power supply cable to the converter

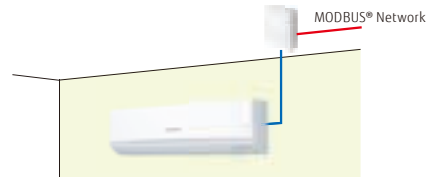

Basic control

- Turning the units on and off
- Mode control (Heat, Cool, Dry, Auto, Fan)
- Fan speed control
- Louver position (airflow direction setting)
- Room temperature setting and display
- Economy mode setting
- Error status

Specifications

Model name	UTY-VMSX
Power supply	12 V DC
Input power (W)	Max. 1.2 W
Dimensions (H × W × D) (mm)	140 × 117 × 43
Weight (g)	200
Maximum number of connectable indoor units per MODBUS® converter	1

Modbus communication specifications

Transfer mode	RTU mode
Communication speed	9600/19200 bps
Data bit	8
Parity	even/odd/none
Stop bit	1/2 (no parity)
Network	RS485
Maximum cable length	1000 m (3280 ft)

MODBUS® interface

FG-RC-MBS1Z1 / FG-AC-MBS1Z1 / FG-IR-BMG1Z1



Intesis
BY THE WAY WE CONTROL



FG-RC-MBS1Z1
(3-wire RC-line type)

MODBUS® interface enables air conditioners to be fully integrated into a MODBUS® network.

- Small, compact, and easy to install on DIN rails.
- No separate external power supply required.
- MODBUS® interface enables central monitoring and control of air conditioners from BMS.

Intesis
BY THE WAY WE CONTROL



FG-AC-MBS1Z1
(CN connector type)

Installation example

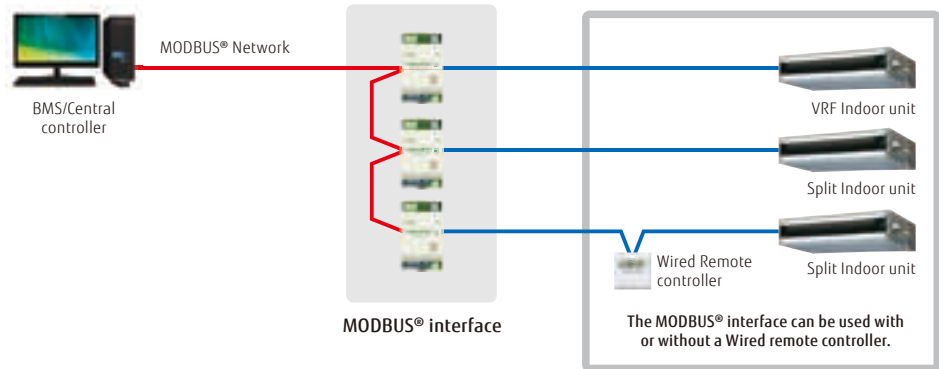

Intesis
BY THE WAY WE CONTROL



FG-IR-BMG1Z1
(IR type)

[IR type] Connection to wall-mounted type

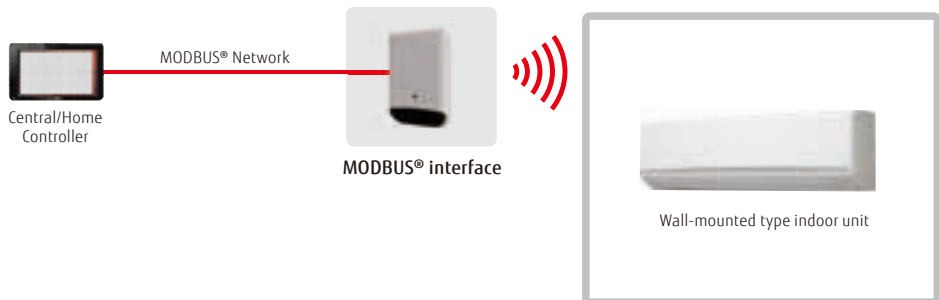

Up to
1 indoor unit

Specifications

Model name	FG-RC-MBS1Z1 (3-wire RC-line type)	FG-AC-MBS1Z1 (CN connector type)	FG-IR-BMG1Z1 (IR type)
Number of controllable groups	1	1	1
Dimensions (H × W × D) (mm)	93 × 53 × 58	93 × 53 × 58	93 × 60 × 21
Weight (g)	85	85	55

MODBUS® convertor for VRF

UTY-VMGX / FG-TL-MBS16Z1

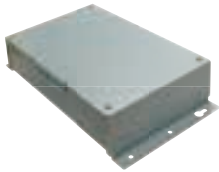

UTY-VMGX

Up to
9 units per VRF system
Up to
100 outdoor units
Up to
128 indoor units

MODBUS® convertor enables air conditioners to be fully integrated into a MODBUS® network.

- Compact and lightweight design
- Direct connection to MODBUS® network
- MODBUS® convertor enables central monitoring and control of air conditioners from BMS or a central controller.
- Up to 9 converters can be connected to a VRF network (UTY-VMGX). Simultaneous control, such as Power ON/OFF and temperature setting, can be performed for each zone.
- If a connection error occurs after installation work is completed, the source of the error can be located easily.

Installation example



FG-TL-MBS16Z1

Up to
16 indoor units
Up to
16 outdoor units
Up to
128 indoor units

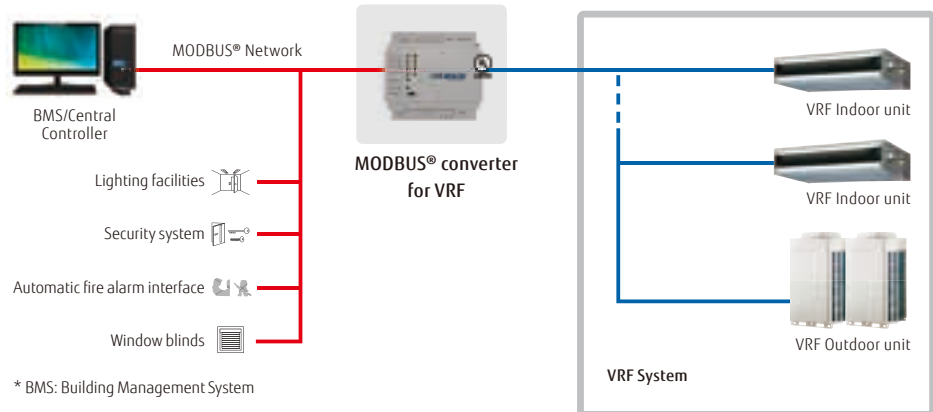
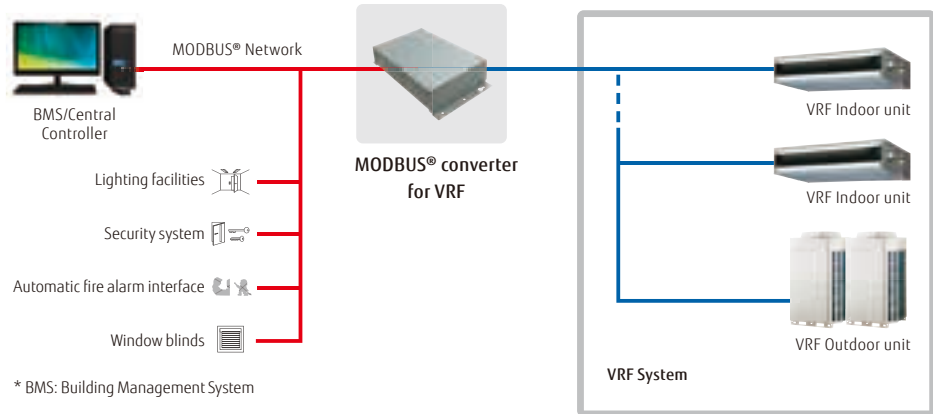

Specifications

Model name	UTY-VMGX	FG-TL-MBS16Z1
Power supply	Single phase ~220 to 240 V 50/60 Hz	9 to 36 V DC, Max.: 140 mA or 24 V AC 50/60 Hz, Max.: 127 mA.*
Input power (W)	Max. 2	1.7
Dimensions (H × W × D) (mm)	54 × 260 × 150	90 × 88 × 56
Weight (g)	1,100	330

*24 V DC power supply is recommended.

BACnet® interface

FG-AC-BAC1Z1 / FG-IR-BMG1Z1



Intesis
BY FUJITSU GENERAL



FG-AC-BAC1Z1
(CN connector type)

- BACnet® interface connects BMS and a Fujitsu General split/multi-split/VRF system.
- Compatible with BACnet® (ANSI/ASHRAE-135-2012) application-specific controller (B-ASC)
- Compatible with BACnet®/IP over Ethernet.

Intesis
BY FUJITSU GENERAL



FG-IR-BMG1Z1
(IR type)

Up to
1 indoor units

Installation example

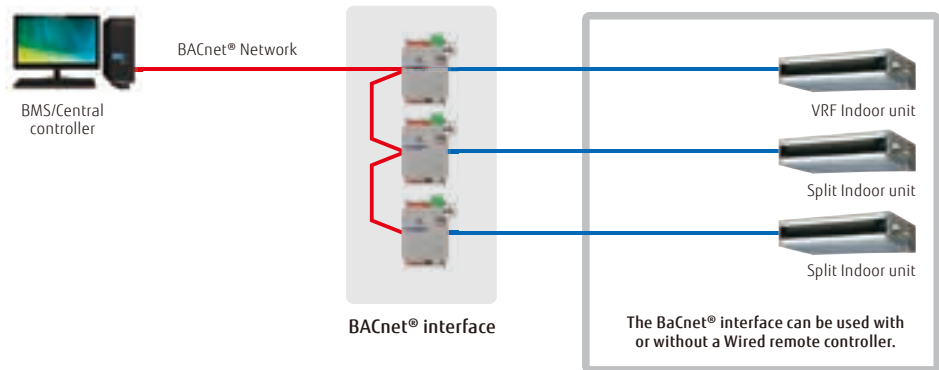

[IR type] Connection to wall-mounted type

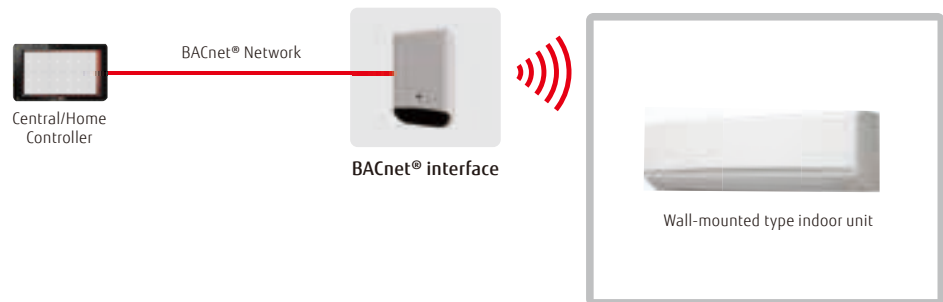

Specifications

Model name	FG-AC-BAC1Z1 (CN connector type)	FG-IR-BMG1Z1 (IR type)
Number of controllable groups	1	1
Dimensions (H × W × D) (mm)	93 × 53 × 58	93 × 60 × 21
Weight (g)	85	55

12 V DC supplied by an indoor unit

BACnet® gateway

UTY-ABGXZ1 Software



BACnet® is a registered trademark of ASHRAE. ASHRAE does not endorse, approve or test products for compliance with ASHRAE standards. Compliance of listed products to the requirements of ASHRAE Standard 135 is the responsibility of BACnet International (BIL). BTL is a registered trademark of BACnet International.

- A medium to large BMS can be connected to a VRF network system via BACnet®, a standard communication protocol for open networks.
- Up to 1,600 indoor units on up to 4 VRF network systems (up to 400 indoor units and 100 outdoor units per system) can be connected to a single BACnet® gateway.
- The VRF network system can be controlled or monitored from BMS via BACnet® gateway.
- Compatible with BACnet® (ANSI/ASHRAE-135-2014) application specific controller (B-ASC).
- Compatible with BACnet®/IP over Ethernet.
- Scheduling, alarm and event setting, and energy cost allocation are provided on the BACnet® gateway.
- The VRF network system can be connected to a computer via a U10 USB interface. Note that Fujitsu General does not supply a U10 USB interface or a computer. They must be purchased separately by the user.
- Corresponds to 7 different languages: English, Chinese, French, German, Spanish, Russian, Polish.

Up to
4 VRF network systems
Up to
400 outdoor units
Up to
1,600 indoor units

Installation example

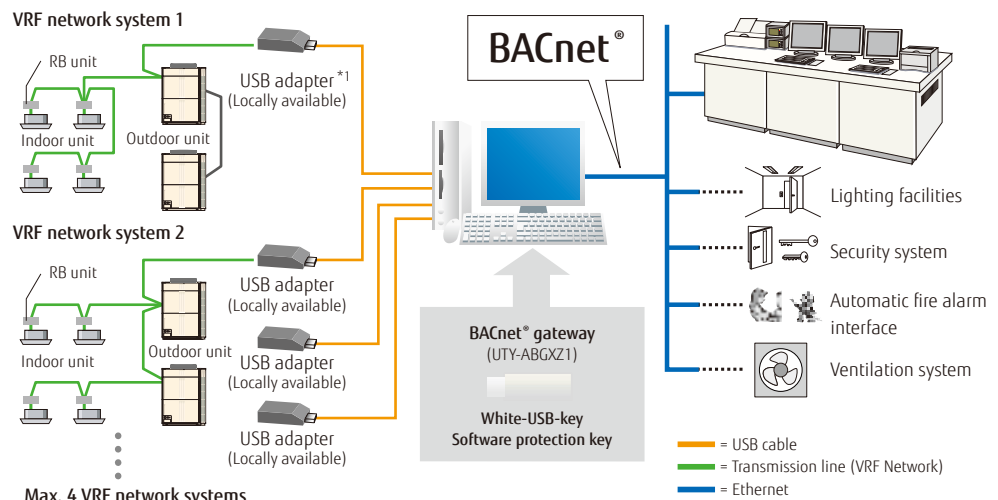

*1: U10 USB network interface available from Echelon® Corporation.

Computer requirements

UTY-ABGXZ1	
Operating system	<ul style="list-style-type: none"> • Microsoft® Windows® 7 Home Premium (32-bit or 64-bit) SP1, Windows® 7 Professional (32-bit or 64-bit) SP1 • Microsoft® Windows® 8.1 (32-bit or 64-bit), Windows® 8.1 Pro (32-bit or 64-bit) • Microsoft® Windows® 10 Home (32-bit or 64-bit), Windows® 10 Pro (32-bit or 64-bit) Supported languages: Chinese, English, French, German, Polish, Russian, and Spanish
CPU	Intel® Core™ i3 2 GHz or higher
Memory	<ul style="list-style-type: none"> • 2 GB or more (for Windows® 7 [32-bit]) • 4 GB or more (for Windows® 7 [64-bit], Windows® 8.1, and Windows® 10)
HDD	40 GB or more of free space
Displayed items	1024 × 768 or higher resolution
Interfaces	<ul style="list-style-type: none"> • Ethernet port (for getting access to the internet using LAN) • Up to 5 USB ports <ul style="list-style-type: none"> - 1 USB port required to connect to a White-USB-key/WibuKey - Up to 4 USB ports required to connect to an Echelon® U10 USB network interface *The maximum number of required USB ports varies depending on the applicable system configuration.
Software	Adobe® Acrobat Reader® 9.0 or later

•Echelon® U10 USB Network interface – TP/FT-10 Channel (Model name: 75010R) (Required for each VRF Network)

Packing list

Name and shape	Quantity	Application
White-USB-key	1	Includes the software, user's manual, and license for BACnet® gateway.

BACnet® gateway

UTY-VBGX **Hardware**



- BACnet® gateway connects BMS and a Fujitsu General VRF system.
- Up to 128 indoor units and 32 refrigerant systems can be connected to a single BACnet® gateway.
- Compatible with BACnet® (ANSI/ASHRAE-135-2012) application-specific controller (B-ASC)
- Compatible with BACnet®/IP over Ethernet.



BACnet® is a registered trademark of ASHRAE. ASHRAE does not endorse, approve or test products for compliance with ASHRAE standards. Compliance of listed products to the requirements of ASHRAE Standard 135 is the responsibility of BACnet International (BI). BTL is a registered trademark of BACnet International.

Up to
1 VRF network systems
Up to
32 refrigerant systems
Up to
128 indoor units

Installation example

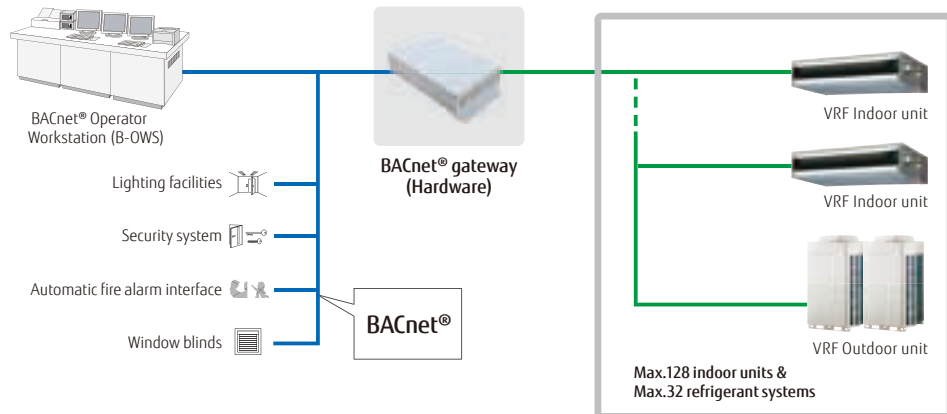

Specifications

Model name	UTY-VBGX
Number of controllable indoor units	128
Number of controllable refrigerant systems	32
Number of controllable VRF networks	1
Number of connectable units / one VRF network	4
Power supply	Single phase, 100-240 V, 50/60 Hz
Power consumption (W)	4.6 (max.)
Dimensions (H × W × D) (mm)	59.6 × 270.4 × 176
Weight (g)	1200

BACnet®/MODBUS® router

FG-RTR-BAC32Z1 / FG-RTR-MBS32Z1



Intesis
BYE BUILT FOR THE FUTURE



FG-RTR-BAC32Z1
(BACnet)

Intesis
BYE BUILT FOR THE FUTURE



FG-RTR-MBS32Z1
(MODBUS®)

Routing between BaCnet® MS/TP and BaCnet® IP networks

- Routing between BaCnet® MS/TP and BaCnet® IP networks
- Routing between MODBUS® RTU and MODBUS® TCP networks

Installation example

[BaCnet® type]

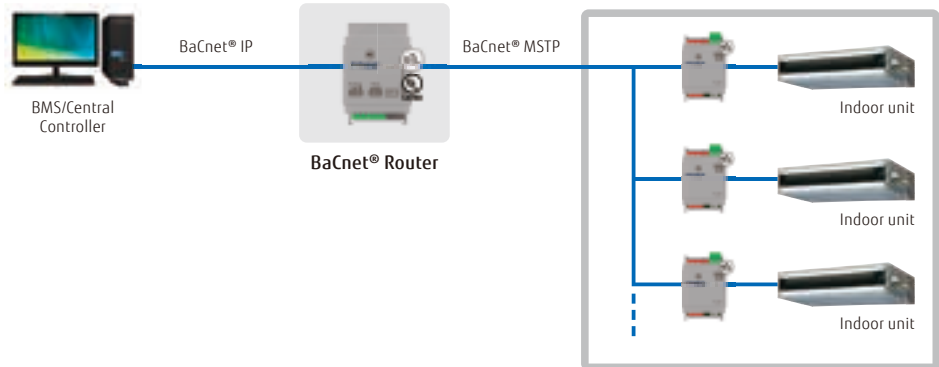

[MODBUS® type]

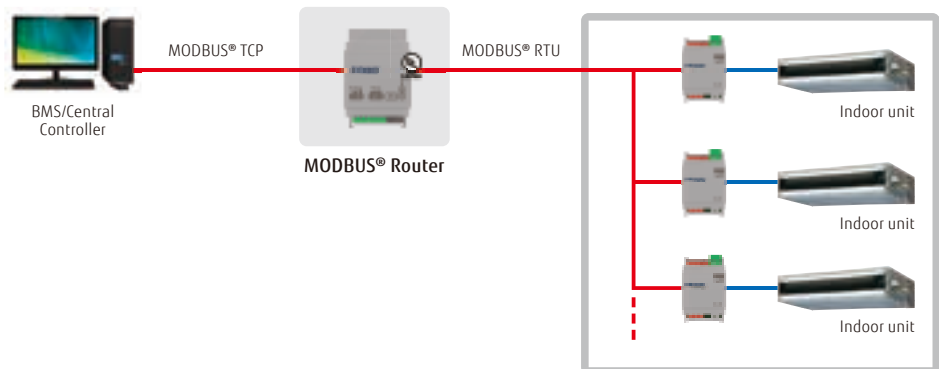

Specifications

Model name	FG-RTR-BAC32Z1 (MS/TP to IP)	FG-RTR-MBS32Z1 (RTU to TCP)
Number of routable devices (max.)	32	32
Power supply	9 to 36 V DC, Max.: 140 mA or 24 V AC 50/60 Hz, Max.: 127 mA	9 to 36 V DC, Max.: 140 mA or 24 V AC 50/60 Hz, Max.: 127 mA
Power consumption (W)	1.7	1.7
Dimensions (H × W × D) (mm)	93 × 53 × 58	93 × 53 × 58
Weight (g)	150	150

BACnet®/MODBUS® cloud device

FG-CLD-BMG4Z1 / FG-CLD-BMG8Z1 / FG-CLD-BMG16Z1 / FG-CLD-BMG32Z1



Intesis
BY THE WAY OF THE WORLD



FG-CLD-BMG4/8/16/32Z1

- The most powerful configuration tool common to all BACnet® gateways provides the system integrators with the power to configure and monitor their systems in an easy and reliable manner.
- A simple, easy-to-use description for the ST Cloud Web and App User Interface, with all widgets customizable to the user's needs, enabling system integrators to easily offer the best user experience to customers who are in control of their BaCnet® or MODBUS® devices.

Installation example

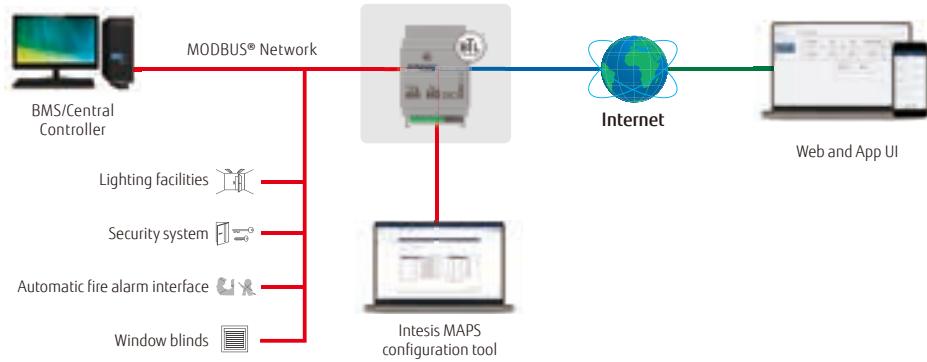

*BMS: Building Management System

Gateway features

- BaCnet® IP/MSTP or MODBUS® TCP/RTU connectivity
- Up to 32 devices can be connected to each gateway.
- Up to 12 widgets per device
- Easy device configuration with Intesis MAPS

Next-generation services

- Industrial-grade connectivity now for building automation
- Fast and scalable real-time edge connectivity over HMS Hub™
- Full data control and protection
- Secure and remote updates during the application lifetime

System Features

- Monitor and control all devices in an intuitive way
- Comes with a native iOS and Android app and a web interface
- Create scenes and interact with multiple concurrent devices
- Calendar that shows the daily planned installation commands
- Notifications keep you updated about system status
- Device sharing and usage permissions management
- Multiple site management from a common dashboard

Specifications

Model name	FG-CLD-BMG4Z1	FG-CLD-BMG8Z1	FG-CLD-BMG16Z1	FG-CLD-BMG32Z1
Number of connectable BaCnet® (IP/MSTP) or MODBUS® (TCP/RTU) devices	4	8	16	32
Power supply	9 to 24 V DC, 50/60Hz	9 to 24 V DC, 50/60Hz	9 to 24 V DC, 50/60Hz	9 to 24 V DC, 50/60Hz
Power consumption (W)	1.7	1.7	1.7	1.7
Dimensions (H × W × D) (mm)	93 × 53 × 58	93 × 53 × 58	93 × 53 × 58	93 × 53 × 58
Weight (g)	150	150	150	150

KNX® converter for indoor unit

UTY-VKSX



Up to
1 indoor unit

KNX® Converter enables individual control of an indoor unit.

- The new KNX® converter connects a central or home controller and a Fujitsu General indoor unit.
- Compact and lightweight design

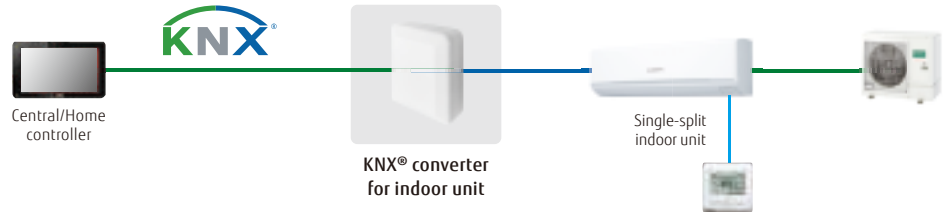

KNX® converter for VRF

UTY-VKGX / FG-TL-KNX16Z1

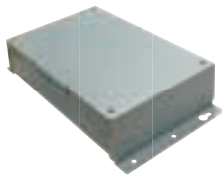

UTY-VKGX

Up to
100 outdoor units
Up to
128 indoor units



FG-TL-KNX16Z1

Up to
16 indoor units
Up to
16 outdoor units

KNX® converter enables centralized control of a system.

- KNX® converter connects a central or home controller and a Fujitsu General VRF system.
- Up to 128 indoor units and 100 outdoor units can be connected to a single KNX® converter. (UTY-VKGX)

Installation example

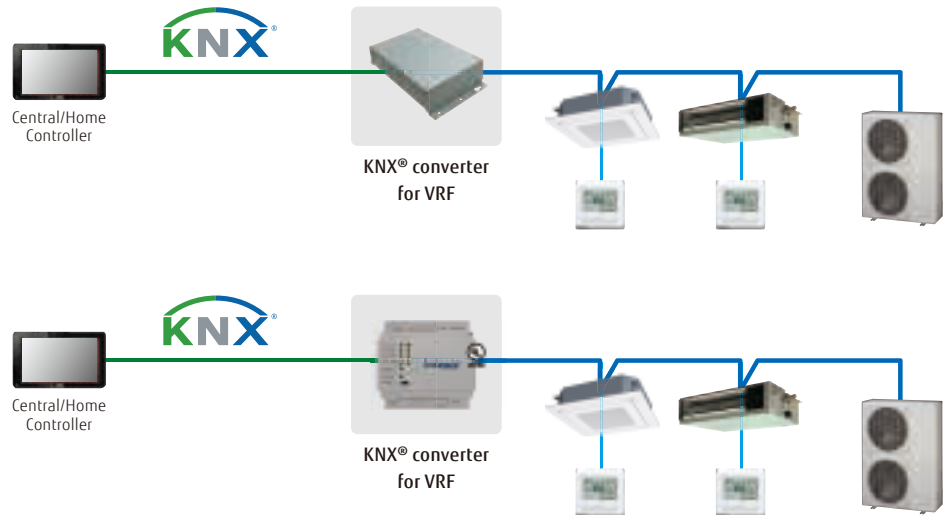

Specifications

Model name	UTY-VKSX	UTY-VKGX	FG-TL-KNX16Z1
Power supply	12 V DC	Single phase ~220 to 240 V 50/60 Hz	9 to 36 V DC, Max.: 140 mA or 24 V AC 50/60 Hz, Max.: 127 mA.*
Input power (W)	0.6	1.5	1.6
Dimensions (H × W × D) (mm)	140 × 117 × 43	54 × 260 × 150	90 × 88 × 56
Weight (g)	215	1,200	340

*24 V DC power supply is recommended.

KNX® interface

FG-RC-KNX1Z1 / FG-AC-KNX1Z1 / FG-IR-KNX1Z1



Intesis
BY THE NAME OF THE FUTURE



FG-RC-KNX1Z1
(3-wire RC-line type)

The KNX® interface enables air conditioners to be fully integrated into a KNX® network system.

- Simple installation due to small and compact size.
- No separate external power supply required (only KNX® bus power required)

Intesis
BY THE NAME OF THE FUTURE



FG-AC-KNX1Z1
(CN connector type)

Installation example

[3-wire RC-line type/CN connector type]

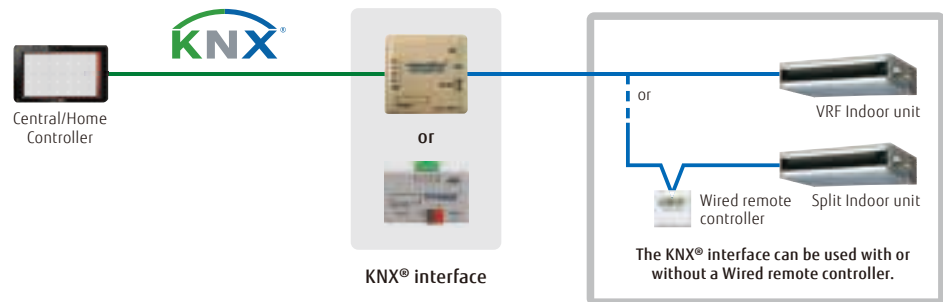

Intesis
BY THE NAME OF THE FUTURE



FG-IR-KNX1Z1
(IR type)

[IR type] Connection to wall-mounted type

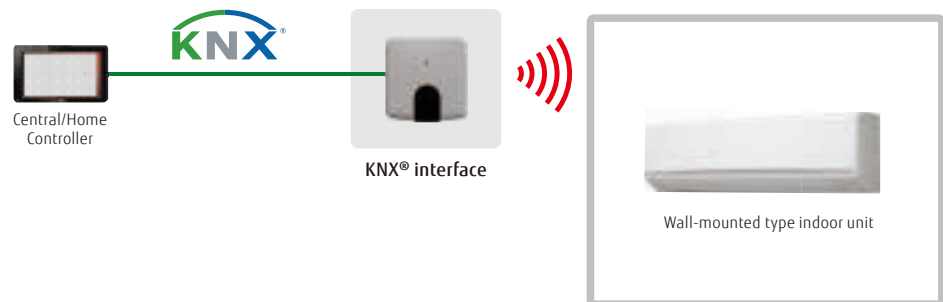

Up to
1 indoor unit

[IR type] Connection to a product other than wall-mounted type

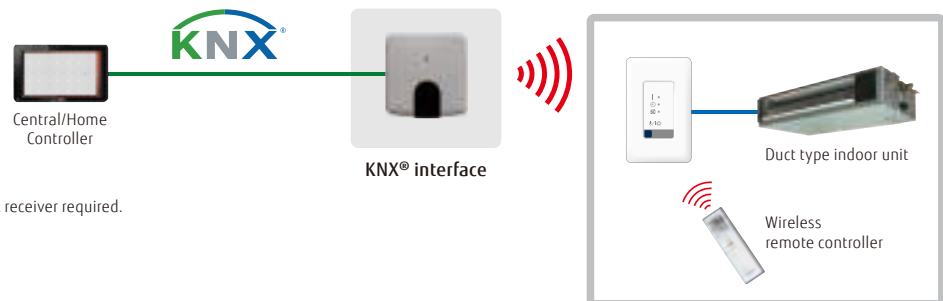

*IR receiver required.

Specifications

Model name	FG-RC-KNX1Z1 (3-wire RC-line type)	FG-AC-KNX1Z1 (CN connector type)	FG-IR-KNX1Z1 (IR type)
Number of controllable groups	1	1	1
Dimensions (H × W × D) (mm)	70 × 70 × 28	45 × 59 × 21	81 × 78 × 28
Weight (g)	70	35	76

Network converter for single-split type

UTY-VTGX / UTY-VTGXV



UTY-VTGX
DC power supply type

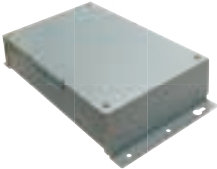

UTY-VTGXV
AC power supply type

Up to
16 single indoor units
Up to
1 group
Up to
100 Network Converters

- A network converter is required when connecting a single-split system to a VRF network system.
- Compact and lightweight design
- Connectable to both nonpolar 2-core and polar 3-core remote controllers

Installation example

- A 1-remote-controller type and a 2-remote-controller type are available.
- Power supply (220 to 240 V AC, 50/60 Hz) is required for the 2-remote-controllers type.

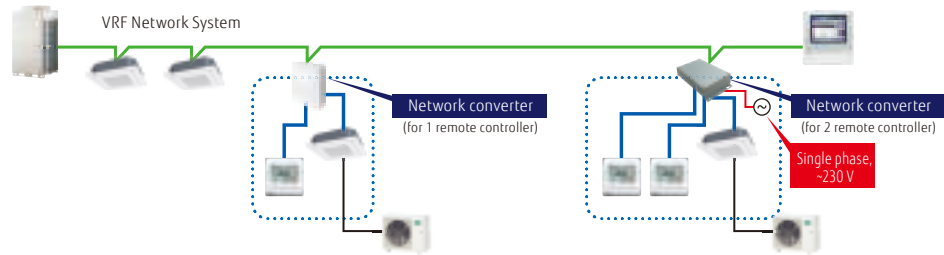

- Both nonpolar 2-core and polar 3-core type Wired remote controllers can be connected.

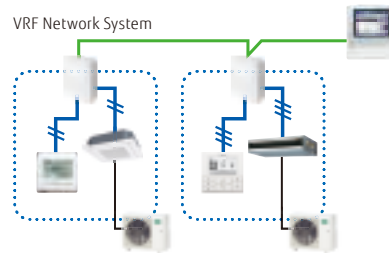

- Central control can be provided for single-split systems. (Up to 100 network converters can be connected in a VRF network system)

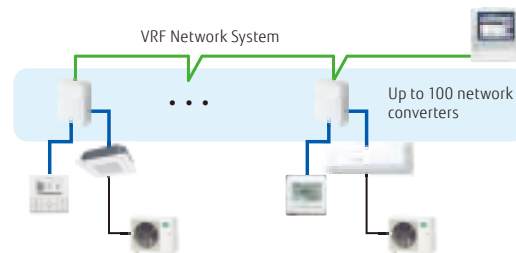

Specifications

Model name	UTY-VTGX		UTY-VTGXV
Power supply	Polar 3-core 12 V DC	Nonpolar 2-core DC 12 V	Single phase ~220 to 240 V 50/60 Hz
Input power (W)	Max. 1.2 W		Max. 3
Dimensions (H × W × D) (mm)	140 × 117 × 43		54 × 260 × 150
Weight (g)	250		1,100

Network converter for LONWORKS™

UTY-VLGX

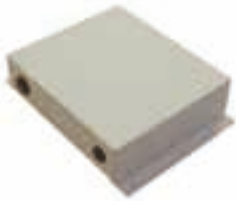

- Connects the VRF network system to a LONWORKS™ open network to manage small and mid-sized BMS and VRF network system.
- The UTY-VLGX enables centralized monitoring and control of VRF network system from a BMS via a LONWORKS™ interface.
- Up to 128 Indoor units can be connected to one network converter for LONWORKS™

Up to
4 units to BMS
Up to
100 outdoor units
Up to
128 indoor units

Installation example

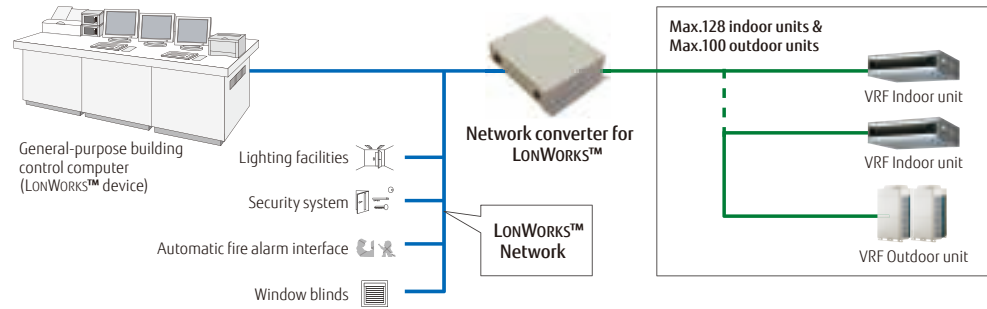

Specifications

Model name	UTY-VLGX
Power supply	Single phase ~208 to 240 V 50/60 Hz
Power consumption (W)	4.5
Dimensions (H × W × D) (mm)	67 × 288 × 211
Weight (g)	1,500

Transmission specifications (BMS side)

Transmission speed	78 kbps
Transceiver	FT-X1 (available from Echelon® Corporation)
Transmission line form	Free topology
Terminal resistor	None (converter to be attached at the terminal of a network)

External switch controller

UTY-TERX



Up to
1 group

Air conditioner switching can be controlled by connecting this external switch controller to other sensor switches.

- In combination with a commercially available card-key switch or other sensors, this External switch controller enables the control of ON/OFF, room temperature, and fan speed of connected air conditioners as well as master control functions. This makes this product an ideal choice for use in hotel rooms.
- Card key or other sensor switches are locally available.
- The set temperature can be specified at two points each for cooling and heating operations (4 points in total).

Installation example

Human sensor monitors the movement of a person in a room. When it detects that the person has left the room, it switches the air conditioner to low-capacity mode. When a person returns to the room, the air conditioner returns to the previous operation mode.

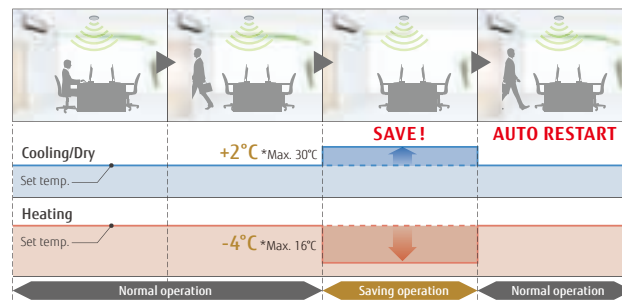

Human sensor equipment needs to be purchased separately.
Human sensor is not mounted on an External switch controller.

Signal amplifier

UTY-VSGXZ1



- The transmission line can be extended up to 3,600 m using multiple Signal amplifiers.
- Up to 8 Signal amplifiers can be added in a VRF network system.
- A Signal amplifier is required.
 - (1) When the total wiring length of the transmission line exceeds 500 m.
 - (2) When the total number of units on the transmission line exceeds 64.

Installation example

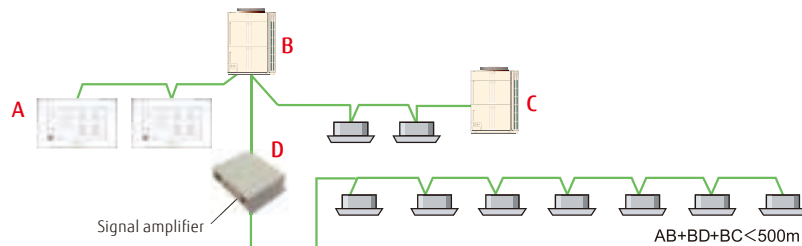

Specifications













Model name	UTY-VSGXZ1	UTY-TERX
Power supply	Single phase ~208 to 240 V 50/60 Hz	6.5 to 16 V DC
Power consumption (W)	4.5	-
Dimensions (H × W × D) (mm)	67 × 288 × 211	140 × 117 × 43
Weight (g)	1,500	250

12 V DC supplied by an indoor unit



Controller system list (available) for Split/Multi-split

Controller Options/Accessories:

Type	Refrigerant	Indoor unit										
		Wall-mounted						Cassette				
		Designer Range		Standard Range		ECO Range		Compact 4-way flow Range	Circular flow Range			
		ASHH07/09/12/14KGTG, ASHG07/09/12/14KGTG, ASHG07/09/12/14KGTG	ASHG 07/09/12/14 KETF, KETF-B KETE, KETE-B	ASHH07/09/12/14KMCG, KMCG-B, ASHG07/09/12/14KMCF, ASHG07/09/12/14KMCE	ASHG 18/24KMTE	ASHH 30/36KMTB	ASHH 07/09/12 KNCA	ASHG 07/09/12 KPCE	ASHH 07/09/12 KLTA	AUXG 09/12/14/18/22/24 KVLA	AUXG 18/22/24/30/36/45/54 KRLB	
												
Controllers		● UTY-RVRG+ UTY-TWRXZ2.									● UTY-RVRG	
		● UTY-RNRGZ5+ UTY-TWRXZ2									● UTY-RNRGZ5	
		● UTY-RLRG+ UTY-TWRXZ2									● UTY-RLRG	
		● UTY-RCRGZ1+ UTY-TWRXZ2									● UTY-RCRGZ1	
										● UTY-RVNGM		
										● UTY-RNNGM		
Simple remote controller	 Nonpolar 2-core type	● UTY-RSRG UTY-RHRG+ UTY-TWRXZ2									● UTY-RSRG UTY-RHRG	
Home central remote controller												
Wireless remote controller										● UTY-LNTG		
IR receiver unit with Wireless remote controller	 For Duct type											
	 For Duct type For Cassette type For Ceiling type									● UTY-LBTGC		



Indoor unit													Outdoor unit	
Slim	Medium static pressure (High-Efficiency & Compact)	Medium static pressure (Compact)	Medium static pressure (Standard)	High static pressure		BIG	Floor	Ceiling	Multi-split				Single phase	
									Wall-mounted	Compact cassette	Mini duct	Slim duct	5/6-unit multi-split	
ARXG 09/12/14/18 KLLAP	ARXH 12/14/18 22/24/30/ 36/45/54 KMTAP	ARXG 12/14/18/ 22/24/30/ 36/45/54 KHTAP	ARXG22KMLB, ARXG 24/30/36/45 KMLA	ARXG 45/54KHTB			AGHG 09/12/14 KVCA	ABHG 18/22/24/30/ 36/45/54 KRTA	ASHH 05KNCA	ASHG 22KMTE	AUXG 07KVLA	ARXG 07/09/12/14/18 KSLAP	ARXG 07KLLAP	AOHG 36KBTAS
					ARHG 60LHTA	ARHG 72/90LHTA								AOHG 45LBLA6
		● UTY-RVRG				● UTY-RVRG	● UTY-RVRG+ UTY-TWRXZ3	● UTY-RVRG		● UTY-RVRG+ UTY-TWRXZ2		● UTY-RVRG		
		● UTY-RNRGZ5				● UTY-RNRGZ5	● UTY-RNRGZ5+ UTY-TWRXZ3	● UTY-RNRGZ5		● UTY-RNRGZ5+ UTY-TWRXZ2		● UTY-RNRGZ5		
		● UTY-RLRG				● UTY-RLRG	● UTY-RLRG+ UTY-TWRXZ3	● UTY-RLRG		● UTY-RLRG+ UTY-TWRXZ2		● UTY-RLRG		
		● UTY-RCRGZ1				● UTY-RCRGZ1	● UTY-RCRGZ1+ UTY-TWRXZ3	● UTY-RCRGZ1		● UTY-RCRGZ1+ UTY-TWRXZ2		● UTY-RCRGZ1		
● UTY-RVNGM		● UTY-RVNGM			● UTY-RVNGM					● UTY-RVNGM+ UTY-TWRXZ2		● UTY-RVNGM		
● UTY-RNNGM		● UTY-RNNGM			● UTY-RNNGM					● UTY-RNNGM+ UTY-TWRXZ2		● UTY-RNNGM		
		● UTY-RSRG UTY-RHRG				● UTY-RSRG UTY-RHRG	● UTY-RSRG UTY-RHRG+ UTY-TWRXZ3	● UTY-RSRG UTY-RHRG		● UTY-RSRG UTY-RHRG+ UTY-TWRXZ2		● UTY-RSRG UTY-RHRG		
														● UTY- DMMGM1*3 (KBTAS) UTY-DMMGM*3 (LBLA6)
											● UTY-LNTG			
					● UTY-LRHGM									
	● UTY-LBTGM					● UTY-LBTGM		● UTY-LBTGM					● UTY-LBTGM	

*1: Available only when the WLAN adapter (UY-TFSXF2) is removed. *2 Available only when the WLAN adapter (UY-TFSXZ1) is removed. *3 Consult your dealer for conditions of use.

Controller system list (available) for Split/Multi-split

Controller Options/Accessories:

Type	Refrigerant	Indoor unit									
		Wall-mounted								Cassette	
		Designer Range	Standard Range			ECO Range				Compact 4-way flow Range	Circular flow Range
	ASHH07/09/12/14KGTG, ASHG07/09/12/14KGTG, ASHG07/09/12/14KGTG	ASHG 07/09/12/14 KETF, KETF-B KETE, KETE-B	ASHH07/09/12/14KMG, KMCG-B, ASHG07/09/12/14KMCF, ASHG07/09/12/14KMCE	ASHG 18/24KMTE	ASHH 30/36KMTB	ASHH 07/09/12 KNCA	ASHG 07/09/12 KPCE	ASHH 07/09/12 KLTA	ASHG 18/24KLCA	AUXG 09/12/14/18/22/24 KVL A	AUXG 18/22/24/30/36/45/54 KRLB
Interfaces	MODBUS® Converter	● UTY-VMSX								● UTY-VMSX	
	MODBUS® interface	● FG-AC-MBS1Z1								● FG-RC-MBS1Z1 ● FG-AC-MBS1Z1	
	IR type	● FG-IR-BMG1Z1								● FG-IR-BMG1Z1+ ● UTY-LBTGC	
KNX® converter	● UTY-VKSX								● UTY-VKSX		
KNX® interface	3-wire RC-line type / CN connector type	● FG-AC-KNX1Z1								● FG-RC-KNX1Z1 ● FG-AC-KNX1Z1	
	IR type	● FG-IR-KNX1Z1								● FG-IR-KNX1Z1+ ● UTY-LBTGC	
WLAN adapter	3-wire RC-line type ¹⁾ / CN connector type									● UTY-TFSXJ3 ● UTY-TFSXZ1	
	USB type ¹⁾	● Accessory (KGTG, KGF, KETF, KETF-B, KMCG, KMCF) ● UTY-TFSXH3, UTY-TFSXF2 (KGTG, KETE, KETE-B, KMCE)			● UTY-TFSXH3 ● UTY-TFSXF2		● Accessory		● UTY-TFSXH3 ● UTY-TFSXF2		
	3-wire RC-line type / CN connector type	● FG-AC-WIF1Z1								● FG-RC-WIF1Z2 ● FG-AC-WIF1Z1	
	IR type	● FG-IR-WIF1Z1								● FG-IR-WIF1Z1+ ● UTY-LBTGC	
	3-wire RC-line type / CN connector type	● FG-AC-WMP1Z1								● FG-RC-WMP1Z1 ● FG-AC-WMP1Z1	
	IR type	● FG-IR-WMP1Z1								● FG-IR-WMP1Z1+ ● UTY-LBTGC	
External switch controller	● UTY-TERX+UTY-TWRXZ2								● UTY-TERX		
Network converter for single-split type	DC power supply type / AC power supply type	● UTY-VTGX+UTY-TWRXZ2 or ● UTY-VTGXV+UTY-TWRXZ2								● UTY-VTGX ● UTY-VTGXV	















Indoor unit														
Slim	Duct					BIG	Floor	Ceiling	Multi-split					
	Medium static pressure <small>(High-Efficiency & Comfort)</small>	Medium static pressure <small>(Compact)</small>	Medium static pressure <small>(Standard)</small>	High static pressure					Wall-mounted	Compact cassette	Mini duct	Slim duct		
ARXG 09/12/14/18 KLLAP	ARXH 12/14/18 22/24/30/ 36/45/54 KMTAP	ARXG 12/14/18/ 22/24/30/ 36/45/54 KHTAP	ARXG22KMLB, ARXG 24/30/36/45 KMLA	ARXG 45/54KHTB		ARHG 60LHTA	ARHG 72/90LHTA	AGHG 09/12/14 KVCA	ABHG 18/22/24/30/ 36/45/54 KRTA	ASHH 05KNCA	ASHG 22KMTE	AUXG 07KVLA	ARXG 07/09/12/14/18 KSLAP	ARXG 07KLLAP
		● UTY-VMSX					● UTY-VMSX	● UTY-VMSX*2	● UTY-VMSX		● UTY-VMSX*1		● UTY-VMSX	
	● FG-RC-MBS1Z1 FG-AC-MBS1Z1			● FG-AC-MBS1Z1	● FG-RC-MBS1Z1	● FG-RC-MBS1Z1 FG-AC-MBS1Z1		● FG-AC-MBS1Z1			● FG-AC-MBS1Z1		● FG-RC-MBS1Z1 FG-AC-MBS1Z1	
		● FG-IR-BMG1Z1+ UTY-LBTGM			● FG-IR-BMG1Z1+ UTY-LRHGM		● FG-IR-BMG1Z1	● FG-IR-BMG1Z1+ UTY-LBTGH		● FG-IR-BMG1Z1			● FG-IR-BMG1Z1+ UTY-LBTGM	
		● UTY-VKSX				● UTY-VKSX	● UTY-VKSX*2	● UTY-VKSX		● UTY-VKSX*1		● UTY-VKSX		
	● FG-RC-KNX1Z1 FG-AC-KNX1Z1			● FG-AC-KNX1Z1	● FG-RC-KNX1Z1	● FG-RC-KNX1Z1 FG-AC-KNX1Z1		● FG-AC-KNX1Z1			● FG-AC-KNX1Z1		● FG-RC-KNX1Z1 FG-AC-KNX1Z1	
	● FG-IR-KNX1Z1+ UTY-LBTGM			● FG-AC-KNX1Z1+ UTY-LBTGM	● FG-IR-KNX1Z1+ UTY-LRHGM		● FG-IR-KNX1Z1	● FG-IR-KNX1Z1+ UTY-LBTGH		● FG-IR-KNX1Z1			● FG-IR-KNX1Z1+ UTY-LBTGM	
		● UTY-TFSXJ3 UTY-TFSXZ1			● UTY-TFNXZ1		● UTY-TFSXJ3 UTY-TFSXZ1						● UTY-TFSXJ3 UTY-TFSXZ1	
										● Accessory	● UTY-TFSXH3 UTY-TFSXF2			
	● FG-RC-WIF1Z2 FG-AC-WIF1Z1			● FG-AC-WIF1Z1	● FG-RC-WIF1Z2	● FG-RC-WIF1Z2 FG-AC-WIF1Z1		● FG-AC-WIF1Z1			● FG-AC-WIF1Z1		● FG-RC-WIF1Z2 FG-AC-WIF1Z1	
		● FG-IR-WIF1Z1+ UTY-LBTGM			● FG-IR-WIF1Z1+ UTY-LRHGM		● FG-IR-WIF1Z1	● FG-IR-WIF1Z1+ UTY-LBTGH		● FG-IR-WIF1Z1			● FG-IR-WIF1Z1+ UTY-LBTGM	
	● FG-RC-WMP1Z1 FG-AC-WMP1Z1			● FG-AC-WMP1Z1	● FG-RC-WMP1Z1	● FG-RC-WMP1Z1 FG-AC-WMP1Z1		● FG-AC-WMP1Z1			● FG-AC-WMP1Z1		● FG-RC-WMP1Z1 FG-AC-WMP1Z1	
	● FG-IR-WMP1Z1+ UTY-LBTGM				● FG-IR-WMP1Z1+ UTY-LRHGM		● FG-IR-WMP1Z1	● FG-IR-WMP1Z1+ UTY-LBTGH		● FG-IR-WMP1Z1			● FG-IR-WMP1Z1+ UTY-LBTGM	
		● UTY-TERX					● UTY-TERX+ UTY-TWRXZ3	● UTY-TERX		● UTY-TERX+ UTY-TWRXZ2		● UTY-TERX		
		● UTY-VTGX UTY-VTGXV					● UTY-VTGX+ UTY-TWRXZ3 UTY-VTGXV+ UTY-TWRXZ3	● UTY-VTGX		● UTY-VTGX+ UTY-TWRXZ2 or UTY-VTGXV+ UTY-TWRXZ2		● UTY-VTGX UTY-VTGXV		

*1: Available only when the WLAN adapter (UY-TFSXF2) is removed. *2 Available only when the WLAN adapter (UTY-TFSXZ1) is removed.
*3: For compatibility of the new WLAN adapters with the indoor units which are not listed in this catalogue, please refer to page C-021.

Controller system list (available) for VRF

Controller Options:

Type	Refrigerant	Indoor unit										
		Cassette					Duct					
		One-way flow	3D flow	Compact Grid type/Standard type		Slim type	Large type	Mini (With drain pump)	Low static pressure duct			
				High Efficiency	Circular flow		Slim (With drain pump)		High Efficiency			
			AUXB 004/005/007/ 009/012/014/ 018HLAH	AUXN 009/012/014 HLAH					ARXD 004/005/007/ 009/012/014/ 018/024 HLAH	ARXP 009/012/014 HLAH		
	AUXV 004/007/009/ 012/014/018/ 024GLEH	AUXS 018/024 GLEH	AUXB 004/007/009/ 012/014/018/ 024GLEH		AUXM 018/024/030 GLEH	AUXK 018/024/030/ 034/036/045/ 054GLEH	ARXK 004/007/009/ 012/014/018/ 024GLGH	ARXD 04GALH	ARXD 007/009/012/ 014/018/024 GLEH			
Controllers	Wired remote controller		● UTY-RVRG									
			● UTY-RNRGZ5									
			● UTY-RLRG									
			● UTY-RCRGZ1									
	Simple remote controller	 Nonpolar 2-core type		● UTY-RSRG ● UTY-RHRG								
		 UTY-LNVG UTY-LNHG		● UTY-LNVG ● UTY-LNHG								
	IR receiver unit			● UTY-TRHX			● UTY-LBHXD	● UTY-TRHX	● UTB-YWC	● UTY-TRHX		
				● UTY-DCCGZ3								
	Touch panel controller			● UTY-DTGGZ1								
System controller, System controller Lite			● UTY-APGXZ1, UTY-ALGXZ1									



Indoor unit												
Duct			Floor		Ceiling/ Floor	Ceiling	Wall-mounted					
Low static pressure duct	Medium static pressure	High static pressure	-	External EEV			-	External EEV	-	External EEV	-	-
High Efficiency	Normal	Normal										
							ASHA 004/005/007/ 009/012/014 HCAH	ASHE 004/005/007/ 009/012/014 HCAH				
ARXP 018/030 GLFH	ARXA 024/030/ 036/045 GLEH	ARXC 036/045/060/ 072/090/096 GTEH	AGHA 004/007/ 009/012/014 GCGH	AGHE 004/007/ 009/012/014 GCEH	ABHA 012/014/ 018/024 GTEH	ABHA 030/036/ 045/054 GTEH	ASHA 004/007/009 GCGH	ASHE 004/007/009 GCEH	ASHA 012/014GCGH	ASHE 012/014GCEH	ASHA 18/24GBCH	ASHA 030/034GTEH

●
UTY-RVRG

●
UTY-RNRGZ5

●
UTY-RLRG

●
UTY-RCRGZ1

●
UTY-RSRG
UTY-RHRG

●
UTY-LNVG
UTY-LNHG

●
UTY-TRHX





















●
UTY-DCCGZ3

●
UTY-DTGGZ1

●
UTY-APGXZ1, UTY-ALGXZ1

Controller system list (available) for VRF

Controller Options:

Type	Refrigerant	Indoor unit									
		Cassette					Duct				
		One-way flow	3D flow	Compact Grid type/Standard type		Slim type	Large type	Low static pressure duct			
				High Efficiency	Circular flow		Mini (With drain pump)	Slim (With drain pump)		High Efficiency	
			AUXB 004/005/007/ 009/012/014/ 018HLAH	AUXN 009/012/014 HLAH					ARXD 004/005/007/ 009/012/014/ 018/024 HLAH	ARXP 009/012/014 HLAH	
	AUXV 004/007/009/ 012/014/018/ 024GLEH	AUXS 018/024 GLEH	AUXB 004/007/009/ 012/014/018/ 024GLEH		AUXM 018/024/030 GLEH	AUXK 018/024/030/ 034/036/045/ 054GLEH	ARXK 004/007/009/ 012/014/018/ 024GLGH	ARXD 04GALH	ARXD 007/009/012/ 014/018/024 GLEH		
Interfaces		● UTY-ABGXZ1, UTY-VBGX									
	 CN connector type	● FG-AC-BAC1Z1					● FG-AC-BAC1Z1				
		● FG-IR-BMG1Z1+ UTY-TRHX	● FG-IR-BMG1Z1	● FG-IR-BMG1Z1+ UTY-LBHXD		● FG-IR-BMG1Z1+ UTY-TRHX	● FG-IR-BMG1Z1+ UTB-YWC	● FG-IR-BMG1Z1+ UTY-TRHX			
Network converter for LonWorks™		● UTY-VLGX									
MODBUS® Converter		● UTY-VMSX									
		● UTY-VMGX FG-TL-MBS16Z1									
MODBUS® interface	 CN connector type	● FG-AC-MBS1Z1					● FG-RC-MBS1Z1	● FG-AC-MBS1Z1			
		● FG-IR-BMG1Z1+ UTY-TRHX	● FG-IR-BMG1Z1	● FG-IR-BMG1Z1+ UTY-LBHXD		● FG-IR-BMG1Z1+ UTY-TRHX	● FG-IR-BMG1Z1+ UTB-YWC	● FG-IR-BMG1Z1+ UTY-TRHX			
KNX® converter		● UTY-VKSX									
		● UTY-VKGX FG-TL-KNX16Z1									
KNX® interface	 CN connector type	● FG-AC-KNX1Z1					● FG-RC-KNX1Z1	● FG-AC-KNX1Z1			
		● FG-IR-KNX1Z1+ UTY-TRHX	● FG-IR-KNX1Z1	● FG-IR-KNX1Z1+ UTY-LBHXD		● FG-IR-KNX1Z1+ UTY-TRHX	● FG-IR-KNX1Z1+ UTB-YWC	● FG-IR-KNX1Z1+ UTY-TRHX			
WLAN adapter	 CN connector type ¹⁾	● UTY-TFSXJ3 UTY-TFSXZ1					● UTY-TFSXJ3 UTY-TFSXZ1 (007-024)	● UTY-TFSXJ3 UTY-TFSXZ1			
	 CN connector type	● FG-AC-WIF1Z1					● FG-RC-WIF1Z2	● FG-AC-WIF1Z1			
		● FG-IR-WIF1Z1+ UTY-TRHX	● FG-IR-WIF1Z1	● FG-IR-WIF1Z1+ UTY-LBHXD		● FG-IR-WIF1Z1+ UTY-TRHX	● FG-IR-WIF1Z1+ UTB-YWC	● FG-IR-WIF1Z1+ UTY-TRHX			
	 CN connector type	● FG-AC-WMP1Z1					● FG-RC-WMP1Z1	● FG-AC-WMP1Z1			
		● FG-IR-WMP1Z1+ UTY-TRHX	● FG-IR-WMP1Z1	● FG-IR-WMP1Z1+ UTY-LBHXD		● FG-IR-WMP1Z1+ UTY-TRHX	● FG-IR-WMP1Z1+ UTB-YWC	● FG-IR-WMP1Z1+ UTY-TRHX			
External switch controller		● UTY-TERX									



Indoor unit													
Duct			Floor		Ceiling/ Floor	Ceiling	Wall-mounted						
Low static pressure duct	Medium static pressure	High static pressure	-	external EEV			-	external EEV	-	external EEV	-	-	
High Efficiency	Normal	Normal					ASHA 004/005/007/ 009/012/014 HCAH	ASHE 004/005/007/ 009/012/014 HCAH					
ARXP 018/030 GLFH	ARXA 024/030/ 036/045 GLEH	ARXC 036/045/060/ 072/090/096 GTEH	AGHA 004/007/ 009/012/014 GCGH	AGHE 004/007/ 009/012/014 GCEH	ABHA 012/014/ 018/024 GTEH	ABHA 030/036/ 045/054 GTEH	ASHA 004/007/009 GCGH	ASHE 004/007/009 GCEH	ASHA 012/014GCGH	ASHE 012/014GCEH	ASHA 18/24GBCH	ASHA 030/034GTEH	
● UTY-ABGXZ1, UTY-VBGX													
					● FG-AC-BAC1Z1								● FG-AC-BAC1Z1
● FG-IR-BMG1Z1+ UTY-TRHX													● FG-IR-BMG1Z1
● UTY-VLGX													
					● UTY-VMSX								● UTY-VMSX
● UTY-VMGX FG-TL-MBS16Z1													
					● FG-AC-MBS1Z1						● FG-RC-MBS1Z1	● FG-AC-MBS1Z1	
● FG-IR-BMG1Z1+ UTY-TRHX													● FG-IR-BMG1Z1
					● UTY-VKSX								● UTY-VKSX
● UTY-VKGX FG-TL-KNX16Z1													
					● FG-AC-KNX1Z1						● FG-RC-KNX1Z1	● FG-AC-KNX1Z1	
● FG-IR-KNX1Z1+ UTY-TRHX													● FG-IR-KNX1Z1
					● UTY-TFSXJ3 UTY-TFSXZ1								● UTY-TFSXJ3 UTY-TFSXZ1
					● FG-AC-WIF1Z1						● FG-RC-WIF1Z2	● FG-AC-WIF1Z1	
● FG-IR-WIF1Z1+ UTY-TRHX													● FG-IR-WIF1Z1
					● FG-AC-WMP1Z1						● FG-AC-WMP1Z1	● FG-AC-WMP1Z1	
● FG-IR-WMP1Z1+ UTY-TRHX													● FG-IR-WMP1Z1
● UTY-TERX													

*1: For compatibility of the new WLAN adapters with the indoor units which are not listed in this catalogue, please refer to page C-021.

Optional parts Overview

For Split & Multi-split, VRF

A variety of optional parts are available to enable installation of the selected indoor unit properly according to the environment.

Optional Parts For Cassette



Human sensor kit
A built-in thermo sensor monitors and controls room temperature accurately.

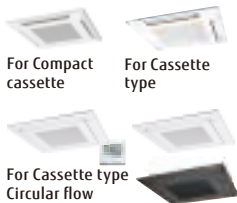

Cassette grille
A lineup of cassette grilles that match a variety of interiors. A grid ceiling-type cassette grille has been added to the lineup.



Silver ion filter
The Silver ion filter helps to keep indoor air free from viruses, bacteria and molds.*



Fresh air intake kit
Fresh air can be taken in by a fan connected to an external control unit.

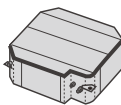

Insulation kit for high humidity
Insulation kit for high humidity is used when the installation location is in a high humidity environment.

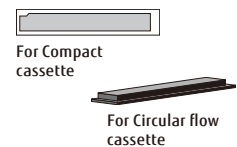

Air outlet shutter plate
Airflow directions can be changed to 3 directions using the Air outlet shutter plate depending on the installation location.

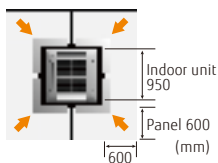

Wide Panel
When a cassette type is installed in a narrow space in the ceiling, the wide panel fills in that space.

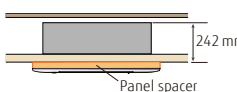

Panel spacer
If the ceiling space is tight and the main body protrudes from the ceiling surface, a panel spacer can be used as a decorative trim.

Optional Parts For V-IV



Pressure sensor kit
When installed, the height difference between the outdoor unit and indoor unit can be allowed up to 110 m.

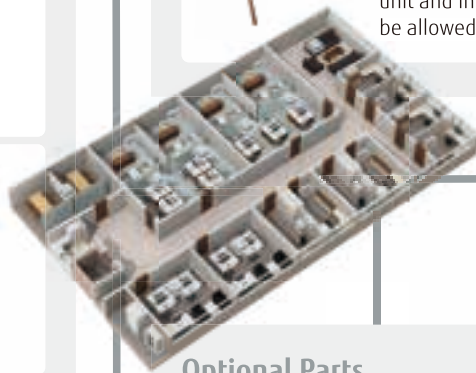

Optional Parts For R32 VRF products

NEW



Gas Sensor kit
Used to ensure standards compliance and safety when R32 VRF products are installed.

NEW



Expansion kit
Connect to indoor units to expand the number of inputs and outputs when using multiple safety devices or external input / output functions.

Optional Parts For Floor



Half concealed kit
Used to half conceal a floor type indoor unit in the wall.



Silver ion filter
The Silver ion filter helps to keep indoor air free from viruses, bacteria and molds.*



Optional Parts For Duct & Ceiling



Auto louver grille kit
The optional clean-looking flat Auto louver grille blends into any interior and provides a comfortable airflow.



Remote sensor unit
The remote sensor provides additional convenience.

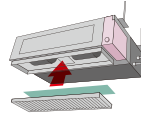

Silver ion filter
The Silver ion filter helps to keep indoor air free from viruses, bacteria and molds.*



Long-life filter
Captures grit and dust. Long-life design with consideration of running costs.



Flange
Flanges are used when connecting a medium static pressure duct type and a ceiling type with air intake and exhaust ducts.



Drain pump unit
Drains water that has accumulated during operation.

Connection Parts



For wall-mounted type

Communication kit
Required for a wall-mounted type when the External connect kit set or a Wired remote controller is connected to the indoor unit.



For wall-mounted type

External input and output PCB

For Wall-mounted, Duct, or Cassette type, these parts are required when the external input and output function is used.



For Duct type and Cassette type



External input and output PCB box & bracket

Box and bracket for installing the External input and output PCB.

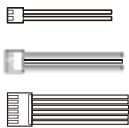

External connect kit & set
Connect the printed circuit board (PCB) to external devices.



Connection Units
Connection units are available to separate the pipes when connecting multiple indoor units in a Multi-split type or VRF system.



External power supply unit
The External power supply unit protects the increment in the system even if the power supply for some of the indoor units is shut down.

*Not a result of experiments in an actual use environment. Silver ion filter inhibits activity or growth of microorganism, but do not prevent infection.

Silver Ion Filter

UTR-FA16-5 / UTR-FA13-3 / UTR-FA03-5 / UTD-HFAA / UTD-HFRA / UTD-HFTA / UTD-HFTB / UTD-HFTC / UTD-HFNC / UTD-HFNB / UTD-HFNA / UTD-HFND / UTD-HFKB / UTD-HFKA



For Wall mounted / Floor
UTR-FA16-5 / UTR-FA13-3
UTR-FA03-5

For Cassette
UTD-HFAA / UTD-HFRA

For Duct
UTD-HFTA / UTD-HFTB
UTD-HFTC / UTD-HFNC
UTD-HFNB / UTD-HFNA
UTD-HFND / UTD-HFKB
UTD-HFKA

The Silver ion filter helps to keep indoor air free from viruses, bacteria and molds.

(Not a result of experiments in an actual use environment. Silver ion filter inhibits activity or growth of microorganism, but do not prevent infection.)

The silver ion filter inhibits the activities of viruses*1, bacteria*2 and molds*3 trapped on the filter.

(Only effective when the microorganism is trapped on the filter with dust or droplet)

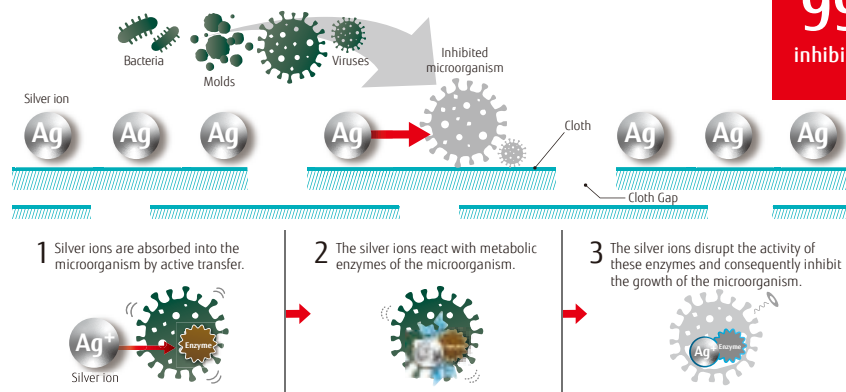

*1 [Testing organization] Kitasato Research Center for Environmental Science [Test Report] No. 2020_0408 [Test virus] Escherichia coli phage Qbeta NBRC 20012 (1 type) [Test Method] Based on the antiviral test method for textile products (JIS L 1922) [Test results] Inhibited by at least 99% in 24 hours. Not tested to prevent transmission of SARS-CoV-2.

*2 [Testing organization] Kitasato Research Center for Environmental Science [Test Report] No. 2020_0409 [Test bacteria] Escherichia coli NBRC 3972 (1 type) [Test Method] Based on the determination of antibacterial activity and efficacy of textile products (JIS L 1902) [Test results] The growth of the test bacteria was inhibited by 24 hours testing

*3 [Testing organization] Kitasato Research Center for Environmental Science [Test Report] No. 2020_0410 [Test fungi] Aspergillus Niger NBRC 105649 and other fungi (3 types) [Test Method] Based on the test for fungus resistance (JIS Z 2911) [Test results] The growth of the fungus was inhibited by 28 days testing

The filter is easily removable* and hand-washable.

(*Wall mounted and floor models only)



*4 Hand-washing or vacuuming by 3 months is recommended. Cleaning frequency varies depending on the environment of use.

Specifications

Model name		For Wall mounted / Floor			for Cassette	
		UTR-FA16-5	UTR-FA13-3	UTR-FA03-5	UTD-HFAA	UTD-HFRA
Net Dimension (H × W × D)	mm	35 × 210 × 6	50 × 364 × 6	43 × 272 × 6	350 × 125 × 6	550 × 136 × 6
Weight	g	2	2	2	7	23
Quantity		2	2	2	1	1

Model name		for Duct								
		UTD-HFTA	UTD-HFTB	UTD-HFTC	UTD-HFNC	UTD-HFNB	UTD-HFNA	UTD-HFND	UTD-HFKB	UTD-HFKA
Net Dimension (H × W × D)	mm	290 × 70 × 6	390 × 70 × 6	290 × 70 × 6 390 × 70 × 6	620 × 88 × 6	420 × 88 × 6	620 × 88 × 6	500 × 79 × 6	420 × 125 × 6	620 × 108 × 6
Weight	g	6	8	10	8	10	16	12	16	20
Quantity		2	2	3	1	2	2	2	2	2

Auto louver grille kit

UTD-GXTA-W / UTD-GXTB-W / UTD-GXTC-W



The optional clean-looking flat Auto louver grille kit blends into any interior and provides a comfortable airflow.



Flexible Control

- The Auto louver grille of the indoor unit can be operated in conjunction with the remote control of the indoor unit.
- **Vertical auto swing**
 - Auto airflow direction and auto swing
 - 4 steps selectable
- **Auto-closing louver**
The louvers will automatically close when the indoor unit stops operating.

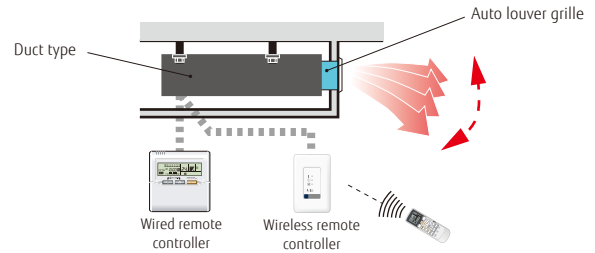

Dimensions

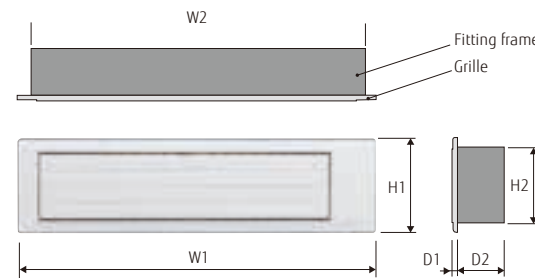

Unit: mm

Model name	W1	W2	H1	H2	D1	D2
UTD-GXTA-W	683	645	180	148	9	84
UTD-GXTB-W	883	845				
UTD-GXTC-W	1,083	1,045				

Specifications

Model name			UTD-GXTA-W	UTD-GXTB-W	UTD-GXTC-W
Applicable indoor unit	SPLIT & MULTI-SPLIT		ARHG07/09LLTA ARXG07/09/12/14KSLAP ARXG07/09/12/14KLLAP ARHG07/09LSLAP	ARXG18KSLAP ARXG18KLLAP	
	VRF		ARXD007/009/012/014GLEH ARXK004/007/009/012/014GLGH ARXD04GALH ARXD004/005/007/009/012/014HLAH ARXP009/012/014HLAH	ARXD018GLEH ARXD018HLAH ARXK018GLGH	ARXD024GLEH ARXD024HLAH ARXK024GLGH
Power supply			Connecting with Control box of indoor unit		
Fixing Auto louver grille			Screwed to Flange or Square duct		
Extension Square duct limit			1.0 m (Max. duct length between indoor unit and Auto louver grille)		
Net Dimensions (H × W × D)		mm	180 × 683 × (84 + 9)	180 × 883 × (84 + 9)	180 × 1,083 × (84 + 9)
Weight	Net	kg (lbs)	2.0 (4.4)	2.5 (5.6)	3.0 (6.7)
Operating range	Cooling	°C	18 to 32		
		% RH	80 % or less		
	Heating	°C	16 to 30		

Pressure sensor kit

UTY-SPWX



Design flexibility

The height difference between the outdoor unit and the indoor unit is normally 50 m for the V-IV Series, but can be extended to 110 m by installing the Pressure sensor kit.

(Can only be connected to the V-IV Series. Also, it can only be connected to outdoor units using outdoor unit software compatible with the product.)

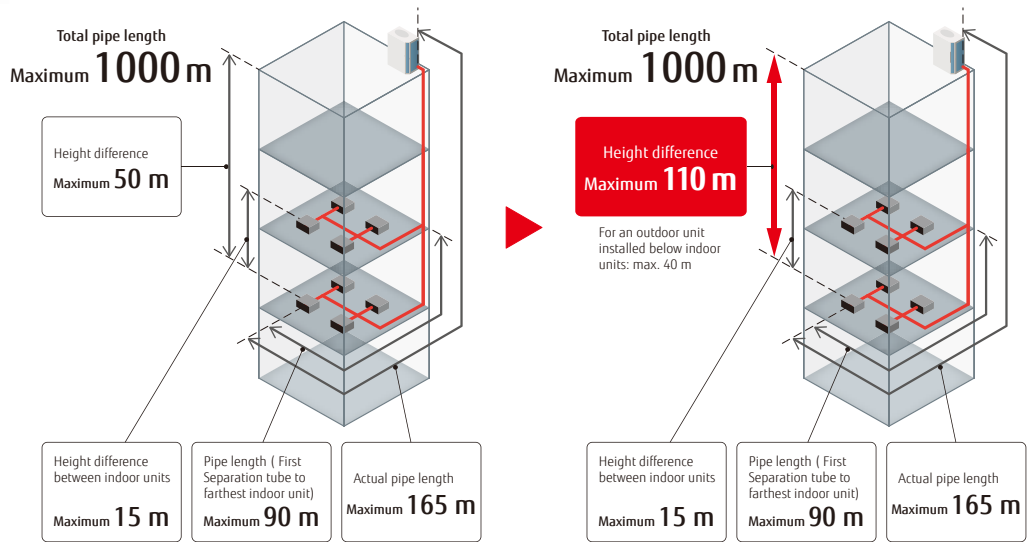

System overview

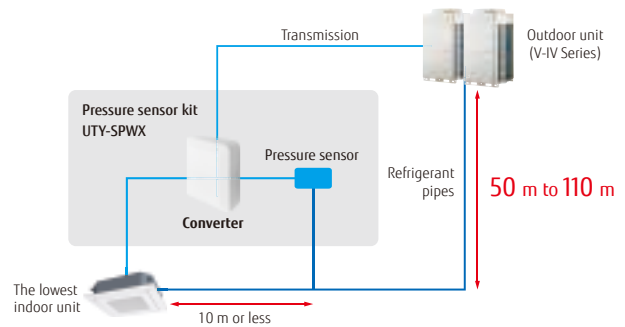

Pressure sensor kit

Pressure sensor kit (Converter)	Refrigerant pressure sensor	Joint pipe

Specifications

Model name	UTY-SPWX
Power supply	9 to 16 V DC
Dimensions (H × W × D) (mm)	140 × 117 × 43
Weight (g)	200

External power supply unit

UTZ-GXXA / UTZ-GXXC



The External power supply unit protects the increment in the system even if the power supply for some of the indoor units is shut down.

Connects to the External power supply unit to supply power to the indoor unit from the auxiliary power supply. This allows for continuous operation without system errors.

Built-in relays reduce installation time and cost.

The UTZ-GXXC have a built-in relay, which reduces installation time and cost.

High reliability

- A: Interruption of the main power supply is detected by the power cut-off detection part.
- B: Supplies power for driving the expansion valve of the indoor unit. (12 V or 5 V DC)
- C: Gives notification of the power supply from the External power supply unit.

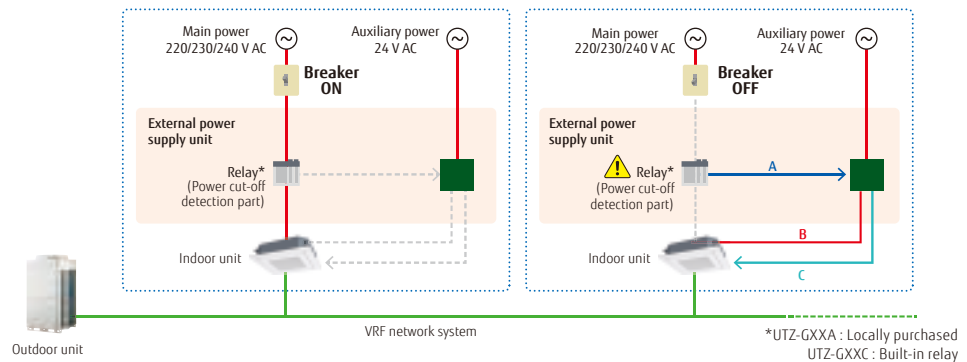

Note

- When changing the power supply voltage to 24 V AC, use a power transformer with an insulated structure that complies with the regulations* of the installation region.
- A powered-off indoor unit driven by the External power supply unit is treated in the same way as an operation-off unit in the electricity charge appointment function. If standby power is generated, the result of the electricity charge appointment may not be zero.

* UL Class II or IEC 61558 Class III, for example.

Specifications

Model name	UTZ-GXXA	UTZ-GXXC
Power supply		24 V AC 50/60 Hz
Dimensions (H × W × D) (mm)		97 × 200 × 178
Weight (g)		800

AIR BEAM

Radiation air outlet unit

*Production by order
Contact us for more details.



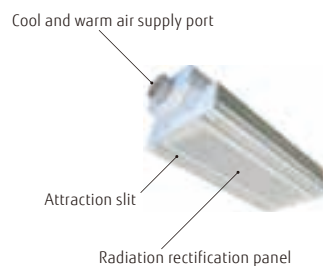

Key component

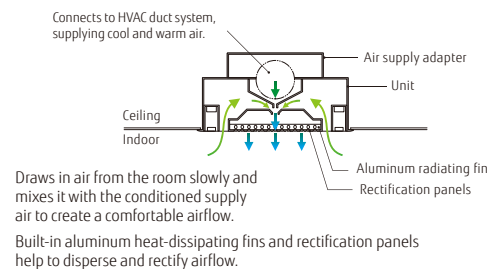

Cross-section view



Airflow rate (m ³ /h)	180 (160-215)	270 (240-325)
Grid	600 × 2	600 × 3
AIR BEAM For system ceiling (Integrated type)	 KS-180	 KS-270

Gas sensor kit

UTY-SGZH



NEW



Enhanced disaster safety measures

The system is designed to meet the environmental safety requirements specified in the IEC 603352-40 standard for the use of R32 refrigerant. The environment requiring safety measures is determined by the size of the room in relation to the amount of refrigerant required.

For example, if the system is designed for maximum pipe length and the refrigerant charge is 6 kg, safety measures are required for rooms of 15 m² or less.

For Example: Total pipe length 120m

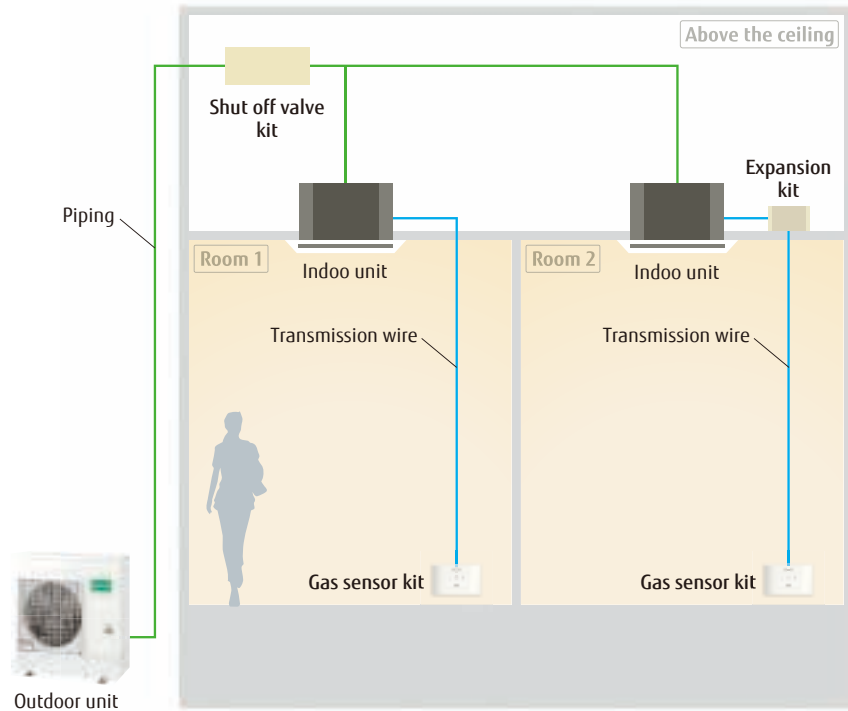

Shut off valve kit
UTP-GX027A, UTP-GX060A

Block the path to prevent refrigerant flow in the event of a refrigerant leakage.



Gas sensor kit
UTY-SGZH*

Gas Sensor kit Used to ensure standards compliance and safety when R32 VRF products are installed.

*Connection cable (UTY-XWZXZL) is required.



Expansion kit
UTZ-JXXA

Used to ensure standards compliance and safety when R32 VRF products are installed.

Conditions requiring safety measures

The graph below will help you determine if a safety design is required when installing R32 VRF products. The amount of refrigerant in a refrigerant system determines the floor area, and if the room to be conditioned by the system is less than that area, a "shut off valve kit" and a "gas sensor kit" must be installed.

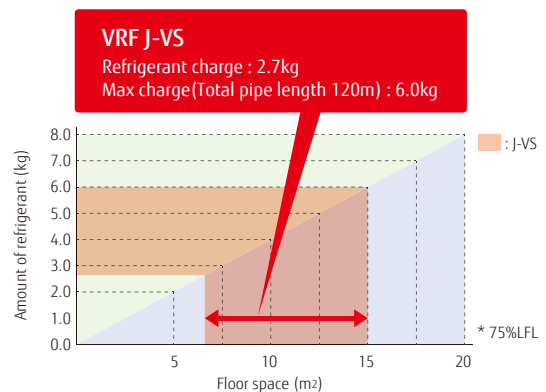

Refrigerant leak detector connection pattern

1) Corresponds to the case where the classification of air conditioner installation differs from property to property.

Installation position of "Shut off valve kit"

- A** Indoor unit 1~4 in one room
- B** Indoor units 1, 2 and 3, 4, if they are set up in two separate rooms.
- C** Indoor units 1~4 are installed in different rooms.

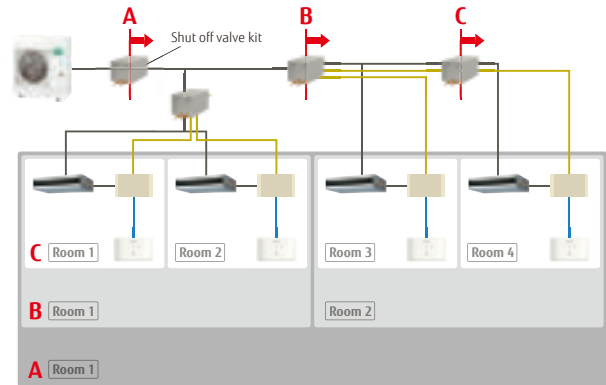

2) Multiple rooms or areas are air conditioned using ducted airflow paths

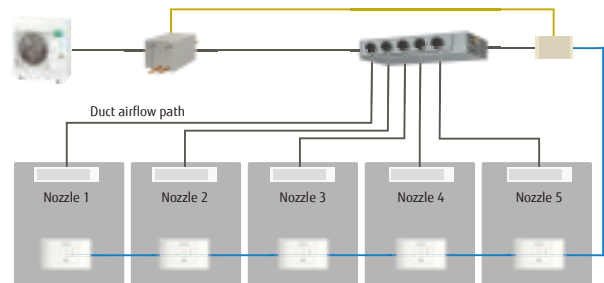



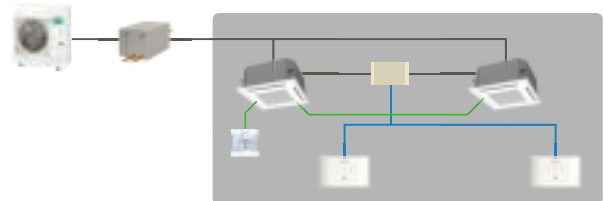





















3) When operating multiple indoor units with a remote control group



Specifications

Model name	UTY-SGZH
Dimensions (H × W × D) (mm)	80 × 130 × 35
Weight (g)	500

Optional parts list for Split/Multi-split

Type	Refrigerant	Indoor unit									
		Wall-mounted									Cassette
		Designer Range		Standard Range			ECO Range				4-way flow Compact
	ASHH07/09/12/14KGTG, ASHG07/09/12/14KGTG, ASHG07/09/12/14KGTG	ASHG 07/09/12/14 KETF, KETF-B KETE, KETE-B	ASHH07/09/12/14KMCG, KMCG-B, ASHG07/09/12/14KMCF, ASHG07/09/12/14KMCE	ASHG 18/24KMTE	ASHH 30/36KMTB	ASHH 05/07/09/12 KNCA	ASHG 07/09/12 KPCE	ASHH 07/09/12 KLTA	ASHG 18/24KLCA	AUXG 09/12/14/18/22/24 KVLA	
											
Human sensor kit											
Remote sensor unit	 The remote sensor provides additional convenience.										
Cassette grille	 UTG-UFGF-W UTG-UKGA-W UTG-UFGD-W UTG-UKGC-W UTG-UKGA-B										
Auto louver grille kit											
Silver ion filter											
Long-life filter											
Flange											
Drain pump unit											
Wide Panel	 Indoor unit: 950mm Panel: 600 (mm) 1400mm										
Panel spacer	 242 mm Panel spacer										
Fresh air intake kit	 For Compact cassette For Circular flow cassette										
Air outlet shutter plate	 For Compact cassette For Circular flow cassette										
Insulation kit for high humidity											
Half concealed kit	 Used to half conceal a floor type indoor unit in the wall.										
L-type piping kit											



Indoor unit											
Cassette		Duct					Duct		Multi-split		
Circular flow	Slim	Medium static pressure (High-Efficiency & Comfort)	Medium static pressure (Compact)	Medium static pressure (Standard)	High static pressure	Big	Floor	Ceiling	4-way flow Compact cassette	Mini duct	Slim duct
AUXG 18/22/24/ 30/36/45/54 KRLB	ARXG 09/12/14/18 KLLAP	ARXH 12/14/18/ 22/24/30/ 36/45/54 KMTAP	ARXG 12/14/18/22/ 24/30/36/45/54 KHTAP	ARXG22KMLB, ARXG 24/30/36/45 KMLA	ARXG45/54KHTB		AGHG 09/12/14 KVCA	ABHG 18/22/24/30/ 36/45/54 KRTA	AUXG07KVLA	ARXG 07/09/12/14/18 KSLAP	ARXG07KLLAP
					ARHG60LHTA	ARHG72/90LHTA			AUHG07/09LVLA	ARHG07/09LSLAP	ARHG07/09LLTA
● UTY-SHZXC											
											● UTY-XSZXZ1
● UTG-UKGA-W, UTG-UKGC-W, UTG-UKGA-B									● UTG-UGF-W (KVLA), UTG-UGD-W (LVLA)		
	● UTD-GXTA-W (09/12/14) UTD-GXTB-W (18)										● UTD-GXTA-W (07/09/12/14), UTD-GXTB-W (18)
● UTD-HFRA	● UTD-HFTA (09/12/14) UTD-HFTB (18)	● UTD-HFNC (12/14/18) UTD-HFNB (22/24), UTD-HFNA (30/36/45/54)	● UTD-HFNC (12/14) UTD-HFNB (18/22/24/30) UTD-HFNA (36/45/54)	● UTD-HFND	● UTD-HFKB (45/54)	● UTD-HFKA	● UTR-FA03-5		● UTD-HFAA	● UTD-HFTA (07/09/12/14) UTD-HFTB (18)	● UTD-HFTA
		● UTD-LFDC (12/14/18) UTD-LFDB (22/24), UTD-LFDA (30/36/45/54)	● UTD-LFNA (36/45/54) UTD-LFNB (18/22/24/30) UTD-LFNC (12/14)	● UTD-LF2SNA	● UTD-LF60KA (45/54)	● UTD-LFKA					
				● UTD-SF045T UTD-RF204							
				● UTZ-PX1NBA		● UTZ-PX1NAB		● UTR-DPB24T			
● UTG-AKXA-W											
● UTG-BKXA-W											
● UTZ-VXRA									● UTZ-VXAA		
● UTR-YDZK									● UTR-YDZB		
● UTZ-KXRA									● UTZ-KXGC		
							● UTR-STA				
								● UTP-FX24A (18/22/24) UTP-FX35A (30/36/45/54)			

Optional parts list for VRF

Type	Refrigerant	Indoor unit									
		Cassette					Duct				
		One-way flow	3D flow	Compact grid type/ Standard type		Slim type	Large type	Low static pressure duct			
				High Efficiency	Circular flow		Mini (With drain pump)	Slim (With drain pump)		High Efficiency	
AUXB 004/005/007/ 009/012/014/ 018HLAH	AUXN 009/012/014 HLAH				ARXD 004/005/007/ 009/012/014/ 018/024 HLAH	ARXP 009/012/014 HLAH					
	AUXV 004/007/009/ 012/014/018/ 024GLEH	AUXS 018/024GLEH	AUXB 004/007/009/ 012/014/018/ 024GLEH		AUXM 018/024/030 GLEH	AUXK 018/024/030/ 034/036/045/ 054GLEH	ARXK 004/007/009/ 012/014/018/ 024GLGH	ARXD 04GALH	ARXD 007/009/012/ 014/018/024 GLEH		
Human sensor kit						●					
Remote sensor unit						●					
Cassette grille		● UTG-UNGA-W (004-012) UTG-UNGB-W (014-024)	● UTG-USGA-W	● UTG-UFGE-W UTG-UFGE-W UTG-UFGE-W (HLAH)	● UTG-UFGE-W UTG-UFGE-W UTG-UFGE-W (HLAH)	● UTG-UFGE-W UTG-UFGE-W UTG-UFGE-W (HLAH)	● UTG-UKGC-W UTG-UKGA-B				
Auto louver grille kit								● UTD-GXTA-W (4-14), UTD-GXTB-W (18), UTD-GXTC-W (24)			
Silver ion filter				● UTD-HFAA		● UTD-HFRA	● UTD-HFTA (004-014) UTD-HFTB (018) UTD-HFTC (024)	● UTD-HFTA	● UTD-HFTA (007-014) UTD-HFTB (018) UTD-HFTC (024)		
Long-life filter											
Flange											
Drain Pump Unit											
Wide Panel						● UTG-AKXA-W					
Panel spacer						● UTG-BKXA-W					
Fresh air intake kit*1				● UTZ-VXAA		● UTZ-VXRA					
Air outlet shutter plate:				● UTR-YDZB		● UTR-YDZK					
Insulation kit for high humidity				● UTZ-KXGC		● UTZ-KXRA					
Half concealed kit											
External power supply unit		● UTZ-GXXA UTZ-GXXC		● UTZ-GXXA UTZ-GXXC (HLAH)		● UTZ-GXXA UTZ-GXXC		● UTZ-GXXA UTZ-GXXC (HLAH)			
Pressure sensor kit											
Gas sensor kit				● UTY-SGZH+ UTY-XWZXZL (HLAH)				● UTY-SGZH+ UTY-XWZXZL (HLAH)	● UTY-SGZH+ UTY-XWZXZL (HLAH)		



Function list for Split/Multi-split

External input and output function/External connect kit/communication kit

Type	Refrigerant	Indoor unit													
		Wall-mounted									Cassette		Duct		
		Designer Range		Standard Range			ECO Range				Compact 4-way flow Range	Circular flow Range	Slim	Medium static pressure (High-Efficiency & Comfort)	Medium static pressure (Compact)
		ASHH07/09/12/14KGTG, ASHG07/09/12/14KGTG, ASHG07/09/12/14KGTG	ASHG 07/09/12/14 KET, KETE-B, KETE-B	ASHH07/09/12/14KMG, KMG-B, ASHG07/09/12/14KMG, ASHG07/09/12/14KMG	ASHG 18/24KMT	ASHH 30/36KMTB	ASHH 07/09/12 KNCA	ASHG 07/09/12 KPCE	ASHH 07/09/12 KLTA	ASHG 18/24KCA	AUXG 09/12/14/18/22/24 KVLA	AUXG 18/22/24/30/36KSL/54KRLB	ARXG 09/12/14/18KLLAP	ARXH 12/14/18/22/24/30/36/45/54 KMTAP	ARXG 12/14/18/22/24/30/36/45/54 KSTAP
indoor	Operation/Stop			● UTY-XCSXZ2+ UTY-XWZXZ5								● PCB Terminal or ● UTY-XCSX+ UTZ-GXRA	● PCB Terminal	● PCB Terminal or ● UTY-XCSX+ UTZ-GXDA	● PCB Terminal or ● UTY-XCSX+ UTZ-GXNA
	Forced stop			● UTY-XCSXZ2+ UTY-XWZXZ5									● PCB Terminal		
	Forced Thermostat off			● UTY-XCSXZ2+ UTY-XWZXZ5								● UTY-XCSX+ UTZ-GXRA		● UTY-XCSX+ UTZ-GXDA	● UTY-XCSX+ UTZ-GXNA
	Low noise mode operation														
	Outdoor unit operation peak control														
indoor	Operation status			○ UTY-XCSXZ2+ UTY-XWZXZ5								● UTY-XWZXZG or ○ UTY-XCSX+ UTZ-GXRA	● UTY-XWZXZG	● UTY-XWZXZG or ○ UTY-XCSX+ UTZ-GXDA	● UTY-XWZXZG or ○ UTY-XCSX+ UTZ-GXNA
	Error status			○ UTY-XCSXZ2+ UTY-XWZXZ5								● UTY-XWZXZG or ○ UTY-XCSX+ UTZ-GXRA		● UTY-XWZXZG or ○ UTY-XCSX+ UTZ-GXDA	● UTY-XWZXZG or ○ UTY-XCSX+ UTZ-GXNA
	Compressor status														
	Indoor unit fan operation status			○ UTY-XCSXZ2+ UTY-XWZXZ5								● UTY-XWZXZG or ○ UTY-XCSX+ UTZ-GXRA	● UTY-XWZXZG	● UTY-XWZXZG or ○ UTY-XCSX+ UTZ-GXDA	● UTY-XWZXZG or ○ UTY-XCSX+ UTZ-GXNA
	Setpoint attainment status														
	Auxiliary heater output												● UTY-XWZXZG or ○ UTY-XCSX+ UTZ-GXRA	● UTY-XWZXZG	● UTY-XWZXZG or ○ UTY-XCSX+ UTZ-GXDA

*1: Included in Fresh air intake kit (UTZ-VXAA or UTZ-VXRA) *2: Functionality for installation in a server room

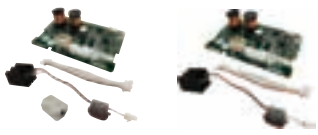
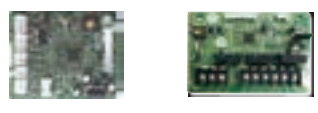
For SPLIT/MULTI-SPLIT/SIMULTANEOUS MULTI-SPLIT

<p>Communication kit</p>  <p>UTY-TWRXZ3 UTY-TWRXZ2</p>	<p>External input and output PCB</p>  <p>UTY-XCSXZ1 (wire length 280 mm) UTY-XCSXZ2 (wire length 80 mm) for Wall-mounted type</p> <p>UTY-XCSX for Duct and Cassette types</p>	<p>External input and output PCB box</p>  <p>UTZ-GXDA (for Duct) UTZ-GXRA (for Cassette) UTZ-GXEA (for Ceiling)</p>	<p>External input and output PCB bracket</p>  <p>UTZ-GXNA</p>
---	---	--	---



Indoor unit				Multi-split							Outdoor unit					
Duct			Big	Floor	Ceiling	Wall-mounted	Mini duct	Slim duct	Compact cassette	Single Split			Simultaneous multi-split			
Medium static pressure (Standard)	High static pressure									ARHG 60LHTA	ARHG 72/90LHTA	ARHG 07/09/12/14 KVCA	ABHG 18/22/24/ 30/36/45/ 54KRTA	ASHG 22KITE	ARXG 07/09/ 12/14/18 KSLAP	ARXG 07KLLAP
ABHG 22KMLB, ARXG 24/30/36/ 45KMLA	ARXG 45/54KRTB															
● PCB Terminal	● PCB Terminal or ○ UTI-XCSX+ UTZ-GXEA	● UTD-ECSSA	● PCB Terminal or ○ UTI-XCSX	● UTY-XWZXZ5	● PCB Terminal or ○ UTI-XCSX+ UTZ-GXEA	● UTY-XCSXZ2+ UTY-XWZXZ5	● PCB Terminal	● UTD-ECSSA	● PCB Terminal							
● PCB Terminal	● UTD-ECSSA	● PCB Terminal	● UTY-XWZXZ5	● PCB Terminal	● UTY-XCSXZ2+ UTY-XWZXZ5	● PCB Terminal	● UTD-ECSSA	● PCB Terminal								
○ UTI-XCSX+ UTZ-GXEA	● UTY-XCSX+ UTZ-GXEA	● UTD-ECSSA	● UTY-XCSX	● UTY-XWZXZ5	● UTY-XCSX+ UTZ-GXEA	● UTY-XCSXZ2+ UTY-XWZXZ5										
											● UTY-XWZXZ3	● UTY-XWZXZ2	● UTY-XWZXZ3	○ UTY-XWZXZ2		
											● UTY-XWZXZ3	● UTY-XWZXZ2	● UTY-XWZXZ3	○ UTY-XWZXZ2		
● UTY-XWZXZG	● UTY-XWZXZG or ○ UTI-XCSX+ UTZ-GXEA	○ UTD-ECSSA	● UTY-XWZXZG or UTY-XCSX	● UTY-XWZXZ5	● UTY-XWZXZG or ○ UTI-XCSX+ UTZ-GXEA	● UTY-XCSXZ2+ UTY-XWZXZ5	● UTY-XWZXZG	● UTD-ECSSA	● UTY-XWZXZG							
	● UTY-XWZXZG or ○ UTI-XCSX+ UTZ-GXEA			● UTY-XWZXZ5	● UTY-XWZXZG or ○ UTI-XCSX+ UTZ-GXEA	● UTY-XCSXZ2+ UTY-XWZXZ5					● UTY-XWZXZ3	● UTY-XWZXZ2	● UTY-XWZXZ3	○ UTY-XWZXZ2		
											● UTY-XWZXZ3	● UTY-XWZXZ2	● UTY-XWZXZ3	○ UTY-XWZXZ2		
● UTY-XWZXZG	● UTY-XWZXZG or ○ UTI-XCSX+ UTZ-GXEA	● UTD-ECSSA	● UTY-XWZXZG or UTY-XCSX	● UTY-XWZXZ5	● UTY-XWZXZG or ○ UTI-XCSX+ UTZ-GXEA	● UTY-XCSXZ2+ UTY-XWZXZ5	● UTY-XWZXZG	● UTD-ECSSA	● UTY-XWZXZG							
● UTY-XWZXZG	● UTY-XWZXZG or ○ UTI-XCSX+ UTZ-GXEA	● UTD-ECSSA	● UTY-XWZXZG or UTY-XCSX		● UTY-XWZXZG or ○ UTI-XCSX+ UTZ-GXEA		● UTY-XWZXZG									

● Dry Contact ○ Apply Voltage

Communication system

External connect kit

For indoor unit



UTY-XWZX

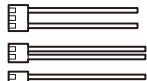

UTY-XWZXZ5



UTY-XWZXZG

For outdoor unit



UTY-XWZXZ2

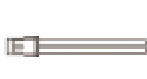

UTY-XWZXZ3

External control set

For indoor unit



UTD-ECSSA



Function list for VRF

External input and output function/External connect kit

Type	Refrigerant	Indoor unit													
		Cassette						Duct						Floor	
		One-way flow	3D flow	Compact grid type/ Standard type		Slim type	Large type	Low static pressure			Low static pressure	Medium static pressure	High static pressure	-	EEV external
				High Efficiency	Circular flow	Mini (With drain pump)	Slim (With drain pump)		High Efficiency	High Efficiency	Normal	Normal			
			AUXB 004/005/007/ 009/012/014/ 018HLAH			AUXN 009/012/014 HLAH				ARXD 004/005/007/ 009/012/014/ 018/024 HLAH	ARXP 009/012/014 HLAH				
	AUXV 004/007/009/ 012/014/018/ 024GLEH	AUXS 018/024 GLEH	AUXB 004/007/009/ 012/014/018/ 024GLEH		AUXM 018/024/030 GLEH	AUXK 018/024/030/ 034/036/045/ 054GLEH	ARXK 004/007/009/ 012/014/018/ 024GLEH	ARXD 007/009/012/ 014/018/024 GLEH ARXD 04GALH		ARXP 018/030 GLFH	ARXA 024/030/ 036/045 GLEH	ARXC 036/045/060 072/090/096 GLEH	AGHA 004/007/ 009/012/014 CGGH	AGHE 004/007/ 009/012/014 CCEH	
Input	Operation/Stop	● UTY-XWZXZD ○ UTY-XWZXZB													
	All On/All Off														
	Group stop														
	Forced stop	● UTY-XWZXZD ○ UTY-XWZXZB													
	Emergency stop	● UTY-XWZXZD ○ UTY-XWZXZB													
	Forced thermostat off	● UTY-XWZXZE ○ UTY-XWZXZ7													
	Low noise mode operation														
	Cooling/ Heating priority														
	Outdoor unit operation peak control														
	Power usage information from electricity meter														
Indoor	Operation status	● UTY-XWZXZC													
	Error status	● UTY-XWZXZC													
	Indoor unit fan operation status	● UTY-XWZXZC													
	Auxiliary heater output	● UTY-XWZXZC													
	Base pan heater														
Other	Expansion kit			●UTZ-JXXA (HLAH)					●UTZ-JXXA (HLAH)						





*2: The Touch panel controller has the functions of dry contact and voltage application, but the external connection kit described above is not necessary because the touch panel controller has an external input terminal block.

For VRF

<p>NEW Expansion kit</p>  <p>UTZ-JXXA</p>	<p>NEW Connection Cable</p>  <p>UTY-XWZXZL</p>
---	--

Communication system

External connect kit

For indoor unit		
UTY-XWZXZ7		UTY-XWZXZD 
UTY-XWZXZB		UTY-XWZXZE 
UTY-XWZXZC		



Floor/Ceiling		Indoor unit				Outdoor unit						controller	Other
		Wall-mounted				J-VS	J-IVL	J-IV	J-IVS	V-IV	VR-IV	Central remote controller	RB unit
		ASHA 004/005/007/ 009/012/014 HCAH	ASHE 004/005/007/ 009/012/014 HCAH			AJH 040/045/054 KCTAH		AJH 040/045/054 LBLDH, AJH 040/045/054 LELDH	AJH 040/045/054 LCLDH	AJH 072/090/108/ 126/144/162 LALDH	AJH 072/090/108/ 126/144 GALDH	UTY-DCGGZ3	UTP-RX01AH UTP-RX01BH UTP-RX01CH UTP-RX04BH UTP-RX08AH UTP-RX12AH
ABHA 012/014/018/ 024GTEH	ABHA 030/036/045/ 054GTEH	ASHA 004/007/009 012/014 CCGH	ASHE 004/007/009 012/014 GEEH	ASHA 18/24GBCH	ASHA 030/034GTEH								
		<ul style="list-style-type: none"> ● UTY-XWZXZD ○ UTY-XWZXZB 											
												<ul style="list-style-type: none"> ● UTY-XWZXZ7 ○ UTY-XWZXZ8 	
						<ul style="list-style-type: none"> ● UTY-XWZXZ6 							
		<ul style="list-style-type: none"> ● UTY-XWZXZD ○ UTY-XWZXZB 											
		<ul style="list-style-type: none"> ● UTY-XWZXZD ○ UTY-XWZXZB 				<ul style="list-style-type: none"> ● UTY-XWZXZ6 						<ul style="list-style-type: none"> ● UTY-XWZXZ7 ○ UTY-XWZXZ8 	
		<ul style="list-style-type: none"> ● UTY-XWZXZE ○ UTY-XWZXZ7 											
						<ul style="list-style-type: none"> ● UTY-XWZXZ6 							
						<ul style="list-style-type: none"> ● UTY-XWZXZ6 						<ul style="list-style-type: none"> ● UTY-XWZXZ6 ○ UTY-XWZXZ8 	
						<ul style="list-style-type: none"> ● UTY-XWZXZ6 							
						<ul style="list-style-type: none"> ● UTY-XWZXZF 							
		<ul style="list-style-type: none"> ● UTY-XWZXZC 				<ul style="list-style-type: none"> ○ UTY-XWZXZ6 						○ UTY-XWZXZA	
		<ul style="list-style-type: none"> ● UTY-XWZXZC 				<ul style="list-style-type: none"> ○ UTY-XWZXZ6 						○ UTY-XWZXZA	
		<ul style="list-style-type: none"> ● UTY-XWZXZC 											
						<ul style="list-style-type: none"> ● UTY-XWZXZ9 						<ul style="list-style-type: none"> ● UTY-XWZXZ9 	
		<ul style="list-style-type: none"> ● UTZ-JXXA (HCAH) 											

●: Dry Contact ○: Apply Voltage

For outdoor unit

UTY-XWZXZ6

UTY-XWZXZ9

UTY-XWZXZF

For RB unit

UTY-XWZXZ6

UTY-XWZXZB

Central remote controller

UTY-XWZXZ7

UTY-XWZXZ8

UTY-XWZXZA

For Touch panel controller



UTY-XWZXZA

Separation tube



For SPLIT/MULTI-SPLIT/SIMULTANEOUS MULTI-SPLIT

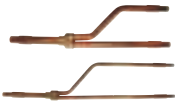

















Separation tube

<p>UTP-SX236A / UTP-SX254A For 3-phase simultaneous multi-split</p> <p>UTP-SX272A For Simultaneous multi-split Twin/ Triple/Double Twin</p> 	<p>UTP-SX354A For 3-phase simultaneous multi-split</p> <p>UTP-SX372A For Simultaneous multi-split Twin/ Triple/Double Twin</p> 
---	--













for VRF

Separation tube

<p>UTP-AX054A</p> <p>Gas pipe</p>  <p>Liquid pipe</p> 	<p>UTP-AX090A</p> <p>Gas pipe</p>  <p>Liquid pipe</p> 	<p>UTP-AX180A</p> <p>Gas pipe</p>  <p>Liquid pipe</p> 	<p>UTP-AX567A</p> <p>Gas pipe</p>  <p>Liquid pipe</p> 
<p>UTP-BX090A</p> <p>Suction Gas pipe</p>  <p>Discharge Gas pipe</p>  <p>Liquid pipe</p> 	<p>UTP-BX180A</p> <p>Suction Gas pipe</p>  <p>Discharge Gas pipe</p>  <p>Liquid pipe</p> 	<p>UTP-BX567A</p> <p>Suction Gas pipe</p>  <p>Discharge Gas pipe</p>  <p>Liquid pipe</p> 	<p>UTP-LX180A For DX kit</p> 



Header

<p>UTR-H0906L / UTR-H1806L</p> <p>Gas pipe</p>  <p>Liquid pipe</p> 	<p>UTR-H0908L / UTR-H1808L</p> <p>Gas pipe</p>  <p>Liquid pipe</p> 	<p>UTP-J0906A / UTP-J1806A</p> <p>Suction gas pipe</p>  <p>Discharge gas pipe</p>  <p>Liquid pipe</p> 	<p>UTP-J0908A / UTP-J1808A</p> <p>Suction gas pipe</p>  <p>Discharge gas pipe</p>  <p>Liquid pipe</p> 
---	---	--	---

Outdoor unit branch kit



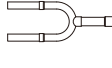
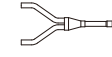
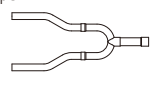
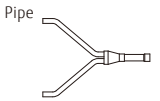

<p>UTP-CX567A</p> <p>Gas Pipe</p>  <p>Liquid Pipe</p> 
--





Separation tube for RB unit

<p>UTP-DX567A</p> <p>Suction Gas Pipe</p>  <p>Discharge Gas Pipe</p>  <p>Liquid Pipe</p> 	<p>UTP-EX060A</p> <p>Gas Pipe</p>  <p>Liquid Pipe</p> 	<p>UTP-EX096A</p> <p>Gas Pipe</p>  <p>Liquid Pipe</p> 
--	--	--



for VRF

EV kit		Shut off valve kit	
Model name ≧ 09: UTR-EV09XB Model name ≧ 12: UTR-EV14XB for compact wall-mounted type	NEW Model name ≧ 09: UTR-EV09XC Model name ≧ 12: UTR-EV14XC for R32 VRF wall-mounted type	NEW UTP-GX027A for R32 VRF indoor unit	NEW UTP-GX060A for R32 VRF outdoor unit
			

RB unit			
UTP-RX01AH / UTP-RX01BH / UTP-RX01CH Single type	UTP-RX04BH Multi-split type	UTP-RX08AH Multi-split type	UTP-RX12AH Multi-split type
			

Specifications

Separation tube

Model name	UTP-AX054A	UTP-AX090A	UTP-AX180A	UTP-AX567A
Total cooling capacity of indoor unit (kW)	19.6 or less	28.0 or less	28.1 to 56.0	56.1 or more
Model name	UTP-BX090A	UTP-BX180A	UTP-BX567A	
Total cooling capacity of indoor unit (kW)	28.0 or less	28.1 to 56.0	56.1 or more	

Header

Model name	3-6 Branches	UTR-H0906L	UTR-H1806L
	3-8 Branches	UTR-H0908L	UTR-H1808L
Total cooling capacity of indoor unit (kW)		28.0 or less	28.1 to 56.0
Model name	3-6 Branches	UTP-J0906A	UTP-J1806A
	3-8 Branches	UTP-J0908A	UTP-J1808A
Total cooling capacity of indoor unit (kW)		28.0 or less	28.1 to 56.0

Outdoor unit branch kit

Model name	UTP-CX567A (for V-IV)	UTP-DX567A (for VR-IV)
Number of outdoor units	2 outdoor units	1
	3 outdoor units	2

EV kit

Model name	UTR-EV09XB		UTR-EV14XB		UTR-EV09XC	UTR-EV14XC
Application model	ASHE004GCEH ASHE007GCEH ASHE009GCEH	AGHE004GCEH AGHE007GCEH AGHE009GCEH	ASHE012GCEH ASHE014GCEH	AGHE012GCEH AGHE014GCEH	ASHE004HCAH ASHE005HCAH ASHE007HCAH ASHE009HCAH	ASHE012HCAH ASHE014HCAH

RB unit

Type	Single type			Multi-split type		
Model name	UTP-RX01AH	UTP-RX01BH	UTP-RX01CH	UTP-RX04BH	UTP-RX08AH	UTP-RX12AH
Power source	230/1/50					
Input power	W					
Number of branches	1	1	1	4	8	12
Maximum capacity of connectable indoor units (Q)	kW					
Maximum capacity of connectable indoor units per branch (Q)	kW					
Maximum Connectable Indoor Units per Branch	3	8	8	8	7	7
Dimensions (H × W × D)	mm					
	198 × 298 × 268			260 × 658 × 428	298 × 660 × 618	298 × 990 × 618

*1: When two RB units are connected in series (8 branches in total), the maximum capacity of the connectable indoor units is up to 56.0 kW.

Shut off valve kit

Model name	UTP-GX027A		UTP-GX060A
Power source	230/1/50		
Input power	W		
Number of branches	1		
Maximum number of connectable Expansion kit	4		
Maximum capacity of connectable indoor units (Q)	kW		
Maximum capacity of Connectable Indoor Units per Branch (Q)	kW		
Dimensions (H × W × D)	mm		
	250 × 540 × 267		250 × 540 × 267

Residential

AIR TO WATER

- W-002 AIR TO WATER Overview
- W-004 AIR TO WATER Lineup
- W-006 Benefits
- W-008 Home Heating & Domestic Hot Water Supply
- W-010 High-Efficiency Technology
- W-012 Split Type
 - Comfort Series
 - Super High Power Series
 - High Power Series
- W-018 Split DHW Integrated Type
 - Comfort Series
 - Super High Power Series
 - High Power Series
- W-024 Control Overview
- W-026 Comfort Control
- W-028 System Configuration
- W-030 Case Studies
- W-032 Simple installation
Easy Installation & Maintenance
- W-034 Installation requirements
- W-035 AIR TO WATER Optional Parts





AIR TO WATER
Residential



AIR TO WATER

FUJITSU GENERAL LIMITED

AIR TO WATER Overview

Solutions that meet a variety of needs

Water heated by Air to water using clean energy is delivered reliably and comfortably throughout the house, including the living room.



Heat Pump System Framework

Heat is absorbed from the atmosphere by expanding the refrigerant. Higher-temperature heat is generated by compressing the refrigerant, and the indoor unit transfers that heat to the water.

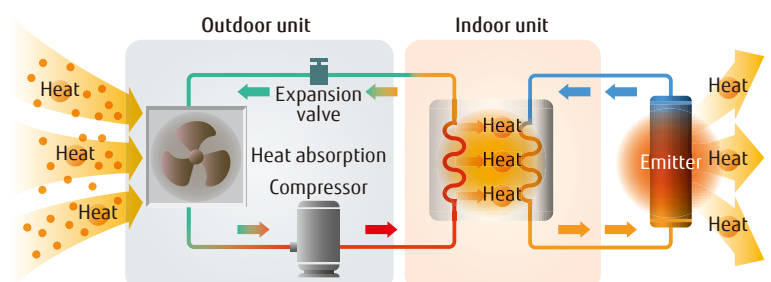

Our Goal

Decarbonisation

European Commission is committed to decarbonisation and has a national target of **"Net Zero"** carbon emissions by 2050.

We need to reduce carbon emissions with green technology products and increase carbon absorption by working to extend nature.

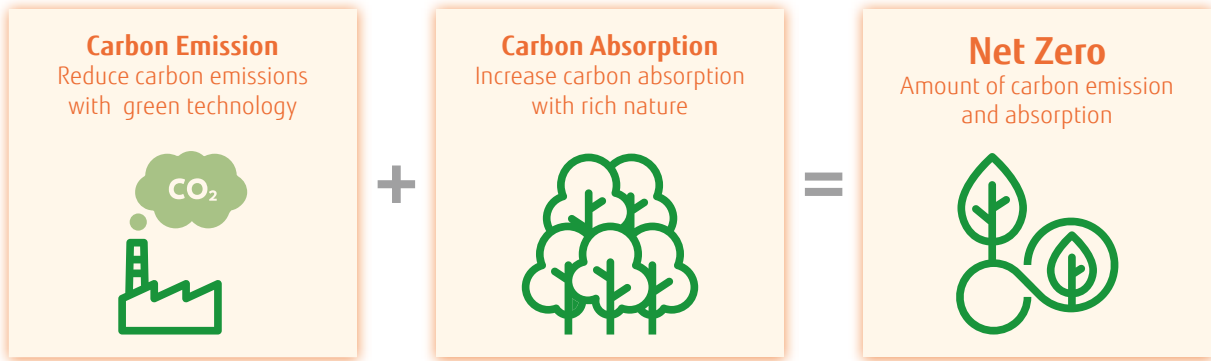

Fujitsu General's ATW system will provide the best solutions that are friendly to the environment and people with products conscious of decarbonisation.

The Choice of ATW

Optimized refrigerant cycle operation

Super High Power and High Power Series deliver high performance and efficiency with twin sensors and hot water heating technology.

Split Type

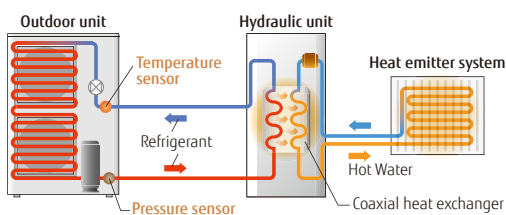

Split DHW Integrated Type

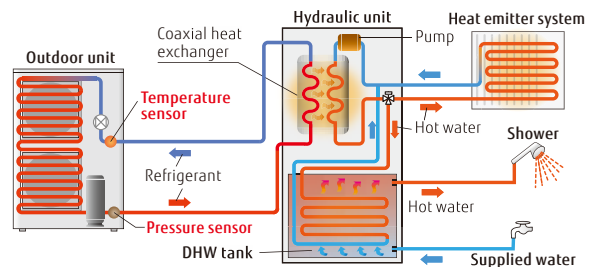

What is a heat pump?

A heat pump extracts heat energy from the atmosphere. It requires only 1 kWh of electricity to generate 3 to 5 kWh of thermal energy.

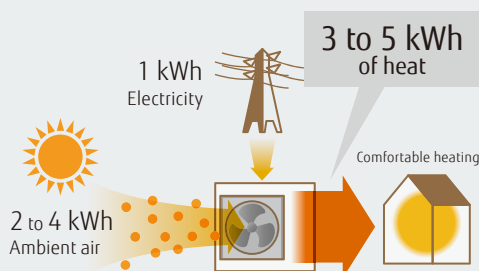

Primary energy usage reduced substantially





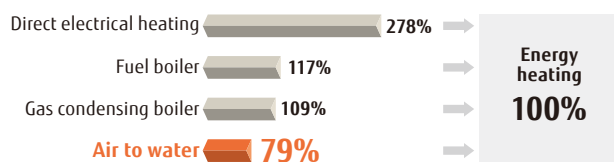

Proportion of primary energy converted into heating energy is 100%

Primary Energy Consumption*



* The amount of electricity loss varies according to the power plant. Typical energy efficiency of a power plant: 36%

AIR TO WATER Lineup

Type	Split Type					
	Comfort Series		Super High Power Series	High Power Series		
Hydraulic unit						
Outdoor unit						
Capacity range	5/6 kW	8 kW	10 kW	16 kW	11/14 kW	11/14/16 kW
System outline	<ul style="list-style-type: none"> Supplies 55°C hot water even when the outdoor temperature is -10°C. Heating and DHW supply in one system.* Equipped with additional electric heater for backup Up to two independent control circuits.* Cooling operation is possible.* Operating range is -20 to 35°C. Can be used with a variety of heating systems, including underfloor heating and radiators.* 		<ul style="list-style-type: none"> Supplies 60°C hot water even when the outdoor temperature is -20°C. Supplies 55°C hot water even when the outdoor temperature is -22°C. Can be used with a variety of heating systems, including underfloor heating and radiators.* Heating and DHW supply in one system.* Equipped with additional electric heater for backup Up to two independent control circuits.* Cooling operation is possible.* Operating range is -25 to 35°C. 	<ul style="list-style-type: none"> Supplies 60°C hot water even when the outdoor temperature is -20°C. Can be used with a variety of heating systems, including underfloor heating and radiators.* Heating and DHW supply in one system.* Up to two independent control circuits.* Cascade connection is possible for up to three systems.* Cooling operation is possible.* Operating range is -25 to 35°C. 		
Power source	Single phase, ~230 V, 50 Hz		Single phase, ~230 V, 50 Hz	Single phase, ~230 V, 50 Hz	3-phase, ~400 V, 50 Hz	
Capacity	5 kW	WSHA050ML3 WOHA060KLT				
	6 kW	WSHA080ML3 WOHA060KLT				
	8 kW	WSHA080ML3 WOHA080KLT				
	10 kW	WSHA100ML3 WOHA100KLT				
	11 kW				WSHG140DG WOHG112LHT	WSHG140DG WOHK112LCTA
	14 kW				WSHG140DG WOHG140LCTA	WSHG140DG WOHK140LCTA
	16 kW			WSHG160DJ6 WOHG160LJL		WSHG140DG WOHK160LCTA
	17 kW					
Approval		●				
						●



Split DHW Integrated Type				
Comfort Series		Super High Power Series	High Power Series	
				
				
5/6 kW 8 kW 10 kW		16 kW	11/14 kW 11/14/16 kW	
<ul style="list-style-type: none"> Supplies 55°C hot water even when the outdoor temperature is -10°C. Heating and DHW supply in one system. Equipped with additional electric heater for backup Up to two independent control circuits.* Cooling operation is possible.* Operating range is -20 to 35°C. Can be used with a variety of heating systems, including underfloor heating and radiators.* 		<ul style="list-style-type: none"> Supplies 60°C hot water even when the outdoor temperature is -20°C. Supplies 55°C hot water even when the outdoor temperature is -22°C. Can be used with a variety of heating systems, including underfloor heating and radiators.* Space saving heating and DHW supply in a single Hydraulic unit Equipped with additional electric heater for backup Up to two independent control circuits.* Cooling operation is possible.* Operating range is -25 to 35°C. 	<ul style="list-style-type: none"> Supplies 60°C hot water even when the outdoor temperature is -20°C. Can be used with a variety of heating systems, including underfloor heating and radiators.* Space saving heating and DHW supply in a single Hydraulic unit Up to two independent control circuits.* Cooling operation is possible.* Operating range is -25 to 35°C. 	
Single phase, ~230 V, 50 Hz		Single phase, ~230 V, 50 Hz	Single phase, ~230 V, 50 Hz	3-phase, ~400 V, 50 Hz
WGHA050ML3 WOHA060KLT				
WGHA080ML3 WOHA060KLT				
WGHA080ML3 WOHA080KLT				
WGHA100ML3 WOHA100KLT				
			WGHG140DG WOHG112LHT	WGHG140DG WOHK112LCTA
			WGHG140DG WOHG140LCTA	WGHG140DG WOHK140LCTA
		WGHG160DJ6 WOHG160LJL		WGHG140DG WOHK160LCTA

* Please refer to page W-038 and W-039 for optional parts information.

Benefits

Less CO₂ Emissions

Air to water is an environmentally friendly system that emits substantially less carbon dioxide than conventional gas and hydrocarbon combustion systems.

Average annual CO₂ emissions

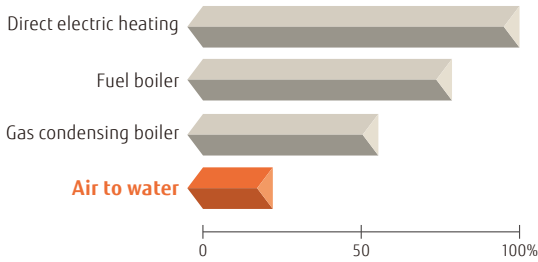

*Calculations based on energy efficiency data provided by the European Programme for Energy Efficiency in EU-27: 89% for fuel boilers; 93% for gas boiler

Low Running Cost

High-efficiency heat pump technology keeps the running cost of an Air to water system.

Average annual running cost

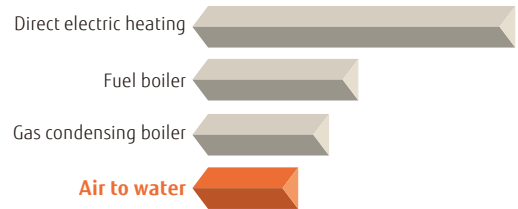

*The running cost may vary depending on a system's installation, geographical location, and operating conditions.

Clean and Healthy

As an Air to water system does not use a burner to heat water, it does not produce NOx or other harmful substances.

Environmentally friendly heating system



Easy Installation and Maintenance

All components are built into a compact outdoor unit or a Hydraulic unit.



Well-designed Hydraulic unit

The sophisticated arrangement of Hydraulic units makes piping and maintenance work easy.

Energy Efficiency Standards

Product labels

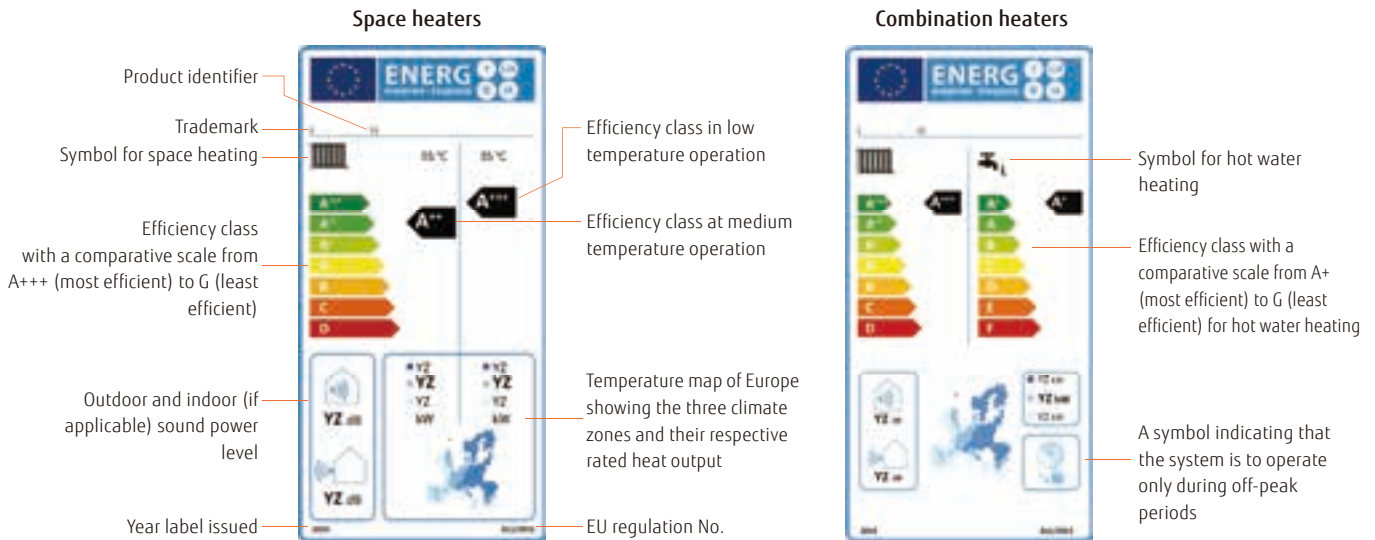

The Ecodesign Directive Lot 1 Regulation 813/2013

The Ecodesign directive defines a regulatory framework for improving the environmental performance of energy-related products (ErP) through design.

Since September 26, 2015, the Ecodesign Directive has applied to space heaters, including heat pumps and fossil fuel fired boilers, combination heaters for space and hot water heating, water heaters, and water storage tanks.

All of these products must meet minimum requirements for energy efficiency*¹ and maximum sound power level. The minimum energy efficiency class were raised on September 26, 2017, and the maximum sound levels were lowered on September 26, 2018.

*1: Energy efficiency is expressed in terms of seasonal space heating efficiencies (η_s). The value is based upon the Seasonal Coefficient of Performance (SCOP).

The Energy Labelling Directive (EU) No. 811/2013

Energy label is intended to enable consumers to make direct comparisons of energy use and product features. All labels should indicate the product identifier, efficiency class, sound power level, and heat output. Heat generators are rated A+++ to D. There are two different product labels. One for space heaters and one for combination heaters.

Seasonal space heating Energy efficiency class

	Except low temp. HP 55°C	Low temp. HP 35°C
A+++	$\eta_s \geq 150$	$\eta_s \geq 175$
A++	$125 \leq \eta_s < 150$	$150 \leq \eta_s < 175$
A+	$98 \leq \eta_s < 125$	$123 \leq \eta_s < 150$
A	$90 \leq \eta_s < 98$	$115 \leq \eta_s < 123$
B	$82 \leq \eta_s < 90$	$107 \leq \eta_s < 115$
C	$75 \leq \eta_s < 82$	$100 \leq \eta_s < 107$
D	$36 \leq \eta_s < 75$	$61 \leq \eta_s < 100$
E	$34 \leq \eta_s < 36$	$59 \leq \eta_s < 61$
F	$30 \leq \eta_s < 34$	$55 \leq \eta_s < 59$
G	$\eta_s < 30$	$\eta_s < 55$

EHPA Quality Label



Fujitsu General's Air to water² has acquired the EHPA Quality Label³ through testing in accordance with the International Standards EN14511 and EN17025. The EHPA Quality Label³ is a label that shows the end-consumer a quality heat pump unit on the market.

*2: 3-phase High Power Series only
*3: Learn more about the validity of the mark at www.ehpa.org/quality/quality-label/

SG ready Label



SG ready is a label issued to heat pumps and their control technologies that meet the requirements set by BWP⁴, and technologies that conform to their standards can be integrated into a smart grid. SG ready labeled heat pumps receive signals from the power grid and PV systems with regard to energy and renewable energy sources such as wind, solar, and water. All of Fujitsu General's new heat pump series are SG ready compatible.

*4: BWP: Bundesverband Wärmepumpe e. V (Federal German Heat Pump Association)

The CEN Heat Pump KEYMARK



The Heat Pump KEYMARK is a full certificate supporting the quality of heat pumps in the European market. The Heat Pump KEYMARK is a voluntary, independent, European certification mark (ISO Type 5 Certification) for all heat pumps, combination heat pumps, and hot water heaters (as covered by Ecodesign, EU Regulation 813/2013 and 814/2013). Fujitsu General's Air to water⁵ has acquired the KEYMARK certificate⁶.

*5: R32 refrigerant comfort model only
*6: Learn more about the validity of the mark at www.heatpumpkeymark.com/about/



Home Heating & Domestic Hot Water Supply

A wide range of products to suit regional characteristics, family structures, and usage patterns. We provide a variety of products to meet the needs of customers from the heating-centered High Power Series to the reasonably priced Compact Series.

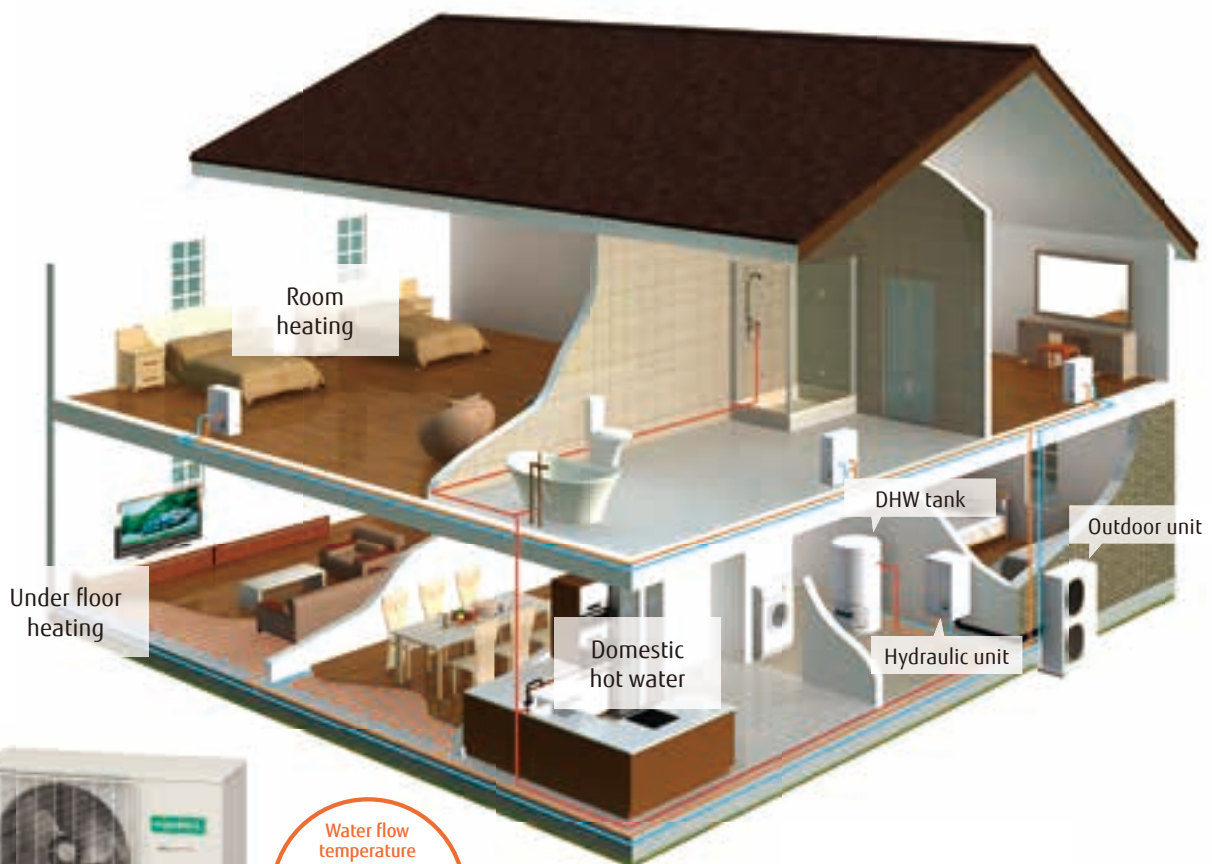

Super High Power Series
High Power Series

High water flow temperature

The temperature of water flow can be maintained at 60°C without using a backup heater, even when the outdoor temperature drops to -20°C.

Floor heating and domestic hot water supply

Outdoor units and hydraulic indoor units can be installed flexibly and easily. Hydraulic units installed inside the house prevent the circulating water from freezing. More units can be cascaded together to provide a greater heating capacity with greater flexibility.*1

*1: High Power Series only

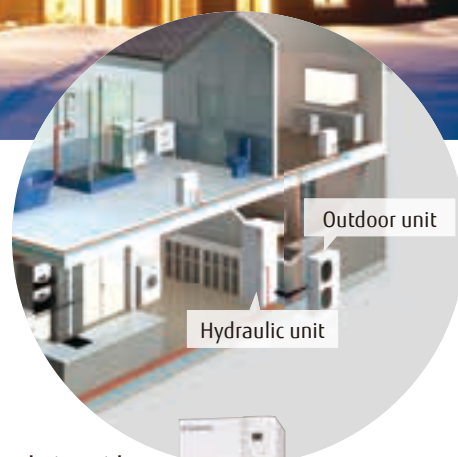

5/6 kW

8 kW

10 kW

Stylish space saving solution with built-in DHW tank



Hydraulic unit

DHW tank

Adopting R32 refrigerant

R32 refrigerant is an environmentally friendly refrigerant with a significantly lower Global Warming Potential (GWP) than conventional refrigerants.

Built-in DHW tank saves a great deal of space.

Existing boilers can be replaced easily. A higher heating capacity can be achieved with the flexibility to cascade more units.



300 Liters

+ DHW tank

A DHW tank (optional) can be connected to supply hot water.

+ Boiler

By combining with an existing boiler, powerful heating can be achieved even at low outdoor temperature.

* Please refer to page W-038 and W-039 for optional parts information.

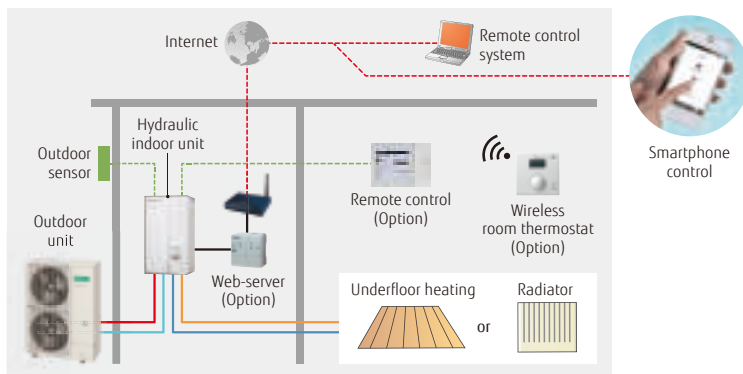

Smart control

To meet the diverse needs of customers, we offer a variety of control options, such as individual control and remote control options.

High-Efficiency Technology

Twin-Rotary Compressor



For Outdoor unit

Twin-Rotary Compressor with Linear Control Injection Port

The compressor achieves a high condensing temperature without overheating the discharge gas temperature due to the Linear control injection process used during compression. This makes the condensing temperature higher than in a normal circuit. Higher water temperatures can be achieved by controlling the injection volume according to usage conditions.

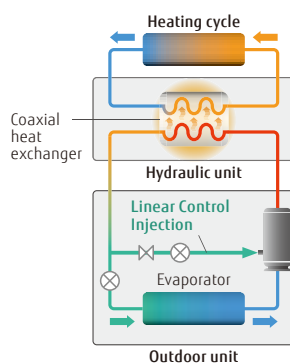
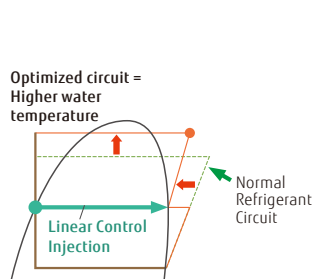

DC inverter technology controls temperatures precisely.

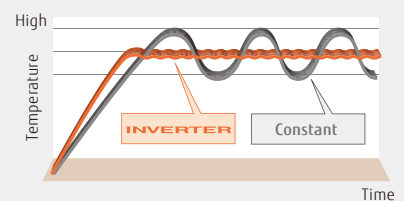

High-durability coaxial heat exchanger

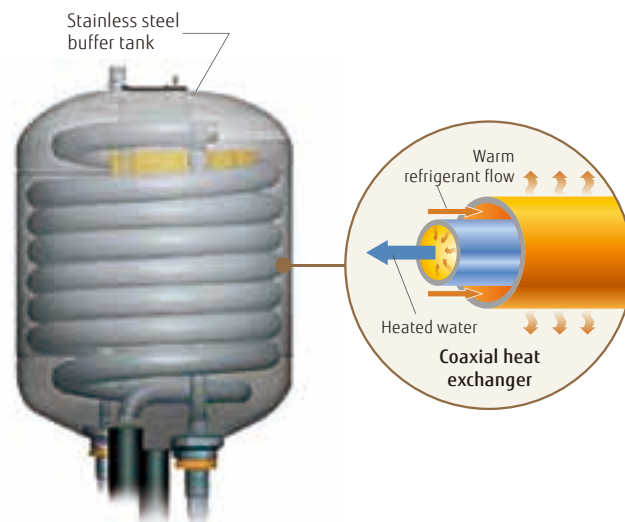

For Hydraulic unit

Stainless steel buffer tank

Heat exchange amount is 25% higher than the previous model. Energy-saving performance has also been improved.

- Anti-corrosion protection
- No flow switch required
- Anti-freeze protection not required

Class A Pump

Energy-saving pump with the ability to adjust the flow rate and pressure to a constant level



Split Type

Comfort Series



High water flow temperature

The temperature of water flow is up to 55°C without a backup heater. Hot water supply temperature can be maintained even at -10°C outdoor temperature.

* If you want to raise the temperature of the water supply to above the maximum temperature, use a backup heater to supplement the primary heater.

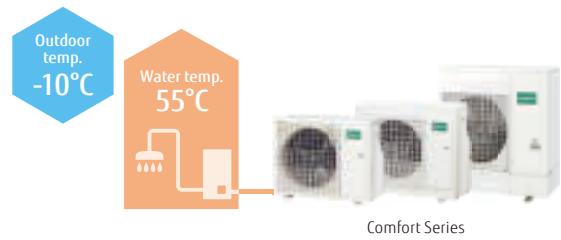

High COP

Heat pumps of ATW Systems work more efficiently and consume less energy than conventional heating systems.

Energy efficiency class



*Temperature application: Heating temp. 35°C

Seasonal space heating energy efficiency (η_s)

Conditions: Outdoor Temp. 7°C Heating Temp. 35°C

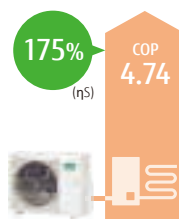

Comfort Series 5 kW class

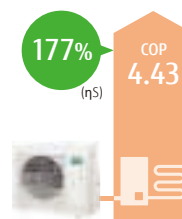

Comfort Series 8 kW class

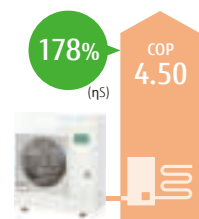

Comfort Series 10 kW class

Outdoor unit technology



DC Fan Motor

High-performance, high-efficiency small DC fan motor mounted

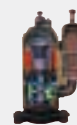

DC Twin-Rotary Compressor

High-efficiency DC twin-rotary compressor



DC Inverter

DC inverter provides smooth water temperature control.

Hydraulic indoor unit:
WSHA050ML3 / WSHA080ML3 /
WSHA100ML3
Outdoor unit:
WOHA060KLT / WOHA080KLT /
WOHA100KLT



Specifications

Model Name	Hydraulic unit	WSHA050ML3	WSHA080ML3	WSHA080ML3	WSHA100ML3				
Capacity Range	Outdoor unit	WOHA060KLT	WOHA060KLT	WOHA080KLT	WOHA100KLT				
		5	6	8	10				
7°C/35°C floor heating *1	Heating capacity	4.50	5.50	7.50	9.50				
	Input power	0.949	1.18	1.69	2.11				
	COP	4.74	4.65	4.43	4.50				
2°C/35°C floor heating *1	Heating capacity	4.50	5.30	6.30	9.30				
	Input power	1.33	1.65	1.96	3.08				
	COP	3.39	3.22	3.21	3.02				
-7°C/35°C floor heating*1	Heating capacity	4.40	5.00	5.70	8.90				
	Input power	1.59	1.90	2.13	3.36				
	COP	2.76	2.63	2.68	2.65				
-7°C/55°C Radiator*1	Heating capacity	3.90	4.25	5.30	8.00				
	Input power	2.11	2.25	2.79	4.10				
	COP	1.85	1.89	1.90	1.95				
Space heating characteristics*2									
Temperature application	°C	55	35	55	35	55	35	55	35
Energy efficiency class		A++	A+++	A++	A+++	A++	A+++	A++	A+++
Rated heat output (P _{rated})	kW	5	5	5	6	6	7	8	9
Seasonal space heating energy efficiency (η _{sp})	%	125	175	125	175	128	177	130	178
Annual energy consumption	kWh	3,035	2,322	3,411	2,594	3,903	2,982	5,083	3,875
Sound power level*3	Hydraulic unit	40	-	40	-	40	-	40	-
	Outdoor unit	57	-	57	-	60	-	62	-
Hydraulic unit specifications									
Power source	Single phase, ~230 V, 50 Hz								
Dimensions H × W × D	mm	847 × 450 × 493	847 × 450 × 493	847 × 450 × 493	847 × 450 × 493				
Weight (Net)	kg	47	47	47	47				
Water circulation	Min./Max. L/min	7.6/22.0	8.5/22.0	10.0/22.0	13.2/30.0				
Buffer tank capacity	L	16	16	16	16				
Expansion vessel capacity	L	8	8	8	8				
Water flow temperature range	Max. °C	55	55	55	55				
Water pipe connection diameter	Flow/Return mm	Ø25.4/Ø25.4	Ø25.4/Ø25.4	Ø25.4/Ø25.4	Ø25.4/Ø25.4				
Backup heater	Capacity kW	3.0	3.0	3.0	3.0				
Outdoor unit specifications									
Power source	Single phase, ~230 V, 50 Hz								
Current	Max. A	13.0	13.0	18.0	19.0				
Dimensions H × W × D	mm	632 × 799 × 290	632 × 799 × 290	716 × 820 × 315	998 × 940 × 320				
Weight (Net)	kg	39	39	42	62				
Refrigerant	Type (Global Warming Potential)	R32 (675)		R32 (675)					
	Charge	kg	0.97	0.97	1.02	1.63			
Additional refrigerant charge	q/m	25	25	25	20				
Connection pipe	Diameter	Liquid	6.35	6.35	6.35	9.52			
		Gas	12.70	12.70	12.70	15.88			
	Length	Min./Max. m	3/30	3/30	3/30	3/30			
	Length (Pre-charge)	m	15	15	15	20			
Operating range	Height difference	Max. m	20	20	20	20			
		Heating °C	-20 to 35	-20 to 35	-20 to 35	-20 to 35			

*1: Heating capacity, input power, and COP are measured using the EN14511 standard. Actual usage environments, such as the operating modes of the heating equipment, room temperature, and controller settings, may cause differences in values between those listed in the catalog and the actual performance characteristics.
 *2: Information about ErP can be downloaded from our website at www.fujitsu-general.com/global/support/downloads/search/
 *3: The sound power level values are based on EN12102 standard measurements under EN14825 standard conditions.

Dimensions

(Unit: mm)

Outdoor Unit:
WOHA060KLT

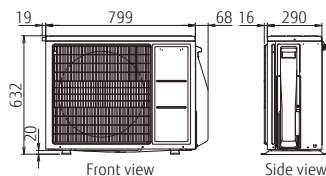

WOHA080KLT

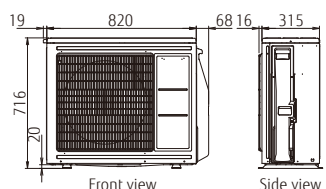

WOHA100KLT

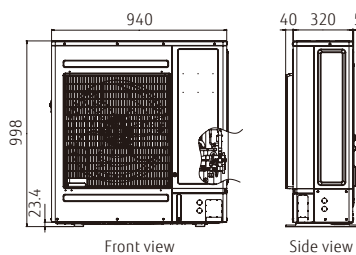

Hydraulic Indoor Unit:
WSHA050ML3/WSHA080ML3/WSHA100ML3

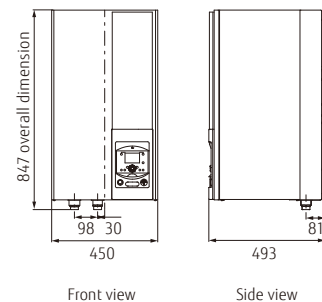

AIR TO WATER

Split Type

Super High Power Series



High water flow temperature

The temperature of water flow can be maintained at 60°C without using a backup heater, even when the outdoor temperature drops to -20°C. The system can supply 55°C water without a backup heater at an outdoor temperature of -22°C.

* If you want to raise the temperature of the water supply to above the maximum temperature, use a backup heater to supplement the primary heater.

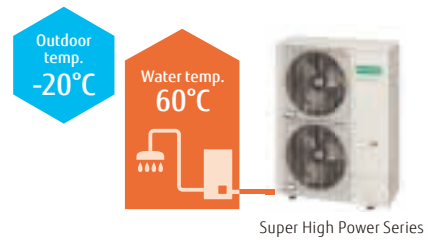

High COP

Heat pumps of ATW Systems work more efficiently and consume less energy than conventional heating systems.

Energy efficiency class



Seasonal space heating energy efficiency (η_s)

Conditions: Outdoor Temp. 7°C Heating Temp. 35°C

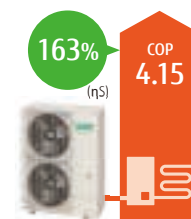

Single phase
16 kW class

Operating range extended to -25°C

Operating range improved down to -25°C outdoor temperature



Hydraulic indoor unit:
WSHG160DJ6
Outdoor unit:
WOHG160LJL



Hydraulic unit
Single phase



Outdoor unit
Single phase 16 kW

Specifications

Model Name	Hydraulic unit	WSHG160DJ6		
Capacity range	Outdoor unit	WOHG160LJL		
		16		
7°C/35°C floor heating *1	Heating capacity	kW		
	Input power	16.00		
	COP	3.86		
2°C/35°C floor heating *1	Heating capacity	kW		
	Input power	13.30		
	COP	4.25		
-7°C/35°C floor heating*1	Heating capacity	kW		
	Input power	14.50		
	COP	5.27		
-7°C/55°C Radiator*1	Heating capacity	kW		
	Input power	10.90		
	COP	5.89		
Space heating characteristics*2				
Temperature application	°C	55	35	
Energy efficiency class		A++	A++	
Rated heat output (P _{rated})	kW	14	16	
Seasonal space heating energy efficiency (η _s)	%	125	163	
Annual energy consumption	kWh	8,757	8,014	
Sound power level	Hydraulic unit	dB(A)		
	Outdoor unit	45		
		67	66	
Hydraulic unit specifications				
Power source	Single phase, ~230 V, 50 Hz			
Dimensions H × W × D	mm	805 × 450 × 471		
Weight (Net)	kg	52.5		
Water circulation	Min./Max.	L/min		
		26.4/57.8		
Buffer tank capacity	L	22		
Expansion vessel capacity	L	10		
Water flow temperature range	Max.	°C		
		60		
Water pipe connection diameter	Flow/Return	mm		
		Ø25.4/Ø25.4		
Backup heater	Capacity	kW		
		6.0 (3.0 kW × 2 pcs.)		
Outdoor unit specifications				
Power source	Single phase, ~230 V, 50 Hz			
Current	Max.	A		
		28.0		
Dimensions H × W × D	mm	1,428 × 1,080 × 480		
Weight (Net)	kg	137		
Refrigerant	Type (Global Warming Potential)	R410A (2,088)		
	Charge	kg		
		3.80		
Additional refrigerant charge	g/m	50		
Connection pipe	Diameter	Liquid	mm	
		Gas	mm	
	Length	Min./Max.	m	
			Ø9.52 / Ø15.88	
Length (Pre-charge)	m			
	5/30			
Height difference	m			
	15			
Operating range	25/15 (Outdoor unit: Upper/Lower)			
	Heating	°C		
	-25 to 35			

*1: Heating capacity, input power, and COP are measured using the EN14511 standard. Actual usage environments, such as the operating modes of the heating equipment, room temperature, and controller settings, may cause differences in values between those listed in the catalog and the actual performance characteristics.

*2: Information about ErP can be downloaded from our website at www.fujitsu-general.com/global/support/downloads/search/

Dimensions

(Unit: mm)

Outdoor Unit:
 WOHG160LJL

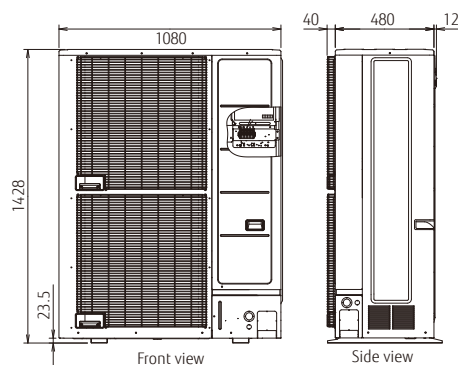

Hydraulic Indoor Unit:
 WSHG160DJ6

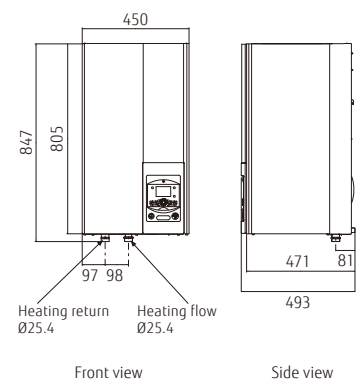

Split Type

High Power Series



High water flow temperature

The temperature of water flow can be maintained at 60°C without using a backup heater, even when the outdoor temperature drops to -20°C.

* If you want to raise the temperature of the water supply to above the maximum temperature, use a backup heater to supplement the primary heater.

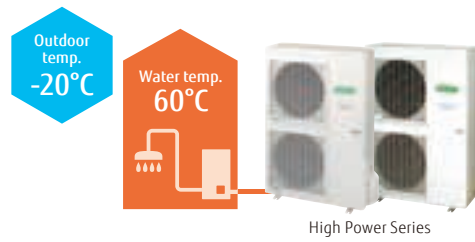

High COP

Heat pumps of ATW Systems work more efficiently and consume less energy than conventional heating systems.

Energy efficiency class



*Temperature application: Heating temp. 35°C

Seasonal space heating energy efficiency (η_s)

Conditions: Outdoor Temp. 7°C Heating Temp. 35°C

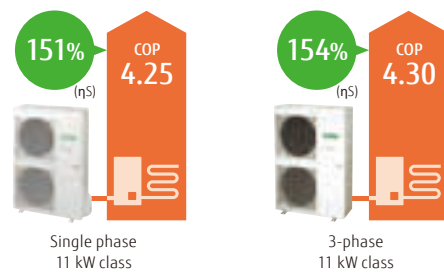

Hydraulic indoor unit:

WSHG140DG

Outdoor unit:

WOHG112LHT / WOHG140LCTA

**[3 phase] WOHK112LCTA / WOHK140LCTA /
WOHK160LCTA**



Hydraulic unit
Single phase/
3-phase



Outdoor unit
Single phase
11/14 kW



Outdoor unit
3-phase
11/14/16 kW

Specifications

Model Name	Hydraulic unit	WSHG140DG	WSHG140DG	WSHG140DG	WSHG140DG	WSHG140DG					
	Outdoor unit	WOHG112LHT	WOHG140LCTA	WOHK112LCTA	WOHK140LCTA	WOHK160LCTA					
Capacity range		11	14	11	14	16					
7°C/35°C floor heating *1	Heating capacity	10.80	13.50	10.80	13.50	15.17					
	Input power	2.54	3.23	2.51	3.20	3.70					
	COP	4.25	4.18	4.30	4.22	4.10					
2°C/35°C floor heating *1	Heating capacity	10.77	12.00	10.77	13.00	13.50					
	Input power	3.44	3.87	3.40	4.15	4.34					
	COP	3.13	3.10	3.17	3.13	3.11					
-7°C/35°C floor heating*1	Heating capacity	10.38	11.54	10.38	12.20	13.50					
	Input power	4.32	5.08	4.28	5.13	5.40					
	COP	2.40	2.27	2.43	2.38	2.50					
-7°C/55°C Radiator*1	Heating capacity	7.57	9.20	9.27	10.10	11.00					
	Input power	4.57	5.08	5.09	5.65	6.29					
	COP	1.66	1.81	1.82	1.79	1.75					
Space heating characteristics*2											
Temperature application	°C	55	35	55	35	55	35	55	35	55	35
Energy efficiency class		A+	A++	A+	A+	A+	A++	A+	A++	A+	A+
Rated heat output (P _{rated})	kW	9	11	11	13	9	11	11	13	13	14
Seasonal space heating energy efficiency (η _s)	%	112	151	113	148	112	154	117	150	117	149
Annual energy consumption	kWh	6,704	6,062	8,041	6,824	6,669	5,930	7,803	6,738	9,062	7,408
Sound power level	Hydraulic unit	46		46		46		46		46	
	Outdoor unit	68		69		69		68		71	
Hydraulic unit specifications											
Power source	Single phase, ~230 V, 50 Hz			3-phase, ~400 V, 50 Hz							
Dimensions H × W × D	mm	800 × 450 × 457			800 × 450 × 457						
Weight (Net)	kg	40			40						
Water circulation	Min./Max.	L/min	19.5/39.0	24.4/48.7	19.5/39.0	24.4/48.7	27.4/54.8				
Buffer tank capacity	L	16			16						
Expansion vessel capacity	L	8			8						
Water flow temperature range	Max.	°C	60			60					
Water pipe connection diameter	Flow/Return	mm	Ø25.4/Ø25.4			Ø25.4/Ø25.4					
Backup heater	Capacity	kW	-			-					
Outdoor unit specifications											
Power source	Single phase, ~230 V, 50 Hz			3-phase, ~400 V, 50 Hz							
Current	Max.	A	22.0	25.0	9.0	9.5	10.5				
Dimensions H × W × D	mm	1,290 × 900 × 330			1,290 × 900 × 330						
Weight (Net)	kg	92			99						
Refrigerant	Type (Global Warming Potential)	R410A (2,088)									
	Charge	kg	2.50								
Additional refrigerant charge		g/m	50								
Connection pipe	Diameter	Liquid	Ø9.52								
		Gas	Ø15.88								
	Length	Min./Max.	5/20								
		Length (Pre-charge)	15								
Height difference	Max.	15									
Operating range	Heating	°C	-25 to 35								

*1: Heating capacity, input power, and COP are measured using the EN14511 standard. Actual usage environments, such as the operating modes of the heating equipment, room temperature, and controller settings, may cause differences in values between those listed in the catalog and the actual performance characteristics.

*2: Information about ErP can be downloaded from our website at www.fujitsu-general.com/global/support/downloads/search/

Dimensions

(Unit: mm)

Outdoor Unit:

Single phase: WOHG112LHT/WOHG140LCTA

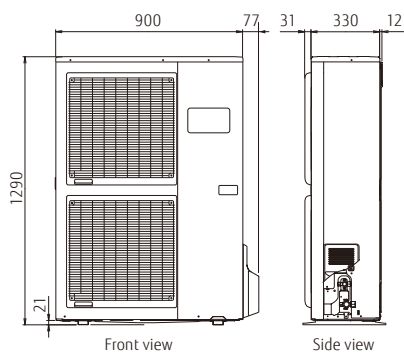

3 phase: WOHK112LCTA/WOHK140LCTA/WOHK160LCTA

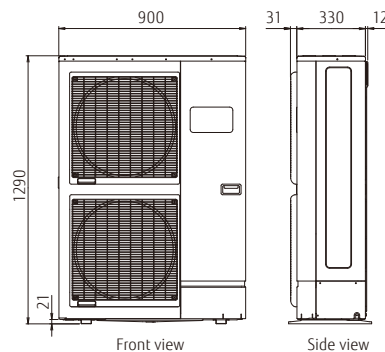

Hydraulic Indoor Unit:

WSHG140DG

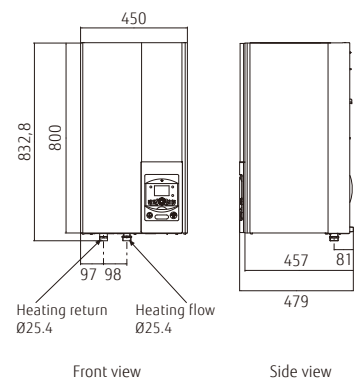

Split DHW Integrated Type

Comfort Series



High water flow temperature

The temperature of water flow is up to 55°C without a backup heater. Hot water supply temperature can be maintained even at -10°C outdoor temperature.

* If you want to raise the temperature of the water supply to above the maximum temperature, use a backup heater to supplement the primary heater.

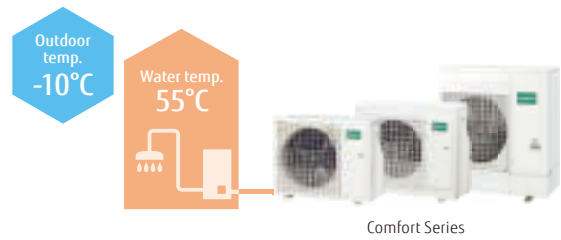

High COP

Heat pumps of ATW Systems work more efficiently and consume less energy than conventional heating systems.

Energy efficiency class



*Temperature application: Heating temp. 35°C

Seasonal space heating energy efficiency (η_s)

Conditions: Outdoor Temp. 7°C Heating Temp. 35°C

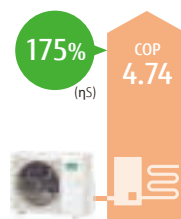

Comfort Series 5 kW class

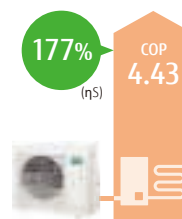

Comfort Series 8 kW class

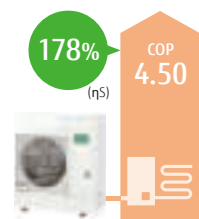

Comfort Series 10 kW class

Outdoor unit technology



DC Fan Motor

High-performance, high-efficiency small DC fan motor mounted



DC Twin-Rotary Compressor

High-efficiency DC twin-rotary compressor



DC Inverter

DC inverter provides smooth water temperature control.

Hydraulic indoor unit:
WGHA050ML3 / WGHA080ML3 /
WGHA100ML3
Outdoor unit:
WOHA060KLT / WOHA080KLT /
WOHA100KLT



Hydraulic unit
Single phase



Outdoor unit
Single phase
5/6 kW



Outdoor unit
Single phase
8 kW



Outdoor unit
Single phase
10 kW

Specifications

Model Name	Hydraulic unit		WGHA050ML3		WGHA080ML3		WGHA080ML3		WGHA100ML3	
	Outdoor unit		WOHA060KLT		WOHA060KLT		WOHA080KLT		WOHA100KLT	
Capacity range			5		6		8		10	
7°C/35°C floor heating *1	Heating capacity	kW	4.50		5.50		7.50		9.50	
	Input power		0.949		1.18		1.69		2.11	
	COP		4.74		4.65		4.43		4.50	
2°C/35°C floor heating *1	Heating capacity	kW	4.50		5.30		6.30		9.30	
	Input power		1.33		1.65		1.96		3.08	
	COP		3.39		3.22		3.21		3.02	
-7°C/35°C floor heating*1	Heating capacity	kW	4.40		5.00		5.70		8.90	
	Input power		1.59		1.90		2.13		3.36	
	COP		2.76		2.63		2.68		2.65	
-7°C/55°C Radiator*1	Heating capacity	kW	3.90		4.25		5.30		8.00	
	Input power		2.11		2.25		2.79		4.10	
	COP		1.85		1.89		1.90		1.95	
Space heating characteristics*2										
Temperature application	°C		55		35		55		35	
Energy efficiency class			A++		A+++		A++		A+++	
Rated heat output (P _{rated})	kW		5		5		6		7	
Seasonal space heating energy efficiency (η _s)	%		125		175		128		177	
Annual energy consumption	kWh		3,035		2,322		3,411		2,594	
Sound power level*3	Hydraulic unit	dB(A)	40		-		40		-	
	Outdoor unit		57		-		60		-	
Domestic hot water characteristics*2										
Load profile			L		L		L		L	
Energy efficiency class			A+		A+		A+		A+	
Energy efficiency (η _{DHW})	%		130		130		130		130	
Annual electricity consumption	kWh		793		793		793		793	
Hydraulic unit specifications										
Power source	Single phase, ~230 V, 50 Hz									
Dimensions H × W × D	mm		1,863 × 648 × 700		1,863 × 648 × 700		1,863 × 648 × 700		1,863 × 648 × 700	
Weight (Net)	kg		145		145		145		145	
Water circulation	Min./Max.		L/min		7.6/22.0		8.5/22.0		10.0/22.0	
DHW capacity	L		190		190		190		190	
Electrical heater capacity	Heating	kW	3.0		3.0		3.0		3.0	
	DHW		1.5		1.5		1.5		1.5	
Buffer tank capacity	L		16		16		16		16	
Expansion vessel capacity	L		8		8		8		8	
Water flow temperature range	Max.		°C		55		55		55	
Water pipe connection diameter	Flow/Return		mm		Ø25.4/Ø25.4		Ø25.4/Ø25.4		Ø25.4/Ø25.4	
Hot water pipe connection diameter	mm		Ø19.05		Ø19.05		Ø19.05		Ø19.05	
Outdoor unit specifications										
Power source	Single phase, ~230 V, 50 Hz									
Current	Max.		A		13.0		13.0		18.0	
Dimensions H × W × D	mm		632 × 799 × 290		632 × 799 × 290		716 × 820 × 315		998 × 940 × 320	
Weight (Net)	kg		39		39		42		62	
Refrigerant	Type (Global Warming Potential)		R32 (675)		R32 (675)		R32 (675)		R32 (675)	
	Charge		kg		0.97		1.02		1.63	
Additional refrigerant charge	q/m		25		25		25		20	
Connection pipe	Diameter	Liquid	mm		6.35		6.35		6.35	
		Gas	mm		12.70		12.70		15.88	
	Length	Min./Max.	m		3/30		3/30		3/30	
		Length (Pre-charge)	m		15		15		20	
Height difference	Max.	m		20		20		20		
		Heating		°C		-20 to 35		-20 to 35		-20 to 35

*1: Heating capacity, input power, and COP are measured using the EN14511 standard. Actual usage environments, such as the operating modes of the heating equipment, room temperature, and controller settings, may cause differences in values between those listed in the catalog and the actual performance characteristics.

*2: Information about ERP can be downloaded from our website at www.fujitsu-general.com/global/support/downloads/search/

*3: The sound power level values are based on EN12102 standard measurements under EN14825 standard conditions.

Dimensions

(Unit: mm)

Outdoor Unit:
WOHA060KLT

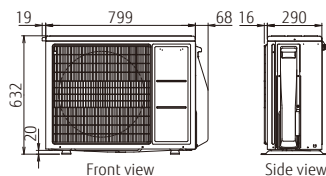

WOHA080KLT

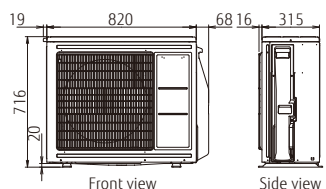

WOHA100KLT

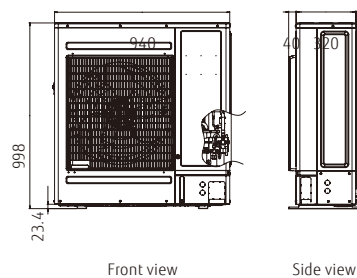

Hydraulic Indoor Unit:
WGHA050ML3/WGHA080ML3/WGHA100ML3

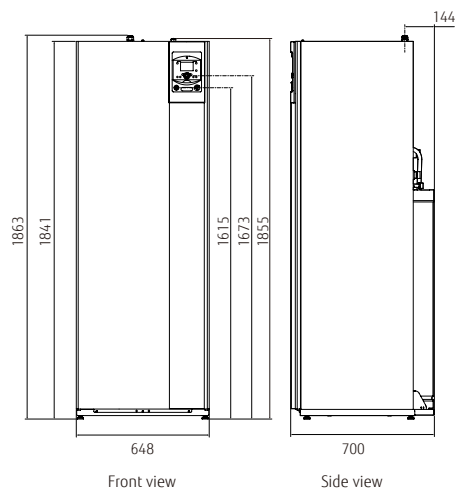

Split DHW Integrated Type

Super High Power Series



High water flow temperature

The temperature of water flow can be maintained at 60°C without using a backup heater, even when the outdoor temperature drops to -20°C. The system can supply 55°C water without a backup heater at an outdoor temperature of -22°C.

* If you want to raise the temperature of the water supply to above the maximum temperature, use a backup heater to supplement the primary heater.

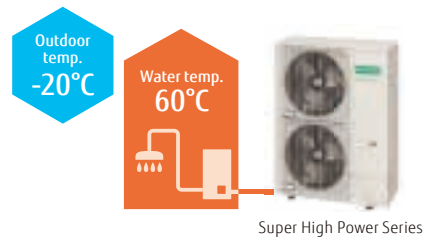

High COP

Heat pumps of ATW Systems work more efficiently and consume less energy than conventional heating systems.

Energy efficiency class



Seasonal space heating energy efficiency (η_s)

Conditions: Outdoor Temp. 7°C Heating Temp. 35°C

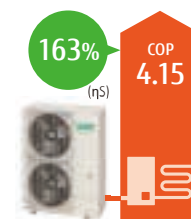

Single phase
16 kW class

Operating range extended to -25°C

Operating range improved down to -25°C outdoor temperature



Stylish space saving solution with
**Built-in High-performance
DHW tank 190 L**



- Coil heat exchanger optimizes DHW supply performance.
- Temperature rises quickly due to the large surface of the exchanger.

Hydraulic indoor unit:
WGHG160DJ6
Outdoor unit:
WOHG160LJL



Hydraulic unit
Single phase



Outdoor unit
Single phase 16 kW

Specifications

Model Name	Hydraulic unit		WGHG160DJ6		
	Outdoor unit		WOHG160LJL		
Capacity range			16		
7°C/35°C floor heating *1	Heating capacity	kW	16.00		
	Input power		3.86		
	COP		4.15		
2°C/35°C floor heating *1	Heating capacity	kW	13.30		
	Input power		4.25		
	COP		3.13		
-7°C/35°C floor heating*1	Heating capacity	kW	14.50		
	Input power		5.27		
	COP		2.75		
-7°C/55°C Radiator*1	Heating capacity	kW	10.90		
	Input power		5.89		
	COP		1.85		
Space heating characteristics*2					
Temperature application	°C		55	35	
Energy efficiency class			A++	A++	
Rated heat output (P _{rated})	kW		14	16	
Seasonal space heating energy efficiency (η _s)	%		125	163	
Annual energy consumption	kWh		8,757	8,014	
Sound power level	Hydraulic unit	dB(A)	45	45	
	Outdoor unit		67	66	
Domestic hot water characteristics*2					
Load profile			L		
Energy efficiency class			A		
Energy efficiency (η _{DHW})	%		109		
Annual electricity consumption	kWh		941		
Hydraulic unit specifications					
Power source			Single phase, ~230 V, 50 Hz		
Dimensions H × W × D	mm		1,841 × 648 × 698		
Weight (Net)	kg		166		
Water circulation	Min./Max.	L/min	26.4/57.8		
DHW capacity	L		190		
Electrical heater capacity	Heating	kW	6.0 (3.0 kW × 2 pcs.)		
	DHW		1.5		
Buffer tank capacity	L		22		
Expansion vessel capacity	L		12		
Water flow temperature range	Max.	°C	60		
Water pipe connection diameter	Flow/Return	mm	Ø25.4/Ø25.4		
Hot water pipe connection diameter	mm		Ø19.05		
Outdoor unit specifications					
Power source			Single phase, ~230 V, 50 Hz		
Current	Max.	A	28.0		
Dimensions H × W × D	mm		1,428 × 1,080 × 480		
Weight (Net)	kg		137		
Refrigerant	Type (Global Warming Potential)		R410A (2,088)		
	Charge	kg	3.80		
Additional refrigerant charge	g/m		50		
Connection pipe	Diameter	Liquid	Ø9.52		
		Gas	Ø15.88		
	Length	Min./Max.	m		
	Length (Pre-charge)	m		5/30	
Height difference	Max.	m		15	
				25/15 (Outdoor unit: Upper/Lower)	
Operating range	Heating	°C	-25 to 35		

*1: Heating capacity, input power, and COP are measured using the EN14511 standard. Actual usage environments, such as the operating modes of the heating equipment, room temperature, and controller settings, may cause differences in values between those listed in the catalog and the actual performance characteristics.
*2: Information about ErP can be downloaded from our website at www.fujitsu-general.com/global/support/downloads/search/

Dimensions

(Unit: mm)

Outdoor Unit:
WOHG160LJL

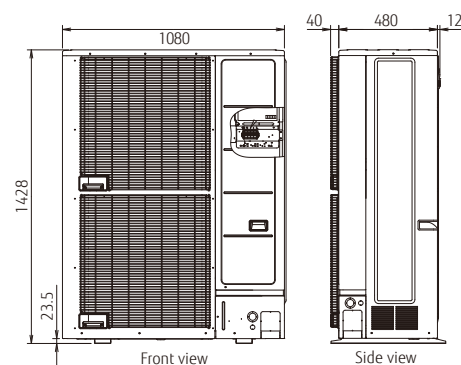

Hydraulic Indoor Unit:
WGHG160DJ6

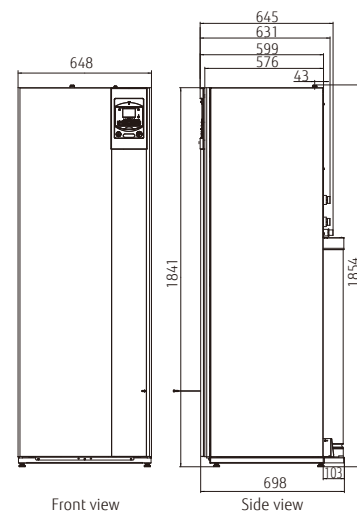

Split DHW Integrated Type

High Power Series



High water flow temperature

The temperature of water flow can be maintained at 60°C without using a backup heater, even when the outdoor temperature drops to -20°C.

* If you want to raise the temperature of the water supply to above the maximum temperature, use a backup heater to supplement the primary heater.

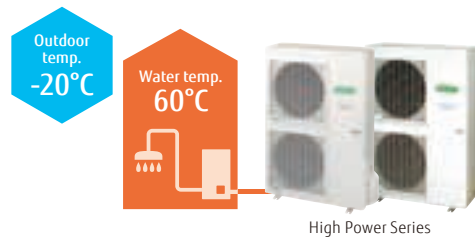

High COP

Heat pumps of ATW Systems work more efficiently and consume less energy than conventional heating systems.

Energy efficiency class



*Temperature application: Heating temp. 35°C

Seasonal space heating energy efficiency (η_s)

Conditions: Outdoor Temp. 7°C Heating Temp. 35°C

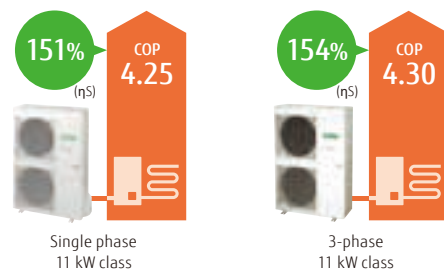

Optimized refrigerant cycle operation

The High Power Series deliver high performance and efficiency with twin sensors and hot water heating technology.

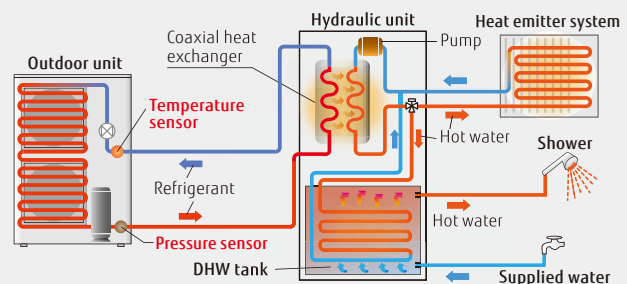

Hydraulic indoor unit:

WGHG140DG

Outdoor unit:

WOHG112LHT / WOHG140LCTA

[3 phase] WOHK112LCTA / WOHK140LCTA /

WOHK160LCTA



Hydraulic unit
Single phase/
3-phase



Outdoor unit
Single phase
11/14 kW



Outdoor unit
3-phase
11/14/16 kW

Specifications

Model Name	Hydraulic unit		WGHG140DG		WGHG140DG		WGHG140DG		WGHG140DG		WGHG140DG	
	Outdoor unit		WOHG112LHT		WOHG140LCTA		WOHK112LCTA		WOHK140LCTA		WOHK160LCTA	
Capacity range			11		14		11		14		16	
7°C/35°C floor heating *1	Heating capacity	kW	10.80		13.50		10.80		13.50		15.17	
	Input power		2.54		3.23		2.51		3.20		3.70	
	COP		4.25		4.18		4.30		4.22		4.10	
2°C/35°C floor heating *1	Heating capacity	kW	10.77		12.00		10.77		13.00		13.50	
	Input power		3.44		3.87		3.40		4.15		4.34	
	COP		3.13		3.10		3.17		3.13		3.11	
-7°C/35°C floor heating*1	Heating capacity	kW	10.38		11.54		10.38		12.20		13.50	
	Input power		4.32		5.08		4.28		5.13		5.40	
	COP		2.40		2.27		2.43		2.38		2.50	
-7°C/55°C Radiator*1	Heating capacity	kW	7.57		9.20		9.27		10.10		11.00	
	Input power		4.57		5.08		5.09		5.65		6.29	
	COP		1.66		1.81		1.82		1.79		1.75	
Space heating characteristics*2												
Temperature application	°C		55		35		55		35		55	
Energy efficiency class			A+		A++		A+		A+		A++	
Rated heat output (P _{rated})	kW		9		11		11		13		14	
Seasonal space heating energy efficiency (η _s)	%		112		151		113		148		117	
Annual energy consumption	kWh		6,704		6,062		8,041		6,824		6,669	
Sound power level	Hydraulic unit	dB(A)	46		46		46		46		46	
	Outdoor unit		68		69		69		68		70	
Domestic hot water characteristics*2												
Load profile											L	
Energy efficiency class											A	
Energy efficiency (η _{wh})	%										88	
Annual electricity consumption	kWh										1166	
Hydraulic unit specifications												
Power source			Single phase, ~230 V, 50 Hz				3-phase, ~400 V, 50 Hz					
Dimensions H × W × D	mm						1,840 × 648 × 698					
Weight (Net)	kg						150					
Water circulation	Min./Max.	L/min	19.5/39.0		24.4/28.7		19.5/39.0		24.4/48.7		27.4/54.8	
DHW capacity	L						190					
Electrical heater capacity	Heating	kW										
	DHW						1.5					
Buffer tank capacity	L						16					
Expansion vessel capacity	L						12					
Water flow temperature range	Max.	°C					60					
Water pipe connection diameter	Flow/Return	mm					Ø25.4/Ø25.4					
Hot water pipe connection diameter	mm						Ø19.05					
Outdoor unit specifications												
Power source			Single phase, ~230 V, 50 Hz				3-phase, ~400 V, 50 Hz					
Current	Max.	A	22.0		25.0		9.0		9.5		10.5	
Dimensions H × W × D	mm						1,290 × 900 × 330					
Weight (Net)	kg						92					
Refrigerant	Type (Global Warming Potential)						R410A (2,088)					
	Charge		kg				2.50					
Additional refrigerant charge	q/m						50					
Connection pipe	Diameter	Liquid	mm				Ø9.52					
		Gas	mm				Ø15.88					
	Length	Min./Max.	m				5/20					
		Length (Pre-charge)	m				15					
Height difference	Max.	m				15						
Operating range	Heating		°C				-25 to 35					

*1: Heating capacity, input power, and COP are measured using the EN14511 standard. Actual usage environments, such as the operating modes of the heating equipment, room temperature, and controller settings, may cause differences in values between those listed in the catalog and the actual performance characteristics.

*2: Information about ErP can be downloaded from our website at www.fujitsu-general.com/global/support/downloads/search/

Dimensions

(Unit: mm)

Outdoor Unit:

Single phase: WOHG112LHT/WOHG140LCTA

3 phase: WOHK112LCTA/WOHK140LCTA/WOHK160LCTA

Hydraulic Indoor Unit:

WGHG140DG

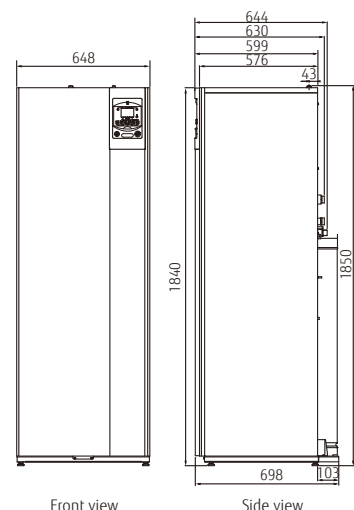
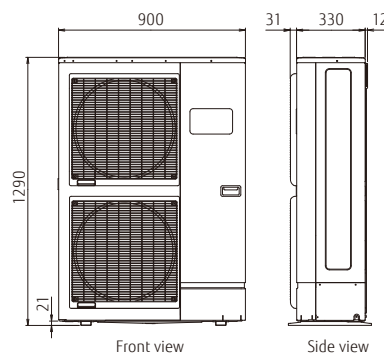
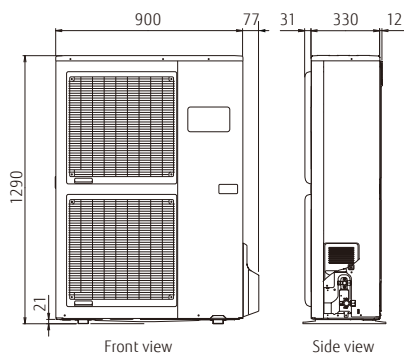

Comfort Control

The high-grade heating controller automatically adjusts the flow temperature according to the climate conditions to maintain the room and domestic hot water temperatures at the desired levels.

Hydraulic unit Controller 4 Heating modes

- 1. Automatic mode**
Enables automatic switching between Comfort mode and Reduce mode according to time program
- 2. Reduce mode**
Maintains water temperature at a lower level
- 3. Comfort mode**
Maintains water temperature at a comfortable level
- 4. Protection mode**
Activates frost protection in standby operation



Useful Features

Automatic heating curve control

Automatic temperature regulation according to heating curve (depending on heating terminal and outdoor temperature)

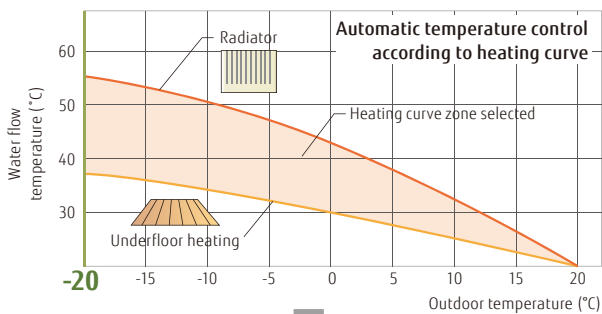

The heating curve will shift to adjust the room temperature setting.

Can be fine-adjusted when it is too warm or too cold.

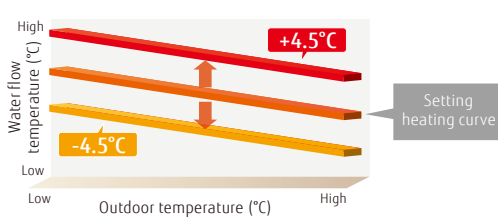

Quick recovery from defrosting

Maintains room temperature by boost start operation during defrosting.

Auto changeover

When cooling mode is selected, the system automatically switches between cooling and heating modes depending on the outdoor temperature to serve as an all-season air conditioner.

2-zone independent control

2-zone independent control (For example, the individual control of 2 underfloor heating zones or the combination of 1 underfloor heating zone and 1 radiator zone)*1

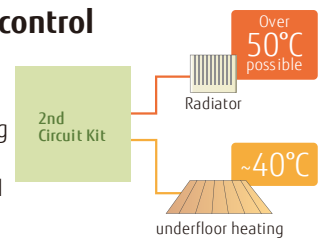

*1: Optional parts required

2-stage low-noise mode

The outdoor unit can be switched to quiet mode, depending on the installation environment.

*Effective only for High Power Series

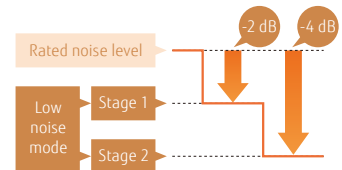

Backup heater operation

Backup heater maintains a comfortable room temperature even when the outside temperature is low. The backup heater is intelligently controlled as a safety backup for very cold days and nights, and only operates when really needed.

* Optional parts is needed for High power Series.

Energy Saving

Time program

- The timer is easy to set.
- You can select the heating mode in conjunction with various times of the day.

Day-weekly timer

- Allows up to 3 settings per day.
- Allows individual settings for each day of the week.

Holiday timer

- Allows up to 8 settings.
- While you are away from home for an extended period during winter, the system prevents your room or house from freezing.

Peak cut Function*2

Sets the peak current value to reduce power consumption.

Mode	Ratio to reduce power consumption
1	100%
2	75%
3	50%
4	Almost 0%

* Please refer to page W-038 and W-039 for optional parts information.



Safety Features

Anti-Legionella function

Prevents the growth of Legionella bacteria in the DHW tank to supply safe and clean hot water at all times.



Anti-freeze function

When the outside temperature drops below a specified level, the compressor will self-activate and water will also be automatically circulated to prevent freezing.

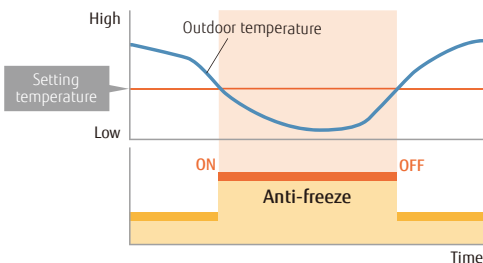

Emergency operation

If an outdoor unit fails to operate, a built-in backup heater or an external boiler is activated to supply an uninterrupted supply of hot water to the house.

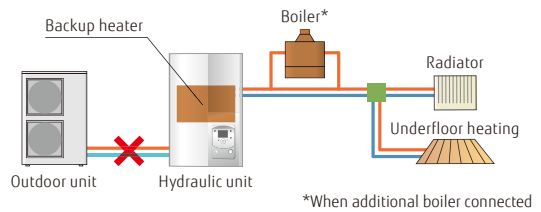

Error and Maintenance Alarm

Enables quick error-handling services and maintenance

- Error
- Maintenance

- Error history saves 10 errors in memory
- Display telephone number of service company

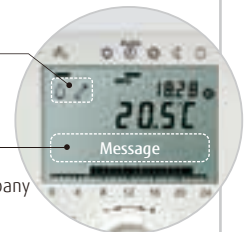

Simple installation

Presetting configurations

A controller installed makes it easy to configure the system without having to set each component or unit individually.

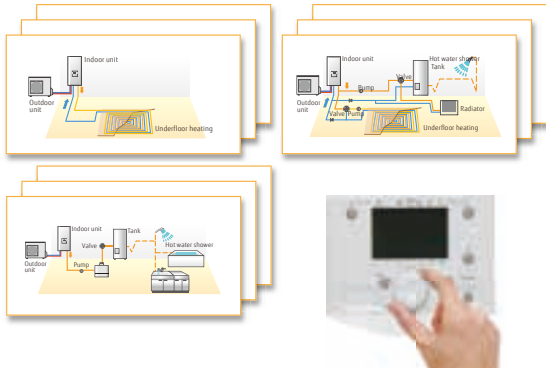

8 simple patterns for system presetting
(Pair of heating: 12 patterns)

Configuration (Parameter 5700)	Installation type
Presetting 1	1 heating circuit
Presetting 2	2 heating circuits
Presetting 3	1 heating circuit with boiler backup
Presetting 4	2 heating circuits with boiler backup
Presetting 5	1/2 heating circuit with buffer control
Presetting 6	1/2 heating circuit with buffer control and boiler backup
Presetting 7	Cascade connection Primary
Presetting 8	Cascade connection A
Presetting 9	Cascade connection B/C

- DHW & solar control auto detection
- Cascade connection only available in High Power models.

Outdoor temperature simulation

It verifies that each unit operates properly under the set conditions and expected outdoor air temperature when the system is actually assembled.

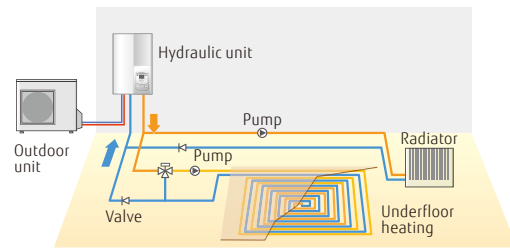

The outdoor temperatures can be simulated in the range of -50°C to +50°C.

Concrete floor drying

Allows the concrete surrounding the hot-water pipes to dry more quickly, shortening the construction period for underfloor heating installations.

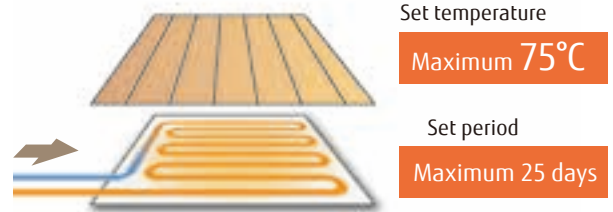

Controller with a large liquid crystal display and buttons for easy function setting

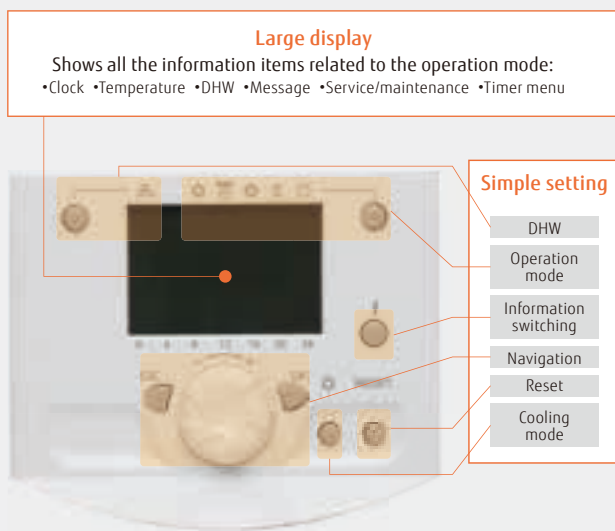

Main operation flow and settings for installers and end users

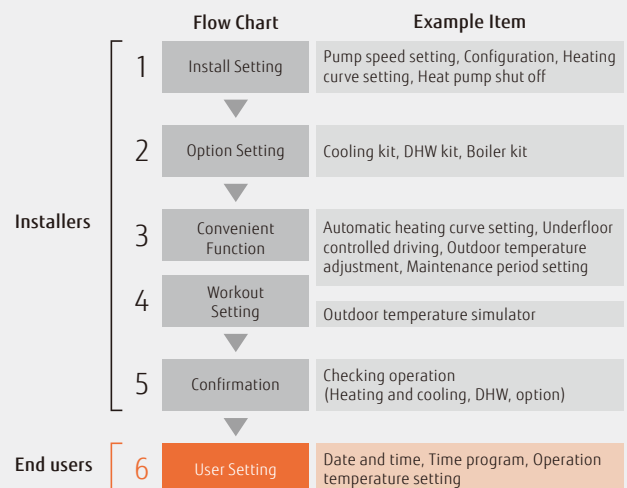

Easy Installation & Maintenance

- All hydraulic safety and control components are built in with no additional selection required.
- Lifting bars for installation free of difficulty or risk
- Easy access for maintenance
- Refrigerant pump down operation

Maintenance Support

Diagnostics functions for troubleshooting

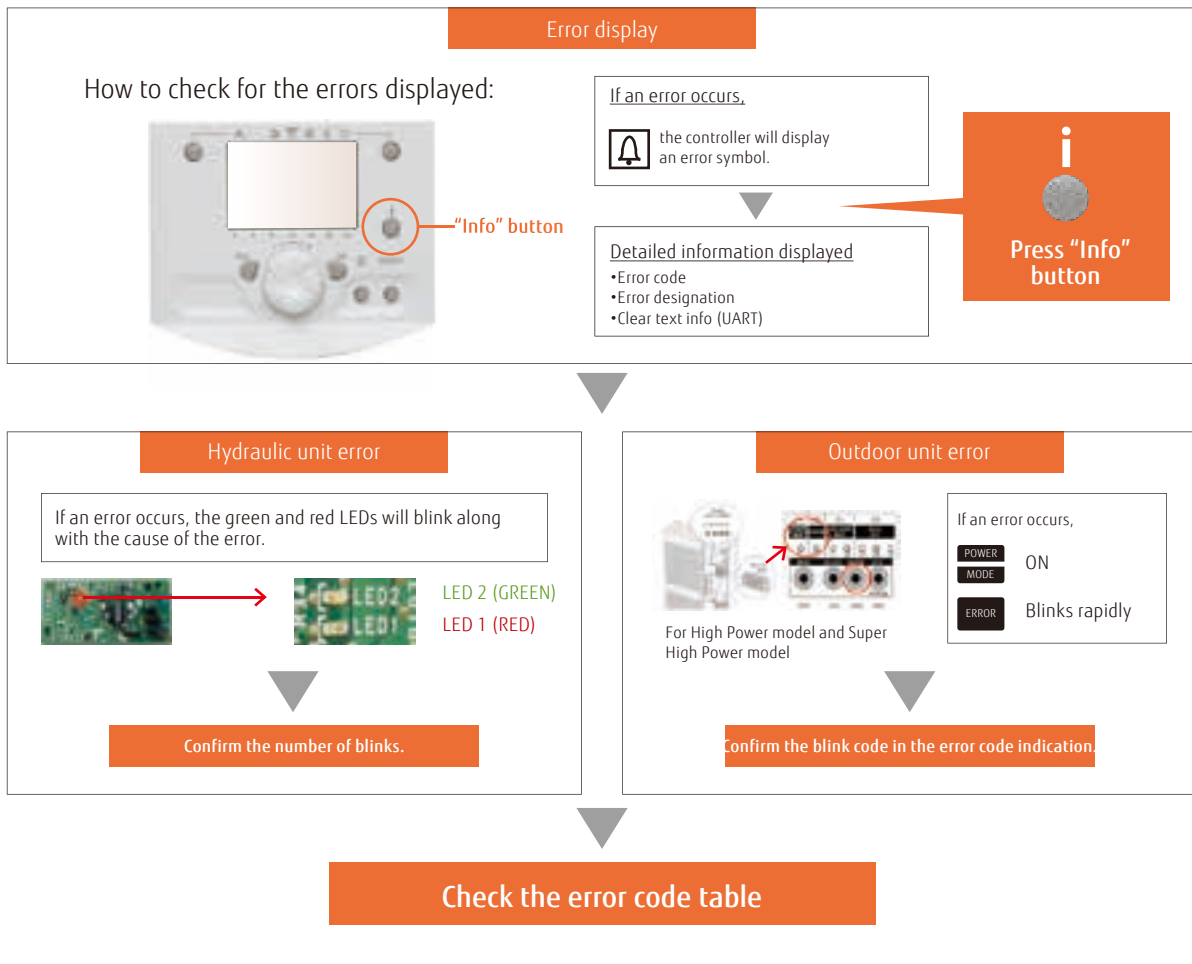

Installation requirements

Installation of equipment & electrical wiring

Split type Hydraulic unit

- The Hydraulic unit is hung on the wall.
- Weight ≤ 88 kg (including water)
- Space for maintenance needs to be taken into consideration.

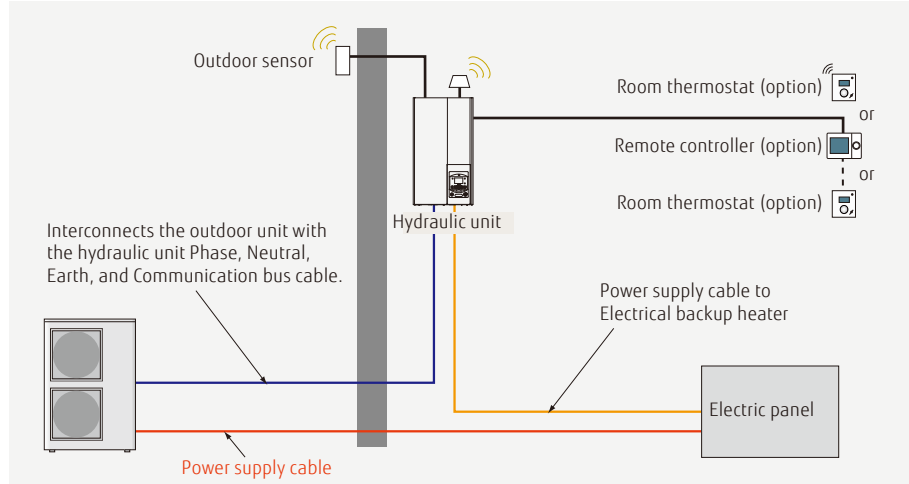
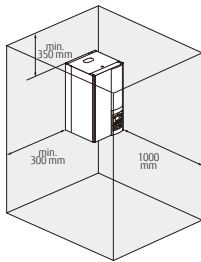

Split DHW Integrated Type Hydraulic Unit

- Floor standing
- Weight ≤ 393 kg (including water)
- Space for maintenance needs to be taken into consideration.

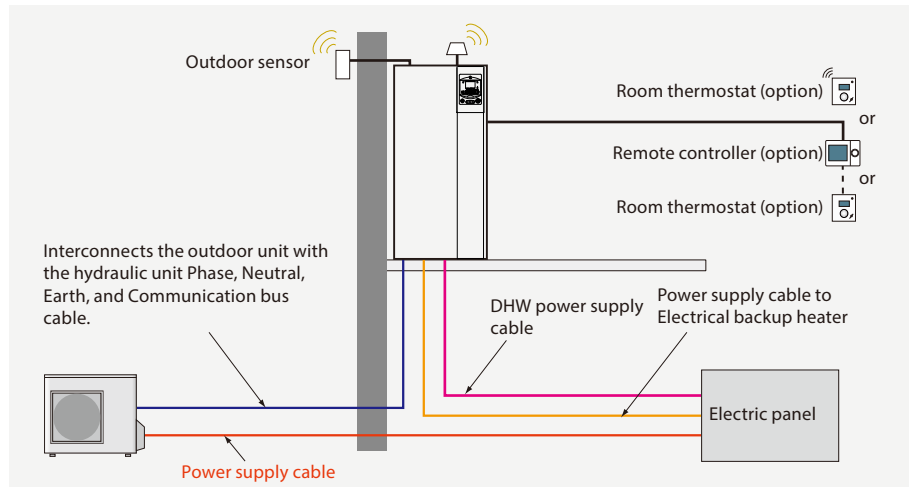
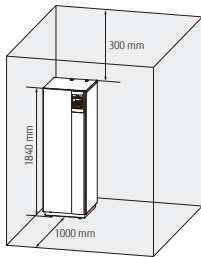

Piping and Wiring split type

Series	Capacity range (kW)	Pipe diameter (Liquid/Gas) (mm)	H1 (m)	H2 (m)	L (m)
R32 Comfort	5	6.35/12.70	+20	-20	3-30
	6				
	8				
High Power	10	9.52/15.88	+15	-15	5-20
	11				
	14				
Super High Power	16	9.52/15.88	+15	-25	5-30

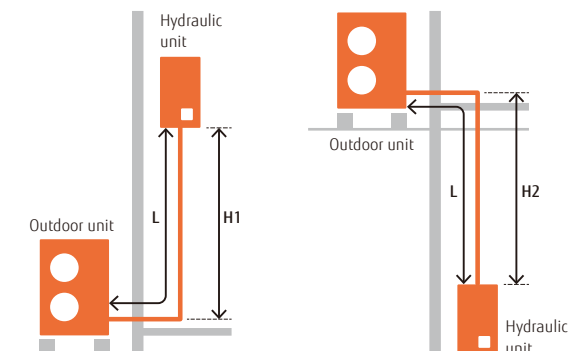



System Configuration

Split Type

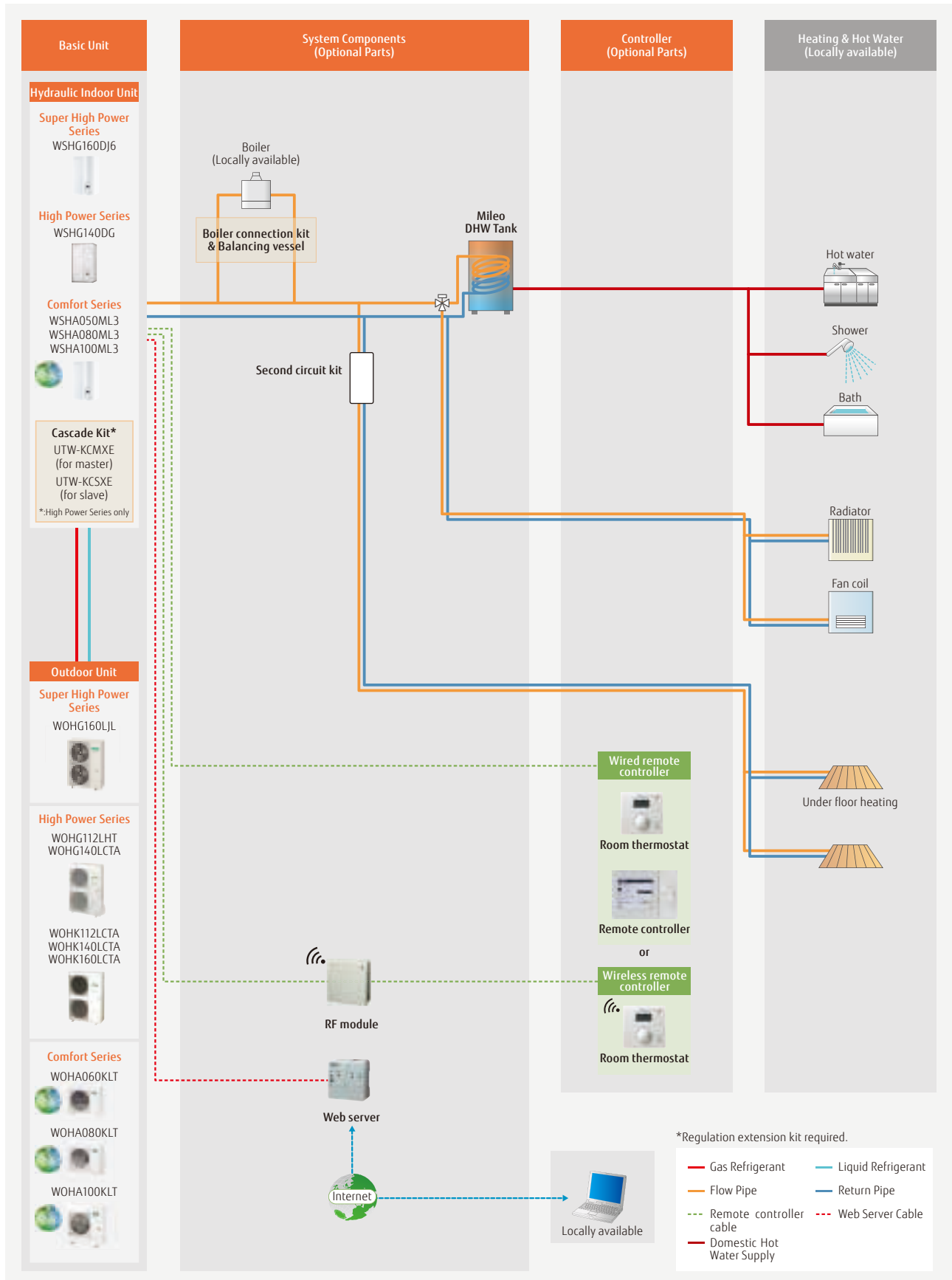

Split DHW Integrated Type

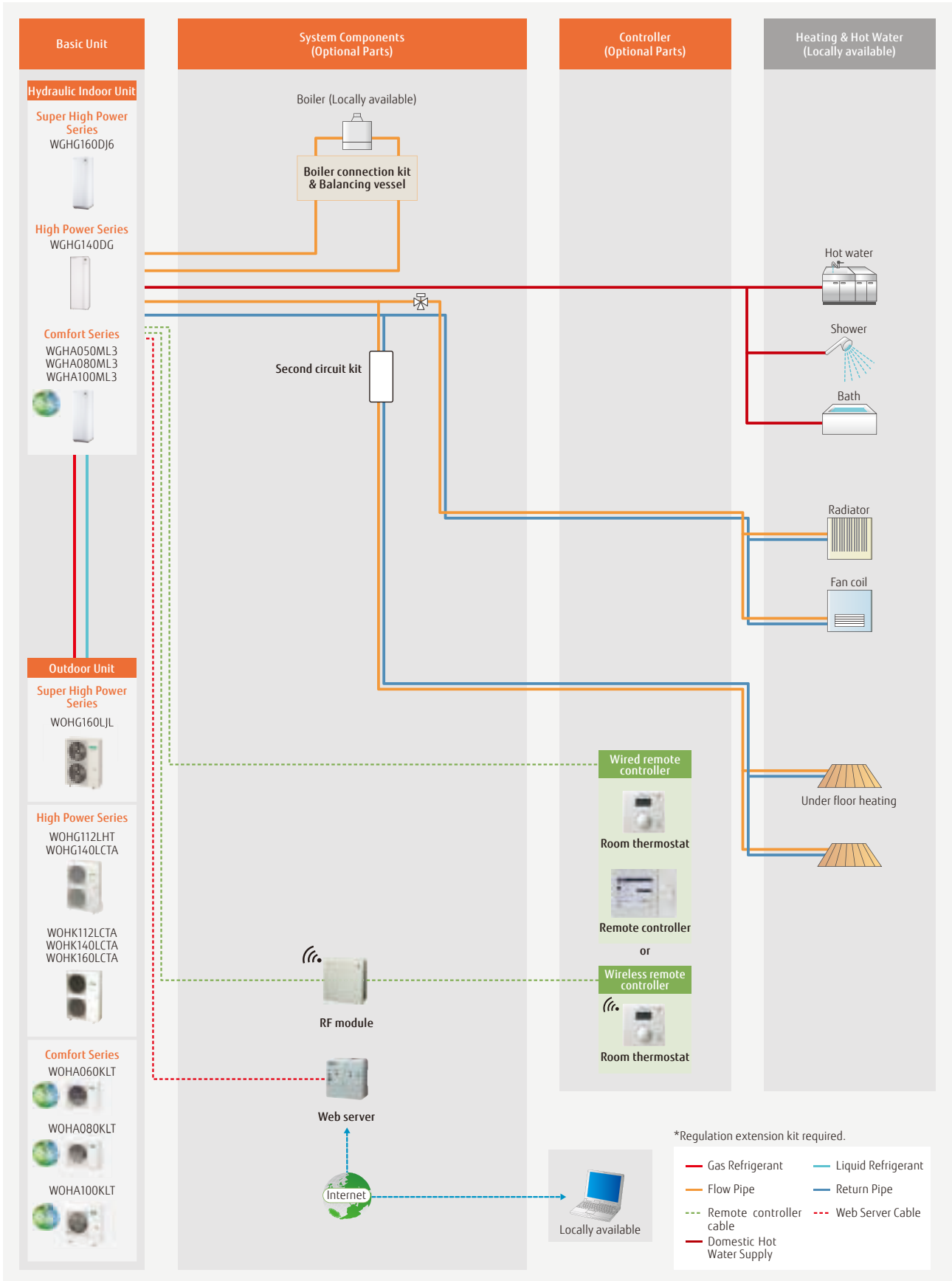

Case Studies

Split Type

**2-emitter simultaneous heating
(Individual control)**
Underfloor heating + Radiator

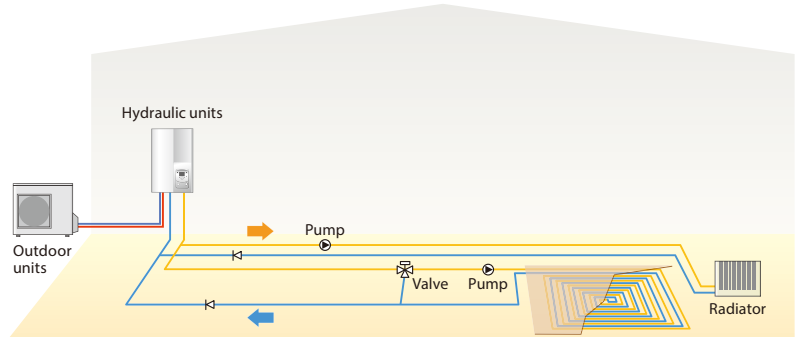

**Boiler connected to heating
(Boiler + Heating)**

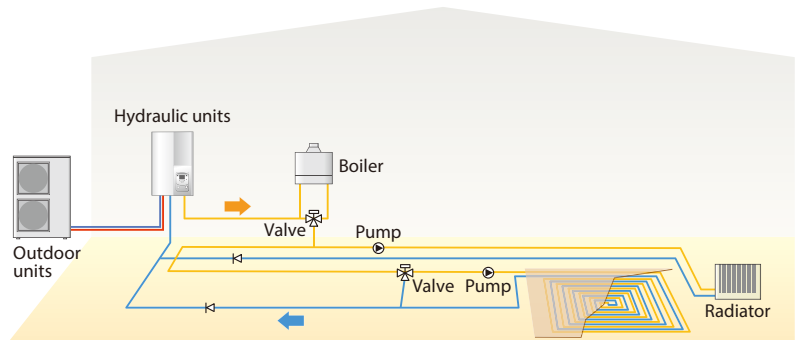

**2-emitter simultaneous heating &
domestic hot water supply (Cascade)**

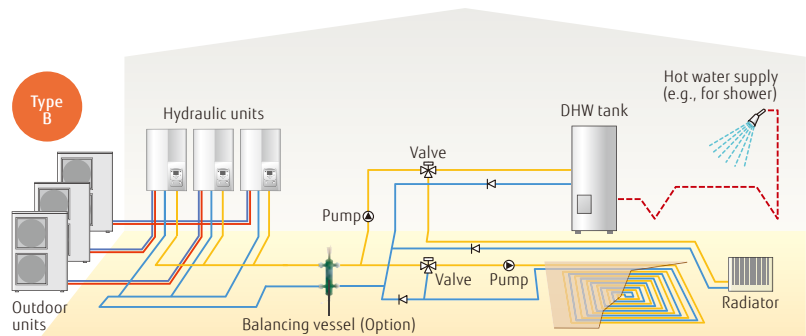
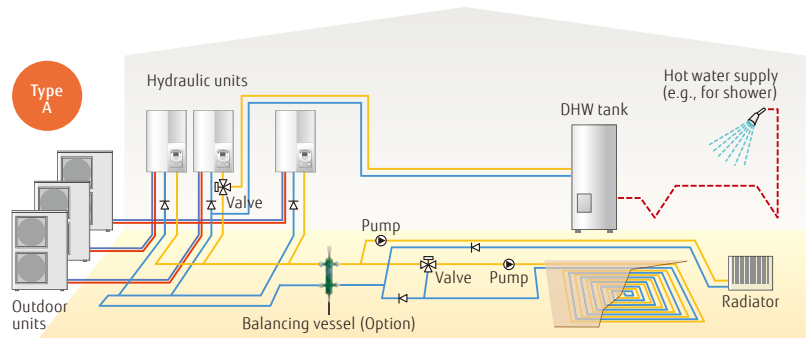

*The hydraulic layouts shown are mainly representation. Please check with local dealer for actual hydraulic connections.

Split DHW Integrated Type

Single heating & domestic hot water supply

Radiator + domestic hot water supply

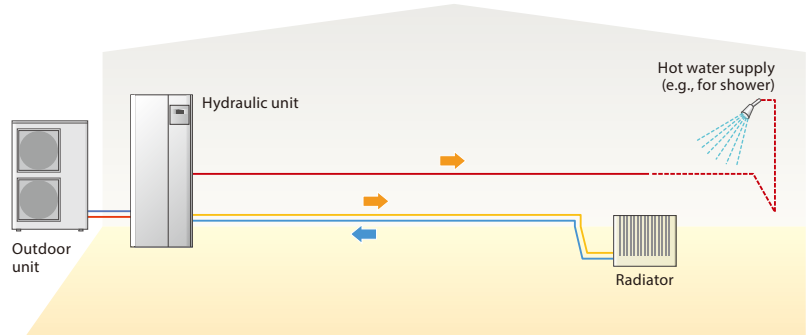

2-emitter simultaneous heating (Individual control) & domestic hot water supply

Radiator + domestic hot water supply

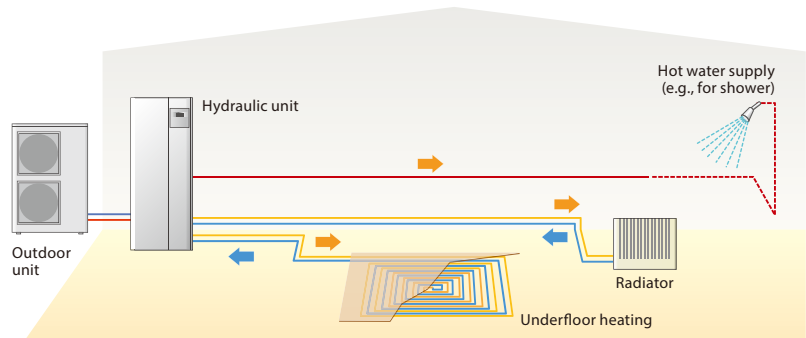

Boiler connected to heating (Boiler + Heating) and domestic hot water supply

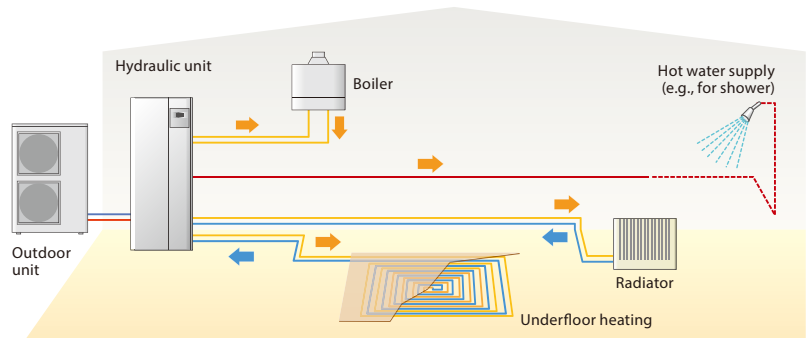

*The hydraulic layouts shown are mainly representation. Please check with local dealer for actual hydraulic connections.

Control Overview

To meet the diverse needs of customers, we offer a variety of control options, such as individual control and remote control options.

Individual Control



Wireless room thermostat (option)
UTW-C58XA



Wired room thermostat (option)
UTW-C55XA



Wired remote controller (option)
UTW-C74TXF*¹
UTW-C74HXF*¹

RF module



UTW-MRCXD



Adapters for external devices



Web server (option)
UTW-KW1XD
UTW-KW4XD



MODBUS[®] clip (option)
UTW-KMBXJ*²

Internet



Remote control system



Smart device control



Home automation system

* Please refer to page W-038 and W-039 for system compatibility information.



Super High Power Series Hydraulic unit

Service & Maintenance Tool



Web server (option)
UTW-KW1XD
UTW-KW4XD

OR



LPB clip (option)
UTW-KL1XD

Service tool (option)



UTW-KPSXD*³
software



UTW-KSTXD*⁴

*³: UTW-KW1XD or UTW-KW4XD is required for the connection.
*⁴: UTW-KL1XD is required for the connection.

Hydraulic unit Controller

Easy-to-set operation modes

- Selecting the heating mode and domestic hot water (DHW) operation

Large liquid crystal display

- Shows operation status
- Shows error messages
- Messages in plain text

Navigation and setting

- Select from heating menu
- Setting Time program



HMI kit (option)
UTW-KHMXE
Supports multiple languages

Optional Parts Overview

Various optional parts are available to use ATW according to needs and environments.

for Locally units



UTW-KZSXE*1

Second circuit Kit

It can supply hot water at different temperatures to each two types of heating equipment, such as radiators and underfloor heating.



UTW-KZDXE*1



UTW-KZSXJ



UTW-KZDXJ

Boiler connection kit

It can build hybrid systems using both boilers and heat pumps. Boiler and heat pumps are switched according to outside air temperature.



UTW-KBSXD



UTW-KBDXD



UTW-KBSXJ

*1: The UTW-KREXD (Regulation extension kit) is not included but is required for connection.



for DHW



DHW kit

UTW-KDWXD (External)
Required to connect locally purchased DHW tanks to air to water.



DHW tank

200 Liters: UTW-T20AXH / UTW-T20BXH
300 Liters: UTW-T30AXH / UTW-T30BXH
The BXH series is a more efficient tank than the AXH series.

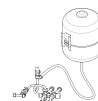

UTW-KDEXE



UTW-KDEXL

DHW expansion kit

The expansion vessel(18L) for connection to DHW water piping.





for Hydraulic unit



Circulating pump

UTW-PHFXG

The high-output pump for replacement of the standard pump in the hydraulic unit. It can be used in properties with longer and more complex water piping.

Cascade master/slave kit

Up to 3 hydraulic units can be connected for large-capacity use. It is need to install a primary kit in one unit and a secondary kit in one or two other units.



Cascade master kit
(incl. LPB clip)



Cascade slave kit
(incl. LPB clip)

Cooling kit

Required when using ATW also for cooling operation. It is used to prevent condensation occurring in the indoor unit.



UTW-KCLXD



UTW-KCLXL

for Outdoor unit



Drain pan

UTW-KDPXB

It is used to collect and drain condensation water generated by outdoor units.



External connect kit

UTY-XWZXZ2 / UTY-XWZXZ3

The signal input (low noise mode, peak cut) and signal output (compressor operation, base pan heater control) for outdoor units are possible externally.



Electrical backup heater relay

UTW-KBHXL

It allows the backup heater for heating at 3 kW as standard can be used at 6 kW.

SUPPORT

- Sp-002 VRF Support
- Sp-004 HVAC system design Support Tool
- Sp-006 Air To Water Support Tool
- Sp-008 Quick Service & Maintenance
- Sp-010 Service monitoring tool
- Sp-012 Service Tool
- Sp-013 Web monitoring tool

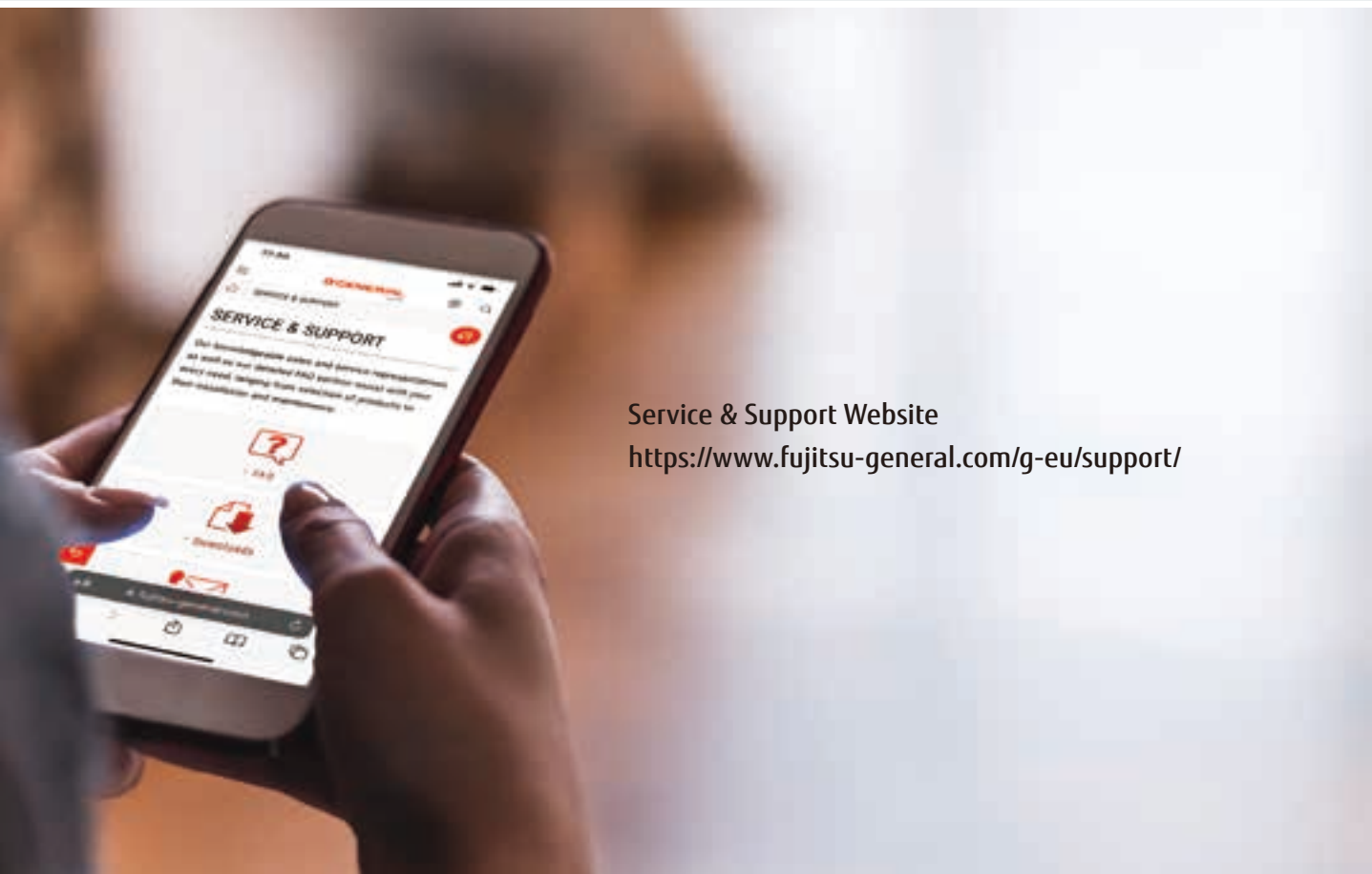

Service & Support Website
<https://www.fujitsu-general.com/g-eu/support/>

Our knowledgeable sales and service representatives assist you, from product selection to installation and maintenance.

Category	Information material											Tool						
	Product sales training material	Product technical training material	Product news	Brochures	Promotional movies	Operation manuals	Design & Technical manuals	Certification data	2D CAD data	3D CAD (Revit) data	Installation manuals	Service manual	Air To Water Package label creator	Design simulator (Room air conditioner, Packaged air conditioner, and VRF)	Air To Water proposer	CFD simulation	Service tool and Web monitoring tool	Mobile technician
Product training	●	●																
Product information seeking			●	●	●	●	●											
Technical information seeking							●	●					●					
Model selection														●	●			
Design							●		●	●								
Verification																●		
Installation							●				●							
After-sales service												●					●	●

VRF Support

Fujitsu General provides engineers and consultants with a wide range of product and technical information. In addition, we conduct research on new products and support design activities. We provide a wide range of support services from design to installation to maintain high quality.

Technical information

We provide equipment selection software that facilitates the design of air conditioning systems by providing performance data for the units and estimation for model selection.

Features

- Design & Technical manuals
- Model selection & estimation
- Certification data
- 2D/3D CAD data

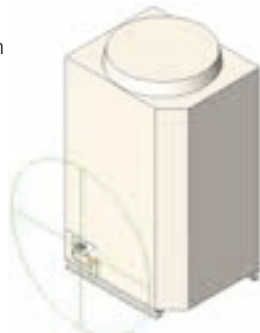

2D/3D CAD data

Product information

Information on new models is provided in the form of documents and movies in a timely manner for release, readily downloadable from the private section of our website. Contact your Fujitsu General representative for access information.

Features

- Product news
- Brochures & manuals
- Promotional movies



<https://www.fujitsu-general.com/g-eu/support/downloads/vrf/>



Technical support

Technical support is offered at every stage, from design through to installation, to assist in optimizing air conditioning solutions.

Features

- CFD simulation
- Guidelines
- Commissioning support

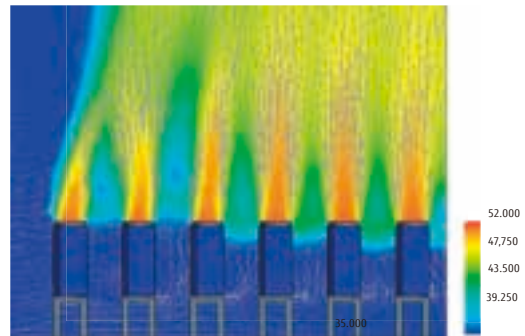

CFD simulation



Commissioning support

Training facilities



Fujitsu General regularly provides professional product, technical and service training at its training facilities worldwide. These research facilities also support the development of human resources with advanced technical skills.

Features

- Designing VRF systems
- On-site training for control systems

- 1 Head office training center in Japan
- 2 Training center in China
- 3 Asia training center in Singapore
- 4 Europe training center in the United Kingdom
- 5 Europe training center in Germany
- 6 America training center in the United States
- 7 Middle East training center in the UAE
- 8 Oceania training center in Australia

HVAC system design Support tool

Put the charts and pens away and design your projects on a computer using the Design simulator. Everything from selecting indoor and outdoor units, allocating controls and optional parts through to designing the piping and wiring systems is made easier using the program's built-in features.

Once the project design is complete, the Export function makes it easy to generate material lists, product specifications, and refrigerant calculations, and more. You can also export in Word, Excel, and Acrobat formats, as well as group CAD data related to your project.



Design simulator

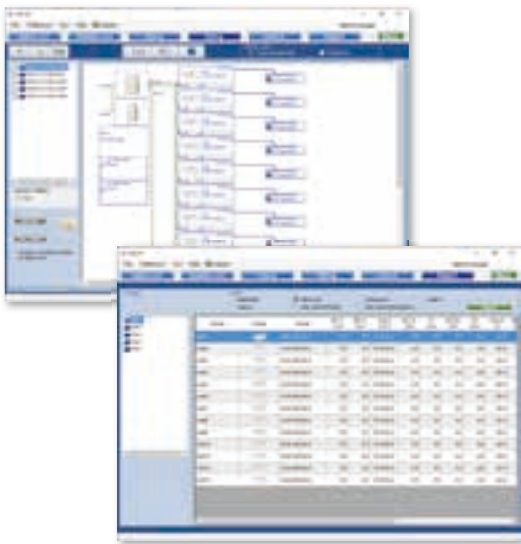

Outputs in the format that matches the application

You can export your project information in a number of industry standard file formats.

- Word format (rtf) (doc)
- Excel format (csv)
- Acrobat format (pdf)
- 2D CAD data (DXF)

Automatically create model selection information

- The required performance, type, and temperature conditions for each indoor unit are entered and then dragged and dropped onto the outdoor unit to automatically set each unit.
- Creates piping and wiring diagrams automatically to facilitate branching, grouping, and option settings.
- The additional refrigerant charging is automatically calculated when the pipe length is entered.
- Easy configuration of remote controller groups, central controller, and converters.
- The equipment list including the equipment information is created automatically.

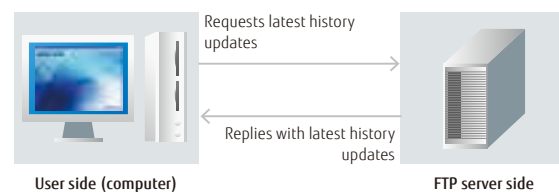

Update your Design simulator

The database can be updated easily online with the AutoUpdate function using FTP.



BIM

Building information modeling



BIM files of Fujitsu General's products are available on BIMObject®

Fujitsu General is releasing BIM files of our products on the BIMObject® website BIMObject.com.

Outline of BIMObject®

BIMObject® is a game changer for the construction industry, offering development, maintenance, and syndication of objects on the world's largest BIM platform.

About BIM files

- BIM files can be viewed in Autodesk Revit® 2018 version or later.
- In each BIM file, the location of the connectors for the refrigerant and drain pipe is different.
- Each BIM file includes several family types.
- A catalog and specification sheet is available in Revit file format for each product.



RFA (Revit data)

A data format available for BIM-designed projects

Data content

- Shape (Size)
- Drain direction
- Pipe direction
- Power supply location
- It contains information about the above specifications.



Type catalog with product specifications



DWG

a standard data format used for Autodesk products



DXF

Intermediate data commonly available in CAD products

Data content

- Shape (Size)

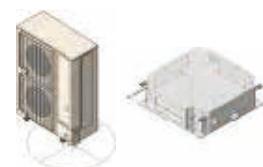

*To learn more about how to use BIM files, refer to the instructional video on each product page. youtu.be/wfL-hwFQ7dM

Air To Water (ATW) Support tool

Fujitsu General's software for ATW automatically creates a combination of ATW equipment by simply providing a few parameters. Supports multiple languages with an automatic update function.

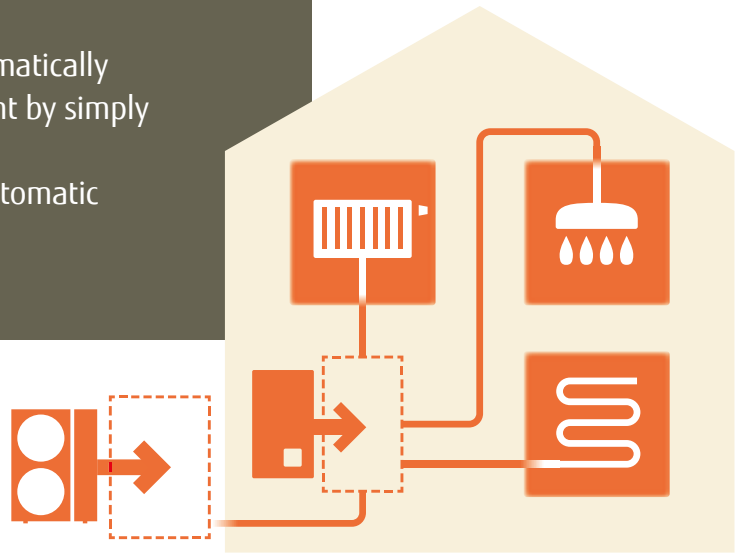

Air To Water proposer



Selecting models with detailed technical information

- Simply enter the region where the equipment will be installed, the required heating capacity, the method of heating and other factors, and the software will select the appropriate equipment automatically.

* From now on, the name will be changed to the new name above.
The current name is WATERSTAGE Proporser.



The images of the optional items will help you configure your system correctly. If more than one ATW equipment is required, all relevant option items will be selected automatically.



The selected unit can be modified after reviewing the overall system configuration. The images and the list of devices are displayed at the same time, helping to avoid mistakes in device selection.

Air To Water Package label creator

Download Energy labels and Fiches from our website

ErP documents such as Energy labels, Product fiches, Package labels, Package lists, Information sheets, and EC Declarations can be searched for and downloaded from our website.

We will also provide an online service in the future so that installers can easily create various package labels and package fiches for different models.

* From now on, the name will be changed to the new name above.
The current name is WATERSTAGE Package label creator.

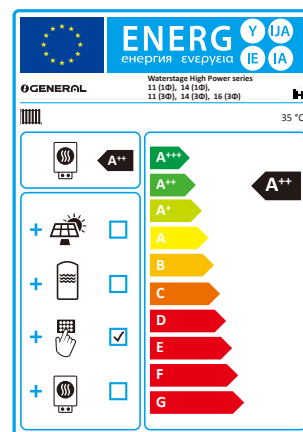
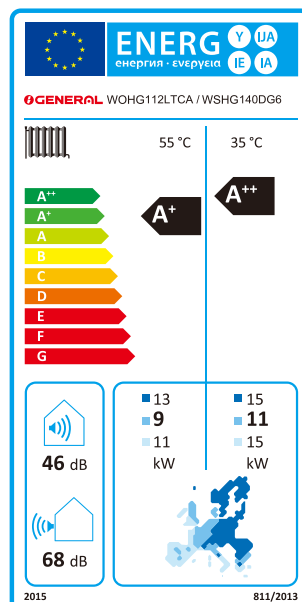

Quick service & maintenance

In the unlikely event that a problem should occur with the unit or system, a wide variety of support tools are available to assist with prompt service and maintenance anytime, anywhere, including error code displays on the product, service tools to check the detailed status of the entire system, and remote monitoring tools using the internet.



Easy maintenance & monitoring

Designed for easy maintenance

The operating status of the air conditioner and detailed trouble conditions are displayed on the 7-segment indicator lamp on the outdoor unit printed circuit board (PCB) and on the screen of the remote controller. Check the status of the unit quickly for a prompt response.

- Display the operation mode at the time.
- Discharge temperature and pressure
- Compressor operation status
- "Address/Type/Number" of the outdoor unit
- Error code

7-segment indicator lamp



Wired remote controller (with touch panel)

Error status/Error history

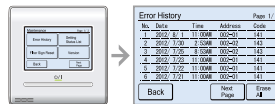

System number

001: Controller
002: Indoor unit

Error code



Unit number

Error diagnosis by Service tool

Connect Service tool to check the status details of units, from single split to VRF, on a computer screen. Check the errors quickly for prompt countermeasures.

- Operating status/control
- Monitoring operating conditions
- Monitoring sensor data
- Indicating trend graphs
- Error history
- Indicating refrigerant circuit diagrams (for VRF)

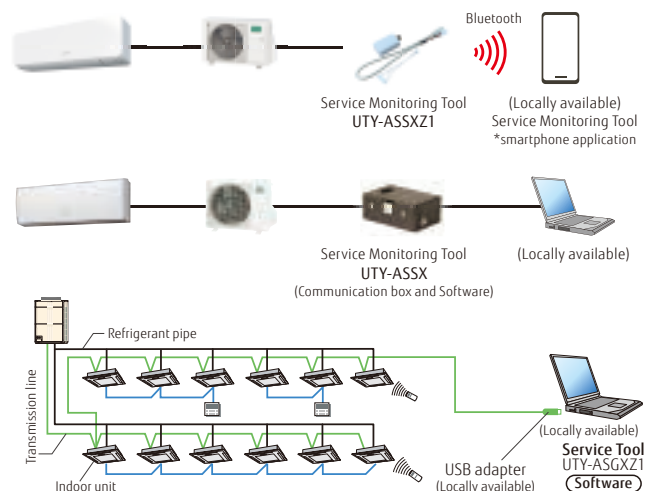

Remote monitoring

VRF system operating status and trouble status details can be monitored remotely at any time via the internet. Prompt coordination is available with service personnel.

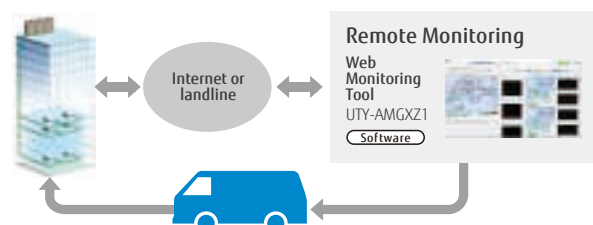



Mobile troubleshooting App for iOS and Android™ devices

We will release an App for troubleshooting tools for iPhone, iPod touch and other Apple devices, and Android products for Fujitsu General air conditioners (Room air conditioner/ Packaged air conditioners VRF and ATW, "AIRSTAGE Mobile", and R32 calculation of allowable refrigerant capacity)

Use Error Code Check, Troubleshooting, and Sensor Check to understand the status of your air conditioner.

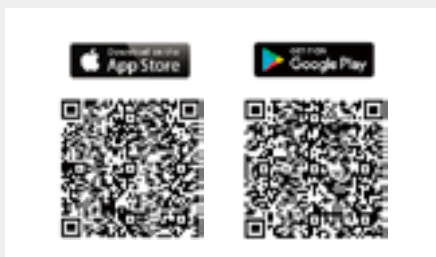

Mobile Technician **FREE**

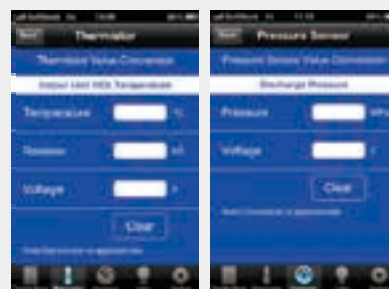

Service monitoring tool for Single split, Multi-split & Air to water



- A quick overview of the temperature sensor readings and the electronic expansion valves (EEVs), fans, compressors and other control components
- It is not always easy to read the temperature sensor and know the status of the control components. So let the Service monitoring tool judge them.
- Visualizes protected operations
- Troubleshoots intermittent problems effectively
- Provides proof of normal operation to customers during periodical maintenance



Actual operating conditions



Graphs



Operational histories

	UTY-ASSX
Dimensions (H × W × D) (mm)	60 × 160 × 160
Weight (g)	500

NEW **AIRSTAGE Service Monitor Tool** for Single-split, Multi-split, Air to water
 UTY-ASSXZ1



Improved work efficiency

AIRSTAGE Service Monitor Tool can diagnose the cause of the error for a wide range of products. It makes maintenance or service support faster and can also reduce the number of visits and maintenance costs.

*The values in the pictures are examples.

Bluetooth communication

AIRSTAGE Service Monitor Tool can diagnose by the smart device*1 and reduce the working time compared with diagnosis by PC. No need to connect a PC makes diagnosis easier even in narrow spaces.

Compact and lightweight design

New model is easy to carry by compact and lightweight design. The service personnel can visit the maintenance site with small luggage.

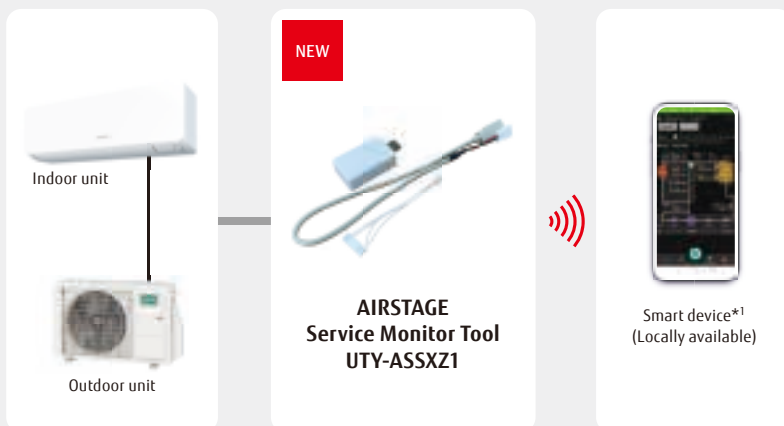

*1 Android only.
 You need to install the "AIRSTAGE Service Monitor Tool" app on your smart device.



New application with simple design

New application for smart devices has been released. The stylish design makes the application easy to use for everyone.



AIRSTAGE Service Monitor Tool



Refrigerant cycle diagram display

The operating status can be displayed with a simple, clear diagram*2 on the smart device. It reduces the time for diagnosis and makes diagnosis easier. It can complement abundant experience and advanced knowledge of refrigerant cycle. This shortens the training time for service personnel.

*2 list and graph displays are also available





*The values in the pictures are examples.

Specifications

	UTY-ASSXZ1
Dimensions (H x W x D) (mm)	20 x 35 x 60 (adapter)
Communication cable (cm)	60
Weight (g)	25 (adapter)
Communication method	Bluetooth 5.3
Max. communication distance (m)	10*3
Compatible device	Android8.0 or above

*3 Depends on the environment

Function List

		UTY-ASSXZ1	UTY-ASSX	
				
Product specification	Installation	Outdoor unit PCB	Outdoor unit PCB	
	Communication	Bluetooth	Wired	
Support product type	Split	●	●	
	Multi-split	●	●	
	ATW	●	●	
	VRF	—	—	
Function	Product distinction	●	●	
	Signal-type distinction	●	●	
	Operating status display	List	●	●
		Graph	●	●
		Refrigerant cycle diagram	●	—
	Adapter firmware update	●	—	
	Adapter status monitoring	●	—	
Input and output of history data	●	●		

Service tool

UTY-ASGXZ1

Extensive monitoring and analysis functions that make installation and maintenance easier

- The operation status of the system can be monitored and analyzed to detect any malfunctions.
- Data on the operation status of the system can be stored on a computer to allow for remote access.
- Up to 400 indoor units in a single VRF network system can be controlled and monitored for a large building or hotel.
- This software can be connected to any point of transmission line with a USB adapter (locally available).

* Saved data can be displayed offline. Note that the data saved by the following software applications cannot be displayed.

- UTR-YSTB/UTR-YSTC (Service tool)
- UTR-YMSA (Web monitoring tool)

Automatic operation check for refrigeration cycles

Once installed, the Service tool automatically checks for refrigeration cycles. The self-diagnosis function determines whether each sensor value is normal, which reduces the need for manual checks. The result of a diagnosis can be provided in a report.





Use the result of a self-diagnosis only as a guide and use your own judgment to make a final decision.

These sensor values are checked automatically:

- ✓ the discharge temperature is normal, "OK"
- ✓ the super heat volume is normal, "OK"
- ✓ the high pressure pipe value is normal, "OK"
- ✓ the low pressure pipe value is normal, "OK"

And the values for other items will also be diagnosed.



Remote technical support and maintenance

On-site check screen can be shared between on-site staff and a service technician in a remote location. When a service technician visits the site for troubleshooting, the system's operation status can be shared in real time with a remote service center for assistance. On-site staff can have an online chat with a remote service center to get further assistance.

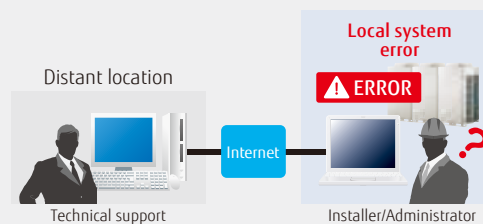

Trend charts

Previous-generation application could display only 3 sets of data from sensors. However, the current generation of the service tool displays multiple charts simultaneously so that refrigeration cycles can be monitored and checked in greater detail.

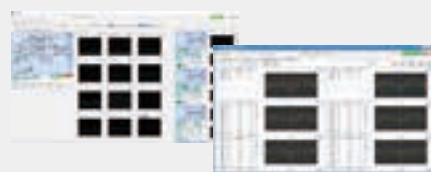

Computer requirements

UTY-ASGXZ1	
Operating system	<ul style="list-style-type: none"> • Microsoft® Windows® 7 Professional (32-bit or 64-bit) SP1 • Microsoft® Windows® 8.1 Pro (32-bit or 64-bit) • Microsoft® Windows® 10 Pro (32-bit or 64-bit)
CPU	1 GHz or higher
Memory	<ul style="list-style-type: none"> • 1 GB or more (for Windows® 7 [32-bit], Windows® 8.1 [32-bit], and Windows® 10 [32-bit]) • 2 GB or more (for Windows® 7 [64-bit], Windows® 8.1 [64-bit], and Windows® 10 [64-bit])
HDD	40 GB or more of free space
Screen resolution	1366 × 768 pixels or higher
Interface	• USB port for U10 USB Network interface and software protection key
Software	Internet Explorer® 11 or Microsoft Edge

Packing list

Name	Quantity	Application
White-USB-key (Software protection key)	1	Software protection key to be connected to a USB port on a Service tool-installed computer. This software runs only on a computer with WibuKey.

- Computer requirements
- Echelon® U10 USB Network Interface – TP/FT-10 Channel (Model name: 75010R) (Required for each VRF Network)

Web monitoring tool

UTY-AMGXZ1

Features

- Troubleshooting is performed by monitoring each air conditioning unit remotely during a periodical system check.
- An error notification is automatically transmitted to several locations via the internet*1.
- Requires either a dedicated internet connection or landline to operate.
- The occurrence of an error can be confirmed through an error alert and equipment status information obtained from a remote location.
- Monitoring data can be downloaded in a remote location. These data can be accessed and displayed even when the service tool is in offline mode.
- Can be viewed on the monitoring computer's Web browser without installing any special software.

*1: Internet e-mail access required.

Web Monitoring System

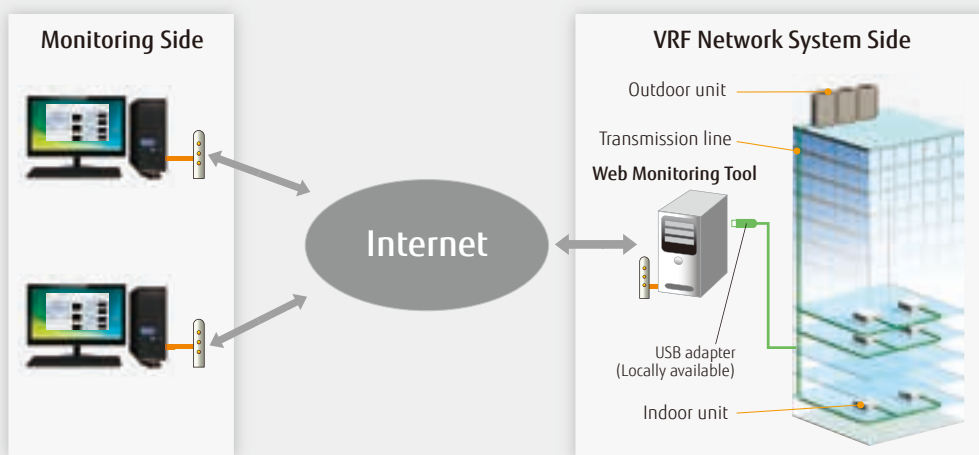

Supporting up to 4 VRF network systems

Up to 4 USB adapters can be connected to a computer, enabling the monitoring of up to 1,600 indoor units.

Suitable for use in a large building or hotel.

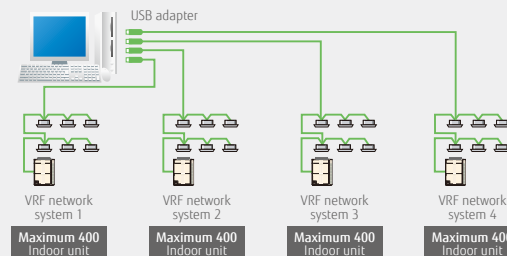

Computer requirements

UTY-AMGXZ1	
Operating system	<ul style="list-style-type: none"> • Microsoft® Windows® 7 Professional (32-bit or 64-bit) SP1 • Microsoft® Windows® 8.1 Pro (32-bit or 64-bit) • Microsoft® Windows® 10 Pro (32-bit or 64-bit)
CPU	1 GHz or higher
Memory	<ul style="list-style-type: none"> • 1 GB or more (for Windows® 7 [32-bit], Windows® 8.1 [32-bit], and Windows® 10 [32-bit]) • 2 GB or more (for Windows® 7 [64-bit], Windows® 8.1 [64-bit], and Windows® 10 [64-bit])
HDD	40 GB or more of free space
Screen resolution	1366 × 768 pixels or higher
Interface	<ul style="list-style-type: none"> • USB ports (one for U10 USB Network interface and up to 4 ports for software protection keys) • Interface for remote connection: <ul style="list-style-type: none"> - Landline: Modem is required. - Internet using LAN: Ethernet port is required.
Software	Internet Explorer® 11 or Microsoft Edge

Packing list

Name	Quantity	Application
White-USB-key (Software protection key)	1	Software protection key to be connected to a USB port on a Service tool-installed computer. This software runs only on a computer with WibuKey.

- Computer requirements
- Echelon® U10 USB Network Interface – TP/FT-10 Channel (Model name: 75010R) (Required for each VRF Network)

Notice regarding specifications

I.U. = Indoor Unit O.U. = Outdoor Unit Qu = Quiet * = Not decided yet

- Specifications and design are subject to change without notice for future improvement.
- For further details, check with our authorized dealers.
- Cooling and heating capacities are based on the following conditions:

Cooling	Indoor temp. : 27°C DB/19°C WB Outdoor temp.: 35°C DB/24°C WB	Heating	Indoor temp. : 20°C DB Outdoor temp.: 7°C DB/6°C WB
---------	--	---------	--

- Performance tests are conducted in accordance with EN14511.
- Seasonal efficiency tests are conducted in accordance with EN14825.
- Sound power tests are conducted in accordance with EN12102.



Fujitsu General (Thailand) Co., Ltd.

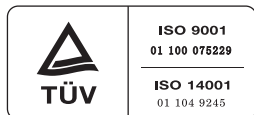

ISO 9001 Certification number: 01 100 075229
ISO 14001 Certification number: 01 104 9245

Fujitsu General (Shanghai) Co., Ltd.



ISO 9001 Certification number: 01 100 79269
ISO 14001 Certification number: CNBJ312244-UK

Fujitsu General Central Air-conditioner (Wuxi) Co., Ltd.



ISO 9001 Certification number: 15917020073R5M
ISO 14001 Certification number: 15918E20021R5M

- The products and equipment listed in this catalog contain fluorinated greenhouse gases.
- "GENERAL" and "AIRSTAGE" are worldwide trademarks of Fujitsu General Limited, and are registered trademarks in Japan and other countries and regions.
- iPhone and iPod touch are trademarks of Apple Inc., registered in the United States and other countries.
- "Microsoft," "Windows," and "DirectX" are trademarks of Microsoft Corporation in the United States and other countries.
- "Intesis" is a registered trademark of HMS Industrial Networks in the European Union and is trademarked in the rest of the world.
- "BACnet" is a trademark and registered trademark of the American Society of Heating, Refrigerating and Air-Conditioning Engineers, Inc.
- "MODBUS" is a registered trademark of Schneider Electric.
- "LONWORKS" and "Echelon" are trademarks of Echelon Corporation registered in the United States and other countries.
- "Adobe" and "Acrobat Reader" are either registered trademarks or trademarks of Adobe in the United States and/or other countries.
- "Android" is a trademark of Google LLC.
- Other company and product names mentioned in this document may be the registered trademarks, trademarks or trade names of their respective owners.
- "Palair" is a worldwide trademark of Fujitsu General Limited.
- "Bluetooth" is a registered trademark of Bluetooth SIG, inc.

Distributed by:

FUJITSU GENERAL LIMITED

3-3-17, Suenaga, Takatsu-ku, Kawasaki, Kanagawa, 213-8502, Japan
www.fujitsu-general.com/g-global/



Copyright© 2008-2024 Fujitsu General Limited. All rights reserved. 3EG038-2405E